

CR-98370
TR-793-8-1105
MARCH 1968

SUPPLEMENT TO:

**ADVANCED LAUNCH VEHICLE COMPUTER
PROGRAMS FOR VERTICAL TAKEOFF
TRAJECTORIES, HORIZONTAL TAKEOFF
TRAJECTORIES, AND HORIZONTAL
TAKEOFF TRAJECTORIES
WITH SONIC BOOM CALCULATION**

Prepared for:
**NATIONAL AERONAUTICS AND SPACE ADMINISTRATION
GEORGE C. MARSHALL SPACE FLIGHT CENTER
Aero-Astroynamics Laboratory**

UNDER CONTRACT NAS8-20082

FACILITY FORM 602

N 69-21019
(ACCESSION NUMBER) (THRU)
157
(PAGES) (CODE)
NASA-CR-98370
(NASA CR OR TMX OR AD NUMBER) (CATEGORY)
30

NORTRONICS - HUNTSVILLE

NORTHROP CORPORATION

6025 TECHNOLOGY DRIVE, P.O. BOX 1484 HUNTSVILLE, ALABAMA 35805
TELEPHONE 837-0580

REPRODUCED BY
**NATIONAL TECHNICAL
INFORMATION SERVICE**
U. S. DEPARTMENT OF COMMERCE
SPRINGFIELD, VA. 22161

SUPPLEMENT TO
ADVANCED LAUNCH VEHICLE
COMPUTER PROGRAMS FOR
VERTICAL TAKEOFF TRAJECTORIES,
HORIZONTAL TAKEOFF TRAJECTORIES,
AND HORIZONTAL TAKEOFF TRAJECTORIES
WITH SONIC BOOM CALCULATION

Nortronics-Huntsville Technical Report No. 361

March 1968

BY

D. P. CONRAD

PREPARED FOR:

NATIONAL AERONAUTICS AND SPACE ADMINISTRATION
GEORGE C. MARSHALL SPACE FLIGHT CENTER
AERO-ASTRODYNAMICS LABORATORY

under contract NAS8-20082

Reviewed and Approved by:



P. R. Odom, Chief, Mission Analysis Branch



D. M. Hammock, Director, Systems Section



Dr. S. S. Hu, Technical Director

NORTRONICS - HUNTSVILLE
HUNTSVILLE, ALABAMA

TABLE OF CONTENTS

<u>SECTION</u>	<u>TITLE</u>	<u>PAGE</u>
I	INTRODUCTION.	1-1
II	DISCUSSION OF MODIFICATIONS	2-1
III	INPUT	3-1
	3.1 HTO INPUT.	3-1
	3.2 VTO INPUT.	3-7
IV	PROGRAM UTILIZATION	4-1
V	DESCRIPTION OF PROGRAM ROUTINES	5-1
VI	HTO SOURCE LISTING	6-1
VII	HTO SAMPLE RUN.	7-1
VIII	HTO FLOWCHART	8-1
IX	VTO SOURCE LISTINGS - 3200 AND 930.	9-1
X	VTO SAMPLE RUN - 3200	10-1
XI	VTO FLOWCHART - 3200.	11-1

SECTION I

INTRODUCTION

Since the publication of "Advanced Launch Vehicle Computer Programs for Vertical Takeoff Trajectories, Horizontal Takeoff Trajectories and Horizontal Takeoff with Sonic Boom Calculations" (TR-293-6-110), several additions and improvements have been made to both the Vertical Takeoff Program (VTO) and the Horizontal Takeoff Program (HTO) to increase the usefulness of these programs. This includes the addition of several calculation options, output options, input changes, and general program streamlining. These changes necessitated converting the HTO from the SDS 930 to the CDC 3200, and setting up two decks for the VTO - a skeletal one on the SDS 930 and an all option version for the CDC 3200. In addition, sketches of the vehicles for which these programs were written have been included.

SECTION II

DISCUSSION OF MODIFICATIONS

The modification to decks VTO - 930, VTO - 3200, and HTO - 3200 include:

- A. The addition of two new options to all three decks. These options are: (1) Step throttling and (2) ISP degradation.
- B. The addition of constant thrust-to-weight ratio to the HTO program.
- C. The conversion of the old 930 sense switches to sense switch options.
- D. The addition of two new options to the 3200 programs only. These options are: (1) Output option and (2) Payload option.
- E. The ability to run existing vehicles on these programs.

These options and the use of the program to run existing vehicles are explained in the following paragraphs. The data needed is explained in Section III.

- A.(1) A step throttling option has been added for the first stage to supplement the continuous throttling already programmed. The throttling can now be done as a certain number (XMOD) of discrete steps. A large number of steps closely approximates continuous throttling. For this option

$$THRI_{new} = THRI_{old} - THRI_{old}/XMOD$$

- A.(2) Isp degradation for both stages is computed from an input table of engine throttling ratios vs specific impulse fractions. This table is described in the original report

With Isp degradation

$$Isp = Isp * Isp \text{ factor}$$

Without Isp degradation

$$Isp = Isp \text{ from the table}$$

- B. A second stage lift-off with constant thrust-to-weight ratio, THR/WT, as described in the original report for the VTO, has been incorporated

NORTRONICS - HUNTSVILLE

into the HTO

Without constant THR/WT

$$\text{THR2} = \text{input value} = \text{constant thrust}$$

With constant THR/WT

$$\text{THR2} = \text{TW2} * \text{WT}$$

Where TW2 is the input THR/WT ratio

- C. The console sense switch options of the earlier versions have been converted to indicator options. Indicator ISW3 corresponds to Sense Switch 3. ISW2 corresponds to Sense Switch 2, as explained in the original report.
- D.(1) The tabulated output option was incorporated to provide a faster, shortened output for use when a more detailed output is not needed, such as for publication of results. This option is illustrated in the HTØ sample run (Section VII).
- D.(2) The payload recalculation option was added to allow iteration of the program on lift-off weight and trajectory to yield a specified payload. Recalculation of the trajectory with a successively improved initial weight value is attempted only if

$$\Delta \text{PLD} > .00001 \times \text{PLD}_{\text{required}}$$

or

$$\Delta \text{PLD} < 1000. \text{ lbs}$$

where

$$\Delta \text{PLD} = \text{PLD}_{\text{CALCULATED}} - \text{PLD}_{\text{required}}$$

$$\text{PLD} = \text{payload}$$

If a recalculation is done

$$W\phi_{\text{new}} = W\phi_{\text{old}} + \text{Increment}$$

$$\text{if } \text{PLD} < \text{PLD}_{\text{req}}$$

$$W\phi_{\text{new}} = W\phi_{\text{old}} - \text{Increment}$$

$$\text{if } \text{PLD} > \text{PLD}_{\text{req}}$$

The increment used is determined by the size of ΔPLD , and the input value DWT is the minimum increment size.

Due to the non-linearity of $W\phi$ vs PLD near the solution, if two solutions within 150 pounds of the required PLD value are found on opposite sides of the required value, linear interpolation is used to calculate a final $W\phi$ value.

- E. All three programs were originally written to calculate from a given total weight and some other known factors, as described in the report, the necessary breakdown of the weight components to be jettisoned at each stage, such as engine, tank, and equipment weights. These equations, used by both stages, are described in Section 3.1.4 of the original report. However, if complete weight data are available for an existing vehicle, this known data can be utilized and the breakdown bypassed.

For the first stage, from page 10 of the original report, everything dropped at staging will be included in W_{JET} where

$$W_{\text{Jet}} = W_{\text{Stage}} + W_{\text{Build2}} \quad \text{where } W_{\text{Build2}} = M_2 T_{\text{Vac}_2}$$

Instructions on inputting the correct data for W_{Stage} and W_{Build2} are in Section III.

The calculations for the first stage, using known data, assume no first stage reserves. Then the second stage weight is

$$W_2 = WT - W_{\text{Jet}}$$

NORTRONICS - HUNTSVILLE

For the second stage, the payload T2 is

$$T2 = WT - W_{\text{Jet}}$$

where W_{Jet} is the total weight jettisoned, input is as described in Section III. If reserves are wanted for the second stage W_{Jet} , then W_{res1} and W_{res2} must be calculated.

$W_{\text{res1}} = V_F$ term in equation (25) of the original report, and

$W_{\text{res2}} = V_V$ term in equation (25). $Delv2$ and $CEE2^*$ are used to control these, as described in the Input.

* CEE and $CEE2$ are c from equation (27) of the original report, rather than the definitions given in the report. These are unitless factors.

"Page missing from available version"

P. 3-1

NORTRONICS - HUNTSVILLE

Option	Value	Note
MAXL	1	The HTO - Maximum lift guidance profile is used (Sec. 3.2.2 in original report).
	0	The HTO - Linear Load profile is used (Sec. 3.2.1 in original report).
ITHROT	1	Continuous throttling of the first stage to prevent the total acceleration from exceeding the input ACLIM.
	0	First stage engines not throttled.
ISW3	1	Recalculation of the final trajectory with complete second by second printout.
	0	Skeletal output only.
ISW2	1	Continuous second by second printout during all calculations. This is primarily for debugging. Print out only at critical points during calculations.
	0	
ISTEP	1	Step throttling of the engines as described using input XMOD. Set ITHROT to 1 also.
	0	No step throttling.
ISPDEG	1	Isp degradation, both stages, using input RATAB table.
	0	No Isp degradation.
IPLD	1	Recalculation of the trajectory to achieve the desired payload. Used with inputs RPLD and DWT.
	0	No trajectory recalculation for payload.
JTAB	1	The final trajectory is recalculated giving second by second printout in tabulated form (one line per second).
	0	The final trajectory is not recalculated and tabulated. (ISW3 would recalculate and print standard output).

Also on this card is the number of data points in each table to be read in later. The same format is continued. These numbers are not printed with the options in the data output.

NTAB1 Number of point sets in the Mach - aerodynamic coefficients table
 NTAB1 = 16 sets for the HT \emptyset sample case (Section VII).

NORTRONICS - HUNTSVILLE

XMØD (on card 6) is the number of modules in which to step-throttle the first stage, used with ISTEP = 1.

Table Input

Three tables are read in. Each is read one complete set of points per card, 12 spaces for each piece of information (format E12.6 where n is 5 for the first table and 3 for the other two). These tables are described in the original report, Table 2.

Table 1

The mach number - aerodynamic coefficients table is input first. A maximum of 16 sets of points may be input.

XMACHT	is	XMACH	data
CLOTAB	is	GLO	data
CL1TAB	is	CL1	data
CL2TAB	is	CL2	data
CDOTAB	is	CDO	data

They are given as

XMACT(1)	CLOTAB(1)	CL1TAB(1)	CL2TAB(1)	CDOTAB(1)
XMACT(NTAB1)	CLOTAB(NTAB1)	CL1TAB(NTAB1)	CL2TAB(NTAB1)	CDOTAB(NTAB1)

where NTAB1 was input on the option card. There are NTAB1 number of cards for this table.

Table 2

Second is the table of altitude vs thrust and Isp. The maximum number of point sets is 10. They are input as

ALTAB(1)	THR1T(1)	BISPT(1)
ALTAB(NTAB2)	THR1T(NTAB2)	BISPT(NTAB2)

There are NTAB2 cards in this table.

NORTRONICS - HUNTSVILLE

Single Point Data

<u>CARD 3</u>	XLAT	AZ	VO	ALTO	GAMO
<u>CARD 4</u>	ALPO	WØ	VKICK	GAMK	ACLIM
<u>CARD 5</u>	TW2	WW	ENN	XMØD	VSTAG
<u>CARD 6</u>	PØINT	VM	HM	DELH	XMGAM
<u>CARD 7</u>	BETA	DELT	PTSTEP	ENGF	BUILD
<u>CARD 8</u>	DECAY	TNKF	WP1	EQP	DELVF
<u>CARD 9</u>	CEE	SCALE	CNTIN	ENG2	BILD2
<u>CARD 10</u>	DKAY2	TNK2	WP2	EQP2	DELV2
<u>CARD 11</u>	CEE2	SCAL2	CNTN2	XISP2	THR2
<u>CARD 12</u>	AREA	CKK	RPLD	DWT	

XMØD, RPLD and DWT are defined in the HTO Input Section. RPLD and DWT are not used on the SDS 930 version. For the ~~903~~⁹³⁰ version

CARD 12 AREA CKK

Table Data

All table data are the same as the HTO Table data.

For all programs the input data, except NTABs, is printed out in the same order as it is read. However, only the four most important characters of each variable name are printed as identification (see Sections VII and IX).

All data must carefully adhere to the formats given and must be in the order specified. Refer to any standard Fortran II or Fortran IV manuals for explanations of A, I, and E formats if unfamiliar with their use.

Suggested reference manuals for the user are:

CONTROL DATA 3200 Computer System Fortran/Reference Manual

SDS 900 Series Fortran II Reference Manual.

For the calculation of the weights using known values, input WJET for the first stage in this manner:

Set $EQP = W_{\text{Stage}}$ The known value, including all applicable components as described in Section II.

NORTRONICS - HUNTSVILLE

SCALE = 1.0 CNTIN = 1.0

ENGF = 0.0 DELVF = 0.0

CEE = 0.0 DECAF = 0.0

ENG = 0.0 WW = 0.0

BILD2 = value needed as M_2 of the equation for W_{Build2} described,

TVAC2 = value needed.

For the second stage, input the weight jettisoned by:

Setting

EQP2 = WJET (without reserves)

SCAL2 = 1.0 CNTN2 = 1.0

ENG2 = 0.0 TNK2 = 0.0

DKAY2 = 0.0 BILD2 = 0.0

DELV2 = 0.0, unless reserves are desired. If they are, input the value needed from the equation previously discussed (Section II).

CEE2 = 0.0, unless reserves are desired. (See the above statement).

SECTION IV

PROGRAM UTILIZATION

For the CDC 3200, the following deck setup should be used by both the HTO and VTO - 3200.

7/9 SEQUENCE, 001, System Information
 Charge number, etc.
 This information varies with each
 installation.

7/9 JOB,,,ND

7/9 FORTRAN, L, X.

If a binary is desired, use instead

7/9 FORTRAN, L, X, P.

PROGRAM NAME

Here use HTO or VTO

(Begins in column 7)

MAIN PROGRAM SECTION

Blank card

FIRST SUBROUTINE

Blank card

SECOND SUBROUTINE

until all subroutines are included. Subroutines should be called prior to their position in the deck setup. Then

FINIS (begins in column 10)

7/9 LOAD, 56

7/9 RUN, 10

maximum run time in minutes.

Data in the order described

7/8

7/8 7/8

NORTRONICS - HUNTSVILLE

To use a CDC 3200 binary of the program, set up the deck in the following manner:

7/9 Sequence,001, etc.

7/9 JOB,,, ND

Binary deck

7/9 RUN, 10

DATA

7/8

7/8 7/8

The CDC 3200 is not usually a programmer operated machine, so operating instructions will not be given.

The facilities needed include the CDC Fortran Compiler on tape (a standard system feature), a reader, a printer, and for binaries, a punch.

As for computer time required, the sample HTO run with tabulated output ran in less than 4 minutes, including compile time. When several iterations are necessary to converge on the correct cutoff conditions, time goes up rapidly, approximately 1 minute per complete Newton-Raphson. Calculations are slowed down very much by use of ISW2 as the work is completely printer bound. (This is also true of the SDS 930 version).

For the VTO - 930 version, the deck setup and machine operating instructions are given in the original report, pages 34 - 35. Delete the sense switch information.

SECTION V

DESCRIPTION OF PROGRAM ROUTINES

- I. The main section of all three programs is outlined as:
 - A. Data
 - Input of data
 - Print out of read in data
 - Initialization of internal data
 - Calculate table data for integration
 - B. ALPHA Control
 - Acceleration or
 - Calculus of variations
 - C. Integration
 - Calculation of needed information
 - Integration
 - D. Output - Choice of
 - Skeletal
 - Standard
 - Tabulated
 - E. Option Control
 - F. Monitoring Cutoff Conditions
 - First stage: WT or V
 - Second stage: V
 - G. First stage weight breakdown
 - H. Second stage initialization
 - I. Final weight iteration

NORTRONICS - HUNTSVILLE

- J. Newton-Raphson
 - CONST - PNT or
 - TIMEP - PNT

 - K. Weight breakout second stage

 - L. Payload option
2. Subroutine RUNKUT is a generalized four-part Runge-Kutta integration, first order only. The DEPVAR values calculated correspond to the integrated variables as shown in the main program common block.

 3. Subroutine OUT is a general output routine for floating point numbers and four character alphanumeric names. Up to five names and values may be printed with each call. An E12.5 format is the format used for most of the output. To change this, i.e., to increase the accuracy, only statement 20 in OUT need be changed.

 4. Subroutine ATMOSP gives the speed of sound, gravitational attraction, and atmospheric density as a function of altitude. When the altitude factor exceeds the maximum value for which data are available, the maximum altitude data are used. No diagnostic is generated.

 5. The trigonometric functions
SIND(X)
COSD(X)
TAND(X) give the sin, cos, and tan, respectively, of the angle X input
in degrees.

 6. Function ARSIN(X) gives the arc sin of an angle X input in radians.

 7. Function Y3 is a linear interpolation equation where Y3 is the unknown variable dependent on X3, a value for which is calculated from two sets of points Y2, X2 and Y1, X1.

8. Function ACCF calculates the acceleration. This was changed to a function to avoid duplication of the equation in the program. (VTO only).

Figures 5-1 and 5-2 show the Test Vehicle used for the sample run.

LENGTH - 208.8 FT
HEIGHT - 51.3 FT
SPAN - 109.0 FT

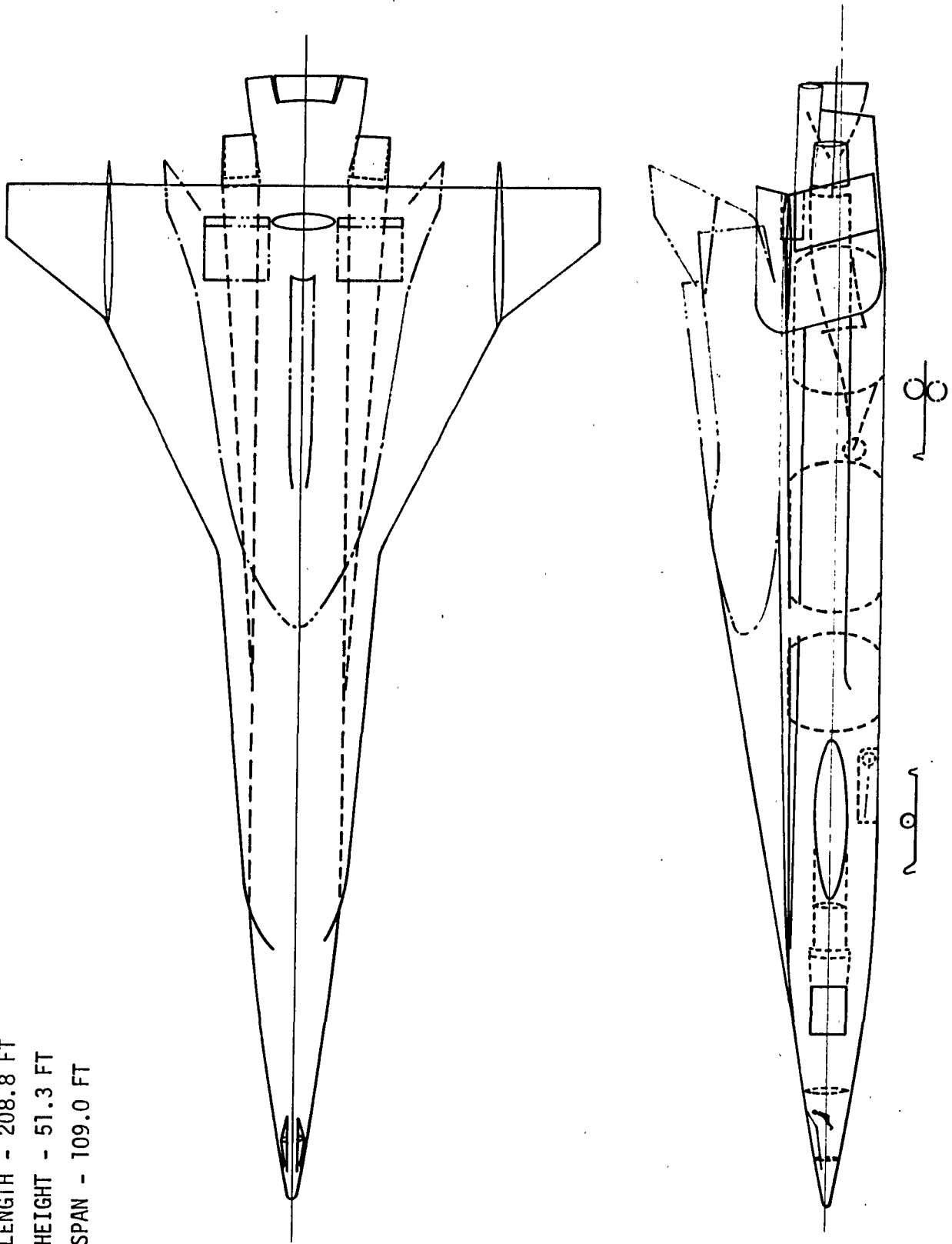

Figure 5-1. HTO SAMPLE RUN TEST VEHICLE

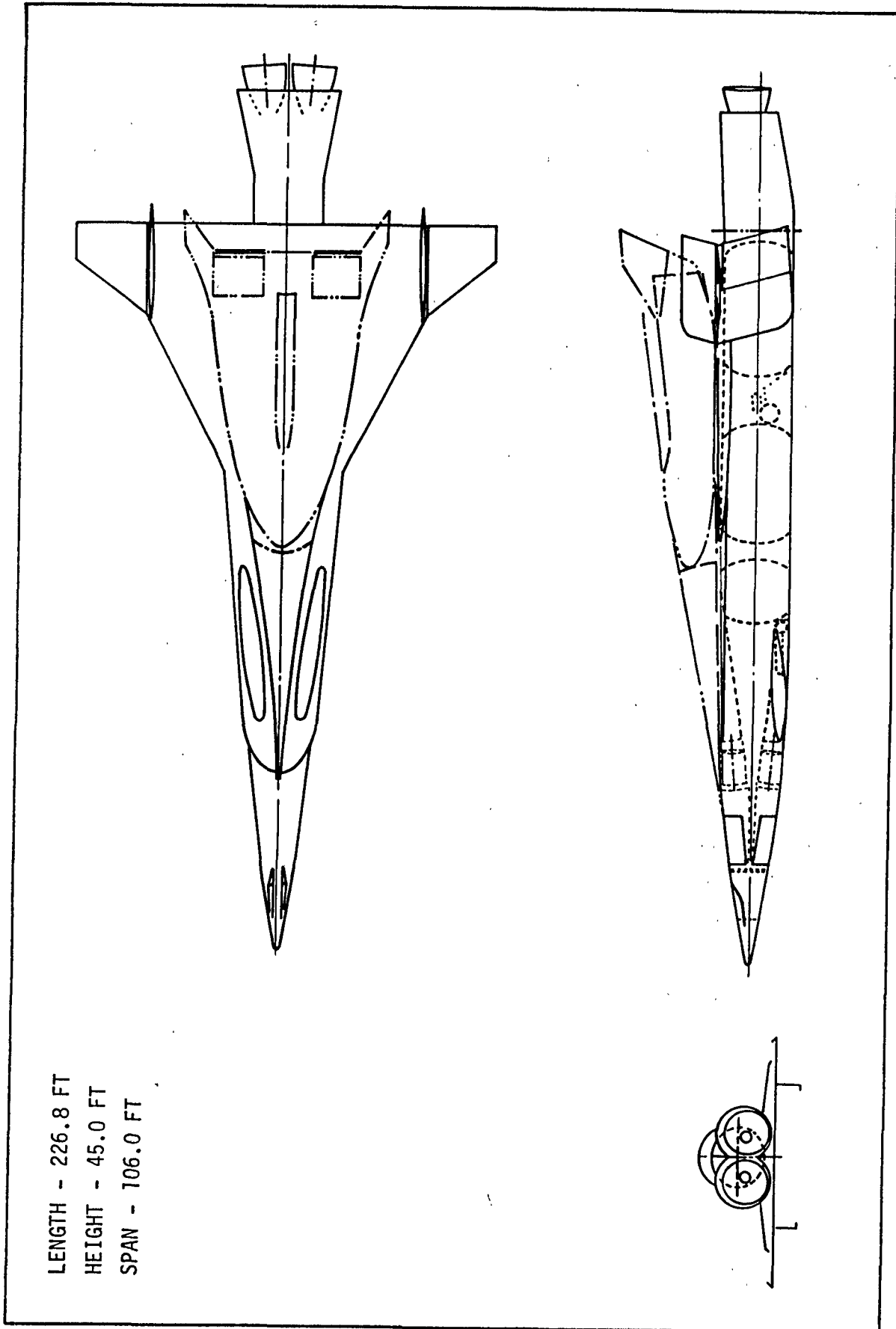

Figure 5-2. VTO SAMPLE RUN TEST VEHICLE

SECTION VI

HTO SOURCE LISTING

3200 FORTRAN (2.1.0)/(RFS)

	PROGRAM HTOT	A	1
C	H I O P I T C H P A R A M E T E R R E P O R T T R - 2 9 3 - 6 - 1 1 0	A	2
C	N O R T H R O P	A	3
	D I M E N S I O N A N S (3) , X M A C H T (1 6) , C L O T A B (1 6) , C L 1 T A B (1 6) , C L 2 T A B (1 6) ,	A	4
	1 C D O T A B (1 6) , A L T A B (1 0) , T H R 1 T (1 0) , R A T A B (1 1) , X I S P F 1 (1 1) , X I S P F 2 (1 1	A	5
	2) , D E R I V (9) , C O D E (9) , B I S P T (1 0) , H H (3) , A N G (3)	A	6
	C O M M O N V I , G A M 1 , A L T I , W T I , V L D , V L G , V L T , V C H A R , R N G I	A	7
	E Q U I V A L E N C E (A N S (1) , S O S) , (A N S (2) , G R A V) , (A N S (3) , D E N S)	A	8
C	T H I S I S E Q U I V A L E N T T O D E P V A R	A	9
	C O M M O N X L I F T , D R A G , S A L P H , C A L P H	A	10
C	H E A D I N G	A	11
	1 2 R E A D 2 8 0 , C O D E	A	12
	P R I N T 3 1 0 , C O D E	A	13
C		A	14
C	O P T I O N S	A	15
	R E A D 2 8 2 , I T W 2 , M A X L , I T H R O T , I S W 3 , I S W 2 , I S T E P , I S P D E G , I P L D , J T A B , N T A B 1 ,	A	16
	1 N T A B 2 , N T A B 3	A	17
	P R I N T 2 8 4 , I T W 2 , M A X L , I T H R O T , I S W 3 , I S W 2 , I S T E P , I S P D E G , I P L D , J T A B	A	18
C		A	19
C	S I N G L E P O I N T I N P U T A N D P R I N T	A	20
	R E A D 2 8 6 , X L A T , A 7 , V 0 , A L T 0 , G A M 0 , A L P 0 , W 0 , C O N A L , A N M A X , C C N S T , A C L I M , G A M	A	21
	1 H P , T I M E P , W W , E N N , T W 2 , X M O D , V S T A G , P N T , V M , H M , D E L H , X M G A M , B E T A , D E L T , P T S T	A	22
	2 E P , E N G F , B U I L D , D E C A Y , T N K F	A	23
	C A L L O U T (4 H Y L A T , X L A T , 2 H A Z , A Z , 2 H V 0 , V 0 , 4 H A L T 0 , A L T 0 , 4 H G A M 0 , G A M 0)	A	24
	C A L L O U T (4 H A L P 0 , A L P 0 , 2 H W 0 , W 0 , 4 H C O M A , C O N A L , 4 H A N M A , A N M A X , 4 H C O N S , C O N	A	25
	1 S I)	A	26
	C A L L O U T (4 H A C L I , A C L I M , 4 H G A M P , G A M E P , 4 H T I M P , I T I M E P , 2 H W W , W W , 3 H E N N , E N N	A	27
	1)	A	28
	C A L L O U T (3 H T W 2 , T W 2 , 4 H X M O D , X M O D , 4 H V S T A , V S T A G , 3 H P N T , P N T , 2 H V M , V M)	A	29
	C A L L O U T (2 H H M , H M , 4 H D E L H , D E L H , 4 H X M G A , X M G A M , 4 H B E T A , B E T A , 4 H D E L T , D E L T	A	30
	1)	A	31
	C A L L O U T (4 H P I S T , P I S T E P , 4 H E N G F , E N G F , 4 H B U I L , B U I L D , 4 H D E C A , D E C A Y , 4 H T N	A	32
	1 K F , T N K F)	A	33
	R E A D 2 8 6 , W P 1 , E Q P , D E L V F , C E E , S C A L E , C N T I N , E N G 2 , B I L D 2 , D K A Y 2 , T N K 2 , W P 2 ,	A	34
	1 E Q P 2 , D E L V 2 , C E E 2 , S C A L 2 , C N T N 2 , X I S P 2 , T H R 2 , C K K , A R E A , R P L D , D W T	A	35
	C A L L O U T (3 H W F 1 , W P 1 , 3 H E Q P , E Q P , 4 H D E L V , D E L V F , 3 H C E E , C E E , 4 H S C A L , S C A L E)	A	36
	C A L L O U T (4 H C N T 1 , C N T I N , 4 H E N G 2 , E N G 2 , 4 H B L D 2 , B I L D 2 , 4 H D K Y 2 , D K A Y 2 , 4 H T N K	A	37
	1 2 , T N K 2)	A	38
	C A L L O U T (3 H W 2 , W P 2 , 4 H E Q P 2 , E Q P 2 , 4 H D L V 2 , D E L V 2 , 4 H C F E 2 , C E E 2 , 4 H S C L 2 , S C	A	39
	1 A L P)	A	40
	C A L L O U T (4 H C N T 2 , C N T N 2 , 4 H X S P 2 , X I S P 2 , 4 H T H R 2 , T H R 2 , 3 H C K K , C K K , 4 H A R E A , A	A	41
	1 P E A)	A	42
	C A L L O U T (4 H R P L D , R P L D , 3 H D W T , D W T , 4 H , , 0 . 0 , 1 H , 0 . , 1 H , 0 . 0)	A	43
		A	44
C	T A B L E I N P U T	A	45
	H E A D 2 9 0 , (X M A C H T (I) , C L O T A B (I) , C L 1 T A B (I) , C L 2 T A B (I) , C D O T A B (I) , I = 1 , N	A	46
	1 T A B 1)	A	47
	P R I N T 2 9 2 , (I , X M A C H T (I) , C L O T A B (I) , C L 1 T A B (I) , C L 2 T A B (I) , C D O T A B (I) , I =	A	48
	1 I , T A B 1)	A	49
	R E A D 2 8 8 , (A L T A B (I) , T H R 1 T (I) , B I S P T (I) , I = 1 , N T A B 2)	A	50
	P R I N T 2 9 4 , (I , A L T A B (I) , T H R 1 T (I) , B I S P T (I) , I = 1 , N T A B 2)	A	51
	R E A D 2 8 8 , (R A T A B (I) , X I S P F 1 (I) , X I S P F 2 (I) , I = 1 , N T A B 3)	A	52
	P R I N T 2 9 6 , (I , R A T A B (I) , X I S P F 1 (I) , X I S P F 2 (I) , I = 1 , N T A B 3)	A	53
		A	54

	PE=20902230.0	A	55
	NOF=NO	A	56
	REFU=32.174	A	57
	ANGV=4.16666E-03	A	58
	N1=NTAR1-1	A	59
	N2=NTAR2-1	A	60
	N3=NTAR3-1	A	61
	RADIAN=57.295/795	A	62
	DELT2=DELT	A	63
	LAST=U	A	64
	NOF=NO	A	65
	ITAR=0	A	66
	IPAG=1	A	67
	LINE=61	A	68
C	TURN OFF ALL FLAGS. INITIALIZE ALL VARIABLES	A	69
C	FOR NEW TRAJECTORY	A	70
14	INI=0	A	71
	DEC=.1	A	72
16	KOUNT=0	A	73
	LAP=0	A	74
	TVBK=0	A	75
	ISTAGE=1	A	76
	T=0.0	A	77
	VLI=0.0	A	78
	VLF=0.0	A	79
	VLE=0.0	A	80
	VCHAR=0.0	A	81
	RNL=0.0	A	82
	JEIT=0	A	83
	MESS=0	A	84
	JACK=0	A	85
	GAI=GAMO	A	86
	ALPH=ALPO	A	87
	V=VU	A	88
	ALI=ALTO	A	89
	RT=WO	A	90
	BBRM=0	A	91
	PATIO=1.0	A	92
	PRI=0.000001	A	93
	JACH=1	A	94
	UPI=0	A	95
C		A	96
18	CALL ATMOSP (ALT,ANS)	A	97
	XMACH=V/SOS	A	98
C		A	99
C	TABLE DATA FIRST STAGE	A	100
	IF (ISTAGE-1) 20,20,62	A	101
20	DO 22 I=1,N2	A	102
	IF (ALT-ALTAB(I)) 24,22,22	A	103
22	IT=I	A	104
24	II=IT+1	A	105
	THRI=Y3(THR1T(II),THR1T(II-1),ALT,ALTAB(II),ALTAB(II-1))	A	106
	YISP=Y3(BISP1(II),BISP1(II-1),ALT,ALTAB(II),ALTAB(II-1))	A	107
	IT=1	A	108
	DO 26 I=1,N1	A	109
	IF (XMACH-XMACHT(I)) 28,26,26	A	110

24	IT=I	A 111
28	IT=I+1	A 112
	XM1=XMACHT(IT-1)	A 113
	XM2=XMACHT(IT)	A 114
	CD=Y3(CDOTAB(IT),CDOTAB(IT-1),XMACH,XM2,XM1)	A 115
	CL0=Y3(CLOTAB(IT),CLOTAB(IT-1),XMACH,XM2,XM1)	A 116
	CL1=Y3(CL1TAB(IT),CL1TAB(IT-1),XMACH,XM2,XM1)	A 117
	CL2=Y3(CL2TAB(IT),CL2TAB(IT-1),XMACH,XM2,XM1)	A 118
		A 119
	IF (UPD) 30,30,66	A 120
30	IF (ALPH) 46,06,32	A 121
32	IF (MAXL) 34,34,36	A 122
34	IF (CONST-.0000001) 36,36,44	A 123
36	IF (TIMER-T-.0000001) 46,46,38	A 124
38	IF (TIMER-(T+DELT2)) 40,42,42	A 125
40	DELT=TIMER-I	A 126
42	IF (MAXL) 48,48,64	A 127
		A 128
	DETERMINE ALPH FOR FTO L L	A 129
44	IF (GAMEP-GAM) 46,46,48	A 130
46	ALPH=0.0	A 131
	GO TO 64	A 132
48	ALPH=ALPH+DELT	A 133
	IF (ALPH-ALP0) 52,52,50	A 134
50	ALPH=ALP0	A 135
52	ACCN=(THRI/WT)*SIND(ALPH)+(CL0+CL1*ALPH+CL2*ALPH**2)*AREA*(.5*DENS	A 136
	1+V**2)/WT	A 137
	IF (NOEM) 54,54,58	A 138
54	IF (ANMAX-ACCN) 56,56,66	A 139
56	NOEM=1	A 140
	VR=V	A 141
58	IF (ANMAX-CONST*(V-VR)-ACCN) 60,66,66	A 142
60	ALPH=ALPH-CONAL	A 143
	IF (ALPH) 46,04,52	A 144
		A 145
	SECOND STAGE GUIDANCE CALCULUS OF VARIATIONS SOLUTION	A 146
62	GAMAL=ATAN(TAND(ALPH2+GAM2)-PNT*(T-T2))*RADIAN	A 147
	ALPH=GAMAL-GAM	A 148
	THPI=THR2	A 149
	XISP=XISP2	A 150
	IF (UPD) 68,68,70	A 151
		A 152
	PRE- INTEGRATION	A 153
64	ACCN=(THRI/WT)*SIND(ALPH)+(CL0+CL1*ALPH+CL2*ALPH**2)*AREA*(.5*DENS	A 154
	1+V**2)/WT	A 155
66	CL=CL0+CL1*ALPH+CL2*ALPH**2	A 156
	CD=CD0+CKK*CL*TAND(ALPH)	A 157
	DYNP=.5*DENS*V**2	A 158
	XLIFT=CL*DYNP*AREA	A 159
	DR=G=CD*DYNP*AREA	A 160
	IF (UPD) 68,68,88	A 161
68	TJ=I	A 162
	VI=V	A 163
	ALFI=ALT	A 164
	RNGI=RF G	A 165
	WTI=WT	A 166

	GAM=SGAM	A 167
70	CALPH=COSD(ALPH)	A 168
	SALPH=SIND(ALPH)	A 169
	IF (OPT) 90,90,88	A 170
		A 171
72	IF (JAHR) 86,86,74	A 172
74	CALPH=COSD(ALPH)	A 173
		A 174
	TABULATION OPTION JTAB=1	A 175
	IF (ITAB) 82,82,76	A 176
76	IF (LINE-60) 80,80,78	A 177
78	PRINT 274, COEF, IPAG	A 178
	IPAG=IPAG+1	A 179
	PRINT 276	A 180
	LINE=5	A 181
80	PRINT 278, I, ALPH, Y, GAM, ALT, THRI, XLIFT, DRAG, XMACH, RNG, VCHAR	A 182
	LINE=LINE+1	A 183
	GO TO 84	A 184
		A 185
	OUTPUT STANDARD FORM	
82	PRINT 71, T, ISLAGE, ALPH, V, CL	
71	FORMAT (5H0TIME, E15.5, 3X, 5HSTAGE, 2X, I2, 13X, 4HALPH, E15.8, 3X, 1HV, E18,	
	15.3X, 2HCL, E17.5)	
	CALL OUT (3HSOS, SOS, 4HGRAV, GRAV, 3HGAM, GAM, 3HALT, ALT, 4HXLIFT, XLIFT)	A 189
	CALL OUT (4HMACH, XMACH, 2HWT, WT, 3HACC, ACC, 4HTHRI, THRI, 2HCD, CD)	A 190
	CALL OUT (4HDENS, DENS, 4HXISP, XISP, 4HACCN, ACCN, 4HRATI, RATIO, 4HDRAG,	A 191
	1HPRAG)	A 192
	CALL OUT (4HDYNP, DYNP, 3HRNG, RNG, 3HVLD, VLD, 3HVLG, VLG, 3HVLT, VLT)	A 193
	CALL OUT (4HVCHR, VCHAR, 4H .0, 0, 1H .0, 1H .0, 1H .0, 1H .0, .)	A 194
84	JAHR=0	A 195
	IF (IVOK) 86,86,172	A 196
		A 197
		A 198
	INTEGRATION	
86	IND=1	A 199
88	SGAM=SINI(GAM1)	A 200
	CGAM=COSD(GAM1)	A 201
	WRITE	A 202
	DERIV(1)=GFE0/WTI*(THRI*CALPH-DRAG)-GRAV*SGAM	A 203
	WRITE	A 204
	DERIV(2)=(GFE0/(WTI*VI))*(THRI*SALPH+XLIFT)+(VI/(RE+ALT)-GRAV/VI)*C	A 205
	1HANG)*RADIAN	A 206
	WRITE	A 207
	DERIV(3)=VI*SGAM	A 208
	WRITE	A 209
	DERIV(4)=-THRI/XISP	A 210
	VELOCITY COMPONENTS	A 211
	DERIV(5)=(DRAG*GRAV)/WTI	A 212
	DERIV(6)=GRAV*SGAM	A 213
	DERIV(7)=(GRAV*THRI/WTI)*(1-CALPH)	A 214
	DERIV(8)=(THRI*GRAV)/WTI	A 215
	DERIV(9)=V*RE+CGAM/(RE+ALT)	A 216
	CALL RUNKUT (II, DERIV, DELT, IND)	A 217
	IND=IND+1	A 218
	WRITE	A 219
	IF (IND-4) 18,18,120	A 220
		A 221
90	ACCF=ACCF(THRI)	A 222

THX=THRI	A 223
IF (ACLIM-ACC) 92,72,72	A 224
92 IF (ITHROT) 94,94,98	A 225
94 IF (MESS) 96,96,72	A 226
96 TH*PI=ACC/ACLIM	A 227
PRINT 312, I1,TEMP1	A 228
GO TO 72	A 229
C	A 230
THROTTLE	A 231
98 IF (ISTEP) 100,100,118	A 232
100 TH*T=DRAG*CALPH-XLIFT*SALPH+SQRT((ACLIM*WTI)**2-(XLIFT*CALPH+DRAG* SALPH)**2)	A 233
RATIO=THRT/THRI	A 234
TH*1=THRI	A 235
102 IF (ISPDEG) 104,112,104	A 237
104 DO 106 I=1,N3	A 238
IF (RATIO-RATAB(I)) 108,106,106	A 239
106 IT=I	A 240
108 IT=IT+1	A 241
IF (ISTAGE-1) 110,110,114	A 242
110 XISPF=Y3(XISPF1(IT),XISPF1(IT-1),RATIO,RATAB(IT),RATAB(IT-1))	A 243
GO TO 116	A 244
112 XISPF=1.00	A 245
GO TO 116	A 246
114 XISPF=Y3(XISPF2(IT),XISPF2(IT-1),RATIO,RATAB(IT),RATAB(IT-1))	A 247
116 XI*P=XISP*XISPF	A 248
ACC=ACCF(THRI)	A 249
GO TO 72	A 250
C	A 251
118 TH*0=THX/XMOD	A 252
TH*1=THRI-TH*0	A 253
RATIO=THRT/TH*1	A 254
TH*1=THRT	A 255
ACC=ACCF(THRI)	A 256
IF (ACLIM-ACC) 118,102,102	A 257
C	A 258
120 T=11	A 259
UPP=0	A 260
FRI=PRT+DELT	A 261
V=Y1	A 262
PNG=RNFI	A 263
ALT=ALTI	A 264
GAM=GAMI	A 265
WT=WTI	A 266
KOUNT=0	A 267
JUMP=0	A 268
IF (ISTAGE-1) 122,122,136	A 269
C FIRST STAGE MONITORING	A 270
122 IF (VSTAG-(V+JFLT2*DERIV(1))*1.1) 128,128,124	A 271
124 IF (WP1-(WO-WI)+DERIV(4)*DELT2) 128,128,126	A 272
126 DELT=DELT2	A 273
GO TO 146	A 274
128 DELT=DELT2/10.0	A 275
IF (VSTAG-V) 132,132,130	A 276
130 IF (WP1-(WO-WI)+(DERIV(4)*0.6*DELT)) 134,146,146	A 277
132 JFLT=1	A 278

	GO TO 152	A 279
134	JETL=2	A 280
	GO TO 152	A 281
C		A 282
C	SECOND STAGE MONITORING	A 283
136	IF (LAP) 138,138,142	A 284
138	IF (VM-(V+DELT1*DERIV(1)*1.1)) 140,140,142	A 285
140	DELT=DELT2/5.0	A 286
	LAP=1	A 287
142	IF (VM-V) 144,144,146	A 288
144	TVAC=1	A 289
	DELT=DELT2	A 290
	LAP=0	A 291
	DELT=0.0	A 292
	JAPR=1	A 293
	GO TO 18	A 294
C	170 CHECK	A 295
146	IF (PTSTEP-PRI) 150,150,148	A 296
148	IF (ISW2) 154,154,152	A 297
150	PRI=0.000001	A 298
152	JAPR=1	A 299
154	IF (TVAC) 156,156,172	A 300
156	IF (JETT-1) 16,158,160	A 301
C		A 302
C	CALCULATE FIRST STAGE WEIGHTS	A 303
158	PRINT 314	A 304
	JAPY=1	A 305
	GO TO 162	A 306
160	PRINT 316	A 307
	LINE=LINE+2	A 308
	JAPY=2	A 309
	VRUT=(ANGV/57.2957795)*RE*COSD(XLAT)*SIND(AZ)	A 310
	V2=SQRT(VROT**2+V**2+2.0*VRUT*V*COSD(GAM))	A 311
	GAM2=(ARSIN((V/V2)*SIND(GAM)))*RADIAN	A 312
	RANG2=ENGI+V2*COSD(GAM2)/(V*COSD(GAM))	A 313
	RADI=RANG2	A 314
	RAI=RANG2	A 315
162	TVAC=THR1*(NTAB2)	A 316
C	LINE=LINE+2	A 317
	WSAVE=WT	A 318
	WENG=SCALE*CNTIN*ENGF*TVAC	A 319
	WEQP=SCALE*CNTIN*EQP	A 320
	WRFS1=WT*(1.0-EXP(-DELVF/(GEE0*BISPT(NTAB2))))	A 321
	WRFS2=WT*(1.0-EXP(-CFE*ALOG(WO/WT)))	A 322
	GAS=(WO-WT)+WRFS1+WRFS2+BUILD*TVAC+DFCAY*TVAC	A 323
	GASD=DFCAY*TVAC+SCALE*CNTIN*ENN*WW+WRFS1+WRFS2	A 324
	WTANK=SCALE*CNTIN*TNKF*GAS+GASD	A 325
164	WJET=WTANK+WENG+WEQP+BILD2*THR2	A 326
	WJ=WSAVE	A 327
	WOP=WT-WJET	A 328
	PROPT=WOP-WI	A 329
	LI=WD2	A 330
	THR2=THR2	A 331
	DELT=DELT2	A 332
C	SECOND STAGE BEGIN	A 333
	ISLAGE=2	A 334

```

164 IF (TH2) 170,170,166
166 TH2=TH2*W1
168 IF (TH2-TH2) 168,170,168
168 IF (ABS(TH2-TH2)-TH2/1000.0) 170,170,164
170 DRAG=0.0
    XLIFT=0.0
    CB=0.0
    LL=0.0
    VLS=VLD
    VLS=VLG
    VLS=VLT
    VCRS=VCHR
    T2=T
    ALP2=AL1
    VROT=(ANGV/57.2957795)*RF*COSD(XLAT)*SIND(AZ)
    WP2=SQRT(VROT**2+V**2+2.0*VROT*V*COSD(GAM))
    GA2=(ARCSIN((V/V2)*SIND(GAM)))*RADIAN
    ALPH2=ALPH
    V=V2
    JF11=0
    GA2=GAM2
    ALPH=0.0
    T2=P+U.0
    PA110=1.0
    GO TO 16
C
C FLIGHT ITERATION
172 IF (INT) 174,174,182
174 IF (WT+WP2-WO2) 176,182,182
176 IF (JWBY-1) 180,180,178
178 WP1=WP1*1.0002+(WO2-WT-WP2)*1.25
    PRINT 336
    PRINT 318, WP1
    GO TO 16
180 VSTAR=VSTAR*100
    PRINT 338
    PRINT 320
    GO TO 16
C
C SECTION-RAPHSON GAM AND ALI CONVERGENCE
182 FA=AL1-HM
    FB=GAM-XMGAM
184 IF (ABS(DA)-DELH) 184,184,190
184 IF (ABS(DG)-BETA) 186,186,190
186 IF (INT) 228,228,188
188 INT=0
    GO TO 174
190 IF (INT-4) 202,196,192
192 IF (ABS(DA)-ABS(DA1)) 196,196,194
194 DA=DA1
    DG=DG1
    FB1=F1
    COS1=C1
    DEL=DEL*.5
198 IF (DEL-.0001) 198,200,200

```

A 335
A 336
A 337
A 338
A 339
A 340
A 341
A 342
A 343
A 344
A 345
A 346
A 347
A 348
A 349
A 350
A 351
A 352
A 353
A 354
A 355
A 356
A 357
A 358
A 359
A 360
A 361
A 362
A 363
A 364
A 365
A 366
A 367
A 368
A 369
A 370
A 371
A 372
A 373
A 374
A 375
A 376
A 377
A 378
A 379
A 380
A 381
A 382
A 383
A 384
A 385
A 386
A 387
A 388
A 389
A 390

196	DA1=DA	A	391
	DG1=DG	A	392
	C1=CONST	A	393
	P1=PNT	A	394
	INT=5	A	395
	DEC=DEC*.5	A	396
	IF (DEC-.0001) 198,200,200	A	397
198	DEC=.0001	A	398
200	CONST=CONST+SIGN(DEC,DA)*CONST	A	399
	PNT=PNT+SIGN(DEC,DG)*PNT	A	400
	GO TO 222	A	401
202	INT=INT+1	A	402
	DEC=.05	A	403
	CALL OUT (3HALT,ALT,3HGAM,GAM,1HT,T,4HCONS,CONST,3HPNT,PNT)	A	404
	CALL OUT (2HW1,WT,3HW2,WP2,3HW02,W02,4H .0.0,1H .0)	A	405
	HH(INT)=ALT	A	406
	ANG(INT)=GAM	A	407
	IF (MAXL) 204,204,206	A	408
204	IF (CONST-0.0000001) 206,206,212	A	409
C		A	410
C	CUTOFF CORRECTION(MAX LIFT) NEWTON-RAPHSON	A	411
206	IF (INT-2) 214,208,210	A	412
208	TIM1=TIMEP	A	413
	DTIM=-TIMEP*SIGN(.015,GAM-XMGAM)	A	414
	TIMEP=TIMEP+DTIM	A	415
	PNT1=PNT1	A	416
	PRINT 334, TIMEP,PNT	A	417
	GO TO 16	A	418
210	TIMEP=TIM1	A	419
	GAMER=ANG(1)-XMGAM	A	420
	ALTER=HH(1)-HM	A	421
	ALPNT=(HH(2)-HH(1))/DPNT	A	422
	ALTIM=(HH(3)-HH(1))/DTIM	A	423
	GMPNT=(ANG(2)-ANG(1))/DPNT	A	424
	GMTIM=(ANG(3)-ANG(1))/DTIM	A	425
	DETER=ALTIM*GMPNT-GMTIM*ALPNT	A	426
	TIMEP=(ALPNT*GAMER-GMPNT*ALTER)/DETER+TIMEP	A	427
	PNT=(GMTIM*ALTER-ALTIM*GAMER)/DETER+PNT	A	428
	INT=0	A	429
	PRINT 336, TIMEP,PNT	A	430
	PRINT 338	A	431
	GO TO 16	A	432
212	IF (INT-2) 214,218,224	A	433
214	PNT1=PNT	A	434
	DPNT=SIGN(.05,DA)*PNT	A	435
	PNT1=PNT1+DPNT	A	436
	IF (PNT) 216,226,226	A	437
216	PNT=0.0	A	438
	DPNT=PNT-PNT1	A	439
	GO TO 226	A	440
218	CONST1=CONST	A	441
	DCON=SIGN(.012,DG)*CONST	A	442
	CONST=CONST+DCON	A	443
	PNT=PNT1	A	444
	IF (CONST) 220,222,222	A	445
220	CONST=0.0	A	446

	BCON=CONST-CONST1	A 447
222	PRINT 322, CONST,PNT	A 448
	CALL OUT (PHDA,UA,2HEG,DG,3HDEC,DEC,4H ,0.0,1H ,0.0)	A 449
	PRINT 338	A 450
	GO TO 16	A 451
C	CALCULATE PARTIAL DERIVATIVES	A 452
224	CONST=CONST1	A 453
	GAMER=ANG(1)-XMGAM	A 454
	ALTER=PH(1)-HM	A 455
	ALPNT=(HH(2)-HH(1))/EPNT	A 456
	ALCON=(HH(3)-HH(1))/ECON	A 457
	GMPNT=(ANG(2)-ANG(1))/DPNT	A 458
	GMCN=(ANG(3)-ANG(1))/DCON	A 459
	DETER=ALCON*GMPNT-GMCN*ALPNT	A 460
C	KREEP FACTOR = .7	A 461
	CONST=(ALPNT*GAMER-ALTER*GMPNT)/DETER+.7+CONST	A 462
	PNT=(GMCN*ALTER-ALCON*GAMER)/DETER+PNT	A 463
	INT=4	A 464
	PRINT 324, CONST,PNT	A 465
	PRINT 338	A 466
	GO TO 16	A 467
226	T=12	A 468
	JUMP=1	A 469
	WT=WO2	A 470
	V=V2	A 471
	VLE=VLDS	A 472
	VLE=VLGS	A 473
	VLT=VLTS	A 474
	VCHAR=VCHRS	A 475
	ALT=ALT2	A 476
	GAM=GAM2	A 477
	ALPH=ALPH2	A 478
	RATIO=1.0	A 479
	IVOK=0	A 480
	PRINT 326, CONST,PNT	A 481
	PRINT 338	A 482
	GO TO 62	A 483
C		A 484
C	FINAL PRINT	A 485
C		A 486
228	IF (LAST) 230,230,238	A 487
230	LAST=1	A 488
	IF (ISW3) 232,232,236	A 489
232	IF (JTAB) 238,238,234	A 490
234	ITAB=1	A 491
	ISW5=1	A 492
	ISW2=1	A 493
	GO TO 16	A 494
236	ISW2=1	A 495
	PRINT 300	A 496
	GO TO 16	A 497
C		A 498
C	WEIGHT BREAKOUT SECOND STAGE	A 499
C		A 500
238	PRINT 328, WENG,WEQP,WTANK,WJET,PROP1,WO2,WRES1,WRES2,T2,ALT2,VROT	A 501
	WENG=SCAL2*CNIN2*ENG2*THR2	A 502

WEQP=SCAL2*CNIN2*EQP2	A	503
WRFS1=WT*(1.0-EXP(-DELV2/(GEE0*XISP2)))	A	504
WRFS2=WT*(1.0-EXP(-CFE2*ALOG(WO2/WT)))	A	505
GAS=(WO2-WT)+WRFS1+BILD2*THR2+WRFS2+DKAY2*THR2	A	506
GASO=DKAY2*(THR2+WRFS1+WRFS2)	A	507
WTANK=SCAL2*CNIN2*INK2*GAS+GASO	A	508
WJET=WTANK+WENG+WEQP	A	509
PROP1=WO2-WT	A	510
T2=WT-WJET	A	511
PRINT 330, WENG, WEQP, WTANK, WJET, PROP1, WRFS1, WRFS2, T2, VLU, VLG, VLT, V	A	512
1CHAR	A	513
PRINT 332, PNI, CONST, GAMEP, TIMEP, VSTAG, WP1	A	514
RETURN TO READ A NEW SET OF DATA IPLD=0	A	515
IF (IPLD) 12, 12, 240	A	516
	A	517
PAYLOAD RECALCULATION OPTION IPLD=1	A	518
	A	519
240 DPLD=T2-RPLD	A	520
PRINT 302, W0, DPLD	A	521
PRINT 304	A	522
IF (ABS(DPLD)-.00001*RPLD) 12, 12, 242	A	523
242 IF (ABS(DPLD)-1000.) 246, 246, 244	A	524
244 PRINT 306	A	525
GO TO 12	A	526
246 IF (IPLD-2) 248, 252, 268	A	527
248 IPLD=2	A	528
SP1=SIGN(1., DPLD)	A	529
SP2=SP1	A	530
GO TO 254	A	531
250 RPLD1=12	A	532
WOLD=WOP	A	533
DPLD1=DPLD	A	534
GO TO 14	A	535
252 SP2=SIGN(1., DPLD)	A	536
IF (SP1+SP2) 254, 260, 254	A	537
254 IF (ABS(DPLD)-150.) 258, 258, 256	A	538
256 W0=W0-DWT*DPLD/70.	A	539
GO TO 250	A	540
258 W0=W0-DWT*SP2	A	541
GO TO 250	A	542
260 RPLD2=12	A	543
DPLD2=DPLD	A	544
IPLD=3	A	545
WOLD2=W0	A	546
262 DPLD=(DPLD2-DPLD1)/ABS(WOLD-WOLD2)	A	547
PRINT 308, DPLD, WOLD, WOLD2	A	548
IF (ABS(DPLD1)-ABS(DPLD2)) 264, 264, 266	A	549
264 DPLD=ABS(DPLD1)/DPLD1	A	550
W0=WOLD+DWD	A	551
GO TO 14	A	552
266 DPLD=ABS(DPLD2)/(-DPLD2)	A	553
W0=WOLD2+DWD	A	554
GO TO 14	A	555
268 SP3=SIGN(1., DPLD)	A	556
IF (SP3+SP2) 270, 272, 270	A	557
270 DPLD2=DPLD	A	558

PLD2=W0	A 559
PLD2=J2	A 560
GO TO 262	A 561
272 DPLD1=UPLD	A 562
W010=W0	A 563
PLD1=T2	A 564
GO TO 262	A 565
<hr/>	
274 FORMAT (1H1, 9A6, 5X, 5F-PAGE, 13)	A 566
276 FORMAT (7H0 TIME, 5X, 5HALPHA, 3X, 8HVELOCITY, 4X, 5HGAMMA, 5X, 8HALTITUDE, 1E7, 6HTHRUST, 9X, 4HLIFT, 10X, 4HDRAG, 7X, 4HMACH, 7X, 5HRANGE, 6X, 5HVCHAR, 2//)	A 567
278 FORMAT (1H, F7.1, 3X, F6.2, 3X, F8.1, 3X, F6.2, 4(3Y, E11.4), 3X, F6.2, 3X, E11.4, 3X, F8.1)	A 568
280 FORMAT (9A6)	A 569
282 FORMAT (20I3)	A 570
284 FORMAT (8H OPTIONS, 4H TW2, 3X, I3, 3X, 4HMAXL, 1E, 3X, 5HTHROT, 14, 3X, 3HS1, 3X, I3, 3X, 3HSW2, 3X, I3, 3X, 4HSTEP, 15, 3X, 6HISF DEG, 13, 3X, 5HPLD, 3X, I3, 2, 3X, 3HTAR, 3X, I3)	A 571
286 FORMAT (5E15.0, 5X)	A 572
288 FORMAT (3E12.0)	A 573
290 FORMAT (5E12.0)	A 574
292 FORMAT (1H0, 9X, 11HMACH NUMBER, 9X, 4HCL 0, 12X, 4HCL 1, 12X, 4HCL 2, 12X, 14H0.0 // (15, 5E16.6))	A 575
294 FORMAT (1H0, 9X, 8HALTITUDE, 9X, 6HTHRUST, 12X, 3HISP // (15, 3E16.6))	A 576
296 FORMAT (1H0, 11X, 5HRAIAR, 11X, 6HISP F1, 10X, 6HISP F2 // (15, 3E16.6))	A 577
300 FORMAT (34H1 RECALCULATION OF FINAL TRAJECTORY)	A 578
302 FORMAT (3H W0, E15.5, 3X, 4HDPLD, E15.5)	A 579
304 FORMAT (1H1)	A 580
306 FORMAT (82H DIFFERENCE BETWEEN PAYLOAD CALC AND PAYLOAD DESIRED IS 1 GREATER THAN 1000. POUNDS)	A 581
308 FORMAT (1H, 3(E15.5, 3X))	A 582
310 FORMAT (214H HORIZONTAL TAKEOFF, 10X, 12A6, /)	A 583
312 FORMAT (5H TIME, F12.2, 2X, 9H ACC/A CLIM, E20.8)	A 584
314 FORMAT (14H VSTAG REACHED)	A 585
316 FORMAT (12H WWP1 REACHED)	A 586
318 FORMAT (9H NEW WWP1 =, E15.6)	A 587
320 FORMAT (13H IGNORE VSTAG, /)	A 588
322 FORMAT (7H END II, 5X, 16H REFLY WITH CONST, E15.6, 4X, 5H PNT, E15.6)	A 589
324 FORMAT (15H NEWTON RAPHSON, 5X, 5H CONST, E15.6, 3X, 5H POINT, E15.8)	A 590
326 FORMAT (13H CUTOFF ERROR, 5X, 16H REFLY WITH CONST, E15.6, 5X, 4H PNT, E15.6)	A 591
328 FORMAT (28H1 FIRST STAGE WEIGHTS LBS. / 1H0, 6H ENGINE, 9X, E15.6, 2X, 9 1HEQUIPMENT, 6X, E15.6, 2X, 4HTANK, 11X, F15.6, 2X, 8HJEITISON, 7X, E15.6 / 1X, 21H USED PROPELLANT, E15.6, 2X, 3H W02, 12X, E15.6, 2X, 14H FIXED RESERVES, 1 3X, E15.6, 2X, 13H VAR. RESERVES, 2X, E15.6 // 1X, 12H STAGING TIME, 3X, E15.6, 42Y, 8HALTITUDE, 7X, E15.6, 2X, 10HV-ROTATION, 5X, F15.6 // 1X)	A 592
330 FORMAT (1H0 / 150 / 29H SECOND STAGE WEIGHTS (LBS.) / 7H ENGINE, 9X, E15.6, 15, 2X, 9HEQUIPMENT, 6X, F15.6, 2X, 4HTANK, 11X, F15.6, 2X, 8HJEITISON, 7X, E15.6 / 1X, 2.6 / 11H PROPELLANT, 5X, E15.6, 2X, 14H FIXED RESERVES, 1X, E15.6, 2X, 13H VAR 3. RESERVES, 2X, E15.6, 2X, 7HPAYLOAD, 8X, E15.6 // 1X, / / / / 1X, 4HVLD =, E13.6, 415X, 4HVLG =, E15.6, 15X, 4HVLIT =, E13.6, 15X, 6HVCHAR =, E13.6)	A 593
332 FORMAT (7, 4H PNT, 4X, E14.6, 2X, 7H CONST, E14.6, 2X, 5H GAMEP, 2X, E14.6, 2 1X, 5H JMEP, 2X, E14.6, 2X, 7, 8H VSTAG, E14.6, 2X, 5H WWP1, 4X, E14.6, / / /)	A 594
	A 595
	A 596
	A 597
	A 598
	A 599
	A 600
	A 601
	A 602
	A 603
	A 605
	A 606
	A 607
	A 608
	A 609
	A 610
	A 611
	A 612
	A 613
	A 614
	A 615

```

334 FORMAT (6H0ENDT1/7HTIMEP=,E15.6,10X,4HPNT=.F15.6)      A 616
336 FORMAT (7H TIMEP=.E15.6,4X,6HPPOINT=.E15.6)             A 617
338 FORMAT (120H *****  

1 *****  

2)                                                            A 619
END                                                            A 620
                                                                A 621-

```

3200 FORTRAN DIAGNOSTIC RESULTS - FOR H101

3200 FORTRAN (2.1.0)/(RTS) / /

```

SUBROUTINE RUNKUT (T,DERIV,DELT,IND)                          B 1
C  SUBGE-KUTIA INTEGRATION AND DIFFERENTIAL EQUATION        B 2
  DIMENSION DERIV(9), DEPVAR(9), AUX(9), SUM(9)              B 3
  COMMON DEPVAR                                              B 4
  IF (IND-2) 2,0,8                                           B 5
  2 CONST1=DELT*0.5                                          B 6
  CONST3=0.5                                                 B 7
  CONST4=1.0                                                 B 8
  T=T+CONST1                                                 B 9
  DO 4 1=1,9                                                B 10
  /DX(I)=DEPVAR(I)                                          B 11
  4 SUM(I)=0.0                                               B 12
  DO 10 12                                                  B 13
  6 CONST4=2.0                                              B 14
  DO 10 12                                                  B 15
  8 IF (IND-3) 10,10,16                                     B 16
  10 T=T+CONST1                                             B 17
  CONST3=1.0                                               B 18
  12 DO 14 1=1,9                                           B 19
  CONST2=DELT*DX(I)                                        B 20
  DEPVAR(I)=AUX(I)+CONST3*CONST2                          B 21
  14 SUM(I)=SUM(I)+CONST4*CONST2                          B 22
  RETURN                                                  B 23
  16 DO 18 1=1,9                                           B 24
  SUM(I)=(SUM(I)+DELT*DERIV(I))/6.0                       B 25
  18 DEPVAR(I)=AUX(I)+SUM(I)                               B 26
  RETURN                                                  B 27
END                                                        B 28-

```

3200 FORTRAN DIAGNOSTIC RESULTS - FOR RUNKUT

NO ERRORS

3200 FORTRAN (2.1.0)/(RTS) / /

```

SUBROUTINE Q01 (I,A,I2,A2,I3,A3,I4,A4,I5,A5)                C 1
C  THE I,S ARE COLLERITH INFORMATION UP TO 4 CHAR PER NAME  C 2
  IF (I2-4P ) 4,2,4                                         C 3
  2 PRINT 20, I,A                                           C 4

```

GO TO 18	C	5
4 IF (13-4H) 8,6,8	C	6
6 PRINT 20, I,A,I2,A2	C	7
GO TO 18	C	8
8 IF (14-4H) 12,10,12	C	9
10 PRINT 20, I,A,I2,A2,I3,A3	C	10
GO TO 18	C	11
12 IF (15-4H) 16,14,16	C	12
14 PRINT 20, I,A,I2,A2,I3,A3,I4,A4	C	13
GO TO 18	C	14
16 PRINT 20, I,A,I2,A2,I3,A3,I4,A4,I5,A5	C	15
18 RETURN	C	16
	C	17
	C	18
20 FORMAT (1H,5(A4,3X,E12.5,3X))	C	19
END	C	20-

3200 FORTRAN DIAGNOSTIC RESULTS - FOR OUT

3200 FORTRAN (2.1.0)/(RTS) / /

SUBROUTINE ATMOSP (H,ANS)	D	1
VER REVISID ATMOSP ROUTINE 1768	D	2
ANS(1)=SOS, ANS(2)=GRAV, ANS(3)=DENS	D	3
DIMENSION ANS(3)	D	4
TM0=518.688	D	5
G=32.173984	D	6
FR=20855531.0	D	7
CO=1116.4551	D	8
ANS(2)=G*(FR/(ER+H))*2	D	9
GPH=(ER*H)/(FR+H)	D	10
IF (GPH-15419.0) 2,2,14	D	11
2 IF (GPH-36089.0) 4,4,6	D	12
4 ANS1=-3.5662E-3+GPH+518.688	D	13
ANS(3)=2.3769E-3*((-6.8753E-6*GPH+1.0)**4.25612)	D	14
GO TO 12	D	15
6 IF (GPH-82021.0) 8,8,10	D	16
8 ANS1=389.958	D	17
ANS(3)=7.0611E-4*(EXP(-4.8063E-5*GPH+1.73457))	D	18
GO TO 12	D	19
10 ANS1=1.6459E-9*GPH+254.988	D	20
ANS(3)=7.7644E-5*((4.2204E-6*GPH+0.65384)**(-12.3885))	D	21
12 ANS(1)=CO*SQRT(ANS1/TM0)	D	22
RETURN	D	23
HIGH ALTITUDE	D	24
14 IF (GPH-17385.0) 16,16,18	D	25
16 ANS1=208.788	D	26
ANS(3)=2.8803E-6*(EXP(-5.68409E-5*GPH+5.68043))	D	27
GO TO 12	D	28
18 IF (GPH-259180.0) 20,20,22	D	29
20 ANS1=-2.4689E-3*GPH+938.088	D	30

```

      ANP(3)=1.3447E-6*((-4.8525E-6*GPH+1.843769)*76.59216)
      GO TO 12
22 IF (GPH-295276.0) 26,26,24
      HI IS HIGH ALTITUDE
      USE DATA FOR GPH=295276. WHEN GPH GREATER THAN 295276.
24 CONTINUE
26 ANP(1)=298.188
      ANP(3)=4.1188E-8*(EXP(-6.28597E-5*GPH+16.292376))
      GO TO 12
      END
  
```

D 31
D 32
D 33
D 34
D 35
D 36
D 37
D 38
D 39
D 40-

3200 FORTRAN DIAGNOSTIC RESULTS - FOR ATMOSP

3200 FORTRAN (2.1.0)/(RTS) / /

```

FUNCTION SIND (X)
GIVES SIN(X) WHERE X IS IN DEGREES
SIND=SIN(X/57.2957795)
RETURN
END
  
```

F 1
F 2
F 3
F 4
F 5-

3200 FORTRAN DIAGNOSTIC RESULTS - FOR SIND

3200 FORTRAN (2.1.0)/(RTS) / /

```

FUNCTION COSD (X)
GIVES COS(X) WHERE X IS IN DEGREES
COSD=COS(X/57.2957795)
RETURN
END
  
```

F 1
F 2
F 3
F 4
F 5-

3200 FORTRAN DIAGNOSTIC RESULTS - FOR COSD

3200 FORTRAN (2.1.0)/(RTS) / /

```

FUNCTION TAND (X)
GIVES TAN(X) WHERE X IS IN DEGREES
TAND=SIND(X)/COSD(X)
RETURN
END
  
```

G 1
G 2
G 3
G 4
G 5-

3200 FORTRAN DIAGNOSTIC RESULTS - FOR TAND

3200 FORTRAN (2.1.0)/(RTS) / /

FUNCTION ARSIN (X)	H	1
ARSIN=ATAN(X/SQRT(1.0-X**2))	H	2
RETURN	H	3
END	H	4-

3200 FORTRAN DIAGNOSTIC RESULTS - FOR ARSIN

3200 FORTRAN (2.1.0)/(RTS) / /

FUNCTION Y3 (Y2,Y1,X3,X2,X1)	I	1
LINEAR INTERPOLATION BETWEEN POINTS	I	2
Y3=Y1+(Y1-Y2)*(X3-X1)/(X1-X2)	I	3
RETURN	I	4
END	I	5-

3200 FORTRAN DIAGNOSTIC RESULTS - FOR Y3

3200 FORTRAN (2.1.0)/(RTS) / /

FUNCTION ACCF (THRI)	J	1
COMMON VI,GAML,ALTI,WTI,VLDI,VLGI,VLTI,VCHARI,RNGI	J	2
COMMON XLIFT,DRAG,SALPH,CALPH	J	3
ACCF=THRI/WTI*SQRT(1.0+(XLIFT**2+DRAG**2)/THRI**2+2.0/THRI*(XLIFT*	J	4
1SALPH-DRAG+CALPH))	J	5
RETURN	J	6
END	J	7-

3200 FORTRAN DIAGNOSTIC RESULTS - FOR ACCF

NO ERRORS
LOAD,56
RUN,10

SUBP											
60157	Q8DERRR	60435	FIXF	60504	FLOATF	60533	ABSF	60547	SQRTF	60660	SIGNF
60704	LOGF	61113	EXPF	61245	ASIN	61364	ATANF	61525	SINCOS	62036	POWRF
62406	XTOI	62632	Q1GADRI	63013	Q8QOUTTB	63014	CONTROL	63554	PAUSE	63634	FORMAT
64175	PCIOUT	65733	BCEINP	66730	TAND	66776	COSD	67040	SIND	67102	ATMOSP
67516	AMOD	67571	OUT	70050	Y3	70134	RUNKUT	70427	VTO		

ENTR											
60435	XFIXF	60533	XABSF	60533	IABS	60533	ABSF	60547	SQRTF	60660	XSIGNF
60660	ISIGNF	60660	SIGNF	60704	ALOG10	60713	LOGF	61113	EXPF	61364	ATANF
61525	COSF	61533	SINF	62036	POWRF	60504	FLCATF	62406	XTOI	60435	FIXF
62755	Q1QSTRX	62732	Q1QSTXR	62675	Q1QSBXR	62650	Q1CADXR	62726	Q1QSBXR	62706	Q1QADRX
62703	Q1QDVIR	62700	Q1QMUIR	62661	Q1QSBRI	62632	Q1CADRI	63113	Q8QIOTAB	63014	Q8QENTRY
63043	Q8QEXITS	63270	Q8QPAUSE	63013	Q8QOUTTB	63500	PWRTBL	64276	Q8CLGOTC	63634	Q8QIFRMT
63665	Q8QFORMT	63067	Q8QIOSET	63047	Q8QSENSE	63312	Q8QCEDITS	60157	Q8QERROR	63476	PWRTBL0
63171	Q8QIQERR	66032	Q8CLGINC	61525	COS	61533	SIN	62036	Q1QEXRR	60435	IFIX
60504	FLOAT	63254	Q8GSTOP	62650	Q1QADIP	62665	Q1QMURI	62671	Q1QDVRI	62675	Q1QSBIR
62406	Q1QEXRI	62732	Q1QSTIR	62743	Q1QSTRI	64276	Q8CLGOTI	66032	Q8CLGINI	64746	Q8QENGOT
64303	Q8CLROTR	64175	Q8CLGOT	66405	Q8QENGIN	66036	Q8CLGINR	63133	Q8QARRAY	65733	Q8QINGIN
60660	SIGN	61263	ASIN	60533	ABS	67520	AMCD	60713	ALOG	61113	EXP
60547	SQRT	70435	RUNKUT	67002	COSD	67044	SIND	66732	TAND	61364	ATAN
70052	Y3	67235	ATMOSP	67601	OUT	73173	VTO	03765	GOFLG	03767	FDPBOXS
05717	PIQ	02432	EINT.	02416	DINT.	05710	BNJ.	01756	LOC5	01757	CIT.RTM
05770	RDCKSUM	06041	START2	05476	ACCOUNTS	07135	LOADER	05543	RDCKF1	03767	ABNORMAL
00014	CIO	05235	MEMORY	04650	MIBUF	04674	MIRKADD	04675	MIFORADD	05313	EST
05243	UST	05305	CST	05456	BRHT	05436	RHT	02011	CIT	05374	AET

COMM
06277 06316

DATA
NONE

EXTA
NONE

6-17

SECTION VII

HTO SAMPLE RUN

HORIZONTAL TAKE-OFF OPTIONS				HTO SAMPLE RUN													
TW2	0	MAX1	0	THNOT	1	SW3	0	SW2	0	STEP	0	ISPDEG	1	PLD	0	TAB	1
XLAT	2.85000E-01		AZ	9.00000E-01	VO	6.50000E-02	ALTO								GAM0		
ALPO	1.40000E-01	WO		1.50000E-06	CONA	2.50000E-02	ANMA	1.50000E-00	CCNS	4.02700E-04							
ACLI	3.00000E-00	GAMP		6.50000E-01	TIMP	1.50000E-03	NW	6.00000E-04	EAN	1.15000E-00							
TW2	1.00000E-00	XMCD		0	VSTA	2.00000E-04	PNT	8.18000E-04	VM	2.57600E-04							
HM	3.03800E-05	DFL4		1.00000E-03	XMGA	0	BETA	1.00000E-00	DELT	1.00000E-00							
PTST	6.00000E-02	ENG4		1.07086E-02	BUIL	9.46670E-03	DECA	3.23423E-03	TAKF	1.70921E-02							
WP1	0.80110E-05	EOP		1.62840E-05	DELV	0	CEE	1.20000E-02	SCAL	1.00000E-00							
CNT1	1.00000E-00	ENG2		1.69023E-02	BLD2	7.34610E-04	DKY2	1.83650E-04	TAK2	3.28876E-02							
NP2	2.52000E-05	EXP2		4.31680E-04	DLV2	6.00000E-02	CEE2	0	SCL2	1.00000E-00							
CNT2	1.00000E-00	XSP2		4.55000E-02	THR2	3.26700E-05	CKK	1.09000E-00	AREA	5.08300E-03							
RPLD	2.43622E-04	DWT		5.00000E-02													

MACH NUMBER	CL 0	CL 1	CL 2	CD 0	
1	0	3.00000E-02	-2.40000E-04	4.32000E-02	
2	2.50000E-01	0	4.00000E-02	-2.40000E-04	4.32000E-02
3	5.00000E-01	0	4.60000E-02	-2.40000E-04	4.32000E-02
4	7.50000E-01	0	4.90000E-02	-2.20000E-04	4.36000E-02
5	1.00000E-00	0	5.10000E-02	-1.00000E-04	8.67000E-02
6	1.25000E-00	0	5.10000E-02	0	7.90000E-02
7	1.50000E-00	0	4.65000E-02	6.00000E-05	7.10000E-02
8	1.75000E-00	0	4.20000E-02	9.00000E-05	6.35000E-02
9	2.00000E-00	0	3.75000E-02	1.20000E-04	5.75000E-02
10	2.50000E-00	0	3.10000E-02	1.50000E-04	4.86000E-02
11	3.00000E-00	0	2.75000E-02	1.60000E-04	4.30000E-02
12	4.00000E-00	0	2.15000E-02	1.50000E-04	3.65000E-02
13	5.00000E-00	0	1.85000E-02	1.20000E-04	3.30000E-02
14	6.00000E-00	0	1.70000E-02	7.00000E-05	3.10000E-02
15	8.00000E-00	0	1.50000E-02	-7.00000E-05	2.95000E-02
16	1.00000E-01	0	1.30000E-02	-1.50000E-04	2.65000E-02

ALTITUDE	THRUST	ISP	
1	0	1.07600E-06	2.630300E-02
2	1.00000E-04	1.950600E-06	2.734900E-02
3	2.00000E-04	2.010000E-06	2.818200E-02
4	3.00000E-04	2.040000E-06	2.860300E-02
5	4.00000E-04	2.070000E-06	2.902400E-02
6	6.00000E-04	2.105000E-06	2.951400E-02
7	8.00000E-04	2.128000E-06	2.983700E-02
8	1.00000E-05	2.140000E-06	3.000500E-02
9	1.20000E-05	2.153400E-06	3.019300E-02
10	1.40000E-05	2.153400E-06	3.019300E-02

RATAH	ISP F1	ISP F2	
1	0	0	
2	1.00000E-01	9.878000E-01	9.878000E-01
3	2.00000E-01	9.914000E-01	9.914000E-01
4	3.00000E-01	9.938000E-01	9.938000E-01
5	4.00000E-01	9.954000E-01	9.954000E-01
6	5.00000E-01	9.966000E-01	9.966000E-01
7	6.00000E-01	9.975000E-01	9.975000E-01
8	7.00000E-01	9.983000E-01	9.983000E-01
9	8.00000E-01	9.989000E-01	9.989000E-01
10	9.00000E-01	9.995000E-01	9.995000E-01
11	1.00000E-00	1.000000E-00	1.000000E-00

TIME	STAGE	ALPH	V	CL	
SOS	1.11646E-03	GRAV 3.21740E-01	GAM 0	ALT 0	LIFT 1.56214E-06
MACH	5.82200E-01	WT 1.50000E-06	ACC 1.59385E-00	THRI 1.87600E-06	CC 2.09669E-01
DENS	2.37690E-03	XISP 2.63030E-02	ACCN 1.3449E-00	RATI 1.00000E-00	DRAG 5.35134E-05
DYNP	5.02120E-02	RNG 0	VLD 0	VLG 0	VLT 0
VCHR	0				

WP1 REACHED

TIME	STAGE	ALPH	V	CL	
SOS	1.23500E-02	GRAV 3.17118E-01	GAM 2.26144E-01	ALT 1.51421E-05	LIFT 0
MACH	6.18533E-00	WT 3.35913E-05	ACC 9.72573E-01	THRI 3.26700E-05	CC 0
DENS	3.36689E-06	XISP 4.55000E-02	ACCN 0	RATI 1.00000E-00	DRAG 0
DYNP	0	RNG 3.11283E-05	VLD 1.34679E-03	VLG 1.88221E-03	VLT 2.24213E-01
VCHR	8.14475E-03				
TIME	4.73700E-02	STAGE 2	ALPH 7.51004137E-00	V 2.57685E-04	CL 0
SOS	8.46512E-02	GRAV 3.12540E-01	GAM -9.79920E-02	ALT 3.04712E-05	LIFT 0
MACH	3.04408E-01	WT 8.48988E-04	ACC 3.00000E-00	THRI 2.54696E-05	CC 0
DENS	3.10267E-09	XISP 4.54444E-02	ACCN 0	RATI 7.79603E-01	DRAG 0
DYNP	0	RNG 5.04264E-06	VLD 1.34679E-03	VLG 2.60774E-03	VLT 4.45738E-02
VCHR	2.76691E-04				

HTO SAMPLE RUN		PAGE 1									
TIME	ALPHA	VELOCITY	GAMMA	ALTITUDE	THRUST	LIFT	DRAG	MACH	RANGE	VCHAR	
0	14.00	650.0		0	1.860E 06	1.5621E 06	5.3513E 05	.58		0	
1.0	14.00	677.4	.97	5.6561E 00	1.860E 06	1.7086E 06	5.8453E 05	.61	6.6368E 02	40.3	
2.0	13.40	703.2	2.17	2.4656E 01	1.860E 06	1.7884E 06	5.9665E 05	.63	1.3537E 03	80.9	
3.0	12.40	728.2	3.47	6.0003E 01	1.860E 06	1.7948E 06	5.7175E 05	.65	2.0686E 03	121.6	
4.0	11.50	753.2	4.71	1.1290E 02	1.860E 06	1.7995E 06	5.5033E 05	.68	2.8076E 03	162.9	
5.0	10.70	778.1	5.86	1.8362E 02	1.860E 06	1.8003E 06	5.3112E 05	.70	3.5704E 03	203.7	
6.0	10.00	804.0	7.00	2.7239E 02	1.860E 06	1.7986E 06	5.1442E 05	.72	4.3568E 03	245.0	
7.0	9.30	829.4	8.06	3.7943E 02	1.860E 06	1.7960E 06	5.0057E 05	.74	5.1664E 03	286.6	
8.0	8.70	854.2	9.04	5.0492E 02	1.860E 06	1.7886E 06	5.0056E 05	.77	5.9991E 03	328.4	
9.0	8.10	879.1	10.04	6.4899E 02	1.860E 06	1.7823E 06	5.0956E 05	.79	6.8542E 03	370.4	
10.0	7.60	904.2	10.97	8.1167E 02	1.860E 06	1.7724E 06	5.2141E 05	.81	7.7312E 03	412.6	
11.0	7.20	928.2	11.84	9.9301E 02	1.860E 06	1.7667E 06	5.3787E 05	.83	8.6292E 03	455.1	
12.0	6.80	951.2	12.71	1.1930E 03	1.860E 06	1.7549E 06	5.5548E 05	.86	9.5475E 03	497.8	
13.0	6.40	974.2	13.54	1.4117E 03	1.860E 06	1.7445E 06	5.7591E 05	.88	1.0485E 04	540.8	
14.0	6.10	996.2	14.33	1.6490E 03	1.860E 06	1.7303E 06	5.9739E 05	.90	1.1441E 04	584.1	
15.0	5.80	1017.2	15.10	1.9049E 03	1.860E 06	1.7132E 06	6.1985E 05	.92	1.2415E 04	627.6	
16.0	5.60	1038.2	15.83	2.1790E 03	1.860E 06	1.7016E 06	6.4480E 05	.94	1.3406E 04	671.3	
17.0	5.50	1058.0	16.55	2.4713E 03	1.860E 06	1.6893E 06	6.7039E 05	.96	1.4412E 04	715.3	
18.0	5.50	1077.1	17.24	2.7815E 03	1.860E 06	1.6774E 06	6.9647E 05	.97	1.5433E 04	759.7	
19.0	4.80	1095.4	17.92	3.1097E 03	1.860E 06	1.6658E 06	7.2131E 05	.99	1.6469E 04	804.3	
20.0	4.80	1113.0	18.58	3.4555E 03	1.860E 06	1.6473E 06	7.4544E 05	1.01	1.7517E 04	849.1	
21.0	4.60	1130.2	19.22	3.8189E 03	1.860E 06	1.6293E 06	7.3712E 05	1.03	1.8578E 04	894.3	
22.0	4.50	1147.2	19.84	4.1994E 03	1.860E 06	1.6165E 06	7.3946E 05	1.04	1.9651E 04	939.8	
23.0	4.40	1164.0	20.45	4.5975E 03	1.860E 06	1.6059E 06	7.4090E 05	1.06	2.0736E 04	985.6	
24.0	4.30	1180.1	21.05	5.0121E 03	1.860E 06	1.5966E 06	7.4300E 05	1.08	2.1832E 04	1031.7	
25.0	4.20	1197.0	21.64	5.4454E 03	1.860E 06	1.5780E 06	7.4423E 05	1.09	2.2939E 04	1078.1	
26.0	4.10	1213.0	22.22	5.8959E 03	1.860E 06	1.5629E 06	7.4463E 05	1.11	2.4057E 04	1124.9	
27.0	4.00	1230.2	22.79	6.3634E 03	1.860E 06	1.5453E 06	7.4424E 05	1.13	2.5186E 04	1172.0	
28.0	3.90	1246.0	23.36	6.8486E 03	1.860E 06	1.5255E 06	7.4310E 05	1.14	2.6325E 04	1219.4	
29.0	3.80	1263.0	23.87	7.3510E 03	1.860E 06	1.5133E 06	7.4269E 05	1.16	2.7474E 04	1267.2	
30.0	3.70	1279.0	24.40	7.8708E 03	1.860E 06	1.4992E 06	7.4154E 05	1.18	2.8634E 04	1315.4	
31.0	3.70	1295.0	24.92	8.4081E 03	1.860E 06	1.4833E 06	7.3968E 05	1.20	2.9804E 04	1363.9	
32.0	3.60	1312.0	25.43	8.9628E 03	1.860E 06	1.4657E 06	7.3714E 05	1.21	3.0983E 04	1412.7	
33.0	3.60	1328.0	25.92	9.5349E 03	1.860E 06	1.4467E 06	7.3533E 05	1.23	3.2173E 04	1462.0	
34.0	3.50	1345.0	26.42	1.0125E 04	1.860E 06	1.4260E 06	7.3146E 05	1.25	3.3372E 04	1511.6	
35.0	3.40	1362.0	26.89	1.0732E 04	1.860E 06	1.4121E 06	7.2757E 05	1.27	3.4582E 04	1561.6	
36.0	3.40	1379.2	27.35	1.1357E 04	1.860E 06	1.4028E 06	7.2435E 05	1.29	3.5801E 04	1612.0	
37.0	3.30	1396.2	27.81	1.1999E 04	1.860E 06	1.3892E 06	7.2048E 05	1.31	3.7030E 04	1662.8	
38.0	3.20	1413.4	28.25	1.2666E 04	1.860E 06	1.3746E 06	7.1597E 05	1.32	3.8270E 04	1714.0	
39.0	3.20	1430.7	28.70	1.3333E 04	1.860E 06	1.3588E 06	7.1082E 05	1.34	3.9519E 04	1765.5	
40.0	3.20	1448.2	29.13	1.4034E 04	1.860E 06	1.3415E 06	7.0507E 05	1.36	4.0778E 04	1817.5	
41.0	3.20	1466.0	29.56	1.4748E 04	1.860E 06	1.3240E 06	6.9873E 05	1.39	4.2048E 04	1869.9	
42.0	3.20	1484.0	29.97	1.5481E 04	1.860E 06	1.3091E 06	6.9181E 05	1.41	4.3328E 04	1922.7	
43.0	3.20	1503.0	30.37	1.6231E 04	1.860E 06	1.2957E 06	6.8432E 05	1.43	4.4619E 04	1975.9	
44.0	3.20	1521.0	30.75	1.7000E 04	1.860E 06	1.2744E 06	6.7751E 05	1.45	4.5920E 04	2029.6	
45.0	3.20	1541.0	31.14	1.7788E 04	1.860E 06	1.2528E 06	6.6890E 05	1.47	4.7232E 04	2083.7	
46.0	3.20	1560.0	31.51	1.8594E 04	1.860E 06	1.2400E 06	6.6095E 05	1.50	4.8556E 04	2138.3	
47.0	3.20	1580.0	31.89	1.9419E 04	1.860E 06	1.2164E 06	6.5159E 05	1.52	4.9891E 04	2193.3	
48.0	3.20	1601.0	32.23	2.0264E 04	1.860E 06	1.2014E 06	6.4292E 05	1.55	5.1238E 04	2248.8	
49.0	3.20	1621.0	32.57	2.1127E 04	1.860E 06	1.1855E 06	6.3370E 05	1.57	5.2597E 04	2304.7	
50.0	3.20	1643.0	32.90	2.2010E 04	1.860E 06	1.1685E 06	6.2390E 05	1.60	5.3969E 04	2361.1	
51.0	3.20	1664.0	33.23	2.2912E 04	1.860E 06	1.1504E 06	6.1354E 05	1.62	5.5353E 04	2417.9	
52.0	3.20	1686.0	33.54	2.3834E 04	1.860E 06	1.1314E 06	6.0262E 05	1.65	5.6751E 04	2475.1	
53.0	3.20	1709.0	33.84	2.4776E 04	1.860E 06	1.1113E 06	5.9113E 05	1.68	5.8163E 04	2532.8	
54.0	3.20	1732.0	34.13	2.5739E 04	1.860E 06	1.0903E 06	5.7917E 05	1.71	5.9588E 04	2590.8	
55.0	3.20	1756.0	34.41	2.6721E 04	1.860E 06	1.0707E 06	5.6769E 05	1.74	6.1028E 04	2649.4	
56.0	3.20	1780.0	34.68	2.7724E 04	1.860E 06	1.0536E 06	5.5569E 05	1.77	6.2483E 04	2708.4	
57.0	3.20	1805.0	34.94	2.8748E 04	1.860E 06	1.0376E 06	5.4462E 05	1.81	6.3955E 04	2767.9	
58.0	3.20	1831.0	35.19	2.9792E 04	1.860E 06	1.0124E 06	5.3204E 05	1.84	6.5440E 04	2827.8	
59.0	3.20	1857.4	35.42	3.0858E 04	1.860E 06	9.9395E 05	5.1994E 05	1.87	6.6943E 04	2888.2	
60.0	3.20	1884.0	35.64	3.1946E 04	1.860E 06	9.7419E 05	5.0733E 05	1.91	6.8463E 04	2949.2	
61.0	3.20	1911.0	35.85	3.3054E 04	1.860E 06	9.5314E 05	4.9422E 05	1.95	7.0001E 04	3010.6	
62.0	3.20	1939.0	36.05	3.4185E 04	1.860E 06	9.3781E 05	4.8153E 05	1.99	7.1557E 04	3072.5	
63.0	3.20	1968.0	36.25	3.5338E 04	1.860E 06	9.1703E 05	4.6860E 05	2.03	7.3133E 04	3134.9	
64.0	3.20	1998.0	36.43	3.6513E 04	1.860E 06	8.9483E 05	4.5537E 05	2.06	7.4728E 04	3197.9	
65.0	3.20	2028.0	36.59	3.7711E 04	1.860E 06	8.7415E 05	4.4038E 05	2.10	7.6344E 04	3261.4	
66.0	3.20	2060.0	36.75	3.8932E 04	1.860E 06	8.5279E 05	4.2543E 05	2.13	7.7981E 04	3325.4	
67.0	3.20	2092.0	36.89	4.0177E 04	1.860E 06	8.3080E 05	4.1054E 05	2.16	7.9640E 04	3390.0	
68.0	3.20	2125.0	37.03	4.1445E 04	1.860E 06	8.0823E 05	3.9570E 05	2.20	8.1321E 04	3455.2	
69.0	3.20	2159.0	37.15	4.2737E 04	1.860E 06	7.8511E 05	3.8094E 05	2.23	8.3027E 04	3520.8	
70.0	3.20	2194.0	37.25	4.4053E 04	1.860E 06	7.6150E 05	3.6626E 05	2.27	8.4757E 04	3587.0	
71.0	3.20	2229.0	37.33	4.5393E 04	1.860E 06	7.3745E 05	3.5170E 05	2.30	8.6513E 04	3653.0	
72.0	3.20	2266.0	37.43	4.6758E 04	1.860E 06	7.1774E 05	3.3795E 05	2.34	8.8295E 04	3721.0	
73.0	3.20	2303.0	37.56	4.8148E 04	1.860E 06	6.9279E 05	3.2363E 05	2.38	9.0105E 04	3788.9	
74.0	3.20	2342.0	37.56	4.9563E 04	1.860E 06	6.7148E 05	3.1011E 05	2.42	9.1943E 04	3857.3	
75.0	4.00	2381.4	37.60	5.1003E 04	1.860E 06	6.4626E 05	2.9611E 05	2.46	9.3810E 04	3926.3	
76.0	4.00	2421.0	37.64	5.2469E 04	1.860E 06	6.2069E 05	2.8237E 05	2.50	9.5707E 04	3995.8	
77.0	4.00	2462.0	37.66	5.3961E 04	1.860E 06	5.9965E 05	2.7047E 05	2.54	9.7636E 04	4066.0	
78.0	4.00	2505.0	37.67	5.5478E 04	1.860E 06	5.7494E 05	2.5817E 05	2.59	9.9598E 04	4136.8	
79.0	4.00	2548.0	37.66	5.7022E 04	1.860E 06	5.5384E 05	2.4602E 05	2.63	1.0159E 05	4208.2	
80.0	4.00	2592.0	37.64	5.8592E 04	1.860E 06	5.2950E 05	2.3475E 05	2.68	1.0362E 05	4280.2	
81.0	4.00	2637.0	37.62	6.0189E 04	1.860E 06	5.0549E 05	2.2314E 05	2.72	1.0569E 05	4352.8	
82.0	4.00	2683.0	37.58	6.1812E 04	1.860E 06	4.8474E 05	2.1226E 05	2.77	1.0779E 05	4426.1	
83.0	4.00	2731.0	37.52	6.3462E 04	1.860E 06	4.6136E 05	2.0116E 05	2.82	1.0993E 05	4500.1	
84.0	4.00	2779.0	37.46	6.5132E 04	1.860E 06	4.3585E 05	1.8993E 05	2.87	1.1211E 05	4574.6	
85.0	4.00	2828.0	37.38	6.6843E 04	1.860E 06	4.1355E 05	1.7944E 05	2.92	1.1433E 05	4649.9	
86.0	4.00	2878.0	37.30	6.8574E 04	1.860E 06	3.9176E 05	1.6927E 05	2.97	1.1659E 05	4725.7	
87.0	4.00	2930.0	37.20	7.0332E 04	1.860E 06	3.6867E 05	1.5945E 05	3.03	1.1889E 05	4802.3	
88.0	4.00	2982.0	37.09	7.2117E 04	1.860E 06	3.4465E 05	1.5003E 05	3.08	1.2124E 05	4879.5	
89.0											

TIME	ALPHA	VELOCITY	SAPAA	ALTITUDE	TRUST	LIFT	DRAG	MACH	RANGE	VCHAR
91.0	4.27	3146.0	36.69	7.7634E 04	2.1753E 06	2.7884E 05	1.2389E 05	3.25	1.2857E 05	5115.4
92.0	4.27	3212.7	36.53	7.9527E 04	2.1775E 06	2.5740E 05	1.1565E 05	3.31	1.3111E 05	5195.5
93.0	4.27	3240.2	36.37	8.1447E 04	2.1769E 06	2.3719E 05	1.0779E 05	3.37	1.3370E 05	5276.4
94.0	4.27	3313.2	36.19	8.3394E 04	2.1760E 06	2.1625E 05	9.9813E 04	3.42	1.3634E 05	5358.0
95.0	4.27	3379.2	36.00	8.5367E 04	2.1712E 06	1.9649E 05	9.2124E 04	3.47	1.3903E 05	5440.3
96.0	4.27	3440.7	35.80	8.7366E 04	2.1624E 06	1.771E 05	8.4810E 04	3.52	1.4178E 05	5523.3
97.0	4.27	3503.1	35.59	8.9392E 04	2.1536E 06	1.5847E 05	7.7890E 04	3.57	1.4459E 05	5607.1
98.0	4.27	3566.0	35.38	9.1444E 04	2.1449E 06	1.4050E 05	7.1376E 04	3.62	1.4746E 05	5691.7
99.0	4.27	3631.3	35.15	9.3522E 04	2.1361E 06	1.2426E 05	6.5396E 04	3.67	1.5038E 05	5777.1
100.0	4.27	3697.1	34.91	9.5629E 04	2.1274E 06	1.0795E 05	5.9700E 04	3.72	1.5337E 05	5863.3
101.0	4.27	3764.1	34.66	9.7753E 04	2.1187E 06	9.2605E 04	5.4424E 04	3.77	1.5642E 05	5950.3
102.0	4.27	3832.6	34.40	9.9906E 04	2.1100E 06	7.6253E 04	4.9563E 04	3.82	1.5954E 05	6038.1
103.0	4.27	3901.7	34.13	1.0208E 05	2.1014E 06	6.0562E 04	4.5171E 04	3.87	1.6272E 05	6126.8
104.0	4.27	3972.4	33.86	1.0428E 05	2.1429E 06	4.5188E 04	4.1100E 04	3.93	1.6596E 05	6216.4
105.0	4.27	4044.2	33.57	1.0651E 05	2.1444E 06	4.1427E 04	3.7412E 04	3.98	1.6928E 05	6306.8
106.0	4.27	4117.3	33.28	1.0876E 05	2.1459E 06	3.2116E 04	3.4223E 04	4.04	1.7267E 05	6398.2
107.0	4.27	4191.0	32.98	1.1103E 05	2.1474E 06	2.2806E 04	3.1374E 04	4.09	1.7613E 05	6490.5
108.0	4.27	4266.2	32.66	1.1332E 05	2.1489E 06	1.4310E 04	2.8632E 04	4.15	1.7972E 05	6583.7
109.0	4.27	4344.0	32.34	1.1563E 05	2.1505E 06	6.9887E 03	2.6585E 04	4.20	1.8328E 05	6677.9
110.0	4.27	4422.1	32.02	1.1792E 05	2.1520E 06	3.5803E 02	2.4597E 04	4.26	1.8697E 05	6773.1
111.0	4.27	4501.4	31.68	1.2032E 05	2.1478E 06	0	2.2805E 04	4.32	1.9074E 05	6869.2
112.0	4.27	4582.0	31.35	1.2277E 05	2.1247E 06	0	2.1141E 04	4.38	1.9459E 05	6966.4
113.0	4.27	4663.7	31.02	1.2529E 05	2.1181E 06	0	1.9595E 04	4.44	1.9852E 05	7064.3
114.0	4.27	4746.4	30.70	1.2788E 05	2.0791E 06	0	1.8159E 04	4.50	2.0253E 05	7163.0
115.0	4.27	4830.2	30.38	1.2994E 05	2.0565E 06	0	1.6824E 04	4.56	2.0663E 05	7262.6
116.0	4.27	4915.1	30.07	1.3239E 05	2.0340E 06	0	1.5585E 04	4.62	2.1081E 05	7363.0
117.0	4.27	5001.0	29.77	1.3486E 05	2.0117E 06	0	1.4435E 04	4.68	2.1508E 05	7464.3
118.0	4.27	5088.1	29.47	1.3735E 05	1.9894E 06	0	1.3368E 04	4.74	2.1944E 05	7566.5
119.0	4.27	5176.3	29.17	1.3987E 05	1.9673E 06	0	1.2377E 04	4.80	2.2389E 05	7669.5
120.0	4.27	5265.7	28.88	1.4244E 05	1.9453E 06	0	1.1458E 04	4.86	2.2842E 05	7773.5
121.0	4.27	5346.2	28.59	1.4495E 05	1.9234E 06	0	1.0606E 04	4.93	2.3304E 05	7878.4
122.0	4.27	5427.0	28.31	1.4752E 05	1.9016E 06	0	9.8154E 03	4.99	2.3776E 05	7984.2
123.0	4.27	5508.7	28.03	1.5012E 05	1.8799E 06	0	9.1047E 03	5.05	2.4257E 05	8091.0
123.1	4.27	5540.0	28.00	1.5034E 05	1.8777E 06	0	9.0369E 03	5.06	2.4306E 05	8101.7
123.2	4.27	5549.4	27.97	1.5064E 05	1.8757E 06	0	8.9696E 03	5.07	2.4354E 05	8112.5
123.3	4.27	5548.0	27.94	1.5099E 05	1.8734E 06	0	8.9027E 03	5.07	2.4403E 05	8123.2
123.4	4.27	5578.1	27.92	1.5114E 05	1.8713E 06	0	8.8364E 03	5.08	2.4452E 05	8134.0

11 REACHED

123.5	-0.01	5797.4	22.51	1.5142E 05	3.2670E 05	0	0	6.19	3.1128E 05	8144.7
124.5	0.19	6816.2	22.36	1.5403E 05	3.2706E 05	0	0	6.18	3.1753E 05	8175.6
125.5	0.39	6835.0	22.16	1.5661E 05	3.2670E 05	0	0	6.18	3.2380E 05	8206.6
126.5	0.58	6853.1	21.93	1.5919E 05	3.2670E 05	0	0	6.20	3.3009E 05	8237.5
127.5	0.75	6874.9	21.70	1.6173E 05	3.2670E 05	0	0	6.22	3.3642E 05	8268.6
128.5	0.93	6894.0	21.48	1.6427E 05	3.2670E 05	0	0	6.24	3.4277E 05	8299.7
129.5	1.12	6914.9	21.26	1.6678E 05	3.2670E 05	0	0	6.25	3.4915E 05	8330.9
130.5	1.31	6935.2	21.04	1.6928E 05	3.2670E 05	0	0	6.27	3.5556E 05	8362.1
131.5	1.49	6955.7	20.81	1.7176E 05	3.2670E 05	0	0	6.29	3.6199E 05	8393.4
132.5	1.68	6976.4	20.60	1.7422E 05	3.2670E 05	0	0	6.31	3.6846E 05	8424.8
133.5	1.84	6997.4	20.38	1.7667E 05	3.2670E 05	0	0	6.35	3.7495E 05	8456.2
134.5	2.01	7018.3	20.16	1.7910E 05	3.2670E 05	0	0	6.40	3.8147E 05	8487.6
135.5	2.18	7039.3	19.95	1.8151E 05	3.2670E 05	0	0	6.46	3.8801E 05	8519.2
136.5	2.35	7060.9	19.73	1.8390E 05	3.2670E 05	0	0	6.52	3.9459E 05	8550.8
137.5	2.53	7082.2	19.52	1.8628E 05	3.2670E 05	0	0	6.58	4.0119E 05	8582.4
138.5	2.70	7104.2	19.31	1.8863E 05	3.2670E 05	0	0	6.64	4.0782E 05	8614.2
139.5	2.87	7126.2	19.10	1.9097E 05	3.2670E 05	0	0	6.70	4.1448E 05	8645.9
140.5	3.04	7148.3	18.89	1.9330E 05	3.2670E 05	0	0	6.76	4.2117E 05	8677.8
141.5	3.21	7170.0	18.68	1.9560E 05	3.2670E 05	0	0	6.82	4.2788E 05	8709.7
142.5	3.37	7193.0	18.48	1.9789E 05	3.2670E 05	0	0	6.89	4.3463E 05	8741.7
143.5	3.54	7215.7	18.27	2.0016E 05	3.2670E 05	0	0	6.95	4.4140E 05	8773.7
144.5	3.70	7238.2	18.07	2.0242E 05	3.2670E 05	0	0	7.01	4.4820E 05	8805.8
145.5	3.87	7261.2	17.87	2.0465E 05	3.2670E 05	0	0	7.08	4.5503E 05	8838.0
146.5	4.03	7284.0	17.67	2.0687E 05	3.2670E 05	0	0	7.15	4.6189E 05	8870.2
147.5	4.19	7308.0	17.47	2.0907E 05	3.2670E 05	0	0	7.21	4.6878E 05	8902.5
148.5	4.34	7331.5	17.27	2.1126E 05	3.2670E 05	0	0	7.28	4.7570E 05	8934.9
149.5	4.49	7355.2	17.08	2.1343E 05	3.2670E 05	0	0	7.35	4.8264E 05	8967.3
150.5	4.64	7379.1	16.88	2.1558E 05	3.2670E 05	0	0	7.42	4.8962E 05	8999.9
151.5	4.81	7403.4	16.69	2.1771E 05	3.2670E 05	0	0	7.49	4.9662E 05	9032.4
152.5	4.95	7427.3	16.49	2.1983E 05	3.2670E 05	0	0	7.57	5.0365E 05	9065.1
153.5	5.11	7451.7	16.30	2.2193E 05	3.2670E 05	0	0	7.64	5.1072E 05	9097.8
154.5	5.28	7476.2	16.11	2.2401E 05	3.2670E 05	0	0	7.71	5.1781E 05	9130.5
155.5	5.44	7500.9	15.92	2.2608E 05	3.2670E 05	0	0	7.79	5.2493E 05	9163.4
156.5	5.65	7525.0	15.74	2.2813E 05	3.2670E 05	0	0	7.87	5.3208E 05	9196.3
157.5	5.89	7550.9	15.55	2.3016E 05	3.2670E 05	0	0	7.94	5.3926E 05	9229.3
158.5	6.14	7576.1	15.37	2.3218E 05	3.2670E 05	0	0	8.02	5.4647E 05	9262.3
159.5	6.39	7601.2	15.16	2.3418E 05	3.2670E 05	0	0	8.10	5.5371E 05	9295.4
160.5	6.65	7627.1	15.00	2.3616E 05	3.2670E 05	0	0	8.18	5.6098E 05	9328.6
161.5	6.91	7652.8	14.82	2.3813E 05	3.2670E 05	0	0	8.26	5.6828E 05	9361.9
162.5	7.17	7678.7	14.64	2.4008E 05	3.2670E 05	0	0	8.35	5.7561E 05	9395.2
163.5	7.43	7704.6	14.46	2.4201E 05	3.2670E 05	0	0	8.43	5.8297E 05	9428.6
164.5	7.69	7731.0	14.29	2.4392E 05	3.2670E 05	0	0	8.52	5.9037E 05	9462.1
165.5	7.95	7757.4	14.11	2.4582E 05	3.2670E 05	0	0	8.60	5.9779E 05	9495.6
166.5	8.21	7784.3	13.94	2.4771E 05	3.2670E 05	0	0	8.69	6.0524E 05	9529.3
167.5	8.47	7810.7	13.76	2.4957E 05	3.2670E 05	0	0	8.78	6.1272E 05	9563.0
168.5	8.73	7837.0	13.59	2.5142E 05	3.2670E 05	0	0	8.87	6.2023E 05	9596.7
169.5	8.99	7864.3	13.42	2.5326E 05	3.2670E 05	0	0	8.96	6.2778E 05	9630.6
170.5	9.25	7891.0	13.25	2.5507E 05	3.2670E 05	0	0	9.06	6.3535E 05	9664.5
171.5	9.51	7918.2	13.08	2.5687E 05	3.2670E 05	0	0	9.15	6.4295E 05	9698.5
172.5	9.77	7945.8	12.92	2.5866E 05	3.2670E 05	0	0	9.25	6.5059E 05	9732.5
173.5	10.03	7974.3	12.75	2.6043E 05	3.2670E 05	0	0	9.34	6.5826E 05	9766.7
174.5	10.29	8002.3	12.59	2.6218E 05	3.2670E 05	0	0	9.44	6.6595E 05	9800.9
175.5	10.55	8030.4	12.42	2.6391E 05	3.2670E 05	0	0	9.49	6.7368E 05	9835.2

TIME	ALPHA	VELOCITY	GAMMA	ALTITUDE	THRUST	LIFT	DRAG	MACH	RANGE	VCHAR
176.5	8.26	8058.0	12.26	2.6563E 05	3.2670E 05	0	0	9.52	6.8144E 05	9889.6
177.5	8.32	8086.9	12.10	2.6734E 05	3.2670E 05	0	0	9.55	6.8924E 05	9904.0
178.5	8.49	8115.4	11.94	2.6902E 05	3.2670E 05	0	0	9.59	6.9706E 05	9938.5
179.5	8.56	8144.1	11.78	2.7070E 05	3.2670E 05	0	0	9.62	7.0492E 05	9973.1
180.5	8.67	8172.9	11.63	2.7235E 05	3.2670E 05	0	0	9.65	7.1280E 05	10007.6
181.5	8.79	8201.9	11.47	2.7399E 05	3.2670E 05	0	0	9.69	7.2072E 05	10042.6
182.5	8.90	8231.1	11.32	2.7561E 05	3.2670E 05	0	0	9.72	7.2867E 05	10077.4
183.5	9.01	8260.3	11.16	2.7722E 05	3.2670E 05	0	0	9.76	7.3665E 05	10112.4
184.5	9.12	8289.8	11.01	2.7881E 05	3.2670E 05	0	0	9.79	7.4467E 05	10147.4
185.5	9.23	8319.5	10.86	2.8039E 05	3.2670E 05	0	0	9.83	7.5271E 05	10182.4
186.5	9.34	8349.3	10.71	2.8195E 05	3.2670E 05	0	0	9.86	7.6079E 05	10217.6
187.5	9.45	8379.2	10.56	2.8349E 05	3.2670E 05	0	0	9.90	7.6890E 05	10252.9
188.5	9.55	8409.3	10.42	2.8502E 05	3.2670E 05	0	0	9.93	7.7705E 05	10288.2
189.5	9.66	8439.6	10.27	2.8653E 05	3.2670E 05	0	0	9.97	7.8522E 05	10323.6
190.5	9.76	8470.0	10.13	2.8803E 05	3.2670E 05	0	0	10.01	7.9343E 05	10359.1
191.5	9.86	8500.6	9.98	2.8951E 05	3.2670E 05	0	0	10.04	8.0167E 05	10394.7
192.5	9.97	8531.3	9.84	2.9098E 05	3.2670E 05	0	0	10.08	8.0995E 05	10430.3
193.5	10.07	8562.2	9.70	2.9243E 05	3.2670E 05	0	0	10.11	8.1825E 05	10466.1
194.5	10.16	8593.2	9.56	2.9386E 05	3.2670E 05	0	0	10.15	8.2659E 05	10501.9
195.5	10.26	8624.3	9.42	2.9528E 05	3.2670E 05	0	0	10.19	8.3497E 05	10537.8
196.5	10.36	8655.8	9.28	2.9668E 05	3.2670E 05	0	0	10.23	8.4337E 05	10573.8
197.5	10.45	8687.9	9.14	2.9807E 05	3.2670E 05	0	0	10.26	8.5181E 05	10609.9
198.5	10.55	8719.0	9.01	2.9944E 05	3.2670E 05	0	0	10.30	8.6029E 05	10646.1
199.5	10.64	8750.8	8.87	3.0080E 05	3.2670E 05	0	0	10.34	8.6879E 05	10682.4
200.5	10.73	8782.8	8.74	3.0214E 05	3.2670E 05	0	0	10.38	8.7733E 05	10718.7
201.5	10.82	8814.9	8.61	3.0347E 05	3.2670E 05	0	0	10.41	8.8591E 05	10755.2
202.5	10.91	8847.2	8.48	3.0478E 05	3.2670E 05	0	0	10.45	8.9452E 05	10791.7
203.5	11.00	8879.6	8.35	3.0608E 05	3.2670E 05	0	0	10.49	9.0316E 05	10828.3
204.5	11.09	8912.2	8.22	3.0736E 05	3.2670E 05	0	0	10.53	9.1184E 05	10865.0
205.5	11.17	8945.0	8.09	3.0863E 05	3.2670E 05	0	0	10.57	9.2055E 05	10901.8
206.5	11.26	8977.9	7.96	3.0988E 05	3.2670E 05	0	0	10.61	9.2929E 05	10938.7
207.5	11.34	9010.9	7.84	3.1111E 05	3.2670E 05	0	0	10.64	9.3807E 05	10975.7
208.5	11.42	9044.2	7.71	3.1234E 05	3.2670E 05	0	0	10.68	9.4688E 05	11012.8
209.5	11.51	9077.5	7.59	3.1354E 05	3.2670E 05	0	0	10.72	9.5573E 05	11049.9
210.5	11.59	9111.1	7.47	3.1473E 05	3.2670E 05	0	0	10.76	9.6461E 05	11087.2
211.5	11.67	9144.7	7.35	3.1591E 05	3.2670E 05	0	0	10.80	9.7353E 05	11124.5
212.5	11.75	9178.6	7.23	3.1707E 05	3.2670E 05	0	0	10.84	9.8248E 05	11162.0
213.5	11.82	9212.6	7.11	3.1822E 05	3.2670E 05	0	0	10.88	9.9147E 05	11199.5
214.5	11.90	9246.7	6.99	3.1935E 05	3.2670E 05	0	0	10.92	1.0005E 06	11237.2
215.5	11.97	9281.0	6.87	3.2047E 05	3.2670E 05	0	0	10.96	1.0096E 06	11274.9
216.5	12.05	9315.3	6.75	3.2157E 05	3.2670E 05	0	0	11.00	1.0186E 06	11312.7
217.5	12.12	9350.1	6.64	3.2266E 05	3.2670E 05	0	0	11.05	1.0278E 06	11350.7
218.5	12.19	9384.8	6.53	3.2373E 05	3.2670E 05	0	0	11.09	1.0369E 06	11388.7
219.5	12.26	9419.7	6.41	3.2479E 05	3.2670E 05	0	0	11.13	1.0461E 06	11426.8
220.5	12.33	9454.8	6.30	3.2584E 05	3.2670E 05	0	0	11.17	1.0554E 06	11465.1
221.5	12.41	9490.0	6.19	3.2687E 05	3.2670E 05	0	0	11.21	1.0646E 06	11503.4
222.5	12.47	9525.4	6.08	3.2789E 05	3.2670E 05	0	0	11.25	1.0740E 06	11541.8
223.5	12.54	9561.0	5.97	3.2890E 05	3.2670E 05	0	0	11.29	1.0833E 06	11580.3
224.5	12.60	9596.6	5.86	3.2987E 05	3.2670E 05	0	0	11.34	1.0927E 06	11618.9
225.5	12.67	9632.2	5.75	3.3085E 05	3.2670E 05	0	0	11.38	1.1021E 06	11657.7
226.5	12.73	9668.0	5.65	3.3181E 05	3.2670E 05	0	0	11.42	1.1115E 06	11696.5
227.5	12.80	9704.0	5.54	3.3275E 05	3.2670E 05	0	0	11.46	1.1210E 06	11735.4
228.5	12.86	9740.9	5.44	3.3368E 05	3.2670E 05	0	0	11.51	1.1306E 06	11774.3
229.5	12.92	9777.4	5.34	3.3460E 05	3.2670E 05	0	0	11.55	1.1401E 06	11813.6
230.5	12.98	9814.0	5.23	3.3550E 05	3.2670E 05	0	0	11.59	1.1497E 06	11852.9
231.5	13.04	9850.8	5.13	3.3639E 05	3.2670E 05	0	0	11.64	1.1594E 06	11892.2
232.5	13.10	9887.7	5.03	3.3726E 05	3.2670E 05	0	0	11.68	1.1690E 06	11931.7
233.5	13.15	9924.8	4.93	3.3812E 05	3.2670E 05	0	0	11.72	1.1787E 06	11971.2
234.5	13.21	9962.1	4.83	3.3897E 05	3.2670E 05	0	0	11.77	1.1885E 06	12010.9
235.5	13.26	9999.3	4.74	3.3980E 05	3.2670E 05	0	0	11.81	1.1983E 06	12050.7
236.5	13.32	10037.0	4.64	3.4062E 05	3.2670E 05	0	0	11.86	1.2081E 06	12090.6
237.5	13.37	10074.7	4.55	3.4143E 05	3.2670E 05	0	0	11.90	1.2180E 06	12130.6
238.5	13.42	10112.0	4.45	3.4222E 05	3.2670E 05	0	0	11.95	1.2279E 06	12170.7
239.5	13.47	10150.6	4.36	3.4300E 05	3.2670E 05	0	0	11.99	1.2378E 06	12210.9
240.5	13.52	10188.8	4.26	3.4376E 05	3.2670E 05	0	0	12.04	1.2478E 06	12251.2
241.5	13.57	10227.1	4.17	3.4451E 05	3.2670E 05	0	0	12.08	1.2578E 06	12291.7
242.5	13.62	10265.6	4.08	3.4525E 05	3.2670E 05	0	0	12.13	1.2679E 06	12332.2
243.5	13.67	10304.3	3.99	3.4597E 05	3.2670E 05	0	0	12.17	1.2780E 06	12372.9
244.5	13.72	10343.1	3.90	3.4668E 05	3.2670E 05	0	0	12.22	1.2881E 06	12413.7
245.5	13.76	10382.1	3.81	3.4738E 05	3.2670E 05	0	0	12.26	1.2983E 06	12454.6
246.5	13.81	10421.2	3.73	3.4806E 05	3.2670E 05	0	0	12.31	1.3085E 06	12495.6
247.5	13.85	10460.2	3.64	3.4873E 05	3.2670E 05	0	0	12.36	1.3187E 06	12536.7
248.5	13.90	10499.9	3.55	3.4939E 05	3.2670E 05	0	0	12.40	1.3290E 06	12578.0
249.5	13.94	10539.3	3.47	3.5003E 05	3.2670E 05	0	0	12.45	1.3393E 06	12619.3
250.5	13.98	10579.3	3.38	3.5066E 05	3.2670E 05	0	0	12.50	1.3497E 06	12660.8
251.5	14.02	10619.2	3.30	3.5129E 05	3.2670E 05	0	0	12.54	1.3601E 06	12702.4
252.5	14.06	10659.3	3.22	3.5189E 05	3.2670E 05	0	0	12.59	1.3705E 06	12744.1
253.5	14.10	10699.3	3.14	3.5248E 05	3.2670E 05	0	0	12.64	1.3810E 06	12786.0
254.5	14.14	10740.0	3.06	3.5306E 05	3.2670E 05	0	0	12.69	1.3916E 06	12827.9
255.5	14.17	10780.5	2.98	3.5362E 05	3.2670E 05	0	0	12.74	1.4021E 06	12870.0
256.5	14.21	10821.3	2.90	3.5418E 05	3.2670E 05	0	0	12.78	1.4127E 06	12912.2
257.5	14.24	10862.2	2.82	3.5472E 05	3.2670E 05	0	0	12.83	1.4234E 06	12954.6
258.5	14.28	10903.2	2.74	3.5525E 05	3.2670E 05	0	0	12.88	1.4341E 06	12997.0
259.5	14.31	10944.4	2.66	3.5576E 05	3.2670E 05	0	0	12.93	1.4448E 06	13039.6
260.5	14.35	10985.8	2.59	3.5626E 05	3.2670E 05	0	0	12.98	1.4556E 06	13082.3
261.5	14.38	11027.4	2.51	3.5675E 05	3.2670E 05	0	0	13.03	1.4664E 06	13125.2
262.5	14.41	11069.1	2.44	3.5723E 05	3.2670E 05	0	0	13.08	1.4772E 06	13168.2
263.5	14.44	11111.0	2.37	3.5770E 05	3.2670E 05	0	0	13.13	1.4881E 06	13211.3
264.5	14.47	11153.0	2.29	3.5815E 05	3.2670E 05	0	0	13.18	1.4991E 06	13254.5
265.5	14.50	11195.2	2.22	3.5859E 05	3.2670E 05	0	0	13.23	1.5100E 06	13297.8
266.5	14.53	11237.6	2.15	3.5902E 05	3.2670E 05	0	0	13.28	1.5211E 06	13341.3

TIME	ALPHA	VELOCITY	GAMMA	ALTITUDE	THRUST	LIFT	DRAG	MACH	RANGE	VCHAR
267.5	14.50	11280.2	2.08	3.5943E 05	3.2670E 05	0	0	13.33	1.5321E 06	13389.0
268.5	14.54	11322.9	2.01	3.5984E 05	3.2670E 05	0	0	13.38	1.5432E 06	13428.7
269.5	14.61	11365.7	1.94	3.6023E 05	3.2670E 05	0	0	13.43	1.5544E 06	13472.6
270.5	14.64	11408.0	1.87	3.6061E 05	3.2670E 05	0	0	13.48	1.5656E 06	13516.6
271.5	14.67	11452.0	1.81	3.6097E 05	3.2670E 05	0	0	13.53	1.5768E 06	13560.8
272.5	14.67	11495.4	1.74	3.6133E 05	3.2670E 05	0	0	13.58	1.5881E 06	13605.1
273.5	14.70	11539.0	1.68	3.6167E 05	3.2670E 05	0	0	13.63	1.5994E 06	13649.5
274.5	14.72	11582.7	1.61	3.6200E 05	3.2670E 05	0	0	13.68	1.6107E 06	13694.1
275.5	14.74	11626.9	1.55	3.6232E 05	3.2670E 05	0	0	13.73	1.6221E 06	13738.8
276.5	14.74	11670.7	1.48	3.6263E 05	3.2670E 05	0	0	13.79	1.6336E 06	13783.6
277.5	14.74	11714.7	1.42	3.6293E 05	3.2670E 05	0	0	13.84	1.6451E 06	13828.6
278.5	14.80	11759.3	1.36	3.6321E 05	3.2670E 05	0	0	13.89	1.6566E 06	13873.8
279.5	14.82	11803.9	1.30	3.6349E 05	3.2670E 05	0	0	13.94	1.6682E 06	13919.1
280.5	14.84	11848.7	1.24	3.6375E 05	3.2670E 05	0	0	14.00	1.6798E 06	13964.5
281.5	14.85	11893.7	1.17	3.6400E 05	3.2670E 05	0	0	14.05	1.6915E 06	14010.1
282.5	14.87	11938.0	1.12	3.6424E 05	3.2670E 05	0	0	14.10	1.7032E 06	14055.8
283.5	14.88	11982.7	1.06	3.6446E 05	3.2670E 05	0	0	14.16	1.7149E 06	14101.6
284.5	14.90	12027.2	1.00	3.6468E 05	3.2670E 05	0	0	14.21	1.7267E 06	14147.6
285.5	14.91	12072.0	0.95	3.6489E 05	3.2670E 05	0	0	14.26	1.7386E 06	14193.8
286.5	14.92	12117.0	0.89	3.6508E 05	3.2670E 05	0	0	14.32	1.7505E 06	14240.1
287.5	14.94	12162.0	0.83	3.6526E 05	3.2670E 05	0	0	14.37	1.7624E 06	14286.6
288.5	14.95	12207.2	0.78	3.6543E 05	3.2670E 05	0	0	14.43	1.7744E 06	14333.2
289.5	14.96	12252.6	0.73	3.6559E 05	3.2670E 05	0	0	14.48	1.7864E 06	14380.0
290.5	14.97	12306.2	0.67	3.6574E 05	3.2670E 05	0	0	14.54	1.7985E 06	14426.9
291.5	14.98	12352.9	0.62	3.6588E 05	3.2670E 05	0	0	14.59	1.8106E 06	14474.0
292.5	14.98	12399.0	0.57	3.6601E 05	3.2670E 05	0	0	14.65	1.8228E 06	14521.2
293.5	14.99	12446.9	0.52	3.6613E 05	3.2670E 05	0	0	14.70	1.8350E 06	14568.6
294.5	15.00	12494.2	0.47	3.6624E 05	3.2670E 05	0	0	14.76	1.8472E 06	14616.1
295.5	15.01	12541.7	0.42	3.6633E 05	3.2670E 05	0	0	14.82	1.8595E 06	14663.8
296.5	15.01	12589.4	0.37	3.6642E 05	3.2670E 05	0	0	14.87	1.8719E 06	14711.7
297.5	15.02	12637.2	0.32	3.6649E 05	3.2670E 05	0	0	14.93	1.8843E 06	14759.7
298.5	15.02	12685.3	0.27	3.6656E 05	3.2670E 05	0	0	14.99	1.8967E 06	14807.9
299.5	15.03	12733.2	0.22	3.6661E 05	3.2670E 05	0	0	15.04	1.9092E 06	14856.3
300.5	15.03	12781.9	0.18	3.6666E 05	3.2670E 05	0	0	15.10	1.9217E 06	14904.8
301.5	15.03	12830.2	0.13	3.6669E 05	3.2670E 05	0	0	15.16	1.9343E 06	14953.5
302.5	15.03	12879.4	0.08	3.6671E 05	3.2670E 05	0	0	15.21	1.9470E 06	15002.4
303.5	15.03	12928.4	0.04	3.6673E 05	3.2670E 05	0	0	15.27	1.9596E 06	15051.4
304.5	15.03	12977.0	-0.00	3.6673E 05	3.2670E 05	0	0	15.33	1.9724E 06	15100.6
305.5	15.03	13026.9	-0.05	3.6673E 05	3.2670E 05	0	0	15.39	1.9852E 06	15150.0
306.5	15.03	13076.5	-0.09	3.6671E 05	3.2670E 05	0	0	15.45	1.9980E 06	15199.6
307.5	15.03	13126.3	-0.13	3.6669E 05	3.2670E 05	0	0	15.51	2.0109E 06	15249.3
308.5	15.03	13176.3	-0.17	3.6666E 05	3.2670E 05	0	0	15.57	2.0238E 06	15299.2
309.5	15.04	13226.3	-0.22	3.6661E 05	3.2670E 05	0	0	15.62	2.0368E 06	15349.2
310.5	15.02	13276.9	-0.26	3.6656E 05	3.2670E 05	0	0	15.68	2.0498E 06	15399.5
311.5	15.02	13327.2	-0.30	3.6649E 05	3.2670E 05	0	0	15.74	2.0628E 06	15449.9
312.5	15.01	13378.2	-0.33	3.6641E 05	3.2670E 05	0	0	15.80	2.0760E 06	15500.5
313.5	15.01	13429.2	-0.37	3.6633E 05	3.2670E 05	0	0	15.86	2.0891E 06	15551.3
314.5	15.00	13480.4	-0.41	3.6624E 05	3.2670E 05	0	0	15.92	2.1024E 06	15602.3
315.5	14.99	13531.0	-0.45	3.6614E 05	3.2670E 05	0	0	15.99	2.1156E 06	15653.5
316.5	14.99	13583.4	-0.48	3.6603E 05	3.2670E 05	0	0	16.05	2.1290E 06	15704.8
317.5	14.98	13635.3	-0.52	3.6591E 05	3.2670E 05	0	0	16.11	2.1423E 06	15756.4
318.5	14.97	13687.3	-0.56	3.6578E 05	3.2670E 05	0	0	16.17	2.1558E 06	15808.1
319.5	14.96	13739.3	-0.59	3.6564E 05	3.2670E 05	0	0	16.23	2.1692E 06	15860.0
320.5	14.95	13792.0	-0.63	3.6550E 05	3.2670E 05	0	0	16.29	2.1828E 06	15912.1
321.5	14.94	13844.7	-0.66	3.6534E 05	3.2670E 05	0	0	16.35	2.1963E 06	15964.4
322.5	14.93	13897.5	-0.69	3.6518E 05	3.2670E 05	0	0	16.42	2.2100E 06	16016.9
323.5	14.92	13950.6	-0.72	3.6500E 05	3.2670E 05	0	0	16.48	2.2237E 06	16069.6
324.5	14.91	14004.0	-0.76	3.6482E 05	3.2670E 05	0	0	16.54	2.2374E 06	16122.5
325.5	14.90	14057.5	-0.79	3.6463E 05	3.2670E 05	0	0	16.61	2.2512E 06	16175.6
326.5	14.89	14111.2	-0.82	3.6444E 05	3.2670E 05	0	0	16.67	2.2650E 06	16228.9
327.5	14.87	14165.2	-0.85	3.6423E 05	3.2670E 05	0	0	16.73	2.2789E 06	16282.4
328.5	14.86	14219.7	-0.88	3.6402E 05	3.2670E 05	0	0	16.80	2.2929E 06	16336.1
329.5	14.84	14273.8	-0.91	3.6380E 05	3.2670E 05	0	0	16.86	2.3069E 06	16390.0
330.5	14.82	14328.3	-0.94	3.6357E 05	3.2670E 05	0	0	16.93	2.3209E 06	16444.1
331.5	14.81	14383.4	-0.96	3.6333E 05	3.2670E 05	0	0	16.99	2.3350E 06	16498.4
332.5	14.79	14438.5	-0.99	3.6308E 05	3.2670E 05	0	0	17.06	2.3492E 06	16553.0
333.5	14.77	14493.8	-1.02	3.6283E 05	3.2670E 05	0	0	17.12	2.3634E 06	16607.7
334.5	14.75	14549.4	-1.04	3.6257E 05	3.2670E 05	0	0	17.19	2.3777E 06	16662.7
335.5	14.74	14605.2	-1.07	3.6230E 05	3.2670E 05	0	0	17.25	2.3920E 06	16717.9
336.5	14.72	14661.2	-1.10	3.6202E 05	3.2670E 05	0	0	17.32	2.4064E 06	16773.3
337.5	14.70	14717.3	-1.12	3.6174E 05	3.2670E 05	0	0	17.39	2.4208E 06	16828.9
338.5	14.68	14774.0	-1.14	3.6145E 05	3.2670E 05	0	0	17.45	2.4353E 06	16884.7
339.5	14.66	14830.8	-1.17	3.6115E 05	3.2670E 05	0	0	17.52	2.4499E 06	16940.8
340.5	14.63	14887.7	-1.19	3.6084E 05	3.2670E 05	0	0	17.59	2.4645E 06	16997.0
341.5	14.61	14945.1	-1.21	3.6053E 05	3.2670E 05	0	0	17.65	2.4791E 06	17053.5
342.5	14.59	15002.5	-1.24	3.6021E 05	3.2670E 05	0	0	17.72	2.4939E 06	17110.3
343.5	14.57	15060.2	-1.26	3.5988E 05	3.2670E 05	0	0	17.79	2.5086E 06	17167.2
344.5	14.54	15118.2	-1.28	3.5955E 05	3.2670E 05	0	0	17.86	2.5235E 06	17224.4
345.5	14.52	15176.4	-1.30	3.5921E 05	3.2670E 05	0	0	17.93	2.5383E 06	17281.9
346.5	14.50	15234.9	-1.32	3.5886E 05	3.2670E 05	0	0	18.00	2.5533E 06	17339.5
347.5	14.47	15293.6	-1.34	3.5851E 05	3.2670E 05	0	0	18.07	2.5683E 06	17397.4
348.5	14.44	15352.0	-1.36	3.5815E 05	3.2670E 05	0	0	18.14	2.5834E 06	17455.4
349.5	14.42	15411.8	-1.37	3.5778E 05	3.2670E 05	0	0	18.21	2.5985E 06	17514.0
350.5	14.39	15471.3	-1.39	3.5741E 05	3.2670E 05	0	0	18.28	2.6136E 06	17572.6
351.5	14.36	15531.1	-1.41	3.5703E 05	3.2670E 05	0	0	18.35	2.6288E 06	17631.5
352.5	14.34	15591.1	-1.43	3.5664E 05	3.2670E 05	0	0	18.42	2.6442E 06	17690.6
353.5	14.31	15651.4	-1.44	3.5625E 05	3.2670E 05	0	0	18.49	2.6595E 06	17750.0
354.5	14.28	15711.9	-1.46	3.5586E 05	3.2670E 05	0	0	18.56	2.6749E 06	17809.6
355.5	14.25	15772.8	-1.47	3.5545E 05	3.2670E 05	0	0	18.63	2.6904E 06	17869.5
356.5	14.22	15833.9	-1.49	3.5505E 05	3.2670E 05	0	0	18.70	2.7060E 06	17929.6
357.5	14.19	15895.2	-1.50	3.5463E 05	3.2670E 05	0	0	18.78	2.7218E 06	17990.0

HTO SAMPLE RUN		PAGE 7									
TIME	ALTITUDE	VELOCITY	GAMMA	ALTITUDE	THRUST	LIFT	DRAW	MACH	RANGE	VCHAR	
358.5	14.17	14946.4	-1.51	3.5421E 04	3.2670E 05	0	0	18.85	2.7372E 06	18030.7	
359.5	14.17	16018.6	-1.53	3.5379E 05	3.2670E 05	0	0	18.92	2.7529E 06	18111.6	
360.5	14.17	16081.0	-1.54	3.5336E 05	3.2670E 05	0	0	19.00	2.7687E 06	18172.8	
361.5	14.17	14143.3	-1.55	3.5293E 05	3.2670E 05	0	0	19.07	2.7845E 06	18234.3	
362.5	14.17	16206.2	-1.56	3.5249E 05	3.2670E 05	0	0	19.14	2.8004E 06	18296.0	
363.5	14.17	16269.3	-1.58	3.5204E 05	3.2670E 05	0	0	19.22	2.8164E 06	18358.0	
364.5	13.97	16332.0	-1.59	3.5159E 05	3.2670E 05	0	0	19.29	2.8324E 06	18420.3	
365.5	13.97	16396.3	-1.60	3.5114E 05	3.2670E 05	0	0	19.37	2.8485E 06	18482.8	
366.5	13.97	16460.2	-1.61	3.5068E 05	3.2670E 05	0	0	19.44	2.8647E 06	18545.7	
367.5	13.97	16524.4	-1.61	3.5021E 05	3.2670E 05	0	0	19.52	2.8809E 06	18608.8	
368.5	13.97	16588.7	-1.62	3.4975E 05	3.2670E 05	0	0	19.60	2.8972E 06	18672.2	
369.5	13.77	16653.0	-1.63	3.4927E 05	3.2670E 05	0	0	19.67	2.9135E 06	18735.9	
370.5	13.77	16718.3	-1.64	3.4880E 05	3.2670E 05	0	0	19.75	2.9299E 06	18799.8	
371.5	13.77	16784.3	-1.65	3.4832E 05	3.2670E 05	0	0	19.83	2.9464E 06	18864.1	
372.5	13.57	16850.1	-1.65	3.4783E 05	3.2670E 05	0	0	19.91	2.9629E 06	18928.7	
373.5	13.57	16916.1	-1.66	3.4734E 05	3.2670E 05	0	0	19.98	2.9795E 06	18993.6	
374.5	13.57	16982.0	-1.67	3.4685E 05	3.2670E 05	0	0	20.06	2.9962E 06	19058.7	
375.5	13.37	17049.2	-1.67	3.4636E 05	3.2670E 05	0	0	20.14	3.0129E 06	19124.2	
376.5	13.37	17116.2	-1.68	3.4586E 05	3.2670E 05	0	0	20.22	3.0297E 06	19190.0	
377.5	13.37	17183.2	-1.68	3.4534E 05	3.2670E 05	0	0	20.30	3.0466E 06	19256.1	
378.5	13.37	17251.1	-1.68	3.4485E 05	3.2670E 05	0	0	20.38	3.0635E 06	19322.5	
379.5	13.37	17319.1	-1.69	3.4434E 05	3.2670E 05	0	0	20.46	3.0805E 06	19389.2	
380.5	13.37	17387.4	-1.69	3.4383E 05	3.2670E 05	0	0	20.54	3.0976E 06	19456.2	
381.5	13.37	17456.0	-1.69	3.4332E 05	3.2670E 05	0	0	20.62	3.1147E 06	19523.6	
382.5	13.17	17525.0	-1.70	3.4280E 05	3.2670E 05	0	0	20.70	3.1319E 06	19591.3	
383.5	13.17	17594.3	-1.70	3.4228E 05	3.2670E 05	0	0	20.78	3.1492E 06	19659.3	
384.5	13.17	17664.0	-1.70	3.4176E 05	3.2670E 05	0	0	20.87	3.1665E 06	19727.6	
385.5	13.17	17734.1	-1.70	3.4123E 05	3.2670E 05	0	0	20.95	3.1839E 06	19796.3	
386.5	13.17	17804.4	-1.70	3.4071E 05	3.2670E 05	0	0	21.03	3.2014E 06	19865.3	
387.5	13.07	17875.1	-1.70	3.4019E 05	3.2670E 05	0	0	21.12	3.2189E 06	19934.7	
388.5	13.07	17946.1	-1.70	3.3965E 05	3.2670E 05	0	0	21.20	3.2365E 06	20004.4	
389.5	12.95	18017.6	-1.70	3.3911E 05	3.2670E 05	0	0	21.28	3.2542E 06	20074.9	
390.5	12.95	18089.3	-1.70	3.3858E 05	3.2670E 05	0	0	21.37	3.2720E 06	20144.9	
391.5	12.86	18161.2	-1.69	3.3804E 05	3.2670E 05	0	0	21.45	3.2898E 06	20215.6	
392.5	12.86	18234.0	-1.69	3.3750E 05	3.2670E 05	0	0	21.54	3.3077E 06	20286.7	
393.5	12.76	18306.9	-1.69	3.3697E 05	3.2670E 05	0	0	21.63	3.3257E 06	20358.2	
394.5	12.71	18380.2	-1.69	3.3643E 05	3.2670E 05	0	0	21.71	3.3437E 06	20430.1	
395.5	12.66	18452.8	-1.68	3.3588E 05	3.2670E 05	0	0	21.80	3.3618E 06	20502.3	
396.5	12.61	18527.1	-1.68	3.3534E 05	3.2670E 05	0	0	21.89	3.3800E 06	20574.9	
397.5	12.57	18602.0	-1.67	3.3480E 05	3.2670E 05	0	0	21.98	3.3983E 06	20647.8	
398.5	12.51	18677.1	-1.67	3.3426E 05	3.2670E 05	0	0	22.06	3.4166E 06	20721.2	
399.5	12.47	18752.3	-1.66	3.3371E 05	3.2670E 05	0	0	22.15	3.4350E 06	20794.9	
400.5	12.41	18827.9	-1.66	3.3317E 05	3.2670E 05	0	0	22.24	3.4535E 06	20869.0	
401.5	12.35	18903.9	-1.65	3.3263E 05	3.2670E 05	0	0	22.33	3.4721E 06	20943.5	
402.5	12.31	18980.4	-1.64	3.3208E 05	3.2670E 05	0	0	22.42	3.4907E 06	21018.5	
403.5	12.26	19057.2	-1.63	3.3154E 05	3.2670E 05	0	0	22.51	3.5094E 06	21093.8	
404.5	12.20	19134.3	-1.63	3.3099E 05	3.2670E 05	0	0	22.60	3.5282E 06	21169.5	
405.5	12.15	19212.1	-1.62	3.3045E 05	3.2670E 05	0	0	22.70	3.5471E 06	21245.6	
406.5	12.10	19290.2	-1.61	3.2991E 05	3.2670E 05	0	0	22.79	3.5660E 06	21322.1	
407.5	12.04	19368.8	-1.60	3.2937E 05	3.2670E 05	0	0	22.88	3.5851E 06	21399.1	
408.5	11.99	19447.7	-1.59	3.2883E 05	3.2670E 05	0	0	22.97	3.6042E 06	21476.5	
409.5	11.94	19527.1	-1.58	3.2829E 05	3.2670E 05	0	0	23.07	3.6233E 06	21554.3	
410.5	11.87	19607.0	-1.57	3.2775E 05	3.2670E 05	0	0	23.16	3.6426E 06	21632.6	
411.5	11.82	19687.9	-1.56	3.2721E 05	3.2670E 05	0	0	23.26	3.6619E 06	21711.3	
412.5	11.76	19768.0	-1.55	3.2668E 05	3.2670E 05	0	0	23.35	3.6814E 06	21790.4	
413.5	11.70	19849.2	-1.54	3.2614E 05	3.2670E 05	0	0	23.45	3.7009E 06	21870.0	
414.5	11.65	19930.9	-1.53	3.2561E 05	3.2670E 05	0	0	23.54	3.7204E 06	21950.0	
415.5	11.59	20013.9	-1.51	3.2507E 05	3.2670E 05	0	0	23.64	3.7401E 06	22030.5	
416.5	11.53	20099.0	-1.50	3.2453E 05	3.2670E 05	0	0	23.74	3.7598E 06	22111.4	
417.5	11.47	20178.7	-1.49	3.2403E 05	3.2670E 05	0	0	23.84	3.7797E 06	22192.9	
418.5	11.41	20262.3	-1.47	3.2351E 05	3.2670E 05	0	0	23.94	3.7994E 06	22274.8	
419.5	11.35	20346.4	-1.46	3.2299E 05	3.2670E 05	0	0	24.04	3.8195E 06	22357.1	
420.5	11.29	20430.9	-1.44	3.2247E 05	3.2670E 05	0	0	24.14	3.8396E 06	22440.0	
421.5	11.23	20516.0	-1.43	3.2196E 05	3.2670E 05	0	0	24.24	3.8598E 06	22523.3	
422.5	11.17	20601.0	-1.41	3.2145E 05	3.2670E 05	0	0	24.34	3.8800E 06	22607.2	
423.5	11.11	20687.0	-1.40	3.2094E 05	3.2670E 05	0	0	24.44	3.9003E 06	22691.5	
424.5	11.05	20774.3	-1.38	3.2044E 05	3.2670E 05	0	0	24.54	3.9208E 06	22776.4	
425.5	10.99	20861.4	-1.36	3.1994E 05	3.2670E 05	0	0	24.64	3.9412E 06	22861.7	
426.5	10.92	20949.0	-1.35	3.1945E 05	3.2670E 05	0	0	24.75	3.9618E 06	22947.6	
427.5	10.86	21037.2	-1.33	3.1894E 05	3.2670E 05	0	0	24.85	3.9825E 06	23034.1	
428.5	10.80	21126.0	-1.31	3.1847E 05	3.2670E 05	0	0	24.96	4.0033E 06	23121.0	
429.5	10.73	21215.3	-1.29	3.1799E 05	3.2670E 05	0	0	25.06	4.0241E 06	23208.5	
430.5	10.67	21305.1	-1.27	3.1751E 05	3.2670E 05	0	0	25.17	4.0450E 06	23296.5	
431.5	10.60	21395.2	-1.26	3.1704E 05	3.2670E 05	0	0	25.27	4.0661E 06	23385.1	
432.5	10.54	21486.3	-1.24	3.1657E 05	3.2670E 05	0	0	25.38	4.0872E 06	23474.3	
433.5	10.47	21578.1	-1.22	3.1611E 05	3.2670E 05	0	0	25.49	4.1084E 06	23564.0	
434.5	10.41	21670.3	-1.20	3.1566E 05	3.2670E 05	0	0	25.60	4.1297E 06	23654.3	
435.5	10.34	21763.0	-1.17	3.1521E 05	3.2670E 05	0	0	25.71	4.1511E 06	23745.1	
436.5	10.27	21856.4	-1.15	3.1477E 05	3.2670E 05	0	0	25.82	4.1726E 06	23836.6	
437.5	10.21	21950.9	-1.13	3.1433E 05	3.2670E 05	0	0	25.93	4.1941E 06	23928.7	
438.5	10.14	22044.9	-1.11	3.1390E 05	3.2670E 05	0	0	26.04	4.2156E 06	24021.3	
439.5	10.07	22140.1	-1.09	3.1348E 05	3.2670E 05	0	0	26.15	4.2376E 06	24114.6	
440.5	10.00	22235.9	-1.06	3.1306E 05	3.2490E 05	0	0	26.27	4.2594E 06	24208.5	

HTO SAMPLE FLW

PAGE 9

TIME	ALPHA	VELOCITY	GAMMA	ALTITUDE	T-RUST	LIFT	DRAG	MACH	RANGE	VCHAR
441.5	9.55	22332.3	-1.04	3.1265E 05	3.1275E 05	0	0	26.38	4.2814E 06	24302.9
442.5	9.46	22429.2	-1.02	3.1225E 05	3.1260E 05	0	0	26.50	4.3034E 06	24397.9
443.5	9.37	22526.1	-0.99	3.1186E 05	3.1245E 05	0	0	26.61	4.3256E 06	24493.4
444.5	9.27	22624.7	-0.97	3.1147E 05	3.1231E 05	0	0	26.73	4.3478E 06	24589.4
445.5	9.16	22723.3	-0.94	3.1109E 05	3.1216E 05	0	0	26.84	4.3701E 06	24686.0
446.5	9.05	22822.2	-0.92	3.1072E 05	3.1202E 05	0	0	26.96	4.3926E 06	24783.2
447.5	8.94	22922.2	-0.89	3.1036E 05	3.1189E 05	0	0	27.08	4.4151E 06	24880.9
448.5	8.83	23022.0	-0.87	3.1001E 05	3.1175E 05	0	0	27.20	4.4377E 06	24979.2
449.5	8.72	23123.0	-0.84	3.0966E 05	3.1162E 05	0	0	27.32	4.4605E 06	25078.0
450.5	8.61	23225.0	-0.81	3.0933E 05	3.1149E 05	0	0	27.44	4.4833E 06	25177.5
451.5	8.50	23327.1	-0.79	3.0900E 05	3.1136E 05	0	0	27.56	4.5062E 06	25277.5
452.5	8.39	23429.9	-0.76	3.0869E 05	3.1123E 05	0	0	27.68	4.5293E 06	25378.2
453.5	8.28	23533.2	-0.73	3.0838E 05	3.1111E 05	0	0	27.80	4.5524E 06	25479.4
454.5	8.17	23637.2	-0.70	3.0809E 05	3.1098E 05	0	0	27.92	4.5757E 06	25581.3
455.5	8.06	23741.0	-0.68	3.0780E 05	3.1087E 05	0	0	28.05	4.5990E 06	25683.8
456.5	7.95	23847.1	-0.65	3.0753E 05	3.1075E 05	0	0	28.17	4.6224E 06	25787.0
457.5	7.84	23953.0	-0.62	3.0726E 05	3.1063E 05	0	0	28.30	4.6460E 06	25890.7
458.5	7.73	24059.0	-0.59	3.0701E 05	3.1052E 05	0	0	28.42	4.6697E 06	25995.2
459.5	7.62	24166.9	-0.56	3.0677E 05	3.1041E 05	0	0	28.55	4.6937E 06	26100.2
460.5	7.51	24274.0	-0.53	3.0654E 05	3.1030E 05	0	0	28.68	4.7173E 06	26206.0
461.5	7.40	24383.0	-0.50	3.0632E 05	3.1020E 05	0	0	28.80	4.7413E 06	26312.4
462.5	7.29	24492.0	-0.47	3.0611E 05	3.1009E 05	0	0	28.93	4.7653E 06	26419.5
463.5	7.18	24602.9	-0.44	3.0592E 05	3.1000E 05	0	0	29.06	4.7895E 06	26527.3
464.5	7.07	24713.1	-0.40	3.0574E 05	3.1009E 05	0	0	29.19	4.8138E 06	26635.9
465.5	6.96	24825.2	-0.37	3.0557E 05	3.1016E 05	0	0	29.33	4.8382E 06	26745.1
466.5	6.85	24937.4	-0.34	3.0541E 05	3.1027E 05	0	0	29.46	4.8628E 06	26855.1
467.5	6.74	25050.4	-0.31	3.0527E 05	3.1031E 05	0	0	29.59	4.8874E 06	26965.8
468.5	6.63	25164.2	-0.27	3.0514E 05	3.1032E 05	0	0	29.73	4.9121E 06	27077.2
469.5	6.52	25278.0	-0.24	3.0503E 05	3.1034E 05	0	0	29.86	4.9370E 06	27189.4
470.5	6.41	25394.1	-0.21	3.0493E 05	3.1035E 05	0	0	30.00	4.9620E 06	27302.4
471.5	6.30	25510.2	-0.17	3.0485E 05	3.1037E 05	0	0	30.14	4.9871E 06	27416.1
472.5	6.19	25627.2	-0.14	3.0478E 05	3.1039E 05	0	0	30.27	5.0122E 06	27530.7
472.7	6.18	25650.0	-0.13	3.0476E 05	3.1037E 05	0	0	30.30	5.0173E 06	27553.7
472.9	6.17	25674.2	-0.13	3.0475E 05	3.1036E 05	0	0	30.33	5.0224E 06	27576.7
473.1	6.16	25697.1	-0.12	3.0474E 05	3.1034E 05	0	0	30.36	5.0274E 06	27599.7
473.3	6.15	25721.0	-0.11	3.0473E 05	3.1033E 05	0	0	30.38	5.0325E 06	27622.8
473.5	6.14	25744.9	-0.10	3.0472E 05	3.1031E 05	0	0	30.41	5.0376E 06	27646.0
473.7	6.13	25768.5	-0.10	3.0471E 05	3.1030E 05	0	0	30.44	5.0426E 06	27669.1

FIRST STAGE WEIGHTS (LBS.)

ENGINE	2.30599E 04	EQUIPMENT	1.62640E 05	TANK	9.60557E 04	JETTISON	2.84195E 05
USED PROPELLANT	5.728912E 05	WC2	3.35913E 05	FIXED RESERVES	0	VAR. RESERVES	6.53838E 03
STAGING TIME	1.235400E 02	ALTITUDE	1.514206E 05	V-ROTATION	1.335847E 03		

SECOND STAGE WEIGHTS (LBS.)

ENGINE	5.521981E 03	EQUIPMENT	4.31680E 04	TANK	1.184696E 04	JETTISON	6.093654E 04
PROPELLANT	2.510144E 05	FIXED RESERVES	3.40931E 03	VAR. RESERVES	0	PAYLOAD	2.488222E 04

VLD= 1.344787E 03 VLG= 2.607738E 03 VLI= 4.457360E 02 VCHAR= 2.766911E 04

PNT 8.15000E 04 CONST 4.027000E 04 GAMEP 6.50000E 01 TIMEP 1.50000E 03
 VSTAG 2.00000E 04 WP1 8.801100E 05

SECTION VIII
HTO FLOW CHART

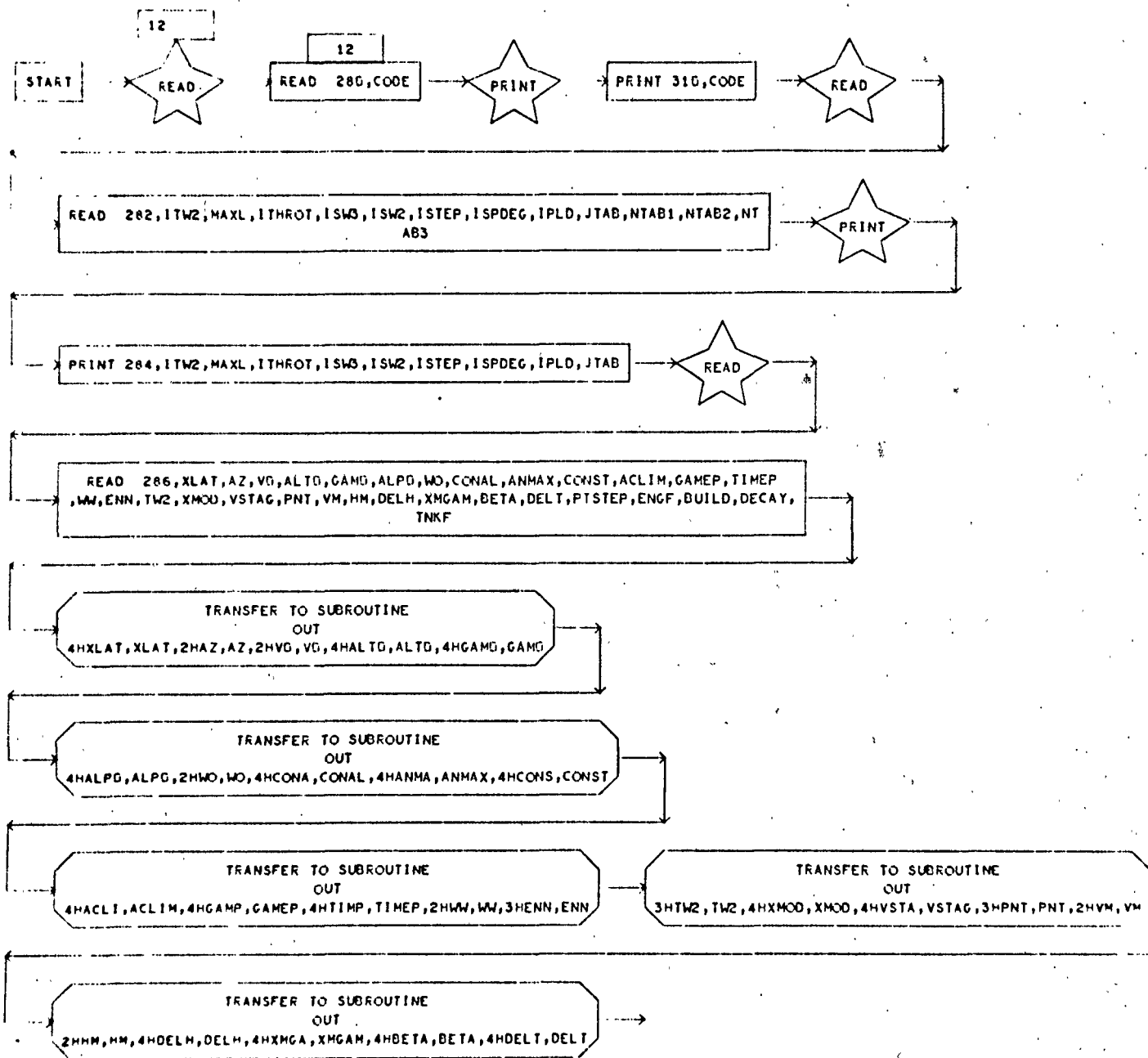

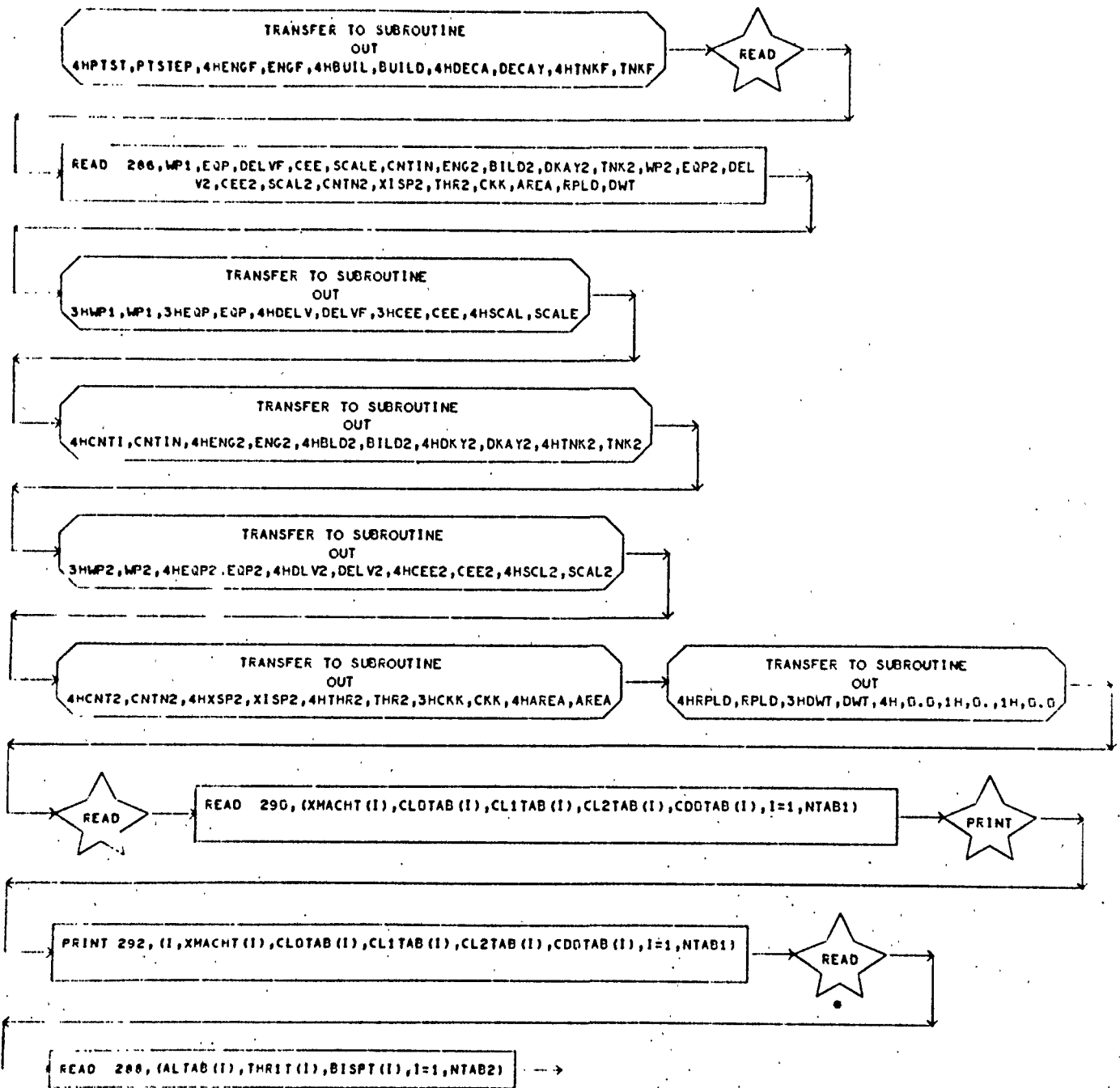

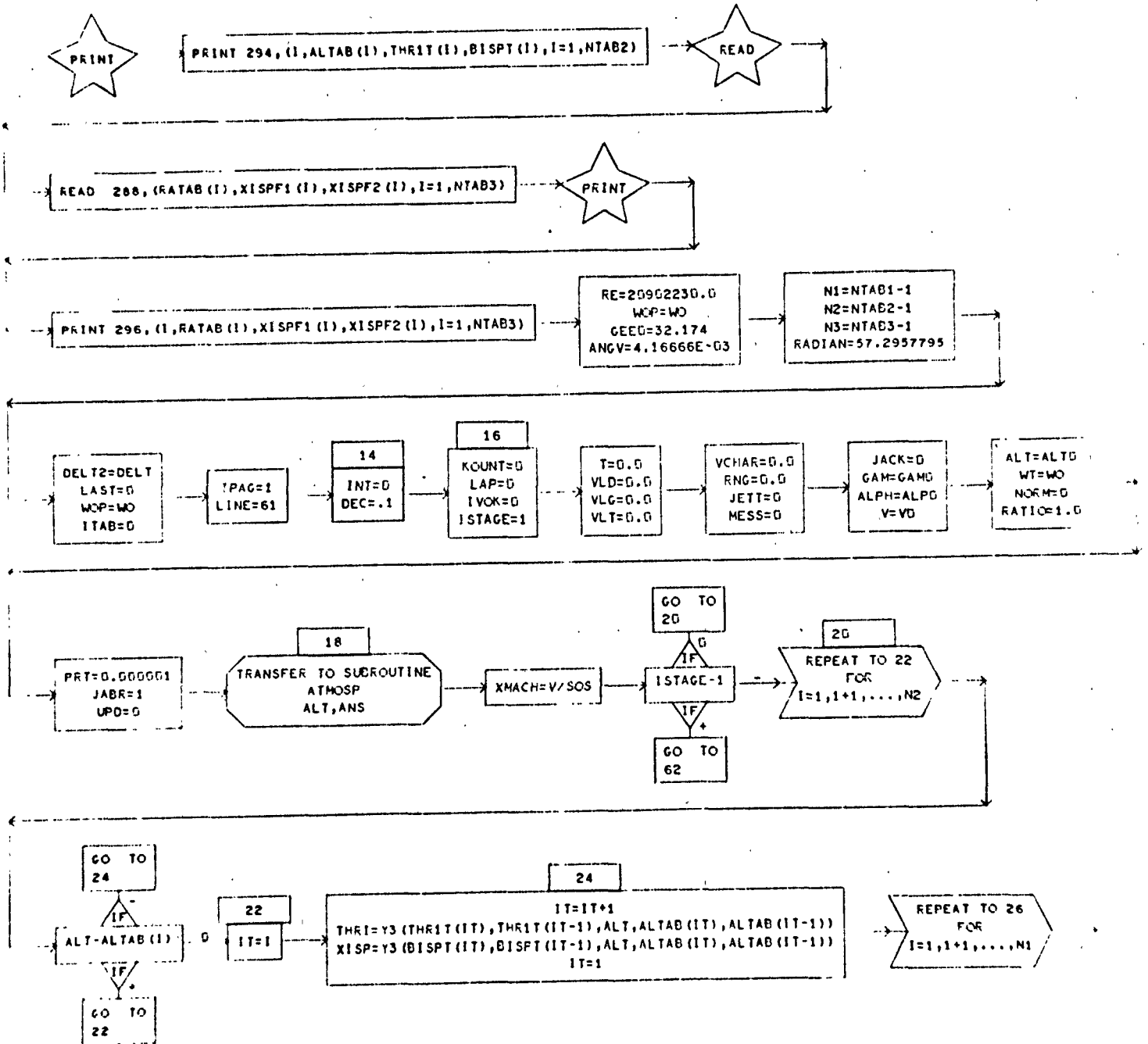

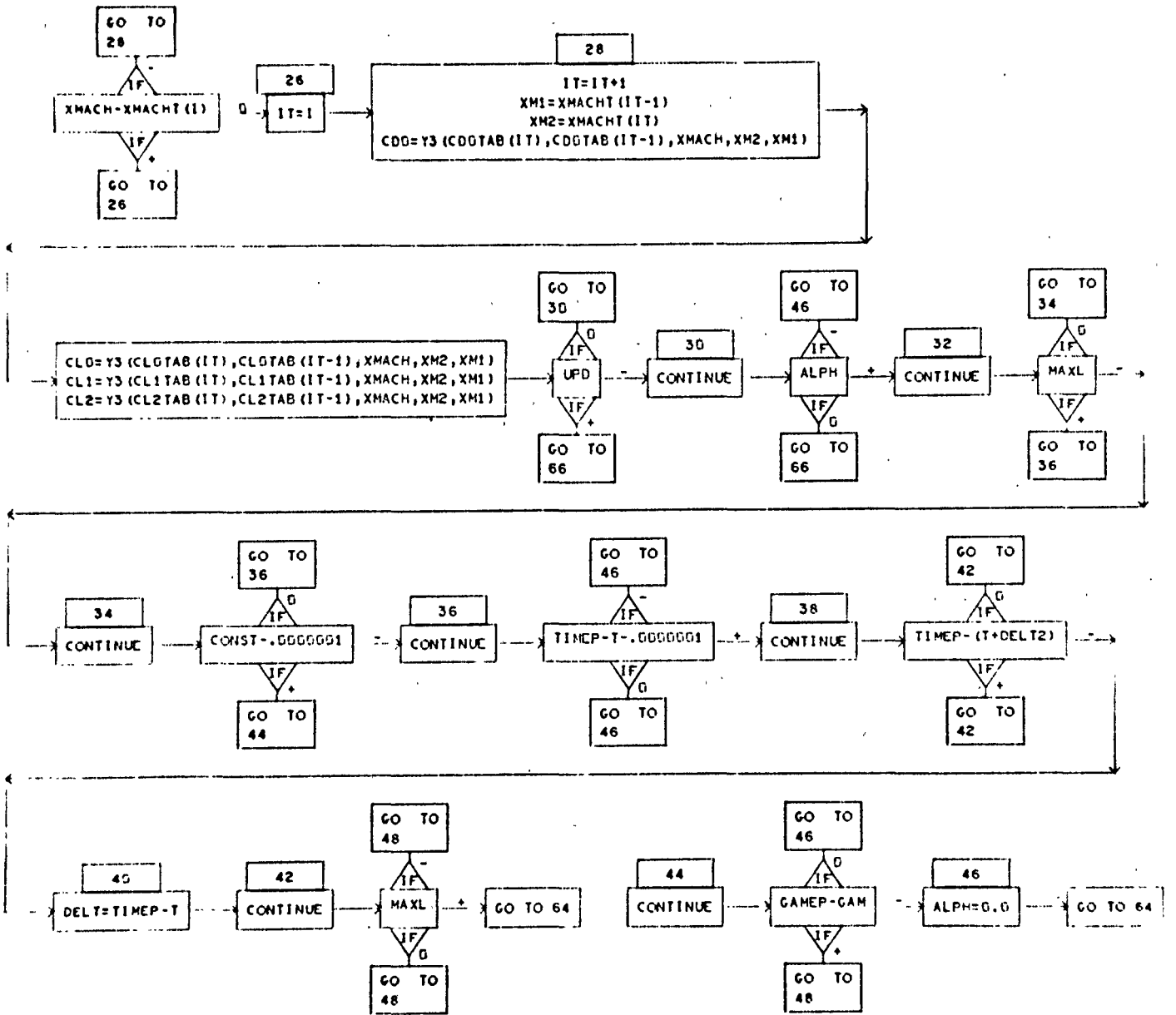

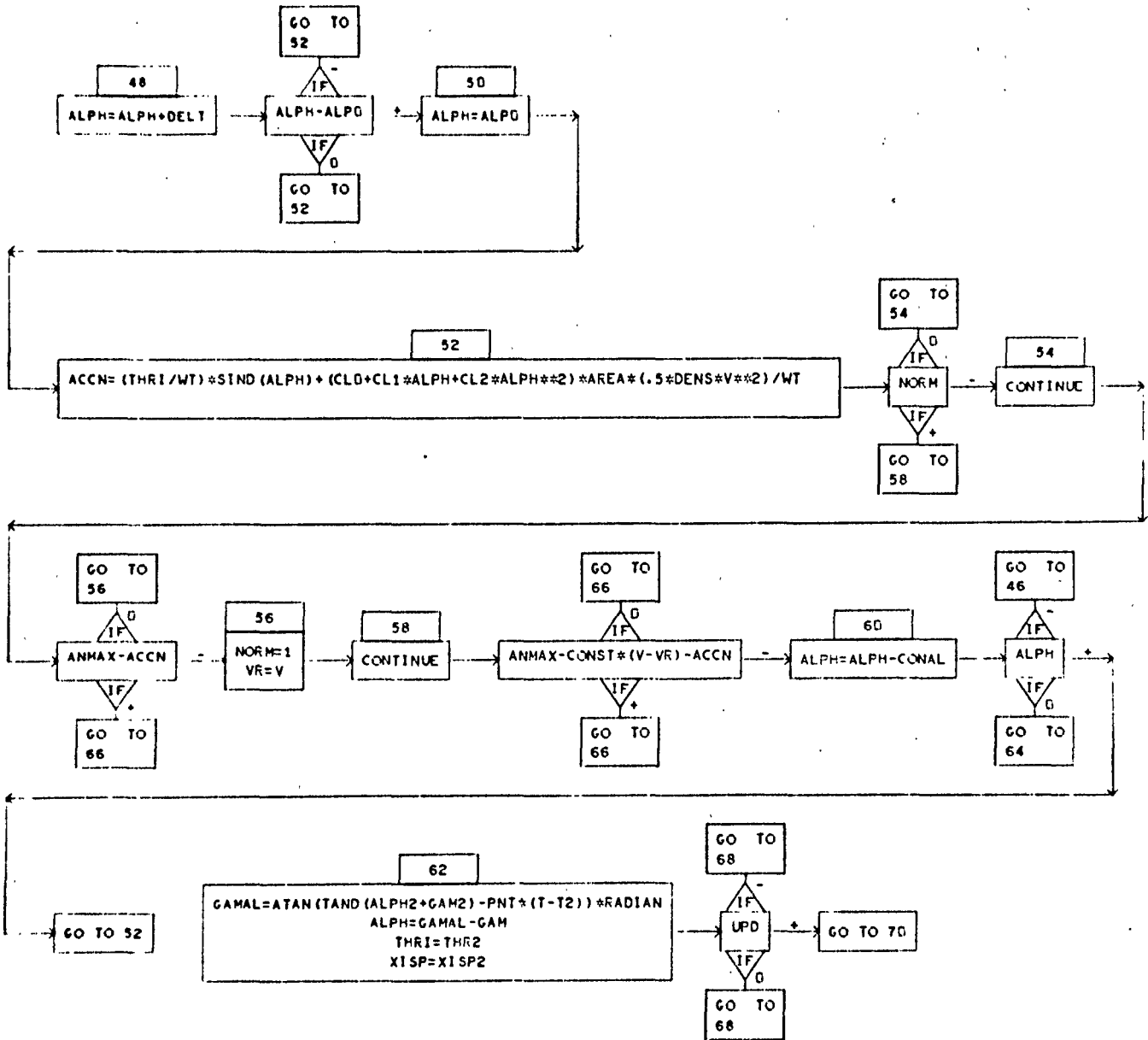

64
 $ACCN = (THR1 / WT) * \sin(\alpha) + (CL0 + CL1 * \alpha + CL2 * \alpha^2) * AREA * (1.5 * DENS * V^2) / WT$

66
 $CL = CL0 + CL1 * \alpha + CL2 * \alpha^2$
 $CD = CD0 + CKK * CL + TAND(\alpha)$
 $DYNP = 0.5 * DENS * V^2$
 $XLIFT = CL * DYNP * AREA$

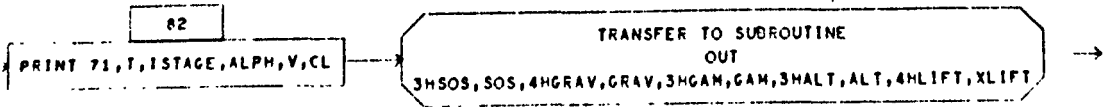
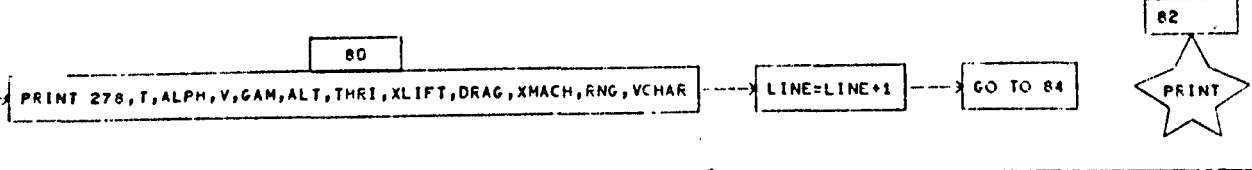
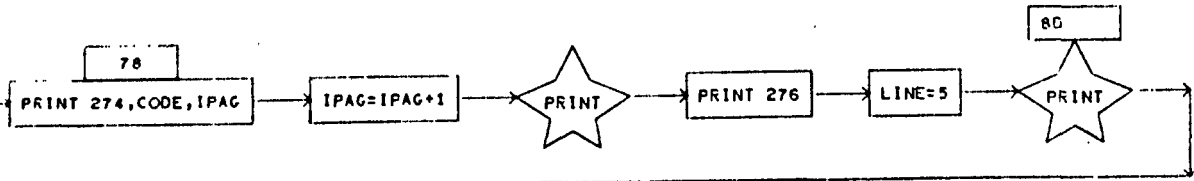
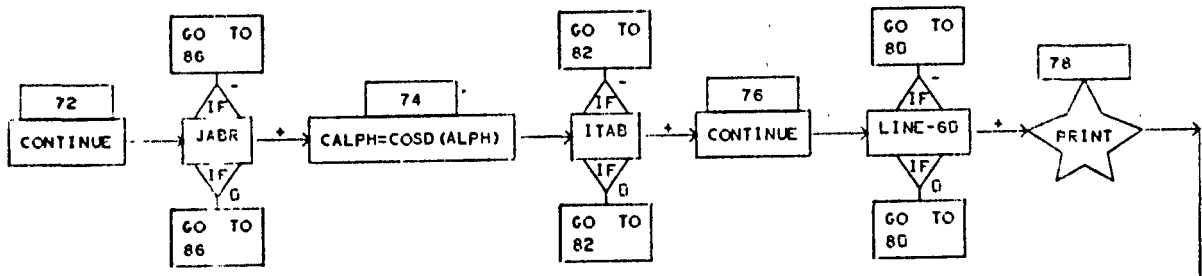
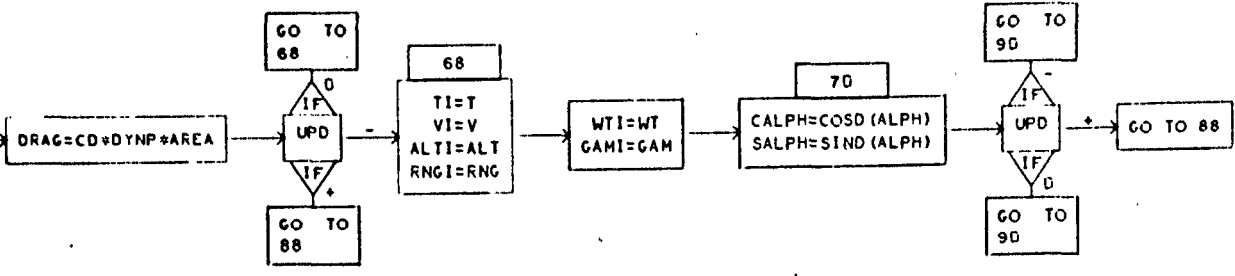

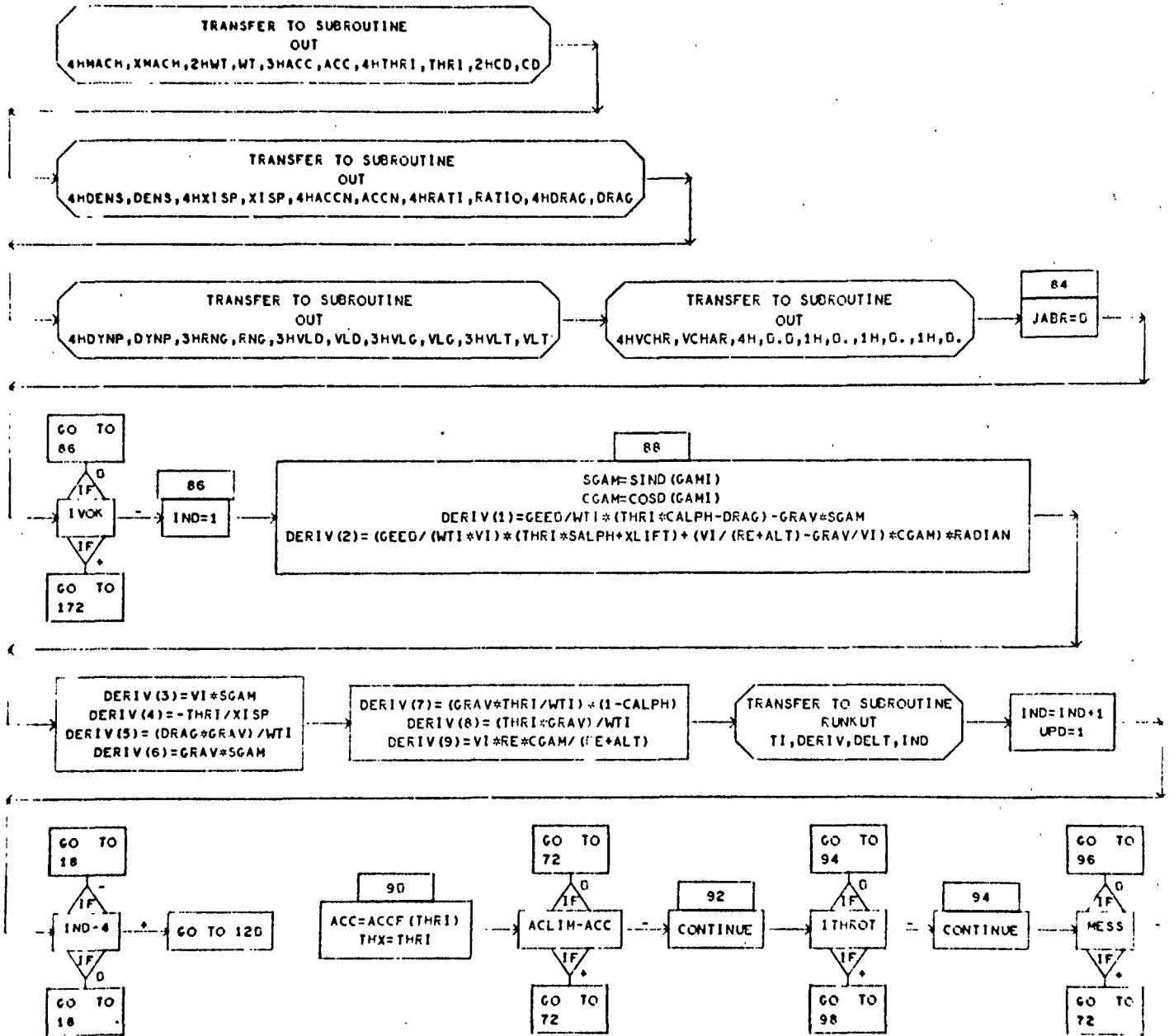

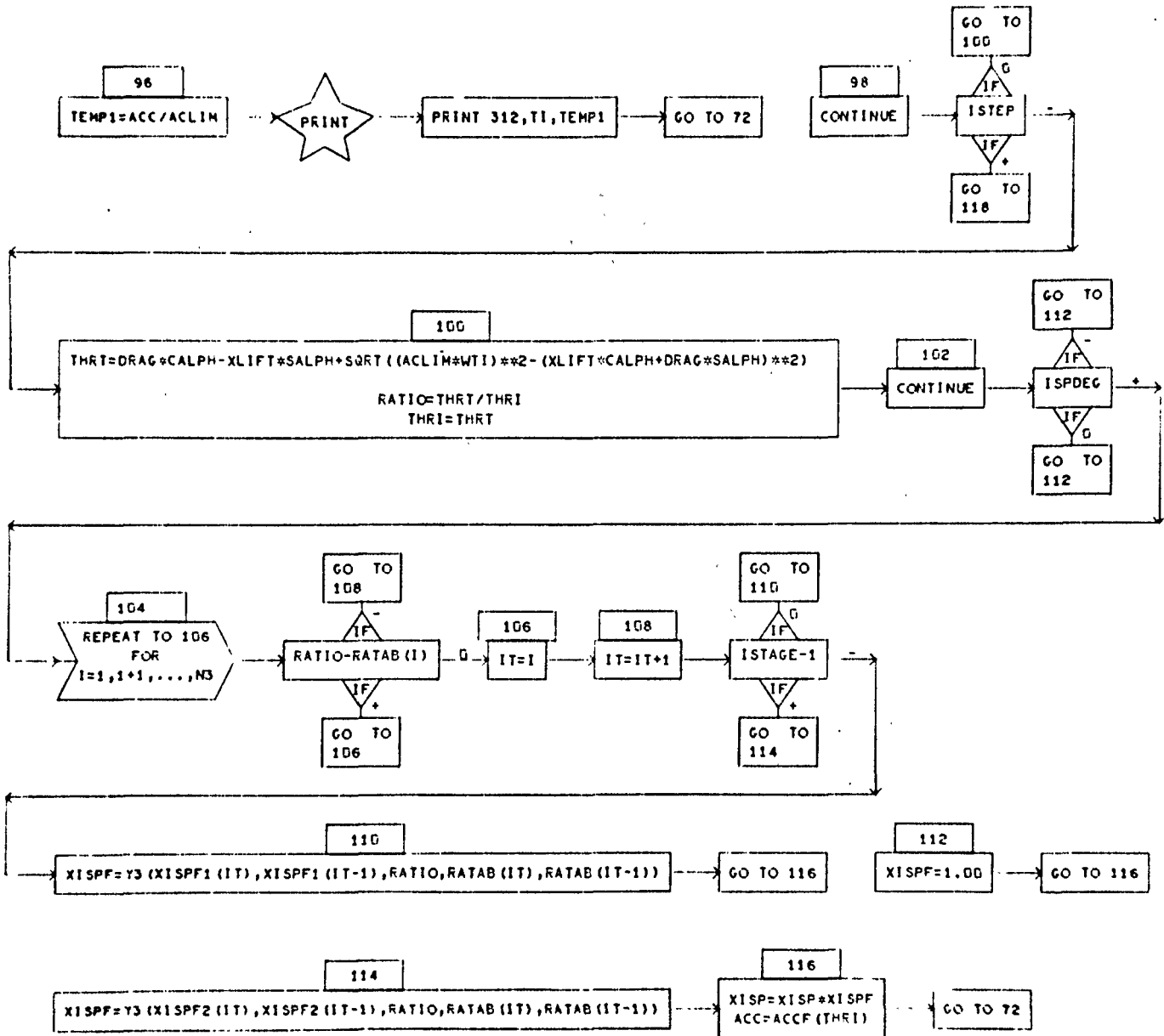

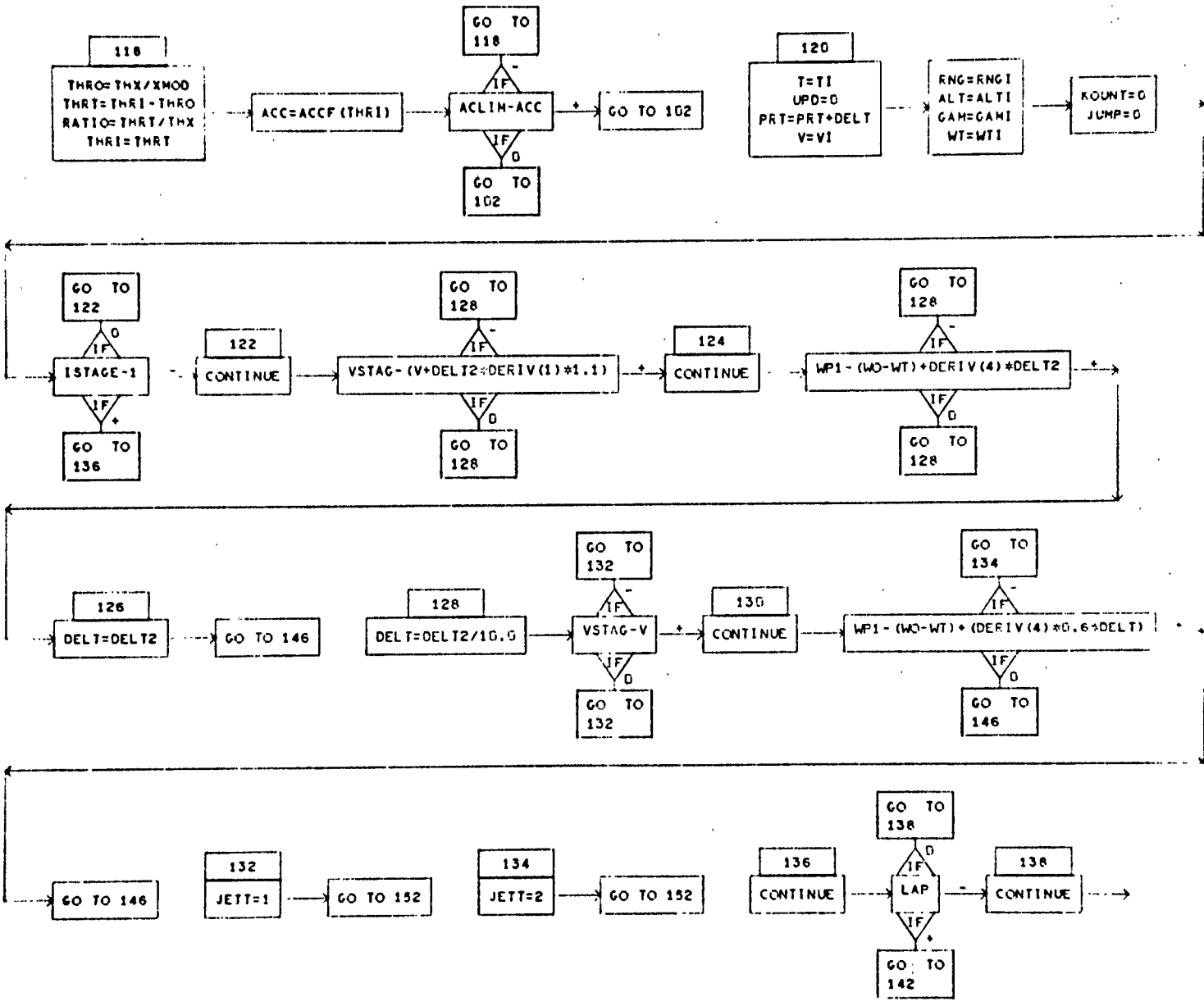

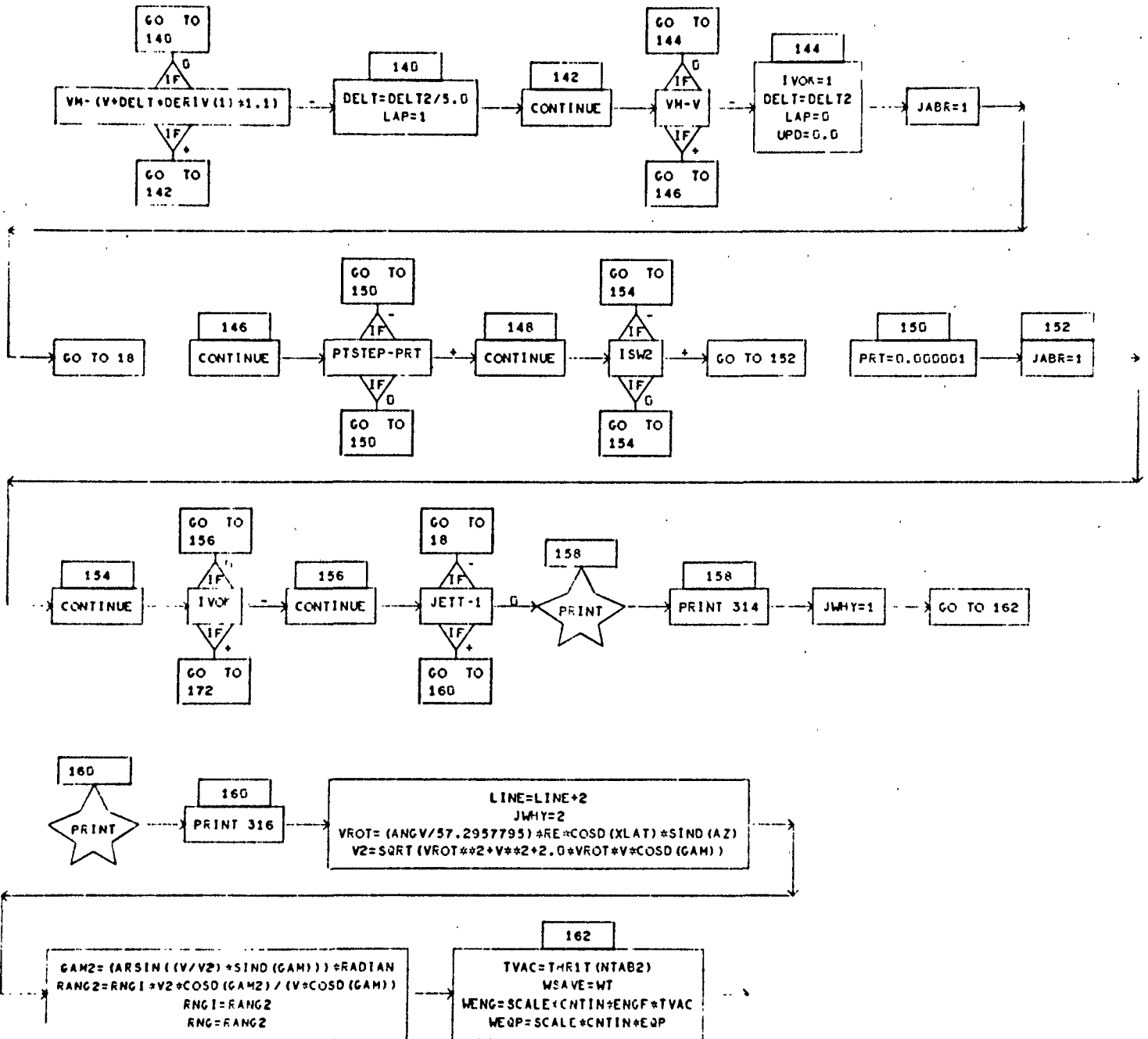

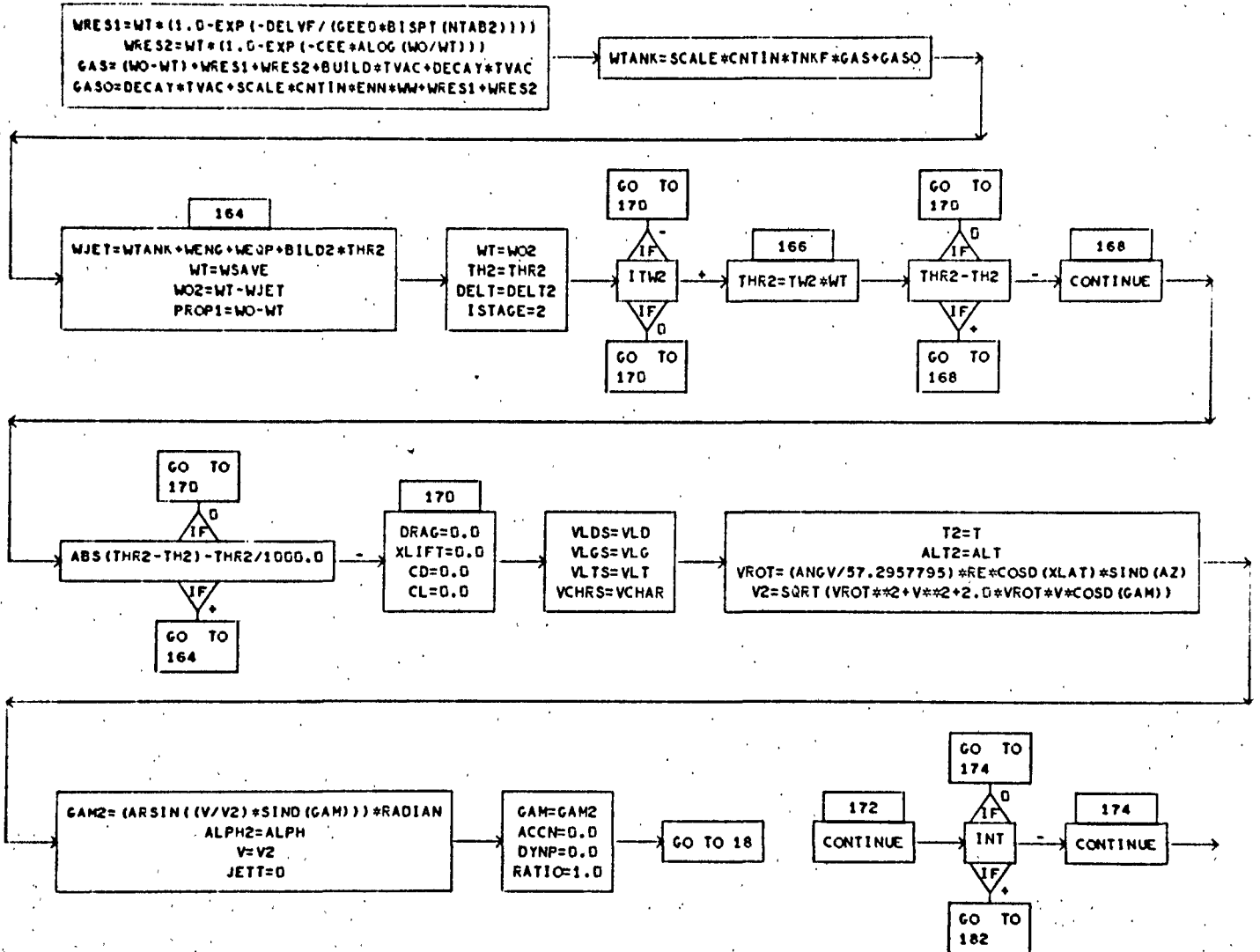

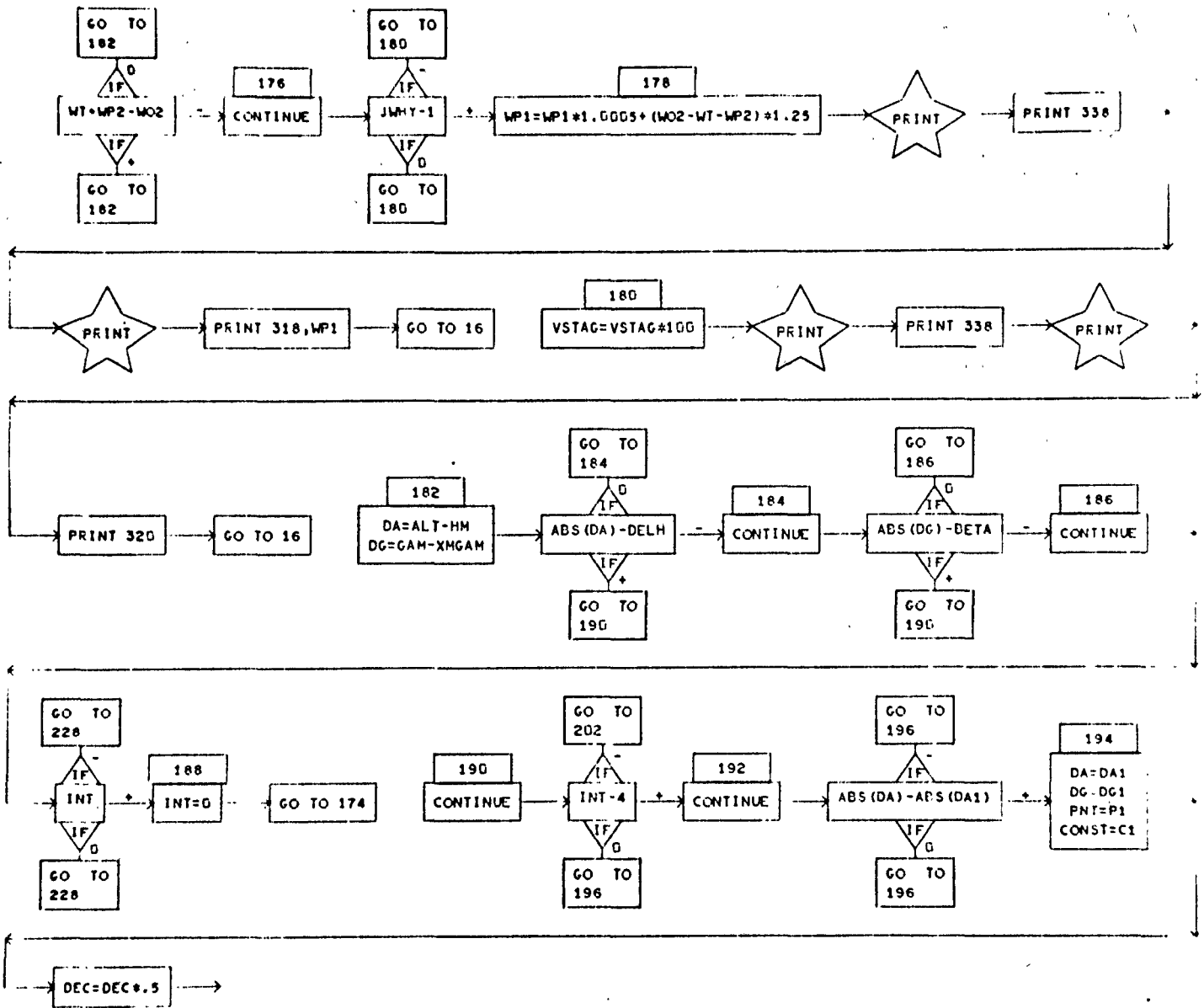

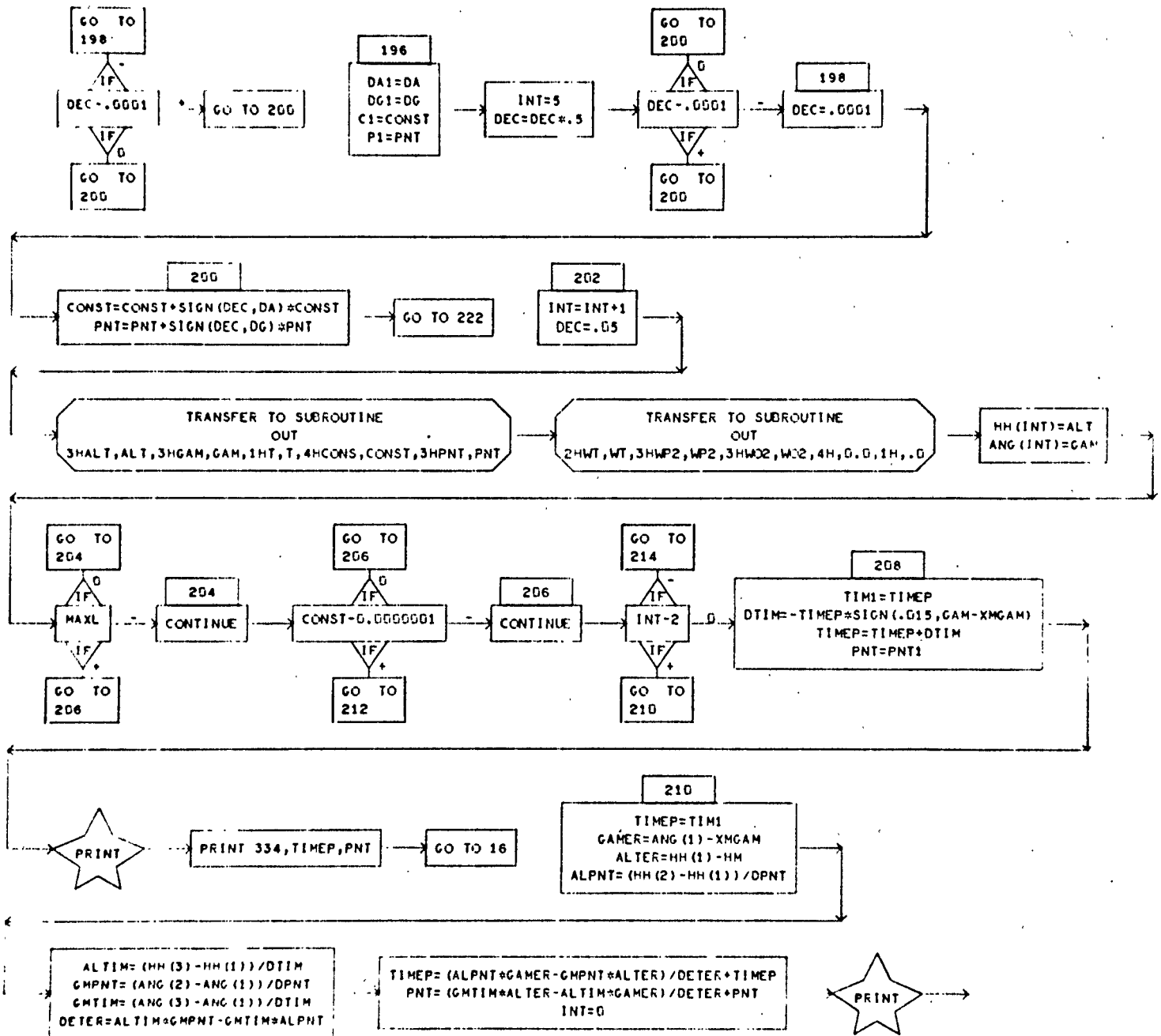

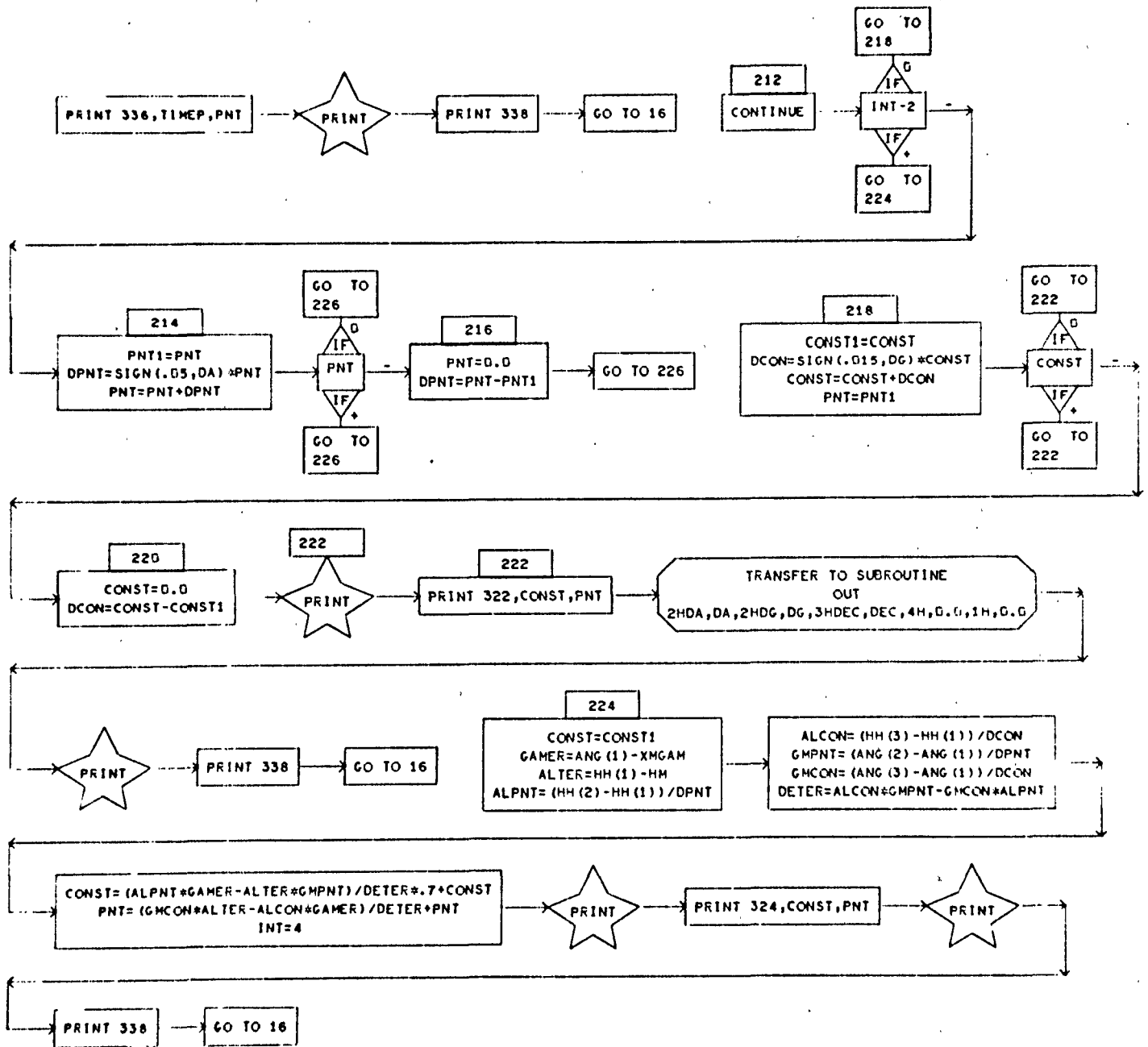

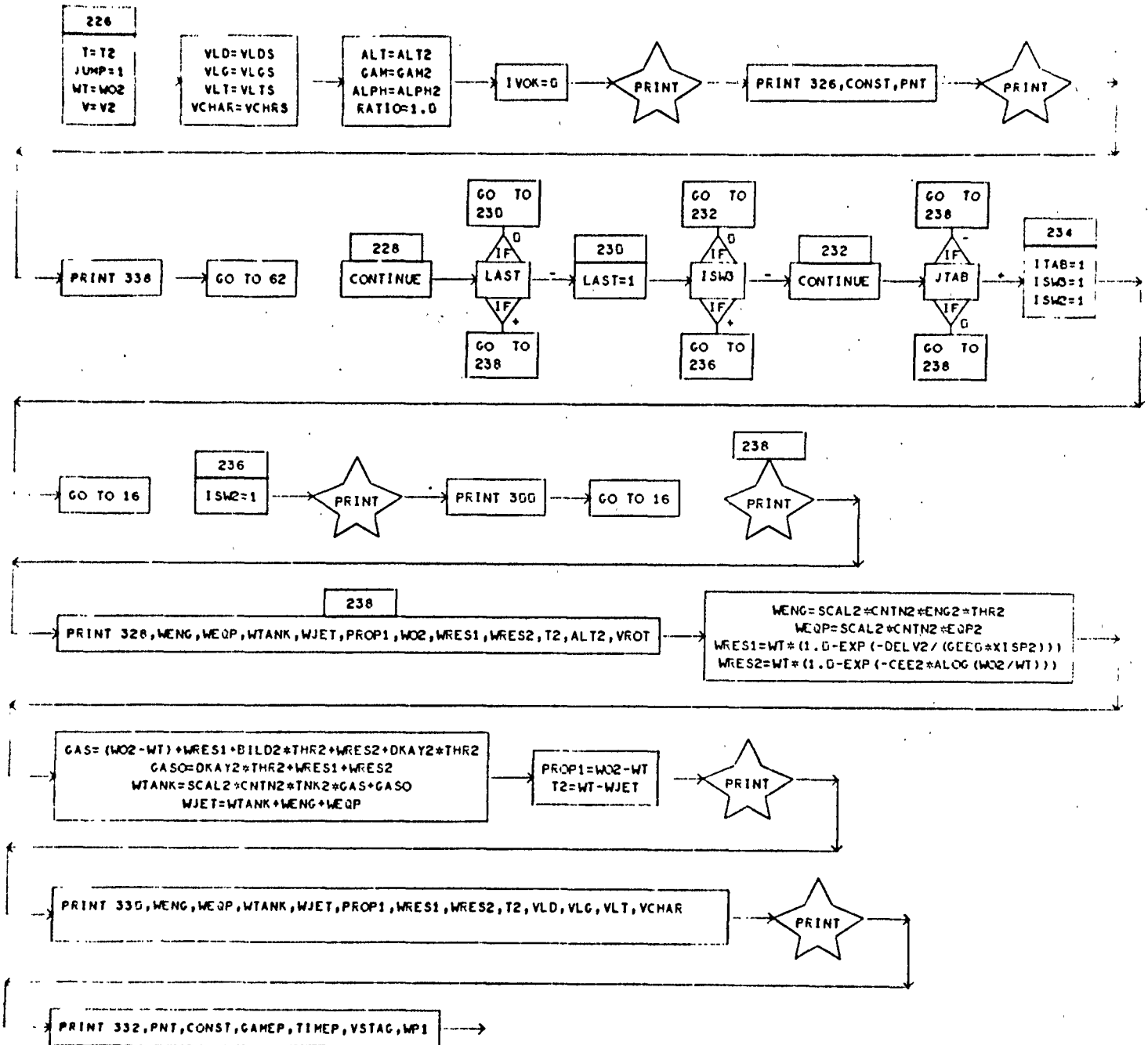

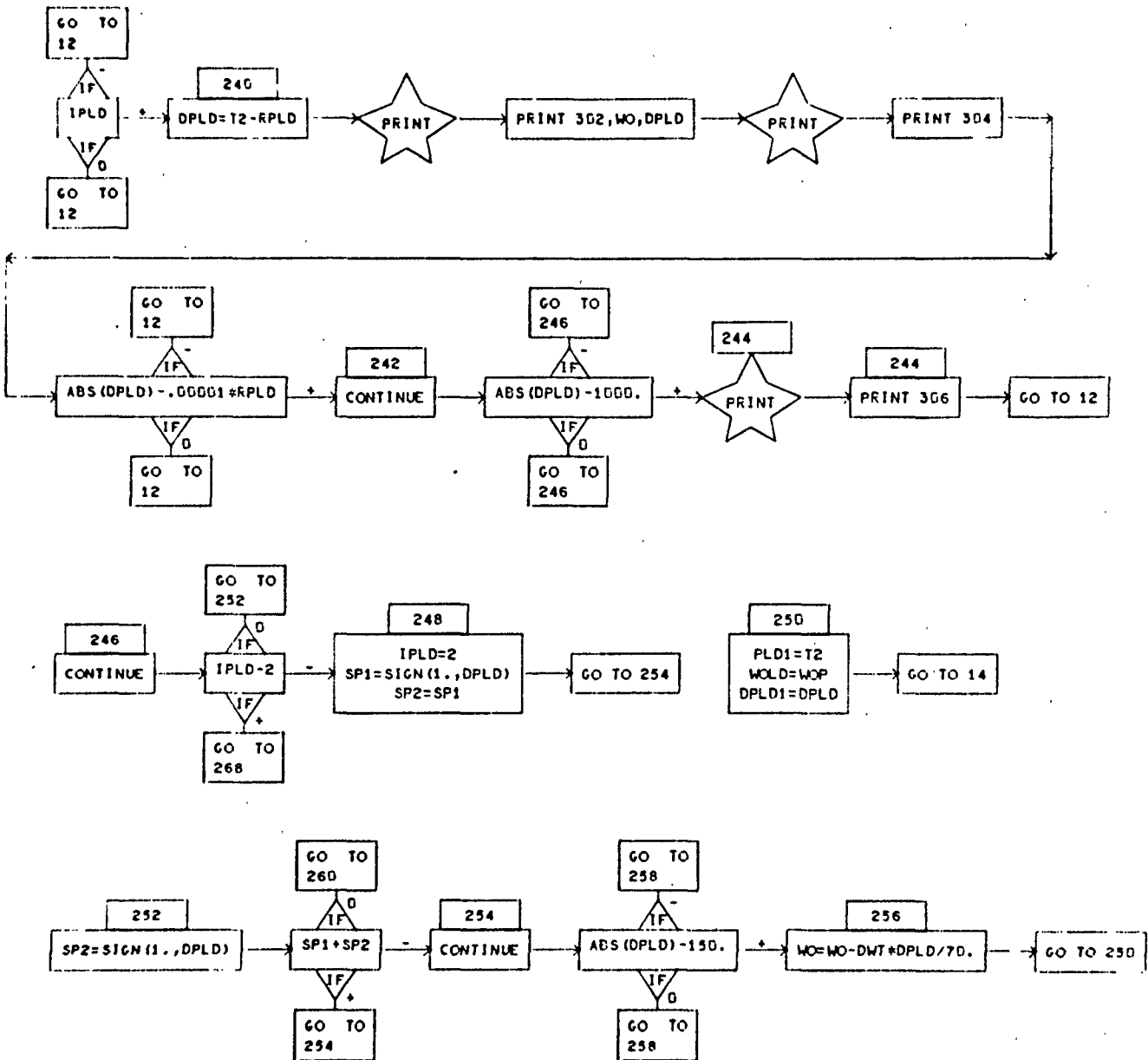

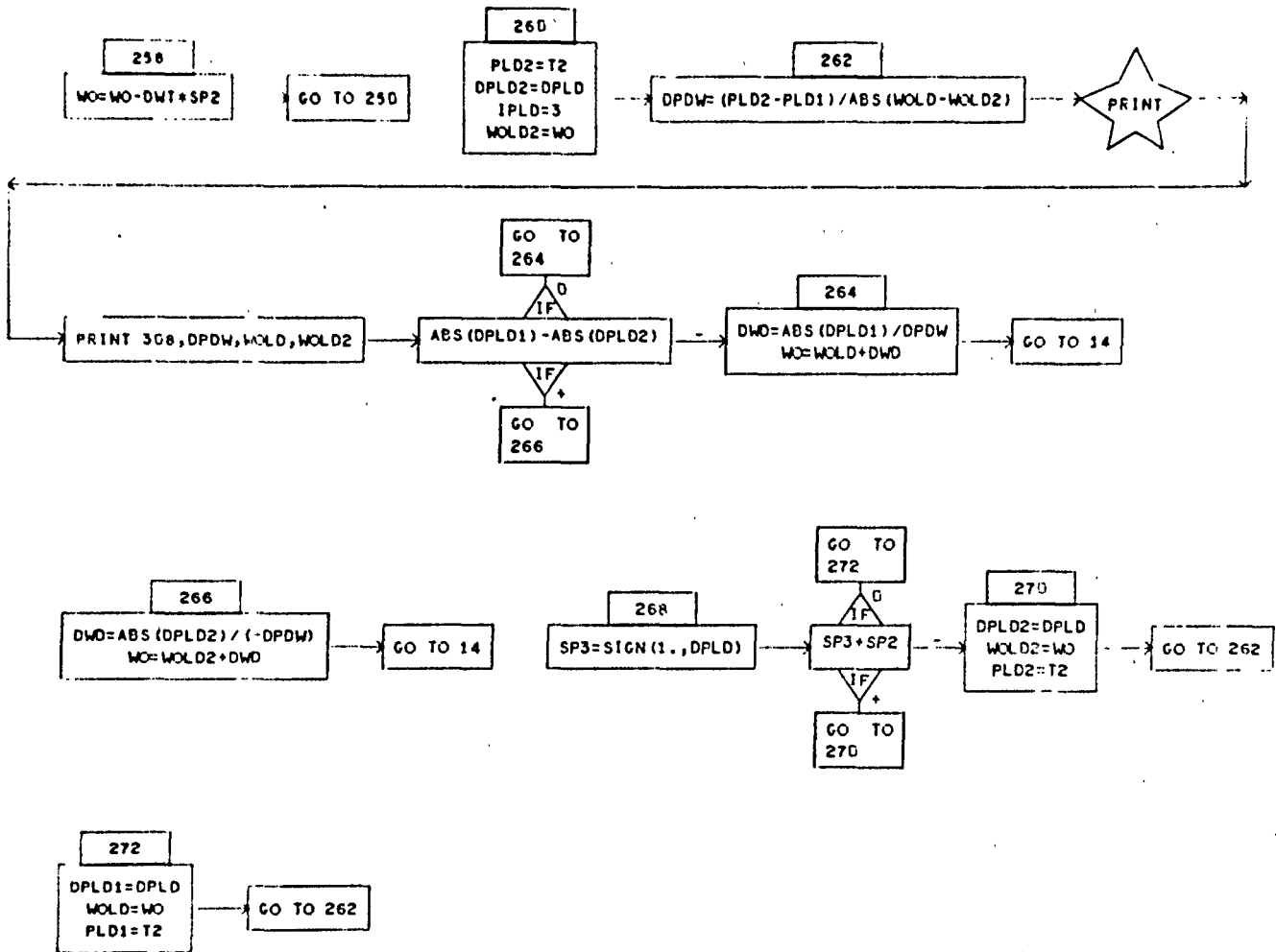

SUBROUTINE RUNKUT

D I M E N S I O N E D V A R I A B L E S

SYMBOL	STORAGES	SYMBOL	STORAGES	SYMBOL	STORAGES	SYMBOL	STORAGES	SYMBOL	STORAGES
DERIV	9	DEPVAR	9	AUX	9	SUM	9		

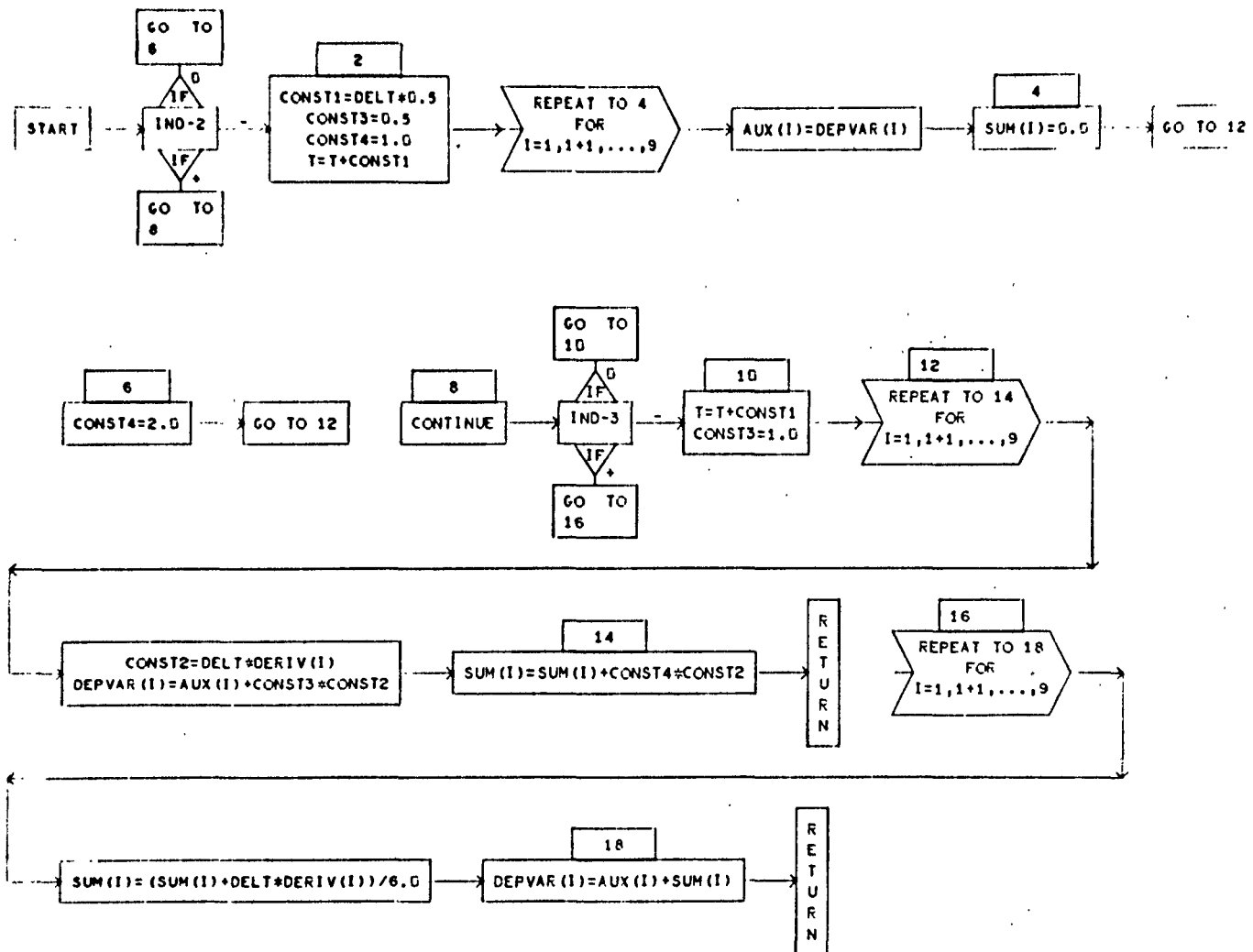

SUBROUTINE OUT

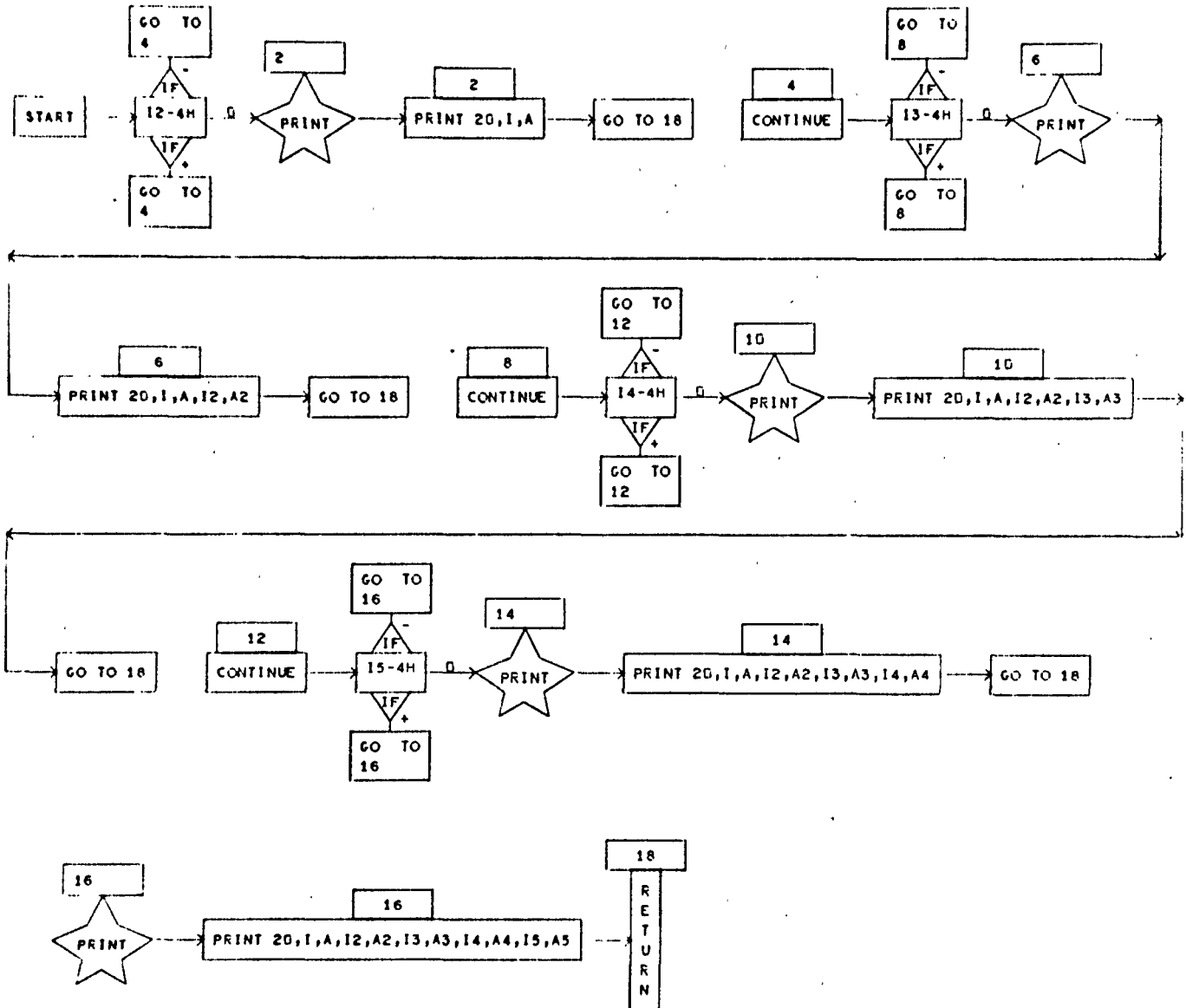

SUBROUTINE ATMOSP

D I M E N S I O N E D V A R I A B L E S

SYMBOL	STORAGES	SYMBOL	STORAGES	SYMBOL	STORAGES	SYMBOL	STORAGES	SYMBOL	STORAGES
ANS	3								

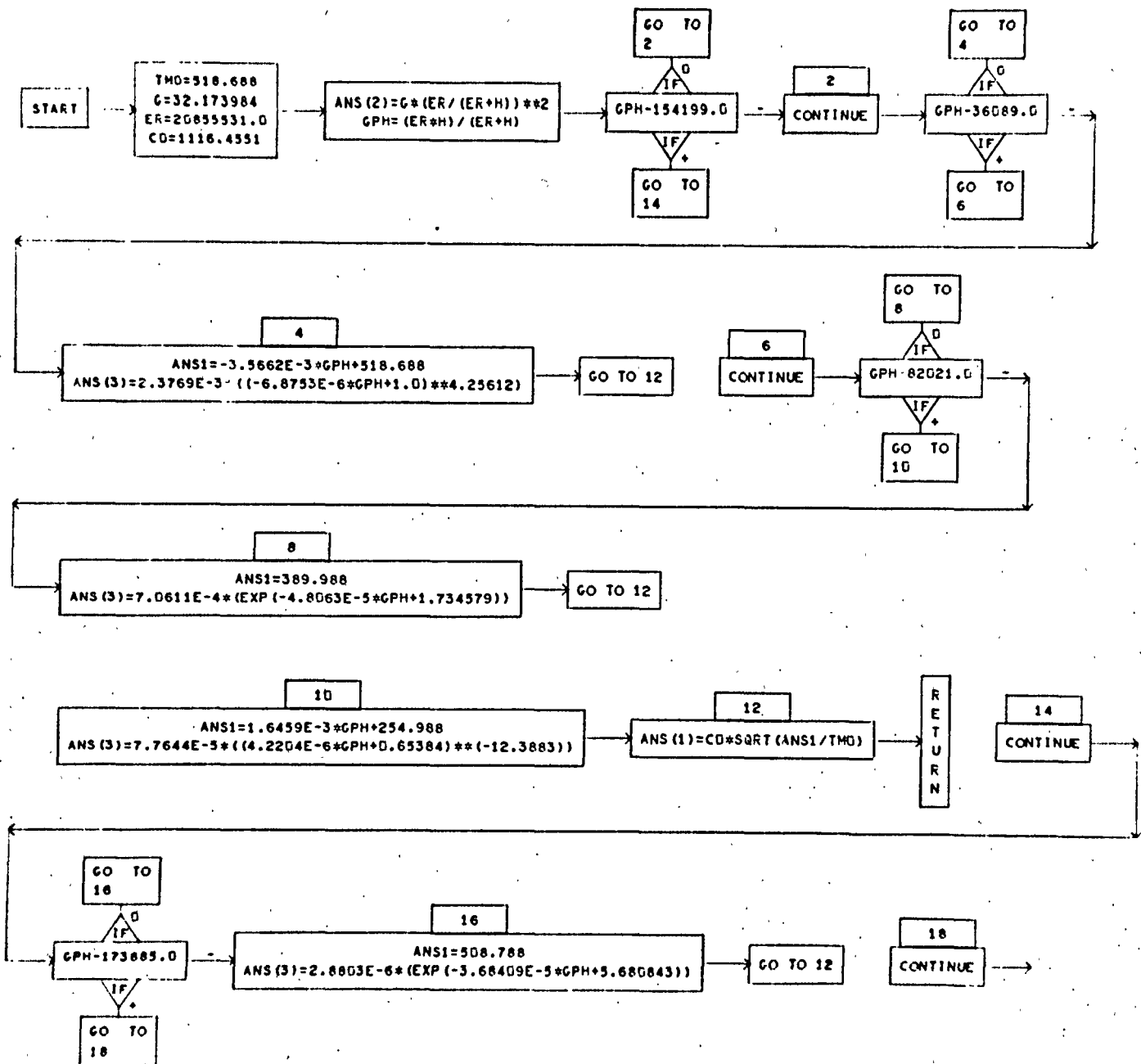

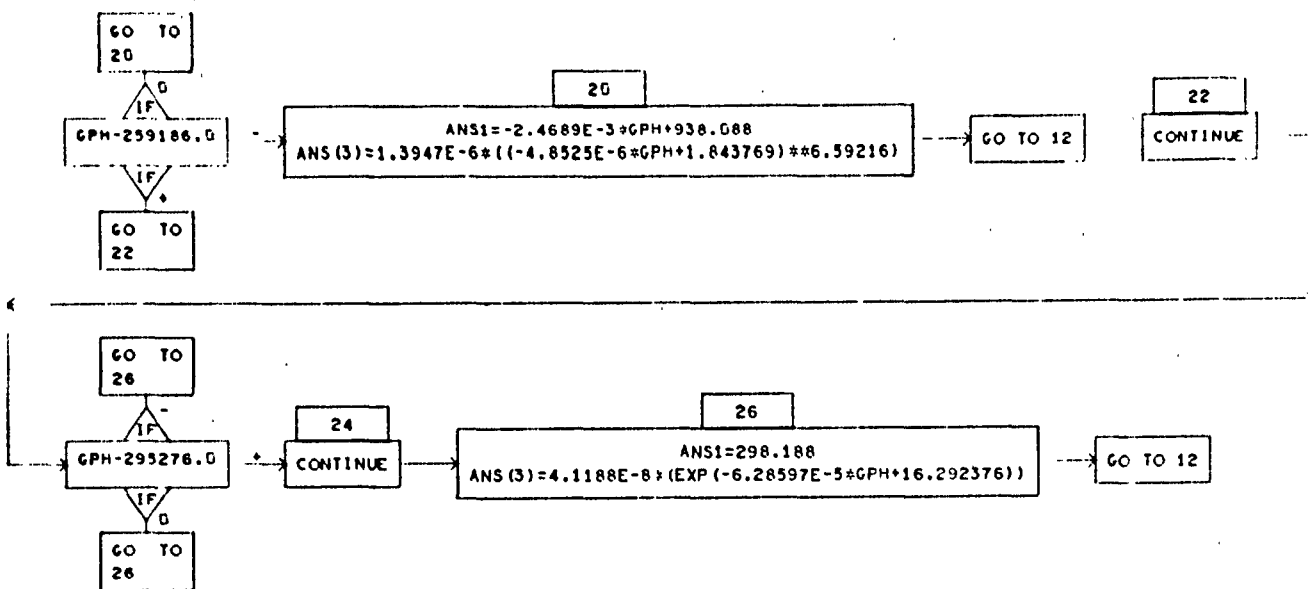

FUNCTION SIND

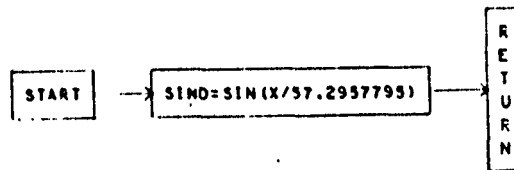

FUNCTION COSD

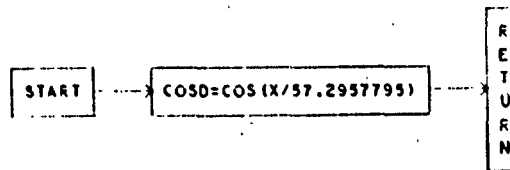

FUNCTION Y3

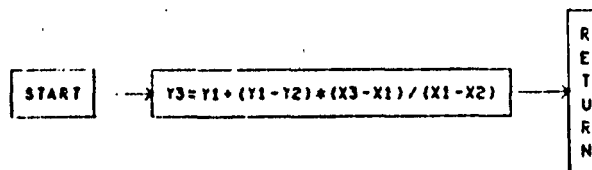

FUNCTION TAND



FUNCTION ARSIN

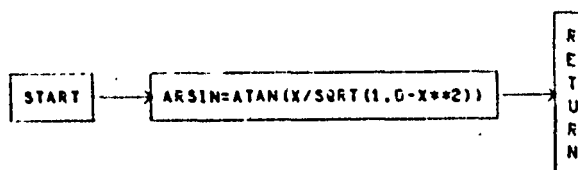

SECTION IX

VTO SOURCE LISTINGS - 3200 AND 930

PROGRAM VTO

C	VERTICAL TAKEOFF PROGRAM	REPORT TR-293-6-110	NORTHROP	A	1
C	2-D FLIGHT EQUATIONS			A	2
C				A	3
	DIMENSION ANS(3), XMACHT(16), CL0TAB(16), CL1TAB(16), CL2TAB(16),			A	4
	CD0TAB(16), ALTAB(10), THR1T(10), RATAB(11), XISPF1(11), XISPF2(11			A	5
	2), DEPVAR(8), DERIV(8), CODE(9), BISPT(10), HH(3), ANG(3)			A	6
	COMMON V, GAM, ALT, WT, VLD, VLG, VLT, VCHAR			A	7
	EQUIVALENCE (ANS(1), SOS), (ANS(2), GRAV), (ANS(3), DENS)			A	8
	CONST=0.0			A	9
	RE=20902230.0			A	10
	GEF0=32.174			A	11
	ANGV=4.16666E-03			A	12
C				A	13
C	HEADING			A	14
	12 READ 260, CODE			A	15
	PRINT 262, CODE			A	16
C				A	17
C	OPTIONS			A	18
	READ 266, ITW2, ITHROT, ISW3, ISW2, ISTEP, ISPDEG, IPLD, JTAB, NTAB1, NTAB2			A	
	* , NTAB3				
	PRINT 270, ITW2, ITHROT, ISW3, ISW2, ISTEP, ISPDEG, IPLD, JTAB				
C				A	22
C	SINGLE POINT DATA			A	23
	READ 268, XLA, A7, V0, ALTO, GAM0, ALPO, W0, VKICK, GAMK, ACLIM, TW2, WW, ENN			A	24
	1, XMOD, VSTAG, POINT, VM, HM, DELH, XMGAM, BETA, DELT, PTSTEP, ENGF, BULD			A	25
	READ 268, DECAY, TNKF, WP1, EQP, DELVF, CEE, SCALE, CNTIN, ENG2, BILD2, DKAY			A	26
	12, TNK2, WP2, EQP2, DELV2, CEE2, SCAL2, CNTN2, XISP2, THR2, AREA, CKK, RPLD, DWT				
	* I				
	CALL OUT (4HXLAT, XLAT, 2HAZ, A7, 2HV0, V0, 4HALTO, ALTO, 4HGAM0, GAM0)			A	28
	CALL OUT (4HALPO, ALPO, 2HWO, W0, 4HVKCK, VKICK, 4HGAMK, GAMK, 4HALCM, ACLI			A	29
	10)			A	30
	CALL OUT (3HTW2, TW2, 2HWW, WW, 3HENN, ENN, 4HXM0D, XMOD, 4HVSTG, VSTAG)			A	31
	CALL OUT (4HP0IN, POINT, 2HV7, VM, 2HHM, HM, 4HDELH, DELH, 4FXMG0M, XMGAM)			A	32
	CALL OUT (4HBETA, BETA, 4HDELT, DELT, 4HPTSP, PTSTEP, 4HENGF, ENGF, 4HBILD			A	33
	1, BILD)			A	34
	CALL OUT (4HDCAY, DECAY, 4HTNKF, TNKF, 3HWP1, WP1, 3HEQP, EQP, 4HDLVF, DELV			A	35
	1F)			A	36
	CALL OUT (3HCEE, CEE, 4HSCALE, SCALE, 4HCNTN, CNTIN, 4HENG2, ENG2, 4HBILD2, B			A	37
	1ILD2)			A	38
	CALL OUT (4HDKY2, DKAY2, 4HTNK2, TNK2, 3HWP2, WP2, 4HEQP2, EQP2, 4HDLV2, DE			A	39
	1LV2)			A	40
	CALL OUT (4HCEE2, CEE2, 4HSCAL2, SCAL2, 4HCNT2, CNTN2, 4HISP2, XISP2, 4HTHR			A	41
	12, THR2)			A	42
	CALL OUT (4HAREA, AREA, 3HCKK, CKK, 4H . . . 0.0, 1F, 0.0, 1F, 0.0)			A	43
				A	44
C	TABLE DATA			A	45
	READ 264, (XMACHT(I), CL0TAB(I), CL1TAB(I), CL2TAB(I), CD0TAB(I), I=1, N			A	46
	1TAB1)			A	47
	READ 240, (ALTAB(I), THR1T(I), BISPT(I), I=1, N1, 4B2)			A	48
	READ 240, (RATAB(I), XISPF1(I), XISPF2(I), I=1, NTAB3)			A	49
	PRINT 242, (I, XMACHT(I), CL0TAB(I), CL1TAB(I), CL2TAB(I), CD0TAB(I), I=			A	50
	11, NTAB1)			A	51
	PRINT 244, (I, ALTAB(I), THR1T(I), BISPT(I), I=1, NTAB2)			A	52
	PRINT 246, (I, RATAB(I), XISPF1(I), XISPF2(I), I=1, NTAB3)			A	53
	PRINT 300			A	54

		A	55
	N1=NTAR1-1	A	56
	MODULS=XMOD	A	57
	N2=NIAR2-1	A	58
	N3=NTAR3-1	A	59
	DELTA2=DELTA	A	60
	PAULAN=57.295/795	A	61
	ITAB=0	A	62
	PNT=POINT	A	63
	INT=0	A	64
	LAST=0	A	65
	LINE=61	A	66
	IPAB=1	A	67
C	TURN OFF ALL FLAGS. INITIALIZE ALL VARIABLES	A	68
C	FOR NEW TRAJECTORY	A	69
	WOP=WO	A	70
14	POINT=0	A	71
	KICK=0	A	72
	KICK2=0	A	73
	MESS=0	A	74
	JETT=0	A	75
	JUMP=0	A	76
	LAP=0	A	77
	IVUK=0	A	78
	I STAGE=1	A	79
	T=0.0	A	80
	V1=0.0	A	81
	V2=0.0	A	82
	V3=0.0	A	83
	VCHAR=0.0	A	84
	GAM=GAM0	A	85
	ALPH=ALP0	A	86
	V=V0	A	87
	ALT=ALTO	A	88
	WT=WO	A	89
	RATIO=1.0	A	90
	PRT=0.000001	A	91
	IF (ITAB) 16,16.18	A	92
16	CONTINUE	A	93
	CALL OUT (3HTIM,T,3HGAM,GAM,3HVEL,V,3HALT,ALT,2HWT,WT)	A	94
18	JARR=1	A	95
	UPD=0	A	96
C		A	97
20	CALL ATMOSP (ALT,ANS)	A	98
	YMACH=V/SOS	A	99
	IF (I STAGE-1) 22,22.34	A	100
22	DO 24 I=1,N2	A	101
	IF (ALT-ALTAB(I)) 26,24.24	A	102
24	IT=I	A	103
26	IT=IT+1	A	104
	THR1=Y3(THR1T(IT),THR1T(IT-1),ALT,ALTAB(IT),ALTAB(IT-1))	A	105
	XISR=Y3(BISRPT(IT),BISRPT(IT-1),ALT,ALTAB(IT),ALTAB(IT-1))	A	106
	IT=I	A	107
	DO 28 J=1,N1	A	108
	IF (XMACH-YMAUCH(I)) 30,28,28	A	109
28	I=I	A	110

30	IT=IT+1	A 111
	XM1=XMACHT(IT-1)	A 112
	XM2=XMACHT(IT)	A 113
	CD0=Y3(CD0TAB(IT),CD0TAB(IT-1),XMACH,XM2,XM1)	A 114
	CL0=Y3(CL0TAB(IT),CL0TAB(IT-1),XMACH,XM2,XM1)	A 115
	CL1=Y3(CL1TAB(IT),CL1TAB(IT-1),XMACH,XM2,XM1)	A 116
	CL2=Y3(CL2TAB(IT),CL2TAB(IT-1),XMACH,XM2,XM1)	A 117
	ALPH=0.0	A 118
	IF (KICK) 32,32,36	A 119
32	GAM=90.0	A 120
	GO TO 36	A 121
C		A 122
C	SECOND STAGE GUIDANCE CALCULUS OF VARIATIONS SOLUTION	A 123
34	GAMAL=ATAN(TAND(ALPH2+GAM2)-PNT*(T-T2))*RADIAN	A 124
	ALPH=GAMAL-GAM	A 125
	THR1=THR2	A 126
	XISP=XISP2	A 127
	GO TO 38	A 128
C		A 129
C	PREINTEGRATION	A 130
36	CL=CL0+CL1-ALPH+CL2*ALPH**2	A 131
	CD=CD0+CKK*CL*TAND(ALPH)	A 132
	DYNP=0.5*DFNS+V**2	A 133
	XLIFT=CL*DYNP*AREA	A 134
	ACCN=(THRI/WT)*SIND(ALPH)+XLIFT/WT	A 135
	DRAG=CD*DYNP*AREA	A 136
	IF (UPD) 38,38,58	A 137
38	CALPH=COSD(ALPH)	A 138
	SALPH=SIND(ALPH)	A 139
	IF (UPD) 74,74,58	A 140
C		A 141
40	IF (JABR) 56,26,42	A 142
42	IF (ITAB) 50,20,44	A 143
44	IF (LINE-60) 48,48,46	A 144
46	PRINT 248, CODE,IPAG	A 145
	IPAG=IPAG+1	A 146
	PRINT 250	A 147
	LINE=5	A 148
48	PRINT 252, T,ALPH,V,GAM,ALT,THRI,XLIFT,DRAG,XMACH	A 149
	LINE=LINE+1	A 150
	GO TO 52	A 151
50	PRINT 254, ISLAGE,ALPH,XMACH,XISP,DYNP	A 152
	CALL OUT (4HGRAV,GRAV,3HACC,ACC,4HTHRI,THRI,2HCL,CL,4HLIFT,XLIFT)	A 153
	CALL OUT (4HDENS,DENS,4HACCN,ACCN,4HRATI,RATIO,2HCD,CD,4HDRAG,DRAG	A 154
	1)	A 155
	CALL OUT (3HVS,SOS,3HVLD,VLD,3HVLG,VLG,3HVL1,VL1,4HVCHR,VCHAR)	A 156
	PRINT 256	A 157
52	IF (JET1-1) 54,154,156	A 158
54	IF (IVOK) 56,26,170	A 159
C		A 160
C	INTEGRATION	A 161
56	IND=1	A 162
	JABR=0	A 163
C		A 164
58	DETV(J)=(GEEU/WT)*(THRI*CALPH-DRAG)-GRAV*SIND(GAM)	A 165
	IF (V) 60,60,62	A 166

60	DERIV(2)=0.0	A	167
	GO TO 64	A	168
C	ROOT	A	169
62	DERIV(2)=(GEE0/(WT*V))*(THRI*SALPH+XLIFT)+(V/(RH+ALT)-GRAV/V)*COS	A	170
	10(GAM))*RADIAN	A	171
C	ADDT	A	172
64	DERIV(3)=V*SIND(GAM)	A	173
C	ROOT	A	174
	DERIV(4)=-THRI/XISP	A	175
C	VELOCITY COMPONENTS	A	176
	DERIV(5)=(DRAG*GRAV)/WT	A	177
	DERIV(6)=GRAV*SIND(GAM)	A	178
	DERIV(7)=(GRAV*THRI/WT)*(1-CALPH)	A	179
	DERIV(8)=(THRI*GRAV)/WT	A	180
	CALL RUNKUT (I,DERIV,DELT,IND)	A	181
	IND=IND+1	A	182
	UPD=1	A	183
	IF (IND-4) 20,20,66	A	184
66	UPI=0	A	185
	PRI=PRI+DELT	A	186
	IF (ISW2) 68,68,72	A	187
68	IF (ITAB) 70,70,104	A	188
70	IF (PTSTEP-PRI) 72,72,104	A	189
72	CALL OUT (3HTIM,T,3HGAM,GAM,3HVEL,V,3HALT,ALI,2HWT,WT)	A	190
	PRI=0.000001	A	191
	JARR=1	A	192
	GO TO 104	A	193
C		A	194
C	THIS IS THE ACCELERATION FELT BY THE PILOT. IT IS THE ABSOLUTE	A	195
C	VALUE OF THE RATE OF CHANGE OF VELOCITY	A	196
C	THIS ACCELERATION IS NOT USED FOR THE INTEGRATION	A	197
74	ACC=THRI/WT*SQRT(1.0+(XLIFT**2+DRAG**2)/THRI**2+2.0/THRI*(XLIFT*SA	A	198
	1LPH-DRAG*CALPH))	A	199
	THX=THRI	A	200
	IF (ACCLIM-ACC) 76,40,40	A	201
76	IF (LIFROT) 78,78,82	A	202
78	IF (MESS) 80,80,40	A	203
80	TEMP1=ACC/ACCLIM	A	204
	PRINT 272, T,TEMP1	A	205
	GO TO 40	A	206
C		A	207
C	THROTTLE	A	208
82	IF (ISTEP) 84,84,102	A	209
84	THRT=DRAG*CALPH-XLIFT*SALPH+SQRT((ACCLIM*WT)**2-(XLIFT*CALPH+DRAG*S	A	210
	1ALPH)**2)	A	211
	RATIO=THRT/THRI	A	212
	THRI=THRT	A	213
86	IF (ISPDEG) 96,96,88	A	214
88	DO 90 I=1,N3	A	215
	IF (RATIO-RATAB(I)) 92,90,90	A	216
90	IT=I	A	217
92	II=II+1	A	218
	IF (ISTAGE-1) 94,94,98	A	219
94	XISPF=Y3(XISPF1(IT),XISPF1(IT-1),RATIO,RATAB(IT),RATAB(IT-1))	A	220
	GO TO 100	A	221
96	XISPF=1.00	A	222

GO TO 100	A 223
98 XISPF=Y3(XISPF2(IT),XISPF2(IT-1),RATIO,RATAB(IT),RATAB(IT-1))	A 224
100 YISP=XISP*XISPF	A 225
ACC=THRT/WT*SQRT(1.0+(XLIFT**2+DRAG**2)/THRT**2+2.0/THRT*(XLIFT*SA	A 226
1LPH-DRAG*CALPH))	A 227
GO TO 40	A 228
102 THVO=THX/MODULS	A 229
THRT=THRI-THRU	A 230
RATIO=THRT/THX	A 231
THRI=THRT	A 232
ACC=THRI/WT*SQRT(1.0+(XLIFT**2+DRAG**2)/THRI**2+2.0/THRI*(XLIFT*SA	A 233
1LPH-DRAG*CALPH))	A 234
IF (ACLIM-ACC) 102,86,86	A 235
C	A 236
104 IF (ISTAGE-1) 106,106,142	A 237
C FIRST STAGE MONITORING SECTION (V AND WP ARE CHECKED)	A 238
106 IF (VKICK-V) 108,108,118	A 239
108 IF (KICK) 110,110,118	A 240
110 IF (ITAB) 112,112,116	A 241
112 IF (JARR) 114,114,116	A 242
114 CALL OUT (3HTIM,T,3HGAM,GAM,3HVEL,V,3HALT,ALT,2HWT,WT)	A 243
JARR=1	A 244
116 GAM=GAMK	A 245
KICK=1	A 246
PRINT 274, GAM	A 247
118 IF (VSTAG-(V+DELT*DERIV(1)*1.1)) 122,122,120	A 248
120 IF (WP1-(WO-WI)+DERIV(4)*DELT) 122,122,124	A 249
122 DELT=DFLT2/10.0	A 250
124 IF (VSTAG-V) 128,128,126	A 251
126 IF (WP1-(WO-WI)+(DERIV(4)*0.6*DELT)) 130,20,20	A 252
128 JETI=1	A 253
GO TO 132	A 254
130 JETI=2	A 255
132 IF (ITAB) 134,134,138	A 256
134 IF (JARR) 136,136,138	A 257
136 CALL OUT (3HTIM,T,3HGAM,GAM,3HVEL,V,3HALT,ALT,2HWT,WT)	A 258
JARR=1	A 259
138 IF (KICK) 140,140,20	A 260
140 PRINT 276	A 261
VKICK=0.9*VKICK	A 262
PRINT 302	A 263
GO TO 14	A 264
C SECOND STAGE MONITORING SECTION (V AND WP)	A 265
142 IF (LAP) 144,144,150	A 266
144 IF (VM-(V+DELT*DERIV(1)*1.1)) 146,146,148	A 267
146 DELT=DELT2/10.0	A 268
LAP=1	A 269
GO TO 150	A 270
148 DELT=DELT2	A 271
150 IF (VM-V) 152,152,20	A 272
152 IMVK=1	A 273
DELT=DFLT2	A 274
LAP=0	A 275
GO TO 134	A 276
C	A 277
C CALCULATE FIRST STAGE WEIGHTS	A 278

154	PRINT 278	A 279
	UNLY=1	A 280
	GO TO 158	A 281
156	PRINT 280	A 282
	UNLY=2	A 283
158	IMAGETHR1(NTAR2)	A 284
	DEL=ELINE+2	A 285
	ISAVE=WT	A 286
	WE=SCALE*CONTIN*ENGF*IVAC	A 287
	WENP=SCALE*CONTIN*EQP	A 288
	GAS=(WO-WT)+WT*(1.0-EXP(-DELVE/(GEE0*BISPT(NTAR2))))+BUILD*TVAC+WT	A 289
	W=(1.0-EXP(-CEE*ALOG(WO/WT)))+DECAY*TVAC	A 290
	WAP=DECAY*IVAC+SCALE*CONTIN*ENN*WW+WT*(1.0-EXP(-DELVE/(GEE0*BISPT(NTAR2))))+WT*(1.0-EXP(-CEE*ALOG(WO/WT)))	A 291
	WTANK=SCALE*CONTIN*TKF*GAS+GASO	A 292
	WPN1=WT*(1.0-EXP(-DELVE/(GEE0*BISPT(NTAR2))))	A 293
	WPN2=WT*(1.0-EXP(-CEE*ALOG(WO/WT)))	A 294
160	MOD1=WTANK+WENG+WENP+BILD2*THR2	A 296
	WT=WSAVE	A 297
	WJ=WT-WJE1	A 298
	WPN1=WO-WT	A 299
	WPN2=WO-WT	A 300
	WPN3=WO-WT	A 301
	WPN4=WO-WT	A 302
	WPN5=WO-WT	A 303
	WPN6=WO-WT	A 304
	WPN7=WO-WT	A 305
	WPN8=WO-WT	A 306
162	THR2=TH2*WT	A 307
	IF (THR2-TH2) 164,166,164	A 308
164	IF (ABS(THR2-TH2)-THR2/1000.0) 166,166,160	A 309
166	LRAG=0.0	A 310
	VLIFT=0.0	A 311
	CD=0.0	A 312
	CL=0.0	A 313
	TR=T	A 314
	AL12=ALT	A 315
	VL1S=VLD	A 316
	VL1S=VLG	A 317
	VL1S=VLT	A 318
	VCHRS=VCHAP	A 319
	VROT=(ANGV*RADIAN)*RE+COSD(XLAT)*SIND(AZ)	A 320
	V2=SQRT(VROT**2+V**2+2.0*VROT*V*COSD(GAM))	A 321
	EA12=(ASIN((V/V2)*SIND(GAM)))*RADIAN	A 322
	ALPH2=ALPH	A 323
	V=V2	A 324
	JET1=0	A 325
	GAM=GAM2	A 326
	ACCN=0.0	A 327
	DYND=0.0	A 328
	RATIO=1.0	A 329
	IF (ITAB) 168,168,20	A 330
168	CALL OUT (3HTIM,T,3HGAM,GAM,3HVEL,V,3HALT,ALT,2HWT,WT)	A 331
	UNLY=1	A 332
	GO TO 20	A 333
		A 334

170 IF (INT) 172,172,180	A 335
172 IF (WT+WP2-W02) 174,180,180	A 336
174 IF (JWHY-1) 178,178,176	A 337
176 WP1=WP1*1.0002+(W02-WT-WP2)*1.25	A 338
PRINT 282, WP1	A 339
PRINT 302	A 340
GO TO 14	A 341
178 VSTAG=VSTAG*1.00	A 342
PRINT 284	A 343
PRINT 302	A 344
GO TO 14	A 345
180 IF (ABS(AL1-HM)-DELH) 182,182,188	A 346
182 IF (ABS(XMGAM-GAM)-BETA) 184,184,188	A 347
184 IF (INT) 200,200,186	A 348
186 INT=0	A 349
GO TO 172	A 350
188 INT=INT+1.0	A 351
HH(INT)=ALT	A 352
ANG(INT)=GAM	A 353
IF (INT-2.0) 190,194,196	A 354
190 PNT1=PNT	A 355
DPNT=SIGN(.05,ALT-HM)*PNT	A 356
PNT=PNT+DPNT	A 357
IF (PNT) 192,198,198	A 358
192 PNT=0.0	A 359
DPNT=PNT-PNT1	A 360
GO TO 198	A 361
194 GAMK1=GAMK	A 362
DGAMK=-SIGN(.001,GAM-XMGAM)*GAMK	A 363
GAMK=GAMK+DGAMK	A 364
PNT=PNT1	A 365
PRINT 286, GAMK,PNT	A 366
PRINT 302	A 367
GO TO 14	A 368
C	A 369
C CALCULATE PARTIAL DERIVATIVES	A 370
196 GAMK=GAMK1	A 371
ALPNT=(HH(2)-HH(1))/DPNT	A 372
ALK=(HH(3)-HH(1))/DGAMK	A 373
GMPNT=(ANG(2)-ANG(1))/DPNT	A 374
GAMK=(ANG(3)-ANG(1))/DGAMK	A 375
DETER=ALK*GMPNT-GAMK*ALPNT	A 376
DELPNT=(GAMK*(HH(1)-HM)-ALK*(ANG(1)-XMGAM))/DETER	A 377
DELGAM=(ALPNT*(ANG(1)-XMGAM)-(HH(1)-HM)*GMPNT)/DETER	A 378
PNT=PNT+DELPNT	A 379
GAMK=GAMK+DELGAM	A 380
INT=0	A 381
PRINT 288, ALPNT, ALK, GMPNT, GAMK, DETER, DELGAM, DELPNT, GAMK, PNT	A 382
PRINT 302	A 383
GO TO 14	A 384
198 T=12	A 385
DELT=DFLT2-AMOD(T,DELT2)	A 386
WT=W02	A 387
V=V2	A 388
VLI=VLDS	A 389
VLS=VLGS	A 390

VLT=VLTS	A 391
VCHAR=VCHRS	A 392
ALT=ALT2	A 393
GAM=GAM2	A 394
ALPH=ALPH2	A 395
PATIO=1.0	A 396
IVOK=0	A 397
PPIN1 290, CONST,PNT	A 398
PRIN1 302	A 399
GO TO 168	A 400
C FINAL RECALCULATION	A 401
200 IF (LAST) 202,202,210	A 402
202 LAST=1	A 403
IF (ISW3) 204,204,208	A 404
204 IF (JTAB) 210,210,206	A 405
206 JTAB=1	A 406
208 IS-2=1	A 407
PTSTEP=DELT2	A 408
PRINT 304	
GO TO 14	A 409
C	A 410
210 STAR=BILD2*THR2	A 411
PRINT 292, WENG,WEQP,WTANK,WJET,PROP1,W02,WRES1,WRES2,VROT,V2,GAM2	A 412
1,ALPH2,12,ALT2	A 413
PRINT 294	A 414
WENG=SCAL2*CNIN2*ENG2*THR2	A 415
WEQP=SCAL2*CNIN2*EQP2	A 416
GAS=(W02-WT)+WT*(1.0-EXP(-DELV2/(GFEO*XISP2)))+BILD2*THR2+WT*(1.0-	A 417
1EXP(-CFE2*ALOG(W02/WT)))+DKAY2*THR2	A 418
GASO=DKAY2*THR2+WT*(1.0-EXP(-DELV2/(GEE0*XISP2)))+WT*(1.0-EXP(-CEE	A 419
12*ALOG(W02/WT)))	A 420
WTANK=SCAL2*CNTN2*TNK2*GAS+GASO	A 421
WRES1=WT*(1.0-EXP(-DELV2/(GEE0*XISP2)))	A 422
WRES2=WT*(1.0-EXP(-CEE2*ALOG(W02/WT)))	A 423
WJET=WTANK+WENG+WEQP	A 424
PROP1=W02-WT	A 425
T2=WT-WJET	A 426
DK=DKAY2*THR2	A 427
PRINT 296, WENG,WEQP,WTANK,WJET,PROP1,WRES1,WRES2,T2,STAR,DK,VLD,V	A 428
1LG,VLT,VCHAR	A 429
PRINT 298	A 430
DPLD=I2-RPLD	A 431
IF (IPLD) 12,12,212	A 432
212 IF (ABS(DPLD)-.00001*RPLD) 12,12,214	A 433
214 IF (ABS(DPLD)-1200.) 218,218,216	A 434
216 PRINT 258	A 435
GO TO 12	A 436
218 IF (IPLD-2) 220,230,238	A 437
220 IF (ABS(DPLD)-100.) 222,222,224	A 438
222 DPLD1=DPLD	A 439
W01D=W0	A 440
IPLD=2	A 441
SP1=DPLD/ARS(DPLD)	A 442
224 IF (ABS(DPLD)-150.) 228,228,226	A 443
226 W0=W0-DWT*DPLD/50.	A 444
GO TO 14	A 445

228	FO=WO-DWT*(DPLD/ABS(DPLD))	A 446
	GO TO 14	A 447
230	SP2=OPLD/ABS(DPLD)	A 448
	IF (SP1+SP2) 232,234,232	A 449
232	IF (ABS(DPLD1)-ABS(DPLD)) 224,224,222	A 450
234	IF (ABS(DPLD)-100.) 236,236,224	A 451
236	WO=Y3(WO,WOLD,0.0,DPLD,DPLD1)	A 452
	DPLD=3	A 453
	GO TO 14	A 454
238	STOP	A 455
C	RETURN TO READ A NEW SET OF DATA	A 456
C		A 457
240	FORMAT (3E12.0)	A 458
242	FORMAT (1H0/9X,11HMACH NUMBER,9X,4HCL 0,12X,4HCL 1,12X,4HCL 2,12X, *4HCL 0,/(15,2E16.6))	
244	FORMAT (1H0,9X,8HALTITUDE,9X,6HTHRUST,12X,3HISP/(15,3E16.6))	A 461
246	FORMAT (1H0,11X,5HRATAR,11X,6HISP F1,10X,6HISP F2/(15,3E16.6))	A 462
248	FORMAT (1H1,9A6,5X,5HPAGE,/,I3)	A 463
250	FORMAT (7H0 TIME,5X,5HALPHA,3X,8HVELOCITY,4X,5HGAMMA,5X,8HALTITUDE, 1E,7X,6HTHRUST,9X,4HLIFE,10X,4HDRAG,7X,4HMACH,/))	A 464
252	FORMAT (1H,/,1,3X,F6.2,3X,F8.1,3X,F6.2,4(3),E11.4),3X,F6.2)	A 466
254	FORMAT (6H STAGE,2X,I2,13X,4HALPH,E15.5,3X,4HMACH,E15.5,3X,4HXISP, 1E15.5,3X,4HDYWP,E15.8)	A 467
256	FORMAT (1H,)	A 468
258	FORMAT (82H DIFFERENCE BETWEEN PAYLOAD CALC AND PAYLOAD DESIRED IS 1 GREATER THAN 1200. POUNDS)	A 469
260	FORMAT (9A6)	A 470
262	FORMAT (17H VERTICAL TAKEOFF,9A6)	A 471
264	FORMAT (5E12.0)	A 472
266	FORMAT (12I3)	A 473
268	FORMAT (5E15.6,5X)	A 474
270	FORMAT (8H OPTIONS,/,4H FW2,I3,3X,5HTHROT,1E,3X,3HSW3,I3,3X,3HSW2, 1I3,3X,4HSTEP,I3,3X,6HISPDEG,I3,3X,3HPLD,I3,3X,3HTAB,I3)	A 476
272	FORMAT (5H TIME,F12.2,2X,9HACC/ACIM,E20.8)	A 477
274	FORMAT (22H END VERTICAL SEGMENT,/,10H SET GAM=,F11.5)	A 479
276	FORMAT (16H VERTICAL TOC LARGE)	A 480
278	FORMAT (/,15H VSTAG REACHED,/,)	A 481
280	FORMAT (12H WPF1 REACHED,/,)	A 482
282	FORMAT (9H WPF WP1=,E15.6)	A 483
284	FORMAT (/,1X,13H IGNORE VSTAG,/,)	A 484
286	FORMAT (6H END II,5X,6H GAMK=,E15.6,10X,5H PNT=,E15.6)	A 485
288	FORMAT (7H DELPNT=,E15.6,4X,4HALK=,E15.6,4X,6HGM PNT=,E15.6,4X,4HGMK 1=,E15.6,/,7H DELFER=,E15.6,4X,7H DELGAM=,E15.6,4X,7H DELPNT=,E15.6,4X 2,5HGAMK=,E15.6,4X,4HPNT=,E15.6)	A 486
290	FORMAT (19H CUTOFF ERROR-REFLY,4X,6HCONST=,1X,E15.6,4X,4HPNT=,1X,E 115.6)	A 487
292	FORMAT (28H FIRST STAGE WEIGHTS (LBS.)/1H0,6HENGINE,9X,E15.6,3X,9 1HEQUIPMENT,6X,E15.6,3X,4HTANK,11X,E15.6,3X,8HJETTISON,7X,E15.6/1X, 215HOUSED PROPELLANT,E15.6,3X,3HWOP,12X,E15.6,3X,14HFIXED RESERVES,1 3X,E15.6,3X,13HVAR. RESERVES,2X,E15.6/1X,4HVAR,11X,E15.6,3X,15HV- 4STAGE (INERT),E15.6,3X,5HGAMMA,10X,E15.6,3X,5HALPHA,10X,E15.6/1X,1 52HSTAGING TIME,3X,E15.6,3X,8HALTITUDE,7X,E15.6/1X)	A 488
294	FORMAT (/,/94H FIRST STAGE JETTISON INCLUDES RESERVES (IF ANY), THR 1UST DECAY, AND 2ND STAGE THRUST BUILD-UP,/,/1X)	A 489
296	FORMAT (1H0/1H0/29HOUSE SECOND STAGE WEIGHTS (LBS.)/7HENGINE,9X,E15. 16,3X,9HEQUIPMENT,6X,E15.6,3X,4HTANK,11X,E15.6,3X,8HJETTISON,7X,E15.	A 490
		A 491
		A 492
		A 493
		A 494
		A 495
		A 496
		A 497
		A 498
		A 499
		A 500
		A 501

```

2.6/11H PROPELLANT.5X,E15.6,3X.14HFIXED RESERVES,1X,E15.6,3X,13HVAR A 502
3. RESERVES.2X,E15.6,3X,7HPAYLOAD,8X,E15.6/16H THRUST BUILD-UP,E15. A 503
46,3X.12HTHRUST DECAY,3X,E15.6//1X,////1X,5HVLID =,E13.6,14X.5HVLG = A 504
5,E13.6,14X.5HVLTL =,E13.6,14X,7HVCHAR =,E13.6//1X) A 505
298 FORMAT (//69H SECOND STAGE JETTISON INCLUDES RESERVES (IF ANY), AN A 506
1D THRUST DECAY, //1X) A 507
300 FORMAT (///) A 508
302 FORMAT (120H ***** A 509
1***** A 510
2) A 511
304 FORMAT(1H1) A 512-
END

```

3200 FORTRAN DIAGNOSTIC RESULTS - FOR VTO

3200 FORTRAN (2.1.0)/(RTS) / /

```

SUBROUTINE RUNKUT (T,DERIV,DELT,IND) B 1
C RUNGE-KUTTA INTEGRATION OF DIFFERENTIAL EQUATIONS IN MAIN PROGRAM B 2
DIMENSION DERIV(8), DEPVAR(8), AUX(8), SUM(8) B 3
C CORRESPONDS TO MAIN PROGRAM COMMON B 4
COMMON DEPVAR B 5
IF (IND-2) 2,6,8 B 6
2 CONST1=DELT*0.5 B 7
CONST3=0.5 B 8
CONST4=1.0 B 9
T=T+CONST1 B 10
DO 4 I=1,8 B 11
AUX(I)=DEPVAR(I) B 12
4 SUM(I)=0.0 B 13
GO TO 12 B 14
6 CONST4=2.0 B 15
GO TO 12 B 16
8 IF (IND-3) 10,10,16 B 17
10 T=T+CONST1 B 18
CONST3=1.0 B 19
12 DO 14 I=1,8 B 20
CONST2=DELT*DERIV(I) B 21
DEPVAR(I)=AUX(I)+CONST3*CONST2 B 22
14 SUM(I)=SUM(I)+CONST4*CONST2 B 23
RETURN B 24
16 DO 18 I=1,8 B 25
SUM(I)=(SUM(I)+DELT*DERIV(I))/6.0 B 26
18 DEPVAR(I)=AUX(I)+SUM(I) B 27
RETURN B 28
END B 29-

```

3200 FORTRAN DIAGNOSTIC RESULTS - FOR RUNKUT

3200 FORTRAN (2.1.0)/(RTS) / /

```

FUNCTION Y3 (Y2,Y1,X3,X2,X1) C 1
C LINEAR INTERPOLATION BETWEEN POINTS C 2
Y3=Y1+(Y1-Y2)*(X3-X1)/(X1-X2) C 3
RETURN C 4
END C 5-

```

3200 FORTRAN DIAGNOSTIC RESULTS - FOR Y3

3200 FORTRAN (2.1.0)/(RTS) / /

	SUBROUTINE OUT (I,A,I2,A2,I3,A3,I4,A4,I5,A5)	D	1
C	OUTPUT ROUTINE UP TO 5 4 LETTER NAMES AND VALUES(FLOATING POINT)	D	2
C	PER LINE	D	3
	IF (I2-4H) 4,2,4	D	4
	2 PRINT 20, I,A	D	5
	GO TO 18	D	6
	4 IF (I3-4H) 8,6,8	D	7
	6 PRINT 20, I,A,I2,A2	D	8
	GO TO 18	D	9
	8 IF (I4-4H) 12,10,12	D	10
	10 PRINT 20, I,A,I2,A2,I3,A3	D	11
	GO TO 18	D	12
	12 IF (I5-4H) 16,14,16	D	13
	14 PRINT 20, I,A,I2,A2,I3,A3,I4,A4	D	14
	GO TO 18	D	15
	16 PRINT 20, I,A,I2,A2,I3,A3,I4,A4,I5,A5	D	16
	18 RETURN	D	17
C		D	18
C		D	19
C		D	20
	20 FORMAT (1H,5(A4,3X,E12.5,3X))	D	21
	END	D	22-

3200 FORTRAN DIAGNOSTIC RESULTS - FOR OUT

3200 FORTRAN (2.1.0)/(RTS) / /

	FUNCTION AMOD (A,B)	F	1
C	SDS930 SYSTEM ROUTINE GIVES REMAINDER OF A/R	F	2
	AMOD=A-FLOAT(IFIX(A/R))*R	F	3
	RETURN	F	4
	END	F	5-

3200 FORTRAN DIAGNOSTIC RESULTS - FOR AMOD

3200 FORTRAN (2.1.0)/(RTS) / /

	SUBROUTINE ATMOSP (H,ANS)	F	1
C	VTD REVISED ATMOSP ROUTINE 1/68	F	2
C	ANS(1)=SOS, ANS(2)=GRAV, ANS(3)=DENS	F	3
	DIMENSION ANS(3)	F	4
	TMO=518.688	F	5
	G=52.173984	F	6
	ER=20855531.0	F	7
	CO=1116.4551	F	8
	ANS(2)=G*(ER/(ER+H))*2	F	9
	GPH=(ER*H)/(ER+H)	F	10
	IF (GPH-154199.0) 2,2,14	F	11
	2 IF (GPH-36089.0) 4,4,6	F	12
	4 ANS1=-3.5662H-3*GPH+518.688	F	13
	ANS(3)=2.3769E-3*((-6.8753E-6*GPH+1.0)**4.25612)	F	14
	GO TO 12	F	15
	6 IF (GPH-82021.0) 8,8,10	F	16
	* ANS1=389.988	F	17
	ANS(3)=7.0611E-4*(EXP(-4.8063E-5*GPH+1.734579))	F	18
	GO TO 12	F	19
	10 ANS1=1.6459E-3*GPH+254.988	F	20

```

ANS(3)=7.7644E-5*((4.2204E-6+GPH+0.65384)**(-12.3883))      F 21
12 ANS(1)=C0*SQR(CANS1/IM0)                                  F 22
    RETURN                                                    F 23
    HIGH ALTITUDE                                             F 24
14 IF (GPH-173880.0) 16,16,18                                F 25
16 ANS1=506.788                                              F 26
    ANS(3)=2.8803E-6*(EXP(-3.68409E-5*GPH+5.680843))        F 27
    GO TO 12                                                  F 28
18 IF (GPH-259180.0) 20,20,22                                F 29
20 ANS1=-2.4689E-3*GPH+938.088                               F 30
    ANS(3)=1.3947E-6*((-4.8525E-6*GPH+1.843769)*.6.59216)   F 31
    GO TO 12                                                  F 32
22 IF (GPH-295276.0) 26,26,24                                F 33
    HIGH HIGH ALTITUDE                                       F 34
24 CONTINUE                                                  F 35
    USE DATA FOR GPH=295276. IF GPH GREATER THAN 295276.   F 36
26 ANS1=298.188                                              F 37
    ANS(3)=4.1188E-8*(EXP(-6.28597E-5*GPH+16.292376))       F 38
    GO TO 12                                                  F 39
    END                                                        F 40-

```

3200 FORTRAN DIAGNOSTIC RESULTS - FOR ATMOSP

3200 FORTRAN (2.1.0)/(RTS) / /

```

FUNCTION SIND (X)                                           G 1
GIVES SIN(X) WHERE X IS IN DEGREES                         G 2
SIND=SIN(X/57.2957795)                                     G 3
RETURN                                                       G 4
END                                                           G 5-

```

3200 FORTRAN DIAGNOSTIC RESULTS - FOR SIND

3200 FORTRAN (2.1.0)/(RTS) / /

```

FUNCTION COSD (X)                                           H 1
GIVES COS(X) WHERE X IS IN DEGREES                         H 2
COSD=COS(X/57.2957795)                                     H 3
RETURN                                                       H 4
END                                                           H 5-

```

3200 FORTRAN DIAGNOSTIC RESULTS - FOR COSD

3200 FORTRAN (2.1.0)/(RTS) / /

```

FUNCTION TAND (X)                                           I 1
GIVES TAN(X) WHERE X IS IN DEGREES                         I 2
TAND=SIND(X)/COSD(X)                                       I 3
RETURN                                                       I 4
END                                                           I 5-

```

3200 FORTRAN DIAGNOSTIC RESULTS - FOR TAND

NO ERRORS
LOAD, 56
RUN, 10

SUBP											
60006	Q8QERROR	60264	FIXF	60333	FLOATF	60362	ABSF	60376	SQRTF	60507	SIGNF
60533	LOGF	60742	EXFF	61074	ATANF	61235	SINCOS	61546	POWRF	62116	XTOI
62342	Q1QADRI	62223	Q8QOUTTB	62524	CONTRQI	63264	FORMAT	63625	RCDOU	65363	BCDINP
66360	ACCF	66471	Y3	66555	ARSIN	66633	TAND	66701	COSD	66743	SIND
67005	ATMOSP	67421	OUT	67700	RUNKUT	70177	HTCT				

ENTR											
60264	IFIX	60264	XFIXF	60333	FLOAT	60362	XABSF	60362	IABS	60362	ABSF
60376	SQRTF	60207	XSIGNF	60507	ISIGN	60507	SIGNF	60533	ALOG10	60542	LOGF
60742	EXFF	61074	ATANF	61235	COSF	61243	SINF	61546	POWRF	60333	FLOATF
62116	XTOI	60264	FIXF	62465	Q1QSTRY	62453	Q1QSTRI	62442	Q1QSTXR	62405	Q1QSBXR
62340	Q1QADXR	62436	Q1QSBXR	62416	Q1QADRX	62413	Q1QDVIR	62410	Q1QMUIR	62360	Q1QADIR
62401	Q1QDVRI	62371	Q1QSBRI	62342	Q1QADRI	62623	Q8C1OTAB	62553	Q8QEXITS	62524	Q8QENTRY
62523	Q8QOUTTB	63210	PWRTRL	63726	Q8QLG01C	63264	Q8C1FRMT	63315	Q8QFORMT	62577	Q8Q10SET
62557	Q8QSENSE	63422	Q8QEDITS	60006	Q8QERROR	63206	PWRTBLQ	62701	Q8Q10ERR	65462	Q8QLGINC
61235	COS	61243	SIN	61546	Q1QEXRP	62375	Q1QMURI	62405	Q1QSBIR	62116	Q1QEXRI
62442	Q1QSTIR	63726	Q8QLG0TI	65462	Q8QLGINI	64376	Q8QENGOT	63733	Q8GLGOTR	63625	Q8QINGOT
66035	Q8QENGIN	65466	Q8QLGINP	62643	Q8QARRAY	65363	Q8QINGIN	60507	SIGN	60362	ABS
60542	ALOG	60742	EXF	66562	ARSIN	60376	SQRT	66367	ACCF	70005	RUNKUT
66705	COSD	66035	TAND	61074	ATAN	66747	SIND	66473	Y3	67140	ATMOSP
67431	OUT	72757	HTCT	03765	GOFLG	03767	FDPBOXS	05717	RIC	02432	EINT.
02416	QINT.	05710	BN.	01756	LOC5	01757	CIT.RTM	05770	RDCKSUM	06041	START2
05476	ACCOUNTS	07135	LOADER	05543	RDCKF1	03767	ABNORMAL	00014	CIC	05535	MEMORY
04650	MIPCF	04674	MIEKADD	04675	MIFORADD	05313	EST	05243	UST	05305	CST
05456	PRFI	05436	RHT	02011	CIT	05374	AET				

COMM	
06277	06340

DATA	
	NONE

EXTA	
	NONE

9-14

TR-793-8-1105

VTO-930

ΔREWIND MT1.

ΔFORTRAN B0, L0.

```

1 C VERTICAL TAKEOFF PROGRAM REPORT TR-293-6-110 NORTHROP
2 C 2-D FLIGHT EQUATIONS
3 C
4 DIMENSION ANS[3], XMACHT[16], CLOTAB[16], CL1TAB[16], CL2TAB[16],
5 1CDOTAB[16], ALTAB[10], THR1T[10], RATAB[11], XISPF1[11], XISPF2[11
6 2], DEPVAR[8], DERIV[8], CODE[9], BISPT[10], HH[3], ANG[3]
7 COMMON VCHAR, VLT, VLG, VLD, WT, ALT, GAM, V
8 EQUIVALENCE [ANS[1], SOS], [ANS[2], GRAV], [ANS[3], DENS]
9 CONST=0.0
10 RE=20902230.0
11 GEE0=37.174
12 ANGV=4.16666E-03
13 C
14 C HEADING
15 12 READ 260, CODE
16 PRINT 262, CODE
17 C
18 C OPTIONS
19 READ 266, ITW2, ITHROT, ISW3, ISW2, ISTEP, ISPDEG, NTAB1, NTAB2, NTAB3
20 PRINT 270, ITW2, ITHROT, ISW3, ISW2, ISTEP, ISPDEG
21 C
22 C SINGLE POINT DATA
23 READ 268, XLAT, AZ, VO, ALTO, GAMO, ALPO, W0, VKICK, GAMK, ACLIM, TW2, WW, ENN
24 1, XM0D, VSTAG, POINT, VM, HM, DELH, XMGAM, BETA, DELT, PTSTEP, ENGF, BUILD
25 READ 268, DECAY, TNKF, WP1, EQP, DELVF, CEE, SCALE, CNTIN, ENG2, BILD2, DKAY
26 12, TNK2, WP2, EQP2, DELV2, CEE2, SCAL2, CNTN2, XISP2, THR2, AREA, CKK
27 CALL OUT [4HXLAT, XLAT, 2HAZ, AZ, 2HVO, VO, 4HALTC, ALTO, 4HGAMO, GAMO]
28 CALL OUT [4HALPO, ALPO, 2HW0, W0, 4HVKCK, VKICK, 4HGAMK, GAMK, 4HALCM, ACLI
29 1M]
30 CALL OUT [3HTW2, TW2, 2HWW, WW, 3HENN, ENN, 4HXM0D, XM0D, 4HVSTG, VSTAG]
31 CALL OUT [4HP0IN, POINT, 2HV7, VM, 2HHM, HM, 4HDELH, DELH, 4HXMGM, XMGAM]
32 CALL OUT [4HBETA, BETA, 4HDELT, DELT, 4HPTSP, PTSTEP, 4HENG2, ENGF, 4HBILD
33 1, BUILD]
34 CALL OUT [4HDCAY, DECAY, 4HTNKF, TNKF, 3HWP1, WP1, 3HEQP, EQP, 4HDLVF, DELV
35 1F]
36 CALL OUT [3HCEE, CEE, 4HSCALE, SCALE, 4HCNTN, CNTIN, 4HENG2, ENG2, 4HBILD2, B
37 1ILD2]
38 CALL OUT [4HDKY2, DKAY2, 4HTNK2, TNK2, 3HWP2, WP2, 4HEQP2, EQP2, 4HDLV2, DE
39 1LV2]
40 CALL OUT [4HCEE2, CEE2, 4HSCALE2, SCAL2, 4HCNT2, CNTN2, 4HISP2, XISP2, 4HTHR
41 12, THR2]
42 CALL OUT [4HAREA, AREA, 3HCKK, CKK, 4H ,0.0, 1H ,0.0, 1H ,0.0]
43 C
44 C TABLE DATA
45 READ 264, [XMACHT[I], CLOTAB[I], CL1TAB[I], CL2TAB[I], CDOTAB[I], I=1, N
46 1TAB1]
47 READ 240, [ALTAB[I], THR1T[I], BISPT[I], I=1, NTAB2]
48 READ 240, [RATAB[I], XISPF1[I], XISPF2[I], I=1, NTAB3]
49 PRINT 242, [I, XMACHT[I], CLOTAB[I], CL1TAB[I], CL2TAB[I], CDOTAB[I], I=
50 11, NTAB1]
51 PRINT 244, [I, ALTAB[I], THR1T[I], BISPT[I], I=1, NTAB2]

```

```

52 PRINT 246, [I,RATAB[I],XISPF1[I],XISPF2[I],I=1,NTAB3]
53 PRINT 300
54 C
55 N1=NTAB1-1
56 MODULS=XMOD
57 N2=NTAB2-1
58 N3=NTAB3-1
59 DELT2=DELT
60 RADIANS=57.2957795
61 PNT=POINT
62 INT=0
63 LAST=0
64 C TURN OFF ALL FLAGS. INITIALIZE ALL VARIABLES
65 C FOR NEW TRAJECTORY
66 WGP=W0
67 14 KOUNT=0
68 KICK=0
69 KICK2=0
70 MESS=0
71 JETT=0
72 JUMP=0
73 LAP=0
74 IVDK=0
75 ISTAGE=1
76 T=0.0
77 VLD=0.0
78 VLG=0.0
79 VLT=0.0
80 VCHAR=0.0
81 GAM=GAMO
82 ALPH=ALPO
83 V=V0
84 ALT=ALTO
85 WT=W0
86 RATIC=1.0
87 PRT=0.000001
88 CALL OUT [3HTIM,T,3HGAM,GAM,3HVEL,V,3HALT,ALT,2HWT,WT]
89 18 JABR=1
90 UPD=0
91 C
92 20 CALL ATMOSP [ALT,ANS]
93 XMACH=V/S0S
94 IF [ISTAGE-1] 22,22,34
95 22 DO 24 I=1,N2
96 IF [ALT-ALTAB[I]] 26,24,24
97 24 IT=I
98 26 IT=IT+1
99 THRI=Y3[THR1T[IT],THR1T[IT-1],ALT,ALTAB[IT],ALTAB[IT-1]]
100 XISP=Y3[BISPT[IT],BISPT[IT-1],ALT,ALTAB[IT],ALTAB[IT-1]]
101 IT=I
102 DO 28 I=1,N1
103 IF [XMACH-XMACHT[I]] 30,28,28
104 28 IT=I
105 30 IT=IT+1

```

```

106      XM1=XMACHI[IT-1]
107      XM2=XMACHI[IT]
108      CD0=Y3[CDOTAB[IT],CDOTAB[IT-1],XMACH,XM2,XM1]
109      CLO=Y3[CLOTAB[IT],CLOTAB[IT-1],XMACH,XM2,XM1]
110      CL1=Y3[CL1TAB[IT],CL1TAB[IT-1],XMACH,XM2,XM1]
111      CL2=Y3[CL2TAB[IT],CL2TAB[IT-1],XMACH,XM2,XM1]
112      ALPH=0.0
113      IF [KICK] 32,32,36
114      32 GAM=90.0
115      GO TO 36
116      C
117      C      SECOND STAGE GUIDANCE CALCULUS OF VARIATIONS SOLUTION
118      34 GAMAL=ATAN[TAND[ALPH2+GAM2]-PNT*[IT-T2]]*RADIAN
119      ALPH=GAMAL-GAM
120      THRI=THR2
121      XISP=XISP2
122      GO TO 38
123      C
124      C      PREINTEGRATION
125      36 CL=CL0+CL1*ALPH+CL2*ALPH**2
126      CD=CD0+CKK*CL*TAND[ALPH]
127      DYNP=0.5*DENS*V**2
128      XLIFT=CL*DYNP*AREA
129      ACCN=[THRI/WT]*SIND[ALPH]+XLIFT/WT
130      DRAG=CD*DYNP*AREA
131      IF [UPD] 38,38,58
132      38 CALPH=COSD[ALPH]
133      SALPH=SIND[ALPH]
134      IF [UPD] 74,74,58
135      C
136      40 IF [JABR] 56,56,42
137      42 PRINT 254, ISTAGE,ALPH, XMACH, XISP, DYNP
138      CALL OUT [4HGRAV, GRAV, 3HACC, ACC, 4HTHRI, THRI, 2HCL, CL, 4HLIFT, XLIFT]
139      CALL OUT [4HDENS, DENS, 4HACCN, ACCN, 4HRATI, RATIO, 2HCD, CD, 4HDRAG, DRAG
140      1]
141      CALL OUT [3HSOS, SOS, 3HVLD, VLD, 3HVLG, VLG, 3HVLT, VLT, 4HVCHR, VCHR]
142      PRINT 256
143      52 IF [JETT-1] 54,154,156
144      54 IF [IVOK] 56,56,170
145      C
146      C      INTEGRATION
147      56 IND=1
148      JABR=0
149      C      VDOT
150      58 DERIV[1]=[GEE0/WT]*[THRI*CALPH-DRAG]-GRAV*SIND[GAM]
151      IF [V] 60,60,62
152      60 DERIV[2]=0.0
153      GO TO 64
154      C      GDOT
155      62 DERIV[2]=[GEE0/[WT*V]]*[THRI*SALPH+XLIFT]+[V/[RE+ALT]-GRAV/V]*COS
156      1D[GAM]]*RADIAN
157      C      ADOT
158      64 DERIV[3]=V*SIND[GAM]
159      C      WDOT

```



```

160     DERIV[4]=-THRI/XISP
161 C     VELOCITY COMPONENTS
162     DERIV[5]=[DRAG*GRAV]/WT
163     DERIV[6]=GRAV*SIND[GAM]
164     DERIV[7]=[GRAV*THRI/WT]*[1-CALPH]
165     DERIV[8]=[THRI*GRAV]/WT
166     CALL RUNKUT [T,DERIV,DELT,IND]
167     IND=IND+1
168     UPD=1
169     IF [IND-4] 20,20,66
170     66 UPD=0
171     PRT=PRT+DELT
172     IF [ISW2] 70,70,72
173     70 IF [PTSTEP-PRT] 72,72,104
174     72 CALL OUT [3HTIM,T,3HGAM,GAM,3HVEL,V,3HALT,ALT,2HWT,WT]
175     PRT=0.000001
176     JABR=1
177     GO TO 104
178 C
179 C     THIS IS THE ACCELERATION FELT BY THE PILOT. IT IS THE ABSOLUTE
180 C     VALUE OF THE RATE OF CHANGE OF VELOCITY
181 C     THIS ACCELERATION IS NOT USED FOR THE INTEGRATION
182     74 ACC=THRI/WT*SQRT[1.0+[XLIFT**2+DRAG**2]/THRI**2+2.0/THRI*[XLIFT*SA
183     1LPH-DRAG*CALPH]]
184     THX=THRI
185     IF [ACLIM-ACC] 76,40,40
186     76 IF [ITHROT] 78,78,82
187     78 IF [MESS] 80,80,40
188     80 TEMP1=ACC/ACLIM
189     PRINT 272, T,TEMP1
190     GO TO 40
191 C
192 C     THROTTLE
193     82 IF [ISTEP] 84,84,102
194     84 THRT=DRAG*CALPH-XLIFT*SALPH+SQRT{[ACLIM*WT]**2-[XLIFT*CALPH+DRAG*S
195     1ALPH]**2}
196     RATIO=THRT/THRI
197     THRI=THRT
198     86 IF [ISPDEG] 96,96,88
199     88 DO 90 I=1,N3
200     IF [RATIO-RATAB[I]] 92,90,90
201     90 IT=I
202     92 IJ=IT+1
203     IF [ISTAGE-1] 94,94,98
204     94 XISPF=Y3[XISPF1[IT],XISPF1[IT-1],RATIO,RATAB[IT],RATAB[IT-1]]
205     GO TO 100
206     96 XISPF=1.00
207     GO TO 100
208     98 XISPF=Y3[XISPF2[IT],XISPF2[IT-1],RATIO,RATAB[IT],RATAB[IT-1]]
209     100 XISP=XISP*XISPF
210     ACC=THRI/WT*SQRT[1.0+[XLIFT**2+DRAG**2]/THRI**2+2.0/THRI*[XLIFT*SA
211     1LPH-DRAG*CALPH]]
212     GO TO 40
213     102 THRO=THX/MODULS

```

```

214      THRT=THRI-THRO
215      RATIO=THRT/THX
216      THRI=THRT
217      ACC=THRI/WT*SQRT[1.0+[XLIFT**2+DRAG**2]/THRI**2+2.0/THRI*[XLIFT*SA
218      1LPH-DRAG*CALPH]]
219      IF [ACLIM-ACC] 102,86,86
220      C
221      104 IF [ISTAGE-1] 106,106,142
222      C      FIRST STAGE MONITORING SECTION [V AND WP ARE CHECKED ]
223      106 IF [VKICK-V] 108,108,118
224      108 IF [KICK] 110,110,118
225      110 IF [JABR] 114,114,116
226      114 CALL OUT [3HTIM,T,3HGAM,GAM,3HVEL,V,3HALT,ALT,2HWT,WT]
227      JABR=1
228      116 GAM=GAMK
229      KICK=1
230      PRINT 274, GAM
231      118 IF [VSTAG-[V+DELT*DERIV[1]*1.1]] 122,122,120
232      120 IF [WP1-[W0-WT]+DERIV[4]*DELT] 122,122,124
233      122 DELT=DELT2/10.0
234      124 IF [VSTAG-V] 128,128,126
235      126 IF [WP1-[W0-WT]+[DERIV[4]*0.6*DELT]] 130,20,20
236      128 JETT=1
237      GO TO 132
238      130 JETT=2
239      132 IF [JABR] 136,136,138
240      136 CALL OUT [3HTIM,T,3HGAM,GAM,3HVEL,V,3HALT,ALT,2HWT,WT]
241      JABR=1
242      138 IF [KICK] 140,140,20
243      140 PRINT 276
244      VKICK=0.9*VKICK
245      PRINT 302
246      GO TO 14
247      C      SECOND STAGE MONITORING SECTION [ V AND WP ]
248      142 IF [LAP] 144,144,150
249      144 IF [VM-[V+DELT*DERIV[1]*1.1]] 146,146,148
250      146 DELT=DELT2/10.0
251      LAP=1
252      GO TO 150
253      148 DELT=DELT2
254      150 IF [VM-V] 152,152,20
255      152 IVOK=1
256      DELT=DELT2
257      LAP=0
258      GO TO 132
259      C
260      C      CALCULATE FIRST STAGE WEIGHTS
261      154 PRINT 278
262      JWHY=1
263      GO TO 158
264      156 PRINT 280
265      JWHY=2
266      158 TVAC=THR1T[NTAB2]
267      LINE=LINE+2

```

```

268      WSAVE=WT
269      WENG=SCALE*CNTIN*ENGF*TVAC
270      WEQP=SCALE*CNTIN*EQP
271      GAS=[W0-WT]+WT*[1.0-EXP[-DELVF/[GEE0*BISPT[NTAB2]]]]+BUILD*TVAC*WT
272      1*[1.0-EXP[-CEE*ALOG[W0/WT]]]+DECAY*TVAC
273      GAS0=DECAY*TVAC+SCALE*CNTIN*ENN*WW+WT*[1.0-EXP[-DELVF/[GEE0*BISPT[
274      1NTAB2]]]]+WT*[1.0-EXP[-CEE*ALOG[W0/WT]]]
275      WTANK=SCALE*CNTIN*TNKF*GAS+GAS0
276      WRES1=WT*[1.0-EXP[-DELVF/[GEE0*BISPT[NTAB2]]]]
277      WRES2=WT*[1.0-EXP[-CEE*ALOG[W0/WT]]]
278      160 WJET=WTANK+WENG+WEPQ+BILD2*THR2
279      WT=WSAVE
280      W02=WT-WJET
281      PROP1=W0-WT
282      C
283      C      BEGIN SECOND STAGE
284      WT=W02
285      TH2=THR2
286      DELT=DELT2-AMOD[T,DELT2]
287      ISTAGE=2
288      IF [ITW2] 166,166,162
289      162 THR2=TW2*WT
290      IF [THR2-TH2] 164,166,164
291      164 IF [ABS[THR2-TH2]-THR2/1000.0] 166,166,160
292      166 DRAG=0.0
293      XLIFT=0.0
294      CD=0.0
295      CL=0.0
296      T2=T
297      ALT2=ALT
298      VLDS=VLD
299      VLGS=VLG
300      VLTS=VLT
301      VCHRS=VCHAR
302      VROT=[ANGV/RADIAN]*RE*COSD[XLAT]*SIND[AZ]
303      V2=SQRT[VROT**2+V**2+2.0*VROT*V*COSD[GAM]]
304      GAM2=[ASIN[(V/V2)*SIND[GAM]]]*RADIAN
305      ALPH2=ALPH
306      V=V2
307      JETT=0
308      GAM=GAM2
309      ACCN=0.0
310      DYNP=0.0
311      RATIO=1.0
312      168 CALL OUT [3HTIM,T,3HGAM,GAM,3HVEL,V,3HALT,ALT,2HWT,WT]
313      JABR=1
314      GO TO 20
315      C
316      170 IF [INT] 172,172,180
317      172 IF [WT+WP2-W02] 174,180,180
318      174 IF [JWHY-1] 178,178,176
319      176 WP1=WP1*1.0005+[W02-WT-WP2]*1.25
320      PRINT 282, WP1
321      PRINT 302

```

```

322      GO TO 14
323      178 VSTAG=VSTAG*100
324      PRINT 284
325      PRINT 302
326      GO TO 14
327      180 IF [ABS[ALT-HM]-DELH] 182,182,188
328      182 IF [ABS[XMGAM-GAM]-BETA] 184,184,188
329      184 IF [INT] 200,200,186
330      186 INT=0
331      GO TO 172
332      188 INT=INT+1.0
333      HH[INT]=ALT
334      ANG[INT]=GAM
335      IF [INT-2.0] 190,194,196
336      190 PNT1=PNT
337      DPNT=SIGN[.05,ALT-HM]*PNT
338      PNT=PNT+DPNT
339      IF [PNT] 192,198,198
340      192 PNT=0.0
341      DPNT=PNT-PNT1
342      GO TO 198
343      194 GAMK1=GAMK
344      DGMK=-SIGN[.001,GAM-XMGAM]*GAMK
345      GAMK=GAMK+DGMK
346      PNT=PNT1
347      PRINT 286, GAMK,PNT
348      PRINT 302
349      GO TO 14
350      C
351      C      CALCULATE PARTIAL DERIVATIVES
352      196 GAMK=GAMK1
353      ALPNT=[HH[2]-HH[1]]/DPNT
354      ALK=[HH[3]-HH[1]]/DGMK
355      GMPNT=[ANG[2]-ANG[1]]/DPNT
356      GMK=[ANG[3]-ANG[1]]/DGMK
357      DETER=ALK*GMPNT-GMK*ALPNT
358      DELPNT=[GMK*[HH[1]-HM]-ALK*[ANG[1]-XMGAM]]/DETER
359      DELGAM=[ALPNT*[ANG[1]-XMGAM]-[HH[1]-HM]*GMPNT]/DETER
360      PNT=PNT+DELPNT
361      GAMK=GAMK+DELGAM
362      INT=0
363      PRINT 288, ALPNT,ALK,GMPNT,GMK,DETER,DELGAM,DELPNT,GAMK,PNT
364      PRINT 302
365      GO TO 14
366      198 T=T2
367      DELT=DELT2-AMOD[T,DELT2]
368      WT=WT2
369      V=V2
370      VLD=VLDS
371      VLG=VLGS
372      VLT=VLTS
373      VCHAR=VCHRS
374      ALT=ALT2
375      GAM=GAM2

```

```

376     ALPH=ALPH2
377     RATIO=1.0
378     IVOK=0
379     PRINT 290, CONST,PNT
380     PRINT 302
381     GO TO 168
382 C    FINAL RECALCULATION
383     200 IF [LAST] 202,202,210
384     202 LAST=1
385     IF [ISW3] 210,210,208
386     208 ISW2=1
387     PTSTEP=DELT2
388     PRINT 304
389     GO TO 14
390 C
391     210 STAR=BILD2*THR2
392     PRINT 292, WENG,WEQP,WTANK,WJET,PROP1,W02,WRES1,WRES2,VROT,V2,GAM2
393     1,ALPH2,T2,ALT2
394     PRINT 294
395     WENG=SCAL2*CNTN2*ENG2*THR2
396     WEQP=SCAL2*CNTN2*EQP2
397     GAS=[W02-WT]+WT*[1.0-EXP[-DELV2/[GEE0*XISP2]]]+BILD2*THR2+W1*[1.0-
398     1EXP[-CEE2*ALOG[W02/WT]]]+DKAY2*THR2
399     GAS0=DKAY2*THR2+WT*[1.0-EXP[-DELV2/[GEE0*XISP2]]]+WT*[1.0-EXP[-CEE
400     12*ALOG[W02/WT]]]
401     WTANK=SCAL2*CNTN2*TNK2*GAS+GAS0
402     WRES1=WT*[1.0-EXP[-DELV2/[GEE0*XISP2]]]
403     WRES2=WT*[1.0-EXP[-CEE2*ALOG[W02/WT]]]
404     WJET=WTANK+WENG+WEQP
405     PROP1=W02-WT
406     T2=WT-WJET
407     DK=DKAY2*THR2
408     PRINT 296, WENG,WEQP,WTANK,WJET,PROP1,WRES1,WRES2,T2,STAR,DK,VLD,V
409     1LG,VLT,VCHAR
410     PRINT 298
411     GO TO 12
412 C    RETURN TO READ A NEW SET OF DATA
413     238 STOP
414 C
415     240 FORMAT [3E12.6]
416     242 FORMAT [1H0/9X,11HMACH NUMBER,9X,4HCL 0,12X,4HCL 1,12X,4HCL 2,12X,
417     *4HCD 0,/[15,5E16.6]]
418     244 FORMAT [1H0,9X,8HALTITUDE,9X,6HTHRUST,12X,3HISP//[15,3E16.6]]
419     246 FORMAT [1H0,11X,5HRATAB,11X,6HISP F1,10X,6HISP F2//[15,3E16.6]]
420     254 FORMAT [6H STAGE,2X,I2,13X,4HALPH,E15.5,3X,4HMACH,E15.5,3X,4HXISP,
421     1E15.5,3X,4HDYNP,E15.8]
422     256 FORMAT [1H ]
423     260 FORMAT [9A6]
424     262 FORMAT [17H VERTICAL TAKEOFF,9A6]
425     264 FORMAT [5E12.6]
426     266 FORMAT [12I3]
427     268 FORMAT [5E15.8,5X]
428     270 FORMAT [8H OPTIONS,/,4H TW2,I3,3X,5HTR0T,I3,3X,3HSW3,I3,3X,3HSW2,
429     1I3,3X,4HSTEP,I3,3X,6HISPDEG,I3]

```

```

430 272 FORMAT [5HOTIME,F12.2,2X,9HACC/ACLIM,E20.8]
431 274 FORMAT [22H END VERTICAL SEGMENT ,/,10H SET GAM=,F11.5]
432 276 FORMAT [16HOVKICK TOO LARGE]
433 278 FORMAT [/,15H VSTAG REACHED ,/]
434 280 FORMAT [12HOWP1 REACHED,/]
435 282 FORMAT [9HONW WP1=,E15.6]
436 284 FORMAT [/,1X,13HIGNORE VSTAG ,/]
437 286 FORMAT [6H ENDII,5X,6H GAMK=,E15.6,10X,5H PNT=,E15.6]
438 288 FORMAT [7HOALPNT=,E15.6,4X,4HALK=,E15.6,4X,6HGMPNT=,E15.6,4X,4HGMP
439 1=,E15.6,/,7H DETER=,E15.6,4X,7HDELGAM=,E15.6,4X,7HDELPNT=,E15.6,4X
440 2,5HGAMK=,E15.6,4X,4HPNT=,E15.6]
441 290 FORMAT [19H CUTOFF ERROR-REFLY,4X,6HCONST=,1X,E15.6,4X,4HPNI=,1X,E
442 115.6]
443 292 FORMAT [28H1FIRST STAGE WEIGHTS [LBS.]/1HO,6HENGINE,9X,E15.6,3X,9
444 1HEQUIPMENT,6X,E15.6,3X,4HTANK,11X,E15.6,3X,8HJETTISON,7X,E15.6/1X,
445 215HUSED PROPELLANT,E15.6,3X,3HWO2,12X,E15.6,3X,14HFIXED RESERVES,1
446 3X,E15.6,3X,13HVAR. RESERVES,2X,E15.6//1X,4HVRT,11X,E15.6,3X,15HV-
447 4STAGE [INERT],E15.6,3X,5HGAMMA,10X,E15.6,3X,5HALPHA,10X,E15.6/1X,1
448 52HSTAGING TIME,3X,E15.6,3X,8HALTITUDE,7X,E15.6//1X]
449 294 FORMAT [/,94H FIRST STAGE JETTISON INCLUDES RESERVES [IF ANY], THR
450 1UST DECAY, AND 2ND STAGE THRUST BUILD-UP.//1X]
451 296 FORMAT [1HO/1HO/29HOSECOND STAGE WEIGHTS [LBS.]/7HOENGINE,9X,E15.
452 16,3X,9HEQUIPMENT,6X,E15.6,3X,4HTANK,11X,E15.6,3X,8HJETTISON,7X,E15
453 2.6/11H PROPELLANT,5X,E15.6,3X,14HFIXED RESERVES,1X,E15.6,3X,13HVAR
454 3. RESERVES,2X,E15.6,3X,7HPAYLOAD,8X,E15.6/16H THRUST BUILD-UP,E15.
455 46,3X,1PHTHRUST DECAY,3X,E15.6//1X,///1X,5HVLD =,E13.6,14X,5HVLG =
456 5,E13.6,14X,5HVLT =,E13.6,14X,7HVCHAR =,E13.6//1X]
457 298 FORMAT [/,69H SECOND STAGE JETTISON INCLUDES RESERVES [IF ANY], AN
458 1D THRUST DECAY. //1X]
459 300 FORMAT [///]
460 302 FORMAT [12OH *****]
461 1*****
462 2]
463 304 FORMAT[1H1]
464 END

```

COMMON ALLOCATION

```

77776 VCHAR      77774 VLT      77772 VLG      77770 VLD
77766 WT        77764 ALT      77762 GAM      77760 V

```

PROGRAM ALLOCATION

```

00041 ANS      00041 SOS      00043 GRAV      00045 DENS
00047 XMACHT   00107 CLOTAB   00147 CL1TAB    00207 CL2TAB
00247 CDOTAB   00307 ALTAB     00333 THR1T     00357 RATAB
00405 XISPF1   00433 XISPF2     00461 DEPVAR    00501 DERIV
00521 CODE     00543 BISPT     00567 HH        00575 ANG
00603 ITW2     00604 ITHROT     00605 ISW3      00606 ISW2
00607 ISTEP    00610 ISPDEG    00611 NTAB1     00612 NTAB2
00613 NTAB3    00614 I          00615 N1        00616 MODULS
00617 N2       00620 N3        00621 INT        00622 LAST

```

00623	KOUNT	00624	KICK	00625	KICK2	00626	MESS
00627	JETT	00630	JUMP	00631	LAP	00632	IVOK
00633	ISTAGE	00634	JABR	00635	IT	00636	IND
00637	JWHY	00640	LINE	00641	CONST	00643	RE
00645	GEE0	00647	ANGV	00651	XLAT	00653	AZ
00655	VO	00657	ALTO	00661	GAM0	00663	ALPC
00665	W0	00667	VKICK	00671	GAMK	00673	ACLIM
00675	TW2	00677	WW	00701	ENN	00703	XMOD
00705	VSTAG	00707	POINT	00711	VM	00713	HM
00715	DELH	00717	XMGAM	00721	BETA	00723	DELT
00725	PTSTEP	00727	ENGF	00731	BUILD	00733	DECAY
00735	TNKF	00737	WP1	00741	EQP	00743	DELVF
00745	CEE	00747	SCALE	00751	CNTIN	00753	ENG2
00755	BILD2	00757	DKAY2	00761	TNK2	00763	WP2
00765	EQP2	00767	DELV2	00771	CEE2	00773	SCAL2
00775	CNTN2	00777	XISP2	01001	THR2	01003	AREA
01005	CKK	01007	DELT2	01011	RADIAN	01013	PNT
01015	WOP	01017	T	01021	ALPH	01023	RATIO
01025	PRT	01027	UPD	01031	XMACH	01033	THRI
01035	XISP	01037	XM1	01041	XM2	01043	CDC
01045	CLO	01047	CL1	01051	CL2	01053	GAMAL
01055	ALPH2	01057	GAM2	01061	T2	01063	CL
01065	CD	01067	DYNP	01071	XLIFT	01073	ACCN
01075	DRAG	01077	CALPH	01101	SALPH	01103	ACC
01105	THX	01107	TEMP1	01111	THRT	01113	XISPF
01115	THR0	01117	TVAC	01121	WSAVE	01123	WENG
01125	WEQP	01127	GAS	01131	GAS0	01133	WTANK
01135	WRES1	01137	WRES2	01141	WJET	01143	W02
01145	PROP1	01147	TH2	01151	ALT2	01153	VLDS
01155	VLGS	01157	VLTS	01161	VCHRS	01163	VR0T
01165	V2	01167	PNT1	01171	DPNT	01173	GAMK1
01175	DGMK	01177	ALPNT	01201	ALK	01203	GMPNT
01205	GMK	01207	DETER	01211	DELPNT	01213	DELGAM
01215	STAR	01217	DK				

SUBPROGRAMS REQUIRED

OUT	ATMOSP	Y3	ATAN	TAND	SIND
COSD	RUNKUT	SQRT	EXP	ALOG	AMOD
ABS	ASIN	SIGN			
THE END					

```

1  SUBROUTINE RUNKUT (T,DERIV,DELT,IND)
2  C  RUNGE-KUTTA INTEGRATION OF DIFFERENTIAL EQUATIONS IN MAIN PROGRAM
3  DIMENSION DERIV(8), DEPVAR(8), AUX(8), SUM(8)
4  C  CORRESPONDS TO MAIN PROGRAM COMMON
5  COMMON DEPVAR
6  IF (IND-2) 2,6,8
7      2  CONST1=DELT*0.5
8  CONST3=0.5
9  CONST4=1.0
10 T=T+CONST1
11 DO 4 I=1,8
12  AUX[I]=DEPVAR[I]
13      4  SUM[I]=0.0
14  GO TO 12
15      6  CONST4=2.0
16  GO TO 12
17      8  IF (IND-3) 10,10,16
18      10 T=T+CONST1
19  CONST3=1.0
20      12 DO 14 I=1,8
21  CONST2=DELT*DERIV[I]
22  DEPVAR[I]=AUX[I]+CONST3*CONST2
23      14 SUM[I]=SUM[I]+CONST4*CONST2
24  RETURN
25      16 DO 18 I=1,8
26  SUM[I]=(SUM[I]+DELT*DERIV[I])/6.0
27      18 DEPVAR[I]=AUX[I]+SUM[I]
28  RETURN
29  END

```

COMMON ALLOCATION

77760 DEPVAR

PROGRAM ALLOCATION

DUMMY DERIV	00010 AUX	00030 SUM	DUMMY IND
00050 I	00051 RUNKUT	00053 CONST1	DUMMY DELT
00055 CONST3	00057 CONST4	DUMMY T	00061 CONST2

THE END

```

1      FUNCTION Y3 (Y2,Y1,X3,X2,X1)
2      C      LINEAR INTERPOLATION BETWEEN POINTS
3      Y3=Y1+[Y1-Y2]*[X3-X1]/[X1-X2]
4      RETURN
5      END

```

PROGRAM ALLOCATION

```

00016 Y3      DUMMY Y1      DUMMY Y2      DUMMY X3
DUMMY X1      DUMMY X2
THE END

```

```

1      SUBROUTINE OUT (I,A,I2,A2,I3,A3,I4,A4,I5,A5)
2      C      OUTPUT ROUTINE UP TO 5 4 LETTER NAMES AND VALUES[FLOATING POINT]
3      C      PER LINE
4      IF (I2-4H ) 4,2,4
5      2 PRINT 20, I,A
6      GO TO 18
7      4 IF (I3-4H ) 8,6,8
8      6 PRINT 20, I,A,I2,A2
9      GO TO 18
10     8 IF (I4-4H ) 12,10,12
11     10 PRINT 20, I,A,I2,A2,I3,A3
12     GO TO 18
13     12 IF (I5-4H ) 16,14,16
14     14 PRINT 20, I,A,I2,A2,I3,A3,I4,A4
15     GO TO 18
16     16 PRINT 20, I,A,I2,A2,I3,A3,I4,A4,I5,A5
17     18 RETURN
18     C
19     C
20     C
21     20 FORMAT (1H ,5(A4,3X,E12.5,3X))
22     END

```

PROGRAM ALLOCATION

```

DUMMY I2      DUMMY I      DUMMY I3      DUMMY I4
DUMMY I5      00024 OUT    DUMMY A      DUMMY A2
DUMMY A3      DUMMY A4      DUMMY A5
THE END

```

```

1      SUBROUTINE ATMOSP (H,ANS)
2  C    VTO      REVISED ATMOSP ROUTINE      1/68
3  C    ANS[1]=SOS,  ANS[2]=GRAV,  ANS[3]=DENS
4      DIMENSION ANS[3]
5      TMO=518.688
6      G=32.173984
7      ER=20855531.0
8      CO=1116.4551
9      ANS[2]=G*[ER/[ER+H]]**2
10     GPH=[ER*H]/[ER+H]
11     IF [GPH-154199.0] 2,2,14
12     2 IF [GPH-36089.0] 4,4,6
13     4 ANS1=-3.5662E-3*GPH+518.688
14     ANS[3]=2.3769E-3*[[-6.8753E-6*GPH+1.0]**4.25612]
15     GO TO 12
16     6 IF [GPH-82021.0] 8,8,10
17     8 ANS1=389.988
18     ANS[3]=7.0611E-4*[EXP[-4.8063E-5*GPH+1.734579]]
19     GO TO 12
20     10 ANS1=1.6459E-3*GPH+254.988
21     ANS[3]=7.7644E-5*[[4.2204E-6*GPH+0.65384]**[-12.3883]]
22     12 ANS[1]=CO*SQRT[ANS1/TMO]
23     RETURN
24  C    HIGH ALTITUDE
25     14 IF [GPH-173885.0] 16,16,18
26     16 ANS1=508.788
27     ANS[3]=2.8803E-6*[EXP[-3.68409E-5*GPH+5.680843]]
28     GO TO 12
29     18 IF [GPH-259186.0] 20,20,22
30     20 ANS1=-2.4689E-3*GPH+938.088
31     ANS[3]=1.3947E-6*[[-4.8525E-6*GPH+1.843769]**6.59216]
32     GO TO 12
33     22 IF [GPH-295276.0] 26,26,24
34  C    HIGH HIGH ALTITUDE
35     24 CONTINUE
36  C    USE DATA FOR GPH=295276. IF GPH GREATER THAN 295276.
37     26 ANS1=298.188
38     ANS[3]=4.1188E-8*[EXP[-6.28597E-5*GPH+16.292376]]
39     GO TO 12
40     END

```

PROGRAM ALLOCATION

DUMMY ANS	00012 ATMOSP	00014 TMO	00016 G
00020 ER	00022 CO	DUMMY H	00024 GPH
00026 ANS1			

SUBPROGRAMS REQUIRED

EXP SQRT
THE END

```

1      FUNCTION SIND (X)
2  C   GIVES SIN[X] WHERE X IS IN DEGREES
3      SIND=SIN[X/57.2957795]
4      RETURN
5      END

```

PROGRAM ALLOCATION

00005 SIND DUMMY X

SUBPROGRAMS REQUIRED

SIN
THE END

```

1      FUNCTION COSD (X)
2  C   GIVES COS[X] WHERE X IS IN DEGREES
3      COSD=COS[X/57.2957795]
4      RETURN
5      END

```

PROGRAM ALLOCATION

00005 COSD DUMMY X

SUBPROGRAMS REQUIRED

COS
THE END

```

1      FUNCTION TAND (X)
2  C   GIVES TAN[X] WHERE X IS IN DEGREES
3      TAND=SIND[X]/COSD[X]
4      RETURN
5      END

```

PROGRAM ALLOCATION

00006 TAND DUMMY X

SUBPROGRAMS REQUIRED

SIND COSD
THE END

SECTION X

VTO SAMPLE RUN - 3200

VERTICAL TAKEOFF VEHICLE TEST CASE

OPTIONS

TW2	THRST	SW3	SW2	STEP	ISPDEG	PLD	TAB			
XLAT	2.85070E-01	A7	9.00000E-01	V0	0	0	ALTO	0	GAM0	9.00000E-01
ALP0	0	W0	2.40000E-05	VKCK	2.00000E-02	0	GAMK	8.86514E-01	ALCM	3.80000E-00
TW2	1.00000E-00	W0	4.02100E-04	ENN	1.16540E-00	0	XMOD	0	VSTG	5.75000E-03
POIN	7.79354E-04	V7	2.57600E-04	HM	3.03406E-05	0	DELW	1.00000E-03	XMGM	0
BETA	1.00000E-01	DFLT	1.00000E-00	PTSP	6.00000E-02	0	ENGF	1.13294E-02	BILD	7.72254E-03
DCAY	2.58950E-03	TNKF	3.61200E-02	WR1	1.72250E-06	0	EOP	1.58080E-05	DLVF	0
CEE	0	SCLF	1.00000E-00	CNTN	1.00000E-00	0	ENG2	1.69023E-02	BLD2	7.34610E-04
DKY2	1.83650E-04	TNK2	3.25745E-02	WR2	5.00000E-05	0	EOP2	4.31680E-04	DLV2	6.00000E-02
CEE2	0	SCL2	1.00000E-00	CNT2	1.00000E-00	0	ISP2	4.55000E-02	THR2	3.84000E-05
AREA	5.11400E-03	CHK	1.05900E-03							

	BACK NUMBER	CL 0	CL 1	CL 2	CD 0
1	0	0	1.00000E-02	-7.40000E-04	4.32000E-02
2	2.50000E-01	0	4.00000E-02	-7.40000E-04	4.32000E-02
3	5.00000E-01	0	4.60000E-02	-7.40000E-04	4.32000E-02
4	7.50000E-01	0	4.90000E-02	-7.20000E-04	4.36000E-02
5	1.00000E-00	0	5.10000E-02	-7.00000E-04	4.67800E-02
6	1.25000E-00	0	5.10000E-02	0	7.90000E-02
7	1.50000E-00	0	4.65000E-02	4.00000E-05	7.10000E-02
8	1.75000E-00	0	4.20000E-02	9.00000E-05	6.35000E-02
9	2.00000E-00	0	3.75000E-02	1.20000E-04	5.75000E-02
10	2.50000E-00	0	3.10000E-02	1.50000E-04	4.86000E-02
11	3.00000E-00	0	2.75000E-02	1.60000E-04	4.50000E-02
12	4.00000E-00	0	2.15000E-02	1.50000E-04	3.65000E-02
13	5.00000E-00	0	1.85000E-02	1.20000E-04	3.30000E-02
14	6.00000E-00	0	1.70000E-02	7.00000E-05	3.10000E-02
15	8.00000E-00	0	1.50000E-02	-7.00000E-05	2.95000E-02
16	1.00000E-01	0	1.30000E-02	-7.50000E-04	2.65000E-02

	ALTITUDE	THRUST	ISP
1	0	3.00000E-06	2.63580E-02
2	1.00000E-04	3.14400E-05	2.76230E-02
3	2.00000E-04	3.22800E-05	2.83610E-02
4	3.00000E-04	3.30400E-05	2.90280E-02
5	4.00000E-04	3.36000E-05	2.95200E-02
6	6.00000E-04	3.41200E-05	2.99770E-02
7	8.00000E-04	3.43200E-05	3.01530E-02
8	1.10000E-03	3.44800E-05	3.02940E-02
9	1.50000E-03	3.46000E-05	3.03990E-02
10	1.80000E-03	3.47300E-05	3.03990E-02

	GATAY	ISP F1	ISP F2
1	0	0	0
2	1.00000E-01	9.97300E-01	9.87800E-01
3	2.00000E-01	9.91400E-01	9.91400E-01
4	3.00000E-01	9.93800E-01	9.93800E-01
5	4.00000E-01	9.95400E-01	9.95400E-01
6	5.00000E-01	9.96600E-01	9.96600E-01
7	6.00000E-01	9.97500E-01	9.97500E-01
8	7.00000E-01	9.98300E-01	9.98300E-01
9	8.00000E-01	9.98900E-01	9.98900E-01
10	9.00000E-01	9.99500E-01	9.99500E-01
11	1.00000E-00	1.00000E-00	1.00000E-00

TIM	GAM	VEL	ALT	WT
0	9.00000E-01	0	0	2.40000E-06
STAGE 1	ALPH	MACH	XISP	DYNP
GRAV	3.21750E-01	ACC	1.25000E-00	THR1
DENS	2.37500E-03	ACCN	0	RAT1
SOS	1.11650E-03	VLD	0	VLG

TIM	GAM	VEL	ALT	WT
2.00000E-01	9.00000E-01	2.03200E-02	1.88389E-03	2.17237E-06

END VERTICAL SEGMENT

SET GAM	RE	52137
STAGE 1	ALPH	MACH
GRAV	3.21600E-01	ACC
DENS	2.22800E-03	ACCN
SOS	1.10920E-03	VLD

TIM	GAM	VEL	ALT	WT
1.34500E-02	2.65816E-01	5.75047E-03	1.49630E-05	8.69235E-05
STAGE 1	ALPH	MACH	XISP	DYNP
GRAV	3.17170E-01	ACC	3.80000E-00	THR1
DENS	3.61765E-06	ACCN	0	RAT1
SOS	1.09562E-03	VLD	2.54404E-02	VLG

VSTAG REACHED

TIM	1.34500E 02	GAM	2.64466E 01	VEL	5.75353E 03	ALT	1.49325E 05	WT	8.69235E 05
STAGE	1	ALPH	0	MACH	5.25400E 00	XISP	3.03972E 02	DYNP	6.06184494E 01
GRAV	3.17182E 01	ACC	3.80000E 00	THRI	3.31311E 06	CL	0	LIFT	0
DENS	3.66240E-06	ACCN	0	RATI	9.57601E-01	CD	3.24920E-02	DRAG	1.00116E 04
SOS	1.09508E 03	VLD	2.54917E 02	VLG	3.48280E 03	VLT	0	VCHR	9.43804E 03

VSTAG RFACHFD

TIM	1.34500E 02	GAM	2.15538E 01	VFL	8.97500E 03	ALT	1.49325E 05	WT	5.59144E 05
STAGE	2	ALPH	0	MACH	6.36941E 00	XISP	4.55000E 02	DYNP	0
GRAV	3.17182E 01	ACC	1.00000E 00	THRI	5.59144E 05	CL	0	LIFT	0
DENS	3.13751E-09	ACCN	0	RATI	1.00000E 00	CD	0	DRAG	0
SOS	1.09508E 03	VLD	2.54917E 02	VLG	3.48280E 03	VLT	0	VCHR	9.43804E 03

TIM	4.72500E 02	GAM	7.12489E-03	VFL	2.57698E 04	ALT	3.04531E 05	WT	1.43784E 05
STAGE	2	ALPH	7.39952E 00	MACH	3.04473E 01	XISP	4.55000E 02	DYNP	0
GRAV	3.12546E 01	ACC	3.80000E 00	THRI	5.46381E 05	CL	0	LIFT	0
DENS	3.13751E-09	ACCN	0	RATI	9.77174E-01	CD	0	DRAG	0
SOS	6.46512E 02	VLD	2.54917E 02	VLG	4.17330E 03	VLT	3.83701E 02	VCHR	2.87286E 04

TIM	0	GAM	9.00000E 01	VFL	0	ALT	0	WT	2.40000E 06
STAGE	1	ALPH	0	MACH	0	XISP	2.63580E 02	DYNP	0
GRAV	3.21740E 01	ACC	1.25000E 00	THRI	3.00000E 06	CL	0	LIFT	0
DENS	2.37690E-03	ACCN	0	RATI	1.00000E 00	CD	4.32000E-02	DRAG	0
SOS	1.11646E 03	VLD	0	VLG	0	VLT	0	VCHR	0

TIM	1.00000E 00	GAM	9.00000E 01	VEL	8.13937E 00	ALT	4.05367E 00	WT	2.38862E 06
STAGE	-1	ALPH	0	MACH	7.29047E-03	XISP	2.63585E 02	DYNP	7.87247041E-02
GRAV	3.21740E 01	ACC	1.25597E 00	THRI	3.00006E 06	CL	0	LIFT	0
DENS	2.37662E-03	ACCN	0	RATI	1.00000E 00	CD	4.32000E-02	DRAG	1.72868E 01
SOS	1.11644E 03	VLD	7.70731E-05	VLG	3.21740E 01	VLT	0	VCHR	4.03134E 01

TIM	2.00000E 00	GAM	9.00000E 01	VEL	1.64724E 01	ALT	1.63433E 01	WT	2.37724E 06
STAGE	1	ALPH	0	MACH	1.47551E-02	XISP	2.63601E 02	DYNP	3.22320940E-01
GRAV	3.21739E 01	ACC	1.26204E 00	THRI	3.00024E 06	CL	0	LIFT	0
DENS	2.37576E-03	ACCN	0	RATI	1.00000E 00	CD	4.32000E-02	DRAG	7.07770E 01
SOS	1.11639E 03	VLD	6.29755E-04	VLG	6.43479E 01	VLT	0	VCHR	8.08209E 01

TIM	3.00000E 00	GAM	9.00000E 01	VEL	2.50022E 01	ALT	3.70641E 01	WT	2.36585E 06
STAGE	1	ALPH	0	MACH	2.23971E-02	XISP	2.63627E 02	DYNP	7.42105483E-01
GRAV	3.21739E 01	ACC	1.26820E 00	THRI	3.00053E 06	CL	0	LIFT	0
DENS	2.37432E-03	ACCN	0	RATI	1.00001E 00	CD	4.32000E-02	DRAG	1.62956E 02
SOS	1.11631E 03	VLD	2.17058E-03	VLG	9.65218E 01	VLT	0	VCHR	1.21526E 02

TIM	4.00000E 00	GAM	9.00000E 01	VEL	3.37317E 01	ALT	6.64142E 01	WT	2.35447E 06
STAGE	1	ALPH	0	MACH	3.02201E-02	XISP	2.63664E 02	DYNP	1.34952352E 00
GRAV	3.21738E 01	ACC	1.27445E 00	THRI	3.00096E 06	CL	0	LIFT	0
DENS	2.37228E-03	ACCN	0	RATI	1.00000E 00	CD	4.32000E-02	DRAG	2.96358E 02
SOS	1.11620E 03	VLD	5.25372E-03	VLG	1.28696E 02	VLT	0	VCHR	1.62432E 02

TIM	5.00000E 00	GAM	9.00000E 01	VEL	4.26640E 01	ALT	1.04595E 02	WT	2.34309E 06
STAGE	1	ALPH	0	MACH	3.82276E-02	XISP	2.63712E 02	DYNP	2.15662612E 00
GRAV	3.21737E 01	ACC	1.28080E 00	THRI	3.00151E 06	CL	0	LIFT	0
DENS	2.36963E-03	ACCN	0	RATI	1.00000E 00	CD	4.32000E-02	DRAG	4.73564E 02
SOS	1.11605E 03	VLD	1.04764E-02	VLG	1.60849E 02	VLT	0	VCHR	2.03543E 02

TIM	6.00000E 00	GAM	9.00000E 01	VEL	5.18024E 01	ALT	1.51811E 02	WT	2.33171E 06
STAGE	1	ALPH	0	MACH	4.64202E-02	XISP	2.63772E 02	DYNP	3.17504517E 00
GRAV	3.21735E 01	ACC	1.28725E 00	THRI	3.00219E 06	CL	0	LIFT	0
DENS	2.36636E-03	ACCN	0	RATI	1.00000E 00	CD	4.32000E-02	DRAG	6.97194E 02
SOS	1.11587E 03	VLD	1.84805E-02	VLG	1.93043E 02	VLT	0	VCHR	2.44863E 02

TIM	7.00000E 00	GAM	9.00000E 01	VEL	6.11499E 01	ALT	2.08270E 02	WT	2.32033E 06
STAGE	1	ALPH	0	MACH	5.46108E-02	XISP	2.63843E 02	DYNP	4.41696560E 00
GRAV	3.21733E 01	ACC	1.29380E 00	THRI	3.00300E 06	CL	0	LIFT	0
DENS	2.36245E-03	ACCN	0	RATI	1.00000E 00	CD	4.32000E-02	DRAG	9.69902E 02
SOS	1.11566E 03	VLD	2.99536E-02	VLG	2.25216E 02	VLT	0	VCHR	2.86394E 02

TIM	8.00000E 00	GAM	9.00000E 01	VEL	7.07099E 01	ALT	2.74182E 02	WT	2.30895E 06
STAGE	1	ALPH	0	MACH	6.33941E-02	XISP	2.63927E 02	DYNP	5.89459497E 00
GRAV	3.21731E 01	ACC	1.30044E 00	THRI	3.00355E 06	CL	0	LIFT	0
DENS	2.35789E-03	ACCN	0	RATI	1.00000E 00	CD	4.32000E-02	DRAG	1.29437E 03
SOS	1.11540E 03	VLD	4.56305E-02	VLG	2.57390E 02	VLT	0	VCHR	3.28142E 02

TIM	9.00000E 00	GAM	9.00000E 01	VEL	8.04057E 01	ALT	3.49761E 02	WT	2.29756E 06
STAGE	1	ALPH	0	MACH	7.21772E-02	XISP	2.64022E 02	DYNP	7.62023009E 00
GRAV	3.21729E 01	ACC	1.30719E 00	THRI	3.00504E 06	CL	0	LIFT	0
DENS	2.35247E-03	ACCN	0	RATI	1.00000E 00	CD	4.32000E-02	DRAG	1.67329E 03
SOS	1.11511E 03	VLD	6.62946E-02	VLG	2.89583E 02	VLT	0	VCHR	3.70110E 02

TIM	1.00000E 01	GAM	9.00000E 01	VEL	9.04806E 01	ALT	4.35226E 02	WT	2.28618E 06
-----	-------------	-----	-------------	-----	-------------	-----	-------------	----	-------------

STAGE	1	ALPH	0	MACH	8.11643E-02	XISP	2.64331E-02	DYNP	9.60622079E-00
GRAV	3.21726E-01	ACC	1.31405E-01	THRI	3.00627E-06	CL	0	LIFT	0
DENS	2.34678E-03	ACCN	0	RATI	1.00000E-00	CD	4.32000E-02	DRAG	2.10939E-03
SOS	1.11478E-03	VLD	9.27789E-02	VLG	3.21735E-02	VLT	0	VCHR	4.12303E-02
TIM	1.10000E-01	GAM	9.00000E-01	VFL	1.00698E-02	ALT	5.30797E-02	WT	2.27480E-06
STAGE	1	ALPH	0	MACH	9.03595E-02	XISP	2.64251E-02	DYNP	1.18649307E-01
GRAV	3.21723E-01	ACC	1.32101E-00	THRI	3.00764E-06	CL	0	LIFT	0
DENS	2.34020E-03	ACCN	0	RATI	1.00000E-00	CD	4.32000E-02	DRAG	2.60537E-03
SOS	1.11442E-03	VLD	1.25967E-01	VLG	3.53908E-02	VLT	0	VCHR	4.54724E-02
TIM	1.20000E-01	GAM	9.00000E-01	VEL	1.11142E-02	ALT	6.36697E-02	WT	2.26342E-06
STAGE	1	ALPH	0	MACH	9.97672E-02	XISP	2.64385E-02	DYNP	1.44086951E-01
GRAV	3.21720E-01	ACC	1.32808E-00	THRI	3.00917E-06	CL	0	LIFT	0
DENS	2.33293E-03	ACCN	0	RATI	1.00000E-00	CD	4.32000E-02	DRAG	3.16394E-03
SOS	1.11401E-03	VLD	1.67795E-01	VLG	3.86080E-02	VLT	0	VCHR	4.97378E-02
TIM	1.30000E-01	GAM	9.00000E-01	VEL	1.21815E-02	ALT	7.53156E-02	WT	2.25204E-06
STAGE	1	ALPH	0	MACH	1.09392E-01	XISP	2.64533E-02	DYNP	1.72497752E-01
GRAV	3.21717E-01	ACC	1.33525E-00	THRI	3.01085E-06	CL	0	LIFT	0
DENS	2.32496E-03	ACCN	0	RATI	1.00000E-00	CD	4.32000E-02	DRAG	3.78780E-03
SOS	1.11356E-03	VLD	2.16249E-01	VLG	4.18225E-02	VLT	0	VCHR	5.40270E-02
TIM	1.40000E-01	GAM	9.00000E-01	VEL	1.32721E-02	ALT	8.80404E-02	WT	2.24066E-06
STAGE	1	ALPH	0	MACH	1.19238E-01	XISP	2.64694E-02	DYNP	2.04003099E-01
GRAV	3.21713E-01	ACC	1.34255E-00	THRI	3.01268E-06	CL	0	LIFT	0
DENS	2.31627E-03	ACCN	0	RATI	1.00000E-00	CD	4.32000E-02	DRAG	4.47961E-03
SOS	1.11307E-03	VLD	2.75373E-01	VLG	4.50433E-02	VLT	0	VCHR	5.83403E-02
TIM	1.50000E-01	GAM	9.00000E-01	VEL	1.43864E-02	ALT	1.01868E-03	WT	2.22927E-06
STAGE	1	ALPH	0	MACH	1.29311E-01	XISP	2.64869E-02	DYNP	2.38722641E-01
GRAV	3.21708E-01	ACC	1.34996E-00	THRI	3.01467E-06	CL	0	LIFT	0
DENS	2.30655E-03	ACCN	0	RATI	1.00000E-00	CD	4.32000E-02	DRAG	5.24201E-03
SOS	1.11254E-03	VLD	3.45260E-01	VLG	4.82244E-02	VLT	0	VCHR	6.26783E-02
TIM	1.60000E-01	GAM	9.00000E-01	VEL	1.55247E-02	ALT	1.16821E-03	WT	2.21789E-06
STAGE	1	ALPH	0	MACH	1.39616E-01	XISP	2.65058E-02	DYNP	2.76773736E-01
GRAV	3.21704E-01	ACC	1.35748E-00	THRI	3.01682E-06	CL	0	LIFT	0
DENS	2.29671E-03	ACCN	0	RATI	1.00000E-00	CD	4.32000E-02	DRAG	6.07755E-03
SOS	1.11196E-03	VLD	4.27061E-01	VLG	5.14765E-02	VLT	0	VCHR	6.70415E-02
TIM	1.70000E-01	GAM	9.00000E-01	VEL	1.66876E-02	ALT	1.32925E-03	WT	2.20651E-06
STAGE	1	ALPH	0	MACH	1.50157E-01	XISP	2.65262E-02	DYNP	3.18270871E-01
GRAV	3.21699E-01	ACC	1.36512E-00	THRI	3.01914E-06	CL	0	LIFT	0
DENS	2.28582E-03	ACCN	0	RATI	1.00000E-00	CD	4.32000E-02	DRAG	6.98877E-03
SOS	1.11134E-03	VLD	5.21979E-01	VLG	5.46935E-02	VLT	0	VCHR	7.14302E-02
TIM	1.80000E-01	GAM	9.00000E-01	VEL	1.78752E-02	ALT	1.50205E-03	WT	2.19513E-06
STAGE	1	ALPH	0	MACH	1.60940E-01	XISP	2.65480E-02	DYNP	3.63325051E-01
GRAV	3.21694E-01	ACC	1.37288E-00	THRI	3.02163E-06	CL	0	LIFT	0
DENS	2.27418E-03	ACCN	0	RATI	1.00000E-00	CD	4.32000E-02	DRAG	7.97809E-03
SOS	1.11068E-03	VLD	6.31275E-01	VLG	5.79105E-02	VLT	0	VCHR	7.58452E-02
TIM	1.90000E-01	GAM	9.00000E-01	VEL	1.90880E-02	ALT	1.68684E-03	WT	2.18375E-06
STAGE	1	ALPH	0	MACH	1.71970E-01	XISP	2.65714E-02	DYNP	4.12043151E-01
GRAV	3.21688E-01	ACC	1.38077E-00	THRI	3.02429E-06	CL	0	LIFT	0
DENS	2.26178E-03	ACCN	0	RATI	1.00000E-00	CD	4.32000E-02	DRAG	9.04787E-03
SOS	1.10906E-03	VLD	7.56262E-01	VLG	6.11274E-02	VLT	0	VCHR	8.02867E-02
TIM	2.00000E-01	GAM	9.00000E-01	VEL	2.03265E-02	ALT	1.88389E-03	WT	2.17237E-06
END VERTICAL SEGMENT									
SET GAM=, 88, 64715									
STAGE	1	ALPH	0	MACH	1.83254E-01	XISP	2.65963E-02	DYNP	4.64527247E-01
GRAV	3.21682E-01	ACC	1.38878E-00	THRI	3.02713E-06	CL	0	LIFT	0
DENS	2.24862E-03	ACCN	0	RATI	1.00000E-00	CD	4.32000E-02	DRAG	1.02003E-04
SOS	1.10920E-03	VLD	8.98309E-01	VLG	6.43442E-02	VLT	0	VCHR	8.47555E-02
TIM	2.10000E-01	GAM	8.84227E-01	VEL	2.15921E-02	ALT	2.09339E-03	WT	2.16098E-06
STAGE	1	ALPH	0	MACH	1.94815E-01	XISP	2.66228E-02	DYNP	5.20925540E-01
GRAV	3.21675E-01	ACC	1.39691E-00	THRI	3.03014E-06	CL	0	LIFT	0
DENS	2.23469E-03	ACCN	0	RATI	1.00000E-00	CD	4.32000E-02	DRAG	1.14388E-04
SOS	1.10839E-03	VLD	1.05884E-00	VLG	6.75600E-02	VLT	0	VCHR	8.92520E-02
TIM	2.20000E-01	GAM	8.81772E-01	VEL	2.28845E-02	ALT	2.31566E-03	WT	2.14980E-06
STAGE	1	ALPH	0	MACH	2.06626E-01	XISP	2.66509E-02	DYNP	5.81300926E-01
GRAV	3.21668E-01	ACC	1.40518E-00	THRI	3.03335E-06	CL	0	LIFT	0
DENS	2.21998E-03	ACCN	0	RATI	1.00000E-00	CD	4.32000E-02	DRAG	1.27645E-04
SOS	1.10753E-03	VLD	1.23936E-00	VLG	7.07753E-02	VLT	0	VCHR	9.37768E-02

TIM	2.30000E 01	GAM	8.79103E 01	VFL	2.42042E 02	ALT	2.55094E 03	WT	2.13822E 06
STAGE	1	ALPH	0	MACH	2.19722E-01	XISP	2.66807E 02	DYNP	6.45744708E 01
GRAV	3.21661E 01	ACC	1.41358E 00	THRI	3.03473E 06	CL	0	LIFT	0
DENS	2.20449E-03	ACCN	0	RATI	1.00000E 00	CD	4.32000E-02	DRAG	1.41796E 04
SOS	1.10662E 03	VLD	1.44139E 00	VLG	7.39901E 02	VLT	0	VCHR	9.83305E 02
TIM	2.40000E 01	GAM	8.76219E 01	VFL	2.55518E 02	ALT	2.79951E 03	WT	2.12684E 06
STAGE	1	ALPH	0	MACH	2.31100E-01	XISP	2.67121E 02	DYNP	7.14342326E 01
GRAV	3.21653E 01	ACC	1.42212E 00	THRI	3.04731E 06	CL	0	LIFT	0
DENS	2.18822E-03	ACCN	0	RATI	1.00000E 00	CD	4.32000E-02	DRAG	1.56859E 04
SOS	1.10566E 03	VLD	1.66652E 00	VLG	7.72842E 02	VLT	0	VCHR	1.02914E 03
TIM	2.50000E 01	GAM	8.73118E 01	VFL	2.69280E 02	ALT	3.06163E 03	WT	2.11546E 06
STAGE	1	ALPH	0	MACH	2.43771E-01	XISP	2.67453E 02	DYNP	7.87172835E 01
GRAV	3.21645E 01	ACC	1.43080E 00	THRI	3.04409E 06	CL	0	LIFT	0
DENS	2.17117E-03	ACCN	0	RATI	1.00000E 00	CD	4.32000E-02	DRAG	1.72852E 04
SOS	1.10464E 03	VLD	1.91640E 00	VLG	8.04175E 02	VLT	0	VCHR	1.07527E 03
TIM	2.60000E 01	GAM	8.69800E 01	VEL	2.83332E 02	ALT	3.33756E 03	WT	2.10407E 06
STAGE	1	ALPH	0	MACH	2.56740E-01	XISP	2.67802E 02	DYNP	8.64308378E 01
GRAV	3.21637E 01	ACC	1.43963E 00	THRI	3.04806E 06	CL	0	LIFT	0
DENS	2.15332E-03	ACCN	0	RATI	1.00000E 00	CD	4.32000E-02	DRAG	1.89790E 04
SOS	1.10357E 03	VLD	2.19272E 00	VLG	8.36300E 02	VLT	0	VCHR	1.12171E 03
TIM	2.70000E 01	GAM	8.66265E 01	VEL	2.97481E 02	ALT	3.62759E 03	WT	2.09269E 06
STAGE	1	ALPH	0	MACH	2.70018E-01	XISP	2.68169E 02	DYNP	9.45813638E 01
GRAV	3.21628E 01	ACC	1.44860E 00	THRI	3.05274E 06	CL	0	LIFT	0
DENS	2.13468E-03	ACCN	0	RATI	1.00000E 00	CD	4.32000E-02	DRAG	2.07687E 04
SOS	1.10245E 03	VLD	2.49723E 00	VLG	8.68473E 02	VLT	0	VCHR	1.16846E 03
TIM	2.80000E 01	GAM	8.62516E 01	VEL	3.12334E 02	ALT	3.93199E 03	WT	2.08131E 06
STAGE	1	ALPH	0	MACH	2.83674E-01	XISP	2.68554E 02	DYNP	1.03174528E 02
GRAV	3.21619E 01	ACC	1.45772E 00	THRI	3.05662E 06	CL	0	LIFT	0
DENS	2.11526E-03	ACCN	0	RATI	1.00000E 00	CD	4.32000E-02	DRAG	2.26556E 04
SOS	1.10126E 03	VLD	2.83172E 00	VLG	9.00533E 02	VLT	0	VCHR	1.21533E 03
TIM	2.90000E 01	GAM	8.58553E 01	VEL	3.27298E 02	ALT	4.25102E 03	WT	2.06993E 06
STAGE	1	ALPH	0	MACH	2.97558E-01	XISP	2.68956E 02	DYNP	1.12215137E 02
GRAV	3.21609E 01	ACC	1.46599E 00	THRI	3.06121E 06	CL	0	LIFT	0
DENS	2.09505E-03	ACCN	0	RATI	1.00000E 00	CD	4.32000E-02	DRAG	2.46408E 04
SOS	1.10002E 03	VLD	3.19803E 00	VLG	9.32598E 02	VLT	0	VCHR	1.26293E 03
TIM	3.00000E 01	GAM	8.54380E 01	VEL	3.42561E 02	ALT	4.58496E 03	WT	2.05855E 06
STAGE	1	ALPH	0	MACH	3.11800E-01	XISP	2.69380E 02	DYNP	1.21707079E 02
GRAV	3.21598E 01	ACC	1.47643E 00	THRI	3.06602E 06	CL	0	LIFT	0
DENS	2.07405E-03	ACCN	0	RATI	1.00000E 00	CD	4.32000E-02	DRAG	2.67251E 04
SOS	1.09872E 03	VLD	3.59805E 00	VLG	9.64666E 02	VLT	0	VCHR	1.31066E 03
TIM	3.10000E 01	GAM	8.50000E 01	VEL	3.58190E 02	ALT	4.93410E 03	WT	2.04717E 06
STAGE	1	ALPH	0	MACH	3.26411E-01	XISP	2.69822E 02	DYNP	1.31653255E 02
GRAV	3.21588E 01	ACC	1.48603E 00	THRI	3.07155E 06	CL	0	LIFT	0
DENS	2.05227E-03	ACCN	0	RATI	1.00000E 00	CD	4.32000E-02	DRAG	2.89092E 04
SOS	1.09736E 03	VLD	4.03371E 00	VLG	9.96713E 02	VLT	0	VCHR	1.35873E 03
TIM	3.20000E 01	GAM	8.45416E 01	VEL	3.74134E 02	ALT	5.29871E 03	WT	2.03578E 06
STAGE	1	ALPH	0	MACH	3.41583E-01	XISP	2.70283E 02	DYNP	1.42055523E 02
GRAV	3.21576E 01	ACC	1.49579E 00	THRI	3.07630E 06	CL	0	LIFT	0
DENS	2.02971E-03	ACCN	0	RATI	1.00000E 00	CD	4.32000E-02	DRAG	3.11933E 04
SOS	1.09593E 03	VLD	4.50698E 00	VLG	1.02874E 03	VLT	0	VCHR	1.40714E 03
TIM	3.30000E 01	GAM	8.40634E 01	VEL	3.90421E 02	ALT	5.67907E 03	WT	2.02440E 06
STAGE	1	ALPH	0	MACH	3.56729E-01	XISP	2.70764E 02	DYNP	1.52914622E 02
GRAV	3.21565E 01	ACC	1.50573E 00	THRI	3.08178E 06	CL	0	LIFT	0
DENS	2.00638E-03	ACCN	0	RATI	1.00000E 00	CD	4.32000E-02	DRAG	3.35778E 04
SOS	1.09445E 03	VLD	5.01986E 00	VLG	1.06074E 03	VLT	0	VCHR	1.45592E 03
TIM	3.40000E 01	GAM	8.35658E 01	VEL	4.07060E 02	ALT	6.07546E 03	WT	2.01302E 06
STAGE	1	ALPH	0	MACH	3.72460E-01	XISP	2.71265E 02	DYNP	1.64230102E 02
GRAV	3.21552E 01	ACC	1.51584E 00	THRI	3.08749E 06	CL	0	LIFT	0
DENS	1.98229E-03	ACCN	0	RATI	1.00000E 00	CD	4.32000E-02	DRAG	3.60626E 04
SOS	1.09290E 03	VLD	5.57439E 00	VLG	1.09270E 03	VLT	0	VCHR	1.50505E 03
TIM	3.50000E 01	GAM	8.30495E 01	VEL	4.24860E 02	ALT	6.48815E 03	WT	2.00164E 06
STAGE	1	ALPH	0	MACH	3.88591E-01	XISP	2.71788E 02	DYNP	1.76000250E 02
GRAV	3.21540E 01	ACC	1.52614E 00	THRI	3.09343E 06	CL	0	LIFT	0
DENS	1.95744E-03	ACCN	0	RATI	1.00000E 00	CD	4.32000E-02	DRAG	3.86471E 04
SOS	1.09128E 03	VLD	6.17265E 00	VLG	1.12464E 03	VLT	0	VCHR	1.55456E 03
TIM	3.60000E 01	GAM	8.25149E 01	VEL	4.41432E 02	ALT	6.91744E 03	WT	1.99023E 06

STAGE	1	ALPH	0	MACH	4.05135E-01	XISP	2.72331E 02	DYNP	1.88222011E 02
GRAV	3.21527E 01	ACC	1.53663E 00	THRI	3.09961E 06	CL	0	LIFT	0
DENS	1.93185E-03	ACCN	0	RATI	1.00000E 00	CD	4.32000E-02	DRAG	4.13308E 04
SOS	1.08959E 03	VLD	6.81674E 00	VLG	1.15654E 03	VLT	0	VCHR	1.60444E 03
TIM	3.70000E 01	GAM	8.15627E 01	VEL	4.59185E 02	ALT	7.36359E 03	WT	1.97887E 06
STAGE	1	ALPH	0	MACH	4.22109E-01	XISP	2.72895E 02	DYNP	2.00890903E 02
GRAV	3.21513E 01	ACC	1.54730E 00	THRI	3.10604E 06	CL	0	LIFT	0
DENS	1.90552E-03	ACCN	0	RATI	1.00000E 00	CD	4.32000E-02	DRAG	4.41127E 04
SOS	1.08784E 03	VLD	7.50876E 00	VLG	1.18840F 03	VLT	0	VCHR	1.65471E 03
TIM	3.80000E 01	GAM	8.13936E 01	VEL	4.77331E 02	ALT	7.82688E 03	WT	1.96749E 06
STAGE	1	ALPH	0	MACH	4.39526E-01	XISP	2.73481E 02	DYNP	2.14000936E 02
GRAV	3.21498E 01	ACC	1.55918E 00	THRI	3.11271E 06	CL	0	LIFT	0
DENS	1.87848E-03	ACCN	0	RATI	1.00000E 00	CD	4.32000E-02	DRAG	4.69915E 04
SOS	1.08601E 03	VLD	8.25087E 00	VLG	1.22021E 03	VLT	0	VCHR	1.70537E 03
TIM	3.90000E 01	GAM	8.06084E 01	VFL	4.95879E 02	ALT	8.30759E 03	WT	1.95611E 06
STAGE	1	ALPH	0	MACH	4.57405E-01	XISP	2.74089E 02	DYNP	2.27544519E 02
GRAV	3.21484E 01	ACC	1.56927E 00	THRI	3.11963E 06	CL	0	LIFT	0
DENS	1.85074E-03	ACCN	0	RATI	1.00000E 00	CD	4.32000E-02	DRAG	4.99655E 04
SOS	1.08411E 03	VLD	9.04521E 00	VLG	1.25197E 03	VLT	0	VCHR	1.75644E 03
TIM	4.00000E 01	GAM	8.02076E 01	VFL	5.14843E 02	ALT	8.80599E 03	WT	1.94473E 06
STAGE	1	ALPH	0	MACH	4.75762E-01	XISP	2.74720E 02	DYNP	2.41512348E 02
GRAV	3.21468E 01	ACC	1.58057E 00	THRI	3.12681E 06	CL	0	LIFT	0
DENS	1.82230E-03	ACCN	0	RATI	1.00000E 00	CD	4.32000E-02	DRAG	5.30326E 04
SOS	1.08214E 03	VLD	9.89394E 00	VLG	1.28368E 03	VLT	0	VCHR	1.80791E 03
TIM	4.10000E 01	GAM	7.95922E 01	VEL	5.34233E 02	ALT	9.32236E 03	WT	1.93335E 06
STAGE	1	ALPH	0	MACH	4.94614E-01	XISP	2.75373E 02	DYNP	2.55893413E 02
GRAV	3.21452E 01	ACC	1.59208E 00	THRI	3.13424E 06	CL	0	LIFT	0
DENS	1.79320E-03	ACCN	0	RATI	1.00000E 00	CD	4.32000E-02	DRAG	5.61905E 04
SOS	1.08010E 03	VLD	1.07992E 01	VLG	1.31533E 03	VLT	0	VCHR	1.85981E 03
TIM	4.20000E 01	GAM	7.89628E 01	VFL	5.54061E 02	ALT	9.85697E 03	WT	1.92197E 06
STAGE	1	ALPH	0	MACH	5.13982E-01	XISP	2.76049E 02	DYNP	2.70674520E 02
GRAV	3.21436E 01	ACC	1.60381E 00	THRI	3.14194E 06	CL	0	LIFT	0
DENS	1.76344E-03	ACCN	0	RATI	1.00000E 00	CD	4.32224E-02	DRAG	5.94670E 04
SOS	1.07798E 03	VLD	1.17634E 01	VLG	1.34691E 03	VLT	0	VCHR	1.91214E 03
TIM	4.30000E 01	GAM	7.83203E 01	VEL	5.74325E 02	ALT	1.04101E 04	WT	1.91058E 06
STAGE	1	ALPH	0	MACH	5.33869E-01	XISP	2.76533E 02	DYNP	2.85824623E 02
GRAV	3.21419E 01	ACC	1.61448E 00	THRI	3.14744E 06	CL	0	LIFT	0
DENS	1.73306E-03	ACCN	0	RATI	1.00000E 00	CD	4.32542E-02	DRAG	6.28417E 04
SOS	1.07578E 03	VLD	1.27891E 01	VLG	1.37842E 03	VLT	0	VCHR	1.96489E 03
TIM	4.40000E 01	GAM	7.76654E 01	VEL	5.94998E 02	ALT	1.09819E 04	WT	1.89920E 06
STAGE	1	ALPH	0	MACH	5.54259E-01	XISP	2.76955E 02	DYNP	3.01286737E 02
GRAV	3.21403E 01	ACC	1.62487E 00	THRI	3.15225E 06	CL	0	LIFT	0
DENS	1.70207E-03	ACCN	0	RATI	1.00000E 00	CD	4.32868E-02	DRAG	6.62912E 04
SOS	1.07350E 03	VLD	1.38784E 01	VLG	1.40986E 03	VLT	0	VCHR	2.01804E 03
TIM	4.50000E 01	GAM	7.69989E 01	VEL	6.16090E 02	ALT	1.15727E 04	WT	1.88782E 06
STAGE	1	ALPH	0	MACH	5.75170E-01	XISP	2.77391E 02	DYNP	3.17034563E 02
GRAV	3.21383E 01	ACC	1.63543E 00	THRI	3.15721E 06	CL	0	LIFT	0
DENS	1.67051E-03	ACCN	0	RATI	1.00000E 00	CD	4.33203E-02	DRAG	6.98100E 04
SOS	1.07114E 03	VLD	1.50334E 01	VLG	1.44122E 03	VLT	0	VCHR	2.07159E 03
TIM	4.60000E 01	GAM	7.63216E 01	VEL	6.37610E 02	ALT	1.21826E 04	WT	1.87644E 06
STAGE	1	ALPH	0	MACH	5.96620E-01	XISP	2.77841E 02	DYNP	3.33042129E 02
GRAV	3.21364E 01	ACC	1.64617E 00	THRI	3.16233E 06	CL	0	LIFT	0
DENS	1.63840E-03	ACCN	0	RATI	1.00000E 00	CD	4.33546E-02	DRAG	7.33930E 04
SOS	1.06870E 03	VLD	1.62559E 01	VLG	1.47249E 03	VLT	0	VCHR	2.12554E 03
TIM	4.70000E 01	GAM	7.56343E 01	VEL	6.59571E 02	ALT	1.28118E 04	WT	1.86506E 06
STAGE	1	ALPH	0	MACH	6.18630E-01	XISP	2.78305E 02	DYNP	3.49281412E 02
GRAV	3.21345E 01	ACC	1.65710E 00	THRI	3.16782E 06	CL	0	LIFT	0
DENS	1.60576E-03	ACCN	0	RATI	1.00000E 00	CD	4.33898E-02	DRAG	7.70342E 04
SOS	1.06618E 03	VLD	1.75479E 01	VLG	1.50366E 03	VLT	0	VCHR	2.17991E 03
TIM	4.80000E 01	GAM	7.49376E 01	VEL	6.81986E 02	ALT	1.34605E 04	WT	1.85367E 06
STAGE	1	ALPH	0	MACH	6.41221E-01	XISP	2.78784E 02	DYNP	3.65722304E 02
GRAV	3.21325E 01	ACC	1.66822E 00	THRI	3.17307E 06	CL	0	LIFT	0
DENS	1.57265E-03	ACCN	0	RATI	1.00000E 00	CD	4.34260E-02	DRAG	8.07274E 04
SOS	1.06357E 03	VLD	1.89111E 01	VLG	1.53474E 03	VLT	0	VCHR	2.23470E 03
TIM	4.90000E 01	GAM	7.42324E 01	VEL	7.04865E 02	ALT	1.41290E 04	WT	1.84229E 06

STAGE	1	ALPH	0	MACH	6.64415E-01	XISP	2.79277E-02	DYNP	3.82332592E-02
GRAV	3.21304E-01	ACC	1.67955E-00	THRI	3.17878E-06	CL	0	LIFT	0
DENS	1.53907E-03	ACCN	0	RATI	1.00000E-00	CD	4.34631E-02	DRAG	8.44660E-04
SOS	1.04088E-03	VLD	2.03472E-01	VLG	1.56572E-03	VLT	0	VCHR	2.28992E-03
TIM	5.00000E-01	GAM	7.35195E-01	VEL	7.28223E-02	ALT	1.48173E-04	WT	1.83091E-06
STAGE	1	ALPH	0	MACH	6.88235E-01	XISP	2.79785E-02	DYNP	3.99077938E-02
GRAV	3.21283E-01	ACC	1.65108E-00	THRI	3.18447E-06	CL	0	LIFT	0
DENS	1.50508E-03	ACCN	0	RATI	1.00000E-00	CD	4.35012E-02	DRAG	8.82427E-04
SOS	1.05810E-03	VLD	2.16579E-01	VLG	1.59658E-03	VLT	0	VCHR	2.34558E-03
TIM	5.10000E-01	GAM	7.27996E-01	VEL	7.52071E-02	ALT	1.55256E-04	WT	1.81953E-06
STAGE	1	ALPH	0	MACH	7.12706E-01	XISP	2.80308E-02	DYNP	4.15921869E-02
GRAV	3.21261E-01	ACC	1.70284E-00	THRI	3.19042E-06	CL	0	LIFT	0
DENS	1.47670E-03	ACCN	0	RATI	1.00000E-00	CD	4.35403E-02	DRAG	9.20500E-04
SOS	1.05523E-03	VLD	2.34446E-01	VLG	1.62733E-03	VLT	0	VCHR	2.40168E-03
TIM	5.20000E-01	GAM	7.20734E-01	VEL	7.76423E-02	ALT	1.62542E-04	WT	1.80815E-06
STAGE	1	ALPH	0	MACH	7.37852E-01	XISP	2.80846E-02	DYNP	4.32825782E-02
GRAV	3.21239E-01	ACC	1.71482E-00	THRI	3.19654E-06	CL	0	LIFT	0
DENS	1.43597E-03	ACCN	0	RATI	1.00000E-00	CD	4.35806E-02	DRAG	9.58796E-04
SOS	1.05227E-03	VLD	2.51088E-01	VLG	1.65796E-03	VLT	0	VCHR	2.45824E-03
TIM	5.30000E-01	GAM	7.13418E-01	VEL	8.01273E-02	ALT	1.70031E-04	WT	1.79677E-06
STAGE	1	ALPH	0	MACH	7.63611E-01	XISP	2.81398E-02	DYNP	4.49727567E-02
GRAV	3.21216E-01	ACC	1.72408E-00	THRI	3.20283E-06	CL	0	LIFT	0
DENS	1.40094E-03	ACCN	0	RATI	1.00000E-00	CD	4.59586E-02	DRAG	1.05060E-05
SOS	1.04923E-03	VLD	2.68709E-01	VLG	1.68846E-03	VLT	0	VCHR	2.51526E-03
TIM	5.40000E-01	GAM	7.06054E-01	VEL	8.26482E-02	ALT	1.77725E-04	WT	1.78538E-06
STAGE	1	ALPH	0	MACH	7.90072E-01	XISP	2.81966E-02	DYNP	4.66411890E-02
GRAV	3.21192E-01	ACC	1.73047E-00	THRI	3.20929E-06	CL	0	LIFT	0
DENS	1.36563E-03	ACCN	0	RATI	1.00000E-00	CD	5.05085E-02	DRAG	1.19744E-05
SOS	1.04608E-03	VLD	2.86854E-01	VLG	1.71883E-03	VLT	0	VCHR	2.57276E-03
TIM	5.50000E-01	GAM	6.98647E-01	VEL	8.52030E-02	ALT	1.85623E-04	WT	1.77400E-06
STAGE	1	ALPH	0	MACH	8.17022E-01	XISP	2.82549E-02	DYNP	4.82797526E-02
GRAV	3.21168E-01	ACC	1.73651E-00	THRI	3.21592E-06	CL	0	LIFT	0
DENS	1.33010E-03	ACCN	0	RATI	1.00000E-00	CD	5.51545E-02	DRAG	1.35352E-05
SOS	1.04255E-03	VLD	3.11860E-01	VLG	1.74905E-03	VLT	0	VCHR	2.63074E-03
TIM	5.60000E-01	GAM	6.91202E-01	VEL	8.77913E-02	ALT	1.93724E-04	WT	1.76262E-06
STAGE	1	ALPH	0	MACH	8.44536E-01	XISP	2.83147E-02	DYNP	4.98818024E-02
GRAV	3.21143E-01	ACC	1.74221E-00	THRI	3.22273E-06	CL	0	LIFT	0
DENS	1.29440E-03	ACCN	0	RATI	1.00000E-00	CD	5.98980E-02	DRAG	1.51871E-05
SOS	1.03952E-03	VLD	3.37931E-01	VLG	1.77913E-03	VLT	0	VCHR	2.68921E-03
TIM	5.70000E-01	GAM	6.83726E-01	VEL	9.04125E-02	ALT	2.02026E-04	WT	1.75124E-06
STAGE	1	ALPH	0	MACH	8.72624E-01	XISP	2.83745E-02	DYNP	5.14406592E-02
GRAV	3.21117E-01	ACC	1.74748E-00	THRI	3.22954E-06	CL	0	LIFT	0
DENS	1.25258E-03	ACCN	0	RATI	1.00000E-00	CD	6.47404E-02	DRAG	1.69279E-05
SOS	1.03610E-03	VLD	3.67269E-01	VLG	1.80906E-03	VLT	0	VCHR	2.74817E-03
TIM	5.80000E-01	GAM	6.76222E-01	VEL	9.30653E-02	ALT	2.10533E-04	WT	1.73986E-06
STAGE	1	ALPH	0	MACH	9.01287E-01	XISP	2.84313E-02	DYNP	5.29488539E-02
GRAV	3.21091E-01	ACC	1.75214E-00	THRI	3.23601E-06	CL	0	LIFT	0
DENS	1.22268E-03	ACCN	0	RATI	1.00000E-00	CD	6.96818E-02	DRAG	1.87541E-05
SOS	1.03258E-03	VLD	4.00078E-01	VLG	1.83883E-03	VLT	0	VCHR	2.80764E-03
TIM	5.90000E-01	GAM	6.68695E-01	VEL	9.57468E-02	ALT	2.19239E-04	WT	1.72847E-06
STAGE	1	ALPH	0	MACH	9.30529E-01	XISP	2.84893E-02	DYNP	5.43995591E-02
GRAV	3.21064E-01	ACC	1.75646E-00	THRI	3.24262E-06	CL	0	LIFT	0
DENS	1.18675E-03	ACCN	0	RATI	1.00000E-00	CD	7.47233E-02	DRAG	2.06619E-05
SOS	1.02897E-03	VLD	4.36557E-01	VLG	1.86844E-03	VLT	0	VCHR	2.86762E-03
TIM	6.00000E-01	GAM	6.61149E-01	VEL	9.84625E-02	ALT	2.28143E-04	WT	1.71709E-06
STAGE	1	ALPH	0	MACH	9.60362E-01	XISP	2.85487E-02	DYNP	5.57865714E-02
GRAV	3.21037E-01	ACC	1.76049E-00	THRI	3.24939E-06	CL	0	LIFT	0
DENS	1.15085E-03	ACCN	0	RATI	1.00000E-00	CD	7.98665E-02	DRAG	2.26472E-05
SOS	1.02526E-03	VLD	4.76902E-01	VLG	1.89788E-03	VLT	0	VCHR	2.92811E-03
TIM	6.10000E-01	GAM	6.53590E-01	VEL	1.01206E-03	ALT	2.37244E-04	WT	1.70571E-06
STAGE	1	ALPH	0	MACH	9.90797E-01	XISP	2.86094E-02	DYNP	5.71039505E-02
GRAV	3.21009E-01	ACC	1.76422E-00	THRI	3.25631E-06	CL	0	LIFT	0
DENS	1.11502E-03	ACCN	0	RATI	1.00000E-00	CD	8.51134E-02	DRAG	2.47050E-05
SOS	1.02146E-03	VLD	5.21304E-01	VLG	1.92715E-03	VLT	0	VCHR	2.98913E-03
TIM	6.20000E-01	GAM	6.46020E-01	VEL	1.03988E-03	ALT	2.46540E-04	WT	1.69433E-06
STAGE	1	ALPH	0	MACH	1.02193E-00	XISP	2.86714E-02	DYNP	5.83559552E-02
GRAV	3.20981E-01	ACC	1.77545E-00	THRI	3.26337E-06	CL	0	LIFT	0

DENS	1.07931E-03	ACCN	0	RATI	1.00000E 00	CD	8.60245E-02	DRAG	2.55169E 05
SOS	1.01756E 03	VLD	5.69068E 01	VLG	1.9553E 03	VLT	0	VCHR	3.05068E 03
TIM	6.30000E 01	GAM	6.38445E 01	VFL	1.06834E 03	ALT	2.56032E 04	WT	1.68295E 06
STAGE	1	ALPH	0	MACH	1.05404E 00	XISP	2.87347E 02	DYNP	5.95654795E 02
GRAV	3.20951E 01	ACC	1.75034E 00	THRI	3.27058E 06	CL	0	LIFT	0
DENS	1.04377E-03	ACCN	0	RATI	1.00010E 00	CD	8.50356E-02	DRAG	2.57463E 05
SOS	1.01357E 03	VLD	6.17793E 01	VLG	1.96514E 03	VLT	0	VCHR	3.11278E 03
TIM	6.40000E 01	GAM	6.30873E 01	VFL	1.09748E 03	ALT	2.65720E 04	WT	1.67156E 06
STAGE	1	ALPH	0	MACH	1.05716E 00	XISP	2.87993E 02	DYNP	6.07304604E 02
GRAV	3.20922E 01	ACC	1.80555E 00	THRI	3.27145E 06	CL	0	LIFT	0
DENS	1.00643E-03	ACCN	0	RATI	1.00000E 00	CD	8.40149E-02	DRAG	2.59348E 05
SOS	1.00947E 03	VLD	6.67245E 01	VLG	2.01385E 03	VLT	0	VCHR	3.17543E 03
TIM	6.50000E 01	GAM	6.23308E 01	VFL	1.12732E 03	ALT	2.75605E 04	WT	1.66018E 06
STAGE	1	ALPH	0	MACH	1.12140E 00	XISP	2.88653E 02	DYNP	6.18468234E 02
GRAV	3.20891E 01	ACC	1.82188E 00	THRI	3.28546E 06	CL	0	LIFT	0
DENS	9.73316E-04	ACCN	0	RATI	1.00000E 00	CD	8.29610E-02	DRAG	2.60802E 05
SOS	1.00528E 03	VLD	7.17353E 01	VLG	2.04237E 03	VLT	0	VCHR	3.23864E 03
TIM	6.60000E 01	GAM	6.15756E 01	VFL	1.15788E 03	ALT	2.85688E 04	WT	1.64880E 06
STAGE	1	ALPH	0	MACH	1.15674E 00	XISP	2.89325E 02	DYNP	6.29104151E 02
GRAV	3.20840E 01	ACC	1.83850E 00	THRI	3.29112E 06	CL	0	LIFT	0
DENS	9.38477E-04	ACCN	0	RATI	1.00000E 00	CD	8.18723E-02	DRAG	2.61806E 05
SOS	1.00099E 03	VLD	7.66038E 01	VLG	2.07109E 03	VLT	0	VCHR	3.30244E 03
TIM	6.70000E 01	GAM	6.06225E 01	VFL	1.18919E 03	ALT	2.95971E 04	WT	1.63742E 06
STAGE	1	ALPH	0	MACH	1.18327E 00	XISP	2.90011E 02	DYNP	6.39170099E 02
GRAV	3.20629E 01	ACC	1.85472E 00	THRI	3.30094E 06	CL	0	LIFT	0
DENS	9.03942E-04	ACCN	0	RATI	1.00000E 00	CD	8.07473E-02	DRAG	2.62340E 05
SOS	9.96586E 02	VLD	8.19220E 01	VLG	2.09480E 03	VLT	0	VCHR	3.36682E 03
TIM	6.80000E 01	GAM	6.00718E 01	VFL	1.22177E 03	ALT	3.06454E 04	WT	1.62604E 06
STAGE	1	ALPH	0	MACH	1.23102E 00	XISP	2.90598E 02	DYNP	6.48615405E 02
GRAV	3.20796E 01	ACC	1.87279E 00	THRI	3.30761E 06	CL	0	LIFT	0
DENS	8.69747E-04	ACCN	0	RATI	1.00000E 00	CD	7.95846E-02	DRAG	2.62363E 05
SOS	9.92081E 02	VLD	8.70812E 01	VLG	2.12671E 03	VLT	0	VCHR	3.43179E 03
TIM	6.90000E 01	GAM	5.93242E 01	VFL	1.25411E 03	ALT	3.17140E 04	WT	1.61465E 06
STAGE	1	ALPH	0	MACH	1.27002E 00	XISP	2.91123E 02	DYNP	6.57364338E 02
GRAV	3.20764E 01	ACC	1.89004E 00	THRI	3.31360E 06	CL	0	LIFT	0
DENS	8.35924E-04	ACCN	0	RATI	1.00000E 00	CD	7.83593E-02	DRAG	2.61828E 05
SOS	9.87469E 02	VLD	9.22715E 01	VLG	2.15411E 03	VLT	0	VCHR	3.49733E 03
TIM	7.00000E 01	GAM	5.85802E 01	VFL	1.28773E 03	ALT	3.28027E 04	WT	1.60327E 06
STAGE	1	ALPH	0	MACH	1.31013E 00	XISP	2.91659E 02	DYNP	6.65374588E 02
GRAV	3.20730E 01	ACC	1.90800E 00	THRI	3.31970E 06	CL	0	LIFT	0
DENS	8.02509E-04	ACCN	0	RATI	1.00000E 00	CD	7.71694E-02	DRAG	2.60656E 05
SOS	9.82748E 02	VLD	9.74603E 01	VLG	2.18109E 03	VLT	0	VCHR	3.56345E 03
TIM	7.10000E 01	GAM	5.78402E 01	VFL	1.32215E 03	ALT	3.39118E 04	WT	1.59189E 06
STAGE	1	ALPH	0	MACH	1.35201E 00	XISP	2.92205E 02	DYNP	6.72604324E 02
GRAV	3.20696E 01	ACC	1.92663E 00	THRI	3.32591E 06	CL	0	LIFT	0
DENS	7.69534E-04	ACCN	0	RATI	1.00000E 00	CD	7.57357E-02	DRAG	2.58929E 05
SOS	9.77916E 02	VLD	1.02697E 02	VLG	2.20914E 03	VLT	0	VCHR	3.63015E 03
TIM	7.20000E 01	GAM	5.71047E 01	VFL	1.35741E 03	ALT	3.50413E 04	WT	1.58051E 06
STAGE	1	ALPH	0	MACH	1.39512E 00	XISP	2.92760E 02	DYNP	6.79011660E 02
GRAV	3.20610E 01	ACC	1.94595E 00	THRI	3.33235E 06	CL	0	LIFT	0
DENS	7.37030E-04	ACCN	0	RATI	1.00000E 00	CD	7.43562E-02	DRAG	2.56634E 05
SOS	9.72920E 02	VLD	1.07909E 02	VLG	2.23520E 03	VLT	0	VCHR	3.69745E 03
TIM	7.30000E 01	GAM	5.63742E 01	VFL	1.39353E 03	ALT	3.61914E 04	WT	1.56913E 06
STAGE	1	ALPH	0	MACH	1.43907E 00	XISP	2.93326E 02	DYNP	6.84321812E 02
GRAV	3.20626E 01	ACC	1.96604E 00	THRI	3.33867E 06	CL	0	LIFT	0
DENS	7.04788E-04	ACCN	0	RATI	1.00000E 00	CD	7.29370E-02	DRAG	2.53705E 05
SOS	9.68066E 02	VLD	1.13106E 02	VLG	2.26299E 03	VLT	0	VCHR	3.76537E 03
TIM	7.40000E 01	GAM	5.56491E 01	VFL	1.43955E 03	ALT	3.73021E 04	WT	1.55774E 06
STAGE	1	ALPH	0	MACH	1.47771E 00	XISP	2.93902E 02	DYNP	6.81844143E 02
GRAV	3.20590E 01	ACC	1.98793E 00	THRI	3.34523E 06	CL	0	LIFT	0
DENS	6.66359E-04	ACCN	0	RATI	1.00000E 00	CD	7.17132E-02	DRAG	2.48545E 05
SOS	9.68086E 02	VLD	1.18256E 02	VLG	2.28958E 03	VLT	0	VCHR	3.83390E 03
TIM	7.50000E 01	GAM	5.49297E 01	VFL	1.46852E 03	ALT	3.85535E 04	WT	1.54636E 06
STAGE	1	ALPH	0	MACH	1.51853E 00	XISP	2.94488E 02	DYNP	6.78668027E 02
GRAV	3.20554E 01	ACC	2.01035E 00	THRI	3.35190E 06	CL	0	LIFT	0
DENS	6.29402E-04	ACCN	0	RATI	1.00000E 00	CD	7.04921E-02	DRAG	2.43174E 05
SOS	9.68086E 02	VLD	1.23334E 02	VLG	2.31594E 03	VLT	0	VCHR	3.90306E 03

TIM	7.60000E 01	GAM	5.42166E 01	VFL	1.50745E 03	ALT	3.97659E 04	WT	1.53498E 06
STAGE	1	ALPH	0	MACH	1.55714E 00	XISP	2.95085E 02	DYNP	6.74794025E 02
GRAV	3.20510E 01	ACC	2.03328E 00	THRI	3.35869E 06	CL	0	LIFT	0
DENS	5.93094E 04	ACCN	0	RATI	1.00000E 00	CD	6.92857E 02	DRAG	2.37648E 05
SOS	9.68086E 02	VLD	1.28336E 02	VLG	2.34205E 03	VLT	0	VCHR	3.97287E 03
TIM	7.70000E 01	GAM	5.35100E 01	VFL	1.54733E 03	ALT	4.09994E 04	WT	1.52360E 06
STAGE	1	ALPH	0	MACH	1.59834E 00	XISP	2.95428E 02	DYNP	6.70205342E 02
GRAV	3.20427E 01	ACC	2.05486E 00	THRI	3.36260E 06	CL	0	LIFT	0
DENS	5.58047E 04	ACCN	0	RATI	1.00000E 00	CD	6.80497E 02	DRAG	2.31822E 05
SOS	9.68086E 02	VLD	1.33256E 02	VLG	2.36793E 03	VLT	0	VCHR	4.04331E 03
TIM	7.80000E 01	GAM	5.28103E 01	VFL	1.58815E 03	ALT	4.22539E 04	WT	1.51222E 06
STAGE	1	ALPH	0	MACH	1.64050E 00	XISP	2.95715E 02	DYNP	6.64872280E 02
GRAV	3.20240E 01	ACC	2.07653E 00	THRI	3.36586E 06	CL	0	LIFT	0
DENS	5.27213E 04	ACCN	0	RATI	1.00000E 00	CD	6.67849E 02	DRAG	2.25703E 05
SOS	9.68086E 02	VLD	1.38066E 02	VLG	2.39358E 03	VLT	0	VCHR	4.11433E 03
TIM	7.90000E 01	GAM	5.21178E 01	VFL	1.62991E 03	ALT	4.35297E 04	WT	1.50083E 06
STAGE	1	ALPH	0	MACH	1.68364E 00	XISP	2.96007E 02	DYNP	6.58809919E 02
GRAV	3.20411E 01	ACC	2.05674E 00	THRI	3.3698E 06	CL	0	LIFT	0
DENS	4.95011E 04	ACCN	0	RATI	1.00000E 00	CD	6.54909E 02	DRAG	2.19311E 05
SOS	9.68086E 02	VLD	1.42819E 02	VLG	2.41899E 03	VLT	0	VCHR	4.18595E 03
TIM	8.00000E 01	GAM	5.14327E 01	VFL	1.67263E 03	ALT	4.48269E 04	WT	1.48945E 06
STAGE	1	ALPH	0	MACH	1.72777E 00	XISP	2.96303E 02	DYNP	6.52037415E 02
GRAV	3.20361E 01	ACC	2.12151E 00	THRI	3.37255E 06	CL	0	LIFT	0
DENS	4.66127E 04	ACCN	0	RATI	1.00000E 00	CD	6.41670E 02	DRAG	2.12669E 05
SOS	9.68086E 02	VLD	1.47448E 02	VLG	2.44415E 03	VLT	0	VCHR	4.25819E 03
TIM	8.10000E 01	GAM	5.07552E 01	VFL	1.71633E 03	ALT	4.61453E 04	WT	1.47807E 06
STAGE	1	ALPH	0	MACH	1.77291E 00	XISP	2.96604E 02	DYNP	6.44574494E 02
GRAV	3.20321E 01	ACC	2.14451E 00	THRI	3.37558E 06	CL	0	LIFT	0
DENS	4.37625E 04	ACCN	0	RATI	1.00000E 00	CD	6.29502E 02	DRAG	2.08248E 05
SOS	9.68086E 02	VLD	1.51967E 02	VLG	2.46908E 03	VLT	0	VCHR	4.33104E 03
TIM	8.20000E 01	GAM	5.00857E 01	VFL	1.76101E 03	ALT	4.74853E 04	WT	1.46669E 06
STAGE	1	ALPH	0	MACH	1.81907E 00	XISP	2.96910E 02	DYNP	6.36432654E 02
GRAV	3.20250E 01	ACC	2.16774E 00	THRI	3.37946E 06	CL	0	LIFT	0
DENS	4.10448E 04	ACCN	0	RATI	1.00000E 00	CD	6.18424E 02	DRAG	2.00059E 05
SOS	9.68086E 02	VLD	1.56387E 02	VLG	2.49377E 03	VLT	0	VCHR	4.40451E 03
TIM	8.30000E 01	GAM	4.94242E 01	VFL	1.80669E 03	ALT	4.88468E 04	WT	1.45531E 06
STAGE	1	ALPH	0	MACH	1.86675E 00	XISP	2.97221E 02	DYNP	6.27637180E 02
GRAV	3.20235E 01	ACC	2.15151E 00	THRI	3.38300E 06	CL	0	LIFT	0
DENS	3.84565E 04	ACCN	0	RATI	1.00000E 00	CD	6.07099E 02	DRAG	1.93682E 05
SOS	9.68086E 02	VLD	1.60702E 02	VLG	2.5181E 03	VLT	0	VCHR	4.47863E 03
TIM	8.40000E 01	GAM	4.87710E 01	VFL	1.85339E 03	ALT	5.02299E 04	WT	1.44392E 06
STAGE	1	ALPH	0	MACH	1.91409E 00	XISP	2.97538E 02	DYNP	6.18216282E 02
GRAV	3.20196E 01	ACC	2.21581E 00	THRI	3.38660E 06	CL	0	LIFT	0
DENS	3.59946E 04	ACCN	0	RATI	1.00000E 00	CD	5.95522E 02	DRAG	1.87137E 05
SOS	9.68086E 02	VLD	1.64909E 02	VLG	2.54241E 03	VLT	0	VCHR	4.55340E 03
TIM	8.50000E 01	GAM	4.81262E 01	VFL	1.90112E 03	ALT	5.16346E 04	WT	1.43254E 06
STAGE	1	ALPH	0	MACH	1.96379E 00	XISP	2.97859E 02	DYNP	6.08199764E 02
GRAV	3.20153E 01	ACC	2.24064E 00	THRI	3.39025E 06	CL	0	LIFT	0
DENS	3.36566E 04	ACCN	0	RATI	1.00000E 00	CD	5.83690E 02	DRAG	1.80447E 05
SOS	9.68086E 02	VLD	1.65000E 02	VLG	2.56638E 03	VLT	0	VCHR	4.62884E 03
TIM	8.60000E 01	GAM	4.74899E 01	VFL	1.94990E 03	ALT	5.30611E 04	WT	1.42116E 06
STAGE	1	ALPH	0	MACH	2.01418E 00	XISP	2.98184E 02	DYNP	5.97618311E 02
GRAV	3.20109E 01	ACC	2.26580E 00	THRI	3.39396E 06	CL	0	LIFT	0
DENS	3.14362E 04	ACCN	0	RATI	1.00000E 00	CD	5.72476E 02	DRAG	1.73901E 05
SOS	9.68086E 02	VLD	1.72974E 02	VLG	2.59009E 03	VLT	0	VCHR	4.70494E 03
TIM	8.70000E 01	GAM	4.68623E 01	VFL	1.99972E 03	ALT	5.45094E 04	WT	1.40978E 06
STAGE	1	ALPH	0	MACH	2.06565E 00	XISP	2.98515E 02	DYNP	5.86496147E 02
GRAV	3.20065E 01	ACC	2.29099E 00	THRI	3.39772E 06	CL	0	LIFT	0
DENS	2.93329E 04	ACCN	0	RATI	1.00000E 00	CD	5.63315E 02	DRAG	1.67933E 05
SOS	9.68086E 02	VLD	1.76839E 02	VLG	2.61357E 03	VLT	0	VCHR	4.78173E 03
TIM	8.80000E 01	GAM	4.62434E 01	VFL	2.05161E 03	ALT	5.59796E 04	WT	1.39839E 06
STAGE	1	ALPH	0	MACH	2.11621E 00	XISP	2.98851E 02	DYNP	5.74865641E 02
GRAV	3.20020E 01	ACC	2.31671E 00	THRI	3.40155E 06	CL	0	LIFT	0
DENS	2.73419E 04	ACCN	0	RATI	1.00000E 00	CD	5.53958E 02	DRAG	1.61869E 05
SOS	9.68086E 02	VLD	1.80597E 02	VLG	2.63680E 03	VLT	0	VCHR	4.85922E 03
TIM	8.90000E 01	GAM	4.56332E 01	VFL	2.10258E 03	ALT	5.74717E 04	WT	1.38701E 06
STAGE	1	ALPH	0	MACH	2.17189E 00	XISP	2.99192E 02	DYNP	5.62763955E 02
GRAV	3.19974E 01	ACC	2.34295E 00	THRI	3.40543E 06	CL	0	LIFT	0

DENS	2.54497E-04	ACCN	0	RATI	1.00000E 00	CD	5.44403E-02	DRAG	1.55728E 05
SOS	9.68086E 02	VLD	1.64246E 02	VLG	2.65980E 03	VLT	0	VCHR	4.93743E 03
TIM	9.00000E 01	GAM	4.50320E 01	VFL	2.15563E 03	ALT	5.89858E 04	WT	1.37563E 06
STAGE	1	ALPH	0	MACH	2.22670E 00	XISP	2.99538E 02	DYNP	5.50229147E 02
GRAV	3.19926E 01	ACC	2.36970E 00	THRI	3.40936E 06	CL	0	LIFT	0
DENS	2.36823E-04	ACCN	0	RATI	1.00000E 00	CD	5.34646E-02	DRAG	1.49531E 05
SOS	9.68086E 02	VLD	1.87782E 02	VLG	2.68225E 03	VLT	0	VCHR	5.01635E 03
TIM	9.10000E 01	GAM	4.44697E 01	VFL	2.20979E 03	ALT	6.05219E 04	WT	1.36425E 06
STAGE	1	ALPH	0	MACH	2.28264E 00	XISP	2.99816E 02	DYNP	5.37298419E 02
GRAV	3.19881E 01	ACC	2.35636E 00	THRI	3.41222E 06	CL	0	LIFT	0
DENS	2.20070E-04	ACCN	0	RATI	1.00000E 00	CD	5.24690E-02	DRAG	1.43297E 05
SOS	9.68086E 02	VLD	1.91201E 02	VLG	2.70507E 03	VLT	0	VCHR	5.09601E 03
TIM	9.20000E 01	GAM	4.38563E 01	VFL	2.26513E 03	ALT	6.26802E 04	WT	1.35287E 06
STAGE	1	ALPH	0	MACH	2.33970E 00	XISP	2.99953E 02	DYNP	5.23992036E 02
GRAV	3.19833E 01	ACC	2.42229E 00	THRI	3.41408E 06	CL	0	LIFT	0
DENS	2.04271E-04	ACCN	0	RATI	1.00000E 00	CD	5.14533E-02	DRAG	1.37043E 05
SOS	9.68086E 02	VLD	1.94501E 02	VLG	2.72735E 03	VLT	0	VCHR	5.17637E 03
TIM	9.30000E 01	GAM	4.32816E 01	VFL	2.32135E 03	ALT	6.36606E 04	WT	1.34148E 06
STAGE	1	ALPH	0	MACH	2.39718E 00	XISP	3.00092E 02	DYNP	5.10347555E 02
GRAV	3.19785E 01	ACC	2.44668E 00	THRI	3.41526E 06	CL	0	LIFT	0
DENS	1.89415E-04	ACCN	0	RATI	1.00000E 00	CD	5.04178E-02	DRAG	1.30789E 05
SOS	9.68086E 02	VLD	1.92680E 02	VLG	2.74939E 03	VLT	0	VCHR	5.25744E 03
TIM	9.40000E 01	GAM	4.27163E 01	VFL	2.37876E 03	ALT	6.52632E 04	WT	1.33018E 06
STAGE	1	ALPH	0	MACH	2.45718E 00	XISP	3.00233E 02	DYNP	4.96409035E 02
GRAV	3.19736E 01	ACC	2.42553E 00	THRI	3.41726E 06	CL	0	LIFT	0
DENS	1.75457E-04	ACCN	0	RATI	1.00000E 00	CD	4.93623E-02	DRAG	1.24553E 05
SOS	9.68086E 02	VLD	2.00736E 02	VLG	2.77120E 03	VLT	0	VCHR	5.33922E 03
TIM	9.50000E 01	GAM	4.21597E 01	VFL	2.43777E 03	ALT	6.68879E 04	WT	1.31872E 06
STAGE	1	ALPH	0	MACH	2.51762E 00	XISP	3.00376E 02	DYNP	4.82219915E 02
GRAV	3.19686E 01	ACC	2.50261E 00	THRI	3.41889E 06	CL	0	LIFT	0
DENS	1.62356E-04	ACCN	0	RATI	1.00000E 00	CD	4.84027E-02	DRAG	1.18641E 05
SOS	9.68086E 02	VLD	2.03668E 02	VLG	2.79277E 03	VLT	0	VCHR	5.42173E 03
TIM	9.60000E 01	GAM	4.16120E 01	VFL	2.49638E 03	ALT	6.85350E 04	WT	1.30734E 06
STAGE	1	ALPH	0	MACH	2.57919E 00	XISP	3.00521E 02	DYNP	4.67817759E 02
GRAV	3.19636E 01	ACC	2.52963E 00	THRI	3.42053E 06	CL	0	LIFT	0
DENS	1.50076E-04	ACCN	0	RATI	1.00000E 00	CD	4.77131E-02	DRAG	1.13458E 05
SOS	9.68086E 02	VLD	2.06494E 02	VLG	2.81411E 03	VLT	0	VCHR	5.50499E 03
TIM	9.70000E 01	GAM	4.10731E 01	VFL	2.55760E 03	ALT	7.02042E 04	WT	1.29596E 06
STAGE	1	ALPH	0	MACH	2.64191E 00	XISP	3.00668E 02	DYNP	4.53244950E 02
GRAV	3.19585E 01	ACC	2.55711E 00	THRI	3.42220E 06	CL	0	LIFT	0
DENS	1.38580E-04	ACCN	0	RATI	1.00000E 00	CD	4.70106E-02	DRAG	1.08305E 05
SOS	9.68086E 02	VLD	2.09216E 02	VLG	2.83522E 03	VLT	0	VCHR	5.58900E 03
TIM	9.80000E 01	GAM	4.05431E 01	VFL	2.61943E 03	ALT	7.18958E 04	WT	1.28457E 06
STAGE	1	ALPH	0	MACH	2.70579E 00	XISP	3.00817E 02	DYNP	4.38545606E 02
GRAV	3.19533E 01	ACC	2.58506E 00	THRI	3.42390E 06	CL	0	LIFT	0
DENS	1.27829E-04	ACCN	0	RATI	1.00000E 00	CD	4.62952E-02	DRAG	1.03198E 05
SOS	9.68086E 02	VLD	2.11835E 02	VLG	2.85611E 03	VLT	0	VCHR	5.67378E 03
TIM	9.90000E 01	GAM	4.00217E 01	VFL	2.68240E 03	ALT	7.36096E 04	WT	1.27319E 06
STAGE	1	ALPH	0	MACH	2.77083E 00	XISP	3.00968E 02	DYNP	4.23762758E 02
GRAV	3.19481E 01	ACC	2.61348E 00	THRI	3.42561E 06	CL	0	LIFT	0
DENS	1.17789E-04	ACCN	0	RATI	1.00000E 00	CD	4.55667E-02	DRAG	9.81500E 04
SOS	9.68086E 02	VLD	2.14350E 02	VLG	2.87676E 03	VLT	0	VCHR	5.75934E 03
TIM	1.00000E 02	GAM	3.95091E 01	VFL	2.74652E 03	ALT	7.53458E 04	WT	1.26181E 06
STAGE	1	ALPH	0	MACH	2.83766E 00	XISP	3.01120E 02	DYNP	4.08938191E 02
GRAV	3.19428E 01	ACC	2.64237E 00	THRI	3.42735E 06	CL	0	LIFT	0
DENS	1.08423E-04	ACCN	0	RATI	1.00000E 00	CD	4.48249E-02	DRAG	9.31745E 04
SOS	9.68086E 02	VLD	2.16761E 02	VLG	2.89770E 03	VLT	0	VCHR	5.84570E 03
TIM	1.01000E 02	GAM	3.90051E 01	VFL	2.81179E 03	ALT	7.71043E 04	WT	1.25043E 06
STAGE	1	ALPH	0	MACH	2.90449E 00	XISP	3.01275E 02	DYNP	3.94112281E 02
GRAV	3.19374E 01	ACC	2.67174E 00	THRI	3.42910E 06	CL	0	LIFT	0
DENS	9.96972E-05	ACCN	0	RATI	1.00000E 00	CD	4.46697E-02	DRAG	8.82837E 04
SOS	9.68086E 02	VLD	2.19068E 02	VLG	2.91741E 03	VLT	0	VCHR	5.93287E 03
TIM	1.02000E 02	GAM	3.85096E 01	VFL	2.87824E 03	ALT	7.88852E 04	WT	1.23905E 06
STAGE	1	ALPH	0	MACH	2.97313E 00	XISP	3.01432E 02	DYNP	3.79323857E 02
GRAV	3.19320E 01	ACC	2.70159E 00	THRI	3.43089E 06	CL	0	LIFT	0
DENS	9.15768E-05	ACCN	0	RATI	1.00000E 00	CD	4.33010E-02	DRAG	8.34887E 04
SOS	9.68086E 02	VLD	2.21271E 02	VLG	2.93740E 03	VLT	0	VCHR	6.02087E 03

TIM	1.03000E 02	GAM	3.80225E 01	VEL	2.94567E 03	ALT	8.06885E 04	WT	1.22766E 06
STAGE	1	ALPH	0	MACH	3.04259E 00	XISP	3.01562E 02	DYNP	3.64609020E 02
GRAV	3.19265E 01	ACC	2.73136E 00	THRI	3.43237E 06	CL	0	LIFT	0
DENS	8.40291E-05	ACCN	0	RATI	1.00000E 00	CD	4.27206E-02	DRAG	7.91744E 04
SOS	9.68665E 02	VLD	2.23374E 02	VLG	2.95717E 03	VLT	0	VCHR	6.10971E 03
TIM	1.04000E 02	GAM	3.75439E 01	VEL	3.01467E 03	ALT	8.25143E 04	WT	1.21628E 06
STAGE	1	ALPH	0	MACH	3.11295E 00	XISP	3.01648E 02	DYNP	3.49729334E 02
GRAV	3.19209E 01	ACC	2.76104E 00	THRI	3.45334E 06	CL	0	LIFT	0
DENS	7.69632E-05	ACCN	0	RATI	1.00000E 00	CD	4.22658E-02	DRAG	7.51348E 04
SOS	9.68427E 02	VLD	2.25390E 02	VLG	2.97673E 03	VLT	0	VCHR	6.19939E 03
TIM	1.05000E 02	GAM	3.70735E 01	VEL	3.08444E 03	ALT	8.43626E 04	WT	1.20490E 06
STAGE	1	ALPH	0	MACH	3.17297E 00	XISP	3.01735E 02	DYNP	3.32827161E 02
GRAV	3.19153E 01	ACC	2.79150E 00	THRI	3.43433E 06	CL	0	LIFT	0
DENS	6.99522E-05	ACCN	0	RATI	1.00000E 00	CD	4.18757E-02	DRAG	7.08437E 04
SOS	9.72364E 02	VLD	2.27314E 02	VLG	2.99606E 03	VLT	0	VCHR	6.28993E 03
TIM	1.06000E 02	GAM	3.66113E 01	VEL	3.15582E 03	ALT	8.62334E 04	WT	1.19352E 06
STAGE	1	ALPH	0	MACH	3.23355E 00	XISP	3.01823E 02	DYNP	3.16528709E 02
GRAV	3.19096E 01	ACC	2.82240E 00	THRI	3.43532E 06	CL	0	LIFT	0
DENS	6.35651E-05	ACCN	0	RATI	1.00000E 00	CD	4.14813E-02	DRAG	6.67399E 04
SOS	9.75932E 02	VLD	2.25144E 02	VLG	3.01551E 03	VLT	0	VCHR	6.38134E 03
TIM	1.07000E 02	GAM	3.61572E 01	VEL	3.22820E 03	ALT	8.81268E 04	WT	1.18214E 06
STAGE	1	ALPH	0	MACH	3.29500E 00	XISP	3.01912E 02	DYNP	3.00830607E 02
GRAV	3.19038E 01	ACC	2.85374E 00	THRI	3.43633E 06	CL	0	LIFT	0
DENS	5.77338E-05	ACCN	0	RATI	1.00000E 00	CD	4.10825E-02	DRAG	6.28202E 04
SOS	9.79229E 02	VLD	2.30883E 02	VLG	3.03414E 03	VLT	0	VCHR	6.47363E 03
TIM	1.08000E 02	GAM	3.57111E 01	VEL	3.30381E 03	ALT	9.00428E 04	WT	1.17075E 06
STAGE	1	ALPH	0	MACH	3.35701E 00	XISP	3.02002E 02	DYNP	2.85727726E 02
GRAV	3.18980E 01	ACC	2.88555E 00	THRI	3.43736E 06	CL	0	LIFT	0
DENS	5.24177E-05	ACCN	0	RATI	1.00000E 00	CD	4.06794E-02	DRAG	5.90809E 04
SOS	9.83556E 02	VLD	2.32536E 02	VLG	3.05286E 03	VLT	0	VCHR	6.56682E 03
TIM	1.09000E 02	GAM	3.52729E 01	VEL	3.37665E 03	ALT	9.19813E 04	WT	1.15937E 06
STAGE	1	ALPH	0	MACH	3.41969E 00	XISP	3.02093E 02	DYNP	2.71213333E 02
GRAV	3.18920E 01	ACC	2.91785E 00	THRI	3.43839E 06	CL	0	LIFT	0
DENS	4.75739E-05	ACCN	0	RATI	1.00000E 00	CD	4.02720E-02	DRAG	5.55181E 04
SOS	9.87413E 02	VLD	2.34104E 02	VLG	3.07138E 03	VLT	0	VCHR	6.66094E 03
TIM	1.10000E 02	GAM	3.48425E 01	VEL	3.45274E 03	ALT	9.39428E 04	WT	1.14799E 06
STAGE	1	ALPH	0	MACH	3.48305E 00	XISP	3.02185E 02	DYNP	2.57279239E 02
GRAV	3.18861E 01	ACC	2.95064E 00	THRI	3.43944E 06	CL	0	LIFT	0
DENS	4.31626E-05	ACCN	0	RATI	1.00000E 00	CD	3.98602E-02	DRAG	5.21272E 04
SOS	9.91299E 02	VLD	2.35591E 02	VLG	3.08969E 03	VLT	0	VCHR	6.75600E 03
TIM	1.11000E 02	GAM	3.44198E 01	VEL	3.53009E 03	ALT	9.59266E 04	WT	1.13661E 06
STAGE	1	ALPH	0	MACH	3.54707E 00	XISP	3.02279E 02	DYNP	2.43915954E 02
GRAV	3.18800E 01	ACC	2.98395E 00	THRI	3.44049E 06	CL	0	LIFT	0
DENS	3.91471E-05	ACCN	0	RATI	1.00000E 00	CD	3.94441E-02	DRAG	4.89037E 04
SOS	9.95213E 02	VLD	2.37001E 02	VLG	3.10781E 03	VLT	0	VCHR	6.85201E 03
TIM	1.12000E 02	GAM	3.40047E 01	VEL	3.60871E 03	ALT	9.79334E 04	WT	1.12523E 06
STAGE	1	ALPH	0	MACH	3.61176E 00	XISP	3.02373E 02	DYNP	2.31112826E 02
GRAV	3.18739E 01	ACC	3.01781E 00	THRI	3.44156E 06	CL	0	LIFT	0
DENS	3.54935E-05	ACCN	0	RATI	1.00000E 00	CD	3.98236E-02	DRAG	4.58428E 04
SOS	9.99157E 02	VLD	2.38335E 02	VLG	3.12574E 03	VLT	0	VCHR	6.94900E 03
TIM	1.13000E 02	GAM	3.35971E 01	VEL	3.68863E 03	ALT	9.99631E 04	WT	1.11385E 06
STAGE	1	ALPH	0	MACH	3.67713E 00	XISP	3.02468E 02	DYNP	2.18858187E 02
GRAV	3.18678E 01	ACC	3.05223E 00	THRI	3.44269E 06	CL	0	LIFT	0
DENS	3.21714E-05	ACCN	0	RATI	1.00000E 00	CD	3.85987E-02	DRAG	4.29393E 04
SOS	1.00313E 03	VLD	2.39599E 02	VLG	3.14347E 03	VLT	0	VCHR	7.04699E 03
TIM	1.14000E 02	GAM	3.31968E 01	VEL	3.76986E 03	ALT	1.02016E 05	WT	1.10246E 06
STAGE	1	ALPH	0	MACH	3.74318E 00	XISP	3.02565E 02	DYNP	2.07139484E 02
GRAV	3.18615E 01	ACC	3.08723E 00	THRI	3.44374E 06	CL	0	LIFT	0
DENS	2.91503E-05	ACCN	0	RATI	1.00000E 00	CD	3.81694E-02	DRAG	4.01881E 04
SOS	1.00713E 03	VLD	2.40793E 02	VLG	3.16100E 03	VLT	0	VCHR	7.14600E 03
TIM	1.15000E 02	GAM	3.28038E 01	VEL	3.85240E 03	ALT	1.04091E 05	WT	1.09108E 06
STAGE	1	ALPH	0	MACH	3.80990E 00	XISP	3.02662E 02	DYNP	1.95943404E 02
GRAV	3.18552E 01	ACC	3.12283E 00	THRI	3.44482E 06	CL	0	LIFT	0
DENS	2.64056E-05	ACCN	0	RATI	1.00000E 00	CD	3.77356E-02	DRAG	3.75839E 04
SOS	1.01116E 03	VLD	2.41923E 02	VLG	3.17836E 03	VLT	0	VCHR	7.24605E 03

TIM	1.16070E-02	GAM	3.24180E-01	VEL	3.93629E-03	ALT	1.06190E-05	WT	1.07970E-06
STAGE	1	ALPH	0	MACH	3.87732E-00	XISP	3.02761E-02	DYNP	1.85256003E-02
GRAV	3.18484E-01	ACC	3.15907E-00	THRI	3.44597E-06	CL	0	LIFT	0
DENS	2.39126E-05	ACCN	0	RATI	1.00000E-00	CD	3.72974E-02	DRAG	3.51214E-04
SOS	1.01521E-03	VLD	2.42989E-02	VLG	3.19522E-03	VLT	0	VCHR	7.34716E-03
TIM	1.17000E-02	GAM	3.20392E-01	VFL	4.02154E-03	ALT	1.08312E-05	WT	1.06832E-06
STAGE	1	ALPH	0	MACH	3.94542E-00	XISP	3.02861E-02	DYNP	1.75062814E-02
GRAV	3.18424E-01	ACC	3.15596E-00	THRI	3.44710E-06	CL	0	LIFT	0
DENS	2.14496E-05	ACCN	0	RATI	1.00000E-00	CD	3.68546E-02	DRAG	3.27950E-04
SOS	1.01929E-03	VLD	2.43996E-02	VLG	3.21250E-03	VLT	0	VCHR	7.44936E-03
TIM	1.18000E-02	GAM	3.16674E-01	VEL	4.10817E-03	ALT	1.10457E-05	WT	1.05694E-06
STAGE	1	ALPH	0	MACH	4.01422E-00	XISP	3.02952E-02	DYNP	1.65348897E-02
GRAV	3.18359E-01	ACC	3.23340E-00	THRI	3.44814E-06	CL	0	LIFT	0
DENS	1.95945E-05	ACCN	0	RATI	1.00000E-00	CD	3.64502E-02	DRAG	3.06353E-04
SOS	1.02346E-03	VLD	2.44945E-02	VLG	3.22931E-03	VLT	0	VCHR	7.55266E-03
TIM	1.19000E-02	GAM	3.13025E-01	VFL	4.19618E-03	ALT	1.12625E-05	WT	1.04555E-06
STAGE	1	ALPH	0	MACH	4.08371E-00	XISP	3.03009E-02	DYNP	1.56098113E-02
GRAV	3.18293E-01	ACC	3.27105E-00	THRI	3.44879E-06	CL	0	LIFT	0
DENS	1.77304E-05	ACCN	0	RATI	1.00000E-00	CD	3.62076E-02	DRAG	2.87283E-04
SOS	1.02754E-03	VLD	2.45644E-02	VLG	3.24593E-03	VLT	0	VCHR	7.65708E-03
TIM	1.20000E-02	GAM	3.05443E-01	VEL	4.28559E-03	ALT	1.14817E-05	WT	1.03417E-06
STAGE	1	ALPH	0	MACH	4.15386E-00	XISP	3.03066E-02	DYNP	1.47294880E-02
GRAV	3.18226E-01	ACC	3.30943E-00	THRI	3.44945E-06	CL	0	LIFT	0
DENS	1.60397E-05	ACCN	0	RATI	1.00000E-00	CD	3.59614E-02	DRAG	2.69243E-04
SOS	1.03171E-03	VLD	2.46695E-02	VLG	3.26288E-03	VLT	0	VCHR	7.76265E-03
TIM	1.21000E-02	GAM	3.05927E-01	VEL	4.37641E-03	ALT	1.17033E-05	WT	1.02279E-06
STAGE	1	ALPH	0	MACH	4.22476E-00	XISP	3.03125E-02	DYNP	1.38923997E-02
GRAV	3.18159E-01	ACC	3.34857E-00	THRI	3.45011E-06	CL	0	LIFT	0
DENS	1.45068E-05	ACCN	0	RATI	1.00000E-00	CD	3.57134E-02	DRAG	2.52190E-04
SOS	1.03590E-03	VLD	2.47501E-02	VLG	3.27866E-03	VLT	0	VCHR	7.86938E-03
TIM	1.22000E-02	GAM	3.02477E-01	VEL	4.46888E-03	ALT	1.19272E-05	WT	1.01141E-06
STAGE	1	ALPH	0	MACH	4.29633E-00	XISP	3.03183E-02	DYNP	1.30970145E-02
GRAV	3.18091E-01	ACC	3.36851E-00	THRI	3.45078E-06	CL	0	LIFT	0
DENS	1.31173E-05	ACCN	0	RATI	1.00000E-00	CD	3.54626E-02	DRAG	2.36084E-04
SOS	1.04012E-03	VLD	2.48265E-02	VLG	3.29477E-03	VLT	0	VCHR	7.97730E-03
TIM	1.23000E-02	GAM	2.99091E-01	VEL	4.56242E-03	ALT	1.21535E-05	WT	1.00003E-06
STAGE	1	ALPH	0	MACH	4.36862E-00	XISP	3.03243E-02	DYNP	1.23417966E-02
GRAV	3.18023E-01	ACC	3.42928E-00	THRI	3.45146E-06	CL	0	LIFT	0
DENS	1.18582E-05	ACCN	0	RATI	1.00000E-00	CD	3.52098E-02	DRAG	2.20883E-04
SOS	1.04436E-03	VLD	2.48987E-02	VLG	3.31071E-03	VLT	0	VCHR	8.08644E-03
TIM	1.24000E-02	GAM	2.95768E-01	VEL	4.65765E-03	ALT	1.23822E-05	WT	9.88645E-06
STAGE	1	ALPH	0	MACH	4.44164E-00	XISP	3.03303E-02	DYNP	1.16252133E-02
GRAV	3.17953E-01	ACC	3.47090E-00	THRI	3.45215E-06	CL	0	LIFT	0
DENS	1.07176E-05	ACCN	0	RATI	1.00000E-00	CD	3.49543E-02	DRAG	2.06548E-04
SOS	1.04863E-03	VLD	2.49670E-02	VLG	3.32648E-03	VLT	0	VCHR	8.19683E-03
TIM	1.25000E-02	GAM	2.92508E-01	VEL	4.75439E-03	ALT	1.26133E-05	WT	9.77264E-06
STAGE	1	ALPH	0	MACH	4.51539E-00	XISP	3.03363E-02	DYNP	1.09457416E-02
GRAV	3.17884E-01	ACC	3.51342E-00	THRI	3.45284E-06	CL	0	LIFT	0
DENS	9.68470E-06	ACCN	0	RATI	1.00000E-00	CD	3.46961E-02	DRAG	1.93040E-04
SOS	1.05293E-03	VLD	2.50316E-02	VLG	3.34210E-03	VLT	0	VCHR	8.30850E-03
TIM	1.26000E-02	GAM	2.89309E-01	VEL	4.85267E-03	ALT	1.28468E-05	WT	9.65882E-06
STAGE	1	ALPH	0	MACH	4.58988E-00	XISP	3.03425E-02	DYNP	1.03018740E-02
GRAV	3.17812E-01	ACC	3.55686E-00	THRI	3.45354E-06	CL	0	LIFT	0
DENS	8.74953E-06	ACCN	0	RATI	1.00000E-00	CD	3.44354E-02	DRAG	1.80319E-04
SOS	1.05725E-03	VLD	2.50926E-02	VLG	3.35755E-03	VLT	0	VCHR	8.42147E-03
TIM	1.27000E-02	GAM	2.86171E-01	VEL	4.95252E-03	ALT	1.30826E-05	WT	9.54500E-06
STAGE	1	ALPH	0	MACH	4.66513E-00	XISP	3.03487E-02	DYNP	9.69212302E-01
GRAV	3.17741E-01	ACC	3.60127E-00	THRI	3.45425E-06	CL	0	LIFT	0
DENS	7.90307E-06	ACCN	0	RATI	1.00000E-00	CD	3.41721E-02	DRAG	1.68349E-04
SOS	1.06161E-03	VLD	2.51503E-02	VLG	3.37289E-03	VLT	0	VCHR	8.53578E-03
TIM	1.28000E-02	GAM	2.83092E-01	VEL	5.05398E-03	ALT	1.33212E-05	WT	9.43118E-06
STAGE	1	ALPH	0	MACH	4.74115E-00	XISP	3.03549E-02	DYNP	9.11502644E-01
GRAV	3.17669E-01	ACC	3.64669E-00	THRI	3.45496E-06	CL	0	LIFT	0
DENS	7.13709E-06	ACCN	0	RATI	1.00000E-00	CD	3.39060E-02	DRAG	1.57092E-04
SOS	1.06598E-03	VLD	2.52048E-02	VLG	3.38799E-03	VLT	0	VCHR	8.65145E-03
TIM	1.29000E-02	GAM	2.80071E-01	VEL	5.15706E-03	ALT	1.35621E-05	WT	9.31736E-06

STAGE	1	ALPH	0	MACH	4.81795E 00	XISP	3.03613E 02	DYNP	8.56915045E 01
GRAV	3.17596E 01	ACC	3.65314E 00	THRI	3.45569E 06	CL	0	LIFT	0
DENS	6.44411E -06	ACCN	0	RATI	1.00000E 00	CD	3.36372E -02	DRAG	1.46513E 04
SOS	1.07039E 03	VLD	2.52562E 02	VLG	3.40298E 03	VLT	0	VCHR	8.76853E 03
TIM	1.30000E 02	GAM	2.77109E 01	VEL	5.26181E 03	ALT	1.38056E 05	WT	9.20354E 05
STAGE	1	ALPH	0	MACH	4.89555E 00	XISP	3.03676E 02	DYNP	8.05309316E 01
GRAV	3.17522E 01	ACC	3.74069E 00	THRI	3.45642E 06	CL	0	LIFT	0
DENS	5.81732E -06	ACCN	0	RATI	1.00000E 00	CD	3.33656E -02	DRAG	1.36578E 04
SOS	1.07422E 03	VLD	2.53047E 02	VLG	3.41782E 03	VLT	0	VCHR	8.88705E 03
TIM	1.31000E 02	GAM	2.74203E 01	VEL	5.36825E 03	ALT	1.40515E 05	WT	9.08972E 05
STAGE	1	ALPH	0	MACH	4.97395E 00	XISP	3.03741E 02	DYNP	7.56548733E 01
GRAV	3.17448E 01	ACC	3.78937E 00	THRI	3.45715E 06	CL	0	LIFT	0
DENS	5.25051E -06	ACCN	0	RATI	1.00000E 00	CD	3.30912E -02	DRAG	1.27253E 04
SOS	1.07027E 03	VLD	2.53505E 02	VLG	3.43251E 03	VLT	0	VCHR	9.00704E 03
TIM	1.32000E 02	GAM	2.71353E 01	VEL	5.47642E 03	ALT	1.43000E 05	WT	8.97590E 05
STAGE	1	ALPH	0	MACH	5.05319E 00	XISP	3.03806E 02	DYNP	7.10500171E 01
GRAV	3.17373E 01	ACC	3.80000E 00	THRI	3.42272E 06	CL	0	LIFT	0
DENS	4.73806E -06	ACCN	0	RATI	9.89827E -01	CD	3.28936E -02	DRAG	1.18794E 04
SOS	1.08375E 03	VLD	2.53937E 02	VLG	3.44705E 03	VLT	0	VCHR	9.12854E 03
TIM	1.33000E 02	GAM	2.68558E 01	VEL	5.58614E 03	ALT	1.45510E 05	WT	8.86228E 05
STAGE	1	ALPH	0	MACH	5.13318E 00	XISP	3.03872E 02	DYNP	6.60986052E 01
GRAV	3.17247E 01	ACC	3.80000E 00	THRI	3.37876E 06	CL	0	LIFT	0
DENS	4.27417E -06	ACCN	0	RATI	9.76911E -01	CD	3.27338E -02	DRAG	1.10977E 04
SOS	1.08626E 03	VLD	2.54345E 02	VLG	3.46146E 03	VLT	0	VCHR	9.25137E 03
TIM	1.34000E 02	GAM	2.65817E 01	VEL	5.69739E 03	ALT	1.48047E 05	WT	8.74890E 05
STAGE	1	ALPH	0	MACH	5.21357E 00	XISP	3.03939E 02	DYNP	6.25881466E 01
GRAV	3.17220E 01	ACC	3.80000E 00	THRI	3.33444E 06	CL	0	LIFT	0
DENS	3.86630E -06	ACCN	0	RATI	9.64000E -01	CD	3.25729E -02	DRAG	1.03626E 04
SOS	1.09250E 03	VLD	2.54732E 02	VLG	3.47522E 03	VLT	0	VCHR	9.37552E 03
TIM	1.34100E 02	GAM	2.65546E 01	VEL	5.70859E 03	ALT	1.48302E 05	WT	8.73758E 05
STAGE	1	ALPH	0	MACH	5.22144E 00	XISP	3.03945E 02	DYNP	6.21896369E 01
GRAV	3.17212E 01	ACC	3.80000E 00	THRI	3.33057E 06	CL	0	LIFT	0
DENS	3.81673E -06	ACCN	0	RATI	9.62735E -01	CD	3.25567E -02	DRAG	1.02915E 04
SOS	1.09325E 03	VLD	2.54769E 02	VLG	3.47714E 03	VLT	0	VCHR	9.38800E 03
TIM	1.34200E 02	GAM	2.65275E 01	VEL	5.71960E 03	ALT	1.48557E 05	WT	8.72627E 05
STAGE	1	ALPH	0	MACH	5.22972E 00	XISP	3.03952E 02	DYNP	6.17934230E 01
GRAV	3.17205E 01	ACC	3.80000E 00	THRI	3.32670E 06	CL	0	LIFT	0
DENS	3.77555E -06	ACCN	0	RATI	9.61411E -01	CD	3.25406E -02	DRAG	1.02209E 04
SOS	1.09371E 03	VLD	2.54807E 02	VLG	3.47856E 03	VLT	0	VCHR	9.40049E 03
TIM	1.34300E 02	GAM	2.65005E 01	VEL	5.73103E 03	ALT	1.48813E 05	WT	8.71496E 05
STAGE	1	ALPH	0	MACH	5.23781E 00	XISP	3.03959E 02	DYNP	6.13994942E 01
GRAV	3.17197E 01	ACC	3.80000E 00	THRI	3.32144E 06	CL	0	LIFT	0
DENS	3.73878E -06	ACCN	0	RATI	9.60167E -01	CD	3.25244E -02	DRAG	1.01507E 04
SOS	1.09417E 03	VLD	2.54844E 02	VLG	3.47997E 03	VLT	0	VCHR	9.41299E 03
TIM	1.34400E 02	GAM	2.64736E 01	VEL	5.74227E 03	ALT	1.49069E 05	WT	8.70366E 05
STAGE	1	ALPH	0	MACH	5.24590E 00	XISP	3.03966E 02	DYNP	6.10078399E 01
GRAV	3.17189E 01	ACC	3.80000E 00	THRI	3.31747E 06	CL	0	LIFT	0
DENS	3.70040E -06	ACCN	0	RATI	9.58864E -01	CD	3.25082E -02	DRAG	1.00809E 04
SOS	1.09462E 03	VLD	2.54880E 02	VLG	3.48139E 03	VLT	0	VCHR	9.42551E 03
TIM	1.34500E 02	GAM	2.64466E 01	VEL	5.75353E 03	ALT	1.49325E 05	WT	8.69235E 05
STAGE	1	ALPH	0	MACH	5.25400E 00	XISP	3.03972E 02	DYNP	6.06184494E 01
GRAV	3.17182E 01	ACC	3.80000E 00	THRI	3.31311E 06	CL	0	LIFT	0
DENS	3.66240E -06	ACCN	0	RATI	9.57601E -01	CD	3.24920E -02	DRAG	1.00116E 04
SOS	1.09508E 03	VLD	2.54917E 02	VLG	3.48280E 03	VLT	0	VCHR	9.43804E 03
VSTAG REACHED									
TIM	1.34500E 02	GAM	2.15536E 01	VEL	6.97510E 03	ALT	1.49325E 05	WT	5.59144E 05
STAGE	2	ALPH	0	MACH	6.36941E 00	XISP	4.55000E 02	DYNP	0
GRAV	3.17182E 01	ACC	1.00000E 00	THRI	5.59144E 05	CL	0	LIFT	0
DENS	3.66240E -06	ACCN	0	RATI	1.00000E 00	CD	0	DRAG	0
SOS	1.09508E 03	VLD	2.54917E 02	VLG	3.48280E 03	VLT	0	VCHR	9.43804E 03
TIM	1.35000E 02	GAM	2.14414E 01	VEL	6.98528E 03	ALT	1.50604E 05	WT	5.58530E 05
STAGE	2	ALPH	0	MACH	6.36558E 00	XISP	4.55000E 02	DYNP	0
GRAV	3.17143E 01	ACC	1.00110E 00	THRI	5.59144E 05	CL	0	LIFT	0
DENS	3.47888E -06	ACCN	0	RATI	1.00000E 00	CD	0	DRAG	0
SOS	1.09735E 03	VLD	2.54917E 02	VLG	3.48861E 03	VLT	6.93617E -06	VCHR	9.45390E 03
TIM	1.36000E 02	GAM	2.12181E 01	VEL	7.00599E 03	ALT	1.53148E 05	WT	5.57301E 05
STAGE	2	ALPH	0	MACH	6.35832E 00	XISP	4.55000E 02	DYNP	0

GRAV	3.170600E-01	ACC	1.00331F 00	THRI	5.59144E 05	CL	0	LIFT	0
DENS	3.14269E-06	ACCN	0	RATI	1.00000E 00	CD	0	DRAG	0
SOS	1.10166E-03	VLD	2.54917E 02	VLG	3.50075E 03	VLT	1.86524E-04	VCHR	9.48568E 03
TIM	1.37000E-02	GAM	2.09961F 01	VFL	7.02019E 03	ALT	1.55675E 05	WT	5.56072E 05
STAGE	2	ALPH	4.60304E-01	MACH	6.35487E 00	XISP	4.55000E 02	DYNP	0
GRAV	3.16990E-01	ACC	1.00552E 00	THRI	5.59144E 05	CL	0	LIFT	0
DENS	2.84631E-06	ACCN	0	RATI	1.00000E 00	CD	0	DRAG	0
SOS	1.10575E-03	VLD	2.54917E 02	VLG	3.51156E 03	VLT	8.61065E-04	VCHR	9.51753E 03
TIM	1.38000E-02	GAM	2.07754E 01	VFL	7.04748E 03	ALT	1.58184E 05	WT	5.54843E 05
STAGE	2	ALPH	6.42051E-01	MACH	6.37344E 00	XISP	4.55000E 02	DYNP	0
GRAV	3.16514E-01	ACC	1.00775E 00	THRI	5.59144E 05	CL	0	LIFT	0
DENS	2.59800E-06	ACCN	0	RATI	1.00000E 00	CD	0	DRAG	0
SOS	1.10575E-03	VLD	2.54917E 02	VLG	3.52266E 03	VLT	2.35049E-03	VCHR	9.54943E 03
TIM	1.39000E-02	GAM	2.05561E 01	VFL	7.06975E 03	ALT	1.60675E 05	WT	5.53614E 05
STAGE	2	ALPH	8.22439E-01	MACH	6.39316E 00	XISP	4.55000E 02	DYNP	0
GRAV	3.16579E-01	ACC	1.00999E 00	THRI	5.59144E 05	CL	0	LIFT	0
DENS	2.37402E-06	ACCN	0	RATI	1.00000E 00	CD	0	DRAG	0
SOS	1.10575E-03	VLD	2.54917E 02	VLG	3.53405E 03	VLT	4.97542E-03	VCHR	9.58140E 03
TIM	1.40000E-02	GAM	2.03381E 01	VFL	7.09071E 03	ALT	1.63148E 05	WT	5.52385E 05
STAGE	2	ALPH	1.00147E 00	MACH	6.41259E 00	XISP	4.55000E 02	DYNP	0
GRAV	3.16774E-01	ACC	1.01224E 00	THRI	5.59144E 05	CL	0	LIFT	0
DENS	2.17030E-06	ACCN	0	RATI	1.00000E 00	CD	0	DRAG	0
SOS	1.10575E-03	VLD	2.54917E 02	VLG	3.5451E 03	VLT	9.04711E-03	VCHR	9.61343E 03
TIM	1.41000E-02	GAM	2.01215E 01	VFL	7.11276E 03	ALT	1.65604E 05	WT	5.51156E 05
STAGE	2	ALPH	1.17913E 00	MACH	6.43216E 00	XISP	4.55000E 02	DYNP	0
GRAV	3.16490E-01	ACC	1.01449E 00	THRI	5.59144E 05	CL	0	LIFT	0
DENS	1.98538E-06	ACCN	0	RATI	1.00000E 00	CD	0	DRAG	0
SOS	1.10575E-03	VLD	2.54917E 02	VLG	3.55607E 03	VLT	1.48725E-02	VCHR	9.64553E 03
TIM	1.42000E-02	GAM	1.99062E 01	VFL	7.13419E 03	ALT	1.68042E 05	WT	5.49927E 05
STAGE	2	ALPH	1.35243E 00	MACH	6.45191E 00	XISP	4.55000E 02	DYNP	0
GRAV	3.16017E-01	ACC	1.01676E 00	THRI	5.59144E 05	CL	0	LIFT	0
DENS	1.81741E-06	ACCN	0	RATI	1.00000E 00	CD	0	DRAG	0
SOS	1.10575E-03	VLD	2.54917E 02	VLG	3.56800E 03	VLT	2.27533E-02	VCHR	9.67769E 03
TIM	1.43000E-02	GAM	1.96922E 01	VFL	7.15621E 03	ALT	1.70462E 05	WT	5.48698E 05
STAGE	2	ALPH	1.53037E 00	MACH	6.47182E 00	XISP	4.55000E 02	DYNP	0
GRAV	3.16544E-01	ACC	1.01904E 00	THRI	5.59144E 05	CL	0	LIFT	0
DENS	1.66476E-06	ACCN	0	RATI	1.00000E 00	CD	0	DRAG	0
SOS	1.10575E-03	VLD	2.54917E 02	VLG	3.57733E 03	VLT	3.29857E-02	VCHR	9.70991E 03
TIM	1.44000E-02	GAM	1.94796E 01	VFL	7.17841E 03	ALT	1.72865E 05	WT	5.47470E 05
STAGE	2	ALPH	1.70394E 00	MACH	6.49100E 00	XISP	4.55000E 02	DYNP	0
GRAV	3.16472E-01	ACC	1.02132E 00	THRI	5.59144E 05	CL	0	LIFT	0
DENS	1.52593E-06	ACCN	0	RATI	1.00000E 00	CD	0	DRAG	0
SOS	1.10575E-03	VLD	2.54917E 02	VLG	3.58824E 03	VLT	4.58009E-02	VCHR	9.74220E 03
TIM	1.45000E-02	GAM	1.92683E 01	VFL	7.20079E 03	ALT	1.75250E 05	WT	5.46241E 05
STAGE	2	ALPH	1.87614E 00	MACH	6.51214E 00	XISP	4.55000E 02	DYNP	0
GRAV	3.16400E-01	ACC	1.02362E 00	THRI	5.59144E 05	CL	0	LIFT	0
DENS	1.39960E-06	ACCN	0	RATI	1.00000E 00	CD	0	DRAG	0
SOS	1.10575E-03	VLD	2.54917E 02	VLG	3.59873E 03	VLT	6.16644E-02	VCHR	9.77456E 03
TIM	1.46000E-02	GAM	1.90584E 01	VFL	7.22336E 03	ALT	1.77617E 05	WT	5.45012E 05
STAGE	2	ALPH	2.04698E 00	MACH	6.53244E 00	XISP	4.55000E 02	DYNP	0
GRAV	3.16390E-01	ACC	1.02593E 00	THRI	5.59144E 05	CL	0	LIFT	0
DENS	1.29802E-06	ACCN	0	RATI	1.00000E 00	CD	0	DRAG	0
SOS	1.00474E-03	VLD	2.54917E 02	VLG	3.60912E 03	VLT	8.04769E-02	VCHR	9.80698E 03
TIM	1.47000E-02	GAM	1.88498E 01	VFL	7.24511E 03	ALT	1.79967E 05	WT	5.43783E 05
STAGE	2	ALPH	2.21545E 00	MACH	6.62659E 00	XISP	4.55000E 02	DYNP	0
GRAV	3.16254E-01	ACC	1.02825E 00	THRI	5.59144E 05	CL	0	LIFT	0
DENS	1.20407E-06	ACCN	0	RATI	1.00000E 00	CD	0	DRAG	0
SOS	1.00349E-03	VLD	2.54917E 02	VLG	3.61939E 03	VLT	1.03173E-01	VCHR	9.83946E 03
TIM	1.48000E-02	GAM	1.86426E 01	VFL	7.26904E 03	ALT	1.82299E 05	WT	5.42554E 05
STAGE	2	ALPH	2.38455E 00	MACH	6.64562E 00	XISP	4.55000E 02	DYNP	0
GRAV	3.16180E-01	ACC	1.03058E 00	THRI	5.59144E 05	CL	0	LIFT	0
DENS	1.11600E-06	ACCN	0	RATI	1.00000E 00	CD	0	DRAG	0
SOS	1.00725E-03	VLD	2.54917E 02	VLG	3.62955E 03	VLT	1.29424E-01	VCHR	9.87202E 03
TIM	1.49000E-02	GAM	1.84367E 01	VFL	7.29215E 03	ALT	1.84614E 05	WT	5.41325E 05
STAGE	2	ALPH	2.55129E 00	MACH	6.74956E 00	XISP	4.55000E 02	DYNP	0
GRAV	3.16118E-01	ACC	1.03292E 00	THRI	5.59144E 05	CL	0	LIFT	0
DENS	1.03520E-06	ACCN	0	RATI	1.00000E 00	CD	0	DRAG	0
SOS	1.00103E-03	VLD	2.54917E 02	VLG	3.63961E 03	VLT	1.59694E-01	VCHR	9.90464E 03

TIM	1.50000E-02	GAM	1.82322E-01	VEL	7.31544E-03	ALT	1.86912E-05	WT	5.40096E-05
STAGE	2	ALPH	2.71666E-00	MACH	6.80622E-00	XISP	4.55000E-02	DYNP	0
GRAV	3.16049E-01	ACC	1.03527E-00	THRI	5.59144E-05	CL	0	LIFT	0
DENS	9.50465E-07	ACCN	0	RATI	1.00000E-00	CD	0	DRAG	0
SOS	1.07482E-03	VLD	2.54917E-02	VLG	3.64955E-03	VLT	1.94242E-01	VCHR	9.93732E-03
TIM	1.51000E-02	GAM	1.80290E-01	VEL	7.33892E-03	ALT	1.89192E-05	WT	5.38867E-05
STAGE	2	ALPH	2.86066E-00	MACH	6.86767E-00	XISP	4.55000E-02	DYNP	0
GRAV	3.15981E-01	ACC	1.03763E-00	THRI	5.59144E-05	CL	0	LIFT	0
DENS	8.89016E-07	ACCN	0	RATI	1.00000E-00	CD	0	DRAG	0
SOS	1.06862E-03	VLD	2.54917E-02	VLG	3.65978E-03	VLT	2.33322E-01	VCHR	9.97007E-03
TIM	1.52000E-02	GAM	1.78271E-01	VEL	7.36257E-03	ALT	1.91454E-05	WT	5.37638E-05
STAGE	2	ALPH	3.04330E-00	MACH	6.92992E-00	XISP	4.55000E-02	DYNP	0
GRAV	3.15913E-01	ACC	1.04000E-00	THRI	5.59144E-05	CL	0	LIFT	0
DENS	8.23516E-07	ACCN	0	RATI	1.00000E-00	CD	0	DRAG	0
SOS	1.06243E-03	VLD	2.54917E-02	VLG	3.66911E-03	VLT	2.77185E-01	VCHR	1.00029E-04
TIM	1.53000E-02	GAM	1.76266E-01	VEL	7.38640E-03	ALT	1.93700E-05	WT	5.36410E-05
STAGE	2	ALPH	3.20458E-00	MACH	6.99298E-00	XISP	4.55000E-02	DYNP	0
GRAV	3.15846E-01	ACC	1.04238E-00	THRI	5.59144E-05	CL	0	LIFT	0
DENS	7.62605E-07	ACCN	0	RATI	1.00000E-00	CD	0	DRAG	0
SOS	1.05826E-03	VLD	2.54917E-02	VLG	3.67873E-03	VLT	3.26074E-01	VCHR	1.00358E-04
TIM	1.54000E-02	GAM	1.74275E-01	VEL	7.41041E-03	ALT	1.95928E-05	WT	5.35161E-05
STAGE	2	ALPH	3.36449E-00	MACH	7.05677E-00	XISP	4.55000E-02	DYNP	0
GRAV	3.15779E-01	ACC	1.04478E-00	THRI	5.59144E-05	CL	0	LIFT	0
DENS	7.06005E-07	ACCN	0	RATI	1.00000E-00	CD	0	DRAG	0
SOS	1.05010E-03	VLD	2.54917E-02	VLG	3.68924E-03	VLT	3.80228E-01	VCHR	1.00687E-04
TIM	1.55000E-02	GAM	1.72296E-01	VEL	7.43426E-03	ALT	1.98139E-05	WT	5.33952E-05
STAGE	2	ALPH	3.52305E-00	MACH	7.12159E-00	XISP	4.55000E-02	DYNP	0
GRAV	3.15712E-01	ACC	1.04718E-00	THRI	5.59144E-05	CL	0	LIFT	0
DENS	6.53419E-07	ACCN	0	RATI	1.00000E-00	CD	0	DRAG	0
SOS	1.04305E-03	VLD	2.54917E-02	VLG	3.69764E-03	VLT	4.39881E-01	VCHR	1.01018E-04
TIM	1.56000E-02	GAM	1.70331E-01	VEL	7.45846E-03	ALT	2.00332E-05	WT	5.32723E-05
STAGE	2	ALPH	3.66024E-00	MACH	7.18716E-00	XISP	4.55000E-02	DYNP	0
GRAV	3.15647E-01	ACC	1.04960E-00	THRI	5.59144E-05	CL	0	LIFT	0
DENS	6.04574E-07	ACCN	0	RATI	1.00000E-00	CD	0	DRAG	0
SOS	1.03782E-03	VLD	2.54917E-02	VLG	3.70894E-03	VLT	5.05262E-01	VCHR	1.01349E-04
TIM	1.57000E-02	GAM	1.68380E-01	VEL	7.48351E-03	ALT	2.02508E-05	WT	5.31494E-05
STAGE	2	ALPH	3.83607E-00	MACH	7.25359E-00	XISP	4.55000E-02	DYNP	0
GRAV	3.15581E-01	ACC	1.05202E-00	THRI	5.59144E-05	CL	0	LIFT	0
DENS	5.50219E-07	ACCN	0	RATI	1.00000E-00	CD	0	DRAG	0
SOS	1.03170E-03	VLD	2.54917E-02	VLG	3.71613E-03	VLT	5.76596E-01	VCHR	1.01680E-04
TIM	1.58000E-02	GAM	1.66442E-01	VEL	7.50873E-03	ALT	2.04668E-05	WT	5.30265E-05
STAGE	2	ALPH	3.95055E-00	MACH	7.32088E-00	XISP	4.55000E-02	DYNP	0
GRAV	3.15517E-01	ACC	1.05446E-00	THRI	5.59144E-05	CL	0	LIFT	0
DENS	5.12115E-07	ACCN	0	RATI	1.00000E-00	CD	0	DRAG	0
SOS	1.02559E-03	VLD	2.54917E-02	VLG	3.72522E-03	VLT	6.54100E-01	VCHR	1.02013E-04
TIM	1.59000E-02	GAM	1.64517E-01	VEL	7.53312E-03	ALT	2.06810E-05	WT	5.29036E-05
STAGE	2	ALPH	4.14367E-00	MACH	7.38906E-00	XISP	4.55000E-02	DYNP	0
GRAV	3.15453E-01	ACC	1.05691E-00	THRI	5.59144E-05	CL	0	LIFT	0
DENS	4.78043E-07	ACCN	0	RATI	1.00000E-00	CD	0	DRAG	0
SOS	1.01950E-03	VLD	2.54917E-02	VLG	3.73421E-03	VLT	7.37990E-01	VCHR	1.02346E-04
TIM	1.60000E-02	GAM	1.62606E-01	VEL	7.55819E-03	ALT	2.08934E-05	WT	5.27807E-05
STAGE	2	ALPH	4.29544E-00	MACH	7.45812E-00	XISP	4.55000E-02	DYNP	0
GRAV	3.15389E-01	ACC	1.05937E-00	THRI	5.59144E-05	CL	0	LIFT	0
DENS	4.41793E-07	ACCN	0	RATI	1.00000E-00	CD	0	DRAG	0
SOS	1.01342E-03	VLD	2.54917E-02	VLG	3.74309E-03	VLT	8.28473E-01	VCHR	1.02679E-04
TIM	1.61000E-02	GAM	1.60708E-01	VEL	7.58343E-03	ALT	2.11042E-05	WT	5.26578E-05
STAGE	2	ALPH	4.44586E-00	MACH	7.52809E-00	XISP	4.55000E-02	DYNP	0
GRAV	3.15326E-01	ACC	1.06184E-00	THRI	5.59144E-05	CL	0	LIFT	0
DENS	4.08122E-07	ACCN	0	RATI	1.00000E-00	CD	0	DRAG	0
SOS	1.00735E-03	VLD	2.54917E-02	VLG	3.75187E-03	VLT	9.25755E-01	VCHR	1.03014E-04
TIM	1.62000E-02	GAM	1.58823E-01	VEL	7.60865E-03	ALT	2.13133E-05	WT	5.25350E-05
STAGE	2	ALPH	4.59493E-00	MACH	7.59898E-00	XISP	4.55000E-02	DYNP	0
GRAV	3.15263E-01	ACC	1.06433E-00	THRI	5.59144E-05	CL	0	LIFT	0
DENS	3.76909E-07	ACCN	0	RATI	1.00000E-00	CD	0	DRAG	0
SOS	1.00130E-03	VLD	2.54917E-02	VLG	3.76055E-03	VLT	1.03004E-00	VCHR	1.03349E-04
TIM	1.63000E-02	GAM	1.56951E-01	VEL	7.63445E-03	ALT	2.15207E-05	WT	5.24121E-05
STAGE	2	ALPH	4.74265E-00	MACH	7.67079E-00	XISP	4.55000E-02	DYNP	0

GRAV	3.15201E-01	ACC	1.06682E-03	THRI	5.59144E-05	CL	0	LIFT	0
DENS	3.48104E-07	ACCN	0	RATI	1.00000E-00	CD	0	DRAG	0
SOS	9.95222E-02	VLD	2.54917E-02	VLG	3.76913E-03	VLT	1.14151E-00	VCHR	1.03685E-04
TIM	1.64000E-02	GAM	1.55003E-01	VFL	7.64021E-03	ALT	2.17264E-05	WT	5.22892E-05
STAGE	2	ALPH	4.82903E-00	MACH	7.74355E-00	XISP	4.55000E-02	DYNP	0
GRAV	3.15140E-01	ACC	1.07933E-00	THRI	5.59144E-05	CL	0	LIFT	0
DENS	3.21329E-07	ACCN	0	RATI	1.00000E-00	CD	0	DRAG	0
SOS	9.86222E-02	VLD	2.54917E-02	VLG	3.77700E-03	VLT	1.26036E-00	VCHR	1.04022E-04
TIM	1.65000E-02	GAM	1.53248E-01	VFL	7.68615E-03	ALT	2.19303E-05	WT	5.21663E-05
STAGE	2	ALPH	5.03407E-00	MACH	7.81726E-00	XISP	4.55000E-02	DYNP	0
GRAV	3.15079E-01	ACC	1.07185E-00	THRI	5.59144E-05	CL	0	LIFT	0
DENS	2.96522E-07	ACCN	0	RATI	1.00000E-00	CD	0	DRAG	0
SOS	9.83222E-02	VLD	2.54917E-02	VLG	3.78598E-03	VLT	1.38679E-00	VCHR	1.04359E-04
TIM	1.66000E-02	GAM	1.51416E-01	VFL	7.71226E-03	ALT	2.21326E-05	WT	5.20434E-05
STAGE	2	ALPH	5.17778E-00	MACH	7.89193E-00	XISP	4.55000E-02	DYNP	0
GRAV	3.15018E-01	ACC	1.07438E-00	THRI	5.59144E-05	CL	0	LIFT	0
DENS	2.73554E-07	ACCN	0	RATI	1.00000E-00	CD	0	DRAG	0
SOS	9.77222E-02	VLD	2.54917E-02	VLG	3.79426E-03	VLT	1.52096E-00	VCHR	1.04697E-04
TIM	1.67000E-02	GAM	1.45597E-01	VFL	7.73855E-03	ALT	2.23332E-05	WT	5.19205E-05
STAGE	2	ALPH	5.32014E-00	MACH	7.96758E-00	XISP	4.55000E-02	DYNP	0
GRAV	3.14958E-01	ACC	1.07692E-00	THRI	5.59144E-05	CL	0	LIFT	0
DENS	2.52288E-07	ACCN	0	RATI	1.00000E-00	CD	0	DRAG	0
SOS	9.71222E-02	VLD	2.54917E-02	VLG	3.80244E-03	VLT	1.66305E-00	VCHR	1.05036E-04
TIM	1.68000E-02	GAM	1.47791E-01	VFL	7.76500E-03	ALT	2.25322E-05	WT	5.17976E-05
STAGE	2	ALPH	5.46118E-00	MACH	8.04423E-00	XISP	4.55000E-02	DYNP	0
GRAV	3.14809E-01	ACC	1.07948E-00	THRI	5.59144E-05	CL	0	LIFT	0
DENS	2.32605E-07	ACCN	0	RATI	1.00000E-00	CD	0	DRAG	0
SOS	9.65222E-02	VLD	2.54917E-02	VLG	3.81052E-03	VLT	1.81325E-00	VCHR	1.05375E-04
TIM	1.69000E-02	GAM	1.45999E-01	VFL	7.79163E-03	ALT	2.27294E-05	WT	5.16747E-05
STAGE	2	ALPH	5.60082E-00	MACH	8.12188E-00	XISP	4.55000E-02	DYNP	0
GRAV	3.14800E-01	ACC	1.08205E-00	THRI	5.59144E-05	CL	0	LIFT	0
DENS	2.14354E-07	ACCN	0	RATI	1.00000E-00	CD	0	DRAG	0
SOS	9.59336E-02	VLD	2.54917E-02	VLG	3.81840E-03	VLT	1.97170E-00	VCHR	1.05716E-04
TIM	1.70000E-02	GAM	1.44219E-01	VFL	7.81842E-03	ALT	2.29250E-05	WT	5.15518E-05
STAGE	2	ALPH	5.73928E-00	MACH	8.20055E-00	XISP	4.55000E-02	DYNP	0
GRAV	3.14718E-01	ACC	1.08462E-00	THRI	5.59144E-05	CL	0	LIFT	0
DENS	1.97520E-07	ACCN	0	RATI	1.00000E-00	CD	0	DRAG	0
SOS	9.53402E-02	VLD	2.54917E-02	VLG	3.82639E-03	VLT	2.13858E-00	VCHR	1.06057E-04
TIM	1.71000E-02	GAM	1.42452E-01	VFL	7.84539E-03	ALT	2.31186E-05	WT	5.14290E-05
STAGE	2	ALPH	5.87634E-00	MACH	8.28025E-00	XISP	4.55000E-02	DYNP	0
GRAV	3.14724E-01	ACC	1.08722E-00	THRI	5.59144E-05	CL	0	LIFT	0
DENS	1.81975E-07	ACCN	0	RATI	1.00000E-00	CD	0	DRAG	0
SOS	9.47422E-02	VLD	2.54917E-02	VLG	3.83440E-03	VLT	2.31404E-00	VCHR	1.06399E-04
TIM	1.72000E-02	GAM	1.40699E-01	VFL	7.87253E-03	ALT	2.33111E-05	WT	5.13061E-05
STAGE	2	ALPH	6.01208E-00	MACH	8.36100E-00	XISP	4.55000E-02	DYNP	0
GRAV	3.14666E-01	ACC	1.08982E-00	THRI	5.59144E-05	CL	0	LIFT	0
DENS	1.67527E-07	ACCN	0	RATI	1.00000E-00	CD	0	DRAG	0
SOS	9.41577E-02	VLD	2.54917E-02	VLG	3.84188E-03	VLT	2.49824E-00	VCHR	1.06741E-04
TIM	1.73000E-02	GAM	1.38958E-01	VFL	7.89983E-03	ALT	2.35016E-05	WT	5.11832E-05
STAGE	2	ALPH	6.14651E-00	MACH	8.44261E-00	XISP	4.55000E-02	DYNP	0
GRAV	3.14609E-01	ACC	1.09244E-00	THRI	5.59144E-05	CL	0	LIFT	0
DENS	1.54272E-07	ACCN	0	RATI	1.00000E-00	CD	0	DRAG	0
SOS	9.35688E-02	VLD	2.54917E-02	VLG	3.84948E-03	VLT	2.69133E-00	VCHR	1.07084E-04
TIM	1.74000E-02	GAM	1.37230E-01	VFL	7.92731E-03	ALT	2.36905E-05	WT	5.10603E-05
STAGE	2	ALPH	6.27964E-00	MACH	8.52269E-00	XISP	4.55000E-02	DYNP	0
GRAV	3.14553E-01	ACC	1.09507E-00	THRI	5.59144E-05	CL	0	LIFT	0
DENS	1.41541E-07	ACCN	0	RATI	1.00000E-00	CD	0	DRAG	0
SOS	9.29814E-02	VLD	2.54917E-02	VLG	3.85699E-03	VLT	2.89344E-00	VCHR	1.07429E-04
TIM	1.75000E-02	GAM	1.35516E-01	VFL	7.95495E-03	ALT	2.38777E-05	WT	5.09374E-05
STAGE	2	ALPH	6.41145E-00	MACH	8.60967E-00	XISP	4.55000E-02	DYNP	0
GRAV	3.14497E-01	ACC	1.09771E-00	THRI	5.59144E-05	CL	0	LIFT	0
DENS	1.30630E-07	ACCN	0	RATI	1.00000E-00	CD	0	DRAG	0
SOS	9.23956E-02	VLD	2.54917E-02	VLG	3.86441E-03	VLT	3.10473E-00	VCHR	1.07773E-04
TIM	1.76000E-02	GAM	1.33814E-01	VFL	7.98276E-03	ALT	2.40633E-05	WT	5.08145E-05
STAGE	2	ALPH	6.54196E-00	MACH	8.69474E-00	XISP	4.55000E-02	DYNP	0
GRAV	3.14442E-01	ACC	1.10036E-00	THRI	5.59144E-05	CL	0	LIFT	0
DENS	1.20150E-07	ACCN	0	RATI	1.00000E-00	CD	0	DRAG	0
SOS	9.18114E-02	VLD	2.54917E-02	VLG	3.87173E-03	VLT	3.32532E-00	VCHR	1.08119E-04

TIM	1.77600E 02	GAM	1.32124E 01	VEL	8.01074E 03	ALT	2.42472E 05	WT	5.06916E 05
STAGE	2	ALPH	6.67117E 00	MACH	8.78094E 00	XISP	4.55000E 02	DYNP	0
GRAV	3.14377E 01	ACC	1.10303E 00	THRI	5.59144E 05	CL	0	LIFT	0
DENS	1.10475E -07	ACCN	0	RATI	1.00000E 00	CD	0	DRAG	0
SOS	9.12286E 02	VLD	2.54917E 02	VLG	3.87896E 03	VLT	3.55535E 00	VCHR	1.08465E 04
TIM	1.78000E 02	GAM	1.30448E 01	VEL	8.03849E 03	ALT	2.44295E 05	WT	5.05687E 05
STAGE	2	ALPH	6.79209E 00	MACH	8.86826E 00	XISP	4.55000E 02	DYNP	0
GRAV	3.14333E 01	ACC	1.10571E 00	THRI	5.59144E 05	CL	0	LIFT	0
DENS	1.01554E -07	ACCN	0	RATI	1.00000E 00	CD	0	DRAG	0
SOS	9.06479E 02	VLD	2.54917E 02	VLG	3.88610E 03	VLT	3.79495E 00	VCHR	1.08813E 04
TIM	1.79000E 02	GAM	1.28784E 01	VEL	8.06720E 03	ALT	2.46101E 05	WT	5.04458E 05
STAGE	2	ALPH	6.92572E 00	MACH	8.95674E 00	XISP	4.55000E 02	DYNP	0
GRAV	3.14279E 01	ACC	1.10840E 00	THRI	5.59144E 05	CL	0	LIFT	0
DENS	9.33223E -08	ACCN	0	RATI	1.00000E 00	CD	0	DRAG	0
SOS	9.00686E 02	VLD	2.54917E 02	VLG	3.89315E 03	VLT	4.04425E 00	VCHR	1.09160E 04
TIM	1.80000E 02	GAM	1.27133E 01	VEL	8.09568E 03	ALT	2.47891E 05	WT	5.03230E 05
STAGE	2	ALPH	7.05106E 00	MACH	9.04637E 00	XISP	4.55000E 02	DYNP	0
GRAV	3.14226E 01	ACC	1.11111E 00	THRI	5.59144E 05	CL	0	LIFT	0
DENS	8.57325E -08	ACCN	0	RATI	1.00000E 00	CD	0	DRAG	0
SOS	8.94919E 02	VLD	2.54917E 02	VLG	3.90011E 03	VLT	4.30335E 00	VCHR	1.09509E 04
TIM	1.81000E 02	GAM	1.25494E 01	VEL	8.12443E 03	ALT	2.49665E 05	WT	5.02001E 05
STAGE	2	ALPH	7.17512E 00	MACH	9.13219E 00	XISP	4.55000E 02	DYNP	0
GRAV	3.14173E 01	ACC	1.11393E 00	THRI	5.59144E 05	CL	0	LIFT	0
DENS	7.87363E -08	ACCN	0	RATI	1.00000E 00	CD	0	DRAG	0
SOS	8.69156E 02	VLD	2.54917E 02	VLG	3.90698E 03	VLT	4.57238E 00	VCHR	1.09859E 04
TIM	1.82000E 02	GAM	1.23868E 01	VEL	8.15314E 03	ALT	2.51422E 05	WT	5.00772E 05
STAGE	2	ALPH	7.29790E 00	MACH	9.22920E 00	XISP	4.55000E 02	DYNP	0
GRAV	3.14120E 01	ACC	1.11656E 00	THRI	5.59144E 05	CL	0	LIFT	0
DENS	7.22845E -08	ACCN	0	RATI	1.00000E 00	CD	0	DRAG	0
SOS	8.83407E 02	VLD	2.54917E 02	VLG	3.91377E 03	VLT	4.85145E 00	VCHR	1.10209E 04
TIM	1.83000E 02	GAM	1.22255E 01	VEL	8.18242E 03	ALT	2.53162E 05	WT	4.99543E 05
STAGE	2	ALPH	7.41941E 00	MACH	9.32442E 00	XISP	4.55000E 02	DYNP	0
GRAV	3.14069E 01	ACC	1.11931E 00	THRI	5.59144E 05	CL	0	LIFT	0
DENS	6.63517E -08	ACCN	0	RATI	1.00000E 00	CD	0	DRAG	0
SOS	8.77682E 02	VLD	2.54917E 02	VLG	3.92046E 03	VLT	5.14067E 00	VCHR	1.10560E 04
TIM	1.84000E 02	GAM	1.20654E 01	VEL	8.21126E 03	ALT	2.54687E 05	WT	4.98314E 05
STAGE	2	ALPH	7.53966E 00	MACH	9.41687E 00	XISP	4.55000E 02	DYNP	0
GRAV	3.14017E 01	ACC	1.12207E 00	THRI	5.59144E 05	CL	0	LIFT	0
DENS	6.08817E -08	ACCN	0	RATI	1.00000E 00	CD	0	DRAG	0
SOS	8.71974E 02	VLD	2.54917E 02	VLG	3.92707E 03	VLT	5.44015E 00	VCHR	1.10912E 04
TIM	1.85000E 02	GAM	1.19065E 01	VEL	8.24057E 03	ALT	2.56595E 05	WT	4.97085E 05
STAGE	2	ALPH	7.65864E 00	MACH	9.51256E 00	XISP	4.55000E 02	DYNP	0
GRAV	3.13967E 01	ACC	1.12485E 00	THRI	5.59144E 05	CL	0	LIFT	0
DENS	5.58468E -08	ACCN	0	RATI	1.00000E 00	CD	0	DRAG	0
SOS	8.66283E 02	VLD	2.54917E 02	VLG	3.93659E 03	VLT	5.74997E 00	VCHR	1.11265E 04
TIM	1.86000E 02	GAM	1.17489E 01	VEL	8.27004E 03	ALT	2.58287E 05	WT	4.95856E 05
STAGE	2	ALPH	7.77635E 00	MACH	9.60950E 00	XISP	4.55000E 02	DYNP	0
GRAV	3.13916E 01	ACC	1.12763E 00	THRI	5.59144E 05	CL	0	LIFT	0
DENS	5.12132E -08	ACCN	0	RATI	1.00000E 00	CD	0	DRAG	0
SOS	8.60611E 02	VLD	2.54917E 02	VLG	3.94002E 03	VLT	6.07025E 00	VCHR	1.11619E 04
TIM	1.87000E 02	GAM	1.15925E 01	VEL	8.29968E 03	ALT	2.59963E 05	WT	4.94627E 05
STAGE	2	ALPH	7.89282E 00	MACH	9.70772E 00	XISP	4.55000E 02	DYNP	0
GRAV	3.13866E 01	ACC	1.13043E 00	THRI	5.59144E 05	CL	0	LIFT	0
DENS	4.69502E -08	ACCN	0	RATI	1.00000E 00	CD	0	DRAG	0
SOS	8.54956E 02	VLD	2.54917E 02	VLG	3.94687E 03	VLT	6.40106E 00	VCHR	1.11973E 04
TIM	1.88000E 02	GAM	1.14374E 01	VEL	8.32948E 03	ALT	2.61623E 05	WT	4.93398E 05
STAGE	2	ALPH	8.00804E 00	MACH	9.80723E 00	XISP	4.55000E 02	DYNP	0
GRAV	3.13817E 01	ACC	1.13325E 00	THRI	5.59144E 05	CL	0	LIFT	0
DENS	4.30293E -08	ACCN	0	RATI	1.00000E 00	CD	0	DRAG	0
SOS	8.49320E 02	VLD	2.54917E 02	VLG	3.95264E 03	VLT	6.74251E 00	VCHR	1.12328E 04
TIM	1.89000E 02	GAM	1.12835E 01	VEL	8.35945E 03	ALT	2.63267E 05	WT	4.92170E 05
STAGE	2	ALPH	8.12201E 00	MACH	9.87516E 00	XISP	4.55000E 02	DYNP	0
GRAV	3.13768E 01	ACC	1.13608E 00	THRI	5.59144E 05	CL	0	LIFT	0
DENS	3.91719E -08	ACCN	0	RATI	1.00000E 00	CD	0	DRAG	0
SOS	8.46512E 02	VLD	2.54917E 02	VLG	3.95882E 03	VLT	7.09468E 00	VCHR	1.12684E 04
TIM	1.90000E 02	GAM	1.11308E 01	VEL	8.38957E 03	ALT	2.64894E 05	WT	4.90941E 05
STAGE	2	ALPH	8.23474E 00	MACH	9.91075E 00	XISP	4.55000E 02	DYNP	0

GRAV	3.13710E 01	ACC	1.13892E 00	THRI	5.59144E 05	CL	0	LIFT	0
DENS	3.54224E-08	ACCN	0	RATI	1.00000E 00	CD	0	DRAG	0
SOS	8.46512E 02	VLD	2.54917E 02	VLG	3.98492E 03	VLT	7.45765E 00	VCHR	1.13041E 04
TIM	3.91100E 02	GAM	1.05793E 01	VFL	8.41986E 03	ALT	2.66506E 05	WT	4.89712E 05
STAGE	2	ALPH	8.34624E 00	MACH	9.94654E 00	XISP	4.55000E 02	DYNP	0
GRAV	3.13672E 01	ACC	1.14178E 00	THRI	5.59144E 05	CL	0	LIFT	0
DFNS	3.21341E-08	ACCN	0	RATI	1.00000E 00	CD	0	DRAG	0
SOS	8.46512E 02	VLD	2.54917E 02	VLG	3.97093E 03	VLT	7.83150E 00	VCHR	1.13399E 04
TIM	1.92000E 02	GAM	1.08290E 01	VFL	8.45022E 03	ALT	2.68101E 05	WT	4.88483E 05
STAGE	2	ALPH	8.45651E 00	MACH	9.98251E 00	XISP	4.55000E 02	DYNP	0
GRAV	3.13675E 01	ACC	1.14465E 00	THRI	5.59144E 05	CL	0	LIFT	0
DENS	2.91244E-08	ACCN	0	RATI	1.00000E 00	CD	0	DRAG	0
SOS	8.46512E 02	VLD	2.54917E 02	VLG	3.97686E 03	VLT	8.21630E 00	VCHR	1.13757E 04
TIM	1.93000E 02	GAM	1.06799E 01	VFL	8.48043E 03	ALT	2.69681E 05	WT	4.87254E 05
STAGE	2	ALPH	8.56555E 00	MACH	1.00187E 01	XISP	4.55000E 02	DYNP	0
GRAV	3.13578E 01	ACC	1.14754E 00	THRI	5.59144E 05	CL	0	LIFT	0
DENS	2.64395E-08	ACCN	0	RATI	1.00000E 00	CD	0	DRAG	0
SOS	8.46512E 02	VLD	2.54917E 02	VLG	3.98272E 03	VLT	8.61213E 00	VCHR	1.14117E 04
TIM	1.94000E 02	GAM	1.05320E 01	VFL	8.51171E 03	ALT	2.71245E 05	WT	4.86025E 05
STAGE	2	ALPH	8.67336E 00	MACH	1.00550E 01	XISP	4.55000E 02	DYNP	0
GRAV	3.13531E 01	ACC	1.15044E 00	THRI	5.59144E 05	CL	0	LIFT	0
DENS	2.40242E-08	ACCN	0	RATI	1.00000E 00	CD	0	DRAG	0
SOS	8.46512E 02	VLD	2.54917E 02	VLG	3.98849E 03	VLT	9.01905E 00	VCHR	1.14477E 04
TIM	1.95000E 02	GAM	1.03854E 01	VFL	8.54266E 03	ALT	2.72793E 05	WT	4.84795E 05
STAGE	2	ALPH	8.77999E 00	MACH	1.00926E 01	XISP	4.55000E 02	DYNP	0
GRAV	3.13465E 01	ACC	1.15336E 00	THRI	5.59144E 05	CL	0	LIFT	0
DENS	2.18511E-08	ACCN	0	RATI	1.00000E 00	CD	0	DRAG	0
SOS	8.46512E 02	VLD	2.54917E 02	VLG	3.99418E 03	VLT	9.43714E 00	VCHR	1.14838E 04
TIM	1.96000E 02	GAM	1.02399E 01	VFL	8.57376E 03	ALT	2.74325E 05	WT	4.83567E 05
STAGE	2	ALPH	8.88539E 00	MACH	1.01283E 01	XISP	4.55000E 02	DYNP	0
GRAV	3.13440E 01	ACC	1.15629E 00	THRI	5.59144E 05	CL	0	LIFT	0
DENS	1.98945E-08	ACCN	0	RATI	1.00000E 00	CD	0	DRAG	0
SOS	8.46512E 02	VLD	2.54917E 02	VLG	3.99979E 03	VLT	9.86644E 00	VCHR	1.15200E 04
TIM	1.97000E 02	GAM	1.00956E 01	VFL	8.60502E 03	ALT	2.75841E 05	WT	4.82339E 05
STAGE	2	ALPH	8.98959E 00	MACH	1.01653E 01	XISP	4.55000E 02	DYNP	0
GRAV	3.13395E 01	ACC	1.15924E 00	THRI	5.59144E 05	CL	0	LIFT	0
DENS	1.81302E-08	ACCN	0	RATI	1.00000E 00	CD	0	DRAG	0
SOS	8.46512E 02	VLD	2.54917E 02	VLG	4.00532E 03	VLT	1.03070E 01	VCHR	1.15563E 04
TIM	1.98000E 02	GAM	9.95244E 00	VFL	8.63645E 03	ALT	2.77342E 05	WT	4.81110E 05
STAGE	2	ALPH	9.09259E 00	MACH	1.02024E 01	XISP	4.55000E 02	DYNP	0
GRAV	3.13350E 01	ACC	1.16220E 00	THRI	5.59144E 05	CL	0	LIFT	0
DENS	1.65388E-08	ACCN	0	RATI	1.00000E 00	CD	0	DRAG	0
SOS	8.46512E 02	VLD	2.54917E 02	VLG	4.01078E 03	VLT	1.07590E 01	VCHR	1.15927E 04
TIM	1.99000E 02	GAM	9.81049E 00	VFL	8.66874E 03	ALT	2.78826E 05	WT	4.79881E 05
STAGE	2	ALPH	9.19439E 00	MACH	1.02397E 01	XISP	4.55000E 02	DYNP	0
GRAV	3.13306E 01	ACC	1.16517E 00	THRI	5.59144E 05	CL	0	LIFT	0
DENS	1.51018E-08	ACCN	0	RATI	1.00000E 00	CD	0	DRAG	0
SOS	8.46512E 02	VLD	2.54917E 02	VLG	4.01615E 03	VLT	1.12223E 01	VCHR	1.16291E 04
TIM	2.00000E 02	GAM	9.66970E 00	VFL	8.69979E 03	ALT	2.80295E 05	WT	4.78652E 05
STAGE	2	ALPH	9.29501E 00	MACH	1.02772E 01	XISP	4.55000E 02	DYNP	0
GRAV	3.13263E 01	ACC	1.16816E 00	THRI	5.59144E 05	CL	0	LIFT	0
DENS	1.38631E-08	ACCN	0	RATI	1.00000E 00	CD	0	DRAG	0
SOS	8.46512E 02	VLD	2.54917E 02	VLG	4.02145E 03	VLT	1.16970E 01	VCHR	1.16657E 04
TIM	2.01000E 02	GAM	9.53008E 00	VFL	8.73170E 03	ALT	2.81749E 05	WT	4.77423E 05
STAGE	2	ALPH	9.39445E 00	MACH	1.03149E 01	XISP	4.55000E 02	DYNP	0
GRAV	3.13220E 01	ACC	1.17117E 00	THRI	5.59144E 05	CL	0	LIFT	0
DENS	1.26283E-08	ACCN	0	RATI	1.00000E 00	CD	0	DRAG	0
SOS	8.46512E 02	VLD	2.54917E 02	VLG	4.02668E 03	VLT	1.21833E 01	VCHR	1.17023E 04
TIM	2.02000E 02	GAM	9.39162E 00	VFL	8.76377E 03	ALT	2.83187E 05	WT	4.76194E 05
STAGE	2	ALPH	9.49271E 00	MACH	1.03528E 01	XISP	4.55000E 02	DYNP	0
GRAV	3.13177E 01	ACC	1.17419E 00	THRI	5.59144E 05	CL	0	LIFT	0
DENS	1.15647E-08	ACCN	0	RATI	1.00000E 00	CD	0	DRAG	0
SOS	8.46512E 02	VLD	2.54917E 02	VLG	4.03183E 03	VLT	1.26810E 01	VCHR	1.17391E 04
TIM	2.03000E 02	GAM	9.25430E 00	VFL	8.79600E 03	ALT	2.84609E 05	WT	4.74965E 05
STAGE	2	ALPH	9.58979E 00	MACH	1.03909E 01	XISP	4.55000E 02	DYNP	0
GRAV	3.13135E 01	ACC	1.17723E 00	THRI	5.59144E 05	CL	0	LIFT	0
DENS	1.06009E-08	ACCN	0	RATI	1.00000E 00	CD	0	DRAG	0
SOS	8.46512E 02	VLD	2.54917E 02	VLG	4.03690E 03	VLT	1.31904E 01	VCHR	1.17759E 04

TIM	2.84000E-02	GAM	9.11814E-00	VEL	8.82839E-03	ALT	2.86016E-05	WT	4.73736E-05
STAGE	2	ALPH	9.6E571E-00	MACH	1.04291E-01	XISP	4.55000E-02	DYNP	0
GRAV	3.13103E-01	ACC	1.1E029E-00	THRI	5.59144E-05	CL	0	LIFT	0
DENS	9.72673E-09	ACCN	0	RATI	1.00000E-00	CD	0	DRAG	0
SOS	8.46512E-02	VLD	2.54917E-02	VLG	4.04190E-03	VLT	1.37113E-01	VCHR	1.18128E-04
TIM	2.0E000E-02	GAM	8.9E312E-00	VFL	8.86004E-03	ALT	2.87407E-05	WT	4.72507E-05
STAGE	2	ALPH	9.7E047E-00	MACH	1.04676E-01	XISP	4.55000E-02	DYNP	0
GRAV	3.13052E-01	ACC	1.1E336E-00	THRI	5.59144E-05	CL	0	LIFT	0
DENS	8.93322E-09	ACCN	0	RATI	1.00000E-00	CD	0	DRAG	0
SOS	8.46512E-02	VLD	2.54917E-02	VLG	4.04682E-03	VLT	1.42439E-01	VCHR	1.18498E-04
TIM	2.0E000E-02	GAM	8.84923E-00	VEL	8.89365E-03	ALT	2.88783E-05	WT	4.71279E-05
STAGE	2	ALPH	9.87408E-00	MACH	1.05062E-01	XISP	4.55000E-02	DYNP	0
GRAV	3.13011E-01	ACC	1.1E644E-00	THRI	5.59144E-05	CL	0	LIFT	0
DENS	8.21223E-09	ACCN	0	RATI	1.00000E-00	CD	0	DRAG	0
SOS	8.46512E-02	VLD	2.54917E-02	VLG	4.05167E-03	VLT	1.47882E-01	VCHR	1.18869E-04
TIM	2.07000E-02	GAM	8.71647E-00	VEL	8.92652E-03	ALT	2.90144E-05	WT	4.70050E-05
STAGE	2	ALPH	9.9E653E-00	MACH	1.05451E-01	XISP	4.55000E-02	DYNP	0
GRAV	3.12971E-01	ACC	1.1E954E-00	THRI	5.59144E-05	CL	0	LIFT	0
DENS	7.55673E-09	ACCN	0	RATI	1.00000E-00	CD	0	DRAG	0
SOS	8.46512E-02	VLD	2.54917E-02	VLG	4.05645E-03	VLT	1.53441E-01	VCHR	1.19241E-04
TIM	2.0E000E-02	GAM	8.5E484E-00	VFL	8.95956E-03	ALT	2.91489E-05	WT	4.68821E-05
STAGE	2	ALPH	1.0E578E-01	MACH	1.05441E-01	XISP	4.55000E-02	DYNP	0
GRAV	3.12931E-01	ACC	1.1E266E-00	THRI	5.59144E-05	CL	0	LIFT	0
DENS	6.96611E-09	ACCN	0	RATI	1.00000E-00	CD	0	DRAG	0
SOS	8.46512E-02	VLD	2.54917E-02	VLG	4.06136E-03	VLT	1.59118E-01	VCHR	1.19613E-04
TIM	2.0E000E-02	GAM	8.45433E-00	VEL	8.99275E-03	ALT	2.92818E-05	WT	4.67592E-05
STAGE	2	ALPH	1.01480E-01	MACH	1.06233E-01	XISP	4.55000E-02	DYNP	0
GRAV	3.12802E-01	ACC	1.1E580E-00	THRI	5.59144E-05	CL	0	LIFT	0
DENS	6.41668E-09	ACCN	0	RATI	1.00000E-00	CD	0	DRAG	0
SOS	8.46512E-02	VLD	2.54917E-02	VLG	4.065F0E-03	VLT	1.64913E-01	VCHR	1.19987E-04
TIM	2.10000E-02	GAM	8.32494E-00	VEL	9.02630E-03	ALT	2.94133E-05	WT	4.66363E-05
STAGE	2	ALPH	1.02371E-01	MACH	1.06627E-01	XISP	4.55000E-02	DYNP	0
GRAV	3.12853E-01	ACC	1.1E605E-00	THRI	5.59144E-05	CL	0	LIFT	0
DENS	5.92126E-09	ACCN	0	RATI	1.00000E-00	CD	0	DRAG	0
SOS	8.46512E-02	VLD	2.54917E-02	VLG	4.07036E-03	VLT	1.70825E-01	VCHR	1.20362E-04
TIM	2.11000E-02	GAM	8.15665E-00	VEL	9.05961E-03	ALT	2.95432E-05	WT	4.65134E-05
STAGE	2	ALPH	1.03250E-01	MACH	1.07023E-01	XISP	4.55000E-02	DYNP	0
GRAV	3.12615E-01	ACC	1.20211E-00	THRI	5.59144E-05	CL	0	LIFT	0
DENS	5.46924E-09	ACCN	0	RATI	1.00000E-00	CD	0	DRAG	0
SOS	8.46512E-02	VLD	2.54917E-02	VLG	4.07485E-03	VLT	1.76855E-01	VCHR	1.20737E-04
TIM	2.12000E-02	GAM	8.06947E-00	VEL	9.09328E-03	ALT	2.96716E-05	WT	4.63905E-05
STAGE	2	ALPH	1.04117E-01	MACH	1.07421E-01	XISP	4.55000E-02	DYNP	0
GRAV	3.12777E-01	ACC	1.20539E-00	THRI	5.59144E-05	CL	0	LIFT	0
DENS	5.05647E-09	ACCN	0	RATI	1.00000E-00	CD	0	DRAG	0
SOS	8.46512E-02	VLD	2.54917E-02	VLG	4.07928E-03	VLT	1.83003E-01	VCHR	1.21114E-04
TIM	2.13000E-02	GAM	7.94338E-00	VEL	9.12711E-03	ALT	2.97985E-05	WT	4.62676E-05
STAGE	2	ALPH	1.04974E-01	MACH	1.07820E-01	XISP	4.55000E-02	DYNP	0
GRAV	3.12739E-01	ACC	1.20850E-00	THRI	5.59144E-05	CL	0	LIFT	0
DENS	4.67923E-09	ACCN	0	RATI	1.00000E-00	CD	0	DRAG	0
SOS	8.46512E-02	VLD	2.54917E-02	VLG	4.08364E-03	VLT	1.89270E-01	VCHR	1.21491E-04
TIM	2.14000E-02	GAM	7.81639E-00	VEL	9.16110E-03	ALT	2.99239E-05	WT	4.61447E-05
STAGE	2	ALPH	1.05820E-01	MACH	1.08222E-01	XISP	4.55000E-02	DYNP	0
GRAV	3.12702E-01	ACC	1.21172E-00	THRI	5.59144E-05	CL	0	LIFT	0
DENS	4.33418E-09	ACCN	0	RATI	1.00000E-00	CD	0	DRAG	0
SOS	8.46512E-02	VLD	2.54917E-02	VLG	4.08792E-03	VLT	1.95655E-01	VCHR	1.21870E-04
TIM	2.15000E-02	GAM	7.65448E-00	VEL	9.19525E-03	ALT	3.00478E-05	WT	4.60219E-05
STAGE	2	ALPH	1.06654E-01	MACH	1.08625E-01	XISP	4.55000E-02	DYNP	0
GRAV	3.12665E-01	ACC	1.21495E-00	THRI	5.59144E-05	CL	0	LIFT	0
DENS	4.01831E-09	ACCN	0	RATI	1.00000E-00	CD	0	DRAG	0
SOS	8.46512E-02	VLD	2.54917E-02	VLG	4.09214E-03	VLT	2.02156E-01	VCHR	1.22249E-04
TIM	2.16000E-02	GAM	7.57165E-00	VEL	9.22956E-03	ALT	3.01701E-05	WT	4.58990E-05
STAGE	2	ALPH	1.07478E-01	MACH	1.09010E-01	XISP	4.55000E-02	DYNP	0
GRAV	3.12629E-01	ACC	1.21821E-00	THRI	5.59144E-05	CL	0	LIFT	0
DENS	3.72891E-09	ACCN	0	RATI	1.00000E-00	CD	0	DRAG	0
SOS	8.46512E-02	VLD	2.54917E-02	VLG	4.09630E-03	VLT	2.08780E-01	VCHR	1.22629E-04
TIM	2.17000E-02	GAM	7.44990E-00	VEL	9.2642E-03	ALT	3.02910E-05	WT	4.57761E-05
STAGE	2	ALPH	1.08290E-01	MACH	1.09458E-01	XISP	4.55000E-02	DYNP	0

GRAV	3.12594E-01	ACC	1.22148E-00	THRI	5.59144E-05	CL	0	LIFT	0
DENS	3.46356E-09	ACCN	0	RATI	1.00000E-00	CD	0	DRAG	0
SOS	8.46512E-02	VLD	2.54917E-02	VLG	4.10038E-03	VLT	2.15520E-01	VCHR	1.23011E-04
TIM	2.18000E-02	GAM	7.32922E-00	VEL	9.29865E-03	ALT	3.04104E-05	WT	4.56532E-05
STAGE	2	ALPH	1.09092E-01	MACH	1.09847E-01	XISP	4.55000E-02	DYNP	0
GRAV	3.12594E-01	ACC	1.22476E-00	THRI	5.59144E-05	CL	0	LIFT	0
DENS	3.22002E-09	ACCN	0	RATI	1.00000E-00	CD	0	DRAG	0
SOS	8.46512E-02	VLD	2.54917E-02	VLG	4.10440E-03	VLT	2.22379E-01	VCHR	1.23393E-04
TIM	2.19000E-02	GAM	7.20961E-00	VEL	9.33343E-03	ALT	3.05282E-05	WT	4.55303E-05
STAGE	2	ALPH	1.09092E-01	MACH	1.10288E-01	XISP	4.55000E-02	DYNP	0
GRAV	3.12594E-01	ACC	1.22807E-00	THRI	5.59144E-05	CL	0	LIFT	0
DENS	2.99642E-09	ACCN	0	RATI	1.00000E-00	CD	0	DRAG	0
SOS	8.46512E-02	VLD	2.54917E-02	VLG	4.10836E-03	VLT	2.29356E-01	VCHR	1.23776E-04
TIM	2.20000E-02	GAM	7.09105E-00	VEL	9.36838E-03	ALT	3.06446E-05	WT	4.54074E-05
STAGE	2	ALPH	1.10663E-01	MACH	1.10620E-01	XISP	4.55000E-02	DYNP	0
GRAV	3.12499E-01	ACC	1.23139E-00	THRI	5.59144E-05	CL	0	LIFT	0
DENS	2.79000E-09	ACCN	0	RATI	1.00000E-00	CD	0	DRAG	0
SOS	8.46512E-02	VLD	2.54917E-02	VLG	4.11225E-03	VLT	2.36452E-01	VCHR	1.24161E-04
TIM	2.21000E-02	GAM	6.97355E-00	VEL	9.40348E-03	ALT	3.07595E-05	WT	4.52845E-05
STAGE	2	ALPH	1.11432E-01	MACH	1.11085E-01	XISP	4.55000E-02	DYNP	0
GRAV	3.12455E-01	ACC	1.23474E-00	THRI	5.59144E-05	CL	0	LIFT	0
DENS	2.60300E-09	ACCN	0	RATI	1.00000E-00	CD	0	DRAG	0
SOS	8.46512E-02	VLD	2.54917E-02	VLG	4.11607E-03	VLT	2.43666E-01	VCHR	1.24546E-04
TIM	2.22000E-02	GAM	6.85710E-00	VEL	9.43675E-03	ALT	3.08730E-05	WT	4.51616E-05
STAGE	2	ALPH	1.12191E-01	MACH	1.11502E-01	XISP	4.55000E-02	DYNP	0
GRAV	3.12422E-01	ACC	1.23701E-00	THRI	5.59144E-05	CL	0	LIFT	0
DENS	2.42775E-09	ACCN	0	RATI	1.00000E-00	CD	0	DRAG	0
SOS	8.46512E-02	VLD	2.54917E-02	VLG	4.11983E-03	VLT	2.50999E-01	VCHR	1.24932E-04
TIM	2.23000E-02	GAM	6.74168E-00	VEL	9.47417E-03	ALT	3.09849E-05	WT	4.50387E-05
STAGE	2	ALPH	1.12939E-01	MACH	1.11920E-01	XISP	4.55000E-02	DYNP	0
GRAV	3.12389E-01	ACC	1.24147E-00	THRI	5.59144E-05	CL	0	LIFT	0
DENS	2.26739E-09	ACCN	0	RATI	1.00000E-00	CD	0	DRAG	0
SOS	8.46512E-02	VLD	2.54917E-02	VLG	4.12353E-03	VLT	2.58449E-01	VCHR	1.25320E-04
TIM	2.24000E-02	GAM	6.62731E-00	VEL	9.50975E-03	ALT	3.10954E-05	WT	4.49159E-05
STAGE	2	ALPH	1.13677E-01	MACH	1.12340E-01	XISP	4.55000E-02	DYNP	0
GRAV	3.12356E-01	ACC	1.24487E-00	THRI	5.59144E-05	CL	0	LIFT	0
DENS	2.11954E-09	ACCN	0	RATI	1.00000E-00	CD	0	DRAG	0
SOS	8.46512E-02	VLD	2.54917E-02	VLG	4.12717E-03	VLT	2.66016E-01	VCHR	1.25708E-04
TIM	2.25000E-02	GAM	6.51397E-00	VEL	9.54549E-03	ALT	3.12044E-05	WT	4.47930E-05
STAGE	2	ALPH	1.14404E-01	MACH	1.12763E-01	XISP	4.55000E-02	DYNP	0
GRAV	3.12324E-01	ACC	1.24829E-00	THRI	5.59144E-05	CL	0	LIFT	0
DENS	1.98312E-09	ACCN	0	RATI	1.00000E-00	CD	0	DRAG	0
SOS	8.46512E-02	VLD	2.54917E-02	VLG	4.13074E-03	VLT	2.73706E-01	VCHR	1.26097E-04
TIM	2.26000E-02	GAM	6.40165E-00	VEL	9.58140E-03	ALT	3.13120E-05	WT	4.46701E-05
STAGE	2	ALPH	1.15120E-01	MACH	1.13187E-01	XISP	4.55000E-02	DYNP	0
GRAV	3.12292E-01	ACC	1.25172E-00	THRI	5.59144E-05	CL	0	LIFT	0
DENS	1.85715E-09	ACCN	0	RATI	1.00000E-00	CD	0	DRAG	0
SOS	8.46512E-02	VLD	2.54917E-02	VLG	4.13426E-03	VLT	2.81511E-01	VCHR	1.26488E-04
TIM	2.27000E-02	GAM	6.29035E-00	VEL	9.61746E-03	ALT	3.14181E-05	WT	4.45472E-05
STAGE	2	ALPH	1.15826E-01	MACH	1.13613E-01	XISP	4.55000E-02	DYNP	0
GRAV	3.12261E-01	ACC	1.25517E-00	THRI	5.59144E-05	CL	0	LIFT	0
DENS	1.74074E-09	ACCN	0	RATI	1.00000E-00	CD	0	DRAG	0
SOS	8.46512E-02	VLD	2.54917E-02	VLG	4.13771E-03	VLT	2.89433E-01	VCHR	1.26879E-04
TIM	2.28000E-02	GAM	6.18007E-00	VEL	9.65388E-03	ALT	3.15227E-05	WT	4.44243E-05
STAGE	2	ALPH	1.16522E-01	MACH	1.14041E-01	XISP	4.55000E-02	DYNP	0
GRAV	3.12230E-01	ACC	1.25864E-00	THRI	5.59144E-05	CL	0	LIFT	0
DENS	1.63306E-09	ACCN	0	RATI	1.00000E-00	CD	0	DRAG	0
SOS	8.46512E-02	VLD	2.54917E-02	VLG	4.14130E-03	VLT	2.97473E-01	VCHR	1.27271E-04
TIM	2.29000E-02	GAM	6.07080E-00	VEL	9.69066E-03	ALT	3.16259E-05	WT	4.43014E-05
STAGE	2	ALPH	1.17206E-01	MACH	1.14470E-01	XISP	4.55000E-02	DYNP	0
GRAV	3.12199E-01	ACC	1.26214E-00	THRI	5.59144E-05	CL	0	LIFT	0
DENS	1.53344E-09	ACCN	0	RATI	1.00000E-00	CD	0	DRAG	0
SOS	8.46512E-02	VLD	2.54917E-02	VLG	4.14443E-03	VLT	3.05631E-01	VCHR	1.27665E-04
TIM	2.30000E-02	GAM	5.96253E-00	VEL	9.72659E-03	ALT	3.17277E-05	WT	4.41785E-05
STAGE	2	ALPH	1.17883E-01	MACH	1.14902E-01	XISP	4.55000E-02	DYNP	0
GRAV	3.12169E-01	ACC	1.26565E-00	THRI	5.59144E-05	CL	0	LIFT	0
DENS	1.44116E-09	ACCN	0	RATI	1.00000E-00	CD	0	DRAG	0

SOS	8.46512E 02	VLD	2.54917E 02	VLG	4.14770E 03	VLT	3.13905E 01	VCHR	1.28060E 04
TIM	2.31000E 02	GAM	5.85527E 00	VEL	9.76329E 03	ALT	3.18280E 05	WT	4.40556E 05
STAGE	2	ALPH	1.18548E 01	MACH	1.15336E 01	XISP	4.55000E 02	DYNP	0
GRAV	3.12140E 01	ACC	1.26918E 00	THRI	5.59144E 05	CL	0	LIFT	0
DENS	1.35563E-09	ACCN	0	RATI	1.00000E 00	CD	0	DRAG	0
SOS	8.46512E 02	VLD	2.54917E 02	VLG	4.15092E 03	VLT	3.22296E 01	VCHR	1.28455E 04
TIM	2.32000E 02	GAM	5.74899E 00	VEL	9.80015E 03	ALT	3.19269E 05	WT	4.39327E 05
STAGE	2	ALPH	1.19203E 01	MACH	1.15771E 01	XISP	4.55000E 02	DYNP	0
GRAV	3.12111E 01	ACC	1.27273E 00	THRI	5.59144E 05	CL	0	LIFT	0
DENS	1.27630E-09	ACCN	0	RATI	1.00000E 00	CD	0	DRAG	0
SOS	8.46512E 02	VLD	2.54917E 02	VLG	4.15000E 03	VLT	3.30804E 01	VCHR	1.28852E 04
TIM	2.33000E 02	GAM	5.64370E 00	VEL	9.83777E 03	ALT	3.20244E 05	WT	4.38099E 05
STAGE	2	ALPH	1.19848E 01	MACH	1.16208E 01	XISP	4.55000E 02	DYNP	0
GRAV	3.12082E 01	ACC	1.27630E 00	THRI	5.59144E 05	CL	0	LIFT	0
DENS	1.20267E-09	ACCN	0	RATI	1.00000E 00	CD	0	DRAG	0
SOS	8.46512E 02	VLD	2.54917E 02	VLG	4.15717E 03	VLT	3.39428E 01	VCHR	1.29250E 04
TIM	2.34000E 02	GAM	5.53940E 00	VEL	9.87435E 03	ALT	3.21204E 05	WT	4.36870E 05
STAGE	2	ALPH	1.20483E 01	MACH	1.16647E 01	XISP	4.55000E 02	DYNP	0
GRAV	3.12054E 01	ACC	1.27989E 00	THRI	5.59144E 05	CL	0	LIFT	0
DENS	1.13428E-09	ACCN	0	RATI	1.00000E 00	CD	0	DRAG	0
SOS	8.46512E 02	VLD	2.54917E 02	VLG	4.16021E 03	VLT	3.48166E 01	VCHR	1.29648E 04
TIM	2.35000E 02	GAM	5.43607E 00	VEL	9.91169E 03	ALT	3.22150E 05	WT	4.35641E 05
STAGE	2	ALPH	1.21108E 01	MACH	1.17089E 01	XISP	4.55000E 02	DYNP	0
GRAV	3.12026E 01	ACC	1.28350E 00	THRI	5.59144E 05	CL	0	LIFT	0
DENS	1.07071E-09	ACCN	0	RATI	1.00000E 00	CD	0	DRAG	0
SOS	8.46512E 02	VLD	2.54917E 02	VLG	4.16319E 03	VLT	3.57024E 01	VCHR	1.30048E 04
TIM	2.36000E 02	GAM	5.33372E 00	VEL	9.94919E 03	ALT	3.23082E 05	WT	4.34412E 05
STAGE	2	ALPH	1.21723E 01	MACH	1.17532E 01	XISP	4.55000E 02	DYNP	0
GRAV	3.11998E 01	ACC	1.28713E 00	THRI	5.59144E 05	CL	0	LIFT	0
DENS	1.01158E-09	ACCN	0	RATI	1.00000E 00	CD	0	DRAG	0
SOS	8.46512E 02	VLD	2.54917E 02	VLG	4.16612E 03	VLT	3.65995E 01	VCHR	1.30449E 04
TIM	2.37000E 02	GAM	5.23233E 00	VEL	9.98685E 03	ALT	3.24000E 05	WT	4.33183E 05
STAGE	2	ALPH	1.22328E 01	MACH	1.17976E 01	XISP	4.55000E 02	DYNP	0
GRAV	3.11971E 01	ACC	1.29078E 00	THRI	5.59144E 05	CL	0	LIFT	0
DENS	9.54541E-10	ACCN	0	RATI	1.00000E 00	CD	0	DRAG	0
SOS	8.46512E 02	VLD	2.54917E 02	VLG	4.16899E 03	VLT	3.75081E 01	VCHR	1.30852E 04
TIM	2.38000E 02	GAM	5.13190E 00	VEL	1.00247E 04	ALT	3.24903E 05	WT	4.31954E 05
STAGE	2	ALPH	1.22924E 01	MACH	1.18423E 01	XISP	4.55000E 02	DYNP	0
GRAV	3.11945E 01	ACC	1.29445E 00	THRI	5.59144E 05	CL	0	LIFT	0
DENS	9.05279E-10	ACCN	0	RATI	1.00000E 00	CD	0	DRAG	0
SOS	8.46512E 02	VLD	2.54917E 02	VLG	4.17181E 03	VLT	3.84281E 01	VCHR	1.31255E 04
TIM	2.39000E 02	GAM	5.03243E 00	VEL	1.00627E 04	ALT	3.25793E 05	WT	4.30725E 05
STAGE	2	ALPH	1.23509E 01	MACH	1.18872E 01	XISP	4.55000E 02	DYNP	0
GRAV	3.11919E 01	ACC	1.29815E 00	THRI	5.59144E 05	CL	0	LIFT	0
DENS	8.57501E-10	ACCN	0	RATI	1.00000E 00	CD	0	DRAG	0
SOS	8.46512E 02	VLD	2.54917E 02	VLG	4.17458E 03	VLT	3.93595E 01	VCHR	1.31659E 04
TIM	2.40000E 02	GAM	4.93391E 00	VEL	1.01008E 04	ALT	3.26669E 05	WT	4.29496E 05
STAGE	2	ALPH	1.24085E 01	MACH	1.19323E 01	XISP	4.55000E 02	DYNP	0
GRAV	3.11893E 01	ACC	1.30186E 00	THRI	5.59144E 05	CL	0	LIFT	0
DENS	8.12941E-10	ACCN	0	RATI	1.00000E 00	CD	0	DRAG	0
SOS	8.46512E 02	VLD	2.54917E 02	VLG	4.17728E 03	VLT	4.03024E 01	VCHR	1.32065E 04
TIM	2.41000E 02	GAM	4.83633E 00	VEL	1.01391E 04	ALT	3.27530E 05	WT	4.28267E 05
STAGE	2	ALPH	1.24652E 01	MACH	1.19775E 01	XISP	4.55000E 02	DYNP	0
GRAV	3.11867E 01	ACC	1.30560E 00	THRI	5.59144E 05	CL	0	LIFT	0
DENS	7.71354E-10	ACCN	0	RATI	1.00000E 00	CD	0	DRAG	0
SOS	8.46512E 02	VLD	2.54917E 02	VLG	4.17994E 03	VLT	4.12565E 01	VCHR	1.32471E 04
TIM	2.42000E 02	GAM	4.73970E 00	VEL	1.01776E 04	ALT	3.28378E 05	WT	4.27039E 05
STAGE	2	ALPH	1.25209E 01	MACH	1.20230E 01	XISP	4.55000E 02	DYNP	0
GRAV	3.11842E 01	ACC	1.30935E 00	THRI	5.59144E 05	CL	0	LIFT	0
DENS	7.32517E-10	ACCN	0	RATI	1.00000E 00	CD	0	DRAG	0
SOS	8.46512E 02	VLD	2.54917E 02	VLG	4.18254E 03	VLT	4.22220E 01	VCHR	1.32879E 04
TIM	2.43000E 02	GAM	4.64400E 00	VEL	1.02162E 04	ALT	3.29212E 05	WT	4.25810E 05
STAGE	2	ALPH	1.25756E 01	MACH	1.20686E 01	XISP	4.55000E 02	DYNP	0
GRAV	3.11818E 01	ACC	1.31313E 00	THRI	5.59144E 05	CL	0	LIFT	0
DENS	6.96225E-10	ACCN	0	RATI	1.00000E 00	CD	0	DRAG	0
SOS	8.46512E 02	VLD	2.54917E 02	VLG	4.18509E 03	VLT	4.31987E 01	VCHR	1.33288E 04

TIM	2.44000E-02	GAM	4.54923E-00	VFL	1.02550E-04	ALT	3.30033E-05	WT	4.24581E-05
STAGE	2	ALPH	1.26294E-01	MACH	1.21144E-01	XISP	4.55000E-02	DYNP	0
GRAV	3.11794E-01	ACC	1.31693E-00	THRI	5.59144E-05	CL	0	LIFT	0
DENS	6.62290E-10	ACCN	0	RATI	1.00000E-00	CD	0	DRAG	0
SOS	8.46512E-02	VLD	2.54917E-02	VLG	4.18759E-03	VLT	4.41866E-01	VCHR	1.33698E-04
TIM	2.45000E-02	GAM	4.45538E-00	VFL	1.02910E-04	ALT	3.30839E-05	WT	4.23352E-05
STAGE	2	ALPH	1.26822E-01	MACH	1.21604E-01	XISP	4.55000E-02	DYNP	0
GRAV	3.11770E-01	ACC	1.32075E-00	THRI	5.59144E-05	CL	0	LIFT	0
DENS	6.30539E-10	ACCN	0	RATI	1.00000E-00	CD	0	DRAG	0
SOS	8.46512E-02	VLD	2.54917E-02	VLG	4.19004E-03	VLT	4.51856E-01	VCHR	1.34109E-04
TIM	2.46000E-02	GAM	4.36245E-00	VFL	1.03331E-04	ALT	3.31632E-05	WT	4.22123E-05
STAGE	2	ALPH	1.27341E-01	MACH	1.22066E-01	XISP	4.55000E-02	DYNP	0
GRAV	3.11747E-01	ACC	1.32460E-00	THRI	5.59144E-05	CL	0	LIFT	0
DENS	6.00814E-10	ACCN	0	RATI	1.00000E-00	CD	0	DRAG	0
SOS	8.46512E-02	VLD	2.54917E-02	VLG	4.19244E-03	VLT	4.61958E-01	VCHR	1.34521E-04
TIM	2.47000E-02	GAM	4.27044E-00	VEL	1.03723E-04	ALT	3.32411E-05	WT	4.20894E-05
STAGE	2	ALPH	1.27851E-01	MACH	1.22530E-01	XISP	4.55000E-02	DYNP	0
GRAV	3.11724E-01	ACC	1.32847E-00	THRI	5.59144E-05	CL	0	LIFT	0
DENS	5.72968E-10	ACCN	0	RATI	1.00000E-00	CD	0	DRAG	0
SOS	8.46512E-02	VLD	2.54917E-02	VLG	4.19478E-03	VLT	4.72170E-01	VCHR	1.34935E-04
TIM	2.48000E-02	GAM	4.17934E-00	VEL	1.04118E-04	ALT	3.33177E-05	WT	4.19665E-05
STAGE	2	ALPH	1.28351E-01	MACH	1.22996E-01	XISP	4.55000E-02	DYNP	0
GRAV	3.11701E-01	ACC	1.33236E-00	THRI	5.59144E-05	CL	0	LIFT	0
DENS	5.46867E-10	ACCN	0	RATI	1.00000E-00	CD	0	DRAG	0
SOS	8.46512E-02	VLD	2.54917E-02	VLG	4.19708E-03	VLT	4.82492E-01	VCHR	1.35350E-04
TIM	2.49000E-02	GAM	4.08914E-00	VEL	1.04514E-04	ALT	3.33929E-05	WT	4.18436E-05
STAGE	2	ALPH	1.28842E-01	MACH	1.23464E-01	XISP	4.55000E-02	DYNP	0
GRAV	3.11679E-01	ACC	1.33627E-00	THRI	5.59144E-05	CL	0	LIFT	0
DENS	5.22387E-10	ACCN	0	RATI	1.00000E-00	CD	0	DRAG	0
SOS	8.46512E-02	VLD	2.54917E-02	VLG	4.19933E-03	VLT	4.92923E-01	VCHR	1.35766E-04
TIM	2.50000E-02	GAM	3.99984E-00	VEL	1.04912E-04	ALT	3.34667E-05	WT	4.17207E-05
STAGE	2	ALPH	1.29324E-01	MACH	1.23934E-01	XISP	4.55000E-02	DYNP	0
GRAV	3.11657E-01	ACC	1.34021E-00	THRI	5.59144E-05	CL	0	LIFT	0
DENS	4.99416E-10	ACCN	0	RATI	1.00000E-00	CD	0	DRAG	0
SOS	8.46512E-02	VLD	2.54917E-02	VLG	4.20152E-03	VLT	5.03464E-01	VCHR	1.36183E-04
TIM	2.51000E-02	GAM	3.91143E-00	VEL	1.05311E-04	ALT	3.35392E-05	WT	4.15979E-05
STAGE	2	ALPH	1.29797E-01	MACH	1.24406E-01	XISP	4.55000E-02	DYNP	0
GRAV	3.11636E-01	ACC	1.34417E-00	THRI	5.59144E-05	CL	0	LIFT	0
DENS	4.72847E-10	ACCN	0	RATI	1.00000E-00	CD	0	DRAG	0
SOS	8.46512E-02	VLD	2.54917E-02	VLG	4.20367E-03	VLT	5.14112E-01	VCHR	1.36601E-04
TIM	2.52000E-02	GAM	3.82391E-00	VEL	1.05712E-04	ALT	3.36104E-05	WT	4.14790E-05
STAGE	2	ALPH	1.30261E-01	MACH	1.24879E-01	XISP	4.55000E-02	DYNP	0
GRAV	3.11615E-01	ACC	1.34815E-00	THRI	5.59144E-05	CL	0	LIFT	0
DENS	4.57845E-10	ACCN	0	RATI	1.00000E-00	CD	0	DRAG	0
SOS	8.46512E-02	VLD	2.54917E-02	VLG	4.20578E-03	VLT	5.24869E-01	VCHR	1.37020E-04
TIM	2.53000E-02	GAM	3.73728E-00	VEL	1.06115E-04	ALT	3.36802E-05	WT	4.13521E-05
STAGE	2	ALPH	1.30716E-01	MACH	1.25355E-01	XISP	4.55000E-02	DYNP	0
GRAV	3.11595E-01	ACC	1.35215E-00	THRI	5.59144E-05	CL	0	LIFT	0
DENS	4.38538E-10	ACCN	0	RATI	1.00000E-00	CD	0	DRAG	0
SOS	8.46512E-02	VLD	2.54917E-02	VLG	4.20783E-03	VLT	5.35733E-01	VCHR	1.37441E-04
TIM	2.54000E-02	GAM	3.65152E-00	VEL	1.06519E-04	ALT	3.37487E-05	WT	4.12292E-05
STAGE	2	ALPH	1.31161E-01	MACH	1.25833E-01	XISP	4.55000E-02	DYNP	0
GRAV	3.11574E-01	ACC	1.35618E-00	THRI	5.59144E-05	CL	0	LIFT	0
DENS	4.20626E-10	ACCN	0	RATI	1.00000E-00	CD	0	DRAG	0
SOS	8.46512E-02	VLD	2.54917E-02	VLG	4.20984E-03	VLT	5.46703E-01	VCHR	1.37863E-04
TIM	2.55000E-02	GAM	3.56664E-00	VEL	1.06925E-04	ALT	3.38159E-05	WT	4.11063E-05
STAGE	2	ALPH	1.31598E-01	MACH	1.26312E-01	XISP	4.55000E-02	DYNP	0
GRAV	3.11555E-01	ACC	1.36024E-00	THRI	5.59144E-05	CL	0	LIFT	0
DENS	4.03773E-10	ACCN	0	RATI	1.00000E-00	CD	0	DRAG	0
SOS	8.46512E-02	VLD	2.54917E-02	VLG	4.21180E-03	VLT	5.57780E-01	VCHR	1.38286E-04
TIM	2.56000E-02	GAM	3.48263E-00	VEL	1.07332E-04	ALT	3.38818E-05	WT	4.09834E-05
STAGE	2	ALPH	1.32026E-01	MACH	1.26794E-01	XISP	4.55000E-02	DYNP	0
GRAV	3.11535E-01	ACC	1.36432E-00	THRI	5.59144E-05	CL	0	LIFT	0
DENS	3.87907E-10	ACCN	0	RATI	1.00000E-00	CD	0	DRAG	0
SOS	8.46512E-02	VLD	2.54917E-02	VLG	4.21372E-03	VLT	5.68962E-01	VCHR	1.38711E-04
TIM	2.57000E-02	GAM	3.39948E-00	VEL	1.07742E-04	ALT	3.39463E-05	WT	4.08605E-05
STAGE	2	ALPH	1.32446E-01	MACH	1.27277E-01	XISP	4.55000E-02	DYNP	0

GRAV	3.11516E 01	ACC	1.36842E 00	THRI	5.59144E 05	CL	0	LIFT	0
DENS	3.72964E-10	ACCN	0	RATI	1.00000E 00	CD	0	DRAG	0
SOS	8.46512E 02	VLD	2.54917E 02	VLG	4.21558E 03	VLT	5.80248E 01	VCHR	1.39136E 04
TIM	2.58000E 02	GAM	3.31720E 00	VFL	1.08153E 04	ALT	3.40096E 05	WT	4.07376E 05
STAGE	2	ALPH	1.32856E 01	MACH	1.27743E 01	XISP	4.55000E 02	DYNP	0
GRAV	3.11498E 01	ACC	1.37255E 00	THRI	5.59144E 05	CL	0	LIFT	0
DENS	3.58683E-10	ACCN	0	RATI	1.00000E 00	CD	0	DRAG	0
SOS	8.46512E 02	VLD	2.54917E 02	VLG	4.21741E 03	VLT	5.91639E 01	VCHR	1.39563E 04
TIM	2.59000E 02	GAM	3.23576E 00	VEL	1.08565E 04	ALT	3.40715E 05	WT	4.06147E 05
STAGE	2	ALPH	1.33258E 01	MACH	1.28250E 01	XISP	4.55000E 02	DYNP	0
GRAV	3.11479E 01	ACC	1.37670E 00	THRI	5.59144E 05	CL	0	LIFT	0
DENS	3.45609E-10	ACCN	0	RATI	1.00000E 00	CD	0	DRAG	0
SOS	8.46512E 02	VLD	2.54917E 02	VLG	4.21919E 03	VLT	6.03133E 01	VCHR	1.39991E 04
TIM	2.60000E 02	GAM	3.15518E 00	VEL	1.08980E 04	ALT	3.41321E 05	WT	4.04919E 05
STAGE	2	ALPH	1.33651E 01	MACH	1.28739E 01	XISP	4.55000E 02	DYNP	0
GRAV	3.11462E 01	ACC	1.38088E 00	THRI	5.59144E 05	CL	0	LIFT	0
DENS	3.33090E-10	ACCN	0	RATI	1.00000E 00	CD	0	DRAG	0
SOS	8.46512E 02	VLD	2.54917E 02	VLG	4.22093E 03	VLT	6.14730E 01	VCHR	1.40421E 04
TIM	2.61000E 02	GAM	3.07544E 00	VEL	1.09395E 04	ALT	3.41915E 05	WT	4.03690E 05
STAGE	2	ALPH	1.34035E 01	MACH	1.29211E 01	XISP	4.55000E 02	DYNP	0
GRAV	3.11444E 01	ACC	1.38508E 00	THRI	5.59144E 05	CL	0	LIFT	0
DENS	3.21278E-10	ACCN	0	RATI	1.00000E 00	CD	0	DRAG	0
SOS	8.46512E 02	VLD	2.54917E 02	VLG	4.22262E 03	VLT	6.26429E 01	VCHR	1.40852E 04
TIM	2.62000E 02	GAM	2.99654E 00	VEL	1.09813E 04	ALT	3.42495E 05	WT	4.02461E 05
STAGE	2	ALPH	1.34411E 01	MACH	1.29724E 01	XISP	4.55000E 02	DYNP	0
GRAV	3.11427E 01	ACC	1.38931E 00	THRI	5.59144E 05	CL	0	LIFT	0
DENS	3.10128E-10	ACCN	0	RATI	1.00000E 00	CD	0	DRAG	0
SOS	8.46512E 02	VLD	2.54917E 02	VLG	4.22427E 03	VLT	6.38230E 01	VCHR	1.41284E 04
TIM	2.63000E 02	GAM	2.91848E 00	VEL	1.10232E 04	ALT	3.43063E 05	WT	4.01232E 05
STAGE	2	ALPH	1.34778E 01	MACH	1.30220E 01	XISP	4.55000E 02	DYNP	0
GRAV	3.11410E 01	ACC	1.39357E 00	THRI	5.59144E 05	CL	0	LIFT	0
DENS	2.99600E-10	ACCN	0	RATI	1.00000E 00	CD	0	DRAG	0
SOS	8.46512E 02	VLD	2.54917E 02	VLG	4.22587E 03	VLT	6.50131E 01	VCHR	1.41717E 04
TIM	2.64000E 02	GAM	2.84125E 00	VEL	1.10653E 04	ALT	3.43618E 05	WT	4.00003E 05
STAGE	2	ALPH	1.35137E 01	MACH	1.30717E 01	XISP	4.55000E 02	DYNP	0
GRAV	3.11394E 01	ACC	1.39785E 00	THRI	5.59144E 05	CL	0	LIFT	0
DENS	2.89655E-10	ACCN	0	RATI	1.00000E 00	CD	0	DRAG	0
SOS	8.46512E 02	VLD	2.54917E 02	VLG	4.22744E 03	VLT	6.62133E 01	VCHR	1.42152E 04
TIM	2.65000E 02	GAM	2.76484E 00	VEL	1.11076E 04	ALT	3.44160E 05	WT	3.98774E 05
STAGE	2	ALPH	1.35488E 01	MACH	1.31216E 01	XISP	4.55000E 02	DYNP	0
GRAV	3.11378E 01	ACC	1.40216E 00	THRI	5.59144E 05	CL	0	LIFT	0
DENS	2.80257E-10	ACCN	0	RATI	1.00000E 00	CD	0	DRAG	0
SOS	8.46512E 02	VLD	2.54917E 02	VLG	4.22896E 03	VLT	6.74233E 01	VCHR	1.42588E 04
TIM	2.66000E 02	GAM	2.68926E 00	VEL	1.11501E 04	ALT	3.44689E 05	WT	3.97545E 05
STAGE	2	ALPH	1.35830E 01	MACH	1.31718E 01	XISP	4.55000E 02	DYNP	0
GRAV	3.11363E 01	ACC	1.40649E 00	THRI	5.59144E 05	CL	0	LIFT	0
DENS	2.71374E-10	ACCN	0	RATI	1.00000E 00	CD	0	DRAG	0
SOS	8.46512E 02	VLD	2.54917E 02	VLG	4.23044E 03	VLT	6.86433E 01	VCHR	1.43025E 04
TIM	2.67000E 02	GAM	2.61449E 00	VEL	1.11927E 04	ALT	3.45206E 05	WT	3.96316E 05
STAGE	2	ALPH	1.36163E 01	MACH	1.32221E 01	XISP	4.55000E 02	DYNP	0
GRAV	3.11348E 01	ACC	1.41085E 00	THRI	5.59144E 05	CL	0	LIFT	0
DENS	2.62975E-10	ACCN	0	RATI	1.00000E 00	CD	0	DRAG	0
SOS	8.46512E 02	VLD	2.54917E 02	VLG	4.23188E 03	VLT	6.98730E 01	VCHR	1.43463E 04
TIM	2.68000E 02	GAM	2.54054E 00	VEL	1.12354E 04	ALT	3.45710E 05	WT	3.95087E 05
STAGE	2	ALPH	1.36489E 01	MACH	1.32726E 01	XISP	4.55000E 02	DYNP	0
GRAV	3.11333E 01	ACC	1.41524E 00	THRI	5.59144E 05	CL	0	LIFT	0
DENS	2.55031E-10	ACCN	0	RATI	1.00000E 00	CD	0	DRAG	0
SOS	8.46512E 02	VLD	2.54917E 02	VLG	4.23328E 03	VLT	7.11124E 01	VCHR	1.43903E 04
TIM	2.69000E 02	GAM	2.46739E 00	VEL	1.12784E 04	ALT	3.46202E 05	WT	3.93859E 05
STAGE	2	ALPH	1.36806E 01	MACH	1.33234E 01	XISP	4.55000E 02	DYNP	0
GRAV	3.11318E 01	ACC	1.41966E 00	THRI	5.59144E 05	CL	0	LIFT	0
DENS	2.47515E-10	ACCN	0	RATI	1.00000E 00	CD	0	DRAG	0
SOS	8.46512E 02	VLD	2.54917E 02	VLG	4.23464E 03	VLT	7.23615E 01	VCHR	1.44345E 04
TIM	2.70000E 02	GAM	2.39505E 00	VEL	1.13215E 04	ALT	3.46681E 05	WT	3.92630E 05
STAGE	2	ALPH	1.37114E 01	MACH	1.33743E 01	XISP	4.55000E 02	DYNP	0
GRAV	3.11304E 01	ACC	1.42410E 00	THRI	5.59144E 05	CL	0	LIFT	0
DENS	2.40403E-10	ACCN	0	RATI	1.00000E 00	CD	0	DRAG	0
SOS	8.46512E 02	VLD	2.54917E 02	VLG	4.23596E 03	VLT	7.36202E 01	VCHR	1.44787E 04

TIM	2.71000F 02	GAM	2.32350E 00	VFL	1.13648E 04	ALT	3.47148E 05	WT	3.91401E 05
STAGE	2	ALPH	1.37415E 01	MACH	1.34255E 01	XISP	4.55000E 02	DYNP	0
GRAV	3.11290F 01	ACC	1.42857E 00	THRI	5.59144E 05	CL	0	LIFT	0
DENS	2.33672E-10	ACCN	0	RATI	1.00000F 00	CD	0	DRAG	0
SOS	8.46512E 02	VLD	2.54917E 02	VLG	4.23725E 03	VLT	7.48883E 01	VCHR	1.45231E 04
TIM	2.72000F 02	GAM	2.25275F 00	VFL	1.14083E 04	ALT	3.47603E 05	WT	3.90172E 05
STAGE	2	ALPH	1.37708F 01	MACH	1.34768E 01	XISP	4.55000E 02	DYNP	0
GRAV	3.11277F 01	ACC	1.43307E 00	THRI	5.59144E 05	CL	0	LIFT	0
DENS	2.27300F-10	ACCN	0	RATI	1.00000F 00	CD	0	DRAG	0
SOS	8.46512E 02	VLD	2.54917E 02	VLG	4.23849F 03	VLT	7.61659E 01	VCHR	1.45677E 04
TIM	2.73000F 02	GAM	2.16279E 00	VFL	1.14519E 04	ALT	3.48045E 05	WT	3.88943E 05
STAGE	2	ALPH	1.37992E 01	MACH	1.35284E 01	XISP	4.55000E 02	DYNP	0
GRAV	3.11264F 01	ACC	1.43760E 00	THRI	5.59144E 05	CL	0	LIFT	0
DENS	2.21268E-10	ACCN	0	RATI	1.00000F 00	CD	0	DRAG	0
SOS	8.46512E 02	VLD	2.54917E 02	VLG	4.23969E 03	VLT	7.74527E 01	VCHR	1.46123E 04
TIM	2.74000E 02	GAM	2.11362E 00	VFL	1.14958E 04	ALT	3.48475E 05	WT	3.87714E 05
STAGE	2	ALPH	1.38269E 01	MACH	1.35802E 01	XISP	4.55000E 02	DYNP	0
GRAV	3.11252F 01	ACC	1.44216E 00	THRI	5.59144E 05	CL	0	LIFT	0
DENS	2.15556E-10	ACCN	0	RATI	1.00000F 00	CD	0	DRAG	0
SOS	8.46512E 02	VLD	2.54917E 02	VLG	4.24006E 03	VLT	7.87489E 01	VCHR	1.46572E 04
TIM	2.75000E 02	GAM	2.04523E 00	VFL	1.15398E 04	ALT	3.48893E 05	WT	3.86485E 05
STAGE	2	ALPH	1.38537E 01	MACH	1.36321E 01	XISP	4.55000E 02	DYNP	0
GRAV	3.11239F 01	ACC	1.44674E 00	THRI	5.59144E 05	CL	0	LIFT	0
DENS	2.10147E-10	ACCN	0	RATI	1.00000F 00	CD	0	DRAG	0
SOS	8.46512E 02	VLD	2.54917E 02	VLG	4.24199E 03	VLT	8.00542E 01	VCHR	1.47021E 04
TIM	2.76000E 02	GAM	1.97761E 00	VFL	1.15839E 04	ALT	3.49299E 05	WT	3.85256E 05
STAGE	2	ALPH	1.38798E 01	MACH	1.36843E 01	XISP	4.55000E 02	DYNP	0
GRAV	3.11227F 01	ACC	1.45136E 00	THRI	5.59144E 05	CL	0	LIFT	0
DENS	2.05025E-10	ACCN	0	RATI	1.00000F 00	CD	0	DRAG	0
SOS	8.46512E 02	VLD	2.54917E 02	VLG	4.24308E 03	VLT	8.13686E 01	VCHR	1.47472E 04
TIM	2.77000F 02	GAM	1.91077E 00	VFL	1.16263E 04	ALT	3.49693E 05	WT	3.84027E 05
STAGE	2	ALPH	1.39051E 01	MACH	1.37367E 01	XISP	4.55000E 02	DYNP	0
GRAV	3.11216F 01	ACC	1.45600E 00	THRI	5.59144E 05	CL	0	LIFT	0
DENS	2.00175E-10	ACCN	0	RATI	1.00000F 00	CD	0	DRAG	0
SOS	8.46512E 02	VLD	2.54917E 02	VLG	4.24414E 03	VLT	8.26920E 01	VCHR	1.47925E 04
TIM	2.78000E 02	GAM	1.84470E 00	VFL	1.16728E 04	ALT	3.50074E 05	WT	3.82799E 05
STAGE	2	ALPH	1.39295F 01	MACH	1.37843E 01	XISP	4.55000E 02	DYNP	0
GRAV	3.11205F 01	ACC	1.46067F 00	THRI	5.59144E 05	CL	0	LIFT	0
DENS	1.95533E-10	ACCN	0	RATI	1.00000F 00	CD	0	DRAG	0
SOS	8.46512E 02	VLD	2.54917E 02	VLG	4.24520E 03	VLT	8.40243E 01	VCHR	1.48378E 04
TIM	2.79000F 02	GAM	1.77939E 00	VFL	1.17175E 04	ALT	3.50444F 05	WT	3.81570E 05
STAGE	2	ALPH	1.39532E 01	MACH	1.38421E 01	XISP	4.55000E 02	DYNP	0
GRAV	3.11194E 01	ACC	1.46538E 00	THRI	5.59144E 05	CL	0	LIFT	0
DENS	1.91234E-10	ACCN	0	RATI	1.00000F 00	CD	0	DRAG	0
SOS	8.46512E 02	VLD	2.54917E 02	VLG	4.24614E 03	VLT	8.53655E 01	VCHR	1.48834E 04
TIM	2.80000F 02	GAM	1.71484E 00	VFL	1.17674E 04	ALT	3.50802E 05	WT	3.80341E 05
STAGE	2	ALPH	1.39762E 01	MACH	1.38951E 01	XISP	4.55000E 02	DYNP	0
GRAV	3.11183F 01	ACC	1.47011E 00	THRI	5.59144E 05	CL	0	LIFT	0
DENS	1.87118E-10	ACCN	0	RATI	1.00000F 00	CD	0	DRAG	0
SOS	8.46512E 02	VLD	2.54917E 02	VLG	4.24709E 03	VLT	8.67155E 01	VCHR	1.49291E 04
TIM	2.81000F 02	GAM	1.65104E 00	VFL	1.18074E 04	ALT	3.51148E 05	WT	3.79132E 05
STAGE	2	ALPH	1.39983E 01	MACH	1.39463F 01	XISP	4.55000E 02	DYNP	0
GRAV	3.11173E 01	ACC	1.47488E 00	THRI	5.59144E 05	CL	0	LIFT	0
DENS	1.83222E-10	ACCN	0	RATI	1.00000F 00	CD	0	DRAG	0
SOS	8.46512E 02	VLD	2.54917E 02	VLG	4.24800F 03	VLT	8.80741E 01	VCHR	1.49749E 04
TIM	2.82000F 02	GAM	1.58800E 00	VFL	1.18577E 04	ALT	3.51483E 05	WT	3.77883E 05
STAGE	2	ALPH	1.40197E 01	MACH	1.40028E 01	XISP	4.55000E 02	DYNP	0
GRAV	3.11163F 01	ACC	1.47967E 00	THRI	5.59144E 05	CL	0	LIFT	0
DENS	1.79535E-10	ACCN	0	RATI	1.00000F 00	CD	0	DRAG	0
SOS	8.46512E 02	VLD	2.54917E 02	VLG	4.24888E 03	VLT	8.94413E 01	VCHR	1.50208E 04
TIM	2.83000F 02	GAM	1.52571F 00	VFL	1.18941E 04	ALT	3.51805E 05	WT	3.76654E 05
STAGE	2	ALPH	1.40403E 01	MACH	1.40554E 01	XISP	4.55000E 02	DYNP	0
GRAV	3.11154E 01	ACC	1.48450E 00	THRI	5.59144E 05	CL	0	LIFT	0
DENS	1.76049E-10	ACCN	0	RATI	1.00000F 00	CD	0	DRAG	0
SOS	8.46512E 02	VLD	2.54917E 02	VLG	4.24973E 03	VLT	9.08170E 01	VCHR	1.50670E 04
TIM	2.84000F 02	GAM	1.46416E 00	VFL	1.19437E 04	ALT	3.52116E 05	WT	3.75425E 05
STAGE	2	ALPH	1.40602E 01	MACH	1.41093E 01	XISP	4.55000E 02	DYNP	0
GRAV	3.11145E 01	ACC	1.48936E 00	THRI	5.59144E 05	CL	0	LIFT	0

DENS	1.72752E-10	ACCN	0	RATI	1.00000E 00	CD	0	DRAG	0
SOS	8.46512E 02	VLD	2.54917E 02	VLG	4.25054E 03	VLT	9.22011E 01	VCHR	1.51132E 04
TIM	2.85000E 02	GAM	1.40334E 00	VEL	1.19895E 04	ALT	3.52416E 05	WT	3.74196E 05
STAGE	2	ALPH	1.40793E 01	MACH	1.41634E 01	XISP	4.55000E 02	DYNP	0
GRAV	3.11136E 01	ACC	1.49425E 00	THRI	5.59144E 05	CL	0	LIFT	0
DENS	1.69634E-10	ACCN	0	RATI	1.00000E 00	CD	0	DRAG	0
SOS	8.46512E 02	VLD	2.54917E 02	VLG	4.25132E 03	VLT	9.35936E 01	VCHR	1.51596E 04
TIM	2.86000E 02	GAM	1.34327E 00	VEL	1.20344E 04	ALT	3.52703E 05	WT	3.72967E 05
STAGE	2	ALPH	1.40976E 01	MACH	1.42147E 01	XISP	4.55000E 02	DYNP	0
GRAV	3.11127E 01	ACC	1.45918E 00	THRI	5.59144E 05	CL	0	LIFT	0
DENS	1.66693E-10	ACCN	0	RATI	1.00000E 00	CD	0	DRAG	0
SOS	8.46512E 02	VLD	2.54917E 02	VLG	4.25206E 03	VLT	9.49943E 01	VCHR	1.52062E 04
TIM	2.87000E 02	GAM	1.28392E 00	VEL	1.20816E 04	ALT	3.52980E 05	WT	3.71739E 05
STAGE	2	ALPH	1.41152E 01	MACH	1.42722E 01	XISP	4.55000E 02	DYNP	0
GRAV	3.11119E 01	ACC	1.50413E 00	THRI	5.59144E 05	CL	0	LIFT	0
DENS	1.63916E-10	ACCN	0	RATI	1.00000E 00	CD	0	DRAG	0
SOS	8.46512E 02	VLD	2.54917E 02	VLG	4.25278E 03	VLT	9.64032E 01	VCHR	1.52529E 04
TIM	2.88000E 02	GAM	1.22531E 00	VEL	1.21279E 04	ALT	3.53245E 05	WT	3.70510E 05
STAGE	2	ALPH	1.41321E 01	MACH	1.43269E 01	XISP	4.55000E 02	DYNP	0
GRAV	3.11112E 01	ACC	1.50912E 00	THRI	5.59144E 05	CL	0	LIFT	0
DENS	1.61297E-10	ACCN	0	RATI	1.00000E 00	CD	0	DRAG	0
SOS	8.46512E 02	VLD	2.54917E 02	VLG	4.25346E 03	VLT	9.78201E 01	VCHR	1.52998E 04
TIM	2.89000E 02	GAM	1.16741E 00	VEL	1.21744E 04	ALT	3.53499E 05	WT	3.69281E 05
STAGE	2	ALPH	1.41482E 01	MACH	1.43818E 01	XISP	4.55000E 02	DYNP	0
GRAV	3.11104E 01	ACC	1.51414E 00	THRI	5.59144E 05	CL	0	LIFT	0
DENS	1.58828E-10	ACCN	0	RATI	1.00000E 00	CD	0	DRAG	0
SOS	8.46512E 02	VLD	2.54917E 02	VLG	4.25411E 03	VLT	9.92450E 01	VCHR	1.53468E 04
TIM	2.90000E 02	GAM	1.11024E 00	VEL	1.22211E 04	ALT	3.53741E 05	WT	3.68052E 05
STAGE	2	ALPH	1.41636E 01	MACH	1.44370E 01	XISP	4.55000E 02	DYNP	0
GRAV	3.11097E 01	ACC	1.51920E 00	THRI	5.59144E 05	CL	0	LIFT	0
DENS	1.56505E-10	ACCN	0	RATI	1.00000E 00	CD	0	DRAG	0
SOS	8.46512E 02	VLD	2.54917E 02	VLG	4.25473E 03	VLT	1.00678E 02	VCHR	1.53940E 04
TIM	2.91000E 02	GAM	1.05378E 00	VEL	1.22680E 04	ALT	3.53972E 05	WT	3.66823E 05
STAGE	2	ALPH	1.41782E 01	MACH	1.44924E 01	XISP	4.55000E 02	DYNP	0
GRAV	3.11090E 01	ACC	1.52429E 00	THRI	5.59144E 05	CL	0	LIFT	0
DENS	1.54322E-10	ACCN	0	RATI	1.00000E 00	CD	0	DRAG	0
SOS	8.46512E 02	VLD	2.54917E 02	VLG	4.25531E 03	VLT	1.02118E 02	VCHR	1.54413E 04
TIM	2.92000E 02	GAM	9.98038E-01	VEL	1.23151E 04	ALT	3.54192E 05	WT	3.65594E 05
STAGE	2	ALPH	1.41921E 01	MACH	1.45480E 01	XISP	4.55000E 02	DYNP	0
GRAV	3.11084E 01	ACC	1.52941E 00	THRI	5.59144E 05	CL	0	LIFT	0
DENS	1.52271E-10	ACCN	0	RATI	1.00000E 00	CD	0	DRAG	0
SOS	8.46512E 02	VLD	2.54917E 02	VLG	4.25587E 03	VLT	1.03567E 02	VCHR	1.54888E 04
TIM	2.93000E 02	GAM	9.43001E-01	VEL	1.23623E 04	ALT	3.54401E 05	WT	3.64365E 05
STAGE	2	ALPH	1.42053E 01	MACH	1.46038E 01	XISP	4.55000E 02	DYNP	0
GRAV	3.11078E 01	ACC	1.53457E 00	THRI	5.59144E 05	CL	0	LIFT	0
DENS	1.50349E-10	ACCN	0	RATI	1.00000E 00	CD	0	DRAG	0
SOS	8.46512E 02	VLD	2.54917E 02	VLG	4.25640E 03	VLT	1.05023E 02	VCHR	1.55365E 04
TIM	2.94000E 02	GAM	8.88669E-01	VEL	1.24098E 04	ALT	3.54599E 05	WT	3.63136E 05
STAGE	2	ALPH	1.42178E 01	MACH	1.46599E 01	XISP	4.55000E 02	DYNP	0
GRAV	3.11072E 01	ACC	1.53976E 00	THRI	5.59144E 05	CL	0	LIFT	0
DENS	1.48551E-10	ACCN	0	RATI	1.00000E 00	CD	0	DRAG	0
SOS	8.46512E 02	VLD	2.54917E 02	VLG	4.25690E 03	VLT	1.06486E 02	VCHR	1.55843E 04
TIM	2.95000E 02	GAM	8.35037E-01	VEL	1.24574E 04	ALT	3.54786E 05	WT	3.61907E 05
STAGE	2	ALPH	1.42295E 01	MACH	1.47161E 01	XISP	4.55000E 02	DYNP	0
GRAV	3.11066E 01	ACC	1.54499E 00	THRI	5.59144E 05	CL	0	LIFT	0
DENS	1.46873E-10	ACCN	0	RATI	1.00000E 00	CD	0	DRAG	0
SOS	8.46512E 02	VLD	2.54917E 02	VLG	4.25736E 03	VLT	1.07957E 02	VCHR	1.56323E 04
TIM	2.96000E 02	GAM	7.82102E-01	VEL	1.25052E 04	ALT	3.54962E 05	WT	3.60679E 05
STAGE	2	ALPH	1.42406E 01	MACH	1.47726E 01	XISP	4.55000E 02	DYNP	0
GRAV	3.11061E 01	ACC	1.55026E 00	THRI	5.59144E 05	CL	0	LIFT	0
DENS	1.45300E-10	ACCN	0	RATI	1.00000E 00	CD	0	DRAG	0
SOS	8.46512E 02	VLD	2.54917E 02	VLG	4.25780E 03	VLT	1.09435E 02	VCHR	1.56804E 04
TIM	2.97000E 02	GAM	7.29860E-01	VEL	1.25532E 04	ALT	3.55128E 05	WT	3.59450E 05
STAGE	2	ALPH	1.42509E 01	MACH	1.48294E 01	XISP	4.55000E 02	DYNP	0
GRAV	3.11056E 01	ACC	1.55556E 00	THRI	5.59144E 05	CL	0	LIFT	0
DENS	1.43857E-10	ACCN	0	RATI	1.00000E 00	CD	0	DRAG	0
SOS	8.46512E 02	VLD	2.54917E 02	VLG	4.25821E 03	VLT	1.10920E 02	VCHR	1.57287E 04

TIM	2.90000E 02	GAM	6.78308E-01	VEL	1.26014E 04	ALT	3.55282E 05	WT	3.58221E 05
STAGE	2	ALPH	1.42605E 01	MACH	1.48863E 01	XISP	4.55000E 02	DYNP	0
GRAV	3.11052E 01	ACC	1.56089E 00	THRI	5.59144E 05	CL	0	LIFT	0
DENS	1.42512E-10	ACCN	0	RATI	1.00000E 00	CD	0	DRAG	0
SOS	8.46512E 02	VLD	2.54917E 02	VLG	4.25859E 03	VLT	1.12413E 02	VCHR	1.57772E 04
TIM	2.90000E 02	GAM	6.27442E-01	VEL	1.26499E 04	ALT	3.55426E 05	WT	3.56992E 05
STAGE	2	ALPH	1.42695E 01	MACH	1.49435E 01	XISP	4.55000E 02	DYNP	0
GRAV	3.11048E 01	ACC	1.56627E 00	THRI	5.59144E 05	CL	0	LIFT	0
DENS	1.41272E-10	ACCN	0	RATI	1.00000E 00	CD	0	DRAG	0
SOS	8.46512E 02	VLD	2.54917E 02	VLG	4.25895E 03	VLT	1.13913E 02	VCHR	1.58259E 04
TIM	3.00000E 02	GAM	5.77259E-01	VEL	1.26984E 04	ALT	3.55559E 05	WT	3.55763E 05
STAGE	2	ALPH	1.42777E 01	MACH	1.50009E 01	XISP	4.55000E 02	DYNP	0
GRAV	3.11044E 01	ACC	1.57168E 00	THRI	5.59144E 05	CL	0	LIFT	0
DENS	1.40132E-10	ACCN	0	RATI	1.00000E 00	CD	0	DRAG	0
SOS	8.46512E 02	VLD	2.54917E 02	VLG	4.25928E 03	VLT	1.15419E 02	VCHR	1.58747E 04
TIM	3.01000E 02	GAM	5.27755E-01	VEL	1.27472E 04	ALT	3.55682E 05	WT	3.54534E 05
STAGE	2	ALPH	1.42852E 01	MACH	1.50585E 01	XISP	4.55000E 02	DYNP	0
GRAV	3.11040E 01	ACC	1.57712E 00	THRI	5.59144E 05	CL	0	LIFT	0
DENS	1.39092E-10	ACCN	0	RATI	1.00000E 00	CD	0	DRAG	0
SOS	8.46512E 02	VLD	2.54917E 02	VLG	4.25958E 03	VLT	1.16933E 02	VCHR	1.59236E 04
TIM	3.02000E 02	GAM	4.78925E-01	VEL	1.27962E 04	ALT	3.55794E 05	WT	3.53305E 05
STAGE	2	ALPH	1.42920E 01	MACH	1.51164E 01	XISP	4.55000E 02	DYNP	0
GRAV	3.11037E 01	ACC	1.58261E 00	THRI	5.59144E 05	CL	0	LIFT	0
DENS	1.38147E-10	ACCN	0	RATI	1.00000E 00	CD	0	DRAG	0
SOS	8.46512E 02	VLD	2.54917E 02	VLG	4.25985E 03	VLT	1.18453E 02	VCHR	1.59728E 04
TIM	3.03000E 02	GAM	4.30768E-01	VEL	1.28454E 04	ALT	3.55896E 05	WT	3.52076E 05
STAGE	2	ALPH	1.42982E 01	MACH	1.51745E 01	XISP	4.55000E 02	DYNP	0
GRAV	3.11034E 01	ACC	1.58813E 00	THRI	5.59144E 05	CL	0	LIFT	0
DENS	1.37295E-10	ACCN	0	RATI	1.00000E 00	CD	0	DRAG	0
SOS	8.46512E 02	VLD	2.54917E 02	VLG	4.26010E 03	VLT	1.19980E 02	VCHR	1.60221E 04
TIM	3.04000E 02	GAM	3.83279E-01	VEL	1.28948E 04	ALT	3.55987E 05	WT	3.50847E 05
STAGE	2	ALPH	1.43037E 01	MACH	1.52328E 01	XISP	4.55000E 02	DYNP	0
GRAV	3.11031E 01	ACC	1.59370E 00	THRI	5.59144E 05	CL	0	LIFT	0
DENS	1.36535E-10	ACCN	0	RATI	1.00000E 00	CD	0	DRAG	0
SOS	8.46512E 02	VLD	2.54917E 02	VLG	4.26032E 03	VLT	1.21513E 02	VCHR	1.60716E 04
TIM	3.05000E 02	GAM	3.36456E-01	VEL	1.29444E 04	ALT	3.56068E 05	WT	3.49619E 05
STAGE	2	ALPH	1.43084E 01	MACH	1.52914E 01	XISP	4.55000E 02	DYNP	0
GRAV	3.11029E 01	ACC	1.59930E 00	THRI	5.59144E 05	CL	0	LIFT	0
DENS	1.35843E-10	ACCN	0	RATI	1.00000E 00	CD	0	DRAG	0
SOS	8.46512E 02	VLD	2.54917E 02	VLG	4.26051E 03	VLT	1.23053E 02	VCHR	1.61212E 04
TIM	3.06000E 02	GAM	2.90293E-01	VEL	1.29941E 04	ALT	3.56139E 05	WT	3.48390E 05
STAGE	2	ALPH	1.43125E 01	MACH	1.53502E 01	XISP	4.55000E 02	DYNP	0
GRAV	3.11027E 01	ACC	1.60494E 00	THRI	5.59144E 05	CL	0	LIFT	0
DENS	1.35279E-10	ACCN	0	RATI	1.00000E 00	CD	0	DRAG	0
SOS	8.46512E 02	VLD	2.54917E 02	VLG	4.26068E 03	VLT	1.24599E 02	VCHR	1.61710E 04
TIM	3.07000E 02	GAM	2.44789E-01	VEL	1.30441E 04	ALT	3.56200E 05	WT	3.47161E 05
STAGE	2	ALPH	1.43160E 01	MACH	1.54092E 01	XISP	4.55000E 02	DYNP	0
GRAV	3.11025E 01	ACC	1.61062E 00	THRI	5.59144E 05	CL	0	LIFT	0
DENS	1.34740E-10	ACCN	0	RATI	1.00000E 00	CD	0	DRAG	0
SOS	8.46512E 02	VLD	2.54917E 02	VLG	4.26083E 03	VLT	1.26151E 02	VCHR	1.62210E 04
TIM	3.08000E 02	GAM	1.99940E-01	VEL	1.30943E 04	ALT	3.56251E 05	WT	3.45932E 05
STAGE	2	ALPH	1.43187E 01	MACH	1.54685E 01	XISP	4.55000E 02	DYNP	0
GRAV	3.11023E 01	ACC	1.61634E 00	THRI	5.59144E 05	CL	0	LIFT	0
DENS	1.34366E-10	ACCN	0	RATI	1.00000E 00	CD	0	DRAG	0
SOS	8.46512E 02	VLD	2.54917E 02	VLG	4.26095E 03	VLT	1.27710E 02	VCHR	1.62712E 04
TIM	3.09000E 02	GAM	1.55742E-01	VEL	1.31447E 04	ALT	3.56291E 05	WT	3.44703E 05
STAGE	2	ALPH	1.43208E 01	MACH	1.55280E 01	XISP	4.55000E 02	DYNP	0
GRAV	3.11022E 01	ACC	1.62210E 00	THRI	5.59144E 05	CL	0	LIFT	0
DENS	1.34034E-10	ACCN	0	RATI	1.00000E 00	CD	0	DRAG	0
SOS	8.46512E 02	VLD	2.54917E 02	VLG	4.26104E 03	VLT	1.29275E 02	VCHR	1.63216E 04
TIM	3.10000E 02	GAM	1.12192E-01	VEL	1.31953E 04	ALT	3.56322E 05	WT	3.43474E 05
STAGE	2	ALPH	1.43223E 01	MACH	1.55878E 01	XISP	4.55000E 02	DYNP	0
GRAV	3.11021E 01	ACC	1.62791E 00	THRI	5.59144E 05	CL	0	LIFT	0
DENS	1.33783E-10	ACCN	0	RATI	1.00000E 00	CD	0	DRAG	0
SOS	8.46512E 02	VLD	2.54917E 02	VLG	4.26112E 03	VLT	1.30846E 02	VCHR	1.63721E 04
TIM	3.11000E 02	GAM	6.92874E-02	VEL	1.32460E 04	ALT	3.56343E 05	WT	3.42245E 05
STAGE	2	ALPH	1.43230E 01	MACH	1.56478E 01	XISP	4.55000E 02	DYNP	0

GRAV	3.11021E 01	ACC	1.63375E 00	THRI	5.59144E 05	CL	0	LIFT	0
DENS	1.33613E-10	ACCN	0	RATI	1.00000E 00	CD	0	DRAG	0
SOS	8.46512E 02	VLD	2.54917E 02	VLG	4.26117E 03	VLT	1.32422E 02	VCHR	1.64229E 04
TIM	3.12000E 02	GAM	2.70243E-02	VEL	1.32970E 04	ALT	3.56354E 05	WT	3.41018E 05
STAGE	2	ALPH	1.43231E 01	MACH	1.57180E 01	XISP	4.55000E 02	DYNP	0
GRAV	3.11020E 01	ACC	1.63964E 00	THRI	5.59144E 05	CL	0	LIFT	0
DENS	1.33523E-10	ACCN	0	RATI	1.00000E 00	CD	0	DRAG	0
SOS	8.46512E 02	VLD	2.54917E 02	VLG	4.26119E 03	VLT	1.34004E 02	VCHR	1.64738E 04
TIM	3.13000E 02	GAM	-1.46003E-02	VEL	1.33482E 04	ALT	3.56356E 05	WT	3.39788E 05
STAGE	2	ALPH	-1.43226E 01	MACH	1.57665E 01	XISP	4.55000E 02	DYNP	0
GRAV	3.11020E 01	ACC	1.64557E 00	THRI	5.59144E 05	CL	0	LIFT	0
DENS	1.33511E-10	ACCN	0	RATI	1.00000E 00	CD	0	DRAG	0
SOS	8.46512E 02	VLD	2.54917E 02	VLG	4.26120E 03	VLT	1.35592E 02	VCHR	1.65248E 04
TIM	3.14000E 02	GAM	-5.55897E-02	VEL	1.33997E 04	ALT	3.56348E 05	WT	3.38559E 05
STAGE	2	ALPH	1.43214E 01	MACH	1.58293E 01	XISP	4.55000E 02	DYNP	0
GRAV	3.11021E 01	ACC	1.65154E 00	THRI	5.59144E 05	CL	0	LIFT	0
DENS	1.33578E-10	ACCN	0	RATI	1.00000E 00	CD	0	DRAG	0
SOS	8.46512E 02	VLD	2.54917E 02	VLG	4.26118E 03	VLT	1.37186E 02	VCHR	1.65761E 04
TIM	3.15000E 02	GAM	-9.59468E-02	VEL	1.34513E 04	ALT	3.56330E 05	WT	3.37330E 05
STAGE	2	ALPH	1.43196E 01	MACH	1.58922E 01	XISP	4.55000E 02	DYNP	0
GRAV	3.11021E 01	ACC	1.65756E 00	THRI	5.59144E 05	CL	0	LIFT	0
DENS	1.33722E-10	ACCN	0	RATI	1.00000E 00	CD	0	DRAG	0
SOS	8.46512E 02	VLD	2.54917E 02	VLG	4.26114E 03	VLT	1.38785E 02	VCHR	1.66276E 04
TIM	3.16000E 02	GAM	-1.35675E-01	VEL	1.35031E 04	ALT	3.56303E 05	WT	3.36101E 05
STAGE	2	ALPH	1.43171E 01	MACH	1.59515E 01	XISP	4.55000E 02	DYNP	0
GRAV	3.11022E 01	ACC	1.66362E 00	THRI	5.59144E 05	CL	0	LIFT	0
DENS	1.33944E-10	ACCN	0	RATI	1.00000E 00	CD	0	DRAG	0
SOS	8.46512E 02	VLD	2.54917E 02	VLG	4.26107E 03	VLT	1.40389E 02	VCHR	1.66792E 04
TIM	3.17000E 02	GAM	-1.74777E-01	VEL	1.35552E 04	ALT	3.56266E 05	WT	3.34872E 05
STAGE	2	ALPH	-1.43139E 01	MACH	1.60129E 01	XISP	4.55000E 02	DYNP	0
GRAV	3.11023E 01	ACC	1.66972E 00	THRI	5.59144E 05	CL	0	LIFT	0
DENS	1.34243E-10	ACCN	0	RATI	1.00000E 00	CD	0	DRAG	0
SOS	8.46512E 02	VLD	2.54917E 02	VLG	4.26099E 03	VLT	1.41999E 02	VCHR	1.67311E 04
TIM	3.18000E 02	GAM	-2.13257E-01	VEL	1.36074E 04	ALT	3.56220E 05	WT	3.33643E 05
STAGE	2	ALPH	-1.43102E 01	MACH	1.60747E 01	XISP	4.55000E 02	DYNP	0
GRAV	3.11024E 01	ACC	1.67587E 00	THRI	5.59144E 05	CL	0	LIFT	0
DENS	1.34618E-10	ACCN	0	RATI	1.00000E 00	CD	0	DRAG	0
SOS	8.46512E 02	VLD	2.54917E 02	VLG	4.26088E 03	VLT	1.43614E 02	VCHR	1.67831E 04
TIM	3.19000E 02	GAM	-2.51116E-01	VEL	1.36599E 04	ALT	3.56165E 05	WT	3.32414E 05
STAGE	2	ALPH	-1.43058E 01	MACH	1.61367E 01	XISP	4.55000E 02	DYNP	0
GRAV	3.11026E 01	ACC	1.68207E 00	THRI	5.59144E 05	CL	0	LIFT	0
DENS	1.35071E-10	ACCN	0	RATI	1.00000E 00	CD	0	DRAG	0
SOS	8.46512E 02	VLD	2.54917E 02	VLG	4.26076E 03	VLT	1.45234E 02	VCHR	1.68353E 04
TIM	3.20000E 02	GAM	-2.88359E-01	VEL	1.37126E 04	ALT	3.56100E 05	WT	3.31185E 05
STAGE	2	ALPH	-1.43007E 01	MACH	1.61969E 01	XISP	4.55000E 02	DYNP	0
GRAV	3.11028E 01	ACC	1.68831E 00	THRI	5.59144E 05	CL	0	LIFT	0
DENS	1.35601E-10	ACCN	0	RATI	1.00000E 00	CD	0	DRAG	0
SOS	8.46512E 02	VLD	2.54917E 02	VLG	4.26061E 03	VLT	1.46858E 02	VCHR	1.68877E 04
TIM	3.21000E 02	GAM	-3.24988E-01	VEL	1.37655E 04	ALT	3.56027E 05	WT	3.29956E 05
STAGE	2	ALPH	-1.42951E 01	MACH	1.62614E 01	XISP	4.55000E 02	DYNP	0
GRAV	3.11030E 01	ACC	1.69460E 00	THRI	5.59144E 05	CL	0	LIFT	0
DENS	1.36209E-10	ACCN	0	RATI	1.00000E 00	CD	0	DRAG	0
SOS	8.46512E 02	VLD	2.54917E 02	VLG	4.26044E 03	VLT	1.48486E 02	VCHR	1.69403E 04
TIM	3.22000E 02	GAM	-3.61006E-01	VEL	1.38186E 04	ALT	3.55944E 05	WT	3.28728E 05
STAGE	2	ALPH	-1.42888E 01	MACH	1.63241E 01	XISP	4.55000E 02	DYNP	0
GRAV	3.11032E 01	ACC	1.70093E 00	THRI	5.59144E 05	CL	0	LIFT	0
DENS	1.36894E-10	ACCN	0	RATI	1.00000E 00	CD	0	DRAG	0
SOS	8.46512E 02	VLD	2.54917E 02	VLG	4.26026E 03	VLT	1.50122E 02	VCHR	1.69931E 04
TIM	3.23000E 02	GAM	-3.96416E-01	VEL	1.38719E 04	ALT	3.55852E 05	WT	3.27499E 05
STAGE	2	ALPH	-1.42819E 01	MACH	1.63871E 01	XISP	4.55000E 02	DYNP	0
GRAV	3.11035E 01	ACC	1.70732E 00	THRI	5.59144E 05	CL	0	LIFT	0
DENS	1.37657E-10	ACCN	0	RATI	1.00000E 00	CD	0	DRAG	0
SOS	8.46512E 02	VLD	2.54917E 02	VLG	4.26005E 03	VLT	1.51761E 02	VCHR	1.70461E 04
TIM	3.24000E 02	GAM	-4.31221E-01	VEL	1.39255E 04	ALT	3.55752E 05	WT	3.26270E 05
STAGE	2	ALPH	-1.42743E 01	MACH	1.64504E 01	XISP	4.55000E 02	DYNP	0
GRAV	3.11038E 01	ACC	1.71375E 00	THRI	5.59144E 05	CL	0	LIFT	0
DENS	1.38500E-10	ACCN	0	RATI	1.00000E 00	CD	0	DRAG	0
SOS	8.46512E 02	VLD	2.54917E 02	VLG	4.25983E 03	VLT	1.53405E 02	VCHR	1.70993E 04

TIM	3.25000E-02	GAM	-4.65424E-01	VEL	1.39793E-04	ALT	3.55643E-05	WT	3.25041E-05
STAGE	2	ALPH	1.42662E-01	MACH	1.65140E-01	XISP	4.55000E-02	DYNP	0
GRAV	3.11041E-01	ACC	1.72023E-00	THRI	5.59144E-05	CL	0	LIFT	0
DENS	1.39422E-10	ACCN	0	RATI	1.00000E-00	CD	0	DRAG	0
SOS	8.46512E-02	VLD	2.54917E-02	VLG	4.25958E-03	VLT	1.55052E-02	VCHR	1.71528E-04
TIM	3.26000E-02	GAM	-4.95027E-01	VEL	1.40333E-04	ALT	3.55525E-05	WT	3.23812E-05
STAGE	2	ALPH	1.42574E-01	MACH	1.65777E-01	XISP	4.55000E-02	DYNP	0
GRAV	3.11045E-01	ACC	1.72676E-00	THRI	5.59144E-05	CL	0	LIFT	0
DENS	1.40424E-10	ACCN	0	RATI	1.00000E-00	CD	0	DRAG	0
SOS	8.46512E-02	VLD	2.54917E-02	VLG	4.25932E-03	VLT	1.56705E-02	VCHR	1.72064E-04
TIM	3.27000E-02	GAM	-5.32034E-01	VEL	1.40875E-04	ALT	3.55398E-05	WT	3.22583E-05
STAGE	2	ALPH	1.42480E-01	MACH	1.66418E-01	XISP	4.55000E-02	DYNP	0
GRAV	3.11048E-01	ACC	1.73333E-00	THRI	5.59144E-05	CL	0	LIFT	0
DENS	1.41508E-10	ACCN	0	RATI	1.00000E-00	CD	0	DRAG	0
SOS	8.46512E-02	VLD	2.54917E-02	VLG	4.25904E-03	VLT	1.58361E-02	VCHR	1.72602E-04
TIM	3.28000E-02	GAM	-5.64447E-01	VEL	1.41419E-04	ALT	3.55263E-05	WT	3.21354E-05
STAGE	2	ALPH	1.42380E-01	MACH	1.67061E-01	XISP	4.55000E-02	DYNP	0
GRAV	3.11052E-01	ACC	1.73996E-00	THRI	5.59144E-05	CL	0	LIFT	0
DENS	1.42674E-10	ACCN	0	RATI	1.00000E-00	CD	0	DRAG	0
SOS	8.46512E-02	VLD	2.54917E-02	VLG	4.25874E-03	VLT	1.60022E-02	VCHR	1.73142E-04
TIM	3.29000E-02	GAM	-5.96269E-01	VEL	1.41966E-04	ALT	3.55120E-05	WT	3.20125E-05
STAGE	2	ALPH	1.42274E-01	MACH	1.67707E-01	XISP	4.55000E-02	DYNP	0
GRAV	3.11057E-01	ACC	1.74664E-00	THRI	5.59144E-05	CL	0	LIFT	0
DENS	1.43924E-10	ACCN	0	RATI	1.00000E-00	CD	0	DRAG	0
SOS	8.46512E-02	VLD	2.54917E-02	VLG	4.25843E-03	VLT	1.61686E-02	VCHR	1.73684E-04
TIM	3.30000E-02	GAM	-6.27503E-01	VEL	1.42515E-04	ALT	3.54968E-05	WT	3.18896E-05
STAGE	2	ALPH	1.42162E-01	MACH	1.68356E-01	XISP	4.55000E-02	DYNP	0
GRAV	3.11061E-01	ACC	1.75337E-00	THRI	5.59144E-05	CL	0	LIFT	0
DENS	1.45259E-10	ACCN	0	RATI	1.00000E-00	CD	0	DRAG	0
SOS	8.46512E-02	VLD	2.54917E-02	VLG	4.25810E-03	VLT	1.63354E-02	VCHR	1.74229E-04
TIM	3.31000E-02	GAM	-6.58152E-01	VEL	1.43067E-04	ALT	3.54808E-05	WT	3.17668E-05
STAGE	2	ALPH	1.42044E-01	MACH	1.69007E-01	XISP	4.55000E-02	DYNP	0
GRAV	3.11066E-01	ACC	1.76015E-00	THRI	5.59144E-05	CL	0	LIFT	0
DENS	1.46681E-10	ACCN	0	RATI	1.00000E-00	CD	0	DRAG	0
SOS	8.46512E-02	VLD	2.54917E-02	VLG	4.25775E-03	VLT	1.65026E-02	VCHR	1.74775E-04
TIM	3.32000E-02	GAM	-6.88217E-01	VEL	1.43621E-04	ALT	3.54639E-05	WT	3.16439E-05
STAGE	2	ALPH	1.41920E-01	MACH	1.69662E-01	XISP	4.55000E-02	DYNP	0
GRAV	3.11071E-01	ACC	1.76699E-00	THRI	5.59144E-05	CL	0	LIFT	0
DENS	1.48190E-10	ACCN	0	RATI	1.00000E-00	CD	0	DRAG	0
SOS	8.46512E-02	VLD	2.54917E-02	VLG	4.25738E-03	VLT	1.66702E-02	VCHR	1.75324E-04
TIM	3.33000E-02	GAM	-7.17702E-01	VEL	1.44177E-04	ALT	3.54463E-05	WT	3.15210E-05
STAGE	2	ALPH	1.41790E-01	MACH	1.70318E-01	XISP	4.55000E-02	DYNP	0
GRAV	3.11076E-01	ACC	1.77388E-00	THRI	5.59144E-05	CL	0	LIFT	0
DENS	1.49789E-10	ACCN	0	RATI	1.00000E-00	CD	0	DRAG	0
SOS	8.46512E-02	VLD	2.54917E-02	VLG	4.25700E-03	VLT	1.68382E-02	VCHR	1.75874E-04
TIM	3.34000E-02	GAM	-7.46610E-01	VEL	1.44735E-04	ALT	3.54278E-05	WT	3.13981E-05
STAGE	2	ALPH	1.41654E-01	MACH	1.70978E-01	XISP	4.55000E-02	DYNP	0
GRAV	3.11081E-01	ACC	1.78082E-00	THRI	5.59144E-05	CL	0	LIFT	0
DENS	1.51479E-10	ACCN	0	RATI	1.00000E-00	CD	0	DRAG	0
SOS	8.46512E-02	VLD	2.54917E-02	VLG	4.25660E-03	VLT	1.70064E-02	VCHR	1.76427E-04
TIM	3.35000E-02	GAM	-7.74943E-01	VEL	1.45296E-04	ALT	3.54086E-05	WT	3.12752E-05
STAGE	2	ALPH	1.41513E-01	MACH	1.71641E-01	XISP	4.55000E-02	DYNP	0
GRAV	3.11087E-01	ACC	1.78782E-00	THRI	5.59144E-05	CL	0	LIFT	0
DENS	1.53262E-10	ACCN	0	RATI	1.00000E-00	CD	0	DRAG	0
SOS	8.46512E-02	VLD	2.54917E-02	VLG	4.25619E-03	VLT	1.71751E-02	VCHR	1.76982E-04
TIM	3.36000E-02	GAM	-8.02703E-01	VEL	1.45859E-04	ALT	3.53885E-05	WT	3.11523E-05
STAGE	2	ALPH	1.41365E-01	MACH	1.72306E-01	XISP	4.55000E-02	DYNP	0
GRAV	3.11093E-01	ACC	1.79487E-00	THRI	5.59144E-05	CL	0	LIFT	0
DENS	1.55140E-10	ACCN	0	RATI	1.00000E-00	CD	0	DRAG	0
SOS	8.46512E-02	VLD	2.54917E-02	VLG	4.25576E-03	VLT	1.73440E-02	VCHR	1.77540E-04
TIM	3.37000E-02	GAM	-8.29894E-01	VEL	1.46425E-04	ALT	3.53677E-05	WT	3.10294E-05
STAGE	2	ALPH	1.41212E-01	MACH	1.72974E-01	XISP	4.55000E-02	DYNP	0
GRAV	3.11099E-01	ACC	1.80198E-00	THRI	5.59144E-05	CL	0	LIFT	0
DENS	1.57116E-10	ACCN	0	RATI	1.00000E-00	CD	0	DRAG	0
SOS	8.46512E-02	VLD	2.54917E-02	VLG	4.25532E-03	VLT	1.75132E-02	VCHR	1.78099E-04
TIM	3.38000E-02	GAM	-8.56517E-01	VEL	1.46993E-04	ALT	3.53461E-05	WT	3.09065E-05
STAGE	2	ALPH	1.41052E-01	MACH	1.73645E-01	XISP	4.55000E-02	DYNP	0
GRAV	3.11105E-01	ACC	1.80915E-00	THRI	5.59144E-05	CL	0	LIFT	0

DENS	1.54192E-10	ACCN	0	RATI	1.00000E 00	CD	0	DRAG	0
SOS	8.46512E 02	VLD	2.54917E 02	VLG	4.25486E 03	VLT	1.76828E 02	VCHR	1.78661E 04
TIM	3.30000E 02	GAM	-8.82976E-01	VEL	1.47563E 04	ALT	3.53238E 05	WT	3.07836E 05
STAGE	2	ALPH	1.40887E 01	MACH	1.74319E 01	XISP	4.55000E 02	DYNP	0
GRAV	3.11112E 01	ACC	1.81637E 00	THRI	5.59144E 05	CL	0	LIFT	0
DENS	1.61369E-10	ACCN	0	RATI	1.00000E 00	CD	0	DRAG	0
SOS	8.46512E 02	VLD	2.54917E 02	VLG	4.25489E 03	VLT	1.78526E 02	VCHR	1.79225E 04
TIM	3.40000E 02	GAM	-9.08072E-01	VEL	1.48136E 04	ALT	3.53006E 05	WT	3.06608E 05
STAGE	2	ALPH	1.40716E 01	MACH	1.74995E 01	XISP	4.55000E 02	DYNP	0
GRAV	3.11119E 01	ACC	1.82365E 00	THRI	5.59144E 05	CL	0	LIFT	0
DENS	1.63651E-10	ACCN	0	RATI	1.00000E 00	CD	0	DRAG	0
SOS	8.46512E 02	VLD	2.54917E 02	VLG	4.25390E 03	VLT	1.86227E 02	VCHR	1.79791E 04
TIM	3.41000E 02	GAM	-9.33008E-01	VEL	1.46711E 04	ALT	3.52768E 05	WT	3.05379E 05
STAGE	2	ALPH	1.40540E 01	MACH	1.75675E 01	XISP	4.55000E 02	DYNP	0
GRAV	3.11126E 01	ACC	1.83099E 00	THRI	5.59144E 05	CL	0	LIFT	0
DENS	1.66041E-10	ACCN	0	RATI	1.00000E 00	CD	0	DRAG	0
SOS	8.46512E 02	VLD	2.54917E 02	VLG	4.25340E 03	VLT	1.81931E 02	VCHR	1.80359E 04
TIM	3.42000E 02	GAM	-9.57367E-01	VEL	1.49289E 04	ALT	3.52522E 05	WT	3.04150E 05
STAGE	2	ALPH	1.40357E 01	MACH	1.76358E 01	XISP	4.55000E 02	DYNP	0
GRAV	3.11133E 01	ACC	1.83838E 00	THRI	5.59144E 05	CL	0	LIFT	0
DENS	1.68540E-10	ACCN	0	RATI	1.00000E 00	CD	0	DRAG	0
SOS	8.46512E 02	VLD	2.54917E 02	VLG	4.25289E 03	VLT	1.83638E 02	VCHR	1.80930E 04
TIM	3.43000E 02	GAM	-9.81210E-01	VEL	1.49869E 04	ALT	3.52269E 05	WT	3.02921E 05
STAGE	2	ALPH	1.40169E 01	MACH	1.77043E 01	XISP	4.55000E 02	DYNP	0
GRAV	3.11140E 01	ACC	1.84584E 00	THRI	5.59144E 05	CL	0	LIFT	0
DENS	1.71153E-10	ACCN	0	RATI	1.00000E 00	CD	0	DRAG	0
SOS	8.46512E 02	VLD	2.54917E 02	VLG	4.25236E 03	VLT	1.85347E 02	VCHR	1.81504E 04
TIM	3.44000E 02	GAM	-1.00448E 00	VEL	1.50452E 04	ALT	3.52009E 05	WT	3.01692E 05
STAGE	2	ALPH	1.39976E 01	MACH	1.77731E 01	XISP	4.55000E 02	DYNP	0
GRAV	3.11148E 01	ACC	1.85336E 00	THRI	5.59144E 05	CL	0	LIFT	0
DENS	1.73882E-10	ACCN	0	RATI	1.00000E 00	CD	0	DRAG	0
SOS	8.46512E 02	VLD	2.54917E 02	VLG	4.25182E 03	VLT	1.87058E 02	VCHR	1.82079E 04
TIM	3.45000E 02	GAM	-1.02720E 00	VEL	1.51037E 04	ALT	3.51742E 05	WT	3.00463E 05
STAGE	2	ALPH	1.39776E 01	MACH	1.78473E 01	XISP	4.55000E 02	DYNP	0
GRAV	3.11156E 01	ACC	1.86094E 00	THRI	5.59144E 05	CL	0	LIFT	0
DENS	1.76730E-10	ACCN	0	RATI	1.00000E 00	CD	0	DRAG	0
SOS	8.46512E 02	VLD	2.54917E 02	VLG	4.25127E 03	VLT	1.88771E 02	VCHR	1.82657E 04
TIM	3.46000E 02	GAM	-1.04937E 00	VEL	1.51625E 04	ALT	3.51467E 05	WT	2.99234E 05
STAGE	2	ALPH	1.39571E 01	MACH	1.79117E 01	XISP	4.55000E 02	DYNP	0
GRAV	3.11164E 01	ACC	1.86858E 00	THRI	5.59144E 05	CL	0	LIFT	0
DENS	1.79701E-10	ACCN	0	RATI	1.00000E 00	CD	0	DRAG	0
SOS	8.46512E 02	VLD	2.54917E 02	VLG	4.25071E 03	VLT	1.90487E 02	VCHR	1.83237E 04
TIM	3.47000E 02	GAM	-1.07100E 00	VEL	1.52215E 04	ALT	3.51186E 05	WT	2.98005E 05
STAGE	2	ALPH	1.39361E 01	MACH	1.79815E 01	XISP	4.55000E 02	DYNP	0
GRAV	3.11172E 01	ACC	1.87629E 00	THRI	5.59144E 05	CL	0	LIFT	0
DENS	1.82798E-10	ACCN	0	RATI	1.00000E 00	CD	0	DRAG	0
SOS	8.46512E 02	VLD	2.54917E 02	VLG	4.25013E 03	VLT	1.92204E 02	VCHR	1.83820E 04
TIM	3.48000E 02	GAM	-1.09208E 00	VEL	1.52808E 04	ALT	3.50898E 05	WT	2.96776E 05
STAGE	2	ALPH	1.39144E 01	MACH	1.80519E 01	XISP	4.55000E 02	DYNP	0
GRAV	3.11180E 01	ACC	1.88406E 00	THRI	5.59144E 05	CL	0	LIFT	0
DENS	1.86026E-10	ACCN	0	RATI	1.00000E 00	CD	0	DRAG	0
SOS	8.46512E 02	VLD	2.54917E 02	VLG	4.24955E 03	VLT	1.93924E 02	VCHR	1.84405E 04
TIM	3.49000E 02	GAM	-1.11263E 00	VEL	1.53404E 04	ALT	3.50604E 05	WT	2.95548E 05
STAGE	2	ALPH	1.38923E 01	MACH	1.81219E 01	XISP	4.55000E 02	DYNP	0
GRAV	3.11189E 01	ACC	1.89189E 00	THRI	5.59144E 05	CL	0	LIFT	0
DENS	1.89387E-10	ACCN	0	RATI	1.00000E 00	CD	0	DRAG	0
SOS	8.46512E 02	VLD	2.54917E 02	VLG	4.24895E 03	VLT	1.95645E 02	VCHR	1.84992E 04
TIM	3.50000E 02	GAM	-1.13263E 00	VEL	1.54002E 04	ALT	3.50303E 05	WT	2.94319E 05
STAGE	2	ALPH	1.38695E 01	MACH	1.81926E 01	XISP	4.55000E 02	DYNP	0
GRAV	3.11198E 01	ACC	1.89979E 00	THRI	5.59144E 05	CL	0	LIFT	0
DENS	1.92847E-10	ACCN	0	RATI	1.00000E 00	CD	0	DRAG	0
SOS	8.46512E 02	VLD	2.54917E 02	VLG	4.24834E 03	VLT	1.97368E 02	VCHR	1.85582E 04
TIM	3.51000E 02	GAM	-1.15210E 00	VEL	1.54603E 04	ALT	3.49999E 05	WT	2.93090E 05
STAGE	2	ALPH	1.38463E 01	MACH	1.82636E 01	XISP	4.55000E 02	DYNP	0
GRAV	3.11207E 01	ACC	1.90776E 00	THRI	5.59144E 05	CL	0	LIFT	0
DENS	1.96529E-10	ACCN	0	RATI	1.00000E 00	CD	0	DRAG	0
SOS	8.46512E 02	VLD	2.54917E 02	VLG	4.24772E 03	VLT	1.99093E 02	VCHR	1.86175E 04

TIM	3.52000E 02	GAM	-1.17103E 00	VEL	1.55207E 04	ALT	3.49681E 05	WT	2.91861E 05
STAGE	2	ALPH	1.38224E 01	MACH	1.83349E 01	XISP	4.55000E 02	DYNP	0
GRAV	3.11216E 01	ACC	1.91579E 00	THRI	5.59144E 05	CL	0	LIFT	0
DENS	2.00318E-10	ACCN	0	RATI	1.00000E 00	CD	0	DRAG	0
SOS	8.46512E 02	VLD	2.54917E 02	VLG	4.24709E 03	VLT	2.00819E 02	VCHR	1.86770E 04
TIM	3.53000E 02	GAM	-1.18943E 00	VEL	1.55813E 04	ALT	3.49361E 05	WT	2.90632E 05
STAGE	2	ALPH	1.37981E 01	MACH	1.84065E 01	XISP	4.55000E 02	DYNP	0
GRAV	3.11226E 01	ACC	1.92389E 00	THRI	5.59144E 05	CL	0	LIFT	0
DENS	2.04257E-10	ACCN	0	RATI	1.00000E 00	CD	0	DRAG	0
SOS	8.46512E 02	VLD	2.54917E 02	VLG	4.24644E 03	VLT	2.02546E 02	VCHR	1.87367E 04
TIM	3.54000E 02	GAM	-1.20729E 00	VEL	1.56422E 04	ALT	3.49034E 05	WT	2.89403E 05
STAGE	2	ALPH	1.37731E 01	MACH	1.84784E 01	XISP	4.55000E 02	DYNP	0
GRAV	3.11235E 01	ACC	1.93206E 00	THRI	5.59144E 05	CL	0	LIFT	0
DENS	2.08353E-10	ACCN	0	RATI	1.00000E 00	CD	0	DRAG	0
SOS	8.46512E 02	VLD	2.54917E 02	VLG	4.24579E 03	VLT	2.04274E 02	VCHR	1.87967E 04
TIM	3.55000E 02	GAM	-1.22464E 00	VEL	1.57034E 04	ALT	3.48702E 05	WT	2.88174E 05
STAGE	2	ALPH	1.37477E 01	MACH	1.85507E 01	XISP	4.55000E 02	DYNP	0
GRAV	3.11245E 01	ACC	1.94030E 00	THRI	5.59144E 05	CL	0	LIFT	0
DENS	2.12610E-10	ACCN	0	RATI	1.00000E 00	CD	0	DRAG	0
SOS	8.46512E 02	VLD	2.54917E 02	VLG	4.24513E 03	VLT	2.06004E 02	VCHR	1.88570E 04
TIM	3.56000E 02	GAM	-1.24145E 00	VEL	1.57648E 04	ALT	3.48363E 05	WT	2.86945E 05
STAGE	2	ALPH	1.37217E 01	MACH	1.86233E 01	XISP	4.55000E 02	DYNP	0
GRAV	3.11255E 01	ACC	1.94861E 00	THRI	5.59144E 05	CL	0	LIFT	0
DENS	2.17033E-10	ACCN	0	RATI	1.00000E 00	CD	0	DRAG	0
SOS	8.46512E 02	VLD	2.54917E 02	VLG	4.24446E 03	VLT	2.07734E 02	VCHR	1.89175E 04
TIM	3.57000E 02	GAM	-1.25774E 00	VEL	1.58265E 04	ALT	3.48019E 05	WT	2.85716E 05
STAGE	2	ALPH	1.36951E 01	MACH	1.86962E 01	XISP	4.55000E 02	DYNP	0
GRAV	3.11265E 01	ACC	1.95699E 00	THRI	5.59144E 05	CL	0	LIFT	0
DENS	2.21628E-10	ACCN	0	RATI	1.00000E 00	CD	0	DRAG	0
SOS	8.46512E 02	VLD	2.54917E 02	VLG	4.24378E 03	VLT	2.09466E 02	VCHR	1.89783E 04
TIM	3.58000E 02	GAM	-1.27351E 00	VEL	1.58885E 04	ALT	3.47668E 05	WT	2.84488E 05
STAGE	2	ALPH	1.36681E 01	MACH	1.87694E 01	XISP	4.55000E 02	DYNP	0
GRAV	3.11275E 01	ACC	1.96544E 00	THRI	5.59144E 05	CL	0	LIFT	0
DENS	2.26399E-10	ACCN	0	RATI	1.00000E 00	CD	0	DRAG	0
SOS	8.46512E 02	VLD	2.54917E 02	VLG	4.24310E 03	VLT	2.11195E 02	VCHR	1.90393E 04
TIM	3.59000E 02	GAM	-1.28876E 00	VEL	1.59508E 04	ALT	3.47312E 05	WT	2.83259E 05
STAGE	2	ALPH	1.36405E 01	MACH	1.88430E 01	XISP	4.55000E 02	DYNP	0
GRAV	3.11286E 01	ACC	1.97397E 00	THRI	5.59144E 05	CL	0	LIFT	0
DENS	2.31354E-10	ACCN	0	RATI	1.00000E 00	CD	0	DRAG	0
SOS	8.46512E 02	VLD	2.54917E 02	VLG	4.24240E 03	VLT	2.12931E 02	VCHR	1.91006E 04
TIM	3.60000E 02	GAM	-1.30349E 00	VEL	1.60134E 04	ALT	3.46951E 05	WT	2.82030E 05
STAGE	2	ALPH	1.36123E 01	MACH	1.89169E 01	XISP	4.55000E 02	DYNP	0
GRAV	3.11296E 01	ACC	1.98257E 00	THRI	5.59144E 05	CL	0	LIFT	0
DENS	2.36497E-10	ACCN	0	RATI	1.00000E 00	CD	0	DRAG	0
SOS	8.46512E 02	VLD	2.54917E 02	VLG	4.24170E 03	VLT	2.14664E 02	VCHR	1.91622E 04
TIM	3.61000E 02	GAM	-1.31770E 00	VEL	1.60762E 04	ALT	3.46584E 05	WT	2.80801E 05
STAGE	2	ALPH	1.35836E 01	MACH	1.89911E 01	XISP	4.55000E 02	DYNP	0
GRAV	3.11307E 01	ACC	1.99125E 00	THRI	5.59144E 05	CL	0	LIFT	0
DENS	2.41835E-10	ACCN	0	RATI	1.00000E 00	CD	0	DRAG	0
SOS	8.46512E 02	VLD	2.54917E 02	VLG	4.24099E 03	VLT	2.16398E 02	VCHR	1.92241E 04
TIM	3.62000E 02	GAM	-1.33140E 00	VEL	1.61393E 04	ALT	3.46211E 05	WT	2.79572E 05
STAGE	2	ALPH	1.35544E 01	MACH	1.90657E 01	XISP	4.55000E 02	DYNP	0
GRAV	3.11318E 01	ACC	2.00000E 00	THRI	5.59144E 05	CL	0	LIFT	0
DENS	2.47374E-10	ACCN	0	RATI	1.00000E 00	CD	0	DRAG	0
SOS	8.46512E 02	VLD	2.54917E 02	VLG	4.24027E 03	VLT	2.18132E 02	VCHR	1.92862E 04
TIM	3.63000E 02	GAM	-1.34459E 00	VEL	1.62028E 04	ALT	3.45834E 05	WT	2.78343E 05
STAGE	2	ALPH	1.35247E 01	MACH	1.91406E 01	XISP	4.55000E 02	DYNP	0
GRAV	3.11329E 01	ACC	2.00883E 00	THRI	5.59144E 05	CL	0	LIFT	0
DENS	2.53122E-10	ACCN	0	RATI	1.00000E 00	CD	0	DRAG	0
SOS	8.46512E 02	VLD	2.54917E 02	VLG	4.23954E 03	VLT	2.19866E 02	VCHR	1.93486E 04
TIM	3.64000E 02	GAM	-1.35727E 00	VEL	1.62665E 04	ALT	3.45451E 05	WT	2.77114E 05
STAGE	2	ALPH	1.34945E 01	MACH	1.92159E 01	XISP	4.55000E 02	DYNP	0
GRAV	3.11340E 01	ACC	2.01774E 00	THRI	5.59144E 05	CL	0	LIFT	0
DENS	2.59084E-10	ACCN	0	RATI	1.00000E 00	CD	0	DRAG	0
SOS	8.46512E 02	VLD	2.54917E 02	VLG	4.23880E 03	VLT	2.21601E 02	VCHR	1.94113E 04

TIM	3.66000E-02	GAM	-1.36943E 00	VEL	1.63305E 04	ALT	3.45063E 05	WT	2.75885E 05
STAGE	2	ALPH	1.34637E 01	MACH	1.92291E 01	XISP	4.55000E 02	DYNP	0
GRAV	3.11352E 01	ACC	2.02673E 00	THRI	5.59144E 05	CL	0	LIFT	0
DENS	2.65268E-10	ACCN	0	RATI	1.00000E 00	CD	0	DRAG	0
SOS	8.46512E-02	VLD	2.54917E 02	VLG	4.23806E 03	VLT	2.23335E 02	VCHR	1.94742E 04
TIM	3.66000E-02	GAM	-1.38110E 00	VEL	1.63948E 04	ALT	3.44671E 05	WT	2.74656E 05
STAGE	2	ALPH	1.34324E 01	MACH	1.93675E 01	XISP	4.55000E 02	DYNP	0
GRAV	3.11363E 01	ACC	2.03579E 00	THRI	5.59144E 05	CL	0	LIFT	0
DENS	2.71682E-10	ACCN	0	RATI	1.00000E 00	CD	0	DRAG	0
SOS	8.46512E-02	VLD	2.54917E 02	VLG	4.23732E 03	VLT	2.25069E 02	VCHR	1.95375E 04
TIM	3.67000E-02	GAM	-1.39225E 00	VEL	1.64594E 04	ALT	3.44273E 05	WT	2.73428E 05
STAGE	2	ALPH	1.34006E 01	MACH	1.94438E 01	XISP	4.55000E 02	DYNP	0
GRAV	3.11375E 01	ACC	2.04494E 00	THRI	5.59144E 05	CL	0	LIFT	0
DENS	2.78332E-10	ACCN	0	RATI	1.00000E 00	CD	0	DRAG	0
SOS	8.46512E-02	VLD	2.54917E 02	VLG	4.23666E 03	VLT	2.26803E 02	VCHR	1.96010E 04
TIM	3.68000E-02	GAM	-1.40291E 00	VEL	1.65243E 04	ALT	3.43871E 05	WT	2.72199E 05
STAGE	2	ALPH	1.33683E 01	MACH	1.95205E 01	XISP	4.55000E 02	DYNP	0
GRAV	3.11387E 01	ACC	2.05418E 00	THRI	5.59144E 05	CL	0	LIFT	0
DENS	2.85228E-10	ACCN	0	RATI	1.00000E 00	CD	0	DRAG	0
SOS	8.46512E-02	VLD	2.54917E 02	VLG	4.23580E 03	VLT	2.28536E 02	VCHR	1.96648E 04
TIM	3.69000E-02	GAM	-1.41306E 00	VEL	1.65895E 04	ALT	3.43464E 05	WT	2.70970E 05
STAGE	2	ALPH	1.33354E 01	MACH	1.95975E 01	XISP	4.55000E 02	DYNP	0
GRAV	3.11399E 01	ACC	2.06349E 00	THRI	5.59144E 05	CL	0	LIFT	0
DENS	2.92375E-10	ACCN	0	RATI	1.00000E 00	CD	0	DRAG	0
SOS	8.46512E-02	VLD	2.54917E 02	VLG	4.23504E 03	VLT	2.30269E 02	VCHR	1.97289E 04
TIM	3.70000E-02	GAM	-1.42271E 00	VEL	1.66551E 04	ALT	3.43053E 05	WT	2.69741E 05
STAGE	2	ALPH	1.33021E 01	MACH	1.96749E 01	XISP	4.55000E 02	DYNP	0
GRAV	3.11411E 01	ACC	2.07289E 00	THRI	5.59144E 05	CL	0	LIFT	0
DENS	2.99784E-10	ACCN	0	RATI	1.00000E 00	CD	0	DRAG	0
SOS	8.46512E-02	VLD	2.54917E 02	VLG	4.23427E 03	VLT	2.32002E 02	VCHR	1.97934E 04
TIM	3.71000E-02	GAM	-1.43187E 00	VEL	1.67209E 04	ALT	3.42637E 05	WT	2.68512E 05
STAGE	2	ALPH	1.32682E 01	MACH	1.97527E 01	XISP	4.55000E 02	DYNP	0
GRAV	3.11423E 01	ACC	2.08238E 00	THRI	5.59144E 05	CL	0	LIFT	0
DENS	3.07463E-10	ACCN	0	RATI	1.00000E 00	CD	0	DRAG	0
SOS	8.46512E-02	VLD	2.54917E 02	VLG	4.23349E 03	VLT	2.33733E 02	VCHR	1.98581E 04
TIM	3.72000E-02	GAM	-1.44053E 00	VEL	1.67870E 04	ALT	3.42217E 05	WT	2.67283E 05
STAGE	2	ALPH	1.32338E 01	MACH	1.98308E 01	XISP	4.55000E 02	DYNP	0
GRAV	3.11435E 01	ACC	2.09195E 00	THRI	5.59144E 05	CL	0	LIFT	0
DENS	3.15420E-10	ACCN	0	RATI	1.00000E 00	CD	0	DRAG	0
SOS	8.46512E-02	VLD	2.54917E 02	VLG	4.23271E 03	VLT	2.35464E 02	VCHR	1.99231E 04
TIM	3.73000E-02	GAM	-1.44870E 00	VEL	1.68535E 04	ALT	3.41793E 05	WT	2.66054E 05
STAGE	2	ALPH	1.31989E 01	MACH	1.99093E 01	XISP	4.55000E 02	DYNP	0
GRAV	3.11448E 01	ACC	2.10162E 00	THRI	5.59144E 05	CL	0	LIFT	0
DENS	3.23665E-10	ACCN	0	RATI	1.00000E 00	CD	0	DRAG	0
SOS	8.46512E-02	VLD	2.54917E 02	VLG	4.23193E 03	VLT	2.37193E 02	VCHR	1.99884E 04
TIM	3.74000E-02	GAM	-1.45637E 00	VEL	1.69203E 04	ALT	3.41365E 05	WT	2.64825E 05
STAGE	2	ALPH	1.31635E 01	MACH	1.99862E 01	XISP	4.55000E 02	DYNP	0
GRAV	3.11460E 01	ACC	2.11137E 00	THRI	5.59144E 05	CL	0	LIFT	0
DENS	3.32207E-10	ACCN	0	RATI	1.00000E 00	CD	0	DRAG	0
SOS	8.46512E-02	VLD	2.54917E 02	VLG	4.23114E 03	VLT	2.38922E 02	VCHR	2.00540E 04
TIM	3.75000E-02	GAM	-1.46355E 00	VEL	1.69874E 04	ALT	3.40933E 05	WT	2.63596E 05
STAGE	2	ALPH	1.31276E 01	MACH	2.00675E 01	XISP	4.55000E 02	DYNP	0
GRAV	3.11473E 01	ACC	2.12121E 00	THRI	5.59144E 05	CL	0	LIFT	0
DENS	3.41055E-10	ACCN	0	RATI	1.00000E 00	CD	0	DRAG	0
SOS	8.46512E-02	VLD	2.54917E 02	VLG	4.23034E 03	VLT	2.40649E 02	VCHR	2.01199E 04
TIM	3.76000E-02	GAM	-1.47025E 00	VEL	1.70548E 04	ALT	3.40497E 05	WT	2.62368E 05
STAGE	2	ALPH	1.30912E 01	MACH	2.01471E 01	XISP	4.55000E 02	DYNP	0
GRAV	3.11486E 01	ACC	2.13115E 00	THRI	5.59144E 05	CL	0	LIFT	0
DENS	3.50220E-10	ACCN	0	RATI	1.00000E 00	CD	0	DRAG	0
SOS	8.46512E-02	VLD	2.54917E 02	VLG	4.22955E 03	VLT	2.42375E 02	VCHR	2.01861E 04
TIM	3.77000E-02	GAM	-1.47645E 00	VEL	1.71225E 04	ALT	3.40058E 05	WT	2.61139E 05
STAGE	2	ALPH	1.30543E 01	MACH	2.02272E 01	XISP	4.55000E 02	DYNP	0
GRAV	3.11499E 01	ACC	2.14118E 00	THRI	5.59144E 05	CL	0	LIFT	0
DENS	3.59711E-10	ACCN	0	RATI	1.00000E 00	CD	0	DRAG	0
SOS	8.46512E-02	VLD	2.54917E 02	VLG	4.22874E 03	VLT	2.44100E 02	VCHR	2.02526E 04
TIM	3.78000E-02	GAM	-1.48217E 00	VEL	1.71906E 04	ALT	3.39615E 05	WT	2.59910E 05
STAGE	2	ALPH	1.30169E 01	MACH	2.03076E 01	XISP	4.55000E 02	DYNP	0
GRAV	3.11512E 01	ACC	2.15130E 00	THRI	5.59144E 05	CL	0	LIFT	0

DENS	3.69540F-10	ACCN	0	RATI	1.00000E 00	CD	0	DRAG	0
SOS	8.46512F-02	VLD	2.54917E 02	VLG	4.22744E 03	VLT	2.45822E 02	VCHR	2.03195E 04
TIM	3.79000E 02	GAM	-1.48741E 00	VEL	1.72590E 04	ALT	3.39168E 05	WT	2.58681E 05
STAGE	2	ALPH	1.29791E 01	MACH	2.03884E 01	XISP	4.55000E 02	DYNP	0
GRAV	3.11529F-01	ACC	2.16152E 00	THRI	5.59144E 05	CL	0	LIFT	0
DENS	3.74716E-10	ACCN	0	RATI	1.00000E 00	CD	0	DRAG	0
SOS	8.46512F-02	VLD	2.54917E 02	VLG	4.22713E 03	VLT	2.47544E 02	VCHR	2.03867E 04
TIM	3.80000E 02	GAM	-1.49215E 00	VEL	1.73278E 04	ALT	3.38719E 05	WT	2.57452E 05
STAGE	2	ALPH	1.29407E 01	MACH	2.04646E 01	XISP	4.55000E 02	DYNP	0
GRAV	3.11538F-01	ACC	2.17184E 00	THRI	5.59144E 05	CL	0	LIFT	0
DENS	3.90251E-10	ACCN	0	RATI	1.00000E 00	CD	0	DRAG	0
SOS	8.46512F-02	VLD	2.54917E 02	VLG	4.22642E 03	VLT	2.49263E 02	VCHR	2.04542E 04
TIM	3.81000E 02	GAM	-1.49643E 00	VEL	1.73969E 04	ALT	3.38266E 05	WT	2.56223E 05
STAGE	2	ALPH	1.29018E 01	MACH	2.05512E 01	XISP	4.55000E 02	DYNP	0
GRAV	3.11551F-01	ACC	2.18225E 00	THRI	5.59144E 05	CL	0	LIFT	0
DENS	4.01155E-10	ACCN	0	RATI	1.00000E 00	CD	0	DRAG	0
SOS	8.46512F-02	VLD	2.54917E 02	VLG	4.22551E 03	VLT	2.50980E 02	VCHR	2.05220E 04
TIM	3.82000E 02	GAM	-1.50022E 00	VEL	1.74663E 04	ALT	3.37810E 05	WT	2.54994E 05
STAGE	2	ALPH	1.28624E 01	MACH	2.06332E 01	XISP	4.55000E 02	DYNP	0
GRAV	3.11565F-01	ACC	2.19277E 00	THRI	5.59144E 05	CL	0	LIFT	0
DENS	4.12441E-10	ACCN	0	RATI	1.00000E 00	CD	0	DRAG	0
SOS	8.46512F-02	VLD	2.54917E 02	VLG	4.22470E 03	VLT	2.52696E 02	VCHR	2.05902E 04
TIM	3.83000E 02	GAM	-1.50353E 00	VEL	1.75361E 04	ALT	3.37352E 05	WT	2.53765E 05
STAGE	2	ALPH	1.28225E 01	MACH	2.07157E 01	XISP	4.55000E 02	DYNP	0
GRAV	3.11578F-01	ACC	2.20339E 00	THRI	5.59144E 05	CL	0	LIFT	0
DENS	4.24120E-10	ACCN	0	RATI	1.00000E 00	CD	0	DRAG	0
SOS	8.46512F-02	VLD	2.54917E 02	VLG	4.22388E 03	VLT	2.54409E 02	VCHR	2.06586E 04
TIM	3.84000E 02	GAM	-1.50637E 00	VEL	1.76062E 04	ALT	3.36890E 05	WT	2.52536E 05
STAGE	2	ALPH	1.27822E 01	MACH	2.07985E 01	XISP	4.55000E 02	DYNP	0
GRAV	3.11592E-01	ACC	2.21411E 00	THRI	5.59144E 05	CL	0	LIFT	0
DENS	4.36204E-10	ACCN	0	RATI	1.00000E 00	CD	0	DRAG	0
SOS	8.46512F-02	VLD	2.54917E 02	VLG	4.22306E 03	VLT	2.56120E 02	VCHR	2.07275E 04
TIM	3.85000E 02	GAM	-1.50872E 00	VEL	1.76766E 04	ALT	3.36426E 05	WT	2.51308E 05
STAGE	2	ALPH	1.27413E 01	MACH	2.08617E 01	XISP	4.55000E 02	DYNP	0
GRAV	3.11606F-01	ACC	2.22494E 00	THRI	5.59144E 05	CL	0	LIFT	0
DENS	4.48705E-10	ACCN	0	RATI	1.00000E 00	CD	0	DRAG	0
SOS	8.46512F-02	VLD	2.54917E 02	VLG	4.22224E 03	VLT	2.57828E 02	VCHR	2.07966E 04
TIM	3.86000E 02	GAM	-1.51061E 00	VEL	1.77475E 04	ALT	3.35959E 05	WT	2.50079E 05
STAGE	2	ALPH	1.27000E 01	MACH	2.09654E 01	XISP	4.55000E 02	DYNP	0
GRAV	3.11619F-01	ACC	2.23587E 00	THRI	5.59144E 05	CL	0	LIFT	0
DENS	4.61635E-10	ACCN	0	RATI	1.00000E 00	CD	0	DRAG	0
SOS	8.46512F-02	VLD	2.54917E 02	VLG	4.22142E 03	VLT	2.59534E 02	VCHR	2.08661E 04
TIM	3.87000E 02	GAM	-1.51202E 00	VEL	1.78166E 04	ALT	3.35490E 05	WT	2.48850E 05
STAGE	2	ALPH	1.26582E 01	MACH	2.10495E 01	XISP	4.55000E 02	DYNP	0
GRAV	3.11633F-01	ACC	2.24691E 00	THRI	5.59144E 05	CL	0	LIFT	0
DENS	4.75008E-10	ACCN	0	RATI	1.00000E 00	CD	0	DRAG	0
SOS	8.46512F-02	VLD	2.54917E 02	VLG	4.22060E 03	VLT	2.61237E 02	VCHR	2.09360E 04
TIM	3.88000E 02	GAM	-1.51296E 00	VEL	1.78902E 04	ALT	3.35019E 05	WT	2.47621E 05
STAGE	2	ALPH	1.26158E 01	MACH	2.11340E 01	XISP	4.55000E 02	DYNP	0
GRAV	3.11647E-01	ACC	2.25806E 00	THRI	5.59144E 05	CL	0	LIFT	0
DENS	4.88836E-10	ACCN	0	RATI	1.00000E 00	CD	0	DRAG	0
SOS	8.46512F-02	VLD	2.54917E 02	VLG	4.21978E 03	VLT	2.62938E 02	VCHR	2.10062E 04
TIM	3.89000E 02	GAM	-1.51344E 00	VEL	1.79621E 04	ALT	3.34546E 05	WT	2.46392E 05
STAGE	2	ALPH	1.25731E 01	MACH	2.12149E 01	XISP	4.55000E 02	DYNP	0
GRAV	3.11661F-01	ACC	2.26933E 00	THRI	5.59144E 05	CL	0	LIFT	0
DENS	5.03131E-10	ACCN	0	RATI	1.00000E 00	CD	0	DRAG	0
SOS	8.46512F-02	VLD	2.54917E 02	VLG	4.21895E 03	VLT	2.64635E 02	VCHR	2.10767E 04
TIM	3.90000E 02	GAM	-1.51344E 00	VEL	1.80343E 04	ALT	3.34070E 05	WT	2.45163E 05
STAGE	2	ALPH	1.25298E 01	MACH	2.13043E 01	XISP	4.55000E 02	DYNP	0
GRAV	3.11675F-01	ACC	2.28070E 00	THRI	5.59144E 05	CL	0	LIFT	0
DENS	5.17908E-10	ACCN	0	RATI	1.00000E 00	CD	0	DRAG	0
SOS	8.46512F-02	VLD	2.54917E 02	VLG	4.21813E 03	VLT	2.66330E 02	VCHR	2.11476E 04
TIM	3.91000E 02	GAM	-1.51297E 00	VEL	1.81070E 04	ALT	3.33593E 05	WT	2.43934E 05
STAGE	2	ALPH	1.24860E 01	MACH	2.13901E 01	XISP	4.55000E 02	DYNP	0
GRAV	3.11689F-01	ACC	2.29219E 00	THRI	5.59144E 05	CL	0	LIFT	0
DENS	5.33179E-10	ACCN	0	RATI	1.00000E 00	CD	0	DRAG	0
SOS	8.46512F-02	VLD	2.54917E 02	VLG	4.21731E 03	VLT	2.68021E 02	VCHR	2.12189E 04

TIM	3.92000E-02	GAM	-1.51204E-00	VFL	1.81800E-04	ALT	3.33114E-05	WT	2.42709E-05
STAGE	2	ALPH	1.24418E-01	MACH	2.14764E-01	XISP	4.55000E-02	DYNP	0
GRAV	3.11760E-01	ACC	2.30380E-00	THRI	5.59144E-05	CL	0	LIFT	0
DENS	5.48447E-10	ACCN	0	RATI	1.00000E-00	CD	0	DRAG	0
SOS	8.46512E-02	VLD	2.54917E-02	VLG	4.21648E-03	VLT	2.69710E-02	VCHR	2.12905E-04
TIM	3.93000E-02	GAM	-1.51065E-00	VEL	1.82534E-04	ALT	3.32634E-05	WT	2.41476E-05
STAGE	2	ALPH	1.23971E-01	MACH	2.12631E-01	XISP	4.55000E-02	DYNP	0
GRAV	3.11717E-01	ACC	2.31552E-00	THRI	5.59144E-05	CL	0	LIFT	0
DENS	5.65258E-10	ACCN	0	RATI	1.00000E-00	CD	0	DRAG	0
SOS	8.46512E-02	VLD	2.54917E-02	VLG	4.21566E-03	VLT	2.71394E-02	VCHR	2.13625E-04
TIM	3.94000E-02	GAM	-1.50879E-00	VFL	1.83272E-04	ALT	3.32152E-05	WT	2.40248E-05
STAGE	2	ALPH	1.23519E-01	MACH	2.16502E-01	XISP	4.55000E-02	DYNP	0
GRAV	3.11731E-01	ACC	2.32737E-00	THRI	5.59144E-05	CL	0	LIFT	0
DENS	5.82093E-10	ACCN	0	RATI	1.00000E-00	CD	0	DRAG	0
SOS	8.46512E-02	VLD	2.54917E-02	VLG	4.21444E-03	VLT	2.73079E-02	VCHR	2.14349E-04
TIM	3.95000E-02	GAM	-1.50647E-00	VEL	1.84013E-04	ALT	3.31669E-05	WT	2.39019E-05
STAGE	2	ALPH	1.23063E-01	MACH	2.17378E-01	XISP	4.55000E-02	DYNP	0
GRAV	3.11746E-01	ACC	2.33933E-00	THRI	5.59144E-05	CL	0	LIFT	0
DENS	5.99478E-10	ACCN	0	RATI	1.00000E-00	CD	0	DRAG	0
SOS	8.46512E-02	VLD	2.54917E-02	VLG	4.21462E-03	VLT	2.74753E-02	VCHR	2.15076E-04
TIM	3.96000E-02	GAM	-1.50369E-00	VFL	1.84759E-04	ALT	3.31184E-05	WT	2.37790E-05
STAGE	2	ALPH	1.22601E-01	MACH	2.18259E-01	XISP	4.55000E-02	DYNP	0
GRAV	3.11760E-01	ACC	2.35142E-00	THRI	5.59144E-05	CL	0	LIFT	0
DENS	6.17425E-10	ACCN	0	RATI	1.00000E-00	CD	0	DRAG	0
SOS	8.46512E-02	VLD	2.54917E-02	VLG	4.21320E-03	VLT	2.76427E-02	VCHR	2.15807E-04
TIM	3.97000E-02	GAM	-1.50045E-00	VFL	1.85508E-04	ALT	3.30699E-05	WT	2.36561E-05
STAGE	2	ALPH	1.22135E-01	MACH	2.19144E-01	XISP	4.55000E-02	DYNP	0
GRAV	3.11774E-01	ACC	2.36364E-00	THRI	5.59144E-05	CL	0	LIFT	0
DENS	6.35949E-10	ACCN	0	RATI	1.00000E-00	CD	0	DRAG	0
SOS	8.46512E-02	VLD	2.54917E-02	VLG	4.21238E-03	VLT	2.78097E-02	VCHR	2.16542E-04
TIM	3.98000E-02	GAM	-1.49675E-00	VEL	1.86262E-04	ALT	3.30213E-05	WT	2.35332E-05
STAGE	2	ALPH	1.21664E-01	MACH	2.20034E-01	XISP	4.55000E-02	DYNP	0
GRAV	3.11788E-01	ACC	2.37598E-00	THRI	5.59144E-05	CL	0	LIFT	0
DENS	6.55063E-10	ACCN	0	RATI	1.00000E-00	CD	0	DRAG	0
SOS	8.46512E-02	VLD	2.54917E-02	VLG	4.21157E-03	VLT	2.79763E-02	VCHR	2.17281E-04
TIM	3.99000E-02	GAM	-1.49259E-00	VEL	1.87019E-04	ALT	3.29726E-05	WT	2.34103E-05
STAGE	2	ALPH	1.21189E-01	MACH	2.20929E-01	XISP	4.55000E-02	DYNP	0
GRAV	3.11803E-01	ACC	2.38845E-00	THRI	5.59144E-05	CL	0	LIFT	0
DENS	6.74741E-10	ACCN	0	RATI	1.00000E-00	CD	0	DRAG	0
SOS	8.46512E-02	VLD	2.54917E-02	VLG	4.21076E-03	VLT	2.81424E-02	VCHR	2.18024E-04
TIM	4.00000E-02	GAM	-1.48798E-00	VEL	1.87781E-04	ALT	3.29239E-05	WT	2.32874E-05
STAGE	2	ALPH	1.20709E-01	MACH	2.21829E-01	XISP	4.55000E-02	DYNP	0
GRAV	3.11817E-01	ACC	2.40106E-00	THRI	5.59144E-05	CL	0	LIFT	0
DENS	6.95117E-10	ACCN	0	RATI	1.00000E-00	CD	0	DRAG	0
SOS	8.46512E-02	VLD	2.54917E-02	VLG	4.20994E-03	VLT	2.83082E-02	VCHR	2.18771E-04
TIM	4.01000E-02	GAM	-1.48291E-00	VEL	1.88546E-04	ALT	3.28751E-05	WT	2.31645E-05
STAGE	2	ALPH	1.20224E-01	MACH	2.22733E-01	XISP	4.55000E-02	DYNP	0
GRAV	3.11831E-01	ACC	2.41379E-00	THRI	5.59144E-05	CL	0	LIFT	0
DENS	7.16084E-10	ACCN	0	RATI	1.00000E-00	CD	0	DRAG	0
SOS	8.46512E-02	VLD	2.54917E-02	VLG	4.20914E-03	VLT	2.84735E-02	VCHR	2.19521E-04
TIM	4.02000E-02	GAM	-1.47739E-00	VEL	1.89316E-04	ALT	3.28263E-05	WT	2.30416E-05
STAGE	2	ALPH	1.19735E-01	MACH	2.23642E-01	XISP	4.55000E-02	DYNP	0
GRAV	3.11846E-01	ACC	2.42667E-00	THRI	5.59144E-05	CL	0	LIFT	0
DENS	7.37695E-10	ACCN	0	RATI	1.00000E-00	CD	0	DRAG	0
SOS	8.46512E-02	VLD	2.54917E-02	VLG	4.20833E-03	VLT	2.86384E-02	VCHR	2.20276E-04
TIM	4.03000E-02	GAM	-1.47142E-00	VEL	1.90090E-04	ALT	3.27775E-05	WT	2.29188E-05
STAGE	2	ALPH	1.19241E-01	MACH	2.24557E-01	XISP	4.55000E-02	DYNP	0
GRAV	3.11860E-01	ACC	2.43968E-00	THRI	5.59144E-05	CL	0	LIFT	0
DENS	7.59964E-10	ACCN	0	RATI	1.00000E-00	CD	0	DRAG	0
SOS	8.46512E-02	VLD	2.54917E-02	VLG	4.20753E-03	VLT	2.88028E-02	VCHR	2.21035E-04
TIM	4.04000E-02	GAM	-1.46499E-00	VEL	1.90868E-04	ALT	3.27287E-05	WT	2.27959E-05
STAGE	2	ALPH	1.18742E-01	MACH	2.25476E-01	XISP	4.55000E-02	DYNP	0
GRAV	3.11875E-01	ACC	2.45283E-00	THRI	5.59144E-05	CL	0	LIFT	0
DENS	7.82903E-10	ACCN	0	RATI	1.00000E-00	CD	0	DRAG	0
SOS	8.46512E-02	VLD	2.54917E-02	VLG	4.20673E-03	VLT	2.89667E-02	VCHR	2.21798E-04
TIM	4.05000E-02	GAM	-1.45812E-00	VEL	1.91650E-04	ALT	3.26799E-05	WT	2.26730E-05
STAGE	2	ALPH	1.18238E-01	MACH	2.26400E-01	XISP	4.55000E-02	DYNP	0

GRAV	3.11859E-01	ACC	2.46612E-00	THRI	5.59144E-05	CL	0	LIFT	0
DENS	8.04525E-10	ACCN	0	RATI	1.00000E-00	CD	0	DRAG	0
SOS	8.46512E-02	VLD	2.54917E-02	VLG	4.20593E-03	VLT	2.91302E-02	VCHR	2.22565E-04
TIM	4.07000E-02	GAM	-1.45079E-00	VFL	1.92437E-04	ALT	3.26311E-05	WT	2.25501E-05
STAGE	2	ALPH	1.17730E-01	MACH	2.27329E-01	XISP	4.55000E-02	DYNP	0
GRAV	3.11903E-01	ACC	2.47956E-00	THRI	5.59144E-05	CL	0	LIFT	0
DENS	8.30842E-10	ACCN	0	RATI	1.00000E-00	CD	0	DRAG	0
SOS	8.46512E-02	VLD	2.54917E-02	VLG	4.20514E-03	VLT	2.92931E-02	VCHR	2.23336E-04
TIM	4.07000E-02	GAM	-1.44301E-00	VFL	1.93228E-04	ALT	3.25824E-05	WT	2.24272E-05
STAGE	2	ALPH	1.17218E-01	MACH	2.28264E-01	XISP	4.55000E-02	DYNP	0
GRAV	3.11918E-01	ACC	2.49315E-00	THRI	5.59144E-05	CL	0	LIFT	0
DENS	8.55644E-10	ACCN	0	RATI	1.00000E-00	CD	0	DRAG	0
SOS	8.46512E-02	VLD	2.54917E-02	VLG	4.20435E-03	VLT	2.94556E-02	VCHR	2.24112E-04
TIM	4.09000E-02	GAM	-1.43479E-00	VFL	1.94024E-04	ALT	3.25338E-05	WT	2.23043E-05
STAGE	2	ALPH	1.16701E-01	MACH	2.29204E-01	XISP	4.55000E-02	DYNP	0
GRAV	3.11932E-01	ACC	2.50689E-00	THRI	5.59144E-05	CL	0	LIFT	0
DENS	8.81604E-10	ACCN	0	RATI	1.00000E-00	CD	0	DRAG	0
SOS	8.46512E-02	VLD	2.54917E-02	VLG	4.20357E-03	VLT	2.96175E-02	VCHR	2.24891E-04
TIM	4.09000E-02	GAM	-1.42612E-00	VFL	1.94824E-04	ALT	3.24853E-05	WT	2.21814E-05
STAGE	2	ALPH	1.16179E-01	MACH	2.30149E-01	XISP	4.55000E-02	DYNP	0
GRAV	3.11946E-01	ACC	2.52078E-00	THRI	5.59144E-05	CL	0	LIFT	0
DENS	9.08072E-10	ACCN	0	RATI	1.00000E-00	CD	0	DRAG	0
SOS	8.46512E-02	VLD	2.54917E-02	VLG	4.20279E-03	VLT	2.97788E-02	VCHR	2.25675E-04
TIM	4.10000E-02	GAM	-1.41701E-00	VFL	1.95628E-04	ALT	3.24368E-05	WT	2.20585E-05
STAGE	2	ALPH	1.15653E-01	MACH	2.31099E-01	XISP	4.55000E-02	DYNP	0
GRAV	3.11960E-01	ACC	2.53482E-00	THRI	5.59144E-05	CL	0	LIFT	0
DENS	9.35277E-10	ACCN	0	RATI	1.00000E-00	CD	0	DRAG	0
SOS	8.46512E-02	VLD	2.54917E-02	VLG	4.20202E-03	VLT	2.99397E-02	VCHR	2.26464E-04
TIM	4.11000E-02	GAM	-1.40745E-00	VFL	1.96437E-04	ALT	3.23885E-05	WT	2.19356E-05
STAGE	2	ALPH	1.15122E-01	MACH	2.32055E-01	XISP	4.55000E-02	DYNP	0
GRAV	3.11975E-01	ACC	2.54902E-00	THRI	5.59144E-05	CL	0	LIFT	0
DENS	9.63229E-10	ACCN	0	RATI	1.00000E-00	CD	0	DRAG	0
SOS	8.46512E-02	VLD	2.54917E-02	VLG	4.20125E-03	VLT	3.00999E-02	VCHR	2.27257E-04
TIM	4.12000E-02	GAM	-1.39745E-00	VFL	1.97251E-04	ALT	3.23403E-05	WT	2.18128E-05
STAGE	2	ALPH	1.14586E-01	MACH	2.33016E-01	XISP	4.55000E-02	DYNP	0
GRAV	3.11989E-01	ACC	2.56338E-00	THRI	5.59144E-05	CL	0	LIFT	0
DENS	9.91934E-10	ACCN	0	RATI	1.00000E-00	CD	0	DRAG	0
SOS	8.46512E-02	VLD	2.54917E-02	VLG	4.20049E-03	VLT	3.02595E-02	VCHR	2.28055E-04
TIM	4.13000E-02	GAM	-1.38700E-00	VFL	1.98069E-04	ALT	3.22923E-05	WT	2.16899E-05
STAGE	2	ALPH	1.14046E-01	MACH	2.33982E-01	XISP	4.55000E-02	DYNP	0
GRAV	3.12003E-01	ACC	2.57790E-00	THRI	5.59144E-05	CL	0	LIFT	0
DENS	1.02140E-09	ACCN	0	RATI	1.00000E-00	CD	0	DRAG	0
SOS	8.46512E-02	VLD	2.54917E-02	VLG	4.19973E-03	VLT	3.04187E-02	VCHR	2.28857E-04
TIM	4.14000E-02	GAM	-1.37611E-00	VFL	1.98892E-04	ALT	3.22445E-05	WT	2.15670E-05
STAGE	2	ALPH	1.13502E-01	MACH	2.34955E-01	XISP	4.55000E-02	DYNP	0
GRAV	3.12017E-01	ACC	2.59259E-00	THRI	5.59144E-05	CL	0	LIFT	0
DENS	1.05164E-09	ACCN	0	RATI	1.00000E-00	CD	0	DRAG	0
SOS	8.46512E-02	VLD	2.54917E-02	VLG	4.19898E-03	VLT	3.05772E-02	VCHR	2.29663E-04
TIM	4.15000E-02	GAM	-1.36479E-00	VFL	1.99720E-04	ALT	3.21968E-05	WT	2.14441E-05
STAGE	2	ALPH	1.12953E-01	MACH	2.35932E-01	XISP	4.55000E-02	DYNP	0
GRAV	3.12031E-01	ACC	2.60745E-00	THRI	5.59144E-05	CL	0	LIFT	0
DENS	1.08245E-09	ACCN	0	RATI	1.00000E-00	CD	0	DRAG	0
SOS	8.46512E-02	VLD	2.54917E-02	VLG	4.19823E-03	VLT	3.07351E-02	VCHR	2.30474E-04
TIM	4.16000E-02	GAM	-1.35302E-00	VFL	2.00552E-04	ALT	3.21493E-05	WT	2.13212E-05
STAGE	2	ALPH	1.12399E-01	MACH	2.36916E-01	XISP	4.55000E-02	DYNP	0
GRAV	3.12045E-01	ACC	2.62248E-00	THRI	5.59144E-05	CL	0	LIFT	0
DENS	1.11443E-09	ACCN	0	RATI	1.00000E-00	CD	0	DRAG	0
SOS	8.46512E-02	VLD	2.54917E-02	VLG	4.19749E-03	VLT	3.08924E-02	VCHR	2.31290E-04
TIM	4.17000E-02	GAM	-1.34081E-00	VFL	2.01389E-04	ALT	3.21021E-05	WT	2.11983E-05
STAGE	2	ALPH	1.11841E-01	MACH	2.37905E-01	XISP	4.55000E-02	DYNP	0
GRAV	3.12059E-01	ACC	2.63768E-00	THRI	5.59144E-05	CL	0	LIFT	0
DENS	1.14699E-09	ACCN	0	RATI	1.00000E-00	CD	0	DRAG	0
SOS	8.46512E-02	VLD	2.54917E-02	VLG	4.19676E-03	VLT	3.10491E-02	VCHR	2.32111E-04
TIM	4.18000E-02	GAM	-1.32816E-00	VFL	2.02232E-04	ALT	3.20551E-05	WT	2.10754E-05
STAGE	2	ALPH	1.11278E-01	MACH	2.38900E-01	XISP	4.55000E-02	DYNP	0
GRAV	3.12073E-01	ACC	2.65306E-00	THRI	5.59144E-05	CL	0	LIFT	0
DENS	1.18034E-09	ACCN	0	RATI	1.00000E-00	CD	0	DRAG	0
SOS	8.46512E-02	VLD	2.54917E-02	VLG	4.19603E-03	VLT	3.12050E-02	VCHR	2.32937E-04

TIM	4.19000E 02	GAM	-1.31508E 00	VEL	2.03079E 04	ALT	3.20084E 05	WT	2.09525E 05
STAGE	2	ALPH	-1.10711E 01	MACH	2.39901E 01	XISP	4.55000E 02	DYNP	0
GRAV	3.12087E 01	ACC	2.66862E 00	THRI	5.59144E 05	CL	0	LIFT	0
DENS	1.21446E -09	ACCN	0	RATI	1.00000E 00	CD	0	DRAG	0
SOS	8.46512E 02	VLD	2.54917E 02	VLG	4.19531E 03	VLT	3.13604E 02	VCHR	2.33767E 04
TIM	4.20000E 02	GAM	-1.30156E 00	VEL	2.03931E 04	ALT	3.19619E 05	WT	2.08296E 05
STAGE	2	ALPH	-1.10140E 01	MACH	2.40908E 01	XISP	4.55000E 02	DYNP	0
GRAV	3.12100E 01	ACC	2.66437E 00	THRI	5.59144E 05	CL	0	LIFT	0
DENS	1.24936E -09	ACCN	0	RATI	1.00000E 00	CD	0	DRAG	0
SOS	8.46512E 02	VLD	2.54917E 02	VLG	4.19460E 03	VLT	3.15150E 02	VCHR	2.34602E 04
TIM	4.21000E 02	GAM	-1.28760E 00	VEL	2.04789E 04	ALT	3.19197E 05	WT	2.07068E 05
STAGE	2	ALPH	-1.09564E 01	MACH	2.41921E 01	XISP	4.55000E 02	DYNP	0
GRAV	3.12114E 01	ACC	2.70030E 00	THRI	5.59144E 05	CL	0	LIFT	0
DENS	1.28504E -09	ACCN	0	RATI	1.00000E 00	CD	0	DRAG	0
SOS	8.46512E 02	VLD	2.54917E 02	VLG	4.19389E 03	VLT	3.16690E 02	VCHR	2.35443E 04
TIM	4.22000E 02	GAM	-1.27321E 00	VEL	2.05651E 04	ALT	3.18699E 05	WT	2.05839E 05
STAGE	2	ALPH	-1.08983E 01	MACH	2.42940E 01	XISP	4.55000E 02	DYNP	0
GRAV	3.12128E 01	ACC	2.71642E 00	THRI	5.59144E 05	CL	0	LIFT	0
DENS	1.32148E -09	ACCN	0	RATI	1.00000E 00	CD	0	DRAG	0
SOS	8.46512E 02	VLD	2.54917E 02	VLG	4.19319E 03	VLT	3.18223E 02	VCHR	2.36288E 04
TIM	4.23000E 02	GAM	-1.25839E 00	VEL	2.06519E 04	ALT	3.18243E 05	WT	2.04610E 05
STAGE	2	ALPH	-1.08398E 01	MACH	2.43965E 01	XISP	4.55000E 02	DYNP	0
GRAV	3.12141E 01	ACC	2.73273E 00	THRI	5.59144E 05	CL	0	LIFT	0
DENS	1.35868E -09	ACCN	0	RATI	1.00000E 00	CD	0	DRAG	0
SOS	8.46512E 02	VLD	2.54917E 02	VLG	4.19250E 03	VLT	3.19748E 02	VCHR	2.37138E 04
TIM	4.24000E 02	GAM	-1.24313E 00	VEL	2.07392E 04	ALT	3.17792E 05	WT	2.03381E 05
STAGE	2	ALPH	-1.07809E 01	MACH	2.44996E 01	XISP	4.55000E 02	DYNP	0
GRAV	3.12154E 01	ACC	2.74924E 00	THRI	5.59144E 05	CL	0	LIFT	0
DENS	1.39664E -09	ACCN	0	RATI	1.00000E 00	CD	0	DRAG	0
SOS	8.46512E 02	VLD	2.54917E 02	VLG	4.19182E 03	VLT	3.21267E 02	VCHR	2.37994E 04
TIM	4.25000E 02	GAM	-1.22743E 00	VEL	2.08271E 04	ALT	3.17343E 05	WT	2.02152E 05
STAGE	2	ALPH	-1.07215E 01	MACH	2.46034E 01	XISP	4.55000E 02	DYNP	0
GRAV	3.12168E 01	ACC	2.76596E 00	THRI	5.59144E 05	CL	0	LIFT	0
DENS	1.43533E -09	ACCN	0	RATI	1.00000E 00	CD	0	DRAG	0
SOS	8.46512E 02	VLD	2.54917E 02	VLG	4.19115E 03	VLT	3.22778E 02	VCHR	2.38855E 04
TIM	4.26000E 02	GAM	-1.21131E 00	VEL	2.09154E 04	ALT	3.16899E 05	WT	2.00923E 05
STAGE	2	ALPH	-1.06617E 01	MACH	2.47078E 01	XISP	4.55000E 02	DYNP	0
GRAV	3.12181E 01	ACC	2.78287E 00	THRI	5.59144E 05	CL	0	LIFT	0
DENS	1.47474E -09	ACCN	0	RATI	1.00000E 00	CD	0	DRAG	0
SOS	8.46512E 02	VLD	2.54917E 02	VLG	4.19049E 03	VLT	3.24281E 02	VCHR	2.39721E 04
TIM	4.27000E 02	GAM	-1.19475E 00	VEL	2.10044E 04	ALT	3.16459E 05	WT	1.99694E 05
STAGE	2	ALPH	-1.06014E 01	MACH	2.48128E 01	XISP	4.55000E 02	DYNP	0
GRAV	3.12194E 01	ACC	2.80000E 00	THRI	5.59144E 05	CL	0	LIFT	0
DENS	1.51486E -09	ACCN	0	RATI	1.00000E 00	CD	0	DRAG	0
SOS	8.46512E 02	VLD	2.54917E 02	VLG	4.18983E 03	VLT	3.25777E 02	VCHR	2.40592E 04
TIM	4.28000E 02	GAM	-1.17776E 00	VEL	2.10938E 04	ALT	3.16023E 05	WT	1.98465E 05
STAGE	2	ALPH	-1.05407E 01	MACH	2.49189E 01	XISP	4.55000E 02	DYNP	0
GRAV	3.12206E 01	ACC	2.81734E 00	THRI	5.59144E 05	CL	0	LIFT	0
DENS	1.55567E -09	ACCN	0	RATI	1.00000E 00	CD	0	DRAG	0
SOS	8.46512E 02	VLD	2.54917E 02	VLG	4.18918E 03	VLT	3.27265E 02	VCHR	2.41469E 04
TIM	4.29000E 02	GAM	-1.16034E 00	VEL	2.11839E 04	ALT	3.15592E 05	WT	1.97237E 05
STAGE	2	ALPH	-1.04795E 01	MACH	2.50249E 01	XISP	4.55000E 02	DYNP	0
GRAV	3.12219E 01	ACC	2.83489E 00	THRI	5.59144E 05	CL	0	LIFT	0
DENS	1.59714E -09	ACCN	0	RATI	1.00000E 00	CD	0	DRAG	0
SOS	8.46512E 02	VLD	2.54917E 02	VLG	4.18855E 03	VLT	3.28746E 02	VCHR	2.42352E 04
TIM	4.30000E 02	GAM	-1.14249E 00	VEL	2.12745E 04	ALT	3.15166E 05	WT	1.96088E 05
STAGE	2	ALPH	-1.04179E 01	MACH	2.51319E 01	XISP	4.55000E 02	DYNP	0
GRAV	3.12232E 01	ACC	2.85266E 00	THRI	5.59144E 05	CL	0	LIFT	0
DENS	1.63925E -09	ACCN	0	RATI	1.00000E 00	CD	0	DRAG	0
SOS	8.46512E 02	VLD	2.54917E 02	VLG	4.18792E 03	VLT	3.30218E 02	VCHR	2.43239E 04
TIM	4.31000E 02	GAM	-1.12422E 00	VEL	2.13657E 04	ALT	3.14744E 05	WT	1.94779E 05
STAGE	2	ALPH	-1.03559E 01	MACH	2.52396E 01	XISP	4.55000E 02	DYNP	0
GRAV	3.12244E 01	ACC	2.87066E 00	THRI	5.59144E 05	CL	0	LIFT	0
DENS	1.68126E -09	ACCN	0	RATI	1.00000E 00	CD	0	DRAG	0
SOS	8.46512E 02	VLD	2.54917E 02	VLG	4.18730E 03	VLT	3.31682E 02	VCHR	2.44133E 04
TIM	4.32000E 02	GAM	-1.10551E 00	VEL	2.14574E 04	ALT	3.14327E 05	WT	1.93550E 05
STAGE	2	ALPH	-1.02934E 01	MACH	2.53480E 01	XISP	4.55000E 02	DYNP	0

GRAV	3.12256E-01	ACC	2.88889E-00	THRI	5.59144E-05	CL	0	LIFT	0
DENS	1.725226E-09	ACCN	0	RATI	1.00000E-00	CD	0	DRAG	0
SOS	8.46512E-02	VLD	2.54917E-02	VLG	4.18669E-03	VLT	3.33138E-02	VCHR	2.45032E-04
TIM	4.33000E-02	GAM	-1.06637E-00	VEL	2.15498E-04	ALT	3.13916E-05	WT	1.92321E-05
STAGE	2	ALPH	1.02305E-01	MACH	2.54571E-01	XISP	4.55000E-02	DYNP	0
GRAV	3.12269E-01	ACC	2.90735E-00	THRI	5.59144E-05	CL	0	LIFT	0
DENS	1.74916E-09	ACCN	0	RATI	1.00000E-00	CD	0	DRAG	0
SOS	8.46512E-02	VLD	2.54917E-02	VLG	4.18610E-03	VLT	3.34586E-02	VCHR	2.45937E-04
TIM	4.34000E-02	GAM	-1.06681E-00	VEL	2.16427E-04	ALT	3.13510E-05	WT	1.91092E-05
STAGE	2	ALPH	1.01671E-01	MACH	2.55669E-01	XISP	4.55000E-02	DYNP	0
GRAV	3.12281E-01	ACC	2.92605E-00	THRI	5.59144E-05	CL	0	LIFT	0
DENS	1.81344E-09	ACCN	0	RATI	1.00000E-00	CD	0	DRAG	0
SOS	8.46512E-02	VLD	2.54917E-02	VLG	4.18551E-03	VLT	3.36025E-02	VCHR	2.46848E-04
TIM	4.35000E-02	GAM	-1.04682E-00	VEL	2.17363E-04	ALT	3.13110E-05	WT	1.89863E-05
STAGE	2	ALPH	1.01033E-01	MACH	2.56774E-01	XISP	4.55000E-02	DYNP	0
GRAV	3.12292E-01	ACC	2.94498E-00	THRI	5.59144E-05	CL	0	LIFT	0
DENS	1.85825E-09	ACCN	0	RATI	1.00000E-00	CD	0	DRAG	0
SOS	8.46512E-02	VLD	2.54917E-02	VLG	4.18493E-03	VLT	3.37456E-02	VCHR	2.47765E-04
TIM	4.36000E-02	GAM	-1.02641E-00	VEL	2.18304E-04	ALT	3.12716E-05	WT	1.88634E-05
STAGE	2	ALPH	1.00391E-01	MACH	2.57887E-01	XISP	4.55000E-02	DYNP	0
GRAV	3.12304E-01	ACC	2.96417E-00	THRI	5.59144E-05	CL	0	LIFT	0
DENS	1.90347E-09	ACCN	0	RATI	1.00000E-00	CD	0	DRAG	0
SOS	8.46512E-02	VLD	2.54917E-02	VLG	4.18437E-03	VLT	3.38877E-02	VCHR	2.48687E-04
TIM	4.37000E-02	GAM	-1.00557E-00	VEL	2.19252E-04	ALT	3.12328E-05	WT	1.87405E-05
STAGE	2	ALPH	9.97445E-00	MACH	2.59006E-01	XISP	4.55000E-02	DYNP	0
GRAV	3.12315E-01	ACC	2.98361E-00	THRI	5.59144E-05	CL	0	LIFT	0
DENS	1.94907E-09	ACCN	0	RATI	1.00000E-00	CD	0	DRAG	0
SOS	8.46512E-02	VLD	2.54917E-02	VLG	4.18382E-03	VLT	3.40290E-02	VCHR	2.49616E-04
TIM	4.38000E-02	GAM	-9.84302E-01	VEL	2.20206E-04	ALT	3.11947E-05	WT	1.86177E-05
STAGE	2	ALPH	9.90935E-00	MACH	2.60133E-01	XISP	4.55000E-02	DYNP	0
GRAV	3.12327E-01	ACC	3.00330E-00	THRI	5.59144E-05	CL	0	LIFT	0
DENS	1.99498E-09	ACCN	0	RATI	1.00000E-00	CD	0	DRAG	0
SOS	8.46512E-02	VLD	2.54917E-02	VLG	4.18327E-03	VLT	3.41694E-02	VCHR	2.50551E-04
TIM	4.39000E-02	GAM	-9.62611E-01	VEL	2.21166E-04	ALT	3.11572E-05	WT	1.84948E-05
STAGE	2	ALPH	9.84381E-00	MACH	2.61268E-01	XISP	4.55000E-02	DYNP	0
GRAV	3.12338E-01	ACC	3.02326E-00	THRI	5.59144E-05	CL	0	LIFT	0
DENS	2.04115E-09	ACCN	0	RATI	1.00000E-00	CD	0	DRAG	0
SOS	8.46512E-02	VLD	2.54917E-02	VLG	4.18274E-03	VLT	3.43089E-02	VCHR	2.51492E-04
TIM	4.40000E-02	GAM	-9.40496E-01	VEL	2.22133E-04	ALT	3.11204E-05	WT	1.83719E-05
STAGE	2	ALPH	9.77784E-00	MACH	2.62410E-01	XISP	4.55000E-02	DYNP	0
GRAV	3.12349E-01	ACC	3.04348E-00	THRI	5.59144E-05	CL	0	LIFT	0
DENS	2.08752E-09	ACCN	0	RATI	1.00000E-00	CD	0	DRAG	0
SOS	8.46512E-02	VLD	2.54917E-02	VLG	4.18222E-03	VLT	3.44475E-02	VCHR	2.52440E-04
TIM	4.41000E-02	GAM	-9.17956E-01	VEL	2.23107E-04	ALT	3.10842E-05	WT	1.82490E-05
STAGE	2	ALPH	9.71144E-00	MACH	2.63560E-01	XISP	4.55000E-02	DYNP	0
GRAV	3.12359E-01	ACC	3.06397E-00	THRI	5.59144E-05	CL	0	LIFT	0
DENS	2.13402E-09	ACCN	0	RATI	1.00000E-00	CD	0	DRAG	0
SOS	8.46512E-02	VLD	2.54917E-02	VLG	4.18172E-03	VLT	3.45851E-02	VCHR	2.53393E-04
TIM	4.42000E-02	GAM	-8.94993E-01	VEL	2.24087E-04	ALT	3.10489E-05	WT	1.81261E-05
STAGE	2	ALPH	9.64460E-00	MACH	2.64718E-01	XISP	4.55000E-02	DYNP	0
GRAV	3.12370E-01	ACC	3.08475E-00	THRI	5.59144E-05	CL	0	LIFT	0
DENS	2.18059E-09	ACCN	0	RATI	1.00000E-00	CD	0	DRAG	0
SOS	8.46512E-02	VLD	2.54917E-02	VLG	4.18122E-03	VLT	3.47218E-02	VCHR	2.54354E-04
TIM	4.43000E-02	GAM	-8.71607E-01	VEL	2.25073E-04	ALT	3.10143E-05	WT	1.80032E-05
STAGE	2	ALPH	9.57733E-00	MACH	2.65883E-01	XISP	4.55000E-02	DYNP	0
GRAV	3.12380E-01	ACC	3.10580E-00	THRI	5.59144E-05	CL	0	LIFT	0
DENS	2.22716E-09	ACCN	0	RATI	1.00000E-00	CD	0	DRAG	0
SOS	8.46512E-02	VLD	2.54917E-02	VLG	4.18074E-03	VLT	3.48575E-02	VCHR	2.55321E-04
TIM	4.44000E-02	GAM	-8.47798E-01	VEL	2.26067E-04	ALT	3.09804E-05	WT	1.78803E-05
STAGE	2	ALPH	9.50962E-00	MACH	2.67057E-01	XISP	4.55000E-02	DYNP	0
GRAV	3.12390E-01	ACC	3.12715E-00	THRI	5.59144E-05	CL	0	LIFT	0
DENS	2.27364E-09	ACCN	0	RATI	1.00000E-00	CD	0	DRAG	0
SOS	8.46512E-02	VLD	2.54917E-02	VLG	4.18027E-03	VLT	3.49922E-02	VCHR	2.56294E-04
TIM	4.45000E-02	GAM	-8.23567E-01	VEL	2.27067E-04	ALT	3.09474E-05	WT	1.77574E-05
STAGE	2	ALPH	9.44148E-00	MACH	2.68239E-01	XISP	4.55000E-02	DYNP	0
GRAV	3.12400E-01	ACC	3.14879E-00	THRI	5.59144E-05	CL	0	LIFT	0
DENS	2.31997E-09	ACCN	0	RATI	1.00000E-00	CD	0	DRAG	0
SOS	8.46512E-02	VLD	2.54917E-02	VLG	4.17982E-03	VLT	3.51260E-02	VCHR	2.57274E-04

TIM	4.46000E 02	GAM	-7.9F914E-01	VEL	2.28075E 04	ALT	3.09151E 05	WT	1.76345E 05
STAGE	2	ALPH	9.37291E 00	MACH	2.69479E 01	XISP	4.55000E 02	DYNP	0
GRAV	3.12409E 01	ACC	3.17073E 00	THRI	5.59144E 05	CL	0	LIFT	0
DENS	2.36604E-09	ACCN	0	RATI	1.00000E 00	CD	0	DRAG	0
SOS	8.46512E 02	VLD	2.54917E 02	VLG	4.17937E 03	VLT	3.52587E 02	VCHR	2.58262E 04
TIM	4.47000E 02	GAM	-7.73839E-01	VEL	2.29089E 04	ALT	3.08838E 05	WT	1.75117E 05
STAGE	2	ALPH	9.30391E 00	MACH	2.70677E 01	XISP	4.55000E 02	DYNP	0
GRAV	3.12418E 01	ACC	3.19298E 00	THRI	5.59144E 05	CL	0	LIFT	0
DENS	2.41179E-09	ACCN	0	RATI	1.00000E 00	CD	0	DRAG	0
SOS	8.46512E 02	VLD	2.54917E 02	VLG	4.17895E 03	VLT	3.53904E 02	VCHR	2.59256E 04
TIM	4.48000E 02	GAM	-7.48343E-01	VEL	2.30111E 04	ALT	3.08533E 05	WT	1.73888E 05
STAGE	2	ALPH	9.23448E 00	MACH	2.71834E 01	XISP	4.55000E 02	DYNP	0
GRAV	3.12427E 01	ACC	3.21555E 00	THRI	5.59144E 05	CL	0	LIFT	0
DENS	2.45711E-09	ACCN	0	RATI	1.00000E 00	CD	0	DRAG	0
SOS	8.46512E 02	VLD	2.54917E 02	VLG	4.17853E 03	VLT	3.55212E 02	VCHR	2.60257E 04
TIM	4.49000E 02	GAM	-7.22426E-01	VEL	2.31140E 04	ALT	3.08237E 05	WT	1.72659E 05
STAGE	2	ALPH	9.16461E 00	MACH	2.73049E 01	XISP	4.55000E 02	DYNP	0
GRAV	3.12436E 01	ACC	3.23843E 00	THRI	5.59144E 05	CL	0	LIFT	0
DENS	2.50191E-09	ACCN	0	RATI	1.00000E 00	CD	0	DRAG	0
SOS	8.46512E 02	VLD	2.54917E 02	VLG	4.17813E 03	VLT	3.56508E 02	VCHR	2.61265E 04
TIM	4.50000E 02	GAM	-6.96088E-01	VEL	2.32176E 04	ALT	3.07950E 05	WT	1.71430E 05
STAGE	2	ALPH	9.09432E 00	MACH	2.74274E 01	XISP	4.55000E 02	DYNP	0
GRAV	3.12445E 01	ACC	3.26165E 00	THRI	5.59144E 05	CL	0	LIFT	0
DENS	2.54609E-09	ACCN	0	RATI	1.00000E 00	CD	0	DRAG	0
SOS	8.46512E 02	VLD	2.54917E 02	VLG	4.17774E 03	VLT	3.57795E 02	VCHR	2.62280E 04
TIM	4.51000E 02	GAM	-6.69330E-01	VEL	2.33270E 04	ALT	3.07673E 05	WT	1.70201E 05
STAGE	2	ALPH	9.02359E 00	MACH	2.75507E 01	XISP	4.55000E 02	DYNP	0
GRAV	3.12453E 01	ACC	3.28520E 00	THRI	5.59144E 05	CL	0	LIFT	0
DENS	2.58955E-09	ACCN	0	RATI	1.00000E 00	CD	0	DRAG	0
SOS	8.46512E 02	VLD	2.54917E 02	VLG	4.17737E 03	VLT	3.59070E 02	VCHR	2.63303E 04
TIM	4.52000E 02	GAM	-6.42152E-01	VEL	2.34271E 04	ALT	3.07405E 05	WT	1.68972E 05
STAGE	2	ALPH	8.95244E 00	MACH	2.76749E 01	XISP	4.55000E 02	DYNP	0
GRAV	3.12461E 01	ACC	3.30909E 00	THRI	5.59144E 05	CL	0	LIFT	0
DENS	2.63219E-09	ACCN	0	RATI	1.00000E 00	CD	0	DRAG	0
SOS	8.46512E 02	VLD	2.54917E 02	VLG	4.17701E 03	VLT	3.60335E 02	VCHR	2.64333E 04
TIM	4.53000E 02	GAM	-6.14554E-01	VEL	2.35330E 04	ALT	3.07148E 05	WT	1.67743E 05
STAGE	2	ALPH	8.88085E 00	MACH	2.78000E 01	XISP	4.55000E 02	DYNP	0
GRAV	3.12468E 01	ACC	3.33333E 00	THRI	5.59144E 05	CL	0	LIFT	0
DENS	2.67389E-09	ACCN	0	RATI	1.00000E 00	CD	0	DRAG	0
SOS	8.46512E 02	VLD	2.54917E 02	VLG	4.17667E 03	VLT	3.61590E 02	VCHR	2.65371E 04
TIM	4.54000E 02	GAM	-5.86538E-01	VEL	2.36397E 04	ALT	3.06900E 05	WT	1.66514E 05
STAGE	2	ALPH	8.80884E 00	MACH	2.79260E 01	XISP	4.55000E 02	DYNP	0
GRAV	3.12476E 01	ACC	3.35793E 00	THRI	5.59144E 05	CL	0	LIFT	0
DENS	2.71456E-09	ACCN	0	RATI	1.00000E 00	CD	0	DRAG	0
SOS	8.46512E 02	VLD	2.54917E 02	VLG	4.17634E 03	VLT	3.62833E 02	VCHR	2.66416E 04
TIM	4.55000E 02	GAM	-5.58100E-01	VEL	2.37472E 04	ALT	3.06664E 05	WT	1.65285E 05
STAGE	2	ALPH	8.73639E 00	MACH	2.80530E 01	XISP	4.55000E 02	DYNP	0
GRAV	3.12483E 01	ACC	3.38290E 00	THRI	5.59144E 05	CL	0	LIFT	0
DENS	2.75406E-09	ACCN	0	RATI	1.00000E 00	CD	0	DRAG	0
SOS	8.46512E 02	VLD	2.54917E 02	VLG	4.17603E 03	VLT	3.64065E 02	VCHR	2.67470E 04
TIM	4.56000E 02	GAM	-5.29244E-01	VEL	2.38555E 04	ALT	3.06438E 05	WT	1.64057E 05
STAGE	2	ALPH	8.66352E 00	MACH	2.81809E 01	XISP	4.55000E 02	DYNP	0
GRAV	3.12499E 01	ACC	3.40824E 00	THRI	5.59144E 05	CL	0	LIFT	0
DENS	2.79230E-09	ACCN	0	RATI	1.00000E 00	CD	0	DRAG	0
SOS	8.46512E 02	VLD	2.54917E 02	VLG	4.17573E 03	VLT	3.65286E 02	VCHR	2.68531E 04
TIM	4.57000E 02	GAM	-4.99569E-01	VEL	2.39648E 04	ALT	3.06223E 05	WT	1.62828E 05
STAGE	2	ALPH	8.59022E 00	MACH	2.83098E 01	XISP	4.55000E 02	DYNP	0
GRAV	3.12496E 01	ACC	3.43396E 00	THRI	5.59144E 05	CL	0	LIFT	0
DENS	2.82915E-09	ACCN	0	RATI	1.00000E 00	CD	0	DRAG	0
SOS	8.46512E 02	VLD	2.54917E 02	VLG	4.17545E 03	VLT	3.66495E 02	VCHR	2.69600E 04
TIM	4.58000E 02	GAM	-4.70275E-01	VEL	2.40745E 04	ALT	3.06020E 05	WT	1.61599E 05
STAGE	2	ALPH	8.51649E 00	MACH	2.84396E 01	XISP	4.55000E 02	DYNP	0
GRAV	3.12502E 01	ACC	3.46008E 00	THRI	5.59144E 05	CL	0	LIFT	0
DENS	2.86450E-09	ACCN	0	RATI	1.00000E 00	CD	0	DRAG	0
SOS	8.46512E 02	VLD	2.54917E 02	VLG	4.17519E 03	VLT	3.67693E 02	VCHR	2.70677E 04
TIM	4.59000E 02	GAM	-4.40163E-01	VEL	2.41853E 04	ALT	3.05826E 05	WT	1.60370E 05
STAGE	2	ALPH	8.44233E 00	MACH	2.85705E 01	XISP	4.55000E 02	DYNP	0

GRAV	3.12507E 01	ACC	3.48659E 00	THRI	5.59144E 05	CL	0	LIFT	0
DENS	2.89823E-09	ACCN	0	RATI	1.00000E 00	CD	0	DRAG	0
SOS	8.46512E 02	VLD	2.54917E 02	VLG	4.17494E 03	VLT	3.68880E 02	VCHR	2.71762E 04
TIM	4.60000E 02	GAM	-4.09632E-01	VEL	2.42969E 04	ALT	3.05648E 05	WT	1.59141E 05
STAGE	2	ALPH	8.36775E 00	MACH	2.87074E 01	XISP	4.55000E 02	DYNP	0
GRAV	3.12513E 01	ACC	3.51351E 00	THRI	5.59144E 05	CL	0	LIFT	0
DENS	2.93022E-09	ACCN	0	RATI	1.00000E 00	CD	0	DRAG	0
SOS	8.46512E 02	VLD	2.54917E 02	VLG	4.17471E 03	VLT	3.70055E 02	VCHR	2.72856E 04
TIM	4.61000E 02	GAM	-3.78683E-01	VEL	2.44094E 04	ALT	3.05481E 05	WT	1.57912E 05
STAGE	2	ALPH	8.29273E 00	MACH	2.86353E 01	XISP	4.55000E 02	DYNP	0
GRAV	3.12518E 01	ACC	3.54086E 00	THRI	5.59144E 05	CL	0	LIFT	0
DENS	2.96035E-09	ACCN	0	RATI	1.00000E 00	CD	0	DRAG	0
SOS	8.46512E 02	VLD	2.54917E 02	VLG	4.17449E 03	VLT	3.71218E 02	VCHR	2.73958E 04
TIM	4.62000E 02	GAM	-3.47316E-01	VEL	2.45278E 04	ALT	3.05326E 05	WT	1.56683E 05
STAGE	2	ALPH	8.21729E 00	MACH	2.86652E 01	XISP	4.55000E 02	DYNP	0
GRAV	3.12522E 01	ACC	3.56863E 00	THRI	5.59144E 05	CL	0	LIFT	0
DENS	2.98850E-09	ACCN	0	RATI	1.00000E 00	CD	0	DRAG	0
SOS	8.46512E 02	VLD	2.54917E 02	VLG	4.17430E 03	VLT	3.72369E 02	VCHR	2.75069E 04
TIM	4.63000E 02	GAM	-3.15531E-01	VEL	2.46371E 04	ALT	3.05183E 05	WT	1.55454E 05
STAGE	2	ALPH	8.14142E 00	MACH	2.91042E 01	XISP	4.55000E 02	DYNP	0
GRAV	3.12526E 01	ACC	3.59684E 00	THRI	5.59144E 05	CL	0	LIFT	0
DENS	3.01456E-09	ACCN	0	RATI	1.00000E 00	CD	0	DRAG	0
SOS	8.46512E 02	VLD	2.54917E 02	VLG	4.17411E 03	VLT	3.73508E 02	VCHR	2.76189E 04
TIM	4.64000E 02	GAM	-2.83328E-01	VEL	2.47523E 04	ALT	3.05054E 05	WT	1.54225E 05
STAGE	2	ALPH	8.06513E 00	MACH	2.92403E 01	XISP	4.55000E 02	DYNP	0
GRAV	3.12530E 01	ACC	3.62550E 00	THRI	5.59144E 05	CL	0	LIFT	0
DENS	3.03841E-09	ACCN	0	RATI	1.00000E 00	CD	0	DRAG	0
SOS	8.46512E 02	VLD	2.54917E 02	VLG	4.17395E 03	VLT	3.74634E 02	VCHR	2.77318E 04
TIM	4.65000E 02	GAM	-2.50708E-01	VEL	2.48684E 04	ALT	3.04939E 05	WT	1.52997E 05
STAGE	2	ALPH	7.98841E 00	MACH	2.93775E 01	XISP	4.55000E 02	DYNP	0
GRAV	3.12534E 01	ACC	3.65482E 00	THRI	5.59144E 05	CL	0	LIFT	0
DENS	3.05994E-09	ACCN	0	RATI	1.00000E 00	CD	0	DRAG	0
SOS	8.46512E 02	VLD	2.54917E 02	VLG	4.17381E 03	VLT	3.75749E 02	VCHR	2.78455E 04
TIM	4.66000E 02	GAM	-2.17869E-01	VEL	2.49854E 04	ALT	3.04837E 05	WT	1.51768E 05
STAGE	2	ALPH	7.91126E 00	MACH	2.95157E 01	XISP	4.55000E 02	DYNP	0
GRAV	3.12537E 01	ACC	3.68421E 00	THRI	5.59144E 05	CL	0	LIFT	0
DENS	3.07904E-09	ACCN	0	RATI	1.00000E 00	CD	0	DRAG	0
SOS	8.46512E 02	VLD	2.54917E 02	VLG	4.17368E 03	VLT	3.76851E 02	VCHR	2.79602E 04
TIM	4.67000E 02	GAM	-1.84213E-01	VEL	2.51034E 04	ALT	3.04749E 05	WT	1.50539E 05
STAGE	2	ALPH	7.83368E 00	MACH	2.96551E 01	XISP	4.55000E 02	DYNP	0
GRAV	3.12539E 01	ACC	3.71429E 00	THRI	5.59144E 05	CL	0	LIFT	0
DENS	3.09560E-09	ACCN	0	RATI	1.00000E 00	CD	0	DRAG	0
SOS	8.46512E 02	VLD	2.54917E 02	VLG	4.17357E 03	VLT	3.77941E 02	VCHR	2.80758E 04
TIM	4.68000E 02	GAM	-1.50339E-01	VEL	2.52224E 04	ALT	3.04676E 05	WT	1.49310E 05
STAGE	2	ALPH	7.75568E 00	MACH	2.97957E 01	XISP	4.55000E 02	DYNP	0
GRAV	3.12541E 01	ACC	3.74486E 00	THRI	5.59144E 05	CL	0	LIFT	0
DENS	3.10922E-09	ACCN	0	RATI	1.00000E 00	CD	0	DRAG	0
SOS	8.46512E 02	VLD	2.54917E 02	VLG	4.17348E 03	VLT	3.79018E 02	VCHR	2.81924E 04
TIM	4.69000E 02	GAM	-1.16047E-01	VEL	2.53474E 04	ALT	3.04617E 05	WT	1.48081E 05
STAGE	2	ALPH	7.67725E 00	MACH	2.99374E 01	XISP	4.55000E 02	DYNP	0
GRAV	3.12543E 01	ACC	3.77593E 00	THRI	5.59144E 05	CL	0	LIFT	0
DENS	3.12070E-09	ACCN	0	RATI	1.00000E 00	CD	0	DRAG	0
SOS	8.46512E 02	VLD	2.54917E 02	VLG	4.17340E 03	VLT	3.80082E 02	VCHR	2.83099E 04
TIM	4.70000E 02	GAM	-8.13378E-02	VEL	2.54633E 04	ALT	3.04573E 05	WT	1.46852E 05
STAGE	2	ALPH	7.59839E 00	MACH	3.00803E 01	XISP	4.55000E 02	DYNP	0
GRAV	3.12544E 01	ACC	3.80000E 00	THRI	5.58038E 05	CL	0	LIFT	0
DENS	3.12905E-09	ACCN	0	RATI	9.98022E-01	CD	0	DRAG	0
SOS	8.46512E 02	VLD	2.54917E 02	VLG	4.17335E 03	VLT	3.81133E 02	VCHR	2.84284E 04
TIM	4.71000E 02	GAM	-4.62232E-02	VEL	2.55853E 04	ALT	3.04545E 05	WT	1.45624E 05
STAGE	2	ALPH	7.51912E 00	MACH	3.02244E 01	XISP	4.55000E 02	DYNP	0
GRAV	3.12545E 01	ACC	3.80000E 00	THRI	5.53370E 05	CL	0	LIFT	0
DENS	3.13448E-09	ACCN	0	RATI	9.89673E-01	CD	0	DRAG	0
SOS	8.46512E 02	VLD	2.54917E 02	VLG	4.17332E 03	VLT	3.82171E 02	VCHR	2.85479E 04
TIM	4.72000E 02	GAM	-1.07422E-02	VEL	2.57061E 04	ALT	3.04532E 05	WT	1.44397E 05
STAGE	2	ALPH	7.43947E 00	MACH	3.03694E 01	XISP	4.55000E 02	DYNP	0
GRAV	3.12546E 01	ACC	3.80000E 00	THRI	5.48708E 05	CL	0	LIFT	0
DENS	3.13693E-09	ACCN	0	RATI	9.81336E-01	CD	0	DRAG	0
SOS	8.46512E 02	VLD	2.54917E 02	VLG	4.17330E 03	VLT	3.83195E 02	VCHR	2.86682E 04

TIM	4.72100E-02	GAM	-7.17614E-03	VEL	2.57204E-04	ALT	3.04531E-05	WT	1.44274E-05
STAGE	2	ALPH	7.43149E-00	MACH	3.03840E-01	XISP	4.55000E-02	DYNP	0
GRAV	3.12546E-01	ACC	3.80000E-00	THRT	5.48242E-05	CL	0	LIFT	0
DENS	3.13705E-09	ACCN	0	RATI	9.80503E-01	CD	0	DRAG	0
SOS	8.44512E-02	VLD	2.54917E-02	VLG	4.17330E-03	VLT	3.83296E-02	VCHR	2.86803E-04
TIM	4.72200E-02	GAM	-3.60639E-03	VEL	2.57377E-04	ALT	3.04531E-05	WT	1.44152E-05
STAGE	2	ALPH	7.42350E-00	MACH	3.03986E-01	XISP	4.55000E-02	DYNP	0
GRAV	3.12546E-01	ACC	3.80000E-00	THRT	5.47777E-05	CL	0	LIFT	0
DENS	3.13705E-09	ACCN	0	RATI	9.79611E-01	CD	0	DRAG	0
SOS	8.44512E-02	VLD	2.54917E-02	VLG	4.17330E-03	VLT	3.83398E-02	VCHR	2.86923E-04
TIM	4.72300E-02	GAM	-3.29559E-05	VEL	2.57451E-04	ALT	3.04531E-05	WT	1.44029E-05
STAGE	2	ALPH	7.41551E-00	MACH	3.04131E-01	XISP	4.55000E-02	DYNP	0
GRAV	3.12546E-01	ACC	3.80000E-00	THRT	5.47532E-05	CL	0	LIFT	0
DENS	3.13705E-09	ACCN	0	RATI	9.78838E-01	CD	0	DRAG	0
SOS	8.44512E-02	VLD	2.54917E-02	VLG	4.17330E-03	VLT	3.83499E-02	VCHR	2.87044E-04
TIM	4.72400E-02	GAM	3.54412E-03	VEL	2.57574E-04	ALT	3.04531E-05	WT	1.43907E-05
STAGE	2	ALPH	7.40752E-00	MACH	3.04277E-01	XISP	4.55000E-02	DYNP	0
GRAV	3.12546E-01	ACC	3.80000E-00	THRT	5.46846E-05	CL	0	LIFT	0
DENS	3.13705E-09	ACCN	0	RATI	9.78006E-01	CD	0	DRAG	0
SOS	8.44512E-02	VLD	2.54917E-02	VLG	4.17330E-03	VLT	3.83600E-02	VCHR	2.87165E-04
TIM	4.72500E-02	GAM	7.12487E-03	VEL	2.57698E-04	ALT	3.04531E-05	WT	1.43784E-05
STAGE	2	ALPH	7.39952E-00	MACH	3.04423E-01	XISP	4.55000E-02	DYNP	0
GRAV	3.12546E-01	ACC	3.80000E-00	THRT	5.46331E-05	CL	0	LIFT	0
DENS	3.13705E-09	ACCN	0	RATI	9.77174E-01	CD	0	DRAG	0
SOS	8.44512E-02	VLD	2.54917E-02	VLG	4.17330E-03	VLT	3.83701E-02	VCHR	2.87286E-04

FIRST STAGE WEIGHTS (LBS.)

ENGINE	3.919972E-04	EQUIPMENT	1.980800E-05	TANK	1.124007E-05	JETTISON	3.100912E-05
USED PROPELLANT	1.530765E-06	LO2	5.591440E-05	FIXED RESERVES	0	VAR. RESERVES	0
YROT	1.335847E-03	V-STAGE (INERT)	6.974959E-03	GAMMA	2.159361E-01	ALPHA	0
STAGING TIME	1.345000E-02	ALTITUDE	1.493248E-05				

FIRST STAGE JETTISON INCLUDES RESERVES (IF ANY), THRUST DECAY, AND 2ND STAGE THRUST BUILD-UP.

SECOND STAGE WEIGHTS (LBS.)

ENGINE	9.450820E-03	EQUIPMENT	4.316800E-04	TANK	1.965380E-04	JETTISON	7.227262E-04
PROPELLANT	4.153595E-05	FIXED RESERVES	5.774006E-03	VAR. RESERVES	0	PAYLOAD	7.151187E-04
THRUST BUILD-UP	4.107528E-02	THRUST DECAY	1.025868E-02				

VLD = 2.549170E-02 VLG = 4.173300E-03 VLT = 3.837010E-02 VCHR = 2.872862E-04

SECOND STAGE JETTISON INCLUDES RESERVES (IF ANY), AND THRUST DECAY.

WEIGHT

SECTION XI
VTO FLOW CHART - 3200 SERIES

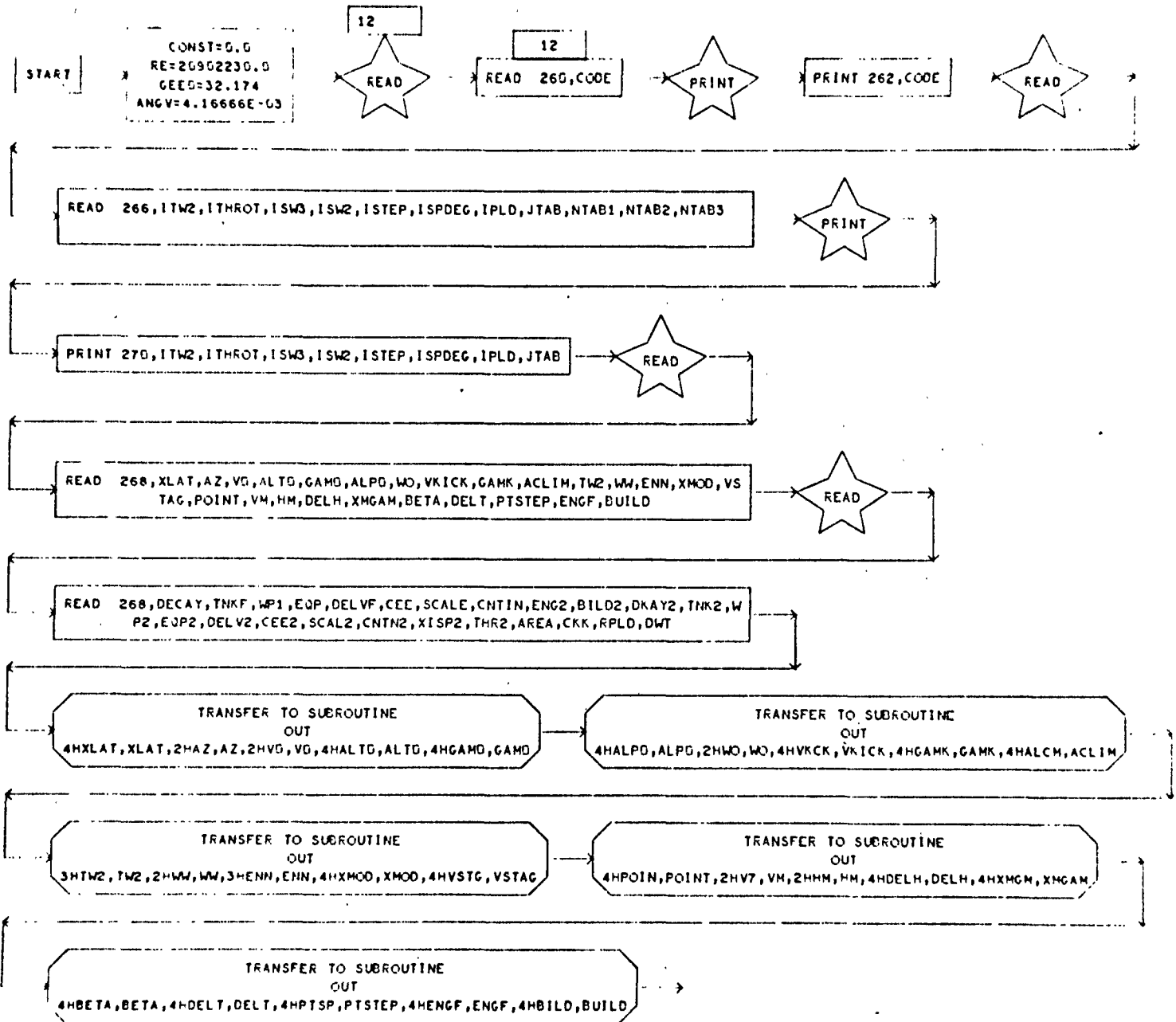

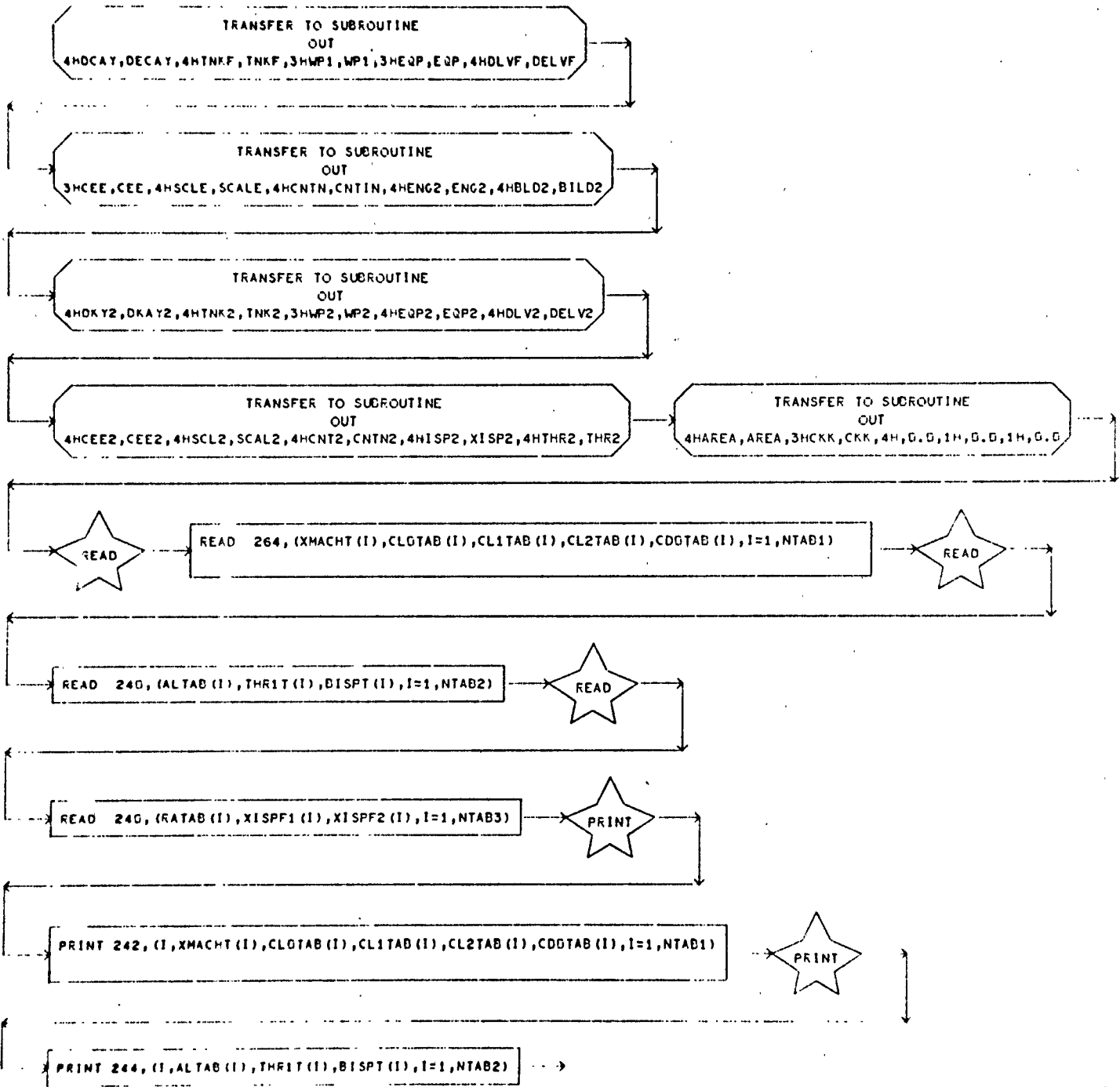

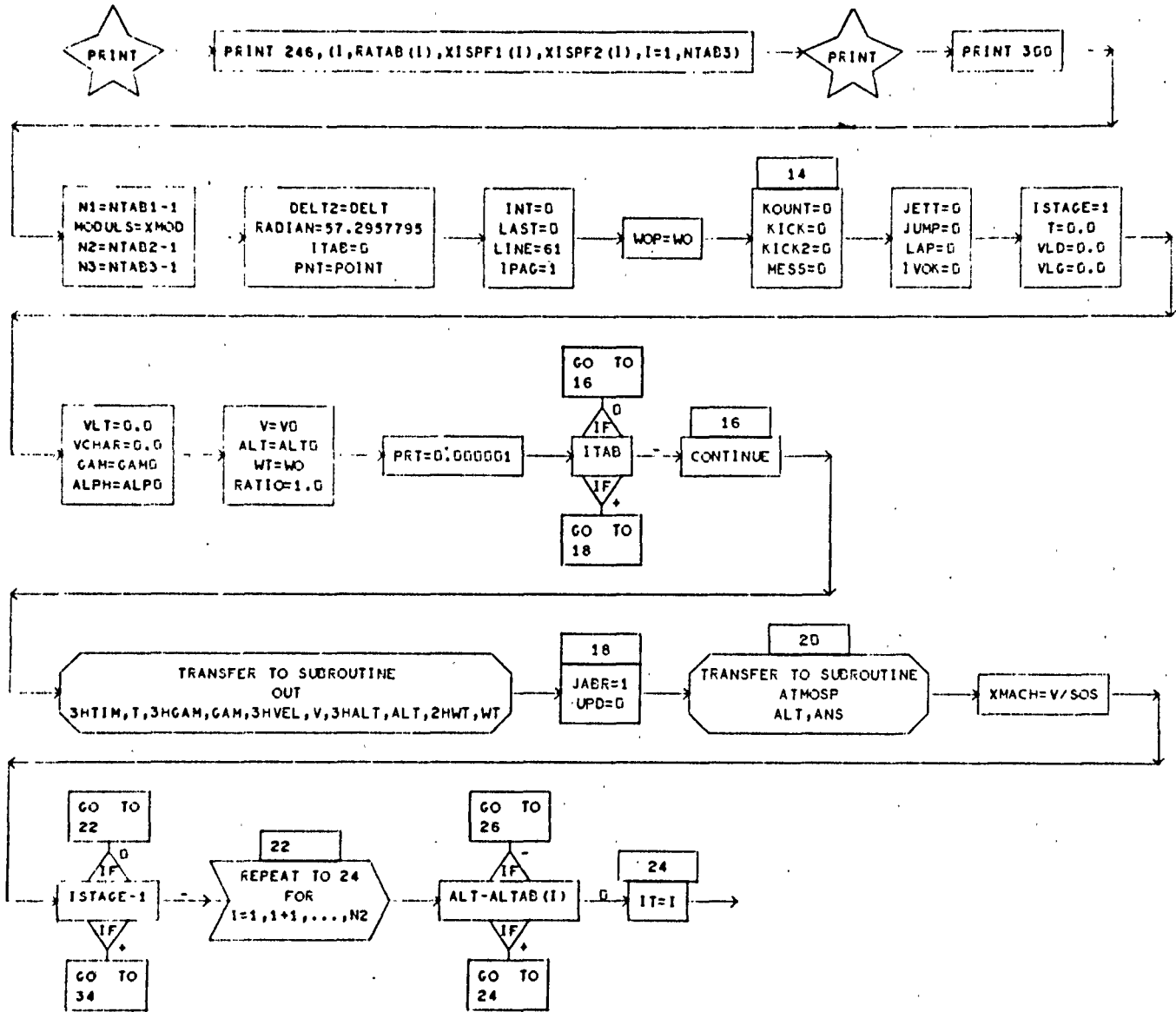

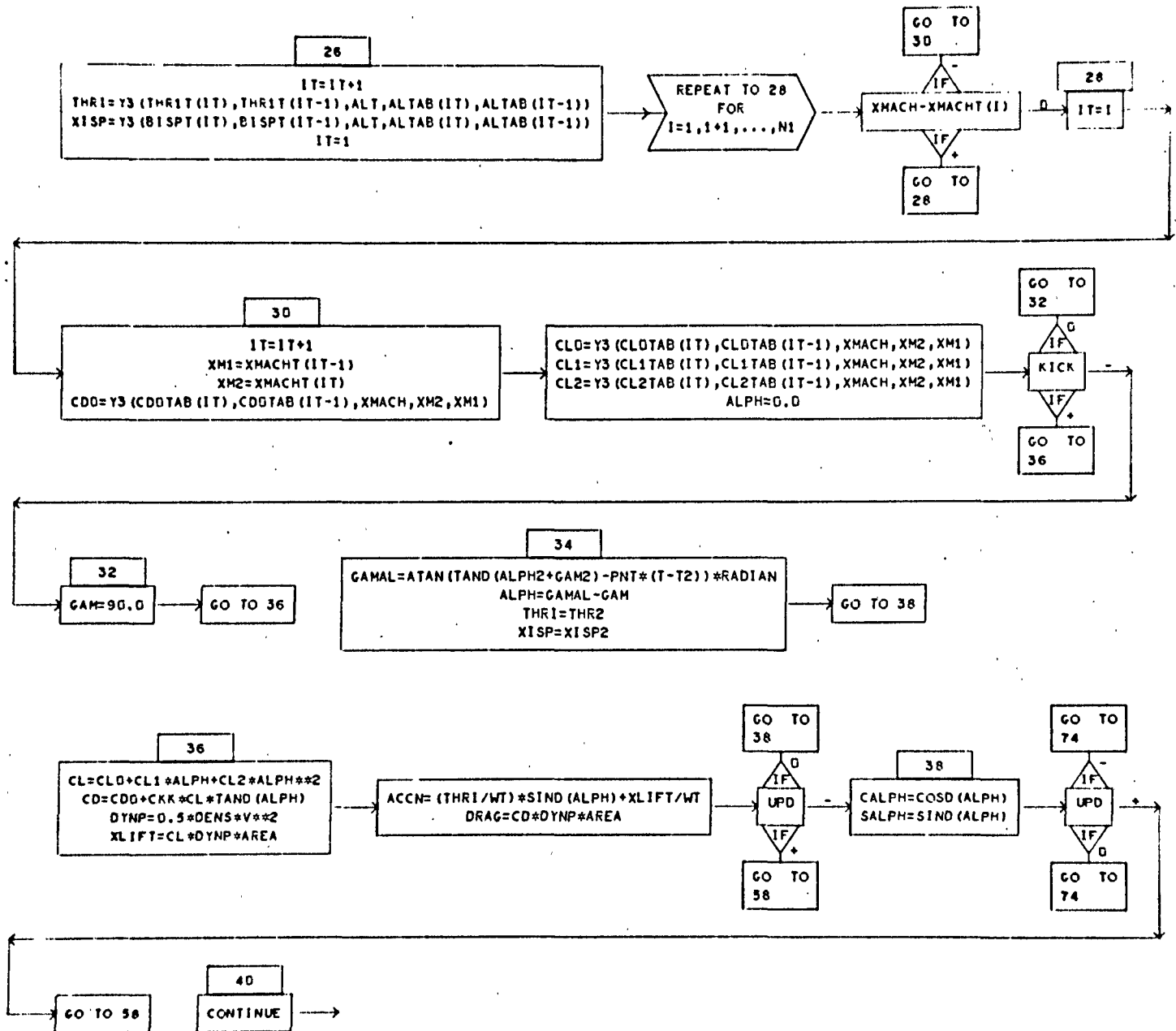

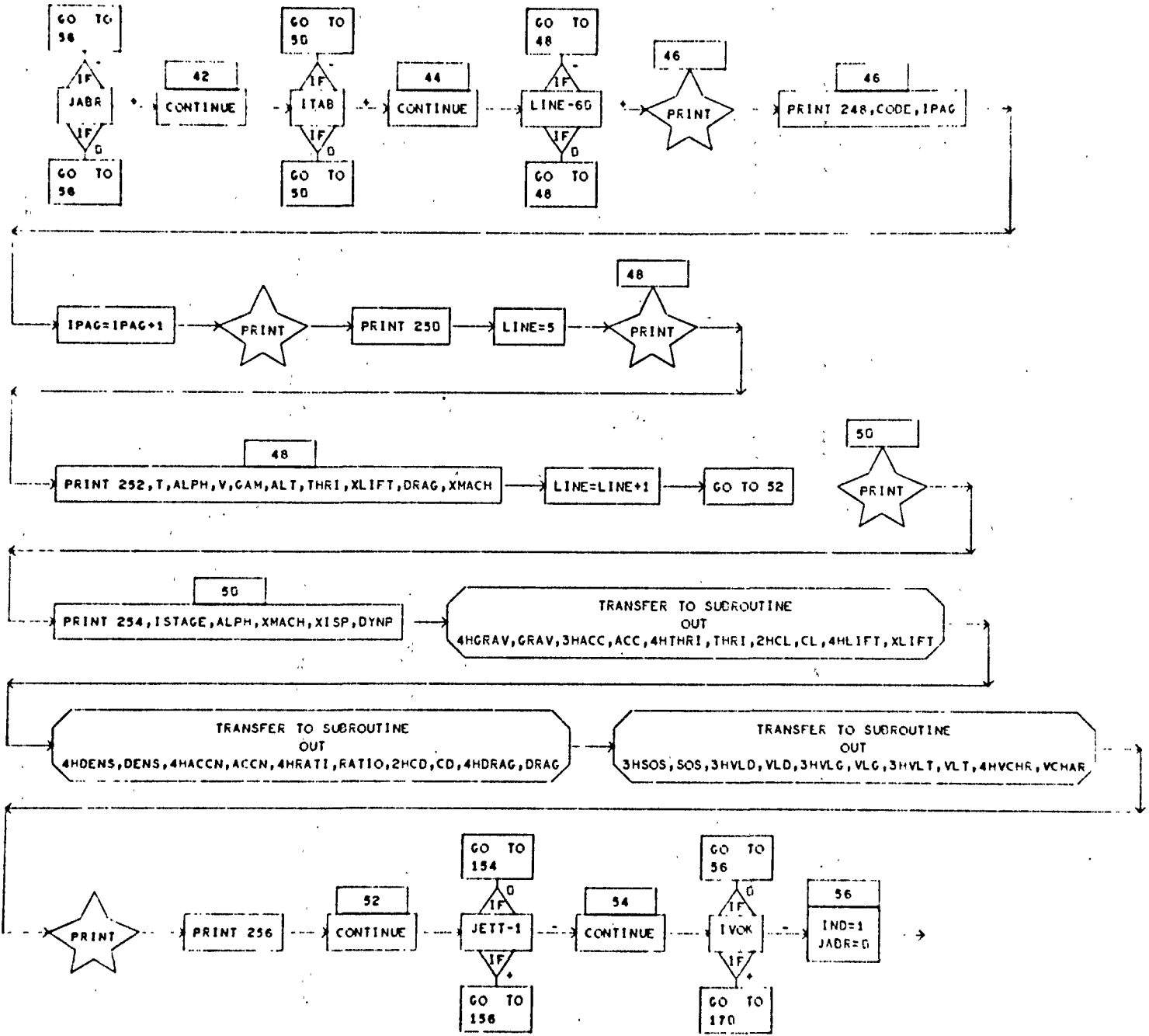

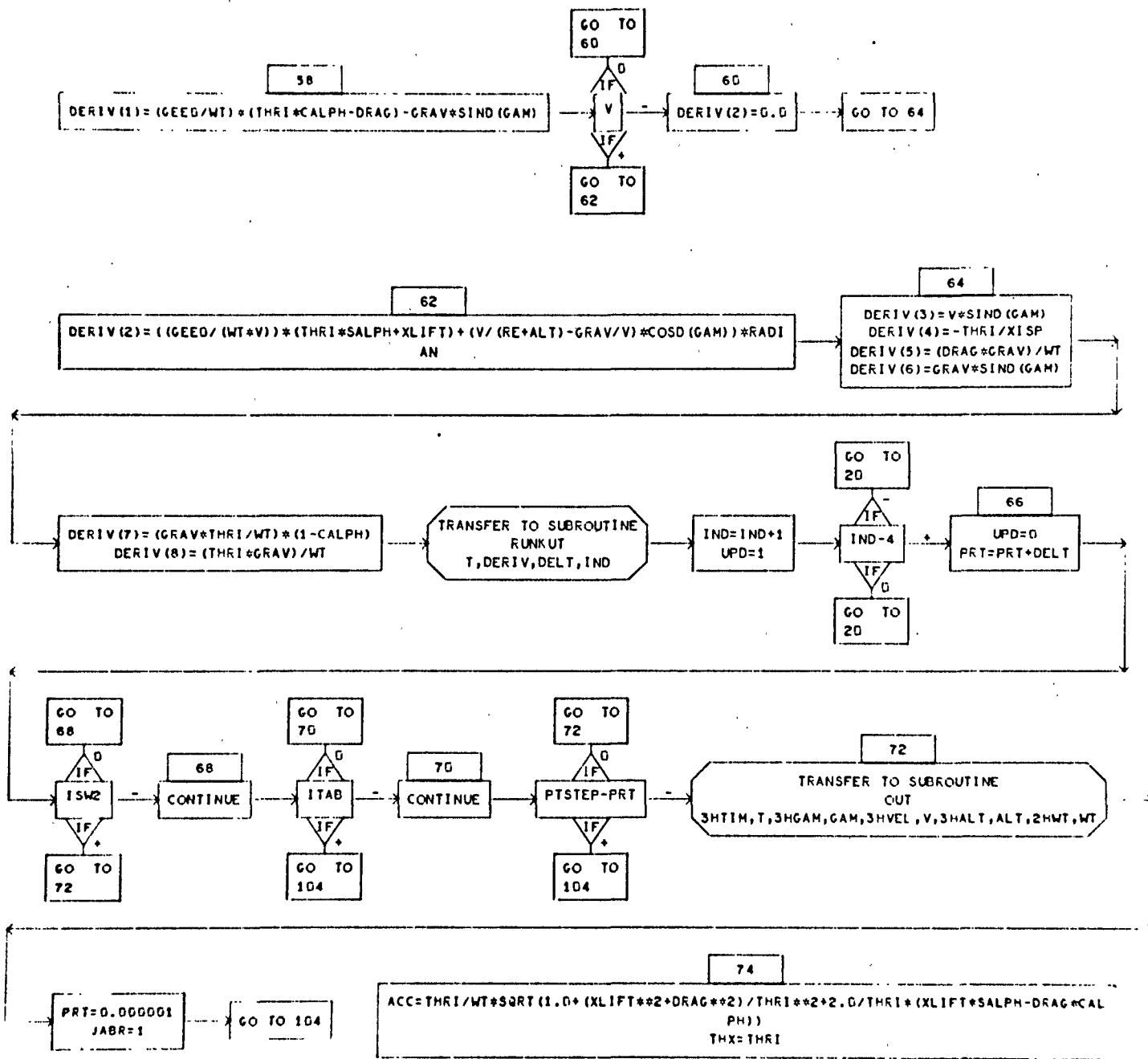

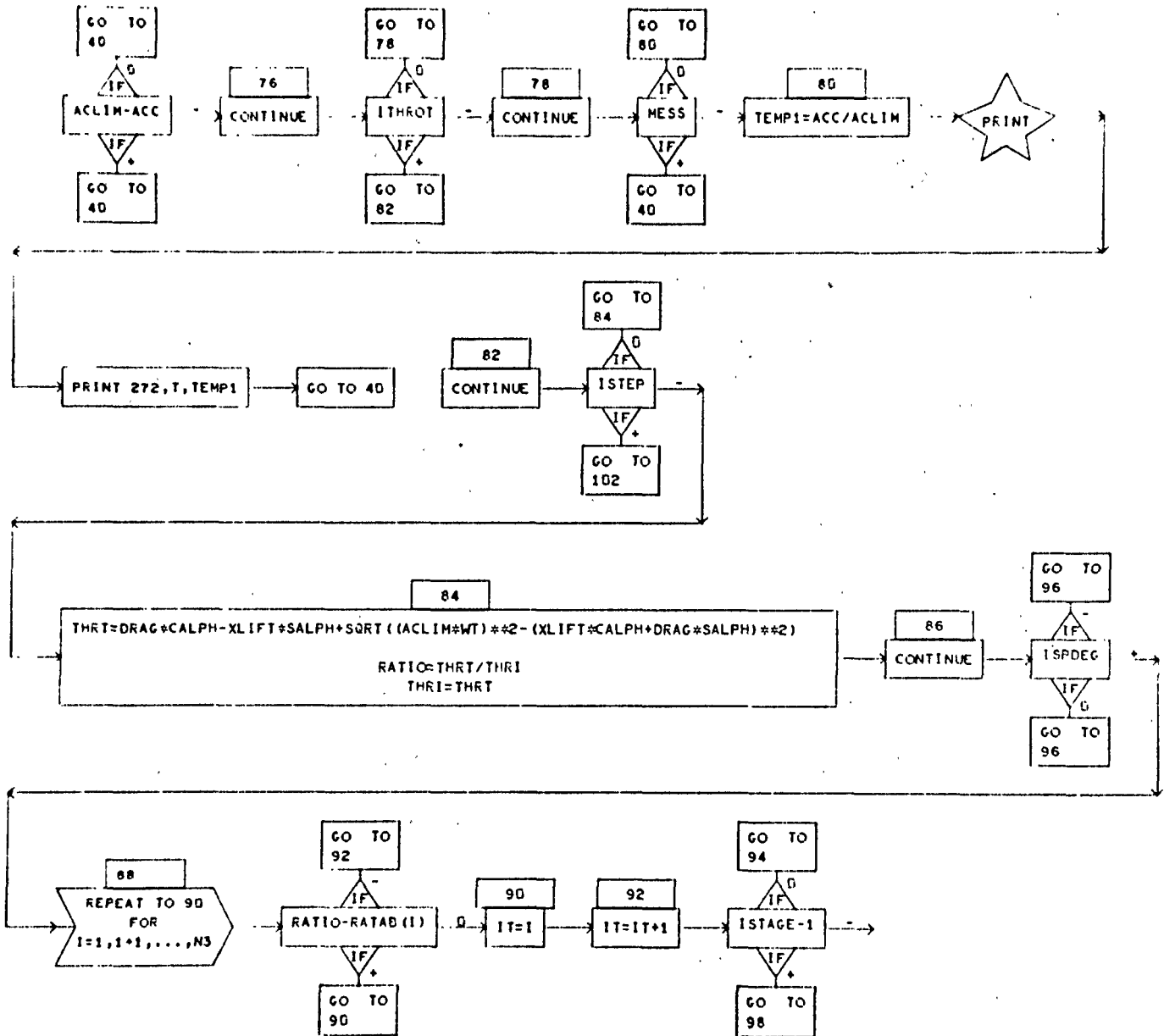

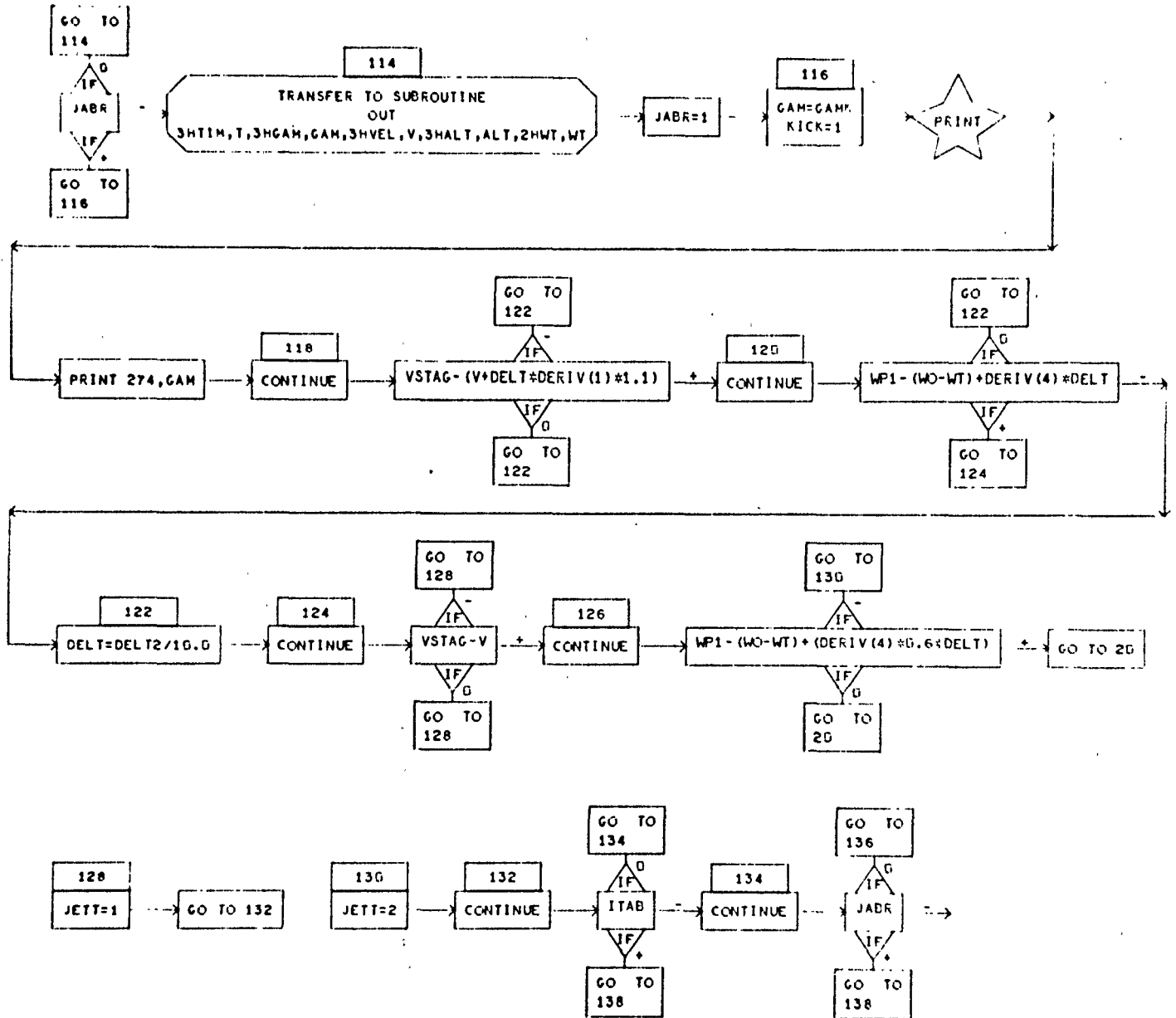

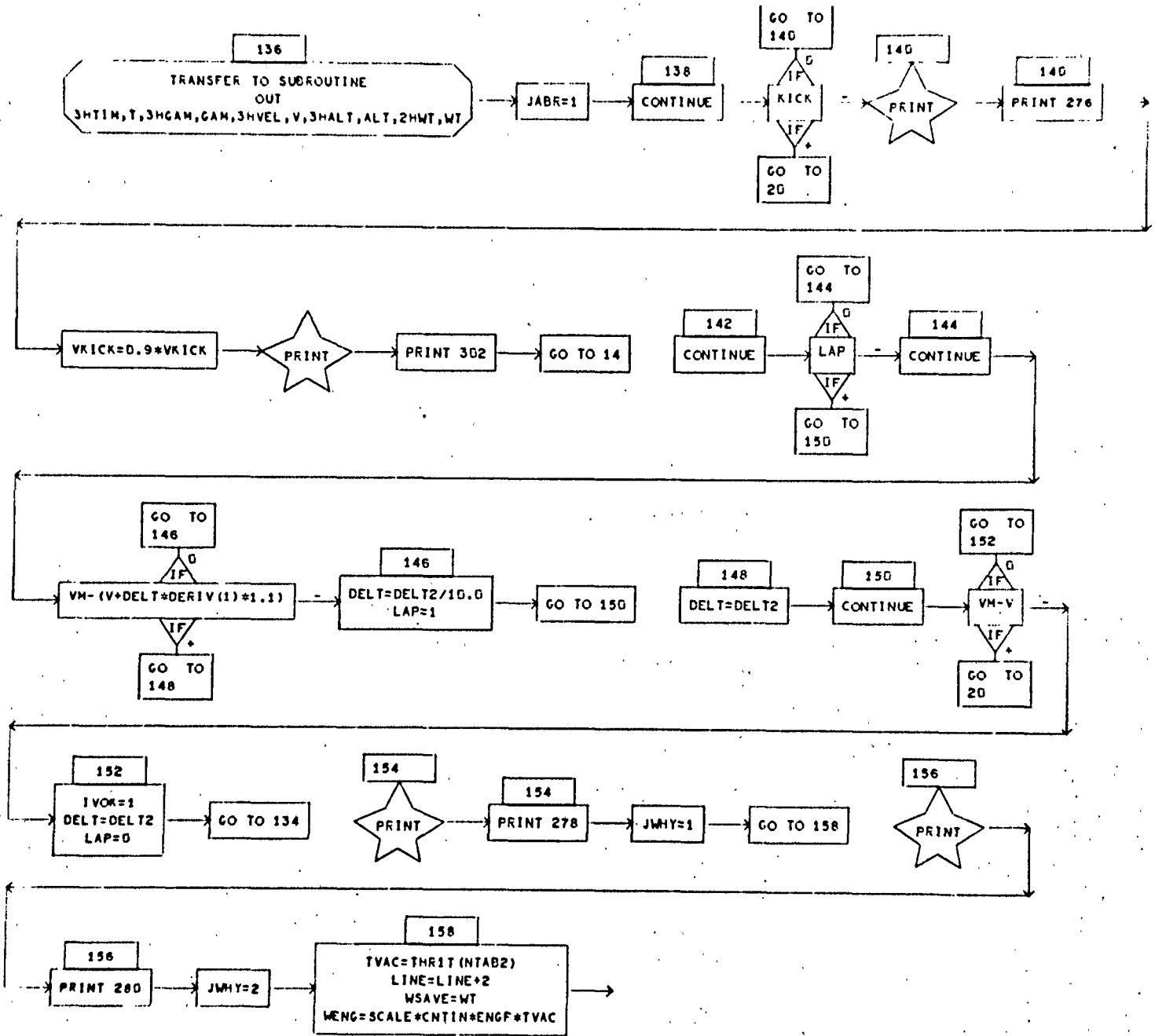

WEQP=SCALE*CNTIN*EQP
 GAS=(WO-WT)*WT*(1.0-EXP(-DELVF/(GEED*BISPT(NTAB2))))+BUILD*TVAC*WT*(1.0-EXP(-CEE*ALOG(WO/WT)))+DECAY*TVAC
 GASO=DECAY*TVAC+SCALE*CNTIN*ENN*WT*(1.0-EXP(-DELVF/(GEED*BISPT(NTAB2))))+WT*(1.0-EXP(-CEE*ALOG(WO/WT)))

WTANK=SCALE*CNTIN*TNKF*GAS*GASO
 WRES1=WT*(1.0-EXP(-DELVF/(GEED*BISPT(NTAB2))))
 WRES2=WT*(1.0-EXP(-CEE*ALOG(WO/WT)))

160
 WJET=WTANK+WENG+WEQP+BILD2*THR2
 WT=WSAVE
 WO2=WT-WJET
 PROP1=WO-WT

WT=WO2
 TH2=THR2
 DELT=DEL T2-AMOD(T,DEL T2)
 I STAGE=2

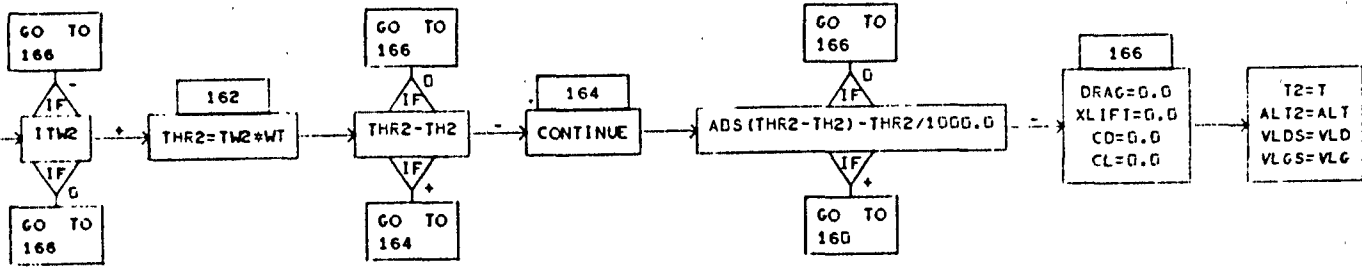

VLTS=VLT
 VCHRS=VCHAR
 VROT=(ANGV/RADIAN)*RE*COSE(XLAT)*SIND(AZ)
 V2=SQRT(VROT**2+V**2+2.0*VROT*V*COSE(GAM))

GAM2=(ASIN((V/V2)*SIND(GAM)))*RADIAN
 ALPH2=ALPH
 V=V2
 JETT=0

GAM=GAM2
 ACCN=0.0
 DYNP=0.0
 RATIO=1.0

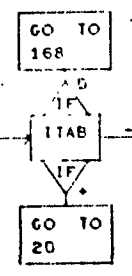

168
 TRANSFER TO SUBROUTINE
 OUT
 3HTIM,T,3HGAM,GAM,3HVEL,V,3HALT,ALT,2HW,WT

JABR=1
 GO TO 20

170
 CONTINUE

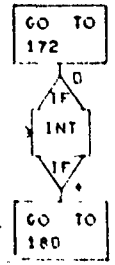

172
 CONTINUE

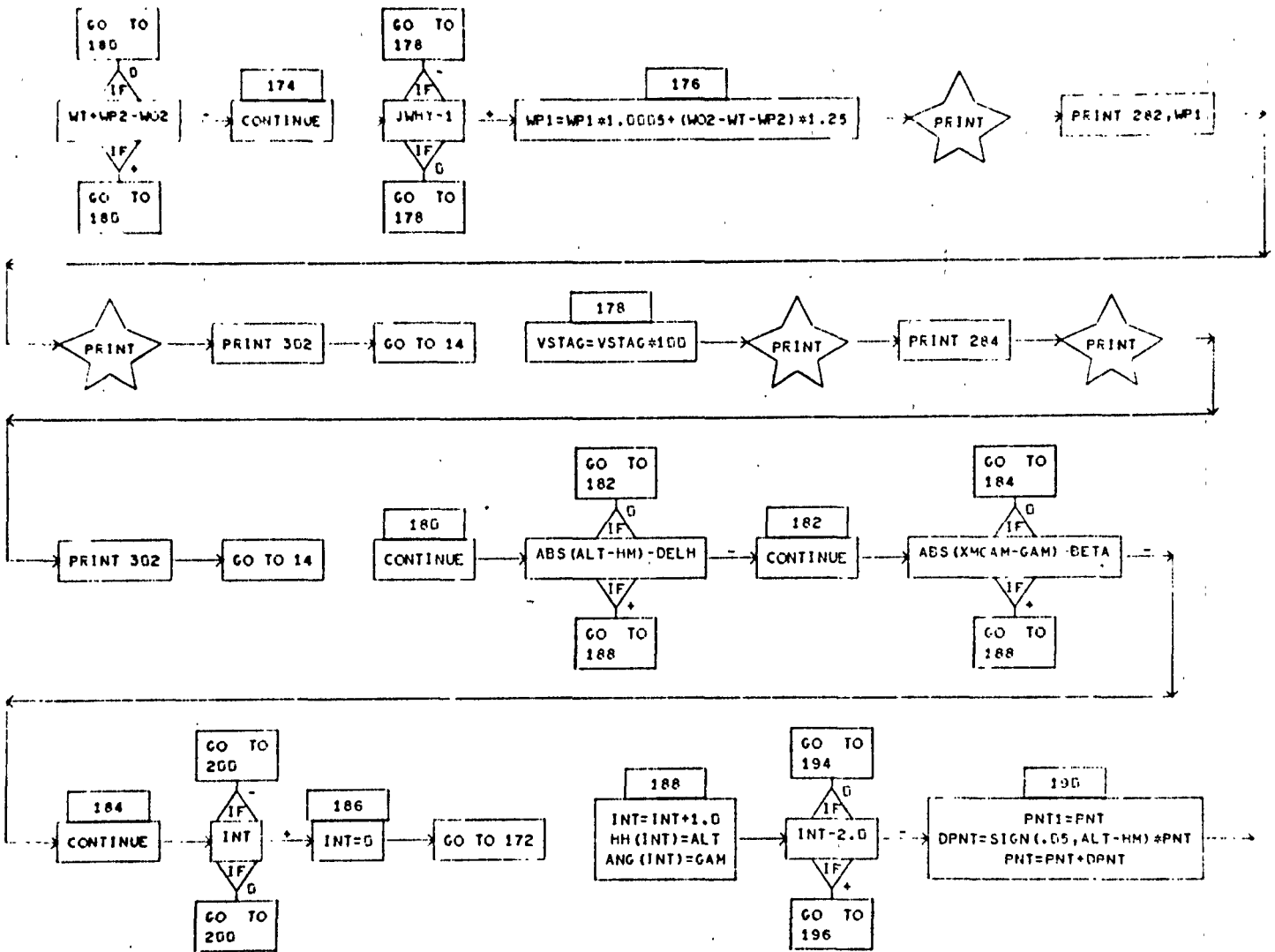

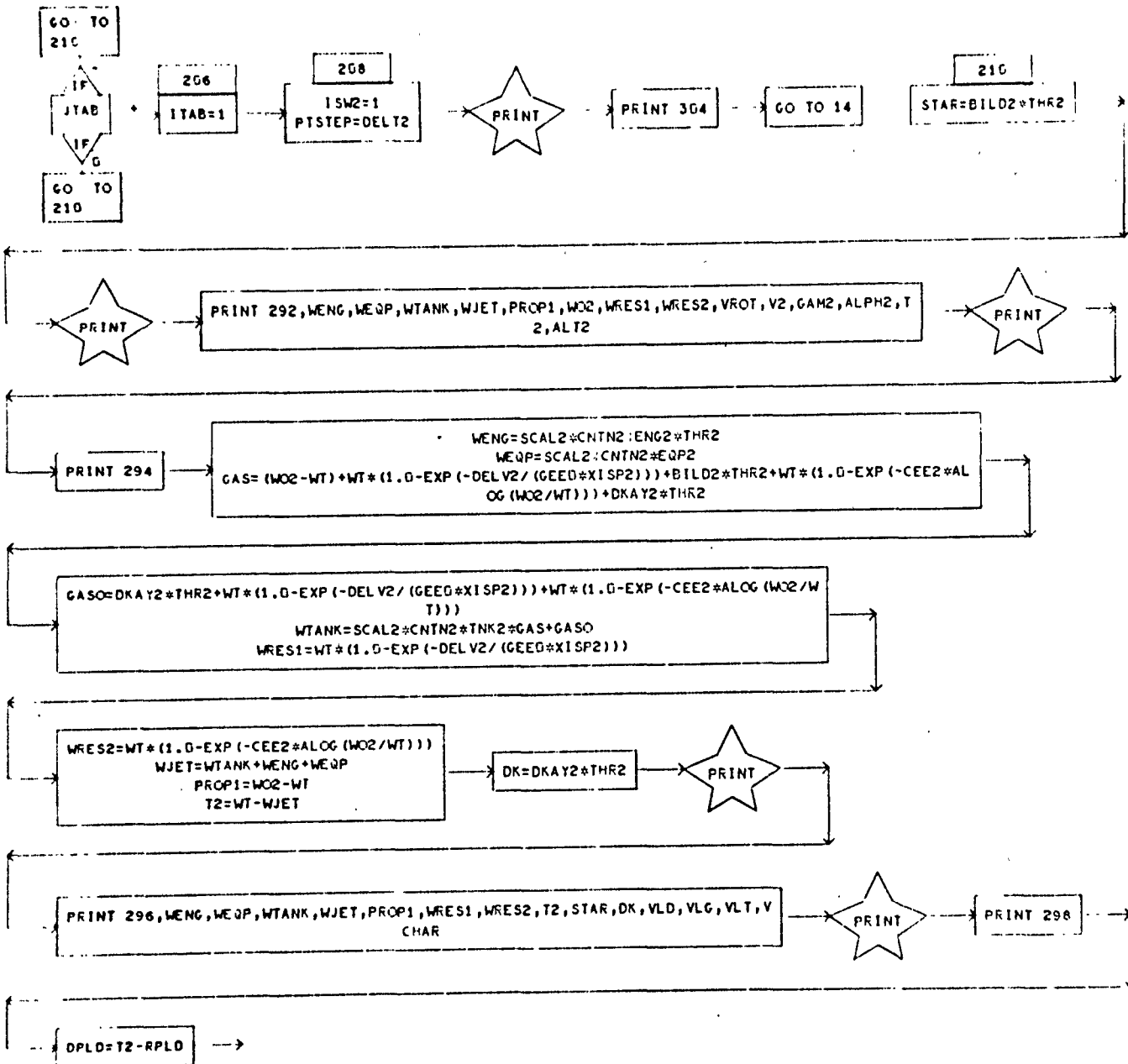

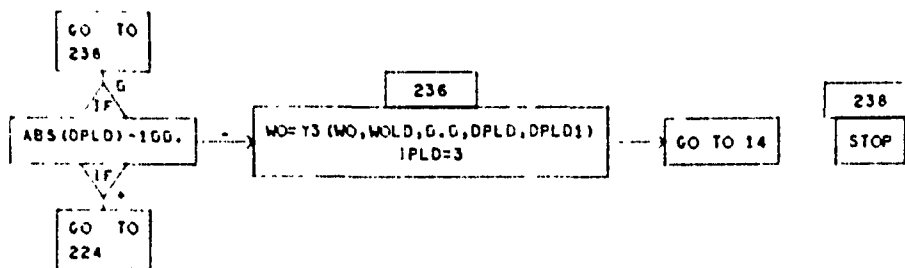
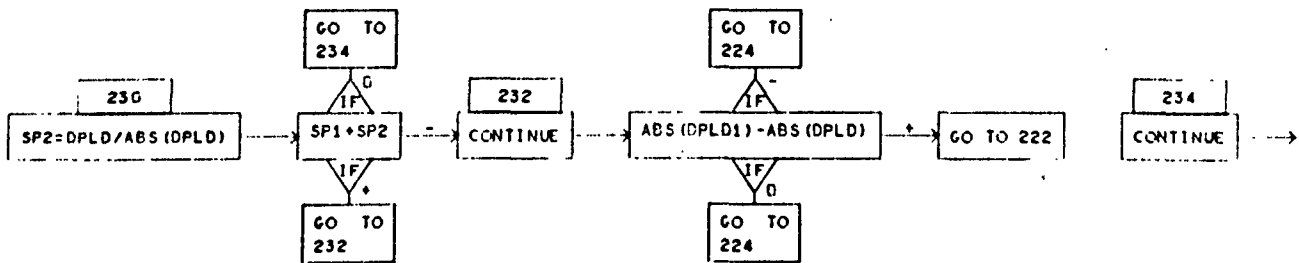
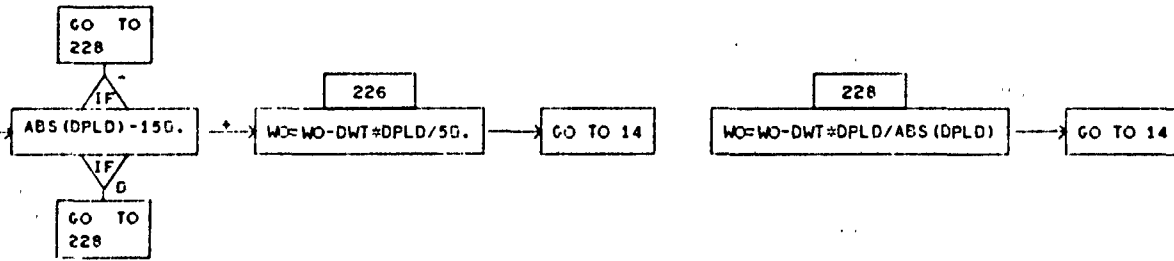
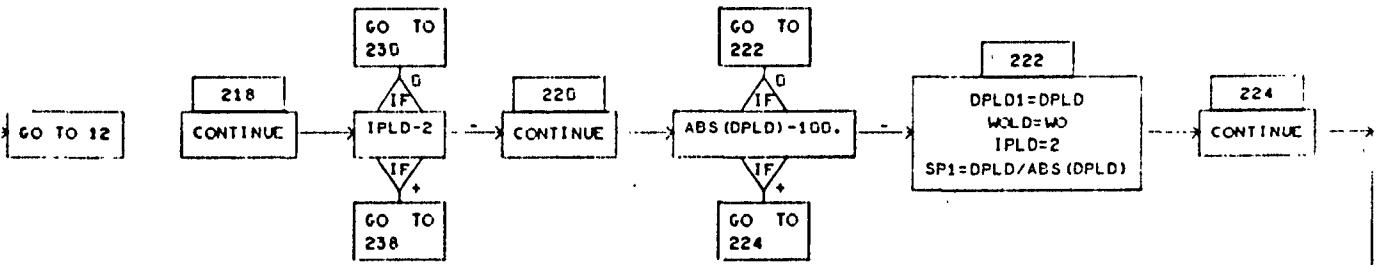
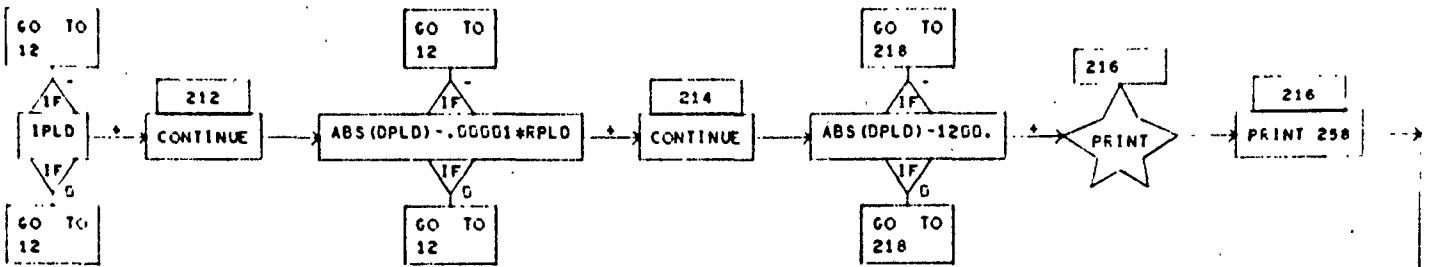

SUBROUTINE RUNKUT

D I M E N S I O N E D V A R I A B L E S

SYMBOL	STORAGES	SYMBOL	STORAGES	SYMBOL	STORAGES	SYMBOL	STORAGES	SYMBOL	STORAGES
DERIV	8	DEPVAR	8	AUX	8	SUM	8		

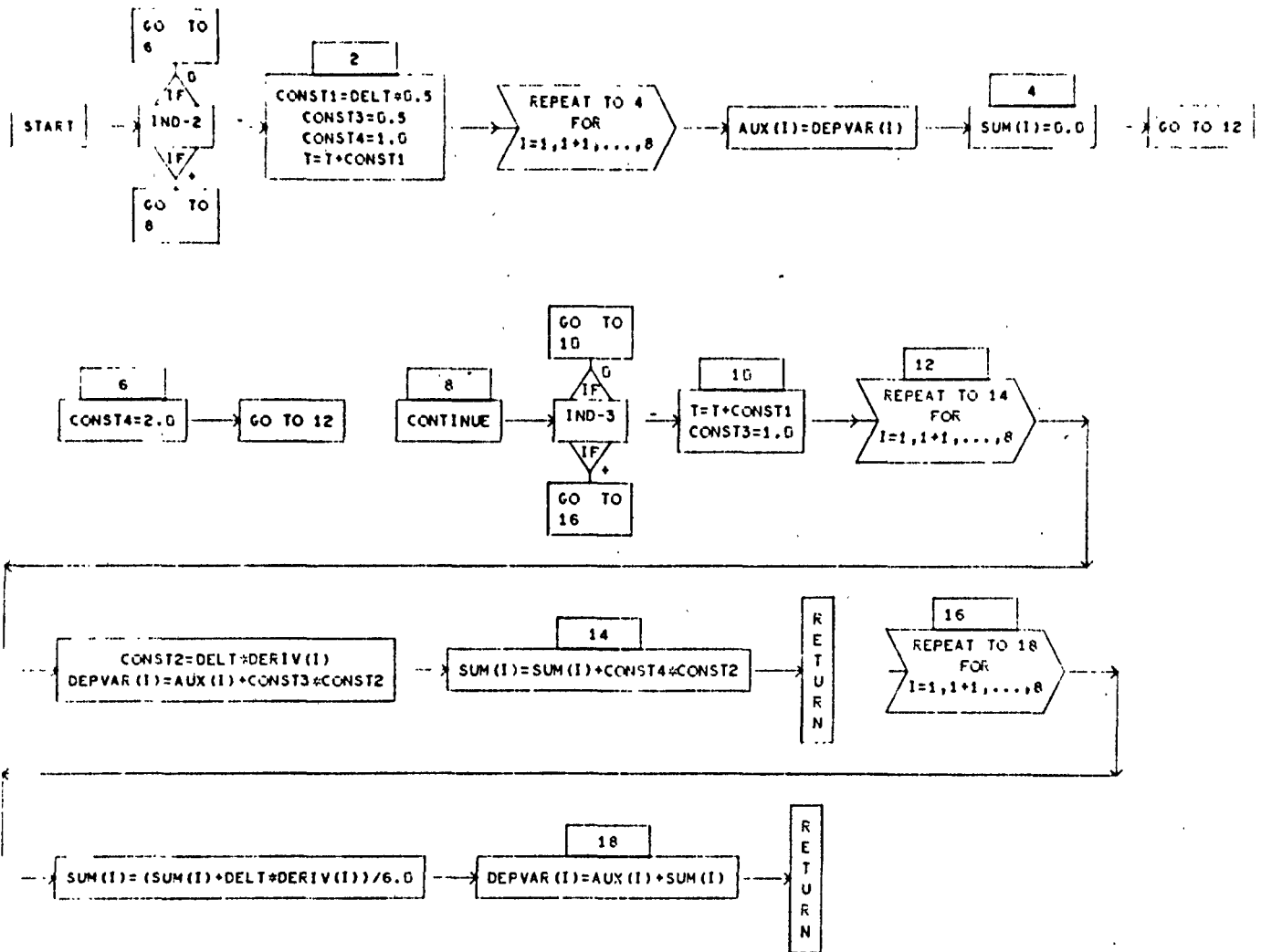

FUNCTION Y3

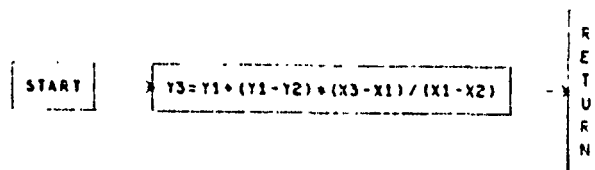

SUBROUTINE OUT

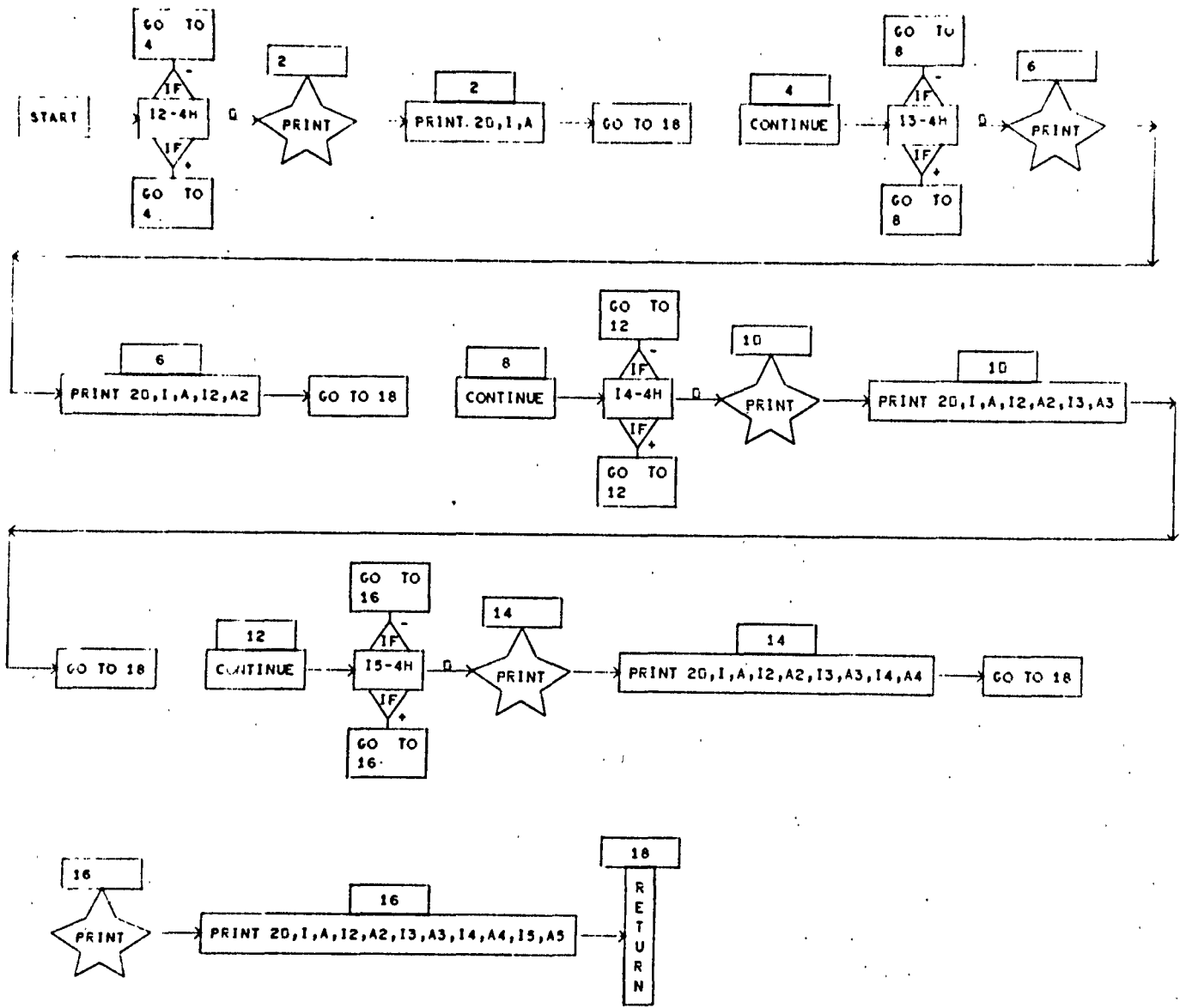

FUNCTION AMOD

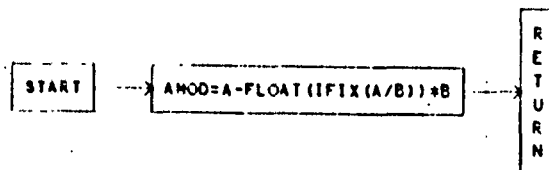

SUBROUTINE ATMOSP

D I M E N S I O N E D V A R I A B L E S

SYMBOL	STORAGES	SYMBOL	STORAGES	SYMBOL	STORAGES	SYMBOL	STORAGES	SYMBOL	STORAGES
ANS	3								

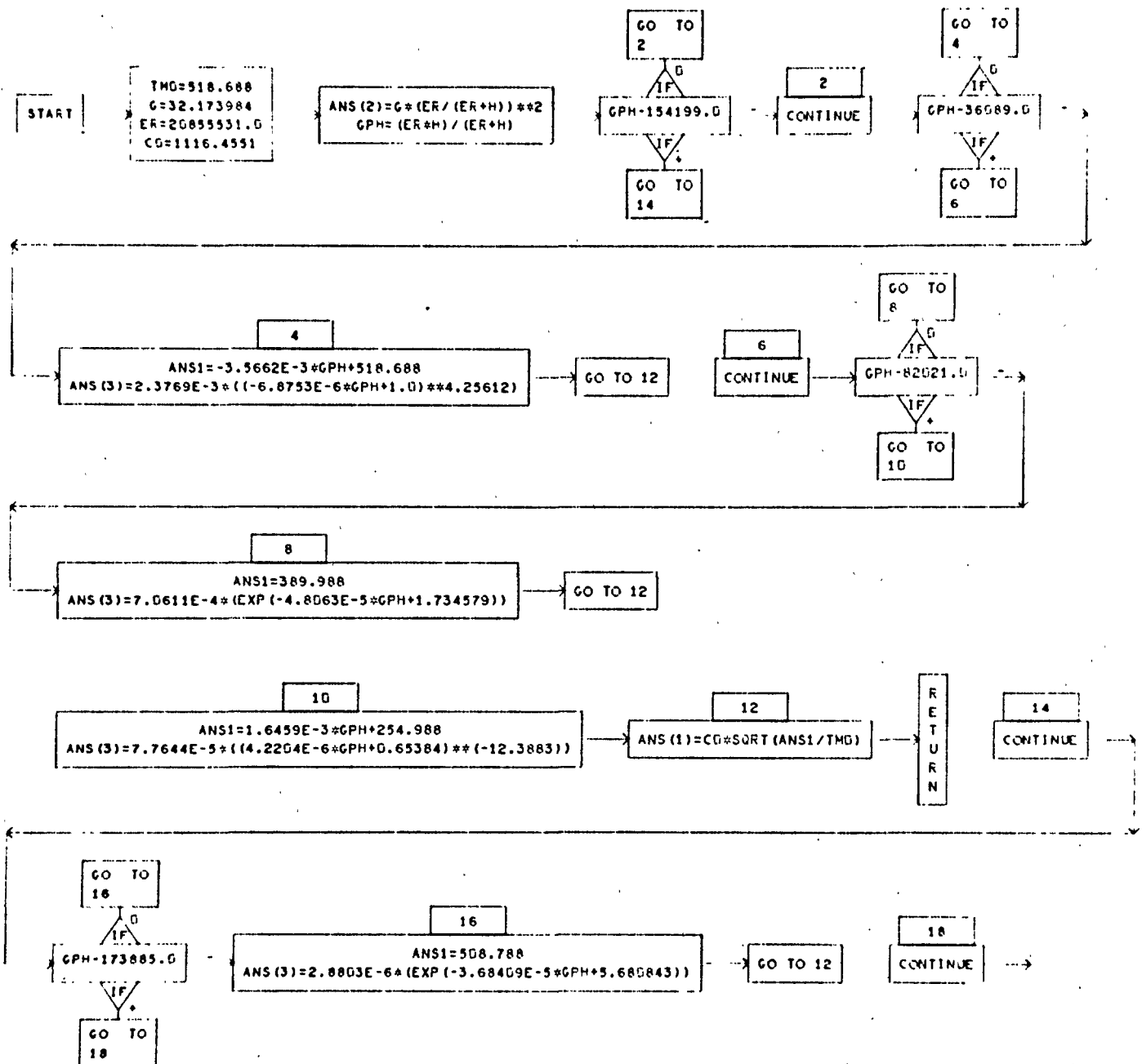

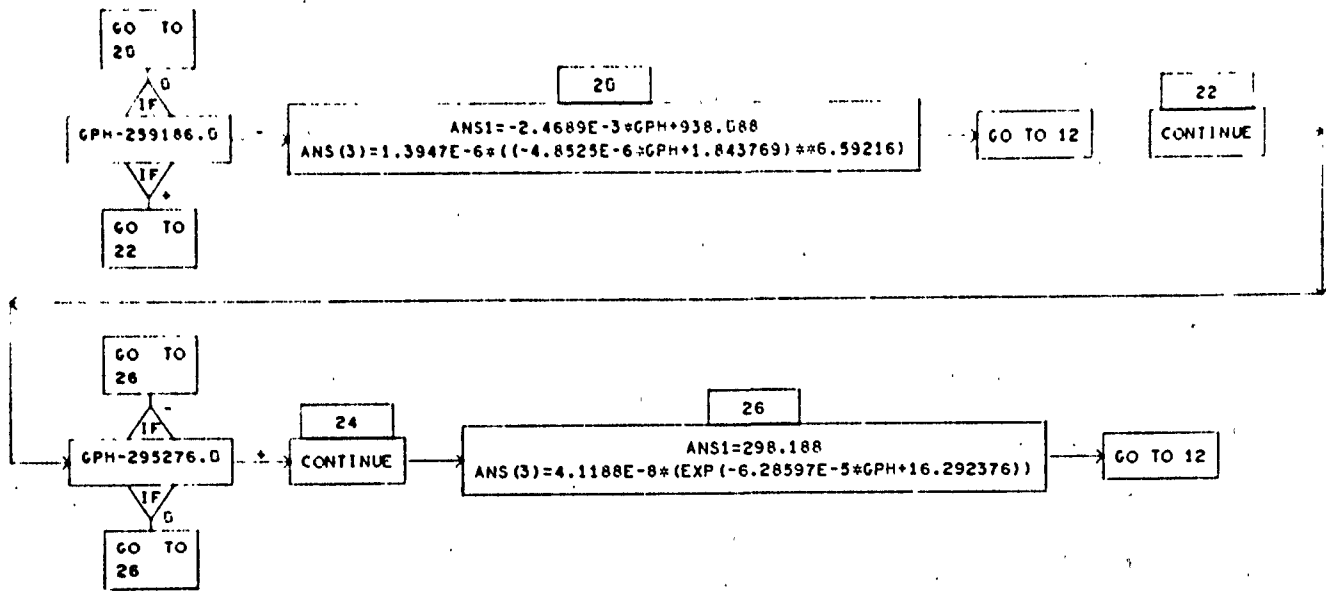

FUNCTION SIND

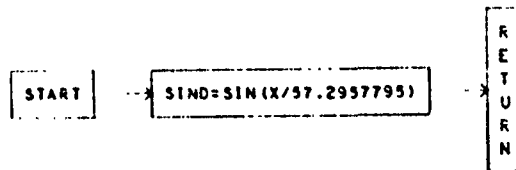

FUNCTION COSD

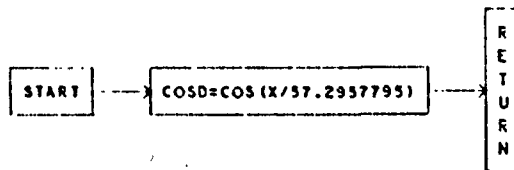

FUNCTION TAND

