

INSTALLATION, OPERATION, MAINTENANCE MANUAL



IntelliROL[®]

Motorized Roller Conveyor

Table of Figures	3
Purpose.....	4
MHS Conveyor Equipment Warranty.....	5
Warnings and Safety Instructions.....	6
Introduction to IntelliROL.....	11
Concept.....	11
Operation	11
Feature/Benefits	11
Application Options	13
Application.....	13
Definition of Terms	13
Installation Arrangements.....	15
General	15
Driver Cards	15
Drive / SLAVE Belt Break-in.....	15
Commissioning of Equipment.....	15
Precautions	16
Receiving & Site Preparation	17
General	17
Preparation of Site.....	17
Parts Inventory & Identification.....	18
Dimensional Reference Points	18
Basics of IntelliROL Installation.....	20
General	20
Elevations.....	21
Component Orientation	21
Establishing Conveyor Flow	22
Supporting Arrangements	23
Floor Supports.....	23
Anchoring.....	23
Curve Support Points	25
Knee Braces.....	25
Diagonal Sway Brace (floor support).....	26
CRUZ®channel to XenoROL® Channel Connections	27
Ceiling Hangers.....	28
Sway Bracing (ceiling hanger).....	31
Anchoring ceiling hangers	31
Adjustable Channel Guard Rail to CRUZ®channel Options.....	34
Air Supply Requirements.....	35
General	35
Main Feeder	35
Air Drops	35
Low Pressure Switch.....	35

Pneumatic Requirements	35
Electrical.....	37
General	37
ITR Variations	37
Straight Bed Construction	37
Curve Construction.....	38
UBT Construction	38
Power Merge Construction.....	40
Wheel Divert Construction.....	40
Spur Construction.....	40
ITRHB Electrical Components.....	41
ITRCB Electrical Components.....	43
ITR Electrical Components.....	43
Typical Bed Description.....	44
Electrical.....	46
General	46
Conveyor Controls - Safety Guidelines	47
Preventive Maintenance.....	48
General	48
Daily	48
Weekly	48
Air Systems	48
Parts Identification.....	50
CB-016 Drivercard.....	51
Transportation Straight Bed	52
Transportation Curve.....	54
Spur 30.....	58
Spur 45.....	64
Power Merge w/30 Degree Spur	70
UBT	72
Accumulation Straight Bed (2 & 30 Zone)	76
Accumulation Curve	79
Induct Bed	80
Mission	81

Table of Figures

Figure 1 – UBT Sensor Location	39
Figure 2 – HB-510 Drivercard	41
Figure 3 – HB 510 Communication Cable LH Flow	42
Figure 4 – HB-510 Communication Cable RH Flow	42
Figure 5 – CB-016 Drivercard	43

Purpose

It is the intent of MHS Conveyor, through this manual, to provide information that acts as a guide in the installation, operation and maintenance of MHS Conveyor IntelliROL conveyors.

This manual describes basic installation practices, assembly arrangements, preventive maintenance and assists in replacement parts identification.

This service manual is intended for use by personnel who are knowledgeable of installation and safe working practices on conveyor systems.

Not all applications and conditions can be covered; therefore, this manual is to be used ONLY as a guide.

If additional copies of this manual are needed or if you have any question concerning the conveyor please contact your Business Partner or MHS Conveyor' Customer Support at 231-798-4547 or Fax 231-798-4146.

MHS Conveyor Equipment Warranty

MHS Conveyor warrants that the material and workmanship entering into its equipment is merchantable and will be furnished in accordance with the specifications stated.

MHS Conveyor agrees to furnish the purchaser without charge any part proved defective within 2 years from date of shipment or before the equipment has forty-one hundred (4100) hours of running use, whichever period is shorter, provided the purchaser gives MHS Conveyor immediate notice in writing and examination proves the claim that such materials or parts were defective when furnished. For drive components specific to XenoROL® (i.e. Xeno belts, slave Xeno belts, drive spools, standard and speed-up, and spacers), this warranty shall be extended to five years or ten thousand (10,000) hours of running use, whichever period is shorter, provided the conveyors are applied, installed and maintained in accordance with MHS Conveyor published standards. Other than the above, there are no warranties which extend beyond the description on the face hereof. Consequential damages of any sort are wholly excluded.

The liability of MHS Conveyor will be limited to the replacement cost of any defective part. All freight and installation costs relative to any warranted part will be at the expense of the purchaser. Any liability of MHS Conveyor under the warranties specified above is conditioned upon the equipment being installed, handled, operated, and maintained in accordance with the written instructions provided or approved in writing by MHS Conveyor.

The warranties specified above do not cover, and MHS Conveyor makes no warranties which extend to, damage to the equipment due to deterioration or wear occasioned by chemicals, abrasion, corrosion or erosion; Purchaser's misapplication, abuse, alteration, operation or maintenance; abnormal conditions of temperature or dirt; or operation of the equipment above rated capacities or in an otherwise improper manner.

IMPORTANT

All equipment and components not manufactured by MHS Conveyor carry only such warranty as given by the manufacturer thereof, which warranty MHS Conveyor will assign or otherwise make available to Purchaser without recourse to MHS Conveyor, provided that such warranty is assignable or may be made available.

For service on motors, reduction units, electrical components, controls, air or hydraulic cylinders, contact the local authorized sales and service representative of respective manufacturer. If none is available in your locality, contact the MHS Conveyor representative. MHS Conveyor will not be responsible for units that have been tampered with or disassembled by anyone other than the authorized representative of the respective manufacturer.

THERE ARE NO WARRANTIES, EXPRESSED OR IMPLIED, INCLUDING, BUT NOT LIMITED TO, WARRANTIES OF MERCHANTABILITY OR FITNESS FOR A PARTICULAR PURPOSE, EXTENDING BEYOND THOSE SET FORTH IN THIS STATEMENT OF WARRANTY.



Rev 08/22/2011

Warnings and Safety Instructions

Failure to follow the instructions and cautions throughout this book, and warning labels on the conveyor, may result in injury to personnel or damage to the equipment.

Your MHS Conveyor conveyor is powered by a motor and can be stopped only by turning off electrical power to the motor. As with all powered machinery, the drive-related components – including sprockets, chains, shafts, universal joints and pneumatic devices – can be dangerous. We have installed or provided guards to prevent accidental contact with these parts, along with warning labels to identify the hazards.

Special attention must be paid to the following areas of this manual:

 WARNING	
	<ul style="list-style-type: none"> Indicates a potentially hazardous situation which, if not avoided, could result in death or serious injury.



CAUTION	
<ul style="list-style-type: none"> Indicates a situation which, if not avoided, could result in property damage. 	

NOTE





This is where you will be notified of helpful information.

 **WARNING**

- After maintenance, REPLACE guards immediately.
- Keep ALL warning labels clean and clear of any obstructions.
- Never remove, deface or paint over WARNING or CAUTION labels. Any damaged label will be replaced by MHS Conveyor at no cost by contacting Lifetime Services.
- It is very important to instruct personnel in proper conveyor use including the location and function of all controls.
- Special emphasis must be given to emergency stop procedures.
- It is important to establish work procedures and access areas which do not require any part of a person to be under the conveyor.
- It should be required that long hair is covered by caps or hair nets.
- Loose clothing, long hair and jewelry must be kept away from moving equipment.
- Maintain enough clearance on each side of all conveyor units for safe adjustment and maintenance of all components.
- Provide crossovers or gates at sufficient intervals where needed to eliminate the temptation for personnel to climb over or under any conveyor.
- Walking or riding on a moving conveyor must be prohibited.
- Before performing maintenance on the conveyor, make sure the start-up controls are locked out and cannot be turned on by any person other than the one performing the maintenance.
- If more than one crew member is working on the conveyor, EACH CREW MEMBER MUST HAVE A LOCK ON THE POWER LOCKOUT.
- All pneumatic devices must be de-energized and air removed to prevent accidental cycling of the device while performing general maintenance.
- Make sure all personnel are clear of all conveyor equipment before restarting the system.
- Before servicing or performing any work in the motor control panel, disconnect and lock out the main incoming service. If only the panel disconnect is off, the incoming side will still be hot.

 <h2 style="margin: 0;">WARNING</h2>	
	<ul style="list-style-type: none"> Before servicing or performing any work in the motor control panel, disconnect and lock out the main incoming service. If only the panel disconnect is off, the incoming side will still be hot. <div style="text-align: center; margin-top: 20px;">  </div>

CEMA Safety Label Placement Guidelines

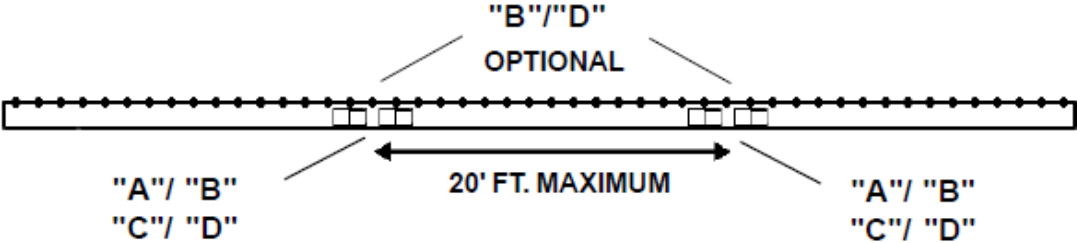
CEMA Safety Labels	Placement Guidelines
Product: Unit Handling	
Equipment: Motor Driven Live Roller Conveyors	
<p>To be placed along both sides of these conveyors since these conveyors provide surfaces and profiles attractive, but hazardous, for climbing, sitting, walking, or riding.</p>	<p>To be placed along the sides of these conveyors to warn personnel that the conveyor can start automatically</p>
 <p>"A"</p> <p>SPACE UP TO A MAXIMUM OF 20 FT. CENTERS (BOTH SIDES)</p>	 <p>"C"</p> <p>SPACE UP TO A MAXIMUM OF 20 FT. CENTERS (BOTH SIDES)</p>
<p>Optional Label to be placed either on the side or top of rails when space available does not permit application of the larger label</p>	<p>Optional Label to be placed either on the side or top of rails when space available does not permit application of the larger label</p>
 <p>"B"</p> <p>SPACE UP TO A MAXIMUM OF 20 FT. CENTERS (Sides or top surface of both rails)</p>	 <p>"D"</p> <p>SPACE UP TO A MAXIMUM OF 20 FT. CENTERS (Sides or top surface of both rails)</p>
 <p style="text-align: center;">"B"/"D" OPTIONAL</p> <p style="text-align: center;">20' FT. MAXIMUM</p> <p style="text-align: center;">"A"/ "B" "C"/ "D" "A"/ "B" "C"/ "D"</p>	
<p>NOTE: Due to the design of these conveyors, there may not be room on the side rails to place the larger labels. In that case, the smaller labels may be used. Optionally, they may also be placed on the top surface of both rails. The key is the space available and visibility by operators and maintainers.</p>	





Package Conveyors



 <p>Do Not Climb, Sit, Stand, Walk, Ride, or Touch the Conveyor at Any Time</p>	 <p>Do Not Perform Maintenance on Conveyor Until Electrical, Air, Hydraulic and Gravity Energy Sources Have Been Locked Out and Blocked</p>	 <p>Operate Equipment Only With All Approved Covers and Guards in Place</p>
 <p>Do Not Load a Stopped Conveyor or Overload a Running Conveyor</p>	 <p>Ensure That All Personnel Are Clear of Equipment Before Starting</p>	 <p>Allow Only Authorized Personnel To Operate or Maintain Material Handling Equipment</p>
 <p>Do Not Modify or Misuse Conveyor Controls</p>	 <p>Keep Clothing, Body Parts and Hair Away from Conveyors</p>	 <p>Remove Trash, Paperwork and Other Debris Only When Power is Locked Out</p>
 <p>Ensure That ALL Controls and Pull Cords are Visible and Accessible</p>	 <p>Know the Location and Function of All Stop and Start Controls</p>	 <p>Report All Unsafe Conditions</p>

POST IN PROMINENT AREA

Introduction to IntelliROL

Concept

Utilizing 24V DC motorized roller, this technology is the most revolutionary since the advent of the line-shaft conveyor in the late-'60s. Its impact is currently expanding rapidly as more users and manufacturers begin to see the benefits of this technology. MHS Conveyor' experience with IntelliROL goes back to 1996 with a major tire handling system.

This fast advancing technology uses a self-contained 24 volt DC motorized roller to power a segment or zone of the conveyor. Rollers adjoining the motorized roller are slave-driven with the same components MHS Conveyor developed in the '60s.

XenoROL® line-shaft driven live rollers and IntelliROL equipment both drive product through the developed tangential force at the conveyor roller surface. The relationship between tangential forces, product weight and product characteristics have been at the root of MHS Conveyor conveyor technology for the past 30 years. This natural extension places MHS Conveyor at the forefront of applying this technology.

Operation

The product-carrying rollers are slave-driven by a series of pre-tensioned belts to the motorized roller in each zone. Since every motorized roller can be individually controlled, every segment of the system becomes a potential zero-pressure zone.

Accumulation begins when an external signal "arms" the first sensor (discharge end). External signals may originate from electrical controls, sensing devices, encoding stations, manually activated switches, etc. The first product stops over the discharge sensor which arms the next sensor in the zone upstream. When a product (armed from the previous zone), stops the carrier rollers within its zone, all rollers in the zone stop. As accumulation takes place from zone-to-zone, accumulated products are under zero-pressure.

Feature/Benefits

- Flexible Modular design / easy to reconfigure
- Run on demand / less noise, wear, and energy consumption
- Non-contact zero-pressure / product protection
- Compact low profile / multi-level usage
- Reversible / less electrical hardware cost
- No scheduled maintenance / lower operating cost
- Low voltage / safety and lower cost
- Simple installation / lower cost

- Soft start/stop / low G-forces
- Variable speed / versatility to suit each requirement
- Intelligent control capabilities / cost no greater than need

Most IntelliROL modules have a maximum depth profile of 6-3/8" T.O.R to bottom of flange including a true vertical lift urethane belt transfer. A bi-directional urethane belt transfer has a maximum rate of 30 cases per minute. Urethane belt transfer belts should only run while transferring a load.

All curves except the minimum radius curve are based on MHS Conveyor' true taper roller for all widths.

IntelliROL optional run-on-demand software can selectively deactivate conveyor zones when not carrying product. Because each IntelliROL module has its own drive and control, any level of control sophistication is possible, including product-tracking, diagnostics, and data collection.

The technology behind IntelliROL is growing and changing quickly. Most applications use a 24 volt DC, 1.9" diameter, brushless motorized roller, and these rollers are the basis of design for most IntelliROL modules. Special applications requiring slow speeds and high torque may require the use of geared motorized rollers and 3-phase AC voltage motorized rollers have been used in heavy duty applications.

Application Options

Application

The application of IntelliROL breaks down into two areas. One is complete systems; the other is the application of specific modules within a system that may be based on line-shaft or some other conveyor technology.

MHS Conveyor has standard designs for straight bed sections for transportation or zoned accumulation. Standard zone lengths are 24" or 36". MHS Conveyor also offers curves in 30°, 45°, 60° and 90°, 30° or 45° spurs, UBT transfers, three designs of product stops, inclines and declines, gates, minimum radius curve, and anti-rollback brakes (inclining). Many options are available including different roller centers, bearings, roller coatings, etc.

Application Specific Modules may be used to solve certain requirements within a system at a most cost-effective manner using IntelliROL conveyor.

Application Specific Module examples include:

- Short spurs
- Workstations
- Fill gaps between conveyors or devices
- Providing power to a lift bed
- Transfer car
- The bed of a turntable
- Gates
- Low Profile requirements over aisles, multi-level, etc.

In nearly all the above examples, space is a major consideration. Weight and balance may even be a consideration on something like a scale, lift, or vertical conveyor.

Definition of Terms

Accumulation - Act of queuing, holding or backing up of product on a conveyor.

Carrying Roller - The conveyor roller upon which the object being transported is supported. It has circumferential grooves near one end to allow the slave belts to ride below the carrying surface.

Coefficient of Friction - A numerical expression of the ratio between the force of contact between two surfaces and the resistant force tending to oppose the motion of one with respect to the other.

Conveyor Width - The dimension outside to outside of frame rails. For the inside dimension, the abbreviation "BF" (between frames) is used.

Crossmember - Structural member which is assembled between two side channels of a conveyor bed.

Frame - The structure which supports the components of a conveyor bed consisting of formed channel rails bolted together with crossmembers.

Indexing Control - Maintains non-contact accumulation and functionality of gates, transfers, curves, etc. by not allowing accumulation in these areas.

IntelliROL Non-Contact Accumulation - "Pure" zero-pressure accumulation which guarantees that one product will not touch any other during accumulation, release, or any time. (Requires product to be inducted singularly and be 3" to 4-1/2" shorter than zone).

Roller Centers - Distance between center lines of adjacent rollers. For curves, roller centers are measured at the inside radius.

Roller Groove - The groove that is fabricated into the carrying roller to provide a seat for the slave belt below the carrying surface.

Singulation Release - A method of individual zone release that spaces product approximately one zone length apart.

Slave Belt - An endless round belt manufactured from elastic material, typically urethane, connecting a motorized roller or carrying rollers or other carrying rollers within a zone.

Slug Release - Simultaneous release of several products.

Tapered Roller - A conical conveyor roller for use in a curve with end and intermediate diameters proportional to their radius.

Zone - A portion of conveyor activated by a motorized roller that may be controlled by a photoeye.

Zone Length - The distance between sensing devices (typically containing one motorized roller).

Zero-Pressure Accumulation - The lack of force between products after accumulation. (Industry standard)

Installation Arrangements

General

IntelliROL conveyors are offered in four standard widths of 16BF, 22BF, 28BF, and 34BF with the overall conveyor width being 3.25" plus the BF. Standard available bed lengths are multiples of the two standard zone lengths of 24" and 30", up to 10'. Standard roller center distance is 3". Other roller centers and widths may be available.

Driver Cards

The driver cards that are supplied with each motorized roller are mounted inside the side channel of a bed, opposite the slave O-ring side of the conveyor. These driver cards condition the 24VDC power coming from a separate power supply. Standard IntelliROL beds are prewired and tested prior to shipping. MHS Conveyor provides an optional plastic shroud that snaps into grooves in the 7.5" deep CRUZchannel to cover the driver cards and wiring. These shrouds are translucent to allow monitoring of the LED condition lights on the driver cards.

Drive / SLAVE Belt Break-in

The roller to roller round drive belts are installed under tension with predetermined initial tension. After a time of static and running conditions, there is an initial tension drop in the belt.

Run all IntelliROL conveyors 48 hours empty before running product. This will ensure motorized rollers are not overloaded under the higher initial belt tension. This run time is best accomplished during installation as soon as the power supplies are wired and during the commissioning phase.

Commissioning of Equipment

Commissioning of the equipment can best be defined as the final adjustments and test of the installed equipment required for its proper operation. The need for commissioning is inherent, since the individual components of equipment are brought together at the installation site to operate as a system.

Mechanical and electrical commissioning is most often carried out simultaneously. Commissioning must simulate the actual operation of the system as close as possible to demonstrate its ability to perform reliably at the specified rate in the prescribed operational sequence.

During the Commissioning Phase, it is necessary to load the equipment with product to be conveyed, which provides the means of detecting those areas requiring adjustment. Personnel will be required to support operational functions and may serve as part of operator training and familiarity with the system. During the commissioning activity,

special attention should be directed toward personnel safety. No unnecessary risks should be taken that would endanger the safety of any commissioning personnel. All personnel must familiarize themselves with all safety features of the system such as emergency stops and motor disconnects.

After commissioning, conduct operator training on all safety and operational aspects of the system. This must include systems start-up, location of emergency stops and familiarity with all operator controls.

Precautions

ULTRAVIOLET RAYS of sunlight will weaken polyurethane slave belts.

OILY OR WET CONDITIONS impair frictional drive characteristics between polyurethane slave belts and roller grooves.

CORROSIVE SUBSTANCES will adversely affect various components, voiding the warranty.

Receiving & Site Preparation

General

IntelliROL conveyor is shipped in subassemblies. These subassemblies are packaged to guard against damage in shipment when handled properly.

Examination immediately following unloading will show if any damage was caused during shipment. If damage is evident, claims for recovery of expenses to repair damage or replace components must be made against the carrier immediately. While unloading, a check must be made against the Bill of Lading, or other packing lists provided, to confirm full receipt of listed items.

CAUTION

- TAKE CARE DURING THE REMOVAL OF EQUIPMENT FROM THE CARRIER.
- Remove small items and boxes first.
- Pull and lift only on the skid, not on the frame, crossmember or any part of the equipment.
- Be sure the skid is free of other materials which may be on top of or against the side of the skid to be removed.

Preparation of Site

After the conveyor is received, move it to the installation site or designated dry storage area as soon as possible. Clean up all packing material immediately before parts get lost in it. Loose parts should remain in the shipping boxes until needed.

Prior to starting assembly of the conveyor, carefully check the installation path to be sure there are no obstructions that will cause interference. Check for access along the path needed to bring in bed sections and components closest to the point where they are needed. It is often necessary to give the area along the system path a general cleanup to improve installation efficiency, access and accuracy.



Parts Inventory & Identification





Typical identification label location.

Each subassembly is shipped completely assembled except typical loose parts, which are in boxes with the subassemblies. Segregate the conveyor subassemblies by types for inventory and ease of locating during installation.

An identification label is attached to the outside of one side channel, close to one end of each conveyor bed. This label contains: job number, part number, order number, tag number (if specified), assembler's initials and date of manufacture. On supports, the tag is located on the bottom side of the foot. On special devices it is located on a convenient flat surface that is not

offensive to the appearance of the equipment but is still accessible for viewing. These numbers can be cross-referenced against the packing list.

Loose parts are boxed and shipped separately. You should have all conveyor sections and supports for a particular conveyor prior to installation. It is cost-effective to identify and procure any missing parts before they are needed for assembly. Small items like nuts and bolts are weigh-counted and packaged by size and type.

 WARNING	
	<ul style="list-style-type: none"> The Installation Supervisor must be experienced with conveyor and qualified in the mechanics of the equipment and enforce safe working procedures for the protection of the crew, customer, and customer's property.

Dimensional Reference Points

The path of each conveyor in the system is determined by establishing a reference point at each end. The center line of the conveyor is established and a chalk line is snapped between these points.

Conveyors should be installed with the center line of the bed matching the center line of the conveyor path within 1/8" of true center. Locate and mark the center of the crossmembers at each end of the conveyor. Use a plumb line or other acceptable means to ensure accuracy to the chalk line.

Always carry out a thorough check for any obstructions such as building columns, manholes, etc. It may be necessary to reroute the conveyor to avoid the obstruction. In this case it would be advisable to begin installation at this point, using the obstruction as a reference point (Datum), and install the sections in either direction as required.

All conveyor sections must be checked for squareness prior to installation as "racking" or being knocked out of square may have occurred during shipping and handling.

Basics of IntelliROL Installation

General

IntelliROL conveyor may be installed using any of the supporting arrangements described under Support Arrangements in this manual. As each bed is installed in the system, level the conveyor from side to side using a bubble level on the roller at each support. The bubble location should be within the level indicator lines of the level. The center line of the conveyor should not bow to the right or left more than 1/8" in either direction from a center line drawn between the centers of the conveyor end assemblies.

A simple way to check this is to tie a nylon string around the center of the end roller, pull it taut, and tie it to the center of the roller at the opposite end. Put a wood spacer under the string at each end so it does not rest on the rollers. With the taut string centered on each end and suspended above the rollers, check the center of the rollers at each support relative to the string and adjust accordingly. (Note that this must be done after side-to-side leveling of the conveyor at each support.)

When joining bed frames it is important to align the rollers and line-shaft. Care must be taken to make sure the rollers are level (carrying surfaces) from bed to bed.

All bed frames should be checked for squareness. To check, measure diagonally from corner to corner. Measure the opposite corners in the same manner. If the bed is square, the two measurements will be the same within 1/16".

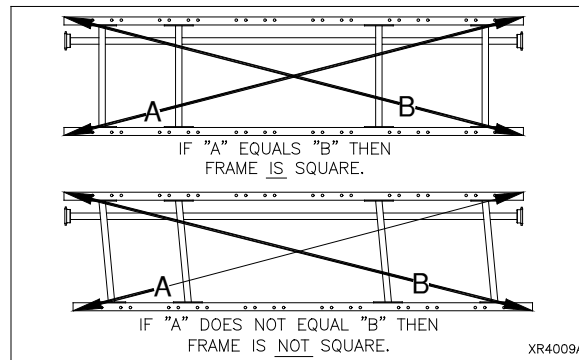

NOTE

Conveyor frames must always be installed in a straight line from end to end. After a number of sections have been installed to the chalk line and leveled, check the alignment of each line-shaft assembly. As the conveyor sections are bolted together, the coupler sprockets may require adjusting. The edge of the 1" diameter lineshaft must be 2" from the frame channel as an initial reference point.

Elevations

All conveyors should be installed in accordance with the elevations shown on the drawings. In addition, all conveyors must be level across the frame width and length (if horizontal). Leveling of the frames is best done using a rotating laser level or a builder's level.

After the first elevation is established at a critical point, the elevation of all other points shall be relative to this first point. Normal practice is to dimension the layout and measure elevations from the floor at each point of support.

As the conveyor system proceeds onto another floor or into another building or room, a new elevation will be measured from the floor at that point. This new elevation will then become the reference for subsequent elevations.

When installing an overhead system, the first elevation is measured from the floor and becomes the reference elevation point until a change in elevation is shown on the layout. Any new elevation is also measured from the floor and becomes the new reference point. The process is repeated each time an elevation change occurs.

CAUTION

- Consult the building architect or a structural engineer regarding ceiling loading or structural limitations of the building if any conveyor section is ceiling hung.

Component Orientation

Using your conveyor system layout drawing and the numbers on the I.D. tags on each component, position and orient the conveyor sections. You must know:

- The direction of product flow
- The elevation height
- Charge and discharge end beds

IMPORTANT! Do not make alterations to the equipment without consulting with user's representative and MHS Conveyor. Unauthorized modifications to the equipment may impair its function, create a hazardous condition, affect its useful life and/or void the warranty.



Establishing Conveyor Flow

Standard IntelliROL beds are supplied as either RH or LH flow. Looking down from above and facing the IntelliROL bed with the slave O-rings on the opposite side and the driver card close to you, with the product conveying to the right, the bed is considered a RH flow bed. Using the same position as noted above and with the product conveying to the left, the bed is considered a LH flow bed. The identification label described under Parts Inventory & Identification has all of the information required to identify the piece of equipment.

Supporting Arrangements

Floor Supports

All IntelliROL bed side channels are punched to match hole spacing for MHS Conveyor standard floor supports. Install bolts used to attach the standhead to the frame so the nut is on the bottom. Standhead bolts should be left finger tight while the conveyor is being assembled and aligned.

Floor supports are ordered by nominal height range, which is the dimension from the floor to top of the support. Conveyor elevations are shown on the layout by top-of-roller elevations. This difference must be recognized when setting the support elevations. IntelliROL conveyor is 6 5/16" from top-of-support to top-of-rollers with a 7 1/2" deep channel. (Rollers mounted low in frame.)

It is important that conveyor frames be installed level. Floor supports will accommodate normal irregularities in the floor surface. Adjustment for elevation in floor supports is accomplished with metal-on-metal bolt clamping force. To achieve the support's stated load rating, it is necessary to tighten the elevation adjustment bolts (3/8" diameter) to 23 lbs. of torque.

Supports should always be installed in the vertical position, and any variations due to conveyor pitch or floor slope will be compensated for in the pivoting standhead of the support.

Anchoring

Anchoring in concrete floors is accomplished by drilling into the floor and inserting the suitable anchor bolt. The hole diameter and depth must be in accordance with the anchor bolt manufacturer's instructions.

Anchor intermediate floor supports with two anchor bolts, one through each support foot plate using minimum 3/8" diameter anchor bolts. For floor supports over 5' high or when supporting drives, use 1/2" diameter anchor bolts. Stagger anchors from front hole on one side to rear hole on opposite side. Anchor bolts for equipment subject to impact loads should be a minimum of 1/2" diameter.

 WARNING	
	<ul style="list-style-type: none">• Place a bolt through the frame and support immediately with finger tight nut. This will prevent the frame from falling off the support, if bumped, and causing injury.

Curve Support Points

The curve illustration indicates proper support locations for curves of various degrees and widths. The dots illustrate the support connecting point to the conveyor. The dark

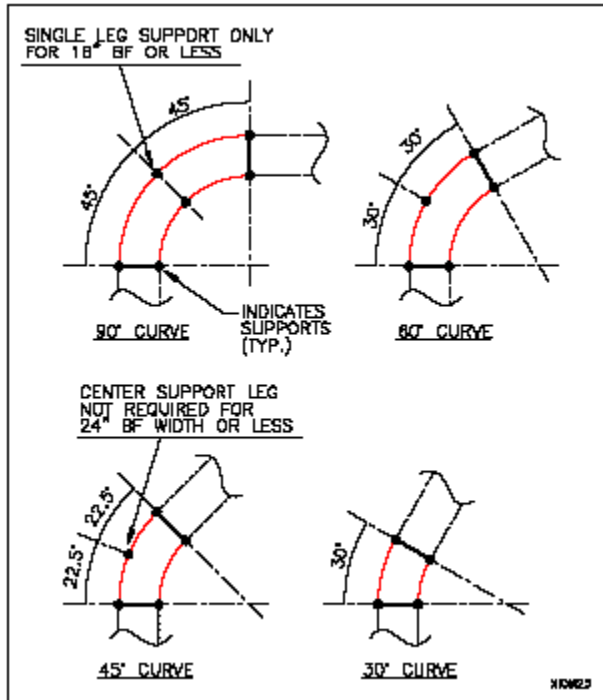

line between dots indicates a full support with crossmember or ceiling hanger cross tube. A single dot on the outside center of the curve indicates only the outer curve rail is supported with either a ceiling hanger drop at that point or a single leg floor support.

If a full width support with crossmember is supplied where only a dot is indicated, use the full support. The illustration below is minimum supporting arrangement.

Knee Braces

Stability along the conveyor length is achieved with knee braces. Braces resist stresses caused by direction of product flow, drives, stops and starts. Every support does not require bracing. Braces

are used at the ends of straight runs and approximately every 30' in between. Braces should be located toward the discharge end (DOWNSTREAM) side putting them in tension. Starting the conveyor puts opposite stresses on the supports, which is resisted by installing a brace near the drive toward the receiving end (UPSTREAM).

For best results the angle between the knee brace and frame should not exceed 45 degrees, or be less than 30 degrees. On short supports where a small angle results, the knee brace may need to be shortened.

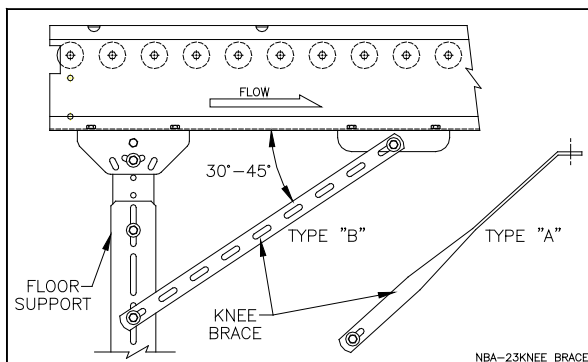
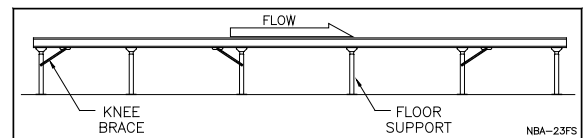

Type "C" braces (not shown) use two type "B" braces overlapped and bolted together for extended length when conveyor height is 48" or more.

Diagonal Sway Brace (floor support)

Floor support sway bracing consists of one 1-1/2" x 1-1/2" structural angle and mounting hardware.

Application: Due to natural side to side movement of line-shaft conveyor, a diagonal sway brace has been designed to reduce side movement in the standard floor support. Side movement is most prevalent in long straight lines which are not side braced by adjoining conveyors, curves, etc. or where they cannot be braced to columns, machinery, or other conveyors. This is more noticeable when the conveyor elevation is greater than its width. One brace can be mounted to every third or fourth support diagonally across the support with the low end on the opposite side of every other brace (alternate orientation). The holes in the support uprights need to be field drilled.

If excessive oscillation persists after bracing has been added, it may be the result of harmonics. This can occur when the conveyor operating speed generates vibrations with a frequency at or near the conveyor's natural frequency of its structure. This rare condition normally occurs between 85 FPM and 120 FPM. It may be minimized by adding more bracing or by either increasing or decreasing conveyor speed.

Sometimes it is better not to add a brace at the drive location. Some experimentation may be required.

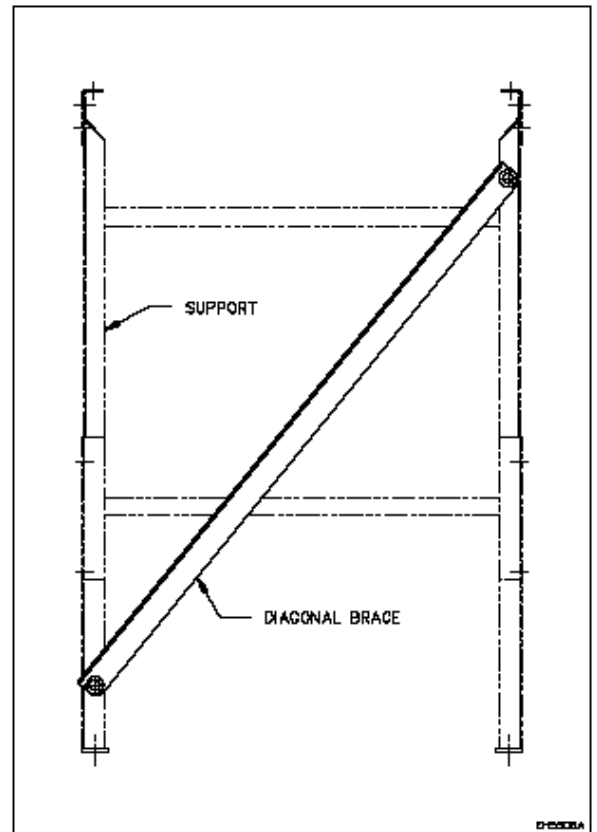

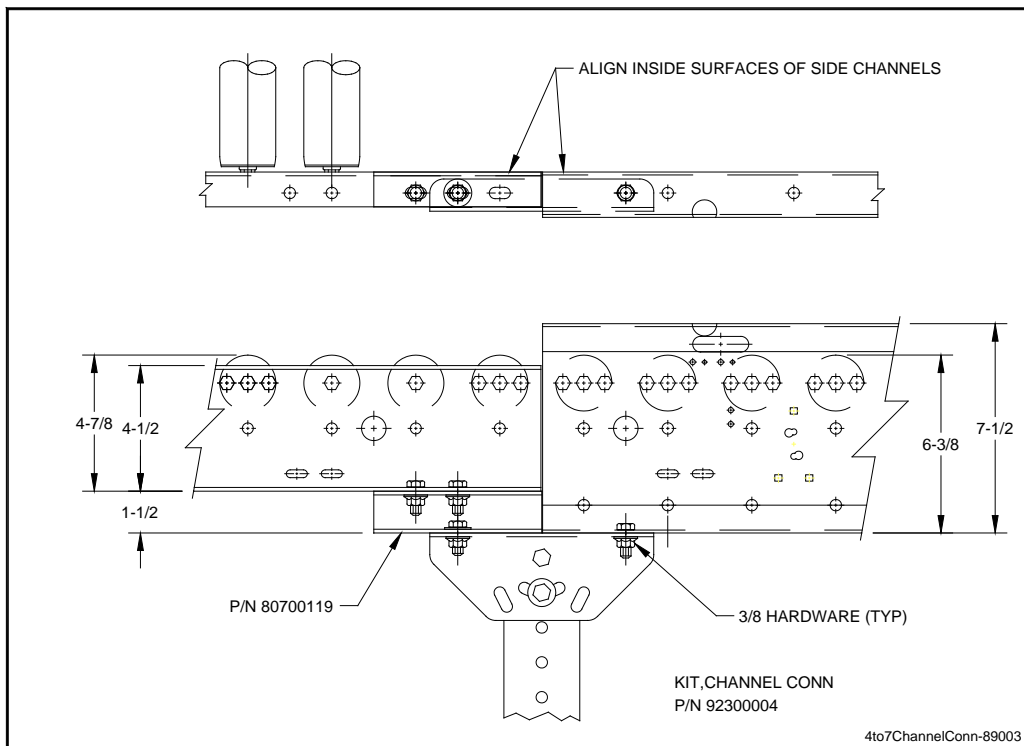
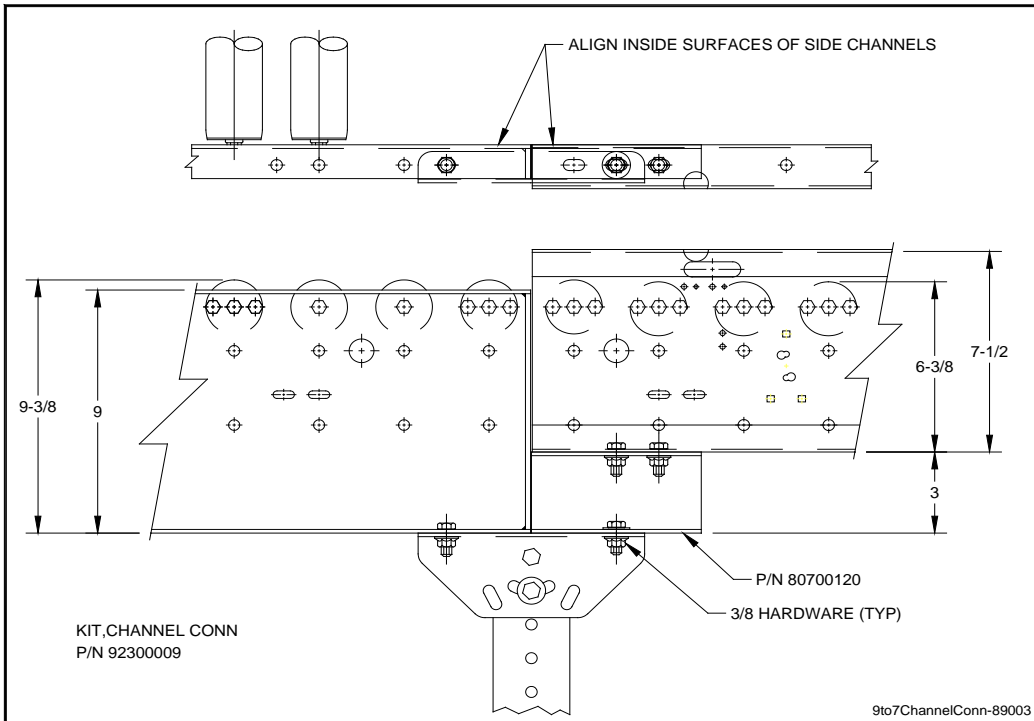

CRUZ®channel to XenoROL® Channel Connections

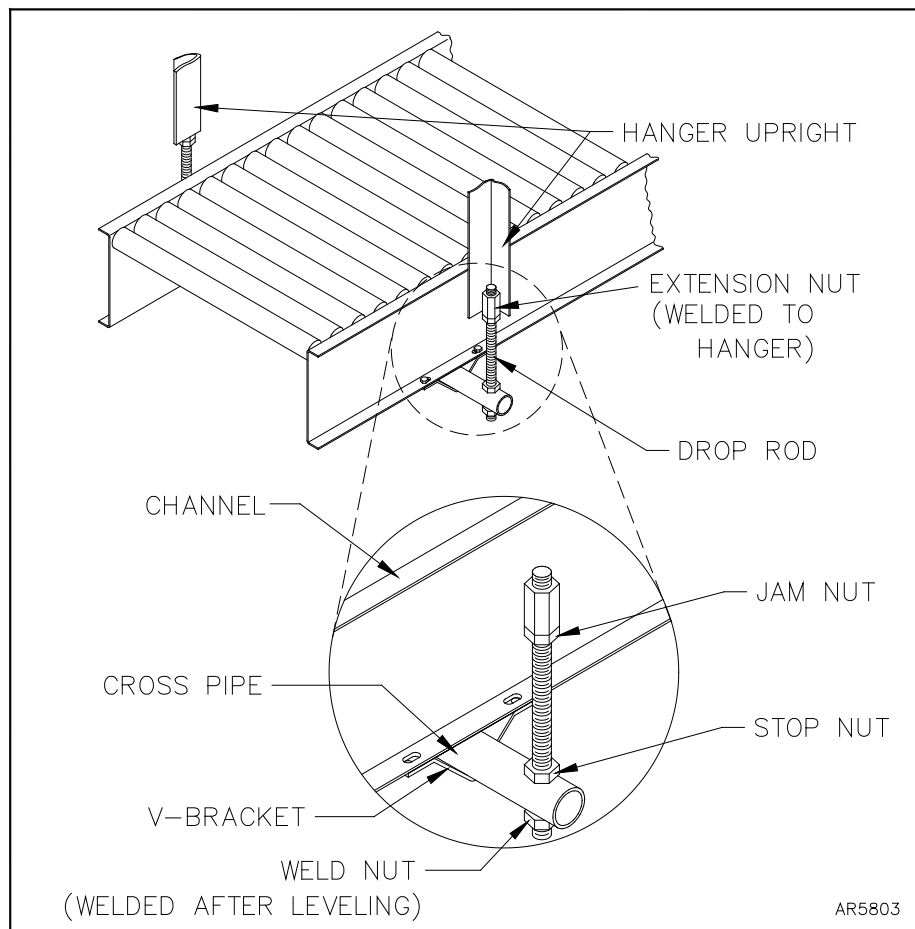

Ceiling Hangers





Drop rods and nuts are optional. The extension nut is welded into the angle hanger upright during installation.

 WARNING	
	<ul style="list-style-type: none"> Consult the building architect or a structural engineer regarding ceiling loading or structural limitations of the building for sizing header steel.

Cross pipes, V-brackets and flat strap connectors are provided with ceiling hangers. Threaded 3/4" rod and attaching nuts are available as an option. Bed connectors are recommended with all ceiling hanger applications.

If hanger uprights are field fabricated, they should be a minimum of 1-1/2" x 1-1/2" x 3/16" angle.

 WARNING	
	<ul style="list-style-type: none"> Consult your distributor or a structural engineer to determine what size hangers should be used to support your maximum anticipated load.

After hanger uprights are installed and the heavy extension nuts welded to angle hangers, thread the drop rods into the extension nuts. Thread the jam nuts and stop nuts on the drop rods far enough up the rods to allow installation and adjustment of the cross pipe.

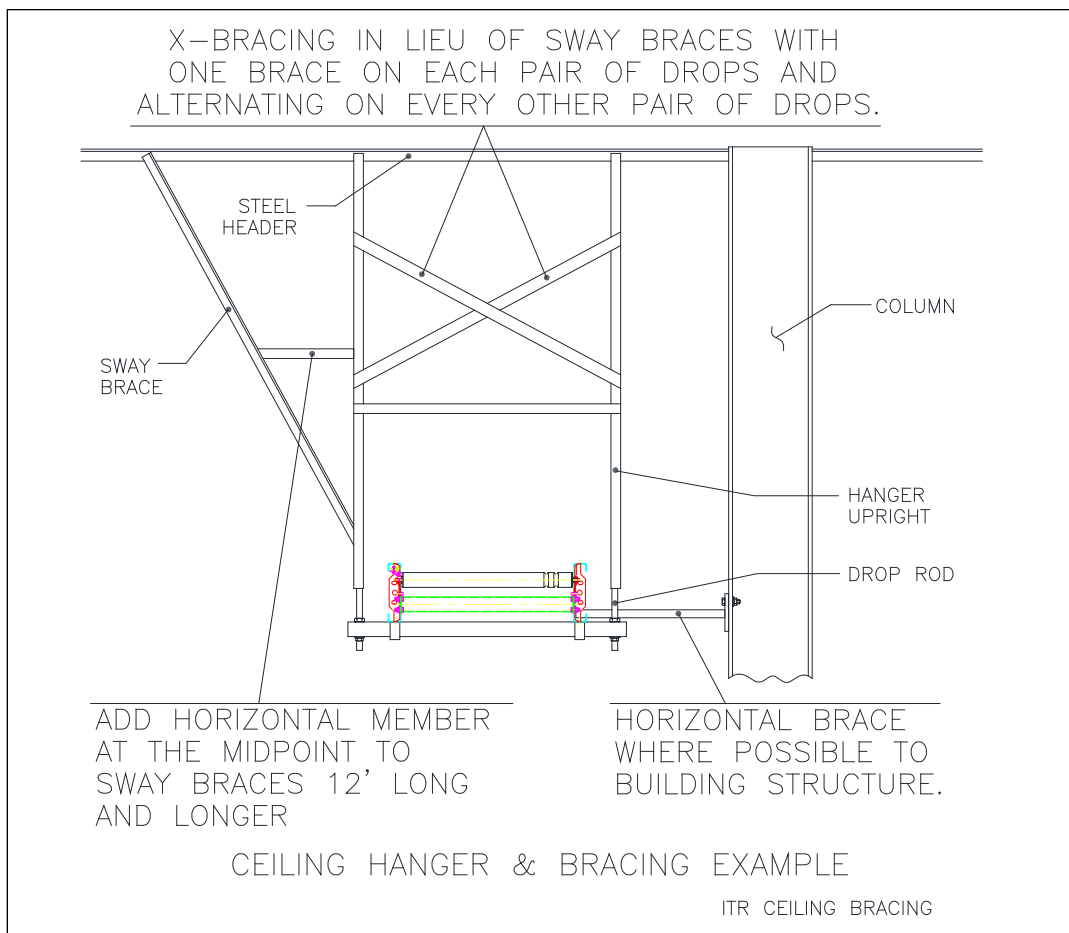

While still on the floor, loosely attach cross pipe, V-brackets, flat strap connectors and bed connector to one end of a bed section. Hoist the bed section between the drop rods guiding the rods through the mounting holes in the cross pipe. Thread the weld nuts on the drop rods to support the bed. Weld the weld nuts to the drop rods to prevent loosening. Hoist the next bed section into place and connect it using the flat strap connectors and V-brackets. Level the bed lengthwise and side to side by threading the

drop rods up or down by using a wrench on the weld nuts. Tighten the jam nuts against the extension nuts and the stop nuts against the crosspipe. Continue for the length of the conveyor.

Sway Bracing (ceiling hanger)

1. Sway bracing should be a minimum of 1-1/2" x 1-1/2" x 3/16" angle.
2. Sway bracing is secured to the hanger upright near the conveyor support and extended upward at an angle of approximately 30 degrees from the hanger upright. The sway brace angle should not be over 45 degrees to the upright. When hangers are installed adjacent to building columns, a horizontal brace may be installed securely to the column.
3. Hanger uprights over 12'-0" in length must have horizontal bridging angles connected between the upright and the sway brace at approximately the half-way point.
4. Sway bracing should be installed on every third hanger (maximum of 30'-0" centers).
5. If sway bracing cannot be placed on the outside of the uprights, alternate X-bracing between every other pair of uprights.
6. Additional bracing should be used:
 - Before and after curves
 - At drives
 - At product diverting points

Anchoring ceiling hangers

Open Building Steel

The following references are from the American Institute for Steel Construction manual (AISC).

Welding of auxiliary steel (stringers or headers) to building steel is prohibited.

Drilling and bolting to building steel is not recommended and will be done only with the customer's written permission.

Clamping of stringers or headers to building trusses will normally be done only at panel points. Specific customer permission and load calculations by a qualified engineer are necessary to safely clamp between panel points.

Headers when used for short spans, such as between roof purlins, will be securely clamped to building steel. Stringers, when used between headers, may be welded or bolted to the headers directly or with suitable angle clips.

Concrete Ceilings

Accomplish anchoring by drilling into the concrete ceiling and inserting suitable anchor bolts. The hole diameter and depth must be in accordance with the lag bolt manufacturer's instructions. Anchor each hanger with four bolts (two per upright) minimum size 1/2" diameter. Consult your distributor or structural engineer to determine your needs.

 WARNING	
	<ul style="list-style-type: none">• Do not use explosive type anchors

For heavier concentrated loads like drives or points where movement or vibration can occur, use 5/8" diameter through bolts with backup plates. If this is not permissible or possible, then header steel must be installed using several anchor bolts to spread the load.

Wood Joists/Beams

Hangers may be attached directly to the joists providing the load rating of the building will permit. Attach hangers to the vertical side of the joist in two places, one above the other, on each hanger upright. Anchoring is accomplished by drilling through the joist in the upper position and using a 1/2" diameter through bolt with a backup plate or heavy washer. A 1/2" diameter lag screw may be used in the lower position.

When a header is required to support the load, it must bridge across two or more joists. This header will be attached to each joist in the manner specified in paragraph above. Hanger uprights should then be bolted or welded securely to the headers.

NOTE

Consult a structural engineer to determine which method should be used for your load requirements.

Concrete/Masonry Walls

Equipment may be supported from concrete walls through use of suitable bolts and anchors or by bolting through the wall if the condition of the wall or load dictates it. A 1/2" diameter through bolt should be used with a backing plate.

Ceiling-hung conveyor header steel should be installed well ahead of the conveyor frame installation to minimize congestion.

Adjustable Channel Guard Rail to CRUZ®channel Options

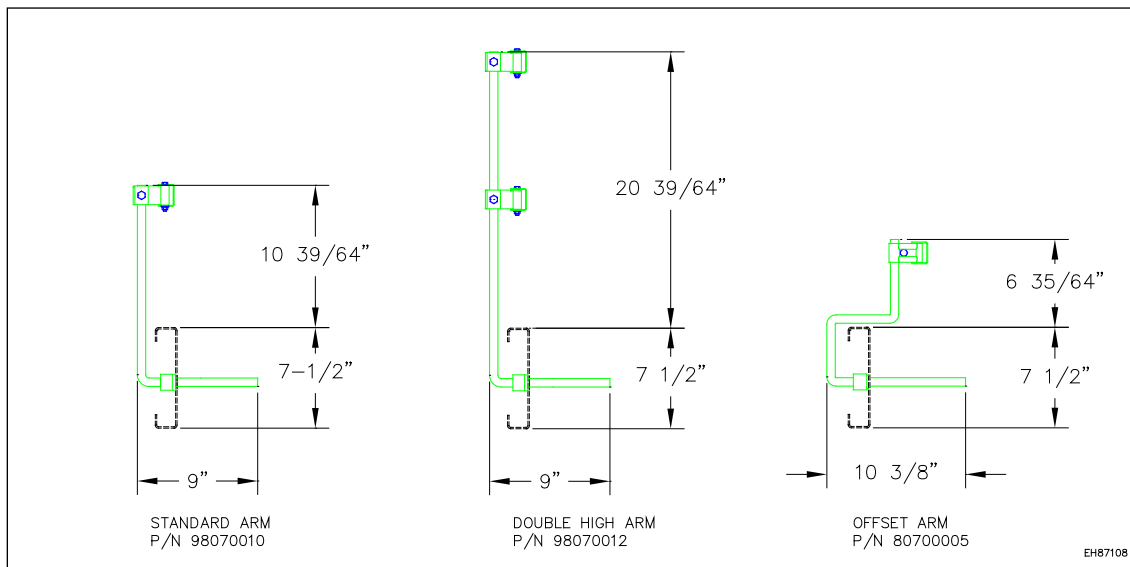

CAUTION

- Before adding X-braces between uprights, check for adequate product clearance.

Air Supply Requirements

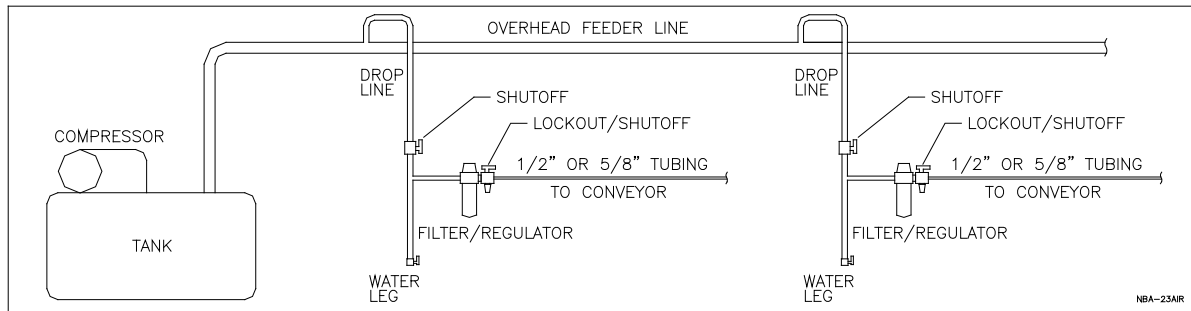

General

Every conveyor system is unique, with its own specific requirements. Therefore, the following is a general guide.

Main Feeder

Air velocity through the main feeder piping can be kept smooth with lower losses using large diameter pipe with minimum bends and restrictions. Standard weight black pipe or copper is suitable for plumbing the compressed air overhead to all points of use.

Air Drops

MHS Conveyor recommends using 3/4" pipe on air drops for high flow and low pressure loss. The drop is terminated with a drain at the bottom. A tee located prior to the drain branches off to the conveyor. This branch line must contain a lockout/shutoff. A shutoff must also be located in the drop before the branch tee. OSHA Rule 29, CFR1910.147 requires energy sources (air drops) be turned off and capable of being locked or labeled with a warning tag.

IMPORTANT! If your air compressor uses a synthetic oil, a coalescing filter plus a regular filter of 5 micron is required. Synthetic oils will shrink the seals in pneumatic devices and valving.

Low Pressure Switch

An air pressure switch is recommended to be installed into the pneumatic circuit to detect a drop in air pressure below required levels. If pressure drops below approximately 35 PSI, the conveyor system will shut off.

Pneumatic Requirements

- Regulator pressure set at 40-45 PSI.
- Maximum conveyor length each way from regulator is 100'. Locate regulator in center of conveyor for maximum length.
- MHS Conveyor supplied low pressure regulator is required.
- Low pressure switch to be set at 35 PSI.

- In high humidity or low temperature, use air dryer.
- Use 5 micron filter.
- Lockout/shutoff valve to be provided by air system installer.

Electrical

General

The ITR product line is based on the following features and concepts:

- Itoh Denki motorized rollers and drivercards (CB-016 or HB-510) are standard.
- Cables are pre-engineered with the appropriate connectors.
- All channels are designed to accommodate any of the electrical variations.
- All CRUZchannels including C6 channels have welded connectors and CRUZbelt tube crossmembers.
- AutoCAD blocks for the ITR product lines are available upon request.

ITR Variations

ITR^{HB} – HB-510

- Standard product offered in Core Technologies.
- ZPA conveyor based on the Itoh HB-510 drivercard and FE-60 motorized roller.
- Can be a standalone conveyor. It does not require an input from a control panel, etc. to operate.
- CRUZ channel with weld bed connectors and integrated photoeyes.
- 24" and 30" zones with 3" centers are standard.
- A start signal can be used to activate the conveyor when using run on demand.

ITR^{CB} – CB-016

- Standard product offered in Core Technologies.
- Transportation conveyor based on the Itoh CB-016 drivercard and FE-60 motorized roller.
- Each drivercard is wired to power, but requires a 24VDC run signal (provided by others) to run each card.
- C6 channel with welded bed connectors.
- 30" roller groups with 3" centers are standard.

Straight Bed Construction

- Straight bed, curve, & spur channels – CZ or C6.
- C6 channel standard has 1.625" flanges.
- C6 channel top flange are punched at ends for transition bezel (1120166) from C6 to CRUZchannel.
- All channels come with a welded bed connector.
- Straight bed crossmembers are tube style as used in the CRUZbelt product line.
- Straight beds will be punched for HB-510 and CB-016 cards in every zone.

- Straight beds with 30" zones will have holes for mounting the motorized roller and mounting bracket in the middle of the zone and at the discharge end of the zone for roller and belted versions respectively.

Curve Construction

- Inside radius standard will be 36".
- Curve channels will be similar to NBC, notched with 10ga strips welded in.
- No tangents, arc only.
- All channels come with a welded bed connector.
- CB-016 and/or HB-510 cards located on the outer channel with an adapter plate (CB-016 Plate: E0006531, HB-510 Plate: E0006532).
- Sensor location is 6" from the end of the zone.

UBT Construction

- 3'-4" OAL is a standard.
- C6 channels are 10ga construction with welded bed connectors.
- Transfer belt centers are based on 4" as a standard.
- ERS or Pick Zone Module transfer belt centers are based on 3.25".
- ERS or Pick Zone Module transfers require 1.75 diameter carrier rollers.
- For UBT's with sensors, PE's (ZL2) & reflectors are mounted in brackets at corners of the transfer. As a standard, there will always be four PE's and reflectors. See Figure 8.1 for a view of the basic 4-sensor (bi-directional) UBT.
- UBT's are universal LH/RH. The power harness is installed for LH flow, but can be reversed by cutting two wire ties and flipping cable end for end at installation.

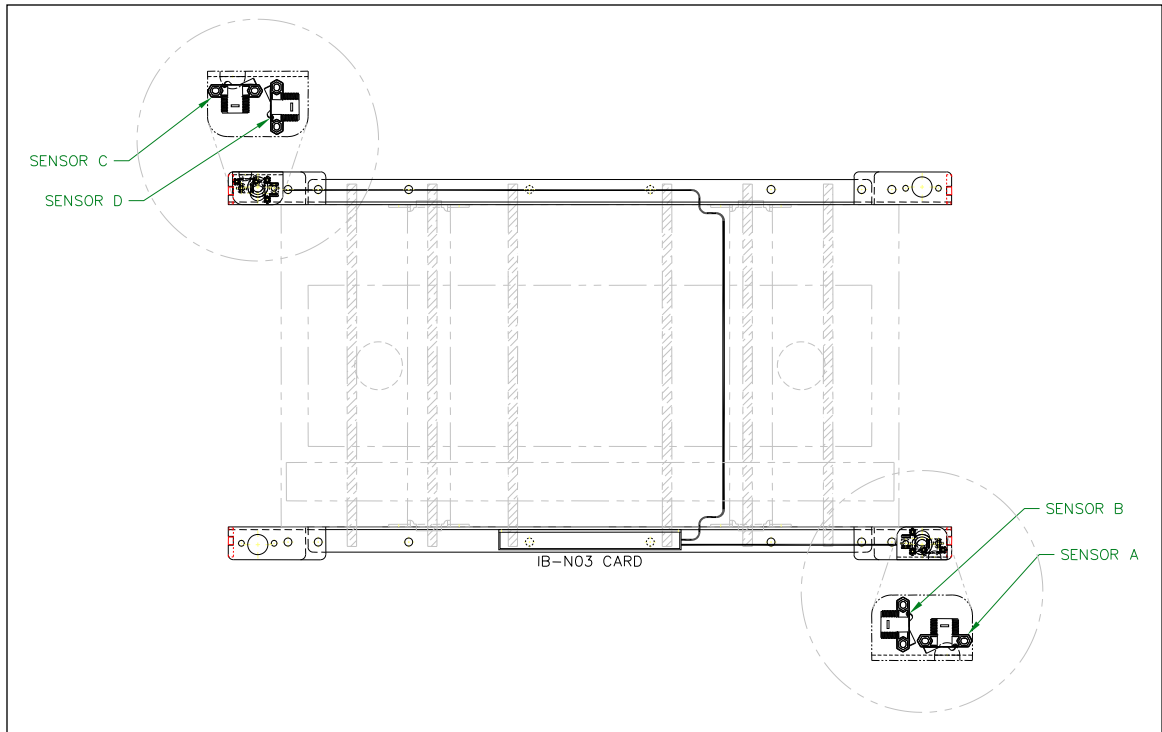

Figure 1 – UBT Sensor Location

Power Merge Construction

- ITRCB is the only version of a standard power merge (Transportation only).
- The C6 channel with weld bed connectors are a standard.
- Standard spur angles are 30 & 45 degree RH/LH beds.
- Spur BF is 6" wider than abutting bed.

Wheel Divert Construction

- ITRCB is the only version of a standard wheel diverter (transportation only)
- The C6 channel with weld bed connectors are a standard.
- Standard spur angle is a 30 degree RH/LH beds.
- Spur BF is 6" wider than abutting bed.
- Diverter has 4 independently acting rows. Each divert wheel row is controlled by a separate solenoid. Having separate solenoids allows for independent control to raise or lower each wheel row independently and increasing the throughput rate.
- Solenoids are included as a standard. 120 VAC or 24 VDC voltages are available.

Spur Construction

- ITRCB is the only version of a standard spur. (transportation only).
- The C6 channel with weld bed connectors are a standard.
- Standards created for 30 & 45 degree RH/LH spurs.
- Each spur has a conversion cable to allow for proper power and control signal flow.

ITRHB Electrical Components

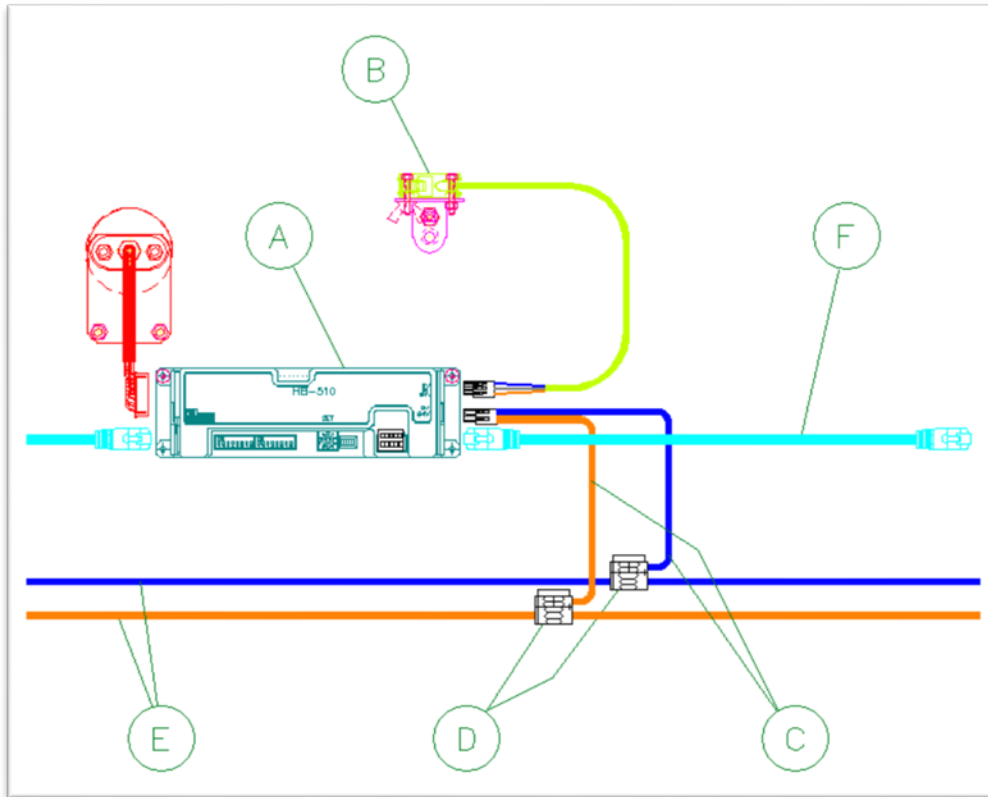

Figure 2 – HB-510 Drivercard

- A HB-510 item (includes hardware and 5-pin connector): 1137754
- B Photoeye (ZL2 eye with 3-pin connector mounted to bracket with reflector in bag): 1137686
- C Power tap cable (for short distances < 6"): 1139543
- D Scotchlok connectors (connect power tap to power harness): 3M567
- E Power harness: See table below
- F Cat5E Communication Cable

Table 1: Power Harness

Item No.	Description
1102286	HARNESS,POWER,10AWG,10.5'
1102287	HARNESS,POWER,10AWG,8'
1102288	HARNESS,POWER,10AWG,5.5'
1102289	HARNESS,POWER,10AWG,3'

Item No.	Description
E0034025	CABLE,CAT5E 3' GRAY
E0034026	CABLE,CAT5E 5' GRAY
E0034027	CABLE,CAT5E 7' GRAY
E0030796	CABLE,CAT5E 10' GRAY
E0009905	CABLE,CAT5E 14' GRAY
E0009904	CABLE,CAT5E 25' GRAY

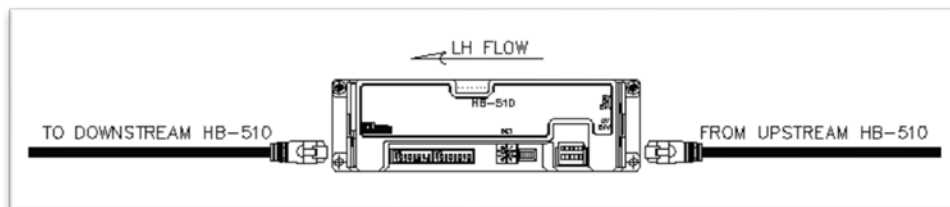

Figure 3 – HB 510 Communication Cable LH Flow

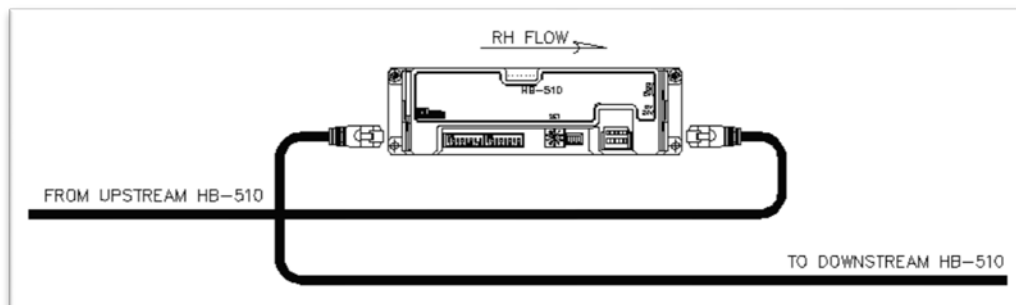

Figure 4 – HB-510 Communication Cable RH Flow

- Cat5E cable (Upstream cable goes in right side of card, and downstream cable comes out the left side of the card, RH generally requires a longer cable). See diagram below :

ITRCB Electrical Components

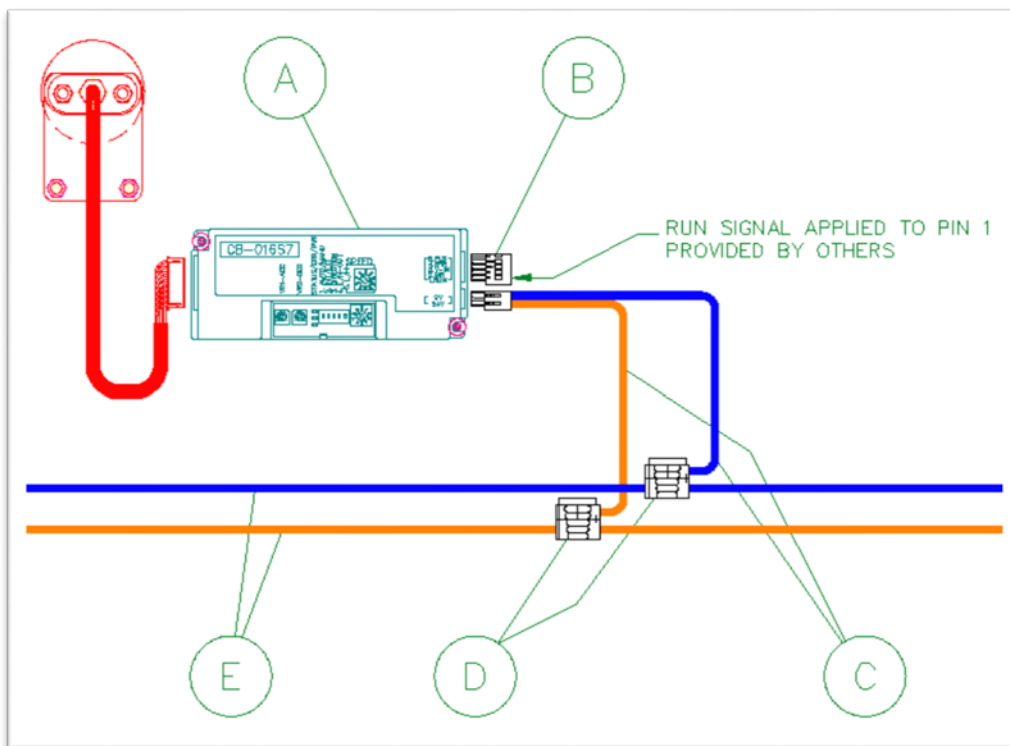

Figure 5 – CB-016 Drivercard

- Ⓐ CB-016 item (with hardware): 1139716
- Ⓑ 5-Pin connector (for run signal connection): 733105
- Ⓒ Power tap cable (for short distances < 6"): 1139543
- Ⓓ Scotchlok connectors (connect power tap to power harness): 3M567
- Ⓔ Power harness – see power harness table

ITR Electrical Components

- Motor extension cables

Item No.	Description	Description 2	Description 3
1138704	CABLE,MOTOR EXTENSION,600MM	ITOH M-F-EXT-9PIN-600	USE W/ CB-016 OR HB-510
1138705	CABLE,MOTOR EXTENSION,1200MM	ITOH M-F-EXT-9PIN-1200	USE W/ CB-016 OR HB-510
1138706	CABLE,MOTOR EXTENSION,2700MM	ITOH M-F-EXT-9PIN-2700	USE W/ CB-016 OR HB-510

Typical Bed Description

Descriptions

Straight Bed:

BED, (i.)BF ITR (ii.)-C (iii.) - (iv.) - (v.) X (vi.)
 (vii.), (viii.), (ix.)MR, (x.)
 __BF Width (16,22,28,34)
 ITR__ ITR Variation (HB, CB, 2, T, K, DN, ER)
 C_ Channel (Z or 6)
 __ Rollers/Belt (R or B) and centers (3,2,etc)
 __ Zone (24, 30, etc.) Do not use with ITRCB
 __'__ OAL
 __ Hand (RH/LH)
 F_ __ Roller type & speed code (E-60 standard)
 _MR Number of motorized rollers

Example: BED, 22BF ITRHB-CZ-R3-30 X 10'0"
 RH, FE-60,4MR
 (Cruz channel with 3"RC, 30" zone, 10'0" OAL, HB-510 card)

Curve:

CURVE, (i.)BF ITR (ii.)-C (iii.)- (iv.) (v.)
 (vi.), (vii), (viii.)MR
 __BF Width (16,22,28,34)
 ITR__ ITR Variation (HB, CB, 2, T, K, DN, ER)
 C_ Channel (Z or 6)
 __ Angle (90, 60, 45, 30)
 _Z Number of zones, Do not use with ITRCB
 __ Hand (RH/LH)
 F_ __ Roller type & speed code (E-60 standard)
 _MR Number of motorized rollers

Example: CURVE, 22BF ITRHB-CZ-60 1Z
 RH, FE-60,2MR
 (Cruz channel, 60° curve, 1 zone with 2 motorized rollers, HB-510 card)
 UBT/Transfer: UBT, (i.)BF ITR (ii.)-C6X (iii.) BD (v.)
 LH/RH, (vi.), (vii.)
 __BF Width (16,22,28,34)
 ITR__ ITR Variation (CB, 2, T, K, DN, ER)

- _ ' _ " OAL (standard 3'4", but 3'0" available as a special)
- _ S Number of strands (normally 6 (4"RC) or 5/7 (3.25"RC))
- F _ _ Roller type & speed code (E-60 standard)
- _ MR Number of motorized rollers

Example: UBT, 22BF ITRCB-C6X3'4" BD 6S
LH/RH, FE-60,3MR

Other Examples:



- PM, 22BF ITRCB-C6-R3-30X7'6", RH, FE-60,5MR
 - WD, 22BF ITRCB-C6-R3-30X7'6", RH, FE-60,6MR, 4-ROW,
 - SPUR, 22BF ITRCB-C6-R3-45, RH, FE-60,2MR
- Figures

Drive and Slave O-rings



Item #	Description	Centers	Application
E0005536	ORING,3/16 DIA X 9.5" HT BLUE	3	Straight Slave PM Slave Spur Slave
D0601626	ORINGS,3/16 DIA X 7-3/4" HT BLUE	2	Straight Slave PM Slave Spur Slave
1127703	ORING,3/16DIA X 11" HT BLUE	4	Straight Slave PM Slave Spur Slave
1103665	ORING,3/16DIA X 13" HT BLUE	N/A	Spur (Twisted)
1102845	ORING,.210 DIA. X 11.5 HT RED	N/A	Curve Delta
1102748	ORING,.210 DIA X 9.4 HT RED	3	Curve Slave
1133173	ORING,88A .218 X 20-1/2, BLK	N/A	UBT (Twisted)

Electrical

General



 WARNING	
	<ul style="list-style-type: none"> • All electrical controls must be installed, wired and connected by a licensed electrician only. • All motor controls and wiring must conform to the National Electrical Code as published by the National Fire Protection Association and approved by the American National Standards Institute, Inc. Since specific electrical codes vary from one area to another, be sure to check with proper authorities before starting.

The electrical voltage of motorized rollers will be stamped on a metal name plate affixed to one end of the roller. This voltage should be checked to see that it matches the output voltage of your power supply. Consult the appropriate MHS Conveyor wiring diagram for the proper connections. If a single speed three phase motorized roller runs the wrong direction, two leads must be switched to reverse rotation.

 WARNING	
	<ul style="list-style-type: none"> • Do not connect the driver card to any other voltage than the one listed on its name plate.

NOTE

All controls equipment is covered by the original manufacturer's equipment warranty.

 WARNING	
	<ul style="list-style-type: none"> • All safety devices, including wiring of electrical safety devices, shall be arranged to operate in a “fail safe” manner. That is, if power failure or failure of the device itself would occur, a hazardous condition must not result.

Conveyor Controls - Safety Guidelines

The following are basic conveyor controls safety guidelines for common controls equipment.

START-UP WARNING HORN - If all conveyor being started cannot be seen from the start pushbutton location, then an audible warning device is required. It could be a horn, buzzer or bell. It must be loud enough to be heard at any point on the conveyor being started. It should sound for a duration of five seconds after the start pushbutton is pushed, prior to the conveyor starting. Any auxiliary equipment such as vertical lifts, turntables, etc. must be included in the warning circuitry.

START PUSHBUTTON - Start pushbutton should be the flush type or guarded such that inadvertently leaning against them will not actuate them. They should be provided with a legend plate clearly defining which conveyors will be started.

STOP PUSHBUTTON - Stop pushbutton should be the extended type such that any contact with it is sufficient to stop the conveyor. They should have a legend plate defining which conveyors will be stopped.

EMERGENCY STOPS - All locations where high voltage motors are used and an operator is working must be protected by an emergency stop.

Emergency stop devices should also protect high pedestrian areas where high voltage motors are used. Actuating an emergency stop must dropout the start circuit and all electrical power, requiring restarting the system using the start pushbutton provided.

All locations where low voltage motors are used (under 50 volts) and an operator is working need to be evaluated on a case-by-case basis as to whether they require an emergency stop circuit. This requirement also applies to high pedestrian areas.

Preventive Maintenance

General

Preventive maintenance will save expensive downtime, wasted energy costs and increase life of components. An accurate record keeping system will track component servicing history.

Periodic maintenance intervals may vary with load, speed, hours of operation, ambient temperature, humidity, etc. Intervals can be established by fairly frequent maintenance at first, and then lengthens the intervals as justified by observation of need based on history. The following schedule is based on 5 days per week, 8 hours per day operation under normal conditions.

Daily

- Listen to everything for unusual noises or vibration.
- Visually inspect to see that conveyor sections are clear and free of debris.
- Check to see that all safety guards are in place.
- Check for loose bolts or parts.
- Listen for air leaks.



Weekly

- Check for proper PSI on air regulators.
- Check air filter bowls for accumulated water.

 WARNING	
	<ul style="list-style-type: none"> • Prohibit walking or riding on conveyor by anyone. • Care should be taken when servicing any conveyor to prevent accidental injury. • All moving parts are potentially dangerous.

Air Systems

The best preventive maintenance for any air operated device is clean air. Dirty air will make pneumatic devices sticky, and they will not operate properly. To ensure the continued performance of filters, monitor filter / regulator bowl drain every week. To manually drain the bowl, push the push button at the bottom of the bowl. Let all accumulated liquid drain until you hear air escaping.

 WARNING	
	<ul style="list-style-type: none">• Do not perform maintenance on the conveyor until the start-up controls, including motor safety switches, are locked out and cannot be turned by any person other than the one performing the maintenance.• If more than one member of a crew is working on the conveyor, EACH CREW MEMBER MUST HAVE A LOCK ON THE POWER LOCK OUT. The air pressure must be turned off to the work area. All pneumatic devices must be de-energized to prevent accidental cycling of the device.• Check the loosened parts have been retightened and all guards reinstalled.• Make sure personnel are clear of all conveyor equipment before restarting the system.

Parts Identification

This section is used to identify parts that may require replacement during the life of the conveyor.

Parts which specifically pertain to IntelliROL are included with illustrations.

A "Recommended Spare Parts List" is published for all conveyor orders of \$20,000 or more. This spare parts list is sent to the purchaser approximately (2) weeks after the order is received. It includes part numbers, description, pricing and recommended quantities to be kept on hand for maintenance.

If you are unable to locate this document another may be obtained by contacting the MHS Conveyor Lifetime Services Department at 231-798-4547 or Fax 231-798-4549.

CB-016 Drivercard

CB-016 DRIVERCARD

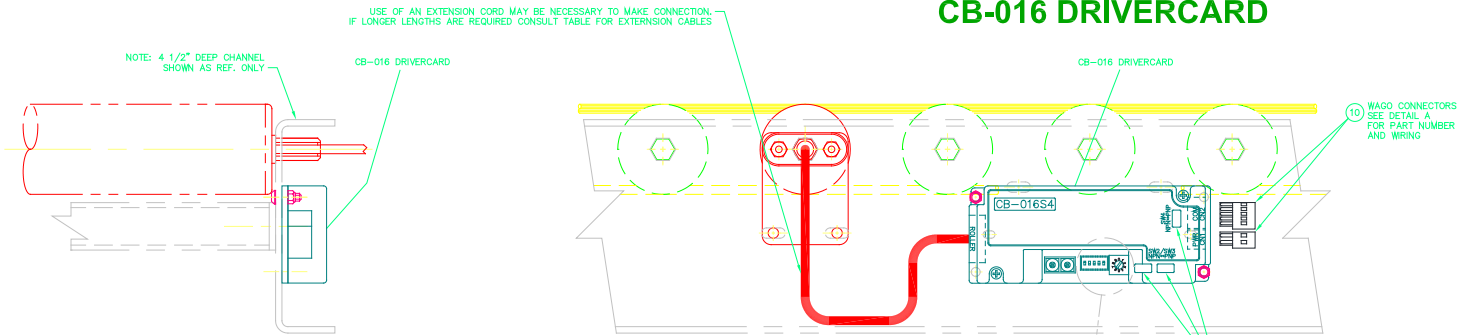

SPEED CHANGE TABLE											
			FP ROLLERS (FPM)			FE ROLLERS (FPM)		FS ROLLERS (FPM)			
3	VOLTAGE INPUT	DIP SW1-5	ROTARY SWS	100,140, 190,255	20,30, 45,55	5,8, 10,15	70,100,14 0180,210	20,30,45 55,60	5,8,10, 15,17	20,30, 45,55	5,8, 10,15
4	9.55-9.95	ON	9	971.9	214.1	56.8	698.9	197.5	55.4	214.1	56.8
5	9.05-9.45	ON	8	890.9	196.3	52.1	640.6	181.0	50.8	196.3	52.1
6	8.55-8.95	ON	7	850.4	187.3	49.7	611.5	172.8	48.5	187.3	49.7
7	8.05-8.45	ON	6	809.9	178.4	47.3	582.4	164.5	46.2	178.4	47.3
8	7.55-7.95	ON	5	769.4	169.5	45.0	553.3	156.3	43.9	169.5	45.0
9	7.05-7.45	ON	4	728.9	160.6	42.6	524.1	148.1	41.6	160.6	42.6
10	6.55-6.95	ON	3	647.9	142.7	37.9	465.9	131.6	36.9	142.7	37.9
11	6.05-6.45	ON	2	607.4	133.8	35.5	436.8	123.4	34.6	133.8	35.5
12	5.55-5.95	ON	1	566.9	124.9	33.1	407.6	115.2	32.3	124.9	33.1
13	5.05-5.45	ON	0	526.4	116.0	30.8	378.5	106.9	30.0	116.0	30.8
14	4.55-4.95	OFF	9	485.9	107.0	28.4	349.4	98.7	27.7	107.0	28.4
15	4.05-4.45	OFF	8	445.4	98.1	26.0	320.3	90.5	25.4	98.1	26.0
16	3.55-3.95	OFF	7	404.8	89.2	23.7	291.1	82.3	23.1	89.2	23.7
17	3.05-3.45	OFF	6	364.3	80.3	21.3	262.0	74.0	20.8	80.3	21.3
18	2.55-2.95	OFF	5	324.0	71.4	18.9	233.0	65.8	18.5	71.4	18.9
19	2.05-2.45	OFF	4	283.5	62.5	16.6	203.9	57.6	16.2	62.5	16.6
20	1.55-1.95	OFF	3	243.0	53.6	14.2	174.8	49.4	13.9	53.5	14.2
21	1.05-1.45	OFF	2	202.5	44.6	11.8	145.6	41.1	11.5	44.6	11.8
22	0.55-0.95	OFF	1	162.0	35.7	9.5	116.5	32.9	9.2	35.7	9.5
23	0.05-0.45	OFF	0	121.5	26.8	7.1	87.4	24.7	6.9	26.8	7.1

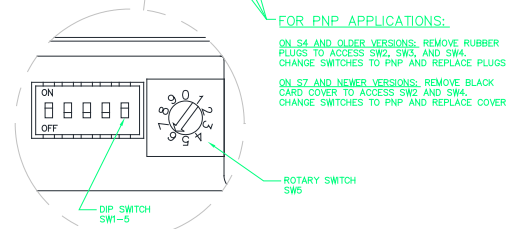

NOTES:
 (1) SW2, SW3, & SW4 ARE USED TO DETERMINE NPN/PNP OPERATION MODE. TO SWITCH OPERATION, REMOVE RUBBER PLUG AND SET SWITCH.
 (2) CARDS COME FROM FACTORY SET FOR NPN OPERATION.

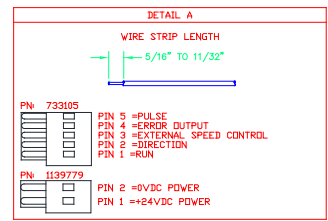

CB-016 DRIVERCARD

Transportation Straight Bed

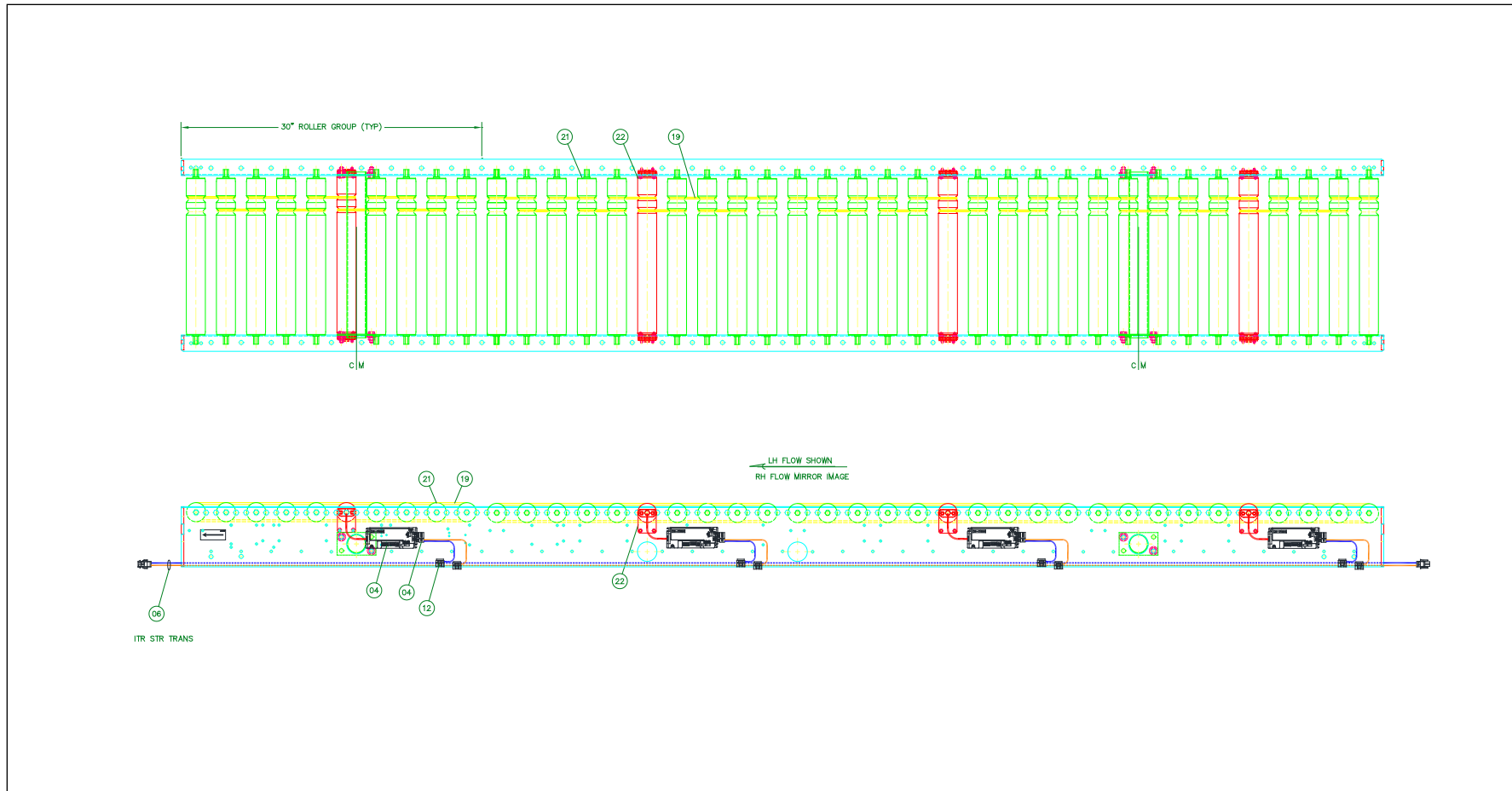

TRANSPORATION STRAIGHT BED					
Balloon	Description	Width & Item #			
		16 BF	22 BF	28 BF	34 BF
4	DRIVERCARD, ITOH CB-016S7	1116036			
---	HARNESS, POWER BROWN & BLUE 14 AWG WITH MALE/FEMALE CONN (NOT BF SPECIFIC)	3'-0" L	5'-6" L	8'-0" L	10'-6" L
		1102289	1102288	1102287	1102286
---	CABLE, MOTOR EXTENSION ,600, 1200, OR 2700 MM LONG	REFERENCE MOTOR EXTENSION CABLE TABLE			
12	CONNECTOR, IDC SCOTCHLOK 567 10-12AWG RUN, 14-18AWG TAP	3M567			
19	ORING, 3/16 DIA X 9.5" HT BLUE	E0005536			
22	ROLLER, ITR __BF 2G ITOH	1138722	1138723	1138729	1138725
21	ROLLER, __ITR 1.9PLTD PRBG	E0002412	E0002413	E0002414	E0006220

Transportation Curve

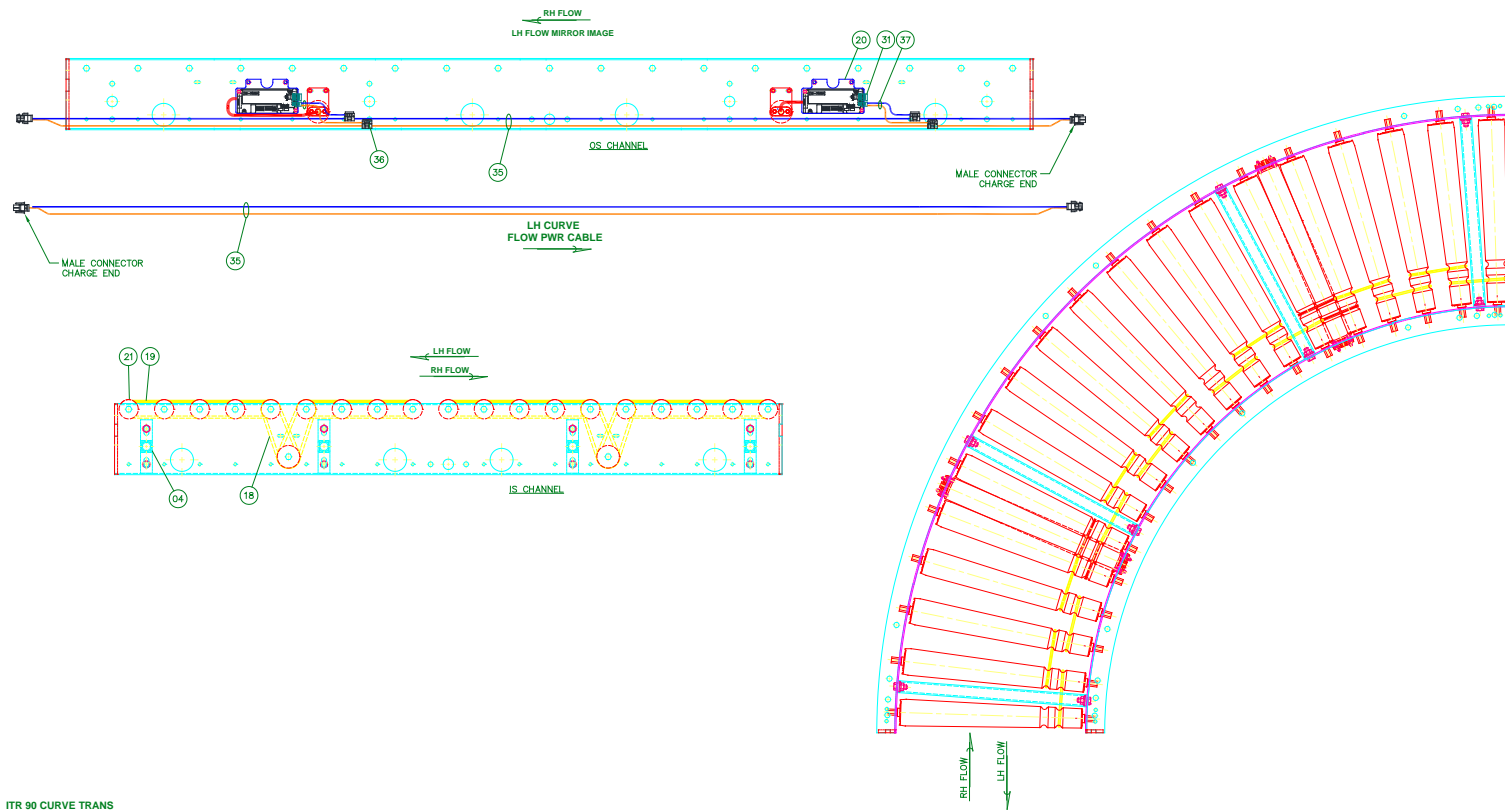

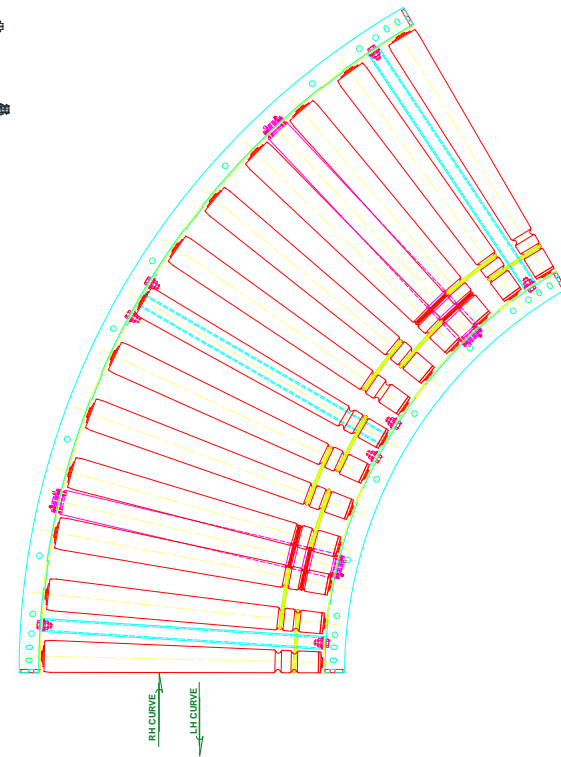
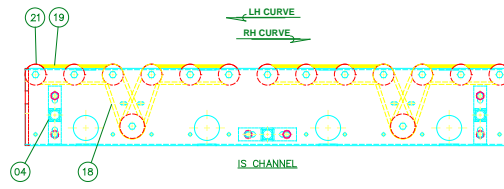
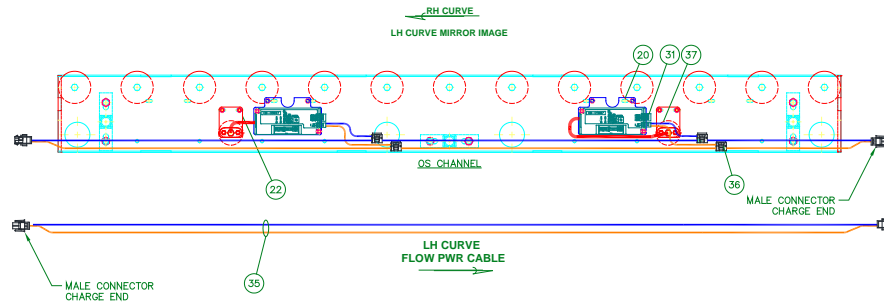

ITR 60 TRANS CURVE

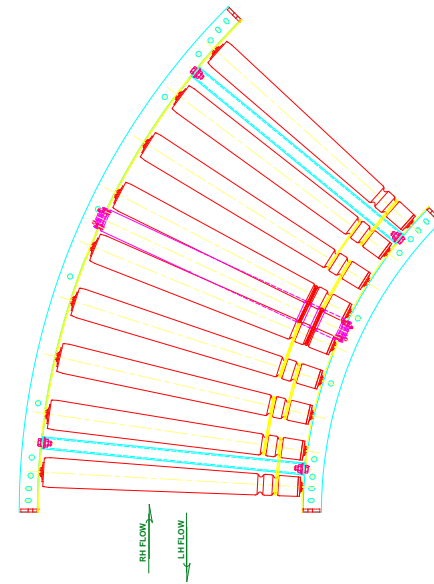
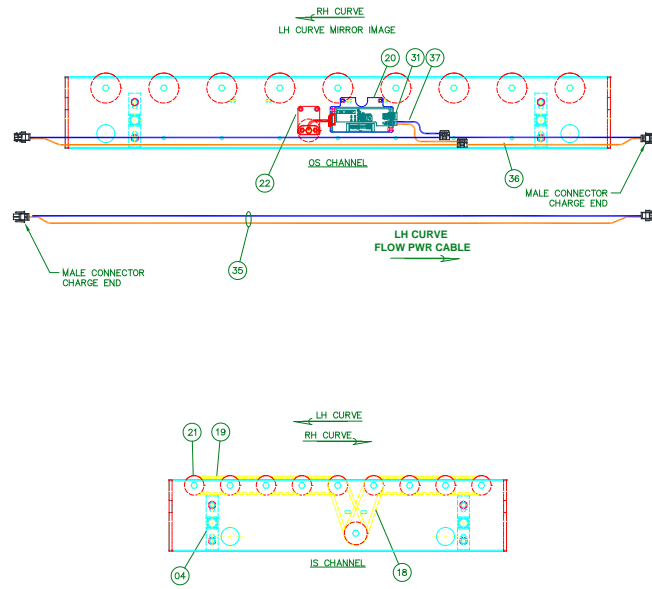

ITR 45 TRANS CURVE

TRANSPORTATION CURVE					
Balloon	Description	Width & Item #			
		16 BF	22 BF	28 BF	34 BF
4	DRIVERCARD, ITOH CB-016S7	1116036			
---	HARNESS, POWER BROWN & BLUE 14 AWG WITH MALE/FEMALE CONN (NOT BF SPECIFIC)	3'-0" L 1102289	5'-6" L 1102288	8'-0" L 1102287	10'-6" L 1102286
---	CABLE, MOTOR EXTENSION ,600, 1200, OR 2700 MM LONG	REFERENCE MOTOR EXTENSION CABLE TABLE			
---	CABLE, CAT5E ___ FT GRAY	REFERENCE COMMUNICATION CABLE TABLE			
12	CONNECTOR, IDC SCOTCHLOK 567 10-12AWG RUN, 14-18AWG TAP	3M567			
19	ORING, .210 DIA X 9.4 HT RED	1102748			
18	ORING, .210 DIA. X 11.5 HT RED MARKED WITH 1 BLACK STRIPE	1102845			
22	ROLLER, ITR ___ BF 2G ITOH	1138722	1138723	1138724	1138725
21	ROLLER, ___ W TT ITR 2GRV PRBG	E0009900	E0009901	E0009902	E0009903

Spur 30

16BF 30 DEGREE SPUR

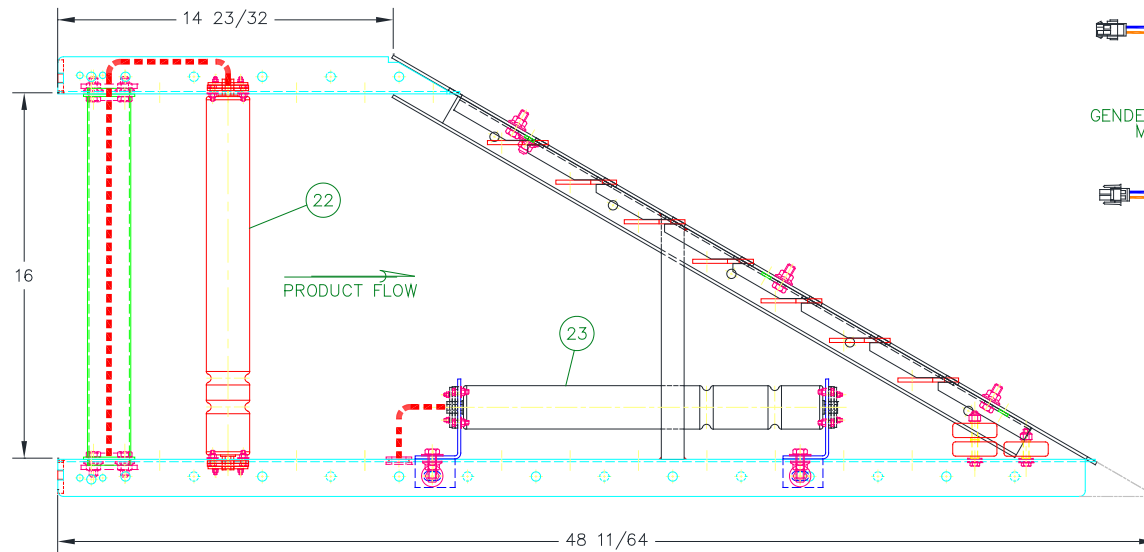

GENDER CHANGE HARNESS
FEMALE/FEMALE CONN.
PN: 1141549



GENDER CHANGE HARNESS
MALE/MALE CONN.
PN: 1141545

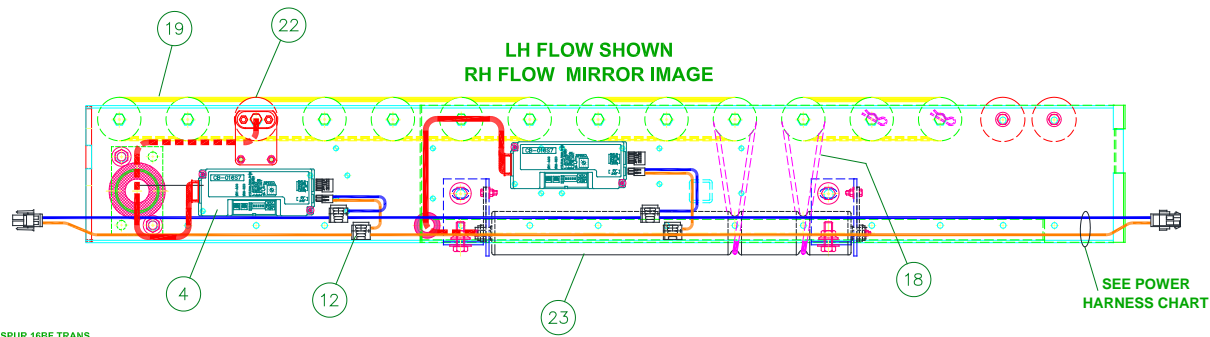

ITR 30 SPUR 16BF TRANS

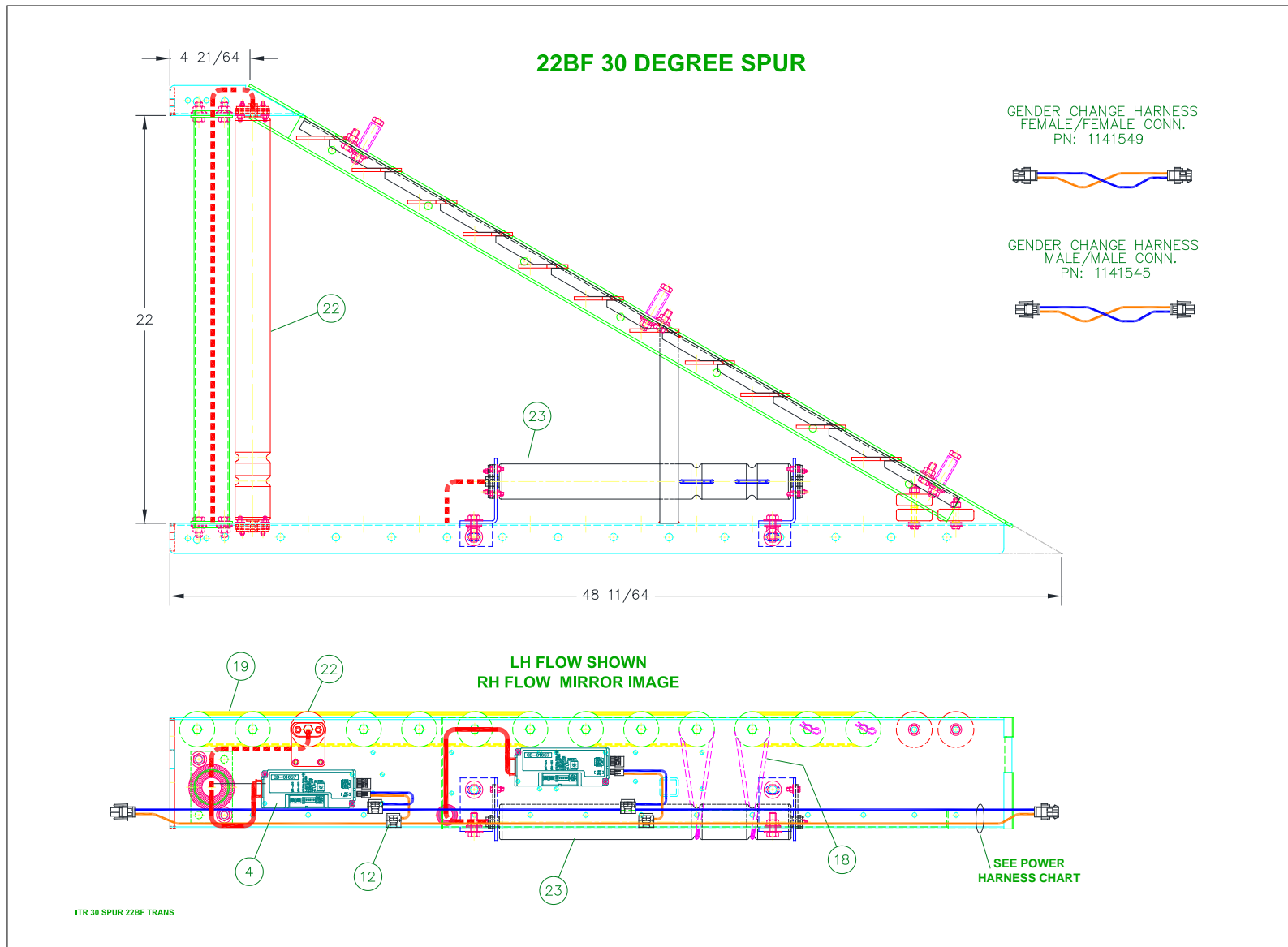

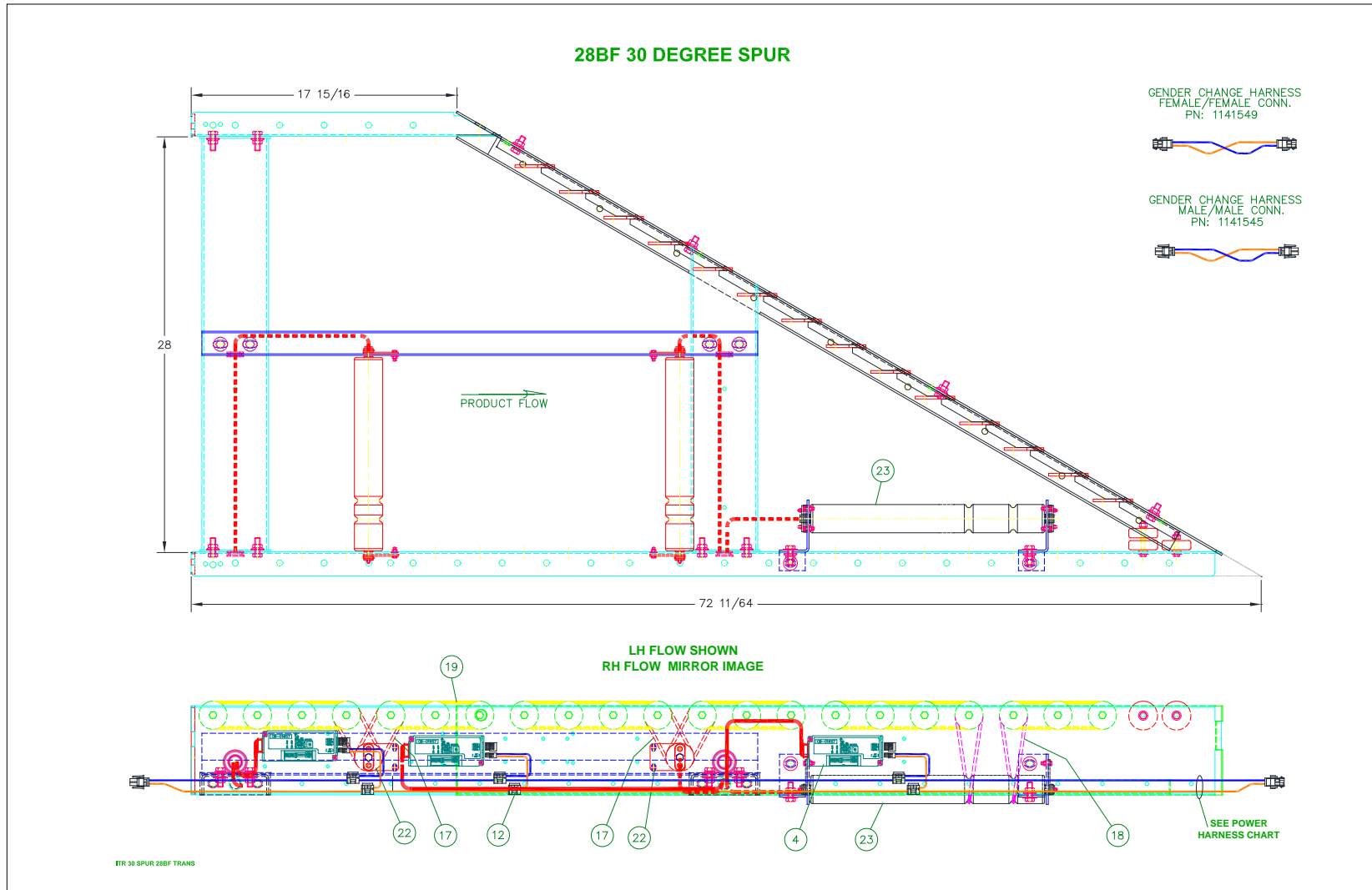

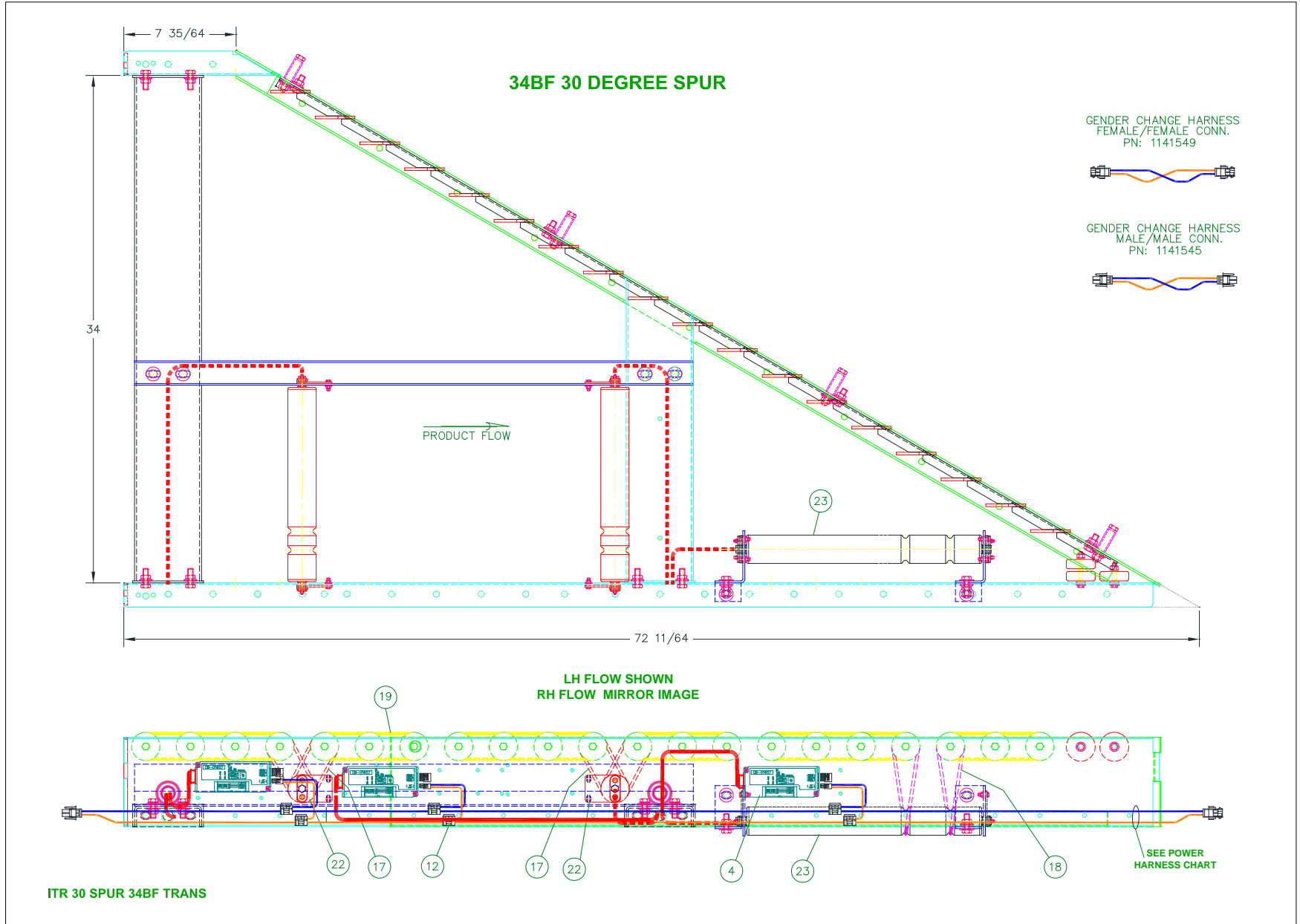

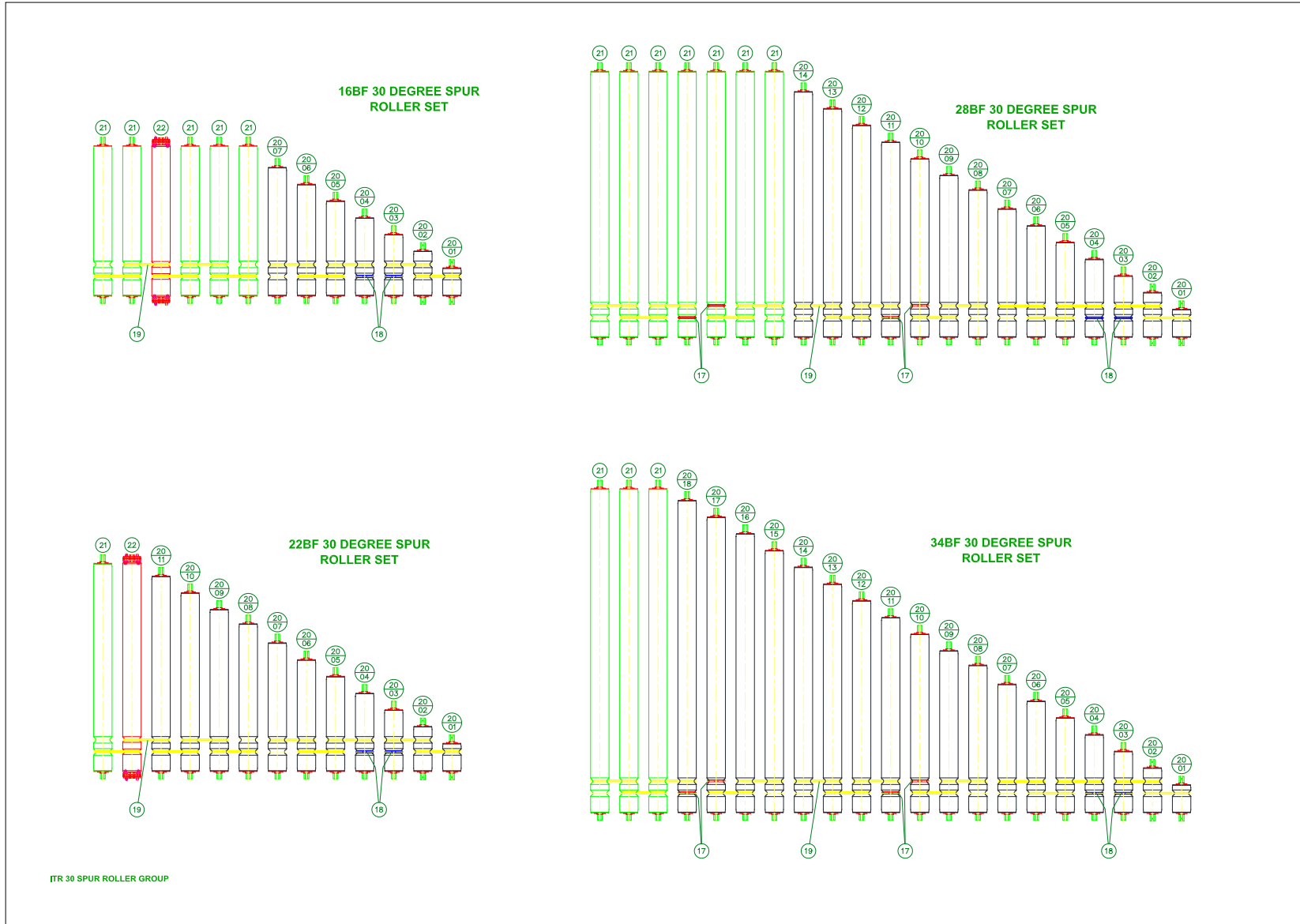

SPUR-30					
Balloon	Description	Width & Item #			
		16 BF	22 BF	28 BF	34 BF
4	DRIVERCARD, ITOH CB-016S7	1116036			
---	HARNESS, POWER BROWN & BLUE 14 AWG WITH MALE/FEMALE CONN (NOT BF SPECIFIC)	3'-0" L	5'-6" L	8'-0" L	10'-6" L
		1102289	1102288	1102287	1102286
12	CONNECTOR, IDC SCOTCHLOK 567 10-12AWG RUN, 14-18AWG TAP, 3M	3M567			
18	ORING, 3/16 DIA X 13" HT BLUE	1103665			
19	ORING, 3/16 DIA X 9.5" HT BLUE	E0005536			
---	CABLE, MOTOR EXTENSION ,600, 1200, OR 2700 MM LONG	REFERENCE MOTOR EXTENSION CABLE TABLE			
22	ROLLER, ITR __ BF 2G ITOH	1138722			1139545
23	ROLLER, 16 BF ITR SPUR 2G ITOH	1126586	1126586	1126586	1126586
21	ROLLER, __ ITR 1.9PLTD PRBG	E0002412	E0002413	E0002414	E0006220
24	ROLLER, ITR 3-3/8" BF PRBG NO AXLE	1143248	1143248	1143248	1143248
25	ROLLER, ITR 5-1/8" BF PRBG NO AXLE	1130834	1130834	1130834	1130834
20-01	ROLLER, 6-27/32 BF ITR 1.9PLTD PRBG	1131620	1131620	1131620	1131620
20-02	ROLLER, 8-9/16 BF ITR 1.9PLTD PRBG	1131621	1131621	1131621	1131621
20-03	ROLLER, 10-5/16 BF ITR 1.9PLTD PRBG	1143250	1143250	1143250	1143250
20-04	ROLLER, 12-1/32 BF ITR 1.9PLTD PRBG	1131622	1131622	1131622	1131622
20-05	ROLLER, 13-25/32 BF ITR 1.9PLTD PRBG	1131623	1131623	1131623	1131623
20-06	ROLLER, 15-1/2 BF ITR 1.9PLTD PRBG	NA	1131624	1131624	1131624
20-07	ROLLER, 17-1/4 BF ITR 1.9PLTD PRBG	NA	1143251	1143251	1143251
20-08	ROLLER, 18-31/32 BF ITR 1.9PLTD PRBG	NA	1131625	1131625	1131625
20-09	ROLLER, 20-11/16 BF ITR 1.9PLTD PRBG	NA	NA	1143252	1143252
20-10	ROLLER, 22-7/16 BF ITR 1.9PLTD PRBG	NA	NA	1131627	1131627
20-11	ROLLER, 24-5/32 BF ITR 1.9PLTD PRBG	NA	NA	1131628	1131628
20-12	ROLLER, 25-29/32 BF ITR 1.9PLTD PRBG	NA	NA	1131629	1131629
20-13	ROLLER, 27-5/8 BF ITR 1.9PLTD PRBG	NA	NA	NA	1143252
20-14	ROLLER, 29-3/8 BF ITR 1.9PLTD PRBG	NA	NA	NA	1131627
20-15	ROLLER, 31-3/32 BF ITR 1.9PLTD PRBG	NA	NA	NA	1131628
20-16	ROLLER, 32-13/16 BF ITR 1.9PLTD PRBG	NA	NA	NA	1131629

Spur 45

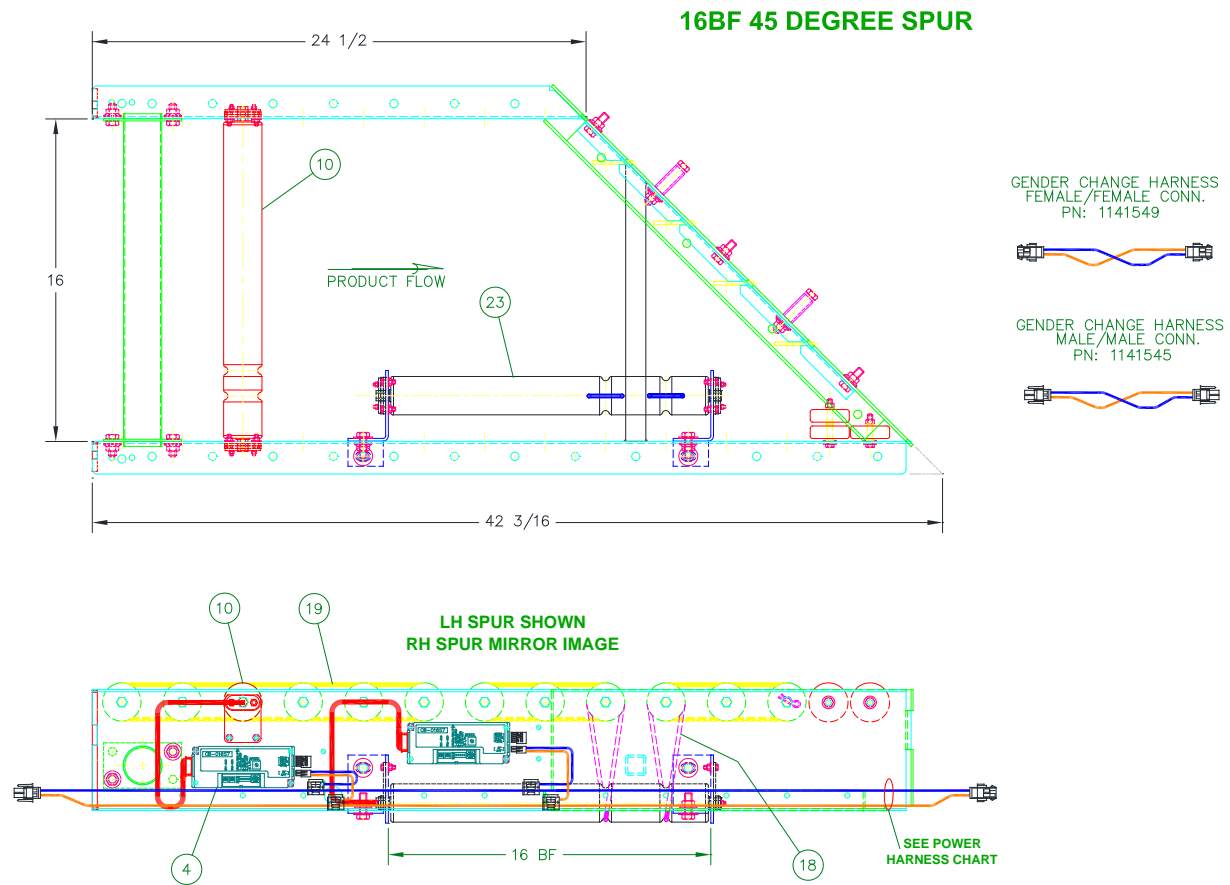

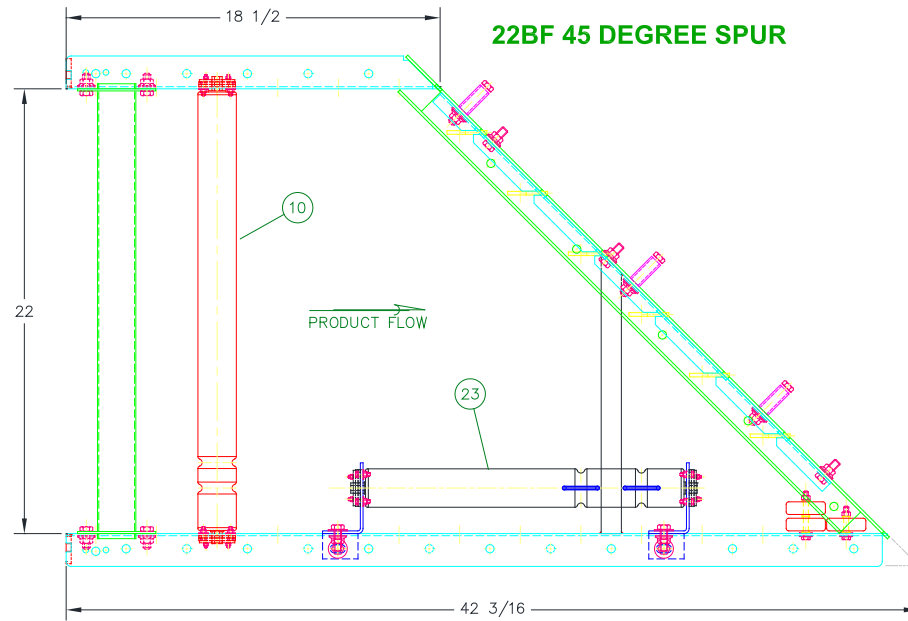

GENDER CHANGE HARNESS
FEMALE/FEMALE CONN.
PN: 1141549



GENDER CHANGE HARNESS
MALE/MALE CONN.
PN: 1141545

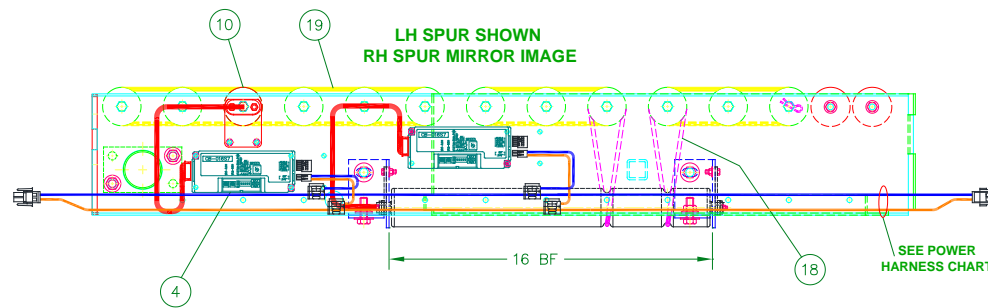

ITR 45 SPUR 22BF TRANS

28BF 45 DEGREE SPUR

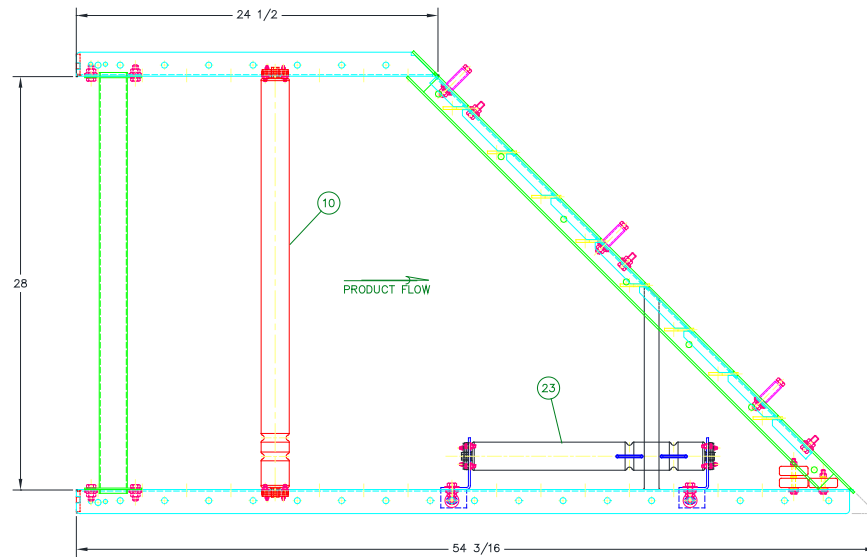

GENDER CHANGE HARNESS
FEMALE/FEMALE CONN.
PN: 1141549



GENDER CHANGE HARNESS
MALE/MALE CONN.
PN: 1141548

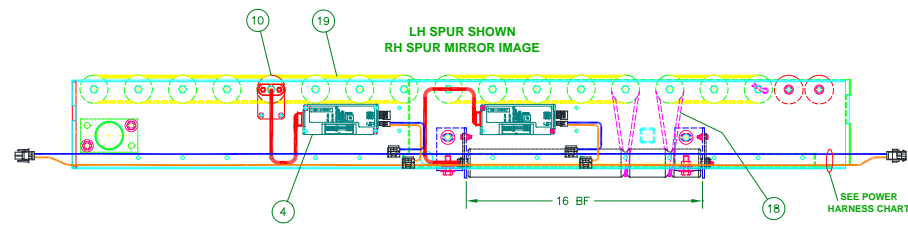

ITR 45 SPUR 28BF TRANS

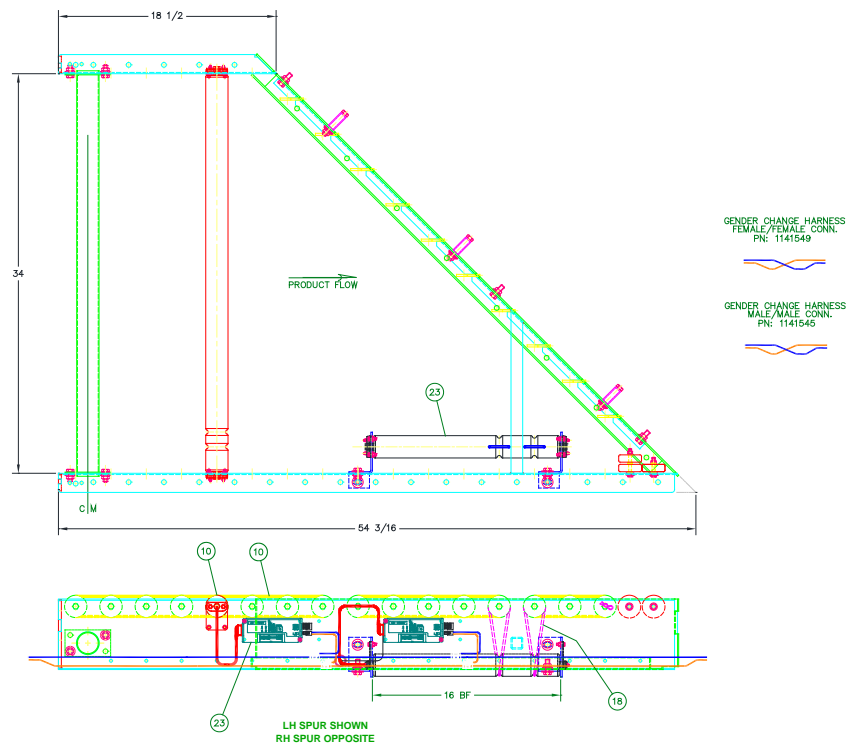

ITR 45 SPUR 34BF TRANS

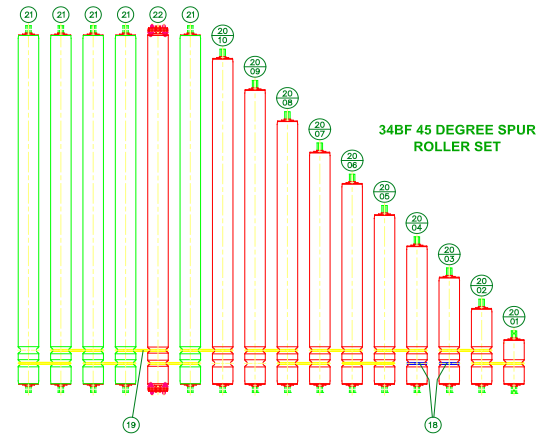
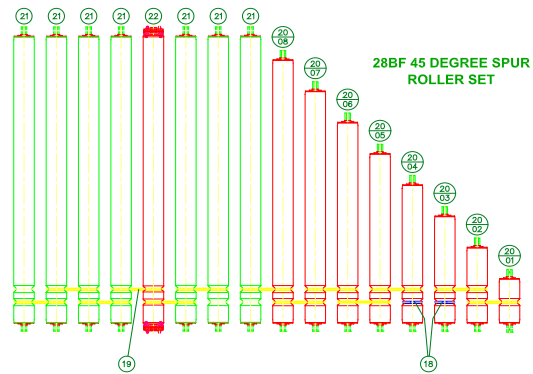
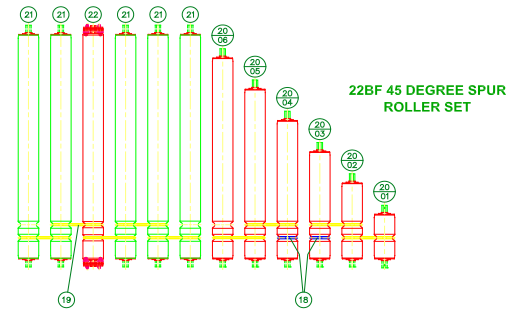
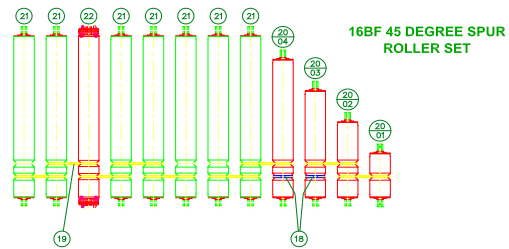

ITR 45 SPUR ROLLER GROUP

SPUR-45					
Balloon	Description	Width & Item #			
		16 BF	22 BF	28 BF	34 BF
4	DRIVERCARD, ITOH CB-016S7	1116036			
---	HARNESS, POWER BROWN & BLUE 14 AWG WITH MALE/FEMALE CONN (NOT BF SPECIFIC)	3'-0" L 1102289	5'-6" L 1102288	8'-0" L 1102287	10'-6" L 1102286
12	CONNECTOR, IDC SCOTCHLOK 567 10-12AWG RUN, 14-18AWG TAP	3M567			
18	ORING, 3/16 DIA X 13" HT BLUE	1103665			
	ORING, 3/16 DIA X 9.5" HT BLUE	E0005536			
---	CABLE, MOTOR EXTENSION ,600, 1200, OR 2700 MM LONG	REFERENCE MOTOR EXTENSION CABLE TABLE			
22	ROLLER, ITR __BF 2G ITOH PM486FE-60-544-D-24-FB-P2-KF	1138723	1138723	1138723	1138723
23	ROLLER, ITR SPUR 2G ITOH PM486FE-60-393-D-24-P2-OS-KF	1126586	1126586	1126586	1126586
21	ROLLER, __ITR 1.9PLTD PRBG	E0002412	E0002413	E0002414	E0006220
20-01	ROLLER, ITR 4-3/4" BF PRBG NO AXLE	E0003268	E0003268	E0003268	E0003268
20-02	ROLLER, 7-3/4 BF ITR 1.9PLTD PRBG	1144370	1144370	1144370	1144370
20-03	ROLLER, 10-3/4 BF ITR 1.9PLTD PRBG	1144371	1144371	1144371	1144371
20-04	ROLLER, 13-3/4 BF ITR 1.9PLTD PRBG	1144372	1144372	1144372	1144372
20-05	ROLLER, 16-3/4 BF ITR 1.9PLTD PRBG	NA	1144373	1144373	1144373
20-06	ROLLER, 19-3/4 BF ITR 1.9PLTD PRBG	NA	1144374	1144374	1144374
20-07	ROLLER, 22-3/4 BF ITR 1.9PLTD PRBG	NA	NA	1144375	1144375
20-08	ROLLER, 25-3/4 BF ITR 1.9PLTD PRBG	NA	NA	1144376	1144376
20-09	ROLLER, 28-3/4 BF ITR 1.9PLTD PRBG	NA	NA	NA	1144377
20-010	ROLLER, 31-3/4 BF ITR 1.9PLTD PRBG	NA	NA	NA	1144378

Power Merge w/30 Degree Spur

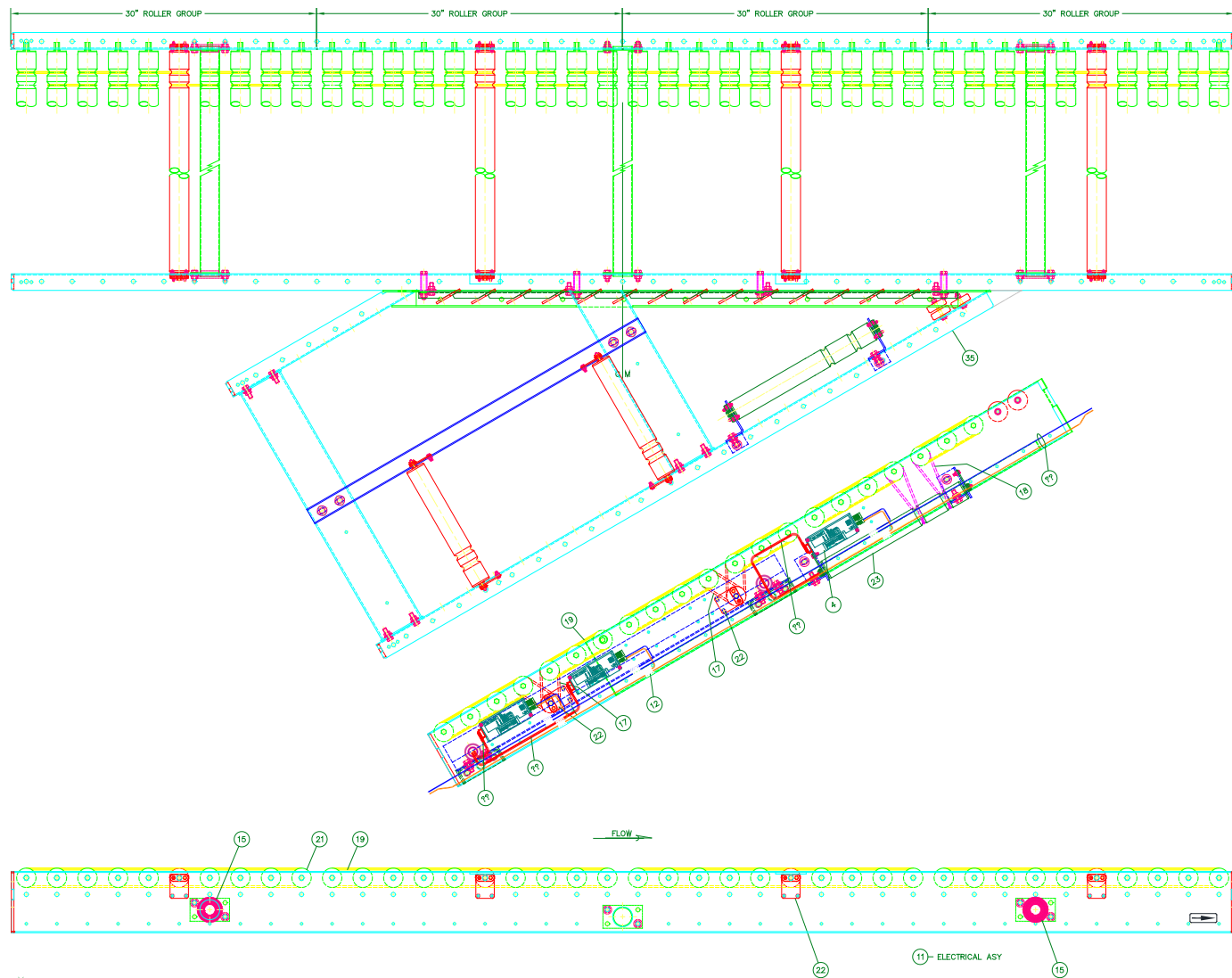

ITR 30 DEG PM

POWER MERGE W/30 DED SPUR					
Balloon	Description	Width & Item #			
		16 BF	22 BF	28 BF	34 BF
4	DRIVERCARD, ITOH CB-016S7	1116036			
---	HARNESS, POWER BROWN & BLUE 14 AWG WITH MALE/FEMALE CONN (NOT BF SPECIFIC)	3'-0" L	5'-6" L	8'-0" L	10'-6" L
		1102289	1102288	1102287	1102286
	CONN, ITOH CB-016 WAGO & HDWE 2-PIN + 5-PIN PAIR	1104417			
12	CONNECTOR, IDC SCOTCHLOK 567 10-12AWG RUN, 14-18AWG TAP	3M567			
	CONNECTOR, IDC SCOTCHLOK 562 10-12AWG RUN, 10-12AWG TAP	3M562			
	ORING, 3/16 DIA X 13" HT BLUE	1103665			
	ORING, 3/16 DIA X 9.5" HT BLUE	E0005536			
---	CABLE, MOTOR EXTENSION ,600, 1200, OR 2700 MM LONG	REFERENCE MOTOR EXTENSION CABLE TABLE			
	ROLLER, ITR_BF 2G ITOH	1138722	1138723	1138724	1138725
	ROLLER, ITR __BF 2G ITOH PM486FE-60-322-D-24-FB-P2-KF			1139545	
23	ROLLER, 16BF ITR SPUR 2G ITOH	1126586	1126586	1126586	1126586
19	ROLLER, __ITR 1.9PLTD PRBG	E0002412	E0002413	E0002414	E0006220
24	ROLLER, ITR 3-3/8" BF PRBG NO AXLE	1143248	1143248	1143248	1143248
25	ROLLER, ITR 5-1/8" BF PRBG NO AXLE	1130834	1130834	1130834	1130834
20-01	ROLLER, 6-27/32BF ITR 1.9PLTD PRBG	1131620	1131620	1131620	1131620
20-02	ROLLER, 8-9/16BF ITR 1.9PLTD PRBG	1131621	1131621	1131621	1131621
20-03	ROLLER, 10-5/16BF ITR 1.9PLTD PRBG	1143250	1143250	1143250	1143250
20-04	ROLLER, 12-1/32BF ITR 1.9PLTD PRBG	1131622	1131622	1131622	1131622
20-05	ROLLER, 13-25/32BF ITR 1.9PLTD PRBG	1131623	1131623	1131623	1131623
20-06	ROLLER, 15-1/2BF ITR 1.9PLTD PRBG	NA	1131624	1131624	1131624
20-07	ROLLER, 17-1/4BF ITR 1.9PLTD PRBG	NA	1143251	1143251	1143251
20-08	ROLLER, 18-31/32BF ITR 1.9PLTD PRBG	NA	1131625	1131625	1131625
20-09	ROLLER, 20-11/16BF ITR 1.9PLTD PRBG	NA	NA	1143252	1143252
20-10	ROLLER, 22-7/16BF ITR 1.9PLTD PRBG	NA	NA	1131627	1131627
20-11	ROLLER, 24-5/32BF ITR 1.9PLTD PRBG	NA	NA	NA	1131628
20-12	ROLLER, 25-29/32BF ITR 1.9PLTD PRBG	NA	NA	NA	1131629

UBT

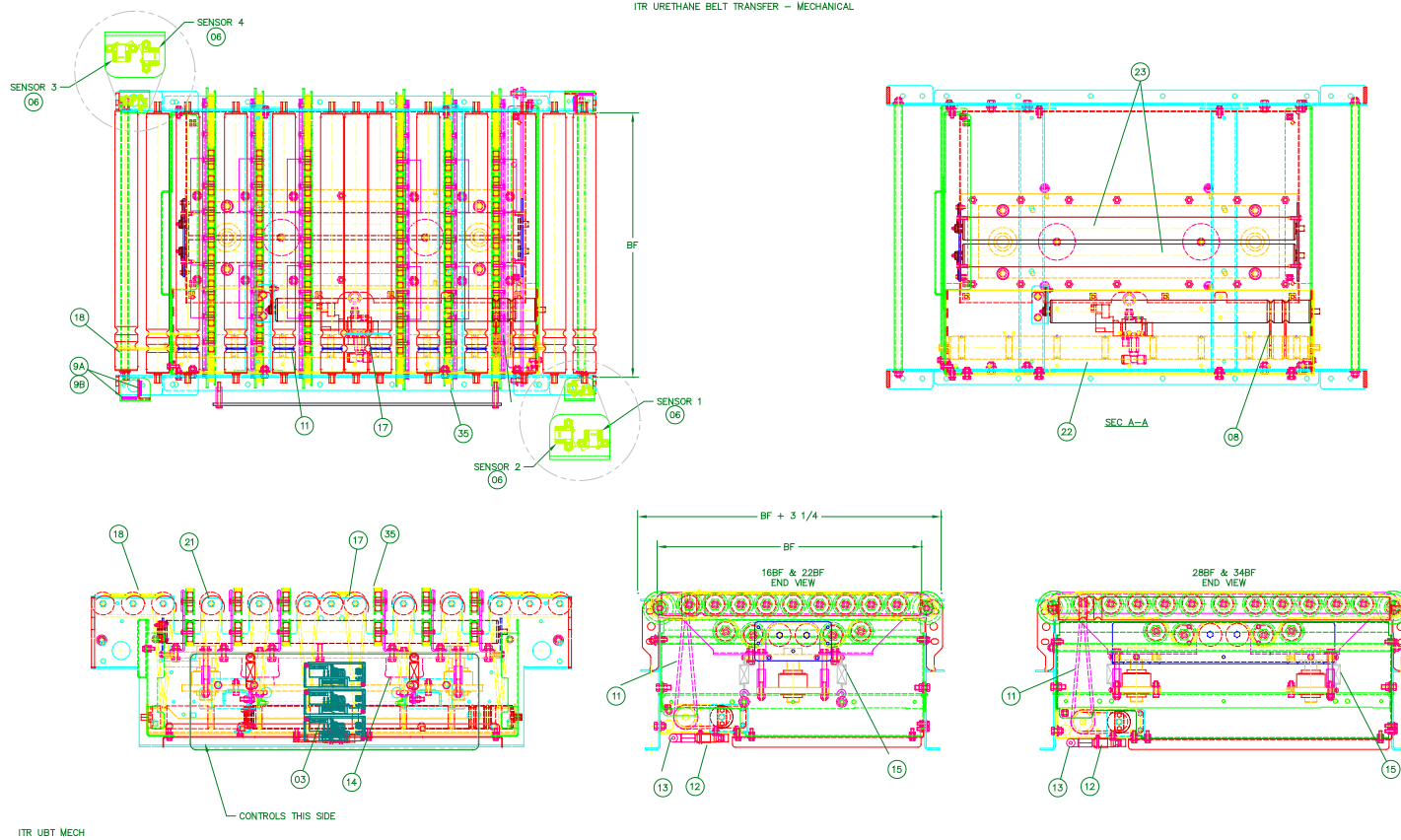

ITR URETHANE BELT TRANSFER – ELECTRICAL

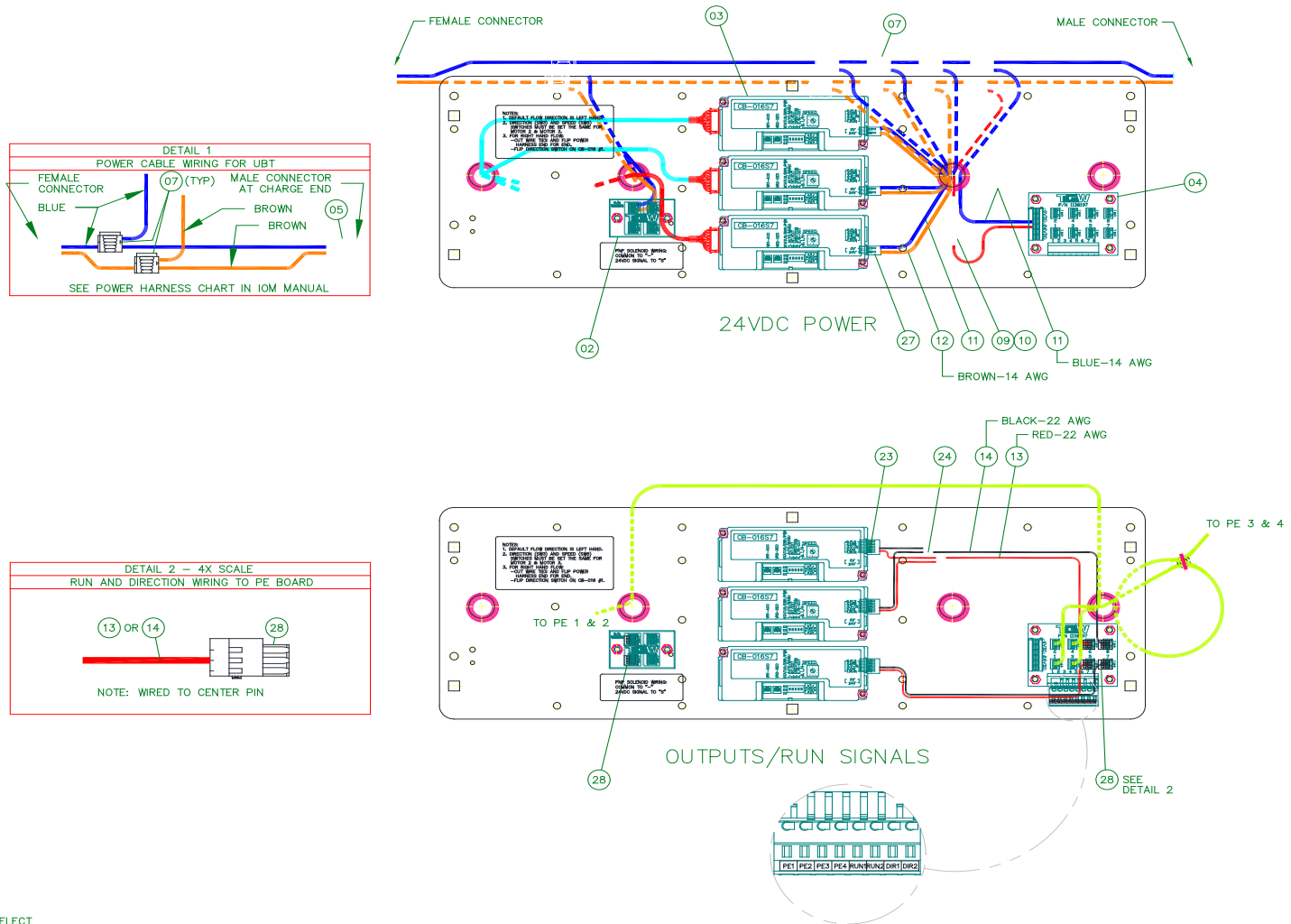

ITR UBT ELECT

UBT					
Balloon	Description	Width & Item #			
		16 BF	22 BF	28 BF	34 BF
3	DRIVERCARD,ITOH CB-016S7	1116036			
---	HARNESS, POWER BROWN & BLUE 14 AWG WITH MALE/FEMALE CONN (NOT BF SPECIFIC)	3'-0" L	5'-6" L	8'-0" L	10'-6" L
		1102289	1102288	1102287	1102286
---	CABLE,MOTOR EXTENSION ,600, 1200, OR 2700 MM LONG	REFERENCE MOTOR EXTENSION CABLE TABLE			
7	CONNECTOR,IDC SCOTCHLOK 567 10-12AWG RUN,14-18AWG TAP	3M567			
24	CONNECTOR,IDC SCOTCHLOK 558 16-22AWG RUN,16-22AWG TAP	1120174			
8	ORING,.210 DIA X 9.5" HT RED	E0002442			
11	ORING,88A .218 X 20-1/2,BLK HD	1133173			
18	ORING,3/16DIA X 8.688 HT BLUE ,FOR ITR 2.625CTRS,20% STRETCH	1137420			
17	ORING,3/16DIA X 7-3/4" HT BLUE ITR 2"CTR	1142656			
12	VALVE,SMC 4WAY 24VDC W/FITT & 2M CABLE,ITR UBT/ERS	1139102			
13	VALVE,SMC 4WAY 24VDC DIN CONN SMC, 24V	1139436			
14	AIRBAG,FIRESTONE	90000025			
35	BELT,83A .188 X .468 X ___",__BF ITR2 UBT	1132754	1132755	1132756	1132757
		35-1/2"	45-3/4"	56"	66"
15	SPRING,EXT 3/4OD X 2"LG .075W LOOPS MUST BE INLINE +/- 20	90800263			
2	PCB, DB, PE, EXTENSION	1138198			
4	PCB, DB, PE, 4A 8 STATION	1138197			
9	FUSE,HOLDER IN-LINE,CARTRIDGE 5X15MM AND 5X20MM FUSES,HHT	1102222			
10	FUSE,4A,125V,CARTRIDGE,GMA 5 X 20MM, BUSSMANN,GMA-4A	1102221			
---	CABLE,MOTOR EXTENSION ,600, 1200, OR 2700 MM LONG	REFERENCE MOTOR EXTENSION CABLE TABLE			
23	ROLLER,ITR_BF NG ITOH	1138739	1138740	1138741	1138742
25	ROLLER,ITR_BF 2G ITOH	1138722	1138723	1138724	1138725
22	ROLLER,CARRIER DRIVE ITR2 UBT 4"C	1132730			
21	ROLLER,__ITR 1.9PLTD PRBG	E0002412	E0002413	E0002414	E0006220
6	PE,REFLEX TYPE ZL2 PNP,LIGHT OPERATE,2M CABLE	1138113			
9A	PE,REFLECTOR 4-3/8" X 1-1/8"	400004			

UBT – Cont.					
Balloon	Description	Width & Item #			
		16 BF	22 BF	28 BF	34 BF
9B	TAPE,FORM DBL SIDED 1" SQUARE	E0005429			
26	CONN,FEMALE 5 POLE PIN	733105			
27	CONN,FEMALE 2 POLE PIN	1139779			
28	CONN,FEMALE 3 POLE PIN	1139780			

Accumulation Straight Bed (2 & 30 Zone)

HB-510 DRIVERCARD

HB-510 DRIVER CARD CONNECTION TERMINALS

CN1		Male Connector on Card	Female Connector for Wiring	CN4 & CN5		Male Connector on Card	Female Connector for Wiring
2 PIN connector for Power		WAGO #733-102	WAGO #733-102	8 PIN connector for Communication Cable		Moise #80018-08-05	RJ-45
1	+24V DC ±10% (full-wave rectified, smoothed current ~10% ripple)		Wire size: 28-14AWG	CN4 PIN	CN5 PIN	Description	
2	0V			1	2	Sensor signal output	Wire size: 26AWG
				2	1	Sensor signal input	Equivalent 8 wire cable
				3	3	Speed variation signal	
				4	4	Error signal	
				5	6	Drive input	
				6	5	Drive output	
				7	7	Direction signal	
				8	8	Emergency stop signal	
CN2 (Ordered Separately)		Male Connector on Card	Female Connector for Wiring	CN6		Male Connector on Card	Female Connector for Wiring
3 PIN connector for External Control		WAGO #733-335	WAGO #733-105	9 or 10 PIN connector for Motor		JST #510-09-A (7 = 9 or 10)	JST #500-7 (7 = 9 or 10)
1	+24V DC or 0V input (NPN/PT)		Wire size: 28-20AWG	1	1	GN2 - Grey	Wire size: 28-22AWG & 24-22AWG motor phases
2	+24V DC or 0V input (DIR & stop)			2	2	+12V DC - Blue	
3	0-10V DC input (V-A)			3	3	Motor phase U - Red	
4	+24V DC or 0V output (OUT A - open collector, 25mA max)			4	4	Motor phase V - White	
5	+24V DC or 0V output (ERR - open collector, 25mA max)			5	5	Motor phase W - Black	
				6	6	Hall sensor U - Violet	
				7	7	Hall sensor V - Orange	
				8	8	Hall sensor W - Green	
				9	9	Thermistor - Light Blue	
				10	10	Brake - Yellow	
CN3		Male Connector on Card	Female Connector for Wiring				
3 PIN connector for Sensor		WAGO #733-383	WAGO #733-103				
1	+24V DC		Wire size: 28-20AWG				
2	+24V DC or 0V (sensor signal input)						
3	0V						

HB-510 ROTARY SWITCH

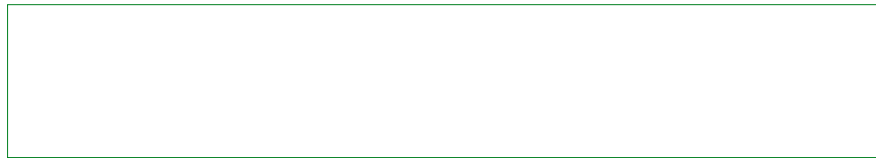

DS1 DS2 HB-510 DIP SWITCHES

Signal Block Settings		ON	OFF	Default Setting	
DIP Switch	Function	CN5 (Left)	CN4 (Right)	CN5 (Left)	CN4 (Right)
1-1	ERR signal transmission	Transmit & Receive	Transmit & Receive	Blocked	Blocked
1-2	DIR signal transmission	Transmit & Receive	Transmit & Receive	Blocked	Blocked
1-3	ESTOP signal transmission	Transmit & Receive	Transmit & Receive	Blocked	Blocked
1-4	SPEED signal transmission Left (Downstream)	Transmit & Receive	Transmit & Receive	Blocked	Blocked
1-5	SPEED signal transmission Right (Upstream)	Transmit & Receive	Transmit & Receive	Blocked	Blocked

Input/Output Settings		ON	OFF	Default Setting
DIP Switch	Function	External	Internal	
1-6	SPEED adjustment	0-10V DC	Rotary switch	OFF
1-7	DIR or ESTOP input (CN2-2)	ESTOP signal input	DIR signal input	OFF
1-8	Reset for manual recovery	Manual input recovery	Automatic recovery	ON
2-1	Output signal type (CN2-4 & CN6-5)	PNP signal output	NPN signal output	ON
2-2	Sensor or Synchronous output (CN2-4)	Output is active while internal motor RUN signal is ON	Output is active while photo-sensor (CN2-2) signal is ON	ON
2-8	STOP or RUN input (CN2-1)	RUN signal input	STOP signal input	ON

Timer Settings		Gear	Time (s)		
DIP Switch	Function	Stages	Sensor Timer	Run Hold Timer	Jam Timer
2-3	ON	2	0.5-1.2	0.5-1.2	0.5-2
2-4	OFF	1	1.0-4.0	1.0-4.0	2.0-8.0
2-5	ON	3	1.0-14.0	4.0-16.0	7.0-21.0
2-6	ON	n/a	Motor runs continuously, troubleshooting purposes only		

Other Settings		ON	OFF	Default Setting
DIP Switch	Function	2P2	2P1	
2-5	Release modes	Train/Slag release	Singulated release	ON
2-6	Last zone mode	Standard zone	ZE	ON
2-7	Motor direction*	FE CCW / FS/FP CW	FE CW / FS/FP CCW	ON

- BASIC SPECIFICATIONS**
- * INPUT VOLTAGE: 24VDC ±10%
 - * APPLICATION ENVIRONMENT:
 - TEMPERATURE: BETWEEN 0 - 40C NON-FREEZING (32-104F)
 - HUMIDITY: 90% RH (NO CONDENSATION)
 - ATMOSPHERE: NO CORROSIVE GAS
 - VIBRATION: 0.5G OR LESS
 - INSTALLATION: INDOOR
 - * DRIVER CARD WILL WORK WITH ITH FM486FS, FM486FE, & FM486FP SERIES BRUSHLESS DC MOTORIZED ROLLERS

HB-510 SETTINGS

USE OF AN EXTENSION CORD MAY BE NECESSARY TO MAKE CONNECTION. MAXIMUM RECOMMENDED LENGTH 4FT. IF LONGER LENGTHS ARE REQUIRED CONSULT ROLLER MANUFACTURER. EXTENSION CORDS CALLED OUT SEPARATELY.

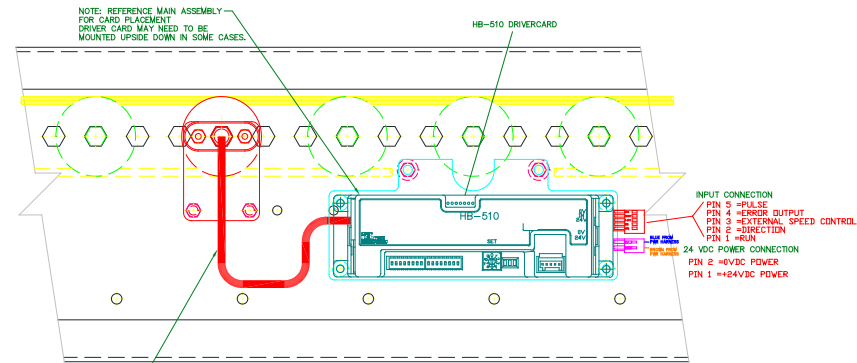

ACCUMULATION STRAIGHT BED (24 & 30 ZONE)					
Balloon	Description	Width & Item #			
		16 BF	22 BF	28 BF	34 BF
4	DRIVERCARD, ITOH HB-510P	1101261			
---	HARNESS, POWER BROWN & BLUE 14 AWG WITH MALE/FEMALE CONN (NOT BF SPECIFIC)	3'-0" L	5'-6" L	8'-0" L	10'-6" L
		1102289	1102288	1102287	1102286
---	CABLE, MOTOR EXTENSION ,600, 1200, OR 2700 MM LONG	REFERENCE MOTOR EXTENSION CABLE TABLE			
6	PE, REFLEX TYPE ZL2-P2400S11 PNP, DARK OPERATE, 700MM CABLE	1137687			
9A	PE, REFLECTOR 4-3/8" X 1-1/8"	400004			
9B	TAPE, FOAM DBL SIDED 1" SQUARE POLYETHYLENE	E0005429			
12	CONNECTOR, IDC SCOTCHLOK 567 10-12AWG RUN, 14-18AWG TAP	3M567			
19	ORING, 3/16 DIA X 9.5" HT BLUE	E0005536			
22	ROLLER, ITR __BF 2G ITOH	1138722	1138723	1138729	1138725
21	ROLLER, __ITR 1.9PLTD PRBG	E0002412	E0002413	E0002414	E0006220

Accumulation Curve

ACCUMULATION CURVE					
Balloon	Description	Width & Item #			
		16 BF	22 BF	28 BF	34 BF
4	DRIVERCARD, ITOH HB-510P	1101261			
---	HARNESS, POWER BROWN & BLUE 14 AWG WITH MALE/FEMALE CONN (NOT BF SPECIFIC)	3'-0" L 1102289	5'-6" L 1102288	8'-0" L 1102287	10'-6" L 1102286
6	PE, REFLEX TYPE ZL2-P2400S11 PNP, DARK OPERATE, 700MM CABLE	1137687			
9A	PE, REFLECTOR 4-3/8" X 1-1/8"	400004			
9B	TAPE, FOAM DBL SIDED 1" SQUARE POLYETHYLENE	E0005429			
12	CONNECTOR, IDC SCOTCHLOK 567 10-12AWG RUN, 14-18AWG TAP	3M567			
---	CABLE, CAT5E ___FT GRAY	REFERENCE COMMUNICATION CABLE TABLE			
---	CABLE, MOTOR EXTENSION ,600, 1200, OR 2700 MM LONG	REFERENCE MOTOR EXTENSION CABLE TABLE			
18	ORING, .210 DIA. X 11.5 HT RED MARKED WITH 1 BLACK STRIPE	1102845			
19	ORING, .210 DIA X 9.4 HT RED	1102748			
22	ROLLER, ITR ___BF 2G ITOH	1138722	1138723	1138724	1138725
21	ROLLER, ___W TT ITR 2GRV PRBG	E0009900	E0009901	E0009902	E0009903

Induct Bed

ITR INDUCT BED - ELECTRICAL

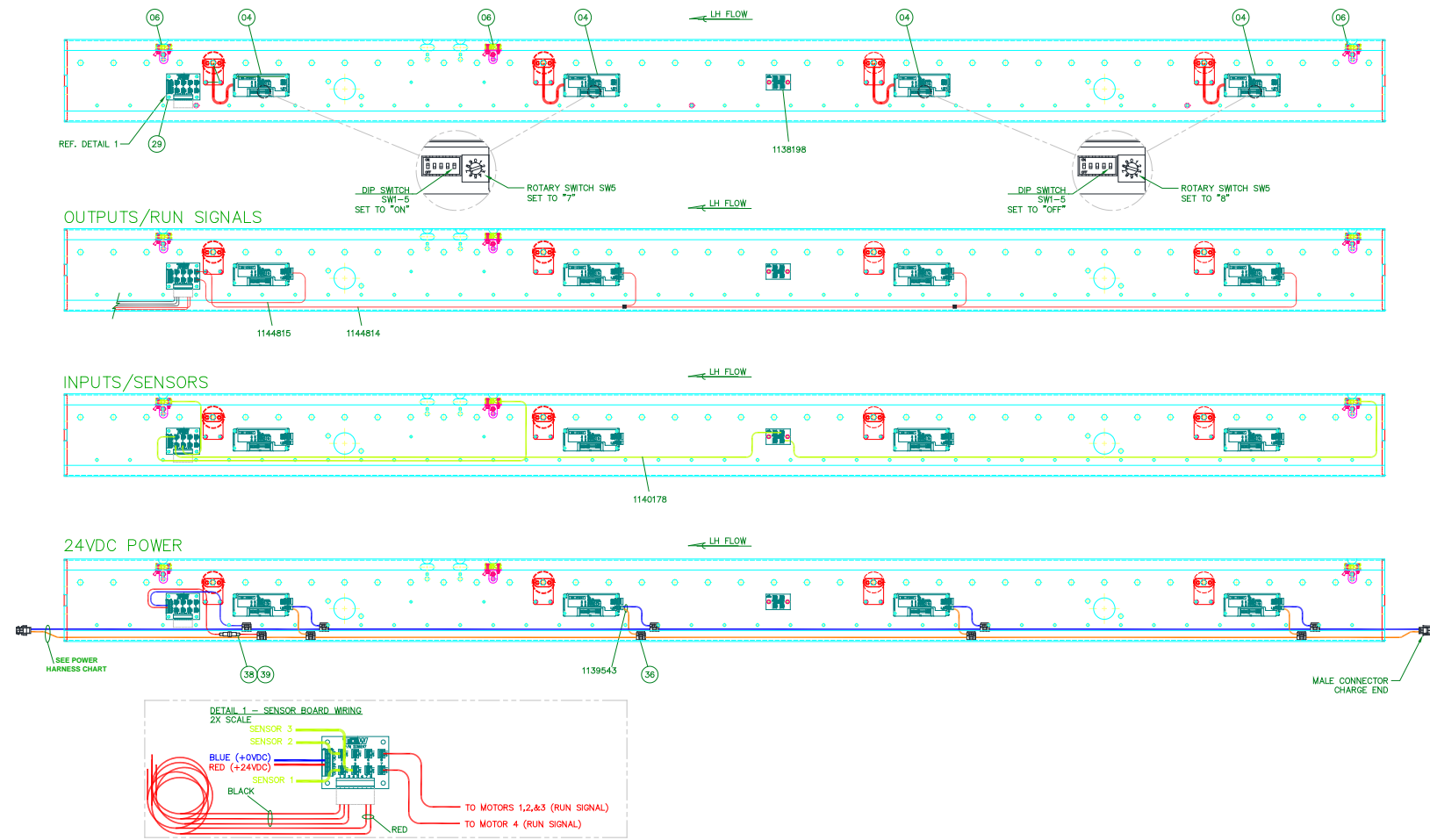

ITR INDUCT BED - ELECTRICAL

ITR INDUCT BED - MECHANICAL

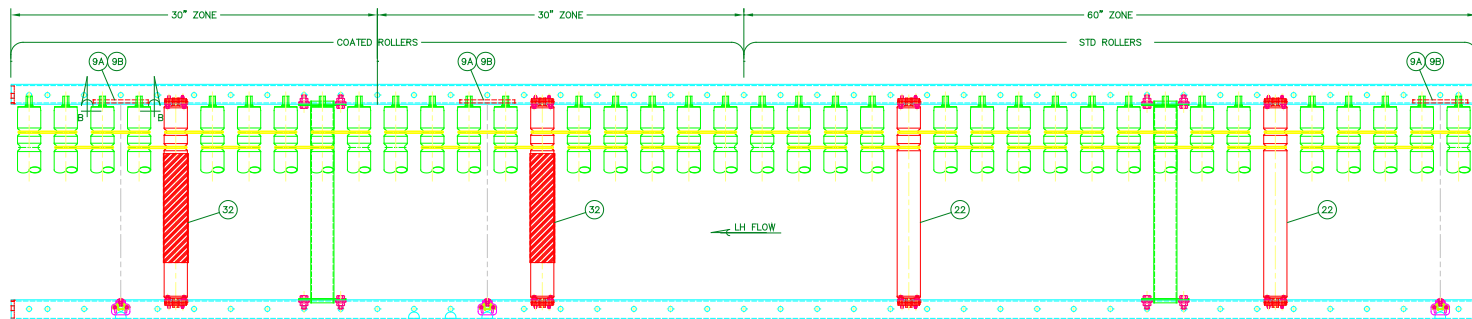

LH SPUR SHOWN
RH SPUR MIRROR IMAGE

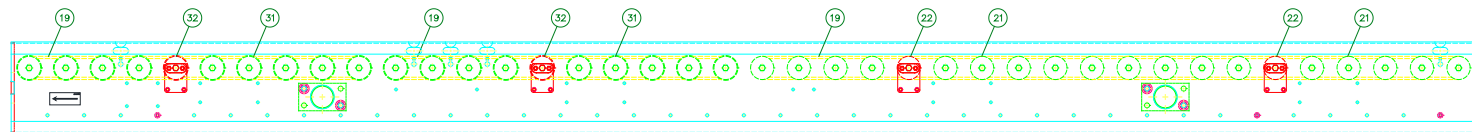

ITR INDUCT BED MECHANICAL

INDUCT BED					
Balloon	Description	Width & Item #			
		16 BF	22 BF	28 BF	34 BF
4	DRIVERCARD, ITOH CB-016S7	1116036			
---	HARNESS, POWER BROWN & BLUE 14 AWG WITH MALE/FEMALE CONN (NOT BF SPECIFIC)	3'-0" L	5'-6" L	8'-0" L	10'-6" L
		1102289	1102288	1102287	1102286
---	CABLE, MOTOR EXTENSION ,600, 1200, OR 2700 MM LONG	REFERENCE MOTOR EXTENSION CABLE TABLE			
6	PE, REFLEX TYPE ZL2-P2465S12 PNP, LIGHT OPERATE, 2M CABLE	1138113			
9A	PE, REFLECTOR 4-3/8" X 1-1/8"	400004			
9B	TAPE, FOAM DBL SIDED 1" SQUARE POLYETHYLENE	E0005429			
12	CONNECTOR, IDC SCOTCHLOK 567 10-12AWG RUN, 14-18AWG TAP	3M567			
19	ORING, 3/16 DIA X 9.5" HT BLUE	E0005536			
29	PCB, DB, PE, 4A 8 STATION	1138197			
38	FUSE, HOLDER IN-LINE, CARTRIDGE 5X15MM AND 5X20MM FUSES, HHT	1102222			
39	FUSE, 4A, 125V, CARTRIDGE, GMA 5 X 20MM, BUSSMANN, GMA-4A	1102221			
22	ROLLER, ITR __BF 2G ITOH	1138722	1138723	1138724	1138725
32	ROLLER, ITR __BF 2G CTD ITOH	1140375	1140376	1140377	1140378
21	ROLLER, __ITR 1.9PLTD PRBG	E0002412	E0002413	E0002414	E0006220
31	ROLLER, __ITR 1.9CTD PRBG 1/16" PVC SLV	1134693	1132204	1131724	1140369

Mission

To meet or exceed all customer expectations by providing the highest quality products and services, on time, at exceptional value, in an environment which promotes safety and personal development.



MHS Conveyor
1300 E Mount Garfield Road
Norton Shores MI 49441-6097 USA
231.798.4547
Email: us-info@mhs-conveyor.com
Web Site: mhs-conveyor.com

Regional sales offices and authorized Business Partners located throughout the United States and Canada.
Licensees and Business Partners in Europe, South America and Southeast Asia.