



# Mellanox SwitchX and SwitchX<sup>®</sup>-2 1U Switch Systems Hardware User Manual

**Models: SX1012/SX1012X/SX1016/SX1024/SX1036/SX1400**

Rev 1.4

NOTE:

THIS HARDWARE, SOFTWARE OR TEST SUITE PRODUCT ("PRODUCT(S)") AND ITS RELATED DOCUMENTATION ARE PROVIDED BY MELLANOX TECHNOLOGIES "ASIS" WITH ALL FAULTS OF ANY KIND AND SOLELY FOR THE PURPOSE OF AIDING THE CUSTOMER IN TESTING APPLICATIONS THAT USE THE PRODUCTS IN DESIGNATED SOLUTIONS. THE CUSTOMER'S MANUFACTURING TEST ENVIRONMENT HAS NOT MET THE STANDARDS SET BY MELLANOX TECHNOLOGIES TO FULLY QUALIFY THE PRODUCT(S) AND/OR THE SYSTEM USING IT. THEREFORE, MELLANOX TECHNOLOGIES CANNOT AND DOES NOT GUARANTEE OR WARRANT THAT THE PRODUCTS WILL OPERATE WITH THE HIGHEST QUALITY. ANY EXPRESS OR IMPLIED WARRANTIES, INCLUDING, BUT NOT LIMITED TO, THE IMPLIED WARRANTIES OF MERCHANTABILITY, FITNESS FOR A PARTICULAR PURPOSE AND NON-INFRINGEMENT ARE DISCLAIMED. IN NO EVENT SHALL MELLANOX BE LIABLE TO CUSTOMER OR ANY THIRD PARTIES FOR ANY DIRECT, INDIRECT, SPECIAL, EXEMPLARY, OR CONSEQUENTIAL DAMAGES OF ANY KIND (INCLUDING, BUT NOT LIMITED TO, PAYMENT FOR PROCUREMENT OF SUBSTITUTE GOODS OR SERVICES; LOSS OF USE, DATA, OR PROFITS; OR BUSINESS INTERRUPTION) HOWEVER CAUSED AND ON ANY THEORY OF LIABILITY, WHETHER IN CONTRACT, STRICT LIABILITY, OR TORT (INCLUDING NEGLIGENCE OR OTHERWISE) ARISING IN ANY WAY FROM THE USE OF THE PRODUCT(S) AND RELATED DOCUMENTATION EVEN IF ADVISED OF THE POSSIBILITY OF SUCH DAMAGE.



Mellanox Technologies  
350 Oakmead Parkway Suite 100  
Sunnyvale, CA 94085  
U.S.A.  
[www.mellanox.com](http://www.mellanox.com)  
Tel: (408) 970-3400  
Fax: (408) 970-3403

© Copyright 2017. Mellanox Technologies Ltd. All Rights Reserved.

Mellanox®, Mellanox logo, Accelio®, BridgeX®, CloudX logo, CompustorX®, Connect-IB®, ConnectX®, CoolBox®, CORE-Direct®, EZchip®, EZchip logo, EZappliance®, EZdesign®, EZdriver®, EZsystem®, GPUDirect®, InfiniHost®, InfiniBridge®, InfiniScale®, Kotura®, Kotura logo, Mellanox CloudRack®, Mellanox CloudXMellanox®, Mellanox Federal Systems®, Mellanox HostDirect®, Mellanox Multi-Host®, Mellanox Open Ethernet®, Mellanox OpenCloud®, Mellanox OpenCloud Logo®, Mellanox PeerDirect®, Mellanox ScalableHPC®, Mellanox StorageX®, Mellanox TuneX®, Mellanox Connect Accelerate Outperform logo, Mellanox Virtual Modular Switch®, MetroDX®, MetroX®, MLNX-OS®, NP-1c®, NP-2®, NP-3®, Open Ethernet logo, PhyX®, PlatformX®, PSIPHY®, SiPhy®, StoreX®, SwitchX®, Tiler®, Tiler logo, TestX®, TuneX®, The Generation of Open Ethernet logo, UFM®, Unbreakable Link®, Virtual Protocol Interconnect®, Voltaire® and Voltaire logo are registered trademarks of Mellanox Technologies, Ltd.

All other trademarks are property of their respective owners.

For the most updated list of Mellanox trademarks, visit <http://www.mellanox.com/page/trademarks>

# Table of Contents

- Revision History . . . . . 8**
- About this Manual . . . . . 9**
- Chapter 1 Introduction to Mellanox SX10XX/SX1X00 Systems . . . . . 10**
  - 1.1 Overview . . . . . 10
  - 1.2 Speed and Switching . . . . . 10
  - 1.3 Management Interfaces and FRUs . . . . . 11
  - 1.4 Features . . . . . 11
    - 1.4.1 Network Management Feature . . . . . 11
  - 1.5 Certifications . . . . . 11
  - 1.6 Ordering Information . . . . . 12
- Chapter 2 Installation . . . . . 14**
  - 2.1 Safety Warnings . . . . . 14
  - 2.2 Air Flow . . . . . 15
  - 2.3 Package Contents . . . . . 17
  - 2.4 Mounting Options . . . . . 18
    - 2.4.1 19" Systems Mounting . . . . . 18
    - 2.4.2 Side-by-Side . . . . . 23
    - 2.4.3 Table Top . . . . . 28
  - 2.5 Grounding . . . . . 30
  - 2.6 Cable Installation . . . . . 31
    - 2.6.1 Using a Breakout Cable . . . . . 31
  - 2.7 SFP+ Removal Tool . . . . . 34
  - 2.8 Initial Power On . . . . . 36
  - 2.9 System Bring-Up . . . . . 38
    - 2.9.1 Configuring Network Attributes . . . . . 38
    - 2.9.2 Remote Connection . . . . . 42
  - 2.10 FRU Replacements . . . . . 43
    - 2.10.1 Power Supply and Fans . . . . . 43
- Chapter 3 Interfaces . . . . . 46**
  - 3.1 Supported Interfaces . . . . . 46
  - 3.2 Data Interfaces . . . . . 46
    - 3.2.1 Speed . . . . . 46
    - 3.2.2 RS232 (Console) . . . . . 47
    - 3.2.3 Management . . . . . 47
    - 3.2.4 USB . . . . . 47

3.2.5 I2C.....	47
3.2.6 Reset Button .....	48
3.3 LEDs .....	48
3.3.1 LED Notifications.....	48
3.4 Inventory Pull-out Tab .....	53
<b>Chapter 4 Software Management .....</b>	<b>55</b>
4.1 Upgrading Software .....	55
<b>Chapter 5 Troubleshooting.....</b>	<b>56</b>
5.1 Troubleshooting Instructions.....	56
<b>Chapter 6 Specifications .....</b>	<b>59</b>
6.1 SX1012 Series .....	59
6.2 SX1016 Series .....	60
6.3 SX1024 Series .....	61
6.4 SX1036 Series .....	62
<b>Appendix A Accessory and Replacement Parts .....</b>	<b>63</b>
<b>Appendix B Thermal Threshold Definitions .....</b>	<b>64</b>
<b>Appendix C Interface Specifications .....</b>	<b>65</b>
C.1 QSFP Interface .....	65
C.2 SFP+ Interface .....	67
C.3 RJ-45 CONSOLE and I2C Interface .....	69
C.4 RJ45 to DB9 Harness Pinout .....	70
<b>Appendix D Disassembly and Disposal .....</b>	<b>71</b>
D.1 Disassembly Procedure.....	71
D.2 Disposal .....	71
<b>Appendix E Safety Warnings (Multiple Languages) .....</b>	<b>72</b>
E.1 Nordic Countries Notices .....	72
E.2 Installation Safety Warnings (English) .....	72
E.3 Installation Safety Warnings (Hebrew) .....	75
E.4 安裝安全性警告 (Chinese) .....	78
E.5 Avertissements de sécurité pour l'installation (French).....	81
E.6 Installation Sicherheitshinweise(German).....	85
E.7 Advertencias de seguridad de instalación (Spanish) .....	88
E.8 Предупреждения по технике безопасности при установке (Russian) .....	91
E.9 Avertismente privind siguranța la instalare (Romanian) .....	94
E.10 Sigurnosna upozorenja za instaliranje (Croatian) .....	97
E.11 Avvertenze di sicurezza per l'installazione (italiano) .....	100
E.12 Montaj Güvenlik Uyarıları (Türkçe) .....	104

## List of Figures

Figure 1:	Ethernet Systems Family Front Side View	10
Figure 2:	Air Flow Direction Marking - Connector Side Inlet to Power Side Outlet	16
Figure 3:	Air Flow Direction Marking - Power Side Inlet to Connector Side Outlet	16
Figure 4:	Rack Rail Kit Parts	19
Figure 5:	Screwing on the Rail	20
Figure 6:	Inserting the Caged Nuts	20
Figure 7:	Slide the Rail into the Rail Slide	21
Figure 8:	Installing the Slides	21
Figure 9:	System Placement in the Rack	22
Figure 10:	Installation Completed	23
Figure 11:	Installation Kit Parts for a Side by Side Installation	24
Figure 12:	Screw on the System Mounted Rails	25
Figure 13:	Two Systems Frame	26
Figure 14:	Placement of Frame in the Rack	26
Figure 15:	Placing the Spacer in the Rack	27
Figure 16:	Using the Spacer Bushings	27
Figure 17:	Insert System into Frame	28
Figure 18:	Placing the Bumpers	29
Figure 19:	Cable Orientation	31
Figure 20:	Breakout or Fanout Cable	32
Figure 21:	SX1024/SX1400 Port Splitting Options	32
Figure 22:	SX1036 Port Splitting Options	33
Figure 23:	Examples of Port Mapping Assignment	34
Figure 24:	SFP+ Removal and Insertion Tool	35
Figure 25:	System Status LEDs 5 Minutes After Power On	37
Figure 26:	Two Power Inlets - Electric Caution Notifications	38
Figure 27:	Power Supply Unit Extraction	44
Figure 28:	PS Unit Pulled Out	44
Figure 29:	Fan Module Latches	45
Figure 30:	System Status LEDs - Front and Rear sides	49
Figure 31:	Fan Status LED - Front and Rear sides	50
Figure 32:	Power Status LED	51
Figure 33:	Rear Side Panel	51
Figure 34:	SFP+ Port LED Assignment	53

Figure 35: Port LEDs .....	53
Figure 36: Pull-out Tab .....	54
Figure 37: Rear View of Module With Pin Placement .....	67
Figure 38: RJ45 to DB9 Harness Pinout .....	70

## List of Tables

Table 1:	Revision History Table	8
Table 2:	References	9
Table 3:	Speed and Switching Capabilities	10
Table 4:	Management Interfaces and FRUs	11
Table 5:	Ordering Part Numbers (OPNs)	12
Table 6:	Air Flow Label Legend	16
Table 7:	Installation Kit Options	18
Table 8:	Port Splitting Options	33
Table 9:	Serial Terminal Program Configuration	39
Table 10:	Configuration Wizard Session - DHCP	39
Table 11:	Configuration Wizard Session - Static IP Configuration	41
Table 12:	Status LEDs	49
Table 13:	System Status LED Assignments	50
Table 14:	Fan Status LED Assignments	50
Table 15:	Power Supply Unit Status LED Assignments	52
Table 16:	Bad Port LED Assignments	52
Table 17:	Port LEDs in Ethernet System Mode	53
Table 18:	Port LEDs in InfiniBand System Mode	53
Table 19:	Troubleshooting	56
Table 20:	SX1012/SX1012X Specifications	59
Table 21:	SX1016 Specifications	60
Table 22:	SX1024 Specifications	61
Table 23:	SX1036 Specifications	62
Table 24:	OPNs for Replacement Parts	63
Table 25:	QSFP Interface Pins 1-23	65
Table 26:	QSFP Interface Pins 24-38	66
Table 27:	SFP+ Interface	67
Table 28:	RJ-45 CONSOLE Pinout	69
Table 29:	RJ-45 I2C Pinout	69

## Revision History

*Table 1 - Revision History Table*

Date	Revision	Description
May 2017	1.4	Updated <a href="#">“Specifications”</a> Edited <a href="#">“Unit Identification LED”</a>
September 2016	1.3	Added SX1012X
May 2017	1.4	Edited <a href="#">“Unit Identification LED”</a>
June 2015	1.2	Added Hebrew safety warnings Added Japan VCCI Statement Removed SX1700Updated <a href="#">“Specifications”</a> Updated <a href="#">“Mounting Options”</a> c
January 2015	1.1	Minor formatting edits
January 2015	1.0	First release of the new edition



## About this Manual

This manual describes the installation and basic use of the Mellanox Ethernet systems.

## Intended Audience

This manual is intended for IT managers and system administrators.

## References

*Table 2 - References*

Document	Description
SwitchX® Switch System Hardware Release Notes	For possible hardware issues see the switch support product page. This document can be found on the support web page for this product.
MLNX-OS® User Manual	This document contains information regarding configuring and managing MLNX-OS software- see <a href="http://www.mellanox.com/page/mlnx_os">http://www.mellanox.com/page/mlnx_os</a> .

## Conventions

The following icons are used throughout this document to indicate information that is important to the user.



This icon makes recommendations to the user.



This icon indicates information that is helpful to the user.



This icon indicates a situation that can potentially cause personal injury or damage to hardware or software.



Risk of electric shock!

# 1 Introduction to Mellanox SX10XX/SX1X00 Systems

## 1.1 Overview

Mellanox Ethernet System Family delivers the highest performance and port density with a complete chassis and fabric management solution enabling converged data centers to operate at any scale while reducing operational costs and infrastructure complexity. This family includes a broad portfolio of Top-of-Rack (TOR) systems that range from 12 to 64 ports, and support 10/40/56Gb/s per port. These systems allow IT managers to build cost-effective and scalable system fabrics for small to large clusters up to 10's-of-thousands of nodes.

Mellanox makes fabric management as easy as it can by providing the lowest latency and highest bandwidth. This allows IT managers to deal with serving the company's business needs, while solving typical networking issues such as congestion and the inefficiencies generated by adding unnecessary rules and limitations when the network resources are sufficient.

**Figure 1: Ethernet Systems Family Front Side View**



## 1.2 Speed and Switching

Table 3 describes maximum throughput and interface speed per system model.

**Table 3 - Speed and Switching Capabilities**

System Model	10GbE* SFP+ Interfaces	40/56GbE QSFP+ Interfaces	Throughput
SX1012	N/A	12	1.34Tb/s
SX1012X	12	N/A	240Gb/s
SX1016	64	N/A	1.28Tb/s
SX1024	48	12	1.92Tb/s
SX1036	N/A	36	4.03Tb/s
SX1400	48	12	1.92Tb/s

\*The switches can support 10Gb/s interfaces using QSFP to SFP adapters

## 1.3 Management Interfaces and FRUs

Table 4 lists the various management interfaces and available replacement parts per system model.

**Table 4 - Management Interfaces and FRUs**

System Model	USB	MGT Ports Qty.	MGT Ports Location	I <sup>2</sup> C	Console	Replaceable PSU	Replaceable Fan
SX1012/ SX1012X	Front (mini-USB)	1	Front	Rear	Front	N/A	N/A
SX1016	Front (mini-USB)	1	Front	N/A	Front	N/A	N/A
SX1024	Rear	2	Front Rear	Rear	Front	2 FRUs	2 FRUs
SX1036	Front	2	Front (x2)	Rear	Front	2 FRUs	1 FRU
SX1400	Rear	2	Front Rear	Rear	Front	2 FRUs	2 FRUs

## 1.4 Features

### 1.4.1 Network Management Feature

For a full feature list, refer to the product brief of the relevant system:

System Model	USB
SX1012	<a href="http://www.mellanox.com/related-docs/prod_eth_switches/PB_SX1012.pdf">http://www.mellanox.com/related-docs/prod_eth_switches/PB_SX1012.pdf</a>
SX1012X	<a href="http://www.mellanox.com/related-docs/prod_eth_switches/PB_SX1012X.pdf">http://www.mellanox.com/related-docs/prod_eth_switches/PB_SX1012X.pdf</a>
SX1016	<a href="http://www.mellanox.com/related-docs/prod_eth_switches/PB_SX1016.pdf">http://www.mellanox.com/related-docs/prod_eth_switches/PB_SX1016.pdf</a>
SX1024	<a href="http://www.mellanox.com/related-docs/prod_eth_switches/PB_SX1024.pdf">http://www.mellanox.com/related-docs/prod_eth_switches/PB_SX1024.pdf</a>
SX1036	<a href="http://www.mellanox.com/related-docs/prod_eth_switches/PB_SX1036.pdf">http://www.mellanox.com/related-docs/prod_eth_switches/PB_SX1036.pdf</a>
SX1400	<a href="http://www.mellanox.com/related-docs/prod_eth_switches/PB_SX1400.pdf">http://www.mellanox.com/related-docs/prod_eth_switches/PB_SX1400.pdf</a>

## 1.5 Certifications

The list of certifications (such as EMC, Safety and others) per system for different regions of the world is located on the Mellanox website at:

[http://www.mellanox.com/page/environmental\\_compliance](http://www.mellanox.com/page/environmental_compliance)

## 1.6 Ordering Information

the following table lists ordering information for the available systems. Please pay attention to the airflow direction when ordering your system. For more details, see “Air Flow” on page 15.\_

**Table 5 - Ordering Part Numbers (OPNs)**

System Model	OPN	Description
SX1012	MSX1012B-1BFS	SwitchX®-2 based 40GbE, 1U Open Ethernet Switch with MLNX-OS, 12 QSFP+ ports, 1 Power Supply (AC), short depth, PPC460, Connector airflow out, Rail Kit must be purchased separately, RoHS6
	MSX1012B-2BFS	SwitchX®-2 based 40GbE, 1U Open Ethernet Switch with MLNX-OS, 12 QSFP+ ports, 2 Power Supplies (AC), short depth, PPC460, Connector airflow out, Rail Kit must be purchased separately, RoHS6
	MSX1012B-2BRS	SwitchX®-2 based 40GbE, 1U Open Ethernet Switch with MLNX-OS, 12 QSFP+ ports, 2 Power Supplies (AC), short depth, PPC460, Connector airflow in, Rail Kit must be purchased separately, RoHS6
SX1012X	SX1012X-2BFS	SwitchX®-2 based, 1U Open Ethernet Switch with MLNX-OS, 12 QSFP+ ports, 2 Power Supplies (AC), short depth, PPC460, Connector airflow out, Rail Kit must be purchased separately, RoHS6
	SX1012X-2BRS	SwitchX®-2 based, 1U Open Ethernet Switch with MLNX-OS, 12 QSFP+ ports, 2 Power Supplies (AC), short depth, PPC460, Connector airflow in, Rail Kit must be purchased separately, RoHS6
SX1016	MSX1016X-2BFR	SwitchX® based 64-port SFP+ 10GbE, 1U Ethernet switch. 2PS, Short depth, PSU side to Connector side airflow, Rail kit and ROHS6
	MSX1016X-2BFS	SwitchX®-2 based 10GbE, 1U Open Ethernet Switch with MLNX-OS, 64 SFP+ ports, 2 Power Supplies (AC), Short depth, PPC460, C2P airflow, Rail kit, RoHS6
	MSX1016X-2BRR	SwitchX® based 64-port SFP+ 10GbE. 1U Ethernet switch. 2PS, Short depth, Connector side to PSU side airflow, Rail kit and ROHS6
	MSX1016X-2BRS	SwitchX®-2 based 10GbE, 1U Open Ethernet Switch with MLNX-OS, 64 SFP+ ports, 2 Power Supplies (AC), Short depth, PPC460, P2C airflow, Rail kit, RoHS6
SX1024	MSX1024B-1BFS	SwitchX®-2 based 10GbE/40GbE, 1U Open Ethernet Switch with MLNX-OS, 48 SFP+ ports, 12 QSFP+ ports, 1 Power Supply (AC), PPC460, short depth, C2P airflow, Rail kit, RoHS6
	MSX1024B-1BRS	SwitchX®-2 based 10GbE/40GbE, 1U Open Ethernet Switch with MLNX-OS, 48 SFP+ ports, 12 QSFP+ ports, 1 Power Supply (AC), PPC460, short depth, P2C airflow, Rail kit, RoHS6
	MSX1024B-2BFS	SwitchX®-2 based 10GbE/40GbE, 1U Open Ethernet Switch with MLNX-OS, 48 SFP+ ports, 12 QSFP+ ports, 2 Power Supplies (AC), PPC460, short depth, C2P airflow, Rail kit, RoHS6
	MSX1024B-2BRS	SwitchX®-2 based 10GbE/40GbE, 1U Open Ethernet Switch with MLNX-OS, 48 SFP+ ports, 12 QSFP+ ports, 2 Power Supplies (AC), PPC460, short depth, P2C airflow, Rail kit, RoHS6

**Table 5 - Ordering Part Numbers (OPNs)**

System Model	OPN	Description
SX1400	MSX1400-BS2F2	SwitchX®-2 based 10GbE/40GbE, 1U Open Ethernet Switch with MLNX-OS, 48 SFP+ ports, 12 QSFP+ ports, 2 Power Supplies (AC), x86 quad core, standard depth, C2P airflow, Rail kit, RoHS6
	MSX1400-BS2R2	SwitchX®-2 based 10GbE/40GbE, 1U Open Ethernet Switch with MLNX-OS, 48 SFP+ ports, 12 QSFP+ ports, 2 Power Supplies (AC), x86 quad core, standard depth, P2C airflow, Rail kit, RoHS6
SX1036	MSX1036B-1BRR	SwitchX® based 36-port QSFP 40GbE 1U Ethernet Switch, 36 QSFP ports, 1 PS, Short depth, Connector side to PSU side airflow, Rail Kit and RoHS6
	MSX1036B-1BRS	SwitchX®-2 based 40GbE, 1U Open Ethernet Switch with MLNX-OS, 36 QSFP+ ports, 1 Power Supply (AC), PPC460, short depth, P2C airflow, Rail Kit, RoHS6
	MSX1036B-1SFR	SwitchX® based 36-port QSFP 40GbE 1U Ethernet Switch, 36 QSFP ports, 1 PS, Standard depth, PSU side to Connector side airflow, Rail Kit and RoHS6
	MSX1036B-1SFS	SwitchX®-2 based 40GbE, 1U Open Ethernet Switch with MLNX-OS, 36 QSFP+ ports, 1 Power Supply (AC), PPC460, standard depth, C2P airflow, Rail Kit, RoHS6
	MSX1036B-2BRS	SwitchX®-2 based 40GbE, 1U Open Ethernet Switch with MLNX-OS, 36 QSFP+ ports, 2 Power Supplies (AC), PPC460, short depth, P2C airflow, Rail Kit, RoHS6
	MSX1036B-2SFS	SwitchX®-2 based 40GbE, 1U Open Ethernet Switch with MLNX-OS, 36 QSFP+ ports, 2 Power Supplies (AC), PPC460, standard depth, C2P airflow, Rail Kit, RoHS6

## 2 Installation

Installation and initialization of the system require attention to the normal mechanical, power, and thermal precautions for rack-mounted equipment.



The rack mounting holes conform to the EIA-310 standard for 19-inch racks. Take precautions to guarantee proper ventilation in order to maintain good airflow at ambient temperature.



Unless otherwise specified, Mellanox products are designed to work in an environmentally controlled data center with low levels of gaseous and dust (particulate) contamination.

The operation environment should meet severity level G1 as per ISA 71.04 for gaseous contamination and ISO 14644-1 class 8 for cleanliness level

➤ ***The installation procedure for the Metrox system involves the following phases:***

1. Follow the safety warnings in Section E.2, “Installation Safety Warnings (English),” on page 72.
2. Pay attention to the air flow consideration within the system and rack - refer to “Air Flow” on page 15.
3. Make sure that none of the package contents is missing or damaged - see “Package Contents” on page 17
4. Mount the system to the rack - see “Mounting Options” on page 18.
5. Ground the system, refer to “Grounding” on page 30.
6. Power on the system - refer to “Initial Power On” on page 36
7. Perform system bring-up - see “System Bring-Up” on page 38

FRU replacements are described in Section 2.10 on page 43.

### 2.1 Safety Warnings

Prior to the installation, please review the safety warnings as follows:

For Nordic Countries Notices, see .Section E.1, “Nordic Countries Notices,” on page 72

For Safety Warnings in English, see Section E.2, “Installation Safety Warnings (English),” on page 72.

For Safety Warnings in Hebrew, see Section E.3, “אזהרות בטיחות בהתקנה (עברית),” on page 73.

For Safety Warnings in Chinese, see page 78.

For Safety Warnings in French, see Section E.5, “Avertissements de sécurité pour l'installation (French),” on page 81.

For Safety Warnings in German, Section E.6, “Installation Sicherheitshinweise(German),” on page 85.

For Safety Warnings in Spanish, see Section E.7, “Advertencias de seguridad de instalación (Spanish),” on page 88.

For Safety Warnings in Russian, see Section E.8, “Предупреждения по технике безопасности при установке (Russian),” on page 91.

For Safety Warnings in Romanian, see Section E.9, “Avertismente privind siguranța la instalare (Romanian),” on page 94.

For Safety Warnings in Croatian, see Section E.10, “Sigurnosna upozorenja za instaliranje (Croatian),” on page 97.

For Safety Warnings in Italian, see Section E.11, “Avvertenze di sicurezza per l’installazione (italiano),” on page 100.

For Safety Warnings in Turkish see Section E.12, “Montaj Güvenlik Uyarıları (Türkçe),” on page 104.

## 2.2 Air Flow

Mellanox systems are offered with two air flow patterns:

- Connector (front) side inlet to power side outlet - marked with red labels on the power supply side as shown in Figure 2.
- Power (rear) side inlet to connector side outlet - marked with blue labels on the power supply side as shown in Figure 3.







All servers and systems in the same rack should be planned with the same air-flow direction.

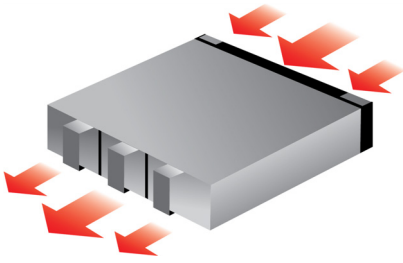

All FRU components need to have the same air flow direction. A mismatch in the air flow will affect the heat dissipation.

Table 6 provides an air flow label color legend and respective OPN designations,

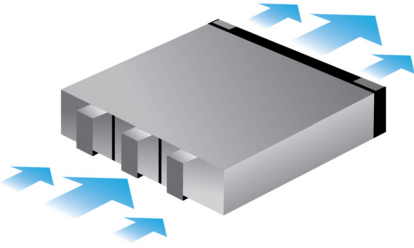
**Table 6 - Air Flow Label Legend**

Direction	Label	OPN Designation	Description
		R	Connector side inlet to power side outlet. Red labels are placed on the power inlet side.
		F	Power side inlet to connector side outlet. Blue labels are placed on the power inlet side.

**Figure 2: Air Flow Direction Marking - Connector Side Inlet to Power Side Outlet**



**Figure 3: Air Flow Direction Marking - Power Side Inlet to Connector Side Outlet**

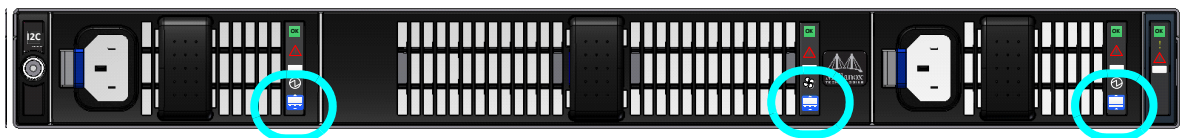



## 2.3 Package Contents



The rear view shown in the above figures does not apply to SX1012/SX1012X, SX1016 and SX1024.

Before installing your new system, unpack the system, and check, against the parts list below, that all the parts have been sent. Check the parts for visible damage that may have occurred during shipping.

The system package content is as follows:

- 1 – System
- 1 – Rail kit (not applicable for half-width systems)
- 1 – Power cable for each power supply unit – Type C13-C14
- 1 – Harness: HAR000028 – Harness RS232 2M cable – DB9 to RJ-45
- 1 – Quick Start Guide



If anything is damaged or missing, contact your sales representative at [support@mellanox.com](mailto:support@mellanox.com).

## 2.4 Mounting Options

### 2.4.1 19" Systems Mounting

This section is applicable for 19" systems.

There are two installation kit options: standard and short. Standard depth systems should be mounted using the standard rail kit; short systems can be mounted using either of the rail kits.

**Table 7 - Installation Kit Options**

Kit OPN	Rack Size
MSX60-BKIT	40-60 cm deep (Short)
MSX60-SKIT	60-80 cm deep (Standard)

The following parts are included in the rail kit rack (see Figure 4):

- Two rails
- Two rail slides
- Two system slides
- 16 recessed flat head (6-32) screws (with extras)
- 10 caged nuts
- 10 pan head (M6) screw bolts

**Figure 4: Rack Rail Kit Parts**

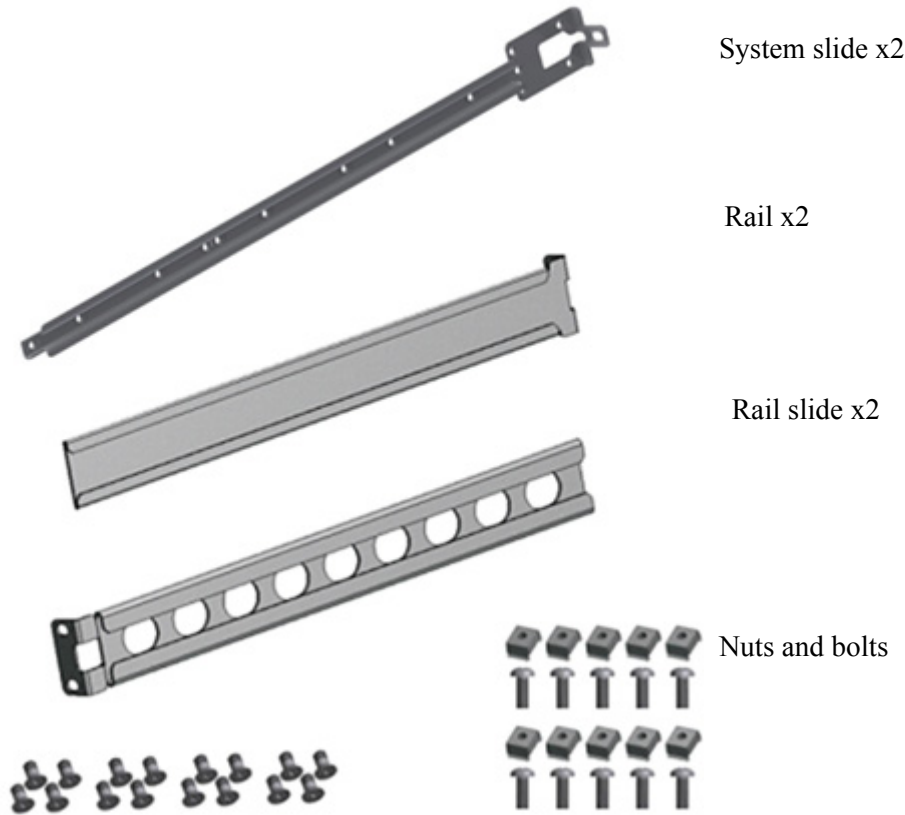

➤ **Planning the system’s placement in the rack**

Before mounting the system to the rack, select the way you wish to place the system. Pay attention to the airflow within the rack cooling, connector and cabling options.

While planning how to place the system, review the following points:

- Make sure the system air flow is compatible with your installation selection. It is important to keep the airflow within the rack in the same direction.
- In case there are cables that cannot bend within the rack or in case more space is needed for cable bending radius, it is possible to recess the connector side or the FRU side by 2” (5.08cm) by optional placement of the system’s rails.
- The FRU side is extractable. Mounting the sliding rail inverted to the system will allow you to slide the FRU side of the system, in and out.

➤ **Mounting the slides to the system**

**Step 1.** The recession feature is bi-directional, meaning that you can recess the system either backward or forward.

**Step 2.** Screw the system slides onto the system. Use 5 flat head 6-32 screws for a short system and 7 screws for a standard depth system to connect each system slide. The recommended tightening torque is 1.5±0.2 Nm.

**Figure 5: Screwing on the Rail**



5 screws per side are needed for the short system.  
 7 screws per side are needed for the standard system.  
 If using a torque screwdriver to tighten the screws, set it to  $1.5 \pm 0.2$  Nm.

**Step 3.** Clip the caged nuts into the holes in the rack on the side of the rack you will be sliding the system into.

**Figure 6: Inserting the Caged Nuts**

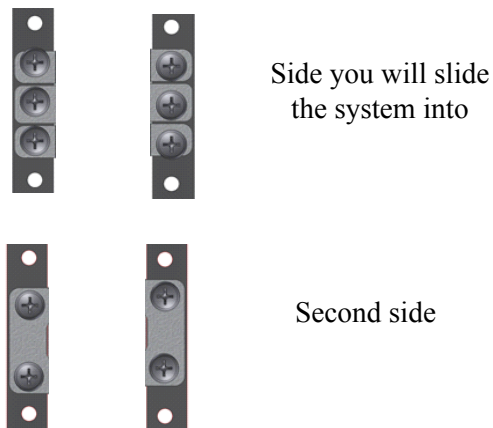

**Step 4.** Slide the rail into the rail slide.

**Step 5.** Using two of the M6 bolts for each corner, install the rails and rail slides in the rack. Do not tighten the bolts yet.

**Figure 7: Slide the Rail into the Rail Slide**

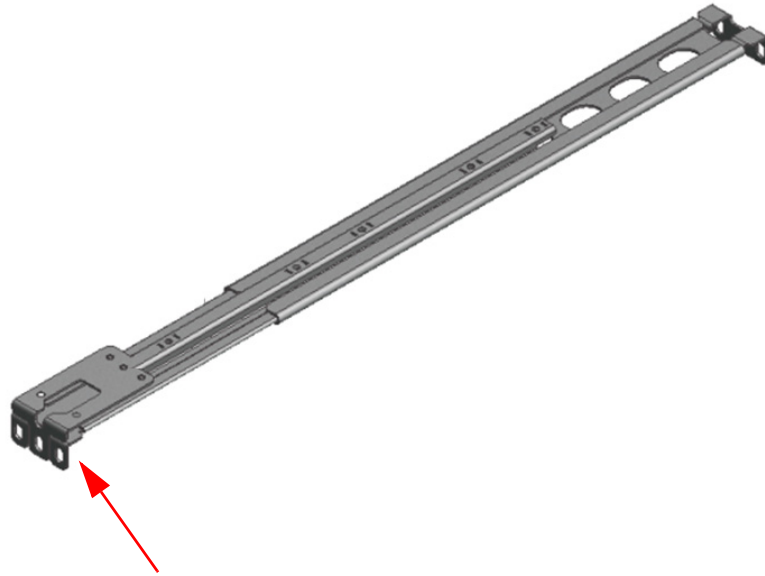

This side of the rail kit goes on the side of the rack you will slide the system into. This is the same side of the system that will be next to the vertical support.

**Figure 8: Installing the Slides**

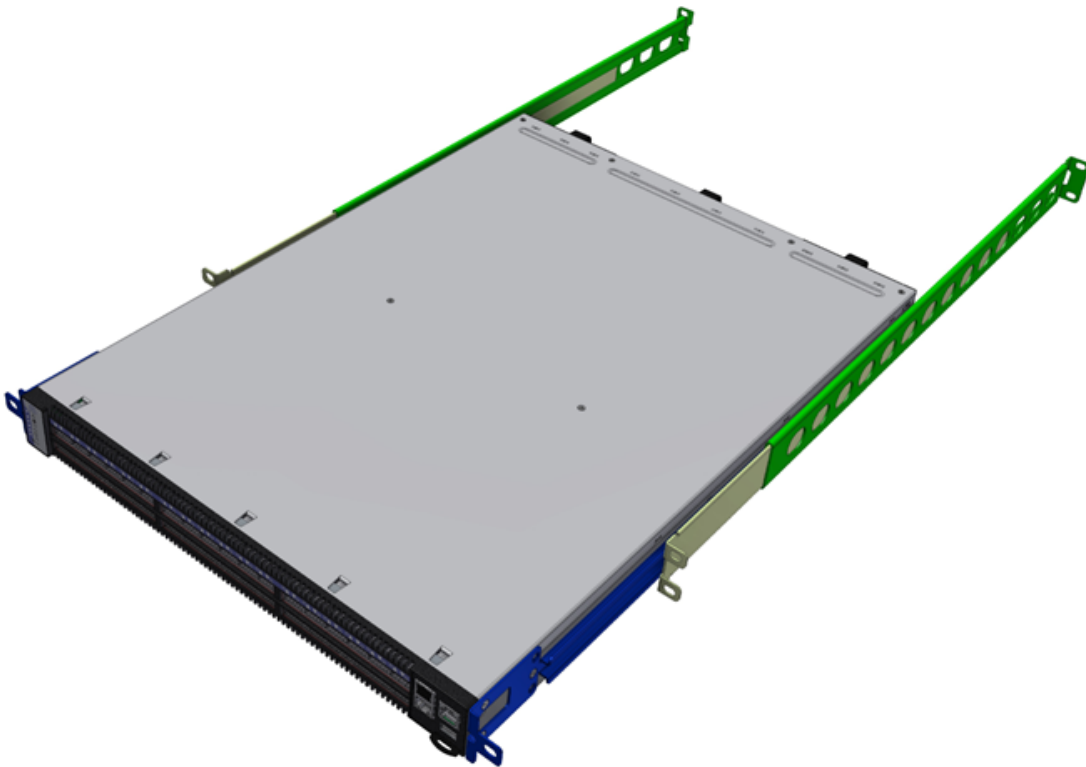

**Step 6.** Slide the system into the rails.

**Step 7.** Place the system and screw the bolts into the nuts. Tighten the bolts to  $4.5\pm 0.5$  Nm.

**Figure 9: System Placement in the Rack**

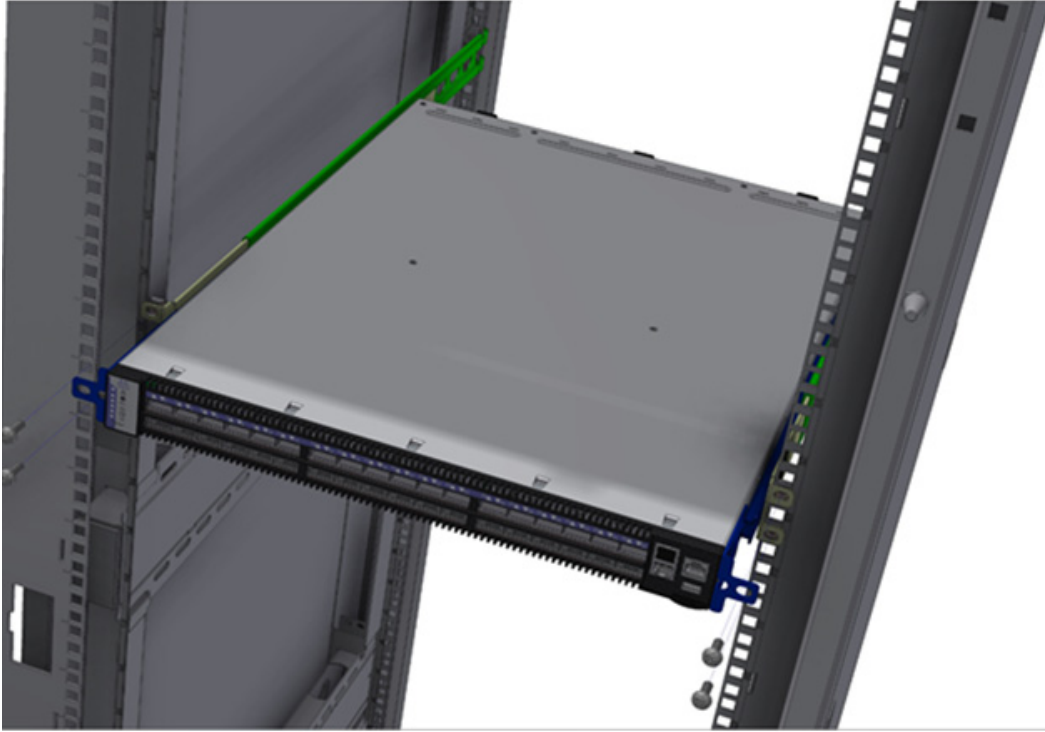

**Figure 10: Installation Completed**



### 2.4.2 Side-by-Side

This section is relevant to short-depth systems that allow such form of installation only. Installation kit parts for a side by side installation:

- 1 Two system metal frame
- 2 frame rail slides
- 4 system mounting rails - The kit contains enough rails to install 2 systems.
- 10 M-5 Pan head screws
- 24 flat head screws - The kit contains enough screws to install 2 systems.
- 1 blank cover
- 10 spacer bushing for frame installation
- 4 rubber stick-on feet  
Not used for side by side installation

The installation kits come with enough system mounted rails and flat head screws to install two systems.

The 2 system frames will fit into racks with from 21” (533mm) to 34” (864mm) between the vertical supports.

**Figure 11: Installation Kit Parts for a Side by Side Installation**

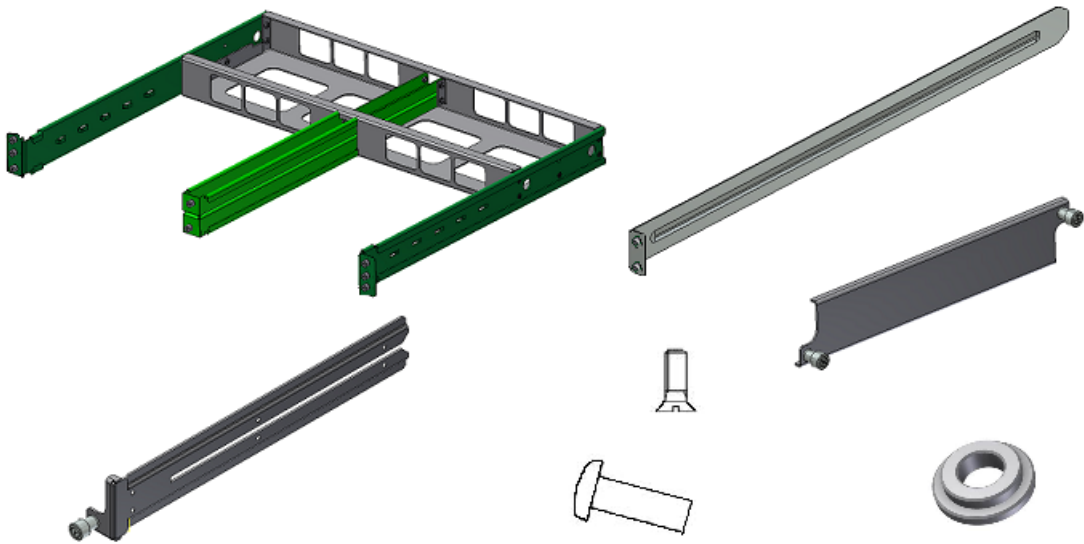



➤ ***Installing the system slides on the system***

- Step 1.** Place the ESD mat on the floor where you will be working, and put on the ESD strap. Make sure the ESD strap is touching your skin and that the other end is connected to a verified ground.
- Step 2.** Screw the two system mounted rails to the system, using six flat head screws per rail. The recommended torque is  $0.7\pm 0.1$  Nm.

**Figure 12: Screw on the System Mounted Rails**



➤ ***Install the two system frame into the rack.***

- Step 1.** Slide the frame slides into the frame.

**Figure 13: Two Systems Frame**

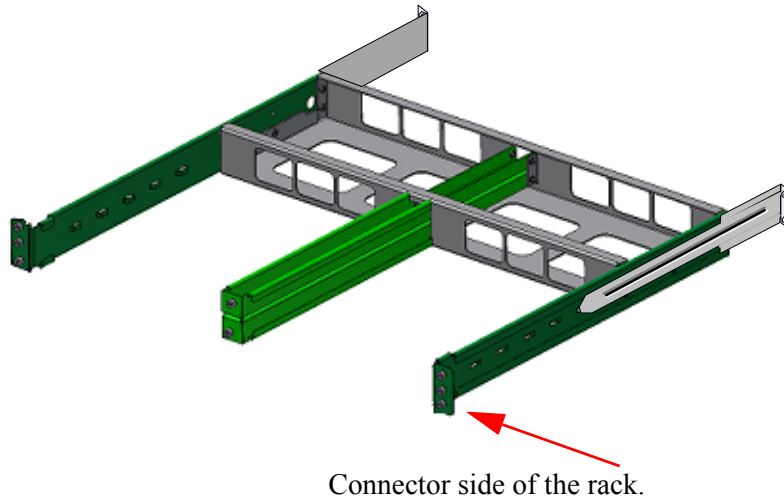

**Step 2.** Place the frame in the rack. Both sides of the frame must be on the inside of the rack.

**Figure 14: Placement of Frame in the Rack**

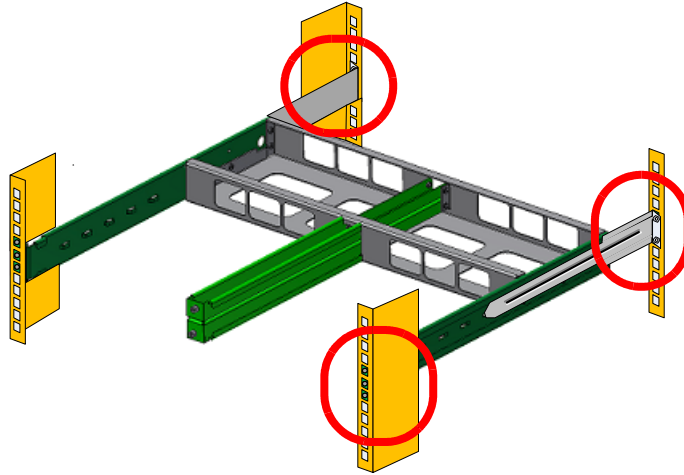

**Step 3.** Take the 10 spacer bushings and use them to adapt the square openings in the vertical support.

**Figure 15: Placing the Spacer in the Rack**

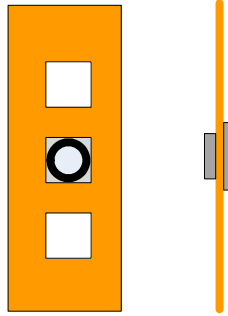

**Step 4.** Use the 10 M5 pan head screws. Do not tighten the screws to the frame.

**Figure 16: Using the Spacer Bushings**

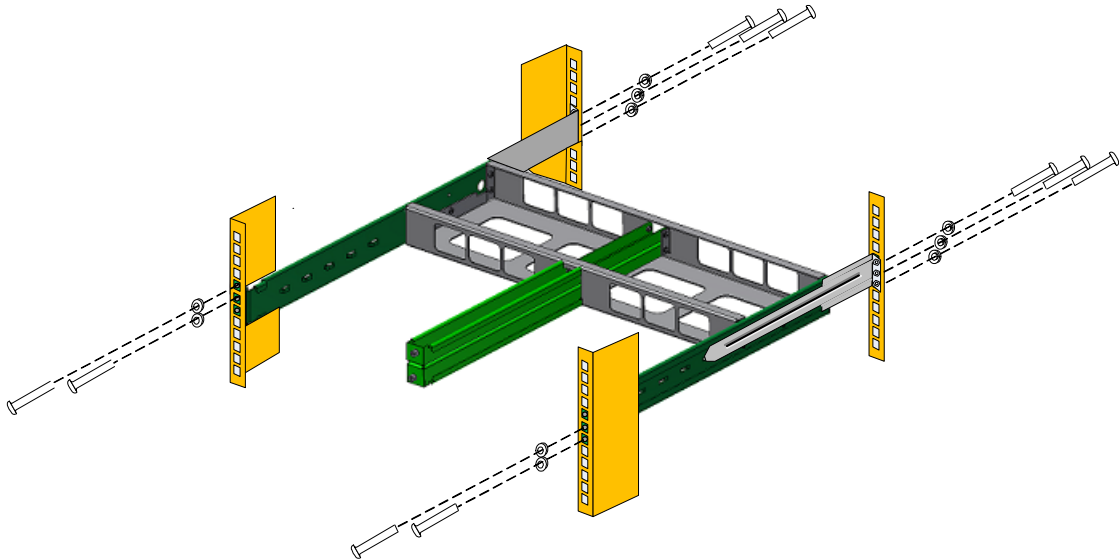

**Step 5.** Slide the system into the frame, and screw in the capture bolts into the frame.

**Figure 17: Insert System into Frame**

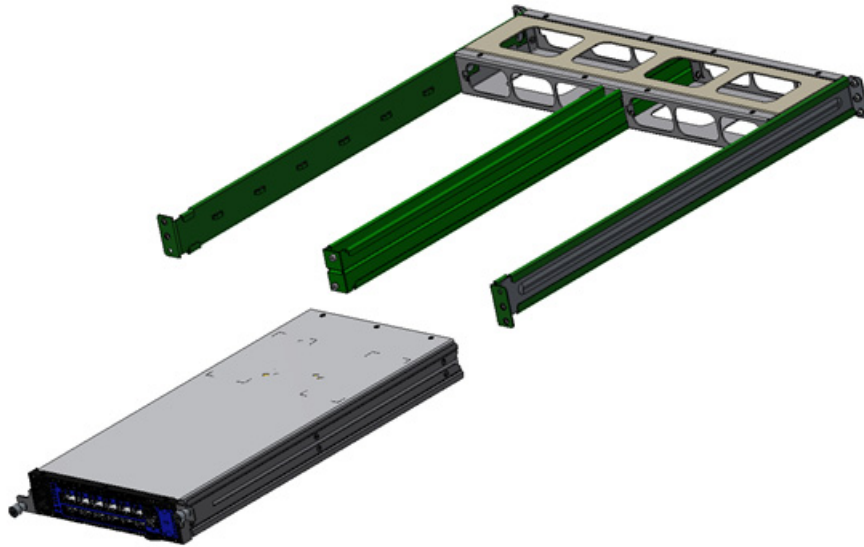

- Step 6.** Tighten the capture nuts.
- Step 7.** Install the blank panel into the frame opposite the system, or install a second system.
- Step 8.** Tighten the capture nuts.
- Step 9.** Tighten all ten screws. The recommended screw torque is  $3.5 \pm 0.3$  Nm.

### 2.4.3 Table Top

This section is relevant to short depth systems that allow such form of installation only. Included in the box is a bag with 4 rubber stick-on feet for table top installation.

➤ **Table Top Installation**

- Step 1.** Peel and stick the four rubber bumpers into the bottom of the system. Place them in the round circles.

**Figure 18: Placing the Bumpers**

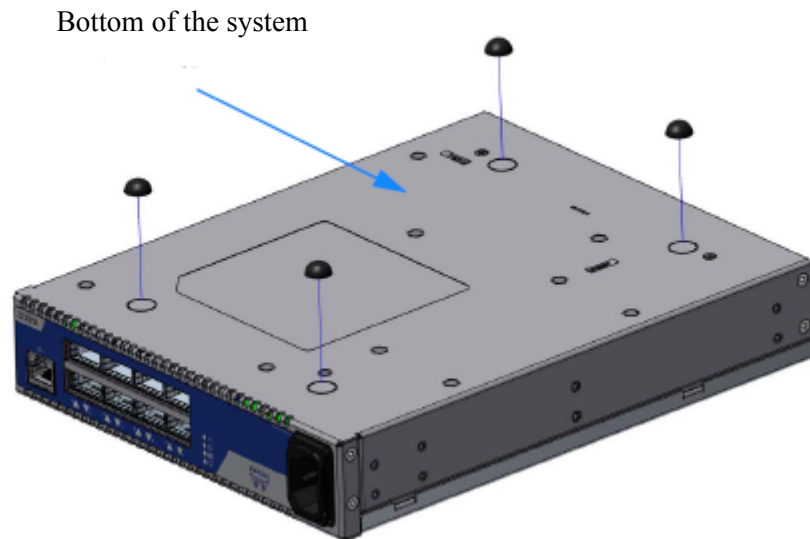

- Step 2.** Place on a flat surface. Make sure the system sits solid on the surface.
- Step 3.** Connect the power cord.
- Step 4.** Connect the data transfer cables.

## 2.5 Grounding

Check to determine if your local or national electrical codes require an external ground to all IT components. If so, connect a ground wire to one of the casing screws and connect the other end to a valid ground. If you choose to not use the ground screw, make sure that the rack is properly grounded and that there is a valid ground connection between the chassis of the system, and the rack. Test the ground using an Ohm meter.



Some national and/or local codes may require IT components to be bonded and externally grounded (not including the power cord ground). You must follow all national and local codes when installing this equipment.

## 2.6 Cable Installation

All cables can be inserted or removed with the unit powered on.

➤ **To insert a cable:**

press the connector into the port receptacle until the connector is firmly seated. The LED indicator, corresponding to each data port, will light when the physical connection is established. When a logical connection is made the relevant port LED will turn on.

➤ **To remove a cable:**

disengage the locks and slowly pull the connector away from the port receptacle. The LED indicator for that port will turn off when the cable is unseated.

For more information about port LEDs refer to Section 3.3.1.6, “Port LEDs,” on page 53.



Do not force the cable into the cage with more than 40 newtons / 9.0 pounds / 4kg force. Greater insertion force may cause damage to the cable or the cage.

**Figure 19: Cable Orientation**

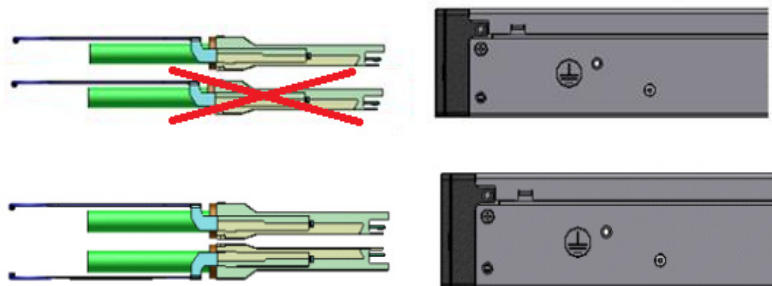

### 2.6.1 Using a Breakout Cable



Only internally managed switches, in Ethernet switch mode, support splitting of the data stream.

A 40GbE port can be split to 4 ports (or less) of 10GbE each, by using a Mellanox breakout cable.

In some switches not all ports can be split. When using a port to split a data stream into 4-10 Gb/s data streams one of the other ports on the switch will be disabled, unmapped from the switch.

When using this feature you should login into the MLNX-OS® CLI and configure the individual ports to be ‘split-2’ or ‘split-4’.

For further information and guidance, it is recommended to read more about Mellanox breakout cables on the [Mellanox Community Website](#).

**Figure 20: Breakout or Fanout Cable**



**2.6.1.1 SX1012/SX1012X**

In this switch, all ports can be split to 4x10GbE, no limitation.

**2.6.1.2 SX1024/SX1400**

**Figure 21: SX1024/SX1400 Port Splitting Options**

1	4	7	10	13	16	19	22	25	28	31	34	37	40	43	46	49	51	53	55	57	59
2	5	8	11	14	17	20	23	26	29	32	35	38	41	44	47					×	
3	6	9	12	15	18	21	24	27	30	33	36	39	42	45	48	50	52	54	56	58	60

- |||| This port can be split into 4 or 2 10Gb/s SFP+
  - ×
  - ×
- This port is unmapped according to the Port Splitting Table



The maximum 10 Gb/s Ethernet ports configurable with this switch is 64.





Ports 59 and 60 can also be split into 2 without unmapping ports 57 or 58.  
When ports 59 or 60 are split into 2 ports 57 and 58 remain as active 40 GbE ports

### 2.6.1.3 SX1036

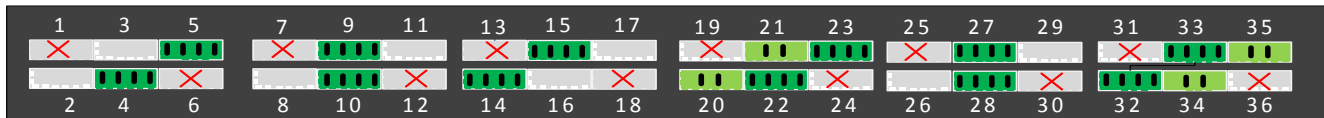
**Figure 22: SX1036 Port Splitting Options**



-  This port can be split into 4 10 Gb/s SFP+
-  This port can be split into 2 10 Gb/s SFP+
-  This port is unmapped according to the Port Splitting Table

The maximum 10 Gb/s Ethernet ports configurable with this switch is 64.

**Table 8 - Port Splitting Options**

Port #	Can be split to 4	Can be split to 2	Port #	Can be split to 4	Can be split to 2
1	No	No	19	No	No
2	No	No	20	No	Yes
3	No	No	21	No	Yes
4	Yes, disables port 1	Yes	22	Yes, disables port 19	Yes
5	Yes, disables port 6	Yes	23	Yes, disables port 24	Yes
6	No	No	24	No	No
7	No	No	25	No	No
8	No	No	26	No	No
9	Yes, disables port 12	Yes	27	Yes, disables port 30	Yes
10	Yes, disables port 7	Yes	28	Yes, disables port 25	Yes
11	No	No	29	No	No
12	No	No	30	No	No
13	No	No	31	No	No
14	Yes, disables port 13	—	32	Yes, disables port 31	Yes
15	Yes, disables port 18	—	33	Yes, disables port 36	Yes
16	No	No	34	No	Yes

**Table 8 - Port Splitting Options**

Port #	Can be split to 4	Can be split to 2	Port #	Can be split to 4	Can be split to 2
17	No	No	35	No	Yes
18	No	No	36	No	No

**Figure 23: Examples of Port Mapping Assignment**

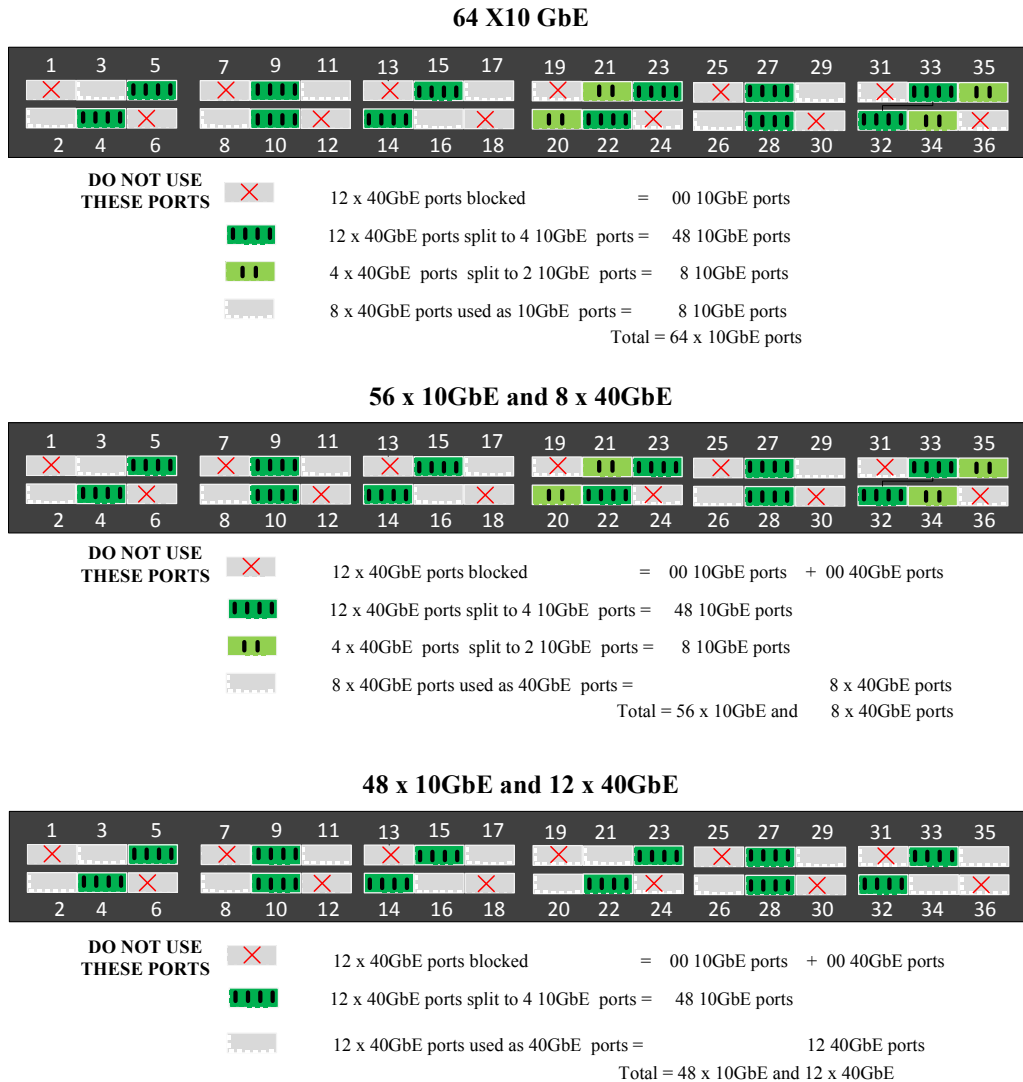

## 2.7 SFP+ Removal Tool

There is a special tool to remove SFP+ cables from switches (such as SX1016 and SX1024/SX1400) with 3 rows of SFP+ ports.

To remove SFP+ cables follow the instruction in the figure below.

**Figure 24: SFP+ Removal and Insertion Tool**

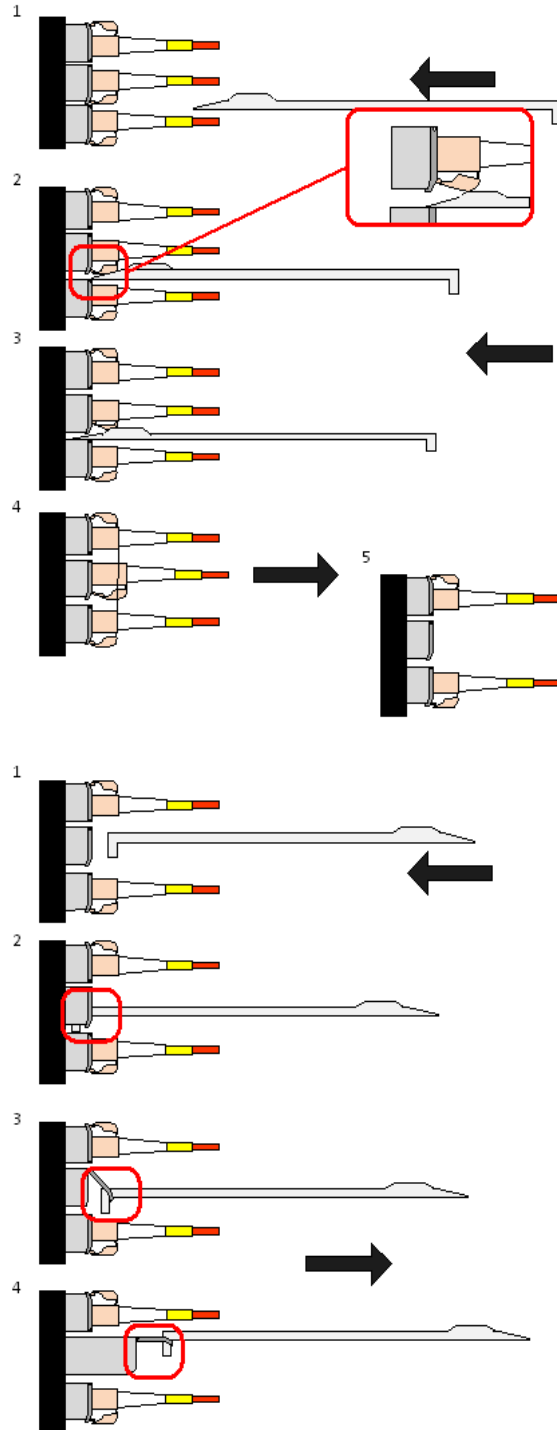

## 2.8 Initial Power On

The system's input voltage is auto-adjusting for 100 - 240VAC, 50-60Hz power connections. The power cords should be standard 3-wire AC power cords including a safety ground and rated for 15A or higher.



Caution: The system platform will automatically power on when AC power is applied. There is no power system. Check all boards, power supplies, and fan tray modules for proper insertion before plugging in a power cable.



This unit is intended for installation in a Restricted Access Location. A restricted access area can be accessed only through the use of a special tool, lock and key, or other means of security.

**Step 1.** Plug in the first power cable.



Do not plug the cords to power supplies yet.

**Step 2.** Plug in the second power cable.

**Step 3.** Wait for the system upload process.



It may take up to five minutes to turn on the system. If the System Status LED shows red after five minutes, unplug the system and call your Mellanox representative for assistance.

**Step 4.** Check the System Status LEDs and confirm that all of the LEDs show status lights consistent with normal operation, as shown in Figure 25 below. For more information, refer to "LEDs" on page 48.

**Figure 25: System Status LEDs 5 Minutes After Power On**

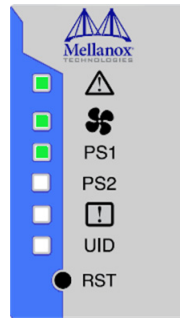

System with 1 PSU

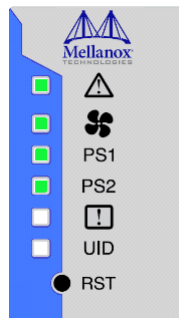

System with 2 PSUs



Caution: After inserting a power cable and confirming the green System Status LED light is on, make sure that the Fan Status LED shows green.

If the Fan Status LED is not green, unplug the power connection and check that the fan module is inserted properly and that the mating connector of the fan unit is free of any dirt and/or obstacles. If no obstacles were found and the problem persists, call your Mellanox representative for assistance.

**Figure 26: Two Power Inlets - Electric Caution Notifications**

Risk of electric shock and energy hazard. The two power supply units are independent.

Disconnect all power supplies to ensure a powered down state inside of the switch platform.

Gefahr des elektrischen Schocks. Entfernen des Netzsteckers eines Netzteils spannungsfrei. Um alle Einheiten spannungsfrei zu machen sind die Netzstecker aller Netzteile zu entfernen

Risque de choc et de danger e'lectriques. Le de'branchement d'une seule alimentation stabilise'e ne de'branch uniquement qu'un module "Alimentation Stabilise'e". Pour isoler completement le module en cause, Il faut de'brancher toutes les alimentations stabilise'es.

## 2.9 System Bring-Up



The bring-up procedures described in this section do not apply to managed systems. Such systems are ready for operation after power-on.

### 2.9.1 Configuring Network Attributes

The procedures described in this chapter assume that you have already installed and powered-on according to the instructions in this document.

➤ *To perform initial configuration of the system, perform the following:*

- Step 1.** Connect a host PC to the Console RJ45  port of the system using the supplied harness cable (DB9 to RJ45). Make sure to connect to the Console RJ45 port and not to the (Ethernet) MGT port.

- Step 2.** Configure a serial terminal program (for example, HyperTerminal, minicom, or Tera Term) on your host PC with the settings described in [Table 9](#). Once you perform that, you should get the CLI prompt of the system.

**Table 9 - Serial Terminal Program Configuration**

Parameter	Setting
Baud Rate	9600 or 115200 (see below)
Data bits	8
Stop bits	1
Parity	None
Flow Control	None



The baud rate is different per CPU type of the system. The systems based on x86 CPU (SX1400) should be configured with baud rate = 115200, while the rest of the systems (based on PPC460), should be configured with 9600.

- Step 3.** Login as *admin* and use *admin* as password. On the first login, the MLNX-OS configuration wizard will start.
- Step 4.** To configure network attributes and other initial parameters to the system, follow the configuration wizard as shown in [Table 10](#).

**Table 10 - Configuration Wizard Session - DHCP**

Wizard Session Display	Comments
Mellanox configuration wizard Do you want to use the wizard for initial configuration? yes	You must perform this configuration the first time you operate the system or after resetting the system. Type 'y' and then press <Enter>.
Step 1: Hostname? [switch ]	If you wish to accept the default hostname, press <Enter>. Otherwise, type a different hostname and press <Enter>.
Step 2: Use DHCP on mgmt0 interface? [no] yes	Perform this step to obtain an IP address for the system. (mgmt0 is the management port of the system). If you wish the DHCP server to assign the IP address, type 'yes' and press <Enter>. If you type 'no' (no DHCP), then you will be asked whether you wish to use the 'zeroconf' configuration or not. If you enter 'no' (no Zeroconf), you must enter a <i>static</i> IP, and the session will continue.
Step 3: Enable IPv6? [yes]	The management interface will be able to use IPv6 addresses.
Step 4: Enable IPv6 auto-config (SLAAC) on mgmt0 interface? [no]	This turns on auto-configuration of the IPv6 addresses. This is unsuitable for DHCPv6. If you enter "no" (no IPv6), you will automatically be referred to Step 6.

**Table 10 - Configuration Wizard Session - DHCP**

Wizard Session Display	Comments
Step 5: Enable DHCPv6 on mgmt0 interface? [no]	To enable DHCPv6 on the MGMT0 interface.
Step 6: Admin password (Press <Enter> to leave unchanged)? <new_password> Step 6: Confirm admin password? <new_password>	To avoid illegal access to the machine, please type a password and then press <Enter>. Then confirm the password by re-entering it.  Note that password characters are <i>not</i> printed.
You have entered the following information:  <A summary of the configuration is now displayed.> To change an answer, enter the step number to return to or hit <enter> to save changes and exit. Choice: <Enter> Configuration changes saved.	The wizard displays a summary of your choices and then asks you to confirm the choices or to re-edit them.  Either press <Enter> to save changes and exit, or enter the configuration step number that you wish to return to.  Note: To re-run the configuration wizard, run the command “configuration jump-start” in Config mode.

The table below shows an example of static IP configuration for mgmt0 interface.



**Table 11 - Configuration Wizard Session - Static IP Configuration**

Wizard Session Display - Static IP Configuration (Example)
<p>Mellanox configuration wizard</p> <p>Do you want to use the wizard for initial configuration? yes</p> <p>Step 1: Hostname? []</p> <p>Step 2: Use DHCP on mgmt0 interface? [yes] no</p> <p>Step 3: Use zeroconf on mgmt0 interface? [no]</p> <p>Step 4: Primary IP address? [for example 192.168.10.4] 10.10.10.10 Mask length may not be zero if address is not zero (interface eth0)</p> <p>Step 5: Netmask? [0.0.0.0] 255.255.255.0</p> <p>Step 6: Default gateway? [for example 192.168.10.1] 10.10.10.255</p> <p>Step 7: Primary DNS server?</p> <p>Step 8: Domain name?</p> <p>Step 9: Enable IPv6? [yes]</p> <p>Step 10: Enable IPv6 autoconfig (SLAAC) on mgmt0 interface? [no]</p> <p>Step 11: Admin password (Enter to leave unchanged)?</p> <p>To change an answer, enter the step number to return to. Otherwise hit &lt;enter&gt; to save changes and exit. Choice: Configuration changes saved.</p> <p>To return to the wizard from the CLI, enter the “configuration jump-start” command from configure mode. Launching CLI... &gt;</p>

- Step 5.** Before attempting a remote (for example, SSH) connection to the system, check the mgmt0 interface configuration. Specifically, verify the existence of an IP address. To check the current mgmt0 configuration, enter the following commands:

```
switch (config) # show interfaces mgmt0
r-qa-sit-sx01 (config) # show interfaces mgmt0
Interface mgmt0 status:
  Comment:
  Admin up:          yes
  Link up:           yes
  DHCP running:     yes
  IP address:        10.209.28.50
  Netmask:           255.255.255.0
  IPv6 enabled:      yes
  Autoconf enabled: no
  Autoconf route:    yes
  Autoconf privacy: no
  DHCPv6 running:   no
  IPv6 addresses:    1
  IPv6 address:      fe80::202:c9ff:fe63:b55a/64
  Speed:             1000Mb/s (auto)
  Duplex:            full (auto)
  Interface type:    ethernet
  Interface source:  physical
  MTU:               1500
  HW address:        00:02:C9:63:B5:5A

  RX bytes:          968810197      TX bytes:          1172590194
  RX packets:        10982099       TX packets:        10921755
  RX mcast packets: 0           TX discards:       0
  RX discards:       0           TX errors:          0
  RX errors:         0           TX overruns:        0
  RX overruns:       0           TX carrier:         0
  RX frame:          0           TX collisions:      0
  TX queue len:      1000

r-qa-sit-sx01 (config) #
```

- Step 6.** You are advised to check the software version embedded in your system, using the command ‘show version’. you can continue and compare this version to the latest version that can be retrieved from Mellanox support site. To upgrade software, simply refer to MLNX-OS user manual.

## 2.9.2 Remote Connection

Once the network attributes are set, you can access the CLI via SSH or the WebUI via HTTP/HTTPS.

➤ *To access the CLI, perform the following steps:*

- Step 1.** Set up an Ethernet connection between the system and a local network machine using a standard RJ45 connector.

**Step 2.** Start a remote secured shell (SSH) using the command: “ssh -l <username> <IP\_address>”,

```
# ssh -l <username> <ip address>
Mellanox MLNX-OS Switch Management

Password:
```

**Step 3.** Login as admin (default username is *admin*, password *admin*).

**Step 4.** Once you get the CLI prompt, you are ready to use the system.

For additional information about MLNX-OS, refer to MLNX-OS User Manual located on Mellanox support web.

## 2.10 FRU Replacements



Never run the system more than 5 minutes with an uncovered (open) PSU or fan slot.



This section does not apply to SX1012/SX1012X

### 2.10.1 Power Supply and Fans

#### 2.10.1.1 Power Supply

Mellanox systems equipped with two replaceable power supply units work in a redundant configuration. Either unit may be extracted without bringing down the system.



Make sure that the power supply unit that you are NOT replacing is showing all green, for both the power supply unit and System Status LEDs.



Power supply units have directional air flows similar to the fan module. The fan module airflow must coincide with the airflow of all of the power supply units. If the power supply unit airflow direction is different from the fan module airflow direction, the system's internal temperature will be affected.

For power supply unit air flow direction, refer to Section 2.2 on page 15.

➤ **To extract a power supply unit:**

**Step 1.** Remove the power cord from the power supply unit.

- Step 2.** Grasping the handle with your right hand, push the latch release with your thumb while pulling the handle outward. As the power supply unit unseats, the power supply unit status LEDs will turn off.
- Step 3.** Remove the power supply unit.

**Figure 27: Power Supply Unit Extraction**

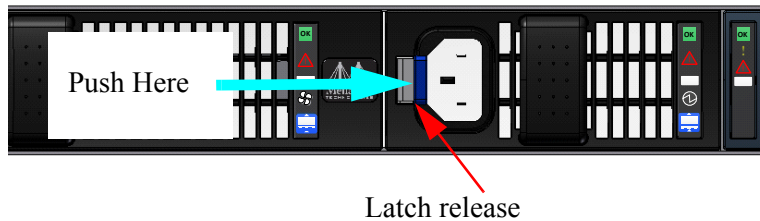

**Figure 28: PS Unit Pulled Out**

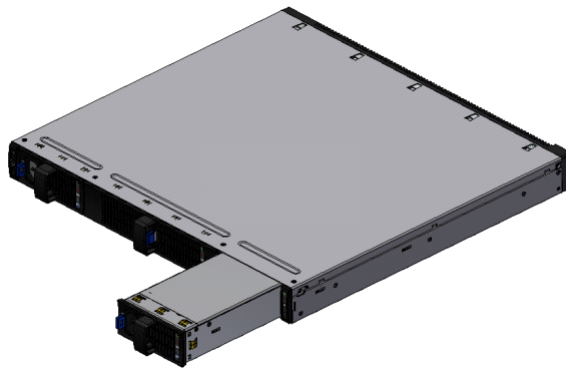

➤ **To insert a power supply unit:**

- Step 1.** Make sure the mating connector of the new unit is free of any dirt and/or obstacles.



Do not attempt to insert a power supply unit with a power cord connected to it.

- Step 2.** Insert the power supply unit by sliding it into the opening until a slight resistance is felt.
- Step 3.** Continue pressing the power supply unit until it seats completely. The latch will snap into place, confirming the proper installation.
- Step 4.** Insert the power cord into the supply connector.
- Step 5.** Insert the other end of the power cord into an outlet of the correct voltage.



The green power supply unit indicator should light. If not, repeat the whole procedure to extract the power supply unit and re-insert it.

### 2.10.1.2 Fan

The system can operate indefinitely with less than a full compliment of fans in the fan modules, so long as the ambient temperature is below 45° Celsius.



Operation without a fan unit should not exceed two minutes. During fan hot-swap, if the LED indicator is OFF, the fan unit is disconnected.



Make sure that the fans have the air flow that matches the model number. An air flow opposite to the system design will cause the system to operate at a higher (less than optimal) temperature.

For power supply unit air flow direction, refer to Section 2.2 on page 15

➤ **To extract a fan unit:**

**Step 1.** For a fan unit composed of two fans: using two fingers, push both latch releases towards each other simultaneously while pulling the fan module out of the system. As the fan unseats, the Fan Status LED will turn off.

For a single fan unit: grasping the handle with your right hand, push the latch release with your thumb while pulling the handle outward. As the fan unit unseats, the fan unit status LEDs will turn off.

**Step 2.** Remove the fan unit.

**Figure 29: Fan Module Latches**

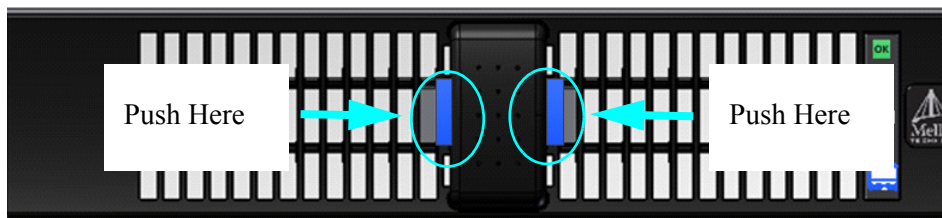

These two latches must be pushed towards each other at the same time while the module is pulled out.

➤ **To insert a fan unit:**

**Step 1.** Make sure the mating connector of the new unit is free of any dirt and/or obstacles.

**Step 2.** Insert the fan unit by sliding it into the opening until slight resistance is felt. Continue pressing the fan unit until it seats completely



The green Fan Status LED should light. If not, extract the fan unit and reinsert it. After two unsuccessful attempts to install the fan unit, power off the system before attempting any system debug.

## 3 Interfaces

### 3.1 Supported Interfaces

The systems support the following interfaces:

- Data interfaces - InfiniBand and Ethernet
- 100/1000 MbE RJ45 management interface(s)
- USB port
- RS232 Console port
- I2C interface
- Reset button
- Status and Port LEDs

In order to review the full configuration options matrix, refer to Table 4, “Management Interfaces and FRUs”.

### 3.2 Data Interfaces

The data interfaces use QSFP+ and/or SFP+ connectors. The full list of interfaces per system is provided in Table 3, “Speed and Switching Capabilities,” on page 10.

- Each QSFP+ port can be connected with QSFP+ cable or connector for 40/56Gb/s, or 10Gb/s when connecting through Mellanox QSFP+ to SFP+ (Dynamix™ QSA) adapters.

The systems offer LR4 transceivers support in the following ports:

- SX1036 - ports 1,3,33,35
- SX1024/SX1400 - ports 50,52,54,56,58,60
- SX1012 - all ports

#### 3.2.1 Speed

Ethernet speed must be set manually. The SFP+ ports can be manually configured to run at speeds ranging from 1GbE to 10 GbE. The QSFP+ ports can be manually configured to run at speeds ranging from 1GbE to 56 GbE. To change the port speed configuration use the command “speed” under interface configuration mode. Refer to MLNX-OS user manual for instructions on port speed re-configuration.



56GbE is upgradable via a software license.

### 3.2.2 RS232 (Console)

The port labeled “Console”  is an RS232 serial port used for initial configuration and debugging. Upon first installation of the system, you need to connect a PC to this interface and configure network parameters for remote connections. Refer to Section 2.9.1 to view the full procedure.

### 3.2.3 Management

The RJ45 Ethernet port labeled “MGT”  provides access for remote management. The management port is configured with auto-negotiation capabilities by default (100MbE to 1000GbE). The management port network attributes (such as IP Address) need to be pre-configured via the RS232 console port before using the port. Refer to Section 2.9.1 to view the full procedure.



Make sure you use only FCC compliant Ethernet cables.

### 3.2.4 USB

The USB interface is USB 2.0 compliant and can be used by MLNX-OS software to connect to an external disk for software upgrade or file management. The USB connector comes with either regular or mini USB shapes.

To view the full matrix of the USB configuration options, refer to Table 4, “Management Interfaces and FRUs”.



USB 1.0 is not supported.



Do NOT use excessive force when inserting or extracting the USB disk from the connector.

### 3.2.5 I2C

The I2C connector is located either on the power supply side (banana connector), or on the front side (RJ45 connector).



The I2C interface is used for debugging and is intended for Mellanox debug personnel only.

### 3.2.6 Reset Button

The reset button is located on the front side panel under the status LEDs. This reset button requires a tool to be pressed.



DO NOT use a sharp pointed object such as a needle or a push pin for pressing the Reset button. Use a flat object to push the reset button.

➤ *To reset the system and the CPU of its management board, perform the following:*

Push the Reset button and keep it pressed for up to 14 seconds.

➤ *To reset the system, the CPU of its management board and the “admin” password, perform the following:*

Push the Reset button and keep it pressed for at least 15 seconds. You will then be able to enter without a password and set a new password for the user “admin”.

In the externally managed systems the reset button resets the device.

## 3.3 LEDs

### 3.3.1 LED Notifications



The system’s LEDs are an important tool for hardware event notification and troubleshooting. Mellanox systems have two types of LEDs:

- Status LEDs
- Port LEDs

The Status LEDs are located to the left side of the front panel and on the power side at the far right. The port LEDs are located on top of the data ports- see Section 3.3.



**Table 12 - Status LEDs**

Symbol	Name	Description	Normal Conditions
	System Status LED	Shows the health of the system	Green
	Fan Status LED	Shows the health of the fans	Green
PS1	Power supply #1*	Shows the health of the right side power supply unit	Green
PS2	Power supply #2*	Shows the health of the left side power supply unit	Green
	Bad Port LED	lights up when a symbol error is detected on one of the ports.	Off
UID	Unit Identifier LED	Lights up on command through the CLI	Off

\*In SX1024 and SX1400, PS1 and PS2 are combined into one LED. In SX1016, there is no power supply monitoring.

### 3.3.1.1 System Status LED

**Figure 30: System Status LEDs - Front and Rear sides**

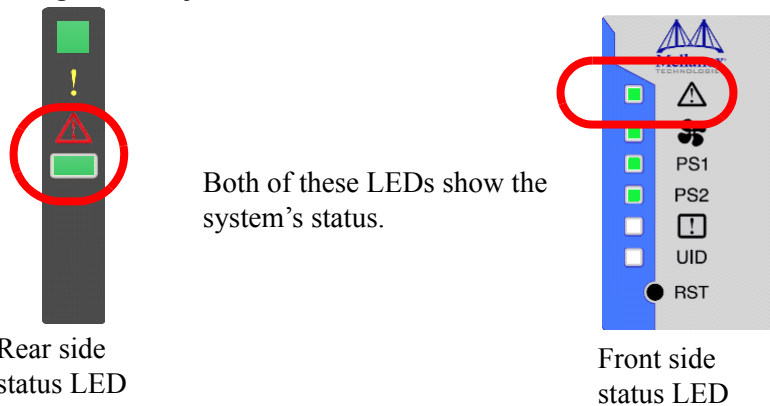

Both of the System Status LEDs (front and back) supply identical information.



It may take up to five minutes to turn on the system. If the System Status LED shows red after five minutes, unplug the system and call your Mellanox representative for assistance.

**Table 13 - System Status LED Assignments**

LED Behavior	Description	Action Required
Solid Green	The system is up and running (normal condition).	N/A
Flashing Green	The system is booting up. This assignment is valid on managed systems only.	Wait up to five minutes for the end of the booting process.
Solid Red	Major Error has occurred. For example, corrupted firmware, system is over-heated etc.	If the System Status LED shows red five minutes after starting the system, unplug the system and call your Mellanox representative for assistance.
Off	The system has no power.	Check the power source and cable.

### 3.3.1.2 Fan Status LED



All fans must be operating while the power supply is plugged in.

**Figure 31: Fan Status LED - Front and Rear sides**

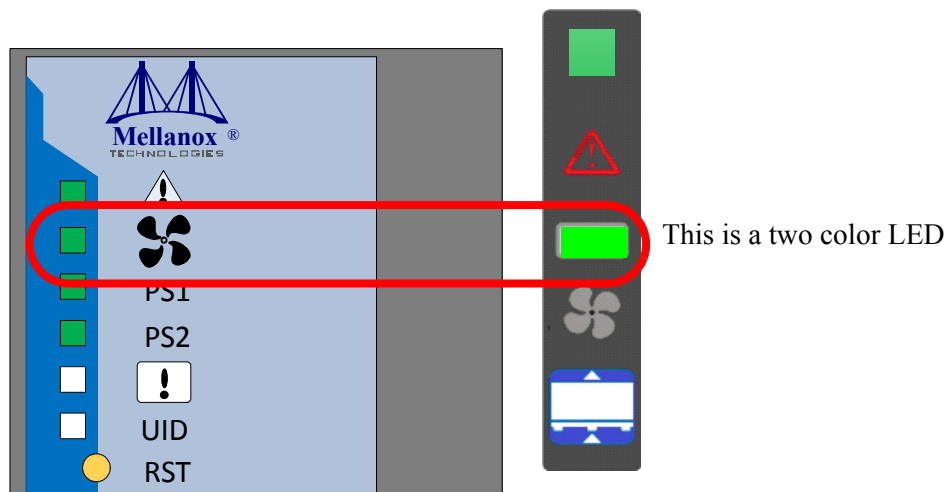

**Table 14 - Fan Status LED Assignments**

LED Behavior	Description	Action Required
Solid Green	All fans are up and running (normal condition).	N/A
Solid Red	Error, one or more fans is not operating properly.	In case there is an FRU, the module should be replaced. Otherwise, the system should be replaced.

**Table 14 - Fan Status LED Assignments**

LED Behavior	Description	Action Required
Off	The fan unit is not receiving any power.	Check that the fan unit is properly and completely inserted.



**Risk of Electric Shock!**  
 With the fan module removed power pins are accessible within the module cavity. DO NOT insert tools or body parts into the fan module cavity.

### 3.3.1.3 Power Supply Status LEDs

**Figure 32: Power Status LED**

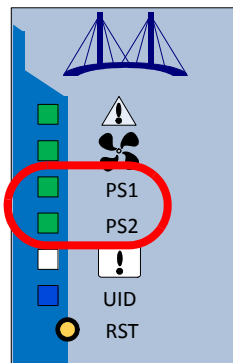

There are two power supply inlets in the system (for redundancy). The system can operate with only one power supply connected. In case the power supply is an FRU, a second power supply unit can be added to support hot-swap ability. Each power supply unit has a single 2 color LED on the right side of the unit, that indicates the status of the unit. In SX1024 and SX1400 PS1 and PS2 are combined into one LED.

**Figure 33: Rear Side Panel**



Power Supply Unit

The primary power supply (PS) unit is located on the left side and the secondary unit is located on the right side.

**Table 15 - Power Supply Unit Status LED Assignments**

LED Behavior	Description	Action Required
Solid Green	The Power supply is running in normal condition.	N/A
Solid Red	Error, the unit is not operational.	In case there is an FRU, the module should be replaced. Otherwise, the system should be replaced.
Off	There is no power to the system, the unit is receiving no power.	Check power source or replace the cable.

### 3.3.1.4 Bad Port LED

The Bad Port LED indicator is used to indicate symbol errors in one or more system ports. Table 16 shows the bad port status LED assignment.

**Table 16 - Bad Port LED Assignments**

LED Configuration	Description	Action Required
Off	No symbol errors have been received in last few seconds (normal condition)	N/A
Flashing Orange	Error, one or more ports have received symbol errors. Possible causes are: <ul style="list-style-type: none"> <li>• Bad cable</li> <li>• Bad connection</li> <li>• Bad connector</li> </ul>	Check symbol error counters on the system UI to identify the ports. Replace the cable on these ports.

### 3.3.1.5 Unit Identification LED

The UID LED is a debug feature, that the user can use to find a particular system within a cluster by turning on the UID blue LED.

➤ **To activate the UID LED on a switch system, run:**

```
switch (config) # led MGMT uid on
```

➤ **To verify the LED status, run:**

```
switch (config) # show leds
Module LED Status
-----
MGMT UID Blue
```

**To deactivate the UID LED on a switch system, run:**

```
switch (config) # led MGMT uid off
```

The UID LED is a debug feature, that upon user configuration, lights a blue LED for ease in finding a particular system within a cluster. This is a future feature that is not yet available.

### 3.3.1.6 Port LEDs

The SFP+ ports come three rows to a column. The LEDs refer to the ports according to the color coding in Figure 34.

**Figure 34: SFP+ Port LED Assignment**

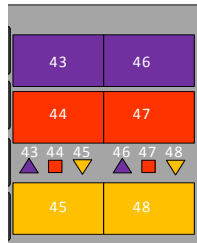

**Figure 35: Port LEDs**

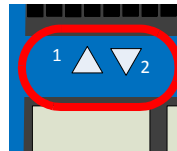

**Table 17 - Port LEDs in Ethernet System Mode**

LED Behavior	Description	Action Required
Off	Physical link is down.	Check the cable
Solid Green	Physical link is up with no traffic.	N/A
Flashing Green	Physical link is up with traffic.	N/A
Flashing Orange	Physical errors.	Check the cable

**Table 18 - Port LEDs in InfiniBand System Mode**

LED Behavior	Description	Action Required
Off	Physical link is down.	Check the cable
Solid Green	Logical link is up.	N/A
Flashing Green	Data activity flashing speed is proportional to data transfer speed.	N/A
Solid Orange	Physical link is up.	Wait for the Logical link to raise. Check that the SM is up.
Flashing Orange	A problem with the physical link.	Check that the SM is up.

## 3.4 Inventory Pull-out Tab

The system’s inventory parameters (such as serial number, part number and MAC address) can be extracted from the Inventory pull-out tab on the lower right side of the front panel.



SX1016 does not contain an inventory pull-out tab.

Figure 36: Pull-out Tab

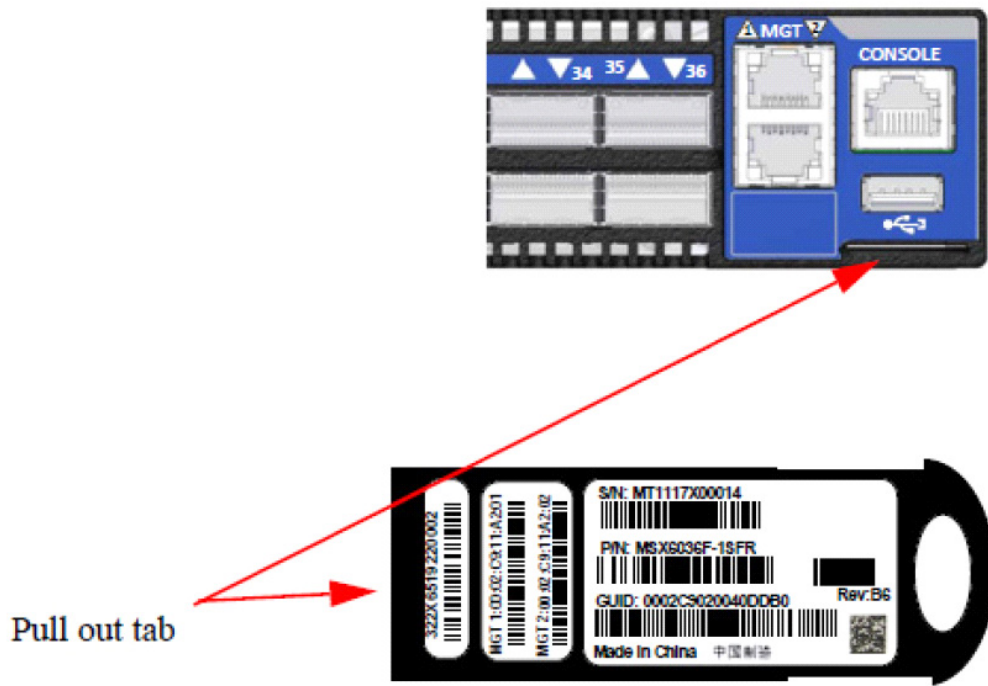

## 4 Software Management

Managed systems come with an embedded management CPU card that runs MLNX-OS® management software.

The MLNX-OS systems management package and related documentation can be downloaded via the product page:

[http://www.mellanox.com/page/mlnx\\_os](http://www.mellanox.com/page/mlnx_os).

### 4.1 Upgrading Software

Software and firmware updates are available from the Mellanox Support website. Check that your current revision is the same one that is on the Mellanox website. If not upgrade your software. Copy the update to a known location on a Remote server within the user's LAN.

Use the CLI or the GUI in order to perform software upgrades. For further information please refer to the MLNX-OS Software User Manual section Upgrading MLNX-OS® Software.

Be sure to read and follow all of the instructions regarding the updating of the software on your system.

Managed systems do not require Firmware updating. Firmware updating is done through the MLNX-OS management software. The system comes standard with a management software module for system management called Mellanox Operating System (MLNX-OS). MLNX-OS® is installed on all SwitchX®-2 based managed systems. MLNX-OS® includes a CLI, WebUI, SNMP, system management software and IB management software (OpenSM).



The Ethernet ports for remote management connect to Ethernet systems. These systems must be configured to 100Mb/1 Gb auto-negotiation.

## 5 Troubleshooting

### 5.1 Troubleshooting Instructions

*Table 19 - Troubleshooting*

Problem Indicator	Symptoms	Corrective Measures
LEDs	System Status LED is blinking for more than 5 minutes	This state means that the MLNX-OS software did not boot properly and only firmware is running. To overcome it, connect to the system via the console port, and check the software status. You might need to contact an FAE if the MLNX-OS software did not load properly
	System Status LED is red	This state can indicate a number of problems: <ul style="list-style-type: none"> <li>• Critical system fault (CPU error, bad firmware)</li> <li>• Over Temperature</li> </ul> To overcome it: <ul style="list-style-type: none"> <li>• Check Environmental conditions (room temperature)</li> </ul>
	Fan Status LED is red	This state is indicative of a problem with the FAN. <ul style="list-style-type: none"> <li>• Check that the FAN is fully inserted and nothing blocks the airflow.</li> <li>• Replace the FAN FRU if needed.</li> </ul>
	PSU Status LED is red	This state is indicative of a problem with the PSU. <ul style="list-style-type: none"> <li>• Check/replace the power cable.</li> <li>• Replace the PSU if needed.</li> </ul>



**Table 19 - Troubleshooting**

Problem Indicator	Symptoms	Corrective Measures
System boot failure	The last software upgrade failed on PPC based systems	<ul style="list-style-type: none"> <li>• Make sure that there is an SM running in the fabric.</li> <li>• Connect the RS232 connector (CONSOLE) to a laptop.</li> <li>• Push the reset button on the system or on the management module.</li> <li>• You will have ~ 5 seconds to stop the U-Boot by pressing Control-B.</li> <li>• Choose the image you wish to upload. Use image 1 or image 2 only.</li> <li>• Select the previous image to boot.</li> </ul> <pre> U-Boot 2009.01-mlnx1.4 (&lt;date&gt;) CPU: AMCC PowerPC 460EX Rev. A at 1000 MHz (PLB=200, OPB=100, EBC=100 MHz) Security/Kasumi support Bootstrap Option H - Boot ROM Location I2C (Addr 0x52) Internal PCI arbiter disabled 32 kB I-Cache 32 kB D-Cache Board: Mellanox PPC460EX Board FDEF: No I2C: ready DRAM: 2 GB (ECC enabled, 400 MHz, CL3) FLASH: 16 MB NAND: 1024 MiB PCI: Bus Dev VenId DevId Class Int PCIE0: link is not up. PCIE1: successfully set as root-complex 01 00 15b3 bd34 0c06 00 Net: ppc_4xx_eth0, ppc_4xx_eth1 Hit Ctrl+B to stop autoboot: 0 Mellanox MLNX-OS Boot Menu: 1. SX_PPC_M460EX 3.3.5006-dev-HA 2013-04-10 12:02:49 ppc 2. SX_PPC_M460EX 3.3.5006-dev-HA 2013-04-11 14:05:39 ppc 3. U-Boot prompt Choice: </pre>

**Table 19 - Troubleshooting**

Problem Indicator	Symptoms	Corrective Measures
System boot failure	The last software upgrade failed on x86 based systems (SX1400)	<ul style="list-style-type: none"> <li>• Connect the RS232 connector (CONSOLE) to a laptop.</li> <li>• Push the system's reset button.</li> <li>• Press the ArrowUp or ArrowDown key during the system boot. GRUB menu will appear. For example:</li> </ul> <pre> Default image: 'SX_X86_64 SX_3.4.0008 2014-11-10 20:07:51 x86_64' Press enter to boot this image, or any other key for boot menu Booting default image in 3 seconds.  Boot Menu ----- ----- 0: SX_X86_64 SX_3.4.0008 2014-11-10 20:07:51 x86_64 1: SX_X86_64 SX_3.4.0007 2014-10-23 17:27:34 x86_64 ----- -----  Use the * and * keys to select which entry is highlighted. Press enter to boot the selected image or 'p' to enter a password to unlock the next set of features.  Highlighted entry is 0: " </pre> <ul style="list-style-type: none"> <li>• Select previous image to boot by pressing an arrow key and choosing the appropriate image.</li> </ul>

## 6 Specifications

### 6.1 SX1012 Series

*Table 20 - SX1012/SX1012X Specifications*

Feature	Value
Mechanical	<b>Size:</b> 1.73" (H) x 7.9" (W) x 15.7" (D), 43.6mm (H) x 200mm (W) x 410.6mm (D)
	<b>Mounting:</b> side by side for 19" rack mount or table top.
	<b>Weight:</b> System with 1 PSU: 2.98kg/6.57lbs System with 2 PSUs: 3.2kg/7.05lbs
	<b>Speed:</b> 10, 40 or 56 GbE per port in SX1012 10GbE per port in SX1012X
	<b>Connector cage:</b> 12 QSFP+
	<b>Heat dissipation:</b> 293 BTUs/hr
Environmental	<b>Humidity:</b> Operational: 10% - 85% non-condensing Non-Operational: 10% - 90% non-condensing
	<b>Temperature:</b> Operational: 0° to 45°C Non-Operational: -40° to 70°C
	<b>Altitude:</b> Operational: 3050m
Regulatory	RoHS6
	<b>Safety:</b> CS, cTUVus, CE, CU <b>EMC:</b> CE, FCC, VCCI, ICES, RCM
Power	<b>Input Voltage:</b> 100 - 240 VAC 50-60Hz  <b>Max Consumption:</b> Passive cables: 136W Active Cables: 163W Optical Cables: 168W <b>Typical (ATIS score under "snake" topology):</b> With passive cables: 49.12W
CPU and Switch	<b>CPU:</b> PPC460EX
	<b>Switch:</b> Mellanox SwitchX®
Switching	<b>SX1012 Capacity:</b> 672Gb/s non-blocking <b>SX1012X Capacity:</b> 120Gb/s non-blocking

## 6.2 SX1016 Series

**Table 21 - SX1016 Specifications**

Feature	Value
Mechanical	<b>Size:</b> 1.716" (H) H x 16.85" (W) x 16.2" (D), 43.6mm (H) x 427.9mm (W) x 408.4mm (D)
	<b>Mounting:</b> 19" Rack mount
	<b>Weight:</b> System with 2PSUs: 7.82kg/17.24lbs
	<b>Speed:</b> 10GbE per port
	<b>Connector cage:</b> 64 SFP+
	<b>Heat dissipation:</b> 686BTUs/hr
Environmental	<b>Temperature:</b> Operational: 0° to 45°C Non-Operational: -40° to 70°C
	<b>Humidity:</b> Operational: 10% - 85% non-condensing Non-Operational: 10% - 90% non-condensing
	<b>Altitude:</b> Operational: 3050m
Regulatory	<b>Safety:</b> CS, cTUVus, CE, CU <b>EMC:</b> CE, FCC, VCCI, ICES, RCM
	RoHS6
Power	<b>Input Voltage:</b> 100 - 240 VAC 50-60Hz  <b>Max Consumption:</b> Active Cables: 239.53 Passive cables: 156.84 <b>Typical (ATIS score under "snake" topology):</b> With passive cables: 63.99W
Main Devices	<b>CPU:</b> PPC460EX
	<b>Switch:</b> Mellanox SwitchX
Switching	<b>Capacity:</b> 640Gb/s non-blocking

## 6.3 SX1024 Series

**Table 22 - SX1024 Specifications**

Feature	Value
Mechanical	<b>Size:</b> 1.716" (H) H x 16.85" (W) x 15.9" (D), 43.6mm (H) x 428mm (W) x 426.3mm (D)
	<b>Mounting:</b> 19" Rack mount
	<b>Weight:</b> System with 1 PSU: 7.01kg/15.45lbs System with 2 PSUs: 7.75kg/17.08bs
	<b>Speed:</b> 10GbE per SFP+ port, 40/56GbE per QSFP+ port
	<b>Connector cage:</b> 48 SFP+, 12 SFP+
	<b>Heat dissipation:</b> 913 BTUs/hr
Environmental	<b>Temperature:</b> Operational: 0° to 45°C Non-Operational: -40° to 70°C
	<b>Humidity:</b> Operational: 10% - 85% non-condensing Non-Operational: 10% - 90% non-condensing
	<b>Altitude:</b> Operational: 3050m
Regulatory	<b>Safety:</b> CS, cTUVus, CE, CU <b>EMC:</b> CE, FCC, VCCI, ICES, RCM
	RoHS6
Power	<b>Input Voltage:</b> 100 - 240 VAC 50-60Hz  <b>Max Consumption:</b> Passive cables: 175 W Active Cables: 263 W Optical cables: 267 W <b>Typical (ATIS score under "snake" topology):</b> With passive cables: 73.15
Main Devices	<b>CPU:</b> PPC460EX
	<b>Switch:</b> Mellanox SwitchX®
Switching	<b>Capacity:</b> 1.15Tb/s non-blocking

## 6.4 SX1036 Series

**Table 23 - SX1036 Specifications**

Feature	Value
Mechanical	<b>Size:</b> Short - 1.716" (H) H x 16.85" (W) x 16.8" (D), 43.6mm (H) x 428mm (W) x 426.9 mm (D) Standard - 1.716" (H) H x 16.85" (W) x 24.75" (D), 43.6mm (H) x 428mm (W) x 627.1mm (D)
	<b>Mounting:</b> 19" Rack mount
	<b>Weight:</b> Short - System with 1PSU: 7.08kg/15.60lbs System with 2PSUs: 7.82kg/17.24lbs Standard - System with 1PSU: 8.02kg/17.68lbs System with 2PSUs: 8.76kg/19.31lbs
	<b>Speed:</b> 40/56GbE per port
	<b>Connector cage:</b> 36 QSFP+
	<b>Heat dissipation:</b> 233 W / 798 BTUs/hr
Environmental	<b>Temperature:</b> Operational: 0° to 45°C Non-Operational: -40° to 70°C
	<b>Humidity:</b> Operational: 10% - 85% non-condensing Non-Operational: 10% - 90% non-condensing
	<b>Altitude:</b> Operational: 3050m
Regulatory	<b>Safety:</b> CS, cTUVus, CE, CU <b>EMC:</b> CE, FCC, VCCI, ICES, RCM
	RoHS6
Power	<b>Input Voltage:</b> 100 - 240 VAC 50-60Hz
	<b>Max Consumption:</b> Active Cables: 224W – 6.2 W/port Passive cables: 119W – 3.3W/port <b>Typ Consumption:</b> Active Cables: 182W – 5W/port Passive cables: 100W – 2.8W/port
	<b>Typical (ATIS score under "snake" topology):</b> 79.42
Main Devices	<b>CPU:</b> PPC460EX
	<b>Switch:</b> Mellanox SwitchX®
Switching	<b>Capacity:</b> 2.02Tb/s non-blocking

## Appendix A: Accessory and Replacement Parts

**Table 24 - OPNs for Replacement Parts**

OPN	Part Description
MSX60-PF	300W Power Supply w/ Power Supply Side to Connector side for MSX-60XX and MSX10XX series switch systems
MSX60-PR	300W Power Supply w/ Connector side to Power Supply side for MSX60XX and MSX10XX series switch systems
MSX62-FF	Dual fan module with power supply side to connector side for SX1024 series switch systems
MSX62-FR	Dual fan module with connector side to power supply side for SX1024 series switch systems
MSX60-FF	Fan module with power supply side to connector side for MSX60XX and MSX10XX series switch systems
MSX60-FR	Fan module with connector side to power supply side for MSX60XX and MSX10XX series switch systems
MSX60-DKIT	Rack installation kit for SX6005/SX6012 and SX1012 series short depth 1U switches, allows installation of One or Two switches side-by-side into standard depth racks.
MSX60-BKIT	Rack installation kit for MSX60XX and MSX10XX series short depth 1U systems to be mounted into short depth racks
MSX60-SKIT	Rack installation kit for MSX60XX and MSX10XX series short/standard depth 1U systems to be mounted into standard depth racks
MTUSB-1	I <sup>2</sup> C DB9 or RJ-45 to USB adapter (located in EVB products only)
HAR000028	Harness RS232 2M cable – DB9 to RJ-45 (for managed switches only)
ACC000501	Power cord Type C13-C14

## Appendix B: Thermal Threshold Definitions

There are three thermal threshold definitions for the SwitchX® switch device which impact the overall switch system operation state: Warning, Critical and Emergency.

### 1.Warning – 105C

On managed systems only: When the SwitchX® device crosses the 100C threshold, a Warning Threshold message will be issued by the MLNX-OS management SW, indicating to system administration that the switch has crossed the Warning threshold.

Note that this temperature threshold does not require nor lead to any action by hardware (such as switch shutdown).

### 2.Critical – 120C

When the SwitchX® device crosses this temperature, the firmware will automatically shut down the device.

### 3.Emergency – 130C

In case the firmware fails to shut down the SwitchX® device upon crossing the Critical threshold, the SwitchX® device will auto-shutdown upon crossing the Emergency (130C) threshold.



# Appendix C: Interface Specifications

## C.1 QSFP Interface

**Table 25 - QSFP Interface Pins 1-23**

Connector Pin Number	Connector Pin Name	Signal Description
1	GND	Ground
2	Tx2n	Transmitter Inverted Data Input
3	Tx2p	Transmitter Non-Inverted Data Input
4	GND	Ground
5	Tx4n	Transmitter Inverted Data Input
6	Tx4p	Transmitter Non-Inverted Data Input
7	GND	Ground
8	ModSelL	Module Select
9	ResetL	Module Reset
10	Vcc Rx	+3.3 V Power supply receiver
11	SCL	2-wire serial interface clock
12	SDA	2-wire serial interface data
13	GND	Ground
14	Rx3p	Receiver Non-Inverted Data Output
15	Rx3n	Receiver Inverted Data Output
16	GND	Ground
17	Rx1p	Receiver Non-Inverted Data Output
18	Rx1n	Receiver Inverted Data Output
19	GND	Ground
20	GND	Ground
21	Rx2n	Receiver Inverted Data Output 3
22	Rx2p	Receiver Non-Inverted Data Output 3
23	GND	Ground



**Table 26 - QSFP Interface Pins 24-38**

Connector Pin Number	Connector Pin Name	Signal Description
24	Rx4n	Receiver Inverted Data Output 3
25	Rx4p	Receiver Non-Inverted Data Output 3
26	GND	Ground
27	ModPrsL	Module Present
28	IntL	Interrupt
29	Vcc Tx	+3.3 V Power supply transmitter
30	Vcc 1	+3.3 V Power Supply
31	LPMode	Low Power Mode
32	GND	Ground
33	Tx3p	Transmitter Non-Inverted Data Input
34	Tx3n	Transmitter Inverted Data Input
35	GND	Ground
36	Tx1p	Transmitter Non-Inverted Data Input
37	Tx1n	Transmitter Inverted Data Input
38	GND	Ground

## C.2 SFP+ Interface

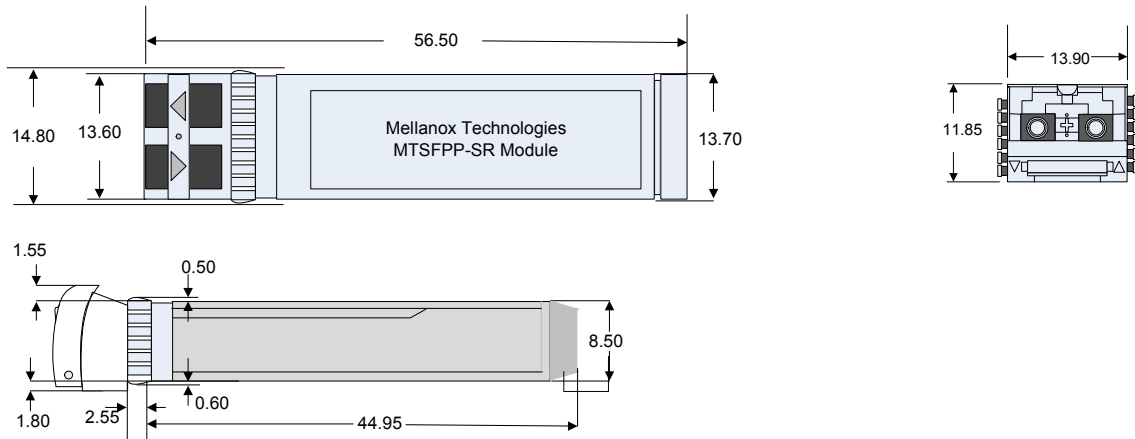

**Figure 37: Rear View of Module With Pin Placement**

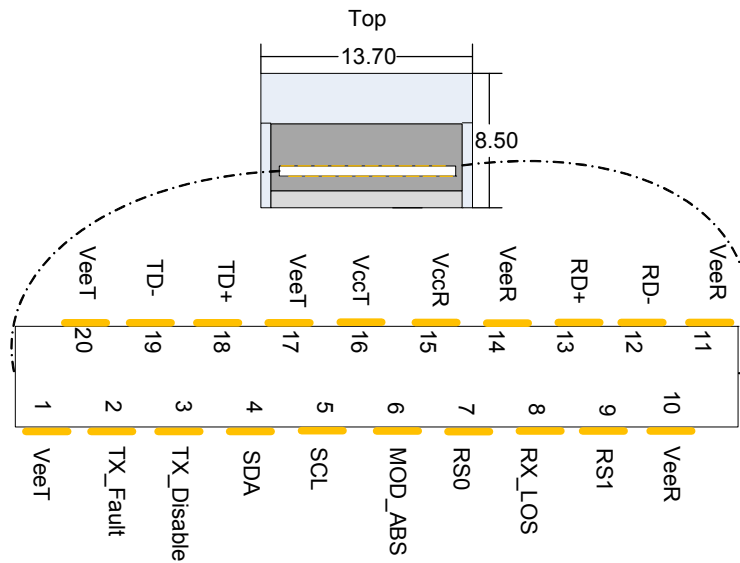

**Table 27 - SFP+ Interface**

Pin	Symbol Name	Description
1	VeeT	Transmitter Ground (Common with Receiver Ground) <sup>a</sup>
2	TX_Fault	Transmitter Fault. <sup>b</sup>
3	TX_Disable	Transmitter Disable. Laser output disabled on high or open. <sup>c</sup>
4	SDA	2-wire Serial Interface Data Line <sup>d</sup>
5	SCL	2-wire Serial Interface Clock Line <sup>d</sup>
6	MOD_ABS	Module Absent. Grounded within the module <sup>d</sup>
7	RS0	No connection required

**Table 27 - SFP+ Interface**

Pin	Symbol Name	Description
8	RX_LOS	Loss of Signal indication. Logic 0 indicates normal operation. <sup>e</sup>
9	RS1	No connection required
10	VeeR	Receiver Ground (Common with Transmitter Ground) <sup>a</sup>
11	VeeR	Receiver Ground (Common with Transmitter Ground) <sup>a</sup>
12	RD-	Receiver Inverted DATA out. AC Coupled
13	RD+	Receiver Non-inverted DATA out. AC Coupled
14	VeeR	Receiver Ground (Common with Transmitter Ground) <sup>a</sup>
15	VccR	Receiver Power Supply
16	VccT	Transmitter Power Supply
17	VeeT	Transmitter Ground (Common with Receiver Ground) <sup>a</sup>
18	TD+	Transmitter Non-Inverted DATA in. AC Coupled.
19	TD-	Transmitter Inverted DATA in. AC Coupled.
20	VeeT	Transmitter Ground (Common with Receiver Ground) <sup>a</sup>

- a. Circuit ground is internally isolated from chassis ground.
- b. T<sub>FAULT</sub> is an open collector/drain output, which should be pulled up with a 4.7k – 10k Ohms resistor on the host board if intended for use. Pull up voltage should be between 2.0V to Vcc + 0.3V. A high output indicates a transmitter fault caused by either the TX bias current or the TX output power exceeding the preset alarm thresholds. A low output indicates normal operation. In the low state, the output is pulled to <0.8V.
- c. Laser output disabled on TDIS >2.0V or open, enabled on TDIS <0.8V
- d. Should be pulled up with 4.7kΩ – 10kΩ on host board to a voltage between 2.0V and 3.6V. MOD\_ABS pulls line low to indicate module is plugged in.
- e. LOS is open collector output. Should be pulled up with 4.7kΩ – 10kΩ on host board to a voltage between 2.0V and 3.6V. Logic 0 indicates normal operation; logic 1 indicates loss of signal.

### C.3 RJ-45 CONSOLE and I2C Interface

The RJ-45 CONSOLE and I2C interface uses the EIA 568A standard wiring color coding.

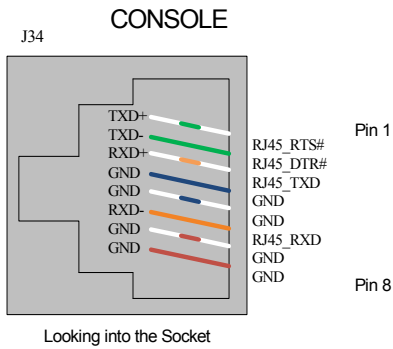

**Table 28 - RJ-45 CONSOLE Pinout**

Connection	Signal	Pin#	Color
TXD+	RJ-45_RTS#	1	G/W
TXD-	RJ-45_DTR#	2	G
RXD+	RJ-45_TXD	3	O/W
GND	GND	4	Bl
GND	GND	5	Bl/W
RXD-	RJ-45_RXD	6	O
GND	GND	7	Br/W
GND	GND	8	Br

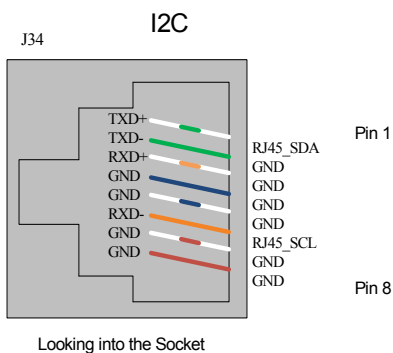

**Table 29 - RJ-45 I2C Pinout**

Connection	Signal	Pin#	Color
TXD+	RJ-45_SDA	1	G/W
TXD-	GND	2	G
RXD+	GND	3	O/W
GND	GND	4	Bl
GND	GND	5	Bl/W
RXD-	RJ-45_SCL	6	O
GND	GND	7	Br/W
GND	GND	8	Br

## C.4 RJ45 to DB9 Harness Pinout

In order to connect a host PC to the Console RJ45 port of the system, a RS232 harness cable (DB9 to RJ45) is supplied.

*Figure 38: RJ45 to DB9 Harness Pinout*

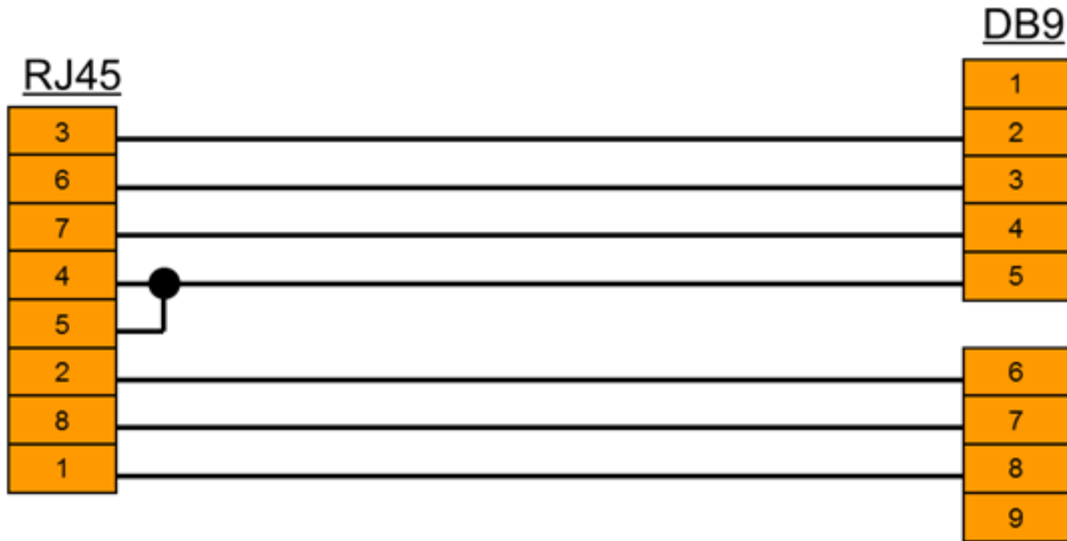

## Appendix D: Disassembly and Disposal

### D.1 Disassembly Procedure

➤ *To disassemble the system from the rack:*

1. Unplug and remove all connectors.
2. Unplug all power cords.
3. Remove the ground wire.
4. Unscrew the center bolts from the side of the system with the bracket.



Support the weight of the system when you remove the screws so that the system does not fall.

5. Slide the system from the rack.
6. Remove the rail slides from the rack.
7. Remove the caged nuts.

### D.2 Disposal

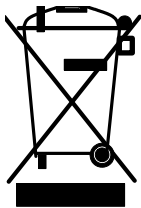

According to the WEEE Directive 2002/96/EC, all waste electrical and electronic equipment (EEE) should be collected separately and not disposed of with regular household waste.

Dispose of this product and all of its parts in a responsible and environmentally friendly way.

Follow the instructions found at [http://www.mellanox.com/page/dismantling\\_procedures](http://www.mellanox.com/page/dismantling_procedures) for proper disassembly and disposal of the switch, according to the WEEE directive.

## Appendix E: Safety Warnings (Multiple Languages)

### E.1 Nordic Countries Notices



In Finland: "Laitte on liitettävä suojakoskettimilla varustettuun pistorasiaan"  
 In Norway: "Apparatet må tilkoples jordet stikkontakt"  
 In Sweden: "Apparaten skall anslutas till jordat uttag"

### E.2 Installation Safety Warnings (English)

#### 1. Installation Instructions



Read all installation instructions before connecting the equipment to the power source.

#### 2. Bodily Injury Due to Weight



Use enough people to safely lift this product.

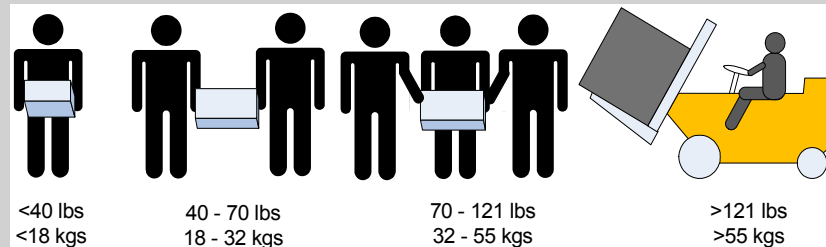

#### 3. Heavy Equipment



This equipment is heavy and should be moved using a mechanical lift to avoid injuries.

#### 4. Risk of Electric Shock!



Risk of Electric Shock!  
 With the fan module removed power pins are accessible within the module cavity.  
 DO NOT insert tools or body parts into the fan module cavity.

#### 5. Over-temperature



This equipment should not be operated in an area with an ambient temperature exceeding the maximum recommended: 45°C (113°F). Moreover, to guarantee proper , allow at least 8cm (3 inches) of clearance around the ventilation openings.



## 6. Stacking the Chassis



The chassis should not be stacked on any other equipment. If the chassis falls, it can cause bodily injury and equipment damage.

## 7. Redundant Power Supply Connection - Electrical Hazard



This product includes a redundant power or a blank in its place. In case of a blank power supply, do not operate the product with the blank cover removed or not securely fastened.

## 8. Multiple Power Inlets



Risk of electric shock and energy hazard.  
The PSUs are all independent.  
Disconnect all power supplies to ensure a powered down state inside of the switch platform.

## 9. During Lightning - Electrical Hazard



During periods of lightning activity, do not work on the equipment or connect or disconnect cables.

## 10. Copper InfiniBand Cable Connecting/Disconnecting



Copper InfiniBand cables are heavy and not flexible, as such they should be carefully attached to or detached from the connectors. Refer to the cable manufacturer for special warnings/instructions.

## 11. Rack Mounting and Servicing



When this product is mounted or serviced in a rack, special precautions must be taken to ensure that the system remains stable. In general you should fill the rack with equipment starting from the bottom to the top.

## 12. Equipment Installation



This equipment should be installed, replaced, and/or serviced only by trained and qualified personnel.

## 13. Equipment Disposal



Disposal of this equipment should be in accordance to all national laws and regulations.

#### 14. Local and National Electrical Codes



This equipment should be installed in compliance with local and national electrical codes.

#### 15. UL Listed and CSA Certified Power Supply Cord



For North American power connection, select a power supply cord that is UL Listed and CSA Certified, 3 - conductor, [16 AWG], terminated with a molded plug rated at 125 V, [13 A], with a minimum length of 1.5m [six feet] but no longer than 4.5m.

For European connection, select a power supply cord that is internationally harmonized and marked “<HAR>”, 3 - conductor, minimum 1.0 mm<sup>2</sup> wire, rated at 300 V, with a PVC insulated jacket. The cord must have a molded plug rated at 250 V, 10 A.

#### 16. Installation codes



This device must be installed according to the latest version of the country national electrical codes. For North America, equipment must be installed in accordance to the applicable requirements in the US National Electrical Code and the Canadian Electrical Code.

#### 17. Interconnection Of Units



Cables for connecting to the unit RS232 and Ethernet Interfaces must be UL certified type DP-1 or DP-2. (Note- when residing in non LPS circuit)

#### 18. Overcurrent Protection



A readily accessible Listed branch circuit overcurrent protective device rated 20 A must be incorporated in the building wiring.

#### 19. Do Not Use the Switch as a Shelf or Work Space

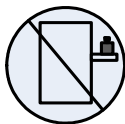

Caution: Slide/rail mounted equipment is not to be used as a shelf or a work space. The rails are not intended for sliding the unit away from the rack. It is for permanent installation at final resting place only, not used for service and maintenance

## 20. WEEE Directive

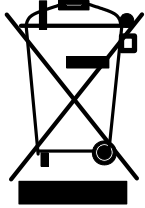

According to the WEEE Directive 2002/96/EC, all waste electrical and electronic equipment (EEE) should be collected separately and not disposed of with regular household waste.

Dispose of this product and all of its parts in a responsible and environmentally friendly way.

## 21. Country of Norway Power Restrictions



This unit is intended for connection to a TN power system and an IT power system of Norway only.

## E.3 הוראות בטיחות בהתקנה (עברית)

### 1. הוראות התקנה

קרא היטב את כל הוראות ההתקנה לפני חיבור המוצר לחשמל.



### 2. תקן ישראלי

יש להתקין את המוצר תוך הקפדה על תקנות החשמל הנהוגות בישראל, ולעשות שימוש ביחידת חלוקת כוח העומדת בתקן ישראל (ת"י) 32.



### 3. חבלת גוף כתוצאה מנשיאת משקל יתר

נדרשת נוכחותם של מספר מתקינים כדי להרים את המוצר בבטחה.

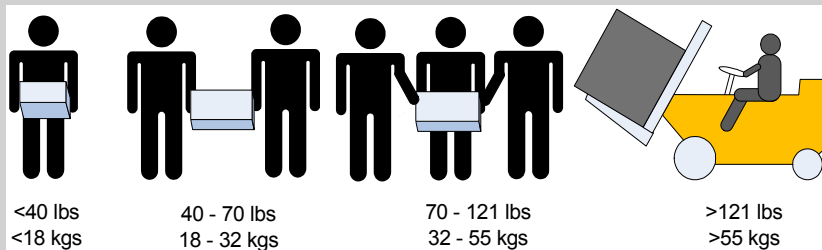

### 4. ציוד כבד

המוצר כבד, ויש לשנעו באמצעות מעלית מכאנית כדי למנוע חבלה.



## 5. סכנת התחשמלות!

סכנת התחשמלות!  
בעת שיחידת המאוורר מפורקת, רכיבי חשמל נחשפים בחלל הריק. אין להחדיר כלים או איברי גוף לחלל המיועד להרכבת היחידה.

## 6. התחממות יתר

אין להפעיל את המוצר באיזור שבו טמפרטורת החדר עולה על הטמפרטורה המקסימלית המומלצת: 45°C (113°F). בנוסף, כדי להבטיח כניסת אוויר תקינה, יש לוודא כי קיים שטח פנוי של 8 ס"מ (3 אינץ') לפחות סביב פתחי האוורור.



## 7. ערימת המערכת

אין לערום את המערכת על גבי ציוד אחר. במקרה של נפילה, עשויים להגרם נזקי גוף ורכוש.



## 8. חיבור ספק כוח נוסף - סכנת התחשמלות

המערכת מכילה ספק כוח לגיבוי, או, בחלק מהמקרים, חלל ריק המאפשר הרכבת ספק כזה. אין לעשות שימוש במערכת כשהמכסה החוסם את החלל הריק אינו סגור כהלכה.

## 9. מספר שקעים חשמליים

סכנת התחשמלות ואזהרת אנרגיה  
כל אחד מספקי הכוח פועל באופן עצמאי. יש לנתק את כל ספקי הכוח, כדי להבטיח ניתוק מוחלט של המערכת מזרם חשמלי.

## 10. בעת סופות ברקים - סכנת התחשמלות!

בעת סופות ברקים, אין להפעיל את המערכת או לחבר/לנתק כבלים

## 11. חיבור או ניתוק של כבלי נחושת

כבלי נחושת הם כבדים וקשיחים. לפיכך, יש לחברם ולנתקם מהמחברים בזירות רבה. לאזהרות נוספות, יש לעיין בעלון לצרכן מטעם יצרן הכבלים.



## 12. הרכבה על גבי מדף בארון

כאשר מרכיבים מוצר זה על גבי מדף בארון, יש לנקוט באמצעי זהירות מיוחדים בכדי להבטיח שיוותר יציב. ככלל, יש להתחיל למלא את הארון מהמדף התחתון, ולהתקדם כלפי מעלה.



### 13. התקנת המוצר

כל התקנה, החלפה או טיפול במוצר זה חייבות להתבצע על ידי איש צוות מיומן ומוסמך בלבד.



### 14. השלכה לאשפה בתום השימוש

השלכת המוצר בתום השימוש חייבת להיעשות בהתאם לכל התקנות והחוקים המקומיים.



### 15. תקנות חשמל מקומיות

יש להתקין מערכת זו בהתאם לתקנות החשמל המקומיות.



### 16. כבל אספקת חשמל

על מנת לחבר את המוצר לחשמל בצפון אמריקה, יש לבחור כבל חשמלי ובעל הסמכת CSA, מוליך 3- [AWG 16], שבקצהו תקע מובנה A13 V125, אורכו המינימלי 1.5 מטר (6 אינץ') ואורכו המקסימלי 4.5 מטר. לחיבור אירופאי, בחר כבל חשמלי בעל התאמה בינלאומית וסימון "<HAR>" מוליך - 3, גידים פנימיים באורך מינימלי של 1.0 מילימטר<sup>2</sup>, 300V, עם עטיפת PVC מבודדת. על הכבל לכלול תקע מובנה A10, V250.



### 17. תקנות התקנה

יש להתקין מערכת זו על פי הגרסה האחרונה של תקנות החשמל המקומיות הנהוגות במדינה. עבור צפון אמריקה, יש להתקין את המערכת בהתאם לתקנות החשמל הלאומיות המיושמות בארה"ב ובקנדה.



### 18. חיבור בין מערכות

על כבלים לחיבור היחידה לממשקי RS232 ו-Ethernet להיות בעלי הסמכת UL מסוג DP-1 או DP-2 (כאשר הם מצויים במעגל חשמלי שאינו מקור כוח מוגבל).



### 19. הגנה מפני מתח גבוה

יש להקפיד על המצאותם בבניין ועל זמינותם של אמצעים להגנה מפני מתח גבוה בתקן 20A.



## 20. אין להשתמש במערכת כמדף או כשטח עבודה

זהירות: אין להשתמש בציוד כמדף או כשטח עבודה. המסילות לא נועדו לשליפת המערכת מהארון, אלא להתקנת המערכת במיקומה הקבוע והסופי בארון.

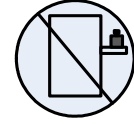

## 21. תקנת WEEE

על פי תקנות WEEE 2002/96/EC, יש להשליך את כל פסולת הציוד החשמלי והאלקטרוני בנפרד מפסולת ביתית רגילה. בתום השימוש, השלך לאשפה את המוצר הזה ואת כל חלקיו באופן אחראי וידידותי לסביבה.

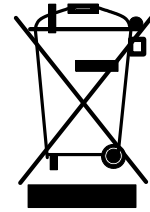

## 22. מגבלות חשמליות בנורבגיה

בנורבגיה בלבד, יחידה זו מיועדת לחיבור למערכת אספקת חשמל מסוג TN, ולמערכת אספקת חשמל מסוג IT.



## E.4 安裝安全性警告 (Chinese)

### 1. 安裝指示



本設備附有備援電源供應器或在適當位置配有空白蓋板。

### 2. 因重量導致的人身受傷



為了安全起見，請安排足夠的人員以合力抬起本產品。

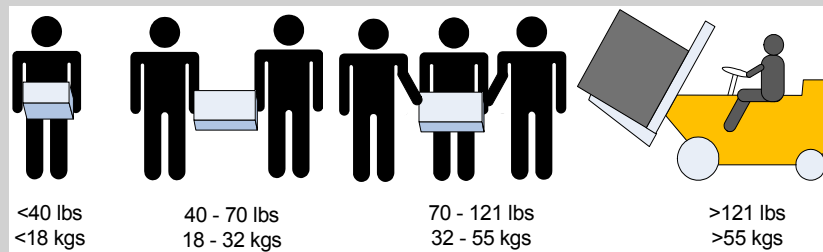

### 3. 重設備



本設備極重，應使用機械式起重機來搬移，以避免人員受傷。

### 4. 有觸電的危險



有觸電的危險！  
拆除風扇模組後，即可接觸到模組空腔內的電源針腳。  
請勿將工具或機身零件插入到風扇模組空腔內。

### 5. 溫度過高



本設備不應在超過所建議的最高環境溫度的區域中運作：45°C (113°F)。此外，為了保證氣流的流通正常，請在通風口旁保留至少 8 公分 (3 英吋) 的間距。

### 6. 堆疊機箱



機箱不應堆疊在任何其他設備上。如果機箱掉落，可能造成人員受傷與設備損壞。

### 7. 複式電源連接時的電擊危險



本設備附有備援電源供應器或在適當位置配有空白蓋板。如果是電源供應器空白蓋板，在空白蓋板已取下或未牢牢固訂的情況下，請勿操作本產品。

### 8. 多電源輸入座



電擊與能源危害的危險。  
所有 PSU 均各自獨立。  
將所有電源供應器斷電，確保交換器平台內部在電源關閉狀態。

### 9. 閃電時的電擊危險



在閃電期間，不要使用本設備或連接或拔下纜線。

### 10. InfiniBand 銅纜連接 / 拔下



InfiniBand 銅纜很重且沒有彈性，因此必須小心裝在連接器上或自連接器上拔下。如需相關的特殊警告 / 指示，請洽詢纜線製造商。

## 11. 機架安裝與維修



此產品已安裝在機架中或在機架中維修時，必須採取特定預防措施以確保系統維持穩定。一般您應該將設備從底部到頂端放滿機架。

## 12. 設備安裝



本設備僅限由經過訓練與 / 或合格的人員安裝、更換或維修。

## 13. 設備棄置



棄置本設備應遵照所有國內法規。

## 14. 當地與國家電氣法規



請遵照當地與國家電氣法規安裝本設備。

## 15. UL 列名和 CSA 認證電源線



北美地區在接上電源時，請選用獲得 UL 列名和 CSA 認證、三個導體、[16 AWG] 附成型插頭，額定值為 125 V、[13 A]，長度至少 1.5 公尺 [六英尺]，但不超過 4.5 公尺的電源線。

歐洲地區在接上電源時，請選用國際協調式且標示有 <HAR> 字樣、三個導體、標稱截面至少 1.0 平方公厘，額定值為 300 V，採用 PVC 絕緣的電源線。電源線需有成型插頭，額定值為 250 V, 10 A。

## 16. 高漏電流



警告：高漏電流；必須執行地線連接，然後再連接電源供應器。

## 17. 安裝法規



請務必遵循最新版的國家電氣法規，安裝本設備。在北美地區，請務必遵循美國國家電工法規和加拿大電工法規中的適用規定，安裝本設備。



## 18. 互連設備



連接至 RS232 設備和乙太網路介面的纜線必須是 UL 認證類型 DP-1 或 DP-2。  
(請注意位於非 LPS 電路時)  
過電流保護：準備好使用的列名分支電路過電流保護裝置最大額定值 20 A 必須整合在配線中。

## 19. 切換開關不可用作機架或工作空間

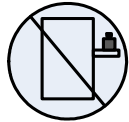

小心：滑軌 / 導軌安裝設備不可用作機架或工作空間。導軌不適用於將設備滑出機架使用。僅限永久安裝在最後安置區域時使用，不可用於維修和保養。

## 20. WEEE 指令

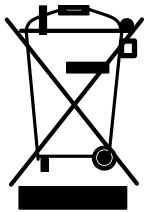

根據 WEEE 指令 2002/96/EC，所有廢棄的電氣與電子設備 (EEE)，應分開集中，而且不應與一般家庭廢棄物一起棄置。  
請以負責和環保的方式棄置本產品及其所有零件。

## 21. 挪威國家電源限制



本設備僅限連接至挪威的 TN 電源系統和 IT 電源系統。

## E.5 Avertissements de sécurité pour l'installation (French)

### 1. Instructions d'installation



Veuillez lire la totalité des instructions d'installation avant de relier l'équipement au secteur.

## 2. Blessures à cause du poids



Prévoyez assez de personnel pour soulever ce produit en toute sécurité.

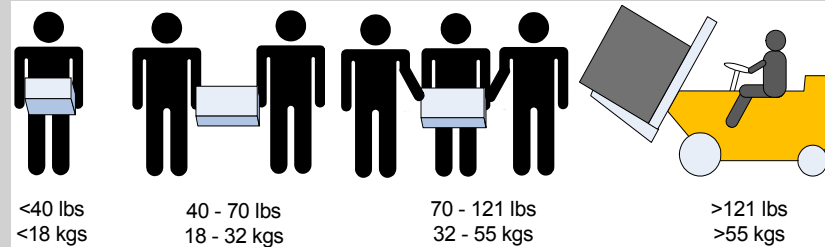

## 3. Équipement lourd



Cet équipement est lourd et doit être déplacé avec un système de levage mécanique pour éviter les blessures.

## 4. Danger d'électrocution



Danger d'électrocution !

Lorsque le module de ventilation est retiré, les broches d'alimentation sont exposées dans l'emplacement du module.

NE PAS insérer d'outils ou la main dans l'emplacement du module.

## 5. Surchauffe



Cet équipement ne doit pas être en service dans un local dont la température dépasse le maximum recommandé de 45°C (113°F). En outre et pour garantir une circulation d'air correcte, laisser un espace d'au moins 8 cm (3") autour des orifices de ventilation.

## 6. Châssis empilé sur d'autres équipements



Le châssis ne doit pas être empilé sur d'autres équipements. S'il tombe, il peut endommager l'équipement ou entraîner des blessures.

## 7. Connexion de l'alimentation redondante : danger d'électrocution



Ce produit est équipé d'une alimentation redondante ou d'un cache si elle est absente. Dans ce dernier cas, ne pas faire fonctionner le produit si le cache est retiré ou mal fixé.

## 8. Plusieurs prises d'alimentation



Risque et danger d'électrocution.

Les alimentations sont toutes indépendantes.

Pour s'assurer que le commutateur est bien hors tension, débranchez toutes les alimentations.

## 9. En cas d'orage, danger d'électrocution



Pendant un orage, ne pas travailler sur l'équipement ni brancher ou débrancher des câbles.

## 10. Connexion et déconnexion du câble InfiniBand en cuivre



Les câbles InfiniBand en cuivre sont lourds et peu flexibles. Par conséquent, il faut procéder avec soin pour les brancher ou les débrancher des connecteurs. Consulter le fabricant du câble pour obtenir des instructions ou des avertissements spécifiques.

## 11. Montage en rack et maintenance



Lors du montage ou de la maintenance de ce produit dans un rack, il faut faire spécialement attention pour s'assurer que l'ensemble reste stable. En règle générale, le rack doit être rempli en commençant par le bas.

## 12. Installation de l'équipement



Cet équipement ne doit être installé, remplacé et maintenu que par un personnel formé et qualifié.

## 13. Mise au rebut de l'équipement



La mise au rebut de cet équipement doit se faire conformément à toutes les lois et réglementations nationales.

## 14. Codes électriques locaux et nationaux



Cet équipement doit être installé conformément aux codes électriques locaux et nationaux.

## 15. Codes d'installation



Cet appareil doit être installé conformément à la version la plus récente des codes électrique nationaux. En Amérique du Nord, l'équipement doit être installé en respectant les exigences de l'US National Electrical Code et du Code canadien de l'électricité.

## 16. Cordon d'alimentation UL Listed et certifié CSA



Pour le branchement électrique en Amérique du Nord, utiliser un cordon d'alimentation UL Listed et CSA Certified, à 3 conducteurs [calibre 16 AWG], avec une prise moulée 125 V [13 A], faisant au moins 1,5 m de long [six pieds] et au plus 4,5 m. Pour le branchement électrique en Europe, utiliser un cordon d'alimentation au format international harmonisé (marqué <HAR>), à 3 conducteurs d'au moins 1 mm<sup>2</sup> de section, 300 V, avec une gaine isolante en PVC. Le cordon doit avoir une prise moulée 250 V 10 A.

## 17. Courant de fuite élevé



**Avertissement** : courant de fuite élevé, une connexion à la terre est indispensable avant de brancher l'alimentation.

## 18. Interconnexion des unités



Les câbles de connexion aux interfaces RS232 et Ethernet de l'appareil doivent être certifié UL de type DP-1 ou DP-2. (Note : en cas d'installation sur un circuit dont la puissance n'est pas limitée)  
Protection contre les surintensités : le câblage de l'immeuble doit intégrer un dispositif certifié de protection contre les surintensités, calibré à 20 A et aisément accessible.

## 19. Ne pas utiliser comme étagère ou plan de travail

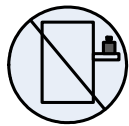

Attention : un équipement coulissant ou monté sur rail ne doit pas servir d'étagère ni de plan de travail. Les rails ne sont pas destinés à faire coulisser l'unité hors du rack. Ils sont destinés à une installation permanente à l'emplacement final, pas pour l'entretien ni la maintenance.

## 20. Directive DEEE

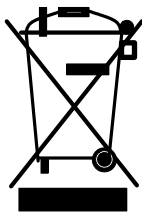

Selon la Directive 2002/96/CE (DEEE), tous les déchets d'équipements électriques et électroniques (EEE) doivent être collectés séparément et ne pas être mis au rebut avec les déchets ménagers habituels.  
Ce produit et toutes ses pièces doivent être mis au rebut d'une manière responsable, respectant l'environnement.

## 21. Restrictions concernant l'alimentation pour la Norvège



Cet appareil est prévu pour être relié à un système d'alimentation TN et un système d'alimentation informatique de Norvège uniquement.

## E.6 Installation Sicherheitshinweise(German)

### 1. Installationsanleitungen



Lesen Sie alle Installationsanleitungen, bevor Sie das Gerät an die Stromversorgung anschließen.

### 2. Verletzungsgefahr wegen des Gewichts



Um das Produkt sicher anzuheben, genügend Personen einsetzen.

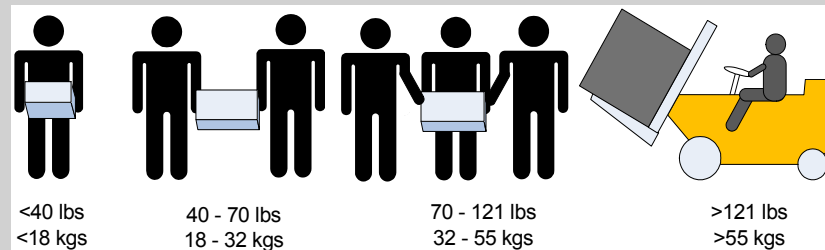

### 3. Schweres Gerät



Dieses Gerät ist schwer und muss mit einem mechanischen Hebegerät verschoben werden, um Verletzungen zu vermeiden.

### 4. Stromschlagrisiko



Stromschlagrisiko!

Bei abgenommenem Ventilatormodul sind die Stromkontakte in der Modulvertiefung zugänglich.

Es dürfen KEINE Werkzeuge oder Körperteile in die Vertiefung des Ventilatormoduls gelangen.

### 5. Übertemperatur



Dieses Gerät sollte nicht in einem Bereich mit einer Umgebungstemperatur über der maximal empfohlenen Temperatur von 45°C (113°F) betrieben werden. Es ist ein Luftstrom von 200 LFM bei maximaler Umgebungstemperatur erforderlich. Außerdem sollten mindestens 8 cm (3 in.) Freiraum um die Belüftungsöffnungen sein, um einen einwandfreien Luftstrom zu gewährleisten.

### 6. Stapeln des Chassis



Das Chassis sollte nicht auf andere Geräte gestapelt werden. Wenn das Chassis heruntermfällt, kann es zu Verletzungen und Beschädigungen an Geräten führen.

## 7. Mehrere Stromeingänge



Risiko eines Stromschlags und Stomgefahr.  
Alle Stromversorgungseinheiten sind unabhängig.  
Trennen Sie alle Stomversorgungen, um einen abgeschalteten Zustand im Inneren der Switch-Plattform sicherzustellen.

## 8. Bei Gewitter - Elektrische Gefahr



Arbeiten Sie während eines Gewitters und Blitzschlag nicht am Gerät, schließen Sie keine Kabel an oder ab.

## 9. Anschließen/Trennen von InfiniBand-Kupferkabel



InfiniBand-Kupferkabel sind schwer und nicht flexible. Deshalb müssen sie vorsichtig an die Anschlüsse angebracht bzw. davon getrennt werden. Lesen Sie die speziellen Warnungen und Anleitungen des Kabelherstellers.

## 10. Rack-Montage und Wartung



Wenn dieses Produkt in einem Rack montiert oder gewartet wird, sind besondere Vorichtsmaßnahmen zu ergreifen, um die Stabilität des Systems zu gewährleisten. Im Allgemeinen sollten Sie das Gestell von unten nach oben mit Geräten füllen.

## 11. Geräteinstallation



Diese Gerät sollte nur von geschultem und qualifiziertem Personal installiert, ausgetauscht oder gewartet werden.

## 12. Geräteentsorgung



Die Entsorgung dieses Geräts sollte unter Beachtung aller nationalen Gesetze Bestimmungen erfolgen.

## 13. Regionale und nationale elektrische Bestimmungen



Dieses Gerät sollte unter Beachtung der regionalen und nationalen elektrischen Bestimmungen installiert werden.

## 14. Installationscodes



Dieses Gerät muss entsprechend der aktuellsten Version des National Electrical Code installiert weden. In Nodamerika muss das Gerät gemäß den geltenden Anforderungen des US National Electrical Code und des Canadian Electrical Code installiert werden.

## 15. UL- und CSA-zertifiziertes Netzkabel



Für Nordamerika Stromanschluss, wählen Sie ein Netzkabel, das UL-und CSA Certified

3 - Leiter, [18 AWG], mit einem angespritztem Stecker bewertet bei 125 V, [15], mit einer Mindestlänge von 1,5 m [Six Feet] aber nicht mehr als 4,5 m.

Für die europäischen Zusammenhang, wählen Sie ein Netzkabel, das international harmonisiert und der Aufschrift "<HAR>",

3 - Leiter, mindestens 0,75 mm<sup>2</sup> Draht, bewertet mit 300 V, mit einem PVC-Mantel isoliert. Das Kabel muss eine angespritztem Stecker bewertet bei 250 V, 10 A. "

## 16. Hoher Ableitstrom



WARNUNG: Hohe Ableitstrom; Earth Verbindung, bevor Sie die Verbindung von wesentlicher Bedeutung werden.

## 17. Installationscodes



Dieses Gerät muss installiert sein, entsprechend auf die neueste Version des Landes National Electrical Code. Für Nordamerika, müssen in Übereinstimmung mit den geltenden Vorschriften in der US-amerikanischen National Electrical Code und dem Canadian Electrical Code.

## 18. Verbindung der Geräte untereinander



Kabel für den Anschluss an das Gerät RS232-und Ethernet-Schnittstellen müssen UL zertifiziert Typ DP-1 oder DP-2. (Hinweis-, wenn nicht mit Wohnsitz in LPS-Schaltung)

Überstromschutz: Eine leicht zugängliche Auflistung Abzweigleitung Überstrom-Schutzeinrichtung 20 A bewertet werden müssen in dem Gebäude Verkabelung.

## 19. Switch nicht als Regal oder Arbeitsplatz nutzen

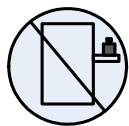

Achtung: Auf Schieber/Schienen montiertes Gerät ist nicht als Regal oder Arbeitsbereich zu nutzen. Die Schienen sind nicht dafür bestimmt, die Einheit aus dem Gestell weg zu ziehen. Sie sind nur für die permanente Installation an einem endgültigen Standort gedacht, nicht für Instandhaltung und Wartung.

## 20. WEEE-Direktive

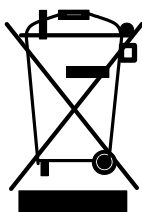

Gemäß WEEE Directive 2002/96/EC müssen alle elektrischen und elektronischen Abfallgeräte (EEE) separat gesammelt und nicht mit normalem Haushaltsmüll entsorgt werden.

Dieses Produkt und alle seine Teile in verantwortungsvoller und umweltfreundlicher Art und Weise entsorgen.

## E.7 Advertencias de seguridad de instalación (Spanish)

### 1. Instrucciones de instalación



Antes de conectar el equipo a la fuente de alimentación, leer todas las instrucciones de instalación.

### 2. Lesión corporal a causa de peso



Recurra a suficientes personas para levantar este producto sin

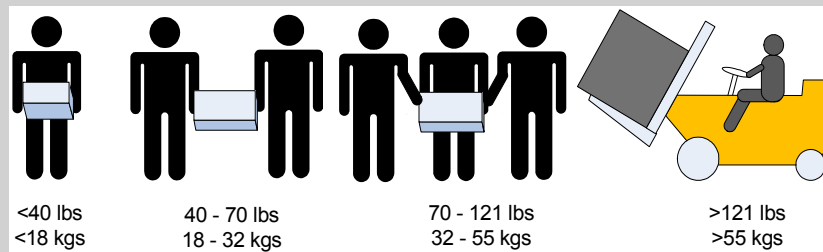

### 3. Equipos pesados



Dado que el equipo es pesado, se debe mover únicamente mediante un elevador mecánico, para evitar lesiones.

### 4. Riesgo de descarga eléctrica



¡Riesgo de descarga eléctrica!

Con el módulo del ventilador quitado, se obtiene acceso a las clavijas de alimentación desde dentro de la cavidad del módulo.

NO introducir herramientas ni partes del cuerpo en la cavidad del módulo del ventilador.

### 5. Sobretemperatura



No se debe utilizar el equipo en un área con una temperatura ambiente superior a la máxima recomendada: 45°C. Además, para garantizar una circulación de aire adecuada, se debe dejar como mínimo un espacio de 8 cm (3 pulgadas) alrededor de las aberturas de ventilación.

### 6. Apilamiento del chasis



Los chasis no se deben apilar sobre otros equipos. La caída del chasis podría causar lesiones corporales, así como daños al equipo.



## 7. Conexión redundante de fuente de alimentación: peligro de descarga



Este producto incluye una fuente de alimentación redundante o, en su lugar, una vacía. Si se dispone de una fuente de alimentación vacía, no utilizar el producto si su tapa está quitada o no está bien cerrada.

## 8. Tomas de alimentación múltiples



Riesgo de descarga eléctrica y peligro de corriente.  
Todas las fuentes de alimentación son independientes.  
Desconecte todas las fuentes de alimentación, para asegurar que no haya corriente alguna dentro de la plataforma de conmutación.

## 9. Al haber rayos: peligro de descarga



No utilizar el equipo ni conectar o desconectar cables durante periodos de actividad de rayos.

## 10. Cable de conexión y desconexión InfiniBand de cobre



Dado que los cables de cobre InfiniBand son pesados y no son flexibles, su conexión a los conectores y su desconexión se deben efectuar con mucho cuidado. Para ver advertencias o instrucciones especiales, consultar al fabricante del cable.

## 11. Montaje y mantenimiento del bastidor



Al instalar o realizar el mantenimiento de este aparato en un bastidor, es preciso adoptar precauciones especiales para garantizar que el sistema se mantenga estable. En general, en un bastidor, los equipos se deben instalar comenzando desde abajo hacia arriba.

## 12. Instalación del equipo



La instalación, el reemplazo y el mantenimiento de este equipo estarán a cargo únicamente de personal capacitado y competente.

## 13. Eliminación del equipo



La eliminación definitiva de este equipo se debe efectuar conforme a todas las leyes y reglamentaciones nacionales.

#### 14. Códigos eléctricos locales y nacionales



Este equipo se debe instalar conforme a los códigos eléctricos locales y nacionales.

#### 15. Códigos de instalación



Este dispositivo se debe instalar conforme a la versión más reciente de los códigos eléctricos nacionales del país en cuestión. En América del Norte, el equipo se debe instalar de acuerdo con las disposiciones vigentes del Código Eléctrico Nacional de los EE.UU. y del Código Eléctrico de Canadá.

#### 16. Cable de alimentación homologado por UL y con certificación CSA



En conexiones de América del Norte, seleccionar un cable de alimentación homologado por UL y con certificación CSA de tres conductores, [16 AWG], terminado en un enchufe moldeado con capuchón de 125 voltios nominal, [13 A], con una longitud mínima de 1,5 metros, pero no más de 4,5 metros.

En conexiones europeas, seleccionar un cable de alimentación armonizado internacionalmente y marcado "<HAR>", de tres conductores, hilo de 1,0 mm<sup>2</sup> como mínimo, 300 voltios nominal, con cobertura protectora aislante de PVC. El cable debe tener un enchufe moldeado con capuchón de 250 voltios nominal, 10 A.

#### 17. Alta corriente de fuga



**ADVERTENCIA:** Alta corriente de fuga. Es esencial efectuar la conexión a tierra antes de conectar la alimentación.

#### 18. Códigos de instalación



Este dispositivo se debe instalar conforme a la versión más reciente de los códigos eléctricos nacionales del país en cuestión. En América del Norte, el equipo se debe instalar de acuerdo con las disposiciones vigentes del Código Eléctrico Nacional de los EE.UU. y del Código Eléctrico de Canadá.

#### 19. Interconexión de unidades



Los cables para la conexión con las interfaces RS232 y Ethernet de la unidad deben estar homologados por UL tipo DP-1 o DP-2. (Nota: cuando residen en circuito no de tipo LPS)

Protección contra sobrecargas: Al cableado del edificio se debe incorporar un dispositivo de protección contra sobrecargas de circuito derivado, de fácil acceso, con una corriente nominal de 20 A.

## 20. No utilizar el conmutador como estante ni como espacio de trabajo

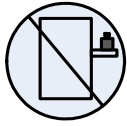

Cuidado: Equipos montados en deslizadores o rieles no se deben utilizar como estantes ni como espacio de trabajo. La finalidad de los rieles no es deslizar la unidad hacia afuera del bastidor. Sirven solo para la instalación permanente en el lugar de destino final, no para fines de servicio o mantenimiento

## 21. Directiva WEEE

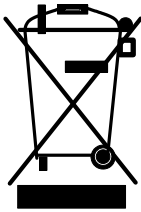

Conforme a la Directiva 2002/96/CE sobre RAEE, todos los residuos de equipos eléctricos y electrónicos (EEE) se deben recolectar por separado y no se deben eliminar junto con residuos domésticos.

Al deshacerse de este producto y de todas sus partes, hágalo de una manera responsable y respetuosa con el medio ambiente.

## E.8 Предупреждения по технике безопасности при установке (Russian)

### 1. Инструкция по установке



Перед подключением оборудования к источнику питания следует ознакомиться с инструкцией по установке.

### 2. Травмы при переносе тяжелых предметов



Для поднятия этого изделия следует задействовать достаточное количество людей.

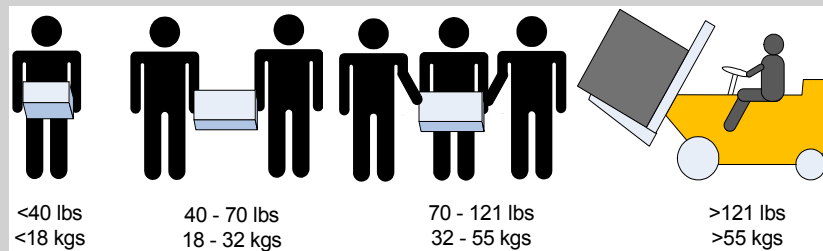

### 3. Тяжелое оборудование



Это тяжелое оборудование, поэтому его следует перемещать с помощью механического подъемника во избежание травм.

#### 4. Опасность поражения электрическим током



Опасность поражения электрическим током!

Когда снят вентиляторный модуль, существует возможность повреждения контактов питания в его углублении.

НЕ вставлять инструменты или части тела в углубление вентиляторного модуля.

#### 5. Перегрев



Не эксплуатировать это оборудование в помещении с температурой окружающей среды, превышающей максимально рекомендуемое значение: 45 °C (113 °F).

Более того, для надлежащей вентиляции следует обеспечить зазор вокруг вентиляционных отверстий не менее 8 см (3 дюйма).

#### 6. Установка шасси поверх другого оборудования



Не устанавливать шасси поверх другого оборудования. Падение шасси может привести к травмам и повреждению оборудования.

#### 7. Опасность поражения электрическим током резервного источника питания



В этом изделии установлен резервный источник питания или модуль-заглушка.

Если установлен модуль-заглушка, не эксплуатировать изделие со снятой или ненадежно закрепленной крышкой модуля-заглушки.

#### 8. Несколько источников питания



Опасность поражения электрическим током и опасные энергетические воздействия.

Блоки питания независимы друг от друга.

Чтобы обесточить все компоненты внутри платформы коммутации, следует отсоединить все блоки питания.

#### 9. Опасность поражения электрическим током во время грозы



Во время грозы запрещается использовать оборудование и подключать или отключать кабели.

#### 10. Подсоединение и отсоединение медных кабелей InfiniBand



Медные кабели InfiniBand тяжелые и негибкие, поэтому следует осторожно их подсоединять и отсоединять. За особыми предупреждениями и указаниями следует обратиться к производителю кабеля.

## 11. Установка или обслуживание в стойке



При установке или обслуживании этого изделия в стойке следует обеспечить устойчивость системы. Как правило, стойка заполняется оборудованием снизу вверх.

## 12. Установка оборудования



Устанавливать, заменять и/или обслуживать это оборудование должен только подготовленный и квалифицированный персонал.

## 13. Утилизация оборудования



Это оборудование утилизируется в соответствии с национальными законами и постановлениями.

## 14. Местные и национальные правила установки электрооборудования



Это оборудование устанавливается в соответствии с местными и национальными правилами установки электрооборудования.

## 15. Правила установки электрооборудования



Это устройство устанавливается в соответствии с последним изданием национальных правил установки электрооборудования. В Северной Америке оборудование устанавливается в соответствии с действующими требованиями Национальных правил эксплуатации и обслуживания электрических установок США и Канады.

## 16. Шнур питания, включенный в номенклатуру UL и сертифицированный Канадской ассоциацией стандартизации (CSA)



Подключение к электропитанию в Северной Америке выполняется с помощью шнура питания, включенного в номенклатуру UL и сертифицированного Канадской ассоциацией стандартизации (CSA), 3-жильного, [16 AWG], длиной от 1,5 м [6 футов] до 4,5 м, с литой вилкой, рассчитанной на 125 В [13 А].  
Подключение к электропитанию в Европе выполняется с помощью гармонизированного шнура питания с маркировкой <HAR>, 3-жильного, с сечением жилы не менее 1,0 мм<sup>2</sup>, рассчитанного на номинальное напряжение 300 В, с ПВХ оболочкой. Шнур должен иметь литую вилку, рассчитанную на 250 В, 10 А.

## 17. Высокий ток утечки



Осторожно! Высокий ток утечки. Заземлить перед подключением к электропитанию.

## 18. Подсоединение устройств



Для подключения к разъемам RS232 и Ethernet используются кабели типа DP-1 или DP-2, сертифицированные организацией UL. (Примечание. При подключении к сети без ограниченного источника электропитания) Максимальная токовая защита. В проводку здания в легкодоступном месте следует включить устройство защиты от перегрузки по току номиналом 20 А.

## 19. Не использовать коммутатор как полку или рабочую

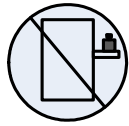

Внимание! Оборудование, установленное на направляющих, не должно использоваться как полка или рабочая поверхность. Направляющие не предназначены для удерживания устройства, выдвинутого из стойки. Они предназначены для стационарной установки только в конечном положении и не используются для обслуживания устройства.

## 20. Директива WEEE

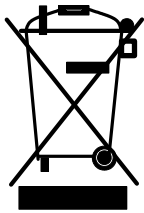

В соответствии с Директивой 2002/96/EC (WEEE) отходы электрического и электронного оборудования должны собираться и утилизироваться отдельно от обычных бытовых отходов.

Следует утилизировать это изделие и все его части ответственным и экологически безопасным способом.

## E.9 Avertismente privind siguranța la instalare (Romanian)

### 1. Instrucțiuni de instalare



Citiți toate instrucțiunile de instalare înainte de a conecta

### 2. Accidentare cauzată de greutate



Apelați la un număr suficient de persoane pentru a ridica în siguranță acest produs.

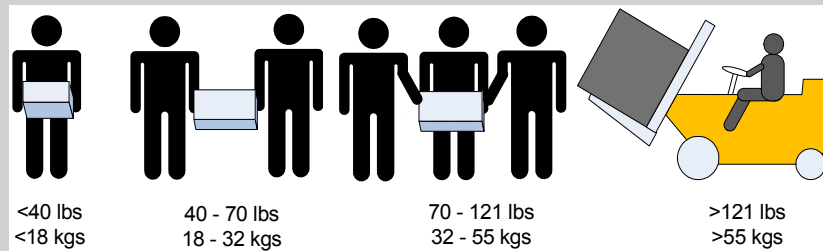

### 3. Echipament greu



Acest echipament este greu și trebuie să fie mutat folosind un dispozitiv mecanic de ridicare pentru a evita producerea de leziuni.

### 4. Risc de șoc electric



Risc de șoc electric!

Odată ce modulul ventilator este îndepărtat, pinii electrici sunt accesibili în cavitatea modulului.

NU introduceți instrumente sau părți din corp în cavitatea modulului ventilator.

### 5. Temperatură în exces



Acest echipament nu trebuie să fie acționat într-o zonă unde temperatura ambiantă depășește valoarea maximă recomandată: 45°C (113°F). În plus, pentru a asigura un flux de aer adecvat, lăsați un spațiu liber de cel puțin 8 cm (3 inchi) în jurul fantelor de ventilare.

### 6. Suprapunerea cadrului



Cadrul nu trebuie să fie suprapus peste niciun alt echipament. În cazul în care cadrul cade, poate cauza leziuni corporale și deteriorări ale echipamentului.

### 7. Conexiunea la o sursă de alimentare electrică suplimentară - pericol electric



Acest produs include o sursă de alimentare suplimentară sau un spațiu gol în locul acesteia. În cazul în care spațiul pentru sursa de alimentare este gol, nu operați produsul când capacul orb este îndepărtat sau nu este fixat în mod sigur.

### 8. Multiple mufe electrice



Risc de șoc electric și pericol electric.

Toate aparatele cu alimentare de la rețea sunt independente.

Deconectați toate sursele de alimentare cu energie pentru a asigura decuplarea în interiorul platformei de comutare.

### 9. În timpul descărcărilor electrice - pericol electric



În timpul perioadelor cu descărcări electrice luminoase, nu lucrați cu echipamentul sau nu conectați sau deconectați cablurile.

### 10. Conectarea/deconectarea cablului din cupru InfiniBand



Cablurile InfiniBand din cupru sunt grele și inflexibile, de aceea trebuie să fie atașate sau detașate de conectori cu grijă. Consultați producătorul de cabluri pentru avertismente/instrucțiuni speciale.

## 11. Montarea sau depanarea într-un rack



Când acest produs este montat sau depanat într-un rack, trebuie să fie luate măsuri de precauție speciale pentru a se asigura că sistemul rămâne stabil. În general, trebuie să umpleți rack-ul cu echipamente începând de jos în sus.

## 12. Instalarea echipamentului



Acest echipament trebuie să fie instalat, înlocuit și/sau depanat numai de către personal instruit și calificat.

## 13. Eliminarea echipamentului



Eliminarea acestui echipament trebuie să se realizeze în conformitate cu toate legile și regulamentele naționale.

## 14. Codurile electrice locale și naționale



Acest echipament trebuie să fie instalat conform codurilor electrice locale și naționale.

## 15. Codurile ed instalare



Acest dispozitiv trebuie să fie instalat în conformitate cu ultima versiune a codurilor electrice naționale ale țării în cauză. Pentru America de Nord, echipamentul trebuie să fie instalat conform cerințelor aplicabile din Codul electric național al SUA și Codul electric canadian.

## 16. Cordon de alimentare electrică înregistrat UL și certificat CSA



Pentru conectarea la o sursă de alimentare pentru America de Nord, selectați un cordon de alimentare care este înregistrat UL și certificat CSA, cu 3 conductoare, [16 AWG], terminat cu o fișă turnată, cu putere nominală egală cu 125 V, [13 A], cu o lungime de minimum 1,5 m [șase picioare], dar nu mai lung de 4,5 m.

Pentru conectarea la o sursă de alimentare în Europa, selectați un cordon de alimentare care este armonizat la nivel internațional și marcat „<HAR>”, cu 3 conductoare, cu minimum 2 fire de 1,0 mm, cu putere nominală egală cu 300 V și cu o manta izolantă din PVC. Cordonul de alimentare trebuie să fie prevăzut cu o fișă turnată cu putere nominală egală cu 250 V, 10 A.

## 17. Curent de scurgere de înaltă frecvență



Avertisment: Curent de scurgere de înaltă frecvență; Împământarea este esențială înainte de a conecta sursa de alimentare.



## 18. Interconectarea unităților



Cablurile pentru conectarea la unitatea RS232 și la interfețele Ethernet trebuie să fie de tipul DP-1 sau DP-2 certificate UL. (Notă- când se regăsesc într-un circuit non-LPS) Protecție la supracurent: Un dispozitiv de protecție la supracurent, înregistrat în circuitul de ramificare, ușor accesibil și cu o putere nominală egală cu 20 A trebuie să fie integrat în cablajul clădirii.

## 19. Nu utilizați comutatorul ca raft sau spațiu de lucru

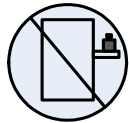

Atenție: Echipamentul montat pe o linie de alunecare/șină nu va fi utilizat ca raft sau spațiu de lucru. Scopul șinelor nu este de a glisa unitatea de pe rack. Acestea sunt destinate instalării permanente numai la punctul final de oprire și nu vor fi folosite pentru depanare și întreținere

## 20. Directiva DEEE

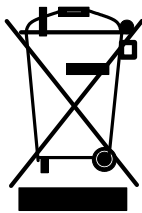

În conformitate cu Directiva DEEE 2002/96/CE, toate deșeurile de echipamente electrice și electronice (EEE) trebuie colectate separat și nu trebuie eliminate împreună cu deșeurile menajere obișnuite. Eliminați acest produs și toate componentele sale în mod responsabil și ecologic.

## E.10 Sigurnosna upozorenja za instaliranje (Croatian)

### 1. Upute za instaliranje



Pažljivo pročitajte upute za instaliranje prije spajanja opreme na izvor električne energije.

### 2. Tjelesne ozljede uslijed težine



Kako biste sigurno podignuli ovaj proizvod, koristite dovoljan broj ljudi.

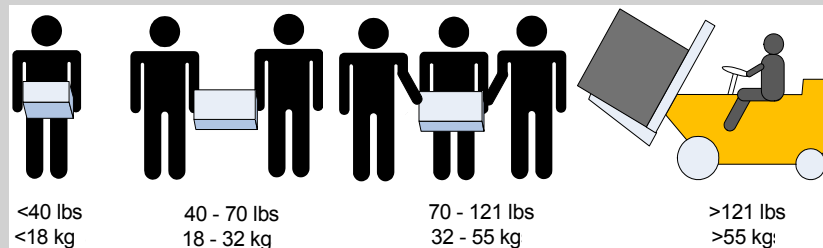

### 3. Teška oprema



Ova oprema je vrlo teška i treba se premještati pomoću mehaničkog dizala kako bi se izbjegle ozljede.

### 4. Rizik od strujnog udara!



Rizik od strujnog udara!

S uklonjenim modulom ventilatora, perima napajanja se može pristupiti u otvoru modula.

NEMOJTE umetati alat ili dijelove tijela u otvor modula ventilatora.

### 5. Pregrijavanje



Ovom se opremom ne bi trebalo rukovati u područjima s temperaturom okoline koja premašuje najviše preporučene vrijednosti: 45°C (113°F). Osim toga, kako bi se osigurao odgovarajući protok zraka, omogućite najmanje 8 cm (3 inča) razmaka oko otvora ventilatora.

### 6. Slaganje kućišta



Kućište se ne bi trebalo slagati na drugu opremu. Ako kućište padne, može izazvati tjelesne ozljede i oštećenje opreme.

### 7. Redundantno napajanje - Opasnost od električne energije



Ovaj proizvod uključuje redundantno napajanje ili prazan prostor na njegovu mjestu. U slučaju praznog prostora za napajanje, nemojte rukovati proizvodom ako je poklopac uklonjen ili ako nije dobro pričvršćen.

### 8. Višestruki ulazi za napajanje



Rizik od strujnog udara i opasnost od električne energije.

PSU jedinice su neovisne.

Odspojite sva napajanja kako biste osigurali stanje bez napajanja unutar platforme preklopnika.

### 9. Tijekom udara munje - Opasnost od električne energije



Tijekom djelovanja munja, nemojte raditi na opremi ili spajati ili odspajati kabele.

### 10. Spajanje/Odspajanje bakrenog kabela InfiniBand



Bakreni kabele InfiniBand su teški i nesavjetljivi i kao takvi se moraju pažljivo priključiti na ili isključiti iz konektora. Obratite se proizvođaču kabela za posebna upozorenja/upute.

## 11. Montaža ormarića i servisiranje



Kad se proizvod montira ili se servisira u ormariću, moraju se poduzeti posebne mjere opreza kako bi se osiguralo da sustav ostane stabilan. Općenito, trebali biste ispunjavati ormarić s opremom počevši od dna prema vrhu.

## 12. Instaliranje opreme



Ovu bi opremu trebalo instalirati, zamjenjivati i/ili servisirati samo obučeno i kvalificirano osoblje.

## 13. Odlaganje opreme



Odlaganje opreme trebalo bi se vršiti sukladno nacionalnim zakonima i propisima.

## 14. Lokalni i nacionalni električni kodovi



Ova oprema trebala bi se instalirati u skladu s lokalnim i nacionalnim električnim kodovima.

## 15. Instalacijski kodovi



Ovaj se uređaj mora instalirati sukladno najnovijoj verziji nacionalnih električnih kodova države. U Sjevernoj Americi oprema se mora instalirati sukladno važećim zahtjevima navedenim u US National Electrical Code i Canadian Electrical Code.

## 16. UL CSA kabel napajanja



Za sjevernoameričku mrežu odaberite kabel napajanja koji je na UL listi i sa CSA certifikatom, 3 - žilni, [16 AWG] (16 AWG) koji završava lijevanim utikačem nazivnog napona od 125 V, [13 A], minimalne duljine od 1,5 m [six feet] (šest stopa), ali ne dulji od 4,5 m.

Za europsku mrežu odaberite kabel napajanja koji je međunarodno usklađen i označen “<HAR>”, 3 - žilni, s najmanje 1,0 mm<sup>2</sup> žice, nazivnog napona od 300 V, s PVC izolacijom. Kabel mora imati lijevani utikač nazivnog napona od 250 V, nazivne struje od 10 A.

## 17. Veliko curenje struje



**Upozorenje:** Veliko curenje struje; Prije spajanja napajanja nužno je spojiti uzemljenje.

## 18. Interkonekcija uređaja



Kabeli za spajanje na jedinicu RS232 i Ethernet sučelja moraju biti s UL certifikatom vrste DP-1 ili DP-2. (Napomena - kad se nalazi u krugu bez LPS vodiča)

Zaštita od strujnog preopterećenja: Uvijek dostupni odobreni zaštitni uređaji od strujnog preopterećenja nazivne struje od 20 A moraju se ugraditi u ožičenje zgrade.

## 19. Nemojte koristiti preklopnik kao policu ili radnu površinu

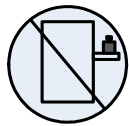

Pozor: Oprema montirana na klizače/vodilice ne bi se trebala koristiti kao policu ili radna površina. Vodilice nisu namijenjene za povlačenje uređaja iz ormarića. Služe samo za trajnu instalaciju na konačnom položaju, a ne za servisiranje i održavanje.

## 20. WEEE direktiva

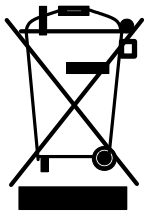

Sukladno WEEE direktivi 2002/96/EZ, sav električni i elektronički otpad (EEE) trebao bi se prikupljati zasebno i ne bi se trebao odlagati kao običan kućanski otpad.

Odlaganje ovog proizvoda i svih njegovih dijelova vršite na odgovoran i ekološki način.

## 21. Električna ograničenja države Norveške



Ovaj je uređaj namijenjen samo za spajanje na električni sustav s TN uzemljenjem i na električni sustav s IT uzemljenjem države Norveške.

## E.11 Avvertenze di sicurezza per l'installazione (italiano)

### 1. Istruzioni di installazione



Leggere tutte le istruzioni di installazione prima di collegare l'apparecchiatura all'alimentazione.

## 2. Lesioni a causa del peso



Usare un numero di persone sufficiente per sollevare in sicurezza questo prodotto.

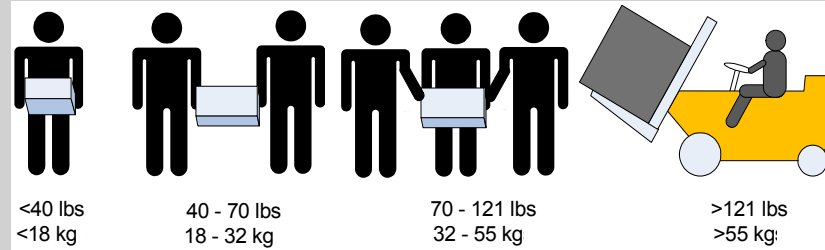

## 3. Apparecchiatura pesante



Questa apparecchiatura è molto pesante e va spostata mediante un sollevatore meccanico, per evitare lesioni.

## 4. Rischio di scosse elettriche!



Rischio di scosse elettriche!

Con il modulo ventola rimosso, i pin di alimentazione sono accessibili all'interno della cavità del modulo.

NON inserire strumenti o parti del corpo nella cavità del modulo della ventola.

## 5. Temperatura eccessiva



Questa apparecchiatura non va utilizzata in un'area con una temperatura ambiente superiore a quella massima consigliata: 45 °C (113 °F). Inoltre, per assicurare un flusso d'aria adeguato, lasciare almeno 8 cm (3 pollici) di spazio attorno alle aperture di ventilazione.

## 6. Impilare lo chassis



Kućište se ne bi trebalo slagati na drugu opremu. Ako kućište padne, može izazvati tjelesne ozljede i oštećenje opreme.

## 7. Collegamento di alimentazione ridondante - Pericoli elettrici



Questo prodotto è dotato di un alimentatore ridondante o, qualora esso non sia installato, di uno spazio vuoto. Qualora l'alimentatore non sia installato, non utilizzare il prodotto con il coperchio rimosso o non fissato correttamente.

## 8. Prese di alimentazione multiple



Rischio e pericolo di scosse elettriche.  
Gli alimentatori sono tutti indipendenti.  
Scollegare tutti gli alimentatori per assicurarsi che il commutatore non sia sotto tensione

## 9. Durante i temporali, pericolo di scosse elettriche



Durante i temporali, non effettuare interventi sull'apparecchiatura e non collegare o scollegare i cavi.

## 10. Collegamento/scollegamento del cavo di rame InfiniBand



I cavi di rame InfiniBand sono pesanti e non flessibili. Di conseguenza, vanno collegati o scollegati con cura dai connettori. Per avvertenze/istruzioni speciali, rivolgersi al produttore di cavi.

## 11. Montaggio su rack e manutenzione



Quando questo prodotto viene montato o sottoposto a manutenzione su un rack, è necessario adottare delle precauzioni speciali per assicurarsi che il sistema resti stabile. In generale, il rack va riempito con apparecchiature, procedendo dal basso verso l'alto.

## 12. Installazione dell'apparecchiatura



Questa apparecchiatura va installata, sostituita e/o sottoposta a manutenzione solo da personale addestrato e qualificato.

## 13. Smaltimento dell'apparecchiatura



Lo smaltimento di questa apparecchiatura va effettuato in conformità con tutte le leggi e le normative nazionali.

## 14. Codici elettrici locali e nazionali



Questa apparecchiatura va installata in conformità con le norme elettriche locali e nazionali.

## 15. Codici di installazione



Questo dispositivo va installato in conformità con l'ultima versione dei codici elettrici nazionali del Paese. Per il Nord America, l'apparecchiatura va installata in conformità con i requisiti applicabili del "codice elettrico nazionale USA" e del "codice elettrico canadese".

## 16. Cavo di alimentazione UL e munito di certificazione CSA



Per una connessione di alimentazione nordamericana, selezionare un cavo di alimentazione di tipo UL e munito di certificazione CSA, a 3 conduttori, [16 AWG], terminato con una spina stampata con tensione nominale pari a 125 V, [13 A], di lunghezza minima pari a 1,5 m [sei piedi] ma non più lunga di 4,5 m.

Per una connessione europea, selezionare un cavo di alimentazione armonizzato a livello internazionale e contrassegnato da “<HAR>”, a 3 conduttori, minimo 1,0 mm<sup>2</sup> fili, con guaina isolante in PVC. Il cavo deve disporre di una spina stampata di potenza nominale pari a 250 V, 10 A.

## 17. Corrente di dispersione elevata



**Avvertenza:** corrente di dispersione elevata; il collegamento a terra è essenziale prima di collegare l'alimentazione.

## 18. Interconnessione delle unità



I cavi per il collegamento all'unità RS232 e alle interfacce Ethernet devono disporre della certificazione UL ed essere del tipo DP-1 o DP-2. (Nota: in caso di installazione su un circuito la cui potenza non è limitata)

Protezione contro le sovracorrenti: la cablatura dell'edificio deve integrare un dispositivo di protezione contro le sovracorrenti di potenza nominale pari a 20.

## 19. Non utilizzare lo switch come scaffale o piano di lavoro

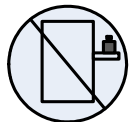

Attenzione: un'apparecchiatura scorrevole o montata su binari non va utilizzata come scaffale o piano di lavoro. I binari non sono progettati per far scorrere e allontanare l'unità dal rack. Essi sono destinati all'installazione permanente solo nel luogo di lavoro e non vengono utilizzati per assistenza e manutenzione

## 20. Direttiva RAEE

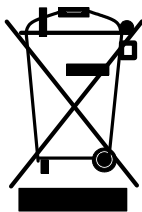

Secondo la direttiva RAEE 2002/96/EC, tutti i rifiuti da apparecchiature elettriche ed elettroniche (RAEE) vanno raccolti separatamente e non smaltiti nei normali rifiuti domestici.

Smaltire questo prodotto e tutte le sue parti in modo responsabile e rispettoso dell'ambiente

## 21. Limitazioni relative all'alimentazione per la Norvegia



Questa apparecchiatura è progettata esclusivamente per il collegamento a un sistema di alimentazione TN e a un sistema di alimentazione IT.

## E.12 Montaj Güvenlik Uyarıları (Türkçe)

### 1. Montaj Talimatları



Ekipmanı güç kaynağına bağlamadan önce tüm montaj talimatlarını okuyun.

### 2. Ağırlık Nedeniyle Fiziksel Yaralanma



Bu ürünü güvenli bir şekilde kaldırmak için yeterli sayıda insandan yardım alın.

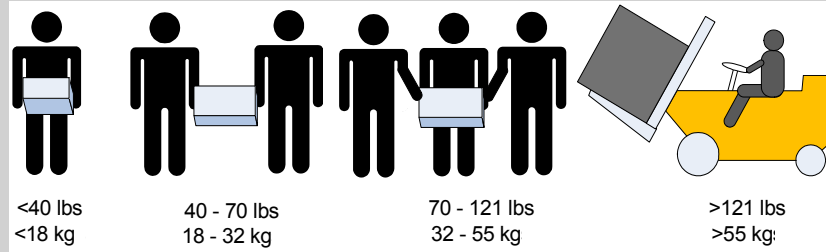

### 3. Ağır Ekipman



Bu ekipman çok ağırdır ve yaralanmaları önlemek için ekipmanın mekanik asansör kullanılarak taşınması gerekir.

### 4. Elektrik Çarpması Riski!



Bu ekipman, önerilen maksimum ortam sıcaklığını aşan alanlarda çalıştırılmamalıdır: 45 °C (113 °F). Ayrıca, düzgün hava akışı sağlamak için havalandırma deliklerinin etrafında en az 8 cm (3 inç) açıklık bırakılmalıdır.

### 5. Aşırı Isınma



Bu ekipman, önerilen maksimum ortam sıcaklığını aşan alanlarda çalıştırılmamalıdır: 45 °C (113 °F). Ayrıca, düzgün hava akışı sağlamak için havalandırma deliklerinin etrafında en az 8 cm (3 inç) açıklık bırakılmalıdır.

### 6. Şasi İstif



Şasinin diğer herhangi bir ekipmanın üzerine istiflenmemesi gerekir. Şasi düşerse, fiziksel yaralanmalara ve ekipmanda hasara neden olabilir.



## 7. Yedekli Güç Kaynağı Bağlantısı -Elektrik Çarpma Tehlikesi



Bu ürün, yedekli güç kaynağı veya onun yerine boş elektrik kutusu içerir. Güç kaynağı için boş elektrik kutusu varsa, kutunun kapağı açıkken veya tam olarak kapatılmamışken ürünü çalıştırmayın.

## 8. Çoklu Güç Girişleri



Elektrik çarpması riski ve enerji tehlikesi.  
Bütün PSU'lar (Güç Kaynağı Üniteleri) ayrıdır.  
Anahtar platformundaki gücü kapatmak için tüm güç kaynaklarının bağlantılarını kesin.

## 9. Şimşek - Elektrik Çarpma Tehlikesi



Gökyüzünde şimşek çaktığı zamanlarda, ekipman üzerinde çalışmayın veya kablo bağlamayın ya da kablo bağlantısı kesmeyin.

## 10. Bakır İnfinitand Kablo Bağlama/Bağlantıyı Kesme



Bakır İnfinitand kablolar ağırdır ve esnemezler. Bu nedenle, bağlantılara çok dikkatli bir şekilde takılmaları veya çıkarılmaları gerekir. Özel uyarılar/talimatlar için kablo üreticinize başvurun.

## 11. İskele Montajı ve Bakım



Bu ürün bir iskelede monte edildiye veya bir iskele ile sunulduysa, sistemin sabit kalması için özel önlemler alınmalıdır. Genelde, ekipmanları iskeleye aşağıdan yukarı doğru doldurmanız gerekir.

## 12. Ekipman Montajı



Ekipmanın yalnızca eğitimli ve nitelikli personel tarafından monte edilmesi, değiştirilmesi ve/veya bakımının yapılması gerekir.

## 13. Ekipmanın Atılması



Bu ekipmanın imhasında tüm ulusal yasalara ve düzenlemelere uyulması gerekir.

## 14. Yerel ve Ulusal Elektrik Kodları



Bu ekipmanın montajında yerel ve ulusal elektrik kodlarına uyulması gerekir.

## 15. Montaj Kodları



Bu cihazın, ülke ulusal elektrik kodlarının son sürümüne göre monte edilmesi gerekir. Kuzey Amerika için, ekipmanın ABD Ulusal Elektrik Kodu ve Kanada Elektrik Kodu'nun uygulama koşullarına göre monte edilmesi gerekir.

## 16. UL Kayıtlı ve CSA Onaylı Güç Kaynağı Kablosu



Kuzey Amerika'da güç bağlantısı için, UL Kayıtlı ve CSA Onaylı bir güç kaynağı kablosu seçin, 3 - iletken, [16 AWG], 125 V değerinde, kalıplanmış bir fişle biten, [13 A], en az 1,5 m (altı fit) uzunluğunda fakat 4,5 m'den uzun olmayan bir kablo. Avrupa'da güç bağlantısı için, uluslararası uyumlu ve “<HAR>” işaretli, 3 - iletken, en az 1,0 mm<sup>2</sup> tel, 300 V değerinde ve PVC yalıtımlı bir güç kaynağı kablosu seçin. Kablonun 250 V, 10 A değerinde bir kalıplanmış fişi olması gerekmektedir.

## 17. Yüksek Kaçak Akım



**Uyarı:** Yüksek kaçak akım varsa; güç kaynağına bağlanmadan önce mutlaka topraklama bağlantısı yapılmalıdır.

## 18. Ünitelerin Ara Bağlantısı



RS232 ünitesini ve Ethernet Arabirimlerini bağlayacak olan kabloların UL onaylı DP-1 veya DP-2 tipi olması gerekir. (Not- LPS olmayan devreye aitse) Aşırı Akım Koruması: Kolayca erişilebilecek 20 V Kayıtlı devre parçası aşırı akım koruma cihazının bina elektrik şebekesinde kurulu olması gerekir.

## 19. Anahtar Raf veya Çalışma Alanı olarak kullanmayın!

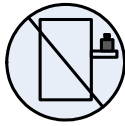

Dikkat: Sürgülü/raylı ekipman raf veya çalışma alanı olarak kullanılamaz. Raylar üniteyi iskeleden uzağa kaydırmak için yapılmamıştır. Sadece, ekipmanın son olarak duracağı yerdeki kalıcı montaj içindir, servis veya bakım için kullanılamaz.

## 20. WEEE Yönergesi

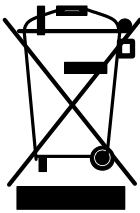

WEEE Yönergesi 2002/96/EC uyarınca, tüm elektrikli ve elektronik ekipman atıkları (EEE) ayrı olarak toplanmalı ve evsel atıklarla birlikte çöpe atılmamalıdır. Bu ürün ve tüm parçaları çevreye dost ve sorumlu bir şekilde imha edilmelidir.

## 21. Norveç Güç Kısıtlamaları



Bu ünite, bir TN güç sistemine ve sadece Norveç'in IT güç sistemine bağlanmak içindir.

## 22. Japan VCCI Statement

この装置は、クラス A 情報技術装置です。この装置を家庭環境で使用すると電波妨害を引き起こすことがあります。この場合には使用者が適切な対策を講ずるよう要求されることがあります。

VCCI-A