

48772-101

P897-100234

REPORT DOCUMENTATION PAGE		1. REPORT NO. NCEER-96-0010	2.	3. 
4. Title and Subtitle IDARC2D Version 4.0: A Computer Program for the Inelastic Damage Analysis of Buildings			5. Report Date June 3, 1996	
7. Author(s) R.E. Valles, A.M. Reinhorn, S.K. Kunnath, C. Li, A. Madan			6.	
9. Performing Organization Name and Address State University of New York at Buffalo Department of Civil Engineering Buffalo, New York 14260			8. Performing Organization Rept. No.	
12. Sponsoring Organization Name and Address National Center for Earthquake Engineering Research Red Jacket Quadrangle Buffalo, New York 14261			10. Project/Task/Work Unit No.	
			11. Contract(C) or Grant(G) No. (C) BCS 90-25010 (G)	
			13. Type of Report & Period Covered Technical report	
15. Supplementary Notes This research was conducted at the State University of New York at Buffalo and was supported in whole or in part by the National Science Foundation under Grant No. B CS 90-25010 and other sponsors.			14.	
16. Abstract (Limit: 200 words) This report summarizes recent enhancements to the IDARC computer program which has been and continues to be developed for the analysis of earthquake-induced damage to inelastic reinforced concrete structures. This report synthesizes all materials on IDARC presented in previous reports, including NCEER-87-0008, NCEER-92-0022, and other related reports. The report also treats a number of other improvements introduced in IDARC 2D, version 4.0: 1) improved plasticity and yield penetration model; 2) new masonry infill panels; 3) new damped bracing systems; 4) new hysteresis models; 5) new global damping formulation; 6) new static pushover analysis including adaptable technique; 7) new damage indicators; 8) improved information on damage progression through snapshots; 9) improved computational efficiency of stiffness calculations; 10) new case studies and examples.				
17. Document Analysis a. Descriptors				
b. Identifiers/Open-Ended Terms IDARC2D, version 4.0. IDARC. Computer programs. Inelastic damage analysis. Reinforced concrete structures. Damage models. Earthquake engineering.				
c. COSATI Field/Group				
1a. Availability Statement Release unlimited		19. Security Class (This Report) Unclassified		21. No. of Pages 350
		20. Security Class (This Page) Unclassified		22. Price



NATIONAL
CENTER FOR
EARTHQUAKE
ENGINEERING
RESEARCH

Headquartered at the State University of New York at Buffalo



1088-3800

ISSN 1088-3800

IDARC2D Version 4.0: A Computer Program for the Inelastic Damage Analysis of Buildings

by

R.E. Valles, A.M. Reinhorn, S.K. Kunnath, C. Li and A. Madan

State University of New York at Buffalo
Department of Civil Engineering
Buffalo, New York 14260

Technical Report NCEER-96-0010

June 3, 1996

This research was conducted at the State University of New York at Buffalo and was supported in whole or in part by the National Science Foundation under Grant No. BCS 90-25010 and other sponsors.

REPRODUCED BY 
U.S. Department of Commerce
National Technical Information Service
Springfield, Virginia 22161

DISCLAIMER

Considerable time and effort has been put into the development and testing of the computer program IDARC. Wherever possible, analytical results have been validated with experimental data. All modules and routines in the program have been carefully tested with examples. Nevertheless, the authors do not take any responsibility due to inadequate analysis results derived from flaws in the modeling techniques or in the program. The user is responsible for verifying the results of the analysis. The program incorporates current knowledge in the field of nonlinear structural dynamic analysis. The user should be knowledgeable in this area to understand the assumptions in the program, adequately use it, and to verify and correctly interpret the results. The following DISCLAIMER OF WARRANTY applies to the use of the computer program IDARC and its associated subroutines.

DISCLAIMER OF WARRANTY

The program IDARC, the associated subroutines, and the data files, are provided "AS IS" without warranty of any kind. The authors and the sponsoring institutions make no warranties, express or implied, that the program is free of error or is consistent with any particular standard of merchantability, or that the program will meet your requirements for any particular application. The program should not be relied on for solving a problem whose incorrect solution could result in injury to a person or loss of property. If you do use the program in such a manner, it is at your own risk. The authors and the sponsoring institutions disclaim all liability for direct or consequential damages resulting from your use of the program.

The ownership of the program remains with the developers. The program should not be resold or redistributed in whole or in part for direct profit. Neither the whole program nor routines of the program shall be incorporated into the source code or the executable binary code of other programs without prior written permission from the authors. Programs containing IDARC routines must acknowledge acceptance of the above DISCLAIMER OF WARRANTY and of the fact that no business relationship is created between the program's users and the authors of IDARC or the sponsoring institutions. The names of the authors and the names of the sponsoring institutions should not be used to promote products derived from this program without specific prior written permission from the authors.

NOTICE

This report was prepared by the State University of New York at Buffalo as a result of research sponsored by the National Center for Earthquake Engineering Research (NCEER) through a grant from the National Science Foundation and other sponsors. Neither NCEER, associates of NCEER, its sponsors, the State University of New York at Buffalo, nor any person acting on their behalf:

- a. makes any warranty, express or implied, with respect to the use of any information, apparatus, method, or process disclosed in this report or that such use may not infringe upon privately owned rights; or
- b. assumes any liabilities of whatsoever kind with respect to the use of, or the damage resulting from the use of, any information, apparatus, method, or process disclosed in this report.

Any opinions, findings, and conclusions or recommendations expressed in this publication are those of the author(s) and do not necessarily reflect the views of NCEER, the National Science Foundation, or other sponsors.



**IDARC2D Version 4.0:
A Computer Program for the Inelastic
Damage Analysis of Buildings**

by

R.E. Valles¹, A.M. Reinhorn², S.K. Kunnath³, C. Li⁴ and A. Madan⁴

Publication Date: June 3, 1996

Submittal Date: February 12, 1996

Technical Report NCEER-96-0010

NCEER Task Numbers 94-3103A and 94-3101A

NSF Master Contract Number BCS 90-25010

- 1 Research Associate, Department of Civil Engineering, State University of New York at Buffalo
- 2 Professor, Department of Civil Engineering, State University of New York at Buffalo
- 3 Associate Professor, Department of Civil and Environmental Engineering, University of Central Florida
- 4 Graduate Student, Department of Civil Engineering, State University of New York at Buffalo

NATIONAL CENTER FOR EARTHQUAKE ENGINEERING RESEARCH
State University of New York at Buffalo
Red Jacket Quadrangle, Buffalo, NY 14261

PREFACE

The National Center for Earthquake Engineering Research (NCEER) was established to expand and disseminate knowledge about earthquakes, improve earthquake-resistant design, and implement seismic hazard mitigation procedures to minimize loss of lives and property. The emphasis is on structures in the eastern and central United States and lifelines throughout the country that are found in zones of low, moderate, and high seismicity.

NCEER's research and implementation plan in years six through ten (1991-1996) comprises four interlocked elements, as shown in the figure below. Element I, Basic Research, is carried out to support projects in the Applied Research area. Element II, Applied Research, is the major focus of work for years six through ten. Element III, Demonstration Projects, have been planned to support Applied Research projects, and will be either case studies or regional studies. Element IV, Implementation, will result from activity in the four Applied Research projects, and from Demonstration Projects.

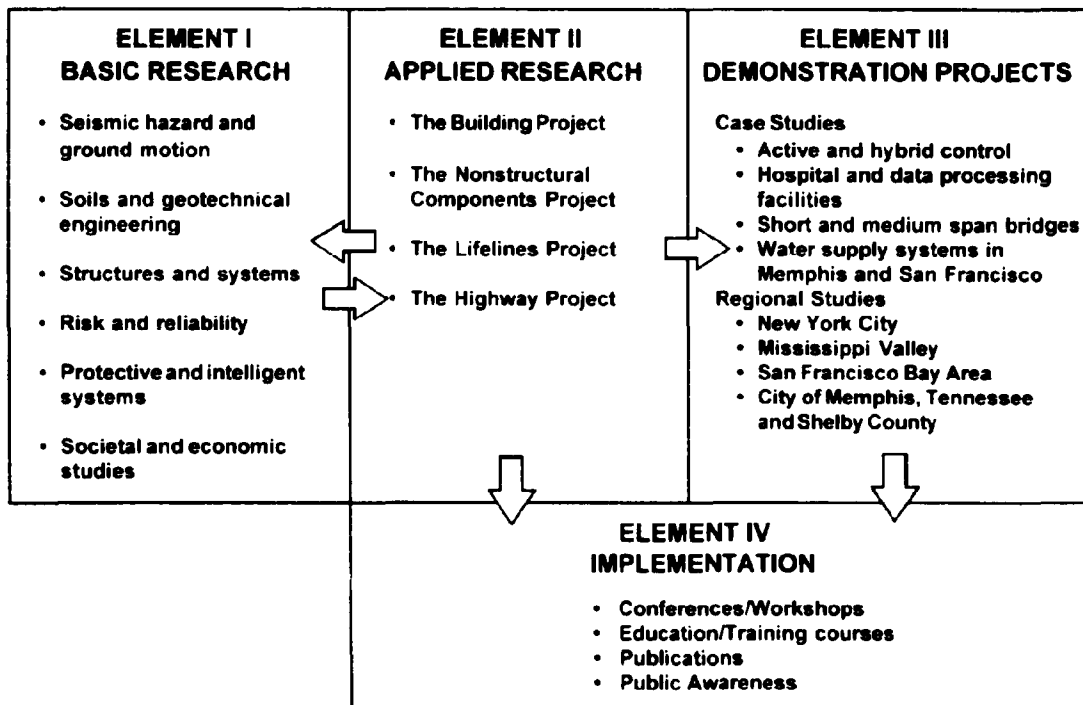

Research in the **Building Project** focuses on the evaluation and retrofit of buildings in regions of moderate seismicity. Emphasis is on lightly reinforced concrete buildings, steel semi-rigid frames, and masonry walls or infills. The research involves small- and medium-scale shake table tests and full-scale component tests at several institutions. In a parallel effort, analytical models and computer programs are being developed to aid in the prediction of the response of these buildings to various types of ground motion.

Two of the short-term products of the **Building Project** will be a monograph on the evaluation of lightly reinforced concrete buildings and a state-of-the-art report on unreinforced masonry.

The **structures and systems program** constitutes one of the important areas of research in the **Building Project**. Current tasks include the following:

1. Continued testing of lightly reinforced concrete external joints.
2. Continued development of analytical tools, such as system identification, idealization, and computer programs.
3. Perform parametric studies of building response.
4. Retrofit of lightly reinforced concrete frames, flat plates and unreinforced masonry.
5. Enhancement of the IDARC (inelastic damage analysis of reinforced concrete) computer program.
6. Research infilled frames, including the development of an experimental program, development of analytical models and response simulation.
7. Investigate the torsional response of symmetrical buildings.

This report presents the continued investigation of computer software development for response analysis of reinforced concrete structures, including dynamic analysis. The previous version of IDARC has been revised and enhanced to include additional features such as modeling and analysis of dampers as passive control devices and static pushover analysis which can be used for design purposes. IDARC2D can be potentially useful in response and damage evaluation of building structures under future seismic ground excitation.

ABSTRACT

This report summarizes the modeling of inelastic structures and enhancements to the program series IDARC developed for analysis, design and support of experimental studies. This report presents a synthesis of all the material presented in previous reports NCEEER-87-0008, NCEEER-92-0022 (and in other related reports). This report presents also the new developments regarding modeling of inelastic elements and structures with supplemental damping devices, infill panels, etc.

The analytical models described herein include, frame structures with rigid or semi-rigid connections made of beams, columns, shear walls, connecting beams, edge elements, infill masonry panels, inelastic discrete springs (connectors), and damping braces (viscoelastic, fluid viscous, friction, hysteretic). The formulations are based on macromodels in which most structural members are represented by a single-comprehensive element with nonlinear characteristics.

The nonlinear characteristics of the basic macromodels are based on a flexibility formulation and a distributed plasticity with yield penetration. Properties of members are calculated by fiber models or by formulations based on mechanics. The solutions are obtained using step-by-step integration of the equations of motion using Newmark beta method. One-step correction and iterative computations are performed to satisfy equilibrium. The nonlinear dampers are treated as time dependent Maxwell models, Kelvin models or hysteretic models. Their solution is obtained by simultaneously solving their individual equations using a semi-implicit Runge-Kutta solution.

This report presents several types of analyses which can be performed by the computer program, i.e., monotonic inelastic static analysis (push-over), time-history analysis with multi-components of ground motion and gravity loads, and quasi-static analyses of the type required by laboratory experiments. The analyses include evaluation of inelastic response through damage analysis of members and of the global structure. Several damage indices formulations are presented (Park et al., Reinhorn & Valles, Cakmak et al.) based on energy, stiffness and ductility including monitored damage progression.

The current report emphasizes also the latest improvements to this analytical platform which include: (i) improved plasticity and yield penetration model; (ii) new masonry infill panels; (iii) new braces with damping; (iv) new hysteretic model and solution; (v) new global damping formulation; (vi) new "push-over" analyses including adaptable technique; (vii) new damage indicators; (viii) improved information on damage progression through snapshots; (ix) improved efficiency through reprogramming of stiffness formulations; (x) new case studies presented as examples of use of inelastic analyses.

The computer program has a users manual which is presented in Appendix A and is distributed to members of the IDARC Users Group. Additional information is posted in an Internet site (see Introduction)

ACKNOWLEDGMENTS

Financial support was provided for the development of IDARC indirectly through projects regarding modeling and evaluation of structural systems by the National Center for Earthquake Engineering Research Project #94-3101A, 94-3103A and 94-5105A. NCEER is supported by the National Science Foundation, and by the State of New York. The support is gratefully acknowledged. Some enhancements to the current release were also sponsored and/or developed with cooperation from:

National Institute of Standards and Technology (NIST), Gaithersburg, MD -
Dr. J. Gross
Dames and Moore, Inc., Los Angeles, CA, - Dr. M. Mehrain
John A. Martin and Associates (JAMA), Los Angeles, CA, Dr. F. Naeim
Sumitomo Construction, Co., Tokyo, Japan, - Dr. Myiazaki
Taylor Devices, Inc., N. Tonawanda, NY - Mr. D. Taylor
Tekton, Inc., Tempe, Arizona, - Mr. P. Attaway

Their cooperation is greatly appreciated.

The authors wish to thank the members of IDARC Users Group for their comments, that initiated some revisions. The members of the Users Group are further encouraged to provide feedback for the improvement of the program.

TABLE OF CONTENTS

SEC.	TITLE	PAGE
1	INTRODUCTION	1
2	THEORY AND BACKGROUND	5
2.1	Nonlinear Structural Analysis Software	5
2.2	The IDARC Computer Program Series	5
2.3	Program Enhancements	7
3	DESCRIPTION OF PROGRAM FEATURES	15
3.1	Introduction	15
3.2	Structural Element Models	15
3.2.1	Stiffness Formulation for General Structural Elements	16
3.2.2	Fiber Model for General Structural Elements	23
3.2.2.1	Moment-Curvature Envelope Computation	25
3.2.2.2	Ultimate Deformation Capacity Computation	28
3.2.3	Column Elements	30
3.2.4	Beam Elements	32
3.2.5	Shear Wall Elements	35
3.2.6	Edge Column Elements	36
3.2.7	Transverse Beam Elements	38
3.2.8	Rotational Inelastic Spring Elements	39
3.2.9	Visco-Elastic Damper Elements	39
3.2.10	Friction Damper Elements	43
3.2.11	Hysteretic Damper Elements	47
3.2.12	Infill Panel Elements	50
3.2.12.1	Masonry Infill Panels	50
3.2.13	Moment Releases	55
3.3	Hysteretic Rules	58
3.3.1	Three Parameter Park Model	58
3.3.2	Tri-Linear Steel Model	61
3.3.3	Bilinear Hysteretic Model	61
3.3.4	Kelvin Model	61
3.3.5	Maxwell Model	67
3.3.6	Smooth Hysteretic Model	70
3.4	Analysis Modules	79
3.4.1	Nonlinear Static Analysis	80
3.4.2	Nonlinear Pushover Analysis	81
3.4.3	Nonlinear Dynamic Analysis	84
3.4.4	Nonlinear Quasi-static Analysis	89
3.5	Additional Program Features	89
3.5.1	P-Delta Effects	89

TABLE OF CONTENTS (cont.)

SEC.	TITLE	PAGE
3.5.2	Spread Plasticity Model	90
3.5.3	Yield Penetration Model	95
3.5.4	Eigenvalue Analysis	98
3.5.5	Structural Response Snapshots	98
3.5.6	Structural Collapse State	100
3.5.7	Element Stress Ratios	102
3.6	Damage Analysis	102
3.6.1	Park & Ang Damage Model	103
3.6.2	Fatigue Based Damage Model	105
3.6.3	Global Damage Model	106
4	PROGRAM VERIFICATIONS AND EXAMPLES: CASE STUDIES	107
4.1	Component Testing: Full Scale Bridge Pier Under Reversed Cyclic Loading	107
4.2	Subassemblage Testing: 1:2 Scale Three-Story Frame	112
4.3	Seismic Simulation: Ten-Story Model Structure	119
4.4	Seismic Response: 1:3 Scale Model Lightly Reinforced Concrete Structure	127
4.5	Damage Analysis: Cypress Viaduct Collapse During the 1989 Loma Prieta Earthquake	132
4.6	Pushover Analysis: Building in the Vicinity of the New Madrid Zone	138
4.7	Response Snapshots: Eight-Story building in Los Angeles	145
4.8	Steel Structure: Evaluation of Seismic Performance of a 11 Story Steel Moment Frame Building during the Northridge Earthquake.....	154
4.9	Passive Energy Dissipation Devices: 1:3 Scale Model Retrofitted Using Different Types of Dampers:	163
4.9.1	Viscous Dampers	163
4.9.2	Friction Dampers	164
4.9.3	Hysteretic Dampers	164
4.10	Masonry Infill Panels: Experimental Test of a Masonry Infilled Frame	174
4.11	Remarks and Conclusions	180
5	CONCLUSIONS AND RECOMMENDATIONS	181
5-1	Conclusions	181
5-2	Further Development Recommendations	183

TABLE OF CONTENTS (cont.)

SEC.	TITLE	PAGE
6	REFERENCES	185
APPENDICES		
A	User's Guide	A-1
B	Sample Input Data Files	B-1
C	Default Setting in File IDDEFN.FOR	C-1
D	Formulation for Masonry Infill Frames	D-1

LIST OF ILLUSTRATIONS

FIG.	TITLE	PAGE
3.1	Structural Model.....	17
3.2	Typical Column Element With Degrees Of Freedom.....	18
3.3	Typical Beam Element With Degrees of Freedom.....	19
3.4	Typical Shear Wall Element With Degrees of Freedom.....	19
3.5	Typical Structural Element With Rigid Zones.....	22
3.6	Section Detail for Fiber Model Analysis.....	24
3.7	Fiber Model Analysis for a Shear Wall.....	24
3.8	Stress-Strain Curve for Unconfined Concrete.....	29
3.9	Deformation Parameters.....	29
3.10	Edge Column Elements.....	37
3.11	Transverse Beam Elements.....	37
3.12	Modeling of Discrete Inelastic Springs.....	40
3.13	Viscoelastic Damper and Installation Detail (From Aiken, 1990).....	42
3.14	Viscous Walls and Hysteresis Loops (From Miyazaki, 1992).....	44
3.15	Sumitomo Friction Damper and Installation Detail (From Aiken,1990).....	46
3.16	Masonry Infill Panel: a) Frame Subassemblage, b) Compression Struts.....	51
3.17	Constitutive Model for Masonry.....	52
3.18	Strength Envelope for Masonry Infill Panel.....	52
3.19	Bouc-Wen Model for Smooth Hysteretic Response of Infill Panels.....	53
3.20	Modeling of Moment Releases in Structural Elements.....	56
3.21	Control Parameters for the Three Parameter Hysteretic Model.....	59
3.22	Influence of Degrading Parameters on the Hysteretic Behavior.....	60
3.23	Tri-Linear Steel Model.....	62
3.24	Bilinear Hysteretic Model.....	63
3.25	Kelvin Model: a) Damper Behavior; b) Linear Stiffness Component; C) Linear Damping Component.....	64
3.26	Maxwell Model for Damping Devices.....	64
3.27	Stiffness and Damping Versus Frequency in Maxwell Model.....	68
3.28	Smooth Hysteretic Model.....	72
3.29	SlipYield Penetration Lengths for Fully Inelastic Members Lock Element: a) Influence on Hysteretic Response; b) Slip-Lock Function.....	75
3.30	Influence of Varying the Slip-Lock Parameters.....	78
3.31	Unbalanced Force Correction.....	87
3.32	Computation of Shear Due to P-Delta Effects.....	87
3.33	Curvature Distribution Along an Element.....	91
3.34	Spread Plasticity Model.....	92
3.35	Yield Penetration Lengths for Fully Inelastic Members.....	92

LIST OF ILLUSTRATIONS (cont.)

FIG.	TITLE	PAGE
3.36	Sample of Collapsed State Response	101
4.1	Configuration and Loading of Full-Scale Bridge Pier.....	108
4.2	Comparison of Observed vs. Computed Response	109
4.3	Progressive Damage History During Cyclic Testing.....	111
4.4	Details of Half-Scale Model Frame.....	113
4.5	Comparison of Observed vs. Simulated Force-Deformation Response.....	114
4.6	Correlation of Dissipated energy and Global Damage	116
4.7	Study of Collapse Mechanism.....	117
4.8	Progressive Story Level Damage.....	118
4.9	Configuration and Reinforcement Details for Model Structure	120
4.10	Achieved Table Motions for Seismic Testing.....	121
4.11	Computed vs. Observed Peak Acceleration Response	123
4.12	Computed vs. Observed Peak Displacement Response.....	123
4.13	Comparison with Other Programs (Low Intensity)	124
4.14	Comparison with Other Programs (Moderate Intensity: Inelastic).....	125
4.15	Comparison with Other Programs (Highly Inelastic).....	126
4.16	Details of Gravity-Load-Designed Frame Building	128
4.17	Comparison with Other Programs - Low Intensity (0.05g).....	130
4.18	Comparison with Other Programs - Moderate Intensity (0.22g).....	131
4.19	Structural Configuration and Reinforcement Details of Type B1 Bent.....	133
4.20	IDARC Model Used in Damage Analysis.....	134
4.21	Displacement Response of Type B1 Bent.....	135
4.22	Damage History of Pedestal Region.....	136
4.23	Plan View of Structure	139
4.24	NS Frame Elevations.....	140
4.25	EW Frame Elevations.....	141
4.26	Overall Pushover Capacity Curves for Different Lateral Load Distributions (NS Direction)	143
4.27	Story Pushover Capacity Curves for Different Lateral Load Distributions (NS Direction)	144
4.28	Typical Floor Plan of Structure	146
4.29	Perspective View of Lateral Load Resisting Elements.....	147
4.30	Response Spectra Used for Evaluation.....	149
4.31	Pushover Capacity Curve with Significant Response Stages (Longitudinal Direction).....	150
4.32	Lateral Story Drift Ratios for Various Earthquake Intensities (Longitudinal Direction).....	151
4.33	Frame Elevation at Grid Line "M"	155
4.34	Typical Moment Connection at Column Flange	156

LIST OF ILLUSTRATIONS (cont.)

FIG.	TITLE	PAGE
4.35	Material Model Used for the Study	158
4.36	Nonlinear Story Shear Versus Story Drift (NS direction)	160
4.37	Comparison of Observed Damage and Computed Damage Indices (Grid Line "M").....	161
4.38	Location of Dampers and Measuring Devices.....	165
4.39	Comparison of Experimental and Analytical Displacements with Viscous Dampers (El Centro 0.3g).....	166
4.40	Comparison of Experimental and Analytical Accelerations with Viscous Dampers (El Centro 0.3g).....	167
4.41	Pushover Response of Structure with Viscous Dampers for Simplified Evaluation.....	168
4.42	Comparison of Experimental and Analytical Displacements with Friction Dampers (El Centro 0.3g).....	169
4.43	Comparison of Experimental and Analytical Displacements with Friction Dampers (El Centro 0.3g).....	170
4.44	Pushover Response of Structure with Friction Dampers for Simplified Evaluation.....	171
4.45	Analytical Displacement Response with Hysteretic Dampers (El Centro 0.3g).....	172
4.46	Analytical Acceleration Response with Hysteretic Dampers (El Centro 0.3g).....	173
4.47	Masonry Infilled Frame Test Specimen.....	175
4.48	Boundary Conditions of Infilled Frame Subassemblage	176
4.49	Idealized Structural Model for Analysis.....	177
5.50	Comparison of Experimental and Analytical Force-Deformation Response (Specimen I)	178
A.1	Frame Discretization and Nodal Identification.....	A-2
A.2	Floor Heights and Nodal Weights	A-6
A.3	Stress Curve for Unconfined Concrete.....	A-8
A.4	Stress Curve for Reinforcing Bars.....	A-10
A.5	Qualitative View of Effects of Degrading Parameters on Hysteretic Behavior	A-13
A.6	Rectangular Columns Input Details.....	A-16
A.7	Circular Column Input Details	A-17
A.8	Notation for User Input Trilinear Envelopes	A-19
A.9	Input Details for Beam-Slab Sections.....	A-21
A.10	Typical Input Details for Shear Wall Sections	A-24
A.11	Shear Wall and Edge Column Details	A-27
A.12	Transverse Beam Input	A-29
A.13	Element Connectivity for Sample Structure	A-36
A.14	Specification of Discrete Inelastic Springs.....	A-40
A.15	Specification of Moment Releases	A-41

LIST OF TABLES

TABLE TITLE	PAGE
3.1 Interpretation of Overall Damage Index (Park et al., 1986)	105
4.1 Element Stress Ratios for Typical Beams	153
4.2 Structural Response, longitudinal direction, for Various Earthquake Intensities	153
A.1 Typical Range of Values for Hysteric Parameters.....	A-12
C.1 Default Maximum Settings in File IDDEFN.POC	C-1

SECTION 1

INTRODUCTION

Significant research has been carried out in an effort to understand the behavior of building structures subjected to earthquake motions. Due to the inherent complexities that buildings have, often, research has focused on understanding element behavior through component testing. The conclusions and models derived from these studies must later be integrated so that the response of the whole structure may be captured. The well known computer program DRAIN-2D (Kaanan and Powell, 1973) was introduced in 1973 with the state of the art knowledge at that time in an attempt to capture the structural response. The program has recently been updated and the new version is called DRAIN-2DX (Allahabadi and Powell, 1988).

A number of programs for the nonlinear dynamic analysis of building structures have been introduced since then. Among them, SARCF (Chung et al., 1988, Gomez et al., 1990), IDARC (Park et al., 1987, Kunnath et al., 1992) and ANSR (Oughourlian and Powell, 1982) became widely used by the research community. The computer program IDARC has been conceived, since its first release, as a platform for nonlinear structural analysis in which various aspects of concrete behavior could be modeled, tested and improved upon. Throughout the various releases of IDARC, program developments and enhancements have been based primarily on the need to link experimental research and analytical developments.

Structural design engineers have been aware of the inherent limitations that widely used elastic analysis have when trying to calculate the response of a building designed to respond inelastically. However, due to the computational effort required to perform a nonlinear analysis, the fact that building codes are mostly concerned with elastic analysis,

the need for a more precise characterization of the input motion, etc., have forced structural engineers to continue using elastic analysis programs

The introduction of new protective systems, such as base isolators and damper elements, require the use of nonlinear dynamic analysis programs for their design. To bridge this gap, commercial software for elastic analysis, such as ETABS (Habibullah, 1995) and SAP (Wilson, 1995), have incorporated nonlinear elements to model the behavior of such devices, allowing design engineers already familiar with those programs to easily incorporate the protective devices in the response of the structure. However, the structure itself is still modeled in the elastic range, therefore, not able to capture the inelastic response of structures. This drawback may not be significant for new buildings, however, retrofitted structures may considerably deviate from an elastic response.

The new release of IDARC incorporates the results from recent experimental testing on reinforced concrete components and structures, as well as structural steel elements, that have led to enhancements in modeling using macromodels with new distributed plasticity models, new hysteretic models, and modifications to the combined model for shear-flexure capacity of members. IDARC is now enhanced to capture, with greater accuracy, the response of reinforced concrete and structural steel elements.

Furthermore, in parallel with an experimental program to study the response of buildings with damper elements for seismic protection, new mathematical models for such elements were incorporated and verified in the program. IDARC is now capable of accurately predicting the response of inelastic multistory buildings with viscoelastic, friction and hysteretic damper elements.

More over, combined with an experimental program, and a loss assessment program in a metropolitan area in the vicinity of the New Madrid zone, a model for infill panel elements was incorporated and tested. This model may be used to study the response of masonry buildings, commonly used as low to medium rise structures in

metropolitan areas. IDARC is now capable of modeling buildings with masonry walls, or other type of infill panels.

In addition, the new method for seismic evaluation proposed in the ATC-33 (1995) using the results from lateral pushover analysis, was already incorporated in previous versions of the program. However, in conjunction with an analytical program to estimate the inelastic response of structures, an extended and more realistic set of options to carry out the pushover analysis have been incorporated. Furthermore, the need to better characterize the structural performance of a building during a seismic event led to an analytical investigation to develop a damage model from basic physical considerations. The new model, referred to as fatigue based damage model, developed by Reinhorn and Valles (1996) was also incorporated in the program, along with a global damage model, and the model by Park and Ang (1984) that was introduced in the first release of IDARC, and is now a benchmark damage quantification index. IDARC now offers a broader range of pushover and damage indices derived from strong physical considerations.

Finally, most of the program routines, internal variables and program structure have been checked and optimized to improve the performance, and considerably reduce execution time. In addition, the users manual was revised and restructured to facilitate the input data preparation. IDARC is now more efficient and user friendly.

This report summarizes the program modeling techniques used, and provides references for each of the broad topics considered. Appendix A has the user's manual for the program. Appendix B includes the sample input files described in Section 4.

SECTION 2

THEORY AND BACKGROUND

2.1 Nonlinear Structural Analysis Software

Building structures are often designed using results from an elastic analysis, although inelastic behavior may well be observed during the design earthquake. To estimate the actual response of the structure when some of the elements behave in the inelastic range, nonlinear structural analysis programs have been introduced. The well known computer program DRAIN-2D (Kaanan and Powell, 1973) was introduced in the early 1970's. The program included the state of the art knowledge at the time. Since then, the program was not considerably modified in its structure, until DRAIN-2DX (Allahabadi and Powell, 1995) was introduced. Nevertheless, the new program has some limitations regarding plasticity and flexibility rules.

Since then, a number of programs for nonlinear analysis of structures have been introduced. Among them SARCF (Chung et al., 1988, Gómez et al., 1990), IDARC (Park et al., 1987, Kunnath et al., 1992) and ANSR (Oughourlian and Powell, 1982) became widely used by the research community.

2.2 The IDARC Computer Program Series

The computer program IDARC was conceived as a platform for nonlinear structural analysis in which various aspects of concrete behavior can be modeled, tested and improved upon. Program development and enhancements have been primarily to link experimental research and analytical developments.

The computer program IDARC was introduced in 1987 as a two-dimensional analysis program to study the nonlinear response of multistory reinforced concrete buildings. The original program released included the following structural element types

- a) Column Elements
- b) Beam Elements
- c) Shear Wall Elements
- d) Edge Column Elements
- e) Transverse Beam Elements

Column elements were modeled considering macromodels with inelastic flexural deformations, and elastic shear and axial deformations. Beam elements were modeled using a nonlinear flexural stiffness model with linear elastic shear deformations considered. Shear walls include inelastic shear and bending deformations, with an uncoupled elastic axial component. Edge column elements were introduced considering only inelastic axial deformations. Transverse beam elements, that have an effect on the rotational deformation of the shear walls or beams to which they are connected, were modeled using elastic linear and rotational springs.

One of the significant features incorporated in the program, to implement inelastic behavior in the macromodels, is the distributed flexibility model that replaced the commonly used hinge model developed for steel frames. The hinge model is not suitable for reinforced concrete elements since the inelastic deformation is distributed along the member rather than being concentrated at critical sections (Park et al., 1987). To trace the hysteretic response of a section, a three parameter model was developed. Through the combination of three basic parameters and a trilinear skeleton curve stiffness degradation, strength deterioration and pinching response can be modeled.

The original version of the program included the damage model developed by Park and Ang (1984) to provide a measure of the accumulated damage sustained by the components of the structure, by each story level, and the entire building. This damage

index included the ratio of the maximum to ultimate deformations, as well as the ratio of the maximum hysteretic energy dissipated to the maximum monotonic energy, therefore capturing both components of damage

The original release of the program consisted of three parts (Park et al . 1987)

- a) System identification: static analysis to determine component properties and the ultimate failure mode of the building
- b) Dynamic response analysis: step by step inelastic dynamic analysis
- c) Substructure analysis and damage analysis: analysis of selected substructures, and comprehensive damage evaluation

Later versions of the program included

- a) The addition of a fiber model routine to automatically calculate the envelope curve of columns, beams and shear wall elements
- b) A quasi-static, or pseudo-dynamic, analysis module for comparisons with experimental tests
- c) Addition of P-Delta effects in the program

2.3 Program Enhancements

The new release of the program, version 4.0, contains a number of enhancements, including

- a) Viscoelastic, friction, and hysteretic damper macro elements
- b) Macro model for infill panel elements
- c) Spread plasticity and yield penetration
- d) New Hysteresis modules
- e) New damage indicators
- f) New pushover options
- g) Response snapshots during analysis
- h) Proportional damping options

- i) Reprogrammed for improved efficiency
- j) New case studies for program validation
- k) User group and internet site

The major highlights of each improvement are briefly described below

a) Viscoelastic, Friction and Hysteretic Damper Macro Elements

The three main types of supplemental damper elements were included in the program. Damper elements oppose the relative displacement of two floors in the structure. Viscoelastic damper elements are modeled using either a Kelvin or a Maxwell model, depending on the characteristics of the dampers. Friction and hysteretic dampers are included using the Bouc-Wen smooth hysteretic model. All models are capable of capturing the response of the dampers during a dynamic, quasi-static and pushover analysis.

An equivalent dynamic stiffness is used for the viscoelastic elements during quasi-static and pushover analysis, while the Bouc-Wen model was reformulated in terms of deformation increments to remove the time dependency in the original formulation. Furthermore, the instantaneous apparent dynamic stiffness of the damper elements is included in the global building stiffness matrix before the eigenvalue analysis takes place. Therefore, the eigenvalue analysis automatically incorporates the actual instantaneous contribution from the damper elements, which is often only accounted for using a user specified equivalent constant stiffness for these elements in other nonlinear analysis programs.

This new element types in the program allows the user to study the response of nonlinear structures with a wide variety of supplemental damping devices. Commercially available programs such as ETABS Version 6 (Habibullah, 1995) are capable of capturing the response of some supplemental damping devices, but are incapable of capturing the nonlinear response of the building. This shortcoming may be unimportant for the design of new structures that can be proportioned to remain elastic during the design earthquake.

However, when existing buildings are retrofitted using supplemental damping devices, often the new design will still allow some level of inelastic response in the structural elements in order to make the retrofit economically viable. Under such conditions, an analysis considering the inelastic response of in the structural elements must be performed to estimate the actual response of the retrofitted structure.

b) Macro Model for Infill Panel Elements

A new element was introduced in IDARC to capture the contribution of infill panels to the lateral load resistance of the structure. The hysteretic response of the infill element is captured using a smooth hysteretic model based on the Bouc-Wen model. The smooth hysteretic model includes stiffness decay, strength deterioration, and pinching response. An important improvement of the implemented model is that strength deterioration is related to a fatigue damage index of the panel element.

The infill panel element was implemented so that the modeling parameters could be easily changed to capture different types of hysteretic loops. Masonry infill walls can be modeled using the infill panel element. Provisions in the program were made so that if a masonry infill wall is used, the program will automatically calculate the hysteretic parameters based on geometric and material considerations. Other types of panel elements, structural or nonstructural, can be modeled using user defined parameters.

c) Spread Plasticity and Yield Penetration

The spread plasticity model in the original release of the program was reformulated to enhance numerical precision and computation efficiency. The spread plasticity formulation includes the effect of shear distortions in the elements. The revised formulation can now handle flexural or shear failures with the possibility of numerical overflow eliminated. This effort is part of a larger project to model element collapse (loss) during analysis.

In addition to the reformulation of the spread plasticity model, yield penetration rules were introduced to allow for varying plastic length zones. The formulation can

capture the change in the plastified length under single or double curvature conditions. The penetration length is updated at each step in the analysis as a function of the instantaneous moment diagram in the element, but the penetration length is never allowed to become smaller than the previous maximum.

d) New Hysteresis Modules

The original IDARC program used the three parameter model to trace the hysteretic response of structural elements. The piece-wise linear three parameter model that included stiffness degradation, strength deterioration and slip was introduced to model the response of reinforced concrete structural elements. With a variation in the hysteretic parameters, and in the monotonic characteristic points, the user could simulate other hysteretic shapes, such as the one observed in steel structures.

A new set of routines were introduced to account for different hysteretic loops: steel and bilinear hysteresis. The structure of the program was modified to facilitate the addition of new hysteretic routines that can be developed in the future, or by other researchers.

e) New Damage Indicators

The original release of IDARC incorporated damage qualifications for the building, the building stories, and the structural elements based on the damage index proposed by Park et al (1984). Since then, the Park and Ang damage model has become a benchmark damage qualification model. A new damage index has been developed (Reinhorn and Valles, 1996) based on basic principles and low cycle fatigue considerations.

The new damage quantification index, fatigue based damage index, was incorporated in the new release of IDARC. The original Park and Ang damage model can be derived after simplifications of the fatigue based damage model. In addition, provisions in the program were made so that the user can request printing of the variation of the fundamental period of the structure as the analysis progresses.

The new fatigue based damage index, the Park and Ang damage model, and the history of the variation of the fundamental frequency of the structure provides the user with a more accurate description of the building performance for damage quantification. The extended damage index options provides three scope levels for quantification: building, story and element damage.

f) New Pushover Options

Pushover analysis is used to determine the force-deformation response characteristics of a structure. Using the results from this analyses, the actual nonlinear dynamic response of the structure can be estimated (Valles et al., 1996). Furthermore, a new set of dynamic evaluation procedures, as suggested in the ATC-33 50% Draft (1995), utilize the results obtained with pushover analyses.

A number of different options for the pushover analysis were added to the program: displacement control, user defined force control distribution, a generalized power distribution, and a modal adaptive lateral force distribution. These options allow a more realistic force distribution to be used in the pushover analysis. The generalized power distribution is also suggested in the ATC-33 50% Draft (1995) to determine the load distribution as a function of the fundamental period of the structure. The modal adaptive force distribution is able to capture the changes in the lateral load distribution as the building responds in the inelastic range.

g) Response Snapshots During Analysis

One of the new features of the program is that the user can request a series of response snapshots during the analysis. The response snapshots provide the user with displacement profile, element stress ratios, collapse states, damage index states, and dynamic characteristics (eigenvalues and eigenvectors) of the building at an instant during the analysis.

The instant where response snapshots are taken can be specified in terms of a desired threshold in overall shear or drift levels. By default, the program can report snapshots at the end of the analysis, and when a column, beam or shear wall cracks, yields or fails. Response snapshots provide the user with the instantaneous building state, which is also required by the ATC-33 50% Draft recommendations for seismic evaluation of existing buildings.

h) Proportional Damping Options

In the new version of IDARC, the damping matrix can be specified to be Rayleigh or stiffness proportional, besides the mass proportional option available in the earlier versions of the program. Proportionality coefficients are calculated internally by the program using the first mode, or the first two modes in the case of Rayleigh damping.

i) Reprogrammed for Improved Efficiency

Most of the solution routines, including the eigenvalue routine, the shear calculation, the spread plasticity and yield penetration routines, and the matrix condensation routines were revised and reprogrammed to improve computational efficiency in the analysis. With these modifications, the program can readily be executed in a personal computer.

j) New Case Studies for Program Validation

Verification examples have been included to highlight the program capabilities and features, as well as to validate, whenever possible, numerical models with experimental results. The case studies will also help new users of the program to become familiar with IDARC capabilities and input formats.

k) User Group and Internet Site

A user group for the program has been organized for questions, suggestions or comments related to the program. The E-mail address is

reinhorn@eng.buffalo.edu

A world-wide web site in the internet has been created where news, updates, comments and current developments are posted. The world-wide web address is

<http://shalom.eng.buffalo.edu/idarc>

SECTION 3

DESCRIPTION OF PROGRAM FEATURES

3.1 Introduction

The program was developed assuming that floor diaphragms behave as rigid horizontal links, therefore, only one horizontal degree of freedom is required per floor. This approach greatly reduces the total computational effort. Therefore, the building is modeled as a series of plane frames linked by a rigid horizontal diaphragm. Each frame is in the same vertical plane, and no torsional effects are considered. Since the floors are considered infinitely rigid, identical frames can be simply lumped together, and the stiffness contribution of each typical frame factored by the number of duplicate equal frames. Input is only required for each of the typical frames.

The computer program IDARC integrates different structural element models in the global stiffness matrix of the system, or treats them as loads in a pseudo-force formulation. Such an arrangement allows for new element modules to be easily added to the global structure of the program.

3.2 Structural Element Models

Version 4.0 of IDARC includes the following types of structural elements:

- a) Column elements
- b) Beam elements
- c) Shear wall elements
- d) Edge column elements
- e) Transverse beam elements

- f) Rotational spring elements
- g) Visco-elastic damper elements
- h) Friction damper elements
- i) Hysteretic damper elements
- j) Infill panel elements
- k) Moment releases

Figure 3.1 schematically shows a building with some of the element types available in IDARC Version 4.0. Each of the element types are discussed below.

3.2.1 Stiffness Formulation for General Structural Elements

Most structural elements, i.e. columns, beams and shear walls, are modeled using the same basic macro formulation. Flexural, shear and axial deformations can be considered in the general structural macro element, although axial deformations are neglected in the beam element. Figures 3.2 to 3.4 show a typical column, beam and shear wall element with the corresponding degrees of freedom. Flexural and shear components in the deformation are coupled in the spread plasticity formulation, as discussed in Section 3.5.2, and any of the following hysteretic models can be used for both the flexural and shear springs:

- a) Three parameter Park model
- b) Three-linear steel model
- c) Bilinear model
- d) Linear model

Axial deformations are modeled using a linear elastic spring element uncoupled to the flexural and shear spring elements.

Rotations and moments at the face of the element are related by the basic element stiffness matrix, according to

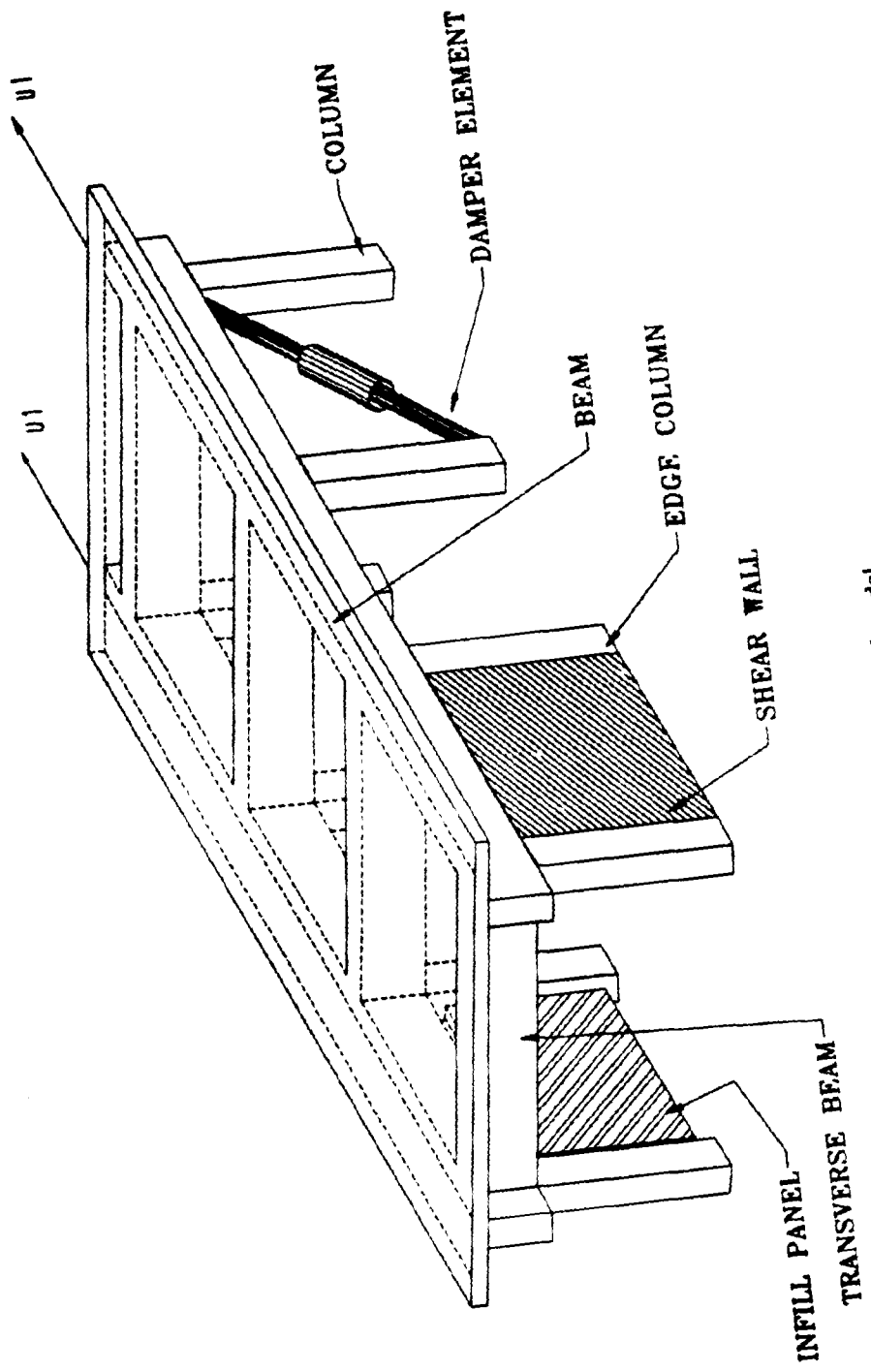

Fig. 3.1 Structural model

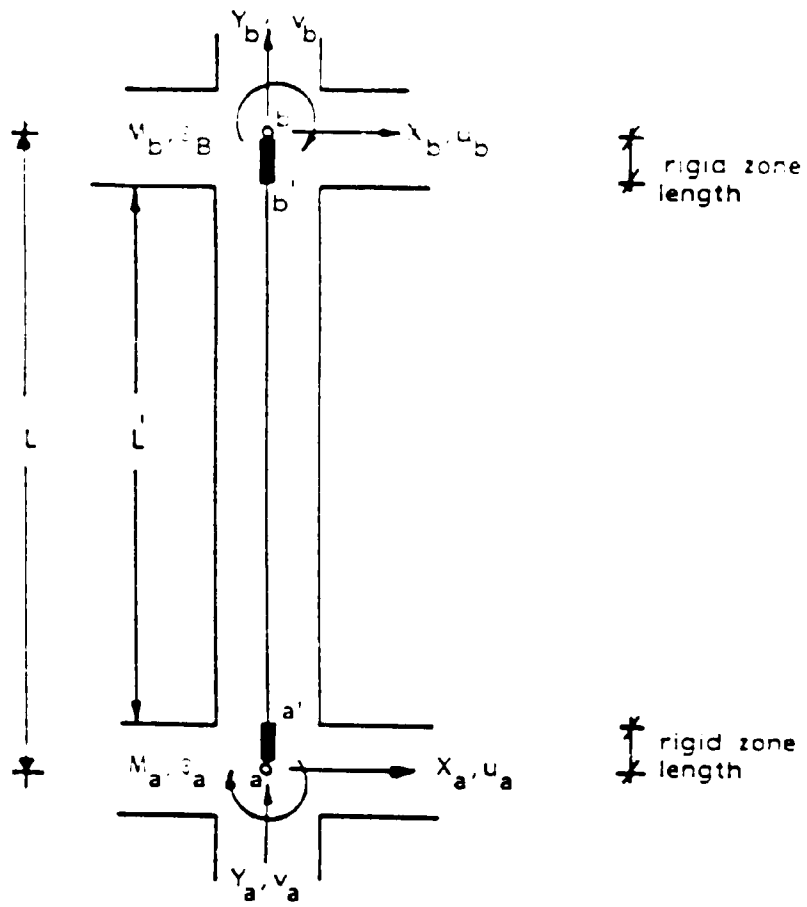

Fig. 3.2 Typical column element with degrees of freedom

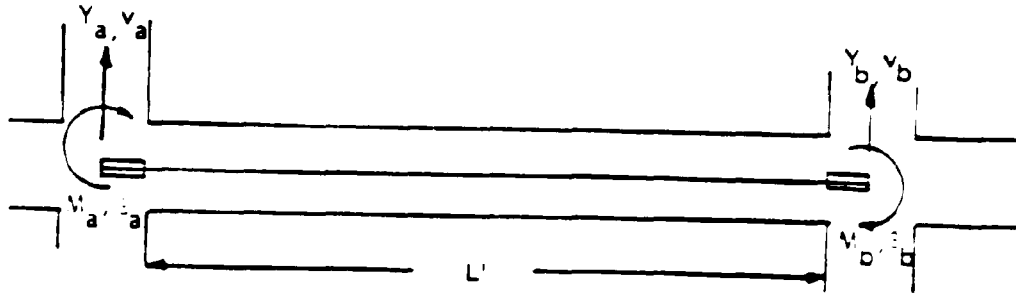

Fig. 3.3 Typical beam element with degrees of freedom

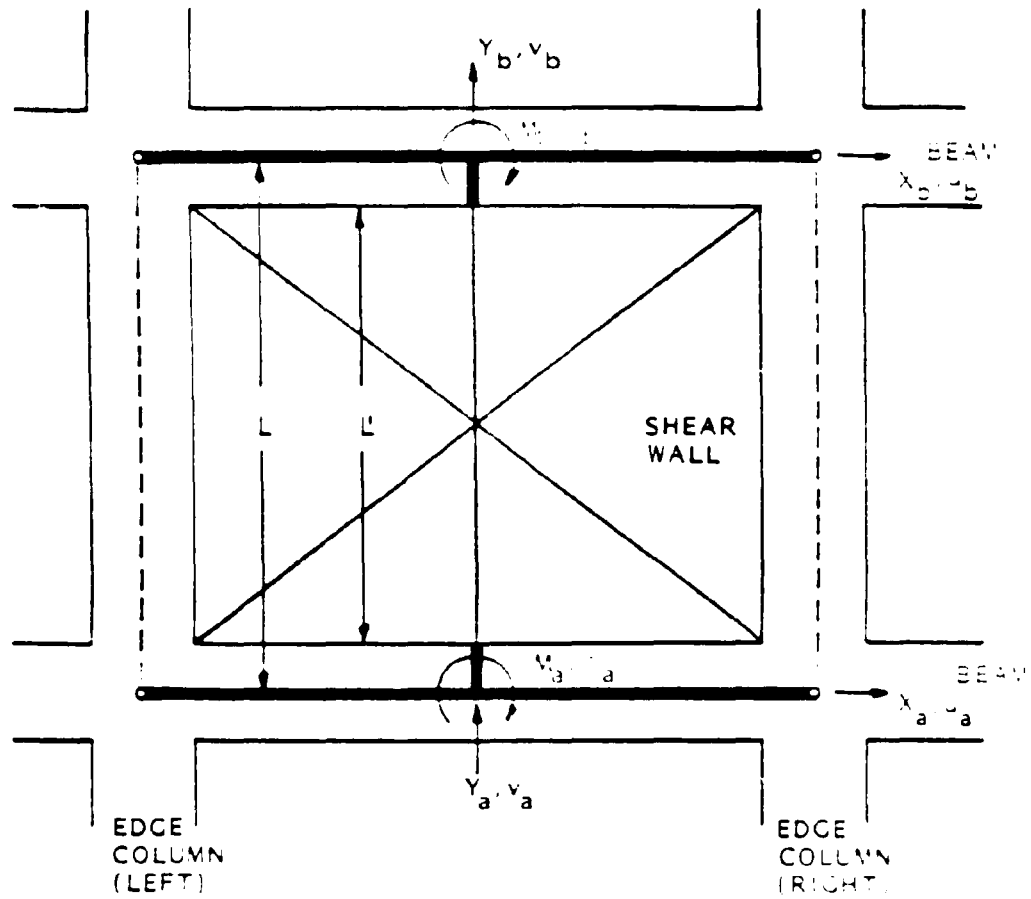

Fig. 3.4 Typical shear wall element with degrees of freedom

$$\begin{Bmatrix} M'_a \\ M'_b \end{Bmatrix} = [\mathbf{K}'] \begin{Bmatrix} \theta'_a \\ \theta'_b \end{Bmatrix} \quad (3.1)$$

Where M'_a and M'_b are the moments at the face of the structural element, θ'_a and θ'_b are the rotations at the face of the element, and $[\mathbf{K}']$ is the basic stiffness matrix of the element including shear and flexural deformations, calculated using the spread plasticity model described in Section 3.5.2

$$[\mathbf{K}'] = \begin{bmatrix} k_{aa} & k_{ab} \\ k_{ba} & k_{bb} \end{bmatrix} \quad (3.2)$$

Where

$$k_{aa} = \frac{12EI_a EI_b EI_c}{D_a L} (f_{bb} GA_s L + 12EI_a EI_b EI_c) \quad (3.3a)$$

$$k_{ab} = k_{ba} = \frac{12EI_a EI_b EI_c}{D_a L} (f_{ab} GA_s L + 12EI_a EI_b EI_c) \quad (3.3b)$$

$$k_{bb} = \frac{12EI_a EI_b EI_c}{D_a L} (f_{aa} GA_s L + 12EI_a EI_b EI_c) \quad (3.3c)$$

with EI_a being the elastic rotational stiffness, EI_a and EI_b the tangent rotational stiffness at the ends of the element, GA_s the shear stiffness, L the length of the member, and the rest of the parameters are described in Section 3.5.2

Column and beam elements can include a rigid length zone to simulate the increase in the stiffness of the element at the joint, or in the connections with shear walls. The effect of the rigid length zone is negligible in typical shear wall elements. The user can specify the length of the rigid length zones depending on the dimensions of the connecting elements. From geometry, the relationship between rotations and moments at the face of the element, and these quantities at the nodes is expressed by the following transformation

$$\begin{Bmatrix} M_a \\ M_b \end{Bmatrix} = [\mathbf{L}] \begin{Bmatrix} M'_a \\ M'_b \end{Bmatrix} \quad (3.4a)$$

$$\begin{Bmatrix} \theta'_a \\ \theta'_b \end{Bmatrix} = [\mathbf{L}]^T \begin{Bmatrix} \theta_a \\ \theta_b \end{Bmatrix} \quad (3.4b)$$

Where

$$[\tilde{\mathbf{L}}] = \frac{1}{1 - \lambda_a - \lambda_b} \begin{bmatrix} 1 - \lambda_b & \lambda_a \\ \lambda_b & 1 - \lambda_a \end{bmatrix} \quad (3.5)$$

Where λ_a and λ_b are the proportions of rigid zone in the element, as shown in Fig. 3.5

Combining the equations, the basic equation relating moments and rotations at the element nodes is:

$$\begin{Bmatrix} M_a \\ M_b \end{Bmatrix} = [\mathbf{K}_c] \begin{Bmatrix} \theta_a \\ \theta_b \end{Bmatrix} \quad (3.6)$$

Where

$$[\mathbf{K}_c] = [\tilde{\mathbf{L}}][\mathbf{K}][\tilde{\mathbf{L}}]^T \quad (3.7)$$

Considering force equilibrium of all the forces perpendicular to the axis of the element:

$$\begin{Bmatrix} X_a \\ M_a \\ X_b \\ M_b \end{Bmatrix} = [\mathbf{R}_c] \begin{Bmatrix} M_a \\ M_b \end{Bmatrix} \quad (3.8)$$

where X_a and X_b are the shear forces at ends "a" and "b", respectively, and

$$[\mathbf{R}_c] = \begin{bmatrix} 1/L & 1/L \\ 1 & 0 \\ -1/L & 1/L \\ 0 & 1 \end{bmatrix} \quad (3.9)$$

That can also be rewritten as

$$\begin{Bmatrix} X_a \\ M_a \\ X_b \\ M_b \end{Bmatrix} = [\mathbf{K}_c] \begin{Bmatrix} u_a \\ \theta_a \\ u_b \\ \theta_b \end{Bmatrix} \quad (3.10)$$

where

$$[\mathbf{K}_c] = [\mathbf{R}_c][\mathbf{K}][\mathbf{R}_c]^T \quad (3.11)$$

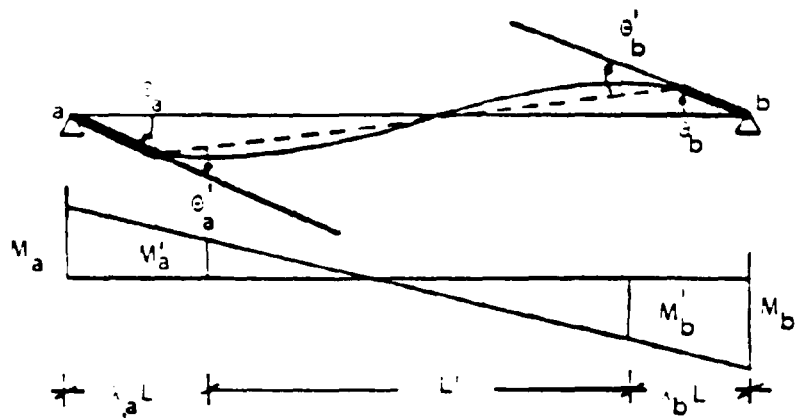

Fig. 3.5 Typical structural element with rigid zones

is the element stiffness matrix relating displacements and forces at the element joints, while $[K_r]$ is the stiffness matrix relating rotations and moments at the element flexible ends, as given by Eq. 3.7

Bending moments and axial forces are considered uncoupled in the formulation, hence, the force deformation relation for the resulting elastic axial stiffness is considered as follows

$$\begin{Bmatrix} Y_a \\ Y_b \end{Bmatrix} = \frac{EA}{L} \begin{bmatrix} 1 & 1 \\ -1 & -1 \end{bmatrix} \begin{Bmatrix} v_a \\ v_b \end{Bmatrix} \quad (3.12)$$

Where Y_a and Y_b are the axial forces in the element at ends "a" and "b", respectively, v_a and v_b are the vertical displacements at ends "a" and "b" of the structural element, respectively, and EA/L is the axial stiffness of the element

The element basic stiffness matrix $[K']$ is constantly varied throughout the analysis according to the formulation for the spread plasticity model presented in Section 3.5.2, and the hysteretic model selected. Depending on the hysteretic model considered, some characteristic values for the response of the element are required, namely moment-curvature or shear-shear distortion. For reinforced concrete elements, the user may select to specify the section dimensions and reinforcement, and use the fiber model to calculate the properties.

3.2.2 Fiber Model for General Structural Elements

The moment curvature envelope describes the changes in the force capacity with deformation during a nonlinear analysis. Therefore, the moment-curvature envelopes for columns, beams and shear walls form an essential part of the analysis. The program IDARC now provides an option for users to input their own cross-section properties directly, and the moment-curvature is computed internally. Fig. 3.6 shows a typical

rectangular section subjected to a combination of axial load and moment. The procedure outlined below is applicable to all types of cross-sections: T-beams, shear walls, columns sections, etc. Some simplifying assumptions are made in the analysis and summarized here:

- a) Plane sections remain plain after bending
- b) Tensile strength of concrete is ignored beyond the tensile cracking capacity
- c) The effect of bond-slip between reinforcement and concrete is ignored
- d) The difference in properties between confined core and cover is ignored
- e) Stress strain properties for concrete and steel are shown in Figs. A.3 and A.4
- f) The axial force applied to the section is constant.

The procedure outlined below works with only a few iterations required to obtain convergence. The program IDARC uses this procedure to set up moment-curvature envelopes for columns (rectangular or circular), beams (rectangular or T-sections) and shear walls (with or without edge columns). Shear walls may be irregular and include "U" or "L" shaped core walls.

3.2.2.1 Moment-Curvature Envelope Computation

The procedure used was outlined by Kunnath et al. (1992a), adapted from Mander (1984). The moment-curvature analysis is carried out on the cross-section by dividing the concrete area into a number of strips or fibers. The section is subjected to increments of curvature and the strain distribution is obtained from compatibility and equilibrium considerations. Steel areas and their respective locations are identified separately. The strain at any section is given by (see Fig. 3.6 and 3.7)

$$\epsilon(z) = \epsilon_c + z\phi \quad (3.13)$$

Where ϵ_c is the centroidal strain, z is the distance from the reference axis, and ϕ is the curvature of the cross-section. The resulting axial load and moment in the cross section can be computed from:

$$N = \int E\epsilon dA \quad (3.14a)$$

$$M = \int E\epsilon z dA \quad (3.14b)$$

Where N is the axial force, M the flexural moment, E is the elastic modulus of the corresponding concrete or steel fiber, ϵ is the strain in the fiber, and z is the distance to the fiber from the reference axis. The axial load N should be equal to the applied load N_0 at all cases. This dictates a certain distribution of the axial strains $\epsilon(z)$. Since the stress-strain relation is nonlinear and the axial strain increment $d\epsilon$ cannot be computed directly for a given value of the axial load and moment, it is necessary to develop an iterative procedure for the moment-curvature analysis. This is done through an iterative fiber analysis as follows:

Substituting Eq. 3.13 into Eq. 3.14 and replacing the integral by a finite summation over the discretized fibers, the following expression is obtained for any incremental step k of strain at neutral axis $\Delta\epsilon_0$ and curvature $\Delta\phi$:

$$\begin{bmatrix} \Delta V \\ \Delta M \end{bmatrix} = \begin{bmatrix} k_1(\epsilon_0, \phi_0) & k_2(\epsilon_0, \phi_0) \\ k_3(\epsilon_0, \phi_0) & k_4(\epsilon_0, \phi_0) \end{bmatrix} \begin{bmatrix} \Delta\epsilon_0 \\ \Delta\phi \end{bmatrix} \quad (3.15)$$

Where

$$k_1 = \sum_{i=1}^{NCC} E_{ci}(\epsilon_i, \phi_i) A_{ci} + \sum_{j=1}^{NSS} E_{sj}(\epsilon_j, \phi_j) A_{sj} \quad (3.16a)$$

$$k_2 = \sum_{i=1}^{NCC} E_{ci}(\epsilon_i, \phi_i) A_{ci} z_i + \sum_{j=1}^{NSS} E_{sj}(\epsilon_j, \phi_j) A_{sj} z_j \quad (3.16b)$$

$$k_3 = \sum_{i=1}^{NCC} E_{ci}(\epsilon_i, \phi_i) A_{ci} z_i^2 + \sum_{j=1}^{NSS} E_{sj}(\epsilon_j, \phi_j) A_{sj} z_j^2 \quad (3.16c)$$

Where NCC and NSS are the number of concrete strips and steel areas considered in the section, respectively, E_{ci} and E_{sj} are the concrete and steel section tangent moduli in the fibers i and j , respectively, and A_{ci} and A_{sj} are the areas of the concrete strip and steel, respectively.

With the above relations, the complete procedure for developing the moment-curvature envelope is as follows

1) Apply a small incremental curvature $\Delta\phi_k$ to a previous known value ϕ_{k-1} , i.e. $\phi_k = \phi_{k-1} + \Delta\phi_k$

2) In the first step ($k = 0$), the entire axial load is applied. Since the computation assumes this axial load to be constant, the axial force increment ΔN_k^n must be zero for the remaining steps. Based on the previous stiffness matrix (in Eq. 3.15), compute the incremental centroidal strain as follows, where n is the iteration step number ($n > 1$)

$$\Delta \varepsilon_k^n = k_{1k}^n \Delta \phi_k / k_{2k}^n \quad (3.17)$$

Note k_{1k}^n and k_{2k}^n are the stiffness characteristics at the previous step, $k = 1$

3) Update the new strains and curvatures

$$\begin{Bmatrix} \varepsilon_{c,k} \\ \phi_k \end{Bmatrix}^n = \begin{Bmatrix} \varepsilon_{c,k} \\ \phi_{k-1} \end{Bmatrix}^n + \begin{Bmatrix} \Delta \varepsilon_k \\ 0 \end{Bmatrix}^n \quad (3.18)$$

4) Recompute the terms of the stiffness matrix of Eq. 3.15 using the expressions in Eq. 3.16

5) Find the unbalanced axial load from

$$\Delta N_k^n = k_{1k}^n \Delta \varepsilon_{c,k}^n + k_{2k}^n \Delta \phi_k \quad (3.19)$$

6) If $|\Delta N_k^n| > \xi$ where ξ is a tolerance limit value, then continue the iteration procedure by returning to step (2). Otherwise calculate the moment increment

$$\Delta M_k = k_{1k}^n \Delta \varepsilon_{c,k}^n + k_{2k}^n \Delta \phi_k \quad (3.20)$$

and update the moment capacity, and continue to search for the moment-curvature relation by adding another increment $\Delta\phi_{k+1}$ to the process and continue to step (1)

In the fiber model analysis, the effect of hoop spacing on the moment-curvature of columns can also be considered. It is assumed that the capacity of the column remains unchanged after the concrete cover has spalled

$$0.85 f'_c A_{c,0} = f'_c A_{c,1} \quad (3.21)$$

Where f'_c is the confined compressive strength, A_c is the area of the core concrete, and A_g is the gross concrete area. An expression relating confined to unconfined strength of concrete is given by Park and Paulay (1975), and is based on the confining stress relation of Richart et al. (1928).

$$f'_c = f'_c + 2.05\rho_s f_c \quad (3.22)$$

where ρ_s is the volumetric ratio of confinement steel to concrete cover

$$\rho_s = \frac{A_h \pi d}{s A_c} \quad (3.23)$$

and A_h is the cross-sectional area of the hoop steel, and s is the spacing of hoops. The modified compressive stress of concrete is obtained substituting Eq. 3.22 into Eq. 3.21

$$f'_m = \frac{(f'_c + 2.05\rho_s f_c) A_c}{0.85 A_g} \quad (3.24)$$

3.2.2.2 Ultimate Deformation Capacity Computation

The ultimate deformation capacity is expressed through the ultimate curvature of the section as determined from the fiber model analysis of the cross-section. The incremental curvature that is applied to the section is continued until one of the following conditions is reached:

- a) The specified ultimate compressive strain in the concrete is reached ($\epsilon > \epsilon_{cu}$)
- b) The specified ultimate strength of one of the rebar is reached ($f_s > f_{su}$)

The attained curvature of the section when either of the two conditions is reached is recorded as the ultimate curvature. This parameter forms an important part of the damage analysis.

The only factor considered to influence the ultimate deformation capacity of the section is the degree of confinement. Since confinement does not significantly affect the maximum compressive stress, the present formulation only considers the effect of confinement on the downward slope of the concrete stress-strain curve (see Fig. 3.8). The

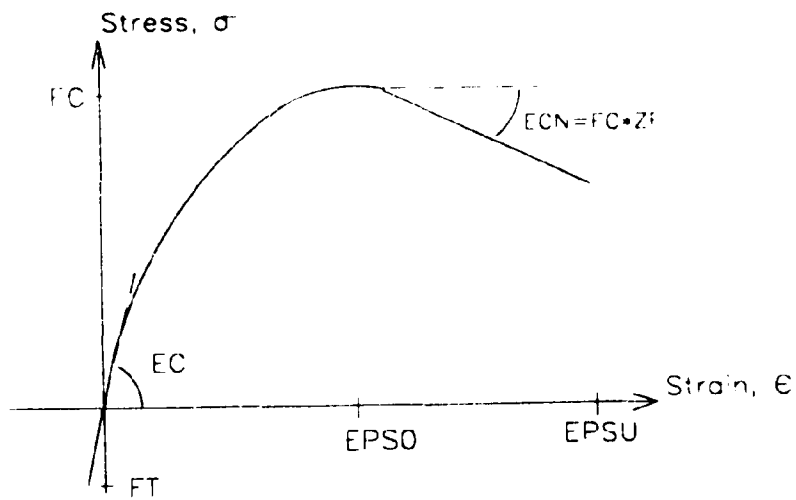

Fig. 3.8 Stress-strain curve for unconfined concrete

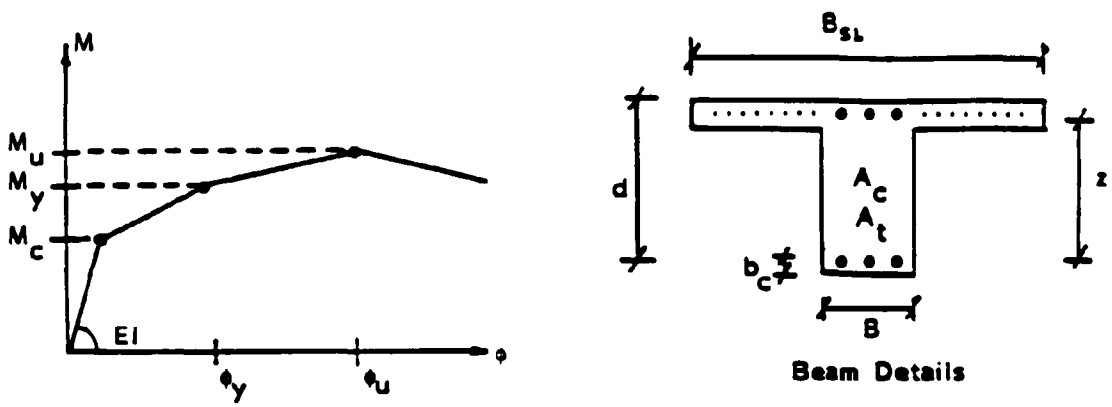

Fig. 3.9 Deformation parameters

factor ZF defines the shape of the descending branch. The expression developed by Kent and Park (1971) is used

$$ZF = \frac{0.5}{\epsilon_{cu} \cdot \epsilon_{cu} - \epsilon} \quad (3.25)$$

where

$$\epsilon_{cu} = \frac{3 + \epsilon_c f'_c}{f'_c - 1000} \quad (3.26a)$$

$$\epsilon_{cu} = 0.75 \rho_s \sqrt{\frac{b}{s_h}} \quad (3.6b)$$

in which the concrete strength is prescribed in psi, ρ_s is the volumetric ratio of confinement steel to core concrete, b is the width of the confined core, and s_h is the spacing of hoops. The effect of introducing this parameter is to define additional ductility to well-confined columns. Improved formulations for stress-strain behavior of confined concrete can be found in a publication by Paulay and Priestley (1992).

3.2.3 Column Elements

Column elements are modeled considering flexural, shear and axial deformations. A typical column element with the corresponding degrees of freedom is shown in Fig. 3.2. Flexural and shear components of the deformation are modeled using one of the following hysteretic models described in Section 3.3:

- a) Three parameter Park model
- b) Three parameter Steel model
- c) Bilinear model
- d) Linear-elastic model

The axial deformation component is modeled using a linear-elastic spring. The column elements include a rigid length zone to simulate the increase in stiffness at the joint. The user can specify the length of the rigid zone depending on the dimensions of the

connecting elements. The stiffness formulation for column elements is described in Section 3.2.1.

The element stiffness matrix $[K_e]$ is constantly varied throughout the analysis according to the formulation for the spread plasticity model presented in Section 3.5.2, and the hysteretic model selected. Depending on the hysteretic model considered, some characteristic values for the response of the element are required, namely moment-curvature or shear to shear distortion. For reinforced concrete elements, the user may select to specify the section dimensions and reinforcement, and use the fiber model to calculate the properties as described in Section 3.2.2, or provide user-supplied values.

Simplified formulations can be used alternatively to determine the moment-curvature characteristics. For reinforced concrete columns, the following formulas may be used to estimate the characteristic values of the moment-curvature response of the element (Park et al., 1984).

a) Cracking moment

$$M_{cr} = 11\sqrt{f'_c} Z_c + Nd/6 \quad (3.27)$$

where f'_c is the concrete strength in ksi, Z_c is the section modulus in in^3 , N is the axial load in kips, and d is the depth to rebar in inches.

b) Yield Curvature (Park and Paulay, 1974)

$$\phi_y^* = \frac{\epsilon_y}{(1-k)d} \quad (3.28)$$

Where ϵ_y is the strain at yield stress of steel, and k is calculated according to

$$k = \frac{(\rho_t + \rho_c)^{-1}}{4\alpha_c} + \frac{(\rho_t + \beta\rho_c)^{-1}}{\alpha_c} - \frac{(\rho_t + \rho_c)^{-1}}{2\alpha_c}$$

$$\rho_t = \frac{A_s f_y}{b d f'_c}, \quad \rho_c = \frac{A_s' f_y}{b d f'_c}, \quad \alpha_c = \frac{\epsilon_y}{\epsilon_c}, \quad \beta = \frac{d}{d_c}$$

Where A_s is the area of the tensile reinforcing bars, A_s' is the area of the compressive reinforcing bars, ϵ_c is the strain at maximum strength of the concrete, and d_c is the cover

depth for compression bars. Note that this expression tends to underestimate the actual curvature since the inelasticity of concrete and the effect of axial loads is not taken into account. Based on the results on an iterative analysis (Aoyama, 1971) the following modification is introduced

$$\phi_c = \left[1.05 + (C_c - 0.05) \frac{n_c}{0.03} \right] \phi_c^* \quad (3.29)$$

Where

$$C_c = 0.45 / (0.84 + \rho_c)$$

$$n_c = N / (f_c b d)$$

c) Yield Moment (Park et al., 1984)

$$M_y = 0.5 f_c b d^2 \left\{ (1 - \beta_c) \eta_c n_c + (2 - \eta_c) \rho_c + (\eta_c - 2\beta_c) \alpha_c \rho_c \right\} \quad (3.30)$$

Where

$$\eta_c = \frac{0.75 \left(\frac{\epsilon_c}{\epsilon_{c1}} \right)^{1.5}}{1 + \alpha_c \left(\frac{\epsilon_c}{\epsilon_{c1}} \right)^{1.5}}$$

$$\alpha_c = (1 - \beta_c) \frac{\epsilon_{c2}}{\epsilon_{c1}} - \beta_c < 1.0$$

d) Ultimate Moment (Park et al., 1984)

$$M_u = (1.24 - 0.15 \rho_c - 0.5 n_c) M_y \quad (3.31)$$

e) Ultimate Curvature

For ultimate curvature estimates, the relations suggested by Park and Paulay (1975) can be used

More up to date relations of capacity of columns are presented by Mander et al (1995), and could be used instead of those suggested

3.2.4 Beam Elements

Beam elements are modeled as flexural elements with shear deformations coupled. A typical beam element with the corresponding degrees of freedom is shown in Fig. 3.3

The flexural component of the deformation is modeled using one of the following hysteretic models described in Section 3.3

- a) Three parameter Park model
- b) Three parameter Steel model
- c) Bilinear model
- e) Linear-elastic model

The beam elements include a rigid length zone to simulate the increase in stiffness at the joint. The user can specify the length of the rigid length depending on the dimensions of the connecting elements. The stiffness formulation for column elements is described in Section 3.2.1.

The element stiffness matrix $[K_e]$ is constantly varied throughout the analysis according to the formulation for the spread plasticity model presented in Section 3.5.2, and the hysteretic model selected. Depending on the hysteretic model considered, some characteristic values for the response of the element are required, namely moment-curvature or shear-shear distortion. For reinforced concrete elements, the user may select to specify the section dimensions and reinforcement, and use the fiber model to calculate the properties as described in Section 3.2.2, or provide user supplied values.

Simplified formulations can be used alternatively to determine the moment-curvature characteristics. For reinforced concrete beams the following formulas may be used to estimate the characteristic values of the moment-curvature response

a) Cracking Moments (Park et al., 1984)

$$M_c = 110\sqrt{f'}(I_c/x) \quad (3.32a)$$

$$M_c = 110\sqrt{f'}(I_c/(h-x)) \quad (3.32b)$$

Where M_c and M_c are the positive and negative cracking moments, I_c is the gross moment of inertia of the section, x is the distance from the base to the centroid of the section, and h is the height of the section.

b) Yield Curvature (Park and Paulay, 1974)

$$\phi_y = c \frac{\epsilon_s}{(1-k)d} \quad (3.33a)$$

$$\phi_y = c \frac{\epsilon_s}{(1-k')d'} \quad (3.3b)$$

Where

$$k = \frac{(\rho_s + \rho'_s)^{-1}}{4\alpha_s} + \frac{(\rho_s + \beta_s \rho'_s)^{-1}}{\alpha_s} + \frac{(\rho_s + \rho'_s)^{-1}}{2\alpha_s}$$

$$\rho_s = \frac{A_s f_s}{b d f'_c}, \quad \rho'_s = \frac{A'_s f_s}{b d f'_c}, \quad \alpha_s = \frac{\epsilon_s}{\epsilon_c}, \quad \beta_s = \frac{d}{d'}$$

and ϵ_s is the strain at yield stress of the steel, c is a factor to amplify the curvature due to inelasticity of the concrete, k' is the neutral axis parameter (similar to k), and the rest of the variables were defined in Section 3.2.1

c) Yield Moment (Park et al., 1984)

$$M_y = 0.5 f'_c b_s d^2 [(2 - \eta)\rho_s + (\eta - 2\beta_s)\alpha_s \rho'_s] \quad (3.34a)$$

$$M_y = 0.5 f'_c b (d')^2 [(2 - \eta)\rho_s + (\eta' - 2\beta_s)\alpha_s \rho'_s] \quad (3.34b)$$

Where

$$\eta = \frac{0.75 \left(\frac{\epsilon_s}{\epsilon_c} \right)}{1 + \alpha_s \left(\frac{\epsilon_s}{\epsilon_c} \right)}, \quad \eta' = \frac{0.75 \left(\frac{\epsilon'_s}{\epsilon_c} \right)}{1 + \alpha_s \left(\frac{\epsilon'_s}{\epsilon_c} \right)}$$

$$\epsilon_s = \phi_y d, \quad \epsilon'_s = \phi_y d', \quad \epsilon'_s$$

$$\alpha = (1 - \beta_s) \frac{\epsilon_c}{\epsilon_s}, \quad \beta_s < 10, \quad \alpha' = (1 - \beta'_s) \frac{\epsilon'_c}{\epsilon'_s}, \quad \beta'_s < 10$$

Where M_y and M'_y are the positive and negative yield moments, ϵ_s and ϵ'_s are the maximum compression and tension strains in the concrete, and all additional parameters are defined in Fig. 3.9

d) Ultimate Moment (Park et al., 1984)

$$M_u = (1.24 - 0.15\rho_s)M_y \quad (3.35a)$$

$$M_u = (1.24 - 0.15\rho'_s)M_y \quad (3.35b)$$

Where M_u^+ and M_u^- are the positive and negative ultimate moments

e) Ultimate Curvature

For the ultimate curvature estimates, the relations suggested by Park and Paulay (1975) could be used as a rough approximation

3.2.5 Shear Wall Elements

Shear wall elements are modeled considering flexural, shear and axial deformations. A typical shear wall element with the corresponding degrees of freedom is shown in Fig. 3.4. Flexural and shear components of the deformation are modeled using one of the following hysteretic models described in Section 3.3

- a) Three parameter Park model
- b) Three parameter steel model
- c) Bilinear model
- d) Linear-elastic model

The axial deformation component is modeled using a linear-elastic spring. The user can specify the length of the rigid zone depending on the dimensions of the connecting elements. The stiffness formulation for shear wall elements is described in Section 3.2.1.

The element stiffness matrix $[K_e]$ is constantly varied throughout the analysis according to the formulation for the spread plasticity model presented in Section 3.5.2, and the hysteretic model selected. Depending on the hysteretic model considered, some characteristic values for the response of the element are required, namely moment-curvature or shear-shear distortion. For reinforced concrete elements the user may select to specify the section dimensions and reinforcement, and use the fiber model to calculate the shear wall flexural properties as described in Section 3.2.2, or provide user supplied values. Simplified formulations can be used alternatively to determine the moment-curvature characteristics.

The inelastic shear properties are evaluated based on a regression analysis of a large number of test data presented by Hirosawa (1975). The cracking and shear strengths, V_c and V_s , are determined from the following empirical relations

$$V_c = \frac{0.6(f'_c + 711)}{M/(lL_w) + 1.7} b_w l_w \quad (3.36a)$$

$$V_s = \left\{ \frac{0.08\rho_s^{0.2}(f'_c + 256)}{M/(lL_w) + 0.12} + 0.32\sqrt{f_c\rho_w} + 0.01f_a \right\} b_w l_w \quad (3.36b)$$

Where $M/(lL_w)$ is the shear span ratio, ρ_s is the tension steel ratio in percent, ρ_w is the wall reinforcement ratio, f_a is the axial stress, b_w is the equivalent web thickness, and l_w is the distance between edge columns

The shear deformation may be determined using the secant stiffness as follows

$$k_s = \frac{0.5M}{lL_w} k_e \quad (3.37)$$

where k_e is the elastic shear stiffness (GA/l_w). The above relations which resulted from the parametric analysis of test data (Hirosawa, 1975) was found to be the most suitable for defining the shear properties of walls. This formulation is incorporated in the program IDARC.

3.2.6 Edge Column Elements

Edge columns are the columns monolithically connected to the shear wall elements. Their behavior is primarily dependent on the deformation of the shear wall, and therefore are modeled as one dimensional axial springs. Fig. 3.10 shows a typical pair of edge column elements with the corresponding degrees of freedom. These elements may also be used to model other transverse elements, such as secondary shear walls that can be lumped with the corresponding column element.

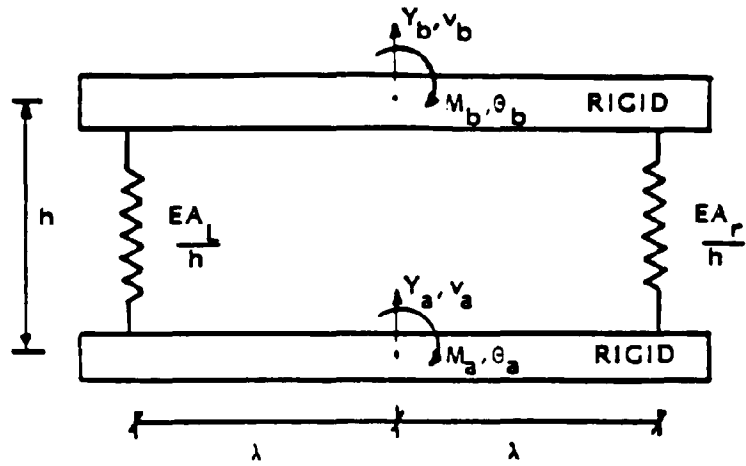

Fig. 3.10 Edge column elements

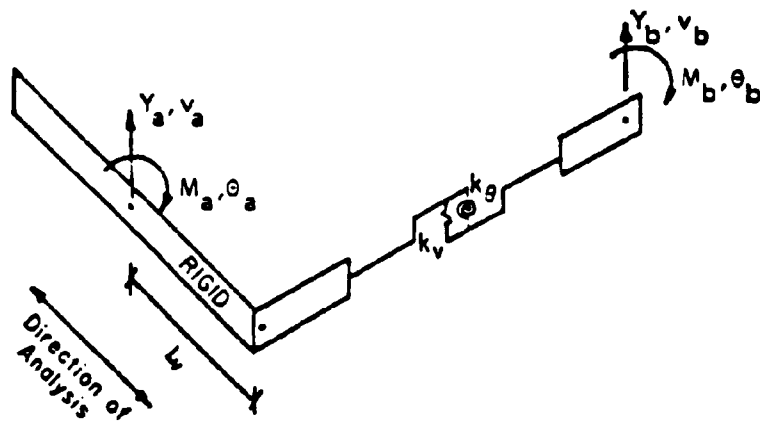

Fig. 3.11 Transverse beam elements

The stiffness matrix for the pair of elements is

$$\begin{Bmatrix} Y_L \\ M_L \\ Y_R \\ M_R \end{Bmatrix} \begin{pmatrix} EA_L & \begin{bmatrix} 1 & \lambda & 1 & \lambda \\ \lambda & \lambda^2 & \lambda & \lambda^2 \end{bmatrix} & EA_R & \begin{bmatrix} 1 & \lambda & 1 & \lambda \\ \lambda & \lambda^2 & \lambda & \lambda^2 \end{bmatrix} \\ h & \begin{bmatrix} 1 & \lambda & 1 & \lambda \\ \lambda & \lambda^2 & \lambda & \lambda^2 \end{bmatrix} & h & \begin{bmatrix} 1 & \lambda & 1 & \lambda \\ \lambda & \lambda^2 & \lambda & \lambda^2 \end{bmatrix} \end{pmatrix} \begin{Bmatrix} v_L \\ \theta_L \\ v_R \\ \theta_R \end{Bmatrix} \quad (3.38)$$

Where A_L and A_R are the cross-sectional areas for the left and right edge column elements, h is the length of the edge columns, and λ is half the distance between the edge columns. The stiffness matrix is added to the one determined for the shear wall elements.

3.2.7 Transverse Beam Elements

Although the modeling of the structure is done using 2D (planar) frames, it is recognized that strong transverse beams may affect the frame behavior. Transverse beams are elements that connect nodes of different frames to take into account the contribution of beams perpendicular to the direction of analysis. The transverse beam elements are modeled by two springs, one to provide resistance to relative vertical motion, and the second, a rotational spring, to provide resistance to relative angular motions (see Fig. 3.11). Both springs are considered linear-elastic. The equation relating nodal forces and nodal displacements is

$$\begin{Bmatrix} Y_L \\ M_L \\ Y_R \\ M_R \end{Bmatrix} \begin{pmatrix} k_v & \begin{bmatrix} 1 & L_o & 1 & 0 \\ L_o & L_o^2 & L_o & 0 \end{bmatrix} & k_t & \begin{bmatrix} 0 & 0 & 0 & 0 \\ 0 & 1 & 0 & 1 \end{bmatrix} \\ k_v & \begin{bmatrix} 1 & L_o & 1 & 0 \\ L_o & L_o^2 & L_o & 0 \end{bmatrix} & k_t & \begin{bmatrix} 0 & 0 & 0 & 0 \\ 0 & 1 & 0 & 1 \end{bmatrix} \end{pmatrix} \begin{Bmatrix} v_L \\ \theta_L \\ v_R \\ \theta_R \end{Bmatrix} \quad (3.39)$$

Where k_v is the stiffness to vertical relative distortions, L_o is the offset to the center of a shear wall, and k_t is the torsional stiffness of the transverse beam. When the transverse beam connects two columns the contribution of the shear stiffness may be neglected. These beams are assumed to remain elastic at all times, therefore, k_v and k_t are constants.

3.2.8 Rotational Inelastic Spring Elements

Discrete inelastic spring elements may be identified and connected to beam or column element ends, to simulate a flexible or semi-rigid connection in the joint. Figure 3.12 shows four elements framing into a joint with three discrete inelastic springs. In general, more than one spring may be specified at the same location, however, the maximum number of springs that can be used in a particular joint must be one less than the number of elements framing into it. The moment deformation of the spring may be modeled using any of the following hysteretic models described in Section 3.3:

- a) Three parameter Park model
- b) Three parameter steel model
- c) Bilinear model
- d) Linear elastic model

The stiffness of the rotational spring element may be varied from a small quantity to simulate a hinge, to a large value to simulate a rigid connection. The spring stiffness is incorporated into the overall structural stiffness matrix as follows

$$\begin{Bmatrix} M_s \\ M_f \end{Bmatrix} = k_{rs} \begin{bmatrix} 1 & -1 \\ -1 & 1 \end{bmatrix} \begin{Bmatrix} \theta_s \\ \theta_f \end{Bmatrix} \quad (3.40)$$

where M_s and M_f are the spring "r" and the fixed joint moment, respectively, θ_s and θ_f are the corresponding rotations, and k_{rs} is the current tangent stiffness of the spring element. Spring rotations are expressed as a function of the fixed joint rotation

3.2.9 Visco-Elastic Damper Elements

An innovative approach to reduce earthquake hazard was introduced by adding protective devices to dissipate energy within the structure. Input energy during a seismic event is transformed into hysteretic, potential, damping and hysteretic energy. The performance of structures can be improved if the total energy input is reduced, or an

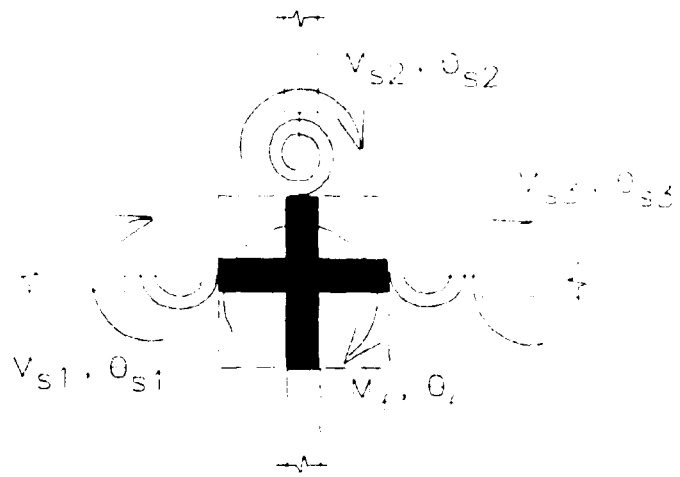

Fig. 3.12 Modeling of discrete inelastic springs

important portion can be dissipated through supplemental damping devices (Reinhorn et al., 1995)

Supplemental damping devices can be broadly classified as viscous dampers, friction dampers, and hysteretic dampers. Viscous dampers exhibit an important velocity dependency. Several types of viscous dampers have been proposed:

- a) Viscoelastic elements
- b) Viscous walls
- c) Fluid viscous dampers

All of these devices can be modeled using a Kelvin Model, a Maxwell model, a Wierchert model, Fractional derivative models, or a convolution model (Reinhorn et al., 1995). The program IDARC includes routines for the Kelvin and Maxwell models. The Maxwell model is recommended when the damper exhibits a strong dependency on the loading frequency.

The above devices are modeled with an axial diagonal element. Forces at the ends of the elements are calculated according to

$$\begin{Bmatrix} F_a \\ F_b \end{Bmatrix} = E_D \begin{Bmatrix} 1 \\ 1 \end{Bmatrix} \quad (3.41)$$

where E_D is the dynamic stiffness of the element, calculated considering a Kelvin or Maxwell model, as described in Sections 3.3.4 and 3.3.5. The forces in the damper elements are considered using a pseudo force approach, that is, the forces in the dampers are subtracted from the external load vector.

a) Viscoelastic dampers. made of bonded viscoelastic layers (acrylic polymers) have been developed by 3M Company Inc., and have been used in wind and seismic applications: World Trade Center in New York (110 stories), Columbia SeeFirst Building in Seattle (73 stories), the Number Two Union Square Building in Seattle (60 stories), and the General Service Administration Building in San Jose (13 stories). Fig. 3.13 shows a

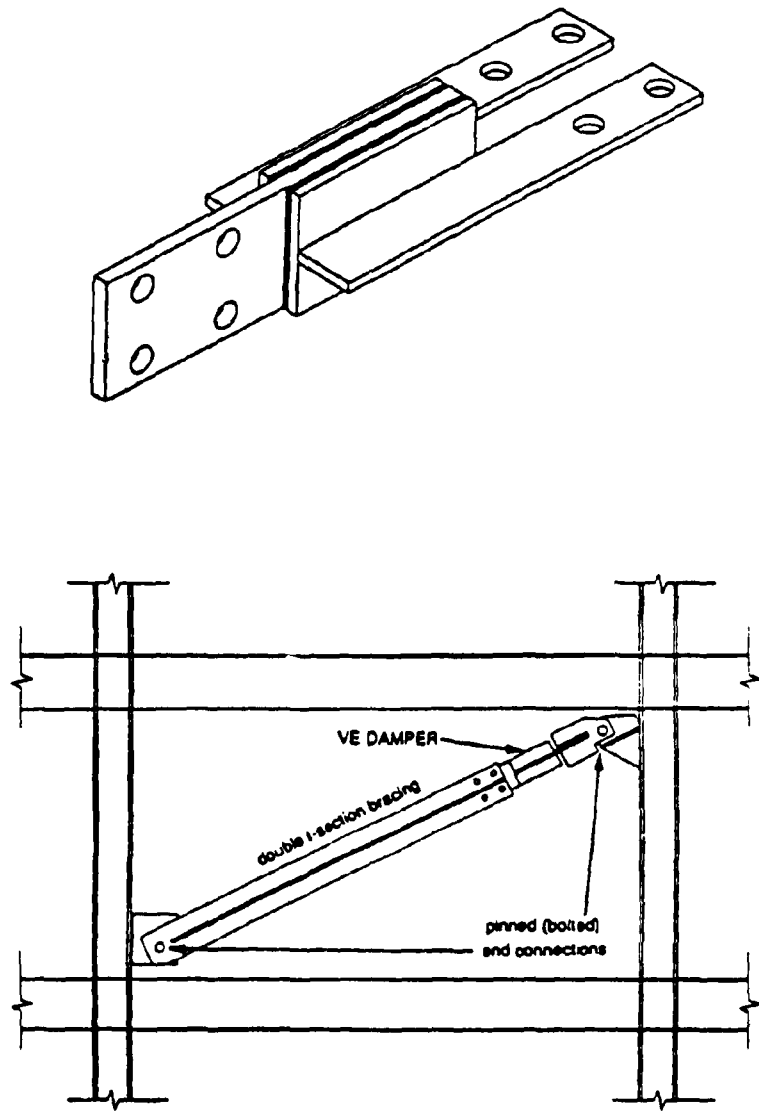

Fig. 3.13 Viscoelastic damper and installation detail (from Aiken, 1990)

typical damper and an installation detail in a steel structure. See Lobo et al. (1993) for a summary.

b) Viscous Walls, consist of a steel plates moving in highly viscous fluid contained in a thin steel case (wall), as shown in Fig. 3.14. The viscous walls were developed by Sumitomo Construction Company Ltd., and the Building Research Institute in Japan. The devices were investigated by Sumitomo Construction Company (Arima, 1988), and installed in a 14 story building in Shizuoka city, 150 km west of Tokyo, Japan. Earthquake simulator tests of a 5 story reduced-scale building, a 4 story full-scale steel frame have been carried out (Arima, 1988). More recently, a 3 story 1/3 scale reinforced concrete building has been tested in the Earthquake simulator at the State University of New York at Buffalo (Reinhorn et al., 1994). The devices exhibit a nonlinear viscous behavior with stiffening characteristics at high frequencies (Reinhorn et al., 1995).

c) Fluid Viscous Dampers, have been extensively used in military applications for many years because of their efficiency and longevity. This kind of devices operate on the principle of fluid flow through orifices. The damper was used to reduce recoil forces. Modern fluid dampers have only recently been used in large scale structural applications. The device is designed to be insensitive to significant temperature changes, and can be designed to exhibit linear or nonlinear viscous behavior (Reinhorn et al., 1995). The size of the device is very compact in comparison to force capacity and stroke. Experimental studies have been recently performed by Constantinou et al. (1993), and by Reinhorn et al. (1995).

3.2.10 Friction Damper Elements

Friction damper elements are one of the types of supplemental energy dissipation devices that have been introduced to enhance the seismic response of buildings. These

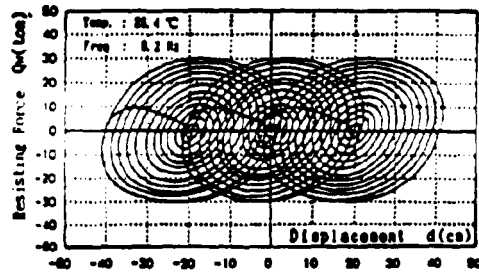
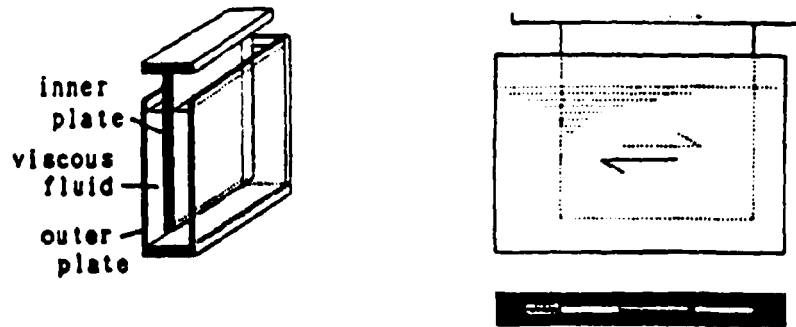

Fig. 3.14 Viscous walls and hysteresis loops (from Miyazaki, 1992)

type of devices dissipate input energy through frictional work. Several types of friction dampers, or friction like devices, have been proposed

- a) Friction devices
- b) Lead extrusion devices
- c) Slotted bolted connections

Modeling of these devices is done using a Wen-Bouc model (Reinhorn et al., 1995) without strength or stiffness degradation. Details of the Wen-Bouc model used in IDARC are described in Section 3.3.6.

The friction devices are modeled with an axial diagonal element. Forces at the ends of the elements are calculated according to

$$\begin{Bmatrix} F_d \\ F_c \end{Bmatrix} = E_d \begin{Bmatrix} 1 \\ -1 \end{Bmatrix} \quad (3.42)$$

where E_d is the dynamic stiffness of the element, calculated considering the smooth hysteretic model described in Section 3.3.6. The forces in the damper elements are considered using a pseudo force approach, that is, the forces in the dampers are subtracted from the external load vector.

a) Friction devices. have been developed and manufactured for many years by Sumitomo Metal Ltd (see Fig. 3.15). The behavior of the devices are nearly unaffected by amplitude, frequency, temperature, or the number of applied loading cycles (Reinhorn et al., 1995). The original application was in railway rolling stock bogie trucks, but since the mid 1980's the friction dampers were extended to the field of structural and seismic protection. Friction dampers were suggested as displacement control devices for bridge structures with sliding supports made of stainless steel-bronze surface (Constantinou et al., 1991). Recently, friction dampers manufactured by the Tekton company were tested in the seismic simulation laboratory of the State University of New York at Buffalo (Reinhorn et al., 1995). This type of friction dampers are manufactured with simple components to minimize the cost of manufacture. The friction force in the damper can be

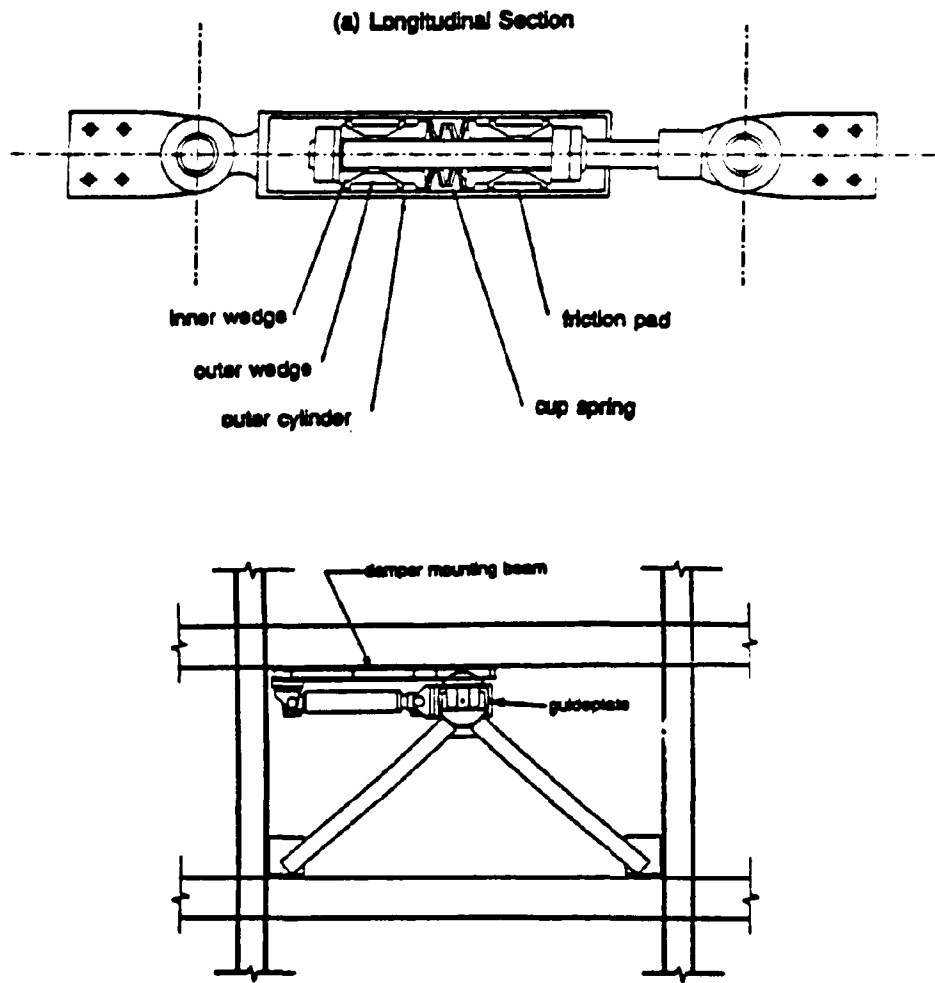

Fig. 3.15 Sumitomo friction damper and installation detail (from Aiken, 1990)

adjusted through appropriate torque of the bolts that control the pressure on the friction surfaces. A detailed evaluation of the dampers is presented by Li et al. (1995).

b) Lead extrusion devices (LED), lead extrusion was identified as an effective mechanism for energy dissipation in the 1970's (Robinson and Greenbank, 1976). The hysteretic behavior is similar to a friction device, and shows stable cycles unaffected by the number of loading cycles, environmental factors, or aging (Robinson and Cousins, 1987). Lead extrusion devices have been used in a 10-story base isolated building in Wellington, New Zealand (Charleston et al., 1987), and in seismically isolated bridges (Skinner et al., 1980). In Japan a 17-story and a 8-story building have lead extrusion devices connecting the precast concrete wall panels and the structural frame (Oiles Corp., 1991).

c) Slotted bolted connections, are bolted connections designed to dissipate energy through friction steel plates and bolts (Grigorian and Popov, 1993). The development of slotted bolted connections is to attempt to use simple modifications to standard construction practice and materials widely available.

3.2.11 Hysteretic Damper Elements

Hysteretic damper devices are energy dissipation devices that reduce the dynamic response of structures subjected to earthquake loads. Hysteretic dampers dissipate energy through inelastic yielding of the device components. Several types of hysteretic dampers have been introduced.

- a) Yielding steel elements
- b) Shape memory alloys
- c) Eccentrically braced frames

Most of these devices can be modeled using a Wen-Bouc model without strength or stiffness degradation. Details of the Wen-Bouc model used in IDARC are described in Section 3.3.6.

The hysteretic dampers are modeled with an axial diagonal element. Forces at the ends of the elements are calculated according to

$$\begin{Bmatrix} F_j \\ F_i \end{Bmatrix} = F_D \begin{Bmatrix} 1 \\ -1 \end{Bmatrix} \quad (3.43)$$

where F_D is the dynamic stiffness of the element, calculated considering the smooth hysteretic model described in Section 3.3.6. The forces in the damper elements are considered using a pseudo force approach, that is, the forces in the dampers are subtracted from the external load vector.

a) Yielding steel elements, take advantage of the hysteretic behavior of mild steel when deformed in their post-elastic range. The devices exhibit stable behavior, long term reliability, and in general good resistance to environmental and temperature factors. Many of these devices use mild steel plates with triangular or hourglass shapes (Tyler, 1987, Stierner et al., 1981) so that yielding occurs almost uniformly in the device. One such device, ADAS, uses X-shaped steel plates (Bergman and Goel, 1987, Whittaker et al., 1991). ADAS devices have been installed in a non-ductile reinforced concrete building in San Francisco (Fiero et al., 1993), and in two buildings in Mexico City.

Triangular plate energy dissipators were originally developed and used in base isolation applications (Boardman et al., 1983). The triangular plate concept was extended to building dampers in the form of triangular ADAS, or T-ADAS (Tsai and Hong, 1992). The T-ADAS device does not require rotational restraint at the top of the brace connection assemblage, and there is no potential for instability of the plate due to excessive axial load on the devices.

An energy dissipator for cross braced structures using mild steel round bars or flat plates was developed by Tyler (1985), and used in several industrial warehouses in New Zealand. Variations on the cross bracing device have been developed in Italy (Ciampi, 1991). A 29-story steel suspension building in Naples utilize tapered steel devices

between the core and the suspended floors. A six-story government building in Wanganui, New Zealand, uses steel tube energy absorbing devices in precast concrete cross braced panels (Matthewson and Davey, 1979). The devices were designed to yield axially. Recent studies have been carried out to study different cladding connection concepts (Craig et al., 1992).

A number of mild steel energy dissipation devices have been introduced in Japan (Kajima Corp., 1991, Kobori et al., 1988). Honeycomb dampers, formed by X-plates loaded in the plane of the X, have been installed in a 15-story and a 29-story building in Tokyo. Kajima Corporation developed two types of omni-directional steel dampers: Bell dampers and Tsudumi dampers (Kobori et al., 1988). The Bell damper is a single tapered steel tube, and the Tsudumi damper is a double tapered tube intended to deform as an ADAS X-plate. Bell dampers have been used in the massive 1600 ft long artificial ski slope structure to allow for differential movement between four dissimilar parts of the structure under seismic loading. A joint damper between two buildings has also been developed (Sakurai et al., 1992), using a short lead tube loaded to deform in shear.

b) Shape memory alloys, are capable of yielding repeatedly without sustaining any permanent deformation because the material undergoes reversible phase transformations as it deforms rather than intergranular dislocations. Thus, the applied load induces crystal phase transformations that are reversed when the loads are removed. The devices are therefore self-centering. Several tests with this type of dampers have been carried out: a 3-story steel model was tested with Nitinol (nickel-titanium) tension devices (Aiken et al., 1992), and a 5-story steel model was tested with a copper-zinc-aluminum device (Witting and Cozzarelli, 1992).

c) Eccentrically braced frames (EBF), have become a well recognized and widely used structural system for resisting lateral seismic forces. Hysteretic behavior is concentrated in specially designed regions, shear links, and other structural elements are designed to remain elastic under all but the most severe excitations. Extensive research

has been devoted to EBF (Roeder et al., 1978, Popov et al., 1987, Whittaker et al., 1987) and the concept has gained recognition and acceptance by the structural engineering profession since the inclusion of design rules into seismic code practice

3.2.12 Infill Panel Elements

Infill panel elements were included in the new version of the program IDARC using a smooth hysteretic model that connects two stories in the building. Details of the smooth hysteretic model used can be found in Section 3.3.6. The proposed analytical formulation assumes that the contribution of an infill panel can be modeled using compression struts (see Fig. 3.16 for masonry infill element). This assumption is often used in the analysis of masonry infill panels (Reinhorn et al., 1995d) and other types of infill panels. The formulation for the infill panel element is capable of modeling a variety of panel types by changing the values of the control parameters in the smooth hysteretic model. The masonry infill panels are described with greater detail below.

3.2.12.1 Masonry Infill Panels

The program is capable of determining the hysteretic parameters for masonry infilled frames. The stress-strain relationship for masonry in compression is commonly idealized using a parabolic function (Reinhorn et al., 1995d) until the peak stress f_m' is reached, then it is assumed to drop linearly with increasing strains to a small fraction of the peak value, and then remains constant at this value of stress (see Fig. 3.17). The assumed constitutive model for the masonry struts is shown in Fig. 3.18. The struts are considered ineffective in tension, however, the combination of both struts provides resistance in both directions of loading. The lateral force-deformation relationship assumed for the system of compression struts is shown in Fig. 3.19. The analytical formulations for the envelope were developed based on the masonry constitutive model and a recent theoretical model

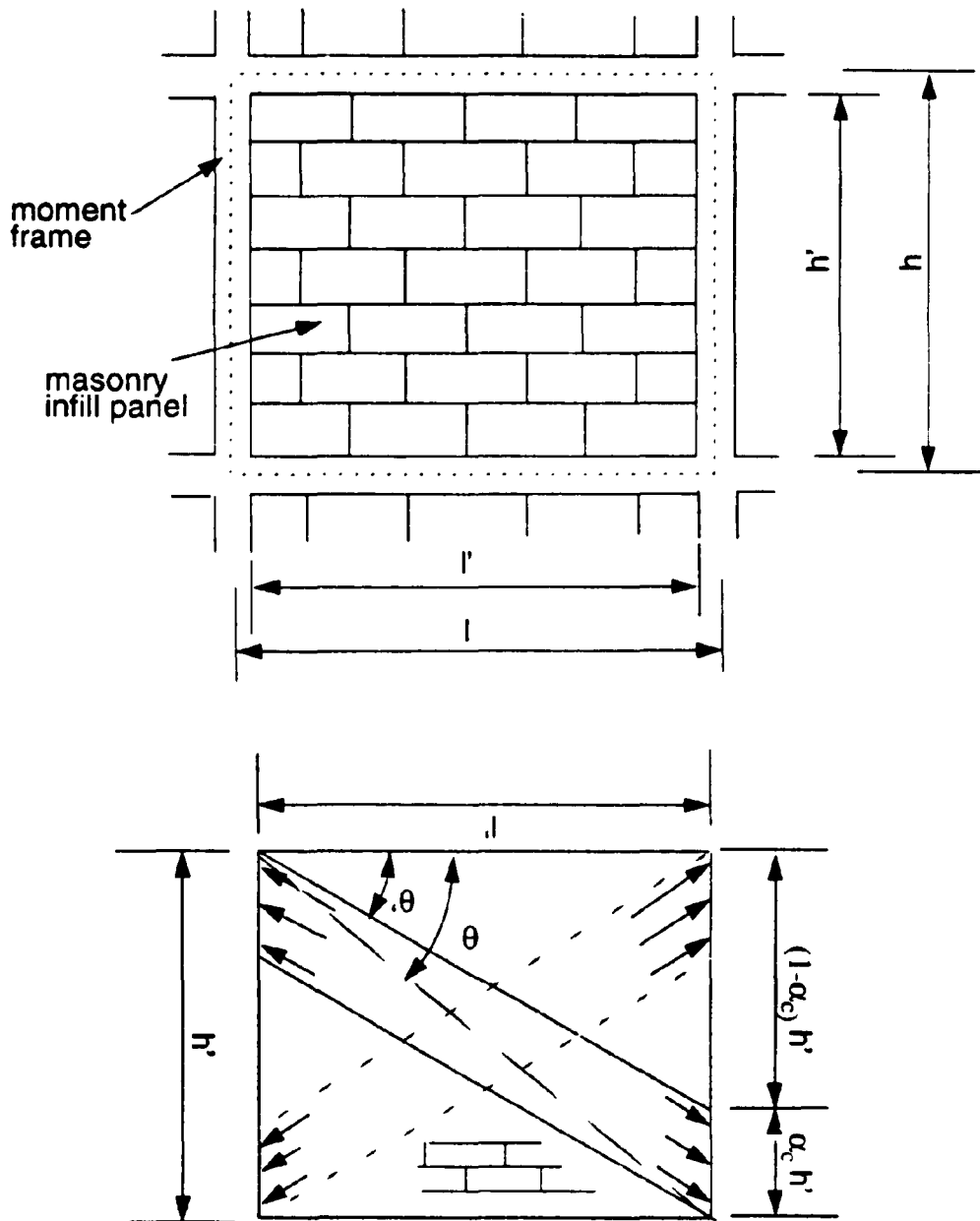

Fig. 3.16 Masonry infill panel: a) Frame subassembly, b) Compression struts

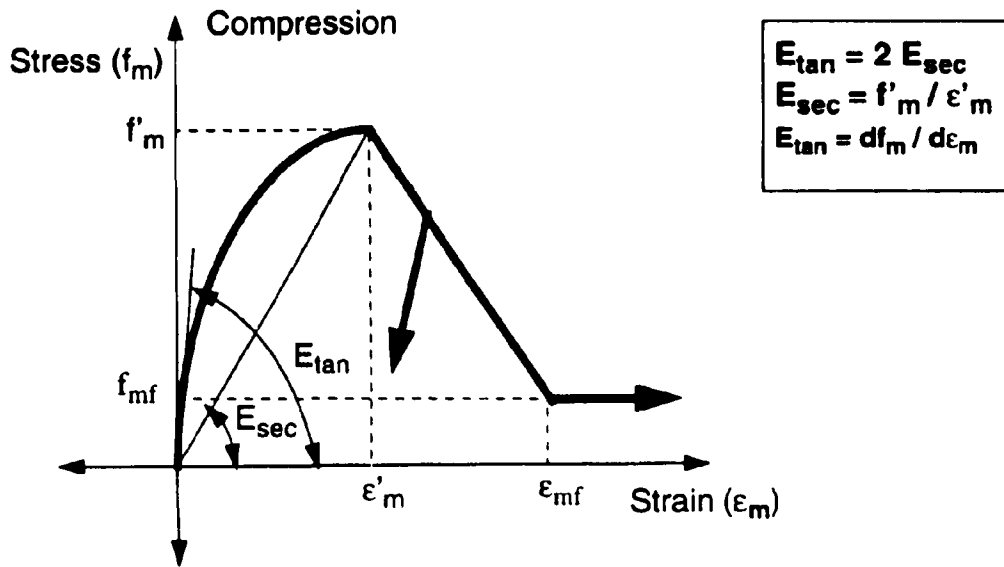

Fig. 3.17 Constitutive model for masonry

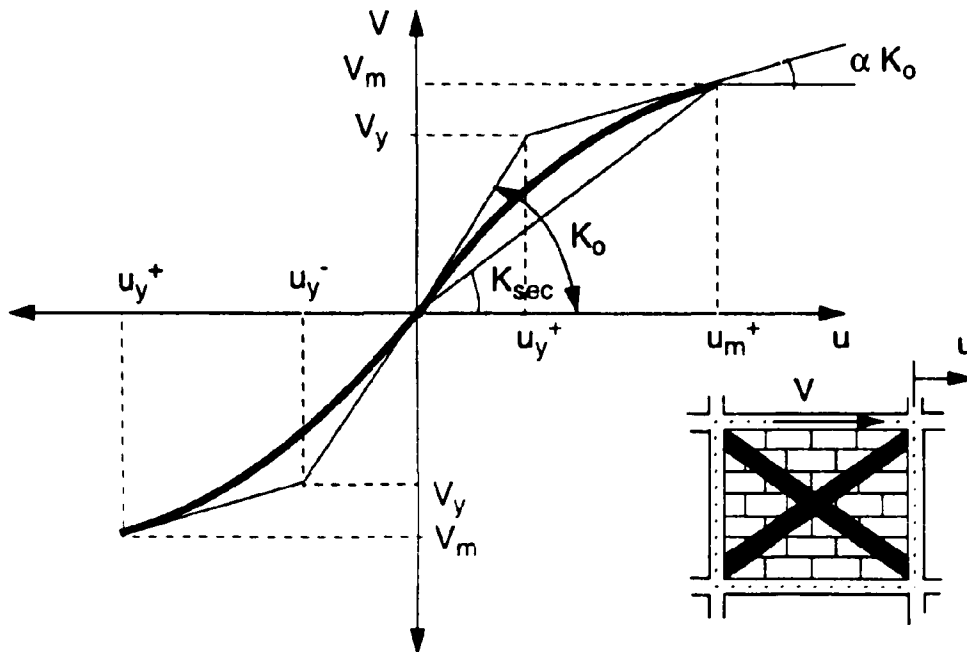

Fig. 3.18 Strength envelope for masonry infill panel

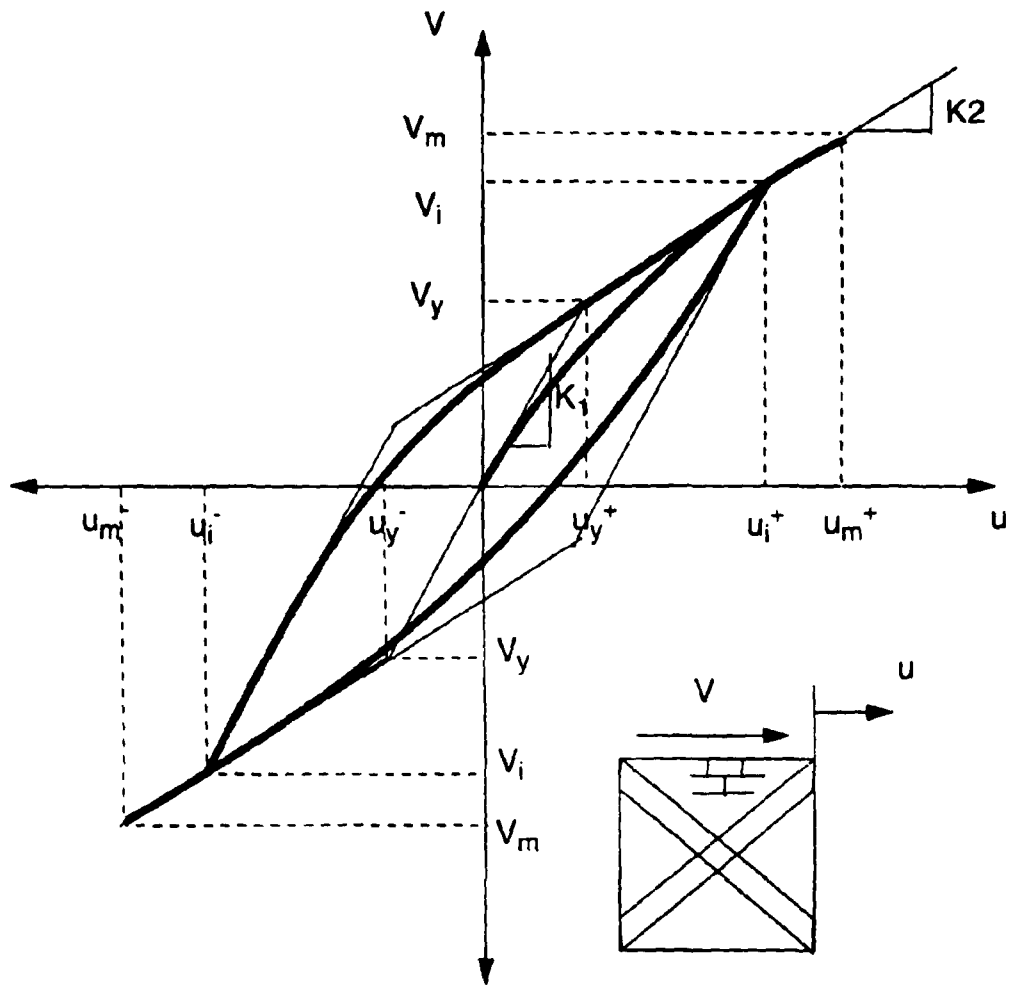

Fig. 3.19 Bouc-Wen model for smooth hysteretic response of infill panels

for infilled masonry frames suggested by Saneinejad and Hobbs (1995). The formulations for masonry infilled frames are briefly summarized herein.

Considering the masonry infilled frame shown in Fig. 3.16, the maximum lateral force V_m and the corresponding displacement u_m are calculated as (Saneinejad and Hobbs, 1995)

$$V_m = A_d f'_m \cos \theta \leq \frac{v t'}{(1 - 0.45 \tan \theta') \cos \theta} \leq \frac{0.83 (MPa) t'}{\cos \theta} \quad (3.44a)$$

$$u_m = \frac{\epsilon'_m L_d}{\cos \theta} \quad (3.44b)$$

in which t is the thickness or out-of-plane dimension of the masonry infill panel, f'_m is the masonry prism strength, ϵ'_m is the corresponding strain, v is the basic shear strength or cohesion of masonry, and A_d and L_d are the area and length of the equivalent diagonal struts obtained from (Saneinejad and Hobbs, 1995)

$$A_d = (1 - \alpha) \alpha t h' \frac{\sigma_c}{f'_c} + \alpha_s t h' \frac{\tau_c}{f'_c} \leq \frac{0.5 t h' f'_c}{\cos \theta} \quad (3.45a)$$

$$L_d = \sqrt{(1 - \alpha) h'^2 + P^2} \quad (3.45b)$$

Where the quantities α_c , α_s , σ_c , τ_c , f'_c and f'_t depend on the geometric and material properties of the frame and the infill panel. The relations used to calculate these quantities are presented in Appendix D.

The monotonic lateral force displacement curve is completely defined by the maximum force V_m , the corresponding displacement u_m , the initial stiffness K and the ratio α of the post-yield to initial stiffness. The initial stiffness K can be estimated using the following relation

$$K = \frac{V_m}{u_m} \quad (3.46)$$

The lateral yield force and displacement in the masonry infill can be calculated from (Reinhorn et al., 1995d)

$$F_y = \frac{F_m + \alpha K_m u_m}{1 + \alpha} \quad (3.47a)$$

$$u_y = \frac{F_m + \alpha K_m u_m}{K_m (1 + \alpha)} \quad (3.47b)$$

A value of 0.1 is suggested for the post-yield stiffness ratio α . The monotonic force deformation model described was extended to account for hysteretic behavior due to loading reversals and strain softening.

A recommended set for the values of the controlling parameters for the smooth hysteretic model described in Section 3.3.6 are listed in Appendix D. However, other values can be used to achieve different hysteretic response characteristics. More information on the solution of hysteretic model with slip is presented in Reinhorn et al. (1995d).

3.2.13 Moment Releases

A perfect hinge could have been modeled as an end spring with zero stiffness, however, the implications in the numerical analysis are leading often to singular matrices. Therefore, a perfect member hinge is modeled by setting the hinge moment to zero and condensing out the corresponding degree of freedom. If a hinge is assigned at the end "b" of an element the relation between moments at the joint "a" and at the face of the element is given by (see Fig. 3.20)

$$M_a = \begin{pmatrix} 1 \\ 1 \\ \lambda_a \end{pmatrix} M_b \quad (3.48)$$

The element stiffness equation relating moments and rotations is

$$\{M_a\} = k_e \{\theta_a\} \quad (3.49)$$

Where k_e is a coefficient obtained by condensing the element stiffness matrix

Reproduced from
best available copy

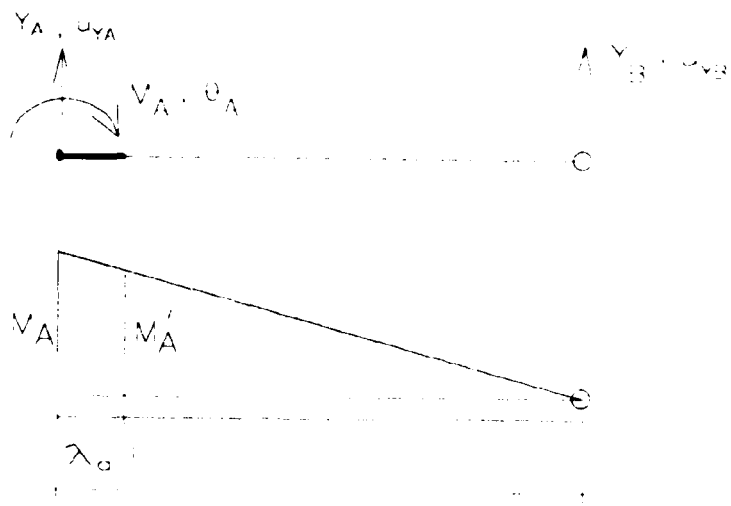

Fig. 3.20 Modeling of moment releases in structural elements

$$k_e = \frac{(\mathbf{K}_e)_{11}}{(\mathbf{K}_e)_{22}} \quad (3.50)$$

Where $[\mathbf{K}_e]_{ij}$ are the coefficients of the element stiffness matrix calculated considering the spread plasticity model

The overall equilibrium equation for the entire element becomes

$$\begin{Bmatrix} N_a \\ M_a \\ N_b \\ M_b \end{Bmatrix} = \left(\frac{1}{1-\lambda_{sp}} \right) k_e \{\mathbf{R}_a\} \{\mathbf{R}_b\} \begin{Bmatrix} u_a \\ \theta_a \\ u_b \\ \theta_b \end{Bmatrix} \quad (3.51)$$

Where

$$\{\mathbf{R}_a\} = \begin{Bmatrix} -1/L \\ 1 \\ 1/L \\ 0 \end{Bmatrix} \quad (3.52)$$

This element can be integrated into the global structural model as a standard element. In case of a single column structure the degree of freedom "b" is eliminated from the global stiffness matrix.

3.3 Hysteretic Rules

Modeling the hysteretic behavior of structural elements is one of the core aspects of a nonlinear structural analysis program. The new release of IDARC includes the following types of hysteretic response curves:

- a) Three parameter Park model
- b) Tri-Linear Steel model
- c) Bilinear hysteretic model
- d) Kelvin model
- e) Maxwell model
- f) Smooth Hysteretic model

Currently, each of the programmed hysteretic models are used for different structural elements. Columns, beams, shear walls and rotational springs can be modeled using a three parameter Park model, a tri-linear steel model, or a bilinear model. The program has been modified to allow for the later addition of other hysteretic models. Viscoelastic dampers are modeled using either a Kelvin or a Maxwell model, while infill panels are modeled using the smooth hysteretic model. Each of the available hysteretic models in the program are described below.

3.3.1 Three Parameter Park Model

The three parameter "Park hysteretic model" was first proposed by Park et al. (1987) as part of the original release of IDARC. The hysteretic model incorporates stiffness degradation, strength deterioration, non-symmetric response, slip-lock, and a trilinear monotonic envelope. The model traces the hysteretic behavior of an element as it changes from one linear stage to another, depending on the history of deformations. The model is therefore piece-wise linear. Each linear stage is referred to as a branch. Figures 3.21 and 3.22 show the influence of various degrading parameters on the shape of the hysteretic loops. For a complete description of the hysteretic model see Park et al. (1987).

Reproduced from
best available copy

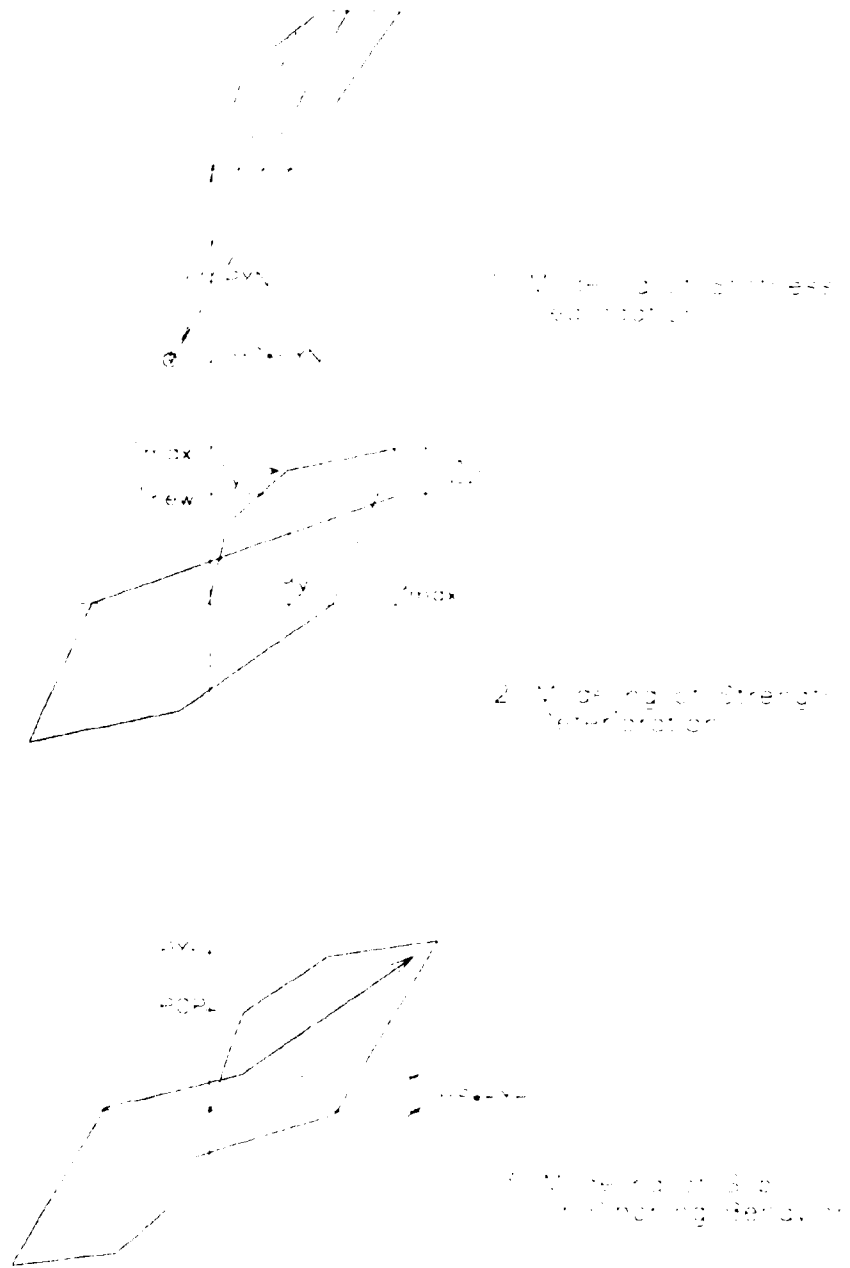

Fig. 3.21 Control parameters for the three parameter hysteretic model

Reproduced from
best available copy

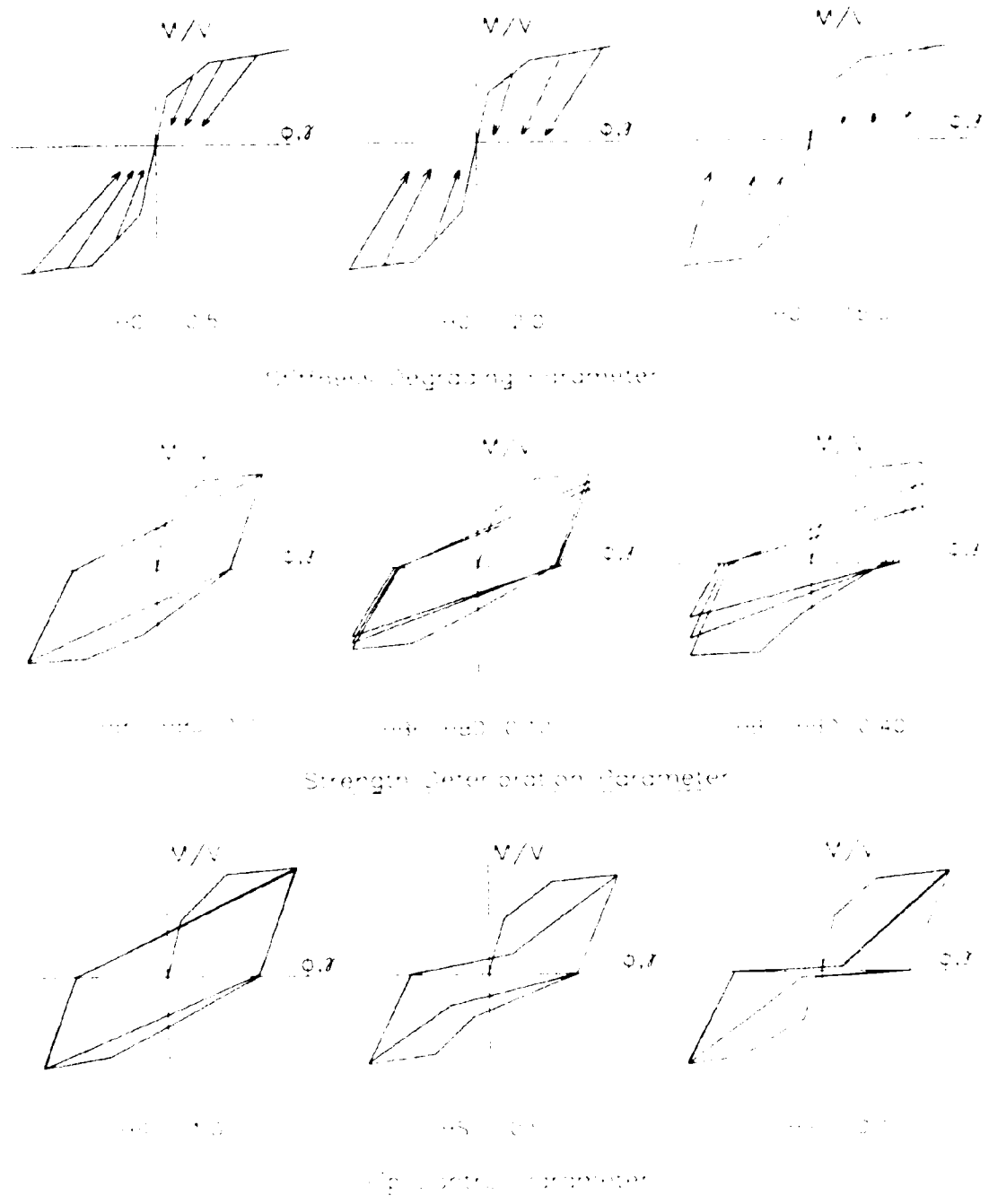

Fig. 3.22 Influence of degrading parameters on the hysteretic behavior

3.3.2 Tri-Linear Steel Model

To capture the response of steel structures a tri-linear hysteretic model was introduced. This hysteretic model does not include stiffness degradation, strength deterioration or slip, since its intended to capture the loops of structural steel elements. Fig. 3.23 presents the branches of the hysteretic model and typical hysteretic curves.

3.3.3 Bilinear Hysteretic Model

The commonly used bilinear hysteretic model was also included as an options for various structural elements. Fig. 3.24 presents the branches of the hysteretic model and typical hysteretic curves.

3.3.4 Kelvin Model

The behavior of viscous dampers can be modeled using a Kelvin or a Maxwell model (Reinhorn et al., 1995a). The Kelvin model includes the contribution of a stiffness element, and a linear viscous damper (see Fig. 3.25). The force displacement relation of a Kelvin element is

$$F_d(t) = Ku(t) + C\dot{u}(t) \quad (3.53)$$

Where $u(t)$ and $\dot{u}(t)$ are the relative displacement and velocity of the damper, K is the damper storage stiffness, and C is the damping coefficient.

Considering the response of a damper element to a harmonic motion, the properties of the damper can be identified (Constantinou and Symans, 1992). Consider that the damper is subjected to a harmonic motion

$$u(t) = u \sin \Omega t \quad (3.54)$$

The force in the linear viscous element is

$$F_d(t) = Cu \Omega \cos \Omega t \quad (3.55)$$

Reproduced from
best available copy

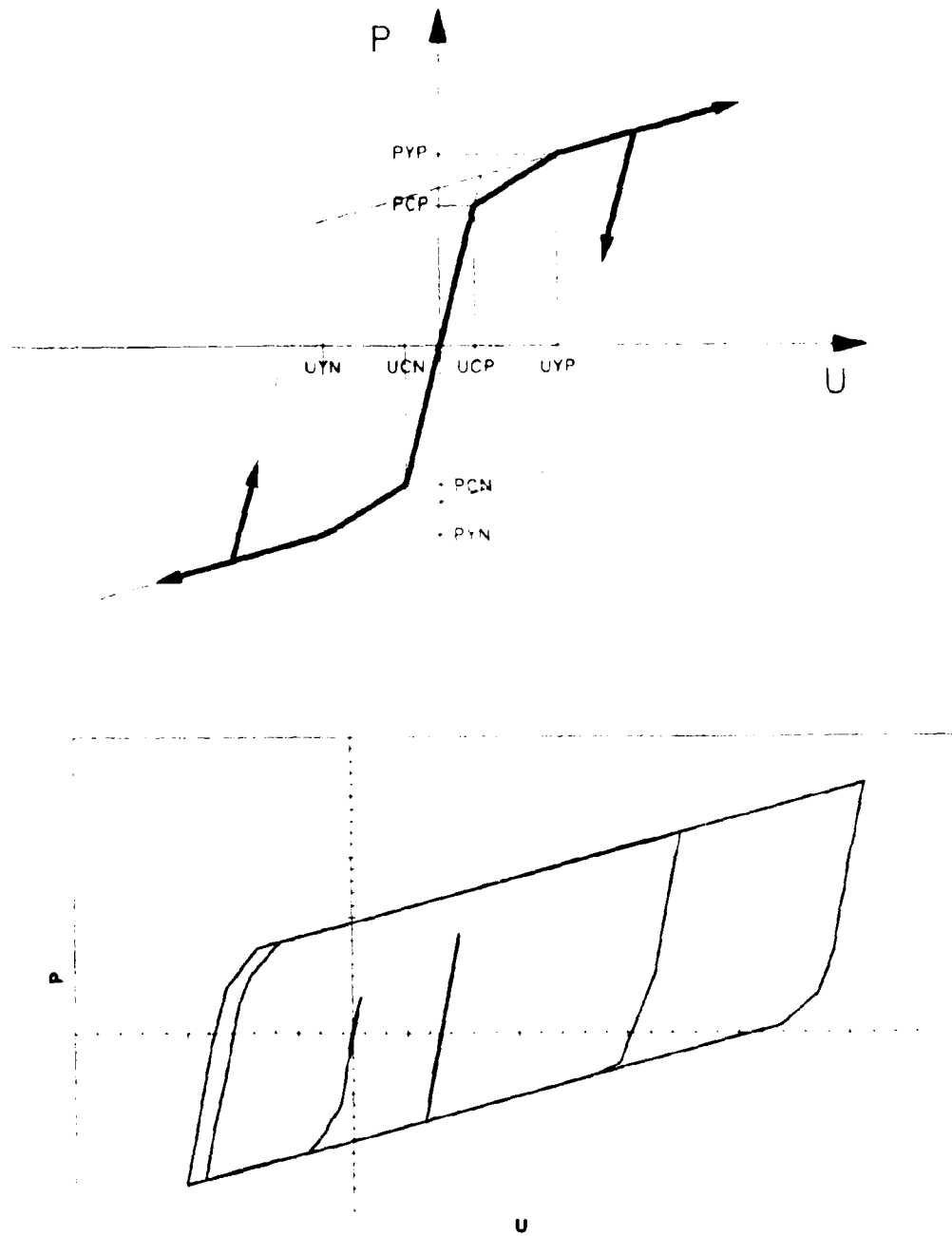

Fig. 3.23 Tri-linear steel model

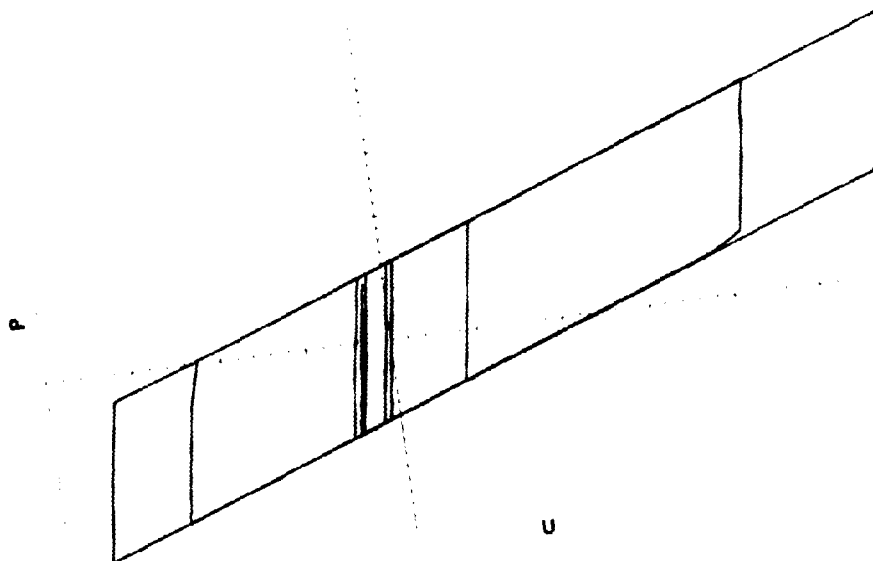
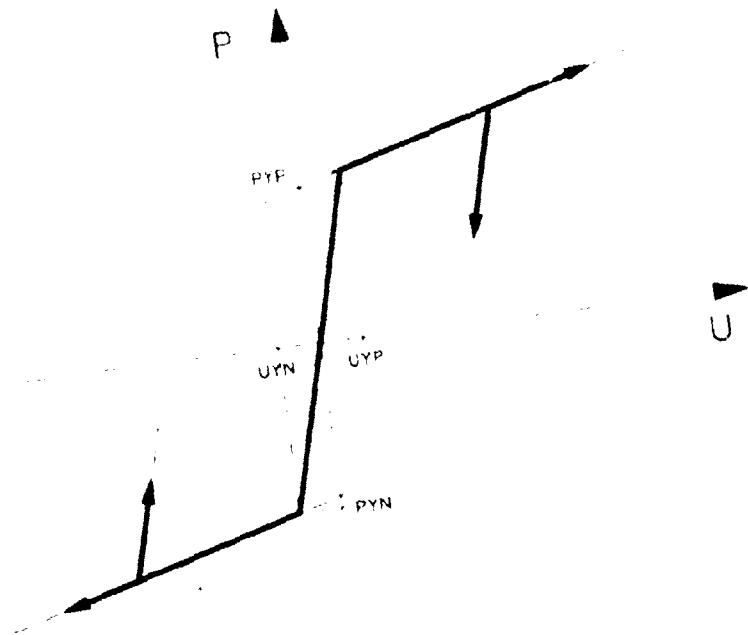

Fig. 3.24 Bilinear hysteretic model

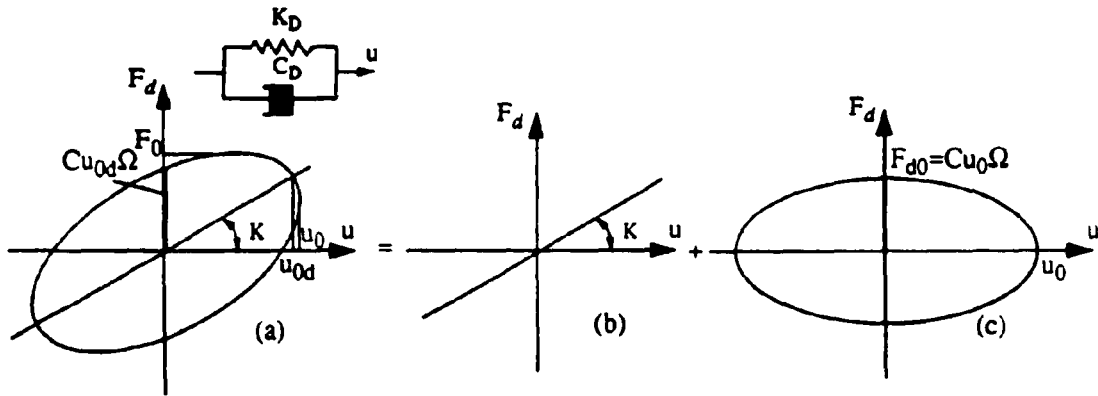

Fig. 3.25 Kelvin model: a) Damper behavior; b) Linear stiffness component; C) Linear damping component

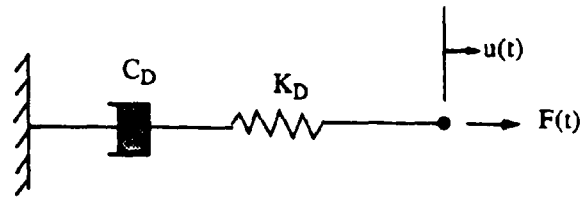

Fig. 3.26 Maxwell model for damping devices

Eliminating time, force and displacements are related according to

$$\left(\frac{F_d}{c\Omega u_0}\right)^2 + \left(\frac{u}{u_0}\right)^2 = 1 \quad (3.56)$$

that represents an ellipse with amplitude u_0 and $c\Omega u_0$ (see Fig. 3.25c). The energy dissipated by the viscous element is obtained by equating the area in the ellipse.

$$W_d = \pi c\Omega u_0^2 \quad (3.57)$$

The damping coefficient is therefore

$$c = \frac{W_d}{\pi\Omega u_0^2} \quad (3.58)$$

From the total element force, the following relation between force and displacements is obtained:

$$\left(\frac{F_d}{c\Omega u_0}\right)^2 + \left(\frac{u}{u_0}\right)^2 \left[1 + \left(\frac{K}{c\Omega}\right)^2 - 2\left(\frac{K}{c\Omega}\right)\left(\frac{F_0}{c\Omega u_0}\right)\left(\frac{u_0}{u}\right)\right] = 1 \quad (3.59)$$

The stiffness coefficient is therefore

$$K = \frac{F_0}{u_0} \left[1 + \left(\frac{c\Omega u_0}{F_0}\right)^2\right]^{1/2} \quad (3.60)$$

Most damping devices display frequency dependency properties, therefore, the stiffness and damping characteristics calculated in Eqs. 3.60 and 3.58 are dependent on the testing frequency Ω . Frequency dependency of the Kelvin model can be determined by Fourier transformation of Eq. 3.53:

$$F_d(\omega) = K(\omega)u(\omega) + i\omega c(\omega)u(\omega) \quad (3.61a)$$

or

$$F_d(\omega) = (K_1(\omega) + iK_2(\omega))u(\omega) = K^*(\omega)u(\omega) \quad (3.61b)$$

Where the complex stiffness $K^*(\omega)$ has a real component, $K_1(\omega)$, known as the "storage" stiffness, and an imaginary component, $K_2(\omega)$ defined as the "loss" stiffness

$$K_2(\omega) = \omega c(\omega) \quad (3.62)$$

In the computer program IDARC the forces in the viscoelastic Kelvin elements are determined as

$$K_d = \sqrt{K_{1eq}^2 + \omega^2 C_{1eq}^2} \quad (3.66)$$

where K_{1eq} and C_{1eq} are determined using Eqs. 3.60 and 3.58 for a value of ω often taken as the fundamental circular frequency of the structure.

3.3.5 Maxwell Model

The behavior of viscous dampers can be modeled using either a Kelvin or a Maxwell model (Reinhorn et al., 1995a). When a damper displays a strong dependency on frequency, the more refined model using a Maxwell model is recommended. This model was found suitable to represent fluid viscous dampers with accumulators (Constantinou and Symans, 1992). The Maxwell model consists of a damper and a spring in series (see Fig. 3.26). The force in the damper is defined by

$$F_d(t) + \lambda \dot{F}_d(t) = C_D \dot{u}(t) \quad (3.67)$$

in which λ is the relaxation time

$$\lambda = \frac{C_D}{K_D} \quad (3.68)$$

Where K_D is the stiffness at an "infinitely" large frequency, C_D is the damping constant at zero frequency. The Maxwell model can be expressed in the frequency domain as

$$F_d(\omega) = (K_1(\omega) + iK_2(\omega))u(\omega) \quad (3.69)$$

Where the storage stiffness and the loss stiffness are

$$K_1(\omega) = C_D \left(\frac{\lambda\omega}{1 + (\lambda\omega)^2} \right) \quad K_2(\omega) = \left(\frac{(\lambda\omega)^2}{1 + (\lambda\omega)^2} \right) \quad (3.70a)$$

$$K_2(\omega) = \omega C(\omega) = \frac{\omega C_D}{1 + (\lambda\omega)^2} \quad (3.70b)$$

The dependence of the normalized damping and stiffness coefficients with frequency is shown in Fig. 3.27

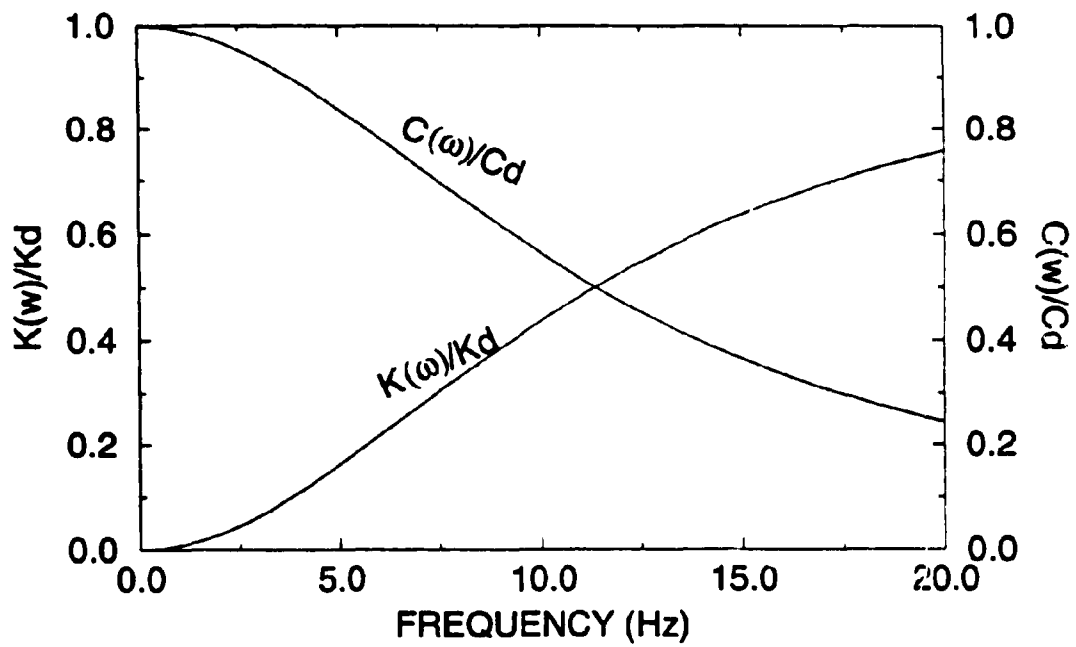

Fig. 3.27 Stiffness and damping versus frequency in Maxwell model

For convenience in the solution procedure, Eq. 3.67 can be expressed as

$$\dot{F}(t) = f(F, u, \dot{u}, t) - \frac{1}{\lambda} F(t) + \frac{C_D}{\lambda} \ddot{u}(t) \quad (3.71)$$

that can be solved simultaneously with the other time dependent structural components. In the computer program IDARC, the forces in the viscoelastic Maxwell dampers are expressed as

$$F_{D_i} = -\frac{1}{\lambda_i} F_i + \frac{C_{D_i}}{\lambda_i} \ddot{u}_i \quad (3.72)$$

The solution of which is found using the semi-implicit Runge-Kutta method (Rosenbrock, 1964)

$$(\Delta F_{D_i})_k = f(F_i, u_i, \dot{u}_i) - R_1 k_i + R_2 I_i \quad (3.73)$$

where $(\Delta F_{D_i})_k$ is the increment in force of damper "i" at time step "k", k_i and I_i are determined from (Reinhorn et al., 1995a)

$$k_i = \left[1 - a_1 M \frac{\partial f(F_i, u_i, \dot{u}_i)}{\partial F} \right]^{-1} f(F_i, u_i, \dot{u}_i) M \quad (3.74a)$$

$$I_i = \left[1 - a_2 M \frac{\partial f(F_i, u_i, \dot{u}_i + c_1 k_i)}{\partial F} \right]^{-1} f(F_i, u_i, \dot{u}_i + b_1 k_i) M \quad (3.74b)$$

Where the constant parameters R_1 , R_2 , a_1 , a_2 , b_1 and c_1 were selected to obtain a fourth order truncation error (Reinhorn et al., 1994). $R_1 = 0.75$, $R_2 = 0.25$, $a_1 = a_2 = 0.7886751$, $b_1 = 1.1547005$, and $c_1 = 0$.

Maxwell elements have a stiffening contribution in the dynamic response, and therefore will also have a contribution to the monotonic or quasi-static loads. The "dynamic stiffening" contributes to a further reduction of displacements, and an increase in the base shear. For pushover and quasi-static analyses the combined influence of the static and dynamic stiffening provided by the Maxwell element is accounted for using an equivalent dynamic stiffness defined as (Reinhorn et al., 1995b)

$$K_d = \sqrt{K_{eq}^2 + \omega^2 C_{eq}^2} \quad (3.75)$$

Where K_{eff} and C_{eff} are determined using Eq. 3.70 for a value of ω often taken as the fundamental circular frequency of the structure

3.3.6 Smooth Hysteretic Model

A smooth hysteretic model is used in IDARC to model the response of friction dampers, hysteretic dampers, and infill panels. The smooth hysteretic model used also for infill panels include the effects of stiffness degradation, strength deterioration and pinching. Such effects are not included in the model used for dampers since no significant degradation, deterioration or pinching is observed in their response. The development of the present hysteretic model is based on the Wen-Bouc model (Bouc, 1967, Baber and Noori, 1985). The hysteretic model with degradation and slip is described below

The force displacement relationship for the smooth hysteretic model is (see Fig. 3.19)

$$F_t = F_y [\alpha \mu_t + (1 - \alpha) Z_t] \quad (3.76)$$

in which F_t and F_y are the instantaneous force and the yield force, respectively, μ_t is the normalized displacement calculated as

$$\mu_t = \frac{u_t}{u_y} \quad (3.77)$$

where the subscript "t" is used to refer to the instantaneous values, while subscript "y" is used to denote yield values, α is the ratio of post-yielding to initial elastic stiffness ($\alpha = 0$ for friction dampers), and Z_t is the hysteretic component determined from the following equations

$$Z_t = \mu_t \left[A - Z_t \right]^\beta (\beta \operatorname{sgn}(\dot{\mu}_t Z_t) + \gamma) \quad (3.78)$$

Where

$$\operatorname{sgn}(\dot{\mu}_t Z_t) = 1 \text{ if } (\dot{\mu}_t Z_t) > 0$$

$$\text{sgn}(\dot{\mu}Z) = 1 \text{ if } (\dot{\mu}Z) > 0$$

Eliminating the time differential dt , and noting that $\text{sgn}(\dot{\mu}Z) = \text{sgn}(d\mu Z)$, Eq. 3.78 can be rewritten for quasi-static or monotonic loading

$$dZ = d\mu \left[A - Z^n (\beta \text{sgn}(d\mu Z) + \gamma) \right] \quad (3.79)$$

In Eqs. 3.78 and 3.79, A , β and γ are constants that control the shape of the generated hysteresis loops, and n controls the rate of transition from the elastic to the yield state (Lobo, 1994). A large value of n approximates a bilinear hysteretic curve, while a lower value will trace a smoother transition. Different hysteretic shapes with variations on the various parameters can be found in Fang (1991). To satisfy viscoplastic conditions the present development assumes that $A - \beta + \gamma = 10$.

An important characteristic in the hysteretic response of infill panels is the loss of stiffness due to deformation beyond yield (see Fig. 3.28). The stiffness deterioration due to plastic excursions of the infill panel is expressed as a function of the attained ductility (Lobo, 1994). The stiffness decay is incorporated directly in the hysteretic model by including the control parameter η . The differential equation for the hysteretic parameter Z (Eq. 3.79) may be modified to generate stiffness deterioration as follows

$$dZ = \frac{d\mu}{\eta} \left[A - Z^n (\beta \text{sgn}(d\mu Z) + \gamma) \right] \quad (3.80)$$

The control parameter is defined as

$$\eta = 10 + s_1 \left(\frac{\mu_{max}^2 + \mu_c^2}{2} \right) \quad (3.81)$$

Where s_1 is a control parameter used to vary the rate of stiffness decay as a function of the current ductility μ_c , as well as the maximum attained ductility μ_{max} before the start of the current unloading or reloading cycle (Reinhorn et al., 1995d). A value of $s_1 = 0$

WEN-BOUC MODEL

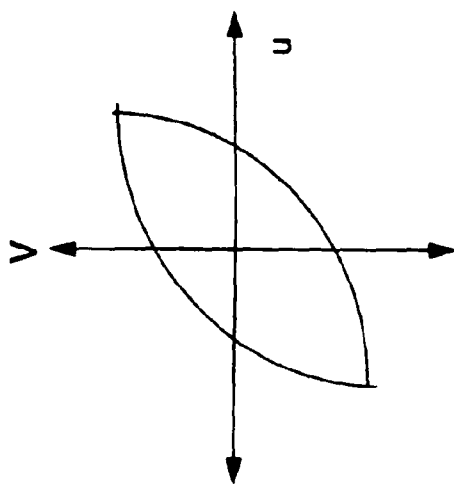

STIFFNESS AND STRENGTH DEGRADATION

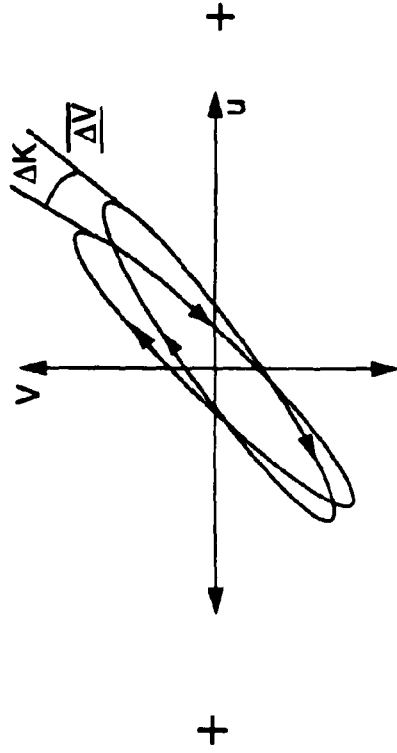

SLIP-LOCK HYSTERETIC MODEL

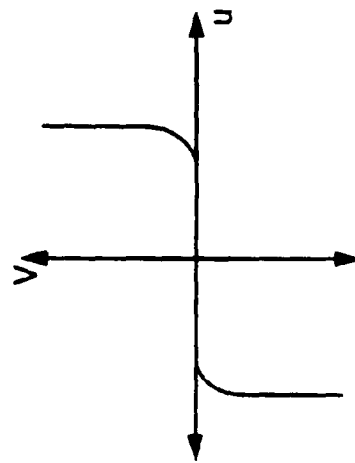

INTEGRATED MODEL IN IDARC 4.0

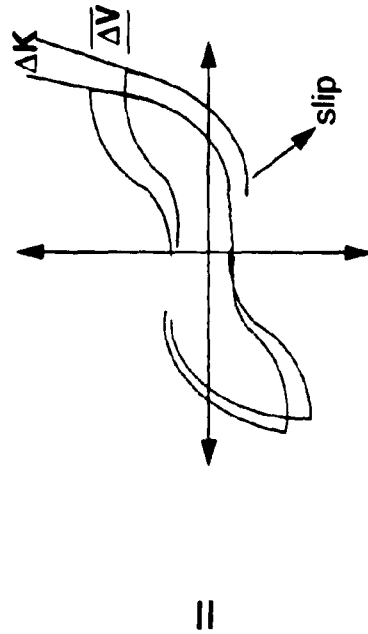

Fig. 3.28 Smooth hysteretic model

simulates a non-degrading system. A default value of $s_y = 0.1$ is suggested (Reinhorn et al., 1995d).

Degrading systems such as masonry infill panels also exhibit a loss of strength when subjected to cyclic loading in the inelastic range (see Fig. 3.28). The strength deterioration in the smooth hysteretic model was modeled reducing the yield force of the panel according to

$$F_y^k = s_y F_y^0 \quad (3.82)$$

where F_y^k is the reduced yield force at the k -th cycle of loading, F_y^0 is the initial non-degraded yield force.

The factor s_y determines the amount of deterioration from the original yield force and depends on the cumulative damage in the infill panel during the response history. A damage index (DI) was used to quantify the cumulative damage in the infill panel. The reduction factor s_y is related to the damage index according to

$$s_y = 1 - DI \quad (3.83)$$

The damage index proposed in this development, known as fatigue based damage index, is a function of the attained ductility and dissipated cyclic energy (Reinhorn and Valles, 1995, see also section 3.6.2)

$$DI = \frac{\mu_{max}^c - 1}{\mu_c - 1} \left(\frac{1}{s_{p1} \int dE_k} \right)^{s_{p2}} \quad (3.84)$$

$$\left(\frac{1}{4E_{mk}} \right)^{s_{p2}}$$

in which μ_{max}^c is the maximum attained ductility in the response history, μ_c is the ductility capacity of the infill panel, the parameters s_{p1} and s_{p2} control the rate of strength deterioration, $\int dE_k$ represents the cyclic energy dissipated before the start of the current reloading cycle, and E_{mk} is the monotonic energy capacity

$$E_{mk} = F_y^k u_c (\mu_c - 1) \quad (3.85)$$

Thus, the damage index DI may also be expressed as (Reinhorn et al., 1995d)

$$DI = \frac{\mu_{\max}^2 - 1}{\mu_{\max}^2 - 1} \left(1 - 0.25 \nu_p \int_{\mu_{\min}}^{\mu_{\max}} \frac{F^*}{F_c} (\mu - 1) d\mu \right) \quad (3.86)$$

The proposed damage index can reflect the cumulative effect of softening due to large inelastic excursions without load reversal as well as strength degradation due to repeated cyclic at moderate or small inelastic deformations

Pinching of the hysteretic loops due to opening and closing of cracks is commonly observed in concrete and masonry structural systems subjected to cyclic loading. Baber and Noori (1985) proposed a general degradation model to incorporate pinching in the response of a single degree of freedom system. The model implements the smooth degrading element developed by Bouc and modified by Baber and Wen (1981) in series with a time dependent slip-lock element (non-linear hardening spring). A rate dependent differential equation was proposed (Baber and Noori, 1995) relating the velocity contribution due to the slip-lock element with the hysteretic parameter Z , which was solved simultaneously with the equations of motion for the single-degree-of-freedom system to obtain the response of dynamically degrading pinching systems.

The concept of slip-lock element proposed by Baber and Noori (1985) has been adapted for this study to formulate a more generalized hysteretic rule for degrading pinching elements. The hysteretic rule is rate-independent and defines the force deformation response of the pinching element for any arbitrary displacement history independent of the system differential equations. The present formulation incorporates a slip-lock element in series with the smooth degrading element to develop a hysteretic model for pinching response (see Fig. 3.29). The normalized displacement of the pinching smooth hysteretic element μ is the sum of the normalized displacement of the smooth degrading element μ_s and the slip-lock element μ_{sl} . In incremental form, the relationship can be expressed as

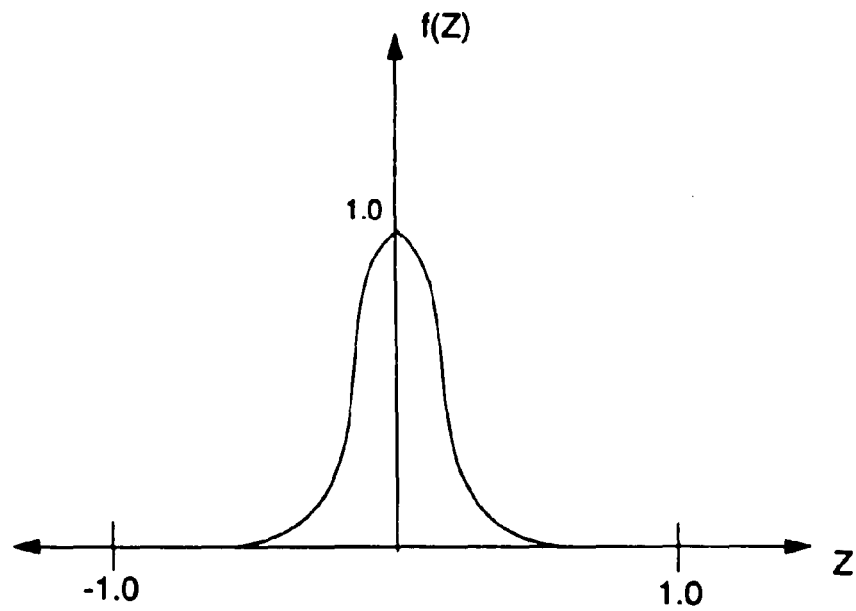
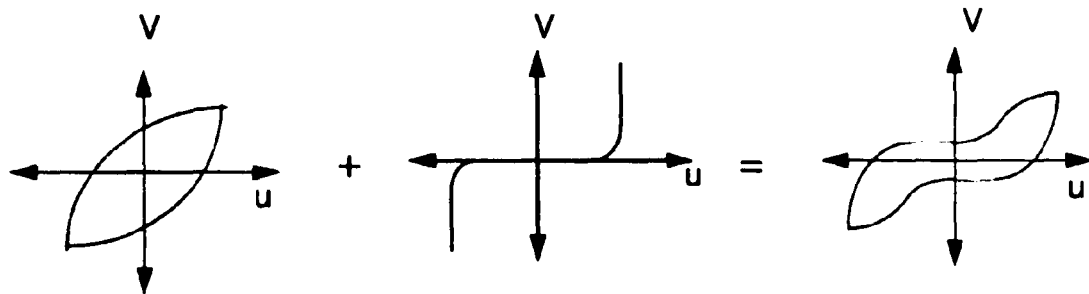

Fig. 3.29 Slip lock element. a) Influence on hysteretic response; b) Slip-lock function

$$d\mu = d\mu_1 + d\mu_2 \quad (3.87)$$

in which $d\mu_1$ and $d\mu_2$ are the incremental normalized displacements of the smooth degrading element and the slip-lock elements, respectively

The smooth degrading element is based on Bouc-Wen's model discussed earlier. Thus, the hysteretic parameter Z can be rewritten in terms of the displacement contribution μ_1

$$dZ = d\mu_1 \frac{[A - |Z|^n (\beta \operatorname{sgn}(d\mu_1 Z) + \gamma)]}{\eta} \quad (3.88)$$

The following relationship is proposed for the displacement component μ_2 in the slip-lock element

$$d\mu_2 = \alpha f(Z) dZ \quad (3.89)$$

in which the function $f(Z)$ is taken as

$$f(Z) = \exp\left(\frac{Z}{Z_s}\right)^2$$

in which Z_s is the range of Z about $Z = 0$, in which the slip occurs and thus controls the sharpness of the slip. The variation of $f(Z)$ is shown in Fig. 3.29b. Upon substitution of Eqs. 3.87 and 3.89 into Eq. 3.88,

$$\frac{dZ}{d\mu} = \frac{A - |Z|^n (\beta \operatorname{sgn}(d\mu Z) + \gamma)}{\eta \left[1 + \alpha \exp\left(\frac{Z}{Z_s}\right)^2 (A - |Z|^n (\beta \operatorname{sgn}(d\mu Z) + \gamma)) \right]} \quad (3.90)$$

In the present development, the slip length α is assumed to be a function of the attained ductility

$$\alpha = R_s (\mu' - 1) \quad (3.91)$$

Where R_s is a control parameter to vary slip length which may be linked to the size of crack openings or reinforcement slip (Lobo, 1994), and μ' is the normalized displacement attained at the load reversal prior to the current loading or reloading cycle. The effect of

varying the control parameters of the slip-lock element on the pinching of hysteresis loops is shown in Fig. 3.30. The parameter Z_s , that controls the sharpness of the slip, is assumed to be independent of the response history. Slip occurs in the range of Z equal to Z_s , and is symmetric about $Z = 0$. In order to shift the effective slip region to be symmetric about an arbitrary $Z = Z_0$, the value of Z used for slip may be offset by a value Z_0 .

$$\frac{dZ}{d\mu} = \frac{A - |Z|^n (\beta \operatorname{sgn}(d\mu Z) + \gamma)}{\eta \left[1 + a \exp\left(-\frac{(Z - Z_0)^2}{Z_s^2}\right) \right] (A - |Z|^n (\beta \operatorname{sgn}(d\mu Z) + \gamma))} \quad (3.92)$$

Equations 3.81 and 3.91 with Eq. 3.92 furnish a modified Bouc-Wen model for hysteretic pinching elements subjected to dynamic or quasi-static loading. For dynamic analysis, Eq. 3.92 can be rewritten in a rate dependent form

$$\dot{Z} = \dot{\mu} \frac{A - |Z|^n (\beta \operatorname{sgn}(\dot{\mu} Z) + \gamma)}{\eta \left[1 + a \exp\left(-\frac{(Z - Z_0)^2}{Z_s^2}\right) \right] (A - |Z|^n (\beta \operatorname{sgn}(\dot{\mu} Z) + \gamma))} \quad (3.93)$$

The solution of the differential equation (Eq. 3.92 for quasi-static loading and Eq. 3.93 for dynamic loading) can be reduced to the following general form

$$\dot{F}(u) = f(F, u) \quad (3.94a)$$

in the quasi-static case, or

$$\dot{F}(u) = f(F, u, \dot{u}) \quad (3.94b)$$

in the dynamic case. Differential equations of this form can be incrementally integrated using the semi-implicit Runge-Kutta method (see section 3.3.5). The increment ΔF is given by

$$\Delta F_k = F_{k+1} - F_k = R_k k_k + R_2 I_k \quad (3.95)$$

in which the subscript " k " denotes the k -th step. The quantities k_k and I_k are determined from

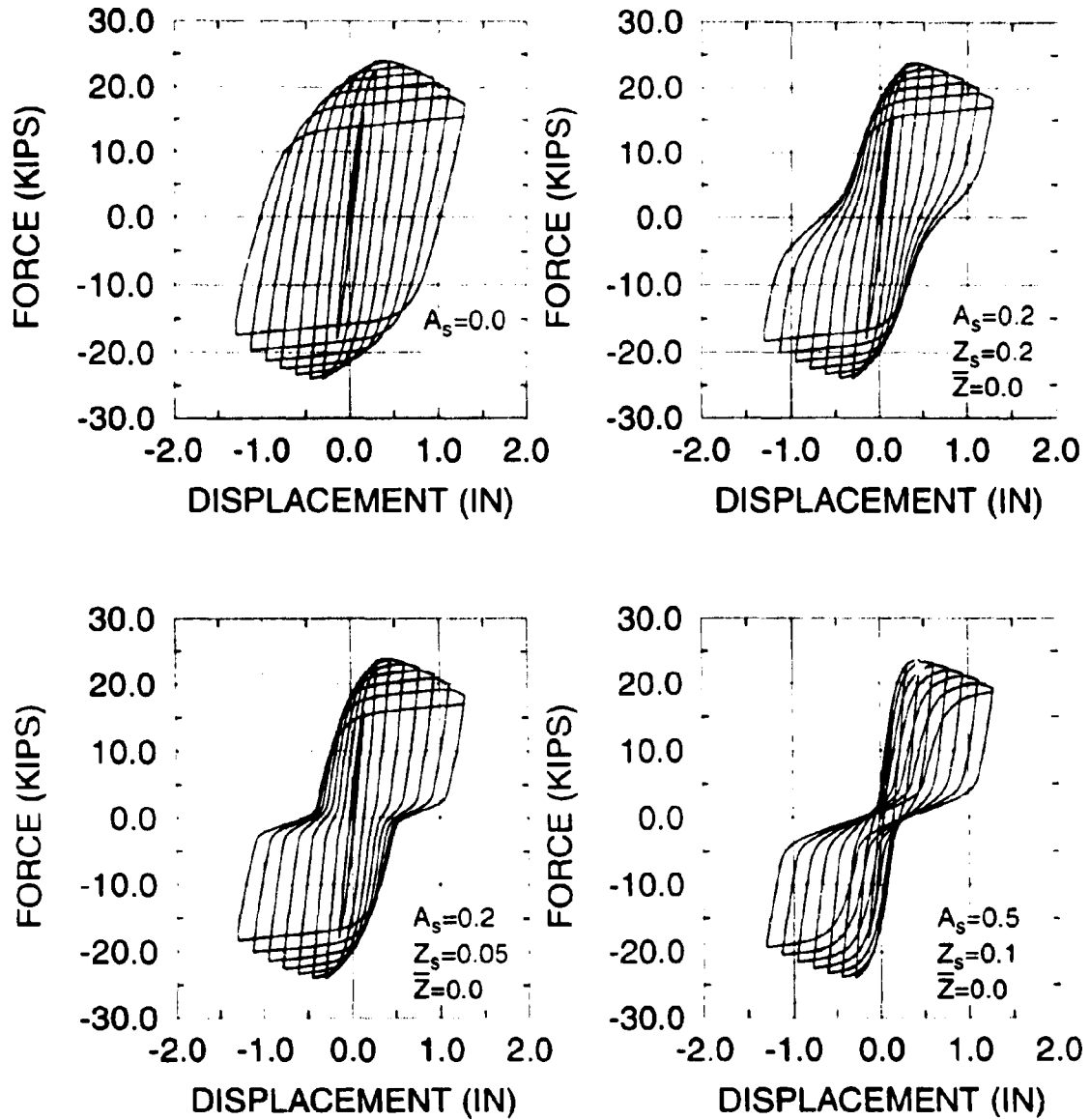

Constant Parameters		
$A = 1.0$	$\alpha = 0.01$	$s_k = 0.1$
$\beta = 0.1$	$V_y = 25 \text{ Kips}$	$s_{p1} = 0.8$
$\gamma = 0.9$	$K_0 = 125 \text{ K/in}$	$s_{p2} = 1.0$
$n = 2$		$\mu_c = 25$

Fig. 3.30 Influence of varying the slip-lock parameters

$$k_i = \left[1 - a_i \Delta x \frac{\partial f(F_i)}{\partial F} \right] f(F_i) \Delta x \quad (3.96a)$$

$$k_i = \left[1 - a_i \Delta x \frac{\partial f(F_i + c k_i)}{\partial F} \right] f(F_i + b k_i) \Delta x \quad (3.96b)$$

To obtain a fourth order truncation error the coefficients are (Reinhorn et al., 1994)

$R_1 = 0.75$, $R_2 = 0.25$, $a_1 = a_2 = 0.7886751$, $b_1 = 1.1547005$ and $c_1 = 0$

3.4 Analysis Modules

The program calculates the nonlinear response of the structure under the following four possible analysis options

- a) Nonlinear Static Analysis
- b) Nonlinear Pushover Analysis
- c) Nonlinear Dynamic Analysis
- d) Nonlinear Quasi-static Analysis

The user may select any of the four options for the analysis, or a combination of a nonlinear static analysis with any of the three other analysis options

For all four analysis options, the system to solve assumes the following form

$$[K_t] \{\Delta u\} = \{\Delta F\} \quad (3.97)$$

Where $[K_t]$ is the overall tangent stiffness matrix of the structure, $\{\Delta u\}$ is the vector of unknown nodal displacement increments, and $\{\Delta F\}$ is the vector of applied load increments. Since the stiffness matrix is banded and symmetric, the matrix is stored in a compact scheme with the diagonal elements in the first column and the remaining half width diagonal terms are stored in the adjacent columns

The element stiffness matrices are first calculated at the element level, and later assembled onto the global stiffness matrix. The stiffness matrix is then modified to

account for P-Delta effects if required by the user. The load vector in the structure is determined depending of the choice of analysis being performed. Element sub-matrices are stored to enable direct computation of the end moments and shears, and the hysteretic model checks for changes in the element stiffness. The global stiffness matrix is only upgraded if an element changed in stiffness. A single step force correction procedure is incorporated in all analysis options.

3.4.1 Nonlinear Static Analysis

The analysis phase begins with the evaluation of the initial stress states of members under dead and live loads that exist in the structure prior to the application of monotonic, cyclic, or earthquake loads. Static loads may be specified as distributed loads in the beams, or as concentrated forces or moments in the model joints. When distributed loads are specified, the program internally calculates the fixed end forces.

Moments are assumed to have a linear distribution when the beam flexural matrix is generated, therefore, stress levels due to initial loads must be relatively small so that the assumed moment distribution pattern is not significantly violated. Otherwise, beam elements must be subdivided into sub-elements so that the moment distribution due to gravity loads is captured effectively.

The prescribed static loads may be applied incrementally to capture stress redistribution due to inelastic response. If the system is expected to remain elastic with the gravity loads applied, the entire load may be applied in a single step, otherwise, care should be taken to sub-divide the static loads in a reasonable number of increments so as to trace the nonlinear response accurately. A simple technique to assure convergence in the static analysis is to increase the number of loading steps until consistent results are obtained. Note that this module may be used also to perform nonlinear nonotonic analysis.

3.4.2 Nonlinear Pushover Analysis

The nonlinear pushover analysis, or collapse mode analysis, is a simple and efficient technique to predict the seismic response of prior to a full dynamic analysis. A pushover analysis can establish the sequence of component yielding, the potential ductility capacity, and the adequacy of the building lateral strength. The pushover analysis option performs an incremental analysis of the structure subjected to a distribution of lateral forces. The system of equations solved in this module are:

$$[\mathbf{K}_t]\{\Delta\mathbf{u}\} - \{\Delta\mathbf{F}\} - \{\Delta\mathbf{P}_f\} - \{\Delta\mathbf{P}_{FR}\} - \{\Delta\mathbf{P}_{FD}\} - \{\Delta\mathbf{P}_{FH}\} + c_{cor}\{\Delta\mathbf{F}_{unb}\} \quad (3.98)$$

Where $[\mathbf{K}_t]$ is the tangent structural stiffness, $\{\Delta\mathbf{u}\}$ is the vector with the increment of lateral displacements, $\{\Delta\mathbf{F}\}$ is the vector with the increment in lateral forces, $\{\Delta\mathbf{P}_f\}$, $\{\Delta\mathbf{P}_{FR}\}$, $\{\Delta\mathbf{P}_{FD}\}$, and $\{\Delta\mathbf{P}_{FH}\}$ are the vector with the increment of forces in viscous dampers, friction dampers, hysteretic dampers, and infill panels respectively, c_{cor} is a correction coefficient (usually taken as one), and $\{\Delta\mathbf{F}_{unb}\}$ is the vector with the unbalanced forces in the structure.

The pushover analysis may be carried out using force control or displacement control. In the former option, the structure is subjected to an incremental distribution of lateral forces and the incremental displacement are calculated. In the latter option the structure is subjected to a displacement profile, and the lateral forces needed to generate that deformation are calculated. Typically, since the deformed profile is not known, and an estimate of the lateral distribution of forces can be made, force control is commonly used. For displacement control, the user must specify the target maximum deformation profile of the structure. This profile is internally divided by the number of steps specified by the user, and then incrementally applied to the structure. In the force control option the user must specify the maximum force distribution, or select one of the force distributions available in the program:

- a) Uniform Distribution
- b) Inverted Triangular Distribution

c) Generalized Power Distribution

d) Modal Adaptive Distribution

Each of the distributions are briefly described below

a) The uniform distribution considers a constant distribution of the lateral forces throughout the height of the building, regardless of the story weights. The force increment at each step for story “ i ” is given by

$$\Delta F_i = \frac{\Delta V_b}{N} \quad (3.99)$$

where ΔV_b is the increment in the base shear of the structure, and N is the total number of stories in the building

b) The inverse triangular distribution, often suggested in building codes, considers that the structure is subjected to a linear distribution of the acceleration throughout the building height. The force increment at each step for story “ i ” is calculated according to

$$\Delta F_i = \frac{W_i h_i}{\sum_{l=1}^N W_l h_l} \Delta V_b \quad (3.100)$$

where W_i and h_i are the story weight and the story elevation, respectively, and ΔV_b is the increment of the building base shear

c) The generalized power distribution was introduced to consider different variations of the story accelerations with the story elevation. This distribution was introduced to capture different modes of deformation, and the influence of higher modes in the response. The force increment at floor “ i ” is calculated according to

$$\Delta F_i = \frac{W_i h_i^k}{\sum_{l=1}^N W_l h_l^k} \Delta V_b \quad (3.101)$$

where k is the parameter that controls the shape of the force distribution. The recommended value for k may be calculated as a function of the fundamental period of the structure (T)

$$\begin{aligned}
 k &= 1.0 \quad \text{for } T \leq 0.5 \text{ sec} \\
 k &= 2.0 \quad \text{for } T > 2.5 \text{ sec} \\
 k &= 1 + \frac{T - 0.5}{2} \quad \text{otherwise}
 \end{aligned}$$

Nevertheless, any value for k may be used to consider different acceleration profiles. Note that $k = 0$ produces a constant variation of the acceleration, while $k = 1$ produces a linear variation (inverted triangle distribution), and $k = 2$ yields a parabolic distribution of story accelerations.

d) The modal adaptive distribution differs significantly from all the previous ones in that the story force increments are not constant. A constant distribution throughout the incremental analysis will force the structure to respond in a certain form. Often the distribution of forces is selected considering force distributions during an elastic response, however, it is clear that when the structure enters the inelastic range, the elastic distribution of forces may not be applicable anymore. If the pushover forces are not modified to account for the new stiffness distribution, the structure is forced to respond in a way that may considerably differ from what an earthquake may impose to the structure.

The modal adaptive distribution was developed to capture the changes in the distribution of lateral forces. Instead of a polynomial distribution, the mode-shapes of the structure are considered. Since the inelastic response of the structure will change the stiffness matrix, the mode shapes will also be affected, and a distribution proportional to the mode shapes will capture this change. If the fundamental mode is considered, the increment in the force distribution is calculated according to

$$\Delta F_i = \frac{W_i \Phi_{i1}}{\sum_{j=1}^n W_j \Phi_{j1}} V_n - F_i^{old} \quad (3.102)$$

where Φ_{i1} is the value of the first mode shape at story " i ", V_n is the new base shear of the structure, and F_i^{old} is the force at floor " i " in the previous loading step.

The modal adaptive distribution may be extended to consider the contribution from more than one mode. In this case, the mode shapes are combined using the SRSS method and scaled according to their modal participation factor. The incremental force at story “ i ” is calculated according to

$$\Delta F_i = \frac{W_i \left[\sum_{j=1}^{nm} (\Phi_{ij} \Gamma_j) \right]}{\sum_{k=1}^n W_k \left[\sum_{j=1}^{nm} (\Phi_{kj} \Gamma_j) \right]} I_k I_i^{mod} \quad (3.103)$$

where Φ_{ij} is the value of mode shape “ j ” at story “ i ”, Γ_j is the modal participation factor for mode “ j ”, I_k is the new base shear of the structure, and I_i^{mod} is the force at floor “ i ” in the previous loading step.

3.4.3 Nonlinear Dynamic Analysis

The nonlinear dynamic analysis is carried out using a combination of the Newmark-Beta integration method, and the pseudo-force method. The solution is carried out in incremental form, according to

$$[\mathbf{M}]\{\Delta\ddot{\mathbf{u}}\} + [\mathbf{C}]\{\Delta\dot{\mathbf{u}}\} + [\mathbf{K}_t]\{\Delta\mathbf{u}\} = -[\mathbf{M}]\left(\left\{\mathbf{L}_h\right\}\Delta\ddot{x}_{gh} + \left\{\mathbf{L}_v\right\}\Delta\ddot{x}_{gv}\right) - \left\{\Delta\mathbf{P}_v\right\} - \left\{\Delta\mathbf{P}_{fr}\right\} - \left\{\Delta\mathbf{P}_{hy}\right\} - \left\{\Delta\mathbf{P}_{in}\right\} + c_{cor}\left\{\Delta\mathbf{F}_{un}\right\} \quad (3.104)$$

where $[\mathbf{M}]$ is the lumped mass matrix of the structure, $[\mathbf{C}]$ is the viscous matrix of the structure, $[\mathbf{K}_t]$ is the tangent stiffness matrix, $\{\Delta\mathbf{u}\}$, $\{\Delta\dot{\mathbf{u}}\}$, and $\{\Delta\ddot{\mathbf{u}}\}$ are the incremental vectors of displacement, velocity and acceleration in the structure, respectively. $\{\mathbf{L}_h\}$ and $\{\mathbf{L}_v\}$ are the allocation vectors for the horizontal and vertical ground accelerations; $\Delta\ddot{x}_{gh}$ and $\Delta\ddot{x}_{gv}$ are the increment in the horizontal and vertical ground accelerations; $\{\Delta\mathbf{P}_v\}$, $\{\Delta\mathbf{P}_{fr}\}$, $\{\Delta\mathbf{P}_{hy}\}$, and $\{\Delta\mathbf{P}_{in}\}$ are the restoring forces from viscous dampers, friction dampers, hysteretic dampers, and infill panels, respectively. c_{cor} is a correction coefficient (usually taken as one), and $\{\Delta\mathbf{F}_{un}\}$ is the vector with the unbalanced forces in the structure.

The solution of the incremental system is carried out using the Newmark-Beta algorithm (Newmark, 1959), that assumes a linear variation of the acceleration, therefore

$$\{\dot{\mathbf{u}}\}_{t+\Delta t} = \{\dot{\mathbf{u}}\}_t + \Delta t \left[(1-\gamma)\{\ddot{\mathbf{u}}\}_t + \gamma\{\ddot{\mathbf{u}}\}_{t+\Delta t} \right] \quad (3.105a)$$

$$\{\mathbf{u}\}_{t+\Delta t} = \{\mathbf{u}\}_t + \Delta t\{\dot{\mathbf{u}}\}_t + (\Delta t)^2 \left[(0.5-\beta)\{\ddot{\mathbf{u}}\}_t + \beta\{\ddot{\mathbf{u}}\}_{t+\Delta t} \right] \quad (3.105b)$$

where β and γ are parameters of the method. The program IDARC is by default set up to perform the unconditionally stable constant average acceleration for numerical integration, for which

$$\beta = 1/4$$

$$\gamma = 1/2$$

but the parameters may be changed to perform a linear acceleration numerical integration, for which

$$\beta = 1/6$$

$$\gamma = 1/2$$

Rearranging Eqs. 3.105 yields the following expressions for the increment in velocity and acceleration

$$\{\Delta\dot{\mathbf{u}}\}_{t+\Delta t} = \left(1 - \frac{\gamma}{2\beta} \right) \Delta t \{\ddot{\mathbf{u}}\}_t + \frac{\gamma}{\beta} \{\ddot{\mathbf{u}}\}_t + \frac{\gamma}{\beta \Delta t} \{\Delta\mathbf{u}\}_{t+\Delta t} \quad (3.106a)$$

$$\{\Delta\ddot{\mathbf{u}}\}_{t+\Delta t} = \frac{1}{\gamma \Delta t} \{\Delta\dot{\mathbf{u}}\}_{t+\Delta t} - \frac{1}{\gamma} \{\ddot{\mathbf{u}}\}_t \quad (3.106b)$$

When substituting in Eq. 3.104, the governing equation of motion can be rewritten as

$$[\mathbf{K}_D] \{\Delta\mathbf{u}\}_{t+\Delta t} = \{\Delta\mathbf{F}_D\} \quad (3.107)$$

where $[\mathbf{K}_D]$ and $\{\Delta\mathbf{F}_D\}$ are known as the equivalent dynamic stiffness and load vectors

$$[\mathbf{K}_D] = \frac{1}{\beta(\Delta t)^2} [\mathbf{M}] + \frac{\gamma}{\beta \Delta t} [\mathbf{C}] + [\mathbf{K}] \quad (3.108a)$$

$$\begin{aligned} \{\Delta\mathbf{F}_D\} = & [\mathbf{M}] \left(\{\mathbf{L}_s\} \Delta \ddot{x}_{ch} + \{\mathbf{L}_c\} \Delta \ddot{x}_{cs} \right) + \{\Delta\mathbf{P}_1\} + \{\Delta\mathbf{P}_{1b}\} + \{\Delta\mathbf{P}_{1m}\} + \{\Delta\mathbf{P}_{1n}\} \\ & + c_{int} \{\Delta\mathbf{F}_{int}\} + \left(\frac{1}{2\beta} [\mathbf{M}] + \left(\frac{\gamma}{2\beta} - 1 \right) \Delta t [\mathbf{C}] \right) \{\ddot{\mathbf{u}}\}_t + \left(\frac{1}{\beta \Delta t} [\mathbf{M}] + \frac{\gamma}{\beta} [\mathbf{C}] \right) \{\dot{\mathbf{u}}\}_t \end{aligned} \quad (3.108b)$$

The increment in displacements is calculated when the system of linear algebraic equations in Eq. 3.107 is solved. Velocity and accelerations may be calculated by direct substitution in Eqs. 3.106a and 3.106b, respectively.

The solution is performed incrementally assuming that the properties of the structure do not change during the time step of analysis. Since the stiffness of some elements is likely to change during the time step, the new configuration may not satisfy equilibrium. A compensation procedure is adopted to minimize the error by applying a one step unbalanced force correction.

At the end of step $t + \Delta t$ the difference between the restoring force calculated using the hysteretic model ($\{R\}$), and the restoring force considering no change in stiffness during the step ($\{R'\}$), yields the unbalanced force (see Fig. 3.31)

$$\{\Delta F_{unb}\} = \{R\} - \{R'\} \quad (3.109)$$

This corrective force is then applied at the next time step of analysis. The unbalanced forces are computed when moments, shears and stiffness are being updated in the hysteretic model. Such a procedure was first adopted in DRAIN2D (Kannan and Powell, 1973) since the cost of performing iterations in the nonlinear analysis would become prohibitive, especially for large building systems. However, it must be pointed out that this technique is not physically accurate, since adding the unbalanced forces at the next time step has the effect of modifying the input loads. Such a procedure generally works well when small unbalanced forces occur. To minimize the magnitude of the unbalanced forces, a sufficiently small time increment must be selected for analysis. Numerical instabilities in the program are often due to an inadequate time step, that have lead to large unbalanced forces and problems in the hysteretic routines to trace the actual response of the elements.

The viscous damping matrix is calculated in the program using one of the following options:

- a) Mass proportional damping
- b) Stiffness proportional damping
- c) Rayleigh damping

All three options can be expressed as

$$[C] = \alpha_M [M] + \alpha_K [K] \quad (3.110)$$

where the coefficients α_M and α_K are calculated depending on the type of damping matrix selected

- a) Mass proportional damping

$$\alpha_M = 2\xi_i \omega_i \quad (3.111a)$$

$$\alpha_K = 0 \quad (3.112b)$$

where ξ_i and ω_i are the critical damping ratio and the circular frequency for mode "i"

- b) Stiffness proportional damping

$$\alpha_M = 0 \quad (3.112a)$$

$$\alpha_K = \frac{2\xi_i}{\omega_i} \quad (3.112b)$$

- c) Rayleigh damping

$$\alpha_M = \frac{2\xi_i \omega_i \omega_j^2 + 2\xi_j \omega_j \omega_i^2}{\omega_i^2 + \omega_j^2} \quad (3.113a)$$

$$\alpha_K = \frac{2\xi_i \omega_j^2 + 2\xi_j \omega_i^2}{\omega_i^2 + \omega_j^2} \quad (3.113b)$$

when the damping ratio is the same in both modes considered ($\xi_i = \xi_j = \xi$) the expressions simplify to

$$\alpha_M = \frac{2\xi \omega_i \omega_j}{\omega_i^2 + \omega_j^2} \quad (3.114a)$$

$$\alpha_K = \frac{2\xi}{\omega_i^2 + \omega_j^2} \quad (3.114b)$$

In the program IDARC, the circular frequency corresponding to the first mode of vibration is used for the mass and stiffness proportional damping, while the circular

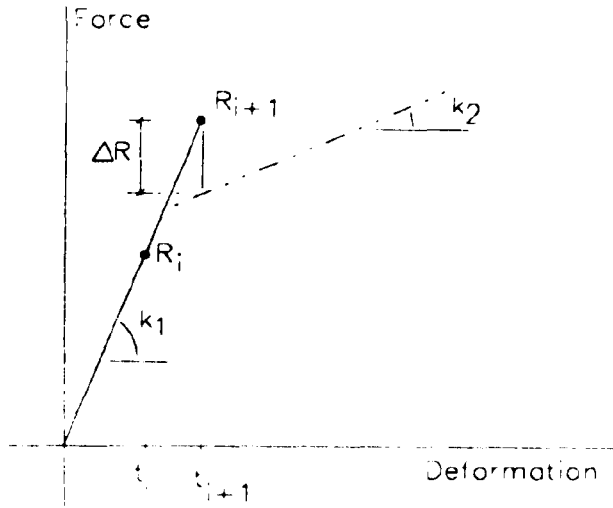

Fig. 3.31 Unbalanced force correction

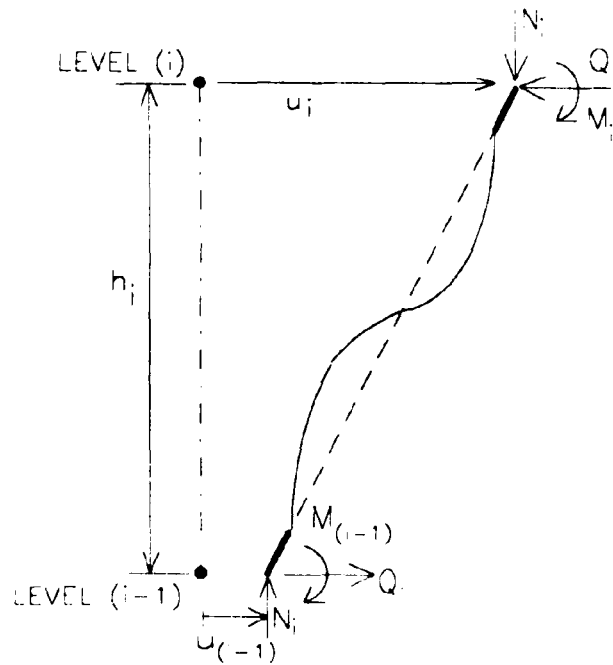

Fig. 3.32 Computation of shear due to P-delta effects

frequencies corresponding to the first and second modes are used for the Rayleigh damping type. Under these conditions, mass proportional damping will yield a smaller damping ratio for the higher modes, while stiffness proportional and Rayleigh damping will yield a higher critical damping ratio for the higher modes.

3.4.4 Nonlinear Quasi-static Analysis

A common testing procedure for components and sub-assemblages is to perform cyclic loading of the specimen against a reaction frame. The history of cyclic loads may be applied to the specimen in force or deformation control. The computer program IDARC is capable of performing both types of cyclic loading by specifying the force or displacement history at one or more story levels. In both cases the program internally interpolates between user-specified points for a more accurate analysis. The system of equations solved in the quasi-static routine are the same ones solved in the pushover routine (Eq. 3.98).

3.5 Additional Program Features

3.5.1 P-Delta Effects

The additional overturning moments generated by the relative inter-story drifts are generally referred to as P-delta effects. Such moments arise essentially due to gravity loads and are usually taken into consideration by evaluating axial forces in the vertical elements and computing a geometric stiffness matrix which is added to the element stiffness matrix.

In the program IDARC, P-delta effects are represented by equivalent lateral forces, equal in magnitude to the overturning moments caused by eccentric gravity forces due to inter-story drift (Wilson and Habibullah, 1987). Consider a typical vertical element

between two story levels shown in Fig. 3.32. Taking moments about the lower story level, the following equilibrium equation is obtained

$$P_i h_i - (M_i + M_{i+1}) - N_i (u_i - u_{i+1}) = 0 \quad (3.115)$$

Considering equilibrium of the additional gravity load shears at story level "i", the following expression is obtained.

$$P_i = \frac{N_i (u_i - u_{i+1})}{h_i} + \frac{N_{i+1} (u_{i+1} - u_i)}{h_i} \quad (3.116)$$

The above equations can be written in the following form for each component.

$$\{P^*\} = [K_G] \{\Delta u\} \quad (3.117)$$

where $[K_G]$ is a tridiagonal matrix similar to the geometric stiffness matrix in the finite elements. This matrix is added to the overall stiffness prior to the start of a new analysis step.

3.5.2 Spread Plasticity Model

The moment distribution along a member subjected to lateral loads is linear, as shown in Fig. 3.33. The presence of gravity loads will alter the distribution, and in cases of significant gravity load moments the structural elements should be subdivided to capture this variation. When the member experiences inelastic deformations, cracks tend to spread from the joint interface resulting in a curvature distribution as shown in Fig. 3.33. Sections along the element will also exhibit different flexibility characteristics, depending on the degree of inelasticity observed (see Fig. 3.34). The program IDARC includes a spread plasticity formulation to capture the variation of the section flexibility, and combine them to determine the element stiffness matrix.

The flexibility distribution in the structural elements is assumed to follow the distribution shown in Fig. 3.34, where EI_A and EI_B are the current flexural stiffness of the sections at end "A" and "B", respectively, EI_C is the stiffness at the center of the element, GA_s is the shear stiffness of the element, assumed constant throughout the

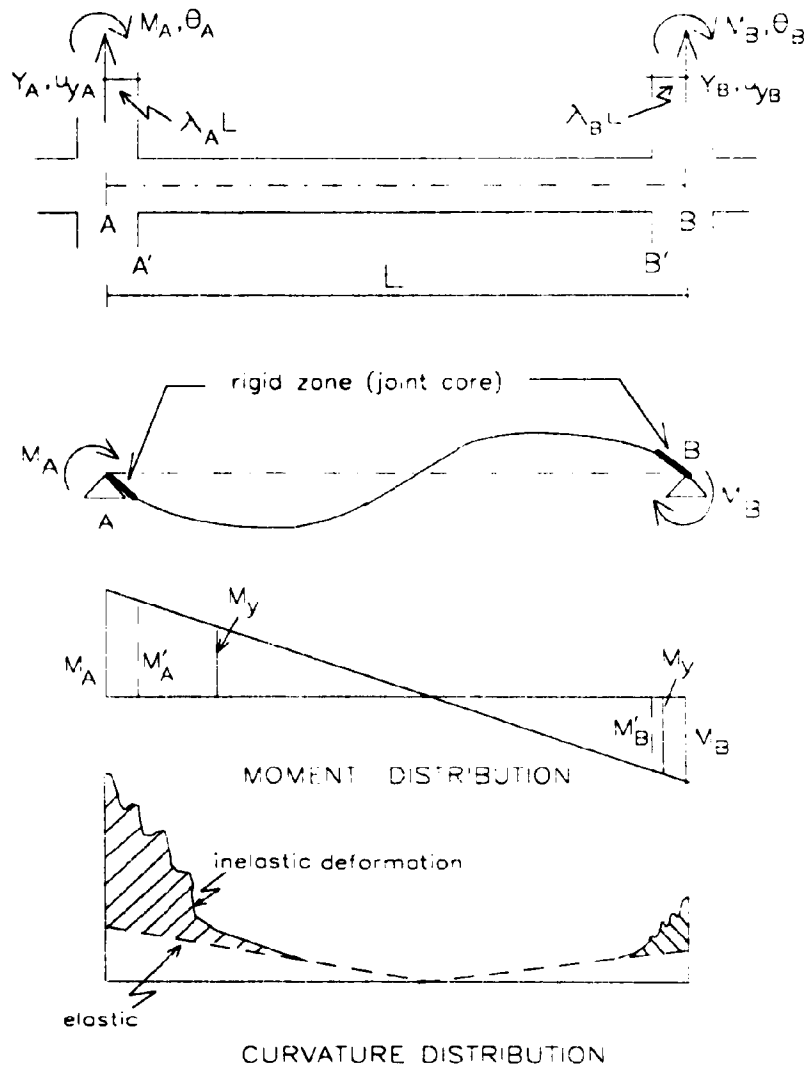

Fig. 3.33 Curvature distribution along an element

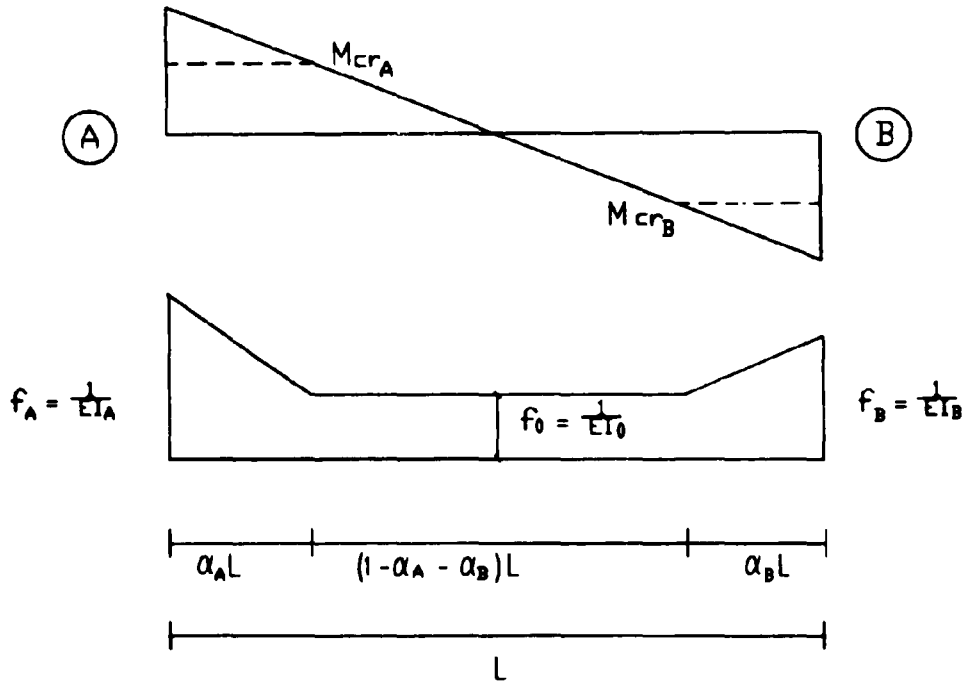

Fig. 3.34 Spread plasticity model

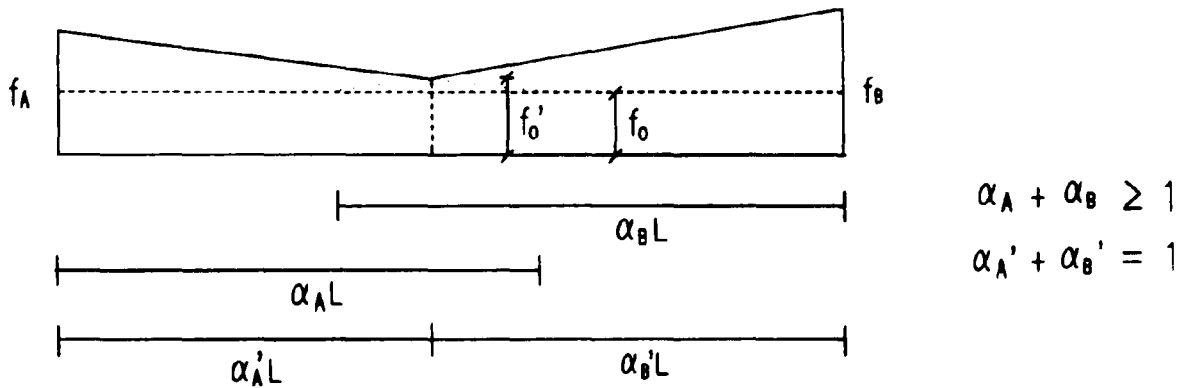

Fig. 3.35 Yield penetration lengths for fully inelastic members

length, α_i and α_R are the yield penetration coefficients, and L is the length of the element. The flexural stiffness EI_i and EI_R , and the shear stiffness GA_s , are determined from the hysteretic model. The stiffness EI_0 and the yield penetration coefficients α_i and α_R are determined as indicated in Section 3.5.3, depending on the moment distribution and the previous yield penetration history

The flexibility matrix, including shear distortions, relating moments and rotations at the ends of the element is:

$$\begin{Bmatrix} \theta_i \\ \theta_R \end{Bmatrix} = \begin{bmatrix} f_{ii} & f_{iR} \\ f_{Ri} & f_{RR} \end{bmatrix} \begin{Bmatrix} M_i \\ M_R \end{Bmatrix} \quad (3.118)$$

where θ_i and θ_R are the rotations at the ends, M_i and M_R are the moments at the ends of the element. The flexibility coefficients are obtained from

$$f_{ij} = \int_0^L \frac{m_i(x)m_j(x)}{EI(x)} dx + \int_0^L \frac{v_i(x)v_j(x)}{GA_s} dx \quad (3.119)$$

Where $m_i(x)$ and $m_j(x)$ are the moment distributions due to a virtual unit moment at end "i" or "j", respectively, $v_i(x)$ and $v_j(x)$ are the corresponding shear distributions

After some algebra, the flexibility coefficients can be written as (Lobo, 1994)

$$f_{ii} = \frac{L}{12} \left[\frac{3}{EI_0} + \left(\frac{1}{EI_i} - \frac{1}{EI_0} \right) (6\alpha_i - 4\alpha_i^2 + \alpha_i^3) + \left(\frac{1}{EI_R} - \frac{1}{EI_0} \right) \alpha_i^3 \right] + \frac{1}{GA_s L} \quad (3.120a)$$

$$f_{iR} = \frac{L}{12} \left[\frac{2}{EI_0} - \left(\frac{1}{EI_i} - \frac{1}{EI_0} \right) (2\alpha_i - \alpha_i^3) - \left(\frac{1}{EI_R} - \frac{1}{EI_0} \right) (2\alpha_R - \alpha_R^3) \right] + \frac{1}{GA_s L} \quad (3.120b)$$

$$f_{Ri} = f_{iR} \quad (3.120c)$$

$$f_{BB} = \frac{L}{12} \left[\frac{4}{EI_0} + \left(\frac{1}{EI_B} - \frac{1}{EI_0} \right) (6\alpha_B - 4\alpha_B^2 + \alpha_B^3) + \left(\frac{1}{EI_A} - \frac{1}{EI_0} \right) \alpha_A^3 \right] + \frac{1}{GA_s L} \quad (3.120d)$$

In the current release of IDARC, the formulation above was rewritten, and close form solutions were derived for the element stiffness matrix to avoid numerical instabilities if close to failure conditions are observed in flexure or shear

The flexibility coefficients in the current release of the program are

$$f_{AA} = \frac{L}{12EI_0EI_AEI_B} f'_{AA} + \frac{1}{GA_s L} \quad (3.121a)$$

$$f_{AB} = f_{BA} = \frac{L}{12EI_0EI_AEI_B} f'_{AB} + \frac{1}{GA_s L} \quad (3.121b)$$

$$f_{BB} = \frac{L}{12EI_0EI_AEI_B} f'_{BB} + \frac{1}{GA_s L} \quad (3.121c)$$

where

$$f'_{AA} = 4EI_AEI_B + (EI_0 - EI_A)EI_B(6\alpha_A - 4\alpha_A^2 + \alpha_A^3) + (EI_0 - EI_B)EI_A\alpha_B^3 \quad (3.122a)$$

$$f'_{AB} = -2EI_AEI_B - (EI_0 - EI_A)EI_B(2\alpha_A^2 - \alpha_A^3) - (EI_0 - EI_B)EI_A(2\alpha_B^2 - \alpha_B^3) \quad (3.122b)$$

$$f'_{BB} = 4EI_AEI_B + (EI_0 - EI_A)EI_B\alpha_{AB}^3 + (EI_0 - EI_B)EI_A(6\alpha_B - 4\alpha_B^2 + \alpha_B^3) \quad (3.122c)$$

Note that the total flexibility of the element is the sum of the flexural and shear contributions.

The element stiffness matrix, including shear deformations, relating moments and rotations at the element ends can be found:

$$\begin{Bmatrix} M_A \\ M_B \end{Bmatrix} = \begin{bmatrix} k_{AA} & k_{AB} \\ k_{BA} & k_{BB} \end{bmatrix} \begin{Bmatrix} \theta_A \\ \theta_B \end{Bmatrix} = [\mathbf{K}'] \begin{Bmatrix} \theta_A \\ \theta_B \end{Bmatrix} \quad (3.123)$$

Where the elements in the stiffness matrix are

$$k_{11} = \frac{12EI_c EI_c EI_c}{D_{cs} L} (f'_{11} GA_c E_c + 12EI_c EI_c EI_c) \quad (3.124a)$$

$$k_{12} = k_{21} = \frac{12EI_c EI_c EI_c}{D_{cs} L} (f'_{12} GA_c E_c + 12EI_c EI_c EI_c) \quad (3.124b)$$

$$k_{22} = \frac{12EI_c EI_c EI_c}{D_{cs} L} (f'_{22} GA_c E_c + 12EI_c EI_c EI_c) \quad (3.124c)$$

$$D_{cs} = GA_c E_c (f'_{11} f'_{22} - f'_{12} f'_{21}) + 12EI_c EI_c EI_c (f'_{11} + f'_{22} - 2f'_{12}) \quad (3.124d)$$

In the present formulation shear or flexural failures of the element can be incorporated

3.5.3 Yield Penetration Model

The yield penetration model combined with the spread plasticity formulation captures the variation of the stiffness in structural elements. The spread plasticity formulation described in Section 3.5.2 is dependent on the yield penetration parameters α_L and α_R , and of the flexural stiffness EI_c at the center of the element. The rules for the variation of these parameters as the moment diagram changes in the element are described below.

The yield penetration parameters, α_L and α_R , specify the proportion of the element where the acting moment is greater than the section cracking moment, M_{Lc} or M_{Rc} . These parameters are first calculated for the current moment distribution, and then checked with the previous maximum penetration lengths α_{Lmax} and α_{Rmax} ; the yield penetration parameters cannot be smaller than the previous maximum values regardless of the current moment distribution. Two cases for the moment distribution are identified: single curvature and double curvature moment diagrams. A set of rules are specified for each of these cases.

a) Single Curvature Moment Diagram ($M_A, M_B > 0$)

In the single curvature moment diagram the moments at the end of the element have the same sign. Depending on the moment distribution four cases can be identified

a 1) End moments smaller than the corresponding cracking moments

$$(|M_A| \leq |M_{A,c}| \text{ and } |M_B| < |M_{B,c}|)$$

$$\alpha_A = 0 \text{ but } \alpha_A > \alpha_{A,max} \quad (3.125)$$

$$\alpha_B = 0 \text{ but } \alpha_B \geq \alpha_{B,max} \quad (3.125b)$$

$$EI_{cr} = \frac{2EI_{A0}EI_{B0}}{EI_{A0} + EI_{B0}} \quad (3.125c)$$

a 2) Moment at end "A" greater than cracking moment ($|M_A| > |M_{A,c}|$ and

$$|M_B| < |M_{B,c}|)$$

$$\alpha_A = \frac{M_A - M_{A,c}}{M_A - M_B} < 1 \text{ but } \alpha_A > \alpha_{A,max} \quad (3.126a)$$

$$\alpha_B = 0 \text{ but } \alpha_B > \alpha_{B,max} \quad (3.126b)$$

$$EI_{cr} = \frac{2EI_{A0}EI_{B0}}{EI_{A0} + EI_{B0}} \quad (3.126c)$$

a 3) Moment at end "B" greater than cracking moment ($|M_A| < |M_{A,c}|$ and

$$|M_B| > |M_{B,c}|)$$

$$\alpha_A = 0 \text{ but } \alpha_A \geq \alpha_{A,max} \quad (3.127a)$$

$$\alpha_B = \frac{M_B - M_{B,c}}{M_B - M_A} < 1 \text{ but } \alpha_B > \alpha_{B,max} \quad (3.127b)$$

$$EI_{cr} = \frac{2EI_{A0}EI_{B0}}{EI_{A0} + EI_{B0}} \quad (3.127c)$$

a 4) Moment at both ends greater than cracking moments ($|M_A| > |M_{A,c}|$ and

$$|M_B| > |M_{B,c}|)$$

$$\alpha_A = 0.5 \quad (3.128a)$$

$$\alpha_B = 0.5 \quad (3.128b)$$

$$EI_{cr} = \frac{2EI_1 EI_B}{EI_1 + EI_B} \quad (3.128c)$$

Where M_{1cr} and M_{Bcr} are the cracking moments of the section corresponding to the sign of the applied moments, EI_{1cr} and EI_{Bcr} are the elastic stiffness of the sections at the ends of the element

b) Double Curvature Moment Diagram ($M_1 M_B < 0$)

In the double curvature moment diagram the moments at the end of the element have different signs. Depending on the moment distribution four cases can be identified

b 1) End moments smaller than the corresponding cracking moments

$$(|M_1| < |M_{1cr}| \text{ and } |M_B| < |M_{Bcr}|)$$

$$\alpha_A = 0 \text{ but } \alpha_B > \alpha_{Bmax} \quad (3.129a)$$

$$\alpha_B = 0 \text{ but } \alpha_A > \alpha_{Amax} \quad (3.129b)$$

$$EI_{cr} = \frac{2EI_1 EI_B}{EI_1 + EI_B} \quad (3.129c)$$

b 2) Moment at end "A" greater than cracking moment ($|M_1| > |M_{1cr}|$ and

$$|M_B| < |M_{Bcr}|)$$

$$\alpha_A = \frac{|M_1|}{|M_{1cr}|} - \frac{|M_B|}{|M_{Bcr}|} < 1 \text{ but } \alpha_A > \alpha_{Amax} \quad (3.130a)$$

$$\alpha_B = 0 \text{ but } \alpha_A > \alpha_{Amax} \quad (3.130b)$$

$$EI_{cr} = \frac{2EI_1 EI_B}{EI_1 + EI_B} \quad (3.130c)$$

b 3) Moment at end "B" greater than cracking moment ($|M_1| < |M_{1cr}|$ and

$$|M_B| > |M_{Bcr}|)$$

$$\alpha_A = 0 \text{ but } \alpha_B > \alpha_{Bmax} \quad (3.131a)$$

$$\alpha_B = \frac{|M_B|}{|M_{Bcr}|} - \frac{|M_1|}{|M_{1cr}|} < 1 \text{ but } \alpha_B > \alpha_{Bmax} \quad (3.131b)$$

$$EI = \frac{2EI_i EI_H}{EI_i + EI_H} \quad (3.131c)$$

b 4) Moment at both ends greater than cracking moments ($M_i > M_{i,c}$ and

$$M_H > M_{H,c}$$

$$\alpha_i = \frac{M_i - M_{i,c}}{M_i - M_H} \text{ but } \alpha_i \leq \alpha_{i,max} \quad (3.132a)$$

$$\alpha_H = \frac{M_H - M_{H,c}}{M_i - M_H} \text{ but } \alpha_H \leq \alpha_{H,max} \quad (3.132b)$$

$$EI = \frac{2EI_i EI_H}{EI_i + EI_H} \quad (3.132c)$$

Where $M_{i,c}$ and $M_{H,c}$ are the cracking moments of the section corresponding to the sign of the applied moments, EI_i and EI_H are the elastic stiffness of the sections at the ends of the element

In the formulation described above, cracking moments are dependent on the sign of the applied moments. Special provisions are made in the program to adjust the flexibility distribution of members where yield penetration has taken place on the whole element, that is, when

$$\alpha_i + \alpha_H \geq 1$$

In such cases the stiffness EI_i is modified to capture the actual distribution considering a new set of yield penetration coefficients that will satisfy $\alpha_i + \alpha_H < 1$ (see Fig. 3.35)

3.5.4 Eigenvalue Analysis

An eigenvalue analysis is carried out using the condensed stiffness matrix of the system

$$([\mathbf{K}_d] - \omega_i^2 [\mathbf{M}_d]) \{\lambda_i\} = \{0\} \quad (3.133)$$

Where $[K_c]$ is the condensed lateral stiffness matrix of the system relating lateral forces and lateral displacements, $[M_c]$ is the diagonal lateral mass matrix of the structure, ω_r circular frequency of the structure for the mode "r", and $\{\lambda\}$ is the corresponding eigenvector. The complete set of eigenvalues for the condensed degrees of freedoms is calculated, that is, the number of eigenvalues calculated equals the number of stories in the building.

The complete set of eigenvectors are stored by columns in the matrix $[\Phi]$. The modal equivalent masses in the structure are calculated according to

$$[M_{eq}] = [\Phi]^T [M_c] [\Phi] \quad (3.134)$$

Where $[M_{eq}]$ is the matrix with the equivalent modal masses in the diagonal. The mass normalized eigenvectors are calculated according to

$$[\Phi_N]_{i,j} = \frac{[\Phi]_{i,j}}{\sqrt{[M_{eq}]_{j,j}}} \quad (3.135)$$

The modal participation is then calculated using the mass normalized eigenvectors

$$\{\Gamma\} = [\Phi_N]^T [M_c] \{1\} \quad (3.136)$$

or for diagonal mass matrices

$$\{\Gamma\}_i = \sum_{j=1}^N M_j [\Phi]_{j,i} \quad (3.137)$$

Where $\{\Gamma\}_i$ is the modal participation factor for mode "r", and $\{1\}$ is a vector of ones.

3.5.5 Structural Response Snapshots

The program IDARC includes the option to determine the response of the structure at instants during the analysis. Several types of response snapshots can be specified

- a) Displacement profile

- b) Element stress ratios
- c) Structural collapse state
- d) Damage indices
- e) Dynamic characteristic (eigenvalue analysis)

Response snapshots can be requested by the user during pushover, quasi-static or dynamic analysis

Two types of response snapshots are specified in the program default and user defined. Default snapshots will be reported, if requested by the user, for the first crack, yield or failure observed in any column, beam or shear wall in the structure during the analysis. Furthermore, all snapshot types are always reported at the end of the analysis. User defined snapshots can be specified for specific base shear or top displacement threshold levels. Using this feature the user can recover the response state of the structure at any particular point during the analysis.

3.5.6 Structural Collapse State

During analysis the state of columns, beams and shear walls is observed. The program keeps track if a structural element has cracked, yielded or failed. The qualification is based on computing deformations to the specified envelope values. This information is automatically reported graphically, at the end of the analysis, but it can also be recovered at any step in the analysis using the response snapshot option. The structural collapse state is reported for each frame in the structure following a simple graphical convention to identify cracked or yielded elements (see Fig. 3.36). Additional information on the state of the structure can be obtained from the damage analysis, presented in Section 3.6.

***** DAMAGED STATE OF FRAMES *****

FINAL STATE OF FRAME NO. 1

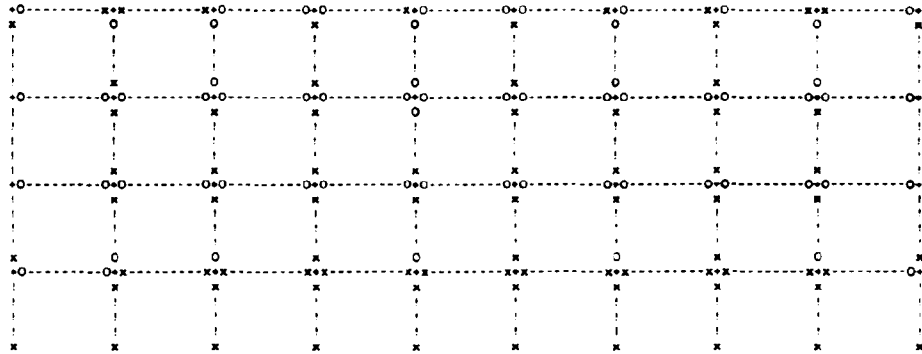

NOTATION:

- = BEAM
- | = COLUMN
- W = SHEAR WALL
- I = EDGE COLUMN
- X = CRACK
- O = YIELD
- FOR EDGE COLS: C: COMPRESSION
- T: TENSION
- O: TENSILE YIELD

FINAL STATE OF FRAME NO. 2

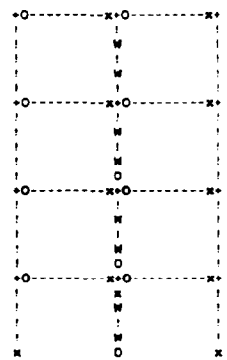

NOTATION:

- = BEAM
- | = COLUMN
- W = SHEAR WALL
- I = EDGE COLUMN
- X = CRACK
- O = YIELD
- FOR EDGE COLS: C: COMPRESSION
- T: TENSION
- O: TENSILE YIELD

Fig. 3.36 Sample of collapsed state response

3.5.7 Element Stress Ratios

During analysis the stress ratios of the structural elements can be reported. This information can only be requested as a response snapshot. This option reports the ratios of demand to ultimate capacity in shear, axial and flexure for columns, beams and shear walls.

3.6 Damage Analysis

Important research efforts have been carried out to develop an accurate damage index to qualify the response of structures. See Reinhorn and Valles (1995) for a summary of various damage indices proposed in the literature. The current release of IDARC incorporates three models for damage index: (i) a modified Park & Ang model (Park et al., 1984, Kunnath et al. 1992b), introduced in the previous releases of the program, (ii) a new fatigue based damage model introduced by Reinhorn and Valles (1995), and (iii) an overall damage qualification based on the variation of the fundamental period of the structure.

The Park & Ang and the fatigue based damage model can be used to calculate different damage indices: element, story (subassembly), and overall building damage. However, for the story and overall damage indices the ultimate inter-story deformation or top story displacement are required, as well as the corresponding story yield shear force or base shear yield force level. Such quantities can be readily determined from a lateral pushover analysis. To determine an estimate of the story and overall damage indices, weighting factors were introduced based on the energy absorption in the different structural elements or stories of the structure. For a description of the methodology necessary to adequately determine story and overall damage indices see Valles et al. (1995).

3.6.1 Park & Ang Damage Model

The Park & Ang damage model (Park et al., 1984) was incorporated in IDARC since the original release of the program. Furthermore, the Park & Ang damage model is also an integral part of the three parameter hysteretic model since the rate of strength degradation is directly related to the parameter β described below (Park et al., 1987).

The Park & Ang damage index for a structural element is defined as

$$DI_{P\&A} = \frac{\delta_m}{\delta_u} + \frac{\beta}{\delta_u P_y} \int dE_h \quad (3.138)$$

where δ_m is the maximum experienced deformation, δ_u is the ultimate deformation of the element, P_y is the yield strength of the element, $\int dE_h$ is the hysteretic energy absorbed by the element during the response history, and β is a model constant parameter. A value of 0.1 for the parameter β has been suggested for nominal strength deterioration (Park et al., 1987). The Park & Ang damage model accounts for damage due to maximum inelastic excursions, as well as damage due to the history of deformations. Both components of damage are linearly combined.

Three damage indices are computed using this damage model.

1. Element damage index: column, beams or shear wall elements
2. Story damage index: vertical and horizontal components and total story damage
3. Overall building damage.

Equation 3.138 is the basis for the damage index computation, although some considerations need to be taken into account as discussed below.

Direct application of the damage model to a structural element, a story, or to the overall building requires the determination of the corresponding overall element, story, or building ultimate deformations. Since the inelastic behavior is confined to plastic zones

near the ends of some members, the relation between element, story or top story deformations, with the local plastic rotations is difficult to establish. For the element end section damage the following modifications to the original model were introduced in version 3.0 (Kunnath et al., 1992b)

$$DI = \frac{\theta_m - \theta_r}{\theta_u - \theta_r} + \frac{\beta}{M_y \theta_u} E_d \quad (3.139)$$

Where θ_m is the maximum rotation attained during the loading history, θ_u is the ultimate rotation capacity of the section, θ_r is the recoverable rotation when unloading, M_y is the yield moment, and E_d is the dissipated energy in the section. The element damage is then selected as the biggest damage index of the end sections.

The two additional indices – story and overall damage indices are computed using weighting factors based on dissipated hysteretic energy at component and story levels respectively.

$$DI_{story} = \frac{\sum (\lambda_i)_{component} (DI)_{component}}{\sum E_{d,component}} \quad (3.140a)$$

$$DI_{overall} = \frac{\sum (\lambda_i)_{story} (DI)_{story}}{\sum E_{d,story}} \quad (3.140b)$$

Where λ_i are the energy weighting factors, and E_d are the total absorbed energy by the component or story “i”.

The Park & Ang damage model has been calibrated with observed structural damage of nine reinforced concrete buildings (Park et al., 1986). Table 3.1 presents the calibrated damage index with the degree of observed damage in the structure.

LIMIT STATE DAMAGE INDEX	DEGREE OF DAMAGE	DAMAGE (SERVICE) STATE	USABILITY	APPEARANCE
(1)	(2)	(3)	(4)	(5)
0.00	None	Undamaged	Usable	Undeformed/uncracked
0.20-0.30	Slight	Serviceable		Moderate to severe cracking
0.50-0.60	Minor Moderate	Repairable	Temporarily Unusable	Spalling of concrete cover
>1.00	Severe	Unrepairable		Buckled bars, exposed core
	Collapse	Collapse	Unusable	Loss of shear/axial capacity

Table 3.1 Interpretation of overall damage index (Park et al., 1986)

3.6.2 Fatigue Based Damage Model

The fatigue based damage model was introduced by Reinhorn and Valles (1996). The damage model was developed based on basic structural response considerations, and a low-cycle fatigue rule. The damage index is:

$$DI = \frac{\delta_u - \delta_y}{\delta_u - \delta_v} \left(\frac{1}{1 - \frac{E_h}{4(\delta_u - \delta_v)F_y}} \right) \quad (3.141)$$

Where δ_u is the maximum experienced deformation, rotation, or curvature; δ_y is the yield deformation capacity; δ_v is the ultimate deformation capacity; F_y is the yield force capacity; and E_h is the cumulative dissipated hysteretic energy

The damage index proposed can be used to qualify the performance of structural elements, stories (subassemblies), or the overall response of the building. Yield and ultimate capacities for story and overall assemblies can be easily determined using the pushover analysis option. However, since these capacities are not readily available during

a time history analysis, weighting of element damage indices using dissipated energy considerations are used (see considerations described in the Park & Ang damage model) See Valles et al. (1995) for a detailed methodology on how story and overall building damages can be obtained combining the results from pushover and time history analysis

Note that simplifying the fatigue based damage model for the case when the ratio $(\delta_u - \delta_v)/(\delta_u + \delta_v)$ is close to one Eq. 3.141 simplifies to

$$DI = \frac{\delta_u - \delta_v}{\delta_u + \delta_v} + \frac{E_p}{4(\delta_u - \delta_v)E_s} \quad (3.142)$$

That is the Park & Ang damage formulation for $\beta = 0.25$. Therefore, the Park & Ang damage model is correlated to the fatigue based model for maximum deformations close to the ultimate capacity of the element. For more details on the fatigue based damage model see Reinhorn and Valles (1995)

3.6.3 Global Damage Model

Another measure of how much the structure has undergone damage is to study the variation in the fundamental period of vibration of the structure. This history is related to the overall stiffness loss in the structure due to inelastic behavior. The history of the variation of the first mode of vibration is part of the user defined snapshot options in the program, as described in Section 3.5.5

DiPasquale and Cakmak (1988) defined the softening of the structure as

$$DI = 1 - \frac{(T_s)_{\text{initial}}}{(T_s)_{\text{equivalent}}} \quad (3.143)$$

Using the snapshot option to print the variation of the fundamental period, the softening of the structure can be estimated

SECTION 4

PROGRAM VERIFICATIONS AND EXAMPLES: CASE STUDIES

4.1 Component Testing: Full Scale Bridge Pier Under Reversed Cyclic Loading

A series of full-scale and scale model circular columns were tested at the laboratories of the National Institute of Standards and Technology (Stone and Cheok, 1989, Cheok and Stone, 1990). These columns represent typical bridge piers designed in accordance with Caltrans specifications. The piers were tested by applying both axial and lateral loads as shown in the experimental set-up in Fig. 4.1. The column analyzed in this sample investigation is a full-scale circular bridge pier measuring 30 feet with an aspect ratio of 6.0. The tests were performed using a displacement controlled quasi-static history as shown in Fig. 4.1. The column was made of 5.2 ksi concrete (measured compressive strength at 28 days) and had a modulus of elasticity of approximately 4110 ksi. Grade 60 steel with an actual yield stress of 68.9 ksi and elasticity modulus of 27438 ksi was used as longitudinal reinforcement. The steel exhibited good ductility in the material testing with a 2% strain and a strain hardening of 1454 ksi before actual rupture. The cross-section in Fig. 4.1 also shows the reinforcement details. The experiment was analyzed using data presented in the Input Data Sheet for Case Study #1 (see Appendix B).

The purpose of this analysis is to simulate the essential characteristics of the hysteretic behavior and compare it with the experimental recorded response. The modified three parameter hysteretic model was used with a stiffness degradation coefficient $HC=9.0$, strength degradation coefficient $HBE=0.05$, $HBD=0.0$ (very little deterioration in strength), and a pinching coefficient $HS=1.0$ (indicating no pinching). These parameters were estimated from the observed experimental loops, and could be used to represent well-detailed section. The response obtained from the analysis is compared with the test results in Fig. 4.2. The maximum loads attained in the analysis,

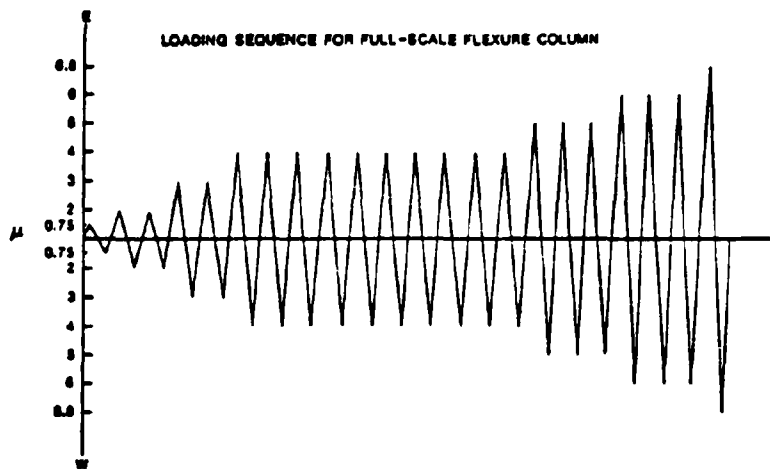
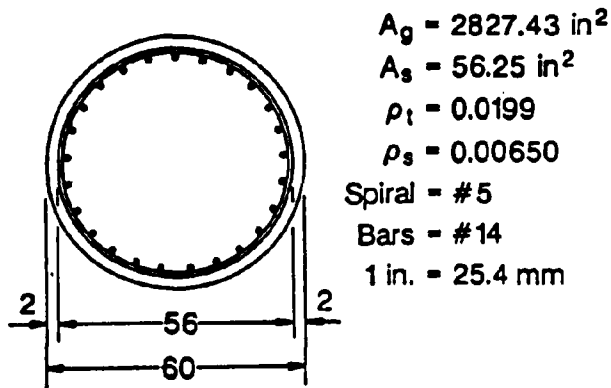
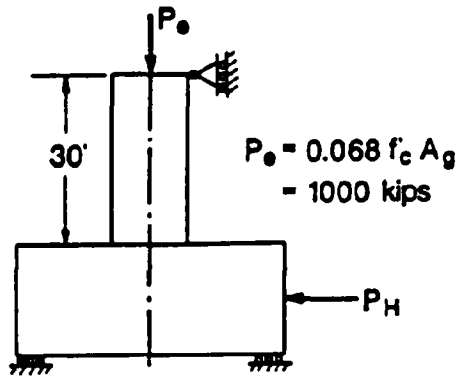

Fig. 4.1 Configuration and loading of full-scale bridge Pier

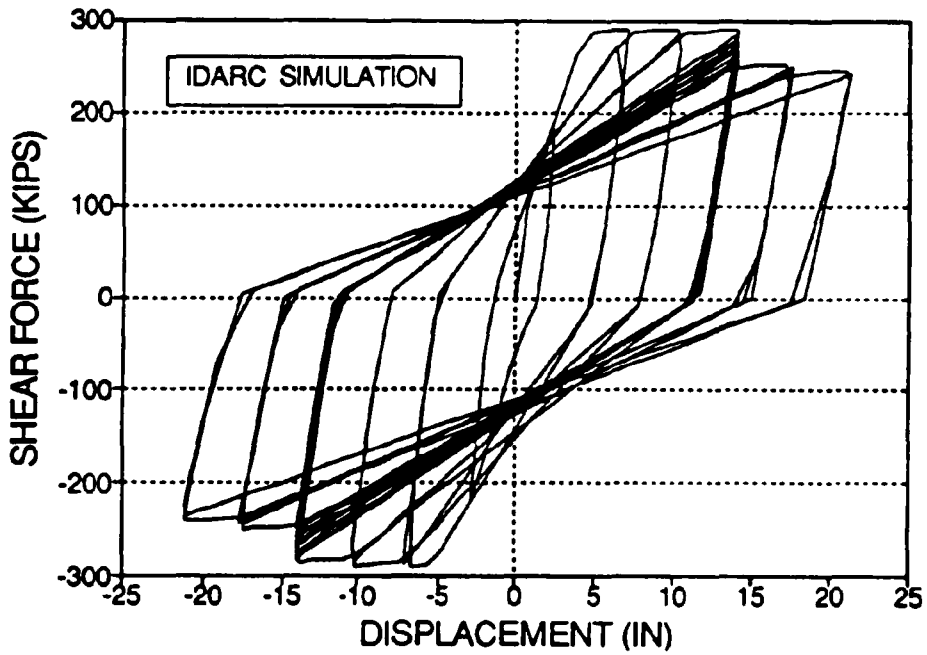
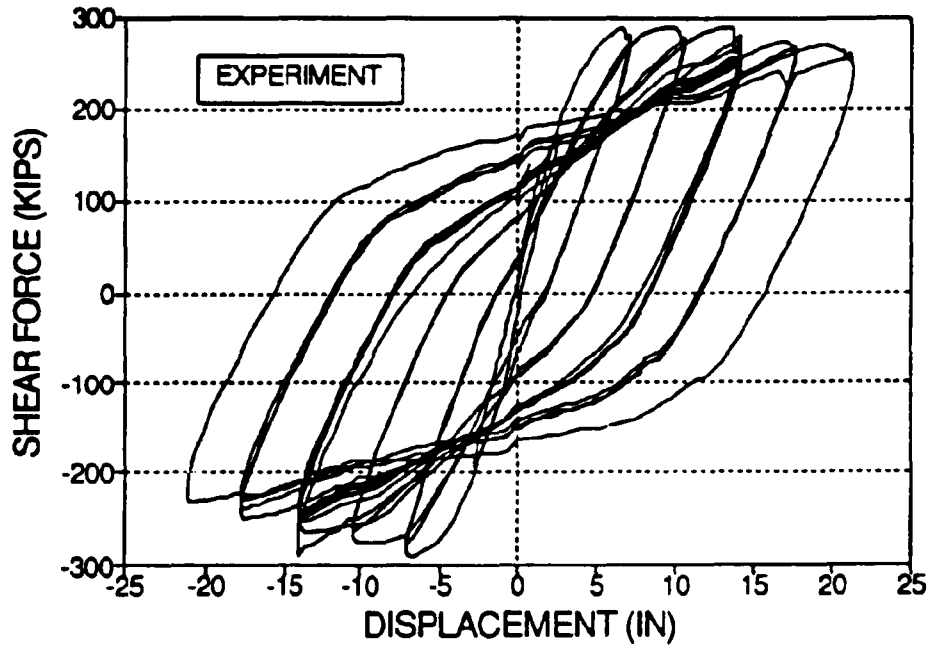

Fig. 4.2 Comparison of observed vs. computed response

290 kips and 3.6 kips (positive and negative) compare well with those observed in the tests, 284 kips and 296 kips, respectively

The damage evaluated using the analytical model is presented in Fig. 4.3. Part of the damage is due to permanent deformations while part is due to strength deterioration from hysteretic behavior. Note that the deformation damage stays constant during the phase in which the column was cycled repeatedly at a ductility of 4.0. The total damage reaches approximately 0.9, which is indicative of extremely large damage, usually beyond repair, as was the case for the tests presented here. It must also be pointed out that the specimen was able to sustain an additional one and half cycles before failure at a ductility of 0.8.

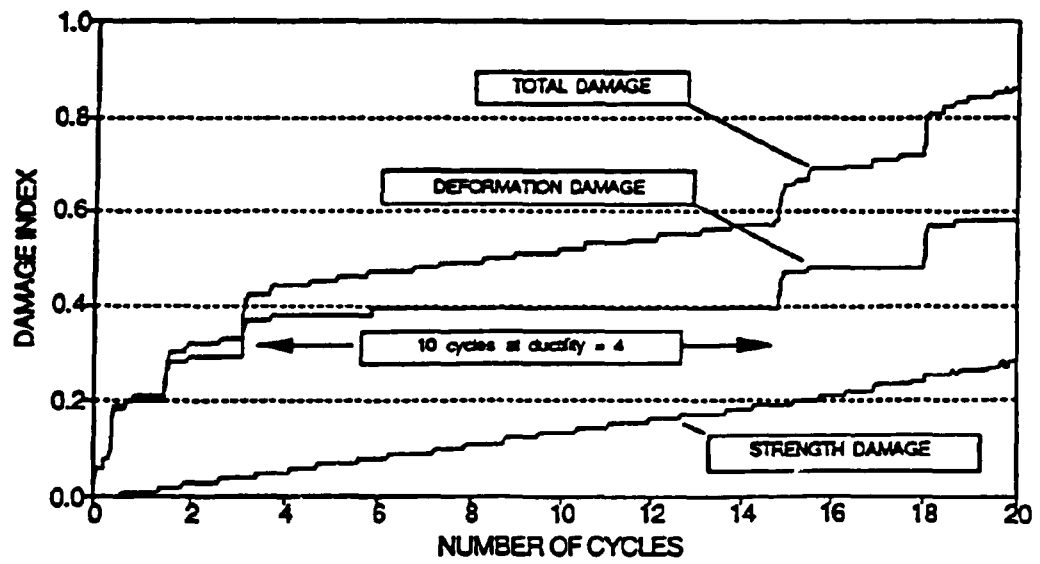

Fig. 4.3 Progressive damage history during cyclic testing

4.2. Subassemblage Testing: 1:2 Scale Three-Story Frame

A 1:2 scale model of a three-story frame, typical to construction practice of reinforced concrete structures in China, was tested in the laboratory by Yunfei et al (1986). The structure was tested using a displacement controlled loading as shown in Fig. 4.4. The geometry of the frame and the essential reinforcement used for the analysis is also shown in Fig. 4.4. The frame is made of 40.2 MPa concrete and is reinforced by Grade 40 steel (400 MPa yield strength). Default parameters were used for the other material property information (see zero input in data Case Study #2, Appendix B). The first three cycles of loading produced cracking and first yielding. Subsequent loading of three cycles at the same ductility were applied until the frame collapsed.

The model was analyzed using the data specified in the data sheet for Case Study #2 in Appendix B. The hysteretic parameters were initially assigned based on well-detailed ductile sections obtained from the previous case study. These parameters were found to be adequate in reproducing the overall system response, however, a better estimate was obtained by increasing the strength degrading parameter. The final parameters, HC=8 for stiffness degradation, HBE=0.1 for strength deterioration and HS=1.0 for bond slip (pinching), produced excellent agreement of force levels at the larger amplitude cycles as shown in Fig. 4.5.

The choice of hysteretic parameters is important, but not critical in establishing the overall system response. For example, values of HC between 4.0 and 9.0, and values between 0.05 and 0.10 would have produced almost comparable results. As will be pointed out later, a proper choice of hysteretic parameters becomes important for local failure cases due to effects of bar pull-out, pinching shear, etc., or when microconcrete is used for small-scale models (1/4 or greater). In this case study, no special connection behavior was modeled.

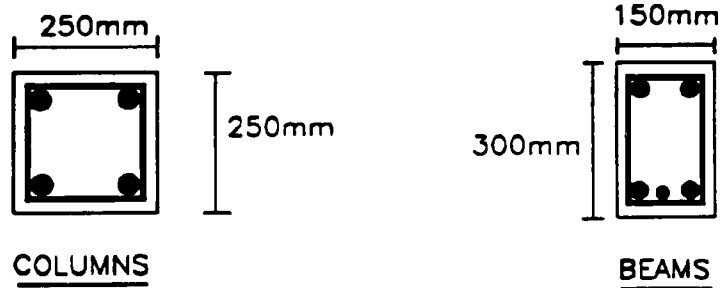
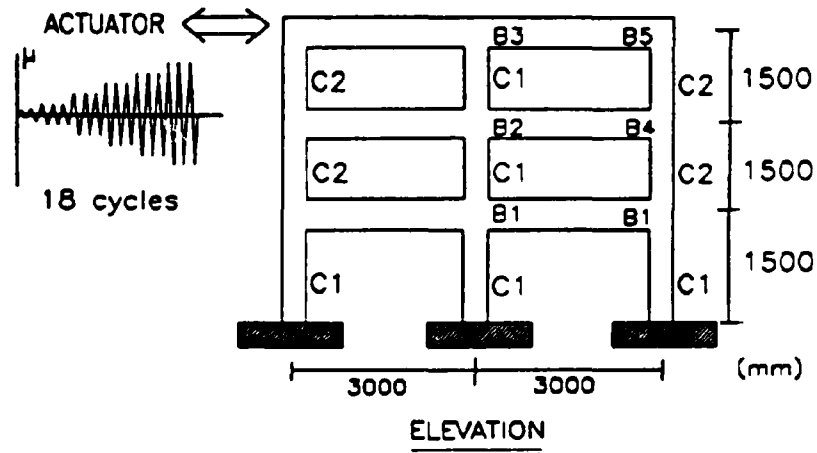

(dimensions in mm)

SECTION	NO OF BARS & BAR DIA	HOOPS
COLUMN C1	4 # 14	12mm@75 mm
COLUMN C2	4 # 12	8mm@75 mm
BEAM B1	TOP: 2 # 16 BOT: 2 # 16	6mm@75 mm
BEAM B2	TOP: 2 # 16 BOT: 2 # 16, 1 # 10	6mm@75 mm
BEAM B3	TOP: 2 # 12 BOT: 2 # 14	6mm@75 mm
BEAM B4	TOP: 2 # 18 BOT: 2 # 16	6mm@75 mm
BEAM B5	TOP: 2 # 14 BOT: 2 # 14	6mm@75 mm

Fig. 4.4 Details of half-scale model frame

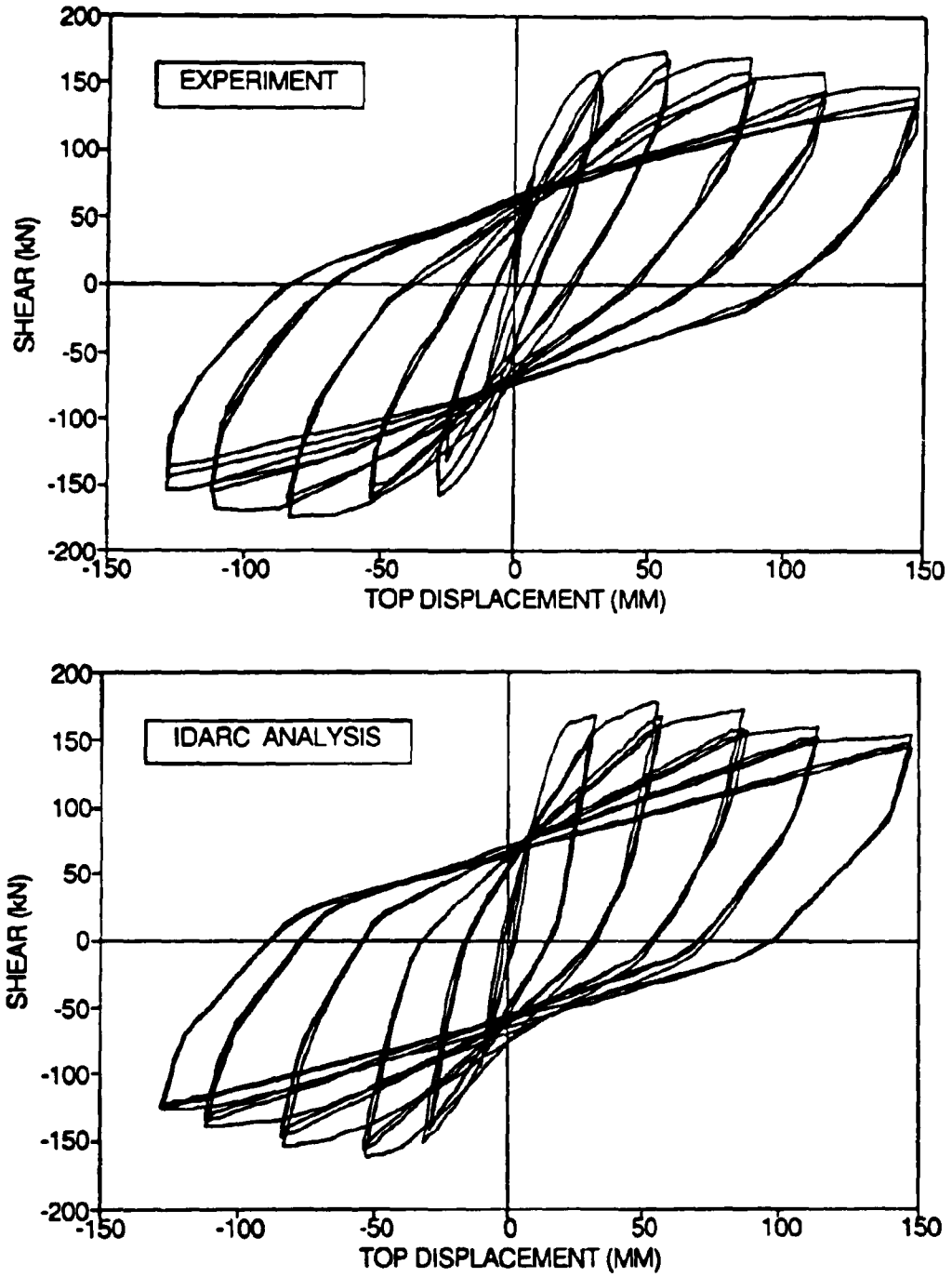

Fig. 4.5 Comparison of observed vs. simulated force-deformation response

The present version of the program calculates the dissipated hysteretic energy of components that can be used as an identification target for the choice of hysteretic parameters. In the current analysis, the identification was directed towards the maximum force level which involves only the strength deterioration parameter. Hysteretic energy is also a known measure of structural damage. Fig. 4.6 presents a comparative representation of dissipated energy and total system damage. A maximum damage of about 0.6 was achieved in the analysis, indicating that the global damage index is less sensitive to local damage accumulated at individual sections. Therefore, it will be necessary to calibrate global indices before they can be used in damage assessment.

Another feature of the IDARC program is the push-over analysis under monotonically increasing lateral loads. This feature was used to determine the correspondence with the observed collapse mechanism. The frame developed a beam side sway collapse mechanism that was clearly documented in the experimental records through measured rebar yielding in the critical beam-column interface and column-base sections, and identified by visual observations. Fig. 4.7 shows the damaged frame with observed plastic hinge locations and computed sequence of hinge formation using IDARC.

Finally, the progression of damage history is shown in Fig. 4.8 for each of the story levels. The upper two levels did not experience any column damage. Studies of this nature can be used to calibrate damage models using ductility demand and dissipated hysteretic energy as controlling criteria.

The two cases studies presented this far are based on displacement controlled loading, which is typical in laboratory testing of components and subassemblies. IDARC can also be used for force-controlled loading histories.

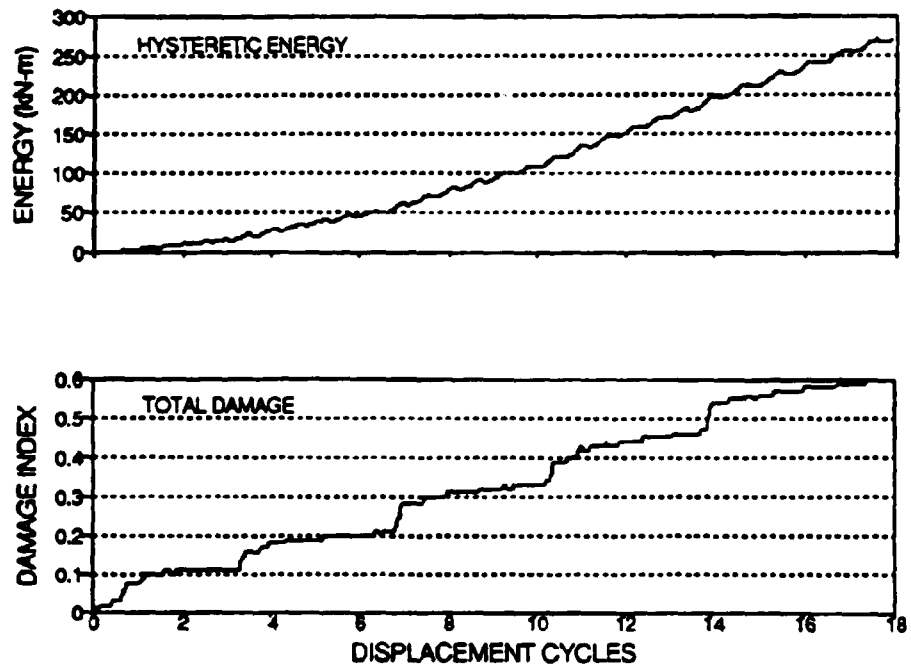
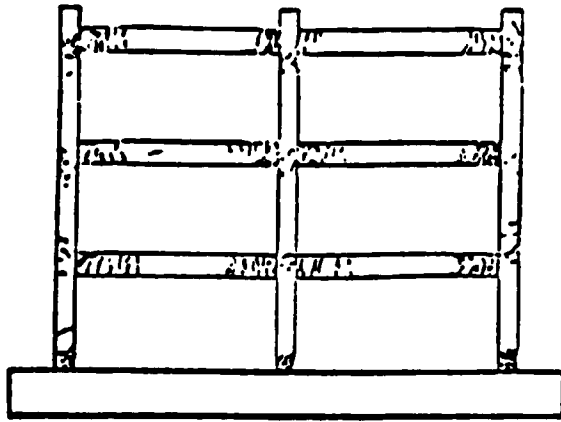
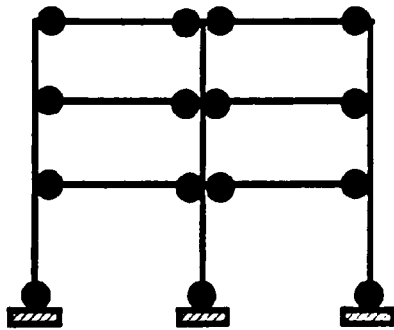

Fig. 4.6 Correlation of dissipated energy and global damage



(a) DAMAGED FRAME



(b) EXPERIMENT

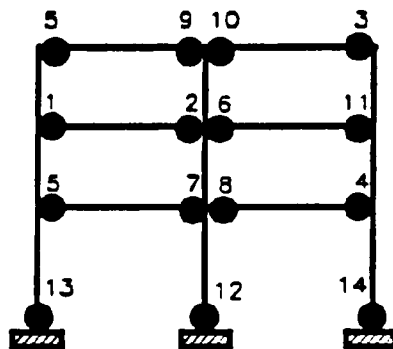

(c) ANALYSIS

NOTATION:

● PLASTIC HINGE

Numbers indicate sequence of plastic hinge formation

Fig. 4.7 Study of collapse mechanism

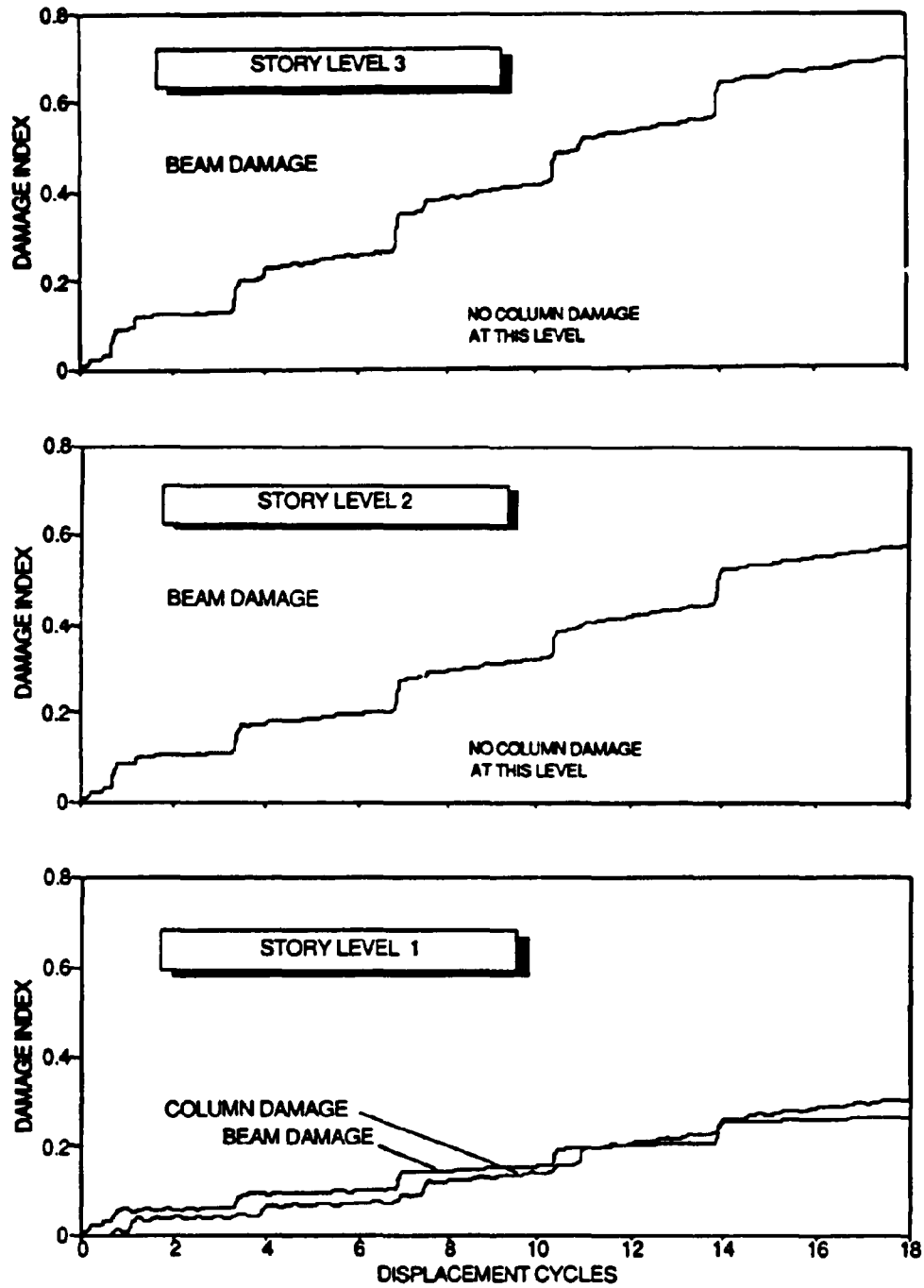
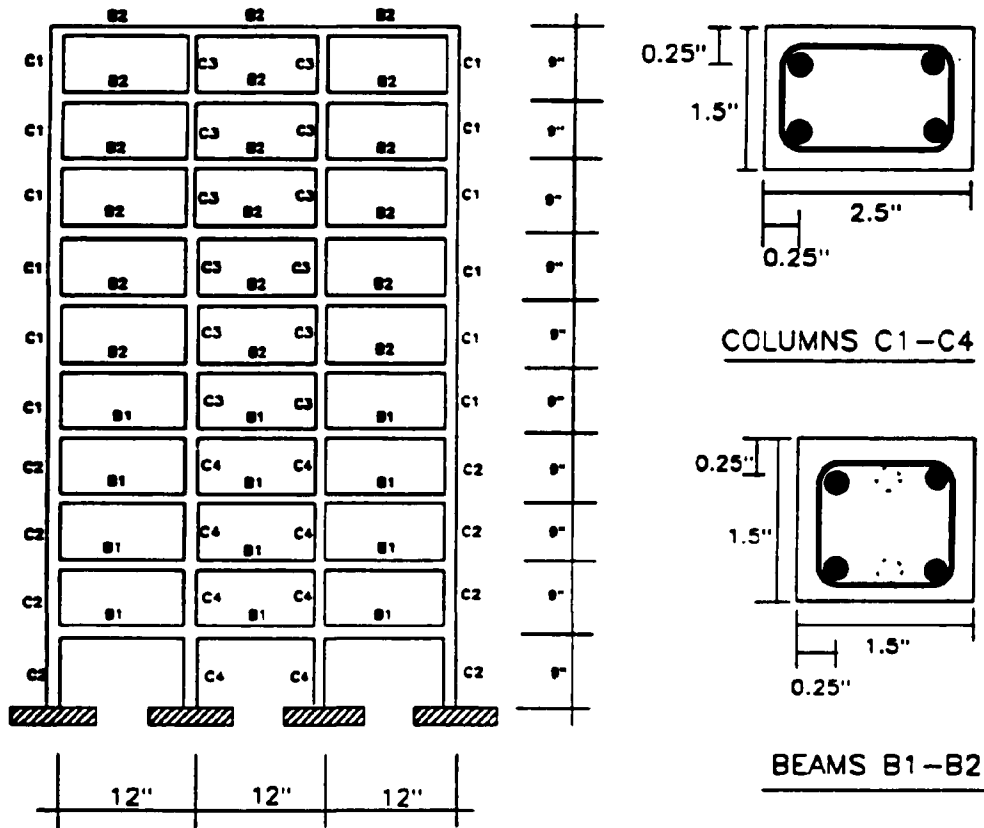

Fig. 4.8 Progressive story level damage

4.3 Seismic Simulation: Ten-Story Model Structure

This study is based on shaking table tests of a ten story, three-bay frame, scale model of a structure conducted at the University of Illinois, Urbana (Cecen, 1979). The model was subjected to similar earthquake ground motions at levels that produce strong inelastic behavior and damage. The geometrical configuration, element designation, dimensions and reinforcement details are shown in Fig. 4.9. The model is made of 4350 psi concrete and grade 60 steel with a measured yielding strength of 70 ksi and modulus of elasticity of 29000 ksi. The initial concrete modulus was adjusted to provide a fundamental period consistent with observed response. This is an important consideration when initial conditions, such as cracking resulting from gravity loads or model construction, produce a system that is not consistent with gross moment of inertia computations.

The model was subjected to scaled ground excitations with 2.5 times compression of the 1940 El Centro accelerogram. The peak base accelerations of the three successive seismic inputs were: 0.36g, 0.84g and 1.6g respectively, as shown in Fig. 4.10. The purpose of this case study is to compare the analytical response with the experimental results when severe nonlinearities resulting from progressive damage are observed. The second objective of the study is to compare the analytical performance with other analytical programs that perform similar tasks. The analysis was done using the information presented in the input data sheets for Case Study #3 (see Appendix B). The structure is modeled by mass similitude with a total floor weight of 1000 lbs per floor. The dynamic analysis is performed considering an integration time step of 0.001 sec. Hysteretic parameters used are listed in the input data sheet. There was no predetermined basis for the choice of hysteretic parameters. The program default values were used for both beams and columns, with the exception of the stiffness degrading parameter for columns where the program assigned default is 2.0. However, results of testing on relatively small scale components (1/4 or greater) indicate that the parameter HC is much smaller, and a suggested value of HC = 0.5 - 1.0 is recommended in such cases.



SECTION	LONG. REINF (each face)	TRANS. REINF.
BEAM B1	2#13	#16 gage @ 0.3"
BEAM B2	3#16	- " -
COLUMN C1	2#10	#16 gage @ 0.35"
COLUMN C2	2#7	- " -
COLUMN C3	2#13	- " -
COLUMN C4	2#8	- " -

Fig. 4.9 Configuration and reinforcement details for model structure

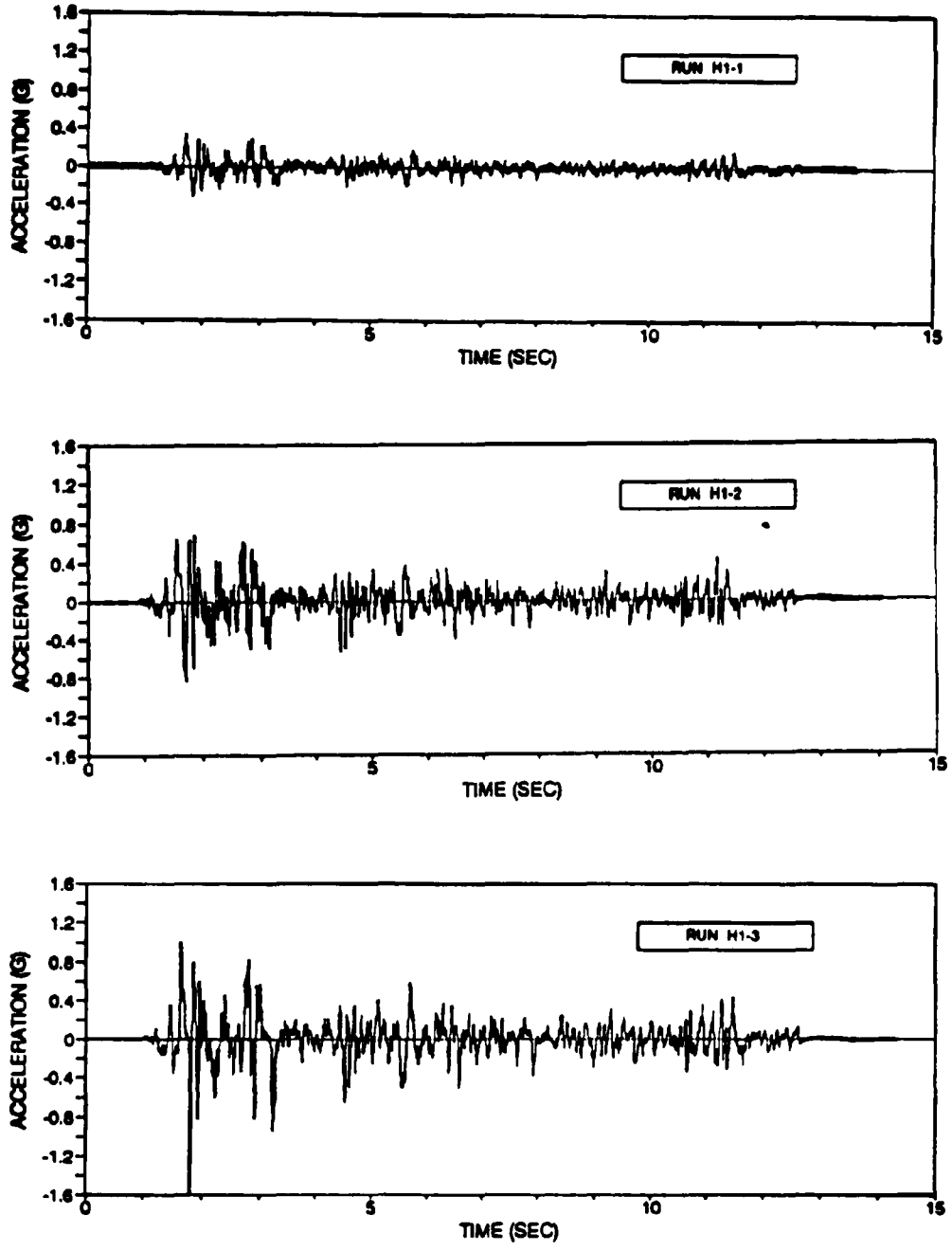

Fig. 4.10 Achieved table motions for seismic testing

The comparison of the analytical and experimental results in terms of (i) peak accelerations is shown in Fig. 4.11, and (ii) peak displacements is shown in Fig. 4.12. The maximum displacement reported in Cecen (1979) are based on one-half the double amplitudes, while the IDARC values are absolute peak. The entire displacement histories compare more favorably as will be discussed next.

The analysis results are also compared with two other computer programs: (i) SARCF-III (Gomes et al., 1990) and (ii) DRAIN-2D (Kaanan and Powell, 1971). Since both SARCF and DRAIN use bilinear envelopes, only the initial stiffness and yield moments were provided as basic input. The default Takeda degrading model was used in DRAIN, while the damage-based hysteretic model was used in SARCF. The results are presented in Figs. 4.13 through 4.15. IDARC shows peak differences ranging between 3% to 10% of experimentally observed values. It can also be observed that an excellent agreement is obtained using IDARC for RUN H1-3 which has the largest inelastic response.

In all three programs, the three seismic inputs were provided successively as a continuous ground motion, so that the effects of each run were carried forth to the next without returning the system to undamaged conditions. Recording instruments, on the other hand, are typically reset to zero conditions between tests, thereby making it difficult to track permanent deformations, if any.

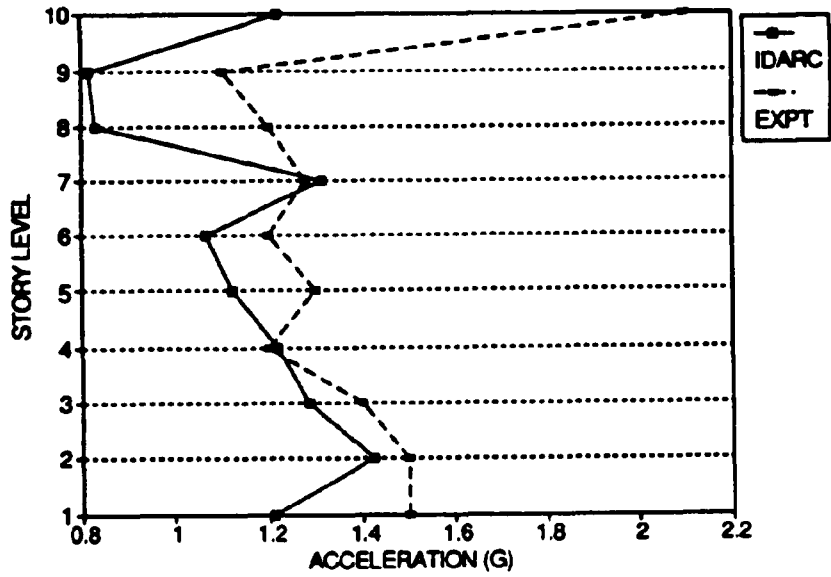

Fig. 4.11 Computed versus observed peak acceleration response.

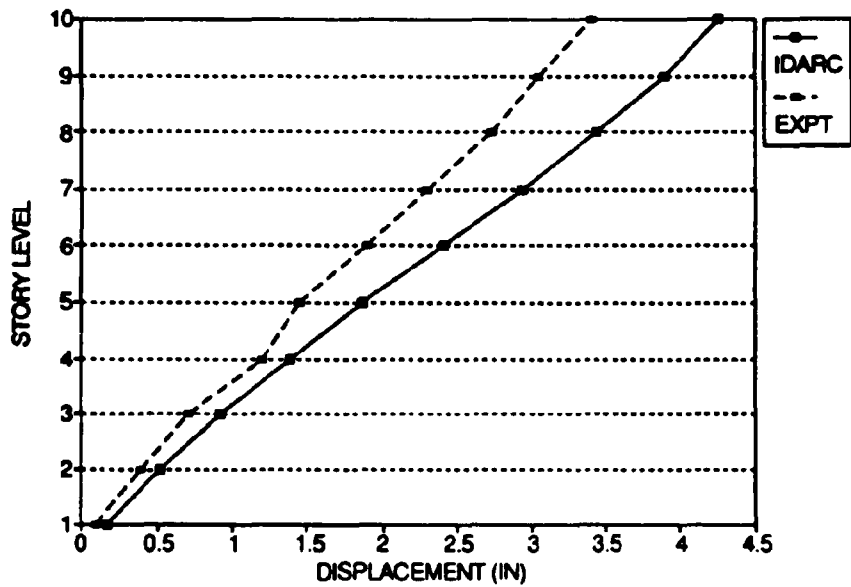

Fig. 4.12 Computed versus observed peak displacement response

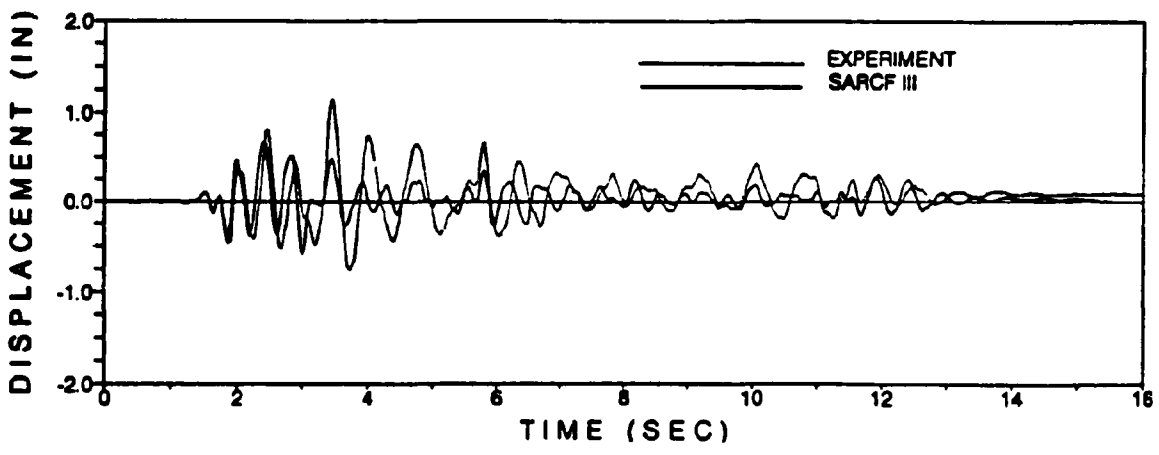
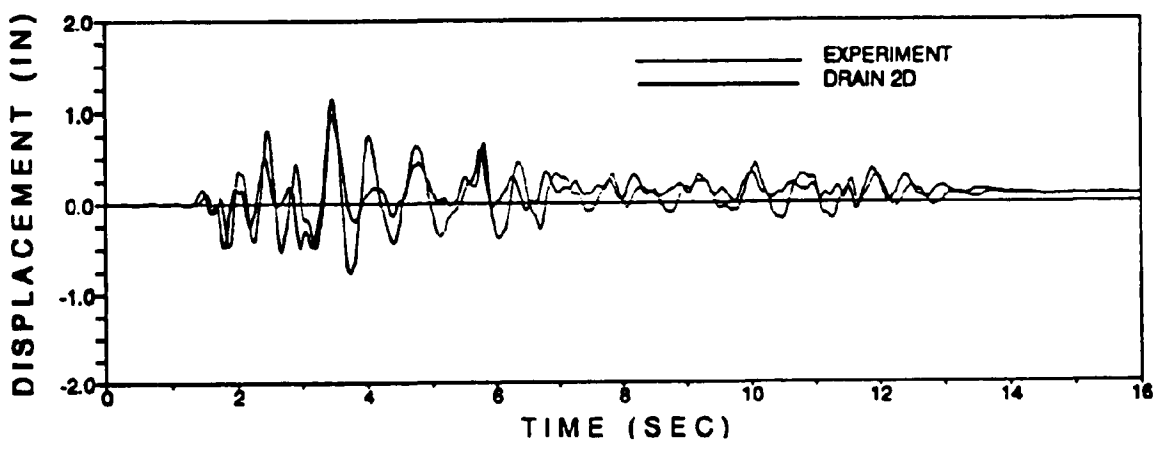
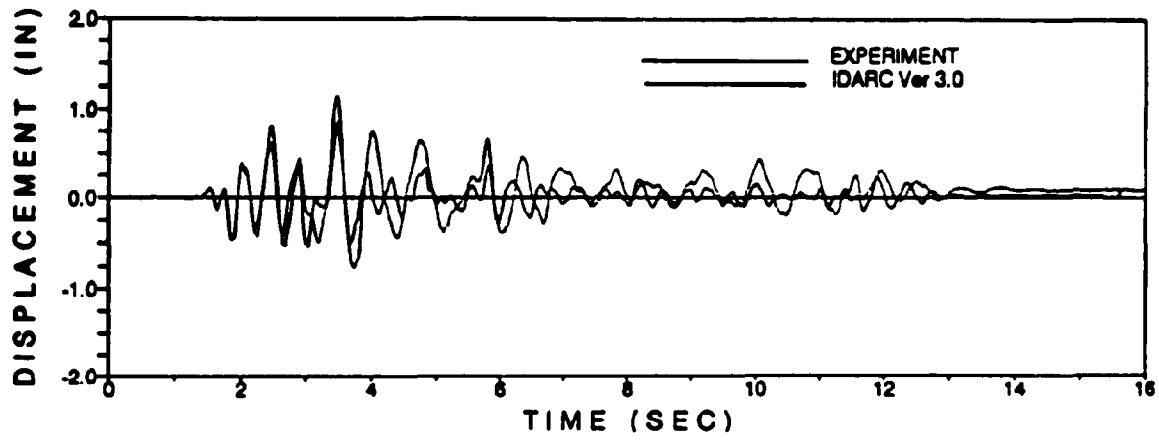

Fig. 4.13 Comparison with other programs (Low intensity)

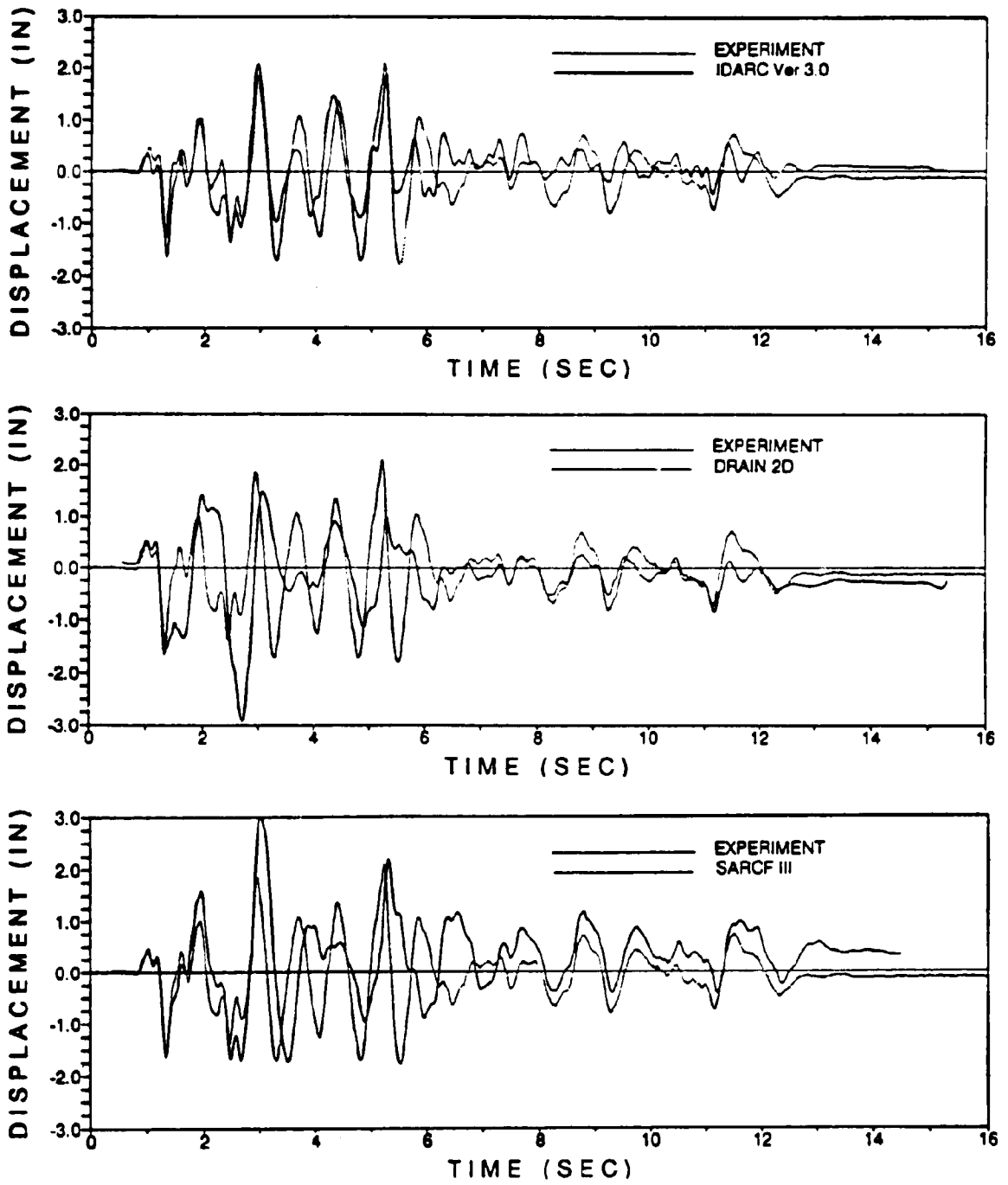

Fig. 4.14 Comparison with other programs (Moderate intensity: Inelastic)

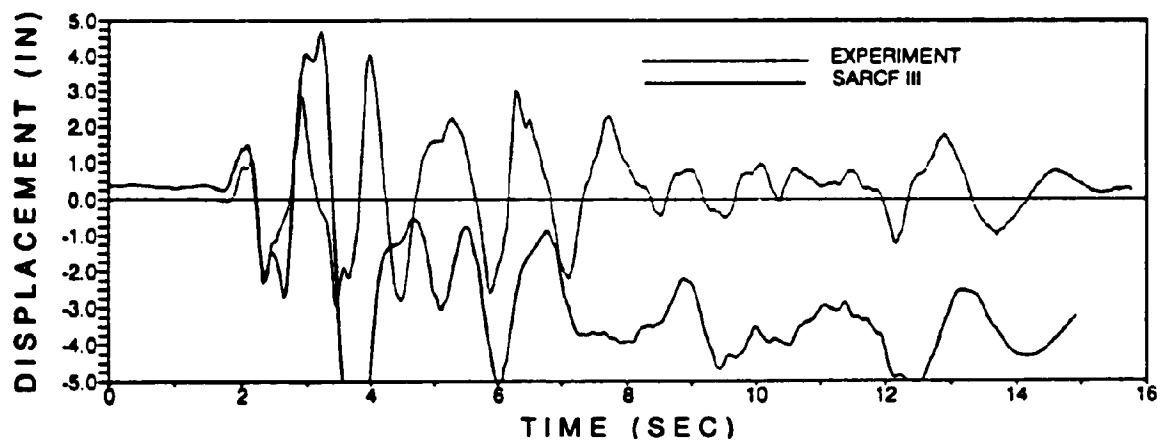
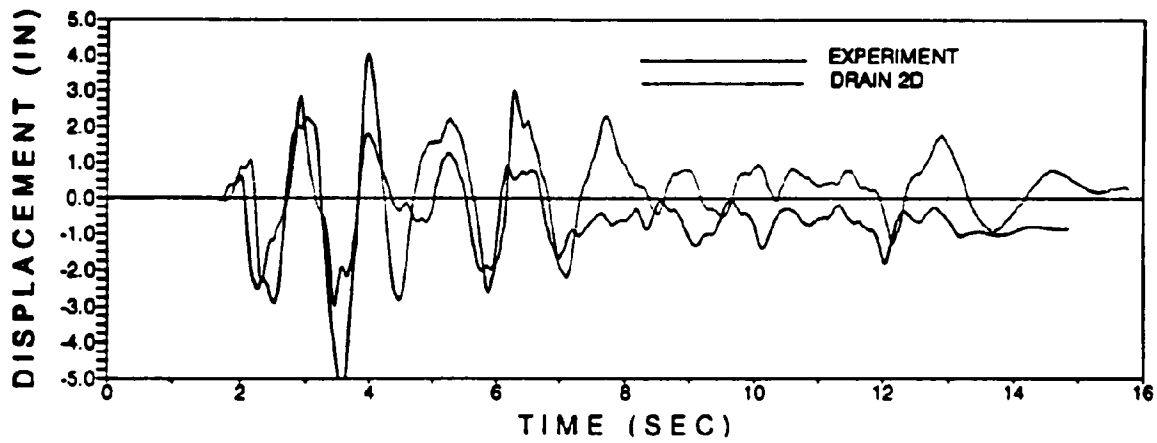
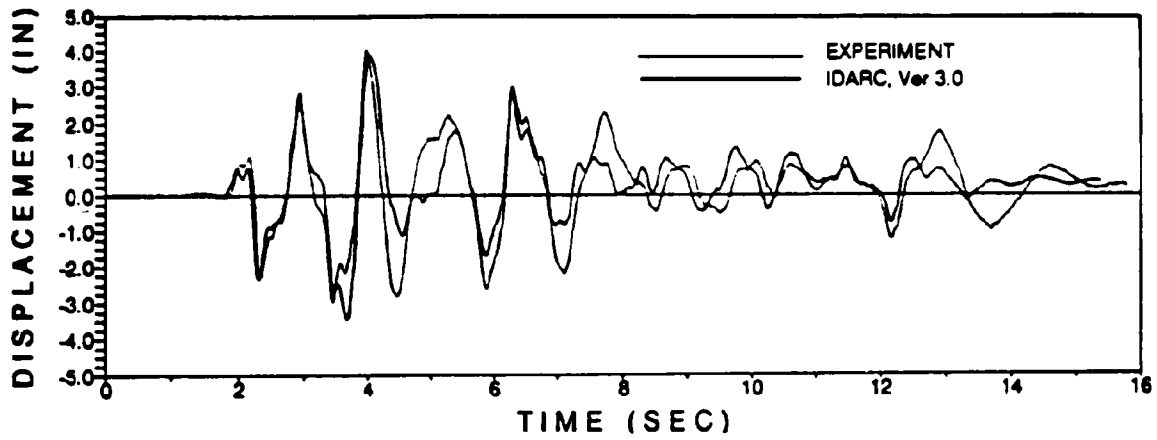

Fig. 4.15 Comparison with other programs (Highly inelastic)

4.4 Seismic Response: 1:3 Scale Model Lightly Reinforced Concrete Structure

A comprehensive study of lightly reinforced frame structures was the subject of numerous investigations at the State University of New York at Buffalo (Bracci, 1992), and at Cornell University (El-Altar, 1990). A 1:3 scaled model was constructed, tested, retrofitted and re-tested using simulated earthquake motion generated by the shaking table at SUNY/Buffalo. The model reflects a "slice" of a long structure with three-bay frames in the transverse direction. The "slice" has two parallel lightly reinforced frames as indicated by the model representation in the plan view in Fig. 4.16. Essential geometrical data and reinforcement details are also shown in the figure. Attained concrete strength were 4000 psi, 3000 psi and 3500 psi at the first, second and third story levels respectively, with an elastic modulus of 2700 ksi, 2300 ksi and 2530 ksi, respectively. The steel had an average yielding strength of 65 ksi after annealing with modulus of elasticity of approximately 29000 ksi. Additional details about the structure and the testing can be found in Bracci (1992).

The model was tested by a sequence of ground (table) motions reflecting a low level earthquake (PGA = 0.05g), a moderate earthquake (PGA = 0.20g) and a severe earthquake (PGA = 0.30g). The ground motion was obtained by scaling the acceleration time history of Taft (1952) N21E component. Only two sets of results are presented here.

The main purpose of this study was to investigate the effectiveness of using identified component properties from separate sub-assembly tests in predicting the dynamic response of the total structure. The data set used for in this example is presented in Appendix B. Only the second run at a measured peak acceleration of 0.22g is included, since the basic data is the same for both runs, with the exception of the initial stiffness and the input ground motion. As indicated, the data was derived entirely from the results of separate interior and exterior beam-column sub-assembly tests which provided information on yield strength and hysteretic behavior. No attempt was made to fit the observed shaking table response.

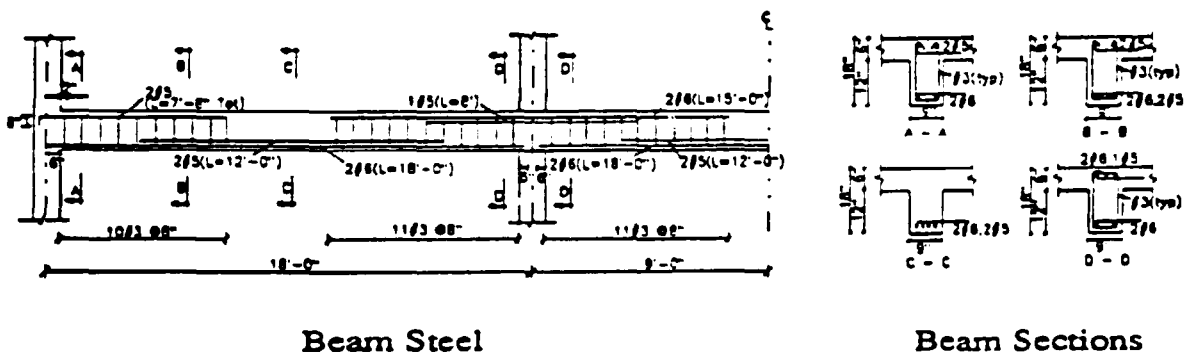
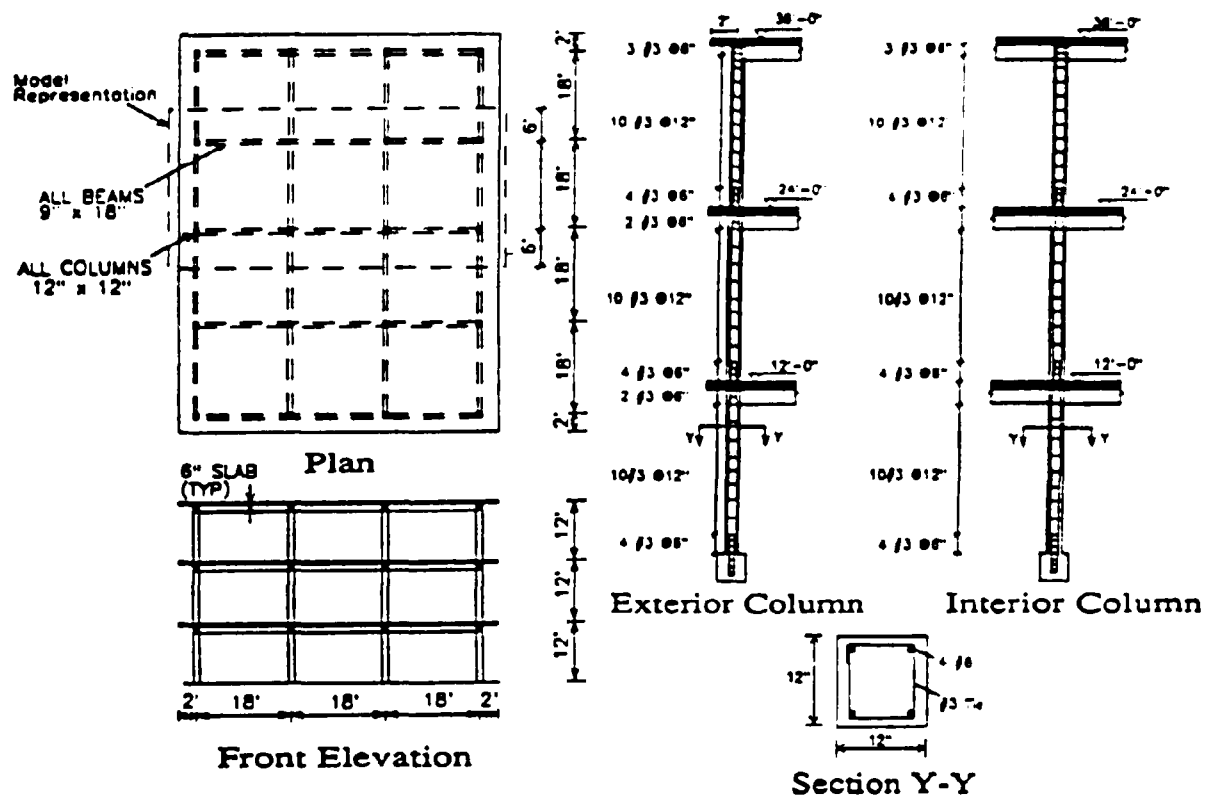

Fig. 4.16 Details of gravity-load-designed frame building

The comparison of displacements for the top story during the mild and moderate earthquakes are shown in Fig. 4.17 and 4.18. IDARC predictions show good agreement for both peak values and the total response history. The comparison includes predictions by DRAIN-2D and SARCF. More data on observed behavior in terms of deformations, stresses and damage mechanisms are reported in Bracci (1992).

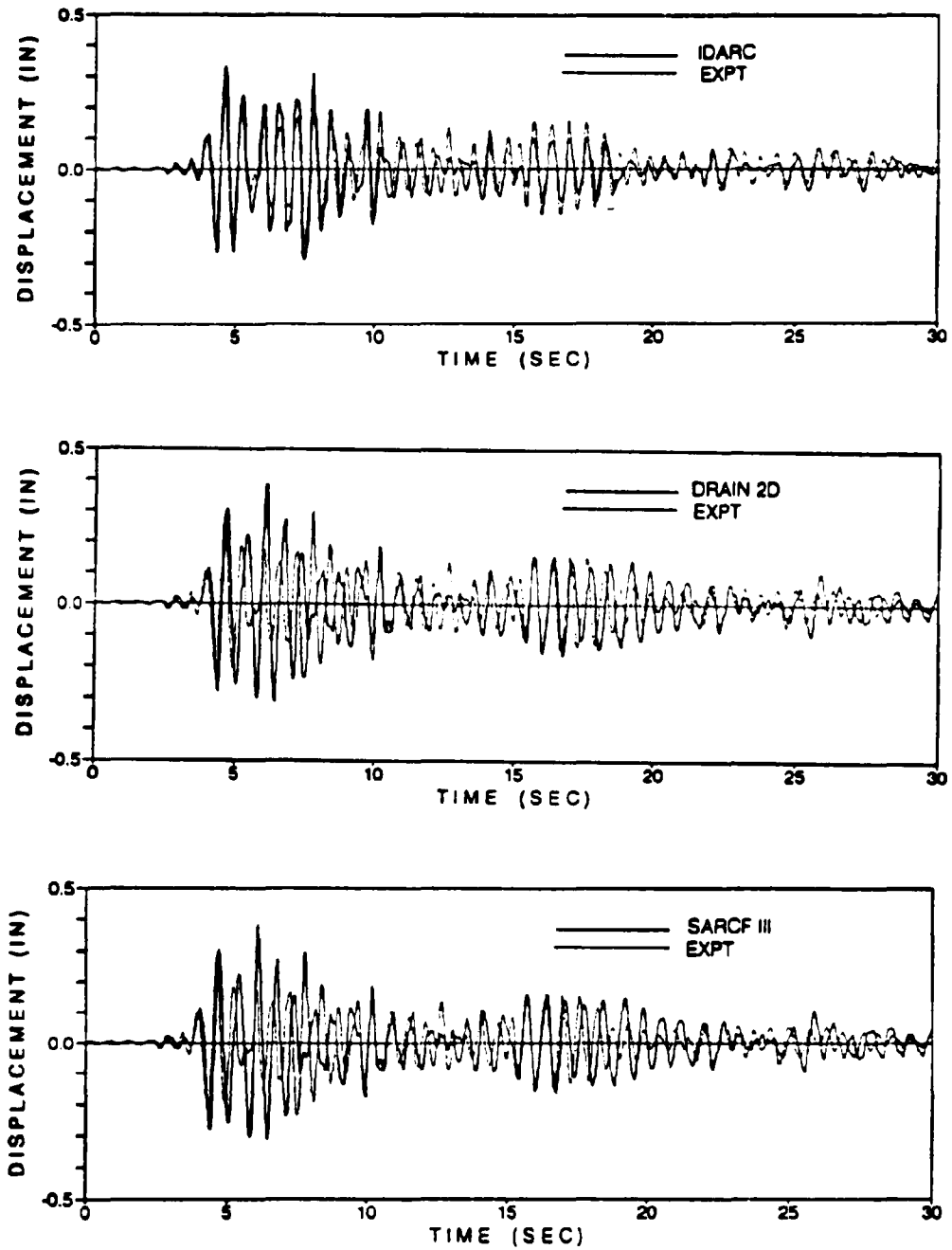

Fig. 4.17 Comparison with other programs - low intensity (0.05g)

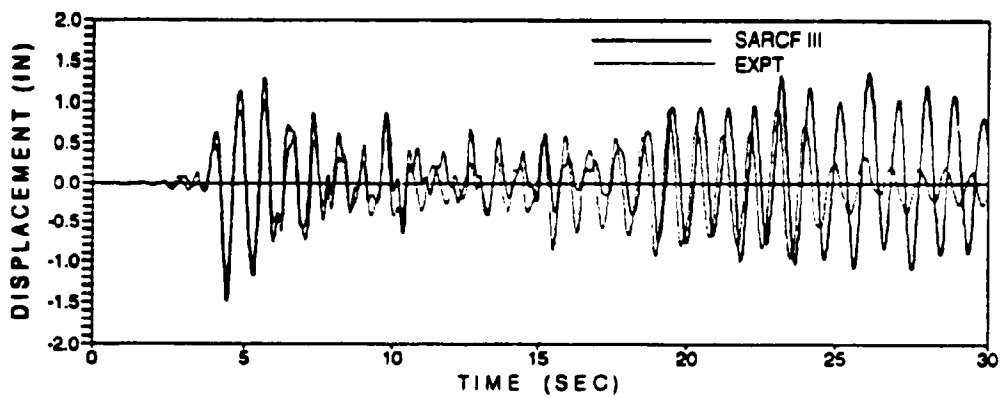
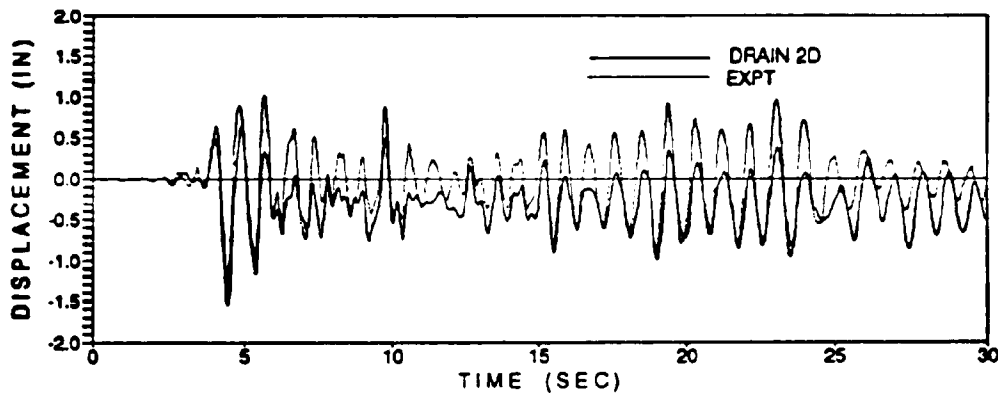
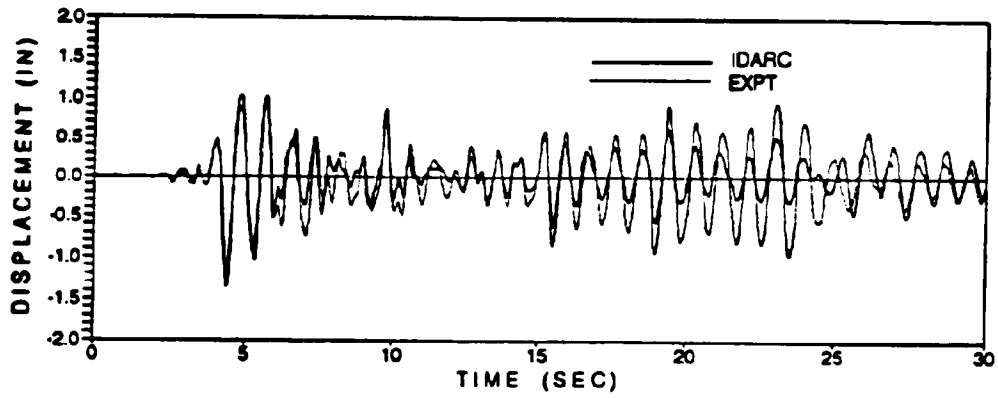

Fig. 4.18 Comparison with other programs - moderate intensity (0.22g)

4.5 Damage Analysis: Cypress Viaduct Collapse During the 1989 Loma Prieta Earthquake

The collapse of the Cypress Viaduct during Loma Prieta Earthquake in 1989 provided an excellent opportunity to verify IDARC in seismic damage evaluation of an existing structure. The Cypress structure consisted of a boxed girder roadway supported by a series of 83 reinforced concrete two-story bents. Eleven bent types were used in the construction of the viaduct. Fifty-three of the bents were designated as Type B1, which consist of two portal frames, one mounted on top of the other (Fig. 4.19). The upper frame is connected to the lower by shear keys (hinges). The dimensions of a typical B1 bent and its reinforcement details are shown in Fig. 4.19. Type B1 bents suffered the most damage and seemed to have failed in the same consistent manner throughout the freeway.

The structure was modeled using a combination of tapered column, shear-panel and beam elements. The pedestal region was modeled as a squat shear wall so that its impending shear failure could be monitored. The Outer Harbor Wharf horizontal strong-motion records were transformed to 94°, which is transverse to the alignment of the collapsed portion of the viaduct. The influence of gravity loads on the structure was simulated by imposing a ramp load in the form of a vertical excitation with magnitude of 1g. The actual ground motions were introduced after the resulting free vibrations had damped out. The data used for the analysis is presented in the data sheet for Case Study #5 in Appendix B.

The purpose of this analysis is to demonstrate the use of the program in the practical analysis of existing structures. The IDARC model of the bent is shown in Fig. 4.20. The imposed vertical and horizontal motions on the structure are shown along with the top level displacement response in Fig. 4.21. The analysis with IDARC revealed that the first element to fail was the left-side pedestal after approximately 12.5 seconds into the earthquake, note that the plot shown in Fig. 4.22 includes an initial 4 seconds of gravity load input. A plot of the damage history of the pedestal is shown in Fig. 4.22, in

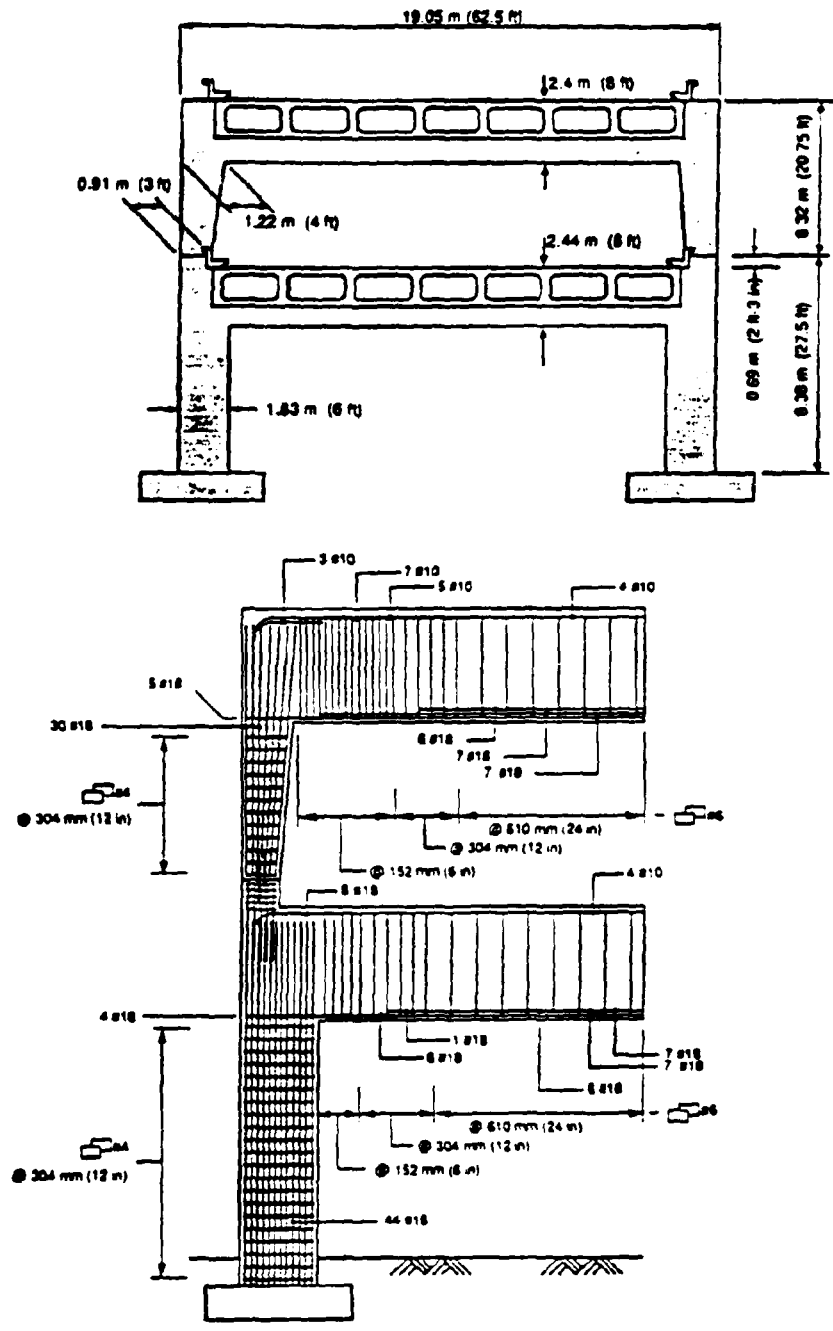

Fig. 4.19 Structural configuration and reinforcement details of type B1 bent

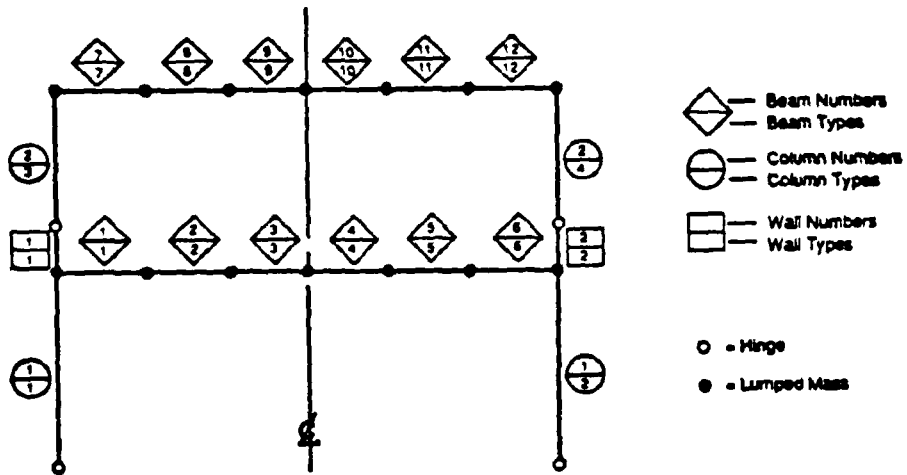
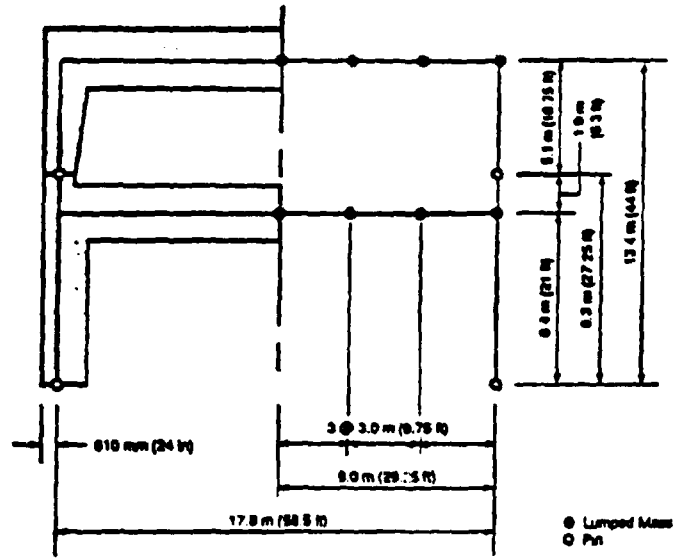

Fig. 4.20 IDARC model used in damage analysis

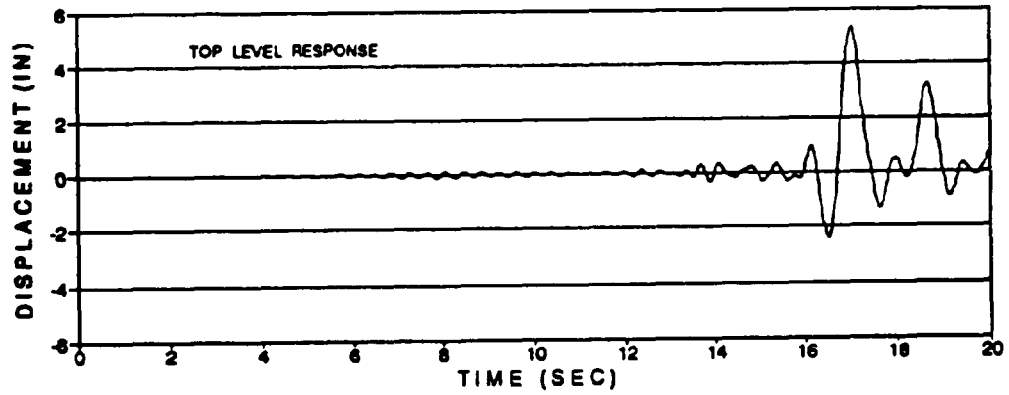
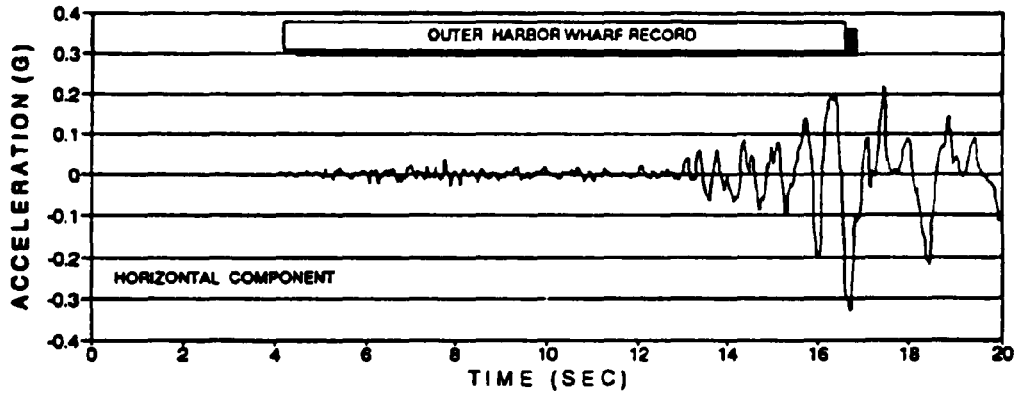
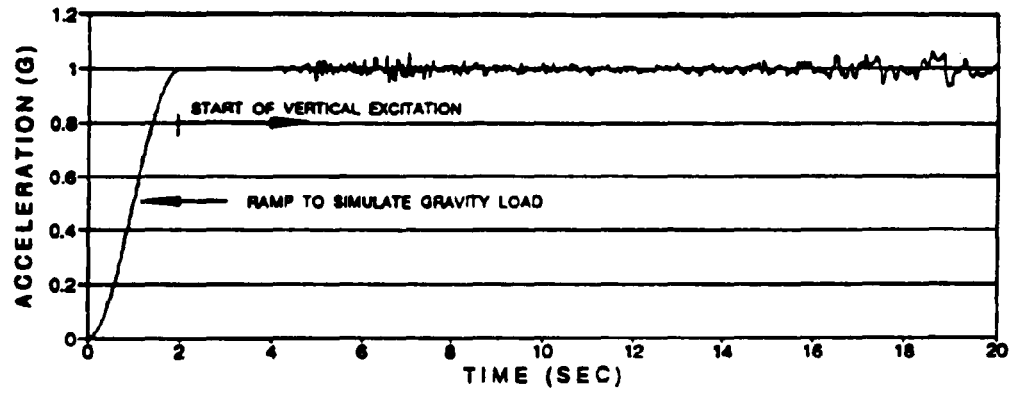

Fig. 4.21 Displacement response of type B1 bent

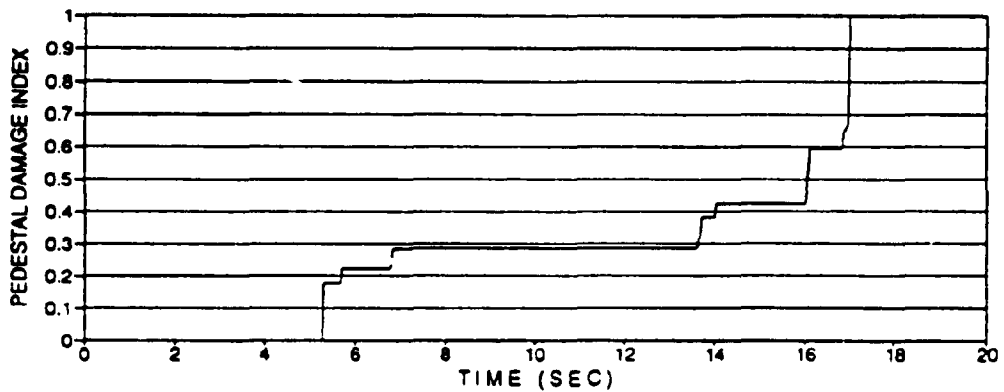
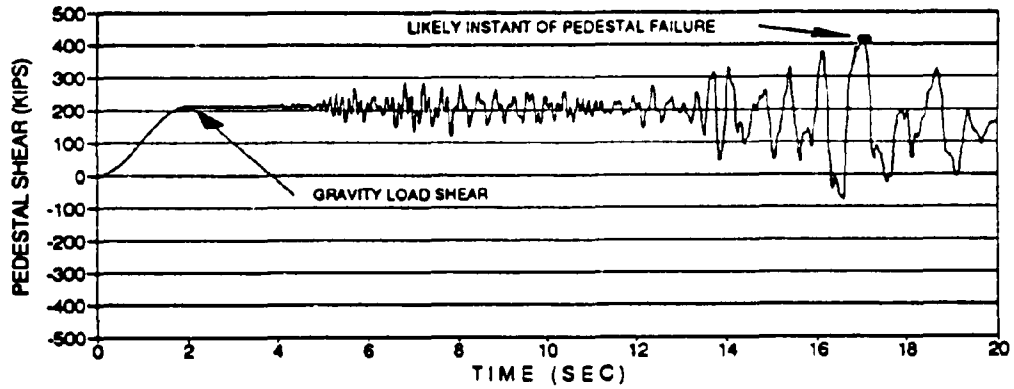
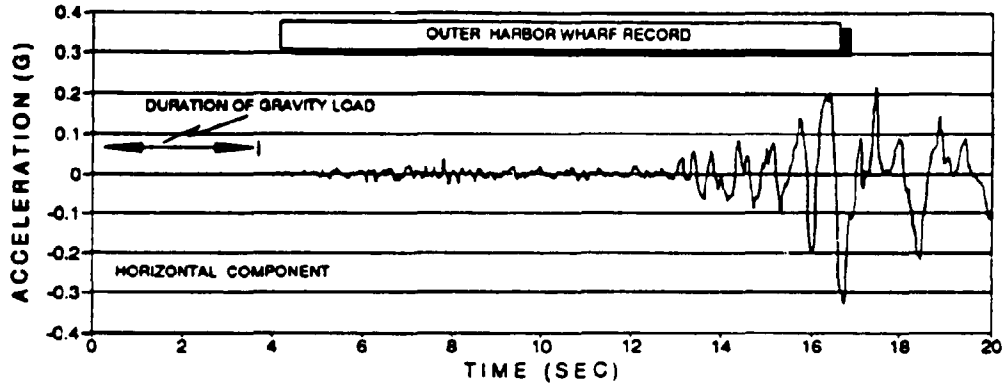

Fig. 4.22 Damage history of pedestal region

which the horizontal input motion and the pedestal shear history are also shown for reference. Complete details of the analysis of the Cypress Viaduct using IDARC can be found in Gross and Kunnath (1992).

4.6 Pushover Analysis: Building in the Vicinity of the New Madrid Zone

This case study describes the different capabilities for pushover analysis available in the program. The pushover analysis was carried out to evaluate a four story reinforced concrete building, subjected to a set of static lateral loads representing the inertial forces that may be observed during an earthquake event. The typical floor framing plan of the building is shown in Fig. 4.23. The lateral load resisting system in both directions consist of shear walls and weak frames, as shown in Figs. 4.24 and 4.25.

The pushover consists of a static analysis of the structure under a set of incremental loads. The results describe the behavior of the structure in the elastic and inelastic ranges, and therefore is often used as a tool to identify the lateral load at which different elements crack, yield, or fail. Furthermore, it captures the sequence of gradual element failures as the structure collapses. A detailed description of the building is presented by Valles et al. (1995).

The pushover curves, often referred to as capacity curves, characterize the strength and displacement capacity of the building. However, the capacity curve is dependent on the force distribution along the height considered during the pushover analysis. Fig. 4.26 shows typical capacity curves for different lateral load distributions. The available options in the program for a pushover analysis are:

- 1) Force control - linear (inverted triangular)
- 2) Force control - uniform
- 3) Modal adaptive
- 4) Force control - user defined
- 5) Force control - generalized power distribution
- 6) Displacement control

In this study the global and the story response of the building were investigated and compared to the results from a non-linear dynamic analysis. The overall capacity

Reproduced from
best available copy

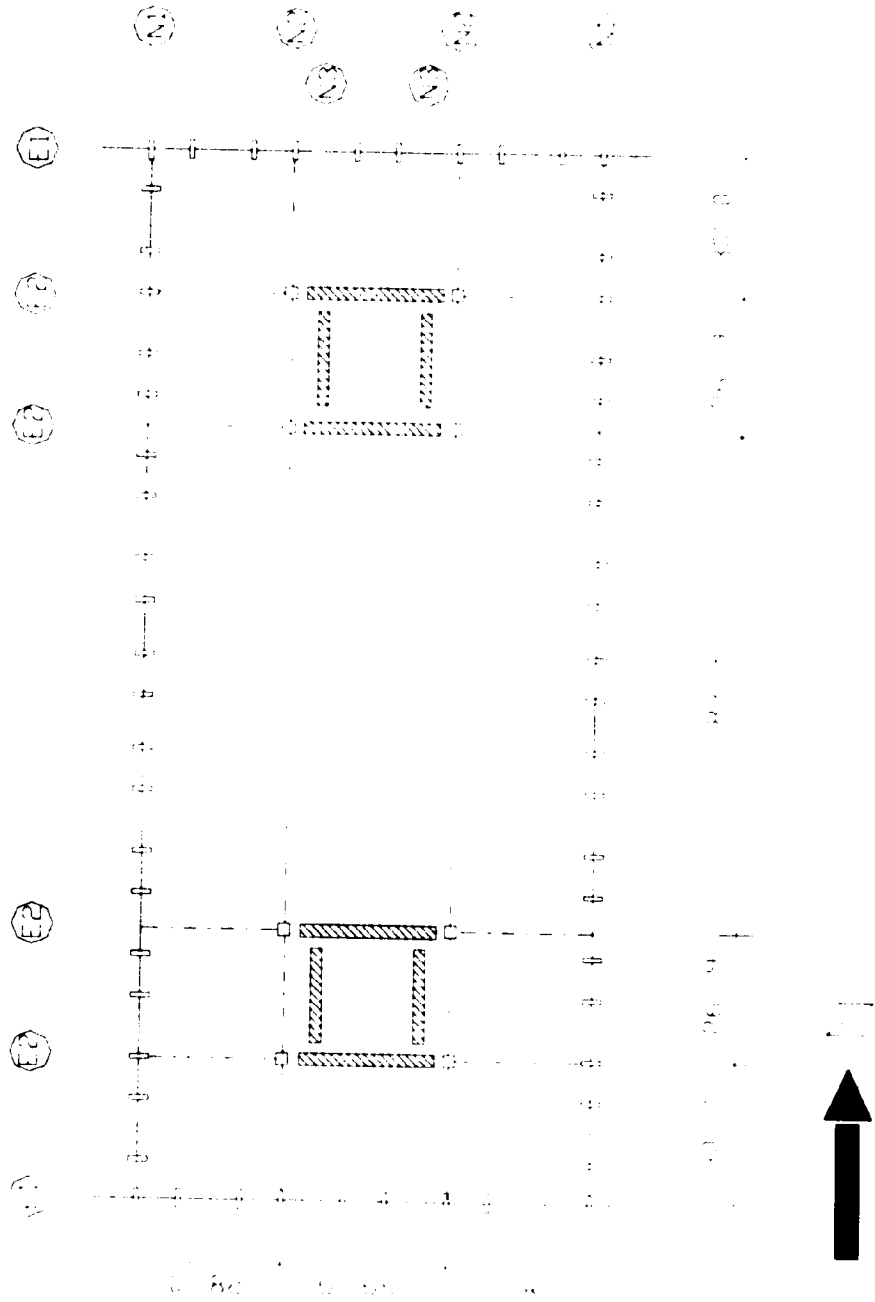

Fig. 4.23 Plan view of structure

Reproduced from
best available copy

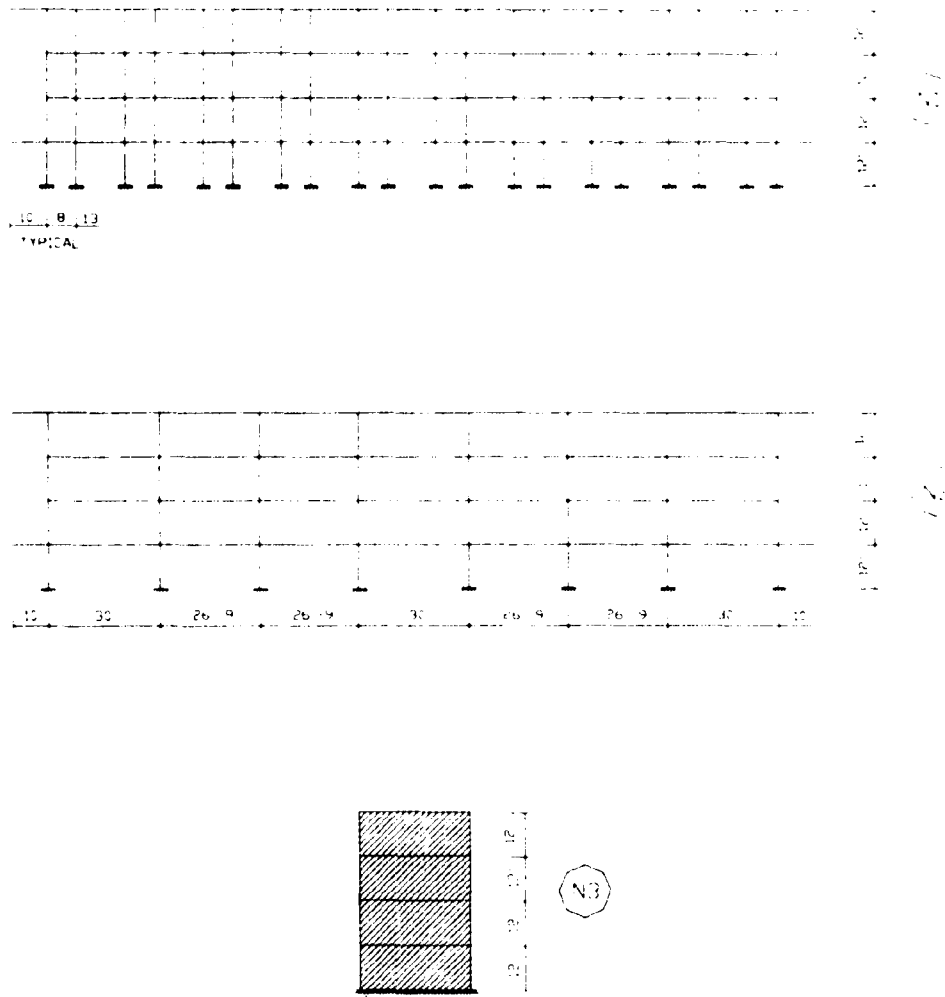

Fig. 4.24 NS frame elevations

Reproduced from
best available copy

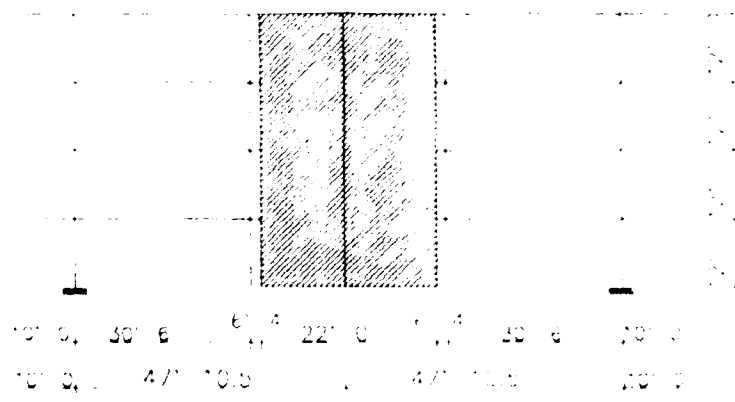
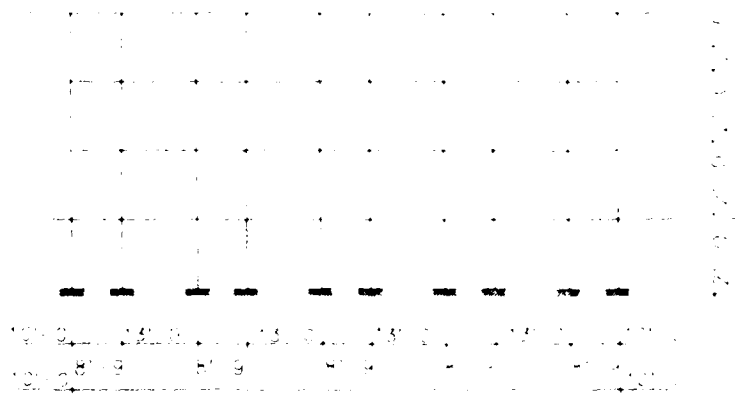

Fig. 4.25 EW frame elevations

curve is defined using the variation of the base shear versus the top story displacement (see Fig. 4.26). On the other hand, the capacity curve for a story was characterized using the variation of the inter-story drift versus the story shear (see Fig. 4.27). The figures include the results from the nonlinear time-history analysis with a black circle. Note that the generalized power distribution with power provides the best match between pushover and dynamic analysis. Further discussions on the results may be found in Valles et al. (1995).

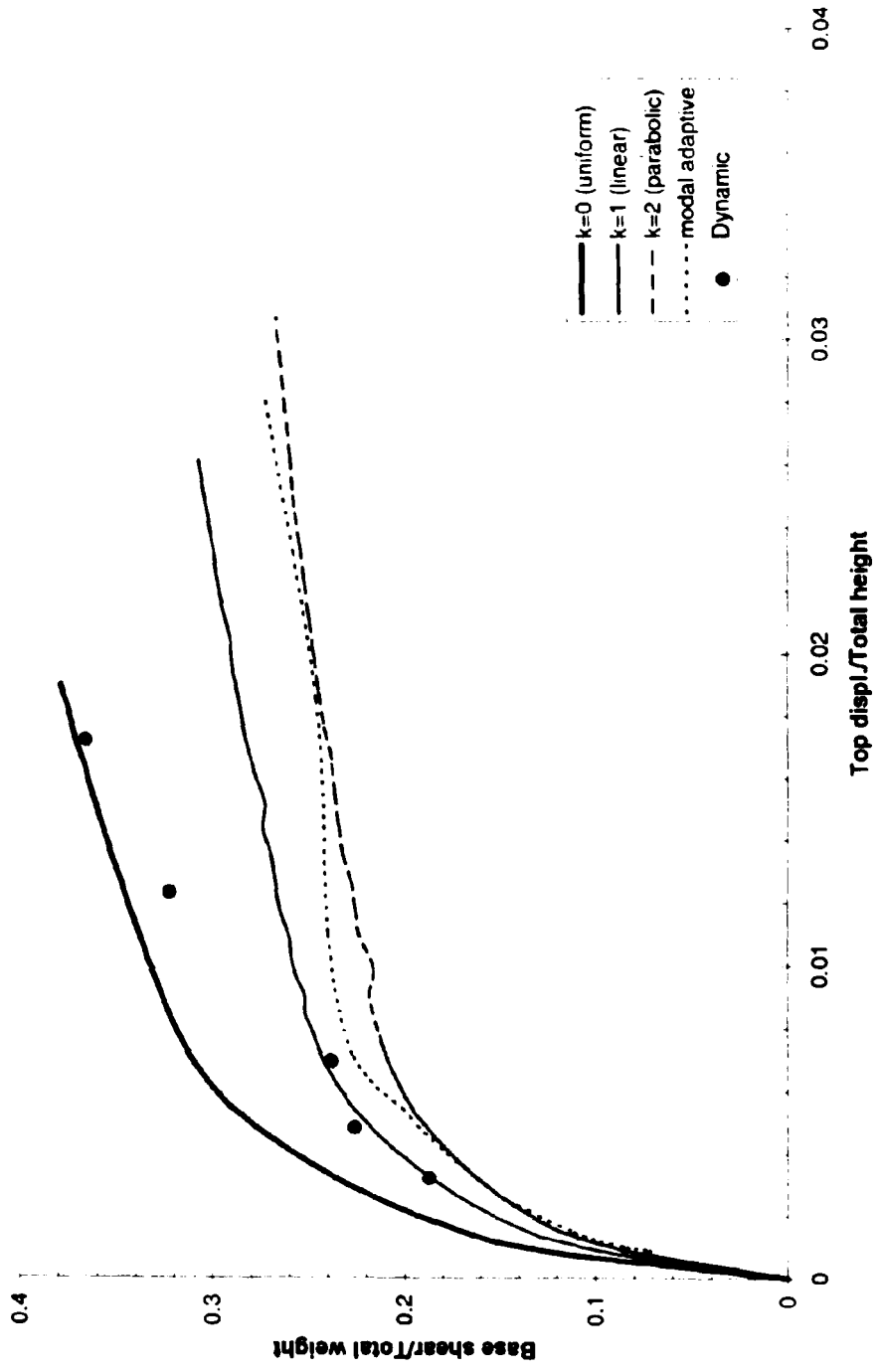

Fig. 4.26 Overall pushover capacity curves for different lateral load distributions (NS Direction)

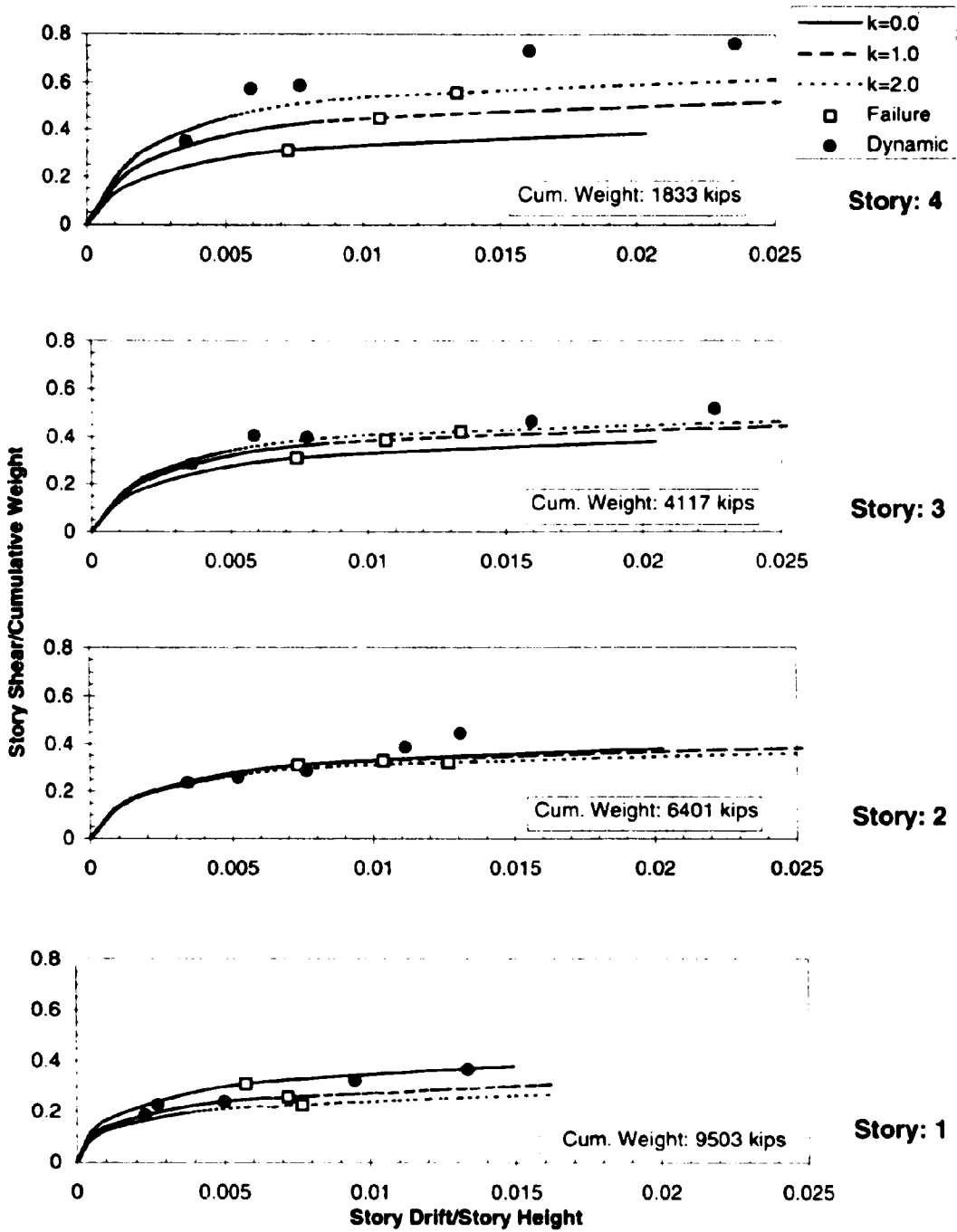

Fig. 4.27 Story pushover capacity curves for different lateral load distributions (NS Direction)

4.7 Response Snapshots: Eight Story Building in Los Angeles

This case study presents the results of the application of the IDARC program in the evaluation of the seismic performance of a reinforced concrete building, using the ATC-33 (50% submittal) guidelines. During the evaluation process a number of response snapshots were required. The building was designed and constructed in 1961 according to the requirements of the 1959 Uniform Building Code. It consists of one subterranean basement level and seven above ground floors the typical floor framing plan of the building is shown in Fig. 4.28.

The lateral load resisting system in the longitudinal direction consist of non-ductile reinforced concrete moment-frames along column lines 2 and 3. Frames 1 and 4 were excluded in the analysis due to the architectural feature which seriously limits their participation. The lateral load resisting system in the transverse direction consists of 12" thick reinforced concrete exterior shear walls (along column lines A and W), and 8" thick reinforced concrete walls along column lines E, G, N, and V. These walls are assisted by several one-bay moment-frames spanning between lines 1-2 and 3-4. Hence, the lateral system in the transverse direction may be considered a dual system featuring shear wall-frame interaction, Figure 4.29.

The following models were considered in the analysis of the building, one three-dimensional linear elastic, and two 2-D non-linear models, one for each principal direction of the structure. Only the results corresponding to the inelastic analysis are shown, for more detailed information see Naeim and Reinhorn (1995). The nonlinear analysis was carried out using the pushover option along with user requested response snapshots to evaluate the seismic performance of the structure according to the recommendations of the ATC-33 (50% draft) guidelines (1995).

Three different response spectra were considered a site specific smooth response spectra representing the 1994 Northridge shaking at this site, as supplied by ATC

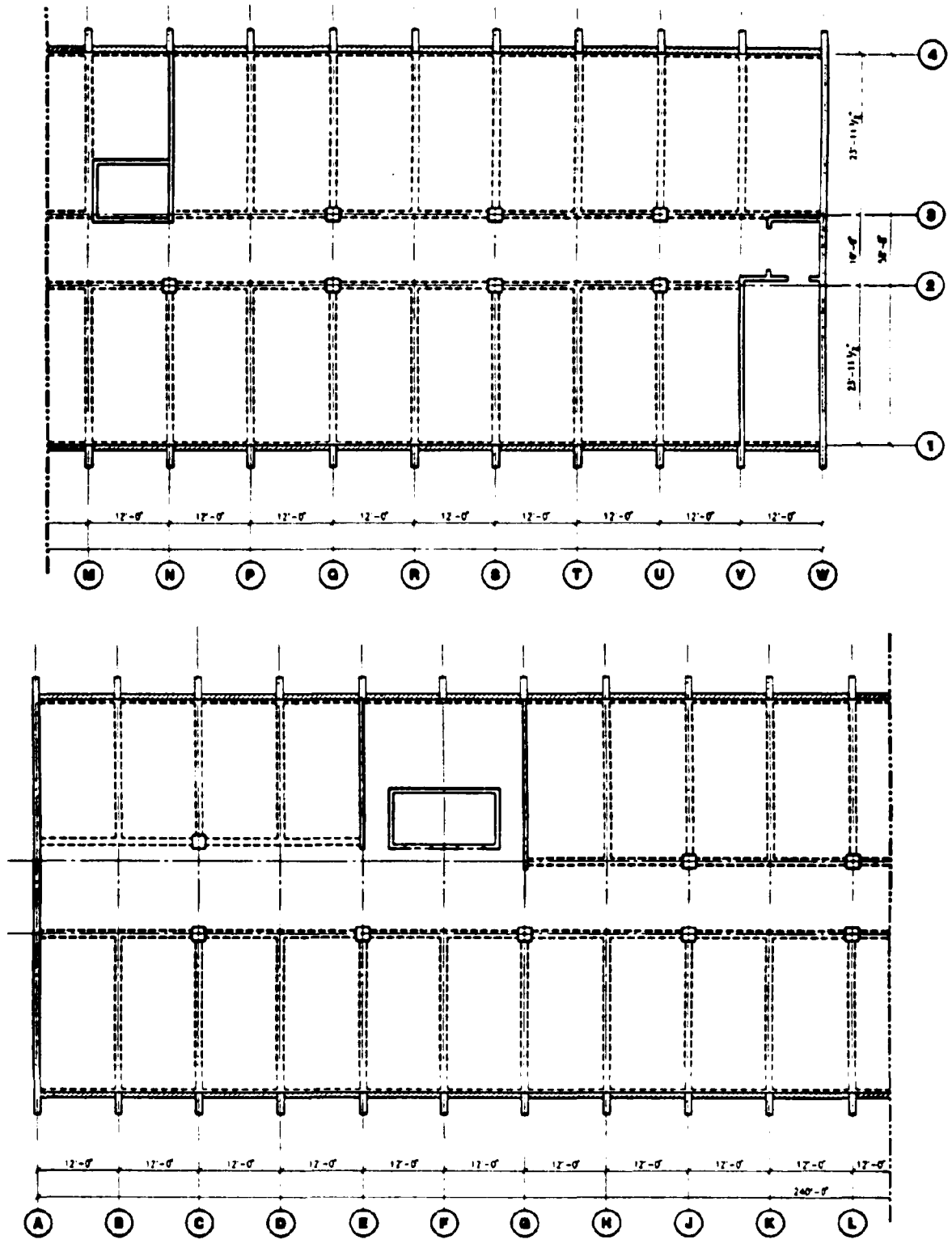

Fig. 4.28 Typical floor plan of structure

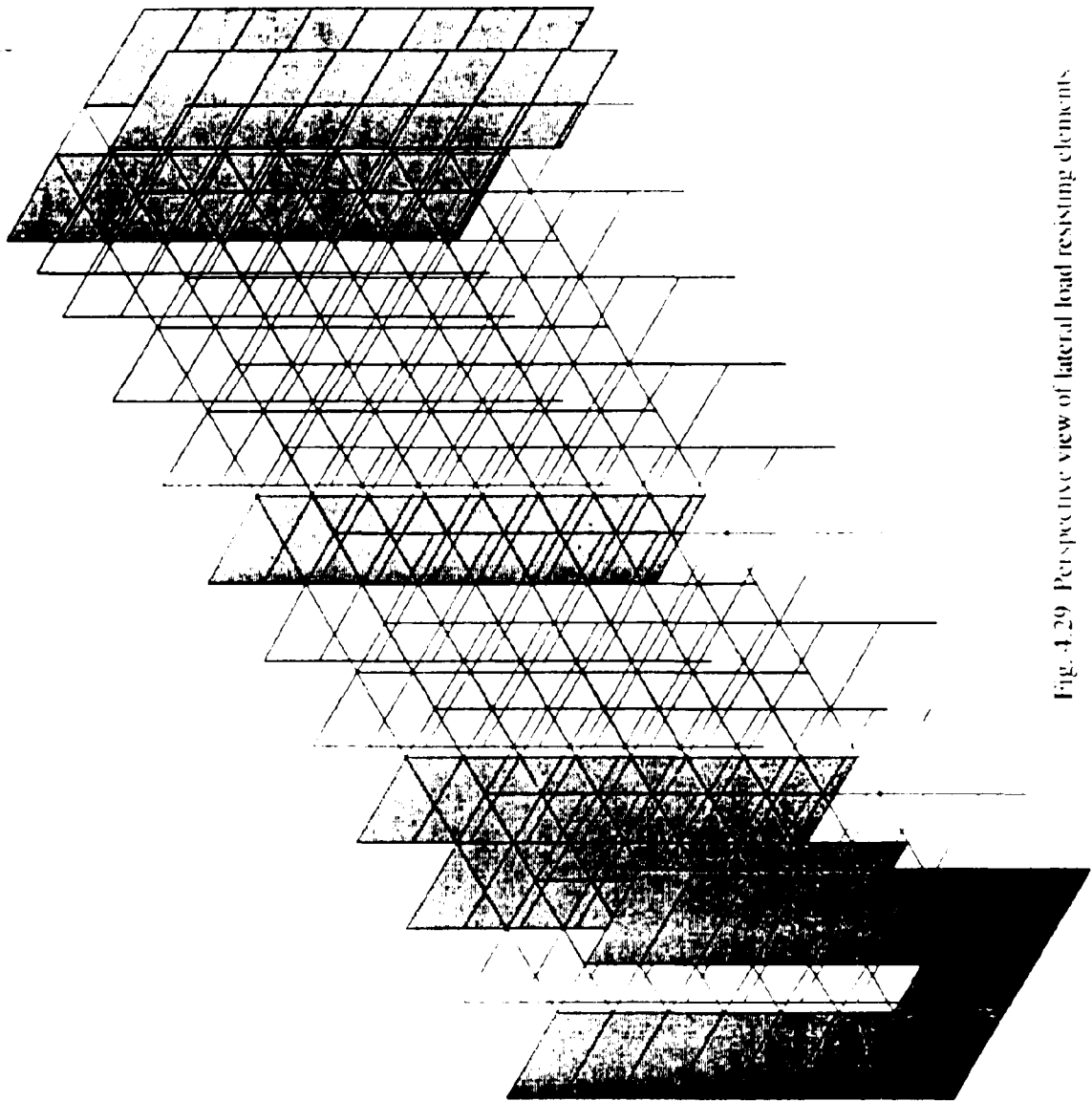

Fig. 4.29 Perspective view of lateral load-resisting elements

(Somerville, 1995), and the ATC-33 5% damped design spectra corresponding to return periods of 500 years and 2500 years for soil type D and map area 7 which correspond to a the ATC site classification for the building (Somerville, 1995). These spectra are shown in Fig. 4.30 where the initial and effective fundamental periods of the building in both directions are identified.

The longitudinal and transverse 2-D models of the structures were pushed using a lateral force distribution as specified in the ATC-33.02 (see generalized power distribution in Section 3.4.2). The exponents for the load distributions were calculated according to the ATC-33.02 recommendations: $k = 1.65$ in the longitudinal direction, and $k = 1.07$ in the transverse direction. In both directions the model was pushed beyond the specified target roof displacement according to the ATC-33 2500 year event.

Preliminary calculations conducted before the 1994 Northridge earthquake, indicated a significant potential for serious damage during a moderate to large earthquake. During the Northridge event, however, although extensive damage were observed in one or two neighboring buildings, no apparent signs of structural damage were observed. This observation is in accordance with the results of the pushover analyses, where no damage to very slight damage was predicted for the structure when subjected to this event.

Important information was obtained from the pushover analyses, including the variation of roof displacement versus base shear, and the response stages of the building. Figure 4.31 shows this variation for the longitudinal direction, with significant stages in the response identified. Using the response snapshots capability of the program, reports for the state of the building at different stages can be generated. User defined snapshots were requested for the three earthquake intensities considered. Figure 4.32 shows the lateral displacements, in the longitudinal direction, corresponding to the three earthquake intensities studied. Other response snapshots were requested, including element stress ratios for beams (see Table 4.1). Based on the curvature demand/capacity ratios reported,

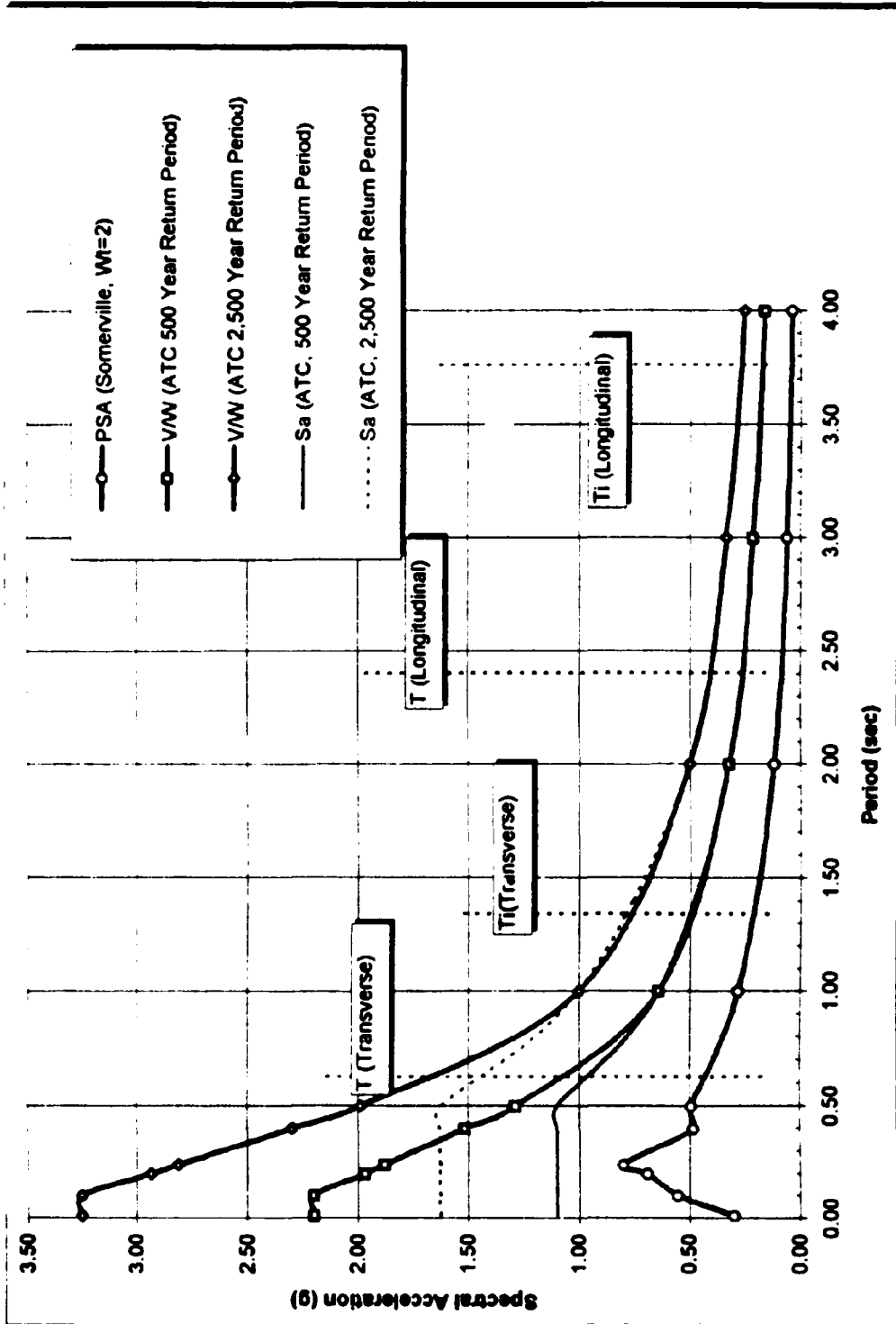

Fig. 4.30 Response spectra used for evaluation

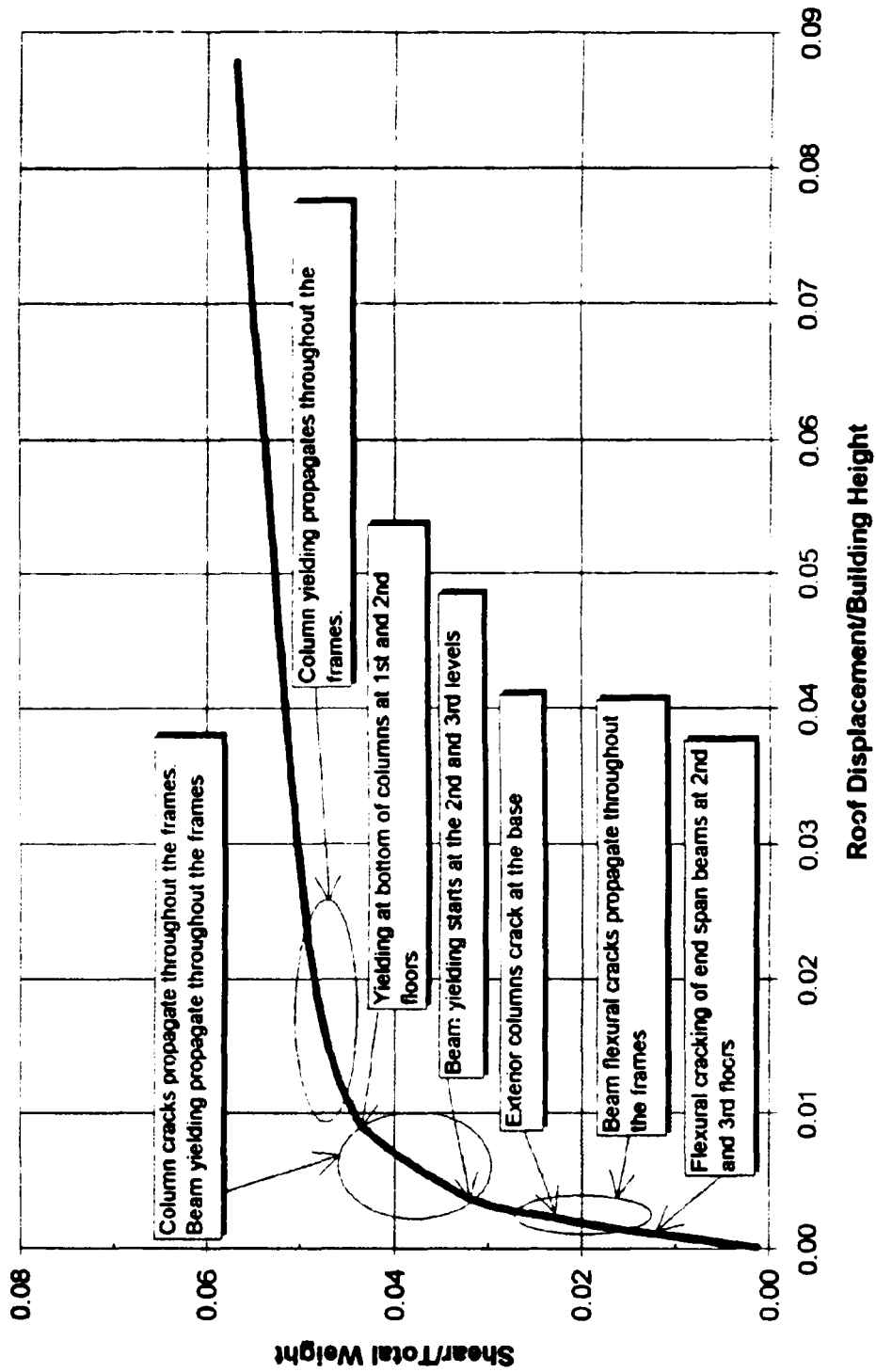

Fig. 4.31 Pushover capacity curve with significant response stages (Longitudinal direction)

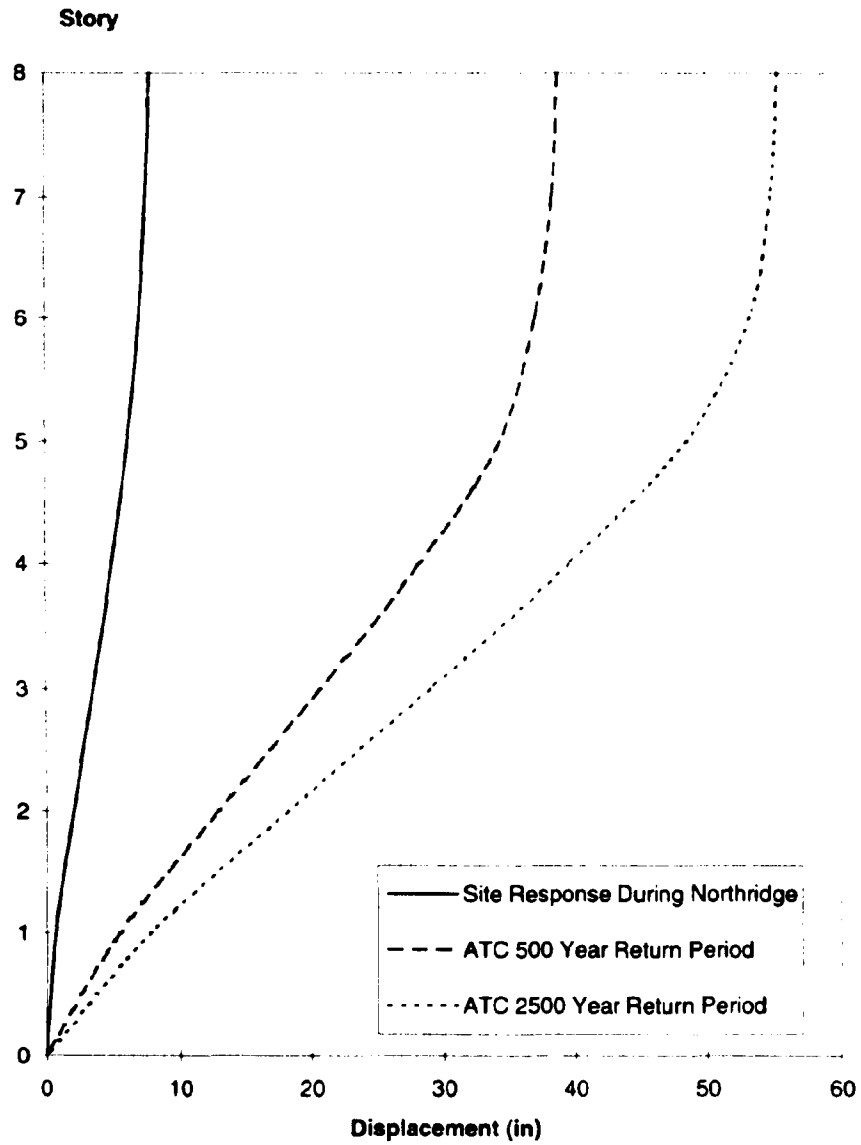

Fig. 4.32 Lateral displacements, longitudinal direction, for various earthquake intensities

beams are expected to undergo severe damage during the ATC 2500 year event. Relevant overall response snapshots are summarized in Table 4.2.

		V/V_u	M/M_u	ϕ/ϕ_u
Northridge				
Story	8	0.1387	0.1935	0.0035
	6	0.4394	0.7860	0.0277
	4	0.5605	0.8760	0.2240
	2	0.5809	0.8820	0.2611
	1	0.5329	0.8625	0.1393
ATC 500				
Story	8	0.2370	0.3412	0.0062
	6	0.5820	0.8837	0.2721
	4	0.6122	0.9428	0.6416
	2	0.6158	0.9482	0.6756
	1	0.6110	0.9379	0.6111
ATC 2500				
Story	8	0.2433	0.3389	0.0062
	6	0.5838	0.8868	0.2915
	4	0.6287	0.9743	0.8390
	2	0.6327	0.9810	0.8809
	1	0.6264	0.9666	0.7911

Table 4.1 Elements stress ratios for typical beams

	δ_{top} / H_{tot}	V_{base} / W_t	DI_{PARA}
Site Northridge	0.0062	0.0410	0.042
ATC 500	0.0256	0.0475	0.351
ATC 2500	0.0488	0.0502	0.502

Table 4.2 Structural response, longitudinal direction, for various earthquake intensities

4.8 Steel Structure: Evaluation of Seismic Performance of a 11 Story Steel Moment Frame Building during the Northridge Earthquake

This case study exemplifies one of the options incorporated in the present IDARC version, this is, the alternative for the user to input their own moment-curvature properties directly. Thus, the program can be used to perform the analysis of buildings with frames made of different materials, besides reinforced concrete. This case presents some results of the inelastic analysis performed to an 11-story steel building subjected to earthquake loads.

This building, located in West Los Angeles, was damaged during the January 17, 1994, Northridge earthquake. An extensive field investigation of damage was performed prior to the start of the analytical study and then compared with the results of the extensive two and three dimensional, linear and non linear, static and dynamic analyses of the building in order to investigate and correlate observed damage with various elastic and inelastic damage predictors. As mentioned above, only some results corresponding to the inelastic analysis are shown. The reader can see the report by Naeim et al. (1995) for an ample description of the observations.

The building is made of composite concrete and steel metal deck slabs which are supported by A36 structural steel beams and columns. The exterior skin is made of precast concrete panels and glass plates. Structural steel columns are supported at the foundation by cast-in-place reinforced concrete friction piles. The seismic load resisting system consist of ordinary moment frames constructed of A36 structural steel, a typical frames shown in Figure 4.33. Seismic loads are carried to the lateral resisting system by the composite concrete and steel deck slabs which act as horizontal diaphragms. Typical moment frame connections at the column flange and web are shown in Fig. 4.34.

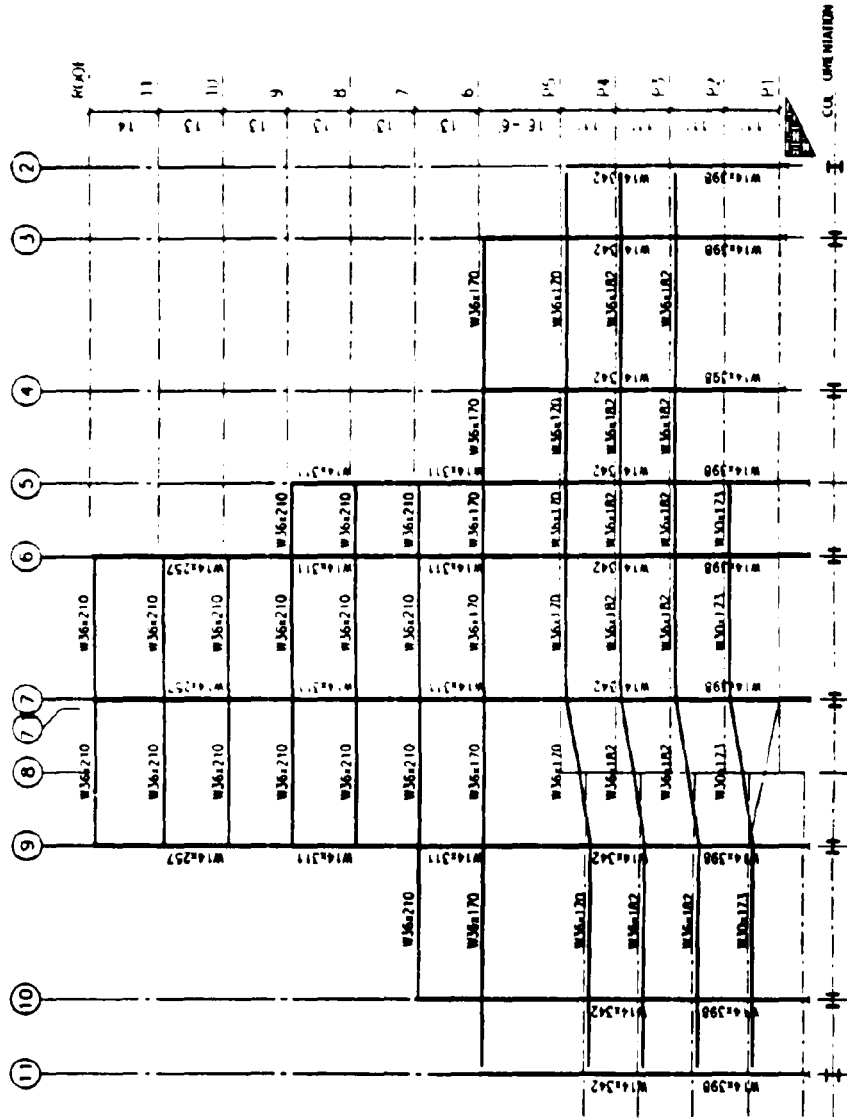

FRAME ELEVATION GRID LINE "M"

Fig. 4.33 Frame elevation at grid line "M"

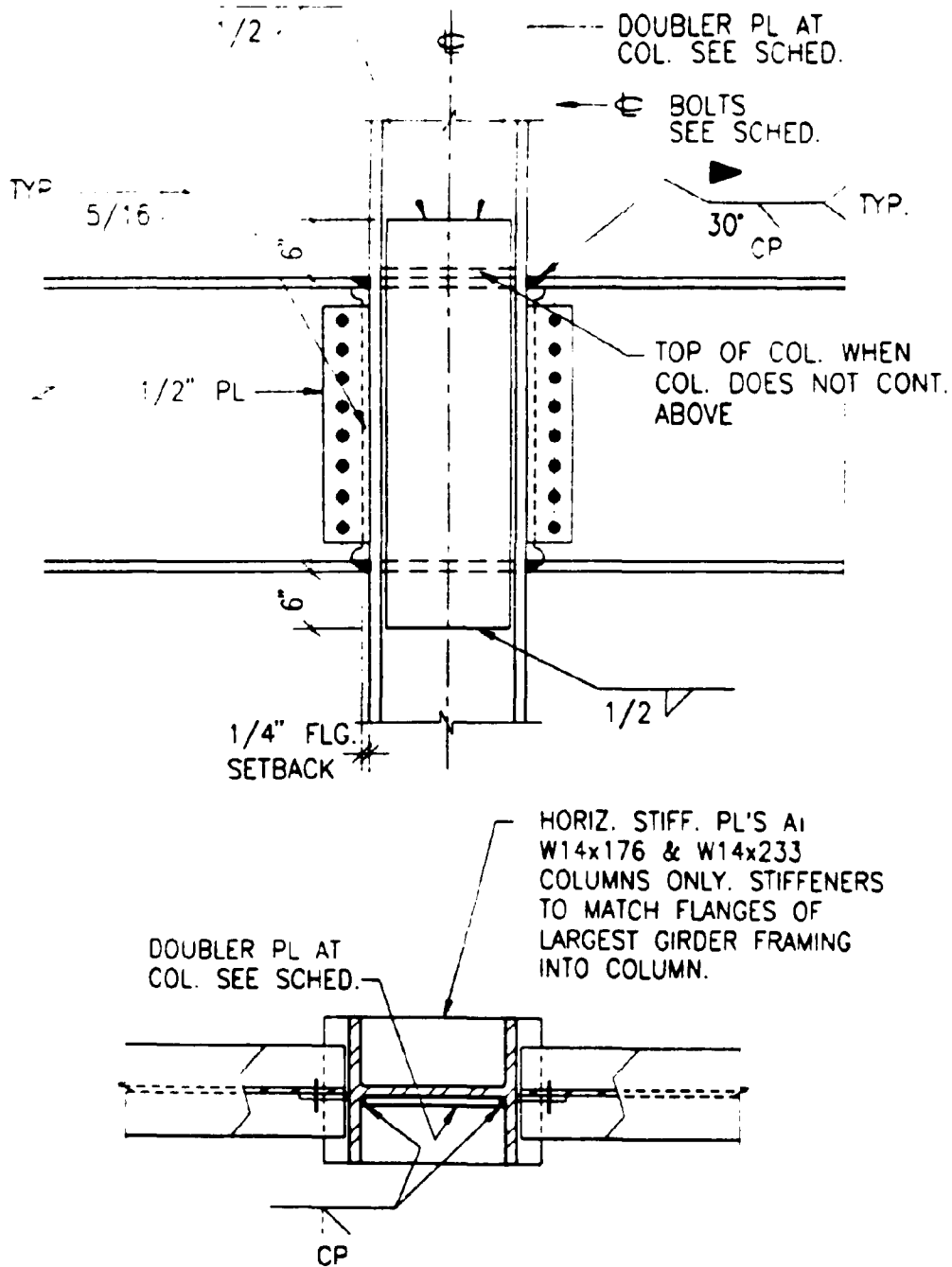

Fig. 4.34 Typical moment connection at column flange

The seismic loads considered were postulated ground motions for the site during the 1994 Northridge earthquake. In addition, the following earthquake records were also considered

- 1 The 1994 Northridge earthquake as recorded at the parking lot of the Sylmar County Hospital Building. This is considered to be one of the records with the highest damage potential for this event (Naeim, 1995)
- 2 The 1994 Northridge earthquake as recorded in Canoga Park (7769 Topanga Canyon Blvd) which represents levels of shaking larger than the motion postulated for the site but less than that recorded at Sylmar
- 3 The 1978 Iran earthquake records at Tabas to represent a larger event
- 4 The 1940 El Centro earthquake as recorded at El Centro Irrigation district because it has been widely cited in previous studies and hence has certain value as a benchmark record
- 5 A uniform risk design spectrum representing 10 % probability of exceedance in 50 years developed for the site of the Sylmar County Hospital (Somerville, 1995)

Two nonlinear 2-D computer models were constructed (one for the E-W and another for the N-S directions). In both mathematical models all frames in the direction under consideration were included and connected by the rigid floor diaphragm assumption, the columns were considered fixed at the foundation level, and 2% damping was assumed for the first mode and the mode nearest to 30 Hz.

Bilinear hysteretic behavior was assumed using a 5% strain-hardening ratio. The yield and ultimate curvatures correspond to the cross section's full elastic and full plastic strengths, respectively (Fig. 4.35). The ultimate deformation (curvature) for members was specified as the lowest of (a) maximum strain at fracture ($\epsilon_u = 15\%$) divided by the distance to neutral axis, or (b) using the maximum plastic moment and a post-yield hardening capacity of 0.05 (Fig. 4.35). The resulting ultimate curvature produces ultimate rotations between 0.03 and 0.04 radians, depending on plastic penetration. Yielding curvature corresponds to a strain of 0.14%, and the curvature at the onset of strain-

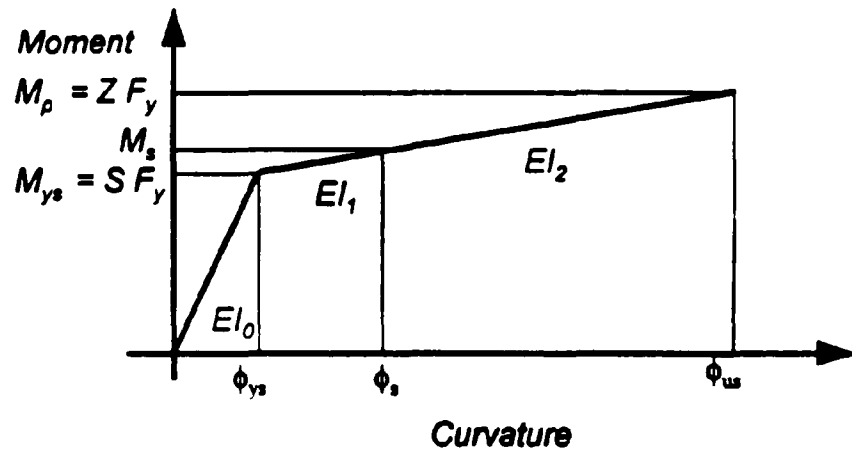

Fig. 4.35 Material model used for the study

hardening corresponds to a strain of 1.5%. These assumptions are in basic agreement with the published A36 steel stress-strain relations

To predict structural damage, damage indices were assigned at the element level (beams and columns), as well as story levels, and to the overall structure. The damage model developed by Park and Ang (1985) was utilized

The following analyses were performed for models corresponding to N-S and E-W frames

- 1 Static nonlinear pushover analysis with an inverted triangular lateral load distribution
- 2 Nonlinear time history analysis with simultaneous applications of horizontal and vertical components of the synthetic ground motion representative of the Northridge earthquake at the site
- 3 Nonlinear time history analysis with simultaneous application of horizontal and vertical components of the 1994 Northridge at the Sylmar County Hospital Parking Lot

Typical plots of story shear versus story drift for the above analyses are presented in Fig. 4.36 for the N-S direction. In these figures, the maximum time history response to the synthetic motion at the site and that of the Sylmar time history are marked by a black circle and a square, respectively. The results of the pushover analyses and the time histories show a very good match at all stories. This is a strong indication that for this building, in spite of its complexity and vertical irregularities, the static pushover analysis may be used to obtain a good approximation to nonlinear dynamic analyses results with ground motions of widely differing severity.

The damage indices corresponding to inelastic dynamic and pushover analyses were computed. Typical damage indices corresponding to pushover analyses in one of the frames are shown in Fig. 4.37. This figure compares the damage observed in the field

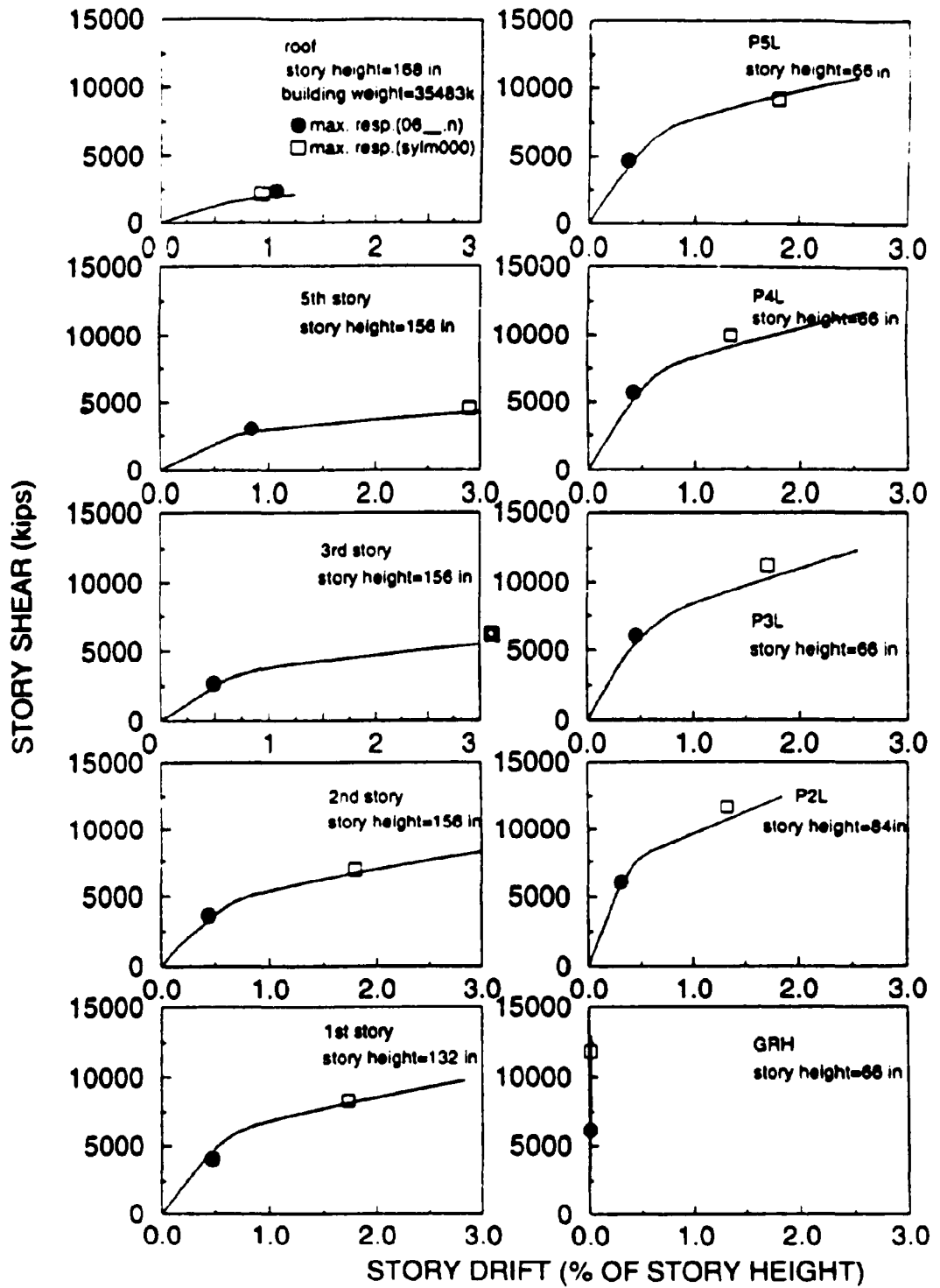
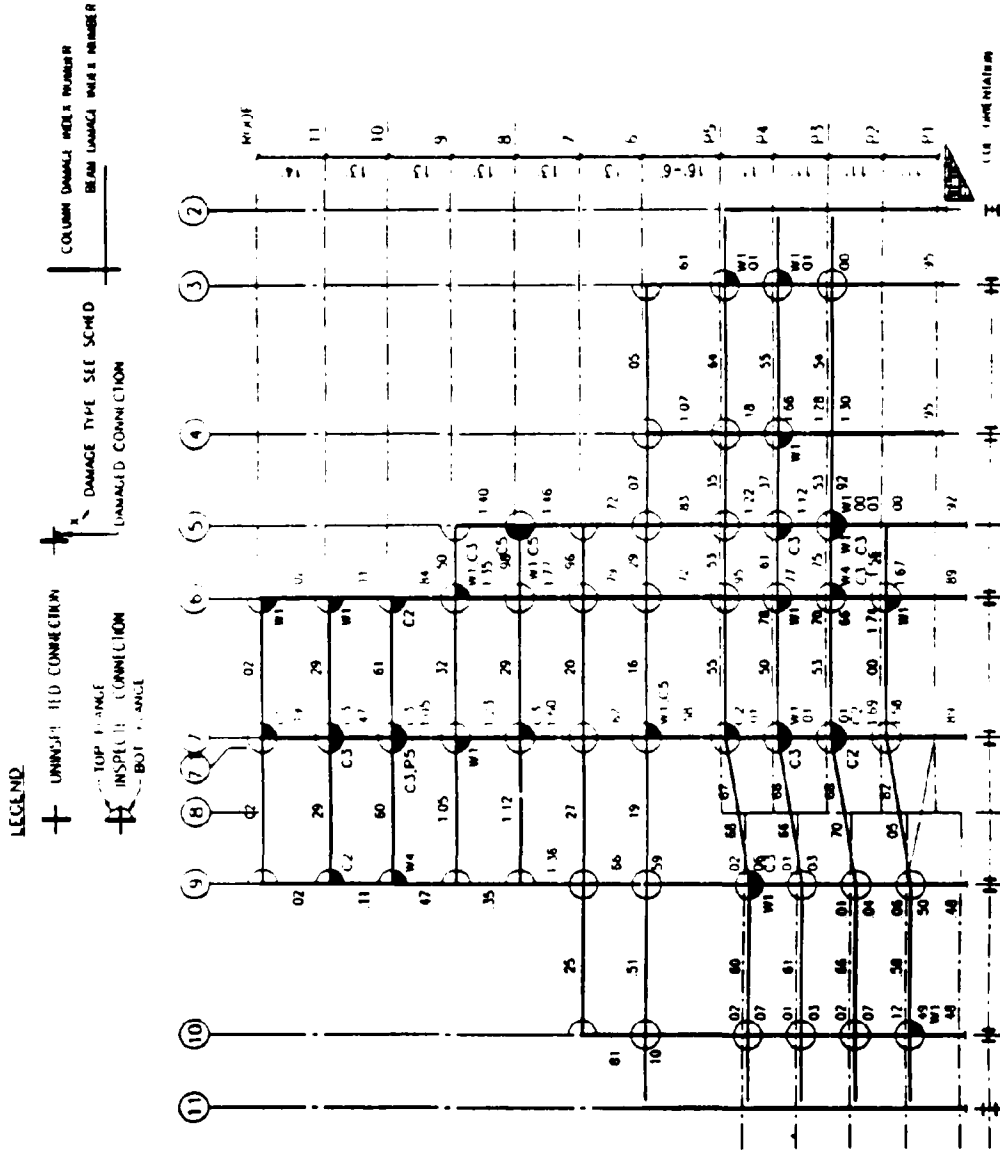

Fig. 4.36 Nonlinear story shear versus story drift (NS direction)

PUSHOVER
(NORTH - SOUTH)



FRAME ELEVATION GRID LINE 'M'
DAMAGE INDEX STATISTICS

Fig. 4.37 Comparison of observed damage and computed damage indices (Grid line "M")

inspection and the numerical damage indices computed. Although there is no one-to-one correspondence between analysis results and observed damage, certain analytical indicators do provide strong indications of where damage might be present.

4.9 Passive Energy Dissipation Devices: 1:3 Scale Model Retrofitted Using Different Types of Dampers

The response of the 1:3 scale three story model structure described in Section 4.4 was investigated using different passive energy dissipation devices. This case study compares numerical predictions of the response with actual experimental measurements of the building with different types of dampers. The tested structure included conventional concrete jacketing in the interior columns and joint beam enhancements (Bracci et al., 1992) to retrofit the original damaged structure. The test program included the following types of dampers:

- a) Viscoelastic dampers by 3M company (Lobo et al., 1993, Shen et al., 1993)
- b) Fluid viscous dampers by Taylor Devices (Reinhorn et al., 1995a)
- c) Friction dampers by Sumitomo Construction Co. (Li and Reinhorn, 1995)
- d) Viscous walls by Sumitomo Construction Co. (Reinhorn et al., 1995b)
- e) Friction dampers by Tekton Co. (Li and Reinhorn, 1995)

The objectives for the retrofit test program was to reduce overall damage progression, provide data for analytical modeling of inelastic structures equipped with linear and non-linear dampers, and to determine the force transfer in retrofitted structures and its local effects.

The new version of the computer program IDARC is capable of modeling viscous, friction and hysteretic dampers. Test results for the Taylor fluid viscous dampers and the Sumitomo friction dampers are summarized. The test program did not include any type of hysteretic dampers, but the numerical results for the structure with hysteretic dampers are included.

4.9.1 Viscous Dampers

The fluid viscous dampers by Taylor Devices were selected for this comparison. Results for the other types of viscous dampers tested can be found in the corresponding

reference listed above. The viscous dampers installed in the brace (see Fig. 4.38), were selected from the catalog of Taylor Devices Inc. Model 3x4, rated to 10,000 lbs (44.6 kN). The damper was connected to the brace using a load cell with a capacity of 30,000 lbs. The damper construction can prevent rotations between its two ends which is suitable to prevent buckling in the brace assembly.

Figures 4.39 and 4.40 presents a comparison of story displacements and accelerations for El Centro 0.3g. Results show a good correlation between the experimental test results and the numerical prediction. Figure 4.41 shows the pushover response of the structure for a simplified evaluation, as presented by Reinhorn et al (1995a).

4.9.2 Friction Dampers

For this comparison the friction dampers by Sumitomo Construction Co. were selected. Results for the other type of friction damper tested can be found in the corresponding reference listed above. The damper was installed using the layout shown in Fig. 4.38, as described for the viscous damper example. Figures 4.42 and 4.43 presents a comparison of story displacements and accelerations. Numerical results show good correlation with the experimental measurements. Figure 4.44 shows the pushover response of the structure that can be used in a simplified response evaluation as described in Reinhorn et al (1995a).

4.9.3 Hysteretic Dampers

The test program on the three story scale model did not include retrofit using hysteretic damper elements. For completeness, the results considering a hysteretic damper are presented in Figs. 4.45 and 4.46.

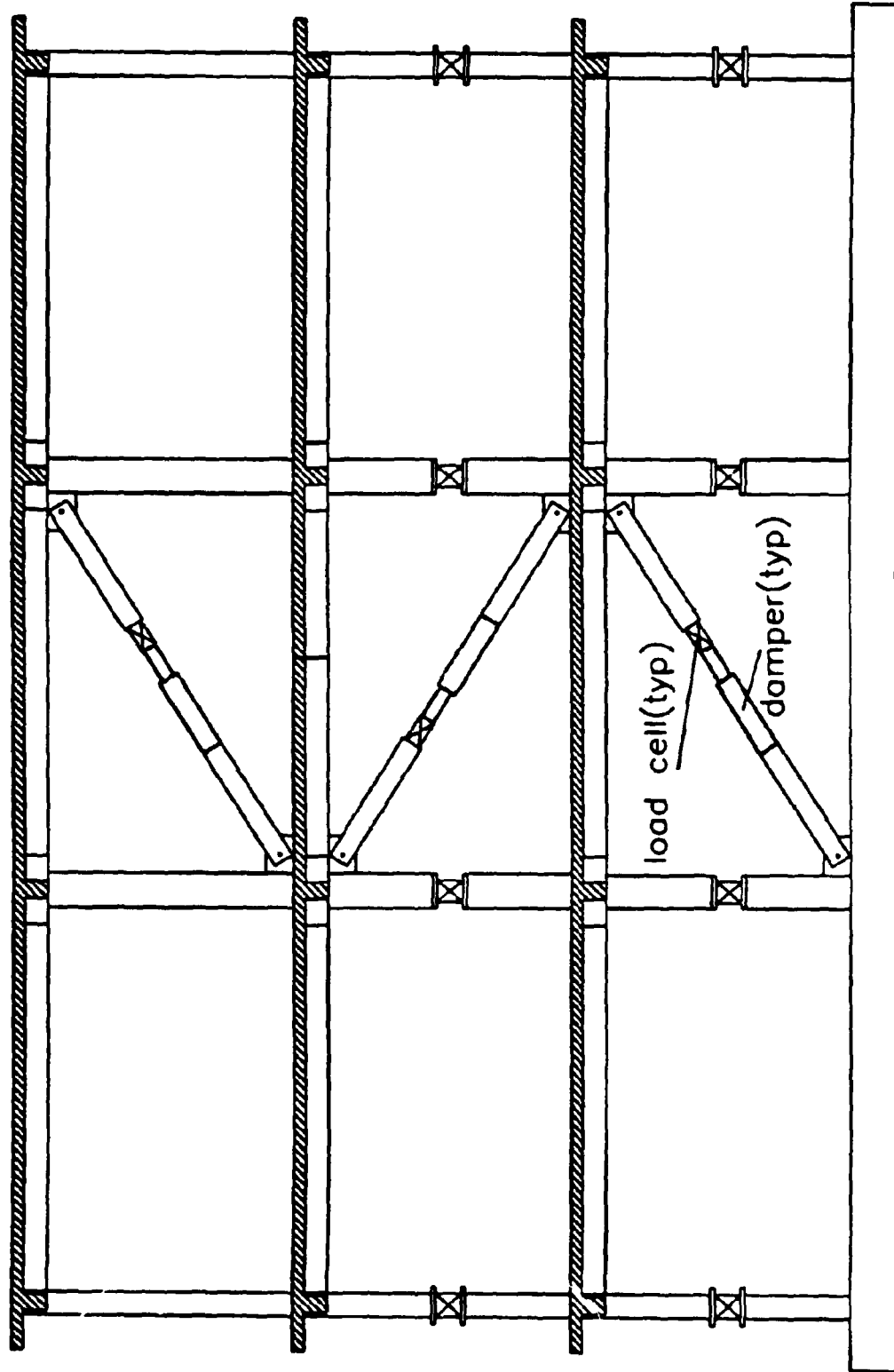

Fig. 4.38 Location of dampers and measuring devices

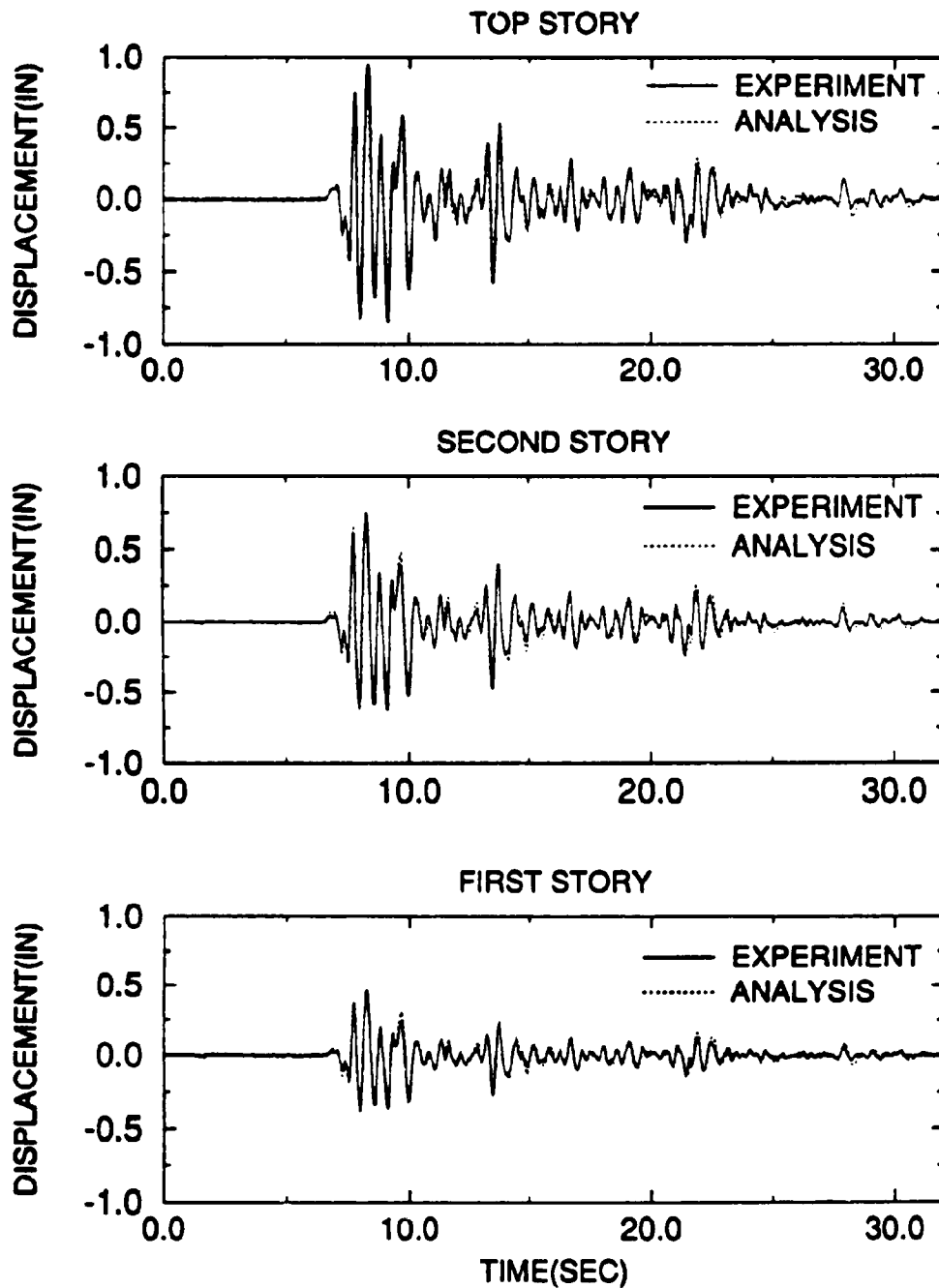

Fig. 4.39 Comparison of experimental and analytical displacements with viscous dampers (El Centro 0.3g)

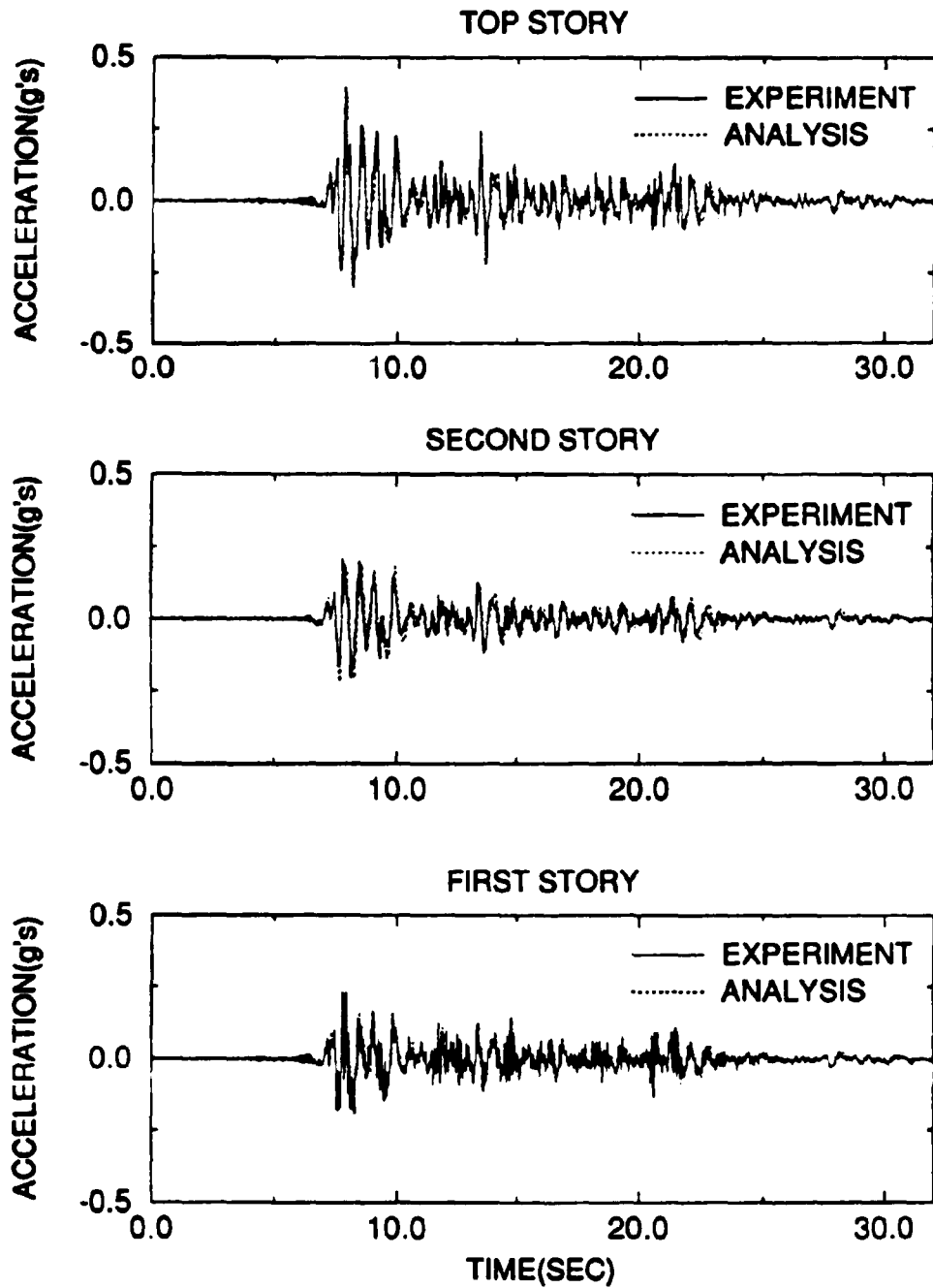

Fig. 4.40 Comparison of experimental and analytical accelerations with viscous dampers (El Centro 0.3g)

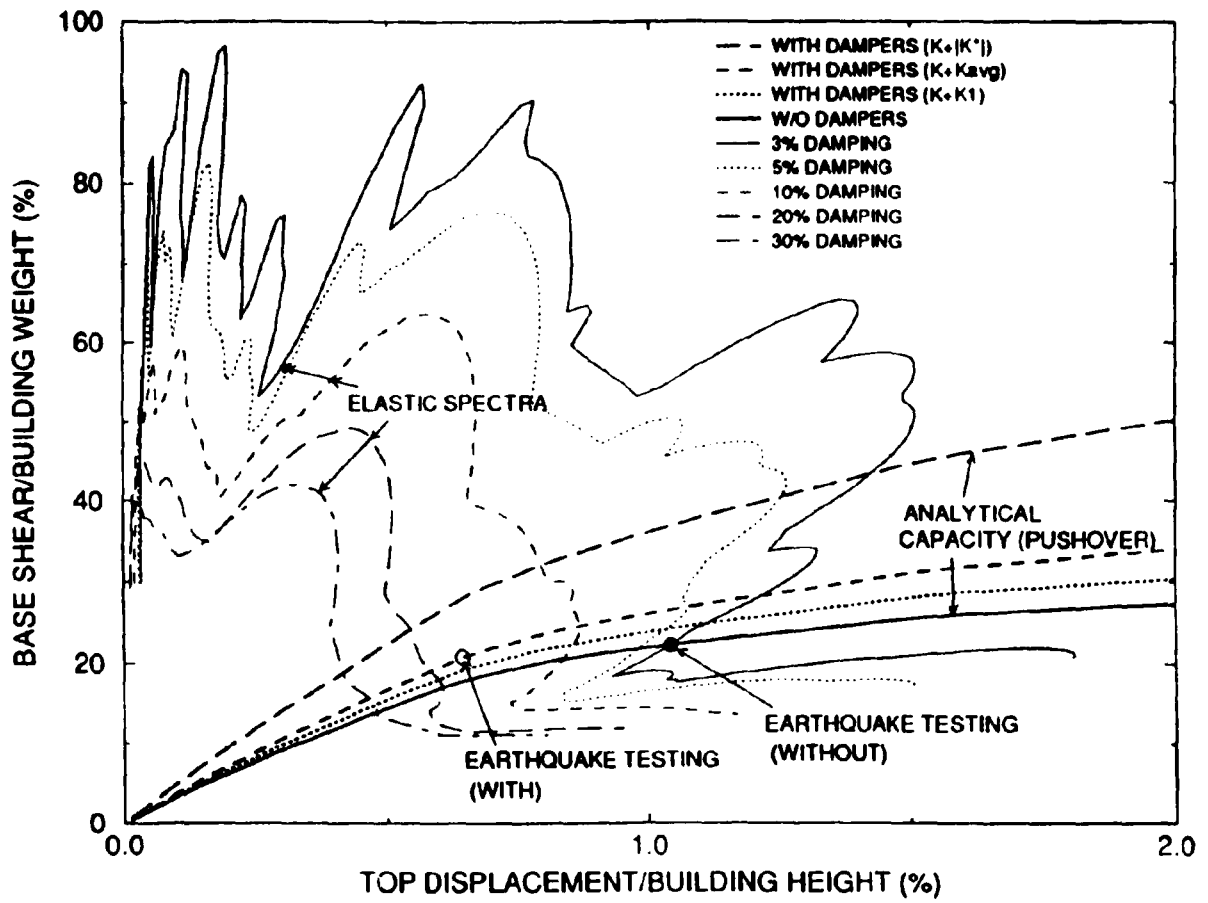

Fig. 4.41 Pushover response of structure with viscous dampers for simplified evaluation

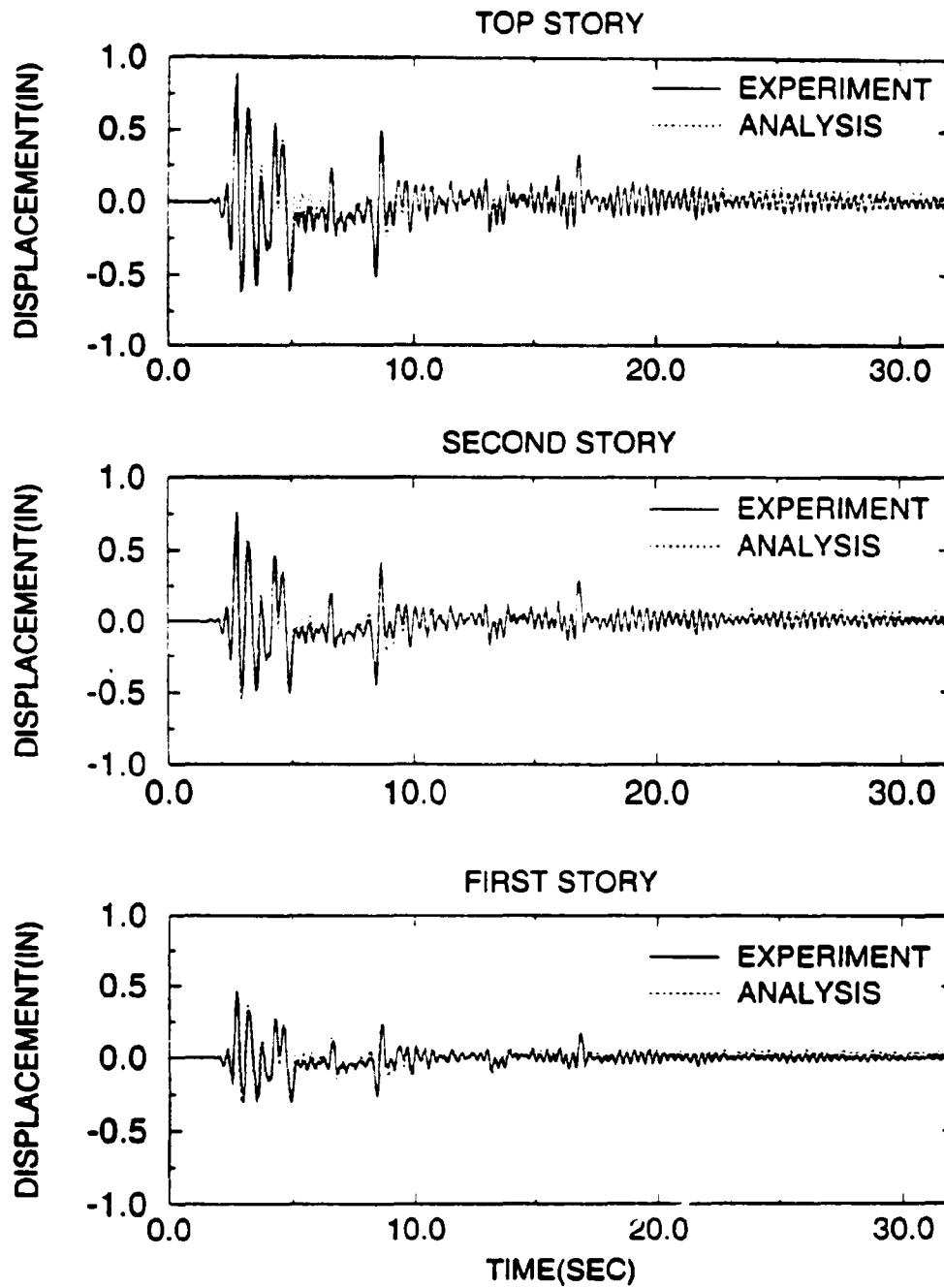

Fig. 4.42 Comparison of experimental and analytical displacements with friction dampers (El Centro 0.3g)

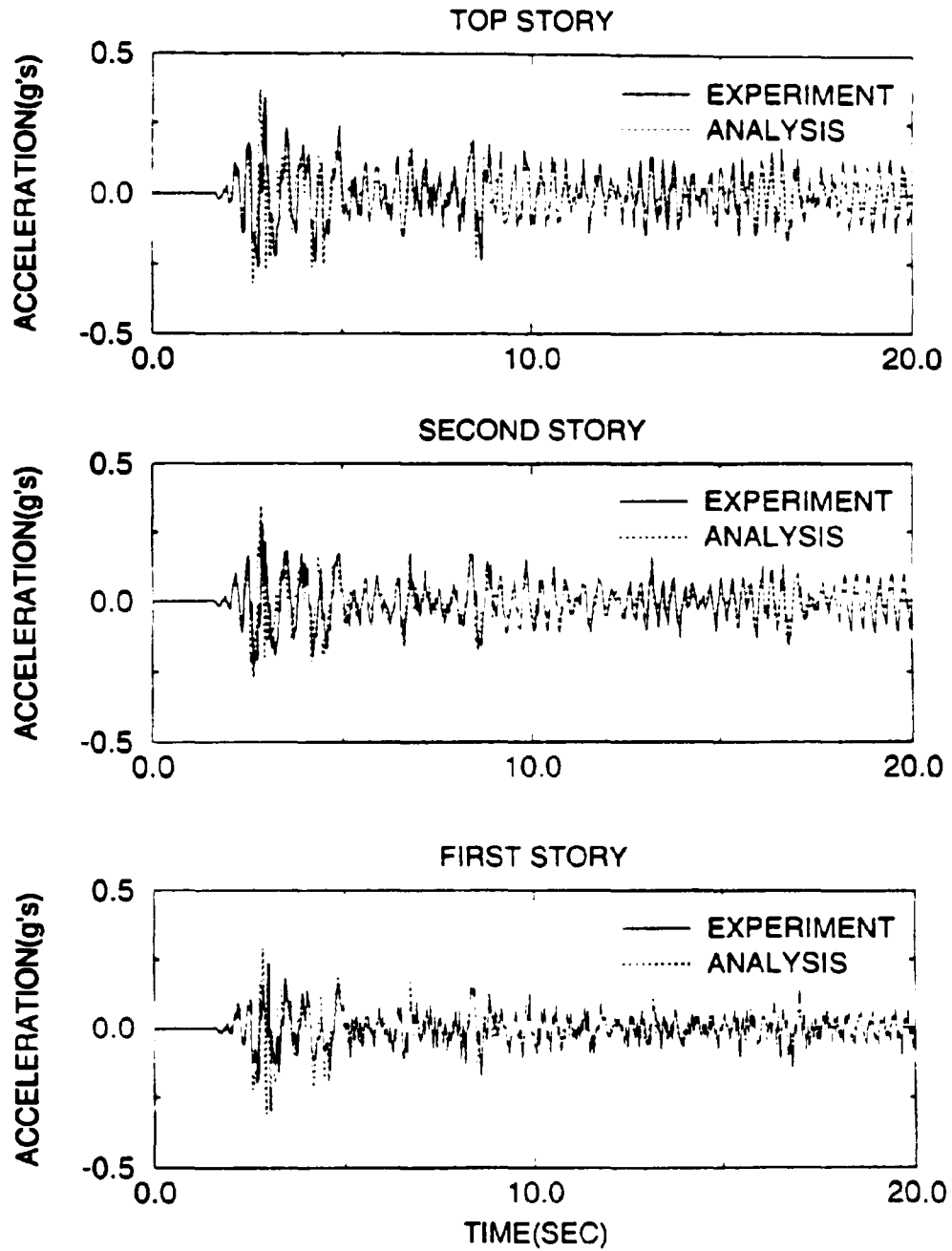

Fig. 4.43 Comparison of experimental and analytical accelerations with friction dampers (El Centro 0.3g)

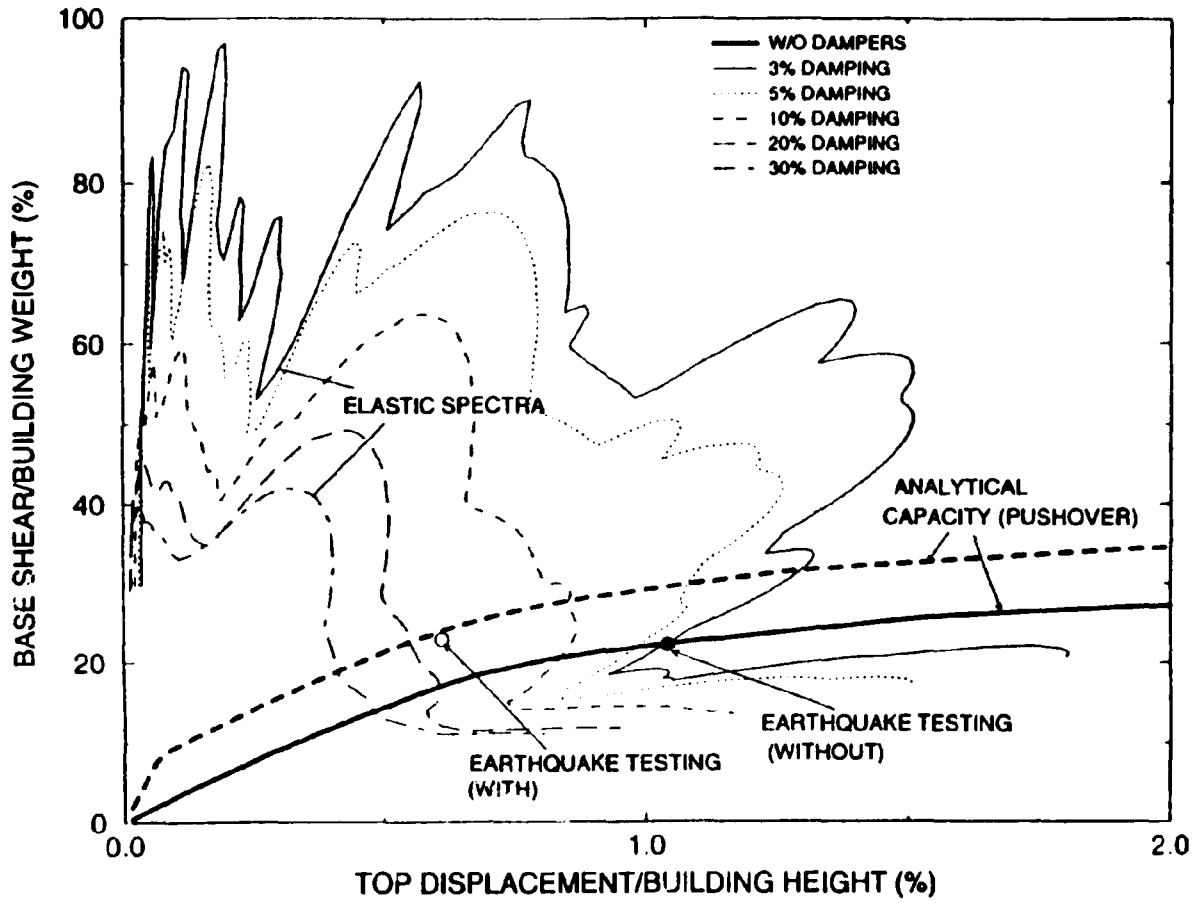

Fig. 4.44 Pushover response of structure with friction dampers for simplified evaluation

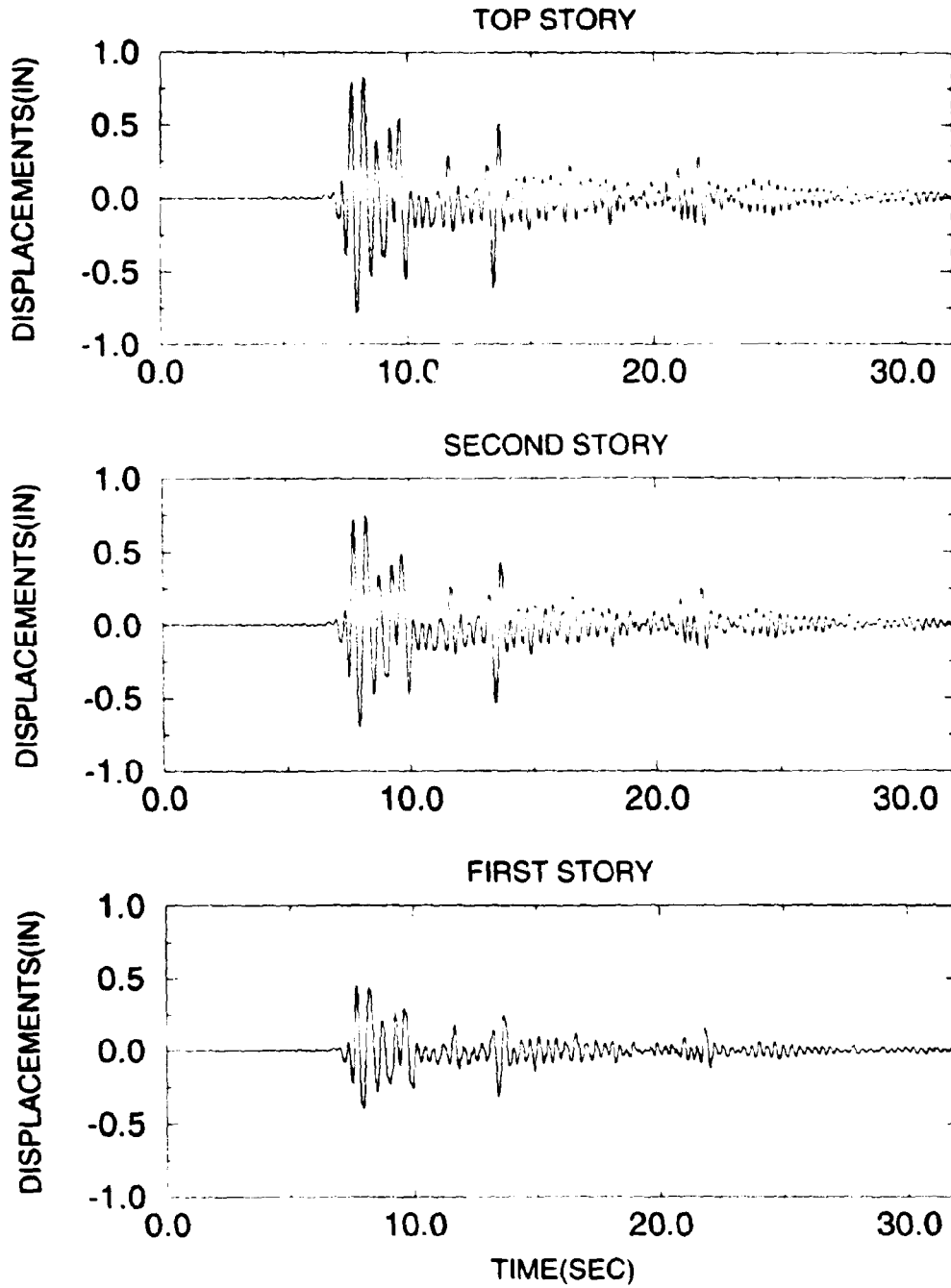

Fig. 4.45 Analytical displacement response with hysteretic dampers (El Centro 0.3g)

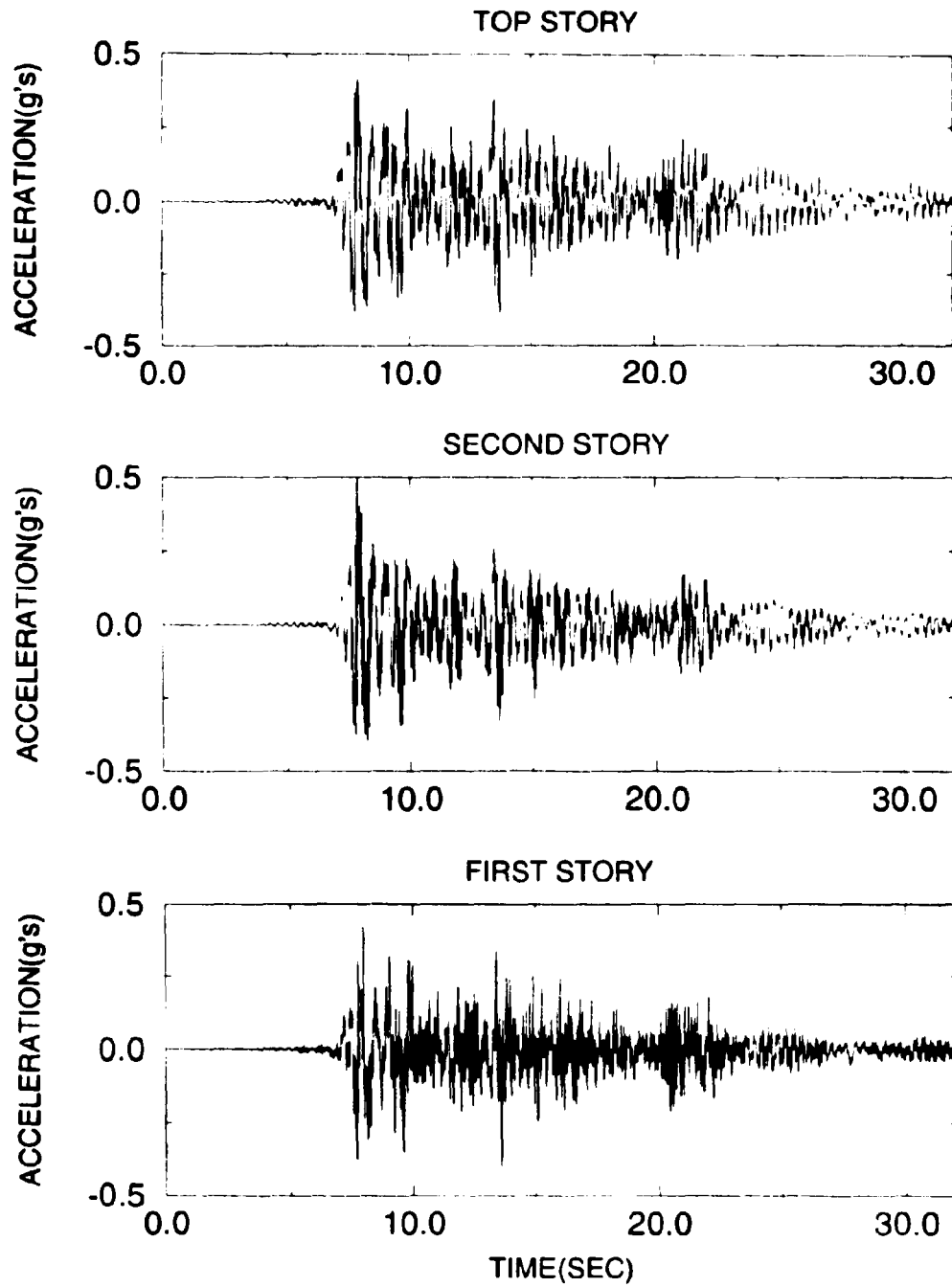

Fig. 4.46 Analytical acceleration response with hysteretic dampers (El Centro 0.3g)

4.10 Masonry Infill Panels: Experimental Test of a Masonry Infilled Frame

The computer program IDARC is capable of analyzing the response of buildings with infill panel elements. In this case study, the response of a masonry infill panel tested at the University of Buffalo (Mander and Nair, 1994) is investigated. The infill frame was part of a research program to obtain the hysteretic force deformation of masonry infilled frames. The subassemblies, constructed from bolted steel frames and infilled with clay brick masonry, were tested under in-plane quasi-static cyclic loading. The test specimens consisted of three story steel frames with the center story infilled with the brick masonry (see Fig. 4.47). Diagonal braces with stiffness similar to the infill were provided at the top and bottom stories.

Connections in the frame were designed to half the strength capacity of the connecting members to achieve concentrated yielding in the connections, preventing therefore damage to the principal members. The test setup was designed to simulate boundary conditions shown in Fig. 4.48, with plastic hinges at the beam ends and a compression strut in the infill. Such conditions exist in frames subjected to lateral loading with the infill being the critical element (Mander et al., 1994). Test specimens were subjected to a sinusoidal cyclic drift history with increasing amplitude.

The program IDARC Ver. 4.0 was used to simulate the observed experimental force deformation response of the masonry infill subassembly. The idealized structural model used for the analysis is shown in Fig. 4.49. The model parameters were determined using the formulas presented in Appendix D (see Reinhorn et al., 1995d, for more details). The same cyclic drift history used for the experimental test was used as input for the model. The comparison of the experimental and analytical force-deformation response for one of the subassemblies tested is presented in Fig. 4.50 (see Reinhorn et al., 1995d, for more comparisons). The figure shows the lateral force vs. interstory drift hysteresis loops obtained in the experiment and the simulation. The comparison indicates that the theoretical model predicts the experimental results to a reasonable degree of accuracy.

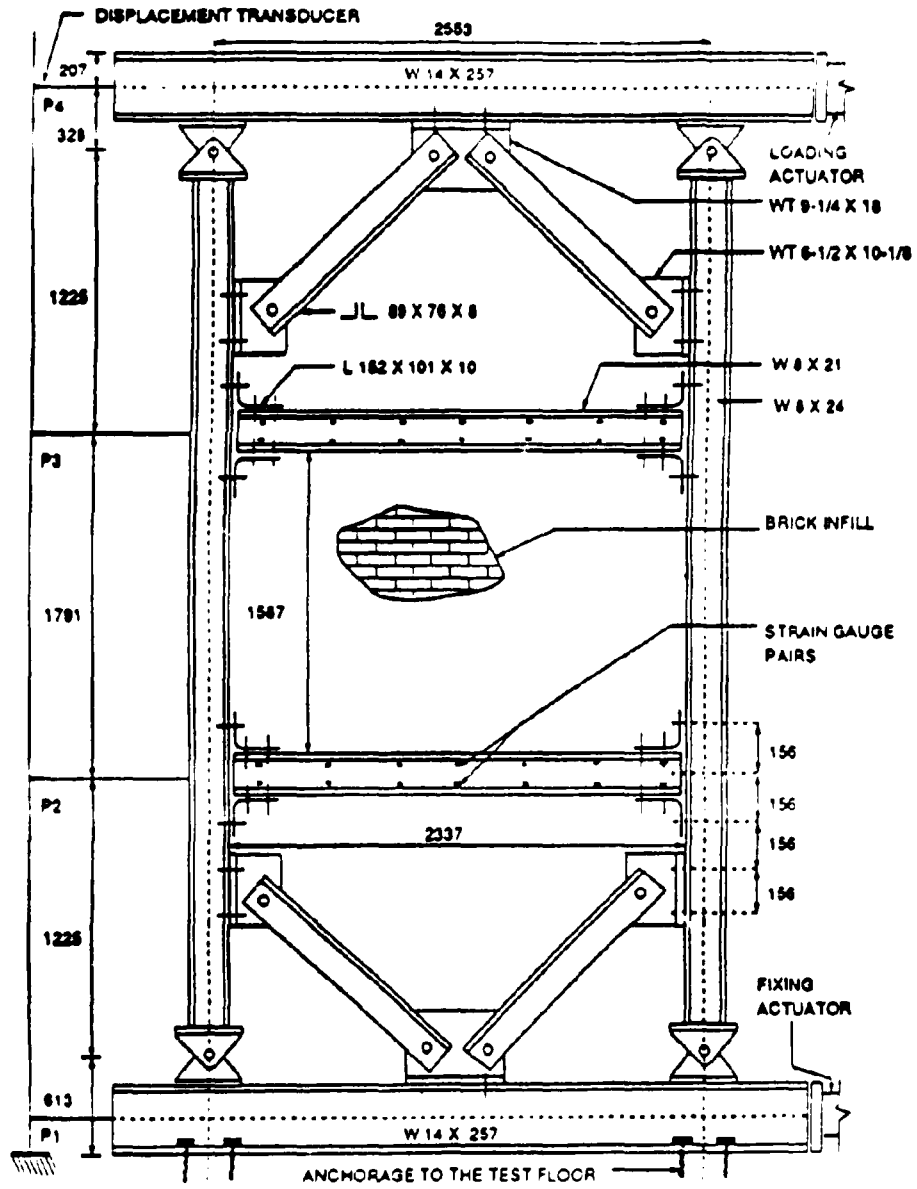

Fig. 4.47 Masonry infilled frame test specimen

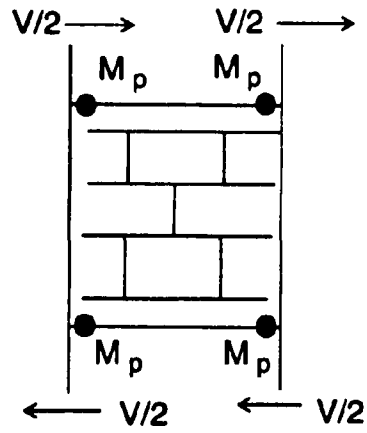

Fig. 4.48 Boundary conditions of infilled frame subassembly

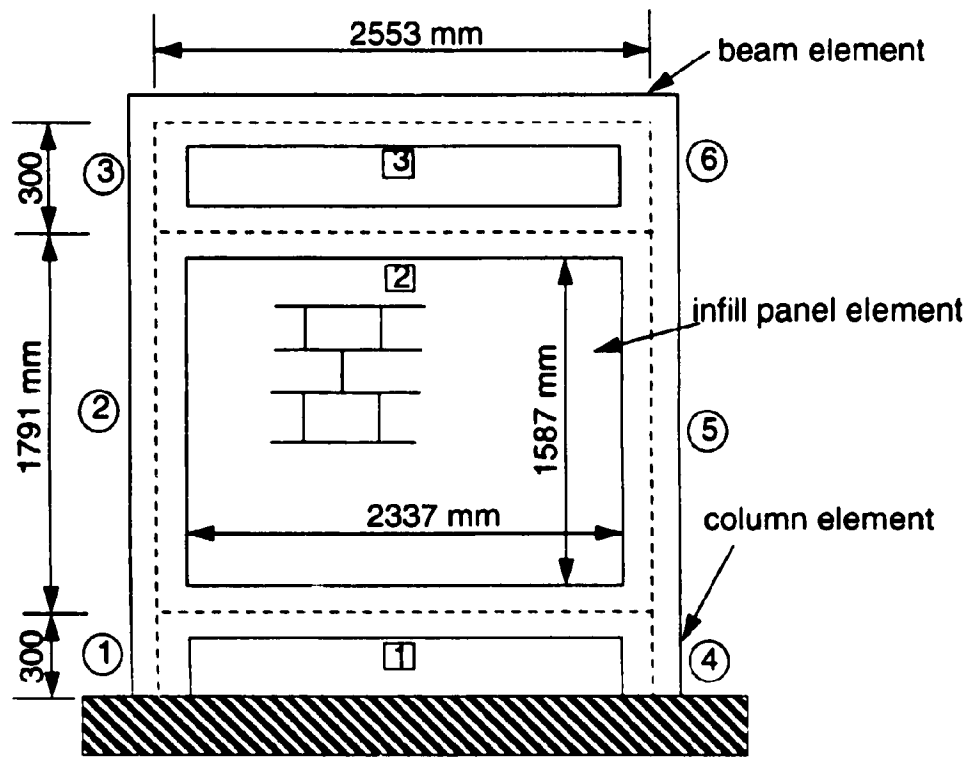

Fig. 4.49 Idealized structural model for analysis

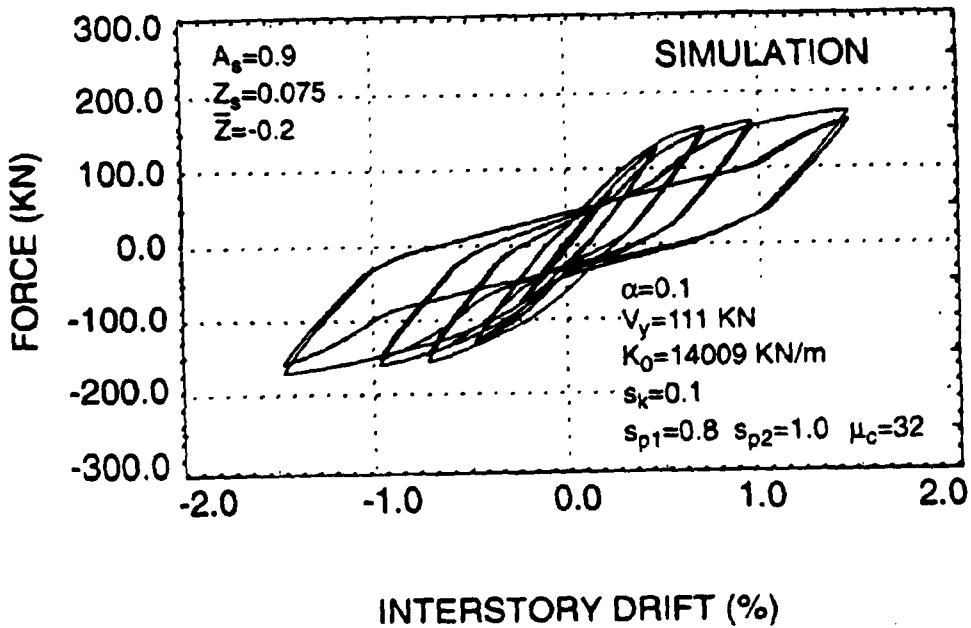
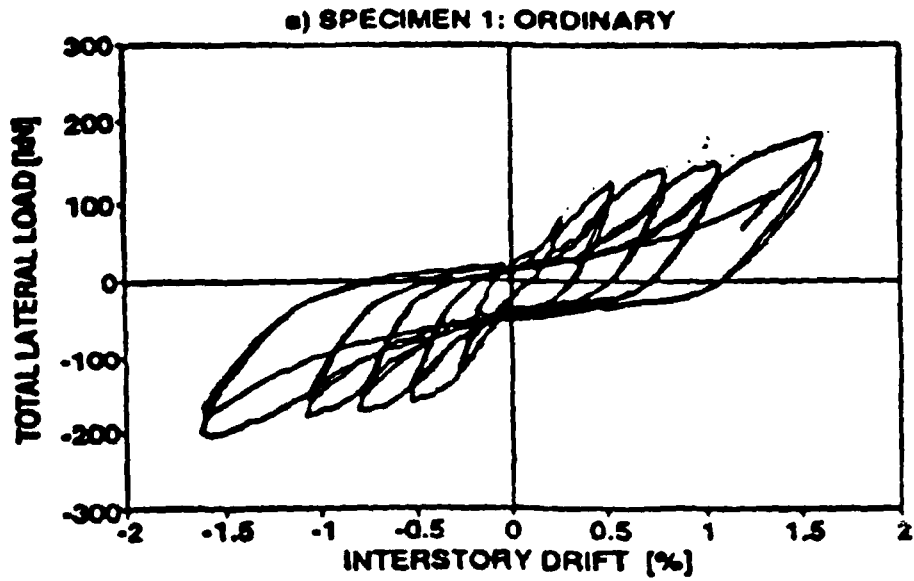

Fig. 4.50 Comparison of experimental and analytical force-deformation response (Specimen 1)

The proposed hysteretic rule is sufficiently versatile and adequate to generate the observed hysteretic loops

4.11 Remarks and Conclusions

The case studies presented in this Section are only meant to show a representative sample of IDARC capabilities. The task of modeling different structures vary from case to case, depending upon the degree of complexity in structural configuration and member connections. While IDARC must still be regarded as a special-purpose program, it can be used with generality in analysis of structures ranging from buildings to bridges and partial subassemblies used in laboratory testing.

The input parameters to the program are obtained directly from engineering drawings or from separate computations of member properties. The only exceptions are the input of hysteretic parameters and the assigned viscous damping analysis. The case studies presented here cover a range of different structures from single components to scaled model frame buildings to full scale existing structures. They also include well-detailed ductile joints to gravity-load-designed non-ductile connections. The parameters used here can serve as a reference for the choice of appropriate parameters. It is recommended to use data from component tests when available, either by actual testing or from the literature of past testing of similar configurations and details.

The choice of hysteretic parameters is critical only in the prediction of local failures at a beam-column interface. For systems with a large number of elements, the overall response is less sensitive to local behavior. Consequently, the prediction of global damage states is more reliable for single components, such as single bridge piers, and structures where the damage is more evenly distributed.

SECTION 5

CONCLUSIONS AND RECOMMENDATIONS

5.1 Conclusions

The present report summarizes the theory, developments, and capabilities of IDARC Ver 4.0 for the inelastic damage analysis of structures. Significant changes and improvements with respect to previous versions are summarized below:

- a) **Viscoelastic, friction and hysteretic damper elements** – The three main types of supplemental damper elements were added to the new release of the program. Viscoelastic damper elements can be modeled using a Kelvin or a Maxwell model, depending on the specific characteristics of the damper used. Friction and hysteretic dampers are modeled using the Bouc-Wen smooth hysteretic model. All damper models are capable of capturing the response during dynamic, quasi-static and pushover analysis.
- b) **Infill panel elements** – Contribution of infill panel elements to the lateral load resistance of the structure were added. The hysteretic response is captured using a smooth hysteretic model that accounts for stiffness degradation, strength deterioration, and pinching of the hysteretic loops. A large variety of infill panel elements can be modeled with changes in the control parameters of the hysteretic model. Formulas to internally calculate the response parameters of masonry infill panels are available in the program.
- c) **Spread plasticity and yield penetration** – The spread plasticity model was reformulated to include the effects of shear distortions with enhanced numerical precision. The new formulation can accommodate shear or flexural failure conditions. Yield penetration rules were introduced to track the variation of the plastic length zones.

-
- d) **New damage indices** Three damage indices can now be calculated in the program the Park & Ang damage model, the fatigue based damage index, and an overall measure of the lateral stiffness loss. The first two damage models can provide damage estimates for structural elements, stories (subassemblies), or the overall buildings response.
 - e) **Hysteresis modules** New set of routines were introduced to model different hysteretic responses, including a three branch steel model, and a bilinear model. The structure of the program was modified to facilitate the addition of new hysteretic routines that can be developed in the future, or by other researchers.
 - f) **New pushover options** A number of different options for the pushover analysis were added to the program displacement control, user defined force control distribution, a generalized power distribution, and a modal adaptive lateral force distribution. These distributions allow for a more realistical force distribution to be used during pushover analysis.
 - g) **Response snapshots during analysis** The user can now request response snapshots during the analysis. Response snapshots provide the user with displacement profile, element stress ratios, collapse states, damage index states, and dynamic characteristics (eigenvalues and eigenvectors) of the building during the analysis.
 - h) **Proportional damping options** In the new version of IDARC the damping matrix can be specified to be mass proportional, stiffness proportional, or Rayleigh proportional. Proportionality coefficients are calculated internally by the program using the first mode, or the first two modes in the case of Rayleigh damping.
 - i) **Reprogrammed for improved efficiency** Most of the solution routines, including the eigenvalue routine, the shear calculation, the spread plasticity and yield penetration routines, and the matrix condensation routines were revised and reprogrammed to improve computational efficiency in the analysis. The program can readily be executed in a personal computer.

j) New case studies for program validation. Verification examples have been included to highlight the program capabilities and features, as well as to validate whenever possible numerical models with experimental results. The case studies will help the new user of the program to understand IDARC capabilities and input formats.

k) A mail user group for the program is available for questions, suggestions or comments related to the program.

Email: CIEREINA@ubvms.cc.buffalo.edu

A web site in the internet has been created where news, updates, comments and current developments will be posted.

<http://shalom.eng.buffalo.edu/idarc>

5.2 Further Development Recommendations

The following is a list of recommendations for further developments of the program:

- Incorporate element collapse.
- Smooth hysteretic model for columns, beams and shear wall elements.
- Include axial, shear, and moment interactions in the element capacity.
- Automatic calculation of overall and story fatigue based damage indices.

—

SECTION 6

REFERENCES

- Allahabadi, R. and Powell, G. H. (1988) "DRAIN-2DX User Guide" Report No UCB/EERC-88/06 University of California, Berkeley
- Applied Technology Council (1995), "Guidelines and Commentary for the Seismic Rehabilitation of Buildings," 3 Volumes, ATC-33 02, 50% Submittal, Second Draft, Federal Emergency Management Agency
- Baber, T. T., and Noori, M. N. (1985), "Random Vibration of Degrading Pinching Systems," *Journal of Engineering Mechanics*, Vol. 111, No. 8, pp 1010-1026, August.
- Baber T. T., and Wen, Y. K. (1981), "Random Vibration of Hysteretic Degrading Systems," *Journal of Engineering Mechanics*, ASCE, Vol. 107
- Bracci, J. M. (1992), "Experimental and Analytical Study of Seismic Damage and Retrofit of Lightly Reinforced Concrete Structures in Low Seismicity Zones", Ph.D. Dissertation, Department of Civil Engineering, State University of New York at Buffalo, New York.
- Bracci, J. M., Reinhorn, A. M., and Mander, J. B. (1992), "Evaluation of Seismic Retrofit of Reinforced Concrete Frame Structures Part III-Experimental Performance and Analytical Study of Retrofitted Structural Model Structure," Technical Report NCEER-92-0031, National Center for Earthquake Engineering Research, State University of New York at Buffalo.
- Bouc, R. (1967), "Forced Vibration of Mechanical Systems with Hysteresis," *Proceedings of the 4th Conference on Non-linear Oscillations*, Prague
- Cecen, H. (1979), "Response of Ten Story Reinforced Concrete Model Frames to Simulated Earthquakes", Ph.D. Dissertation, Department of Civil Engineering, University of Illinois, Urbana
- Cheok, G. S. and Stone, W. C. (1990), "Behavior of 1/6 Scale Model Bridge Columns Subjected to Inelastic Cyclic Loading", *ACI Structural Journal*, Vol. 87, No. 6, pp 630-638
- Chung, Y. S., Meyer, C. and Shinozuka, M. (1988), "SARCF User's Guide Seismic Analysis of Reinforced Concrete Frames", Technical Report NCEER-88-0044, State University of New York at Buffalo

- Constantinou, M. C., and Symans, M. D. (1992), "Experimental and Analytical Investigation of Seismic Response of Structures with Supplemental Fluid Viscous Dampers," Technical Report NCEER-92-0032, National Center for Earthquake Engineering Research, State University of New York at Buffalo
- DiPasquale, E., and Cakmak, A. S. (1988), "Identification of the Serviceability Limit State and Detection of Seismic Structural Damage," Technical Report NCEER-88-0022, National Center for Earthquake Engineering Research, Princeton University
- El-Attar, A. G. (1991), "A Study of the Seismic Behavior of Lightly Reinforced Concrete Structures", Ph.D. Dissertation, Department of Civil Engineering, Cornell University, Ithaca
- Gomez, S. R., Chung, Y. S., and Meyer, C. (1990), "SARCF-II User's Guide - Seismic Analysis of Reinforced Concrete Frames", Technical Report NCEER-90-0027, State University of New York at Buffalo
- Gross, J. L. and Kunnath, S. K. (1992), "Application of Inelastic Damage Analysis to Double Deck Highway Structures", Technical Report NISTIR-4857, U.S. Department of Commerce, National Institute of Standards and Technology, Gaithersburg, M. D.
- Habibullah, A. (1995), "ETABS v6.0 - Three Dimensional Analysis of Building Systems," User's Manual, Computers & Structures Inc.
- Kabeyasawa, T., Shiohara, H., Otani, S., and Aoyama, H. (1983), "Analysis of the Full-Scale Seven-Story Reinforced Concrete Test Structure," Journal of the Faculty of Engineering, University of Tokyo, Vol. XXXVII, No. 2
- Kanaan, A. E. and Powell, G. H. (1973), "DRAIN-2D-A General Purpose Computer Program for Dynamic Analysis of Inelastic Plane Structures", Reports No. UCB/EERC/73/06 and 73/22, University of California, Berkeley
- Kent, D. C., and Park, R. (1971), "Flexural Members with Confined Concrete", Journal of Structural Division, ASCE, Vol. 97, ST7, 1969-1990
- Kunnath, S. K., Reinhorn, A. M., and Abel, J. F. (1992a), "A Computational Tool for Seismic Performance of Reinforced Concrete Buildings", Computers and Structures, Pergamon Press, Vol. 41, No. 1, 157-173
- Kunnath, S. K., Reinhorn, A. M., and Lobo, R. F. (1992b), "IDARC Version 3.0 - A Program for the Inelastic Damage Analysis of Reinforced Concrete Structures," Report No. NCEER-92-0022, National Center for Earthquake Engineering Research, State University of New York at Buffalo

- Kunnath, S. K., Reinhorn, A. M., and Park, Y. J. (1990), "Analytical Modeling of Inelastic Seismic Response of R/C Structures", *Journal of Structural Engineering, ASCE*, Vol 116, No. 4, 996-1017
- Li, C., and Reinhorn, A. M. (1995), "Experimental and Analytical Investigation of Seismic Retrofit of Structures with Supplemental Damping Part II-Friction Damping Devices," Report No. NCEER-95-0009, National Center for Earthquake Engineering Research, State University of New York at Buffalo
- Lobo, R. F. (1994), "Inelastic Dynamic Analysis of Reinforced Concrete Structures in Three Dimensions," Ph.D. Dissertation, Department of Civil Engineering, State University of New York at Buffalo
- Lobo, R. F., Bracci, J. M., Shen, K. L., Reinhorn, A. M., and Soong, T. T. (1993), "Inelastic Response of Reinforced Concrete Structures with Viscoelastic Braces," Technical Report No. NCEER-93-0006, National Center for Earthquake Engineering Research, State University of New York at Buffalo
- Mander, J. B., and Nair, B. (1994), "Seismic Resistance of Brick-Filled Steel Frames with and without Retrofit," *The Masonry Journal, The Professional Journal of Masonry Society*, pp. 24-37, February
- Mander, J. B. (1984), "Seismic Design of Bridge Piers", Ph.D. Dissertation, Department of Civil Engineering, University of Canterbury, New Zealand
- Naeim, F., DiJulio, R., Benuska, K., Reinhorn, A. M., and Li, C. (1995), "Evaluation of the Seismic Performance of an 11 Story Steel Moment Frame Building During the 1994 Northridge Earthquake," Report to SAC Joint Venture, SAC Task 3.1, Building No. 6, John A. Martin & Associates, Inc.
- Naeim, F., and Reinhorn, A. M. (1995), "Seismic Performance Analysis of a 7 Story Reinforced Concrete Building," Report to the Applied Technology Council, Task 12, Subcontract No. 330 1-24-569, John A. Martin & Associates, Inc.
- Otani, S. (1974), "SAKE: A Computer Program for Inelastic Response of RC Frames Subject to Earthquakes", *Civil Engineering Studies, Technical Report No. SRS 413*, University of Illinois, Urbana
- Oughourlian, C. V., and Powell, G. H. (1982), "ANSR-III General Purpose Computer Program for Nonlinear Structural Analysis," Report No. UCB/EERC-82/21, Earthquake Engineering Research Center, University of California at Berkeley
- Park, R., and Paulay, T. (1975), "Reinforced Concrete Structures", John Wiley
- Park, Y. J., Reinhorn, A. M., and Kunnath, S. K. (1987), "IDARC: Inelastic Damage Analysis of Reinforced Concrete Frame - Shear-Wall Structures", Technical Report NCEER-87-0008, State University of New York at Buffalo

- Park, Y. J., Ang, A. H-S., and Wen, Y. K. (1986), "Damage-Limiting Aseismic Design of Buildings," *Earthquake Spectra*, May
- Park, Y. J., Ang, A. H-S., and Wen, Y. K. (1984), "Seismic Damage Analysis and Damage-Limiting design of R/C Buildings", *Civil Engineering Studies, Technical Report No. SRS 516*, University of Illinois, Urbana
- Paulay, T., and Priestley, M. J. N. (1992), "Seismic Design of Reinforced Concrete and Masonry Buildings", John Wiley
- Prakash, V., Powell, G. H., and Filippou, F. C. (1992), "DRAIN-2DX Base Program User Guide," Report No. UCB/SEMM-92/29, Department of Civil Engineering, University of California at Berkeley, December
- Reinhorn, A. M., Li, C., and Constantinou, M. C. (1995a), "Experimental and Analytical Investigation of Seismic Retrofit of Structures with Supplemental Damping Part I-Fluid Viscous Damping Devices," Report No. NCEER-95-0001, National Center for Earthquake Engineering Research, State University of New York at Buffalo
- Reinhorn, A. M., and Li, C. (1995b), "Experimental and Analytical Investigation of Seismic Retrofit of Structures with Supplemental Damping Part III-Viscous Walls," Report No. NCEER-95-0013, National Center for Earthquake Engineering Research, State University of New York at Buffalo
- Reinhorn, A. M., Li, C., and Constantinou, M. C. (1996), "Experimental and Analytical Investigation of Seismic Retrofit of Structures with Supplemental Damping Part IV-Summary Volume," Report No. NCEER-96-xxxx, National Center for Earthquake Engineering Research, State University of New York at Buffalo (in press)
- Reinhorn, A. M., Madan, A., Valles, R. E., Reichman, Y., and Mander, J. B. (1995c), "Modeling of Masonry Infill Panels for Analysis of Frame Structures," Report No. NCEER-95-0018, National Center for Earthquake Engineering Research, State University of New York at Buffalo (in press)
- Reinhorn, A. M., and Valles, R. E. (1996), "Damage Evaluation in Inelastic Response of Structures A Deterministic Approach," Report No. NCEER-95-xxxx, National Center for Earthquake Engineering Research, State University of New York at Buffalo
- Reinhorn, A. M., Nagarajaiah, S., Constantinou, M. C., Tsopelas, P., and Li, R. (1994), "3D-BASIS-TABS Version 2.0 Computer Program for Nonlinear Dynamic Analysis of Three Dimensional Base Isolated Structures," Technical Report NCEER-94-0018, National Center for Earthquake Engineering Research, State University of New York at Buffalo

- Richart, F. E., Brandtzaeg, A., and Brown, R. L. (1928), "A Study of the Failure of Concrete Under Combined Compressive Stresses", University of Illinois Engineering Experimental Station, Bulletin No. 185
- Rosenbrock, H. H. (1964), "Some General Implicit Processes for the Numerical Solution of Differential Equations," *Computer Journal*, Vol. 18, pp. 50-64
- Saneinejad, A. and Hobbs, B. (1995), "Inelastic Design of Infilled Frames," *Journal of Structural Engineering*, Vol. 121, No. 4, pp. 634-650, April.
- Shen, K. L. (1994) "Viscoelastic Dampers: Theory, Experimental and Applications in Earthquake Engineering," Ph.D. Dissertation, Department of Civil Engineering, State University of New York at Buffalo.
- Somerville, P. (1995), "Site-Specific Northridge Response Spectra for ATC-33 Task 12, Subcontract No. 330.1-24-569
- Stone, W. C., and Cheok, G. C. (1989), "Inelastic Behavior of Full-Scale Bridge Columns Subjected to Cyclic Loading", NIST Building Science Series 166, National Institute of Standards and Technology, Gaithersburg, M. D.
- Valles, R. E., Reinhorn, A.M., and Barrón, R. (1996), "Seismic Evaluation of a Low-Rise RC Building in the Vicinity of the New Madrid Seismic Zone," Technical Report NCEER-95-xxxx, National Center for Earthquake Engineering Research, State University of New York at Buffalo (in press)
- Wight, J. K. (Editor) (1985), "Earthquake Effects on Reinforced Concrete Structures", U.S.-Japan Research, ACI Special Publication SP-84, American Concrete Institute, Detroit.
- Wilson, E. L. (1995). "SADSAP: Static and Dynamic Structural Analysis Programs," Version 2.04, Structural Analysis Programs Inc., El Cerrito, CA.
- Wilson, E. L., and Habibullah, A. (1987), "Static and Dynamic Analysis Multistory Buildings, Including P-Delta Effects", *Earthquake Spectra*, Vol. 3, No. 2.
- Yunfei, H., Yufeng, C., Chang, S., and Bainian, H. (1986), "The Experimental Study of a Two-Bay Three Story Reinforced Concrete Frame Under Cyclic Loading", *Proceedings of the 8th Symposium on Earthquake Engineering*, Roorkee, India.

APPENDIX A USER'S GUIDE

INPUT FORMAT

A free format is used to read all input data. Hence, conventional delimiters (commas, blanks) may be used to separate data items. Standard FORTRAN variable format is used to distinguish integers and floating point numbers. Input data must, therefore, conform to the specified variable type.

Notes: 1. Provision is made for a line of text between each set of data items. Refer to the sample data files accompanying this Manual.

2. No blank lines are to be input.

3. A zero input will result in program default values, where applicable.

SET A: GENERAL INFORMATION

- Title of Problem:

TITLE

Description: TITLE: Alpha-numeric title, up to 80 characters.

- Control Data (See Figure A-1):

USER_TEXT

NSO, NFR, NCON, NSTL, NMSR, NPDEL, IPC

Description: USER_TEXT: Reference information, up to 80 characters of text.

NSO: Number of stories.

NFR: Number of typical (non-identical) frames

NCON: Number of different concrete material properties sets.

NSTL: Number of different steel reinforcement properties sets.

NMSR: Number of different masonry material properties sets.

NPDEL: 0 to ignore P-Delta effects, or
1 to include P-Delta effects.

IPC: 0 for Unix operating system, or
1 for DOS/WINDOWS operating system.

Notes: A structure must be decomposed into a series of parallel frames. Input is required only for non-identical frames, denoted here by the integer variable NFR. The number of duplicates of each typical frame is specified later in this DATA SET. The entire group of frames can be defined in the IDARC I-I-J nodal locator system. This concept is shown graphically in Figure A-1. Three examples of different frame definitions are shown. In Figure A-1a, the four-story building made up of a total of four frames is assumed to have

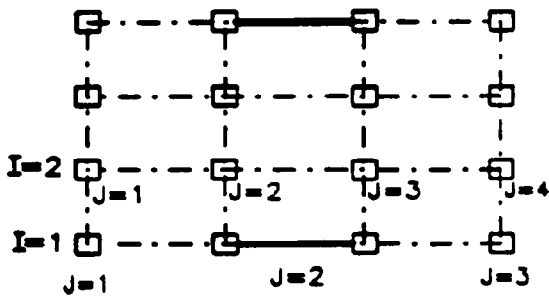

PLAN

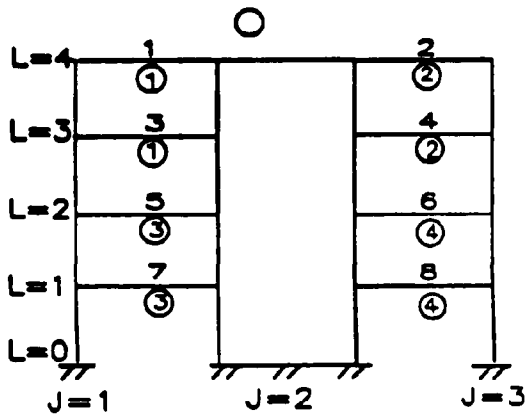

EXTERIOR FRAMES ○ TYPE NUMBER

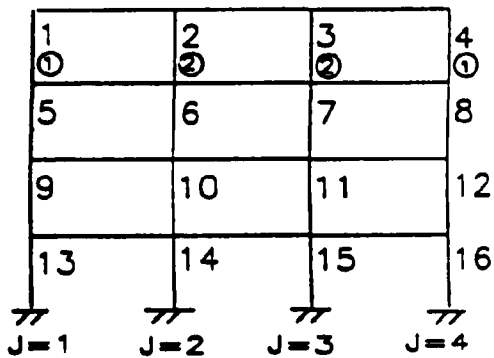

INTERIOR FRAMES

(a) Typical Building

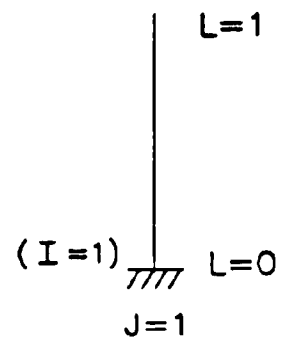
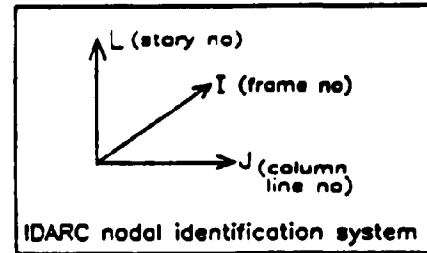

(b) Cantilever Beam-Column

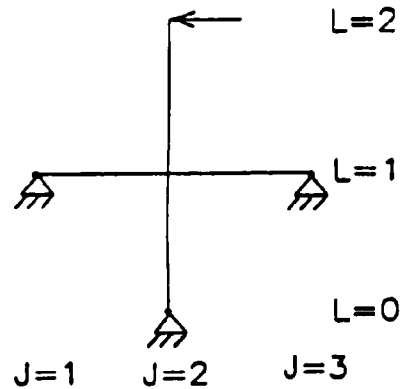

(c) Typical Beam-Column Subassemblage

Fig. A.1 Frame discretization and nodal identification

two pairs of identical frames, hence, only two of them need be input in IDARC (NFR=2). The cantilever beam-column shown in Figure A-1b is defined as a single-story structure with one column line. Likewise, the subassemblage shown in Figure 1c is defined as a 2-story structure with three column lines. The number of concrete and steel properties refer to the number of stress-strain envelopes to be input in Set B and Set C respectively.

SET A1: ELEMENT TYPES

- Control Data (See Figure A-1):

USER TEXT

MCOL, MBEM, MWAL, MEDG, MTRN, MSPR, MBRV, MBRE, MBRH,

MIW

<i>Description:</i>	USER TEXT: Reference information, up to 80 characters of text.
	MCOL: No. of column types.
	MBEM: No. of beam types.
	MWAL: No. of shear wall types.
	MEDG: No. of edge column types.
	MTRN: No. of transverse beam types.
	MSPR: No. of rotational spring types.
	MBRV: No. of visco-elastic brace types.
	MBRE: No. of friction brace types.
	MBRH: No. of hysteretic brace types.
	MIW: No. of infill panel types.

Notes: Elements are grouped into identical sets based on cross-section data and initial conditions such as axial loads. For example, in the exterior frame shown in Figure A-1a, there are 8 columns. Typically, the exterior columns at each level will be identical, hence, only 4 column types need to be defined. The interior frame, assuming identical interior and exterior columns in each floor, will require only 8 column types to define all 16 elements, i.e., 2 types per each level as shown in the Figure.

SET A2: ELEMENT DATA

- Control Data:

USER TEXT

NCOL, NBEM, NWAL, NEDG, NTRN, NSPR, NMR, NBR, NIW

<i>Description:</i>	USER TEXT: Reference information, up to 80 characters of text.
	NCOL: No. of columns.
	NBEM: No. of beams.
	NWAL: No. of shear walls.
	NEDG: No. of edge columns.
	NTRN: No. of transverse beams.

NSPR:	No. of rotational springs.
NMR:	No. of moment releases.
NBR:	No. of braces (VE + friction + hysteretic).
NIW:	No. of infill panels.

Notes: NMR is used to specify moment releases (hinge locations) at member ends. Releasing a moment at a member end results in a hinge condition at that end thereby disallowing moments to develop at the section.

SET A3: SYSTEM OF UNITS

- Control Flag:

USER_TEXT
IU

Description: USER_TEXT: Reference information, up to 80 characters of text.

IU: System of units
1 for inch, kips
2 for mm, kN

DEFAULT SYSTEM OF UNITS: *inch, kip*

A zero input for IU will result in the use of *inch and kip units*.

SET A4: FLOOR ELEVATIONS

- Control Data (See Figure A-2):

USER_TEXT
HIGT(1), HIGT(2), ..., HIGT(NSO)

Description: USER_TEXT: Reference information, up to 80 characters of text.

HIGT(i): Elevation of story "i" from the base, beginning with the first floor level.

SET A5: DESCRIPTION OF IDENTICAL FRAMES

- Control Data:

USER_TEXT
NDUP(1), NDUP(2), ..., NDUP(NFR)

Description: USER_TEXT: Reference information, up to 80 characters of text.

NDUP(i): List with the number of duplicate frames of typical (non-identical) frame "i".

Notes: In the sample structure shown in Figure A-1, there are four frames. However, the two interior frames are identical as are the exterior frames. In this case, NFR=2, and NDUP(1) = NDUP(2) = 2.

SET A6: PLAN CONFIGURATION

- **Control Data:**

USER_TEXT

NVLN(1), NVLN(2), ..., NVLN(NFR)

Description: **USER_TEXT:** Reference information, up to 80 characters of text.

NVLN(i): Number of column lines (or J-locator points) in frame "i".

Notes: A set of NVLN points for each frame should define completely the column lines necessary to specify every vertical element in that frame. If a beam element is subdivided into two or more segments, then the number of column lines specified must include these internal beam nodes as well.

SET A7: NODAL WEIGHTS

- **Control Data (See Figure A-2):**

USER_TEXT

LEVEL, IFR(1), WWT(1), WWT(2), ..., WWT(NVLN(1))

IFR(2), WWT(1), WWT(2), ..., WWT(NVLN(2))

....repeat for NFR frames

....repeat for NSO levels (in ascending or descending order)

Description: **USER_TEXT:** Reference information, up to 80 characters of text.

LEVEL: Story level number.

IFR(J): Frame number.

WWT(K): Nodal weight.

Notes: 1. Nodal weights are only used for the story mass computation.

2. Nodal weights may be input in ascending or descending story level

SET B: MATERIAL PROPERTIES SETS

- **Envelope Generation Option:**

USER_TEXT

IUSER

Description: **USER_TEXT:** Reference information, up to 80 characters of text.

IUSER: Code for specification of user properties:
0, produces IDARC generated envelopes for at least one element.

1, requires complete moment-curvature envelope data to be provided by user.

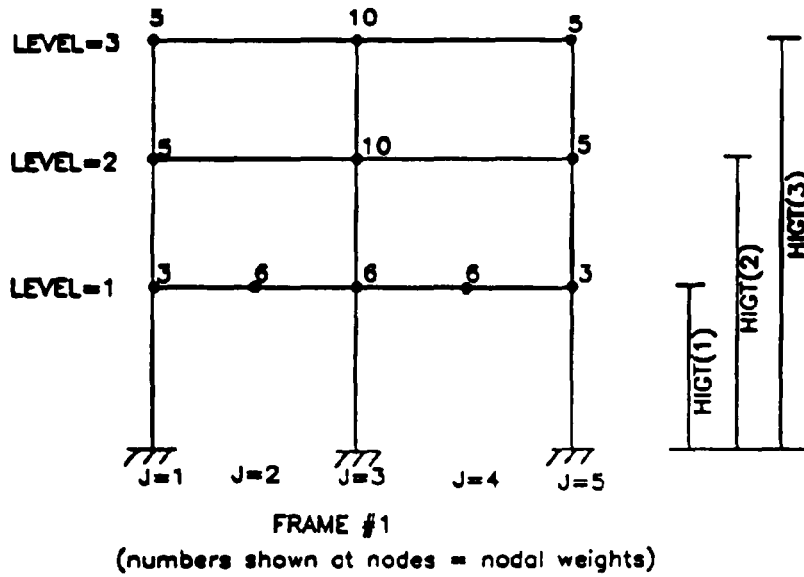

INPUT DATA:

1,	1,	3.0,	6.0,	6.0,	6.0,	3.0
2,	1,	5.0,	0.0,	10.0,	0.0,	5.0
3,	1,	5.0,	0.0,	10.0,	0.0,	5.0

Fig. A.2 Floor heights and nodal weights

SET B1: CONCRETE PROPERTIES SETS (SEE FIGURE A-3)
(SKIP THIS INPUT IF IUSER=1 OR NCON=0)

- **Reference text:**
USER_TEXT
Description: **USER_TEXT:** Reference information, up to 80 characters of text.

- **Characteristics of concrete stress-strain curve (one line for each of the NCON concrete types):**
IM, FC, EC, EPS0, FT, EPSU, ZF
Description: **IM:** Concrete property type (set) number.
FC: Unconfined compressive strength.
EC: Initial Young's Modulus of concrete.
EPS0: Strain at max. strength of concrete (%).
FT: Stress at tension cracking.
EPSU: Ultimate strain in compression (%).
ZF: Parameter defining slope of falling branch.
DEFAULT VALUES (if a zero was specified as data input):
EC = $57 \cdot \sqrt{FC} \cdot 1000$ ksi ; EPS0 = 0.2% ; FT = 0.12*FC ;
EPSU and ZF are derived from Equation (3.12) and depends on section data.

SET B2: REINFORCEMENT PROPERTIES SETS (SEE FIGURE A-4)
(SKIP THIS INPUT IF IUSER=1 OR NSTL=0)

- **Reference Text:**
USER_TEXT
Description: **USER_TEXT:** Reference information, up to 80 characters of text.

- **Characteristics of steel stress-strain curve (one line for each of the NSTL steel types):**
IM, FS, FSU, ES, ESH, EPSH
Description: **IM:** Steel type (set) number.
FS: Yield strength.
FSU: Ultimate strength.
ES: Modulus of elasticity.
ESH: Modulus of strain hardening.
EPSH: Strain at start of hardening (%).
DEFAULT VALUES (if a zero was specified as data input):
FSU = 1.4 * FS ; ES = 29,000 ksi ; ESH = (ES / 60) ksi ; EPSH = 3.0%

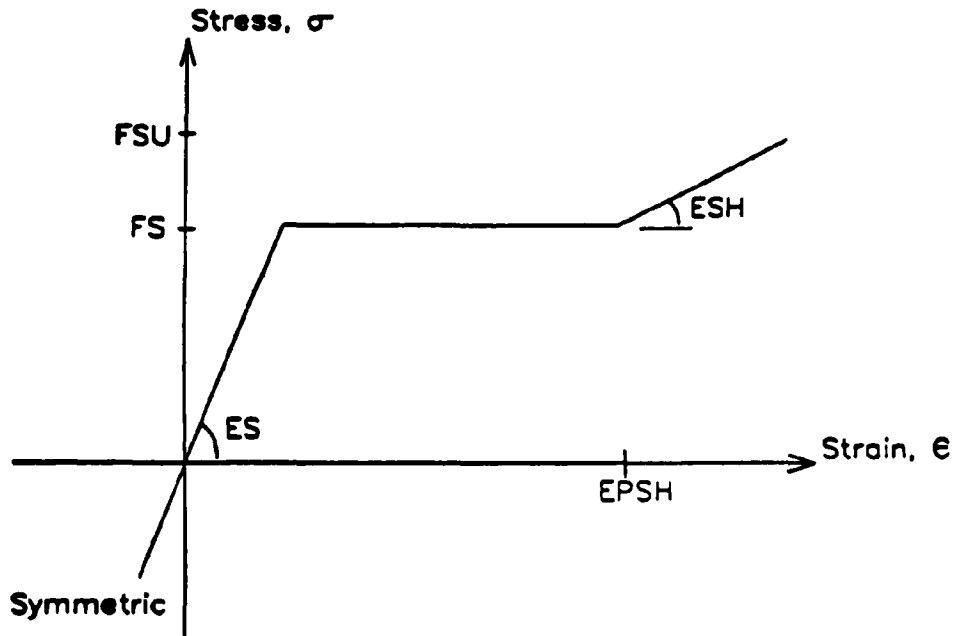

Fig. A.4 Stress curve for reinforcing bars

SET B3: MASONRY INFILL PROPERTIES SETS

(SKIP THIS SECTION IF IUSER=1 OR NMSR=0)

- **Reference text:**
USER_TEXT
Description: **USER_TEXT:** Reference information, up to 80 characters of text.

- **Characteristics of masonry (one line for each of the NMSR masonry types):**
IM, FM, FMCR, EPSM, VM, SIGMM, CFM
Description: **IM:** Masonry type number.
FM: Prism strength of masonry.
FMCR: Cracking modulus of masonry
EPSM: Strain corresponding to prism strength (%).
VM: Basic shear strength of masonry bed joints.
SIGMM: Maximum allowable shear strength
CFM: Coefficient of friction of frame-infill interface.

DEFAULT VALUES (if a zero was specified as data input):
EPSM = 0.2% ; FMCR = 0.05*FM; VM = 0.04 ksi; SIGMM = 0.05*FM;
CFM=0.3

SET C: HYSTERETIC MODELING RULES (SETS)

(SEE FIGURE A-5)

- **Control Data:**
USER_TEXT
NHYS
Description: **USER_TEXT:** Reference information, up to 80 characters of text.
NHYS: Number of types (sets) of hysteretic rules.

- **Hysteretic Model Parameters (one line for each NHYS hysteresis rule types):**
IR, HC, HBD, HBE, HS
Description: **IR:** Parameter set number.
HC: Stiffness degrading coefficient.
HBD: Ductility-based strength decay parameter.
HBE: Energy-based strength decay parameter.
HS: Target slip or crack-closing parameter.

DEFAULT VALUES (if a zero was specified as data input):
HC = 2.0 ; HBD = 0.0; HBE = 0.10 ; HS = 1.0

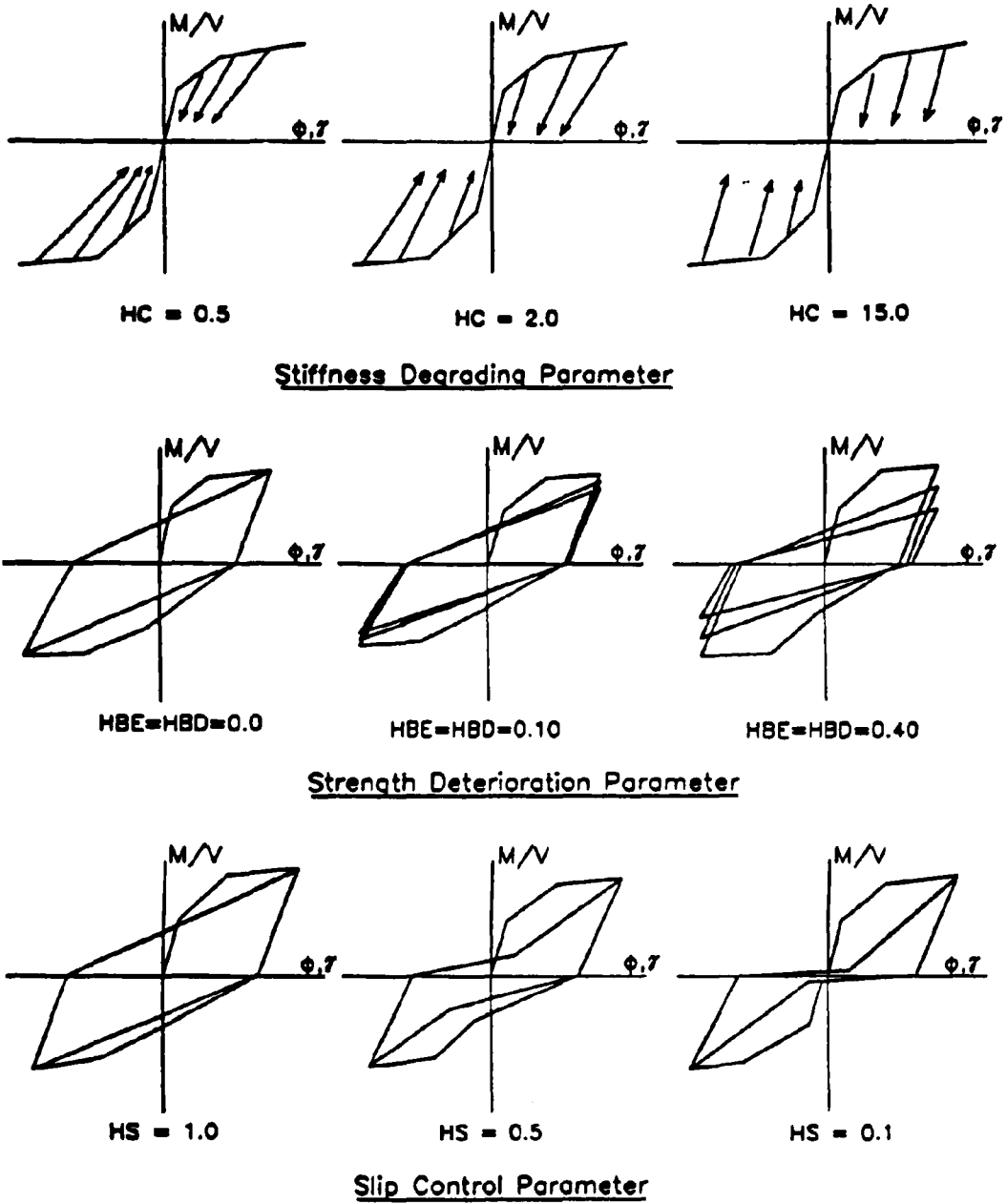

Fig. A.5 Qualitative view of effects of degrading parameters on hysteretic behavior

Notes: Hysteretic behavior is specified at both ends of each member. Access to experimental results of the cyclic force-deformation characteristics of components typical to the structure being analyzed provides the best means of specifying the above degrading parameters. Table A-1 and Figure A-5 provide a number of qualitative insights into modeling of the hysteretic parameters. The loops shown in Figure A-5 are only meant to show the relative effects of changing the parameters. The general meaning of the parameters can be characterized as follows: An increase in HC retards the amount of stiffness degradation; an increase in HBD, HBE accelerates the strength deterioration; and an increase in HS reduces the amount of slip. (Also refer to Section 3.3 of this report)

Table A-1. Typical Range of Values for Hysteretic Parameters

Parameter	Meaning	Value	Effect
HC	Stiffness degrading parameter	0.1	Severe degradation
		2.0	Nominal degradation (default)
		10.0	Negligible degradation
HBD	Strength degrading parameter (ductility-based)	0.0	No degradation (default)
		0.1	Nominal deterioration
		0.4	Severe deterioration
HBE	Strength degrading parameter (energy-controlled)	0.0	No deterioration
		0.1	Nominal deterioration (default)
		0.4	Severe deterioration
HS	Slip or crack-closing parameter	0.1	Extremely pinched loops
		0.5	Nominal pinching
		1.0	No pinching (default)

SET D: COLUMN PROPERTIES

(SKIP THIS INPUT IF THE STRUCTURE HAS NO COLUMNS)

- Control Data:

USER_TEXT

IUCOL

Description:

USER_TEXT: Reference information, up to 80 characters of text.

IUCOL: Type of column input:

0: Section dimensions and reinf. to be specified.

1: Moment-curvature envelope to be specified

IF IUCOL = 1, GO TO SET D3

- **Reference Text:**
USER_TEXT
Description: **USER_TEXT:** Reference information, up to 80 characters of text.
- **For each column type (MCOL), input the following:**
ICTYPE
Data from SET D1 (ICTYPE=1) or SET D2 (ICTYPE=2)
Description: **ICTYPE:** Type of column:
1; rectangular (*DEFAULT*),
2; circular.

READ DATA FROM SET D1 OR D2 (See below)
GO TO SET E WHEN FINISHED READING ALL COLUMN TYPES.

SET D1: for ICTYPE=1; *Rectangular Column Data Set (SEE FIGURE A-6)*

- **General data:**
KC, IMC, IMS, AN, AMLC, RAMC1, RAMC2
- **Bottom section:**
KHYSC, D, B, DC, AT, HBD, HBS, CEF
- **Top section:**
If KHYSC for bottom section is input with negative sign, section is symmetric, hence, do not input top section data, otherwise repeat as above, starting with KHYSC.
Description: **KC:** Column type set number.
IMC: Concrete type number.
IMS: Steel type number.
AN: Axial load.
AMLC: Center-to-center column height.
RAMC1: Rigid zone length at bottom.
RAMC2: Rigid zone length at top.
KHYSC: Hysteretic rule number (may be negative)*.
D: Depth of column.
B: Width of column.
DC: Distance from centroid of reinforcement to face of column.
AT: Area of reinforcement on one face.
HBD: Hoop bar diameter.
HBS: Hoop bar spacing.
CEF: Effectiveness of column confinement.

Note: * An input value of KHYSC with negative sign for the bottom section will result in symmetric values being assigned to the top section.

Return to input of ICTYPE for next column type. When done go to SET E.

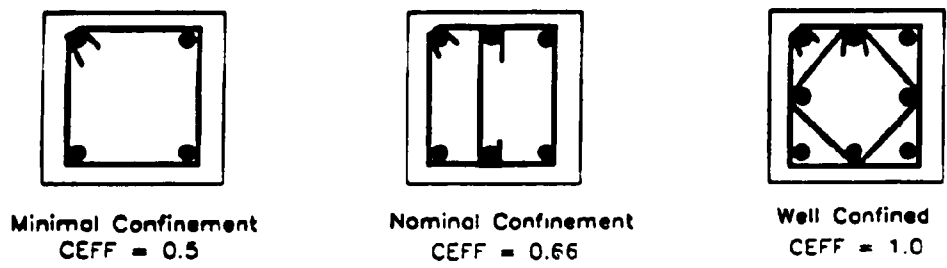
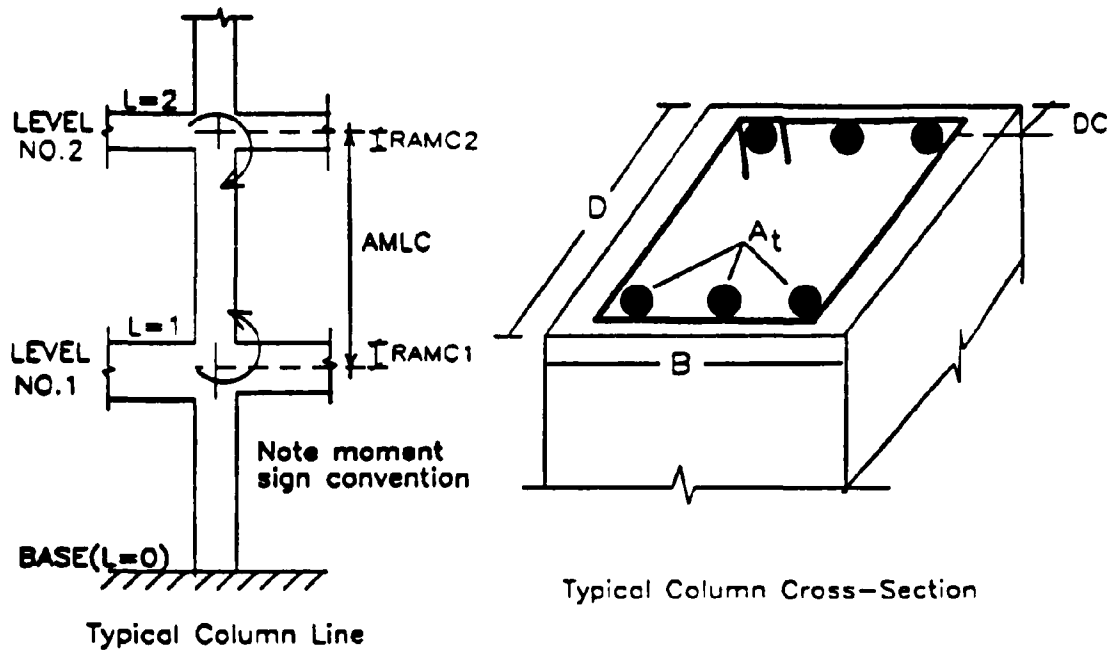

Effectiveness of Confinement for Some Typical Hoop Arrangements

Fig. A.6 Rectangular columns input details

SET D2: ICTYPE = 2; Circular Column Input (SEE FIGURE A-7)

• **General Data:**

KC, IMC, IMS, KHYSK, AMLC, RAMC1, RAMC2

• **Column Section:**

AN, DO, CVR, DST, NBAR, BDIA, HBD, HBS

<i>Description:</i>	KC:	Column type set number.
	IMC:	Concrete type number.
	IMS:	Steel type number.
	KHYSK:	Hysteretic Rule number.
	AMLC:	Center-to-center column height.
	RAMC1:	Rigid arm bottom.
	RAMC2:	Rigid arm top.
	AN:	Axial load on the column.
	DO:	Outer diameter of column.
	CVR:	Cover to center of hoop bar.
	DST:	Distance between centers of long. bars.
	NBAR:	Number of longitudinal bars.
	BDIA:	Diameter of longitudinal bar.
	HBD:	Diameter of hoop bar.
	HBS:	Spacing of hoop bars.

Return to input of ICTYPE for next column type. When done go to SET E.

SET D3: USER INPUT PROPERTIES (Rectangular or Circular) (SEE FIGURE A-8)

• **Reference Text:**

USER_TEXT

Description: USER_TEXT: Reference information, up to 80 characters of text.

For each section type provide the following data:

• **General Data:**

KC, AMLC, RAMC1, RAMC2, HHYSK

• **Bottom section:**

KHYSK, EI, EA, GA, PCP, PYP, UYP, UUP, EI3P,
PCN, PYN, UYN, UUN, EI3N

• **Top section:**

If KHYSK for bottom section is input with negative sign, section is symmetric, hence, do not input top section data, otherwise repeat as above, starting with KHYSK.

<i>Description:</i>	KC:	Column type number.
	AMLC:	Column Length.
	RAMC1:	Rigid Arm (Bottom).
	RAMC2:	Rigid Arm (Top).
	HHYSK:	Type of hysteresis model to be used:

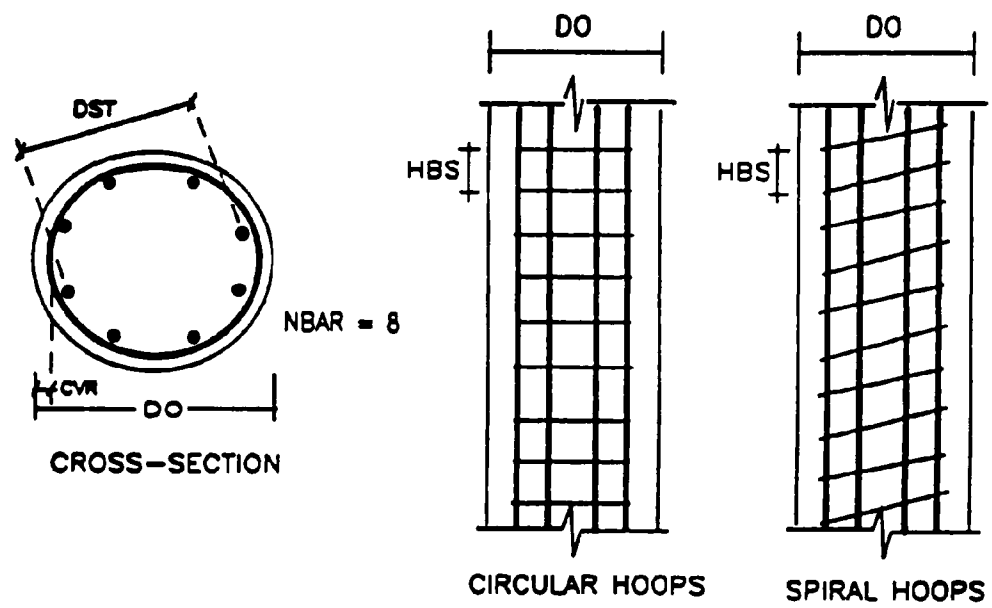

Fig. A.7 Circular column input details

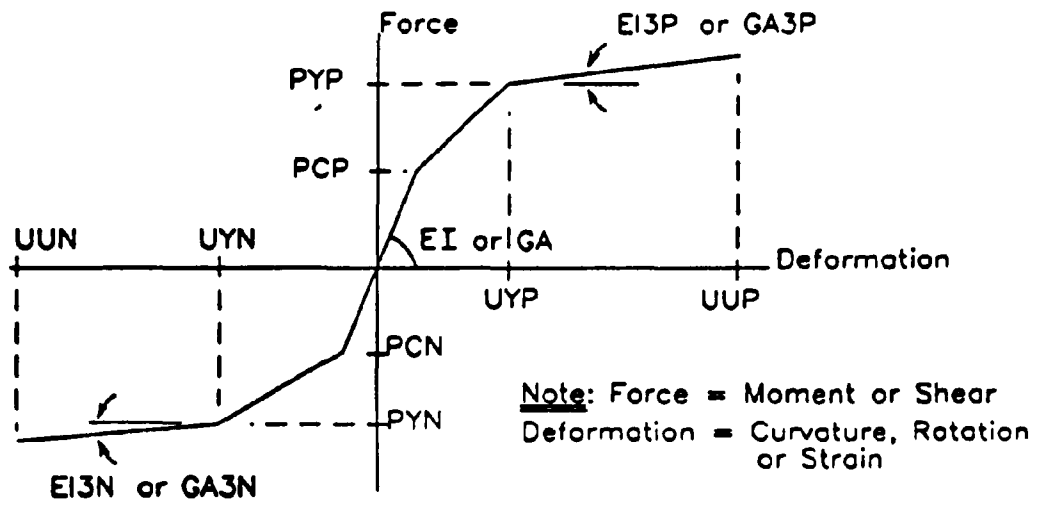

Fig. A.8 Notation for user input trilinear envelopes

1 for three parameter Park model,
 2 for three parameter Park model for steel,
 3 for three parameter steel model,
 4 for bilinear model.

KHYSC: Hysteretic rule number (may be negative)*.
EI: Initial Flexural Rigidity (EI).
EA: Axial Stiffness (EA/L).
GA: Shear Stiffness (Shear modulus*Shear Area).
PCP: Cracking Moment (positive).
PYP: Yield Moment (positive).
UYP: Yield Curvature (positive).
UUP: Ultimate Curvature (positive).
EI3P: Post Yield Flexural Stiffness (positive).
PCN: Cracking Moment (negative).
PYN: Yield Moment (negative).
UYN: Yield Curvature (negative).
UUN: Ultimate Curvature (negative).
EI3N: Post yield Flexural Stiffness (negative).

*Note: * An input value of KHYSC with negative sign for the bottom section will result in symmetric values being assigned to the top section.*

Repeat for each column type, starting with General Data (SET D3)

SET E: BEAM PROPERTIES SETS

(SKIP THIS INPUT IF THE STRUCTURE HAS NO BEAMS)

• **Control Data:**

USER_TEXT
IUBEM

Description: **USER_TEXT:** Reference information, up to 80 characters of text.
IUBEM: Type of beam input:
 0: Section dimensions, and reinforcement details (internal computation of moment-curvature envelope).
 1: User specified moment-curvature envelope.

IF IUBEM = 1, GO TO SET E2

SET E1: BEAMS SECTION DIMENSIONS SETS (SEE FIGURE A-9)

• **Reference Text:**

USER_TEXT

Description: **USER_TEXT:** Reference information, up to 80 characters of text.

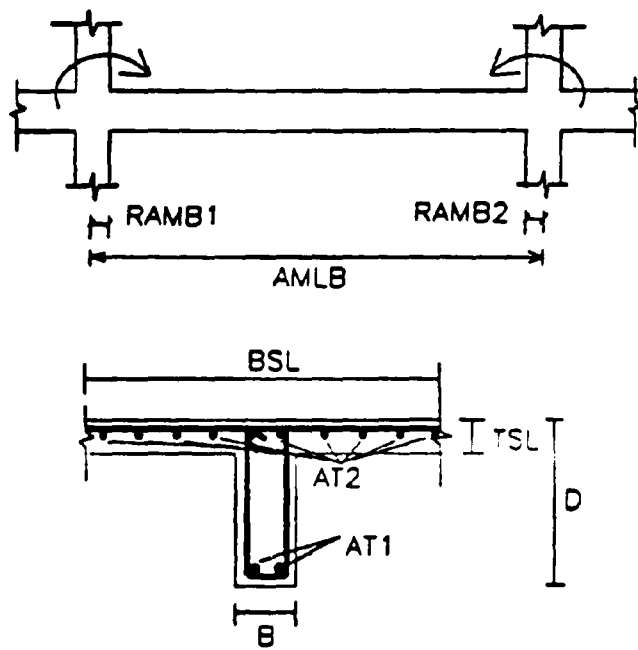

Fig. A.9 Input details for beam-slab sections

For each section type provide the following data:

- **General data:**
KB, IMC, IMS, AMLB, RAMB1, RAMB2
- **Left section:**
KHYSB, D, B, BSL, TSL, BC, AT1, AT2, HBD, HBS
- **Right section:**
If KHYSB for left section is input with negative sign, section is symmetric, hence, do not input right section data, otherwise input right section data starting with KHYSB as in the left section.

<i>Description:</i>	KB:	Beam type set number.
	IMC:	Concrete type number.
	IMS:	Steel type number.
	AMLB:	Member length.
	RAMB1:	Rigid zone length (left).
	RAMB2:	Rigid zone length (right).
	KHYSB:	Hysteretic rule number (may be negative)*.
	D:	Overall depth**.
	B:	Lower width**.
	BSL:	Effective slab width**.
	TSL:	Slab thickness**.
	BC:	Cover to centroid of steel.
	AT1:	Area of bottom bars.
	AT2:	Area of top bars.
	HBD:	Diameter of stirrup bars.
	HBS:	Spacing of stirrups.

Notes: * An input value of KHYSB with negative sign for the left section will result in symmetric values being assigned to the right section.

** For a rectangular beam or flat slab D is the overall depth, B=BSL&TSL=0

Repeat for each beam type starting with General Data (SET E1)

When done, go to SET F

SET E2: USER INPUT PROPERTIES SETS (SEE FIGURE A-8)

- **Reference Text:**
USER_TEXT
Description: USER_TEXT: Reference information, up to 80 characters of text.

For each section type provide the following data:

- **General Data:**
KB, AMLB, RAMB1, RAMB2, IHYSB
- **Left section:**
KHYSB, EI, GA, PCP, PYP, UYP, UUP, EI3P,
PCN, PYN, UYN, UUN, EI3N
- **Right section**

If KHYSB for left section is input with negative sign, section is symmetric, hence, do not input right section data, otherwise repeat as above, starting with KHYSB as in the left section.

Description:

KB:	Beam type set number.
AMLB:	Beam Length.
RAMB1:	Rigid Arm (Left).
RAMB2:	Rigid Arm (Right).
HHYSB:	Type of hysteresis model to be used: 1 for three parameter Park model, 2 for three parameter Park model for steel, 3 for three parameter steel model, 4 for bilinear model.
KHYSB:	Hysteretic rule number (may be negative)*.
EI:	Initial Flexural Rigidity.
GA:	Shear Stiffness (Shear modulus*Shear Area).
PCP:	Cracking Moment (positive).
PYP:	Yield Moment (positive).
UYP:	Yield Curvature (positive).
UUP:	Ultimate Curvature (positive).
EI3P:	Post Yield Flexural Stiffness (positive).
PCN:	Cracking Moment (negative).
PYN:	Yield Moment (negative).
UYN:	Yield Curvature (negative).
UUN:	Ultimate Curvature (negative).
EI3N:	Post yield Flexural Stiffness (negative).

*Note: * An input value of KHYSB with negative sign for the left section will result in symmetric values being assigned to the right section.*

Repeat for each beam type, starting with General Data (SET E2)

SET F: SHEARWALL PROPERTIES SETS (SEE FIGURES A-10 AND A-11)
(SKIP THIS INPUT IF THE STRUCTURE HAS NO SHEAR WALLS)

- **Control Data:**
USER_TEXT
IUWAL

Description:

USER_TEXT:	Reference information, up to 80 characters of text.
IUWAL:	Type of wall input: 0: Section dimensions and reinforcement details (internal computation of moment-curvature and shear strain envelopes). 1: User specified moment-curvature and shear-strain envelopes.

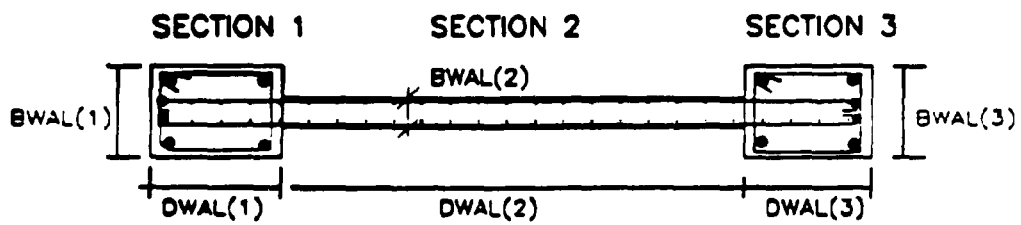

WALL SECTION WITH EDGE COLUMNS

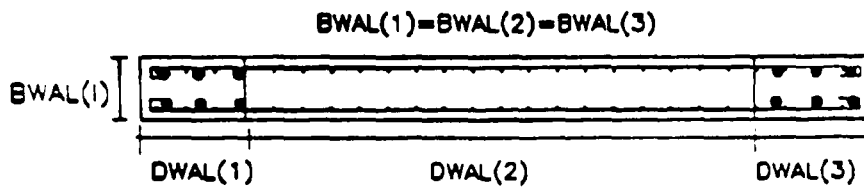

WALL WITHOUT EDGE COLUMNS

Fig. A.10 Typical input details for shear wall sections

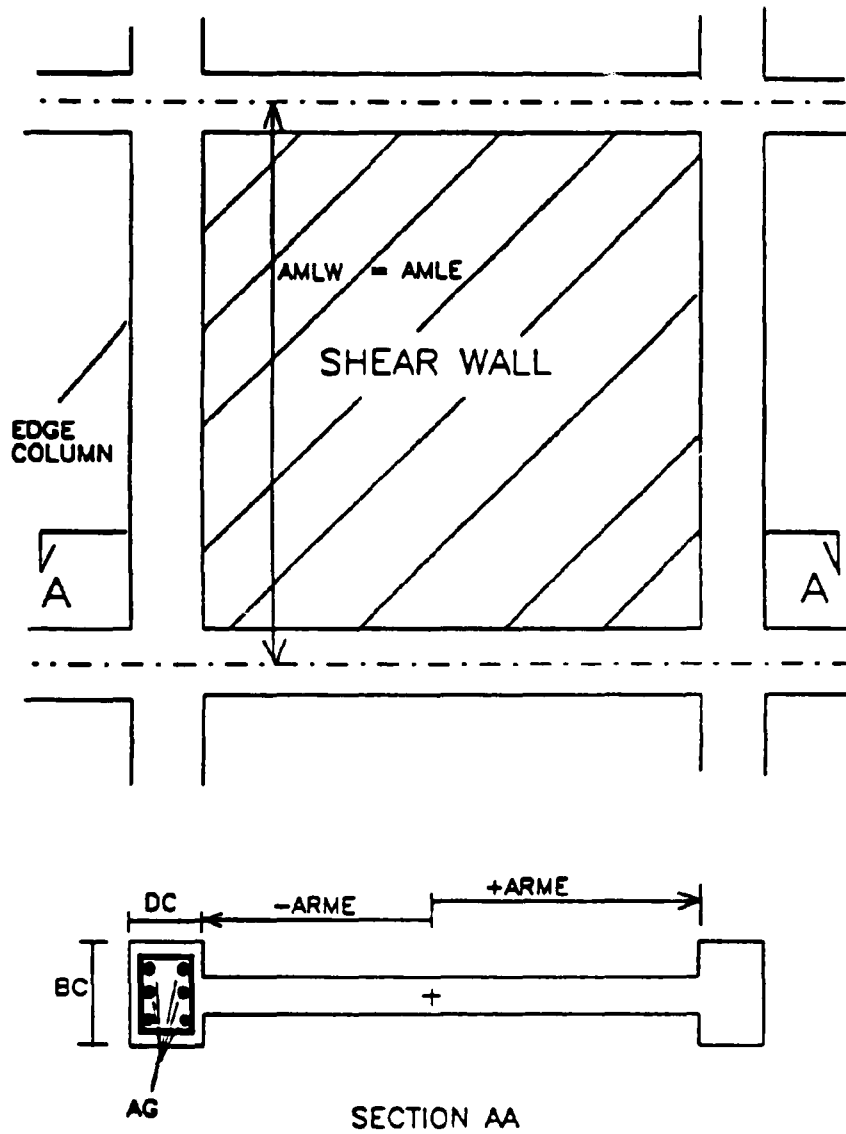

Fig. A.11 Shear wall and edge column details

IF IUWAL = 1, GO TO SET F2

SET F1: WALLS SECTION DIMENSIONS SETS

- **Reference Text:**
USER_TEXT
Description: **USER_TEXT:** Reference information, up to 80 characters of text.

For each section type provide the following data:

- **General Data:**
KW, IMC, KHYSW(1), KHYSW(2), KHYSW(3), AN, AMLW, NSECT
- **For each of the NSECT sections, input the following:**
KS, IMS, DWAL, BWAL, PT, PW
Description:
KW: Shear wall type set number.
IMC: Concrete type number.
KHYSW(1): Hysteretic Rule Number (bottom).
KHYSW(2): Hysteretic Rule Number (top).
KHYSW(3): Hysteretic Rule Number (shear).
AN: Axial load.
AMLW: Height of shear wall.
NSECT: Number of Sections.
KS: Section number.
IMS: Steel type number.
DWAL: Depth of section.
BWAL: Width of section.
PT: Vertical reinforcement ratio (%).
PW: Horizontal reinf ratio (%).

Repeat for each wall type starting with General Data; When done go to SET G

SET F2: USER INPUT PROPERTIES SETS (SEE FIGURE A-8)

- **Reference Text:**
USER_TEXT
Description: **USER_TEXT:** Reference information, up to 80 characters of text.

For each section type provide the following data:

- **General Data:**
KW, AMLW, EAW, IHYSWF, IHYSWS
- **Flexure BOT:**
KHYSW, EI, PCP, PYP, UYP, UUP, EI3P, PCN, PYN, UYN, UUN, EI3N
- **Flexure TOP:**

If KHYSW for bottom section is input with negative sign, section is symmetric, hence, do not input top section data, otherwise repeat as above, starting with KHYSW.

- **Shear:**

KHYSW, GA, PCP, PYP, UYP, UUP, GA3P, PCN, PYN, UYN, UUN, GA3N

Description: **KW:** Wall type set number.
AMLW: Wall length.
EAW: Axial Stiffness (EA/L).
IHYSWF: Type of hysteretic model to be used for flexure:
 1 for three parameter Park model,
 2 for three parameter Park model for steel,
 3 for three parameter steel model,
 4 for bilinear model.
IHYSWS: Type of hysteretic model to be used for shear:
 1 for three parameter Park model,
 2 for three parameter Park model for steel,
 3 for three parameter steel model,
 4 for bilinear model.

Data for Flexural Properties:

KHYSW: Hysteretic rule number (may be negative)*.
EI: Initial flexural stiffness (EI).
PCP: Cracking Moment (positive).
PYP: Yield Moment (positive).
UYP: Yield Curvature (positive).
UUP: Ultimate Curvature (positive).
EI3P: Post Yield Flexural Stiffness (positive).
PCN: Cracking Moment (negative).
PYN: Yield Moment (negative).
UYN: Yield Curvature (negative).
UUN: Ultimate Curvature (negative).
EI3N: Post yield Flexural Stiffness (negative).

Data for shear properties:

KHYSW: Hysteretic Rule Number.
GA: Initial Shear Stiffness (shear modulus*area).
PCP: Cracking Shear (positive).
PYP: Yield Shear (positive).
UYP: Yield Shear strain (positive).
UUP: Ultimate Shear strain (positive).
GA3P: Post Yield Shear Stiffness (positive).
PCN: Cracking Shear (negative).
PYN: Yield Shear (negative).
UYN: Yield Shear strain (negative). **UUN:** Ultimate Shear strain (negative).

GA3N: Post Yield Shear Stiffness (negative).

*Note: * An input value of KHYSW with negative sign for the bottom section will result in symmetric values being assigned to the top section.*

Return to start of General Data (SET F2). Repeat for each wall type

SET G: EDGE COLUMN PROPERTIES SETS (SEE FIGURE A-11)

(SKIP THIS INPUT IF THE STRUCTURE HAS NO EDGE COLUMNS)

Do not duplicate edge column data if already input in SHEAR WALL data.

- **Reference Text:**

USER_TEXT

Description: **USER_TEXT:** Reference information, up to 80 characters of text.

- **Edge Column Data (Provide one line for each MEDG edge column type):**

KE, IMC, IMS, AN, DC, BC, AG, AMLE, ARME

Description: **KE:** Edge column type set number.
IMC: Concrete type number.
IMS: Steel type number.
AN: Axial load.
DC: Depth of edge column.
BC: Width of edge column.
AG: Gross area of main bars.
AMLE: Member length.
ARME: Arm length.

Repeat for each of MEDG elements starting with edge column type number.

SET H: TRANSVERSE BEAM PROPERTIES SETS (SEE FIGURE A-12)

(THIS INPUT NOT REQUIRED IF STRUCTURE HAS NO TRANSVERSE BEAMS OR IS MADE OF IDENTICAL BEAMS ONLY)

- **Reference Text:**

USER_TEXT

Description: **USER_TEXT:** Reference information, up to 80 characters of text.

- **Transverse Beam Data (Provide one line for each MTRN transverse beam type):**

KT, AKV, ARV, ALV

Description: **KT:** Transverse beam type set number
AKV: Vertical Stiffness
ARV: Torsional Stiffness
ALV: Arm length

Repeat for each of MTRN elements

Notes: 1. Transverse elements are assumed to remain elastic. The degree of fixity at the ends will depend on the state of the joint and the state of the members that frame into the joint before and during the application of load. If the entire

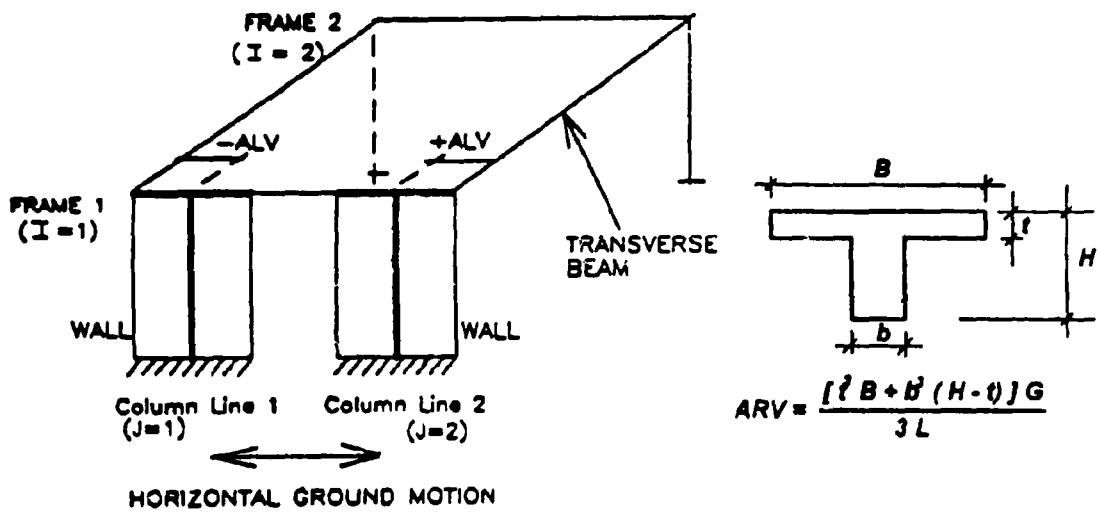

Fig. A.12 Transverse beam input

region is expected to stay elastic, then the vertical stiffness should be computed as : $AKV = 12EI/L^3$. In the extreme case that one of ends do not transmit stiffness due to yielding of adjoining members or deterioration of the joint, then $AKV = 3EI/L^3$. An intermediate value is a good average approximation.

2. If duplicate frames are present, extreme care should be taken in specifying transverse beam properties. The program multiplies the input values by the number of duplicate frames to which they are attached. For example, for the frames shown in Figure A-1, $NDUP(1) = NDUP(2) = 2$. The program will factor the input stiffness values by $(NDUP(1)+NDUP(2))=4.0$. Input stiffnesses should, therefore, be modified to account for this effect. If the modeling of transverse elements is not crucial to the analysis, the use of duplicate frames should be avoided.

SET I: ROTATIONAL SPRINGS PROPERTIES SETS (SEE FIGURE A-8)
(THIS INPUT NOT REQUIRED IF ROTATIONAL SPRINGS ARE NOT SPECIFIED)

• **Reference Text:**

USER_TEXT

Description: **USER_TEXT:** Reference information, up to 80 characters of text.

• **General Data (Provide one line of data for each MSPR spring type):**

KS, IHYSR, KHYSR, EI, PCP, PYP, UYP, UUP, EIBP, PCN, PYN, UYN,

UUN, EIBN

Description: **KS:** Rotational spring set number.
IHYSR: Type of hysteretic model to be used:
 1 for three parameter Park model,
 2 for three parameter Park model for steel,
 3 for three parameter steel model,
 4 for bilinear model.
KHYSR: Hysteretic Rule Number.
EI: Initial Rotational Stiffness.
PCP: Cracking moment (positive).
PYP: Yield moment (positive).
UYP: Yield rotation (positive, radians).
UUP: Ultimate rotation (positive, radians).
EIBP: Post-yield stiffness ratio (positive).
PCN: Cracking moment (negative).
PYN: Yield moment (negative).
UYN: Yield rotation (negative).
UUN: Ultimate rotation capacity (negative).
EIBN: Post yield stiffness ratio (negative).

repeat for each spring type

Notes: Spring properties, unlike other element types, are specified in terms of moment and rotation (in radians). The envelope follows the same nonsymmetric trilinear pattern as shown in Figure A-8.

SET J: BRACES PROPERTIES SETS

SET J1: VISCO-ELASTIC BRACE PROPERTIES SETS **(SKIP THIS IF NO VISCO-ELASTIC BRACES ARE SPECIFIED)**

- **Control Information:**

USER_TEXT
ITMODEL, ITDVCON

Description: **USER_TEXT:** Reference information, up to 80 characters of text.
 ITMODEL: Model for viscous dampers:
 0 for Maxwell model,
 1 for Kelvin model.
 ITDVCON: Type of connection:
 0 for diagonal braces,
 1 for chevron braces.

SET J1-1: VISCO-ELASTIC BRACE PROPERTIES

- **General Data (Provide one set of data for each MBRV visco-elastic brace type):**
ITDV, CDV, KDV

- **Chevron Braces Data (Provide only if ITDVCON=1):**
KDVCH, ANGDV

Description: **ITDV:** Visco-elastic brace type set number.
 CDV: Damping constant C of this type of visco-elastic brace.
 KDV: Axial stiffness of this type of visco-elastic brace (EA/L).
 KDVCH: Axial stiffness of one leg of the Chevron bracing (EA/L).
 ANGDV: Angle of inclination of the brace with respect to a horizontal line.

Repeat set J1-1 for each visco-elastic brace type

SET J2: FRICTION DAMPER BRACE PROPERTIES SETS **(SKIP THIS IF NO FRICTION DAMPER BRACES ARE SPECIFIED)**

- **Reference Text:**
USER_TEXT
ITDFCON

Description: **USER_TEXT:** Reference information, up to 80 characters of text.
 ITDFCON: Type of connection:
 0 for diagonal braces,
 1 for chevron braces.

SET J2-1: FRICTION DAMPER BRACE PROPERTIES

- **General Data (Provide one line of data for each MBRF friction brace type):**
 ITDF, KDF, FYDF
- **Chevron Brace Data (Provide only if ITDFCON=1):**
 KDFCH, ANGDF

Description: **ITDF:** Friction (damper) brace type set number.
 KDF: Axial stiffness.
 FYDF: Friction force of this type of friction dampers.
 KDFCH: Axial stiffness of one leg of the Chevron brace (EA/L).
 ANGDF: Angle of inclination of the brace with respect to a horizontal line.

Repeat set J2-1 for each friction damper brace type

SET J3: HYSTERETIC DAMPER BRACE PROPERTIES SETS
(SKIP THIS IF NO HYSTERETIC DAMPER BRACES ARE SPECIFIED)

- **Reference Text:**

USER_TEXT, ITDHCON

Description: **USER_TEXT:** Reference information, up to 80 characters of text.
 ITDHCON: Type of connection:
 0 for diagonal braces,
 1 for chevron braces.

SET J3-1: HYSTERETIC DAMPER BRACE PROPERTIES

- **General Data (Provide one line of data for each MBRH hysteretic brace type):**
 ITDH, KDH, FYDH, RPSTDH
- **Chevron Brace Data (Provide only if ITDHCON=1):**
 KDHCH, ANGDH

Description: **ITDH:** Hysteretic damper brace type set number.
 KDH: Axial stiffness.
 FYDH: Yield force of this type of hysteretic dampers.
 RPSTDH: Post yield stiffness ratio.
 KDHCH: Axial stiffness of one leg of the Chevron bracing (EA/L).

ANGDH: Angle of inclination of the brace with respect to a horizontal line.

Repeat set J3-1 for each hysteretic damper type

SET K: INFILL PANEL PROPERTIES SETS

(SKIP THIS IF NO INFILL PANEL ELEMENTS ARE SPECIFIED)

- Reference Text

USER_TEXT

Description: **USER_TEXT:** Reference information, up to 80 characters of text.

SET K1: CONTROL DATA

- Control Information

USER_TEXT

IPT, ICTYPE

Description: **USER_TEXT:** Reference information, up to 80 characters of text.

IPT: Masonry infill panel type set

ICTYPE: Type of infill panel input:

0, Masonry panel dimensions to be

specified for automatic generation of panel strength envelope parameters.

1, User specified panel strength envelope parameters

SET K2-1: INPUT FOR GENERATION OF STRENGTH ENVELOPE PARAMETERS

(SKIP TO K2-2 IF ICTYPE = 1)

- Infill panel dimensions (provide two lines of data for each IPT infill panel type set):

IMT,TMP,VLMP,VHMP

Description: **IMT:** Masonry property type number

TMP: Thickness of masonry infill panel

VLMP: Length of infill panel

VHMP: Height of infill panel

QMPC,QMPB,QMPJ,QMPC

Description: **QMPC:** Plastic moment capacity of column

QMPB: Plastic moment capacity of beam

QMPJ: Plastic moment capacity of joint

SET K2-2: USER INPUT FOR STRENGTH ENVELOPE PARAMETERS
(SKIP THIS INPUT IF ICTYPE = 0)

- User specified infill panel strength envelope properties (provide one line of data for each IPT infill panel type set):

EAIW, VYIW

Description: **EAIW:** Initial elastic stiffness of the panel type
 VYIW: Lateral yield force of the panel type

SET K3: INFILL PANEL HYSTERETIC PROPERTIES

- Hysteretic model parameters for infill panel (provide three lines of data for each IPT infill panel type set):

AIW, BTA, GMA, ETA, ALPHIW

IS, AS, ZS, ZBS

SK, SP1, SP2, MU

Description: **AIW:** Parameter A in Wen's model.
 BTA: Parameter beta in Wen's model.
 GMA: Parameter gamma in Wen's model.
 ETA: Parameter eta in Wen's model.
 ALPHIW: Post yielding stiffness ratio.
 IS: Flag to indicate no slip (=0), or slip (=1) in
 the hysteretic response.
 AS: Control parameter for slip length.
 ZS: Parameter that controls the sharpness of the
 slip.
 ZBS: Offset value for slip response.
 SK: Control parameter to vary the rate of
 stiffness decay.
 SP1: Parameter to control the rate of strength
 deterioration.
 SP2: Parameter to control the rate of strength
 deterioration.
 MU: Ductility capacity of the infill panel.

Notes: 1 DEFAULT VALUES (if a zero was specified as data input):

AIW=1.0, BTA=0.1, GMA=0.9, ETA=2.0, ALPHIW=0.01

IS=1, AS=0.3, ZS=0.1, ZBS=0.0

SK=0.1, SP1=0.8, SP2=1.0, MU=5.0

2 See Section 3.3 for details on the role of hysteretic model parameters.

Repeat Sets K1, K2 and K3 for each IPT infill panel type set.

SET L: ELEMENT CONNECTIVIES

Notes: Element connectivity is established through the 3 positional locaters described in Figure A-1: a story level, a frame number and a column line. The I position locater (or story level) varies from 0 to the number of stories; the J position locater (or frame number) varies from 1 to the number of frames; and the K locater varies from 1 to the number of NVLN positions (column lines) for each frame. The hypothetical structure shown below is used to demonstrate the input format. Only a representative data set is shown.

Element Type	Number	Type	IC	JC	LBC	LTC
COLUMNS	1	1	1	1	3	4
	2	2	1	2	3	4
	10	8	1	4	0	2
BEAMS	Number	Type	LB	IB	JLB	JRB
	1	1	4	1	1	2
	2	2	4	1	2	3
	6	3	3	1	3	4
WALLS	Number	Type	IW	JW	LBW	LTW
	1	1	1	3	3	4
	2	2	1	3	2	3

**SET LI: COLUMNS CONNECTIVITY (SEE FIGURE A-13)
(SKIP THIS INPUT IF THE STRUCTURE HAS NO COLUMNS)**

- **Reference Text:**
USER_TEXT
Description: **USER_TEXT:** Reference information, up to 80 characters of text.
- **Column Connectivities (Provide one line of data for each NCOL column):**
M, ITC, IC, JC, LBC, LTC
Description: **M:** Column number.
ITC: Column type number.
IC: Frame number.
JC: Column Line number.
LBC: Story level at bottom of column.
LTC: Story level at top of column.

Notes: Input is required for each of the NCOL columns.

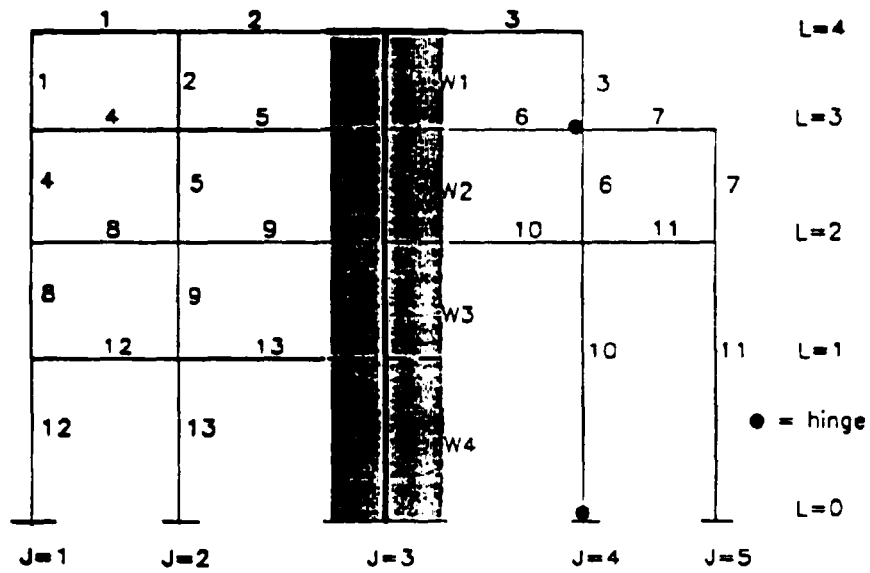

Element Type	Number	Type	IC	JC	LBC	LTC
COLUMNS	1	1	1	1	3	4
	2	2	1	2	3	4
	10	8	1	4	0	2
BEAMS	Number	Type	LB	IB	JLB	JRB
	1	1	4	1	1	2
	2	2	4	1	2	3
6	3	3	1	3	4	
WALLS	Number	Type	IW	JW	LBW	LTW
	1	1	1	3	3	4
	2	2	1	3	2	3

Fig. A.13 Element connectivity for sample structure

SET L2: BEAMS CONNECTIVITY (SEE FIGURE A-13)
(SKIP THIS INPUT IF STRUCTURE HAS NO BEAMS)

- **Reference Text:**
USER_TEXT
Description: **USER_TEXT:** Reference information, up to 80 characters of text.
- **Beam Connectivities (Provide one line of data for each NBEM beam):**
M, ITB, LB, IB, JLB, JRB
Description:

M:	Beam number.
ITB:	Beam type number.
LB:	Story level.
IB:	Frame number.
JLB:	Column Line number of left section.
JRB:	Column Line number of right section.

Note: Input is required for each of the NBEM beams.

SET L3: SHEAR WALLS CONNECTIVITY (SEE FIGURE A-13)
(SKIP THIS INPUT IF STRUCTURE HAS NO SHEAR WALLS)

- **Reference Text:**
USER_TEXT
Description: **USER_TEXT:** Reference information, up to 80 characters of text.
- **Wall Connectivities (Provide one line of data for each NWAL wall):**
M, ITW, IW, JW, LBW, LTW
Description:

M:	Wall number.
ITW:	Wall type number.
IW:	Frame number.
JW:	Column line number.
LBW:	Story level at bottom.
LTW:	Story level at top.

Note: Input is required for each of the NWAL shear walls.

SET L4: EDGE COLUMNS CONNECTIVITY
(SKIP THIS INPUT IF STRUCTURE HAS NO EDGE COLUMNS)

- **Reference Text:**
USER_TEXT
Description: **USER_TEXT:** Reference information, up to 80 characters of text.
- **Edge Column Connectivities (Provide one line of data for each NEDG edge column):**

M, ITE, IE, JE, LBE, LTE

Description:

M:	Edge column number.
ITE:	Edge column type number.
IE:	Frame number.
JE:	Column line number.
LBE:	Story level at bottom of column.
LTE:	Story level at top of column.

SET L5: TRANSVERSE BEAMS CONNECTIVITY
(SKIP THIS INPUT IF STRUCTURE HAS NO TRANSVERSE BEAMS)

- **Reference Text:**
USER_TEXT
Description: **USER_TEXT:** Reference information, up to 80 characters of text.

- **Transverse Beam Connectivities (Provide one line of data for each NTRN transverse beam):**
M, ITT, LT, IWT, JWT, IFT, JFT
Description:

M:	Transverse beam number.
ITT:	Transverse beam type number.
LT:	Story level.
IWT:	Frame number of origin of transverse beam*.
JWT:	Column line of origin of transverse beam*.
IFT:	Frame number of connecting wall or column.
JFT:	Column line of connecting wall or column.

Note: *For beam-to-wall connections, **IWT** and **JWT** refer to the **I,J** locations of the wall.

SET L6: SPRINGS LOCATIONS (SEE FIGURE A-14)
(SKIP THIS INPUT IF ROTATIONAL SPRINGS ARE NOT SPECIFIED)

- **Reference Text:**
USER_TEXT
Description: **USER_TEXT:** Reference information, up to 80 characters of text.

- **Spring Location (Provide one line of data for each NSPR springs):**
M, ITRSP, ISP, JSP, LSP, KSPL
Description:

M:	Spring number.
ITRSP:	Rotational Spring Type Number.
ISP:	Frame number.
JSP:	Column line number.
LSP:	Story level.

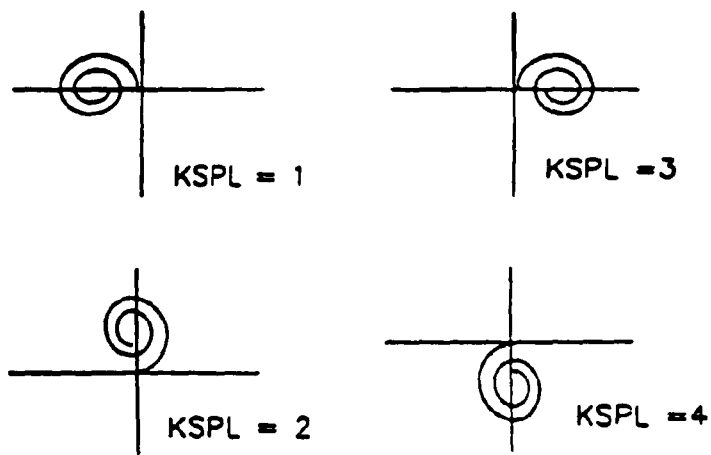

SPRING LOCATION IDENTIFIERS

Fig. A.14 Specification of discrete inelastic springs

KSPL: Relative spring location as follows:
1, for spring on beam, left of joint, or
2, for spring on column, top of joint, or
3, for spring on beam, right of joint, or
4, for spring on column, bottom of joint.

Note: The number of springs at a joint is limited to one less than the total number of members framing into the joint.

SET L7: MOMENT RELEASES (SEE FIGURE A-15)

(SKIP THIS INPUT IF MOMENT RELEASES ARE NOT REQUIRED. NMR = 0)

• **Reference Text:**

USER_TEXT

Description: **USER_TEXT:** Reference information, up to 80 characters of text.

• **Moment Release Locations (Provide one line of data for each NMR moment releases):**

IDM, IHTY, INUM, IREG

Description: **IDM:** ID number.
IHTY: Element type using following code:
1 for COLUMN, or
2 for BEAM, or
3 for WALL.
INUM: Column, Beam or Wall number.
IREG: Location of hinge or moment release:
1 for BOTTOM or LEFT,
2 for TOP or RIGHT.

Sample Input (with reference to Fig A-13)

IDM	IHTY	INUM	IREG
1	1 (col)	10 (col #)	1 (bot)
2	2 (beam)	6 (beam#)	2 (right)

Fig. A.15 Specification of moment releases

SET L8: BRACES CONNECTIVITIES
(SKIP THIS IF NO BRACES ARE SPECIFIED)

- **Reference Text:**
USER_TEXT
Description: **USER_TEXT:** Reference information, up to 80 characters of text.

- **Brace Connectivities (Provide one line of data for each NBR braces):**
M, IF, ITBR, ITD, LT, LB, JT, JB, AMLBR
Description:
M: Brace number.
IF: Frame number.
ITBR: Brace type:
1, Visco-elastic brace, or
2, Friction damper brace, or
3, Hysteretic damper brace.
ITD: Property type number of specified brace.
LT: Story level at top side of the brace.
LB: Story level at bottom side of the brace.
JT: Column line number at top side of the brace.
JB: Column line number at bottom side of the brace.
AMLBR: Brace length (joint to joint).

SET L9: INFILL PANELS CONNECTIVITIES
(SKIP THIS IF NO INFILL PANELS ARE SPECIFIED)

- **Reference Text:**
USER_TEXT
Description: **USER_TEXT:** Reference information, up to 80 characters of text.

- **Infill panels connectivities (Provide one line of data for each of NIW panels):**
M, IF, ITIW, LT, LB, JL, JR, JBMT
Description:
M: Infill panel number.
IF: Frame number.
ITIW: Property type number of specified infill panel.
LT: Story level at top of infill panel.
LB: Story level at bottom of infill panel.
JL: Column line number at left side of the infill panel.
JR: Column line number at right side of the infill panel.
JBMT: Beam type number on top of infill panel

SET M: ANALYSIS OPTIONS

- **General Data:**

USER_TEXT

IOPT

Description: **USER_TEXT:** Reference information, up to 80 characters of text.

IOPT: **Option for continuing analysis:**

0 , STOP (Data check mode).

1 , for Inelastic incremental static analysis
 (with static loads,if specified)

2 , for Monotonic "pushover" analysis
 including static loads (if specified).

3 , for Inelastic dynamic analysis including
 static loads (if specified).

4 , for Quasi-static cyclic analysis including
 static loads (if specified).

Notes: It is generally advisable to use the "data check" mode for the first trial run of a new data set. The program performs only minimal checking of input data. Structural elevation plots generated by IDARC help identify errors in connectivity specification. Since IDARC prints all input data almost immediately after they are read, the task of detecting the source of input errors is generally expedited. It is also important to verify all printed output, especially section properties such as flexural stiffness and yield moment. OPTION 1 permits an independent nonlinear static analysis. Static loads are input in data set M1. OPTIONS 2 - 4 may be combined with long-term static loads which is input in data set M1.

SET M1: LONG-TERM LOADING (STATIC LOADS)

- **Control Information:**

USER_TEXT

NLU, NLJ, NLM, NLC

Description: **USER_TEXT:** Reference information, up to 80 characters of text.

NLU: **No. of uniformly loaded beams.**

NLJ: **No. of laterally loaded joint.**

NLM: **No. of specified nodal moments.**

NLC: **No. of concentrated vertical loads.**

Note: This input is required for all analysis options.

- **Long Term Loading Analysis (Provide only when static loads are present):**

JSTP, IOCRI

Description: **JSTP:** **No. of incremental steps in which to apply the static loads (default = 1 step).**

IOCRI: Steps between printing output (If IOCRI=0, only final results will be printed; if IOCRI=2, printout will result every 2 steps, and so on).

Notes: Dead and live loads that exist prior to the application of seismic or quasi-static cyclic loads can be input in this section. Such loads are typically specified through uniformly loaded beam members. An option is also available for lateral load analysis and the specification of nodal loads at joints. When used in conjunction with Options 2-4, the resulting forces are carried forward to the monotonic, dynamic and quasi-static analysis.

- **Uniformly Loaded Beam Data (Skip this input section if NLU=0):**

USER_TEXT

Provide NLU lines of data as following:

IL, IBN, FU

Description: **USER_TEXT:** Reference information, up to 80 characters of text.
IL: Load number.
IBN: Beam number.
FU: Magnitude of load (Force/length).

- **Laterally Loaded Joints (Skip this input section if NLJ=0):**

USER_TEXT

Provide NLJ lines of data as following:

IL, LF, IF, FL

Description: **USER_TEXT:** Reference information, up to 80 characters of text.
IL: Load number.
LF: Story level number.
IF: Frame number.
FL: Magnitude of load.

- **Nodal Moment Data (Skip this input section if NLM=0):**

USER_TEXT

Provide NLM lines of data as following (See Figure A-9 for beam moment sign convention):

IL, IBM, FM1, FM2

Description: **USER_TEXT:** Reference information, up to 80 characters of text.
IL: Load number.
IBM: Beam number.
FM1: Nodal moment (left).
FM2: Nodal moment (right).

- **Data on Concentrated Vertical Loads (Skip this input section if NLC=0):**

USER_TEXT

Provide NLC lines of data as following:

IL, IFV, LV, JV, FV

Description: **USER_TEXT:** Reference information, up to 80 characters of text.

IL: Load number.

IFV: Frame number.

LV: Story level number.

JV: Column line number.

FV: Magnitude of load.

IF IOPT = 2, CONTINUE TO SET M2.

IF IOPT = 3, CONTINUE TO SET M3.

IF IOPT = 4, CONTINUE TO SET M4.

SET M2: MONOTONIC PUSH-OVER ANALYSIS (FOR IOPT = 2 ONLY)

- **General Data:**

USER_TEXT

JOPT

Description: **USER_TEXT:** Reference information, up to 80 characters of text.

JOPT: Push over option:
 1, force control
 2, displacement control

For JOPT = 2 GO TO SET M2.2

SET M2.1: Force Controlled Input
(PROVIDE ONLY IF JOPT=1)

- **Control Data:**

USER_TEXT

ITYP

Description: **USER_TEXT:** Reference information, up to 80 characters of text.

ITYP: Option for lateral load distribution:
 1 for linear (inverted triangle), or
 2 for uniform, or
 3 for modal adaptive pushover distribution,
 or
 4 for user input, or
 5 for distribution proportional to a power of
 the story elevation.

For ITYP = 4 GO TO Set M2.2

- **Stop Criteria:**

PMAX, MSTEPS, DRFLIM

Description: **PMAX:** Target ultimate base shear coefficient.
 MSTEPS: Number of steps to reach PMAX.
 DRFLIM: Upper limit for displacement of structure top-story (percentage of building height).

- **Number of Modes for Modal Adaptive Option (Provide only if ITYP=3):**

NMOD

Description: **NMOD:** Number of modes used during the modal adaptive pushover analysis.

- **Power for lateral distribution (Provide only if ITYP=5):**

EXPK

Description: **EXPK:** Power for story elevation.

Note: The lateral forces at story "i" are proportional to the story weight (W_i), and the story elevation (h_i) to the power EXPK, according to:

$$\frac{W_i h_i^{\text{EXPK}}}{\sum_{i=1}^{\text{NSO}} W_i h_i^{\text{EXPK}}}$$

The exponential distribution will take into account the effects of higher modes in the response. If EXPK<0 a default value is calculated as a function of the fundamental period (T):

$$10 - \text{EXPK} = 1 + \frac{T - 0.5}{2} - 2.0$$

Continue to SET N

SET M2.2: Displacement Controlled Input (or User Defined Force Control)
 (PROVIDE ONLY IF JOPT=2 OR JOPT=1 AND ITYP=4) ✓

- **Displacement Control Data (or User Defined Force Control Data):**

USER_TEXT

NLDED

NSTLD(1), NSTLD(2), ..., NSTLD(NLDED)

PX(1), PX(2), ..., PX(NLDED)

MSTEPS, DRFLIM

Description: **USER_TEXT:** Reference information, up to 80 characters of text.
 NLDED: number of loaded stories (levels).
 NSTLD(i): list of loaded stories.
 PX(i): list of maximum forces/displacements applied at loaded stories (levels).

MSTEPS: number of steps to reach each ultimate story force/displacement.
DRFLIM: upper limit for displacement of structure top story (percentage of building height).

Continue to SET N

SET M3: DYNAMIC ANALYSIS CONTROL PARAMETERS (FOR IOPT = 3 ONLY)

• Control Data:

USER_TEXT

GMAXH, GMAXV, DTCAL, TDUR, DAMP, ITDMP

Description: USER_TEXT: Reference information, up to 80 characters of text.
GMAXH: Peak horizontal acceleration (g's).
GMAXV: Peak vertical acceleration (g's).
DTCAL: Time step for response analysis (secs).
TDUR: Total duration of analysis (secs).
DAMP: Damping coefficient (% of critical).
ITDMP: Type of structural damping:
1 for Mass proportional (default),
2 for Stiffness proportional, or
3 for Rayleigh proportional damping.

Notes: 1. The input accelerogram is scaled uniformly to achieve the specified peak acceleration. DTCAL should not exceed the time interval of the input wave, DTINP. The nonlinear analysis of the structure is often very sensitive to the choice for DTCAL, a value of 0.005 is suggested for typical buildings, however, a smaller value may be necessary if drastic changes in the stiffness of the elements are expected, or if the structure consists of only a few elements. Larger values can be used for smoother transitions in the stiffness of the elements. Often an inadequate choice of this parameter will yield large unbalanced forces, that may cause numerical instabilities, and stop the execution of the program, or report extremely large values in the damage indices ($DI >> 3$) of some or all elements.

2. The ratio (DTINP/DTCAL) must yield an integer number.

3. TDUR may be less than the total duration of the earthquake. If TDUR is greater than the total time duration of the input wave, a free vibration analysis of the system will result for the remaining time.

• Input Wave:

USER_TEXT

IWV, NDATA, DTINP

Description: USER_TEXT: Reference information, up to 80 characters of text.

IWV: 0 for Vertical component of acceleration not included, or
1 for Vertical component of acceleration included.

NDATA: Number of points in earthquake wave files.

DTINP: Time interval of input wave.

- **Wave Title:**
NAMEW
Description: **NAMEW:** Alpha-numeric title for input wave upto 80 characters.

- **Filename - Horizontal Component:**
WHFILE
Description: **WHFILE:** Name of file (with extension) from which to read horizontal component of earthquake record. Note: Filename should not exceed 12 characters.
WINPH(I),I=1,NDATA
Horizontal component of earthquake wave (NDATA points).
NOTE: This data is read from the file **WHFILE** specified in the previous data item.

- **Filename - Vertical Component (Skip this input if IWV=0):**
WVFILE
Description: **WVFILE:** Name of file (with extension) from which to read vertical component of earthquake record. Note: Filename should not exceed 12 characters.
WINPV(I),I=1,NDATA
Vertical component of earthquake wave (NDATA points).
NOTE: This data is read from the file **WVFILE** specified in the previous data item.

Notes: Accelerogram data may be input in any system of units. The accelerogram is scaled uniformly to achieve the specified peak values of GMAXH and GMAXV. Since data is read in free format, as many lines as necessary to read the entire wave must be input. The data points of the input wave may, therefore, be entered sequentially until the last (or NDATA) point.

Continue to SET N

Description: **USER_TEXT:** Reference information, up to 80 characters of text.

NPRNT: Additional number of snapshots of the structural response during pushover (≤ 10).

Notes: 1. Output in this set is written in file "DEFORMED.OUT". The story displacements, and the element stress ratios are provided at each snapshot.

2. By default the program will always identify the structural response at the first crack, first yield, or first collapse of a column, beam and wall.

- **Ratios for which Additional Snapshots are Required (Provide only if NPRNT>0):**
ITPRNT, UPRNT(1), UPRNT(2), ..., UPRNT(NPRNT)

Description: **ITPRNT:** Type of data provided to print snapshots:
1 if Base shear/Total weight is specified, or
2 if Top displacement/Total height is specified.

UPRNT(i): List of base shear/total weight ratios (if ITPRNT=1), or top displacement/total building height (if ITPRNT=2), for which printing of additional snapshots is required.

Continue to set N1.3

SET N1.2: Dynamic and Quasistatic Analysis Snapshot Control Data

(Provide only if Dynamic or Quasistatic analysis was selected in set M: IOPT=3 or IOPT=4)

- **Control Data:**

USER_TEXT

NPRNT

Description: **USER_TEXT:** Reference information, up to 80 characters of text.

NPRNT: Flag to indicate if additional snapshots during dynamic analysis are required:
0 for no user defined additional snapshots.
1 for user defined additional snapshots.

Notes: 1. Output in this set is written in file "DEFORMED.OUT". The story displacements, and the element stress ratios are provided at each snapshot.

2. By default the program will always identify the structural response at the first crack, first yield, or first collapse of a column, beam and wall.

- **User Defined Snapshots (Provide only if NPRNT=1)**

DTPRNT, DFPRNT, BSPRNT

Description: **DTPRNT:** Time increment for printing additional snapshots (Use DTPRNT= 0 to deactivate this option)

DFPRNT: Threshold story drift ratio at which snapshots are desired (Use DFPRNT= 0 to deactivate this option)

BSPRNT: Threshold base shear coefficient at which snapshots are desired (Use BSPRNT= 0 to deactivate this option)

- Notes: 1. Output in this set is written in file "DEFORMED.OUT". The story displacements, and the element stress ratios are provided at each snapshot.*
- 2. By default the program will always identify the structural response at the first crack, first yield, or first collapse of a column, beam and wall.*

SET N1.3: General Snapshot Control Flags (Provide Always)

- **Control Flags for Default Snapshots:**

ICDPRNT(1), ICDPRNT(2), ICDPRNT(3), ICDPRNT(4), ICDPRNT(5)

Description: **ICDPRNT(1):** Flag to activate (=1), or deactivate (=0), printing of the displacement profile during default snapshots.

ICDPRNT(2): Flag to activate (=1), or deactivate (=0), printing of the element stress ratios during default snapshots.

ICDPRNT(3): Flag to activate (=1), or deactivate (=0), printing of the element collapsed state during default snapshots.

ICDPRNT(4): Flag to activate (=1), or deactivate (=0), printing of the structural damage indices during default snapshots.

ICDPRNT(5): Flag to activate (=1), or deactivate (=0), printing of the structural dynamic characteristics during default snapshots.

- Notes: 1. By default the program will identify the first crack, yield, and collapse of a column, beam and wall. At these stages during the pushover analysis, the user may indicate the program to report the displaced profile, the stress ratios, collapse state, damage indices, and periods.*
- 2. Output for the default snapshots is written in the file "DEFORMED.OUT".*

- **Control Flags for User Defined Snapshots (Provide only if NPRNT>0):**

ICPRNT(1), ICPRNT(2), ICPRNT(3), ICPRNT(4), ICPRNT(5)

Description: **ICPRNT(1):** Flag to activate (=1), or deactivate (=0), printing of the displacement profile during user defined snapshots.

ICPRNT(2): Flag to activate (=1), or deactivate (=0), printing of the element stress ratios during user defined snapshots.

- ICPRNT(3): Flag to activate (=1), or deactivate (=0), printing of the element collapsed state during user defined snapshots.
- ICPRNT(4): Flag to activate (=1), or deactivate (=0), printing of the structural damage indices during user defined snapshots.
- ICPRNT(5): Flag to activate (=1), or deactivate (=0), printing of the structural dynamic characteristics during user defined snapshots.

SET N2: STORY OUTPUT CONTROL

- **Output Control Data:**

USER_TEXT
NSOUT, DTOUT, ISO(1), ISO(2), ..., ISO(NSOUT)
FNAMES(1)
FNAMES(2)
 ...
FNAMES(NSOUT)

Description: **USER_TEXT:** Reference information, up to 80 characters of text.

NSOUT: No. of output histories.

DTOUT: Output time/step interval¹.

ISO(i): List of output story numbers.

FNAMES(i): Filename to store time history output for story number ISO(i).

Notes: 1 If the pushover or quasi-static cyclic analysis option is used, DTOUT refers to the number of steps between output printing; for example, DTOUT=2 will print results every 2 steps.

SET N3: ELEMENT HYSTERESIS OUTPUT

- **Control Data for Element Output:**

USER_TEXT
KCOUT, KBOUT, KWOUT, KSOUT, KBROUT, KIWOUT

Description: **USER_TEXT:** Reference information, up to 80 characters of text.

KCOUT: Number of columns for which hysteresis output is required (< 10).

KBOUT: Number of beams for which hysteresis output is required (< 10).

KWOUT: Number of walls for which hysteresis output is required (< 10).

- KSOUT:** Number of springs for which hysteresis output is required (≤ 10).
- KBROUT:** Number of braces for which hysteresis output is required (≤ 10).
- KIWOUT:** Number of infill panels for which hysteresis output is required (≤ 10).

SET N3.1: Column Output

- **Column Output Specification (Skip this input if KCOUT=0):**
USER_TEXT
ICLIST(1), ICLIST(2), ..., ICLIST(KCOUT)
Description: **USER_TEXT:** Reference information, up to 80 characters of text.
ICLIST(i): List of column numbers for which moment-curvature hysteresis is required.

SET N3.2: Beam Output

- **Beam Output Specification (Skip this input if KBOUT=0):**
USER_TEXT
IBLIST(1), IBLIST(2), ..., IBLIST(KBOUT)
Description: **USER_TEXT:** Reference information, up to 80 characters of text.
IBLIST(i): List of beam numbers for which moment-curvature hysteresis is required.

SET N3.3: Shear Wall Output

- **Shear Wall Output Specification (Skip this input if KWOUT=0):**
USER_TEXT
IWLIST(1), IWLIST(2), ..., IWLIST(KWOUT)
Description: **USER_TEXT:** Reference information, up to 80 characters of text.
IWLIST(i): List of shear wall numbers for which moment-curvature and shear-strain hysteresis is required.

SET N3.4: Spring Output

- **Discrete Spring Output Specification (Skip this input if KSOUT=0):**
USER_TEXT
ISLIST(1), ISLIST(2), ..., ISLIST(KSOUT)

Description: **USER_TEXT:** Reference information, up to 80 characters of text.
 ISLIST(i): List of spring numbers for which moment-rotation hysteresis is required.

SET N3.5: Brace Output

- **Brace Output Specifications (Skip this input if KBROUT=0):**

USER_TEXT
IBRLIST(1), IBRLIST(2), ..., IBRLIST(KBROUT)

Description: **USER_TEXT:** Reference information, up to 80 characters of text.
 IBRLIST(i): List of brace numbers for which force-displacement hysteresis is required.

SET N3.6: Infill Panel Output

- **Infill Panel Output Specifications (Skip this input if KIWOUT=0):**

USER_TEXT
HWLIST(1), HWLIST(2), ..., HWLIST(KIWOUT)

Description: **USER_TEXT:** Reference information, up to 80 characters of text.
 HWLIST(i): List of infill panel numbers for which force-displacement hysteresis is required.

Notes: *All the output generated in this section refers to moment-curvature hysteresis for beams, columns and shear-walls; in addition shear vs. shear strain history is generated for walls; whereas moment-rotation hysteresis is produced for the discrete spring elements. Output filenames are generated as follows:*

IF KCOUT = 2, AND ICLIST(1) = 3 AND ICLIST(2) = 12, THEN THE FOLLOWING FILES WILL BE CREATED:

COL_003.PRN and COL_012.PRN

(where 3 and 12 refer to the element numbers for which output is requested)

END OF DATA INPUT

**APPENDIX B
SAMPLE INPUT**

CASE STUDY #1

input filename: idarc.dat
data filename: case1.dat
output filename: idarc.out
results filename: case1.out

file: idarc.dat
case1.dat
case1.out

file: case1.dat
CASE STUDY # 1 : Circular Column Test
CONTROL DATA
1, 1, 1, 1, 0, 1, 0
ELEMENT TYPES
1, 0, 0, 0, 0, 0, 0, 0, 0
ELEMENT DATA
1, 0, 0, 0, 0, 0, 0, 0
UNIT SYSTEM (KIPS/INCH)
1
FLOOR ELEVATIONS
360.0
DESCRIPTION OF IDENTICAL FRAMES
1
PLAN CONFIGURATION (SINGLE COLUMN LINE)
1
NODAL WEIGHTS
1, 1, 300.0
CODE FOR SPECIFICATION OF USER PROPERTIES
0
CONCRETE PROPERTIES
1, 5.2, 4110.0, 0.2, 0.624, 0.0, 0.0
REINFORCEMENT PROPERTIES
1, 68.9, 103.6, 27438.0, 0.0, 0.0
HYSTERETIC MODELING RULES
1
1, 9.0, 0.00, 0.05, 1.0
MOMENT CURVATURE ENVELOPE GENERATION
0
COLUMN DIMENSIONS

2
 1,1,1,1, 360.0,0.0,0.0, 1000.0, 60.0, 2.5, 54.5, 25, 1.69, 0.625, 3.5
 COLUMN CONNECTIVITY
 1,1,1,1,0,1
 ANALYSIS TYPE
 4
 STATIC ANALYSIS OPTION (Axial Force Only)
 0,0,0,1
 4,1
 Nodal Loads
 1, 1, 1, 1, 900.0
 Quasistatic Analysis
 1
 1
 1
 301
 0.0 2.5 0.0 -2.80 0.0 3.5 7.060 3.5 0.0 -3.5
 -7.03 -3.5 0.0 3.50 7.08 3.5 0.0 -3.5 -7.02 -3.5
 0.0 5.0 9.0 10.60 9.0 5.0 0.0 -5.0 -9.0 -10.55
 -9.0 -5.0 0.0 5.0 9.0 10.6 9.0 5.0 0.0 -5.0
 -9.0 -10.55 -9.0 -5.0 0.0 5.0 10.0 13.5 14.08 13.5
 10.0 5.0 0.0 -5.0 -10.0 -13.5 -14.05 -13.5 -10.0 -5.0
 0.0 5.0 10.0 13.5 14.07 13.5 10.0 5.0 0.0 -5.0
 -10.0 -13.5 -14.05 -13.5 -10.0 -5.0
 0.0 5.0 10.0 13.5 14.08 13.5 10.0 5.0 0.0 -5.0
 -10.0 -13.5 -14.08 -13.5 -10.0 -5.0
 0.0 5.0 10.0 13.5 14.08 13.5 10.0 5.0 0.0 -5.0
 -10.0 -13.5 -14.07 -13.5 -10.0 -5.0
 0.0 5.0 10.0 13.5 14.10 13.5 10.0 5.0 0.0 -5.0
 -10.0 -13.5 -14.07 -13.5 -10.0 -5.0
 0.0 5.0 10.0 13.5 14.10 13.5 10.0 5.0 0.0 -5.0
 -10.0 -13.5 -14.07 -13.5 -10.0 -5.0
 0.0 5.0 10.0 13.5 14.12 13.5 10.0 5.0 0.0 -5.0
 -10.0 -13.5 -14.07 -13.5 -10.0 -5.0
 0.0 5.0 10.0 13.5 14.12 13.5 10.0 5.0 0.0 -5.0
 -10.0 -13.5 -14.07 -13.5 -10.0 -5.0
 0.0 5.0 10.0 13.5 14.12 13.5 10.0 5.0 0.0 -5.0
 -10.0 -13.5 -14.07 -13.5 -10.0 -5.0
 0.0 5.0 10.0 13.5 14.10 13.5 10.0 5.0 0.0 -5.0
 -10.0 -13.5 -14.07 -13.5 -10.0 -5.0
 0.0 5.0 10.0 16.0 17.66 15.5 10.0 5.0 0.0 -5.0
 -10.0 -15.5 -17.66 -15.5 -10.0 -5.0
 0.0 5.0 10.0 16.0 17.66 15.5 10.0 5.0 0.0 -5.0

```

-10.0 -15.5 -17.66 -15.5 -10.0 -5.0
  0.0  5.0 10.0 16.0 17.66 15.5 10.0  5.0  0.0 -5.0
-10.0 -15.5 -17.66 -15.5 -10.0 -5.0
  0.0  6.0 12.0 20.0 21.30 20.0 12.0  6.0  0.0 -6.0
-12.0 -20.0 -21.19 -20.0 -12.0 -6.0
  0.0  6.0 12.0 20.0 21.32 20.0 12.0  6.0  0.0 -6.0
-12.0 -20.0 -21.27 -20.0 -12.0 -6.0  0.0
0.05
SNAPSHOT OUTPUT
0,
0,0,0,0,0
OUTPUT CONTROL
1,6,1
CYCL.OUT
MISCELLANEOUS OUTPUT INFORMATION
1,0,0,0,0,0
COLUMN OUTPUT
1

```

CASE STUDY #2

```

input filename:   idarc.dat
data filename:   case2.dat
output filename:  idarc.out
results filename: case2.out

```

```

file: idarc.dat
case2.dat
case2.out

```

```

file: case2.dat
CASE STUDY # 2: 1:2 SCALE THREE STORY FRAME
CONTROL DATA
3,1,1,1,0,0,0
ELEMENT TYPES
4,5,0,0,0,0,0,0,0,0
ELEMENT DATA
9,6,0,0,0,0,0,0,0
UNITS SYSTEM : KN - MM
2
FLOOR ELEVATIONS
1500.0, 3000.0, 4500.0
DESCRIPTION OF IDENTICAL FRAMES
1

```

PLAN CONFIGURATION: NO OF COLUMN LINES
 3
 NODAL WEIGHTS
 1,1, 22.24, 22.24, 22.24
 2,1, 22.24, 22.24, 22.24
 3,1, 22.24, 22.24, 22.24
 CODE FOR SPECIFICATION OF USER PROPERTIES
 0
 CONCRETE PROPERTIES
 1, 0.0402, 0.0, 0.0, 0.0, 0.0, 0.0
 REINFORCEMENT PROPERTIES
 1, 0.4, 0.0, 0.0, 0.0, 0.0
 HYSTERETIC MODELING RULES
 2
 1, 8.0, 0.00, 0.10, 1.0
 2, 8.0, 0.00, 0.10, 1.0
 MOMENT CURVATURE ENVELOPE GENERATION
 0
 COLUMN DIMENSIONS
 1
 1,1,1, 594.2, 1498.6, 149.86, 149.86,
 1, 250.0, 250.0, 15.0, 226.2, 8.0, 75.0, 0.5
 1, 250.0, 250.0, 15.0, 226.2, 8.0, 75.0, 0.5
 1
 2,1,1, 990.6, 1498.6, 149.86, 149.86,
 1, 250.0, 250.0, 15.0, 307.7, 12.0, 75.0, 0.5
 1, 250.0, 250.0, 15.0, 307.7, 12.0, 75.0, 0.5
 1
 3,1,1, 594.2, 1498.6, 0.0, 149.86,
 1, 250.0, 250.0, 15.0, 307.7, 12.0, 75.0, 0.5
 1, 250.0, 250.0, 15.0, 307.7, 12.0, 75.0, 0.5
 1
 4,1,1, 990.6, 1498.6, 0.0, 149.86,
 1, 250.0, 250.0, 15.0, 307.7, 12.0, 75.0, 0.5
 1, 250.0, 250.0, 15.0, 307.7, 12.0, 75.0, 0.5
 BEAM MOMENT CURVATURE ENVELOPE GENERATION
 0
 BEAM DIMENSIONS
 1,1,1, 3000.0, 125.0, 125.0
 2, 300.0,150.0,150.0,0.0,15.0, 401.9,401.9, 6.0, 75.0
 2, 300.0,150.0,150.0,0.0,15.0, 401.9,401.9, 6.0, 75.0
 2,1,1, 3000.0, 125.0, 125.0
 2, 300.0,150.0,150.0,0.0,15.0, 480.6,401.9, 6.0, 75.0
 2, 300.0,150.0,150.0,0.0,15.0, 401.9,509.0, 6.0, 75.0
 3,1,1, 3000.0, 125.0, 125.0

2, 300.0,150.0,150.0,0.0,15.0, 401.9,509.0, 6.0, 75.0
 2, 300.0,150.0,150.0,0.0,15.0, 480.6,401.9, 6.0, 75.0
 4.1.1, 3000.0, 125.0, 125.0
 2, 300.0,150.0,150.0,0.0,15.0, 307.7,226.5, 6.0, 75.0
 2, 300.0,150.0,150.0,0.0,15.0, 307.7,307.7, 6.0, 75.0
 5.1.1, 3000.0, 125.0, 125.0
 2, 300.0,150.0,150.0,0.0,15.0, 307.7,226.5, 6.0, 75.0
 2, 300.0,150.0,150.0,0.0,15.0, 307.7,307.7, 6.0, 75.0

COLUMN CONNECTIVITY

1,1,1,1,2,3
 2,2,1,2,2,3
 3,1,1,3,2,3
 4,1,1,1,1,2
 5,2,1,2,1,2
 6,1,1,3,1,2
 7,3,1,1,0,1
 8,4,1,2,0,1
 9,3,1,3,0,1

BEAM CONNECTIVITY

1,5,3,1,1,2
 2,4,3,1,2,3
 3,3,2,1,1,2
 4,2,2,1,2,3
 5,1,1,1,1,2
 6,1,1,1,2,3

ANALYSIS TYPE

4

STATIC ANALYSIS OPTION

0,0,0,0

QUASI-STATIC CYCLIC ANALYSIS

1

1

3

249

0.0000	6.8580	0.0000	-6.8580	0.0000	10.1600
0.0000	-10.1600	0.0000	12.7000	25.4000	32.4104
25.4000	12.7000	0.0000	-12.7000	-25.4000	-32.0802
-25.4000	-12.7000	0.0000	12.7000	25.4000	31.9024
25.4000	12.7000	0.0000	-12.7000	-25.4000	-29.7180
-25.4000	-12.7000	0.0000	12.7000	25.4000	30.0482
25.4000	12.7000	0.0000	-12.7000	-25.4000	-28.7020
-25.4000	-12.7000	0.0000	20.3200	40.6400	50.8000
55.8800	50.8000	40.6400	20.3200	0.0000	-20.3200
-40.6400	-50.8000	-53.3400	-50.8000	-40.6400	-20.3200
0.0000	20.3200	40.6400	50.8000	57.4040	50.8000

40.6400	20.3200	0.0000	-20.3200	-40.6400	-50.8000
-54.3560	-50.8000	-40.6400	-20.3200	0.0000	20.3200
40.6400	50.8000	56.1340	50.8000	40.6400	20.3200
0.0000	-20.3200	-40.6400	-50.8000	-54.1020	-50.8000
-40.6400	-20.3200	0.0000	25.4000	50.8000	76.2000
86.8680	76.2000	50.8000	25.4000	0.0000	-25.4000
-50.8000	-76.2000	-83.3120	-76.2000	-50.8000	-25.4000
0.0000	25.4000	50.8000	76.2000	87.1220	76.2000
50.8000	25.4000	0.0000	-25.4000	-50.8000	-76.2000
-84.5820	-76.2000	-50.8000	-25.4000	0.0000	25.4000
50.8000	76.2000	88.6460	76.2000	50.8000	25.4000
0.0000	-25.4000	-50.8000	-76.2000	-84.5820	-76.2000
-50.8000	-25.4000	0.0000	38.1000	76.2000	106.6800
114.3000	106.6800	76.2000	38.1000	0.0000	-38.1000
-76.2000	-106.6800	-111.7600	-106.6800	-76.2000	-38.1000
0.0000	38.1000	76.2000	106.6800	114.3000	106.6800
76.2000	38.1000	0.0000	-38.1000	-76.2000	-106.6800
-112.2680	-106.6800	-76.2000	-38.1000	0.0000	38.1000
76.2000	106.6800	113.5380	106.6800	76.2000	38.1000
0.0000	-38.1000	-76.2000	-106.6800	-112.2680	-106.6800
-76.2000	-38.1000	0.0000	38.1000	76.2000	114.3000
139.7000	147.8280	139.7000	114.3000	76.2000	38.1000
0.0000	-38.1000	-76.2000	-114.3000	-121.9200	-127.7620
-121.9200	-114.3000	-76.2000	-38.1000	0.0000	38.1000
76.2000	114.3000	139.7000	147.0660	139.7000	114.3000
76.2000	38.1000	0.0000	-38.1000	-76.2000	-114.3000
-121.9200	-128.0160	-121.9200	-114.3000	-76.2000	-38.1000
0.0000	38.1000	76.2000	114.3000	139.7000	147.3200
139.7000	114.3000	76.2000	38.1000	0.0000	-38.1000
-76.2000	-114.3000	-121.9200	-127.0000	-121.9200	-114.3000
-76.2000	-38.1000	0.0000			

0.02

SNAPSHOT OUTPUT CONTROL

0

0,0,0,0

STORY OUTPUT CONTROL

3,10,1,2,3

LEVEL1.OUT

LEVEL2.OUT

LEVEL3.OUT

ELEMENT HYSTERESIS OUTPUT INFORMATION

0,0,0,0,0

CASE STUDY #3

input filename: *idarc.dat*
data filename: *case3.dat*
output filename: *idarc.out*
results filename: *case3.out*

file: idarc.dat
case3.dat
case3.out

file: case3.dat
CASE STUDY # 3 : TEN STORY MODEL STRUCTURE
CONTROL DATA
10,1,1,1,0,0,0
ELEMENT TYPES
20,2,0,0,0,0,0,0,0,0
ELEMENT DATA
40,30,0,0,0,0,0,0,0
UNITS SYSTEM
1
FLOOR ELEVATIONS
9.0,18.0,27.0,36.0,45.0,54.0,63.0,72.0,81.0,90.0
DESCRIPTION OF IDENTICAL FRAMES
2
PLAN CONFIGURATION
4
NODAL WEIGHTS
1, 1, 0.125, 0.125, 0.125, 0.125
2, 1, 0.125, 0.125, 0.125, 0.125
3, 1, 0.125, 0.125, 0.125, 0.125
4, 1, 0.125, 0.125, 0.125, 0.125
5, 1, 0.125, 0.125, 0.125, 0.125
6, 1, 0.125, 0.125, 0.125, 0.125
7, 1, 0.125, 0.125, 0.125, 0.125
8, 1, 0.125, 0.125, 0.125, 0.125
9, 1, 0.125, 0.125, 0.125, 0.125
10, 1, 0.125, 0.125, 0.125, 0.125
CODE FOR SPECIFICATION OF USER PROPERTIES
0
CONCRETE PROPERTIES
1, 4.35, 1000.0, 0.3, 0.435, 1.2, 100.0
REINFORCEMENT PROPERTIES
1, 70.0, 72.5, 29000.0, 40.0, 2.0
HYSTERETIC MODELING RULES

2
 1, 1.0.0.0.1,1.0
 2, 2.0.0.0.1,1.0
 COLUMN MOMENT CURVATURE ENVELOPE GENERATION
 0
 COLUMN DIMENSIONS
 1
 1,1,1,1.25,9.0,0.0,0.75, 1, 2.0,1.5,0.25,0.049,0.0625,0.35,0.5
 1, 2.0,1.5,0.25,0.049,0.0625,0.35,0.5
 1
 2,1,1,1.12,9.0,0.75,0.75, 1, 2.0,1.5,0.25,0.049,0.0625,0.35,0.5
 1, 2.0,1.5,0.25,0.049,0.0625,0.35,0.5
 1
 3,1,1,1.00,9.0,0.75,0.75, 1, 2.0,1.5,0.25,0.049,0.0625,0.35,0.5
 1, 2.0,1.5,0.25,0.049,0.0625,0.35,0.5
 1
 4,1,1,0.88,9.0,0.75,0.75, 1, 2.0,1.5,0.25,0.049,0.0625,0.35,0.5
 1, 2.0,1.5,0.25,0.049,0.0625,0.35,0.5
 1
 5,1,1,0.75,9.0,0.75,0.75, 1, 2.0,1.5,0.25,0.049,0.0625,0.35,0.5
 1, 2.0,1.5,0.25,0.029,0.0625,0.35,0.5
 1
 6,1,1,0.63,9.0,0.75,0.75, 1, 2.0,1.5,0.25,0.029,0.0625,0.35,0.5
 1, 2.0,1.5,0.25,0.029,0.0625,0.35,0.5
 1
 7,1,1,0.50,9.0,0.75,0.75, 1, 2.0,1.5,0.25,0.029,0.0625,0.35,0.5
 1, 2.0,1.5,0.25,0.029,0.0625,0.35,0.5
 1
 8,1,1,0.38,9.0,0.75,0.75, 1, 2.0,1.5,0.25,0.029,0.0625,0.35,0.5
 1, 2.0,1.5,0.25,0.029,0.0625,0.35,0.5
 1
 9,1,1,0.25,9.0,0.75,0.75, 1, 2.0,1.5,0.25,0.029,0.0625,0.35,0.5
 1, 2.0,1.5,0.25,0.029,0.0625,0.35,0.5
 1
 10,1,1,0.13,9.0,0.75,0.75, 1, 2.0,1.5,0.25,0.029,0.0625,0.35,0.5
 1, 2.0,1.5,0.25,0.029,0.0625,0.35,0.5
 1
 11,1,1,1.25,9.0,0.0,0.75, 1, 2.0,1.5,0.25,0.041,0.0625,0.35,0.5
 1, 2.0,1.5,0.25,0.041,0.0625,0.35,0.5
 1
 12,1,1,1.13,9.0,0.75,0.75, 1, 2.0,1.5,0.25,0.041,0.0625,0.35,0.5
 1, 2.0,1.5,0.25,0.041,0.0625,0.35,0.5
 1
 13,1,1,1.00,9.0,0.75,0.75, 1, 2.0,1.5,0.25,0.041,0.0625,0.35,0.5
 1, 2.0,1.5,0.25,0.041,0.0625,0.35,0.5

1
14,1,1,0.88,9,0,0.75,0.75, 1, 2.0,1.5,0.25,0.041,0.0625,0.35,0.5
1, 2.0,1.5,0.25,0.041,0.0625,0.35,0.5

1
15,1,1,0.75,9,0,0.75,0.75, 1, 2.0,1.5,0.25,0.041,0.0625,0.35,0.5
1, 2.0,1.5,0.25,0.013,0.0625,0.35,0.5

1
16,1,1,0.63,9,0,0.75,0.75, 1, 2.0,1.5,0.25,0.013,0.0625,0.35,0.5
1, 2.0,1.5,0.25,0.013,0.0625,0.35,0.5

1
17,1,1,0.50,9,0,0.75,0.75, 1, 2.0,1.5,0.25,0.013,0.0625,0.35,0.5
1, 2.0,1.5,0.25,0.013,0.0625,0.35,0.5

1
18,1,1,0.38,9,0,0.75,0.75, 1, 2.0,1.5,0.25,0.013,0.0625,0.35,0.5
1, 2.0,1.5,0.25,0.013,0.0625,0.35,0.5

1
19,1,1,0.25,9,0,0.75,0.75, 1, 2.0,1.5,0.25,0.013,0.0625,0.35,0.5
1, 2.0,1.5,0.25,0.013,0.0625,0.35,0.5

1
20,1,1,0.13,9,0,0.75,0.75, 1, 2.0,1.5,0.25,0.013,0.0625,0.35,0.5
1, 2.0,1.5,0.25,0.013,0.0625,0.35,0.5

BEAM MOMENT CURVATURE ENVELOPE GENERATION

0

BEAM DIMENSIONS

1,1,1,12.0,0.75,0.75,
2, 1.5,1.5,1.5,0.0,0.25,0.0092,0.0092,0.0625,0.3
2, 1.5,1.5,1.5,0.0,0.25,0.0092,0.0092,0.0625,0.3
2,1,1,12.0,0.75,0.75,
2, 1.5,1.5,1.5,0.0,0.25,0.013,0.013,0.0625,0.3
2, 1.5,1.5,1.5,0.0,0.25,0.013,0.013,0.0625,0.3

COLUMN CONNECTIVITY

1 1 1 1 0 1
2 2 1 1 1 2
3 3 1 1 2 3
4 4 1 1 3 4
5 5 1 1 4 5
6 6 1 1 5 6
7 7 1 1 6 7
8 8 1 1 7 8
9 9 1 1 8 9
10 10 1 1 9 10
11 11 1 2 0 1
12 12 1 2 1 2
13 13 1 2 2 3
14 14 1 2 3 4

15 15 1 2 4 5
16 16 1 2 5 6
17 17 1 2 6 7
18 18 1 2 7 8
19 19 1 2 8 9
20 20 1 2 9 10
21 11 1 3 0 1
22 12 1 3 1 2
23 13 1 3 2 3
24 14 1 3 3 4
25 15 1 3 4 5
26 16 1 3 5 6
27 17 1 3 6 7
28 18 1 3 7 8
29 19 1 3 8 9
30 20 1 3 9 10
31 1 1 4 0 1
32 2 1 4 1 2
33 3 1 4 2 3
34 4 1 4 3 4
35 5 1 4 4 5
36 6 1 4 5 6
37 7 1 4 6 7
38 8 1 4 7 8
39 9 1 4 8 9
40 10 1 4 9 10

BEAM CONNECTIVITY

1 2 1 1 1 2
2 2 2 1 1 2
3 2 3 1 1 2
4 2 4 1 1 2
5 1 5 1 1 2
6 1 6 1 1 2
7 1 7 1 1 2
8 1 8 1 1 2
9 1 9 1 1 2
10 1 10 1 1 2
11 2 1 1 2 3
12 2 2 1 2 3
13 2 3 1 2 3
14 2 4 1 2 3
15 1 5 1 2 3
16 1 6 1 2 3
17 1 7 1 2 3
18 1 8 1 2 3

19 1 9 1 2 3
20 1 10 1 2 3
21 2 1 1 3 4
22 2 2 1 3 4
23 2 3 1 3 4
24 2 4 1 3 4
25 1 5 1 3 4
26 1 6 1 3 4
27 1 7 1 3 4
28 1 8 1 3 4
29 1 9 1 3 4
30 1 10 1 3 4
ANALYSIS TYPE
3
STATIC ANALYSIS OPTION
0,0,0,0
DYNAMIC ANALYSIS CONTROL PARAMETERS
1.6163, 0.0, 0.001, 43.5, 2.0, 1
INPUT WAVE INFORMATION
0,1000,0.004
Recorded Table Motion
waveh.dat
SNAPSHOT CONTROL
0
0,0,0,0,0
OUTPUT CONTROL
5,0.02,1,3,5,7,10
LEVEL1.OUT
LEVEL3.OUT
LEVEL5.OUT
LEVEL7.OUT
LEVEL10.OUT
ELEMENT HYSTERESIS OUTPUT INFORMATION
1,1,0,0,0,0
COLUMN OUTPUT
1,37
BEAM OUTPUT
1,21

*NOTES : The earthquake ground acceleration record is read separately from a file
named 'waveh.dat' as specified in the input data*

CASE STUDY #4

input filename: *idarc.dat*
data filename: *case4.dat*
output filename: *idarc.out*
results filename: *case4.out*

file: idarc.dat
case4.dat
case4.out

file: case4.dat
Case Study 4: Analysis of 1:3 Scale Three Story Model 0.05g
Control Data
3,1,0,0,0,0,0
Element types
6,1,0,0,0,0,0,0,0
Element data
12,9,0,0,0,0,0,0,0
Unit system
1
Floor elevations
45.0, 93.0, 141.0
Number of duplicate frames
2
No of column lines
4
Nodal weights
1, 1, 3.375, 3.375, 3.375, 3.375
2, 1, 3.375, 3.375, 3.375, 3.375
3, 1, 3.375, 3.375, 3.375, 3.375
Env generation option
1
Hysteretic Control
2
1, 0.5, 0.0, 0.1, 1.0
2, 2.0, 0.0, 0.1, 1.0
Column input option
1
Column data
1, 48.0,3.0,3.0,0
1, 45400.0, 843.0, 19980.8, 10.0, 18.0, 0.00200, 0.006, 400.0
10.0, 18.0, 0.00200, 0.006, 400.0
1, 45400.0, 843.0, 19980.8, 10.0, 18.0, 0.00200, 0.006, 400.0
10.0, 18.0, 0.00200, 0.006, 400.0

2, 48.0.3.0.3.0.0
 1, 45400.0, 843.0, 19980.8, 10.0, 22.0, 0.00200, 0.006, 400.0
 10.0, 22.0, 0.00200, 0.006, 400.0
 1, 45400.0, 843.0, 19980.8, 10.0, 22.0, 0.00200, 0.006, 400.0
 10.0, 22.0, 0.00200, 0.006, 400.0

3, 48.0.3.0.3.0.0
 1, 45900.0, 900.0, 24160.0, 10.0, 22.0, 0.003, 0.006, 400.0,
 10.0, 22.0, 0.003, 0.006, 400.0,
 1, 45900.0, 900.0, 22528.0, 10.0, 22.0, 0.003, 0.006, 400.0,
 10.0, 22.0, 0.003, 0.006, 400.0

4, 48.0.3.0.3.0.0
 1, 45900.0, 900.0, 24160.0, 14.0, 29.0, 0.003, 0.006, 400.0,
 14.0, 29.0, 0.003, 0.006, 400.0,
 1, 45900.0, 900.0, 22528.0, 14.0, 29.0, 0.003, 0.006, 400.0,
 14.0, 29.0, 0.003, 0.006, 400.0

5, 45.0.0.0.3.0.0
 1, 45200.0, 960.0, 20640.0, 12.0, 28.0, 0.003, 0.008, 400.0,
 12.0, 28.0, 0.003, 0.008, 400.0,
 1, 45200.0, 960.0, 24000.0, 12.0, 28.0, 0.003, 0.008, 400.0,
 12.0, 28.0, 0.003, 0.008, 400.0

6, 45.0.0.0.3.0.0
 1, 45200.0, 960.0, 20640.0, 16.0, 38.0, 0.003, 0.008, 400.0,
 16.0, 38.0, 0.003, 0.008, 400.0,
 1, 45200.0, 960.0, 24000.0, 16.0, 38.0, 0.003, 0.008, 400.0,
 16.0, 38.0, 0.003, 0.008, 400.0

Beam input type

1

Beam data

1, 72.0, 2.0, 2.0,0
 2, 140000.0, 20000.0, 15.0, 30.0, 0.001, 0.01, 2400.0
 30.0, 70.0, 0.001, 0.01, 2400.0
 2, 140000.0, 20000.0, 15.0, 30.0, 0.001, 0.01, 2400.0
 30.0, 70.0, 0.001, 0.01, 2400.0

Column connectivity

1,1,1,1,2,3
 2,2,1,2,2,3
 3,2,1,3,2,3
 4,1,1,4,2,3
 5,3,1,1,1,2
 6,4,1,2,1,2
 7,4,1,3,1,2
 8,3,1,4,1,2
 9,5,1,1,0,1
 10,6,1,2,0,1
 11,6,1,3,0,1

12,5,1,4,0,1
Beam connectivity
1,1,3,1,1,2
2,1,3,1,2,3
3,1,3,1,3,4
4,1,2,1,1,2
5,1,2,1,2,3
6,1,2,1,3,4
7,1,1,1,1,2
8,1,1,1,2,3
9,1,1,1,3,4
Type of Analysis
3
Static loads
0,0,0,0
Dynamic Analysis Control Data
0.05, 0.0, 0.005, 20.0, 1.2, 1
Wave data
0, 2000, 0.01
TAFT - EARTHQUAKE
wave05.dat
SNAPSHOT CONTROL DATA
0
0,0,0,0,0
Output options
1, 0.02, 3
JELAS.PRN
Hys output
0,0,0,0,0,0

*NOTES : The earthquake ground acceleration record is read separately from a file
named 'wave05.dat' as specified in the input data*

CASE STUDY #5

*input filename: idarc.dat
data filename: case5.dat
output filename: idarc.out
results filename: case5.out*

**file: idarc.dat
case5.dat
case5.out**

file: case5.dat
CASE 5: Seismic Damage Analysis of Cypress Viaduct
Control Data - 4 stories, 1 frame, 1 conc and 1 steel type
4, 1, 1, 1, 0, 0, 0
Element types: 2 cols, 12 beams, 2 walls
2, 12, 2, 0, 0, 0, 0, 0, 0, 0
Element data: 4 columns, 12 beams, 2 walls
4, 12, 2, 0, 0, 0, 4, 0, 0
System of units: k/in
1
Floor elevations
252.0 327.0 327.0 528.0
Duplicate frame info
1
No of column lines
7
Nodal weights (Note: Story 2 & 3 are dummy levels)
1 1 116.7 233.3 233.3 233.3 233.3 233.3 116.7
2 1 0.0 0.0 0.0 0.0 0.0 0.0 0.0
3 1 0.0 0.0 0.0 0.0 0.0 0.0 0.0
4 1 116.7 233.3 233.3 233.3 233.3 233.3 116.7
Option for M-phi input
1
Hysteresis Rules
4
1 2.0, 0.0, 0.1, 1.0
2 2.0, 0.0, 0.1, 1.0
3 2.0, 0.0, 0.1, 1.0
4 1.0, 0.0, 0.2, 1.0
Option for column input
1
COLUMN DATA
1 252.0 0.0 48.0 0
-1 8.38E+9 8.73e+4 0.0
50350 266300 5.12e-5 2.19e-4 1.37e+8
50350 266300 5.12e-5 2.19e-4 1.37e+8
2 201 0.0 48.0 0
1 1.02e+9 5.82e+4 0.0
12200 64350 1.04e-4 4.07e-4 1.85e+7
12200 64350 1.04e-4 4.07e-4 1.85e+7
1 2.32e+9 7.41e+4 0.0
19200 90300 7.24e-5 3.70e-4 3.21e+7
19200 90300 7.24e-5 3.70e-4 3.21e+7
Option for beam input

```

1
BEAM DATA
1 117.0 48.0 0.0 0
  2 2.00E+10 0.0 45700 70500 2.29E-5 8.78E-4 6.29E-7
    47100 136800 2.51E-5 5.68E-4 1.16E+8
  2 2.00E+10 0.0 45900 117800 2.48E-5 5.68E-4 1.01E+8
    40900 45600 2.27E-5 9.21E-4 4.23E+7
2 117.0 0.0 0.0 0
  2 2.00E+10 0.0 45900 117800 2.48E-5 5.68E-4 1.01E+8
    40900 45600 2.27E-5 9.21E-4 4.23E+7
  2 2.00E+10 0.0 48500 208200 2.84E-5 3.07E-4 1.27E+8
    18500 20600 2.11E-5 8.23E-4 2.71E+7
3 117.0 0.0 0.0 0
  2 2.00E+10 0.0 48500 208200 2.84E-5 3.07E-4 1.27E+8
    18500 20600 2.11E-5 8.23E-4 2.71E+7
  2 2.00E+10 0.0 49000 222300 2.87E-5 2.89E-4 1.30E+8
    18500 20600 2.10E-5 7.81E-4 2.90E+7
4 117.0 0.0 0.0 0
  2 2.00E+10 0.0 49000 222300 2.87E-5 2.89E-4 1.30E+8
    18500 20600 2.10E-5 7.81E-4 2.90E+7
  2 2.00E+10 0.0 48500 208200 2.84E-5 3.07E-4 1.27E+8
    18500 20600 2.11E-5 8.23E-4 2.71E+7
5 117.0 0.0 0.0 0
  2 2.00E+10 0.0 48500 208200 2.84E-5 3.07E-4 1.27E+8
    18500 20600 2.11E-5 8.23E-4 2.71E+7
  2 2.00E+10 0.0 45900 117800 2.48E-5 5.68E-4 1.01E+8
    40900 45600 2.27E-5 9.21E-4 4.23E+7
6 117.0 0.0 48.0 0
  2 2.00E+10 0.0 45900 117800 2.48E-5 5.68E-4 1.01E+8
    40900 45600 2.27E-5 9.21E-4 4.23E+7
  2 2.00E+10 0.0 45700 70500 2.29E-5 8.78E-4 6.29E-7
    47100 136800 2.51E-5 5.68E-4 1.16E+8
7 117.0 24.0 0.0 0
  2 2.00E+10 0.0 44800 86800 2.39E-5 6.36E-4 7.57E+7
    44100 54500 2.31E-5 9.10E-4 4.90E+7
  2 2.00E+10 0.0 49200 224300 2.98E-5 2.96E-4 1.28E+8
    25500 28600 2.24E-5 7.51E-4 3.62E+7
8 117.0 0.0 0.0 0
  2 2.00E+10 0.0 49200 224300 2.98E-5 2.96E-4 1.28E+8
    25500 28600 2.24E-5 7.51E-4 3.62E+7
  2 2.00E+10 0.0 51200 301900 3.33E-5 2.16E-4 9.77E+7
    21600 24000 2.14E-5 5.62E-4 5.70E+7
9 117.0 0.0 0.0 0
  2 2.00E+10 0.0 51200 301900 3.33E-5 2.16E-4 9.77E+7
    21600 24000 2.14E-5 5.62E-4 5.70E+7

```

```

2 2.00E+10 0.0 51200 301900 3.33E-5 2.16E-4 9.77E-7
    21600 24000 2.14E-5 5.62E-4 5.70E-7
10 117.0 0.0 0.0 0
2 2.00E+10 0.0 51200 301900 3.33E-5 2.16E-4 9.77E-7
    21600 24000 2.14E-5 5.62E-4 5.70E-7
2 2.00E+10 0.0 51200 301900 3.33E-5 2.16E-4 9.77E-7
    21600 24000 2.14E-5 5.62E-4 5.70E-7
11 117.0 0.0 0.0 0
2 2.00E+10 0.0 51200 301900 3.33E-5 2.16E-4 9.77E-7
    21600 24000 2.14E-5 5.62E-4 5.70E-7
2 2.00E+10 0.0 49200 224300 2.98E-5 2.96E-4 1.28E+8
    25500 28600 2.24E-5 7.51E-4 3.62E+7
12 117.0 0.0 24.0 0
2 2.00E+10 0.0 49200 224300 2.98E-5 2.96E-4 1.28E+8
    25500 28600 2.24E-5 7.51E-4 3.62E+7
2 2.00E+10 0.0 44800 86800 2.39E-5 6.36E-4 7.57E+7
    44100 54500 2.31E-5 9.10E-4 4.90E+7

```

Option for wall input

1

WALL DATA

```

1 75.0 2.83e+5 0 0
-3 9.9e+15 9.9e+15 9.99e+15 2.0 10.0 9.9e+12
    9.9e+15 9.99e+15 2.0 10.0 9.9e+12
4 9.433+5 400 520 9.380e-4 1.600e-3 1.500e+4
    250 405 1.105e-3 5.333e-3 1.125e+4
2 75 2.83e+5 0 0
-3 9.9e+15 9.9e+15 9.99e+15 2.0 10.0 9.9e+12
    9.9e+15 9.99e+15 2.0 10.0 9.9e+12
4 9.433+5 250 405 1.105e-3 5.333e-3 1.125e+4
    400 520 9.380e-4 1.600e-3 1.500e+4

```

Column connectivity

```

1, 1, 1, 1, 0, 1
2, 1, 1, 7, 0, 1
3, 2, 1, 1, 2, 4
4, 2, 1, 7, 3, 4

```

Beam connectivity

```

1, 1, 1, 1, 1, 2
2, 2, 1, 1, 2, 3
3, 3, 1, 1, 3, 4
4, 4, 1, 1, 4, 5
5, 5, 1, 1, 5, 6
6, 6, 1, 1, 6, 7
7, 7, 4, 1, 1, 2
8, 8, 4, 1, 2, 3
9, 9, 4, 1, 3, 4

```

10, 10, 4, 1, 4, 5
11, 11, 4, 1, 5, 6
12, 12, 4, 1, 6, 7
Shear wall connectivity
1, 1, 1, 1, 1, 2
2, 2, 1, 7, 1, 3
Moment releases
1, 1, 1, 1
2, 1, 2, 1
3, 1, 3, 1
4, 1, 4, 1
Phase II option (=0, STOP; =3, Seismic; =4, Quasistatic)
3
Long term loading: static loads
0 0 0 0
Control data for dynamic analysis
0.33, 1.065, 0.001, 20.0, 3.0, 1
Wave control data
1, 2201, 0.02
GRAVITY LOAD PLUS OUTER HARBOUR WHARF RECORD
ohw_hori.dat
ohw_vert.dat
SNAPSHOT CONTROL DATA
0 1
0 0 0 0
Output control
2, 0.02, 1, 4
FIRST.PRN
SECOND.PRN
Hysteresis Output
0, 0, 2, 0, 0, 0
Wall numbers for output
1, 2

*NOTES : The earthquake ground acceleration record is read separately from files:
ohw_hori.dat (horizontal component)
ohw_vert.dat (vertical component)
as specified in the input data*

CASE STUDY #6

input filename: *idarc.dat*
data filename: *case6_ew.dat*
output filename: *idarc.out*
results filename: *case6_ew.out*

file: idarc.dat
case6_ew.dat
case6_ew.out

file: case6_ew.dat
PATTERSON BUILDING EAST-WEST FRAMES HALF STRUCTURE (simplified)
CONTROL DATA
4, 2, 1, 1, 0, 1, 1
ELEMENT TYPES
12, 6, 4, 0, 0, 0, 0, 0, 0, 0
ELEMENT DATA
48, 44, 4, 0, 0, 0, 0, 0, 0, 0
UNITS
1
FLOOR ELEVATIONS
144. 288. 432. 576.
IDENTICAL FRAMES
1, 2
COLUMN LINES
10, 3
NODAL WEIGHTS
1, 1, 87. 66. 66. 66. 66. 66. 66. 66. 66. 87.
2, 349. 495. 349.
2, 1, 16. 39. 39. 39. 39. 39. 39. 39. 39. 16.
2, 242. 484. 242.
3, 1, 16. 39. 39. 39. 39. 39. 39. 39. 39. 16.
2, 242. 484. 242.
4, 1, 52. 39. 39. 39. 39. 39. 39. 39. 39. 52.
2, 206. 293. 206.
ENVELOPE GENERATION
0
CONCRETE PROPERTIES
1, 3.0, 3122. 0.2, 0.36, 0.4, 0.
REINFORCEMENT PROPERTIES
1, 60. 0. 0. 0. 0.
HYSTERETIC RULES
1
1, 2. 0. 0.1 1.

COLUMN PROPERTIES

0

COLUMN DATA

1

1, 1, 1, 171, 144, 0, 8.
-1, 24, 30, 1.5, 1.8, 0.25, 9, 0.5

1

2, 1, 1, 183, 144, 0, 8.
-1, 12, 30, 1.5, 1.8, 0.25, 9, 0.5

1

3, 1, 1, 84, 144, 8, 8.
-1, 24, 30, 1.5, 1.8, 0.25, 9, 0.5

1

4, 1, 1, 117, 144, 8, 8.
-1, 12, 30, 1.5, 1.8, 0.25, 9, 0.5

1

5, 1, 1, 68, 144, 8, 8.
-1, 24, 30, 1.5, 1.8, 0.25, 9, 0.5

1

6, 1, 1, 78, 144, 8, 8.
-1, 12, 30, 1.5, 1.8, 0.25, 9, 0.5

1

7, 1, 1, 52, 144, 8, 8.
-1, 24, 30, 1.5, 1.8, 0.25, 9, 0.5

1

8, 1, 1, 39, 144, 8, 8.
-1, 12, 30, 1.5, 1.8, 0.25, 9, 0.5

1

9, 1, 1, 1039, 144, 0, 8.
-1, 30, 36, 1.5, 3.6, 0.25, 9, 0.5

1

10, 1, 1, 690, 144, 8, 8.
-1, 30, 36, 1.5, 3.6, 0.25, 9, 0.5

1

11, 1, 1, 448, 144, 8, 8.
-1, 30, 36, 1.5, 3.6, 0.25, 9, 0.5

1

12, 1, 1, 206, 144, 8, 8.
-1, 30, 36, 1.5, 3.6, 0.25, 9, 0.5

BEAM PROPERTIES

0

BEAM DATA

1, 1, 1, 105, 6, 6.
-1, 17, 60, 69, 3, 1.5, 3.08, 3.08, 0.5, 18.
2, 1, 1, 156, 6, 6

-1, 17. 60. 69. 3. 1.5 3.08 0. 0.5 18.
3, 1, 1, 105. 6. 6.
-1, 17. 30. 39. 3. 1.5 1.76 1.76 0.375 18.
4, 1, 1, 156. 6. 6.
-1, 17. 30. 39. 3. 1.5 2.2 0. 0.375 18.
5, 1, 1, 585. 18. 120.
-1, 14. 24. 120 3. 1.5 2.48 1.6 0. 12.
6, 1, 1, 585. 120. 18.
-1, 14. 24. 120 3. 1.5 2.48 1.6 0. 12.

SHEAR WALL PROPERTIES

0

SHEAR WALL DATA

1, 1, 1, 1, 1, 1756. 144. 1
1, 1, 264. 12. 0.09 0.14
2, 1, 1, 1, 1, 1261. 144. 1
1, 1, 264. 12. 0.09 0.14
3, 1, 1, 1, 1, 777. 144. 1
1, 1, 264. 12. 0.09 0.14
4, 1, 1, 1, 1, 293. 144. 1
1, 1, 264. 12. 0.09 0.14

COLUMN CONNECTIONS

1, 1, 1, 1, 0, 1
2, 2, 1, 2, 0, 1
3, 2, 1, 3, 0, 1
4, 2, 1, 4, 0, 1
5, 2, 1, 5, 0, 1
6, 2, 1, 6, 0, 1
7, 2, 1, 7, 0, 1
8, 2, 1, 8, 0, 1
9, 2, 1, 9, 0, 1
10, 1, 1, 10, 0, 1
11, 3, 1, 1, 1, 2
12, 4, 1, 2, 1, 2
13, 4, 1, 3, 1, 2
14, 4, 1, 4, 1, 2
15, 4, 1, 5, 1, 2
16, 4, 1, 6, 1, 2
17, 4, 1, 7, 1, 2
18, 4, 1, 8, 1, 2
19, 4, 1, 9, 1, 2
20, 3, 1, 10, 1, 2
21, 5, 1, 1, 2, 3
22, 6, 1, 2, 2, 3
23, 6, 1, 3, 2, 3
24, 6, 1, 4, 2, 3

25, 6, 1, 5, 2, 3
26, 6, 1, 6, 2, 3
27, 6, 1, 7, 2, 3
28, 6, 1, 8, 2, 3
29, 6, 1, 9, 2, 3
30, 5, 1, 10, 2, 3
31, 7, 1, 1, 3, 4
32, 8, 1, 2, 3, 4
33, 8, 1, 3, 3, 4
34, 8, 1, 4, 3, 4
35, 8, 1, 5, 3, 4
36, 8, 1, 6, 3, 4
37, 8, 1, 7, 3, 4
38, 8, 1, 8, 3, 4
39, 8, 1, 9, 3, 4
40, 7, 1, 10, 3, 4
41, 9, 2, 1, 0, 1
42, 9, 2, 3, 0, 1
43, 10, 2, 1, 1, 2
44, 10, 2, 3, 1, 2
45, 11, 2, 1, 2, 3
46, 11, 2, 3, 2, 3
47, 12, 2, 1, 3, 4
48, 12, 2, 3, 3, 4

BEAM CONNECTIONS

1, 1, 1, 1, 1, 2
2, 2, 1, 1, 2, 3
3, 1, 1, 1, 3, 4
4, 2, 1, 1, 4, 5
5, 1, 1, 1, 5, 6
6, 2, 1, 1, 6, 7
7, 1, 1, 1, 7, 8
8, 2, 1, 1, 8, 9
9, 1, 1, 1, 9, 10
10, 3, 2, 1, 1, 2
11, 4, 2, 1, 2, 3
12, 3, 2, 1, 3, 4
13, 4, 2, 1, 4, 5
14, 3, 2, 1, 5, 6
15, 4, 2, 1, 6, 7
16, 3, 2, 1, 7, 8
17, 4, 2, 1, 8, 9
18, 3, 2, 1, 9, 10
19, 3, 3, 1, 1, 2
20, 4, 3, 1, 2, 3

21, 3, 3, 1, 3, 4
22, 4, 3, 1, 4, 5
23, 3, 3, 1, 5, 6
24, 4, 3, 1, 6, 7
25, 3, 3, 1, 7, 8
26, 4, 3, 1, 8, 9
27, 3, 3, 1, 9, 10
28, 3, 4, 1, 1, 2
29, 4, 4, 1, 2, 3
30, 4, 4, 1, 3, 4
31, 4, 4, 1, 4, 5
32, 4, 4, 1, 5, 6
33, 4, 4, 1, 6, 7
34, 4, 4, 1, 7, 8
35, 4, 4, 1, 8, 9
36, 3, 4, 1, 9, 10
37, 5, 1, 2, 1, 2
38, 6, 1, 2, 2, 3
39, 5, 2, 2, 1, 2
40, 6, 2, 2, 2, 3
41, 5, 3, 2, 1, 2
42, 6, 3, 2, 2, 3
43, 5, 4, 2, 1, 2
44, 6, 4, 2, 2, 3
SHEAR WALL CONNECTIONS
1, 1, 2, 2, 0, 1
2, 2, 2, 2, 1, 2
3, 3, 2, 2, 2, 3
4, 4, 2, 2, 3, 4
ANALYSIS OPTION (PUSHOVER FORCE CONTROL)
2
STATIC LOADS
0 0 0 0
(FORCE CONTROL)
1
DISTRIBUTION PROPORTIONAL WITH THE HEIGHT
3
0.5 400 15.0
1
RESPONSE SNAPSHOTS
0
0 0 0 0
STORY OUTPUT CONTROL
4 1 4 3 2 1
po_ew4ml.out

po_ew3m1.out
po_ew2m1.out
po_ew1m1.out
ELEMENT HYSTERESIS OUTPUT
0 0 0 0 0 0

CASE STUDY #7

input filename: idarc.dat
data filename: case7.dat
output filename: idarc.out
results filename: case7.out

file: idarc.dat
case7.dat
case7.out

file: case7.dat

Physics Building in UCLA, Longitudinal model [kips-in]

CONTROL DATA

8 1 1 1 0 1 0

ELEMENT TYPES

10 4 0 0 0 0 0 0 0 0

ELEMENT DATA

88 80 0 0 0 0 0 0 0

UNIT SYSTEM

1

FLOOR ELEVATIONS

162 324 486 648 810 972 1134 1296

DESCRIPTION OF IDENTICAL FRAMES

2

PLAN CONFIGURATION

11

NODAL WEIGHTS

8 1 66.05 132.1 132.1 132.1 132.1 132.1 132.1 132.1 132.1 66.05
7 1 73.95 147.9 147.9 147.9 147.9 147.9 147.9 147.9 147.9 73.95
6 1 73.95 147.9 147.9 147.9 147.9 147.9 147.9 147.9 147.9 73.95
5 1 73.95 147.9 147.9 147.9 147.9 147.9 147.9 147.9 147.9 73.95
4 1 73.95 147.9 147.9 147.9 147.9 147.9 147.9 147.9 147.9 73.95
3 1 73.95 147.9 147.9 147.9 147.9 147.9 147.9 147.9 147.9 73.95
2 1 73.95 147.9 147.9 147.9 147.9 147.9 147.9 147.9 147.9 73.95
1 1 73.95 147.9 147.9 147.9 147.9 147.9 147.9 147.9 147.9 73.95

ENVELOPE GENERATION OPTION

0

CONCRETE PROPERTIES

1 3 0 0 0 0 0

REINFORCEMENT PROPERTIES

1 50 0 0 0 0

HYSTERETIC MODEL RULES

1

1 2 0 0.1 0.5

COLUMN PROPERTIES

0

RECTANGULAR COLUMNS

1

1 1 1 82.8 162 12 12

-1 12 144 2 1.6 0.625 18 0.5

1

2 1 1 170.3 162 12 12

-1 12 144 2 1.6 0.625 18 0.5

1

3 1 1 257.8 162 12 12

-1 12 144 2 1.6 0.625 18 0.5

1

4 1 1 301.5 162 12 12

-1 12 144 2 1.6 0.625 18 0.5

1

5 1 1 345.2 162 12 12

-1 12 144 2 1.6 0.625 18 0.5

1

6 1 1 165.6 162 12 12

-1 24 24 2 3.12 0.375 18 0.5

1

7 1 1 340.6 162 12 12

-1 24 24 2 3.12 0.375 18 0.5

1

8 1 1 515.5 162 12 12

-1 24 24 2 2.37 0.5 2.5 1

1

9 1 1 603.3 162 12 12

-1 24 24 2 2.37 0.5 2.5 1

1

10 1 1 690.4 162 12 12

-1 24 24 2 2.37 0.5 2.5 1

BEAM PROPERTIES

0

BEAM DATA

1 1 1 288 12 12

-1 24 12 12 0 2 3.12 3.54 0.375 12

2 1 1 288 12 12
 -1 24 12 12 0 2 1.58 3.81 0.375 12
 3 1 1 288 12 12
 -1 24 12 12 0 2 2.54 4.1 0.375 9
 4 1 1 288 12 12
 -1 24 12 12 0 2 2 4.1 0.375 9

COLUMN CONNECTIONS

1 1 1 1 7 8
 2 1 1 1 6 7
 3 2 1 1 5 6
 4 2 1 1 4 5
 5 3 1 1 3 4
 6 3 1 1 2 3
 7 4 1 1 1 2
 8 5 1 1 0 1
 9 6 1 2 7 8
 10 6 1 2 6 7
 11 7 1 2 5 6
 12 7 1 2 4 5
 13 8 1 2 3 4
 14 8 1 2 2 3
 15 9 1 2 1 2
 16 10 1 2 0 1
 17 6 1 3 7 8
 18 6 1 3 6 7
 19 7 1 3 5 6
 20 7 1 3 4 5
 21 8 1 3 3 4
 22 8 1 3 2 3
 23 9 1 3 1 2
 24 10 1 3 0 1
 25 6 1 4 7 8
 26 6 1 4 6 7
 27 7 1 4 5 6
 28 7 1 4 4 5
 29 8 1 4 3 4
 30 8 1 4 2 3
 31 9 1 1 1 2
 32 10 1 4 0 1
 33 6 1 5 7 8
 34 6 1 5 6 7
 35 7 1 5 5 6
 36 7 1 5 4 5
 37 8 1 5 3 4
 38 8 1 5 2 3

39 9 1 5 1 2
40 10 1 5 0 1
41 6 1 6 7 8
42 6 1 6 6 7
43 7 1 6 5 6
44 7 1 6 4 5
45 8 1 6 3 4
46 8 1 6 2 3
47 9 1 6 1 2
48 10 1 6 0 1
49 6 1 7 7 8
50 6 1 7 6 7
51 7 1 7 5 6
52 7 1 7 4 5
53 8 1 7 3 4
54 8 1 7 2 3
55 9 1 7 1 2
56 10 1 7 0 1
57 6 1 8 7 8
58 6 1 8 6 7
59 7 1 8 5 6
60 7 1 8 4 5
61 8 1 8 3 4
62 8 1 8 2 3
63 9 1 8 1 2
64 10 1 8 0 1
65 6 1 9 7 8
66 6 1 9 6 7
67 7 1 9 5 6
68 7 1 9 4 5
69 8 1 9 3 4
70 8 1 9 2 3
71 9 1 9 1 2
72 10 1 9 0 1
73 6 1 10 7 8
74 6 1 10 6 7
75 7 1 10 5 6
76 7 1 10 4 5
77 8 1 10 3 4
78 8 1 10 2 3
79 9 1 10 1 2
80 10 1 10 0 1
81 1 1 11 7 8
82 1 1 11 6 7
83 2 1 11 5 6

84 2 1 11 4 5
 85 3 1 11 3 4
 86 3 1 11 2 3
 87 4 1 11 1 2
 88 5 1 11 0 1

BEAM CONNECTIVITY

1 1 8 1 1 2
 2 2 8 1 2 3
 3 2 8 1 3 4
 4 2 8 1 4 5
 5 2 8 1 5 6
 6 2 8 1 6 7
 7 2 8 1 7 8
 8 2 8 1 8 9
 9 2 8 1 9 10
 10 1 8 1 10 11
 11 3 7 1 1 2
 12 4 7 1 2 3
 13 4 7 1 3 4
 14 4 7 1 4 5
 15 4 7 1 5 6
 16 4 7 1 6 7
 17 4 7 1 7 8
 18 4 7 1 8 9
 19 4 7 1 9 10
 20 3 7 1 10 11
 21 3 6 1 1 2
 22 4 6 1 2 3
 23 4 6 1 3 4
 24 4 6 1 4 5
 25 4 6 1 5 6
 26 4 6 1 6 7
 27 4 6 1 7 8
 28 4 6 1 8 9
 29 4 6 1 9 10
 30 3 6 1 10 11
 31 3 5 1 1 2
 32 4 5 1 2 3
 33 4 5 1 3 4
 34 4 5 1 4 5
 35 4 5 1 5 6
 36 4 5 1 6 7
 37 4 5 1 7 8
 38 4 5 1 8 9
 39 4 5 1 9 10

40 3 5 1 10 11
41 3 4 1 1 2
42 4 4 1 2 3
43 4 4 1 3 4
44 4 4 1 4 5
45 4 4 1 5 6
46 4 4 1 6 7
47 4 4 1 7 8
48 4 4 1 8 9
49 4 4 1 9 10
50 3 4 1 10 11
51 3 3 1 1 2
52 4 3 1 2 3
53 4 3 1 3 4
54 4 3 1 4 5
55 4 3 1 5 6
56 4 3 1 6 7
57 4 3 1 7 8
58 4 3 1 8 9
59 4 3 1 9 10
60 3 3 1 10 11
61 3 2 1 1 2
62 4 2 1 2 3
63 4 2 1 3 4
64 4 2 1 4 5
65 4 2 1 5 6
66 4 2 1 6 7
67 4 2 1 7 8
68 4 2 1 8 9
69 4 2 1 9 10
70 3 2 1 10 11
71 3 1 1 1 2
72 4 1 1 2 3
73 4 1 1 3 4
74 4 1 1 4 5
75 4 1 1 5 6
76 4 1 1 6 7
77 4 1 1 7 8
78 4 1 1 8 9
79 4 1 1 9 10
80 3 1 1 10 11

ANALYSIS OPTION (PUSHOVER)

2

LONG-TERM LOADING

0 0 0 0

MONOTONIC PUSH-OVER ANALYSIS

1
FORCE CONTROL
5
0.2 150 10.0
2
SNAPSHOT OUTPUT CONTROL
0
0,0,0,0,0
GLOBAL OUTPUT CONTROL
8 1 8 7 6 5 4 3 2 1
push18.out
push17.out
push16.out
push15.out
push14.out
push13.out
push12.out
push11.out
ELEMENT HYSTERSYS OUTPUT
0 0 0 0 0 0

CASE STUDY #8

input filename: idarc.dat
data filename: case8.dat
output filename: idarc.out
results filename: case8.out

file: idarc.dat
case8.dat
case8.out

file: case8.dat
Pushover analysis of frame #1, LINE 2,6,9 and 11, Olym. Ctr. CA.
control data
17, 4, 1, 1, 0, 0, 1
element types
32, 6, 0, 0, 0, 0, 0, 0, 0, 0
element data
543, 289, 0, 0, 0, 0, 0, 0, 0
units
1
elevations

12,78,162,228,294,360,426,492,558,624,756,912,1068,1224,1380,1536,1704

description of identical frames

1, 1, 1, 1

plan configuration

9, 11, 11, 10

nodal weights

1, 1, 0, 0, 0, 0, 0, 0, 0, 0

2, 5, 5, 5, 5, 5, 5, 5, 5, 5, 0

3, 0, 0, 0, 0, 0, 0, 0, 0, 0, 0

4, 0, 0, 0, 0, 0, 0, 0, 0, 0, 0

2, 1, 0, 0, 0, 0, 0, 0, 0, 0, 0

2, 10, 10, 10, 10, 10, 10, 10, 10, 10, 10

3, 0, 10, 10, 10, 10, 10, 10, 10, 10, 10

4, 0, 0, 0, 0, 0, 0, 0, 0, 0, 0

3, 1, 0, 0, 0, 0, 0, 0, 0, 0, 0

2, 0, 0, 0, 0, 0, 0, 0, 0, 0, 0

3, 92, 92, 92, 92, 92, 92, 92, 92, 92, 92

4, 0, 37, 37, 37, 37, 37, 37, 37, 37, 37

4, 1, 73, 73, 73, 73, 73, 73, 73, 73, 73

2, 129, 129, 129, 129, 129, 129, 129, 129, 129, 129

3, 0, 0, 0, 0, 0, 0, 0, 0, 0, 0

4, 0, 0, 0, 0, 0, 0, 0, 0, 0, 0

5, 1, 0, 0, 0, 0, 0, 0, 0, 0, 0

2, 0, 0, 0, 0, 0, 0, 0, 0, 0, 0

3, 131, 131, 131, 131, 131, 131, 131, 131, 131, 131

4, 0, 53, 53, 53, 53, 53, 53, 53, 53, 53

6, 1, 105, 105, 105, 105, 105, 105, 105, 105, 105

2, 179, 179, 179, 179, 179, 179, 179, 179, 179, 179

3, 0, 0, 0, 0, 0, 0, 0, 0, 0, 0

4, 0, 0, 0, 0, 0, 0, 0, 0, 0, 0

7, 1, 0, 0, 0, 0, 0, 0, 0, 0, 0

2, 0, 0, 0, 0, 0, 0, 0, 0, 0, 0

3, 250, 250, 250, 250, 250, 250, 250, 250, 250, 250

4, 0, 53, 53, 53, 53, 53, 53, 53, 53, 53

8, 1, 100, 100, 100, 100, 100, 100, 100, 100, 100

2, 175, 175, 175, 175, 175, 175, 175, 175, 175, 175

3, 0, 0, 0, 0, 0, 0, 0, 0, 0, 0

4, 0, 0, 0, 0, 0, 0, 0, 0, 0, 0

9, 1, 0, 0, 0, 0, 0, 0, 0, 0, 0

2, 0, 0, 0, 0, 0, 0, 0, 0, 0, 0

3, 250, 250, 250, 250, 250, 250, 250, 250, 250, 250

4, 0, 53, 53, 53, 53, 53, 53, 53, 53, 53

10, 1, 100, 100, 100, 100, 100, 100, 100, 100, 100

2, 175, 175, 175, 175, 175, 175, 175, 175, 175, 175

3, 0, 0, 0, 0, 0, 0, 0, 0, 0, 0

4, 0, 0, 0, 0, 0, 0, 0, 0, 0, 0
 11, 1, 125, 125, 125, 125, 125, 125, 125, 125, 0
 2, 219, 219, 219, 219, 219, 219, 219, 219, 219, 219
 3, 157, 157, 157, 157, 157, 157, 157, 157, 157, 157
 4, 0, 63, 63, 63, 63, 63, 63, 63, 63, 63
 12, 1, 169, 169, 169, 169, 169, 169, 0, 0, 0
 2, 0, 169, 169, 169, 169, 169, 0, 0, 0, 0
 3, 0, 169, 169, 169, 169, 169, 169, 169, 169, 0
 4, 0, 0, 0, 0, 0, 0, 0, 0, 0
 13, 1, 139, 139, 139, 139, 139, 139, 0, 0, 0
 2, 0, 139, 139, 139, 139, 139, 139, 0, 0, 0, 0
 3, 0, 0, 0, 139, 139, 139, 139, 139, 139, 139, 0
 4, 0, 0, 0, 0, 0, 0, 0, 0, 0
 14, 1, 134, 134, 134, 134, 134, 134, 0, 0, 0
 2, 0, 134, 134, 134, 134, 134, 0, 0, 0, 0
 3, 0, 0, 0, 134, 134, 134, 134, 134, 134, 134, 0
 4, 0, 0, 0, 0, 0, 0, 0, 0, 0
 15, 1, 0, 138, 138, 138, 138, 138, 0, 0, 0
 2, 0, 138, 138, 138, 138, 138, 0, 0, 0, 0
 3, 0, 0, 0, 138, 138, 138, 138, 138, 138, 138, 0
 4, 0, 0, 0, 0, 0, 0, 0, 0, 0
 16, 1, 0, 144, 144, 144, 144, 0, 0, 0, 0
 2, 0, 144, 144, 144, 144, 144, 0, 0, 0, 0
 3, 0, 0, 0, 144, 144, 144, 144, 144, 144, 144, 0
 4, 0, 0, 0, 0, 0, 0, 0, 0, 0
 17, 1, 0, 190, 190, 190, 190, 0, 0, 0, 0
 2, 0, 0, 190, 190, 190, 190, 0, 0, 0, 0
 3, 0, 0, 0, 190, 190, 190, 190, 190, 190, 190, 0
 4, 0, 0, 0, 0, 0, 0, 0, 0, 0
 envelope generation
 1
 hys prop
 1
 1, -1.0, 0.0, 0.0, 0.0
 column property option
 1
 column data
 1, 156, 0, 0, 2
 -1, 8.70E7, 1.99E6, 7.64E5, 13511, 14198, .00025, 0.0005, 5.99E6
 13511, 14198, .00025, 0.0005, 5.99E6
 2, 168, 0, 0, 2
 -1, 9.80E7, 2.19E6, 8.43E5, 14945, 15747, .00026, .00059, 5.41E6
 14945, 15747, .00026, .00059, 5.41E6
 3, 156, 0, 0, 2
 -1, 9.80E7, 2.19E6, 8.43E5, 14945, 15747, .00026, .00059, 5.41E6

14945, 15747, .00026, .00059, 5.41E6
 4, 156, 0, 0,2
 -1, 1.11E8, 2.42E6, 9.29E5, 16516, 17438, .00025, .00054, 7.15E6
 16516, 17438, .00025, .00054, 7.15E6
 5, 132, 0, 0,2
 -1, 1.11E8, 2.42E6, 9.29E5, 16516, 17438, .00025, .00054, 7.15E6
 16516, 17438, .00025, .00054, 7.15E6
 6, 156, 0, 0,2
 -1, 1.26E8, 2.65E6, 1.02E6, 18210, 19275, .00024, .00056, 7.6E6
 18210, 19275, .00024, .00056, 7.6E6
 7, 132, 0, 0,2
 -1, 1.26E8, 2.65E6, 1.02E6, 18210, 19275, .00024, .00056, 7.6E6
 18210, 19275, .00024, .00056, 7.6E6
 8, 168, 0, 0,2
 -1, 5.25E7, 2.93E6, 1.13E6, 7966, 9107, 0.00051, .0016, 2.78E6
 7966, 9107, 0.00051, .0016, 2.78E6
 9, 156, 0, 0,2
 -1, 5.25E7, 2.93E6, 1.13E6, 7966, 9107, 0.00051, .0016, 2.78E6
 7966, 9107, 0.00051, .0016, 2.78E6
 10, 66, 0, 0,2
 -1, 1.42E8, 2.93E6, 1.13E6, 20114, 21345, .00025, .00057, 8.90E6
 20114, 21345, .00025, .00057, 8.90E6
 11, 156, 0, 0,2
 -1, 1.58E8, 3.16E6, 1.22E6, 21857, 23017, .00025, .00059, 1.02E7
 21857, 23017, .00025, .00059, 1.02E7
 12, 132, 0, 0,2
 -1, 1.58E8, 3.16E6, 1.22E6, 21857, 23017, .00025, .00059, 1.02E7
 21857, 23017, .00025, .00059, 1.02E7
 13, 66, 0, 0,2
 -1, 6.29E7, 3.39E6, 1.30E6, 9418, 10789, .00051, .0016, 1.94E6
 9418, 10789, .00051, .0016, 1.94E6
 14, 84, 0, 0,2
 -1, 6.29E7, 3.39E6, 1.30E6, 9418, 10789, .00051, .0016, 1.94E6
 9418, 10789, .00051, .0016, 1.94E6
 15, 66, 0, 0,2
 -1, 1.74E8, 3.39E6, 1.30E6, 23619, 24923, .00025, .0006, 1.12E7
 23619, 24923, .00025, .0006, 1.12E7
 16, 66, 0, 0,2
 -1, 1.51E10, 7.25E7, 2.79E7, 749952, 852151, .00016, .0005, 7.79E8
 749952, 852151, .00016, .0005, 7.79E8
 17, 66, 0, 0,2
 -1, 8.70E7, 1.99E6, 7.64E5, 13511, 14198, .00025, 0.0005, 5.99E6
 13511, 14198, .00025, 0.0005, 5.99E6
 18, 66, 0, 0,2
 -1, 1.26E8, 2.65E6, 1.02E6, 18210, 19275, .00024, .00056, 7.6E6

18210, 19275, .00024, .00056, 7.6E6
 19, 84, 0, 0,2
 -1, 1.74E8, 3.39E6, 1.30E6, 23619, 24923, .00025, .0006, 1.12E7
 23619, 24923, .00025, .0006, 1.12E7
 20, 42, 30, 0,2
 -1, 1.51E+0, 7.25E7, 2.79E7, 749952,852151, .00016, .0005, 7.79E8
 749952,852151, .00016, .0005, 7.79E8
 21, 168, 0, 0,2
 -1, 8.70E7, 1.99E6, 7.64E5, 13511, 14198, .00025, 0.0005, 5.99E6
 13511, 14198, .00025, 0.0005, 5.99E6
 22, 132, 0, 0,2
 -1, 8.70E7, 1.99E6, 7.64E5, 13511, 14198, .00025, 0.0005, 5.99E6
 13511, 14198, .00025, 0.0005, 5.99E6
 23, 66, 0, 0,2
 -1, 8.70E7, 1.99E6, 7.64E5, 13511, 14198, .00025, 0.0005, 5.99E6
 13511, 14198, .00025, 0.0005, 5.99E6
 24, 168, 0, 0,2
 -1, 1.11E8, 2.42E6, 9.29E5, 16516, 17438, .00025, .00054, 7.15E6
 16516, 17438, .00025, .00054, 7.15E6
 25, 66, 0, 0,2
 -1, 1.26E8, 2.65E6, 1.02E6, 18210, 19275, .00024, .00056, 7.6E6
 18210, 19275, .00024, .00056, 7.6E6
 26, 132, 0, 0,2
 -1, 5.25E7, 2.93E6, 1.13E6, 7966, 9107, 0.00051, .0016, 2.78E6
 7966, 9107, 0.00051, .0016, 2.78E6
 27, 66, 0, 0,2
 -1, 5.25E7, 2.93E6, 1.13E6, 7966, 9107, 0.00051, .0016, 2.78E6
 7966, 9107, 0.00051, .0016, 2.78E6
 28, 66, 0, 0,2
 -1, 5.25E7, 2.93E6, 1.13E6, 7966, 9107, 0.00051, .0016, 2.78E6
 7966, 9107, 0.00051, .0016, 2.78E6
 29, 84, 0, 0,2
 -1, 1.42E8, 2.93E6, 1.13E6, 20114, 21345, .00025, .00057, 8.90E6
 20114, 21345, .00025, .00057, 8.90E6
 30, 66, 0, 0,2
 -1, 6.29E7, 3.39E6, 1.30E6, 9418, 10789, .00051, .0016, 1.94E6
 9418, 10789, .00051, .0016, 1.94E6
 31, 42, 20, 20,2
 -1, 1.51E10, 7.25E7, 2.79E7, 749952,852151, .00016, .0005, 7.79E8
 749952,852151, .00016, .0005, 7.79E8
 32, 66, 0, 0,2
 -1, 6.21E7, 1.50E6, 5.78E5, 13511, 14198, .00025, 0.0005, 5.99E6
 13511, 14198, .00025, 0.0005, 5.99E6

beam property option

1

beam data

1, 344, 7, 7,2
-1, 2.62E8, 1.28E6, 18080., 18968., 0.00011, 0.00021, 1.9E7
18080., 18968., 0.00011, 0.00021, 1.9E7
2, 344, 7, 7,2
-1, 3.05E8, 1.45E6, 21000., 21980., 0.0001, 0.0002, 2.07E7
21000., 21980., 0.0001, 0.0002, 2.07E7
3, 344, 7, 7,2
-1, 3.28E8, 1.55E6, 22600., 23646., 0.0001, 0.0002, 2.20E7
22600., 23646., 0.0001, 0.0002, 2.20E7
4, 344, 7, 7,2
-1, 3.83E8, 1.79E6, 26400., 27297., 0.0001, 0.0002, 2.7E7
26400., 27297., 0.0001, 0.0002, 2.7E7
5, 344, 7, 7,2
-1, 4.06E9, 3.76E7, 280000, 318126, 0.00022, 0.00069, 2.17E8
280000, 318126, 0.00022, 0.00069, 2.17E8
6, 344, 7, 7,2
-1, 2.62E8, 1.28E6, 18080., 18968., 0.00011, 0.00021, 1.9E7
18080., 18968., 0.00011, 0.00021, 1.9E7

column connectivities

1, 2, 1, 2, 16, 17
2, 8, 1, 3, 16, 17
3, 2, 1, 4, 16, 17
4, 2, 1, 5, 16, 17
5, 3, 1, 2, 15, 16
6, 9, 1, 3, 15, 16
7, 3, 1, 4, 15, 16
8, 3, 1, 5, 15, 16
9, 3, 1, 2, 14, 15
10, 9, 1, 3, 14, 15
11, 3, 1, 4, 14, 15
12, 3, 1, 5, 14, 15
13, 6, 1, 6, 14, 15
14, 1, 1, 1, 13, 14
15, 6, 1, 2, 13, 14
16, 11, 1, 3, 13, 14
17, 6, 1, 4, 13, 14
18, 6, 1, 5, 13, 14
19, 6, 1, 6, 13, 14
20, 1, 1, 1, 12, 13
21, 6, 1, 2, 12, 13
22, 11, 1, 3, 12, 13
23, 6, 1, 4, 12, 13
24, 6, 1, 5, 12, 13
25, 6, 1, 6, 12, 13

26.4. 1, 1, 11, 12
27.6. 1, 2, 11, 12
28.11.1, 3, 11, 12
29.6. 1, 4, 11, 12
30.6. 1, 5, 11, 12
31.6. 1, 6, 11, 12
32.5. 1, 1, 10, 11
33.7. 1, 2, 10, 11
34.12.1, 3, 10, 11
35.7. 1, 4, 10, 11
36.7. 1, 5, 10, 11
37.7. 1, 6, 10, 11
38.17.1, 7, 10, 11
39.17.1, 8, 10, 11
40.18.1, 1, 9, 10
41.10.1, 2, 9, 10
42.13.1, 3, 9, 10
43.10.1, 4, 9, 10
44.10.1, 5, 9, 10
45.10.1, 6, 9, 10
46.17.1, 7, 9, 10
47.17.1, 8, 9, 10
48.17.1, 9, 9, 10
49.18.1, 1, 8, 9
50.10.1, 2, 8, 9
51.13.1, 3, 8, 9
52.10.1, 4, 8, 9
53.10.1, 5, 8, 9
54.10.1, 6, 8, 9
55.17.1, 7, 8, 9
56.17.1, 8, 8, 9
57.17.1, 9, 8, 9
58.18.1, 1, 7, 8
59.10.1, 2, 7, 8
60.13.1, 3, 7, 8
61.10.1, 4, 7, 8
62.10.1, 5, 7, 8
63.10.1, 6, 7, 8
64.17.1, 7, 7, 8
65.17.1, 8, 7, 8
66.17.1, 9, 7, 8
67.18.1, 1, 6, 7
68.10.1, 2, 6, 7
69.13.1, 3, 6, 7
70.10.1, 4, 6, 7

71,10,1, 5, 6, 7
72,10,1, 6, 6, 7
73,17,1, 7, 6, 7
74,17,1, 8, 6, 7
75,17,1, 9, 6, 7
76,15,1, 1, 5, 6
77,15,1, 2, 5, 6
78,13,1, 3, 5, 6
79,15,1, 4, 5, 6
80,15,1, 5, 5, 6
81,15,1, 6, 5, 6
82,15,1, 7, 5, 6
83,15,1, 8, 5, 6
84,15,1, 9, 5, 6
85,15,1, 1, 4, 5
86,15,1, 2, 4, 5
87,13,1, 3, 4, 5
88,15,1, 4, 4, 5
89,15,1, 5, 4, 5
90,15,1, 6, 4, 5
91,15,1, 7, 4, 5
92,15,1, 8, 4, 5
93,15,1, 9, 4, 5
94,15,1, 1, 3, 4
95,15,1, 2, 3, 4
96,13,1, 3, 3, 4
97,15,1, 4, 3, 4
98,15,1, 5, 3, 4
99,15,1, 6, 3, 4
100,15,1,7,3,4
101,15,1,8,3,4
102,15,1,9,3,4
103,19,1,1,2,3
104,19,1,2,2,3
105,14,1,3,2,3
106,19,1,4,2,3
107,19,1,5,2,3
108,19,1,6,2,3
109,19,1,7,2,3
110,19,1,8,2,3
111,19,1,9,2,3
112,16,1,1,1,2
113,16,1,2,1,2
114,16,1,3,1,2
115,16,1,4,1,2

116.16.1.5.1.2
117.16.1.6.1.2
118.16.1.7.1.2
119.16.1.8.1.2
120.16.1.9.1.2
121.20.1.1.0.1
122.20.1.2.0.1
123.20.1.3.0.1
124.20.1.4.0.1
125.20.1.5.0.1
126.20.1.6.0.1
127.20.1.7.0.1
128.20.1.8.0.1
129.20.1.9.0.1
130. 2, 2, 3, 16, 17
131. 24, 2, 4, 16, 17
132. 2, 2, 5, 16, 17
133. 21, 2, 6, 16, 17
134. 4, 2, 2, 15, 16
135. 3, 2, 3, 15, 16
136. 4, 2, 4, 15, 16
137. 3, 2, 5, 15, 16
138. 1, 2, 6, 15, 16
139. 4, 2, 2, 14, 15
140. 3, 2, 3, 14, 15
141. 4, 2, 4, 14, 15
142. 3, 2, 5, 14, 15
143. 1, 2, 6, 14, 15
144. 9, 2, 2, 13, 14
145. 6, 2, 3, 13, 14
146. 9, 2, 4, 13, 14
147. 6, 2, 5, 13, 14
148. 6, 2, 6, 13, 14
149. 9, 2, 2, 12, 13
150. 6, 2, 3, 12, 13
151. 9, 2, 4, 12, 13
152. 6, 2, 5, 12, 13
153. 6, 2, 6, 12, 13
154. 9, 2, 2, 11, 12
155. 6, 2, 3, 11, 12
156. 9, 2, 4, 11, 12
157. 6, 2, 5, 11, 12
158. 6, 2, 6, 11, 12
159. 22, 2, 1, 10, 11
160. 26, 2, 2, 10, 11

161,7,2, 3, 10, 11
162,26,2, 4, 10, 11
163,7,2, 5, 10, 11
164,7,2, 6, 10, 11
165,26,2, 7, 10, 11
166,7,2, 8, 10, 11
167,7,2, 9, 10, 11
168,26,2,10, 10, 11
169,22, 2,11, 10, 11
170,23,2, 1, 9, 10
171,28,2, 2, 9, 10
172,10,2, 3, 9, 10
173,28,2, 4, 9, 10
174,10,2, 5, 9, 10
175,10,2, 6, 9, 10
176,27,2, 7, 9, 10
177,25,2, 8, 9, 10
178,25,2, 9, 9, 10
179,28,2, 10, 9, 10
180,25,2, 11, 9, 10
181,23,2, 1, 8, 9
182,28,2, 2, 8, 9
183,10,2, 3, 8, 9
184,28,2, 4, 8, 9
185,10,2, 5, 8, 9
186,10,2, 6, 8, 9
187,27,2, 7, 8, 9
188,25,2, 8, 8, 9
189,25,2, 9, 8, 9
190,28,2, 10, 8, 9
191,25,2, 11, 8, 9
192,23,2, 1, 7, 8
193,28,2, 2, 7, 8
194,10,2, 3, 7, 8
195,28,2, 4, 7, 8
196,10,2, 5, 7, 8
197,10,2, 6, 7, 8
198,27,2, 7, 7, 8
199,25,2, 8, 7, 8
200,25,2, 9, 7, 8
201,28,2, 10, 7, 8
202,25,2, 11, 7, 8
203,23,2, 1, 6, 7
204,28,2, 2, 6, 7
205,10,2, 3, 6, 7

206.28.2, 4, 6, 7
207.10.2, 5, 6, 7
208.10.2, 6, 6, 7
209.27.2, 7, 6, 7
210.25.2, 8, 6, 7
211.25.2, 9, 6, 7
212.28.2, 10, 6, 7
213.25.2, 11, 6, 7
214.25.2, 1, 5, 6
215.30.2, 2, 5, 6
216.15.2, 3, 5, 6
217.30.2, 4, 5, 6
218.15.2, 5, 5, 6
219.15.2, 6, 5, 6
220.28.2, 7, 5, 6
221.10.2, 8, 5, 6
222.10.2, 9, 5, 6
223.30.2, 10, 5, 6
224.10.2, 11, 5, 6
225.25.2, 1, 4, 5
226.30.2, 2, 4, 5
227.15.2, 3, 4, 5
228.30.2, 4, 4, 5
229.15.2,5,4,5
230.15.2,6,4,5
231.28.2,7,4,5
232.10.2,8,4,5
233.10.2,9,4,5
234.30.2,10,4,5
235.10.2,11,4,5
236.25.2,1,3,4
237.30.2,2,3,4
238.15.2,3,3,4
239.30.2,4,3,4
240.15.2,5,3,4
241.15.2,6,3,4
242.28.2,7,3,4
243.10.2,8,3,4
244.10.2,9,3,4
245.30.2,10,3,4
246.10.2,11,3,4
247.25.2,1,2,3
248.14.2,2,2,3
249.19.2,3,2,3
250.14.2,4,2,3

251,19,2,5,2,3
252,19,2,6,2,3
253,29,2,7,2,3
254,29,2,8,2,3
255,29,2,9,2,3
256,14,2,10,2,3
257,29,2,11,2,3
258,16,2,1,1,2
259,16,2,2,1,2
260,16,2,3,1,2
261,16,2,4,1,2
262,16,2,5,1,2
263,16,2,6,1,2
264,16,2,7,1,2
265,16,2,8,1,2
266,16,2,9,1,2
267,16,2,10,1,2
268,16,2,11,1,2
269,20,2,1,0,1
270,20,2,2,0,1
271,20,2,3,0,1
272,20,2,4,0,1
273,20,2,5,0,1
274,20,2,6,0,1
275,20,2,7,0,1
276,20,2,8,0,1
277,20,2,9,0,1
278,20,2,10,0,1
279,20,2,11,0,1
280,24,3,4,16,17
281,2,3,5,16,17
282,2,3,6,16,17
283,24,3,7,16,17
284,2,3,8,16,17
285,2,3,9,16,17
286,24,3,10,16,17
287,4,3,4,15,16
288,3,3,5,15,16
289,3,3,6,15,16
290,4,3,7,15,16
291,3,3,8,15,16
292,3,3,9,15,16
293,4,3,10,15,16
294,4,3,4,14,15
295,3,3,5,14,15

296,3,3,6,14,15
297,9,3,7,14,15
298,3,3,8,14,15
299,3,3,9,14,15
300,4,3,10,14,15
301,9,3,4,13,14
302,6,3,5,13,14
303,6,3,6,13,14
304,9,3,7,13,14
305,6,3,8,13,14
306,6,3,9,13,14
307,6,3,10,13,14
308,9,3,4,12,13
309,6,3,5,12,13
310,6,3,6,12,13
311,9,3,7,12,13
312,6,3,8,12,13
313,6,3,9,12,13
314,6,3,10,12,13
315,1,3,2,11,12
316,1,3,3,11,12
317,9,3,4,11,12
318,6,3,5,11,12
319,6,3,6,11,12
320,9,3,7,11,12
321,6,3,8,11,12
322,6,3,9,11,12
323,6,3,10,11,12
324,22,3,1,10,11
325,22,3,2,10,11
326,22,3,3,10,11
327,26,3,4,10,11
328,7,3,5,10,11
329,7,3,6,10,11
330,26,3,7,10,11
331,7,3,8,10,11
332,7,3,9,10,11
333,7,3,10,10,11
334,22,3,11,10,11
335,23,3,1,9,10
336,23,3,2,9,10
337,23,3,3,9,10
338,25,3,4,9,10
339,25,3,5,9,10
340,25,3,6,9,10

341,27,3,7,9,10
342,25,3,8,9,10
343,25,3,9,9,10
344,25,3,10,9,10
345,8,3,11,9,10
346,8,3,1,8,9
347,25,3,2,8,9
348,10,3,3,8,9
349,28,3,4,8,9
350,10,3,5,8,9
351,10,3,6,8,9
352,28,3,7,8,9
353,10,3,8,8,9
354,10,3,9,8,9
355,28,3,10,8,9
356,23,3,11,8,9
357,23,3,1,7,8
358,25,3,2,7,8
359,10,3,3,7,8
360,28,3,4,7,8
361,10,3,5,7,8
362,10,3,6,7,8
363,28,3,7,7,8
364,10,3,8,7,8
365,10,3,9,7,8
366,28,3,10,7,8
367,23,3,11,7,8
368,23,3,1,6,7
369,25,3,2,6,7
370,10,3,3,6,7
371,28,3,4,6,7
372,10,3,5,6,7
373,10,3,6,6,7
374,28,3,7,6,7
375,10,3,8,6,7
376,10,3,9,6,7
377,28,3,10,6,7
378,23,3,11,6,7
379,23,3,1,5,6
380,25,3,2,5,6
381,10,3,3,5,6
382,28,3,4,5,6
383,10,3,5,5,6
384,10,3,6,5,6
385,28,3,7,5,6

386.10,3,8,5,6
387.10,3,9,5,6
388.28,3,10,5,6
389.23,3,11,5,6
390.25,3,1,4,5
391.25,3,2,4,5
392.25,3,3,4,5
393.30,3,4,4,5
394.15,3,5,4,5
395.15,3,6,4,5
396.30,3,7,4,5
397.15,3,8,4,5
398.15,3,9,4,5
399.30,3,10,4,5
400.27,3,11,4,5
401.25,3,1,3,4
402.25,3,2,3,4
403.15,3,3,3,4
404.30,3,4,3,4
405.15,3,5,3,4
406.15,3,6,3,4
407.30,3,7,3,4
408.15,3,8,3,4
409.15,3,9,3,4
410.30,3,10,3,4
411.27,3,11,3,4
412.25,3,1,2,3
413.27,3,2,2,3
414.19,3,3,2,3
415.14,3,4,2,3
416.19,3,5,2,3
417.19,3,6,2,3
418.14,3,7,2,3
419.19,3,8,2,3
420.19,3,9,2,3
421.14,3,10,2,3
422.27,3,11,2,3
423.25,3,1,1,2
424.27,3,2,1,2
425.15,3,3,1,2
426.30,3,4,1,2
427.15,3,5,1,2
428.15,3,6,1,2
429.30,3,7,1,2
430.19,3,8,1,2

431,15,3,9,1,2
432,30,3,10,1,2
433,27,3,11,1,2
434,31,3,1,0,1
435,31,3,2,0,1
436,31,3,3,0,1
437,31,3,4,0,1
438,31,3,5,0,1
439,31,3,6,0,1
440,31,3,7,0,1
441,31,3,8,0,1
442,31,3,9,0,1
443,31,3,10,0,1
444,31,3,11,0,1
445,5,4,2,10,11
446,5,4,3,10,11
447,5,4,4,10,11
448,5,4,5,10,11
449,5,4,6,10,11
450,5,4,7,10,11
451,5,4,8,10,11
452,5,4,9,10,11
453,5,4,10,10,11
454,32,4,2,9,10
455,32,4,3,9,10
456,32,4,4,9,10
457,32,4,5,9,10
458,32,4,6,9,10
459,32,4,7,9,10
460,32,4,8,9,10
461,32,4,9,9,10
462,32,4,10,9,10
463,32,4,2,8,9
464,32,4,3,8,9
465,32,4,4,8,9
466,32,4,5,8,9
467,32,4,6,8,9
468,32,4,7,8,9
469,32,4,8,8,9
470,32,4,9,8,9
471,32,4,10,8,9
472,32,4,2,7,8
473,32,4,3,7,8
474,32,4,4,7,8
475,32,4,5,7,8

476,32,4,6,7,8
477,32,4,7,7,8
478,32,4,8,7,8
479,32,4,9,7,8
480,32,4,10,7,8
481,32,4,2,6,7
482,32,4,3,6,7
483,32,4,4,6,7
484,32,4,5,6,7
485,32,4,6,6,7
486,32,4,7,6,7
487,32,4,8,6,7
488,32,4,9,6,7
489,32,4,10,6,7
490,32,4,2,5,6
491,32,4,3,5,6
492,32,4,4,5,6
493,32,4,5,5,6
494,32,4,6,5,6
495,32,4,7,5,6
496,32,4,8,5,6
497,32,4,9,5,6
498,32,4,10,5,6
499,17,4,2,4,5
500,17,4,3,4,5
501,17,4,4,4,5
502,17,4,5,4,5
503,17,4,6,4,5
504,17,4,7,4,5
505,17,4,8,4,5
506,17,4,9,4,5
507,17,4,10,4,5
508,17,4,2,3,4
509,17,4,3,3,4
510,17,4,4,3,4
511,17,4,5,3,4
512,17,4,6,3,4
513,17,4,7,3,4
514,17,4,8,3,4
515,17,4,9,3,4
516,17,4,10,3,4
517,17,4,2,2,3
518,17,4,3,2,3
519,17,4,4,2,3
520,17,4,5,2,3

521,17,4,6,2,3
522,17,4,7,2,3
523,17,4,8,2,3
524,17,4,9,2,3
525,17,4,10,2,3
526,17,4,2,1,2
527,17,4,3,1,2
528,17,4,4,1,2
529,17,4,5,1,2
530,17,4,6,1,2
531,17,4,7,1,2
532,17,4,8,1,2
533,17,4,9,1,2
534,17,4,10,1,2
535,31,4,2,0,1
536,31,4,3,0,1
537,31,4,4,0,1
538,31,4,5,0,1
539,31,4,6,0,1
540,31,4,7,0,1
541,31,4,8,0,1
542,31,4,9,0,1
543,31,4,10,0,1
beam connectivities
1, 1, 17, 1, 2, 3
2, 1, 17, 1, 3, 4
3, 1, 17, 1, 4, 5
4, 1, 16, 1, 2, 3
5, 1, 16, 1, 3, 4
6, 1, 16, 1, 4, 5
7, 3, 15, 1, 2, 3
8, 3, 15, 1, 3, 4
9, 3, 15, 1, 4, 5
10,3, 15, 1, 5, 6
11,3, 14, 1, 1, 2
12,3, 14, 1, 2, 3
13,3, 14, 1, 3, 4
14,3, 14, 1, 4, 5
15,3, 14, 1, 5, 6
16,4, 13, 1, 1, 2
17,4, 13, 1, 2, 3
18,4, 13, 1, 3, 4
19,4, 13, 1, 4, 5
20,4, 13, 1, 5, 6
21,4, 12, 1, 1, 2

22.4, 12, 1, 2, 3
23.4, 12, 1, 3, 4
24.4, 12, 1, 4, 5
25.4, 12, 1, 5, 6
26.2, 11, 1, 1, 2
27.2, 11, 1, 2, 3
28.2, 11, 1, 3, 4
29.2, 11, 1, 4, 5
30.2, 11, 1, 5, 6
31.2, 11, 1, 6, 7
32.2, 11, 1, 7, 8
33.2, 10, 1, 1, 2
34.2, 10, 1, 2, 3
35.2, 10, 1, 3, 4
36.2, 10, 1, 4, 5
37.2, 10, 1, 5, 6
38.2, 10, 1, 6, 7
39.2, 10, 1, 7, 8
40.2, 10, 1, 8, 9
41.3, 8, 1, 1, 2
42.3, 8, 1, 2, 3
43.3, 8, 1, 3, 4
44.3, 8, 1, 4, 5
45.3, 8, 1, 5, 6
46.3, 8, 1, 6, 7
47.3, 8, 1, 7, 8
48.3, 8, 1, 8, 9
49.3, 6, 1, 1, 2
50.3, 6, 1, 5, 6
51.3, 6, 1, 6, 7
52.3, 6, 1, 7, 8
53.3, 6, 1, 8, 9
54.5, 2, 1, 1, 2
55.5, 2, 1, 2, 3
56.5, 2, 1, 3, 4
57.5, 2, 1, 4, 5
58.5, 2, 1, 5, 6
59.5, 2, 1, 6, 7
60.5, 2, 1, 7, 8
61.5, 2, 1, 8, 9
62, 1, 17, 2, 3, 4
63, 1, 17, 2, 4, 5
64, 1, 17, 2, 5, 6
65, 1, 16, 2, 2, 3
66, 1, 16, 2, 3, 4

67, 1, 16, 2, 4, 5
68, 1, 16, 2, 5, 6
69, 2, 15, 2, 2, 3
70, 2, 15, 2, 3, 4
71, 2, 15, 2, 4, 5
72, 2, 15, 2, 5, 6
73, 2, 14, 2, 2, 3
74, 2, 14, 2, 3, 4
75, 2, 14, 2, 4, 5
76, 2, 14, 2, 5, 6
77, 3, 13, 2, 2, 3
78, 3, 13, 2, 3, 4
79, 3, 13, 2, 4, 5
80, 3, 13, 2, 5, 6
81, 3, 12, 2, 2, 3
82, 3, 12, 2, 3, 4
83, 3, 12, 2, 4, 5
84, 3, 12, 2, 5, 6
85, 2, 11, 2, 1, 2
86, 2, 11, 2, 2, 3
87, 2, 11, 2, 3, 4
88, 2, 11, 2, 4, 5
89, 2, 11, 2, 5, 6
90, 2, 11, 2, 6, 7
91, 2, 11, 2, 7, 8
92, 2, 11, 2, 8, 9
93, 2, 11, 2, 9, 10
94, 2, 11, 2, 10, 11
95, 2, 10, 2, 1, 2
96, 2, 10, 2, 2, 3
97, 2, 10, 2, 3, 4
98, 2, 10, 2, 4, 5
99, 2, 10, 2, 5, 6
100, 2, 10, 2, 6, 7
101, 2, 10, 2, 7, 8
102, 2, 10, 2, 8, 9
103, 2, 10, 2, 9, 10
104, 2, 10, 2, 10, 11
105, 2, 8, 2, 1, 2
106, 2, 8, 2, 2, 3
107, 2, 8, 2, 3, 4
108, 2, 8, 2, 4, 5
109, 2, 8, 2, 5, 6
110, 2, 8, 2, 6, 7
111, 2, 8, 2, 7, 8

112,2, 8, 2, 8, 9
113,2, 8, 2, 9, 10
114,2, 8, 2, 10, 11
115,2, 6, 2, 1, 2
116,2, 6, 2, 2, 3
117,2, 6, 2, 3, 4
118,2, 6, 2, 4, 5
119,2, 6, 2, 5, 6
120,2, 6, 2, 6, 7
121,2, 6, 2, 7, 8
122,2, 6, 2, 8, 9
123,2, 6, 2, 9, 10
124,2, 6, 2, 10, 11
125,2, 4, 2, 2, 3
126,6, 4, 2, 3, 4
127,6, 4, 2, 4, 5
128,6, 4, 2, 5, 6
129,6, 4, 2, 6, 7
130,6, 4, 2, 7, 8
131,6, 4, 2, 8, 9
132,6, 4, 2, 9, 10
133,2, 4, 2, 10, 11
134,5, 2, 2, 1, 2
135,5, 2, 2, 2, 3
136,5, 2, 2, 3, 4
137,5, 2, 2, 4, 5
138,5, 2, 2, 5, 6
139,5, 2, 2, 6, 7
140,5, 2, 2, 7, 8
141,5, 2, 2, 8, 9
142,5, 2, 2, 9, 10
143,5, 2, 2, 10, 11
144,1,17,3,4,5
145,1,17,3,5,6
146,1,17,3,6,7
147,1,17,3,7,8
148,1,17,3,8,9
149,1,17,3,9,10
150,1,16,3,4,5
151,1,16,3,5,6
152,1,16,3,6,7
153,1,16,3,7,8
154,1,16,3,8,9
155,1,16,3,9,10
156,2,15,3,4,5

157.2,15.3,5,6
158.2,15.3,6,7
159.2,15.3,7,8
160.2,15.3,8,9
161.2,15.3,9,10
162.2,14.3,4,5
163.2,14.3,5,6
164.2,14.3,6,7
165.2,14.3,7,8
166.2,14.3,8,9
168.2,14.3,9,10
169.2,13.3,4,5
170.2,13.3,5,6
171.2,13.3,6,7
172.2,13.3,7,8
173.2,13.3,8,9
174.2,13.3,9,10
175.2,12.3,2,3
176.2,12.3,3,4
177.2,12.3,4,5
178.2,12.3,5,6
179.2,12.3,6,7
180.2,12.3,7,8
181.2,12.3,8,9
182.2,12.3,9,10
183.2,11.3,1,2
184.2,11.3,2,3
185.2,11.3,3,4
186.2,11.3,4,5
187.2,11.3,5,6
188.2,11.3,6,7
189.2,11.3,7,8
190.2,11.3,8,9
191.2,11.3,9,10
192.2,11.3,10,11
193.2,9.3,1,2
194.2,9.3,2,3
195.2,9.3,3,4
196.2,9.3,4,5
197.2,9.3,5,6
198.2,9.3,6,7
199.2,9.3,7,8
200.2,9.3,8,9
201.2,9.3,9,10
202.2,9.3,10,11

203,2,7,3,1,2
204,2,7,3,2,3
205,2,7,3,3,4
206,2,7,3,4,5
207,2,7,3,5,6
208,2,7,3,6,7
209,2,7,3,7,8
210,2,7,3,8,9
211,2,7,3,9,10
212,2,7,3,10,11
213,2,5,3,1,2
214,2,5,3,2,3
215,2,5,3,3,4
216,2,5,3,4,5
217,2,5,3,5,6
218,2,5,3,6,7
219,2,5,3,7,8
220,2,5,3,8,9
221,2,5,3,9,10
222,2,5,3,10,11
223,2,4,3,1,2
224,2,4,3,2,3
225,2,4,3,3,4
226,2,4,3,4,5
227,2,4,3,5,6
228,2,4,3,6,7
229,2,4,3,7,8
230,2,4,3,8,9
231,2,4,3,9,10
232,2,4,3,10,11
233,5,3,3,1,2
234,5,3,3,2,3
235,5,3,3,3,4
236,5,3,3,4,5
237,5,3,3,5,6
238,5,3,3,6,7
239,5,3,3,7,8
240,5,3,3,8,9
241,5,3,3,9,10
242,5,3,3,10,11
243,6,11,4,2,3
244,6,11,4,3,4
245,6,11,4,4,5
246,6,11,4,5,6
247,6,11,4,6,7

248,6,11,4,7,8
249,6,11,4,8,9
250,6,11,4,9,10
251,6,9,4,2,3
252,6,9,4,3,4
253,6,9,4,4,5
254,6,9,4,5,6
255,6,9,4,6,7
256,6,9,4,7,8
257,6,9,4,8,9
258,6,9,4,9,10
259,6,7,4,2,3
260,6,7,4,3,4
261,6,7,4,4,5
262,6,7,4,5,6
263,6,7,4,6,7
264,6,7,4,7,8
265,6,7,4,8,9
266,6,7,4,9,10
267,6,5,4,2,3
268,6,5,4,3,4
269,6,5,4,4,5
270,6,5,4,5,6
271,6,5,4,6,7
272,6,5,4,7,8
273,6,5,4,8,9
274,6,5,4,9,10
275,6,3,4,2,3
276,6,3,4,3,4
277,6,3,4,4,5
278,6,3,4,5,6
279,6,3,4,6,7
280,6,3,4,7,8
281,6,3,4,8,9
282,6,3,4,9,10
283,5,1,4,2,3
284,5,1,4,3,4
285,5,1,4,4,5
286,5,1,4,5,6
287,5,1,4,6,7
288,5,1,4,7,8
289,5,1,4,8,9
290,5,1,4,9,10
Type of analysis
2

static loads
0,0,0,0
Monotonic Pushover Analysis (1=force control; 2=displacement control)
1
FORCE CONTROLLED ANALYSIS
1
0,2,50,1
Snapshot Control Data
0
0,0,0,0,0
OUTPUT CONTROL
3,1,2,3,5,7,9,11,12,13,15,17
story2
story3
story5
ELEMENT HYSTERESIS OUTPUT
0,0,0,0,0

CASE STUDY #9.1

input filename: idarc.dat
data filename: case9_1.dat
output filename: idarc.out
results filename: case9_1.out

file: idarc.dat
case9_1.dat
case9_1.out

file: case9_1.dat
CASE STUDY 9.1: 3 STORY R/C FRAME WITH VISCOUS DAMPERS
Control Data
3,1,0,0,0,0,0
Element types
6,9,0,0,0,0,1,0,0,0
Element data
12,9,0,0,0,0,0,3,0
Unit system
1
Floor elevations
45.0, 93.0, 141.0
Number of duplicate frames
2
No of column lines

4

Nodal weights

1, 1, 3.375, 3.375, 3.375, 3.375

2, 1, 3.375, 3.375, 3.375, 3.375

3, 1, 3.375, 3.375, 3.375, 3.375

Env generation option

1

Hysteretic Control

3

1, 2, 0.1, 0.0, 1.0

2, 2, 0.1, 0.0, 1.0

3, 2, 0.1, 0.0, 0.1

Column input option

1

Column data

1, 48.0, 0.3, 0.1

1, 72264.6, 1140.0, 21888, 7.0, 16.0, 0.0008, 0.003, 400.0

7.0, 16.0, 0.0008, 0.003, 400.0

1, 72264.6, 1140.0, 21888, 7.0, 16.0, 0.0008, 0.003, 400.0

7.0, 16.0, 0.0008, 0.003, 400.0

2, 48.0, 0.3, 0.1

1, 369360.0, 2322.0, 49248, 24.0, 72.0, 0.0006, 0.001, 600.0

24.0, 72.0, 0.0006, 0.001, 600.0

1, 369360.0, 2322.0, 49248, 24.0, 72.0, 0.0006, 0.001, 600.0

24.0, 72.0, 0.0006, 0.001, 600.0

3, 48.0, 0.3, 0.1

1, 47559, 887, 17024, 11.0, 21.0, 0.0008, 0.003, 400.0

11.0, 21.0, 0.0008, 0.003, 400.0

1, 47559, 887, 17024, 11.0, 21.0, 0.0008, 0.003, 400.0

11.0, 21.0, 0.0008, 0.003, 400.0

4, 48.0, 0.3, 0.1

1, 250800.0, 1995.0, 38304, 32.0, 84.0, 0.001, 0.003, 600.0

32.0, 84.0, 0.001, 0.003, 600.0

1, 250800.0, 1995.0, 38304, 32.0, 84.0, 0.001, 0.003, 600.0

32.0, 84.0, 0.001, 0.003, 600.0

5, 45.0, 0.0, 3.0, 1

3, 14453.2, 380.0, 7296, 8, 10.0, 0.0025, 0.006, 40.0

8, 10.0, 0.0025, 0.006, 40.0

3, 14453.2, 380.0, 7296, 1, 2.0, 0.0025, 0.006, 40.0

1, 2.0, 0.0025, 0.006, 40.0

6, 45.0, 0.0, 3.0, 1

1, 62496.0, 885.0, 16416, 115, 120, 0.003, 0.008, 600.0

115, 120, 0.003, 0.008, 600.0

1, 82496.0, 885.0, 16416, 115, 120, 0.003, 0.008, 600.0

115, 120, 0.003, 0.008, 600.0

Beam input type

1

Beam data

1, 72.0, 2.0, 7.0, 1

2, 181980.0, 24264.0, 7.38, 37.0, 0.0004, 0.003, 2400.0
7.38, 37.0, 0.0004, 0.003, 2400.0

2, 181980.0, 24264.0, 7.38, 37.0, 0.0004, 0.003, 2400.0
7.38, 37.0, 0.0004, 0.003, 2400.0

2, 72.0, 7.0, 7.0, 1

2, 181980.0, 24264.0, 7.38, 37.0, 0.0004, 0.003, 2400.0
7.38, 37.0, 0.0004, 0.003, 2400.0

2, 181980.0, 24264.0, 7.38, 37.0, 0.0004, 0.003, 2400.0
7.38, 37.0, 0.0004, 0.003, 2400.0

3, 72.0, 7.0, 2.0, 1

2, 181980.0, 24264.0, 7.38, 37.0, 0.0004, 0.003, 2400.0
7.38, 37.0, 0.0004, 0.003, 2400.0

2, 181980.0, 24264.0, 7.38, 37.0, 0.0004, 0.003, 2400.0
7.38, 37.0, 0.0004, 0.003, 2400.0

4, 72.0, 2.0, 7.0, 1

2, 123186.0, 19411.2, 7.38, 37.0, 0.0004, 0.003, 2400.0
7.38, 37.0, 0.0004, 0.003, 2400.0

2, 123186.0, 19411.2, 7.38, 37.0, 0.0004, 0.003, 2400.0
7.38, 37.0, 0.0004, 0.003, 2400.0

5, 72.0, 7.0, 7.0, 1

2, 123186.0, 19411.2, 7.38, 37.0, 0.0004, 0.003, 2400.0
7.38, 37.0, 0.0004, 0.003, 2400.0

2, 123186.0, 19411.2, 7.38, 37.0, 0.0004, 0.003, 2400.0
7.38, 37.0, 0.0004, 0.003, 2400.0

6, 72.0, 7.0, 2.0, 1

2, 123186.0, 19411.2, 7.38, 37.0, 0.0004, 0.003, 2400.0
7.38, 37.0, 0.0004, 0.003, 2400.0

2, 123186.0, 19411.2, 7.38, 37.0, 0.0004, 0.003, 2400.0
7.38, 37.0, 0.0004, 0.003, 2400.0

7, 72.0, 2.0, 7.0, 1

2, 43675.0, 9705.6, 7.38, 37.0, 0.001, 0.003, 2400.0
7.38, 37.0, 0.001, 0.003, 2400.0

2, 43675.0, 9705.6, 7.38, 37.0, 0.001, 0.003, 2400.0
7.38, 37.0, 0.001, 0.003, 2400.0

8, 72.0, 7.0, 7.0, 1

2, 43675.0, 9705.6, 7.38, 37.0, 0.001, 0.003, 2400.0
7.38, 37.0, 0.001, 0.003, 2400.0

2, 43675.0, 9705.6, 7.38, 37.0, 0.001, 0.003, 2400.0
7.38, 37.0, 0.001, 0.003, 2400.0

9, 72.0, 7.0, 2.0, 1

2, 43675.0, 9705.6, 7.38, 37.0, 0.001, 0.003, 2400.0

7.38, 37.0, 0.001, 0.003, 2400.0
2, 43675.0, 9705.6, 7.38, 37.0, 0.001, 0.003, 2400.0
7.38, 37.0, 0.001, 0.003, 2400.0

VE BRACE PROPERTIES

0, 0

1, 0.05, 80

Column connectivity

1,1,1,1,2,3

2,2,1,2,2,3

3,2,1,3,2,3

4,1,1,4,2,3

5,3,1,1,1,2

6,4,1,2,1,2

7,4,1,3,1,2

8,3,1,4,1,2

9,5,1,1,0,1

10,6,1,2,0,1

11,6,1,3,0,1

12,5,1,4,0,1

Beam connectivity

1,1,3,1,1,2

2,2,3,1,2,3

3,3,3,1,3,4

4,4,2,1,1,2

5,5,2,1,2,3

6,6,2,1,3,4

7,7,1,1,1,2

8,8,1,1,2,3

9,9,1,1,3,4

VE connectivity

1,1,1,1,1,0,3,2,76

2,1,1,1,2,1,2,3,76

3,1,1,1,3,2,3,2,76

Type of Analysis

3

Static loads

0,0,0,0

Dynamic Analysis Control Data

0.30, 0.0, 0.0005, 32.0, 6, 0

Wave data

0, 6400, 0.005

EI-Centro - EARTHQUAKE

flea30.a

Output options

0

0 0 0 0 0
STORY OUTPUT CONTROL
3, 0.005, 1, 2, 3
floor1d
floor2d
floor3d
Hys output
0, 0, 0, 0, 0, 0

*NOTES : The earthquake ground acceleration record is read separately from a file
named 'flea30.a' as specified in the input data*

CASE STUDY #9.2

*input filename: idarc.dat
data filename: case9_2.dat
output filename: idarc.out
results filename: case9_2.out*

file: idarc.dat
case9_2.dat
case9_2.out

file: case9_2.dat
70% reduction 1st fl. 35% 2nd & 10% 3rd. consider col. compre
Control Data
3, 1, 0, 0, 0, 0, 1
Element types
6, 9, 0, 0, 0, 0, 0, 1, 0, 0
Element data
12, 9, 0, 0, 0, 0, 0, 3, 0
Unit system
1
Floor elevations
45.0, 93.0, 141.0
Number of duplicate frames
2
No of column lines
4
Nodal weights
1, 1, 3.375, 3.375, 3.375, 3.375
2, 1, 3.375, 3.375, 3.375, 3.375
3, 1, 3.375, 3.375, 3.375, 3.375
Env generation option

1
 Hysteretic Control
 3
 1, 2, 0.1, 0.0, 1.0
 2, 2, 0.1, 0.0, 1.0
 3, 2, 0.1, 0.0, 0.1
 Column input option
 1
 Column data
 1, 48.0,0,3.0,1
 1, 72264.6, 1140.0, 21888, 7.0, 16.0, 0.0008, 0.003, 400.0
 7.0, 16.0, 0.0008, 0.003, 400.0
 1, 72264.6, 1140.0, 21888, 7.0, 16.0, 0.0008, 0.003, 400.0
 7.0, 16.0, 0.0008, 0.003, 400.0
 2, 48.0,0,3.0,1
 1, 369360.0, 2322.0, 49248, 24.0, 72.0, 0.0006, 0.001, 600.0
 24.0, 72.0, 0.0006, 0.001, 600.0
 1, 369360.0, 2322.0, 49248, 24.0, 72.0, 0.0006, 0.001, 600.0
 24.0, 72.0, 0.0006, 0.001, 600.0
 3, 48.0,0,3.0,1
 1, 47559, 887, 17024, 11.0, 21.0, 0.0008, 0.003, 400.0
 11.0, 21.0, 0.0008, 0.003, 400.0
 1, 47559, 887, 17024, 11.0, 21.0, 0.0008, 0.003, 400.0
 11.0, 21.0, 0.0008, 0.003, 400.0
 4, 48.0,0,3.0,1
 1, 250800.0, 1995.0, 38304, 32.0, 84.0, 0.001, 0.003, 600.0
 32.0, 84.0, 0.001, 0.003, 600.0
 1, 250800.0, 1995.0, 38304, 32.0, 84.0, 0.001, 0.003, 600.0
 32.0, 84.0, 0.001, 0.003, 600.0
 5, 45.0,0.0,3.0,1
 3, 14453.2, 380.0, 7296, 8, 10.0, 0.0025, 0.006, 40.0
 8, 10.0, 0.0025, 0.006, 40.0
 3, 14453.2, 380.0, 7296, 1, 2.0, 0.0025, 0.006, 40.0
 1, 2.0, 0.0025, 0.006, 40.0
 6, 45.0,0.0,3.0,1
 1, 62496.0, 885.0, 16416, 115, 120, 0.003, 0.008, 600.0
 115, 120, 0.003, 0.008, 600.0
 1, 82496.0, 885.0, 16416, 115, 120, 0.003, 0.008, 600.0
 115, 120, 0.003, 0.008, 600.0
 Beam input type
 1
 Beam data
 1, 72.0, 2.0, 7.0, 1
 2, 181980.0, 24264.0, 7.38, 37.0, 0.0004, 0.003, 2400.0
 7.38, 37.0, 0.0004, 0.003, 2400.0

2, 181980.0, 24264.0, 7.38, 37.0, 0.0004, 0.003, 2400.0
 7.38, 37.0, 0.0004, 0.003, 2400.0
 2, 72.0, 7.0, 7.0, 1
 2, 181980.0, 24264.0, 7.38, 37.0, 0.0004, 0.003, 2400.0
 7.38, 37.0, 0.0004, 0.003, 2400.0
 2, 181980.0, 24264.0, 7.38, 37.0, 0.0004, 0.003, 2400.0
 7.38, 37.0, 0.0004, 0.003, 2400.0
 3, 72.0, 7.0, 2.0, 1
 2, 181980.0, 24264.0, 7.38, 37.0, 0.0004, 0.003, 2400.0
 7.38, 37.0, 0.0004, 0.003, 2400.0
 2, 181980.0, 24264.0, 7.38, 37.0, 0.0004, 0.003, 2400.0
 7.38, 37.0, 0.0004, 0.003, 2400.0
 4, 72.0, 2.0, 7.0, 1
 2, 123186.0, 19411.2, 7.38, 37.0, 0.0004, 0.003, 2400.0
 7.38, 37.0, 0.0004, 0.003, 2400.0
 2, 123186.0, 19411.2, 7.38, 37.0, 0.0004, 0.003, 2400.0
 7.38, 37.0, 0.0004, 0.003, 2400.0
 5, 72.0, 7.0, 7.0, 1
 2, 123186.0, 19411.2, 7.38, 37.0, 0.0004, 0.003, 2400.0
 7.38, 37.0, 0.0004, 0.003, 2400.0
 2, 123186.0, 19411.2, 7.38, 37.0, 0.0004, 0.003, 2400.0
 7.38, 37.0, 0.0004, 0.003, 2400.0
 6, 72.0, 7.0, 2.0, 1
 2, 123186.0, 19411.2, 7.38, 37.0, 0.0004, 0.003, 2400.0
 7.38, 37.0, 0.0004, 0.003, 2400.0
 2, 123186.0, 19411.2, 7.38, 37.0, 0.0004, 0.003, 2400.0
 7.38, 37.0, 0.0004, 0.003, 2400.0
 7, 72.0, 2.0, 7.0, 1
 2, 43675.0, 9705.6, 7.38, 37.0, 0.001, 0.003, 2400.0
 7.38, 37.0, 0.001, 0.003, 2400.0
 2, 43675.0, 9705.6, 7.38, 37.0, 0.001, 0.003, 2400.0
 7.38, 37.0, 0.001, 0.003, 2400.0
 8, 72.0, 7.0, 7.0, 1
 2, 43675.0, 9705.6, 7.38, 37.0, 0.001, 0.003, 2400.0
 7.38, 37.0, 0.001, 0.003, 2400.0
 2, 43675.0, 9705.6, 7.38, 37.0, 0.001, 0.003, 2400.0
 7.38, 37.0, 0.001, 0.003, 2400.0
 9, 72.0, 7.0, 2.0, 1
 2, 43675.0, 9705.6, 7.38, 37.0, 0.001, 0.003, 2400.0
 7.38, 37.0, 0.001, 0.003, 2400.0
 2, 43675.0, 9705.6, 7.38, 37.0, 0.001, 0.003, 2400.0
 7.38, 37.0, 0.001, 0.003, 2400.0

FRICION DAMPER BRACES PROPERTIES

0

1, 1., 80

Column connectivity

1,1,1,1,2,3
2,2,1,2,2,3
3,2,1,3,2,3
4,1,1,4,2,3
5,3,1,1,1,2
6,4,1,2,1,2
7,4,1,3,1,2
8,3,1,4,1,2
9,5,1,1,0,1
10,6,1,2,0,1
11,6,1,3,0,1
12,5,1,4,0,1

Beam connectivity

1,1,3,1,1,2
2,2,3,1,2,3
3,3,3,1,3,4
4,4,2,1,1,2
5,5,2,1,2,3
6,6,2,1,3,4
7,7,1,1,1,2
8,8,1,1,2,3
9,9,1,1,3,4

BRACE CONNECTIVITY

1,1,2,1,1,0,3,2,76
2,1,2,1,2,1,2,3,76
3,1,2,1,3,2,3,2,76

Type of Analysis

3

Static loads

0,0,0,0

Dynamic Analysis Control Data

0.30, 0.0, 0.0005, 32.0, 6, 1

Wave data

0, 6400, 0.005

EI-Centro - EARTHQUAKE

fla30.a

Output options

0

0 0 0 0 0

STORY OUTPUT CONTROL

3, 0.005, 1, 2, 3

floor1f

floor2f

floor3f

Hys output
0,0,0,0,0,0

*NOTES : The earthquake ground acceleration record is read separately from a file
named 'flea30 a' as specified in the input data*

CASE STUDY #9.3

*input filename: idarc.dat
data filename: case9_3.dat
output filename: idarc.out
results filename: case9_3.out*

file: idarc.dat
case9_3.dat
case9_3.out

file: case9_3.dat

CASE STUDY 9.1: 3 STORY R/C FRAME WITH HYSTERETIC DAMPERS

Control Data

3,1,0,0,0,0

Element types

6,9,0,0,0,0,0,1,0

Element data

12,9,0,0,0,0,3,0

Unit system

1

Floor elevations

45.0, 93.0, 141.0

Number of duplicate frames

2

Nc of column lines

4

Nodal weights

1, 1, 3.375, 3.375, 3.375, 3.375

2, 1, 3.375, 3.375, 3.375, 3.375

3, 1, 3.375, 3.375, 3.375, 3.375

Env generation option

1

Hysteretic Control

3

1, 2, 0.1, 0.0, 1.0

2, 2, 0.1, 0.0, 1.0

3, 2, 0.1, 0.0, 0.1

Column input option

1

Column data

1, 48.0, 0.3, 0.1

1, 72264.6, 1140.0, 21888, 7.0, 16.0, 0.0008, 0.003, 400.0

7.0, 16.0, 0.0008, 0.003, 400.0

1, 72264.6, 1140.0, 21888, 7.0, 16.0, 0.0008, 0.003, 400.0

7.0, 16.0, 0.0008, 0.003, 400.0

2, 48.0, 0.3, 0.1

1, 369360.0, 2322.0, 49248, 24.0, 72.0, 0.0006, 0.001, 600.0

24.0, 72.0, 0.0006, 0.001, 600.0

1, 369360.0, 2322.0, 49248, 24.0, 72.0, 0.0006, 0.001, 600.0

24.0, 72.0, 0.0006, 0.001, 600.0

3, 48.0, 0.3, 0.1

1, 47559, 887, 17024, 11.0, 21.0, 0.0008, 0.003, 400.0

11.0, 21.0, 0.0008, 0.003, 400.0

1, 47559, 887, 17024, 11.0, 21.0, 0.0008, 0.003, 400.0

11.0, 21.0, 0.0008, 0.003, 400.0

4, 48.0, 0.3, 0.1

1, 250800.0, 1995.0, 38304, 32.0, 84.0, 0.001, 0.003, 600.0

32.0, 84.0, 0.001, 0.003, 600.0

1, 250800.0, 1995.0, 38304, 32.0, 84.0, 0.001, 0.003, 600.0

32.0, 84.0, 0.001, 0.003, 600.0

5, 45.0, 0.0, 3.0, 1

3, 14453.2, 380.0, 7296, 8, 10.0, 0.0025, 0.006, 40.0

8, 10.0, 0.0025, 0.006, 40.0

3, 14453.2, 380.0, 7296, 1, 2.0, 0.0025, 0.006, 40.0

1, 2.0, 0.0025, 0.006, 40.0

6, 45.0, 0.0, 3.0, 1

1, 62496.0, 885.0, 16416, 115, 120, 0.003, 0.008, 600.0

115, 120, 0.003, 0.008, 600.0

1, 82496.0, 885.0, 16416, 115, 120, 0.003, 0.008, 600.0

115, 120, 0.003, 0.008, 600.0

Beam input type

1

Beam data

1, 72.0, 2.0, 7.0, 1

2, 181980.0, 24264.0, 7.38, 37.0, 0.0004, 0.003, 2400.0

7.38, 37.0, 0.0004, 0.003, 2400.0

2, 181980.0, 24264.0, 7.38, 37.0, 0.0004, 0.003, 2400.0

7.38, 37.0, 0.0004, 0.003, 2400.0

2, 72.0, 7.0, 7.0, 1

2, 181980.0, 24264.0, 7.38, 37.0, 0.0004, 0.003, 2400.0

7.38, 37.0, 0.0004, 0.003, 2400.0

2, 181980.0, 24264.0, 7.38, 37.0, 0.0004, 0.003, 2400.0
 7.38, 37.0, 0.0004, 0.003, 2400.0
 3, 72.0, 7.0, 2.0, 1
 2, 181980.0, 24264.0, 7.38, 37.0, 0.0004, 0.003, 2400.0
 7.38, 37.0, 0.0004, 0.003, 2400.0
 2, 181980.0, 24264.0, 7.38, 37.0, 0.0004, 0.003, 2400.0
 7.38, 37.0, 0.0004, 0.003, 2400.0
 4, 72.0, 2.0, 7.0, 1
 2, 123186.0, 19411.2, 7.38, 37.0, 0.0004, 0.003, 2400.0
 7.38, 37.0, 0.0004, 0.003, 2400.0
 2, 123186.0, 19411.2, 7.38, 37.0, 0.0004, 0.003, 2400.0
 7.38, 37.0, 0.0004, 0.003, 2400.0
 5, 72.0, 7.0, 7.0, 1
 2, 123186.0, 19411.2, 7.38, 37.0, 0.0004, 0.003, 2400.0
 7.38, 37.0, 0.0004, 0.003, 2400.0
 2, 123186.0, 19411.2, 7.38, 37.0, 0.0004, 0.003, 2400.0
 7.38, 37.0, 0.0004, 0.003, 2400.0
 6, 72.0, 7.0, 2.0, 1
 2, 123186.0, 19411.2, 7.38, 37.0, 0.0004, 0.003, 2400.0
 7.38, 37.0, 0.0004, 0.003, 2400.0
 2, 123186.0, 19411.2, 7.38, 37.0, 0.0004, 0.003, 2400.0
 7.38, 37.0, 0.0004, 0.003, 2400.0
 7, 72.0, 2.0, 7.0, 1
 2, 43675.0, 9705.6, 7.38, 37.0, 0.001, 0.003, 2400.0
 7.38, 37.0, 0.001, 0.003, 2400.0
 2, 43675.0, 9705.6, 7.38, 37.0, 0.001, 0.003, 2400.0
 7.38, 37.0, 0.001, 0.003, 2400.0
 8, 72.0, 7.0, 7.0, 1
 2, 43675.0, 9705.6, 7.38, 37.0, 0.001, 0.003, 2400.0
 7.38, 37.0, 0.001, 0.003, 2400.0
 2, 43675.0, 9705.6, 7.38, 37.0, 0.001, 0.003, 2400.0
 7.38, 37.0, 0.001, 0.003, 2400.0
 9, 72.0, 7.0, 2.0, 1
 2, 43675.0, 9705.6, 7.38, 37.0, 0.001, 0.003, 2400.0
 7.38, 37.0, 0.001, 0.003, 2400.0
 2, 43675.0, 9705.6, 7.38, 37.0, 0.001, 0.003, 2400.0
 7.38, 37.0, 0.001, 0.003, 2400.0

HYSTERETIC DAMPER BRACES PROPERTIES

0

1, 1.0, 80, 3,

Column connectivity

1,1,1,1,2,3

2,2,1,2,2,3

3,2,1,3,2,3

4,1,1,4,2,3

5.3,1,1,1,2
6.4,1,2,1,2
7.4,1,3,1,2
8.3,1,4,1,2
9.5,1,1,0,1
10.6,1,2,0,1
11.6,1,3,0,1
12.5,1,4,0,1
Beam connectivity
1,1,3,1,1,2
2,2,3,1,2,3
3,3,3,1,3,4
4,4,2,1,1,2
5.5,2,1,2,3
6,6,2,1,3,4
7,7,1,1,1,2
8,8,1,1,2,3
9,9,1,1,3,4
BRACE CONNECTIVITY
1,1,3,1,1,0,3,2,76
2,1,3,1,2,1,2,3,76
3,1,3,1,3,2,3,2,76
Type of Analysis
3
Static loads
0,0,0,0
Dynamic Analysis Control Data
0.30, 0.0, 0.0005, 32.0, 6, 1
Wave data
0, 6400, 0.005
El-Centro - EARTHQUAKE
flca30.a
Output options
0
0 0 0 0 0
STORY OUTPUT CONTROL
3, 0.005,1,2,3
floor1d
floor2d
floor3d
Hys output
0,0,0,0,0

NOTES : The earthquake ground acceleration record is read separately from a file named 'flea30.a' as specified in the input data

CASE STUDY #10

*input filename: idarc.dat
data filename: case10.dat
output filename: idarc.out
results filename: case10.out*

file: idarc.dat
case10.dat
case10.out

file: case10.dat
CASE STUDY 10: MASONRY INFILLED FRAME TESTED IN SEISMIC LAB
Control Data
3,1,0,0,1,0,1
Element types
2,1,0,0,0,0,0,0,1
Element data
6,3,0,0,0,0,0,1
Unit system
1
Floor elevations
12,82.512,94.512
Number of duplicate frames
1
No of column lines
2
Nodal weights
1, 1, 3.375, 3.375
2, 1, 3.375, 3.375
3, 1, 3.375, 3.375
Env generation option
0
Masonry properties
1,3.408,0.123,0.003,0.115,0.120,0.3
Hysteretic Control
1
1, 10.0, 0.0, 0.0, 1.0
Column input option
1
Column data

1, 70.512,4.0,4.0,1
1, 456228, 553.2, 138187, 142.96, 146.19, 0.000735, 0.003, 2850
142.96, 146.19, 0.000735, 0.003, 2850
1, 456228, 553.2, 138187, 142.96, 146.19, 0.000735, 0.003, 2850
142.96, 146.19, 0.000735, 0.003, 2850
2, 16.0,4.0,4.0,1
1, 456228, 3250., 138187, 142.96, 146.19, 0.000735, 0.003, 2850
142.96, 146.19, 0.000735, 0.003, 2850
1, 456228, 3250., 138187, 142.96, 146.19, 0.000735, 0.003, 2850
142.96, 146.19, 0.000735, 0.003, 2850

Beam input type

1

Beam data

1,100.5,4.0,4.0,1
1, 414903, 4610.2, 124.45, 127.3, 0.000725, 0.003, 2375
124.45, 127.3, 0.000725, 0.003, 2375
1, 414903, 4610.2, 124.45, 127.3, 0.000725, 0.003, 2375
124.45, 127.3, 0.000725, 0.003, 2375

Infill Wall input

Infill panel geometry

1,0
1,3.504,92.008,62.480
175.23,165.504,112.726
1.0,0.1,0.9,2.0,0.02
1,0.22,0.05,0.1
0.2,0.8,1.0,10.0

Column connectivity

1,2,1,1,0,1
2,1,1,1,1,2
3,2,1,1,2,3
4,2,1,2,0,1
5,1,1,2,1,2
6,2,1,2,2,3

Beam connectivity

1,1,1,1,1,2
2,1,2,1,1,2
3,1,3,1,1,2

Infill wall connectivity

1,1,1,2,1,1,2,1

Type of Analysis

4

Static loads

0,0,0,0

Quasi Static Analysis Control Data

1

1
3
25
0,0.3,0,-0.3,0,0.3,0,-0.3,0,0.65,0,-0.65,0,0.65,0,-0.65,0,1.3,0,-1.3,0,1.3,0,-1.3,0
0.001
Snapshot Output
0
0,0,0,0,0
Output options
3,1,1,2,3
FR11.PRN
FR22.PRN
FR33.PRN
Hys output
0,0,0,0,1
Infill Wall # to be printed
1

APPENDIX C

DEFAULT SETTINGS IN FILE IDDEFN.FOR

The following table contains the list of the control variables used in IDARC to dimension the variables used during analysis. The executable PC version of the program is compiled using the default values listed below. The default value for each variable may be changed in the file IDDEFN.FOR, and the program recompiled to take into account the new variable sizes.

Variable Name	Default Setting	Variable Description
NN1	10	Maximum Number of Stories.
NN2	5	Maximum Number of Frames.
NN4	15	Maximum Number of Vertical Lines.
NN5	500	Maximum Number of Degrees of Freedom.
NN6	300	Maximum Half Band Width.
NNC	100	Maximum Number of Column Elements.
NNB	80	Maximum Number of Beam Elements.
NNW	40	Maximum Number of Shear Wall Elements.
NNE	10	Maximum Number of Edge Beams.
NNT	10	Maximum Number of Transverse Beams.
NNR	10	Maximum Number of Rotational Spring Elements.
NND1	10	Maximum Number of Viscoelastic Damper Elements.
NND2	10	Maximum Number of Friction Damper Elements.
NND3	10	Maximum Number of Hysteretic Damper Elements.
NND4	10	Maximum Number of Infill Panels.
NP1	5	Maximum Number of Concrete Types.
NP2	5	Maximum Number of Steel Reinforcement Types.
NZ1	10	Maximum Number of Output Histories for Dynamic Analysis.
NZ2	3001	Maximum Number of Points in Earthquake Wave.
NZ3	10	Maximum Number of Hysteretic Properties Specified.
NZ4	200	Maximum Number of Points in Monotonic Analysis and Quasi-Static Input.

Table B.1 Default Maximum Settings in File IDDEFN.FOR

APPENDIX D

FORMULATION FOR MASONRY INFILL FRAMES

The following formulation is used in the program to calculate the hysteretic parameters for masonry infill frames. The formulation is adapted from Saneinejad and Hobbs (1995).

The permissible stress f_u for the masonry strut in compression is calculated as:

$$f_u = f_c \left[1 - \left(\frac{l_e \sigma}{40l} \right)^2 \right] \text{ where } f_c = 0.6\phi f'_m \text{ and } \phi = 0.65 \quad (\text{D.1})$$

The upper bound or failure normal uniform contact stresses at the column-infill interface σ_{c0} and beam-infill interface σ_{b0} are calculated from the Tresca hexagonal yield criterion as:

$$\sigma_{c0} = \frac{f_c}{\sqrt{1 + 3\mu_f^2 r^4}} ; \sigma_{b0} = \frac{f_c}{\sqrt{1 + 3\mu_f^2}} \quad (\text{D.2})$$

Where r is the aspect ratio of the infill, i.e. $r = h/l$; and μ_f is the coefficient of friction of the frame-infill surface. The contact lengths at the column-infill interface $\alpha_c h$ and beam-infill interface $\alpha_b l$ are calculated from equilibrium as:

$$\alpha_c h = \sqrt{\frac{2M_{pj} + 2\beta_c M_{pc}}{\sigma_{c0} t}} \leq 0.4h' \quad (\text{D.3})$$

$$\alpha_b l = \sqrt{\frac{2M_{pj} + 2\beta_c M_{pc}}{\sigma_{b0} t}} \leq 0.4l' \quad (\text{D.4})$$

in which $\beta_0 = 0.2$.

The actual normal contact stresses σ_c and σ_b are calculated from the rotational equilibrium of the infill panel using the following methodology:

If $A_c \geq A_b$ then

$$\sigma_b = \sigma_{b0} \text{ and } \sigma_c = \sigma_{c0} \left(\frac{A_b}{A_c} \right) \quad (\text{D.5})$$

If $A_b \geq A_c$ then:

$$\sigma_c = \sigma_{c0} \text{ and } \sigma_b = \sigma_{b0} \left(\frac{A_c}{A_b} \right) \quad (\text{D.6})$$

Where:

$$A_c = r^2 \sigma_{c0} \alpha_c (1 - \alpha_c - \mu_f r) \quad (\text{D.7})$$

$$A_b = \sigma_{b0} \alpha_b (1 - \alpha_b - \mu_f r) \quad (\text{D.8})$$

The contact shear stresses at the column-infill interface τ_c and beam-infill interface τ_b are given as:

$$\tau_c = \mu_f r^2 \sigma_c \quad (\text{D.9})$$

$$\tau_b = \mu_f \sigma_b \quad (\text{D.10})$$

The sloping angle θ' of the masonry diagonal strut at shear failure is given as:

$$\theta' = \tan^{-1}[(1 - \alpha_c)h'/l'] \quad (\text{D.11})$$

The controlling parameters of the smooth hysteretic model exhibit well defined physical characteristics if the following constraint is imposed:

$$A = \beta + \gamma \quad (3.???)$$

When using masonry infill panel elements, the following are suggested values of the smooth hysteretic parameters (Reinhorn et al., 1995d):

$$A = 1.0, \beta = 0.1, \gamma = 0.9, \eta = 2.0$$

$$\mu_c = 5.0$$

$$A_r = 0.3$$

$$Z_r = 0.1$$

$$\bar{Z} = 0.0$$

$$s_k = 0.1$$

$$s_{p1} = 0.8$$

$$s_{p2} = 1.0$$

Other values can be used to achieve different hysteretic response characteristics.

**NATIONAL CENTER FOR EARTHQUAKE ENGINEERING RESEARCH
LIST OF TECHNICAL REPORTS**

The National Center for Earthquake Engineering Research (NCEER) publishes technical reports on a variety of subjects related to earthquake engineering written by authors funded through NCEER. These reports are available from both NCEER Publications and the National Technical Information Service (NTIS). Requests for reports should be directed to NCEER Publications, National Center for Earthquake Engineering Research, State University of New York at Buffalo, Red Jacket Quadrangle, Buffalo, New York 14261. Reports can also be requested through NTIS, 5285 Port Royal Road, Springfield, Virginia 22161. NTIS accession numbers are shown in parenthesis, if available.

- NCEER-87-0001 "First-Year Program in Research, Education and Technology Transfer," 3/5/87, (PB88-134275, A04, MF-A01).
- NCEER-87-0002 "Experimental Evaluation of Instantaneous Optimal Algorithms for Structural Control," by R.C. Lin, T.T. Soong and A.M. Reinhorn, 4/20/87, (PB88-134341, A04, MF-A01).
- NCEER-87-0003 "Experimentation Using the Earthquake Simulation Facilities at University at Buffalo," by A.M. Reinhorn and R.L. Ketter, to be published.
- NCEER-87-0004 "The System Characteristics and Performance of a Shaking Table," by J.S. Hwang, K.C. Chang and G.C. Lee, 6/1/87, (PB88-134259, A03, MF-A01). This report is available only through NTIS (see address given above).
- NCEER-87-0005 "A Finite Element Formulation for Nonlinear Viscoplastic Material Using a Q Model," by O. Gyeht and G. Dasgupta, 11/2/87, (PB88-213764, A08, MF-A01).
- NCEER-87-0006 "Symbolic Manipulation Program (SMP) - Algebraic Codes for Two and Three Dimensional Finite Element Formulations," by X. Lee and G. Dasgupta, 11/9/87, (PB88-218522, A05, MF-A01).
- NCEER-87-0007 "Instantaneous Optimal Control Laws for Tall Buildings Under Seismic Excitations," by J.N. Yang, A. Akbarpour and P. Ghaemmaghami, 6/10/87, (PB88-134333, A06, MF-A01). This report is only available through NTIS (see address given above).
- NCEER-87-0008 "IDARC: Inelastic Damage Analysis of Reinforced Concrete Frame - Shear-Wall Structures," by Y.J. Park, A.M. Reinhorn and S.K. Kunmath, 7/20/87, (PB88-134325, A09, MF-A01). This report is only available through NTIS (see address given above).
- NCEER-87-0009 "Liquefaction Potential for New York State: A Preliminary Report on Sites in Manhattan and Buffalo," by M. Budhu, V. Vijayakumar, R.F. Giese and L. Baumgras, 8/31/87, (PB88-163704, A03, MF-A01). This report is available only through NTIS (see address given above).
- NCEER-87-0010 "Vertical and Torsional Vibration of Foundations in Inhomogeneous Media," by A.S. Veletsos and K.W. Dotson, 6/1/87, (PB88-134291, A03, MF-A01). This report is only available through NTIS (see address given above).
- NCEER-87-0011 "Seismic Probabilistic Risk Assessment and Seismic Margins Studies for Nuclear Power Plants," by Howard H.M. Hwang, 6/15/87, (PB88-134267, A03, MF-A01). This report is only available through NTIS (see address given above).
- NCEER-87-0012 "Parametric Studies of Frequency Response of Secondary Systems Under Ground-Acceleration Excitations," by Y. Yong and Y.K. Lin, 6/10/87, (PB88-134309, A03, MF-A01). This report is only available through NTIS (see address given above).
- NCEER-87-0013 "Frequency Response of Secondary Systems Under Seismic Excitation," by J.A. HoLung, J. Cai and Y.K. Lin, 7/31/87, (PB88-134317, A05, MF-A01). This report is only available through NTIS (see address given above).

- NCEER-87-0014 "Modelling Earthquake Ground Motions in Seismically Active Regions Using Parametric Time Series Methods," by G.W. Ellis and A.S. Cakmak, 8/25/87, (PB88-134283, A08, MF-A01). This report is only available through NTIS (see address given above).
- NCEER-87-0015 "Detection and Assessment of Seismic Structural Damage," by E. DiPasquale and A.S. Cakmak, 8/25/87, (PB88-163712, A05, MF-A01). This report is only available through NTIS (see address given above).
- NCEER-87-0016 "Pipeline Experiment at Parkfield, California," by J. Isenberg and E. Richardson, 9/15/87, (PB88-163720, A03, MF-A01). This report is available only through NTIS (see address given above).
- NCEER-87-0017 "Digital Simulation of Seismic Ground Motion," by M. Shinozuka, G. Deodatis and T. Harada, 8/31/87, (PB88-155197, A04, MF-A01). This report is available only through NTIS (see address given above).
- NCEER-87-0018 "Practical Considerations for Structural Control: System Uncertainty, System Time Delay and Truncation of Small Control Forces," J.N. Yang and A. Akbarpour, 8/10/87, (PB88-163738, A08, MF-A01). This report is only available through NTIS (see address given above).
- NCEER-87-0019 "Modal Analysis of Nonclassically Damped Structural Systems Using Canonical Transformation," by J.N. Yang, S. Sarkam and F.X. Long, 9/27/87, (PB88-187851, A04, MF-A01).
- NCEER-87-0020 "A Nonstationary Solution in Random Vibration Theory," by J.R. Red-Horse and P.D. Spanos, 11/3/87, (PB88-163746, A03, MF-A01).
- NCEER-87-0021 "Horizontal Impedances for Radially Inhomogeneous Viscoelastic Soil Layers," by A.S. Veletsos and K.W. Dotson, 10/15/87, (PB88-150859, A04, MF-A01).
- NCEER-87-0022 "Seismic Damage Assessment of Reinforced Concrete Members," by Y.S. Chung, C. Meyer and M. Shinozuka, 10/9/87, (PB88-150867, A05, MF-A01). This report is available only through NTIS (see address given above).
- NCEER-87-0023 "Active Structural Control in Civil Engineering," by T.T. Soong, 11/11/87, (PB88-187778, A03, MF-A01).
- NCEER-87-0024 "Vertical and Torsional Impedances for Radially Inhomogeneous Viscoelastic Soil Layers," by K.W. Dotson and A.S. Veletsos, 12/87, (PB88-187786, A03, MF-A01).
- NCEER-87-0025 "Proceedings from the Symposium on Seismic Hazards, Ground Motions, Soil-Liquefaction and Engineering Practice in Eastern North America," October 20-22, 1987, edited by K.H. Jacob, 12/87, (PB88-188115, A23, MF-A01).
- NCEER-87-0026 "Report on the Whittier-Narrows, California, Earthquake of October 1, 1987," by J. Pantelic and A. Reinhorn, 11/87, (PB88-187752, A03, MF-A01). This report is available only through NTIS (see address given above).
- NCEER-87-0027 "Design of a Modular Program for Transient Nonlinear Analysis of Large 3-D Building Structures," by S. Srivastav and J.F. Abel, 12/30/87, (PB88-187950, A05, MF-A01). This report is only available through NTIS (see address given above).
- NCEER-87-0028 "Second-Year Program in Research, Education and Technology Transfer," 3/8/88, (PB88-219480, A04, MF-A01).
- NCEER-88-0001 "Workshop on Seismic Computer Analysis and Design of Buildings With Interactive Graphics," by W. McGuire, J.F. Abel and C.H. Conley, 1/18/88, (PB88-187760, A03, MF-A01). This report is only available through NTIS (see address given above).

- NCEER-88-0002 "Optimal Control of Nonlinear Flexible Structures," by J.N. Yang, F.X. Long and D. Wong, 1/22/88, (PB88-213772, A06, MF-A01).
- NCEER-88-0003 "Substructuring Techniques in the Time Domain for Primary-Secondary Structural Systems," by G.D. Manolis and G. Juhn, 2/10/88, (PB88-213780, A04, MF-A01).
- NCEER-88-0004 "Iterative Seismic Analysis of Primary-Secondary Systems," by A. Singhal, L.D. Lutes and P.D. Spanos, 2/23/88, (PB88-213798, A04, MF-A01).
- NCEER-88-0005 "Stochastic Finite Element Expansion for Random Media," by P.D. Spanos and R. Ghanem, 3/14/88, (PB88-213806, A03, MF-A01).
- NCEER-88-0006 "Combining Structural Optimization and Structural Control," by F.Y. Cheng and C.P. Pantelides, 1/10/88, (PB88-213814, A05, MF-A01).
- NCEER-88-0007 "Seismic Performance Assessment of Code-Designed Structures," by H.H.-M. Hwang, J.W. Jaw and H.J. Shau, 3/20/88, (PB88-219423, A04, MF-A01). This report is only available through NTIS (see address given above).
- NCEER-88-0008 "Reliability Analysis of Code-Designed Structures Under Natural Hazards," by H.H.-M. Hwang, H. Ushiba and M. Shinozuka, 2/29/88, (PB88-229471, A07, MF-A01). This report is only available through NTIS (see address given above).
- NCEER-88-0009 "Seismic Fragility Analysis of Shear Wall Structures," by J.W. Jaw and H.H.-M. Hwang, 4/30/88, (PB89-102867, A04, MF-A01).
- NCEER-88-0010 "Base Isolation of a Multi-Story Building Under a Harmonic Ground Motion - A Comparison of Performances of Various Systems," by F.-G. Fan, G. Ahmadi and I.G. Tadjbakhsh, 5/18/88, (PB89-122238, A06, MF-A01). This report is only available through NTIS (see address given above).
- NCEER-88-0011 "Seismic Floor Response Spectra for a Combined System by Green's Functions," by F.M. Lavelle, L.A. Bergman and P.D. Spanos, 5/1/88, (PB89-102875, A03, MF-A01).
- NCEER-88-0012 "A New Solution Technique for Randomly Excited Hysteretic Structures," by G.Q. Cai and Y.K. Lin, 5/16/88, (PB89-102883, A03, MF-A01).
- NCEER-88-0013 "A Study of Radiation Damping and Soil-Structure Interaction Effects in the Centrifuge," by K. Weissman, supervised by J.H. Prevost, 5/24/88, (PB89-144703, A06, MF-A01).
- NCEER-88-0014 "Parameter Identification and Implementation of a Kinematic Plasticity Model for Frictional Soils," by J.H. Prevost and D.V. Griffiths, to be published.
- NCEER-88-0015 "Two- and Three- Dimensional Dynamic Finite Element Analyses of the Long Valley Dam," by D.V. Griffiths and J.H. Prevost, 6/17/88, (PB89-144711, A04, MF-A01).
- NCEER-88-0016 "Damage Assessment of Reinforced Concrete Structures in Eastern United States," by A.M. Reinhorn, M.J. Seidel, S.K. Kunnath and Y.J. Park, 6/15/88, (PB89-122220, A04, MF-A01). This report is only available through NTIS (see address given above).
- NCEER-88-0017 "Dynamic Compliance of Vertically Loaded Strip Foundations in Multilayered Viscoelastic Soils," by S. Ahmad and A.S.M. Israel, 6/17/88, (PB89-102891, A04, MF-A01).
- NCEER-88-0018 "An Experimental Study of Seismic Structural Response With Added Viscoelastic Dampers," by R.C. Lim, Z. Liang, T.T. Soong and R.H. Zhang, 6/30/88, (PB89-122212, A05, MF-A01). This report is available only through NTIS (see address given above).

- NCEER-88-0019 "Experimental Investigation of Primary - Secondary System Interaction," by G.D. Manolis, G. Juhn and A.M. Reinhorn, 5/27/88, (PB89-122204, A04, MF-A01).
- NCEER-88-0020 "A Response Spectrum Approach For Analysis of Nonclassically Damped Structures," by J.N. Yang, S. Sarkani and F.X. Long, 4/22/88, (PB89-102909, A04, MF-A01).
- NCEER-88-0021 "Seismic Interaction of Structures and Soils: Stochastic Approach," by A.S. Veletsos and A.M. Prasad, 7/21/88, (PB89-122196, A04, MF-A01). This report is only available through NTIS (see address given above).
- NCEER-88-0022 "Identification of the Serviceability Limit State and Detection of Seismic Structural Damage," by E. DiPasquale and A.S. Cakmak, 6/15/88, (PB89-122188, A05, MF-A01). This report is available only through NTIS (see address given above).
- NCEER-88-0023 "Multi-Hazard Risk Analysis: Case of a Simple Off-shore Structure," by B.K. Bhartia and E.H. Vanmarcke, 7/21/88, (PB89-145213, A05, MF-A01).
- NCEER-88-0024 "Automated Seismic Design of Reinforced Concrete Buildings," by Y.S. Chung, C. Meyer and M. Shinozuka, 7/5/88, (PB89-122170, A06, MF-A01). This report is available only through NTIS (see address given above).
- NCEER-88-0025 "Experimental Study of Active Control of MDOF Structures Under Seismic Excitations," by L.L. Chung, R.C. Lin, T.T. Soong and A.M. Reinhorn, 7/10/88, (PB89-122600, A04, MF-A01).
- NCEER-88-0026 "Earthquake Simulation Tests of a Low-Rise Metal Structure," by J.S. Hwang, K.C. Chang, G.C. Lee and R.L. Ketter, 8/1/88, (PB89-102917, A04, MF-A01).
- NCEER-88-0027 "Systems Study of Urban Response and Reconstruction Due to Catastrophic Earthquakes," by E. Kozin and H.K. Zhou, 9/22/88, (PB90-162348, A04, MF-A01).
- NCEER-88-0028 "Seismic Fragility Analysis of Plane Frame Structures," by H.H-M. Hwang and Y.K. Low, 7/31/88, (PB89-131445, A06, MF-A01).
- NCEER-88-0029 "Response Analysis of Stochastic Structures," by A. Karama, C. Bucher and M. Shinozuka, 9/22/88, (PB89-174429, A04, MF-A01).
- NCEER-88-0030 "Nonnormal Accelerations Due to Yielding in a Primary Structure," by D.C.K. Chen and L.D. Lutes, 9/19/88, (PB89-131437, A04, MF-A01).
- NCEER-88-0031 "Design Approaches for Soil-Structure Interaction," by A.S. Veletsos, A.M. Prasad and Y. Tang, 12/30/88, (PB89-174437, A03, MF-A01). This report is available only through NTIS (see address given above).
- NCEER-88-0032 "A Re-evaluation of Design Spectra for Seismic Damage Control," by C.J. Turkstra and A.G. Tallin, 11/7/88, (PB89-145221, A05, MF-A01).
- NCEER-88-0033 "The Behavior and Design of Noncontact Lap Splices Subjected to Repeated Inelastic Tensile Loading," by V.E. Sagan, P. Gergely and R.N. White, 12/8/88, (PB89-163737, A08, MF-A01).
- NCEER-88-0034 "Seismic Response of Pile Foundations," by S.M. Mamon, P.K. Banerjee and S. Ahmad, 11/1/88, (PB89-145239, A04, MF-A01).
- NCEER-88-0035 "Modeling of R/C Building Structures With Flexible Floor Diaphragms (IDARC2)," by A.M. Reinhorn, S.K. Kunnath and N. Panahshahi, 9/7/88, (PB89-207153, A07, MF-A01).

- NCEER-88-0036 "Solution of the Dam-Reservoir Interaction Problem Using a Combination of FEM, BEM with Particular Integrals, Modal Analysis, and Substructuring," by C-S. Tsai, G.C. Lee and R.L. Ketter, 12/31/88, (PB89-207146, A04, MF-A01).
- NCEER-88-0037 "Optimal Placement of Actuators for Structural Control," by F.Y. Cheng and C.P. Pantelides, 8/15/88, (PB89-162846, A05, MF-A01).
- NCEER-88-0038 "Teflon Bearings in Aseismic Base Isolation: Experimental Studies and Mathematical Modeling," by A. Mokha, M.C. Constantinou and A.M. Reinhorn, 12/5/88, (PB89-218457, A10, MF-A01). This report is available only through NTIS (see address given above).
- NCEER-88-0039 "Seismic Behavior of Flat Slab High-Rise Buildings in the New York City Area," by P. Weidinger and M. Ettouney, 10/15/88, (PB90-145681, A04, MF-A01).
- NCEER-88-0040 "Evaluation of the Earthquake Resistance of Existing Buildings in New York City," by P. Weidinger and M. Ettouney, 10/15/88, to be published.
- NCEER-88-0041 "Small-Scale Modeling Techniques for Reinforced Concrete Structures Subjected to Seismic Loads," by W. Kim, A. El-Attar and R.N. White, 11/22/88, (PB89-189625, A05, MF-A01).
- NCEER-88-0042 "Modeling Strong Ground Motion from Multiple Event Earthquakes," by G.W. Ellis and A.S. Cakmak, 10/15/88, (PB89-174445, A03, MF-A01).
- NCEER-88-0043 "Nonstationary Models of Seismic Ground Acceleration," by M. Grigoriu, S.E. Ruiz and E. Rosenblueth, 7/15/88, (PB89-189617, A04, MF-A01).
- NCEER-88-0044 "SARCF User's Guide: Seismic Analysis of Reinforced Concrete Frames," by Y.S. Chung, C. Meyer and M. Shinozuka, 11/9/88, (PB89-174452, A08, MF-A01).
- NCEER-88-0045 "First Expert Panel Meeting on Disaster Research and Planning," edited by J. Pantelic and J. Stoyle, 9/15/88, (PB89-174460, A05, MF-A01). This report is only available through NTIS (see address given above).
- NCEER-88-0046 "Preliminary Studies of the Effect of Degrading Infill Walls on the Nonlinear Seismic Response of Steel Frames," by C.Z. Chryssostomou, P. Gergely and J.F. Abel, 12/19/88, (PB89-208383, A05, MF-A01).
- NCEER-88-0047 "Reinforced Concrete Frame Component Testing Facility - Design, Construction, Instrumentation and Operation," by S.P. Pessiki, C. Conley, T. Bond, P. Gergely and R.N. White, 12/16/88, (PB89-174478, A04, MF-A01).
- NCEER-89-0001 "Effects of Protective Cushion and Soil Compliancy on the Response of Equipment Within a Seismically Excited Building," by J.A. Holung, 2/16/89, (PB89-207179, A04, MF-A01).
- NCEER-89-0002 "Statistical Evaluation of Response Modification Factors for Reinforced Concrete Structures," by H.H.M. Hwang and J-W. Jaw, 2-17/89, (PB89-207187, A05, MF-A01).
- NCEER-89-0003 "Hysteretic Columns Under Random Excitation," by G-Q. Cai and Y.K. Lin, 1/9/89, (PB89-196513, A03, MF-A01).
- NCEER-89-0004 "Experimental Study of 'Elephant Foot Bulge' Instability of Thin-Walled Metal Tanks," by Z-H. Jia and R.L. Ketter, 2/22/89, (PB89-207195, A03, MF-A01).
- NCEER-89-0005 "Experiment on Performance of Buried Pipelines Across San Andreas Fault," by J. Isenberg, E. Richardson and T.D. O'Rourke, 3/10/89, (PB89-218440, A04, MF-A01). This report is available only through NTIS (see address given above).

- NCEER-89-0006 "A Knowledge-Based Approach to Structural Design of Earthquake-Resistant Buildings," by M. Subramani, P. Gergely, C.H. Conley, J.F. Abel and A.H. Zaghw, 1/15/89, (PB89-218465, A06, MF-A01).
- NCEER-89-0007 "Liquefaction Hazards and Their Effects on Buried Pipelines," by T.D. O'Rourke and P.A. Lane, 2/1/89, (PB89-218481, A09, MF-A01).
- NCEER-89-0008 "Fundamentals of System Identification in Structural Dynamics," by H. Imai, C-B. Yun, O. Maruyama and M. Shinozuka, 1/26/89, (PB89-207211, A04, MF-A01).
- NCEER-89-0009 "Effects of the 1985 Michoacan Earthquake on Water Systems and Other Buried Lifelines in Mexico," by A.G. Ayala and M.J. O'Rourke, 3/8/89, (PB89-207229, A06, MF-A01).
- NCEER-89-R010 "NCEER Bibliography of Earthquake Education Materials," by K.E.K. Ross, Second Revision, 9/1/89, (PB90-125352, A05, MF-A01). This report is replaced by NCEER-92-0018.
- NCEER-89-0011 "Inelastic Three-Dimensional Response Analysis of Reinforced Concrete Building Structures (IDARC-3D), Part I - Modeling," by S.K. Kunnath and A.M. Reinhorn, 4/17/89, (PB90-114612, A07, MF-A01).
- NCEER-89-0012 "Recommended Modifications to ATC-14," by C.D. Poland and J.O. Malley, 4/12/89, (PB90-108648, A15, MF-A01).
- NCEER-89-0013 "Repair and Strengthening of Beam-to-Column Connections Subjected to Earthquake Loading," by M. Corazao and A.J. Durrani, 2/28/89, (PB90-109885, A06, MF-A01).
- NCEER-89-0014 "Program EXKAL2 for Identification of Structural Dynamic Systems," by O. Maruyama, C-B. Yun, M. Hoshiya and M. Shinozuka, 5/19/89, (PB90-109877, A09, MF-A01).
- NCEER-89-0015 "Response of Frames With Bolted Semi-Rigid Connections, Part I - Experimental Study and Analytical Predictions," by P.J. DiCorso, A.M. Reinhorn, J.R. Dickerson, J.B. Radzinski and W.L. Harper, 6/1/89, to be published.
- NCEER-89-0016 "ARMA Monte Carlo Simulation in Probabilistic Structural Analysis," by P.D. Spanos and M.P. Mignolet, 7/10/89, (PB90-109893, A03, MF-A01).
- NCEER-89-P017 "Preliminary Proceedings from the Conference on Disaster Preparedness - The Place of Earthquake Education in Our Schools," Edited by K.E.K. Ross, 6/23/89, (PB90-108606, A03, MF-A01).
- NCEER-89-0017 "Proceedings from the Conference on Disaster Preparedness - The Place of Earthquake Education in Our Schools," Edited by K.E.K. Ross, 12/31/89, (PB90-207895, A012, MF-A02). This report is available only through NTIS (see address given above).
- NCEER-89-0018 "Multidimensional Models of Hysteretic Material Behavior for Vibration Analysis of Shape Memory Energy Absorbing Devices, by E.J. Graesser and F.A. Cozzarelli, 6/7/89, (PB90-164146, A04, MF-A01).
- NCEER-89-0019 "Nonlinear Dynamic Analysis of Three-Dimensional Base Isolated Structures (3D-BASIS)," by S. Nagarajah, A.M. Reinhorn and M.C. Constantinou, 8/3/89, (PB90-161936, A06, MF-A01). This report has been replaced by NCEER-93-0011.
- NCEER-89-0020 "Structural Control Considering Time-Rate of Control Forces and Control Rate Constraints," by F.Y. Cheng and C.P. Pantelides, 8/3/89, (PB90-120445, A04, MF-A01).
- NCEER-89-0021 "Subsurface Conditions of Memphis and Shelby County," by K.W. Ng, T-S. Chang and H-H.M. Hwang, 7/26/89, (PB90-120437, A03, MF-A01).
- NCEER-89-0022 "Seismic Wave Propagation Effects on Straight Jointed Buried Pipelines," by K. Elhadi and M.J. O'Rourke, 8/24/89, (PB90-162322, A10, MF-A02).

- NCEER-89-0023 "Workshop on Serviceability Analysis of Water Delivery Systems," edited by M. Grigoriu, 3/6/89, (PB90-127424, A03, MF-A01).
- NCEER-89-0024 "Shaking Table Study of a 1/5 Scale Steel Frame Composed of Tapered Members," by K.C. Chang, J.S. Hwang and G.C. Lee, 9/18/89, (PB90-160169, A04, MF-A01).
- NCEER-89-0025 "DYNAID: A Computer Program for Nonlinear Seismic Site Response Analysis - Technical Documentation," by Jean H. Prevost, 9/14/89, (PB90-161944, A07, MF-A01). This report is available only through NTIS (see address given above).
- NCEER-89-0026 "1:4 Scale Model Studies of Active Tendon Systems and Active Mass Dampers for Seismic Protection," by A.M. Reinhorn, T.T. Soong, R.C. Lin, Y.P. Yang, Y. Fukao, H. Abe and M. Nakai, 9/15/89, (PB90-173246, A10, MF-A02).
- NCEER-89-0027 "Scattering of Waves by Inclusions in a Nonhomogeneous Elastic Half Space Solved by Boundary Element Methods," by P.K. Hadley, A. Askar and A.S. Cakmak, 6/15/89, (PB90-145699, A07, MF-A01).
- NCEER-89-0028 "Statistical Evaluation of Deflection Amplification Factors for Reinforced Concrete Structures," by H.H.M. Hwang, J.W. Jaw and A.L. Ch'ng, 8/31/89, (PB90-164633, A05, MF-A01).
- NCEER-89-0029 "Bedrock Accelerations in Memphis Area Due to Large New Madrid Earthquakes," by H.H.M. Hwang, C.H.S. Chen and G. Yu, 11/7/89, (PB90-162330, A04, MF-A01).
- NCEER-89-0030 "Seismic Behavior and Response Sensitivity of Secondary Structural Systems," by Y.Q. Chen and T.T. Soong, 10/23/89, (PB90-164658, A08, MF-A01).
- NCEER-89-0031 "Random Vibration and Reliability Analysis of Primary-Secondary Structural Systems," by Y. Ibrahim, M. Grigoriu and T.T. Soong, 11/10/89, (PB90-161951, A04, MF-A01).
- NCEER-89-0032 "Proceedings from the Second U.S. - Japan Workshop on Liquefaction, Large Ground Deformation and Their Effects on Lifelines, September 26-29, 1989," Edited by T.D. O'Rourke and M. Hamada, 12/1/89, (PB90-209388, A22, MF-A03).
- NCEER-89-0033 "Deterministic Model for Seismic Damage Evaluation of Reinforced Concrete Structures," by J.M. Bracci, A.M. Reinhorn, J.B. Mander and S.K. Kunnath, 9/27/89, (PB91-108803, A06, MF-A01).
- NCEER-89-0034 "On the Relation Between Local and Global Damage Indices," by E. DiPasquale and A.S. Cakmak, 8/15/89, (PB90-173865, A05, MF-A01).
- NCEER-89-0035 "Cyclic Undrained Behavior of Nonplastic and Low Plasticity Silts," by A.J. Walker and H.E. Stewart, 7/26/89, (PB90-183518, A10, MF-A01).
- NCEER-89-0036 "Liquefaction Potential of Surficial Deposits in the City of Buffalo, New York," by M. Budhu, R. Giese and L. Baumgrass, 1/17/89, (PB90-208455, A04, MF-A01).
- NCEER-89-0037 "A Deterministic Assessment of Effects of Ground Motion Incoherence," by A.S. Veletsos and Y. Tang, 7/15/89, (PB90-164294, A03, MF-A01).
- NCEER-89-0038 "Workshop on Ground Motion Parameters for Seismic Hazard Mapping," July 17-18, 1989, edited by R.V. Whitman, 12/1/89, (PB90-173923, A04, MF-A01).
- NCEER-89-0039 "Seismic Effects on Elevated Transit Lines of the New York City Transit Authority," by C.J. Costantino, C.A. Miller and E. Heymsfield, 12/26/89, (PB90-207887, A06, MF-A01).
- NCEER-89-0040 "Centrifugal Modeling of Dynamic Soil-Structure Interaction," by K. Weissman, Supervised by J.H. Prevost, 5/10/89, (PB90-207879, A07, MF-A01).

- NCEER-89-0041 "Linearized Identification of Buildings With Cores for Seismic Vulnerability Assessment," by I.K. Ho and A.E. Aktan, 11/1/89, (PB90-251943, A07, MF-A01).
- NCEER-90-0001 "Geotechnical and Lifeline Aspects of the October 17, 1989 Loma Prieta Earthquake in San Francisco," by T.D. O'Rourke, H.E. Stewart, F.T. Blackburn and T.S. Dickerman, 1/90, (PB90-208596, A05, MF-A01).
- NCEER-90-0002 "Nonnormal Secondary Response Due to Yielding in a Primary Structure," by D.C.K. Chen and L.D. Lutes, 2/28/90, (PB90-251976, A07, MF-A01).
- NCEER-90-0003 "Earthquake Education Materials for Grades K-12," by K.E.K. Ross, 4/16/90, (PB91-251984, A05, MF-A05). This report has been replaced by NCEER-92-0018.
- NCEER-90-0004 "Catalog of Strong Motion Stations in Eastern North America," by R.W. Busby, 4/3/90, (PB90-251984, A05, MF-A01).
- NCEER-90-0005 "NCEER Strong-Motion Data Base: A User Manual for the GeoBase Release (Version 1.0 for the Sun3)," by P. Friberg and K. Jacob, 3/31/90 (PB90-258062, A04, MF-A01).
- NCEER-90-0006 "Seismic Hazard Along a Crude Oil Pipeline in the Event of an 1811-1812 Type New Madrid Earthquake," by H.H.M. Hwang and C.H.S. Chen, 4/16/90, (PB90-258054, A04, MF-A01).
- NCEER-90-0007 "Site-Specific Response Spectra for Memphis Sheahan Pumping Station," by H.H.M. Hwang and C.S. Lee, 5/15/90, (PB91-108811, A05, MF-A01).
- NCEER-90-0008 "Pilot Study on Seismic Vulnerability of Crude Oil Transmission Systems," by T. Arman, R. Dobry, M. Grigoriu, F. Kozin, M. O'Rourke, T. O'Rourke and M. Shinozuka, 5/25/90, (PB91-108837, A06, MF-A01).
- NCEER-90-0009 "A Program to Generate Site Dependent Time Histories: EQGEN," by G.W. Ellis, M. Srinivasan and A.S. Cakmak, 1/30/90, (PB91-108829, A04, MF-A01).
- NCEER-90-0010 "Active Isolation for Seismic Protection of Operating Rooms," by M.E. Talbot, Supervised by M. Shinozuka, 6/8/9, (PB91-110205, A05, MF-A01).
- NCEER-90-0011 "Program LINEARID for Identification of Linear Structural Dynamic Systems," by C-B. Yun and M. Shinozuka, 6/25/90, (PB91-110312, A08, MF-A01).
- NCEER-90-0012 "Two-Dimensional Two-Phase Elasto-Plastic Seismic Response of Earth Dams," by A.N. Ylagos, Supervised by J.H. Prevost, 6/20/90, (PB91-110197, A13, MF-A02).
- NCEER-90-0013 "Secondary Systems in Base-Isolated Structures: Experimental Investigation, Stochastic Response and Stochastic Sensitivity," by G.D. Manolis, G. Juhn, M.C. Constantinou and A.M. Reinhorn, 7/1/90, (PB91-110320, A08, MF-A01).
- NCEER-90-0014 "Seismic Behavior of Lightly-Reinforced Concrete Column and Beam-Column Joint Details," by S.P. Pessiki, C.H. Conley, P. Gergely and R.N. White, 8/22/90, (PB91-108795, A11, MF-A02).
- NCEER-90-0015 "Two Hybrid Control Systems for Building Structures Under Strong Earthquakes," by J.N. Yang and A. Danielians, 6/29/90, (PB91-125393, A04, MF-A01).
- NCEER-90-0016 "Instantaneous Optimal Control with Acceleration and Velocity Feedback," by J.N. Yang and Z. Li, 6/29/90, (PB91-125401, A03, MF-A01).
- NCEER-90-0017 "Reconnaissance Report on the Northern Iran Earthquake of June 21, 1990," by M. Mehrain, 10/4/90, (PB91-125377, A03, MF-A01).

- NCEER-90-0018 "Evaluation of Liquefaction Potential in Memphis and Shelby County," by T.S. Chang, P.S. Tang, C.S. Lee and H. Hwang, 8/10/90, (PB91-125427, A09, MF-A01).
- NCEER-90-0019 "Experimental and Analytical Study of a Combined Sliding Disc Bearing and Helical Steel Spring Isolation System," by M.C. Constantinou, A.S. Mokha and A.M. Reinhorn, 10/4/90, (PB91-125385, A06, MF-A01). This report is available only through NTIS (see address given above).
- NCEER-90-0020 "Experimental Study and Analytical Prediction of Earthquake Response of a Sliding Isolation System with a Spherical Surface," by A.S. Mokha, M.C. Constantinou and A.M. Reinhorn, 10/11/90, (PB91-125419, A05, MF-A01).
- NCEER-90-0021 "Dynamic Interaction Factors for Floating Pile Groups," by G. Gazetas, K. Fan, A. Kayma and E. Kausel, 9/10/90, (PB91-170381, A05, MF-A01).
- NCEER-90-0022 "Evaluation of Seismic Damage Indices for Reinforced Concrete Structures," by S. Rodriguez-Gomez and A.S. Cakmak, 9/30/90, (PB91-171322, A06, MF-A01).
- NCEER-90-0023 "Study of Site Response at a Selected Memphis Site," by H. Desai, S. Ahmad, E.S. Gazetas and M.R. Oh, 10/11/90, (PB91-196857, A03, MF-A01).
- NCEER-90-0024 "A User's Guide to Strongmo: Version 1.0 of NCEER's Strong-Motion Data Access Tool for PCs and Terminals," by P.A. Friberg and C.A.T. Susch, 11/15/90, (PB91-171272, A03, MF-A01).
- NCEER-90-0025 "A Three-Dimensional Analytical Study of Spatial Variability of Seismic Ground Motions," by I.-I. Hong and A.H.-S. Ang, 10/30/90, (PB91-170399, A09, MF-A01).
- NCEER-90-0026 "MUMOID User's Guide - A Program for the Identification of Modal Parameters," by S. Rodriguez-Gomez and E. DiPasquale, 9/30/90, (PB91-171298, A04, MF-A01).
- NCEER-90-0027 "SARCF-II User's Guide - Seismic Analysis of Reinforced Concrete Frames," by S. Rodriguez-Gomez, Y.S. Chung and C. Meyer, 9/30/90, (PB91-171280, A05, MF-A01).
- NCEER-90-0028 "Viscous Dampers: Testing, Modeling and Application in Vibration and Seismic Isolation," by N. Makris and M.C. Constantinou, 12/20/90, (PB91-190561, A06, MF-A01).
- NCEER-90-0029 "Soil Effects on Earthquake Ground Motions in the Memphis Area," by H. Hwang, C.S. Lee, K.W. Ng and T.S. Chang, 8/2/90, (PB91-190751, A05, MF-A01).
- NCEER-91-0001 "Proceedings from the Third Japan-U.S. Workshop on Earthquake Resistant Design of Lifeline Facilities and Countermeasures for Soil Liquefaction, December 17-19, 1990," edited by T.D. O'Rourke and M. Hamada, 2/1/91, (PB91-179259, A99, MF-A04).
- NCEER-91-0002 "Physical Space Solutions of Non-Proportionally Damped Systems," by M. Tong, Z. Liang and G.C. Lee, 1/15/91, (PB91-179242, A04, MF-A01).
- NCEER-91-0003 "Seismic Response of Single Piles and Pile Groups," by K. Fan and G. Gazetas, 1/10/91, (PB92-174994, A04, MF-A01).
- NCEER-91-0004 "Damping of Structures: Part I - Theory of Complex Damping," by Z. Liang and G. Lee, 10/10/91, (PB92-197235, A12, MF-A03).
- NCEER-91-0005 "3D-BASIS - Nonlinear Dynamic Analysis of Three Dimensional Base Isolated Structures: Part II," by S. Nagarajah, A.M. Reinhorn and M.C. Constantinou, 2/28/91, (PB91-190553, A07, MF-A01). This report has been replaced by NCEER-93-0011.

- NCEER-91-0006 "A Multidimensional Hysteretic Model for Plasticity Deforming Metals in Energy Absorbing Devices," by E.J. Graesser and F.A. Cozzarelli, 4/9/91, (PB92-108364, A04, MF-A01).
- NCEER-91-0007 "A Framework for Customizable Knowledge-Based Expert Systems with an Application to a KBES for Evaluating the Seismic Resistance of Existing Buildings," by E.G. Ibarra-Anaya and S.J. Fennes, 4/9/91, (PB91-210930, A08, MF-A01).
- NCEER-91-0008 "Nonlinear Analysis of Steel Frames with Semi-Rigid Connections Using the Capacity Spectrum Method," by G.G. Deierlein, S-H. Hsieh, Y-J. Shen and J.E. Abel, 7/2/91, (PB92-113828, A05, MF-A01).
- NCEER-91-0009 "Earthquake Education Materials for Grades K-12," by K.E.K. Ross, 4/30/91, (PB91-212142, A06, MF-A01). This report has been replaced by NCEER-92-0018.
- NCEER-91-0010 "Phase Wave Velocities and Displacement Phase Differences in a Harmonically Oscillating Pile," by N. Makris and G. Gazetas, 7/8/91, (PB92-108356, A04, MF-A01).
- NCEER-91-0011 "Dynamic Characteristics of a Full-Size Five-Story Steel Structure and a 2/5 Scale Model," by K.C. Chang, G.C. Yao, G.C. Lee, D.S. Hao and Y.C. Yeh," 7/2/91, (PB93-116648, A06, MF-A02).
- NCEER-91-0012 "Seismic Response of a 2/5 Scale Steel Structure with Added Viscoelastic Dampers," by K.C. Chang, T.T. Soong, S-T. Oh and M.L. Lai, 5/17/91, (PB92-110816, A05, MF-A01).
- NCEER-91-0013 "Earthquake Response of Retaining Walls: Full-Scale Testing and Computational Modeling," by S. Alampalli and A-W.M. Elgarnal, 6/20/91, to be published.
- NCEER-91-0014 "3D-BASIS-M: Nonlinear Dynamic Analysis of Multiple Building Base Isolated Structures," by P.C. Tsopelas, S. Nagarajah, M.C. Constantinou and A.M. Reinhorn, 5/28/91, (PB92-113885, A09, MF-A02).
- NCEER-91-0015 "Evaluation of SEAOC Design Requirements for Sliding Isolated Structures," by D. Theodossiou and M.C. Constantinou, 6/10/91, (PB92-114602, A11, MF-A03).
- NCEER-91-0016 "Closed-Loop Modal Testing of a 27-Story Reinforced Concrete Flat Plate-Core Building," by H.R. Somaprasad, T. Toksoy, H. Yoshiyuki and A.E. Aktan, 7/15/91, (PB92-129980, A07, MF-A02).
- NCEER-91-0017 "Shake Table Test of a 1/6 Scale Two-Story Lightly Reinforced Concrete Building," by A.G. El-Attar, R.N. White and P. Gergely, 2/28/91, (PB92 222447, A06, MF-A02).
- NCEER-91-0018 "Shake Table Test of a 1/8 Scale Three-Story Lightly Reinforced Concrete Building," by A.G. El-Attar, R.N. White and P. Gergely, 2/28/91, (PB93-116630, A08, MF-A02).
- NCEER-91-0019 "Transfer Functions for Rigid Rectangular Foundations," by A.S. Veletsos, A.M. Prasad and W.H. Wu, 7/31/91, to be published.
- NCEER-91-0020 "Hybrid Control of Seismic-Excited Nonlinear and Inelastic Structural Systems," by J.N. Yang, Z. Li and A. Danielians, 8/1/91, (PB92-143171, A06, MF-A02).
- NCEER-91-0021 "The NCEER-91 Earthquake Catalog: Improved Intensity-Based Magnitudes and Recurrence Relations for U.S. Earthquakes - East of New Madrid," by L. Seeber and J.G. Armbruster, 8/28/91, (PB92-176742, A06, MF-A02).
- NCEER-91-0022 "Proceedings from the Implementation of Earthquake Planning and Education in Schools: The Need for Change - The Roles of the Changemakers," by K.E.K. Ross and F. Winslow, 7/23/91, (PB92-129998, A12, MF-A03).
- NCEER-91-0023 "A Study of Reliability-Based Criteria for Seismic Design of Reinforced Concrete Frame Buildings," by H.H.M. Hwang and H-M. Hsu, 8/10/91, (PB92-140235, A09, MF-A02).

- NCEER-91-0024 "Experimental Verification of a Number of Structural System Identification Algorithms," by R.G. Ghanem, H. Gavin and M. Shinozuka, 9/18/91, (PB92-176577, A18, MF-A04).
- NCEER-91-0025 "Probabilistic Evaluation of Liquefaction Potential," by H.H.M. Hwang and C.S. Lee, 11/25/91, (PB92-143429, A05, MF-A01).
- NCEER-91-0026 "Instantaneous Optimal Control for Linear, Nonlinear and Hysteretic Structures - Stable Controllers," by J.N. Yang and Z. Li, 11/15/91, (PB92-163807, A04, MF-A01).
- NCEER-91-0027 "Experimental and Theoretical Study of a Sliding Isolation System for Bridges," by M.C. Constantinou, A. Kartoum, A.M. Reinhorn and P. Bradford, 11/15/91, (PB92-176973, A10, MF-A03).
- NCEER-92-0001 "Case Studies of Liquefaction and Lifeline Performance During Past Earthquakes, Volume 1: Japanese Case Studies," Edited by M. Hamada and T. O'Rourke, 2/17/92, (PB92-197243, A18, MF-A04).
- NCEER-92-0002 "Case Studies of Liquefaction and Lifeline Performance During Past Earthquakes, Volume 2: United States Case Studies," Edited by T. O'Rourke and M. Hamada, 2/17/92, (PB92-197250, A20, MF-A04).
- NCEER-92-0003 "Issues in Earthquake Education," Edited by K. Ross, 2/3/92, (PB92-222389, A07, MF-A02).
- NCEER-92-0004 "Proceedings from the First U.S. - Japan Workshop on Earthquake Protective Systems for Bridges," Edited by I.G. Buckle, 2/4/92, (PB94-142239, A99, MF-A06).
- NCEER-92-0005 "Seismic Ground Motion from a Haskell-Type Source in a Multiple-Layered Half-Space," A.P. Theoharis, G. Dondatis and M. Shinozuka, 1/2/92, to be published.
- NCEER-92-0006 "Proceedings from the Site Effects Workshop," Edited by R. Whitman, 2/29/92, (PB92-197201, A04, MF-A01).
- NCEER-92-0007 "Engineering Evaluation of Permanent Ground Deformations Due to Seismically-Induced Liquefaction," by M.H. Biazar, R. Dobry and A-W.M. Elgamal, 3/24/92, (PB92-222421, A13, MF-A03).
- NCEER-92-0008 "A Procedure for the Seismic Evaluation of Buildings in the Central and Eastern United States," by C.D. Poland and J.O. Malley, 4/2/92, (PB92-222439, A20, MF-A04).
- NCEER-92-0009 "Experimental and Analytical Study of a Hybrid Isolation System Using Friction Controllable Sliding Bearings," by M.Q. Feng, S. Fujii and M. Shinozuka, 5/15/92, (PB93-150282, A06, MF-A02).
- NCEER-92-0010 "Seismic Resistance of Slab-Column Connections in Existing Non-Ductile Flat-Plate Buildings," by A.J. Durrani and Y. Du, 5/18/92, (PB93-116812, A06, MF-A02).
- NCEER-92-0011 "The Hysteretic and Dynamic Behavior of Brick Masonry Walls Upgraded by Ferrocement Coatings Under Cyclic Loading and Strong Simulated Ground Motion," by H. Lee and S.P. Prawel, 5/11/92, to be published.
- NCEER-92-0012 "Study of Wire Rope Systems for Seismic Protection of Equipment in Buildings," by G.F. Demetriades, M.C. Constantinou and A.M. Reinhorn, 5/20/92, (PB93-116655, A08, MF-A02).
- NCEER-92-0013 "Shape Memory Structural Dampers: Material Properties, Design and Seismic Testing," by P.R. Witting and F.A. Cozzarelli, 5/26/92, (PB93-116663, A05, MF-A01).
- NCEER-92-0014 "Longitudinal Permanent Ground Deformation Effects on Buried Continuous Pipelines," by M.J. O'Rourke, and C. Nordberg, 6/15/92, (PB93-116671, A08, MF-A02).
- NCEER-92-0015 "A Simulation Method for Stationary Gaussian Random Functions Based on the Sampling Theorem," by M. Grigoriu and S. Balopoulou, 6/11/92, (PB93-127496, A05, MF-A01).

- NCEER-92-0016 "Gravity-Load-Designed Reinforced Concrete Buildings: Seismic Evaluation of Existing Construction and Detailing Strategies for Improved Seismic Resistance." by G.W. Hoffmann, S.K. Kunnath, A.M. Reinhorn and J.B. Mander, 7/15/92, (PB94-142007, A08, MF-A02).
- NCEER-92-0017 "Observations on Water System and Pipeline Performance in the Limón Area of Costa Rica Due to the April 22, 1991 Earthquake," by M. O'Rourke and D. Ballantyne, 6/30/92, (PB93-126811, A06, MF-A02).
- NCEER-92-0018 "Fourth Edition of Earthquake Education Materials for Grades K-12," Edited by K.E.K. Ross, 8/10/92, (PB93-114023, A07, MF-A02).
- NCEER-92-0019 "Proceedings from the Fourth Japan-U.S. Workshop on Earthquake Resistant Design of Lifeline Facilities and Countermeasures for Soil Liquefaction," Edited by M. Hamada and T.D. O'Rourke, 8/12/92, (PB93-163939, A99, MF-E11).
- NCEER-92-0020 "Active Bracing System: A Full Scale Implementation of Active Control," by A.M. Reinhorn, T.T. Soong, R.C. Lin, M.A. Riley, Y.P. Wang, S. Aizawa and M. Higashino, 8/14/92, (PB93-127512, A06, MF-A02).
- NCEER-92-0021 "Empirical Analysis of Horizontal Ground Displacement Generated by Liquefaction-Induced Lateral Spreads," by S.F. Bartlett and T.L. Youd, 8/17/92, (PB93-188241, A06, MF-A02).
- NCEER-92-0022 "IDARC Version 3.0. Inelastic Damage Analysis of Reinforced Concrete Structures," by S.K. Kunnath, A.M. Reinhorn and R.F. Lobo, 8/31/92, (PB93-227502, A07, MF-A02).
- NCEER-92-0023 "A Semi-Empirical Analysis of Strong-Motion Peaks in Terms of Seismic Source, Propagation Path and Local Site Conditions," by M. Kamiyama, M.J. O'Rourke and R. Flores-Berrones, 9/9/92, (PB93-150266, A08, MF-A02).
- NCEER-92-0024 "Seismic Behavior of Reinforced Concrete Frame Structures with Nonductile Details, Part I: Summary of Experimental Findings of Full Scale Beam-Column Joint Tests," by A. Beres, R.N. White and P. Gergely, 9/30/92, (PB93-227783, A05, MF-A01).
- NCEER-92-0025 "Experimental Results of Repaired and Retrofitted Beam-Column Joint Tests in Lightly Reinforced Concrete Frame Buildings," by A. Beres, S. El-Borgi, R.N. White and P. Gergely, 10/29/92, (PB93-227791, A05, MF-A01).
- NCEER-92-0026 "A Generalization of Optimal Control Theory: Linear and Nonlinear Structures," by J.N. Yang, Z. Li and S. Vongchavalitkul, 11/2/92, (PB93-188621, A05, MF-A01).
- NCEER-92-0027 "Seismic Resistance of Reinforced Concrete Frame Structures Designed Only for Gravity Loads: Part I - Design and Properties of a One-Third Scale Model Structure," by J.M. Bracci, A.M. Reinhorn and J.B. Mander, 12/1/92, (PB94-104502, A08, MF-A02).
- NCEER-92-0028 "Seismic Resistance of Reinforced Concrete Frame Structures Designed Only for Gravity Loads: Part II - Experimental Performance of Subassemblages," by L.E. Aycardi, J.B. Mander and A.M. Reinhorn, 12/1/92, (PB94-104510, A08, MF-A02).
- NCEER-92-0029 "Seismic Resistance of Reinforced Concrete Frame Structures Designed Only for Gravity Loads: Part III - Experimental Performance and Analytical Study of a Structural Model," by J.M. Bracci, A.M. Reinhorn and J.B. Mander, 12/1/92, (PB93-227528, A09, MF-A01).
- NCEER-92-0030 "Evaluation of Seismic Retrofit of Reinforced Concrete Frame Structures: Part I - Experimental Performance of Retrofitted Subassemblages," by D. Choudhury, J.B. Mander and A.M. Reinhorn, 12/8/92, (PB93-198307, A07, MF-A02).

- NCEER-92-0031 "Evaluation of Seismic Retrofit of Reinforced Concrete Frame Structures: Part II - Experimental Performance and Analytical Study of a Retrofitted Structural Model," by J.M. Bracci, A.M. Reinhorn and J.B. Mander, 12/8/92, (PB93-198315, A09, MF-A03).
- NCEER-92-0032 "Experimental and Analytical Investigation of Seismic Response of Structures with Supplemental Fluid Viscous Dampers," by M.C. Constantinou and M.D. Symans, 12/21/92, (PB93-191435, A10, MF-A03).
- NCEER-92-0033 "Reconnaissance Report on the Cairo, Egypt Earthquake of October 12, 1992," by M. Khater, 12/23/92, (PB93-188621, A03, MF-A01).
- NCEER-92-0034 "Low-Level Dynamic Characteristics of Four Tall Flat-Plate Buildings in New York City," by H. Gavin, S. Yuan, J. Grossman, E. Pekelis and K. Jacob, 12/28/92, (PB93-188217, A07, MF-A02).
- NCEER-93-0001 "An Experimental Study on the Seismic Performance of Brick-Infilled Steel Frames With and Without Retrofit," by J.B. Mander, B. Nair, K. Wojtkowski and J. Ma, 1/29/93, (PB93-227510, A07, MF-A02).
- NCEER-93-0002 "Social Accounting for Disaster Preparedness and Recovery Planning," by S. Cole, E. Pantoja and V. Razak, 2/22/93, (PB94-142114, A12, MF-A03).
- NCEER-93-0003 "Assessment of 1991 NEHRP Provisions for Nonstructural Components and Recommended Revisions," by T.T. Soong, G. Chen, Z. Wu, R.H. Zhang and M. Grigoriu, 3/1/93, (PB93-188639, A06, MF-A02).
- NCEER-93-0004 "Evaluation of Static and Response Spectrum Analysis Procedures of SEAOC/UBC for Seismic Isolated Structures," by C.W. Winters and M.C. Constantinou, 3/23/93, (PB93-198299, A10, MF-A03).
- NCEER-93-0005 "Earthquakes in the Northeast - Are We Ignoring the Hazard? A Workshop on Earthquake Science and Safety for Educators," edited by K.F.K. Ross, 4/2/93, (PB94-103066, A09, MF-A02).
- NCEER-93-0006 "Inelastic Response of Reinforced Concrete Structures with Viscoelastic Braces," by R.F. Lobo, J.M. Bracci, K.L. Shen, A.M. Reinhorn and T.T. Soong, 4/5/93, (PB93-227486, A05, MF-A02).
- NCEER-93-0007 "Seismic Testing of Installation Methods for Computers and Data Processing Equipment," by K. Kosar, T.T. Soong, K.L. Shen, J.A. HoLung and Y.K. Lin, 4/12/93, (PB93-198299, A07, MF-A02).
- NCEER-93-0008 "Retrofit of Reinforced Concrete Frames Using Added Dampers," by A. Reinhorn, M. Constantinou and C. Li, to be published.
- NCEER-93-0009 "Seismic Behavior and Design Guidelines for Steel Frame Structures with Added Viscoelastic Dampers," by K.C. Chang, M.L. Lai, T.T. Soong, D.S. Hao and Y.C. Yeh, 5/1/93, (PB94-141959, A07, MF-A02).
- NCEER-93-0010 "Seismic Performance of Shear-Critical Reinforced Concrete Bridge Piers," by J.B. Mander, S.M. Waheed, M.T.A. Chaudhary and S.S. Chen, 5/12/93, (PB93-227494, A08, MF-A02).
- NCEER-93-0011 "3D-BASIS-TABS: Computer Program for Nonlinear Dynamic Analysis of Three Dimensional Base Isolated Structures," by S. Nagarajaiah, C. Li, A.M. Reinhorn and M.C. Constantinou, 8/2/93, (PB94-141819, A09, MF-A02).
- NCEER-93-0012 "Effects of Hydrocarbon Spills from an Oil Pipeline Break on Ground Water," by O.J. Helweg and H.H.M. Hwang, 8/3/93, (PB94-141942, A06, MF-A02).
- NCEER-93-0013 "Simplified Procedures for Seismic Design of Nonstructural Components and Assessment of Current Code Provisions," by M.P. Singh, L.E. Suarez, E.E. Matheu and G.O. Maldonado, 8/4/93, (PB94-141827, A09, MF-A02).
- NCEER-93-0014 "An Energy Approach to Seismic Analysis and Design of Secondary Systems," by G. Chen and T.T. Soong, 8/6/93, (PB94-142767, A11, MF-A03).

- NCEER-93-0015 "Proceedings from School Sites: Becoming Prepared for Earthquakes - Commemorating the Third Anniversary of the Loma Prieta Earthquake," Edited by F.E. Winslow and K.E.K. Ross, 8/16/93, (PB94-154275, A16, MF-A02).
- NCEER-93-0016 "Reconnaissance Report of Damage to Historic Monuments in Cairo, Egypt Following the October 12, 1992 Dahshur Earthquake," by D. Sykora, D. Look, G. Croci, E. Karaesmen and E. Karaesmen, 8/19/93, (PB94-142221, A08, MF-A02).
- NCEER-93-0017 "The Island of Guam Earthquake of August 8, 1993," by S.W. Swan and S.K. Harris, 9/30/93, (PB94-141843, A04, MF-A01).
- NCEER-93-0018 "Engineering Aspects of the October 12, 1992 Egyptian Earthquake," by A.W. Elgamal, M. Amer, K. Adalier and A. Abul-Fadl, 10/7/93, (PB94-141983, A05, MF-A01).
- NCEER-93-0019 "Development of an Earthquake Motion Simulator and its Application in Dynamic Centrifuge Testing," by I. Krstelj, Supervised by J.H. Prevost, 10/23/93, (PB94-181773, A-10, MF-A03).
- NCEER-93-0020 "NCEER-Taisei Corporation Research Program on Sliding Seismic Isolation Systems for Bridges: Experimental and Analytical Study of a Friction Pendulum System (FPS)," by M.C. Constantinou, P. Tsopelas, Y-S. Kim and S. Okamoto, 11/1/93, (PB94-142775, A08, MF-A02).
- NCEER-93-0021 "Finite Element Modeling of Elastomeric Seismic Isolation Bearings," by L.J. Billings, Supervised by R. Shepherd, 11/8/93, to be published.
- NCEER-93-0022 "Seismic Vulnerability of Equipment in Critical Facilities: Life-Safety and Operational Consequences," by K. Porter, G.S. Johnson, M.M. Zadeh, C. Scawthorn and S. Eder, 11/24/93, (PB94-181765, A16, MF-A03).
- NCEER-93-0023 "Hokkaido Nansei-oki, Japan Earthquake of July 12, 1993, by P.I. Yanev and C.R. Scawthorn, 12/23/93, (PB94-181500, A07, MF-A01).
- NCEER-94-0001 "An Evaluation of Seismic Serviceability of Water Supply Networks with Application to the San Francisco Auxiliary Water Supply System," by I. Markov, Supervised by M. Grigoriu and T. O'Rourke, 1/21/94, (PB94-204013, A07, MF-A02).
- NCEER-94-0002 "NCEER-Taisei Corporation Research Program on Sliding Seismic Isolation Systems for Bridges: Experimental and Analytical Study of Systems Consisting of Sliding Bearings, Rubber Restoring Force Devices and Fluid Dampers," Volumes I and II, by P. Tsopelas, S. Okamoto, M.C. Constantinou, D. Ozaki and S. Fujii, 2/4/94, (PB94-181740, A09, MF-A02 and PB94-181757, A12, MF-A03).
- NCEER-94-0003 "A Markov Model for Local and Global Damage Indices in Seismic Analysis," by S. Rahman and M. Grigoriu, 2/18/94, (PB94-206000, A12, MF-A03).
- NCEER-94-0004 "Proceedings from the NCEER Workshop on Seismic Response of Masonry Infills," edited by D.P. Abrams, 3/1/94, (PB94-180783, A07, MF-A02).
- NCEER-94-0005 "The Northridge, California Earthquake of January 17, 1994: General Reconnaissance Report," edited by J.D. Goltz, 3/11/94, (PB193943, A10, MF-A03).
- NCEER-94-0006 "Seismic Energy Based Fatigue Damage Analysis of Bridge Columns. Part I - Evaluation of Seismic Capacity," by G.A. Chang and J.B. Mander, 3/14/94, (PB94-219185, A11, MF-A03).
- NCEER-94-0007 "Seismic Isolation of Multi-Story Frame Structures Using Spherical Sliding Isolation Systems," by T.M. Al-Hussaini, V.A. Zayas and M.C. Constantinou, 3/17/94, (PB193745, A09, MF-A02).

- NCEER-94-0008 "The Northridge, California Earthquake of January 17, 1994: Performance of Highway Bridges," edited by I.G. Buckle, 3/24/94, (PB94-193851, A06, MF-A02).
- NCEER-94-0009 "Proceedings of the Third U.S.-Japan Workshop on Earthquake Protective Systems for Bridges," edited by I.G. Buckle and I. Friedland, 3/31/94, (PB94-195815, A99, MF-A06).
- NCEER-94-0010 "3D-BASIS-ME: Computer Program for Nonlinear Dynamic Analysis of Seismically Isolated Single and Multiple Structures and Liquid Storage Tanks," by P.C. Tsopelas, M.C. Constantinou and A.M. Reinhorn, 4/12/94, (PB94-204922, A09, MF-A02).
- NCEER-94-0011 "The Northridge, California Earthquake of January 17, 1994: Performance of Gas Transmission Pipelines," by T.D. O'Rourke and M.C. Palmer, 5/16/94, (PB94-204989, A05, MF-A01).
- NCEER-94-0012 "Feasibility Study of Replacement Procedures and Earthquake Performance Related to Gas Transmission Pipelines," by T.D. O'Rourke and M.C. Palmer, 5/25/94, (PB94-206638, A09, MF-A02).
- NCEER-94-0013 "Seismic Energy Based Fatigue Damage Analysis of Bridge Columns: Part II - Evaluation of Seismic Demand," by G.A. Chang and J.B. Mander, 6/1/94, (PB95-18106, A08, MF-A02).
- NCEER-94-0014 "NCEER-Taisei Corporation Research Program on Sliding Seismic Isolation Systems for Bridges: Experimental and Analytical Study of a System Consisting of Sliding Bearings and Fluid Restoring Force/Damping Devices," by P. Tsopelas and M.C. Constantinou, 6/13/94, (PB94-219144, A10, MF-A03).
- NCEER-94-0015 "Generation of Hazard-Consistent Fragility Curves for Seismic Loss Estimation Studies," by H. Hwang and J.R. Huo, 6/14/94, (PB95-181996, A09, MF-A02).
- NCEER-94-0016 "Seismic Study of Building Frames with Added Energy-Absorbing Devices," by W.S. Pong, C.S. Tsai and G.C. Lee, 6/20/94, (PB94-219136, A10, A03).
- NCEER-94-0017 "Sliding Mode Control for Seismic-Excited Linear and Nonlinear Civil Engineering Structures," by J. Yang, J. Wu, A. Agrawal and Z. Li, 6/21/94, (PB95-138483, A06, MF-A02).
- NCEER-94-0018 "3D-BASIS-TABS Version 2.0: Computer Program for Nonlinear Dynamic Analysis of Three Dimensional Base Isolated Structures," by A.M. Reinhorn, S. Nagarajaiah, M.C. Constantinou, P. Tsopelas and R. Li, 6/22/94, (PB95-182176, A08, MF-A02).
- NCEER-94-0019 "Proceedings of the International Workshop on Civil Infrastructure Systems: Application of Intelligent Systems and Advanced Materials on Bridge Systems," Edited by G.C. Lee and K.C. Chang, 7/18/94, (PB95-252474, A20, MF-A04).
- NCEER-94-0020 "Study of Seismic Isolation Systems for Computer Floors," by V. Lambrou and M.C. Constantinou, 7/19/94, (PB95-138533, A10, MF-A03).
- NCEER-94-0021 "Proceedings of the U.S.-Italian Workshop on Guidelines for Seismic Evaluation and Rehabilitation of Unreinforced Masonry Buildings," Edited by D.P. Abrams and G.M. Calvi, 7/20/94, (PB95-138749, A13, MF-A03).
- NCEER-94-0022 "NCEER-Taisei Corporation Research Program on Sliding Seismic Isolation Systems for Bridges: Experimental and Analytical Study of a System Consisting of Lubricated PTFE Sliding Bearings and Mild Steel Dampers," by P. Tsopelas and M.C. Constantinou, 7/22/94, (PB95-182184, A08, MF-A02).
- NCEER-94-0023 "Development of Reliability-Based Design Criteria for Buildings Under Seismic Load," by Y.K. Wen, H. Hwang and M. Shinozuka, 8/1/94, (PB95-211934, A08, MF-A02).

- NCEER-94-0024 "Experimental Verification of Acceleration Feedback Control Strategies for an Active Tendon System," by S.J. Dyke, B.F. Spencer, Jr., P. Quast, M.K. Sam, D.C. Kaspari, Jr. and T.T. Soong, 8/29/94, (PB95-212320, A05, MF-A01).
- NCEER-94-0025 "Seismic Retrofitting Manual for Highway Bridges," Edited by I.G. Buckle and I.F. Friedland, to be published.
- NCEER-94-0026 "Proceedings from the Fifth U.S.-Japan Workshop on Earthquake Resistant Design of Lifeline Facilities and Countermeasures Against Soil Liquefaction," Edited by T.D. O'Rourke and M. Hamada, 11/7/94, (PB95-220802, A99, MF-F08).
- NCEER-95-0001 "Experimental and Analytical Investigation of Seismic Retrofit of Structures with Supplemental Damping: Part I - Fluid Viscous Damping Devices," by A.M. Reinhorn, C. Li and M.C. Constantinou, 1/3/95, (PB95-266599, A09, MF-A02).
- NCEER-95-0002 "Experimental and Analytical Study of Low-Cycle Fatigue Behavior of Semi-Rigid Top-And-Seat Angle Connections," by G. Pekcan, J.B. Mander and S.S. Chen, 1/5/95, (PB95-220042, A07, MF-A02).
- NCEER-95-0003 "NCEER-ATC Joint Study on Fragility of Buildings," by T. Anagnos, C. Rojahn and A.S. Kiremidjian, 1/20/95, (PB95-220026, A06, MF-A02).
- NCEER-95-0004 "Nonlinear Control Algorithms for Peak Response Reduction," by Z. Wu, T.T. Soong, V. Gattulli and R.C. Lin, 2/16/95, (PB95-220349, A05, MF-A01).
- NCEER-95-0005 "Pipeline Replacement Feasibility Study: A Methodology for Minimizing Seismic and Corrosion Risks to Underground Natural Gas Pipelines," by R.T. Iguchi, H.A. Seligson and D.G. Honegger, 3/2/95, (PB95-252326, A06, MF-A02).
- NCEER-95-0006 "Evaluation of Seismic Performance of an 11-Story Frame Building During the 1994 Northridge Earthquake," by F. Naeim, R. DiSullo, K. Benuska, A. Reinhorn and C. Li, to be published.
- NCEER-95-0007 "Prioritization of Bridges for Seismic Retrofitting," by N. Basoz and A.S. Kiremidjian, 4/24/95, (PB95-252300, A08, MF-A02).
- NCEER-95-0008 "Method for Developing Motion Damage Relationships for Reinforced Concrete Frames," by A. Singhal and A.S. Kiremidjian, 5/11/95, (PB95-266607, A06, MF-A02).
- NCEER-95-0009 "Experimental and Analytical Investigation of Seismic Retrofit of Structures with Supplemental Damping: Part II - Friction Devices," by C. Li and A.M. Reinhorn, 7/6/95, (PB96-128087, A11, MF-A03).
- NCEER-95-0010 "Experimental Performance and Analytical Study of a Non-Ductile Reinforced Concrete Frame Structure Retrofitted with Elastomeric Spring Dampers," by G. Pekcan, J.B. Mander and S.S. Chen, 7/14/95, (PB96-137161, A08, MF-A02).
- NCEER-95-0011 "Development and Experimental Study of Semi-Active Fluid Damping Devices for Seismic Protection of Structures," by M.D. Symans and M.C. Constantinou, 8/3/95, (PB96-136940, A23, MF-A04).
- NCEER-95-0012 "Real-Time Structural Parameter Modification (RSPM): Development of Innervated Structures," by Z. Liang, M. Tong and G.C. Lee, 4/11/95, (PB96-137153, A06, MF-A01).
- NCEER-95-0013 "Experimental and Analytical Investigation of Seismic Retrofit of Structures with Supplemental Damping: Part III - Viscous Damping Walls," by A.M. Reinhorn and C. Li, 10/1/95.
- NCEER-95-0014 "Seismic Fragility Analysis of Equipment and Structures in a Memphis Electric Substation," by J-R. Huo and H.H.M. Hwang, 8/10/95.

- NCEER-95-0015 "The Hanshin-Awaji Earthquake of January 17, 1995: Performance of Lifelines," Edited by M. Shinozuka, 11/3/95, (PB96-176383, A15, MF-A03).
- NCEER-95-0016 "Highway Culvert Performance During Earthquakes," by T.L. Youd and C.J. Beckman, 11/6/95, to be published.
- NCEER-95-0017 "The Hanshin-Awaji Earthquake of January 17, 1995: Performance of Highway Bridges," Edited by I.G. Buckle, 12/1/95, to be published.
- NCEER-95-0018 "Modeling of Masonry Infill Panels for Structural Analysis," by A.M. Reinhorn, A. Madan, R.E. Valles, Y. Reichmann and J.B. Mander, 12/8/95.
- NCEER-95-0019 "Optimal Polynomial Control for Linear and Nonlinear Structures," by A.K. Agrawal and J.N. Yang, 12/11/95, (PB96-168737, A07, MF-A02).
- NCEER-95-0020 "Retrofit of Non-Ductile Reinforced Concrete Frames Using Friction Dampers," by R.S. Rao, P. Gergely and R.N. White, 12/22/95.
- NCEER-95-0021 "Parametric Results for Seismic Response of Pile-Supported Bridge Bents," by G. Mylonakis, A. Nikolaou and G. Gazetas, 12/22/95.
- NCEER-95-0022 "Kinematic Bending Moments in Seismically Stressed Piles," by A. Nikolaou, G. Mylonakis and G. Gazetas, 12/23/95.
- NCEER-96-0001 "Dynamic Behavior of Unreinforced Masonry Buildings with Flexible Diaphragms," by A.C. Costley and D.P. Abrams, to be published.
- NCEER-96-0002 "State of the Art Review: Foundations and Retaining Structures," by I. Po Lam, to be published.
- NCEER-96-0003 "Ductility of Rectangular Reinforced Concrete Bridge Columns with Moderate Confinement," by N. Wehbe, M. Saïdi, D. Sanders and B. Douglas, 5/24/96.
- NCEER-96-0004 "Proceedings of the Long-Span Bridge Seismic Research Workshop," by I.G. Buckle and I.M. Friedland, to be published.
- NCEER-96-0005 "Establish Representative Pier Types for Comprehensive Study: Eastern United States," by J. Kulicki and Z. Prucz, 5/28/96.
- NCEER-96-0006 "Establish Representative Pier Types for Comprehensive Study: Western United States," by R. Imbsen, R.A. Schamber and T.A. Osterkamp, 5/28/96.
- NCEER-96-0007 "Nonlinear Control Techniques for Dynamical Systems with Uncertain Parameters," by R.G. Ghanem and M.I. Bujakov, 5/27/96.
- NCEER-96-0008 "Seismic Evaluation of a 30-Year Old Non-Ductile Highway Bridge Pier and Its Retrofit," by J.B. Mander, B. Mahmoodzadegan, S. Bhadra and S.S. Chen, 5/31/96.
- NCEER-96-0009 "Seismic Performance of a Model Reinforced Concrete Bridge Pier Before and After Retrofit," by J.B. Mander, J.H. Kim and C.A. Ligozio, 5/31/96.
- NCEER-96-0010 "IDARC2D Version 4.0: A Computer Program for the Inelastic Damage Analysis of Buildings," by R.E. Valles, A.M. Reinhorn, S.K. Kunnath, C. Li and A. Madan, 6/3/96.