

Exploded diagram and spare parts list

For machines with - GL192-03

[Click](#)







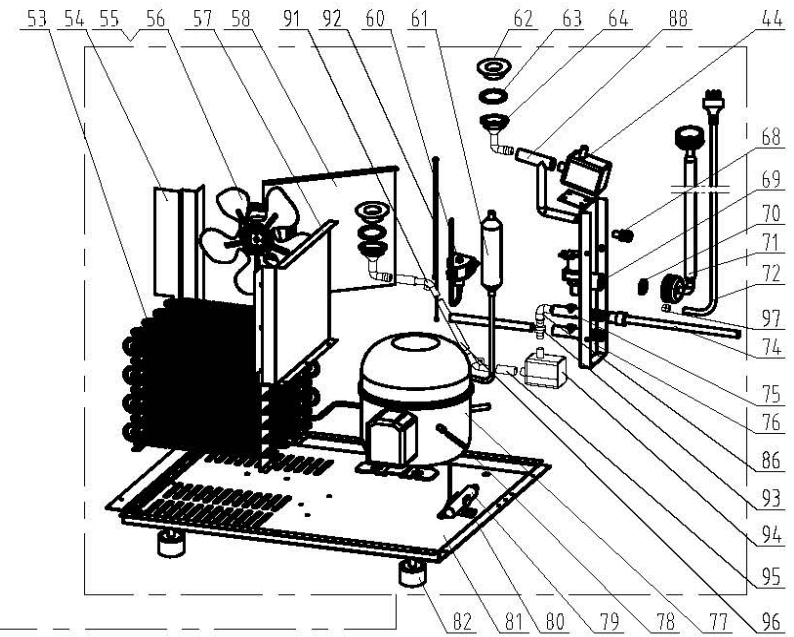
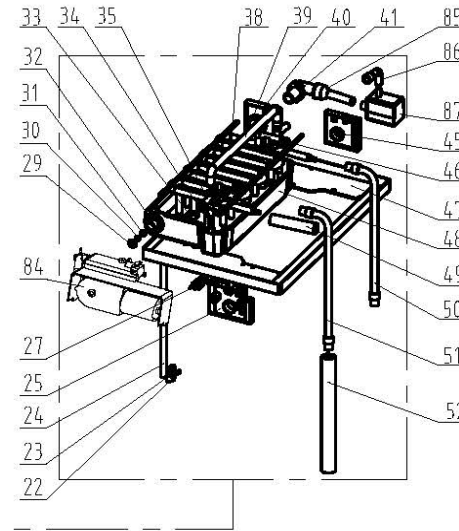
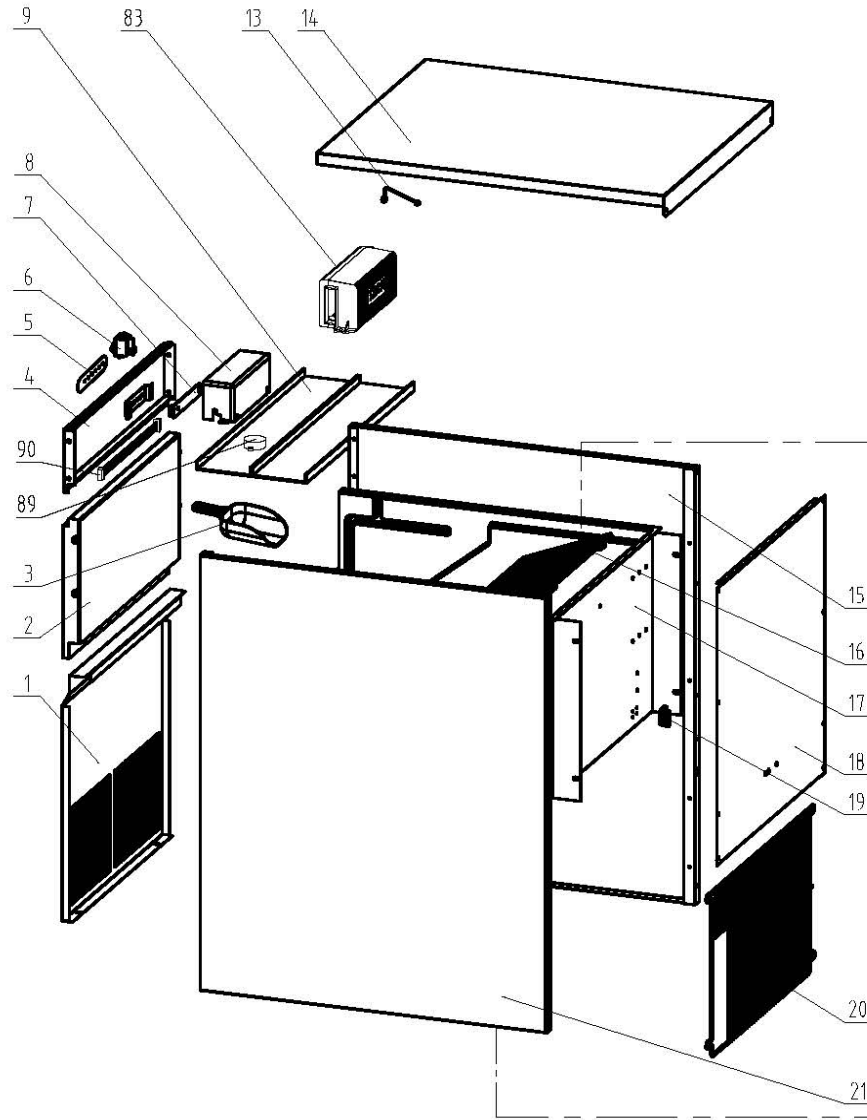

From 5085237-UK(5K19060001-5K19060072), 25977-EU(1KB19120001-1KB19120108)

For machines with – GL192-02/GL192

[Click](#)









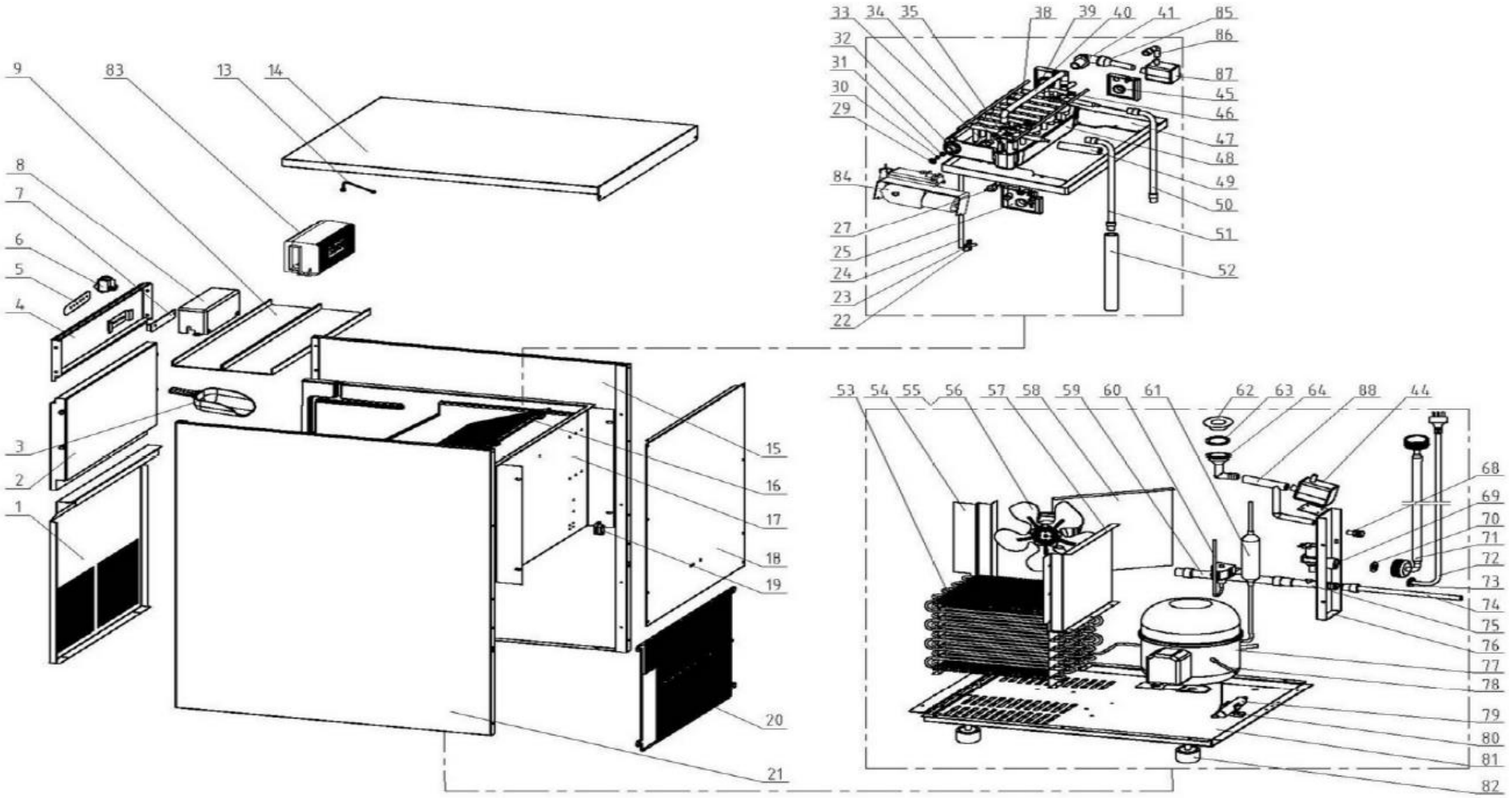

Prior to 5085237-UK(5K19060001-5K19060072), 25977-EU(1KB19120001-1KB19120108)











Machine	Explode	Code	Description
GL192 - Polar Bullet Ice Maker - 50kg/24hr	1	AN680	Lower Front Panel
GL192 - Polar Bullet Ice Maker - 50kg/24hr	2	AM520	Door (Stainless Steel)
GL192 - Polar Bullet Ice Maker - 50kg/24hr	3	AA107	Ice Scoop
GL192 - Polar Bullet Ice Maker - 50kg/24hr	4		Upper Front Panel
GL192 - Polar Bullet Ice Maker - 50kg/24hr	5	AH074	PVC Cover with Auto-Clean Button
GL192 - Polar Bullet Ice Maker - 50kg/24hr	6	AA226	On-off Switch
GL192 - Polar Bullet Ice Maker - 50kg/24hr	7	AH346	Indicator Panel with Auto-Clean
GL192 - Polar Bullet Ice Maker - 50kg/24hr	8		Operation Panel Cover
GL192 - Polar Bullet Ice Maker - 50kg/24hr	9		Upper Edge Pane
GL192 - Polar Bullet Ice Maker - 50kg/24hr	13	AG101	Ambient Temperature Sensor
GL192 - Polar Bullet Ice Maker - 50kg/24hr	14	AJ777	Top Panel
GL192 - Polar Bullet Ice Maker - 50kg/24hr	15		Left Panel
GL192 - Polar Bullet Ice Maker - 50kg/24hr	16	AG102	Ice Shelf
GL192 - Polar Bullet Ice Maker - 50kg/24hr	17	AN595	Inner Liner
GL192 - Polar Bullet Ice Maker - 50kg/24hr	18		Back Panel
GL192 - Polar Bullet Ice Maker - 50kg/24hr	19	AA178	Fixer for Cable
GL192 - Polar Bullet Ice Maker - 50kg/24hr	20		Grill
GL192 - Polar Bullet Ice Maker - 50kg/24hr	21		Right Panel
GL192 - Polar Bullet Ice Maker - 50kg/24hr	22	AA278	Ice Level Sensor Fixer
GL192 - Polar Bullet Ice Maker - 50kg/24hr	23	AA244	Ice Level Sensor
GL192 - Polar Bullet Ice Maker - 50kg/24hr	24	AN257	Wiring Pipe
GL192 - Polar Bullet Ice Maker - 50kg/24hr	25	AE946	Motor Fixer
GL192 - Polar Bullet Ice Maker - 50kg/24hr	27	AA129	Water Level Sensor-old version
GL192 - Polar Bullet Ice Maker - 50kg/24hr	27	AL127	Water Level Sensor-From GL192-04
GL192 - Polar Bullet Ice Maker - 50kg/24hr	29	AA256	Plain Washer (M6 SS)
GL192 - Polar Bullet Ice Maker - 50kg/24hr	30	AA257	Spring Washer (M6 SS)
GL192 - Polar Bullet Ice Maker - 50kg/24hr	31	AA115	Stopping Nut
GL192 - Polar Bullet Ice Maker - 50kg/24hr	32	AH060	Axis Cover
GL192 - Polar Bullet Ice Maker - 50kg/24hr	33	AE944	Water Running Nozzle Cover
GL192 - Polar Bullet Ice Maker - 50kg/24hr	34	AA244	Water Temperature Sensor
GL192 - Polar Bullet Ice Maker - 50kg/24hr	35	AA237	Water Shower
GL192 - Polar Bullet Ice Maker - 50kg/24hr	38	AG106	Evaporator
GL192 - Polar Bullet Ice Maker - 50kg/24hr	39	AL476	Injection Pipe Connector
GL192 - Polar Bullet Ice Maker - 50kg/24hr	40	AA240	Evaporator Fixer
GL192 - Polar Bullet Ice Maker - 50kg/24hr	41	AA241	Rinse Pipe Connector
GL192 - Polar Bullet Ice Maker - 50kg/24hr	44	AA560	Recycle Pump (TP-450)
GL192 - Polar Bullet Ice Maker - 50kg/24hr	45	AL477	Small Evaporator Bracket
GL192 - Polar Bullet Ice Maker - 50kg/24hr	46	AA249	Elbow Of Water Inlet
GL192 - Polar Bullet Ice Maker - 50kg/24hr	47		Upper Fixing Board
GL192 - Polar Bullet Ice Maker - 50kg/24hr	48	AH072	Water Box
GL192 - Polar Bullet Ice Maker - 50kg/24hr	49		Heat Preservation Pipe for Ice Pipe
GL192 - Polar Bullet Ice Maker - 50kg/24hr	50	AL582	Water Filling Tube
GL192 - Polar Bullet Ice Maker - 50kg/24hr	51	AL911	Cycle Pipe
GL192 - Polar Bullet Ice Maker - 50kg/24hr	52		Heat Preservation Pipe for Water Pipe
GL192 - Polar Bullet Ice Maker - 50kg/24hr	53	AG108	Condenser (R290)

GL192 - Polar Bullet Ice Maker - 50kg/24hr	54		Right Baffle Board
GL192 - Polar Bullet Ice Maker - 50kg/24hr	55	AG120	Fan & Blade
GL192 - Polar Bullet Ice Maker - 50kg/24hr	56		Fan Fixer
GL192 - Polar Bullet Ice Maker - 50kg/24hr	57		Left Baffle Board
GL192 - Polar Bullet Ice Maker - 50kg/24hr	58		Front Baffle Board
GL192 - Polar Bullet Ice Maker - 50kg/24hr	60	AA263	Magnetic Valve
GL192 - Polar Bullet Ice Maker - 50kg/24hr	61		Suction Pipe Sub-assembly
GL192 - Polar Bullet Ice Maker - 50kg/24hr	62	AL611	Drainage Cover
GL192 - Polar Bullet Ice Maker - 50kg/24hr	63	AE699	Drainage Pipe Gasket
GL192 - Polar Bullet Ice Maker - 50kg/24hr	64	AL612	Discharged Elbow Connector
GL192 - Polar Bullet Ice Maker - 50kg/24hr	68	AG111	Water Outlet Valve
GL192 - Polar Bullet Ice Maker - 50kg/24hr	69	AA265	Water Inlet Valve
GL192 - Polar Bullet Ice Maker - 50kg/24hr	70	AN165	Water Inlet Tube Gasket
GL192 - Polar Bullet Ice Maker - 50kg/24hr	71	AE695	Water Inlet Tube
GL192 - Polar Bullet Ice Maker - 50kg/24hr	72	AN294	Power Cord
GL192 - Polar Bullet Ice Maker - 50kg/24hr	74	AE948	Drainage Tube
GL192 - Polar Bullet Ice Maker - 50kg/24hr	75	AL496	Drainage Connector
GL192 - Polar Bullet Ice Maker - 50kg/24hr	76		Water Valve Fixer Board
GL192 - Polar Bullet Ice Maker - 50kg/24hr	77	AG112	Compressor (R290)
GL192 - Polar Bullet Ice Maker - 50kg/24hr	78		Pipe
GL192 - Polar Bullet Ice Maker - 50kg/24hr	79	AG877	Filter
GL192 - Polar Bullet Ice Maker - 50kg/24hr	80		Filter Fixer
GL192 - Polar Bullet Ice Maker - 50kg/24hr	81		Compressor Fixing Board
GL192 - Polar Bullet Ice Maker - 50kg/24hr	82	AA276	Feet
GL192 - Polar Bullet Ice Maker - 50kg/24hr	83	AK585	Main Control Box Assembly to Control Extra Drainage Pump with Auto-Clean
GL192 - Polar Bullet Ice Maker - 50kg/24hr	84	AG104	DC Tray Motor Subassembly
GL192 - Polar Bullet Ice Maker - 50kg/24hr	85	AM397	Water Inlet Pipe Connection with Pump(TP-600)
GL192 - Polar Bullet Ice Maker - 50kg/24hr	86	AM398	Water Outlet Pipe Connection with Pump(TP-600)
GL192 - Polar Bullet Ice Maker - 50kg/24hr	87	AH023	Water Pump (TP-600)
GL192 - Polar Bullet Ice Maker - 50kg/24hr	88	AL613	Water Recycle T Pipe
GL192 - Polar Bullet Ice Maker - 50kg/24hr	89		Warning Alarm
GL192 - Polar Bullet Ice Maker - 50kg/24hr	90		Wiring
GL192 - Polar Bullet Ice Maker - 50kg/24hr	91	AL987	Water Level Sensor Tube
GL192 - Polar Bullet Ice Maker - 50kg/24hr	92	AL337	Water Pump Wire
GL192 - Polar Bullet Ice Maker - 50kg/24hr	93	AL338	One Way Valve
GL192 - Polar Bullet Ice Maker - 50kg/24hr	94	AJ776	Water Pump
GL192 - Polar Bullet Ice Maker - 50kg/24hr	95	AL339	Water Intlet Pipe for New Drain Pump
GL192 - Polar Bullet Ice Maker - 50kg/24hr	96	AL340	Water Outlet Pipe for New Drain Pump
GL192 - Polar Bullet Ice Maker - 50kg/24hr	97		Power Cord Fixer
GL192 - Polar Bullet Ice Maker - 50kg/24hr	N/A	AN218	Drain Pump Connectors Assembly
GL192 - Polar Bullet Ice Maker - 50kg/24hr	N/A	AN394	Pump Wirings
GL192 - Polar Bullet Ice Maker - 50kg/24hr	N/A	AL341	Mirco Switch
GL192 - Polar Bullet Ice Maker - 50kg/24hr	N/A		Rubber Bung



Machine	Explode	Code	Description
GL192 - Polar Bullet Ice Maker - 50kg/24hr	1	AN680	Lower Front Panel
GL192 - Polar Bullet Ice Maker - 50kg/24hr	2	AM520	Door (Stainless Steel)
GL192 - Polar Bullet Ice Maker - 50kg/24hr	3	AA107	Ice Scoop
GL192 - Polar Bullet Ice Maker - 50kg/24hr	4		Upper Front Panel
GL192 - Polar Bullet Ice Maker - 50kg/24hr	5	AA224	PVC Cover (old version)
GL192 - Polar Bullet Ice Maker - 50kg/24hr	5	AH074	PVC Cover with Auto-Clean Button-From 5054534-UK
GL192 - Polar Bullet Ice Maker - 50kg/24hr	6	AA226	On-off Switch
GL192 - Polar Bullet Ice Maker - 50kg/24hr	7	AA102	Indicator Panel (old version)
GL192 - Polar Bullet Ice Maker - 50kg/24hr	7	AH346	Indicator Panel with Auto-Clean (From 5054534-UK)
GL192 - Polar Bullet Ice Maker - 50kg/24hr	8		Operation Panel Cover
GL192 - Polar Bullet Ice Maker - 50kg/24hr	9		Upper Edge Pane
GL192 - Polar Bullet Ice Maker - 50kg/24hr	13	AG101	Ambient Temperature Sensor
GL192 - Polar Bullet Ice Maker - 50kg/24hr	14	AJ777	Top Panel
GL192 - Polar Bullet Ice Maker - 50kg/24hr	15		Left Panel
GL192 - Polar Bullet Ice Maker - 50kg/24hr	16	AG102	Ice Shelf
GL192 - Polar Bullet Ice Maker - 50kg/24hr	17	AN595	Inner Liner
GL192 - Polar Bullet Ice Maker - 50kg/24hr	18		Back Panel
GL192 - Polar Bullet Ice Maker - 50kg/24hr	19	AA178	Fixer for Cable
GL192 - Polar Bullet Ice Maker - 50kg/24hr	20		Grill
GL192 - Polar Bullet Ice Maker - 50kg/24hr	21		Right Panel
GL192 - Polar Bullet Ice Maker - 50kg/24hr	22	AA278	Ice Level Sensor Fixer
GL192 - Polar Bullet Ice Maker - 50kg/24hr	23	AA244	Ice Level Sensor
GL192 - Polar Bullet Ice Maker - 50kg/24hr	24	AN257	Wiring Pipe
GL192 - Polar Bullet Ice Maker - 50kg/24hr	25	AE946	Motor Fixer
GL192 - Polar Bullet Ice Maker - 50kg/24hr	27	AA129	Water Level Sensor
GL192 - Polar Bullet Ice Maker - 50kg/24hr	29	AA256	Plain Washer (M6 SS)
GL192 - Polar Bullet Ice Maker - 50kg/24hr	30	AA257	Spring Washer (M6 SS)
GL192 - Polar Bullet Ice Maker - 50kg/24hr	31	AA115	Stopping Nut
GL192 - Polar Bullet Ice Maker - 50kg/24hr	32	AH060	Axis Cover
GL192 - Polar Bullet Ice Maker - 50kg/24hr	33	AE944	Water Running Nozzle Cover
GL192 - Polar Bullet Ice Maker - 50kg/24hr	34	AA244	Water Temperature Sensor
GL192 - Polar Bullet Ice Maker - 50kg/24hr	35	AA237	Water Shower
GL192 - Polar Bullet Ice Maker - 50kg/24hr	38	AG106	Evaporator
GL192 - Polar Bullet Ice Maker - 50kg/24hr	39	AL476	Injection Pipe Connector
GL192 - Polar Bullet Ice Maker - 50kg/24hr	40	AA240	Evaporator Fixer
GL192 - Polar Bullet Ice Maker - 50kg/24hr	41	AA241	Rinse Pipe Connector
GL192 - Polar Bullet Ice Maker - 50kg/24hr	44	AA560	Recycle Pump (TP-450)
GL192 - Polar Bullet Ice Maker - 50kg/24hr	45	AL477	Small Evaporator Bracket
GL192 - Polar Bullet Ice Maker - 50kg/24hr	46	AA249	Elbow Of Water Inlet
GL192 - Polar Bullet Ice Maker - 50kg/24hr	47		Upper Fixing Board
GL192 - Polar Bullet Ice Maker - 50kg/24hr	48	AH072	Water Box
GL192 - Polar Bullet Ice Maker - 50kg/24hr	49		Heat Preservation Pipe For Ice Pipe
GL192 - Polar Bullet Ice Maker - 50kg/24hr	50	AL582	Water Filling Tube
GL192 - Polar Bullet Ice Maker - 50kg/24hr	51	AL911	Cycle Pipe
GL192 - Polar Bullet Ice Maker - 50kg/24hr	52		Heat Preservation Pipe For Water Pipe

GL192 - Polar Bullet Ice Maker - 50kg/24hr	53	AG108	Condenser (R290)
GL192 - Polar Bullet Ice Maker - 50kg/24hr	54		Right Baffle Board
GL192 - Polar Bullet Ice Maker - 50kg/24hr	55	AG120	Fan & Blade
GL192 - Polar Bullet Ice Maker - 50kg/24hr	56		Fan Fixer
GL192 - Polar Bullet Ice Maker - 50kg/24hr	57		Left Baffle Board
GL192 - Polar Bullet Ice Maker - 50kg/24hr	58		Front Baffle Board
GL192 - Polar Bullet Ice Maker - 50kg/24hr	59		Ice Water Drain Tube
GL192 - Polar Bullet Ice Maker - 50kg/24hr	60	AA263	Magnetic Valve
GL192 - Polar Bullet Ice Maker - 50kg/24hr	61		Suction Pipe Sub-assembly
GL192 - Polar Bullet Ice Maker - 50kg/24hr	62	AL611	Drainage Cover
GL192 - Polar Bullet Ice Maker - 50kg/24hr	63	AE699	Drainage Pipe Gasket
GL192 - Polar Bullet Ice Maker - 50kg/24hr	64	AL612	Discharged Elbow Connector
GL192 - Polar Bullet Ice Maker - 50kg/24hr	68	AG111	Water Outlet Valve
GL192 - Polar Bullet Ice Maker - 50kg/24hr	69	AA265	Water Inlet Valve
GL192 - Polar Bullet Ice Maker - 50kg/24hr	70	AN165	Water Inlet Tube Gasket
GL192 - Polar Bullet Ice Maker - 50kg/24hr	71	AE695	Water Inlet Tube
GL192 - Polar Bullet Ice Maker - 50kg/24hr	72	AN294	Power Cord
GL192 - Polar Bullet Ice Maker - 50kg/24hr	73	AP026	Cover For Power Cord
GL192 - Polar Bullet Ice Maker - 50kg/24hr	74	AE948	Drainage Tube
GL192 - Polar Bullet Ice Maker - 50kg/24hr	75	AL496	Drainage Connector
GL192 - Polar Bullet Ice Maker - 50kg/24hr	76		Water Valve Fixer Board
GL192 - Polar Bullet Ice Maker - 50kg/24hr	77	AG112	Compressor (R290)
GL192 - Polar Bullet Ice Maker - 50kg/24hr	78		Pipe
GL192 - Polar Bullet Ice Maker - 50kg/24hr	79	AG877	Filter
GL192 - Polar Bullet Ice Maker - 50kg/24hr	80		Filter Fixer
GL192 - Polar Bullet Ice Maker - 50kg/24hr	81		Compressor Fixing Board
GL192 - Polar Bullet Ice Maker - 50kg/24hr	82	AA276	Feet
GL192 - Polar Bullet Ice Maker - 50kg/24hr	83	AG100	Main Control Box Assembly (old version)
GL192 - Polar Bullet Ice Maker - 50kg/24hr	83	AH347	Main Control Box Assembly with Auto-Clean (From 5054534-UK)
GL192 - Polar Bullet Ice Maker - 50kg/24hr	84	AA125	AC Tray Motor-old
GL192 - Polar Bullet Ice Maker - 50kg/24hr	84	AG104	DC Tray Motor Subassembly-new
GL192 - Polar Bullet Ice Maker - 50kg/24hr	85	AE941	Water Recycling Tube for TP-450
GL192 - Polar Bullet Ice Maker - 50kg/24hr	86	AE943	Pump Connector for TP-450
GL192 - Polar Bullet Ice Maker - 50kg/24hr	85	AM397	Water Inlet Pipe Connection with Pump(TP-600)
GL192 - Polar Bullet Ice Maker - 50kg/24hr	86	AM398	Water Outlet Pipe Connection with Pump(TP-600)
GL192 - Polar Bullet Ice Maker - 50kg/24hr	87	AH023	Water Pump (TP-600)
GL192 - Polar Bullet Ice Maker - 50kg/24hr	88	AL613	Water Recycle T Pipe