

Modular Wiring System

For Lighting



Atkore[™]
ACS/Uni-Fab



Suspended Ceiling Lighting

ACS/Uni-Fab Modular Wiring Systems For Lighting

The total solution to your wiring needs.

- Industrial
- Commercial
- Retail
- Institutional

ACS offers wiring systems for suspended ceiling lighting and for high and low bay fixtures. These systems feature a modular design, with components that snap together for quick, reliable installation, saving time and money over hard-wired methods.

The modularity also makes it easy for end users to reconfigure facilities. When a plant manager lays out a new assembly line or an office manager relocates work stations, they simply unplug fixtures and replug them at their new locations. The same is true in big box stores, hospitals, schools, and warehouses.

ACS provides these lighting systems with clear wiring diagrams from the factory. This helps speed installation, making it easy to complete the wiring right the first time.

All ACS wiring system components are UL tested and union-manufactured to exacting standards in a controlled environment. Each system is 100% factory tested prior to shipment, your assurance of a high quality, reliable product.

ACS offers two modular wiring systems for Suspended Ceiling lighting fixtures, Flex² and Flex⁴. These systems are ideal for commercial, industrial, retail and institutional applications including offices, department stores, schools and hospitals.

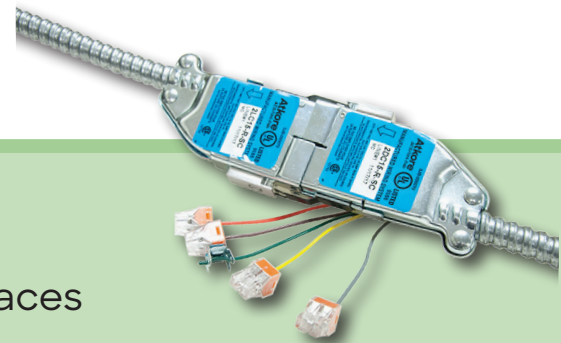

Extremely Durable

.060 thickness – same as junction box which it replaces

Easy to Assemble

Components easily connect and disconnect from each other

Secure Connections and Highest Conductivity

Ensured by connectors' proprietary pin and sleeve design and unique latch and strike configuration

Why Modular Wiring

Labor Savings for Highbay Applications

- 30-50% Savings on Total Installed Cost vs. Conventional Wiring

Labor Savings for Troffer Applications

- 10-25% Savings on Total Installed Cost vs. Conventional Wiring

Adds, Moves & Changes

- Plug & Play Wiring System
- Easily facilitates the inevitable changes over the life of your building

Potential Tax Saving Benefits

- ACS Modular Wiring is portable and may be designated by IRS Tax Codes as "Tangible Personal Property." As such, it is eligible for accelerated depreciation for potential tax savings.

Environmental Stewardship

- Green, Reusable and Recyclable
- Customers have received LEED's points for innovation using ACS Systems

These easy to install modular wiring systems save time and money over traditional hard-wired methods. The components simply plug together to supply power to every fixture down the line. When relocation occurs, components can easily be unplugged and plugged back in at their new location. Systems are available to address local and panel switching in single or dual level applications.

Flex² is a simple modular wiring system requiring only two components. Flex⁴ adds two more components to address various switching options.

All system components are UL listed and labeled.



Table of Contents

Modular Wiring Systems for Lighting 2
Why Modular Wiring 3
Table of Contents 4

Suspended Ceiling Lighting Applications

Flex2 Basic Components 5 - 6
Flex4 Basic Components 7 - 10
Flex4 Accessory Components 11 - 13

High & Low Bay Lighting Applications

Overview 14
Flex³ Basic Components 15 - 18
Flex³⁺ Sample Drawings 19
Flex³⁺ Basic Components 20 - 21
Flex^{3+C} Basic Components 22 - 23
Luminary Flex^{4C} Basic Components 24 - 25
Luminary Flex^{4C} Accessory Components 26
Accessory Components 27



Flex² Basic Components

The Flex² modular wiring for lighting system requires only two basic components to supply power to suspended ceiling lighting fixtures. These components simply plug together and connect directly to the lighting fixture leads. This makes installation quick and easy, yielding impressive time and labor savings. The flexibility of the Flex² system allows lighting fixtures to be easily relocated by simply unplugging connections, moving the fixtures, and plugging the cables back in again.

Flex² is ideal for commercial, retail and institutional applications requiring panel switching. It can also be adapted to provide local switching. Flex² is widely used in offices, department stores, supermarkets, schools and hospitals.

All components in the Flex² system are rated for use on 20 ampere branch circuits and are UL listed and labeled.

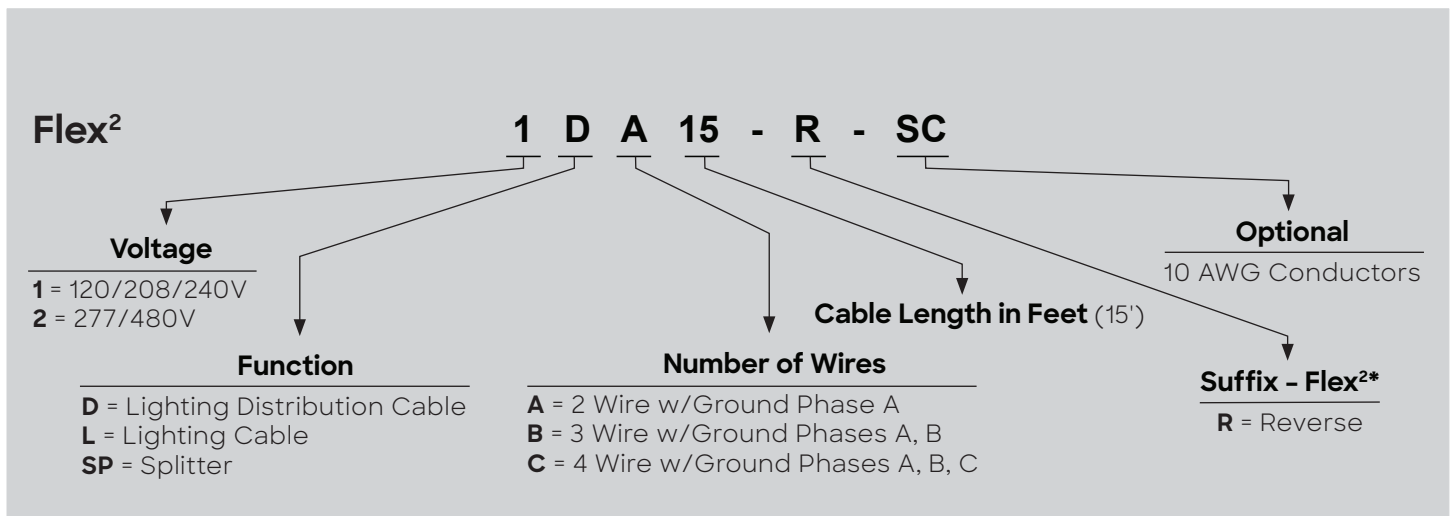

Flex² is the simplest system on the market for fast, accurate installations. The ease of installation of the Flex² system makes it attractive for recessed lighting applications in locations such as libraries, hospitals and other medical facilities.

Lighting Distribution Cable



Function:
Supplies power from junction box to the first lighting fixture in a run.

Lighting Cable

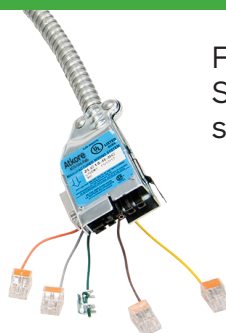

Function:
Supplies power to successive lighting fixtures.

Flex² Basic Components

Lighting Distribution Cable

Application

The Lighting Distribution Cable is the first component of the Flex² modular wiring system. Once power is brought from the lighting panel to the point of distribution by conventional hard-wiring means, the Lighting Distribution Cable is installed through a ½" trade size knock-out. The cable conductors are spliced to the hard-wired conductors and the interface is complete. The opposite end of the component is connected to the first lighting fixture of a run.

Features

- Rated for use on 20 ampere branch circuits
- Manufactured from Type MC Cable featuring 90°C insulated, #12 AWG solid copper conductors and a #12 AWG solid copper ground
- Lighting cable leads are 105°C insulated, #18 AWG, solid copper conductors
- 6 inches of THHN insulated conductors are provided through a ½" connector for connection to the hard-wire system
- Pin and sleeve connector design
- To eliminate inter-voltage connection each connector is keyed and color coded to meet specific voltage requirements
- UL listed and labeled



Catalog #'s	Description	Colors
120/208V		
1DA*R	Single Circuit, 2-Wire W/Ground	Black, White and Green
1DB*R	Two Circuit, 3-Wire W/Ground	Black, Red, White and Green
1DC*R	Three Circuit, 4-Wire W/Ground	Black, Red, Blue, White and Green
277/480V		
2DA*R	Single Circuit, 2-Wire W/Ground	Brown, Gray and Green
2DB*R	Two Circuit, 3-Wire W/Ground	Brown, Orange, Gray and Green
2DC*R	Three Circuit, 4-Wire W/Ground	Brown, Orange, Yellow, Gray and Green

* Denotes Cable Length In Feet
Note: Add (-SC) suffix for 10 AWG conductors

Lighting Cable

Application

Once installed, the Lighting Cable delivers panel-controlled branch circuit power to a lighting fixture in an accessible ceiling. This is accomplished simply by joining the lighting fixture leads to the lighting cable leads via the push-in fixture connectors supplied and then plugging the cable into the ½" knock-out in the fixture access plate. The other end of the Lighting Cable, featuring snap-in plug connectors, delivers power from fixture to fixture in a run.

Features

- Rated for use on 20 ampere branch circuits
- Manufactured from Type MC Cable featuring 90°C insulated, #12 AWG solid copper conductors and a #12 AWG insulated, solid copper ground
- Lighting cable leads are 105°C insulated, #18 AWG, solid copper conductors
- Pin and sleeve connector design
- To eliminate inter-voltage connection each connector is keyed and color coded to meet specific voltage requirements
- UL listed and labeled



Catalog #'s	Description	Colors
120/208V		
1LA*R	Single Circuit, 2-Wire W/Ground	Black, White and Green
1LB*R	Two Circuit, 3-Wire W/Ground	Black, Red, White and Green
1LC*R	Three Circuit, 4-Wire W/Ground	Black, Red, Blue, White and Green
277/480V		
2LA*R	Single Circuit, 2-Wire W/Ground	Brown, Gray and Green
2LB*R	Two Circuit, 3-Wire W/Ground	Brown, Orange, Gray and Green
2LC*R	Three Circuit, 4-Wire W/Ground	Brown, Orange, Yellow, Gray and Green

* Denotes Cable Length In Feet
Note: Add (-SC) suffix for 10 AWG conductors



Flex⁴ Basic Components

The Flex⁴ modular wiring system provides a quick and easy way to power suspended ceiling lighting fixtures. Its four basic components allow you to install and reconfigure lighting fixtures by simply plugging in and unplugging connections. The system also includes four accessory components which give the installer more options and greater flexibility when wiring the lighting fixtures.

Flex⁴ can support any switching application that is specified, single- or dual-level, single- or dual-circuit. Its unique, user-friendly design means installers need fewer cables than with any other system.

Common applications of the Flex⁴ system include suspended ceiling lighting fixtures in commercial, retail and institutional applications such as commercial offices, department stores and schools.

All components in the Flex⁴ system are rated for use on 20 ampere branch circuits and are UL listed and labeled.

The Flex⁴ system handles a wide variety of local switching applications in commercial, industrial, retail and institutional locations.

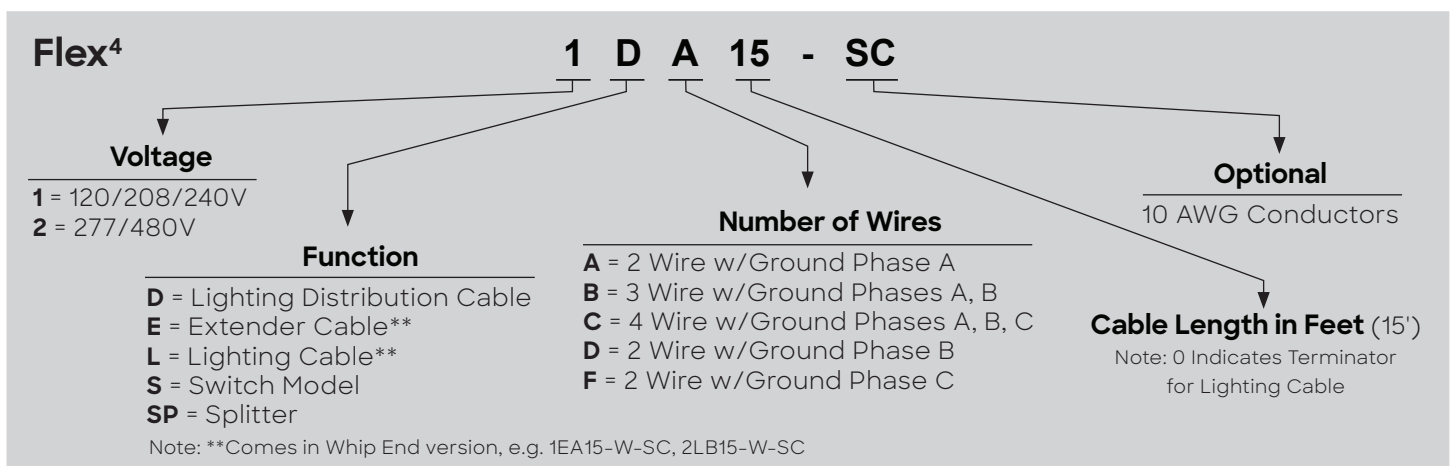

Flex⁴, the original ACS system, is the industry standard for reliability, versatility and economy.

Distribution Cable



Function:
Interface between hard-wiring and Flex⁴ system.

Lighting



Function:
Supplies branch circuit power to a lighting fixture.

Terminator



Function:
Used at end of lighting runs

Extender Cable



Function:
Delivers branch circuit power to a Switch Module and extends the length of the other cables

Flex⁴ Sample Drawing

TYPICAL INTERCONNECTION SEQUENCE EXAMPLE without switching capabilities

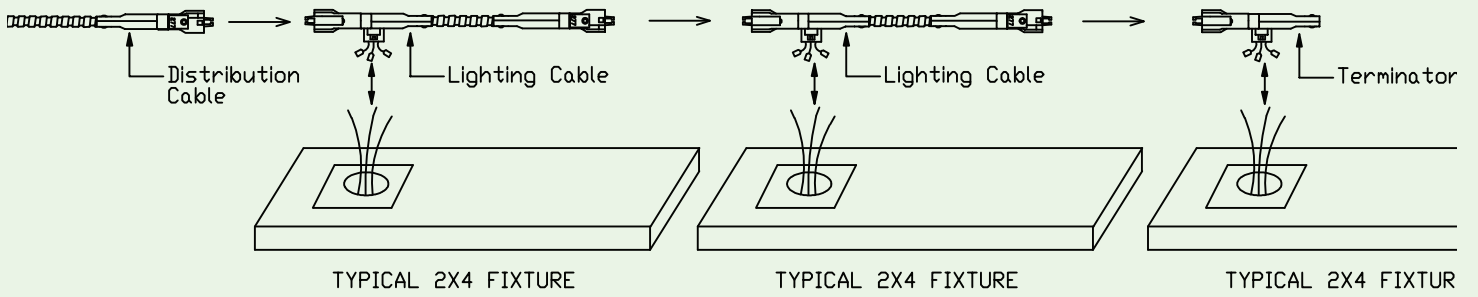

Flex⁴ Basic Components

Distribution Cable

Application

The Distribution Cable functions as the starting point from which all other Flex⁴ system components are connected. Once power is brought from the lighting panel to the point of distribution by conventional hard-wiring means, the Distribution Cable is installed through a ½" trade size knock-out. The cable conductors are spliced to the hard-wired conductors and the interface is complete.

Features

- Rated for use on 20 ampere branch circuits
- Manufactured from Type MC Cable featuring 90°C insulated, #12 AWG, solid copper conductors and a #12 AWG insulated, solid copper ground
- 6 inches of THHN insulated conductors are provided through a ½" connector for connection to the hard-wire system
- Pin and sleeve connector design
- To eliminate inter-voltage connection each connector is keyed and color coded to meet specific voltage requirements
- UL listed and labeled



Catalog #'s	Description	Colors
120/208V		
1DA*	Single Circuit, 2-Wire W/Ground	Black, White and Green
1DB*	Two Circuit, 3-Wire W/Ground	Black, Red, White and Green
1DC*	Three Circuit, 4-Wire W/Ground	Black, Red, Blue, White and Green
277/480V		
2DA*	Single Circuit, 2-Wire W/Ground	Brown, Gray and Green
2DB*	Two Circuit, 3-Wire W/Ground	Brown, Orange, Gray and Green
2DC*	Three Circuit, 4-Wire W/Ground	Brown, Orange, Yellow, Gray and Green

* Denotes Cable Length In Feet
Note: Add (-SC) suffix for 10 AWG conductors

Lighting Cable

Application

Once installed, the Lighting Cable delivers locally or panel-controlled branch circuit power to a lighting fixture in an accessible ceiling. This is accomplished simply by joining the lighting fixture leads to the Lighting Cable leads via the push-in fixture connectors supplied, then plugging the cable into the ½" knock-out in the fixture access plate. Alternatively, a factory-installed fixture receptacle may be employed to make connection.

Features

- Rated for use on 20 ampere branch circuits
- Manufactured from Type MC Cable featuring 90°C insulated, #12 AWG solid copper conductors and a #12 AWG insulated, solid copper ground
- Lighting cable leads are 105°C insulated, #18 AWG solid copper conductors
- Pin and sleeve connector design
- To eliminate inter-voltage connection each connector is keyed and color coded to meet specific voltage requirements
- UL listed and labeled



Catalog #'s	Description	Colors
120/208V		
1LA*	Single Circuit, 2-Wire W/Ground	Black, White and Green
1LB*	Two Circuit, 3-Wire W/Ground	Black, Red, White and Green
1LC*	Three Circuit, 4-Wire W/Ground	Black, Red, Blue, White and Green
277/480V		
2LA*	Single Circuit, 2-Wire W/Ground	Brown, Gray and Green
2LB*	Two Circuit, 3-Wire W/Ground	Brown, Orange, Gray and Green
2LC*	Three Circuit, 4-Wire W/Ground	Brown, Orange, Yellow, Gray and Green

* Denotes Cable Length In Feet
Note: Add (-SC) suffix for 10 AWG conductors



Flex⁴ Basic Components

Terminator

Application

Designed to be used at the last lighting fixture of each cable run, the Terminator eliminates the coiling of excess cable above the last lighting fixture which will occur if a lighting cable is used instead.

Features

- Rated for use on 20 ampere branch circuits
- Lighting cable leads are 105°C insulated, #18 AWG, solid copper conductors
- Pin and sleeve connector design
- To eliminate inter-voltage connection each connector is keyed and color coded to meet specific voltage requirements
- UL listed and labeled

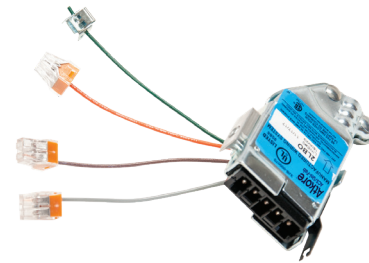

Catalog #'s	Description	Colors
120/208V		
1LBO	3-Wire W/Ground, used to terminate both single and dual circuit runs	Black, Red, White and Green
1LCO	4-Wire W/Ground, three circuit	Black, Red, Blue, White and Green
277/480V		
2LBO	3-Wire W/Ground, used to terminate both single and dual circuit runs	Brown, Orange, Gray and Green
2LCO	4-Wire W/Ground, three circuit	Brown, Orange, Yellow, Gray and Green

Extender Cable

Application

A versatile component in the Flex⁴ wiring system, the Extender Cable is used primarily to carry branch circuit power to a switch module for a locally-switched application. However, it can also be used to extend the length of other cables.

Features

- Rated for use on 20 ampere branch circuits
- Manufactured from Type MC Cable featuring 90°C insulated, #12 AWG solid copper conductors and a #12 AWG insulated solid copper ground
- Pin and sleeve connector design
- To eliminate inter-voltage connection each connector is keyed and color coded to meet specific voltage requirements
- UL listed and labeled



Catalog #'s	Description	Colors
120/208V		
1EA*	Single Circuit, 2-Wire W/Ground	Black, White and Green
1EB*	Two Circuit, 3-Wire W/Ground	Black, Red, White and Green
1EC*	Three Circuit, 4-Wire W/Ground	Black, Red, Blue, White and Green
277/480V		
2EA*	Single Circuit, 2-Wire W/Ground	Brown, Gray and Green
2EB*	Two Circuit, 3-Wire W/Ground	Brown, Orange, Gray and Green
2EC*	Three Circuit, 4-Wire W/Ground	Brown, Orange, Yellow, Gray and Green

* Denotes Cable Length In Feet
Note: Add (-SC) suffix for 10 AWG conductors



Flex⁴ Accessory Components

Switch Module

Application

Designed to provide locally-controlled switching of a room or other indoor area as desired, the Switch Module comes factory pre-wired with a “power-in,” “power-out,” and switched “power-out” tap. An Extender Cable, or a Distribution Cable plugged into the Switch Module’s “power-in” tap supplies the Switch Module with unswitched power. To complete the installation, simply plug the “switched power-out” tap into the first Lighting Cable being controlled and make the proper terminations at the switch or switches.

Features

- Rated for use on 20 ampere branch circuits
- Factory pre-wired with a “power-in,” “power-out,” and switched power-out” tap
- Provides switched and unswitched power at each location
- Manufactured from Type MC Cable featuring 90°C insulated, #12 AWG solid copper conductors and a #12 AWG insulated, solid copper ground
- Pin and sleeve connector design
- To eliminate inter-voltage connection each connector is keyed and color coded to meet specific voltage requirements
- UL listed and labeled



Catalog #'s	Description	Colors
120/208V		
1SA*	Single Circuit, 2-Wire W/Ground	Black Feed, Pink Return and Green
1SB*	Two Circuit, 3-Wire W/Ground	Black Feed, Pink Return, Light Blue Return and Green
1SC*	Three Circuit, 4-Wire W/Ground	Black Feed, Red Feed, Pink Return, Light Blue Return, and Green
277/480V		
2SA*	Single Circuit, 2-Wire W/Ground	Brown Feed, Purple Return, and Green
2SB*	Two Circuit, 3-Wire W/Ground	Brown Feed, Purple Return, Tan Return and Green
2SC*	Three Circuit, 4-Wire W/Ground	Brown Feed, Orange Feed, Purple Return, Tan Return and Green

* Denotes Cable Length In Feet
Note: Add (-SC) suffix for 10 AWG conductors

Splitter

Application

Designed with one “power-in” tap and two “power-out” taps, the Splitter makes it possible to split a single cable run into two directions.

Features

- Rated for use on 20 ampere branch circuits
- Designed with one “power-in” tap and two “power-out” taps
- Internally wired with 90°C insulated, #12 AWG solid copper conductors and a #12 AWG insulated, solid copper ground
- Pin and sleeve connector design
- To eliminate inter-voltage connection each connector is keyed and color coded to meet specific voltage requirements
- UL listed and labeled



Catalog #'s	Description	Colors
120/208V		
1SPB	Two circuit, 3-Wire W/Ground	Black, Red, White and Green
1SPC	Three circuit, 4-Wire W/Ground	Black, Red, Blue, White and Green
277/480V		
2SPB	Two circuit, 3-Wire W/Ground	Brown, Orange, Gray and green
2SPC	Three circuit, 4-Wire W/Ground	Brown, Orange, Yellow, Gray and Green

* Denotes Cable Length In Feet
Note: Add (-SC) suffix for 10 AWG conductors



Flex⁴ Accessory Components

Whip End Lighting Cable

Application

In operation, the Whip End Lighting Cable is used to deliver locally or panel-controlled branch circuit power to a lighting fixture in an accessible ceiling without the use of a factory-installed receptacle. This can be accomplished by joining the lighting fixture leads to the lighting cable leads via the push-in feature connectors supplied, then plugging the cable into a ½" knock-out in the fixture access plate. The "Whip-End" of the cable serves to extend the same branch circuit power to a non-accessible ceiling area.

Features

- Rated for use on 20 ampere branch circuits
- Manufactured from Type MC Cable featuring 90°C insulated, #12 AWG solid copper conductors and a #12 AWG insulated, solid copper ground
- Lighting cable leads are 105°C insulated, #18 AWG, solid copper conductors
- Pin and sleeve connector design
- To eliminate inter-voltage connection each connector is keyed and color coded to meet specific voltage requirements
- UL listed and labeled



Catalog #s	Description	Colors
120/208V		
1LA*-W	Single Circuit, 2-Wire W/Ground	Black, White and Green
1LB*-W	Two Circuit, 3-Wire W/Ground	Black, Red, White and Green
1LC*-W	Three Circuit, 4-Wire W/Ground	Black, Red, Blue, White and Green
277/480V		
2LA*-W	Single Circuit, 2-Wire W/Ground	Brown, Gray and Green
2LB*-W	Two Circuit, 3-Wire W/Ground	Brown, Orange, Gray and Green
2LC*-W	Three Circuit, 4-Wire W/Ground	Brown, Orange, Yellow, Gray and Green

* Denotes Cable Length In Feet
Note: Add (-SC) suffix for 10 AWG conductors

Whip End Extender Cable

Application

Provides an easy way to carry branch circuit power from any "power-out" tap to a non-accessible ceiling area.

Features

- Rated for use on 20 ampere branch circuits
- Manufactured from Type MC Cable featuring 90°C insulated, #12 AWG solid copper conductors and a #12 AWG insulated, solid copper ground
- Pin and sleeve connector design
- To eliminate inter-voltage connection each connector is keyed and color coded to meet specific voltage requirements
- UL listed and labeled

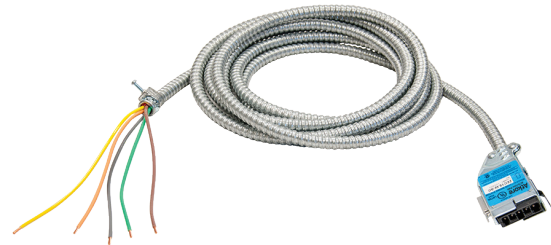

Catalog #s	Description	Colors
120/208V		
1EA*-W	Single Circuit, 2-Wire W/Ground	Black, White and Green
1EB*-W	Two Circuit, 3-Wire W/Ground	Black, Red, White and Green
1EC*-W	Three Circuit, 4-Wire W/Ground	Black, Red, Blue, White and Green
277/480V		
2EA*-W	Single Circuit, 2-Wire W/Ground	Brown, Gray and Green
2EB*-W	Two Circuit, 3-Wire W/Ground	Brown, Orange, Gray and Green
2EC*-W	Three Circuit, 4-Wire W/Ground	Brown, Orange, Yellow, Gray and Green

* Denotes Cable Length In Feet
Note: Add (-SC) suffix for 10 AWG conductors



Flex⁴ Accessory Components

Lighting “T”

Application

The Lighting “T” is used in conjunction with the Distribution Cable and Extender Cable. This component has power-in & power-out to feed fixtures down the line.

Features

- Rated for 20 ampere branch circuits
- Manufactured with 105°C THHN insulated, #18 AWG solid copper conductors and an #18 AWG insulated, solid copper ground
- Pin and sleeve connector design
- To eliminate inter-voltage connection each connector is keyed and color coded to meet specific voltage requirements
- Can be field wired or factory installed and shipped with the fixtures
- UL Listed and Labeled

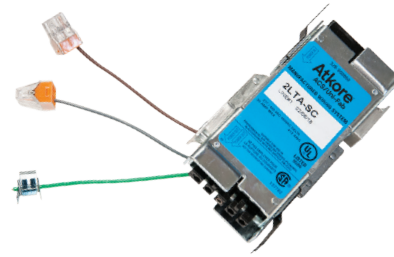

Catalog #'s	Description	Colors
120/208V		
1LTA	Single Circuit, 2-Wire W/Ground	Black, White and Green
1LTB	Two Circuit, 3-Wire W/Ground	Black, Red, White and Green
1LTC	Three Circuit, 4-Wire W/Ground	Black, Red, Blue, White and Green
277/480V		
2LTA	Single Circuit, 2-Wire W/Ground	Brown, Gray And Green
2LTB	Two Circuit, 3-Wire W/Ground	Brown, Orange, Gray and Green
2LTC	Three Circuit, 4-Wire W/Ground	Brown, Orange, Yellow, Gray and Green

Power “T”

Application

The Power “T” is designed to deliver branch circuit power to a device or convenience wall outlet, this is accomplished by the MC Cable drop with a connector to be installed into a ½” connector trade size knockout on the enclosure. The “T” has power-in & power-out port and is fed by an Extender Cable.

Features

- Rated for 20 ampere branch circuits
- Manufactured from Type MC Cable featuring with 90°C insulated, #12 AWG solid copper conductors and a #12 AWG insulated, solid copper ground
- 6 inches of THHN insulated conductors are provided through a ½” connector
- Pin and sleeve connector design
- To eliminate inter-voltage connection each connector is keyed and color coded to meet specific voltage requirements
- UL Listed and Labeled

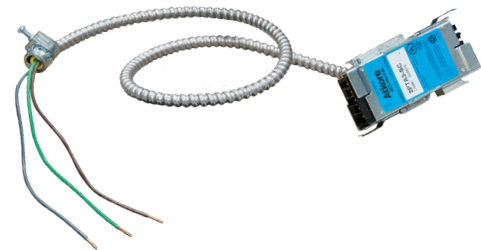

Catalog #'s	Description	Colors
120/208V		
1PTA*	Single Circuit, 2-Wire W/Ground	Black, White and Green
1PTB*	Two Circuit, 3-Wire W/Ground	Black, Red, White and Green
1PTC*	Three Circuit, 4-Wire W/Ground	Black, Red, Blue, White and Green
277/480V		
2PTA*	Single Circuit, 2-Wire W/Ground	Brown, Gray and Green
2PTB*	Two Circuit, 3-Wire W/Ground	Brown, Orange, Gray and Green
2PTC*	Three Circuit, 4-Wire W/Ground	Brown, Orange, Yellow, Gray and Green

* Denotes Cable Length In Feet
Note: Add (-SC) suffix for 10 AWG conductors



High & Low Bay Lighting

ACS offers three modular wiring systems for high and low bay lighting fixtures, Flex³, Flex³⁺ and Flex^{3+C}. These systems are ideal for virtually any commercial, industrial, retail and institutional location requiring high or low bay fixtures including factories, warehouses, super stores and supermarkets.

These easy to install modular wiring systems offer significant benefits over traditional hard-wiring methods including lower installation costs, due to dramatic reduction in time spent on the job site. Flex³⁺'s simplicity of design, needing only one pass at each fixture location, produces savings in total installed cost of 30-50% or more, depending on local labor rates.

The Flex³ high bay wiring system requires only three components. Flex³⁺ and Flex^{3+C} still only three components, permits the disconnection and removal of lighting fixtures without interrupting power supply down the line.

All system components are UL listed and labeled.

Single Circuit Panel Switched

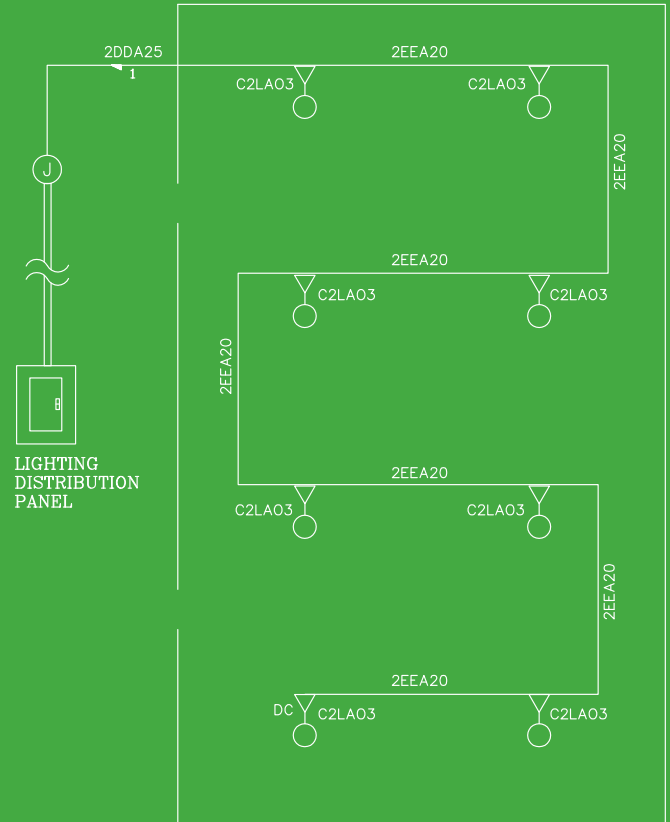

Flex³ Basic Components

The Flex³ modular wiring system requires only three basic components to supply power to lighting fixtures in both high and low bay locations. These components can easily be installed or relocated by simply unplugging and plugging in connections.

Common applications of Flex³ include high and low bay lighting fixtures in industrial locations such as factories or warehouses and retail locations such as supermarkets and super stores.

All components in the Flex³ system are rated for use on 20 ampere branch circuits and are UL listed and labeled.

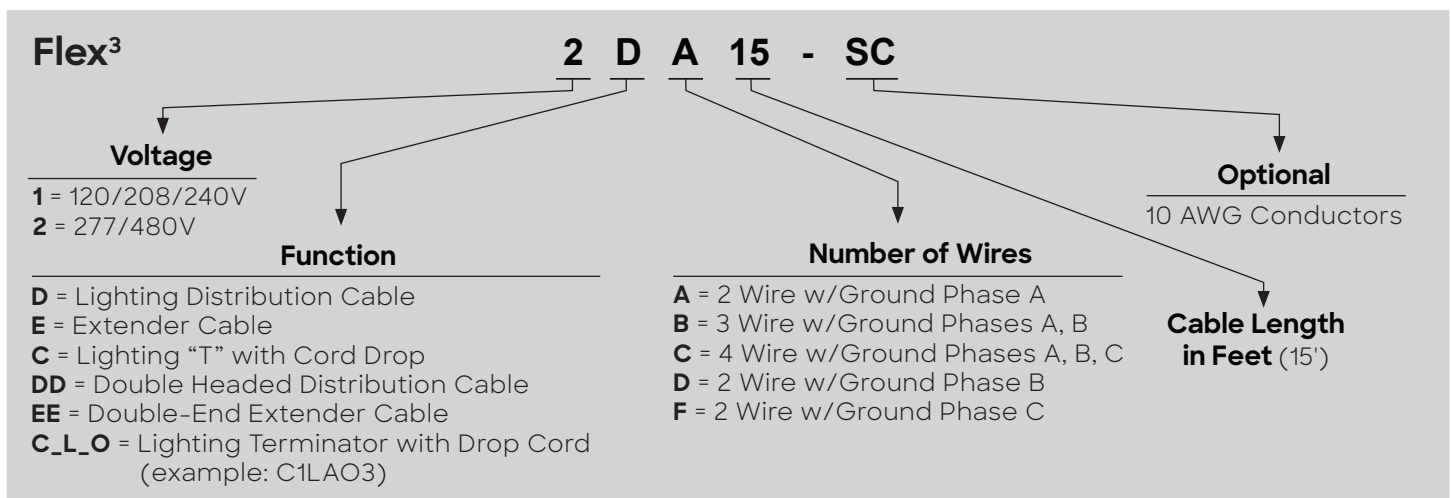

The Flex³ single pass installation saves time on the job, eases coordination with other trades, and requires less manpower.

Distribution Cable

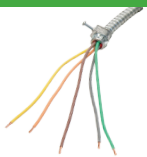

Function:
Interface between hard-wiring and Flex³ system.

Extender Cable



Function:
Delivers branch circuit power from one Lighting "T" Cable to the next.

Lighting "T" with Armored Drop



Function:
Delivers branch circuit power to the lighting fixture in a high bay or low bay application.

Flex³ Basic Components

Distribution Cable

Application

The Distribution Cable is the first component of the Flex³ modular wiring system. Once power is brought from the Lighting Panel to the point of distribution by conventional hard-wiring means, the Distribution Cable is installed through a ½" grade size knockout. The cable conductors are spliced to the hard-wired conductors and the interface is complete.

Features

- Rated for use on 20 ampere branch circuits
- Manufactured from Type MC Cable featuring 90°C insulated, #12 AWG solid copper conductors and a #12 AWG insulated, solid copper ground
- 6 inches of THHN insulated conductors are provided through a ½" connector for connection to the hard-wire system
- Pin and sleeve connector design
- To eliminate inter-voltage connection each connector is keyed and color coded to meet specific voltage requirements
- UL listed and labeled



Catalog #'s	Description	Colors
120/208V		
1DA*	Single Circuit, 2-Wire W/Ground	Black, White and Green
1DB*	Two Circuit, 3-Wire W/Ground	Black, Red, White and Green
1DC*	Three Circuit, 4-Wire W/Ground	Black, Red, Blue, White and Green
277/480V		
2DA*	Single Circuit, 2-Wire W/Ground	Brown, Gray and Green
2DB*	Two Circuit, 3-Wire W/Ground	Brown, Orange, Gray and Green
2DC*	Three Circuit, 4-Wire W/Ground	Brown, Orange, Yellow, Gray and Green

* Denotes Cable Length In Feet
Note: Add (-SC) suffix for 10 AWG conductors

Extender Cable

Application

Extender Cables are primarily used to deliver branch circuit power from one Lighting “T” Cable to the next Lighting “T” Cable. They are also utilized when project changes necessitate the lengthening of a cable set.

Features

- Rated for use on 20 ampere branch circuits
- Manufactured from Type MC Cable featuring 90°C insulated, #12 AWG solid copper conductors and a #12 AWG insulated, solid copper ground
- Pin and sleeve connector design
- To eliminate inter-voltage connection each connector is keyed and color coded to meet specific voltage requirements
- UL listed and labeled



Catalog #'s	Description	Colors
120/208V		
1EA*	Single Circuit, 2-Wire W/Ground	Black, White and Green
1EB*	Two Circuit, 3-Wire W/Ground	Black, Red, White and Green
1EC*	Three Circuit, 4-Wire W/Ground	Black, Red, Blue, White and Green
277/480V		
2EA*	Single Circuit, 2-Wire W/Ground	Brown, Gray and Green
2EB*	Two Circuit, 3-Wire W/Ground	Brown, Orange, Gray and Green
2EC*	Three Circuit, 4-Wire W/Ground	Brown, Orange, Yellow, Gray and Green

* Denotes Cable Length In Feet
Note: Add (-SC) suffix for 10 AWG conductors



Flex³ Basic Components

Lighting “T” with Armored Drop

Application

The heart of the Flex³ modular wiring system, the Lighting “T” with Armored Drop is used with the Distribution Cable and Extender Cable. It delivers branch circuit power to the lighting fixture. The Lighting “T” system allows for the removal of a lighting fixture by simply unplugging the Extender Cables, removing the lighting fixture and Lighting “T” Armored Drop, and reconnecting the Extender Cables to each other.

Features

- Rated for use on 20 ampere branch circuits
- Manufactured from Type MC Cable featuring 90 C insulated, #16 AWG, solid copper conductors and a #16 AWG insulated, solid copper ground
- Pin and sleeve connector design
- To eliminate inter-voltage connection each connector is keyed and color coded to meet specific voltage requirements
- Can be field wired or factory installed and shipped with fixtures
- UL Listed and labeled



Catalog #'s	Description	Colors
120/208V		
1PTAL*	Single Circuit, 2-Wire W/Ground	Black, White and Green
1PTBL*	Two Circuit, 3-Wire W/Ground	Black, Red, White and Green
1PTCL*	Three Circuit, 4-Wire W/Ground	Black, Red, Orange, White and Green
1PTDL*	Single Circuit, B phase, 2-Wire W/Ground	Black, White and Green
1PTFL*	Single Circuit, C phase, 2-Wire W/Ground	Black, White and Green
277/480V		
2PTAL*	Single Circuit, 2-Wire W/Ground	Black, White and Green
2PTBL*	Two Circuit, 3-Wire W/Ground	Black, Red, White and Green
2PTCL*	Three Circuit, 4-Wire W/Ground	Black, Red, Orange, White and Green
2PTDL*	Single Circuit, B phase, 2-Wire W/Ground	Black, White and Green
2PTFL*	Single Circuit, C phase, 2-Wire W/Ground	Black, White and Green

* Denotes Cable Length In Feet
Note: Add (-SC) suffix for 10 AWG conductors

Flex³⁺ Basic Components

The Flex³⁺ modular wiring for lighting system allows the disconnection and removal of lighting fixtures without interrupting the power supply down the line. This three component system plugs together quickly and easily, supplying power to lighting fixtures installed in both high and low bay applications. As with Flex³, one pass installation at the fixture and simple design means Flex³⁺ delivers dramatic savings in total installed cost.

The double connectors featured on the Flex³⁺ Double Headed Distribution Cables and Double-End Extender Cables allow the system to provide constant, uninterrupted

power to each fixture in the run. The system's modular approach provides the end user with the highest degree of flexibility and versatility when relocating fixtures.

Flex³⁺ is designed for installation in commercial, industrial, retail and institutional applications that contain high and low bay fixtures such as warehouses, super stores and schools.

All components in the Flex³⁺ system are rated for use on 20 ampere branch circuits and are UL listed and labeled.

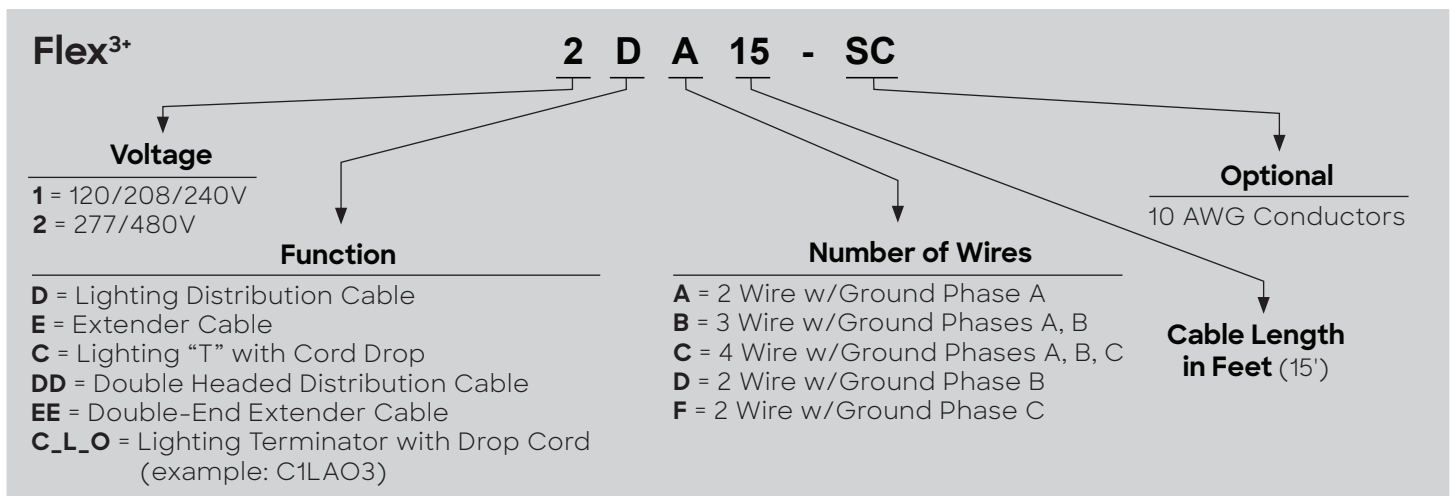

Flex³⁺ is fast and flexible. You can disconnect fixtures without disturbing power downstream.

Double Headed Distribution Cable



Function:
Interface between hard-wiring and Flex³⁺ system.

Double-End Extender Cable



Function:
Delivers branch circuit power to Fixture Cord Drops as well as the next consecutive Double-End Extender Cable.

Fixture Cord Drop



Function:
Delivers branch circuit power to the lighting fixture.

Armored Fixture Drop



Function:
Interface between hard-wiring and Flex³⁺ system.

Flex³⁺ Basic Components

Double Headed Distribution Cable

Application

The Double Headed Distribution Cable is the first component of the Flex³⁺ modular wiring system. Once power is brought from the Lighting Panel to the point of distribution by conventional hard-wiring means, the Double Headed Distribution Cable is installed through a ½" grade size knockout. The cable conductors are spliced to the hard-wired conductors and the interface is complete.

Features

- Rated for use on 20 ampere branch circuits
- Manufactured from Type MC Cable featuring 90°C insulated, #12 AWG solid copper conductors and a #12 AWG insulated, solid copper ground
- 6 inches of THHN insulated conductors are provided through a ½" connector for connection to the hard-wire system
- Pin and sleeve connector design
- To eliminate inter-voltage connection each connector is keyed and color coded to meet specific voltage requirements
- UL listed and labeled



Catalog #'s	Description	Colors
120/208V		
1DDA*	Single Circuit, 2-Wire W/Ground	Black, White and Green
1DDB*	Two Circuit, 3-Wire W/Ground	Black, Red, White and Green
1DDC*	Three Circuit, 4-Wire W/Ground	Black, Red, Blue, White and Green
277/480V		
2DDA*	Single Circuit, 2-Wire W/Ground	Brown, Gray and Green
2DDB*	Two Circuit, 3-Wire W/Ground	Brown, Orange, Gray and Green
2DDC*	Three Circuit, 4-Wire W/Ground	Brown, Orange, Yellow, Gray and Green

* Denotes Cable Length In Feet
Note: Add (-SC) suffix for 10 AWG conductors

Double-End Extender Cable

Application

The Double-End Extender Cable is used in conjunction with the Fixture Cord Drop. This component allows power to be fed to the Fixture Cord Drop as well as being fed to the next consecutive Double-End Extender Cable.

Features

- Rated for use on 20 ampere branch circuits
- Manufactured from Type MC Cable featuring 90°C insulated, #12 AWG solid copper conductors and a #12 AWG insulated, solid copper ground
- Pin and sleeve connector design
- To eliminate inter-voltage connection each connector is keyed and color coded to meet specific voltage requirements
- UL listed and labeled



Catalog #'s	Description	Colors
120/208V		
1EEA*	Single Circuit, 2-Wire W/Ground	Black, White and Green
1EEB*	Two Circuit, 3-Wire W/Ground	Black, Red, White and Green
1EEC*	Three Circuit, 4-Wire W/Ground	Black, Red, Blue, White and Green
277/480V		
2EEA*	Single Circuit, 2-Wire W/Ground	Brown, Gray and Green
2EEB*	Two Circuit, 3-Wire W/Ground	Brown, Orange, Gray and Green
2EEC*	Three Circuit, 4-Wire W/Ground	Brown, Orange, Yellow, Gray and Green

* Denotes Cable Length In Feet
Note: Add (-SC) suffix for 10 AWG conductors



Flex³⁺ Basic Components

Whip End Extender Cord

Application

The Whip End Extender Cord is used in conjunction with the Double-End Extender Cable and the Double Headed Distribution Cable. This component, when used with the Double-End Extender Cable enables the removal of a particular fixture without interrupting power flow down the line.

Features

- Rated for use on 20 ampere branch circuits
- Fixture Cord Drop manufactured from WWWS.E.O. Cord
- Tap conductors are 105°C insulated, #16 AWG, stranded copper conductors with a #16 AWG stranded copper ground
- Pin and sleeve connector design
- Can be field wired or factory installed and shipped with fixtures
- UL listed and labeled

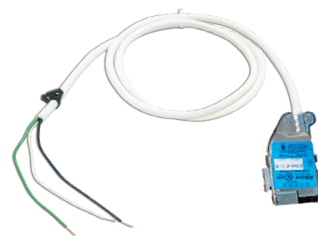

Catalog #'s	Description	Colors
120/208V		
1CEA*-W	Single Circuit, 2-Wire W/Ground	Black, White and Green
1CEB*-W	Two Circuit, 3-Wire W/Ground	Black, Red, White and Green
1CEC*-W	Three Circuit, 4-Wire W/Ground	Black, Red, Orange, White and Green
1CED*-W	Single Circuit, B phase, 2-Wire W/Ground	Black, White and Green
1CEF*-W	Single Circuit, C phase, 2-Wire W/Ground	Black, White and Green
277/480V		
2CEA*-W	Single Circuit, 2-Wire W/Ground	Black, White and Green
2CEB*-W	Two Circuit, 3-Wire W/Ground	Black, Red, White and Green
2CEC*-W	Three Circuit, 4-Wire W/Ground	Black, Red, Orange, White and Green
2CED*-W	Single Circuit, B phase, 2-Wire W/Ground	Black, White and Green
2CEF*-W	Single Circuit, C phase, 2-Wire W/Ground	Black, White and Green

* Denotes Cable Length In Feet
Note: Add (-SC) suffix for 10 AWG conductors

Armored Fixture Drop

Application

The Armored fixture drop is used in conjunction with the double end distribution and double end extender cables. This component, when used with the double end extender cable enables the removal of a particular fixture without interrupting power down the line.

Features

- Rated for use on 20 ampere branch circuits
- Manufactured from Type MC Cable featuring 90 C insulated, #16 AWG, solid copper conductors and a #16 AWG insulated, solid copper ground
- Pin and sleeve connector design
- To eliminate inter-voltage connection each connector is keyed and color coded to meet specific voltage requirements
- Can be field wired or factory installed and shipped with fixtures
- UL listed and labeled



Catalog #'s	Description	Colors
120/208V		
1EA*-LW	Single Circuit, 2-Wire W/Ground	Black, White and Green
1EB*-LW	Two Circuit, 3-Wire W/Ground	Black, Red, White and Green
1EC*-LW	Three Circuit, 4-Wire W/Ground	Black, Red, Blue, White and Green
277/480V		
2EA*-LW	Single Circuit, 2-Wire W/Ground	Brown, Gray and Green
2EB*-LW	Two Circuit, 3-Wire W/Ground	Brown, Orange, Gray and Green
2EC*-LW	Three Circuit, 4-Wire W/Ground	Brown, Orange, Yellow, Gray and Green

* Denotes Cable Length In Feet
Note: Add (-SC) suffix for 10 AWG conductors



Luminary Flex^{3+C} Basic Components

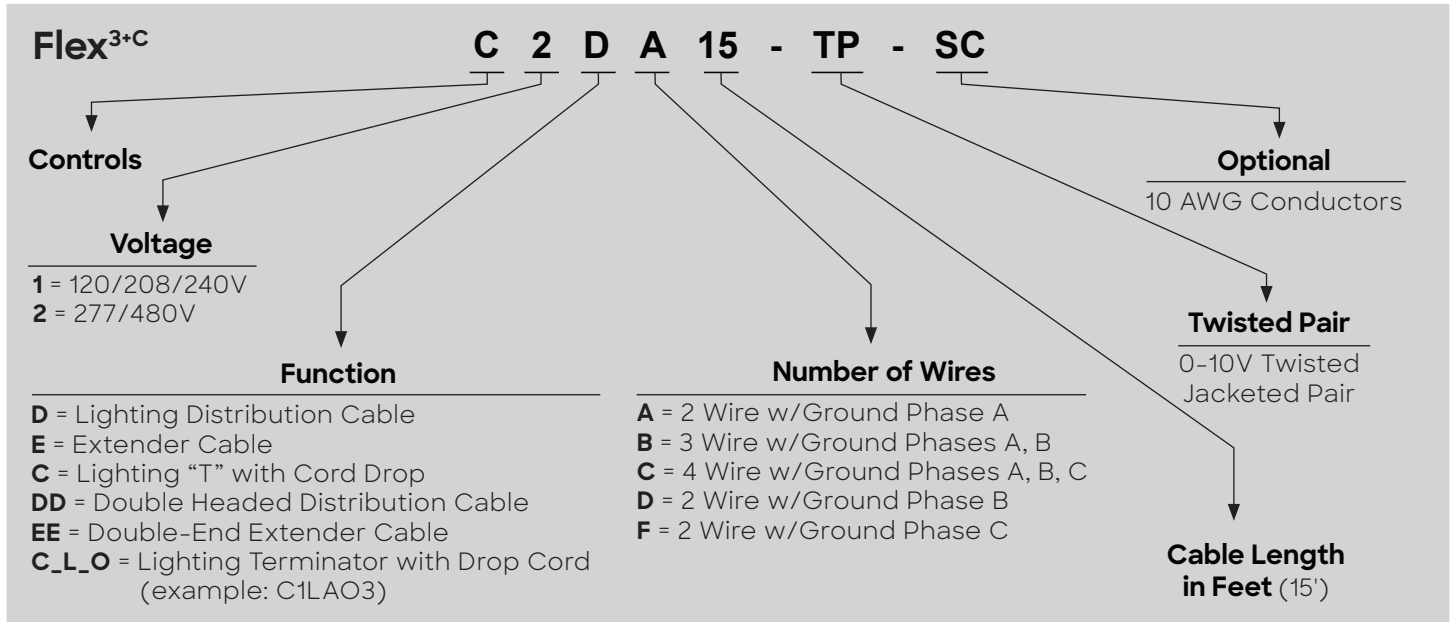

Double-End Distribution Cable

Application

The Double Headed Distribution Cable is the first component of the Flex^{3+C} modular wiring system. Once power is brought from the Lighting Panel to the point of distribution by conventional hard-wiring means, the Double Headed Distribution Cable is installed through a ½" grade size knockout. The cables, power and 0-10V control conductors are spliced to the hard-wired conductors and the interface is complete.

Features

- Rated for use on 20 ampere branch circuits
- Manufactured from Type MC_PCS Cable featuring 90°C insulated, #12 AWG solid copper conductors and a #12 AWG insulated, solid solid copper ground and two 0-10V, 16 AWG twisted jacketed pair controls
- 6 inches of THHN insulated conductors are provided through a ½" connector for connection to the hard-wire system
- Pin and sleeve connector design
- To eliminate inter-voltage connection each connector is keyed and color coded to meet specific voltage requirements
- UL listed and labeled



Catalog #'s	Description	Colors
120/208V		
C1DDC*-TP	Single Circuit/ Two 0-10V Controls, 2-wire w/16AWG Twisted Pair & Ground	Phase: Black, White, Green Controls: Purple, Pink
277/480V		
C2DDC*-TP	Single Circuit/ Two 0-10V Controls, 2-wire w/16AWG Twisted Pair & Ground	Phase: Brown, Gray, Green Controls: Purple, Pink

* Denotes Cable Length In Feet
Note: Add (-SC) suffix for 10 AWG conductors



Luminary Flex^{3+C} Basic Components

Double-End Extender Cable

Application

The Double-End Extender Cable is used in conjunction with the Whip End Extender Fixture Drop. This component allows power and controls 0-10V to be fed to the Whip End Extender Fixture Drop as well as being fed to the next consecutive Double-End Extender Cable.

Features

- Rated for use on 20 ampere branch circuits
- Manufactured from Type MC_PCS Cable featuring 90°C insulated, #12 AWG solid copper conductors and a #12 AWG insulated, solid solid copper ground and two 0-10V, 16 AWG twisted jacketed pair controls
- Pin and sleeve connector design
- To eliminate inter-voltage connection each connector is keyed and color coded to meet specific voltage requirements
- UL listed and labeled



Catalog #'s	Description	Colors
120/208V		
C1EEC*-TP	Single Circuit/ Two 0-10V Controls, 2-wire w/16AWG Twisted Pair & Ground	Phase: Black, White, Green Controls: Purple, Pink
277/480V		
C2EEC*-TP	Single Circuit/ Two 0-10V Controls, 2-wire w/16AWG Twisted Pair & Ground	Phase: Brown, Gray, Green Controls: Purple, Pink

* Denotes Cable Length In Feet
Note: Add (-SC) suffix for 10 AWG conductors

Whip End Extender Fixture Drop

Application

The Whip End Extender Fixture Drop is used in conjunction with the Double-End Extender Cable and the Double Headed Distribution Cable. This component, when used with the Double-End Extender Cable enables the removal of a particular fixture without interrupting power flow down the line.

Features

- Rated for use on 20 ampere branch circuits
- Fixture cord drop manufactured from S.E.O. Cord
- Manufactured from Type MC_PCS Cable featuring 90°C insulated, #12 AWG, solid copper conductors and a #12 AWG insulated, solid copper ground and two 0-10V, 16 AWG twisted jacketed pair controls
- Pin and sleeve connector design
- Can be field wired or factory installed and shipped with fixtures
- UL listed and labeled

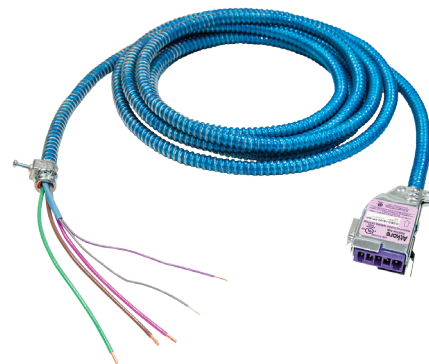

Catalog #'s	Description	Colors
120/208V		
C1EC*-W-TP	Single Circuit/ Two 0-10V Controls, 2-wire w/16AWG Twisted Pair & Ground	Phase: Black, White, Green Controls: Purple, Pink
277/480V		
C2EC*-W-TP	Single Circuit/ Two 0-10V Controls, 2-wire w/16AWG Twisted Pair & Ground	Phase: Brown, Gray, Green Controls: Purple, Pink

* Denotes Cable Length In Feet
Note: Add (-SC) suffix for 10 AWG conductors

Luminary Flex^{4C} Basic Components

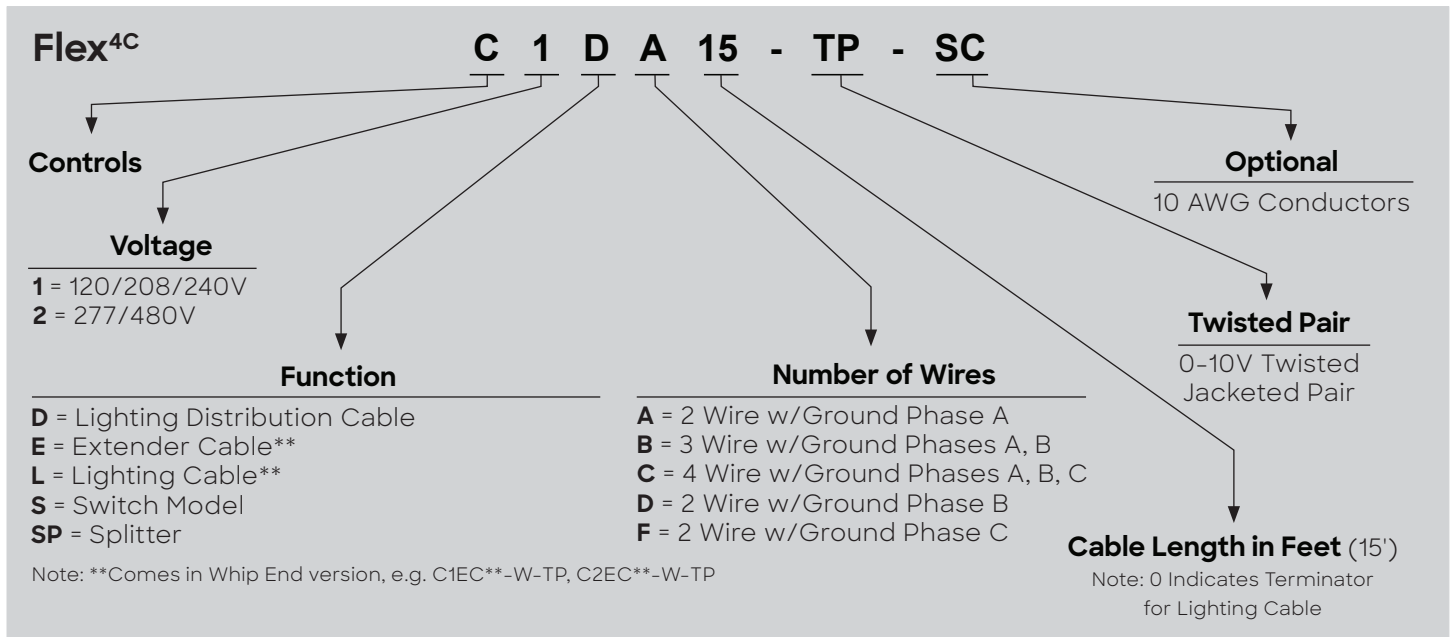

Distribution Cable

Application

The Distribution Cable functions as the starting point from which all other Flex4 system components are connected. Once power is brought from the lighting panel to the point of distribution by conventional hard-wiring means, the Distribution Cable is installed through a ½" trade size knock-out. The cable conductors are spliced to the hard-wired conductors and the interface is complete.

Features

- Rated for use on 20 ampere branch circuits
- Manufactured from Type MC_PCS Cable featuring 90°C insulated, #12 AWG solid copper conductors and a #12 AWG insulated, solid copper ground and two 0-10V, 16 AWG twisted jacketed pair controls
- 6 inches of THHN insulated conductors are provided through a ½" connector for connection to the hard-wire system
- Pin and sleeve connector design
- To eliminate inter-voltage connection each connector is keyed and color coded to meet specific voltage requirements
- UL listed and labeled

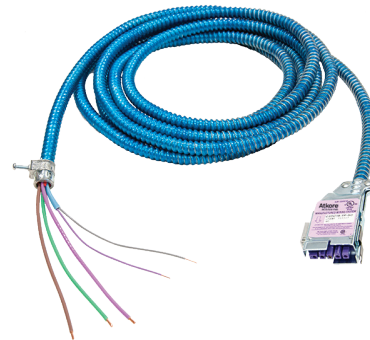

Catalog #'s	Description	Colors
120/208V		
C1EC**-W-TP	Single Circuit/ Two 0-10V Controls, 2-wire w/16AWG Twisted Pair & Ground	Phase: Black, White, Green Controls: Purple, Pink
277/480V		
C2EC**-W-TP	Single Circuit/ Two 0-10V Controls, 2-wire w/16AWG Twisted Pair & Ground	Phase: Brown, Gray, Green Controls: Purple, Pink

* Denotes Cable Length In Feet

**Comes in Whip End version

Note: Add (-SC) suffix for 10 AWG conductors



Luminary Flex^{4C} Basic Components

Lighting Cable

Application

Once installed, the Lighting Cable delivers locally or panel-controlled branch circuit power and controls to a lighting fixture in an accessible ceiling. This is accomplished simply by joining the lighting fixture leads to the Lighting Cable leads via the push-in fixture connectors supplied then plugging the cable into the ½" knock-out in the fixture access plate. Alternatively, a factory-installed fixture receptacle may be employed to make connection.

Features

- Rated for use on 20 ampere branch circuits
- Manufactured from Type MC_PCS Cable featuring 90°C insulated, #12 AWG solid copper conductors and a #12 AWG insulated, solid copper ground and two 0-10V, 16 AWG twisted jacketed pair controls
- Lighting cable leads are 105°C insulated, #18 AWG, solid copper conductors
- Pin and sleeve connector design
- To eliminate inter-voltage connection each connector is keyed and color coded to meet specific voltage requirements
- UL listed and labeled



Catalog #'s	Description	Colors
120/208V		
C1LC*-TP	Single Circuit/ Two 0-10V Controls, 2-wire w/16AWG Twisted Pair & Ground	Phase: Black, White, Green Controls: Purple, Pink
277/480V		
C2LC*-TP	Single Circuit/ Two 0-10V Controls, 2-wire w/16AWG Twisted Pair & Ground	Phase: Brown, Gray, Green Controls: Purple, Pink

* Denotes Cable Length In Feet
Note: Add (-SC) suffix for 10 AWG conductors

Extender Cable

Application

A versatile component in the Flex^{4C} wiring system, the Extender Cable is used primarily to carry branch circuit power and 0-10V controls between the Lighting "T" and to extend the length of other cables.

Features

- Rated for use on 20 ampere branch circuits
- Manufactured from Type MC_PCS Cable featuring 90°C insulated, #12 AWG solid copper conductors and a #12 AWG insulated, solid copper ground and two 0-10V, 16 AWG twisted jacketed pair controls
- Pin and sleeve connector design
- To eliminate inter-voltage connection each connector is keyed and color coded to meet specific voltage requirements
- UL listed and labeled



Catalog #'s	Description	Colors
120/208V		
C1EC*-TP	Single Circuit/ Two 0-10V Controls, 2-wire w/16AWG Twisted Pair & Ground	Phase: Black, White, Green Controls: Purple, Pink
277/480V		
C2EC*-TP	Single Circuit/ Two 0-10V Controls, 2-wire w/16AWG Twisted Pair & Ground	Phase: Brown, Gray, Green Controls: Purple, Pink

* Denotes Cable Length In Feet
Note: Add (-SC) suffix for 10 AWG conductors

Luminary Flex^{4C} Accessory Components

Whip End Lighting Cable

Application

In operation, the Whip End Lighting Cable is used to deliver locally or panel-controlled branch circuit power and controls to a lighting fixture in an accessible ceiling without the use of a factory-installed fixture receptacle. This can be accomplished by joining the lighting fixture leads to the lighting cable leads via the push-in fixture connectors supplied, then plugging the cable into a ½" knock-out in the fixture access plate. The "Whip-End" of the cable serves to extend the same branch circuit power and 0-10V controls to a non-accessible ceiling area.

Features

- Rated for use on 20 ampere branch circuits
- Manufactured from Type MC_PCS Cable featuring 90°C insulated, #12 AWG, solid copper conductors and a #12 AWG insulated, solid copper ground and two 0-10V, 16 AWG twisted jacketed pair controls
- Lighting cable leads are 105°C insulated, #18 AWG, solid copper conductors
- Pin and sleeve connector design
- To eliminate inter-voltage connection each connector is keyed and color coded to meet specific voltage requirements
- UL listed and labeled

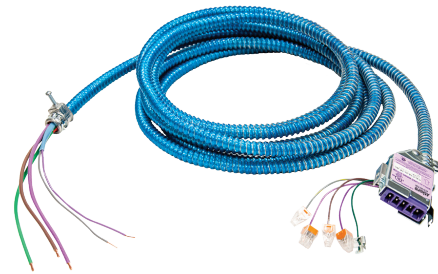

Catalog #'s	Description	Colors
120/208V		
C1LC*-W-TP	Single Circuit/ Two 0-10V Controls, 2-wire w/16AWG Twisted Pair & Ground	Phase: Black, White, Green Controls: Purple, Pink
277/480V		
C2LC*-W-TP	Single Circuit/ Two 0-10V Controls, 2-wire w/16AWG Twisted Pair & Ground	Phase: Brown, Gray, Green Controls: Purple, Pink

* Denotes Cable Length In Feet
Note: Add (-SC) suffix for 10 AWG conductors

Whip End Extender Cable

Application

Provides an easy way to carry branch circuit power and 0-10V controls from any "power-out" tap to a non-accessible ceiling area.

Features

- Rated for use on 20 ampere branch circuits
- Manufactured from Type MC_PCS Cable featuring 90°C insulated, #12 AWG solid copper conductors and a #12 AWG insulated, solid copper ground and two 0-10V, 16 AWG twisted jacketed pair controls
- Pin and sleeve connector design
- To eliminate inter-voltage connection each connector is keyed and color coded to meet specific voltage requirements
- UL listed and labeled

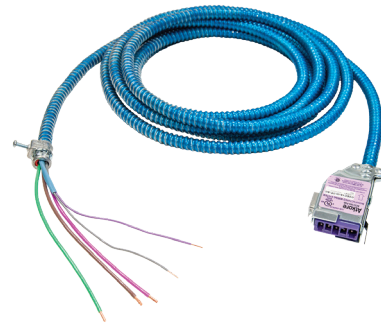

Catalog #'s	Description	Colors
120/208V		
C1EC*-W-TP	Single Circuit/ Two 0-10V Controls, 2-wire w/16AWG Twisted Pair & Ground	Phase: Black, White, Green Controls: Purple, Pink
277/480V		
C2EC*-W-TP	Single Circuit/ Two 0-10V Controls, 2-wire w/16AWG Twisted Pair & Ground	Phase: Brown, Gray, Green Controls: Purple, Pink

* Denotes Cable Length In Feet
Note: Add (-SC) suffix for 10 AWG conductors

Conduit Systems	Cable Systems	Cable Tray Systems	Framing Systems
<p>Steel Conduit</p> <ul style="list-style-type: none"> • E-Z Pull® & True Color™ EMT • EMT Elbows • IMC • Rigid (GRC) • GRC Elbows, Nipples & Couplings <p>Kwik Products</p> <ul style="list-style-type: none"> • Kwik-Fit® EMT (built-in set-screw coupling) • Super Kwik-Couple™ IMC/GRC (built-in rotating coupling) • Kwik-Fit® Compression EMT <p>Aluminum Conduit</p> <ul style="list-style-type: none"> • Rigid • Aluminum Elbows • Aluminum Couplings <p>PVC</p> <ul style="list-style-type: none"> • Schedule - 40 & 80 Rigid PVC • EB/DB Duct • PVC Elbows • Fittings, Spacers & Accessories <p style="text-align: right;">Atkore Columbia-MBF</p>	<p>AC & MC Cable</p> <ul style="list-style-type: none"> • MC Luminary Cable® • MC Luminary Jacketed Cable® • MC Luminary Multizone Lite™ Cable • MC Luminary HCF™ Lite Cable • MC TUFF® Lightweight Steel (MC) Cable • MC TUFF® IG (MC) Cable with Isolated Ground • MC Lite® Metal Clad Aluminum (MC) Cable • MC-Quik® (MC) Cable • MC-Stat® (MC) Cable • MC-Plus® (MC) Cable • HCF-90® & HCF-Lite™ • AC-90® & AC-Lite™ • Fire Alarm® Cable • Home Run Cable® • Parking Deck/Lot Cable® • Super Neutral Cable® <p>Flexible Conduit</p> <ul style="list-style-type: none"> • LIQUID-TUFF® Liquid-Tight Flexible Conduit • Full and Reduced Wall Flexible Metal Conduit <p>AFC Accessories</p> <ul style="list-style-type: none"> • Light, Power, & Appliance Whips • Bare Armored Ground • Pack N Roll™ • MC Snapit™ • Tripod • Hand Cart <p style="text-align: right;">Atkore ACS/Uni-Fab</p>	<p>Aluminum Tray</p> <ul style="list-style-type: none"> • Aluminum Ladder Tray • Aluminum Trof Tray • Aluminum Channel • Aluminum Fittings <p>Steel Tray</p> <ul style="list-style-type: none"> • Steel Ladder Tray • Steel Trof Tray • Steel Channel • Steel Fittings <p>I-Beam™ Cable Tray</p> <ul style="list-style-type: none"> • I-BEAM™ Aluminum Tray • I-BEAM™ Accessories <p>Fiberglass Tray</p> <ul style="list-style-type: none"> • Cope-glas™ Fiberglass Tray • Fiberglass Fittings • Fiberglass Support Systems <p>Other Cope Products</p> <ul style="list-style-type: none"> • Covers • Barrier Strips • Grounding Equipment • Seismic Hold-Downs • Support Systems <p>Wire Basket</p> <ul style="list-style-type: none"> • Wire Basket Tray • Wire Basket Accessories <p style="text-align: right;">Atkore Heritage Plastics</p>	<p>Channel</p> <ul style="list-style-type: none"> • Steel Channel • Aluminum Channel • Stainless Steel Channel • Fiberglass Channel • Junior Channel <p>Fittings & Accessories</p> <ul style="list-style-type: none"> • Beam Clamps • Channel Fittings • Pipe & Conduit Clamps • Threaded Rods • Fiberglass Fittings • Electrical Fittings • Concrete Inserts • Trolley Systems <p>Finishes</p> <ul style="list-style-type: none"> • Pre-Galvanized Channel • Green Channel • Hot-Dip Galv. Channel • Gold Channel • Unistrut Defender™ Channel <p>Gratings</p> <p>Roof Walks</p> <p>Solar Products</p> <p>Telestrut® Telescoping Strut System</p> <p>UniPier® Rooftop Supports</p> <p style="text-align: right;">Atkore Allied Tube & Conduit</p>
<p style="text-align: center;">Conduit Systems Canada</p>	<p style="text-align: center;">Modular Wiring Systems</p>	<p style="text-align: center;">PVC</p>	<p style="text-align: center;">Fittings</p>
<p>All items listed above, plus</p> <ul style="list-style-type: none"> • Aluminum Nipples and except for the following: <ul style="list-style-type: none"> • IMC • Kwik-Couple IMC • PVC 	<p>ACS/Uni-Fab</p> <ul style="list-style-type: none"> • Modular Lighting Systems • Raised Floor Assemblies • Pre-Fab Assemblies 	<p>PVC</p> <ul style="list-style-type: none"> • Schedule - 40 & 80 Rigid PVC • EB/DB Duct • PVC Elbows • Fittings, Spacers & Accessories 	<p>Fittings</p> <ul style="list-style-type: none"> • Universal Super Fitting™ • EMT Steel Compression & Set-Screw Fittings • Liquid-Tight Metallic & Non-Metallic Fittings • MC/AC Cable Connectors





Allied Tube & Conduit ▲ AFC Cable Systems ▲ Heritage Plastics ▲ Unistrut
Unistrut Construction ▲ Cope ▲ US Tray ▲ Calbrite ▲ Calbond ▲ Kaf-Tech
Power-Strut ▲ Calconduit ▲ Razor Ribbon ▲ Calpipe Security ▲ Vergokan ▲ Cii
Columbia-MBF ▲ Eastern Wire + Conduit ▲ ACS/Uni-Fab ▲ Sasco Strut ▲ Marco
FRE Composites ▲ Queen City Plastics ▲ Four Star Industries ▲ Flexicon

Atkore

260 Duchaine Blvd.
New Bedford, MA 02745

TOLL FREE / 800-426-3170
FAX / 508-998-7720

atkore.com/acsunifab

Want to join a company that helps you build
the mindset, skill set and tool set for success?
Visit us at atkore.com/careers