

HAWORTH®

May 1, 2020 Update
All GSA SIN in this price book
changed to SIN 33721

Accessories®

North America Price List – February 2020



Electronic Update Page – Accessories Price List

- The table below lists all of the updates and addendums added to this price list since the original version was created.
- All updated pages will replace the existing pages within the document.
- All new Pages will be placed at the back of the document.

Link	Date	Page	Description
Click Here	March 2020	1A-2A	New – Price list pages added for the Collaborative Power Station and Flush Mounted - Round
Click Here	May 2020	98	Update – Updated the Width and Depth for the Wireless Charging Modules
Click Here	May 2020	All Price List Pages	Update – GSA SIN number updated in the footer.



Price Book Overview

The following overview explains how information is organized within this price book.

- 1 Front Cover**
 - Includes the price book title and pricing effectivity date.
- 2 Canadian Conversion / Update Page**
 - Pricing conversion information for converting US pricing into the equivalent Canadian pricing is located on the footer of this page.
 - All Price Book updates will be listed on this page including the date, page number and description of the update.
- 3 Price List Table of Contents**
 - Price List table of contents with page numbers.
- 4 Statement of Line**
 - Provides a pictorial outline of the entire product offering.
- 5 Price List**

Each price list page contains the following:

 - Product Illustration
 - Catalog Number
 - To Order Specify – sequencing for ordering product options and finishes
 - List Prices
 - Product Specification Dimensions
 - Features
 - Specification Tips
 - Class, Discount Group Number (used for discounting) and GSA information
- 6 Finishes, Fabrics and COM**
 - Lists information for material finishes and availability.
 - Provides COM information and requirements (if applicable).
- 7 North American Terms of Sale**
 - Haworth terms for ordering, pricing, shipping and delivery, general terms, and services.
- 8 Index**
 - Products are listed alphabetically by alpha-numeric catalog numbers with price list page number.
- 9 Product Non-Obsolescence and Warranty Policy**
 - Provides information about the Haworth policy for non-obsolence and warranty.

Additional Information and Resources

Prices are subject to change without notice or approval. Haworth dealers should always submit proposals through Lynx before presenting to customers. See North American Terms of Sale for more information.

Online Resources

haworth.com

- Haworth's corporate website provides access to price books and a variety of other resources and publications.

surfaces.haworth.com

- Website provides access to the most current fabrics and finishes offered across Haworth's various product lines.

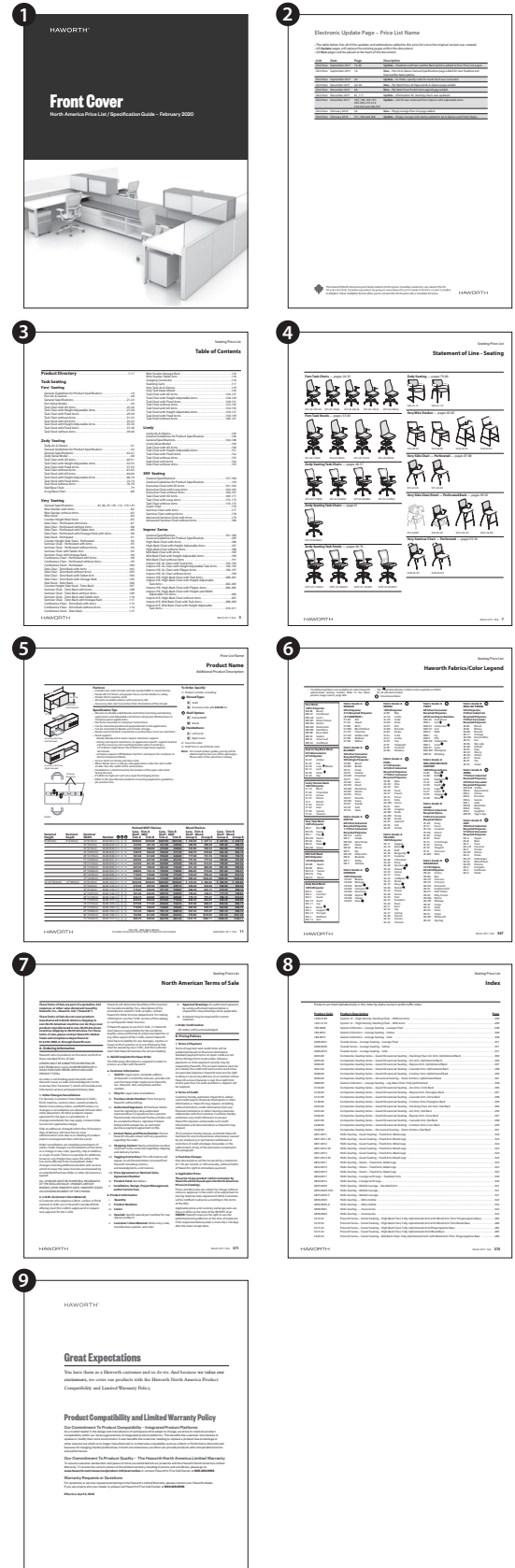

Table of Contents

Statement of Line 7-20

Adjustable Keyboard Pads

Locking Tilt AKP	21
Dial Tilt AKP	21
Dial Tilt AKP - Extended Arm	22
Sit-to-Stand AKP	22
Keyboard Trays – included with Number KU AKP Arm	23
Thin Profile AKP	24
Boogie Board Keyboard Tray with Palm Rest and Integrated Mouse Pad	25
Boogie Board Keyboard Tray with Palm Rest	25
Boogie Board Mouse Pad	25

CPU Holders

Fixed Mount CPU Holder	26
Adjustable CPU Holder	26

Electrical Components

Classic Power Module	27
Classic Power Module Bracket - Angled	28
Classic Power Module Bracket - Vertical Bracket	28
Classic Power Module Bracket - Under Surface	28
Seamless Enhanced Power Module	29
Flush Mounted Power — Corded	33
Flush Mounted Power — Hardwire	37
Flush Mounted Power — Spiral Cord for Height Adjustable	41
Flush Mounted Power — Cord for Height Adjustable	44
Power Tap — Horizontal	47
Power Tap — Vertical	48
Power Tap — Hardwire	49
Power Tap — Corded Horizontal and Vertical	49
Power Tap Bracket — Fixed	50
Power Tap Bracket — Adjustable	50
Power Tap Bracket — Under Surface	50
Power Tap Bracket with Grommet — Beside Storage Only	50
Bezel Utility Module	51
Data Bezel	51
Enhanced Power Module — Corded	52
Enhanced Power Module — Hardwire	58
Enhanced Power Module — Spiral Corded — Height Adjustable	63
Enhanced Power Module — Cord for Height Adjustable	64
Above Worksurface – Adjustable	65
Above Worksurface – Adjustable with Tackboard Offset	66
Above Worksurface – Fixed	66
Under Worksurface – Fixed	66
For Use with Side Car — Basic	67
For Use with Side Car — Deluxe	67
For Use with X Series	68
For use with Suite Lower Storage – Mounts to the Inner Back of the Cabinet	69
For use with Suite Lower Storage – Mounts to Storage Top	69
For use with Suite Technology Access Blotter and Utility Cabinet	70
Power and Data	71
Flip Top Unit — Non-Powered	72
Flip Top Unit – Corded – Single-Sided — Power, Data and USB	74
Flip Top Unit – Corded – Double-Sided — Power, Data and USB	80
Flip Top Unit – Hardwire – Single-Sided — Power, Data and USB	86
Flip Top Unit – Hardwire – Double-Sided — Power, Data and USB	92
Mounting Clip for Flip Top Unit	97
Wireless Charging Module	98
Cables	99
Retrofit USB Charging Cable	99

Ergotron Keyboard Tray

Keyboard Tray with Mouse Pad	100
Neo-Flex Keyboard Tray	100

Ergotron CPU Holder

Small CPU Holder	101
Universal CPU Holder	101
Cable CPU Holder	101

Ergotron Monitor Arms and Accessories

HX Single Arm	102
HX Dual Arm	102
HX Triple Monitor Bow Kit	103
LX Desk Mount Single Arm	104
LX Desk Mount Dual Arm	104
LX Dual Stacking Arm - Tall Pole Monitor Arm	105
LX Sit-to-Stand Mount Single Arm	106
LX Desk Dual Direct Arm	107
LX Desk Dual Direct Handle Kit	107
LX One-Stop Rotational Control Kit	108
LX Two-Stop Rotational Control Kit	108
LX Extension	109
LX Sit-to-Stand Extension	109
LX Pole Collar	109
LX Arm, Extension and Collar Kit	109
MXV Desk Mount Single Arm	110
MXV Desk Mount Dual Arm	110
MX Desk Mount Single Arm	111
MX Mini Desk Mount	111
Dual Monitor and Handle Kit	112
Monitor Quick Release LCD Bracket	112
Neo-Flex	113
Neo-Flex Extend	113
Neo-Flex Tablet	113
Under Mount C-Clamp for LX Dual Side-by-Side, LX Dual Stacking, LX Desk Mount Tall Pole	114
Under Mount C-Clamp for LX Desk Mount Single, LX Dual Direct, and MXV Monitor Arms	114
Under Mount C-Clamp for use with HX Arms	114
Under Mount C-Clamp for MX Mini Desk Mount Arms	114
Grommet Mount for LX Single and Dual Direct Arms	115
Grommet Mount for LX Dual Arm	115
Grommet Mount for LX Arm on WorkFit-T/TL	115
Grommet Mount for MXV Single Monitor Arm	115
Grommet Mount for MXV Dual Monitor Arm	115
Top Mount C-Clamp for LX Single, LX Dual Direct, and MXV Single Monitor Arms	116
Top Mount C-Clamp for LX Dual Side-by-Side and Stacking, LX Desk Mount Tall Pole, and MXV Dual Monitor Arms	116
Top Mount C-Clamp for HX Arms	116
Top Mount C-Clamp for MX Mini Arms	116

Ergotron

Ergotron WorkFit-A — Single Attached Sit-Stand Workstation	117
Ergotron WorkFit-A — Dual Attached Sit-Stand Workstation	118
Ergotron WorkFit-S — Single Attached Sit-Stand Workstation	119
Ergotron WorkFit-S — Dual Attached Sit-Stand Workstation	120
Ergotron WorkFit-SR — Single Attached Sit-Stand Workstation	121
Ergotron WorkFit-SR — Dual Attached Sit-Stand Workstation	122
Ergotron WorkFit-T — Desktop Sit-Stand Workstation	123
Ergotron WorkFit-TL — Desktop Sit-Stand Workstation	124
Ergotron WorkFit LX - Sit-Stand Desk Mount System	125
Grommet Mount	126
Conversion Kit Single HD to Dual	126
Conversion Kit Single HD to LCD & Laptop	126
Worksurface	127
Large Keyboard Tray	127
Tablet/Document Holder	127
Grommet Mount	127
Conversion Kit: Dual to LCD & Laptop	128
Conversion Kit: LCD & Laptop to Dual	128
Tall-User Kit for WorkFit Dual	128

Table of Contents

Deep Keyboard Tray	129	Mobile Screens	
Corner Keyboard Tray	129	Fabric Scrim Insert	165
WorkFit Single LCD Monitor Kit	130	Translucent Insert	165
WorkFit Dual Monitor Kit	130	Monitor Arms — Haworth	
WorkFit LCD & Laptop Kit	130	Adjustable Post Arm	166
Dual Monitor Double- Hinged Bow	131	Extend Arm	166
Tall-User Kit for Single Display	131	Adjustable Post Arm – for Use with Intuity Benching	167
Ergotron WorkFit — Anti-Fatigue Floor Mat	132	Extend Arm – For Use with Intuity Benching	167
Ergotron Neo-Flex Laptop Cart	133	Adjustable Post Arm – for Use with Reside Desking	168
Ergotron Teachwell® Mobile Digital Workspace	134	Extend Arm — For Use with Reside Desking	168
LearnFit Desk	135	iPad Attachment	169
Storage Bin	135	Pip	
Ergotron Zip 12 Charging	136	Pip	170
Grommets		Recycling Solutions	
Grommets	137	Recycling Solutions	171
Flip Top Unit — Hatch	138	Recycling/Trash Bin	171
Planes Information Display and Accessories		Recycle Bin Carriage	171
Standard Easel	139	Storage Accessories	
Large Easel	140	Drawer Insert	172
Information Boards	141	Wire Management	
Horizontal Wall Rail for Information Boards	141	Cord Manager — Mesh	173
Wall Cleat for Information Boards	141	Cable Chain	173
Horizontal Wall Rail End Caps	142	Compose Connections Cable Chain	173
Y-Leg Bumper	142	Vertical Cable Chain	173
Markerboard Insert	143	J-Channel	174
Markerboard Accessories	144	Conduit Clamp	174
Lighting		Wire Management Loop	174
Adaptable LED Task Light - Stand-Alone	145	Wire Manager Clips	174
Adaptable LED Task Light - Starter Kit	145	Wire Manager — Horizontal	175
Adaptable LED Task Light - Add-On Kit	146	Horizontal Wire Management	175
Reed Premier™ Stand-Alone LED Task Light	147	Vertical Cable Guide	175
Reed Premier™ Starter LED Task Light	147	Wire Management Trough	175
Reed Premier™ Add-On LED Task Light — For Use with Reed Premier Starter LED Task Lights	148	Wire Management Basket	176
Reed Premier™ Add-On Occupancy Sensor	148	Basket Cover	176
Voyage without Occupancy Sensor	149	Vertical Wire Channel - Leg Attached	176
Voyage with Occupancy Sensor	149	Planes C-Leg Training Table Vertical Wire Manager	177
Brazo Freestanding Lighting	150	Compose Task Light Cord Manager	177
Brazo Mounted Lighting	150	PREMISE Vertical Wire Manager	177
Grommet — For Use with Brazo Grommet Mounted Light Only	150	PREMISE Task Light Cord Manager	178
Circa Table Light	151	UniGroup Too, UniGroup and PLACES Task Light Wire Manager	178
Circa Floor Light	151	UniGroup Too, UniGroup and PLACES Wire Manager	178
Clamp Table Light	152	Cable Base	179
Clamp Floor Light	152	Cable Column	179
Contour Table Light	153	Work Tools — Mounting	
Contour Floor Light	153	Wall Accessory Slat Pad – For Use with PREMISE	180
Corner Office Table Light	154	Slat, Wall Mount	180
Corner Office Table Light with Small Panel	154	Belong Single Side	181
Corner Office Table Light with Large Panel	154	Tool Rail — Horizontal Surface Mount C-Clamp or Thru-Mount	182
Giraffa Table Light	155	Tool Rail — Single Post — C-Clamp or Thru-mount	183
LIM Freestanding Lighting	156	Tool Rail — Under Horizontal Surface Mount — L-Bracket	184
LIM Worksurface Mounted Lighting	157	Tool Rail — Single Post — L-Bracket Mount	185
LIM Mounted Lighting	158	Tool Rail — Single Sided Continuous Benching End	186
LIM Hardware	159	Tool Rail — Double-Sided Continuous Benching End Application Only	187
LIM360 Table Light	160	Tool Rail — Internal Single Sided Continuous Benching Application	188
LIM360 Grommet Mounted Light	160	Tool Rail — Internal Continuous Benching Application Only	189
Pixo Table Light	161	Tool Rail — Single Post Internal/Benching	189
Superlight Table Light	162		
Superlight Floor Light	162		
Superlight Base Pads	162		
Tube Top Table Light	163		
Tube Top Floor Light	163		
UMA Audio Lantern	164		

Table of Contents

Work Tools

Territory Screen — End-of Run	190
Territory Screen — Shared	190
Territory L-Screen	191
Structural Screen Tile	192
Belong Systems Tile — External Mount for use with Compose Panels	192
Screen Rail	193
Open C Cubby	193
Base Tray	194
Desk Top L-Screen	194
Desk Top Reference Shelf	194
Paper Tray — Landscape	195
Tool Cup	195
Hanging Sorter	195
Mini Shelf	195
Blotter	196
Reference Shelves	196
Accessory Kit	196
Tool Cup	197
Paper Sorter	197
Binder Bin	197
Tack Strip	197
Gooseneck Kit	198
Mini Shelf	198
Tote	198
Tote Strap	198
Phone Shelf	199
Phone Shelf Bracket	199
Personal Shelf	199
Personal Shelf Bracket	199
Letter Tray	200
Letter Tray Stacking Kit	200
Letter Tray Stacking Bracket	200
Waste Bin	200
Pile Master Kit	200
File Master Kit	201
Task Master Kit	201
Mini Master Kit	201
Magnet Board	202
Magnet Hooks	202
Magnet Hook	202
Round Peg Magnets	202
Mirror	202

Workstation Accessories

Shallow Drawer	203
Steel Center Drawer	203
Pencil + Drawer	203
Pencil Drawer	203
Adjustable Laptop Holder	204
Adjustable Document Holder	204
Adjustable Footrest	204
Make-A-Corner	204
Compose All-Purpose Hook	205
PLACES All-Purpose Hook	205
PLACES All-Purpose Hook — For Low Profile Wood Top Cap Panels	205
UniGroup All-Purpose Hook	205
UniGroup Too All Purpose Hook	205
PREMISE All Purpose Hooks	205
Bag Hook	206

Lock Programs

HW Lock Plugs and Keys	212
HW Plugs and Keys	213
HW Replacement Keys	213
HW Master Key	213
HW Control Key	213
HW Key Blank	213
Digital Lock	214
Digital Lock Control Key Fob	214
Digital Lock Applications	215-217
Service Parts	218

Finishes

Finish/Color Legend	219
---------------------	-----

Terms of Sale

North American	220-223
----------------	---------

Index	224-231
-------	---------

Ergotron Warranty	232
-------------------	-----

Lifetime Product Warranty	Inside Back Cover
---------------------------	-------------------

Statement of Line

Adjustable Keyboard Pads — pages 21-25

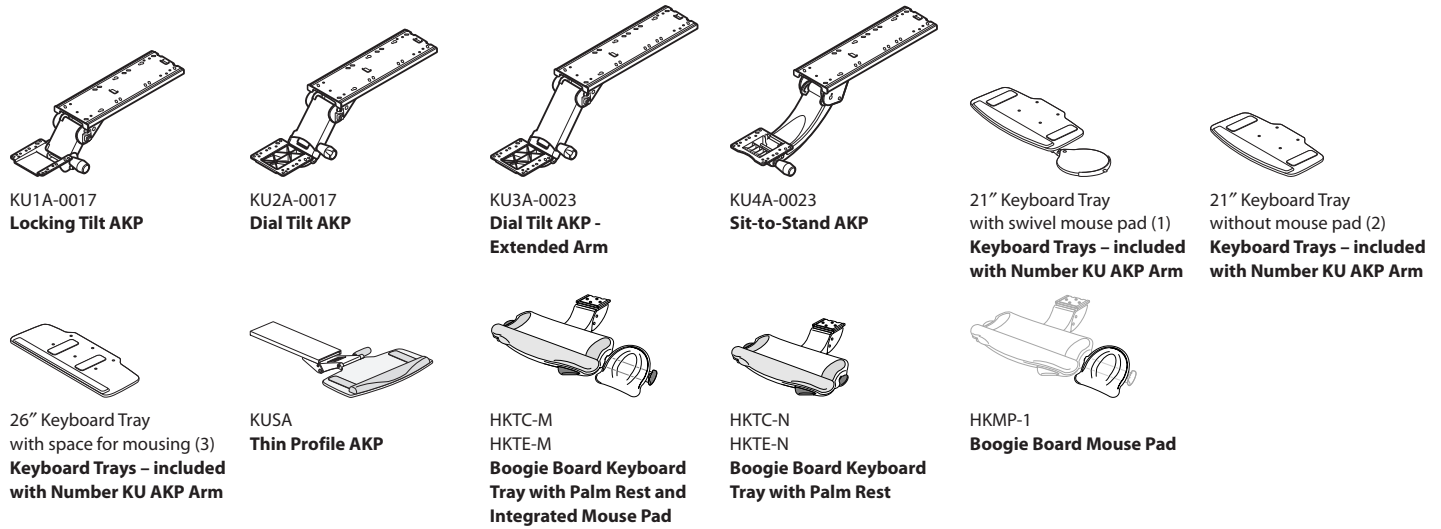

CPU Holders — page 26

Seamless Enhanced Power Module — pages 27-31

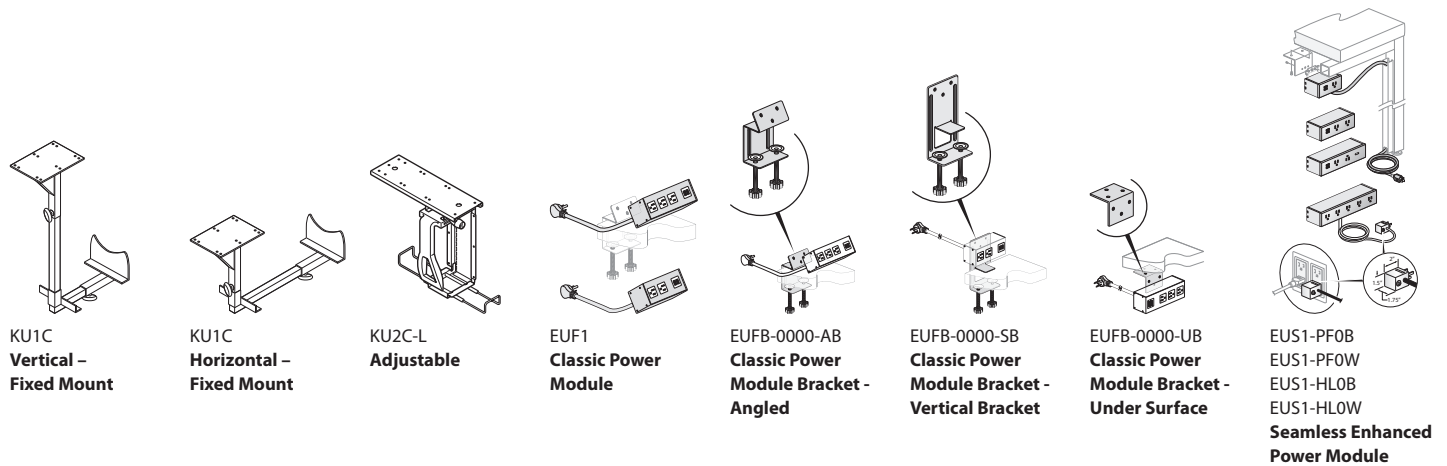

Electrical Components – Flush Mounted — pages 33-46

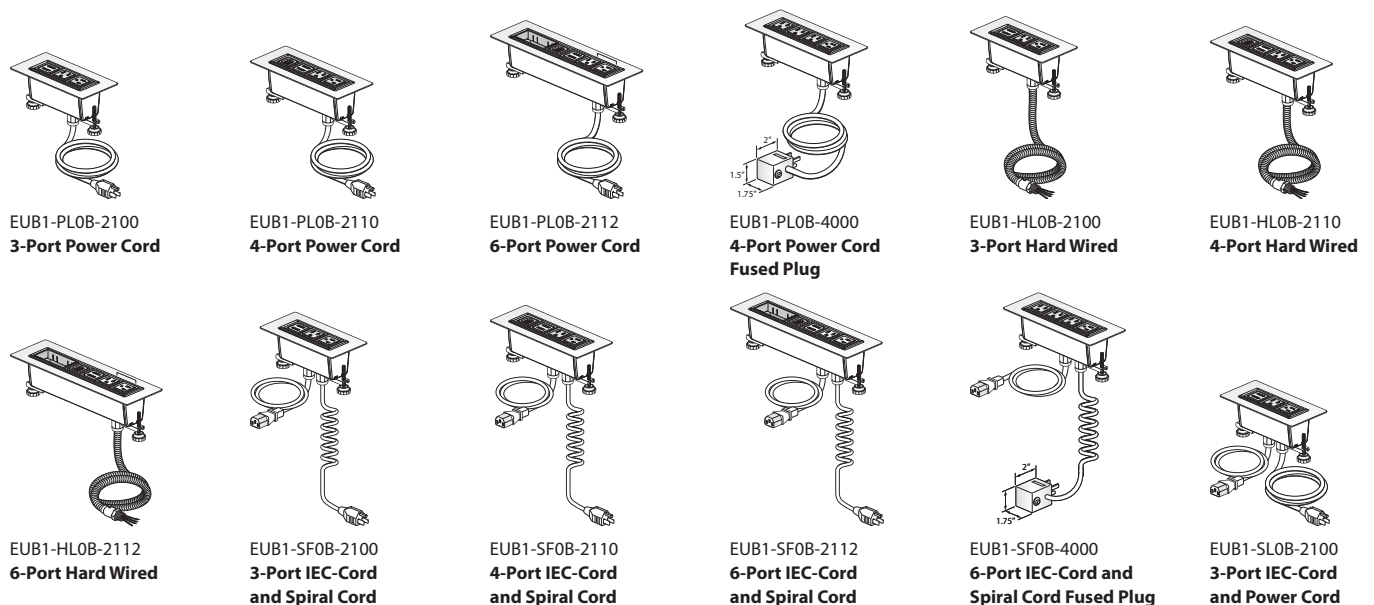

Statement of Line

Electrical Components – Flush Mounted (cont'd) — pages 33-46



EUB1-SLOB-2110
4-Port IEC-Cord
and Power Cord

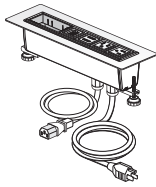

EUB1-SLOB-2112
6-Port IEC-Cord
and Power Cord

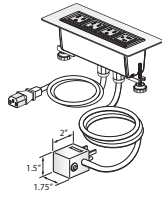

EUB1-SLOB-4000
6-Port IEC-Cord and
Power Cord Fused Plug

Electrical Components – Belong Power Tap — pages 47-49



EUET-0030-3M3N
EUET-0030-2M3N
EUET-0030-4M3N
Horizontal



EUET-0030-3M3N
EUET-0030-2M3N
EUET-0030-4M3N
Vertical



EUET-0030-CM3N
Horizontal Hard Wired



EUET-0030-CM3N
Vertical Hard Wired



EUET-0000-1M3N
Horizontal Corded



EUET-0000-1M3N
Vertical Corded

Electrical Components – Belong Power Tap Brackets — page 50

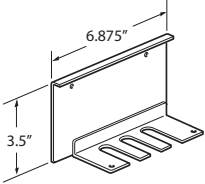

ZUAP-0000-PFD
Fixed

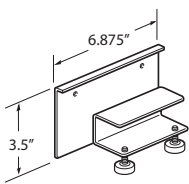

ZUAP-0000-PAN
Adjustable

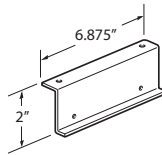

ZUAP-0000-PUR
Under Surface

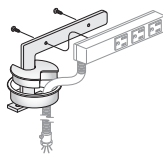

ZUAP-0000-PGH
with Grommet Beside
Storage Only

Electrical Components – Bezel Utility Module — page 51

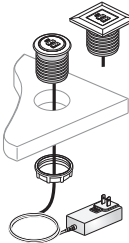

EURT-0072-1100
EURT-0072-1010
USB Charging: Round
or Square

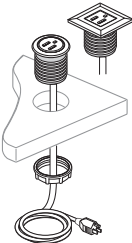

EURT-00E4-1100
EURT-00E4-1010
Power Outlet: Round
or Square

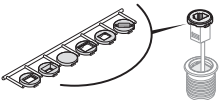

EURT-0000-N001CB
EURT-0000-N001CW
Round Data Bezel

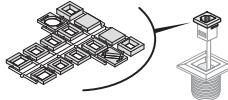

EURT-0000-N001SB
EURT-0000-N001SW
Square Data Bezel

Electrical Components – Enhanced Power Module — pages 52-64



EUD1-PF0B-2010
3-Port Power Cord

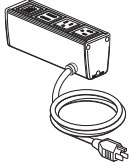

EUD1-PF0B-2110
4-Port Power Cord

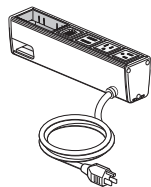

EUD1-PF0B-2112
6-Port Power Cord

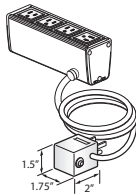

EUD1-PF0B-4000
6-Port Power Cord
Fused Plug

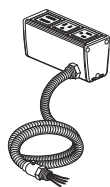

EUD1-HF0B-2010
3-Port Hard Wired

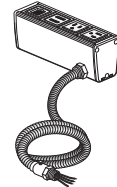

EUD1-HF0B-2110
4-Port Hard Wired

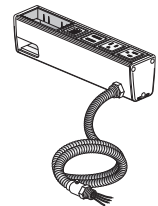

EUD1-HF0B-2112
6-Port Hard Wired

Statement of Line

Electrical Components – Enhanced Power Module (cont'd) — pages 52-64

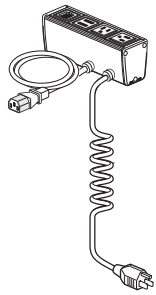

EUD1-SF0B-2110
4-Port IEC-Cord and
Spiral Cord

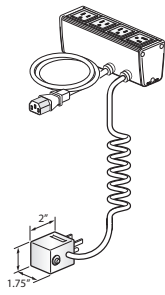

EUD1-SF0B-4000
4-Port IEC-Cord and
Spiral Cord Fused Plug

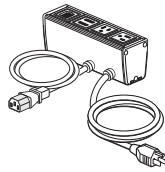

EUD1-SL0B-2110
4-Port IEC-Cord and
Power Cord

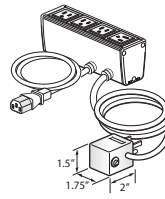

EUD1-SL0B-4000
4-Port IEC-Cord and
Power Cord Fused Plug

Electrical Components – Enhanced Power Module Brackets — pages 65-70

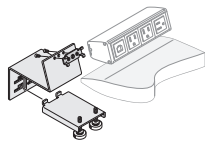

EUDB-0000-H
Adjustable

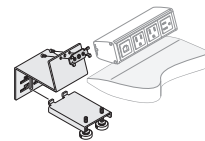

EUDB-0000-N
Adjustable

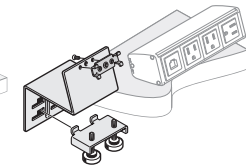

EUDB-0000-T
Adjustable with offset

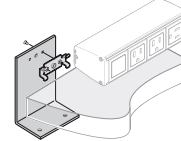

EUDB-0000-W
Above Worksurface Fixed

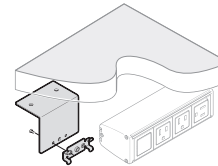

EUDB-0000-U
Below Worksurface Fixed

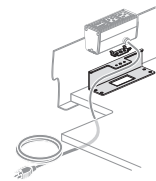

EUDB-0000-SB
Side Bar Basic

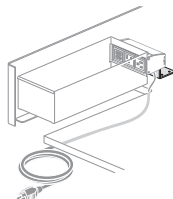

EUDB-0000-SD
Side Bar Deluxe

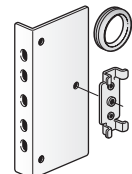

EUDB-J
X Series

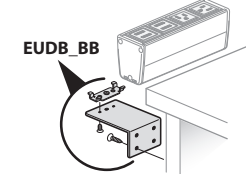

EUDB-0000-B
Suite Lower Storage
Inner Mount

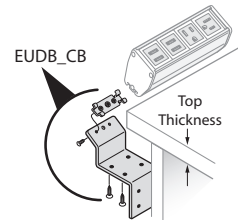

EUDB-0000-C
Suite Lower Storage
Top Mount

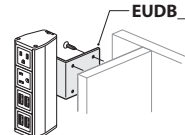

EUDB-0000-A
Suite Technology Blotter

Electrical Components – Flip Top Units — pages 71-97

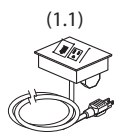

EUE1-1111W
Single Sided Corded

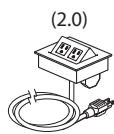

EUE1-1B01W
Single Sided Corded

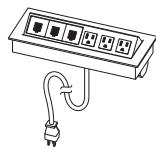

EUE1-1331W
Single Sided Corded

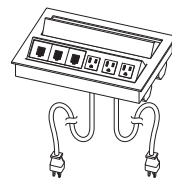

EUE2-1331W
Double Sided Corded

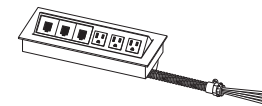

EUE1-C331W
Single Sided Hard Wired

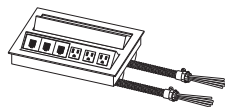

EUE2-C331W
Double Sided Hard Wired

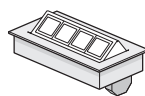

EUE1-000B
Single Sided
Non Powered

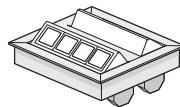

EUE2-000B
Double Sided
Non Powered

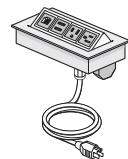

EUE1-PF0B-2110
4-Port Flip Top Unit –
Corded – Single-Sided

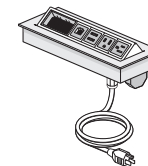

EUE1-PF0B-1212
6-Port Flip Top Unit –
Corded – Single-Sided

Statement of Line

Electrical Components – Flip Top Units (cont'd) — pages 71-97

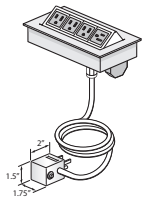

EUE1-PFOB-4000
4-Port Flip Top Unit –
Corded – Single-Sided –
Fused Plug

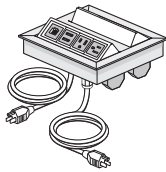

EUE2-PFOB-2110
4-Port Flip Top Unit –
Corded – Double-Sided

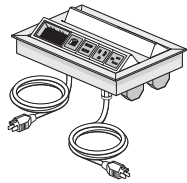

EUE2-PFOB-1212
6-Port Flip Top Unit –
Corded – Double-Sided

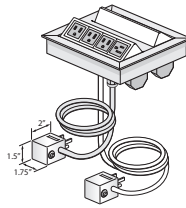

EUE2-PFOB-4000
4-Port Flip Top Unit –
Corded – Double-Sided –
Fused Plug

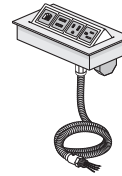

EUE1-HFOB-2110
4-Port Flip Top Unit –
Hardwire – Single-Sided

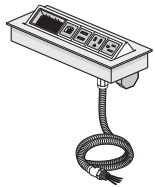

EUE1-HFOB-1212
6-Port Flip Top Unit –
Hardwire – Single-Sided

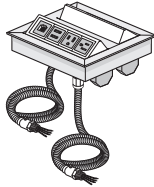

EUE2-HFOB-2110
4-Port Flip Top Unit –
Hardwire – Double-Sided

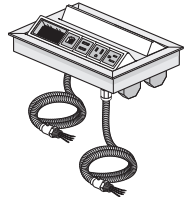

EUE2-HFOB-1212
6-Port Flip Top Unit –
Hardwire – Double-Sided

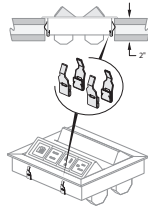

EUMC-0201
Mounting Clip for
Flip Top Unit

Electrical Components – Wireless Charging Module — page 98

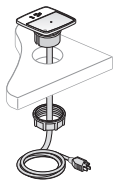

EUWC-PFOB-11001
Wireless Charging Module

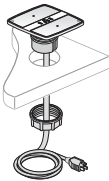

EUWC-PFOB-12002
Wireless Charging Module

Electrical Components – Cables — page 99

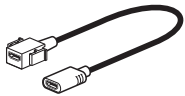

EUDX-H000-B
Cable

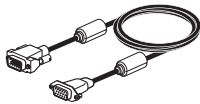

EUDX-V000-B
Cable



EUDX-3000-B
Cable

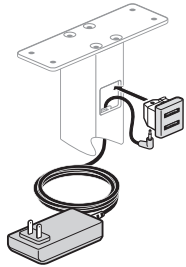

EUDX-U000-B
Retrofit USB Charging
Cable

Ergotron Keyboard Tray — page 100



169BK
Keyboard Tray with
Mouse Pad



UKMCBK
Keyboard Tray with
Mouse Pad

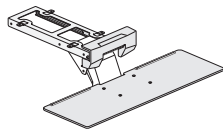

97-582-009
Neo-Flex Keyboard Tray

Statement of Line

Ergotron CPU Holders — page 101



80-063
Small CPU Holder

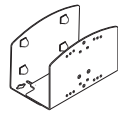

97-468
Universal CPU Holder



80-105-064
Cable CPU Holder

Ergotron Monitor Arms – HX and LX Arms — pages 102-107

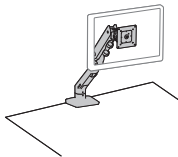

45-475
45-478
HX Single Arm

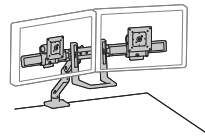

45-476
45-479
HX Dual Arm

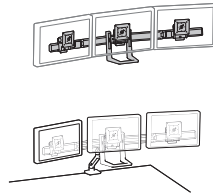

98-009-026
98-009-216
HX Triple Monitor
Bow Kit

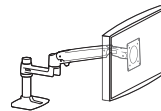

45-241-026
45-490-216
45-295-026
45-537-216
LX Desk Mount
Single Arm

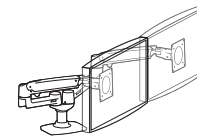

45-245-026
45-491-216
LX Desk Mount
Dual Arm

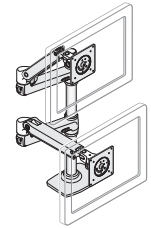

45-248-026
45-492-216
LX Desk Mount
Dual Arm

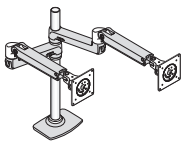

45-549-026
45-509-216
LX Dual Stacking Arm -
Tall Pole Monitor Arm

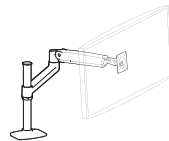

45-360-026
45-384-026
LX Sit-to-Stand Mount
Single Arm

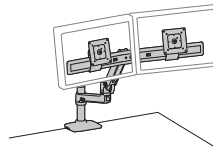

45-489
LX Desk Dual Direct Arm

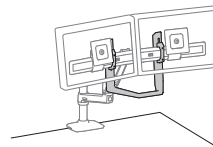

98-037-062
LX Desk Dual Direct
Handle Kit

Ergotron Monitor Arms – LX Arms Accessories — pages 108-109

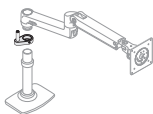

45-475
45-478
LX One-Stop Rotational
Control Kit

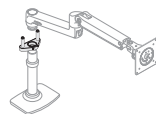

45-476
45-479
LX Two-Stop Rotational
Control Kit

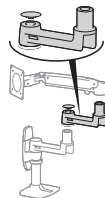

45-289-026
LX Extension

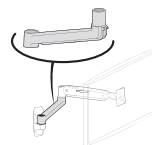

45-362-026
LX Sit-to-Stand
Extension



97-844
LX Pole Collar

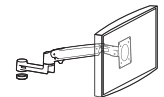

97-940-026
98-130-216
LX Arm, Extension
and Collar Kit

Ergotron Monitor Arms – MXV Desk Mount — page 110

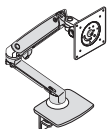

45-486
MXV Desk Mount
Single Arm

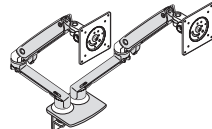

45-496
MXV Desk Mount
Dual Arm

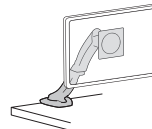

45-214-026
MX Desk Mount
Single Arm



45-436-026
MX Mini Desk Mount

Ergotron Monitor Arms – MX Desk Mount — page 111

Statement of Line

Ergotron Monitor Arms – Accessories — page 112

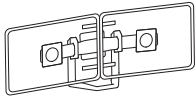

97-783
Dual Monitor and Handle Kit



60-589-060
Monitor Quick Release LCD Bracket

Ergotron Monitor Arms – Neo-Flex — page 113



45-174-300
Neo-Flex



45-235-194
Neo-Flex Extend

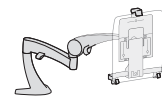

45-306-101
Neo-Flex Tablet

Ergotron Monitor Arms – Mounting Options — pages 114-116

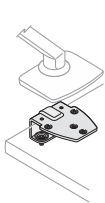

98-236-009
98-082
Under Mount C-Clamp

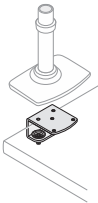

45-306-101
98-083
Under Mount C-Clamp

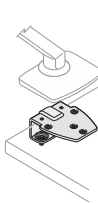

98-081
Under Mount C-Clamp

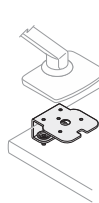

98-084
Under Mount C-Clamp



98-034
Grommet Mount



98-035
Grommet Mount

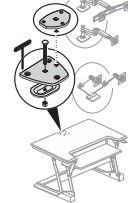

98-017
Grommet Mount



98-110
Grommet Mount



98-111
Grommet Mount

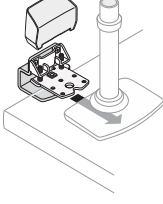

98-237-009
98-121
Top Mount C-Clamp

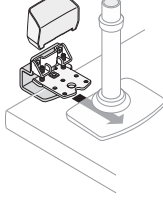

98-238-009
98-125
Top Mount C-Clamp

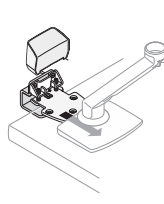

98-122
Top Mount C-Clamp

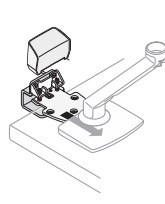

98-126
Top Mount C-Clamp

Ergotron WorkFit — pages 117-125

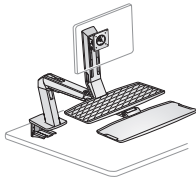

24-317-026
WorkFit-A Single Attached Sit-Stand Workstation

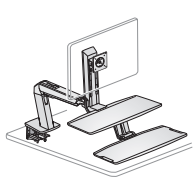

24-390-026
WorkFit-A Single Attached Sit-Stand Workstation

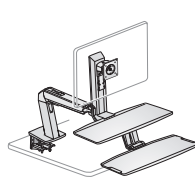

24-391-026
WorkFit-A Single Attached Sit-Stand Workstation

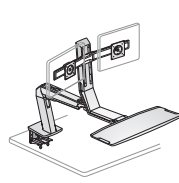

24-312-026
WorkFit-A Dual Attached Sit-Stand Workstation

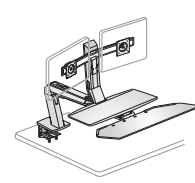

24-316-026
WorkFit-A Dual Attached Sit-Stand Workstation

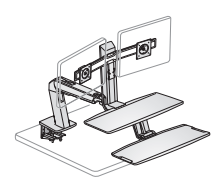

24-392-026
WorkFit-A Dual Attached Sit-Stand Workstation

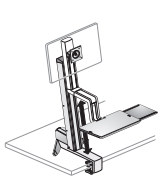

3-342-200
WorkFit-S Single Attached Sit-Stand Workstation

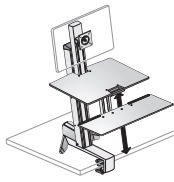

33-350-200
33-350-211
WorkFit-S Single Attached Sit-Stand Workstation

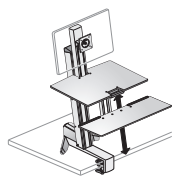

33-351-200
33-351-211
WorkFit-S Single Attached Sit-Stand Workstation

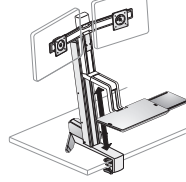

33-341-200
WorkFit-S Dual Attached Sit-Stand Workstation

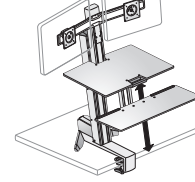

33-349-200
33-349-211
WorkFit-S Dual Attached Sit-Stand Workstation

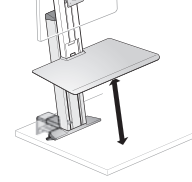

33-415-085
33-415-062
WorkFit-SR Single Attached Sit-Stand Workstation

Statement of Line

Ergotron WorkFit (cont'd) — pages 117-125

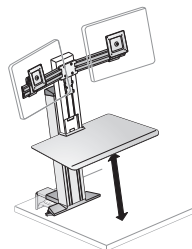

33-407-085
33-407-062
WorkFit-SR Dual Attached Sit-Stand Workstation

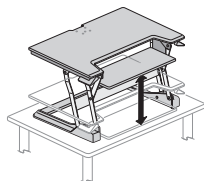

33-397-085
33-397-062
WorkFit-T Desktop Sit-Stand Workstation

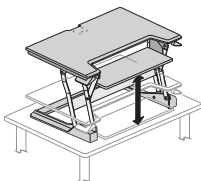

33-406-085
33-406-062
33-418-085
WorkFit-TL Desktop Sit-Stand Workstation

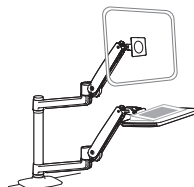

45-405-026
WorkFit-LX Sit-Stand Desk Mount System

Ergotron WorkFit – Accessories — pages 126-132

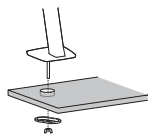

97-692
WorkFit-A Grommet Mount

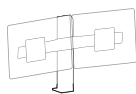

97-606
WorkFit-A Conversion Kit Single HD to Dual

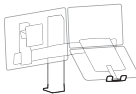

97-605
WorkFit-A Conversion Kit Single HD to LCD & Laptop

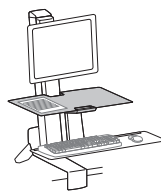

97-581-019
WorkFit-S Worksurface

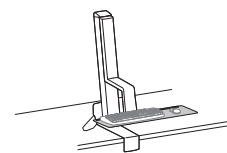

97-653
WorkFit-S Large Keyboard Tray



97-558-200
WorkFit-S Tablet/Document Holder

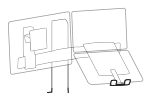

97-617
WorkFit-A/WorkFit-S Conversion Kit: Dual to LCD & Laptop

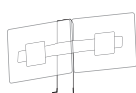

97-616
WorkFit-A/WorkFit-S Conversion Kit: LCD & Laptop to Dual

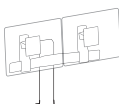

97-615
WorkFit-A/WorkFit-S Tall-User Kit for WorkFit Dual

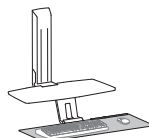

97-897
WorkFit-A/WorkFit-S Deep Keyboard Tray

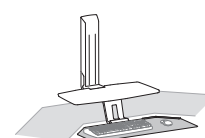

97-898
WorkFit-A/WorkFit-S Corner Keyboard Tray

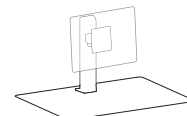

97-935-085
97-935-062
WorkFit-T/WorkFit-TL Single LCD Monitor Kit

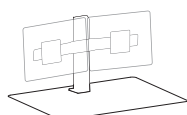

97-934-085
97-934-062
WorkFit-T/WorkFit-TL Dual LCD Monitor Kit



97-933-085
97-933-062
WorkFit-T/WorkFit-TL LCD & Laptop Kit

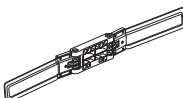

98-101-009
Dual Monitor Double-Hinged Bow



97-845
Tall-User Kit for Single Display

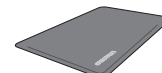

97-620-060
Anti-Fatigue Floor Mat

Ergotron Neo-Flex Laptop Cart — page 133



24-205-214

Ergotron Teachwell® Mobile Digital Workspace — page 134



24-220-055

Statement of Line

Ergotron LearnFit — page 135

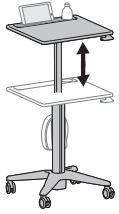

24-547-003
24-481-003
LearnFit Desk

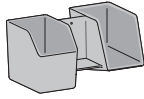

97-926-064
Storage Bin

Ergotron Zip 12 Charging — page 136

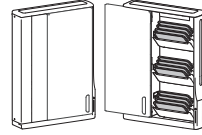

DM12-1006-1

Grommets — pages 137-138



WUAC-WSG



WQAG



JAG-1



JAG-2



TA01-0220

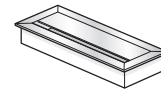

EUG1
Flip Top Unit — Hatch

Planes Information Displays and Accessories — pages 139-143



KAIE-0029
Standard Easel

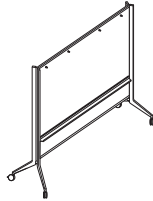

KAIE-0072
Large Easel



KAIB-0040
Information Boards

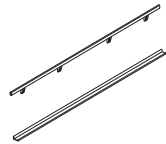

KAIW-0096
Horizontal Wall Rail for Information Boards

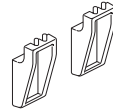

KAIH-0000
Wall Cleat for Information Boards



KAIC-0000
Horizontal Wall Rail End Caps



TA01-0214
Y-Leg Bumper

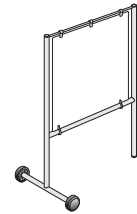

NBFS-M
Markerboard Insert

Markerboard Accessories — page 144



7062-8001



7031-7002



7031-7001

Lighting — pages 145-164

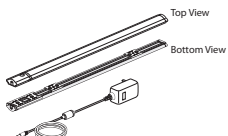

LUTN
Adaptable LED Task Light - Stand-Alone

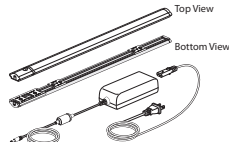

LUTT
Adaptable LED Task Light - Starter Kit

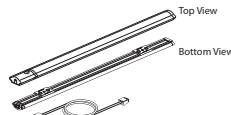

LUTA
Adaptable LED Task Light - Add-On Kit

Statement of Line

Lighting (cont'd) — pages 145-164

							
LUTS-0017-19ULD5 Reed Premier™ Stand-Alone LED Task Light	LUTS-0017-12ULD6 Reed Premier™ Starter LED Task Light	LUTD-0017-1NULDN Reed Premier™ Add-On LED Task Lights	LUTS-0000 Reed Premier™ Add-On Occupancy Sensor	LUV1 Voyage without Occupancy Sensor	LUV2 Voyage with Occupancy Sensor	LBJ1 Brazo Freestanding Light	LBJ2 Brazo Freestanding Light
							
LBJ3 Brazo Mounted Light	LBJ4 Brazo Mounted Light	WQAG Grommet	LRT1-1408 Circa Table Light	LRF0-5208 Circa Floor Light	LRF1-5208 Circa Floor Light	LCC1-1808-NFLC Clamp Table Light	
							
LCC2-2608-NFLC Clamp Floor Light	LCT1-1708 Contour Table Light	LCF1-6009 Corner Floor Light	HCPL-COT1-07 Corner Office Table Light	HCPL-COT2-15 Corner Office Table Light with Small Panel	HCPL-COT3-30 Corner Office Table Light with Large Panel	HCPL-GFT1-13 Giraffa Table Light	
							
LLL1 LIM Table Light with Block	LLL2 LIM Table Light with Pivot	LLL3 LIM Floor Light	LLC1 LIM Worksurface Mounted Light	LLM1 LIM Mounted Light - Slat	LLM1 LIM Mounted Light - Belong Rail	LLM2 LIM Mounted Light - Panel	
							
LLU2 LIM Mounted Light - Under Shelf	LL31-2210-NFLC LIM 360 Table Light	LL32-2210-NGLC LIM 360 Grommet Mounted Light	LUPT Pixo Table Light	HCPL-SLT1-17 Superlight Table Light	HCPL-SLF1-47 Superlight Floor Light	HCPL-SLSV-4BP Superlight Base Pads	
							
HCPL-TTT1-14 Tube Top Table Light	HCPL-TTT2-21 Tube Top Table Light	HCPL-TTT3-27 Tube Top Table Light	HCPL-TTF1-60 Tube Top Floor Light	HCPL-UMT2-11 UMA Audio Lantern			

Statement of Line

Mobile Screens — page 165

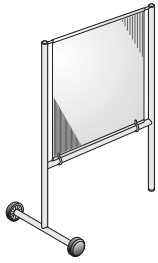

NBFS-F
Fabric Scrim Insert

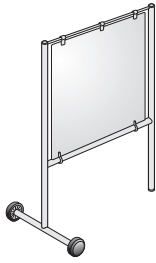

NBFS-X
Translucent Insert

Monitor Arms – Haworth — pages 166-169

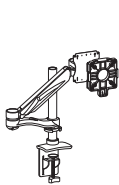

KU5M-1NNN
Adjustable Post Arm -
Single

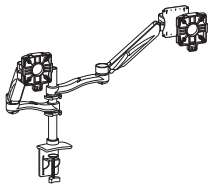

KU5M-2NNN
Adjustable Post Arm -
Double

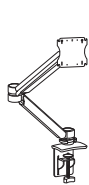

KU6M-1NNN
Extend Arm - Single

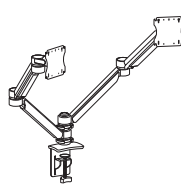

KU6M-2NNN
Extend Arm - Double

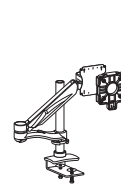

KU5M-1NNNB
Adjustable Post Arm -
Single – for Use with
Intuity Benching

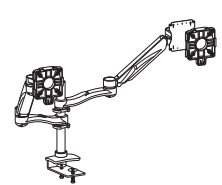

KU5M-2NNNB
Adjustable Post Arm -
Double – for Use with
Intuity Benching

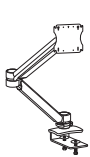

KU6M-1NNB
Extend Arm - Single –
for Use with Intuity
Benching

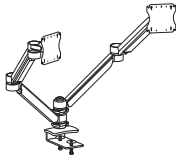

KU6M-2NNB
Extend Arm - Double –
for Use with Intuity
Benching

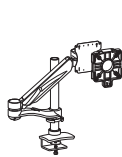

KU5M-1NNK
Adjustable Post Arm -
Single – for Use with
Reside Benching

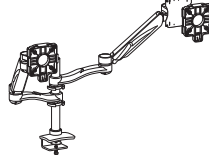

KU5M-2NNK
Adjustable Post Arm -
Double – for Use with
Reside Benching

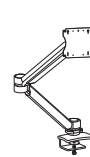

KU6M-1NNK
Extend Arm - Single –
for Use with Reside
Benching

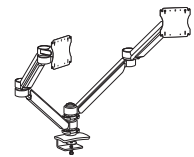

KU6M-2NNK
Extend Arm - Double –
for Use with Reside
Benching

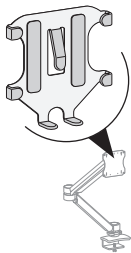

KU6T
iPad Attachment

Pip Personal Laptop Table — page 170



STP-P26-TH

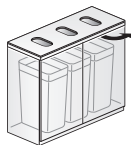

JRPY-3948

Recycling Solutions — page 171

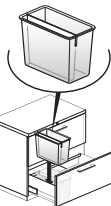

KURB
Recycling/Trash Bin

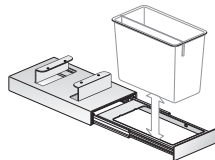

KURD
Recycling Bin Carriage

Storage Accessories – Drawer Inserts — page 172

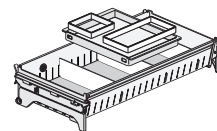

KJFI-00XX-D
Lateral File Drawer
Insert

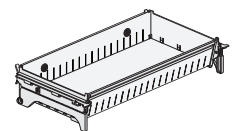

KFI-00XX-B
Lateral File Drawer
Insert

Statement of Line

Wire Management — pages 173-179

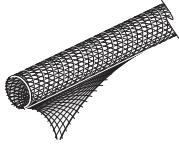

**EUAW-0000-NHS
Cord Manager — Mesh**

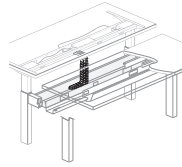

**EAAW-0000-H
Cable Chain**

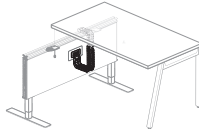

**EUAW-4000-V
Compose Connections
Cable Chain**



**EUAW-3100-NV
Vertical Cable Chain**

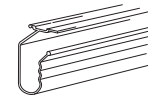

**4TJC-72
J-Channel**

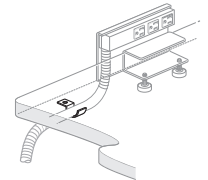

**EUAM-0000
Conduit Clamp**



**NEH-8
Wire Management Loop**

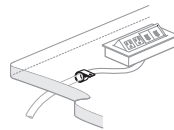

**TA01-0225
Wire Manager Clips**

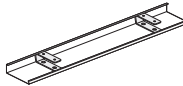

**EUAW-NH
Wire Manager —
Horizontal**



**WUAW-PNH
Horizontal Wire
Management**

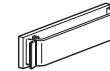

**NECG-V
Vertical Cable Guide**

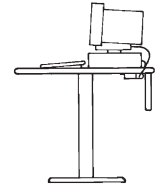

**KWT
KWMF
Wire Management Trough**

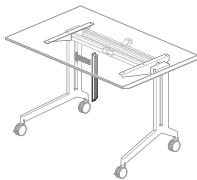

**TA01-0228-F
Planes C-Leg Training
Table Vertical Wire
Manager**



**VZAW-0000-V
Compose Task Light
Cord Manager**

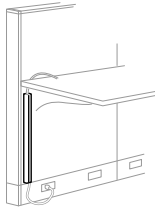

**NEV-1
PREMISE Vertical
Wire Manager**

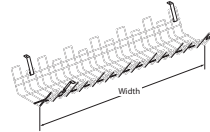

**TAWB
Wire Management Basket**

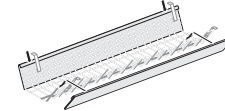

**TABC
Basket Cover**

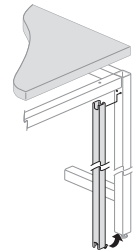

**TYVW
Vertical Wire Channel —
Leg Attached**



**NEV-2
PREMISE Task Light
Cord Manager**



**WC-17
UniGroup Too, UniGroup
and PLACES Task Light
Wire Manager**

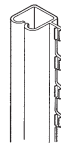

**WC-6
UniGroup Too, UniGroup
and PLACES Wire Manager**

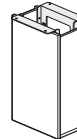

**TA01-0814
Cable Base**

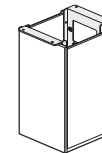







**TA01-1414
Cable Base**

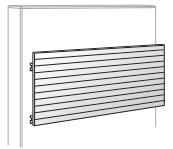
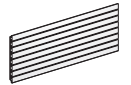
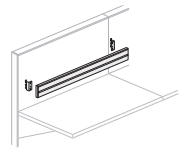
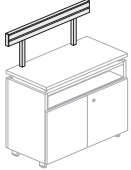
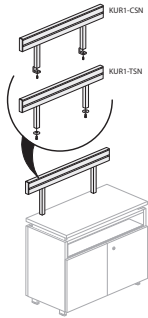
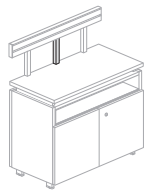
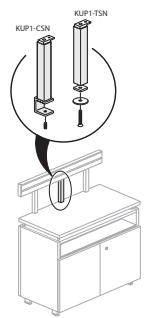
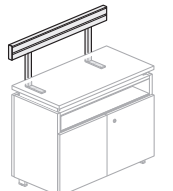
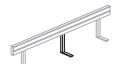
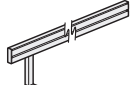
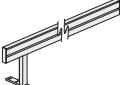
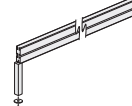
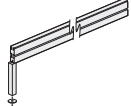
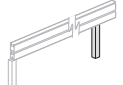
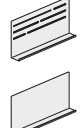
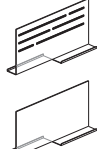
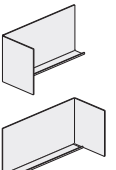
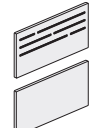
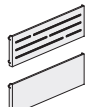
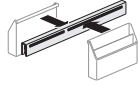
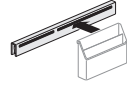
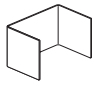

**TA01-0217
Cable Column**

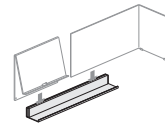
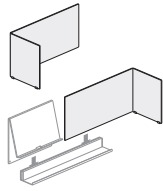
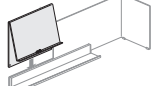
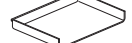
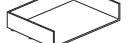
Statement of Line

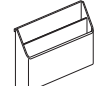
Work Tools — pages 180-202

						
NAPY Wall Accessory Slat Pad - for Use with PREMISE	KUPY Slat, Wall Mount	KUR1-0424-PZN Belong Single Side	KUR1-1224-CSN Belong Tool Rail — Horizontal Surface Mount C-Clamp or Thru-Mount	KUR1-CSN KUR1-TSN Belong Tool Rail — Horizontal Surface Mount C-Clamp or Thru-Mount	KUP1-0000-CSN Belong Tool Rail — Single Post — C-Clamp or Thru-mount	KUP1-CSN KUP1-TSN Belong Tool Rail — Single Post — C-Clamp or Thru-mount
						
KUR1-1224-USN Belong Tool Rail — Under Horizontal Surface Mount — L-Bracket	KUP1-0000-USN Belong Tool Rail — Single Post — L-Bracket Mount	KUR1-1224-USE Belong Tool Rail — Single Sided Continuous Benching End	KUR2-1224-UBE Belong Tool Rail — Double-Sided Continuous Benching End Application Only	KUR1-1224-USI Belong Tool Rail — Internal Single Sided Continuous Benching Application	KUR2-1224-UBI Belong Tool Rail — Internal Continuous Benching Application Only	
						
KUP2-0000-UBI Belong Tool Rail — Single Post Internal/Benching	KUTS-E Belong Territory Screen — End-of Run	KUTS-S Belong Territory Screen — Shared	KUTS-L Belong Territory L-Screen	KUTB Belong Structural Screen Tile	KZTB Belong Systems Tile — External Mount for use with Compose Panels	
						
KUSR Screen Rail - Double Sided	KUSR Belong Screen Rail - Single Sided	KUCU-0915-BNN Belong Open C Cubby No Slots	KUCU-1215-BNS Belong Open C Cubby With Slots	KUBT Belong Base Tray	KULS Belong Desk Top L-Screen	
						
KURS Belong Desk Top Reference Shelf	KUPT-0913-H Belong Paper Tray	KUPT-0913-F Belong Paper Tray	KUTC-0000-H Belong Tool Cup	KUHS-0000-H Belong Hanging Sorter	KUSH-0408-H Belong Mini Shelf	

Statement of Line

Work Tools (cont'd) — pages 180-202

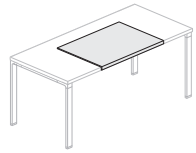

**KUBL-2030-FJ
Belong Blotter**



**KURS-0010-H
Belong Reference Shelf**

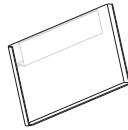

**KURS-0019-H
Belong Reference Shelf**

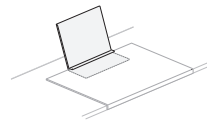

**KURS-0012-B
Belong Reference Shelf**

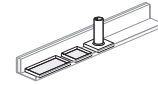

**KUAK
Belong Accessory Kit**

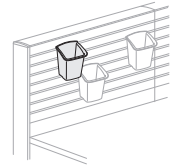

**DTWC-2
Jump Stuff Tool Cup**

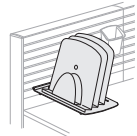

**DTPR-3
Jump Stuff Paper Sorter**

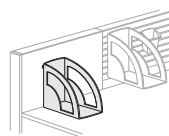

**DTSB-3
Jump Stuff Binder Bin**

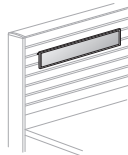

**DTTS-12
DTTS-24
Jump Stuff Tack Strip**

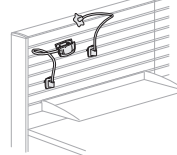

**DTGK-3
Jump Stuff Gooseneck Kit**

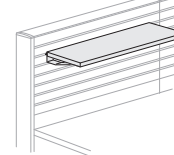

**DMSP
Jump Stuff Mini Shelf**

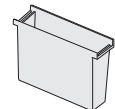

**DTTE-3
Jump Stuff Tote**

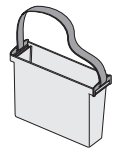

**DTTH-3
Jump Stuff Tote**



**DHT-1
Jump Stuff Tote Strap**

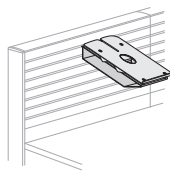

**DTPT-3
Jump Stuff Phone Shelf**

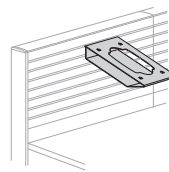

**DTBS-3
Jump Stuff Phone Shelf
Bracket**

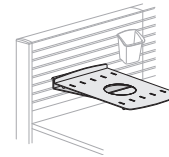

**DTES-3
Jump Stuff Personal Shelf**

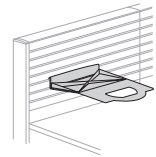

**DTAR-3
Jump Stuff Personal Shelf
Bracket**

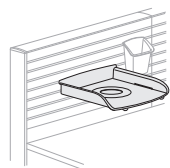

**DTLT-2
Jump Stuff Letter Tray**

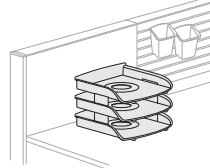

**DTLS-2
Jump Stuff Letter Tray
Stacking Kit**

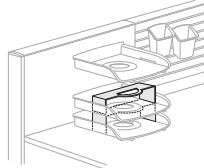

**DTSB-1
Jump Stuff Letter Tray
Stacking Kit Bracket**

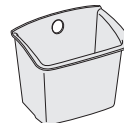

**DTRB
Jump Stuff Waste Bin**

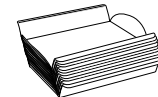

**DPKY-1
Jump Stuff Pile Master Kit**

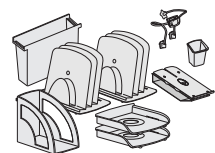

**DPKP-5
DBKP-5
Jump Stuff File Master Kit**

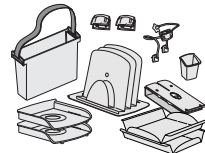

**DPKT-5
DBKT-5
Jump Stuff Task Master Kit**

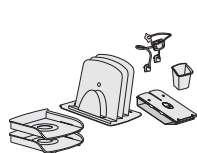

**DPKS-5
DBKS-5
Jump Stuff Mini Master Kit**

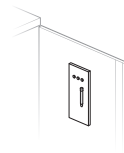

**KUAM-0411
Magnetic Board**



**KUAM-0518
Magnetic Board**

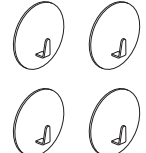

**KUAH-0002
Magnetic Hooks**



**KUAH-0003
Magnetic Hook**

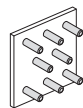

**KUAP-0000
Magnetic Round
Peg Magnets**

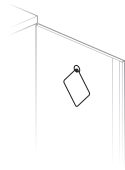

**KUAR-0403
Magnetic Mirror**

Statement of Line

Workstation Accessories — pages 203-206

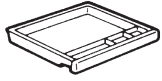

DS-3
Shallow Drawer

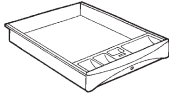

SCD-19
Steel Center Drawer

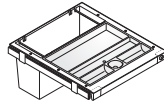

KUDP-2420
Pencil + Drawer

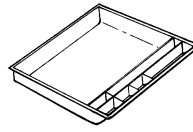

JAC-18
Pencil Drawer

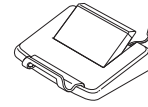

KU1L-0000-U
Adjustable Laptop Holder

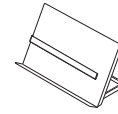

KU1D-0000
Adjustable Document Holder



KU1F-0000
Adjustable Footrest

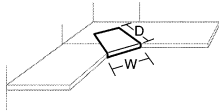

MAC-0001
Make-A-Corner



VZAC-0000-P
Compose All-Purpose Hook

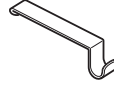

VZAC-0000-H
Compose All-Purpose Hook

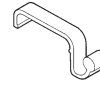

HCH-0008
PLACES All-Purpose Hook

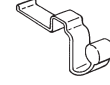

HCH-0008-W
PLACES All-Purpose Hook
— For Low Profile Wood Top Cap Panels



CH-8
UniGroup All-Purpose Hook



E2CH-8
UniGroup Too All-Purpose Hook



NAH-12
PREMISE All-Purpose Hook



NAH-12-S
PREMISE All-Purpose Hook

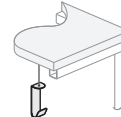

KUWH-0202
Bag Hook

Lock Programs — pages 212-214

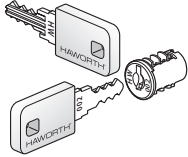

LSET
HW Lock Plugs and Keys

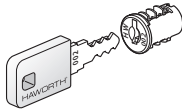

HW-SVC
HW Plugs and Keys



HWSK
HW Replacement Keys

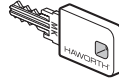

HWMK-1
HW Master Key



CK-3
HW Control Key

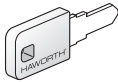

HWKB-1
HW Key Blank

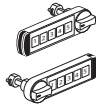

HUDR-R
HUDR-L
Digital Lock

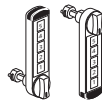

HUDR-B
HUDR-T
Digital Lock



HUDF-F
Digital Lock Control Key Fob

Adjustable Keyboard Pads

Locking Tilt AKP

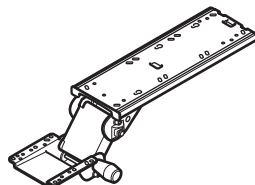

KU1A-0017

Description	Height Adjustment	Number ①	Price
17"(432mm) Long Track/Locking Tilt	2.5" Above/5.9" Below	KU1A-0017- N	\$379.07
21"(533mm) Long Track/Locking Tilt	2.5" Above/5.9" Below	KU1A-0021- N	379.07

Features

- Includes one locking tilt arm with track and Keyboard Tray.
- Patented spring-assisted Lift-n-Lock™ counter balancing system.
- Height adjustment range: 2.5" above/5.9" below worksurface.
- Soft-touch knob for locking tilt adjustment -15°/+15°.
- 360° rotation.
- In/Out travel:
 - 17" track length - 12"
 - 21" track length - 16.8"
- Track allows Keyboard Tray to be fully retracted under worksurface.
- Keyboard Tray Option: (Refer to Keyboard Tray for features)
 - (1) 21" wide Keyboard Tray with swivel Mouse Pad
 - (2) 21" wide Keyboard Tray without Mouse Pad
 - (3) 26" wide Keyboard Tray with space for mousing
- Standard in supplier black textured paint.
- Field installed.

To Order, Specify:

1) Product number, including:

① Keyboard Tray Option

- 1 21" Keyboard with Mouse Pad, add \$40.38 list
- 2 21" Keyboard without Mouse Pad, no upcharge
- 3 26" Keyboard with built-in Mouse Pad, add \$80.77 list
(No finish specification required.)

Specification Tips

- 17" long (432mm) track fits under worksurfaces 18"(457mm) or deeper.
- 21" long (533mm) track fits under worksurfaces 22"(559mm) or deeper.
- Recommended for most corner applications.

Dial Tilt AKP

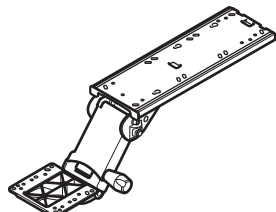

KU2A-0017

Description	Height Adjustment	Number ① ②	Price
17"(432mm) Long Track/Dial Tilt	2.5" Above/6.1" Below	KU2A-0017- N N	\$406.42
21"(533mm) Long Track/Dial Tilt	2.5" Above/6.1" Below	KU2A-0021- N N	406.42

Features

- Includes one Dial Tilt arm with track and Keyboard Tray.
- Includes gauges that show tilt and height adjustments.
- Patented Dial Tilt adjustment of keyboard tray as knob is turned.
- Patented spring-assisted Lift-n-Lock™ counter balancing system.
- Height adjustment range: 2.5" above/6.1" below worksurface.
- Tilt allows adjustment -15°/+10°.
- Positive Tilt Lock Option allows tilt adjustment -15°/+0°.
- 5.5"(140mm) standard arm length.
- In/Out travel:
 - 17" track length - 12"
 - 21" track length - 16.8"
- Track allows Keyboard Tray to be fully retracted under worksurface.
- 360° rotation.
- Keyboard Tray Option: (Refer to Keyboard Tray for features)
 - (1) 21" wide Keyboard Tray with swivel Mouse Pad
 - (2) 21" wide Keyboard Tray without Mouse Pad
 - (3) 26" wide Keyboard Tray with space for mousing
- Standard in supplier black textured paint.
- Field installed.

To Order, Specify:

1) Product number, including:

① Keyboard Tray Option

- 1 21" Keyboard with Mouse Pad, add \$40.38 list
- 2 21" Keyboard without Mouse Pad, no upcharge
- 3 26" Keyboard with space for mousing, add \$80.77 list

② Positive Tilt Lock Option

- P Positive Tilt Lock
- N None
(No finish specification required.)

Specification Tips

- 17"(432mm) track fits under worksurfaces 18"(457mm) or deeper.
- 21"(533mm) track fits under worksurfaces 22"(559mm) or deeper.
- Recommended for most corner applications.

Adjustable Keyboard Pads

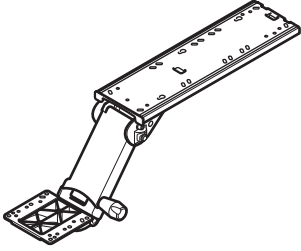
	Description	Height Adjustment	Number ① ②	Price
 <p>KU3A-0023</p>	23"(584mm) Long Extended Track/Dial Tilt	2.75" Above/8" Below	KU3A-0023- <input type="checkbox"/> <input type="checkbox"/>	\$440.31
	<p>Description</p> <p>Features</p> <ul style="list-style-type: none"> • Includes one Dial Tilt arm with track and Keyboard Tray. • Includes gauges that show tilt and height adjustments. • Patented Dial Tilt adjustment of keyboard tray as knob is turned. • Patented spring-assisted Lift-n-Lock™ counter balancing system. • Height adjustment range: 2.75" above/8" below worksurface. • Tilt allows adjustment -15°/+10°. • Positive Tilt Lock Option allows tilt adjustment -15°/+0°. • 7.5"(191mm) standard arm length. • In/Out travel: 18.1" • Track allows Keyboard Tray to be fully retracted under worksurface. • 360° rotation. • Keyboard Tray Option: (Refer to Keyboard Tray for features) <ul style="list-style-type: none"> –(1) 21" wide Keyboard Tray with swivel Mouse Pad –(2) 21" wide Keyboard Tray without Mouse Pad –(3) 26" wide Keyboard Tray with space for mousing • Standard in supplier black textured paint. • Field installed. <p>Specification Tips</p> <ul style="list-style-type: none"> • 23"(584mm) track fits under worksurfaces 23"(584mm) or deeper. • Recommended for most corner applications. 	<p>To Order, Specify:</p> <p>1) Product number, including:</p> <p>① Tray Option</p> <ul style="list-style-type: none"> 1 21" Keyboard with Mouse Pad, add \$40.38 list 2 21" Keyboard without Mouse Pad, no upcharge 3 26" Keyboard with space for mousing, add \$80.77 list <p>② Positive Tilt Lock Option</p> <ul style="list-style-type: none"> P Positive Tilt Lock N None <p>(No finish specification required.)</p>		

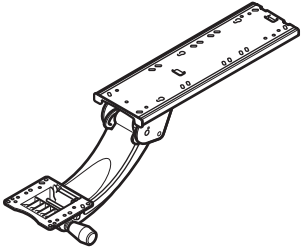
	Description	Height Adjustment	Number ① ②	Price
 <p>KU4A-0023</p>	23"(584mm) Long Track/Sit-to-Stand	8.25" Above/5.9" Below	KU4A-0023- <input type="checkbox"/> <input type="checkbox"/>	\$467.66
	<p>Description</p> <p>Features</p> <ul style="list-style-type: none"> • Includes one locking tilt arm with track and Keyboard Tray. • Patented spring-assisted Lift-n-Lock™ counter balancing system. • Height adjustment range: 8.25" above/5.9" below worksurface. • Tilt allows adjustment -15°/+10°. • Positive Tilt Lock Option allows tilt adjustment -15°/+0°. • 7.5"(191mm) standard arm length. • In/Out travel: 18.1" • Track allows Keyboard Tray to be fully retracted under worksurface. • 360° rotation. • Keyboard Tray Option: (Refer to Keyboard Tray for features) <ul style="list-style-type: none"> –(1) 21" wide Keyboard Tray with swivel Mouse Pad –(2) 21" wide Keyboard Tray without Mouse Pad –(3) 26" wide Keyboard Tray with space for mousing • Standard in supplier black textured paint. • Field installed. <p>Specification Tips</p> <ul style="list-style-type: none"> • 23"(584mm) track fits under worksurfaces 23"(584mm) or deeper. • Recommended for most corner applications. 	<p>To Order, Specify:</p> <p>1) Product number, including:</p> <p>① Keyboard Tray Option</p> <ul style="list-style-type: none"> 1 21" Keyboard with Mouse Pad, add \$40.38 list 2 21" Keyboard without Mouse Pad, no upcharge 3 26" Keyboard with space for mousing, add \$80.77 list <p>② Positive Tilt Lock Option</p> <ul style="list-style-type: none"> P Positive Tilt Lock N None <p>(No finish specification required.)</p>		

Adjustable Keyboard Pads

Keyboard Trays – included with Number KU AKP Arm

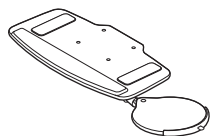

21" Keyboard Tray with swivel mouse pad (1)

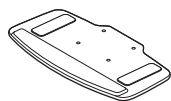

21" Keyboard Tray without mouse pad (2)

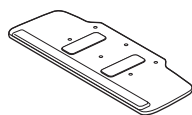

26" Keyboard Tray with space for mousing (3)

Features

- Includes one Keyboard Tray in different configurations.
- Sizes: 20"(508mm) wide x 11"(279mm) deep; Mouse Pad adds 8.4"(213mm) to width 26"(660mm) wide x 11"(279mm) deep
- Keyboard Tray Options:
 - (1) 21" wide Keyboard Tray with 360° swivel Mouse Pad with mouse edge guard and cable manager
 - (2) 21" wide Keyboard tray without Mouse Pad
 - (3) 26" wide Keyboard Tray with space for mousing
- Keyboards are made from 0.5" thick HDPE (High Density Polyethylene) in textured supplier black.
- Keyboard Trays include anti-skid strips to hold keyboard in place.
- Standard with removable palm rest.
- Keyboard with mouse pad; Mouse Pad can be attached on either right or left side of Keyboard Tray; rotates 360° independent of keyboard tray.
- Field installed.

Specification Tips

- Keyboard Tray has mounting holes for attachment to AKP numbers: KU1A, KU2A, KU3A and KU4A.
- 21" Keyboard Tray recommended for use with most corner worksurfaces.
- 26" Keyboard Tray recommended for rectangular worksurfaces with flat edges; not recommended for corner worksurfaces.

Adjustable Keyboard Pads

	Description	Number ¹ ²	Price
Thin Profile AKP	17"(432mm) Thin Profile	KU5A-0017- <input type="checkbox"/> <input type="checkbox"/>	\$379.07
	21"(533mm) Thin Profile	KU5A-0021- <input type="checkbox"/> <input type="checkbox"/>	379.07

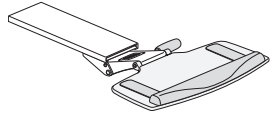

KU5A

Features

- Includes one Dial Tilt arm with track and Keyboard Tray.
- Gauges show tilt and height adjustments.
- Patented Dial Tilt adjustment of keyboard tray .
- Patented spring-assisted Lift-n-Lock™ counter balancing system.
- Height adjustment range: 1.19"(30mm) above/6.5"(165mm) below worksurface.
- Tilt allows adjustment -20°/+10°.
- Positive Tilt Lock Option allows tilt adjustment -20°/+0°.
- 7.5"(191 mm) standard arm length.
- In/Out travel: 12"(305mm) for 17"(432mm) and 16.75"(419mm) for 21"(533mm) track.
- Track allows Keyboard Tray to be fully retracted under worksurface.
- 360° rotation.
- Keyboard Tray Option: (Refer to Keyboard Tray for features)
 - (1) 21"(533mm) wide Keyboard Tray with swivel Mouse Pad
 - (2) 21"(533mm) wide Keyboard Tray without Mouse Pad
 - (3) 26"(660mm) wide Keyboard Tray with space for mousing
- Standard in supplier black textured paint.
- Field installed.

To Order, Specify:

1) Product number, including:

1 Tray Option:

- 1** Keyboard with Mouse Pad, add **\$40.38** list
- 2** Keyboard without Mouse Pad, no upcharge
- 3** Keyboard with space for mousing, add **\$80.77** list

2 Positive Tilt Lock Option:

- P** Positive Tilt Lock
- N** None

(No finish specification required.)

Adjustable Keyboard Pads

	Height	Depth	Width	Description	Number	Price
Boogie Board Keyboard Tray with Palm Rest and Integrated Mouse Pad	5.3"(135mm)	12"(305mm)	28"(711mm)	17"(432mm) track, Comfort Palm Rest	HKTC-17-M	\$672.97
				17"(432mm) track, Ergonomic Palm Rest	HKTE-17-M	672.97
				21"(533mm) track, Comfort Palm Rest	HKTC-21-M	672.97
				21"(533mm) track, Ergonomic Palm Rest	HKTE-21-M	672.97

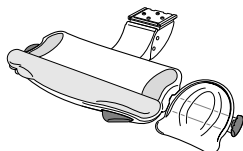

HKTC-M
HKTE-M

Features

- Palm rests available in ergonomic height adjustable or soft comfort versions.
- Stores under worksurface or lift entire tray to pull out. Release tray and it automatically saves distance-to-desk position.
- Intuitive single lever on front of AKP adjusts both height and tilt.
- Spring assisted adjustment (with automatic lock) of 6.5"(165mm) above worksurface and 4"(102mm) below.
- Integrated mouse pad tilts independently of keyboard tray.
- Includes mouse pad insert (not shown) for optional use.
- Mouse pad is interchangeable between right- and left-hand applications.
- Ease of modifying positions reduces repetitive stress injuries by encouraging AKP repositioning throughout the day.
- Superior stability (patented arm mechanism makes for smooth and stable operation).
- A simple guide for new users located within the AKP for referencing.
- Keyboard tray and mouse pad tilt +/-15°.
- 360° rotation.
- 17"(432mm) track fits under worksurfaces 18"(457mm) or deeper.
- 21"(533mm) track fits under worksurfaces 22"(559mm) or deeper.

To Order, Specify:

- 1) Product number.
- 2) Translucent finish color.

Boogie Board is available in the following finish colors:

- TR-0LX Ice (translucent blue) Keyboard tray in smoke with accents of graphite (palm rest, mouse pad insert and bottom of keyboard tray), and black (arm).
- TR-0LU Shadow (translucent charcoal) Keyboard tray in charcoal with accents of graphite (palm rest, mouse pad insert and bottom of keyboard tray), and black (arm).

Positive Tilt Lock-Out Option:

For positive tilt lock-out option (0° to -15° tilt only), add suffix **P** to the product number.

Example: HKTC-17-MP

Boogie Board Keyboard Tray with Palm Rest	5.3"(135mm)	12"(305mm)	21"(533mm)	17"(432mm) track, Comfort Palm Rest	HKTC-17-N	\$636.86
				17"(432mm) track, Ergonomic Palm Rest	HKTE-17-N	636.86
				21"(533mm) track, Comfort Palm Rest	HKTC-21-N	636.86
				21"(533mm) track, Ergonomic Palm Rest	HKTE-21-N	636.86

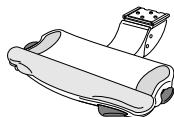

HKTC-N
HKTE-N

Features

- Palm rests available in ergonomic height adjustable or soft comfort versions.
- Stores under worksurface or lift entire tray to pull out. Release tray and it automatically saves distance-to-desk position.
- Intuitive single lever on front of AKP adjusts both height and tilt.
- Spring assisted adjustment (with automatic lock) of 6.5"(165mm) above worksurface and 4"(102mm) below.
- Ease of modifying positions reduces repetitive stress injuries by encouraging AKP repositioning throughout the day.
- Superior stability (patented arm mechanism makes for smooth and stable operation).
- A simple guide for new users located within the AKP for referencing.
- Keyboard tray and mouse pad tilt +/-15°.
- 360° rotation.
- 17"(432mm) track fits under worksurfaces 18"(457mm) or deeper.
- 21"(533mm) track fits under worksurfaces 22"(559mm) or deeper. Recommended for most corner applications.

To Order, Specify:

- 1) Product number.
- 2) Translucent finish color.

Boogie Board is available in the following finish colors:

- TR-0LX Ice (translucent blue) Keyboard tray in smoke with accents of graphite (palm rest and bottom of keyboard tray), and black (arm).
- TR-0LU Shadow (translucent charcoal) Keyboard tray in charcoal with accents of graphite (palm rest and bottom of keyboard tray), and black (arm).

Positive Tilt Lock-Out Option:

For positive tilt lock-out option (0° to -15° tilt only), add suffix **P** to the product number.

Example: HKTC-17-MP

Boogie Board Mouse Pad	1"(25mm)	11"(279mm)	8"(203mm)		HKMP-1	\$68.43
-------------------------------	----------	------------	-----------	--	--------	----------------

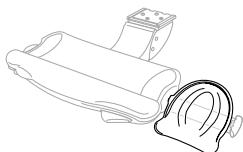

HKMP-1

Features

- For use with Boogie Board AKP or on top of worksurface.
- Integrated teeth allow right- or left-handed keyboard applications.
- Easily attaches to keyboard tray.
- Includes mouse pad insert (not shown) for optional use.

To Order, Specify:

- 1) Product number.
- 2) Translucent finish color.

Boogie Board mouse pad is available in the following finish colors:

- TR-0LX Ice (translucent blue) Mouse pad insert standard in graphite.
- TR-0LU Shadow (translucent charcoal) Mouse pad insert standard in graphite.

CPU Holders

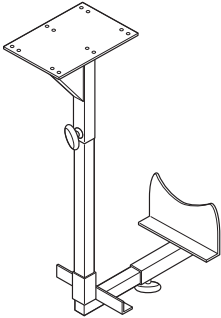
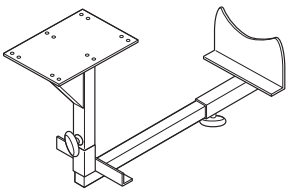
	Description	Number	Price
 <p>KU1C - Vertical</p>	Fixed Mount CPU Holder	KU1C-0000-N	\$122.45
	<p>Features</p> <ul style="list-style-type: none"> Includes one fixed mount CPU holder. Mounts under tops in either vertical or horizontal position. Vertical Mount adjustment ranges: <ul style="list-style-type: none"> Height adjustment for CPU: 15.5" to 20" Width adjustment for CPU: 5.5" to 9.8" Overall height adjustment: 17.5" to 22" Overall width adjustment: 9.25" to 13.5" Horizontal Mount adjustment ranges: <ul style="list-style-type: none"> Height adjustment for CPU: 7.3" to 11.3" Width adjustment for CPU: 13.8" to 18.8" Overall height adjustment: 9.25" to 13.5" Overall width adjustment: 17.5" to 22.5" Control knobs allow adjustments as needed. Standard in supplier black. Field installed. <p>To Order, Specify:</p> <p>1) Product number. (No finish specification required.)</p>		
 <p>KU1C - Horizontal Class YA - GSA: Open Market</p>	<p>Specification Tips</p> <ul style="list-style-type: none"> 85 lbs. maximum weight load. Fits under tops 18"(457mm) or deeper. Mounting Plate Size: <ul style="list-style-type: none"> 5.35"(136mm) deep x 3.94"(100mm) wide <p>Note: Recommended for use with:</p> <ul style="list-style-type: none"> UniGroup[®] Too applications. PREMISE[®] and Compose[®] applications directly adjacent to floor support. X Series Caseloads. Contact Sales Engineering for all other applications. 		

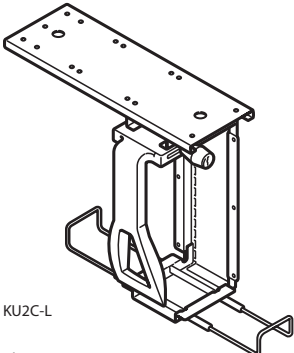
	Description	Track Length	Number	Price
 <p>KU2C-L Class YA - SIN 711-2; Discount Group X</p>	Adjustable Mount CPU Holder	17"(432mm)	KU2C-0000-N	\$175.85
	Adjustable Mount CPU Holder - Locking	17"(432mm)	KU2C-0000-L	\$298.30
<p>Features</p> <ul style="list-style-type: none"> Includes one adjustable mount CPU Holder with or without lock. Mounts under tops. CPU holder mechanism 360° rotation dependent upon track location. Plastic side clamp with bumpers; control knob adjusts clamp. Adjustment Ranges: <ul style="list-style-type: none"> Height: 13.5" to 22.5" Width: 3.5" to 9.3" Depth: 14.75" to 22.3" 17"(432mm) adjustable track with plastic glides. Locks cannot be retrofitted nor keyed-alike to match Haworth lock plugs or keys. Standard in supplier black textured paint. Field installed. <p>To Order, Specify:</p> <p>1) Product number. (No finish specification required.)</p>				
<p>Specification Tips</p> <ul style="list-style-type: none"> 85 lbs. maximum weight load. 17"(432mm) track fits under tops 18"(457mm) or deeper. <p>Note: Recommended for use with:</p> <ul style="list-style-type: none"> UniGroup[®] Too applications. PREMISE[®] and Compose[®] applications directly adjacent to floor support. X Series Caseloads. Contact Sales Engineering for all other applications. 				

Electrical Components

Classic Power Module

Width	Depth	Cord Length	Trim Color	Color	Port	Configuration	Number	Price
Corded								
		6'(1829mm)	Black	Black	3	2 Power Receptacles, 1 USB Charging	EUF1-PF0B-21000	\$199.60
					4	3 Power Receptacles, 1 USB Charging	EUF1-PF0B-31000	209.91
		6'(1829mm)	White	White	3	2 Power Receptacles, 1 USB Charging	EUF1-PF0W-21000	\$199.60
					4	3 Power Receptacles, 1 USB Charging	EUF1-PF0W-31000	209.91
		10'(3048mm)	Black	Black	3	2 Power Receptacles, 1 USB Charging	EUF1-PJ0B-21000	\$214.84
					4	3 Power Receptacles, 1 USB Charging	EUF1-PJ0B-31000	225.15
		10'(3048mm)	White	White	3	2 Power Receptacles, 1 USB Charging	EUF1-PJ0W-21000	\$214.84
					4	3 Power Receptacles, 1 USB Charging	EUF1-PJ0W-31000	225.15

Classic Power Module

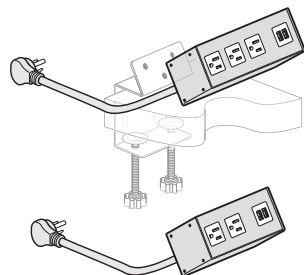

EUF1



Features

- Includes power module with 3 or 4 ports configured with simplex outlets (NEMA-5-15R), USB charging port (with two USB outlets).
- Corded power module with 15 amp - 6'(1829mm) or 10'(3048mm) long cord with plug (NEMA 5-15P).
- USB Charging Port consists of two 5V USB 2.0 style A outlets, each with 10.5W (2.1Amp) charging capacity.
- Attaches to surface with separately specified mounting brackets.
- Color option of black or white front.

Specification Tips

- Configuration and quantity of power and USB ports cannot be modified in the field.
- For use with 120 volt 60 hertz power source only.
- Requires field installation.
- Application may require approval of local authority having jurisdiction (AHJ); ensure compliance before placing orders and installation.
- Separately specified:
 - Mounting Bracket

To Order, Specify:

- 1) Product number.
(No finish specification required.)

Electrical Components

Classic Power Module Brackets

	Description	Number	Price
Classic Power Module Bracket - Angled	Black	EUFB-0000-AB	\$47.88
	White	EUFB-0000-AW	47.88

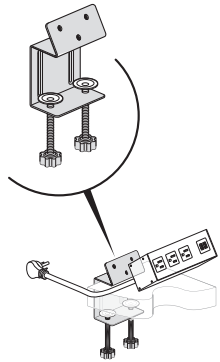

EUFB-0000-AB

Features

- Includes one Classic Power Module mounting bracket and mounting hardware.
- Fixed Bracket mounts Classic Power Module to edge of worksurface with thumb screws for ease of relocation.

Specification Tips

- Accommodates 2”(51mm) thick tops.
- Classic Power Module applications should be reviewed by local authorities (electrical inspector) prior to ordering due to varying local codes.
- Recommended for use on panel mounted worksurface or freestanding table top.

To Order, Specify:

- 1) Product number.
(No finish specification required.)

Classic Power Module Bracket - Vertical Bracket	Black	EUFB-0000-SB	\$47.88
	White	EUFB-0000-SW	47.88

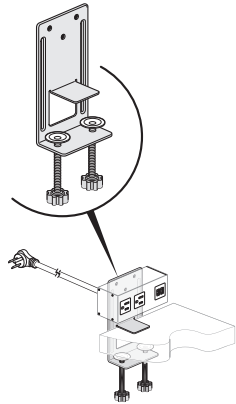

EUFB-0000-SB

Features

- Includes one Classic Power Module mounting bracket and mounting hardware.
- Adjustable bracket mounts Classic Power Module to edge of worksurface with thumb screws for ease of relocation.

Specification Tips

- Accommodates 2”(51mm) thick tops.
- Adjustable Classic Power Module Bracket may interfere with Screen application.
- Classic Power Module applications should be reviewed by local authorities (electrical inspector) prior to ordering due to varying local codes.
- Recommended for use on freestanding table top.

To Order, Specify:

- 1) Product number.
(No finish specification required.)

Classic Power Module Bracket - Under Surface	Black	EUFB-0000-UB	\$47.88
	White	EUFB-0000-UW	47.88

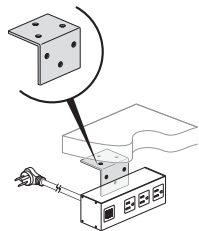

EUFB-0000-UB

Features

- Includes one Classic Power Module mounting bracket and mounting hardware.
- Under Surface bracket mounts Classic Power Module under worksurface with mounting screws.

Specification Tips

- Under surface Classic Power Module bracket may be used on top of worksurface in restricted reach (ADA) applications. Mounting screws will deface top of worksurface.
- Classic Power Module applications should be reviewed by local authorities (electrical inspector) prior to ordering due to varying local codes.

To Order, Specify:

- 1) Product number.
(No finish specification required.)

Electrical Components

Seamless Enhanced Power Module

Seamless Enhanced Power Module

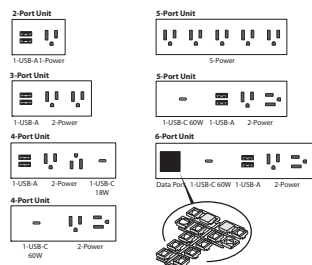
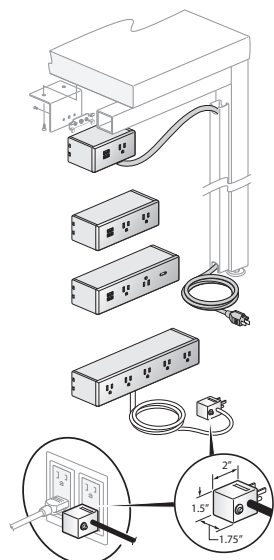

EUS1-PF0B
EUS1-PF0W
EUS1-HL0B
EUS1-HL0W



Features

- Includes power module with 2, 3, 4, 5 or 6 ports configured with simplex outlets (NEMA-5-15R), USB charging port or data ports and mounting hardware.
- Power Modules specified with a data port includes a variety of data port adapters and blank covers, which accommodate most varieties of field supplied data/AV Jacks.
- Corded power module with 15 amp - 6'(1829mm) or 12'(3658mm) long cord with plug (NEMA 5-15P).
- Hardwire power module with 12'(3658mm) flexible galvanized metal conduit with fitting for 0.5"(13mm) knockout and wires for hardwire connection.
- USB-A provides two 10W charging ports.
- USB-C 18W and USB-C 60W charging ports not available for hardwire.
- USB-C 18W can provide fast charge for a mobile phone. Occupies one charging port.
- USB-C 60W can charge a computer. Occupies two charging ports.
- Attaches to surface with separately specified mounting brackets.
- Enhanced Power Module Bracket EUDB-0000-B_ for perimeter edge power.
- Color option of black or white plastic front.

Specification Tips

- Configuration and quantity of power and data ports cannot be modified in the field.
- For use with 120 volt 60 hertz power source only.
- Requires field installation.
- Specify AV cables separately.
- Application may require approval of local authority having jurisdiction (AHJ); ensure compliance before placing orders and installation.
- Separately specified:
 - Mounting Bracket
 - Horizontal and Vertical Wire Management

To Order, Specify:

- 1) Product number.
(No finish specification required.)

Electrical Components

Seamless Enhanced Power Module

Width	Depth	Cord Length	Trim Color	Color	Port	Configuration	Number	Price
Corded								
4"(102mm)	1.875"(48mm)	6'(1829mm)	Black	Black	2	1 Power Receptacles, 1 Data Port	EUS1-PF0B-1010	\$350.98
						1 Power Receptacles, 1 USB-A Charging	EUS1-PF0B-1100	419.80
						2 Power Receptacles	EUS1-PF0B-2000	350.98
5.5"(140mm)					3	1 Power Receptacles, 1 USB-C 60W Charging	EUS1-PF0B-100001	\$600.94
						2 Power Receptacles, 1 Data Port	EUS1-PF0B-2010	410.62
						2 Power Receptacles, 1 USB-A Charging	EUS1-PF0B-2100	479.44
						3 Power Receptacles	EUS1-PF0B-3000	410.62
7"(178mm)					4	2 Power Receptacles, 2 USB-A Charging	EUS1-PF0B-2200	\$548.26
						2 Power Receptacles, 1 USB-A Charging, 1 USB-C 18W Charging	EUS1-PF0B-210010	595.29
						2 Power Receptacles, 1 USB-C 60W Charging	EUS1-PF0B-200001	600.94
						2 Power Receptacles, 1 USB-A Charging, 1 Data Port	EUS1-PF0B-2110	479.44
						2 Power Receptacles, 1 Data Port, 1 USB-C 18W Charging	EUS1-PF0B-201010	526.47
9.5"(241mm)					5	2 Power Receptacles, 1 USB-A Charging, 1 USB-C 60W Charging	EUS1-PF0B-210001	\$729.41
						3 Power Receptacles, 1 USB-A Charging, 1 Data Port	EUS1-PF0B-3110	539.09
						3 Power Receptacles, 2 USB-A Charging	EUS1-PF0B-3200	607.91
						4 Power Receptacles, 1 Data Port	EUS1-PF0B-4010	470.27
11"(279mm)					6	5 Power Receptacles	EUS1-PF0B-5000	470.27
						2 Power Receptacles, 1 USB-A Charging, 1 Data Port, 1 USB-C 60W Charging	EUS1-PF0B-211001	\$789.05
4"(102mm)	1.875"(48mm)	6'(1829mm)	White	White	2	1 Power Receptacles, 1 Data Port	EUS1-PF0W-1010	\$231.69
						1 Power Receptacles, 1 USB-A Charging	EUS1-PF0W-1100	300.51
						2 Power Receptacles	EUS1-PF0W-2000	231.69
5.5"(140mm)					3	1 Power Receptacles, 1 USB-C 60W Charging	EUS1-PF0W-100001	\$481.65
						2 Power Receptacles, 1 Data Port	EUS1-PF0W-2010	291.33
						2 Power Receptacles, 1 USB-A Charging	EUS1-PF0W-2100	360.15
7"(178mm)					4	3 Power Receptacles	EUS1-PF0W-3000	291.33
						2 Power Receptacles, 2 USB-A Charging	EUS1-PF0W-2200	\$428.97
						2 Power Receptacles, 1 USB-A Charging, 1 USB-C 18W Charging	EUS1-PF0W-210010	476.00
						2 Power Receptacles, 1 USB-C 60W Charging	EUS1-PF0W-200001	481.65
9.5"(241mm)					5	2 Power Receptacles, 1 USB-A Charging, 1 Data Port	EUS1-PF0W-2110	360.15
						2 Power Receptacles, 1 Data Port, 1 USB-C 18W Charging	EUS1-PF0W-201010	407.18
						2 Power Receptacles, 1 USB-A Charging, 1 USB-C 60W Charging	EUS1-PF0W-210001	\$608.12
						3 Power Receptacles, 1 USB-A Charging, 1 Data Port	EUS1-PF0W-3110	419.80
11"(279mm)					6	3 Power Receptacles, 2 USB-A Charging	EUS1-PF0W-3200	488.62
						4 Power Receptacles, 1 Data Port	EUS1-PF0W-4010	350.98
						5 Power Receptacles	EUS1-PF0W-5000	350.98
						2 Power Receptacles, 1 USB-A Charging, 1 Data Port, 1 USB-C 60W Charging	EUS1-PF0W-211001	\$669.80
4"(102mm)	1.875"(48mm)	12'(3658mm)	Black	Black	2	1 Power Receptacles, 1 Data Port	EUS1-PL0B-1010	\$407.05
						1 Power Receptacles, 1 USB-A Charging	EUS1-PL0B-1100	475.87
						2 Power Receptacles	EUS1-PL0B-2000	407.05
5.5"(140mm)					3	1 Power Receptacles, 1 USB-C 60W Charging	EUS1-PL0B-100001	\$657.01
						2 Power Receptacles, 1 Data Port	EUS1-PL0B-2010	466.69
						2 Power Receptacles, 1 USB-A Charging	EUS1-PL0B-2100	535.51
7"(178mm)					4	3 Power Receptacles	EUS1-PL0B-3000	466.69
						2 Power Receptacles, 2 USB-A Charging	EUS1-PL0B-2200	\$604.33
						2 Power Receptacles, 1 USB-A Charging, 1 USB-C 18W Charging	EUS1-PL0B-210010	651.36
						2 Power Receptacles, 1 USB-C 60W Charging	EUS1-PL0B-200001	657.01
9.5"(241mm)					5	2 Power Receptacles, 1 USB-A Charging, 1 Data Port	EUS1-PL0B-2110	535.51
						2 Power Receptacles, 1 Data Port, 1 USB-C 18W Charging	EUS1-PL0B-201010	582.54
						2 Power Receptacles, 1 USB-A Charging, 1 USB-C 60W Charging	EUS1-PL0B-210001	\$785.48
						3 Power Receptacles, 1 USB-A Charging, 1 Data Port	EUS1-PL0B-3110	595.16
11"(279mm)					6	3 Power Receptacles, 2 USB-A Charging	EUS1-PL0B-3200	663.98
						4 Power Receptacles, 1 Data Port	EUS1-PL0B-4010	526.34
						5 Power Receptacles	EUS1-PL0B-5000	526.34
						2 Power Receptacles, 1 USB-A Charging, 1 Data Port, 1 USB-C 60W Charging	EUS1-PL0B-211001	\$845.16

Electrical Components

Seamless Enhanced Power Module

Width	Depth	Cord Length	Trim Color	Color	Port	Configuration	Number	Price
Corded								
4"(102mm)	1.875"(48mm)	12'(3658mm)	White	White	2	1 Power Receptacles, 1 Data Port	EUS1-PL0W-1010	\$287.76
						1 Power Receptacles, 1 USB-A Charging	EUS1-PL0W-1100	356.58
						2 Power Receptacles	EUS1-PL0W-2000	287.76
5.5"(140mm)					3	1 Power Receptacles, 1 USB-C 60W Charging	EUS1-PL0W-100001	\$537.72
						2 Power Receptacles, 1 Data Port	EUS1-PL0W-2010	347.40
						2 Power Receptacles, 1 USB-A Charging	EUS1-PL0W-2100	416.22
						3 Power Receptacles	EUS1-PL0W-3000	347.40
7"(178mm)					4	2 Power Receptacles, 2 USB-A Charging	EUS1-PL0W-2200	\$485.04
						2 Power Receptacles, 1 USB-A Charging, 1 USB-C 18W Charging	EUS1-PL0W-210010	532.07
						2 Power Receptacles, 1 USB-C 60W Charging	EUS1-PL0W-200001	537.72
						2 Power Receptacles, 1 USB-A Charging, 1 Data Port	EUS1-PL0W-2110	416.22
						2 Power Receptacles, 1 Data Port, 1 USB-C 18W Charging	EUS1-PL0W-201010	463.25
9.5"(241mm)					5	2 Power Receptacles, 1 USB-A Charging, 1 USB-C 60W Charging	EUS1-PL0W-210001	\$610.12
						3 Power Receptacles, 1 USB-A Charging, 1 Data Port	EUS1-PL0W-3110	475.87
						3 Power Receptacles, 2 USB-A Charging	EUS1-PL0W-3200	544.69
						4 Power Receptacles, 1 Data Port	EUS1-PL0W-4010	407.05
11"(279mm)					6	5 Power Receptacles	EUS1-PL0W-5000	407.05
						2 Power Receptacles, 1 USB-A Charging, 1 Data Port, 1 USB-C 60W Charging	EUS1-PL0W-211001	725.87
Hardwire								
4"(102mm)	1.875"(48mm)	12'(3658mm)	Black	Black	2	1 Power Receptacles, 1 Data Port	EUS1-HL0B-1010	\$477.34
						1 Power Receptacles, 1 USB-A Charging	EUS1-HL0B-1100	546.16
						2 Power Receptacles	EUS1-HL0B-2000	477.34
5.5"(140mm)					3	2 Power Receptacles, 1 Data Port	EUS1-HL0B-2010	\$536.98
						2 Power Receptacles, 1 USB-A Charging	EUS1-HL0B-2100	605.80
						3 Power Receptacles	EUS1-HL0B-3000	536.98
7"(178mm)					4	2 Power Receptacles, 2 USB-A Charging	EUS1-HL0B-2200	\$674.62
						2 Power Receptacles, 1 USB-A Charging, 1 Data Port	EUS1-HL0B-2110	605.80
9.5"(241mm)					5	3 Power Receptacles, 1 USB-A Charging, 1 Data Port	EUS1-HL0B-3110	\$665.45
						3 Power Receptacles, 2 USB-A Charging	EUS1-HL0B-3200	734.27
						4 Power Receptacles, 1 Data Port	EUS1-HL0B-4010	596.63
						5 Power Receptacles	EUS1-HL0B-5000	596.63
4"(102mm)	1.875"(48mm)	12'(3658mm)	White	White	2	1 Power Receptacles, 1 Data Port	EUS1-HL0W-1010	\$358.05
						1 Power Receptacles, 1 USB-A Charging	EUS1-HL0W-1100	426.87
						2 Power Receptacles	EUS1-HL0W-2000	358.05
5.5"(140mm)					3	2 Power Receptacles, 1 Data Port	EUS1-HL0W-2010	\$417.69
						2 Power Receptacles, 1 USB-A Charging	EUS1-HL0W-2100	486.51
						3 Power Receptacles	EUS1-HL0W-3000	417.69
7"(178mm)					4	2 Power Receptacles, 2 USB-A Charging	EUS1-HL0W-2200	\$555.33
						2 Power Receptacles, 1 USB-A Charging, 1 Data Port	EUS1-HL0W-2110	486.51
9.5"(241mm)					5	3 Power Receptacles, 1 USB-A Charging, 1 Data Port	EUS1-HL0W-3110	\$546.16
						3 Power Receptacles, 2 USB-A Charging	EUS1-HL0W-3200	614.98
						4 Power Receptacles, 1 Data Port	EUS1-HL0W-4010	477.34
						5 Power Receptacles	EUS1-HL0W-5000	477.34

This page intentionally blank

Electrical Components

Flush Mounted Power — Corded

3-Port:

- (2) Power
- (1) USB

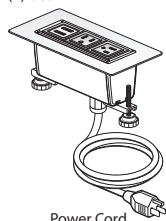

Power Cord

EUB1-PL0B-2100

4-Port:

- (2) Power
- (1) USB
- (1) Data

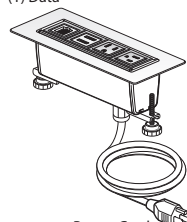

Power Cord

EUB1-PL0B-2110

6-Port:

- (2) Power
- (1) USB
- (1) Data
- (1) Cable Bay

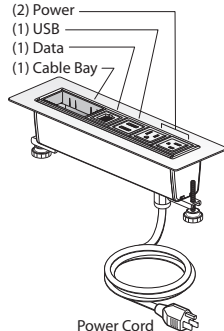

Power Cord

EUB1-PL0B-2112

4-Port:

- (4) Power

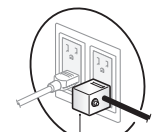
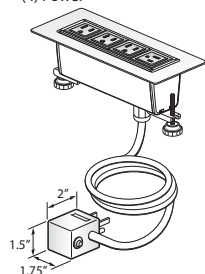

NOTE:
Always Fused Plug when more than 3 power outlets specified.
EUB1-PL0B-4000



Features

- Includes power module with 3, 4 or 6 ports that can be configured with simplex outlets (NEMA-5-15R), USB charging port (with two USB outlets), data ports or cable bay(s) that can accept up to two pull out data/AV cables and mounting hardware.
- Data port accommodate most varieties of field supplied data/AV jacks.
- Corded power module with 15 amp - 12'(3658mm) long cord with plug (NEMA 5-15P).
- USB Charging Port consists of two USB 2.0 style A outlets. 4 Amp (shared) charging capacity.
- Attaches to surface with use of included mounting brackets.
- Flush Mount has an overall housing depth of 4"(102mm) and will extend into mounting surface.
- Color option of black painted bezel with black receptacles or white painted bezel with white receptacles.

Specification Tips

- **Configuration and quantity of power and data ports cannot be modified in the field.**
- **For use with 120 volt 60 hertz power source only.**
- Requires field installation.
- Requires field cut access hole for power cord/conduit routing.
- Specify AV cables separately.
- Cable Bay requires cables less than 0.3"(7.6mm) diameter.
- Application may require approval of local authority having jurisdiction (AHJ); ensure compliance before placing orders and installation.

To Order, Specify:

- 1) Product number.
(No finish specification required.)

Electrical Components

Flush Mounted Power — Corded

Top Width	Top Depth	Cord Length	Trim Color	Port Color	Port	Configuration	Number	Price						
Corded														
6.75"(171mm)	3"(76mm)	12'(3658mm)	Black	Black	3	1 Power Receptacle, 1 Cable Bay	EUB1-PL0B-1002	\$ 890.56						
						1 Power Receptacle, 2 Data Ports	EUB1-PL0B-1020	890.56						
						1 Power Receptacle, 1 Data Port, 1 USB Charging	EUB1-PL0B-1110	962.82						
						1 Power Receptacle, 2 USB Charging	EUB1-PL0B-1200	1035.08						
						2 Power Receptacles, 1 Data Port	EUB1-PL0B-2010	890.56						
						2 Power Receptacles, 1 USB Charging	EUB1-PL0B-2100	962.82						
						3 Power Receptacles	EUB1-PL0B-3000	890.56						
8.25"(210mm)	3"(76mm)				4	1 Power Receptacle, 1 Data Port, 1 Cable Bay	EUB1-PL0B-1012	\$ 953.18						
						1 Power Receptacle, 3 Data Ports	EUB1-PL0B-1030	953.18						
						1 Power Receptacle, 1 USB Charging, 1 Cable Bay	EUB1-PL0B-1102	1025.44						
						1 Power Receptacle, 3 USB Charging	EUB1-PL0B-1300	1169.96						
						2 Power Receptacles, 1 Cable Bay	EUB1-PL0B-2002	953.18						
						2 Power Receptacles, 2 Data Ports	EUB1-PL0B-2020	953.18						
						2 Power Receptacles, 1 USB Charging, 1 Data Port	EUB1-PL0B-2110	1025.44						
						2 Power Receptacles, 2 USB Charging	EUB1-PL0B-2200	1097.70						
						3 Power Receptacles, 1 Data Port	EUB1-PL0B-3010	953.18						
						3 Power Receptacles, 1 USB Charging	EUB1-PL0B-3100	1025.44						
						4 Power Receptacles	EUB1-PL0B-4000	953.18						
						9.75"(248mm)	3"(76mm)				6	1 Power Receptacle, 1 USB Charging, 2 Cable Bays	EUB1-PL0B-1104	\$1088.07
												1 Power Receptacle, 1 USB Charging, 2 Data Ports, 1 Cable Bay	EUB1-PL0B-1122	1088.07
1 Power Receptacle, 1 USB Charging, 4 Data Ports	EUB1-PL0B-1140	1088.07												
1 Power Receptacle, 2 USB Charging, 1 Data Port, 1 Cable Bay	EUB1-PL0B-1212	1160.33												
1 Power Receptacle, 2 USB Charging, 3 Data Ports	EUB1-PL0B-1230	1160.33												
1 Power Receptacle, 3 USB Charging, 1 Cable Bay	EUB1-PL0B-1302	1232.59												
1 Power Receptacle, 3 USB Charging, 2 Data Ports	EUB1-PL0B-1320	1232.59												
1 Power Receptacle, 4 USB Charging, 1 Data Port	EUB1-PL0B-1410	1304.85												
2 Power Receptacles, 2 Cable Bays	EUB1-PL0B-2004	1015.81												
2 Power Receptacles, 2 Data Ports, 1 Cable Bay	EUB1-PL0B-2022	1015.81												
2 Power Receptacles, 4 Data Ports	EUB1-PL0B-2040	1015.81												
2 Power Receptacles, 1 USB Charging, 1 Data Port, 1 Cable Bay	EUB1-PL0B-2112	1088.07												
2 Power Receptacles, 1 USB Charging, 3 Data Ports	EUB1-PL0B-2130	1088.07												
2 Power Receptacles, 2 USB Charging, 1 Cable Bay	EUB1-PL0B-2202	1160.33												
2 Power Receptacles, 2 USB Charging, 2 Data Ports	EUB1-PL0B-2220	1160.33												
2 Power Receptacles, 3 USB Charging, 1 Data Port	EUB1-PL0B-2310	1232.59												
2 Power Receptacles, 4 USB Charging	EUB1-PL0B-2400	1304.85												
3 Power Receptacles, 3 Data Ports	EUB1-PL0B-3030	1015.81												
3 Power Receptacles, 1 USB Charging, 1 Cable Bay	EUB1-PL0B-3102	1088.07												
3 Power Receptacles, 1 USB Charging, 2 Data Ports	EUB1-PL0B-3120	1088.07												
3 Power Receptacles, 2 USB Charging, 1 Data Port	EUB1-PL0B-3210	1160.33												
3 Power Receptacles, 3 USB Charging	EUB1-PL0B-3300	1232.59												
4 Power Receptacles, 1 Cable Bay	EUB1-PL0B-4002	1015.81												
4 Power Receptacles, 2 Data Ports	EUB1-PL0B-4020	1015.81												
4 Power Receptacles, 1 USB Charging, 1 Data Port	EUB1-PL0B-4110	1088.07												
4 Power Receptacles, 2 USB Charging	EUB1-PL0B-4200	1160.33												
5 Power Receptacles, 1 Data Port	EUB1-PL0B-5010	1015.81												
5 Power Receptacles, 1 USB Charging	EUB1-PL0B-5100	1088.07												
6 Power Receptacles	EUB1-PL0B-6000	1015.81												

Electrical Components

Flush Mounted Power — Corded

Top Width	Top Depth	Cord Length	Trim Color	Port Color	Port	Configuration	Number	Price						
6.75"(171mm)	3"(76mm)	12'(3658mm)	White	White	3	1 Power Receptacle, 1 Cable Bay	EUB1-PL0W-1002	\$ 765.31						
						1 Power Receptacle, 2 Data Ports	EUB1-PL0W-1020	765.31						
						1 Power Receptacle, 1 Data Port, 1 USB Charging	EUB1-PL0W-1110	837.57						
						1 Power Receptacle, 2 USB Charging	EUB1-PL0W-1200	909.83						
						2 Power Receptacles, 1 Data Port	EUB1-PL0W-2010	765.31						
						2 Power Receptacles, 1 USB Charging	EUB1-PL0W-2100	837.57						
						3 Power Receptacles	EUB1-PL0W-3000	765.31						
8.25"(210mm)	3"(76mm)				4	1 Power Receptacle, 1 Data Port, 1 Cable Bay	EUB1-PL0W-1012	\$ 827.93						
						1 Power Receptacle, 3 Data Ports	EUB1-PL0W-1030	827.93						
						1 Power Receptacle, 1 USB Charging, 1 Cable Bay	EUB1-PL0W-1102	900.19						
						1 Power Receptacle, 3 USB Charging	EUB1-PL0W-1300	1044.71						
						2 Power Receptacles, 1 Cable Bay	EUB1-PL0W-2002	827.93						
						2 Power Receptacles, 2 Data Ports	EUB1-PL0W-2020	827.93						
						2 Power Receptacles, 1 USB Charging, 1 Data Port	EUB1-PL0W-2110	900.19						
						2 Power Receptacles, 2 USB Charging	EUB1-PL0W-2200	972.45						
						3 Power Receptacles, 1 Data Port	EUB1-PL0W-3010	827.93						
						3 Power Receptacles, 1 USB Charging	EUB1-PL0W-3100	900.19						
						4 Power Receptacles	EUB1-PL0W-4000	827.93						
						9.75"(248mm)	3"(76mm)				6	1 Power Receptacle, 1 USB Charging, 2 Cable Bays	EUB1-PL0W-1104	\$ 962.82
												1 Power Receptacle, 1 USB Charging, 2 Data Ports, 1 Cable Bay	EUB1-PL0W-1122	962.82
1 Power Receptacle, 1 USB Charging, 4 Data Ports	EUB1-PL0W-1140	962.82												
1 Power Receptacle, 2 USB Charging, 1 Data Port, 1 Cable Bay	EUB1-PL0W-1212	1035.08												
1 Power Receptacle, 2 USB Charging, 3 Data Ports	EUB1-PL0W-1230	1035.08												
1 Power Receptacle, 3 USB Charging, 1 Cable Bay	EUB1-PL0W-1302	1107.34												
1 Power Receptacle, 3 USB Charging, 2 Data Ports	EUB1-PL0W-1320	1107.34												
1 Power Receptacle, 4 USB Charging, 1 Data Port	EUB1-PL0W-1410	1179.60												
2 Power Receptacles, 2 Cable Bays	EUB1-PL0W-2004	890.56												
2 Power Receptacles, 2 Data Ports, 1 Cable Bay	EUB1-PL0W-2022	890.56												
2 Power Receptacles, 4 Data Ports	EUB1-PL0W-2040	890.56												
2 Power Receptacles, 1 USB Charging, 1 Data Port, 1 Cable Bay	EUB1-PL0W-2112	962.82												
2 Power Receptacles, 1 USB Charging, 3 Data Ports	EUB1-PL0W-2130	962.82												
2 Power Receptacles, 2 USB Charging, 1 Cable Bay	EUB1-PL0W-2202	1035.08												
2 Power Receptacles, 2 USB Charging, 2 Data Ports	EUB1-PL0W-2220	1035.08												
2 Power Receptacles, 3 USB Charging, 1 Data Port	EUB1-PL0W-2310	1107.34												
2 Power Receptacles, 4 USB Charging	EUB1-PL0W-2400	1179.60												
3 Power Receptacles, 3 Data Ports	EUB1-PL0W-3030	890.56												
3 Power Receptacles, 1 USB Charging, 1 Cable Bay	EUB1-PL0W-3102	962.82												
3 Power Receptacles, 1 USB Charging, 2 Data Ports	EUB1-PL0W-3120	962.82												
3 Power Receptacles, 2 USB Charging, 1 Data Port	EUB1-PL0W-3210	1035.08												
3 Power Receptacles, 3 USB Charging	EUB1-PL0W-3300	1107.34												
4 Power Receptacles, 1 Cable Bay	EUB1-PL0W-4002	890.56												
4 Power Receptacles, 2 Data Ports	EUB1-PL0W-4020	890.56												
4 Power Receptacles, 1 USB Charging, 1 Data Port	EUB1-PL0W-4110	962.82												
4 Power Receptacles, 2 USB Charging	EUB1-PL0W-4200	1035.08												
5 Power Receptacles, 1 Data Port	EUB1-PL0W-5010	890.56												
5 Power Receptacles, 1 USB Charging	EUB1-PL0W-5100	962.82												
6 Power Receptacles	EUB1-PL0W-6000	890.56												

This page intentionally blank

Electrical Components

Flush Mounted Power — Hardwire

3-Port:

- (2) Power
- (1) USB

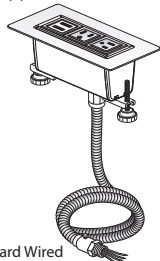

Hard Wired

EUB1-HLOB-2100

4-Port:

- (2) Power
- (1) USB
- (1) Data

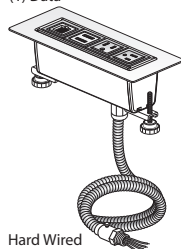

Hard Wired

EUB1-HLOB-2110

6-Port:

- (2) Power
- (1) USB
- (1) Data
- (1) Cable Bay

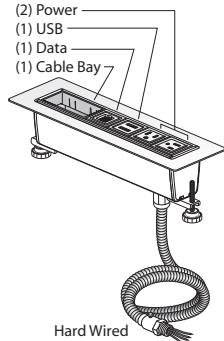

Hard Wired

EUB1-HLOB-2112



Features

- Includes power module with 3, 4 or 6 ports that can be configured with simplex outlets (NEMA-5-15R), USB charging port (with two USB outlets), data ports or cable bay(s) that can accept up to two pull out data/AV cables and mounting hardware.
- Data port accommodate most varieties of field supplied data/AV jacks.
- Hardwired power module with 12'(3658mm) long flexible metal conduit feed, 0.5"(13mm) conduit fitting and wires for hardwire connection.
- USB Charging Port consists of two USB 2.0 style A outlets. 4 Amp (shared) charging capacity.
- Attaches to surface with use of included mounting brackets.
- Flush Mount has an overall housing depth of 4"(102mm) and will extend into mounting surface.
- Color option of black painted bezel with black receptacles or white painted bezel with white receptacles.

Specification Tips

- **Configuration and quantity of power and data ports cannot be modified in the field.**
- **For use with 120 volt 60 hertz power source only.**
- Requires field installation.
- Requires field cut access hole for power cord/conduit routing.
- Specify AV cables separately.
- Cable Bay requires cables less than 0.3"(7.6mm) diameter.
- Application may require approval of local authority having jurisdiction (AHJ); ensure compliance before placing orders and installation.

To Order, Specify:

- 1) Product number.
(No finish specification required.)

Electrical Components

Flush Mounted Power — Hardwire

Top Width	Top Depth	Conduit Length	Trim Color	Port Color	Port	Power	USB Charging	Data Port	Cable Bay	Description	Number	Price
Corded												
6.75" (171mm)	3" (76mm)	12' (3658mm)	Black	Black	3	1	0	0	2	1 Power Receptacle, 1 Cable Bay	EUB1-HLOB-1002	\$ 974.20
						1	0	2	0	1 Power Receptacle, 2 Data Ports	EUB1-HLOB-1020	974.20
						1	1	1	0	1 Power Receptacle, 1 Data Port, 1 USB Charging	EUB1-HLOB-1110	1046.46
						1	2	0	0	1 Power Receptacle, 2 USB Charging	EUB1-HLOB-1200	1118.72
						2	0	1	0	2 Power Receptacles, 1 Data Port	EUB1-HLOB-2010	974.20
						2	1	0	0	2 Power Receptacles, 1 USB Charging	EUB1-HLOB-2100	1046.46
						3	0	0	0	3 Power Receptacles	EUB1-HLOB-3000	974.20
8.25" (210mm)	3" (76mm)				4	1	0	1	2	1 Power Receptacle, 1 Data Port, 1 Cable Bay	EUB1-HLOB-1012	\$1036.82
						1	0	3	0	1 Power Receptacle, 3 Data Ports	EUB1-HLOB-1030	1036.82
						1	1	0	2	1 Power Receptacle, 1 USB Charging, 1 Cable Bay	EUB1-HLOB-1102	1109.08
						1	3	0	0	1 Power Receptacle, 3 USB Charging	EUB1-HLOB-1300	1253.60
						2	0	0	2	2 Power Receptacles, 1 Cable Bay	EUB1-HLOB-2002	1036.82
						2	0	2	0	2 Power Receptacles, 2 Data Ports	EUB1-HLOB-2020	1036.82
						2	1	1	0	2 Power Receptacles, 1 USB Charging, 1 Data Port	EUB1-HLOB-2110	1109.08
						2	2	0	0	2 Power Receptacles, 2 USB Charging	EUB1-HLOB-2200	1181.34
						3	0	1	0	3 Power Receptacles, 1 Data Port	EUB1-HLOB-3010	1036.82
						3	1	0	0	3 Power Receptacles, 1 USB Charging	EUB1-HLOB-3100	1109.08
						4	0	0	0	4 Power Receptacles	EUB1-HLOB-4000	1036.82
9.75" (248mm)	3" (76mm)				6	1	1	0	4	1 Power Receptacle, 1 USB Charging, 2 Cable Bays	EUB1-HLOB-1104	\$1171.71
						1	1	2	2	1 Power Receptacle, 1 USB Charging, 2 Data Ports, 1 Cable Bay	EUB1-HLOB-1122	1171.71
						1	1	4	0	1 Power Receptacle, 1 USB Charging, 4 Data Ports	EUB1-HLOB-1140	1171.71
						1	2	1	2	1 Power Receptacle, 2 USB Charging, 1 Data Port, 1 Cable Bay	EUB1-HLOB-1212	1243.97
						1	2	3	0	1 Power Receptacle, 2 USB Charging, 3 Data Ports	EUB1-HLOB-1230	1243.97
						1	3	0	2	1 Power Receptacle, 3 USB Charging, 1 Cable Bay	EUB1-HLOB-1302	1316.23
						1	3	2	0	1 Power Receptacle, 3 USB Charging, 2 Data Ports	EUB1-HLOB-1320	1316.23
						1	4	1	0	1 Power Receptacle, 4 USB Charging, 1 Data Port	EUB1-HLOB-1410	1388.49
						2	0	0	4	2 Power Receptacles, 2 Cable Bays	EUB1-HLOB-2004	1099.45
						2	0	2	2	2 Power Receptacles, 2 Data Ports, 1 Cable Bay	EUB1-HLOB-2022	1099.45
						2	0	4	0	2 Power Receptacles, 4 Data Ports	EUB1-HLOB-2040	1099.45
						2	1	1	2	2 Power Receptacles, 1 USB Charging, 1 Data Port, 1 Cable Bay	EUB1-HLOB-2112	1171.71
						2	1	3	0	2 Power Receptacles, 1 USB Charging, 3 Data Ports	EUB1-HLOB-2130	1171.71
						2	2	0	2	2 Power Receptacles, 2 USB Charging, 1 Cable Bay	EUB1-HLOB-2202	1243.97
						2	2	2	0	2 Power Receptacles, 2 USB Charging, 2 Data Ports	EUB1-HLOB-2220	1243.97
						2	3	1	0	2 Power Receptacles, 3 USB Charging, 1 Data Port	EUB1-HLOB-2310	1316.23
						2	4	0	0	2 Power Receptacles, 4 USB Charging	EUB1-HLOB-2400	1388.49
						3	0	3	0	3 Power Receptacles, 3 Data Ports	EUB1-HLOB-3030	1099.45
						3	1	0	2	3 Power Receptacles, 1 USB Charging, 1 Cable Bay	EUB1-HLOB-3102	1171.71
						3	1	2	0	3 Power Receptacles, 1 USB Charging, 2 Data Ports	EUB1-HLOB-3120	1171.71
						3	2	1	0	3 Power Receptacles, 2 USB Charging, 1 Data Port	EUB1-HLOB-3210	1243.97
						3	3	0	0	3 Power Receptacles, 3 USB Charging	EUB1-HLOB-3300	1316.23
						4	0	0	2	4 Power Receptacles, 1 Cable Bay	EUB1-HLOB-4002	1099.45
						4	0	2	0	4 Power Receptacles, 2 Data Ports	EUB1-HLOB-4020	1099.45
						4	1	1	0	4 Power Receptacles, 1 USB Charging, 1 Data Port	EUB1-HLOB-4110	1171.71
						4	2	0	0	4 Power Receptacles, 2 USB Charging	EUB1-HLOB-4200	1243.97
						5	0	1	0	5 Power Receptacles, 1 Data Port	EUB1-HLOB-5010	1099.45
						5	1	0	0	5 Power Receptacles, 1 USB Charging	EUB1-HLOB-5100	1171.71
						6	0	0	0	6 Power Receptacles	EUB1-HLOB-6000	1099.45

Electrical Components

Flush Mounted Power — Hardwire

Top Width	Top Depth	Conduit Length	Trim Color	Port Color	Port	Power	USB Charging	Data Port	Cable Bay	Description	Number	Price						
6.75" (171mm)	3" (76mm)	12' (3658mm)	White	White	3	1	0	0	2	1 Power Receptacle, 1 Cable Bay	EUB1-HLOW-1002	\$ 848.95						
						1	0	2	0	1 Power Receptacle, 2 Data Ports	EUB1-HLOW-1020	848.95						
						1	1	1	0	1 Power Receptacle, 1 Data Port, 1 USB Charging	EUB1-HLOW-1110	921.21						
						1	2	0	0	1 Power Receptacle, 2 USB Charging	EUB1-HLOW-1200	993.47						
						2	0	1	0	2 Power Receptacles, 1 Data Port	EUB1-HLOW-2010	848.95						
						2	1	0	0	2 Power Receptacles, 1 USB Charging	EUB1-HLOW-2100	921.21						
						3	0	0	0	3 Power Receptacles	EUB1-HLOW-3000	848.95						
8.25" (210mm)	3" (76mm)				4	1	0	1	2	1 Power Receptacle, 1 Data Port, 1 Cable Bay	EUB1-HLOW-1012	\$ 911.57						
						1	0	3	0	1 Power Receptacle, 3 Data Ports	EUB1-HLOW-1030	911.57						
						1	1	0	2	1 Power Receptacle, 1 USB Charging, 1 Cable Bay	EUB1-HLOW-1102	983.83						
						1	3	0	0	1 Power Receptacle, 3 USB Charging	EUB1-HLOW-1300	1128.35						
						2	0	0	2	2 Power Receptacles, 1 Cable Bay	EUB1-HLOW-2002	911.57						
						2	0	2	0	2 Power Receptacles, 2 Data Ports	EUB1-HLOW-2020	911.57						
						2	1	1	0	2 Power Receptacles, 1 USB Charging, 1 Data Port	EUB1-HLOW-2110	983.83						
						2	2	0	0	2 Power Receptacles, 2 USB Charging	EUB1-HLOW-2200	1056.09						
						3	0	1	0	3 Power Receptacles, 1 Data Port	EUB1-HLOW-3010	911.57						
						3	1	0	0	3 Power Receptacles, 1 USB Charging	EUB1-HLOW-3100	983.83						
						4	0	0	0	4 Power Receptacles	EUB1-HLOW-4000	911.57						
						9.75" (248mm)	3" (76mm)				6	1	1	0	4	1 Power Receptacle, 1 USB Charging, 2 Cable Bays	EUB1-HLOW-1104	\$1046.46
												1	1	2	2	1 Power Receptacle, 1 USB Charging, 2 Data Ports, 1 Cable Bay	EUB1-HLOW-1122	1046.46
1	1	4	0	1 Power Receptacle, 1 USB Charging, 4 Data Ports	EUB1-HLOW-1140							1046.46						
1	2	1	2	1 Power Receptacle, 2 USB Charging, 1 Data Port, 1 Cable Bay	EUB1-HLOW-1212							1118.72						
1	2	3	0	1 Power Receptacle, 2 USB Charging, 3 Data Ports	EUB1-HLOW-1230							1118.72						
1	3	0	2	1 Power Receptacle, 3 USB Charging, 1 Cable Bay	EUB1-HLOW-1302							1190.98						
1	3	2	0	1 Power Receptacle, 3 USB Charging, 2 Data Ports	EUB1-HLOW-1320							1190.98						
1	4	1	0	1 Power Receptacle, 4 USB Charging, 1 Data Port	EUB1-HLOW-1410							1263.24						
2	0	0	4	2 Power Receptacles, 2 Cable Bays	EUB1-HLOW-2004							974.20						
2	0	2	2	2 Power Receptacles, 2 Data Ports, 1 Cable Bay	EUB1-HLOW-2022							974.20						
2	0	4	0	2 Power Receptacles, 4 Data Ports	EUB1-HLOW-2040							974.20						
2	1	1	2	2 Power Receptacles, 1 USB Charging, 1 Data Port, 1 Cable Bay	EUB1-HLOW-2112							1046.46						
2	1	3	0	2 Power Receptacles, 1 USB Charging, 3 Data Ports	EUB1-HLOW-2130							1046.46						
2	2	0	2	2 Power Receptacles, 2 USB Charging, 1 Cable Bay	EUB1-HLOW-2202							1118.72						
2	2	2	0	2 Power Receptacles, 2 USB Charging, 2 Data Ports	EUB1-HLOW-2220							1118.72						
2	3	1	0	2 Power Receptacles, 3 USB Charging, 1 Data Port	EUB1-HLOW-2310							1190.98						
2	4	0	0	2 Power Receptacles, 4 USB Charging	EUB1-HLOW-2400							1263.24						
3	0	3	0	3 Power Receptacles, 3 Data Ports	EUB1-HLOW-3030							974.20						
3	1	0	2	3 Power Receptacles, 1 USB Charging, 1 Cable Bay	EUB1-HLOW-3102							1046.46						
3	1	2	0	3 Power Receptacles, 1 USB Charging, 2 Data Ports	EUB1-HLOW-3120							1046.46						
3	2	1	0	3 Power Receptacles, 2 USB Charging, 1 Data Port	EUB1-HLOW-3210							1118.72						
3	3	0	0	3 Power Receptacles, 3 USB Charging	EUB1-HLOW-3300							1190.98						
4	0	0	2	4 Power Receptacles, 1 Cable Bay	EUB1-HLOW-4002							974.20						
4	0	2	0	4 Power Receptacles, 2 Data Ports	EUB1-HLOW-4020	974.20												
4	1	1	0	4 Power Receptacles, 1 USB Charging, 1 Data Port	EUB1-HLOW-4110	1046.46												
4	2	0	0	4 Power Receptacles, 2 USB Charging	EUB1-HLOW-4200	1118.72												
5	0	1	0	5 Power Receptacles, 1 Data Port	EUB1-HLOW-5010	974.20												
5	1	0	0	5 Power Receptacles, 1 USB Charging	EUB1-HLOW-5100	1046.46												
6	0	0	0	6 Power Receptacles	EUB1-HLOW-6000	974.20												

This page intentionally blank

Electrical Components

Flush Mounted Power — Spiral Cord for Height Adjustable

3-Port:

- (2) Power
- (1) USB

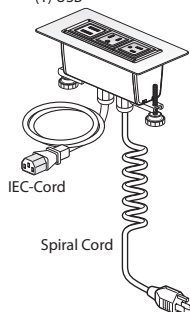

EUB1-SF0B-2100

4-Port:

- (2) Power
- (1) USB
- (1) Data

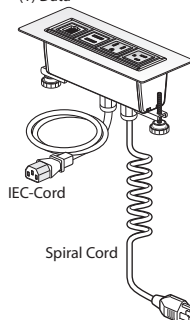

EUB1-SF0B-2110

6-Port:

- (2) Power
- (1) USB
- (1) Data
- (1) Cable Bay

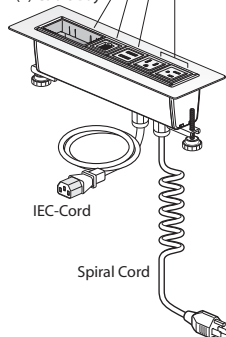

EUB1-SF0B-2112



Features

- Includes power module with 3, 4 or 6 ports that can be configured with simplex outlets (NEMA-5-15R), USB charging port (with two USB outlets), data ports or cable bay(s) that can accept up to two pull out data/AV cables and mounting hardware.
- Data port accommodate most varieties of field supplied data/AV jacks.
- Spiral Cord includes 15 amp plug (NEMA 5-15P) and expands to 12'(3658mm) when stretched.
- Auxiliary 24"(610mm) power cord includes IEC connector (IEC C13) for motor controller.
- USB Charging Port consists of two USB 2.0 style A outlets. 4 Amp (shared) charging capacity.
- Attaches to surface with use of included mounting brackets.
- Flush Mount has an overall housing depth of 4"(102mm) and will extend into mounting surface.
- Color option of black painted bezel with black receptacles or white painted bezel with white receptacles.

To Order, Specify:

- 1) Product number.
(No finish specification required.)

Specification Tips

- **Configuration and quantity of power and data ports cannot be modified in the field.**
- **For use with 120 volt 60 hertz power source only.**
- **For use with Suite, Planes Height Adjustable Tables, Planes Height Adjustable Bench, Hop 120° Benches and 3-Leg Hop Height Adjustable Tables. For 2-Leg Hop Height Adjustable Tables use IEC C6 to IEC C14 adapter.**
- Not for use with cable chain.
- Requires field installation.
- Requires field cut access hole for power cord/conduit routing.
- Specify AV cables separately.
- Cable Bay requires cables less than 0.3"(7.6mm) diameter.
- Application may require approval of local authority having jurisdiction (AHJ); ensure compliance before placing orders and installation.

4-Port:

- (4) Power

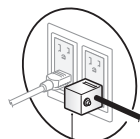
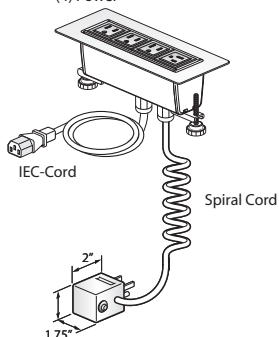

NOTE:

Always Fused Plug when more than 3 power outlets specified.

EUB1-SF0B-4000

Electrical Components

Flush Mounted Power — Spiral Cord for Height Adjustable

Top Width	Top Depth	Cord Length	Trim Color	Port Color	Port	Configuration	Number	Price
Corded								
6.75"(171mm)	3"(76mm)	10'(3048mm)	Black	Black	3	2 Power Receptacles, 1 Data Port	EUB1-SF0B-2010	\$1100.98
						2 Power Receptacles, 1 USB Charging	EUB1-SF0B-2100	1173.24
						3 Power Receptacles	EUB1-SF0B-3000	1100.98
8.25"(210mm)	3"(76mm)				4	2 Power Receptacles, 1 Cable Bay	EUB1-SF0B-2002	1163.60
						2 Power Receptacles, 2 Data Ports	EUB1-SF0B-2020	1163.60
						2 Power Receptacles, 1 USB Charging, 1 Data Port	EUB1-SF0B-2110	1235.86
						2 Power Receptacles, 2 USB Charging	EUB1-SF0B-2200	1308.12
						3 Power Receptacles, 1 Data Port	EUB1-SF0B-3010	1163.60
						3 Power Receptacles, 1 USB Charging	EUB1-SF0B-3100	1235.86
						4 Power Receptacles	EUB1-SF0B-4000	1163.60
9.75"(248mm)	3"(76mm)				6	2 Power Receptacles, 2 Cable Bays	EUB1-SF0B-2004	\$1226.23
						2 Power Receptacles, 2 Data Ports, 1 Cable Bay	EUB1-SF0B-2022	1226.23
						2 Power Receptacles, 4 Data Ports	EUB1-SF0B-2040	1226.23
						2 Power Receptacles, 1 USB Charging, 1 Data Port, 1 Cable Bay	EUB1-SF0B-2112	1298.49
						2 Power Receptacles, 1 USB Charging, 3 Data Ports	EUB1-SF0B-2130	1298.49
						2 Power Receptacles, 2 USB Charging, 1 Cable Bay	EUB1-SF0B-2202	1370.75
						2 Power Receptacles, 2 USB Charging, 2 Data Ports	EUB1-SF0B-2220	1370.75
						2 Power Receptacles, 3 USB Charging, 1 Data Port	EUB1-SF0B-2310	1443.01
						2 Power Receptacles, 4 USB Charging	EUB1-SF0B-2400	1515.27
						3 Power Receptacles, 1 USB Charging, 1 Cable Bay	EUB1-SF0B-3012	1226.23
						3 Power Receptacles, 3 Data Ports	EUB1-SF0B-3030	1226.23
						3 Power Receptacles, 1 USB Charging, 1 Cable Bay	EUB1-SF0B-3102	1298.49
						3 Power Receptacles, 1 USB Charging, 2 Data Ports	EUB1-SF0B-3120	1298.49
						3 Power Receptacles, 2 USB Charging, 1 Data Port	EUB1-SF0B-3210	1370.75
						3 Power Receptacles, 3 USB Charging	EUB1-SF0B-3300	1443.01
						4 Power Receptacles, 1 Cable Bay	EUB1-SF0B-4002	1226.23
						4 Power Receptacles, 2 Data Ports	EUB1-SF0B-4020	1226.23
4 Power Receptacles, 1 USB Charging, 1 Data Port	EUB1-SF0B-4110	1298.49						
4 Power Receptacles, 2 USB Charging	EUB1-SF0B-4200	1370.75						
5 Power Receptacles, 1 Data Port	EUB1-SF0B-5010	1226.23						
5 Power Receptacles, 1 USB Charging	EUB1-SF0B-5100	1298.49						
6 Power Receptacles	EUB1-SF0B-6000	1226.23						

Electrical Components

Flush Mounted Power — Spiral Cord for Height Adjustable

Top Width	Top Depth	Cord Length	Trim Color	Port Color	Port	Configuration	Number	Price
6.75"(171mm)	3"(76mm)	10'(3048mm)	White	White	3	2 Power Receptacles, 1 Data Port	EUB1-SF0W-2010	\$ 975.73
						2 Power Receptacles, 1 USB Charging	EUB1-SF0W-2100	1047.99
						3 Power Receptacles	EUB1-SF0W-3000	975.73
8.25"(210mm)	3"(76mm)				4	2 Power Receptacles, 1 Cable Bay	EUB1-SF0W-2002	\$1038.35
						2 Power Receptacles, 2 Data Ports	EUB1-SF0W-2020	1038.35
						2 Power Receptacles, 1 USB Charging, 1 Data Port	EUB1-SF0W-2110	1110.61
						2 Power Receptacles, 2 USB Charging	EUB1-SF0W-2200	1182.87
						3 Power Receptacles, 1 Data Port	EUB1-SF0W-3010	1038.35
						3 Power Receptacles, 1 USB Charging	EUB1-SF0W-3100	1110.61
						4 Power Receptacles	EUB1-SF0W-4000	1038.35
9.75"(248mm)	3"(76mm)				6	2 Power Receptacles, 2 Cable Bays	EUB1-SF0W-2004	\$1100.98
						2 Power Receptacles, 2 Data Ports, 1 Cable Bay	EUB1-SF0W-2022	1100.98
						2 Power Receptacles, 4 Data Ports	EUB1-SF0W-2040	1100.98
						2 Power Receptacles, 1 USB Charging, 1 Data Port, 1 Cable Bay	EUB1-SF0W-2112	1173.24
						2 Power Receptacles, 1 USB Charging, 3 Data Ports	EUB1-SF0W-2130	1173.24
						2 Power Receptacles, 2 USB Charging, 1 Cable Bay	EUB1-SF0W-2202	1245.50
						2 Power Receptacles, 2 USB Charging, 2 Data Ports	EUB1-SF0W-2220	1245.50
						2 Power Receptacles, 3 USB Charging, 1 Data Port	EUB1-SF0W-2310	1317.76
						2 Power Receptacles, 4 USB Charging	EUB1-SF0W-2400	1390.02
						3 Power Receptacles, 1 USB Charging, 1 Cable Bay	EUB1-SF0W-3012	1100.98
						3 Power Receptacles, 3 Data Ports	EUB1-SF0W-3030	1100.98
						3 Power Receptacles, 1 USB Charging, 1 Cable Bay	EUB1-SF0W-3102	1173.24
						3 Power Receptacles, 1 USB Charging, 2 Data Ports	EUB1-SF0W-3120	1173.24
						3 Power Receptacles, 2 USB Charging, 1 Data Port	EUB1-SF0W-3210	1245.50
						3 Power Receptacles, 3 USB Charging	EUB1-SF0W-3300	1317.76
						4 Power Receptacles, 1 Cable Bay	EUB1-SF0W-4002	1100.98
						4 Power Receptacles, 2 Data Ports	EUB1-SF0W-4020	1100.98
4 Power Receptacles, 1 USB Charging, 1 Data Port	EUB1-SF0W-4110	1173.24						
4 Power Receptacles, 2 USB Charging	EUB1-SF0W-4200	1245.50						
5 Power Receptacles, 1 Data Port	EUB1-SF0W-5010	1100.98						
5 Power Receptacles, 1 USB Charging	EUB1-SF0W-5100	1173.24						
6 Power Receptacles	EUB1-SF0W-6000	1100.98						

Electrical Components

Flush Mounted Power — Cord for Height Adjustable

3-Port:

- (2) Power
- (1) USB

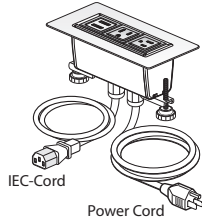

EUB1-SLOB-2100

4-Port:

- (2) Power
- (1) USB
- (1) Data

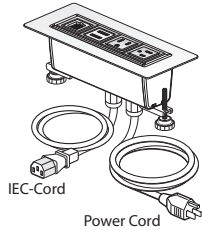

EUB1-SLOB-2110

6-Port:

- (2) Power
- (1) USB
- (1) Data
- (1) Cable Bay

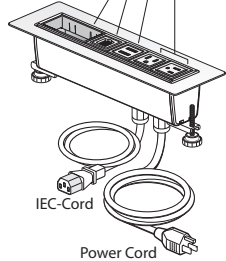

EUB1-SLOB-2112

4-Port:

- (4) Power

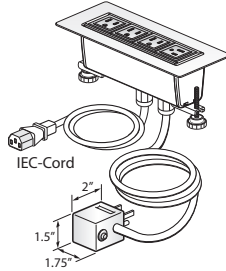

NOTE:

Always Fused Plug when more than 3 power outlets specified.

EUB1-SLOB-4000



Features

- Includes power module with 3, 4 or 6 ports that can be configured with simplex outlets (NEMA-5-15R), USB charging port (with two USB outlets), data ports or cable bay(s) that can accept up to two pull out data/AV cables and mounting hardware.
- Data port accommodate most varieties of field supplied data/AV jacks.
- Corded power module with 15 amp - 12'(3658mm) long cord with plug (NEMA 5-15P).
- Auxiliary 24"(610mm) power cord includes IEC connector (IEC C13) for motor controller.
- USB Charging Port consists of two USB 2.0 style A outlets. 4 Amp (shared) charging capacity.
- Attaches to surface with use of included mounting brackets.
- Flush Mount has an overall housing depth of 4"(102mm) and will extend into mounting surface.
- Color option of black painted bezel with black receptacles or white painted bezel with white receptacles.

Specification Tips

- **Configuration and quantity of power and data ports cannot be modified in the field.**
- **For use with 120 volt 60 hertz power source only.**
- **For use with Suite, Planes Height Adjustable Tables, Planes Height Adjustable Bench, Hop 120° Benches and 3-Leg Hop Height Adjustable Tables. For 2-Leg Hop Height Adjustable Tables use IEC C6 to IEC C14 adapter.**
- Designed to be used with cable chain.
- Requires field installation.
- Requires field cut access hole for power cord/conduit routing.
- Specify AV cables separately.
- Cable Bay requires cables less than 0.3"(7.6mm) diameter.
- Application may require approval of local authority having jurisdiction (AHJ); ensure compliance before placing orders and installation.

To Order, Specify:

- 1) Product number.
(No finish specification required.)

Electrical Components

Flush Mounted Power — Cord for Height Adjustable

Top Width	Top Depth	Cord Length	Trim Color	Port Color	Port	Configuration	Number	Price
Corded								
6.75"(171mm)	3"(76mm)	12'(3658mm)	Black	Black	3	2 Power Receptacles, 1 Data Port	EUB1-SLOB-2010	\$1159.85
						2 Power Receptacles, 1 USB Charging	EUB1-SLOB-2100	1232.11
						3 Power Receptacles	EUB1-SLOB-3000	1159.85
8.25"(210mm)	3"(76mm)				4	2 Power Receptacles, 1 Cable Bay	EUB1-SLOB-2002	\$1222.47
						2 Power Receptacles, 2 Data Ports	EUB1-SLOB-2020	1222.47
						2 Power Receptacles, 1 USB Charging, 1 Data Port	EUB1-SLOB-2110	1294.73
						2 Power Receptacles, 2 USB Charging	EUB1-SLOB-2200	1366.99
						3 Power Receptacles, 1 Data Port	EUB1-SLOB-3010	1222.47
						3 Power Receptacles, 1 USB Charging	EUB1-SLOB-3100	1294.73
						4 Power Receptacles	EUB1-SLOB-4000	1222.47
9.75"(248mm)	3"(76mm)				6	2 Power Receptacles, 2 Cable Bays	EUB1-SLOB-2004	\$1285.10
						2 Power Receptacles, 2 Data Ports, 1 Cable Bay	EUB1-SLOB-2022	1285.10
						2 Power Receptacles, 4 Data Ports	EUB1-SLOB-2040	1285.10
						2 Power Receptacles, 1 USB Charging, 1 Data Port, 1 Cable Bay	EUB1-SLOB-2112	1357.36
						2 Power Receptacles, 1 USB Charging, 3 Data Ports	EUB1-SLOB-2130	1357.36
						2 Power Receptacles, 2 USB Charging, 1 Cable Bay	EUB1-SLOB-2202	1429.62
						2 Power Receptacles, 2 USB Charging, 2 Data Ports	EUB1-SLOB-2220	1429.62
						2 Power Receptacles, 3 USB Charging, 1 Data Port	EUB1-SLOB-2310	1501.88
						2 Power Receptacles, 4 USB Charging	EUB1-SLOB-2400	1574.14
						3 Power Receptacles, 1 USB Charging, 1 Cable Bay	EUB1-SLOB-3012	1285.10
						3 Power Receptacles, 3 Data Ports	EUB1-SLOB-3030	1285.10
						3 Power Receptacles, 1 USB Charging, 1 Cable Bay	EUB1-SLOB-3102	1357.36
						3 Power Receptacles, 1 USB Charging, 2 Data Ports	EUB1-SLOB-3120	1357.36
						3 Power Receptacles, 2 USB Charging, 1 Data Port	EUB1-SLOB-3210	1429.62
						3 Power Receptacles, 3 USB Charging	EUB1-SLOB-3300	1501.88
						4 Power Receptacles, 1 Cable Bay	EUB1-SLOB-4002	1285.10
						4 Power Receptacles, 2 Data Ports	EUB1-SLOB-4020	1285.10
4 Power Receptacles, 1 USB Charging, 1 Data Port	EUB1-SLOB-4110	1357.36						
4 Power Receptacles, 2 USB Charging	EUB1-SLOB-4200	1429.62						
5 Power Receptacles, 1 Data Port	EUB1-SLOB-5010	1285.10						
5 Power Receptacles, 1 USB Charging	EUB1-SLOB-5100	1357.36						
6 Power Receptacles	EUB1-SLOB-6000	1285.10						

Electrical Components

Flush Mounted Power — Cord for Height Adjustable

Top Width	Top Depth	Cord Length	Trim Color	Port Color	Port	Configuration	Number	Price
6.75"(171mm)	3"(76mm)	12'(3658mm)	White	White	3	2 Power Receptacles, 1 Data Port	EUB1-SLOW-2010	\$1034.60
						2 Power Receptacles, 1 USB Charging	EUB1-SLOW-2100	1106.86
						3 Power Receptacles	EUB1-SLOW-3000	1034.60
8.25"(210mm)	3"(76mm)				4	2 Power Receptacles, 1 Cable Bay	EUB1-SLOW-2002	\$1097.22
						2 Power Receptacles, 2 Data Ports	EUB1-SLOW-2020	1097.22
						2 Power Receptacles, 1 USB Charging, 1 Data Port	EUB1-SLOW-2110	1169.48
						2 Power Receptacles, 2 USB Charging	EUB1-SLOW-2200	1241.74
						3 Power Receptacles, 1 Data Port	EUB1-SLOW-3010	1097.22
						3 Power Receptacles, 1 USB Charging	EUB1-SLOW-3100	1169.48
						4 Power Receptacles	EUB1-SLOW-4000	1097.22
9.75"(248mm)	3"(76mm)				6	2 Power Receptacles, 2 Cable Bays	EUB1-SLOW-2004	\$1159.85
						2 Power Receptacles, 2 Data Ports, 1 Cable Bay	EUB1-SLOW-2022	1159.85
						2 Power Receptacles, 4 Data Ports	EUB1-SLOW-2040	1159.85
						2 Power Receptacles, 1 USB Charging, 1 Data Port, 1 Cable Bay	EUB1-SLOW-2112	1232.11
						2 Power Receptacles, 1 USB Charging, 3 Data Ports	EUB1-SLOW-2130	1232.11
						2 Power Receptacles, 2 USB Charging, 1 Cable Bay	EUB1-SLOW-2202	1304.37
						2 Power Receptacles, 2 USB Charging, 2 Data Ports	EUB1-SLOW-2220	1304.37
						2 Power Receptacles, 3 USB Charging, 1 Data Port	EUB1-SLOW-2310	1376.63
						2 Power Receptacles, 4 USB Charging	EUB1-SLOW-2400	1448.89
						3 Power Receptacles, 1 USB Charging, 1 Cable Bay	EUB1-SLOW-3012	1159.85
						3 Power Receptacles, 3 Data Ports	EUB1-SLOW-3030	1159.85
						3 Power Receptacles, 1 USB Charging, 1 Cable Bay	EUB1-SLOW-3102	1232.11
						3 Power Receptacles, 1 USB Charging, 2 Data Ports	EUB1-SLOW-3120	1232.11
						3 Power Receptacles, 2 USB Charging, 1 Data Port	EUB1-SLOW-3210	1304.37
						3 Power Receptacles, 3 USB Charging	EUB1-SLOW-3300	1376.63
						4 Power Receptacles, 1 Cable Bay	EUB1-SLOW-4002	1159.85
						4 Power Receptacles, 2 Data Ports	EUB1-SLOW-4020	1159.85
4 Power Receptacles, 1 USB Charging, 1 Data Port	EUB1-SLOW-4110	1232.11						
4 Power Receptacles, 2 USB Charging	EUB1-SLOW-4200	1304.37						
5 Power Receptacles, 1 Data Port	EUB1-SLOW-5010	1159.85						
5 Power Receptacles, 1 USB Charging	EUB1-SLOW-5100	1232.11						
6 Power Receptacles	EUB1-SLOW-6000	1159.85						

Electrical Components

Belong Power Tap — Horizontal

Power Tap — Horizontal

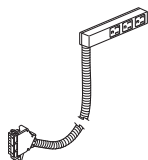

EUET-0030-3M3N
EUET-0030-2M3N
EUET-0030-4M3N



Description	Circuit Access	Number	Price
3-Circuit Conduit Length — Horizontal			
30"(762mm)	1	EUET-0030-3M3N1NL	\$156.33
	2	EUET-0030-3M3N2NL	156.33
	3	EUET-0030-3M3N3NL	156.33
6'(1829mm)	1	EUET-0072-3M3N1NL	\$181.88
	2	EUET-0072-3M3N2NL	181.88
	3	EUET-0072-3M3N3NL	181.88
9'(2743mm)	1	EUET-00A8-3M3N1NL	\$203.78
	2	EUET-00A8-3M3N2NL	203.78
	3	EUET-00A8-3M3N3NL	203.78
4-Circuit, (2+2) Conduit Length — Horizontal			
30"(762mm)	1	EUET-0030-2M3N1NL	\$156.33
	2	EUET-0030-2M3N2NL	156.33
	3	EUET-0030-2M3N3NL	156.33
	4	EUET-0030-2M3N4NL	156.33
6'(1829mm)	1	EUET-0072-2M3N1NL	\$181.88
	2	EUET-0072-2M3N2NL	181.88
	3	EUET-0072-2M3N3NL	181.88
	4	EUET-0072-2M3N4NL	181.88
9'(2743mm)	1	EUET-00A8-2M3N1NL	\$203.78
	2	EUET-00A8-2M3N2NL	203.78
	3	EUET-00A8-2M3N3NL	203.78
	4	EUET-00A8-2M3N4NL	203.78
4-Circuit, (3+1) Conduit Length — Horizontal			
30"(762mm)	1	EUET-0030-4M3N1NL	\$156.33
	2	EUET-0030-4M3N2NL	156.33
	3	EUET-0030-4M3N3NL	156.33
	4	EUET-0030-4M3N4NL	156.33
6'(1829mm)	1	EUET-0072-4M3N1NL	\$181.88
	2	EUET-0072-4M3N2NL	181.88
	3	EUET-0072-4M3N3NL	181.88
	4	EUET-0072-4M3N4NL	181.88
9'(2743mm)	1	EUET-00A8-4M3N1NL	\$203.78
	2	EUET-00A8-4M3N2NL	203.78
	3	EUET-00A8-4M3N3NL	203.78
	4	EUET-00A8-4M3N4NL	203.78

Features

- Includes Power Tap housing with three 15A receptacle outlets (NEMA 5-15R) with 0.375"(10mm) conduit and Power Base connector.
- Power Base connector is used to connect to PDA.
- Power Tap housing with receptacles available in charcoal or graphite finish; conduit standard in black only.
- Field installed.

To Order, Specify:

- 1) Product number.
- 2) Trim color.

TR-K	Charcoal
TR-J	Graphite

Specification Tips:

- Specify conduit length, circuit configuration and circuit access with Power Base connector.
- Specify mounting bracket separately.
 - Fixed Bracket with three patch cord holder mounts Power Tap to edge of worksurface with mounting screws. **Horizontal Power Tap required.**
 - Adjustable bracket mounts Power Tap to edge of worksurface with thumb screws for ease of relocation. **Horizontal Power Tap required.**
- Application may require approval of local authority having jurisdiction (AHJ); ensure compliance before placing orders and installation.
- Do not mix 3-circuit and 6-circuit with 4-circuit components. Do not mix 2+2 and 3+1 components. Components have unique polarity key and color coding (3-circuit=black, 6-circuit=ivory, 2+2=blue and 3+1=green).

Electrical Components

Belong Power Tap — Vertical

Power Tap — Vertical

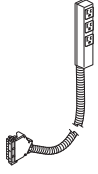

EUET-0030-3M3N
EUET-0030-2M3N
EUET-0030-4M3N



Description	Circuit Access	Number	Price
3-Circuit Conduit Length — Vertical			
30"(762mm)	1	EUET-0030-3M3N1NS	\$156.33
	2	EUET-0030-3M3N2NS	156.33
	3	EUET-0030-3M3N3NS	156.33
6'(1829mm)	1	EUET-0072-3M3N1NS	\$181.88
	2	EUET-0072-3M3N2NS	181.88
	3	EUET-0072-3M3N3NS	181.88
9'(2743mm)	1	EUET-00A8-3M3N1NS	\$203.78
	2	EUET-00A8-3M3N2NS	203.78
	3	EUET-00A8-3M3N3NS	203.78
4-Circuit (2+2) Conduit Length — Vertical			
30"(762mm)	1	EUET-0030-2M3N1NS	\$156.33
	2	EUET-0030-2M3N2NS	156.33
	3	EUET-0030-2M3N3NS	156.33
	4	EUET-0030-2M3N4NS	156.33
6'(1829mm)	1	EUET-0072-2M3N1NS	\$181.88
	2	EUET-0072-2M3N2NS	181.88
	3	EUET-0072-2M3N3NS	181.88
	4	EUET-0072-2M3N4NS	181.88
9'(2743mm)	1	EUET-00A8-2M3N1NS	\$203.78
	2	EUET-00A8-2M3N2NS	203.78
	3	EUET-00A8-2M3N3NS	203.78
	4	EUET-00A8-2M3N4NS	203.78
4-Circuit (3+1) Conduit Length — Vertical			
30"(762mm)	1	EUET-0030-4M3N1NS	\$156.33
	2	EUET-0030-4M3N2NS	156.33
	3	EUET-0030-4M3N3NS	156.33
	4	EUET-0030-4M3N4NS	156.33
6'(1829mm)	1	EUET-0072-4M3N1NS	\$181.88
	2	EUET-0072-4M3N2NS	181.88
	3	EUET-0072-4M3N3NS	181.88
	4	EUET-0072-4M3N4NS	181.88
9'(2743mm)	1	EUET-00A8-4M3N1NS	\$203.78
	2	EUET-00A8-4M3N2NS	203.78
	3	EUET-00A8-4M3N3NS	203.78
	4	EUET-00A8-4M3N4NS	203.78

Features

- Includes Power Tap housing with three 15A receptacle outlets (NEMA 5-15R) with 0.375"(10mm) conduit and Power Base connector.
- Power Base connector is used to connect to PDA.
- Power Tap housing with receptacles available in charcoal or graphite finish; conduit standard in black only.
- Field installed.

To Order, Specify:



- 1) Product number.
- 2) Trim color.
TR-K Charcoal
TR-J Graphite

Specification Tips:

- Specify conduit length, circuit configuration and circuit access with Power Base connector.
- Specify mounting bracket separately.
 - Fixed Bracket with three patch cord holder mounts Power Tap to edge of worksurface with mounting screws. **Horizontal Power Tap required.**
 - Adjustable bracket mounts Power Tap to edge of worksurface with thumb screws for ease of relocation. **Horizontal Power Tap required.**
- Application may require approval of local authority having jurisdiction (AHJ); ensure compliance before placing orders and installation.
- Do not mix 3-circuit and 6-circuit with 4-circuit components. Do not mix 2+2 and 3+1 components. Components have unique polarity key and color coding (3-circuit=black, 6-circuit=ivory, 2+2=blue and 3+1=green).

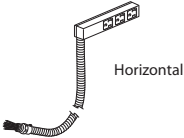
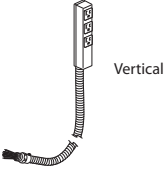

Electrical Components

Belong Power Tap — Hardwire and Corded

	Description	Circuit	Number	Price
Power Tap — Hardwire  Horizontal  Vertical EUET-0030-CM3N 	Hardwire Length — Horizontal			
	30'(762mm)	1	EUET-0030-CM3N1NL	\$156.33
	6'(1829mm)	1	EUET-0072-CM3N1NL	181.88
	9'(2743mm)	1	EUET-00A8-CM3N1NL	203.78
	15'(4572mm)	1	EUET-00J0-CM3N1NL	247.58
	Hardwire Length — Vertical			
	30'(762mm)	1	EUET-0030-CM3N1NS	\$156.33
	6'(1829mm)	1	EUET-0072-CM3N1NS	181.88
	9'(2743mm)	1	EUET-00A8-CM3N1NS	203.78
	15'(4572mm)	1	EUET-00J0-CM3N1NS	247.58
Features		To Order, Specify:		
<ul style="list-style-type: none"> Includes Power Tap with three 15A receptacle outlets (MEMA 5-15) with conduit and conduit fitting. Hardwire option for connection to field wired junction box with 0.5"(13mm) knockout. Power Tap housing with receptacles available in charcoal or graphite finish; conduit standard in black only. Field installed. 		1) Product number. 2) Trim color. TR-K Charcoal TR-J Graphite		

Specification Tips

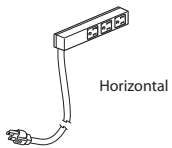
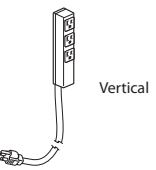
- For use with 120 volt 60 hertz power source only.
- Specify mounting bracket separately.
 - Fixed Bracket with three patch cord holder mounts Power Tap to edge of worksurface with mounting screws. **Horizontal Power Tap required.**
 - Adjustable bracket mounts Power Tap to edge of worksurface with thumb screws for ease of relocation. **Horizontal Power Tap required.**
 - Under Surface bracket mounts Power Tap under worksurface. **Vertical Power Tap required.**
- Application may require approval of local authority having jurisdiction (AHJ); ensure compliance before placing orders and installation.

	Description	Circuit	Number	Price
Power Tap — Corded Horizontal and Vertical  Horizontal  Vertical EUET-0000-1M3N 	Corded Length — Horizontal			
	6'(1829mm)	1	EUET-0000-1M3N16L	\$110.71
	9'(2743mm)	1	EUET-0000-1M3N19L	118.51
	15'(4572mm)	1	EUET-0000-1M3N1EL	134.11
	25'(7620mm)	1	EUET-0000-1M3N1YL	160.11
	Corded Length — Vertical			
	6'(1829mm)	1	EUET-0000-1M3N16S	\$110.71
	9'(2743mm)	1	EUET-0000-1M3N19S	118.51
	15'(4572mm)	1	EUET-0000-1M3N1ES	134.11
	25'(7620mm)	1	EUET-0000-1M3N1YS	160.11
Features		To Order, Specify:		
<ul style="list-style-type: none"> Includes Power Tap with three 15A receptacle outlets (MEMA 5-15R) with cord and plug (15A NEMA 5-15-P). Power Tap housing with receptacles available in charcoal or graphite finish; cord standard in black only. Field installed. 		1) Product number. 2) Trim color. TR-K Charcoal TR-J Graphite		

Specification Tips

- For use with 120 volt 60 hertz power source only.
- Specify mounting bracket separately.
 - Fixed Bracket with three patch cord holder mounts Power Tap to edge of worksurface with mounting screws. **Horizontal Power Tap required.**
 - Adjustable bracket mounts Power Tap to edge of worksurface with thumb screws for ease of relocation. **Horizontal Power Tap required.**
 - Under Surface bracket mounts Power Tap under worksurface. **Vertical Power Tap required.**
- Application may require approval of local authority having jurisdiction (AHJ); ensure compliance before placing orders and installation.

Electrical Components

Belong Power Tap Brackets

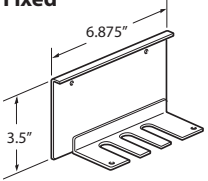
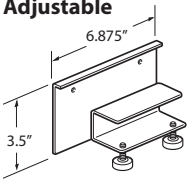
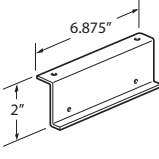
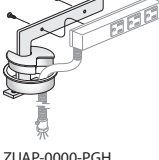
	Description	Number	Trim	
			A	B
Power Tap Bracket — Fixed  ZUAP-0000-PFD	Fixed	ZUAP-0000-PFD	\$45.59	\$52.12
	Features <ul style="list-style-type: none"> Includes one Power Tap mounting bracket and mounting hardware. Fixed Bracket mounts Power Tap to edge of worksurface with mounting screws. Fixed bracket accommodates three patch cords. Horizontal Power Tap required. 	To Order, Specify: <ol style="list-style-type: none"> Product number. Trim color. 		
Power Tap Bracket — Adjustable  ZUAP-0000-PAN	Adjustable	ZUAP-0000-PAN	\$57.31	\$63.84
	Features <ul style="list-style-type: none"> Includes one Power Tap mounting bracket and mounting hardware. Adjustable bracket mounts Power Tap to back edge of worksurface with thumb screws for ease of relocation. Horizontal Power Tap required. 	To Order, Specify: <ol style="list-style-type: none"> Product number. Trim color. 		
Power Tap Bracket — Under Surface  ZUAP-0000-PUR	Under Surface — Right-hand	ZUAP-0000-PUR	\$45.59	\$52.12
	Under Surface — Left-hand	ZUAP-0000-PUL	\$45.59	\$52.12
Power Tap Bracket with Grommet — Beside Storage Only  ZUAP-0000-PGH	Fixed Grommet — Horizontal	ZUAP-0000-PGH	\$102.90	\$109.43
	Fixed Grommet — Vertical	ZUAP-0000-PGV	\$102.90	\$109.43
	Features <ul style="list-style-type: none"> Includes one Power Tap bracket, grommet with cover and mounting hardware. Horizontal bracket mounts to Beside Storage Top through field installed grommet. Horizontal Power Tap required. Vertical bracket mounts to Beside Storage Top through field installed grommet. Vertical Power Tap required. 	To Order, Specify: <ol style="list-style-type: none"> Product number. Trim color. 		
	Specification Tips <ul style="list-style-type: none"> Accommodates 1.19" (30mm) thick tops. Power Tap applications should be reviewed by local authorities (electrical inspector) prior to ordering due to varying local codes. Not compatible with the Power Tap-Corded shipped prior to July 2013. 			

Electrical Components

Bezel Utility Module

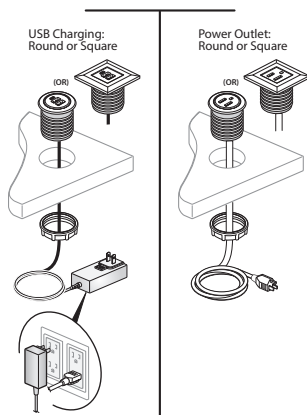

EURT-0072-1100
EURT-0072-1010



Features

- Includes: Either a round or square faced Power Module and mounting hardware.
- For use on surfaces 0.75”(19mm) - 1.44”(37mm) thick.
- Available with either:
 - One power outlet (NEMA 5-15R)
 - One two port USB charger. Consists of two USB outlets with 1000mA of charging power (5 volts) per USB outlet.
 - One data/video jack
- Available in black or supplier white only.

Specification Tips

- For use with 120 volt 60 hertz power source only.
- Power configuration has one cord with plug (NEMA 5-15P).
- USB configuration has one cord with 2”(51mm) x 1”(25mm) x 3”(76mm) voltage transformer plug. Transformer may block adjacent outlets (see illustration).
- Data jacks and AV cables field supplied.
- Data jack adapters accommodate most varieties of field supplied data jacks or separately specified AV cables.
- Requires field cut 1.75”(44mm) hole and field installation.
- Application may require approval of local authority having jurisdiction (AHJ); ensure compliance before placing orders and installing.

To Order, Specify:

1) Product number, including:

1 Shape:

S Square

C Round

2 Color Options:

B Black

W White

Description	Depth	Number	1 2	Price
6' Cord				
Power	1.75”(44mm)	EURT-0072-1100	■ ■	\$ 84.30
USB		EURT-0072-1010	■ ■	252.92
12' Cord				
Power	1.75”(44mm)	EURT-00E4-1100	■ ■	\$144.52
USB		EURT-00E4-1010	■ ■	313.14

Data Bezel

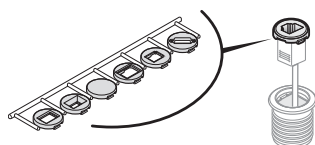

EURT-0000-N001CB
EURT-0000-N001CW

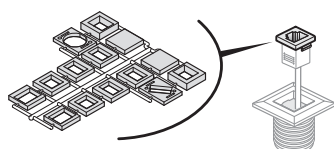

EURT-0000-N001SB
EURT-0000-N001SW

Description

Round

Black EURT-0000-N001CB \$84.30

White EURT-0000-N001CW 84.30

Square

Black EURT-0000-N001SB \$84.30

White EURT-0000-N001SW 84.30

Feature

- Includes one round or square bezel for the Bezel Utility Module.
- Available in black or supplier white only.

To Order, Specify:

1) Product number.
(No finish specification required.)

Electrical Components

Enhanced Power Module — Corded

3-Port:

- (2) Power
- (1) USB

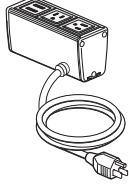

EUD1-PF0B-2010

4-Port:

- (2) Power
- (1) USB
- (1) Data

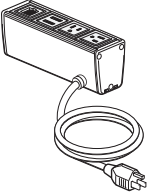

EUD1-PF0B-2110

6-Port:

- (2) Power
- (1) USB
- (1) Data
- (1) Cable Bay

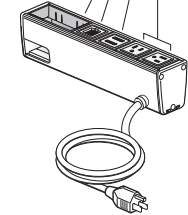

EUD1-PF0B-2112

4-Port:

- (4) Power

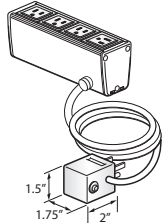

NOTE:
Always Fused Plug
when more than 3
power outlets specified.

EUD1-PF0B-4000



Features

- Includes power module with 3, 4 or 6 ports that can be configured with simplex outlets (NEMA-5-15R), USB charging port (with two USB outlets), data ports or cable bay(s) that can accept up to two pull out data/AV cables and mounting hardware.
- Data port accommodate most varieties of field supplied data/AV jacks.
- Attaches to surface with use of separately specified mounting brackets.
- Corded power module available with 15 amp - 6'(1829mm) or 12'(3658mm) long cord with plug (NEMA 5-15P).
- USB Charging Port consists of two USB 2.0 style A outlets. 4 Amp (shared) charging capacity.
- Color option of black anodized housing with black receptacles or clear anodized housing with white receptacles.

Specification Tips

- **Configuration and quantity of power and data ports cannot be modified in the field.**
- **For use with 120 volt 60 hertz power source only.**
- Separately specify attachment hardware for desired application.
- Requires field installation.
- Specify AV cables separately.
- Cable Bay requires cables less than 0.3"(7.6mm) diameter.
- Application may require approval of local authority having jurisdiction (AHJ); ensure compliance before placing orders and installation.

To Order, Specify:

- 1) Product number.
(No finish specification required.)

Electrical Components

Enhanced Power Module — Corded

Top Width	Top Depth	Cord Length	Housing Color	Port Color	Port	Configuration	Number	Price
5" (127mm)	3" (76mm)	6' (1829mm)	Black Anodized	Black	3	1 Power Receptacle, 1 Cable Bay	EUD1-PF0B-1002	\$403.62
						1 Power Receptacle, 2 Data Ports	EUD1-PF0B-1020	403.62
						1 Power Receptacle, 1 Data Port, 1 USB Charging	EUD1-PF0B-1110	472.44
						1 Power Receptacle, 2 USB Charging	EUD1-PF0B-1200	541.26
						2 Power Receptacles, 1 Data Port	EUD1-PF0B-2010	403.62
						2 Power Receptacles, 1 USB Charging	EUD1-PF0B-2100	472.44
						3 Power Receptacles	EUD1-PF0B-3000	403.62
6.5" (165mm)	3" (76mm)				4	1 Power Receptacle, 1 Data Port, 1 Cable Bay	EUD1-PF0B-1012	\$403.62
						1 Power Receptacle, 3 Data Ports	EUD1-PF0B-1030	403.62
						1 Power Receptacle, 1 USB Charging, 1 Cable Bay	EUD1-PF0B-1102	472.44
						1 Power Receptacle, 3 USB Charging	EUD1-PF0B-1300	610.08
						2 Power Receptacles, 1 Cable Bay	EUD1-PF0B-2002	403.62
						2 Power Receptacles, 2 Data Ports	EUD1-PF0B-2020	403.62
						2 Power Receptacles, 1 USB Charging, 1 Data Port	EUD1-PF0B-2110	472.44
						2 Power Receptacles, 2 USB Charging	EUD1-PF0B-2200	541.26
						3 Power Receptacles, 1 Data Port	EUD1-PF0B-3010	403.62
						3 Power Receptacles, 1 USB Charging	EUD1-PF0B-3100	472.44
						4 Power Receptacles	EUD1-PF0B-4000	403.62
9.5" (241mm)	3" (76mm)				6	1 Power Receptacle, 1 USB Charging, 2 Cable Bays	EUD1-PF0B-1104	\$532.09
						1 Power Receptacle, 1 USB Charging, 2 Data Ports, 1 Cable Bay	EUD1-PF0B-1122	532.09
						1 Power Receptacle, 1 USB Charging, 4 Data Ports	EUD1-PF0B-1140	532.09
						1 Power Receptacle, 2 USB Charging, 1 Data Port, 1 Cable Bay	EUD1-PF0B-1212	600.91
						1 Power Receptacle, 2 USB Charging, 3 Data Ports	EUD1-PF0B-1230	600.91
						1 Power Receptacle, 3 USB Charging, 1 Cable Bay	EUD1-PF0B-1302	669.73
						1 Power Receptacle, 3 USB Charging, 2 Data Ports	EUD1-PF0B-1320	669.73
						1 Power Receptacle, 4 USB Charging, 1 Data Port	EUD1-PF0B-1410	738.55
						2 Power Receptacles, 2 Cable Bays	EUD1-PF0B-2004	463.27
						2 Power Receptacles, 2 Data Ports, 1 Cable Bay	EUD1-PF0B-2022	463.27
						2 Power Receptacles, 4 Data Ports	EUD1-PF0B-2040	463.27
						2 Power Receptacles, 1 USB Charging, 1 Data Port, 1 Cable Bay	EUD1-PF0B-2112	532.09
						2 Power Receptacles, 1 USB Charging, 3 Data Ports	EUD1-PF0B-2130	532.09
						2 Power Receptacles, 2 USB Charging, 1 Cable Bay	EUD1-PF0B-2202	600.91
						2 Power Receptacles, 2 USB Charging, 2 Data Ports	EUD1-PF0B-2220	600.91
						2 Power Receptacles, 3 USB Charging, 1 Data Port	EUD1-PF0B-2310	669.73
						2 Power Receptacles, 4 USB Charging	EUD1-PF0B-2400	738.55
						3 Power Receptacles, 3 Data Ports	EUD1-PF0B-3030	463.27
						3 Power Receptacles, 1 USB Charging, 1 Cable Bay	EUD1-PF0B-3102	532.09
						3 Power Receptacles, 1 USB Charging, 2 Data Ports	EUD1-PF0B-3120	532.09
						3 Power Receptacles, 2 USB Charging, 1 Data Port	EUD1-PF0B-3210	600.91
						3 Power Receptacles, 3 USB Charging	EUD1-PF0B-3300	669.73
						4 Power Receptacles, 1 Cable Bay	EUD1-PF0B-4002	463.27
4 Power Receptacles, 2 Data Ports	EUD1-PF0B-4020	463.27						
4 Power Receptacles, 1 USB Charging, 1 Data Port	EUD1-PF0B-4110	532.09						
4 Power Receptacles, 2 USB Charging	EUD1-PF0B-4200	600.91						
5 Power Receptacles, 1 Data Port	EUD1-PF0B-5010	463.27						
5 Power Receptacles, 1 USB Charging	EUD1-PF0B-5100	532.09						
6 Power Receptacles	EUD1-PF0B-6000	463.27						

Electrical Components

Enhanced Power Module — Corded

Top Width	Top Depth	Cord Length	Housing Color	Port Color	Port	Configuration	Number	Price
9.5" (241mm)	3" (76mm)	6' (1829mm)	Clear Anodized	White	3	1 Power Receptacle, 1 Cable Bay	EUD1-PF0W-1002	\$284.33
						1 Power Receptacle, 2 Data Ports	EUD1-PF0W-1020	284.33
						1 Power Receptacle, 1 Data Port, 1 USB Charging	EUD1-PF0W-1110	353.15
						1 Power Receptacle, 2 USB Charging	EUD1-PF0W-1200	421.97
						2 Power Receptacles, 1 Data Port	EUD1-PF0W-2010	284.33
						2 Power Receptacles, 1 USB Charging	EUD1-PF0W-2100	353.15
						3 Power Receptacles	EUD1-PF0W-3000	284.33
					4	1 Power Receptacle, 1 Data Port, 1 Cable Bay	EUD1-PF0W-1012	\$284.33
						1 Power Receptacle, 3 Data Ports	EUD1-PF0W-1030	284.33
						1 Power Receptacle, 1 USB Charging, 1 Cable Bay	EUD1-PF0W-1102	353.15
						1 Power Receptacle, 3 USB Charging	EUD1-PF0W-1300	490.79
						2 Power Receptacles, 1 Cable Bay	EUD1-PF0W-2002	284.33
						2 Power Receptacles, 2 Data Ports	EUD1-PF0W-2020	284.33
						2 Power Receptacles, 1 USB Charging, 1 Data Port	EUD1-PF0W-2110	353.15
						2 Power Receptacles, 2 USB Charging	EUD1-PF0W-2200	421.97
						3 Power Receptacles, 1 Data Port	EUD1-PF0W-3010	284.33
						3 Power Receptacles, 1 USB Charging	EUD1-PF0W-3100	353.15
						4 Power Receptacles	EUD1-PF0W-4000	284.33
					6	1 Power Receptacle, 1 USB Charging, 2 Cable Bays	EUD1-PF0W-1104	\$412.80
						1 Power Receptacle, 1 USB Charging, 2 Data Ports, 1 Cable Bay	EUD1-PF0W-1122	412.80
						1 Power Receptacle, 1 USB Charging, 4 Data Ports	EUD1-PF0W-1140	412.80
						1 Power Receptacle, 2 USB Charging, 1 Data Port, 1 Cable Bay	EUD1-PF0W-1212	481.62
						1 Power Receptacle, 2 USB Charging, 3 Data Ports	EUD1-PF0W-1230	481.62
						1 Power Receptacle, 3 USB Charging, 1 Cable Bay	EUD1-PF0W-1302	550.44
						1 Power Receptacle, 3 USB Charging, 2 Data Ports	EUD1-PF0W-1320	550.44
						1 Power Receptacle, 4 USB Charging, 1 Data Port	EUD1-PF0W-1410	619.26
						2 Power Receptacles, 2 Cable Bays	EUD1-PF0W-2004	343.98
						2 Power Receptacles, 2 Data Ports, 1 Cable Bay	EUD1-PF0W-2022	343.98
						2 Power Receptacles, 4 Data Ports	EUD1-PF0W-2040	343.98
						2 Power Receptacles, 1 USB Charging, 1 Data Port, 1 Cable Bay	EUD1-PF0W-2112	412.80
						2 Power Receptacles, 1 USB Charging, 3 Data Ports	EUD1-PF0W-2130	412.80
						2 Power Receptacles, 2 USB Charging, 1 Cable Bay	EUD1-PF0W-2202	481.62
						2 Power Receptacles, 2 USB Charging, 2 Data Ports	EUD1-PF0W-2220	481.62
						2 Power Receptacles, 3 USB Charging, 1 Data Port	EUD1-PF0W-2310	550.44
						2 Power Receptacles, 4 USB Charging	EUD1-PF0W-2400	619.26
						3 Power Receptacles, 3 Data Ports	EUD1-PF0W-3030	343.98
						3 Power Receptacles, 1 USB Charging, 1 Cable Bay	EUD1-PF0W-3102	412.80
						3 Power Receptacles, 1 USB Charging, 2 Data Ports	EUD1-PF0W-3120	412.80
						3 Power Receptacles, 2 USB Charging, 1 Data Port	EUD1-PF0W-3210	481.62
						3 Power Receptacles, 3 USB Charging	EUD1-PF0W-3300	550.44
						4 Power Receptacles, 1 Cable Bay	EUD1-PF0W-4002	343.98
						4 Power Receptacles, 2 Data Ports	EUD1-PF0W-4020	343.98
						4 Power Receptacles, 1 USB Charging, 1 Data Port	EUD1-PF0W-4110	412.80
						4 Power Receptacles, 2 USB Charging	EUD1-PF0W-4200	481.62
						5 Power Receptacles, 1 Data Port	EUD1-PF0W-5010	343.98
						5 Power Receptacles, 1 USB Charging	EUD1-PF0W-5100	412.80
						6 Power Receptacles	EUD1-PF0W-6000	343.98

Electrical Components

Enhanced Power Module — Corded

Top Width	Top Depth	Cord Length	Housing Color	Port Color	Port	Configuration	Number	Price
9.5" (241mm)	3" (76mm)	12' (3658mm)	Black Anodized	Black	3	1 Power Receptacle, 1 Cable Bay	EUD1-PL0B-1002	\$459.69
						1 Power Receptacle, 2 Data Ports	EUD1-PL0B-1020	459.69
						1 Power Receptacle, 1 Data Port, 1 USB Charging	EUD1-PL0B-1110	528.51
						1 Power Receptacle, 2 USB Charging	EUD1-PL0B-1200	597.33
						2 Power Receptacles, 1 Data Port	EUD1-PL0B-2010	459.69
						2 Power Receptacles, 1 USB Charging	EUD1-PL0B-2100	528.51
						3 Power Receptacles	EUD1-PL0B-3000	459.69
					4	1 Power Receptacle, 1 Data Port, 1 Cable Bay	EUD1-PL0B-1012	\$459.69
						1 Power Receptacle, 3 Data Ports	EUD1-PL0B-1030	459.69
						1 Power Receptacle, 1 USB Charging, 1 Cable Bay	EUD1-PL0B-1102	528.51
						1 Power Receptacle, 3 USB Charging	EUD1-PL0B-1300	666.15
						2 Power Receptacles, 1 Cable Bay	EUD1-PL0B-2002	459.69
						2 Power Receptacles, 2 Data Ports	EUD1-PL0B-2020	459.69
						2 Power Receptacles, 1 USB Charging, 1 Data Port	EUD1-PL0B-2110	528.51
						2 Power Receptacles, 2 USB Charging	EUD1-PL0B-2200	597.33
						3 Power Receptacles, 1 Data Port	EUD1-PL0B-3010	459.69
						3 Power Receptacles, 1 USB Charging	EUD1-PL0B-3100	528.51
						4 Power Receptacles	EUD1-PL0B-4000	459.69
					6	1 Power Receptacle, 1 USB Charging, 2 Cable Bays	EUD1-PL0B-1104	\$588.16
						1 Power Receptacle, 1 USB Charging, 2 Data Ports, 1 Cable Bay	EUD1-PL0B-1122	588.16
						1 Power Receptacle, 1 USB Charging, 4 Data Ports	EUD1-PL0B-1140	588.16
						1 Power Receptacle, 2 USB Charging, 1 Data Port, 1 Cable Bay	EUD1-PL0B-1212	656.98
						1 Power Receptacle, 2 USB Charging, 3 Data Ports	EUD1-PL0B-1230	656.98
						1 Power Receptacle, 3 USB Charging, 1 Cable Bay	EUD1-PL0B-1302	725.80
						1 Power Receptacle, 3 USB Charging, 2 Data Ports	EUD1-PL0B-1320	725.80
						1 Power Receptacle, 4 USB Charging, 1 Data Port	EUD1-PL0B-1410	794.62
						2 Power Receptacles, 2 Cable Bays	EUD1-PL0B-2004	519.34
						2 Power Receptacles, 2 Data Ports, 1 Cable Bay	EUD1-PL0B-2022	519.34
						2 Power Receptacles, 4 Data Ports	EUD1-PL0B-2040	519.34
						2 Power Receptacles, 1 USB Charging, 1 Data Port, 1 Cable Bay	EUD1-PL0B-2112	588.16
						2 Power Receptacles, 1 USB Charging, 3 Data Ports	EUD1-PL0B-2130	588.16
						2 Power Receptacles, 2 USB Charging, 1 Cable Bay	EUD1-PL0B-2202	656.98
						2 Power Receptacles, 2 USB Charging, 2 Data Ports	EUD1-PL0B-2220	656.98
						2 Power Receptacles, 3 USB Charging, 1 Data Port	EUD1-PL0B-2310	725.80
						2 Power Receptacles, 4 USB Charging	EUD1-PL0B-2400	794.62
						3 Power Receptacles, 3 Data Ports	EUD1-PL0B-3030	519.34
						3 Power Receptacles, 1 USB Charging, 1 Cable Bay	EUD1-PL0B-3102	588.16
						3 Power Receptacles, 1 USB Charging, 2 Data Ports	EUD1-PL0B-3120	588.16
						3 Power Receptacles, 2 USB Charging, 1 Data Port	EUD1-PL0B-3210	656.98
						3 Power Receptacles, 3 USB Charging	EUD1-PL0B-3300	725.80
						4 Power Receptacles, 1 Cable Bay	EUD1-PL0B-4002	519.34
						4 Power Receptacles, 2 Data Ports	EUD1-PL0B-4020	519.34
						4 Power Receptacles, 1 USB Charging, 1 Data Port	EUD1-PL0B-4110	588.16
						4 Power Receptacles, 2 USB Charging	EUD1-PL0B-4200	656.98
						5 Power Receptacles, 1 Data Port	EUD1-PL0B-5010	519.34
						5 Power Receptacles, 1 USB Charging	EUD1-PL0B-5100	588.16
						6 Power Receptacles	EUD1-PL0B-6000	519.34

Electrical Components

Enhanced Power Module — Corded

Top Width	Top Depth	Cord Length	Housing Color	Port Color	Port	Configuration	Number	Price
9.5" (241mm)	3" (76mm)	12' (3658mm)	Clear Anodized	White	3	1 Power Receptacle, 1 Cable Bay	EUD1-PL0W-1002	\$340.40
						1 Power Receptacle, 2 Data Ports	EUD1-PL0W-1020	340.40
						1 Power Receptacle, 1 Data Port, 1 USB Charging	EUD1-PL0W-1110	409.22
						1 Power Receptacle, 2 USB Charging	EUD1-PL0W-1200	478.04
						2 Power Receptacles, 1 Data Port	EUD1-PL0W-2010	340.40
						2 Power Receptacles, 1 USB Charging	EUD1-PL0W-2100	409.22
						3 Power Receptacles	EUD1-PL0W-3000	340.40
					4	1 Power Receptacle, 1 Data Port, 1 Cable Bay	EUD1-PL0W-1012	\$340.40
						1 Power Receptacle, 3 Data Ports	EUD1-PL0W-1030	340.40
						1 Power Receptacle, 1 USB Charging, 1 Cable Bay	EUD1-PL0W-1102	409.22
						1 Power Receptacle, 3 USB Charging	EUD1-PL0W-1300	546.86
						2 Power Receptacles, 1 Cable Bay	EUD1-PL0W-2002	340.40
						2 Power Receptacles, 2 Data Ports	EUD1-PL0W-2020	340.40
						2 Power Receptacles, 1 USB Charging, 1 Data Port	EUD1-PL0W-2110	409.22
						2 Power Receptacles, 2 USB Charging	EUD1-PL0W-2200	478.04
						3 Power Receptacles, 1 Data Port	EUD1-PL0W-3010	340.40
						3 Power Receptacles, 1 USB Charging	EUD1-PL0W-3100	409.22
						4 Power Receptacles	EUD1-PL0W-4000	340.40
					6	1 Power Receptacle, 1 USB Charging, 2 Cable Bays	EUD1-PL0W-1104	\$468.87
						1 Power Receptacle, 1 USB Charging, 2 Data Ports, 1 Cable Bay	EUD1-PL0W-1122	468.87
						1 Power Receptacle, 1 USB Charging, 4 Data Ports	EUD1-PL0W-1140	468.87
						1 Power Receptacle, 2 USB Charging, 1 Data Port, 1 Cable Bay	EUD1-PL0W-1212	537.69
						1 Power Receptacle, 2 USB Charging, 3 Data Ports	EUD1-PL0W-1230	537.69
						1 Power Receptacle, 3 USB Charging, 1 Cable Bay	EUD1-PL0W-1302	606.51
						1 Power Receptacle, 3 USB Charging, 2 Data Ports	EUD1-PL0W-1320	606.51
						1 Power Receptacle, 4 USB Charging, 1 Data Port	EUD1-PL0W-1410	675.33
						2 Power Receptacles, 2 Cable Bays	EUD1-PL0W-2004	400.05
						2 Power Receptacles, 2 Data Ports, 1 Cable Bay	EUD1-PL0W-2022	400.05
						2 Power Receptacles, 4 Data Ports	EUD1-PL0W-2040	400.05
						2 Power Receptacles, 1 USB Charging, 1 Data Port, 1 Cable Bay	EUD1-PL0W-2112	468.87
						2 Power Receptacles, 1 USB Charging, 3 Data Ports	EUD1-PL0W-2130	468.87
						2 Power Receptacles, 2 USB Charging, 1 Cable Bay	EUD1-PL0W-2202	537.69
						2 Power Receptacles, 2 USB Charging, 2 Data Ports	EUD1-PL0W-2220	537.69
						2 Power Receptacles, 3 USB Charging, 1 Data Port	EUD1-PL0W-2310	606.51
						2 Power Receptacles, 4 USB Charging	EUD1-PL0W-2400	675.33
						3 Power Receptacles, 3 Data Ports	EUD1-PL0W-3030	400.05
						3 Power Receptacles, 1 USB Charging, 1 Cable Bay	EUD1-PL0W-3102	468.87
						3 Power Receptacles, 1 USB Charging, 2 Data Ports	EUD1-PL0W-3120	468.87
						3 Power Receptacles, 2 USB Charging, 1 Data Port	EUD1-PL0W-3210	537.69
						3 Power Receptacles, 3 USB Charging	EUD1-PL0W-3300	606.51
						4 Power Receptacles, 1 Cable Bay	EUD1-PL0W-4002	400.05
						4 Power Receptacles, 2 Data Ports	EUD1-PL0W-4020	400.05
						4 Power Receptacles, 1 USB Charging, 1 Data Port	EUD1-PL0W-4110	468.87
						4 Power Receptacles, 2 USB Charging	EUD1-PL0W-4200	537.69
						5 Power Receptacles, 1 Data Port	EUD1-PL0W-5010	400.05
						5 Power Receptacles, 1 USB Charging	EUD1-PL0W-5100	468.87
						6 Power Receptacles	EUD1-PL0W-6000	400.05

This page intentionally blank

Electrical Components

Enhanced Power Module — Hardwire

3-Port:

- (2) Power
- (1) USB

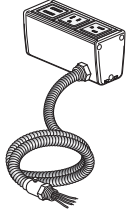

EUD1-HF0B-2010

4-Port:

- (2) Power
- (1) USB
- (1) Data

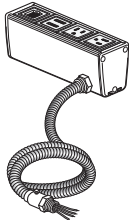

EUD1-HF0B-2110

6-Port:

- (2) Power
- (1) USB
- (1) Data
- (1) Cable Bay

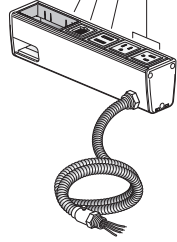

EUD1-HF0B-2112



Features

- Includes power module with 3, 4 or 6 ports that can be configured with simplex outlets (NEMA-5-15R), USB charging port (with two USB outlets), data ports or cable bay(s) that can accept up to two pull out data/AV cables and mounting hardware.
- Data port accommodate most varieties of field supplied data/AV jacks.
- Attaches to surface with use of separately specified mounting brackets.
- Hardwired power module with 6'(1829mm) or 12'(3658mm) long flexible metal conduit feed, 0.5"(13mm) conduit fitting and wires for hardwire connection.
- USB Charging Port consists of two USB 2.0 style A outlets. 4 Amp (shared) charging capacity.
- Color option of black anodized housing with black receptacles or clear anodized housing with white receptacles.

Specification Tips

- **Configuration and quantity of power and data ports cannot be modified in the field.**
- **For use with 120 volt 60 hertz power source only.**
- Separately specify attachment hardware for desired application.
- Requires field installation.
- Specify AV cables separately.
- Cable Bay requires cables less than 0.3"(7.6mm) diameter.
- Application may require approval of local authority having jurisdiction (AHJ); ensure compliance before placing orders and installation.

To Order, Specify:

- 1) Product number.
(No finish specification required.)

Electrical Components

Enhanced Power Module — Hardwire

Top Width	Top Depth	Conduit Length	Housing Color	Port Color	Port	Configuration	Number	Price
5" (127mm)	3" (76mm)	6' (1829mm)	Black Anodized	Black	3	1 Power Receptacle, 1 Cable Bay	EUD1-HF0B-1002	\$473.91
						1 Power Receptacle, 2 Data Ports	EUD1-HF0B-1020	473.91
						1 Power Receptacle, 1 Data Port, 1 USB Charging	EUD1-HF0B-1110	542.73
						1 Power Receptacle, 2 USB Charging	EUD1-HF0B-1200	611.55
						2 Power Receptacles, 1 Data Port	EUD1-HF0B-2010	473.91
						2 Power Receptacles, 1 USB Charging	EUD1-HF0B-2100	542.73
						3 Power Receptacles	EUD1-HF0B-3000	473.91
6.5" (165mm)	3" (76mm)				4	1 Power Receptacle, 1 Data Port, 1 Cable Bay	EUD1-HF0B-1012	\$473.91
						1 Power Receptacle, 3 Data Ports	EUD1-HF0B-1030	473.91
						1 Power Receptacle, 1 USB Charging, 1 Cable Bay	EUD1-HF0B-1102	542.73
						1 Power Receptacle, 3 USB Charging	EUD1-HF0B-1300	680.37
						2 Power Receptacles, 1 Cable Bay	EUD1-HF0B-2002	473.91
						2 Power Receptacles, 2 Data Ports	EUD1-HF0B-2020	473.91
						2 Power Receptacles, 1 USB Charging, 1 Data Port	EUD1-HF0B-2110	542.73
						2 Power Receptacles, 2 USB Charging	EUD1-HF0B-2200	611.55
						3 Power Receptacles, 1 Data Port	EUD1-HF0B-3010	473.91
						3 Power Receptacles, 1 USB Charging	EUD1-HF0B-3100	542.73
						4 Power Receptacles	EUD1-HF0B-4000	473.91
9.5" (241mm)	3" (76mm)				6	1 Power Receptacle, 1 USB Charging, 2 Cable Bays	EUD1-HF0B-1104	\$602.38
						1 Power Receptacle, 1 USB Charging, 2 Data Ports, 1 Cable Bay	EUD1-HF0B-1122	602.38
						1 Power Receptacle, 1 USB Charging, 4 Data Ports	EUD1-HF0B-1140	602.38
						1 Power Receptacle, 2 USB Charging, 1 Data Port, 1 Cable Bay	EUD1-HF0B-1212	671.20
						1 Power Receptacle, 2 USB Charging, 3 Data Ports	EUD1-HF0B-1230	671.20
						1 Power Receptacle, 3 USB Charging, 1 Cable Bay	EUD1-HF0B-1302	740.02
						1 Power Receptacle, 3 USB Charging, 2 Data Ports	EUD1-HF0B-1320	740.02
						1 Power Receptacle, 4 USB Charging, 1 Data Port	EUD1-HF0B-1410	808.84
						2 Power Receptacles, 2 Cable Bays	EUD1-HF0B-2004	533.56
						2 Power Receptacles, 2 Data Ports, 1 Cable Bay	EUD1-HF0B-2022	533.56
						2 Power Receptacles, 4 Data Ports	EUD1-HF0B-2040	533.56
						2 Power Receptacles, 1 USB Charging, 1 Data Port, 1 Cable Bay	EUD1-HF0B-2112	602.38
						2 Power Receptacles, 1 USB Charging, 3 Data Ports	EUD1-HF0B-2130	602.38
						2 Power Receptacles, 2 USB Charging, 1 Cable Bay	EUD1-HF0B-2202	671.20
						2 Power Receptacles, 2 USB Charging, 2 Data Ports	EUD1-HF0B-2220	671.20
						2 Power Receptacles, 3 USB Charging, 1 Data Port	EUD1-HF0B-2310	740.02
						2 Power Receptacles, 4 USB Charging	EUD1-HF0B-2400	808.84
						3 Power Receptacles, 3 Data Ports	EUD1-HF0B-3030	533.56
						3 Power Receptacles, 1 USB Charging, 1 Cable Bay	EUD1-HF0B-3102	602.38
						3 Power Receptacles, 1 USB Charging, 2 Data Ports	EUD1-HF0B-3120	602.38
						3 Power Receptacles, 2 USB Charging, 1 Data Port	EUD1-HF0B-3210	671.20
3 Power Receptacles, 3 USB Charging	EUD1-HF0B-3300	740.02						
4 Power Receptacles, 1 Cable Bay	EUD1-HF0B-4002	533.56						
4 Power Receptacles, 2 Data Ports	EUD1-HF0B-4020	533.56						
4 Power Receptacles, 1 USB Charging, 1 Data Port	EUD1-HF0B-4110	602.38						
4 Power Receptacles, 2 USB Charging	EUD1-HF0B-4200	671.20						
5 Power Receptacles, 1 Data Port	EUD1-HF0B-5010	533.56						
5 Power Receptacles, 1 USB Charging	EUD1-HF0B-5100	602.38						
6 Power Receptacles	EUD1-HF0B-6000	533.56						

Electrical Components

Enhanced Power Module — Hardwire

Top Width	Top Depth	Conduit Length	Housing Color	Port Color	Port	Configuration	Number	Price
5" (127mm)	3" (76mm)	6' (1829mm)	Clear Anodized	White	3	1 Power Receptacle, 1 Cable Bay	EUD1-HF0W-1002	\$354.62
						1 Power Receptacle, 2 Data Ports	EUD1-HF0W-1020	354.62
						1 Power Receptacle, 1 Data Port, 1 USB Charging	EUD1-HF0W-1110	423.44
						1 Power Receptacle, 2 USB Charging	EUD1-HF0W-1200	492.26
						2 Power Receptacles, 1 Data Port	EUD1-HF0W-2010	354.62
						2 Power Receptacles, 1 USB Charging	EUD1-HF0W-2100	423.44
6.5" (165mm)	3" (76mm)				4	3 Power Receptacles	EUD1-HF0W-3000	354.62
						1 Power Receptacle, 1 Data Port, 1 Cable Bay	EUD1-HF0W-1012	\$354.62
						1 Power Receptacle, 3 Data Ports	EUD1-HF0W-1030	354.62
						1 Power Receptacle, 1 USB Charging, 1 Cable Bay	EUD1-HF0W-1102	423.44
						1 Power Receptacle, 3 USB Charging	EUD1-HF0W-1300	561.08
						2 Power Receptacles, 1 Cable Bay	EUD1-HF0W-2002	354.62
						2 Power Receptacles, 2 Data Ports	EUD1-HF0W-2020	354.62
						2 Power Receptacles, 1 USB Charging, 1 Data Port	EUD1-HF0W-2110	423.44
						2 Power Receptacles, 2 USB Charging	EUD1-HF0W-2200	492.26
						3 Power Receptacles, 1 Data Port	EUD1-HF0W-3010	354.62
						3 Power Receptacles, 1 USB Charging	EUD1-HF0W-3100	423.44
						4 Power Receptacles	EUD1-HF0W-4000	354.62
9.5" (241mm)	3" (76mm)				6	1 Power Receptacle, 1 USB Charging, 2 Cable Bays	EUD1-HF0W-1104	\$483.09
						1 Power Receptacle, 1 USB Charging, 2 Data Ports, 1 Cable Bay	EUD1-HF0W-1122	483.09
						1 Power Receptacle, 1 USB Charging, 4 Data Ports	EUD1-HF0W-1140	483.09
						1 Power Receptacle, 2 USB Charging, 1 Data Port, 1 Cable Bay	EUD1-HF0W-1212	551.91
						1 Power Receptacle, 2 USB Charging, 3 Data Ports	EUD1-HF0W-1230	551.91
						1 Power Receptacle, 3 USB Charging, 1 Cable Bay	EUD1-HF0W-1302	620.73
						1 Power Receptacle, 3 USB Charging, 2 Data Ports	EUD1-HF0W-1320	620.73
						1 Power Receptacle, 4 USB Charging, 1 Data Port	EUD1-HF0W-1410	689.55
						2 Power Receptacles, 2 Cable Bays	EUD1-HF0W-2004	414.27
						2 Power Receptacles, 2 Data Ports, 1 Cable Bay	EUD1-HF0W-2022	414.27
						2 Power Receptacles, 4 Data Ports	EUD1-HF0W-2040	414.27
						2 Power Receptacles, 1 USB Charging, 1 Data Port, 1 Cable Bay	EUD1-HF0W-2112	483.09
						2 Power Receptacles, 1 USB Charging, 3 Data Ports	EUD1-HF0W-2130	483.09
						2 Power Receptacles, 2 USB Charging, 1 Cable Bay	EUD1-HF0W-2202	551.91
						2 Power Receptacles, 2 USB Charging, 2 Data Ports	EUD1-HF0W-2220	551.91
						2 Power Receptacles, 3 USB Charging, 1 Data Port	EUD1-HF0W-2310	620.73
						2 Power Receptacles, 4 USB Charging	EUD1-HF0W-2400	689.55
						3 Power Receptacles, 3 Data Ports	EUD1-HF0W-3030	414.27
						3 Power Receptacles, 1 USB Charging, 1 Cable Bay	EUD1-HF0W-3102	483.09
						3 Power Receptacles, 1 USB Charging, 2 Data Ports	EUD1-HF0W-3120	483.09
3 Power Receptacles, 2 USB Charging, 1 Data Port	EUD1-HF0W-3210	551.91						
3 Power Receptacles, 3 USB Charging	EUD1-HF0W-3300	620.73						
4 Power Receptacles, 1 Cable Bay	EUD1-HF0W-4002	414.27						
4 Power Receptacles, 2 Data Ports	EUD1-HF0W-4020	414.27						
4 Power Receptacles, 1 USB Charging, 1 Data Port	EUD1-HF0W-4110	483.09						
4 Power Receptacles, 2 USB Charging	EUD1-HF0W-4200	551.91						
5 Power Receptacles, 1 Data Port	EUD1-HF0W-5010	414.27						
5 Power Receptacles, 1 USB Charging	EUD1-HF0W-5100	483.09						
6 Power Receptacles	EUD1-HF0W-6000	414.27						

Electrical Components

Enhanced Power Module — Hardwire

Top Width	Top Depth	Conduit Length	Housing Color	Port Color	Port	Configuration	Number	Price
5" (127mm)	3" (76mm)	12' (3658mm)	Black Anodized	Black	3	1 Power Receptacle, 1 Cable Bay	EUD1-HLOB-1002	\$529.98
						1 Power Receptacle, 2 Data Ports	EUD1-HLOB-1020	529.98
						1 Power Receptacle, 1 Data Port, 1 USB Charging	EUD1-HLOB-1110	598.80
						1 Power Receptacle, 2 USB Charging	EUD1-HLOB-1200	667.62
						2 Power Receptacles, 1 Data Port	EUD1-HLOB-2010	529.98
						2 Power Receptacles, 1 USB Charging	EUD1-HLOB-2100	598.80
						3 Power Receptacles	EUD1-HLOB-3000	529.98
6.5" (165mm)	3" (76mm)				4	1 Power Receptacle, 1 Data Port, 1 Cable Bay	EUD1-HLOB-1012	\$529.98
						1 Power Receptacle, 3 Data Ports	EUD1-HLOB-1030	529.98
						1 Power Receptacle, 1 USB Charging, 1 Cable Bay	EUD1-HLOB-1102	598.80
						1 Power Receptacle, 3 USB Charging	EUD1-HLOB-1300	736.44
						2 Power Receptacles, 1 Cable Bay	EUD1-HLOB-2002	529.98
						2 Power Receptacles, 2 Data Ports	EUD1-HLOB-2020	529.98
						2 Power Receptacles, 1 USB Charging, 1 Data Port	EUD1-HLOB-2110	598.80
						2 Power Receptacles, 2 USB Charging	EUD1-HLOB-2200	667.62
						3 Power Receptacles, 1 Data Port	EUD1-HLOB-3010	529.98
						3 Power Receptacles, 1 USB Charging	EUD1-HLOB-3100	598.80
9.5" (241mm)	3" (76mm)				6	1 Power Receptacle, 1 USB Charging, 2 Cable Bays	EUD1-HLOB-1104	\$658.45
						1 Power Receptacle, 1 USB Charging, 2 Data Ports, 1 Cable Bay	EUD1-HLOB-1122	658.45
						1 Power Receptacle, 1 USB Charging, 4 Data Ports	EUD1-HLOB-1140	658.45
						1 Power Receptacle, 2 USB Charging, 1 Data Port, 1 Cable Bay	EUD1-HLOB-1212	727.27
						1 Power Receptacle, 2 USB Charging, 3 Data Ports	EUD1-HLOB-1230	727.27
						1 Power Receptacle, 3 USB Charging, 1 Cable Bay	EUD1-HLOB-1302	796.09
						1 Power Receptacle, 3 USB Charging, 2 Data Ports	EUD1-HLOB-1320	796.09
						1 Power Receptacle, 4 USB Charging, 1 Data Port	EUD1-HLOB-1410	864.91
						2 Power Receptacles, 2 Cable Bays	EUD1-HLOB-2004	589.63
						2 Power Receptacles, 2 Data Ports, 1 Cable Bay	EUD1-HLOB-2022	589.63
						2 Power Receptacles, 4 Data Ports	EUD1-HLOB-2040	589.63
						2 Power Receptacles, 1 USB Charging, 1 Data Port, 1 Cable Bay	EUD1-HLOB-2112	658.45
						2 Power Receptacles, 1 USB Charging, 3 Data Ports	EUD1-HLOB-2130	658.45
						2 Power Receptacles, 2 USB Charging, 1 Cable Bay	EUD1-HLOB-2202	727.27
						2 Power Receptacles, 2 USB Charging, 2 Data Ports	EUD1-HLOB-2220	727.27
						2 Power Receptacles, 3 USB Charging, 1 Data Port	EUD1-HLOB-2310	796.09
						2 Power Receptacles, 4 USB Charging	EUD1-HLOB-2400	864.91
						3 Power Receptacles, 3 Data Ports	EUD1-HLOB-3030	589.63
						3 Power Receptacles, 1 USB Charging, 1 Cable Bay	EUD1-HLOB-3102	658.45
						3 Power Receptacles, 1 USB Charging, 2 Data Ports	EUD1-HLOB-3120	658.45
3 Power Receptacles, 2 USB Charging, 1 Data Port	EUD1-HLOB-3210	727.27						
3 Power Receptacles, 3 USB Charging	EUD1-HLOB-3300	796.09						
4 Power Receptacles, 1 Cable Bay	EUD1-HLOB-4002	589.63						
4 Power Receptacles, 2 Data Ports	EUD1-HLOB-4020	589.63						
4 Power Receptacles, 1 USB Charging, 1 Data Port	EUD1-HLOB-4110	658.45						
4 Power Receptacles, 2 USB Charging	EUD1-HLOB-4200	727.27						
5 Power Receptacles, 1 Data Port	EUD1-HLOB-5010	589.63						
5 Power Receptacles, 1 USB Charging	EUD1-HLOB-5100	658.45						
6 Power Receptacles	EUD1-HLOB-6000	589.63						

Electrical Components

Enhanced Power Module — Hardwire

Top Width	Top Depth	Conduit Length	Housing Color	Port Color	Port	Configuration	Number	Price						
5" (127mm)	3" (76mm)	12' (3658mm)	Clear Anodized	White	3	1 Power Receptacle, 1 Cable Bay	EUR1-HLOW-1002	\$410.69						
						1 Power Receptacle, 2 Data Ports	EUR1-HLOW-1020	410.69						
						1 Power Receptacle, 1 Data Port, 1 USB Charging	EUR1-HLOW-1110	479.51						
						1 Power Receptacle, 2 USB Charging	EUR1-HLOW-1200	548.33						
						2 Power Receptacles, 1 Data Port	EUR1-HLOW-2010	410.69						
						2 Power Receptacles, 1 USB Charging	EUR1-HLOW-2100	479.51						
						3 Power Receptacles	EUR1-HLOW-3000	410.69						
6.5" (165mm)	3" (76mm)				4	1 Power Receptacle, 1 Data Port, 1 Cable Bay	EUR1-HLOW-1012	\$410.69						
						1 Power Receptacle, 3 Data Ports	EUR1-HLOW-1030	410.69						
						1 Power Receptacle, 1 USB Charging, 1 Cable Bay	EUR1-HLOW-1102	479.51						
						1 Power Receptacle, 3 USB Charging	EUR1-HLOW-1300	617.15						
						2 Power Receptacles, 1 Cable Bay	EUR1-HLOW-2002	410.69						
						2 Power Receptacles, 2 Data Ports	EUR1-HLOW-2020	410.69						
						2 Power Receptacles, 1 USB Charging, 1 Data Port	EUR1-HLOW-2110	479.51						
						2 Power Receptacles, 2 USB Charging	EUR1-HLOW-2200	548.33						
						3 Power Receptacles, 1 Data Port	EUR1-HLOW-3010	410.69						
						3 Power Receptacles, 1 USB Charging	EUR1-HLOW-3100	479.51						
						4 Power Receptacles	EUR1-HLOW-4000	410.69						
						9.5" (241mm)	3" (76mm)				6	1 Power Receptacle, 1 USB Charging, 2 Cable Bays	EUR1-HLOW-1104	\$539.16
												1 Power Receptacle, 1 USB Charging, 2 Data Ports, 1 Cable Bay	EUR1-HLOW-1122	539.16
1 Power Receptacle, 1 USB Charging, 4 Data Ports	EUR1-HLOW-1140	539.16												
1 Power Receptacle, 2 USB Charging, 1 Data Port, 1 Cable Bay	EUR1-HLOW-1212	607.98												
1 Power Receptacle, 2 USB Charging, 3 Data Ports	EUR1-HLOW-1230	607.98												
1 Power Receptacle, 3 USB Charging, 1 Cable Bay	EUR1-HLOW-1302	676.80												
1 Power Receptacle, 3 USB Charging, 2 Data Ports	EUR1-HLOW-1320	676.80												
1 Power Receptacle, 4 USB Charging, 1 Data Port	EUR1-HLOW-1410	745.62												
2 Power Receptacles, 2 Cable Bays	EUR1-HLOW-2004	470.34												
2 Power Receptacles, 2 Data Ports, 1 Cable Bay	EUR1-HLOW-2022	470.34												
2 Power Receptacles, 4 Data Ports	EUR1-HLOW-2040	470.34												
2 Power Receptacles, 1 USB Charging, 1 Data Port, 1 Cable Bay	EUR1-HLOW-2112	539.16												
2 Power Receptacles, 1 USB Charging, 3 Data Ports	EUR1-HLOW-2130	539.16												
2 Power Receptacles, 2 USB Charging, 1 Cable Bay	EUR1-HLOW-2202	607.98												
2 Power Receptacles, 2 USB Charging, 2 Data Ports	EUR1-HLOW-2220	607.98												
2 Power Receptacles, 3 USB Charging, 1 Data Port	EUR1-HLOW-2310	676.80												
2 Power Receptacles, 4 USB Charging	EUR1-HLOW-2400	745.62												
3 Power Receptacles, 3 Data Ports	EUR1-HLOW-3030	470.34												
3 Power Receptacles, 1 USB Charging, 1 Cable Bay	EUR1-HLOW-3102	539.16												
3 Power Receptacles, 1 USB Charging, 2 Data Ports	EUR1-HLOW-3120	539.16												
3 Power Receptacles, 2 USB Charging, 1 Data Port	EUR1-HLOW-3210	607.98												
3 Power Receptacles, 3 USB Charging	EUR1-HLOW-3300	676.80												
4 Power Receptacles, 1 Cable Bay	EUR1-HLOW-4002	470.34												
4 Power Receptacles, 2 Data Ports	EUR1-HLOW-4020	470.34												
4 Power Receptacles, 1 USB Charging, 1 Data Port	EUR1-HLOW-4110	539.16												
4 Power Receptacles, 2 USB Charging	EUR1-HLOW-4200	607.98												
5 Power Receptacles, 1 Data Port	EUR1-HLOW-5010	470.34												
5 Power Receptacles, 1 USB Charging	EUR1-HLOW-5100	539.16												
6 Power Receptacles	EUR1-HLOW-6000	470.34												

Electrical Components

Enhanced Power Module — Spiral Corded — Height Adjustable

Top Depth	Top Width	Cord Length	Housing Color	Port Color	Port	Configuration	Number	Price
3" (76mm)	6.5" (165mm)	10'(3048mm)- 12'(3658mm)	Black Anodized	Black	4	2 Power Receptacles, 1 USB Charging, 1 Data Port	EUD1-SF0B-2110	\$728.91
					4	2 Power Receptacles, 2 USB Charging	EUD1-SF0B-2200	797.73
					4	3 Power Receptacles, 1 Data Port	EUD1-SF0B-3010	660.09
					4	3 Power Receptacles, 1 USB Charging	EUD1-SF0B-3100	728.91
			4	4 Power Receptacles	EUD1-SF0B-4000	660.09		
			Clear Anodized	White	4	2 Power Receptacles, 1 USB Charging, 1 Data Port	EUD1-SF0W-2110	\$609.62
					4	2 Power Receptacles, 2 USB Charging	EUD1-SF0W-2200	678.44
					4	3 Power Receptacles, 1 Data Port	EUD1-SF0W-3010	540.80
					4	3 Power Receptacles, 1 USB Charging	EUD1-SF0W-3100	609.62
					4	4 Power Receptacles	EUD1-SF0W-4000	540.80

4-Port:

- (2) Power
- (1) USB
- (1) Data

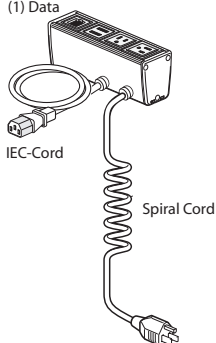

EUD1-SF0B-2110

4-Port:

- (4) Power

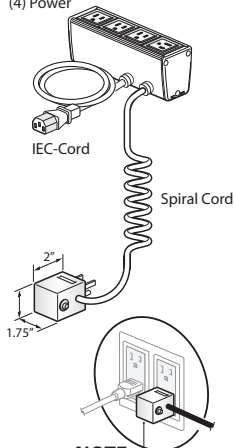

NOTE:
Always Fused Plug when more than 3 power outlets specified.

EUD1-SF0B-4000



Features

- Includes power module with 3, 4 or 6 ports that can be configured with simplex outlets (NEMA-5-15R), USB charging port (with two USB outlets), data ports or cable bay(s) that can accept up to two pull out data/AV cables and mounting hardware.
- Data port accommodate most varieties of field supplied data/AV jacks.
- Spiral Cord includes 15 amp plug (NEMA 5-15P) and expands to 12'(3658mm) when stretched.
- Auxiliary 24"(610mm) power cord includes IEC connector (IEC C13) for motor controller.
- Attaches to surface with use of separately specified mounting brackets.
- USB Charging Port consists of two USB 2.0 style A outlets. 4 Amp (shared) charging capacity.
- Color option of black anodized housing with black receptacles or clear anodized housing with white receptacles.

To Order, Specify:

- 1) Product number.
(No finish specification required.)

Specification Tips

- **Configuration and quantity of power and data ports cannot be modified in the field.**
- **For use with 120 volt 60 hertz power source only.**
- **For use with Suite, Planes Height Adjustable Tables, Planes Height Adjustable Bench, Hop 120° Benches and 3-Leg Hop Height Adjustable Tables use IEC C6 to IEC C14 adapter.**
- Separately specify attachment hardware for desired application.
- Not for use with cable chain.
- Requires field installation.
- Application may require approval of local authority having jurisdiction (AHJ); ensure compliance before placing orders and installation.

Electrical Components

Enhanced Power Module — Cord for Height Adjustable

Top Depth	Top Width	Cord Length	Housing Color	Port Color	Port	Configuration	Number	Price
3" (76mm)	6.5" (165mm)	10'(3048mm)- 12'(3658mm)	Black Anodized	Black	4	2 Power Receptacles, 1 USB Charging, 1 Data Port	EUD1-SLOB-2110	\$784.98
					4	2 Power Receptacles, 2 USB Charging	EUD1-SLOB-2200	853.80
					4	3 Power Receptacles, 1 Data Port	EUD1-SLOB-3010	716.16
					4	3 Power Receptacles, 1 USB Charging	EUD1-SLOB-3100	784.98
			4	4 Power Receptacles	EUD1-SLOB-4000	716.16		
			Clear Anodized	White	4	2 Power Receptacles, 1 USB Charging, 1 Data Port	EUD1-SLOW-2110	\$665.69
					4	2 Power Receptacles, 2 USB Charging	EUD1-SLOW-2200	734.51
					4	3 Power Receptacles, 1 Data Port	EUD1-SLOW-3010	596.87
					4	3 Power Receptacles, 1 USB Charging	EUD1-SLOW-3100	665.69
					4	4 Power Receptacles	EUD1-SLOW-4000	596.87

4-Port:

- (2) Power
- (1) USB
- (1) Data

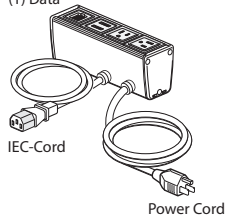

EUD1-SLOB-2110

4-Port:

- (4) Power

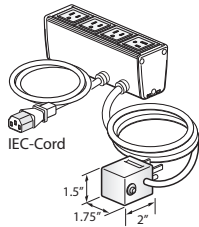

NOTE:
Always Fused Plug when more than 3 power outlets specified.

EUD1-SLOB-4000



Features

- Includes power module with 3, 4 or 6 ports that can be configured with simplex outlets (NEMA-5-15R), USB charging port (with two USB outlets), data ports or cable bay(s) that can accept up to two pull out data/AV cables and mounting hardware.
- Data port accommodate most varieties of field supplied data/AV jacks.
- Corded power module with 15 amp - 12'(3658mm) long cord with plug (NEMA 5-15P).
- Auxiliary 24"(610mm) power cord includes IEC connector (IEC C13) for motor controller.
- Attaches to surface with use of separately specified mounting brackets.
- USB Charging Port consists of two USB 2.0 style A outlets. 4 Amp (shared) charging capacity.
- Color option of black anodized housing with black receptacles or clear anodized housing with white receptacles.

Specification Tips

- **Configuration and quantity of power and data ports cannot be modified in the field.**
- **For use with 120 volt 60 hertz power source only.**
- **For use with Suite, Planes Height Adjustable Tables, Planes Height Adjustable Bench, Hop 120° Benches and 3-Leg Hop Height Adjustable Tables. For 2-Leg Hop Height Adjustable Tables use IEC C6 to IEC C14 adapter.**
- Separately specify attachment hardware for desired application.
- Designed to be used with cable chain.
- Requires field installation.
- Application may require approval of local authority having jurisdiction (AHJ); ensure compliance before placing orders and installation.

To Order, Specify:

- 1) Product number.
(No finish specification required.)

Electrical Components

Enhanced Power Module Brackets

	Height	Width	Length	Description	Number	Price
Above Worksurface – Adjustable	4"(102mm)	3.5"(89mm)	3.5"(89mm)	Black Bracket	EUDB-0000-HB	\$62.62
				White Bracket	EUDB-0000-HW	62.62

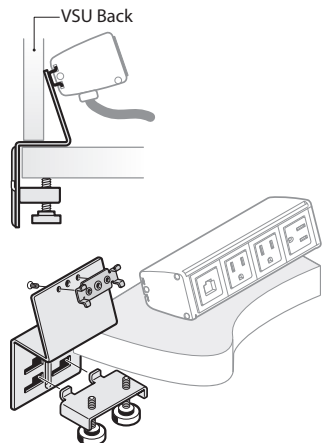

EUDB-0000-H
Class YA - SIN 711-2
Discount Group XIII



Features

- Includes bracket and mounting hardware.
- For use with 3, 4 or 6 port Enhanced Power Module.
- Available in black or white.
- Mounts to back edge of 1.125"(29mm) to 2"(51mm) worktop.
- Not for use with a tack board.

To Order, Specify:

- 1) Product number.
(No finish specification required.)

Specification Tips

- Specify Enhanced Power Module separately.
- Requires field installation.
- Application may require approval of local authority having jurisdiction (AHJ); ensure compliance before placing orders and installation.

	4"(102mm)	3.5"(89mm)	3.5"(89mm)	Black Bracket	EUDB-0000-NB	\$90.33
				White Bracket	EUDB-0000-NW	90.33

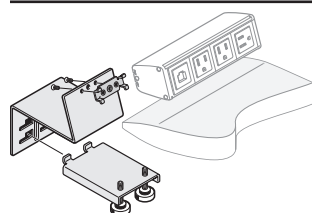

EUDB-0000-NB

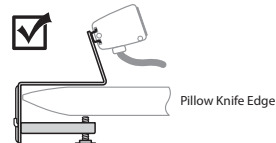

Pillow Knife Edge

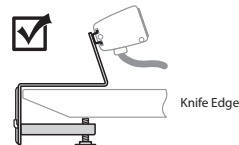

Knife Edge

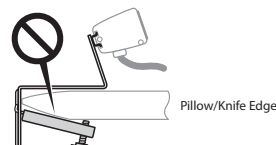

Pillow/Knife Edge

EUDB-0000-N
Class YA – GSA: Open Market



Features

- Includes bracket and mounting hardware.
- For use with 3, 4 or 6 port Enhanced Power Module.
- Available in black or white.
- Mounts to worksurface edge.

To Order, Specify:

- 1) Product number.
(No finish specification required.)

Specification Tips

- Specify Enhanced Power Module separately.
- Requires field installation.
- Application may require approval of local authority having jurisdiction (AHJ); ensure compliance before placing orders and installation.
- Designed to be used with knife edge or pillowed knife edge worksurfaces.

Electrical Components

Enhanced Power Module Brackets

	Height	Width	Length	Description	Number	Price
Above Worksurface – Adjustable with Tackboard Offset	4"(102mm)	3.5"(89mm)	3.5"(89mm)	Black Bracket	EUDB-0000-TB	\$62.62
				White Bracket	EUDB-0000-TW	62.62

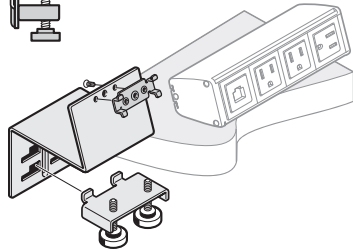
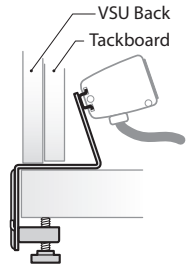

EUDB-0000-T

Features

- Includes bracket and mounting hardware.
- For use with 3, 4 or 6 port Enhanced Power Module.
- Available in black or white.
- Mounts to back edge of 1.125"(29mm) to 2"(51mm) worktop when a tackboard is present.

To Order, Specify:

- 1) Product number.
(No finish specification required.)

Specification Tips

- Specify Enhanced Power Module separately.
- Requires field installation.
- Application may require approval of local authority having jurisdiction (AHJ); ensure compliance before placing orders and installation.

Above Worksurface – Fixed	4.25"(107mm)	3"(76mm)	2"(51mm)	Black Bracket	EUDB-0000-WB	\$62.62
				White Bracket	EUDB-0000-WW	62.62

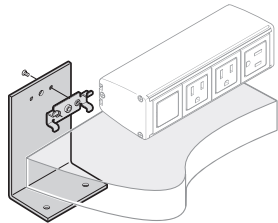
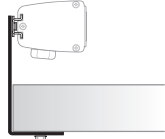

EUDB-0000-W

Features

- Includes bracket and mounting hardware.
- For use with 3, 4 or 6 port Enhanced Power Module.
- Available in black or white.
- Mounts under worksurface with Enhanced Power Module above worksurface.

To Order, Specify:

- 1) Product number.
(No finish specification required.)

Specification Tips

- Specify Enhanced Power Module separately.
- Requires field installation.
- Application may require approval of local authority having jurisdiction (AHJ); ensure compliance before placing orders and installation.

Under Worksurface – Fixed	2"(51mm)	3"(76mm)	2.5"(64mm)	Black Bracket	EUDB-0000-UB	\$62.62
				White Bracket	EUDB-0000-UW	62.62

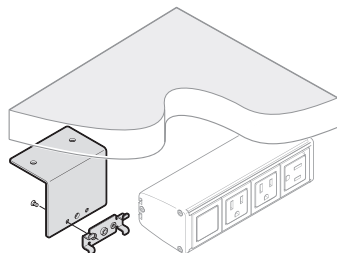
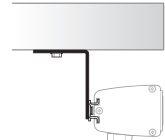

EUDB-0000-U

Features

- Includes bracket and mounting hardware.
- For use with 3, 4 or 6 port Enhanced Power Module.
- Available in black or white.
- Mounts under worksurface with offset to accommodate most transformer plugs.

To Order, Specify:

- 1) Product number.
(No finish specification required.)

Specification Tips

- Specify Enhanced Power Module separately.
- Requires field installation.
- Application may require approval of local authority having jurisdiction (AHJ); ensure compliance before placing orders and installation.

Electrical Components

Enhanced Power Module Brackets

	Height	Width	Length	Description	Number	Price
For Use with Side Car — Basic	4"(102mm)	3.5"(89mm)	3.5"(89mm)	Black Bracket	EUDB-0000-SBB	\$90.33
				White Bracket	EUDB-0000-SBW	90.33

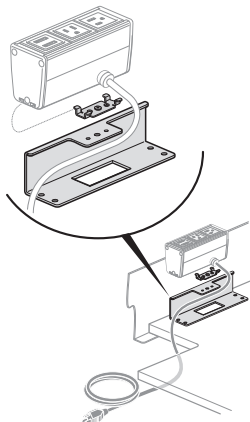

EUDB-0000-SB



Features

- Includes bracket and mounting hardware.
- For use with 3 port Enhanced Power Module.
- Available in black or white.
- Mounts to bottom shelf of Side Car - Basic.

To Order, Specify:

- 1) Product number.
(No finish specification required.)

Specification Tips

- Designed to be used with Side Car - Basic only.
- Specify Enhanced Power Module separately.
- Requires field installation.
- Application may require approval of local authority having jurisdiction (AHJ); ensure compliance before placing orders and installation.

For Use with Side Car — Deluxe	4"(102mm)	3.5"(89mm)	3.5"(89mm)	Black Bracket	EUDB-0000-SDB	\$62.62
				White Bracket	EUDB-0000-SDW	62.62

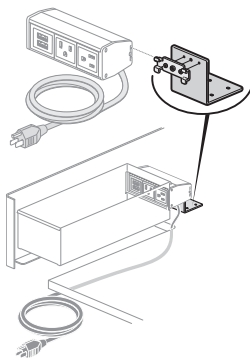

EUDB-0000-SD



Features

- Includes bracket and mounting hardware.
- For use with 3 port Enhanced Power Module.
- Available in black or white.
- Mounts to drop in Accessory Box with power cutout.

To Order, Specify:

- 1) Product number.
(No finish specification required.)

Specification Tips

- Designed to be used with Side Car - Deluxe only.
- Specify Enhanced Power Module separately.
- Requires field installation.
- Application may require approval of local authority having jurisdiction (AHJ); ensure compliance before placing orders and installation.

Electrical Components

Enhanced Power Module Bracket

	Height	Width	Depth	Trim Color	Number	Price
For Use with X Series	5"(127mm)	2.375"(60mm)	1.125"(29mm)	Black	EUDB-0000-JB	\$62.62
				White	EUDB-0000-JW	\$62.62

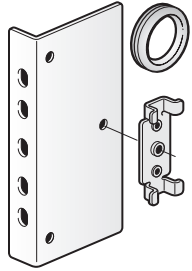

EUDB-J

Features

- Includes bracket, grommet and mounting hardware.
- Field installed.

Specification Tips

- Bracket designed to be used with X Series Enhanced Power Module only.
- Designed to be used in open storage cavities of lockers, group lockers, cubby lockers and combination units.
- Cannot be used in drawers or personal storage towers.
- A 1.25"(32mm) diameter Greenlee punch is recommended to punch the power hole through the back of our products (lockers).
- Application may require approval of local authority having jurisdiction (AHJ); ensure compliance before placing orders and installation.

To Order, Specify:

- 1) Product number.

Electrical Components

Enhanced Power Module Brackets

	Height	Width	Length	Description	Number	Price
For use with Suite Lower Storage – Mounts to the Inner Back of the Cabinet	1.75"(44mm)	2"(51mm)	3.375"(85mm)	Black Bracket	EUDB-0000-BB	\$62.62
				White Bracket	EUDB-0000-BW	62.62

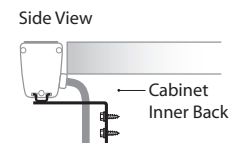
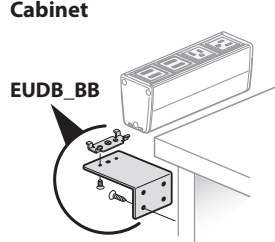

EUDB-0000-B



Features

- Includes bracket and mounting hardware.
- For use with 3, 4 or 6 port Enhanced Power Module on Suite cabinets.
- Available in black or white.
- Mounts to inner back of cabinet to position Enhanced Power Module at back edge of worktop.

To Order, Specify:

- 1) Product number.
(No finish specification required.)

Specification Tips

- Specify Enhanced Power Module separately.
- Requires field installation.
- Requires field cut of brush at back edge of cabinet.
- Power Module face must be mounted above worktop to accommodate transformer plugs.
- Application may require approval of local authority having jurisdiction (AHJ); ensure compliance before placing orders and installation.

For use with Suite Lower Storage – Mounts to Storage Top	2"(51mm)	2"(51mm)	3"(76mm)	Black Bracket	EUDB-0000-CB	\$62.62
				White Bracket	EUDB-0000-CW	62.62

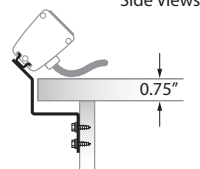
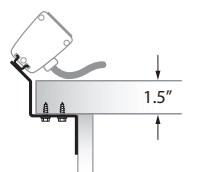
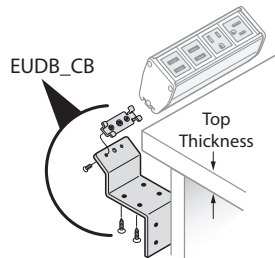

EUDB-0000-C



Features

- Includes bracket and mounting hardware.
- For use with 3, 4 or 6 port Enhanced Power Module on Suite cabinets.
- Available in black or white.
- Mounts to bottom of work top for 2H or inner back for 1.5h.
- Mounts to bottom of work top to position Enhanced Power Module at 45° angle at back edge of worktop.

To Order, Specify:

- 1) Product number.
(No finish specification required.)

Specification Tips

- Specify Enhanced Power Module separately.
- Requires field installation.
- Requires field cut of brush at back edge of cabinet.
- Application may require approval of local authority having jurisdiction (AHJ); ensure compliance before placing orders and installation.

Electrical Components

Enhanced Power Module Brackets

	Height	Width	Length	Description	Number	Price
For use with Suite Technology Access Blotter and Utility Cabinet	1.375"(35mm)	2"(51mm)	2"(51mm)	Black Bracket	EUDB-0000-AB	\$62.62
				White Bracket	EUDB-0000-AW	62.62

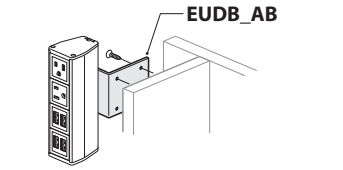

Features

- Includes bracket and mounting hardware.
- For use with 4 port Enhanced Power Module under Suite blotter.
- Mounts to bottom of work top adjacent to blotter opening.
- For use with 3, 4 or 6 port Enhanced Power Module in Suite utility cabinet.
- Mounts to inner back of Suite utility cabinet.
- Available in black or white.

To Order, Specify:

- 1) Product number.
(No finish specification required.)

Specification Tips

- Specify Enhanced Power Module separately.
- Requires field installation.
- Application may require approval of local authority having jurisdiction (AHJ); ensure compliance before placing orders and installation.

Top View

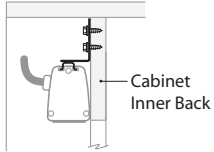

Side View

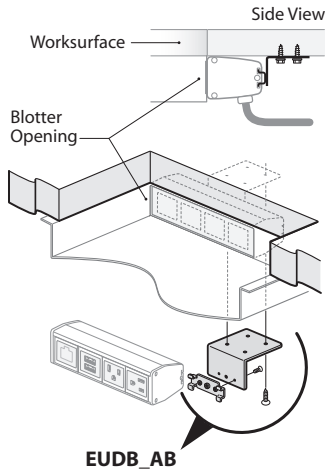

EUDB-0000-A



Electrical Components

Flip Top Units

Power and Data

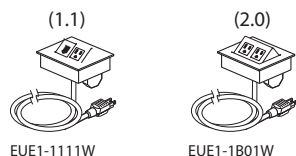

EUE1-1111W

EUE1-1B01W

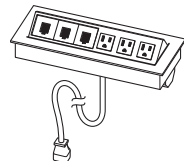

EUE1-1331W

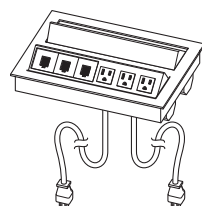

EUE2-1331W

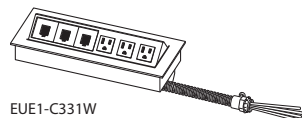

EUE1-C331W

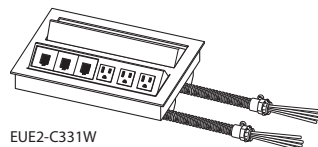

EUE2-C331W

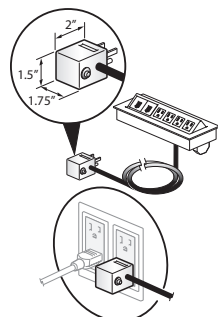

Fused Plug Detail

Width	Bezel Depth	Configuration	Number	Price
Corded Single-Sided Outlets				
5.24"(133mm)	4.37"(111mm)	1 Power, 1 Data	EUE1-0000-1111W	\$ 439.81
		2 Power, 0 Data	EUE1-0000-1B01W	439.81
8.31"(211mm)	4.37"(111mm)	2 Power, 2 Data	EUE1-0000-1221W	568.64
		3 Power, 1 Data	EUE1-0000-1311W	568.64
11.25"(286mm)		3 Power, 3 Data	EUE1-0000-1331W	568.64
		4 Power, 2 Data	EUE1-0000-1421W	568.64
Corded Double-Sided Outlets				
8.31"(211mm)	8"(203mm)	2 Power, 2 Data	EUE2-0000-1221W	\$1137.25
		3 Power, 1 Data	EUE2-0000-1311W	1137.25
11.25"(286mm)		3 Power, 3 Data	EUE2-0000-1331W	1137.25
		4 Power, 2 Data	EUE2-0000-1421W	1137.25
Hardwire Single-Sided Outlets				
8.31"(211mm)	4.37"(111mm)	2 Power, 2 Data	EUE1-0000-C221W	\$ 590.04
11.25"(286mm)		3 Power, 3 Data	EUE1-0000-C331W	590.04
Hardwire Double-Sided Outlets				
8.31"(211mm)	8"(203mm)	2 Power, 2 Data	EUE2-0000-C221W	\$1238.92
11.25"(286mm)		3 Power, 3 Data	EUE2-0000-C331W	1238.92

Features

- Hardwire flip top unit includes one flip top unit with power outlets and communication openings, mounting clips, 6 foot flexible metal conduit feed with wires for hardwire, multiple data jack adapters to accommodate most varieties of field supplied data jacks, also includes blank data covers.
- Corded flip top unit includes one flip top unit with power outlets and communication openings, 12 foot long – 15-amp cord with plug, mounting clips, multiple data jack adapters to accommodate most varieties of field supplied data jacks, also includes blank data covers.
- Flip top unit is flush mounted with spring release cover.
- Flip top unit overall height is 2.75"(70mm) and will extend below the table tops.
- Standard in anodized finish.
- Ships assembled.

To Order, Specify:

- 1) Product number.
(No finish specification required.)

Specification Tips

- **For use with 120 volt 60 hertz power source only.**
- Flip top unit plug-in cord drops down from bottom of unit to plug into external power outlet.
- Flip top unit must be field installed on worksurfaces by field cutting hole.
- Corded flip top units with four receptacles utilize a fused plug that may block adjacent building receptacle outlet.
- Application may require approval of local authority having jurisdiction (AHJ); ensure compliance before placing orders and installation.

Electrical Components

Flip Top Unit — Non-Powered

Width	Bezel Depth	Trim Color	Port Color	Port	Configuration	Number	Price
Single-Sided Outlets							
5.32"(135mm)	4.37"(111mm)	Black Anodized	Black	2	1 Cable Bay	EUE1-000B-0002	\$ 767.06
					2 Data Ports	EUE1-000B-0020	767.06
8.31"(211mm)	4.37"(111mm)			4	2 Data Ports, 1 Cable Bay	EUE1-000B-0022	\$ 767.06
					4 Data Ports	EUE1-000B-0040	767.06
11.3"(287mm)	4.37"(111mm)			6	4 Data Ports, 1 Cable Bay	EUE1-000B-0042	\$ 767.06
					6 Data Ports	EUE1-000B-0060	767.06
5.32"(135mm)	4.37"(111mm)	Clear Anodized	White	2	1 Cable Bay	EUE1-000W-0002	\$ 572.21
					2 Data Ports	EUE1-000W-0020	572.21
8.31"(211mm)	4.37"(111mm)			4	2 Data Ports, 1 Cable Bay	EUE1-000W-0022	\$ 572.21
					4 Data Ports	EUE1-000W-0040	572.21
11.3"(287mm)	4.37"(111mm)			6	4 Data Ports, 1 Cable Bay	EUE1-000W-0042	\$ 572.21
					6 Data Ports	EUE1-000W-0060	572.21
Double-Sided Outlets							
8.31"(211mm)	8.07"(205mm)	Black Anodized	Black	4	2 Data Ports, 1 Cable Bay	EUE2-000B-0022	\$1335.67
					4 Data Ports	EUE2-000B-0040	1335.67
11.3"(287mm)	8.07"(205mm)			6	4 Data Ports, 1 Cable Bay	EUE2-000B-0042	\$1335.67
					6 Data Ports	EUE2-000B-0060	1335.67
8.31"(211mm)	8.07"(205mm)	Clear Anodized	White	4	2 Data Ports, 1 Cable Bay	EUE2-000W-0022	\$1140.82
					4 Data Ports	EUE2-000W-0040	1140.82
11.3"(287mm)	8.07"(205mm)			6	4 Data Ports, 1 Cable Bay	EUE2-000W-0042	\$1140.82
					6 Data Ports	EUE2-000W-0060	1140.82

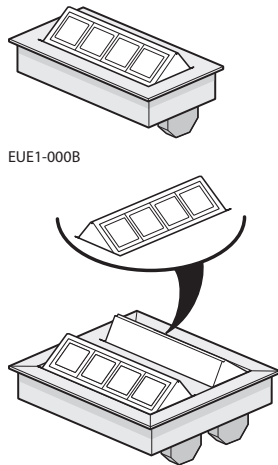

EUE1-000B

EUE2-000B



Features

- Includes bezel and nonpowered flip top module with 2, 4 or 6 ports that can be configured with data ports or cable bays and mounting hardware.
- Data port accommodate most varieties of field supplied data/AV jacks.
- Each Cable Bay can accept up to 2 pull out data/AV cables
- Flip top unit is flush mounted with spring release flip module(s).
- Flip top unit overall height is 2.75"(70mm) and will extend below the table tops.
- Color option of black anodized housing with black receptacles or clear anodized housing with white receptacles.
- Ships assembled.

Specification Tips

- **Configuration and quantity of power and data ports cannot be modified in the field.**
- Requires field installation.
- Specify factory cut hole or field cut hole as required.
- Specify AV cables separately.
- Cable Bay requires cables less than 0.3"(7.6mm) diameter.
- Application may require approval of local authority having jurisdiction (AHJ); ensure compliance before placing orders and installation.

To Order, Specify:

- 1) Product number.
(No finish specification required.)

This page intentionally blank

Electrical Components

Flip Top Unit – Corded – Single-Sided

Power, Data and USB

4-Port:

- (2) Power
- (1) USB
- (1) Data

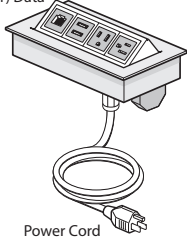

Power Cord

EUE1-PF0B-2110

6-Port:

- (2) Power
- (1) USB
- (1) Data
- (1) Cable Bay

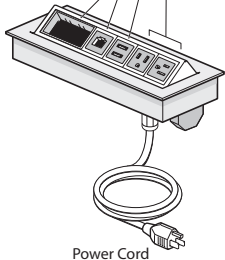

Power Cord

EUE1-PF0B-1212

4-Port:

- (4) Power

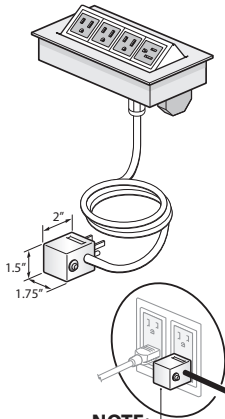

NOTE:

Always Fused Plug when more than 3 power outlets specified.

EUE1-PF0B-4000



Features

- Includes bezel and flip top module with 2, 4 or 6 ports that can be configured with simplex outlets (NEMA-5-15R), USB charging port (with two USB outlets), data ports or cable bay(s) that can accept up to 2 pull out data/AV cables and mounting hardware.
- Data port accommodate most varieties of field supplied data/AV jacks.
- Corded power module available with 15 amp - 6'(1829mm) or 12'(3658mm) long cord with plug (NEMA 5-15P).
- USB Charging Port consists of two USB 2.0 style A outlets. 4 Amp (shared) charging capacity.
- Flip top unit is flush mounted with spring release flip module.
- Flip top unit overall height is 2.75"(70mm) and will extend below the table tops.
- Color option of black anodized housing with black receptacles or clear anodized housing with white receptacles.
- Ships assembled.

Specification Tips

- **Configuration and quantity of power and data ports cannot be modified in the field.**
- **For use with 120 volt 60 hertz power source only.**
- Requires field installation.
- Specify factory cut hole or field cut hole as required.
- Specify AV cables separately.
- Cable Bay requires cables less than 0.3"(7.6mm) diameter.
- Corded flip top units with four or more receptacles utilize a fused plug that may block adjacent building receptacle outlet.
- Application may require approval of local authority having jurisdiction (AHJ); ensure compliance before placing orders and installation.

To Order, Specify:

- 1) Product number.
(No finish specification required.)

Note: Order flip top units to match flip top unit cutout option specified for each top (A/B, F/V or J/K).

Electrical Components

Flip Top Unit – Corded – Single-Sided

Bezel Width	Bezel Depth	Cord Length	Trim Color	Port Color	Port	Configuration	Flip Top Unit Cutout Code Options	Number	Price
5.31" (135mm)	4.37" (111mm)	6' (1829mm)	Black Anodized	Black	2	1 Power Receptacle, 1 Data Port	A, B	EUE1-PF0B-1010	\$ 767.06
						1 Power Receptacle, 1 USB Charging	A, B	EUE1-PF0B-1100	839.11
						2 Power Receptacles	A, B	EUE1-PF0B-2000	767.06
8.31" (211mm)	4.37" (111mm)				4	1 Power Receptacle, 1 Data Port, 1 Cable Bay	F, V	EUE1-PF0B-1012	\$ 767.06
						1 Power Receptacle, 3 Data Ports	F, V	EUE1-PF0B-1030	767.06
						1 Power Receptacle, 1 USB Charging, 1 Cable Bay	F, V	EUE1-PF0B-1102	839.11
						1 Power Receptacle, 1 USB Charging, 2 Data Ports	F, V	EUE1-PF0B-1120	839.11
						1 Power Receptacle, 3 USB Charging	F, V	EUE1-PF0B-1300	983.21
						2 Power Receptacles, 1 Cable Bay	F, V	EUE1-PF0B-2002	767.06
						2 Power Receptacles, 2 Data Ports	F, V	EUE1-PF0B-2020	767.06
						2 Power Receptacles, 1 USB Charging, 1 Data Port	F, V	EUE1-PF0B-2110	839.11
						2 Power Receptacles, 2 USB Charging	F, V	EUE1-PF0B-2200	911.16
						3 Power Receptacles, 1 Data Port	F, V	EUE1-PF0B-3010	767.06
						3 Power Receptacles, 1 USB Charging	F, V	EUE1-PF0B-3100	839.11
						4 Power Receptacles	F, V	EUE1-PF0B-4000	767.06
						11.3" (287mm)	4.37" (111mm)		
1 Power Receptacle, 5 Data Ports	J, K	EUE1-PF0B-1050	767.06						
1 Power Receptacle, 1 USB Charging, 2 Data Ports, 1 Cable Bay	J, K	EUE1-PF0B-1122	839.11						
1 Power Receptacle, 1 USB Charging, 4 Data Ports	J, K	EUE1-PF0B-1140	839.11						
1 Power Receptacle, 2 USB Charging, 1 Data Port, 1 Cable Bay	J, K	EUE1-PF0B-1212	911.16						
1 Power Receptacle, 2 USB Charging, 3 Data Ports	J, K	EUE1-PF0B-1230	911.16						
1 Power Receptacle, 3 USB Charging, 1 Cable Bay	J, K	EUE1-PF0B-1302	983.21						
1 Power Receptacle, 3 USB Charging, 2 Data Ports	J, K	EUE1-PF0B-1320	983.21						
2 Power Receptacles, 2 Data Ports, 1 Cable Bay	J, K	EUE1-PF0B-2022	767.06						
2 Power Receptacles, 4 Data Ports	J, K	EUE1-PF0B-2040	767.06						
2 Power Receptacles, 1 USB Charging, 1 Data Port, 1 Cable Bay	J, K	EUE1-PF0B-2112	839.11						
2 Power Receptacles, 1 USB Charging, 3 Data Ports	J, K	EUE1-PF0B-2130	839.11						
2 Power Receptacles, 2 USB Charging, 1 Cable Bay	J, K	EUE1-PF0B-2202	911.16						
2 Power Receptacles, 2 USB Charging, 2 Data Ports	J, K	EUE1-PF0B-2220	911.16						
2 Power Receptacles, 3 USB Charging, 1 Data Port	J, K	EUE1-PF0B-2310	983.21						
2 Power Receptacles, 4 USB Charging	J, K	EUE1-PF0B-2400	1055.26						
3 Power Receptacles, 1 Data Port, 1 Cable Bay	J, K	EUE1-PF0B-3012	767.06						
3 Power Receptacles, 3 Data Ports	J, K	EUE1-PF0B-3030	767.06						
3 Power Receptacles, 1 USB Charging, 1 Cable Bay	J, K	EUE1-PF0B-3102	839.11						
3 Power Receptacles, 1 USB Charging, 2 Data Ports	J, K	EUE1-PF0B-3120	839.11						
3 Power Receptacles, 2 USB Charging, 1 Data Port	J, K	EUE1-PF0B-3210	911.16						
3 Power Receptacles, 3 USB Charging	J, K	EUE1-PF0B-3300	983.21						
4 Power Receptacles, 1 Cable Bay	J, K	EUE1-PF0B-4002	767.06						
4 Power Receptacles, 2 Data Ports	J, K	EUE1-PF0B-4020	767.06						
4 Power Receptacles, 1 USB Charging, 1 Data Port	J, K	EUE1-PF0B-4110	839.11						
4 Power Receptacles, 2 USB Charging	J, K	EUE1-PF0B-4200	911.16						
5 Power Receptacles, 1 Data Port	J, K	EUE1-PF0B-5010	767.06						
5 Power Receptacles, 1 USB Charging	J, K	EUE1-PF0B-5100	839.11						
6 Power Receptacles	J, K	EUE1-PF0B-6000	767.06						

Electrical Components

Flip Top Unit – Corded – Single-Sided

Bezel Width	Bezel Depth	Cord Length	Trim Color	Port Color	Port	Configuration	Flip Top Unit Cutout Code Options	Number	Price						
5.31" (135mm)	4.37" (111mm)	6' (1829mm)	Clear Anodized	White	2	1 Power Receptacle, 1 Data Port	A, B	EUE1-PF0W-1010	\$572.21						
						1 Power Receptacle, 1 USB Charging	A, B	EUE1-PF0W-1100	644.26						
						2 Power Receptacles	A, B	EUE1-PF0W-2000	572.21						
8.31" (211mm)	4.37" (111mm)				4	1 Power Receptacle, 1 Data Port, 1 Cable Bay	F, V	EUE1-PF0W-1012	\$572.21						
						1 Power Receptacle, 3 Data Ports	F, V	EUE1-PF0W-1030	572.21						
						1 Power Receptacle, 1 USB Charging, 1 Cable Bay	F, V	EUE1-PF0W-1102	644.26						
						1 Power Receptacle, 1 USB Charging, 2 Data Ports	F, V	EUE1-PF0W-1120	644.26						
						1 Power Receptacle, 3 USB Charging	F, V	EUE1-PF0W-1300	788.36						
						2 Power Receptacles, 1 Cable Bay	F, V	EUE1-PF0W-2002	572.21						
						2 Power Receptacles, 2 Data Ports	F, V	EUE1-PF0W-2020	572.21						
						2 Power Receptacles, 1 USB Charging, 1 Data Port	F, V	EUE1-PF0W-2110	644.26						
						2 Power Receptacles, 2 USB Charging	F, V	EUE1-PF0W-2200	716.31						
						3 Power Receptacles, 1 Data Port	F, V	EUE1-PF0W-3010	572.21						
						3 Power Receptacles, 1 USB Charging	F, V	EUE1-PF0W-3100	644.26						
						4 Power Receptacles	F, V	EUE1-PF0W-4000	572.21						
						11.3" (287mm)	4.37" (111mm)				6	1 Power Receptacle, 3 Data Ports, 1 Cable Bay	J, K	EUE1-PF0W-1032	\$572.21
												1 Power Receptacle, 5 Data Ports	J, K	EUE1-PF0W-1050	572.21
												1 Power Receptacle, 1 USB Charging, 2 Data Ports, 1 Cable Bay	J, K	EUE1-PF0W-1122	644.26
1 Power Receptacle, 1 USB Charging, 4 Data Ports	J, K	EUE1-PF0W-1140	644.26												
1 Power Receptacle, 2 USB Charging, 1 Data Port, 1 Cable Bay	J, K	EUE1-PF0W-1212	716.31												
1 Power Receptacle, 2 USB Charging, 3 Data Ports	J, K	EUE1-PF0W-1230	716.31												
1 Power Receptacle, 3 USB Charging, 1 Cable Bay	J, K	EUE1-PF0W-1302	788.36												
1 Power Receptacle, 3 USB Charging, 2 Data Ports	J, K	EUE1-PF0W-1320	788.36												
2 Power Receptacles, 2 Data Ports, 1 Cable Bay	J, K	EUE1-PF0W-2022	572.21												
2 Power Receptacles, 4 Data Ports	J, K	EUE1-PF0W-2040	572.21												
2 Power Receptacles, 1 USB Charging, 1 Data Port, 1 Cable Bay	J, K	EUE1-PF0W-2112	644.26												
2 Power Receptacles, 1 USB Charging, 3 Data Ports	J, K	EUE1-PF0W-2130	644.26												
2 Power Receptacles, 2 USB Charging, 1 Cable Bay	J, K	EUE1-PF0W-2202	716.31												
2 Power Receptacles, 2 USB Charging, 2 Data Ports	J, K	EUE1-PF0W-2220	716.31												
2 Power Receptacles, 3 USB Charging, 1 Data Port	J, K	EUE1-PF0W-2310	788.36												
2 Power Receptacles, 4 USB Charging	J, K	EUE1-PF0W-2400	860.41												
3 Power Receptacles, 1 Data Port, 1 Cable Bay	J, K	EUE1-PF0W-3012	572.21												
3 Power Receptacles, 3 Data Ports	J, K	EUE1-PF0W-3030	572.21												
3 Power Receptacles, 1 USB Charging, 1 Cable Bay	J, K	EUE1-PF0W-3102	644.26												
3 Power Receptacles, 1 USB Charging, 2 Data Ports	J, K	EUE1-PF0W-3120	644.26												
3 Power Receptacles, 2 USB Charging, 1 Data Port	J, K	EUE1-PF0W-3210	716.31												
3 Power Receptacles, 3 USB Charging	J, K	EUE1-PF0W-3300	788.36												
4 Power Receptacles, 1 Cable Bay	J, K	EUE1-PF0W-4002	572.21												
4 Power Receptacles, 2 Data Ports	J, K	EUE1-PF0W-4020	572.21												
4 Power Receptacles, 1 USB Charging, 1 Data Port	J, K	EUE1-PF0W-4110	644.26												
4 Power Receptacles, 2 USB Charging	J, K	EUE1-PF0W-4200	716.31												
5 Power Receptacles, 1 Data Port	J, K	EUE1-PF0W-5010	572.21												
5 Power Receptacles, 1 USB Charging	J, K	EUE1-PF0W-5100	644.26												
6 Power Receptacles	J, K	EUE1-PF0W-6000	572.21												

Electrical Components

Flip Top Unit – Corded – Single-Sided

Bezel Width	Bezel Depth	Cord Length	Trim Color	Port Color	Port	Configuration	Flip Top Unit Cutout Code Options	Number	Price
5.31" (135mm)	4.37" (111mm)	12' (3658mm)	Black Anodized	Black	2	1 Power Receptacle, 1 Data Port	A, B	EUE1-PL0B-1010	\$ 825.93
						1 Power Receptacle, 1 USB Charging	A, B	EUE1-PL0B-1100	897.98
						2 Power Receptacles	A, B	EUE1-PL0B-2000	825.93
8.31" (211mm)	4.37" (111mm)				4	1 Power Receptacle, 1 Data Port, 1 Cable Bay	F, V	EUE1-PL0B-1012	\$ 825.93
						1 Power Receptacle, 3 Data Ports	F, V	EUE1-PL0B-1030	825.93
						1 Power Receptacle, 1 USB Charging, 1 Cable Bay	F, V	EUE1-PL0B-1102	897.98
						1 Power Receptacle, 1 USB Charging, 2 Data Ports	F, V	EUE1-PL0B-1120	897.98
						1 Power Receptacle, 3 USB Charging	F, V	EUE1-PL0B-1300	1042.08
						2 Power Receptacles, 1 Cable Bay	F, V	EUE1-PL0B-2002	825.93
						2 Power Receptacles, 2 Data Ports	F, V	EUE1-PL0B-2020	825.93
						2 Power Receptacles, 1 USB Charging, 1 Data Port	F, V	EUE1-PL0B-2110	897.98
						2 Power Receptacles, 2 USB Charging	F, V	EUE1-PL0B-2200	970.03
						3 Power Receptacles, 1 Data Port	F, V	EUE1-PL0B-3010	825.93
						3 Power Receptacles, 1 USB Charging	F, V	EUE1-PL0B-3100	897.98
						4 Power Receptacles	F, V	EUE1-PL0B-4000	825.93
						11.3" (287mm)	4.37" (111mm)		
1 Power Receptacle, 5 Data Ports	J, K	EUE1-PL0B-1050	825.93						
1 Power Receptacle, 1 USB Charging, 2 Data Ports, 1 Cable Bay	J, K	EUE1-PL0B-1122	897.98						
1 Power Receptacle, 1 USB Charging, 4 Data Ports	J, K	EUE1-PL0B-1140	897.98						
1 Power Receptacle, 2 USB Charging, 1 Data Port, 1 Cable Bay	J, K	EUE1-PL0B-1212	970.03						
1 Power Receptacle, 2 USB Charging, 3 Data Ports	J, K	EUE1-PL0B-1230	970.03						
1 Power Receptacle, 3 USB Charging, 1 Cable Bay	J, K	EUE1-PL0B-1302	1042.08						
1 Power Receptacle, 3 USB Charging, 2 Data Ports	J, K	EUE1-PL0B-1320	1042.08						
2 Power Receptacles, 2 Data Ports, 1 Cable Bay	J, K	EUE1-PL0B-2022	825.93						
2 Power Receptacles, 4 Data Ports	J, K	EUE1-PL0B-2040	825.93						
2 Power Receptacles, 1 USB Charging, 1 Data Port, 1 Cable Bay	J, K	EUE1-PL0B-2112	897.98						
2 Power Receptacles, 1 USB Charging, 3 Data Ports	J, K	EUE1-PL0B-2130	897.98						
2 Power Receptacles, 2 USB Charging, 1 Cable Bay	J, K	EUE1-PL0B-2202	970.03						
2 Power Receptacles, 2 USB Charging, 2 Data Ports	J, K	EUE1-PL0B-2220	970.03						
2 Power Receptacles, 3 USB Charging, 1 Data Port	J, K	EUE1-PL0B-2310	1042.08						
2 Power Receptacles, 4 USB Charging	J, K	EUE1-PL0B-2400	1114.13						
3 Power Receptacles, 1 Data Port, 1 Cable Bay	J, K	EUE1-PL0B-3012	825.93						
3 Power Receptacles, 3 Data Ports	J, K	EUE1-PL0B-3030	825.93						
3 Power Receptacles, 1 USB Charging, 1 Cable Bay	J, K	EUE1-PL0B-3102	897.98						
3 Power Receptacles, 1 USB Charging, 2 Data Ports	J, K	EUE1-PL0B-3120	897.98						
3 Power Receptacles, 2 USB Charging, 1 Data Port	J, K	EUE1-PL0B-3210	970.03						
3 Power Receptacles, 3 USB Charging	J, K	EUE1-PL0B-3300	1042.08						
4 Power Receptacles, 1 Cable Bay	J, K	EUE1-PL0B-4002	825.93						
4 Power Receptacles, 2 Data Ports	J, K	EUE1-PL0B-4020	825.93						
4 Power Receptacles, 1 USB Charging, 1 Data Port	J, K	EUE1-PL0B-4110	897.98						
4 Power Receptacles, 2 USB Charging	J, K	EUE1-PL0B-4200	970.03						
5 Power Receptacles, 1 Data Port	J, K	EUE1-PL0B-5010	825.93						
5 Power Receptacles, 1 USB Charging	J, K	EUE1-PL0B-5100	897.98						
6 Power Receptacles	J, K	EUE1-PL0B-6000	825.93						

Electrical Components

Flip Top Unit – Corded – Single-Sided

Bezel Width	Bezel Depth	Cord Length	Trim Color	Port Color	Port	Configuration	Flip Top Unit Cutout Code Options	Number	Price						
5.31" (135mm)	4.37" (111mm)	12' (3658mm)	Clear Anodized	White	2	1 Power Receptacle, 1 Data Port	A, B	EUE1-PL0W-1010	\$631.08						
						1 Power Receptacle, 1 USB Charging	A, B	EUE1-PL0W-1100	703.13						
						2 Power Receptacles	A, B	EUE1-PL0W-2000	631.08						
8.31" (211mm)	4.37" (111mm)				4	1 Power Receptacle, 1 Data Port, 1 Cable Bay	F, V	EUE1-PL0W-1012	\$631.08						
						1 Power Receptacle, 3 Data Ports	F, V	EUE1-PL0W-1030	631.08						
						1 Power Receptacle, 1 USB Charging, 1 Cable Bay	F, V	EUE1-PL0W-1102	703.13						
						1 Power Receptacle, 1 USB Charging, 2 Data Ports	F, V	EUE1-PL0W-1120	703.13						
						1 Power Receptacle, 3 USB Charging	F, V	EUE1-PL0W-1300	847.23						
						2 Power Receptacles, 1 Cable Bay	F, V	EUE1-PL0W-2002	631.08						
						2 Power Receptacles, 2 Data Ports	F, V	EUE1-PL0W-2020	631.08						
						2 Power Receptacles, 1 USB Charging, 1 Data Port	F, V	EUE1-PL0W-2110	703.13						
						2 Power Receptacles, 2 USB Charging	F, V	EUE1-PL0W-2200	775.18						
						3 Power Receptacles, 1 Data Port	F, V	EUE1-PL0W-3010	631.08						
						3 Power Receptacles, 1 USB Charging	F, V	EUE1-PL0W-3100	703.13						
						4 Power Receptacles	F, V	EUE1-PL0W-4000	631.08						
						11.3" (287mm)	4.37" (111mm)				6	1 Power Receptacle, 3 Data Ports, 1 Cable Bay	J, K	EUE1-PL0W-1032	\$631.08
												1 Power Receptacle, 5 Data Ports	J, K	EUE1-PL0W-1050	631.08
												1 Power Receptacle, 1 USB Charging, 2 Data Ports, 1 Cable Bay	J, K	EUE1-PL0W-1122	703.13
1 Power Receptacle, 1 USB Charging, 4 Data Ports	J, K	EUE1-PL0W-1140	703.13												
1 Power Receptacle, 2 USB Charging, 1 Data Port, 1 Cable Bay	J, K	EUE1-PL0W-1212	775.18												
1 Power Receptacle, 2 USB Charging, 3 Data Ports	J, K	EUE1-PL0W-1230	775.18												
1 Power Receptacle, 3 USB Charging, 1 Cable Bay	J, K	EUE1-PL0W-1302	847.23												
1 Power Receptacle, 3 USB Charging, 2 Data Ports	J, K	EUE1-PL0W-1320	847.23												
2 Power Receptacles, 2 Data Ports, 1 Cable Bay	J, K	EUE1-PL0W-2022	631.08												
2 Power Receptacles, 4 Data Ports	J, K	EUE1-PL0W-2040	631.08												
2 Power Receptacles, 1 USB Charging, 1 Data Port, 1 Cable Bay	J, K	EUE1-PL0W-2112	703.13												
2 Power Receptacles, 1 USB Charging, 3 Data Ports	J, K	EUE1-PL0W-2130	703.13												
2 Power Receptacles, 2 USB Charging, 1 Cable Bay	J, K	EUE1-PL0W-2202	775.18												
2 Power Receptacles, 2 USB Charging, 2 Data Ports	J, K	EUE1-PL0W-2220	775.18												
2 Power Receptacles, 3 USB Charging, 1 Data Port	J, K	EUE1-PL0W-2310	847.23												
2 Power Receptacles, 4 USB Charging	J, K	EUE1-PL0W-2400	919.28												
3 Power Receptacles, 1 Data Port, 1 Cable Bay	J, K	EUE1-PL0W-3012	631.08												
3 Power Receptacles, 3 Data Ports	J, K	EUE1-PL0W-3030	631.08												
3 Power Receptacles, 1 USB Charging, 1 Cable Bay	J, K	EUE1-PL0W-3102	703.13												
3 Power Receptacles, 1 USB Charging, 2 Data Ports	J, K	EUE1-PL0W-3120	703.13												
3 Power Receptacles, 2 USB Charging, 1 Data Port	J, K	EUE1-PL0W-3210	775.18												
3 Power Receptacles, 3 USB Charging	J, K	EUE1-PL0W-3300	847.23												
4 Power Receptacles, 1 Cable Bay	J, K	EUE1-PL0W-4002	631.08												
4 Power Receptacles, 2 Data Ports	J, K	EUE1-PL0W-4020	631.08												
4 Power Receptacles, 1 USB Charging, 1 Data Port	J, K	EUE1-PL0W-4110	703.13												
4 Power Receptacles, 2 USB Charging	J, K	EUE1-PL0W-4200	775.18												
5 Power Receptacles, 1 Data Port	J, K	EUE1-PL0W-5010	631.08												
5 Power Receptacles, 1 USB Charging	J, K	EUE1-PL0W-5100	703.13												
6 Power Receptacles	J, K	EUE1-PL0W-6000	631.08												

This page intentionally blank

Electrical Components

Flip Top Unit — Corded — Double-Sided

Power, Data and USB

4-Port:

- (2) Power
- (1) USB
- (1) Data

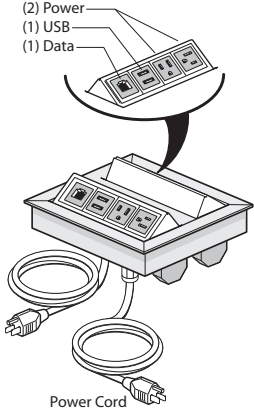

EUE2-PF0B-2110

6-Port:

- (2) Power
- (1) USB
- (1) Data
- (1) Cable Bay

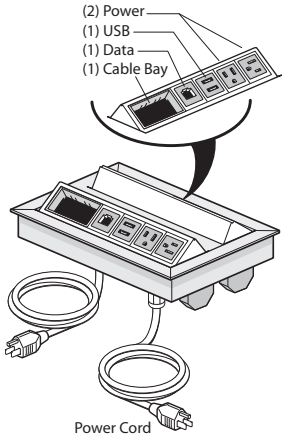

EUE2-PF0B-1212

4-Port:

- (4) Power

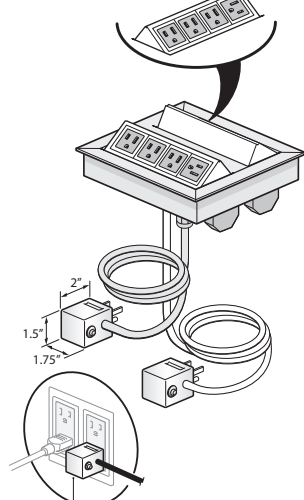

NOTE:
Always Fused Plug
when more than 3
power outlets specified.

EUE2-PF0B-4000



Features

- Includes bezel and two flip top modules, each flip top module with 2, 4 or 6 ports that can be configured with simplex outlets (NEMA-5-15R), USB charging port (with two USB outlets), data ports or cable bay(s) that can accept up to 2 pull out data/AV cables and mounting hardware.
- Data port accommodate most varieties of field supplied data/AV jacks.
- Each flip top module within the bezel provided with 15 amp - 6'(1829mm) or 12'(3658mm) long cord with plug (NEMA5-15P).
- USB Charging Port consists of two USB 2.0 style A outlets. 4 Amp (shared) charging capacity.
- Flip top unit is flush mounted with spring release flip module.
- Flip top unit overall height is 2.75"(70mm) and will extend below the table tops.
- Color option of black anodized housing with black receptacles or clear anodized housing with white receptacles.
- Ships assembled.

Specification Tips

- **Configuration and quantity of power and data ports cannot be modified in the field.**
- **For use with 120 volt 60 hertz power source only.**
- Requires field installation.
- Specify factory cut hole or field cut hole as required.
- Specify AV cables separately.
- Cable Bay requires cables less than 0.3"(7.6mm) diameter.
- Corded flip top units with four receptacles utilize a fused plug that may block adjacent building receptacle outlet.
- Application may require approval of local authority having jurisdiction (AHJ); ensure compliance before placing orders and installation.

Note: Two cord feeds are provided from the double-sided flip top unit.

To Order, Specify:

- 1) Product number.
(No finish specification required.)

Note: Order flip top units to match flip top unit cutout option specified for each top (M/P or Q/T).

Electrical Components

Flip Top Unit — Corded — Double-Sided

Width	Bezel Depth	Cord Length	Trim Color	Port Color	Port	Configuration	Flip Top Unit Cutout Code Options	Number	Price	
5.31" (135mm)	8" (203mm)	6' (1829mm)	Black Anodized	Black	4	1 Power Receptacle, 1 Data Port, 1 Cable Bay	M, P	EUE2-PF0B-1012	\$1335.67	
						1 Power Receptacle, 3 Data Ports	M, P	EUE2-PF0B-1030	1335.67	
						1 Power Receptacle, 1 USB Charging, 1 Cable Bay	M, P	EUE2-PF0B-1102	1407.72	
						1 Power Receptacle, 1 USB Charging, 2 Data Ports	M, P	EUE2-PF0B-1120	1407.72	
						1 Power Receptacle, 3 USB Charging	M, P	EUE2-PF0B-1300	1551.82	
						2 Power Receptacles, 1 Cable Bay	M, P	EUE2-PF0B-2002	1335.67	
						2 Power Receptacles, 2 Data Ports	M, P	EUE2-PF0B-2020	1335.67	
						2 Power Receptacles, 1 USB Charging, 1 Data Port	M, P	EUE2-PF0B-2110	1407.72	
						2 Power Receptacles, 2 USB Charging	M, P	EUE2-PF0B-2200	1479.77	
						3 Power Receptacles, 1 Data Port	M, P	EUE2-PF0B-3010	1335.67	
						3 Power Receptacles, 1 USB Charging	M, P	EUE2-PF0B-3100	1407.72	
						4 Power Receptacles	M, P	EUE2-PF0B-4000	1335.67	
						6	1 Power Receptacle, 3 Data Ports, 1 Cable Bay	Q, T	EUE2-PF0B-1032	\$1335.67
							1 Power Receptacle, 5 Data Ports	Q, T	EUE2-PF0B-1050	1335.67
							1 Power Receptacle, 1 USB Charging, 2 Data Ports, 1 Cable Bay	Q, T	EUE2-PF0B-1122	1407.72
							1 Power Receptacle, 1 USB Charging, 4 Data Ports	Q, T	EUE2-PF0B-1140	1407.72
							1 Power Receptacle, 2 USB Charging, 1 Data Port, 1 Cable Bay	Q, T	EUE2-PF0B-1212	1479.77
							1 Power Receptacle, 2 USB Charging, 3 Data Ports	Q, T	EUE2-PF0B-1230	1479.77
							1 Power Receptacle, 3 USB Charging, 2 Cable Bays	Q, T	EUE2-PF0B-1302	1551.82
							1 Power Receptacle, 3 USB Charging, 2 Data Ports	Q, T	EUE2-PF0B-1320	1551.82
					2 Power Receptacles, 2 Data Ports, 2 Cable Bays		Q, T	EUE2-PF0B-2022	1335.67	
					2 Power Receptacles, 4 Data Ports		Q, T	EUE2-PF0B-2040	1335.67	
					2 Power Receptacles, 1 USB Charging, 1 Data Port, 2 Cable Bays		Q, T	EUE2-PF0B-2112	1407.72	
					2 Power Receptacles, 1 USB Charging, 3 Data Ports		Q, T	EUE2-PF0B-2130	1407.72	
					2 Power Receptacles, 2 USB Charging, 2 Cable Bays		Q, T	EUE2-PF0B-2202	1479.77	
					2 Power Receptacles, 2 USB Charging, 2 Data Ports		Q, T	EUE2-PF0B-2220	1479.77	
					2 Power Receptacles, 3 USB Charging, 1 Data Port		Q, T	EUE2-PF0B-2310	1551.82	
					2 Power Receptacles, 4 USB Charging		Q, T	EUE2-PF0B-2400	1623.87	
					3 Power Receptacles, 1 Data Port, 2 Cable Bays		Q, T	EUE2-PF0B-3012	1335.67	
					3 Power Receptacles, 3 Data Ports		Q, T	EUE2-PF0B-3030	1335.67	
					3 Power Receptacles, 1 USB Charging, 2 Cable Bays		Q, T	EUE2-PF0B-3102	1407.72	
					3 Power Receptacles, 1 USB Charging, 2 Data Ports		Q, T	EUE2-PF0B-3120	1407.72	
					3 Power Receptacles, 2 USB Charging, 1 Data Port	Q, T	EUE2-PF0B-3210	1479.77		
					3 Power Receptacles, 3 USB Charging	Q, T	EUE2-PF0B-3300	1551.82		
					4 Power Receptacles, 2 Cable Bays	Q, T	EUE2-PF0B-4002	1335.67		
					4 Power Receptacles, 2 Data Ports	Q, T	EUE2-PF0B-4020	1335.67		
					4 Power Receptacles, 1 USB Charging, 1 Data Port	Q, T	EUE2-PF0B-4110	1407.72		
					4 Power Receptacles, 2 USB Charging	Q, T	EUE2-PF0B-4200	1479.77		
					5 Power Receptacles, 1 Data Port	Q, T	EUE2-PF0B-5010	1335.67		
					5 Power Receptacles, 1 USB Charging	Q, T	EUE2-PF0B-5100	1407.72		
6 Power Receptacles	Q, T	EUE2-PF0B-6000	1335.67							

Electrical Components

Flip Top Unit — Corded — Double-Sided

Width	Bezel Depth	Cord Length	Trim Color	Port Color	Port	Configuration	Flip Top Unit Cutout Code Options	Number	Price
5.31" (135mm)	8" (203mm)	6' (1829mm)	Clear Anodized	White	4	1 Power Receptacle, 1 Data Port, 1 Cable Bay	M, P	EUE2-PF0W-1012	\$1140.82
						1 Power Receptacle, 3 Data Ports	M, P	EUE2-PF0W-1030	1140.82
						1 Power Receptacle, 1 USB Charging, 1 Cable Bay	M, P	EUE2-PF0W-1102	1212.87
						1 Power Receptacle, 1 USB Charging, 2 Data Ports	M, P	EUE2-PF0W-1120	1212.87
						1 Power Receptacle, 3 USB Charging	M, P	EUE2-PF0W-1300	1356.97
						2 Power Receptacles, 1 Cable Bay	M, P	EUE2-PF0W-2002	1140.82
						2 Power Receptacles, 2 Data Ports	M, P	EUE2-PF0W-2020	1140.82
						2 Power Receptacles, 1 USB Charging, 1 Data Port	M, P	EUE2-PF0W-2110	1212.87
						2 Power Receptacles, 2 USB Charging	M, P	EUE2-PF0W-2200	1284.92
						3 Power Receptacles, 1 Data Port	M, P	EUE2-PF0W-3010	1140.82
						3 Power Receptacles, 1 USB Charging	M, P	EUE2-PF0W-3100	1212.87
						4 Power Receptacles	M, P	EUE2-PF0W-4000	1140.82
					6	1 Power Receptacle, 3 Data Ports, 1 Cable Bay	Q, T	EUE2-PF0W-1032	\$1140.82
						1 Power Receptacle, 5 Data Ports	Q, T	EUE2-PF0W-1050	1140.82
						1 Power Receptacle, 1 USB Charging, 2 Data Ports, 1 Cable Bay	Q, T	EUE2-PF0W-1122	1212.87
						1 Power Receptacle, 1 USB Charging, 4 Data Ports	Q, T	EUE2-PF0W-1140	1212.87
						1 Power Receptacle, 2 USB Charging, 1 Data Port, 1 Cable Bay	Q, T	EUE2-PF0W-1212	1284.92
						1 Power Receptacle, 2 USB Charging, 3 Data Ports	Q, T	EUE2-PF0W-1230	1284.92
						1 Power Receptacle, 3 USB Charging, 1 Cable Bay	Q, T	EUE2-PF0W-1302	1356.97
						1 Power Receptacle, 3 USB Charging, 2 Data Ports	Q, T	EUE2-PF0W-1320	1356.97
						2 Power Receptacles, 2 Data Ports, 1 Cable Bay	Q, T	EUE2-PF0W-2022	1140.82
						2 Power Receptacles, 4 Data Ports	Q, T	EUE2-PF0W-2040	1140.82
						2 Power Receptacles, 1 USB Charging, 1 Data Port, 1 Cable Bay	Q, T	EUE2-PF0W-2112	1212.87
						2 Power Receptacles, 1 USB Charging, 3 Data Ports	Q, T	EUE2-PF0W-2130	1212.87
						2 Power Receptacles, 2 USB Charging, 1 Cable Bay	Q, T	EUE2-PF0W-2202	1284.92
						2 Power Receptacles, 2 USB Charging, 2 Data Ports	Q, T	EUE2-PF0W-2220	1284.92
						2 Power Receptacles, 3 USB Charging, 1 Data Port	Q, T	EUE2-PF0W-2310	1356.97
						2 Power Receptacles, 4 USB Charging	Q, T	EUE2-PF0W-2400	1429.02
						3 Power Receptacles, 1 Data Port, 1 Cable Bay	Q, T	EUE2-PF0W-3012	1140.82
						3 Power Receptacles, 3 Data Ports	Q, T	EUE2-PF0W-3030	1140.82
3 Power Receptacles, 1 USB Charging, 1 Cable Bay	Q, T	EUE2-PF0W-3102	1212.87						
3 Power Receptacles, 1 USB Charging, 2 Data Ports	Q, T	EUE2-PF0W-3120	1212.87						
3 Power Receptacles, 2 USB Charging, 1 Data Port	Q, T	EUE2-PF0W-3210	1284.92						
3 Power Receptacles, 3 USB Charging	Q, T	EUE2-PF0W-3300	1356.97						
4 Power Receptacles, 1 Cable Bay	Q, T	EUE2-PF0W-4002	1140.82						
4 Power Receptacles, 2 Data Ports	Q, T	EUE2-PF0W-4020	1140.82						
4 Power Receptacles, 1 USB Charging, 1 Data Port	Q, T	EUE2-PF0W-4110	1212.87						
4 Power Receptacles, 2 USB Charging	Q, T	EUE2-PF0W-4200	1284.92						
5 Power Receptacles, 1 Data Port	Q, T	EUE2-PF0W-5010	1140.82						
5 Power Receptacles, 1 USB Charging	Q, T	EUE2-PF0W-5100	1212.87						
6 Power Receptacles	Q, T	EUE2-PF0W-6000	1140.82						

Electrical Components

Flip Top Unit — Corded — Double-Sided

Width	Bezel Depth	Cord Length	Trim Color	Port Color	Port	Configuration	Flip Top Unit Cutout Code Options	Number	Price	
5.31" (135mm)	8" (203mm)	12' (3658mm)	Black Anodized	Black	4	1 Power Receptacle, 1 Data Port, 1 Cable Bay	M, P	EUE2-PL0B-1012	\$1394.54	
						1 Power Receptacle, 3 Data Ports	M, P	EUE2-PL0B-1030	1394.54	
						1 Power Receptacle, 1 USB Charging, 1 Cable Bay	M, P	EUE2-PL0B-1102	1466.59	
						1 Power Receptacle, 1 USB Charging, 2 Data Ports	M, P	EUE2-PL0B-1120	1466.59	
						1 Power Receptacle, 3 USB Charging	M, P	EUE2-PL0B-1300	1610.69	
						2 Power Receptacles, 1 Cable Bay	M, P	EUE2-PL0B-2002	1394.54	
						2 Power Receptacles, 2 Data Ports	M, P	EUE2-PL0B-2020	1394.54	
						2 Power Receptacles, 1 USB Charging, 1 Data Port	M, P	EUE2-PL0B-2110	1466.59	
						2 Power Receptacles, 2 USB Charging	M, P	EUE2-PL0B-2200	1538.64	
						3 Power Receptacles, 1 Data Port	M, P	EUE2-PL0B-3010	1394.54	
						3 Power Receptacles, 1 USB Charging	M, P	EUE2-PL0B-3100	1466.59	
						4 Power Receptacles	M, P	EUE2-PL0B-4000	1394.54	
						6	1 Power Receptacle, 3 Data Ports, 1 Cable Bay	Q, T	EUE2-PL0B-1032	\$1394.54
							1 Power Receptacle, 5 Data Ports	Q, T	EUE2-PL0B-1050	1394.54
							1 Power Receptacle, 1 USB Charging, 2 Data Ports, 1 Cable Bay	Q, T	EUE2-PL0B-1122	1466.59
					1 Power Receptacle, 1 USB Charging, 4 Data Ports		Q, T	EUE2-PL0B-1140	1466.59	
					1 Power Receptacle, 2 USB Charging, 1 Data Port, 1 Cable Bay		Q, T	EUE2-PL0B-1212	1538.64	
					1 Power Receptacle, 2 USB Charging, 3 Data Ports		Q, T	EUE2-PL0B-1230	1538.64	
					1 Power Receptacle, 3 USB Charging, 1 Cable Bay		Q, T	EUE2-PL0B-1302	1610.69	
					1 Power Receptacle, 3 USB Charging, 2 Data Ports		Q, T	EUE2-PL0B-1320	1610.69	
					2 Power Receptacles, 2 Data Ports, 1 Cable Bay		Q, T	EUE2-PL0B-2022	1394.54	
					2 Power Receptacles, 4 Data Ports		Q, T	EUE2-PL0B-2040	1394.54	
					2 Power Receptacles, 1 USB Charging, 1 Data Port, 1 Cable Bay		Q, T	EUE2-PL0B-2112	1466.59	
					2 Power Receptacles, 1 USB Charging, 3 Data Ports		Q, T	EUE2-PL0B-2130	1466.59	
					2 Power Receptacles, 2 USB Charging, 1 Cable Bay		Q, T	EUE2-PL0B-2202	1538.64	
					2 Power Receptacles, 2 USB Charging, 2 Data Ports		Q, T	EUE2-PL0B-2220	1538.64	
					2 Power Receptacles, 3 USB Charging, 1 Data Port		Q, T	EUE2-PL0B-2310	1610.69	
					2 Power Receptacles, 4 USB Charging		Q, T	EUE2-PL0B-2400	1682.74	
					3 Power Receptacles, 1 Data Port, 1 Cable Bay		Q, T	EUE2-PL0B-3012	1394.54	
					3 Power Receptacles, 3 Data Ports		Q, T	EUE2-PL0B-3030	1394.54	
					3 Power Receptacles, 1 USB Charging, 1 Cable Bay	Q, T	EUE2-PL0B-3102	1466.59		
					3 Power Receptacles, 1 USB Charging, 2 Data Ports	Q, T	EUE2-PL0B-3120	1466.59		
					3 Power Receptacles, 2 USB Charging, 1 Data Port	Q, T	EUE2-PL0B-3210	1538.64		
3 Power Receptacles, 3 USB Charging	Q, T	EUE2-PL0B-3300	1610.69							
4 Power Receptacles, 1 Cable Bay	Q, T	EUE2-PL0B-4002	1394.54							
4 Power Receptacles, 2 Data Ports	Q, T	EUE2-PL0B-4020	1394.54							
4 Power Receptacles, 1 USB Charging, 1 Data Port	Q, T	EUE2-PL0B-4110	1466.59							
4 Power Receptacles, 2 USB Charging	Q, T	EUE2-PL0B-4200	1538.64							
5 Power Receptacles, 1 Data Port	Q, T	EUE2-PL0B-5010	1394.54							
5 Power Receptacles, 1 USB Charging	Q, T	EUE2-PL0B-5100	1466.59							
6 Power Receptacles	Q, T	EUE2-PL0B-6000	1394.54							

Electrical Components

Flip Top Unit — Corded — Double-Sided

Width	Bezel Depth	Cord Length	Trim Color	Port Color	Port	Configuration	Flip Top Unit Cutout Code Options	Number	Price	
5.31" (135mm)	8" (203mm)	12' (3658mm)	Clear Anodized	White	4	1 Power Receptacle, 1 Data Port, 1 Cable Bay	M, P	EUE2-PL0W-1012	\$1199.69	
						1 Power Receptacle, 3 Data Ports	M, P	EUE2-PL0W-1030	1199.69	
						1 Power Receptacle, 1 USB Charging, 1 Cable Bay	M, P	EUE2-PL0W-1102	1271.74	
						1 Power Receptacle, 1 USB Charging, 2 Data Ports	M, P	EUE2-PL0W-1120	1271.74	
						1 Power Receptacle, 3 USB Charging	M, P	EUE2-PL0W-1300	1415.84	
						2 Power Receptacles, 1 Cable Bay	M, P	EUE2-PL0W-2002	1199.69	
						2 Power Receptacles, 2 Data Ports	M, P	EUE2-PL0W-2020	1199.69	
						2 Power Receptacles, 1 USB Charging, 1 Data Port	M, P	EUE2-PL0W-2110	1271.74	
						2 Power Receptacles, 2 USB Charging	M, P	EUE2-PL0W-2200	1343.79	
						3 Power Receptacles, 1 Data Port	M, P	EUE2-PL0W-3010	1199.69	
						3 Power Receptacles, 1 USB Charging	M, P	EUE2-PL0W-3100	1271.74	
						4 Power Receptacles	M, P	EUE2-PL0W-4000	1199.69	
						6	1 Power Receptacle, 3 Data Ports, 1 Cable Bay	Q, T	EUE2-PL0W-1032	\$1199.69
							1 Power Receptacle, 5 Data Ports	Q, T	EUE2-PL0W-1050	1199.69
							1 Power Receptacle, 1 USB Charging, 2 Data Ports, 1 Cable Bay	Q, T	EUE2-PL0W-1122	1271.74
					1 Power Receptacle, 1 USB Charging, 4 Data Ports		Q, T	EUE2-PL0W-1140	1271.74	
					1 Power Receptacle, 2 USB Charging, 1 Data Port, 1 Cable Bay		Q, T	EUE2-PL0W-1212	1343.79	
					1 Power Receptacle, 2 USB Charging, 3 Data Ports		Q, T	EUE2-PL0W-1230	1343.79	
					1 Power Receptacle, 3 USB Charging, 1 Cable Bay		Q, T	EUE2-PL0W-1302	1415.84	
					1 Power Receptacle, 3 USB Charging, 2 Data Ports		Q, T	EUE2-PL0W-1320	1415.84	
					2 Power Receptacles, 2 Data Ports, 1 Cable Bay		Q, T	EUE2-PL0W-2022	1199.69	
					2 Power Receptacles, 4 Data Ports		Q, T	EUE2-PL0W-2040	1199.69	
					2 Power Receptacles, 1 USB Charging, 1 Data Port, 1 Cable Bay		Q, T	EUE2-PL0W-2112	1271.74	
					2 Power Receptacles, 1 USB Charging, 3 Data Ports		Q, T	EUE2-PL0W-2130	1271.74	
					2 Power Receptacles, 2 USB Charging, 1 Cable Bay		Q, T	EUE2-PL0W-2202	1343.79	
					2 Power Receptacles, 2 USB Charging, 2 Data Ports		Q, T	EUE2-PL0W-2220	1343.79	
					2 Power Receptacles, 3 USB Charging, 1 Data Port		Q, T	EUE2-PL0W-2310	1415.84	
					2 Power Receptacles, 4 USB Charging	Q, T	EUE2-PL0W-2400	1487.89		
					3 Power Receptacles, 1 Data Port, 1 Cable Bay	Q, T	EUE2-PL0W-3012	1199.69		
					3 Power Receptacles, 3 Data Ports	Q, T	EUE2-PL0W-3030	1199.69		
3 Power Receptacles, 1 USB Charging, 1 Cable Bay	Q, T	EUE2-PL0W-3102	1271.74							
3 Power Receptacles, 1 USB Charging, 2 Data Ports	Q, T	EUE2-PL0W-3120	1271.74							
3 Power Receptacles, 2 USB Charging, 1 Data Port	Q, T	EUE2-PL0W-3210	1343.79							
3 Power Receptacles, 3 USB Charging	Q, T	EUE2-PL0W-3300	1415.84							
4 Power Receptacles, 1 Cable Bay	Q, T	EUE2-PL0W-4002	1199.69							
4 Power Receptacles, 2 Data Ports	Q, T	EUE2-PL0W-4020	1199.69							
4 Power Receptacles, 1 USB Charging, 1 Data Port	Q, T	EUE2-PL0W-4110	1271.74							
4 Power Receptacles, 2 USB Charging	Q, T	EUE2-PL0W-4200	1343.79							
5 Power Receptacles, 1 Data Port	Q, T	EUE2-PL0W-5010	1199.69							
5 Power Receptacles, 1 USB Charging	Q, T	EUE2-PL0W-5100	1271.74							
6 Power Receptacles	Q, T	EUE2-PL0W-6000	1199.69							

This page intentionally blank

Electrical Components

Flip Top Unit — Hardwire — Single-Sided

Power, Data and USB

4-Port:

- (2) Power
- (1) USB
- (1) Data

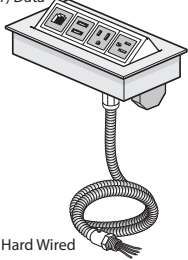

Hard Wired

EUE1-HF0B-2110

6-Port:

- (2) Power
- (1) USB
- (1) Data
- (1) Cable Bay

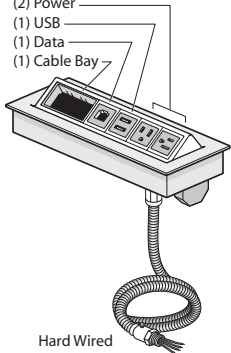

Hard Wired

EUE1-HF0B-1212



Features

- Includes bezel and flip top module with 2, 4 or 6 ports that can be configured with simplex outlets (NEMA-5-15R), USB charging port (with two USB outlets), data ports or cable bay(s) that can accept up to 2 pull out data/AV cables and mounting hardware.
- Data port accommodate most varieties of field supplied data/AV jacks.
- Hardwired power module with 6'(1829mm) or 12'(3658mm) long flexible metal conduit feed, 0.5"(13mm) conduit fitting and wires for hardwire connection.
- USB Charging Port consists of two USB 2.0 style A outlets. 4 Amp (shared) charging capacity.
- Flip top unit is flush mounted with spring release flip module(s).
- Flip top unit overall height is 2.75"(70mm) and will extend below the table tops.
- Color option of black anodized housing with black receptacles or clear anodized housing with white receptacles.

Specification Tips

- **Configuration and quantity of power and data ports cannot be modified in the field.**
- **For use with 120 volt 60 hertz power source only.**
- Requires field installation.
- Specify factory cut hole or field cut hole as required.
- Specify AV cables separately.
- Cable Bay requires cables less than 0.3"(7.6mm) diameter.
- Application may require approval of local authority having jurisdiction (AHJ); ensure compliance before placing orders and installation.

To Order, Specify:

- 1) Product number.
(No finish specification required.)

Note: Order flip top units to match flip top unit cutout option specified for each top (A/B, F/V or J/K).

Electrical Components

Flip Top Unit — Hardwire — Single-Sided

Width	Bezel Depth	Cord Length	Trim Color	Port Color	Port	Configuration	Flip Top Unit Cutout Code Options	Number	Price
5.31" (135mm)	4.37" (111mm)	6' (1829mm)	Black Anodized	Black	2	1 Power Receptacle, 1 Data Port	A, B	EUE1-HFOB-1010	\$ 847.33
						1 Power Receptacle, 1 USB Charging	A, B	EUE1-HFOB-1100	919.38
						2 Power Receptacles	A, B	EUE1-HFOB-2000	847.33
					4	1 Power Receptacle, 1 Data Port, 1 Cable Bay	F, V	EUE1-HFOB-1012	\$ 847.33
						1 Power Receptacle, 3 Data Ports	F, V	EUE1-HFOB-1030	847.33
						1 Power Receptacle, 1 USB Charging, 1 Cable Bay	F, V	EUE1-HFOB-1102	919.38
						1 Power Receptacle, 1 USB Charging, 2 Data Ports	F, V	EUE1-HFOB-1120	919.38
						1 Power Receptacle, 3 USB Charging	F, V	EUE1-HFOB-1300	1063.48
						2 Power Receptacles, 1 Cable Bay	F, V	EUE1-HFOB-2002	847.33
						2 Power Receptacles, 2 Data Ports	F, V	EUE1-HFOB-2020	847.33
						2 Power Receptacles, 1 USB Charging, 1 Data Port	F, V	EUE1-HFOB-2110	919.38
						2 Power Receptacles, 2 USB Charging	F, V	EUE1-HFOB-2200	991.43
						3 Power Receptacles, 1 Data Port	F, V	EUE1-HFOB-3010	847.33
						3 Power Receptacles, 1 USB Charging	F, V	EUE1-HFOB-3100	919.38
						4 Power Receptacles	F, V	EUE1-HFOB-4000	847.33
					6	1 Power Receptacle, 3 Data Ports, 1 Cable Bay	J, K	EUE1-HFOB-1032	\$ 847.33
						1 Power Receptacle, 5 Data Ports	J, K	EUE1-HFOB-1050	847.33
						1 Power Receptacle, 1 USB Charging, 2 Data Ports, 1 Cable Bay	J, K	EUE1-HFOB-1122	919.38
						1 Power Receptacle, 1 USB Charging, 4 Data Ports	J, K	EUE1-HFOB-1140	919.38
						1 Power Receptacle, 2 USB Charging, 1 Data Port, 1 Cable Bay	J, K	EUE1-HFOB-1212	991.43
						1 Power Receptacle, 2 USB Charging, 3 Data Ports	J, K	EUE1-HFOB-1230	991.43
						1 Power Receptacle, 3 USB Charging, 1 Cable Bay	J, K	EUE1-HFOB-1302	1063.48
						1 Power Receptacle, 3 USB Charging, 2 Data Ports	J, K	EUE1-HFOB-1320	1063.48
						2 Power Receptacles, 2 Data Ports, 1 Cable Bay	J, K	EUE1-HFOB-2022	847.33
						2 Power Receptacles, 4 Data Ports	J, K	EUE1-HFOB-2040	847.33
						2 Power Receptacles, 1 USB Charging, 1 Data Port, 1 Cable Bay	J, K	EUE1-HFOB-2112	919.38
						2 Power Receptacles, 1 USB Charging, 3 Data Ports	J, K	EUE1-HFOB-2130	919.38
						2 Power Receptacles, 2 USB Charging, 1 Cable Bay	J, K	EUE1-HFOB-2202	991.43
						2 Power Receptacles, 2 USB Charging, 2 Data Ports	J, K	EUE1-HFOB-2220	991.43
						2 Power Receptacles, 3 USB Charging, 1 Data Port	J, K	EUE1-HFOB-2310	1063.48
						2 Power Receptacles, 4 USB Charging	J, K	EUE1-HFOB-2400	1135.53
						3 Power Receptacles, 1 Data Port, 1 Cable Bay	J, K	EUE1-HFOB-3012	847.33
						3 Power Receptacles, 3 Data Ports	J, K	EUE1-HFOB-3030	847.33
						3 Power Receptacles, 1 USB Charging, 1 Cable Bay	J, K	EUE1-HFOB-3102	919.38
						3 Power Receptacles, 1 USB Charging, 2 Data Ports	J, K	EUE1-HFOB-3120	919.38
						3 Power Receptacles, 2 USB Charging, 1 Data Port	J, K	EUE1-HFOB-3210	991.43
						3 Power Receptacles, 3 USB Charging	J, K	EUE1-HFOB-3300	1063.48
						4 Power Receptacles, 1 Cable Bay	J, K	EUE1-HFOB-4002	847.33
						4 Power Receptacles, 2 Data Ports	J, K	EUE1-HFOB-4020	847.33
						4 Power Receptacles, 1 USB Charging, 1 Data Port	J, K	EUE1-HFOB-4110	919.38
						4 Power Receptacles, 2 USB Charging	J, K	EUE1-HFOB-4200	991.43
						5 Power Receptacles, 1 Data Port	J, K	EUE1-HFOB-5010	847.33
						5 Power Receptacles, 1 USB Charging	J, K	EUE1-HFOB-5100	919.38
						6 Power Receptacles	J, K	EUE1-HFOB-6000	847.33

Electrical Components

Flip Top Unit — Hardwire — Single-Sided

Width	Bezel Depth	Cord Length	Trim Color	Port Color	Port	Configuration	Flip Top Unit		
							Cutout Code Options	Number	Price
5.31" (135mm)	4.37" (111mm)	6' (1829mm)	Clear Anodized	White	2	1 Power Receptacle, 1 Data Port	A, B	EUE1-HFOW-1010	\$652.48
						1 Power Receptacle, 1 USB Charging	A, B	EUE1-HFOW-1100	724.53
					4	2 Power Receptacles	A, B	EUE1-HFOW-2000	652.48
						1 Power Receptacle, 1 Data Port, 1 Cable Bay	F, V	EUE1-HFOW-1012	\$652.48
					1 Power Receptacle, 3 Data Ports	F, V	EUE1-HFOW-1030	652.48	
					1 Power Receptacle, 1 USB Charging, 1 Cable Bay	F, V	EUE1-HFOW-1102	724.53	
					1 Power Receptacle, 1 USB Charging, 2 Data Ports	F, V	EUE1-HFOW-1120	724.53	
					1 Power Receptacle, 3 USB Charging	F, V	EUE1-HFOW-1300	868.63	
					2 Power Receptacles, 1 Cable Bay	F, V	EUE1-HFOW-2002	652.48	
					2 Power Receptacles, 2 Data Ports	F, V	EUE1-HFOW-2020	652.48	
					2 Power Receptacles, 1 USB Charging, 1 Data Port	F, V	EUE1-HFOW-2110	724.53	
					2 Power Receptacles, 2 USB Charging	F, V	EUE1-HFOW-2200	796.58	
					3 Power Receptacles, 1 Data Port	F, V	EUE1-HFOW-3010	652.48	
					3 Power Receptacles, 1 USB Charging	F, V	EUE1-HFOW-3100	724.53	
					4 Power Receptacles	F, V	EUE1-HFOW-4000	652.48	
					6	1 Power Receptacle, 3 Data Ports, 1 Cable Bay	J, K	EUE1-HFOW-1032	\$652.48
						1 Power Receptacle, 5 Data Ports	J, K	EUE1-HFOW-1050	652.48
						1 Power Receptacle, 1 USB Charging, 2 Data Ports, 1 Cable Bay	J, K	EUE1-HFOW-1122	724.53
						1 Power Receptacle, 1 USB Charging, 4 Data Ports	J, K	EUE1-HFOW-1140	724.53
						1 Power Receptacle, 2 USB Charging, 1 Data Port, 1 Cable Bay	J, K	EUE1-HFOW-1212	796.58
						1 Power Receptacle, 2 USB Charging, 3 Data Ports	J, K	EUE1-HFOW-1230	796.58
						1 Power Receptacle, 3 USB Charging, 1 Cable Bay	J, K	EUE1-HFOW-1302	868.63
						1 Power Receptacle, 3 USB Charging, 2 Data Ports	J, K	EUE1-HFOW-1320	868.63
						2 Power Receptacles, 2 Data Ports, 1 Cable Bay	J, K	EUE1-HFOW-2022	652.48
						2 Power Receptacles, 4 Data Ports	J, K	EUE1-HFOW-2040	652.48
						2 Power Receptacles, 1 USB Charging, 1 Data Port, 1 Cable Bay	J, K	EUE1-HFOW-2112	724.53
						2 Power Receptacles, 1 USB Charging, 3 Data Ports	J, K	EUE1-HFOW-2130	724.53
						2 Power Receptacles, 2 USB Charging, 1 Cable Bay	J, K	EUE1-HFOW-2202	796.58
						2 Power Receptacles, 2 USB Charging, 2 Data Ports	J, K	EUE1-HFOW-2220	796.58
						2 Power Receptacles, 3 USB Charging, 1 Data Port	J, K	EUE1-HFOW-2310	868.63
						2 Power Receptacles, 4 USB Charging	J, K	EUE1-HFOW-2400	940.68
						3 Power Receptacles, 1 Data Port, 1 Cable Bay	J, K	EUE1-HFOW-3012	652.48
						3 Power Receptacles, 3 Data Ports	J, K	EUE1-HFOW-3030	652.48
						3 Power Receptacles, 1 USB Charging, 1 Cable Bay	J, K	EUE1-HFOW-3102	724.53
						3 Power Receptacles, 1 USB Charging, 2 Data Ports	J, K	EUE1-HFOW-3120	724.53
						3 Power Receptacles, 2 USB Charging, 1 Data Port	J, K	EUE1-HFOW-3210	796.58
						3 Power Receptacles, 3 USB Charging	J, K	EUE1-HFOW-3300	868.63
						4 Power Receptacles, 1 Cable Bay	J, K	EUE1-HFOW-4002	652.48
						4 Power Receptacles, 2 Data Ports	J, K	EUE1-HFOW-4020	652.48
						4 Power Receptacles, 1 USB Charging, 1 Data Port	J, K	EUE1-HFOW-4110	724.53
						4 Power Receptacles, 2 USB Charging	J, K	EUE1-HFOW-4200	796.58
						5 Power Receptacles, 1 Data Port	J, K	EUE1-HFOW-5010	652.48
						5 Power Receptacles, 1 USB Charging	J, K	EUE1-HFOW-5100	724.53
					6 Power Receptacles	J, K	EUE1-HFOW-6000	652.48	

Electrical Components

Flip Top Unit — Hardwire — Single-Sided

Width	Bezel Depth	Cord Length	Trim Color	Port Color	Port	Configuration	Flip Top Unit Cutout Code Options	Number	Price		
5.31" (135mm)	4.37" (111mm)	12' (3658mm)	Black Anodized	Black	2	1 Power Receptacle, 1 Data Port	A, B	EUE1-HLOB-1010	\$ 906.20		
						1 Power Receptacle, 1 USB Charging	A, B	EUE1-HLOB-1100	978.25		
						2 Power Receptacles	A, B	EUE1-HLOB-2000	906.20		
						4	1 Power Receptacle, 1 Data Port, 1 Cable Bay	F, V	EUE1-HLOB-1012	\$ 906.20	
							1 Power Receptacle, 3 Data Ports	F, V	EUE1-HLOB-1030	906.20	
							1 Power Receptacle, 1 USB Charging, 1 Cable Bay	F, V	EUE1-HLOB-1102	978.25	
							1 Power Receptacle, 1 USB Charging, 2 Data Ports	F, V	EUE1-HLOB-1120	978.25	
							1 Power Receptacle, 3 USB Charging	F, V	EUE1-HLOB-1300	1122.35	
							2 Power Receptacles, 1 Cable Bay	F, V	EUE1-HLOB-2002	906.20	
							2 Power Receptacles, 2 Data Ports	F, V	EUE1-HLOB-2020	906.20	
							2 Power Receptacles, 1 USB Charging, 1 Data Port	F, V	EUE1-HLOB-2110	978.25	
							2 Power Receptacles, 2 USB Charging	F, V	EUE1-HLOB-2200	1050.30	
							3 Power Receptacles, 1 Data Port	F, V	EUE1-HLOB-3010	906.20	
							3 Power Receptacles, 1 USB Charging	F, V	EUE1-HLOB-3100	978.25	
							4 Power Receptacles	F, V	EUE1-HLOB-4000	906.20	
							6	1 Power Receptacle, 3 Data Ports, 1 Cable Bay	J, K	EUE1-HLOB-1032	\$ 906.20
								1 Power Receptacle, 5 Data Ports	J, K	EUE1-HLOB-1050	906.20
								1 Power Receptacle, 1 USB Charging, 2 Data Ports, 1 Cable Bay	J, K	EUE1-HLOB-1122	978.25
								1 Power Receptacle, 1 USB Charging, 4 Data Ports	J, K	EUE1-HLOB-1140	978.25
								1 Power Receptacle, 2 USB Charging, 1 Data Port, 1 Cable Bay	J, K	EUE1-HLOB-1212	1050.30
								1 Power Receptacle, 2 USB Charging, 3 Data Ports	J, K	EUE1-HLOB-1230	1050.30
								1 Power Receptacle, 3 USB Charging, 1 Cable Bay	J, K	EUE1-HLOB-1302	1122.35
								1 Power Receptacle, 3 USB Charging, 2 Data Ports	J, K	EUE1-HLOB-1320	1122.35
						2 Power Receptacles, 2 Data Ports, 1 Cable Bay		J, K	EUE1-HLOB-2022	906.20	
						2 Power Receptacles, 4 Data Ports		J, K	EUE1-HLOB-2040	906.20	
						2 Power Receptacles, 1 USB Charging, 1 Data Port, 1 Cable Bay		J, K	EUE1-HLOB-2112	978.25	
						2 Power Receptacles, 1 USB Charging, 3 Data Ports		J, K	EUE1-HLOB-2130	978.25	
						2 Power Receptacles, 2 USB Charging, 1 Cable Bay		J, K	EUE1-HLOB-2202	1050.30	
						2 Power Receptacles, 2 USB Charging, 2 Data Ports	J, K	EUE1-HLOB-2220	1050.30		
						2 Power Receptacles, 3 USB Charging, 1 Data Port	J, K	EUE1-HLOB-2310	1122.35		
						2 Power Receptacles, 4 USB Charging	J, K	EUE1-HLOB-2400	1194.40		
						3 Power Receptacles, 1 Data Port, 1 Cable Bay	J, K	EUE1-HLOB-3012	906.20		
						3 Power Receptacles, 3 Data Ports	J, K	EUE1-HLOB-3030	906.20		
3 Power Receptacles, 1 USB Charging, 1 Cable Bay	J, K	EUE1-HLOB-3102	978.25								
3 Power Receptacles, 1 USB Charging, 2 Data Ports	J, K	EUE1-HLOB-3120	978.25								
3 Power Receptacles, 2 USB Charging, 1 Data Port	J, K	EUE1-HLOB-3210	1050.30								
3 Power Receptacles, 3 USB Charging	J, K	EUE1-HLOB-3300	1122.35								
4 Power Receptacles, 1 Cable Bay	J, K	EUE1-HLOB-4002	906.20								
4 Power Receptacles, 2 Data Ports	J, K	EUE1-HLOB-4020	906.20								
4 Power Receptacles, 1 USB Charging, 1 Data Port	J, K	EUE1-HLOB-4110	978.25								
4 Power Receptacles, 2 USB Charging	J, K	EUE1-HLOB-4200	1050.30								
5 Power Receptacles, 1 Data Port	J, K	EUE1-HLOB-5010	906.20								
5 Power Receptacles, 1 USB Charging	J, K	EUE1-HLOB-5100	978.25								
6 Power Receptacles	J, K	EUE1-HLOB-6000	906.20								

Electrical Components

Flip Top Unit — Hardwire — Single-Sided

Width	Bezel Depth	Cord Length	Trim Color	Port Color	Port	Configuration	Flip Top Unit Cutout Code Options	Number	Price
5.31" (135mm)	4.37" (111mm)	12' (3658mm)	Clear Anodized	White	2	1 Power Receptacle, 1 Data Port	A, B	EUE1-HLOW-1010	\$711.35
						1 Power Receptacle, 1 USB Charging	A, B	EUE1-HLOW-1100	783.40
						2 Power Receptacles	A, B	EUE1-HLOW-2000	711.35
					4	1 Power Receptacle, 1 Data Port, 1 Cable Bay	F, V	EUE1-HLOW-1012	\$711.35
						1 Power Receptacle, 3 Data Ports	F, V	EUE1-HLOW-1030	711.35
						1 Power Receptacle, 1 USB Charging, 1 Cable Bay	F, V	EUE1-HLOW-1102	783.40
						1 Power Receptacle, 1 USB Charging, 2 Data Ports	F, V	EUE1-HLOW-1120	783.40
						1 Power Receptacle, 3 USB Charging	F, V	EUE1-HLOW-1300	927.50
						2 Power Receptacles, 1 Cable Bay	F, V	EUE1-HLOW-2002	711.35
						2 Power Receptacles, 2 Data Ports	F, V	EUE1-HLOW-2020	711.35
						2 Power Receptacles, 1 USB Charging, 1 Data Port	F, V	EUE1-HLOW-2110	783.40
						2 Power Receptacles, 2 USB Charging	F, V	EUE1-HLOW-2200	855.45
						3 Power Receptacles, 1 Data Port	F, V	EUE1-HLOW-3010	711.35
						3 Power Receptacles, 1 USB Charging	F, V	EUE1-HLOW-3100	783.40
						4 Power Receptacles	F, V	EUE1-HLOW-4000	711.35
					6	1 Power Receptacle, 3 Data Ports, 1 Cable Bay	J, K	EUE1-HLOW-1032	\$711.35
						1 Power Receptacle, 5 Data Ports	J, K	EUE1-HLOW-1050	711.35
						1 Power Receptacle, 1 USB Charging, 2 Data Ports, 1 Cable Bay	J, K	EUE1-HLOW-1122	783.40
						1 Power Receptacle, 1 USB Charging, 4 Data Ports	J, K	EUE1-HLOW-1140	783.40
						1 Power Receptacle, 2 USB Charging, 1 Data Port, 1 Cable Bay	J, K	EUE1-HLOW-1212	855.45
						1 Power Receptacle, 2 USB Charging, 3 Data Ports	J, K	EUE1-HLOW-1230	855.45
						1 Power Receptacle, 3 USB Charging, 1 Cable Bay	J, K	EUE1-HLOW-1302	927.50
						1 Power Receptacle, 3 USB Charging, 2 Data Ports	J, K	EUE1-HLOW-1320	927.50
						2 Power Receptacles, 2 Data Ports, 1 Cable Bay	J, K	EUE1-HLOW-2022	711.35
						2 Power Receptacles, 4 Data Ports	J, K	EUE1-HLOW-2040	711.35
						2 Power Receptacles, 1 USB Charging, 1 Data Port, 1 Cable Bay	J, K	EUE1-HLOW-2112	783.40
						2 Power Receptacles, 1 USB Charging, 3 Data Ports	J, K	EUE1-HLOW-2130	783.40
						2 Power Receptacles, 2 USB Charging, 1 Cable Bay	J, K	EUE1-HLOW-2202	855.45
						2 Power Receptacles, 2 USB Charging, 2 Data Ports	J, K	EUE1-HLOW-2220	855.45
						2 Power Receptacles, 3 USB Charging, 1 Data Port	J, K	EUE1-HLOW-2310	927.50
						2 Power Receptacles, 4 USB Charging	J, K	EUE1-HLOW-2400	999.55
						3 Power Receptacles, 1 Data Port, 1 Cable Bay	J, K	EUE1-HLOW-3012	711.35
						3 Power Receptacles, 3 Data Ports	J, K	EUE1-HLOW-3030	711.35
						3 Power Receptacles, 1 USB Charging, 1 Cable Bay	J, K	EUE1-HLOW-3102	783.40
						3 Power Receptacles, 1 USB Charging, 2 Data Ports	J, K	EUE1-HLOW-3120	783.40
						3 Power Receptacles, 2 USB Charging, 1 Data Port	J, K	EUE1-HLOW-3210	855.45
						3 Power Receptacles, 3 USB Charging	J, K	EUE1-HLOW-3300	927.50
						4 Power Receptacles, 1 Cable Bay	J, K	EUE1-HLOW-4002	711.35
						4 Power Receptacles, 2 Data Ports	J, K	EUE1-HLOW-4020	711.35
						4 Power Receptacles, 1 USB Charging, 1 Data Port	J, K	EUE1-HLOW-4110	783.40
						4 Power Receptacles, 2 USB Charging	J, K	EUE1-HLOW-4200	855.45
						5 Power Receptacles, 1 Data Port	J, K	EUE1-HLOW-5010	711.35
						5 Power Receptacles, 1 USB Charging	J, K	EUE1-HLOW-5100	783.40
						6 Power Receptacles	J, K	EUE1-HLOW-6000	711.35

This page intentionally blank

Electrical Components

Flip Top Unit — Hardwire — Double-Sided

Power, Data and USB

4-Port:

- (2) Power
- (1) USB
- (1) Data

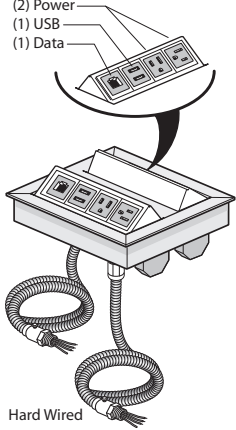

EUE2-HF0B-2110

6-Port:

- (2) Power
- (1) USB
- (1) Data
- (1) Cable Bay

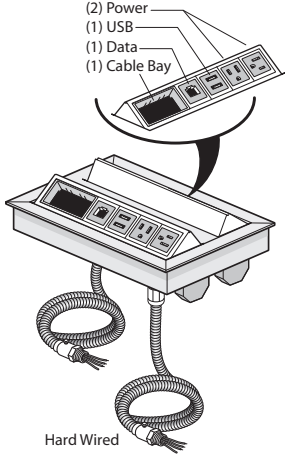

EUE2-HF0B-1212



Features

- Includes bezel and two flip top modules, each with 2, 4 or 6 ports that can be configured with simplex outlets (NEMA-5-15R), USB charging port (with two USB outlets), data ports or cable bay(s) that can accept up to 2 pull out data/AV cables and mounting hardware.
- Data port accommodate most varieties of field supplied data/AV jacks.
- Each flip top module within the bezel provided with 6'(1829mm) or 12'(3658mm) long flexible metal conduit feed, 0.5"(13mm) conduit fitting and wires for hardwire connection.
- USB Charging Port consists of two USB 2.0 style A outlets. 4 Amp (shared) charging capacity.
- Flip top frame is flush mounted with two spring release flip module(s).
- Flip top unit overall height is 2.75"(70mm) and will extend below the table tops.
- Color option of black anodized housing with black receptacles or clear anodized housing with white receptacles.
- Ships assembled.

Specification Tips

- **Configuration and quantity of power and data ports cannot be modified in the field.**
- **For use with 120 volt 60 hertz power source only.**
- Note two conduit feeds are provided from the double-sided flip top unit.
- Requires field installation.
- Specify factory cut hole or field cut hole as required.
- Specify AV cables separately.
- Cable Bay requires cables less than 0.3"(7.6mm) diameter.
- Application may require approval of local authority having jurisdiction (AHJ); ensure compliance before placing orders and installation.

To Order, Specify:

- 1) Product number.
(No finish specification required.)

Note: Order flip top units to match flip top unit cutout option specified for each top (M/P or Q/V).

Electrical Components

Flip Top Unit — Hardwire — Double-Sided

Width	Bezel Depth	Cord Length	Trim Color	Port Color	Port	Configuration	Flip Top Unit Cutout Code Options	Number	Price	
5.31" (135mm)	8" (203mm)	6' (1829mm)	Black Anodized	Black	4	1 Power Receptacle, 1 Data Port, 1 Cable Bay	M, P	EUE2-HFOB-1012	\$1496.21	
						1 Power Receptacle, 3 Data Ports	M, P	EUE2-HFOB-1030	1496.21	
						1 Power Receptacle, 1 USB Charging, 1 Cable Bay	M, P	EUE2-HFOB-1102	1568.26	
						1 Power Receptacle, 1 USB Charging, 2 Data Ports	M, P	EUE2-HFOB-1120	1568.26	
						1 Power Receptacle, 3 USB Charging	M, P	EUE2-HFOB-1300	1712.36	
						2 Power Receptacles, 1 Cable Bay	M, P	EUE2-HFOB-2002	1496.21	
						2 Power Receptacles, 2 Data Ports	M, P	EUE2-HFOB-2020	1496.21	
						2 Power Receptacles, 1 USB Charging, 1 Data Port	M, P	EUE2-HFOB-2110	1568.26	
						2 Power Receptacles, 2 USB Charging	M, P	EUE2-HFOB-2200	1640.31	
						3 Power Receptacles, 1 Data Port	M, P	EUE2-HFOB-3010	1496.21	
						3 Power Receptacles, 1 USB Charging	M, P	EUE2-HFOB-3100	1568.26	
						4 Power Receptacles	M, P	EUE2-HFOB-4000	1496.21	
						6	1 Power Receptacle, 3 Data Ports, 1 Cable Bay	Q, V	EUE2-HFOB-1032	\$1496.21
							1 Power Receptacle, 5 Data Ports	Q, V	EUE2-HFOB-1050	1496.21
							1 Power Receptacle, 1 USB Charging, 2 Data Ports, 1 Cable Bay	Q, V	EUE2-HFOB-1122	1568.26
					1 Power Receptacle, 1 USB Charging, 4 Data Ports		Q, V	EUE2-HFOB-1140	1568.26	
					1 Power Receptacle, 2 USB Charging, 1 Data Port, 1 Cable Bay		Q, V	EUE2-HFOB-1212	1640.31	
					1 Power Receptacle, 2 USB Charging, 3 Data Ports		Q, V	EUE2-HFOB-1230	1640.31	
					1 Power Receptacle, 3 USB Charging, 1 Cable Bay		Q, V	EUE2-HFOB-1302	1712.36	
					1 Power Receptacle, 3 USB Charging, 2 Data Ports		Q, V	EUE2-HFOB-1320	1712.36	
					2 Power Receptacles, 2 Data Ports, 1 Cable Bay		Q, V	EUE2-HFOB-2022	1496.21	
					2 Power Receptacles, 4 Data Ports		Q, V	EUE2-HFOB-2040	1496.21	
					2 Power Receptacles, 1 USB Charging, 1 Data Port, 1 Cable Bay		Q, V	EUE2-HFOB-2112	1568.26	
					2 Power Receptacles, 1 USB Charging, 3 Data Ports		Q, V	EUE2-HFOB-2130	1568.26	
					2 Power Receptacles, 2 USB Charging, 1 Cable Bay		Q, V	EUE2-HFOB-2202	1640.31	
					2 Power Receptacles, 2 USB Charging, 2 Data Ports		Q, V	EUE2-HFOB-2220	1640.31	
					2 Power Receptacles, 3 USB Charging, 1 Data Port		Q, V	EUE2-HFOB-2310	1712.36	
					2 Power Receptacles, 4 USB Charging		Q, V	EUE2-HFOB-2400	1784.41	
					3 Power Receptacles, 1 Data Port, 1 Cable Bay		Q, V	EUE2-HFOB-3012	1496.21	
					3 Power Receptacles, 3 Data Ports		Q, V	EUE2-HFOB-3030	1496.21	
					3 Power Receptacles, 1 USB Charging, 1 Cable Bay	Q, V	EUE2-HFOB-3102	1568.26		
					3 Power Receptacles, 1 USB Charging, 2 Data Ports	Q, V	EUE2-HFOB-3120	1568.26		
					3 Power Receptacles, 2 USB Charging, 1 Data Port	Q, V	EUE2-HFOB-3210	1640.31		
3 Power Receptacles, 3 USB Charging	Q, V	EUE2-HFOB-3300	1712.36							
4 Power Receptacles, 1 Cable Bay	Q, V	EUE2-HFOB-4002	1496.21							
4 Power Receptacles, 2 Data Ports	Q, V	EUE2-HFOB-4020	1496.21							
4 Power Receptacles, 1 USB Charging, 1 Data Port	Q, V	EUE2-HFOB-4110	1568.26							
4 Power Receptacles, 2 USB Charging	Q, V	EUE2-HFOB-4200	1640.31							
5 Power Receptacles, 1 Data Port	Q, V	EUE2-HFOB-5010	1496.21							
5 Power Receptacles, 1 USB Charging	Q, V	EUE2-HFOB-5100	1568.26							
6 Power Receptacles	Q, V	EUE2-HFOB-6000	1496.21							

Electrical Components

Flip Top Unit — Hardwire — Double-Sided

Width	Bezel Depth	Cord Length	Trim Color	Port Color	Port	Configuration	Flip Top Unit Cutout Code Options	Number	Price
5.31" (135mm)	8" (203mm)	6' (1829mm)	Clear Anodized	White	4	1 Power Receptacle, 1 Data Port, 1 Cable Bay	M, P	EUE2-HF0W-1012	\$1301.36
						1 Power Receptacle, 3 Data Ports	M, P	EUE2-HF0W-1030	1301.36
						1 Power Receptacle, 1 USB Charging, 1 Cable Bay	M, P	EUE2-HF0W-1102	1373.41
						1 Power Receptacle, 1 USB Charging, 2 Data Ports	M, P	EUE2-HF0W-1120	1373.41
						1 Power Receptacle, 3 USB Charging	M, P	EUE2-HF0W-1300	1517.51
						2 Power Receptacles, 1 Cable Bay	M, P	EUE2-HF0W-2002	1301.36
						2 Power Receptacles, 2 Data Ports	M, P	EUE2-HF0W-2020	1301.36
						2 Power Receptacles, 1 USB Charging, 1 Data Port	M, P	EUE2-HF0W-2110	1373.41
						2 Power Receptacles, 2 USB Charging	M, P	EUE2-HF0W-2200	1445.46
						3 Power Receptacles, 1 Data Port	M, P	EUE2-HF0W-3010	1301.36
						3 Power Receptacles, 1 USB Charging	M, P	EUE2-HF0W-3100	1373.41
						4 Power Receptacles	M, P	EUE2-HF0W-4000	1301.36
					6	1 Power Receptacle, 3 Data Ports, 1 Cable Bay	Q, V	EUE2-HF0W-1032	\$1301.36
						1 Power Receptacle, 5 Data Ports	Q, V	EUE2-HF0W-1050	1301.36
						1 Power Receptacle, 1 USB Charging, 2 Data Ports, 1 Cable Bay	Q, V	EUE2-HF0W-1122	1373.41
						1 Power Receptacle, 1 USB Charging, 4 Data Ports	Q, V	EUE2-HF0W-1140	1373.41
						1 Power Receptacle, 2 USB Charging, 1 Data Port, 1 Cable Bay	Q, V	EUE2-HF0W-1212	1445.46
						1 Power Receptacle, 2 USB Charging, 3 Data Ports	Q, V	EUE2-HF0W-1230	1445.46
						1 Power Receptacle, 3 USB Charging, 1 Cable Bay	Q, V	EUE2-HF0W-1302	1517.51
						1 Power Receptacle, 3 USB Charging, 2 Data Ports	Q, V	EUE2-HF0W-1320	1517.51
						2 Power Receptacles, 2 Data Ports, 1 Cable Bay	Q, V	EUE2-HF0W-2022	1301.36
						2 Power Receptacles, 4 Data Ports	Q, V	EUE2-HF0W-2040	1301.36
						2 Power Receptacles, 1 USB Charging, 1 Data Port, 1 Cable Bay	Q, V	EUE2-HF0W-2112	1373.41
						2 Power Receptacles, 1 USB Charging, 3 Data Ports	Q, V	EUE2-HF0W-2130	1373.41
						2 Power Receptacles, 2 USB Charging, 1 Cable Bay	Q, V	EUE2-HF0W-2202	1445.46
						2 Power Receptacles, 2 USB Charging, 2 Data Ports	Q, V	EUE2-HF0W-2220	1445.46
						2 Power Receptacles, 3 USB Charging, 1 Data Port	Q, V	EUE2-HF0W-2310	1517.51
						2 Power Receptacles, 4 USB Charging	Q, V	EUE2-HF0W-2400	1589.56
3 Power Receptacles, 1 Data Port, 1 Cable Bay	Q, V	EUE2-HF0W-3012	1301.36						
3 Power Receptacles, 3 Data Ports	Q, V	EUE2-HF0W-3030	1301.36						
3 Power Receptacles, 1 USB Charging, 1 Cable Bay	Q, V	EUE2-HF0W-3102	1373.41						
3 Power Receptacles, 1 USB Charging, 2 Data Ports	Q, V	EUE2-HF0W-3120	1373.41						
3 Power Receptacles, 2 USB Charging, 1 Data Port	Q, V	EUE2-HF0W-3210	1445.46						
3 Power Receptacles, 3 USB Charging	Q, V	EUE2-HF0W-3300	1517.51						
4 Power Receptacles, 1 Cable Bay	Q, V	EUE2-HF0W-4002	1301.36						
4 Power Receptacles, 2 Data Ports	Q, V	EUE2-HF0W-4020	1301.36						
4 Power Receptacles, 1 USB Charging, 1 Data Port	Q, V	EUE2-HF0W-4110	1373.41						
4 Power Receptacles, 2 USB Charging	Q, V	EUE2-HF0W-4200	1445.46						
5 Power Receptacles, 1 Data Port	Q, V	EUE2-HF0W-5010	1301.36						
5 Power Receptacles, 1 USB Charging	Q, V	EUE2-HF0W-5100	1373.41						
6 Power Receptacles	Q, V	EUE2-HF0W-6000	1301.36						

Electrical Components

Flip Top Unit — Hardwire — Double-Sided

Width	Bezel Depth	Cord Length	Trim Color	Port Color	Port	Configuration	Flip Top Unit Cutout Code Options	Number	Price	
5.31" (135mm)	8" (203mm)	12' (3658mm)	Black Anodized	Black	4	1 Power Receptacle, 1 Data Port, 1 Cable Bay	M, P	EUE2-HLOB-1012	\$1555.08	
						1 Power Receptacle, 3 Data Ports	M, P	EUE2-HLOB-1030	1555.08	
						1 Power Receptacle, 1 USB Charging, 1 Cable Bay	M, P	EUE2-HLOB-1102	1627.13	
						1 Power Receptacle, 1 USB Charging, 2 Data Ports	M, P	EUE2-HLOB-1120	1627.13	
						1 Power Receptacle, 3 USB Charging	M, P	EUE2-HLOB-1300	1771.23	
						2 Power Receptacles, 1 Cable Bay	M, P	EUE2-HLOB-2002	1555.08	
						2 Power Receptacles, 2 Data Ports	M, P	EUE2-HLOB-2020	1555.08	
						2 Power Receptacles, 1 USB Charging, 1 Data Port	M, P	EUE2-HLOB-2110	1627.13	
						2 Power Receptacles, 2 USB Charging	M, P	EUE2-HLOB-2200	1699.18	
						3 Power Receptacles, 1 Data Port	M, P	EUE2-HLOB-3010	1555.08	
						3 Power Receptacles, 1 USB Charging	M, P	EUE2-HLOB-3100	1627.13	
						4 Power Receptacles	M, P	EUE2-HLOB-4000	1555.08	
						6	1 Power Receptacle, 3 Data Ports, 1 Cable Bay	Q, V	EUE2-HLOB-1032	\$1555.08
							1 Power Receptacle, 5 Data Ports	Q, V	EUE2-HLOB-1050	1555.08
							1 Power Receptacle, 1 USB Charging, 2 Data Ports, 1 Cable Bay	Q, V	EUE2-HLOB-1122	1627.13
							1 Power Receptacle, 1 USB Charging, 4 Data Ports	Q, V	EUE2-HLOB-1140	1627.13
							1 Power Receptacle, 2 USB Charging, 1 Data Port, 1 Cable Bay	Q, V	EUE2-HLOB-1212	1699.18
							1 Power Receptacle, 2 USB Charging, 3 Data Ports	Q, V	EUE2-HLOB-1230	1699.18
							1 Power Receptacle, 3 USB Charging, 1 Cable Bay	Q, V	EUE2-HLOB-1302	1771.23
							1 Power Receptacle, 3 USB Charging, 2 Data Ports	Q, V	EUE2-HLOB-1320	1771.23
					2 Power Receptacles, 2 Data Ports, 1 Cable Bay		Q, V	EUE2-HLOB-2022	1555.08	
					2 Power Receptacles, 4 Data Ports		Q, V	EUE2-HLOB-2040	1555.08	
					2 Power Receptacles, 1 USB Charging, 1 Data Port, 1 Cable Bay		Q, V	EUE2-HLOB-2112	1627.13	
					2 Power Receptacles, 1 USB Charging, 3 Data Ports		Q, V	EUE2-HLOB-2130	1627.13	
					2 Power Receptacles, 2 USB Charging, 1 Cable Bay		Q, V	EUE2-HLOB-2202	1699.18	
					2 Power Receptacles, 2 USB Charging, 2 Data Ports		Q, V	EUE2-HLOB-2220	1699.18	
					2 Power Receptacles, 3 USB Charging, 1 Data Port		Q, V	EUE2-HLOB-2310	1771.23	
					2 Power Receptacles, 4 USB Charging		Q, V	EUE2-HLOB-2400	1843.28	
					3 Power Receptacles, 1 Data Port, 1 Cable Bay		Q, V	EUE2-HLOB-3012	1555.08	
					3 Power Receptacles, 3 Data Ports		Q, V	EUE2-HLOB-3030	1555.08	
					3 Power Receptacles, 1 USB Charging, 1 Cable Bay		Q, V	EUE2-HLOB-3102	1627.13	
					3 Power Receptacles, 1 USB Charging, 2 Data Ports		Q, V	EUE2-HLOB-3120	1627.13	
					3 Power Receptacles, 2 USB Charging, 1 Data Port	Q, V	EUE2-HLOB-3210	1699.18		
					3 Power Receptacles, 3 USB Charging	Q, V	EUE2-HLOB-3300	1771.23		
					4 Power Receptacles, 1 Cable Bay	Q, V	EUE2-HLOB-4002	1555.08		
					4 Power Receptacles, 2 Data Ports	Q, V	EUE2-HLOB-4020	1555.08		
					4 Power Receptacles, 1 USB Charging, 1 Data Port	Q, V	EUE2-HLOB-4110	1627.13		
					4 Power Receptacles, 2 USB Charging	Q, V	EUE2-HLOB-4200	1699.18		
					5 Power Receptacles, 1 Data Port	Q, V	EUE2-HLOB-5010	1555.08		
					5 Power Receptacles, 1 USB Charging	Q, V	EUE2-HLOB-5100	1627.13		
6 Power Receptacles	Q, V	EUE2-HLOB-6000	1555.08							

Electrical Components

Flip Top Unit — Hardwire — Double-Sided

Width	Bezel Depth	Cord Length	Trim Color	Port Color	Port	Configuration	Flip Top Unit Cutout Code Options	Number	Price
5.31" (135mm)	8" (203mm)	12' (3658mm)	Clear Anodized	White	4	1 Power Receptacle, 1 Data Port, 1 Cable Bay	M, P	EUE2-HLOW-1012	\$1360.23
						1 Power Receptacle, 3 Data Ports	M, P	EUE2-HLOW-1030	1360.23
						1 Power Receptacle, 1 USB Charging, 1 Cable Bay	M, P	EUE2-HLOW-1102	1432.28
						1 Power Receptacle, 1 USB Charging, 2 Data Ports	M, P	EUE2-HLOW-1120	1432.28
						1 Power Receptacle, 3 USB Charging	M, P	EUE2-HLOW-1300	1576.38
						2 Power Receptacles, 1 Cable Bay	M, P	EUE2-HLOW-2002	1360.23
						2 Power Receptacles, 2 Data Ports	M, P	EUE2-HLOW-2020	1360.23
						2 Power Receptacles, 1 USB Charging, 1 Data Port	M, P	EUE2-HLOW-2110	1432.28
						2 Power Receptacles, 2 USB Charging	M, P	EUE2-HLOW-2200	1504.33
						3 Power Receptacles, 1 Data Port	M, P	EUE2-HLOW-3010	1360.23
						3 Power Receptacles, 1 USB Charging	M, P	EUE2-HLOW-3100	1432.28
						4 Power Receptacles	M, P	EUE2-HLOW-4000	1360.23
					6	1 Power Receptacle, 3 Data Ports, 1 Cable Bay	Q, V	EUE2-HLOW-1032	\$1360.23
						1 Power Receptacle, 5 Data Ports	Q, V	EUE2-HLOW-1050	1360.23
						1 Power Receptacle, 1 USB Charging, 2 Data Ports, 1 Cable Bay	Q, V	EUE2-HLOW-1122	1432.28
						1 Power Receptacle, 1 USB Charging, 4 Data Ports	Q, V	EUE2-HLOW-1140	1432.28
						1 Power Receptacle, 2 USB Charging, 1 Data Port, 1 Cable Bay	Q, V	EUE2-HLOW-1212	1504.33
						1 Power Receptacle, 2 USB Charging, 3 Data Ports	Q, V	EUE2-HLOW-1230	1504.33
						1 Power Receptacle, 3 USB Charging, 1 Cable Bay	Q, V	EUE2-HLOW-1302	1576.38
						1 Power Receptacle, 3 USB Charging, 2 Data Ports	Q, V	EUE2-HLOW-1320	1576.38
						2 Power Receptacles, 2 Data Ports, 1 Cable Bay	Q, V	EUE2-HLOW-2022	1360.23
						2 Power Receptacles, 4 Data Ports	Q, V	EUE2-HLOW-2040	1360.23
						2 Power Receptacles, 1 USB Charging, 1 Data Port, 1 Cable Bay	Q, V	EUE2-HLOW-2112	1432.28
						2 Power Receptacles, 1 USB Charging, 3 Data Ports	Q, V	EUE2-HLOW-2130	1432.28
						2 Power Receptacles, 2 USB Charging, 1 Cable Bay	Q, V	EUE2-HLOW-2202	1504.33
						2 Power Receptacles, 2 USB Charging, 2 Data Ports	Q, V	EUE2-HLOW-2220	1504.33
						2 Power Receptacles, 3 USB Charging, 1 Data Port	Q, V	EUE2-HLOW-2310	1576.38
2 Power Receptacles, 4 USB Charging	Q, V	EUE2-HLOW-2400	1648.43						
3 Power Receptacles, 1 Data Port, 1 Cable Bay	Q, V	EUE2-HLOW-3012	1360.23						
3 Power Receptacles, 3 Data Ports	Q, V	EUE2-HLOW-3030	1360.23						
3 Power Receptacles, 1 USB Charging, 1 Cable Bay	Q, V	EUE2-HLOW-3102	1432.28						
3 Power Receptacles, 1 USB Charging, 2 Data Ports	Q, V	EUE2-HLOW-3120	1432.28						
3 Power Receptacles, 2 USB Charging, 1 Data Port	Q, V	EUE2-HLOW-3210	1504.33						
3 Power Receptacles, 3 USB Charging	Q, V	EUE2-HLOW-3300	1576.38						
4 Power Receptacles, 1 Cable Bay	Q, V	EUE2-HLOW-4002	1360.23						
4 Power Receptacles, 2 Data Ports	Q, V	EUE2-HLOW-4020	1360.23						
4 Power Receptacles, 1 USB Charging, 1 Data Port	Q, V	EUE2-HLOW-4110	1432.28						
4 Power Receptacles, 2 USB Charging	Q, V	EUE2-HLOW-4200	1504.33						
5 Power Receptacles, 1 Data Port	Q, V	EUE2-HLOW-5010	1360.23						
5 Power Receptacles, 1 USB Charging	Q, V	EUE2-HLOW-5100	1432.28						
6 Power Receptacles	Q, V	EUE2-HLOW-6000	1360.23						

Electrical Components

Flip Top Power Module Clips

	Width	Height	Number	Price
Mounting Clip for Flip Top Unit	0.5"(1mm)	2"(51mm)	EUMC-0201	\$112.52

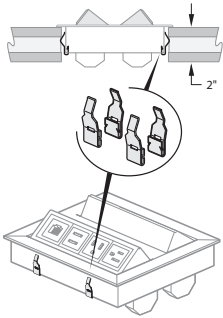

EUMC-0201

Features

- Includes twelve brackets.
- For mounting Flip Top Unit in 2"(51mm) hollow core top.
- Four brackets required per Flip Top Unit.

Specification Tip

- Required for Flip Top Unit on the 2"(51mm) core worksurface.

To Order, Specify:

- 1) Product number.
(No finish specification required.)

Electrical Components

Wireless Charging Module

Wireless Charging Module

EUWC-PFOB-11001

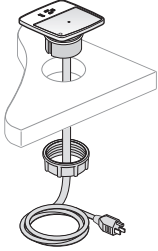

EUWC-PFOB-12002

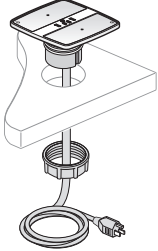

EUWC-PFOB
EUWC-PFOW
EUWC-HLOB
EUWC-HLOW



Features

- Includes power module with simplex outlet (NEMA-15R), one or two USB charging simplex or one or two charging Qi pads with soft touch plastic inserts and mounting hardware.
- 5 Watt Qi charging coil.
- Corded power module with 15 amp - 6'(1829mm) or 12'(3658mm) long cord with plug (NEMA 5-15P).
- Hardwired power module with 12'(3658mm) long flexible metal conduit feed, 1/2"(13mm) conduit fitting and wires for hardwire connection.
- USB Charging Port consists of one 5V USB 2.0 style A outlet. 2 Amp (shared) charging capacity.
- Attaches to 1"(25mm) to 1 1/2"(38mm) thick surface with use of included mounting brackets.
- Color option of black or white plastic face.

Specification Tips

- **Not for use with 2"(51mm) thick tops.**
- Configuration and quantity of power and USB ports cannot be modified in the field.
- For use with 120 volt 60 hertz power source only.
- Requires field installation.
- Requires field cut 3"(76mm) diameter access hole for power cord/conduit routing.
- Application may require approval of local authority having jurisdiction (AHJ); ensure compliance before placing orders and installation.
- Separately specified:
 - Horizontal and Vertical Wire Management



To Order, Specify:



- 1) Product number.
(No finish specification required.)

Width	Depth	Cord Length	Housing Color	Port	Configuration	Number	Price
Corded							
5.56"(141mm)	5.56"(141mm)	6'(1829mm)	Black		1 Power Receptacle, 1 USB Charging, 1 Charging Pad	EUWC-PFOB-11001	\$402.41
7.38"(187mm)	7"(178mm)				1 Power Receptacle, 2 USB Charging, 2 Charging Pad	EUWC-PFOB-12002	718.83
5.56"(141mm)	5.56"(141mm)		White		1 Power Receptacle, 1 USB Charging, 1 Charging Pad	EUWC-PFOW-11001	402.41
7.38"(187mm)	7"(178mm)				1 Power Receptacle, 2 USB Charging, 2 Charging Pad	EUWC-PFOW-12002	718.83
5.56"(141mm)	5.56"(141mm)	12'(3658mm)	Black		1 Power Receptacle, 1 USB Charging, 1 Charging Pad	EUWC-PL0B-11001	\$459.03
7.38"(187mm)	7"(178mm)				1 Power Receptacle, 2 USB Charging, 2 Charging Pad	EUWC-PL0B-12002	775.45
5.56"(141mm)	5.56"(141mm)		White		1 Power Receptacle, 1 USB Charging, 1 Charging Pad	EUWC-PL0W-11001	459.03
7.38"(187mm)	7"(178mm)				1 Power Receptacle, 2 USB Charging, 2 Charging Pad	EUWC-PL0W-12002	775.45
Hardwire							
5.56"(141mm)	5.56"(141mm)	12'(3658mm)	Black		1 Power Receptacle, 1 USB Charging, 1 Charging Pad	EUWC-HLOB-11001	\$530.00
7.38"(187mm)	7"(178mm)				1 Power Receptacle, 2 USB Charging, 2 Charging Pad	EUWC-HLOB-12002	846.42
5.56"(141mm)	5.56"(141mm)		White		1 Power Receptacle, 1 USB Charging, 1 Charging Pad	EUWC-HLOW-11001	530.00
7.38"(187mm)	7"(178mm)				1 Power Receptacle, 2 USB Charging, 2 Charging Pad	EUWC-HLOW-12002	846.42

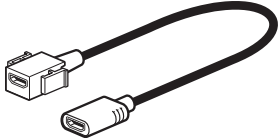
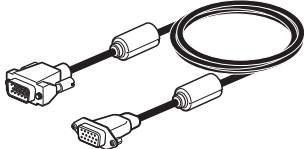
Electrical Components

Cables

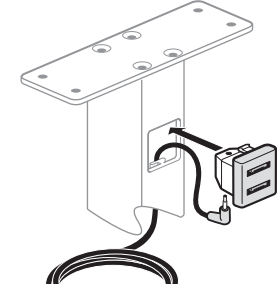
	Length	Description	Color	Number	Price
Cables  EUDX-H000-B  EUDX-V000-B  EUDX-3000-B	HDMI Coupler				
	N/A	HDMI	Black	EUDX-H000-B	\$149.11
	N/A	HDMI	White	EUDX-H000-W	149.11
	VGA Cable				
	120"(3048mm)	VGA	Black	EUDX-V000-B	\$178.93
		VGA	White	EUDX-V000-W	178.93
	Audio Cable — 3.5mm				
	120"(3048mm)	VGA	Black	EUDX-3000-B	\$ 41.76
		VGA	White	EUDX-3000-W	41.76
	Features			To Order, Specify:	
<ul style="list-style-type: none"> Includes one black HDMI Coupler, one VGA cable or one 3.5mm mini audio cable. Installs in an open data port in one of the following products: <ul style="list-style-type: none"> –Flip Top Unit –Double Sided Flip Top Unit –Quick Connect Power –Workware Interface Module –Flush Mount Module –Enhanced Power Module 			1) Product number. (No finish specification required.)		
Specification Tips					
<ul style="list-style-type: none"> Provides communication between components: i.e. laptop, processor, monitor, etc. HDMI transmits digital video signals. VGA transmits analog video signals without audio. 					

Retrofit USB Charging Cable  EUDX-U000-B 	72"(1829mm)		Black	EUDX-U000-B	\$137.36
			White	EUDX-U000-W	137.36
Features			To Order, Specify:		
<ul style="list-style-type: none"> Includes one USB charging simplex (with two USB outlets) with 72"(1829mm) cord and power supply. Installs in an open data port in one of the following products: <ul style="list-style-type: none"> –Flip Top Unit –Double Sided Flip Top Unit –Quick Connect Power –Workware Interface Module –Flush Mount Module –Enhanced Power Module USB Charging Port consists of 2 USB outlets. 1,000mA of charging power per USB outlet. 			1) Product number. (No finish specification required.)		

Ergotron Keyboard Tray

	Description	Height Adjustment	Number	Price
Keyboard Tray with Mouse Pad	11"(279mm) Track	0" Above/6" Below	169BK	\$447.78
	18.5"(457mm) Track	0" Above/6" Below	UKMCBK	479.40

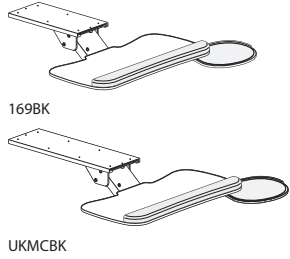

Features

- Includes: Keyboard tray with mouse pad and attachment hardware.
- Keyboard tray includes integrated foam wrist rest.
- Oval mouse extension pivots out from the right side.
- Height adjustment range: Level with to 6"(152mm) below worksurface.
- Tilt adjustment -20°/ +10°
- Pans 360°.
- Available with 11"(279mm) track or 18.5"(470mm) track.
- Weight capacity: 10 lbs.
- Black only.
- TAA Compliant.

To Order, Specify:

- 1) Product number.

Specification Tips

- Keyboard tray extends 4"(102mm) from front of worksurface when retracted.
- 11"(279mm) or 18.5"(470mm) under surface depth required for track installation.

Neo-Flex Keyboard Tray	Keyboard Tray	0" Above/6" Below	97-582-009	\$255.51
-------------------------------	---------------	-------------------	------------	-----------------

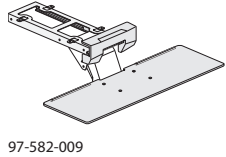

Features

- Includes: Keyboard tray, arm, desk clamp, slide mechanism and mounting hardware.
- Height adjustment range: Level with to 6"(152mm) below worksurface.
- Tilt adjustment +15°
- Fully retracts under worksurface when not in use.
- 26.9"(683mm)W x 8.9"(226mm)D keyboard trays allows room for keyboard and mouse.
- Weight capacity: 3 lbs.
- Keyboard tray extends approximately 9.25"(235mm) from front of surface.
- 15"(381mm) track.
- Black only.

To Order, Specify:

- 1) Product number.

Specification Tips

- Clamps to front edge of worksurface with clamp and one screw or remove clamp and attach under worksurface with four screws.
- Compatible with surfaces .75"(19mm) - 1.5"(25mm) thick.
- For use on surfaces with minimum depth of 17".

Ergotron CPU Holder

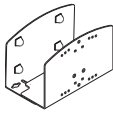
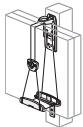
	Description	Number	Price
Small CPU Holder  80-063	Black	80-063-200	\$105.06
	White	80-063-216	105.06
	Features <ul style="list-style-type: none"> Includes: One vertical steel CPU holder, mounting hardware and fasteners. Mounts to any sturdy vertical surface. CPU Holder is 6"(152mm)H x 10"(254mm)D. Accommodates CPUs 1.4"(25mm) to 3.75"(76mm) wide. Weight capacity: 50 lbs. 	To Order, Specify: <ul style="list-style-type: none"> 1) Product number. 	
Universal CPU Holder  97-468	Silver	97-468-202	\$138.72
	White	97-468-216	138.72
	Features <ul style="list-style-type: none"> Includes: One vertical steel CPU holder, mounting hardware and fasteners. Mounts to any sturdy vertical surface. CPU Holder is 6.6"(152mm)H x 10"(254mm)D. Accommodates CPUs 2"(51mm) - 8"(203mm) wide. Weight capacity: 40 lbs. 	To Order, Specify: <ul style="list-style-type: none"> 1) Product number. 	
Cable CPU Holder  80-105-064	Grey/Silver	80-105-064	\$76.38
	Features <ul style="list-style-type: none"> Includes: One size-adjustable CPU holder and hardware. Mounts directly to wall or under worksurface. Size adjusts from 9.4"(229mm) x 2.6"(51mm) to 18"(457mm) x 8.5"(203mm). Unique security fasteners deter theft. Weight capacity: 50 lbs. 	To Order, Specify: <ul style="list-style-type: none"> 1) Product number. 	

Ergotron Monitor Arms

HX Arm

Single Arm

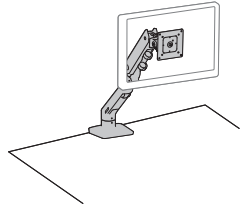

45-475
45-478

Description	Number	Price
Desk Mount		
Polished Aluminum	45-475-026	\$633.42
White	45-475-216	633.42
Wall Mount		
Polished Aluminum	45-478-026	\$633.42
White	45-478-216	633.42

Features

- Includes: Adjustable height monitor arm, extension, monitor pivot, mounting hardware.
 - Desk mount includes desk clamp and grommet mount.
 - Wall mount includes mounting hardware.
- For use with screen 42”(1067mm) or smaller.
- Weight capacity 20-42 pounds.
- Height adjustment range is 11.5”(292mm).
- Tilts 70° up and 5° down from center.
- 180° rotation base stop.
- Pans 180°.
- Rotates 360°.
- Extends out up to 25”(635mm).
- Integrated cable management.
- One touch adjustment.

To Order, Specify:

- Product number.

Specification Tips

- Desk clamp mounts on worksurface 0.4”(10mm)-2.5”(64mm) thick.
- Grommet mount attaches through surface holes 0.4”(10mm)-2”(51mm) wide and up to 2.25”(57mm) thick.
- For additional mounting options refer to pages 114-116.

Dual Arm

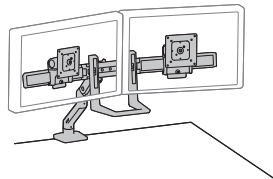

45-476
45-479

Desk Mount		
Polished Aluminum	45-476-026	\$1031.22
White	45-476-216	1031.22
Wall Mount		
Polished Aluminum	45-479-026	\$1031.22
White	45-479-216	1031.22

Features

- Includes: Adjustable height monitor arm, extension, two monitor pivots, hinged bow, handle, mounting hardware.
 - Desk mount includes desk clamp and grommet mount.
 - Wall mount includes mounting hardware.
- For use with screen 32”(813mm) or smaller.
- Weight capacity is 5-17.5 pounds per screen. Maximum combined weight is 35 pounds.
- Height adjustment range is 11.5”(292mm).
- Tilts 70° up and 5° down from center.
- 180° rotation base stop.
- Pans 180° - Hinged bow allows monitors to pan from left to right independently.
- Rotates 360°.
- Extends out up to 24”(610mm).
- Quick release monitor.
- Integrated cable management.
- One touch adjustment.
- Handle allows for easy positioning of multiple monitors simultaneously.

To Order, Specify:

- Product number.

Specification Tips

- Desk clamp mounts on worksurface 0.6”(15mm)-2.5”(64mm) thick.
- Grommet mount attaches through surface holes 0.4”(10mm)-2”(51mm) wide and up to 2.25”(57mm) thick.
- For additional mounting options refer to pages 114-116.

Ergotron Monitor Arms

HX Triple Monitor Bow Kit

Description	Number	Price
Polished Aluminum	98-009-026	\$608.72
White	98-009-216	608.72

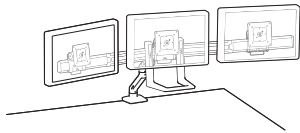
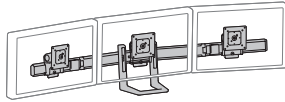

98-009-026
98-009-216

Features

- Includes: Triple monitor hinge bow, three monitor pivots, handle, monitor mounting hardware.
- For use with screen 24"(610mm) or smaller.
- Maximum weight capacity is 10.2 pounds per arm. Maximum combined weight is 30.6 pounds.
- Tilts 70° up and 5° down from center.
- Pans 180°.
- Rotates 360°.
- Extends out up to 24"(610mm).
- Quick release monitor.
- One touch adjustment.
- Handle allows for easy positioning of multiple monitors simultaneously.

To Order, Specify:

- 1) Product number.

Specification Tip

- Attaches to HX single or dual monitor arm.

Ergotron Monitor Arms

LX Desk Mount

Single Arm

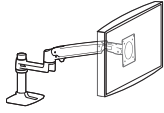

45-241-026
45-490-216
45-241-224
45-295-026
45-537-216

Description	Number	Price
Single Arm		
Polished Aluminum	45-241-026	\$296.29
White	45-490-216	296.29
Matte Black	45-241-224	296.29
Single Arm — Tall Pole		
Polished Aluminum	45-295-026	\$389.64
White	45-537-216	389.64

Features

- Includes: Adjustable height monitor arm, pole, extension, desk clamp and grommet mount base (polished aluminum only).
- Grommet mount base available on Polished Aluminum model only.
- Standard pole length is 7"(178mm). Tall pole length is 13.25"(337mm).
- Standard pole height for use with screen 32"(813mm) or smaller. Tall pole for use with screens 34"(864mm) or smaller.
- Accommodates monitors from 7-25 pounds.
- Height adjustment range is 13"(330mm) from installed height.
- Tilts 70° up and 5° down from center.
- Rotates 360°.
- Extends LCD's out up to 25"(635mm).
- Integrated cable management.
- One touch adjustment.

To Order, Specify:

- 1) Product number.

Specification Tips

- Desk clamp mounts on worksurface 0.4"(10mm)-2.4"(61mm) thick.
- Grommet mount attaches through surface holes 0.31"(8mm)-2"(51mm) wide and up to 3"(76mm) thick.
- For additional mounting options refer to pages 114-116.

Dual Arm

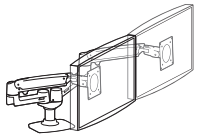

45-245-026
45-491-216
45-245-224

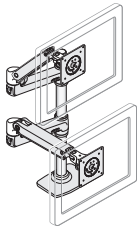

45-248-026
45-492-216
45-492-224

Side-by-Side		
Polished Aluminum	45-245-026	\$597.04
White	45-491-216	597.04
Matte Black	45-245-224	597.04
Stacking		
Polished Aluminum	45-248-026	\$597.04
White	45-492-216	597.04
Matte Black	45-492-224	597.04

Features

- Includes: Two adjustable height monitor arms, extensions, pole, grommet mount (polished aluminum only) and desk clamp.
- Grommet mount base available on Polished Aluminum model only.
- Screen size:
 - Side by Side application; screens 27"(686mm) or smaller.
 - Stacking application; screens 24"(610mm) or smaller. Screen height cannot exceed 14"(356mm) when stacking.
- Accommodates monitors from 7-20 pounds per arm. Maximum combined weight is 40 pounds.
- Height adjustment range is 13"(330mm).
- Tilts 70° up and 5° down from center.
- Pans 360°.
- Rotates 360°.
- Extends LCD's out up to 25"(635mm).
- Integrated cable management.
- One touch adjustment.

To Order, Specify:

- 1) Product number.

Specification Tips

- Desk clamp mounts on worksurface 0.4"(10mm)-2.4"(61mm) thick.
- Grommet mounts attached through surface holes 0.31"(8mm)-2"(51mm) wide and up to 3"(76mm) thick.
- For additional mounting options refer to pages 114-116.

Ergotron Monitor Arm

LX Monitor Arm — Tall Pole

	Description	Number	Price
LX Dual Stacking Arm - Tall Pole Monitor Arm	Polished Aluminum	45-549-026	\$599.15
	White	45-509-216	599.15

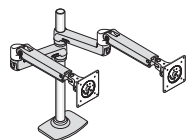

45-549-026
45-509-216

Features

- Includes: Two adjustable height monitor arms, extensions, 22”(559mm) pole, grommet mount, desk clamp and mounting hardware.
- Screen size:
 - Side by Side application; screens 40”(1016mm) wide or smaller.
 - Stacking application; screens 21”(533mm) high or shorter.
- Accommodates monitors from 7-20 pounds per arm. maximum combined weight is 40 pounds.
- Height adjustment range is 13”(330mm).
- Tilts 70° up and 5° down from center.
- Pans 360°.
- Rotates 360°.
- Extends LCDs out up to 25”(635mm).
- Integrated cable management.
- One touch adjustment.

To Order, Specify:

- 1) Product number.

Specification Tips

- Desk clamp mounts on worksurface 0.4”(10mm) - 2.4”(61mm) thick.
- Grommet mount attaches through surface holes .31”(8mm) - 2”(51mm) wide and up to 3”(76mm) thick.
- A third or fourth display can be added by ordering the LX Arm, Extension and Collar Kit. When adding a third or fourth monitor the maximum weight capacity per arm is 11 pounds.
- When using LX Arm Extension and Collar Kit with 3 monitors side by side, maximum screen width is 20.7” (526mm). When using LX Arm Extension and Collar kit with 4 monitors side by side, maximum screen width is 13.7” (348mm).
- For additional mounting options refer to pages 114-116.

Ergotron Monitor Arm

LX Sit-to-Stand Mount

Single Arm

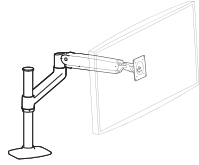

45-360-026
45-384-026

Description	Number	Price
LD — Light Duty		
Polished Aluminum	45-360-026	\$552.84
HD — Heavy Duty		
Polished Aluminum	45-384-026	\$680.34

Features

- Includes: Adjustable height monitor arm, extension, desk clamp and grommet base.
- Screen size:
 - LD - Light Duty for use with screen 42”(1067mm) or smaller.
 - HD - Heavy Duty for use with screen 46”(1168mm) or smaller.
- Monitor weight:
 - LD - Light Duty 7-25 pounds.
 - HD - Heavy Duty 14-30 pounds.
- Height adjustment range is 20”(508mm).
- Tilts 70° up and 5° down from center.
- Pans 360°.
- Rotates 90°.
- Extends LCD's out up to 33”(838mm).
- Integrated cable management.
- One touch adjustment.
- Locking connections between arm, extension and base provides theft deterrence and prevent potential disconnections caused by jarring or impacts.

To Order, Specify:

- 1) Product number.

Specification Tips

- Desk clamp mounts on worksurface 0.8”(20mm)-2.6”(66mm) thick.
- Grommet mounts attached through surface holes 0.5”(13mm)-2.5”(64mm) wide and up to 2.25”(57mm) thick.
- For additional mounting options refer to pages 114-116.

Ergotron Monitor Arm

LX Desk Dual Direct

Dual Direct Arm

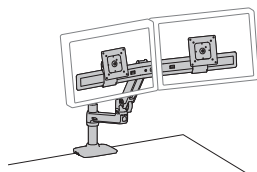

45-489

Description	Number	Price
Polished Aluminum	45-489-026	\$453.79
White	45-489-216	453.79
Matte Black	45-489-224	453.79

Features

- Includes: LX arm, extension, desk clamp, dual bow, two monitor pivots, pole and mounting hardware.
- For use with screens 25”(635mm) or smaller.
- Accommodates monitors from 2-11 pounds per monitor. Maximum combined weight is 22 pounds.
- Height adjustment range is 13”(330mm).
- Each monitor has individual tilt of 15° up and 15° down from center.
- Pans 360°.
- Rotates 360°.
- Extends LCD's out up to 24”(610mm).
- Integrated cable management.
- One touch adjustment.
- Move two monitors simultaneously.

To Order, Specify:

- 1) Product number.

Specification Tip

- Desk clamp mounts on worksurface 0.4”(10mm)-2.4”(61mm) thick.
- For additional mounting options refer to pages 114-116.

Dual Direct Handle Kit

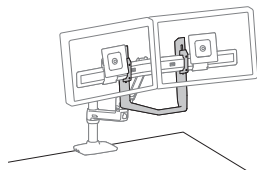

98-037-062

Polished Aluminum	98-037-062	\$99.24
-------------------	------------	----------------

Features

- Includes: One handle and mounting hardware.
- For use with LX Dual Direct monitor arm.
- Allows repositioning of screens without touching the screen.

To Order, Specify:

- 1) Product number.

Ergotron Monitor Arm Accessories

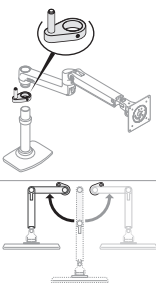

For use with LX Monitor Arms

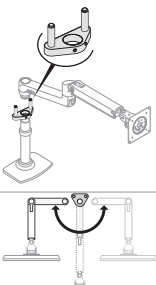
	Description	Number	Price
LX One-Stop Rotational Control Kit  <p>97-774-003</p>	Silver	97-774-003	\$28.57
	Features <ul style="list-style-type: none"> Includes: Single rotation stop collar, stop post, and hardware. Controls LX arm motion range to prevent extension arm from hitting the wall. 		To Order, Specify: <ul style="list-style-type: none"> 1) Product number.
Specification Tips <ul style="list-style-type: none"> Compatible with LX Single Arm, LX Tall Pole Arm, LX Dual Stacking Arm, LX Dual Direct Arm and LX Dual Stacking Tall Pole arm. Not compatible with LX Dual Side by Side Arms or LX Sit-Stand arms. When used on LX Dual Stacking arm a quantity of two is needed. 			

LX Two-Stop Rotational Control Kit  <p>98-060-003</p>	Silver	98-060-003	\$36.33
	Features <ul style="list-style-type: none"> Includes: Dual rotation stop collar, two stop posts, and hardware. Provides a fixed 180° stop to prevent LX arm extension from hitting the wall. 		To Order, Specify: <ul style="list-style-type: none"> 1) Product number.
Specification Tips <ul style="list-style-type: none"> Compatible with LX Single Arm, LX Tall Pole Arm, LX Dual Stacking Arm, LX Dual Direct Arm and LX Dual Stacking Tall Pole arm. Not compatible with LX Dual Side by Side Arms or LX Sit-Stand arms. 			

Ergotron Monitor Arm Accessories

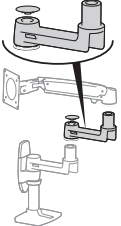
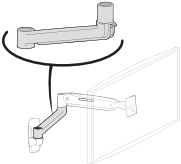
For use with LX Monitor Arms

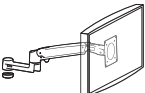
	Description	Number	Price
LX Extension  45-289-026	Polished Aluminum	45-289-026	\$74.34
	Features <ul style="list-style-type: none"> Includes: One extension. Add additional pivot-point for additional flexibility. Increases the reach of an LX arm by 9”(229mm). Specification Tip <ul style="list-style-type: none"> Only one extension to be used per monitor arm. 	To Order, Specify: <ol style="list-style-type: none"> Product number. 	
LX Sit-to-Stand Extension  45-362-026	Polished Aluminum	45-362-026	\$126.33
	Features <ul style="list-style-type: none"> Includes: One sit-to-stand extension. Add additional pivot-point for additional flexibility. Increases the reach of an LX Sit-to-Stand arm by 11.7”(297mm). Specification Tip <ul style="list-style-type: none"> Only one extension to be used per monitor arm. 	To Order, Specify: <ol style="list-style-type: none"> Product number. 	
LX Pole Collar  97-844	Polished Aluminum	97-844	\$11.55
	Features <ul style="list-style-type: none"> Includes: One collar and hardware. Used to attach a second LX Sit-to-Stand Arm at any point of an installed base. Reposition height on pole by loosening/tightening the collar's set screws. 	To Order, Specify: <ol style="list-style-type: none"> Product number. 	
LX Arm, Extension and Collar Kit  97-940-026 98-130-216	Polished Aluminum	97-940-026	\$329.96
	White	98-130-216	329.96
	Features <ul style="list-style-type: none"> Includes: LX arm, extension, collar and hardware. Converts existing LX Tall Pole Arm to hold two monitors creating an LX Dual Stacking Arm configuration. Attaches to pole of the desk mount base. For use with screen 32”(813mm) or smaller. Weight capacity is 7-20 pounds. Height adjustment range is 13”(330mm). Tilts 70° up and 5° down from center. Pans 360°. Rotates 360°. Extends LCD's out up to 25”(635mm). Integrated cable management. One touch adjustment. Specification Tip <ul style="list-style-type: none"> Recommended for use with LX Desk Mount LCD Arm, Tall Pole. 	To Order, Specify: <ol style="list-style-type: none"> Product number. 	

Ergotron Monitor Arm

MXV Desk Mount

Single Arm

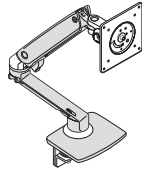

45-486

Description	Number	Price
Polished Aluminum	45-486-026	\$333.85
White	45-486-216	333.84
Matte Black	45-486-224	333.84

Features

- Includes: Fully assembled slim profile arm, two-piece desk clamp, and mounting hardware.
- For use with screen 34”(864mm) or smaller.
- Accommodates monitors from 7-20 pounds per arm.
- Height adjustment range is 13”(330mm).
- Tilts 90° backward and 90° forward.
- Rotates 360°.
- Pans 180° at base; 360° between extension and arm. Rotation stop on base can be disengaged at time of installation to increase range to a full 360°.
- Extends LCD monitor out 22.2”(559mm).
- Arm folds back over base into a compact retracted position; perfect for tucking under systems furniture storage shelves or cabinets in space constrained areas.
- Integrated cord management.
- One touch adjustment.

To Order, Specify:

- 1) Product number.

Specification Tips

- Desk clamp mounts on worksurface 0.47”(0mm) - 1.25”(25mm) thick.
- Desk clamp has anti-rotation screws to prevent base from slipping.
- Grommet mount available; separately specified part 98-110.
- For additional mounting options refer to pages 114-116.

Dual Arm

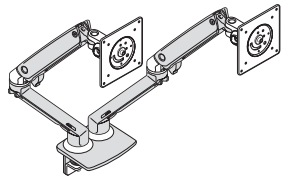

45-496

Polished Aluminum	45-496-026	\$648.79
White	45-496-216	648.80
Matte Black	45-496-224	648.80

Features

- Includes: Fully assembled slim profile dual arm, two-piece desk clamp, and mounting hardware.
- For use with screen 24”(610mm) or smaller. Screen size may affect adjustment capability.
- Accommodates monitors from 7-20 pounds.
- Height adjustment range is 13”(330mm).
- Tilts 90° backward and 90° forward.
- Rotates 360°.
- Pans 180° at base; 360° between extension and arm. Rotation stop on base can be disengaged at time of installation to increase range to a full 360°.
- Extends LCD monitor out 22.2”(559mm).
- Arm folds back over base into a compact retracted position; perfect for tucking under systems furniture storage shelves or cabinets in space constrained areas.
- Integrated cord management.
- One touch adjustment.

To Order, Specify:

- 1) Product number.

Specification Tips

- Desk clamp mounts on worksurface .047”(0mm) - 1.25”(25mm) thick.
- Desk clamp has anti-rotation screws to prevent base from slipping.
- Grommet mount available; separately specified part 98-111.
- For additional mounting options refer to pages 114-116.

Ergotron Monitor Arms

MX Desk Mount

	Description	Number	Price
Single Arm	Polished Aluminum	45-214-026	\$384.86

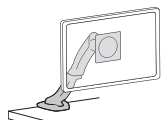

45-214-026

Features

- Includes: Adjustable height monitor arm, desk clamp and grommet mount.
- For use with screen 30”(762mm) or smaller.
- Accommodates monitors from 14-30 pounds.
- Height adjustment range is 5”(127mm).
- Tilts 75° up and 5° down from center.
- Rotates 90°.
- Pans 360°.
- Extends LCD's out up to 17”(432mm).
- Integrated cable management.
- One touch adjustment.

To Order, Specify:

- 1) Product number.

Specification Tips

- Desk clamp mounts on worksurface 0.4”(10mm)-2.5”(64mm) thick.
- Grommet mounts attach through surface holes 0.31”(8mm)-2”(51mm) wide and up to 3”(76mm) thick.

MX Mini Desk Mount	Polished Aluminum	45-436-026	\$368.22
---------------------------	-------------------	------------	-----------------

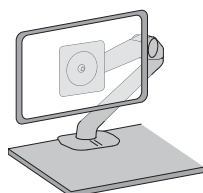

45-436-026

Features

- Includes: Adjustable height monitor arm, desk clamp and grommet mount.
- For use with screen 24”(610mm) or smaller.
- Weight capacity is 8 pounds.
- Height adjustment range is 13”(330mm).
- Tilts 90° up and 5° down from center.
- Rotates 360°.
- Pans 360°.
- Extends LCD's out up to 19.5”(495mm).
- Integrated cord management.
- One touch adjustment

To Order, Specify:



- 1) Product number.

Specification Tips

- Desk clamp mounts on worksurface 0.4”(10mm)-2.5”(64mm) thick.
- Grommet mounts attach through surface holes 0.31”(8mm)-2”(51mm) wide and up to 3”(76mm) thick.
- Can be installed on Ergotron WorkFit-T or TL.
- For additional mounting options refer to pages 114-116.

Ergotron Monitor Arm

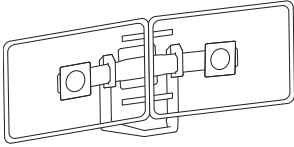
Accessories

	Description	Number	Price
Dual Monitor and Handle Kit	Polished Aluminum/Black	97-783	\$202.98
 <p data-bbox="45 449 94 468">97-783</p>	<p>Features</p> <ul style="list-style-type: none"> Includes: Monitor bow, two monitor pivots, handle and mounting hardware. For use with screens 26"(660mm) or smaller. Maximum weight capacity is 18 pounds per arm. Maximum combined weight is 36 pounds. Rotates 360°. Arm in polished aluminum, bow and handle in black. 	<p>To Order, Specify:</p> <p>1) Product number.</p>	
	<p>Specification Tips</p> <ul style="list-style-type: none"> This product adds an additional 6 pounds to your mounting solution. Monitor arm's maximum weight capacity must be reduced by 6 pounds. Attaches to mounts with four-hole interface of 50 x 50 mm or 100 x 100 mm. 		
Monitor Quick Release LCD Bracket	Black	60-589-060	\$34.98
 <p data-bbox="45 858 123 875">60-589-060</p>	<p>Features</p> <ul style="list-style-type: none"> Includes: Bracket, screws and stand-offs. For use with monitors less than 3"(76mm) thick. Bracket weighs 1.2 pounds and is 0.5"(13mm) thick. Weight of the bracket needs to be considered when determining weight capacity of the monitor arm. 	<p>To Order, Specify:</p> <p>1) Product number.</p>	

Ergotron Monitor Arms

Neo-Flex

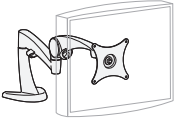
	Description	Number	Price
 <p>45-174-300</p>	Neo-Flex Silver	45-174-300	\$191.12
	Features <ul style="list-style-type: none"> • Includes: Arm, extension, LCD pivot, desk clamp and grommet mount. • For use with screen 22"(559mm) or smaller. • Maximum weight capacity 18 pounds. • Height adjustment range is 8"(203mm). • Tilts 180° up and down. • Rotates 360°. • Pans 360°. • Extends LCD's out up to 19.3"(490mm). • Integrated cord management. 		To Order, Specify: 1) Product number.
Specification Tips <ul style="list-style-type: none"> • Desk clamp mounts to surfaces up to 2"(51mm) thick. • Grommet mounts attach through surface holes up to 2"(51mm) wide and up to 1.75"(44mm) thick. 			

	Description	Number	Price
 <p>45-235-194</p>	Neo-Flex Extend Polished Aluminum	45-235-194	\$279.48
	Features <ul style="list-style-type: none"> • Includes: Two extensions, LCD pivot, desk clamp and grommet mount. • For use with screen 24"(610mm) or smaller. • Weight capacity 7-20 pounds. • Pole height adjustment range is 9.5"(241mm). • Tilts 75° up and 5° down from center. • Rotates 360°. • Pans 360°. • Extends LCD's out up to 22"(559mm). • Integrated cable management. 		To Order, Specify: 1) Product number.
Specification Tips <ul style="list-style-type: none"> • Desk clamp mounts on worksurface 0.5"(13mm)-2"(51mm) thick. • Grommet mounts attached through surface holes 0.3"(8mm)-2"(51mm) wide and up to 2.5"(64mm) thick. 			

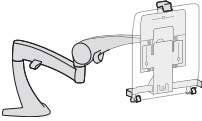
	Description	Number	Price
 <p>45-306-101</p>	Neo-Flex Tablet Black	45-306-101	\$256.26
	Features <ul style="list-style-type: none"> • Includes: Arm, optional extension, tablet cradle, desk clamp and grommet mount. • Accommodates tablets with a minimum size of 5.5"(140mm) x 8"(203mm) and a maximum size of 8"(203mm) x 9.75"(248mm). Depth of tablet cannot exceed 0.75"(19mm). • Maximum weight capacity is 2.5 pounds. • Height adjustment range is 8"(203mm). • Tilts 180°. • Pans 360°. • Rotates 360°. • Extends tablets out up to 19.3"(490mm). 		To Order, Specify: 1) Product number.
Specification Tips <ul style="list-style-type: none"> • Desk clamp mounts on worksurface 0.5"(13mm)-1.8"(46mm) thick. • Grommet mounts attached through surface holes 0.3"(8mm)-2"(51mm) wide and up to 1.75"(44mm) thick. 			



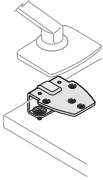
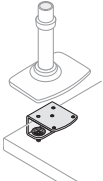
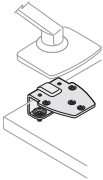
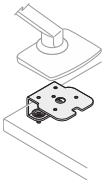

Ergotron Monitor Arm Accessories

Under Mount C-Clamp

	Description	Number	Price
Under Mount C-Clamp for LX Dual Side-by-Side, LX Dual Stacking, LX Desk Mount Tall Pole  98-236-009 98-082	Black	98-236-009	\$54.56
	White	98-082	54.56
Feature <ul style="list-style-type: none"> Includes: Under mount C-clamp and mounting hardware and two extension screws. 		To Order, Specify: 1) Product number.	
Specification Tips <ul style="list-style-type: none"> Compatible with LX Dual Side-by-Side Arm and LX Dual Stacking Arm as well as Single Monitor LX Desk Mount Arm (tall pole). Clamp can slide on from side of worksurface. Installation from the rear requires 1.2"(25mm) from edge of desktop to wall to slide clamp on. Attaches to surface edge 0.5"(0mm) - 1.26"(25mm) thick. For use when mounting monitor arm to Intuity with Access Hatches to avoid understructure interference with the standard two-piece clamp included with the arm. 			
Under Mount C-Clamp for LX Desk Mount Single, LX Dual Direct, and MXV Monitor Arms  45-306-101 98-083	Black	98-235-009	\$54.56
	White	98-083	54.56
Feature <ul style="list-style-type: none"> Includes: Under mount C-clamp and mounting hardware and two extension screws. 		To Order, Specify: 1) Product number.	
Specification Tips <ul style="list-style-type: none"> Compatible with LX Desk Mount Arm, LX Dual Direct Arm and MXV Arms. Clamp can slide on from side of worksurface. Installation from the rear requires 1.2"(25mm)1.2" from edge of desktop to wall to slide clamp on. Attaches to surface edge 0.5"(0mm) - 1.26"(25mm) thick. For use when mounting monitor arm to Intuity with Access Hatches to avoid understructure interference with the standard two-piece clamp included with the arm. 			
Under Mount C-Clamp for use with HX Arms  98-081	White	98-081	\$54.56
	Feature <ul style="list-style-type: none"> Includes: Under mount C-clamp, mounting hardware. 		To Order, Specify: 1) Product number.
Specification Tips <ul style="list-style-type: none"> Compatible with HX Desk Single and Dual Monitor Arms. Clamp can slide on from side of worksurface. Installation from the rear requires 1.2"(25mm) from edge of desktop to wall to slide clamp on. Attaches to surface edge 0.5"(0mm) - 1.26"(25mm) thick. For use when mounting monitor arm to Intuity with Access Hatches to avoid understructure interference with the standard two-piece clamp included with the arm. 			
Under Mount C-Clamp for MX Mini Desk Mount Arms  98-084	White	98-084	\$54.56
	Feature <ul style="list-style-type: none"> Includes: Under mount C-clamp and mounting hardware. 		To Order, Specify: 1) Product number.
Specification Tips <ul style="list-style-type: none"> Compatible with MX Mini Desk Mount Arm only. Clamp can slide on from side of worksurface. Installation from the rear requires 1.2"(25mm) from edge of desktop to wall to slide clamp on. Attaches to surface edge 0.5"(0mm) - 1.26"(25mm) thick. For use when mounting monitor arm to Intuity with Access Hatches to avoid understructure interference with the standard two-piece clamp included with the arm. 			

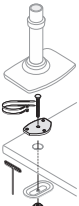
Ergotron Monitor Arm Accessories

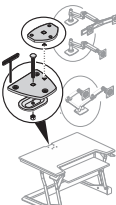
Grommet Mount

	Description	Number	Price
 <p>98-034</p>	Grommet Mount for LX Single and Dual Direct Arms	98-034	\$18.97
	<p>Feature</p> <ul style="list-style-type: none"> Includes: Grommet plate and attachment hardware. <p>Specification Tips</p> <ul style="list-style-type: none"> Compatible with LX Dual Direct Arm and the single monitor LX Desk Mount Arm (standard pole). Mounts through surface .31"(8mm) - 2"(51mm) wide and 3"(76mm) thick. 	<p>To Order, Specify:</p> <p>1) Product number.</p>	
 <p>98-035</p>	Grommet Mount for LX Dual Arm	98-035	\$28.46
	<p>Feature</p> <ul style="list-style-type: none"> Includes: Grommet plate and attachment hardware. <p>Specification Tips</p> <ul style="list-style-type: none"> Compatible with LX Dual Side-by-Side Arm and LX Dual Stacking Arm as well as Single Monitor LX Desk Mount Arm (tall pole). Mounts through surface .31"(8mm) - 2"(51mm) wide and 3"(76mm) thick. 	<p>To Order, Specify:</p> <p>1) Product number.</p>	
 <p>98-017</p>	Grommet Mount for LX Arm on WorkFit-T/TL	Zinc Plated Steel 98-017	\$29.51
	<p>Feature</p> <ul style="list-style-type: none"> Includes: Grommet plate and attachment hardware. <p>Specification Tips</p> <ul style="list-style-type: none"> Compatible with LX Dual Side-by-Side Arm and LX Dual Direct and LX Desk Mount Arm. Mounts through surface .31"(8mm) - 2"(51mm) wide and 3"(76mm) thick. Weight capacity: <ul style="list-style-type: none"> -LX Desk Mount Arm - 14 pounds -LX Dual Direct Arm - 4.8 pounds per monitor -LX Dual Side-by-Side Arm - 6 pounds per monitor Weight capacity is limited when mounting LX arms on WorkFit T/TL. 	<p>To Order, Specify:</p> <p>1) Product number.</p>	
 <p>98-110</p>	Grommet Mount for MXV Single Monitor Arm	98-110	\$20.02
	<p>Feature</p> <ul style="list-style-type: none"> Includes: Grommet plate and attachment hardware. <p>Specification Tips</p> <ul style="list-style-type: none"> Compatible with MXV Single Monitor Arm. Mounts through surface .31"(8mm) - 1.25"(32mm) wide and less than or equal to 1.3"(33mm) thick. 	<p>To Order, Specify:</p> <p>1) Product number.</p>	
 <p>98-111</p>	Grommet Mount for MXV Dual Monitor Arm	98-111	\$30.57
	<p>Feature</p> <ul style="list-style-type: none"> Includes: Grommet plate and attachment hardware. <p>Specification Tips</p> <ul style="list-style-type: none"> Compatible with MXV Dual Monitor Arm. Mounts through surface .31"(8mm) - 1.25"(32mm) wide and less than or equal to 1.3"(33mm) thick. 	<p>To Order, Specify:</p> <p>1) Product number.</p>	

Ergotron Monitor Arm Accessories

Top Mount C-Clamp

	Description	Number	Price
Top Mount C-Clamp for LX Single, LX Dual Direct, and MXV Single Monitor Arms	Black	98-237-009	\$57.71
	White	98-121	57.71

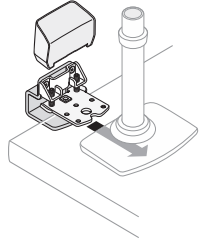

98-237-009
98-121

Feature

- Includes: Top mount C-Clamp and mounting hardware.

To Order, Specify:

- 1) Product number.

Specification Tips

- Compatible with LX Single, LX Dual Direct and MXV single monitor arms.
- Clamp can slide on from side of worksurface. Installation from the rear requires 2.7”(69mm) from edge of desktop to wall to slide clamp on.
- Attaches to surface edge 0.5”(13mm) - 1.26”(32mm) thick.
- Ergonomic installation can be completed from the top of the surface, no crawling under desks necessary.

Top Mount C-Clamp for LX Dual Side-by-Side and Stacking, LX Desk Mount Tall Pole, and MXV Dual Monitor Arms	Black	98-238-009	\$57.71
	White	98-125	57.71

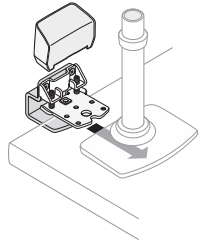

98-238-009
98-125

Feature

- Includes: Top mount C-Clamp and mounting hardware.

To Order, Specify:

- 1) Product number.

Specification Tips

- Compatible with LX Dual Side-by-Side, LX Dual Stacking, LX Desk Mount Tall Pole, and MXV dual monitor arms.
- Clamp can slide on from side of worksurface. Installation from the rear requires 2.7”(69mm) from edge of desktop to wall to slide clamp on.
- Attaches to surface edge 0.5”(13mm) - 1.26”(32mm) thick.
- Ergonomic installation can be completed from the top of the surface, no crawling under desks necessary.

Top Mount C-Clamp for HX Arms	White	98-122	\$57.71
--------------------------------------	-------	--------	---------

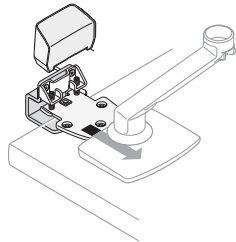

98-122

Feature

- Includes: Top mount C-Clamp and mounting hardware and two extension screws.

To Order, Specify:

- 1) Product number.

Specification Tips

- Compatible with HX Desk Single and Dual Arms and HX triple bow kit.
- Clamp can slide on from side of worksurface. Installation from the rear requires 2.7”(69mm) from edge of desktop to wall to slide clamp on.
- Attaches to surface edge 0.5”(13mm) - 1.26”(32mm) thick.
- Ergonomic installation can be completed from the top of the surface, no crawling under desks necessary.

Top Mount C-Clamp for MX Mini Arms	White	98-126	\$57.71
---	-------	--------	---------

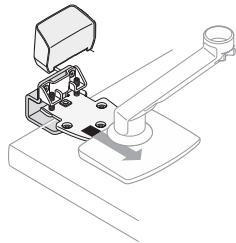

98-126

Feature

- Includes: Top mount C-Clamp and mounting hardware.

To Order, Specify:

- 1) Product number.

Specification Tips

- Compatible with MX Mini Arm only.
- Clamp can slide on from side of worksurface. Installation from the rear requires 2.7”(69mm) from edge of desktop to wall to slide clamp on.
- Attaches to surface edge 0.5”(13mm) - 1.26”(32mm) thick.
- Ergonomic installation can be completed from the top of the surface, no crawling under desks necessary.

Ergotron WorkFit-A — Single Attached Sit-Stand Workstation

Description	Height	Depth	Width	Number	Price
LD — Light Duty with WorkSurface					
Polished Aluminum/Black	42.7"(1085mm)	16.9"(429mm)- 43.7"(1110mm)	27"(686mm)	24-317-026	\$ 983.58
LD — Light Duty with WorkSurface and Suspended Keyboard					
Polished Aluminum/Black	38.8"(986mm)	16.9"(429mm)- 43.7"(1110mm)	27"(686mm)	24-390-026	\$1030.57
HD — Heavy Duty with Worksurface and Suspended Keyboard					
Polished Aluminum/Black	38.8"(986mm)	16.9"(429mm)- 43.7"(1110mm)	27"(686mm)	24-391-026	\$1101.56

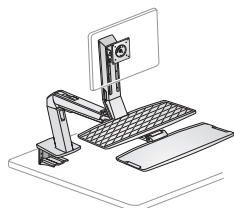

24-317-026
LD with Worksurface

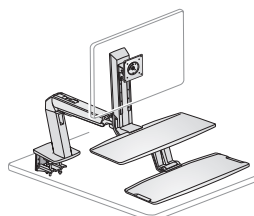

24-390-026
LD with Suspended Keyboard

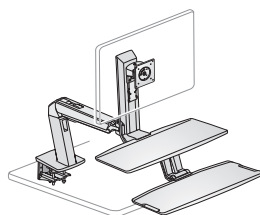

24-391-026
HD with Suspended Keyboard

Features

- Includes: Height-adjustment column, desk clamp, LCD pivot, keyboard tray, worksurface (when applicable) and hardware.
- Grommet mount included on models with suspended keyboard tray.
- Keyboard tray dimensions: 9.75"(248mm) D x 27"(686mm)W.
- Worksurface dimensions: 9.75"(248mm) D x 23"(584mm)W.
- Height adjustment range is 20"(508mm) with LCD and keyboard tray in tandem. LCD's adjust 5"(127mm) independently from worksurface. Maximum LCD height adjustment is 25"(635mm).
- Tilts 30°.
- Pans 180°.
- Rotates 90°.
- In seated position, suspended keyboard tray can drop down approximately 4"(102mm) below desktop surface.
- Integrated cable management.
- Black with polished aluminum arm extension and base.

To Order, Specify:

- 1) Product number.

Specification Tips

- Desk clamp mounts on worksurface up to 31.5"(800mm) deep and 0.78"(29mm)-2.6"(66mm) thick.
- Keyboard tray can be installed in three different positions: centered, offset right or offset left.

Description	Maximum Screen Size	Weight Capacity			
		Total	LCD	Keyboard Tray	Worksurface
LD with Worksurface	24"(610mm)	20 lbs.	5-15 lbs.	5 lbs.	5 lbs.
LD with Suspended Keyboard	24"(610mm)	20 lbs.	5-15 lbs.	5 lbs.	5 lbs.
HD with Suspended Keyboard	27"(686mm)	25 lbs.	10-20 lbs.	5 lbs.	5 lbs.

Ergotron WorkFit-A — Dual Attached Sit-Stand Workstation

Description	Height	Depth	Width	Number	Price
Without Worksurface	42.7"(1085mm)	16.9"(429mm)- 43.7"(1110mm)	27"(686mm)	24-312-026	\$ 875.16
With Worksurface	42.7"(1085mm)	16.9"(429mm)- 43.7"(1110mm)	27"(686mm)	24-316-026	1081.88
With Worksurface and Suspended Keyboard	38.8"(986mm)	16.9"(429mm)- 43.7"(1110mm)	27"(686mm)	24-392-026	1125.64

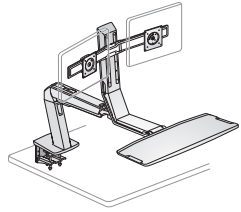

24-312-026

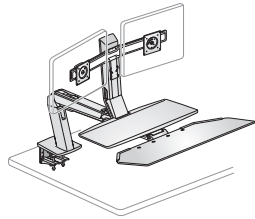

24-316-026

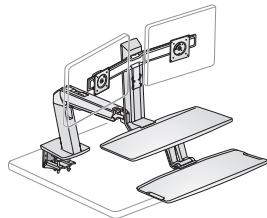

24-392-026

Features

- Includes: Arm, two LCD pivots, worksurface (if applicable), crossbow, keyboard tray, desk clamp and hardware.
- For use with screen 24"(610mm) or smaller.
- Maximum weight capacity:
 - Total capacity 25 pounds
 - LCD - 4.5-10 pounds each.
 - Keyboard tray - 2 pounds
 - Worksurface - 5 pounds
- Keyboard tray dimension: 9.75"(248mm) D x 27"(686mm) W.
- In seated position, keyboard tray can drop down approximately 4"(102mm) below desktop surface.
- Worksurface dimension: 9.75"(248mm) D x 22.63"(575mm) W.
- Height adjustment range is 20"(508mm) with LCD and keyboard tray in tandem. LCD's adjust 5"(127mm) independently from worksurface. Maximum LCD height adjustment is 25"(635mm).
- Pans 180°.
- Rotates 360°.
- Integrated cable management.
- Black with polished aluminum extension and base.

To Order, Specify:

- 1) Product number.

Specification Tips

- Desk clamp mounts on worksurface up to 31.5"(800mm) deep and 0.5"(13mm) - 2.5(64mm) thick.
- Minimum weight capacity of 12 pounds to ensure proper operation.
- Keyboard tray can be installed in three different positions: centered, offset right or offset left.

Ergotron WorkFit-S — Single Attached Sit-Stand Workstation

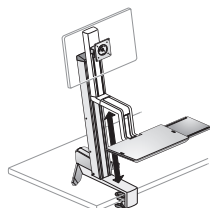

33-342-200

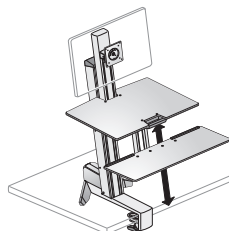

33-350-200
33-350-211

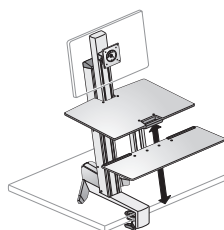

33-351-200
33-351-211

Description	Height	Depth	Width	Number	Price
LD — Light Duty					
Black	29.4(747mm)-35"(889mm)	16.3"(414mm)	24"(610mm)	33-342-200	\$ 838.44
LD — Light Duty with WorkSurface					
Black	29.4(747mm)-35"(889mm)	16.3"(414mm)	27"(686mm)	33-350-200	\$1096.48
White	29.4(747mm)-35"(889mm)	16.3"(414mm)	27"(686mm)	33-350-211	1096.48
HD — Heavy Duty with Worksurface					
Black	29.4(747mm)-35"(889mm)	16.3"(414mm)	27"(686mm)	33-351-200	\$1241.20
White	29.4(747mm)-35"(889mm)	16.3"(414mm)	27"(686mm)	33-351-211	1241.20

Features

- Includes: Height-adjustment column, desk clamp, LCD pivot, keyboard tray, and left/right mouse tray or worksurface when applicable.
- Keyboard tray dimensions:
 - Without Worksurface - 9.3"(236mm) D x 16.5"(419mm) W.
 - With Worksurface - 9"(229mm) D x 27"(686mm) W.
- Worksurface dimensions: 15"(381mm) D x 23"(584mm) W.
- Mouse tray available on no worksurface model only. May be installed on left or right side of keyboard tray. Dimensions: 7.9"(201mm) D x 7.5"(191mm) W.
- Height adjustment range is 18"(457mm) with LCD and keyboard tray in tandem. LCD's adjust 5"(127mm) independently. Maximum LCD height adjustment is 23"(584mm).
- Tilts 30°.
- Rotation: LD rotates 360°. HD rotates 90°.
- Keyboard tray tilts back 5°.

To Order, Specify:

- 1) Product number.

Specification Tips

- Desk clamp mounts on front of worksurface 0.5"(13mm)-2.4"(61mm) thick.
- Height measured from desktop to lowest and highest positions.

Description	Maximum Screen Size	Weight Capacity			
		Total	LCD	Keyboard Tray	Worksurface
LD	24"(610mm)	24 lbs.	6-16 lbs.	5 lbs.	NA
LD with Worksurface	24"(610mm)	24 lbs.	6-16 lbs.	5 lbs.	5 lbs.
HD with Worksurface	30"(762mm)	29 lbs.	16-28 lbs.	5 lbs.	5 lbs.

Ergotron WorkFit-S — Dual Attached Sit-Stand Workstation

Description	Height	Depth	Width	Number	Price
Without Worksurface					
Black	29.4(747mm)-35"(889mm)	16.3"(414mm)	24"(610mm)	33-341-200	\$ 896.58
With Worksurface					
Black	29.4(747mm)-35"(889mm)	16.3"(414mm)	27"(686mm)	33-349-200	\$1159.74
White	29.4(747mm)-35"(889mm)	16.3"(414mm)	27"(686mm)	33-349-211	1169.94

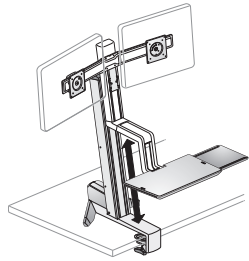

33-341-200

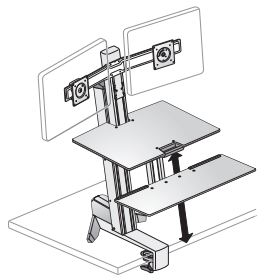

33-349-200
33-349-211

Features

- Includes: Height-adjustment column, desk clamp, crossbar, two LCD pivots, keyboard tray, and left/right mouse tray or worksurface when applicable.
- For use with screen 24"(610mm) or smaller.
- Maximum weight capacity:
 - Total capacity 31 pounds.
 - LCD - 6-14 pounds without worksurface. With worksurface LCD weight capacity 6-12 pounds..
 - Keyboard tray - 5 pounds.
 - Worksurface (when specified) - 5 pounds
- Keyboard tray dimensions:
 - Without Worksurface - 9.3"(236mm) D x 16.5"(419mm) W.
 - With Worksurface - 9"(229mm) D x 27"(686mm) W.
- Mouse tray available on without worksurface model only. May be installed on left or right side of keyboard tray. Dimensions: 7.9"(201mm) D x 7.5"(191mm) W.
- Worksurface dimensions: 15"(381mm) D x 23"(584mm) W.
- Height adjustment range is 18"(457mm) with LCD and keyboard tray in tandem. LCD's adjust 5"(127mm) independently. Maximum LCD height adjustment is 23"(584mm).
- Rotates 90°.
- Keyboard tray tilts back 5°.

To Order, Specify:

- 1) Product number.

Specification Tips

- Desk clamp mounts on front of worksurface 0.5"(13mm)-2.4"(61mm) thick.
- Height measured from desktop to lowest and highest positions.

Ergotron WorkFit-SR — Single Attached Sit-Stand Workstation

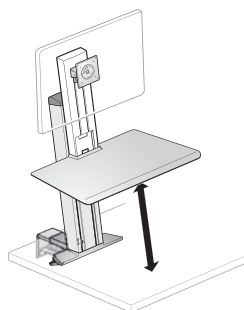

33-415-085
33-415-062

Description	Height	Depth	Width	Number	Price
Standard					
Black	28.9(734mm)-37"(940mm)	24.2"(615mm)	29.5"(749mm)	33-415-085	\$1305.60
White	28.9(734mm)-37"(940mm)	24.2"(615mm)	29.5"(749mm)	33-415-062	1305.60

Features

- Includes: Height-adjustment column, LCD pivot, worksurface, one USB extension cable, one cable wrap and desk clamp.
- For use with screen size 24"(610mm) or smaller.
- Maximum weight capacity:
 - Total capacity 24 lbs.
 - LCD 3-13 lbs.
 - Worksurface 5 lbs.
- Worksurface dimensions: 22"(559mm) D x 29.5"(749mm) W.
- Height adjustment range is 18"(457mm) with monitor and keyboard in tandem. Monitors have an additional 5"(127mm) of independent lift.
- Tilts 30°.
- Rotates 360°.
- Integrated cable management.
- Standard with pre-installed USB cable.

To Order, Specify:

- 1) Product number.

Specification Tips

- Desk clamp attaches to the rear of surfaces up to 2.5"(64mm) thick.
- Recommended for use on 30"(762mm)-36"(914mm) worksurfaces. Desks shorter than 30"(762mm) worksurface will extend beyond desktop edge. Desks deeper than 36"(914mm), worksurface will not extend to desktop edge.
- Short surface model available for worksurfaces less than 30"(762mm) deep.
- Height measured from desktop to lowest and highest positions.

Ergotron WorkFit-SR — Dual Attached Sit-Stand Workstation

Description	Height	Depth	Width	Number	Price
Black	28.9(734mm)- 37”(940mm)	25.2”(640mm)	29.5”(749mm)	33-407-085	\$1467.44
White	28.9(734mm)- 37”(940mm)	25.2”(640mm)	29.5”(749mm)	33-407-062	1467.44

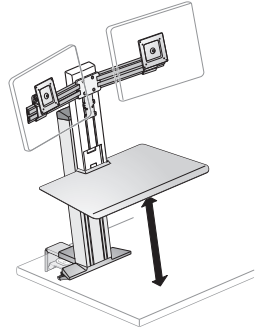

33-407-085
33-407-062

Features

- Includes: Height-adjustment column, crossbar, two LCD pivots, worksurface, one USB extension cable, two cable wraps and desk clamp.
- For use with screen 24”(610mm) or smaller.
- Maximum weight capacity:
 - Total capacity 25 pounds.
 - Monitor arm 3-11 pounds each.
 - Worksurface 5 pounds.
- Worksurface dimensions: 22”(559mm) D x 30”(762mm) W.
- Height adjustment range is 18”(457mm) with monitor and keyboard in tandem. Monitors lift independently 5”(127mm) additional.
- Tilts 35°.
- Rotates 360°.

To Order, Specify:

- 1) Product number.

Specification Tips

- Desk clamp attaches to rear of surfaces up to 2.5”(64mm) thick.
- Recommended for use on 30”(762mm)-36”(914mm) worksurfaces. Desks shorter than 30”(762mm) worksurface will extend beyond desktop edge. Desks deeper than 36”(914mm), worksurface will not extend to desktop edge.
- Height measured from desktop to lowest and highest positions.

Ergotron WorkFit-T — Desktop Sit-Stand Workstation

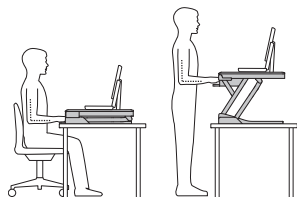
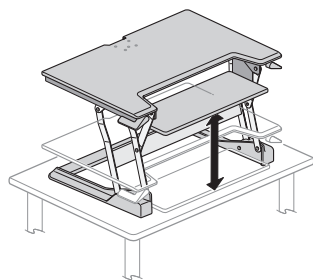

33-397-085
33-397-062

Description	Depth	Width	Number	Price
Black	25"(635mm)	35"(889mm)	33-397-085	\$837.86
White	25"(635mm)	35"(889mm)	33-397-062	837.86

Features

- Includes: One height adjustable workstation with keyboard tray.
- For use with screen 30"(762mm) or smaller.
- Maximum weight capacity: 10-35 pounds.
- Keyboard tray dimensions are 25"(635mm) W x 9"(229mm) D.
- Total height adjustment range is 15"(381mm). Monitor and keyboard move in tandem.
- Keyboard tray sits 4.5"(114mm) below WorkFit worksurface.
- Ships fully assembled.

To Order, Specify:

- 1) Product number.

Specification Tips

- Fits on surfaces 24"(610mm) deep or larger including corner surfaces.
- Monitor can be placed directly on the worksurface or monitor mount can be used; sold separately.

Ergotron WorkFit-TL — Desktop Sit-Stand Workstation

Description	Depth	Width	Number	Price
Black	27"(686mm)	37.5"(953mm)	33-406-085	\$ 863.36
White	27"(686mm)	37.5"(953mm)	33-406-062	863.36
Black - TAA Compliant	27"(686mm)	37.5"(953mm)	33-418-085	1264.80

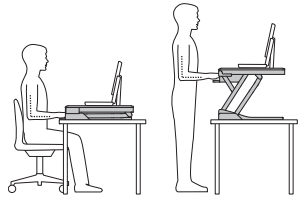
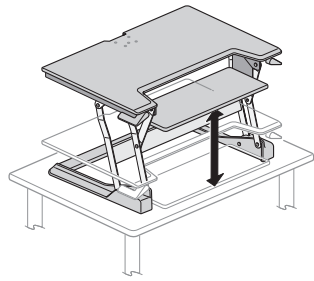

33-406-085
33-406-062
33-418-085

Features

- Includes: One height adjustable workstation with keyboard tray.
- TAA compliant version assembled in the USA in black only.
- For use with screen 30"(762mm) or smaller.
- Maximum weight capacity: 10-40 pounds.
- Keyboard tray dimensions are 27.5"(699mm) W x 11"(279mm) D.
- Total height adjustment range is 15"(381mm). Monitor and keyboard move in tandem.
- Keyboard tray sits 4.5"(114mm) below WorkFit worksurface.
- Ships fully assembled.

To Order, Specify:

- 1) Product number.

Specification Tips

- Fits on desks 24"(610mm) deep or larger.
- Monitor can be placed directly on the worksurface or monitor mount can be used; sold separately.

Ergotron WorkFit LX - Sit-Stand Desk Mount System

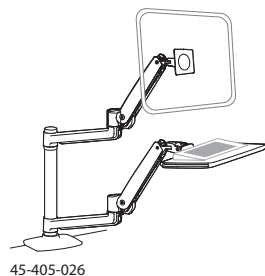

45-405-026

Description	Number	Price
Polished Aluminum	45-405-026	\$1296.42

Features

- Includes: Monitor arm, two extensions, keyboard arm and tray, slide-out mouse tray, pole, two pole collars, desk clamp, grommet mount, VESA brackets, wrist rest and hardware.
- For use with screen 42”(1067mm) or smaller.
- Maximum weight capacity:
 - Monitor arm 7-25 pounds.
 - Keyboard arm 5 pounds.
- Keyboard tray dimensions: 8.9”(226mm) D x 18.3”(465mm) W.
- Keyboard tray tilts back 5°.
- Mouse tray dimensions: 8”(203mm) D x 8”(203mm) W.
- Height adjustment range is 20”(508mm).
- Side-to-Side movement range of 62”(1575mm).
- Arm extension is 33”(838mm).
- Tilts 75°.
- Pans 360°.
- Rotates 360°.
- Mouse Tray may be installed on the left or right side.

To Order, Specify:

- 1) Product number.

Specification Tips

- Desk clamp attaches to rear edge up to 2.5”(64mm) thick.
- Grommet mount attaches through hole 0.5”(13mm) to 2.5”(64mm) wide and up to 2.25”(57mm) thick.

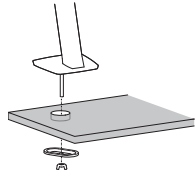
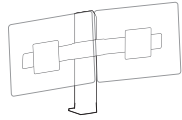
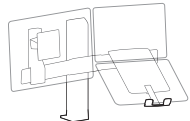

Ergotron WorkFit — Accessories

WorkFit-A

	Description	Number	Price
Grommet Mount	Polished Aluminum/Black	97-692	\$53.28
 <p>97-692</p>	<p>Features</p> <ul style="list-style-type: none"> • Includes one grommet mount. • For use with WorkFit-A. • Black pole and hardware with polished aluminum base. <hr/> <p>Specification Tips</p> <ul style="list-style-type: none"> • Attaches through surface hole 0.5”(13mm) to 2.5”(64mm) wide and up to 2.6”(66mm) thick. • For maximum support, screw should be centered through hole. 	<p>To Order, Specify:</p> <p>1) Product number.</p>	
Conversion Kit Single HD to Dual	Black	97-606	\$115.96
 <p>97-606</p>	<p>Features</p> <ul style="list-style-type: none"> • Includes: Crossbar, two monitor pivots and mounting hardware. • Converts WorkFit-A single HD workstation into a WorkFit Dual workstation. • For use with screens 24”(610mm) or smaller. • Pivots 360°. • LCD weight capacity is 6-14 pounds. • Total weight capacity is contingent on the WorkFit platform to which the kit is added. <hr/> <p>Specification Tips</p> <ul style="list-style-type: none"> • Compatible with WorkFit-A products. • Not for use with WorkFit-S. 	<p>To Order, Specify:</p> <p>1) Product number.</p>	
Conversion Kit Single HD to LCD & Laptop	Black	97-605	\$166.91
 <p>97-605</p>	<p>Features</p> <ul style="list-style-type: none"> • Includes: Laptop tray, riser bracket, LCD pivot and mounting hardware. • Converts WorkFit-A single HD workstation into a WorkFit LCD and laptop workstation. • For use with screens 20”(508mm) or smaller. • Monitor tilts 30°. • Rotates 360°. • LCD weight capacity is 6-16 pounds. • Laptop weight capacity is 10 pounds. • Total weight capacity is contingent on the WorkFit platform to which the kit is added. <hr/> <p>Specification Tips</p> <ul style="list-style-type: none"> • Compatible with WorkFit-A products. • Not for use with WorkFit-S. 	<p>To Order, Specify:</p> <p>1) Product number.</p>	

Ergotron WorkFit — Accessories

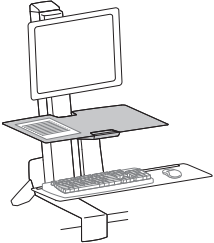
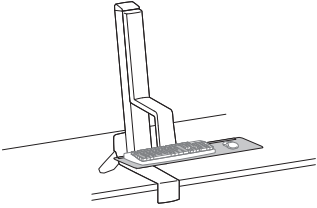
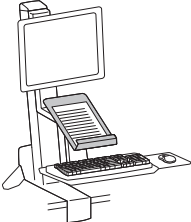
WorkFit-S

	Description	Height	Depth	Width	Number	Price
 <p>97-581-019</p>	Black	.25"(6mm)	15"(381mm)	23"(584mm)	97-581-019	\$185.28
	Features <ul style="list-style-type: none"> Includes: Worksurface, mounting brackets and mounting hardware. For use on WorkFit-S workstation. Weight capacity is 5 pounds. 				To Order, Specify: 1) Product number.	
<hr/>						
 <p>97-653</p>	Black	.25"(6mm)	9"(229mm)	27"(686mm)	97-653	\$101.68
	Features <ul style="list-style-type: none"> Includes: Keyboard tray and mounting hardware. For use on WorkFit-S workstation. Weight capacity is 5 pounds. 				To Order, Specify: 1) Product number.	
<hr/>						
 <p>97-558-200</p>	Black	10.7"(272mm)	1.5"(38mm)	7.25"(184mm)	97-558-200	\$58.14
	Features <ul style="list-style-type: none"> Includes: document holder, handle and mounting hardware. For use with WorkFit-S. Maximum weight capacity: 2.2 pounds 				To Order, Specify: 1) Product number.	
<hr/>						
 <p>97-649-085</p>	Black				97-649-085	\$38.76
	Features <ul style="list-style-type: none"> Includes one grommet mount. For use with WorkFit-S. 				To Order, Specify: 1) Product number.	
<hr/>						
Specification Tips <ul style="list-style-type: none"> Installs in three different positions under laptop or displays. Tablet/Document Holder may reduce WorkFit's 5"(127mm) independent height adjustment range for displays. When added to the WorkFit-S, total weight capacity of workstation is reduced by 1 pound. Not for use with WorkFit-S worksurface. 						

Ergotron WorkFit — Accessories

WorkFit-A / WorkFit-S

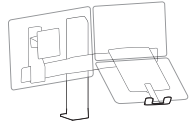
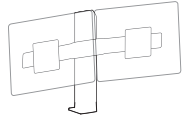
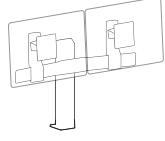
	Description	Number	Price
Conversion Kit: Dual to LCD & Laptop	<p>Black</p> <p>Features</p> <ul style="list-style-type: none"> • Includes: Laptop tray, riser bracket, monitor pivot and mounting hardware. • Converts WorkFit-S or WorkFit-A Dual workstation into a WorkFit LCD and laptop workstation. • For use with screens 24”(610mm) or smaller. • Monitor tilts 30°. • Pans 180°. • Monitor rotates 360°. • Weight capacity is contingent on the WorkFit platform to which the kit is added. 	97-617	\$126.19
 <p>97-617</p>	<p>To Order, Specify:</p> <p>1) Product number.</p> <hr/> <p>Specification Tip</p> <ul style="list-style-type: none"> • Compatible with WorkFit-A or WorkFit-S workstation. 		
Conversion Kit: LCD & Laptop to Dual	<p>Black</p> <p>Features</p> <ul style="list-style-type: none"> • Includes: Two monitor pivots and mounting hardware. • Converts WorkFit-S or WorkFit-A LCD & Laptop workstation into a Dual Workstation. • For use with screens 22”(559mm) or smaller. • Rotates 360°. • Weight capacity is contingent on the WorkFit platform to which the kit is added. 	97-616	\$73.63
 <p>97-616</p>	<p>To Order, Specify:</p> <p>1) Product number.</p>		
Tall-User Kit for WorkFit Dual	<p>Black</p> <p>Features</p> <ul style="list-style-type: none"> • Includes: Two monitor pivots, two riser brackets and mounting hardware. • Converts WorkFit-S or WorkFit-A Dual display workstation to improve ergonomic height requirements of taller users. • For use with screens 24”(610mm) or smaller. • Maximum weight capacity: <ul style="list-style-type: none"> –Total capacity 28 pounds. –LCD – 6-14 pounds. • Rotates 360°. • Adds 30° of up/down tilt to displays. • Weight capacity is contingent on the WorkFit platform to which the kit is added. 	97-615	\$102.53
 <p>97-615</p>	<p>To Order, Specify:</p> <p>1) Product number.</p> <hr/> <p>Specification Tip</p> <ul style="list-style-type: none"> • Compatible with WorkFit-S and WorkFit-A. Also works with Dual Monitor Kit for WorkFit-T. 		

Ergotron WorkFit — Accessories

WorkFit-A/WorkFit-S

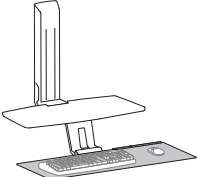
	Description	Height	Depth	Width	Number	Price
	Black	.25"(6mm)	11"(279mm)	27"(686mm)	97-897	\$124.24
	Features <ul style="list-style-type: none"> Includes: Large single piece keyboard tray and mounting hardware. Maximum weight capacity is 5 pounds. 				To Order, Specify: <ul style="list-style-type: none"> 1) Product number. 	
Specification Tips <ul style="list-style-type: none"> Compatible with WorkFit-S and WorkFit-A. Installs centered of offset to the right or left side. 						

97-897

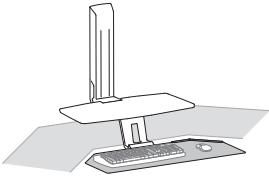
	Black	.25"(6mm)	11"(279mm)	27"(686mm)	97-898	\$124.22
	Features <ul style="list-style-type: none"> Includes: Corner single piece keyboard tray and mounting hardware. Maximum weight capacity is 5 pounds. 				To Order, Specify: <ul style="list-style-type: none"> 1) Product number. 	
Specification Tips <ul style="list-style-type: none"> Compatible with WorkFit-S and WorkFit-A. Installs centered of offset to the right or left side. 						

97-898

Ergotron WorkFit — Accessories

WorkFit-T/WorkFit-TL

	Description	Number	Price
WorkFit Single LCD Monitor Kit	Black	97-935-085	\$207.35
	White	97-935-062	201.92

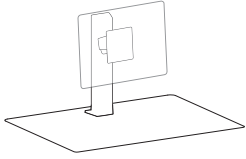

97-935-085
97-935-062

Features

- Includes: 5”(127mm) lift engine, one monitor pivot, dual bow, and hardware.
- For use with screen 24”(610mm) or smaller.
- Maximum weight capacity: 6-16 pounds.
- Tilts 30°.
- Rotates 360°.

To Order, Specify:

- 1) Product number.

Specification Tips

- Compatible with WorkFit-T and WorkFit-TL.
- When added to the WorkFit-T, overall capacity of the WorkFit-T decreases from 35 pounds to 28.4 pounds.
- When added to the WorkFit-TL, overall capacity of the WorkFit-TL is decreased from 40 pounds to 33.4 pounds.

WorkFit Dual Monitor Kit	Black	97-934-085	\$308.55
	White	97-934-062	303.97

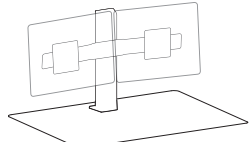

97-934-085
97-934-062

Features

- Includes: 5”(127mm) lift engine, two monitor pivots, dual bow, and hardware.
- For use with screen 24”(610mm) or smaller.
- Maximum weight capacity:
 - Total weight 12-28 pounds.
 - LCD weight 6-14 pounds each.
- Rotates 360°.

To Order, Specify:

- 1) Product number.

Specification Tips

- Compatible with WorkFit-T and WorkFit-TL.
- When added to the WorkFit-T, overall capacity of the WorkFit-T decreases from 35 pounds to 25.3 pounds.
- When added to WorkFit-TL, overall capacity of the WorkFit TL is decreased from 40 pounds to 30.3 pounds.

WorkFit LCD & Laptop Kit	Black	97-933-085	\$303.25
	White	97-933-062	290.70

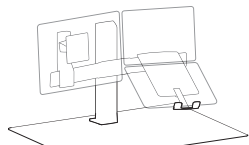

97-933-085
97-933-062

Features

- Includes: 5”(127mm) lift engine, one monitor pivot, one laptop tray, dual bow, and hardware.
- For use with screen 24”(610mm) or smaller.
- Maximum weight capacity: 12-26 pounds.
 - LCD 6-16 pounds.
 - Laptop Tray 10 pounds.
- Monitor tilts 30°.
- Monitor rotates 360°.



To Order, Specify:

- 1) Product number.

Specification Tips

- Compatible with WorkFit-T and WorkFit-TL.
- When added to the WorkFit-T, overall capacity of the WorkFit-T decreases from 35 pounds to 25 pounds.
- When added to the WorkFit-TL, overall capacity of the WorkFit-TL decreases from 40 pounds to 30 pounds.

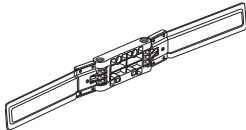
Ergotron Monitor Arm Accessories

	Description	Number	Price
 <p>98-101-009</p>	<p>Black</p> <p>98-101-009</p> <p>Price</p> <p>\$118.27</p>		
	<p>Description</p> <p>Features</p> <ul style="list-style-type: none"> Includes: Double-hinged bow and mounting hardware. For use with screens 25"(635mm) or smaller. Weight capacity is 6-14 pounds each. Capacity may vary depending on WorkFit capacity. Pans 168° from front to back using monitors 18"(457mm) or smaller. Panning motion may be restricted when using screens 19"(483mm) - 25"(635mm) in size. <p>To Order, Specify:</p> <ul style="list-style-type: none"> 1) Product number. 		
	<p>Specification Tips</p> <ul style="list-style-type: none"> Compatible with WorkFit-A, WorkFit-S, WorkFit-SR dual workstations. Pivots are not included. Use pivots from current workstation. 		
 <p>97-845</p>	<p>Black</p> <p>97-845</p> <p>Price</p> <p>\$32.19</p>		
	<p>Description</p> <p>Features</p> <ul style="list-style-type: none"> Includes: Bracket, recess spacer, and screws. Raises monitor 4"(102mm) - 6"(152mm). Screen size dependent on product to which it is attached. <p>To Order, Specify:</p> <ul style="list-style-type: none"> 1) Product number. 		
	<p>Specification Tips</p> <ul style="list-style-type: none"> Compatible with WorkFit-S, WorkFit-A and WorkFit-T as well as any VESA mount where portrait/landscape adjustment is locked or not present. Kit adds one pound to the mount weight. De-rate weight capacity of accompanying mount by one pound. Monitor weight should never exceed 29 pounds. 		

Ergotron WorkFit — Anti-Fatigue Floor Mat

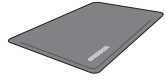

97-620-060

Height	Depth	Width	Number	Price
6.25"(159mm)	24"(610mm)	36"(914mm)	97-620-060	\$417.56

Features

- Includes: One floor mat.
- 0.625"(16mm) thick.
- Custom blended medium density polyurethane foam.
- High tear strength polyurethane outer membrane.
- Black only.
- TAA (Trade Agreements Act) compliant.

To Order, Specify:

- 1) Product number.

Ergotron Neo-Flex Laptop Cart

Height	Depth	Width	Number	Price
26.6"(676mm)-46.6"(1184mm)	22.8"(579mm)	17.5"(445mm)	24-205-214	\$1486.92

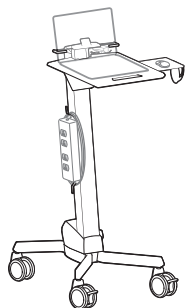

24-205-214
(power strip shown not included)

Features

- Includes: Integrated worksurface/keyboard tray with left/right mouse tray, scanner holder bracket, mouse holder, cable storage area, four dual casters (two locking), laptop security system, bracket for power strip and cable wrap.
- Compatible with most 12"(305mm)-17"(432mm) laptops. Maximum outside width of laptop is 18"(457mm).
- Maximum weight capacity is 15 pounds.
- Front handle on worksurface allows for easy mobility.
- 20"(508mm) height range adjustment allows for use from a seated or standing position.
- Worksurface dimensions 16.5"(419mm) W x 20.5"(521mm) D.
- Laptop cart standard in gray with 2 piece gray plastic worksurface.

To Order, Specify:

- 1) Product number.

Ergotron Teachwell® Mobile Digital Workspace

Height	Depth	Width	Number	Price
32"(813mm)-52"(1321mm)	24"(610mm)	31"(787mm)	24-220-055	\$1261.33

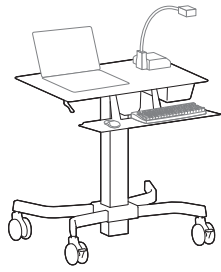

24-220-055

Features

- Includes: Cart, integrated phenolic worksurface, seamless keyboard/mousing tray, cable management box, cable winding brackets, four dual casters (two locking).
- Maximum weight capacity 38.5 pounds.
- Worksurface height adjustment range: 32"(813mm)-52"(1321mm).
Note: worksurface and keyboard tray adjust in tandem.
- Worksurface dimensions: 31"(787mm) W x 21"(533mm) D.
- Keyboard Tray: 26"(660mm) W x 9.4"(239mm) D stows under worksurface. Includes 5° back-tilt.
- Cable management box interior: 13.4"(340mm) W x 5"(127mm) D x 3.4"(86mm) H. Provides storage for one standard six-outlet power strip, two power bricks and the associated cables.
- Available in supplier graphite grey only.
- Includes mechanical mounting holes to mount many major document camera models. Ordered separately.
- Ships assembled.

To Order, Specify:

- 1) Product number.

Ergotron LearnFit

LearnFit Desk

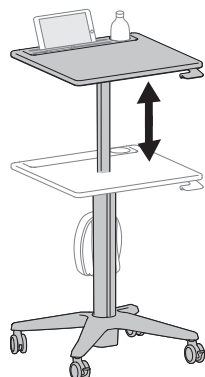

24-547-003
24-481-003

Description	Height	Depth	Width	Number	Price
Sit-Stand	29"(737mm)-44"(1118mm)	22"(559mm)	24"(610mm)	24-547-003	\$762.82
Standing	33"(838mm)-49"(1245mm)	22"(559mm)	24"(610mm)	24-481-003	762.77

Features

- Includes: One adjustable height desk with two locking and 2 non-locking casters and backpack hook.
- PrecisionHeight™ Technology allows for one-touch height adjustment.
- Worksurface includes built in cup holder, tablet stand pocket and pencil tray.
- Maximum weight capacity for desk surface is 15 pounds.
- Sit-Stand desk height range is 29"(737mm)-45"(1143mm). Adjustable Standing desk height range is 33"(838mm)-49"(1245mm).
- Standard with polished aluminum column and base with feathered gray laminate surface. Edgeband and cup holder/pencil tray standard in dark gray.

To Order, Specify:

- 1) Product number.

Storage Bin

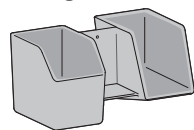

97-926-064

Dark Gray	8"(203mm)	8"(203mm)	14.5"(368mm)	97-926-064	\$76.50
-----------	-----------	-----------	--------------	------------	----------------

Features

- Includes: Molded plastic bins and mounting hardware.
- Sized to hold notebooks, folders and books.
- Smooth plastic surface.
- Maximum weight capacity is 8 pounds.
- Three separate compartments:
 - Enclosed, top-loaded on left side.
 - 3-sided, front-loaded on right side.
 - Smaller, 3-sided, front-loaded in center.

To Order, Specify:

- 1) Product number.

Specification Tips

- Compatible with LearnFit Adjustable Standing Desk
- Attaches at any height along the desk column.

Ergotron Zip 12 Charging

	Height	Depth	Width	Number	Price
	35.6"(904mm)	5.9"(150mm)	40.9"(1039mm)	DM12-1006-1	\$1860.53

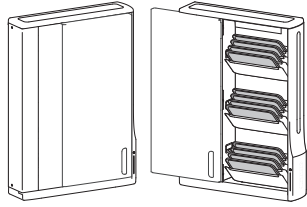

DM12-1006-1



Features

- Includes: Cabinet, 6' power cord, key and wall mounting hardware.
- Charges and secures up to 12 tablets or notebooks with screens up to 12"(305mm).
- Show & Stow™ technology tilting tablet trays pull out to load/unload and automatically retract.
- Sliding front access door.
- 12 receptacle outlet strip designed to work with oversized adapters. AC adapter maximum dimensions 4.1(104mm) H x 2"(51mm) W x 4"(102mm) D.
- Individual device maximum weight 3 pounds. Total weight capacity 44.4 pounds.
- Contains one 12V DC continuous operation cooling fan.
- Uses AC adapters that come with each device. AC adapters not included.
- Black with polished aluminum sliding door and laptop tray fronts.

To Order, Specify:

- 1) Product number.

Grommets

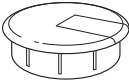
	Height	Inside Diameter	Outside Diameter	Number	Price
	1"(25mm)	2.75"(70mm)	3"(76mm)	WUAC-WSG	\$24.28

WUAC-WSG
Class CA – SIN 711-1;
Discount Group I

Features

- Includes one cover.
- Must be field-installed.
- Available in Charcoal color only.

To Order, Specify:

- 1) Product number.
(No finish specification required.)

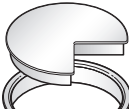
	Top Thickness	Diameter	Number	Trim A	B
	1.19"(30mm)	3"(76mm)	WQAG-0303-PS	\$45.42	\$54.75
	2"(51mm)	3"(76mm)	WQAG-0303-PM	45.42	54.75

WQAG
Class PT – SIN 711-11;
Discount Group IX

Features

- Includes one 3"(76mm) diameter grommet with cover.
- Requires 2.75"(70mm) diameter field drilled hole.
- Field installed.

To Order, Specify:

- 1) Product number.
- 2) Trim color.

	Size	Diameter	Hole Size	Number	Price
	Small grommet	1.57" inside	1.75"(45mm)	JAG-1	\$19.13

JAG-1
Class TA – GSA: Open Market

Features

- Includes one 1.57"(40mm) round grommet.
- Field drilled 1.75"(44mm) hole.
- Standard in black.

To Order, Specify:

- 1) Product number.
(No finish specification required.)

	Size	Diameter	Hole Size	Number	Price
	Large grommet	2.75" inside	3"(76mm)	JAG-2	\$22.07

JAG-2
Class TA – SIN 711-11;
Discount Group X

Features

- Install in field drilled 3"(76mm) hole.
- Standard in black.
- Removable cap.

To Order, Specify:

- 1) Product number.
(No finish specification required.)

	Top Thickness	Diameter	Number	Trim A	B
	0.75"(19mm)	2.75"(70mm)	TA01-0220	\$31.95	\$36.87

TA01-0220
Class TA – SIN 711-11;
Discount Group X

Features

- Includes one grommet.
- Field installed into field cut opening.

To Order, Specify:

- 1) Product number.
- 2) Trim color.

Grommets

Flip Top Unit — Hatch

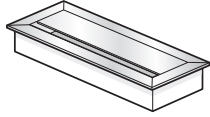

EUG1

Finishes	Bezel Width	Bezel Depth	Flip Top Unit Cutout Code	Configuration	Number	Price
Anodized						
	5.24"(133mm)	4.375"(111mm)	A, B	2	EUG1-0000-G2NNNW	\$192.80
	8.31"(211mm)		F, V	4	EUG1-0000-G4NNNW	204.85
	11.25"(286mm)		J, K	6	EUG1-0000-G6NNNW	216.91
Black						
	5.24"(133mm)	4.375"(111mm)	A, B	2	EUG1-0000-G2NNNB	\$253.05
	8.31"(211mm)		F, V	4	EUG1-0000-G4NNNB	265.10
	11.25"(286mm)		J, K	6	EUG1-0000-G6NNNB	277.16

Features

- Includes one flip top unit hatch.
- Hatch is flush mounted with spring release cover; 0.5"(13mm) gap between cover and bezel for cords.
- Available in anodized or black finish.
- Field installed.

To Order, Specify:

- 1) Product number.
(No finish specification required.)

Specification Tips

- Specify for cord management as needed.
- Order hatch to match cutouts specified for each table.

Information Display

Planes Easels

	Height	Depth	Width	Number	①	Trim A	B
Standard Easel	75"(1905mm)	28"(711mm)	45"(1143mm)	KAIE-0029-LJS	■	B	\$1601.96 \$1647.74

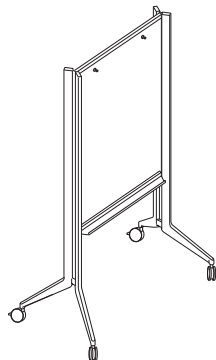

KAIE-0029

Features

- Includes frame and attached, two-sided laminate writing surface/center board with attached marker tray.
- Markers and erasers separately specified.
- **One information board can be hung from each side of easel; specify separately.**
- Center board has pins to allow hanging of standard size easel paper pad.
- Writable surface/center board is 0.64"(16mm) thick with 1mm bright white edgeband and has a 31"(787mm) wide x 43"(1092mm) high writing surface.
- Aluminum frame available in metallic trim colors only.
- Easel marker tray is 30"(762mm) wide x 1.375"(35mm) high x 3"(76mm) deep. Accessible from one side only.
- Optional casters or glides are field interchangeable:
 - Casters (two locking/two non-locking) are available with:
 - Light platinum or fog hub with graphite tread, or
 - black hub with black tread.
- Optional glides (four) are available in light platinum, fog or black with 0.5"(13mm) height adjustment.
 - Glide stem is painted to match base; glide base disc color must be specified.
- Easel can be used as a projection screen and/or space divider.
- Easel height with information board(s) attached is 78"(1981mm).
- Ships unassembled.

To Order, Specify:

- 1) Product number, including:
 - ① **Base Option:**
 - Caster
 - Glide, add **\$78.00** list
- 2) Frame trim color.
- 3) Caster/Glide base disc trim color:
 - Black – TR-F
 - Fog – TR-7
 - Light Platinum – TR-LPL

Specification Tips

- Only Planes information boards can be hung off the Planes easel.
- The following Planes products are separately specified:
 - Information Boards
- **The following products are recommended to maintain the markerboard appearance:**
 - Dry erase marker kit (includes holder, six markers and eraser), order part# 7062-8001.
 - Markerboard cleaner and conditioner, order part# 7031-7001.
 - Markerboard spray cleaner, order part# 7031-7002.

Information Display

Planes Easels

	Height	Depth	Width	Number	①	Trim A	B
Large Easel	75"(1905mm)	28"(711mm)	88"(2235mm)	KAIE-0072-LJS	■	B	\$2277.96 \$2323.74

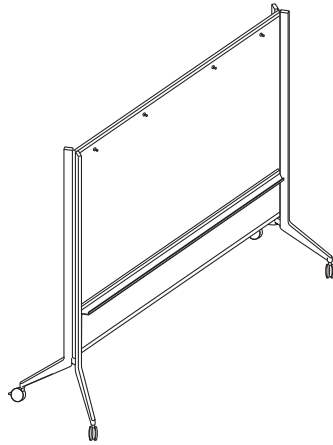

KAIE-0072

Features

- Includes frame, and attached, two-sided laminate writing surface/center board with attached marker tray.
- Markers and erasers separately specified.
- **Two information boards can be hung from each side of easel; specify separately.**
- Center board has pins to allow hanging of standard size easel paper pads.
- Writable surface/center board is 0.64"(16mm) thick with 1mm bright white edgeband and has a 74"(1880mm) wide x 43"(1092mm) high writing surface.
- Aluminum frame available in metallic trim colors only.
- Easel marker tray is 73"(1854mm) wide x 1.375"(35mm) high x 3"(76mm) deep. Accessible from one side only.
- Optional casters or glides are field interchangeable:
 - Casters (two locking/two non-locking) are available with:
 - Light platinum or fog hub with graphite tread, or
 - black hub with black tread.
- Optional glides (four) are available in light platinum, fog or black with 0.5"(13mm) height adjustment.
 - Glide stem is painted to match base; glide base disc color must be specified.
- Easel can be used as a projection screen and/or space divider.
- Easel height with information board(s) attached is 78"(1981mm).
- Ships unassembled.

To Order, Specify:

- 1) Product number, including:

① Base Option:

- C** Caster
- G** Glide, add **\$78.00** list

- 2) Frame trim color.
- 3) Caster/Glide base disc trim color:
 - Black – TR-F
 - Fog – TR-7
 - Light Platinum – TR-LPL

Specification Tips

- Only Planes information boards can be hung off the Planes easel.
- The following Planes products are separately specified:
 - Information Boards
- **The following products are recommended to maintain the markerboard appearance:**
 - Dry erase marker kit (includes holder, six markers and eraser), order part# 7062-8001.
 - Markerboard cleaner and conditioner, order part# 7031-7001.
 - Markerboard spray cleaner, order part# 7031-7002.

Information Display

Planes Boards and Accessories

	Height	Width	Number	Price
Information Boards	42"(1067mm)	40"(1016mm)	KAIB-0040-LJSNA	\$521.74

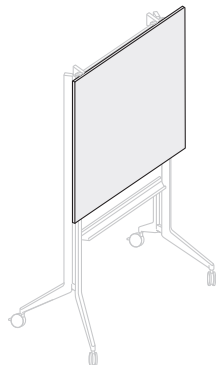

KAIB-0040

Features

- Includes one information board and attachment cleats.
- Markers and erasers separately specified.
- Laminate writable surface/information boards are 0.64"(16mm) thick with one usable side and 1mm bright white edgeband.
- Safety interlock prevents dislodgement from easels and horizontal wall rail.
- Lightweight construction – each board is approximately 19 pounds.
- Information board cleats and bumpers are light platinum.
- Ships assembled.

To Order, Specify:

- 1) Product number.
(No finish specification required.)

Specification Tips

- **Planes information boards add 3"(76mm) to overall easel height.**
- Information board back cleats (2) fit over top rail of easel and lower bumpers (2) allow vertical alignment.
- The following Planes products are separately specified:
 - Standard Easel
 - Large Easel
 - Horizontal Wall Rail for Information Boards
- **The following products are recommended to maintain the markerboard appearance:**
 - Dry erase marker kit (includes holder, six markers and eraser), order part# 7062-8001.
 - Markerboard cleaner and conditioner, order part# 7031-7001.
 - Markerboard spray cleaner, order part# 7031-7002.

Horizontal Wall Rail for Information Boards

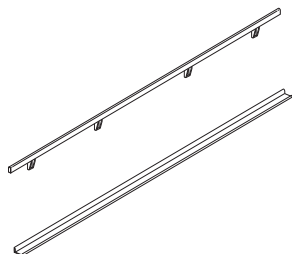

KAIW-0096

	Width	Number	Trim A	B
	96"(2438mm)	KAIW-0096	\$1195.88	\$1241.66

Features

- Includes upper and lower rails, four wall cleats, two end caps and hardware.
- Lower rail also functions as a 2.25"(57mm) x 96"(2438mm) marker tray.
- 96"(2438mm) horizontal wall rail accommodates two information boards side-by-side.
- Rails can be cut down to accommodate desired width.
- Rail end caps and cleats are light platinum.
- Wall rails are mounted horizontally.
- Ships unassembled.

To Order, Specify:

- 1) Product number.
- 2) Trim color for rail.

Specification Tips

- **Planes horizontal wall rail requires proper structural wall backing for support. Mounting hardware is field supplied.**
- The following Planes products are separately specified:
 - Information Boards

Wall Cleat for Information Boards

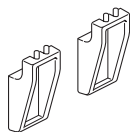

KAIH-0000

Height	Depth	Width	Number	Price
3.5"(89mm)	1.5"(38mm)	1.75"(44mm)	KAIH-0000	\$85.55

Features

- Includes two cleats in light platinum.
- For use with the Planes information board horizontal wall rail in field modified application.

To Order, Specify:

- 1) Product number.
(No finish specification required.)

Specification Tip

- **Planes horizontal wall rail requires proper structural wall backing for support. Mounting hardware is field supplied.**

Information Display

Planes Boards and Accessories

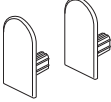
	Number	Price
Horizontal Wall Rail End Caps  KAIC-0000	KAIC-0000	\$15.16
Features <ul style="list-style-type: none"> Includes two end caps in light platinum. For use with the Planes information board horizontal wall rail in field modified application. 		
Specification Tip <ul style="list-style-type: none"> Planes horizontal wall rail requires proper structural wall backing for support. Mounting hardware is field supplied. 		
To Order, Specify: <ol style="list-style-type: none"> Product number. (No finish specification required.) 		

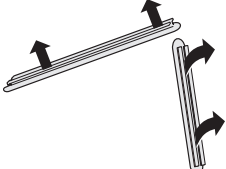
	Number	Price
Y-Leg Bumper  TA01-0214	TA01-0214	\$8.61
Description For use on 30"(762mm) deep top		
Feature <ul style="list-style-type: none"> Includes 4 bumpers in light platinum, for easel Y-leg. 		
Specification Tip <ul style="list-style-type: none"> Protects Y-leg tables when nested. 		
To Order, Specify: <ol style="list-style-type: none"> Product number (No color specification required.) 		

Information Display – Planes Markerboard

Markerboard Insert

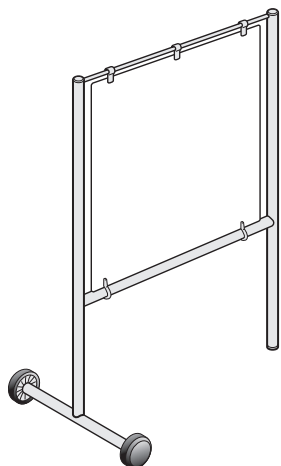

NBFS-M

Height	Width	Number	Trim A	B
53"(1346mm)	36"(914mm)	NBFS-5336-M	\$1301.63	\$1327.75
	48"(1219mm)	NBFS-5348-M	1570.55	1601.89
64"(1626mm)	36"(914mm)	NBFS-6436-M	\$1465.97	\$1494.70
	48"(1219mm)	NBFS-6448-M	1794.65	1828.60

Features

- Includes frame, markerboard insert, and attachment hardware.
- Markers and erasers not included.
- Attachment hardware is clear.
- 4"(102mm) wheels are non-locking. Standard in black finish color only.
- Screens are non-load bearing.
- Two-sided acrylic markerboard.
- Screens are shipped unassembled.

To Order, Specify:

- 1) Product number.
- 2) Trim color for frame.

Specification Tips

- 53"(1346mm) high freestanding screens have 20"(508mm) wheel span centered on 1.25"(32mm) thick frame.
- 64"(1626mm) high freestanding screens have 24"(610mm) wheel span centered on 1.25"(32mm) thick frame.
- Clearance height is 17.375"(441mm).
- **The following products are recommended to maintain the markerboard appearance:**
 - Dry erase marker kit (includes holder, six markers and eraser), order part# 7062-8001.
 - Markerboard cleaner and conditioner, order part# 7031-7001.
 - Markerboard spray cleaner, order part# 7031-7002.

Information Display – Planes Markerboard Accessories

	Description	Number	Price
Markerboard Accessories	Dry Erase Marker Kit (holder, six markers and eraser)	7062-8001	\$139.38
	Cleaner and Conditioner	7031-7001	158.74
	Spray Cleaner	7031-7002	50.80

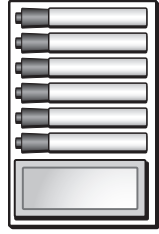

7062-8001



7031-7002



7031-7001

Feature

- Recommended dry erase marker products to maintain, clean & condition markerboards.

To Order, Specify:

- 1) Product number
(No finish specification required.)

Lighting — Haworth

	Fixture Length	Total Length with Switch	Watts	Number	Price
Adaptable LED Task Light - Stand-Alone	17"(432mm)	18.6"(472mm)	5.6	LUTN-0017-19ULDN	\$176.13
	31"(787mm)	32.6"(828mm)	10.3	LUTN-0031-19ULDN	199.93
	44"(1118mm)	45.6"(1158mm)	14.3	LUTN-0044-19ULDN	222.03

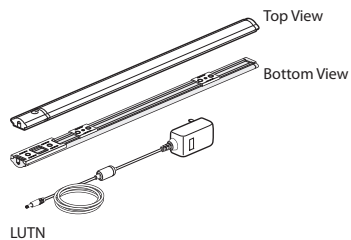

LUTN



Features

- Includes 17"(432mm), 31"(787mm) or 44"(1118mm) LED fixture, one on/off/dimmer pack, 18 watt power supply with black nine foot power cord, two adhesive cord managers and screw/magnetic attachment hardware.
- Standard in anodized (silver) color with black caps.
- Height: 0.5"(12.7mm); Width: 1.18"(30mm).
- Automatic turn off after 12 hours (+/- 15 mins).

To Order, Specify:

- 1) Product number.
(No finish specification required.)

Specification Tips

- For use with 120 volt, 60 hertz electrical system.
- Color Temp: 3500K.
- Color Rendition Index: 85 CRI.
- Rated Lifespan: 52,000 hour.
- **Not intended for daisy chaining.**
- Single touch on/off with continuous dimming from 15-100% with last state memory.
- Intended for use under shelf or cabinet.

Adaptable LED Task Light - Starter Kit	17"(432mm)	18.6"(472mm)	5.6	LUTT-0017-11ULDN	\$199.82
	31"(787mm)	32.6"(828mm)	10.3	LUTT-0031-11ULDN	223.62
	44"(1118mm)	45.6"(1158mm)	14.3	LUTT-0044-11ULDN	245.72

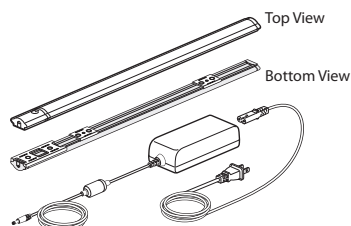

LUTT



Features

- Includes LED fixture, one on/off/dimmer pack, 65 watt power supply with eleven foot power cord, two adhesive cord managers, and screw/magnetic attachment hardware.
- Standard in anodized (silver) color with black caps.
- Height: 0.5"(12.7mm); Width: 1.18"(30mm).
- Automatic turn off after 12 hours (+/- 15 mins).

To Order, Specify:

- 1) Product number.
(No finish specification required.)

Specification Tips

- For use with 120 volt, 60 hertz electrical system.
- Color Temp: 3500K.
- Color Rendition Index: 85 CRI.
- Rated Lifespan: 52,000 hour.
- Refer to the Specification Guide or under the Adaptable LED Task Light - Add-on Kit for a chart showing the total number of light fixtures that can be daisy chained together.
- Single touch on/off with continuous dimming from 15-100% with last state memory.
- The on/off dimmer switch on the Starter Kit fixture will control all connected Add-On lights.
- Intended for use under shelf or cabinet.

Lighting — Haworth

	Fixture Length	Watts	Number	Price
Adaptable LED Task Light - Add-On Kit	17"(432mm)	5.6	LUTA-0017-1NULDN	\$148.32
	31"(787mm)	10.3	LUTA-0031-1NULDN	172.12
	44"(1118mm)	14.3	LUTA-0044-1NULDN	194.22

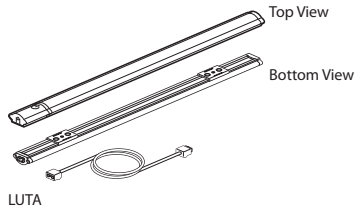

LUTA



Features

- Includes LED fixture, 18"(457mm) daisy chain cord, two adhesive cord mangers, and screw/magnetic attachment hardware.
- Standard in anodized (silver) color with black caps.
- Height: 0.5"(12.7mm); Width: 1.18"(30mm).

To Order, Specify:





- 1) Product number.
(No finish specification required.)

Specification Tips

- For use with 120 volt, 60 hertz electrical system.
- Color Temp: 3500K.
- Color Rendition Index: 85 CRI.
- Rated Lifespan: 52,000 hour.
- Refer to the chart below for the total number of light fixtures that can be daisy chained together.
- The on/off dimmer switch on the Starter Kit fixture will control all connected Add-On lights.
- Intended for use under shelf or cabinet.

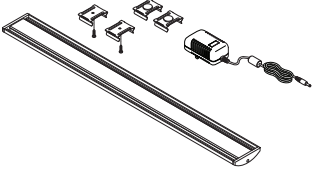
Acceptable Daisy Chain Light Combinations			
Daisy Chair Combinations	# of 17" Lights	# of 31" Lights	# of 44" Lights
Combination 1	1	1	1
Combination 2	1	1	0
Combination 3	1	2	0
Combination 4	1	0	1
Combination 5	1	0	0
Combination 6	2	1	0
Combination 7	2	0	1
Combination 8	2	0	0
Combination 9	3	1	0
Combination 10	3	0	0
Combination 11	4	0	0
Combination 12	0	1	1
Combination 14	0	2	0
Combination 15	0	3	0
Combination 17	0	0	2

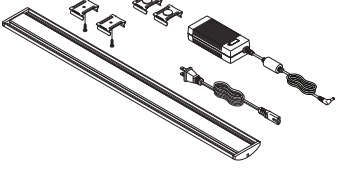
Lighting — Haworth

	Fixture Length	Watts	Number	Price
Reed Premier™ Stand-Alone LED Task Light  LUTS-0017-19ULD5 	16.4"(417mm)	7.8	LUTS-0017-19ULD5	\$250.45
	Features		To Order, Specify:	
	<ul style="list-style-type: none"> Includes 17"(432mm) LED fixture, 15 watt power supply with nine foot removable power cord. Standard in anodized (silver) color with white end caps. Height: 0.5"(12.7mm); Width: 2.0"(51mm); Length: 16.4"(417mm). 		1) Product number. (No finish specification required.)	
	Specification Tips			
Reed Premier™ Starter LED Task Light  LUTS-0017-12ULD6 	16.4"(417mm)	7.8	LUTS-0017-12ULD6	\$344.38
	30.1"(765mm)	17.6	LUTS-0031-12ULD6	501.18
	43.7"(1110mm)	25.9	LUTS-0044-12ULD6	646.78
	57.4"(1458mm)	33.6	LUTS-0058-12ULD6	803.58
	Features		To Order, Specify:	
<ul style="list-style-type: none"> Includes LED fixture, 60 watt power supply with twelve foot removable power cord. Standard in anodized (silver) color with white end caps. Height: 0.5"(12.7mm); Width: 2.0"(51mm); Lengths: 16.4"(417mm), 30.1"(765mm), 43.7"(1110mm) or 57.4"(1458mm). 		1) Product number. (No finish specification required.)		
Specification Tips				
<ul style="list-style-type: none"> For use with 120 volt, 60 hertz electrical system. Color Temp: 3500K. Color Rendition Index: 84 CRI. Rated Lifespan: 5 0,000 hour. Refer to the Specification Guide for a chart showing the total number of light fixtures that can be daisy chained together. Single touch on/off with continuous dimming from 15-100%. Automatic shutoff after 10 hours. Includes screw and magnetic attachment hardware for steel, laminate and wood. Intended for use in horizontal applications. 				

Lighting — Haworth

	Fixture Length	Watts	Number	Price
Reed Premier™	16.4"(417mm)	7.8	LUTD-0017-1NULDN	\$250.45
Add-On LED Task Light —	30.1"(765mm)	17.6	LUTD-0031-1NULDN	407.25
For Use with Reed Premier Starter	43.7"(1110mm)	25.9	LUTD-0044-1NULDN	552.85
LED Task Lights	57.4"(1458mm)	33.6	LUTD-0058-1NULDN	709.65

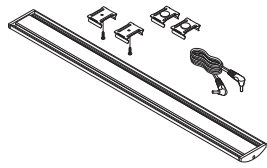

LUTD-0017-1NULDN



Features

- Includes LED fixture, 8"(203mm) and 30"(762mm) daisy chain cord.
- Standard in anodized (silver) color with white end caps.
- Height: 0.5"(12.7mm); Width: 2.0"(51mm); Lengths: 16.4"(417mm), 30.1"(765mm), 43.7"(1110mm) or 57.4"(1458mm).

To Order, Specify:

- 1) Product number.
(No finish specification required.)

Specification Tips

- For use with 120 volt, 60 hertz electrical system.
- Color Temp: 3500K.
- Color Rendition Index: 84 CRI.
- Rated Lifespan: 5 0,000 hour.
- Refer to the Specification Guide for a chart showing the total number of light fixtures that can be daisy chained together.
- Single touch on/off with continuous dimming from 15-100%.
- Automatic shutoff after 10 hours.
- Includes screw and magnetic attachment hardware for steel, laminate and wood.
- Intended for use in horizontal applications.

Reed Premier™ Add-On Occupancy Sensor

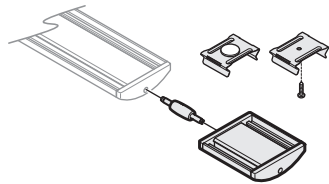

LUTS-0000



LUTS-0000

\$281.79

Features

- Includes occupancy sensor and attachment connector.
- Standard in anodized (silver) color with white end caps.
- Height: 0.7"(17.8mm); Width: 2.0"(51mm); Length: 2.3"(58mm).



To Order, Specify:



- 1) Product number.
(No finish specification required.)

Specification Tips

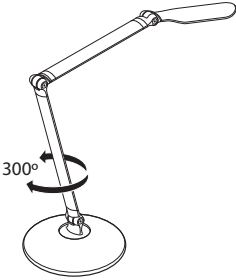
- For use with 120 volt, 60 hertz electrical system.
- Includes screw and magnetic attachment hardware for steel, laminate and wood.
- Intended for use in horizontal applications.

Lighting — Haworth

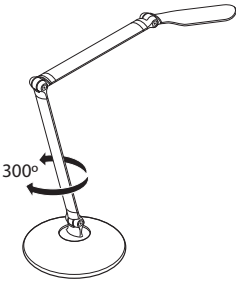
	Number	Price
Voyage without Occupancy Sensor	LUV1-0012-07 LC	\$553.63
 <p>LUV1</p> 	<p>Features</p> <ul style="list-style-type: none"> • Includes base, adjustable arm fixture with LED light and 6'(182cm) removable cord. • Available in supplier silver, white or black. • Touch controls for On/Off switching and continuous 100-15% dimming. • Arm rotates 300°. • Base footprint: 6"(152mm) diameter. • Clamp mount can be used on horizontal surfaces from 0.90"(23mm) to 1.87"(47mm) thick. • Auto turn off after 10 hours of use. • Power consumption: 7W. • Color temperature 3500k. • Luminosity: 250 Lumens. • Color Rendition Index: 84 CRI. • 50K hour lifespan. • Cord length: 6'(182cm). <p>Specification Tips</p> <ul style="list-style-type: none"> • Minor assembly required. • For use with 120 volt 60 hertz electrical system. 	<p>To Order, Specify:</p> <p>1) Product number, including:</p> <p>1 Attachment:</p> <p>F Freestanding G Clamp</p> <p>2) Trim color.</p> <p>TR-11 Black TR-12 Silver TR-13 White</p>

Voyage with Occupancy Sensor	LUV2-0012-07 LO	\$814.17
 <p>LUV2</p> 	<p>Features</p> <ul style="list-style-type: none"> • Includes base, adjustable arm fixture with LED light and 6'(182cm) removable cord. • Available in supplier silver, white or black. • Touch controls for On/Off switching and continuous 100-15% dimming. • Arm rotates 300°. • Base footprint: 6"(152mm) diameter. • Clamp mount can be used on horizontal surfaces from 0.90"(23mm) to 1.87"(47mm) thick. • Power consumption: 7W. • Color temperature 3500k. • Luminosity: 250 Lumens. • Color Rendition Index: 84 CRI. • 50K hour lifespan. • Cord length: 6'(182cm). <p>Specification Tips</p> <ul style="list-style-type: none"> • Minor assembly required. • For use with 120 volt 60 hertz electrical system. 	<p>To Order, Specify:</p> <p>1) Product number, including:</p> <p>1 Attachment:</p> <p>F Freestanding G Clamp</p> <p>2) Trim color.</p> <p>TR-11 Black TR-12 Silver TR-13 White</p>

Lighting — Haworth Brazo Collection

Brazo

	Base Diameter	Model	Number	Price
Freestanding Lighting	8.5"(216mm)	Table Light	LBJ1-0026-19FLC	\$500.00
		Floor Light	LBJ2-0026-19FLC	560.00

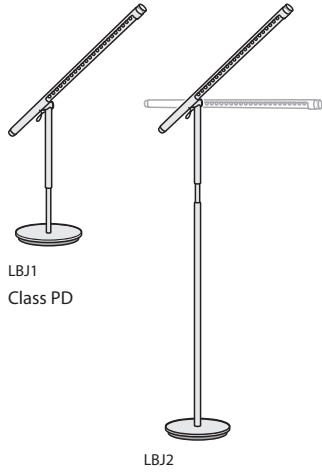

LBJ1
Class PD

LBJ2



Features

- Includes base, adjustable height fixture, 26.5"(673mm) arm with LED light and clear lens, nine foot removable silvertone cord.
- Available in Brushed Aluminum, Gloss White, Anodized Black or Anodized Bronze finish colors.
- Features a LED light source with full dim control knob located on end of arm and 90° disbursement adjustment.
- 1.5 to 9 watts.
- Arm rotates 360°.
- Table light adjustable height fixture range is 14"-22"(356mm-559mm) from desktop.
- Floor light adjustable height fixture range is 48"-56"(1219-1422mm) from floor.
- Base includes scratch-resistant bottom cover with side cord location.
- Table light overall height range with arm extended at 180° is 41"(1041mm).
- Floor light overall height range with arm extended at 180° is 74.75"(1899mm).

Specification Tips

- Minor assembly required.
- **For use with 120 volt 60 hertz electrical system.**

To Order, Specify:

1) Product number, including:

1 Finish Color

- N** Brushed Aluminum
- W** Gloss White
- B** Anodized Black
- Z** Anodized Bronze

	Grommet/Hole Diameter	Model	Number	Price
Mounted Lighting	3"(76mm)	Grommet Mounted Light	LBJ3-0026-19GLC	\$465.00
	1"(25mm)	Worksurface Mounted Light	LBJ4-0026-19GLC	465.00

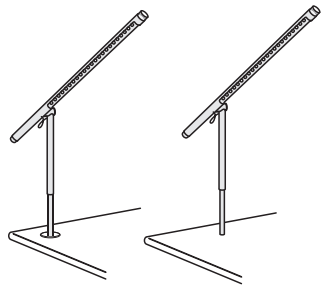

LBJ3
Class PD

LBJ4



Features

- Grommet Mount includes adjustable height fixture, 26.5"(673mm) arm with LED light and clear lens, nine foot removable silvertone cord and attachment hardware. **Grommet ordered separately.**
- Worksurface Mount includes adjustable height fixture, 26.5"(673mm) arm with LED light and clear lens, nine foot removable silvertone cord and attachment hardware with trim ring.
- Available in Brushed Aluminum, Gloss White, Anodized Black or Anodized Bronze finish colors.
- Features a LED light source with full dim control knob located on end of arm and 90° disbursement adjustment.
- 1.5 to 9 watts.
- Arm rotates 360°.
- Both mounted light adjustable height fixture range is 13"-21"(330mm-533mm) from desktop.
- Overall height range with arm extended at 180° is 40"(1016mm).

Specification Tips

- **Grommet Mount Brazo requires a separately specified grommet.**
- Field drilling of surface required.
- Minor assembly required.
- **For use with 120 volt 60 hertz electrical system.**

To Order, Specify:

1) Product number, including:

1 Finish Color

- N** Brushed Aluminum
- W** Gloss White
- B** Anodized Black
- Z** Anodized Bronze

2 Worksurface Thickness

- S** 1 3/16"(30mm)
- M** 2"(51mm)
- Q** 3"(76mm)

	Top Thickness	Number	Price
Grommet — For Use with Brazo Grommet Mounted Light Only	1.19"(30mm)	WQAG-0303-PSN	\$30.00
	2"(51mm)	WQAG-0303-PMN	30.00
	3"(76mm)	WQAG-0303-PQN	30.00

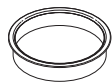

WQAG
Class PT

Feature

- Includes one 3"(76mm) diameter grommet without cover.

Specification Tips

- Specify grommet to match product top thickness.
- Requires a 2.75"(70mm) diameter field drilled hole.
- For use with Brazo Grommet Mounted Light only.

To Order, Specify:

1) Product number.

2) Trim color.

- TR-TW Plaster
- TR-LE Metallic Silver
- TR-MC Metallic Champagne

Lighting — Haworth Collection

Circa

	Description	Number	Price
Table Light	Table Light	LRT1-1408	\$500.00
	Grommet Mounted Light	LRT1-1408-G	450.00

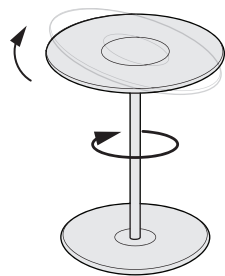

LRT1-1408



Features

- Includes base, aluminum stem, lamp shade with LED flat panel light, polycarbonate lens assembly and 8’ fabric wrapped cord.
- Grommet mounted base includes attachment hardware with grommet.
- Base: 10”(254mm) diameter plastic with a steel insert and built-in USB charging port.
- 12”(305mm) diameter flat panel lamp shade is plastic with a polycarbonate lens assembly.
- Lamp shade rotates 360° and tilts 45° in two directions.
- Stem 14”(356mm) high.
- Features a LED light source with full range dim control.
- 9 watts.

To Order, Specify:

- 1) Product number.
- 2) Trim color.
TR-R01 Graphite
TR-R02 White

Specification Tips

- For use with 120 volt 60 hertz electrical system.
- Minor assembly required.

	Description	Number	Price
Floor Light	Without Pedestal	LRF0-5208	\$795.00
	With Pedestal	LRF1-5208	865.00

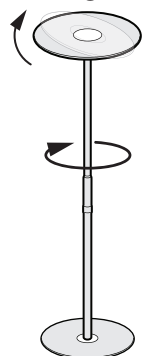

LRF0-5208

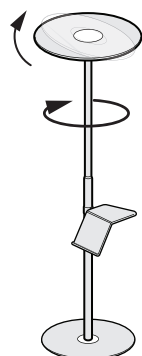

LRF1-5208



Features

- Includes base, aluminum stem, lamp shade with LED flat panel light, polycarbonate lens assembly and 8’ fabric wrapped cord.
- Base: 14”(356mm) diameter base is plastic with a steel insert.
- 16”(406mm) diameter flat panel lamp shade is plastic with a polycarbonate lens assembly.
- Lamp shade rotates 360° and tilts 45° in two directions.
- Stem 52”(1321mm) high with built-in USB port.
- Features a LED light source with full range dim control.
- 11 watts.
- Available with optional steel pedestal that can be used to dock tablets, phones and books.
- Optional pedestal is 22.5”(572mm) from floor and 5.5”(140mm) wide.

To Order, Specify:



- 1) Product number.
- 2) Trim color.
TR-R01 Graphite
TR-R02 White



Specification Tips

- For use with 120 volt 60 hertz electrical system.
- Minor assembly required.

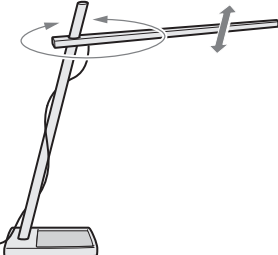
Lighting — Haworth Collection

Clamp

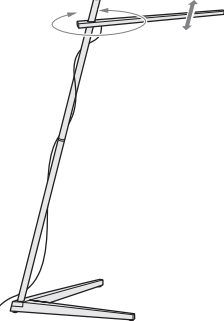
	Number	Price
Table Light  LCC1-1808-NFLC 	LCC1-1808-NFLC	\$345.00
Features <ul style="list-style-type: none"> • Includes wooden base, arm and stem, clear polycarbonate lens, 8' fabric wrapped cord. • Advanced LED array eliminates shadows and has dim control. • Arm slides up and down stem of light and rotates 360°. • Table base features an integrated tray. • Base: 8"(203mm) wide and 5.5"(140mm) deep. • Arm: 18.25"(464mm) wide. • Stem: 18"(457mm) high. • 6 watts. 		
To Order, Specify: <ol style="list-style-type: none"> 1) Product number. 2) Wood finish. VR-2 Walnut NR-2 White Oak 3) Cord fabric color. TR-H31 Black TR-H30 Red 		
Specification Tips <ul style="list-style-type: none"> • For use with 120 volt 60 hertz electrical system. • Minor assembly required. 		

Floor Light  LCC2-2608-NFLC 	LCC2-2608-NFLC	\$650.00
Features <ul style="list-style-type: none"> • Includes wooden base, arm and stem, clear polycarbonate lens, and 8' fabric wrapped cord. • Advanced LED array eliminates shadows and has dim control. • Arm slides up and down stem of light and rotates 360°. • Base: 18.5"(470mm) wide and 18.25"(464mm) deep. • Arm: 26"(660mm) wide. • Stem: 52"(1321mm) high. • 9 watts. 		
To Order, Specify: <ol style="list-style-type: none"> 1) Product number. 2) Wood finish. VR-2 Walnut NR-2 White Oak 3) Cord fabric color. TR-H31 Black TR-H30 Red 		
Specification Tips <ul style="list-style-type: none"> • For use with 120 volt 60 hertz electrical system. • Minor assembly required. 		

Lighting — Haworth Collection

Contour

Table Light

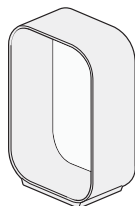

LCT1-1708



Description	Height	Depth	Width	Number	Price
Small Table Light					
Fabric Interior	17.5"(445mm)	6"(152mm)	12"(305mm)	LCT1-1708	\$400.00
Wood Interior	17.5"(445mm)	6"(152mm)	12"(305mm)	LCT1-1708	425.00
Large Table Light					
Fabric Interior	25"(635mm)	6"(152mm)	13"(330mm)	LCT2-2508	\$470.00
Wood Interior	25"(635mm)	6"(152mm)	13"(330mm)	LCT2-2508	495.00

Features

- Includes one aluminum body construction light with polycarbonate lens assembly, USB charging port and 8' fabric wrapped cord.
- Full range dim control for glare free, high output LED light.
- Base: Plastic with built-in USB charging port. Interior of light is lined with wood veneer or fabric.
- 8 watts.
- Available in the following colors:
 - Fabric Interior
 - Graphite Exterior, Coal Interior (TR-C04)
 - White Exterior, Pearl Interior (TR-C07)
 - Wood Interior
 - Graphite Exterior, Walnut Interior (TR-C05)
 - Graphite Exterior, White Oak Interior (TR-C06)
 - White Exterior, Walnut Interior (TR-C08)
 - White Exterior, White Oak Interior (TR-C09)

To Order, Specify:

- 1) Product number.
- 2) Trim color.

Specification Tip

- For use with 120 volt 60 hertz electrical system.

Floor Light

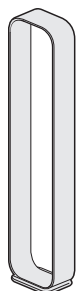

LCF1-6009



Fabric Interior	60"(1524mm)	8"(203mm)	13"(330mm)	LCF1-6009	\$720.00
Wood Interior	60"(1524mm)	8"(203mm)	13"(330mm)	LCF1-6009	750.00

Features

- Includes one aluminum body construction light with polycarbonate lens assembly, USB charging port and 9' fabric wrapped cord.
- Full range dim control for glare free, high output LED light.
- Base: Plastic with built-in USB charging port. Interior of light is lined with wood veneer or fabric.
- 21.5 watts.
- Available in the following colors:
 - Fabric Interior
 - Graphite Exterior, Coal Interior (TR-C04)
 - White Exterior, Pearl Interior (TR-C07)
 - Wood Interior
 - Graphite Exterior, Walnut Interior (TR-C05)
 - Graphite Exterior, White Oak Interior (TR-C06)
 - White Exterior, Walnut Interior (TR-C08)
 - White Exterior, White Oak Interior (TR-C09)

To Order, Specify:

- 1) Product number.
- 2) Trim color.

Specification Tip

- For use with 120 volt 60 hertz electrical system.

Lighting — Haworth Collection

Corner Office

	Height	Depth	Width	Number	Price
Table Light	18"(457mm)	7.5"(191mm)	7.5"(191mm)	HCPL-COT1-07	\$530.00



HCPL-COT1-07



Features

- Includes one white metal base and arm, light and 10' cord.
- LED light with full range dim control.
- Optical touch switch.
- Two USB 2.0 ports (10W) and one USB-C 3.1 C port (35W) built into arm.
- Light: 8 watts.
- System power: 63 watts.

To Order, Specify:

- 1) Product number.

Specification Tips

- **For use with 120 volt 60 hertz electrical systems.**
- Minor assembly required.

Table Light with Small Panel	18"(457mm)	15.5"(390mm)	15.5"(390mm)	HCPL-COT2-15	\$750.00
-------------------------------------	------------	--------------	--------------	--------------	-----------------

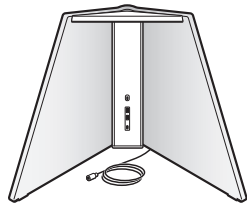

HCPL-COT2-15



Features

- Includes one white metal base and arm, fabric panel, light, and 10' cord.
- LED light with full range dim control.
- Optical touch switch.
- Two USB 2.0 ports (10W) and one USB-C 3.1 C port (35W) built into arm.
- Fabric panel provides visual and acoustic privacy.
- Light 8 watts.
- System power: 63 watts

To Order, Specify:

- 1) Product number.
- 2) Fabric color.
 - 6P-1 Anthracite
 - 6P-2 Chestnut
 - 6P-3 Stone Grey
 - 6P-4 Turquoise

Specification Tips

- **For use with 120 volt 60 hertz electrical system.**
- Minor assembly required.

Table Light with Large Panel	18"(457mm)	15.5"(390mm)	30"(762mm)	HCPL-COT3-30	\$850.00
-------------------------------------	------------	--------------	------------	--------------	-----------------

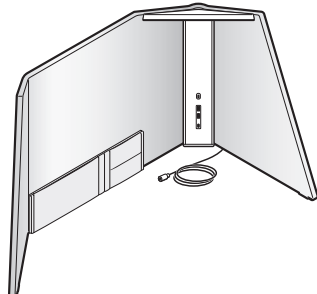

HCPL-COT3-30



Features

- Includes one white metal base and arm, fabric panel, light, 10' cord, and removable pocket accessory.
- LED light with full range dim control.
- Optical touch switch.
- Two USB 2.0 ports (10W) and one USB-C 3.1 C port (35W) built into arm.
- Reversible fabric panel provides visual and acoustic privacy.
- Light 8 watts.
- System power: 63 watts

To Order, Specify:

- 1) Product number.
- 2) Fabric color.
 - 6P-1 Anthracite
 - 6P-2 Chestnut
 - 6P-3 Stone Grey
 - 6P-4 Turquoise

Specification Tips

- **For use with 120 volt 60 hertz electrical system.**
- Minor assembly required.

Lighting — Haworth Collection

Giraffa

	Description	Height	Depth	Width	Number	Price
Table Light	Standard Trim	13"(330mm)	2.25"(57mm)	7"(178mm)	HCPL-GFT1-13	\$290.00
	Premium Trim				HCPL-GFT1-13	310.00

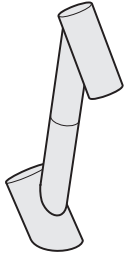

HCPL-GFT1-13



Features

- Includes one high output LED light with aluminum body and polycarbonate lens assembly, and 6' fabric cord.
- Integrated touch switch control.
- Full range dimming built into the base.
- Light source rotates 360°.
- 4.6 watts.

Specification Tip

- **For use with 120 volt 60 hertz electrical system.**

To Order, Specify:

- 1) Product number.
- 2) Trim color.
 - Standard
 - TR-G01 Black
 - TR-G03 White
 - Premium
 - TR-G02 Copper

Lighting — Haworth Collection

LIM

	Base/Mount	Number	Price
Freestanding Lighting	Table Light with Block	LLL1-0022-19FLC	\$375.00
	Table Light with Pivot	LLL2-0022-19FLC	350.00
	Floor Light	LLL3-0022-19FLC	425.00

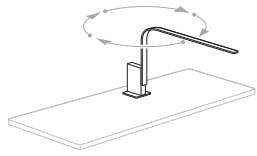

Table Light with Block
LLL1

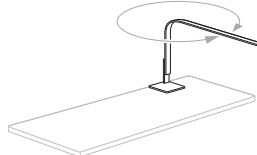

Table Light with Pivot
LLL2



Floor Light
LLL3



Features

- Includes base/mount, 22"(599mm) arm with LED light with a clear lens, nine foot removable silvertone cord, and one wire management clip.
- Features two-stage light control with 3.0 watt and 7.3 watt selection.
- All lights use magnets to attach to base or brackets.
- **Table Light with Block:**
 - Available in **Textured White, Textured Black and Brushed Aluminum.**
 - Arm rotates around magnetic connection between base and light arm.
 - Adjustable height fixture range is 12"-15.75"(305mm-400mm) from desktop.
 - Base includes scratch-resistant bottom with cord management.
 - Base size: 6.63"(168mm) height, 3"(76mm) width, 3.5"(89mm) depth.
- **Table Light with Pivot:**
 - Available in **Textured White and Textured Black.**
 - Pivot rotates 360° around the base.
 - Arm rotates around magnetic connection between base and light arm.
 - Pivot light does not have adjustable height.
 - Base includes scratch-resistant bottom.
 - Base size: 5"(127mm) height, 4.5"(114mm) width, 5.5"(140mm) depth.
- **Floor Light:**
 - Available in **Textured White and Textured Black.**
 - Arm rotates around magnetic connection between base and light arm.
 - Adjustable height fixture range is 13"-50.75"(330mm-1289mm) from floor.
 - Base includes scratch-resistant bottom.
 - Base size: 38"(965mm) height, 9"(229mm) width, 9"(229mm) depth.

To Order, Specify:

- 1) Product number.
- 2) Trim color:
 - Pivot/Floor available in:
 - TR-L2 Textured White
 - TR-L3 Textured Black
 - Block available in:
 - TR-L2 Textured White
 - TR-L3 Textured Black
 - TR-L1 Brushed Aluminum

Specification Tips

- For use with **120 volt 60 hertz electrical system.**
- Minor assembly required.

Lighting — Haworth Collection

LIM

	Base/Mount	Average Height	Number	Price
Worksurface Mounted Lighting	Worksurface Mounted Light	18.5"(470mm)	LLC1-0022-19WLC	\$295.00

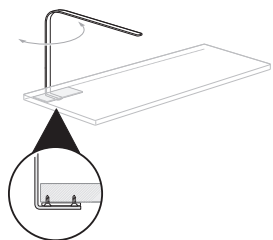

Worksurface Mount
LLC1



Features

- Includes base/mount, 22"(559mm) arm with LED light with a clear lens, nine foot removable silvertone cord, and one wire management clip.
- Under Shelf attachment bracket painted to compliment the LED light.
- Features two-stage light control with 3.0 watt and 7.3 watt selection.
- All lights use magnets to attach to base or brackets.
- **Worksurface Mount:**
 - Available in **Brushed Aluminum, Textured White, Textured Black.**
 - Arm rotates at Under Worksurface attachment bracket.
 - Light does not have adjustable height.
 - Flat Bracket is scratch-resistant.
 - Mount includes a 11"(279mm) flat bracket with adhesive.

To Order, Specify:

- 1) Product number.
- 2) Trim color:

TR-L2	Textured White
TR-L3	Textured Black
TR-L1	Brushed Aluminum

Specification Tips

- **For use with 120 volt 60 hertz electrical system.**
- Minor assembly required.

Lighting — Haworth Collection

LIM

	Base/Mount	Panel System	Number	Price
Mounted Lighting	Slat/Rail		LLM1-0023-19MLC	\$285.00
	Panel	for PREMISE	LLM2-0023-19MLCN	\$285.00
		for Compose	LLM2-0023-19MLCZ	285.00
		for UniGroup Too	LLM2-0023-19MLCE	285.00
	Under Shelf Proud		LLU2-0023-19ULC	\$285.00

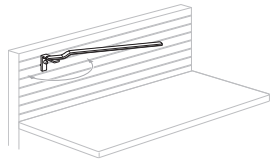

Slat
LLM1

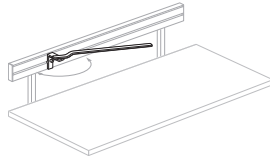

Belong Rail
LLM1

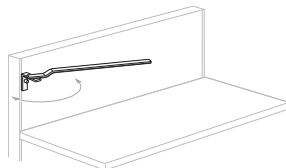

Panel
LLM2

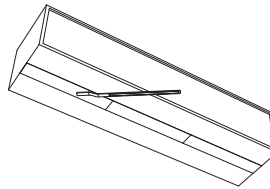

Under Shelf
LLU2



Features

- Includes base/mount, 23.25”(591mm) arm with LED light with a clear lens, nine foot removable silver tone cord, and one wire management clip.
- Features two-stage light control with 3.0 watt and 7.3 watt selection.
- *Overall height ranges dependent on the mount.*
- All lights use magnets to attach to base or brackets.
- **Slat:**
 - **Available in Textured White and Textured Black.**
 - Rotates 180 degrees horizontally around the mount.
 - Slat Mount can be adjusted within the slat profiles – hooks into the second bottom slat and can be adjusted to the top slat off the slat tiles.
 - Mount is scratch-resistant.
 - Can be used on any Haworth slat tile.
 - Slat Tile Bracket size: 3”(76mm) height, 1”(25mm) width, 3”(76mm) depth.
- **Panel:**
 - **Available in Textured White and Textured Black.**
 - Rotates 180 degrees horizontally around the mount.
 - Panel Mount can be adjusted within the panel slot profiles.
 - Mount is scratch-resistant.
 - Can be used on any Haworth Panel System.
 - Panel Mount Bracket size: 3”(76mm) height, 1”(25mm) width, 3”(76mm) depth.
- **Under Shelf Proud:**
 - **Available in Brushed Aluminum, Textured White, Textured Black.**
 - Arm rotates at Under Shelf attachment bracket.
 - Slat Mount can be adjusted within the slat tile profiles.
 - Flat Bracket is scratch-resistant.
 - **Can be used on: Adaptable Upper Storage.**
- Under Shelf attachment bracket painted to complement the LED light.

To Order, Specify:

- 1) Product number.
- 2) Trim color:
 - Slat/Panel mount available in:
 - TR-L2 Textured White
 - TR-L3 Textured Black
 - Under Shelf mount available in:
 - TR-L2 Textured White
 - TR-L3 Textured Black
 - TR-L1 Brushed Aluminum

Specification Tips

- **For use with 120 volt 60 hertz electrical system.**
- Minor assembly required.

Lighting — Haworth Collection

LIM

	Base/Mount	Panel System	Units	Number	Price
LIM Hardware	Slat Mount Bracket		1	LLH1-0000	\$ 40.00
	Panel Mount Bracket	for PREMISE	1	LLH2-0000-N	\$ 40.00
		for Compose	1	LLH2-0000-Z	40.00
		for UniGroup Too	1	LLH2-0000-E	40.00
	Under Shelf Flat/Under Shelf Proud/Worksurface Bracket*		5	LLH3-0000	\$100.00
	Wire Management Clips		10	LLH6-0000	\$ 50.00

Features

- Hardware for use with LIM lights to provide additional attachment.
- Each bracket description correlates with the appropriate LIM light. Please specify accordingly.
- For use if greater user adjustment is required.
- Slat and Panel Mount available in Textured White and Textured Black.
- Under Shelf available in Textured White, Textured Black and Brushed Aluminum.
- Wire management clips are standard in White.

***Same brackets are used for Under Shelf Proud and Worksurface Mount LIM light applications.**



To Order, Specify:



- 1) Product number.
- 2) Trim color for brackets:

TR-L2	Textured White
TR-L3	Textured Black
TR-L1	Brushed Aluminum

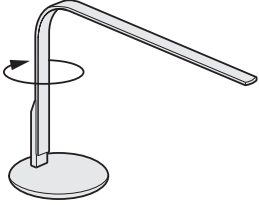
Lighting — Haworth Collection

LIM360

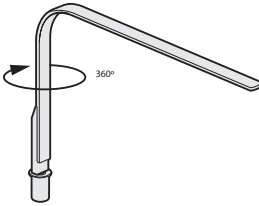
		Number	Price
Table Light  LL31-2210-NFLC 	Grade A	LL31-2210-NFLC	\$350.00
	Grade B	LL31-2210-NFLC	\$360.00
	Grade C	LL31-2210-NFLC	\$370.00
Features <ul style="list-style-type: none"> • Includes base, aluminum arm with USB charging port, LED lights, clear lens, full range dim control and 10' removable cord. • Base is scratch resistant aluminum ring with wood or plastic magnetic base insert. • Base is 6.5"(165mm) diameter. • Arm is 13.5"(343mm) high x 21.5"(546mm) wide and 1"(25mm) deep. • Features a LED light source with full range dim control and 360° swivel adjustment. • 7 watts. 		To Order, Specify: <ol style="list-style-type: none"> 1) Product number. 2) Trim color. <ul style="list-style-type: none"> Grade A <ul style="list-style-type: none"> TR-L8 White Arm, Silver Base TR-L13 Black Arm, Black Base Grade B <ul style="list-style-type: none"> TR-L10 Aluminum Arm, Silver Base TR-L11 Aluminum Arm, Walnut Base TR-L14 Black Arm, Walnut Base TR-L12 Naranjo Arm, Walnut Base TR-L9 White Arm, Walnut Base Grade C <ul style="list-style-type: none"> TR-L25 Brass Arm, Brushed Brass Base TR-L26 Copper Arm, Copper Base 	
Specification Tips <ul style="list-style-type: none"> • For use with 120 volt 60 hertz electrical system. • Minor assembly required. 			

Grommet Mounted Light  LL32-2210-NGLC 	Grade A	LL32-2210-NGLC	\$330.00
	Grade B	LL32-2210-NGLC	\$340.00
	Grade C	LL32-2210-NGLC	\$360.00
Features <ul style="list-style-type: none"> • Includes base, aluminum arm with USB charging port, LED lights, clear lens, full range dim control and 10' removable cord. • Surface mount grommet is 2"(51mm) high and 1"(25mm) wide and finished in satin aluminum. • Arm is 13"(330mm) high x 20"(508mm) wide and 1"(25mm) deep. • Features a LED light source with full range dim control and 360° swivel adjustment. • 7 watts. 		To Order, Specify: <ol style="list-style-type: none"> 1) Product number. 2) Trim color. <ul style="list-style-type: none"> Grade A <ul style="list-style-type: none"> TR-L4 White TR-L6 Black Grade B <ul style="list-style-type: none"> TR-L5 Aluminum Grade C <ul style="list-style-type: none"> TR-L7 Naranjo Grade C <ul style="list-style-type: none"> TR-L27 Brass TR-L28 Copper 	
Specification Tips <ul style="list-style-type: none"> • For use with 120 volt 60 hertz electrical system. • Minor assembly required. 			

Lighting — Haworth Collection

Pixo

	Number 1	Trim A	B
Table Light	LUPT-0016-05FL <input type="checkbox"/>	\$250.00	\$260.00

Table Light

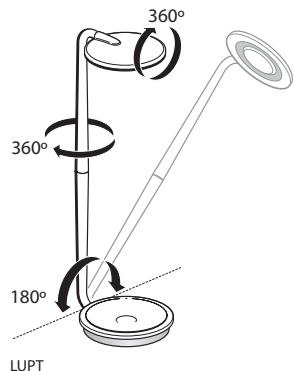

Features

- Includes base/mount with USB charging port, 16.5”(419mm) arm with LED light and 6’(182cm) attached cord.
- Available with optional integrated occupancy sensor.
- Available in supplier silver, white or black.
- Hi-low dim control.
- 360° arm rotation.
- 180° arm tilt.
- 360° shade rotation.
- USB port for charging cell phones.
- Advanced LED array eliminates multiple shadows.
- Power consumption: 6W.
- Color temperature: 3000K.
- Luminosity: 285 Lumens.
- Color Rendition Index: 90 CRI.
- 50K hour lifespan.
- Cord length: 6’(182cm).

Specification Tips

- Minor assembly required.
- **For use with 120 volt 60 hertz electrical system.**

To Order, Specify:

1) Product number.

1 Occupancy Sensor:

- C No Occupancy Sensor
- O Occupancy Sensor, add **\$40.00** list

2) Trim color.

Table Light

- Standard Trim*
- TR-16 Azure
- TR-11 Black
- TR-17 Glow
- TR-18 Orange
- TR-12 Silver
- TR-13 White
- Premium Trim*
- TR-19 White/Brass

Table Light with Occupancy Sensor Standard Trim

- TR-11 Black
- TR-12 Silver
- TR-13 White

Lighting — Haworth Collection

Superlight

	Height	Depth	Width	Number	Price
Table Light	25.75"(645mm)	8"(203mm)	23.5"(597mm)	HCPL-SLT1-17	\$330.00

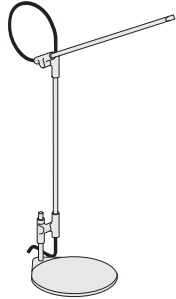

HCPL-SLT1-17



Features

- Includes one aluminum body with polycarbonate lens, steel base 9' cord and magnetic base pad.
- Ultra light, minimal frame.
- LED array with full range dim control.
- Lens rotates 90°.
- Joints have three axis rotation.
- Six hour energy saving auto-off timer.
- 8.6 watts.

Specification Tips

- **For use with 120 volt 60 hertz electrical system.**
- Minor assembly required.

To Order, Specify:

- 1) Product number.
- 2) Trim color.
TR-S10 Black
TR-S11 White
- 3) Base Pad
TR-S15 Charcoal
TR-S16 Chestnut
TR-S18 Mustard
TR-S17 Turquoise

Floor Light	57.5"(1460mm)	8"(203mm)	23.5"(597mm)	HCPL-SLF1-47	\$390.00
--------------------	---------------	-----------	--------------	--------------	-----------------

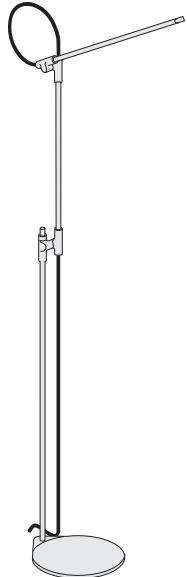

HCPL-SLF1-47



Features

- Includes one aluminum body with polycarbonate lens, steel base 9' cord and magnetic base pad.
- Slim ultra light, minimal frame.
- LED light with full range dim control.
- Lens rotates 90°.
- Joints have three axis rotation.
- Six hour energy saving auto-off timer.
- 8.6 watts.

Specification Tips

- **For use with 120 volt 60 hertz electrical system.**
- Minor assembly required.

To Order, Specify:

- 1) Product number.
- 2) Trim color.
TR-S10 Black
TR-S11 White
- 3) Base Pad
TR-S15 Charcoal
TR-S16 Chestnut
TR-S18 Mustard
TR-S17 Turquoise

	Diameter	Number	Price
Base Pads	8"(203mm)	HCPL-SLSV-4BP	\$50.00

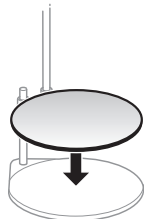

HCPL-SLSV-4BP

Feature

- Includes set of four felt base pads, one each of four colors.

To Order, Specify:

- 1) Product number.

Lighting — Haworth Collection

Tube Top

	Description	Height	Depth	Width	Number	Price
Table Light	Small	14"(356mm)	4.5"(114mm)	9.5"(241mm)	HCPL-TTT1-14	\$160.00
	Medium	21"(533mm)	6.5"(165mm)	15"(381mm)	HCPL-TTT2-21	295.00
	Large	27"(686mm)	9"(229mm)	18"(457mm)	HCPL-TTT3-27	450.00

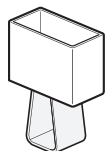

HCPL-TTT1-14

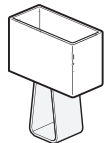

HCPL-TTT2-21

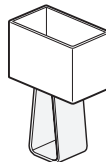

HCPL-TTT3-27



Features

- Includes one polyester mesh shade, acrylic body and 6' fabric cord.
- Fully dimmable LED light controlled by in-line rotary dimmer.
- 6 watts (small table light)
- 13 watts (medium and large table lights)

Specification Tip

- **For use with 120 volt 60 hertz electrical system.**

To Order, Specify:

- 1) Product number.
- 2) Trim color.
 - TR-T40 Charcoal Shade, Charcoal Body
 - TR-T41 Silver Shade, Clear Body
 - TR-T42 White Shade, Charcoal Body
 - TR-T43 White Shade, Clear Body

Additional colors for Small Table Light only:

- TR-T44 White Shade, Green Body
- TR-T45 White Shade, Cobalt Body
- TR-T46 White Shade, Hot Pink Body
- TR-T47 White Shade, Ruby Red Body
- TR-T48 White Shade, Sky Blue Body
- TR-T49 White Shade, Yellow Body

Floor Light

	60"(1524mm)	9"(229mm)	18"(457mm)	HCPL-TTF1-60	\$880.00
--	-------------	-----------	------------	--------------	----------

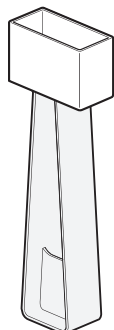

HCPL-TTF1-60



Features

- Includes one polyester mesh shade, acrylic body and 6' fabric cord.
- Fully dimmable LED light controlled by in-line rotary dimmer.
- 13 watts.

Specification Tip



- **For use with 120 volt 60 hertz electrical system.**

To Order, Specify:

- 1) Product number.
- 2) Trim color.
 - TR-T40 Charcoal Shade, Charcoal Body
 - TR-T41 Silver Shade, Clear Body
 - TR-T42 White Shade, Charcoal Body
 - TR-T43 White Shade, Clear Body

Lighting — Haworth Collection

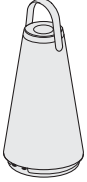
UMA

	Number	Price
<p>Audio Lantern</p>  <p>HCPL-UMT2-11</p> 	<p>HCPL-UMT2-11</p>	<p>\$479.00</p>
<p>Features</p> <ul style="list-style-type: none"> • Includes one battery powered light with polycarbonate lens, steel grille and silicone feet, two interchangeable leather handles (one grey and one tan) and storage bag. • Portable and rechargeable. <ul style="list-style-type: none"> –Battery Life - 8 hours –Charging time - up to 3.5 hours • Bluetooth connectivity provides 360° sound with touch sensitive volume control. • Intuitive full range light control dial adjusts warm dim LED technology. • Storage bag is cotton with a leather drawstring. • Light is 6”(152mm) in diameter at the base and 11”(279mm) high (leather handle adds 2.25”(57mm) to height.) • 4.2 watts (light), 12 watts (speakers). 		
<p>To Order, Specify:</p> <p>1) Product number.</p>		
<p>Specification Tip</p> <ul style="list-style-type: none"> • For use with 120 volt 60 hertz electrical system. 		

Mobile Screens

Fabric Scrim Insert

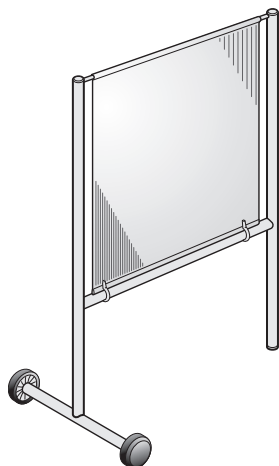

NBFS-F

Height	Width	Number	Trim	
			A	B
53"(1346mm)	36"(914mm)	NBFS-5336-F	\$ 937.42	\$ 963.54
	48"(1219mm)	NBFS-5348-F	1084.12	1115.46
64"(1626mm)	36"(914mm)	NBFS-6436-F	\$1027.07	\$1055.80
	48"(1219mm)	NBFS-6448-F	1206.37	1240.32

Features

- Includes frame, fabric scrim insert, and attachment hardware.
- Scrim is a lightweight open weave textile.
- Attachment hardware is clear.
- 4"(102mm) wheels are non-locking. Standard in black finish color only.
- Screens are non-load bearing.
- Screens have no acoustical or tackable properties.
- Screens are shipped unassembled.

To Order, Specify:

- 1) Product number.
- 2) Fabric scrim/colorway; FO-NW (New White).
- 3) Trim color for frame.

Specification Tips

- 53"(1346mm) high freestanding screens have 20"(508mm) wheel span centered on 1.25"(32mm) thick frame.
- 64"(1626mm) high freestanding screens have 24"(610mm) wheel span centered on 1.25"(32mm) thick frame.
- Clearance height is 17.375"(441mm).

Translucent Insert

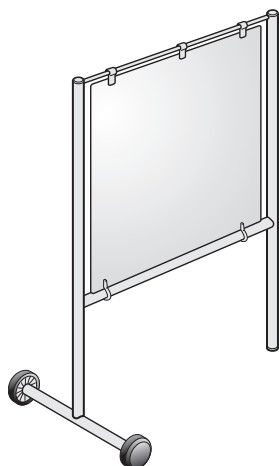

NBFS-X

Height	Width	Number	White	
			A	B
53"(1346mm)	36"(914mm)	NBFS-5336-X	\$1440.25	\$1466.37
	48"(1219mm)	NBFS-5348-X	1672.45	1703.79
64"(1626mm)	36"(914mm)	NBFS-6436-X	\$1582.15	\$1610.88
	48"(1219mm)	NBFS-6448-X	1865.95	1899.90

Features

- Includes frame, translucent insert, and attachment hardware.
- Attachment hardware is clear.
- 4"(102mm) wheels are non-locking. Standard in black finish color only.
- Screens are non-load bearing.
- Screens have no acoustical or writable properties.
- Screens are shipped unassembled.

To Order, Specify:

- 1) Product number.
- 2) Translucent color/pattern.
- 3) Trim color for frame.

Specification Tips

- 53"(1346mm) high freestanding screens have 20"(508mm) wheel span centered on 1.25"(32mm) thick frame.
- 64"(1626mm) high freestanding screens have 24"(610mm) wheel span centered on 1.25"(32mm) thick frame.
- Clearance height is 17.375"(441mm).

Monitor Arms — Haworth

	Description	Number	Price
Adjustable Post Arm	Single Arm	KU5M-0000-1NNN	\$586.20
	Double Arm	KU5M-0000-2NNN	976.99

Adjustable Post Arm

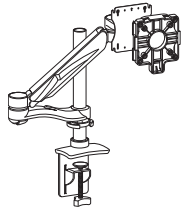

KU5M-1NNN

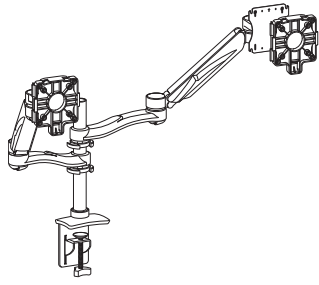

KU5M-2NNN

GSA: Open Market

Features

- Includes one single or double Monitor Arm with quick connect bracket, desk clamp and grommet mount.
- Quick-install mechanism allows flat-screen monitors to quickly and securely snap into position.
- Allows for installation of one or two flat-screen monitors above worksurface.
- Provides easy adjustment of monitor height and position up and down post or by adjustable arm. Requires adjustment of monitor arm to weight of monitor with supplied allen wrench.
- Integrated cord management.
- Monitor Arms:
 - Extension 24”(610mm)
 - Height Adjustment range: 13”(330mm) counter balance adjustable arm and 9”(229mm) post adjustment.
 - Joint rotation 360° at three joints
 - Pivots from landscape to portrait positions
 - 180° of tilt
 - 180° of side to side movement
- Double arm will displays screens up to 35”(889mm).
- Displays screens 5-20 lbs per Monitor Arm.
- Double Monitor Arms attach to central post.
- Monitor Arms available in supplier silver, black, white, or polished.

To Order, Specify:

- 1) Product number.
- 2) Trim color.
 - TR-SR Silver
 - TR-OF Black
 - TR-OW White
 - TR-PD Polished

Specification Tips

- Certified VESA plate includes 75mm and 100mm hole patterns.
- For additional monitor arms options see Ergotron Monitor Arms.

Extend Arm

Extend Arm	Single Arm	KU6M-0000-1NNN	\$325.66
	Double Arm	KU6M-0000-2NNN	586.18

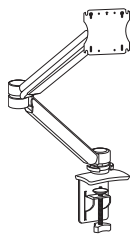

KU6M-1NNN

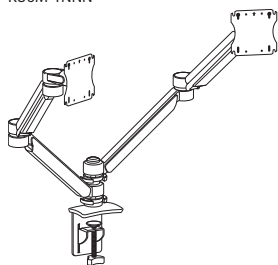

KU6M-2NNN

SIN 711-2;
Discount Group XIII

Features

- Includes one single or double Monitor Arm with desk clamp and grommet mount.
- Allows for installation of one or two flat-screen monitors above worksurface.
- Provides easy adjustment of monitor by adjustable arm. Requires adjustment of monitor arm to weight of monitor with supplied allen wrench.
- Integrated cord management.
- Monitor Arms:
 - Extension 26”(660mm)
 - Height Adjustment range: 13”(330mm)
 - Joint rotation 360° at three joints
 - Pivots from landscape to portrait positions
 - 180° degrees of tilt
 - 180° of side to side movement
- Double arm will displays screens up to 35”(889mm).
- Displays screens up to 2 lbs – 14 lbs per arm.
- Double Monitors Arms attach to central post.
- Monitor Arms available in supplier silver, black, or white.

To Order, Specify:

- 1) Product number.
- 2) Trim color.
 - TR-SR Silver
 - TR-OF Black
 - TR-OW White

Specification Tips

- Certified VESA plate includes 75mm x 75mm and 100mm x 100mm hole patterns.
- For additional monitor arms options see Ergotron Monitor Arms.

Monitor Arms — Haworth

	Description	Number	Price
Adjustable Post Arm – for Use with Intuity Benching	Single Arm	KU5M-0000-1NNB	\$586.20
	Double Arm	KU5M-0000-2NNB	976.99

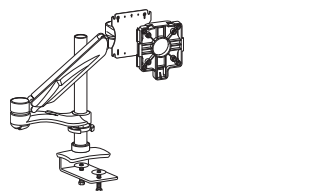

KU5M-1NNB

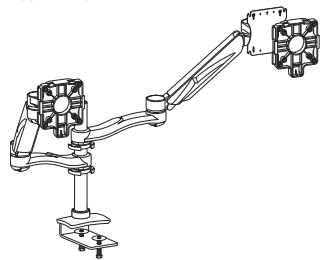

KU5M-2NNB
GSA: Open Market

Features

- Includes one single or double Monitor Arm with desk clamp and grommet mount.
- Quick-install mechanism allows flat-screen monitors to quickly and securely snap into position.
- Allows for installation of one or two flat-screen monitors above worksurface.
- Provides easy adjustment of monitor height and position up and down post or by adjustable arm. Requires adjustment of monitor arm to weight of monitor with supplied allen wrench.
- Integrated cord management.
- Monitor Arms:
 - Extension 24”(610mm)
 - Height Adjustment range: 13”(330mm) counter balance adjustable arm and 9”(229mm) post adjustment for a maximum height adjustment of 15.5”(394mm)
 - Joint rotation 360° at three joints
 - Pivots from landscape to portrait positions
 - 180° of tilt
 - 180° of side to side movement
- Double arm will displays screens up to 35”(889mm).
- Displays screens 5-20 lbs per Monitor Arm.
- Double Monitor Arms attach to central post.
- Monitor Arms available in supplier silver, black, white, or polished.

To Order, Specify:

- 1) Product number.
- 2) Trim color.
 - TR-SR Silver
 - TR-OBA Black
 - TR-OWH White
 - TR-PD Polished

Specification Tips

- Intuity desk clamp can mount to 1.19”(30mm) thick worksurfaces.
- Certified VESA plate includes 75mm and 100mm hole patterns.

Extend Arm – For Use with Intuity Benching	Single Arm	KU6M-0000-1NNB	\$325.66
	Double Arm	KU6M-0000-2NNB	586.18

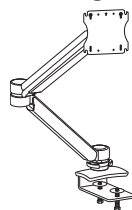

KU6M-1NNB

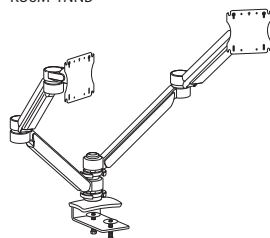

KU6M-2NNB
SIN 711-2;
Discount Group XIII

Features

- Includes one single or double Monitor Arm with desk clamp and grommet mount.
- Allows for installation of one or two flat-screen monitors above worksurface.
- Provides easy adjustment of monitor by adjustable arm. Requires adjustment of monitor arm to weight of monitor with supplied allen wrench.
- Integrated cord management.
- Monitor Arms:
 - Extension 26”(660mm)
 - Height Adjustment range: 13”(330mm)
 - Joint rotation 360° at three joints
 - Pivots from landscape to portrait positions
 - 180° of tilt
 - 180° of side to side movement
- Double arm will displays screens up to 35”(889mm).
- Displays screens up to 2 lbs. – 14 lbs.
- Double Monitors Arms attach to central post.
- Monitor Arms available in supplier silver, black, or white.

To Order, Specify:

- 1) Product number.
- 2) Trim color.
 - TR-SR Silver
 - TR-OBA Black
 - TR-OWH White

Specification Tips

- Intuity desk clamp can mount to 1.19”(30mm) thick worksurfaces.
- Certified VESA plate includes 75mm and 100mm hole patterns.

Monitor Arms — Haworth

	Description	Number	Price
Adjustable Post Arm – for Use with Reside Desking	Single Arm	KU5M-0000-1NNK	\$586.20
	Double Arm	KU5M-0000-2NNK	976.99

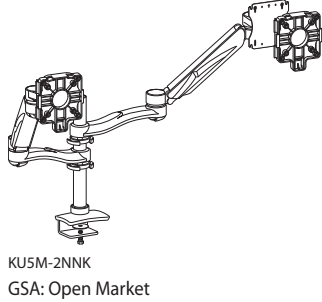
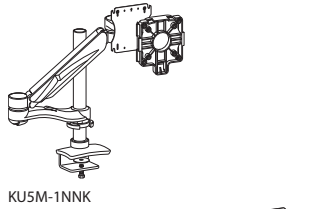

Features

- Includes one single or double Monitor Arm with desk clamp and grommet mount.
- Quick-install mechanism allows flat-screen monitors to quickly and securely snap into position.
- Allows for installation of one or two flat-screen monitors above workspace.
- Provides easy adjustment of monitor height and position up and down post or by adjustable arm. Requires adjustment of monitor arm to weight of monitor with supplied allen wrench.
- Integrated cord management.
- Monitor Arms:
 - Extension 24”(610mm)
 - Height Adjustment range: 13”(330mm) counter balance adjustable arm and 9”(229mm) post adjustment for a maximum height adjustment of 15.5”(394mm)
 - Joint rotation 360° at three joints
 - Pivots from landscape to portrait positions
 - 180° of tilt
 - 180° of side to side movement
- Double arm will displays screens up to 35”(889mm).
- Displays screens 5-20 lbs per Monitor Arm.
- Double Monitor Arms attach to central post.
- Monitor Arms available in supplier silver, black, white, or polished.

To Order, Specify:

- 1) Product number.
- 2) Trim color.
 - TR-SR Silver
 - TR-OBA Black
 - TR-OWH White
 - TR-PD Polished

Specification Tips

- Reside desk clamp can mount to 1.19”(30mm) thick worksurfaces.
- Certified VESA plate includes 75mm and 100mm hole patterns.

Extend Arm — For Use with Reside Desking	Single Arm	KU6M-0000-1NNK	\$325.66
	Double Arm	KU6M-0000-2NNK	586.18

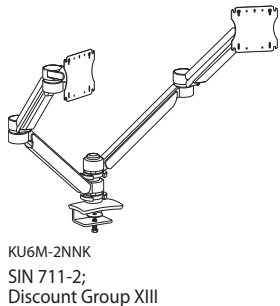
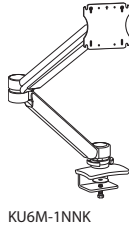

Features

- Includes one single or double Monitor Arm with desk clamp and grommet mount.
- Allows for installation of one or two flat-screen monitors above workspace.
- Provides easy adjustment of monitor by adjustable arm. Requires adjustment of monitor arm to weight of monitor with supplied allen wrench.
- Integrated cord management.
- Monitor Arms:
 - Extension 26”(660mm)
 - Height Adjustment range: 13”(330mm)
 - Joint rotation 360° at three joints
 - Pivots from landscape to portrait positions
 - 180° of tilt
 - 180° of side to side movement
- Double arm will displays screens up to 35”(889mm).
- Displays screens up to 2 lbs. – 14 lbs.
- Double Monitors Arms attach to central post.
- Monitor Arms available in supplier silver, black, or white.

To Order, Specify:

- 1) Product number.
- 2) Trim color.
 - TR-SR Silver
 - TR-OBA Black
 - TR-OWH White

Specification Tips

- Reside desk clamp can mount to 1.19”(30mm) thick worksurfaces.
- Certified VESA plate includes 75mm and 100mm hole patterns.

Monitor Arms — Haworth

	Height	Width	Number	Price
iPad Attachment	7.88"(200mm)	8"(203mm)	KU6T-0000	\$325.66

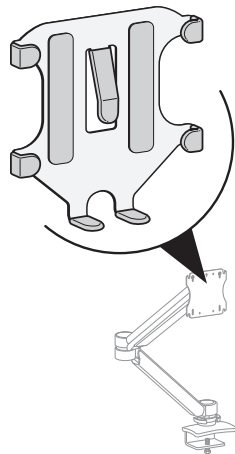

KU6T

Features

- Includes one steel tablet holder with cutouts and mounting hardware.
- Works with tablets size 6.75"-7.5"(171-191mm) wide and at least 7"(178mm) high with a 0.5"(13mm) maximum thickness.
- Mounts directly onto the Extend Arm with standard VESA 100mm connection.
- Rotates from landscape orientation to portrait orientation.
- Cutouts allow for use of cables.

To Order, Specify:

- 1) Product number.
- 2) Trim color.
 TR-SR Silver
 TR-OF Black
 TR-OW White

Specification Tips

- Designed to be used with Extend Arm.
- iPad not included.

Pip

Personal Laptop Table



STP-P26-TH

Height	Depth	Width	Number ① ②	Painted MDF	White Oak	Walnut
26"(660mm)	13"(330mm)	21.25"(540mm)	STP- 26-T	\$591.56	\$1075.06	\$1208.74

Features

- Includes table top, base and hardware.
- Top available in painted MDF or planked wood in White Oak or Walnut.
- Wood tops are designed to be unique using solid wood planks with a clear, low-gloss finish showing natural variation.
- Base: Painted aluminum support plate and column with painted steel base plate.
- Ships unassembled.

To Order, Specify:

1) Product number, including:

① Surface Material:

- P** Painted MDF
- W** Planked Wood

② Glide Type:

- H** Hard Plastic
- F** Felt

2) Top surface and color.

3) Base trim color.

Recycling Solutions

Height	Depth	Width	Number	Painted	
				A	B
39.5"(1003mm)	18.75"(476mm)	48"(1219mm)	JRPY-3948-SJAN	\$4111.23	\$4336.80

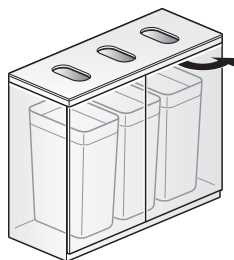

JRPY-3948
Class FM – SIN 711-3,
Discount Group XII

Features

- Includes:
 - Painted steel cabinet and top with three 11"(279mm) x 6"(152mm) openings.
 - Non-locking hinged doors
 - Clear acrylic overlay for top
 - 3 removable Rubbermaid recycle bins
- Acrylic top has specific cleaning requirements. Please follow cleaning guidelines found in Haworth's Care and Maintenance Standards.

To Order, Specify:

- 1) Product number.
- 2) Trim color.

Recycling/Trash Bin

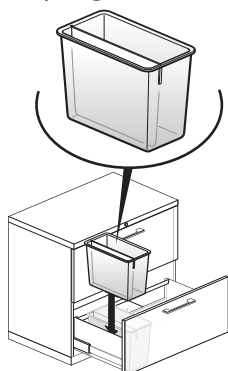

KURB
Class YA – SIN 711-2,
Discount Group XIII

Nominal Height	Nominal Depth	Nominal Width	Number	Price
9"(229mm)	12.5"(318mm)	6.5"(165mm)	KURB-0912	\$213.11

Features

- Includes one plastic bin with removable plastic divider.
- Can be used with Recycle Bin Carriage for Reside or suspended from hanging rails in X Series, V Series, A Series, Beside, Compose and Masters Series pedestals and lateral filing drawers.
- Recycling/Trash Bin can be easily removed from carriage or drawer body to dispose of waste contents.
- Not designed to be freestanding.
- Available in Snow only.
- The removable divider subdivides the space into nominal 4.25"(108mm) and 1.5"(38mm) sections.

To Order, Specify:

- 1) Product number.
(No finish specification required.)

Specification Tip

- Cannot accommodate hanging files.

Recycle Bin Carriage

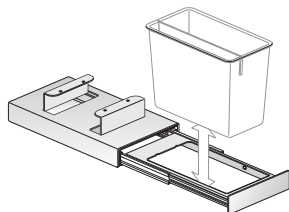

KURD
Class YA – GSA: Open Market

Description	Depth	Width	Number	Trim	
				A	B
For use with Reside	15.34"(390mm)	8.35"(212mm)	KURD-0000	\$240.37	\$255.71

Features

- Includes one painted metal carriage with steel ball bearing slides and attachment bracket.
- Full extension carriage.
- To be used with separately specified Recycling/Trash Bin.
- Attaches to underside of Reside worksurface between support beams.
- Carriage plus Recycling/Trash Bin suspends 12.5"(318mm) underneath worksurface.
- To accommodate the support beams, there will be a 2"(51mm) gap from the underside of the worksurface to the top of the carriage.

To Order, Specify:

- 1) Product number.
- 2) Trim color.

Specification Tips

- For use with Reside Rectangular worksurfaces only; mechanism is not designed for use with any other worksurface platform.
- Carriage requires separately specified Recycling/Trash Bin; not intended to house any other inserts/bins.

Storage Accessories

Lateral File Drawer Insert

Drawer Insert

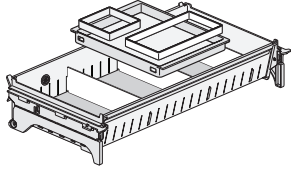

KJFI-00XX-D

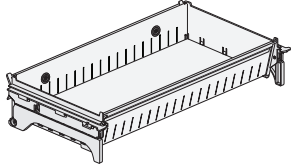

KFI-00XX-B

Description	Height	Depth	Width	Number	Price
Deluxe Drawer Insert					
	5"(127mm)	14"(356mm)	30"(762mm)	KJFI-0030-D	\$281.64
	5"(127mm)	14"(356mm)	36"(914mm)	KJFI-0036-D	301.56
	5"(127mm)	14"(356mm)	42"(1067mm)	KJFI-0042-D	321.48
Base Option Insert					
	5"(127mm)	14"(356mm)	30"(762mm)	KJFI-0030-B	\$216.53
	5"(127mm)	14"(356mm)	36"(914mm)	KJFI-0036-B	236.45
	5"(127mm)	14"(356mm)	42"(1067mm)	KJFI-0042-B	256.37

Features

- Includes drawer insert that subdivides a 12"(305mm) high lateral file drawer into two 6"(152mm) deep compartments.
- **For use in X Series and V Series 12"(305mm) high lateral file drawers.**
- Drawer Insert is 5"(127mm) shallower than file drawer allowing the Drawer Insert to slide from front-to-back to access contents in the lower compartment.
- Deluxe Drawer Insert:
 - Includes: Drawer Insert, Drawer Liner, three dividers and one PDA Tray with ring subdivision.
 - Drawer Insert available in Accent Red (TR-1F) or Smoke (TR-E).
- Base Option Insert:
 - Includes: Drawer insert only.
 - Available in black only.
- Drawer Insert and PDA Tray have cut outs/grommets to allow for low voltage cable routing. Lateral files can be modified in the field to accommodate routing of cables to access building power.
- PDA Tray, rings and dividers are plastic in Snow trim color.

To Order, Specify:

- 1) Product number.
- 2) Trim color (Deluxe Drawer Insert only)
 - TR-1F Accent Red
 - TR-E Smoke

Specification Tips

- Drawer Insert cannot be used in lateral files that have full backs on the drawer body. (ex. Beside, Compose Storage, Master Series)
- Drawer Insert cannot be used in lateral files with individually locking drawers.
- Top lateral file drawer, or only file drawer, of an X Series combination unit will not accommodate a Drawer Insert; the remaining positions are able to accommodate the Drawer Insert.
- Top lateral file drawer in an X Series Lateral File with sliding or hinge doors cannot accommodate a Drawer Insert; the remaining positions are able to accommodate the Drawer Insert.
- Drawer Insert cannot be used in a drawer with a receding door.
- PDA Tray is designed to slide side-to-side along the Drawer Insert front and back panels allowing access to drawer contents below the PDA Tray.

Note: Snow (TR-FM) plastic trim color is not recommended for use with painted trim colors Plaster (TR-TW) or Chalk (TR-AK). Refer to Very® Seating chainset for Snow.

Wire Management

	Diameter	Length	Mesh Color	Number	Price
Cord Manager — Mesh	1"(25mm)	100'(30480mm)	Black	EUAW-0000-NHS	\$749.04
			Grey	EUAW-0000-NHSG	749.04
			Orange	EUAW-0000-NHSO	749.04
			White	EUAW-0000-NHSW	749.04
	2"(51mm)	50'(15240mm)	Black	EUAW-0000-NHL	\$749.04
			Grey	EUAW-0000-NHLG	749.04
			Orange	EUAW-0000-NHLO	749.04
			White	EUAW-0000-NHLW	749.04

EUAW-0000-NHS
Class YA – SIN 711-2,
Discount Group XIII

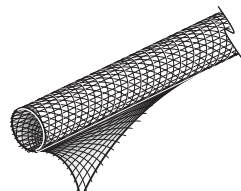

Features

- Includes flexible mesh cord manager.
- Available in black, grey, orange and white.
- Field cut to length.

To Order, Specify:

- 1) Product number.
(No finish specification required.)

Specification Tip

- Wraps around and manages power cords and data cables.

	Height	Width	Actual Length	Installed Length	Number	Price
Cable Chain	0.75"(19mm)	2.25"(58mm)	40"(1016mm)	36"(914mm)	EAAW-0000-H	\$225.04

EAAW-0000-H
Class YA – SIN 711-2,
Discount Group XIII

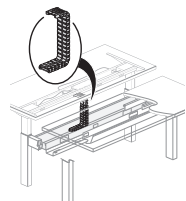

Features

- Includes 36"(914mm) active length cable chain and mounting hardware.
- Color black only.
- Mounts to cable trough and underside of worksurface to contain power cords/data cables that are routed from the cable tray to the worksurface.

To Order, Specify:

- 1) Product number.
(No finish specification required.)

Specification Tip

- Holds up to three power cords and two data cables.

Compose Connections Cable Chain	0.75"(19mm)	2.25"(58mm)	40"(1016mm)	36"(914mm)	EUAW-4000-V	\$297.55
--	-------------	-------------	-------------	------------	-------------	-----------------

EUAW-4000-V
Class YA – SIN 711-2,
Discount Group XIII

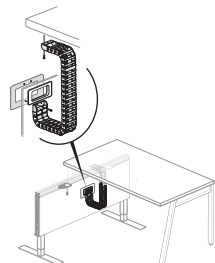

Features

- Includes grommet, grommet backer plate, cable chain, bracket to mount to adjacent table and mounting hardware.
- Color black only.
- Mounts to tile and underside of adjacent worksurface to contain power cords and data cables that are routed from inside Compose Connections panel to an adjacent worksurface.

To Order, Specify:

- 1) Product number.
(No finish specification required.)

Specification Tip

- Holds up to three power cords and two data cables.

Vertical Cable Chain	Description	Number	Trim	
			A	B
	31"(787mm) cable chain	EUAW-3100-NV	\$208.43	\$214.96

EUAW-3100-NV
Class YA – SIN 711-11,
Discount Group XIII



Features

- Includes cable chain and attachment hardware (2 screws).
- Bottom cable chain link is weighted.
- Available in translucent material only.
- Chain is clear translucent. Weight is painted as specified.

To Order, Specify:

- 1) Product number.
- 2) Trim color.

Specification Tip

- Not designed to be used with 36"(914mm) and 42"(1067mm) high tables.

Wire Management

	Length	Height	Width	Description	Number	Price
J-Channel	72"(1829mm)	4.25"(108mm)	2.75"(70mm)	Straight table	4TJC-72	\$188.18

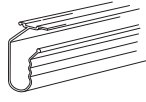

4TJC-72
Class YA – SIN 711-11;
Discount Group X

Features

- Includes J-Channel and mounting hardware.
- Field-installed.
- Provides wire management below table tops.
- Attaches to the underside of the table top with screws.
- J-channel to be field cut to length.
- Available in black finish color only.

To Order, Specify:

- 1) Product number.
(No finish specification required.)

Conduit Clamp

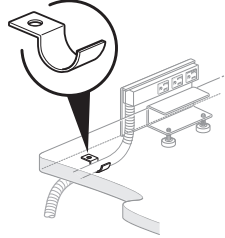

EUAM-0000
Class YA – SIN 711-2
Discount Group XIII

Features

- Includes 25 clamps and 25 screws.
- For managing Power Tap cord or conduit under horizontal surfaces.

To Order, Specify:

- 1) Product number.
(No finish specification required.)

EUAM-0000 **\$65.12**

Wire Management Loop

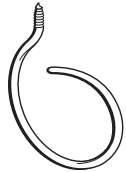

NEH-8
Class CA – SIN 711-1;
Discount Group I

	Width	Installed Height	Number	Price
	2.75"(70mm)	3.25"(83mm)	NEH-8	\$43.80

Features

- Includes box of eight wire management loops.
- Manages and stores wires or cables through loops attached to horizontal surface.
- Threaded top allows installation anywhere under horizontal surfaces in recommended 18"(457mm) intervals.
- Wire management loop is 2"(51mm) in diameter with 3.1 sq. in.(2000mm²) of cross section area.
- Standard in charcoal trim color only.

To Order, Specify:

- 1) Product number.
(No finish specification required.)

Wire Manager Clips

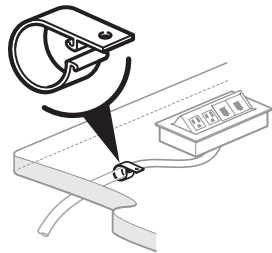

TA01-0225
Class TA – SIN 711-11;
Discount Group X

Features

- Includes ten wire manager clips and screws.
- Standard in black plastic.
- Field installed.

To Order, Specify:

- 1) Product number.
(No finish specification required.)

Specification Tip

- Specify for cord management as needed.

TA01-0225 **\$24.11**

Wire Management

	Length	Clips	Number	Price
Wire Manager — Horizontal	48"(1219mm)	2	EUAW-0048-NH	\$153.32
	72"(1829mm)	3	EUAW-0072-NH	229.99
	96"(2438mm)	3	EUAW-0096-NH	306.66
	120"(3048mm)	4	EUAW-00C0-NH	383.21

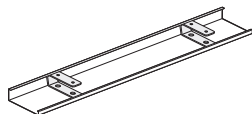

EUAW-NH
Class PT – SIN 711-11;
Discount Group IX

Features

- Includes one wire manager and attachment clips.
- Standard in light platinum.
- Field installed.

To Order, Specify:

- 1) Product number.
(No finish specification required.)

Specification Tip

- Manages and stores wire and cables under horizontal surfaces.

	Length	Depth	Number	Price
Horizontal Wire Management	15"(381mm)	2"(51mm)	WUAW-1500-PNH	\$179.03

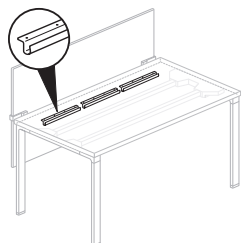

WUAW-PNH
Class CA – SIN 711-1;
Discount Group I

Features

- Includes ten plastic wire managers and attachment hardware.
- Manages and stores wires or cables under horizontal surface.
- Standard in charcoal trim color only.

To Order, Specify:

- 1) Product number.
(No finish specification required.)

	Height	Depth	Width	Number	Price
Vertical Cable Guide	0.75"(19mm)	0.5"(13mm)	3"(76mm)	NECG-V	\$60.77

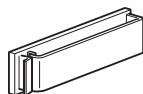

NECG-V
Class FA – SIN 711-1
Discount Group XI

Features

- Includes package of twelve cable guides.
- Manages communication cables.
- Self-adhesive back attaches to the top or bottom of horizontal surface.
- Standard in gray trim color only.

To Order, Specify:

- 1) Product number.
(No finish specification required.)

	Length	Application	Number	Price
Wire Management Trough	24"(610mm)	Stationary/Flip-Top Tables Only	KWT-24	\$ 48.02
	30"(762mm)		KWT-30	58.53
	36"(914mm)		KWT-36	69.04
	42"(1067mm)		KWT-42	79.55
	48"(1219mm)		KWT-48	90.06
	54"(1372mm)		KWT-54	100.57
	60"(1524mm)		KWT-60	111.08
	66"(1676mm)		KWT-66	121.59
	72"(1829mm)		KWT-72	132.10
			For 60", 66" and 72" folding tables only	KWMF-72
	For 84" and 96" folding tables only	KWMF-96	174.14	

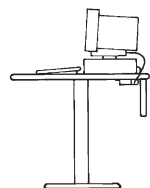

KWT
KWMF
Class TA – SIN 711-11;
Discount Group X

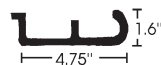

Features

- KWT wire management trough for use with stationary and flip-top tables only, with or without modesty panels.
- KWMF wire management trough for use with folding tables only, with or without modesty panels.
- Wire management trough attaches to underside of rectangle tables for storage of electronic equipment wiring and cabling.
- Both trough versions are field-attached.
- KWT wire management trough must be specified 6"(152mm) shorter than the table width.
- KWMF-72 is two pieces, and KWMF-96 is four pieces to allow for folding table leg clearance.
- Standard in Charcoal finish only.

To Order, Specify:

- 1) Product number.
(No finish specification required.)

Wire Management

	Width	Number	Price
Wire Management Basket	18"(457mm)	TAWB-0918	\$127.47
	24"(610mm)	TAWB-0924	133.92
	36"(914mm)	TAWB-0936	146.76

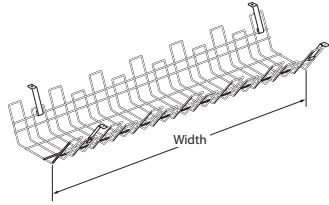

TAWB
Class TA – GSA: Open Market

Features

- Includes one basket, four brackets and attachment hardware.
- Standard in black.
- Basket is 8.5"(203mm) deep x 3.5"(76mm) high. With mounting hardware overall height is 4.94"(102mm) and depth is 10.82"(254mm).
- Accessible from both sides.
- Basket detaches without tools.

To Order, Specify:

- 1) Product number.
(No finish specification required.)

Specification Tips

- Verify mounting clearance with table understructure.
- Separately specify covers.

	Width	Number	Price
Basket Cover	18"(457mm)	TABC-0918	\$37.49
	24"(610mm)	TABC-0924	50.38
	36"(914mm)	TABC-0936	\$76.08

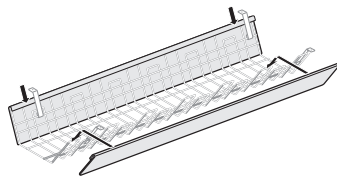

TABC (Two covers shown)
Class TA – GSA: Open Market

Feature

- Includes one painted cover.

To Order, Specify:

- 1) Product number.
- 2) Trim color.

Specification Tips

- Designed to be used with wire management basket. Up to two can be installed.
- Order to match wire management basket width.

Note: \$11.27 upcharge list for Metallic and Accent trim colors.

	For Use With	Height	Width	Number	Trim	
					A	B
Vertical Wire Channel - Leg Attached	28" Frame	25.7"(635mm)	1.17"(25mm)	TYVW-2601-P	\$79.44	\$84.12
	40" Frame	37.7"(940mm)	1.17"(25mm)	TYVW-3801-P	\$83.59	\$90.37

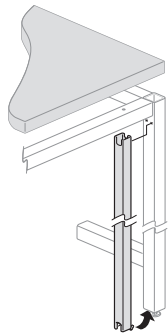

TYVW
Class CL – GSA: Open Market

Feature

- Includes wire manager and attachment screws.

To Order, Specify:

- 1) Product number.
- 2) Trim color.

Specification Tips

- Order correct model for table height.
- Add additional Vertical Wire Channels if cord number exceeds three cords.
- Accommodates 2-3 cords/cables (depending on cable diameter) or one 1/2" Flexible Conduit.

Wire Management

	Length	Number	Price
Planes C-Leg Training Table Vertical Wire Manager	16"(406mm)	TA01-0228-F	\$44.58

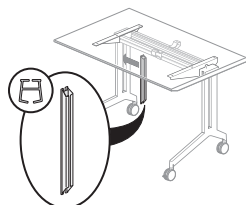

TA01-0228-F
Class TA – SIN 711-11;
Discount Group X

Features

- Includes one plastic wire manager.
- Standard in black.
- Field installed.

To Order, Specify:

- 1) Product number.
(No finish specification required.)

Specification Tips

- For use on Planes C-Leg Training Tables for wire management.
- Snaps into top portion of C-leg base.

Compose Task Light Cord Manager	Description	Length	Number	Price
	Wire Manager, Vertical	17"(432mm)	VZAW-0000-V	\$188.89



VZAW-0000-V
Class BC – SIN 711-1;
Discount Group XI

Features

- Includes package of 10.
- Vertical wire manager conceals task light cord.
- Attaches into Compose panel frame slots.
- Black finish only.

To Order, Specify:

- 1) Product number.
(No finish specification required.)

PREMISE Vertical Wire Manager	Height	Depth	Width	Number	Price
	60"(1524mm)	0.625"(16mm)	1"(25mm)	NEV-1	\$56.54

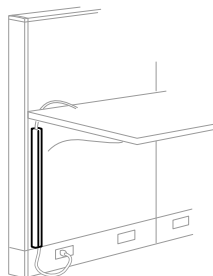

NEV-1
Class FA – SIN 711-1;
Discount Group XI

Features

- Includes one vertical wire manager and six attachment clips.
- Guides wires or cables vertically from base raceway to worksurface or from worksurface to overhead storage unit or shelf.
- Two wire managers will fit in a single set of panel slots.

To Order, Specify:

- 1) Product number.
- 2) Trim color (standard trim only).

Specification Tips

- May be field cut to appropriate length. Requires two attachment clips per field cut section.
- Wire manager may be installed in same connector slots with shared or handed cantilever support.
- Attached into PREMISE panel frame slots.

Wire Management

	Height	Inside Diameter	Number	Price
PREMISE Task Light Cord Manager	17.5"(444mm)	0.43"(11mm)	NEV-2	\$137.10

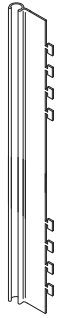

NEV-2

Class FA – SIN 711-1;
Discount Group XI

Features

- Includes ten vertical wire managers.
- Vertically routes and conceals cords along panel surface above or below the worksurface.
- Wire manager, NEV-2, extends 0.5"(13mm) from panel surface.
- Standard in black trim only.

To Order, Specify:

- 1) Product number.
(No finish specification required.)

Specification Tips

- Suggested application: use to conceal single task light cord between overhead storage and worksurface.
- May be field cut to appropriate size.
- For NEV-2, panel connectors slots will accommodate a wire manager and one adjacent panel mounted component.
- Attached into PREMISE panel frame slots.

	Height	Inside Diameter	Number	Price
UniGroup Too, UniGroup and PLACES Task Light Wire Manager	17.5"(444mm)	0.43"(11mm)	WC-17	\$120.41

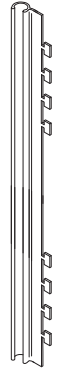

WC-17

Class AA – SIN 711-1;
Discount Group I

Features

- Includes ten vertical wire managers.
- Vertically routes and conceals cords along panel surface above or below the worksurface.
- Wire manager extends 0.5"(13mm) from panel surface.
- Standard in black finish only.

To Order, Specify:

- 1) Product number.
(No finish specification required.)

Specification Tips

- Suggested application: use to conceal single task light cord between overhead storage and worksurface.
- May be field cut to appropriate size.
- Insert into panel side rail reveals.
- Panel side rails will not accommodate multiple components in the same location.
- For use with UniGroup Too, UniGroup and PLACES.

	Height	Depth	Width	Number	Price
UniGroup Too, UniGroup and PLACES Wire Manager	72"(1829mm)	0.75"(19mm)	0.75"(19mm)	WC-6	\$31.54

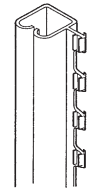

WC-6

Class AA – SIN 711-1;
Discount Group I

Features

- Includes field-cuttable channel.
- Guides wires or cables vertically.
- Inserts into the panel side rail reveals.
- Not available for use in the city of Los Angeles.

To Order, Specify:

- 1) Product number.
- 2) Trim color.

Specification Tip

- For use with UniGroup Too, UniGroup and PLACES.

Wire Management

	Height	Depth	Width	Number	Laminate A	B	Wood Group A	Group B
Cable Base	Laminate							
	28"(711mm)	8"(203mm)	14"(356mm)	TA01-0814-L	\$658.77	\$711.61		
		14"(356mm)	14"(356mm)	TA01-1414-L	701.75	758.23		
	Wood							
	28"(711mm)	8"(203mm)	14"(356mm)	TA01-0814-W			\$1113.53	\$1146.72
		14"(356mm)	14"(356mm)	TA01-1414-W			1189.27	1239.61

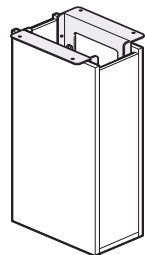

TA01-0814

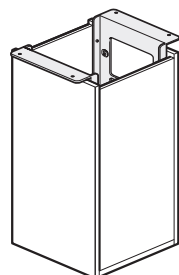

TA01-1414

Features

- Includes 28"(711mm) high cable base and mounting hardware.
- Laminate with 1mm edgeband or wood veneer with 1mm wood edgeband.
- Provides internal cable management with removable panels for access.
- Standard in green core.
- Bracket is standard in charcoal.
- Includes 1"(25mm) adjustable glides.
- Ships assembled.

To Order, Specify:

- 1) Product number.
- 2) Laminate surface color or wood finish color.
- 3) Edge trim color for laminate.

Specification Tips

- Refer to Specification Guide for use guidelines.
- **Cable base not recommended for use with 30"(762mm) deep tables, half round tables, polygon tables or Y-leg tables or 36"(914mm) deep tables with (M) or (Q) flip top unit cutout options.**
- Specify 8"(203mm) x 14"(356mm) cable base for 36"(914mm) deep tables.
- Specify 14"(356mm) x 14"(356mm) cable base for 42"(1067mm) deep and deeper tables.
- One and two-piece table tops – one cable base.
- Three-piece table tops – two cable bases.
- Cable base cord access:
 - 1.5"(38mm) at top
 - adjustable side panels allow 1"(25mm) gap at bottom edges
 - 8"(203mm) depth base has a 3"(76mm) deep cutout in bottom;
 - 14"(356mm) depth base has an 8"(203mm) deep cutout in bottom.

The following Planes products are separately specified:

- Horizontal wire management

Cable Column	Height	Depth	Width	Number	Price
	28"(711mm)	2"(51mm)	4.5"(114mm)	TA01-0217	\$239.14



TA01-0217

Features

- Cable Column offers a wire management option for conference tables when the Cable Base Option cannot be used.
- Includes one Cable Column with mounting hardware for attaching to underside of table.
- Hardware for attaching Cable Column to floor is field supplied.
- Ships unassembled.

To Order, Specify:

- 1) Product number.
- 2) Trim color.

Specification Tips

- Cable Column attaches to underside of table, extends to the floor where it is also attached.
- Cable Column is not load bearing and does not replace table leg(s).
- Cable Column can be installed anywhere under a conference table unless it would interfere with table legs, Horizontal Wire Manager or Flip Top Power/Data Units.
- The Cable Column can be used with the Horizontal Wire Manager for cable management.

Work Tools — Mounting

	Height	Width	Number	Trim A	B
Wall Accessory Slat Pad – For Use with PREMISE	16"(406mm)	24"(610mm)	NAPY-1624	\$305.15	\$341.54
		30"(762mm)	NAPY-1630	342.94	379.33
		36"(914mm)	NAPY-1636	380.73	417.12
		42"(1067mm)	NAPY-1642	418.52	454.91
		48"(1219mm)	NAPY-1648	456.31	492.70
		60"(1524mm)	NAPY-1660	531.89	568.28

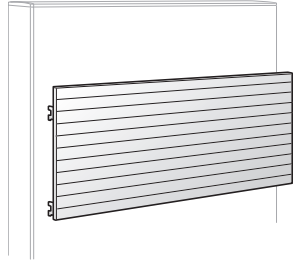

NAPY
Class FA – SIN 711-1;
Discount Group XI

Features

- Includes one pad and attachment brackets.
- Assembled stack pad thickness is 0.375"(10mm).

To Order, Specify:

- 1) Product number.
- 2) Trim color.

Specification Tips

- To be installed in connector slots on same size panel or on a combination of panels that equal the pad width.
- Designed to work with Jump Stuff and Belong slat pad tools.
- For use with PREMISE wall track only.

Slat, Wall Mount

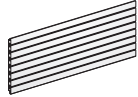

KUPY
Class CA – SIN 711-1;
Discount Group I

Nominal Height	Width	Number	Trim A	B
16"(406mm)	18"(457mm)	KUPY-1618	\$286.19	\$291.50
	24"(610mm)	KUPY-1624	309.81	316.44
	30"(762mm)	KUPY-1630	333.43	341.38
	36"(914mm)	KUPY-1636	357.05	366.32
	42"(1067mm)	KUPY-1642	380.67	391.26
	48"(1219mm)	KUPY-1648	404.29	416.20
	54"(1372mm)	KUPY-1654	427.91	441.14
	60"(1524mm)	KUPY-1660	451.53	466.08

Features

- Includes slat tile & attachment brackets for structural wall.
- Belong and Jump Stuff work tools may be used; separately specified.

To Order, Specify:

- 1) Product number.
- 2) Trim color.

Specification Tips

- Designed to be used under wall mounted overhead storage units.
- Allows space for task light cord routing.
- **Not for use with wall track.**

Work Tools — Mounting

Belong

Single Side

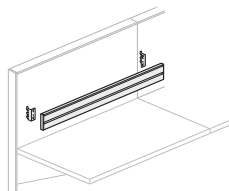

KUR1-0424-PZN

Height	Depth	Width	Number	Trim A	B
Compose					
4"(102mm)	1"(25mm)	24"(610mm)	KUR1-0424-PZN	\$168.58	\$182.91
		30"(762mm)	KUR1-0430-PZN	180.76	196.39
		36"(914mm)	KUR1-0436-PZN	192.94	209.87
		42"(1067mm)	KUR1-0442-PZN	205.12	223.35
		48"(1219mm)	KUR1-0448-PZN	217.30	236.83
		54"(1372mm)	KUR1-0454-PZN	229.48	250.31
60"(1524mm)	KUR1-0460-PZN	328.94	351.07		
PREMISE					
4"(102mm)	1"(25mm)	24"(610mm)	KUR1-0424-PNN	\$168.58	\$182.91
		30"(762mm)	KUR1-0430-PNN	180.76	196.39
		36"(914mm)	KUR1-0436-PNN	192.94	209.87
		42"(1067mm)	KUR1-0442-PNN	205.12	223.35
		48"(1219mm)	KUR1-0448-PNN	217.30	236.83
		60"(1524mm)	KUR1-0460-PNN	328.94	351.07
UniGroup					
4"(102mm)	1"(25mm)	24"(610mm)	KUR1-0424-PEN	\$168.58	\$182.91
		30"(762mm)	KUR1-0430-PEN	180.76	196.39
		36"(914mm)	KUR1-0436-PEN	192.94	209.87
		42"(1067mm)	KUR1-0442-PEN	205.12	223.35
		48"(1219mm)	KUR1-0448-PEN	217.30	236.83
		60"(1524mm)	KUR1-0460-PEN	328.94	351.07

Features

- Includes one rail with panel attachment brackets.
- Mounts to panel side trim rails/connectors/slotted frame/wall track to support rail tools.
- Tool Rail is 0.625"(16mm) thick; brackets provide 0.375"(10mm) gap for cord management.
- Belong and Jump Stuff work tools may be used; separately specified.

To Order, Specify:

- 1) Product number.
- 2) Trim Color for rail/brackets (product line specific; refer to appropriate price list).

Specification Tips

- **Supports maximum load of 40 pounds of Paper Management evenly distributed.**
- Panel mounted rail may span one or more panels equivalent to rail width.
- Recommended mounting position is approximately 9"(229mm) above worksurface.
- Rail is for use with specific product lines: Compose®, PREMISE® and UniGroup Too®.

Work Tools — Mounting

Belong

Tool Rail — Horizontal Surface Mount C-Clamp or Thru-Mount

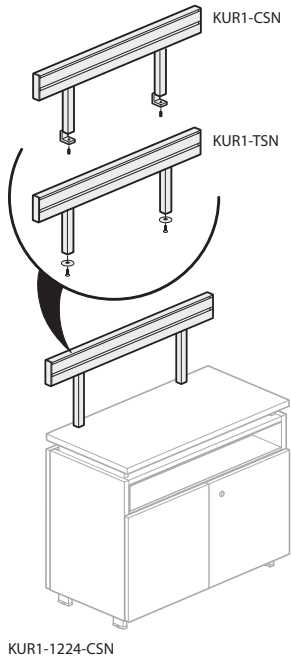

Rail Height	Width	Description	Number	Trim A	B
1.19" (30mm) Thick Top					
4" (102mm)	24" (610mm)	C-Clamp	KUR1-1224-CSN	\$319.15	\$333.48
	30" (762mm)		KUR1-1230-CSN	336.09	351.72
	36" (914mm)		KUR1-1236-CSN	353.03	369.96
	42" (1067mm)		KUR1-1242-CSN	369.97	388.20
	48" (1219mm)		KUR1-1248-CSN	386.91	406.44
	54" (1372mm)		KUR1-1254-CSN	403.85	424.68
	60" (1524mm)		KUR1-1260-CSN	508.07	530.20
2" (51mm) Thick Top					
4" (102mm)	24" (610mm)	C-Clamp	KUR1-1224-CMN	\$319.15	\$333.48
	30" (762mm)		KUR1-1230-CMN	336.09	351.72
	36" (914mm)		KUR1-1236-CMN	353.03	369.96
	42" (1067mm)		KUR1-1242-CMN	369.97	388.20
	48" (1219mm)		KUR1-1248-CMN	386.91	406.44
	54" (1372mm)		KUR1-1254-CMN	403.85	424.68
	60" (1524mm)		KUR1-1260-CMN	508.07	530.20
1.19" (30mm) Thick Top					
4" (102mm)	24" (610mm)	Thru-mount	KUR1-1224-TSN	\$319.15	\$333.48
	30" (762mm)		KUR1-1230-TSN	336.09	351.72
	36" (914mm)		KUR1-1236-TSN	353.03	369.96
	42" (1067mm)		KUR1-1242-TSN	369.97	388.20
	48" (1219mm)		KUR1-1248-TSN	386.91	406.44
	54" (1372mm)		KUR1-1254-TSN	403.85	424.68
	60" (1524mm)		KUR1-1260-TSN	508.07	530.20
2" (51mm) Thick Top					
4" (102mm)	24" (610mm)	Thru-mount	KUR1-1224-TMN	\$319.15	\$333.48
	30" (762mm)		KUR1-1230-TMN	336.09	351.72
	36" (914mm)		KUR1-1236-TMN	353.03	369.96
	42" (1067mm)		KUR1-1242-TMN	369.97	388.20
	48" (1219mm)		KUR1-1248-TMN	386.91	406.44
	54" (1372mm)		KUR1-1254-TMN	403.85	424.68
	60" (1524mm)		KUR1-1260-TMN	508.07	530.20

Features

- Includes one double sided rail with two posts, two rail end caps and attachment hardware.
- Mounts to horizontal surface to support rail tools.
- 1.19" (30mm) C-clamp Rail mounts on horizontal surfaces from 0.75" (19mm) to 1.75" (44mm) thick.
- Thru-mount Rail mounts on 1.19" (30mm) thick horizontal surfaces.
- Posts are 1.25" (32mm) thick.
- Belong and Jump Stuff work tools may be used; separately specified.
- Rail overall height above horizontal surface: 11.81" (300mm).
- Distance between rail bottom and top of horizontal surface: 7.44" (189mm).
- Ships unassembled.

To Order, Specify:

- 1) Product number.
- 2) Trim color for rail/post.
- 3) Trim color for rail end caps:
 - TR-K Charcoal
 - TR-J Graphite
 - TR-FM Snow

Specification Tips

- Designed for single sided Reside desking and single sided benching applications or Beside base units.
- **Not designed to be used in front of panel mounted accessories (tackboard, markerboard).**
- For ease of installation, it is required that tool rail posts are attached to Beside storage top prior to attaching storage top to base unit.
- Tool Rail supports a maximum load of 40 pounds evenly distributed on user side.
- If supporting two monitor arms (up to 13 pounds each); an additional C-clamp or thru-mount post is recommended.
- Rail may be installed off modular.
- Heavy load application; additional posts can be ordered.
- Monitor arm cannot be mounted in post positions.
- Thru-mount post can be attached flush to back edge of horizontal surface.
- C-clamp rail can be attached to panel mounted horizontal surface with notch or radius wireways without removing the horizontal surface.
- Under horizontal surface: 4" (102mm) of clearance is necessary between back of horizontal surface and adjacent component for clamp attachment.
- Gap between screen and horizontal surface allows installation of Belong Tool Rail.
- Utility tray provides clearance for installation of Belong Tool Rail.

Note: No more than 6" (152mm) of rail can be extended beyond outside of support.

Work Tools — Mounting

Belong

Tool Rail — Single Post — C-Clamp or Thru-mount

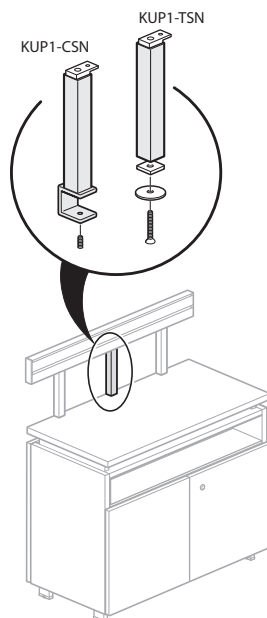

KUP1-0000-CSN

Post Height	Description	Number	Trim A	B
1.19"(30mm) Thick Top				
7.5"(191mm)	C-Clamp	KUP1-0000-CSN	\$98.99	\$106.80
2"(51mm) Thick Top				
7.5"(191mm)	C-Clamp	KUP1-0000-CMN	\$98.99	\$106.80
1.19"(30mm) Thick Top				
7.5"(191mm)	Thru-mount	KUP1-0000-TSN	\$98.99	\$106.80
2"(51mm) Thick Top				
7.5"(191mm)	Thru-mount	KUP1-0000-TMN	\$98.99	\$106.80

Features

- Includes one C-clamp or one Thru-mount Post and attachment hardware.
- Posts mount on horizontal surfaces 1.19"-2"(30mm-51mm) thick.
- Posts are 1.25"(32mm) thick.

To Order, Specify:

- 1) Product number.
- 2) Trim color.

Specification Tips

- For ease of installation, it is required that tool rail post is attached to Beside storage top prior to attaching storage top to base unit.
- Posts supports slide along rail bottom groove.
- For use with C-clamp or Thru-mount tool rail only.
- Monitor arm cannot be mounted in post position.
- Extra single posts can be ordered when additional support for monitor arms and paper management are attached to Tool Rail.

Work Tools — Mounting

Belong

Tool Rail — Under Horizontal Surface Mount — L-Bracket	Rail Height	Width	Number	Trim A	B
	4"(102mm)	24"(610mm)	KUR1-1224-USN	\$319.15	\$333.48
	30"(762mm)	KUR1-1230-USN	336.09	351.72	
	36"(914mm)	KUR1-1236-USN	353.03	369.96	
	42"(1067mm)	KUR1-1242-USN	369.97	388.20	
	48"(1219mm)	KUR1-1248-USN	386.91	406.44	
	54"(1372mm)	KUR1-1254-USN	403.85	424.68	
	60"(1524mm)	KUR1-1260-USN	508.07	530.20	
	66"(1676mm)	KUR1-1266-USN	536.71	561.44	
	72"(1829mm)	KUR1-1272-USN	565.35	590.08	
	78"(1981mm)	KUR1-1278-USN	593.99	620.02	
	84"(2134mm)	KUR1-1284-USN	622.63	649.96	
	90"(2286mm)	KUR1-1290-USN	651.27	679.90	
	96"(2438mm)	KUR1-1296-USN	679.91	709.84	

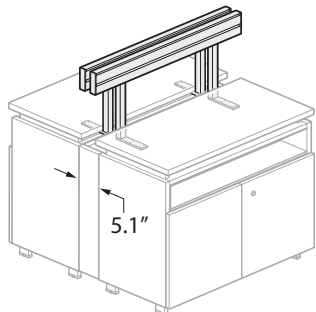
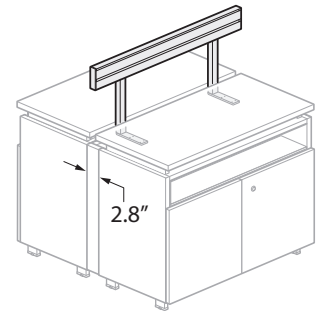
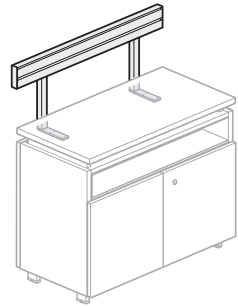

KUR1-1224-USN

Features

- One double sided rail with two or three posts, two rail end caps and attachment brackets.
- Rails 66"-96" (1676mm-2438mm) include three posts.
- L-bracket mounts under 1.19" (30mm) thick horizontal surface to support rail tools on both sides.
- Belong Work Tools or Jump Stuff Slat Pad Tools may be used; separately specified.
- Rail overall height above horizontal surface: 11.18" (284mm).
- Distance between rail bottom and top of horizontal surface: 7.44" (189mm).
- Post is 1.25" (32mm) thick.
- Ships unassembled.

To Order, Specify:

- 1) Product number.
- 2) Trim color for rail/post.
- 3) Trim color for rail end caps:
 - TR-K Charcoal
 - TR-J Graphite
 - TR-FM Snow

Specification Tips

- **Rail with L-bracket or shared bracket mount can only be used in non-panel applications.**
- **Designed for single sided Beside desking and single sided benching applications or Beside base unit.**
- **Tool Rail supports a maximum load of 40 pounds (18.14kg) evenly distributed on user side or supports two monitor arms up to 13 pounds each; additional L-bracket mount post recommended.**
- For use with one Beside base unit or back-to-back base units; L-Bracket Tool Rail is double sided to accommodate Belong work tool accessories on both sides.
- For back-to-back Beside base unit applications, one or two L-Bracket tool rail(s) may be used:
 - One L-Bracket tool rail may be used between base units which results in an aesthetically unbalanced tool rail condition. Both users share a single tool rail. L-Brackets are attached to only one of the two back-to-back Beside storage tops. (Note: KUR2-USN Under Worksurface Mount T-Bracket is not recommended for use with back-to-back base units due to installation issues.)
 - Two back-to-back L-Bracket tool rails may be used between base units for an aesthetically balanced tool rail condition.
 - For a single tool rail application, a 2.8" (71mm) deep filler panel may be used to fill gap between back-to-back units.
 - For two back-to-back tool rails, a 5.1" (130mm) deep filler panel may be used to fill gap between back-to-back base units.
- Tool Rail should be specified 6" (152mm) shorter than screen if both are specified.
- Can be installed off modular.
- Under horizontal surface: 4" (102mm) of clearance is necessary between back of horizontal surface and adjacent component for flat bracket attachment.
- Heavy load application; additional posts can be ordered.
- Monitor arm cannot be mounted in post positions.
- Gap between screen and horizontal surface allows installation of Belong Tool Rail.
- Utility tray provides clearance for installation of Belong Tool Rail.
- Posts mount flush to back edge of horizontal surface.

Note: No more than 6" (152mm) of rail can be extended beyond outside of support.

Work Tools — Mounting

Belong

	Post Height	Number	Trim A	B
Tool Rail — Single Post — L-Bracket Mount	8.85"(225mm)	KUP1-0000-USN	\$98.99	\$106.80

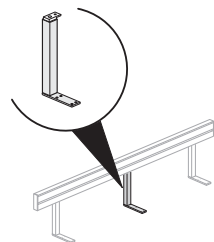

KUP1-0000-USN

Features

- Includes one under horizontal surface L-Bracket mount post and attachment hardware.
- Post is 1.25"(32mm) thick.

To Order, Specify:

- 1) Product number.
- 2) Trim color.

Specification Tips

- For use with under horizontal surface mount tool rail.
- Single Support Post may interfere with central casting.
- Monitor arm cannot be mounted in post position.
- Extra single posts can be ordered when additional support for monitor arms and paper management are attached to Tool Rail.

Work Tools — Mounting

Belong

	Rail Height	Width	Description	Number	Trim A	B
Tool Rail — Single Sided Continuous Benching End	4"(102mm)	24"(610mm)	End	KUR1-1224-USE	\$319.15	\$333.48
		30"(762mm)		KUR1-1230-USE	336.09	351.72
		36"(914mm)		KUR1-1236-USE	353.03	369.96
		42"(1067mm)		KUR1-1242-USE	369.97	388.20
		48"(1219mm)		KUR1-1248-USE	386.91	406.44
		54"(1372mm)		KUR1-1254-USE	403.85	424.68
		60"(1524mm)		KUR1-1260-USE	508.07	530.20
		66"(1676mm)		KUR1-1266-USE	536.71	561.44
		72"(1829mm)		KUR1-1272-USE	565.35	590.08
		78"(1981mm)		KUR1-1278-USE	593.99	620.02
		84"(2134mm)		KUR1-1284-USE	622.63	649.96
		90"(2286mm)		KUR1-1290-USE	651.27	679.90
		96"(2438mm)		KUR1-1296-USE	679.91	709.84

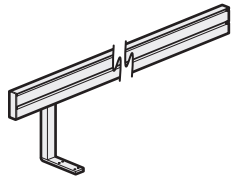

KUR1-1224-USE

Features

- One single sided tool rail with one or two posts, one rail end cap and attachment brackets.
- Tool Rails 66"-96" includes two posts.
- Mounts under 1.19"(30mm) thick horizontal surface to support rail tools.
- Belong Work Tools or Jump Stuff Slat Pad Tools may be used; separately specified.
- Tool rail overall height above horizontal surface: 11.18"(284mm).
- Distance between tool rail bottom and top of horizontal surface: 7.44"(189mm).
- Post is 1.25"(32mm) thick.
- Ships unassembled.

To Order, Specify:

- 1) Product number.
- 2) Trim color for tool rail/post.
 - TR-K Charcoal
 - TR-J Graphite
 - TR-FM Snow
- 3) Trim color for tool rail end cap:

Specification Tips

- **Designed for Reside Single Sided Continuous Benching or Beside continuous storage applications only.**
- **For use with another tool rail end or internal tool rail; internal benching single post must be specified.**
- **Tool Rail supports maximum of 40 pounds(18.14kg) evenly distributed on one side.**
- **For continuous benching application, two monitor arms up to 13 pounds each side, requires additional post.**
- **Tool Rail should be specified 6" shorter than screen if both are specified.**
- Can be installed off modular.
- Under horizontal surface: 4"(102mm) of clearance is necessary between back of horizontal surface and pedestal for flat bracket attachment.
- Gap between screen and horizontal surface allows installation of Belong Tool Rail.
- Utility tray provides clearance for installation of Belong Tool Rail.

Note: No more than 6"(152mm) of rail can be extended beyond outside of support.

Work Tools — Mounting

Belong

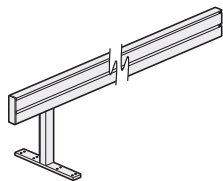
**Tool Rail — Double-Sided
Continuous Benching End
Application Only**

KUR2-1224-UBE

Rail Height	Width	Number	Price	
			A	B
4"(102mm)	24"(610mm)	KUR2-1224-UBE	\$319.15	\$333.48
	30"(762mm)	KUR2-1230-UBE	336.09	351.72
	36"(914mm)	KUR2-1236-UBE	353.03	369.96
	42"(1067mm)	KUR2-1242-UBE	369.97	388.20
	48"(1219mm)	KUR2-1248-UBE	386.91	406.44
	54"(1372mm)	KUR2-1254-UBE	403.85	424.68
	60"(1524mm)	KUR2-1260-UBE	508.07	530.20
	66"(1676mm)	KUR2-1266-UBE	536.71	561.44
	72"(1829mm)	KUR2-1272-UBE	565.35	590.08
	78"(1981mm)	KUR2-1278-UBE	593.99	620.02
	84"(2134mm)	KUR2-1284-UBE	622.63	649.96
	90"(2286mm)	KUR2-1290-UBE	651.27	679.90
96"(2438mm)	KUR2-1296-UBE	679.91	709.84	

Features

- One double sided tool rail with one or two posts, one rail end cap and attachment brackets.
- Tool Rails 66"(1676mm)-96"(2438mm) include two posts.
- Mounts under 1.19"(30mm) thick worksurface to support rail tools.
- Belong Work Tools or Jump Stuff Slat Pad Tools may be used; separately specified.
- Tool rail overall height above worksurface: 11.18"(284mm).
- Distance between tool rail bottom and top of worksurface: 7.44"(189mm).
- Post is 1.25"(32mm) thick.
- Ships unassembled.

To Order, Specify:

- 1) Product number.
- 2) Trim color for tool rail/post.
- 3) Trim color for tool rail end cap:

TR-K	Charcoal
TR-J	Graphite
TR-FM	Snow

Specification Tips

- **Designed for Reside Continuous Benching applications only.**
- **For use with another tool rail end or internal tool rail; internal benching single post must be specified.**
- **Tool Rail supports maximum of 40 pounds(18.14kg) evenly distributed on each side.**
- **For continuous benching application, two monitor arms up to 13 pounds each side, requires additional post.**
- **Tool Rail should be specified 6"(152mm) shorter than screen if both are specified.**
- **For back-to-back application, 1 or 2 monitors up to 13 grounds each side, requires additional post.**
- Can be installed off modular.
- Under worksurface: 4"(102mm) of clearance is necessary between back of worksurface and pedestal for flat bracket attachment.
- Gap between screen and horizontal surface allows installation of Belong Tool Rail.
- Utility tray provides clearance for installation of Belong Tool Rail.
- Posts mount centered within 3.65"(93mm) gap.
- Refer to Specification Guide for planning rules.

Note: No more than 6"(152mm) of rail can be extended beyond outside of support.

Work Tools — Mounting

Belong

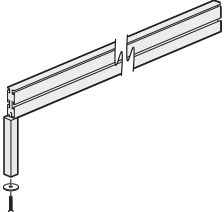
	Rail Height	Width	Description	Number	Trim A	B
 <p>KUR1-1224-USI</p>	4"(102mm)	24"(610mm)	Internal	KUR1-1224-USI	\$319.15	\$333.48
		30"(762mm)		KUR1-1230-USI	336.09	351.72
		36"(914mm)		KUR1-1236-USI	353.03	369.96
		42"(1067mm)		KUR1-1242-USI	369.97	388.20
		48"(1219mm)		KUR1-1248-USI	386.91	406.44
		54"(1372mm)		KUR1-1254-USI	403.85	424.68
		60"(1524mm)		KUR1-1260-USI	508.07	530.20
		66"(1676mm)		KUR1-1266-USI	536.71	561.44
		72"(1829mm)		KUR1-1272-USI	565.35	590.08
		78"(1981mm)		KUR1-1278-USI	593.99	620.02
		84"(2134mm)		KUR1-1284-USI	622.63	649.96
		90"(2286mm)		KUR1-1290-USI	651.27	679.90
	96"(2438mm)		KUR1-1296-USI	679.91	709.84	

Features

- One single sided tool rail with one or two post and attachment brackets.
- Tool Rails 66"(1676mm)-96"(2438mm) includes two posts.
- Mounts on 1.19"(30mm) thick horizontal surface to support rail tools.
- Belong Work Tools or Jump Stuff Slat Pad Tools may be used; separately specified.
- Tool rail overall height above horizontal surface: 11.18"(284mm).
- Distance between tool rail bottom and top of horizontal surface: 7.44"(189mm).
- Post is 1.25"(32mm) thick.
- Ships unassembled.

Specification Tips

- **Designed for Reside Single Sided Continuous Benching or Beside continuous storage applications only.**
- **For use with two rail ends; Internal Benching single post must be specified.**
- **Tool Rail supports a maximum of 40 pounds(18.14kg) evenly distributed on one side.**
- **For use with benching application, 1 or 2 monitors up to 13 pounds each side, requires additional post.**
- Mounts into 0.25"(6mm) gap between shared block connectors or center attachment location on shared column.
- Under horizontal surface: 4"(102mm) of clearance is necessary between back of horizontal surface and pedestal for flat bracket attachment.
- Gap between screen and horizontal surface allows installation of Belong Tool Rail.
- Utility tray provides clearance for installation of Belong Tool Rail.

To Order, Specify:

- 1) Product number.
- 2) Trim color for tool rail/post.

Work Tools — Mounting

Belong

	Rail Height	Width	Description	Number	Trim A	B
Tool Rail — Internal Continuous Benching Application Only	4"(102mm)	24"(610mm)	Internal	KUR2-1224-UBI	\$319.15	\$333.48
		30"(762mm)		KUR2-1230-UBI	336.09	351.72
		36"(914mm)		KUR2-1236-UBI	353.03	369.96
		42"(1067mm)		KUR2-1242-UBI	369.97	388.20
		48"(1219mm)		KUR2-1248-UBI	386.91	406.44
		54"(1372mm)		KUR2-1254-UBI	403.85	424.68
		60"(1524mm)		KUR2-1260-UBI	508.07	530.20
		66"(1676mm)		KUR2-1266-UBI	536.71	561.44
		72"(1829mm)		KUR2-1272-UBI	565.35	590.08
		78"(1981mm)		KUR2-1278-UBI	593.99	620.02
		84"(2134mm)		KUR2-1284-UBI	622.63	649.96
		90"(2286mm)		KUR2-1290-UBI	651.27	679.90
	96"(2438mm)		KUR2-1296-UBI	679.91	709.84	

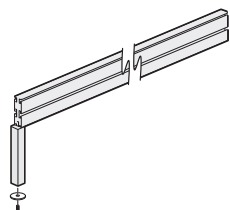

KUR2-1224-UBI

Features

- One double sided tool rail with one or two post and attachment brackets.
- Tool Rails 66"(1676mm)-96"(2438mm) includes two posts.
- Mounts on 1.19"(30mm) thick horizontal surface to support rail tools.
- Belong Work Tools or Jump Stuff Slat Pad Tools may be used; separately specified.
- Tool rail overall height above horizontal surface: 11.18"(284mm).
- Distance between tool rail bottom and top of horizontal surface: 7.44"(189mm).
- Post is 1.25"(32mm) thick.
- Ships unassembled.

To Order, Specify:

- 1) Product number.
- 2) Trim color for tool rail/post.

Specification Tips

- **Designed for Reside Continuous Benching and Beside continuous storage applications only.**
- **For use with two rail ends; Internal Benching single post must be specified.**
- **Tool Rail supports a maximum of 40 pounds(18.14kg) evenly distributed.**
- **Tool Rail should be specified 6" shorter than screen if both are specified.**
- **For use with benching application, 1 or 2 monitors up to 13 pounds each side, requires additional post.**
- Mounts into 0.25"(6mm) gap between shared block connectors or center attachment location on shared column.
- Under horizontal surface: 4"(102mm) of clearance is necessary between back of horizontal surface and pedestal for flat bracket attachment.
- Gap between screen and horizontal surface allows installation of Belong Tool Rail.
- Utility tray provides clearance for installation of Belong Tool Rail.
- Posts mount centered within 3.65"(93mm) gap.

Note: No more than 6"(152mm) of rail can be extended beyond outside of support.

Tool Rail — Single Post Internal/Benching

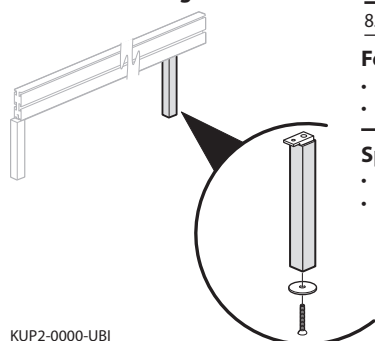

KUP2-0000-UBI

	Post Height	Description	Number	Trim A	B
	8.9"(226mm)	Internal	KUP2-0000-UBI	\$98.99	\$106.80

Features

- Includes one Internal position post and attachment hardware.
- Post is 1.25"(32mm) thick.

To Order, Specify:

- 1) Product number.
- 2) Trim color.

Specification Tips

- For use with benching mount tool rail.
- Mounts into 0.25"(6mm) gap between shared block connectors or center attachment location on shared column.

Work Tools

Belong

	Actual Height	Actual Depth	Actual Width	Weight Pounds	Description	Number	Trim A	B
Territory Screen — End-of Run	11.78"(299mm)	3"(76mm)	23.75"(603mm)	8.0 (3.6kg)	With Slots	KUTS-1224-ESN	\$168.66	\$176.32
				8.7 (3.9kg)	Without Slots	KUTS-1224-ENN	127.78	135.44
	11.78"(299mm)	3"(76mm)	29.75"(756mm)	8.0 (3.6kg)	With Slots	KUTS-1230-ESN	\$186.84	\$208.12
				8.7 (3.9kg)	Without Slots	KUTS-1230-ENN	145.96	167.24

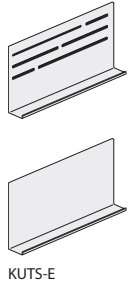

KUTS-E

Features

- Includes one freestanding steel End-of-Run Territory Screen with double sided attachment material.
- End-of-Run Territory Screen Options:
 - With Slots (S); without Slots (N).
 - With Accessory Kit (A) (square and rectangular trays with bud base).
 - Without Accessory Kit (N).
- Optional Slotted Territory Screen includes three rows of two slots; 2"(51mm) between rows (centerline-to-centerline):
- Slot Widths for 23.75"(603mm):
 - Top Row: 15.31"(389mm) and 5.25"(133mm).
 - Middle Row: 10.28"(261mm) and 10.28"(261mm).
 - Bottom Row: 5.25"(133mm) and 15.31"(389mm).
- Slot Widths for 29.75"(762mm):
 - Top Row: 19.73"(501mm) and 6.83"(174mm).
 - Middle Row: 13.28"(337mm) and 13.28"(337mm).
 - Bottom Row: 6.83"(174mm) and 19.73"(501mm).
- Supports maximum weight of 5 pounds (2.3kg) on side with ledge.
- Non-writable, magnetic surface.

To Order, Specify:

1) Product number including:

1 Accessory Kit Option:

- A** Accessory Kit, add \$44.72 list
- N** No Accessory Kit

2) Trim color.

Specification Tips

- End-of-Run Territory Screen is not designed for use with Base Tray.
- For use with separately specified Belong or Jump Stuff work tools.
- Accessory Kit is designed to sit on ledge of End-of-Run Territory Screen.
- Hanging accessories should be mounted in ledge side of End-of-Run Territory Screen with slots.

Territory Screen — Shared	11.78"(299mm)	6"(152mm)	23.75"(603mm)	8.0 (3.6kg)	With Slots	KUTS-1224-SSN	\$181.43	\$189.09
				8.7 (3.9kg)	Without Slots	KUTS-1224-SNN	140.55	148.21
	11.78"(299mm)	6"(152mm)	29.75"(756mm)	8.0 (3.6kg)	With Slots	KUTS-1230-SSN	\$199.61	\$220.89
				8.7 (3.9kg)	Without Slots	KUTS-1230-SNN	158.73	180.01

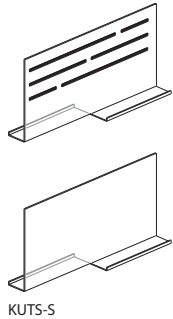

KUTS-S

Features

- Includes one freestanding steel Shared Territory Screen with double sided attachment material.
- Shared Territory Screen Options:
 - With Slots (S); without Slots (N).
 - With Accessory Kit (A) (square and rectangular trays with bud base).
 - Without Accessory Kit (N).
- Optional Slotted Territory Screen includes three rows of two slots; 2"(51mm) between rows (centerline-to-centerline):
- Slot Widths for 23.75"(603mm):
 - Top Row: 15.31"(389mm) and 5.25"(133mm).
 - Middle Row: 10.28"(261mm) and 10.28"(261mm).
 - Bottom Row: 5.25"(133mm) and 15.31"(389mm).
- Slot Widths for 29.75"(762mm):
 - Top Row: 19.73"(501mm) and 6.83"(174mm).
 - Middle Row: 13.28"(337mm) and 13.28"(337mm).
 - Bottom Row: 6.83"(174mm) and 19.73"(501mm).
- Supports maximum weight of 5 pounds (2.3kg).
- Non-writable, magnetic surface.

To Order, Specify:

1) Product number including:

1 Accessory Kit Option:

- A** Accessory Kit, add \$44.72 list
- N** No Accessory Kit

2) Trim color.

Specification Tips

- Shared Territory Screen is not designed for use with Base Tray.
- For use with separately specified Belong or Jump Stuff work tools.
- Accessory Kit is designed to sit on 11.8"(300mm) wide ledges of Shared Territory Screen.
- Hanging accessories may be mounted from either side of Shared Territory Screen with slots.

Work Tools

Belong

	Actual Height	Actual Depth	Actual Width	Weight Pounds	Description	Number	1	Trim A	B
Territory L-Screen	Right-hand								
	11.78"(299mm)	10"(254mm)	23.75"(603mm)	11.0 (5.4kg)	With Slots	KUTS-1224-LSR		\$207.00	\$214.66
				11.9 (5.0kg)	Without Slots	KUTS-1224-LNR		166.12	173.78
	11.78"(299mm)	10"(254mm)	29.75"(756mm)	11.0 (5.4kg)	With Slots	KUTS-1230-LSR		\$225.18	\$246.46
				11.9 (5.0kg)	Without Slots	KUTS-1230-LNR		225.18	246.46
	Left-hand								
	11.78"(299mm)	10"(254mm)	23.75"(603mm)	11.0 (5.4kg)	With Slots	KUTS-1224-LSL		\$207.00	\$214.66
				11.9 (5.0kg)	Without Slots	KUTS-1224-LNL		166.12	173.78
	11.78"(299mm)	10"(254mm)	29.75"(756mm)	11.0 (5.4kg)	With Slots	KUTS-1230-LSL		\$225.18	\$246.46
			11.9 (5.0kg)	Without Slots	KUTS-1230-LNL		184.30	205.58	

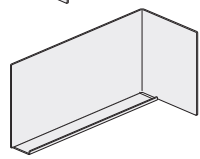
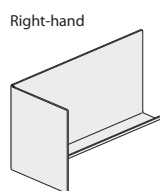
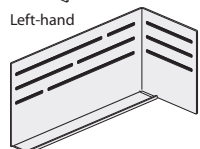
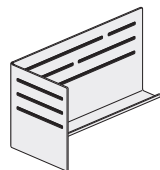

KUTS-L

Features

- Includes one freestanding steel Territory L- Screen with double sided attachment material.
- Territory L-Screen Options:
 - With Slots (S); without Slots (N).
 - With Accessory Kit (A) (square and rectangular trays with bud base).
 - Without Accessory Kit (N).
- Optional Slotted Territory L-Screen includes three rows of two slots; 2"(51mm) between rows (centerline-to-centerline):
- Slot Widths on 23.75"(603mm):
 - Top Row: 15.31"(389mm) and 5.25"(133mm).
 - Middle Row: 10.28"(261mm) and 10.28"(261mm).
 - Bottom Row: 5.25"(133mm) and 15.31"(388mm).
 - Slot widths on 10"(254mm) portion: three rows of 8.25"(210mm).
- Slot Widths for 29.75"(762mm):
 - Top Row: 19.73"(501mm) and 6.83"(174mm).
 - Middle Row: 13.28"(337mm) and 13.28"(337mm).
 - Bottom Row: 6.83"(174mm) and 19.73"(501mm).
- Supports maximum weight of 5 pounds (2.3kg) on inside of Territory L-Screen.
- Non-writable, magnetic surface.

To Order, Specify:

- 1) Product number, including:
 - 1 Accessory Kit Option:**
 - A** Accessory Kit, add \$44.72 list
 - N** No Accessory Kit
- 2) Trim color.

Specification Tips

- Territory L-Screen is not designed for use with Base Tray.
- For use with separately specified Belong or Jump Stuff work tools.
- Accessory Kit is designed to sit on ledge of Territory L-Screen.
- Hanging accessories should be mounted on inside of Territory L-Screen with slots.

Work Tools

Belong

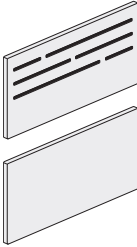
	Actual Height	Actual Depth	Actual Width	Weight Pounds	Number	Trim		
						A	B	
Structural Screen Tile  KUTB	With Slots							
	12"(305mm)	0.67"(17mm)	18"(457mm)	7.1 (3.2kg)	KUTB-1218-S	\$167.43	\$171.41	
			22.5"(572mm)	8.9 (4.0kg)	KUTB-1222-S	176.71	186.01	
			27"(686mm)	10.6 (4.8kg)	KUTB-1227-S	188.31	204.26	
			31.5"(800mm)	12.5 (5.7kg)	KUTB-1232-S	199.91	222.51	
			36"(914mm)	14.2 (6.4kg)	KUTB-1236-S	209.19	237.11	
	Without Slots							
	12"(305mm)	0.67"(17mm)	18"(457mm)	7.5 (3.4kg)	KUTB-1218-N	\$111.63	\$115.61	
			22.5"(572mm)	9.4 (4.3kg)	KUTB-1222-N	120.91	130.21	
			27"(686mm)	11.2 (5.1kg)	KUTB-1227-N	132.51	148.46	
			31.5"(800mm)	13.1 (5.9kg)	KUTB-1232-N	144.11	166.71	
			36"(914mm)	15.0 (6.8kg)	KUTB-1236-N	153.39	181.31	

Features

- Includes one steel Structural Screen Tile with or without slats and attachment hardware.
- Supports maximum weights of:
 - 18"(457mm) - 10 pounds (4.5kg).
 - 22.5"(572mm) - 10 pounds (4.5kg).
 - 27"(686mm) - 15 pounds (6.8kg).
 - 31.5"(800mm) - 17 pounds (7.7kg).
 - 36"(914mm) - 20 pounds (9.0kg).
- Non-writable, magnetic surface.

To Order, Specify:

- 1) Product number.
- 2) Trim color.

Specification Tips

- Designed for use on Belong Structural Screen (defaces screen) or structural building wall.
- May be wall mounted to structural building wall if properly mounted;
 - Anchors are not provided, must be field supplied.
- Cords cannot be passed behind the Structural Screen Tile.
- Not for use with Wall Track.
- For use with separately specified Belong or Jump Stuff work tools.

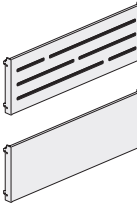
Belong Systems Tile — External Mount for use with Compose Panels	Actual Height	Actual Depth	Actual Width	Weight Pounds	Number	Trim		
						A	B	
 KZTB	With Slots							
	7.87"(200mm)	1.36"(35mm)	24"(610mm)	4.8 (2.2kg)	KZTB-0824-S	\$149.45	\$161.41	
			30"(762mm)	6.0 (2.7kg)	KZTB-0830-S	163.37	183.31	
			36"(914mm)	7.1 (3.2kg)	KZTB-0836-S	177.29	205.21	
			42"(1067mm)	8.2 (3.7kg)	KZTB-0842-S	191.21	227.11	
			48"(1219mm)	9.3 (4.2kg)	KZTB-0848-S	205.13	249.01	
	Without Slots							
	7.87"(200mm)	1.36"(35mm)	24"(610mm)	5.4 (2.4kg)	KZTB-0824-N	\$ 93.65	\$105.61	
			30"(762mm)	6.6 (3.0kg)	KZTB-0830-N	107.57	127.51	
			36"(914mm)	7.8 (3.5kg)	KZTB-0836-N	121.49	149.41	
			42"(1067mm)	9.1 (4.1kg)	KZTB-0842-N	135.41	171.31	
			48"(1219mm)	10.3 (4.7kg)	KZTB-0848-N	149.33	193.21	

Features

- Includes one steel external mount Systems Tile with or without slots with integrated attachment brackets for use with Compose Panel Frames with Tiles.
- Supports maximum weights of:
 - 24"(610mm) - 15 pounds (6.8kg).
 - 30"(762mm) - 17 pounds (7.7kg).
 - 36"(914mm) - 17 pounds (7.7kg).
 - 42"(1067mm) - 20 pounds (9.0kg).
 - 48"(1219mm) - 20 pounds (9.0kg).
- Non-writable, magnetic surface.

To Order, Specify:

- 1) Product number.
- 1) Trim color.

Specification Tips

- Designed for use with Compose Panel Frames with Tiles only.
- Nominal height is 8"(203mm).
- To be installed in panel frame slots on same width panel, a combination of panels equal to tile width.
- Vertical panel frame face dimensions:
 - Panel frame/non-raceway cover = frame height minus 2"(51mm).
 - Panel frame with raceway cover = frame height minus 10"(254mm).
- For use with separately specified Belong or Jump Stuff work tools.

Work Tools

Belong

	Actual Height	Actual Width	Weight Pounds	Description	Number	Trim A	B
Screen Rail	2.19"(56mm)	23.75"(603mm)	2.8 (1.3kg)	Single Sided	KUSR-0224-S	\$73.07	\$86.35
			2.8 (1.3kg)	Double Sided	KUSR-0224-D	86.35	99.63

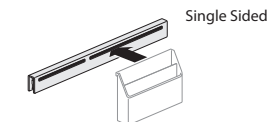
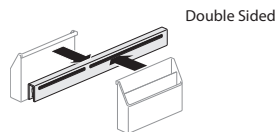

KUSR

Features

- Includes one steel Screen Rail; single sided with row of two slots or double sided with two slots on each side.
- Slot Widths: 8.19"(208mm) and 12.94"(329mm).
- Supports maximum weight of:
 - Single Sided: 5 pounds (2.3kg).
 - Double Sided: 5 pounds (2.3kg) each side.
- Non-writable, magnetic surface.

To Order, Specify:

- 1) Product number.
- 2) Trim color.

Specification Tips

- For use with separately specified Belong or Jump Stuff work tools.
- For use on top of fabric, laminate or wood Belong Screens.
- Not for use on Glass Screens, Structural L-screens or Territory Screens.

Open C Cubby

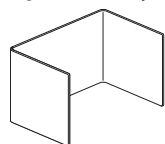

KUCU-0915-BNN

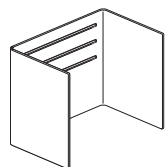

KUCU-1215-BNS

Height	Depth	Width	Description	Number	Trim A	B
9"(229mm)	10"(254mm)	15"(381mm)	No Slots	KUCU-0915-BNN	\$111.58	\$124.86
12"(305mm)	10"(254mm)	15"(381mm)	No Slots	KUCU-1215-BNN	116.90	130.18
12"(305mm)	10"(254mm)	15"(381mm)	With Slots	KUCU-1215-BNS	130.18	143.46

Features

- Includes one freestanding Open C Cubby.
- Freestanding Open C Cubby's are designed for supporting binders and books.
- Open C Cubby with slots allows use of Belong Work Tools or Jump Stuff Slat Pad work tools; separately specified.
- Open C Cubby's can be used in Beside Overhead Storage.

To Order, Specify:

- 1) Product number.
- 2) Trim color.

Work Tools

Belong

	Actual Height	Actual Depth	Actual Width	Weight Pounds	Description	Number	Trim A	B
Base Tray	2.09"(53mm)	3.55"(90mm)	23.75"(603mm)	5.0 (2.3kg)	With Accessory Kit	KUBT-0224-A	\$185.98	\$199.26
					Without Accessory Kit	KUBT-0224-N	139.49	152.77

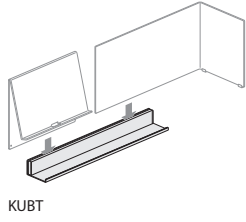

KUBT

Features

- Includes one freestanding steel Base Tray with aluminum insert rail.
- Base Tray is available with or without Accessory Kit.

Specification Tips

- Designed for use with L-Screen, Reference Shelf and Accessory Kit.
- L-Screen and Reference Shelf slide into space between steel back and aluminum insert.
- Base Tray accommodates one Reference Shelf and one L-Screen.
- Accessory Kit is designed to sit on 2.84"(72mm) deep base tray ledge.

To Order, Specify:

- 1) Product number.
- 2) Trim color.

Desk Top L-Screen	11.87"(301mm)	10"(254mm)	23.75"(603mm)	9.7 (4.4kg)	Right-hand	KULS-0000-TR	\$128.87	\$142.15
					Left-hand	KULS-0000-TL	128.87	142.15

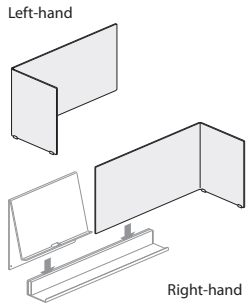

KULS

Features

- Includes one steel Desk Top L-screen with semi-transparent plastic feet.
- Non-writable, magnetic surface.
- Desk Top L-Screen is handed.
- Supports maximum weight of 5 pounds (2.3kg).

Specification Tips

- Designed for use with Base Tray or as freestanding.
- Desk Top L-Screen may be used alone in Base Tray or with Reference Shelf.
- Depth portion of L-Screen, when used adjacent to Reference Shelf, is the same width as Base Tray; width portion of L-Screen perpendicularly wraps around Base Tray ledge.
- Width portion of Desk Top L-Screen may be positioned to fill Base Tray or a portion may overhang past end of Base Tray to accommodate Reference Shelf.

To Order, Specify:

- 1) Product number.
- 2) Trim color.

Desk Top Reference Shelf	12.03"(306mm)	4.25"(108mm)	14.5"(368mm)	8.1 (3.7kg)		KURS-0014-T	\$99.62	\$106.27
---------------------------------	---------------	--------------	--------------	-------------	--	-------------	----------------	-----------------

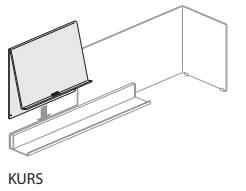

KURS

Features

- Includes one steel desk Top Reference Shelf.
- Desk Top Reference Shelf lip is 1"(25mm) deep with a 15 degree angle.
- Includes a cutout for cord drop if used for charging of electronic devices.
- Supports maximum weight of 5 pounds (2.3kg).
- Non-writable, magnetic surface.

Specification Tips

- Desk Top Reference Shelf may not be used alone in Base Tray; must be used together with Desk Top L-Screen for support purposes.
- Desk Top Reference Shelf is not freestanding.
- Desk Top Reference Shelf adjacent to depth portion of L-Screen are the same width as Base Tray; width portion of L-Screen perpendicularly wraps around Base Tray ledge.
- Desk Top Reference Shelf adjacent to width portion of L-Screen will overhang past end of Base Tray.

To Order, Specify:

- 1) Product number.
- 2) Trim color.

Work Tools

Belong

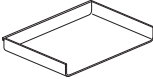
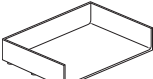
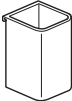
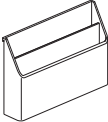
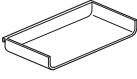
	Height	Depth	Width	Description	Number	Price
Paper Tray — Landscape	1.5"(38mm)	8.875"(225mm)	12.75"(324mm)	Slat — Document Tray	KUPT-0913-H	\$27.89
	2.5"(38mm)	8.875"(225mm)	12.75"(324mm)	Freestanding — Stacking Tray	KUPT-0913-F	\$33.21
 KUPT-0913-H  KUPT-0913-F	Features <ul style="list-style-type: none"> Includes one plastic tray. Slat document tray mounts on Belong rail, Belong slat tile and Beside stanchion and Compose slat tile. Slat document tray supports maximum of one ream (5 pounds/2.3kg) of paper. Freestanding stacking tray is freestanding and stacks 4 high. 			To Order, Specify: <ol style="list-style-type: none"> Product number. Trim color. <ul style="list-style-type: none"> TR-R Beige TR-1R Brownstone TR-RR Rusty Red TR-FM Snow <p>Note: Snow (TR-FM) plastic trim color is not recommended for use with painted trim colors Plaster (TR-TW) or Chalk (TR-AK). Refer to Very' Seating chainset for Snow.</p>		
Tool Cup	3.5"(90mm)	2.5"(38mm)	2.5"(38mm)		KUTC-0000-H	\$23.91
 KUTC-0000-H	Features <ul style="list-style-type: none"> Includes one plastic tool cup. Tool cup mounts on: <ul style="list-style-type: none"> –Belong rail –Belong slat tile –Beside stanchion –Open C Cubby with slots –Compose slat tile Can also be used in freestanding applications. 			To Order, Specify: <ol style="list-style-type: none"> Product number. Trim color. <ul style="list-style-type: none"> TR-R Beige TR-1R Brownstone TR-RR Rusty Red TR-FM Snow <p>Note: Snow (TR-FM) plastic trim color is not recommended for use with painted trim colors Plaster (TR-TW) or Chalk (TR-AK). Refer to Very' Seating chainset for Snow.</p>		
Hanging Sorter	8.5"(216mm)	2.5"(64mm)	12.75"(324mm)		KUHS-0000-H	\$65.11
 KUHS-0000-H	Features <ul style="list-style-type: none"> Includes one hanging sorter with two paper sorters. Interior depth of each sorter is 1"(25mm). Hanging sorter mounts on: <ul style="list-style-type: none"> –Belong rail –Belong slat tile –Beside stanchion –Open C Cubby with slots –Compose slat tile 			To Order, Specify: <ol style="list-style-type: none"> Product number. Trim color. <ul style="list-style-type: none"> TR-R Beige TR-1R Brownstone TR-RR Rusty Red TR-FM Snow <p>Note: Snow (TR-FM) plastic trim color is not recommended for use with painted trim colors Plaster (TR-TW) or Chalk (TR-AK). Refer to Very' Seating chainset for Snow.</p>		
Mini Shelf	1"(25mm)	4"(102mm)	8"(203mm)		KUSH-0408-H	\$23.91
 KUSH-0408-H	Features <ul style="list-style-type: none"> Includes one plastic shelf. Mini shelf mounts on: <ul style="list-style-type: none"> –Belong rail –Belong slat tile –Beside stanchion –Open C Cubby with slots –Compose slat tile 			To Order, Specify: <ol style="list-style-type: none"> Product number. Trim color. <ul style="list-style-type: none"> TR-R Beige TR-1R Brownstone TR-RR Rusty Red TR-FM Snow <p>Note: Snow (TR-FM) plastic trim color is not recommended for use with painted trim colors Plaster (TR-TW) or Chalk (TR-AK). Refer to Very' Seating chainset for Snow.</p>		

Work Tools

Belong

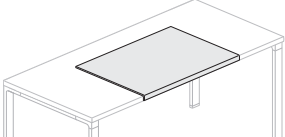
	Depth	Width	Edge	Number	Fabric Grade	
					D	E
 KUBL-2030-FJ	19.7"(500mm)	29.5"(749mm)	3mm	KUBL-2030-FJ	\$539.36	\$569.93
	19.7"(500mm)	35.4"(899mm)		KUBL-2036-FJ	552.64	585.86
	23.6"(599mm)	35.4"(899mm)		KUBL-2436-FJ	565.92	601.79
	19.7"(500mm)	29.5"(749mm)	Knife	KUBL-2030-FF	\$539.36	\$569.93
	19.7"(500mm)	35.4"(899mm)		KUBL-2036-FF	552.64	585.86
	23.6"(599mm)	35.4"(899mm)		KUBL-2436-FF	565.92	601.79

Features

- Includes one blotter with protective back.
- Specify blotter profile to match desking edge:
 - 3mm Edgeband
 - Knife edge
- Belong Blotter radius is 0.5"(13mm).

To Order, Specify:

- 1) Product number.
- 2) Fabric

Specification Tips

- 20"(508mm) deep blotter can be used on 24"(610mm) deep desking without hatch.
- 20"(508mm) deep blotter can be used on 30"(762mm) deep desking with hatch.
- 24"(610mm) deep blotter can be used on 36"(914mm) deep desking with hatch.

Reference Shelves

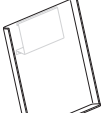
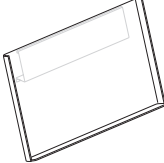
	Height	Width	Description	Number	Trim	
					A	B
 KURS-0010-H	11.25"(286mm)	9.875"(251mm)	Reference — Small	KURS-0010-H	\$66.41	\$ 73.06
		18.5"(470mm)	Reference — Large	KURS-0019-H	99.62	106.27
 KURS-0012-B	9.875"(251mm)	11.625"(295mm)	Blotter Reference Shelf	KURS-0012-B	\$66.41	\$ 73.06

Features

- Includes one metal reference shelf
- Large and Small Reference shelves mount on:
 - Belong rail
 - Belong slat tile
 - Beside stanchion
 - Open C Cubby with slots
- Blotter Reference Shelf slides under blotter for support.

To Order, Specify:

- 1) Product number.
- 2) Trim color.

Specification Tips

- In installed position large and small referencing shelves are 0.88"(22mm) high and 4.3"(109mm) deep.
- Reference shelf lip is 1.375"(35mm) deep.

Accessory Kit

	Number	Price
 KUAK	KUAK-0000-BSR	\$54.47

Features

- Includes one square tray, one rectangular tray and bud vase with square base. All items are plastic.
- Sizes:
 - Square tray: 2.75"(70mm).
 - Rectangular tray: 2.75" x 5.5"(70mm x 140mm).
 - Bud Vase: 4"(102mm) tall, 0.75"(19mm) inside diameter, 2.75"(70mm) square base.
- Designed for use with the Base Tray, Territory Screen or as freestanding pieces.
- Standard in snow trim color.

To Order, Specify:

- 1) Product number.
(No finish specification required)

Note: Snow (TR-FM) plastic trim color is not recommended for use with painted trim colors Plaster (TR-TW) or Chalk (TR-AK). Refer to Very Seating chainset for Snow.

Work Tools

Jump Stuff

	Height	Depth	Width	Number	Price
--	--------	-------	-------	--------	-------

Tool Cup

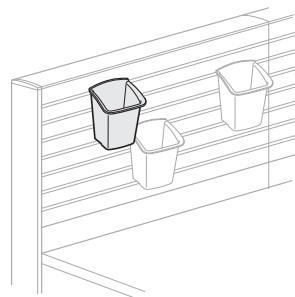

DTWC-2

Feature

- Mounts on rail and slat pad. Can also be used in freestanding applications.

To Order, Specify:

- 1) Product number.
- 2) Translucent trim color.

	Height	Depth	Width	Number	Trim A	B	Price
--	--------	-------	-------	--------	--------	---	-------

Paper Sorter

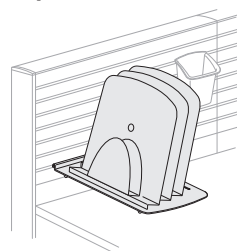

DTPR-3

Features

- Includes three dividers, one shelf, and mounting bracket.
- Mounts on slat pad.
- Can also be used as a horizontal freestanding tray.
- Supports maximum of two reams (ten pounds/4.6 kilograms) of paper.

To Order, Specify:

- 1) Product number.
- 2) Translucent trim color.
- 3) Trim color for bracket.

	Height	Depth	Width	Number	Price
--	--------	-------	-------	--------	-------

Binder Bin

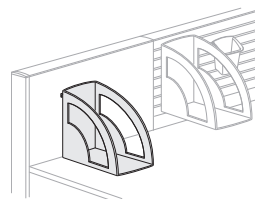

DTSB-3

Features

- Mounts on slat pad. Can also be used in freestanding applications.
- Bin accommodates two 3"(76mm) thick binders.

To Order, Specify:

- 1) Product number.
- 2) Translucent trim color.

	Height	Depth	Width	Number	Price
--	--------	-------	-------	--------	-------

Tack Strip

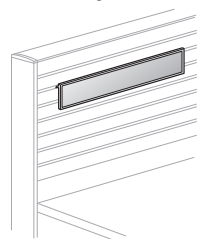

DTTS-12
DTTS-24

Features

- Mounts on slat pad.
- Brown and black cork and rubber composite material.

To Order, Specify:

- 1) Product number.
- 2) Trim color for bracket.

Work Tools

Jump Stuff

	Number	Price
Gooseneck Kit	DTGK-3	\$74.81

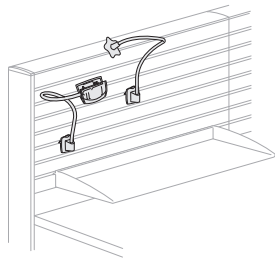

DTGK-3

Features

- Includes two flex arms, two base clips, assortment of three tops (one grip clip, one round top, and one flower top) and two stick-on clips.
- Mounts on slat pad to display miscellaneous notes/items or anywhere with stick-on clips.
- Stick-on clips include double-sided tape.

To Order, Specify:

- 1) Product number.
- 2) Translucent trim color.

Mini Shelf

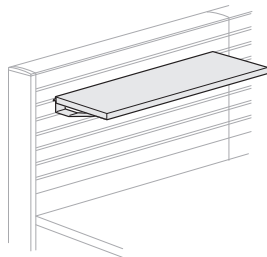

DMSP

Height	Depth	Width	Number	Laminate	
				A	B
1.75"(44mm)	6.25"(159mm)	18"(457mm)	DMSP-18	\$124.94	\$134.92
		24"(610mm)	DMSP-24	130.64	140.62
		30"(762mm)	DMSP-30	136.31	146.29
		36"(914mm)	DMSP-36	142.01	151.99
		42"(1067mm)	DMSP-42	147.67	157.65
		48"(1219mm)	DMSP-48	153.34	163.32

Features

- Includes shelf and brackets.
- Mounts on slat pad.
- Shelf thickness 0.75"(19mm)
- Designed for lightweight accessories.

To Order, Specify:

- 1) Product number.
- 2) Shelf trim color.
- 3) Edgeband color.
- 4) Trim color for brackets.

	Height	Depth	Width	Description	Number	Price
Tote	10"(254mm)	4"(102mm)	13"(330mm)	Tote	DTTE-3	\$ 71.33
				Tote, clips, and strap	DTTH-3	101.30

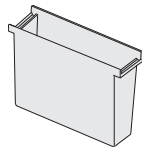

DTTE-3

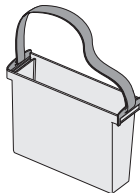

DTTH-3

Features

- Mounts on slat pad.
- Clip and strap standard in black.
- Fits in lateral files.
- Accommodates hanging files.

To Order, Specify:

- 1) Product number.
- 2) Translucent trim color.

Tote Strap



DTHT-1

					DTHT-1	\$32.83
--	--	--	--	--	--------	---------

Features

- Includes strap and two clips.
- Strap is 27"(686mm) long and non-adjustable.
- Converts DTTE-3 to DTTH-3.
- Standard in black.

To Order, Specify:

- 1) Product number.
(No finish specification required.)

Work Tools

Jump Stuff

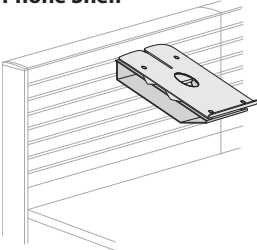
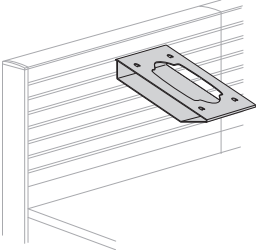
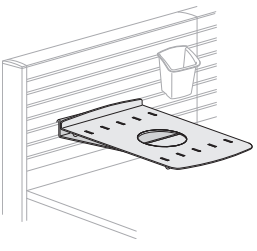
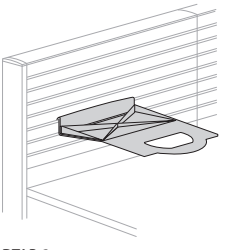
	Height	Depth	Width	Number	Trim A	B
Phone Shelf  DTPT-3	2.5"(64mm)	11.25"(286mm)	9"(229mm)	DTPT-3	\$97.01	\$99.87
Features <ul style="list-style-type: none"> • Includes phone shelf and bracket. • Mounts on slat pad at 30° angle. • Supports maximum of two reams (ten pounds/4.6 kilograms) of paper. 	To Order, Specify: <ol style="list-style-type: none"> 1) Product number. 2) Translucent trim color. 3) Trim color for bracket. 					
Phone Shelf Bracket  DTBS-3	1.5"(38mm)	11"(279mm)	7.5"(191mm)	DTBS-3	\$59.91	\$62.77
Feature <ul style="list-style-type: none"> • Used to convert DTPT-1 for mounting rail phone shelf to slat pad. 	To Order, Specify: <ol style="list-style-type: none"> 1) Product number. 2) Trim color for bracket. 					
Personal Shelf  DTES-3	1.75"(44mm)	11"(279mm)	8"(203mm)	DTES-3	\$67.06	\$69.92
Features <ul style="list-style-type: none"> • Includes mounting bracket and personal shelf. • Mounts on rail at 60° angle or horizontally. • Can also be used as a horizontal freestanding tray. • Supports maximum of two reams (ten pounds/4.6 kilograms) of paper. 	To Order, Specify: <ol style="list-style-type: none"> 1) Product number. 2) Translucent trim color. 3) Trim color for bracket. 					
Personal Shelf Bracket  DTAR-3				DTAR-3	\$44.23	\$47.09
Feature <ul style="list-style-type: none"> • Used in combination with DTPR-3 or DTES-3 for mounting rail personal shelf or paper sorter to slat pad. 	To Order, Specify: <ol style="list-style-type: none"> 1) Product number. 2) Trim color for bracket. 					

Work Tools

Jump Stuff

	Height	Depth	Width		Number	Price
Letter Tray	2.5"(64mm)	12"(305mm)	10.5"(267mm)		DTLT-2	\$29.97

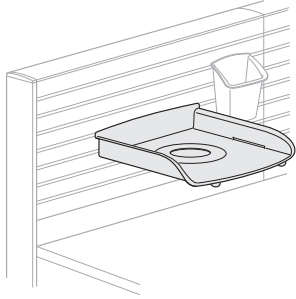

DTLT-2

Features

- Mounts on rail at 60° angle or horizontally.
- Mounts on slat pad horizontally.
- Can also be used in freestanding applications.
- Use Letter Tray Stacking Brackets (DTLS-2) to convert to stacking letter trays.
- Supports maximum of one ream (five pounds/2.3 kilograms) of paper.

To Order, Specify:

- 1) Product number.
- 2) Translucent trim color.

Letter Tray Stacking Kit	8"(203mm)	12"(305mm)	10.5"(267mm)		DTLS-2	\$77.04
---------------------------------	-----------	------------	--------------	--	--------	---------

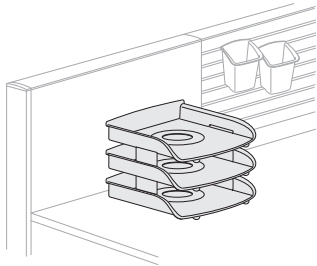

DTLS-2

Features

- Includes three letter trays and two stacking brackets.
- Used in freestanding applications.

To Order, Specify:

- 1) Product number.
- 2) Translucent trim color.

Letter Tray Stacking Bracket	2.25"(57mm)	5"(127mm)	9.5"(241mm)		DTSB-1	\$21.40
-------------------------------------	-------------	-----------	-------------	--	--------	---------

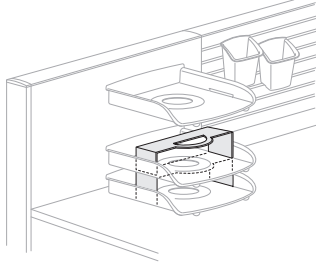

DTSB-1

Features

- Includes two stacking brackets.
- Used in freestanding applications.

To Order, Specify:

- 1) Product number.
- 2) Translucent trim color.

	Height	Depth	Width	Description	Number	Price
Waste Bin	15.5"(394mm)	12"(305mm)	13"(330mm)	Black	DTRB-1B	\$57.05
				Translucent	DTRB-1	75.60

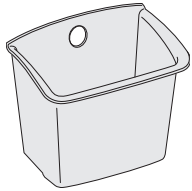

DTRB

Features

- Used in freestanding applications.
- Five gallon capacity.

To Order, Specify:

- 1) Product number.
- 2) Translucent trim color.

	Description	Number	Price
Pile Master Kit	Pre-Packaged	DPKY-1	\$343.81

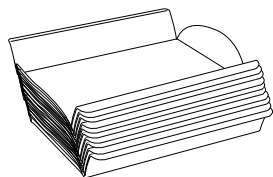

DPKY-1

Features

- Kit includes ten pile dividers.
- Requires no mounting rail.

To Order, Specify:

- 1) Product number.
- 2) Translucent trim color.

Work Tools

Jump Stuff

	Mounting System	Slat Pad Width	Packaging	Number	Trim	
					A	B
File Master Kit	Slat Pad	69"(1753mm)	Pre-Packaged	DPKP-S	\$560.65	\$572.54
	Slat Pad		Bulk-Packaged	DBKP-S	490.74	502.63

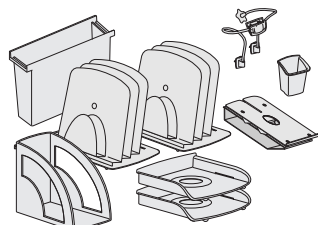

DPKP-S
DBKP-S

Features

- Kit includes gooseneck kit, two paper sorters, two letter trays, phone shelf, tote, tool cup, and binder bin.
- Mounts on separately specified slat pad.
- Ships either pre-packaged or bulk-packaged.
- Bulk-packaged offers reduced list price, and ships with each set of parts packaged in separate cartons.

Note: Minimum 10 kits required to order as bulk-packaged.

To Order, Specify:

- 1) Product number.
- 2) Translucent trim color.
- 3) Trim color for brackets.

Task Master Kit	Slat Pad	51"(1295mm)	Pre-Packaged	DPKT-S	\$537.17	\$549.06
	Slat Pad		Bulk-Packaged	DBKT-S	470.02	481.91

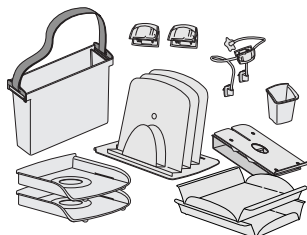

DPKT-S
DBKT-S

Features

- Kit includes gooseneck kit, paper sorter, two letter trays, phone shelf, tote, two grip clips, two pile dividers, and tool cup.
- Mounts on separately specified slat pad.
- Ships either pre-packaged or bulk-packaged.
- Bulk-packaged offers reduced list price, and ships with each set of parts packaged in separate cartons.

Note: Minimum 10 kits required to order as bulk-packaged.

To Order, Specify:

- 1) Product number.
- 2) Translucent trim color.
- 3) Trim color for brackets.

Mini Master Kit	Slat Pad	49"(1245mm)	Pre-Packaged	DPKS-S	\$356.64	\$365.21
	Slat Pad		Bulk-Packaged	DBKS-S	302.43	311.00

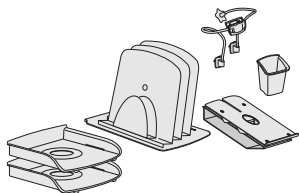

DPKS-S
DBKS-S

Features

- Kit includes gooseneck kit, paper sorter, two letter trays, phone shelf, and tool cup.
- Mounts on separately specified slat pad.
- Ships either pre-packaged or bulk-packaged.
- Bulk-packaged offers reduced list price, and ships with each set of parts packaged in separate cartons.

Note: Minimum 10 kits required to order as bulk-packaged.

To Order, Specify:

- 1) Product number.
- 2) Translucent trim color.
- 3) Trim color for brackets.

Work Tools

Magnetic Accessories

	Actual Height	Actual Width	Number	Price
Magnet Board	11"(279mm)	4"(102mm)	KUAM-0411	\$30.70
	18"(457mm)	5"(127mm)	KUAM-0518	61.40

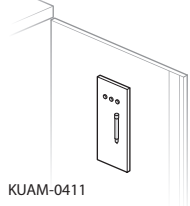

KUAM-0411

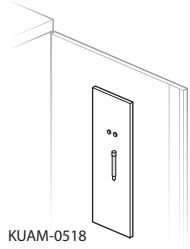

KUAM-0518

Features

- Includes:
 - Magnetic dry-erase board
 - Three round magnets on 11"(279mm) high magnet board, two round magnets on 18"(457mm) high magnet board
 - One magnetic dry erase pen
 - Magnetic attachment strip for attachment to magnetic surfaces
 - Adhesive strip for attachment to non-magnetic surfaces
- Available in white (not matched to Haworth's color palette).

To Order, Specify:

- 1) Product number.

Specification Tip

- Use on non-textured surfaces for best performance.

Magnet Hooks

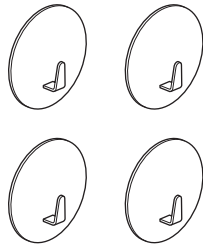

KUAH-0002

Diameter	Number	Price
1.5"(38mm)	KUAH-0002	\$29.48

Features

- Includes four 1.5"(38mm)-diameter magnetic hooks for holding personal items.
- Available in white (not matched to Haworth's color palette).

To Order, Specify:

- 1) Product number.

Specification Tip

- Use on non-textured surfaces for best performance.

Magnet Hook



KUAH-0003

Diameter	Number	Price
3"(76mm)	KUAH-0003	\$18.43

Features

- Includes one 3"(76mm)-diameter magnetic hook for holding personal items.
- Available in white (not matched to Haworth's color palette).

To Order, Specify:

- 1) Product number.

Specification Tip

- Use on non-textured surfaces for best performance.

Round Peg Magnets

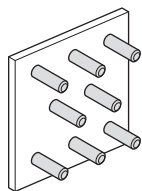

KUAP-0000

Depth	Diameter	Number	Price
0.375"(10mm)	0.16"(4mm)	KUAP-0000	\$29.48

Features

- Includes eight round magnets and acrylic storage box.
- Available in chrome.

To Order, Specify:

- 1) Product number.

Specification Tips

- Use on non-textured surfaces for best performance.
- Each magnet can hold up to eight sheets of letter-size paper.

Mirror

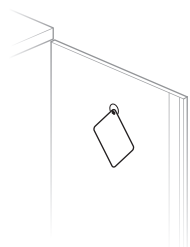

KUAR-0403

Actual Width	Actual Length	Number	Price
3.125"(80mm)	4.375"(111mm)	KUAR-0403	\$20.87

Features

- Includes one acrylic mirror.
- Can be hung from a Belong magnetic hook, or placed in a Belong pouch (specified separately).

To Order, Specify:

- 1) Product number.
(No color specification required.)

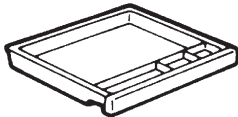
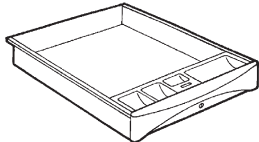
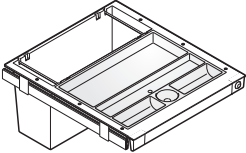
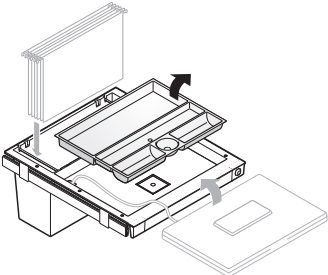
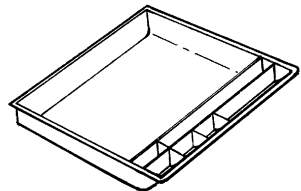

Workstation Accessories

	Height	Depth	Width	Number	Price
<p>Shallow Drawer</p>  <p>DS-3 Class AA – SIN 711-1; Discount Group I</p>	3"(76mm)	15.375"(391mm)	18.25"(464mm)	DS-3	\$66.11
<p>Features</p> <ul style="list-style-type: none"> • Shallow drawer has four compartments. • Drawer does not stack. • Available in charcoal or gray tone finish colors only. 				<p>To Order, Specify:</p> <ol style="list-style-type: none"> 1) Product number. 2) Trim color. TR-K Charcoal TR-G Gray Tone 	
<p>Steel Center Drawer</p>  <p>SCD-19 Class MA – SIN 711-3; Discount Group II</p>	2"(51mm)	17.5"(445mm)	19.125"(486mm)	SCD-19	\$316.98
<p>Features</p> <ul style="list-style-type: none"> • Includes mounting hardware. • Standard with lock. • Standard in charcoal finish color only. 				<p>To Order, Specify:</p> <ol style="list-style-type: none"> 1) Product number. (No finish specification required.) 	
<p>Pencil + Drawer</p>   <p>KUDP-2420 Class YA – SIN 711-1; Discount Group XIII</p>	11"(279mm)	24"(610mm)	19.5"(495mm)	KUDP-2420	\$397.06
<p>Features</p> <ul style="list-style-type: none"> • Multi-purpose drawer provides organization, hanging filing along with laptop storage. • Knock-outs at rear of drawer provide electronic charging access while contents are locked. • Removable organizing tray. • Thin profile maximizes knee clearance under front of drawer. • Standard in black trim color with black locks. • Standard with lock (shipped separately); keyed-alike and master keying options available. 				<p>To Order, Specify:</p> <ol style="list-style-type: none"> 1) Product number. (No finish specification required.) 	
<p>Specification Tips</p> <ul style="list-style-type: none"> • To be mounted below worksurfaces 24"(610mm) or deeper. • Not for use with 24"(610mm) deep knife edge worksurface. • Pencil + drawer must be used adjacent to worksurface floor support when specified for use with panel system. 					
<p>Pencil Drawer</p>  <p>JAC-18 Class FP – SIN 711-11; Discount Group XII</p>	1.625"(41mm)	19"(483mm)	18"(457mm)	JAC-18	\$79.79
<p>Features</p> <ul style="list-style-type: none"> • Includes black plastic drawer, slides, and mounting hardware. • Attaches under freestanding desks, returns, bridges, system convergent or rectangular worksurfaces. 				<p>To Order, Specify:</p> <ol style="list-style-type: none"> 1) Product number. (No finish specification required.) 	
<p>Specification Tip</p> <ul style="list-style-type: none"> • Do not install in area where cantilever bracket is installed. 					

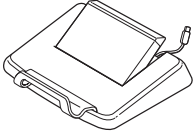
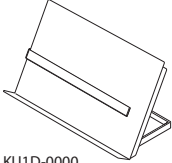
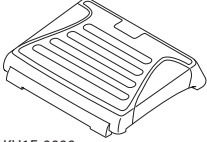
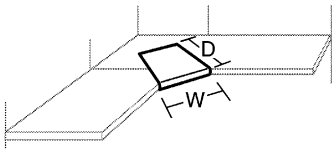
Workstation Accessories

	Description	Number	Price				
 <p>KU1L-0000-U</p>	<p>Adjustable Laptop Holder</p> <p>Laptop Holder with 4-port USB</p> <p>Features</p> <ul style="list-style-type: none"> • Includes adjustable Laptop Holder with or without built-in 4-port USB hub (2.0). • Accommodates laptops 16"(406mm) wide x 12"(305mm) deep. • Five laptop angle adjustments: 4°, 14°, 23°, 33° and 43°. • Size: 12.75"(324mm) wide x 10"(254mm) deep. 1.25"(32mm) high in stored position. • Protective pads on bottom. • Standard in supplier black with silver accent. <p>Specification Tips</p> <ul style="list-style-type: none"> • Hub Specifications: <ul style="list-style-type: none"> –Fully compliant with universal serial bus specification revision 2.0 (data rate 1.5/12/480 Mbps) –LED indicates the hub is ready –Direct bus power mode eliminates need for external power –Over-current detection and protection for each downstream port –Plug and play and hot swap function supported –Windows and Mac compatible –CE/US/FCC approved –RoHS compliant 	KU1L-0000-U	\$161.54				
 <p>KU1D-0000</p>	<p>Adjustable Document Holder</p> <p>Document Holder</p> <p>Features</p> <ul style="list-style-type: none"> • Includes painted steel Adjustable Document Holder with magnetic attached line guide. • Infinite angle adjustment up to 80° with tension adjustment lever. • Accommodates papers or books. • Size: 16.7"(425mm) wide x 7.5"(191mm) deep x 9.75"(215mm) high. • Standard in supplier black. • Protection pads on bottom. 	KU1D-0000	\$135.48				
 <p>KU1F-0000</p>	<p>Adjustable Footrest</p> <p>Footrest</p> <p>Features</p> <ul style="list-style-type: none"> • Includes Adjustable Foot Rest with anti-slip rubber mat on top. • Angle adjustment by hand: 6°, 12°, 16° and 25° • Size: 15.75"(400mm) wide x 14.75"(375mm) deep x 3.25"-5"(83mm-127mm) high. • Folds flat for easy storage. • Standard in supplier black with silver accent. • Protective pads on bottom. 	KU1F-0000	\$135.48				
 <p>MAC-0001 Class AA</p>	<p>Make-A-Corner</p> <table border="1"> <thead> <tr> <th>Depth</th> <th>Width</th> </tr> </thead> <tbody> <tr> <td>21.125"(537mm)</td> <td>26.125"(664mm)</td> </tr> </tbody> </table> <p>Features</p> <ul style="list-style-type: none"> • Creates an angled edge between two (2) perpendicular regular worksurfaces. • Slides over the top of 1.19"(30mm) thick worksurfaces. • Accommodates an adjustable keyboard or mouse pad track (screws included). 	Depth	Width	21.125"(537mm)	26.125"(664mm)	MAC-0001	\$199.24
Depth	Width						
21.125"(537mm)	26.125"(664mm)						
		<p>To Order, Specify:</p> <p>1) Product number. (No finish specification required.)</p>					
		<p>To Order, Specify:</p> <p>1) Product number. (No finish specification required.)</p>					
		<p>To Order, Specify:</p> <p>1) Product number. (No finish specification required.)</p>					
		<p>To Order, Specify:</p> <p>1) Product number. 2) Non-metallic trim color.</p>					

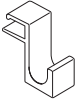
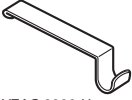
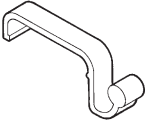
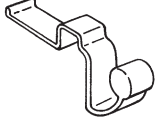
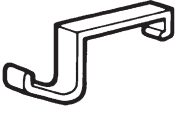
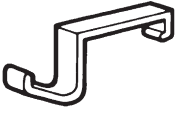
Workstation Accessories

	Height	Width	Depth	Number	Trim A	B	
 VZAC-0000-P	1.375"(35mm)	0.5"(13mm)	0.75"(19mm)	VZAC-0000-P	\$412.93	\$429.87	
	1.375"(35mm)	0.625"(16mm)	3.375"(86mm)	VZAC-0000-H	392.10	409.04	
 VZAC-0000-H Class BC – SIN 711-1, Discount Group XI	Features <ul style="list-style-type: none"> Includes eight coat hooks. (P) For use with full profile aluminum trim. (H) For use with thin profile steel trim. 						
To Order, Specify: <ol style="list-style-type: none"> Product number. Trim color. 							
Specification Tip <ul style="list-style-type: none"> Attaches to Compose panel frame or stack frame top with trim. 							
Note: Not available for use on Glass panels or glass stacks.							
 HCH-0008 Class BA – SIN 711-1, Discount Group I	1"(25mm)	3"(76mm)	0.5"(13mm)	HCH-0008	\$150.10		
	Features <ul style="list-style-type: none"> Includes eight hooks. Attaches to PLACES steel top cap panels only. 						
To Order, Specify: <ol style="list-style-type: none"> Product number. Trim color. 							
 HCH-0008-W Class BA – SIN 711-1, Discount Group I	1"(25mm)	3"(76mm)	0.625"(16mm)	HCH-0008-W	\$150.10		
	Features <ul style="list-style-type: none"> Includes eight hooks. Attaches to PLACES wood top cap panels only. 						
To Order, Specify: <ol style="list-style-type: none"> Product number. Trim color. 							
 CH-8 Class AA – SIN 711-1, Discount Group I	1"(25mm)	3"(76mm)	0.625"(16mm)	CH-8	\$129.00		
	Features <ul style="list-style-type: none"> Includes eight hooks. Attaches to panel steel top cap. For use with UniGroup panels only. 						
To Order, Specify: <ol style="list-style-type: none"> Product number. Trim color. 							
 E2CH-8 Class AC – SIN 711-1, Discount Group I				Number	Trim A	B	
				E2CH-8	\$120.63	\$141.90	
Features <ul style="list-style-type: none"> Includes eight hooks. For use with UniGroup Too square painted top cap panels. 							
To Order, Specify: <ol style="list-style-type: none"> Product number. Trim color. 							
 NAH-12-S Class FA – SIN 711-1, Discount Group XI	Application				Number	Trim A	B
	PREMISE Stack Kits				NAH-12-S	\$98.96	\$114.51
Features <ul style="list-style-type: none"> Includes package of eight hooks. Attaches to the cross bar on a stack kit. Fifty pound capacity. Can not be used with grooved top caps. 							
To Order, Specify: <ol style="list-style-type: none"> Product number. Trim color. 							

Workstation Accessories

	Number	Trim A	B
Bag Hook	KUWH-0202	\$41.90	\$47.41

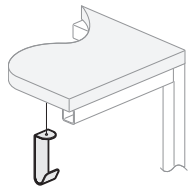

KUWH-0202

Features

- Includes one hook and attachment hardware.
- Hook will swivel if plastic washers are installed.

Specification Tips

- Attaches to the bottom of the 1.19”(30mm) and 2”(51mm) thick top.
- Weight Limit 50 lbs max.

To Order, Specify:

- 1) Product number.
- 2) Trim color.

Workstation Accessories

2/90 Sign Systems

2/90 Sign Systems is a recommended signage program for use with Haworth Systems. Signage options include ADA-compliant panel-mounted name signs, department signs, building directories, in/out boards, restroom and no smoking signs.

For inquiries, catalogs or orders, contact System 2/90 directly at 1-800-777-4310, fax (616) 656-4300, 5350 Corporate Grove Blvd SE, Grand Rapids, MI 49512.

This page intentionally blank

Lock Programs

Specification Guidelines

Locking Components Shipping Format

Locking components in all Haworth systems, casegoods, files and storage furniture are shipped with the lock housings factory-installed in each unit ready to receive separate lock plug cores. Lock plugs are field installed by means of a control key. Lock plugs and keys will be shipped with random numbering unless they are specified "keyed-alike". Quantity of locks will match quantity required for locking components on the order.

HW Lock Program

All HW lock plugs and keys will be standard in a Master Lock Program. A Master Lock program allows for better management of the facility where one "Master Key" can be used by Facility Management to service all locking components within a facility. Individual offices can be keyed-alike and will receive single-key access specific to the locking components within that workstation. Multiple locks in credenza components should be keyed-alike for the convenience of single-key access. General storage or file areas may also be keyed-alike so that individuals may have access to shared department documents or supplies.

To order new products within a workstation keyed-alike, the specifier should select the number of locks within the workstation and specify LSET quantities through Orderline. CSET lock plug and keys are to key-alike existing product for reconfigurations.

On Site Lock Installation

One Control Key for installing the lock plug will be included with each incremental order unit of up to 200 locks. The control key is used to insert and remove the lock plug into the housing at the installation site. The control key cannot be used to remove a lock plug in the locked position from its housing. Additional control keys are available and should be considered for the convenience of installing locks in widely separated areas of a facility (see Keys Only, page 213).

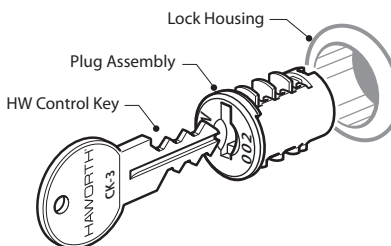

Replacement Lock Plugs and Keys

To order replacement lock plugs and keys, use the appropriate service parts catalog number or CSETS. For Wood Casegoods replacement lock plugs and keys, refer to appropriate pages.

Coding the Office Plan

Each lock location should be identified graphically on the plan by a dash mark. Encode your office floor plan by using your own coding system to identify each workstation or area that requires keyed-alike locks. Remember that some furniture will have more than one lock — a double pedestal desk, for instance. The coded floor plan with office identification numbers and lock quantities and color code will be required at the time of installation. The installer will be responsible for assignment of lock quantities based on this plan.

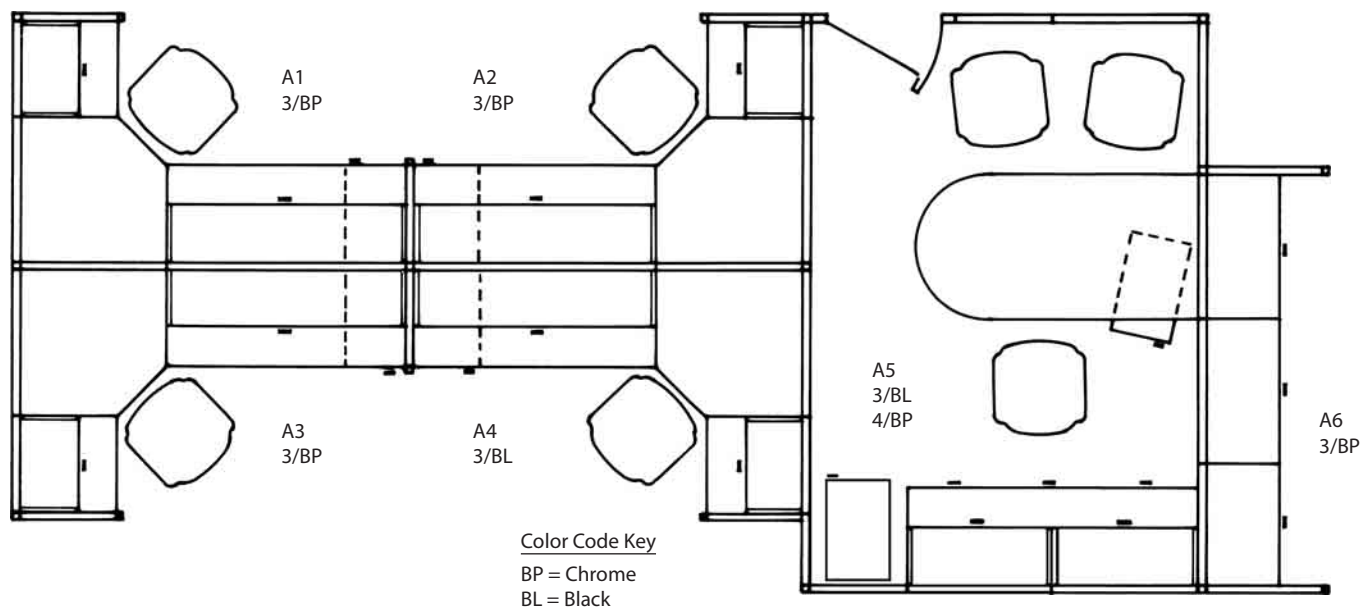

Lock Programs

HW Lock Program

HW Lock Program

The Haworth HW Lock Program is a Master Lock Program and offers the option to have workstations keyed-alike with 300 lock numbers. LSET keyed-alike lock plugs/keys are for new locking product orders only and are available at no charge.

For reconfiguration projects, there are CSET lock plugs and keys available at a nominal charge.

Work Sheet Preparation

Photocopy the HW Lock Work Sheet to assist in specifying locks. This work sheet is for your convenience and is not to be submitted with your purchase order.

Using the Coded Office Plan

Enter the workstation or area identification codes from the plan into the columns headed OFFICE NUMBER on the HW Lock work sheet. The work sheet can accommodate 100 location entries.

Specifying Keyed-Alike Lock Quantities and Colors

Using the plan, count the number of locking components in each workstation. Enter the number of locks under "QUANTITY" columns, taking into account the chrome or black finish, depending on lock finishes offered. When completed, each workstation should be assigned a quantity of LSETs. For file banks or storage areas requiring a larger quantity of the same lock numbers, specify LSET-999.

NO KEYED-ALIKE NOTE:
When no LSETS are specified, plugs and keys for the total number of locking components will be shipped automatically.

A Master Key will need to be separately specified.

Example:

Office Number	Quantity		LSET Number	Totals	
	Chrome	Black		Chrome	Black
A1	3		LSET-3	1	
A2	3		LSET-3	1	
A3	3		LSET-3	1	
A4		3	LSET-3		1
A5	4	3	LSET-3		1
			LSET-4	1	
A6	3		LSET-3	1	

Total the number of LSET quantities at the bottom of the work sheet. Transfer each total quantity to your Orderline or written purchase order.

When specifying Keyed-Alike (LSETS): LSETS must be ordered for the total number of locking components. Only the quantity of LSETS ordered will be shipped. We do not ship based upon number of locking components on order.

LSETS ordered in excess of quantities required for new locking product on the order may result in the order being placed on hold.

As a final verification of quantity, review the plan carefully to be sure that all products with locks have been identified. Remember that desks, credenzas and storage units may have multiple locking components.

Line Item Entry

Transfer the data from the work sheet to your Orderline or written purchase order. Enter the appropriate LSET catalog numbers on your order, followed by finish option code -BP or -BL.

Example:

Quantity	Description
4	LSET-3, LR-BP
1	LSET-4, LR-BL
2	LSET-3, LR-BL

Order Processing and Packing Method

Haworth will assign the lock numbers for all keyed-alike orders. Note: Specific key numbers cannot be requested.

Upon receipt of your keyed-alike order, Haworth will draw from our standard inventory of 300 lock numbers. Lock plugs will be shipped according to finish in sets per the quantity specified. HW locks and keys (Figure 3) will carry a stamped "HW" on one side with 1 through 300 on the other side as an indication of the "HW lock" program.

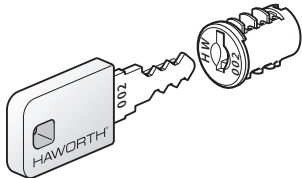

Figure 3.

Order Changes

For Order Changes/Cancellations; refer to North American Terms of Sale.

Lock Programs

HW Lock Plugs and Keys

HW Lock Plugs and Keys

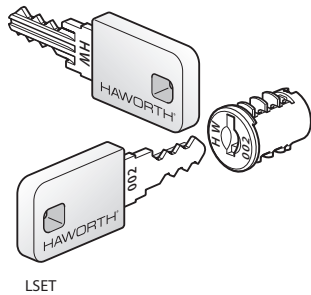

Description	Number	Price
Order with new product orders only*		
1 Lock Plug and Key	LSET-1	N/C
2 Lock Plugs and Keys	LSET-2	N/C
3 Lock Plugs and Keys	LSET-3	N/C
4 Lock Plugs and Keys	LSET-4	N/C
5 Lock Plugs and Keys	LSET-5	N/C
6 Lock Plugs and Keys	LSET-6	N/C
7 Lock Plugs and Keys	LSET-7	N/C
8 Lock Plugs and Keys	LSET-8	N/C
9 Lock Plugs and Keys	LSET-9	N/C
10 Lock Plugs and Keys	LSET-10	N/C
11 Lock Plugs and Keys	LSET-11	N/C
12 Lock Plugs and Keys	LSET-12	N/C
30 Lock Plugs and Keys	LSET-30	N/C
Key all locks alike (quantities greater than 30)	LSET-999	N/C
Order for reconfiguration of existing product		
1 Lock Plug and Key	CSET-1	\$ 9.53
2 Lock Plugs and Keys	CSET-2	19.06
3 Lock Plugs and Keys	CSET-3	28.59
4 Lock Plugs and Keys	CSET-4	38.12
5 Lock Plugs and Keys	CSET-5	47.65
6 Lock Plugs and Keys	CSET-6	57.18
7 Lock Plugs and Keys	CSET-7	66.71
8 Lock Plugs and Keys	CSET-8	76.24
9 Lock Plugs and Keys	CSET-9	85.77
12 Lock Plugs and Keys	CSET-12	114.36
30 Lock Plugs and Keys	CSET-30	285.90
Key all locks alike (quantities greater than 30)	CSET-999	9.53

Features

- The Haworth HW Lock Program offers 300 lock numbers. LSET keyed-alike lock plugs/keys are for new locking product orders only and are available at no charge. LSET's ordered in excess of quantities required for new locking product on the order may result in order being placed on hold.
- For reconfiguration projects there are CSET lock plugs and keys available at a nominal charge.
- All lock plugs and keys with one LSET/CSET will ship with the same key number which is chosen at random.
- LSET-999 and CSET-999 are for quantities greater than 30 lock plugs and keys. Specify quantity of locks; locks are priced "per piece". Numbers will be the same for all locks and chosen at random.
- Haworth will assign key numbers from the inventory of 1 through 300.
- To order specific key numbers for replacement; refer to page 213.
- Master key available; separately specified.
- Keys are standard in nickel with black overmolded head; Locks plugs are available in chrome and black finishes.

To Order LSET, Specify:

- 1) Product number.
- 2) Lock plug finish color.
LX-BP Chrome
LX-BL Black

To Order CSET, Specify:

- 1) Product number.
- 2) Lock plug finish color.
LR-BP Chrome
LR-BL Black

Lock Programs

Keys

	Key Number Selection	Number	Price
HW Plugs and Keys	KY-001 through KY-300	HW-SVC	\$18.96

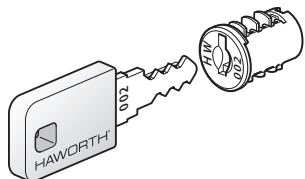

HW-SVC

Features

- Includes one lock plug and one key.
- Keys are standard in nickel with black overmolded head.
- Lock plugs are available in chrome or black finishes.
- One control key (CK-3) for installing lock plugs into lock housings is provided.
- The key number will print on one side of key and HW on other side.
- Lock plug will also show HW and key number (refer to illustrations).

To Order, Specify:

- 1) Product number.
- 2) Lock plug finish color.
LR-BP Chrome
LR-BL Black
- 3) Key number.

HW Replacement Keys

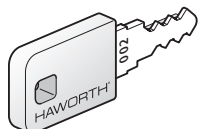

HWSK

Description	Quantity Included	Key Numbers Included	Number	Price
Includes one HW key; specify key number/quantity	1		HWSK-1	\$ 15.02
	50	1-50	HWSK-2	\$ 238.90
	50	51-100	HWSK-3	238.90
	50	101-150	HWSK-4	238.90
	50	151-200	HWSK-5	238.90
	50	201-250	HWSK-6	238.90
	50	251-300	HWSK-7	238.90
	300	1-300	HWSK-300	1298.92

Features

- Includes HW keys only.
- HWSK-1; order for specific HW key number replacement; Specify HW key number.
- HWSK-2 through HWSK-300; specific HW key number series included.

To Order, Specify:

- 1) Product number.
- 2) Key number (HWSK-1 only).
(No finish specification required.)

HW Master Key

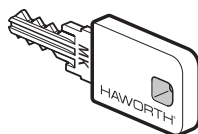

HWMK-1

Description	Number	Price
Master key	HWMK-1	\$16.38

Features

- Includes one key.
- HWMK keys are silver with a **red** overmolded head.

To Order, Specify:

- 1) Product number.
(No finish specification required.)

Note: Master keys can only be used for HW Lock Program.

HW Control Key



CK-3

Control key (no key number selection required)	CK-3	\$16.38
--	------	----------------

Features

- A single control key is provided with each lock shipment.
- CK-3 control key can be used to remove HW lock plug in unlocked position only.

To Order, Specify:

- 1) Product number.
(No finish specification required.)

HW Key Blank

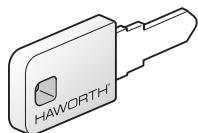

HWKB-1

Key Blank	HWKB-1	\$359.04
-----------	--------	-----------------

Features



- Includes 100 key blanks for use with HW Lock Program only.

To Order, Specify:

- 1) Product number.
(No finish specification required.)

Lock Programs

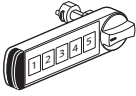
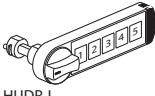
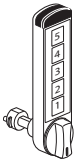
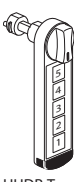
Digital Locks

	Length	Width	Height	Number ① ② ③	Price
Digital Lock	3 7/8"(98mm)	1"(25mm)	3/4"(19mm)	HUDR-■ ■ - ■ Y	\$649.58
 <p>HUDR-R</p>  <p>HUDR-L</p>  <p>HUDR-B</p>  <p>HUDR-T</p>	<p>Features</p> <ul style="list-style-type: none"> Includes: <ul style="list-style-type: none"> Digital lock with 5-digit horizontal or vertical keypad and rotating lock knob CR2032 3-volt lithium battery Factory-assigned access code Attachment hardware and spacer for metal and wood surfaces Fits standard lock housings in all Haworth systems, casegoods, files and storage furniture. Two software versions allow the lock to be programmed by individual users each time it's used, or by a facility manager for workstations where re-programming is infrequent. Master codes can be created by facilities management to override factory-assigned access codes. Factory or master codes provide manager access and enable re-programming. Available in black or brushed chrome. 	<p>To Order, Specify:</p> <p>1) Product number, including:</p> <p>① Keypad Orientation</p> <ul style="list-style-type: none"> L Horizontal, knob left R Horizontal, knob right T Vertical, knob top B Vertical, knob bottom <p>② Knob Rotation</p> <ul style="list-style-type: none"> 090 90 degree 180 180 degree <p>③ Software Option</p> <ul style="list-style-type: none"> U User-programmable (Locker Mode) F Facility-programmed (Station Mode) <p>2) Trim color for lock</p>			
<p>Digital Lock Control Key Fob</p>  <p>HUDF-F</p>	<p>Number</p> <p>HUDF-F</p>	<p>Price</p> <p>\$596.34</p>	<p>Features</p> <ul style="list-style-type: none"> Includes one control key fob and CR2032 3-volt lithium battery. Provides facility management of factory, master, and user codes, allowing management access and re-programming of digital locks (HUDR). Stores an unlimited number of factory and master codes. 	<p>To Order, Specify:</p> <p>1) Product number.</p>	<p>Specification Tip</p> <ul style="list-style-type: none"> Each lock must be programmed to accept key fob before use.

Lock Programs

Digital Lock Applications

	Lock Location	HUDR-T180 Knob Top	HUDR-B180 Knob Bottom	HUDR-L180 Knob Left	HUDR-R180 Knob Right	HUDR-T090 Knob Top	HUDR-B090 Knob Bottom	HUDR-L090 Knob Left	HUDR-R090 Knob Right
A Series									
Credenza w/Drawers & Doors	Drawer Front	•		•	•				
Active Components									
Security Drawer	Drawer Front				•				•
Suspended Pedestal - Open w/Box Drawer	Drawer Front				•				•
Suspended Pedestal - Box/File Drawers	Drawer Front	•			•	•			•
Suspended Ender - Open w/Box Drawer	Drawer Front				•				•
Suspended Ender - Box/File Drawer	Drawer Front	•			•	•			•
Adaptable Overhead Storage Unit									
Flipper & Single Slider			•	•	•				
Hinge			•	•					
Beside									
Credenza w/Drawers & Doors	Drawer Front	•		•	•				
Beside Overhead Storage Unit									
Hinged Door, Left-Hand	Top Right						•		•
Hinged Door, Right-Hand	Top Left						•	•	
Sliding Door, Left-Hand	Top Left						•		•
Sliding Door, Right-Hand	Top Right						•	•	
Beside Pantry									
Pantry Door, Left Side	Top Right	•						•	
Pantry Door, Right Side	Top Left	•							•
Compose Storage Lower Storage-Mobile Pedestals									
1.5H (Box/File)	Top Right	•			6, 7, 8, F				
2H (Box/Box/File & File/File)	Top Right	•			6, 7, 8, F				
Compose Pedestal									
1H (Box/Box)	Top Right	•			6, 7, 8, F				
1.5H (Box/File)	Top Right	•			6, 7, 8, F				
2H (Box/Box/File & File/File)	Top Right	•			6, 7, 8, F				
Compose Lateral Files									
1H	Top Right					•			•
1.5H	Top Right	•			•				
2H	Top Right	•			•				
3H	Top Right	•			•				
Compose Open Shelf Lateral Files									
1.5H	Top Right					•			•
2H	Top Right					•			•
Compose Combination Units									
2H Left-Hand	Top Right	•			6, 7, 8, F				
2H Right-Hand	Top Right	•			6, 7, 8, F				
Compose Storage Units w/Doors									
1H	Top Left Corner of Right Door	•		•					
2H	Top Left Corner of Right Door	•		•					
3H	Top Left Corner of Right Door	•		•					
Compose Personal Storage Tower w/Side Bookcase									
Right-Hand	Top Right of BBF	•			6, 7, 8, F				
Left-Hand	Top Right of BBF	•			6, 7, 8, F				

Compose Pull Options	
6	Patterns
7	Crescent
8	Linear

Compose Pull Options	
9	Classic
F	Wood Finger Pull
K	Aluminum J-Pull

Lock Programs

Digital Lock Applications

	Lock Location	HUDR-T180 Knob Top	HUDR-B180 Knob Bottom	HUDR-L180 Knob Left	HUDR-R180 Knob Right	HUDR-T090 Knob Top	HUDR-B090 Knob Bottom	HUDR-L090 Knob Left	HUDR-R090 Knob Right
Compose Personal Storage Tower w/Wardrobe — One Unit									
Right-Hand Wardrobe - Wardrobe Door	Left Edge of Door	•	•	•					
Right-Hand Wardrobe - Storage Door	Bottom Right Corner of Door		•		•				
Right-Hand Wardrobe - BBF	Top Right of BBF	•			6, 7, 8, F				
Left-Hand Wardrobe - Wardrobe Door	Right Edge of Door	•	•		•				
Left-Hand Wardrobe - Storage Door	Bottom Left Corner of Door		•	•					
Left-Hand Wardrobe - BBF	Top Right of BBF	•			6, 7, 8, F				
Compose Wardrobes									
Wardrobe - Right		•	•	•					
Wardrobe - Left		•	•		•				
Compose Full Height Doors Stack-on Storage									
1H Base Unit	Lower Left Corner of Right Door		•	•					
2H Base Unit	Lower Left Corner of Right Door		•	•					
Compose Partial Height Doors Stack-On Storage									
1H Base Unit	Lower Left Corner of Right Door		•	•					
2H Base Unit	Lower Left Corner of Right Door		•	•					
Masters Lower Storage Pedestals & Attached Lateral Files									
Attached Pedestal (Box/Box/File & File/File)	Upper Right Drawer Front	*			*				
Mobile Pedestal (Box/File)	Upper Right Drawer Front	*			*				
Attached Lateral File (1H, 1.5H & 2H)	Upper Right Drawer Front	*			*				
Masters Freestanding Lateral Files (3H, 4H, 5H & 6H)									
Freestanding Lateral File (Drawer 3H, 4H, 5H & 6H)	Upper Right Drawer Front (2nd Drawer from Bottom)	*			*				
Freestanding Lateral File (Upper Doors 5H & 6H only)	Lower Left of RH Door Front		*	*					
Masters Lower 2-door Storage									
2H Lower Storage	Upper Left of RH Door Front	*		*					
3H Lower Storage	Middle Left of RH Door Front	*	*	*					
Masters Combination Units									
Doors	Lower Left of RH Door Front		*	*					
Drawers	Upper Right of Top Drawer Front	*			*				
Masters Wardrobe with Open Storage									
Door on LH Side (LH Unit)	Lower Mid RH of Door Front	*	*		*				
Door on RH Side (RH Unit)	Lower Mid LH of Door Front	*	*	*					
Masters Wardrobe with Closed Storage									
2-Door Unit	Lower Mid of RH Door Front	*	*	*					
Masters Personal Storage Tower with F/F/F & V									
Valet Door on LH Side	Lower Mid RH of Door Front	*	*		*				
Storage Door on RH Side	Lower LH of Door Front		*	*					
Valet Door on RH Side	Middle Left of Door Front	*	*	*					
Storage Door on LH Side	Lower RH of Door Front		*		*				
Ped Drawer (The Same Regardless of LH or RH Unit)	Upper Right of Middle Drawer	*			*				

Compose Pull Options	
6	Patterns
7	Crescent
8	Linear

Compose Pull Options	
9	Classic
F	Wood Finger Pull
K	Aluminum J-Pull

Lock Programs

Digital Lock Applications

	Lock Location	HUDR-T180 Knob Top	HUDR-B180 Knob Bottom	HUDR-L180 Knob Left	HUDR-R180 Knob Right	HUDR-T090 Knob Top	HUDR-B090 Knob Bottom	HUDR-L090 Knob Left	HUDR-R090 Knob Right
Masters Personal Storage Tower with F/F & Valet									
Valet Door on LH Side	Middle Right of Door Front	*	*		*				
Storage Door on RH Side	Lower LH of Door Front		*	*					
Valet Door on RH Side	Middle Left of Door Front	*	*	*					
Storage Door on LH Side	Lower RH of Door Front		*		*				
Ped Drawer (The Same Regardless of LH or RH Unit)	Upper Right of Top Drawer	*			*				
Masters Storage Tower									
Storage Door on RH Unit	Lower LH of Door Front		*	*					
Storage Door on LH Unit	Lower RH of Door Front		*		*				
Ped Drawer (The Same Regardless of LH or RH Unit)	Upper Right of Top Drawer	*			*				
Masters Freestanding Wardrobe Tower									
Door on RH Unit	Lower Mid LH of Door Front	*	*	*					
Door on LH Unit	Lower Mid RH of Door Front	*	*		*				
Masters Credenza Units									
Pedestals or Lateral Files	Upper Right of Top Drawer	*			*				
Closed Storage Units	Upper Left of RH Door Front	*		*					
Masters Upper Storage									
Vertical Storage Units	Lower Left of RH Door Front		*	*					
Overhead Storage Units	Lower Left of RH Door Front		*	*					
X Series and V Series									
Attached, Suspended, Mobile Pedestals	Lockbar, Right-Hand				•				
	Lockbar, Left-Hand (individually locking only)			•					
Personal Storage Tower (2H and 3H only)	Top of Tower			•	•				
Personal Storage Tower Pedestal Section	Lockbar, Right-Hand				•				
	Lockbar, Left-Hand (individually locking only)			•					
Personal Storage Tower Valet Section	Valet Door, Right-Hand	•	•	•					
	Valet Door, Left-Hand	•	•		•				
Personal Storage Tower Storage Unit Section	Storage Door, Left-Hand	•	•		•				
	Storage Door, Right-Hand	•	•	•					
Locker, Group Locker, Cubby Locker	Left-Hand Door	•	•		•				
	Right-Hand Door	•	•	•					
Lateral File	Top of File			•	•				
	Drawer Front	•		•	•				
Combination Unit Drawer Section	Top of Unit			•	•				
Combination Unit Storage Unit Section	Storage Door, Left-Hand	•	•		•				
	Storage Door, Right-Hand	•	•	•					
Combination Unit Valet Section	Valet Door, Left-Hand	•	•		•				
	Valet Door, Right-Hand	•	•	•					
Storage Cabinet and Wardrobe	Top of Cabinet			•	•				
	Right-Hand Door	•	•	•					

Lock Programs

Service Parts

Service Parts

Service parts for the SL, ML and MLP are available through www.EasyKeys.com; Haworth will not be supplying these products directly.

To order products, dealers must set up an account with Easy Keys.

Easy Key is offering discounts to Haworth dealers. To set-up an account, use the link provided on The Voice - search Easy Keys.

After the account is set up, dealers can order product at the negotiated rate. For future orders, dealers can go directly to www.EasyKeys.com and log in. In order to receive the discounted pricing, dealers must log in with the username and password that was created while setting up the account.

Finish/Color Legend

Trim Grade A

Smooth

TR-R	Beige
TR-AK	Chalk
TR-K	Charcoal
TR-C1	Cocoa
TR-J	Graphite
TR-G	Gray Tone
TR-AA	Putty
TR-E	Smoke
TR-PLS	Smooth Plaster
TR-FM	Snow

Textured

TR-TY	Cement
TR-TG	Grout
TR-TF	Pitch
TR-TW	Plaster

Translucents

TR-LQ	Frost
TR-LX	Ice
TR-LY	Moon
TR-LU	Shadow

Grade B

Smooth

TR-1C	Accent Blue
TR-1D	Accent Green
TR-1E	Accent Orange
TR-1F	Accent Red
TR-1G	Blue Jay
TR-1L	Brindle
TR-1R	Brownstone
TR-CTS	Chartreuse
TR-1N	Night
TR-1Q	Park
TR-RR	Rusty Red
TR-1M	Sable
TR-1P	Seville
TR-1J	Sky Blue
TR-1H	Terra
TR-1K	Wren

Smooth Metallic

TR-DM	Dark Bronze Metallic
TR-MC	Metallic Champagne
TR-LE	Metallic Silver

Textured Metallic

TR-AL	Alloy
TR-AR	Argent
TR-HE	Hellenic

Laminate Grade A

Solid Color

H-34	Beige
H-AK	Chalk
H-8J	Charcoal
H-3J	Graphite
H-62	Gray Tone
H-WL	Linen
H-3P	Platinum
H-AA	Putty
H-3E	Smoke

Patterned

H-P1	Linen Casual
H-P2	Linen Classic
H-P3	Linen Crisp
H-P4	Linen Flax

Wood Grain

H-AM	Amber Cherry
H-AE	Maple
H-AD	Medium Cherry

Grade B

Premium Wood Grain

H-KA	Brazilwood
H-KG	Columbian Walnut
H-KP	Field Elm
H-KN	Grey Elm
H-KM	Landmark Wood
H-KL	Neo Walnut
H-KC	New Age Oak
H-KR	Phantom Ecru
H-KS	Phantom Pearl
H-KD	River Cherry
H-KE	Sanara
H-KF	Williamsburg Cherry

Edgeband

Solid Color

HP-34	Beige
HP-AK	Chalk
HP-8J	Charcoal
HP-3J	Graphite
HP-62	Gray Tone
HP-WL	Linen
HP-3P	Platinum
HP-AA	Putty
HP-3E	Smoke

Patterned Edgeband

HP-P1	Linen Casual
HP-P2	Linen Classic
HP-P3	Linen Crisp
HP-P4	Linen Flax

Wood Grain

HP-AM	Amber Cherry
HP-KA	Brazilwood
HP-KG	Columbian Walnut
HP-KP	Field Elm
HP-KN	Grey Elm
HP-KM	Landmark Wood
HP-AE	Maple
HP-AD	Medium Cherry
HP-KL	Neo Walnut
HP-KC	New Age Oak
HP-KR	Phantom Ecru
HP-KS	Phantom Pearl
HP-KD	River Cherry
HP-KE	Sanara
HP-KF	Williamsburg Cherry

Planked Wood

VH-W35	Walnut
VB-W35	White Oak

Painted MDF

PW-R	Beige
PW-F	Black
PW-AK	Chalk
PW-G	Gray Tone
PW-PL	Polar
PW-RR	Rusty Red
PW-1J	Sky Blue
PW-SP	Sparrow
PW-SY	Stormy
PW-ST	Straw
PW-1H	Terra
PW-VA	Vapor

ALERT: These materials are current, however they are being considered for future obsolescence due to low volume.

Laminate:

H-EK	Owl Nest
H-EC	Quail Nest
H-EA	Robin Nest
H-DE	Wheat Grain

Forest Stewardship Council (FSC) Statement:

In our continuing support of sustainable forestry and responsible purchasing, Haworth North America is offering FSC certified wood products at no up-charge. By providing FSC certified material, Haworth is supporting our client's green building goals and demonstrating our collective commitment to source materials more sustainably.

Haworth will provide to you the necessary FSC-certified paperwork with your shipment. For more information, FAQs, and a complete FSC product list (including product exceptions), go to the Library and search FSC.

North American Terms of Sale

These Terms of Sale are part of a quotation, bid response, or other sales document issued by Haworth, Inc., Haworth, Ltd. ("Haworth").

These Terms of Sale do not cover products manufactured in North America shipping to non-North American countries nor do they cover products manufactured in non-North American countries shipping to North America. For those terms of sale, please contact Haworth's Global Trade and Compliance Department at 616.393.3000 or through Haworth.com.

A. Ordering Information

Haworth sells its products on the terms set forth in these standard Terms of Sale:

ORDERS MUST BE SUBMITTED IN WRITING OR ELECTRONICALLY (Lynx) AS REPRESENTED BY A VALID PURCHASE ORDER, WHICH INCLUDES PRODUCT TOTAL.

An order is not binding upon Haworth until Haworth issues an order acknowledgment to the customer (the "Customer"), which will include price information and an anticipated delivery date.

1. Order Changes/Cancellations

For Specials, Customer's Own Material (C.O.M.), finish matches, custom colors, custom products, Master lock and key orders, and RUSH orders, no changes or cancellations are allowed 24 hours after order placement. All other products require approval for changes or cancellations. A change/cancellation fee may apply. Contact Order Services for applicable charges.

Ship-to addresses changed within five (5) business days of delivery will incur fees to cover administrative costs due to re-labeling of product and/or reconsignment fees with the carrier.

Order cancellations are complete annulments of orders. Order changes are the deletion of line items or a change in size, color, quantity, ship-to address, or scope of work. There is no penalty for additions; however, any change may cause the order or the line items affected to be rescheduled. Order changes involving additional product and services which increase the value must be accompanied by an amended Purchase Order or other document as agreed.

ALL CHANGES MUST BE IN WRITING, REGARDLESS OF THE (DOLLAR) VALUE. CHANGES ARE NOT BINDING UPON HAWORTH UNTIL HAWORTH ISSUES AN ACKNOWLEDGMENT OF THE CHANGE.

2. C.O.M. (Customer's Own Material)

A Customer who requests a fabric, surface or finish material (C.O.M.) not in Haworth's standard finish offering must first confirm approval of or request new approval for the C.O.M.

Haworth will determine feasibility of the material for manufacturability. For a description of the procedure to submit C.O.M. samples, contact Haworth's Order Services department. For testing information, see the C.O.M. section of the catalog, or call Haworth Order Services.

If Haworth agrees to use the C.O.M., (1) Haworth shall have no responsibility for the condition, quality, value, performance, physical properties, or any other aspect of the C.O.M.; and (2) Haworth shall have no liability for any damages, injuries, or losses to the Customer or to any third party that shall be caused by any C.O.M., and the Customer shall hold Haworth harmless for all such liability.

3. Valid/Complete Purchase Order

The following information is required in order to process an order with Haworth:

a. Customer Information

- i. **Sold To:** Legal name, complete address (if Haworth is to bill the end user, provide end user Purchase Order made out to Haworth, Inc., Haworth, Ltd.) and phone and fax number.
- ii. **Ship To:** Legal name and address.
- iii. **Purchase Order Number:** From the party Haworth will be billing.
- iv. **Authorized Signature:** All Purchase Orders must be signed by a duly authorized representative if a signature line is present. Electronically transmitted Purchase Orders will be accepted without a signature if dealer billed and the dealer has an electronic purchase payment agreement on file.
- v. **Contact Name and Phone Number:** Person Haworth should contact with any questions regarding the order.
- vi. **Shipping Contact:** Name and phone number of person to be contacted regarding shipping and delivery matters.
- vii. **Tagging Instructions:** This information will appear on all documentation received from Haworth including: cartons, acknowledgments, and invoices.
- viii. **Price Agreement or National Sales Agreement Number**
- ix. **Product Total:** Net dollars.
- x. **Installation, Design, Project Management, and/or Service Fees**

b. Product Information

- i. **Quantity**
- ii. **Product Numbers**
- iii. **Colors**
- iv. **Specials:** Specify special part number for new special products.
- v. **Customer's Own Material:** Order entry code, manufacturer, pattern, and color.

vi. **Approval Drawings:** An authorized signature by a duly authorized representative is required for shop drawings when applicable.

vii. A deposit may be required for custom materials.

c. Order Confirmation

All orders will be acknowledged.

B. Pricing Policies

1. Terms of Payment

Terms of payment and credit limits will be established based on financial information. Standard payment terms on open credit are net thirty (30) days from invoice date. Advance payments or other payment security may be required by Haworth. The account balance must be at or below the credit limit and current at all times (no past-due balances). Haworth reserves the right to delay or cancel any delivery to a Customer whose Haworth account balance is over the credit limit and/or past due. For walls and floors a deposit will be required.

2. Terms of Credit

Customer hereby authorizes Haworth to obtain such credit reports, financial information or other information as Haworth may request, including, without limitation, credit information from any financial institutions or others having a business relationship with the Customer. Customer hereby authorizes any credit references to answer Haworth's inquiries and provide such credit information and documentation as Haworth may request.

The Customer hereby releases and holds Haworth harmless for any inconvenience whatsoever, caused by any temporary or permanent withdrawal or restriction of credit privileges hereunder, or the enforcement of any of the provisions contained in this paragraph.

3. Past-Due Charges

Past-due balances will be increased by a maximum of 1.5% per month, or 18% annually, without forfeit of Haworth's right to immediate payment.

4. Applicable Prices

The price of any product sold to Customer by Haworth will be based upon the North American Price List (Catalog).

Prices and discounts are subject to change without notice or approval. In the event of an adjustment to pricing, National Sales Agreement (NSA) Customers will be notified in advance according to the terms of the NSA.

Applicable prices and currency exchange rates are those in effect at the time of the RECEIPT of an ORDER; Haworth reserves the right to use the published pricing effective at the time of shipment, if the requested delivery date is more than 120 days after the order receipt date.

North American Terms of Sale

Haworth Flooring products are sold using the North American price list in US dollars. Currency exchange rates at the time of the transaction will be used to convert the USD amount into the alternate currency. Should the currency exchange rate between the USD and alternate currency change between a quote and the receipt of an order, the alternate currency amount will also change to equal the current, equivalent USD amount.

5. C.O.M. (Customer's Own Material) Charges

Refer to appropriate Customer's Own Material (C.O.M.) form for applicable surface material charges.

6. Taxes

Haworth prices do not include customs duty, sales, use, value added or similar taxes. Any federal, state/provincial or other taxes or assessments based upon the sale or delivery of products or services sold applicable to the customer at present or later imposed by federal, state/provincial or municipal agencies, shall be added and paid by the customer. Customer is responsible for all such taxes.

NOTE: For all countries a valid sales tax exemption certificate must be approved by and on file with Haworth prior to product shipment. Otherwise, sales tax will be due and payable to Haworth when such tax is invoiced to Customer.

7. Services

If, as a result of Customer request, the Haworth dealer or Haworth subsidiary provides planning/design services, storage, project management, special handling, set-up, installation and/or other services, the Customer will be charged at the local Haworth dealer/subsidiary's prevailing rates.

8. Termination by Haworth

Haworth may immediately terminate an order upon written notice in the event bankruptcy or insolvency proceedings are instituted by or against the Customer, or the Customer is adjudicated as bankrupt, becomes insolvent, makes an assignment for the benefit of creditors, or proposes or makes any arrangements for the liquidation of its debts, or a receiver or receiver and manager is appointed with respect to all or any part of the assets of the Customer.

C. Shipping and Delivery

Haworth will have the right to determine the method of shipment and routing of product.

If, for any reason, a delivery has to be made to an intermediate location (i.e. a location other than the "Ship To" location noted on the order or ultimate end user location), all handling and re-delivery costs incurred would be at the Customer's expense.

1. U.S.A. - Contiguous

All deliveries will be CPT (Carriage Paid To) (ICC Incoterms 2010) Haworth's manufacturing facilities or distribution centers. Freight charges will be prepaid by Haworth on all orders to locations within the continental United States. Customer bears all risk of loss or damage to the goods when they are placed on Haworth's means of transport.

2. U.S.A. - Non-contiguous (Alaska, Hawaii and Puerto Rico)

All deliveries will be CIF (Cost, Insurance and Freight) (ICC Incoterms 2010). Haworth's catalog prices include ocean freight and insurance to the port of the final destination. Haworth has the right to determine the carrier, method of shipment and routing. Haworth will contract with the insurer and provide minimal insurance coverage (CIF @ 110%) made payable to the Customer. Customer is responsible to obtain greater insurance if so desired.

Customer bears all risk of loss or damage to the goods when the goods are effectively at the disposal of the Customer on board the vessel at the named port of destination. Proof of delivery is a clean on board bill of lading. Customer will be responsible for all on-carriage from the receiving port to the final destination.

3. Canada

All deliveries will be DDP (Delivered Duty Paid) (ICC Incoterms 2010). Haworth's catalog prices include delivery to Customer's named place, not unloaded from any arriving means of transport. Customer bears all risk of loss or damage to the goods when they are delivered to the Customer's named facility not unloaded. Haworth will assume responsibility to file all freight claims with the carrier for any loss/damage which may occur while product is in transit, and will promptly repair or replace any damaged or lost product. Haworth requires the Customer to report all freight damage and/or loss to both the carrier and to Haworth.

NOTE: Under all delivery terms (U.S.A. and Canada), any additional expense resulting from Customer's request for expedited transportation, special services, packaging, handling, routing, and/or shipping method will be billed to Customer.

4. Mexico

All deliveries will be DAP (Delivered to Place) (ICC Incoterms 2010). Haworth's catalog prices include freight charges for normal surface transportation to a United States point of exportation within the 48 contiguous states. Haworth has the right to determine the carrier, method of shipment and routing.

Customer bears all risk of loss or damage to the goods when the goods are delivered to the named United States point of exportation. Haworth will provide customs clearance facilitation and arrangement of local delivery through an Authorized Dealer in Mexico, on a separately negotiated basis. Otherwise the Customer will be responsible for all customs clearance formalities and on-carriage from the United States point of exportation to the final destination in Mexico.

5. Delivery Dates and Delay

If Haworth cannot deliver products as scheduled due to causes beyond its reasonable control (such as casualty, labor disputes, or accident; inability to obtain necessary labor, material or transportation; or changes requested by the Customer), the delivery date will be extended to compensate for the delay as determined by Haworth.

6. Delivery Shortages and Damage

Product shortages and damage must be noted on delivery receipts at the time of delivery and reported to the carrier for correction.

Claims against Haworth for shortages, errors, or damage must be made within ten (10) days of the date of delivery or the Customer waives the right to make such a claim. Signed Bill of Ladings or Delivery Receipt must be sent in with claims. See the Haworth/Haworth Dealers Roles and Responsibilities document for further details.

7. Storage

Haworth may transfer product to storage at the Customer's risk and expense if the Customer is unable or unwilling to take delivery of product as originally scheduled. Upon such transfer to storage, the Customer assumes risk of loss. Haworth will invoice the Customer for storage fees and the Customer will make payments in accordance with Haworth's standard payment terms.

North American Terms of Sale

D. General Terms

1. Governing Law

For products purchased for delivery in the U.S. pursuant hereto, this Agreement shall be governed by and construed according to the laws of the State of Michigan. Where Products are purchased for delivery in Canada pursuant hereto, this Agreement shall be governed by and construed according to the laws of the Province of Alberta. In either case, the parties attorn to the exclusive jurisdiction of the courts of Michigan and Alberta, respectively for the purpose of hearing any disputes arising under this Agreement or with respect to any Products sold pursuant hereto, and agree that the provisions of the United Nations Convention on Contracts for the International Sale of Goods and any other provision or law which would have the effect of applying the laws of any jurisdiction other than Michigan or Alberta, as the case may be, shall be excluded.

2. Force Majeure

In the event that the performance of Customer or Haworth or its participating dealer assignee(s) would be prevented, restricted, interfered with or rendered commercially impracticable by reason of Force Majeure, then upon the giving of notice to the other parties, the party affected by the Force Majeure shall be excused from performing hereunder until the Force Majeure no longer prevents, restricts, interferes with, or renders such performance commercially impracticable.

"Force Majeure" shall mean: fire, explosion, breakdown of plant, epidemic, hailstorm, snow/ice storms en route, hurricane, tornado, cyclone, flood or power failure; war, revolution, civil or military disturbances, acts of public enemies, acts of terrorism, blockade or embargo; any law, order, proclamation, regulation, ordinance, demand or requirement of any applicable governmental authority or any subdivision, authority, or representative of any such government; labor difficulties, including without limitation, strikes, slowdowns, picketing or boycotts; or difficulties beyond Haworth's reasonable control in obtaining necessary raw materials, labor, fuels and electric power, components or facilities, and any other circumstances beyond the control of the party affected.

3. Delays by Customer

Where Haworth has not received adequate site dimensions, Product specifications, shipping information, installation particulars or other information required by Haworth to permit the efficient manufacture of any Products, or where site conditions are not in accordance with the Installation Requirements set forth, or are not otherwise suitable to permit effective and efficient installation, the manufacture and/or delivery of Products may be delayed, and such event shall constitute a delay by the Customer. When manufacture, delivery or installation is delayed by the Customer or at the Customer's request: (i) Haworth may, at its option, present the invoice for the full price of the Products to the Customer as then due and payable; (ii) the Customer shall pay to

Haworth all reasonable storage, handling and other reasonable incidental expenses incurred by Haworth in connection with such delay; and (iii) the Customer shall bear all risk of loss or damage to the Products being held by Haworth for the Customer.

4. Use and Installation of Products

Haworth recommends that its products be installed by certified, qualified and approved installers according to Haworth's written installation procedures. The Customer agrees to use Haworth products properly; not to remove or alter safety devices, warnings, or operation instructions placed on products by Haworth, and to instruct employees as to the proper care and use of the products according to printed instructions.

5. Warranty

Haworth's standard North American Warranty will apply as appropriate. All product line warranty specifics are available in each catalog or upon request.

E. Services

Service requests for design, installation, relocation, storage, etc. are handled by the local Haworth dealer on a separately negotiated basis. Contact the local Haworth dealer, affiliate or area sales office for more details.

Scope of Work - Design

Customer acknowledges that the Products to be manufactured or procured by Haworth in connection with the order are or may be custom manufactured for the Customer and that Haworth may be required to perform extensive work in relation to the design and specification of such Products. Where Customer requests that Haworth create as-built drawings or make more than two material revisions to any particular Product design or specification, Customer agrees that Haworth shall be entitled to invoice Customer with respect to such additional work on the basis of Haworth's then prevailing rates for related design and specification services.

Installation Requirements

Where installation services are to be provided by Haworth, its authorized dealer or subcontractor, a document will be provided setting forth the scope of installation work to be performed (the "Scope of Work") and the price to be charged therefore. Unless otherwise specified in the scope of work, Haworth's installation services are limited to products sold by Haworth with the exception of lighting, under floor electrical and data.

General Conditions

(a) Sufficient time shall be allocated by the Customer following delivery of Products and prior to Customer's occupation of the premises to allow the installation of all Products during conventional working hours, Monday through Friday, 7:30 a.m. to 4:30 p.m. Where sufficient time is not allocated and Haworth is required or requested to perform installation work outside of such times, overtime charges shall be charged at Haworth's then prevailing rates. (b) Haworth shall be given free and exclusive access to; (i) a loading dock within 150' of the freight elevator or hoist, which loading dock shall be of sufficient size to enable full-size tractor-trailer deliveries to the premises (where required by Haworth); (ii) a freight elevator or hoist of sufficient size and capacity to allow the efficient movement of the Products; (iii) an unobstructed and safe pathway to the area where Products are to be stored or staged; (iv) a secure storage / staging area; (v) convenient trash facilities; (vi) adequate lighting; (vii) a work site that complies with applicable health and safety legislation. Where such areas and facilities are not available, Haworth shall be entitled to bill Customer for all amounts incurred by Haworth for double-handling, product movement, lifting, hoisting, trash removal and any other resulting charges. (c) The installation site shall be free and clear of existing furniture, debris, or other obstructions (including construction in progress) and shall otherwise be in the reasonable opinion of Haworth ready for installation of the Products. Any building where Products are to be installed shall be fully closed in, dry and protected from the natural elements, with temperatures between 40°F and 90°F (4°C and 32°C) and relative humidity not to exceed 70% at all times including receipt of products, during and after installation and shall be adequately heated and/or air-conditioned. Where unusual site conditions exist which impede or prevent the normal installation of any Products, applicable extra charges shall apply at prevailing rates. (d) Haworth's installation pricing is based upon the installation occurring as one continuous delivery and installation project. Phased installation pricing shall be provided by Haworth on a case by case basis. (e) Electrical hardwiring, plumbing and mechanical work is not included and shall be the responsibility of the Customer. (f) Except as may be otherwise specifically indicated, installation pricing does not apply to projects where union labor is required. Where Haworth has provided installation pricing on the basis that non-union labor be utilized, and where Haworth is required to use union labor or it otherwise becomes impractical to use non-union labor, or where Haworth is required by law to use prevailing wages, Haworth shall be entitled to charge the Customer for any cost differential between the anticipated cost of non-union labor and the actual cost of utilizing union or prevailing wage labor. (g) Haworth shall not be responsible for obtaining permits.

North American Terms of Sale

Project / Site Conditions

Lateral load bracing is not included in the scope of Haworth's work and shall not be performed by Haworth. In areas where flooring Products are to be installed by Haworth overhead construction must be completed prior to the commencement of such work to avoid damage to the panels and finishes. The existing subfloor must be smooth, mopped clean, free of moisture, dust, dirt and debris. Once installed, the access floor must be maintained in the same manner. The subfloor must have a maximum vertical elevation deviation of 0.375" (10mm) over a horizontal span of 10'-0" (3m), and without discontinuities in floor slope. For greater certainty, the scope of Haworth's installation work in such areas shall not be deemed to include any work required to level such subfloor, remove protrusions, remove pre-existing floor coverings or adhesives, or any other work which is required to remedy any conditions which may impede the efficient installation of flooring. Except as may be otherwise specifically indicated in the order, installation pricing for flooring Products and the Scope of Work in relation thereto shall not include any work required to remove and replace floor panels following their initial installation to provide tradespersons or others with access to the underpanel cable management cavity. In areas where movable walls are to be installed, all flooring (including carpeting) and ceiling components (including dropped ceiling grid components) shall be fully complete and ready for the installation of the movable wall products. Further, the existing floor (or other surface on which the movable wall panels are to be installed) shall have a maximum vertical deviation of 1.25" (30mm) and the dropped ceiling grid shall have a maximum vertical deviation of 0.375" (10mm) from the specifications to which such movable wall panels were designed and manufactured (collectively the "Permitted Tolerances"), and shall otherwise comply with any site condition assumptions made known to Haworth prior to the manufacture of such Products (the "Site Assumptions"). Where the Permitted Tolerances or Site Assumptions are not strictly adhered to or met, additional charges may be incurred in connection with site remediation and/or the modification or remanufacture of affected movable wall products, together with all resulting shipping and labor charges at Haworth's then prevailing rates for such Products and services.

Installation Change Orders

Where Customer requests work to be performed or materials to be provided which are not contemplated in the Scope of Work, or Customer otherwise requests Products or services not contemplated in the order (collectively "Extras"), prior to providing such Extras Haworth reserves the right to require the Customer to provide and sign a written Purchase Order or Change Order acceptable to Haworth describing the Extras and the amounts to be charged therefore, and the Customer agrees to pay such charges.

Entire Agreement

The order and this Agreement (including applicable Schedules) constitute the sole agreement between the parties and supercede any prior understanding or written or oral agreements between the parties (excluding National Sales Agreements). No waiver of any of the provisions of these Standard Terms and Conditions shall be binding on Haworth unless expressly agreed in writing.

Revision Date: April 1, 2019

Index

Products are listed alphabetically in this index by alpha-numeric prefix/suffix codes.

Product Code	Product Description	Page
169BK	Ergotron Keyboard Tray – Keyboard Tray with Mouse Pad	100
24-205-214	Ergotron Neo-Flex Laptop Cart – Ergotron Neo-Flex Laptop Cart	133
24-220-055	Ergotron Teachwell® Mobile Digital Workspace – Ergotron Teachwell® Mobile Digital Workspace	134
24-312-026	Ergotron WorkFit-A — Dual Attached Sit-Stand Workstation	118
24-316-026	Ergotron WorkFit-A — Dual Attached Sit-Stand Workstation	118
24-317-026	Ergotron WorkFit-A — Single Attached Sit-Stand Workstation	117
24-390-026	Ergotron WorkFit-A — Single Attached Sit-Stand Workstation	117
24-391-026	Ergotron WorkFit-A — Single Attached Sit-Stand Workstation	117
24-392-026	Ergotron WorkFit-A — Dual Attached Sit-Stand Workstation	118
24-481-003	Ergotron LearnFit – LearnFit Desk	135
24-547-003	Ergotron LearnFit – LearnFit Desk	135
33-341-200	Ergotron WorkFit-S — Dual Attached Sit-Stand Workstation	120
33-342-200	Ergotron WorkFit-S — Single Attached Sit-Stand Workstation	119
33-349-200	Ergotron WorkFit-S — Dual Attached Sit-Stand Workstation	120
33-349-211	Ergotron WorkFit-S — Dual Attached Sit-Stand Workstation	120
33-350-200	Ergotron WorkFit-S — Single Attached Sit-Stand Workstation	119
33-350-211	Ergotron WorkFit-S — Single Attached Sit-Stand Workstation	119
33-351-200	Ergotron WorkFit-S — Single Attached Sit-Stand Workstation	119
33-351-211	Ergotron WorkFit-S — Single Attached Sit-Stand Workstation	119
33-397-062	Ergotron WorkFit-T — Desktop Sit-Stand Workstation	123
33-397-085	Ergotron WorkFit-T — Desktop Sit-Stand Workstation	123
33-406-062	Ergotron WorkFit-TL — Desktop Sit-Stand Workstation	124
33-406-085	Ergotron WorkFit-TL — Desktop Sit-Stand Workstation	124
33-407-062	Ergotron WorkFit-SR — Dual Attached Sit-Stand Workstation	122
33-407-085	Ergotron WorkFit-SR — Dual Attached Sit-Stand Workstation	122
33-415-062	Ergotron WorkFit-SR — Single Attached Sit-Stand Workstation	121
33-415-085	Ergotron WorkFit-SR — Single Attached Sit-Stand Workstation	121
33-418-085	Ergotron WorkFit-TL — Desktop Sit-Stand Workstation	124
45-174-300	Ergotron Monitor Arms – Neo-Flex	113
45-214-026	Ergotron Monitor Arms – Single Arm	111
45-235-194	Ergotron Monitor Arms – Neo-Flex Extend	113
45-241-026	Ergotron Monitor Arms – Single Arm	104
45-241-224	Ergotron Monitor Arms – Single Arm	104
45-245-026	Ergotron Monitor Arms – Dual Arm	104
45-245-224	Ergotron Monitor Arms – Dual Arm	104
45-248-026	Ergotron Monitor Arms – Dual Arm	104
45-289-026	Ergotron Monitor Arm Accessories – LX Extension	109
45-295-026	Ergotron Monitor Arms – Single Arm	104
45-306-101	Ergotron Monitor Arm Accessories – Under Mount C-Clamp for LX Desk Mount Single, LX Dual Direct, and MXV Monitor Arms	114
45-306-101	Ergotron Monitor Arms – Neo-Flex Tablet	113
45-360-026	Ergotron Monitor Arm – Single Arm	106
45-362-026	Ergotron Monitor Arm Accessories – LX Sit-to-Stand Extension	109
45-384-026	Ergotron Monitor Arm – Single Arm	106
45-405-026	Ergotron WorkFit LX - Sit-Stand Desk Mount System	125
45-436-026	Ergotron Monitor Arms – MX Mini Desk Mount	111
45-475	Ergotron Monitor Arms – Single Arm	102
45-476	Ergotron Monitor Arms – Dual Arm	102
45-478	Ergotron Monitor Arms – Single Arm	102
45-479	Ergotron Monitor Arms – Dual Arm	102
45-486	Ergotron Monitor Arm – Single Arm	110
45-489	Ergotron Monitor Arm – Dual Direct Arm	107

Index

<u>Product Code</u>	<u>Product Description</u>	<u>Page</u>
45-490-216	Ergotron Monitor Arms – Single Arm	104
45-491-216	Ergotron Monitor Arms – Dual Arm	104
45-492-216	Ergotron Monitor Arms – Dual Arm	104
45-492-224	Ergotron Monitor Arms – Dual Arm	104
45-496	Ergotron Monitor Arm – Dual Arm	110
45-509-216	Ergotron Monitor Arm – LX Dual Stacking Arm - Tall Pole Monitor Arm	105
45-537-216	Ergotron Monitor Arms – Single Arm	104
45-549-026	Ergotron Monitor Arm – LX Dual Stacking Arm - Tall Pole Monitor Arm	105
4TJC-72	Wire Management – J-Channel	174
60-589-060	Ergotron Monitor Arm Accessories – Monitor Quick Release LCD Bracket	112
7031-7001	Information Display – Planes Markerboard Accessories – Markerboard Accessories	144
7031-7002	Information Display – Planes Markerboard Accessories – Markerboard Accessories	144
7062-8001	Information Display – Planes Markerboard Accessories – Markerboard Accessories	144
80-063	Ergotron CPU Holder – Small CPU Holder	101
80-105-064	Ergotron CPU Holder – Cable CPU Holder	101
97-468	Ergotron CPU Holder – Universal CPU Holder	101
97-558-200	Ergotron WorkFit — Accessories – Tablet/Document Holder	127
97-581-019	Ergotron WorkFit — Accessories – Worksurface	127
97-582-009	Ergotron Keyboard Tray – Neo-Flex Keyboard Tray	100
97-605	Ergotron WorkFit — Accessories – Conversion Kit Single HD to LCD & Laptop	126
97-606	Ergotron WorkFit — Accessories – Conversion Kit Single HD to Dual	126
97-615	Ergotron WorkFit — Accessories – Tall-User Kit for WorkFit Dual	128
97-616	Ergotron WorkFit — Accessories – Conversion Kit: LCD & Laptop to Dual	128
97-617	Ergotron WorkFit — Accessories – Conversion Kit: Dual to LCD & Laptop	128
97-620-060	Ergotron WorkFit — Anti-Fatigue Floor Mat – Ergotron WorkFit — Anti-Fatigue Floor Mat	132
97-649-085	Ergotron WorkFit — Accessories – Grommet Mount	127
97-653	Ergotron WorkFit — Accessories – Large Keyboard Tray	127
97-692	Ergotron WorkFit — Accessories – Grommet Mount	126
97-774-003	Ergotron Monitor Arm Accessories – LX One-Stop Rotational Control Kit	108
97-783	Ergotron Monitor Arm – Dual Monitor and Handle Kit	112
97-844	Ergotron Monitor Arm Accessories – LX Pole Collar	109
97-845	Ergotron Monitor Arm Accessories – Tall-User Kit for Single Display	131
97-897	Ergotron WorkFit — Accessories – Deep Keyboard Tray	129
97-898	Ergotron WorkFit — Accessories – Corner Keyboard Tray	129
97-926-064	Ergotron LearnFit – Storage Bin	135
97-933-062	Ergotron WorkFit — Accessories – WorkFit LCD & Laptop Kit	130
97-933-085	Ergotron WorkFit — Accessories – WorkFit LCD & Laptop Kit	130
97-934-062	Ergotron WorkFit — Accessories – WorkFit Dual Monitor Kit	130
97-934-085	Ergotron WorkFit — Accessories – WorkFit Dual Monitor Kit	130
97-935-062	Ergotron WorkFit — Accessories – WorkFit Single LCD Monitor Kit	130
97-935-085	Ergotron WorkFit — Accessories – WorkFit Single LCD Monitor Kit	130
97-940-026	Ergotron Monitor Arm Accessories – LX Arm, Extension and Collar Kit	109
98-009-026	Ergotron Monitor Arms – HX Triple Monitor Bow Kit	103
98-009-216	Ergotron Monitor Arms – HX Triple Monitor Bow Kit	103
98-017	Ergotron Monitor Arm Accessories – Grommet Mount for LX Arm on WorkFit-T/TL	115
98-034	Ergotron Monitor Arm Accessories – Grommet Mount for LX Single and Dual Direct Arms	115
98-035	Ergotron Monitor Arm Accessories – Grommet Mount for LX Dual Arm	115
98-037-062	Ergotron Monitor Arm – Dual Direct Handle Kit	107
98-060-003	Ergotron Monitor Arm Accessories – LX Two-Stop Rotational Control Kit	108
98-081	Ergotron Monitor Arm Accessories – Under Mount C-Clamp for use with HX Arms	114
98-082	Ergotron Monitor Arm Accessories – Under Mount C-Clamp for LX Dual Side-by-Side, LX Dual Stacking, LX Desk Mount Tall Pole	114
98-083	Ergotron Monitor Arm Accessories – Under Mount C-Clamp for LX Desk Mount Single, LX Dual Direct, and MXV Monitor Arms	114
98-084	Ergotron Monitor Arm Accessories – Under Mount C-Clamp for MX Mini Desk Mount Arms	114

Index

<u>Product Code</u>	<u>Product Description</u>	<u>Page</u>
98-101-009	Ergotron Monitor Arm Accessories – Dual Monitor Double- Hinged Bow	131
98-110	Ergotron Monitor Arm Accessories – Grommet Mount for MXV Single Monitor Arm	115
98-111	Ergotron Monitor Arm Accessories – Grommet Mount for MXV Dual Monitor Arm	115
98-121	Ergotron Monitor Arm Accessories – Top Mount C-Clamp for LX Single, LX Dual Direct, and MXV Single Monitor Arms	116
98-122	Ergotron Monitor Arm Accessories – Top Mount C-Clamp for HX Arms	116
98-125	Ergotron Monitor Arm Accessories – Top Mount C-Clamp for LX Dual Side-by-Side and Stacking, LX Desk Mount Tall Pole, and MXV Dual Monitor Arms	116
98-126	Ergotron Monitor Arm Accessories – Top Mount C-Clamp for MX Mini Arms	116
98-130-216	Ergotron Monitor Arm Accessories – LX Arm, Extension and Collar Kit	109
98-236-009	Ergotron Monitor Arm Accessories – Under Mount C-Clamp for LX Dual Side-by-Side, LX Dual Stacking, LX Desk Mount Tall Pole	114
98-237-009	Ergotron Monitor Arm Accessories – Top Mount C-Clamp for LX Single, LX Dual Direct, and MXV Single Monitor Arms	116
98-238-009	Ergotron Monitor Arm Accessories – Top Mount C-Clamp for LX Dual Side-by-Side and Stacking, LX Desk Mount Tall Pole, and MXV Dual Monitor Arms	116
CH-8	Workstation Accessories – UniGroup All-Purpose Hook	205
CK-3	Lock Programs	213
DBKP-S	Work Tools – File Master Kit	201
DBKS-S	Work Tools – Mini Master Kit	201
DBKT-S	Work Tools – Task Master Kit	201
DM12-1006-1	Ergotron Zip 12 Charging – Ergotron Zip 12 Charging	136
DMSP	Work Tools – Mini Shelf	198
DPKP-S	Work Tools – File Master Kit	201
DPKS-S	Work Tools – Mini Master Kit	201
DPKT-S	Work Tools – Task Master Kit	201
DPKY-1	Work Tools – Pile Master Kit	200
DS-3	Workstation Accessories – Shallow Drawer	203
DTAR-3	Work Tools – Personal Shelf Bracket	199
DTBS-3	Work Tools – Phone Shelf Bracket	199
DTES-3	Work Tools – Personal Shelf	199
DTGK-3	Work Tools – Gooseneck Kit	198
DTHT-1	Work Tools – Tote Strap	198
DTLS-2	Work Tools – Letter Tray Stacking Kit	200
DTLT-2	Work Tools – Letter Tray	200
DTPR-3	Work Tools – Paper Sorter	197
DTPT-3	Work Tools – Phone Shelf	199
DTRB	Work Tools – Waste Bin	200
DTSB-1	Work Tools – Letter Tray Stacking Bracket	200
DTSB-3	Work Tools – Binder Bin	197
DTTE-3	Work Tools – Tote	198
DTTH-3	Work Tools – Tote	198
DTTS-12	Work Tools – Tack Strip	197
DTTS-24	Work Tools – Tack Strip	197
DTWC-2	Work Tools – Tool Cup	197
E2CH-8	Workstation Accessories – UniGroup Too All Purpose Hook	205
EAAW-0000-H	Wire Management – Cable Chain	173
EUAM-0000	Wire Management – Conduit Clamp	174
EUAW-0000-NHS	Wire Management – Cord Manager — Mesh	173
EUAW-3100-NV	Wire Management – Vertical Cable Chain	173
EUAW-4000-V	Wire Management – Compose Connections Cable Chain	173
EUAW-NH	Wire Management – Wire Manager — Horizontal	175
EUB1-HLOB-2100	Electrical Components – Flush Mounted Power — Hardwire	37
EUB1-HLOB-2110	Electrical Components – Flush Mounted Power — Hardwire	37
EUB1-HLOB-2112	Electrical Components – Flush Mounted Power — Hardwire	37
EUB1-PL0B-2100	Electrical Components – Flush Mounted Power — Corded	33

Index

Product Code	Product Description	Page
EUB1-PL0B-2110	Electrical Components – Flush Mounted Power — Corded	33
EUB1-PL0B-2112	Electrical Components – Flush Mounted Power — Corded	33
EUB1-PL0B-4000	Electrical Components – Flush Mounted Power — Corded	33
EUB1-SF0B-2100	Electrical Components – Flush Mounted Power — Spiral Cord for Height Adjustable	41
EUB1-SF0B-2110	Electrical Components – Flush Mounted Power — Spiral Cord for Height Adjustable	41
EUB1-SF0B-2112	Electrical Components – Flush Mounted Power — Spiral Cord for Height Adjustable	41
EUB1-SF0B-4000	Electrical Components – Flush Mounted Power — Spiral Cord for Height Adjustable	41
EUB1-SL0B-2100	Electrical Components – Flush Mounted Power — Cord for Height Adjustable	44
EUB1-SL0B-2110	Electrical Components – Flush Mounted Power — Cord for Height Adjustable	44
EUB1-SL0B-2112	Electrical Components – Flush Mounted Power — Cord for Height Adjustable	44
EUB1-SL0B-4000	Electrical Components – Flush Mounted Power — Cord for Height Adjustable	44
EUD1-HF0B-2010	Electrical Components – Hardwire	58
EUD1-HF0B-2110	Electrical Components – Hardwire	58
EUD1-HF0B-2112	Electrical Components – Hardwire	58
EUD1-PF0B-2010	Electrical Components – Corded	52
EUD1-PF0B-2110	Electrical Components – Corded	52
EUD1-PF0B-2112	Electrical Components – Corded	52
EUD1-PF0B-4000	Electrical Components – Corded	52
EUD1-SF0B-2110	Electrical Components – Enhanced Power Module — Spiral Corded — Height Adjustable	63
EUD1-SF0B-4000	Electrical Components – Enhanced Power Module — Spiral Corded — Height Adjustable	63
EUD1-SL0B-2110	Electrical Components – Enhanced Power Module — Cord for Height Adjustable	64
EUD1-SL0B-4000	Electrical Components – Enhanced Power Module — Cord for Height Adjustable	64
EUDB-0000-A	Electrical Components – For use with Suite Technology Access Blotter and Utility Cabinet	70
EUDB-0000-B	Electrical Components – For use with Suite Lower Storage – Mounts to the Inner Back of the Cabinet	69
EUDB-0000-C	Electrical Components – For use with Suite Lower Storage – Mounts to Storage Top	69
EUDB-0000-H	Electrical Components – Above Worksurface – Adjustable	65
EUDB-0000-N	Electrical Components – Above Worksurface – Adjustable	65
EUDB-0000-SB	Electrical Components – For Use with Side Car — Basic	67
EUDB-0000-SD	Electrical Components – For Use with Side Car — Deluxe	67
EUDB-0000-T	Electrical Components – Above Worksurface – Adjustable with Tackboard Offset	66
EUDB-0000-U	Electrical Components – Under Worksurface – Fixed	66
EUDB-0000-W	Electrical Components – Above Worksurface – Fixed	66
EUDB-J	Electrical Components – For Use with X Series	68
EUDX-3000-B	Electrical Components – Cables	99
EUDX-H000-B	Electrical Components – Cables	99
EUDX-U000-B	Electrical Components – Retrofit USB Charging Cable	99
EUDX-V000-B	Electrical Components – Cables	99
EUE1-000B	Electrical Components – Flip Top Unit — Non-Powered	72
EUE1-1111W	Electrical Components – Power and Data	71
EUE1-1331W	Electrical Components – Power and Data	71
EUE1-1B01W	Electrical Components – Power and Data	71
EUE1-C331W	Electrical Components – Power and Data	71
EUE1-HF0B-1212	Electrical Components – Power, Data and USB	86
EUE1-HF0B-2110	Electrical Components – Power, Data and USB	86
EUE1-PF0B-1212	Electrical Components – Power, Data and USB	74
EUE1-PF0B-2110	Electrical Components – Power, Data and USB	74
EUE1-PF0B-4000	Electrical Components – Power, Data and USB	74
EUE2-000B	Electrical Components – Flip Top Unit — Non-Powered	72
EUE2-1331W	Electrical Components – Power and Data	71
EUE2-C331W	Electrical Components – Power and Data	71
EUE2-HF0B-1212	Electrical Components – Power, Data and USB	92
EUE2-HF0B-2110	Electrical Components – Power, Data and USB	92
EUE2-PF0B-1212	Electrical Components – Power, Data and USB	80

Index

Product Code	Product Description	Page
EUE2-PF0B-2110	Electrical Components – Power, Data and USB	.80
EUE2-PF0B-4000	Electrical Components – Power, Data and USB	.80
EUET-0000-1M3N	Electrical Components – Power Tap — Corded Horizontal and Vertical	.49
EUET-0030-2M3N	Electrical Components – Power Tap — Horizontal	.47
EUET-0030-2M3N	Electrical Components – Power Tap — Vertical	.48
EUET-0030-3M3N	Electrical Components – Power Tap — Horizontal	.47
EUET-0030-3M3N	Electrical Components – Power Tap — Vertical	.48
EUET-0030-4M3N	Electrical Components – Power Tap — Horizontal	.47
EUET-0030-4M3N	Electrical Components – Power Tap — Vertical	.48
EUET-0030-CM3N	Electrical Components – Power Tap — Hardwire	.49
EUF1	Electrical Components – Classic Power Module	.27
EUFB-0000-AB	Electrical Components – Classic Power Module Bracket - Angled	.28
EUFB-0000-SB	Electrical Components – Classic Power Module Bracket - Vertical Bracket	.28
EUFB-0000-UB	Electrical Components – Classic Power Module Bracket - Under Surface	.28
EUG1	Grommets – Flip Top Unit — Hatch	.138
EUMC-0201	Electrical Components – Mounting Clip for Flip Top Unit	.97
EURT-0000-N001CB	Electrical Components – Data Bezel	.51
EURT-0000-N001CW	Electrical Components – Data Bezel	.51
EURT-0000-N001SB	Electrical Components – Data Bezel	.51
EURT-0000-N001SW	Electrical Components – Data Bezel	.51
EURT-0072-1010	Electrical Components – Bezel Utility Module	.51
EURT-0072-1100	Electrical Components – Bezel Utility Module	.51
EUS1-HLOB	Electrical Components – Seamless Enhanced Power Module	.29
EUS1-HLOW	Electrical Components – Seamless Enhanced Power Module	.29
EUS1-PF0B	Electrical Components – Seamless Enhanced Power Module	.29
EUS1-PF0W	Electrical Components – Seamless Enhanced Power Module	.29
EUWC-HLOB	Electrical Components – Wireless Charging Module	.98
EUWC-HLOW	Electrical Components – Wireless Charging Module	.98
EUWC-PF0B	Electrical Components – Wireless Charging Module	.98
EUWC-PF0W	Electrical Components – Wireless Charging Module	.98
HCH-0008	Workstation Accessories – PLACES All-Purpose Hook	.205
HCH-0008-W	Workstation Accessories – PLACES All-Purpose Hook — For Low Profile Wood Top Cap Panels	.205
HCPL-COT1-07	Lighting — Haworth Collection – Table Light	.154
HCPL-COT2-15	Lighting — Haworth Collection – Table Light with Small Panel	.154
HCPL-COT3-30	Lighting — Haworth Collection – Table Light with Large Panel	.154
HCPL-GFT1-13	Lighting — Haworth Collection – Table Light	.155
HCPL-SLF1-47	Lighting — Haworth Collection – Floor Light	.162
HCPL-SLSV-4BP	Lighting — Haworth Collection – Base Pads	.162
HCPL-SLT1-17	Lighting — Haworth Collection – Table Light	.162
HCPL-TTF1-60	Lighting — Haworth Collection – Floor Light	.163
HCPL-TTT1-14	Lighting — Haworth Collection – Table Light	.163
HCPL-TTT2-21	Lighting — Haworth Collection – Table Light	.163
HCPL-TTT3-27	Lighting — Haworth Collection – Table Light	.163
HCPL-UMT2-11	Lighting — Haworth Collection – Audio Lantern	.164
HKMP-1	Adjustable Keyboard Pads – Boogie Board Mouse Pad	.25
HKTC-M	Adjustable Keyboard Pads – Boogie Board Keyboard Tray with Palm Rest and Integrated Mouse Pad	.25
HKTC-N	Adjustable Keyboard Pads – Boogie Board Keyboard Tray with Palm Rest	.25
HKTE-M	Adjustable Keyboard Pads – Boogie Board Keyboard Tray with Palm Rest and Integrated Mouse Pad	.25
HKTE-N	Adjustable Keyboard Pads – Boogie Board Keyboard Tray with Palm Rest	.25
HUDF-F	Lock Programs – Digital Lock Control Key Fob	.214
HUDR-B	Lock Programs – Digital Lock	.214
HUDR-L	Lock Programs – Digital Lock	.214
HUDR-R	Lock Programs – Digital Lock	.214

Index

<u>Product Code</u>	<u>Product Description</u>	<u>Page</u>
HUDR-T	Lock Programs – Digital Lock	214
HWKB-1	Lock Programs	213
HWMK-1	Lock Programs	213
HWSK	Lock Programs	213
HW-SVC	Lock Programs	213
JAC-18	Workstation Accessories – Pencil Drawer	203
JAG-1	Planes Accessories –	137
JAG-2	Planes Accessories –	137
JRPY-3948	Recycling Solutions – Recycling Solutions	171
KAIB-0040	Information Display – Information Boards	141
KAIC-0000	Information Display – Horizontal Wall Rail End Caps	142
KAIE-0029	Information Display – Standard Easel	139
KAIE-0072	Information Display – Large Easel	140
KAIH-0000	Planes Information Display – Boards and Accessories – Wall Cleat for Information Boards	141
KAIW-0096	Planes Information Display – Boards and Accessories – Horizontal Wall Rail for Information Boards	141
KFI-00XX-B	Storage Accessories – Drawer Insert	172
KJFI-00XX-D	Storage Accessories – Drawer Insert	172
KU1A-0017	Adjustable Keyboard Pads – Locking Tilt AKP	21
KU1C	CPU Holders – Fixed Mount CPU Holder	26
KU1C	CPU Holders – Fixed Mount CPU Holder	26
KU1D-0000	Workstation Accessories – Adjustable Document Holder	204
KU1F-0000	Workstation Accessories – Adjustable Footrest	204
KU1L-0000-U	Workstation Accessories – Adjustable Laptop Holder	204
KU2A-0017	Adjustable Keyboard Pads – Dial Tilt AKP	21
KU2C-L	CPU Holders – Adjustable CPU Holder	26
KU3A-0023	Adjustable Keyboard Pads – Dial Tilt AKP - Extended Arm	22
KU4A-0023	Adjustable Keyboard Pads – Sit-to-Stand AKP	22
KU5A	Adjustable Keyboard Pads – Thin Profile AKP	24
KU5M-1NNB	Monitor Arms — Haworth – Adjustable Post Arm – for Use with Intuity Benching	167
KU5M-1NNK	Monitor Arms — Haworth – Adjustable Post Arm – for Use with Reside Desking	168
KU5M-1NNN	Monitor Arms — Haworth – Adjustable Post Arm	166
KU5M-2NNB	Monitor Arms — Haworth – Adjustable Post Arm – for Use with Intuity Benching	167
KU5M-2NNK	Monitor Arms — Haworth – Adjustable Post Arm – for Use with Reside Desking	168
KU5M-2NNN	Monitor Arms — Haworth – Adjustable Post Arm	166
KU6M-1NNB	Monitor Arms — Haworth – Extend Arm – For Use with Intuity Benching	167
KU6M-1NNK	Monitor Arms — Haworth – Extend Arm — For Use with Reside Desking	168
KU6M-1NNN	Monitor Arms — Haworth – Extend Arm	166
KU6M-2NNB	Monitor Arms — Haworth – Extend Arm – For Use with Intuity Benching	167
KU6M-2NNK	Monitor Arms — Haworth – Extend Arm — For Use with Reside Desking	168
KU6M-2NNN	Monitor Arms — Haworth – Extend Arm	166
KU6T	Monitor Arms — Haworth – iPad Attachment	169
KUAH-0002	Work Tools – Magnet Hooks	202
KUAH-0003	Work Tools – Magnet Hook	202
KUAK	Work Tools – Accessory Kit	196
KUAM-0411	Work Tools – Magnet Board	202
KUAM-0518	Work Tools – Magnet Board	202
KUAP-0000	Work Tools – Round Peg Magnets	202
KUAR-0403	Work Tools – Mirror	202
KUBL-2030-FJ	Work Tools – Blotter	196
KUBT	Work Tools – Base Tray	194
KUCU-0915-BNN	Work Tools – Open C Cubby	193
KUCU-1215-BNS	Work Tools – Open C Cubby	193
KUDP-2420	Workstation Accessories – Pencil + Drawer	203

Index

<u>Product Code</u>	<u>Product Description</u>	<u>Page</u>
KUHS-0000-H	Work Tools – Hanging Sorter	195
KULS	Work Tools – Desk Top L-Screen	194
KUP1-0000-CSN	Work Tools — Mounting – Tool Rail — Single Post — C-Clamp or Thru-mount	183
KUP1-0000-USN	Work Tools — Mounting – Tool Rail — Single Post — L-Bracket Mount	185
KUP2-0000-UBI	Work Tools — Mounting – Tool Rail — Single Post Internal/Benching	189
KUPT-0913-F	Work Tools – Paper Tray — Landscape	195
KUPT-0913-H	Work Tools – Paper Tray — Landscape	195
KUPY	Work Tools — Mounting – Slat, Wall Mount	180
KUR1-0424-PZN	Work Tools — Mounting	181
KUR1-1224-CSN	Work Tools — Mounting – Tool Rail — Horizontal Surface Mount C-Clamp or Thru-Mount	182
KUR1-1224-USE	Work Tools — Mounting – Tool Rail — Single Sided Continuous Benching End	186
KUR1-1224-USI	Work Tools — Mounting – Tool Rail — Internal Single Sided Continuous Benching Application	188
KUR1-1224-USN	Work Tools — Mounting – Tool Rail — Under Horizontal Surface Mount — L-Bracket	184
KUR2-1224-UBE	Work Tools — Mounting – Tool Rail — Double-Sided Continuous Benching End Application Only	187
KUR2-1224-UBI	Work Tools — Mounting – Tool Rail — Internal Continuous Benching Application Only	189
KURB	Recycling Solutions – Recycling/Trash Bin	171
KURD	Recycling Solutions – Recycle Bin Carriage	171
KURS	Work Tools – Desk Top Reference Shelf	194
KURS-0010-H	Work Tools – Reference Shelves	196
KURS-0012-B	Work Tools – Reference Shelves	196
KURS-0019-H	Work Tools – Reference Shelves	196
KUSH-0408-H	Work Tools – Mini Shelf	195
KUSR	Work Tools – Screen Rail	193
KUTB	Work Tools – Structural Screen Tile	192
KUTC-0000-H	Work Tools – Tool Cup	195
KUTS-E	Work Tools – Territory Screen — End-of Run	190
KUTS-L	Work Tools – Territory L-Screen	191
KUTS-S	Work Tools – Territory Screen — Shared	190
KUWH-0202	Workstation Accessories – Bag Hook	206
KWMF	Wire Management – Wire Management Trough	175
KWT	Wire Management – Wire Management Trough	175
KZTB	Work Tools – Belong Systems Tile — External Mount for use with Compose Panels	192
LBJ1	Lighting — Haworth Collection – Freestanding Lighting	150
LBJ2	Lighting — Haworth Collection – Freestanding Lighting	150
LBJ3	Lighting — Haworth Collection – Mounted Lighting	150
LBJ4	Lighting — Haworth Collection – Mounted Lighting	150
LCC1-1808-NFLC	Lighting — Haworth Collection – Table Light	152
LCC2-2608-NFLC	Lighting — Haworth Collection – Floor Light	152
LCF1-6009	Lighting — Haworth Collection – Floor Light	153
LCT1-1708	Lighting — Haworth Collection – Table Light	153
LL31-2210-NFLC	Lighting — Haworth Collection – Table Light	160
LL32-2210-NGLC	Lighting — Haworth Collection – Grommet Mounted Light	160
LLC1	Lighting — Haworth Collection – Worksurface Mounted Lighting	157
LLL1	Lighting — Haworth Collection – Freestanding Lighting	156
LLL2	Lighting — Haworth Collection – Freestanding Lighting	156
LLL3	Lighting — Haworth Collection – Freestanding Lighting	156
LLM1	Lighting — Haworth Collection – Mounted Lighting	158
LLM1	Lighting — Haworth Collection – Mounted Lighting	158
LLM2	Lighting — Haworth Collection – Mounted Lighting	158
LLU2	Lighting — Haworth Collection – Mounted Lighting	158
LRF0-5208	Lighting — Haworth Collection – Floor Light	151
LRF1-5208	Lighting — Haworth Collection – Floor Light	151
LRT1-1408	Lighting — Haworth Collection – Circa	151

Index

<u>Product Code</u>	<u>Product Description</u>	<u>Page</u>
LSET	HW Lock Plugs and Keys	212
LUPT	Lighting — Haworth Collection – Table Light	161
LUTA	Lighting — Haworth – Adaptable LED Task Light - Add-On Kit	146
LUTD-0017-1NULDN	Lighting — Haworth – Reed Premier™ Add-On LED Task Light — For Use with Reed Premier Starter LED Task Lights	148
LUTN	Lighting — Haworth – Adaptable LED Task Light - Stand-Alone	145
LUTS-0000	Lighting — Haworth – Reed Premier™ Add-On Occupancy Sensor	148
LUTS-0017-12ULD6	Lighting — Haworth – Reed Premier™ Starter LED Task Light	147
LUTS-0017-19ULD5	Lighting — Haworth – Reed Premier™ Stand-Alone LED Task Light	147
LUTT	Lighting — Haworth – Adaptable LED Task Light - Starter Kit	145
LUV1	Lighting — Haworth – Voyage without Occupancy Sensor	149
LUV2	Lighting — Haworth – Voyage with Occupancy Sensor	149
MAC-0001	Workstation Accessories – Make-A-Corner	204
NAH-12-S	Workstation Accessories – PREMISE All Purpose Hooks	205
NAPY	Work Tools — Mounting – Wall Accessory Slat Pad – For Use with PREMISE	180
NBFS-F	Mobile Screens – Fabric Scrim Insert	165
NBFS-M	Information Display – Planes Markerboard – Markerboard Insert	143
NBFS-X	Mobile Screens – Translucent Insert	165
NECG-V	Wire Management – Vertical Cable Guide	175
NEH-8	Wire Management – Wire Management Loop	174
NEV-1	Wire Management – PREMISE Vertical Wire Manager	177
NEV-2	Wire Management – PREMISE Task Light Cord Manager	178
SCD-19	Workstation Accessories – Steel Center Drawer	203
STP-P26-TH	Pip	170
TA01-0214	Planes Information Display – Boards and Accessories – Y-Leg Bumper	142
TA01-0217	Wire Management – Cable Column	179
TA01-0220	Planes Accessories –	137
TA01-0225	Wire Management – Wire Manager Clips	174
TA01-0228-F	Wire Management – Planes C-Leg Training Table Vertical Wire Manager	177
TA01-0814	Wire Management – Cable Base	179
TA01-1414	Wire Management – Cable Base	179
TABC	Wire Management – Basket Cover	176
TAWB	Wire Management – Wire Management Basket	176
TYVW	Wire Management – Vertical Wire Channel - Leg Attached	176
UKMCBK	Ergotron Keyboard Tray – Keyboard Tray with Mouse Pad	100
VZAC-0000-H	Workstation Accessories – Compose All-Purpose Hook	205
VZAC-0000-P	Workstation Accessories – Compose All-Purpose Hook	205
VZAW-0000-V	Wire Management – Compose Task Light Cord Manager	177
WC-17	Wire Management – UniGroup Too, UniGroup and PLACES Task Light Wire Manager	178
WC-6	Wire Management – UniGroup Too, UniGroup and PLACES Wire Manager	178
WQAG	Lighting — Haworth Collection – Grommet — For Use with Brazo Grommet Mounted Light Only	150
WQAG	Planes Accessories	137
WUAC-WSG	Grommets	137
WUAW-PNH	Wire Management – Horizontal Wire Management	175
ZUAP-0000-PAN	Electrical Components – Power Tap Bracket — Adjustable	50
ZUAP-0000-PFD	Electrical Components – Power Tap Bracket — Fixed	50
ZUAP-0000-PGH	Electrical Components – Power Tap Bracket with Grommet — Beside Storage Only	50
ZUAP-0000-PUR	Electrical Components – Power Tap Bracket — Under Surface	50

Warranty

Ergotron branded products in this price list are covered exclusively by the warranty statement below.

All Ergotron® products will remain free of defects in material and workmanship for a period of five years from the date of receipt of the product, subject to any exclusions and limitations as set forth below.

Ten-year warranty on all LX and MX Ergotron Products, purchased on or after August 1, 2014

Zip Charging Systems: Lifetime material/workmanship; three years electrical components; one year cables (power/Ethernet)

Ten-year warranty on LearnFit Adjustable Standing Desk (24-481-003)

Three-year warranty on all Neo-Flex® Ergotron Products

Original Equipment Manufacturer (OEM) Products resold by Ergotron are warranted by the respective manufacturer

FURTHER EXCLUSIONS AND LIMITATIONS

These warranties do not cover product abuse, modification and failure to adhere to product instructions, improper operations and/or misuse. Ergotron is not responsible for damage arising from failure to follow instructions relating to the product's intended use. Ergotron is not responsible for injury or loss caused by or associated with the installation and/or use of equipment in any manner other than in strict conformance with the instructions set forth in its installation manuals, supplemental assembly and installation instruction sheets, technical bulletins and/or product literature. You will provide Ergotron immediate written notice of any personal injury resulting from the use of Ergotron products.

Ergotron does not warrant damages or defects to the Ergotron product under the following conditions: an Act of God, unauthorized service or repair of the Ergotron products, damage from electrical power problems, usage of parts or components not supplied by Ergotron, failure to follow product instructions and guidelines, unauthorized changes to the Ergotron product, shipping damage (other than original shipment from Ergotron), failure to perform preventative maintenance, or damage caused by peripherals or software or from other external sources.

EXCLUSIVE REMEDY

Warranty Repair: In the event that any Ergotron equipment becomes defective in material or workmanship during the warranty period, Ergotron will determine with you if the product defect is covered under warranty. Ergotron, at its sole discretion, may replace or repair the unit determined to be under warranty at a designated Ergotron location or at your location. The labor costs associated with the repair of the product may be the responsibility of Ergotron if determined to be under warranty. You must receive pre-approval by Ergotron for the labor costs prior to repair or replacement of warranty products. You must contact Ergotron to obtain a Return Material Authorization (RMA) number. An RMA number may be obtained by contacting Ergotron Customer Care online or by telephone within your specific region. Contact information is available to you on the Ergotron web site at www.ergotron.com. Performance of any repair or replacement on product under warranty does not renew or extend the warranty period.

Non-Warranty Repair: You may return a product for repair that is not covered by warranty only if you have received a preapproved RMA number from Ergotron Customer Care. Labor costs and freight charges associated with non-warranty repair will be the sole responsibility of the customer, reseller or installer/integrator. A standard repair fee, specific to the product, is charged for any product that is repaired outside of the warranty period. Repairs on products out of warranty also carry a 90-day warranty, effective the day that you receive the item after repair.

For products that are not covered under warranty, Ergotron offers you the following options:

You may upgrade to a newer, functionally equivalent product at a normal list price

Ergotron will return the product to you

You can request in writing that Ergotron appropriately dispose of the product for you. A fee may apply for this service as designated by local law

Non-Defective Products: You are notified if, after examining and testing a returned product, Ergotron concludes that the product is not defective. The product is returned to you and you would be responsible for the freight charges associated with the return.

WARRANTY DISCLAIMER

Except as expressly set forth in this Limited Warranty and to the greatest extent allowed by law, Ergotron makes no other representations, warranties or conditions, express or implied, including any implied representations, warranties or conditions of merchantability, fitness for a particular purpose, non-infringement, and noninterference. Ergotron does not warrant that your use of the Ergotron product will be uninterrupted or error free. Any implied warranties that may be imposed by law are limited in duration to the Limited Warranty period, to the greatest extent allowed by law. Some states or countries do not allow a limitation on how long an implied warranty lasts or the exclusion or limitation of incidental or consequential damages for consumer products. In such states or countries, some exclusions or limitations of this Limited Warranty may not apply to you. This Limited Warranty is subject to change without notification.

Ergotron devices are not intended to cure, treat, mitigate or prevent any disease.

WARRANTY TRANSFERABILITY

This Limited Warranty is available only to the original end consumer and is non-transferable. For this warranty to be valid, the Ergotron product must have been purchased directly from an authorized distributor, reseller and/or authorized representative of Ergotron.

For additional information reference Ergotron.com or warranty inquiries contact Ergotron at 844-429-9678 or email haworth@Ergotron.com.

Ergotron Limited Warranty Terms and Conditions

©Ergotron Inc.

Effective Date: 1 June 2017

Content is subject to change without notification

Great Expectations

You have them as a Haworth customer and so do we. And because we value our customers, we cover our products with the Haworth North America Product Compatibility and Limited Warranty Policy.

Product Compatibility and Limited Warranty Policy

Our Commitment To Product Compatibility – Integrated Product Platforms

As a market leader in the design and manufacture of workspaces that adapt to change, we strive to maintain product compatibility within our various generations of integrated product platforms. This benefits the customer who desires to update or modify their work environment. It also benefits the customer needing to replace a product due to damage or other reasons but which is no longer manufactured or is otherwise unavailable, such as a fabric or finish that is discontinued because of changing market preferences. In both circumstances, we often can provide products with comparable function and performance.

Our Commitment To Product Quality – The Haworth North America Limited Warranty

To ensure customer satisfaction and peace of mind, we stand behind our products with the Haworth North America Limited Warranty. To review the current version of the limited warranty including its terms and conditions, please go to:

www.haworth.com/resources/product-info/warranties or contact Haworth's First Call Center at **800.426.8562**.

Warranty Requests or Questions

For questions or service requests pertaining to the Haworth Limited Warranty, please contact your Haworth dealer.

If you are unsure who your dealer is, please call Haworth's First Call Center at **800.426.8562**.

Effective: January 1, 2020

HAWORTH®

HAWORTH® is a registered trademark of Haworth, Inc.

© Haworth, Inc. All rights reserved. 2020 2.20 | Item #1222

haworth.com | 800 344 2600

Electrical Components

Collaborative Power Station

	Color	Number	Price
Collaborative Power Station	Fog/Matte Fog	EUCN-PJ0F-311	\$ 965.00
	Storm/Matte Storm	EUCN-PJ0S-311	965.00
	Black/Matte Black	EUCN-PJ0B-311	965.00
	Fog/Weathered Aspen Veneer	EUCN-PJ0V-311	1332.00

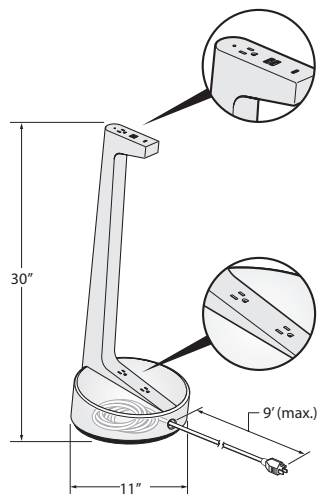

EUCN-PJ



Features

- Includes power module with 5 ports (3 on the top and 2 on the bottom) configured with simplex outlets (NEMA-5-15R) and USB charging port.
- Corded power module with 15 amp - 9'(2743mm) long cord with plug (NEMA 5-15P).
- USB-A provides two 10W charging ports.
- USB-C 18W provides a single 18w USB-C port that can provide a fast charge for mobile phones and tablets.
- Color options:
 - Fog/Matte Fog
 - Storm/Matte Storm
 - Black/Matte Black
 - Fog/Weathered Aspen Veneer

To Order, Specify:

- 1) Product number.
(No finish specification required.)

Specification Tips

- Configuration and quantity of power and data ports cannot be modified in the field.
- For use with 120 volt 60 hertz power source only.
- Requires field installation.
- Application may require approval of local authority having jurisdiction (AHJ); ensure compliance before placing orders and installation.

Electrical Components

Flush Mounted — Round

Flush Mounted — Round

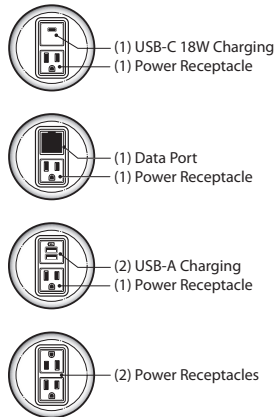
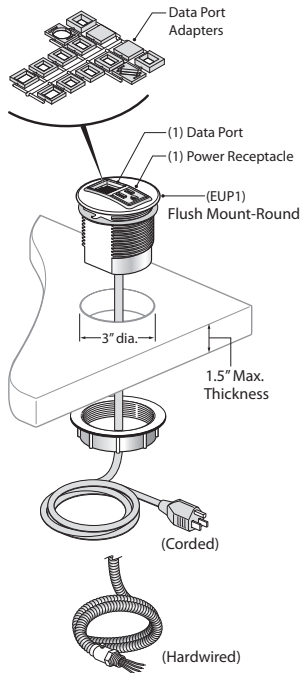

EUP1-PF
EUP1-HF



Cord Length	Port	Configuration	Number	Price
Corded				
6'(1829mm)	2	1 Power Receptacle, 1 Data Port	EUP1-PFOP-100010	\$219.00
		1 Power Receptacle, 1 USB-A Charging	EUP1-PFOP-110000	334.00
		1 Power Receptacle, 1 USB-C 18W Charging	EUP1-PFOP-101000	449.85
		2 Power Receptacles	EUP1-PFOP-200000	224.00
10'(3048mm)	2	1 Power Receptacle, 1 Data Port	EUP1-PJOP-100010	\$236.00
		1 Power Receptacle, 1 USB-A Charging	EUP1-PJOP-110000	351.00
		1 Power Receptacle, 1 USB-C 18W Charging	EUP1-PJOP-101000	466.85
		2 Power Receptacles	EUP1-PJOP-200000	241.00
Hardwire				
6'(1829mm)	2	1 Power Receptacle, 1 Data Port	EUP1-HFOP-100010	\$289.29
		1 Power Receptacle, 1 USB-A Charging	EUP1-HFOP-110000	404.29
		1 Power Receptacle, 1 USB-C 18W Charging	EUP1-HFOP-101000	520.14
		2 Power Receptacles	EUP1-HFOP-200000	294.29
10'(3048mm)	2	1 Power Receptacle, 1 Data Port	EUP1-HJOP-100010	\$306.29
		1 Power Receptacle, 1 USB-A Charging	EUP1-HJOP-110000	421.29
		1 Power Receptacle, 1 USB-C 18W Charging	EUP1-HJOP-101000	537.14
		2 Power Receptacles	EUP1-HJOP-200000	311.29

Features

- Includes power module with 2 ports configured with simplex outlets (NEMA-5-15R), USB charging port or data ports and mounting hardware.
- Power Modules specified with a data port includes a variety of data port adapters and blank covers, which accommodate most varieties of field supplied data/AV jacks.
- Corded power module with 15 amp - 6'(1829mm) or 10'(3048mm) long cord with plug (NEMA 5-15P).
- Hardwire power module with 6'(1829mm) or 10'(3048mm) long flexible galvanized metal conduit.
- USB-A provides two 10W charging ports.
- USB-C 18W provides a single 18w USB-C port that can provide a fast charge for mobile phones and tablets.

To Order, Specify:

- 1) Product number.
- 2) Trim color.
TR-PM1 Silver
TR-PM2 Midnight Black
TR-PM3 Parchment

Specification Tips

- Installs into a 3" diameter hole into surfaces with a maximum thickness of 1.5".
- Configuration and quantity of power and data ports cannot be modified in the field.
- For use with 120 volt 60 hertz power source only.
- Requires field installation.
- Specify AV cables separately.
- Application may require approval of local authority having jurisdiction (AHJ); ensure compliance before placing orders and installation.