

### FEATURES

- HIGH FREQUENCY OPERATION TO 3 GHz
- SELECTABLE DIVIDE RATIO: ÷64, ÷128, ÷256
- LOW CURRENT CONSUMPTION: 19 mA at 5 V
- SMALL PACKAGE: 8 pin SSOP
- AVAILABLE IN TAPE AND REEL

### TEST CIRCUIT

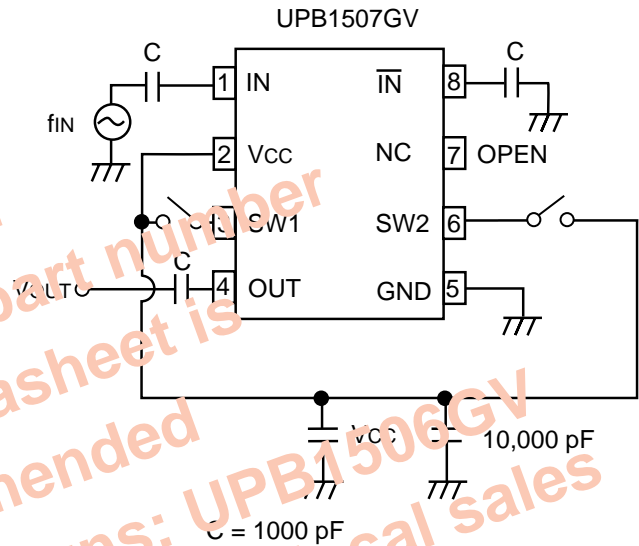

### DESCRIPTION

NEC's UPB1506GV and UPB1507GV are Silicon MMIC digital prescalers manufactured with the NESAT™ IV silicon bipolar process. They feature high frequency response to 3 GHz, selectable divide-by-64, 128, or 256 modes, and operate on a 5 volt supply while drawing only 19 mA. The devices are housed in a small 8 pin SSOP package that contributes to system miniaturization. These devices are designed for use in a PLL synthesizer for DBS and CATV settop and WLAN applications.

### ELECTRICAL CHARACTERISTICS (TA = -40 to +85°C, Vcc = 4.5 to 5.5 V, Zs = 50Ω)

PART NUMBER PACKAGE OUTLINE			UPB1506GV,UPB1507GV S08		
SYMBOLS	PARAMETERS AND CONDITIONS	UNITS	MIN	TYP	MAX
Icc	Circuit Current	mA	12.5	19	26.5
f <sub>IN(U)</sub>	Upper Limit Operating Frequency, P <sub>IN</sub> = -15 to +6 dBm	GHz		3.0	
f <sub>IN(L)1</sub>	Lower Limit Operating Frequency, P <sub>IN</sub> = -10 to +6 dBm	GHz			0.5
f <sub>IN(L)2</sub>	Lower Limit Operating Frequency, P <sub>IN</sub> = -15 to +6 dBm	GHz			1.0
P <sub>IN1</sub>	Input Power, f <sub>IN</sub> = 1.0 to 3.0 GHz	dBm	-15		+6
P <sub>IN2</sub>	Input Power, f <sub>IN</sub> = 0.5 to 1.0 GHz	dBm	-10		+6
V <sub>OUT</sub>	Output Voltage, C <sub>L</sub> = 0.8 pF	V <sub>P-P</sub>	1.2	1.6	
V <sub>IN(H)</sub>	Division Ratio Control Input High	V		V <sub>cc</sub>	
V <sub>IN(L)</sub>	Division Ratio Control Input Low	V		OPEN or GND	

# UPB1506GV, UPB1507GV

## ABSOLUTE MAXIMUM RATINGS<sup>1</sup> (T<sub>A</sub> = 25°C)

SYMBOLS	PARAMETERS	UNITS	RATINGS
V <sub>CC</sub>	Supply Voltage	V	-0.5 to 6.0
V <sub>IN</sub>	Input Voltage	V	-0.5 to V <sub>CC</sub> + 0.5
P <sub>IN</sub>	Input Power	dBm	+10
P <sub>D</sub>	Power Dissipation <sup>2</sup>	mW	250
T <sub>OP</sub>	Operating Temperature	°C	-45 to +85
T <sub>STG</sub>	Storage Temperature	°C	-55 to +150

### Notes:

1. Operation in excess of any one of these parameters may result in permanent damage.
2. Mounted on a double-sided copper clad 50x50x1.6 mm epoxy glass PWB (T<sub>A</sub> = +85°C).

## RECOMMENDED OPERATING CONDITIONS

SYMBOL	PARAMETER	UNITS	MIN	TYP	MAX
V <sub>CC</sub>	Supply Voltage	V	4.5	5.0	5.5
T <sub>OP</sub>	Operating Temperature	°C	-40	+25	+85

## PIN DESCRIPTIONS

Pin No.		Pin Name	Applied Voltage (V)	Pin Voltage (V)	Description															
UPB1506GV	UPB1507GV																			
2	1	IN	–	2.9	Signal input pin. This pin should be coupled to the source with a capacitor (eg 1000 pF).															
3	8	$\overline{\text{IN}}$	–	2.9	Signal input bypass pin. This pin must be equipped with a bypass capacitor (eg 1000 pF) to ground.															
4	5	GND	0	–	Ground pin. Ground pattern on the board should be formed as wide as possible to minimize ground impedance.															
1	3	SW1	H/L	–	Divided ratio input pin. The ratio can be controlled by the following input data to these pins. <table border="1" style="margin: 10px auto;"> <thead> <tr> <th colspan="2"></th> <th colspan="2">SW2</th> </tr> <tr> <th colspan="2"></th> <th>H</th> <th>L</th> </tr> </thead> <tbody> <tr> <th rowspan="2">SW1</th> <th>H</th> <td>+64</td> <td>+128</td> </tr> <tr> <th>L</th> <td>+128</td> <td>+256</td> </tr> </tbody> </table>			SW2				H	L	SW1	H	+64	+128	L	+128	+256
		SW2																		
		H	L																	
SW1	H	+64	+128																	
	L	+128	+256																	
6	6	SW2			These pins should be equipped with a bypass capacitor (e.g. 1000 pF) to ground.															
8	2	V <sub>CC</sub>	4.5 to 5.5	–	Power supply pin. This pin must be equipped with bypass capacitor (eg 1000 pF) to ground.															
7	4	OUT	–	2.6 to 4.7	Divided frequency output pin. This pin is designed as an emitter follower output. This pin can be connected to CMOS input due to 1.2 V <sub>p-p</sub> MIN output.															
5	7	NC	–	–	No connection. This pin must be opened.															

**TYPICAL PERFORMANCE CURVES** ( $T_A = +25^\circ\text{C}$  unless otherwise noted)

**CURRENT vs. VOLTAGE and TEMPERATURE**

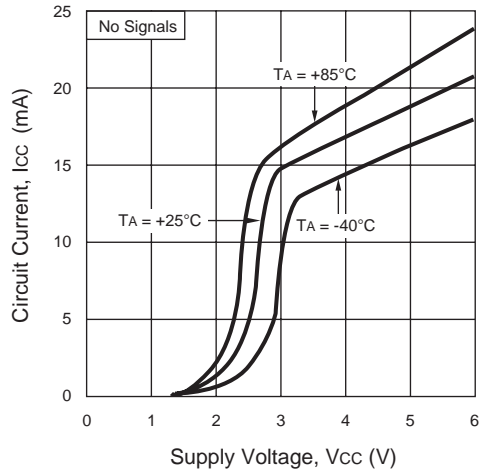

**INPUT POWER vs. INPUT FREQUENCY and VOLTAGE**

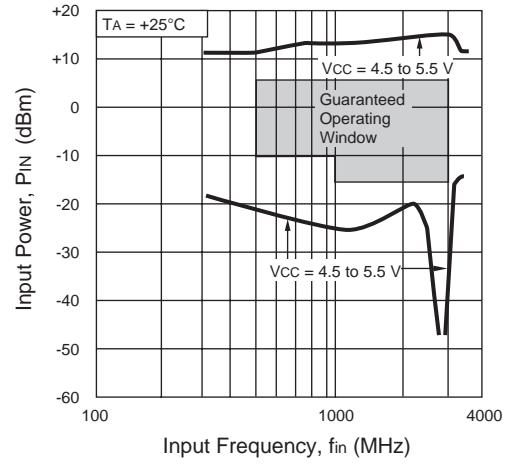

**INPUT POWER vs. INPUT FREQUENCY and TEMPERATURE**

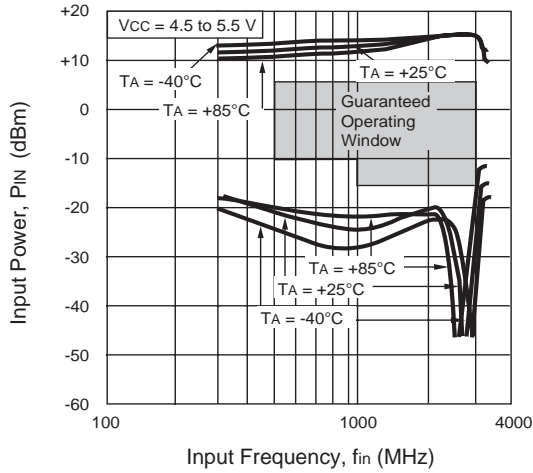

**OUTPUT VOLTAGE vs. INPUT FREQUENCY and VOLTAGE**

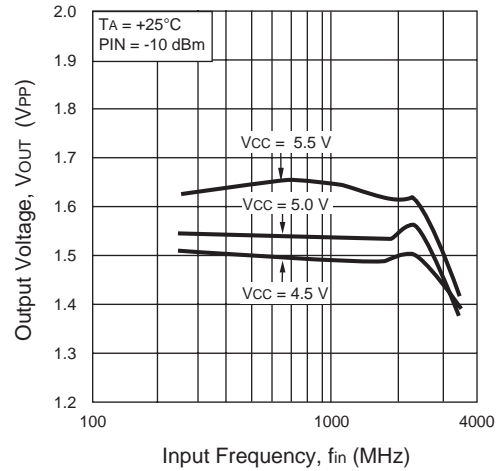

**OUTPUT VOLTAGE vs. INPUT FREQUENCY and VOLTAGE**

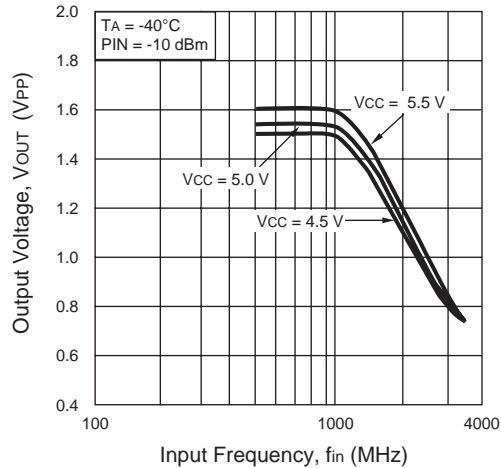

**OUTPUT VOLTAGE vs. INPUT FREQUENCY and VOLTAGE**

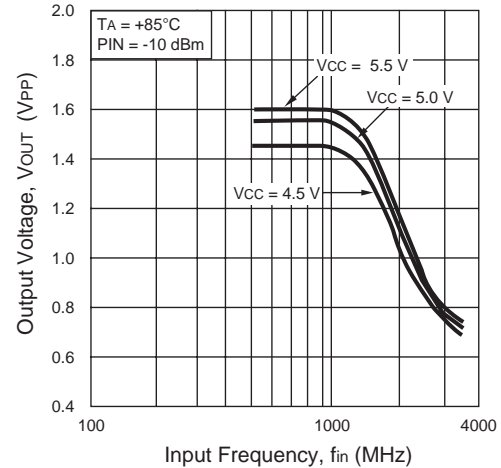

TYPICAL PERFORMANCE CURVES (TA = +25°C unless otherwise noted)

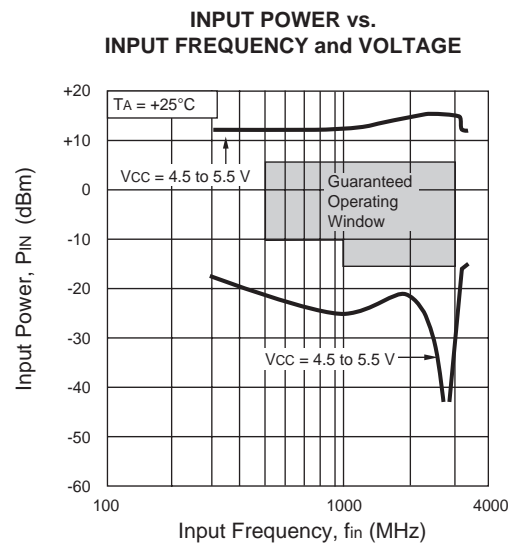
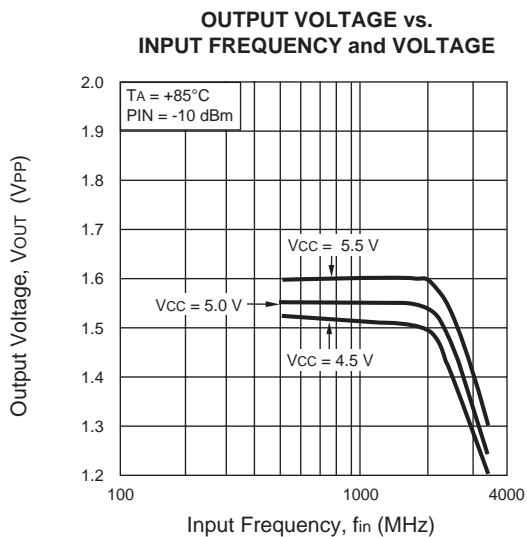
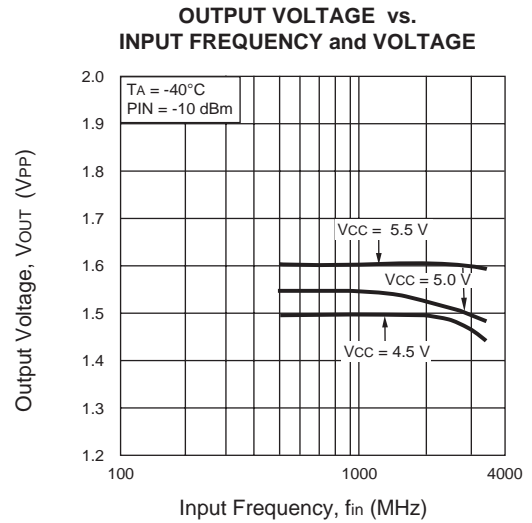
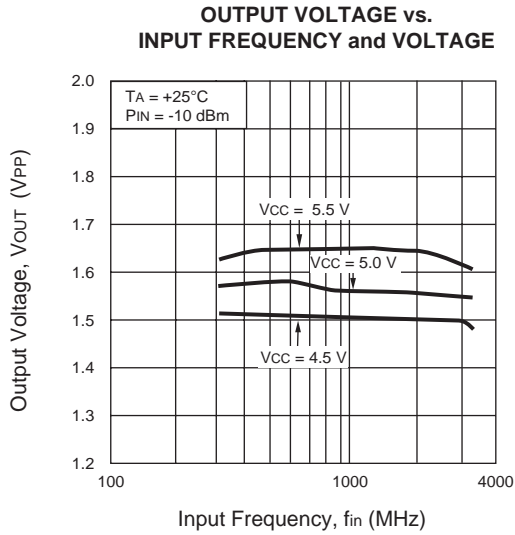
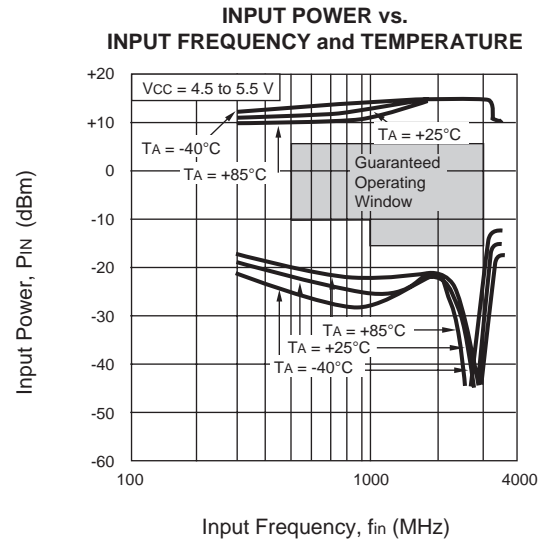
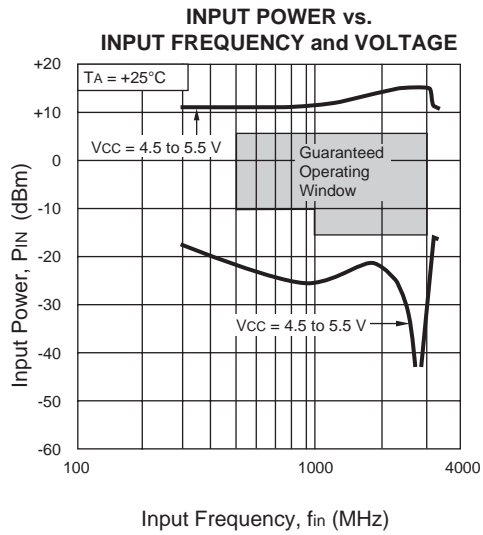

**TYPICAL PERFORMANCE CURVES** (TA = +25°C unless otherwise noted)

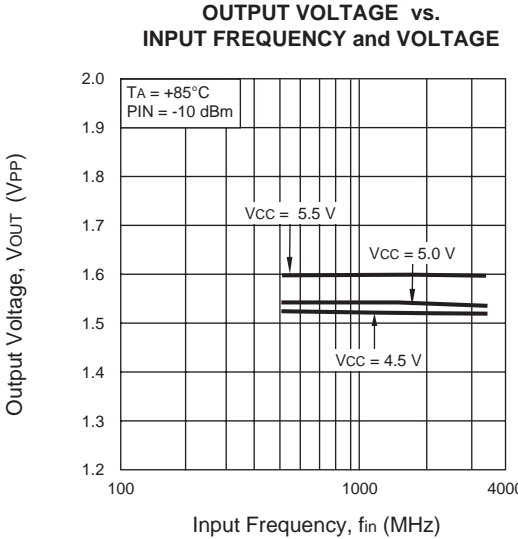
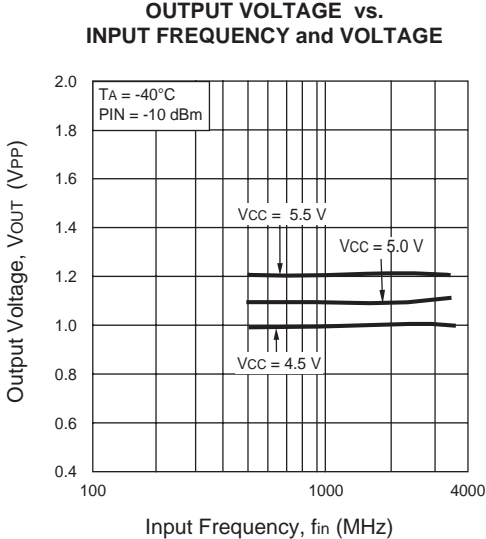
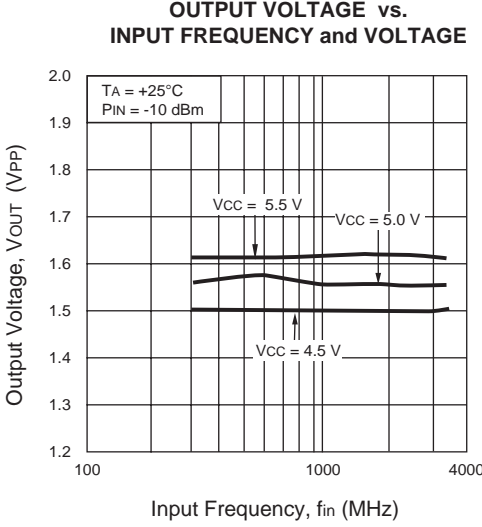
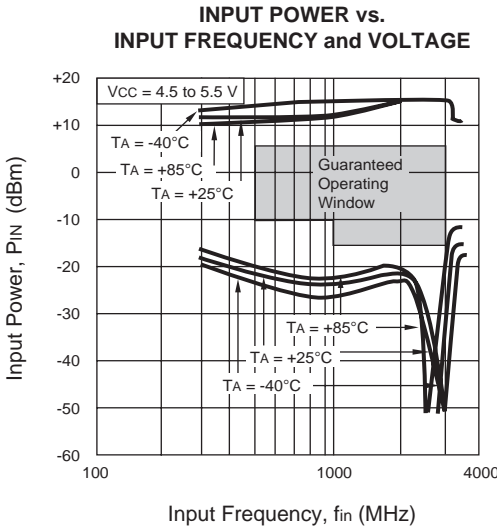

TYPICAL SCATTERING PARAMETERS (TA = 25°C)

UPB1506GV

S11 vs. INPUT FREQUENCY  
Vcc = 5.0 V

S11 Z  
REF 1.0 Units  
3 200.0 mUnits/  
▽ 33.881 Ω -52.875 Ω  
hp

C  
D

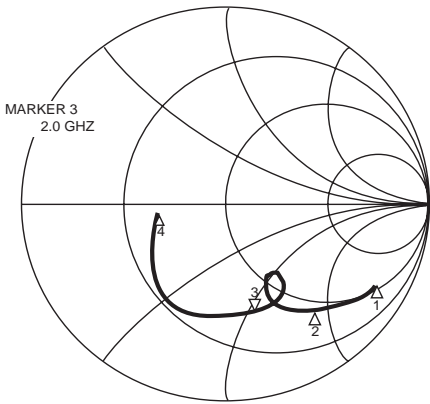

START 0.500000000 GHz  
STOP 3.000000000 GHz

FREQUENCY	S11	
	MAG	ANG
0.5	0.868	-26.6
0.6	0.828	-32.6
0.7	0.794	-37.4
0.8	0.761	-41.9
0.9	0.721	-46.5
1.0	0.706	-49.3
1.1	0.662	-54.0
1.2	0.629	-57.2
1.3	0.595	60.2
1.4	0.554	-62.9
1.5	0.516	-64.8
1.6	0.440	-61.9
1.7	0.428	51.0
1.8	0.543	-61.5
1.9	0.555	-68.4
2.0	0.560	-74.7
2.1	0.558	-79.5
2.2	0.564	-84.9
2.3	0.570	-90.9
2.4	0.574	-98.3
2.5	0.574	-107.9
2.6	0.564	-118.3
2.7	0.530	-131.4
2.8	0.476	-144.6
2.9	0.411	-159.1
3.0	0.331	-175.8

UPB1506GV

S22 vs. OUTPUT FREQUENCY  
Divide by 64 mode, Vcc = 5.0 V

S22 Z  
REF 1.0 Units  
1 200.0 mUnits/  
▽ 171.22 Ω -04.438 Ω  
hp

C  
D

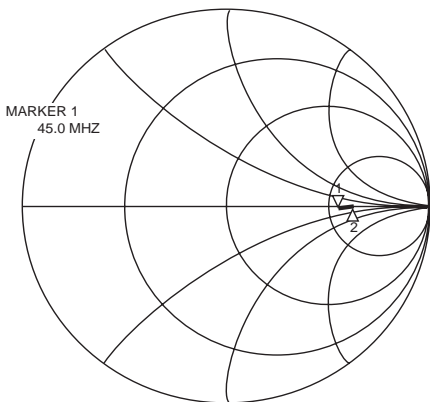

START 0.045000000 GHz  
STOP 0.100000000 GHz

FREQUENCY	S22	
	MAG	ANG
45.0	0.542	-1.4
50.0	0.602	-0.3
55.0	0.616	0.0
60.0	0.605	1.1
65.0	0.609	0.7
70.0	0.616	0.3
75.0	0.620	0.1
80.0	0.622	0.0
85.0	0.619	0.6
90.0	0.610	0.9
95.0	0.626	-0.7
100.0	0.623	-1.7

**TYPICAL SCATTERING PARAMETERS** ( $T_A = 25^\circ\text{C}$ )

**UPB1506GV**

**S22 vs. OUTPUT FREQUENCY**  
Divide by 128 mode, Vcc = 5.0 V

S22 Z  
REF 1.0 Units  
1 200.0 mUnits/  
▽ 192.34 Ω 03.109 Ω

hp

C

D

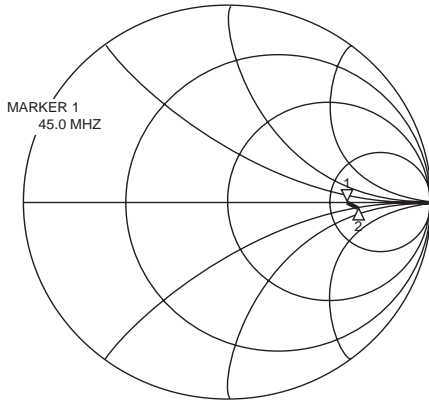

START 0.045000000 GHz  
STOP 0.100000000 GHz

Δ<sub>1</sub> : 45 MHz  
Δ<sub>2</sub> : 100 MHz

FREQUENCY	S22	
	MHz	MAG
45.0	0.590	-0.4
50.0	0.604	-1.0
55.0	0.610	-1.1
60.0	0.607	-0.8
65.0	0.548	-5.9
70.0	0.630	-0.0
75.0	0.615	-1.0
80.0	0.618	-1.4
85.0	0.617	-1.2
90.0	0.616	-2.2
95.0	0.623	-2.4
100.0	0.624	-2.3

**UPB1506GV**

**S22 vs. OUTPUT FREQUENCY**  
Divide by 256 mode, Vcc = 5.0 V

S22 Z  
REF 1.0 Units  
1 200.0 mUnits/  
▽ 199.25 Ω -05.992 Ω

hp

C

D

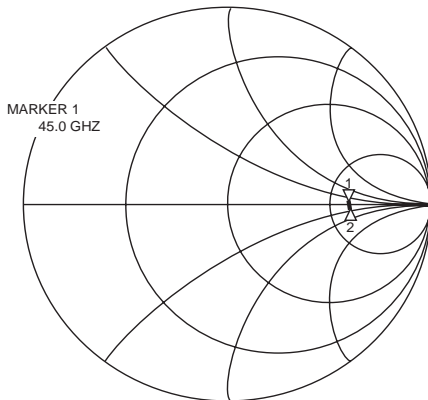

START 0.045000000 GHz  
STOP 0.100000000 GHz

Δ<sub>1</sub> : 45 MHz  
Δ<sub>2</sub> : 100 MHz

FREQUENCY	S22	
	MHz	MAG
45.0	0.601	-0.9
50.0	0.609	-1.6
55.0	0.611	-1.5
60.0	0.620	-1.4
65.0	0.607	-2.1
70.0	0.615	-1.9
75.0	0.613	-3.2
80.0	0.611	-2.8
85.0	0.607	-2.5
90.0	0.605	-2.4
95.0	0.610	-3.0
100.0	0.608	-2.8

# UPB1506GV, UPB1507GV

## TYPICAL SCATTERING PARAMETERS (T<sub>A</sub> = 25°C)

### UPB1507GV

**S<sub>11</sub> vs. INPUT FREQUENCY**  
V<sub>CC</sub> = 5.0 V

S<sub>11</sub> Z  
REF 1.0 Units  
4 200.0 mUnits/  
▽ 38.111 Ω 0.9707 Ω

hp

C

D

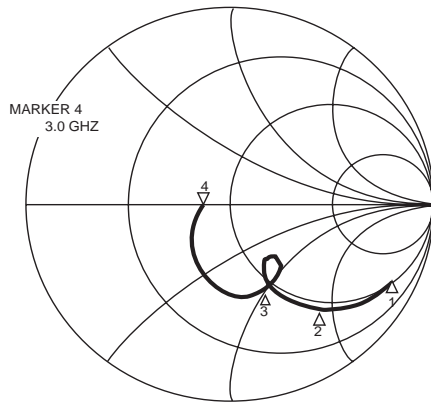

START 0.500000000 GHz  
STOP 3.000000000 GHz

**FREQUENCY**

**S<sub>11</sub>**

GHz	MAG	ANG
0.5	0.857	-27.5
0.6	0.849	-32.0
0.7	0.800	-38.9
0.8	0.764	-43.8
0.9	0.725	-49.0
1.0	0.665	-50.9
1.1	0.619	-55.3
1.2	0.573	-59.3
1.3	0.531	-61.3
1.4	0.484	-62.8
1.5	0.439	-63.0
1.6	0.377	-59.1
1.7	0.340	-54.1
1.8	0.377	-54.7
1.9	0.441	-59.5
2.0	0.464	-67.2
2.1	0.443	-67.4
2.2	0.466	-74.5
2.3	0.465	-81.3
2.4	0.454	-89.4
2.5	0.433	-99.2
2.6	0.383	-109.6
2.7	0.350	-114.0
2.8	0.332	-124.2
2.9	0.271	-141.2
3.0	0.185	-163.6

### UPB1507GV

**S<sub>22</sub> vs. OUTPUT FREQUENCY**  
Divide by 64 mode, V<sub>CC</sub> = 5.0 V

S<sub>22</sub> Z  
REF 1.0 Units  
1 200.0 mUnits/  
▽ 185.13 Ω 17.789 Ω

hp

C

D

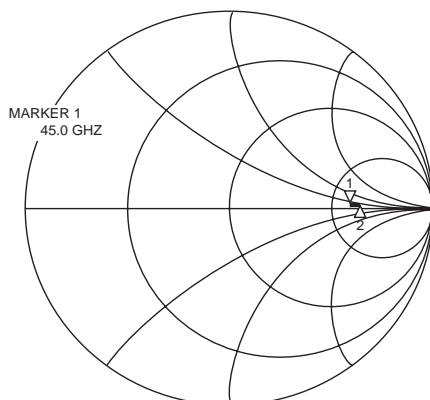

START 0.045000000 GHz  
STOP 0.100000000 GHz

**FREQUENCY**

**S<sub>22</sub>**

MHz	MAG	ANG
45.0	0.580	3.4
50.0	0.572	2.5
55.0	0.574	3.0
60.0	0.574	2.7
65.0	0.584	3.0
70.0	0.587	2.6
75.0	0.592	2.4
80.0	0.587	2.6
85.0	0.589	2.9
90.0	0.591	2.9
95.0	0.573	1.7
100.0	0.604	2.9

Δ<sub>1</sub> : 45 MHz  
Δ<sub>2</sub> : 100 MHz



**TYPICAL SCATTERING PARAMETERS** ( $T_A = 25^\circ\text{C}$ )

**UPB1507GV**

**S22 vs. OUTPUT FREQUENCY**  
Divide by 128 mode,  $V_{CC} = 5.0\text{ V}$

S22 Z  
REF 1.0 Units  
1 200.0 mUnits/  
▽ 185.02 Ω 18.953 Ω

hp

C

D

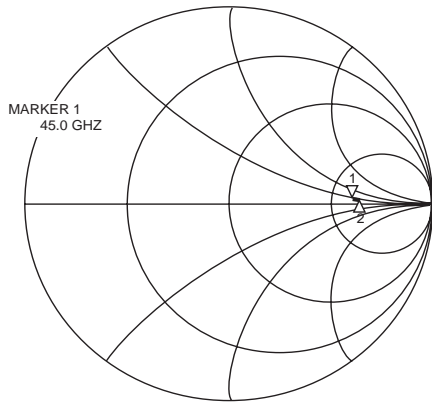

START 0.045000000 GHz  
STOP 0.100000000 GHz

**FREQUENCY** **S22**

MHz	MAG	ANG
45.0	0.578	3.2
50.0	0.571	2.8
55.0	0.572	3.3
60.0	0.576	3.0
65.0	0.584	3.1
70.0	0.587	2.8
75.0	0.589	2.4
80.0	0.589	2.8
85.0	0.588	3.0
90.0	0.593	2.8
95.0	0.598	3.0
100.0	0.602	2.9

△<sub>1</sub> : 45 MHz  
△<sub>2</sub> : 100 MHz

**UPB1507GV**

**S22 vs. OUTPUT FREQUENCY**  
Divide by 256 mode,  $V_{CC} = 5.0\text{ V}$

S22 Z  
REF 1.0 Units  
4 200.0 mUnits/  
▽ 186.76 Ω 17.82 Ω

hp

C

D

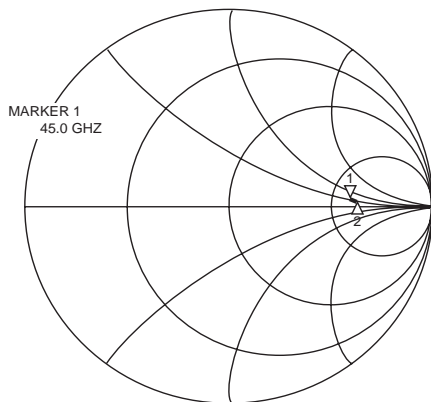

START 0.045000000 GHz  
STOP 0.100000000 GHz

**FREQUENCY** **S22**

MHz	MAG	ANG
45.0	0.580	3.0
50.0	0.572	2.8
55.0	0.571	2.9
60.0	0.576	2.9
65.0	0.585	3.2
70.0	0.590	2.8
75.0	0.589	2.5
80.0	0.590	2.6
85.0	0.588	2.9
90.0	0.597	2.9
95.0	0.600	3.1
100.0	0.601	3.1

△<sub>1</sub> : 45 MHz  
△<sub>2</sub> : 100 MHz

**SYSTEM APPLICATION EXAMPLE**

**RF unit block of Analog DBS tuners**

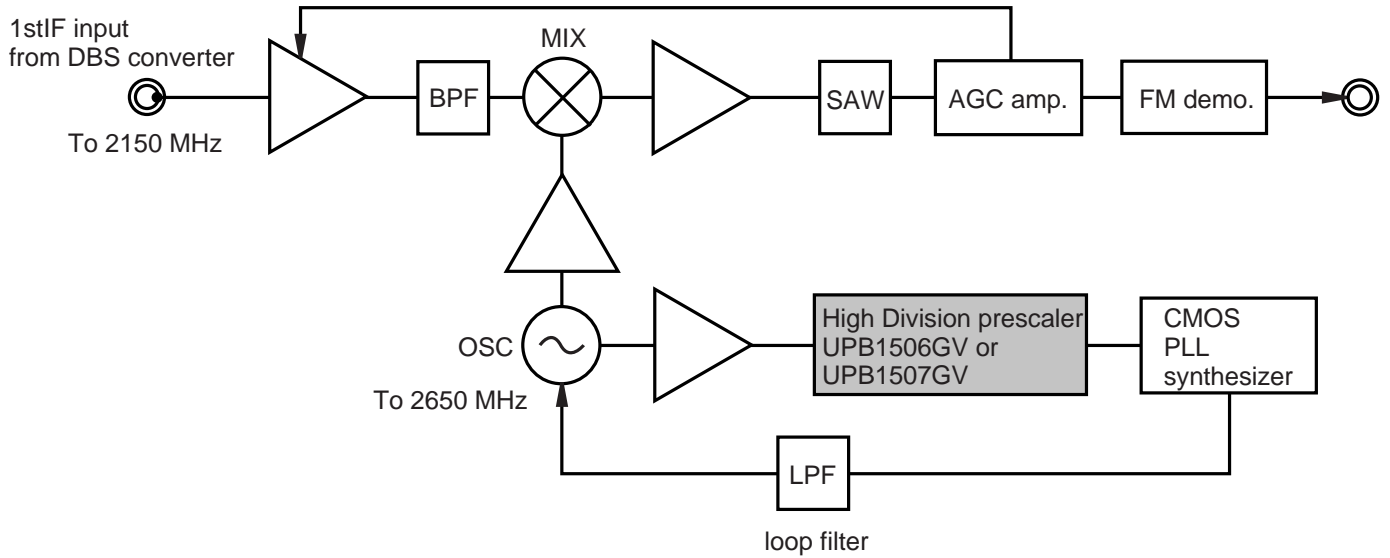

**RF unit block of Analog CATV converter**

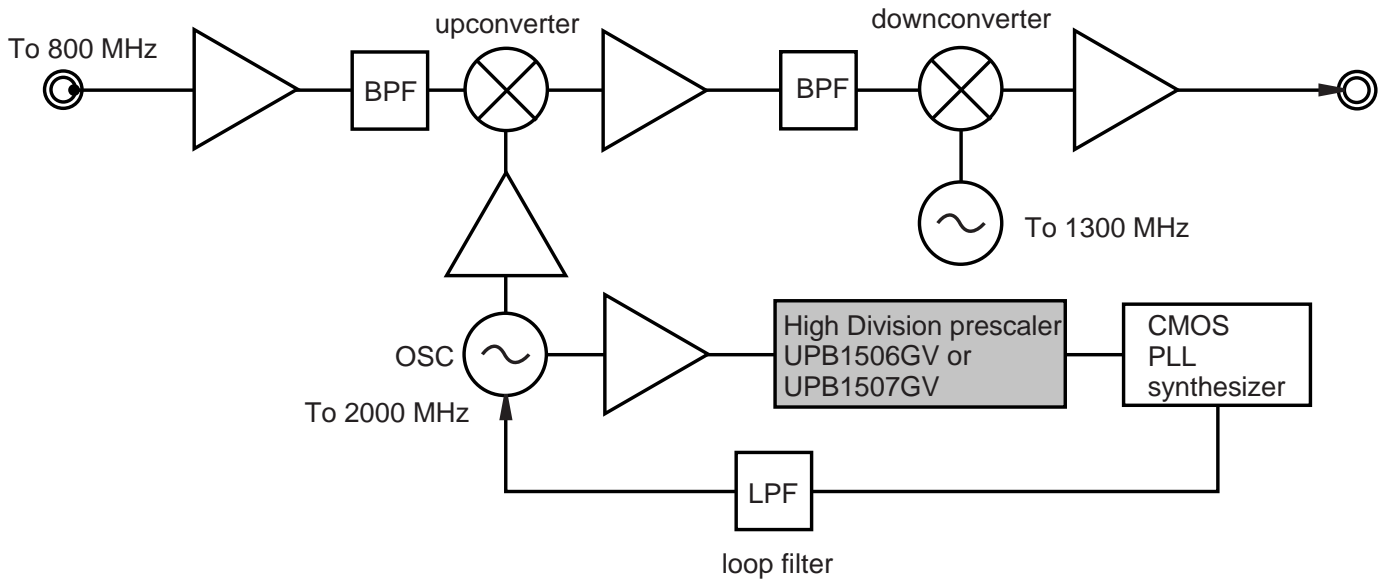

**INTERNAL BLOCK DIAGRAM**

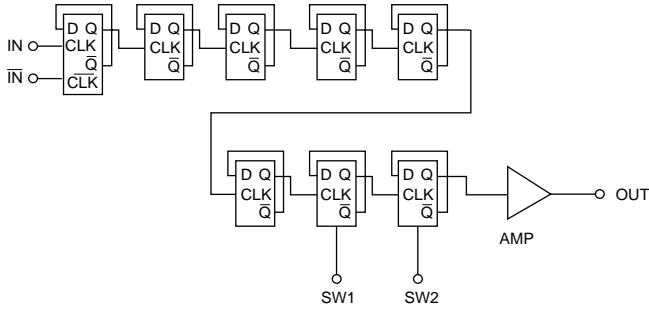

**OUTLINE DIMENSIONS** (Units in mm)

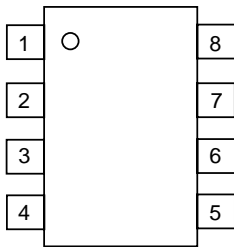
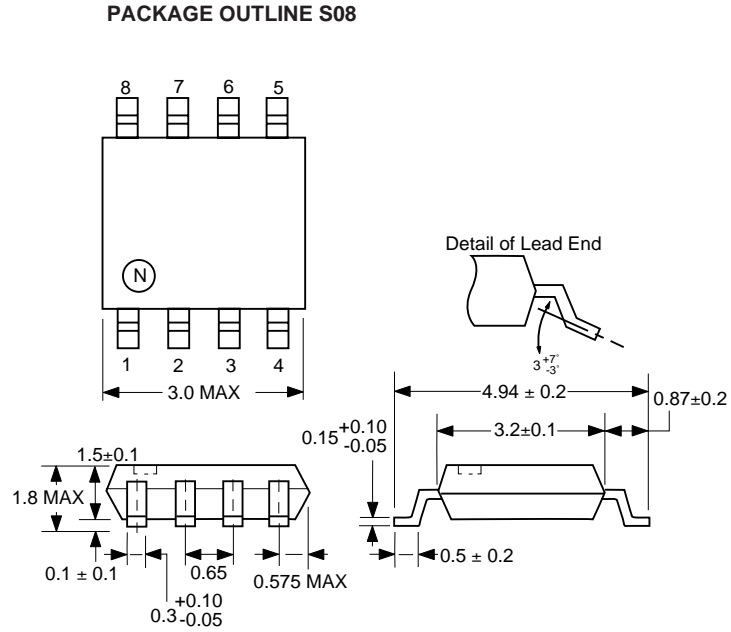

PIN CONNECTIONS

Pin No.	UPB1506GV	UPB1507GV
1	SW1	IN
2	IN	Vcc
3	IN-bar	SW1
4	GND	OUT
5	OPEN	GND
6	SW2	SW2
7	OUT	OPEN
8	Vcc	IN-bar

**ORDERING INFORMATION**

PART NUMBER	QUANTITY	MARKING
UPB1506GV-E1	1000/Reel	1506
UPB1507GV-E1	1000/Reel	1507

Note:

- 1. Embossed tape 8 mm wide.  
Pin 1 is in the tape pull-out direction.

Life Support Applications

These NEC products are not intended for use in life support devices, appliances, or systems where the malfunction of these products can reasonably be expected to result in personal injury. The customers of CEL using or selling these products for use in such applications do so at their own risk and agree to fully indemnify CEL for all damages resulting from such improper use or sale.

**CEL** California Eastern Laboratories, Your source for NEC RF, Microwave, Optoelectronic, and Fiber Optic Semiconductor Devices.  
4590 Patrick Henry Drive • Santa Clara, CA 95054-1817 • (408) 988-3500 • FAX (408) 988-0279 • [www.cel.com](http://www.cel.com)

DATA SUBJECT TO CHANGE WITHOUT NOTICE

7/22/2004