

WASHINGTON STATE COMMERCIAL VEHICLE GUIDE

M 30-39.07



Prepared by the
Washington State Department of Transportation
Washington State Patrol
Washington State Department of Licensing
Washington State Utilities and Transportation Commission

Americans with Disabilities Act (ADA) Information

English

Title VI Notice to Public It is the Washington State Department of Transportation's (WSDOT) policy to assure that no person shall, on the grounds of race, color, national origin or sex, as provided by Title VI of the Civil Rights Act of 1964, be excluded from participation in, be denied the benefits of, or be otherwise discriminated against under any of its federally funded programs and activities. Any person who believes his/her Title VI protection has been violated, may file a complaint with WSDOT's Office of Equal Opportunity (OEO). For additional information regarding Title VI complaint procedures and/or information regarding our non-discrimination obligations, please contact OEO's Title VI Coordinator at 360-705-7090.

Americans with Disabilities Act (ADA) Information This material can be made available in an alternate format by emailing the Office of Equal Opportunity at wsdotada@wsdot.wa.gov or by calling toll free, 855-362-4ADA(4232). Persons who are deaf or hard of hearing may make a request by calling the Washington State Relay at 711.

Spanish

Notificación de Título VI al Público Es la póliza de el Departamento de Transportes del Estado de Washington de asegurar que ninguna persona sea excluida de participación o sea negado los beneficios, o sea discriminado bajo cualquiera de sus programas y actividades financiado con fondos federales sobre la base de raza, color, origen nacional o sexo, como proveído por el Título VI de el Acto de Derechos Civiles de 1964. Cualquier persona que cree que sus protecciones de Título VI han sido violadas, puede hacer una queja con la Oficina de Igualdad de Oportunidades (OEO). Para información adicional con respecto a procedimientos de quejas de Título VI y/o información con respecto a nuestras obligaciones sin discriminación, por favor de comunicarse con el Coordinador de Título VI de la Oficina de Igualdad de Oportunidades (OEO) 360-705-7090.

Información del Acta Americans with Disabilities Act (ADA)

Este material es disponible en un formato alternative. Envie su petición por correo electrónico al equipo de Oficina de Igualdad de Oportunidades (OEO) en wsdotada@wsdot.wa.gov o llamando gratis, 855-362-4ADA (4232). Personas sordas o con problemas de audición pueden solicitar llamando el relé de estado de Washington al 711. For public events (like Open Houses, etc) English Accommodation requests for people with disabilities can be made by contacting the WSDOT Diversity/ADA Affairs team at wsdotada@wsdot.wa.gov or by calling toll-free, 855-362-4ADA (4232). Persons who are deaf or hard of hearing may make a request by calling the Washington State Relay at 711. Spanish Solicitudes de alojamiento para personas con discapacidad pueden hacer comunicándose con el equipo de Asuntos de diversidad/ADA WSDOT en wsdotada@wsdot.wa.gov o llamando al número gratuito, 855-362-4ADA (4232). Personas sordas o con problemas de audición pueden solicitar llamando el relé del estado de Washington al 711.

To get the latest information on WSDOT publications, sign up for individual email updates at www.wsdot.wa.gov/publications/manuals.

Multi-Agency Listings

For information and procedures not specifically addressed in this booklet, please refer to the appropriate agency listed on this page.

**Washington State
Department of Transportation**
Commercial Vehicle Services
7345 Linderson Way SW
PO Box 47367
Olympia, WA 98504-7367
Phone: 360-704-6340
Fax: 360-704-6391

Commercial Vehicle Safety Alliance
6303 Ivy Lane, Suite 310
Greenbelt, MD 20770-6319
Phone: 301-830-6143
Fax: 301-830-6144
Email: cvsahq@aol.com
www.cvsa.org

Permits Email:
cvspermits@wsdot.wa.gov

Weigh Station Bypass:
Phone: 888-877-8567
Fax: 360-705-6836
Email: transponderadmin@wsdot.wa.gov
www.wsdot.wa.gov/commercialvehicle

Washington State Department of Licensing
1125 Washington Street SE
PO Box 9020
Olympia, WA 98507-9020
Phone: 360-902-3770
TDD: 360-664-8885 x1125
Prorate: 360-664-1858
IFTA: 360-664-1858
Commercial Driver's License: 360-902-3619
www.dol.wa.gov

**Washington Utilities and
Transportation Commission**
1300 S Evergreen Park Drive SW
PO Box 47250
Olympia, WA 98504-7250
Phone: 360-664-1222
Fax: 360-586-1181
Email: transportation@utc.wa.gov
www.utc.wa.gov

Washington State Patrol
Commercial Vehicle Division
PO Box 42614
Olympia, WA 98504-2614
Phone: 360-596-3800
Fax: 360-596-3829
www.wsp.wa.gov

Federal Motor Carrier Safety Administration
2424 Heritage Court SW, Suite 302
Olympia, WA 98502
Phone: 360-753-9875
Toll Free Hotline: 1-888-DOT-SAFT
(household goods)
Complaint Form:
www.fmcsa.dot.gov/factsfigs/formspubs.htm
www.fmcsa.dot.gov



Lynn Peterson.
Secretary
Department of Transportation

John R. Batiste
Chief
Washington State Patrol

Pat Kohler
Director
Department of Licensing

A MESSAGE FROM THE STATE OF WASHINGTON

The *Washington State Commercial Vehicle Guide 2016–2017* is intended for the professional commercial vehicle operator and others who are concerned about safe truck operations. It has been compiled by Commercial Vehicle Services within the Washington State Department of Transportation (WSDOT) in cooperation with the Commercial Vehicle Enforcement Division of the Washington State Patrol (WSP/CVD), Washington State Department of Licensing (WSDOL) Driver and Vehicle Services Divisions, the Washington Utilities and Transportation Commission, and the U.S. Department of Transportation, Federal Motor Carrier Safety Administration (FMCSA), in an effort to provide a starting point for information for commercial vehicle operators driving within the State of Washington.

The *Washington State Commercial Vehicle Guide 2016–2017* is a tool. Carriers are responsible for knowing and complying with all state and federal regulations, whether or not they are discussed in the guide. *For enforcement officers, the information in the guide has been condensed and summarized and must not be cited in place of specific federal and state laws. Do not use this guide as the basis for legal interpretations.* It cannot, and does not, contain all of the rules and regulations that apply to operating a commercial vehicle safely within the State of Washington. The guide does contain sufficient information for you as a commercial vehicle operator, to confidently and safely operate your commercial vehicle within our state. For more detailed information, we recommend you contact the pertinent agency or consult the Code of Federal Regulations (CFR), Revised Code of Washington (RCW), Washington Administrative Code (WAC), or the appropriate hazardous materials regulations.

The 2016–2017 edition is the ninth edition of the *Washington State Commercial Vehicle Guide*. We welcome your ideas and suggestions on how the Guide can be improved. Please send your comments and ideas to:

Washington State Department of Transportation
Commercial Vehicle Services
7345 Linderson Way SW
PO Box 47367
Olympia, WA 98504-7367
Phone: 360-704-6340
Fax: 360-704-6391

PLEASE DRIVE SAFELY AND ENJOY OUR BEAUTIFUL STATE

Chapter 1	Commercial Vehicle Enforcement	1-1
	Speed Limits	1-1
	Slow Vehicle Rule	1-1
	Crossview Mirrors and Backup Alert	1-1
	Left-Lane Restrictions	1-1
	Load Securement Information	1-2
	Tire Chain Requirements	1-2
	Accident Reporting	1-6
	Vehicle Size and Weight, Credentials, and Safety	1-6
	How to Get a Transponder	1-7
	Transponders Saved Industry	1-7
	How Does Electronic Screening Work	1-7
	Self Tarping Systems	1-7
	Transportation of Farm Implements and Agricultural Hazardous Materials	1-8
Chapter 2	Prorate and Fuel Tax Services	2-1
	International Fuel Tax Agreement	2-1
	International Registration Plan	2-3
	Record Keeping Requirements	2-5
	Cab Cards	2-5
	Trip Permits	2-6
	PRISM Program	2-6
Chapter 3	Commercial Driver's License Standards, Requirements, and Penalties	3-1
	Commercial Driver's License Information System (CDLIS)	3-1
	CDL Endorsements	3-2
	CDL Restriction(s)	3-2
	CLP Endorsements	3-3
	CLP Restriction(s)	3-3
	Who Does Not Need a CDL?	3-3
	Procedures for Obtaining a CDL or Commercial Learners Permit (CLP)	3-4
	Testing	3-4
	Fees	3-5
	Renewal/Upgrade	3-5
	Hazardous Materials Endorsement Background Check and Disqualifications	3-5
	CDL Disqualification	3-5
	Traffic Violations in Your Personal Vehicle	3-6
	Serious Traffic Violations	3-6
	Driver's Medical Certificate	3-7
	Medical Waiver Procedures	3-7
	Interstate Waivers	3-7
	Intrastate Waivers	3-8
	Licenses of Persons Serving in Armed Forces to Remain in Force – Duration	3-9
	National Driver Register File Check – Federal Privacy Act of 1974	3-9
	Requests for NDR Record Checks	3-9

Chapter 4	Administration of Vehicle Size and Weight	4-1
	Obtaining Special Motor Vehicle Permits	4-1
	Permit Types available online for Self-issue	4-1
	Permit Violations Resulting in Permit Confiscations, for Self-issuers	4-4
	Highway Movements Requiring a Permit	4-4
	Permits for Over Dimensional Loads	4-8
	Permits for Oversize/Overweight Motor Vehicles.	4-11
	Permit Fees	4-13
	Overweight Fee Schedule	4-14
	Special Motor Vehicle Permit Regulations and Conditions.	4-14
	Curfew Hours.	4-15
	Western Regional Permit System	4-18
	Superloads	4-19
	Farm Implements.	4-19
	Procedures for the Movement of Over Legal Vehicles/Loads in Emergency Conditions	4-21
	Refuse Collection Trucks.	4-22
	Tow Trucks	4-23
	Crossing Puget Sound Via Washington State Ferries	4-24
	Location of Offices and Agencies Issuing WSDOT Permits.	4-26
	Washington State County/City Permit Approval*.	4-27
	Washington State Ports of Entry	4-28
Chapter 5	Alcohol Misuse and Substance Abuse Testing	5-1
	Safety Sensitive Functions.	5-1
	Random Testing for Alcohol	5-2
	Consequences of Alcohol Misuse	5-2
	Rules Relating to Controlled Substances.	5-3
	Types of Tests Required.	5-3
	Specimens Analyzed	5-3
	Consequences of a Positive Controlled Substance Test.	5-3
	Random Testing.	5-4
	Records Retention Requirements	5-4
Chapter 6	Comprehensive/Focus Investigations/Safety Audit	6-1
	What Can a Carrier Expect When Contacted for a Compliance Review?.	6-2
	New Entrant Safety Assurance Program	6-3
Chapter 7	Commercial Vehicle Safety Alliance	7-1
	Out-of-Service Criteria	7-1
	CVSA Decal Criteria	7-1
	Placement of CVSA Decal.	7-1
	Placing a Vehicle or Driver Out-of-Service.	7-2

Chapter 8 Motor Carriers Operating Requirements 8-1

Registered Interstate Carriers – Unified Carrier Registration (UCR) 8-1

Required Vehicle Markings 8-1

Intrastate For-Hire Carriers 8-3

Insurance Filing Requirements – UTC Carriers 8-4

Insurance Filing Requirements – UTC Carriers 8-4

Permit/Certificate Requirements – UTC Carriers 8-5

Intrastate Carriers Transporting Passengers. 8-5

Intrastate Carriers Transporting Property/Solid Waste Collection Companies 8-6

Appendix 1 Do I Need a Commercial Driver’s License? A-1

Appendix 2 Tire Conversion Charts A-2

Non-Metric Tire Conversion Charts A-2

Metric Tire Conversion Chart A-2

Appendix 3 Axle Weight Table A-3

Appendix 4 Table of Minimum Liability Insurance Requirements A-5

Appendix 5 Western United States and Canadian Jurisdictional Agencies A-6

Index 1

The Washington State Department of Transportation, Department of Licensing, Washington Utilities and Transportation Commission, and Washington State Patrol share a set of objectives intended to provide for the safety of the motoring public, protect the public infrastructure, and work with industry to produce safe, efficient, and economical solutions to commercial vehicle transport.

The **Washington State Patrol (WSP)**, through its Commercial Vehicle Division, strives to protect the integrity and safety of the state highways system by promoting public compliance through enforcement, education, and the application of modern technology for enforcement of size, weight, load, and equipment laws mandated by state and federal government. WSP also administers and enforces state laws, administrative code, and federal rules relating to motor vehicle safety. Effective April 25, 1994, WSP adopted Parts 382-383, 390-393, and 395-397 of Chapter 49 Code of Federal Regulation (CFR) for commercial motor vehicles.

The **Washington Utilities and Transportation Commission (UTC)** regulates all privately-owned electric, natural gas, water, and telephone companies. UTC also regulates solid waste collection companies, bus companies, household good movers, and railroads. UTC prescribes rules and regulations for household goods carriers and common carriers in the state of Washington. UTC also administers and enforces Washington State laws, administrative code, and federal rules relating to motor vehicle safety. For those carriers subject to Commission regulations, UTC publishes rulebooks containing complete carrier regulations (excluding Federal Regulations). The rulebooks are available, free of charge, by contacting UTC at 360-664-1222. Additional copies may be obtained from UTC upon request, subject to pertinent copying charges. Copies are also available from the Government Printing Office, Seattle, Washington, online at www.utc.wa.gov and numerous other private vendors.

The **Washington State Department of Transportation (WSDOT)** administers the vehicle size and weight state laws, administrative code, and federal rules. WSDOT, through its Commercial Vehicle Services Office, is authorized, by statute, to issue special permits to operate vehicles of a size or weight greater than the legal maximum on state highways. Permits are issued through approximately 38 locations statewide (see [page 4-27](#)). The Commercial Vehicle Services Office also offers approved companies the opportunity to self-issue permits through eSNOOPI which is a web-based permitting program.

The **Department of Licensing (DOL)**, as part of their overall responsibilities, administers state laws and administrative code relating to the licensing and regulation of commercial vehicles and their owner/operators.

Commercial vehicle operations within the state of Washington are based on the following criteria:

CFR	Code of Federal Regulations (adopted by statute)
RCW	Revised Code of Washington (state statutes)
WAC	Washington Administrative Code (agency rules)

Specific booklets and brochures are also available. Some selected titles are:

- *Revised Code of Washington* (RCW) selected titles
- *Washington State Commercial Driver's Guide* (DOL)
- *Your Guide to Achieving a Satisfactory Safety Record* (UTC), IRP/PRORATE

Informational brochures, in many cases, are available at many of the interstate highway weigh stations.

Transportation Agencies Contacts

This guide is intended to cover situations and answer questions that arise most frequently. However, situations may occur where specific answers are needed. The following offices will usually be able to provide either answers or direction:

Department of Licensing

Prorate and Fuel Tax Services
360-664-1858 (Prorate)

Washington State Patrol

Commercial Vehicle Enforcement Division
360-596-3800

Equipment requirements, enforcement practices, road conditions, and weight enforcement.

Department of Licensing

Driver Policy and Programs
Commercial Driver's License (CDL) Program
360-902-3619

Commercial driver's license, medical cards and waivers, hazardous material endorsement clearances, minimum training requirements.

Department of Transportation

Permits (Commercial Vehicle Services)
360-704-6340

Interpretation of statutes or rules, restricted roads or bridges, permit practices, and construction projects.

Department of Licensing

Commercial Driver's License (CDL) Skills Testing Program
360-902-3607

Commercial driver's license, skills test scheduling, customer testing inquiries.

U.S. Department of Transportation

Federal Motor Carrier Safety Administration
360-753-9875

Utilities and Transportation Commission

Permits and Registrations
360-664-1222
Fax: 360-586-1181

Email: transportation@utc.wa.gov

Authority to carry freight for hire, certificate of necessity, and exempt commodities.

(Washington State Patrol)

Speed Limits

Washington State law establishes a 60 mph basic speed for state highways. Law authorizes both decreases and increases to that basic speed, but the Washington State Department of Transportation (WSDOT) must base both on engineering and traffic investigations. *State law also mandates a maximum speed limit of 70 mph, with the exception of vehicles over 10,000 pounds gross weight (large trucks) and vehicles in combination (trucks with trailers, for example). Their maximum speed is 60 mph.*



Slow Vehicle Rule

If you are driving a slow-moving vehicle on a two-lane highway, the slow vehicle rule applies. If you have five or more vehicles behind you, you must make way at the first available and safe turnout to allow following vehicles to safely pass you. When traveling in convoy with other trucks on two lane roads, you must leave sufficient room between your vehicles to allow other traffic to safely pull back into your lane of traffic.

Crossview Mirrors and Backup Alert

(RCW 46.37.400)

Every truck registered or based in Washington State that is equipped with a cube-style walk-in cargo box, up to 18 feet long, used in the commercial delivery of goods and services, must be equipped with a rear crossview mirror or backup device to alert the driver that a person or object is behind the truck.

Left-Lane Restrictions

Any vehicle towing a trailer, or other vehicle or combination over 10,000 pounds, may not be driven in the left-hand lane of limited-access roadways that have three or more lanes in one direction, excluding HOV (high occupancy vehicle) lanes. This includes commercial trucks, recreational vehicles, vehicles towing boats, and any car or truck towing a trailer. Commercial vehicles over 10,000 pounds GVW are prohibited from HOV lanes, even with the minimum number of occupants specified on signs.

This law affects any limited-access roadway that has three or more general-purpose lanes in one direction. The law primarily affects I-5, portions of I-90 and I-405 in King and Snohomish Counties, and portions of I-90 in Spokane. It does not apply to HOV lanes, or to drivers of affected vehicles who are preparing to turn left at an intersection, or exit onto a private road or driveway. WSDOT will have signs posted in those areas where the law is in affect. Failure to obey the law in areas where signs are posted will result in a citation by the Washington State Patrol (WSP).

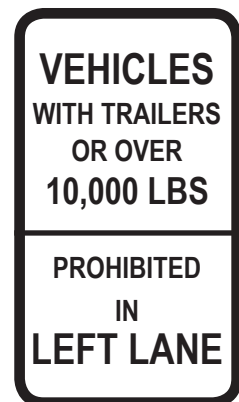

Load Securement Information

For specific load securement laws, contact the WSP Commercial Vehicle Division at 360-596-3800.

Preventing Escape of Load – All loads and any required covering must be secured. All vehicles loaded with dirt, sand, or gravel, which do not maintain at least six (6) inches of freeboard must have a secured cover.

Any vehicle with deposits of mud, rock, or other debris on the vehicle's body, fenders, frame, undercarriage, wheels, or tires shall be cleaned of such material before the operation of the vehicle on a paved public highway. A broom and shovel should be carried in the truck to accomplish this cleaning.

If the load is a type of material that will be blown from the vehicle while the vehicle is in motion, then that type of load shall be covered to prevent this from occurring.

The six (6) inches of freeboard shall be maintained, if the load is not covered, after the load has had an opportunity to settle. See [RCW 46.61.655](#).

Tire Chain Requirements

([WAC 204-24-050](#) and [468-38-095](#))

From November 1 to April 1 of each year on the following routes, all vehicles and combinations of vehicles over 10,000 pounds shall carry sufficient tire chains to meet the requirements of this chapter.

- I-90 between North Bend (MP 32) and Ellensburg (MP 101)
- I-82 between Ellensburg Exit 3 (MP 3) and Selah Exit 26 (MP 26)
- SR 97 between (MP 145) and Junction SR 2
- SR 2 between Dryden (MP 108) and Index (MP 36)
- SR 12 between Packwood (MP 135) and Naches (MP 187)
- SR 97 between Junction SR 14 (MP 4) Columbia River and Toppenish (MP 59)
- SR 410 from Enumclaw to Naches
- SR 20 between Tonasket (MP 262) and Kettle Falls (MP 342)
- SR 155 between Omak (MP 79) and Nespelem (MP 45)
- SR 970 between (MP 0) and (MP 10)
- SR 14 (MP 18) to Junction 97 (MP 102)
- SR 542 Mt. Baker Highway between (MP 22.91) and (MP 57.26)

Vehicles making local deliveries, as indicated on bills of lading, and not crossing the mountain pass are exempt from this requirement if operating outside of a chain-required area.

All vehicles over 10,000 pounds gross vehicle weight **shall carry a minimum of two extra chains** for use in the event that road conditions require the use of more chains or in the event that chains in use are broken or otherwise made useless. Approved chains for vehicles over 10,000 pounds gross vehicle weight shall have at least two side chains to which are attached sufficient cross chains of hardened metal so that at least one cross chain is in contact with the road surface at all times. Plastic chains shall not be allowed. The State Patrol may approve other devices as chains if the devices are equivalent to regular chains in their performance (cable chains allowable).

Minimum Chain Requirements for Vehicles and Combinations Over 10,000 Pounds GVWR

Two to Four Axles

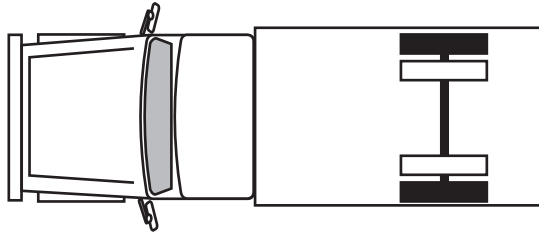

One tire on each side of the drive axle.

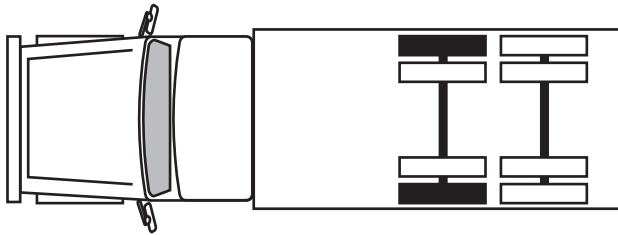

Either drive axle, one tire on each side, same axle.

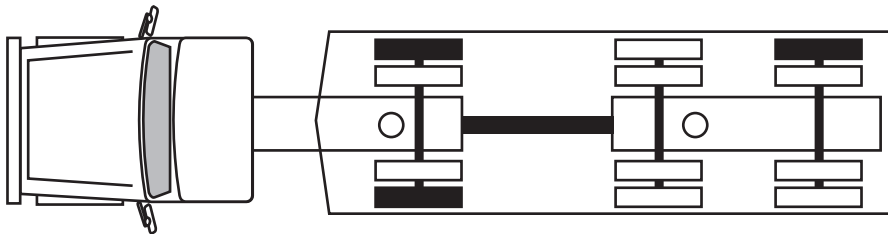

One tire on each side of the drive axle and one tire on either side of the trailer. This includes auto transporters with single drive axles.

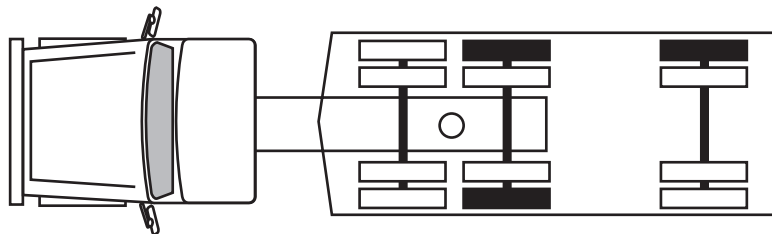

Either drive axle, one tire on each side of the same axle, and one tire on either side of the trailer.

Super-Single Tires

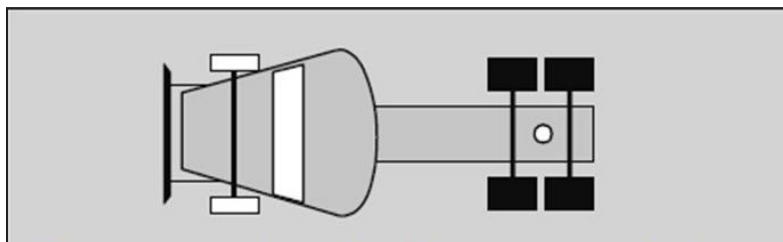

Tractors equipped with super-single tires: chain each tire on each drive axle. (Refer to other illustrations for trailer chain requirements.)

Five Axles

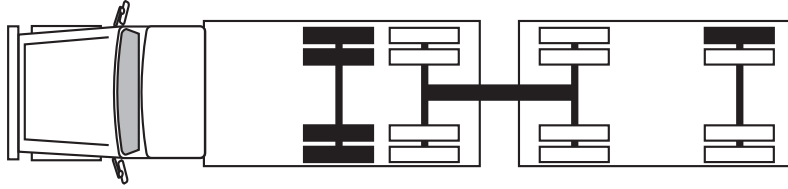

All tires on one drive axle and one tire on either side of last trailer axle.

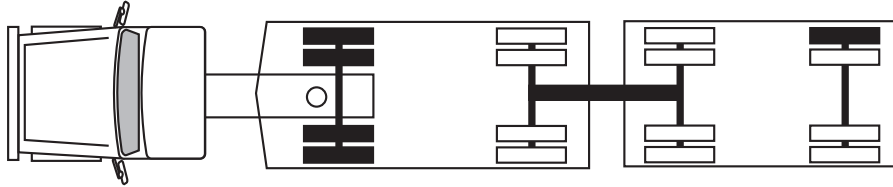

All tires on the drive axle and one tire on either side of the last axle of the last trailer.

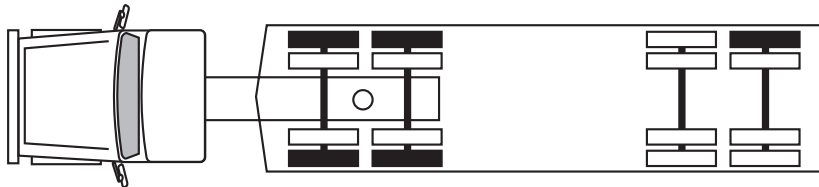

All tires on one drive axle or one tire on each side of both drive axles. One tire on either side of either trailer axle. This includes Automobile Transporters.

Six or More Axles

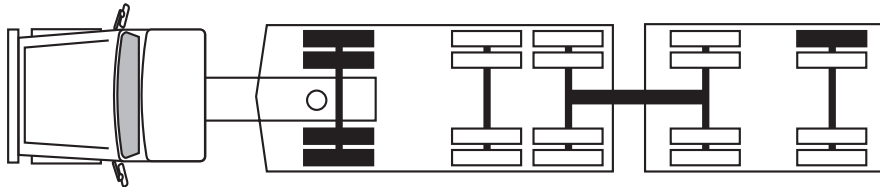

All tires on the drive axle and one tire on either side of the last axle of the last trailer.

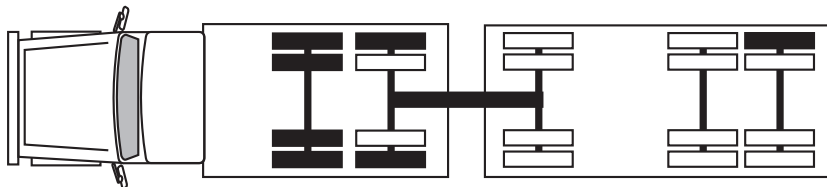

All tires on one drive axle, one tire on each side of second drive axle, and one tire on either side of the last two axles.

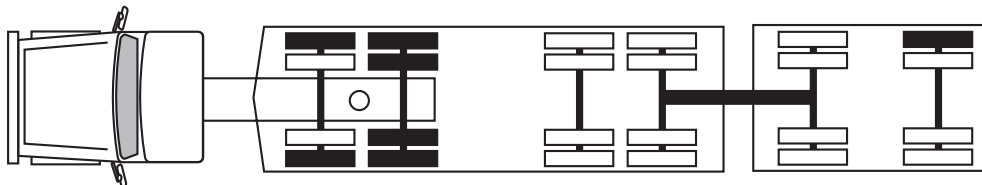

Only on six or more axle combinations when posted "CHAINS REQUIRED" one additional tire on each side of the drive axle shall be chained.

Please use caution during the winter months while you are applying or removing chains from your vehicle. It is unlawful for you to apply or remove chains in the traveled portion of the roadway. Most passes have sufficient room for you to pull off the traveled portion of the road and chain up safely.

The Washington State Department of Transportation or Washington State Patrol may prohibit any vehicle from entering a chain/approved traction device control area when it is determined that the vehicle will experience difficulty in safely traveling the area.

Accident Reporting

If you are involved in an accident, stop immediately. You are legally required to remain at the scene of the accident, give aid to the injured if aid is needed or requested, and provide information to law officers as required. You are no longer legally required to file a Civilian Collision Report unless the investigating officer advises you otherwise at the scene of the accident. You do however; have the option of filing a Civilian Collision Report. If you elect to file the report, you have four days to file the report with the local city, county or state police authority.

Vehicle Size and Weight, Credentials, and Safety

The Commercial Vehicle Division of the Washington State Patrol (WSP) has the responsibility to enforce state law relative to the operation of commercial vehicles, including: size, weight, licensing, hazardous materials, equipment inspection, and the inspection of equipment at accident scenes involving commercial vehicles.

WSP has vehicle size and weight enforcement jurisdiction over all highways in the state, including those in urban areas. WSP operates five ports of entry with fixed scales, 49 other fixed scale sites, four plug and run sites, and seven other weigh station locations with wheel load scales. In addition, 11 of the fixed scale sites are equipped with high-speed main line weigh-in-motion (WIM) and Commercial Vehicle Information Systems and Networks (CVISN) technology used for sorting and bypassing safer and legal vehicles.

The term CVISN (www.wsdot.wa.gov/commercialvehicle) refers to the collection of information and communication systems owned and operated by the Federal Motor Carrier Safety Administration (FMCSA), states, motor carriers, and other stakeholders. Integral parts to making CVISN work are the use of the transponder and the license plate reader. Both the transponder and the license plate reader identify a truck to a system that automatically checks safety ratings, credentials, and weight while the truck travels at freeway speeds. If all of the checks are satisfactory, the driver will receive electronic notification to bypass the weigh station. Of course, the bypass is subject to a random pull-in rate of about 5 percent.

The transponders used in the CVISN system are the most commonly used transponders on the market today. They will work in the pre-clearance systems in the following areas: Washington, Idaho, British Columbia, the Oregon Green Light System, and NORPASS states throughout the country. These transponders are also compatible with the Help, Inc., system. However, you must register your transponder with Help, Inc., before it will work in their system.

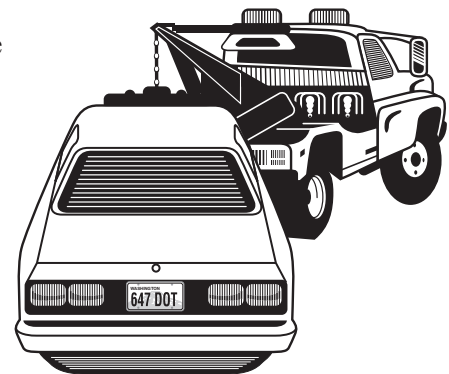

How to Get a Transponder

If you are a motor carrier traveling within or through the State of Washington and would like to obtain a transponder, call the Washington State Department of Transportation (WSDOT) at 1-888-877-8567 and ask for an application. You will be asked to (1) submit a completed application, (2) provide a copy of your cab card, and (3) remit a check to WSDOT reimbursing the state for the cost of the transponder. Once the application has been accepted, you will receive the transponder(s) in the mail. The transponder becomes your property and the rights to the transponder will revert to your company. Transponder applications are available at www.wsdot.wa.gov/commercialvehicle.



Transponders Saved Industry

Transponder equipped trucks were pre-cleared and received more than 1,329,000 green lights at Washington weigh stations in 2016. It is estimated that each bypass saves a carrier approximately 5 minutes and approximately \$9.60 in operating and fuel costs. The savings to industry in 2016 was approximately 111,000 hours of travel time and \$12.8 million dollars.

How Does Electronic Screening Work

WSDOT has deployed CVISN technology at 11 weigh stations in Washington. Using Weigh-in-Motion (WIM), Automatic Vehicle Identification (AVI), Transponders and Automated License Plate Recognition (ALPR) commercial vehicles are electronically screened on the mainline approximately ½ mile ahead of the weigh station. The trucks weight, size, registration and safety record are verified and within milliseconds, the driver is notified to bypass or exit to the weigh station.



- Transponders receive a red or green light signal inside the cab of the vehicle. If a green light is received, the driver can bypass the weigh station. If a red light is received, the driver must pull into the weigh station.
- The ALPR camera reads the license plate and the Changeable Message Sign displays either Truck Must Exit to Weigh Station or Truck Bypass Weigh Station to the driver.

If a vehicle cannot be identified, “Truck Must Exit to Weigh Station” is displayed on the changeable message sign.

Self Tarping Systems

The self tarping system is an aftermarket system that encloses the cargo area of a flatbed semi-trailer. It is designed to be stowed accordion style at either end of the trailer during loading, and then rolled out and locked into place. The system protects the cargo from adverse weather conditions and road debris, while sparing drivers the difficulty and danger of climbing onto the trailer to tie down conventional tarpaulins.

The design of the self tarping system requires that some equipment be added to each side of the flatbed, extending the width of the vehicle beyond 102 inches.

Washington State will treat equipment like the self tarping system as width-exclusive under the following conditions:

1. There is allowed a “front-end structure” and “rear-end structure” used to provide structural support for the tarping system, not to exceed 108 inches in width. There is also allowed a rail system that will not exceed 3 inches beyond either side of the vehicle. The front-end structure” **may not** double as the bulkhead used to prevent load shifting or penetration or crushing of the drivers compartment as required by 49 CFR 393.106, which is limited to 102 inches in width.
2. When the vehicle is in operation, no component of the tarping system may extend laterally more than 3 inches beyond the cargo-carrying portion of the vehicle.
3. An overwidth permit, termed a Tarping System Permit, may be issued to a vehicle or vehicle combination for a divisible load when such vehicle is equipped with a tarping system under the following conditions:
 - a. The divisible load must be authorized by a Tarping System Permit in order to display the special conditions on the permit.
 - b. A Tarping System Permit is required for any divisible load exceeding 8 feet 6 inches in width but not exceeding 9 feet in width, all of which must be within the confines of the tarping system dimensions. For example, bulging of the tarping material, to accommodate the load, is not authorized.
 - c. A Tarping System Permit is authorized to be used in conjunction with either of the overlength permits authorized under a. or b. of this subsection.
 - d. Vehicles operating with a Tarping System Permit are exempt from the requirements and restrictions listed in [WAC 468-38-075\(1\)](#).

Transportation of Farm Implements and Agricultural Hazardous Materials

Hazardous Materials Transportation

The Hazardous Materials Regulations (HMR) set forth requirements that you must follow if you ship or transport a hazardous materials, interstate or intrastate, in the course of your business.

Many fertilizers, pesticides, soil amendments, and fuels in farming are hazardous materials. If you transport a hazardous material on a public road in the course of your business, the HMR apply to you.

Hazardous material exemptions for farmers can be found in the Hazardous Materials Regulations under CFR 173.5

Agricultural Products

Agricultural products are defined as hazardous materials used to support farming operations, such as fertilizer, pesticide, soil amendment or fuel, but limited to:

- Flammable and non-flammable gases (Class 2)
- Flammable or combustible liquids (Class 3)
- Corrosive materials (Class 8)
- Miscellaneous hazardous materials (Class 9)
- Oxidizers (Division 5.1)
- Poisons (Division 6.1)
- Consumer commodities (ORM-D)

(Department of Licensing)

General Information

State of Washington
Department of Licensing

Prorate Services

Phone: 360-664-1858
Fax: 360-570-7829

IFTA Services

Phone: 360-664-1858

Olympia Headquarters

Office Hours: 8:00 am to 5:00 pm
Monday through Friday

Mailing Address: PO Box 9228
Olympia, WA 98507-9228

Physical Address: 2424 Bristol Court SW
Olympia, WA 98502

Days Closed

January 1 (New Year's Day)
3rd Monday in January (M. L. King, Jr's Birthday)
3rd Monday in February (President's Day)
Last Monday in May (Memorial Day)
July 4 (Independence Day)
1st Monday in September (Labor Day)
November 11 (Veteran's Day)
4th Thursday in November (Thanksgiving Day)
The Day after Thanksgiving Day
December 25 (Christmas Day)

Field Office Locations

Office Hours: 8:30 am to 4:30 pm
Monday through Friday

Olympia Counter

405 Black Lake Blvd
Olympia, Washington 98502
360-664-1858
"No semi-truck parking available"

Vancouver Counter

1301 NE 136th Avenue
Vancouver, WA 98663
360-260-6396

Services provided at counter areas: new accounts, vehicle additions, deletions, gross weight increases/decreases, added jurisdiction transactions, and limited renewal processing. ***You may also apply for an IFTA license and file IFTA tax returns at these locations.***

International Fuel Tax Agreement

The International Fuel Tax Agreement (IFTA) is an agreement among states and Canadian provinces that standardizes the reporting of fuel taxes by motor carriers operating in more than one state or province. An IFTA license allows you to file only one tax return to your base jurisdiction and report miles traveled in all IFTA jurisdictions.

The plan requires licensees to report fuel taxes by filing quarterly tax returns. Types of fuel include gasoline, diesel, propane, natural gas, and gasohol. Within Prorate and Fuel Tax, the IFTA unit processes tax returns and reports information to IFTA, Inc. Your fuel taxes are collected and distributed to member jurisdictions.

To qualify for a Washington IFTA license, you must have:

- A commercial vehicle over 26,000 pounds gvwt (gross vehicle weight) traveling in two or more states or provinces,
- Vehicles with three or more axles regardless of weight, and,
- A combination of vehicles that weigh more than a total of 26,000 pounds gvwt or registered gvwt.
- Recreational vehicles do not qualify for the IFTA program.

An IFTA license is valid for one calendar year and expires on December 31. A copy of the IFTA license must be carried in each qualified vehicle. You must purchase and display the current year IFTA decals within 60 days of the first day of the calendar year. The decals are purchased annually at \$10 a set. The decals must be on both the driver's and passenger side lower exterior of the cab. You can renew your license by:

- Submitting a completed decal application which we mail to you at the end of October the current year,
- Filing all returns up to the revocation, and,
- Paying any fuel taxes due.

Application/Licensing

The IFTA Fuel Tax License Application and the IFTA Decal Application may be downloaded from our website at www.dol.wa.gov/forms/formsprft.html or you may call us at 360-664-1858 for an application.

To receive your IFTA license and decals, complete the applications and mail them with the applicable decal fee to:

Prorate and Fuel Tax
Department of Licensing
PO Box 3777
Seattle, WA 98124-3777

All applications will be examined for correctness. If more information is required, the applicant will be contacted. If the application is correct, you will be issued an IFTA license and decals.

Special Fuel Permits

If you are not an IFTA licensee and need to travel in Washington, you may purchase a Special Fuel permit. These three-day permits may be purchased by contacting an authorized Vehicle Licensing agent or from DOT's permitting office.

Recordkeeping Requirements

You must keep your IFTA records for four years from the date the tax return was due or filed, whichever is later. The IFTA procedure manual requires you to keep the Driver's Daily Logs for four years if they represent the only source documentation for operations. Additional Recordkeeping information is available at our website www.dol.wa.gov/vehicleregistration/iftarecords.html.

Your records will certify the correctness of the information submitted on your quarterly IFTA tax return for audit purposes.

You can use on-board electronic recording devices in place of, or in addition to, hand-written records of your trips. If you use electronic devices, they must meet the standards outlined in the IFTA Procedures Manual.

Reporting Requirements

You must file a report every calendar quarter with your base state.

- You have to pay your quarterly fuel tax for all states or Canadian provinces with one check made out to your base state and include it when submitting your return.
- The information reported on the quarterly IFTA tax return would include all intrastate and interstate travel and tax paid gallons purchased for the previous quarter.
- You are required to file a **No Operation** return if you did not operate during the quarter you are filing.

Credits/Refunds

You will receive credit for any fuel used outside of the state where the fuel was purchased. This credit is applied to fuel tax liabilities incurred in other IFTA jurisdictions. Remaining credits will be refunded on a quarterly basis to accounts in good standing.

License revocations

- A revocation of an IFTA license will occur for failing to file a quarterly tax return or for not paying your fuel taxes in a timely manner. We will send you a “Notice of Intent to Revoke” letter and you will have 20 days to submit your tax return and payment. You cannot operate in any member jurisdiction if you have a revoked license. If you are licensed under the International Registration Plan (IRP) in Washington, this license will also be revoked.
- To reissue your revoked or cancelled license, you will need to complete the following:
 - complete a new IFTA License Application
 - submit all tax returns due and pay any unpaid fees due for each license
 - include \$100 reinstatement fee for each revoked license reissued
 - have decals for the current year. If not, you will need to submit a Decal Application form along with the decal fee.

Due Dates For Reporting Schedules	Reporting Schedule	Due dates**
1 st quarter:	January, February, March	April 30
2 nd quarter:	April, May, June	July 31
3 rd quarter:	July, August, September	October 31
4 th quarter:	October, November, December	January 31

**Tax returns must be postmarked the next working day if any of the dates fall on a weekend or a state holiday.

International Registration Plan

The International Registration Plan (IRP) is an agreement between the states and most Canadian provinces that allows you to apply for registration, pay one state, receive one plate, and be legally registered in the other states, D.C., and Canadian provinces that currently are members.

Apportioned Registration

Apportioned registration is a method of licensing a fleet of commercial vehicles operating in more than one jurisdiction. Fees collected are divided up or “prorated” among the member states.

Eligibility to Use Apportioned Registration

Vehicles are eligible for apportionment under the provisions of the International Registration Plan if they meet the following criteria:

- Intended for use in two or more jurisdictions.
- Is a power unit having two axles and a gross vehicle or registered gross vehicle weight in excess of 26,000 pounds.
- Is used in combination, when the weight exceeds 26,000 pounds gross vehicle weight.
- Is a power unit having three or more axles with a registered gross vehicle weight of at least 14,000 pounds.



IRP Plate (Apportioned)



IRP Plate (Apportioned Combination)

Reciprocity

Washington has various reciprocity agreements with other states and Canadian provinces, which authorize the movement of commercial vehicles licensed in jurisdictions, which do not participate in the International Registration Plan or which operate using specialized plates. The terms of each reciprocity agreement vary. It is advisable to contact the Prorate and Fuel Tax Services office at 360-664-1858.

Application/Licensing

You can get additional information and a license application by contacting the Department of Licensing or visiting the IRP Offices in Olympia, Union Gap, and Vancouver.

Department of Licensing
 IRP Section
 PO BOX 9228
 Olympia, Washington 98507-9228

Olympia Counter
 405 Black Lake Blvd
 Olympia, Washington 98502

Vancouver Counter
 1301 NE 136th Avenue
 Vancouver, WA 98684
 360-260-6396

Office hours are from 8:00 am to 5:00 pm, Monday through Friday
 Counter hours are from 8:30 am to 4:30 pm, Monday through Friday

Record Keeping Requirements

The International Fuel Tax Agreement (IFTA) and International Registration Plan (IRP) agreements have specific records requirements for motor carriers.

Motor carriers must maintain detailed mileage distance records for each individual vehicle. IFTA records must be kept for four years from the date the tax return was due or filed, whichever is later. IRP vehicle mileage records must be summarized monthly, quarterly, and annually by fleet and state or Canadian province. These records must be kept for four years following the period the registration application was based upon. In addition, they must substantiate the information filed with the department and are subject to review by audit.

A record keeping system must maintain detailed supporting records, including:

- Motor carrier name.
- Vehicle fleet number.
- Operator Equipment Number (OEN) or vehicle identification number (VIN).
- Beginning and ending odometer or hub odometer reading for each trip.
- Starting and ending date of each trip.
- Trip origin and destination by city, all pick-up and delivery locations, and fueling locations.
- Routes of travel.
- Mileage by state or Canadian province, highway, non-highway and deadhead.
- Total trip mileage.
- Original fuel invoices, including date, customer and seller name, gallons, fuel type, tax paid, and OEN or VIN.

The Driver's Daily Logs required by the Federal Highway Administration (FHWA) must be maintained for the department's required period if they represent the source documentation for operations.

Other state and federal agencies may have differing record keeping requirements and record retention periods than Washington State. Missing or inadequate records may result in audit adjustments to fuel consumption, tax-paid credits, jurisdictional distance, or monies owing.

If you have general questions concerning record keeping, please contact the IFTA unit or the IRP unit at 360-664-1858. For questions relating to records required for an audit, please contact the Audit unit at 360-664-1818.

Cab Cards

A cab card will be issued to you. This is your new registration and replaces the original Washington registration. Your cab card will have all of the jurisdictions you can legally operate displayed on it. Your cab card must be in the vehicle that is described on the cab card.

Trip Permits

Vehicle trip permits may be purchased for \$25.00 per permit. A trip permit will be required for each separate unlicensed vehicle. The permit will allow you to operate a maximum legal weight for a single vehicle up to 40,000 pounds and a combination vehicle up to 80,000 pounds, for a period of three consecutive days. No more than three trip permits per unit may be used within any consecutive 30-day period. Trip permits must be properly filled out prior to moving the vehicle(s).

Operators of vehicles with a gross weight of 26,001 pounds or more must have an IFTA license or a special fuel trip permit to enter this state. The cost for each permit issued is \$30.00.

Each permit is valid for three consecutive days beginning and ending on the dates specified on the face of the permit. Every permit shall identify, as DOL may require, the vehicle for which it is issued and shall be completed in its entirety, signed, and dated before operation of the vehicle on any public highway. Any correction such as the date, license number, or VIN number invalidates the permit.

PRISM Program

PRISM is a cooperative federal/state safety program designed to identify motor carriers with deficient safety records, and to tie a motor carrier's safety fitness to the ability to register their trucks. PRISM links the Federal Motor Carrier Safety Administration's (FMCSA) safety information with the state's motor vehicle registration process to achieve two purposes:

- To determine the motor carrier's safety fitness prior to issuing a registration plate; and
- To motivate the unsafe carrier to improve its safety performance through an improvement process and, where necessary, the application of registration sanctions.

The PRISM program includes two major processes—the commercial Vehicle Registration process (IRP registration) and enforcement that work in parallel to identify motor carriers and to hold them responsible for the safety of their operations. The performance of unsafe carriers is improved through a comprehensive system of identification, education, awareness, data gathering, safety monitoring, and treatment.

Chapter 3 **Commercial Driver's License Standards, Requirements, and Penalties**

(49 CFR, Part 383)

The Commercial Motor Vehicle Safety Act of 1986 requires all states to meet the same minimum standards for testing and licensing commercial drivers. All drivers of commercial vehicles throughout the United States are required to have a Commercial Driver's License (CDL).

Only professional drivers will receive and keep the CDL. It takes special skills and a professional attitude to safely operate large trucks and buses. Your CDL is proof of your professional skills and attitude. Welcome to the ranks of professional drivers.

Washington State began to issue Commercial Driver's Licenses on October 3, 1989. The CDL replaced the intermediate and combination classified endorsements of the classified license program. Intermediate/Combination Endorsed Licenses are not valid. See [Appendix 1](#) to see the type of CDL you will need if you operate a commercial vehicle.

The purpose of [RCW 46.25](#), Uniform Commercial Driver's License Act, and [WAC 308-100](#) and Part 383 of the Federal Motor Carrier Safety Regulations, is to help reduce or prevent commercial vehicle accidents, fatalities, and injuries by:

- Requiring that no driver has more than one driver's license.
- Disqualifying drivers who have committed certain serious traffic violations, or other specified offenses.
- Strengthening licensing and testing standards.

Commercial Driver's License Information System (CDLIS)

The CDLIS enables the states to exchange information about the driving records and driver's licenses of commercial vehicle operators. This helps assure that only one license is issued to a driver and that disqualified drivers are prevented from obtaining a CDL. Employers have ready access to the commercial driving status of their drivers through their state's licensing agency.

All commercial vehicle operators must have a current medical examination certification on their person while operating a commercial vehicle. If you are not a resident of Washington State and operate a commercial motor vehicle within the borders of Washington State, you must have a valid driver's license issued by your base state along with your current medical certification. Canadian carriers need not carry medical certification.

You must have a CDL if you operate any of the following vehicles:

- All single vehicles with a gross weight rating (GVWR) of 26,001 pounds or more.
- All trailers with a GVWR of 10,001 pounds or more, if the gross weight rating of the combined vehicle(s) is 26,001 pounds or more.
- All vehicles designed to transport 16 or more persons (including the driver).

These vehicles are divided into three classes: A, B, and C. The higher class CDL allows you to drive vehicles in any of the lower classes, provided you have the correct endorsements.

Occasional drivers are also required to apply for a CDL and all appropriate endorsements.

For Example: Mechanics or truck sales people who test drive on a public roadway. In addition to a CDL, drivers may need special endorsements if they:

- Drive vehicles carrying passengers (buses).
- Pull double or triple trailers (see following section on exemptions).
- Drive tank vehicles (see following section on exemptions).
- Haul placarded hazardous materials (see following section on exemptions).

The following endorsements/restrictions require knowledge and/or skills tests.

CDL Endorsements

(RCW 46.25.080)

- T: Doubles/Triples** - Trailers Endorsement required for drivers pulling sets of double or triple trailers.
- N: Tank** - Tank vehicle endorsement means any commercial motor vehicle that is designed to transport any liquid or gaseous materials within a tank or tanks having an individual rated capacity of more than 119 gallons and an aggregate rated capacity of 1,000 gallons or more that is either permanently or temporarily attached to the vehicle or the chassis. A commercial motor vehicle transporting an empty storage container tank, not designed for transportation, with a rated capacity of 1,000 gallons or more that is temporarily attached to a flatbed trailer is not considered a tank vehicle.
- H: Hazardous Materials** - Hazardous Materials Endorsement required for drivers of vehicles carrying hazardous materials which require the vehicle to be marked with a placard.
- P: Passenger** - Authorizes driving all passenger vehicles designed to carry 16 or more passengers to include the driver.
- S: School Bus** - Required to operate any school bus.
- X: Tank & HazMat** - Combines both tank and hazardous material endorsements.

CDL Restriction(s)

- L: No Air Brake Equipped CMV** - Drivers of commercial vehicles with full air brakes must pass the required tests on air brakes. Drivers who do not take and pass these tests are restricted on their CDL to operate only non-air brake equipped commercial vehicles.
- Z: No Full Air Brake Equipped CMV** - Drivers of commercial vehicles with partial air brakes must pass the required tests on air brakes. Drivers who do not take and pass these tests are restricted on their CDL to operate only non-air brake equipped commercial vehicles.
- E: No Manual Transmission Equipped CMV** - Drivers that complete a skills test in a vehicle with an automatic transmission are restricted to operate commercial vehicles with automatic transmissions. They are restricted from operating commercial vehicles with a manual transmission.
- O: No Tractor-trailer CMV** - Drivers that complete a skills test in a commercial vehicle with a pintle hook trailer connection are restricted to operate commercial vehicles with pintle hook trailer. They are restricted from operating commercial vehicles with 5th wheel trailers.
- M: No Class A Passenger Vehicle** - Drivers that complete a skills test in a class B passenger vehicle are restricted to operate Class B passenger vehicles.

- N: No Class A and B Passenger Vehicle** - Drivers that complete a skills test in a class C passenger vehicle are restricted to operate Class C passenger vehicles.
- K: Intrastate Only** - Drivers that self-certify as Non-accepted intrastate or is under the age of 21. Driving is restricted to intrastate commerce.

CLP Endorsements

- N: Tank** - Tank vehicle endorsement means any commercial motor vehicle that is designed to transport any liquid or gaseous materials within a tank or tanks having an individual rated capacity of more than 119 gallons and an aggregate rated capacity of 1,000 gallons or more that is either permanently or temporarily attached to the vehicle or the chassis. A commercial motor vehicle transporting an empty storage container tank, not designed for transportation, with a rated capacity of 1,000 gallons or more that is temporarily attached to a flatbed trailer is not considered a tank vehicle.
- P: Passenger** - Authorizes driving all passenger vehicles designed to carry 16 or more passengers to include the driver.
- S: School Bus** - Required to operate any school bus.

CLP Restriction(s)

- L: No Air brake equipped CMV** - Drivers of commercial vehicles with full air brakes must pass the required tests on air brakes. Drivers who do not take and pass these tests are restricted on their CDL to operate only non-air brake equipped commercial vehicles.
- P: No passengers in CMV** - Drivers with a passenger endorsement on the CLP are not allowed to transport passengers
- M: No Class A Passenger vehicle** - Drivers that complete a skills test in a class B passenger vehicle are restricted to operate Class B passenger vehicles
- N: No Class A and B Passenger vehicle** - Drivers that complete a skills test in a class C passenger vehicle are restricted to operate Class C passenger vehicles
- K: Intrastate Only** - Drivers that self-certify as Non-accepted intrastate or is under the age of 21.
- X: No cargo in CMV tank vehicle** - Drivers with a tank endorsement on the CLP are not allowed to transport anything in the tank. Tank must be purged.

Who Does Not Need a CDL?

The law exempts certain groups of drivers from the requirement to obtain a CDL ([RCW 46.25.050](#)):

- **Farmers transporting farm equipment**, supplies, or products to or from their farm in their farm vehicle are exempted, provided the vehicle is operated by the farmer or farm employee, as long as they stay within 150 miles from the farm. (Products include Christmas trees or wood products transported by vehicles 40,000 pounds GVW or less.)
- **Firefighters/law enforcement personnel** operating equipment during an emergency situation are exempted, provided they have completed the Emergency Vehicle Accident Prevention Program (EVAP) and they carry a card certifying completion. Driving emergency vehicles in non-emergency situations does require a CDL.
- Recreational vehicle operators are exempted when driving RVs for non-commercial purposes. This includes two-axle rental trucks ([WAC 308-100-210](#)), and horse trailers ([RCW 46.25.050](#)).

- **Certain military vehicle drivers** operating under a military license issued by the appropriate service and only while operating appropriate military vehicles.

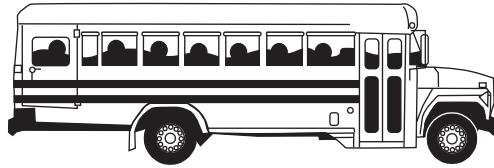

CDL Required



CDL NOT Required (15 passengers or less)

Procedures for Obtaining a CDL or Commercial Learners Permit (CLP)

To get a CDL or CLP, you are required to be at least 18 years of age and have a valid Washington State driver's license. You are required to provide proof of lawful permanent residence and your Social Security number which will be verified through an online process. Visit www.dol.wa.gov for information on providing proof of lawful permanent residence.

Note: Employers may impose additional standards and/or higher minimum age requirements.

Washington drivers obtaining their first time CDL or reinstating a CDL that has been canceled, suspended, revoked or surrendered for more than one year, will be required to present a certificate of training by a certified commercial driving school or employer. Mandatory CDL training requirements do not pertain to commercial drivers transferring a CDL from another state or upgrading their existing Washington CDL. Visit www.dol.wa.gov for information on minimum training requirements.

A CLP may be issued to an individual who holds a Washington base driver's license. The CLP will be issued as a separate document. The driver will receive a paper temporary document at the time of issuance and will receive a card in the mail a couple weeks later. The CLP will display the vehicle class, endorsements and restrictions that indicate the type of vehicle the CLP holder is allowed to drive. The holder of a CLP may drive a commercial motor vehicle on a highway only when accompanied by the holder of a commercial driver's license, valid for the type of vehicle driven, who occupies a seat beside the individual, for the purpose of giving instruction in driving the commercial motor vehicle.

- The CLP is valid for 180 days, and may be renewed one time only.
- The CLP fee is \$40.00.

Testing

Both the knowledge (written) and skill (driving) tests are required to receive a CDL. A knowledge test is required for:

- The class of vehicle.
- Each endorsement, and/or restriction.

The skills test consists of a pre-trip vehicle inspection, backing exercises, and a road test. You will need to provide a vehicle appropriate to the class of license you apply for, including a bus (designed to carry 16 or more persons including the driver) if applying for a passenger/school bus endorsement.

After a CDL is issued, adding a passenger endorsement, upgrading a license, or removing a restriction may require both knowledge and skills tests and applicable fees.

All drivers who surrender the CDL or any endorsement will be required to pay all applicable fees. Driver's whose CDL has been surrendered or inactivated for one year or more will be required to provide proof of training, retake both the knowledge and skills tests and pay applicable fees to obtain a new CDL.

Fees

These fees are associated with the cost to get your CDL with a Washington driver's license:

- \$35 fee for knowledge testing and knowledge retests.
- \$250 maximum fee per skills test. Allows for two skills tests.
- \$100 maximum fee for school bus skills tests. Allows for two skills tests.
- \$10 license issuance fee plus \$17 per year for the time remaining on your license to add a CDL to your Washington driver's license.
- \$10 issuance fee for upgrading a CDL class or endorsement to your existing Washington CDL.

All fees are in addition to those for your basic driver's license.

Visit www.dol.wa.gov/driverslicense/fees.html for more information about fees.

Renewal/Upgrade

When applying for a renewal or upgrade of a CDL, applicants shall:

- Provide any updated information.
- Pass a written hazardous materials test if wishing to retain or upgrade a hazardous materials endorsement.
- Complete any additional testing requirements for an upgrade.

Hazardous Materials Endorsement Background Check and Disqualifications

To get or renew a hazardous materials (hazmat) endorsement, you must complete a Transportation Security Administration security clearance. Federal clearance is required prior to the issuance of a "hazmat" endorsement. This process can take 30 to 90 days to complete. Drivers will be denied or will lose their hazmat endorsement for the following circumstances:

- Are not a lawful permanent resident of the United States.
- Renounce their United States citizenship.
- Are wanted or under indictment for certain felonies.
- Have a conviction in military or civilian court for certain felonies.
- Have been judged to be a mental defective or have been committed to a mental institution.
- Are considered to pose a security threat as determined by the Transportation Security Administration.

CDL Disqualification

You are required to notify your employer if your license is suspended, revoked, or canceled or if you are disqualified from operating a commercial vehicle. You have one day from the day of notification to do this.

There is no Occupational Driver's License available for commercial motor vehicle drivers, regardless if conviction is for offense in a private or commercial motor vehicle. You must notify your employer, in writing, of all traffic convictions within 30 days. This includes those in your private automobile as well as a commercial vehicle.

You must notify the Department of Licensing, in writing, of all out-of-state convictions within 30 days of the conviction. Write to:

Department of Licensing
PO Box 9030
Olympia, WA 98507-9030

If your license is suspended or revoked, your commercial driving privilege is invalid. After your suspension or revocation, to reinstate you must file proof of financial responsibility with the Department of Licensing. Your filing must include a letter from your employer's insurance company indicating that you are insured to operate commercial vehicles.

Traffic Violations in Your Personal Vehicle

The Motor Carrier Safety Improvement Act (MCSIA) of 1999 requires a CDL holder to be disqualified from operating a commercial motor vehicle if they have been convicted of certain types of moving violations in their personal vehicle.

If your license to operate your personal vehicle is revoked, cancelled, or suspended due to serious speeding violations, you will lose your CDL for period ranging from 60 to 120 days.

If your license to operate your personal vehicle is revoked, cancelled, or suspended due to alcohol violations, you will lose your CDL for one year. If you are convicted of a second alcohol conviction in your personal vehicle, you will lose your CDL for life.

Serious Traffic Violations

Serious traffic violations include:

- Driving a CMV without a CDL or in the driver's possession.
- Driving a CMV without the proper class of CDL or endorsements.
- Excessive speed (15 mph over posted limit).
- Reckless driving.
- Negligent driving.
- Improper lane changes.
- Following too closely.
- Violation of a state or local law relating to motor vehicle traffic control, other than a parking violation, in connection with an accident or collision resulting in a death to any person.

A driver is disqualified for one year for a first-time conviction of the following offenses while operating a commercial vehicle:

- Driving under the influence of alcohol or any controlled substance.
- Driving with an alcohol concentration of .04 percent or more.
- Leaving the scene of an accident.
- Refusing to take an alcohol test as required by a state.
- Using the vehicle to commit a felony.
- Driving a CMV when suspended or revoked.
- Causing a fatality through the negligent operation of a CMV.

If convicted of any of the above while operating a vehicle placarded for hazardous materials, the disqualification increases to three years.

- A second conviction of the above offense will result in disqualification for life. The second conviction may be for the same or a different offense.
- Using a commercial vehicle in the making, selling, or distribution of controlled substances results in a lifetime disqualification.
- If you hold a CDL, you have given consent to taking a breath or blood test to determine alcohol content as prescribed by Washington Law. Consent is implied by driving a commercial motor vehicle (49 CFR part 383.72).

If any level of alcohol is detected, law enforcement can place a commercial driver out-of-service for 24 hours. It is illegal to operate a commercial vehicle with any alcohol in your system.

If the driver is convicted of operating a CMV in violation of a federal, state, or local law regarding failure to stop at railroad crossings:

- The driver is not required to always stop, but fails to slow down and check that railroad tracks are clear of an approaching train.
- The driver is not required to always stop, but fails to stop before reaching the crossing, if the tracks are not clear.
- The driver is always required to stop, but fails to stop before driving onto the crossing.
- The driver fails to have sufficient space to drive completely through the crossing without stopping.
- The driver fails to obey a traffic control device or the directions of an enforcement official at the crossing.
- The driver fails to negotiate a crossing because of insufficient undercarriage clearance.

Driver's Medical Certificate

A completed physical examination form or Department of Transportation physical card filled out by a licensed medical examiner. The physical is valid for no more than two years from the date of examination. Date of expiration must be reflected on the Medical Certificate.

Medical Waiver Procedures

All commercial drivers must meet minimum medical standards as established by federal and state rules and regulations 49 CFR parts 391.41 through 391.49 and [WAC 446-65-020](#).

Interstate Waivers

Interstate waivers are processed by the Federal Motor Carrier Safety Administration. Drivers who are missing or have the impaired use of a foot, leg, hand, or arm, vision, and diabetic also may be eligible to apply for an interstate waiver. To apply, contact:

Please visit the FMCSA website at:

www.fmcsa.dot.gov/medical/driver-medical-requirements/driver-exemption-programs

Intrastate Waivers

All commercial drivers must meet the medical standards established by federal and state laws, rules, and regulations. The Washington Utilities and Transportation Commission (UTC) and the Washington State Patrol (WSP) have adopted these same medical standards for all Washington license commercial drivers who do not meet minimum medical standards to apply to the Department of Licensing (DOL) for an intrastate medical waiver.

If you don't meet the medical standards, you can apply for an Intrastate Medical Waiver. The waiver is:

- Valid for operation in Washington State only.
- Valid for no more than a two-year cycle.
- Issued only to Washington-licensed drivers or those who have an active application for a Washington driver's license on file.

If you need an intrastate waiver, complete a Washington CDL Intrastate Medical Waiver Application with the information listed below. This form is available on DOL's website, or may be obtained at any Licensing Service Office:

- Your name.
- Your driver's license number.
- Your residential mailing address.
- Your mailing address, if different from your residential address.
- Your medical examiner's name, title, business address and telephone number.
- A description of all medical condition(s) that do not meet federal medical standards.
- The cycle of the waiver request, 6 months, 1 year, or 2 years.
- A copy of your current Department of Transportation Medical Examiner Report long form and wallet card completed by an authorized medical examiner that clearly states any reason why you are not medically qualified.

Mail these forms to:

Department of Licensing
CDL Program/Medical Waiver Unit
PO Box 9030
Olympia, WA 98507-9030
Phone: 360-902-3619
Fax: 360-570-4915

Requests for intrastate medical waivers are processed within 7 to 10 business days of receipt and mailed directly to the driver. Incomplete forms will delay the approval of the waiver. The medical waiver, DOT card and CDL must be carried at all times when operating a commercial vehicle.

Licenses of Persons Serving in Armed Forces to Remain in Force – Duration

(RCW 46.20.027)

If you are living outside of the state of Washington and serving in the armed forces of the United States, your license is good as long as it is not suspended, revoked, or canceled. It is valid for 90 days after separation from the armed forces of the United States.

National Driver Register File Check – Federal Privacy Act of 1974

(Public Law 93-579)

The National Driver Register (NDR) contains only a listing of names and related identification, provided by state driver licensing officials, of those drivers whose driver's licenses have been canceled, denied, revoked, or suspended or who have been convicted of certain serious traffic violations. The NDR does not contain a list of other drivers. If you have not had a driver's license canceled, denied, revoked, or suspended, or have not been convicted of serious traffic violations, you would not be listed in the NDR. Every individual is entitled, however, to request a check of the NDR records to determine whether they appear on the NDR file. The NDR will respond to every valid NDR inquiry.

The record content for those persons who are listed in the NDR files is limited to identification of the state(s), which have taken action to cancel, deny, revoke, or suspend, or have records of conviction of serious traffic violations. Any specific information about the driver history, or a request for the entire driver history, may be obtained only from the state(s) where the detailed information is recorded. The state(s) maintaining records are the (only) contacts able to correct records in error, and the NDR will correct records in error, and the NDR will correct its pointer records when so advised by a state indicating that a report previously made to the NDR is in error.

If the NDR has a record on you, the full record will be copied and sent to you including any older records which may have contained a reason for license cancellation, denial, revocation, or suspension. In addition, if such information has been disclosed by the NDR, the recipient will also be identified.

The name and address of the state driver licensing official will be provided for each state listed as having reported information on you to the NDR.

Requests for NDR Record Checks

The NDR response will be mailed to the mailing address shown, but incomplete or illegible inquiries will not be processed. All inquiries will be acknowledged if a return address is readable. Forms which are not notarized will not be processed.

This page intentionally left blank.

Chapter 4 Administration of Vehicle Size and Weight

The Commercial Vehicle Services Office of WSDOT located in Olympia administers vehicle size and weight, including the special motor vehicle permit program. Special motor vehicle permits may be issued by Self-issuers, WSDOT employees and approved WSDOT agents. Correspondence or questions relating to special motor vehicle permits should be directed to:

Washington State Department of Transportation
Commercial Vehicle Services
7345 Linderson Way SW
PO Box 47367
Olympia, WA 98504-7637
Phone: 360-704-6340
Fax: 360-704-6391
Website: www.wsdot.wa.gov/commercialvehicle

Obtaining Special Motor Vehicle Permits

Vehicles that are over dimensional and/or overweight must have a special motor vehicle permit prior to entering the state or prior to moving within the state.

Most routine permits may be self-issued online 24 hours a day, 7 days a week at www.wsdot.wa.gov/commercialvehicle.

Many WSDOT offices issue permits, which can be purchased using cash or check at all participating offices.

Permit agents, (contracted through WSDOT) can also issue most permits. Some agents operate evenings, weekends and/or 24 hours a day, 7 days a week.

Refer to the list of participating WSDOT offices and agents on the CVS website at www.wsdot.wa.gov/commercialvehicle, or refer to [page 4-26](#).

Permits are not available at the Ports of Entry.

Permit Types available online for Self-issue

Most routine permits may be self-issued online 24 hours a day, 7 days a week at www.wsdot.wa.gov/commercialvehicle using Visa or MasterCard.

61' Non-Divisible Load

Dimensional only: Load length up to 61 feet for a tractor and trailer combination. (30 day period up to one year) Length is \$10.00 per month. This permit complies with [WAC 468-38-075\(2\)\(e\)](#). Load must have a legal rear overhang to comply with the above WAC

Canadian Weights/SR9 Special

Allows drivers to haul reducible loads with Canadian Weights from the Canadian border to Sumas, Washington on SR 9. \$14.00 annual

Canadian Weights/SR97 Special

Allows drivers to haul reducible loads with Canadian Weights from the Canadian border to milepost 331.12 (Oroville Rail Yard). \$100.00 per month/\$1000.00 annual

Collection Truck

Two or Three axle single unit permit for limited excess weight (annual) 2 axle \$252.00 or 3 axle \$336.00 -Required to check the collection truck restrictions in addition to the overweight restrictions prior to moving. This permit is not allowed on the federal highway system

Double Trailer

Allows for divisible loads to be carried on a set of double trailers up to 68 feet (30 day periods up to one year) \$10.00 per month/\$100.00 per year

Empty Apple Bins

Permits height up to but not to exceed 15 feet (30 day periods up to one year) \$20 per month/\$240.00 per year

Fuel

A fuel permit is required upon entering the State of Washington when a commercial vehicle (equipped with two axles with a GVW exceeding 26,000 lbs or a three-axle vehicle regardless of GVW) is powered by special fuel, including but not limited to diesel or propane and does not pay fuel tax under the International Fuel Tax agreement (IFTA) \$30.00

Hay Bales

Permits height up to but not to exceed 15 feet (30 day periods up to one year) \$20 per month/\$240.00 per year

Heavy Haul Corridor

Allows for sealed shipping containers to travel on a portion of SR 509 in the Port of Tacoma. \$100.00 per month/\$1,000.00 per year

Log Tolerance

Permits weights in excess of federal bridge formula for Three-axle log truck pulling Two-axle pole trailer (quarterly periods up to one year) \$12.50 per quarter/\$50.00 per year

Manufactured Housing (14×85 Max)

Dimensional only: 14 ft wide, 15 ft high and up to 85 feet of overall length (Yearly permit from start date) is \$150.00 year

Manufactured Housing (Over 14×85)

Dimensional only: 15 feet wide, 15 feet high and up to 75 feet of trailer/load length (30 day period up to 1 year) \$30 per month/\$360.00 year

Non-Divisible Load (Variable Size)

Dimensional only: 14 ft wide, 15 ft high and up to 125 ft of length depending on combination type (30 day period up to 1 year) Length is \$10.00 per month and Height/Width is \$20.00 per month

Oversize/Overweight

Single trip, one way, oversize and/or overweight, route specific permit to haul a non-divisible load

Single Trailer

Allows for a divisible load carried on a semi-trailer up to 56 feet of length (30 day periods to one year) \$10.00 per month/\$100.00 per year

Tarping System

Permits divisible load width up to nine feet This permit is for loaded vehicles that are equipped with a tarping system. \$20.00 per month/\$240.00 per year

Temporary Additional Tonnage

Temporarily increases licensed weight of single units or combinations. For legal weights only. (Minimum of five- day periods up to one month) \$14.00 per ton

Tow Truck

For Class B and Class C tow trucks, including Class E tow trucks with either a Class B or Class C rating (Yearly permit from start date) Class B \$75.00 and Class C \$150.00 year

Trip

Provides temporary vehicle Washington State Licensing for three consecutive days to a vehicle in lieu of regular licensing. The permit grants legal capacity up to 40,000 lbs for a single vehicle and up to 80,000 lbs for combination vehicles. \$25.00 (Max three permits per VIN number in a 30 day period)

Trip/Fuel Combo

This permit is a combination of the trip permit and the fuel permit. It allows for temporary licensing and fuel use for three consecutive days. \$55.00 total fee

Oversize/Overweight Permit for Self-Issue

Access to issue this permit type requires an initial permit training followed by a short quiz (approximately 20 questions). A refresher training is mandatory every two years for the permit program user to continue access to this permit type. The permit program will prompt the user when the training is approaching and will allow a minimal grace period before access is denied, until the quiz is taken. The permit program will prompt the user when the training due date is approaching.

- This permit type can be issued for weights up to 200,000 lbs and will require an Axle Spacing Report Number

The tractor/trailer combination will be considered a tractor and trailing unit(s) which can include jeeps and boosters to distribute the weight. This permit is not valid for double trailers. Double trailers are not eligible for overweight permits.

Road and bridge restrictions are displayed on the permit. The carrier must abide by the restrictions on the permit with no exceptions. Overheight, clearances are the responsibility of the carrier not WSDOT.

Self-issuing companies will have the ability to access reports of permits issued to their company vehicles from any permit issuer. It will be the responsibility of the carrier to check road restrictions on the Commercial Vehicle Services website prior to moving (www.wsdot.wa.gov/commercialvehicle). It is also the responsibility of the carrier to know and follow the rules and regulations related to oversize/overweight loads. These rules and regulations can also be found on the Commercial Vehicle Services website at www.wsdot.wa.gov/commercialvehicle.

Permit Violations Resulting in Permit Confiscations, for Self-issuers

Permit violations resulting in permit confiscations within a twelve-month period, beginning at the time and date of the first confiscation.

- First confiscation will suspend self-issue authorization for the company for twenty-four hours from the date of the first confiscation
- Second confiscation will suspend self-issue authorization for the company for fifteen days from the date of the second confiscation
- Third confiscation will suspend self-issue authorization for the company for thirty days from the date of the third confiscation
- Fourth confiscation will suspend self-issue authorization for the company for one year from the date of the fourth confiscation.

For a list of WSDOT offices or agents that can issue permits during an online permit program suspension, visit www.wsdot.wa.gov/commercialvehicle.

Highway Movements Requiring a Permit

Movements that exceed any of the following legal features may require a special permit, if eligible.

Legal Dimensions

Legal maximum **width** of a vehicle or load is 8 feet 6 inches. Vehicles/loads wider than this need permits. Overwidth vehicles/loads are subject to route curfews. Vehicle loads over 16 feet wide must submit a request to the CVS Office for approval to move.

Legal maximum **height** is 14 feet. Vehicles or loads higher than this need a permit. Vehicles/non-divisible loads higher than 14 feet 6 inches must be accompanied by a front escort, with a height pole on all Washington highways ([WAC 468-38-100\(h\)](#)). Loads over 16 feet high must submit a request to the CVS Office for approval to move.

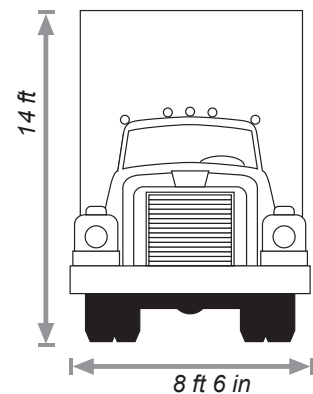

The legal **length** of a single unit, i.e., dump truck, box van, concrete pumper, is 40 feet. There are permits for front and rear overhang on these units; however, there are limitations to the amount of overhang a vehicle can have and still be able to travel during commuter and curfew hours.

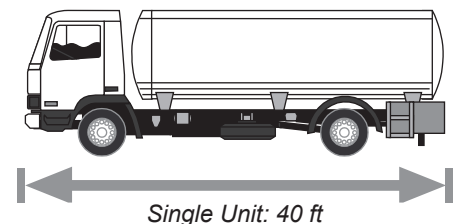

Legal Overhangs – Front overhang is 3 feet from the front of the normal bumper line. Rear overhang is 15 feet measured from the center of the last axle.

A **log truck and stinger-steered pole trailer** is limited to 75 feet in overall length, with or without load.

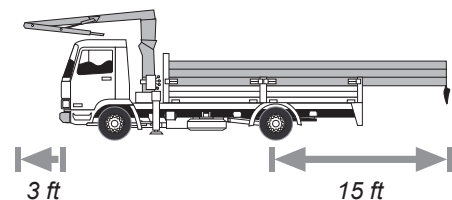

The log truck, pole-trailer, trailer combination, when loaded with two distinct loads of logs (as shown), will be treated like a set of doubles for measurement purposes. Measurement will begin at the front of the first bunk and extend to the end of the second trailer or load, whichever is greater. Operation without permit is limited to 61 feet, and 68 feet with permit.

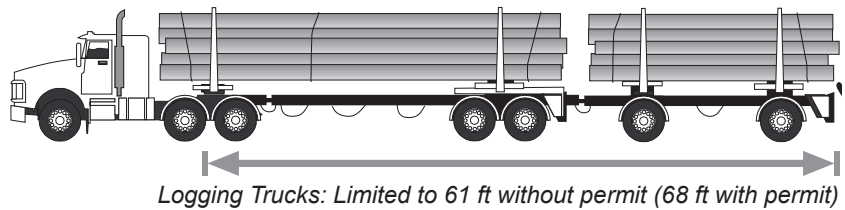

Only trailer and load constitute regulated length unless the tractor also carries freight. Single trailers may not exceed 53 feet (56 feet maximum with permit). The legal length of combination vehicles may vary. For example, truck and trailer combinations may not exceed 75 feet. Two trailing units (doubles) may not exceed 61 feet (68 feet maximum with permit).

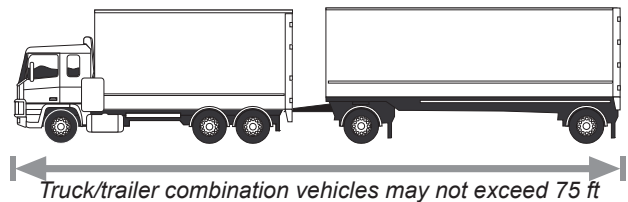
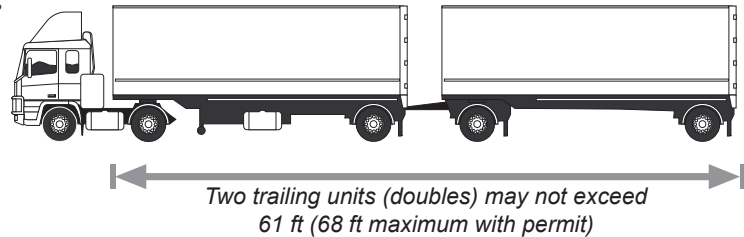
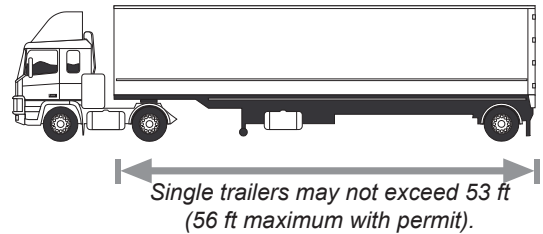

Legal Weights

Gross vehicle weight (GVW) for a vehicle or a vehicle combination is determined by an overlapping set of three criteria: tire size, axle weight, and the weight table ([Appendix 3](#)). The lesser of any one of the criteria will govern the weight of any axle or axle group. For help in determining the legal gross vehicle weight, call the Commercial Vehicle Services Office at 360-704-6340.

Legal Weight Maximums	
Gross Vehicle Weight	105,500 pounds
Single Axle	20,000 pounds
Tandem Axle	34,000 pounds
Two Tire Axle	500 pounds per inch width,* except**
Steer Axle	600 pounds per inch width

**As marked by the manufacturer on the sidewall. Metric conversion to inches: divide metric size by 25.4 (i.e., 285 ÷ 25.4 = 11.22 in).*

***Fixed steer axles, driver operated, equipped with single tires are limited to 600 pounds per inch width. Other than the steer axle, axles carrying more than 10,000 pounds and equipped with single tires are limited to 500 pounds per inch width. For other exceptions, refer to [RCW 46.44.042](#) Maximum Gross Weights – Axle and Tire Factors.*

Legal Vehicles or Combinations

Auto or Boat Carriers (WAC 468-38-270(2)) – “Stinger steered” auto and boat carriers are allowed a 4-foot front overhang and a 6-foot rear overhang beyond the 80-foot limit that regular truck and trailer combinations are allowed, with a total length of 90 feet. Conventional fifth wheel (mounted above drive axles) carriers are allowed a 3-foot overhang and a 4-foot rear overhang beyond the 65-foot length limit, with a total length of 72 feet. These combinations are referred to as “specialized equipment.”

Stinger-Steered Auto Transporter Combination

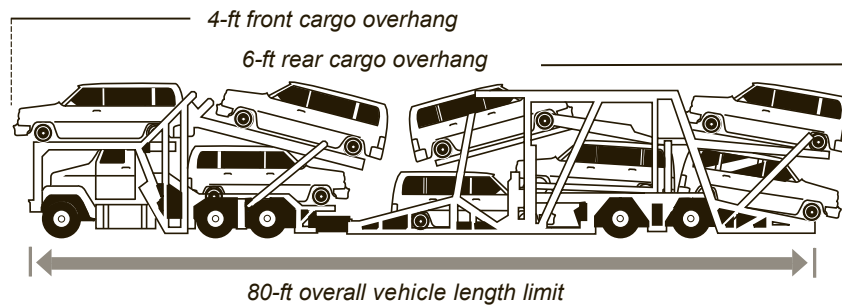

Conventional Automobile Transporter Combination

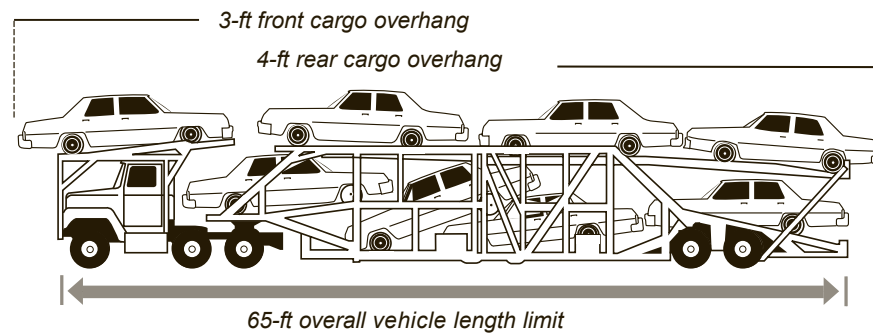

Tractor Trailer Combination with Automobiles

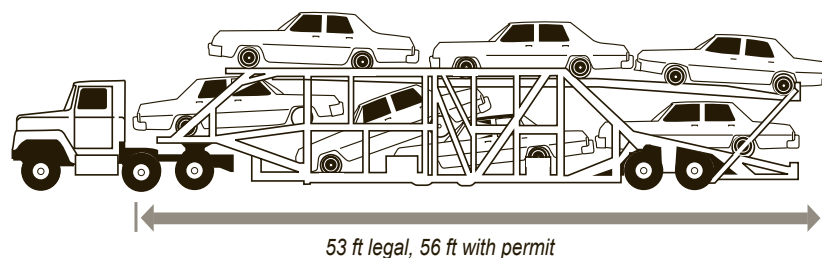

To be considered specialized equipment, the power unit and trailer must both be designed to transport automobiles.

The tractor-trailer configuration without modified tractor does not have an overall length or bonus overhangs. The configuration may have a trailing unit, with load, up to 56 feet with permit.

Buses (RCW 46.44.030) – Buses may be up to 46 feet in length; however, articulated buses may be as long as 61 feet

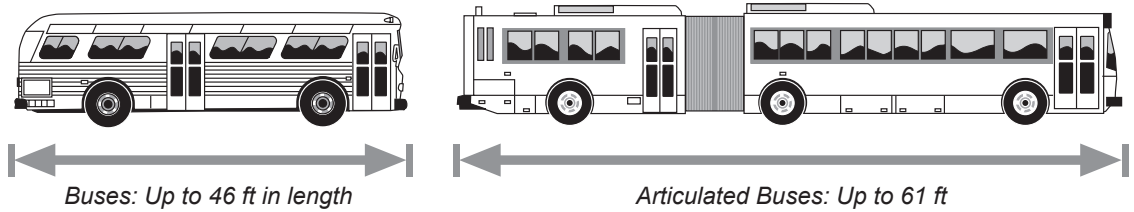

Saddlemounts (RCW 46.44.037) – A saddlemount configuration is made up of a tractor pulling up to three additional tractors in a “piggy back” arrangement. The configuration is allowed an overall length of 97 feet with or without full mount. This configuration may include one full mount.

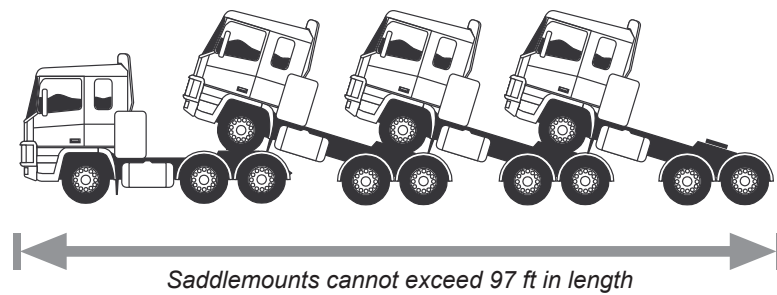

Empty Trailers

Loads that are over dimensional, but not overweight, may be hauled under authority of a monthly permit that covers the dimensions. The “item” to be hauled on the combination will simply be referred to as “non-divisible load.” This permit then covers any empty over dimensional trailer on the return trip.

Temporary Additional Tonnage (RCW 46.44.095 and WAC 468-38-030)

In order to obtain temporary additional tonnage, a single unit must be licensed to a minimum 40,000 pounds and a combination must be licensed to a minimum 80,000 pounds. The rate is \$2.80 per day for every 2,000 pounds or fraction thereof up to the maximum legal weight allowed for the vehicle or vehicle combination as shown in the vehicle weight tables in [Appendix 3](#). A minimum of five days must be purchased.

These permits are for legal loads meeting the weight table in [Appendix 3](#). Only single units licensed to a minimum of 40,000 pounds or combinations licensed to a minimum of 80,000 pounds may be issued temporary additional tonnage. DOL trip permits may be used to increase the licensed gross weight up to 40,000 pounds for a single unit or 80,000 for a combination unit ([RCW 46.16.160](#)).

Days	2000	4000	6000	8000	10000	12000	14000	16000	18000	20000	22000	24000	26000
5	\$14	\$28	\$42	\$56	\$70	\$84	\$98	\$112	\$126	\$140	\$154	\$168	\$182
6	17	34	50	67	84	101	118	134	151	168	185	202	218
7	20	39	59	78	98	118	137	157	176	196	216	235	255
8	22	45	67	90	112	134	157	179	202	224	246	269	291
9	25	50	76	101	126	151	176	202	227	252	277	302	328
10	28	56	84	112	140	168	196	224	252	280	308	336	364

Log Tolerance Permits

(RCW 46.44.047)

Unprocessed logs may be hauled in excess of weight limits imposed on other loads. The effect is that a log truck combination with a short wheel base may carry more weight than is allowed for other freight. The conditions under which a log tolerance permit may be used are:

- The combination is a **three-axle truck-tractor and two-axle pole trailer** (five-axle combination only) hauling unprocessed logs. (Four-axle truck-tractors with a drop axle up or down are not eligible for Log Tolerance Permits.)
- The entire combination gross weight cannot exceed 74,800 pounds.
- The gross weight on tandem axles cannot exceed 33,600 pounds.
- The distance between the first and fifth axle is no less than 37 feet.
- Local approval is required for use on city streets and county roads.
- The permit is not valid during emergency or severe emergency road restrictions.
- The annual permit commences on April 1 of one year and expires on March 31 of the following year.

Fees: \$50.00 for 1 year
\$37.50 if purchased after July 1
\$25.00 if purchased after October 1
\$12.50 if purchased after January 1

Variable Lift Axles

Lift axles that are used in conjunction with another axle or series of axles must meet these criteria:

- They must have a manufacturer's rating of at least 8,000 pounds.
- They must be self-steering.
- They must be capable of being controlled from a location out of reach of the driver's compartment. The raising or lowering switch may be located in the cab.
- Lift axles must be engaged for all overweight loads and need not be self-steering.

However, four tire lift axles that are within 60 inches of a drive axle to create a tandem axle on the power unit only, need not be self-steering. Two or more tire lift axles within 60 inches of a trailer axle need not be self-steering.

Permits for Over Dimensional Loads

Permits will only be issued to transport loads that are non-divisible. *If the load or any part of the load can be reasonably reduced, it must be reduced.*

Height

High loads must be carefully planned with an escort vehicle operator who is certified for Washington and is familiar with the area to be covered. Overheight loads often require detours on city streets and county roads, requiring their approval (see counties and cities list on [page 4-27](#)).

Loads over 16 feet high (Superload) must be fully explained in a Request for Approval application to the Commercial Vehicle Services Office. The application process may require the inclusion of the need for the move, the route, the traffic control plan for the move, use of escort vehicles, and the dimensions of the combination and load.

A vehicle, or vehicle combination, hauling empty apple bins, or ranchers hauling hay from their own fields for use with their own livestock, may be issued a permit, for vehicle and load, not to exceed 15 feet high, measured from a level road surface.

Width

The route for overwidth loads must also be discussed with an escort vehicle operator familiar with the area. Overwidth loads may require detours.

Loads over 16 feet wide (Superload) **must be fully explained in a Request for Approval application to the Commercial Vehicle Services Office.** The application process may require the inclusion of the need for the move, the route, traffic control plan, escort vehicles, and the dimensions.

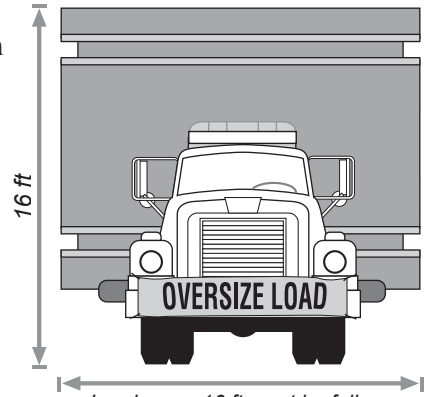

Loads over 16 ft must be fully explained in a Superload request to the Commercial Vehicle Services Office.

Length – Divisible Loads

Measurement for a single trailer will be from the front of the trailer, or load, to the rear of the trailer, or load, whichever provides the greater distance up to 56 feet. Measurement for double trailers will be from the front of the first trailer, or load, to the end of the second trailer or load, whichever provides the greatest distance up to 68 feet. Measurements shall not include non-load carry devices designed for the safe and efficient operations of the semi-trailer or trailer; for example: external refrigeration unit, resilient bumper, and aerodynamic shells.

The following are exempt from some restrictions:

- Single trailer permits.
- Double trailers permits.
- 61-foot non-divisible loads with legal overhangs.
- Vehicles with a front overhang not more than 4 feet beyond the 3-foot legal front overhang.
- Single Fixed Load Permit (must not exceed 45 feet overall length).

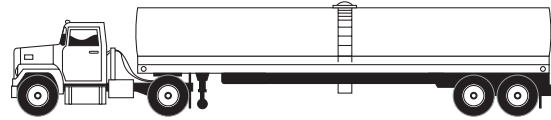

Measurement for a single trailer is up to 56 ft



Measurement for a double trailer is up to 68 ft

Restrictions from which they are exempt are:

- Oversize load signs.
- Weekend, holidays, commuter curfew, and nighttime travel restriction.
- Mountain pass restrictions for oversize vehicles/loads.

Load Restrictions

The load must be reduced to a practicable minimum, even if additional vehicles are required to transport the divided item. Loads created by welding, bolting, or tying will be construed as divisible, unless proven with good cause not to be divisible.

- **Tractor and Semi-trailer or Full Trailer** – Trailers in excess of 8 feet 6 inches wide or legal length of 53 feet, or the permitted length of 56 feet, shall not exceed the length or width of the load, unless the added dimension is necessary to spread the weight of load to protect the infrastructure.
- **Tractor With Semi-trailer or Full Trailer** – Combined trailer length, including space between trailers, may not exceed 61 feet. This combination may carry non-divisible loads not to exceed 10 feet wide. Both trailers may carry non-divisible loads with the widest load contained on the first trailer. This configuration may not carry over height, overlength, or overweight loads.

Oversize Load Signs

“OVERSIZE LOAD” signs are required on all over dimensional loads, except as provided for in [WAC 468-38-075](#). Signs must be 7 feet long and 18 inches high with black lettering at least 10 inches high. Signs on escort vehicles must be at least 5 feet long, 10 inches high, with black lettering at least 8 inches high on a yellow background.

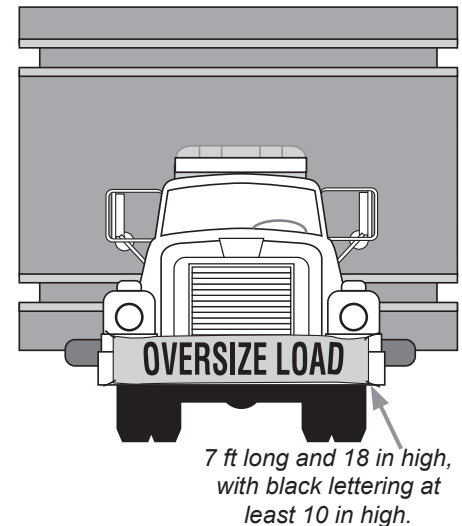
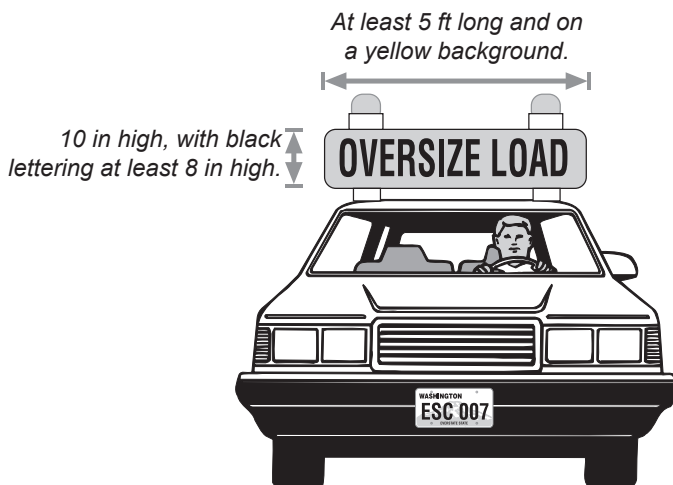

Permits for Oversize/Overweight Motor Vehicles

Non-Divisible Loads

(WAC 468-38-050 and 468-38-070)

To qualify for a permit, the hauler must show that the load cannot reasonably be dismantled or disassembled. If the load can be reduced, even if that would require the use of additional vehicles, no special permit will be issued.

Overweight Loads

(RCW 46.44.091)

Permits may be issued if the load cannot reasonably be reduced and if WSDOT determines that the structures and roads over which the load is to travel can sustain the weight without undue stress.

Permits for heavy loads are not to exceed weight limits as follows:

- 600 pounds per inch of tire width.
- 22,000 pounds on a single axle.
- 43,000 pounds on a tandem axle. The weight allowed on any series of axles can be computed by the following formula:

Distance in Feet Between First and Last Axles in the Group	Weight Allowed (In Pounds)
7 feet to less than 10 feet, multiply	(Feet) x 6,500
10 feet to less than 30 feet	(Feet plus 20) x 2,200
30 feet or greater	(Feet plus 40) x 1,600

- Bridge restrictions may limit single axle capacities to 21,500 pounds or less on selected highways.

The lesser of any of these calculations will govern the capacity of any series of axles.

The weight on a single axle (at 600 pounds per inch tire width) may be up to 45,000 pounds if the equipment being moved has single pneumatic tires having a rim width of 20 inches or more and rim diameter of 24 inches or more, or dual pneumatic tires having a rim width of 16 inches or more and rim diameter of 24 inches or more. Specially designed vehicles manufactured and certified for special permits prior to July 1, 1975, may also be allowed.

Over Axle Permit (Overweight)

An over axle permit is for a load that falls within the legal gross weight, but axle(s) is over the legal weight limit. Over axle weight on an axle would be weight exceeding 20,000 pounds on a single axle and 34,000 pounds on a set of tandems. Tridem weight would depend on the measurement between the three axles. After determining the distance, check the vehicle weight table to see what the legal capacity would be. The price of the permit is calculated with the amount of weight over the legal axle weight and the number of miles to be traveled.

Heavy Haul Corridor-Overweight Sealed Container

The department may issue special permits to vehicles operating in the heavy haul industrial corridor at the Port of Tacoma to carry weight in excess of weight limitations established in [RCW 46.44.041](#). However, the excess weight on a single axle (22,000), tandem axle (43,000), or any axle group must not exceed that allowed by [RCW 46.44.091\(1\)](#) and [\(2\)](#), weight per tire must not exceed 600 pounds per inch width of tire, and gross vehicle weight must not exceed 105,500 lbs.

An overweight sealed container used in international trade, including its contents, is considered non divisible when transported within a heavy haul industrial corridor, such as SR 509 between milepost .25 in the vicinity of East “D” Street and milepost 3.88 in the vicinity of Taylor Way.

Manufactured Homes (Mobile Home)

[\(WAC 468-38-120\)](#)

A Manufactured Home (transported on its own axles) including tongue may not exceed 75 feet. The width may not exceed a box (base) width of 16 feet.

The eave(s) for a box of less than 16 feet may not exceed 30 inches. The eave(s) for a 16-foot box may not exceed 16 inches. The total width (box and eaves) must not exceed 18 feet.

Permits with widths up to 14 feet wide are governed by the Manufactured Home Movement Route map. The Department of Transportation reviews moves that are greater than 15 feet wide and/or 16 feet high on a case-by-case basis.

Modular Homes

Modular homes are transported on registered/licensed trailers, and are not treated like mobile homes. They must comply with all standard oversize load codes and regulations.

The manufactured home-restricted map does not apply to modular homes.

Permit Fees

[RCW 46.44.0941](#) lists the various types of permits that may be issued, and the fees to be charged for them:

All over legal loads, except overweight, single trip.	\$10.00
Continuous operation of over legal loads having either overwidth and/or overheight features only, for a period not to exceed 30 days.	\$20.00
Continuous operation of over legal loads having over length only, for a period not to exceed 30 days.	\$10.00
Continuous operation of a combination of vehicles having one trailing unit that exceeds 53 feet and is not more than 56 feet in length, for a period of one year.	\$100.00
Continuous operation of a combination of vehicles having two trailing units which together exceed 61 feet and are not more than 68 feet in length, for a period of one year.	\$100.00
Continuous operation of a three-axle fixed load vehicle having no more than 65,000 pounds gross weight, for a period not to exceed 30 days.	\$70.00
Continuous operation of a four-axle fixed load vehicle meeting the requirements of RCW 46.44.091(1) and weighing no more than 86,000 pounds gross weight, not to exceed 30 days.	\$90.00
Continuous movement of a mobile home or manufactured home having nonreducible features not to exceed 85 feet in total length and 14 feet in width, for a period of one year.	\$150.00
Continuous operation of a Class C tow truck or a Class E tow truck with Class C rating while performing emergency and non-emergency tows of oversize or overweight, or both, vehicles and vehicle combinations, under rules adopted by the Transportation Commission, for a period of one year.	\$150.00
Continuous operation of a Class B tow truck or a Class E tow truck with a Class B rating while performing emergency and non-emergency tows of oversize or overweight, or both, vehicles and vehicle combinations, under rules adopted by the Transportation Commission, for a period of one year.	\$75.00
Continuous operation of a two- or three-axle collection truck, actually engaged in the collection of solid waste or recyclables, or both, under Chapter 81.77 or 35.21 RCW or by contract under RCW 36.58.090 , for one year with an additional 6,000 pounds more than the weight authorized in RCW 46.16.070 on the rear axle of a two-axle truck or 8,000 pounds for the tandem axles of a three-axle truck. RCW 46.44.041 and RCW 46.44.091 notwithstanding, the tire limits specified in RCW 46.44.042 apply, but none of the excess weight is valid or may be permitted on any part of the federal interstate highway system.	\$42.00 per 1,000 pounds
Sealed Container Heavy Haul Corridor Weight Permit (Monthly)	\$100.00
Sealed Container Heavy Haul Corridor Weight Permit (Annual)	\$1,000.00
<i>Permits for weight may not be issued for periods greater than listed above.</i>	

Overweight Fee Schedule

(RCW 46.44.0941)

Weight Over Maximum Legal Capacity in Pounds	Fee Per Mile on State Highways
1 to 9,999	\$.07
10,000 to 14,999	\$.14
15,000 to 19,999	\$.21
20,000 to 24,999	\$.28
25,000 to 29,999	\$.35
30,000 to 34,999	\$.49
35,000 to 39,999	\$.63
40,000 to 44,999	\$.79
45,000 to 49,999	\$.93
50,000 to 54,999	\$1.14

Weight Over Maximum Legal Capacity in Pounds	Fee Per Mile on State Highways
55,000 to 59,999	\$1.35
60,000 to 64,999	\$1.56
65,000 to 69,999	\$1.77
70,000 to 74,999	\$2.12
75,000 to 79,999	\$2.47
80,000 to 84,999	\$2.82
85,000 to 89,999	\$3.17
90,000 to 94,999	\$3.52
95,000 to 99,999	\$3.87
100,000*	\$4.25

*The fee for weights in excess of 100,000 pounds is \$4.25 plus 50 cents for each 5,000 pound increment or portion thereof exceeding 100,000 pounds.

Provided:

- The minimum fee for any overweight permit shall be \$14.00.
- The fee for issuance of a duplicate or transfer permit shall be \$14.00.
- When computing overweight fees that result in an amount other than even dollars, the fee shall be carried to the next full dollar if 50 cents or over and shall be reduced to the previous dollar if 49 cents or under.

Special Motor Vehicle Permit Regulations and Conditions

A signed copy of the permit must be carried in the power unit at all times.

Pilot/Escort Vehicle Requirements

An escort vehicle and operator must comply with the requirements of [WAC 468-38-100](#) *Escort Vehicle Requirements*. Escort vehicles are required per [WAC 468-38-100](#) when:

1. The vehicle(s) or load is over 11 feet wide. Two pilot/escort vehicles are required on two-lane roads, one in front and one in back.
2. The vehicle(s) or load is over 14 feet wide. One escort vehicle is required at the rear of the movement on multi-lane highways.
3. The vehicle(s) or load is over 20 feet wide. Two pilot/escort vehicles are required on multi-lane undivided highways, one in front and one in back.
4. The trailer length, including load, of a tractor/trailer combination exceeds 105 feet, or when the rear overhang of a load measured from the center of the rear axle exceeds one-third of the trailer length plus load of a tractor/trailer or truck/trailer combination. One pilot/escort vehicle is required at the rear of the movement on two-lane highways.
5. The trailer length, including load, of a tractor/trailer combination exceeds 125 feet. One pilot/escort vehicle is required at the rear of the movement on multi-lane highways.

6. The front overhang of a load measured from the center of the front steer axle exceeds 20 feet. One pilot/escort vehicle is required at the front on all two-lane highways.
7. The rear overhang of a load on a single unit vehicle, measured from the center of the rear axle, exceeds 20 feet. One pilot/escort vehicle is required at the rear of the movement on two-lane highways.
8. The height of the vehicle(s) or load exceeds 14 feet 6 inches. One pilot/escort vehicle with height measuring device (pole) is required at the front of the movement on all state highways and roads.
9. The vehicle(s) or load exceeds twelve feet in width on a multilane highway and has a height that requires a front pilot/escort vehicle: One rear pilot/escort vehicle is required.
10. The operator, using rearview mirrors, cannot see 200 feet to the rear of the vehicle or vehicle combination.
11. In the opinion of the department, a pilot/escort vehicle(s) is necessary to protect the traveling public. Assignments of this nature must be authorized through the department's administrator for commercial vehicle services.

Curfew Hours

Days When Travel is Restricted

Vehicles operating under special permit for overweight/over dimensional, except as provided for in [WAC 468-38-075](#), may be restricted from the state highways on the holidays of New Year's Day, Memorial Day, Independence Day, Labor Day, Thanksgiving Day and the day after Thanksgiving, Christmas Day, and commencing at noon of the day preceding said holidays.

Nighttime Movements

A vehicle or vehicle combinations not exceeding the defined envelope of 12 feet wide, 14 feet 6 inches high and 105 feet long, including legal overhang(s), may move at night. A vehicle or vehicle combination which exceeds the defined envelope may also be permitted to move at night on state highways subject to department preferred hours/routes of travel, and must have "Nighttime movement approved" stated on permits. All night moves must comply with published curfew restrictions. Night means one-half hour after sunset to one-half hour before sunrise. Vehicle and load must have proper lighting (49 CFR 393.11).

Winter Road Restrictions

Movement by permit is prohibited in areas where any of the following signs are displayed: "TRACTION ADVISORY/OVERSIZED VEHICLES PROHIBITED," "CHAINS REQUIRED ON ALL VEHICLES EXCEPT ALL-WHEEL DRIVE," "VEHICLES OVER 10,000 GVWR CHAINS REQUIRED" except vehicles with specific permits listed in [WAC 468-38-075](#).

Permit Refund Policy

Refunds will only be made in cases of department initiated error.

Other Regulations

Other regulations relating to the movement of permitted loads are printed in [Chapter 468-38 WAC](#) (Washington Administrative Code).

Use of County Roads or City Streets

The use of county roads or city streets is subject to approval by the jurisdiction that maintains those roadways. This permit from the State of Washington in no way authorizes the use of roadways under local jurisdiction, but if applicable, county/city miles must be included on state permit.

Consult the chart on [page 4-27](#) for a list of counties and cities along with the appropriate phone numbers to call before moving oversize or overweight loads on county roads.

Warning: Rules are subject to change. Holders of monthly or annual permits are subject to current rule. Rules, as described herein, should be periodically reviewed for updates to insure compliance on Commercial Vehicle Services website at www.wsdot.wa.gov/commercialvehicle.

Commuter Curfew Hours

Below is a page from WSDOT Form 560-002 depicting the current commuter curfew hours by vicinity, direction, location, hours, and width of vehicle.

Commuter Curfew Hours: (Monday through Friday only)

Vehicles operating under a Special Motor Vehicle Permit that are required to display "Oversize Load" signs are restricted from the following areas during the listed times (table). Exception: Vehicles with over dimension in width only and do not exceed the width limits of the table are not subject to curfew hours. Over weight is not a factor in this restriction unless the vehicle cannot maintain the speed of surrounding traffic.

Vicinity	SR	Direction	Mile Post	Location and Boundaries	Hours (M-F)	Width
Seattle- Everett	2	EB	0 - 2.42	I-5 to SR 204	3-7 PM	9'
		WB	2.42 - 0		6-9 AM	9'
	5	NB	127.48 - 155.94	SR 512 to SR 599	6-9 AM, 3-6 PM	10'
		SB	155.94 - 127.48		3-6 PM	10'
		NB	155.94 -174.58	SR 599 to SR 523	6-9 AM, 3-6 PM	9'
		SB	174.58 - 155.94		6-9 AM, 3-6 PM	9'
		NB	174.58 -199.11	SR 523 to SR 528	3-6 PM	10'
		SB	199.11 - 174.58		6-9 AM, 3-6 PM	10'
		NB	199.11 - 206.08	SR 528 to SR 531	4-6 PM	10'
		SB	206.08 - 199.11		7-9 AM, 4-6 PM	10'
	18	EB	.01 - 4.15	I-5 to SR 164	6-9 AM, 3-7 PM	10'
		WB	4.15 - .01		6-9 AM, 3-7 PM	10'
		EB	4.15 -11.38	SR 164 to SR 516	6:30-8:30 AM, 3-7 PM	10'
		WB	11.38 - 4.15		6-9 AM, 3-7 PM	10'
	90	EB	2.54 - 9.93	I-5 to I-405	6-9 AM, 3-7 PM	10'
		WB	9.93 - 2.54		6-9 AM, 3-7 PM	10'
		EB	9.93 -18.36	I-405 to Sunset I/C	3-7 PM	10'
		WB	18.36 - 9.93		6-9 AM, 3-7 PM	10'
	167	NB	5.98 - 14.33	SR 512 to SR 18	6-9 AM	10'
		SB	14.33 - 5.98		3-7 PM	10'
NB		14.33 - 26.29	SR 18 to I-405	6-9 AM, 3-7 PM	10'	
SB		26.29 - 14.33		3-7 PM	10'	
405	NB	0 - 30.32	Entire Route	6-9 AM, 3-7 PM	10'	
	SB	30.32 - 0		6-9 AM, 3-7 PM	10'	
518	EB	0 - 3.81	SR 509 to I-5	6-9 AM, 3-7 PM	10'	
	WB	3.81 - 0		6-9 AM, 3-7 PM	10'	
522	EB	11.10 - 14.09	I-405 to SR 9	3-7 PM	10'	
	WB	14.09 - 11.10		6-9 AM	10'	
Tacoma	5	NB	118 - 127.48	Exit 118 to SR 512	6:30-8:30 AM, 4-6 PM	10'
		SB	127.48 - 118		6:30-8:30 AM, 4-6 PM	10'
	16	EB	10.28 - 0	I-5 to Olympic Drive	6-9 AM	10'
		WB	0 - 10.28		3-7 PM	10'
	512	EB	0 - 8.74	I-5 to SR 161	3-7 PM	10'
		WB	8.74 - 0		7-9 AM, 3-7 PM	10'
	EB	8.74 - 12.06	SR 161 to SR 167	3-7 PM	10'	
	WB	12.06 - 8.74		3-7 PM	10'	
Olympia	5	NB	99 - 109	Exit 99 to Exit 109	4-6 PM	10'
		SB	109 - 99		4-6 PM	10'
Vancouver	5	NB	0 - 7.48	Oregon to I-205	3-6 PM	10'
		SB	7.48 - 0		6-9 AM	10'
	205	NB	26.59 - 37.16	Oregon to I-5	4-7 PM	10'
		SB	37.16 - 26.59	I-5 to Oregon	6-9 AM	10'
Kelso	433	NB	.94 - 0	Lewis and Clark Bridge	6-9 AM	10'
		SB	0 - .94		6-9 AM	10'
Spokane	90	EB	272.66 - 295.73	Medical Lk. to Liberty Lk. Exit	6-9 AM, 3-7 PM	11'2"
		WB	296.64 - 272.96	Liberty Lk. to Medical Lk. Exit	6-9 AM, 3-7 PM	11'2"

Western Regional Permit System

A number of western states have entered into an agreement which authorized the issuance of regional oversize/overweight permits. One of the member states where the load is beginning, ending, or passing through may issue an oversize/overweight permit which authorizes travel for all member states if the vehicle does not exceed the sizes and weights of the envelope vehicle and it is operating on approved routes. The Regional Permit may be obtained through the following locations:

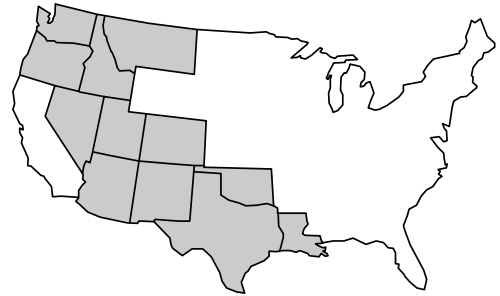

Commercial Vehicle Services Office

360-704-6340

Arizona

602-712-8851

Montana

406-444-7262

Oregon

503-373-0000 Option 1

Colorado

303-757-9539

Nevada

775-888-7410

Texas

1-800-299-1700 Option 1, 3

Idaho

208-334-8420

New Mexico

505-476-2475

Utah

801-465-4892

Louisiana

1-800-654-1433

Oklahoma

405-522-9002 Option 2

State of Issuance

A regional permit may be issued by the origin, pass through, or destination state. The state of issuance will collect the fees for all member states in which the vehicle is permitted for travel.

Envelope Vehicle

The vehicles operating on a regional oversize/overweight permit must comply with the following requirements and maximum dimensions:

- Length: 110 feet overall
- Width: 14 feet
- Height: 14 feet
- Weight:
 - 600 pounds per inch of tire width
 - 21,500 pounds per single axle
 - 43,000 pounds per tandem axle
 - 53,000 pounds per tridem (wheelbase more than 8 feet, but not more than 13 feet)
 - 160,000 pounds gross weight
 - Axle, group axle weights, or the weight specified by the permit, whichever is less
 - A minimum of five axles is required for the issuance of a regional overweight permit

Special Conditions

The member states have developed a list of special conditions within each state, which apply to the operation of the envelope size vehicle. This list must be attached to all regional oversize/overweight permits.

Superloads

(WAC 468-38-405)

Loads over 200,000 pounds gross weight, over 16 feet high, 16 feet wide, and/or 125 feet trailer load length will require special review and must submit written applications before a permit will be issued. The following information is required to move a superload:

- Describe the purpose of the movement and explain how the public will be served by the movement.
- Submit documentation from private or public entity that the move is necessary.
- You must also demonstrate that movement by other methods of transportation for all or part of the trip is not reasonable.
- Provide a sketch or photograph detailing why it cannot be reduced.
- Provide a sketch of the loaded vehicle configuration showing axle loadings, axle spacing, tire sizes, tires per axle, width, height, and length.
- Propose a route that will handle the height and width of the unit and appears adequate to handle the weight of the vehicle and load. If the route includes the use of county roads or city streets, you must show that permits for the county and/or city will be issued.
- Submit a traffic control plan including the speed, the route, escort vehicle requirements, the times of movement, and the traffic control to ensure safe movement.
- If the department agrees the move is necessary, they will begin an analysis of bridges and pavements along your route. You may be required to pay for this analysis if the time used by the WSDOT staff in conducting this study becomes longer than normally allowed.
- If the analysis shows the bridges or pavement to be inadequate to handle the load, the permit request will be denied. If, however, the structures might be strengthened to support the load, and agreement to do so at your expense is settled upon, a permit may be granted.

Farm Implements

(WAC 468-38-290 and RCW 46.44.130 and 46.44.140)

Farm implement means any device that directly affects the production of agricultural products. For purposes of this section, it must meet the following specifications:

- Must weigh less than 65,000 pounds.
- Be equipped with pneumatic tires or hard rubber tracks having protuberances that will not cause damage to the highway.
- Less than 20 feet wide.
- Less than 16 feet in height in most counties.

Farm Permit Requirements – Farmers/Implement Dealers

A farm implement 16 feet wide or less does not require a permit when traveling on the highway system. A farm implement permit can be issued from over 16 feet wide, but less than 20 feet wide for one year.

A quarterly or annual permit to move farm implements may be purchased by a farmer or by a person engaged in the business of selling or maintaining farm implements to move within a designated area, generally three to four counties. The permit is required to be physically present at the time of movement.

An original or faxed permit will allow the person or company identified on the permit to draw, drive, or haul any farm implement on state highways.

For farm implements over 16 feet wide, less than 16 feet in height, and less than 20 feet wide, a letter must be submitted for approval to the following address. The counties must be specified.

Commercial Vehicle Services
7345 Linderson Way SW
PO Box 47367
Olympia, WA 98504-7367

Email: cvspermits@wsdot.wa.gov
Fax: 360-704-6391

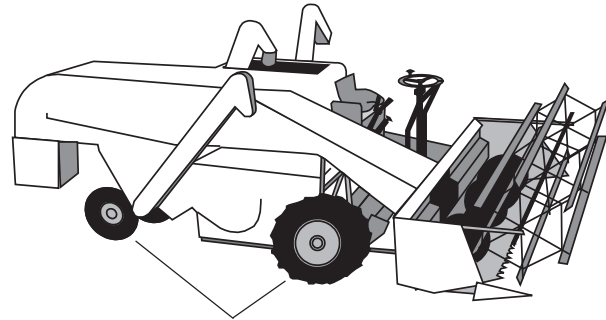

Pneumatic tires or hard rubber tracks.

Safety Requirements for Moving Farm Implements

Oversize Signs

If the farm implement exceeds 10 feet wide, it must display “OVERSIZE LOAD” sign(s) visible to both oncoming and overtaking traffic. Signs must comply with the requirements of [WAC 468-38-155](#). If the implement is both preceded and followed by escort vehicles, a sign will not be required on the implement itself.

Curfew/Commuter Hours

Movement of a farm implement in excess of 10 feet wide must also comply with any published curfew or commuter hour restrictions.

Red Flags

If the farm implement, moving during daylight hours, exceeds 10 feet wide, the vehicle configuration must display clean, bright red flags at least 18 inches square, so as to wave freely at all four corners, or extremities, of the overwidth implement and at the extreme ends of all protrusions, projections, or overhangs.

Warning Lights

Lamps and other lighting must be in compliance with [RCW 46.37.160](#) (hazard warning lights and reflectors on farm equipment). The slow moving vehicle emblem is for equipment moving at a speed of 25 miles per hour or less.

Convoys

Farm implement convoys shall maintain at least 500 feet between vehicles to allow the traveling public room to pass safely. If five or more vehicles become lined up behind an implement, escorted or unescorted, the driver/operator of the transported implement, and escorts, if any, shall pull off the road at the first point wide enough to allow traffic to pass safely. Convoying of farm implements is permitted with properly equipped escort vehicles.

Escort Vehicles

In general, the use of escort vehicles must comply with [WAC 468-38-100](#) (Pilot/Escort Vehicle and Operator Requirements).

Road Posting

Posting signs along a route may be used in lieu of escort vehicles if the route to be traveled is less than 2 miles.

Farm Permit Fees

Farmers in the course of farming activities, for any three-month period	\$10.00
Farmers in the course of farming activities, for a period not to exceed one year	\$25.00
Persons engaged in the business of the sale, repair, or maintenance of such farm implements, for any three-month period	\$25.00
Persons engaged in the business of the sale, repair, or maintenance of such farm implements, for a period not to exceed one year	\$100.00

Procedures for the Movement of Over Legal Vehicles/Loads in Emergency Conditions

Purpose

The following procedures are provided in order for state, and other jurisdictions, to safely secure the equipment necessary to mitigate the proclaimed emergency. Failure to comply with these procedures may result in compounding the emergency by damaging or eliminating available accesses.

Criteria

- Emergent conditions where life or property is in immediate danger, including, but not limited to, oil spills, train derailment, power outages, or storm damage.
- All size and weight criteria, found in [RCW 46.44](#) and [WAC 468-38](#), for the permitted transport of over legal vehicles/loads must be met.

Procedures

During Non-Business Hours, self-issue or contact one of the 24-hour, 7-days a week Agent to request permit. If unable to contact Agent, notification of emergency over legal vehicle/loads must be made to one of the following five Traffic Management Centers (TMCs):

Seattle
206-440-4490

Vancouver
360-905-2269

Spokane
509-343-6401

Tacoma
253-536-6089

Yakima
509-577-1910

The carrier must furnish the following information to TMC:

1. Proposed route.
2. Description of vehicle and/or load being transported.

A tracking number will be given to the carrier over the phone. A permit will be issued on the following business day. The TMC will inform the carrier to check Road Restrictions and Bridge Restrictions listed on the Commercial Vehicle Services website to ensure the route and structures, if any, can accommodate the move. If TMC was contacted you must notify Commercial Vehicle Services the following business day at 360-704-6340.

Refuse Collection Trucks

Two-axle collection trucks may be issued a permit authorizing an additional 6,000 pounds on the rear axle. Three-axle collection trucks may be issued a permit authorizing an additional 8,000 pounds on the rear tandem axles. The wheelbase distance need not meet the lengths required in [RCW 46.44.041](#).

This permit is not valid on interstate highways and tire size limits apply ([RCW 46.44.042](#)). The basic fee for collection trucks is \$42 per thousand pounds per year.

A copy of the collection truck restricted bridge list must be attached to the permit.

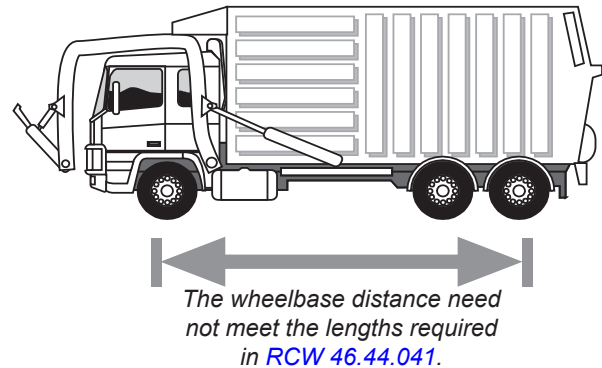

Tow Trucks

Moves are defined as being hired to move a specific job (not a hazard). No special privilege for obtaining these permits will be granted under normal circumstances. The permit must be in hand and obtained from a local permit office. These moves are NOT exempt for size and weight. If a permit agent is not nearby, or just for faxing convenience, the Washington Trucking Association is available by phone, providing facsimile services.

Annual Tow Truck permits ([WAC 468-38-265](#)) are available to Class B and Class C tow trucks. These permits can be used for emergent and non-emergent tows. Annual Tow Truck permits allow extra weight but vehicles are not to exceed:

- 600 pounds per inch of tire width up to 22,000 pounds per single axle; or
- 43,000 pounds per tandem axle set; or
- The weight allowed for axle groups per formula in [RCW 46.44.091](#).

These permits will authorize up to 10 feet wide for disabled vehicles that have been disfigured by an accident or collision.

If towing company does not have an annual tow truck permit:

- **Emergent Tow** – Self issue or contact one of the 24-hour, 7-days a week Agents request permit.

Note: Emergent tow truck moves may be made without a permit only when instructed to do so by a law enforcement officer. These moves have specific requirements and are outlined in [WAC 204-91A-30\(6\)](#). Emergent in this section means a disabled vehicle on any public highway, including shoulders and access ramps.

Crossing Puget Sound Via Washington State Ferries

Warning – Ferry Travel – Call Prior to Traveling: Commercial vehicles planning on using Washington State Ferries (WSF) must take special precautions. This requirement is due to the numerous variables associated with traveling on marine highways, such as: terminal, dock, and/or boat load capacities; tidal activity which affects the angle of the loading ramp; and, preferential loading policies. Vehicles registered with a GVW in excess of 80,000 pounds, or exceed 13 feet 4 inches in height measured from the road bed, or exceed 8 feet 6 inches in width at the widest point, or in excess of 85 feet bumper to bumper, must have travel permission from WSF. **This requirement is also true if the vehicle is operating under a Special Motor Vehicle Permit for oversize or overweight loads as authorized by RCW 46.44.**

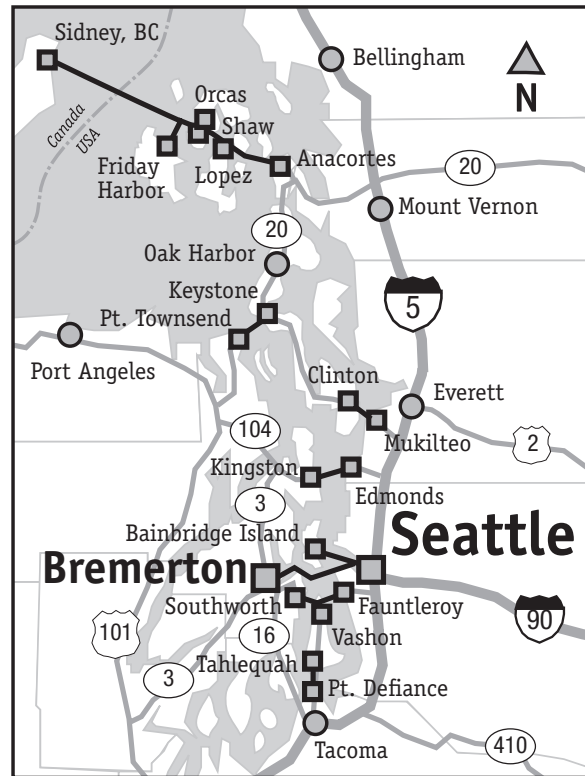

To receive approval, contact WSF Information Staff (see phone numbers on next page) allowing at least one business day to process your request. Staff is available to assist from 7:00 am to 5:00 pm, Monday to Friday”.

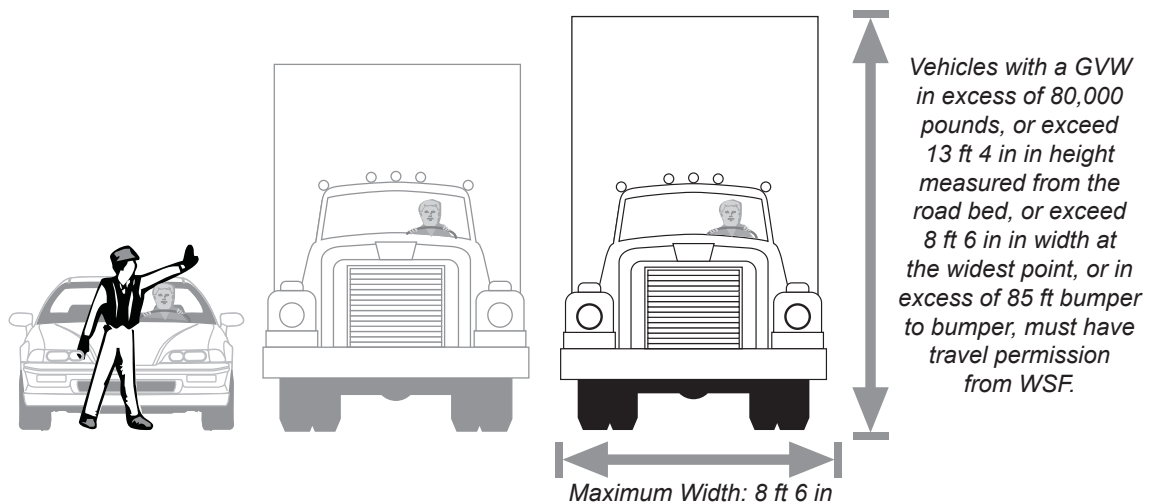

Be prepared to provide the following information (forms are available):

- Gross weight.
- Total length of vehicle or vehicle combination.
- Height from road to highest point.
- Width at widest point on vehicle.
- Ground clearance from road to lowest point on vehicle.
- Number of axles.
- Weight per axle, with load, for the trip in question.

WSF Ferry Travel Request/Permit

If the vehicle has a registered GVW for more than 80,000 pounds, but the vehicle and load for the trip in question are under 80,000 pounds, and all height and width criteria are met, the operator may display a dated and printed weight slip, verifying the GVW, in lieu of contacting the WSF for written approval. All other vehicles more than 80,000 pounds, but less than 105,000 pounds, that meet the height and width criteria, must present an approved WSF Ferry Travel Request/Permit. These vehicles will be provided access on a first come, first served basis.

WSDOT Special Motor Vehicle Permit — WSF Ferry Travel Request/Permit

Vehicles operating under a Special Motor Vehicle Permit, as authorized by [RCW 46.44](#), for oversize or overweight loads must receive prior approval from WSF before securing a WSDOT Special Motor Vehicle Permit for trips including travel on a ferry route. If the request is approved, it will include a specific sailing, scheduled with the customer on a priority basis. If the sailing is missed or canceled, the trip must be rescheduled with WSF.

Hazardous Materials

Federal regulations (49 CFR) prohibit the transport, by ferries while carrying passengers, such as, but not limited to, the following common compressed gases: commercial propane, butane, acetylene, and gasoline. Hazardous material charters are available and request for charters must be made seven days in advance to allow time for securing a charter agreement.

Tank trucks must demonstrate that cargo being carried meets the requirements of 49 CFR and any empty tank truck must certify that they are vapor free prior to being allowed to board the ferries.

Contacting Washington State Ferries

For more detailed information, the following phone numbers are provided:

Automated message on basic travel conditions (in state use only).	511
WSF Information Agents and transfer to terminals for local and outside of state.	206-464-6400
For travel requests (7 days a week, 7:00 a.m. to 7:00 p.m.).	1-888-808-7977
WSF customer service agent to work with truck requests.	206-390-8543 Fax: 206-515-3846
Internet Website	www.wsdot.wa.gov/ferries

Location of Offices and Agencies Issuing WSDOT Permits

DOT Offices

HQ-Tumwater	360-704-6340	Mount Vernon	360-848-7230
Bellevue	425-739-3730	Okanogan	509-826-7364
Bellingham	360-788-2500	Pasco	509-545-2202
Chehalis	360-740-8640	Port Angeles	360-565-0680
Cle Elum	509-674-4443	Port Orchard	360-874-3050
Colfax	509-397-3051	Raymond	360-942-2092
Colville	509-684-7434	Spokane	509-324-6566
Davenport	509-324-6583	Tacoma	253-983-7550
Ephrata	509-754-2056	Walla Walla	509-527-4548
Everett	425-258-8300	Wenatchee	509-667-2802
Goldendale	509-773-4533	Yakima	509-577-1920
Kent	253-372-3900	Vancouver	360-905-2133

Agents

Better Weigh Mfg	360-864-6800
Comdata Inc.	800-749-7166
Hoquiam Licensing & Transportation	360-532-5912
The Permit Company	323-475-1601
VitalChek Network Inc DBA	615-372-6850
WTA Services Inc	253-838-1650
Permit America Inc.	502-695-5852 ×232
T-Chek Systems Inc	877-237-2435
US Permit Services & Consulting	888-453-3763
Reliable Permit Solutions LLC	909-436-4220
Transport Permits of Des Moines, Inc DBA	515-327-6260
JJ Keller & Associates Inc.	920-722-2848 ×7401
Transport Permits Ltd	319-235-9033 ×17
Coast 2 Coast Trucking Permits, LLC	865-963-0821
On the Move Permits Inc	727-942-2006
WCS Permits	626-930-9292
Glostone Trucking Solutions	503-607-1088
State Permits Inc	330-497-0446
Jet Permit Ltd	800-788-0603

Permits not available at Ports of Entry

Washington State County/City Permit Approval*

County

Adams	509-659-3276	Lewis	360-740-1122 360-740-1123
Benton	509-786-5611	Lincoln	509-725-7041
Chelan	509-667-6415	Mason	360-427-9670 ×450
Clallam	360-417-2379	Okanogan	509-422-7300
Clark	360-397-2434	Pacific	360-875-9368
Columbia	509-382-2534	Pend Oreille	509-447-4513
Cowlitz	360-577-3030	Pierce	253-798-3687
Douglas	509-884-7173	San Juan	360-370-0500
Ferry	509-775-5222	Skagit	360-416-1400
Franklin	509-545-3514	Skamania	509-427-3920
Garfield	509-843-1301	Snohomish	425-388-6453
Grant	509-754-6082	Spokane	509-477-3600
Grays Harbor	360-533-4333	Stevens	509-684-4548
Island	360-679-7331	Thurston	360-867-2300
Jefferson	360-385-0890 360-385-9160	Walla Walla	509-524-2710
King	206-477-6531	Whatcom	360-676-6730
Kitsap	360-337-5777	Whitman	509-397-4622
Kittitas	509-962-7523	Yakima	509-574-2300
Klickitat	509-773-4616		

City

Aberdeen	360-537-3218	Redmond Police Dept.	425-556-2570
Bellevue	425-452-4617 425-452-4599	Renton	425-430-7266
Bellingham	360-778-8300	Richland	509-942-7742 509-942-7790
Bremerton	360-473-5270	Ritzville	509-659-1930
Centralia	360-330-7512	Seattle	206-684-5086 206-684-5313
Chehalis	360-748-0271 360-748-0238	Spokane	509-625 7749
Everett	425-257-8810, press 7 425-257-7790	Stevenson	509-427-5970
Kennewick	509-585-4247	Tacoma	253-591-5479
Kent	253-856-5300	Vancouver	360-487-7800, press 2
Longview	360-442-5200	Woodinville	425-489-2754, press 1
Mercer Island	206-236-3580	Yakima	509-575-6126
Olympia	360-753-8419		

**Not all cities and counties (i.e., Wahkiakum County) have formal permit systems, although the cities listed above do. If a carrier wants to move a heavy or over dimensional load in other cities, the carrier should call the city hall of the city maintaining the highways for approval. Note: This list was up-to-date at the time of printing; however, telephone numbers are subject to change.*

Washington State Ports of Entry**Bow Hill Port of Entry**

235 Interstate 5 SB
Bow, WA 98232
360-766-6196

Ridgefield Port of Entry

29317 Interstate 5 NB
Ridgefield, WA 98642
360-887-8231

Spokane Port of Entry

Rural Rt. 1 I-90 WB MP 297
Liberty Lake, WA 99019-9801
509-838-9400

Plymouth Port of Entry

143302 East Law Lane
Kennewick, WA 99337-2002
509-734-7043

All trucks with a GVW greater than 16,000 pounds are required to stop at scales when “open.”

Chapter 5

Alcohol Misuse and Substance Abuse Testing

(49 CFR, Part 382)

Under the Uniform Commercial Driver's Act, operating a commercial motor vehicle within Washington State with a controlled substance in your system is illegal.

Safety Sensitive Functions

(49 CFR, Part 382)

Under federal regulations, you may not perform any safety sensitive functions while:

- Using alcohol.
- Having a breath alcohol concentration of 0.02 percent or greater.
- Within four hours after using alcohol.
- Post-accident alcohol test—alcohol use prohibited until post-accident test completed or eight hours has elapsed.
- Refusing to submit to alcohol test.

Safety sensitive functions are defined in 49 CFR, Part 382.107 as follows:

- Time at a carrier or shipper plant, terminal facility, or other property, waiting to be dispatched, unless the driver has been relieved from duty by the employer.
- Time inspecting equipment as required by 49 CFR, 392.7 and 392.8, or otherwise inspecting, servicing, or conditioning a commercial motor vehicle.
- Time spent in or on any commercial vehicle. You may use the sleeper berth.
- Time spent loading or unloading a vehicle, supervising or assisting in the loading or unloading, attending a vehicle being loaded or unloaded, remaining in readiness to operate the vehicle, or in giving or receiving receipts for shipments loaded or unloaded.
- Time spent repairing, obtaining assistance, or remaining in attendance upon a disabled vehicle.
- All time spent at the controls of a commercial motor vehicle in operation.

Alcohol tests are required for the following:

- **Post-Accident** – Conducted after accidents on drivers when required by 49 CFR 382.303.
- **Reasonable Suspicion** – Conducted when a trained supervisor or company official observes behavior or appearance that is characteristic of alcohol misuse.
- **Random** – Conducted on a random, unannounced basis just before, during, or just after the performance of safety sensitive functions.
- **Return to Duty and Follow-Up** – Conducted when an individual who has violated the prohibited alcohol conduct standards returns to performing safety sensitive duties. Follow-up tests are unannounced and at least six test must be conducted in the first 12 months after a driver returns to duty. Follow-up testing may last up to 60 months after returning to duty.

Note: Rules no longer require pre-employment alcohol testing, but they also do not prevent the employer from doing so.

Random Testing for Alcohol

- Must be conducted just before, during, or just after a driver's performance of safety sensitive duties.
- The driver is randomly selected for testing—usually from a “pool” of drivers subject to testing.
- Tests are unannounced and are with unpredictable frequency throughout the year.
- The minimum annual percentage rate for random alcohol testing shall be 10 percent of the average number of driver positions.
- Must be done using evidential breath testing devices approved by the National Highway Traffic Safety Administration (NHTSA).
- Two breath tests are required to determine if a person has a prohibited alcohol concentration. A screening test is conducted first. Any result less than 0.02 alcohol concentration is considered a “negative” test. If the alcohol concentration is greater than 0.02, but less than 0.04 (24 hours off), if greater than 0.04, a second confirmation test is conducted.
- The driver and the individual conducting the breath test complete the alcohol testing form to ensure that the results are properly recorded.
- Confirmation test results determine actions taken.
- Employers are responsible for implementing and conducting the testing programs. They may do this using their own employees, contract services, or by joining together in a consortium that provides services to all member companies.

Consequences of Alcohol Misuse

- If you engage in prohibited alcohol conduct you must be immediately removed from safety sensitive functions.
- You cannot return to safety sensitive duties until you have been evaluated by a substance abuse professional and complied with any treatment recommendations.
- If you have alcohol in your system (defined as greater than 0.02 but less than 0.04) when tested, you must be removed from safety sensitive functions for 24 hours.
- [RCW 46.25.110](#) states:
 - You may not drive, operate, or be in physical control of a commercial motor vehicle while having alcohol in your system.
 - Law enforcement must place you out-of-service for 24 hours when you drive, operate, or are in physical control of a commercial motor vehicle while having alcohol in your system.
- [RCW 46.25.120](#) states:
 - That if you operate a commercial motor vehicle within Washington, you have given consent, subject to [RCW 46.61.506](#), to take a test or tests of your blood or breath for the purpose of determining your alcohol concentration or the presence of other controlled substances.
- Employers must provide detailed information about alcohol misuse, the employer's policy, the testing requirements, and how and where drivers can get help for alcohol misuse.
- Supervisors of safety-sensitive drivers must attend at least one hour of training on alcohol misuse symptoms and indicators used in making determinations for reasonable suspicion testing.

- The employer is not required to provide rehabilitation, pay for treatment, or reinstate the driver in his or her safety sensitive position.
- Driver alcohol testing records are confidential.

Rules Relating to Controlled Substances

Controlled substance testing rules have been in effect since November 1988 for interstate drivers. The WUTC adopted the controlled substance rules for Washington intrastate drivers in June and July of 1994. The Federal Motor Carrier Safety Administration's (FMCSA) new rules related to controlled substance testing split samples became effective on August 15, 1994.

Controlled substance testing rules cover the same drivers as alcohol testing rules.

Types of Tests Required

- Pre-employment
- Random
- Reasonable suspicion
- Return to duty
- Post-accident
- Follow-up

Controlled substance testing is conducted by analyzing a driver's urine specimen. The driver provides a urine specimen in a location that affords privacy and the "collector" seals and labels the specimen, completes a chain of custody document, and prepares the specimen and accompanying paperwork for shipment to a controlled substance testing lab.

Analysis is performed at laboratories certified and monitored by the U.S. Department of Health and Human Services (DHHS). There are over 90 DHHS labs located throughout the United States. A list of DHHS approved labs is published monthly in the Federal Register.

Specimens Analyzed

Specimens are analyzed for the following controlled substances:

- Marijuana (THC metabolite)
- Cocaine
- Amphetamines
- Opiates (including heroin)
- Phencyclidine (PCP)

All controlled substance test results are reviewed and interpreted by a Medical Review Officer (MRO) before they are reported to the employer.

Controlled substance rules prohibit any unauthorized use of the controlled substances. Illegal use of controlled substances by safety sensitive drivers is prohibited on or off duty. The FMCSA has some additional rules that prohibit use of legally prescribed controlled substances by safety sensitive drivers while involved in interstate commerce.

Consequences of a Positive Controlled Substance Test

- A driver will be required to reinstate their driver's license with DOL for a \$150.00 fee.
- A driver must be removed from safety sensitive duty.

- A driver cannot be returned to safety sensitive duties until he/she has been evaluated by a substance abuse professional, has complied with recommended rehabilitation, and has a negative result on a return-to-duty controlled substance test.
- Follow-up testing to monitor the driver's abstinence from controlled substance use may be required.

Random Testing

- Employers are responsible for conducting random, unannounced controlled substance tests.
- The minimum annual percentage rate for random controlled substances testing shall be 50 percent of the average number of driver positions.
- Once notified of selection for testing, a driver must proceed immediately to a collection site to accomplish the urine specimen collection.

Other provisions of Part 382 include the requirement for employers to provide information on controlled substance use and treatment resources to safety sensitive drivers. All supervisors and officials of businesses with safety sensitive drivers must attend at least one hour of training on the signs and symptoms of controlled substance abuse and another 60 minutes of training on alcohol misuse. Driver controlled substance testing results and records are confidential.

Records Retention Requirements

Must maintain for **five** years:

- Alcohol test results indicating a Breath Alcohol Concentration (BAC) of 0.02 or greater.
- Verified positive controlled substance test results.
- Refusals to submit to required alcohol and controlled substance tests.
- Required calibration of Evidential Breath Testing (EBT) devices.
- Driver evaluation and referrals.
- Annual calendar year summary.
- Records related to alcohol/controlled substance testing program.

Must maintain for **two** years:

- Records related to the collection process.

Must maintain for **one** year:

- Negative and canceled controlled substance test results.
- Alcohol test results indicating a BAC of less than 0.02.

Must maintain for **indefinite** period:

- Records related to training and education of BATs, STTs, supervisors, and drivers (while the person performs these functions and for an additional two years).

All records shall be maintained in a secure location with limited access, and shall be made available for inspection by authorized representatives of any US DOT agency or state regulatory agencies.

All employers, including owner/operators, must provide educational materials that explain the requirements of Part 382 and the policies and procedures with respect to meeting the requirements. The employer must ensure that a copy of the materials is given to each driver. Each driver must sign a statement certifying that he/she has received a copy of the materials. The employer must keep the original signed statement, but may give the driver a copy.

A compliance review is an on-site examination of a motor carrier's operations to determine a motor carrier's safety fitness. This involves a review of all applicable federal and state safety regulations with company management, review of documents relating to accidents, drivers, and equipment, as well as inspection of equipment at the carrier's place of business.

In December 2010, the Federal Motor Carrier Safety Administration (FMCSA) initiated rollout of the first phase of the Compliance, Safety, Accountability (CSA) program and replaced the Safety Status (SafeStat) system with an improved Carrier Safety Measurement System (CSMS).

The Carrier Safety Measurement System (CSMS) monitors and quantifies the on-road safety performance of motor carriers on a monthly basis using roadside performance data available in FMCSA's Motor Carrier Management Information System (MCMIS) collected during the previous 24 months. The CSMS groups these data into eight Behavioral Analysis Safety Improvement Categories (BASICS):

1. Unsafe Driving
2. Hours of Service Compliance
3. Driver Fitness
4. Controlled Substances and Alcohol
5. Vehicle Maintenance
6. Insurance and other
7. Crash Indicator
8. Hazardous Materials Compliance

CSMS produces a percentile ranking for each BASIC from 0 to 100 for motor carriers having sufficient roadside inspection or crash events to be evaluated. Using percentile rankings provides an easily understandable value for each BASIC. Higher percentile rankings reflect poor performance relative to other motor carriers with similar levels of exposure or inspection activity. For example, a Vehicle Maintenance BASIC of 80 indicates that approximately 80% of the motor carrier population with a similar number of inspections had better vehicle inspection results.

A motor carrier will be prioritized for an investigation based on their roadside performance and/or previously cited serious violations. This assessment is available through the FMCSA Portal and SMS Online located at <http://ai.fmcsa.dot.gov>.

Companies can also receive a compliance review for one of the following actions:

- Complaints
- Accidents
- When vehicles/drivers violates an out-of-service order
- Hazardous materials violations

What Can a Carrier Expect When Contacted for a Compliance Review?

In most cases, an officer will contact the carrier official and make an appointment to do the review. Under some conditions (e.g., an accident, violating an out-of-service order), officers may not make an appointment and just show up to conduct the review.

When the officer arrives, he/she will meet with carrier management and review their information. All information is input into a laptop computer during the review.

Compliance with the following parts and subparts contained in the Code of Federal Regulations (49 CFR) and Washington Administrative Code 446-65-010 will then be checked:

- **Part 380** – Special training requirements
- **Part 382** – Controlled substance abuse and alcohol misuse and testing. (Applies to every person who operates a commercial motor vehicle in interstate or intrastate commerce and who is subject to commercial driver's license (CDL) requirements.)
- **Part 383** – Commercial Driver's License Standards.
- **Part 387** – Minimum levels of financial responsibility for motor carriers
- **Part 391** – Qualifications of Drivers.
- **Part 393** – Parts and Accessories Necessary for Safe Operations.
- **Part 395** – Hours of Service for Drivers.
- **Part 396** – Inspection, Repair, and Maintenance.
- **Part 397** – Transportation of Hazardous Materials, Driving, and Parking Rules.
- **Parts 100 through 177** – Hazardous Materials Regulations.

Officers will hold an exit interview with company officials to discuss any violations found, and they will recommend methods to correct any safety violations. Company management will be requested to submit a letter detailing remedial action if safety violations have been found. The Carrier's Safety Measurement System (CSMS) scores will then be monitored for compliance.

New Entrant Safety Assurance Program

The purpose of the safety audit is to provide educational and technical assistance for new entrant motor carriers (any Interstate carrier applying for a new USDOT number on or after January 1, 2003) and to gather safety data to make an assessment of the new entrant's safety performance and adequacy of its basic safety management controls. A safety audit should be conducted on the new entrant, once it has been in operation for at least three months. This rule applies to both U.S. and Canadian carriers.

The safety audit will focus on the new entrant's basic safety management systems by reviewing the following (1) driver qualifications; (2) driver records of duty status; (3) vehicle maintenance; (4) accident register; (5) controlled substances and alcohol use and testing requirement; and (6) hazardous materials, if applicable. The audit will not result in a safety rating. It will result in a pass or fail notification.

Pass – If the safety audit discloses that the new entrant has adequate safety management controls in place, the Federal Motor Carrier Safety Administration (FMCSA) will provide a new entrant with written notice, no later than 45 days after the completion of the audit, that it has passed the audit.

Fail – If the safety audit discloses that the new entrant's basic safety management controls are inadequate, the FMCSA will provide the new entrant with written notice, no later than 45 days after the completion of the safety audit, that its USDOT new entrant registration will be revoked and its operations placed out-of-service unless it takes action to remedy its safety practices.

How to Obtain a USDOT Number

Before a motor carrier begins interstate/intrastate operations, it must apply for registration with FMCSA and receive a USDOT number. To successfully complete the application process, a carrier must correctly complete and file:

1. MCS-150, the Motor Carrier Identification Report; and
2. MCS-150-B, Hazardous Materials Permit application.

Carriers registering as an interstate carrier, the FMCSA will review these documents and, upon approval, the carrier will be given a new entrant registration (USDOT number). Failure to complete these documents will delay processing of a carrier's application for new entrant registration. The new entrant can apply for registration with FMCSA to receive a USDOT number via the Internet (www.safer.fmcsa.dot.gov) or by mail.

This page intentionally left blank.

The Commercial Vehicle Safety Alliance (CVSA) is an international association of federal, state, and provincial officials responsible for the administration and enforcement of motor carrier safety laws in the United States, Canada, and Mexico. CVSA works to promote uniformity, compatibility, and reciprocity of commercial vehicle inspections and motor carrier safety enforcement activities in North America.

The North American Standard is a careful inspection of the CRITICAL items related to commercial motor vehicle safety. To the extent possible, Washington State CVSA qualified inspectors concentrate on those vehicle and driver items most often associated with accidents.

Out-of-Service Criteria

The North American Commercial Vehicle Critical Safety Inspection Items and Out-of-Service Criteria, simply referred to as the “Out-of-Service Criteria,” is a document under constant revision. It is published and updated annually by the Commercial Vehicle Safety Alliance and is identical to the Out-of-Service Criteria adhered to by the United States Department of Transportation and Canadian regulatory agencies.

CVSA Decal Criteria

The North American Standard is the only inspection that will allow your vehicle to display a CVSA decal. To qualify for a decal, a vehicle must not have any violations of the items found on the North American Commercial Vehicle Critical Safety Inspection Items List.

The decal criteria apply only to the condition of the vehicle, not the driver. It is possible for a driver to be out-of-service and still have the vehicle(s) qualify for the decal.

If each vehicle, whether used singly or in a combination, passes the inspection, a current CVSA decal will be applied to the inspected vehicles. You may display only one CVSA decal per vehicle at a time.

Placement of CVSA Decal

On power units, decals must be placed in the lower right corner of the outside surface of the passenger’s windshield.

On any type of trailer, decals must be placed on the right side, at the lower right corner, as near the front as possible.

Placement of decal on passenger vehicles shall be on the glass portion (window) of the passenger door at the inspector’s eye level.



Placing a Vehicle or Driver Out-of-Service

When a vehicle is placed out-of-service, it may not be moved under its own power to a place of repair. The following are two exceptions:

- Vehicles transporting hazardous materials that require placarding may be escorted to a repair facility or safe parking space.
- When the imminently hazardous condition is automatically removed by the disconnection of the power unit from a towed unit, the power unit may be moved. In these instances, the CVSA decal will not be issued.

Movement of a vehicle that has been placed out-of-service is punishable as a gross misdemeanor and will result in the loss of your CDL driving privileges.

There are four mechanical defect conditions which meet this criterion:

- Defective coupling mechanism on the power unit.
- Defective detachable wiring cable to the trailer plug.
- Defective emergency or service brake hoses, or tubing between tractor and trailer.
- A combination vehicle without front end structures or equivalent devices.

When a driver or vehicle is placed out-of-service, the carriers must be notified in the following cases:

- Vehicles transporting hazardous materials that require placarding or prohibit leaving the vehicle unattended.
- Vehicles transporting perishable commodities.
- Cargo tanks transporting commodities that require temperature control.
- Vehicles transporting livestock or other living creatures.
- When alcohol and/or controlled substance usage by the driver is suspected or confirmed.
- Vehicles transporting mail for the U.S. Postal Service (USPS). When vehicles or drivers of Highway Mail Carriers (HMC) are placed out-of-service, telephone notice of the out-of-service action shall be given to both the USPS and the HMC. The USPS manuals require a driver who is delayed en route to contact postal personnel at the location of his/her scheduled stop. The driver can supply this information to the inspector.

In all contacts with the carrier, they will be advised that responsibility for protection of the vehicle, its cargo, accessories, and contents rests solely with the carrier. In driver out-of-service actions, the carrier should be informed that action does not prohibit the driver from remaining on duty with the vehicle, rather, the action prohibits the driver from driving a vehicle until he/she has met the requirements of the specified section found to be in violation.

Registered Interstate Carriers – Unified Carrier Registration (UCR) (WAC 480-12-100 and 480-14-300)

The Federal Single State Registration System (SSRS) was repealed as part of the 2005 highway reauthorization measure, which mandated a more inclusive system to collect fees and data from a broader motor carrier population. Previously, for-hire carriers were the only group of motor carriers subject to SSRS fees. Now interstate exempt, private carriers, freight brokers/forwarders, and for-hire carriers are subject to the SSRS replacement program called Unified Carrier Registration (UCR) Program.

Under the UCR program, interstate exempt, private carriers, freight brokers/forwarders, and for-hire carriers whose principal place of business is in Washington State must register with UTC and pay a fee based on the size of their fleet. The registration is renewed annually. All carriers with an active USDOT number and Interstate status must register in the UCR program.

UCR is similar to SSRS because the motor carrier can pay a single fee in Washington, which allows the carrier to travel in the 38 other UCR participating states, without having additional operating requirements in those states.

Check the UTC’s website at www.utc.wa.gov for additional information including registration forms.

Required Vehicle Markings

Interstate For-Hire Carriers — 49 CFR 390.21 Marking of Commercial Motor Vehicles

(a) **General.** Every self-propelled commercial motor vehicle operated in interstate commerce and subject to the rules of subchapter B of this chapter must be marked as specified in paragraphs (b), (c), and (d) of this section. Self-propelled commercial motor vehicles operated by for-hire motor carriers under authority issued by the Federal Motor Carrier Safety Administration (FMCSA) may meet the requirements of this section by complying with the marking requirements set forth in 49 CFR section 365-378. To apply for a DOT number, visit www.safersys.org.

(b) **Nature of Marking.** The marking must display the following information:

1. The legal name or a single trade name of the motor carrier operating the self-propelled commercial motor vehicle, as listed on the motor carrier identification report (Form MCS-150) and submitted in accordance with Part 390.19.

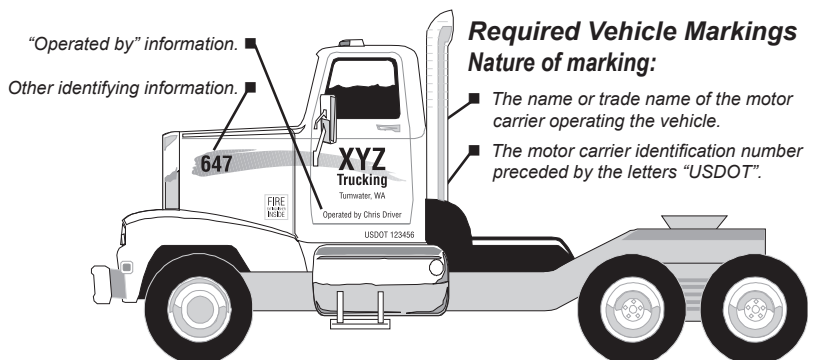

2. The motor carrier identification number issued by the FMCSA, preceded by the letters “USDOT.”
 3. If the name of any person other than the operating carrier appears on the CMV, the name of the operating carrier must be followed by the information required by paragraphs (b)(1) and (2) of this section, and be preceded by the words “operated by.”
 4. Other identifying information may be displayed on the vehicle if it is not inconsistent with the information required by this paragraph.
 5. Each motor carrier shall meet the following requirements pertaining to its operation:
 - i. All commercial motor vehicles that are part of a motor carrier’s existing fleet on July 3, 2000, and which are marked with an ICCMC number must come into compliance with paragraph (b)(2) of this section by July 3, 2002.
 - ii. All CMVs that are part of a motor carrier’s existing fleet on July 3, 2000, and which are not marked with the legal name or a single trade name on both sides of their commercial motor vehicles, as shown on the Motor Carrier Identification Report, Form MCS-150, must come into compliance with paragraph (b)(1) of this section by July 5, 2005.
 - iii. All commercial motor vehicles added to a motor carrier’s fleet on or after July 3, 2000, must meet the requirements of this section before being put into service and operating on public ways.
- (c) **Size, Shape, Location, and Color of Marking** – The marking must:
1. Appear on both sides of the self-propelled commercial motor vehicle.
 2. Be in letters that contrast sharply in color with the background on which the letters are placed.
 3. Be readily legible, during daylight hours, from a distance of 50 feet while the commercial motor vehicle is stationary.
 4. Be kept and maintained in a manner that retains the legibility required by paragraph (c) (3) of this section.
- (d) **Construction and Durability** – The markings may be painted on the commercial motor vehicle or may consist of a removable device, if that device meets the identification and legibility requirements of paragraph (c) of this section, and such markings shall be maintained in such a manner as to remain legible as required by this section.
- (e) **Rented Commercial Motor Vehicles** – A motor carrier operating in a self-propelled commercial motor vehicle under a rental agreement having a term not in excess of 30 calendar days may meet the requirements of this section in either one of two ways:
1. The commercial motor vehicle is marked in accordance with the provisions of paragraphs (b) through (d) of this section, or
 2. The commercial motor vehicle is marked as set forth below:
 - i. The name or trade name of the lessor is displayed in accordance with paragraphs (c) and (d) of this section;
 - ii. The lessor’s identification number preceded by the letters “USDOT” is displayed in accordance with paragraphs (c) and (d) of this section; and

- iii. The rental agreement entered into by the lessor and renting motor carrier conspicuously contains the following information:
 - a. The name and complete physical address of the principal place of business of the renting motor carrier;
 - b. The identification number issued to the renting motor carrier by the Federal Motor Carrier Safety Administration (FMCSA), preceded by the letters “USDOT,” if the motor carrier has been issued such a number. In lieu of the identification number required in this paragraph, the following may be shown:
 - Information which will indicate if the motor carrier is engaged in “interstate” or “intrastate” commerce, and
 - Information which will indicate if the renting motor carrier is transporting hazardous materials in the rented commercial motor vehicle.
 - c. The sentence, *“This lessor cooperates with all federal, state, and local law enforcement officials nationwide to provide the identity of the customers who operate this rental commercial motor vehicle.”*
- iv. The rental agreement entered into by the lessor and the renting motor carrier is carried on the rental commercial motor vehicle during the full term of the rental agreement.

Intrastate For-Hire Carriers

(RCW 81.80.305)

Markings Required

1. All motor vehicles other than those exempt under subsection (2) of this section, must display a permanent marking identifying the name or number, or both, on each side of the power unit. For a motor vehicle that is a common or contract carrier under permit by the UTC as described in subsection (3) (a), a private carrier under subsection (4), or a leased carrier as described in sub-section (5) of this section, any required identification that is added, modified, or renewed after September 1, 1991, must be displayed on the driver and passenger doors of the power unit. The identification must be in a clearly legible style with letters no less than three inches high and in a color contrasting with the surrounding body panel.

Must be displayed on the driver and passenger doors.

Permanent marking identifying the name of the permittee, or business name.

Address of either the business operating the vehicle or the registered owner.

USDOT certificate number or UTC permit number.

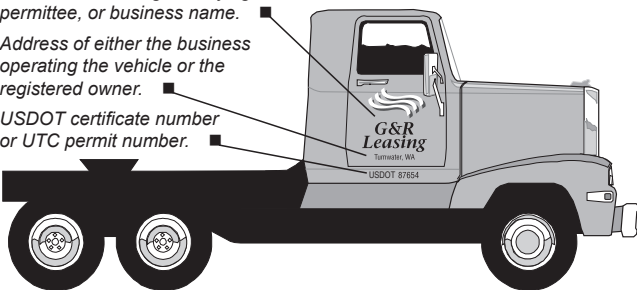

The diagram shows a side view of a truck. Three callout boxes with arrows point to specific markings on the driver and passenger doors. The first callout points to the text 'G&R Leasing' on the driver's door. The second callout points to the text 'Sumner, WA' on the passenger's door. The third callout points to the text 'USDOT 87654' on the passenger's door.
2. This section does not apply to (a) vehicles exempt under [RCW 81.80.040](#), and (b) vehicles operated by private carrier that singly or in combination are less than 36,000 pounds gross vehicle weight.

3. If the motor vehicle is operated as:
 - a. A common or contract carrier under a permit by the UTC, the identification must contain the name of the permittee, or business name, and the permit number, or
 - b. A common or contract carrier holding both intrastate and interstate authority, the identification may be either the commission permit number or the federal vehicle marking requirement established by the USDOT for interstate motor carriers.
4. If the motor vehicle is a private carrier, the identification must contain the name and address of either the business operating the vehicle or the registered owner.
5. If the motor vehicle is operated under lease, the vehicle must display either permanent markings or placards on the driver and passenger doors of the power unit. A motor vehicle under lease
 - a. That is operated as a common or contract carrier under permit by the commission must display identification as provided in subsection (3) (a) of this section, and
 - b. That is operated as a private carrier must display identification as provided in subsection (4) of this section.

Insurance Filing Requirements – UTC Carriers

Intrastate

Motor carriers of property, for-hire carriers of passengers, household goods carriers, and solid waste collection companies must have a minimum amount of liability and property damage insurance. See Permit/Certificate Requirements.

- You are required to have your insurance company file evidence of liability and property damage insurance. The insurance filed must be written by a company authorized to write such insurance in the state of Washington.
- If you fail to file and keep insurance in full force and effect, your permit/certificate will be canceled.
- Your insurance company must submit your evidence of insurance on a uniform motor carrier bodily injury and property damage liability certificate of insurance (Form E) covering each motor vehicle as defined in [RCW 81.80.010](#) used or to be used under the permit/certificate.

Insurance Filing Requirements – UTC Carriers

Interstate

If you are a motor carrier of property operating a commercial motor vehicle in interstate or foreign commerce, you must have minimum amount of insurance as prescribed by 49 CFR, Part 387. You must have proof of insurance of the minimum level of insurance at your company's principal place of business and you must file and maintain proof of insurance with the Federal Motor Carrier Safety Administration when you submit an application for operating authority.

Carriers operating in interstate commerce **only**, do not need to file insurance with the Utilities and Transportation Commission.

Private carriers operating in Washington intrastate commerce are not required to file insurance with the Utilities and Transportation Commission. You must, however, comply with the insurance limits contained in [Title 46 RCW](#).

Proof of insurance for **interstate** carriers can be any of the following:

- Endorsement(s) for Motor Carrier Policies of Insurance for Public Liability under Sections 29 and 30 of the Motor Carrier Act of 1980 (Form MCS-90) issued by an insurer(s).
- Endorsement(s) for Motor Carrier Policies of Insurance for Public Liability under Section 18 of the Bus Regulatory Reform Act of 1982 (Form MCS-90B) issued by an insurer(s).
- A Motor Carrier Surety Bond for Public Liability under Sections 29 and 30 of the Motor Carrier Act of 1980 (Form MC-82) issued by a surety.
- A Motor Carrier Public Liability Surety Bond under Section 18 of the Bus Regulatory Reform Act of 1982 (Form MCS-82B) issued by a surety.
- A written decision, order, or authorization of the Federal Motor Carrier Safety Administration (FMCSA) authorizing the motor carrier to self-insure under 49 CFR, Part 1043.5.

Permit/Certificate Requirements – UTC Carriers

Property and passenger carriers who provide transportation services, by motor vehicle, over the public highways, for compensation, in the state of Washington, must obtain a permit or certificate from the UTC prior to conducting business.

Intrastate Carriers Transporting Passengers

Charter Party Carrier of Passengers is defined as transporting a group of persons for compensation who as a group have a common purpose and are under a single contract. They have acquired the use of a motor bus to travel together to a specific destination or for a particular itinerary. The vehicle used must have a manufacturer's seating capacity for eight or more persons, including the driver. [WAC 480-30](#)

Excursion Service Carrier is defined as transporting persons for compensation from points of origin within a city, town, or area to another location within the state and returning to that same point of origin (no passengers are picked up or dropped off during the trip). Compensation is charged on an individual fare basis. The vehicle used must have seating capacity for eight or more persons including the driver. [WAC 480-30](#)

Certificate issued to any qualifying applicant who submits application, fees, and proof of insurance, completes a safety questionnaire, and has vehicles inspected. The vehicles must pass the vehicle inspection.

Certificates are issued as a Charter/Excursion Certificate to a qualifying applicant who submits a completed application, appropriate fee, proof of insurance, and has vehicles inspected. The vehicles must pass the vehicle inspection conducted by UTC staff.

- Application fee: \$200.
- Annual regulatory fee: \$25 per vehicle paid with annual report.
- No rate regulation.
- Driver and equipment safety compliance audits performed by the UTC.
- Minimum public liability and property damage insurance:
 - Vehicles 15 passenger or less – \$1,500,000 combined single limit (CSL).
 - Vehicles 16 passengers or more – \$5,000,000 CSL.

Auto Transportation company is defined as any person owning, controlling, operating, or managing a motor-propelled vehicle not usually operated on or over the rails, used in the business of transporting persons over any public highway in this state between fixed termini or over a regular route, and not operating exclusively within the incorporated limits of any city or town.

- Application fee: \$200.
Application must include, but not limited to: a complete description of the proposed service including the line, route, or service territory; a map of the proposed territory; a proposed tariff and time schedule; justification for the proposed service; ridership and revenue forecasts for the first twelve months; and a statement of the applicant's prior experience and familiarity with the statutes and rules that govern the operations it proposes.
- Driver and equipment safety compliance audits performed by the UTC.
- Minimum public liability and property damage insurance:
 - Passenger seating capacity of 15 or less – \$1,500,000 combined single limit (CSL).
 - Passenger seating capacity of 16 or more – \$5,000,000 CSL.
- Annual regulatory fee based on percentage of revenue—paid with annual report.
- Company filed tariffs, rates, and charges, subject to UTC approval.

Intrastate Carriers Transporting Property/Solid Waste Collection Companies

General Commodities Carriers are defined as transporting all types of goods or property, excluding residential household goods. [WAC 480-14](#)

- Permit is issued to any applicant who submits a completed application, appropriate fees, proof of insurance, and completes a safety questionnaire.
- Application fee: \$275 for new entrants and \$100 for extension or reinstatement (within 10 months of cancellation).
- Driver and equipment safety compliance audits performed by the WSP.
- Minimum public liability and property damage insurance:
 - Vehicles under 10,000 GVWR – Property (non-hazardous) – \$300,000 CSL.
 - Vehicles over 10,000 GVWR – Property (non-hazardous) – \$750,000 CSL.
- Hazardous substances, as defined in 49 CFR 171.8 transported in cargo tanks, portable tanks, on hopper-type vehicles with capacities in excess of 3,500 water gallons; or in bulk, poison gas, liquefied compressed gas, or compressed gas; or highway route controlled quantity of radioactive materials – \$5,000,000 CSL.
- Oil, hazardous waste, hazardous materials, and hazardous substances defined in 49 CFR, Part 171.8 and listed in 49 CFR, Part 172.101 not listed above – \$1,000,000 CSL.

Household Goods Movers are defined as transporting items used or to be used in a household, when part of a household, between residences or between a residence and a storage facility.

[WAC 480-15](#)

- Application fee: \$550 for permanent authority. New Entrants must serve a temporary provisional period of six months prior to being considered for permanent authority. Operations under temporary provisional authority will be used in determining if permanent authority should be granted.
- UTC publishes a tariff of rates and charges that must be followed.
- Annual regulatory fee based on percentage of revenue—paid with annual report.
- Driver and equipment safety compliance audits performed by the UTC.
- Minimum public liability and property damage insurance:
 - Vehicles under 10,000 GVWR – Household Goods – \$300,000 CSL.
 - Vehicles over 10,000 GVWR – Household Goods – \$750,000 CSL.
- Minimum cargo insurance:
 - Vehicles under 10,000 GVWR – \$10,000
 - Vehicles over 10,000 GVWR – \$20,000

Freight Broker is a person engaged in the business of providing, contracting for or undertaking to arrange for, transportation of property by two or more common carriers.

[WAC 480-12](#)

- Registration fee is \$25.
- Intrastate Broker must file a \$10,000 bond.
- Interstate Broker must file a copy of their FMCSA operating authority and their broker bond.

Solid Waste Collection Companies are defined as those carriers who, for compensation, transport garbage, refuse, biohazardous, or biomedical waste for collection and/or disposal.

Solid waste also includes residential source-separated recyclable materials. [WAC 480-70](#)

- “Garbage” or “refuse” means animal or vegetable waste, scrap, waste materials, discarded articles, rubbish, debris, worthless or discarded materials.
- “Biohazardous or biomedical waste” means untreated solid waste including human body fluids, cultures, disease waste and sharps.
- Certificates are issued under public convenience and necessity standards. Applicant must prove there is an unmet need for service they are applying for.
- Application fee: Permanent authority \$200, temporary authority \$25.
- Company filed tariffs, rates and charges subject to UTC approval.
- Annual regulatory fee based on percentage of revenue—paid with annual report.
- Driver and equipment safety compliance audits performed by UTC.
 - Vehicles under 10,000 GVWR – \$300,000 CSL.
 - Vehicles over 10,000 GVWR – \$750,000 CSL.
 - Vehicles over 10,000 GVWR transporting quantities of biomedical waste not subject to federal regulation – \$1,000,000 CSL.

This page intentionally left blank.

Appendix 1

Do I Need a Commercial Driver's License?

There are three types of Commercial Driver's Licenses:

- Class A
- Class B
- Class C

To see if you need a Commercial Driver's License, follow the shaded area in the chart:

Is the manufacturer's weight rating of your trailer 10,001 pounds or more?	YES, and	Is the manufacturer's weight rating of your combination 26,001 pounds or more?	If so,	You need a CDL Class A license
Is the manufacturer's weight rating of your <i>single</i> vehicle 26,001 pounds or more (includes all buses)?			YES, then	You need a CDL Class B license
Is your vehicle designed to carry 16 or more persons including the driver?			YES, then	You need a CDL Class C license
Is your vehicle a public school bus with a GVWR or registered weight <i>under</i> 26,001 pounds, regardless of passenger capacity?			YES, then	You need a CDL Class C license
Does your vehicle <i>under</i> 26,001 pounds carry placarded hazardous materials?			YES, then	You need a CDL Class C license
If the vehicle you are driving <i>DOES NOT</i> meet any of the above conditions			THEN	You <i>DO NOT</i> need a CDL license

Website: www.dol.wa.gov/driverslicense/cdl.html

Non-Metric Tire Conversion Charts

Legal Tire Weights: 500/600 pounds per inch of tire width

*Steer axle tires remain at 600 pounds per inch of tire width.

Tire Size	Single Tire Capacity		Two Tire Capacity		Four Tire Capacity	
	500 lbs	600 lbs	500 lbs	600 lbs	500 lbs	600 lbs
8:25	4125	4950	8250	9900	16500	19800
9:00	4500	5400	9000	10800	18000	21600
10:00	5000	6000	10000	12000	20000	24000
11:00	5500	6600	11000	13200	22000	26400
12:00	6000	7200	12000	14400	24000	28800
13:00	6500	7800	13000	15600	26000	31200
14:00	7000	8400	14000	16800	28000	33600
15:00	7500	9000	15000	18000	30000	36000
16:00	8000	9600	16000	19200	32000	38400
18:00	9000	10800	18000	21600	36000	43200

Converting Inches to Decimals	
1"	0.08
2"	0.16
3"	0.25
4"	0.33
5"	0.41
6"	0.5
7"	0.58
8"	0.66
9"	0.75
10"	0.83
11"	0.91

Caution: Actual vehicle carrying capacity is determined by the tire size as well as axle spacing's and Gross Vehicle Weight. See [Appendix 3, Axle Weight Table](#), for additional information.

Metric Tire Conversion Chart

Legal Tire Weights Metric Dimensions: $.03937 \times \text{the metric tire size} \times 500/600^*$

Tire Size	Single Tire Axles		Tire Size	Single Tire Axles	
	500 lbs	600 lbs		500 lbs	600 lbs
135	5311	6372	225	8860	10632
145	5710	6852	235	9250	11100
155	6100	7320	240	9450	11340
165	6500	7800	245	9650	11580
175	6890	8268	255	10040	12048
180	7090	8508	275	10830	12996
185	7280	8736	280	11020	13224
190	7480	8976	285	11220	13464
195	7680	9216	295	11610	13932
200	7870	9440	315	12400	14880
205	8070	9684	365	14370	17244
215	8460	10152	385	15150	18180
220	8660	10392	425	16730	20076

Conversion Factor: Multiply millimeters by .03937 or divide millimeters by 25.4. Round off to hundredths of an inch.

Appendix 3

Axle Weight Table

Feet	2 Axle	3 Axle	4 Axle	5 Axle	6 Axle	7 Axle	8 Axle	9 Axle
4	34,000							
5	34,000							
6	34,000							
7	34,000							
8 & Less	34,000	34,000						
over 8	38,000	42,000						
9	39,000	42,500						
10	40,000	43,500						
11		44,000						
12		45,000	50,000					
13		45,500	50,500					
14		46,500	51,500					
15		47,000	52,000					
16		48,000	52,500	58,000				
17		48,500	53,500	58,500				
18		49,500	54,000	59,000				
19		50,000	54,500	60,000				
20		51,000	55,500	60,500	66,000			
21		51,500	56,000	61,000	66,500			
22		52,500	56,500	61,500	67,000			
23		53,000	57,500	62,500	68,000			
24		54,000	58,000	63,000	68,500	74,000		
25		54,500	58,500	63,500	69,000	74,500		
26		55,500	59,500	64,000	69,500	75,000		
27		56,000	60,000	65,000	70,000	75,500		
28		57,000	60,500	65,500	71,000	76,500	82,000	
29		57,500	61,500	66,000	71,500	77,000	82,500	
30		58,500	62,000	66,500	72,000	77,500	83,000	
31		59,000	62,500	67,500	72,500	78,000	83,500	
32		60,000	63,500	68,000	73,000	78,500	84,500	90,000
33			64,000	68,500	74,000	79,000	85,000	90,500
34			64,500	69,000	74,500	80,000	85,500	91,000
35			65,500	70,000	75,000	80,500	86,000	91,500
36*			66,000	70,500	75,500	81,000	86,500	92,000
37			66,500	71,000	76,000	81,500	87,000	93,000
38			67,500	71,500	77,000	82,000	87,500	93,500
39			68,000	72,500	77,500	82,500	88,500	94,000
40			68,500	73,000	78,000	83,500	89,000	94,500
41			69,500	73,500	78,500	84,000	89,500	95,000
42			70,000	74,000	79,000	84,500	90,000	95,500
43			70,500	75,000	80,000	85,000	90,500	96,000
44			71,500	75,500	80,500	85,500	91,000	96,500
45			72,000	76,000	81,000	86,000	91,500	97,500
46			72,500	76,500	81,500	87,000	92,500	98,000
47			73,500	77,500	82,000	87,500	93,000	98,500
48			74,000	78,000	83,000	88,000	93,500	99,000
49			74,500	78,500	83,500	88,500	94,000	99,500

*No vehicle or combination of vehicles shall operate upon the public highways of this state with a gross load on any single axle in excess of 20,000 lbs, or upon any group of axles in excess of that set forth in the following table, except that two consecutive sets of tandem axles may carry a gross load of 34,000 lbs each, if the overall distance between the first and last axles of such consecutive sets of tandem axles is 36 ft or more.

Feet	2 Axle	3 Axle	4 Axle	5 Axle	6 Axle	7 Axle	8 Axle	9 Axle
50			75,500	79,000	84,000	89,000	94,500	100,000
51			76,000	80,000	84,500	89,500	95,000	100,500
52			76,500	80,500	85,000	90,500	95,500	101,000
53			77,500	81,000	86,000	91,000	96,500	102,000
54			78,000	81,500	86,500	91,500	97,000	102,500
55			78,500	82,500	87,000	92,000	97,500	103,000
56			79,500	83,000	87,500	92,500	98,000	103,500
57			80,000	83,500	88,000	93,000	98,500	104,000
58				84,000	89,000	94,000	99,000	104,500
59				85,000	89,500	94,500	99,500	105,000
60				85,500	90,000	95,000	100,500	105,500
61				86,000	90,500	95,500	101,000	105,500
62				86,500	91,000	96,000	101,500	105,500
63				87,500	92,000	96,500	102,000	105,500
64				88,000	92,500	97,500	102,500	105,500
65				88,500	93,000	98,000	103,000	105,500
66				89,000	93,500	98,500	103,500	105,500
67				90,000	94,000	99,000	104,500	105,500
68				90,500	95,000	99,500	105,000	105,500
69				91,000	95,500	100,000	105,500	105,500
70				91,500	96,000	101,000	105,500	105,500
71				92,500	96,500	101,500	105,500	105,500
72				93,000	97,000	102,000	105,500	105,500
73				93,500	98,000	102,500	105,500	105,500
74				94,000	98,500	103,000	105,500	105,500
75				95,000	99,000	103,500	105,500	105,500
76				95,500	99,500	104,500	105,500	105,500
77				96,000	100,000	105,000	105,500	105,500
78				96,500	101,000	105,500	105,500	105,500
79				97,500	101,500	105,500	105,500	105,500
80				98,000	102,000	105,500	105,500	105,500
81				98,500	102,500	105,500	105,500	105,500
82				99,000	103,000	105,500	105,500	105,500
83				100,000	104,000	105,500	105,500	105,500
84					104,500	105,500	105,500	105,500
85					105,000	105,500	105,500	105,500
86 or more					105,500	105,500	105,500	105,500

When inches are involved — under 6 in, take the lower; 6 in or over, take the higher (except between 8 and 9 ft).

Appendix 4

Table of Minimum Liability Insurance Requirements

Vehicles – Over 10,000 pounds GVWR non-hazardous property:
\$750,000 combined single limit (CSL)

Vehicles – Under 10,000 pounds GVWR non-hazardous property:
\$300,000 CSL

Vehicles – Under 10,000 pounds GVWR hazardous property; any quantity of Class A or B explosives, any quantity of poison gas (Poison A), or highway route controlled quantity of radioactive materials as defined in 49 CFR 173.455:
\$5,000,000 CSL

Vehicles – Hazardous substances in bulk, in vehicles with capacities exceeding 3,500 water gallons, explosives A or B (any quantity), poison gas (any quantity), liquefied compressed gas or compressed gas in bulk (containers exceeding 3,500 water gallons), or highway route controlled quantity radioactive materials:
\$5,000,000 CSL

Vehicles – Oil (49 CFR 172.101) hazardous waste, hazardous materials and hazardous substances listed in 49 CFR 172.101, but not listed in the panel above:
\$1,000,000 CSL

Vehicles – Solid waste collection (solid waste, garbage and/or refuse):

- Gross Weight Rating (GVWR) less than 10,000 pounds: \$300,000 combined single limit coverage
- Gross Weight Rating (GVWR) 10,000 pounds or more: \$750,000 combined single limit coverage
- Transport quantities of biomedical waste not subject to federal regulation: \$1,000,000 combined single limit coverage
- Transport quantities of hazardous or biomedical waste that are subject to federal regulation: the federal minimum combined single limit

Passenger Charter – 15 passengers or less (excluding limousines):
\$100,000 each person; \$1,500,000 each accident; \$50,000 property damage or \$1,500,000 CSL

Passenger Charter – 16 passengers or more (excluding limousines):
\$100,000 each person; \$5,000,000 each accident; \$50,000 property damage or \$5,000,000 CSL

Auto Transportation – 15 passengers or less (other than passenger charter):
\$100,000 each person; \$1,500,000 each accident; \$50,000 property damage or \$1,500,000 CSL

Auto Transportation – 16 passengers or more (other than passenger charter):
\$100,000 each person; \$5,000,000 each accident; \$50,000 property damage or \$5,000,000 CSL

Appendix 5

Western United States and Canadian Jurisdictional Agencies

Registration/Fuel Tax/Authority/Oversize and Weight

Washington	
Registration	360-664-1858
Fuel Permits	360-664-1858
Size/Weight	360-704-6340

California www.dot.ca.gov	
Registration	800-777-0133
Fuel Permits	800-400-7115
Size/Weight	North 916-322-1297 South 909-383-4637

Colorado www.dot.state.co.us	
Registration	303-205-5607
Fuel Permits	303-205-8205
Size/Weight	800-350-3765

Idaho www.itd.idaho.gov	
Registration	208-334-8611
Fuel Permits	208-334-7834
Size/Weight	208-334-8420

Montana www.mdt.state.mt.us	
Registration	406-444-6130, ext. 4
Fuel Permits	406-444-6130, ext. 5
Size/Weight	406-444-6130, ext. 5

Nevada www.dmv.nv.com	
Registration	877-368-7828
Fuel Permits	877-368-7828
Size/Weight	800-552-2127

Oregon www.oregontruckingonline.com	
Registration	503-378-6699
Fuel Permits	503-378-6699
Size/Weight	503-373-0000

Utah www.sr.ex.state.ut.us	
Registration	801-535-2650
Fuel Permits	801-535-2650
Size/Weight	801-965-4508

Wyoming www.wydotweb.state.wy.us	
Registration	307-777-4375
Fuel Permits	307-777-4826
Size/Weight:	307-777-4376

Canada

Alberta www.transportation.alberta.ca	
Registration	800-662-7138
Fuel Permits	800-662-7138
Size/Weight	800-662-7138

British Columbia	
Registration	800-559-9688
Fuel Permits	800-559-9688
Size/Weight	800-559-9688

Saskatchewan	
Registration	800-667-7575
Fuel Permits	800-667-7575
Size/Weight	306-787-7575 306-787-5307

A

Accidents/accident reporting 1-6, 5-3
 Acetylene 4-25. See Hazardous materials
 Aerodynamic shells..... 4-9
 Agricultural products 1-8, 4-19
 Air brakes..... 3-2
 Alcohol/alcohol misuse..... 3-6, 5-1, 5-2, 5-4, 7-2
 Alcohol testing/tests..... 5-1, 5-2, 5-3, 5-4
 Amphetamines 5-3
 Apple bins 4-9
 Application/licensing 2-4
 Apportioned registration 2-4
 Arizona..... 4-18
 Armed forces..... 3-9
 Auto or boat carriers 4-6
 Auto transportation companies A-5
 Axles 4-8, 4-11, 4-13, 4-18, 4-24

B

Backup alert 1-1
 Bills of lading..... 1-2
 Blood alcohol test 3-6
 Boat or auto carriers..... 4-6
 Breath test 5-2
 Bridges/bridge restrictions 4-11, 4-19
 Bumper..... 4-4, 4-9
 Buses 3-2, 4-7, 7-2, A-1. See Charter buses
 Butane 4-25. See Hazardous materials

C

Cab cards..... 2-5
 California A-6
 Canada/Canadian Provinces..... 2-3, 2-4, 7-1, A-6
 Cargo tank 7-2
 CDL driving privileges, loss of..... 7-2
 CDL endorsements..... 3-2
 CDL restrictions 3-2
 CDL testing 3-4
 Chains 1-6, 4-16
 Charter buses..... A-5. See Buses
 City/county permits..... 4-16
 Civilian Collision Report 1-6
 Cocaine 5-3
 Code of Federal Regulations (CFR) 5-1
 Collection trucks 4-22
 Colorado..... 4-18, A-6
 Commercial driver's license 3-1, A-1

Commercial driver's license standards 3-1
 Commercial motor vehicles 3-5, 8-1, 8-2
 Commercial Vehicle Enforcement 1-1
 Commercial Vehicle Safety Alliance 1, 7-1
 Commercial Vehicle Services 4-1, 4-8, 4-9, 4-18
 Common carrier 8-4
 Compliance review 6-1
 Consequences..... 5-2, 5-3, 5-4
 Controlled substances 3-6, 3-7, 5-3, 5-4, 7-2
 Convictions 3-6, 3-7
 County/City permits..... 4-16, 4-27
 Crossview mirrors 1-1
 Curfew..... 4-15, 4-20
 CVISN..... 1-6

D

Decals..... 7-1. See Markings
 Department of Licensing, Washington State. 1, 8, 2-1, 2-4, 3-6
 Department of Transportation, U.S. 8-2
 Department of Transportation, Washington State. 1, 8, 4-1, 4-26
 Detours..... 4-9
 Disqualification 3-5, 3-6
 Doubles/double trailers 1-3, 3-2, 4-5, 4-9
 Driver services 8
 Driver's license 3-3, 3-4, A-1
 Driver's medical certificate..... 3-7
 Driving under the influence (alcohol, etc.) 3-6
 Dump truck 4-4

E

Emergency conditions..... 4-21
 Empty trailers..... 4-7
 Enforcement..... 7-1
 Envelope vehicle..... 4-18
 Escort vehicles 4-8, 4-9, 4-14, 4-19, 4-20, 4-21
 Excessive speed 3-6
 External refrigeration unit..... 4-9

F

Farm 1-8
 Farmers 3-3, 4-21
 Farm implements 4-19, 4-21
 Farm permit fees 4-21
 Farm permit requirements..... 4-20
 Federal Highway Administration (FHWA).... 5-3, 5-4, 8-1, 8-3, 8-7

Federal Motor Carrier Safety Regulations.....	3-1	L	
Federal Privacy Act.....	3-9	Law enforcement	5-2
Federal regulations.....	5-1	Law enforcement personnel.....	3-3
Fees.....	3-5, 4-8, 4-14	Left lane restrictions	1-1
Felony	3-6	Legal height	4-4
Ferry travel.....	4-24	Legal length	4-4
Ferry travel request/permit, WSF.....	4-25	Legal overhangs.....	4-4
Firefighters.....	3-3	Legal vehicles	4-6
Fixed load.....	4-13	Legal weight.....	4-5
Following too closely.....	3-6	Legal width	4-4
Freight brokers.....	8-7	Length	4-4, 4-5, 4-18, 4-19
Fuel tax.....	2-1, A-6	Liability insurance	A-5
G		Lift axles	4-8
Gasoline	4-25. See Hazardous materials	Limited-access roadways.....	1-1
General commodities carriers	8-6	Livestock.....	4-9, 7-2
Gross misdemeanor.....	7-2	Load securement.....	1-2
Gross vehicle weight (GVW).....	3-1, 4-5, 4-8	Logging trucks	4-4, 4-5
H		Log tolerance permits	4-8
Hay.....	4-9	M	
Hazardous materials/substances....	1-6, 1-8, 3-2, 4-25, 4-23, 4-25, 6-2, 7-2, 8-6, 8-7, A-1, 3-2, A-5	Manufactured homes.....	4-12
Height.....	4-4, 4-8, 4-18, 4-19, 4-24, 4-25	Marijuana	5-3
Heroin	5-3	Markings	8-3. See Decals
Highway mail carriers (HMC).....	7-2	Measurement.....	4-9
Holidays/legal holidays.....	4-9, 4-15	Mechanical defect	7-2
Household goods movers	8-7	Medical certificate.....	3-7
HOV lanes.....	1-1	Medical examination certification.....	3-1
I		Medical Review Officer (MRO).....	5-3
Idaho	4-18, A-6	Medical waiver.....	3-7
Improper lane changes	3-6	Metric conversion	A-2
Inspection(s).....	1-6, 7-1	Metric tire.....	A-2
Insurance	8-4, 8-6	Mexico	7-1
Insurance filing.....	8-4	Military vehicle drivers.....	3-4
Insurance requirements	A-5	Mirrors, crossview	1-1
International Fuel Tax Agreement (IFTA).....	2-1	Modular homes	4-12
International Registration Plan	2-3, 2-4	Montana	4-18, A-6
Interstate.....	8-1	Motor Carrier Identification Number.....	8-2
Interstate for-hire carriers.....	8-1	Motor Carrier Identification Report.....	8-2
Intrastate carriers.....	8-5, 8-6	Motor carriers.....	8-1
Intrastate for-hire carriers.....	8-3	Motor vehicle permit, WSDOT Special.....	4-24, 4-25
Intrastate waivers	3-8	Mountain.....	1-2
		Mountain pass	4-9

N

National Driver Register File Check.....	3-9
Negligent driving	3-6
Nevada	A-6
New Mexico.....	4-18
Nighttime movement	4-15
Non-divisible load(s)	1-3, 4-4, 4-8, 4-9, 4-11
Non-hazardous property.....	A-5
North American Standard	7-1

O

Offices issuing permits.....	4-26, 4-27
Oklahoma	4-18
Opiates	5-3
Oregon.....	4-18, A-6
Out-of-service	7-1, 7-2
Overdimensional loads.....	4-8, 4-10
Over hang(s).....	4-4, 4-6, 4-9
Over height.....	4-13
Over legal vehicles.....	4-21
Over length.....	4-13
Oversize	4-10, 4-11, A-6
Oversize load signs	4-9, 4-10
Overweight.....	4-11, 4-13, A-6
Overweight fee schedule.....	4-14
Overweight loads	4-11

P

Pavement.....	4-19
Penalties	3-1, A-5
Permanent plated trailers.....	2-4
Permit fees	4-13
Permits	4-5, 4-8, 4-11, 4-20, 4-22, 4-26
Phencyclidine (PCP).....	5-3
Pneumatic tires.....	4-11, 4-19
Preferential loading policies	4-24
PRISM Program.....	2-6
Privacy act, federal.....	3-9
Privileges, loss of.....	7-2
Propane	4-25. See Hazardous materials
Prorate.....	2-1
Puget Sound	4-24

R

Ranchers.....	4-9
Random testing	5-1, 5-2, 5-3, 5-4
Reasonable suspicion.....	5-1
Reciprocity agreements.....	2-4
Reckless driving.....	3-6
Record keeping	2-5

Record retention requirements.....	5-4
Records	5-3
Recreational vehicle operators.....	3-3
Refund policy.....	4-15, 4-16
Regional permits	4-18
Registered carriers	8-1
Rental commercial motor vehicles.....	8-3
Restriction(s).....	1-3, 4-8, 4-9
Return to duty	5-1, 5-3
Road restrictions	4-8

S

Saddlemounts.....	4-7
Safety	5-1, 7-1
Safety Assurance Program	6-3
Signs.....	4-20
Single trailer(s).....	1-3, 4-9
Single unit	4-4
Slow vehicle rule.....	1-1
Solid waste collection	8-6, 8-7
Special conditions	4-19
Specialized equipment	4-6
Special motor vehicle permits.....	4-25
Speed limits.....	1-1
Substance abuse testing.....	5-1
Superloads.....	4-9, 4-19

T

Tank trucks/vehicles.....	3-2, 4-25
Temporary additional tonnage	4-7
Tests/testing.....	3-2, 3-4, 5-2, 5-3
Texas	4-18
Tire.....	4-11, 4-18, A-2
Tire chain	1-2
Tire conversion chart	A-2
Tongue.....	4-12
Tonnage.....	4-7
Tow Trucks.....	4-23
Traction tires	4-15, 4-16
Traffic violations	3-6
Trailer combination.....	4-5, 4-6
Trailers	3-2, 7-1
Trailers, empty	4-7
Trailing unit.....	4-13
Travel restriction	4-9
Trip permits.....	2-5
Truck and trailer combinations	4-5

U

Unified Carrier Registration (UCR).....	8-1
Uniform Commercial Driver’s Act	5-1
Uniform Commercial Driver’s License Act.....	3-1
United States	7-1
Urine specimen	5-3, 5-4
U.S. Department of Health and Human Services ..	5-3
U.S. Department of Transportation.....	8, 8-2
U.S. Postal Service.....	7-2
Utah.....	4-18, A-6
Utilities and Transportation Commission (UTC).....	8

V

Variable lift axles	4-8
Vehicle markings.....	8-1
Vehicle size and weight.....	1-6

W

Washington.....	A-6
Washington State Department of Licensing (DOL)..	1, 7, 8, 2-1, 2-4, 3-6
Washington State Department of Transportation (WSDOT)	1, 7, 8, 4-1, 4-25, 4-26
Washington State Ferries (WSF).....	4-24, 4-25
Washington State Patrol (WSP) ...	1, 7, 8, 1-1, 1-6, 8-6
Washington Utilities and Transportation Commission	1, 7, 8-5, 8-7
Weigh-in-Motion (WIM)	1-6
Weight	1-6, 4-5, 4-8, 4-18, 4-19, 4-21, 4-25, A-1, A-2, A-3, A-6
Western regional permit system	4-18
Wheelbase	4-22
Width.....	4-4, 4-9, 4-18, 4-19, 4-24, 4-25
Winter road information.....	1-3
Winter road restrictions.....	4-15
WSF Ferry Travel Request/Permit.....	4-25