

# MARTIN<sup>®</sup>

*Safety Solutions*

We Help Companies *Operate Better*

**CUSTOM  
TAILORED  
SOLUTIONS**



Safety Product & Solutions Catalog

▶ 2019-2020

# ABOUT MARTIN SAFETY SOLUTIONS



*We Help  
Companies  
Operate  
Better... ▶*

*The Leaders of  
Martin Inc. –  
Douglas, David and  
Gordon Ruggles*

## ▶ THE MARTIN ADVANTAGE

- Privately Owned
- “Custom Tailored Solutions”
- Focused on Cost Elimination, Increased Productivity, and Asset Management
- Affiliated Distributors Member

## OUR CORE VALUES

**INTEGRITY**



**Entrepreneurial  
Spirit**



**CONTINUOUS  
IMPROVEMENT**



**Customer  
Focused**



**Good Citizenship**





**Martin Safety** is ready to help with the right solution & product expertise to help your company with safety compliance and OSHA laws/standard changes. Our goal is to strategically partner with our Customers to develop the best Custom Tailored Safety Solutions for your workforce.

## SERVICES



- ▶ Qualitative & Quantitative Fit Testing
- ▶ Fall Protection Inspections (Competent & Qualified Persons)
- ▶ D&E Quality Testing for Compressor & SCBA
- ▶ Level A Suit Testing
- ▶ Instrumentation Repair & Calibration
- ▶ Gas Refills
- ▶ Full Engraving Capacity
- ▶ Facility Printing, Systems, Demos, & Technical Support
- ▶ Print on Demand Signs & Labels
- ▶ Safety Audits
- ▶ Safety Meeting Presentations
- ▶ Learning Management System

## EXTENSIVE RENTAL OFFERINGS



If you have projects outside your normal course of work and will need specialized equipment, Martin has extensive rental offerings available. This provides you with the flexibility to get jobs done as safely as possible, for a fraction of the price.

- ▶ Supplied Air Breathing Equipment (SAR, SCBA, EEBA, etc.)
- ▶ Respirators
- ▶ Multi-gas Detection Equipment
- ▶ Single-gas Detection Instruments
- ▶ Environmental Instrumentation
- ▶ Radiation Instrumentation
- ▶ Air Sampling Equipment
- ▶ Specialty Instrumentation
- ▶ Water Quality Equipment
- ▶ Abatement Equipment
- ▶ Communication Equipment
- ▶ Fall Protection Equipment
- ▶ Confined Space Equipment
- ▶ First Aid/Eyewash/Personal Cooling Equipment

# SERVICE SOLUTIONS



## VENDING

- ▶ Decrease usage **up to 30%**
- ▶ Increase accountability through advanced usage tracking
- ▶ Web-based reporting
- ▶ Usage tracking by device, user or job
- ▶ Material closer to point-of-use

## VMI

Keep your focus on production while we apply a 5S Methodology for **up to a 99% Fill Rate** with an added data analysis to optimize stock levels.

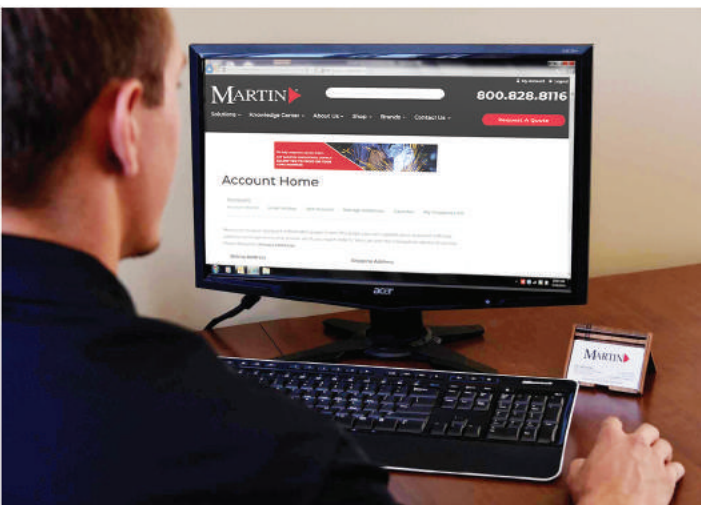

## CUSTOM WEBSITE

- ▶ **Customized** Product Catalog
- ▶ Customer-Specific Pricing
- ▶ Save Favorites & Shopping Carts
- ▶ Purchase Approval Routing Options

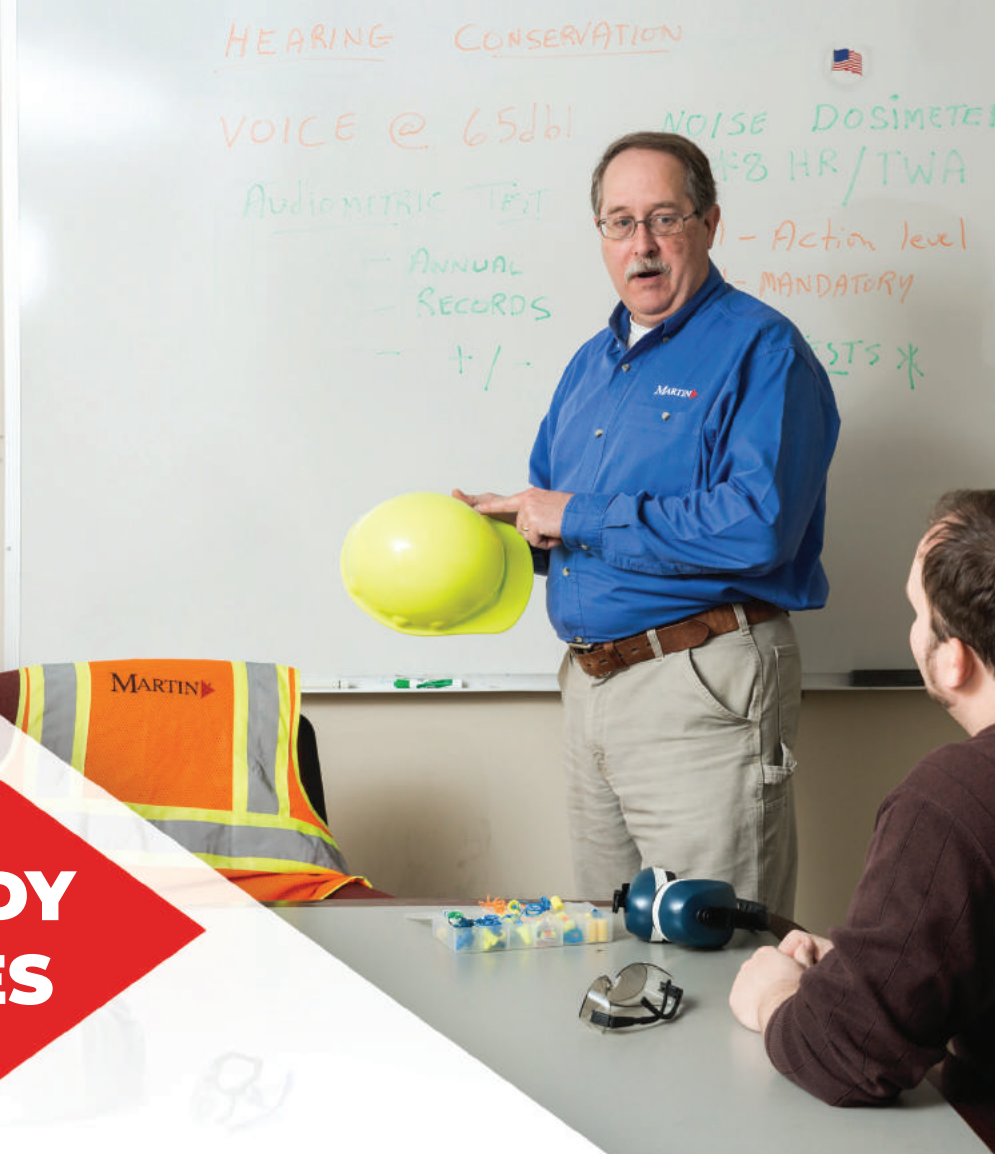

## ARE YOU READY IF OSHA COMES TO CALL?

At **Martin Safety Solutions**, we've been helping manufacturers & the industry with training in issues that are important. No matter where you are, we help train workers, supervisors, & anyone in your business that needs to know about important safety issues - and to keep you ready for OSHA. Instructor **Malcolm Ritchie**, BS, QSSP, HMTRI is OSHA Outreach Authorized & is one of the industry's leading and most experienced trainers. Whether it's a standard training program or a custom-designed program just for you, let Martin Safety Solutions help you operate better.

### TOPICS AVAILABLE

- OSHA 10 & 30 Hour General
- Industrial Plant Safety Audits
- Forklift
- Lockout-Tagout
- Machine Guarding
- Confined Space
- Bloodborne Pathogens
- Hazard Communications
- Personal Protective Equipment
- Respiratory
- Hearing Conservation
- Heat Stress
- Ladder Safety
- SDS
- Drug-Free Workforce

# THE **LAST** WORD IN CONNECTED SAFETY

Blackline's award-winning connected gas detection technology has changed the game forever. We build a decade of wireless safety innovation into every G7. The result? We surpassed our competitors and are winning over businesses like yours, around the world.

Our new G7 Insight system addresses every facet of your gas detection program — **we do it all for you with no extra work on your side**. No more data logs to retrieve or compile, and no more building reports. G7 Insight helps you and your team stay focused on what's important.

Our online compliance dashboard and second-generation data analytics software are fully automatic. With just a few minutes of connectivity per day, more data than you've ever had before is uploaded to the Blackline Safety Network. It's easy and quick to dig deeper, uncovering valuable insights to keep your gas detection program running smoothly.

## G7 INSIGHT

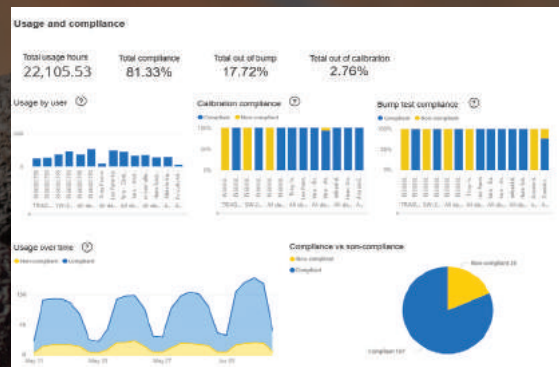

- Online automated compliance dashboard
- Manage your fleet with Blackline Analytics
- Turn-key, integrated 3G connectivity
- Automatic compliance reporting
- Plug-and-play gas sensor cartridges
- Zero gas sensor downtime
- Lifetime gas sensor warranty
- Broad range of gas sensors
- Real-time safety options



## Head-to-toe PPE solutions for every work environment

**Honeywell**

© 2016 Honeywell International. All rights reserved.

Minimize risk, increase compliance and improve productivity with head-to-toe PPE solutions that incorporate premium performance, fit, comfort and style.

Constantly innovating new products such as the North Zone™ Hard Hat, Uvex Hydroshield™ Anti-Fog eyewear coating, and Howard Leight™ FirmFit™ earplugs.

For more information, please visit  
[www.honeywellsafety.com](http://www.honeywellsafety.com)  
or call 800.430.5490 (US)  
and 888.212.7233 (CANADA)

# CONTACT US!

Telephone:  
**888.372.3604**

Mailing Address:  
**125 North Court Street  
Florence, Alabama  
35630**

Fax:  
**901.620.2655**

Email:  
**MSSrequests@martinsafety.com**

Web:  
**www.martinsupply.com**

# LOCATIONS:

## ALABAMA

**Sheffield**  
256.383.3131  
800.828.8116  
Fax 256.383.3136

**Decatur**  
256.355.6311  
800.239.6190  
Fax 256.351.8512

**Tuscaloosa**  
205.752.0421  
800.239.6195  
Fax 205.345.1940

**Birmingham**  
205.733.9292  
800.554.4516  
Fax 205.733.9299

**Anniston**  
256.389.3365  
Fax 256.389.3364

## GEORGIA

**Atlanta**  
404.346.2141  
800.282.5111  
Fax 404.346.5508

## MISSISSIPPI

**Tupelo**  
662.869.1800  
800.284.9714  
Fax 662.869.1121

## SOUTH CAROLINA

**Greenville**  
864.848.1958  
800.897.9777  
Fax 864.848.3122

## TENNESSEE

**Jackson**  
731.424.4300  
800.935.1386  
Fax 731.935.8601

**Memphis**  
901.620.2732  
Fax 901.620.2655

**Nashville**  
615.851.8040  
Fax 615.851.7488



## About Martin Safety Solutions

1

## Head & Face Protection

7-46

Glasses & Goggles 8-18  
Hard Hats 19-23  
Respiratory 24-37  
Hearing 38-46

## Hand Protection

47-74

Cut-Resistant 48-56  
Leather 56-59  
General Purpose 59-62  
Disposable 62-64  
Chemical-Resistant 65-68  
Heat-Resistant 68-71  
Welding 71-74

## Protective Clothing

75-94

Ergonomics 76  
Disposable Clothing 77-79  
Flame-Resistant Clothing 79-83  
Specialty Clothing 84-85  
Hi-Viz Clothing 85-88  
Rainwear 89-90  
Footwear 91-93

## Fall Protection

95-112

Harnesses 96-99  
Lanyards 99-101  
SRLs 101-104  
Anchors 104-105  
Lifeline Systems 106-107  
Confined Space & Rescue 107  
Accessories 108  
Carabiners & Tools 108-112

## Facility Care

113-154

Monitors & Instrumentation 114-121  
First Aid 122-126  
Matting 127-128  
LOTO 129-136  
Heat Stress 137-142  
Signs 143-148  
Spill Containment 149-154

## Index, Terms & Conditions

155-160



# ▶ HEAD & FACE PROTECTION



*These fine manufacturers help us bring you custom tailored solutions:*



Eye and face protection must be provided whenever necessary to protect against chemicals, environmental, and radiological hazards or mechanical irritants. Head protection must be provided whenever necessary to protect against a potential for injury to the head from falling objects. Ensuring worker safety includes conducting a workplace hazard assessment and providing the adequate training to make sure everyone goes home safely to their families.

Glasses & Goggles .....	8-18
Hard Hats.....	19-23
Respiratory .....	24-37
Hearing .....	38-46

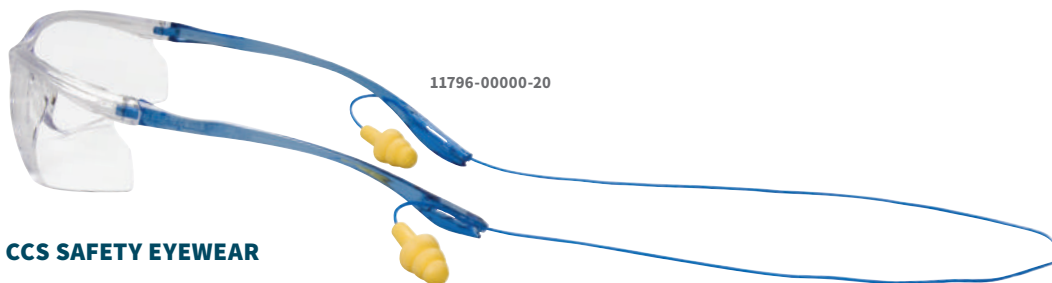

11796-00000-20

**3M™ VIRTUA™ SPORT CCS SAFETY EYEWEAR**

Lightweight, contemporary eyewear is designed to work with hearing protection to help aid compliance. Corded earplug Control System (CCS) is a unique temple design that allows the wearer to keep earplugs attached to eyewear. Provides convenient access to hearing protection, serves as a lanyard for eyewear, and is compatible with a variety of vinyl-corded earplugs. Features polycarbonate lenses that absorb 99.9% UV. Free earplugs included. Meets ANSI Z87.1+ High Impact standard. Certified to the requirements of the CSA Z94.3 standard.

ITEM #	MARTIN #	DESCRIPTION	FRAME	LENS	UOM	PRICE
11796-00000-20	3M11796-00000-20	Virtua Sport CCS	Blue	Clear, anti-fog	PR	\$4.45
11797-00000-20	3M11797-00000-20	Virtua Sport CCS	Blue	Clear, hardcoat	PR	\$3.91
11798-00000-20	3M11798-00000-20	Virtua Sport CCS	Blue	Gray, anti-fog	PR	\$4.45
11799-00000-20	3M11799-00000-20	Virtua Sport CCS	Blue	Gray, hardcoat	PR	\$3.91



**3M™ VIRTUA™ V4 SAFETY EYEWEAR**

Soft, dual-injected temples for all-day comfort. Lightweight design and unisex styling. Polycarbonate wraparound lens. Meets ANSI Z87.1+ High Impact standard.

ITEM #	MARTIN #	DESCRIPTION	FRAME	LENS	UOM	PRICE
11670-00000-20	3M11670-00000-20	Virtua V4	Black	Clear, hardcoat	PR	\$2.15
11672-00000-20	3M11672-00000-20	Virtua V4	Black	Clear, anti-fog	PR	\$2.75
11671-00000-20	3M11671-00000-20	Virtua V4	Black	Gray, hardcoat	PR	\$2.29
11673-00000-20	3M11673-00000-20	Virtua V4	Black	Gray, anti-fog	PR	\$2.97
11674-00000-20	3M11674-00000-20	Virtua V4	Black	I/O mirror	PR	\$3.00



11671-00000-20



**3M™ VIRTUA™ SAFETY EYEWEAR**

Features lightweight frame design, unisex styling and a high-wrap lens for front and side impact protection. Lenses available with anti-fog coating or hardcoat. Polycarbonate lens absorbs 99.9% UV. Meets ANSI Z87.1+ High Impact standard.

ITEM #	MARTIN #	DESCRIPTION	FRAME	LENS	UOM	PRICE
11326-00000-20	3M11326-00000-20	Virtua	Clear	Clear, hardcoat	PR	\$1.42
11329-00000-20	3M11329-00000-20	Virtua	Clear	Clear, anti-fog	PR	\$1.66
11228-00000-100	3M11228-00000-100	Virtua	Clear	Clear, uncoated	PR	\$0.88
11328-00000-20	3M11328-00000-20	Virtua	Clear	I/O mirror, hardcoat	PR	\$2.15
11327-00000-20	3M11327-00000-20	Virtua	Gray	Gray, hardcoat	PR	\$1.58
11330-00000-20	3M11330-00000-20	Virtua	Gray	Gray, anti-fog	PR	\$1.77
11331-00000-20	3M11331-00000-20	Virtua	Blue Mirror	Blue mirror, hardcoat	PR	\$2.48
11385-00000-20	3M11385-00000-20	Virtua Sport	Clear	Clear, hardcoat	PR	\$1.88
11384-00000-20	3M11384-00000-20	Virtua Sport	Clear	Clear, anti-fog	PR	\$2.31
11386-00000-20	3M11386-00000-20	Virtua Sport	Gray	Gray, anti-fog	PR	\$2.45
11388-00000-20	3M11388-00000-20	Virtua Sport	I/O	I/O mirror	PR	\$2.62
11742-00000-20	3M11742-00000-20	Virtua Sport	I/O gray	I/O gray, anti-fog	PR	\$3.31
11542-00000-20	3M11542-00000-20	Virtua Sport	Light blue	Light blue, anti-fog	PR	\$2.40
11543-00000-20	3M11543-00000-20	Virtua Sport	Light blue	Light blue, hardcoat	PR	\$2.06
11544-00000-20	3M11544-00000-20	Virtua Sport	Light amber	Light amber, anti-fog	PR	\$2.40
11545-00000-20	3M11545-00000-20	Virtua Sport	Light amber	Light amber, hardcoat	PR	\$3.82



11327-00000-20

**WARNING**

These eye and face protection products help provide limited eye and face protection. **Misuse or failure to follow warnings and instructions may result in serious potential injury, including blindness or death.** For proper use, selection, and applications against flying particles, optical radiation and/or splash see supervisor, read *User Instructions* and warnings on the package or call 3M PSD Technical Service in the USA at 1-800-243-4630. In Canada, call 1-800-267-4414.



**3M™ LEXA™ FIGHTER SAFETY EYEWEAR**

Features stylish, sleek wraparound design with adjustable length temples and lens angle adjustment for customized fit. DX™ anti-fog hardcoat helps protect lens from fog, scratching and many chemicals. Available with the patriotic American red, white and blue (RWB) frame. Polycarbonate lens absorbs 99.9% UV. Meets ANSI Z87.1+ High Impact standard. Certified to the requirements of the CSA Z94.3 standard.



15152-00000-100

ITEM #	MARTIN #	FRAME	LENS	SIZES	UOM	PRICE
15152-00000-100	3M15152-00000-100	Black	Clear, anti-fog	M	PR	\$6.68
15154-00000-100	3M15154-00000-100	Black	Clear, anti-fog	L	PR	\$6.68
15258-00000-100	3M15258-00000-100	American RWB	Clear, anti-fog	M	PR	\$10.69



**3M™ LEXA™ SAFETY READERS**

Contoured lens eliminates need for sideshields, and adjustable temple lengths and lens angle provide custom fit. Easy-change lenses are compatible with Lexa Splash Gogglegear and Lexa Dust Gogglegear. DX™ anti-fog hardcoat helps protect lens from fog, scratching and many chemicals. Meets ANSI Z87.1+ High Impact standard. Certified to the requirements of the CSA Z94.3 standard.



13353-00000-20

ITEM #	MARTIN #	FRAME	LENS	UOM	PRICE
13353-00000-20	3M13353-00000-20	Black	Clear, anti-fog, +1.5	PR	\$15.23
13355-00000-20	3M13355-00000-20	Black	Clear, anti-fog, +2.5	PR	\$9.52



**3M™ MAXIM™ SAFETY EYEWEAR**

Lightweight style offers a dual-injected, cushioned browguard for comfort, and ventilation channel designed to help minimize fogging. Features 3-position pantoscopic lens adjustment, adjustable temple lengths and soft, adjustable nosebridge. Available with the MinimizeR™ lens for use in low light welding applications to protect against “flash burn.” Meets ANSI Z87.1+ High Impact standard. Certified to the requirements of the CSA Z94.3 standard.



13251-00000-20

ITEM #	MARTIN #	FRAME	LENS	UOM	PRICE
13250-00000-20	3M13250-00000-20	Black	Clear	PR	\$9.31
13251-00000-20	3M13251-00000-20	Black	Bronze	PR	\$10.18
<i>Maxim Replacement Lens</i>					
13267-00000-20	3M13267-00000-20		Clear	PR	\$8.51



**3M™ MAXIM™ GT SAFETY EYEWEAR**

Lightweight frame designed with a high-wrap lens for extended coverage and optical clarity. Features elastomeric browguard and dual-injected adjustable temples with 3-position lens adjustment for better fit. Polycarbonate lens absorbs 99.9% UV. Meets ANSI Z87.1+ High Impact standard. Certified to the requirements of the CSA Z94.3 standard.



14246-00000-20

ITEM #	MARTIN #	FRAME	LENS	UOM	PRICE
14246-00000-20	3M14246-00000-20	Silver/black	Clear, anti-fog	PR	\$8.58
14247-00000-20	3M14247-00000-20	Silver/black	Gray, anti-fog	PR	\$8.77
14248-00000-20	3M14248-00000-20	Silver/black	I/O mirror	PR	\$9.49



**3M™ MAXIM™ SPORT SAFETY EYEWEAR**

Dual-color frame design features sport-grip, dual-injected temples and browguard with soft, elastomeric cushion. High wrap offers additional coverage. DX™ anti-fog hardcoat helps protect lens from fog, scratching and many chemicals. Meets ANSI Z87.1+ High Impact standard. Certified to the requirements of the CSA Z94.3 standard.



13274-10000-20

ITEM #	MARTIN #	FRAME	LENS	UOM	PRICE
13274-10000-20	3M13274-10000-20	Silver/blue	Clear, anti-fog	PR	\$9.49



**3M™ NITROUST™ CCS SAFETY EYEWEAR**



11801-00000-20

Features the Corded earplug Control System (CCS), a unique temple design that allows the wearer to keep earplugs attached to eyewear. Design provides convenient access to hearing protection, serves as a lanyard for safety glasses when neither product is in use and is compatible with a variety of vinyl-corded earplugs. Nitroust CCS also offers soft temple tips and a lightweight, contemporary design. Polycarbonate lens absorbs 99.9% UV. Meets ANSI Z87.1+ High Impact standard.

ITEM #	MARTIN #	FRAME	LENS	UOM	PRICE
11802-00000-20	3M11802-00000-20	Black	Gray, anti-fog	PR	\$9.37



**3M™ NITROUST™ SAFETY EYEWEAR**

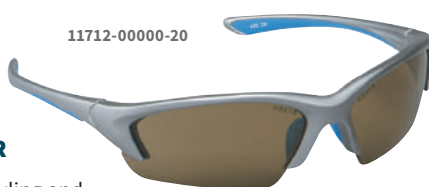

11712-00000-20

Sleek, street-wear styling and semi-frameless, unisex design. Features soft, comfortable temple tips and nosebridge for all day comfort and polycarbonate lenses that absorb 99.9% UV. Lanyard and micro-fiber bag included. Meets ANSI Z87.1+ High Impact standard.

ITEM #	MARTIN #	FRAME	LENS	UOM	PRICE
11712-00000-20	3M11712-00000-20	Metallic silver	Bronze, anti-fog	PR	\$13.25
11713-00000-20	3M11713-00000-20	Metallic blue	Clear, anti-fog	PR	\$21.09
11715-00000-20	3M11715-00000-20	Met. champagne	I/O mirror	PR	\$14.17



**3M™ PRIVO™ SAFETY EYEWEAR**



12261-00000-20

Features color-accented temples and European-inspired styling. Soft-tipped temples for comfortable fit. Polycarbonate lenses absorb 99.9% UV. Meets ANSI Z87.1+ High Impact standard. Certified to the requirements of the CSA Z94.3 standard.

ITEM #	MARTIN #	FRAME	LENS	UOM	PRICE
<i>Orange Accent Temple Tips</i>					
12261-00000-20	3M12261-00000-20	Black	Clear, anti-fog	PR	\$5.57
12262-00000-20	3M12262-00000-20	Black	Gray, anti-fog	PR	\$4.13
12263-00000-20	3M12263-00000-20	Black	Amber, anti-fog	PR	\$6.43
12264-00000-20	3M12264-00000-20	Black	I/O mirror	PR	\$7.52
<i>Red Accent Temple Tips</i>					
12265-00000-20	3M12265-00000-20	Silver	Clear, anti-fog	PR	\$5.63
12266-00000-20	3M12266-00000-20	Silver	Gray, anti-fog	PR	\$6.43
12267-00000-20	3M12267-00000-20	Silver	Amber, anti-fog	PR	\$6.43
12268-00000-20	3M12268-00000-20	Silver	I/O mirror	PR	\$7.52



**3M™ SECUREFIT™ PROTECTIVE EYEWEAR**



SF202AF

3M™ Pressure Diffusion Temple Technology means there are no moving parts and nothing to adjust, while the versatile design is suited for a wide variety of faces. Lightweight, weighs less than 1 oz. Continually self-adjusting for a secure, comfortable fit. Polycarbonate lens absorbs 99.9% UV. Meets ANSI Z87.1+ High Impact standard. Certified to the requirements of the CSA Z94.3 standard.

ITEM #	MARTIN #	FRAME	LENS	UOM	PRICE
SF201AF	3MSF201AF	Clear	Clear, anti-fog	PR	\$2.31
SF202AF	3MSF202AF	Gray	Gray, anti-fog	PR	\$2.48
SF203AF	3MSF203AF	Amber	Amber, anti-fog	PR	\$2.48
SF201AS	3MSF201AS	Clear	Clear, anti-scratch	PR	\$1.97
SF202AS	3MSF202AS	Gray	Gray, anti-scratch	PR	\$2.14
SF203AS	3MSF203AS	Amber	Amber, anti-scratch	PR	\$2.14



**3M™ SECUREFIT™ 400-SERIES PROTECTIVE EYEWEAR**



SF401AF

Stylish design weighs less than 1 oz., has a soft adjustable nosepiece to help reduce slippage, incorporates dual-material on temples to provide cushioned comfort plus enhanced style and features the proprietary 3M™ Pressure Diffusion Temple Technology – a scientific advancement that helps diffuse pressure over the ear, enhanced temple comfort while not compromising the security of fit across diverse workforces. Polycarbonate lens absorbs 99.9% UV. Meets the ANSI Z87.1+ High Impact standard.

ITEM #	MARTIN #	LENS	UOM	PRICE
SF401AF	3MSF401AF	Clear, anti-fog	PR	\$3.35
SF402AF	3MSF402AF	Gray, anti-fog	PR	\$3.52
SF410AS	3MSF410AS	I/O mirror	PR	\$4.22



**3M™ SMART LENS™ PROTECTIVE EYEWEAR**



13407-00000-5

Light reactive lens lightens and darkens with changing outdoor light conditions: light to dark in less than 20 seconds, dark to light in less than 3 minutes. Nylon brow and magnesium alloy temples. Spring-hinged temples for a narrow or wide fit. Soft, adjustable nosebridge. Polycarbonate lens absorbs 99.9% UV. Meets the High Impact requirements of ANSI Z87.1-2003.

*Note: Safety directors should assess their particular workplace and make all Smart Lens wearers aware of the time required for the lens transition. Special care should be taken when moving from outdoors to indoors. Outdoor temperatures may affect lens transition time.*

ITEM #	MARTIN #	FRAME	LENS	UOM	PRICE
13407-00000-5	3M13407-00000-5	Black	Photochromic, anti-fog	PR	\$62.00

**WARNING**

These eye and face protection products help provide limited eye and face protection. **Misuse or failure to follow warnings and instructions may result in serious potential injury, including blindness or death.** For proper use, selection, and applications against flying particles, optical radiation and/or splash see supervisor, read *User Instructions* and warnings on the package or call 3M PSD Technical Service in the USA at 1-800-243-4630. In Canada, call 1-800-267-4414.



### 3M™ LIGHT VISION™ AND LIGHT VISION2™ SAFETY EYEWEAR WITH LED LIGHTS

Features hands-free, adjustable direct lighting, (2) bright, adjustable LED lights, wraparound design, and cushioned brow, nosebridge and temple tips for comfort. Polycarbonate lenses absorb 99.9% UV. Includes replaceable CR2032 3 V batteries, microfiber storage bag and lanyard. Both models meet ANSI Z87.1+ High Impact standard; Light Vision2 also certified to the requirements of the CSA Z94.3 standard.



11356-00000-10

ITEM #	MARTIN #	DESCRIPTION	FRAME	LENS	UOM	PRICE
11356-00000-10	3M11356-00000-10	Light Vision	Gray	Clear, anti-fog	PR	\$15.58
11476-00000-10	3M11476-00000-10	Light Vision2	Gray	Clear, anti-fog	PR	\$16.62
11477-00000-10	3M11477-00000-10	Light Vision2 Readers	Gray	Clear, +1.5	PR	\$22.86
11478-00000-10	3M11478-00000-10	Light Vision2 Readers	Gray	Clear, +2.0	PR	\$22.86
11479-00000-10	3M11479-00000-10	Light Vision2 Readers	Gray	Clear, +2.5	PR	\$22.86



### 3M™ BX™ AND BX™ READERS SAFETY EYEWEAR

Contoured, fully adjustable design features soft-tip temples, soft nosebridge, three lens angles for custom fit, and polycarbonate lenses that absorb 99.9% UV. Available with integrated bifocal reader for workers who need extra magnification during close-up work. Meets ANSI Z87.1+ High Impact standard. Certified to the requirements of the CSA Z94.3 standard.



11471-00000-20

ITEM #	MARTIN #	DESCRIPTION	FRAME	LENS	UOM	PRICE
11380-00000-20	3M11380-00000-20	BX	Silver/black	Clear, anti-fog	PR	\$4.65
11381-00000-20	3M11381-00000-20	BX	Silver/black	Gray, anti-fog	PR	\$5.42
11471-00000-20	3M11471-00000-20	BX	Ocean blue	Clear, anti-fog	PR	\$4.65
11472-00000-20	3M11472-00000-20	BX	Ocean blue	I/O mirror	PR	\$5.14
11523-00000-20	3M11523-00000-20	BX	Ocean blue	Light blue, anti-fog	PR	\$5.42
11524-00000-20	3M11524-00000-20	BX	Ocean blue	Light amber, anti-fog	PR	\$5.42
11525-00000-20	3M11525-00000-20	BX	Ocean blue	I/O gray mirror	PR	\$5.42
11374-00000-20	3M11374-00000-20	BX Readers	Silver/black	Clear, anti-fog, +1.5	PR	\$11.05
11375-00000-20	3M11375-00000-20	BX Readers	Silver/black	Clear, anti-fog, +2.0	PR	\$11.05
11376-00000-20	3M11376-00000-20	BX Readers	Silver/black	Clear, anti-fog, +2.5	PR	\$11.05
11377-00000-20	3M11377-00000-20	BX Readers	Silver/black	Gray, anti-fog, +1.5	PR	\$11.74
11378-00000-20	3M11378-00000-20	BX Readers	Silver/black	Gray, anti-fog, +2.0	PR	\$11.74
11379-00000-20	3M11379-00000-20	BX Readers	Silver/black	Gray, anti-fog, +2.5	PR	\$11.62
11473-00000-20	3M11473-00000-20	BX Readers	Ocean blue	I/O mirror, anti-fog, +1.5	PR	\$11.74
11474-00000-20	3M11474-00000-20	BX Readers	Ocean blue	I/O mirror, anti-fog, +2.0	PR	\$11.74
11475-00000-20	3M11475-00000-20	BX Readers	Ocean blue	I/O mirror, anti-fog, +2.5	PR	\$11.85



11380-00000-20



11377-00000-20



### XV100 SERIES SAFETY GLASSES

Features 10-base, wraparound unilens for great peripheral vision and protection; molded, universal nosepiece for easy fit; lightweight design and thin, shaped temples for all-day comfort. Anti-scratch lens hardcoat protects against scuffing, scratching, and a variety of chemicals. UVextra® anti-fog coating helps keep lenses clear in humid or extreme environments. Meets ANSI Z87.1+ standard.



XV101

ITEM #	MARTIN #	FRAME	LENS	UOM	PRICE
XV100	NTHXV100	Clear frosted	Clear, hardcoat	PR	\$1.34
XV101	NTHXV101	Gray frosted	Gray, hardcoat	PR	\$1.31



### GENESIS® SAFETY GLASSES

Features dual 9-base curve, wraparound lenses for peripheral protection, flexible nosepiece fingers for reduced slippage, elastomer browguard for impact protection, and adjustable spatulite temples and lens inclination. Impact-resistant polycarbonate lenses block 99.9% of UV radiation. Ultra-dura® hardcoat provides enhanced chemical and scratch resistance. Lifetime frame guarantee. Meets Military V<sub>0</sub> Test for Impact.



S3200

ITEM #	MARTIN #	DESCRIPTION	FRAME	LENS	UOM	PRICE
S3200	NTHS3200	Genesis	Black	Clear, Ultra-dura	PR	\$7.69
S6900	NTHS6900	Replacement lens		Clear, Ultra-dura	PR	\$3.25



**GENESIS® SAFETY GLASSES WITH HYDROSHIELD®**

Features dual 9-base curve, wraparound lenses for peripheral protection, flexible nosepiece fingers for reduced slippage, elastomer browguard for impact protection, and adjustable spatulite temples and lens inclination. Impact-resistant polycarbonate lenses block 99.9% of UV radiation. HydroShield anti-fog lens coating is permanently-bonded and provides consistent fog-free time of 90X longer than majority of other anti-fog coatings. Lifetime frame guarantee. Meets the ANSI Z87.1+ and Z94.3 standards. Lens tints meet Military V<sub>0</sub> Test for Impact.

ITEM #	MARTIN #	FRAME	LENS	UOM	PRICE
S3200HS	NTHS3200HS	Black	Clear, HydroShield	PR	\$8.49
S3201HS	NTHS3201HS	Black	Espresso, HydroShield	PR	\$9.34
<i>Genesis Replacement Lens</i>					
S6900HS	NTHS6900HS		Clear, HydroShield	PR	\$4.05



**A800 SERIES SAFETY GLASSES**

Features sports-styled temples, extra flexible, padded inserts and soft nosepiece for a non-slip fit. The 9-base curve, polycarbonate lens provides 180° field of distortion-free vision and 99.9% UV protection. Anti-scratch lens hardcoat protects against scuffing, scratching, and a variety of chemicals. Uvextra® anti-fog coating helps keep lenses clear in humid or extreme environments. Meets ANSI Z87.1+ standard.

ITEM #	MARTIN #	FRAME	LENS	UOM	PRICE
A800	NTHA800	Clear	Clear, hardcoat	PR	\$2.46
A801	NTHA801	Gray	TSR gray, hardcoat	PR	\$2.86



**PROTÉGÉ SAFETY GLASSES WITH HYDROSHIELD®**

Proprietary Floating Lens™ technology offers increased flexibility for a more comfortable fit. Includes standard 6-base curve lens. Features expandable wraparound brow, ultra-lightweight design (only 25 grams), soft cushioned temple tip pads and soft nose pads. HydroShield anti-fog lens coating is permanently-bonded and provides consistent fog-free time of 90X longer than majority of other anti-fog coatings. Meets ANSI Z87.1+ and Z94.3 standards. Also meets Military V<sub>0</sub> Test for Impact.

ITEM #	MARTIN #	FRAME	LENS	UOM	PRICE
S4200HS	NTHS4200HS	Metallic black	Clear, HydroShield	PR	\$5.18



**SEISMIC® SEALED EYEWEAR**

Contemporary, flexible design can be worn with or without the removable temples. Includes flame-resistant, adjustable headband and cushioned subframe. Protects against impact, sun, wind, dust and airborne debris, making it ideal for dirty, high-particulate work environments. Includes soft nasal pads, face cushioning and padded temple tips. Wraparound 8-base dual-lens style for maximum peripheral coverage. Top and bottom indirect ventilation helps to minimize fogging. Meets ANSI Z87.1+ and Z94.3 standards.

ITEM #	MARTIN #	FRAME	LENS	UOM	PRICE
S0600X	NTHS0600X	Black	Clear, Uvextra	PR	\$14.20



**TIRADE™ SEALED EYEWEAR**

Offers protection in high particulate environments where dust, dirt and debris present the risk of eye injury. Features a large unilens design for a wide field of unobstructed peripheral vision, and a soft foam subframe to ensure a comfortable gap-free fit. Indirect ventilation channels on the foam and subframe provide superior dust filtration keeping debris out of the eyes. Quick-release hinge system converts easily from temples to headband. Dependable, cost-effective solution for indoor and outdoor environments requiring sealed eyewear protection. Removable temples and standard adjustable headband included; hypoallergenic latex-free option available. Uvextra® anti-fog coating helps keep lenses clear in humid or extreme environments. 100% Non-conductive dielectric design. Can be worn in environments where accidental exposure to electrical charge is possible. Meets ANSI Z87.1+ and Z94.3 standards (with and without foam subframe in place). Not for chemical splash applications.

ITEM #	MARTIN #	FRAME	LENS	UOM	PRICE
S4040	NTHS4040	Gloss black	Clear, Uvextra	PR	\$6.78



**LIVEWIRE® SEALED EYEWEAR WITH HYDROSHIELD®**

Delivers the fit, performance and protection required in extreme environments, protecting workers against intense wind, sun, dirt, dust and debris, as well as high heat and humidity. Optimized design ensures excellent, comfortable fit for almost any wearer. Streamlined, wraparound frame design accommodates respirators and other PPE, while the low-profile temples fit comfortably with earmuffs. Foam-lined subframe is precision engineered to offer maximum comfort and a gap-free seal around the eyes to keep debris out. Padded temples are engineered to provide ideal tension and flex for superior comfort and fit. Ratcheting temples adjust lens angle by up to 15° for optimal coverage and air circulation. HydroShield anti-fog lens coating is permanently-bonded and consistently 90X longer than the majority of other anti-fog coatings. Can be worn with a headband like a goggle or with temples like a spectacle. Highly adjustable, flame-resistant cloth headband provides an excellent fit and is latex-free. Meets ANSI Z87.1+ and Z94.3 standards.

ITEM #	MARTIN #	FRAME	LENS	UOM	PRICE
S2600HS	NTHS2600HS	Matte black	Clear, HydroShield	PR	\$15.43



## ZENON Z11™ SAFETY GLASSES



Lightweight, rimless safety glasses feature a molded bridge design that fits most wearers. Thin, flexible temples for a secure, comfortable fit. Meets ANSI Z87.1+ High Impact standard.

**⚠️ WARNING:** This product can expose you to chemicals including Bisphenol A (BPA), which is known to the State of California to cause birth defects or other reproductive harm. For more information go to [www.P65Warnings.ca.gov](http://www.P65Warnings.ca.gov).

ITEM #	MARTIN #	FRAME	LENS	UOM	PRICE
250-00-0000	PIP250-00-0000	Black	Clear, anti-scratch	PR	\$1.27
250-00-0001	PIP250-00-0001	Black	Gray, anti-scratch	PR	\$1.27
250-00-0002	PIP250-00-0002	Black	I/O, anti-scratch	PR	\$1.42
250-00-0900	PIP250-00-0900	Clear	Clear, anti-scratch	PR	\$1.27
250-00-0920	PIP250-00-0920	Black	Clear, anti-fog/scratch	PR	\$1.64



## ZENON Z12™ SAFETY GLASSES



Features a saddle bridge design that fits most wearers and thin, flexible temples that provide a secure fit without pinching. Lightweight, rimless frame is ideal for long-term wear. Meets ANSI Z87.1+ High Impact standard.

**⚠️ WARNING:** This product can expose you to chemicals including Bisphenol A (BPA), which is known to the State of California to cause birth defects or other reproductive harm. For more information go to [www.P65Warnings.ca.gov](http://www.P65Warnings.ca.gov).

ITEM #	MARTIN #	FRAME	LENS	UOM	PRICE
250-01-0000	PIP250-01-0000	Black	Clear, anti-scratch	PR	\$1.27
250-01-0001	PIP250-01-0001	Black	Gray, anti-scratch	PR	\$1.27
250-01-0002	PIP250-01-0002	Black	I/O, anti-scratch	PR	\$1.42
250-01-0004	PIP250-01-0004	Black	Orange, anti-scratch	PR	\$1.27
250-01-0005	PIP250-01-0005	Black	Silver mirror, anti-scratch	PR	\$1.42
250-01-0020	PIP250-01-0020	Black	Clear, anti-fog/scratch	PR	\$1.64
250-01-0021	PIP250-01-0021	Black	Gray, anti-fog/scratch	PR	\$1.64
250-01-0080	PIP250-01-0080	Black	Clear, uncoated	PR	\$1.18
250-01-0900	PIP250-01-0900	Clear	Clear, anti-scratch	PR	\$1.27
250-01-0902	PIP250-01-0902	Clear	I/O, anti-scratch	PR	\$1.42
250-01-0920	PIP250-01-0920	Clear	Clear, anti-fog/scratch	PR	\$1.64
250-01-0980	PIP250-01-0980	Clear	Clear, uncoated	PR	\$1.18
250-01-5503	PIP250-01-5503	Light blue	Light blue, anti-scratch	PR	\$1.27
250-01-5504	PIP250-01-5504	Dark brown	Dark brown, anti-scratch	PR	\$1.27
250-01-5509	PIP250-01-5509	Amber	Amber, anti-scratch	PR	\$1.27



## ZENON Z12F™ FOAM SAFETY GLASSES

Foam padding design forms a seal to keep out dust and airborne particles. Lightweight, rimless design provides all day user comfort. Thin, flexible temples provide secure fit without uncomfortable pressure points. 9.5 Base curve lens. Anti-scratch, anti-fog coating. Meets ANSI Z87.1+ High Impact standard.

**⚠️ WARNING:** This product can expose you to chemicals including Bisphenol A (BPA), which is known to the State of California to cause birth defects or other reproductive harm. For more information go to [www.P65Warnings.ca.gov](http://www.P65Warnings.ca.gov).

ITEM #	MARTIN #	FRAME	LENS	UOM	PRICE
250-01-F020	PIP250-01-F020	Black	Clear	PR	\$3.69
250-01-F021	PIP250-01-F021	Black	Gray	PR	\$3.69



## ZENON Z13™ SAFETY GLASSES



Rimless, lightweight design is ideal for long-term wear. Features molded nosebridge and soft temple end pieces for behind-the-ear comfort. Matching temple and lens color options. Meets ANSI Z87.1+ High Impact standard.

**⚠️ WARNING:** This product can expose you to chemicals including Bisphenol A (BPA), which is known to the State of California to cause birth defects or other reproductive harm. For more information go to [www.P65Warnings.ca.gov](http://www.P65Warnings.ca.gov).

ITEM #	MARTIN #	FRAME	LENS	UOM	PRICE
250-06-0000	PIP250-06-0000	Clear	Clear, anti-scratch	PR	\$1.51
250-06-0002	PIP250-06-0002	Clear	I/O, anti-scratch	PR	\$1.69
250-06-0020	PIP250-06-0020	Clear	Clear, anti-fog/scratch	PR	\$2.09
250-06-0080	PIP250-06-0080	Clear	Clear, uncoated	PR	\$1.45
250-06-5501	PIP250-06-5501	Dark gray	Gray, anti-scratch	PR	\$1.51
250-06-5503	PIP250-06-5503	Light blue	Light blue, anti-scratch	PR	\$1.51
250-06-5504	PIP250-06-5504	Dark brown	Dark brown, anti-scratch	PR	\$1.51
250-06-5509	PIP250-06-5509	Amber	Amber, anti-scratch	PR	\$1.51
250-06-0005	PIP250-06-0005	Black	Silver mirror, anti-scratch	PR	\$1.69
250-06-0006	PIP250-06-0006	Black	Blue mirror, anti-scratch	PR	\$1.69
250-06-5521	PIP250-06-5521	Dark gray	Gray, anti-fog/scratch	PR	\$2.09



## ANSER™ SAFETY GLASSES



Sleek, lightweight, sporty design in a semi-rimless style incorporates wraparound protection. Bayonet temples with flexible rubber tips and soft rubber nose pads offer a comfortable, secure fit. Polycarbonate lenses. Each style is supplied with free neck cord. Meets ANSI Z87.1+ High Impact standard.

**⚠️ WARNING:** This product can expose you to chemicals including Bisphenol A (BPA), which is known to the State of California to cause birth defects or other reproductive harm. For more information go to [www.P65Warnings.ca.gov](http://www.P65Warnings.ca.gov).

ITEM #	MARTIN #	FRAME	LENS	UOM	PRICE
250-AN-10110	PIP250-AN-10110	Black	Clear, anti-scratch	PR	\$3.56
250-AN-10111	PIP250-AN-10111	Black	Clear, anti-scratch, anti-fog	PR	\$4.07
250-AN-10112	PIP250-AN-10112	Black	Gray, anti-scratch	PR	\$3.56
250-AN-10113	PIP250-AN-10113	Black	Light blue, anti-scratch	PR	\$3.56
250-AN-10114	PIP250-AN-10114	Black	I/O, anti-scratch	PR	\$3.84
250-AN-10115	PIP250-AN-10115	Black	Blue mirror, anti-scratch	PR	\$5.45
250-AN-10116	PIP250-AN-10116	Black	Red mirror, anti-scratch	PR	\$5.45
250-AN-10117	PIP250-AN-10117	Red	Gray, anti-scratch	PR	\$4.38
250-AN-10118	PIP250-AN-10118	Black	IRUV 3.0, anti-scratch	PR	\$7.65
250-AN-10119	PIP250-AN-10119	Black	IRUV 5.0, anti-scratch	PR	\$8.40
250-AN-10120	PIP250-AN-10120	Black	Amber, anti-scratch	PR	\$3.56
250-AN-10121	PIP250-AN-10121	Camouflage	Brown, anti-scratch	PR	\$6.20
250-AN-10122	PIP250-AN-10122	Camouflage	Amber, anti-scratch	PR	\$6.20
250-AN-10123	PIP250-AN-10123	Camouflage	Gray, anti-scratch	PR	\$6.20
250-AN-10125	PIP250-AN-10125	Black	Silver mirror, anti-scratch	PR	\$3.84
250-AN-10126	PIP250-AN-10126	Gray	Gray, anti-scratch, anti-fog	PR	\$4.07
250-AN-10131	PIP250-AN-10131	Camouflage	Clear, anti-scratch, anti-fog	PR	\$6.56



ITEM #	MARTIN #	FRAME	LENS	UOM	PRICE
250-01-F022	PIP250-01-F022	Black	I/O	PR	\$4.96



**RECON™ SAFETY GLASSES**

Lightweight, rimless design offers all-day comfort. Flexible bayonet temples contain rubber pads for a secure, non-slip fit. Adjustable rubber nosepiece provides a comfortable fit. FogLess™ lens coating standard except on anti-reflective lens. Polycarbonate lenses block 99.99% of UV rays. Meets ANSI Z87.1+ High Impact standard. Certified to the requirements of the CSA Z94.3 standard.

**⚠️ WARNING:** This product can expose you to chemicals including Bisphenol A (BPA), which is known to the State of California to cause birth defects or other reproductive harm, and Diisononyl phthalate (DINP), which is known to the State of California to cause cancer. For more information go to [www.P65Warnings.ca.gov](http://www.P65Warnings.ca.gov).

ITEM #	MARTIN #	FRAME	LENS	UOM	PRICE
250-32-0020	PIP250-32-0020	Clear	Clear, anti-scratch, anti-fog	PR	\$5.07
250-32-0021	PIP250-32-0021	Gloss black	Gray, anti-scratch, anti-fog	PR	\$5.07
250-32-0010	PIP250-32-0010	Clear	Clear, anti-scratch, anti-reflective	PR	\$6.93
250-32-0226	PIP250-32-0226	Translucent brown	I/O blue, anti-scratch, anti-fog	PR	\$7.24

250-32-0226



**ACCURIST SAFETY GLASSES**

Sporty design for on and off the job. Inner foam padding is flame-resistant. Built-in rubber nosepiece. Durable frame features dual-injected straight back temples. Other lens options available. Scratch-resistant polycarbonate lens provides 99% UV protection.

ITEM #	MARTIN #	FRAME	LENS	UOM	PRICE
SB8710DTP	PYRASB8710DTP	Black	Clear, anti-fog	PR	\$9.00
SB8725DTP	PYRASB8725DTP	Black	Light gray, anti-fog	PR	\$9.45



SB8710DTP



**ALAIR® SAFETY GLASSES**

Features a polycarbonate frameless design with straight temples and integrated nosepiece that fits all facial sizes. Lens is coated for superior scratch resistance and provides 99% UV protection. Other lens options available. Meets ANSI Z87.1+ High Impact standard. CE EN166 certified.

ITEM #	MARTIN #	FRAME	LENS	UOM	PRICE
S3210S	PYRAS3210S	Clear	Clear	PR	\$1.35



S3210S



**EVER-LITE® SAFETY GLASSES**

Features soft nosepiece for snug fit and semi-frame and slim co-material temple design for lightweight spectacle - weighs only 22 gm. Offers a clear panoramic view without obstruction; 8-base wraparound lens provides full front and side protection. Scratch-resistant, polycarbonate lens provides 99.9% UV protection. Also available with H2MAX anti-fog coating for high-performing, superior anti-fog protection. Meets ANSI Z87.1+ High Impact standard.

ITEM #	MARTIN #	FRAME	LENS	UOM	PRICE
SB8610D	PYRASB8610D	Black	Clear, anti-scratch	PR	\$3.00
SB8610DT	PYRASB8610DT	Black	Clear, anti-scratch, anti-fog	PR	\$3.55
SB8620D	PYRASB8620D	Black	Gray, anti-scratch	PR	\$3.45



**ENDEAVOR PLUS SAFETY GLASSES**

Lightweight and durable protective eyewear. Built-in brow guard shields against overhead particles. Special dielectric hinge design contains no metal parts. Curved, co-material temples allow for comfortable all day wear. Scratch-resistant polycarbonate lens provides 99% UVA/B/C protection. 9.5 base 1-piece wraparound lens provides excellent side protection. Soft and adjustable nosepiece provides a customized fit to prevent slipping. Additional frames and lens options available.

ITEM #	MARTIN #	FRAME	LENS	UOM	PRICE
SBGR9620S	PYRASBGR9620S	Black/green	Gray	PR	\$2.73
SBGR9610S	PYRASBGR9610S	Black/green	Clear	PR	\$2.45
SBG9610S	PYRASBG9610S	Black/gray	Clear	PR	\$2.45
SBG9620S	PYRASBG9620S	Black/gray	Gray	PR	\$2.73
SBG9620ST	PYRASBG9620ST	Black/gray	Gray, anti-fog	PR	\$3.27

SBGR9620S



**INTRUDER® SAFETY GLASSES**

Economical, lightweight safety glasses feature 100% polycarbonate scratch-resistant lenses. Provides 99% UV protection. Other lens options available. Meets ANSI Z87.1+ High Impact standard. Certified to the requirements of the CSA Z94.3 standard.

ITEM #	MARTIN #	FRAME	LENS	UOM	PRICE
S4110S	PYRAS4110S	Clear	Clear	PR	\$1.13
S4120S	PYRAS4120S	Gray	Gray	PR	\$1.33
S4180S	PYRAS4180S	I/O mirror	I/O mirror	PR	\$1.51

S4180S



SB8665D



ITEM #	MARTIN #	FRAME	LENS	UOM	PRICE
SB8620D	PYRASB8620D	Black	Gray, anti-scratch, anti-fog	PR	\$4.00
SB8665D	PYRASB8665D	Black	Ice blue mirror, anti-scratch	PR	\$4.82
SB8620DTM	PYRASB8620DTM	Black	Gray, H2MAX anti-fog	PR	\$5.00





## PMXTREME® SAFETY GLASSES

Stylish, ergonomic frame combines with sleek polycarbonate lenses for the ultimate in protection and style. Features ventilated straight-back flexible temples with rubber temple tips to keep eyewear secure, and built-in rubber nosepiece for all-day comfort. Base curve 9 polycarbonate lenses provide 99% UV protection. Includes black lanyard cord. Also available with Rx options. Meets ANSI Z87.1+ High Impact standard.

ITEM #	MARTIN #	FRAME	LENS	UOM	PRICE
SB6310SP	PYRASB6310SP	Black	Clear	PR	\$3.24
SB6320SP	PYRASB6320SP	Black	Gray	PR	\$3.71

SB6310SP



## ZTEK® SAFETY GLASSES

Features wraparound single lens with panoramic view. Rubber temple tips provide non-binding fit. Lenses are coated for superior scratch resistance and provide 99% UV protection. Meets ANSI Z87.1+ High Impact standard. Certified to the requirements of the CSA Z94.3 standard. CE EN 166 certified.

ITEM #	MARTIN #	FRAME	LENS	UOM	PRICE
S2510S	PYRAS2510S	Clear	Clear	PR	\$2.07
S2510ST	PYRAS2510ST	Clear	Clear, anti-fog	PR	\$2.64
S2520S	PYRAS2520S	Gray	Gray	PR	\$2.35
S2520ST	PYRAS2520ST	Gray	Gray, anti-fog	PR	\$2.91
S2530S	PYRAS2530S	Amber	Amber	PR	\$2.35
S2580S	PYRAS2580S	I/O mirror	I/O mirror	PR	\$2.35

S2520S



## VENTURE II® SAFETY GLASSES

9.75-Base curve lens provides full side protection without distracting seams or traditional sideshields. Lenses are coated for superior scratch resistance and offer 99% UV protection. Comfortable nose buds secure glass, prevent slipping and provide pillow-soft fit. Other lens options available. Meets ANSI Z87.1+ High Impact standard. Certified to the requirements of the CSA Z94.3 standard. CE EN 166 certified.

ITEM #	MARTIN #	FRAME	LENS	UOM	PRICE
SB1810S	PYRASB1810S	Black	Clear	PR	\$3.09
SB1820S	PYRASB1820S	Black	Gray	PR	\$3.56
SB1860S	PYRASB1860S	Black	Infinity Blue	PR	\$3.56

SB1810S



## RENDEZVOUS® SAFETY GLASSES

Adaptable design accommodates most facial sizes. Ratcheting lens pitch adjustment allows wearer to align lens angle to proper position for individual work applications. Flexible nylon temples have four size settings for custom, comfortable fit. Adjustable nose pad conforms to broad range of bridge sizes. Lens/frame design allows air to flow freely up and away from lens to prevent fogging. Other lens options available. Meets ANSI Z87.1+ High Impact standard. CE EN 166 Certified. MCEPS GL-PD 10-12.

ITEM #	MARTIN #	FRAME	LENS	UOM	PRICE
SB2810S	PYRASB2810S	Black	Clear	PR	\$3.35
SB2820S	PYRASB2820S	Black	Gray	PR	\$3.64
SB2830S	PYRASB2830S	Black	Amber	PR	\$3.64

SB2810S



40300-00000-10



## 3M™ CENTURION™ GOGGLES

Impact-resistant, wraparound lens offers exceptional peripheral vision. Large lens opening fits over most Rx eyewear. Two styles available: impact (direct vented) and splash (indirect vented). Polycarbonate lens with anti-fog coating provides 99.9% UV protection. Meets ANSI Z87.1+ High Impact standard. Certified to the requirements of the CSA Z94.3 standard. 10/Case.

ITEM #	MARTIN #	FRAME	LENS	UOM	PRICE
<b>Centurion Impact Goggles</b>					
40300-00000-10	3M40300-00000-10	Clear	Clear	PR	\$6.11
40301-00000-10	3M40301-00000-10	Clear	Clear, anti-fog	PR	\$7.86
<b>Centurion Splash Goggles</b>					
40304-00000-10	3M40304-00000-10	Clear	Clear	PR	\$7.03
40305-00000-10	3M40305-00000-10	Clear	Clear, anti-fog	PR	\$8.38



### WARNING

These eye and face protection products help provide limited eye and face protection. **Misuse or failure to follow warnings and instructions may result in serious potential injury, including blindness or death.** For proper use, selection, and applications against flying particles, optical radiation and/or splash see supervisor, read *User Instructions* and warnings on the package or call 3M PSD Technical Service in the USA at 1-800-243-4630. In Canada, call 1-800-267-4414.



**3M™ LEXA™ SPLASH GOGGLEGEAR™**

Lightweight, low-profile, contoured design with soft PVC shroud that gently hugs the face. Patented ellipsoidal lens extends the viewing range in every direction. Indirect ventilation allows air to circulate and helps reduce fogging. Comes fully assembled with Lexa eyewear and headstrap. DX™ anti-fog hardcoat helps protect lens from fog, scratching and many chemicals. Meets ANSI Z87.1+ High Impact standard. Certified to the requirements of the CSA Z94.3 standard.

16644-00000-10



ITEM #	MARTIN #	FRAME	LENS	SIZES	UOM	PRICE
16644-00000-10	3M16644-00000-10	Clear	Clear, anti-fog	M	PR	\$11.17

ITEM #	MARTIN #	FRAME	LENS	SIZES	UOM	PRICE
16645-00000-10	3M16645-00000-10	Clear	Clear, anti-fog	L	PR	\$17.88



**3M™ GOGGLE GEAR 500 SERIES**

Splash goggle with low-profile design, adjustable strap and optional prescription insert. Polycarbonate lenses absorb 99.9% of UV rays. Scotchgard™ Anti-Fog Coating lasts longer than traditional anti-fog coatings, helping to increase eyewear performance in wet and steamy environments. Workers may enjoy reliable, clearer sight longer, because the coating, with its active ingredient, is bonded to the lens. Coating retains its effectiveness for at least 25 washings, allowing workers to wear their eyewear longer. Coating can be disinfected with diluted bleach soaking or alcohol wipes without losing its anti-fog performance. Meets the requirements of ANSI Z87.1 and CSA Z94.3.

GG501SGAF



ITEM #	MARTIN #	FRAME	LENS	UOM	PRICE
GG501SGAF	3MGG501SGAF	Red/gray	Clear, Scotchgard anti-fog	PR	\$14.37
<i>Rx Insert</i>					
GG500-PI	3MGG500-PI		Clear, Scotchgard anti-fog	PR	\$7.66



**3M™ MAXIM™ 2 X 2 AIR FLOW GOGGLES**

Vented air seal is designed to help minimize fogging. Features excellent orbital eye coverage and a wide field of vision. Elastic strap helps ensure a comfortable, secure fit. Also sold in a 10-piece kit with replacement lenses, temple bars and a case. Meets ANSI Z87.1+ High Impact standard.

40698-00000



ITEM #	MARTIN #	FRAME	LENS	UOM	PRICE
40698-00000	3M40698-00000	Black	Clear, anti-fog	PR	\$26.58
40699-00000	3M40699-00000	Black	Gray, anti-fog	PR	\$26.58



**3M™ LEXA™ DUST GOGGLEGEAR™**

Provides a wider viewing area and lighter solution to standard impact goggles. Easy-to clean foam helps seal out particulates. DX™ anti-fog hardcoat protects lens from fog, scratching and many chemicals. Meets ANSI Z87.1+ High Impact standard. Certified to the requirements of the CSA Z94.3 standard.

16615-00000-10



ITEM #	MARTIN #	FRAME	LENS	SIZES	UOM	PRICE
<i>Lexa Dust GoggleGear with Adjustable Temples</i>						
16615-00000-10	3M16615-00000-10	Black	Clear, anti-fog	M	PR	\$17.55
16616-00000-10	3M16616-00000-10	Black	Clear, anti-fog	L	PR	\$17.55
<i>Lexa Dust GoggleGear with Strap</i>						
16617-00000-10	3M16617-00000-10	Black	Clear, anti-fog	M	PR	\$10.97
16618-00000-10	3M16618-00000-10	Black	Clear, anti-fog	L	PR	\$10.86

12305-00000-20



**3M™ MAXIM™ PLUS DUST GOGGLES**

Interchangeable lenses offer the flexibility to adapt your eye protection based on the environment. Features adjustable elastic headband, pivoting temple, soft foam lens backing to help keep out dust particles and direct ventilation to channel heat away from the face. DX™ anti-fog hardcoat helps protect lens from fog, scratching and many chemicals. Meets ANSI Z87.1+ High Impact standard. Certified to the requirements of the CSA Z94.3 standard.

ITEM #	MARTIN #	FRAME	LENS	UOM	PRICE
12305-00000-20	3M12305-00000-20	Black	Clear, anti-fog	PR	\$41.42

**WARNING**

These eye and face protection products help provide limited eye and face protection. **Misuse or failure to follow warnings and instructions may result in serious potential injury, including blindness or death.** For proper use, selection, and applications against flying particles, optical radiation and/or splash see supervisor, read *User Instructions* and warnings on the package or call 3M PSD Technical Service in the USA at 1-800-243-4630. In Canada, call 1-800-267-4414.



### 3M™ MAXIM™ SPLASH GOGGLES

40671-00000-10



Low-profile and sleek design complements facial shapes, and the advanced DuoSoft™ polymeric shroud ensures comfort at every point of contact. “Over-the-Glass” lens is available for workers who wear prescription eyewear. Low-profile model includes DX™ anti-fog hardcoat to help protect lens from fog, scratching and many chemicals. Meets ANSI Z87.1+ High Impact standard. Certified to the requirements of the CSA Z94.3 standard.

ITEM #	MARTIN #	FRAME	LENS	UOM	PRICE
40671-00000-10	3M40671-00000-10	Black	Clear, anti-fog	PR	\$18.89



### ISOTOPE SAFETY GLASSES

Dielectric design with interchangeable temples and neoprene strap. Temples adjust to three different lengths. Wraparound lens provides excellent side protection. Dual frame design features a rubber gasket for a comfortable fit while protecting from splash and dust. Rubber gasket forms a trough that channels liquids away from the face. Scratch-resistant polycarbonate lens provides 99% UV protection.



GB9410STM

ITEM #	MARTIN #	FRAME	LENS	UOM	PRICE
GB9410STM	PYRAGB9410STM	Black	Clear, anti-fog	PR	\$12.64
GB9420STM	PYRAGB9420STM	Black	Gray, anti-fog	PR	\$13.09



### FUSELAGE™ DUST GOGGLES

250-50-0429



Full frame design can be used as a safety glass for impact and UV protection or convert into a tight-sealing goggle. Detachable, interchangeable temples and headband strap (both included) easily snap into place with no tools required. Soft rubber temple and bridge pads ensure secure, comfortable fit. Polycarbonate lenses feature a blended anti-fog coating and scratch-resistant hardcoat. Filters out 99.99% UV rays. Meets ANSI Z87.1+ High Impact standard.

**⚠️ WARNING:** This product can expose you to chemicals including Bisphenol A (BPA), which is known to the State of California to cause birth defects or other reproductive harm. For more information go to [www.P65Warnings.ca.gov](http://www.P65Warnings.ca.gov).

ITEM #	MARTIN #	FRAME	LENS	UOM	PRICE
250-50-0420	PIP250-50-0420	Black/gray	Clear, anti-scratch, anti-fog	PR	\$8.38
250-50-0421	PIP250-50-0421	Black/gray	Gray, anti-scratch, anti-fog	PR	\$8.38
250-50-0429	PIP250-50-0429	Black/gray	Amber, anti-scratch, anti-fog	PR	\$8.38
250-50-0520	PIP250-50-0520	Black/gray	Clear, anti-scratch, FogLess 3Sixty	PR	\$10.73
250-50-0521	PIP250-50-0521	Black/gray	Gray, anti-scratch, FogLess 3Sixty	PR	\$10.73

**▶ OTHER STYLES AVAILABLE AT [WWW.MARTINSUPPLY.COM](http://WWW.MARTINSUPPLY.COM)**



### STEALTH® GOGGLES WITH HYDROSHIELD®

Features lightweight, comfortable, low-profile design, and toric lenses for superior optics and peripheral vision. Unique lens system for quick and simple replacement. HydroShield anti-fog lens coating is permanently-bonded and provides consistent fog-free time of 90X longer than the majority of other anti-fog coatings. Quick-adjust neoprene headband clips permit fast and easy fitting even on hard hats. Meets the Z87.1+ and Z94.3 standards.

S3961HS



ITEM #	MARTIN #	DESCRIPTION	FRAME	LENS	UOM	PRICE
S3960HS	NTHS3960HS	Stealth w/ HydroShield	Gray/gray	Clear, HydroShield	PR	\$12.45
S3961HS	NTHS3961HS	Stealth w/ HydroShield	Gray/gray	Gray, HydroShield	PR	\$13.14
S700HS	NTHS700HS	Stealth replacement lens w/ HydroShield		Clear, HydroShield	PR	\$4.89
S701HS	NTHS701HS	Stealth replacement lens w/ HydroShield		Gray, HydroShield	PR	\$5.71



### 440 AND 441 BASIC™ GOGGLES

Universal goggle design features pliable one-piece frame, clear lenses and elastic braid strap. Fits over most prescription eyewear. Polycarbonate lens blocks 99.9% of UV rays. Choose direct side ventilation or indirect side ventilation via hooded vents. Meets ANSI Z87.1+ High Impact standard.

248-4400-300



**⚠️ WARNING:** This product can expose you to chemicals including Bisphenol A (BPA), which is known to the State of California to cause birth defects or other reproductive harm. For more information go to [www.P65Warnings.ca.gov](http://www.P65Warnings.ca.gov).

ITEM #	MARTIN #	FRAME	LENS	UOM	PRICE
<i>440 Basic, Direct Vent</i>					
248-4400-300	PIP248-4400-300	Clear	Clear	PR	\$1.64
248-4400-400	PIP248-4400-400	Clear	Clear, anti-scratch, anti-fog	PR	\$2.73

ITEM #	MARTIN #	FRAME	LENS	UOM	PRICE
<i>441 Basic, Indirect Vent</i>					
248-4401-300	PIP248-4401-300	Clear	Clear	PR	\$2.04
248-4401-400	PIP248-4401-400	Clear	Clear, anti-scratch, anti-fog	PR	\$3.15



**CAPSTONE SERIES SAFETY GOGGLES**



Offers protection from excessive glare and provides 99% UV protection. Fits over prescription glasses. Fully adjustable elastic band. Goggle incorporated with removable shield provides full face protection. Ratchet shield allows user to open or close in 3 positions for adjustment. Four ventilation holes provide appropriate airflow. Polycarbonate shield conforms to the face offering increased impact and dust protection. Indirect-vent frame provides protection against splash and dust. Soft vinyl goggle body conforms to facial contours for a very comfortable fit. Scratch-resistant polycarbonate lens. Meets ANSI Z87.1, CSA Z94.3 and CE EN166 requirements.

ITEM #	MARTIN #	FRAME	LENS	UOM	PRICE
GG504TSHIELD	PYRAGG504TSHIELD	Clear	Clear, anti-fog	PR	\$19.91



**V2G® SAFETY GLASSES**



Flame-resistant foam padding forms a perfect seal to keep out dust and airborne particles. Anti-fog lenses provide 99% UV protection. Headband features quick-fit retainer. Includes interchangeable temples/strap. Lens and frame are vented to increase airflow. Other lens options available. Meets ANSI Z87.1+ High Impact standard. Certified to the requirements of the CSA Z94.3 standard. CE EN 166 certified.

ITEM #	MARTIN #	FRAME	LENS	UOM	PRICE
GB1810ST	PYRAGB1810ST	Black	Clear, anti-fog	PR	\$7.93



**3M™ CLEAR EYEWEAR SIDE COVERS**



Can be used with many different spectacle styles.

*WARNING: This product does not meet the side impact performance requirement of ANSI Z87.1+ High Impact standard. If user is exposed to potential side impacts, use ANSI Z87.1 compliant safety spectacles with side protection, goggles or faceshields with primary eye protection to avoid serious eye injuries.*

ITEM #	MARTIN #	DESCRIPTION	UOM	PRICE
23451-00030-20	3M23451-00030-20	Clear eyewear side covers	PR	\$2.66



**3M™ SUPER-CLEAR™ PROTECTIVE EYEWEAR LENS CLEANING TOWELETTES**

Individual protective eyewear lens cleaning towelette packets. Safe for use on all lens types including hardcoat and anti-fog lenses. Convenient self-dispensing box.



ITEM #	MARTIN #	DESCRIPTION	UOM	PRICE
83745-00000	3M83745-00000	Lens cleaning towelettes	BX	\$23.46



**SLIP-ON SIDE SHIELDS**



Adapt to the shape of a wide range of frames. No tools required to install or remove. Clear. Meets ANSI Z87.1+ High Impact standard.

ITEM #	MARTIN #	DESCRIPTION	UOM	PRICE
SS100	PYRASS100	Slip-on side shields	PR	\$2.87



**DISPOSABLE LENS CLEANING STATION**



Includes (1) 8 oz. bottle of solution and (600) lens cleaning tissues. The anti-fog, anti-static formula cleans plastic, glass, and polycarbonate lenses, making it safe to use on goggles, glasses, and faceshields.

ITEM #	MARTIN #	DESCRIPTION	UOM	PRICE
252-LCS08	PIP252-LCS08	Disposable lens cleaning station	EA	\$77.48

**WARNING**

These eye and face protection products help provide limited eye and face protection. **Misuse or failure to follow warnings and instructions may result in serious potential injury, including blindness or death.** For proper use, selection, and applications against flying particles, optical radiation and/or splash see supervisor, read *User Instructions* and warnings on the package or call 3M PSD Technical Service in the USA at 1-800-243-4630. In Canada, call 1-800-267-4414.



The Safety Company

### V-GARD® PROTECTIVE FULL-BRIM HARD HATS

Constructed of durable, high-density polyethylene (HDPE) shell with Fas-Trac® III ratchet suspension system. Includes sweatband and adjustable crown straps. Meets ANSI Z89.1-2014, Type 1, Class E, CSA Z94.1-2015 (Class E) and voluntary standard for low temperature [LT] and reverse donning.



ITEM #	MARTIN #	DESCRIPTION	COLOR	UOM	PRICE
475366	MSA475366	V-Gard full-brim hat	Yellow	EA	\$21.45
475369	MSA475369	V-Gard full-brim hat	White	EA	\$21.45
475370	MSA475370	V-Gard full-brim hat	Green	EA	\$21.45



The Safety Company

### V-GARD® SLOTTED CAPS

Features durable, injection-molded, high-density polyethylene (HDPE) shell designed with accessory slots to accommodate many add-on features. Available with Fas-Trac® III ratchet suspension: 4-point webbed system with a large knob for easy adjustment. Includes sweatband and adjustable crown straps. Meets ANSI/ISEA Z89.1-2014, Type 1, Class E and voluntary standard for low temperature [LT] and reverse donning. Meets CSA Z94.1-2015 (Class E).



ITEM #	MARTIN #	DESCRIPTION	COLOR	UOM	PRICE
475358	MSA475358	Standard V-Gard cap	White	EA	\$16.07
475359	MSA475359	Standard V-Gard cap	Blue	EA	\$16.07
475360	MSA475360	Standard V-Gard cap	Yellow	EA	\$16.07
488146	MSA488146	Standard V-Gard cap	Hi-viz orange	EA	\$16.07
10061512	MSA10061512	Standard V-Gard cap	Hi-viz yellow green	EA	\$16.07



The Safety Company

### SKULLGARD® PROTECTIVE HATS AND CAPS

Features heavy-duty construction for use in steel mills and other heavy industries where elevated temperatures are common. Includes Staz-On® pinlock suspension. Meets all applicable requirements for a Type I (top impact) helmet as outlined in ANSI/ISEA Z89.1-2014 (Class G). Also meets the ANSI/ISEA Z89.1-2014 voluntary standard for low temperature [LT].



ITEM #	MARTIN #	DESCRIPTION	COLOR	UOM	PRICE
454617	MSA454617	Skullgard cap	Natural tan	EA	\$98.35
454618	MSA454618	Skullgard cap	White	EA	\$103.59
454619	MSA454619	Skullgard cap	Chrome yellow	EA	\$103.59
454664	MSA454664	Skullgard full brim hat	Natural tan	EA	\$109.53
454665	MSA454665	Skullgard full brim hat	White	EA	\$114.58



The Safety Company

### V-GARD® AND SKULLGARD® FRAMES

Offers helmet-mounted frames for various work conditions and user helmets. Sloped design allows liquids, chips and other materials to slide off frame and away from the line of sight. Meets ANSI/ISEA Z87.1-2015 requirements.

ITEM #	MARTIN #	DESCRIPTION	UOM	PRICE
10115730	MSA10115730	V-Gard frame for slotted caps w/ debris control	EA	\$12.83
10116627	MSA10116627	V-Gard frame for hats	EA	\$15.40
10158799	MSA10158799	Metal frame for caps	EA	\$14.01
10176739	MSA10176739	Metal frame for hats	EA	\$14.99
10158800	MSA10158800	Metal frame for Skullgard caps	EA	\$14.01





**V-GARD® VISORS**

For use with V-Gard chin protectors and frames. Made of polycarbonate with optional anti-fog and anti-scratch (AF/AS) coating. Lightweight and durable. Only works with V-Gard frames. Radiant heat/elevated temp visor has reflective coating that helps reflect infrared and dissipate heat, and is not for use where an IR Shade visor is required. Meets ANSI/ISEA Z87.1-2015 requirements.

10115853



10115850



ITEM #	MARTIN #	DESCRIPTION	SIZES	UOM	PRICE
10115853	MSA10115853	V-Gard visor, clear, PC, AF/AS	10.375" x 17" x .098"	EA	\$28.01
10115850	MSA10115850	Radiant heat/ET visor, green	9.5" x 17.75" x .07"	EA	\$130.24



**SERIES P2A HARD HATS**

Proprietary injection-molded fiberglass compound offers exceptional impact and crack resistance and is 8 times stronger than common high density polyethylene (HDPE) cap shells. Best-in-class heat resistance. Meets ANSI-Z89.1-2014 impact resistance tests at extreme temperatures of up to 370°F. Solid color resin provides a permanent, no-chip, no-peel matte finish. Technically-advanced SuperEight® suspension balances and spreads weight over a wide area for added comfort and impact protection. Available with Fibre-Metal® non-slip/non-strip ratchet, SwingStrap™ or TabLok™ headgear. Ready-to-use with versatile Quick-Lok® or Speedy® Loop helmet attachment system for faceshields and welding helmets. For added assurance of performance, all Roughneck caps are factory-assembled and SEI third party certified to meet ANSI Z89.1 Type I Class G and CSA Z94.1 Type I Class G or C in both forward and reverse.

P2ARW01



P2ARW15



P2ARW02



P2ARW74



P2ARW71



P1ARW71



P1ARW11

ITEM #	MARTIN #	DESCRIPTION	COLOR	SUSPENSION	UOM	PRICE
<i>Ratchet Suspension with 3R Ratchet Headband and Speedy Loop</i>						
P2ARW01A000	NTHP2ARW01	Cap-style hard hat	White	Ratchet	EA	\$28.78
P2ARW02A000	NTHP2ARW02	Cap-style hard hat	Yellow	Ratchet	EA	\$28.78
P2ARW09A000	NTHP2ARW09	Cap-style hard hat	Gray	Ratchet	EA	\$28.78
P2ARW11A000	NTHP2ARW11	Cap-style hard hat	Black	Ratchet	EA	\$28.78
P2ARW15A000	NTHP2ARW15	Cap-style hard hat	Red	Ratchet	EA	\$28.78
P2ARW71A000	NTHP2ARW71	Cap-style hard hat	Blue	Ratchet	EA	\$28.78
P2ARW74A000	NTHP2ARW74	Cap-style hard hat	Green	Ratchet	EA	\$28.78
P1ARW01A000	NTHP1ARW01	Full brim hard hat	White	Ratchet	EA	\$39.50
P1ARW09A000	NTHP1ARW09	Full brim hard hat	Gray	Ratchet	EA	\$39.50
P1ARW11A000	NTHP1ARW11	Full brim hard hat	Black	Ratchet	EA	\$39.50
P1ARW71A000	NTHP1ARW71	Full brim hard hat	Blue	Ratchet	EA	\$39.50
<i>SwingStrap Suspension with Speedy Loop</i>						
P2ASW01A000	NTHP2ASW01	Cap-style hard hat	White	Swingstrap	EA	\$31.70
P2ASW02A000	NTHP2ASW02	Cap-style hard hat	Yellow	Swingstrap	EA	\$31.70
P2ASW11A000	NTHP2ASW11	Cap-style hard hat	Black	Swingstrap	EA	\$31.70
P2ASW15A000	NTHP2ASW15	Cap-style hard hat	Red	Swingstrap	EA	\$31.70
P2ASW71A000	NTHP2ASW71	Cap-style hard hat	Blue	Swingstrap	EA	\$31.70
P2ASW74A000	NTHP2ASW74	Cap-style hard hat	Green	Swingstrap	EA	\$31.70
P1ASW01A000	NTHP1ASW01	Full brim hard hat	White	Swingstrap	EA	\$42.65
P1ASW02A000	NTHP1ASW02	Full brim hard hat	Yellow	Swingstrap	EA	\$42.65
P1ASW15A000	NTHP1ASW15	Full brim hard hat	Red	Swingstrap	EA	\$42.65
P1ASW71A000	NTHP1ASW71	Full brim hard hat	Blue	Swingstrap	EA	\$42.65
P1ASW74A000	NTHP1ASW74	Full brim hard hat	Green	Swingstrap	EA	\$42.65

## Honeywell

### SUPEREIGHT® HIGH PERFORMANCE HATS AND CAPS

Thermoplastic full brim hard hat with unique, smooth crown that eliminates the danger of falling objects being trapped by ribs, ridges, or slots. Adjust head size by using rear-located ratchet mechanism and tilting the headband. Includes 8-point suspension with ratchet adjustment, unless otherwise indicated. Caps are also available in heavy-duty, lightweight fiberglass for optimum impact resistance, durability and crack resistance, Quick-Lok® mounting blocks for attaching a welding helmet or faceshield, and Swingstrap™ suspension that allows the wearer to convert from front to rear wearing positions without reversing the suspension or headband. Full brim hats provide extended protection from the sun, nontoxic splash, dust, dirt and debris. All models are SEI certified to meet ANSI Z89.1-2014, Type 1, Class E, G or C.

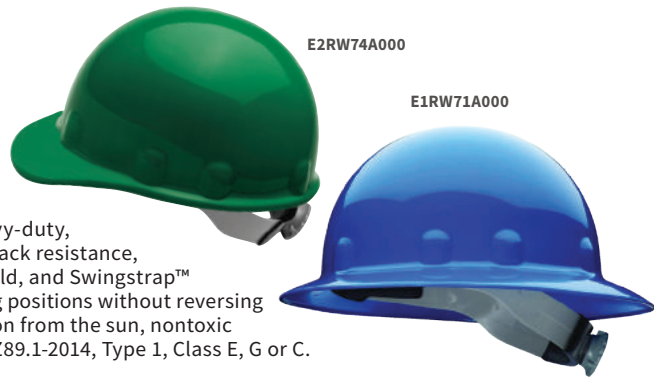

ITEM #	MARTIN #	COLOR	SUSPENSION	UOM	PRICE
<i>Cap-Style Hard Hat</i>					
E2SW01A000	NTHE2SWWE	White	Swingstrap	EA	\$22.03
E2SW02A000	NTHE2SWYW	Yellow	Swingstrap	EA	\$22.03
E2SW09A000	NTHE2SW09	Gray	Swingstrap	EA	\$22.03
E2SW11A000	NTHE2SW11	Black	Swingstrap	EA	\$22.03
E2SW15A000	NTHE2SWRD	Red	Swingstrap	EA	\$22.03
E2SW46A000	NTHE2SWSO	Strong orange	Swingstrap	EA	\$22.03
E2SW71A000	NTHE2SW71	Blue	Swingstrap	EA	\$22.03
E2SW74A000	NTHE2SW74	Green	Swingstrap	EA	\$22.03
E2RW01A000	NTHE2RWWE	White	Ratchet	EA	\$18.92
E2RW02A000	NTHE2RWYW	Yellow	Ratchet	EA	\$18.92
E2RW03A000	NTHE2RWOR	Orange	Ratchet	EA	\$18.92
E2RW09A000	NTHE2RWGY	Gray	Ratchet	EA	\$18.92
E2RW11A000	NTHE2RWBLACK	Black	Ratchet	EA	\$18.92
E2RW15A000	NTHE2RWRD	Red	Ratchet	EA	\$18.92
E2RW44A000	NTHE2RW44	Hi-viz yellow	Ratchet	EA	\$18.92
E2RW71A000	NTHE2RWBE	Blue	Ratchet	EA	\$18.92
E2RW74A000	NTHE2RWGN	Green	Ratchet	EA	\$18.92
E2RW75A000	NTHE2RWDB	Dark blue	Ratchet	EA	\$18.92

ITEM #	MARTIN #	COLOR	SUSPENSION	UOM	PRICE
<i>Full Brim Hard Hat</i>					
E1SW01A000	NTHE1SWWE	White	Swingstrap	EA	\$24.40
E1SW02A000	NTHE1SWYW	Yellow	Swingstrap	EA	\$24.40
E1SW09A000	NTHE1SWG	Gray	Swingstrap	EA	\$24.40
E1SW15A000	NTHE1SWRD	Red	Swingstrap	EA	\$24.40
E1SW46A000	NTHE1SWSO	Strong orange	Swingstrap	EA	\$24.40
E1SW71A000	NTHE1SWBE	Blue	Swingstrap	EA	\$24.40
E1SW74A000	NTHE1SWG	Green	Swingstrap	EA	\$24.40
E1RW01A000	NTHE1RW01	White	Ratchet	EA	\$21.65
E1RW02A000	NTHE1RW02	Yellow	Ratchet	EA	\$21.65
E1RW03A000	NTHE1RW03	Orange	Ratchet	EA	\$21.65
E1RW09A000	NTHE1RW09	Gray	Ratchet	EA	\$21.65
E1RW11A000	NTHE1RW11	Black	Ratchet	EA	\$21.65
E1RW15A000	NTHE1RW15	Red	Ratchet	EA	\$21.65
E1RW46A000	NTHE1RW46	Strong orange	Ratchet	EA	\$21.65
E1RW71A000	NTHE1RW71	Blue	Ratchet	EA	\$21.65

## Honeywell

### NORTH ZONE™ HARD HATS

Contemporary high-density polyethylene (HDPE) shell design with 4 large areas for custom logo imprinting or other personalization options. Features slots for cap-mounted earmuffs, faceshields and other PPE accessories, removable and replaceable rear comfort cradle, 3-level height adjustment (Low, Medium, High), ratchet suspension and ergonomic headband for easy adjustment to 3 different sizes (S, M/L and XL). Includes moisture-wicking, breathable sweatband that is easily removable, washable and replaceable. Meets ANSI Type I, Class C, G and E requirements. Certified to ANSI Z89.1 Type I Class E and CSA Z94.1 Type I Class E.



ITEM #	MARTIN #	DESCRIPTION	COLOR	UOM	PRICE
N10R010000	NTHN10R010000	North Zone hard hat	White	EA	\$18.13
N10R030000	NTHN10R030000	North Zone hard hat	Orange	EA	\$6.22
N10R040000	NTHN10R040000	North Zone hard hat	Green	EA	\$18.10
N10R150000	NTHN10R150000	North Zone hard hat	Red	EA	\$10.18
N10R200000	NTHN10R200000	North Zone hard hat	Hot pink	EA	\$22.43

## Honeywell

### A79 PEAK SERIES HARD HATS

Features versatility and dependability with grooved high density polyethylene (HDPE) outer shell, rain trough and accessory slots. Available with an adjustable ratchet headband for a more secure fit. All suspensions come with 3-level height adjustment. Meets ANSI Z89.1-2014, Type I, Class E.



ITEM #	MARTIN #	DESCRIPTION	COLOR	UOM	PRICE
A79010000	NTHA79010000	Model A79 Peak Series	White	EA	\$18.13
A79020000	NTHA79020000	Model A79 Peak Series	Yellow	EA	\$6.22
A79R010000	NTHA79R010000	Model A79R Peak Series	White	EA	\$18.10
A79R020000	NTHA79R020000	Model A79R Peak Series	Yellow	EA	\$10.18
A79R030000	NTHA79R030000	Model A79R Peak Series	Orange	EA	\$22.43
A79R040000	NTHA79R040000	Model A79R Peak Series	Dark green	EA	\$19.83
A79R150000	NTHA79R150000	Model A79R Peak Series	Red	EA	\$20.40



**SL SERIES  
HARD HATS**

Made from high-density polyethylene (HDPE) with a low-profile design. Features universal accessory slots that fit cap-mounted earmuffs and chin straps. Has rain trough on sides and back of helmet that channels moisture away. White. Meets ANSI Z89.1-2009, Type 1, Class C, G and E.

HP14010



Additional colors and 6-point suspensions are also available.

ITEM #	MARTIN #	DESCRIPTION	UOM	PRICE
HP14010	PYRAHP14010	Cap-style hard hat w/ 4-pt. snap lock suspension	EA	\$4.98
HP14110	PYRAHP14110	Cap-style hard hat w/ 4-pt. ratchet suspension	EA	\$6.13
HP24110	PYRAHP24110	Full brim hard hat w/ 4-pt. ratchet suspension	EA	\$8.58



**RIDGELINE® HARD HATS**

Made of strong, yet ultra-light ABS material for seemingly weightless protection. Features 4-point ratchet suspension, rear padded suspension, replaceable sweatband, vented pressure pad and swinging hinge points.

HP54117



Additional colors are also available.

ITEM #	MARTIN #	DESCRIPTION	COLOR	UOM	PRICE
HP44110	PYRAHP44110	Cap-style hard hat	White	EA	\$9.92
HP54110	PYRAHP54110	Full brim hard hat	White	EA	\$12.42
HP54116	PYRAHP54116	Full brim hard hat	Matte white graphite	EA	\$26.65
HP54117	PYRAHP54117	Full brim hard hat	Graphite black	EA	\$26.65

▶ OTHER COLORS AVAILABLE AT [WWW.MARTINSUPPLY.COM](http://WWW.MARTINSUPPLY.COM)



**TURBOSHIELD™**

Perfect for workers exposed to falling or flying objects, impact, splash and airborne debris; it can also be comfortably worn with most goggles, respirators and earmuffs. Flexible head-cushioning suspension cradle provides 300% greater contact area than traditional suspensions to eliminate pressure points for all-day wear. Simple push-button release system allows for easy visor exchange in seconds. Feel safer with 50% more chin coverage compared to traditional visors. Control knobs are large and ergonomically designed for easy adjustment, even while wearing gloves. Visor slides back 7", improving balance and weight distribution. Headgear features breathable, removable, washable headband; toric lens provides excellent optics, increased field of view and added chin coverage without bulky attachments. Clear and Gray lenses available with dual anti-scratch/anti-fog coating for longer visor life and reduced fogging. Ergonomically designed ratcheting headgear mechanism assures quick, easy adjustment to achieve an optimal fit. Hard hat adapter accessory is compatible with multiple hard hats, including Fibre-Metal®, North® and most major competitor styles. Positive-locking hinge secures visor in raised and lowered positions. Integrated brim guard ensures gap-free fit and protection from overhead debris. Meets ANSI Z87.1-2015 and CSA Z94.3 standards. Faceshields offer secondary protection and must be worn with spectacles or goggles.

S9500 & S9575



ITEM #	MARTIN #	DESCRIPTION	LENS	UOM	PRICE
S9500	NTHS9500	Turboshield ratchet headgear, black		EA	\$18.10
S9510	NTHS9510	Turboshield hard hat adapter, black		EA	\$21.03
S9550	NTHS9550	Polycarbonate replacement visor	Clear, uncoated	EA	\$12.32

ITEM #	MARTIN #	DESCRIPTION	LENS	UOM	PRICE
S9555	NTHS9555	Polycarbonate replacement visor	Clear, hardcoat, anti-fog	EA	\$28.78
S9575	NTHS9575	Polycarbonate replacement visor	Gray, hardcoat, anti-fog	EA	\$28.78
S9560	NTHS9560	Polycarbonate replacement visor	Shade 3.0, uncoated	EA	\$28.78
S9565	NTHS9565	Polycarbonate replacement visor	Shade 5.0, uncoated	EA	\$28.78



**BIONIC® FACESHIELDS**

Provides excellent optics, visibility, and enhanced protection from airborne debris. Ideal for workers exposed to falling or flying objects, impact, chemical splash and other debris. Features extended chin and top-of-head protection, lightweight and balanced design to reduce head and neck strain, cell foam on back of headgear, and breathable, washable sweatband up front. Dual position visors are easy to replace and attach securely. Comfortably worn with most goggles, eyewear and respirators. Meets ANSI Z87.1+ High Impact standard. Certified to the requirements of the CSA Z94.3 standard.

S8500



ITEM #	MARTIN #	DESCRIPTION	LENS	UOM	PRICE
S8500	NTHS8500	Bionic faceshield, visor	Clear, uncoated	EA	\$27.13
S8510	NTHS8510	Bionic faceshield, visor	Clear, hardcoat, anti-fog	EA	\$41.18

ITEM #	MARTIN #	DESCRIPTION	LENS	UOM	PRICE
S8505	NTHS8505	Bionic faceshield, visor w/ hard hat adapter	Clear, uncoated	EA	\$41.20
S8515	NTHS8515	Bionic faceshield, visor w/ hard hat adapter	Clear, hardcoat, anti-fog	EA	\$51.00



## Honeywell

### F400 AND F500 FACESHIELD HEADGEAR

A variety of faceshield headgear with crown protectors provides the level of protection you need. All models feature lightweight and heat-resistant Noryl® (the same material used in welding helmets) crown protectors and ratchet headbands (windows sold separately). Meets ANSI Z87.1+ High Impact standard. Certified to the requirements of the CSA Z94.3 standard.

**F400** features a deeper 4" crown protector to extend protection without increasing weight. Incorporates wide-vision (8" x 17") wraparound windows and screens which provide 40% more protective area than standard size faceshields. Fits easily over required spectacles or respirators.

**F500** includes a broader, deeper 7" crown protector to provide an extra margin of protection when harsh working conditions require it. Features the exclusive Channel Grip System that mounts wide, wraparound windows and locks them into place to form a perfect seal from dust, dirt and debris. Includes Fibre-Metal classic 3-C, free-floating headgear.



F500-H5

ITEM #	MARTIN #	DESCRIPTION	UOM	PRICE
F400	NTHF400	Medium-duty faceshield headgear w/ 4" crown protector	EA	\$20.40

ITEM #	MARTIN #	DESCRIPTION	UOM	PRICE
F500-H5	NTHF500	Heavy-duty faceshield headgear w/ 7" crown protector	EA	\$24.55

## Honeywell

### FACESHIELD HEADGEAR COMBINATIONS

Protective cap-mounting mechanisms easily and safely secure Fibre-Metal® faceshields to hard hats. Constructed from Noryl®, these faceshield brackets offer durable protection. Model 4000 with Quick-Lok® cups is for mounting on Fibre-Metal caps equipped with Quick-Lok® blocks for more permanent mounting. Model 5000 with Speedy® mounting loops is adjustable and provides easy on and off mounting on protective caps.



F5400

ITEM #	MARTIN #	DESCRIPTION	UOM	PRICE
4000-H5	NTH4000	4000 Quick-Lok complete adapter kit	EA	\$17.52
5000	NTH5000	5000 Speedy Loop attachment & adapter headband kit	EA	\$9.65
F5400	NTHF5400	5000 Speedy-Loop system for E2 & P2 hard hats	EA	\$18.13



### BOUTON® OPTICAL POLYCARBONATE SAFETY VISORS

Made with virgin resin, which leads to better uniformity of the viewing area. Universal hole pattern will fit most headgear and hard hat adapters in the market. Ships with masking on both sides to prevent scratching. Flat shape and .040" thickness. Meets ANSI Z87.1+ and CSA Z94.3 standards.



251-01-5210

**⚠️ WARNING:** Faceshield can expose you to chemicals including Bisphenol A (BPA), which is known to the State of California to cause birth defects or other reproductive harm. For more information go to [www.P65Warnings.ca.gov](http://www.P65Warnings.ca.gov).

ITEM #	MARTIN #	DESCRIPTION	UOM	PRICE
251-01-5201	PIP251-01-5201	Polycarbonate safety visor	EA	\$3.08
251-01-5210	PIP251-01-5210	Polycarbonate safety visor w/ chin cup	EA	\$11.57

## Honeywell

### HIGH-PERFORMANCE® FACESHIELD WINDOWS AND FRAMES

Easily and comfortably fit over required protective spectacles or respirators. Windows are injection-molded from propionate for superior performance and are preformed to the exact curve of crown protectors for easy installation, an exact fit and a perfect seal against dust, dirt and debris. Windows are .060" thick and fit F400, F500 Series and FH66, FM70, FM71. Choose from clear or green windows, which protect from glare and bright light. (Not suitable for welding protection).

Dual channel mounting system anchors one channel to the hat and the other to the window, allowing users to lock windows into the work position or pivot up and out of the way when not needed. Locked channels prevent debris from getting between the cap and faceshield.

ITEM #	MARTIN #	DESCRIPTION	COLOR	SIZES	UOM	PRICE
4178CL	NTH4178CL	Wide faceshield window	Clear	8" x 16 1/2"	EA	\$6.22
4178IRUV3	NTH4178IRUV3	Wide faceshield window	Shade 3.0	8" x 16 1/2"	EA	\$18.10
4178IRUV5	NTH4178IRUV5	Wide faceshield window	Shade 5.0	8" x 16 1/2"	EA	\$18.10
4199CL	NTH4199CL	Extended view window	Clear	9 3/4" x 19"	EA	\$10.18
4199IRUV3	NTH4199IRUV3	Extended view window	Shade 3.0	9 3/4" x 19"	EA	\$22.43
4199IRUV5	NTH4199IRUV5	Extended view window	Shade 5.0	9 3/4" x 19"	EA	\$22.43

#### Mounted Aluminum Faceshield Frame

ITEM #	MARTIN #	DESCRIPTION	UOM	PRICE
FH66	NTHFH66	For heavy-duty use & wide/deep extended view windows	EA	\$19.83



4178CL



**3M™ PARTICULATE RESPIRATOR 8200, N95**

Designed to help provide reliable protection against certain non-oil based particles. Features Advanced Electret Media, adjustable noseclip and nose foam to help provide a custom fit and secure seal. Suggested applications include grinding, sanding, sweeping, bagging, sawing and other dusty operations. Meets NIOSH 42 CFR 84 N95 requirements.



ITEM #	MARTIN #	DESCRIPTION	UOM	PRICE
8200	3M8200	Particulate Respirator N95	20/BX	\$17.14



**3M™ PARTICULATE RESPIRATORS 8210PLUS AND 8210PLUSPRO, N95**

Designed to help provide comfortable, reliable worker respiratory protection against certain non-oil based particles. Features comfortable braided headbands, staple-free attachment, soft nose foam and adjustable noseclip. Meets NIOSH 42 CFR 84 N95 requirements.



ITEM #	MARTIN #	DESCRIPTION	UOM	PRICE
8210Plus	3M8210Plus	Particulate Respirator N95 w/ Advanced Electret Media	20/BX	\$21.43
8210PlusPro	3M8210PlusPro	Particulate Respirator N95	10/BX	\$11.07



**3M™ PARTICULATE RESPIRATOR 8210, N95**

Designed to help provide comfortable, reliable worker respiratory protection against certain non-oil based particles in suggested applications including grinding, sanding, sweeping, bagging and other dusty operations. Lightweight construction helps promote greater worker acceptance and comfort. Features 3M's Advanced Electret Media, welded strap attachment, soft nose foam and adjustable noseclip to help provide a custom and secure seal. NIOSH Approval TC-84A-0007.



ITEM #	MARTIN #	DESCRIPTION	UOM	PRICE
8210	3M8210	Particulate Respirator N95	20/BX	\$18.62



**3M™ PARTICULATE RESPIRATOR 8233, N100**

Excellent choice for lead abatement, pharmaceutical manufacturing, welding, metal pouring and work involving select OSHA substance-specific particle exposures in concentrations up to 10 x the OSHA PEL, excluding those containing oil aerosols and asbestos. Features 3M™ Cool Flow™ Exhalation Valve, comfortable foam face seal, adjustable straps and lightweight construction. Respirators are individually packaged. NIOSH Approval TC-84A-1298.



ITEM #	MARTIN #	DESCRIPTION	UOM	PRICE
8233	3M8233	Particulate Respirator N100	20/BX	\$9.42



**3M™ PARTICULATE RESPIRATOR 8210V, N95 WITH 3M™ COOL FLOW™ VALVE**

Proprietary 3M™ Cool Flow™ valve is designed for easy exhalation and reduces heat build-up inside respirator to help keep wearer more comfortable. Features adjustable noseclip and 2-strap design with dual point attachment. Ideally suited for many work settings that involve heat, humidity or longer periods of wear. NIOSH Approval TC-84A-5410.



ITEM #	MARTIN #	DESCRIPTION	UOM	PRICE
8210V	3M8210V	Particulate Respirator N95 w/ Cool Flow™ Valve	10/BX	\$13.00

**WARNING**



These respirators help protect against certain airborne contaminants. Before use, the wearer must read and understand the *User Instructions* provided as a part of the product packaging. A written respiratory protection program must be implemented meeting all the requirements of OSHA 1910.134 including training, fit testing and medical evaluation. In Canada, CSA standards Z94.4 requirements must be met and/or requirements of the applicable jurisdiction, as appropriate. **Misuse may result in sickness or death.** For proper use, see packaging instructions, supervisor, or call 3M PSD Technical Service in USA at 1-800-243-4630 and in Canada at 1-800-267-4414.



**3M™ PARTICULATE RESPIRATOR 8247, R95 WITH NUISANCE LEVEL\* ORGANIC VAPOR RELIEF**

Designed to help provide comfortable protection against certain oil and non-oil based particles including those present with nuisance levels\* of organic vapor, such as solvents, degreasers and resins. Meets NIOSH 42 CFR 84 requirements.

*\*3M™ recommended for relief against nuisance levels of organic vapors. Nuisance level organic vapors refer to concentrations less than the OSHA PEL or other applicable government exposure limits, whichever is lower.*

8247



ITEM #	MARTIN #	DESCRIPTION	UOM	PRICE
8247	3M8247	Particulate Respirator R95 w/ Nuisance Level* Organic Vapor Relief	20/BX	\$76.17



**3M™ PARTICULATE WELDING RESPIRATOR 8515, N95**

Designed to help provide comfortable, reliable worker protection for non-oil based particles from applications such as welding, soldering, cutting, grinding and sanding. Features the 3M™ Cool Flow™ Exhalation Valve, adjustable M-noseclip, flame-resistant\* protective layers (not a substitute for a faceshield) and braided headband to help provide a custom fit and secure seal. Meets NIOSH 42 CFR 84 N95 requirements.

*\*Flame resistant per ASTM D2859.*

8515



**3M™ VFLEX™ PARTICULATE RESPIRATORS 9105, 9105S, N95**

V-shaped pleats flex with mouth movement for easier talking and expand to help ease breathing. Features adjustable noseclip, embossed front panel, elastic headbands and 3M™ proprietary technology filter media. Flat-fold style for convenient storage. Potential applications include: sweeping, sanding, grinding, bagging, food preparation, general maintenance and more. Meets NIOSH 42 CFR 84 N95 requirements.

9105



ITEM #	MARTIN #	DESCRIPTION	UOM	PRICE
8515	3M8515	Particulate Welding Respirator N95	10/BX	\$30.41

ITEM #	MARTIN #	DESCRIPTION	UOM	PRICE
9105	3M9105	VFlex™ Particulate Respirator, N95, standard	50/BX	\$29.03
9105S	3M9105S	VFlex™ Particulate Respirator, N95, small	50/BX	\$29.03



**3M™ PARTICULATE RESPIRATORS, N95 WITH 3M™ COOL FLOW™ VALVE**

Helps provide protection against certain non-oil based particles and is ideally suited for work settings that involve heat, humidity or long periods of wear. Proprietary 3M™ Cool Flow™ Exhalation Valve for easy exhalation and cool comfort. Braided headbands and an adjustable M-noseclip are designed to help enhance user comfort and increase wearability. NIOSH Approval TC-84A-1299.

8511



**3M™ AURA™ PARTICULATE RESPIRATORS 9210+ AND 9211+, N95**

Features comfortable braided headbands and contoured nose panel. Chin tab is designed for ease of positioning, donning and adjustment. Embossed top panel helps reduce potential fogging of eyewear from warm, moist exhaled airflow. Individually wrapped. Meets NIOSH 42 CFR 84 N95 requirements.

9211+



ITEM #	MARTIN #	DESCRIPTION	UOM	PRICE
8511	3M8511	Particulate Respirator N95 w/ Advanced Electret Media	10/BX	\$17.70
8211	3M8211	Particulate Respirator N95 w/ Faceseal	10/BX	\$33.23
8511Pro	3M8511Pro	Particulate Respirator N95	5/BX	\$11.06

ITEM #	MARTIN #	DESCRIPTION	UOM	PRICE
9210+	3M9210+	3M™ Aura™ Particulate Respirator	20/BX	\$24.59
9211+	3M9211+	3M™ Aura™ Particulate Respirator w/ Cool Flow™ Valve	10/BX	\$25.52



**NUISANCE DISPOSABLE DUST MASK**

Features single strap with an adjustable nosebridge for a more comfortable fit. One size fits most faces. Protects against pollen, dust, mold and dander. Not for use against silica, asbestos or other harmful substances. Not NIOSH Approved.

14110094CC



ITEM #	MARTIN #	DESCRIPTION	UOM	PRICE
14110094CC	NTH14110094CC	Nuisance disposable dust mask	50/BX	\$6.91



**SAF-T-FIT® PLUS DISPOSABLE PARTICULATE RESPIRATORS**

Lightweight, humidity-resistant design features a latex-free filter media for lower breathing resistance. Options include: boomerang nose seal, full-sealing flange and an exhalation valve. NIOSH approved N95, N99, P95 and P100 protection.

14110390



ITEM #	MARTIN #	DESCRIPTION	SIZES	UOM	PRICE
14110390	NTH14110390	N1115 N95 w/ boomerang nose seal	S	20/BX	\$20.32
14110391	NTH14110391	N1115 N95 w/ boomerang nose seal	M/L	20/BX	\$20.32
14110392	NTH14110392	N1115 N95 w/ boomerang nose seal	XL	20/BX	\$20.32
14110393	NTH14110393	N1125 N95 w/ boomerang nose seal & valve	S	20/BX	\$41.63
14110394	NTH14110394	N1125 N95 w/ boomerang nose seal & valve	M/L	20/BX	\$41.63
14110395	NTH14110395	N1125 N95 w/ boomerang nose seal & valve	XL	20/BX	\$41.63
14110440	NTH14110440	P100 w/ full-sealing flange & valve	M/L	EA	\$9.03



**ONE-FIT™ MOLDED CUP N95 RESPIRATORS**

Features one-size molded cup design with durable, ridged outer shell and form-fitted nosebridge. Soft inner liner. Latex-free woven suspension straps. Optional exhalation valve expels warm air. Offers 95% filtration efficiency against solid particulates and non-petroleum based liquid aerosols. Universal fit. Meets NIOSH and CDC standards for N95 protection against airborne pathogens and M.tuberculosis.

14110444



ITEM #	MARTIN #	DESCRIPTION	UOM	PRICE
14110445	NTH14110445	N95 Particulate respirator w/ exhalation valve	10/BX	\$12.43
14110444	NTH14110444	N95 Particulate respirator, non valved	20/BX	\$12.98



**2200N95 SERIES N95 DISPOSABLE RESPIRATORS**

Dura-Mesh® shell protects filter media so it stays cleaner-looking longer. Shell resists collapsing, even in heat and humidity. Softspun® inner lining for added comfort and durability. Contour-molded nosebridge with soft foam nose cushion provides comfortable fit. No metal noseband to adjust. NIOSH certified for a filter efficiency level of 95% or greater against particulate aerosols free of oil. Meets heat and flame resistance in accordance with ANSI/ISEA 110-2003 Section 7.11.1.

2200N95



ITEM #	MARTIN #	DESCRIPTION	SIZES	UOM	PRICE
2201N95	MOL2201N95	N95 Disposable respirator w/out valve	S	20/BX	\$20.54
2200N95	MOL2200N95	N95 Disposable respirator w/out valve	M/L	20/BX	\$20.54
2207N95	MOL2207N95	N95 Disposable respirator w/out valve	Low profile	20/BX	\$20.54



**2300N95 SERIES N95 DISPOSABLE RESPIRATORS WITH EXHALE VALVE**

Suitable for most welding applications. Exhale valve reduces hot air buildup and breathing resistance, keeping workers cooler. Dura-Mesh® shell protects filter media so it stays cleaner-looking longer. Shell resists collapsing, even in heat and humidity. Contour-molded nosebridge with soft foam nose cushion provides a comfortable fit. No metal noseband to adjust. Softspun® lining gives added comfort and durability. NIOSH certified for a filter efficiency of 95% or greater against particulate aerosols free of oil. Meets heat and flame resistance in accordance with ANSI/ISEA 110-2003, Section 7.11.1. If used for welding, wear appropriate eye and face protection.

2300N95

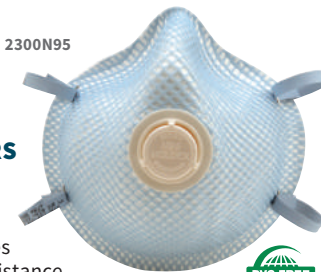

ITEM #	MARTIN #	DESCRIPTION	SIZES	UOM	PRICE
2301N95	MOL2301N95	N95 Disposable respirator w/ valve	S	10/BX	\$25.16
2300N95	MOL2300N9	N95 Disposable respirator w/ valve	M/L	10/BX	\$25.16
2307N95	MOL2307N95	N95 Disposable respirator w/ valve	Low profile	10/BX	\$25.16
2350	MOL2350	2300 Series respirator locker, 5/Locker	M/L	EA	\$15.23

## MOLDEX

### 2360P100 SERIES P100 DISPOSABLE RESPIRATOR

Dura-Mesh® shell protects the filter media so it stays cleaner looking longer. Resists collapsing in regular use and even under hot and humid conditions. Molded nosebridge with foam face cushion eliminates pressure points for added comfort. Also features adjustable cloth straps, Ventex® exhalation valve, and Softspun® lining for increased comfort and durability. NIOSH certified to have a filter efficiency of 99.97% against oil and non-oil based particulates. Meets heat and flame resistance in accordance with ANSI/ISEA 110-2003, Section 7.11.1.



ITEM #	MARTIN #	DESCRIPTION	SIZES	UOM	PRICE
2360P100	MOL2360P100	P100 Disposable respirator w/ adjustable straps & Ventex valve	M/L	5/BG	\$47.15

## MOLDEX

### 2700N95 SERIES N95 DISPOSABLE RESPIRATOR WITH HANDYSTRAP® AND VENTEX® VALVE

Features HandyStrap with buckle allowing mask to hang around neck when not in use. Ventex valve lets hot air out faster so workers stay cool longer. Dura-Mesh® shell resists collapsing in heat and humidity. Molded nosebridge seals easily without a metal noseband. Naturally contoured facepiece and Softspun® lining offers added comfort and durability as well as relief on pressure points. NIOSH certified for a filter efficiency level of 95% or greater against particulate aerosols free of oil. Meets heat and flame resistance in accordance with ANSI/ISEA 110-2003, Section 7.11.1.

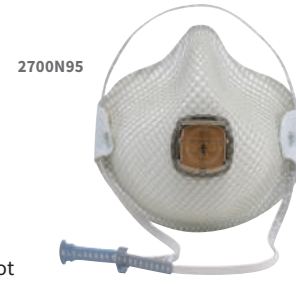

ITEM #	MARTIN #	DESCRIPTION	SIZES	UOM	PRICE
2701N95	MOL2701N95	N95 Disposable respirator w/ HandyStrap & Ventex valve	S	10/BX	\$30.69
2700N95	MOL2700N95	N95 Disposable respirator w/ HandyStrap & Ventex valve	M/L	10/BX	\$30.69
2707N95	MOL2707N95	N95 Disposable respirator w/ HandyStrap & Ventex valve	Low profile	10/BX	\$30.69

## MOLDEX

### 2400N95 SERIES N95 PLUS NUISANCE ORGANIC VAPORS/OZONE DISPOSABLE RESPIRATOR

Pinch-free nosebridge eliminates discomfort and readjustment necessary with metal nosebands. Exhale valve releases hot air easier and reduces breathing resistance, which keeps workers cooler and allows masks to last longer. Dura-Mesh® shell resists collapsing, even in heat and humidity. Added carbon layer helps filter out nuisance levels of ozone and organic vapors (less than OSHA PEL). Meets heat and flame resistance in accordance with ANSI/ISEA 110-2003, Section 7.11.1.

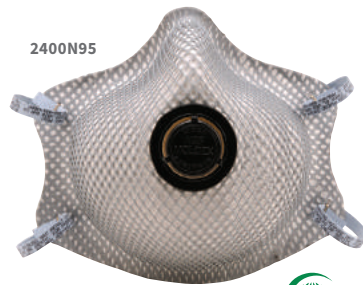

ITEM #	MARTIN #	DESCRIPTION	SIZES	UOM	PRICE
2400N95	MOL2400N95	N95 Disposable respirator w/ nuisance OV relief	M/L	10/BG	\$42.79

## MOLDEX

### 2730N100 SERIES N100 DISPOSABLE RESPIRATORS WITH HANDYSTRAP®

HandyStrap allows mask to hang around neck so it's always ready for use, preventing premature disposal. Dura-Mesh® shell protects filter media so it stays cleaner-looking longer. Shell resists collapsing, even in heat and humidity. Ventex® valve lets hot air out faster so workers stay cool longer. Contour-molded nosebridge with soft foam face cushion for an easy, comfortable fit. No metal noseband to adjust and the seal is maintained without pressure points. Softspun® lining offers added comfort and durability. NIOSH certified to have a filter efficiency of 99.97% effective against non-oil based particulates. Meets heat and flame resistance in accordance with ANSI/ISEA 110-2003, Section 7.11.1.



ITEM #	MARTIN #	DESCRIPTION	SIZES	UOM	PRICE
2731N100	MOL2731N100	N100 Disposable respirator	S	5/BX	\$36.55
2730N100	MOL2730N100	N100 Disposable respirator	M/L	5/BX	\$36.55
2731AN100	MOL2731AN100	N100 Disposable respirator (indv. wrapped)	S	5/BX	\$7.94
2730AN100	MOL2730AN	N100 Disposable respirator (indv. wrapped)	M/L	5/BX	\$7.94

## MOLDEX

### 2500N95 DISPOSABLE RESPIRATOR PLUS NUISANCE LEVEL OF ACID GAS IRRITANTS

Added sorbent layer helps to filter nuisance levels of acid gas irritants (less than OSHA PEL). Exhale valve reduces hot air build-up to keep workers cooler. Dura-Mesh® shell resists collapsing even in hot, humid work environments. Contour-molded nosebridge with soft foam nose cushion provides all-day comfort. Softspun® lining increases comfort and durability. NIOSH certified to have a filter efficiency of 95% or greater against particulates free of oil. Meets heat and flame resistance in accordance with ANSI/ISEA 110-2003, Section 7.11.1.

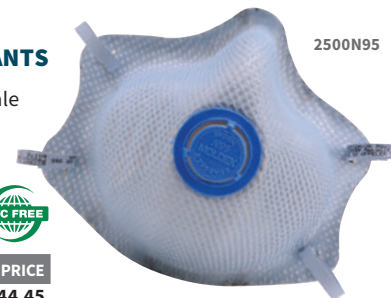

ITEM #	MARTIN #	DESCRIPTION	UOM	PRICE
2500N95	MOL2500N95	N95 Disposable respirator w/ nuisance acid gas relief	10/BG	\$44.45

## MOLDEX

### 2800N95 SERIES N95 WITH NUISANCE ORGANIC VAPORS DISPOSABLE RESPIRATOR WITH HANDYSTRAP®

Added carbon layer helps filter out nuisance levels of ozone and organic vapors (less than OSHA PEL). Can be used for most welding applications. HandyStrap with buckle allows the mask to hang down around the user's neck when not in use. Cloth strap feels cool and comfortable against the skin. Ventex® valve lets the hot air out faster so workers stay cooler. Exclusive Dura-Mesh® shell resists collapsing in regular use and even under hot and humid conditions. Softspun® lining increases comfort and durability. 95% efficient against non-oil based particulates. When used for welding always use with a welding shield or helmet. Meets heat and flame resistance in accordance with ANSI/ISEA 110-2003, Section 7.11.1.



ITEM #	MARTIN #	DESCRIPTION	SIZES	UOM	PRICE
2801N95	MOL2801N95	N95 Plus nuisance OV disposable respirator w/ HandyStrap	S	10/BX	\$459.29
2800N95	MOL2800N95	N95 Plus nuisance OV disposable respirator w/ HandyStrap	M/L	10/BX	\$459.29

## MOLDEX

### 4200 SERIES AIRWAVE® N95 DISPOSABLE RESPIRATORS

Breathes easier than a valve respirator. Patented wave design technology allows more airflow in and out for cool comfort. Unique waves double the filter area of comparable respirators. Exclusive Dura-Mesh® shell resists collapsing in heat and humidity and protects the filter media so it stays cleaner-looking longer. FlexFit® design expands and contracts as there is movement and speaking, for optimal comfort. Features pinch-free molded nosebridge with soft foam cushion and Softspun® lining. Meets heat and flame resistance in accordance with ANSI/ISEA 110-2003, Section 7.11.1. NIOSH Approved.



ITEM #	MARTIN #	DESCRIPTION	SIZES	UOM	PRICE
4201 N95	MOL4201 N95	AirWave N95 disposable respirator	S	10/BX	\$17.12
4200 N95	MOL4200 N95	AirWave N95 disposable respirator	M/L	10/BX	\$17.12

## MOLDEX

### 4300 SERIES AIRWAVE® P95 DISPOSABLE RESPIRATOR

Exclusive easy-breathing wave design is 95% efficient against oil and non-oil based particulates. FlexFit® design moves easily and stays in place. Dura-Mesh® shell resists collapsing in heat and humidity. Soft, cloth SmartStrap® is both hangable and adjustable. Foam face cushion for added comfort and no pressure points. Metal-free. Ideal for pharmaceutical manufacturing, petrochemical manufacturing, dry chemical handling, conventional and nuclear power generation, and paper processing. Meets heat and flame resistance in accordance with ANSI/ISEA 110-2003 Section 7.11.1.



ITEM #	MARTIN #	DESCRIPTION	SIZES	UOM	PRICE
4300P95	MOL4300P95	4300 Series AirWave P95 disposable respirator	M/L	8/BX	\$31.46

## MOLDEX

### 4700 SERIES AIRWAVE® N100 DISPOSABLE RESPIRATOR

Exclusive easy-breathing wave design offers less resistance and better breatheability. 99.97% Efficient against non-oil based particulates. FlexFit® design moves easily and stays in place. Exclusive Dura-Mesh® shell resists collapsing in heat and humidity. Ventex® valve lets hot air out faster so workers breathe easier and stay cooler. Soft, cloth SmartStrap® is both hangable and adjustable. Foam face cushion for added comfort and no pressure points. Metal-free. Ideal for pharmaceutical manufacturing, battery manufacturing, welding, cutting and metal pouring. Meets heat and flame resistance in accordance with ANSI/ISEA 110-2003 Section 7.11.1.



ITEM #	MARTIN #	DESCRIPTION	SIZES	UOM	PRICE
4700N100	MOL4700N100	4700 Series AirWave N100 disposable respirator	M/L	5/BX	\$41.41

## 3M

### 3M™ HALF FACEPIECE RESPIRATORS 5000 SERIES, DISPOSABLE

Suited for intermittent respirator wearers. Preassembled with permanently attached cartridges for ease of use and no maintenance. Use against a variety of gases, vapors and particles according to NIOSH approvals. Meets NIOSH 42 CFR 84 requirements.



ITEM #	MARTIN #	DESCRIPTION	SIZES	UOM	PRICE
5101	3M5101	Organic Vapor Respirator Assembly	S	EA	\$17.66
5201	3M5201	Organic Vapor Respirator Assembly	M	EA	\$17.66
5301	3M5301	Organic Vapor Respirator Assembly	L	EA	\$17.66
5103	3M5103	Organic Vapors/Acid Gas Respirator Assembly	S	EA	\$18.55
5203	3M5203	Organic Vapors/Acid Gas Respirator Assembly	M	EA	\$18.55
5303	3M5303	Organic Vapors/Acid Gas Respirator Assembly	L	EA	\$18.55
51P71	3M51P71	Organic Vapor/P95 Respirator Assembly	S	EA	\$23.44
52P71	3M52P71	Organic Vapor/P95 Respirator Assembly	M	EA	\$23.44
53P71	3M53P71	Organic Vapor/P95 Respirator Assembly	L	EA	\$23.44



**3M™ HALF FACEPIECE 6000 SERIES, REUSABLE RESPIRATORS**

Economical, low-maintenance, simple-to-handle and extremely lightweight reusable half face respirator. Made of thermoplastic elastomer (TPE) material for comfort during long periods of work. Can be used with any of the 3M™ bayonet-style filters to protect against gases, vapors and particulates. Head harness cradle suspension is designed for a comfortable fit. Low profile design helps improve balance and visibility. Twin filter design provides lower breathing resistance. Meets NIOSH 42 CFR 84 requirements.



ITEM #	MARTIN #	DESCRIPTION	SIZES	UOM	PRICE
6100	3M6100	Half Facepiece	S	EA	\$13.47
6200	3M6200	Half Facepiece	M	EA	\$13.48

ITEM #	MARTIN #	DESCRIPTION	SIZES	UOM	PRICE
6300	3M6300	Half Facepiece	L	EA	\$13.48
6281	3M6281	Head harness assembly		EA	\$9.45



**3M™ HALF FACEPIECE RESPIRATOR ASSEMBLIES, 6000 SERIES**

Reusable respirator assembly offers comfort and particulate protection. Each facepiece is remarkably comfortable and soft. Assemblies use the simple bayonet mounting system with low-profile P100 filters. Meets NIOSH 42 CFR 84 requirements.



ITEM #	MARTIN #	DESCRIPTION	SIZES	UOM	PRICE
6191	3M6191	Half Facepiece Respirator Assembly w/ 3M™ Particulate Filters, P100	S	EA	\$20.82
6291	3M6291	Half Facepiece Respirator Assembly w/ 3M™ Particulate Filters, P100	M	EA	\$20.82
6391	3M6391	Half Facepiece Respirator Assembly w/ 3M™ Particulate Filters, P100	L	EA	\$20.82



**3M™ HALF FACEPIECE 7500 SERIES, REUSABLE**

Soft face seal design and unique 3M™ Cool Flow™ Valve for unsurpassed comfort. Made from advanced silicone and can be used with any of the 3M™ bayonet-style filters and cartridges. Meets NIOSH 42 CFR 84 requirements.



ITEM #	MARTIN #	DESCRIPTION	SIZES	UOM	PRICE
7501	3M7501	Half Facepiece	S	EA	\$29.17
7502	3M7502	Half Facepiece	M	EA	\$29.17
7503	3M7503	Half Facepiece	L	EA	\$29.17
7583	3M7583	3M™ Cool Flow™ Exhalation Valve		10/CS	\$40.40



**3M™ RUGGED COMFORT HALF FACEPIECE REUSABLE RESPIRATORS, 6500 SERIES**

Helps provide respiratory protection against airborne contaminants in harsh, dirty environments. Facepiece is designed to help promote comfort, durability and stability with a firm, lightly textured silicone face seal and strong body construction. Helps provide respiratory protection at concentrations up to 10 x the Permissible Exposure Limit (PEL) when respirator is properly fitted. Sleek, overmolded/low-profile design helps to give a wide field of view that better suits compact work spaces and simplifies cleaning. Resilient silicone face seal offers an extended facepiece life, even keeping its shape in high-heat environments. Facepiece offers numerous other comfort features including a special valve cover that helps to direct exhaled breath and moisture downward and 3M's proprietary Cool Flow™ Valve that helps to make breathing easier by reducing heat and moisture. Made to fit securely and comfortably on the head, the facepiece comes with an adjustable head harness assembly featuring polyester/spandex straps that stretch and conform. Facepiece is compatible with all 3M™ bayonet-style filters and cartridges to help provide respiratory protection against a variety of gases, vapors and particulate hazards according to NIOSH approvals. The 6500QL Series features a proprietary Quick Latch design offering an easy, one-hand touch drop-down mechanism for putting the facepiece on and off while moving in and out of contaminated areas. NIOSH/MSHA Approved.



ITEM #	MARTIN #	DESCRIPTION	SIZES	UOM	PRICE
6501	3M6501	6500 Series Half Facepiece	S	EA	\$18.25
6502	3M6502	6500 Series Half Facepiece	M	EA	\$18.25
6503	3M6503	6500 Series Half Facepiece	L	EA	\$18.25

ITEM #	MARTIN #	DESCRIPTION	SIZES	UOM	PRICE
6501QL	3M6501QL	6500 Series Half Facepiece, Quick Latch	S	EA	\$19.78
6502QL	3M6502QL	6500 Series Half Facepiece, Quick Latch	M	EA	\$19.78
6503QL	3M6503QL	6500 Series Half Facepiece, Quick Latch	L	EA	\$19.78

**WARNING**



These respirators help protect against certain airborne contaminants. Before use, the wearer must read and understand the *User Instructions* provided as a part of the product packaging. A written respiratory protection program must be implemented meeting all the requirements of OSHA 1910.134 including training, fit testing and medical evaluation. In Canada, CSA standards Z94.4 requirements must be met and/or requirements of the applicable jurisdiction, as appropriate. **Misuse may result in sickness or death.** For proper use, see packaging instructions, supervisor, or call 3M PSD Technical Service in USA at 1-800-243-4630 and in Canada at 1-800-267-4414.



**5500 SERIES HALF MASK RESPIRATORS**

Thermoplastic elastomer mask is soft and comfortable; free of latex allergens. Cartridges and filters are replaceable so facepiece can be re-used. Ideal as an economical respirator for sub-contractors, plant guests and occasional users. Can be adapted to PAPR or Supplied Air to offer flexibility in the workplace. Combines comfort and design of the popular 7700 Series half mask in a convenient version. Compatible with Honeywell North N-Series cartridges and filters (sold separately).



ITEM #	MARTIN #	DESCRIPTION	SIZES	UOM	PRICE
550030S	NTH550030S	5500 Series half mask respirator	S	EA	\$14.94
550030M	NTH550030M	5500 Series half mask respirator	M	EA	\$14.94

ITEM #	MARTIN #	DESCRIPTION	SIZES	UOM	PRICE
550030L	NTH550030L	5500 Series half mask respirator	L	EA	\$14.94



770030

**7700 SERIES SILICONE HALF MASKS**

The 100% medical-grade silicone half mask is flexible, to provide a soft, secure and comfortable fit. Dual elasticity headstraps provide a secure and flexible fit. Wide contoured sealing area fits a greater variety of facial types. Variable thickness in sealing area provides the optimal amount of seal on each area of the face for superior comfort without sacrificing fit. Can be adapted to PAPR or Supplied Air to offer flexibility in the workplace. NIOSH Approved. Compatible with Honeywell North N-Series cartridges and filters (sold separately).



ITEM #	MARTIN #	DESCRIPTION	SIZES	UOM	PRICE
770030S	NTH770030S	7700 Series half mask respirator	S	EA	\$31.31
770030M	NTH770030M	7700 Series half mask respirator	M	EA	\$31.31
770030L	NTH770030L	7700 Series half mask respirator	L	EA	\$31.31
76BAG	NTH76BAG	Half mask carrying bag		EA	\$19.71



FF-402

**3M™ ULTIMATE FX FULL FACEPIECE FF-400 SERIES, REUSABLE**

Rugged facepiece designed to provide flexibility in extreme environments. Features soft, silicone nosecup and large lens allowing for superior peripheral vision. Comfort cradle positions respirator to help reduce pressure points. Scotchgard™ protector helps lens resist dirt, paint and stains, making it easier to clean. Cool Flow™ Exhalation Valve helps reduce heat and moisture buildup inside the facepiece. Durable, long-lasting head harness features a 6-strap configuration for secure fit. Low-profile bayonet design helps improve balance.



ITEM #	MARTIN #	DESCRIPTION	SIZES	UOM	PRICE
FF-401	3MFF-401	Ultimate FX Full Facepiece	S	4/CS	\$208.12
FF-402	3MFF-402	Ultimate FX Full Facepiece	M	4/CS	\$208.12
FF-403	3MFF-403	Ultimate FX Full Facepiece	L	4/CS	\$208.12



**7000 SERIES REUSABLE HALF MASK RESPIRATORS**

Lightweight design plus extra-wide sealing area provides all-day comfort. Mask drops down for convenient storage around neck or locks down for custom fit. Features adjustable head cradle and curved neck buckles for extra comfort. Low-profile design allows a wide field of vision. Fits under welding helmets and with safety glasses. Maintenance and cleaning are made simple with very few replacement parts. Free of metal parts. 100% PVC-Free®. Available as pre-assembled respirators with the most popular cartridge/filter combinations. Paint spray/pesticide respirators include the added convenience of coming with organic vapor cartridges and N95 or R95 prefilters. Multi-gas respirators come with 7600 Smart® cartridges which replace up to five gas/vapor cartridges, making cartridge selection easier for workers. P100 respirator comes with 7940P100 filter disks. NIOSH Approved.



7001

ITEM #	MARTIN #	DESCRIPTION	SIZES	UOM	PRICE
7001	MOL7001	7000 Series half mask respirator facepiece	S	EA	\$12.25
7002	MOL7002	7000 Series half mask respirator facepiece	M	EA	\$12.25
7003	MOL7003	7000 Series half mask respirator facepiece	L	EA	\$12.25
7101	MOL7101	Organic Vapor pre-assembled half mask respirator	S	EA	\$24.18
7102	MOL7102	Organic Vapor pre-assembled half mask respirator	M	EA	\$24.18
7103	MOL7103	Organic Vapor pre-assembled half mask respirator	L	EA	\$24.18
7111	MOL7111	Oil-free paint spray/pesticide pre-assembled half mask respirator	S	EA	\$29.36
7112	MOL7112	Oil-free paint spray/pesticide pre-assembled half mask respirator	M	EA	\$29.36
7113	MOL7113	Oil-free paint spray/pesticide pre-assembled half mask respirator	L	EA	\$29.36

ITEM #	MARTIN #	DESCRIPTION	SIZES	UOM	PRICE
7601	MOL7601	Multi-gas pre-assembled half mask respirator	S	EA	\$26.52
7602	MOL7602	Multi-gas pre-assembled half mask respirator	M	EA	\$26.52
7603	MOL7603	Multi-gas pre-assembled half mask respirator	L	EA	\$26.52
7941	MOL7941	P100 particulates pre-assembled half mask respirator	S	EA	\$21.92
7942	MOL7942	P100 particulates pre-assembled half mask respirator	M	EA	\$21.92
7943	MOL7943	P100 particulates pre-assembled half mask respirator	L	EA	\$21.92
7171	MOL7171	Oil-based paint spray/pesticide pre-assembled half mask respirator	S	EA	\$30.55
7172	MOL7172	Oil-based paint spray/pesticide pre-assembled half mask respirator	M	EA	\$30.55
7173	MOL7173	Oil-based paint spray/pesticide pre-assembled half mask respirator	L	EA	\$30.55



HEAD & FACE PROTECTION | RESPIRATORY PROTECTION







### RU6500 FULL FACEPIECE RESPIRATORS

Silicone, full facepiece is the redesigned Sperian Survivair Opti-Fit™, re-engineered to accept Honeywell North N-series cartridges and filters and has options for both PAPR and CF-SAR configurations in the Honeywell respiratory line. Features silicone nose cup and face seal for all day comfort and polycarbonate lens for open view and peripheral vision. Available with a 5-point headstrap or mesh headnet.

RU65001



ITEM #	MARTIN #	DESCRIPTION	SIZES	UOM	PRICE
RU65001S	NTHRU65001S	Full facepiece respirator w/ 5-point headstrap	S	EA	\$160.57
RU65001M	NTHRU65001M	Full facepiece respirator w/ 5-point headstrap	M	EA	\$160.57
RU65001L	NTHRU65001L	Full facepiece respirator w/ 5-point headstrap	L	EA	\$160.57
RU65002S	NTHRU65002-S	Full facepiece respirator w/ mesh headnet	S	EA	\$160.57

ITEM #	MARTIN #	DESCRIPTION	SIZES	UOM	PRICE
RU65002M	NTHRU65002-M	Full facepiece respirator w/ mesh headnet	M	EA	\$160.57
RU65002L	NTHRU65002-L	Full facepiece respirator w/ mesh headnet	L	EA	\$160.57
CF4001	NTHCF4001	Combination continuous flow supplied air respirator w/ PAPR adapter, breathing tube & caps (RU6500 only)		EA	\$201.60



### 3M™ FULL FACEPIECE RESPIRATORS 6000 SERIES, REUSABLE

Faceseal is made of silicone rubber for enhanced comfort and durability. Lightweight and well-balanced. Unique 3M™ Cool Flow™ Valve for unsurpassed comfort. Features large lens providing user a wide field of vision.

6700



ITEM #	MARTIN #	DESCRIPTION	SIZES	UOM	PRICE
6700	3M6700	Full Facepiece	S	EA	\$146.89
6800	3M6800	Full Facepiece	M	EA	\$146.89
6900	3M6900	Full Facepiece	L	EA	\$146.89
6885	3M6885	Faceshield Covers		100/CS	\$181.69
6864	3M6864	Center Adapter Assembly		EA	\$80.54
6878	3M6878	Spectacle Kit		EA	\$108.84
6886	3M6886	Tinted Lens Cover		25/CS	\$122.54
6893	3M6893	Inhalation Valve		EA	\$55.18
6894	3M6894	Nose Cup Assembly		EA	\$32.68
6895	3M6895	Inhalation Port Gasket		EA	\$25.32
6897	3M6897	Head Harness		EA	\$26.63
6898	3M6898	Lens Assembly		EA	\$84.97



### 7600 SERIES FULL FACEPIECES

The 100% medical-grade silicone facepiece is flexible, to provide a soft, secure and comfortable fit. Wide sealing area for improved fit and ability to fit more facial types. Nose cup provides less dead air space and channels exhaled breath. Speech diaphragm is standard to provide speech clarity. Lens offers 200° field of vision and downward view for optimal viewing area in all directions. Polycarbonate lens meets ANSI requirements for high impact. Can be adapted to PAPR or Supplied Air. Optional welding kit available. NIOSH Approved. Compatible with Honeywell North N-Series cartridges and filters (sold separately).

760008A



ITEM #	MARTIN #	DESCRIPTION	SIZES	UOM	PRICE
760008AS	NTH760008AS	Full facepiece, dual flange silicone seal	S	EA	\$267.35
760008A	NTH760008A	Full facepiece, dual flange silicone seal	M/L	EA	\$267.35
760008AW	NTH760008AW	Full facepiece w/ welding attachment	M/L	EA	\$364.32
76BAG	NTH76BAG	Full mask carrying bag		EA	\$19.71

OTHER PRODUCTS AVAILABLE. VISIT [WWW.MARTINSUPPLY.COM](http://WWW.MARTINSUPPLY.COM)



### 3M™ FULL FACEPIECE 7800S, ULTIMATE REUSABLE

Durable elastomeric facepieces are designed for a wide range of applications. Full facepiece is made of silicone and features a double-flap faceseal and (6) easy-adjusting straps. Soft and pliable with a hard-coated polycarbonate lens. Extra large inhalation and exhalation valves help make breathing easier. Three sizes to fit most faces.

7800S



ITEM #	MARTIN #	DESCRIPTION	SIZES	UOM	PRICE
7800S-S	3M7800S-S	Full Facepiece Respirator	S	EA	\$389.09
7800S-M	3M7800S-M	Full Facepiece Respirator	M	EA	\$389.09
7800S-L	3M7800S-L	Full Facepiece Respirator	L	EA	\$389.09
7884	3M7884	Facepiece Lens		5/PK	\$81.54

ITEM #	MARTIN #	DESCRIPTION	SIZES	UOM	PRICE
7893S	3M7893S	Head Strap/Harness Assembly		2/CS	\$182.83
7894	3M7894	3M™ Eyeglass Frame & Mount		EA	\$180.68
7899-25	3M7899-25	Lens Cover		25/BX	\$251.26

### WARNING



These respirators help protect against certain airborne contaminants. Before use, the wearer must read and understand the *User Instructions* provided as a part of the product packaging. A written respiratory protection program must be implemented meeting all the requirements of OSHA 1910.134 including training, fit testing and medical evaluation. In Canada, CSA standards Z94.4 requirements must be met and/or requirements of the applicable jurisdiction, as appropriate. **Misuse may result in sickness or death.** For proper use, see packaging instructions, supervisor, or call 3M PSD Technical Service in USA at 1-800-243-4630 and in Canada at 1-800-267-4414.



54001

**5400 SERIES  
LOW-MAINTENANCE  
FULL FACEPIECES**

Wide-sealing area for improved fit and ability to fit more facial types. Nose cup provides less dead air space and channels exhaled breath. Latex-free thermoplastic elastomer with no natural rubber proteins which may cause an allergic reaction. Lens offers 200° field of vision and downward view for optimal viewing area in all directions. Polycarbonate lens meets ANSI requirements for high impact. Can be adapted to PAPR or Supplied Air to offer flexibility in the workplace. NIOSH Approved. Compatible with Honeywell North N-Series cartridges and filters (sold separately).



ITEM #	MARTIN #	DESCRIPTION	SIZES	UOM	PRICE
54001S	NTH54001S	5400 Series full facepiece respirator	S	EA	\$124.78
54001	NTH54001	5400 Series full facepiece respirator	M/L	EA	\$123.58



**9000 SERIES REUSABLE  
FULL FACE RESPIRATORS**

Exclusive over-molded lens design eliminates usual heavy-clamping frame. to create an innovative full face with lighter weight, greater field of vision, fewer parts, minimal maintenance and completely free of metal parts. Lightweight respirator features stand away head harness with extra wide opening for easy on/off. Strap buckles are securely molded directly to facepiece for rugged use and ease of adjustment. Coated lens for scratch resistance. NIOSH Approved.



9002



ITEM #	MARTIN #	DESCRIPTION	SIZES	UOM	PRICE
9001	MOL9001	9000 Series reusable full face respirator	S	EA	\$119.87
9002	MOL9002	9000 Series reusable full face respirator	M	EA	\$119.87
9003	MOL9003	9000 Series reusable full face respirator	L	EA	\$119.87
0093	MOL0093	9000 Faceshield protector		15/BX	\$239.72



**N-SERIES CARTRIDGES, FILTERS AND  
CARTRIDGE/FILTER COMBINATIONS**

Air-purifying respirators with cartridges provide respiratory protection against gases and vapors by using sorbents to purify the inhaled air. Honeywell North N-Series filter/cartridge combinations also remove dusts, fibers and other particles. All Honeywell North N-Series cartridges and filters are NIOSH approved with select Honeywell North air-purifying half masks (7700, RU8500, 5500, RU8800) and full facepieces (7600, RU6500, 5400).

75SCL



7506N95



7581P100L



ITEM #	MARTIN #	DESCRIPTION	UOM	PRICE
75SCL	NTH75SCL	Defender™ multi gas & vapor cartridge	PR	\$13.82
75SCP100L	NTH75SCP100L	Defender multi gas & vapor cartridge w/ P100 particulate filter	PR	\$25.58
N75001L	NTHN75001L	Organic vapor cartridge	PR	\$12.92
7581P100L	NTH7581P100L	Organic vapor cartridge w/ P100 particulate filter	PR	\$24.80
N75002L	NTHN75002L	Acid gas cartridge	PR	\$13.51
7582P100L	NTH7582P100L	Acid gas cartridge w/ P100 particulate filter	PR	\$25.32
N75003L	NTHN75003L	Organic vapor, acid gas cartridge	PR	\$13.14
7583P100L	NTH7583P100L	Organic vapor, acid gas cartridge w/ P100 particulate filter	PR	\$24.95
N75004L	NTHN75004L	Ammonia, methylamine cartridge	PR	\$14.32
7584P100L	NTH7584P100L	Ammonia, methylamine cartridge w/ P100 particulate filter	PR	\$26.09

ITEM #	MARTIN #	DESCRIPTION	UOM	PRICE
N750052L	NTHN750052	Mercury vapor cartridge w/ ESLI	PR	\$41.17
7580P100	NTH7580P100	P100 Particulate filter	PR	\$9.31
75FFP100	NTH75FFP100	Flexible, low-profile P100 particulate filter	PR	\$6.85
7506N95	NTH7506N95	N95 pad filters	10/PK	\$11.94
7506R95	NTH7506R95	R95 pad filters	10/PK	\$27.86
N750029	NTHN750029	Shower cap for 7580P100 filter, black	PR	\$1.95
75FFP100NL	NTH75FFP100NL	Flexible, low-profile P100 particulate filter w/ odor relief from nuisance levels of organic vapors, acid gases & ozone	PR	\$10.43
75852P100L	NTH75852P100L	Mercury vapor cartridge P100 Filter	PR	\$53.18
N750036	NTHN750036	Filter assembly, includes (2) filter covers & (2) filter supports; attaches pad filters to cartridge	PR	\$3.92



**CARTRIDGES/FILTERS FOR CA200 SERIES PAPR**

High-efficiency particulate air-purifying (HEPA) filters and cartridges for use with the CA200 Series PAPR.

40HE



4001HE



ITEM #	MARTIN #	DESCRIPTION	UOM	PRICE
40HE	NTH40HE	HEPA	3/PK	\$58.88
4001-H5	NTH4001	Organic vapor	3/PK	\$89.85
4003-H5	NTH4003	Organic vapor/acid gas	3/PK	\$116.71

ITEM #	MARTIN #	DESCRIPTION	UOM	PRICE
4004HE	NTH4004HE	Ammonia/methyl cartridge w/ HEPA filter	3/PK	\$108.43
4001HE	NTH4001HE	Organic vapor cartridge w/ HEPA filter	3/PK	\$108.43
4003HE	NTH4003HE	Organic vapor/acid gas cartridge w/ HEPA filter	3/PK	\$133.23



### 3M™ REPLACEMENT CARTRIDGES AND FILTERS

Use with 3M™ Respirators 5000, 6000, 7000 and FF-400 Series, according to NIOSH approvals. When properly selected, cartridges and filters help provide protection from a variety of gases, vapors and particulate hazards. Available with 3M™ Service Life Indicator, an end-of-service-life indicator (ESLI) that can help users determine when to change cartridges in appropriate environments.

Only 3M™ filters 2000 Series, 7093, 5N11 or 5P71 are approved for use with 3M™ 5000 Series Respirators. Cartridges on 5000 Series Respirators cannot be replaced. The 3M™ Filter Adapter 502 is required for use of the 2000 Series and 7093 filters with the 5000 Series Respirators and 6000 Series Cartridges. The 3M™ Filter Retainer 501 is required for use of the 5N11 and 5P71 prefilters with the 5000 Series Respirators. The 502 adapter cannot be reused.



ITEM #	MARTIN #	DESCRIPTION	UOM	PRICE
6001	3M6001	Organic Vapor Cartridge	2/BX	\$5.98
6002	3M6002	Acid Gas Cartridge	2/BX	\$6.58
6003	3M6003	Organic Vapor/Acid Gas Cartridge	2/BX	\$6.42
6004	3M6004	Ammonia/Methylamine Cartridge	2/BX	\$7.20
6005	3M6005	Formaldehyde****/Organic Vapor Cartridge	2/BX	\$7.26
6006	3M6006	Multi-Gas/Vapor Cartridge	2/BX	\$6.42
60921	3M60921	Cartridge/Filter Organic Vapor/P100	2/BX	\$11.65
60922	3M60922	Cartridge/Filter Acid Gas/P100	2/BX	\$12.28
60923	3M60923	Cartridge/Filter Organic Vapor/Acid Gas/P100	2/BX	\$11.80
60924	3M60924	Cartridge/Filter Ammonia/Methylamine/P100	2/BX	\$13.51
60925	3M60925	Cartridge/Filter Formaldehyde****/Organic Vapor/P100	2/BX	\$13.63
60926	3M60926	Cartridge/Filter Multi-Gas/Vapor/P100	2/BX	\$12.88
2071	3M2071	Particulate Filter P95	2/BX	\$2.25
2076HF	3M2076HF	Particulate Filter, Hydrogen Fluoride P95 Filter w/ Nuisance Level Acid Gas** Relief	2/BG	\$8.96
2091	3M2091	Particulate Filter P100	2/BX	\$3.58
2096	3M2096	Particulate Filter P100 w/ Nuisance Level Acid Gas** Relief	2/BX	\$4.98
2097	3M2097	Particulate Filter P100 w/ Nuisance Level Organic Vapor* Relief & Ozone Protection***	2/BX	\$4.91
2291	3M2291	Advanced Particulate Filters P100	2/BX	\$3.86
2296	3M2296	Advanced Particulate Filters P100 w/ Nuisance Level Acid Gas**	2/BX	\$5.35
2297	3M2297	Advanced Particulate Filters P100 w/ Nuisance Level Organic Vapor Relief* & Ozone Protection***	2/BX	\$5.29
7093	3M7093	Particulate Filter P100, Solid Top Air Inlet	12/BX	\$4.55

ITEM #	MARTIN #	DESCRIPTION	UOM	PRICE
501	3M501	Filter Retainer	20/BX	\$2.08
502	3M502	Filter Adapter for Filter 2000 Series or Filter 7093	20/BX	\$4.55
5N11	3M5N11	Particulate Pre-Filter N95	10/BX	\$15.16
5P71	3M5P71	Particulate Pre-Filter P95	10/BX	\$18.49
504	3M504	Respirator Cleaning Wipes	100/BX	\$48.54
60928	3M60928	Cartridge/Filter Organic Vapor/Acid Gas/P100, radioiodine or methyl bromide	2/BX	\$18.25
7093C	3M7093C	Cartridge/Filter Hydrogen Fluoride w/ Nuisance Level Organic Vapor/Acid Gas*	EA	\$7.13
2078	3M2078	Particulate Filter, P95 w/ Nuisance Level Organic Vapor*/Acid Gas** Relief & Ozone Protection***	2/BX	\$3.97
6009S	3M6009S	Mercury Vapor/Chlorine or Sulfur Dioxide Gas Cartridge	EA	\$12.74
60929S	3M60929S	Mercury Vapor/Chlorine or Sulfur Dioxide Gas/P100 Particulate Filter Combination Cartridge	EA	\$17.23
7093B	3M7093B	3M™ Hydrogen Fluoride Cartridge/Filter P100 w/ Nuisance Level Organic Vapor*/Acid Gas** Relief	2/BX	\$3.16
7093CB	3M7093CB	Hydrogen Fluoride Cartridge/Filter P100 w/ Nuisance Level Organic Vapor*/Acid Gas** Relief	2/BX	\$13.88
701	3M701	Filter Adapter, Black/Orange	2/BX	\$13.11
6001i	3M6001i	OV ESLI Cartridge	60/CS	\$399.05
60921i	3M60921i	OV ESLI/P100 Cartridge	60/CS	\$765.89
5P71-6	3M5P71-6	Replacement Particulate P95 Filter	6/PK	\$11.34
601	3M601	Fit Test Adapter for 6000 Series	EA	\$166.72

\*Nuisance level organic vapors refer to concentrations less than the OSHA PEL or applicable government occupational exposure limits, whichever is lower. Do not use for respiratory protection against organic vapors.

\*\*Nuisance level acid gases refer to concentrations less than the OSHA PEL or applicable government occupational exposure limits, whichever is lower. Do not use for respiratory protection against acid gases.

\*\*\*3M™ recommended for ozone protection up to 10 x OSHA PEL or applicable government occupational exposure limits, whichever is lower. Not NIOSH approved for use against ozone.

\*\*\*\*OSHA regulations require gas proof goggles be worn with half facepiece respirators when used against formaldehyde.

### WARNING



These respirators help protect against certain airborne contaminants. Before use, the wearer must read and understand the *User Instructions* provided as a part of the product packaging. A written respiratory protection program must be implemented meeting all the requirements of OSHA 1910.134 including training, fit testing and medical evaluation. In Canada, CSA standards Z94.4 requirements must be met and/or requirements of the applicable jurisdiction, as appropriate. **Misuse may result in sickness or death.** For proper use, see packaging instructions, supervisor, or call 3M PSD Technical Service in USA at 1-800-243-4630 and in Canada at 1-800-267-4414.



**7000/7800/9000 SERIES CARTRIDGES AND FILTERS**

A variety of cartridges and filters for use with the 7000/7800 Series half mask respirators or 9000 Series full face respirators. NIOSH Approved.



ITEM #	MARTIN #	DESCRIPTION	UOM	PRICE
7100	MOL7100	Organic Vapor cartridge	PR	\$10.95
7200	MOL7200	Acid Gas cartridge	PR	\$11.87
7300	MOL7300	Organic Vapor/Acid Gas cartridge	PR	\$11.43
7400	MOL7400	Ammonia/Methylamine cartridge	PR	\$13.93
7500	MOL7500	Formaldehyde cartridge	PR	\$14.35
7600	MOL7600	Multi-Gas/Vapor Smart® cartridge	PR	\$11.68
7020	MOL7020	Pre-filter retainer	PR	\$3.51
7990	MOL7990	P100 Particulates cartridge	PR	\$9.92

ITEM #	MARTIN #	DESCRIPTION	UOM	PRICE
7940	MOL7940	P100 filter disk	PR	\$7.15
7920	MOL7920	Piggyback adapter	PR	\$4.67
7960	MOL7960	P100 w/ nuisance OV filter disk	PR	\$9.70
7950	MOL7950	P100 filter disk w/ nuisance organic vapors/acid gas	2/PK	\$9.95
7999	MOL7999	P100 Filter disk cover	2/PK	\$3.54
7140	MOL7140	Organic Vapor cartridge/P100 filter disk combination	PR	\$25.15
7640	MOL7640	Multi-Gas/Vapor Smart cartridge/P100 filter disk combination	PR	\$25.97



**3M™ VERSAFLO™ 800 SERIES PPR ASSEMBLY KIT**

The Versaflo™ 800 Series PPR kit features an intrinsically safe (IS) motor/blower. Heavy-duty belt designed with airflow channels, multiple size adjustments and belt extender options. Intuitive, colored touchpoints plus visual and audible alarms help make the TR-800 easy to use. Multi-speed blower functions up to 16,000' and battery offers long run time, less charge time and, ultimately, reduced down time. Blower is rated at Division I for Classes I,II, and III under the most current UL® standard.

ITEM #	MARTIN #	DESCRIPTION	UOM	PRICE
TR-800-HIK	3MTR-800-HIK	3M™ Versaflo™ Powered Air Purifying Respirator Heavy Industry Kit	EA	\$2,034.00

**WARNING**



These respirators help protect against certain airborne contaminants. Before use, the wearer must read and understand the *User Instructions* provided as a part of the product packaging. A written respiratory protection program must be implemented meeting all the requirements of OSHA 1910.134 including training, fit testing and medical evaluation. In Canada, CSA standards Z94.4 requirements must be met and/or requirements of the applicable jurisdiction, as appropriate. **Misuse may result in sickness or death.** For proper use, see packaging instructions, supervisor, or call 3M PSD Technical Service in USA at 1-800-243-4630 and in Canada at 1-800-267-4414.



### 3M™ SPEEDGLAS™ FRESH-AIR III SUPPLIED AIR SYSTEMS

Supplied air respiratory protection system. Includes Speedglas™ 9100-Air and 9100 FX-Air Welding Helmets with Fresh-Air III Supplied Air System. Available with V-100 Vortex Air-Cooling valve, V-200 Vortemp™ Air-Heating valve or V-300 Air-Regulating Valve.



#### Features:

- SideWindows - Shade 5 side filters that increase peripheral vision
- Ergonomic, adjustable head suspension for increased comfort, helmet stability and weight distribution
- 3M™ Speedglas™ Auto-Darkening Filter
- Selectable Shades 5, 8-13 and Shade 3 light state; Grinding and Tack modes
- For use with all Stick, MIG, and TIG welding processes
- Five-position sensitivity control
- Adjustable recovery delay
- Meets ANSI Z87.1-2010

ITEM #	MARTIN #	DESCRIPTION	UOM	PRICE
25-5702-10SW	3M25-5702-10SW	Speedglas™ Welding Helmets w/ V-100 Vortex Air-Cooling valve & ADF 9100V	EA	\$1,229.50
25-5702-20SW	3M25-5702-20SW	Speedglas™ Welding Helmets w/ V-100 Vortex Air-Cooling valve & ADF 9100X	EA	\$1,338.98
25-5702-30SW	3M25-5702-30SW	Speedglas™ Welding Helmets w/ V-100 Vortex Air-Cooling valve & ADF 9100XX	EA	\$1,441.70
25-5802-10SW	3M25-5802-10SW	Speedglas™ Welding Helmets w/ V-200 Vortemp™ Air-Heating valve & ADF 9100V	EA	\$1,393.22
25-5802-20SW	3M25-5802-20SW	Speedglas™ Welding Helmets w/ V-200 Vortemp™ Air-Heating valve & ADF 9100X	EA	\$1,508.89
25-5802-30SW	3M25-5802-30SW	Speedglas™ Welding Helmets w/ V-200 Vortemp™ Air-Heating valve & ADF 9100XX	EA	\$1,598.99
27-5902-10SW	3M27-5902-10SW	Speedglas™ Welding Helmets w/ V-300 Air-Regulating valve & ADF 9100V	EA	\$1,325.26
27-5902-20SW	3M27-5902-20SW	Speedglas™ Welding Helmets w/ V-300 Air-Regulating valve & ADF 9100X	EA	\$1,437.76
27-5902-30SW	3M27-5902-30SW	Speedglas™ Welding Helmets w/ V-300 Air-Regulating valve & ADF 9100XX	EA	\$1,550.27



### PUREFLO ESM PAPP

Designed to protect from welding fumes and Hexavalent Chromium. Welding helmet comes with auto-darkening filter shades 9-13 and unique grind cut mode with shade 5. Welding helmet lifts up to allow welder to grind and clean welds looking through clear ANSI faceshield. PAPP features a complete helmet system, no uncomfortable backpacks or hoses to tangle. ESM monitors air flow with heads-up visual and audible alarms for low flow, battery and filter life. Air flow of 7.6 CFM with boost mode delivering over 8.2 CFM. Assigned protection factor of 1000 with no fit testing required. NIOSH and ANSI certified hard hat and faceshield. FM certified CL I Div 2. ESM comes with NIOSH approved HEPA filter or HE/HF for hydrogen fluoride and nuisance odor relief of most organic vapors, acid gas and ozone. Nuisance level refers to levels under OSHA PEL. NIOSH does not approve nuisance level filters. Black.

PUREFLO ESM PAPP



ITEM #	MARTIN #	DESCRIPTION	COLOR	UOM	PRICE
PRO2000-SHL	ISAPPRO2000-SHL	Pureflo ESM respirator w/ hard hat, HE filter & liftable visor	Black	EA	\$1,313.31
PRO2000-CHL	ISAPPRO2000-CHL	Pureflo ESM respirator hard hat w/ lifting visor, face seal & HE filter	Black	EA	\$1,358.86
PRO2000-SHL-B0C	ISAPPRO2000-SHL-B0C	Pureflo ESM respirator w/ hard hat & HE/HF/HC filter	Black	EA	\$1,358.86
PRO2000-SHL-B2A	ISAPPRO2000-SHL-B2A	Pureweld ESM respirator w/ hard hat, HE filter & welding mask	Black	EA	\$1,807.62
PRO2000-SHL-V0A	ISAPPRO2000-SHL-V0A	Pureflo ESM respirator w/ hard hat, HE filter & liftable visor	Hi-viz yellow/green	EA	\$1,313.31



**PUREFLO ESM P APR ACCESSORIES**

A variety of accessories for ESM P APR.

ITEM #	MARTIN #	DESCRIPTION	UOM	PRICE
PRO2020SP-BP	ISAPPRO2020SP-BP	ESM High efficiency HE filter	32/BX	\$1,186.34
PRO2026SP	ISAPPRO2026SP	ESM filter, HE/HF/HC cartridge	EA	\$86.26
PRO2040SP	ISAPPRO2040SP	ESM spare battery charger	1/BX	\$187.06
PRO2030SP	ISAPPRO2030SP	ESM Battery pack	1/BX	\$112.43
PRO2042SP	ISAPPRO2042SP	EMS multi-charger, 16 bank	EA	\$2,127.46
PRO2153SP	ISAPPRO2153SP	Secondary visor attachment bar	EA	\$92.08
PRO2545SP	ISAPPRO2545SP	Visor protector overlay, disposable	6/PK	\$19.38
PRO2050SP	ISAPPRO2050SP	Visor assembly, non-welding	4/BX	\$493.34
PRO2510SP	ISAPPRO2510SP	Visor protector	4/BX	\$88.20
HB14BLP	ISAPHB14BLP	Helmet bag, black w/ embroidered Pureflo logo	EA	\$69.31
PRO2101SP	ISAPPRO2101SP	Secondary visor, gold-coated #3 green visor	1/BX	\$145.38
PRO2113SP	ISAPPRO2113SP	Inside cover for ADF lens	10/PK	\$20.85
PRO2605SP	ISAPPRO2605SP	Premium head lining kit	EA	\$40.23
PRO2475SP-LC	ISAPPRO2475SP-LC	Neck cape, black, stedprene w/ snap-on leather overlay for use with welding P APR	EA	\$247.15

PRO2101SP

PRO2042SP



**CA200 SERIES P APR**

Triple alarm system creates an audible, vibratory and visual alarm to warn workers of battery life and/or filter clog. Vibratory alarm can be felt even through welding jackets; warns workers who are hearing impaired or in high noise environments. Two visual alarms: one for low battery and another one for a clogged filter. Lightweight for improved comfort and longer wear. Unit can be used for either tight facepieces or loose fitting hoods to accommodate different needs and preferences. Airflow is automatically adjusted to meet OSHA and CSA CFM requirements. Filters/cartridges sold separately.

**Complete assembly includes:**

- (1) Blower
- (1) Lithium-ion battery
- (1) Flow meter
- (1) Single unit battery charge
- (1) Carry case

ITEM #	MARTIN #	DESCRIPTION	UOM	PRICE
CA201D	NTHCA201D	CA200 Series P APR assembly w/ PVC decon belt	EA	\$1,321.98
CA127	NTHCA127	34" Breathing tube for use w/ Primair® Series loose fitting headcovers	EA	\$48.12
CA127L	NTHCA127L	40" Breathing tube for use w/ Primair Series loose fitting headcovers	EA	\$56.00
CA229	NTHCA229	34" Y breathing tube for use w/ Honeywell North tight-fitting facepieces	EA	\$124.20

CA201D



**PRIMAIR® SERIES HOODS**

For painting applications or where full head and shoulder coverage is desired. Workers can select the length that is right for them. Tyvek® for most applications; Saranex®-coated for additional chemical protection. Protects the lens from splatter. Universal size. For use with CA200 Series P APR and CF1000 Series CF-SAR.

**Complete assembly includes:**

- (1) Adjustable headgear
- (1) Hood with bib (available standard or coated for additional protection against occasional splashes)
- (1) Replacement sweatband
- (1) Peel-off cover lens

ITEM #	MARTIN #	DESCRIPTION	UOM	PRICE
PA111	NTHPA111	Primair 100 headgear & bibbed hood	EA	\$73.77
PA131	NTHPA131	Primair 100 headgear & hood w/ knit neck seal	EA	\$144.97

PA111



ITEM #	MARTIN #	DESCRIPTION	UOM	PRICE
PA201E01	NTHPA201E01	Primair FM 200 E2 style hard hat & hood w/ knit neck seal	EA	\$289.91

## Honeywell

### COUGAR™ SCBA

888888

Silicone facepiece provides comfort and durability, even in extreme heat or cold.

Won't oxidize or react with ozone. Provides better sealing ability for improved comfort and fit. Features low-pressure, 30-minute, 2216 psig, bell alarm, aluminum cylinder without locking collar, Twenty20+® facepiece, nose cup and headstrap. Second stage regulator has compact, Air Klic™ fastening system; first-breathon; better downward vision for less chance of damage; allows attachment in any orientation; regulator holder on waist strap allows regulator to be kept in stand-by mode. Mighty-Light® backpack is light, easy to use, and comfortable; no tools required for quick, easy disassembly and assembly.



ITEM #	MARTIN #	DESCRIPTION	SIZES	UOM	PRICE
888888	NTH888888	Basic industrial SCBA	M	EA	\$1,955.00

## Honeywell

### PUMA™ SCBA

777777

Rated for entry into immediately dangerous to life or health (IDLH) environments. No need for spectacles kits. Hood is made from Challenge® NXT barrier fabric (fluoropolymer films laminated to aramid substrates) for excellent permeation resistance. Lens is made from 10 mil FEP Teflon®. Flexible neoprene neck seal provides excellent protection against contaminants in IDLH atmospheres. Features hood with factory-installed medium silicone nose cup; plain whistle alarm, 2216 psig 30-minute aluminum cylinder without locking collar.



ITEM #	MARTIN #	DESCRIPTION	SIZES	UOM	PRICE
777777	NTH777777	PUMA SCBA	M	EA	\$2,317.00

TO SEE MORE STYLES, VISIT [WWW.MARTINSUPPLY.COM](http://WWW.MARTINSUPPLY.COM)

## Honeywell

### REFRESHERS ALCOHOL RESPIRATOR TOWELETTES

Refresher wipe pads provide a quick, easy method of removing perspiration and body oils from the respirator facepiece between scheduled cleanings. Wipe pads make respirator usage more acceptable to the wearer by improving comfort. Individually wrapped towelettes sold per box.

ITEM #	MARTIN #	DESCRIPTION	UOM	PRICE
7003A	NTH7003A	Refresher wipe pads, alcohol free	100/BX	\$27.83

7003A



## MOLDEX

### BITREX® FIT TEST KIT

Comply with OSHA standards for qualitative fit testing. Kit includes everything needed to perform fit testing on all Moldex® respirators.

Includes BITREX® aerosol, fit test hood, instructions and certificates.

Respirators sold separately.

**⚠️ WARNING:** This product can expose you to chemicals including carbon black, which is known to the State of California to cause cancer. For more information go to [www.P65Warnings.ca.gov](http://www.P65Warnings.ca.gov).

ITEM #	MARTIN #	DESCRIPTION	UOM	PRICE
0102	MOL0102	Qualitative Fit Test Kit	EA	\$299.95
0201	MOL0201	Hood	EA	\$49.09
0301	MOL0301	Nebulizer #1, Threshold screening	EA	\$86.95
0302	MOL0302	Nebulizer #2, Fit Test	EA	\$86.95
0503	MOL0503	Threshold Screening solution, BITREX	EA	\$15.74

0102



ITEM #	MARTIN #	DESCRIPTION	UOM	PRICE
0504	MOL0504	Fit Test solution, BITREX	EA	\$15.74
0702	MOL0702	Qualitative Fit Test instructions	EA	\$15.74
9702-716	MOL9702-716	Wallet Respirator ID cards	10/PK	\$15.74
9702-717	MOL9702-717	Respirator training certificates	10/PK	\$15.74



**3M™ E-A-R™ CLASSIC™ EARPLUGS**

Made with Thermal-Reactive™ foam. Features moisture and flame-resistant design. Test compatible with 3M™ E-A-Rfit™ Validation System.



ITEM #	MARTIN #	DESCRIPTION	NRR*	UOM	PRICE
310-1103	3M310-1103	Classic, uncorded, small size	29	500 PR/BX	\$35.82
310-1001	3M310-1001	Classic, uncorded, pillow pack	29	200 PR/BX	\$34.09
312-1201	3M312-1201	Classic, uncorded, poly bag	29	200 PR/BX	\$32.74
311-1101	3M311-1101	Classic, corded, poly bag	29	200 PR/BX	\$63.87
310-1080	3M310-1080	Classic, corded, poly bag	29	100 PR/BX	\$35.28
391-1001	3M391-1001	Classic, uncorded, One Touch™ refill bottle	29	500 PR/BX	\$75.63
311-1081	3M311-1081	Classic, corded, Econopack (bulk)	29	500 PR/BX	\$43.09
312-1080	3M312-1080	Classic, uncorded, Econopack (bulk)	29	500 PR/BX	\$75.37
310-1101	3M310-1101	Classic Plus, uncorded, pillow pack	33	200 PR/BX	\$37.93

ITEM #	MARTIN #	DESCRIPTION	NRR*	UOM	PRICE
311-1105	3M311-1105	Classic Plus, corded, poly bag	33	200 PR/BX	\$69.06
311-4101	3M311-4101	Classic Plus, metal detectable, corded	29	200 PR/BX	\$120.85
311-6000	3M311-6000	Classic Soft, uncorded	31	200 PR/BX	\$45.74
311-6001	3M311-6001	Classic Soft, corded	31	200 PR/BX	\$86.19
390-1000	3M390-1000	Classic, uncorded, Value Pack™ dispenser	29	200 PR/BX	\$29.47
311-1106	3M311-1106	Classic small corded earplugs	29	200 PR/BX	\$67.07
VP312-1201	3MVP312-1201	E-A-R Classic uncorded earplugs, vendor pack	29	5 PR/PK	\$9.74
VP311-1101	3MVP311-1101	E-A-R Classic corded earplugs, vendor pack	29	5 PR/PK	\$18.27



**3M™ E-A-R™ E-Z FIT™ EARPLUGS**

Made with low-pressure foam. Features bright yellow color that aids in compliance checks. Test compatible with 3M™ E-A-Rfit™ Validation System.



ITEM #	MARTIN #	DESCRIPTION	NRR*	UOM	PRICE
312-1208	3M312-1208	E-Z Fit, uncorded	28	200 PR/BX	\$34.75
312-1222	3M312-1222	E-Z Fit, corded	28	200 PR/BX	\$66.30



**3M™ E-A-RSOFT™ YELLOW NEONS™ AND YELLOW NEON BLASTS™ DISPOSABLE FOAM EARPLUGS**

Soft foam provides low-pressure comfort. Features optional breakaway cord. Metal detectable models feature a stainless steel ball encapsulated into the earplug's foam and a metal detectable cord. Test compatible with 3M™ E-A-Rfit™ Validation System.



ITEM #	MARTIN #	DESCRIPTION	NRR*	SIZES	UOM	PRICE
312-1250	3M312-1250	Yellow Neons, uncorded, poly bag	33	Regular	200 PR/BX	\$25.59
312-1251	3M312-1251	Yellow Neons, uncorded, poly bag	33	L	200 PR/BX	\$29.84
311-1256	3M311-1256	Yellow Neons, corded, poly bag	33	Regular	200 PR/BX	\$30.16
311-1251	3M311-1251	Yellow Neons, corded, poly bag	33	L	200 PR/BX	\$60.84
311-4106	3M311-4106	Yellow Neons, metal detectable, corded	33	Regular	200 PR/BX	\$89.94
312-1252	3M312-1252	Yellow Neon Blasts, uncorded, poly bag	33	Regular	200 PR/BX	\$30.89
311-1252	3M311-1252	Yellow Neon Blasts, corded, poly bag	33	Regular	200 PR/BX	\$60.47
311-1257	3M311-1257	Yellow Neon Blasts, corded, poly bag	33	Regular	200 PR/BX	\$30.84



**3M™ E-A-RSOFT™ SUPERFIT™ METAL DETECTABLE EARPLUGS**

Made of polyurethane with tapered design. Features SuperFit fitting ring, stainless steel ball bearing implanted into plug and metal detectable cord.



ITEM #	MARTIN #	DESCRIPTION	NRR*	UOM	PRICE
311-4109	3M311-4109	E-A-R Soft SuperFit metal detectable earplugs	32	200 PR/BX	\$104.31

**WARNING**

These hearing protectors help reduce exposure to hazardous noise and other loud sounds. **Misuse or failure to wear hearing protectors at all times that you are exposed to noise may result in hearing loss or injury.** For proper use, see supervisor, *User Instructions*, or call 3M in U.S.A. at 1-800-243-4630. In Canada, call Technical Service at 1-800-267-4414. If there is any drainage from your ear or you have an ear infection, consult with your physician before wearing ear plugs. Failure to do so may result in hearing loss or injury.

\* NRR is the Noise Reduction Rating in decibels (dB). It is the average noise reduction obtained by a group of people wearing a specific hearing protector in a laboratory test. Research suggests that many users will receive less noise reduction than indicated by the NRR due to variation in earplug fit and wearing time. It is recommended that the NRR be reduced by 50% for estimating the average amount of noise reduction provided.





**3M™ E-A-R™ EXPRESS™ POD PLUGS™**

Features reusable design with pod shape and flexible grip. No touching or roll-down needed for insertion. Test compatible with 3M™ E-A-Rfit™ Validation System.

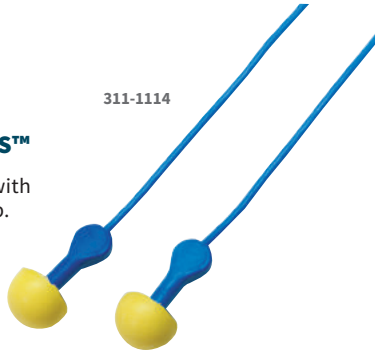

ITEM #	MARTIN #	DESCRIPTION	NRR*	UOM	PRICE
321-2100	3M321-2100	Express Pod Plugs, uncorded w/ blue color grips	25	100 PR/BX	\$60.61
321-2200	3M321-2200	Express Pod Plugs, uncorded w/ assorted color grips	25	100 PR/BX	\$60.31
311-1114	3M311-1114	Express Pod Plugs, corded w/ blue grips	25	100 PR/BX	\$96.76
311-1115	3M311-1115	Express Pod Plugs, corded w/ assorted color grips	25	100 PR/BX	\$96.75
311-1127	3M311-1127	Express Pod Plugs, corded, metal detectable	25	100 PR/BX	\$134.34



**3M™ E-A-R™ CAPS™ HEARING PROTECTOR**

Comfortable foam caps on a flexible band that holds caps in place to block ear canal opening. Easy to use. Designed to be worn under-the-chin only.

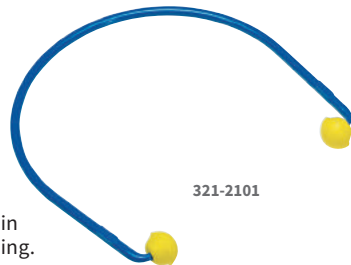

ITEM #	MARTIN #	DESCRIPTION	NRR*	UOM	PRICE
321-2101	3M321-2101	E-A-R Caps	17	10 PR/BX	\$53.75
321-2103	3M321-2103	Replacement caps	17	5 PR/PK	\$13.19



**3M™ ULTRAFIT™ SILICONE CORDED EARPLUGS**

Made from durable, medical-grade silicone. Features cloth cord, triple-flange design and individual plastic carrying case. Recommended applications include assembly, mechanical and welding.

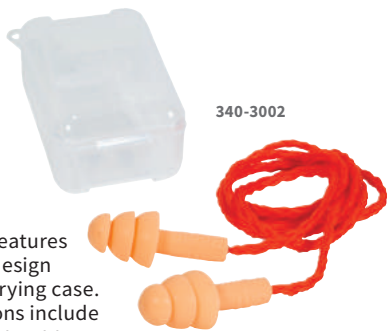

ITEM #	MARTIN #	DESCRIPTION	NRR*	UOM	PRICE
340-3002	3M340-3002	UltraFit silicone corded earplugs	24	80 PR/BX	\$126.47



**3M™ E-A-R™ TAPERFIT™ 2 EARPLUGS**

Soft, roll-down foam expands to fit ear canal and provides low-pressure seal. Test compatible with 3M™ E-A-Rfit™ Validation System.



ITEM #	MARTIN #	DESCRIPTION	NRR*	SIZES	UOM	PRICE
312-1219	3M312-1219	TaperFit 2, uncorded	32	Regular	200 PR/BX	\$33.75
312-1223	3M312-1223	TaperFit 2, corded	32	Regular	200 PR/BX	\$63.81
312-1221	3M312-1221	TaperFit 2, uncorded	32	Plus	200 PR/BX	\$35.80
312-1224	3M312-1224	TaperFit 2, corded	32	Plus	200 PR/BX	\$68.71



**3M™ FOAM EARPLUGS 1100 AND 1110**

Made with tapered foam. Can be combined with earmuffs. Test compatible with 3M™ E-A-Rfit™ Validation System. Corded plugs are not for use in the 3M™ Foam Earplug Dispenser.



ITEM #	MARTIN #	DESCRIPTION	NRR*	UOM	PRICE
1100	3M1100	Foam Earplugs 1100, uncorded	29	200 PR/BX	\$28.22
1110	3M1110	Foam Earplugs 1110, corded	29	100 PR/BX	\$66.90



**3M™ E-A-R™ CLASSIC™ SUPERFIT™ 30 AND SUPERFIT™ 33 EARPLUGS**

Features cylindrical shape that fits wide range of ear canals. Best fit achieved when plug is fully inserted so no ring is visible. Test compatible with 3M™ E-A-Rfit™ Validation System.

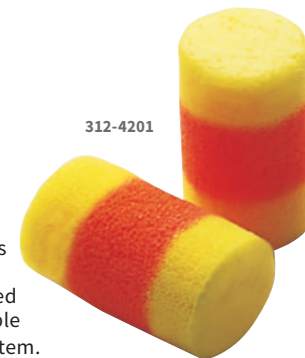

ITEM #	MARTIN #	DESCRIPTION	NRR*	UOM	PRICE
312-4201	3M312-4201	SuperFit 30, uncorded, poly bag	30	200 PR/BX	\$37.01
310-1009	3M310-1009	SuperFit 30, uncorded, pillow pack	30	200 PR/BX	\$36.65
311-1126	3M311-1126	SuperFit 30, corded, poly bag	30	200 PR/BX	\$71.74
310-1008	3M310-1008	SuperFit 33, uncorded, pillow pack	33	200 PR/BX	\$41.01
311-1125	3M311-1125	SuperFit 33, corded, poly bag	33	200 PR/BX	\$73.85



### 3M™ E-A-RSOFT™ SUPERFIT™ EARPLUGS

Provides all-day comfort and secure fit for wide range of ear canals. For best fit, insert plug into ear canal so that no ring is visible. Packaged in poly bags. Test compatible with 3M™ E-A-Rfit™ Validation System.

ITEM #	MARTIN #	DESCRIPTION	NRR*	UOM	PRICE
312-1256	3M312-1256	E-A-Rsoft SuperFit, uncorded	33	200 PR/BX	\$31.35
311-1254	3M311-1254	E-A-Rsoft SuperFit, corded	33	200 PR/BX	\$60.77



312-1256



### 3M™ E-A-R™ PUSH-INS™ EARPLUGS

Features E-A-Rform™ tip and blue stem. Metal detectable model features no roll-down design and a flexible stem. Grip ring models feature cone shape and built-in grip rings. SofTouch™ model features ergonomic insertion “pistol-grip” stem and soft tip. Test compatible with 3M™ E-A-Rfit™ Validation System.



318-1000

ITEM #	MARTIN #	DESCRIPTION	NRR*	UOM	PRICE
318-1000	3M318-1000	Push-Ins, uncorded	28	100 PR/BX	\$37.54
318-1001	3M318-1001	Push-Ins, corded	28	100 PR/BX	\$59.96
318-1002	3M318-1002	Push-Ins, uncorded	28	200 PR/BX	\$64.34
318-1003	3M318-1003	Push-Ins, corded	28	200 PR/BX	\$108.92
318-1008	3M318-1008	Push-Ins w/ grip rings, uncorded	30	200 PR/BX	\$83.83
318-1009	3M318-1009	Push-Ins w/ grip rings, corded	30	200 PR/BX	\$130.63
318-3000	3M318-3000	Push-Ins metal detectable, corded	28	200 PR/BX	\$201.18
318-4000	3M318-4000	Push-Ins SofTouch, uncorded	31	200 PR/BX	\$80.88
318-4001	3M318-4001	Push-Ins SofTouch, corded	31	200 PR/BX	\$133.28



### 3M™ E-A-R™ ULTRAFIT™ EARPLUGS

Features triple-flange design that fits a wide range of ear canals. Washable and reusable. Metal detectable version features stainless steel ball in stem and metal detectable cord. Test compatible with 3M™ E-A-Rfit™ Validation System.



340-4003

ITEM #	MARTIN #	DESCRIPTION	NRR*	UOM	PRICE
340-4003	3M340-4003	UltraFit, uncorded	25	100 PR/BX	\$101.36
340-4004	3M340-4004	UltraFit, corded	25	100 PR/BX	\$137.35
340-4007	3M340-4007	UltraFit metal detectable, corded	25	100 PR/BX	\$162.70
340-4017	3M340-4017	UltraFit metal detectable, corded, Econopack	25	200 PR/BX	\$235.03
340-4014	3M340-4014	UltraFit, corded, Econopack	25	200 PR/BX	\$215.49
340-6004	3M340-6004	UltraFit Plus, corded, poly bag	26	100 PR/BX	\$178.14
340-8001	3M340-8001	UltraFit 27, uncorded	27	100 PR/BX	\$117.33
340-8002	3M340-8002	UltraFit 27, corded	27	100 PR/BX	\$160.89
340-4036	3M340-4036	UltraFit w/ cloth cord in poly bag	25	100 PR/BX	\$180.66
340-4044	3M340-4044	UltraFit w/ cloth cord in paper bag	25	100 PR/BX	\$180.66



### 3M™ PISTONZ™ EARPLUGS

Features race-inspired design and bi-axially-stiff stem. No roll-down design is ready for instant use. Cylindrical shape is designed to fit most ear canals. Officially Licensed Hearing Protection of NASCAR®.

ITEM #	MARTIN #	DESCRIPTION	NRR*	UOM	PRICE
P1400	3MP1400	PISTONZ, uncorded	29	100 PR/BX	\$74.75
P1401	3MP1401	PISTONZ, corded	29	100 PR/BX	\$91.88



P1400

#### WARNING

These hearing protectors help reduce exposure to hazardous noise and other loud sounds. **Misuse or failure to wear hearing protectors at all times that you are exposed to noise may result in hearing loss or injury.** For proper use, see supervisor, *User Instructions*, or call 3M in U.S.A. at 1-800-243-4630. In Canada, call Technical Service at 1-800-267-4414. If there is any drainage from your ear or you have an ear infection, consult with your physician before wearing ear plugs. Failure to do so may result in hearing loss or injury.

\* NRR is the Noise Reduction Rating in decibels (dB). It is the average noise reduction obtained by a group of people wearing a specific hearing protector in a laboratory test. Research suggests that many users will receive less noise reduction than indicated by the NRR due to variation in earplug fit and wearing time. It is recommended that the NRR be reduced by 50% for estimating the average amount of noise reduction provided.



391-1004

### 3M™ E-A-R™ ONE TOUCH™ EARPLUG DISPENSER

One Touch dispenser allows users to reuse base and dispenser. The base is designed for use as a table top unit or can be wall mounted. Refills available. Features flame- and moisture-resistant design.



ITEM #	MARTIN #	DESCRIPTION	NRR*	SIZES	UOM	PRICE
391-1002	3M391-1002	E-A-R Classic SuperFit 30 refill	30	Regular	500 PR/BX	\$86.08
391-1004	3M391-1004	E-A-Rsoft Yellow Neons refill	33	Regular	500 PR/BX	\$62.86
391-1005	3M391-1005	E-A-Rsoft Yellow Neons refill	33	L	400 PR/BX	\$59.37
391-1010	3M391-1010	E-A-Rsoft Yellow Blasts refill	33	Regular	500 PR/BX	\$76.09
391-1254	3M391-1254	E-A-Rsoft SuperFit refill	33	Regular	500 PR/BX	\$76.86



391-0000

### 3M™ ONE TOUCH™ PRO EARPLUG DISPENSER

Made from ABS plastic that offers impact resistance, wide temperature tolerance and smooth operation. Features reusable, free-standing or wall hanging dispenser. Built for harsh working environments and repeated use.



ITEM #	MARTIN #	DESCRIPTION	UOM	PRICE
391-0000	3M391-0000	One Touch Pro dispenser	EA	\$82.22



HOWARD LEIGHT

### MAX® DISPOSABLE EARPLUGS

Superior noise-blocking performance in a disposable earplug. The world's most-used polyurethane foam earplug. Contoured bell shape is easy to insert. Polyurethane foam enhances comfort, especially for long-term wear.



MAX-1S

ITEM #	MARTIN #	DESCRIPTION	COLOR	NRR	UOM	PRICE
MAX-1	NTHMAX-1	MAX, uncorded, polybag	Coral	33	200 PR/BX	\$31.67
MAX-1S	NTHMAX-1S	MAX Small, uncorded, polybag	Orange	30	200 PR/BX	\$31.69
MAX-30S	NTHMAX-30S	MAX Small, corded, polybag	Orange	30	100 PR/BX	\$29.94



HOWARD LEIGHT

### MAXLITE® DISPOSABLE EARPLUGS

Made with low-pressure polyurethane foam. Features soil-resistant, closed-cell foam skin and prevents dirt build-up. Ideal size for workers with smaller ear canals. Contoured T-shape for easy handling and wearing.

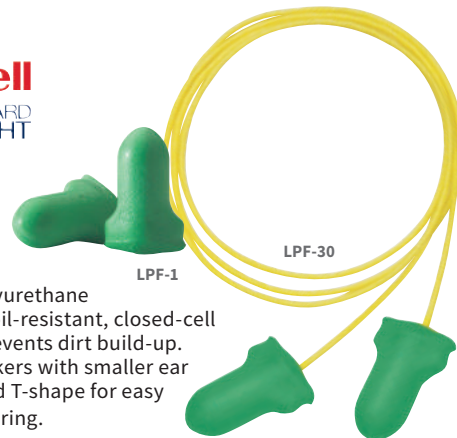

LPF-1

LPF-30

ITEM #	MARTIN #	DESCRIPTION	NRR	UOM	PRICE
LPF-1	NTHLPF-1	MAXLite, uncorded, polybag	30	200 PR/BX	\$25.90
LPF-30	NTHLPF-30	MAXLite, corded, polybag	30	100 PR/BX	\$25.55

TO SEE MORE STYLES, VISIT [WWW.MARTINSUPPLY.COM](http://WWW.MARTINSUPPLY.COM)



HOWARD LEIGHT

### FIRMFIT® DISPOSABLE EARPLUGS

Comfortable, classic style, firm foam earplug provides excellent protection in most medium-to-high noise environments. Easy to insert- requires less pressure to roll down. Slow recovery rate allows plenty of time to correctly insert in ear canal and exerts less expansion pressure on the ear canal. Distinct warning orange color makes compliance checks easy.

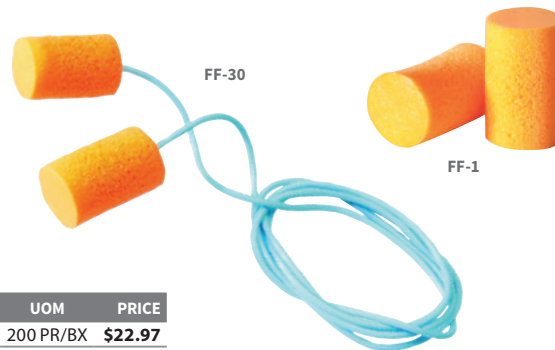

FF-30

FF-1

ITEM #	MARTIN #	DESCRIPTION	NRR	UOM	PRICE
FF-1	NTHFF-1	FirmFit, uncorded in polybag	30	200 PR/BX	\$22.97
FF-30	NTHFF-30	FirmFit, corded in polybag	30	100 PR/BX	\$26.23

**Honeywell**  
HOWARD LEIGHT

**TRUSTFIT® POD PUSH-IN FOAM EARPLUGS**

Push-in foam earplugs designed with an ergonomic stem and dimpled foam tip so they are easy to fully insert and remove, even while wearing work gloves. Comfortable to wear during the work day. No roll-down foam reduces hygiene concerns and makes for easy insertion.

TRUSTFITPOD-1

TRUSTFITPOD-30



ITEM #	MARTIN #	DESCRIPTION	NRR	UOM	PRICE
TRUSTFITPOD-1	NTHTRUSTFITPOD-1	TrustFit Pod, uncorded	28	100 PR/BX	\$26.26
TRUSTFITPOD-30	NTHTRUSTFITPOD-30	TrustFit Pod, corded	28	100 PR/BX	\$47.20

**Honeywell**  
HOWARD LEIGHT

**LASER LITE®  
DISPOSABLE  
EARPLUGS**

Self-adjusting polyurethane foam that expands to fit most wearers. Contoured T-shape for easy insertion and wear. Vibrant magenta/yellow color for visible protection. Smooth, soil-resistant closed-cell foam skin prevents dirt build-up.



LL-1

LL-30

ITEM #	MARTIN #	DESCRIPTION	NRR	UOM	PRICE
LL-1	NTHLL-1	Laser Lite, uncorded, polybag	32	200 PR/BX	\$26.25
LL-30	NTHLL-30	Laser Lite, corded, polybag	32	100 PR/BX	\$25.37

**Honeywell**  
HOWARD LEIGHT

**LASER TRAK®  
DETECTABLE EARPLUGS**

Disposable, detectable earplugs feature self-adjusting, polyurethane foam to fit virtually any wearer and contoured T-shape for easy handling. Non-ferrous metal grommet is detectable by automated processes. Bright orange/blue color for easy compliance checks. Blue polycord attached. Tested to ANSI S3.19-1974. 1,000 Pair/case.

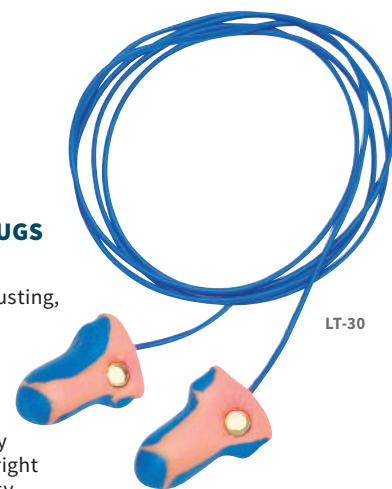

LT-30

ITEM #	MARTIN #	DESCRIPTION	NRR	UOM	PRICE
LT-30	NTHLT-30	Laser Trak detectable, corded, polybag	33	100 PR/BX	\$38.79

**Honeywell**  
HOWARD LEIGHT

**FUSION® REUSABLE EARPLUGS**

Reusable earplugs feature FlexiFirm® stem for easy insertion and SoftFlange™ design for all-day comfort and easy handling. Four-flange design distributes pressure evenly on ear canal for superior attenuation. Includes HearPack® storage case and detachable cord system. 1,000 Pair/case.

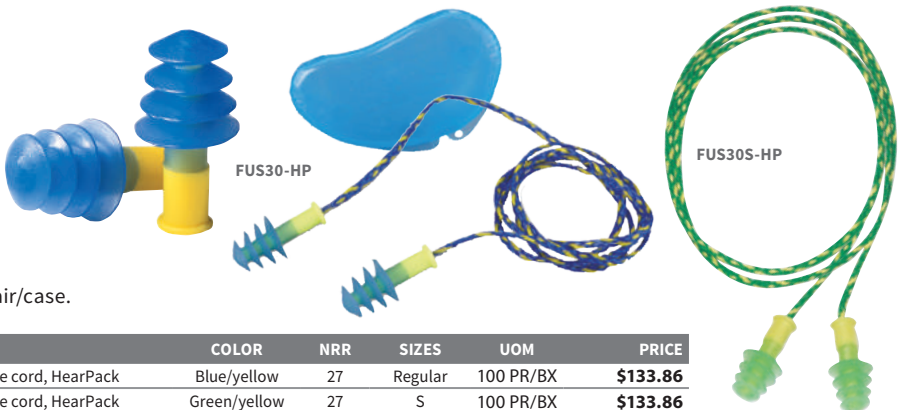

FUS30-HP

FUS30S-HP

ITEM #	MARTIN #	DESCRIPTION	COLOR	NRR	SIZES	UOM	PRICE
FUS30-HP	NTHFUS30-HP	Fusion, detachable cord, HearPack	Blue/yellow	27	Regular	100 PR/BX	\$133.86
FUS30S-HP	NTHFUS30S-HP	Fusion, detachable cord, HearPack	Green/yellow	27	S	100 PR/BX	\$133.86

## Honeywell

HOWARD LEIGHT

### HL400™ EARPLUG DISPENSER

Designed to be durable, lightweight, and compatible with other dispenser mounts. Universal hole positions eliminate the need to drill new holes. Can be used as a table-top or wall-mount dispenser. High-visibility turn knob assembly turns in either direction. Clear canister to easily identify inventory of current earplugs. Catch basin prevents earplugs from falling to the ground. Holds 400 pairs of Howard Leight disposable earplugs: MAX®, Max Small®, MAXLite®, Laser Lite® and FirmFit®.

HL400-MAX-INTRO



ITEM #	MARTIN #	DESCRIPTION	NRR	UOM	PRICE
HL400-MAX-INTRO	NTHHL400-MAX-INTRO	HL400MAXINTRO dispenser w/ MAX earplugs	33	EA	\$76.23
HL400-MAXS-INTRO	NTHHL400-MAXS-INTRO	HL400MAXSINTRO dispenser w/ MAX Small earplugs	30	EA	\$76.23
HL400-LPF-INTRO	NTHHL400-LPF-INTRO	HL400LPFINTRO dispenser w/ MAXLite earplugs	30	EA	\$67.65
HL400-LL-INTRO	NTHHL400-LL-INTRO	HL400LLINTRO dispenser w/ Laser Lite earplugs	32	EA	\$67.65
HL400-FF-INTRO	NTHHL400-FF-INTRO	HL400FFINTRO dispenser w/ FirmFit earplugs	30	EA	\$60.78

## MOLDEX

### GLIDE® FOAM TWIST-IN EARPLUGS

Unique multi-curved stem rotates for a custom fit inside each ear canal. Features large handle on curved stem for easy insertion and removal. Hygienic, no-roll design, perfect for workers wearing gloves or with dirty hands. Cord can be attached at any desired length. 100% PVC-Free®.



ITEM #	MARTIN #	DESCRIPTION	NRR	UOM	PRICE
6940	MOL6940	Glide Foam, uncorded	30	100 PR/BX	\$41.29
6945	MOL6945	Glide Foam, corded	30	100 PR/BX	\$60.05
6883	MOL6883	PlugStation® w/ Glide Foam, corded	30	150 PR/DSP	\$93.06

## MOLDEX

### METEORS® DISPOSABLE EARPLUGS

Foam roll-down earplugs feature a unique undercut shape with a smaller diameter that fits comfortably in narrower part of ear canal. Larger base ensures proper insertion, fit and removal. 100% PVC-free slow-recovery foam molds with individual contours of ear canal, and soft, smooth surface will not irritate skin. Available in a small size for women and other workers with smaller ear canals. Available in PlugStation® dispenser. Independently tested to ANSI S3.19-1974.



ITEM #	MARTIN #	DESCRIPTION	NRR	UOM	PRICE
6870	MOL6870	Meteors, uncorded	33	200 PR/BX	\$33.62
6970	MOL6970	Meteors, corded	33	100 PR/BX	\$33.16
6630	MOL6630	Meteors Small, uncorded	28	200 PR/BX	\$33.94
6632	MOL6632	Meteors Small, corded	28	100 PR/BX	\$33.48
6875	MOL6875	PlugStation w/ Meteors, uncorded	33	500 PR/DSP	\$87.32
6634	MOL6634	PlugStation w/ Meteors Small, uncorded	28	250 PR/DSP	\$45.33

## MOLDEX

### GLIDE® TRIO REUSABLE EARPLUGS

Unique multi-curved stem rotates for a custom fit inside each ear canal. Simply push and twist to find your fit. Large handle on curved stem for easy insertion and removal. Soft triple flange plug is washable and reusable. Cord can be attached at any desired length. Bright green color is a symbol of Moldex® quality. 100% PVC-Free®, like all Moldex products and packaging, for a greener alternative.



ITEM #	MARTIN #	DESCRIPTION	NRR	UOM	PRICE
6445	MOL6445	Glide Trio reusable, corded	27	50 PR/BX	\$57.71

## MOLDEX

### MELLOWS® FOAM EARPLUGS

Made of extra-soft, extra-light foam. Tapered shape fits easily in ear canal and gently and snugly seals without pressure. Smaller design is perfect for extended wear. Provide maximum foam comfort with appropriate protection for mid- to high-level noise areas. Hi-viz bright orange plug. Non-irritating, 100% PVC-free. Independently tested to ANSI S3.19-1974.



ITEM #	MARTIN #	DESCRIPTION	NRR	UOM	PRICE
6820	MOL6820	Mellows, uncorded	30	200 PR/BX	\$25.27
6840	MOL6840	Mellows, corded	30	100 PR/BX	\$26.56
6846	MOL6846	PlugStation w/ Mellows, uncorded	30	250 PR/DSP	\$36.90
6847	MOL6847	PlugStation w/ Mellows, uncorded	30	500 PR/DSP	\$70.97

## MOLDEX

### SPARKPLUGS® FOAM EARPLUGS

Made of extra-soft, extra light PVC-Free® foam. Tapered shape fits easily in ear canal, and seals gently and snugly without pressure. Metal detectable version is a bright blue color that is perfect for food processing applications. Enclosed metal ball bearing eliminates any exposed metal. Ball bearing and cord are in separate holes earplugs remain detectable even if the cord is removed. All Moldex hearing protection is independently tested for protection you can count on. Available in PlugStation dispensers. Tested to ANSI S3.19-1974.



ITEM #	MARTIN #	DESCRIPTION	NRR	UOM	PRICE
6604	MOL6604	SparkPlugs, uncorded	33	200 PR/BX	\$29.03
6654	MOL6654	SparkPlugs, corded	33	100 PR/BX	\$29.56
6615	MOL6615	SparkPlugs, metal detectable, corded	33	100 PR/BX	\$46.95

DISPENSER ALSO AVAILABLE  
WWW.MARTINSUPPLY.COM

## MOLDEX

### PURA-FIT® FOAM EARPLUGS

Features longer design for easy fitting and removal. Soft, PVC-free foam has non-irritating smooth surface. Tapered for easy insertion into any size ear canal. The bright green color is a symbol of Moldex quality. Available with PlugStation® dispenser. Independently tested to ANSI S3.19-1974.

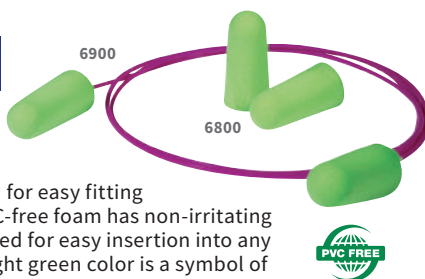

ITEM #	MARTIN #	DESCRIPTION	NRR	UOM	PRICE
6800	MOL6800	Pura-Fit, uncorded	33	200 PR/BX	\$32.97
6900	MOL6900	Pura-Fit, corded	33	100 PR/BX	\$32.03

## MOLDEX

### PLUGSTATION® EARPLUG DISPENSERS

With the PlugStation, you can afford to put earplugs in all the places they're needed. Convenient, quick access and ease of use lead to higher compliance. Hang one near work stations, one outside the restrooms and another in the break room. When the PlugStation is empty simply hang a new one - no messy, hard to use refills. Mounting bracket and necessary hardware included. Tested to ANSI S3. 19-1974.



PLUGSTATIONS



ITEM #	MARTIN #	DESCRIPTION	NRR	UOM	PRICE
6644	MOL6644	PlugStation w/ SparkPlugs, uncorded	33	250 PR/DSP	\$39.20
6645	MOL6645	PlugStation w/ SparkPlugs, uncorded	33	500 PR/DSP	\$75.38
6845	MOL6845	PlugStation w/ Pura-Fit, uncorded	33	500 PR/DSP	\$86.05
6847	MOL6847	PlugStation w/ Mellows, uncorded	30	500 PR/DSP	\$70.97
6881	MOL6881	PlugStation w/ Metal Detectable SparkPlugs, corded	33	150 PR/DSP	\$75.04
6882	MOL6882	PlugStation w/ Pura-Fit, corded	33	150 PR/DSP	\$51.09

## 3M

### 3M™ MODEL 1000 EARMUFFS

Three-position earmuff can be worn over-the-head, behind-the-head or under-the-chin. Includes crown strap required for under-the-chin or behind-the-head wear. Lightweight, durable plastic construction is non-conductive. Features large ear cup openings with foam-filled cushions, replaceable foam cup liners and take-apart assembly. NRR 20 (over-the-head), NRR 22 (under-the-chin) and (behind-the-head).



330-3001

ITEM #	MARTIN #	DESCRIPTION	NRR*	UOM	PRICE
330-3001	3M330-3001	Model 1000 multi-position earmuffs	20/22	EA	\$16.00

## 3M

### 3M™ MODEL 2000H HELMET-MOUNT EARMUFFS

Mounts to most hard hats without adapter and features lightweight, durable plastic construction that is non-conductive for tough environments. "At-rest" position prevents contact with dirty hard hats.



330-3031

ITEM #	MARTIN #	DESCRIPTION	NRR*	UOM	PRICE
330-3031	3M330-3031	Model 2000H helmet-mount earmuffs	21	EA	\$29.96



### 3M™ MODEL 3000 EARMUFFS

Three-position earmuff can be worn over-the-head, behind-the-head or under-the-chin. Includes crown strap required for under-the-chin or behind-the-head wear.

Features large ear cup openings with foam-filled cushions, replaceable foam cup liners and take-apart assembly. NRR 25 (over-the-head), NRR 26 (behind-the-head) and (under-the-chin).



330-3002

ITEM #	MARTIN #	DESCRIPTION	NRR*	UOM	PRICE
330-3002	3M330-3002	Model 3000 earmuffs	25/26	EA	\$26.20
331-3010	3M331-3010	Replaceable ear cushions		EA	\$40.40



### 3M™ PELTOR™ OPTIME™ 105 SERIES EARMUFFS

Recommended for noise levels up to 105 dBA. Features double-shell ear cup design, wide padded headband and stainless steel headband wires. Offers liquid foam-filled cushions.



H10A

ITEM #	MARTIN #	DESCRIPTION	NRR*	UOM	PRICE
H10A	3MH10A	Peltor Optime 105 Series, headband	30	EA	\$27.39
H10B	3MH10B	Peltor Optime 105 Series, neckband	29	EA	\$27.39
H10P3E	3MH10P3E	Peltor Optime 105 Series, cap-mount	27	EA	\$27.39
H10P3E-01	3MH10P3E-01	Peltor Optime 105 Series, cap attachable dual cup dielectric protector	27	EA	\$41.33
H10AHV	3MH10AHV	Peltor Optime 105 Series, hi-viz headband	30	EA	\$28.88
HY10	3MHY10	Hygiene kit		KIT	\$11.52

▶ OTHER STYLES AVAILABLE AT [WWW.MARTINSUPPLY.COM](http://WWW.MARTINSUPPLY.COM)



### 3M™ PELTOR™ LITECOM PLUS – TWO-WAY HEADSET RADIO

All-in-one, 2-way radio headset allows 2-way conversation on up to 30 channels and has a range of up to 9,500 feet. Level-dependent listening of ambient sound ensures users are not isolated from surroundings, allowing users to still hear alarm signals, machinery and voices, all at a level below 25 db. Features cable-free design. Headset switches off automatically if it is inactive for more than 2 hours. Automatic connection.

MT7H7A4610-NA



ITEM #	MARTIN #	DESCRIPTION	UOM	PRICE
MT7H7A4610-NA	3MMT7H7A4610-NA	Peltor LiteCom Plus, headband	EA	\$746.75
MT7H7P3E4610-NA	3MMT7H7P3E4610-NA	Peltor LiteCom Plus, hard hat	EA	\$746.75
HY79	3MHY79	Hygiene kit	KIT	\$21.95
HY100A	3MHY100A	Single-use protectors	EA	\$107.13
HYM1000	3MHYM1000	Microphone protector	EA	\$25.46
MT7N-02	3MMT7N-02	Dynamic microphone (standard)	EA	\$82.40
ACK081	3MACK081	Battery	EA	\$87.55
AL2AI	3MAL2AI	Charging cable	EA	\$33.99

ITEM #	MARTIN #	DESCRIPTION	UOM	PRICE
FR08	3MFR08	Power supply	EA	\$33.99
M60/2	3MM60/2	Wind protection for microphones	EA	\$12.88
FL6CS	3MFL6CS	Connecting cable, 2.5 mm stereo connector	EA	\$97.85
FL6CT	3MFL6CT	Connecting cable, 3.5 mm mono connector	EA	\$97.85
FL6BR	3MFL6BR	Connecting cable, Peltor J11 connector	EA	\$136.48
MT90-02	3MMT90-02	Throat microphone	EA	\$432.60

#### WARNING

These hearing protectors help reduce exposure to hazardous noise and other loud sounds. **Misuse or failure to wear hearing protectors at all times that you are exposed to noise may result in hearing loss or injury.** For proper use, see supervisor, *User Instructions*, or call 3M in U.S.A. at 1-800-243-4630. In Canada, call Technical Service at 1-800-267-4414. If there is any drainage from your ear or you have an ear infection, consult with your physician before wearing ear plugs. Failure to do so may result in hearing loss or injury.

\* NRR is the Noise Reduction Rating in decibels (dB). It is the average noise reduction obtained by a group of people wearing a specific hearing protector in a laboratory test. Research suggests that many users will receive less noise reduction than indicated by the NRR due to variation in earplug fit and wearing time. It is recommended that the NRR be reduced by 50% for estimating the average amount of noise reduction provided.



**3M™ PELTOR™ X SERIES EARMUFFS**

Features dielectric wire headband on over-the-head models. Offers ear cushion foam technology for protection. Spacer design on X3, X4 and X5 models.

X3A



ITEM #	MARTIN #	DESCRIPTION	NRR*	UOM	PRICE
X1A	3MX1A	Peltor X1, over-the-head	22	EA	\$15.84
X1P3E	3MX1P3E	Peltor X1, cap-mount	21	EA	\$18.03
X2A	3MX2A	Peltor X2, over-the-head	24	EA	\$17.87
X2P3E	3MX2P3E	Peltor X2, cap-mount	24	EA	\$20.13
X3A	3MX3A	Peltor X3, over-the-head	28	EA	\$24.30
X3P3E	3MX3P3E	Peltor X3, cap-mount	25	EA	\$27.38
X4A	3MX4A	Peltor X4, over-the-head	27	EA	\$32.72
X4P3E	3MX4P3E	Peltor X4, cap-mount	25	EA	\$36.87
X5A	3MX5A	Peltor X5, over-the-head	31	EA	\$35.73
X5P3E	3MX5P3E	Peltor X5, cap-mount	31	EA	\$40.27
HYX1	3MHYX1	Peltor X1 replacement hygiene kit, 1 pr.		EA	\$11.62
HYX2	3MHYX2	Peltor X2 replacement hygiene kit, 1 pr.		EA	\$11.62
HYX3	3MHYX3	Peltor X3 replacement hygiene kit, 1 pr.		EA	\$13.37
HYX4	3MHYX4	Peltor X4 replacement hygiene kit, 1 pr.		EA	\$1.40
HYX5	3MHYX5	Peltor X5 replacement hygiene kit, 1 pr.		EA	\$1.45



**3M™ PELTOR™ MT SERIES H79 HIGH NOISE HEADSETS**

Features stainless steel spring arms, low-pressure, deep ear cup design, and liquid/gel-filled ear cushions. Adaptable to any new or existing radio. Radio specific FL50 push-to-talk (PTT) adapter cable required (sold separately).

MT7H79A



ITEM #	MARTIN #	DESCRIPTION	NRR*	UOM	PRICE
MT7H79A	3MMT7H79A	2-Way headset, headband model w/ noise canceling boom microphone	25	EA	\$283.25
MT7H79A-C0054	3MMT7H79A-C0054	2-Way headband headset, direct lead to Motorola HT750	25	EA	\$458.35
MT7H79B-C0054	3MMT7H79B-C0054	2-Way neckband headset, direct lead to Motorola HT750	24	EA	\$283.25
MT7H79A-C0057	3MMT7H79A-C0057	2-Way headband headset, direct lead to direct lead to Motorola GP300	25	EA	\$458.35
MT7H79A-C0060	3MMT7H79A-C0060	2-Way headband headset, direct lead to Motorola HT1000	25	EA	\$458.35
MT7H79A-C0046	3MMT7H79A-C0046	2-Way headband headset, direct lead to Kenwood headband model TK220/320	25	EA	\$468.65



**IMPACT® PRO INDUSTRIAL EARMUFFS**

Built to protect workers' hearing while allowing them to have environmental awareness. Strategically placed directional stereo microphones to amplify ambient sounds, including alarms/warning, signals, and conversations while suppressing loud, impact noises down to a safe level of 82dB. Features textile headband with extra cushion and offers all day comfort and an audio jack connection capability to pair up with a personal listening device. (2) AAA batteries included. Black/yellow.



1030943

ITEM #	MARTIN #	DESCRIPTION	NRR	UOM	PRICE
1030943	NTH1030943	Impact Pro industrial earmuff	30	EA	\$152.13



**MX-5 AND MX-6 EARMUFFS**

Features soft cushion-ribbed open air headband for cool comfort all day long. Overmolded headband is durable for rugged wear over many shifts. Larger ear cushions allow freedom to fit almost all ears comfortably. Lightweight wire frame allows easy cup adjustment yet holds its position for lasting comfort. Extra soft foam cushions. Glossy surface for easy cleaning and longer wear. Independently tested NRR for protection.



6120



6130

ITEM #	MARTIN #	DESCRIPTION	NRR	UOM	PRICE
6120	MOL6120	MX-5 earmuffs	27	EA	\$20.80
6130	MOL6130	MX-6 earmuffs	30	EA	\$25.79

**WARNING**

These hearing protectors help reduce exposure to hazardous noise and other loud sounds. **Misuse or failure to wear hearing protectors at all times that you are exposed to noise may result in hearing loss or injury.** For proper use, see supervisor, *User Instructions*, or call 3M in U.S.A. at 1-800-243-4630. In Canada, call Technical Service at 1-800-267-4414. If there is any drainage from your ear or you have an ear infection, consult with your physician before wearing ear plugs. Failure to do so may result in hearing loss or injury.

\* NRR is the Noise Reduction Rating in decibels (dB). It is the average noise reduction obtained by a group of people wearing a specific hearing protector in a laboratory test. Research suggests that many users will receive less noise reduction than indicated by the NRR due to variation in earplug fit and wearing time. It is recommended that the NRR be reduced by 50% for estimating the average amount of noise reduction provided.



# ▶ HAND PROTECTION



These fine manufacturers help us bring you custom tailored solutions:



Hand protection must be provided whenever necessary to protect against employees' hands that are exposed to hazards such as those from skin absorption of harmful substances; severe cuts or lacerations; severe abrasions; punctures; chemical burns; thermal burns; and harmful temperature extremes. Ensuring worker safety includes conducting a workplace hazard assessment and providing the adequate training to make sure everyone goes home safely to their families.

Cut-Resistant .....	48-56
Leather .....	56-59
General Purpose .....	59-62
Disposable .....	62-64
Chemical-Resistant .....	65-68
Heat-Resistant .....	68-71
Welding .....	71-74

# Ansell

## HYFLEX® 11-800 LIGHT-DUTY MULTI-PURPOSE GLOVES

Big comfort when handling small parts. Ansell® original foam nitrile coating offers improved grip in dry and slightly oily environments along with extended durability. Featuring ZONZ™ Comfort Fit Technology, this glove molds naturally to the hand, minimizing fatigue and providing exceptional, unmatched comfort for workers. ANSI level A1 cut resistance, ANSI level 3 abrasion resistance.



11-800

ITEM #	MARTIN #	DESCRIPTION	SIZES	UOM	PRICE
11-800-7	ANE11-800-7	HyFlex 11-800 multi-purpose gloves	7	PR	\$3.95
11-800-8	ANE11-800-8	HyFlex 11-800 multi-purpose gloves	8	PR	\$3.95

ITEM #	MARTIN #	DESCRIPTION	SIZES	UOM	PRICE
11-800-9	ANE11-800-9	HyFlex 11-800 multi-purpose gloves	9	PR	\$3.95
11-800-10	ANE11-800-10	HyFlex 11-800 multi-purpose gloves	10	PR	\$3.95

# Ansell

## HYFLEX® 11-518 FIRST-TO-MARKET ULTRALIGHT CUT-RESISTANT GLOVES

First-to-market 18-gauge style glove provides barehand-like dexterity for high tactility. Dyneema® Diamond Technology provides high cut-to-dexterity ratio for safety with comfort. D3 Pinky matches natural contours of hand. Thin polyurethane coating enables high tactility. High abrasion resistance extends glove life. ANSI cut level A2, ANSI level 3 abrasion resistance.

11-518



ITEM #	MARTIN #	DESCRIPTION	SIZES	UOM	PRICE
11-518-7	ANE11-518-7	HyFlex 11-518 cut-resistant gloves	7	PR	\$8.98
11-518-8	ANE11-518-8	HyFlex 11-518 cut-resistant gloves	8	PR	\$8.98
11-518-9	ANE11-518-9	HyFlex 11-518 cut-resistant gloves	9	PR	\$8.98
11-518-10	ANE11-518-10	HyFlex 11-518 cut-resistant gloves	10	PR	\$8.98
11-518-11	ANE11-518-11	HyFlex 11-518 cut-resistant gloves	11	PR	\$8.98

# Ansell

## HYFLEX® 11-537 GLOVES

Features 18G ultralight weight liner with INTERCEPT™ yarns and ZONZ™ Comfort Fit technology for breathability and ergonomic movement. The 3/4-dipped coating and FORTIX™ formulation provide enhanced abrasion resistance and grip. ANSI cut level A2.

11-537



ITEM #	MARTIN #	DESCRIPTION	SIZES	UOM	PRICE
11-537-7	ANE11-537-7	HyFlex 11-537 gloves	7	PR	\$11.03
11-537-8	ANE11-537-8	HyFlex 11-537 gloves	8	PR	\$11.03
11-537-9	ANE11-537-9	HyFlex 11-537 gloves	9	PR	\$11.03
11-537-10	ANE11-537-10	HyFlex 11-537 gloves	10	PR	\$11.03
11-537-11	ANE11-537-11	HyFlex 11-537 gloves	11	PR	\$11.03

HAND PROTECTION | CUT-RESISTANT

# Ansell

## HYFLEX® 11-531 CUT-RESISTANT GLOVES

Made from 18G ultralight weight liner with Ansell Grip Technology™ for breathability and ergonomic movement. Black nitrile palm coating hides soil, extending glove wear life. ANSI cut level A2.

11-531



ITEM #	MARTIN #	DESCRIPTION	SIZES	UOM	PRICE
11-531-7	ANE11-531-7	HyFlex 11-531 gloves	7	PR	\$10.38
11-531-8	ANE11-531-8	HyFlex 11-531 gloves	8	PR	\$10.38
11-531-9	ANE11-531-9	HyFlex 11-531 gloves	9	PR	\$10.38
11-531-10	ANE11-531-10	HyFlex 11-531 gloves	10	PR	\$10.38
11-531-11	ANE11-531-11	HyFlex 11-531 gloves	11	PR	\$10.38

# Ansell

## HYFLEX® 11-550 CUT-RESISTANT GLOVES

Features INTERCEPT™ Technology for excellent cut resistance. Foam nitrile coating channels away oil from surface of glove, providing a secure grip in light oil applications. Ideal for a broad range of assembly applications. ANSI cut level A2.

11-550



ITEM #	MARTIN #	DESCRIPTION	SIZES	UOM	PRICE
11-550-6	ANE11-550-6	HyFlex cut-resistant gloves	6	PR	\$4.31
11-550-7	ANE11-550-7	HyFlex cut-resistant gloves	7	PR	\$4.31
11-550-8	ANE11-550-8	HyFlex cut-resistant gloves	8	PR	\$4.31
11-550-9	ANE11-550-9	HyFlex cut-resistant gloves	9	PR	\$4.31
11-550-10	ANE11-550-10	HyFlex cut-resistant gloves	10	PR	\$4.31
11-550-11	ANE11-550-11	HyFlex cut-resistant gloves	11	PR	\$4.31

## Ansell

### HYFLEX® 11-644 GLOVES WITH ANSELL CUT PROTECTION TECHNOLOGY™

Features INTERCEPT™ Cut Resistance Technology offering protection, durability and comfort. Proprietary polyurethane coating provides grip in light oil and dry applications. Soft and cool to the skin for all-day comfort. Can be washed and re-used without loss of cut protection. Ideal for glass handling, machining, stamping and final assembly. Meets ANSI cut level A2 and ANSI level 5 abrasion resistance for longer life.



11-644

ITEM #	MARTIN #	DESCRIPTION	SIZES	UOM	PRICE
11-644-7	ANE11-644-7	HyFlex 11-644 cut protection gloves	7	PR	\$7.54
11-644-8	ANE11-644-8	HyFlex 11-644 cut protection gloves	8	PR	\$7.54
11-644-9	ANE11-644-9	HyFlex 11-644 cut protection gloves	9	PR	\$7.54
11-644-10	ANE11-644-10	HyFlex 11-644 cut protection gloves	10	PR	\$7.54
11-644-11	ANE11-644-11	HyFlex 11-644 cut protection gloves	11	PR	\$7.54



### PARA-ARAMID CUT-RESISTANT GLOVES

Standard weight, 7-gauge gloves with the strength and durability of 100% para-aramid. Good cut and abrasion resistance. Tough, durable and long lasting. ANSI cut level A2.



MK30

ITEM #	MARTIN #	DESCRIPTION	SIZES	UOM	PRICE
MK30/XS	WWGLMK30/XS	Para-aramid cut-resistant gloves	XS	DZ	\$54.06
MK30/S	WWGLMK30/S	Para-aramid cut-resistant gloves	S	DZ	\$54.06
MK30/M	WWGLMK30/M	Para-aramid cut-resistant gloves	M	DZ	\$54.06
MK30/L	WWGLMK30/L	Para-aramid cut-resistant gloves	L	DZ	\$54.06
MK30/XL	WWGLMK30/XL	Para-aramid cut-resistant gloves	XL	DZ	\$54.06
MK30/XXL	WWGLMK30/XXL	Para-aramid cut-resistant gloves	2XL	DZ	\$54.06



### KEVLAR® GLOVES WITH NITRILE COATING

Lightweight, 13-gauge Kevlar with solid nitrile coating and smooth grip. ANSI cut level A2; EN cut level A2.

Note: DuPont™ and Kevlar® are trademarks or registered trademarks of E.I. du Pont de Nemours and Company. Products made with Kevlar® Technology are cut-resistant but not cut-proof. Do not use with serrated or moving blades.

ITEM #	MARTIN #	DESCRIPTION	SIZES	UOM	PRICE
09-K1450/L	PIP09-K1450/L	Kevlar gloves	L	DZ	\$64.20



09-K1450



### MAXICUT3 BY ATG® PREMIUM MICRO-FOAM NITRILE-COATED GLOVES

Made from a combination of engineered yarns for moderate cut resistance. Breathable, gray nitrile coating keeps hands cool and dry. Features thin, gray, 15-gauge stretch liner. Excellent wet or dry grip. Ideal for protection against glass, sharp parts, components, sheet metal, ceramics, plastic and paper. Used in glass, bottling, automotive, domestic appliances, plastics, paper, metal and engineering industries. ANSI cut level A2.

18-570



ITEM #	MARTIN #	DESCRIPTION	SIZES	UOM	PRICE
18-570/L	PIP18-570/L	MaxiCut3 premium micro-foam nitrile-coated gloves	L	DZ	\$105.73



### G-TEK® POLYKOR™ POLYURETHANE-COATED GLOVES

Made with PolyKor fiber. Features polyurethane-coated palm and knit wrist. Abrasion- and puncture-resistant. Ideal for electronics, glass cutting and sheet metal handling. ANSI cut level A2.

**⚠️ WARNING:** This product can expose you to chemicals including N,N-Dimethylformamide, which is known to the State of California to cause cancer. For more information go to [www.P65Warnings.ca.gov](http://www.P65Warnings.ca.gov).



16-150

ITEM #	MARTIN #	DESCRIPTION	SIZES	UOM	PRICE
16-150/L	PIP16-150/L	G-Tek PolyKor polyurethane-coated gloves	L	DZ	\$41.38



**MAXICUT3® BY ATG® KNIT ENGINEERED YARN GLOVES**

Made with MicroFoam nitrile coating. Features knit wrist, green engineered yarn shell with reinforcement between thumb and forefinger. Micro-foam nitrile coating offers 360° breathability. ANSI cut level A2.



18-575

ITEM #	MARTIN #	DESCRIPTION	SIZES	UOM	PRICE
18-575/L	PIP18-575/L	MaxiCut3 by ATG knit engineered yarn gloves	L	DZ	\$106.50



**MAXIFLEX® CUT™ BY ATG® GLOVES**

Seamless knit engineered yarn with premium nitrile-coated micro-foam grip. Available with coating on palm and fingertips or palm and full finger. Reinforcement between thumb and forefinger improves cut resistance. Silicone-free. Ideal for finishing, inspection, assembly, maintenance and handling of small oily parts and components. ANSI cut level A2.



34-8743



ITEM #	MARTIN #	DESCRIPTION	SIZES	UOM	PRICE
34-8743/L	PIP34-8743/L	MaxiFlex Cut by ATG gloves w/ palm & fingertip coating	L	DZ	\$97.73
34-8753/L	PIP34-8753/L	MaxiFlex Cut by ATG gloves w/ palm & full finger coating	L	DZ	\$101.12



**ATA® PALM-COATED CUT-RESISTANT GLOVES**

Lightweight, ergonomic design for outstanding fit and dexterity. Featuring ATA Advanced Technology Armor performance-engineered yarns. Water-based polyurethane coated palms provide great wet/dry grip. Silicone free. ANSI cut level A3.

500



ITEM #	MARTIN #	DESCRIPTION	SIZES	UOM	PRICE
500/XS	WWGL500/XS	ATA palm-coated cut-resistant gloves	XS	PR	\$7.18
500/S	WWGL500/S	ATA palm-coated cut-resistant gloves	S	PR	\$7.18
500/M	WWGL500/M	ATA palm-coated cut-resistant gloves	M	PR	\$7.18
500/L	WWGL500/L	ATA palm-coated cut-resistant gloves	L	PR	\$7.18
500/XL	WWGL500/XL	ATA palm-coated cut-resistant gloves	XL	PR	\$7.18
500/XXL	WWGL500/XXL	ATA palm-coated cut-resistant gloves	2XL	PR	\$7.18

HAND PROTECTION | CUT-RESISTANT



**TASSET® PALM-COATED CUT-RESISTANT GLOVES**

Lightweight 13-gauge HPPE gloves provide excellent cut protection, dexterity and tactile sensitivity. Gray polyurethane palm coating for a sure grip plus abrasion resistance. Washable. ANSI cut level A3.



960



ITEM #	MARTIN #	DESCRIPTION	SIZES	UOM	PRICE
960/S	WWGL960/S	Tasset palm-coated cut-resistant gloves	S	PR	\$5.38
960/M	WWGL960/M	Tasset palm-coated cut-resistant gloves	M	PR	\$5.38
960/L	WWGL960/L	Tasset palm-coated cut-resistant gloves	L	PR	\$5.38
960/XL	WWGL960/XL	Tasset palm-coated cut-resistant gloves	XL	PR	\$5.38
960/XXL	WWGL960/XXL	Tasset palm-coated cut-resistant gloves	2XL	PR	\$5.38



**G-TEK® 3GX GREAT WHITE® GLOVES WITH DYNEEMA® DIAMOND**

Features seamless, Dyneema Diamond blend construction. Polyurethane-coated grip for superior puncture and abrasion resistance. Washable. Resistant to chemicals, water and ultraviolet light. Used for electronics, glass cutting, sheet metal handling, general-duty, parts assembly and construction. ANSI cut level A3.



19-D322



**⚠️ WARNING:** This product can expose you to chemicals including N,N-Dimethylformamide, which is known to the State of California to cause cancer. For more information go to [www.P65Warnings.ca.gov](http://www.P65Warnings.ca.gov).

ITEM #	MARTIN #	DESCRIPTION	SIZES	UOM	PRICE
19-D322/M	PIP19-D322/M	G-Tek 3GX GREAT WHITE gloves	M	DZ	\$115.62



### G-TEK® POLYKOR™ POLYURETHANE GRIP GLOVES

Polykor protects against mechanical hazards in the toughest environments. Seamless construction offers increased comfort and breathability. Features polyurethane-coated palm and fingertips, knit wrist and cotton color binding to denote size. Ideal for electronics, glass cutting, sheet metal handling, parts assembly and other general-duty applications. ANSI cut level A3.



**WARNING:** This product can expose you to chemicals including N,N-Dimethylformamide, which is known to the State of California to cause cancer. For more information go to [www.P65Warnings.ca.gov](http://www.P65Warnings.ca.gov).

ITEM #	MARTIN #	DESCRIPTION	SIZES	UOM	PRICE
16-530/L	PIP16-530/L	G-Tek PolyKor polyurethane grip gloves	L	DZ	\$60.22

▶ TO SEE MORE STYLES, VISIT [WWW.MARTINSUPPLY.COM](http://WWW.MARTINSUPPLY.COM)



### G-TEK® 3GX™ WITH DYNEEMA® DIAMOND GLOVES

Features polyurethane-coated palm and fingertips, knit wrist and seamless construction. Dyneema® Diamond and nylon shell provides dexterity and cut resistance. Abrasion and puncture resistant. ANSI cut level A3.



**WARNING:** This product can expose you to chemicals including N,N-Dimethylformamide, which is known to the State of California to cause cancer. For more information go to [www.P65Warnings.ca.gov](http://www.P65Warnings.ca.gov).

ITEM #	MARTIN #	DESCRIPTION	SIZES	UOM	PRICE
19-D360/XL	PIP19-D360/XL	G-Tek 3GX w/ Dyneema Diamond gloves	XL	DZ	\$121.08



### MAXIMUM SAFETY® TUFFMAX5™ GLOVES

Features engineered yarn shell, "Micro-Surface" nitrile-coated padded palm and thermoplastic rubber molded fingers. Reinforced leather between thumb and index finger with Velcro® closure. ANSI cut level A3.

ITEM #	MARTIN #	DESCRIPTION	SIZES	UOM	PRICE
120-5150/L	PIP120-5150/L	Maximum Safety TuffMax5 gloves	L	PR	\$22.38



## Ansell

### HYFLEX® 11-928 CUT-RESISTANT GLOVES

Double layer of RIPEL™ coating keeps hands dry and comfortable when handling oily parts and tools. INTERCEPT™ Technology offers ultimate cut protection. Intermittent contact heat protection when handling hot parts up to 212° F. Ideal for automotive, glass, metal fabrication, machinery and equipment and transport. ANSI cut level A4.



ITEM #	MARTIN #	DESCRIPTION	SIZES	UOM	PRICE
11-928-6	ANE11-928-6	HyFlex cut-resistant gloves	6	PR	\$4.31
11-928-7	ANE11-928-7	HyFlex cut-resistant gloves	7	PR	\$4.31
11-928-8	ANE11-928-8	HyFlex cut-resistant gloves	8	PR	\$4.31
11-928-9	ANE11-928-9	HyFlex cut-resistant gloves	9	PR	\$4.31
11-928-10	ANE11-928-10	HyFlex cut-resistant gloves	10	PR	\$4.31
11-928-11	ANE11-928-11	HyFlex cut-resistant gloves	11	PR	\$4.31

## Ansell

### HYFLEX® 11-515 MEDIUM-DUTY HI-VIZ™ CUT PROTECTION GLOVES

Features orange foam nitrile-coated palm for superior grip, tactility and assurance with high-visibility in low-light situations. Exclusive Hi-Viz™ DuPont™ Kevlar® stretch armor liner. INTERCEPT™ Technology yarn creates improved fit and greater comfort. Extended cuff provides additional cut protection in wrist area. Silicone-free and not made with latex to ensure worker and product protection. ANSI cut level A4, ANSI level 4 abrasion resistance.



ITEM #	MARTIN #	DESCRIPTION	SIZES	UOM	PRICE
11-515-7	ANE11-515-7	HyFlex 11-515 medium-duty gloves	7	PR	\$15.26
11-515-8	ANE11-515-8	HyFlex 11-515 medium-duty gloves	8	PR	\$15.26
11-515-9	ANE11-515-9	HyFlex 11-515 medium-duty gloves	9	PR	\$15.26
11-515-10	ANE11-515-10	HyFlex 11-515 medium-duty gloves	10	PR	\$15.26
11-515-11	ANE11-515-11	HyFlex 11-515 medium-duty gloves	11	PR	\$15.26

# Ansell

## HYFLEX® 11-511 CUT-RESISTANT GLOVES

Green foam nitrile coating on exclusive INTERCEPT Technology cut-resistant liner provides increased wear in thumb crotch and palm area. Silicone and latex-free construction with redesigned finger length for comfort, dexterity, wear and flexibility. Enhanced Cuff Overedging (ECO) provides elasticity for donning and doffing. Patented knitted variable stitch design (KVSD) provides improved fit. Ideal for door/wood framing, glass installation, knife handling and maintenance operations. ANSI level A4, EN Level 4 cut protection.



ITEM #	MARTIN #	DESCRIPTION	SIZES	UOM	PRICE
11-511-7	ANE11-511-7	HyFlex 11-511 cut-resistant gloves	7	PR	\$14.54
11-511-8	ANE11-511-8	HyFlex 11-511 cut-resistant gloves	8	PR	\$14.54
11-511-9	ANE11-511-9	HyFlex 11-511 cut-resistant gloves	9	PR	\$14.54
11-511-10	ANE11-511-10	HyFlex 11-511 cut-resistant gloves	10	PR	\$14.54
11-511-11	ANE11-511-11	HyFlex 11-511 cut-resistant gloves	11	PR	\$14.54



## ATA® ACTIVGRIP™ 534 NITRILE MICROFINISH™-COATED GLOVES

Combining ATA® and ActivGrip™ technologies deliver remarkable cut resistance plus reliable grip. Nitrile MicroFinish palm coat for a secure grasp, even on slick, wet and oily surfaces. ANSI cut level A4.



ITEM #	MARTIN #	DESCRIPTION	SIZES	UOM	PRICE
534-S	WWGL534-S	ATA ActivGrip nitrile MicroFinish-coated gloves	S	PR	\$7.92
534-M	WWGL534-M	ATA ActivGrip nitrile MicroFinish-coated gloves	M	PR	\$7.92
534-L	WWGL534-L	ATA ActivGrip nitrile MicroFinish-coated gloves	L	PR	\$7.92
534-XL	WWGL534*XL	ATA ActivGrip nitrile MicroFinish-coated gloves	XL	PR	\$7.92
534-2XL	WWGL534-2XL	ATA ActivGrip nitrile MicroFinish-coated gloves	2XL	PR	\$7.92



## ATA® PALM-COATED CUT-RESISTANT GLOVES

Lightweight, 13-gauge gloves featuring ATA Advanced Technology Armor engineered yarns. Thin, hybrid palm coating for flexibility and dexterity. Improves grip and abrasion resistance. ANSI cut level A4.

ITEM #	MARTIN #	DESCRIPTION	SIZES	UOM	PRICE
505/XS	WWGL505/XS	ATA palm-coated cut-resistant gloves	XS	PR	\$7.11
505/S	WWGL505/S	ATA palm-coated cut-resistant gloves	S	PR	\$7.11
505/M	WWGL505/M	ATA palm-coated cut-resistant gloves	M	PR	\$7.11



## ATA® CUT-RESISTANT GLOVES

7-Gauge gloves featuring ATA Advanced Technology Armor engineered yarns. Cotton-plated for comfort. Provides cut and abrasion resistance. ANSI cut level A4.



MATA30PL

ITEM #	MARTIN #	DESCRIPTION	SIZES	UOM	PRICE
MATA30PL/XS	WWGLMATA30PL/XS	ATA cut-resistant gloves	XS	DZ	\$48.91
MATA30PL/S	WWGLMATA30PL/S	ATA cut-resistant gloves	S	DZ	\$48.91
MATA30PL/M	WWGLMATA30PL/M	ATA cut-resistant gloves	M	DZ	\$48.91
MATA30PL/L	WWGLMATA30PL/L	ATA cut-resistant gloves	L	DZ	\$48.91
MATA30PL/XL	WWGLMATA30PL/XL	ATA cut-resistant gloves	XL	DZ	\$48.91
MATA30PL/XXL	WWGLMATA30PL/XXL	ATA cut-resistant gloves	2XL	DZ	\$48.91



## ATA® CUT-RESISTANT GLOVES WITH PVC GRIP DOTS

7-Gauge cut-resistant gloves featuring ATA Advanced Technology Armor engineered yarns, cotton plated for comfort. PVC dots on the palms improve grip and extend wear life. ANSI cut level A4.



MATA30PL-PD1

ITEM #	MARTIN #	DESCRIPTION	SIZES	UOM	PRICE
MATA30PL-PD1/XS	WWGLMATA30PL-PD1/XS	ATA cut-resistant gloves w/ grip dots	XS	DZ	\$51.22
MATA30PL-PD1/S	WWGLMATA30PL-PD1/S	ATA cut-resistant gloves w/ grip dots	S	DZ	\$51.22
MATA30PL-PD1/M	WWGLMATA30PL-PD1/M	ATA cut-resistant gloves w/ grip dots	M	DZ	\$51.22
MATA30PL-PD1/L	WWGLMATA30PL-PD1/L	ATA cut-resistant gloves w/ grip dots	L	DZ	\$51.22
MATA30PL-PD1/XL	WWGLMATA30PL-PD1/XL	ATA cut-resistant gloves w/ grip dots	XL	DZ	\$51.22
MATA30PL-PD1/XXL	WWGLMATA30PL-PD1/XXL	ATA cut-resistant gloves w/ grip dots	2XL	DZ	\$51.22



505

ITEM #	MARTIN #	DESCRIPTION	SIZES	UOM	PRICE
505/L	WWGL505/L	ATA palm-coated cut-resistant gloves	L	PR	\$7.11
505/XL	WWGL505/XL	ATA palm-coated cut-resistant gloves	XL	PR	\$7.11
505/XXL	WWGL505/XXL	ATA palm-coated cut-resistant gloves	2XL	PR	\$7.11



## TASSET® CUT-RESISTANT GLOVES WITH SANDED NITRILE PALMS

13-Gauge knit gloves deliver cut and abrasion resistance plus tactile sensitivity and dexterity. Sanded nitrile palm coating provides a better grip, especially on wet or oily surfaces. ANSI cut level A4.

ITEM #	MARTIN #	DESCRIPTION	SIZES	UOM	PRICE
973/XS	WWGL973/XS	Cut-resistant gloves w/ sanded nitrile palms	XS	PR	\$4.77
973/S	WWGL973/S	Cut-resistant gloves w/ sanded nitrile palms	S	PR	\$4.77
973/M	WWGL973/M	Cut-resistant gloves w/ sanded nitrile palms	M	PR	\$4.77



## JAVELINA™ ATA® LEATHER CUT-RESISTANT GLOVES

Powerful protection against cuts, abrasion and conductive heat. Leather and canvas gloves featuring an ATA Advanced Technology Armor cut-resistant liner. Split cowhide leather on the palm, fingers and knuckles. Sewn with Kevlar® thread. ANSI cut level A4.



ITEM #	MARTIN #	DESCRIPTION	SIZES	UOM	PRICE
MJVATA/M	WWGLMJVATA/M	Javelina ATA cut-resistant gloves	M	DZ	\$152.17
MJVATA/L	WWGLMJVATA/L	Javelina ATA cut-resistant gloves	L	DZ	\$152.17
MJVATA/XL	WWGLMJVATA/XL	Javelina ATA cut-resistant gloves	XL	DZ	\$152.17
MJVATA/XXL	WWGLMJVATA/XXL	Javelina ATA cut-resistant gloves	2XL	DZ	\$152.17



## G-TEK® POLYKOR® XRYSTAL® GLOVES

Seamless construction offers increased comfort and breathability. Lightweight shell provides excellent dexterity, tactile sensitivity and cut resistance. NeoFoam® coated palm and fingertips offers great abrasion resistance and outstanding wet/dry grip. Reinforced thumb crotch for extended glove life. Touch screen compatible to allow the user to operate a touch screen phone or device without removing gloves. Knit wrist helps prevent dirt and debris from entering the glove. Complies with FDA food handling requirements 21 CFR 177.2600. ANSI cut level A4.



ITEM #	MARTIN #	DESCRIPTION	SIZES	UOM	PRICE
16-X575/S	PIP16-X575/S	G-Tek PolyKor Xrystal gloves	S	DZ	\$104.12
16-X575/M	PIP16-X575/M	G-Tek PolyKor Xrystal gloves	M	DZ	\$104.12
16-X575/L	PIP16-X575/L	G-Tek PolyKor Xrystal gloves	L	DZ	\$104.12
16-X575/XL	PIP16-X575/XL	G-Tek PolyKor Xrystal gloves	XL	DZ	\$104.12
16-X575/XXL	PIP16-X575/XXL	G-Tek PolyKor Xrystal gloves	2XL	DZ	\$104.12



## G-TEK® SUPRENE™ NEOFOAM™-COATED GLOVES

Suprene fiber shell is 100 times stronger than steel. Seamless knit construction provides comfort without sacrificing dexterity. Neofoam-coated palm and fingertips for abrasion resistance and wet/dry grip. Knit wrist helps prevent dirt and debris from entering the glove. Ideal for electronics, general-duty, parts assembly and construction. ANSI cut level A4.

15-440



ITEM #	MARTIN #	DESCRIPTION	SIZES	UOM	PRICE
15-440/S	PIP15-440/S	G-Tek Suprene Neofoam-coated gloves	S	DZ	\$92.27
15-440/M	PIP15-440/M	G-Tek Suprene Neofoam-coated gloves	M	DZ	\$92.27
15-440/L	PIP15-440/L	G-Tek Suprene Neofoam-coated gloves	L	DZ	\$92.27
15-440/XL	PIP15-440/XL	G-Tek Suprene Neofoam-coated gloves	XL	DZ	\$92.27
15-440/XXL	PIP15-440/XXL	G-Tek Suprene Neofoam-coated gloves	2XL	DZ	\$92.27



## G-TEK® POLYKOR® HI-VIZ GLOVES

PolyKor seamless knit blended gloves with polyurethane-coated smooth grip on palm and fingers. Lightweight for excellent dexterity, tactile sensitivity and cut resistance. Great abrasion resistance, excellent puncture resistance and outstanding wet/dry grip. Knit wrist helps prevent dirt and debris from entering the glove. Hi-viz color for visibility. ANSI cut level A5.

16-645LG



**⚠ WARNING:** This product can expose you to chemicals including N,N-Dimethylformamide, which is known to the State of California to cause cancer. For more information go to [www.P65Warnings.ca.gov](http://www.P65Warnings.ca.gov).

ITEM #	MARTIN #	DESCRIPTION	SIZES	UOM	PRICE
16-645LG/S	PIP16-645LG/S	G-Tek PolyKor hi-viz gloves	S	DZ	\$70.18
16-645LG/M	PIP16-645LG/M	G-Tek PolyKor hi-viz gloves	M	DZ	\$70.18
16-645LG/L	PIP16-645LG/L	G-Tek PolyKor hi-viz gloves	L	DZ	\$70.18
16-645LG/XL	PIP16-645LG/XL	G-Tek PolyKor hi-viz gloves	XL	DZ	\$70.18
16-645LG/XXL	PIP16-645LG/XXL	G-Tek PolyKor hi-viz gloves	2XL	DZ	\$70.18



MATA30-BH



**BOAR HOG™ ATA® LEATHER PALMED CUT-RESISTANT GLOVES**

Heavy-duty protection against cuts and conductive heat. 7-Gauge cut-resistant gloves featuring ATA Advanced Technology Armor engineered yarns with extra reinforcement in the thumb crotch area. Split leather patch sewn onto the palm using high strength Kevlar® thread. Cotton lined for comfort. ANSI cut level A6.



ITEM #	MARTIN #	DESCRIPTION	SIZES	UOM	PRICE
MATA30-BH/S	WWGLMATA30-BH/S	Boar Hog ATA leather palmed gloves	S	DZ	\$113.69
MATA30-BH/M	WWGLMATA30-BH/M	Boar Hog ATA leather palmed gloves	M	DZ	\$113.69
MATA30-BH/L	WWGLMATA30-BH/L	Boar Hog ATA leather palmed gloves	L	DZ	\$113.69
MATA30-BH/XL	WWGLMATA30-BH/XL	Boar Hog ATA leather palmed gloves	XL	DZ	\$113.69
MATA30-BH/XXL	WWGLMATA30-BH/XXL	Boar Hog ATA leather palmed gloves	2XL	DZ	\$113.69



11-542



**HY-FLEX® 11-542 LIGHTWEIGHT CUT-RESISTANT GLOVES**

Features INTERCEPT™ Cut-Resistant Technology offering dexterity and comfort. Protects for intermittent heat contact up to 212° F. Fiberglass-free, NRL-free and silicone-free. Black. ANSI cut level A7.

ITEM #	MARTIN #	DESCRIPTION	SIZES	UOM	PRICE
11-542-6	ANE11-542-6	Hy-Flex lightweight cut-resistant gloves	6	PR	\$13.95
11-542-7	ANE11-542-7	Hy-Flex lightweight cut-resistant gloves	7	PR	\$13.95
11-542-8	ANE11-542-8	Hy-Flex lightweight cut-resistant gloves	8	PR	\$13.95
11-542-9	ANE11-542-9	Hy-Flex lightweight cut-resistant gloves	9	PR	\$13.95
11-542-10	ANE11-542-10	Hy-Flex lightweight cut-resistant gloves	10	PR	\$13.95



**100% PARA-ARAMID CUT-RESISTANT SLEEVES**

100% Para-aramid sleeves protect the wearer from cuts, abrasion and conductive heat. 3" Wide sleeve stretches for a comfortable fit. Multiple lengths available, with and without thumbhole. 2-Ply sleeves are ANSI cut level A3. 1-Ply sleeves are ANSI cut level A2.

ITEM #	MARTIN #	DESCRIPTION	SIZES	UOM	PRICE
MSK-10	WWGLMSK-10	2-Ply sleeve	10"	PR	\$1.74
MSK-12	WWGLMSK-12	2-Ply sleeve	12"	PR	\$2.08
MSK-14	WWGLMSK-14	2-Ply sleeve	14"	PR	\$2.43
MSK-16	WWGLMSK-16	2-Ply sleeve	16"	PR	\$2.78
MSK-18	WWGLMSK-18	2-Ply sleeve	18"	PR	\$3.14
MSK-22	WWGLMSK-22	2-Ply sleeve	22"	PR	\$3.83
MSK-24	WWGLMSK-24	2-Ply sleeve	24"	PR	\$4.18
MSK-10T	WWGLMSK-10T	2-Ply sleeve w/ thumbhole	10"	PR	\$1.89
MSK-12T	WWGLMSK-12T	2-Ply sleeve w/ thumbhole	12"	PR	\$2.23
MSK-14T	WWGLMSK-14T	2-Ply sleeve w/ thumbhole	14"	PR	\$2.58
MSK-16T	WWGLMSK-16T	2-Ply sleeve w/ thumbhole	16"	PR	\$2.94
MSK-18T	WWGLMSK-18T	2-Ply sleeve w/ thumbhole	18"	PR	\$3.29
MSK-22T	WWGLMSK-22T	2-Ply sleeve w/ thumbhole	22"	PR	\$3.98
MSK-24T	WWGLMSK-24T	2-Ply sleeve w/ thumbhole	24"	PR	\$4.34
MSK1-10	WWGLMSK1-10	1-Ply sleeve	10"	PR	\$0.82
MSK1-14	WWGLMSK1-14	1-Ply sleeve	14"	PR	\$1.12



09-K1600



**G-TEK® KEV™ GLOVES WITH ANSI A7 CUT LEVEL**

Seamless knit construction provides comfort and dexterity. Kevlar® fiber shell provides high tensile strength. Features foam nitrile coating on palm and fingers. Compatible with light oils and will provide a good grip and excellent abrasion resistance. Touch screen compatible to allow the user to operate a touch screen phone or device without removing gloves. Knit wrist helps prevent dirt and debris from entering glove. Ideal for automotive, metal stamping, material handling and general maintenance. ANSI cut level A7.

ITEM #	MARTIN #	DESCRIPTION	SIZES	UOM	PRICE
09-K1600/S	PIP09-K1600/S	G-Tek KEV nitrile-coated gloves	S	DZ	\$204.35
09-K1600/M	PIP09-K1600/M	G-Tek KEV nitrile-coated gloves	M	DZ	\$204.35
09-K1600/L	PIP09-K1600/L	G-Tek KEV nitrile-coated gloves	L	DZ	\$204.35
09-K1600/XL	PIP09-K1600/XL	G-Tek KEV nitrile-coated gloves	XL	DZ	\$204.35
09-K1600/XXL	PIP09-K1600/XXL	G-Tek KEV nitrile-coated gloves	2XL	DZ	\$214.05



11-211

**HYFLEX® MEDIUM-DUTY CUT-RESISTANT SLEEVES**

Features cut-resistant INTERCEPT™ Technology that provides optimal cut protection while offering a soft and cool feel on skin. Seamless design and option of wide or narrow sizes ensure an excellent fit and best-in-class comfort. Comes without or with a thumb slot. 18" Length. Light gray. ANSI cut level A2.

ITEM #	MARTIN #	DESCRIPTION	SIZES	UOM	PRICE
11-210-N	ANE11-210-N	Medium-duty sleeves	Narrow	EA	\$5.46
11-210-W	ANE11-210-W	Medium-duty sleeves	Wide	EA	\$5.46
11-211-N	ANE11-211-N	Medium-duty sleeves w/ thumb slot	Narrow	EA	\$5.46
11-211-W	ANE11-211-W	Medium-duty sleeves w/ thumb slot	Wide	EA	\$5.46



MSK-18T

ITEM #	MARTIN #	DESCRIPTION	SIZES	UOM	PRICE
MSK1-18	WWGLMSK1-18	1-Ply sleeve	18"	PR	\$1.45
MSK1-24	WWGLMSK1-24	1-Ply sleeve	24"	PR	\$1.92
MSK1-10T	WWGLMSK1-10T	1-Ply sleeve w/ thumbhole	10"	PR	\$0.97
MSK1-14T	WWGLMSK1-14T	1-Ply sleeve w/ thumbhole	14"	PR	\$1.28
MSK1-18T	WWGLMSK1-18T	1-Ply sleeve w/ thumbhole	18"	PR	\$1.60
MSK1-24T	WWGLMSK1-24T	1-Ply sleeve w/ thumbhole	24"	PR	\$2.06
MSK-14-SU	WWGLMSK-14-SU	2-Ply sleeve w/ elastic top	14"	PR	\$3.20
MSK-16-SU	WWGLMSK-16-SU	2-Ply sleeve w/ elastic top	16"	PR	\$3.55
MSK-18-SU	WWGLMSK-18-SU	2-Ply sleeve w/ elastic top	18"	PR	\$3.91
MSK-20-SU	WWGLMSK-20-SU	2-Ply sleeve w/ elastic top	20"	PR	\$4.25
MSK-14T-SU	WWGLMSK-14T-SU	2-Ply sleeve w/ elastic top & thumbhole	14"	PR	\$3.35
MSK-16T-SU	WWGLMSK-16T-SU	2-Ply sleeve w/ elastic top & thumbhole	16"	PR	\$3.71
MSK-18T-SU	WWGLMSK-18T-SU	2-Ply sleeve w/ elastic top & thumbhole	18"	PR	\$4.06
MSK-20T-SU	WWGLMSK-20T-SU	2-Ply sleeve w/ elastic top & thumbhole	20"	PR	\$4.75

HAND PROTECTION | CUT-RESISTANT







## ATA® GRAY CUT-RESISTANT KNIT SLEEVE

For moderate cut and abrasion hazards. Knit sleeves featuring ATA Advanced Technology Armor engineered fibers. Elastic band at the wrist keeps the sleeve comfortably in place. Dirt-hiding gray color extends wear life. ANSI cut level A2.



MSATP/18T

ITEM #	MARTIN #	DESCRIPTION	SIZES	UOM	PRICE
MSATP-18	WWGLMSATP-18	ATA gray knit sleeve	18"	PR	\$3.00
MSATP/18T	WWGLMSATP/18T	ATA gray knit sleeve w/ thumbhole	18"	PR	\$3.15



## PRITEX® FILAMENT POLYESTER SLEEVE

Made of textured filament polyester and antimicrobial fabric. Resistant to acids, alkali, organic solvents and chlorine bleach. Silicone and latex free. Meets FDA and USDA food handling requirements. 18" Length. ANSI cut level A2.



15-218BK

ITEM #	MARTIN #	DESCRIPTION	SIZES	UOM	PRICE
15-218BK	PIP15-218BK	Pritex filament polyester sleeve	L	PR	\$3.53



## HYFLEX® 11-280 AND 11-281 CUT-RESISTANT SLEEVES

Economical, light-duty sleeve is made of nylon. Double-layered seamless design. INTERCEPT™ Technology offers protection with a cool and soft feel. Available in narrow, wide and extra wide widths, with or without a thumb hole. ANSI cut level A4.

ITEM #	MARTIN #	DESCRIPTION	SIZES	UOM	PRICE
11-280-120-XW	ANE11-280-120-XW	HyFlex sleeve, extra wide w/out thumb hole	12"	EA	\$7.31
11-280-160-XW	ANE11-280-160-XW	HyFlex sleeve, extra wide w/out thumb hole	16"	EA	\$7.31
11-280-180-XW	ANE11-280-180-XW	HyFlex sleeve, extra wide w/out thumb hole	18"	EA	\$7.31
11-280-220-XW	ANE11-280-220-XW	HyFlex sleeve, extra wide w/out thumb hole	22"	EA	\$7.31
11-280-120-W	ANE11-280-120-W	HyFlex sleeve, wide w/out thumb hole	12"	EA	\$7.31
11-280-160-W	ANE11-280-160-W	HyFlex sleeve, wide w/out thumb hole	16"	EA	\$7.31
11-280-180-W	ANE11-280-180-W	HyFlex sleeve, wide w/out thumb hole	18"	EA	\$7.31
11-280-220-W	ANE11-280-220-W	HyFlex sleeve, wide w/out thumb hole	22"	EA	\$7.31
11-280-120-N	ANE11-280-120-N	HyFlex sleeve, narrow w/out thumb hole	12"	EA	\$7.31
11-280-160-N	ANE11-280-160-N	HyFlex sleeve, narrow w/out thumb hole	16"	EA	\$7.31
11-280-180-N	ANE11-280-180-N	HyFlex sleeve, narrow w/out thumb hole	18"	EA	\$7.31
11-280-220-N	ANE11-280-220-N	HyFlex sleeve, narrow w/out thumb hole	22"	EA	\$7.31



## HYFLEX® 11-250 AND 11-251 CUT-RESISTANT SLEEVES

Made of 15-gauge black HPPE yarn. Silicone-free for friendly paint and finish process. Features Intercept™ Technology and knitted bicep cuffs to keep sleeve in place. With or without a thumb slot. Seamless design is available in a variety of lengths and widths for optimal fit and comfort to fit every worker in the best possible way. Color-coding will help for easy sorting. Ideal for automotive, machinery/equipment and metal fabrication. ANSI cut level A3.



11-250

ITEM #	MARTIN #	DESCRIPTION	SIZES	UOM	PRICE
11-250-120-W	ANE11-250-120-W	HyFlex sleeve, wide width, w/out thumb hole	12"	EA	\$5.00
11-250-160-W	ANE11-250-160-W	HyFlex sleeve, wide width, w/out thumb hole	16"	EA	\$5.00
11-250-180-W	ANE11-250-180-W	HyFlex sleeve, wide width, w/out thumb hole	18"	EA	\$5.00
11-250-120-N	ANE11-250-120-N	HyFlex sleeve, narrow width, w/out thumb hole	12"	EA	\$5.00
11-250-160-N	ANE11-250-160-N	HyFlex sleeve, narrow width, w/out thumb hole	16"	EA	\$5.00
11-250-180-N	ANE11-250-180-N	HyFlex sleeve, narrow width, w/out thumb hole	18"	EA	\$5.00
11-251-120-W	ANE11-251-120-W	HyFlex sleeve, wide width, w/ thumb hole	12"	EA	\$5.00
11-251-160-W	ANE11-251-160-W	HyFlex sleeve, wide width, w/ thumb hole	16"	EA	\$5.00
11-251-180-W	ANE11-251-180-W	HyFlex sleeve, wide width, w/ thumb hole	18"	EA	\$5.00
11-251-120-N	ANE11-251-120-N	HyFlex sleeve, narrow width, w/ thumb hole	12"	EA	\$5.00
11-251-160-N	ANE11-251-160-N	HyFlex sleeve, narrow width, w/ thumb hole	12"	EA	\$5.00
11-251-180-N	ANE11-251-180-N	HyFlex sleeve, narrow width, w/ thumb hole	18"	EA	\$5.00



11-281

ITEM #	MARTIN #	DESCRIPTION	SIZES	UOM	PRICE
11-281-120-XW	ANE11-281-120-XW	HyFlex sleeve, extra wide w/ thumb hole	12"	EA	\$7.31
11-281-160-XW	ANE11-281-160-XW	HyFlex sleeve, extra wide w/ thumb hole	16"	EA	\$7.31
11-281-180-XW	ANE11-281-180-XW	HyFlex sleeve, extra wide w/ thumb hole	18"	EA	\$7.31
11-281-220-XW	ANE11-281-220-XW	HyFlex sleeve, extra wide w/ thumb hole	22"	EA	\$7.31
11-281-120-W	ANE11-281-120-W	HyFlex sleeve, wide w/ thumb hole	12"	EA	\$7.31
11-281-160-W	ANE11-281-160-W	HyFlex sleeve, wide w/ thumb hole	16"	EA	\$7.31
11-281-180-W	ANE11-281-180-W	HyFlex sleeve, wide w/ thumb hole	18"	EA	\$7.31
11-281-220-W	ANE11-281-220-W	HyFlex sleeve, wide w/ thumb hole	22"	EA	\$7.31
11-281-120-N	ANE11-281-120-N	HyFlex sleeve, narrow w/ thumb hole	12"	EA	\$7.31
11-281-160-N	ANE11-281-160-N	HyFlex sleeve, narrow w/ thumb hole	16"	EA	\$7.31
11-281-180-N	ANE11-281-180-N	HyFlex sleeve, narrow w/ thumb hole	18"	EA	\$7.31
11-281-220-N	ANE11-281-220-N	HyFlex sleeve, narrow w/ thumb hole	22"	EA	\$7.31



**KUT-GARD® KNITTED SLEEVES WITH KEVLAR®**

Feature seamless rib-knit. DuPont™ Kevlar fiber provides high tensile strength. Designed to be cut-resistant; will not melt, ignite or conduct electricity. Offers arm cut protection for applications that require large object handling. ANSI cut level A3.

*Note: DuPont and Kevlar are trademarks or registered trademarks of E.I. du Pont de Nemours and Company. Products made with Kevlar technology are cut-resistant but not cut-proof. Do not use with serrated or moving blades.*



ITEM #	MARTIN #	DESCRIPTION	UOM	PRICE
10-KS18	PIP10-KS18	2-Ply sleeve, 18" length	EA	\$3.35



**GRAIN COW LEATHER DRIVERS GLOVES**

Constructed from select grade cow leather. Features shirred elastic back, rolled fabric hem and keystone thumb. Unlined. Ideal for general purpose applications requiring dexterity.



**⚠️ WARNING:** Cancer and reproductive harm. For more information go to [www.P65Warnings.ca.gov](http://www.P65Warnings.ca.gov).

ITEM #	MARTIN #	DESCRIPTION	SIZES	UOM	PRICE
3211-S	MCR3211-S	Select grade drivers gloves	S	DZ	\$91.00
3211-M	MCR3211-M	Select grade drivers gloves	M	DZ	\$91.00
3211-L	MCR3211-L	Select grade drivers gloves	L	DZ	\$91.00
3211-XL	MCR3211-XL	Select grade drivers gloves	XL	DZ	\$94.40
3211-2XL	MCR3211-2XL	Select grade drivers gloves	2XL	DZ	\$97.40
3211-3XL	MCR3211-3XL	Select grade drivers gloves	3XL	DZ	\$50.00



71-3601



**ECONOMY TOP-GRAIN GOATSKIN DRIVERS GLOVES**

Goatskin is softer, has greater tactile sensitivity and outwears other leathers of the same weight. Provides excellent abrasion resistance. Features keystone thumb. Ideal for use where all-leather gloves are desired, extended wear is expected and superior worker satisfaction is demanded.

ITEM #	MARTIN #	DESCRIPTION	SIZES	UOM	PRICE
71-3601/L	PIP71-3601/L	Top-grain goatskin drivers gloves	L	DZ	\$92.07



**COWHIDE LEATHER DRIVERS GLOVES, STRAIGHT THUMB**

Features a straight thumb, shirred elastic wrist and color cotton binding. Unlined. Top-grain cowhide construction offers excellent dexterity and abrasion resistance. Used in construction, machine operation, light-duty welding, utility work, farming and general applications.

ITEM #	MARTIN #	DESCRIPTION	SIZES	UOM	PRICE
68-103/L	PIP68-103/L	Top-grain cowhide gloves	L	DZ	\$57.40



68-103



**GOATSKIN DRIVERS GLOVES**

Constructed with premium goatskin leather for greater softness, sense of touch, exceptional durability and tensile strength. Unlined with a cotton hem and keystone thumb. Ideal for construction and farm equipment, forklifts, ranching, auto industry, material handling, repackaging and bundling operations, stamping, plus all general-purpose applications requiring greater dexterity. Durable, launderable by hand, machine washable, or dry clean.

**⚠️ WARNING:** Cancer and reproductive harm. For more information go to [www.P65Warnings.ca.gov](http://www.P65Warnings.ca.gov).

ITEM #	MARTIN #	DESCRIPTION	SIZES	UOM	PRICE
3611-S	MCR3611-S	Goatskin drivers gloves	S	DZ	\$90.80
3611-M	MCR3611-M	Goatskin drivers gloves	M	DZ	\$90.80
3611-L	MCR3611-L	Goatskin drivers gloves	L	DZ	\$90.80
3611-XL	MCR3611-XL	Goatskin drivers gloves	XL	DZ	\$97.20
3611-2XL	MCR3611-2XL	Goatskin drivers gloves	2XL	DZ	\$105.00



3611



**ECONOMY GRADE TOP-GRAIN COWHIDE LEATHER DRIVERS GLOVES WITH HI-VIZ FINGERTIPS**

Top-grain cowhide leather construction provides comfort, durability, excellent abrasion resistance, and breathability. Smooth, provides durability and dexterity. Slip-on cuff for a good fit and comfort. Keystone thumb is ergonomic, reduces hand fatigue, offers superior dexterity and durability. "WATCH YOUR HANDS" logo is imprinted in hi-viz orange on back of glove. Elastic closure is sewn inside glove for safety and comfort. Used in construction, machine operation, light-duty welding, utility work, farming, roping and many other general applications.



68-162HV

ITEM #	MARTIN #	DESCRIPTION	SIZES	UOM	PRICE
68-162HV/S	PIP68-162HV/S	Top-grain cowhide leather drivers gloves w/ hi-viz fingertips	S	DZ	\$50.93
68-162HV/M	PIP68-162HV/M	Top-grain cowhide leather drivers gloves w/ hi-viz fingertips	M	DZ	\$50.93
68-162HV/L	PIP68-162HV/L	Top-grain cowhide leather drivers gloves w/ hi-viz fingertips	L	DZ	\$50.93
68-162HV/XL	PIP68-162HV/XL	Top-grain cowhide leather drivers gloves w/ hi-viz fingertips	XL	DZ	\$54.17
68-162HV/2XL	PIP68-162HV/2XL	Top-grain cowhide leather drivers gloves w/ hi-viz fingertips	2XL	DZ	\$52.40



## CUT-RESISTANT COWHIDE DRIVERS GLOVES

Cut-resistant leather driver with arc flash is made of premium grain cow leather for heavy-duty comfort and protection. Para-aramid liner provides ANSI cut level A4 protection.

ITEM #	MARTIN #	DESCRIPTION	SIZES	UOM	PRICE
KS992K/M	WCMKS992K/M	Cut-resistant cowhide drivers gloves	M	PR	\$16.58
KS992K/L	WCMKS992K/L	Cut-resistant cowhide drivers gloves	L	PR	\$16.58
KS992K/XL	WCMKS992K/XL	Cut-resistant cowhide drivers gloves	XL	PR	\$16.58
KS992K/2XL	WCMKS992K/2XL	Cut-resistant cowhide drivers gloves	2XL	PR	\$16.58

KS992K



## SHEEPSKIN CUT-RESISTANT DRIVERS GLOVES

Cut-resistant sheepskin leather drivers are more supple than cow leather, making them feel like they're already broken in even when new. Engineered yarn liner offers protection for medium-duty cut hazards. Keystone thumb gives range of motion for a wide variety of jobs. ANSI cut level A4.



9110

ITEM #	MARTIN #	DESCRIPTION	SIZES	UOM	PRICE
9110/M	WCM9110/M	Sheepskin cut-resistant drivers gloves	M	PR	\$12.17
9110/L	WCM9110/L	Sheepskin cut-resistant drivers gloves	L	PR	\$12.17
9110/XL	WCM9110/XL	Sheepskin cut-resistant drivers gloves	XL	PR	\$12.17
9110/2XL	WCM9110/2XL	Sheepskin cut-resistant drivers gloves	2XL	PR	\$12.17



## OIL ARMOR™ AQUA ARMOR® CUT-RESISTANT GOAT DRIVERS GLOVES

Cut-resistant goatskin driver with liquid protection is ideal for tough jobs in wet and greasy situations. Goatskin is naturally soft, luxurious leather known for high resistance to abrasion and puncture, and also highly flexible and durable. Unique Oil Armor and Aqua Armor finishes add protection from water and oils that won't wash off and last the life of the glove. Features Para-aramid liner and heavy-duty hi-visibility TPRs to protect against crush and pinch. ANSI cut level A4.



KS993KOAB

ITEM #	MARTIN #	DESCRIPTION	SIZES	UOM	PRICE
KS993KOAB/M	WCMKS993KOAB/M	Oil Armor Aqua Armor goat drivers gloves	M	PR	\$26.25
KS993KOAB/L	WCMKS993KOAB/L	Oil Armor Aqua Armor goat drivers gloves	L	PR	\$26.25
KS993KOAB/XL	WCMKS993KOAB/XL	Oil Armor Aqua Armor goat drivers gloves	XL	PR	\$26.25
KS993KOAB/2XL	WCMKS993KOAB/2XL	Oil Armor Aqua Armor goat drivers gloves	2XL	PR	\$26.25



## GOAT TPR DRIVERS GLOVES

Goatskin is a naturally soft, flexible leather that is highly resistant to abrasion and puncture. Aramid liner provides heavy-duty cut protection. High profile TPR on the back of hand protects against impact and adds visibility for enhanced safety. L-Patch protects webbing between the thumb and forefinger. ANSI cut level A7.



9916

ITEM #	MARTIN #	DESCRIPTION	SIZES	UOM	PRICE
9916/M	WCM9916/M	Goat TPR drivers gloves	M	PR	\$30.83
9916/L	WCM9916/L	Goat TPR drivers gloves	L	PR	\$30.83
9916/XL	WCM9916/XL	Goat TPR drivers gloves	XL	PR	\$30.83
9916/2XL	WCM9916/2XL	Goat TPR drivers gloves	2XL	PR	\$30.83



## MUSTANG UTILITY DRIVERS GLOVES WITH DOUBLE PALM

Made from premium brown goatskin leather with strategically positioned second layers of premium brown goatskin in the palm, fingertips, thumb crotch, index finger and knuckle. Features wing-style thumb, 4" gauntlet cuff, fourchette panels for enhanced fit and shirred elastic wrist. Double stitched seams with DuPont™ Kevlar® thread. Ideal for utilities, cable, HVAC, construction, carpentry and farming.

MU3624G



**WARNING:** Cancer and reproductive harm. For more information go to [www.P65Warnings.ca.gov](http://www.P65Warnings.ca.gov).

ITEM #	MARTIN #	DESCRIPTION	SIZES	UOM	PRICE
MU3624GM	MCRMU3624GM	Mustang utility drivers gloves w/ double palm	M	PR	\$30.00
MU3624GL	MCRMU3624GL	Mustang utility drivers gloves w/ double palm	L	PR	\$30.00
MU3624GXL	MCRMU3624GXL	Mustang utility drivers gloves w/ double palm	XL	PR	\$30.00
MU3624GXLL	MCRMU3624GXLL	Mustang utility drivers gloves w/ double palm	2XL	PR	\$30.00



KS993KOA



**OIL ARMOR™ CUT-RESISTANT DRIVERS GLOVES**

Cut-resistant goatskin driver with liquid protection is ideal for tough jobs in wet and greasy situations. Goatskin is naturally soft, luxurious leather known for high resistance to abrasion and puncture, and also highly flexible and durable. Para-aramid liner provides ANSI cut level A4 protection. Arc flash level 4 provides the highest level of protection against arc flash.

ITEM #	MARTIN #	DESCRIPTION	SIZES	UOM	PRICE
KS993KOA/M	WCMKS993KOA/M	Oil Armor cut-resistant drivers gloves	M	PR	\$19.92
KS993KOA/L	WCMKS993KOA/L	Oil Armor cut-resistant drivers gloves	L	PR	\$19.92
KS993KOA/XL	WCMKS993KOA/XL	Oil Armor cut-resistant drivers gloves	XL	PR	\$19.92
KS993KOA/2XL	WCMKS993KOA/2XL	Oil Armor cut-resistant drivers gloves	2XL	PR	\$19.92



**SHOULDER SPLIT COWHIDE LEATHER PALM GLOVES**

Constructed of split cowhide leather with cotton-lined palm for extra comfort. Elastic closure sewn inside glove for safety and comfort. Features Gunn cut, rubberized safety cuff and leather knucklestrap and finger tips for extra protection. Ideal for construction, material handling and general maintenance. Gray and red striped.



85-7512

**⚠️ WARNING:** This product can expose you to chemicals including Formaldehyde (gas), which is known to the State of California to cause cancer, and Chromium (hexavalent compounds), which is known to the State of California to cause cancer and birth defects or other reproductive harm. For more information go to [www.P65Warnings.ca.gov](http://www.P65Warnings.ca.gov).

ITEM #	MARTIN #	DESCRIPTION	SIZES	UOM	PRICE
85-7512	PIP85-7512	Shoulder split cowhide leather palm gloves	Men's	DZ	\$29.65



**SPLIT COWHIDE LEATHER PALM GLOVES**

Select split cowhide leather palm gloves feature a canvas back and wing thumb. Ideal for construction, masonry, agriculture, transportation and general-duty applications. Available with choice of rubberized safety cuff or rubberized gauntlet cuff



558

ITEM #	MARTIN #	DESCRIPTION	SIZES	UOM	PRICE
558	WCM558	Select split cowhide gloves w/ 2 1/2" rubberized safety cuff	L	DZ	\$25.40
558/XL	WCM558/XL	Select split cowhide gloves w/ 2 1/2" rubberized safety cuff	XL	DZ	\$28.00
858	WCM858	Select split cowhide gloves w/ 4 1/2" rubberized gauntlet cuff	L	DZ	\$29.60
858/XL	WCM858/XL	Select split cowhide gloves w/ 4 1/2" rubberized gauntlet cuff	XL	DZ	\$32.00



**MUSTANG™ LEATHER PALM GLOVES**

Made from premium grain cowhide leather and cotton. Naturally suited for wet or insulated conditions. Features 2 1/2" safety cuff for a snug, secure fit. Can be used for general applications requiring abrasion protection and breathability.



1935

ITEM #	MARTIN #	DESCRIPTION	SIZES	UOM	PRICE
1935-S	MCR1935-S	Mustang leather palm gloves	S	DZ	\$104.40
1935-M	MCR1935-M	Mustang leather palm gloves	M	DZ	\$104.40
1935-L	MCR1935-L	Mustang leather palm gloves	L	DZ	\$104.40
1935-XL	MCR1935-XL	Mustang leather palm gloves	XL	DZ	\$110.00

HAND PROTECTION | LEATHER

TO SEE MORE STYLES, VISIT [WWW.MARTINSUPPLY.COM](http://WWW.MARTINSUPPLY.COM)



**SPLIT LEATHER PALM GLOVES WITH DENIM CUFFS**

Made from split shoulder leather with a Gunn cut pattern and a denim cuff and back. General purpose applications include areas requiring abrasion protection and breathability of leather and cotton, such as assembly, construction, fabricating, landscaping, maintenance, metal working, mining and sanitation.

**⚠️ WARNING:** Cancer and reproductive harm. For more information go to [www.P65Warnings.ca.gov](http://www.P65Warnings.ca.gov).

ITEM #	MARTIN #	DESCRIPTION	SIZES	UOM	PRICE
1220DX	MCR1220DX	Split leather gloves w/ denim cuff & palm patch	L	DZ	\$19.80
1200S	MCR1200S	Economy shoulder split leather w/ starched 2 1/2" safety cuffs	L	DZ	\$24.80

1200S





## BIG JAKE® LEATHER PALM GLOVES

Made of heavy, select premium A+ chrome-tanned, side-split leather, 9 oz. cotton back and absorbent 8 oz. fleece-lined palm. Fully in-sewn on thumb and little finger with strong, heat-resistant DuPont™ Kevlar® thread. Ideal for assembly, cable construction, farming, foundry, iron and steel work, lumberjack and millwright operations, mining, pipe fitting, re-barb, rope handling, and stamping.



1700

**⚠️ WARNING:** Cancer and reproductive harm. For more information go to [www.P65Warnings.ca.gov](http://www.P65Warnings.ca.gov).

ITEM #	MARTIN #	DESCRIPTION	SIZES	UOM	PRICE
1700-S	MCR1700S	Leather palm gloves w/ 2 3/4" safety cuff	S	DZ	\$91.80
1700-M	MCR1700M	Leather palm gloves w/ 2 3/4" safety cuff	M	DZ	\$91.80
1700-L	MCR1700L	Leather palm gloves w/ 2 3/4" safety cuff	L	DZ	\$91.80
1700-XL	MCR1700XL	Leather palm gloves w/ 2 3/4" safety cuff	XL	DZ	\$99.80
1700-2XL	MCR1700XXL	Leather palm gloves w/ 2 3/4" safety cuff	2XL	DZ	\$111.40
1713	MCR1713	Leather palm gloves w/ 3/4 leather back & 2 1/2" safety cuff	XL	DZ	\$131.20
1717	MCR1717	Leather palm gloves w/ full leather back & 2 3/4" safety cuff	XL	DZ	\$127.80



WEST CHESTER  
PROTECTIVE GEAR

## PREMIUM SPLIT COWHIDE PALM GLOVES WITH RUBBERIZED CUFF

Made from select split cowhide leather with reinforced knuckle strap for better protection and shirred elastic at wrist for comfortable fit. Features absorbent cotton lining, wing thumb, yellow canvas back and 2 1/2" rubberized safety cuff.

500Y



ITEM #	MARTIN #	DESCRIPTION	SIZES	UOM	PRICE
500Y/M	WCM500Y/M	Premium split cowhide gloves	M	DZ	\$36.00
500Y/L	WCM500Y/L	Premium split cowhide gloves	L	DZ	\$36.00
500Y/XL	WCM500Y/XL	Premium split cowhide gloves	XL	DZ	\$38.60
500Y/2XL	WCM500Y/2XL	Premium split cowhide gloves	2XL	DZ	\$39.80



PROTECTIVE INDUSTRIAL PRODUCTS

## MAXIFLEX® ULTIMATE™ BY ATG® MICRO-FOAM NITRILE-COATED NYLON GLOVES

Cool, seamless, gray knit nylon liner and black nitrile micro-foam coating keep hands cool and dry. Contoured hand shape provides fit, dexterity, sensitivity and tactility. Excellent dry grip. Pre-laundered to reduce shrinkage. Delivers patented 360° breathability.

ITEM #	MARTIN #	COLOR	SIZES	UOM	PRICE
<i>MaxiFlex Ultimate Gloves w/ Coated Palm &amp; Fingertips</i>					
34-874/S	PIP34-874/S	Gray/black	S	DZ	\$49.67
34-874/M	PIP34-874/M	Gray/black	M	DZ	\$49.67
34-874/L	PIP34-874/L	Gray/black	L	DZ	\$49.67
34-874/XL	PIP34-874/XL	Gray/black	XL	DZ	\$49.67
<i>MaxiFlex Ultimate Gloves w/ Full Fingers &amp; Knuckles</i>					
34-875/S	PIP34-875/S	Gray/black	S	DZ	\$53.73
34-875/M	PIP34-875/M	Gray/black	M	DZ	\$53.73

## Ansell

### HYFLEX® 11-600 LIGHT-DUTY MULTI-PURPOSE GLOVES

Safety without sacrificing performance. Polyurethane palm coating offers maximum tactile sensitivity in finger area for exceptional feel, and an ultra-cool stretch nylon liner increases worker acceptance and safety compliance. Barehand dexterity, excellent fit and performance help to maintain high productivity.



11-600

ITEM #	MARTIN #	DESCRIPTION	SIZES	UOM	PRICE
11-600B-7	ANE11-600B-7	HyFlex 11-600 multi-purpose gloves	7	DZ	\$29.17
11-600B-8	ANE11-600B-8	HyFlex 11-600 multi-purpose gloves	8	DZ	\$29.17
11-600B-9	ANE11-600B-9	HyFlex 11-600 multi-purpose gloves	9	DZ	\$29.17
11-600B-10	ANE11-600B-10	HyFlex 11-600 multi-purpose gloves	10	DZ	\$29.17

## Ansell

### HYFLEX® 11-816 GLOVES

A combination between a thin liner and coating provide extreme comfort and a barehand feel for workers who rely on fingertip sensitivity for precision tasks. FORTIX™ Abrasion Resistance Technology delivers extended wear time for enhanced worker safety and productivity. Ultra-thin ergonomic design provides extreme tactility to handle small parts easily. Features foam nitrile coating and knit wrist.

11-816



ITEM #	MARTIN #	DESCRIPTION	SIZES	UOM	PRICE
11-816-6	ANE11-816-6	HyFlex gloves	6	PR	\$2.40
11-816-7	ANE11-816-7	HyFlex gloves	7	PR	\$2.40
11-816-8	ANE11-816-8	HyFlex gloves	8	PR	\$2.40
11-816-9	ANE11-816-9	HyFlex gloves	9	PR	\$2.40
11-816-10	ANE11-816-10	HyFlex gloves	10	PR	\$2.40
11-816-11	ANE11-816-11	HyFlex gloves	11	PR	\$2.40



34-874

ITEM #	MARTIN #	COLOR	SIZES	UOM	PRICE
34-875/L	PIP34-875/L	Gray/black	L	DZ	\$53.73
34-875/XL	PIP34-875/XL	Gray/black	XL	DZ	\$53.73
<i>MaxiFlex Ultimate Gloves w/ Coated Palm &amp; Fingertips</i>					
34-874FY/S	PIP34-874FY/S	Hi-viz yellow	S	DZ	\$58.78
34-874FY/M	PIP34-874FY/M	Hi-viz yellow	M	DZ	\$58.78
34-874FY/L	PIP34-874FY/L	Hi-viz yellow	L	DZ	\$58.78
34-874FY/XL	PIP34-874FY/XL	Hi-viz yellow	XL	DZ	\$58.78



PROTECTIVE INDUSTRIAL PRODUCTS

**MAXIFOAM® LITE™ BY ATG® NITRILE-COATED GLOVES**

Seamless 1-piece nylon shell offers increased comfort, finger dexterity and breathability. Dark coating and gray shell hide dirt. Features nitrile coated foam grip on palm and fingers. Extended cuff provides comfort and keeps dirt out. Silicone-free. Ideal for general assembly, micro-engineering, automotive, painting and horticulture. Made from component materials that comply with Federal Regulations for food contact 21 CFR, 170-199. CFIA Approved. EN388: 3121.



34-900

ITEM #	MARTIN #	DESCRIPTION	SIZES	UOM	PRICE
34-900/S	PIP34-900/S	MaxiFoam Lite nitrile-coated gloves	S	DZ	\$40.73
34-900/M	PIP34-900/M	MaxiFoam Lite nitrile-coated gloves	M	DZ	\$40.73

ITEM #	MARTIN #	DESCRIPTION	SIZES	UOM	PRICE
34-900/L	PIP34-900/L	MaxiFoam Lite nitrile-coated gloves	L	DZ	\$40.73
34-900/XL	PIP34-900/XL	MaxiFoam Lite nitrile-coated gloves	XL	DZ	\$40.73



PROTECTIVE INDUSTRIAL PRODUCTS

**MAXIDRY® GLOVES BY ATG®**

Ultra lightweight nitrile on fine gauge seamless knit nylon liner. GripTech® coating for non-slip capabilities. Locking cuff ensures glove doesn't slip and LiquiTech® Barrier Technology provides resistance to oil and liquids. 10" Length.



56-426

ITEM #	MARTIN #	DESCRIPTION	SIZES	UOM	PRICE
56-425/S	PIP56-425/S	ATG MaxiDry gloves, 3/4 coated	S	DZ	\$69.83
56-425/M	PIP56-425/M	ATG MaxiDry gloves, 3/4 coated	M	DZ	\$69.83
56-425/L	PIP56-425/L	ATG MaxiDry gloves, 3/4 coated	L	DZ	\$69.83
56-425/XL	PIP56-425/XL	ATG MaxiDry gloves, 3/4 coated	XL	DZ	\$69.83
56-426/S	PIP56-426/S	ATG MaxiDry nitrile gloves, fully coated	S	DZ	\$90.40
56-426/M	PIP56-426/M	ATG MaxiDry nitrile gloves, fully coated	M	DZ	\$90.40
56-426/L	PIP56-426/L	ATG MaxiDry nitrile gloves, fully coated	L	DZ	\$90.40
56-426/XL	PIP56-426/XL	ATG MaxiDry nitrile gloves, fully coated	XL	DZ	\$90.40



PROTECTIVE INDUSTRIAL PRODUCTS

**G-TEK® GP GLOVES WITH POLYURETHANE COATING**

Features seamless knit nylon with polyurethane coating on palm and fingers for dexterity and abrasion resistance. Breathable back offers extra comfort. Ideal for electronic and computer assembly, quality control, inspection and general assembly. Black.



33-B125

**⚠️ WARNING:** This product can expose you to chemicals including N,N-Dimethylformamide, which is known to the State of California to cause cancer. For more information go to [www.P65Warnings.ca.gov](http://www.P65Warnings.ca.gov).

ITEM #	MARTIN #	DESCRIPTION	SIZES	UOM	PRICE
33-B125/S	PIP33-B125/S	G-Tek gloves w/ polyurethane coating	S	DZ	\$12.53
33-B125/M	PIP33-B125/M	G-Tek gloves w/ polyurethane coating	M	DZ	\$12.53
33-B125/L	PIP33-B125/L	G-Tek gloves w/ polyurethane coating	L	DZ	\$12.53
33-B125/XL	PIP33-B125/XL	G-Tek gloves w/ polyurethane coating	XL	DZ	\$12.53



PROTECTIVE INDUSTRIAL PRODUCTS

**G-TEK® GLOVES WITH NITRILE COATING**

Features 13-gauge blue nylon liner with black nitrile MicroSurface coating and knit wrist. MicroSurface provides superior grip in dry, wet and oily conditions by reacting like tiny suction cups attaching firmly to material being handled. Excellent resistance to liquid permeation. Strong protection from punctures and abrasions. Ideal for general assembly of oily parts, metal handling and machine operation.



34-500

ITEM #	MARTIN #	DESCRIPTION	SIZES	UOM	PRICE
34-500/XS	PIP34-500/XS	G-Tek gloves w/ nitrile coating	XS	DZ	\$27.80
34-500/S	PIP34-500/S	G-Tek gloves w/ nitrile coating	S	DZ	\$27.80
34-500/M	PIP34-500/M	G-Tek gloves w/ nitrile coating	M	DZ	\$27.80
34-500/L	PIP34-500/L	G-Tek gloves w/ nitrile coating	L	DZ	\$27.80
34-500/XL	PIP34-500/XL	G-Tek gloves w/ nitrile coating	XL	DZ	\$27.80
34-500/XXL	PIP34-500/XXL	G-Tek gloves w/ nitrile coating	2XL	DZ	\$27.80



**NINJA® BNF GLOVES**

Features 18-gauge red nylon/Spandex® shell with black BNF (breathable nitrile foam) technology coated palm and fingertips. Ergonomic design for minimum hand fatigue, enhanced productivity and maximum comfort. Excellent wet/dry grip.



N96970

**⚠️ WARNING:** Cancer and reproductive harm. For more information go to [www.P65Warnings.ca.gov](http://www.P65Warnings.ca.gov).

ITEM #	MARTIN #	DESCRIPTION	SIZES	UOM	PRICE
N96970-S	MCRN96970-S	Ninja BNF gloves	S	DZ	\$41.20
N96970-M	MCRN96970-M	Ninja BNF gloves	M	DZ	\$41.20
N96970-L	MCRN96970-L	Ninja BNF gloves	L	DZ	\$41.20
N96970-XL	MCRN96970-XL	Ninja BNF gloves	XL	DZ	\$41.20
N96970-2XL	MCRN96970-2XL	Ninja BNF gloves	2XL	DZ	\$40.00

HAND PROTECTION | GENERAL PURPOSE



### NINJA® BNF GLOVES WITH PALM COATING

Features 15-gauge nylon/Spandex® shell with breathable nitrile foam (BNF) coating on palm and fingertips. Provides dexterity, sense of touch, and protection. Ideal for automotive assembly, farming, landscaping and material handling. Black/gray.



N96790

**⚠️ WARNING:** Cancer and reproductive harm. For more information go to [www.P65Warnings.ca.gov](http://www.P65Warnings.ca.gov).

ITEM #	MARTIN #	DESCRIPTION	SIZES	UOM	PRICE
N96790XS	MCRN96790XS	Ninja BNF gloves w/ palm & fingertip coating	XS	DZ	\$35.80
N96790S	MCRN96790S	Ninja BNF gloves w/ palm & fingertip coating	S	DZ	\$35.80
N96790M	MCRN96790M	Ninja BNF gloves w/ palm & fingertip coating	M	DZ	\$35.80
N96790L	MCRN96790L	Ninja BNF gloves w/ palm & fingertip coating	L	DZ	\$35.80
N96790XL	MCRN96790XL	Ninja BNF gloves w/ palm & fingertip coating	XL	DZ	\$35.80



### BI-POLYMER COATED GLOVES

Features seamless 15-gauge black nylon/spandex shell with 3/4-dipped black bi-polymer coating. Nitrile dots on palm and fingers for added grip. Ideal for automotive assembly, farming, landscaping and material handling.



MG9694

**⚠️ WARNING:** Cancer and reproductive harm. For more information go to [www.P65Warnings.ca.gov](http://www.P65Warnings.ca.gov).

ITEM #	MARTIN #	DESCRIPTION	SIZES	UOM	PRICE
MG9694XS	MCRM9694XS	Bi-polymer coated gloves	XS	DZ	\$43.00
MG9694S	MCRM9694S	Bi-polymer coated gloves	S	DZ	\$43.00
MG9694M	MCRM9694M	Bi-polymer coated gloves	M	DZ	\$43.00
MG9694L	MCRM9694L	Bi-polymer coated gloves	L	DZ	\$43.00
MG9694XL	MCRM9694XL	Bi-polymer coated gloves	XL	DZ	\$43.00



### PREDATOR® MULTI-TASK GLOVES WITH TIRE TREAD TPR

Made from 13-gauge black nylon shell and black foam nitrile coated palm and fingers. Unique TPR design provides excellent coverage for back of hand protection. ID panel on the wrist allows for personalized identification. Ideal for agriculture, automotive, assembly, carpentry, construction and manufacturing.



PD2950

**⚠️ WARNING:** Cancer and reproductive harm. For more information go to [www.P65Warnings.ca.gov](http://www.P65Warnings.ca.gov).

ITEM #	MARTIN #	DESCRIPTION	SIZES	UOM	PRICE
PD2950M	MCRPD2950M	Predator multi-task gloves	M	PR	\$13.38
PD2950L	MCRPD2950L	Predator multi-task gloves	L	PR	\$13.38
PD2950XL	MCRPD2950XL	Predator multi-task gloves	XL	PR	\$13.38
PD2950XXL	MCRPD2950XXL	Predator multi-task gloves	2XL	PR	\$13.38



### MAXIMUM SAFETY® MAD MAX RIGGERS GLOVES

Features hi-viz lime foam-laminated spandex fabric back with TPR molded knuckle and back hand guards. Diamond grip PVC is impregnated on fingertips and thumb crotch reinforcements. Breathable airprene wrist keeps debris out.



120-4000

ITEM #	MARTIN #	DESCRIPTION	SIZES	UOM	PRICE
120-4000/L	PIP120-4000/L	Mad Max gloves w/ black reinforced synthetic leather palm	L	PR	\$22.63



### “WATCH YOUR HANDS” HI-VIZ NITRILE FOAM-DIPPED GLOVES

Made from 15-gauge gray nylon shell with hi-viz orange nitrile foam coating on palm and fingertips with a personal reminder to “Watch Your Hands” on the back of the glove. Offers users tactile sensitivity, dexterity and abrasion resistance. Ideal for agriculture, assembly, baggage handling, carpentry, construction, manufacturing and warehouse.

**⚠️ WARNING:** Cancer and reproductive harm. For more information go to [www.P65Warnings.ca.gov](http://www.P65Warnings.ca.gov).

96790HIV

ITEM #	MARTIN #	DESCRIPTION	SIZES	UOM	PRICE
96790HVIS	MCR96790HVIS	“Watch Your Hands” hi-viz gloves	S	DZ	\$33.20
96790HVIM	MCR96790HVIM	“Watch Your Hands” hi-viz gloves	M	DZ	\$33.20
96790HVIL	MCR96790HVIL	“Watch Your Hands” hi-viz gloves	L	DZ	\$33.20
96790HVIXL	MCR96790HVIXL	“Watch Your Hands” hi-viz gloves	XL	DZ	\$33.20
96790HVIXXL	MCR96790HVIXXL	“Watch Your Hands” hi-viz gloves	2XL	DZ	\$33.20





**100% NYLON SEAMLESS KNIT GLOVES**

Seamless construction provides comfort and reduces hand fatigue. Low lint gloves knit from nylon filament yarns. Nylon yarns absorb perspiration and leave hands cool and comfortable. Color-coded hems for easy size identification. Liners can be worn under disposable and other liquid-proof gloves. Ideal for product handling, finishing and assembly, electronics assembly, photography labs and computer manufacturing.

40-730



ITEM #	MARTIN #	DESCRIPTION	SIZES	UOM	PRICE
40-730/S	PIP40-730/S	100% Nylon seamless knit gloves	S	DZ	\$10.10
40-730/M	PIP40-730/M	100% Nylon seamless knit gloves	M	DZ	\$10.10
40-730/L	PIP40-730/L	100% Nylon seamless knit gloves	L	DZ	\$10.10
40-730/XL	PIP40-730/XL	100% Nylon seamless knit gloves	XL	DZ	\$10.10



**COTTON CANVAS SINGLE PALM GLOVES**

Made from 8 oz. natural cotton canvas fabric with Clute cut and knit wrist. Multi-purpose gloves are ideal for light protection in many general applications.



90-9081

ITEM #	MARTIN #	DESCRIPTION	SIZES	UOM	PRICE
90-9081	PIP90-9081	Cotton canvas gloves	Men's	DZ	\$7.52



**TERRY CLOTH SEAMLESS GLOVES**

Loop-out fabric wicks heat away from the hand and is made of 100% cotton. Resistant to cuts and abrasions and outlasts regular string knits. Features 24 oz. construction and knit wrist. Natural.



42-C700

ITEM #	MARTIN #	DESCRIPTION	SIZES	UOM	PRICE
42-C700/L	PIP42-C700/L	Terry cloth seamless gloves	L	DZ	\$19.33



92-500

**Ansell**

**TOUCHNTUFF® 92-500 AND 92-600 100% NITRILE DISPOSABLE GLOVES**

Premium quality, 100% nitrile formulation 5-mil disposable gloves offer 3X the puncture resistance of standard latex or vinyl gloves. Superior chemical splash resistance combines excellent fingertip sensitivity with exceptional durability. Gives a high level of protection against grease and oil. Lightweight and comfortable to wear. Made without silicone. Complies with FDA food handling requirements (21 CFR 177.2600).

ITEM #	MARTIN #	DESCRIPTION	SIZES	UOM	PRICE
92-500-S	ANE92-500-S	TouchNTuff 92-500 disposable nitrile gloves, powdered	S	100/BX	\$10.54
92-500-M	ANE92-500-M	TouchNTuff 92-500 disposable nitrile gloves, powdered	M	100/BX	\$10.54
92-500-L	ANE92-500-L	TouchNTuff 92-500 disposable nitrile gloves, powdered	L	100/BX	\$10.54
92-500-XL	ANE92-500-XL	TouchNTuff 92-500 disposable nitrile gloves, powdered	XL	100/BX	\$10.54
92-600-S	ANE92-600-S	TouchNTuff 92-600 disposable nitrile gloves, powder-free	S	100/BX	\$12.00
92-600-M	ANE92-600-M	TouchNTuff 92-600 disposable nitrile gloves, powder-free	M	100/BX	\$12.00
92-600-L	ANE92-600-L	TouchNTuff 92-600 disposable nitrile gloves, powder-free	L	100/BX	\$12.00
92-600-XL	ANE92-600-XL	TouchNTuff 92-600 disposable nitrile gloves, powder-free	XL	100/BX	\$12.00



# Ansell

## TOUCHNTUFF® 92-575 AND 92-675 BLUE DISPOSABLE NITRILE GLOVES

Durable, 5-mil nitrile gloves are soft and comfortable and have textured fingers for exceptional grip. Complies with FDA food handling requirements (21 CFR 177.2600).



ITEM #	MARTIN #	DESCRIPTION	SIZES	UOM	PRICE
92-575-S	ANE92-575-S	TouchNTuff 92-575 gloves, powdered	S	100/BX	\$9.54
92-575-M	ANE92-575-M	TouchNTuff 92-575 gloves, powdered	M	100/BX	\$9.54
92-575-L	ANE92-575-L	TouchNTuff 92-575 gloves, powdered	L	100/BX	\$9.54
92-575-XL	ANE92-575-XL	TouchNTuff 92-575 gloves, powdered	XL	100/BX	\$9.54
92-675-S	ANE92-675-S	TouchNTuff 92-675 gloves, powder-free	S	100/BX	\$10.14
92-675-M	ANE92-675-M	TouchNTuff 92-675 gloves, powder-free	M	100/BX	\$10.14
92-675-L	ANE92-675-L	TouchNTuff 92-675 gloves, powder-free	L	100/BX	\$10.14
92-675-XL	ANE92-675-XL	TouchNTuff 92-675 gloves, powder-free	XL	100/BX	\$10.14



**MICROFLEX**  
THE MOST TRUSTED NAME IN GLOVES®

## XCEED® NITRILE EXAM GLOVES

Designed with ERGOFORM™ Technology and ergonomically certified, these 2.8-mil exam gloves are scientifically designed to reduce muscle effort. Lowest pinhole rates (AQL 0.65) standard of protection. Smart packaging reduces cost and waste. Features textured fingertips and beaded cuff. Powder-free, chlorinated. Blue. Compliant with U.S. Food Contact Regulations.

ITEM #	MARTIN #	DESCRIPTION	SIZES	UOM	PRICE
XC-310-XS	ANEXC-310-XS	XCEED nitrile exam gloves	XS	250/BX	\$22.05
XC-310-S	ANEXC-310-S	XCEED nitrile exam gloves	S	250/BX	\$22.05
XC-310-M	ANEXC-310-M	XCEED nitrile exam gloves	M	250/BX	\$22.05
XC-310-L	ANEXC-310-L	XCEED nitrile exam gloves	L	250/BX	\$22.05
XC-310-XL	ANEXC-310-XL	XCEED nitrile exam gloves	XL	250/BX	\$22.05



**MICROFLEX**  
THE MOST TRUSTED NAME IN GLOVES®

## SUPRENO® SE NITRILE EXAM GLOVES

Made from durable nitrile with advanced barrier protection (0.65 AQL). Sturdy glove is ideal for longer wear times and demanding applications. Powder-free examination grade. Compliant with U.S. Food Contact Regulations.

ITEM #	MARTIN #	DESCRIPTION	SIZES	UOM	PRICE
SU-690-XS	ANESU-690-XS	Supreno SE nitrile exam gloves	XS	100/BX	\$14.62
SU-690-S	ANESU-690-S	Supreno SE nitrile exam gloves	S	100/BX	\$14.62
SU-690-M	ANESU-690-M	Supreno SE nitrile exam gloves	M	100/BX	\$14.62
SU-690-L	ANESU-690-L	Supreno SE nitrile exam gloves	L	100/BX	\$14.62
SU-690-XL	ANESU-690-XL	Supreno SE nitrile exam gloves	XL	100/BX	\$14.62



## HYPERSENSE™ X9 LATEX EXAM GLOVES

Powder-free latex exam gloves provide excellent chemical and biological barrier protection. Fully textured surface delivers excellent grip. Beaded cuff allows easy donning and removal. Ideal for light metal fabricating, machinery repair, cleaning/maintenance, janitorial/sanitation and painting. Natural.

ITEM #	MARTIN #	DESCRIPTION	SIZES	UOM	PRICE
L009201	SWSL009201	Hypersense X9 latex exam gloves	XS	100/BX	\$11.94
L009202	SWSL009202	Hypersense X9 latex exam gloves	S	100/BX	\$11.94
L009203	SWSL009203	Hypersense X9 latex exam gloves	M	100/BX	\$11.94
L009204	SWSL009204	Hypersense X9 latex exam gloves	L	100/BX	\$11.94
L009205	SWSL009205	Hypersense X9 latex exam gloves	XL	100/BX	\$11.94





L070303



**HYPERSENSE™ X11+ LATEX EXAM GLOVES**

Powder-free latex exam gloves provide excellent chemical and biological barrier protection. Thicker construction and extended length cuff provide extra protection. Features beaded cuff and fully textured surface for excellent grip. Ideal for light metal fabricating, machinery repair, cleaning/maintenance, janitorial/sanitation and painting. Royal blue.

ITEM #	MARTIN #	DESCRIPTION	SIZES	UOM	PRICE
L070302	SWSL070302	Hypersense X11+ latex exam gloves	S	50/BX	\$13.83
L070303	SWSL070303	Hypersense X11+ latex exam gloves	M	50/BX	\$13.83
L070304	SWSL070304	Hypersense X11+ latex exam gloves	L	50/BX	\$13.83
L070305	SWSL070305	Hypersense X11+ latex exam gloves	XL	50/BX	\$13.83



N260883



**MEGAMAN™ NITRILE INDUSTRIAL GLOVES**

Provides excellent chemical and biological barrier protection and an ultra-clean TouchTek™ surface. Powder-free flock lining with natural cotton fibers absorbs moisture to help keep hands dry and comfortable during extended use. Features beaded cuff for added easy donning and removal, and fully textured surface that delivers excellent grip. Ideal for light assembly, light metal fabricating, machine repair, cleaning/maintenance and production/packaging. Black.

ITEM #	MARTIN #	DESCRIPTION	SIZES	UOM	PRICE
N260882	SWSN260882	MEGAMAN nitrile industrial gloves	S	50/BX	\$14.67
N260883	SWSN260883	MEGAMAN nitrile industrial gloves	M	50/BX	\$14.67
N260884	SWSN260884	MEGAMAN nitrile industrial gloves	L	50/BX	\$14.67
N260885	SWSN260885	MEGAMAN nitrile industrial gloves	XL	50/BX	\$14.67
N260886	SWSN260886	MEGAMAN nitrile industrial gloves	2XL	50/BX	\$14.67

▶ OTHER STYLES AVAILABLE AT [WWW.MARTINSUPPLY.COM](http://WWW.MARTINSUPPLY.COM)



**AMBI-DEX® POWDER-FREE NITRILE GLOVES**

Features 5-mil thickness, fully textured grip and ambidextrous design. Contains no natural rubber latex proteins. Ideal for light hand protection from liquids and debris.



63-732

ITEM #	MARTIN #	DESCRIPTION	SIZES	UOM	PRICE
63-732PF/L	PIP63-732PF/L	Ambi-dex nitrile gloves	L	100/BX	\$11.80



**AMBI-DEX® TURBO DISPOSABLE NITRILE GLOVES**

For light hand protection from liquids, chemicals and debris. Contains no natural rubber latex proteins. Ambidextrous, 5-mil thickness. Meets FDA Regulations for food contact, 21 CFR, 170-199. Complies with FDA food handling requirements 21 CFR 177.2600.



63-332PF

ITEM #	MARTIN #	DESCRIPTION	SIZES	UOM	PRICE
63-332/L	PIP63-332/L	Ambi-dex disposable nitrile gloves, powdered	L	100/BX	\$10.19
63-332PF/L	PIP63-332PF/L	Ambi-dex disposable nitrile gloves, powder-free	L	100/BX	\$10.35



**STELLAR™ S6 MULTI-PURPOSE INDUSTRIAL NITRILE GLOVES**

Powder-free nitrile industrial gloves provide excellent chemical and barrier protection. MilTek™ technology delivers a consistent thickness for a stronger glove. TouchTek™ surfaces reduce irritants and contaminants to protect hands and sensitive items being handled. Fully textured grip allows better handling of small parts and slippery objects. 100% Biodegradable.

ITEM #	MARTIN #	DESCRIPTION	SIZES	UOM	PRICE
N716882	SWSN716882	STELLAR S6 nitrile industrial gloves, powder-free	S	100/BX	\$8.89
N716883	SWSN716883	STELLAR S6 nitrile industrial gloves, powder-free	M	100/BX	\$8.89
N716884	SWSN716884	STELLAR S6 nitrile industrial gloves, powder-free	L	100/BX	\$8.89
N716885	SWSN716885	STELLAR S6 nitrile industrial gloves, powder-free	XL	100/BX	\$8.89
N716886	SWSN716886	STELLAR S6 nitrile industrial gloves, powder-free	2XL	100/BX	\$8.89



N716883



### ASSURANCE® UNLINED NITRILE GLOVES

Lightweight, 8-mil construction and hand specific design provides real comfort and protection. Provides flexibility, tactile sensitivity and dexterity. Unlined to reduce potential product contamination. Features straight cuff and raised diamond pattern for enhanced grip. Chlorinated. Ideal for light chemical applications, printing, meat and poultry processing. Complies with 21 CFR-170-199.



50-N092B

ITEM #	MARTIN #	DESCRIPTION	SIZES	UOM	PRICE
50-N092B/L	PIP50-N092B/L	Assurance unlined nitrile gloves	L	DZ	\$14.07



### ASSURANCE® UNSUPPORTED NEOPRENE/LATEX GLOVES

Provides comfort and hand protection from wide range of chemicals including acids, caustics, solvents and oils. Double-dipped gloves are 28-mil thick. Ideal for use in petrochemical industry, janitorial, general maintenance and photo finishing.



52-3670

**CAUTION:** Contains natural rubber latex which may cause allergic reactions. Safe use by or on latex-sensitive individuals has not been established.

ITEM #	MARTIN #	DESCRIPTION	SIZES	UOM	PRICE
52-3670/L	PIP52-3670/L	Assurance unsupported neoprene gloves	L	DZ	\$25.78



### ASSURANCE® UNSUPPORTED LIGHTWEIGHT NITRILE GLOVES

Unsupported nitrile gloves feature 11-mil thickness, raised diamond grip and straight cuff. Unlined, 13" length. Green. Made from component materials which comply with FDA regulations for food contact. 21 CFR 170-199.

ITEM #	MARTIN #	DESCRIPTION	SIZES	UOM	PRICE
50-N110G/S	PIP50-N110G/S	Assurance unsupported lightweight nitrile gloves	S	DZ	\$14.87
50-N110G/M	PIP50-N110G/M	Assurance unsupported lightweight nitrile gloves	M	DZ	\$14.87
50-N110G/L	PIP50-N110G/L	Assurance unsupported lightweight nitrile gloves	L	DZ	\$14.87
50-N110G/XL	PIP50-N110G/XL	Assurance unsupported lightweight nitrile gloves	XL	DZ	\$14.87
50-N110G/XXL	PIP50-N110G/XXL	Assurance unsupported lightweight nitrile gloves	2XL	DZ	\$14.87



50-N110G



### KLEENGUARD™ G29 CHEMICAL GLOVES

Features textured fingertips and 12-mil thickness at fingers/9-mil on palm for the highest level of dexterity. Neoprene blend; silicone-free. Touchscreen compatible. 12" Length, ambidextrous. Ideal for small parts handling, janitorial/general maintenance, automotive and chemical plants/processing. Meets U.S. FDA regulations for food handling applications.



49824

ITEM #	MARTIN #	DESCRIPTION	SIZES	UOM	PRICE
49823	KC49823	G29 Chemical Gloves	7 (S)	50/BX	\$27.92
49824	KC49824	G29 Chemical Gloves	8 (M)	50/BX	\$27.92
49825	KC49825	G29 Chemical Gloves	9 (L)	50/BX	\$27.92
49826	KC49826	G29 Chemical Gloves	10 (XL)	50/BX	\$27.92
49827	KC49827	G29 Chemical Gloves	11 (2XL)	50/BX	\$27.92



### KLEENGUARD™ G80 NITRILE CHEMICAL-RESISTANT GLOVES

Cotton flock lining for added comfort. Features 13" length, 15-mil thickness and textured palm and fingertips for enhanced grip. Ideal for chemical processing, oil refining, fabrication, automotive assembly and painting. Green.



94447

**WARNING:** This product can expose you to 2-mercaptobenzothiazole, which is known to the State of California to cause cancer. For more information go to [www.P65Warnings.ca.gov](http://www.P65Warnings.ca.gov).

ITEM #	MARTIN #	DESCRIPTION	SIZES	UOM	PRICE
94445	KC94445	G80 Nitrile Gloves	7 (S)	DZ	\$24.05
94446	KC94446	G80 Nitrile Gloves	8 (M)	DZ	\$24.05
94447	KC94447	G80 Nitrile Gloves	9 (L)	DZ	\$24.05
94448	KC94448	G80 Nitrile Gloves	10 (XL)	DZ	\$24.05
94449	KC94449	G80 Nitrile Gloves	11 (2XL)	DZ	\$24.05



**KLEENGUARD™  
G80 NEOPRENE/LATEX  
CHEMICAL-RESISTANT  
GLOVES**

Neoprene outer layer provides high chemical resistance along with durability, flexibility and sensitivity. Latex with cotton flock lining adds comfort and absorbs perspiration for easy donning and removal. Offers high resistance to acids, alkalis and water-based solvents. Ideal for chemical processing, cleaning and degreasing and wiping down parts and machinery. Meets EN 374-AKL standard. Blue and yellow.



38743

ITEM #	MARTIN #	DESCRIPTION	SIZES	UOM	PRICE
38741	KC38741	G80 neoprene/latex chemical-resistant gloves	7 (S)	12/BG	\$28.15
38742	KC38742	G80 neoprene/latex chemical-resistant gloves	8 (M)	12/BG	\$28.15
38743	KC38743	G80 neoprene/latex chemical-resistant gloves	9 (L)	12/BG	\$28.15
38744	KC38744	G80 neoprene/latex chemical-resistant gloves	10 (XL)	12/BG	\$28.15

**Ansell**

**SOLVEX® ALPHATEC®  
CHEMICAL-RESISTANT  
UNSUPPORTED GLOVES**

Versatile chemical protection that performs across a diverse range of applications. High performance nitrile compound provides an outstanding combination of chemical resistance and strength. Offers superior snag, puncture and abrasion protection over rubber or neoprene gloves. Features 15-mil thickness, flock lining, straight cuff, sandpatch grip and 13" length. Suitable for heavy-duty cleaning applications. High levels of flexibility, comfort and dexterity. Won't swell, weaken or degrade, and does not promote contact dermatitis. Complies with FDA food handling requirements (21 CFR 177.2600).



37-175

ITEM #	MARTIN #	DESCRIPTION	SIZES	UOM	PRICE
37-175-7	ANE37-175-7	Solvex AlphaTec gloves	7	PR	\$1.58
37-175-8	ANE37-175-8	Solvex AlphaTec gloves	8	PR	\$1.58
37-175-9	ANE37-175-9	Solvex AlphaTec gloves	9	PR	\$1.58
37-175-10	ANE37-175-10	Solvex AlphaTec gloves	10	PR	\$1.58
37-175-11	ANE37-175-11	Solvex AlphaTec gloves	11	PR	\$1.58

**Ansell**

**ALPHATEC® NEOPRENE-COATED GLOVES**

Heavy-duty protection against a wide range of chemicals. Specially designed neoprene construction with a knit-liner for comfort and easy donning and doffing. Textured finish provides excellent grip on wet and slippery materials with great flexibility. Snug fit with high degree of fingertip sensitivity. Interlock knit cotton 2-piece lining eliminates seams that can cause hand irritation.

ITEM #	MARTIN #	DESCRIPTION	SIZES	UOM	PRICE
8-352-9	ANE8-352-9	AlphaTec 8-352 gloves w/ 12" gauntlet cuff	9	PR	\$4.37
8-354-9	ANE8-354-9	AlphaTec 8-354 gloves w/ 14" gauntlet cuff	9	PR	\$5.38



8-354

**Ansell**

**ALPHATEC® 23-202  
INSULATED GLOVES**

Made of PVC coating material with polar acrylic liner. Features 13-gauge construction, roughened sandblast finish on glove and smooth finish on cuff. Designed to protect at temperatures down to -22° F.



23-202

ITEM #	MARTIN #	DESCRIPTION	SIZES	UOM	PRICE
23-202-8	ANE23-202-8	AlphaTec insulated gloves	8	PR	\$6.69
23-202-9	ANE23-202-9	AlphaTec insulated gloves	9	PR	\$6.69
23-202-10	ANE23-202-10	AlphaTec insulated gloves	10	PR	\$6.69

**Ansell**

**ALPHATEC® 58-430  
AND 58-435 GLOVES**

Ansell Grip Technology™ creates safe and secure glove contact with tools or part surfaces by wicking liquids into glove coating micro-channels, for optimal control and confidence when handling wet and oily objects. High performance nitrile compound coating offers superior snag, puncture and abrasion protection for long-term wear. Snug, second-skin tailoring tightens fit across palm for added comfort, greater tactility and improved dexterity. Comfortable cotton flocked liner helps manage perspiration. Complies with FDA food handling requirements (21 CFR 177.2600).



58-430

ITEM #	MARTIN #	DESCRIPTION	SIZES	UOM	PRICE
58-430-7	ANE58-430-7	AlphaTec gloves w/ gauntlet cuff, 10-mil	7	PR	\$3.85
58-430-8	ANE58-430-8	AlphaTec gloves w/ gauntlet cuff, 10-mil	8	PR	\$3.85
58-430-9	ANE58-430-9	AlphaTec gloves w/ gauntlet cuff, 10-mil	9	PR	\$3.85
58-430-10	ANE58-430-10	AlphaTec gloves w/ gauntlet cuff, 10-mil	10	PR	\$3.85
58-430-11	ANE58-430-11	AlphaTec gloves w/ gauntlet cuff, 10-mil	11	PR	\$3.85
58-435-7	ANE58-435-7	AlphaTec gloves w/ extra long cuff, 16-mil	7	PR	\$4.31
58-435-8	ANE58-435-8	AlphaTec gloves w/ extra long cuff, 16-mil	8	PR	\$4.31
58-435-9	ANE58-435-9	AlphaTec gloves w/ extra long cuff, 16-mil	9	PR	\$4.31
58-435-10	ANE58-435-10	AlphaTec gloves w/ extra long cuff, 16-mil	10	PR	\$4.31
58-435-11	ANE58-435-11	AlphaTec gloves w/ extra long cuff, 16-mil	11	PR	\$4.31

## Ansell

### ALPHATEC® 04-644 PVC CHEMICAL-RESISTANT GLOVES

Provides optimum abrasion resistance in combination with excellent wet grip. Offers excellent chemical resistance to petrochemicals and acids. Features 63-mil thickness, gauntlet cuff and jersey lining for cushioned comfort and moderate insulation. Ideal for fisheries and petrochemical refining.



04-644

ITEM #	MARTIN #	DESCRIPTION	SIZES	UOM	PRICE
04-644-8	ANE04-644-8	AlphaTec PVC chemical-resistant gloves	8	PR	\$3.14
04-644-9	ANE04-644-9	AlphaTec PVC chemical-resistant gloves	9	PR	\$3.14
04-644-10	ANE04-644-10	AlphaTec PVC chemical-resistant gloves	10	PR	\$3.14
04-644-11	ANE04-644-11	AlphaTec PVC chemical-resistant gloves	11	PR	\$3.14

## Ansell

### ALPHATEC® 58-735 CHEMICAL- AND CUT-RESISTANT GLOVES

Features INTERCEPT™ Cut Resistance Technology and Ansell Grip Technology™. Ideal for agriculture, automotive, chemical, food service, machinery, metal fabrication and oil/gas industries. ANSI cut level A3.



58-735

ITEM #	MARTIN #	DESCRIPTION	SIZES	UOM	PRICE
58-735-6	ANE58-735-6	AlphaTec cut- & chemical-resistant gloves	6	PR	\$9.71
58-735-7	ANE58-735-7	AlphaTec cut- & chemical-resistant gloves	7	PR	\$9.71
58-735-8	ANE58-735-8	AlphaTec cut- & chemical-resistant gloves	8	PR	\$9.71
58-735-9	ANE58-735-9	AlphaTec cut- & chemical-resistant gloves	9	PR	\$9.71
58-735-10	ANE58-735-10	AlphaTec cut- & chemical-resistant gloves	10	PR	\$9.71
58-735-11	ANE58-735-11	AlphaTec cut- & chemical-resistant gloves	11	PR	\$9.71



### PERMFLEX® AND XTRATUFF® PVC-DIPPED GLOVES

PermFlex styles are cold-resistant, staying soft and flexible in cold applications. Rough-coated palm provides a great grip. Seamless liner provides excellent tactile sensitivity and is treated to resist germs and odors. Great for cold water marine applications. XtraTuff styles are oil-resistant, staying soft and strong even after exposure to machine oils. Rough-coated palm provides a great grip. Seamless liner provides a excellent tactile sensitivity and is treated to resist germs and odors.

ITEM #	MARTIN #	DESCRIPTION	COLOR	SIZES	UOM	PRICE
58-8651/S	PIP58-8651/S	PermFlex cold-resistant gloves, 12" length	Brown	S	DZ	\$41.82
58-8651/M	PIP58-8651/M	PermFlex cold-resistant gloves, 12" length	Brown	M	DZ	\$41.82
58-8651/L	PIP58-8651/L	PermFlex cold-resistant gloves, 12" length	Brown	L	DZ	\$41.82
58-8651/XL	PIP58-8651/XL	PermFlex cold-resistant gloves, 12" length	Brown	XL	DZ	\$41.82
58-8657/S	PIP58-8657/S	XtraTuff oil-resistant gloves w/ sleeve, 25" overall length	Blue	S	DZ	\$150.93
58-8657/M	PIP58-8657/M	XtraTuff oil-resistant gloves w/ sleeve, 25" overall length	Blue	M	DZ	\$150.93
58-8657/L	PIP58-8657/L	XtraTuff oil-resistant gloves w/ sleeve, 25" overall length	Blue	L	DZ	\$150.93
58-8657/XL	PIP58-8657/XL	XtraTuff oil-resistant gloves w/ sleeve, 25" overall length	Blue	XL	DZ	\$150.93



58-8657



### MAXICHEM® BY ATG® MULTI-POLYMER BLEND GLOVES

Features blended polymer on fine gauge seamless knit liner and 12" gauntlet cuff. Exclusive micro-cup non-slip grip on palm and fingers. LiquiTech® Barrier Technology provides resistance to oils and liquids. Used for chemical sampling, offshore petroleum, acids and caustics, solvent-based cleaning, fertilizer and pesticide handling. Certified 100% chemical-resistant blended polymer, EN 374 AKL.



56-630

ITEM #	MARTIN #	DESCRIPTION	SIZES	UOM	PRICE
56-630/L	PIP56-630/L	MaxiChem gloves	L	DZ	\$126.10



### MAXIDRY® PLUS™ BY ATG® HI-PERFORMANCE NITRILE GLOVES

Features ultra lightweight nitrile on fine gauge seamless knit liner and gauntlet cuff. Exclusive micro-cup non-slip coating on palm and fingers offer non-slip capabilities. Unique wrist shape eliminates slippage in wrist area. LiquiTech® Barrier Technology provides resistance to oils and liquids. Silicone-free. 12" length. Used for offshore petroleum, light metal fabrication, parts handling and maintenance. EN certified 100% low level chemical and oil repellent, EN 374-2.



56-530

ITEM #	MARTIN #	DESCRIPTION	SIZES	UOM	PRICE
56-530/S	PIP56-530/S	MaxiDry Plus hi-performance nitrile gloves	S	DZ	\$92.53
56-530/M	PIP56-530/M	MaxiDry Plus hi-performance nitrile gloves	M	DZ	\$92.53
56-530/L	PIP56-530/L	MaxiDry Plus hi-performance nitrile gloves	L	DZ	\$92.53
56-530/XL	PIP56-530/XL	MaxiDry Plus hi-performance nitrile gloves	XL	DZ	\$92.53
56-530/XXL	PIP56-530/XXL	MaxiDry Plus hi-performance nitrile gloves	2XL	DZ	\$92.53



**PROCOAT®  
FOAM-INSULATED  
HI-VIZ PVC-COATED  
GLOVES**

Hi-viz color is great for visibility in warehouses and on highways. PVC coating is liquid-proof, and foam insulation helps keep hands warm and dry. Ideal for grease, acids, caustics and solvents. Features smooth coating and knit wrist.



58-7303

**⚠️ WARNING:** This product can expose you to chemicals including Diisononyl phthalate (DINP), which is known to the State of California to cause cancer. For more information go to [www.P65Warnings.ca.gov](http://www.P65Warnings.ca.gov).

ITEM #	MARTIN #	DESCRIPTION	SIZES	UOM	PRICE
58-7303	PIP58-7303	ProCoat insulated hi-viz PVC-coated gloves	Men's	DZ	\$52.38



**PBI/KEVLAR® HIGH  
HEAT GLOVES WITH  
GLASS CLOTH CUFF**

Made from 22 oz. PBI/Kevlar blend with 32 oz. glass cloth cuff and 22 oz. Thermonol palm patch. Features 14 oz. wool lining, clute cut and set in thumb style. Sewn with Kevlar. 14" Length.



GL PB22 221-14 AW06

ITEM #	MARTIN #	DESCRIPTION	UOM	PRICE
GL PB22 221-14 AW06	STGRGL PB22 221-14 AW06	PBI/Kevlar® high heat gloves	PR	\$75.29

**WELLS LAMONT  
Industrial**

**JOMAC®  
HEAVYWEIGHT  
TERRY  
CLOTH GLOVES**

White loop-out cut-and-sewn terry gloves with knit wrist. Protects up to 325° F. Ambidextrous.



766

ITEM #	MARTIN #	DESCRIPTION	SIZES	UOM	PRICE
766	WELS766	Jomac heavyweight terry cloth gloves	L	DZ	\$36.00

**WELLS LAMONT  
Industrial**

**JOMAC® EXTRA  
HEAVYWEIGHT  
TERRY  
CLOTH GLOVES**

Brown and white loop-out terry cloth gloves with 5" gauntlet. Ambidextrous. Lined to protect up to 450° F.



636HRL

ITEM #	MARTIN #	DESCRIPTION	SIZES	UOM	PRICE
636HRL	WELS636HRL	Extra heavyweight terry cloth gloves	XL	DZ	\$44.30

▶ OTHER STYLES AVAILABLE AT [WWW.MARTINSUPPLY.COM](http://WWW.MARTINSUPPLY.COM)



**PBI/KEVLAR® HIGH HEAT GLOVES WITH WING THUMB**

Made from 30 oz. PBI/Kevlar blend with 22 oz. Thermonol cuff and 14 oz. wool lining. Features Nomex® aramid palm patch and wing thumb. Sewn with Kevlar thread. 14" Length.



TH PB30 221-14 CWX02

ITEM #	MARTIN #	DESCRIPTION	UOM	PRICE
TH PB30 221-14 CWX02	STGRTH PB30 221-14 CWX02	PBI/Kevlar high heat gloves	PR	\$108.86



### GRIP N® HOT MILL NITRILE-COATED GLOVES

51/7147

Heavyweight, seamless knit glove helps to protect against high-heat, up to 400° F. Features a nitrile N-pattern palm coating for excellent grip and long life. Knit design allows hands to breathe. Used in auto assembly, food processing and manufacturing.

ITEM #	MARTIN #	DESCRIPTION	SIZES	UOM	PRICE
51/7147	NTH51/7147	Glove-within-glove seamless knit thermal gloves	Men's, 10 (XL)	DZ	\$70.35
51/7147C	NTH51/7147C	Glove-within-glove seamless knit thermal gloves w/ extended cuff	Men's, 10 (XL)	DZ	\$98.92



### WELLS LAMONT Industrial

#### STANDARD WEIGHT HOT MILL GLOVES

Features 24 oz. natural cotton with nap out, straight thumb and safety cuff. Protects up to 300° F.



Y6243

ITEM #	MARTIN #	DESCRIPTION	SIZES	UOM	PRICE
Y6243L	WELSY6243L	Standard weight hot mill gloves	L	DZ	\$29.40



### KEVLAR® BLEND HIGH HEAT PROTECTION GLOVES

Durable, flame-resistant, heat- and cut-resistant. Features Thermonal blend, full 11 oz. wool lining, 14" length and Kevlar stitching for added protection.



TH210-14F

ITEM #	MARTIN #	DESCRIPTION	UOM	PRICE
TH210-14F	STGRTH210-14F	14" High heat gloves	PR	\$35.00
TH252R-14	STGRTH252R-14	14" Reversible high heat mitts	PR	\$35.71
ATH TH 210-14 F	STGRATH TH 210-14 F	14" Aluminized Thermonal gloves	PR	\$49.71
TH 250R-14 F	STGRTH 250R-14 F	14" Reversible Thermonal high heat mitts	PR	\$29.00



### 14" ALUMINIZED CARBON/KEVLAR® GLOVES WITH LEATHER PALM

Aluminized back gloves with 19 oz. aluminized Carbon/Kevlar and 3.5 oz. special tanned split heat-resistant leather palm. Features wing thumb, Gunn cut and 11 oz. knitted wool lining. Sewn with Kevlar. 14" Length.



ACK SC 13902-14 F

ITEM #	MARTIN #	DESCRIPTION	UOM	PRICE
ACK SC 13902-14 F	STGRACK SC 13902-14 F	Aluminized Carbon/Kevlar gloves	PR	\$42.29

### WELLS LAMONT Industrial

#### JOMAC® KEVLAR® HEAT-RESISTANT GLOVES

Heavyweight, 100% Kevlar outer shell fully lined with virgin wool. 5" Flame-resistant duck gauntlet cuff. Loop-out, clute pattern. Protects up to 700° F.



625

ITEM #	MARTIN #	DESCRIPTION	SIZES	UOM	PRICE
625	WELS625	Heat-resistant gloves w/ gauntlet cuff	XL	DZ	\$410.40

## WELLS LAMONT

Industrial

### KEVLAR®/NOMEX® SEAMLESS GLOVES

Kevlar/Nomex outer shell allows wearers to handle hot objects and protects up to 500° F. Fully lined with cotton for softness. Ambidextrous with knit continuous cuff.

ITEM #	MARTIN #	DESCRIPTION	SIZES	UOM	PRICE
2610S	WELS2610S	Kevlar/Nomex seamless gloves	S	DZ	\$129.60
2610M	WELS2610M	Kevlar/Nomex seamless gloves	M	DZ	\$129.60
2610L	WELS2610L	Kevlar/Nomex seamless gloves	L	DZ	\$129.60
2610XL	WELS2610XL	Kevlar/Nomex seamless gloves	XL	DZ	\$152.60



2610

## WELLS LAMONT

Industrial

### JOMAC® COTTON-LINED KEVLAR® GLOVES

Heavyweight glove with 100% Kevlar outer shell, cotton lining and 5 1/2" gauntlet cuff. Loop-out, clute pattern. Protects to 700° F.

ITEM #	MARTIN #	DESCRIPTION	SIZES	UOM	PRICE
636KCL	WELS636KCL	Jomac cotton-lined Kevlar gloves	XL	DZ	\$527.40



636KCL

## WELLS LAMONT

Industrial

### JOMAC® KEVLAR® WOOL-LINED GLOVES

100% Kevlar outer shell fully lined with virgin wool. Clute cut, loop-out. Protects up to 700° F.

ITEM #	MARTIN #	DESCRIPTION	SIZES	UOM	PRICE
305KWL	WELS305KWL	Jomac Kevlar wool-lined gloves	XL	DZ	\$730.60



305KWL



STEEL GRIP INC.

PB22 9738-14 B01W

### REVERSIBLE PBI/KEVLAR® HIGH HEAT MITTS

Made from 22 oz. PBI/Kevlar blend with 3-ply insulating palm patch and full 14 oz. knit wool lining. Features butterfly thumb and 14" length. Reversible style. Sewn with Kevlar.

ITEM #	MARTIN #	DESCRIPTION	UOM	PRICE
PB22 9738-14 B01W	STGRPB22 9738-14 B01W	Reversible PBI/Kevlar High Heat Mitts	PR	\$65.00



STEEL GRIP INC.

### 8" REVERSIBLE THERMONOL HIGH HEAT COVER MITTS

Reversible, open-end style. Full thumb fits over most gloves. Made from 22 oz. Thermonol. Sewn with Kevlar®. 8" Length.

ITEM #	MARTIN #	DESCRIPTION	UOM	PRICE
TH 7614R-8 CA	STGRTH 7614R-8 CA	8" Reversible Thermonol high heat cover mitts	PR	\$16.57



TH 7614R-8 CA





### 10" REVERSIBLE GLASS COVER MITTS

High heat cover mitts for extreme handling. Reversible, closed-end style. Made from 28 oz. glass cloth (Vermiculite) with inner glass palm patch, 2-ply inconel wire mesh over outer layer and set-in thumb style. Sewn with Kevlar®. 10" Length.



GLP 9001-10 S02

ITEM #	MARTIN #	DESCRIPTION	UOM	PRICE
GLP 9001-10 S02	STGRGLP 9001-10 S02	10" Reversible glass cover mitts	PR	\$95.00



### 1329 ECONOMY GOATSKIN TIG GLOVES

Top-grain goatskin. Features 4" cuff, unlined construction and wing thumb. Sewn with Kevlar® thread.



1329

ITEM #	MARTIN #	DESCRIPTION	SIZES	UOM	PRICE
1329M	TILL1329M	Goatskin TIG gloves	M	PR	\$6.58
1329L	TILL1329L	Goatskin TIG gloves	L	PR	\$6.58
1329XL	TILL1329XL	Goatskin TIG gloves	XL	PR	\$6.58



### MIG TIG WELDERS GLOVES

All-leather construction with no inside linings. Provides dexterity and light heat protection. Ideal for MIG TIG welding and automotive assembly.

Note: DuPont™ and Kevlar® are trademarks or registered trademarks of E. I. du Pont de Nemours and Company.

**⚠️ WARNING:** Model 75-320 can expose you to chemicals including Formaldehyde (gas), which is known to the State of California to cause cancer, and Chromium (hexavalent compounds), which is known to the State of California to cause cancer and birth defects or other reproductive harm. For more information go to [www.P65Warnings.ca.gov](http://www.P65Warnings.ca.gov).



75-320

ITEM #	MARTIN #	DESCRIPTION	SIZES	UOM	PRICE
75-2022/L	PIP75-2022/L	MIG TIG gloves, top grain cowhide, band top cuff, wing thumb	L	DZ	\$136.93
75-2022/XL	PIP75-2022/XL	MIG TIG gloves, top grain cowhide, band top cuff, wing thumb	XL	DZ	\$140.17
75-320/L	PIP75-320/L	MIG TIG gloves, top grain pigskin w/ split leather cuff, unlined palm & straight thumb	L	DZ	\$117.12
75-4854	PIP75-4854	MIG TIG gloves, top grain goatskin, 4" leather cuff, wing thumb	S-XL	DZ	\$111.95
75-4904/L	PIP75-4904/L	MIG TIG gloves, top grain goatskin, 2" leather cuff, clute pattern	L	DZ	\$113.82



### 750 STICK WELDERS GLOVES

Premium top-grain elkskin gloves feature reinforced thumb, lock stitching with Kevlar® thread, welted fingers to protect seams, and unlined palm for added dexterity. Cotton/foam-lined back offers added heat protection and 14" length enhances safety. Pearl.



750

ITEM #	MARTIN #	DESCRIPTION	SIZES	UOM	PRICE
750S	TILL750S	Top-grain elkskin welders gloves	S	PR	\$24.63
750M	TILL750M	Top-grain elkskin welders gloves	M	PR	\$24.63
750L	TILL750L	Top-grain elkskin welders gloves	L	PR	\$24.63
750XL	TILL750XL	Top-grain elkskin welders gloves	XL	PR	\$24.63



### IRONCAT® PREMIUM KIDSKIN TIG GLOVES

Made of premium top grain kidskin. Features soft leather, straight thumb and heat/flame resistance. Sewn with Kevlar® thread.

6141

ITEM #	MARTIN #	DESCRIPTION	SIZES	UOM	PRICE
6141/S	WCM6141/S	IRONCAT premium kidskin TIG gloves	S	PR	\$9.40
6141/M	WCM6141/M	IRONCAT premium kidskin TIG gloves	M	PR	\$9.40
6141/L	WCM6141/L	IRONCAT premium kidskin TIG gloves	L	PR	\$9.40
6141/XL	WCM6141/XL	IRONCAT premium kidskin TIG gloves	XL	PR	\$9.40
6141/2XL	WCM6141/2XL	IRONCAT premium kidskin TIG gloves	2XL	PR	\$9.90





**855 GOLD DEERSKIN STICK GLOVES**

Made with top grain deerskin back and cowhide palm. Features cotton/foam lined back for heat protection, unlined palm for dexterity, straight thumb and fully welted fingers. Sewn with Kevlar® thread.



855

ITEM #	MARTIN #	DESCRIPTION	SIZES	UOM	PRICE
855M	TILL855M	Gold deerskin stick gloves	M	PR	\$20.75
855L	TILL855L	Gold deerskin stick gloves	L	PR	\$20.75
855XL	TILL855XL	Gold deerskin stick gloves	XL	PR	\$20.75



**1000 SHOULDER SPLIT COWHIDE STICK WELDERS GLOVES**

Shoulder split cowhide with cotton lining for comfort. Features welted fingers and locked stitching with cotton thread. 14" Length. Also available in left hand only (1000LL). Pearl.



1000

ITEM #	MARTIN #	DESCRIPTION	SIZES	UOM	PRICE
1000S	TILL1000S	1000 Stick welders gloves	S	Pr	\$6.15
1000M	TILL1000M	1000 Stick welders gloves	M	Pr	\$6.15
1000L	TILL1000L	1000 Stick welders gloves	L	Pr	\$6.15
1000XL	TILL1000XL	1000 Stick welders gloves	XL	Pr	\$6.15



**48 INSULATED MIG GLOVES**

Top-grain goatskin palm and cowhide split back resists heat. Fleece-lined for added protection. Features straight thumb, elastic back, 3 1/2" cuff, thumb strap for extra strength and Kevlar® stitching for seam protection.



48

ITEM #	MARTIN #	DESCRIPTION	SIZES	UOM	PRICE
48M	TILL48M	Insulated MIG gloves	M	PR	\$12.72
48L	TILL48L	Insulated MIG gloves	L	PR	\$12.72
48XL	TILL48XL	Insulated MIG gloves	XL	PR	\$12.72



**50 MIG WELDERS GLOVES**

Top-grain cowhide palm with cowhide split reinforcements and cowhide split back with elastic for best fit. Features top-grain seamless index finger, fleece lining and 4" cuff for added protection. Sewn with Kevlar® thread for strength and heat resistance.



50

ITEM #	MARTIN #	DESCRIPTION	SIZES	UOM	PRICE
50L	TILL50L	Cowhide MIG welders gloves	L	PR	\$17.62
50XL	TILL50XL	Cowhide MIG welders gloves	XL	PR	\$17.62



### 1250 PREMIUM COWHIDE SPLIT STICK WELDERS GLOVES

Durable, premium side split cowhide with cotton/foam lining for insulation. Double reinforced thumb. Welted fingers protect stitching. Lock stitched with Kevlar® thread for added strength. 14" Length. Blue.



1250

ITEM #	MARTIN #	DESCRIPTION	SIZES	UOM	PRICE
1250S	TILL1250S	Side split cowhide welders gloves	S	PR	\$10.15
1250M	TILL1250M	Side split cowhide welders gloves	M	PR	\$10.15
1250L	TILL1250L	Side split cowhide welders gloves	L	PR	\$10.00
1250XL	TILL1250XL	Side split cowhide welders gloves	XL	PR	\$10.15
12502X	TILL12502X	Side split cowhide welders gloves	2XL	PR	\$10.15



### GLOVES FOR GLORY CUT-RESISTANT MIG/TIG GLOVES

Made from premium top-grain goatskin with Kevlar® lining. Features Gunn cut, wing thumb and 4 1/2" blue split cow leather cuff. Sewn with Kevlar. ANSI cut level A2.

**⚠️ WARNING:** Cancer and reproductive harm. For more information go to [www.P65Warnings.ca.gov](http://www.P65Warnings.ca.gov).



4850K

ITEM #	MARTIN #	DESCRIPTION	SIZES	UOM	PRICE
4850KS	MCR4850KS	Gloves for Glory cut-resistant MIG/TIG gloves	S	DZ	\$210.00
4850KM	MCR4850KM	Gloves for Glory cut-resistant MIG/TIG gloves	M	DZ	\$210.00
4850KL	MCR4850KL	Gloves for Glory cut-resistant MIG/TIG gloves	L	DZ	\$210.00
4850KXL	MCR4850KXL	Gloves for Glory cut-resistant MIG/TIG gloves	XL	DZ	\$225.00
4850KXXL	MCR4850KXXL	Gloves for Glory cut-resistant MIG/TIG gloves	2XL	DZ	\$235.00



### 1354 COWHIDE CUT-RESISTANT MIG WELDING GLOVES

Top-grain cowhide palm with cowhide split back. Features full Kevlar® sock lining, seamless index finger and 4" cuff. ANSI cut level A2.

ITEM #	MARTIN #	DESCRIPTION	SIZES	UOM	PRICE
1354S	TILL1354S	Cowhide cut-resistant MIG gloves	S	PR	\$23.54
1354M	TILL1354M	Cowhide cut-resistant MIG gloves	M	PR	\$23.54
1354L	TILL1354L	Cowhide cut-resistant MIG gloves	L	PR	\$23.54
1354XL	TILL1354XL	Cowhide cut-resistant MIG gloves	XL	PR	\$23.54
13542X	TILL13542X	Cowhide cut-resistant MIG gloves	2XL	PR	\$23.54



1354



### MUSTANG™ MIG/TIG WELDING GLOVES

Made from premium grain, select heavy side cow leather on the palm and back. Features die-cut Gunn pattern, wing thumb, in-sewn at all fingertips and a long gauntlet cuff. All seams are fully-welted with turned leather hems and flame-resistant sleeves. Sewn throughout with heat-resistant DuPont™ Kevlar® thread. Unlined. Ideal for welding and heat applications, plus all general purpose applications requiring heat, flame or spark protection.

**⚠️ WARNING:** Cancer and reproductive harm. For more information go to [www.P65Warnings.ca.gov](http://www.P65Warnings.ca.gov).



4950

ITEM #	MARTIN #	DESCRIPTION	SIZES	UOM	PRICE
4940-S	MCR4940-S	Welding gloves w/ reinforced thumb & 5" gauntlet cuff	S	DZ	\$208.20
4940-M	MCR4940-M	Welding gloves w/ reinforced thumb & 5" gauntlet cuff	M	DZ	\$208.20
4940-L	MCR4940-L	Welding gloves w/ reinforced thumb & 5" gauntlet cuff	L	DZ	\$208.20
4940-XL	MCR4940-XL	Welding gloves w/ reinforced thumb & 5" gauntlet cuff	XL	DZ	\$225.00
4950-S	MCR4950S	Mig/Tig welding gloves, unlined	S	DZ	\$196.80
4950-M	MCR4950M	Mig/Tig welding gloves, unlined	M	DZ	\$196.80
4950-L	MCR4950L	Mig/Tig welding gloves, unlined	L	DZ	\$196.80
4950-XL	MCR4950XL	Mig/Tig welding gloves, unlined	XL	DZ	\$205.80



**WELDA-BEAST WELDING GLOVES**

Features all blue select side split cow leather, reinforced palm strap and thumb pad, fully welted, full sock cotton palm lining with red foam padding, and a self-hemmed cuff with black cotton drill lining. One-piece back is sewn with DuPont™ Kevlar®.



4602

ITEM #	MARTIN #	DESCRIPTION	SIZES	UOM	PRICE
4602	MCR4602	Welda-Beast welding gloves	XL	DZ	\$155.00



**BLUE BISON™ WELDERS GLOVES**

Sewn with DuPont™ Kevlar® thread to prolong glove life and avoid burning. Fully welted and with a 1-piece back to extend wear. Features cotton foam lining and reinforced palm. Ideal for welding and hot, heavy material handling. Blue.



73-7007

**⚠️ WARNING:** This product can expose you to chemicals including Chromium (hexavalent compounds), which is known to the State of California to cause cancer and birth defects or other reproductive harm. For more information go to [www.P65Warnings.ca.gov](http://www.P65Warnings.ca.gov).

ITEM #	MARTIN #	DESCRIPTION	UOM	PRICE
73-7007	PIP73-7007	Shoulder grade welders gloves	DZ	\$104.87



**WELDERS GLOVES**

Features leather split cowhide construction and fully welted design with a 1-piece back to extend wear. Ideal for welding and hot, heavy material handling.

**⚠️ WARNING:** This product can expose you to chemicals including Formaldehyde (gas), which is known to the State of California to cause cancer, and Chromium (hexavalent compounds), which is known to the State of California to cause cancer and birth defects or other reproductive harm. For more information go to [www.P65Warnings.ca.gov](http://www.P65Warnings.ca.gov).

ITEM #	MARTIN #	DESCRIPTION	COLOR	SIZES	UOM	PRICE
73-7015A	PIP73-7015A	Welders gloves, shoulder grade w/ cotton lining	Russet	L	DZ	\$79.58
73-7018	PIP73-7018	Welders gloves, shoulder grade w/ cotton foam lining, reinforced thumb, Kevlar sewn	Blue	L	DZ	\$105.50
73-7250	PIP73-7250	Welders gloves, side split w/ cotton foam lining, double reinforced palm & thumb, Kevlar sewn	Blue	L	DZ	\$121.43
73-888A	PIP73-888A	Welders gloves, economy grade w/ cotton lining	Gray	L	DZ	\$60.12



73-7015A



# ▶ PROTECTIVE CLOTHING



*These fine manufacturers help us bring you custom tailored solutions:*

DuPont  
Personal Protection



Employers have duties concerning the provision and use of personal protective equipment (PPE) at work. PPE is equipment that will protect the user against health or safety risks at work. Protective clothing is any clothing specifically designed or treated to protect personnel from hazards that are caused by extreme environmental conditions, or a dangerous work environment.

Ergonomics.....	76
Disposable Clothing .....	77-79
Flame-Resistant Clothing .....	79-83
Specialty Clothing.....	84-85
Hi-Viz Clothing .....	85-88
Rainwear .....	89-90
Footwear .....	91-93



**PROFLEX® 1100SF  
STANDARD BACK SUPPORTS**

Features patented non-conductive Sticky Fingers® stays that deliver firm, continuous lower back and abdominal support. Durable 280-denier spandex body cloth offers breathability and consistent stretch. Adjustable 2-stage closure helps remind wearers to lift properly. The 1 1/4" knit elastic suspenders are adjustable and detachable. Patented Power Panel Positioners™ keep elastic bands close to sides. Machine washable. Black.



1100SF

ITEM #	MARTIN #	DESCRIPTION	SIZES	UOM	PRICE
11601	ERGO11601	Standard back support	XS	EA	\$31.00
11602	ERGO11602	Standard back support	S	EA	\$31.00
11603	ERGO11603	Standard back support	M	EA	\$31.00
11604	ERGO11604	Standard back support	L	EA	\$31.00
11605	ERGO11605	Standard back support	XL	EA	\$31.00
11606	ERGO11606	Standard back support	2XL	EA	\$31.00
11607	ERGO11607	Standard back support	3XL	EA	\$31.00
11608	ERGO11608	Standard back support	4XL	EA	\$31.00

▶ OTHER STYLES AVAILABLE AT [WWW.MARTINSUPPLY.COM](http://WWW.MARTINSUPPLY.COM)



**PROFLEX® 2000SF  
HIGH-PERFORMANCE  
BACK SUPPORTS**

Contoured V-shape naturally positions the back support. Sticky Fingers® stays provide excellent gripping properties and deliver firm, continuous lower back and abdominal support. Power Panel Positioners™ keep elastic bands close to sides so they won't fall out of reach when not in use. Also features reinforced woven cinch tabs and 840-denier durable spandex body cloth for breathability and consistent stretch. Adjustable 2-stage closure reminds wearers to lift properly. Includes detachable 1 1/2" knit elastic suspenders. Machine washable. Black.



2000SF

ITEM #	MARTIN #	DESCRIPTION	SIZES	UOM	PRICE
11281	ERGO11281	High-performance back support	XS	EA	\$41.18
11282	ERGO11282	High-performance back support	S	EA	\$41.18
11283	ERGO11283	High-performance back support	M	EA	\$41.18
11284	ERGO11284	High-performance back support	L	EA	\$41.18
11285	ERGO11285	High-performance back support	XL	EA	\$41.18
11286	ERGO11286	High-performance back support	2XL	EA	\$41.18
11287	ERGO11287	High-performance back support	3XL	EA	\$41.18
11288	ERGO11288	High-performance back support	4XL	EA	\$41.18



**PROFLEX® 4000 SINGLE  
STRAP WRIST SUPPORTS**

Limits downward wrist movements and features patented Open-Center Stay™ to reduce pressure on the median nerve. Durable fabric design is fully adjustable for an exact fit. Machine washable.

70002



ITEM #	MARTIN #	DESCRIPTION	COLOR	SIZES	UOM	PRICE
70002	ERGO70002	Single strap wrist support, right hand	Black	S	EA	\$12.55
70004	ERGO70004	Single strap wrist support, right hand	Black	M	EA	\$12.55
70006	ERGO70006	Single strap wrist support, right hand	Black	L	EA	\$12.55
70008	ERGO70008	Single strap wrist support, right hand	Black	XL	EA	\$12.55
70012	ERGO70012	Single strap wrist support, left hand	Black	S	EA	\$12.55
70014	ERGO70014	Single strap wrist support, left hand	Black	M	EA	\$12.55
70016	ERGO70016	Single strap wrist support, left hand	Black	L	EA	\$12.55
70018	ERGO70018	Single strap wrist support, left hand	Black	XL	EA	\$12.55
70102	ERGO70102	Single strap wrist support, right hand	Tan	S	EA	\$12.55
70104	ERGO70104	Single strap wrist support, right hand	Tan	M	EA	\$12.55
70106	ERGO70106	Single strap wrist support, right hand	Tan	L	EA	\$12.55
70108	ERGO70108	Single strap wrist support, right hand	Tan	XL	EA	\$12.55
70112	ERGO70112	Single strap wrist support, left hand	Tan	S	EA	\$12.55
70114	ERGO70114	Single strap wrist support, left hand	Tan	M	EA	\$12.55
70116	ERGO70116	Single strap wrist support, left hand	Tan	L	EA	\$12.55
70118	ERGO70118	Single strap wrist support, left hand	Tan	XL	EA	\$12.55



**PROFLEX® 4010 DUAL  
STRAP WRIST SUPPORTS**

Durable, dual strap wrist supports limit upward and downward wrist movements and include patented Open-Center Stay™ to reduce pressure on median nerve. Fully adjustable for comfortable wear. Machine washable.

70022



ITEM #	MARTIN #	DESCRIPTION	COLOR	SIZES	UOM	PRICE
70022	ERGO70022	Dual strap wrist support, right hand	Black	S	EA	\$16.55
70024	ERGO70024	Dual strap wrist support, right hand	Black	M	EA	\$16.55
70026	ERGO70026	Dual strap wrist support, right hand	Black	L	EA	\$16.55
70028	ERGO70028	Dual strap wrist support, right hand	Black	XL	EA	\$16.55
70032	ERGO70032	Dual strap wrist support, left hand	Black	S	EA	\$16.55
70034	ERGO70034	Dual strap wrist support, left hand	Black	M	EA	\$16.55
70036	ERGO70036	Dual strap wrist support, left hand	Black	L	EA	\$16.55
70038	ERGO70038	Dual strap wrist support, left hand	Black	XL	EA	\$16.55
70122	ERGO70122	Dual strap wrist support, right hand	Tan	S	EA	\$16.55
70124	ERGO70124	Dual strap wrist support, right hand	Tan	M	EA	\$16.55
70126	ERGO70126	Dual strap wrist support, right hand	Tan	L	EA	\$16.55
70128	ERGO70128	Dual strap wrist support, right hand	Tan	XL	EA	\$16.55
70132	ERGO70132	Dual strap wrist support, left hand	Tan	S	EA	\$16.55
70134	ERGO70134	Dual strap wrist support, left hand	Tan	M	EA	\$16.55
70136	ERGO70136	Dual strap wrist support, left hand	Tan	L	EA	\$16.55
70138	ERGO70138	Dual strap wrist support, left hand	Tan	XL	EA	\$16.55

## DuPont Personal Protection

### DUPONT™ PROSHIELD® 10 COVERALLS

Spunbond-meltblown-spunbond (SMS) garments have been optimized for comfort, softness and breathability. Features serged seams and zipper front with storm flap. Offers protection from dirt, grime and non-hazardous dry particles. Applications include general maintenance and janitorial/cleaning. 25/Case.



ITEM #	MARTIN #	COLOR	SIZES	UOM	PRICE
<i>Collar, Open Wrists and Ankles</i>					
PB120SBUMD002500	EIDUPB120SBUMD002500	Blue	M	CS	\$53.52
PB120SBULG002500	EIDUPB120SBULG002500	Blue	L	CS	\$53.52
PB120SBUXL002500	EIDUPB120SBUXL002500	Blue	XL	CS	\$53.52
PB120SBU2X002500	EIDUPB120SBU2X002500	Blue	2XL	CS	\$56.73
PB120SBU3X002500	EIDUPB120SBU3X002500	Blue	3XL	CS	\$60.13
PB120SBU4X002500	EIDUPB120SBU4X002500	Blue	4XL	CS	\$64.95
PB120SBU5X002500	EIDUPB120SBU5X002500	Blue	5XL	CS	\$70.13
PB120SWHMD002500	EIDUPB120SWHMD002500	White	M	CS	\$53.52
PB120SWHLG002500	EIDUPB120SWHLG002500	White	L	CS	\$53.52
PB120SWHXL002500	EIDUPB120SWHXL002500	White	XL	CS	\$53.52
PB120SWH2X002500	EIDUPB120SWH2X002500	White	2XL	CS	\$56.73
PB120SWH3X002500	EIDUPB120SWH3X002500	White	3XL	CS	\$60.13
PB120SWH4X002500	EIDUPB120SWH4X002500	White	4XL	CS	\$64.95
<i>Collar, Elastic Wrists and Ankles</i>					
PB125SBUMD002500	EIDUPB125SBUMD002500	Blue	M	CS	\$56.78
PB125SBULG002500	EIDUPB125SBULG002500	Blue	L	CS	\$56.78
PB125SBUXL002500	EIDUPB125SBUXL002500	Blue	XL	CS	\$56.78
PB125SBU2X002500	EIDUPB125SBU2X002500	Blue	2XL	CS	\$60.18
PB125SBU3X002500	EIDUPB125SBU3X002500	Blue	3XL	CS	\$63.80

ITEM #	MARTIN #	COLOR	SIZES	UOM	PRICE
<i>Attached Hood, Elastic Wrists and Ankles</i>					
PB127SBUMD002500	EIDUPB127SBUMD002500	Blue	M	CS	\$60.85
PB127SBULG002500	EIDUPB127SBULG002500	Blue	L	CS	\$60.85
PB127SBUXL002500	EIDUPB127SBUXL002500	Blue	XL	CS	\$60.85
PB127SBU2X002500	EIDUPB127SBU2X002500	Blue	2XL	CS	\$64.50
PB127SBU3X002500	EIDUPB127SBU3X002500	Blue	3XL	CS	\$68.37
PB127SBU4X002500	EIDUPB127SBU4X002500	Blue	4XL	CS	\$73.83
PB127SWHMD002500	EIDUPB127SWHMD002500	White	M	CS	\$60.85
PB127SWHLG002500	EIDUPB127SWHLG002500	White	L	CS	\$60.85
PB127SWHXL002500	EIDUPB127SWHXL002500	White	XL	CS	\$60.85
PB127SWH2X002500	EIDUPB127SWH2X002500	White	2XL	CS	\$64.50
PB127SWH3X002500	EIDUPB127SWH3X002500	White	3XL	CS	\$68.37
PB127SWH4X002500	EIDUPB127SWH4X002500	White	4XL	CS	\$73.83



### MICROMAXNS COVERALLS

Offers lightweight and economical microporous protection from dirt, grease, grime and light chemical splash. Features high moisture vapor transmission rate (MVTR) for better ventilation, worker comfort and strength, wet or dry. Zipper front closure. White. 25/Case.

ITEM #	MARTIN #	SIZES	UOM	PRICE
<i>Collar, Open Wrists and Ankles</i>				
CTL412-S	LAKCTL412-S	S	CS	\$74.17
CTL412-M	LAKCTL412-M	M	CS	\$74.17
CTL412-L	LAKCTL412-L	L	CS	\$74.17
CTL412-XL	LAKCTL412-XL	XL	CS	\$74.17
CTL412-2X	LAKCTL412-2X	2XL	CS	\$74.17
CTL412-3X	LAKCTL412-3X	3XL	CS	\$77.90
CTL412-4X	LAKCTL412-4X	4XL	CS	\$82.55
CTL412-5X	LAKCTL412-5X	5XL	CS	\$88.75
<i>Attached Hood and Boots, Elastic Wrists</i>				
CTL414-S	LAKCTL414-S	S	CS	\$93.87
CTL414-M	LAKCTL414-M	M	CS	\$93.87
CTL414-L	LAKCTL414-L	L	CS	\$93.87
CTL414-XL	LAKCTL414-XL	XL	CS	\$93.87
CTL414-2X	LAKCTL414-2X	2XL	CS	\$93.87
CTL414-3X	LAKCTL414-3X	3XL	CS	\$98.55
CTL414-4X	LAKCTL414-4X	4XL	CS	\$104.47
CTL414-5X	LAKCTL414-5X	5XL	CS	\$112.30

ITEM #	MARTIN #	SIZES	UOM	PRICE
<i>Collar, Elastic Wrists and Ankles</i>				
CTL417-S	LAKCTL417-S	S	CS	\$81.95
CTL417-M	LAKCTL417-M	M	CS	\$81.95
CTL417-L	LAKCTL417-L	L	CS	\$81.95
CTL417-XL	LAKCTL417-XL	XL	CS	\$81.95
CTL417-2X	LAKCTL417-2X	2XL	CS	\$81.95
CTL417-3X	LAKCTL417-3X	3XL	CS	\$86.03
CTL417-4X	LAKCTL417-4X	4XL	CS	\$91.22
CTL417-5X	LAKCTL417-5XL	5XL	CS	\$98.05
<i>Attached Hood, Elastic Wrists and Ankles</i>				
CTL428-S	LAKCTL428-S	S	CS	\$86.27
CTL428-M	LAKCTL428-M	M	CS	\$86.27
CTL428-L	LAKCTL428-L	L	CS	\$86.27
CTL428-XL	LAKCTL428-XL	XL	CS	\$86.27
CTL428-2X	LAKCTL428-2X	2XL	CS	\$86.27
CTL428-3X	LAKCTL428-3X	3XL	CS	\$90.58
CTL428-4X	LAKCTL428-4X	4XL	CS	\$96.02
CTL428-5X	LAKCTL428-5X	5XL	CS	\$103.22





**MICROMAXNS APPAREL**

Offers lightweight and economical microporous protection from dirt, grease, grime and light chemical splash. Features high moisture vapor transmission rate (MVTR) for better ventilation, worker comfort and strength, wet or dry. Lab coats and shirts have snap front closure. Pants have an elastic waist. White.

ITEM #	MARTIN #	DESCRIPTION	SIZES	UOM	PRICE
CTL101-S	LAKCTL101-S	MicroMaxNS long sleeve lab coats, 2 pockets	S	30/CS	\$88.83
CTL101-M	LAKCTL101-M	MicroMaxNS long sleeve lab coats, 2 pockets	M	30/CS	\$88.83
CTL101-L	LAKCTL101-L	MicroMaxNS long sleeve lab coats, 2 pockets	L	30/CS	\$88.83
CTL101-XL	LAKCTL101-XL	MicroMaxNS long sleeve lab coats, 2 pockets	XL	30/CS	\$88.83
CTL101-2X	LAKCTL101-2X	MicroMaxNS long sleeve lab coats, 2 pockets	2XL	30/CS	\$88.83
CTL101-3X	LAKCTL101-3X	MicroMaxNS long sleeve lab coats, 2 pockets	3XL	30/CS	\$93.28
CTL101-4X	LAKCTL101-4X	MicroMaxNS long sleeve lab coats, 2 pockets	4XL	30/CS	\$98.88
CTL101-5X	LAKCTL101-5X	MicroMaxNS long sleeve lab coats, 2 pockets	5XL	30/CS	\$106.32
CTL201-M	LAKCTL201-M	MicroMaxNS long sleeve shirts	M	50/CS	\$140.90
CTL201-L	LAKCTL201-L	MicroMaxNS long sleeve shirts	L	50/CS	\$140.90
CTL201-XL	LAKCTL201-XL	MicroMaxNS long sleeve shirts	XL	50/CS	\$140.90
CTL301-S	LAKCTL301-S	MicroMaxNS pants	S	50/CS	\$108.98
CTL301-M	LAKCTL301-M	MicroMaxNS pants	M	50/CS	\$108.98
CTL301-L	LAKCTL301-L	MicroMaxNS pants	L	50/CS	\$108.98
CTL301-XL	LAKCTL301-XL	MicroMaxNS pants	XL	50/CS	\$108.98
CTL301-2X	LAKCTL301-2X	MicroMaxNS pants	2XL	50/CS	\$108.98
CTL301-3X	LAKCTL301-3X	MicroMaxNS pants	3XL	50/CS	\$114.42
CTL301-4X	LAKCTL301-4X	MicroMaxNS pants	4XL	50/CS	\$121.28
CTL301-5X	LAKCTL301-5X	MicroMaxNS pants	5XL	50/CS	\$130.40
CTL601	LAKCTL601	MicroMaxNS aprons w/ sewn ties	28" x 36"	100/CS	\$90.70
CTL850-18	LAKCTL850-18	MicroMaxNS sleeves w/ elastic both ends	18"	100 PR/CS	\$57.52
901NS-L/XL	LAK901NS-L/XL	MicroMaxNS non-skid shoe covers	L/XL	200/CS	\$178.12
903NS-L/XL	LAK903NS-L/XL	MicroMaxNS non-skid boot covers	L/XL	200/CS	\$271.07



▶ OTHER STYLES AVAILABLE AT [WWW.MARTINSUPPLY.COM](http://WWW.MARTINSUPPLY.COM)

PROTECTIVE CLOTHING | DISPOSABLE



**KLEENGUARD™ A40 BREATHABLE BACK LIQUID AND PARTICLE PROTECTION COVERALLS**

Front and sleeves are a microporous film laminate designed for protection against hazardous particles and liquids while breathable back is a SMS fabric extending from shoulder to ankle to keep wearer cool. Features attached hood, elastic wrists and ankles. Provides air movement and ventilation. Ideal for fiberglass manufacturing, tank cleaning, utilities and liquid handling. White with blue back. 25/Case. NFPA 99 compliant anti-static material. Passes ASTM F1670 testing for penetration of blood and bodily fluids. Meets ANSI/ISEA 101-1996 sizing standard.

ITEM #	MARTIN #	DESCRIPTION	SIZES	UOM	PRICE
37591	KCC37591	A40 Breathable Back Coveralls	L	CS	\$107.63
37163	KCC37163	A40 Breathable Back Coveralls	XL	CS	\$107.63
37164	KCC37164	A40 Breathable Back Coveralls	2XL	CS	\$107.63
37165	KCC37165	A40 Breathable Back Coveralls	3XL	CS	\$112.88
38508	KCC38508	A40 Breathable Back Coveralls	4XL	CS	\$118.13
37584	KCC37584	A40 Breathable Back Coveralls	5XL/6XL	CS	\$124.25







### KLEENGUARD™ A20 BREATHABLE PARTICLE PROTECTION LAB COATS

Constructed of breathable, patented white MicroForce\* barrier SMS fabric which provides protection against hazardous particles. Patented Reflex\* Coverall design offers excellent fit and freedom of movement. Features hook-and-loop front closure, elastic wrists and no pockets. Typical uses include laboratories, decontamination modesty garment, remediation, pesticides and heavy-dust environments. 30/Pack.

ITEM #	MARTIN #	DESCRIPTION	SIZES	UOM	PRICE
35619	KCC35619	A20 Lab coats	M	PK	\$108.15
35620	KCC35620	A20 Lab coats	L	PK	\$108.15
35621	KCC35621	A20 Lab coats	XL	PK	\$108.15
35622	KCC35622	A20 Lab coats	2XL	PK	\$108.15
35623	KCC35623	A20 Lab coats	3XL	PK	\$116.55
35624	KCC35624	A20 Lab coats	4XL	PK	\$126.00

35623



### KLEENGUARD™ A40 LIQUID AND PARTICLE PROTECTION SHOE COVERS

Made of breathable, microporous white film laminate. Serged seams. Low in lint. Passes NFPA 99 criteria for anti-static materials. 400/Case.

ITEM #	MARTIN #	DESCRIPTION	SIZES	UOM	PRICE
44490	KCC44490	7" Shoe covers, fully elasticized	XL/2XL	CS	\$133.00

44490



### FLAME-RESISTANT JACKET

Treated with Westex™ Indura® for flame resistance. Made of 12 oz., 100% pre-shrunk cotton for secondary protection that safeguards workers exposed to open flame, sparks and similar heat sources. Applications include welding, foundry and utilities. Features snap closure on front and wrists, inside left breast pocket, 3" lay-down collar and set-in sleeve. 30" Length. Green.

ITEM #	MARTIN #	SIZES	UOM	PRICE
WC 16750-S	STGRWC 16750-S	S	EA	\$36.00
WC 16750-M	STGRWC 16750-M	M	EA	\$36.00
WC 16750-L	STGRWC 16750-L	L	EA	\$36.00
WC 16750-XL	STGRWC 16750-XL	XL	EA	\$36.00
WC 16750-2XL	STGRWC 16750-2XL	2XL	EA	\$36.00
WC 16750-3XL	STGRWC 16750-3XL	3XL	EA	\$36.00
WC 16750-4XL	STGRWC 16750-4XL	4XL	EA	\$36.00
WC 16750-5XL	STGRWC 16750-5XL	5XL	EA	\$36.00
WC 16750-6XL	STGRWC 16750-6XL	6XL	EA	\$36.00

WC 16750



GU9 9450-30



### INDURA® ULTRASOFT® FR JACKET

Made of 9 oz. Westex™ UltraSoft fabric. Features lay down collar, front and wrist snap closures and inside breast pocket. 30" Length. Green. Arc rating: 12.4 cal/cm<sup>2</sup>, CAT 2.

ITEM #	MARTIN #	SIZES	UOM	PRICE
GU9 9450-30-S	STGRGU9 9450-30-S	S	EA	\$53.00
GU9 9450-30-M	STGRGU9 9450-30-M	M	EA	\$53.00
GU9 9450-30-L	STGRGU9 9450-30-L	L	EA	\$53.00
GU9 9450-30-XL	STGRGU9 9450-30-XL	XL	EA	\$53.00

ITEM #	MARTIN #	SIZES	UOM	PRICE
GU9 9450-30-2XL	STGRGU9 9450-30-2XL	2XL	EA	\$58.30
GU9 9450-30-3XL	STGRGU9 9450-30-3XL	3XL	EA	\$58.30
GU9 9450-30-4XL	STGRGU9 9450-30-4XL	4XL	EA	\$63.60
GU9 9450-30-5XL	STGRGU9 9450-30-5XL	5XL	EA	\$63.60



**FR-TREATED COTTON WHIPCORD PANTS**

Constructed of 12 oz., 100% FR-treated cotton whipcord material. Features (7) belt loops, (2) front reach-in pockets, (2) patch hip pockets and zipper fly closure with covered snap at waist. Arc rating: 12 cal/cm<sup>2</sup>, CAT 2. Visual green color. Meets NFPA 70E requirements.

ITEM #	MARTIN #	SIZES	UOM	PRICE
WCP 9460-30x30	STGRWCP 9460-30x30	30" x 30"	EA	\$47.50
WCP 9460-32x30	STGRWCP 9460-32x30	32" x 30"	EA	\$47.50
WCP 9460-34x30	STGRWCP 9460-34x30	34" x 30"	EA	\$47.50
WCP 9460-36x30	STGRWCP 9460-36x30	36" x 30"	EA	\$47.50
WCP 9460-38x30	STGRWCP 9460-38x30	38" x 30"	EA	\$47.50
WCP 9460-40x30	STGRWCP 9460-40x30	40" x 30"	EA	\$47.50
WCP 9460-42x30	STGRWCP 9460-42x30	42" x 30"	EA	\$47.50
WCP 9460-44x30	STGRWCP 9460-44x30	44" x 30"	EA	\$47.50
WCP 9460-46x30	STGRWCP 9460-46x30	46" x 30"	EA	\$47.50
WCP 9460-48x30	STGRWCP 9460-48x30	48" x 30"	EA	\$47.50
WCP 9460-50x30	STGRWCP 9460-50x30	50" x 30"	EA	\$47.50
WCP 9460-52x30	STGRWCP 9460-52x30	52" x 30"	EA	\$47.50
WCP 9460-30x32	STGRWCP 9460-30x32	30" x 32"	EA	\$47.50
WCP 9460-32x32	STGRWCP 9460-32x32	32" x 32"	EA	\$47.50
WCP 9460-34x32	STGRWCP 9460-34x32	34" x 32"	EA	\$47.50
WCP 9460-36x32	STGRWCP 9460-36x32	36" x 32"	EA	\$47.50
WCP 9460-38x32	STGRWCP 9460-38x32	38" x 32"	EA	\$47.50
WCP 9460-40x32	STGRWCP 9460-40x32	40" x 32"	EA	\$47.50

ITEM #	MARTIN #	SIZES	UOM	PRICE
WCP 9460-42x32	STGRWCP 9460-42x32	42" x 32"	EA	\$47.50
WCP 9460-44x32	STGRWCP 9460-44x32	44" x 32"	EA	\$47.50
WCP 9460-46x32	STGRWCP 9460-46x32	46" x 32"	EA	\$47.50
WCP 9460-48x32	STGRWCP 9460-48x32	48" x 32"	EA	\$47.50
WCP 9460-50x32	STGRWCP 9460-50x32	50" x 32"	EA	\$47.50
WCP 9460-52x32	STGRWCP 9460-52x32	52" x 32"	EA	\$47.50
WCP 9460-30x34	STGRWCP 9460-30x34	30" x 34"	EA	\$47.50
WCP 9460-32x34	STGRWCP 9460-32x34	32" x 34"	EA	\$47.50
WCP 9460-34x34	STGRWCP 9460-34x34	34" x 34"	EA	\$47.50
WCP 9460-36x34	STGRWCP 9460-36x34	36" x 34"	EA	\$47.50
WCP 9460-38x34	STGRWCP 9460-38x34	38" x 34"	EA	\$47.50
WCP 9460-40x34	STGRWCP 9460-40x34	40" x 34"	EA	\$47.50
WCP 9460-42x34	STGRWCP 9460-42x34	42" x 34"	EA	\$47.50
WCP 9460-44x34	STGRWCP 9460-44x34	44" x 34"	EA	\$47.50
WCP 9460-46x34	STGRWCP 9460-46x34	46" x 34"	EA	\$47.50
WCP 9460-48x34	STGRWCP 9460-48x34	48" x 34"	EA	\$47.50
WCP 9460-50x34	STGRWCP 9460-50x34	50" x 34"	EA	\$47.50
WCP 9460-52x34	STGRWCP 9460-52x34	52" x 34"	EA	\$47.50



WCP 9460



**18" FLAME-RESISTANT SLEEVES**

Protect arms from sparks and flames with these 12 oz. green whipcord FR-7A® treated cotton sleeves. 2 1/2" elastic closures at top and wrist. 18" Length.

ITEM #	MARTIN #	DESCRIPTION	UOM	PRICE
WC871-18A	STGRWC871-18A	Flame-resistant sleeves	EA	\$13.17



WC871-18A



**ECLIPSE™ FR APPAREL**

Revolutionary Quad-Hazard® protection offers high visibility, liquid proof, arc flash and flash fire protection. Patent pending Thermo-Grid® technology helps block out heat energy while the flame resistant PVC coating on Nomex® provides 100% liquid proof protection in a soft, lightweight suit. Therm-O-Rad sealed seams for 100% liquid protection and 2" silver reflective tape that reflects light for 360° nighttime conspicuity. Features FR corduroy collar with roll-a-way hood, oversized 3-piece hood with adjustable hook and loop take-up strap, full-vented cape back, D-ring access for fall protection harness, hook and loop take-up straps on wrists, adjustable elastic drawcord on jacket, zipper/storm fly front with snap closure and hidden hardware, self material suspenders with heavy-duty quick release buckles and crossover, and non-conductive, non-corrosive hardware. Yellow-green. Conforms to ASTM F1891 for Arc Thermal performance and NFPA 70E. Arc rating: 8.7 cal/cm<sup>2</sup>. Jacket and overalls conform to ASTM F2733 for Flash Fire performance. ANSI/ISEA 107 Type R Class 3 compliant for flame resistance and high visibility.

**⚠ WARNING:** This product can expose you to chemicals which are known to the state of California to cause birth defects and other reproductive harm and/or cancer. For more information go to [www.P65Warnings.ca.gov](http://www.P65Warnings.ca.gov).



J44122

O44122

ITEM #	MARTIN #	DESCRIPTION	SIZES	UOM	PRICE
C44122-S	TINGC44122-S	Eclipse coat, 48"	S	EA	\$158.72
C44122-M	TINGC44122-M	Eclipse coat, 48"	M	EA	\$158.72
C44122-L	TINGC44122-L	Eclipse coat, 48"	L	EA	\$158.72
C44122-XL	TINGC44122-XL	Eclipse coat, 48"	XL	EA	\$158.72
C44122-2X	TINGC44122-2X	Eclipse coat, 48"	2XL	EA	\$162.88
C44122-3X	TINGC44122-3X	Eclipse coat, 48"	3XL	EA	\$167.05
C44122-4X	TINGC44122-4X	Eclipse coat, 48"	4XL	EA	\$171.22
J44122-S	TINGJ44122-S	Eclipse jacket	S	EA	\$145.10
J44122-M	TINGJ44122-M	Eclipse jacket	M	EA	\$145.10
J44122-L	TINGJ44122-L	Eclipse jacket	L	EA	\$145.10
J44122-XL	TINGJ44122-XL	Eclipse jacket	XL	EA	\$145.10

ITEM #	MARTIN #	DESCRIPTION	SIZES	UOM	PRICE
J44122-2X	TINGJ44122-2X	Eclipse jacket	2XL	EA	\$149.27
J44122-3X	TINGJ44122-3X	Eclipse jacket	3XL	EA	\$153.43
J44122-4X	TINGJ44122-4X	Eclipse jacket	4XL	EA	\$157.60
J44122-5X	TINGJ44122-5X	Eclipse jacket	5XL	EA	\$161.77
O44122-S	TINGO44122-S	Eclipse overalls	S	EA	\$88.12
O44122-M	TINGO44122-M	Eclipse overalls	M	EA	\$88.12
O44122-L	TINGO44122-L	Eclipse overalls	L	EA	\$88.12
O44122-XL	TINGO44122-XL	Eclipse overalls	XL	EA	\$88.12
O44122-2X	TINGO44122-2X	Eclipse overalls	2XL	EA	\$92.28
O44122-3X	TINGO44122-3X	Eclipse overalls	3XL	EA	\$96.45
O44122-4X	TINGO44122-4X	Eclipse overalls	4XL	EA	\$100.62
O44122-5X	TINGO44122-5X	Eclipse overalls	5XL	EA	\$104.78



## BIG JAKE FLAME-RESISTANT HI-VIZ JACKET

Made of PVC/Nomex® fabric with 2" silver reflective stripes. Features sturdy zipper front with large storm flap, cape ventilated back with D-ring access, attached drawstring hood, (2) front patch pockets and adjustable hook-and-loop wrists. Fluorescent lime. Arc rating: 8.9 cal/cm<sup>2</sup>, CAT 2. Meets ASTM F1891 standard specification for arc and flame-resistant rainwear. ANSI/ISEA 107-2015 Class 3, Type R compliant.



BJ38JH

**⚠️ WARNING:** This product can expose you to chemicals which are known to the state of California to cause birth defects and other reproductive harm and/or cancer. For more information go to [www.P65Warnings.ca.gov](http://www.P65Warnings.ca.gov).

ITEM #	MARTIN #	DESCRIPTION	SIZES	UOM	PRICE
BJ38JHM	MCRBJ38JHM	FR hi-viz jacket	M	EA	\$79.17
BJ38JHL	MCRBJ38JHL	FR hi-viz jacket	L	EA	\$79.17
BJ38JHXL	MCRBJ38JHXL	FR hi-viz jacket	XL	EA	\$79.17
BJ38JHX2	MCRBJ38JHX2	FR hi-viz jacket	2XL	EA	\$79.17
BJ38JHX3	MCRBJ38JHX3	FR hi-viz jacket	3XL	EA	\$83.92
BJ38JHX4	MCRBJ38JHX4	FR hi-viz jacket	4XL	EA	\$89.00
BJ38JHX5	MCRBJ38JHX5	FR hi-viz jacket	5XL	EA	\$95.00



## BIG JAKE FLAME-RESISTANT HI-VIZ BIB PANTS

Made of PVC/Nomex® fabric with 2" silver reflective stripes around legs. Features easy release FR suspender straps, plain front, adjustable side snaps and adjustable hook-and-loop ankle straps. Fluorescent lime. Arc rating: 8.9 cal/cm<sup>2</sup>, CAT 2. Meets ASTM F1891 standard specification for arc and flame-resistant rainwear. ANSI/ISEA 107-2015 Class E, Type R compliant.



BJ38BP

**⚠️ WARNING:** This product can expose you to chemicals which are known to the state of California to cause birth defects and other reproductive harm and/or cancer. For more information go to [www.P65Warnings.ca.gov](http://www.P65Warnings.ca.gov).

ITEM #	MARTIN #	DESCRIPTION	SIZES	UOM	PRICE
BJ38BPM	MCRBJ38BPM	FR hi-viz bib pants	M	EA	\$64.17
BJ38BPL	MCRBJ38BPL	FR hi-viz bib pants	L	EA	\$64.17
BJ38BPXL	MCRBJ38BPXL	FR hi-viz bib pants	XL	EA	\$64.17
BJ38BPX2	MCRBJ38BPX2	FR hi-viz bib pants	2XL	EA	\$64.17
BJ38BPX3	MCRBJ38BPX3	FR hi-viz bib pants	3XL	EA	\$68.08
BJ38BPX4	MCRBJ38BPX4	FR hi-viz bib pants	4XL	EA	\$72.00
BJ38BPX5	MCRBJ38BPX5	FR hi-viz bib pants	5XL	EA	\$76.50



## STEEL GRIP APRONS

A variety of aprons designed to help the end user with their needs. These aprons feature adjustable web neck and waist straps attached with slide snaps. All edges are serged to prevent raveling. Measures: 24" x 36".

CL125-36



ITEM #	MARTIN #	DESCRIPTION	UOM	PRICE
CL125-36	STGRCL125-36	Pearl gray split leather apron	EA	\$41.50
WC100-36	STGRWC100-36	12 oz FR whipcord cotton bib apron	EA	\$16.83
WC100-36KA	STGRWC100-36KA	12 oz FR whipcord cotton split leg apron	EA	\$29.17



## FR CONTROL 2.0™ SHORT SLEEVE T-SHIRTS

Actively regulates body temperature keeping wearer cool on hot days and warm on cooler days. Moisture wicking and anti-microbial 5.5 oz. modacrylic blend. No pockets. More stretch for a customized fit. Arc rating/Ebt: 4 cal/cm<sup>2</sup>, CAT 1.



C52FKSR

C52JKSR

ITEM #	MARTIN #	COLOR	SIZES	UOM	PRICE
C52FKSRSM	NASAC52FKSRSM	Navy	S	EA	\$125.00
C52FKSRMD	NASAC52FKSRMD	Navy	M	EA	\$125.00
C52FKSRLG	NASAC52FKSRLG	Navy	L	EA	\$125.00
C52FKSRXL	NASAC52FKSRXL	Navy	XL	EA	\$125.00
C52FKSR2X	NASAC52FKSR2X	Navy	2XL	EA	\$137.50
C52FKSR3X	NASAC52FKSR3X	Navy	3XL	EA	\$137.50
C52FKSR4X	NASAC52FKSR4X	Navy	4XL	EA	\$137.50
C52FKSR5X	NASAC52FKSR5X	Navy	5XL	EA	\$137.50
C52JKSRSM	NASAC52JKSRSM	Desert sand	S	EA	\$125.00
C52JKSRMD	NASAC52JKSRMD	Desert sand	M	EA	\$125.00
C52JKSRLG	NASAC52JKSRLG	Desert sand	L	EA	\$125.00
C52JKSRXL	NASAC52JKSRXL	Desert sand	XL	EA	\$125.00
C52JKSR2X	NASAC52JKSR2X	Desert sand	2XL	EA	\$137.50
C52JKSR3X	NASAC52JKSR3X	Desert sand	3XL	EA	\$137.50



## STRETCH NOMEX® FULL FACE HOOD

Made of 2-ply stretch white Nomex with 1-ply cape. Features full face opening. Flame-resistant and launderable.



NK 2310

ITEM #	MARTIN #	DESCRIPTION	UOM	PRICE
NK 2310	STGRNK 2310	Stretch Nomex full face hood	EA	\$30.83



C52FKSRLS



C52JKSRLS



**FR CONTROL  
2.0™ LONG  
SLEEVE T-SHIRTS**

Actively regulates body temperature keeping wearer cool on hot days and warm on cooler days. Moisture wicking and anti-microbial 5.5 oz. modacrylic blend. No pockets. More stretch for a customized fit. Arc rating/Ebt: 4 cal/cm<sup>2</sup>, CAT 1. Compliant to OSHA 1910.269, ASTM F1506 and NFPA 70E for Arc Flash, and CSA Z462 for Arc Flash (Canada).

ITEM #	MARTIN #	COLOR	SIZES	UOM	PRICE
C52FKSRLSSM	NASAC52FKSRLSSM	Navy	S	EA	\$140.00
C52FKSRLSMD	NASAC52FKSRLSMD	Navy	M	EA	\$140.00
C52FKSRLSLG	NASAC52FKSRLSLG	Navy	L	EA	\$140.00
C52FKSRLSXL	NASAC52FKSRLSXL	Navy	XL	EA	\$140.00
C52FKSRLS2X	NASAC52FKSRLS2X	Navy	2XL	EA	\$154.00
C52FKSRLS3X	NASAC52FKSRLS3X	Navy	3XL	EA	\$152.33
C52FKSRLS4X	NASAC52FKSRLS4X	Navy	4XL	EA	\$154.00
C52FKSRLS5X	NASAC52FKSRLS5X	Navy	5XL	EA	\$154.00
C52JKSRLSSM	NASAC52JKSRLSSM	Desert sand	S	EA	\$140.00
C52JKSRLSMD	NASAC52JKSRLSMD	Desert sand	M	EA	\$140.00
C52JKSRLSLG	NASAC52JKSRLSLG	Desert sand	L	EA	\$140.00
C52JKSRLSXL	NASAC52JKSRLSXL	Desert sand	XL	EA	\$140.00
C52JKSRLS2X	NASAC52JKSRLS2X	Desert sand	2XL	EA	\$154.00
C52JKSRLS3X	NASAC52JKSRLS3X	Desert sand	3XL	EA	\$154.00



DF2-450C-CA-NB



**DRIFIRE® 4.4™ COVERALLS**

Constructed of 4.4 oz. FR fabric for inherent flame resistance. Fabric is lightweight yet durable, and includes odor control technology and moisture management technology. Allows quick identification of compliance with exterior tagless printed label. Navy. Arc rating: 10 cal/cm<sup>2</sup>, CAT 2. UL® certified to NFPA 2112 for Flash Fire. Compliant to OSHA 1910.269. Compliant to NFPA 70E and ASTM F1506 for Arc Flash.

ITEM #	MARTIN #	SIZES	UOM	PRICE
<b>DRIFIRE 4.4 Coveralls</b>				
DF2-450C-CA-NB-SM	NASADF2-450C-CA-NB-SM	S	EA	\$388.33
DF2-450C-CA-NB-MD	NASADF2-450C-CA-NB-MD	M	EA	\$388.33
DF2-450C-CA-NB-LG	NASADF2-450C-CA-NB-LG	L	EA	\$388.33
DF2-450C-CA-NB-XL	NASADF2-450C-CA-NB-XL	XL	EA	\$388.33
DF2-450C-CA-NB-2X	NASADF2-450C-CA-NB-2X	2XL	EA	\$427.17
DF2-450C-CA-NB-3X	NASADF2-450C-CA-NB-3X	3XL	EA	\$427.17
<b>DRIFIRE 4.4 Coveralls, Tall</b>				
DF2-450C-CA-NB-MDT	NASADF2-450C-CA-NB-MDT	M	EA	\$427.17
DF2-450C-CA-NB-LGT	NASADF2-450C-CA-NB-LGT	L	EA	\$427.17
DF2-450C-CA-NB-XLT	NASADF2-450C-CA-NB-XLT	XL	EA	\$427.17
DF2-450C-CA-NB-2XT	NASADF2-450C-CA-NB-2XT	2XL	EA	\$427.17
DF2-450C-CA-NB-3XT	NASADF2-450C-CA-NB-3XT	3XL	EA	\$427.17



**TECGEN SELECT®  
FR COVERALLS**

Constructed of 5.5 oz. OPF blend fabric for inherent flame resistance. Features elastic waistband, pass-through side pockets with snaps, (2) chest pockets with flaps, and 2-way zipper. Arc rating: 8 cal/cm<sup>2</sup>, CAT 2. UL® certified to NFPA 2112 for Flash Fire. Compliant to OSHA 1910. Compliant to NFPA 70E for Arc Flash and CSA Z462 for Arc Flash (Canada).



TCG021208

TCG021508

TCG021608

ITEM #	MARTIN #	COLOR	SIZES	UOM	PRICE
<b>TECGEN SELECT FR Coveralls</b>					
TCG02120857	NASATCG02120857	Khaki	S	EA	\$293.33
TCG02120861	NASATCG02120861	Khaki	M	EA	\$271.07
TCG02120865	NASATCG02120865	Khaki	L	EA	\$146.25
TCG02120869	NASATCG02120869	Khaki	XL	EA	\$146.25
TCG02120873	NASATCG02120873	Khaki	2XL	EA	\$146.25
TCG02120877	NASATCG02120877	Khaki	3XL	EA	\$146.25
TCG02120881	NASATCG02120881	Khaki	4XL	EA	\$146.25
TCG02120885	NASATCG02120885	Khaki	5XL	EA	\$146.25
TCG02150857	NASATCG02150857	Gray	S	EA	\$146.25
TCG02150861	NASATCG02150861	Gray	M	EA	\$146.25
TCG02150865	NASATCG02150865	Gray	L	EA	\$146.25
TCG02150869	NASATCG02150869	Gray	XL	EA	\$146.25
TCG02150873	NASATCG02150873	Gray	2XL	EA	\$146.25
TCG02150877	NASATCG02150877	Gray	3XL	EA	\$146.25
TCG02150881	NASATCG02150881	Gray	4XL	EA	\$146.25
TCG02150885	NASATCG02150885	Gray	5XL	EA	\$146.25
TCG02160857	NASATCG02160857	Navy	S	EA	\$146.25
TCG02160861	NASATCG02160861	Navy	M	EA	\$146.25
TCG02160865	NASATCG02160865	Navy	L	EA	\$146.25
TCG02160869	NASATCG02160869	Navy	XL	EA	\$146.25
TCG02160873	NASATCG02160873	Navy	2XL	EA	\$146.25
TCG02160877	NASATCG02160877	Navy	3XL	EA	\$146.25
TCG02160881	NASATCG02160881	Navy	4XL	EA	\$146.25
TCG02160885	NASATCG02160885	Navy	5XL	EA	\$146.25
<b>TECGEN SELECT FR Coveralls, Tall</b>					
TCG02120862	NASATCG02120862	Khaki	M	EA	\$146.25
TCG02120866	NASATCG02120866	Khaki	L	EA	\$146.25
TCG02120870	NASATCG02120870	Khaki	XL	EA	\$146.25
TCG02120874	NASATCG02120874	Khaki	2XL	EA	\$146.25
TCG02120878	NASATCG02120878	Khaki	3XL	EA	\$146.25
TCG02120882	NASATCG02120882	Khaki	4XL	EA	\$146.25
TCG02120886	NASATCG02120886	Khaki	5XL	EA	\$146.25
TCG02150862	NASATCG02150862	Gray	M	EA	\$146.25
TCG02150866	NASATCG02150866	Gray	L	EA	\$146.25
TCG02150870	NASATCG02150870	Gray	XL	EA	\$146.25
TCG02150874	NASATCG02150874	Gray	2XL	EA	\$146.25
TCG02150878	NASATCG02150878	Gray	3XL	EA	\$146.25
TCG02150882	NASATCG02150882	Gray	4XL	EA	\$146.25
TCG02150886	NASATCG02150886	Gray	5XL	EA	\$146.25
TCG02160862	NASATCG02160862	Navy	M	EA	\$146.25
TCG02160866	NASATCG02160866	Navy	L	EA	\$146.25
TCG02160870	NASATCG02160870	Navy	XL	EA	\$146.25
TCG02160874	NASATCG02160874	Navy	2XL	EA	\$146.25
TCG02160878	NASATCG02160878	Navy	3XL	EA	\$146.25
TCG02160882	NASATCG02160882	Navy	4XL	EA	\$146.25
TCG02160886	NASATCG02160886	Navy	5XL	EA	\$146.25

PROTECTIVE CLOTHING | FLAME-RESISTANT



## WOMEN'S TECGEN SELECT® FR COVERALLS

Contoured to the feminine silhouette with an elastic waist band for comfort. Made of 5.5 oz. OPF blend fabric for inherent flame resistance. Features pass-through side pockets with snaps, (2) chest pockets with flaps, and 2-way zipper. Arc rating: 8 cal/cm<sup>2</sup>, CAT 2. UL® certified to NFPA 2112 for Flash Fire. Compliant to OSHA 1910. Compliant to NFPA 70E for Arc Flash and CSA Z462 for Arc Flash (Canada).



TCGSCWN00112

TCGSCWN00116

ITEM #	MARTIN #	COLOR	SIZES	UOM	PRICE
TCGSCWN00112SMRG00	NASATCGSCWN00112SMRG00	Khaki	S	EA	\$146.25
TCGSCWN00112MDRG00	NASATCGSCWN00112MDRG00	Khaki	M	EA	\$146.25
TCGSCWN00112LGRG00	NASATCGSCWN00112LGRG00	Khaki	L	EA	\$146.25
TCGSCWN00112XLRG00	NASATCGSCWN00112XLRG00	Khaki	XL	EA	\$146.25
TCGSCWN001122XRG00	NASATCGSCWN001122XRG00	Khaki	2XL	EA	\$146.25
TCGSCWN001123XRG00	NASATCGSCWN001123XRG00	Khaki	3XL	EA	\$146.25
TCGSCWN00116SMRG00	NASATCGSCWN00116SMRG00	Navy	S	EA	\$146.25
TCGSCWN00116MDRG00	NASATCGSCWN00116MDRG00	Navy	M	EA	\$146.25
TCGSCWN00116LGRG00	NASATCGSCWN00116LGRG00	Navy	L	EA	\$146.25
TCGSCWN00116XLRG00	NASATCGSCWN00116XLRG00	Navy	XL	EA	\$146.25
TCGSCWN001162XRG00	NASATCGSCWN001162XRG00	Navy	2XL	EA	\$146.25
TCGSCWN001163XRG00	NASATCGSCWN001163XRG00	Navy	3XL	EA	\$146.25



## LIMITED FLAMMABILITY COTTON JACKET

Made of 9 oz. green sateen cotton treated to offer limited flammability. Includes black anodized front button snap closures, snaps on sleeves for a snug fit and a large inside pocket. The 100% cotton fabric is cool and comfortable. Provides economical protection from sudden flame exposure, light molten splash and sparks. 30" Length. Launderable to maintain flame resistance up to 50 home washings or 25 commercial washings (up to 165° F). Meets NFPA-701 and ASTM-D6413 specifications for flame-retardant fabric and clothing.



39030

**⚠️ WARNING:** This product can expose you to chemicals which are known to the state of California to cause birth defects and other reproductive harm and/or cancer. For more information go to [www.P65Warnings.ca.gov](http://www.P65Warnings.ca.gov).

ITEM #	MARTIN #	DESCRIPTION	SIZES	UOM	PRICE
39030S	MCR39030S	Limited flammability cotton jacket	S	EA	\$21.92
39030M	MCR39030M	Limited flammability cotton jacket	M	EA	\$21.92
39030L	MCR39030L	Limited flammability cotton jacket	L	EA	\$21.92
39030XL	MCR39030XL	Limited flammability cotton jacket	XL	EA	\$21.92
39030X2	MCR39030X2	Limited flammability cotton jacket	2XL	EA	\$23.58
39030X3	MCR39030X3	Limited flammability cotton jacket	3XL	EA	\$25.25
39030X4	MCR39030X4	Limited flammability cotton jacket	4XL	EA	\$28.50



## HEAVYWEIGHT PULLOVER FR SWEATSHIRTS

Premium 14.25 oz. sweatshirts designed for more room in hood, shoulders, chest and sleeves. May be worn as stand alone garment or layered for added protection. Features generous fit, rib-knit cuffs and drawstring hood. Navy. Arc rating: 28 cal/cm<sup>2</sup>, CAT 3. UL® certified to NPFA 2112 for Flash Fire.



C211F03

ITEM #	MARTIN #	SIZES	UOM	PRICE
C211F03SM	NASAC211F03SM	S	EA	\$280.00
C211F03MD	NASAC211F03MD	M	EA	\$280.00
C211F03LG	NASAC211F03LG	L	EA	\$280.00
C211F03XL	NASAC211F03XL	XL	EA	\$308.00
C211F032X	NASAC211F032X	2XL	EA	\$308.00
C211F033X	NASAC211F033X	3XL	EA	\$308.00

 OTHER STYLES AVAILABLE AT [WWW.MARTINSUPPLY.COM](http://WWW.MARTINSUPPLY.COM)



## LIMITED FLAMMABILITY COTTON SLEEVES

Made of 9 oz. green sateen cotton treated to offer limited flammability. Economical protection from sudden flame exposure, light molten splash and sparks. 23" Length. Maintains limited flammability up to 50 home washings or 25 commercial washings up to 165° F. Tested in accordance with ASTM D6413 Test Method.



39423

**⚠️ WARNING:** This product can expose you to chemicals which are known to the state of California to cause birth defects and other reproductive harm and/or cancer. For more information go to [www.P65Warnings.ca.gov](http://www.P65Warnings.ca.gov).

ITEM #	MARTIN #	DESCRIPTION	UOM	PRICE
39423	MCR39423	Sateen cotton sleeves w/ elastic wrist	PR	\$8.83



**BIB APRON WITH FRONT POCKET**

Heavy select gray side-split leather offers outstanding protection from heat, sparks, slag, and cuts. Sewn with Kevlar®. Ideal for welding applications. Measures: 24" x 36".

**⚠️ WARNING:** This product can expose you to chemicals which are known to the state of California to cause birth defects and other reproductive harm and/or cancer. For more information go to [www.P65Warnings.ca.gov](http://www.P65Warnings.ca.gov).



38136MW

ITEM #	MARTIN #	DESCRIPTION	UOM	PRICE
38136MW	MCR38136MW	Bib apron w/ front pocket	EA	\$30.08



**CARBON ARMOUR™ SILVERS DELUXE ALUMINIZED COATS**

Provides protection from radiant heat, sparks and molten metal splash hazards. Features aluminized vented back, covered snap front closure, snaps at wrists for adjustment, split sleeves with snaps for easy fastening, and under-arm eyelets for ventilation. Tested according to ASTM F955. EN 531:1996 Performance Levels A, B1, C4, D3, E3.



C22NL\_\_30

C22NL\_\_45

**⚠️ WARNING:** This product can expose you to chemicals which are known to the state of California to cause birth defects and other reproductive harm and/or cancer. For more information go to [www.P65Warnings.ca.gov](http://www.P65Warnings.ca.gov).

ITEM #	MARTIN #	SIZES	UOM	PRICE
<i>Deluxe Aluminized Short Coat, 30"</i>				
C22NLM30	NASAC22NLM30	M	EA	\$606.67
C22NLLG30	NASAC22NLLG30	L	EA	\$606.67
C22NLXL30	NASAC22NLXL30	XL	EA	\$663.33
C22NL2X30	NASAC22NL2X30	2XL	EA	\$729.67
<i>Deluxe Aluminized Long Coat, 45"</i>				
C22NLM45	NASAC22NLM45	M	EA	\$733.33
C22NLLG45	NASAC22NLLG45	L	EA	\$733.33
C22NLXL45	NASAC22NLXL45	XL	EA	\$733.33
C22NL2X45	NASAC22NL2X45	2XL	EA	\$806.67



**HRC3 ARC FLASH KIT - 33 CAL/CM²**

Contains jacket, overalls, arc hood, safety glasses, hard hat and back pack. NFPA 70E compliant.



9150-21712

ITEM #	MARTIN #	SIZES	UOM	PRICE
9150-21712/S	PIP9150-21712/S	S	EA	\$1,242.17
9150-21712/M	PIP9150-21712/M	M	EA	\$1,242.17
9150-21712/L	PIP9150-21712/L	L	EA	\$1,242.17
9150-21712/XL	PIP9150-21712/XL	XL	EA	\$1,242.17
9150-21712/2X	PIP9150-21712/2X	2XL	EA	\$1,296.67
9150-21712/3X	PIP9150-21712/3X	3XL	EA	\$1,356.57
9150-21712/4X	PIP9150-21712/4X	4XL	EA	\$1,423.73
9150-21712/5X	PIP9150-21712/5X	5XL	EA	\$1,498.35



**12 CAL ARCGUARD® ULTRASOFT® ARC FLASH KIT WITH BALACLAVA**

- Two garment choices: coveralls or short coat and bib overalls
- Arc flash shield with slotted hard hat
- Safety glasses
- Class "0" gloves and leather protectors (colors vary)
- Faceshield bag and glove bag
- Electrical gear bag

Note: "\_ \_" indicates glove size. Available sizes 07-12.



KIT2CV11B

**⚠️ WARNING:** This product can expose you to chemicals which are known to the state of California to cause birth defects and other reproductive harm and/or cancer. For more information go to [www.P65Warnings.ca.gov](http://www.P65Warnings.ca.gov).

ITEM #	MARTIN #	SIZES	UOM	PRICE
<i>UltraSoft Coveralls Kit with Balaclava (12 cal/cm²)</i>				
KIT2CV11BSM__	NASAKIT2CV11BSM__	S	EA	\$1,130.00
KIT2CV11BMD__	NASAKIT2CV11BMD__	M	EA	\$1,130.00
KIT2CV11BLG__	NASAKIT2CV11BLG__	L	EA	\$1,130.00
KIT2CV11BXL__	NASAKIT2CV11BXL__	XL	EA	\$1,130.00
KIT2CV11B2X__	NASAKIT2CV11B2X__	2XL	EA	\$1,243.00
KIT2CV11B3X__	NASAKIT2CV11B3X__	3XL	EA	\$1,243.00
<i>UltraSoft Short Coat and Bib Overall Kit with Balaclava</i>				
KIT2SC11BSM__	NASAKIT2SC11BSM__	S	EA	\$628.33
KIT2SC11BMD__	NASAKIT2SC11BMD__	M	EA	\$628.33
KIT2SC11BLG__	NASAKIT2SC11BLG__	L	EA	\$628.33
KIT2SC11BXL__	NASAKIT2SC11BXL__	XL	EA	\$628.33
KIT2SC11B2X__	NASAKIT2SC11B2X__	2XL	EA	\$628.33
KIT2SC11B3X__	NASAKIT2SC11B3X__	3XL	EA	\$628.33



9150-53883

**HRC2 ARC FLASH KIT - 12 CAL/CM²**

Electricians back pack kit contains coveralls, balaclava hood, arc shield with safety helmet, safety glasses and storage bag. NFPA 70E compliant.

ITEM #	MARTIN #	SIZES	UOM	PRICE
9150-5488E/S	PIP9150-5488E/S	S	EA	\$296.48
9150-5488E/M	PIP9150-5488E/M	M	EA	\$296.48
9150-5488E/L	PIP9150-5488E/L	L	EA	\$296.48
9150-5488E/XL	PIP9150-5488E/XL	XL	EA	\$296.48
9150-5488E/2X	PIP9150-5488E/2X	2XL	EA	\$299.71
9150-5488E/3X	PIP9150-5488E/3X	3XL	EA	\$302.95
9150-5488E/4X	PIP9150-5488E/4X	4XL	EA	\$306.18
9150-5488E/5X	PIP9150-5488E/5X	5XL	EA	\$309.41

PROTECTIVE CLOTHING | SPECIALTY



## 40 CAL ARCGUARD® REVOLITE™ ARC FLASH KIT WITH LIFT FRONT HOOD

Inherently flame-resistant. Olive green. Compliant to OSHA 1910.269, ASTM F1506 and NFPA 70E for Arc Flash, and CSA Z462 for Arc Flash (Canada).

### Kit features:

- FR short coat
- FR bib overalls
- 14" Class "2" rubber insulating gloves
- 12" Leather glove protectors
- Arc flash hood unit with lift front shield and hard hat
- Safety glasses
- Hood bag
- Glove bag
- Gear bag

Note: " \_ \_ " indicates glove size. Available sizes 07-12.

**⚠ WARNING:** This product can expose you to chemicals which are known to the state of California to cause birth defects and other reproductive harm and/or cancer. For more information go to [www.P65Warnings.ca.gov](http://www.P65Warnings.ca.gov).

ITEM #	MARTIN #	SIZES	UOM	PRICE
KIT4SCLT40LFSM_ _	NASAKIT4SCLT40LFSM_ _	S	EA	\$3,141.67
KIT4SCLT40LFMD_ _	NASAKIT4SCLT40LFMD_ _	M	EA	\$3,141.67
KIT4SCLT40LFLG_ _	NASAKIT4SCLT40LFLG_ _	L	EA	\$3,141.67
KIT4SCLT40LFXL_ _	NASAKIT4SCLT40LFXL_ _	XL	EA	\$3,141.67
KIT4SCLT40LF2X_ _	NASAKIT4SCLT40LF2X_ _	2XL	EA	\$3,455.83
KIT4SCLT40LF3X_ _	NASAKIT4SCLT40LF3X_ _	3XL	EA	\$3,455.83



KIT4SCLT40LF



## TYPE R, CLASS 2 HOOK-AND-LOOP VEST

Value vest made of cool mesh material with 2" silver reflective stripes and hook-and-loop front closure. No pockets. Fluorescent lime. ANSI/ISEA 107-2015 Class 2, Type R compliant.

**⚠ WARNING:** This product can expose you to chemicals which are known to the state of California to cause birth defects and other reproductive harm and/or cancer. For more information go to [www.P65Warnings.ca.gov](http://www.P65Warnings.ca.gov).

ITEM #	MARTIN #	SIZES	UOM	PRICE
V2CL2MLM	MCRV2CL2MLM	M	EA	\$3.97
V2CL2MLL	MCRV2CL2MLL	L	EA	\$3.97
V2CL2MLXL	MCRV2CL2MLXL	XL	EA	\$3.97
V2CL2MLX2	MCRV2CL2MLX2	2XL	EA	\$3.97
V2CL2MLX3	MCRV2CL2MLX3	3XL	EA	\$3.97
V2CL2MLX4	MCRV2CL2MLX4	4XL	EA	\$3.97

V2CL2ML



## TYPE R, CLASS 2 ZIPPERED VEST

Value vest made of cool mesh material with 2" silver reflective stripes and zipper front closure. No pockets. Fluorescent lime. ANSI/ISEA 107-2015 Class 2, Type R compliant.

**⚠ WARNING:** This product can expose you to chemicals which are known to the state of California to cause birth defects and other reproductive harm and/or cancer. For more information go to [www.P65Warnings.ca.gov](http://www.P65Warnings.ca.gov).

ITEM #	MARTIN #	SIZES	UOM	PRICE
V2CL2MLZM	MCRV2CL2MLZM	M	EA	\$4.28
V2CL2MLZL	MCRV2CL2MLZL	L	EA	\$4.28
V2CL2MLZX	MCRV2CL2MLZX	XL	EA	\$4.28
V2CL2MLZX2	MCRV2CL2MLZX2	2XL	EA	\$4.28
V2CL2MLZX3	MCRV2CL2MLZX3	3XL	EA	\$4.28
V2CL2MLZX4	MCRV2CL2MLZX4	4XL	EA	\$4.28

V2CL2MLZ



## PUREVIEW™ ARC FLASH FACESHIELD KITS

Lightweight, comfortable faceshield provides high visible light transmission for greater visibility. Adjustable settings allow faceshield to be secured in various positions, including above hard hat. Features attached see-through chin cup for enhanced peripheral vision. Kit includes PureView faceshield, UltraSoft® balaclava and safety glasses. Compliant to OSHA 1910.269, NFPA 70E for Arc Flash, and ASTM F2178 for Arc Flash Hoods.

**⚠ WARNING:** This product can expose you to chemicals which are known to the state of California to cause birth defects and other reproductive harm and/or cancer. For more information go to [www.P65Warnings.ca.gov](http://www.P65Warnings.ca.gov).

ITEM #	MARTIN #	ARC RATING	UOM	PRICE
KITHP12PV	NASAKITHP12PV	12 cal/cm <sup>2</sup> , CAT 2	EA	\$411.67
KITHP20PV	NASAKITHP20PV	20 cal/cm <sup>2</sup> , CAT 2	EA	\$443.33



KITHP12PV



## LUMINATOR® CLASS 2 MESH SURVEYORS VEST

Made of mesh polyester material with black side panels and 3" silver/contrasting reflective stripes. Features reinforced zipper front, (2) upper and (2) lower grommets, clear badge holder, mic tab holder, and (4) outer and (2) inner pockets. ANSI/ISEA 107-2015 Class 2, Type R compliant.

**⚠ WARNING:** This product can expose you to chemicals which are known to the state of California to cause birth defects and other reproductive harm and/or cancer. For more information go to [www.P65Warnings.ca.gov](http://www.P65Warnings.ca.gov).

ITEM #	MARTIN #	SIZES	UOM	PRICE
SURVCL2LM	MCRSURVCL2LM	M	EA	\$17.42
SURVCL2LL	MCRSURVCL2LL	L	EA	\$17.42
SURVCL2LXL	MCRSURVCL2LXL	XL	EA	\$17.42
SURVCL2LX2	MCRSURVCL2LX2	2XL	EA	\$17.42
SURVCL2LX3	MCRSURVCL2LX3	3XL	EA	\$17.42
SURVCL2LX4	MCRSURVCL2LX4	4XL	EA	\$17.42

SURVCL2L





**CLASS 3 ECONOMY MESH VESTS**

Made of 100% polyester mesh with 2" silver reflective stripes with contrasting two-tone tape: (1) 360°, (2) vertical and (1) around each sleeve. Features zipper front closure and (2) pockets. ANSI 107 Type R Class 3 compliant.

ITEM #	MARTIN #	COLOR	SIZES	UOM	PRICE
303-HSVP-LY/M	PIP303-HSVP-LY/M	Lime yellow	M	EA	\$12.28
303-HSVP-LY/L	PIP303-HSVP-LY/L	Lime yellow	L	EA	\$12.28
303-HSVP-LY/XL	PIP303-HSVP-LY/XL	Lime yellow	XL	EA	\$12.28
303-HSVP-LY/2X	PIP303-HSVP-LY/2X	Lime yellow	2XL	EA	\$12.28
303-HSVP-LY/3X	PIP303-HSVP-LY/3X	Lime yellow	3XL	EA	\$12.28
303-HSVP-LY/4X	PIP303-HSVP-LY/4X	Lime yellow	4XL	EA	\$12.28
303-HSVP-LY/5X	PIP303-HSVP-LY/5X	Lime yellow	5XL	EA	\$12.28
303-HSVP-OR/M	PIP303-HSVP-OR/M	Orange	M	EA	\$12.28
303-HSVP-OR/L	PIP303-HSVP-OR/L	Orange	L	EA	\$12.28
303-HSVP-OR/XL	PIP303-HSVP-OR/XL	Orange	XL	EA	\$12.28
303-HSVP-OR/2X	PIP303-HSVP-OR/2X	Orange	2XL	EA	\$12.28
303-HSVP-OR/3X	PIP303-HSVP-OR/3X	Orange	3XL	EA	\$12.28
303-HSVP-OR/4X	PIP303-HSVP-OR/4X	Orange	4XL	EA	\$12.28
303-HSVP-OR/5X	PIP303-HSVP-OR/5X	Orange	5XL	EA	\$12.28



**CLASS 3 BREAKAWAY VESTS**

Made of breathable polyester with 2" two-tone tape for optimum visibility. Features 5-point breakaway, hook-and-loop closure, (2) lower internal pockets and (2) upper chest pockets including (4) pen pockets. ANSI 107 Type R Class 3 compliant.

ITEM #	MARTIN #	COLOR	SIZES	UOM	PRICE
303-5PMTT-LY/M	PIP303-5PMTT-LY/M	Lime yellow	M	EA	\$14.80
303-5PMTT-LY/L	PIP303-5PMTT-LY/L	Lime yellow	L	EA	\$14.80
303-5PMTT-LY/XL	PIP303-5PMTT-LY/XL	Lime yellow	XL	EA	\$14.80
303-5PMTT-LY/2X	PIP303-5PMTT-LY/2X	Lime yellow	2XL	EA	\$14.80
303-5PMTT-LY/3X	PIP303-5PMTT-LY/3X	Lime yellow	3XL	EA	\$14.80
303-5PMTT-LY/4X	PIP303-5PMTT-LY/4X	Lime yellow	4XL	EA	\$14.80
303-5PMTT-LY/5X	PIP303-5PMTT-LY/5X	Lime yellow	5XL	EA	\$14.80
303-5PMTT-OR/M	PIP303-5PMTT-OR/M	Orange	M	EA	\$14.80
303-5PMTT-OR/L	PIP303-5PMTT-OR/L	Orange	L	EA	\$14.80
303-5PMTT-OR/XL	PIP303-5PMTT-OR/XL	Orange	XL	EA	\$14.80
303-5PMTT-OR/2X	PIP303-5PMTT-OR/2X	Orange	2XL	EA	\$14.80
303-5PMTT-OR/3X	PIP303-5PMTT-OR/3X	Orange	3XL	EA	\$14.80
303-5PMTT-OR/4X	PIP303-5PMTT-OR/4X	Orange	4XL	EA	\$14.80
303-5PMTT-OR/5X	PIP303-5PMTT-OR/5X	Orange	5XL	EA	\$14.80



**VIZABLE® FR HI-VIS STANDARD MESH VEST - TYPE R CLASS 3**

Vest features 5.8 oz. hi-vis modacrylic and para-aramid mesh material and 3M™ Scotchlite™ FR silver segmented material. Designed with FR hook-and-loop closure. Fluorescent yellow. Arc rating: 4.6 cal/cm². Compliant to OSHA 1910.269, ANSI/ISEA 107 Type R Class 3, ASTM F1506 and NFPA 70E for Arc Flash, and CSA Z462 for Arc Flash (Canada).

ITEM #	MARTIN #	SIZES	UOM	PRICE
V00HA3VMD	NASAV00HA3VMD	M	EA	\$109.97
V00HA3VLG	NASAV00HA3VLG	L	EA	\$109.97
V00HA3VXL	NASAV00HA3VXL	XL	EA	\$109.97
V00HA3V2X	NASAV00HA3V2X	2XL	EA	\$122.87
V00HA3V3X	NASAV00HA3V3X	3XL	EA	\$122.87





### CLASS 2 SHORT SLEEVE T-SHIRT

Made of 100% polyester, solid jersey fabric with 2" silver stripes. Features left chest pocket. Fluorescent lime. ANSI/ISEA 107-2015 Class 2, Type R compliant.

**⚠️ WARNING:** This product can expose you to chemicals which are known to the state of California to cause birth defects and other reproductive harm and/or cancer. For more information go to [www.P65Warnings.ca.gov](http://www.P65Warnings.ca.gov).

ITEM #	MARTIN #	SIZES	UOM	PRICE
STSC2SLM	MCRSTSC2SLM	M	EA	\$10.38
STSC2SLL	MCRSTSC2SLL	L	EA	\$10.38
STSC2SLXL	MCRSTSC2SLXL	XL	EA	\$10.38

ITEM #	MARTIN #	SIZES	UOM	PRICE
STSC2SLX2	MCRSTSC2SLX2	2XL	EA	\$10.38
STSC2SLX3	MCRSTSC2SLX3	3XL	EA	\$10.38
STSC2SLX4	MCRSTSC2SLX4	4XL	EA	\$10.38

STSC2SL



LTSC2L



### CLASS 2 LONG SLEEVE T-SHIRT

Made of lightweight and breathable solid fabric with 2" silver stripes. Features left chest pocket. Fluorescent lime. ANSI/ISEA 107-2015 Class 2, Type R compliant.

**⚠️ WARNING:** This product can expose you to chemicals which are known to the state of California to cause birth defects and other reproductive harm and/or cancer. For more information go to [www.P65Warnings.ca.gov](http://www.P65Warnings.ca.gov).

ITEM #	MARTIN #	SIZES	UOM	PRICE
LTSC2LM	MCRLTSC2LM	M	EA	\$16.23
LTSC2LL	MCRLTSC2LL	L	EA	\$16.23
LTSC2LXL	MCRLTSC2LXL	XL	EA	\$16.23

ITEM #	MARTIN #	SIZES	UOM	PRICE
LTSC2LX2	MCRLTSC2LX2	2XL	EA	\$16.23
LTSC2LX3	MCRLTSC2LX3	3XL	EA	\$17.42
LTSC2LX4	MCRLTSC2LX4	4XL	EA	\$18.25

313-1300-LY

313-1300-OR



### CLASS 3 LONG SLEEVE T-SHIRTS

Made of moisture-wicking polyester with crew neck, knit cuffs, chest pocket and 2" silver reflective tape. ANSI 107 Type R Class 3 compliant.



ITEM #	MARTIN #	COLOR	SIZES	UOM	PRICE
313-1300-LY/S	PIP313-1300-LY/S	Lime yellow	S	EA	\$17.55
313-1300-LY/M	PIP313-1300-LY/M	Lime yellow	M	EA	\$17.55
313-1300-LY/L	PIP313-1300-LY/L	Lime yellow	L	EA	\$17.55
313-1300-LY/XL	PIP313-1300-LY/XL	Lime yellow	XL	EA	\$17.55
313-1300-LY/2X	PIP313-1300-LY/2X	Lime yellow	2XL	EA	\$17.55
313-1300-LY/3X	PIP313-1300-LY/3X	Lime yellow	3XL	EA	\$17.55
313-1300-LY/4X	PIP313-1300-LY/4X	Lime yellow	4XL	EA	\$17.55
313-1300-LY/5X	PIP313-1300-LY/5X	Lime yellow	5XL	EA	\$17.55
313-1300-OR/S	PIP313-1300-OR/S	Orange	S	EA	\$17.55
313-1300-OR/M	PIP313-1300-OR/M	Orange	M	EA	\$17.55
313-1300-OR/L	PIP313-1300-OR/L	Orange	L	EA	\$17.55
313-1300-OR/XL	PIP313-1300-OR/XL	Orange	XL	EA	\$17.55
313-1300-OR/2X	PIP313-1300-OR/2X	Orange	2XL	EA	\$17.55
313-1300-OR/3X	PIP313-1300-OR/3X	Orange	3XL	EA	\$17.55
313-1300-OR/4X	PIP313-1300-OR/4X	Orange	4XL	EA	\$17.55
313-1300-OR/5X	PIP313-1300-OR/5X	Orange	5XL	EA	\$17.55

C21HC03C3



### VIZABLE® FR HI-VIS PULLOVER SWEATSHIRT - TYPE R CLASS 3

Made of comfortable 10.5 oz modacrylic/cotton blend, hi-vis yellow fleece. Features 3M™ Scotchlite™ FR silver segmented material. Arc rating/ATPV: 20 cal/cm<sup>2</sup>, CAT 2. Compliant to OSHA 1910.269, ANSI/ISEA 107 Type R Class 3, ASTM F1506 and NFPA 70E for Arc Flash, and CSA Z462 for Arc Flash (Canada).

ITEM #	MARTIN #	SIZES	UOM	PRICE
C21HC03C3SM	NASAC21HC03C3SM	S	EA	\$195.00
C21HC03C3MD	NASAC21HC03C3MD	M	EA	\$195.00
C21HC03C3LG	NASAC21HC03C3LG	L	EA	\$195.00
C21HC03C3XL	NASAC21HC03C3XL	XL	EA	\$195.00
C21HC03C32X	NASAC21HC03C32X	2XL	EA	\$217.00
C21HC03C33X	NASAC21HC03C33X	3XL	EA	\$217.00



**ANSI TYPE R CLASS 3 4-IN-1 REVERSIBLE MULTI-SEASONAL WINDBREAKER**

Heavy-duty PU-coated polyester outer shell offers protection from rain and wind. Dark gray bottom, collar and cuffs help hide dirt, and 2" silver reflective tape for added conspicuity. Features zipper closure with storm flap, elastic cuffs, detachable zippered sleeves, adjustable bottom hem, dropped tail back, (2) external flap pockets and (1) upper chest radio pocket. Reversible to dark gray with silver reflective piping, (2) slash pockets and (1) chest pocket. Passed Water Resistant (Rain Test) AATCC 35. Meets ANSI 107 Type R Class3 standards.

ITEM #	MARTIN #	SIZES	UOM	PRICE
333-1500-R/S	PIP333-1500-R/S	S	EA	\$66.68
333-1500-R/M	PIP333-1500-R/M	M	EA	\$66.68
333-1500-R/L	PIP333-1500-R/L	L	EA	\$66.68
333-1500-R/XL	PIP333-1500-R/XL	XL	EA	\$66.68
333-1500-R/2X	PIP333-1500-R/2X	2XL	EA	\$66.68
333-1500-R/3X	PIP333-1500-R/3X	3XL	EA	\$66.68
333-1500-R/4X	PIP333-1500-R/4X	4XL	EA	\$66.68
333-1500-R/5X	PIP333-1500-R/5X	5XL	EA	\$66.68

333-1500-R



SLEEVES REMOVED

REVERSED



**CLASS 3 BOMBER JACKETS WITH ZIP OUT LINING**

Durable, waterproof, lime yellow polyester outer shell with taped seams. Black trim and collar helps conceal dirt. Features removable black fleece liner, black knit waist band and cuff, 2" silver reflective tape, adjustable hideaway hood, (2) mic tabs, (5) pockets with radio and pen pockets. ANSI 107 Type R, Class 3 compliant.

333-1766-LY



333-1766-OR

ITEM #	MARTIN #	COLOR	SIZES	UOM	PRICE
333-1766-LY/M	PIP333-1766-LY/M	Lime yellow	M	EA	\$52.95
333-1766-LY/L	PIP333-1766-LY/L	Lime yellow	L	EA	\$52.95
333-1766-LY/XL	PIP333-1766-LY/XL	Lime yellow	XL	EA	\$52.95
333-1766-LY/2X	PIP333-1766-LY/2X	Lime yellow	2XL	EA	\$52.95
333-1766-LY/3X	PIP333-1766-LY/3X	Lime yellow	3XL	EA	\$52.95
333-1766-LY/4X	PIP333-1766-LY/4X	Lime yellow	4XL	EA	\$52.95
333-1766-LY/5X	PIP333-1766-LY/5X	Lime yellow	5XL	EA	\$52.95
333-1766-OR/M	PIP333-1766-OR/M	Orange	M	EA	\$52.95
333-1766-OR/L	PIP333-1766-OR/L	Orange	L	EA	\$52.95
333-1766-OR/XL	PIP333-1766-OR/XL	Orange	XL	EA	\$52.95
333-1766-OR/2X	PIP333-1766-OR/2X	Orange	2XL	EA	\$52.95
333-1766-OR/3X	PIP333-1766-OR/3X	Orange	3XL	EA	\$52.95
333-1766-OR/4X	PIP333-1766-OR/4X	Orange	4XL	EA	\$52.95
333-1766-OR/5X	PIP333-1766-OR/5X	Orange	5XL	EA	\$52.95

BBCL3L (BACK)



BBCL3L



**LUMINATOR™ TWO-TONE BOMBER JACKET**

Insulated hi-viz bomber jacket keeps wearer warmer in cold temperatures. Black in high wear areas to hide dirty discoloration. Features zipper front closure, cape ventilated back with D-ring access, hide away hood, hybrid elastic/hook-and-loop wrist closures, (2) outer zip up pockets and (1) cell phone pocket on chest. Fluorescent lime. ANSI/ISEA 107-2015 Class 3, Type R compliant.

**⚠️ WARNING:** This product can expose you to chemicals which are known to the state of California to cause birth defects and other reproductive harm and/or cancer. For more information go to [www.P65Warnings.ca.gov](http://www.P65Warnings.ca.gov).

ITEM #	MARTIN #	SIZES	UOM	PRICE
BBCL3LXL	MCRBBCL3LXL	XL	EA	\$50.67
BBCL3LX3	MCRBBCL3LX3	3XL	EA	\$53.83
BBCL3LX4	MCRBBCL3LX4	4XL	EA	\$57.00



### CLASSIC 3-PIECE RAIN SUIT

Made from .35 mm PVC on polyester broadloom fabric for double-layered protection and durability. Consists of jacket, detachable hood and fly-front bib pants. Ideal for construction, utilities, airlines and municipalities. Yellow. 20/Case.

**⚠️ WARNING:** This product can expose you to chemicals which are known to the state of California to cause birth defects and other reproductive harm and/or cancer. For more information go to [www.P65Warnings.ca.gov](http://www.P65Warnings.ca.gov).



ITEM #	MARTIN #	DESCRIPTION	SIZES	UOM	PRICE
2003S	MCR2003S	Classic 3-piece rain suit	S	EA	\$8.53
2003M	MCR2003M	Classic 3-piece rain suit	M	EA	\$8.53
2003L	MCR2003L	Classic 3-piece rain suit	L	EA	\$8.53
2003XL	MCR2003XL	Classic 3-piece rain suit	XL	EA	\$8.53
2003X2	MCR2003X2	Classic 3-piece rain suit	2XL	EA	\$8.53
2003X3	MCR2003X3	Classic 3-piece rain suit	3XL	EA	\$9.25
2003X4	MCR2003X4	Classic 3-piece rain suit	4XL	EA	\$9.63
2003X5	MCR2003X5	Classic 3-piece rain suit	5XL	EA	\$10.37



### .35 MM PVC ON POLYESTER INDUSTRIAL WORK SUIT

Durable, general-purpose garments at an economical price are made to exact specifications for best fit. Features Therm-O-Rad sealed seams for 100% waterproof protection, storm-fly front to seal out wind, rain and contaminants with non-conductive, non-corrosive hardware. Suit consists of jacket, hood and overalls. Yellow.

**⚠️ WARNING:** This product can expose you to chemicals which are known to the state of California to cause birth defects and other reproductive harm and/or cancer. For more information go to [www.P65Warnings.ca.gov](http://www.P65Warnings.ca.gov).



ITEM #	MARTIN #	DESCRIPTION	SIZES	UOM	PRICE
S53307-M	TINGS53307-M	3-Piece suit	M	EA	\$15.58
S53307-L	TINGS53307-L	3-Piece suit	L	EA	\$15.58
S53307-XL	TINGS53307-XL	3-Piece suit	XL	EA	\$15.58
S53307-2X	TINGS53307-2X	3-Piece suit	2XL	EA	\$16.25
S53307-3X	TINGS53307-3X	3-Piece suit	3XL	EA	\$16.25
S53307-4X	TINGS53307-4X	3-Piece suit	4XL	EA	\$24.60
S53307-5X	TINGS53307-5X	3-Piece suit	5XL	EA	\$24.60



### HYDROBLAST RAINWEAR

Suits offer excellent strength and durability. Available in tough .35 mm PVC/polyester fabric. Features Velcro® closures at neck, ankles and front of jacket for a watertight seal. Includes attached hood and overall-style pants. Ideal for light hydroblasting applications or any cleanup operation. Yellow. Limited flammability tested in accordance with ASTM D6413-08.

**⚠️ WARNING:** This product can expose you to chemicals which are known to the state of California to cause birth defects and other reproductive harm and/or cancer. For more information go to [www.P65Warnings.ca.gov](http://www.P65Warnings.ca.gov).

ITEM #	MARTIN #	SIZES	UOM	PRICE
2603L	MCR2603L	L	EA	\$21.58
2603XL	MCR2603XL	XL	EA	\$21.58
2603X2	MCR2603X2	2XL	EA	\$21.58
2603X3	MCR2603X3	3XL	EA	\$22.83
2603X4	MCR2603X4	4XL	EA	\$24.25
2603X5	MCR2603X5	5XL	EA	\$25.25



### DURASCRIPT™ 3-PIECE SUIT

Open-weave, polyester scrim fabric sandwiched between (2) layers of flame resistant PVC coating provides high tear strength. Thicker outside coating offers abrasion resistance and light interior coating protects fabric from chemical contamination. Three-piece suit consists of jacket, detachable hood and snap-fly front overall. FR: self-extinguishing with flameout and afterglow less than or equal to 2 seconds after removal of ignition source and char length less than 6" per Test Method ASTM D6413. Features full-cut shoulder with 90° sleeve-to-body angle for maximum freedom of movement, Therm-O-Rad sealed seams, storm-fly front on jacket, detachable hood, snap-fly front on overall, take-up snaps on sleeves and ankle cuffs for adjustable fit, self-material collar and non-conductive, non-corrosive hardware. Mildew resistant. 100% Waterproof. Yellow.

**⚠️ WARNING:** This product can expose you to chemicals which are known to the state of California to cause birth defects and other reproductive harm and/or cancer. For more information go to [www.P65Warnings.ca.gov](http://www.P65Warnings.ca.gov).

ITEM #	MARTIN #	DESCRIPTION	SIZES	UOM	PRICE
S56307-S	TINGS56307-S	DuraScrim 3-piece suit	S	EA	\$23.93
S56307-M	TINGS56307-M	DuraScrim 3-piece suit	M	EA	\$23.93
S56307-L	TINGS56307-L	DuraScrim 3-piece suit	L	EA	\$23.93
S56307-XL	TINGS56307-XL	DuraScrim 3-piece suit	XL	EA	\$23.93
S56307-2X	TINGS56307-2X	DuraScrim 3-piece suit	2XL	EA	\$24.60
S56307-3X	TINGS56307-3X	DuraScrim 3-piece suit	3XL	EA	\$24.60
S56307-4X	TINGS56307-4X	DuraScrim 3-piece suit	4XL	EA	\$24.60
S56307-5X	TINGS56307-5X	DuraScrim 3-piece suit	5XL	EA	\$24.60





**DOMINATOR RAINWEAR**

Made with .42 mm PVC/ hi-tensile polyester/PVC in green for easy identification. Offers excellent splash protection and is a good choice for use in environments where exposure to many chemicals and acids is possible. Jacket has attached hood and zipper front with storm flap; bib pants have plain front and black plastic take-up snaps at ankles. Limited flammability tested in accordance with ASTM D6413-08 test method.



3882

**⚠️ WARNING:** This product can expose you to chemicals which are known to the state of California to cause birth defects and other reproductive harm and/or cancer. For more information go to [www.P65Warnings.ca.gov](http://www.P65Warnings.ca.gov).

ITEM #	MARTIN #	DESCRIPTION	SIZES	UOM	PRICE
3882S	MCR3882S	Dominator 2-piece rain suit	S	EA	\$37.67
3882M	MCR3882M	Dominator 2-piece rain suit	M	EA	\$37.67
3882L	MCR3882L	Dominator 2-piece rain suit	L	EA	\$37.67
3882XL	MCR3882XL	Dominator 2-piece rain suit	XL	EA	\$37.67
3882X2	MCR3882X2	Dominator 2-piece rain suit	2XL	EA	\$37.67
3882X3	MCR3882X3	Dominator 2-piece rain suit	3XL	EA	\$39.88
3882X4	MCR3882X4	Dominator 2-piece rain suit	4XL	EA	\$42.27
3882X5	MCR3882X5	Dominator 2-piece rain suit	5XL	EA	\$44.80



**CLASS 3 ALL PURPOSE 48" RAINCOATS**

Made of lightweight polyester with waterproof PU coating and taped seams. Features zipper closure with storm flap with snaps, side access pockets, concealable hood for extra protection, and badge holder. ANSI 107 Type R Class 3 compliant.

353-1048-OR 353-1048-LY



ITEM #	MARTIN #	COLOR	SIZES	UOM	PRICE
353-1048-LY/S	PIP353-1048-LY/S	Lime yellow	S	EA	\$35.48
353-1048-LY/M	PIP353-1048-LY/M	Lime yellow	M	EA	\$35.48
353-1048-LY/L	PIP353-1048-LY/L	Lime yellow	L	EA	\$35.48
353-1048-LY/XL	PIP353-1048-LY/XL	Lime yellow	XL	EA	\$35.48
353-1048-LY/2X	PIP353-1048-LY/2X	Lime yellow	2XL	EA	\$35.48
353-1048-LY/3X	PIP353-1048-LY/3X	Lime yellow	3XL	EA	\$35.48
353-1048-LY/4X	PIP353-1048-LY/4X	Lime yellow	4XL	EA	\$35.48
353-1048-LY/5X	PIP353-1048-LY/5X	Lime yellow	5XL	EA	\$35.48
353-1048-OR/S	PIP353-1048-OR/S	Orange	S	EA	\$35.48
353-1048-OR/M	PIP353-1048-OR/M	Orange	M	EA	\$35.48
353-1048-OR/L	PIP353-1048-OR/L	Orange	L	EA	\$35.48
353-1048-OR/XL	PIP353-1048-OR/XL	Orange	XL	EA	\$35.48
353-1048-OR/2X	PIP353-1048-OR/2X	Orange	2XL	EA	\$35.48
353-1048-OR/3X	PIP353-1048-OR/3X	Orange	3XL	EA	\$35.48
353-1048-OR/4X	PIP353-1048-OR/4X	Orange	4XL	EA	\$35.48
353-1048-OR/5X	PIP353-1048-OR/5X	Orange	5XL	EA	\$35.48



**HYDROLITE FR™ HI-VIS RAINWEAR KIT - TYPE R CLASS 3**

Made of 8.3 oz. GORE-TEX® PYRAD® hi-vis yellow/black fabric with 3M™ Scotchlite™ FR segmented silver reflective trim. Features covered D-ring opening for fall protection, covered zip front closure with zipper pull, covered zipper closure on legs, fleece-lined handwarmer pockets, zip-off adjustable hood and snap fly closure. Designed with (1) front bib pocket, (2) front pockets with hook-and-loop closure flaps, and heavy-duty quick-release suspender system. Arc rating: 31 cal/cm<sup>2</sup>, CAT 3. Compliant to ANSI/ISEA 107 Type R Class 3 (jacket) and ANSI/ISEA 107 Class E (bib overalls). Compliant to ASTM F1891 for Arc Flash and ASTM F2733 for Flash Fire.



KITHYDRO-YB

**⚠️ WARNING:** This product can expose you to chemicals which are known to the state of California to cause birth defects and other reproductive harm and/or cancer. For more information go to [www.P65Warnings.ca.gov](http://www.P65Warnings.ca.gov).

ITEM #	MARTIN #	SIZES	UOM	PRICE
KITHYDRO-YB-SM	NASAKITHYDRO-YB-SM	S	EA	\$2,860.00
KITHYDRO-YB-MD	NASAKITHYDRO-YB-MD	M	EA	\$2,860.00
KITHYDRO-YB-LG	NASAKITHYDRO-YB-LG	L	EA	\$2,860.00
KITHYDRO-YB-XL	NASAKITHYDRO-YB-XL	XL	EA	\$2,860.00
KITHYDRO-YB-2X	NASAKITHYDRO-YB-2X	2XL	EA	\$3,146.00
KITHYDRO-YB-3X	NASAKITHYDRO-YB-3X	3XL	EA	\$3,146.00



**ARC H20™ FR HI-VIS RAINWEAR KIT - TYPE R CLASS 3**

Made of flame-resistant PU/FR cotton knit that is 100% waterproof with sealed seams and 2" reflective trim. Key stress points reinforced for durable construction. FR Fabric will NOT melt, drip, or ignite. Jacket features back ventilation system with FR mesh for increased airflow, contoured collar with tuck away attached hood, covered D-ring opening access, adjustable cuffs, covered zipper/snap closures and FR hook-and-loop tab wrist cuff adjusters. Bib overalls feature adjustable shoulder straps, fly opening, FR hook-and-loop adjustable leg closures and heavy-duty quick-release suspender system. Hi-vis yellow. Arc rating: 19 cal/cm<sup>2</sup>, CAT 2. Compliant to ANSI/ISEA 107 Type R Class 3 (jacket) and ANSI/ISEA 107 Class E (bib overalls). Compliant to ASTM F1891 for Arc Flash and ASTM F2733 for Flash Fire.



KITRLC3

**⚠️ WARNING:** This product can expose you to chemicals which are known to the state of California to cause birth defects and other reproductive harm and/or cancer. For more information go to [www.P65Warnings.ca.gov](http://www.P65Warnings.ca.gov).

ITEM #	MARTIN #	SIZES	UOM	PRICE
KITRLC3SM	NASAKITRLC3SM	S	EA	\$953.33
KITRLC3MD	NASAKITRLC3MD	M	EA	\$953.33
KITRLC3LG	NASAKITRLC3LG	L	EA	\$953.33
KITRLC3XL	NASAKITRLC3XL	XL	EA	\$953.33
KITRLC32X	NASAKITRLC32X	2XL	EA	\$1,048.67
KITRLC33X	NASAKITRLC33X	3XL	EA	\$1,048.67

PROTECTIVE CLOTHING | RAINWEAR

## WOLVERINE

### 6" TARMAC WATERPROOF REFLECTIVE CARBONMAX® EH WORK BOOTS



W10305

Features leather upper, removable cushion footbed, ultra-light EVA midsole, rubber outsole and fatigue-fighting nylon shank. High visibility reflective wrap for safety. Feet stay dry with waterproof construction and lightweight cement construction. Brown. CarbonMax toe rated ASTM F2413-11 M I/75 C/75 EH.

ITEM #	MARTIN #	SIZES	UOM	PRICE
<i>6" Tarmac CarbonMax EH Work Boots</i>				
W10305-7M	WWWW10305-7M	7	PR	\$130.00
W10305-7.5M	WWWW10305-7.5M	7.5	PR	\$130.00
W10305-8M	WWWW10305-8M	8	PR	\$130.00
W10305-8.5M	WWWW10305-8.5M	8.5	PR	\$130.00
W10305-9M	WWWW10305-9M	9	PR	\$130.00
W10305-9.5M	WWWW10305-9.5M	9.5	PR	\$130.00
W10305-10M	WWWW10305-10M	10	PR	\$130.00
W10305-10.5M	WWWW10305-10.5M	10.5	PR	\$130.00
W10305-11M	WWWW10305-11M	11	PR	\$130.00
W10305-11.5M	WWWW10305-11.5M	11.5	PR	\$130.00
W10305-12M	WWWW10305-12M	12	PR	\$130.00
W10305-13M	WWWW10305-13M	13	PR	\$130.00
W10305-14M	WWWW10305-14M	14	PR	\$130.00
<i>6" Tarmac CarbonMax EH Work Boots, Extra-Wide</i>				
W10305-8EW	WWWW10305-8EW	8	PR	\$130.00
W10305-8.5EW	WWWW10305-8.5EW	8.5	PR	\$130.00
W10305-9EW	WWWW10305-9EW	9	PR	\$130.00
W10305-9.5EW	WWWW10305-9.5EW	9.5	PR	\$130.00
W10305-10EW	WWWW10305-10EW	10	PR	\$130.00
W10305-10.5EW	WWWW10305-10.5EW	10.5	PR	\$130.00
W10305-11EW	WWWW10305-11EW	11	PR	\$130.00
W10305-11.5EW	WWWW10305-11.5EW	11.5	PR	\$130.00
W10305-12EW	WWWW10305-12EW	12	PR	\$130.00
W10305-13EW	WWWW10305-13EW	13	PR	\$130.00

## WOLVERINE

### WOMEN'S PIPER WATERPROOF COMPOSITE TOE WORK BOOTS



W10180

Constructed of waterproof roughneck leather upper and grippy rubber outsole. Features lightweight cement construction, waterproof membrane, wave mesh lining, removable air cell PU cushion and molded EVA midsole. Non-metallic hardware prevents surface-scratching. Brown. Also available in black. Composite toe meets ASTM F2413-11 M I/75 C/75 EH standards.

ITEM #	MARTIN #	SIZES	UOM	PRICE
<i>Piper Composite Toe Work Boots</i>				
W10180-5M	WWWW10180-5M	5	PR	\$105.00
W10180-5.5M	WWWW10180-5.5M	5.5	PR	\$105.00
W10180-6M	WWWW10180-6M	6	PR	\$105.00
W10180-6.5M	WWWW10180-6.5M	6.5	PR	\$105.00
W10180-7M	WWWW10180-7M	7	PR	\$105.00
W10180-7.5M	WWWW10180-7.5M	7.5	PR	\$105.00
W10180-8M	WWWW10180-8M	8	PR	\$105.00
W10180-8.5M	WWWW10180-8.5M	8.5	PR	\$105.00
W10180-9M	WWWW10180-9M	9	PR	\$105.00
W10180-9.5M	WWWW10180-9.5M	9.5	PR	\$105.00
W10180-10M	WWWW10180-10M	10	PR	\$105.00
W10180-11M	WWWW10180-11M	11	PR	\$105.00
<i>Piper Composite Toe Work Boots, Wide</i>				
W10180-5W	WWWW10180-5W	5	PR	\$105.00
W10180-5.5W	WWWW10180-5.5W	5.5	PR	\$105.00
W10180-6W	WWWW10180-6W	6	PR	\$105.00
W10180-6.5W	WWWW10180-6.5W	6.5	PR	\$105.00
W10180-7W	WWWW10180-7W	7	PR	\$105.00
W10180-7.5W	WWWW10180-7.5W	7.5	PR	\$105.00
W10180-8W	WWWW10180-8W	8	PR	\$105.00
W10180-8.5W	WWWW10180-8.5W	8.5	PR	\$105.00
W10180-9W	WWWW10180-9W	9	PR	\$105.00
W10180-9.5W	WWWW10180-9.5W	9.5	PR	\$105.00
W10180-10W	WWWW10180-10W	10	PR	\$105.00

## WOLVERINE

### OVERPASS CARBONMAX® SAFETY TOE BOOTS

Constructed of premium waterproof leather with moisture-wicking mesh lining and abrasion-resistant toe upper. Designed with Contour Welt® and Motion Max™ technology for maximum comfort and flexibility. Features removable OrthoLite® cushioning footbed, advanced comfort PU midsole, nylon shank and dual compound rubber and PU outsole. Brown. CarbonMax safety toe meets ASTM F2413-11 M I/75 C/75 EH standards.

W10717



ITEM #	MARTIN #	SIZES	UOM	PRICE
<i>Overpass CarbonMax Safety Toe Boots</i>				
W10717-7M	WWWW10717-7M	7	PR	\$129.17
W10717-7.5M	WWWW10717-7.5M	7.5	PR	\$129.17
W10717-8M	WWWW10717-8M	8	PR	\$129.17
W10717-8.5M	WWWW10717-8.5M	8.5	PR	\$129.17
W10717-9M	WWWW10717-9M	9	PR	\$129.17
W10717-9.5M	WWWW10717-9.5M	9.5	PR	\$129.17
W10717-10M	WWWW10717-10M	10	PR	\$129.17
W10717-10.5M	WWWW10717-10.5M	10.5	PR	\$129.17
W10717-11M	WWWW10717-11M	11	PR	\$129.17
W10717-11.5M	WWWW10717-11.5M	11.5	PR	\$129.17
W10717-12M	WWWW10717-12M	12	PR	\$129.17
W10717-13M	WWWW10717-13M	13	PR	\$129.17
W10717-14M	WWWW10717-14M	14	PR	\$129.17

ITEM #	MARTIN #	SIZES	UOM	PRICE
<i>Overpass CarbonMax Safety Toe Boots, Extra-Wide</i>				
W10717-7EW	WWWW10717-7EW	7	PR	\$129.17
W10717-7.5EW	WWWW10717-7.5EW	7.5	PR	\$129.17
W10717-8EW	WWWW10717-8EW	8	PR	\$129.17
W10717-8.5EW	WWWW10717-8.5EW	8.5	PR	\$129.17
W10717-9EW	WWWW10717-9EW	9	PR	\$129.17
W10717-9.5EW	WWWW10717-9.5EW	9.5	PR	\$129.17
W10717-10EW	WWWW10717-10EW	10	PR	\$129.17
W10717-10.5EW	WWWW10717-10.5EW	10.5	PR	\$129.17
W10717-11EW	WWWW10717-11EW	11	PR	\$129.17
W10717-11.5EW	WWWW10717-11.5EW	11.5	PR	\$129.17
W10717-12EW	WWWW10717-12EW	12	PR	\$129.17
W10717-13EW	WWWW10717-13EW	13	PR	\$129.17



**BLADE LX WATERPROOF CARBONMAX® BOOTS**

Constructed of full grain leather upper, advanced comfort PU midsole and rubber lug outsole. Features moisture-wicking mesh lining, removable EPX™ anti-fatigue footbed and nylon shank. Black. CarbonMax safety toe rated ASTM F2413-11 M I/75 C/75 EH.

W10652



ITEM #	MARTIN #	SIZES	UOM	PRICE
<i>Blade LX Waterproof CarbonMax Boots</i>				
W10652-7M	WWWWW10652-7M	7	PR	\$145.83
W10652-7.5M	WWWWW10652-7.5M	7.5	PR	\$145.83
W10652-8M	WWWWW10652-8M	8	PR	\$145.83
W10652-8.5M	WWWWW10652-8.5M	8.5	PR	\$145.83
W10652-9M	WWWWW10652-9M	9	PR	\$145.83
W10652-9.5M	WWWWW10652-9.5M	9.5	PR	\$145.83
W10652-10M	WWWWW10652-10M	10	PR	\$145.83
W10652-10.5M	WWWWW10652-10.5M	10.5	PR	\$145.83
W10652-11M	WWWWW10652-11M	11	PR	\$145.83
W10652-11.5M	WWWWW10652-11.5M	11.5	PR	\$145.83
W10652-12M	WWWWW10652-12M	12	PR	\$145.83
W10652-13M	WWWWW10652-13M	13	PR	\$145.83
W10652-14M	WWWWW10652-14M	14	PR	\$145.83

ITEM #	MARTIN #	SIZES	UOM	PRICE
<i>Blade LX Waterproof CarbonMax Boots, Extra-Wide</i>				
W10652-7EW	WWWWW10652-7EW	7	PR	\$145.83
W10652-7.5EW	WWWWW10652-7.5EW	7.5	PR	\$145.83
W10652-8EW	WWWWW10652-8EW	8	PR	\$145.83
W10652-8.5EW	WWWWW10652-8.5EW	8.5	PR	\$145.83
W10652-9EW	WWWWW10652-9EW	9	PR	\$145.83
W10652-9.5EW	WWWWW10652-9.5EW	9.5	PR	\$145.83
W10652-10EW	WWWWW10652-10EW	10	PR	\$145.83
W10652-10.5EW	WWWWW10652-10.5EW	10.5	PR	\$145.83
W10652-11EW	WWWWW10652-11EW	11	PR	\$145.83
W10652-11.5EW	WWWWW10652-11.5EW	11.5	PR	\$145.83
W10652-12EW	WWWWW10652-12EW	12	PR	\$145.83
W10652-13EW	WWWWW10652-13EW	13	PR	\$145.83



**8" MCKAY WATERPROOF INTERNAL METATARSAL GUARD STEEL TOE BOOTS**

Full-grain leather for extra strength and comfort. Features waterproof leather upper, CK mesh lining, removable, full-cushion footbed, Goodyear® welt construction for flexibility, internal metatarsal guard and slip-resistant rubber/PU outsole. 8" Height. Brown. Steel toe rated ASTM F2413-05 M I/75 C/75 MT/75 EH.

W05680



**10" OVERMAN CARBONMAX® WATERPROOF EH WORK BOOTS**

Features waterproof full-grain leather upper with reinforced, abrasion-resistant heel and toe, removable full-foot Multishox® heel and toe compression pads and nylon shank. CarbonMax uses nanotechnology to produce a strong, lighter, more comfortable safety toe. Enhanced flexibility from Contour Welt® rubber outsole stand up to worksite conditions. Sweat-fighting mesh lining wicks for comfort. Lightweight, durable polyurethane midsole. Brown/black. Meets ASTM F2413-11 M I/75 C/75 EH.

W10488



ITEM #	MARTIN #	SIZES	UOM	PRICE
<i>Internal Metatarsal Guard Steel Toe Boots</i>				
W05680-5M	WWWWW05680-5M	5	PR	\$137.50
W05680-5.5M	WWWWW05680-5.5M	5.5	PR	\$137.50
W05680-6M	WWWWW05680-6M	6	PR	\$137.50
W05680-6.5M	WWWWW05680-6.5M	6.5	PR	\$137.50
W05680-7M	WWWWW05680-7M	7	PR	\$137.50
W05680-7.5M	WWWWW05680-7.5M	7.5	PR	\$137.50
W05680-8M	WWWWW05680-8M	8	PR	\$137.50
W05680-8.5M	WWWWW05680-8.5M	8.5	PR	\$137.50
W05680-9M	WWWWW05680-9M	9	PR	\$137.50
W05680-9.5M	WWWWW05680-9.5M	9.5	PR	\$137.50
W05680-10M	WWWWW05680-10M	10	PR	\$137.50
W05680-10.5M	WWWWW05680-10.5M	10.5	PR	\$137.50
W05680-11M	WWWWW05680-11M	11	PR	\$137.50
W05680-11.5M	WWWWW05680-11.5M	11.5	PR	\$137.50
W05680-12M	WWWWW05680-12M	12	PR	\$137.50
W05680-13M	WWWWW05680-13M	13	PR	\$137.50
W05680-14M	WWWWW05680-14M	14	PR	\$137.50
<i>Internal Metatarsal Guard Steel Toe Boots, Extra-Wide</i>				
W05680-8EW	WWWWW05680-8EW	8	PR	\$137.50
W05680-8.5EW	WWWWW05680-8.5EW	8.5	PR	\$137.50
W05680-9EW	WWWWW05680-9EW	9	PR	\$137.50
W05680-9.5EW	WWWWW05680-9.5EW	9.5	PR	\$137.50
W05680-10EW	WWWWW05680-10EW	10	PR	\$137.50
W05680-10.5EW	WWWWW05680-10.5EW	10.5	PR	\$137.50
W05680-11EW	WWWWW05680-11EW	11	PR	\$137.50
W05680-11.5EW	WWWWW05680-11.5EW	11.5	PR	\$137.50
W05680-12EW	WWWWW05680-12EW	12	PR	\$137.50
W05680-13EW	WWWWW05680-13EW	13	PR	\$137.50

ITEM #	MARTIN #	SIZES	UOM	PRICE
<i>10" Overman CarbonMax Work Boots</i>				
W10488-7M	WWWWW10488-7M	7	PR	\$158.33
W10488-7.5M	WWWWW10488-7.5M	7.5	PR	\$158.33
W10488-8M	WWWWW10488-8M	8	PR	\$158.33
W10488-8.5M	WWWWW10488-8.5M	8.5	PR	\$158.33
W10488-9M	WWWWW10488-9M	9	PR	\$158.33
W10488-9.5M	WWWWW10488-9.5M	9.5	PR	\$158.33
W10488-10M	WWWWW10488-10M	10	PR	\$158.33
W10488-10.5M	WWWWW10488-10.5M	10.5	PR	\$158.33
W10488-11M	WWWWW10488-11M	11	PR	\$158.33
W10488-11.5M	WWWWW10488-11.5M	11.5	PR	\$158.33
W10488-12M	WWWWW10488-12M	12	PR	\$158.33
W10488-13M	WWWWW10488-13M	13	PR	\$158.33
W10488-14M	WWWWW10488-14M	14	PR	\$158.33
<i>10" Overman CarbonMax Work Boots, Extra-Wide</i>				
W10488-8EW	WWWWW10488-8EW	8	PR	\$158.33
W10488-8.5EW	WWWWW10488-8.5EW	8.5	PR	\$158.33
W10488-9EW	WWWWW10488-9EW	9	PR	\$158.33
W10488-9.5EW	WWWWW10488-9.5EW	9.5	PR	\$158.33
W10488-10EW	WWWWW10488-10EW	10	PR	\$158.33
W10488-10.5EW	WWWWW10488-10.5EW	10.5	PR	\$158.33
W10488-11EW	WWWWW10488-11EW	11	PR	\$158.33
W10488-11.5EW	WWWWW10488-11.5EW	11.5	PR	\$158.33
W10488-12EW	WWWWW10488-12EW	12	PR	\$158.33
W10488-13EW	WWWWW10488-13EW	13	PR	\$158.33
W10488-14EW	WWWWW10488-14EW	14	PR	\$158.33

PROTECTIVE CLOTHING | FOOTWEAR





# ENGINEERED. TESTED. CERTIFIED.

## DROPPED TOOLS CAN CREATE SIGNIFICANT HUMAN AND ASSET DAMAGE

- In 2012, people being struck by objects replaced people falling as the 3rd leading cause of death in the workplace.<sup>1</sup>
- A 3 lb object falling 200ft carries more than 1,000 lbs of force per square inch on impact.
- It is very common for falling objects to deflect and travel significant distances from their original path.

<sup>1</sup> Bureau of Statistics

## KEEP YOUR PEOPLE SAFE AND ASSETS SECURE WITH SNAP-ON INDUSTRIAL BRANDS TOOLS@HEIGHT PROGRAM

### SNAP-ON INDUSTRIAL BRANDS TOOLS@HEIGHT PROGRAM OFFERS UNIQUE ADVANTAGES

**ENGINEERED, TESTED and CERTIFIED SYSTEM** to maintain or enhance functionality of tools when used at height

- 4 side lock holes
- Safety coils
- Screwdriver tabs
- Pipe wrenches
- Differentiated proposition: engineered attachment points + tool transportation products
- With over 1,000 products, the industry's most comprehensive drop prevention system
- Turnkey provider of customized solutions
- Worldwide sales and service
- Stocked selection to ensure fast delivery
- Same warranty as standard tools

### SNAP-ON TOOLS@HEIGHT OFFERS THESE ADVANTAGES:

- **ENGINEERED ATTACHMENT POINTS** - carefully placed attachment points are designed and tested to maintain the functionality of the tools
- **A TURNKEY SOLUTION** - from individual tools to custom-designed kits, we'll help create the systems you need, then ship the assembled components that are ready to work upon arrival
- **RELIABLE EFFECTIVENESS** - our Tools@Height system has been proven again and again to reduce dropped object occurrences in real world applications in a variety of industries
- **STANDARDIZATION** - our process provides consistent placement of tethering attachment points, and a wide selection of lanyards, that provide workers with familiar, reliable tools across multiple facilities. When your crews relocate to a different worksite, there's no need for additional training on the tools they'll be using
- **INTEGRATION** - attachment points, lanyards, tool bags and other components of our system work together to create innovative, dependable systems
- **EASY REPLACEMENT** - Tools@Height kits contain standard Snap-on tools that have been enhanced with appropriate drop prevention components. If a tool needs to be replaced, you can be assured that an identical item, equipped with Tools@Height modifications, will be readily available for use "right out of the box"
- **DROP PREVENTION TRAINING** - Snap-on Account Managers have the knowledge and experience to train your employees on the safe and effective use of tethered tools
- **LOWER IMPLEMENTATION COST OVERALL** - Tools@Height drop prevention can be implemented for only a portion of the cost of in-house systems

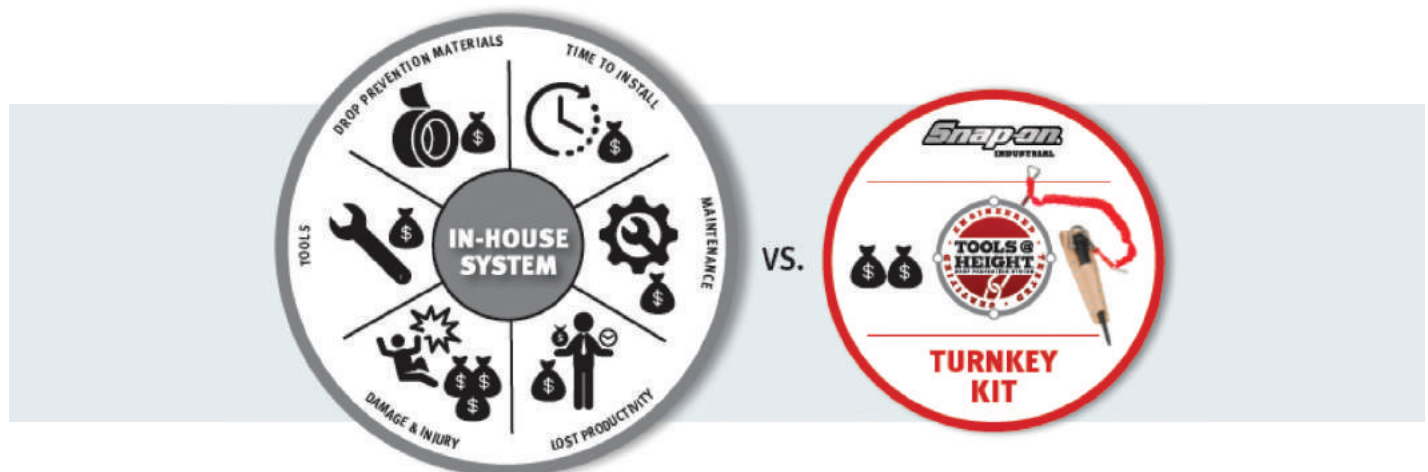

**Snap-on** INDUSTRIAL BRANDS





# ▶ FALL PROTECTION



These fine manufacturers help us bring you custom tailored solutions:



Fall protection must be provided whenever necessary to protect against any risk exists that a worker may fall from an elevated position, as a general rule, the fall arrest system should be used anytime a working height of six feet or more is reached. Ensuring worker safety includes conducting a workplace hazard assessment and providing the adequate training to make sure everyone goes home safely to their families.

Harnesses .....	96-99
Lanyards .....	99-101
SRLs .....	101-104
Anchors .....	104-105
Lifeline Systems .....	106-107
Confined Space & Rescue .....	107
Accessories .....	108
Carabiners & Tools .....	108-112



**3M™ DBI-SALA® CONSTRUCTION VEST STYLE HARNESS**

Constructed from highly durable polyester webbing that resists sunlight and chemicals. No-Tangle® feature increases user acceptance by eliminating tangling and innovative design provides extra comfort throughout neck, shoulders and back areas. Includes standup back D-ring and side D-rings, belt loops, body belt, back and shoulder pads, and adjustable tongue-buckle leg straps. Capacity is 420 lbs. i-Safe™ enabled with RFID technology. Meets all applicable OSHA requirements, ANSI standards and CSA certifications.

1101655



ITEM #	MARTIN #	DESCRIPTION	SIZES	UOM	PRICE
1101654	DBI1101654	Construction vest style harness	M	EA	\$223.38
1101655	DBI1101655	Construction vest style harness	L	EA	\$223.38
1101656	DBI1101656	Construction vest style harness	XL	EA	\$223.38



**3M™ DBI-SALA® DELTA™ VEST STYLE HARNESSSES**

No-Tangle triangular design allows harness to fall into place for quick and easy donning and holds its basic shape so shoulder straps don't rub against neck. Water-repellent Repel™ webbing has built-in rip-stitch impact indicators for inspection of harness for prior damaging impact loads. Revolver™ vertical torso adjuster makes adjustments simple and fast, eliminating loose ends and locking into place to prevent slippage. Includes tongue-buckle leg straps and incorporates a spring-loaded, stand-up dorsal D-ring for fast, easy and safe connections. Tech-Lite™ aluminum alloy buckles reduce both carried weight and energy required for all-day job performance. Features lanyard keepers for holding unused snap hooks and reducing trip hazards. i-Safe™ enabled with RFID technology; label protector has Velcro® cover for holding harness labels and i-Safe identification tag. Capacity: 420 lbs. Meets or exceeds all applicable OSHA regulations and ANSI standards, including ANSI Z359.11.



1102000

ITEM #	MARTIN #	DESCRIPTION	SIZES	UOM	PRICE
1102000	DBI1102000	Vest style harness w/ tongue-buckle legs w/ back D-ring	Universal	EA	\$132.00
1102008	DBI1102008	Vest style harness w/ tongue-buckle legs w/ back & side D-rings	Universal	EA	\$158.77



**3M™ DBI-SALA® EXOFIT NEX™ CONSTRUCTION STYLE HARNESS**

Full-body harness provides comfort and function with soft, yet extremely durable, anti-absorbent webbing, strategically placed padding and protective elements that prolong service life of harness. Chest platform places labels and i-Safe™ RFID tag behind a Velcro® cover to protect labels and provide easy access. Covered pocket with elastic sides is conveniently placed on front of chest strap to hold workplace or personal items such as a cellular phone. Includes reflective material that increases worker safety in low-visibility environments, stand-up dorsal D-ring, side D-rings, integrated suspension trauma straps for post fall-arrest comfort, sewn-in hip pad and removable body belt, impact indicator stitches and breakaway lanyard keepers. Capacity: 420 lbs. Meets all applicable OSHA regulations and ANSI Z359.11 standards.



1113124

**Features:**

- Duo-Lok™ quick-connect buckles: lightweight, one-hand use with memory-fit
- Revolver™ vertical torso adjusters: simple, fast adjustment that locks into position
- Hybrid comfort padding: combines premium comfort with durability
- Tech-Lite™ aluminum D-rings: lightweight alloy for added comfort
- Repel™ technology webbing: provides up to 5 times more abrasion resistance and water repellency

ITEM #	MARTIN #	DESCRIPTION	SIZES	UOM	PRICE
1113124	DBI1113124	Construction style harness	M	EA	\$461.54
1113127	DBI1113127	Construction style harness	L	EA	\$461.54
1113130	DBI1113130	Construction style harness	XL	EA	\$461.54

**WARNING**

Compliant fall protection and emergency rescue systems help prevent serious injury during fall arrest. Users must read and understand the *User Instructions* provided with the product and be properly trained by their employer prior to use per OSHA 1910.66 and 1926.503 or applicable local standards. **Misuse or failure to follow warnings and instructions may result in serious personal injury or death.** For proper use, see supervisor, *User Instructions*, or call Technical Service at 1-800-560-1094.



### 3M™ DBI-SALA® EXOFIT NEX™ TOWER CLIMBING HARNESS

Full-body harness provides comfort and function with soft, yet extremely durable, anti-absorbent webbing, strategically placed padding and protective elements that prolong service life of harness. Chest platform places labels and i-Safe™ RFID tag behind a Velcro® cover to protect labels and provide easy access. Covered pocket with elastic sides is conveniently placed on front of chest strap to hold workplace or personal items such as a cellular phone. Includes reflective material that increases worker safety in low-visibility environments, stand-up dorsal and front D-rings, integrated suspension trauma straps for post fall-arrest comfort, sewn-in hip pad and body belt with side D-rings, removable seat sling with positioning D-rings, impact indicator stitches and breakaway lanyard keepers. Capacity: 420 lbs. Meets all applicable OSHA regulations and ANSI standards.



1113191

#### Features:

- Duo-Lok™ quick-connect buckles: lightweight, one-hand use with memory-fit
- Revolver™ vertical torso adjusters: simple, fast adjustment that locks into position
- Hybrid comfort padding: combines premium comfort with durability
- Tech-Lite™ aluminum D-rings: lightweight alloy for added comfort
- Repel™ technology webbing: provides up to 5 times more abrasion resistance and water repellency

ITEM #	MARTIN #	DESCRIPTION	SIZES	UOM	PRICE
1113191	DBI1113191	Tower climbing harness	M	EA	\$765.23
1113192	DBI1113192	Tower climbing harness	L	EA	\$765.23
1113193	DBI1113193	Tower climbing harness	XL	EA	\$765.23



### 3M™ DBI-SALA® EXOFIT NEX™ VEST STYLE HARNESS

Full-body harness provides comfort and function with soft, yet extremely durable, anti-absorbent webbing, strategically placed padding and protective elements that prolong service life of harness. Chest platform places labels and i-Safe™ RFID tag behind a Velcro® cover to protect labels and provide easy access. Covered pocket with elastic sides is conveniently placed on front of chest strap to hold workplace or personal items such as a cellular phone. Includes reflective material that increases worker safety in low-visibility environments, stand-up, aluminum dorsal D-ring, integrated suspension trauma straps for post fall-arrest comfort, impact indicator stitches and breakaway lanyard keepers. Capacity: 420 lbs. Meets all applicable OSHA regulations and ANSI Z359.11 standards.



1113004

#### Features:

- Duo-Lok™ quick-connect buckles: lightweight, one-hand use with memory-fit
- Revolver™ vertical torso adjusters: simple, fast adjustment that locks into position
- Hybrid comfort padding: combines premium comfort with durability, protective shoulder caps
- Tech-Lite™ aluminum D-rings: lightweight alloy for added comfort
- Repel™ technology webbing: provides up to 5 times more abrasion resistance and water repellency

ITEM #	MARTIN #	DESCRIPTION	SIZES	UOM	PRICE
1113004	DBI1113004	Vest style harness	M	EA	\$397.85
1113007	DBI1113007	Vest style harness	L	EA	\$397.85
1113010	DBI1113010	Vest style harness	XL	EA	\$397.85



### MILLER AIRCORE™ HARNESSSES

Lightweight, full-body harness designed with breathable, open-core padding technology that provides optimal air flow while reducing heat and moisture entrapment, keeping worker drier and cooler. Patented Miller DuraFlex® stretchable webbing provides greater flexibility and increased comfort. Unique cam buckles on the shoulder straps make vertical webbing adjustment easy. Original, vibrant style design for easy identification and greater visibility. Includes stand-up back D-ring, quick-connect chest strap, sub-pelvic strap, and steel components. Universal size is L/XL. Meets all applicable OSHA, ANSI and CSA requirements.



AC-QC/UGN



AC-QC-BDP/UGN

ITEM #	MARTIN #	DESCRIPTION	SIZES	UOM	PRICE
AC-QC/UGN	NTHAC-QC/UGN	AirCore harness w/ quick-connect leg straps	Universal	EA	\$262.77
AC-TB/UGN	NTHAC-TB/UGN	AirCore harness w/ tongue-buckle leg straps	Universal	EA	\$256.38
AC-QC-BDP/UGN	NTHAC-QC-BDP/UGN	AirCore harness w/ side D-rings, lumbar pad, removable belt & quick-connect leg straps	Universal	EA	\$319.45

**Honeywell**  
**MILLER**

**MILLER CONTRACTOR HARNESS**

Specifically designed for use in construction. Lightweight, non-stretch webbing with a combination back D-ring pad/shoulder pads to minimize discomfort and stress around neck and shoulders. Soft lumbar back pad adds support and comfort. Features side D-rings, belt loops and removable waist belt, tongue-buckle leg straps, friction-buckle shoulder adjustments, mating-buckle chest straps, self-contained label pack and (2) pull-free lanyard rings. Rated to 400 lbs. capacity. Universal size is L/XL. Meets all applicable OSHA, ANSI and CSA standards and requirements.

650CN-BDP/UGN



ITEM #	MARTIN #	DESCRIPTION	SIZES	UOM	PRICE
650CN-BDP/UGN	NTH650CN-BDP/UGN	Contractor harness	Universal	EA	\$168.78

**Honeywell**  
**MILLER**

**MILLER DURAFLEX PYTHON® HARNESS**

P950-4/UGN

Shoulder straps with friction buckles are constructed of soft, cushioned tubular webbing; lower torso straps of specially-formulated DuraFlex® stretchable webbing; and leg straps of lightweight, non-stretch webbing. Increases overall comfort when using tool belt and holds its shape for ease of donning. Includes comfort-touch back D-ring pad, pull-free lanyard rings, mating-buckle chest straps and belt loops. Universal size is L/XL. Green. Meets all applicable OSHA, ANSI and CSA standards and requirements, including ANSI Z359.1.



ITEM #	MARTIN #	DESCRIPTION	SIZES	UOM	PRICE
P950-4/UGN	NTHP950-4/UGN	Python harness	Universal	EA	\$140.31

**Honeywell**  
**MILLER**

**MILLER REVOLUTION™ HARNESS WITH DUALTECH™ WEBBING**

RDT-QC/UBK

DualTech webbing offers soft, textured inside and durable, chemical-resistant polyester outer material. Features ErgoArmor™ semi-flexible back shield for impact protection, PivotLink™ connection, quick-release cam buckles for one-hand adjustments, self-contained label pack, quick-connect chest and leg buckles, stand-up back D-ring, sub-pelvic strap and web finials. Tested to 7,000-lb. minimum tensile strength for greater safety and longer service life. Rated to 400 lbs. Universal size is L/XL. Meets all applicable OSHA, ANSI and CSA standards and requirements.



ITEM #	MARTIN #	DESCRIPTION	SIZES	UOM	PRICE
RDT-QC/UBK	NTHRDT-QC/UBK	Harness w/ DualTech webbing	Universal	EA	\$288.02

**SAFEWAZE™**

**VLINE FULL-BODY HARNESSES**

Universal-sized (up to size XL) with multiple adjustment points, a single back D-ring and grommet leg straps.

ITEM #	MARTIN #	DESCRIPTION	SIZES	UOM	PRICE
FS99185-E-S/M	EXCOFS99185-E-S/M	Full-body harness	S/M	EA	\$48.07
FS99185-E-L/XL	EXCOFS99185-E-L/XL	Full-body harness	L/XL	EA	\$48.07

FS99185-E



**SAFEWAZE™**

**VLINE COMPLIANCE KIT**

Includes single D-ring harness with pass-through leg straps, adjustable buckles, fall arrest indicators and lanyard keepers; 6' Shock-absorbing lanyard with 1" polyester webbing and double-locking snap hooks (3,600-lb. rated gates); and transport bag.

ITEM #	MARTIN #	DESCRIPTION	UOM	PRICE
FS126-E	EXCOFS126-E	V-LINE compliance kit	EA	\$84.07

FS126-E





## PRO+ CONSTRUCTION HARNESSSES

Ergonomic design for comfort and wearability. Features comfort shoulder pad, quick-release chest buckle, quick adjustment buckles, convenient lanyard keepers, fall arrest indicators and grommet leg straps. Rated at 420 lbs.

FS-FLEX360



ITEM #	MARTIN #	DESCRIPTION	SIZES	UOM	PRICE
FS-FLEX185-S/M	EXCOFS-FLEX185-S/M	Construction harness w/ back D-ring	S/M	EA	\$103.00
FS-FLEX185-L/XL	EXCOFS-FLEX185-L/XL	Construction harness w/ back D-ring	L/XL	EA	\$103.00
FS-FLEX185-XXL	EXCOFS-FLEX185-XXL	Construction harness w/ back D-ring	2XL	EA	\$103.00
FS-FLEX360-S	EXCOFS-FLEX360-S	Construction harness w/ back & side D-rings & back pad	S	EA	\$191.67
FS-FLEX360-M	EXCOFS-FLEX360-M	Construction harness w/ back & side D-rings & back pad	M	EA	\$191.67
FS-FLEX360-L	EXCOFS-FLEX360-L	Construction harness w/ back & side D-rings & back pad	L	EA	\$191.67
FS-FLEX360-XL	EXCOFS-FLEX360-XL	Construction harness w/ back & side D-rings & back pad	XL	EA	\$191.67
FS-FLEX360-XXL	EXCOFS-FLEX360-XXL	Construction harness w/ back & side D-rings & back pad	2XL	EA	\$191.67



## 3M™ DBI-SALA® SHOCKWAVE2™ SHOCK-ABSORBING LANYARDS

Stretchable lanyard incorporates a unique inner core that immediately begins to extend and absorb energy during a fall, limiting arresting forces to an average of 900 lbs. Features abrasion-resistant tubular webbing for durability and 3,600-lb. gated hooks. Expands to 6' and contracts to 4 1/2' in reaction to movements, reducing trip fall hazards and snagging. Impact indicator allows for visual inspection of unit. i-Safe™ RFID technology enabled. Meets or exceeds all applicable OSHA regulations and ANSI standards, including ANSI Z359.1.



## 3M™ DBI-SALA® EZ-STOP™ II SHOCK-ABSORBING LANYARDS

Utilizes a controlled tearing action when subjected to fall arrest forces, limiting arresting forces to no more than 900 lbs. Features soft-cover shock absorber for added comfort. Web models feature 1" wide polyester web. 3,600-lb. Compliant snap hooks. i-Safe™ RFID technology enabled. Capacity: 310 lbs. Meets or exceeds all applicable OSHA regulations and ANSI standards, including ANSI Z359.1.



ITEM #	MARTIN #	DESCRIPTION	SIZES	UOM	PRICE
<i>Single Leg Lanyards</i>					
1244306	DBI1244306	Web lanyard w/ self-locking steel snap hooks both ends	6'	EA	\$108.92
1244321	DBI1244321	Web lanyard w/ self-locking snap hook & 2 1/2" gate flat steel hook	6'	EA	\$156.00
<i>Twin-Leg Lanyards</i>					
1244412	DBI1244412	Web lanyard w/ self-locking snap hook & 2 1/2" gate flat steel hooks at leg ends	6'	EA	\$263.08
1244456	DBI1244456	Web lanyard w/ self-locking snap hook & 2 1/2" flat steel hooks leg ends, D-ring for SRL attachment on legs	6'	EA	\$278.77

ITEM #	MARTIN #	DESCRIPTION	SIZES	UOM	PRICE
1246011	DBI1246011	Web lanyard, single leg w/ snap hooks both ends	6'	EA	\$109.85
1246234	DBI1246234	Web adjustable lanyard, single leg w/ snap hooks both ends	6'	EA	\$118.15
1246188	DBI1246188	Vinyl covered cable lanyard, single leg w/ snap hooks both ends	6'	EA	\$138.46
1246021	DBI1246021	Web lanyard, twin leg w/ snap hook & gate aluminum rebar hooks at leg ends	6'	EA	\$306.46



## 3M™ PROTECTA® PRO SHOCK-ABSORBING LANYARDS

Secure and durable energy-absorbing lanyard available in pack style, tubular jacket with internal shock absorber or stretch design. Stretch tubular lanyard expands to 6' and contracts to 4 1/2'. Single or double-leg configurations with standard snap hooks or flat steel rebar (2" gate) hooks. Polyester webbing. Meets or exceeds OSHA 1926 regulation.



ITEM #	MARTIN #	DESCRIPTION	SIZES	UOM	PRICE
<i>PRO STOP Lanyards</i>					
1340220	DBI1340220	Tubular lanyard, single leg w/ snap hooks both ends	6'	EA	\$43.38
1340250	DBI1340250	Tubular lanyard, single leg w/ snap hook & rebar hook	6'	EA	\$93.69
<i>PRO STRETCH Lanyards</i>					
1340101	DBI1340101	Stretch lanyard, twin-leg w/ snap hooks both ends	6'	EA	\$57.23
1340161	DBI1340161	Stretch lanyard, twin-leg w/ snap hook & rebar hooks	6'	EA	\$106.15

### WARNING

Compliant fall protection and emergency rescue systems help prevent serious injury during fall arrest. Users must read and understand the *User Instructions* provided with the product and be properly trained by their employer prior to use per OSHA 1910.66 and 1926.503 or applicable local standards. **Misuse or failure to follow warnings and instructions may result in serious personal injury or death.** For proper use, see supervisor, *User Instructions*, or call Technical Service at 1-800-560-1094.



**3M™ DBI-SALA® FORCE2™ SHOCK-ABSORBING LANYARD**

Used when there is no overhead anchorage and the only option is to tie-off at your feet. Can also be used as a standard lanyard. 1" Standard webbing with 3,600-lb. snap hooks. A soft cover shock absorber is added for comfort. Appropriate for up to a 12' free fall and still limits arresting forces below 1,800 lbs. per OSHA standards. i-Safe™ enabled with RFID technology. Meets or exceeds all industry standards for fall arrest forces including OSHA.



ITEM #	MARTIN #	DESCRIPTION	SIZES	UOM	PRICE
1246167	DBI1246167	Lanyard, single leg w/ snap hooks both ends	6'	EA	\$131.08



**MILLER MANYARD® II STRETCHABLE SHOCK-ABSORBING LANYARDS**

Contracts from 6' to 4', reducing chances of tripping, snagging or dragging. Woven shock-absorbing inner core smoothly expands to reduce fall arrest forces, while outer jacket serves as a back-up web lanyard. Unique warning flag provides visual proof that lanyard has been involved in a fall and must be removed from service. Snap hooks have 3/4" gate opening and rebar hooks have 2 1/2" opening. Includes inspection log label. Meets all applicable OSHA, ANSI and CSA requirements. Connectors rated at 3,600 lbs.



ITEM #	MARTIN #	DESCRIPTION	SIZES	UOM	PRICE
219M-Z7/6FTGN	NTH219M-Z7/6FTGN	Single leg lanyard w/ locking snap hook & rebar hook	6'	EA	\$141.40
231M-Z7/6FTGN	NTH231M-Z7/6FTGN	Twin-leg lanyard w/ locking snap hook & rebar hooks	6'	EA	\$254.95



**MILLER MANYARD® SHOCK-ABSORBING LANYARD**

Specially woven shock-absorbing inner core smoothly expands to reduce fall arrest forces, while outer jacket serves as a back-up web lanyard. Unique warning flag provides visual proof that lanyard has been involved in a fall and must be removed from service. Yellow. Meets all applicable OSHA, ANSI and CSA requirements.



ITEM #	MARTIN #	DESCRIPTION	SIZES	UOM	PRICE
216WLS-Z7/6FTYL	NTH216WLS-Z7/6FTYL	Single leg lanyard w/ snap hooks both ends	6'	EA	\$89.48



**MILLER BACKBITER® TIE-BACK LANYARD**

All-in-one lanyard designed specifically for tie-back use reduces inventory and increases worker compliance. Features SofStop® shock absorber designed with a specially-woven inner core that smoothly expands to reduce fall arrest forces. Includes locking Miller 5K® snap hook (5,000-lb. gate load capacity from any angle), locking snap hook with 3/4" gate opening harness connection, heavy-duty webbing and cross-arm anchorage connector. Twin-leg model; can be used for 100% tie-off requirements. Connectors rated at 3,600-lb. gate strength. Meets all applicable OSHA, ANSI and CSA requirements.



ITEM #	MARTIN #	DESCRIPTION	SIZES	UOM	PRICE
8798B/6FTGN	NTH8798B/6FTGN	Tie-back lanyard	6'	EA	\$211.52



**VLINE STRETCH LOW PROFILE ENERGY ABSORBING LANYARDS**

Fall arrest lanyard with (2) snap hooks—one end attaches to anchor point and other end attaches to harness D-ring. Elastic webbing stretches 4'-6' in length to reduce potential trip hazards when not in use. Internal shock tear away lessens body impact by eliminating an external shock pack while still providing the required fall arrest energy absorption.



ITEM #	MARTIN #	DESCRIPTION	UOM	PRICE
FS88590	EXCOFS88590	Single leg energy absorbing lanyard w/ snap hooks	EA	\$46.35
FS88596	EXCOFS88596	Twin-leg energy absorbing lanyard w/ rebar hook	EA	\$85.83



**ADJUSTABLE WEB POSITIONING LANYARD**

Constructed of 1" polyester webbing with high-strength polyester stitching. Features (2) double-action forged steel snap hooks with 0.83" openings. Adjustable from 4' to 6'. 310-lb. Weight capacity. Meets OSHA 1926.502, ANSI Z359.3 and ANSI A10.32 standards.



ITEM #	MARTIN #	DESCRIPTION	UOM	PRICE
FS33310	EXCOFS33310	Adjustable web positioning lanyard	EA	\$38.33

**WARNING**

Compliant fall protection and emergency rescue systems help prevent serious injury during fall arrest. Users must read and understand the *User Instructions* provided with the product and be properly trained by their employer prior to use per OSHA 1910.66 and 1926.503 or applicable local standards. **Misuse or failure to follow warnings and instructions may result in serious personal injury or death.** For proper use, see supervisor, *User Instructions*, or call Technical Service at 1-800-560-1094.



### STREAMLINE ENERGY-ABSORBING LANYARDS

Features tubular webbing construction with double-locking snap hooks or rebar hooks (3,600-lb. rated gates).

ITEM #	MARTIN #	DESCRIPTION	UOM	PRICE
FS580	EXCOFS580	Shock-absorbing lanyard, single leg w/ snap hooks	EA	\$45.00
FS586	EXCOFS586	Shock-absorbing lanyard, twin-leg w/ rebar hooks	EA	\$115.00



### 3M™ PROTECTA® REBEL™ CABLE SELF-RETRACTING LIFELINES

Safer than traditional lanyards due to retractable technology to ensure falls are stopped within a few inches. Lightweight, compact and durable. Rugged thermoplastic housing with stainless steel working components and swivel housing connector to withstand rough use. Ergonomic for greater comfort and ease of use with smooth case and rounded corners. Increases worker productivity and reduces worker fatigue. Unique speed-sensing brake keeps forces to a minimum and reduces clearance requirements. Maximum arresting force of 900 lbs. and support capacity of 420 lbs. Galvanized cable features 5 mm dia. No annual re-certification required. Meets all applicable OSHA regulations and ANSI standards, including ANSI Z359.1.



ITEM #	MARTIN #	DESCRIPTION	SIZES	UOM	PRICE
3590517	DBI3590517	Cable SRL w/ swiveling snap hook & anchorage carabiner	20'	EA	\$365.54
3590500	DBI3590500	Cable SRL w/ carabiner	33'	EA	\$502.15
3590550	DBI3590550	Cable SRL w/ carabiner	50'	EA	\$678.46



### 3M™ DBI-SALA® SEALED-BLOK™ SELF-RETRACTING LIFELINES

Features environmentally sealed dynamic components, 3-way emergency retrieval system, and integrated quick-mount bracket. Extremely durable construction with 3/16" stainless steel cable lifeline, anti-ratcheting locking system, built-in carrying handle and ergonomic cable handle equipped with i-Safe™. Includes swiveling stainless steel snap hook with impact indicator, large pivoting anchorage loop, Saflok™ anchorage carabiner, cable tie-off adapter x 4' with carabiner and reserve lifeline system. FAST-Line™ cable lifeline replacement system.



ITEM #	MARTIN #	DESCRIPTION	SIZES	UOM	PRICE
3400826	DBI3400926	Sealed-Blok SRL w/ stainless steel cable & swivel hook	15'	EA	\$1,116.00
3400923	DBI3400923	Sealed-Blok SRL w/ galvanized cable, swivel snap hook, 3-way retrieval winch & mounting bracket, anchorage carabiner, 4' cable tie-off adapter	50'	EA	\$4,218.46



### 3M™ DBI-SALA® ULTRA-LOK™ CABLE SELF-RETRACTING LIFELINES

Constructed with a durable, polyurethane thermoplastic housing, stainless steel working components for corrosion resistance and aluminum side plates for maximum durability and minimum weight. Anti-ratcheting twin disc brake system with an audio indicator lets worker know it is functioning properly. Features 3/16" galvanized steel cable lifeline, reserve lifeline retention system for added safety, 3,600-lb. rated swivel snap hook and swiveling anchorage loop to prevent twisting of lifeline. i-Safe™ enabled with RFID technology. Meets or exceeds all applicable OSHA regulations and ANSI standards, including ANSI Z359.1.



ITEM #	MARTIN #	DESCRIPTION	SIZES	UOM	PRICE
3504433	DBI3504433	Cable SRL w/ swivel snap hook	20'	EA	\$780.00
3504430	DBI3504430	Cable SRL w/ swivel snap hook	30'	EA	\$1,153.85
3504450	DBI3504450	Cable SRL w/ swivel snap hook	50'	EA	\$1,396.62



### 3M™ DBI-SALA® SMART LOCK SELF-RETRACTING LIFELINES

Rugged and lightweight thermoplastic housing with built in ergonomic handle. Magnetic retraction control system allows lifeline to retract smoothly, hands free. Features zinc-plated steel anchor hook, snap hook connector and 3/16" dia. galvanized steel cable lifeline. 4' Fall clearance allows workers up to 310 lbs. to meet OSHA's 1910 general industry rule. Also meets ANSI Z359.14, ANSI Z359.7, CSA Z259.2.2 and ISO170025 standards.



ITEM #	MARTIN #	DESCRIPTION	SIZES	UOM	PRICE
3503803	DBI3503803	Smart Lock Self-Retracting Lifeline	20'	EA	\$649.85
3503800	DBI3503800	Smart Lock Self-Retracting Lifeline	30'	EA	\$884.31
3503824	DBI3503824	Smart Lock Self-Retracting Lifeline	50'	EA	\$1,044.46



**3M™ DBI-SALA® NANO-LOK™ SELF-RETRACTING LIFELINES**

Ergonomically designed for ease-of-use and ideal for direct connection to most harnesses. Lightweight, stays out of the way and can easily be used as a lanyard replacement. Locks quickly, stopping a fall within inches and providing more protection at low heights. Tension is always kept on the lifeline, which reduces dragging, snagging and trip falls. Features impact-resistant housing, automatic, quick-activating arrestor, impact indicator, 3,600-lb. rated gate openings on carabiners and hooks, and 6' retractable lifeline. i-Safe™ enabled. Capacity: 420 lbs. Meets or exceeds all applicable OSHA regulations and ANSI standards.



3101277

ITEM #	MARTIN #	DESCRIPTION	SIZES	UOM	PRICE
3101280	DBI3101280	SRL, twin-leg w/ connector & (2) steel rebar hooks	6'	EA	\$463.38
3101277	DBI3101277	SRL, twin-leg w/ connector & (2) aluminum rebar hooks	6'	EA	\$444.00

**MORE PRODUCTS AT WWW.MARTINSUPPLY.COM**



**3M™ DBI-SALA® TALON™ SELF-RETRACTING LIFELINE**

Compact, lightweight design with an all-metal braking system. Anti-ratcheting dual pawl design limits maximum arresting force to 900 lbs. Two styles of anchorage connectors for larger and smaller diameter anchorage points. Features spring-loaded locking pin, impact-resistant nylon housing with 1" nylon webbing and snap hook impact indicator to warn when unit needs to be replaced. Audible indicator ensures unit is functioning properly. No service/recertification required, reducing cost of ownership. i-Safe™ enabled with RFID technology. Meets or exceeds all applicable OSHA regulations and ANSI standards, including ANSI A10.14-1991 and ANSI Z359.1-2007.



3102000

ITEM #	MARTIN #	DESCRIPTION	SIZES	UOM	PRICE
3102000	DBI3102000	SRL, twin-leg w/ 2 1/4" gate aluminum rebar hooks, Delta™ comfort pad & (2) lanyard keepers	6'	EA	\$514.15



**MILLER FALCON™ SELF-RETRACTING LIFELINES**

High impact-resistant nylon housing with smooth, round edges increases durability. Corrosion-resistant stainless steel and aluminum internal components. Unique side payout design reduces wear on entry guide bushing and cable. Spring tension operation designed not to pull or drag on worker to improve productivity and reduce fatigue. Available in 3/16" galvanized cable or 0.69" web. Cable models have dual swivels (unit top and snap hook) included to minimize lifeline twisting during use. Improved load indicator on snap hook identifies when unit needs to be removed from service. No annual factory recertification required. Web models rated for up to a 400 lb. worker, cable models rated for up to a 310 lb. worker. Meets all applicable OSHA, ANSI (Class B) and CSA requirements. Connectors rated at 3,600 lbs.

MP20G-Z7/20FT



ITEM #	MARTIN #	DESCRIPTION	SIZES	UOM	PRICE
MP16P-Z7/16FT	NTHMP16P-Z7/16FT	SRL, web w/ stainless steel swivel, carabiner & steel snap hook	16'	EA	\$433.35
MP20P-Z7/20FT	NTHMP20P-Z7/20FT	SRL, web w/ stainless steel swivel, carabiner & steel snap hook	20'	EA	\$473.62
MP20G-Z7/20FT	NTHMP20G-Z7/20FT	SRL, galvanized cable w/ tagline & carabiner	20'	EA	\$602.40
MP30G-Z7/30FT	NTHMP30G-Z7/30FT	SRL, galvanized cable w/ tagline & carabiner	30'	EA	\$865.22
MP50G-Z7/50FT	NTHMP50G-Z7/50FT	SRL, galvanized cable w/ tagline & carabiner	50'	EA	\$1,062.29



**MILLER MIGHTYLITE™ SELF-RETRACTING LIFELINES**

Ideally suited to a variety of construction, industrial, warehouse, utility and confined space applications. Compact design with swivels on snap hook and on top of unit perfect for hard-to-mount and permanent mount locations. Constructed with corrosion-resistant aluminum and stainless steel for long life. Automatic inertia brakes engage during a fall. No annual factory recertification required. Meets all applicable OSHA, ANSI (Class B) and CSA requirements. Connectors rated at 3,600 lbs.

RL20SS-Z7/20FT



ITEM #	MARTIN #	DESCRIPTION	SIZES	UOM	PRICE
RL20SS-Z7/20FT	NTHRL20SS-Z7/20FT	SRL, stainless steel cable w/ tagline & carabiner	20'	EA	\$857.12
RLS30G-Z7/30FT	NTHRLS30G-Z7/30FT	SRL, galvanized steel cable w/ tagline & carabiner	30'	EA	\$1,120.66

**WARNING**

Compliant fall protection and emergency rescue systems help prevent serious injury during fall arrest. Users must read and understand the *User Instructions* provided with the product and be properly trained by their employer prior to use per OSHA 1910.66 and 1926.503 or applicable local standards. **Misuse or failure to follow warnings and instructions may result in serious personal injury or death.** For proper use, see supervisor, *User Instructions*, or call Technical Service at 1-800-560-1094.



## Honeywell MILLER

### MILLER SCORPION™ PERSONAL FALL LIMITERS

Lightweight, compact design offers greater mobility, requires less fall clearance and reduces tripping hazards. Greater versatility through dual operation. Attaches directly to harness D-ring for use as personal fall limiter or as traditional self-retracting lifeline. Includes quick-activating, high strength stainless steel braking system to arrest free falls; visual load indicator to warn when unit must be removed from service; and carabiner. No annual factory recertification required. Capacity: 310 lbs. (400-lb. rated models available). Meets all applicable OSHA, ANSI (Class A and B) and CSA standards and requirements. Connectors rated at 3,600 lbs.



ITEM #	MARTIN #	DESCRIPTION	SIZES	UOM	PRICE
PFL-2-Z7/9FT	NTHPFL-2-Z7/9FT	PFL w/ steel twist-lock carabiner & locking snap hook	9'	EA	\$196.66
PFL-4-Z7/9FT	NTHPFL-4-Z7/9FT	PFL w/ carabiner, swivel shackle & locking snap hook	9'	EA	\$219.52

## Honeywell MILLER

### MILLER TWIN TURBO™ FALL PROTECTION SYSTEMS WITH G2 CONNECTOR

Twin Turbo™ G2 Connector provides 100% tie-off for Miller TurboLite™ Personal Fall Limiters (PFLs). G2 Connector provides an alternative to double-leg lanyards - reducing fall clearance requirements for use in more applications. Connects to harness webbing below the D-ring and frees harness D-ring for rescue and connection to an overhead self-retracting lifeline (SRL). PFLs swivel independently for increased worker mobility and prevent webbing from twisting and binding in the unit. Lightweight twin connector increases productivity by reducing worker fatigue. Corrosion-resistant aluminum connector with high-impact nylon result in a longer product life. Webbing Retainer Clip rotates freely to prevent unintentional opening of carabiner gate during a fall; accommodates thicker webbing designs for more versatility and allows for easy insertion of webbing. D-Pad Clip maintains harness adjustment while working by keeping the harness webbing and D-Pad in place. Twin Turbo G2 Connector meets all applicable OSHA, ANSI (Class A and B) and CSA standards and requirements. Connectors rated at 3,600 lbs.

MFLC-12-Z7/6FT



ITEM #	MARTIN #	DESCRIPTION	SIZES	UOM	PRICE
<i>Twin Turbo G2 Fall Protection Systems</i>					
MFLC-12-Z7/9FT	NTHMFLC-12-Z7/9FT	G2 connector w/ aluminum rebar hooks	9'	EA	\$510.49
MFLC-3-Z7/6FT	NTHMFLC-3-Z7/6FT	G2 connector w/ steel snap hooks	6'	EA	\$351.15
MFLC-4-Z7/6FT	NTHMFLC-4-Z7/6FT	G2 connector w/ steel rebar hooks	6'	EA	\$436.03
MFLC-12-Z7/6FT	NTHMFLC-12-Z7/6FT	G2 connector w/ aluminum rebar hooks	6'	EA	\$428.15
<i>Twin Turbo T-BAK G2 Fall Protection System</i>					
MFLTC-1/7.5FT	NTHMFLTC-1/7.5FT	G2 connector w/ Miller 5K® snap hooks	7 1/2'	EA	\$543.52

## SAFEWAZE™

### CLASS A WEB SELF-RETRACTING LIFELINES

Lightweight dual leg unit features 6' length, 3/4" Ultrahigh Molecular weight webbing with aluminum locking snap or rebar hooks and carabiner. Unique braking system eases shock of fall. Fall indicator incorporated into swivel top. Meets Class "A" ANSI Z359.14 standard.



FS-EX10065-W-RBH-BWB

ITEM #	MARTIN #	SIZES	UOM	PRICE
<i>Dual-Leg SRL with Snap Hooks &amp; Behind the Web Bracket</i>				
FS-EX10065-W-BWB	EXCOFS-EX10065-W-BWB	6'	EA	\$325.00
<i>Dual-Leg SRL with Rebar Hooks &amp; Behind the Web Bracket</i>				
FS-EX10065-W-RBH-BWB	EXCOFS-EX10065-W-RBH-BWB	6'	EA	\$375.00

## SAFEWAZE™

### CLASS A WEB ALUMINUM HOUSING SRLS

Designed for use as a single person fall protection device. Built of rugged components for abrasive environments. High-strength, durable housing allows for lightweight design and dependability. Unique braking system eases shock in the event of a fall. Includes mobility-enhancing swivel top, 11/16" twist-lock carabiner and a forged steel snap hook or locking rebar hook. Hook gates rated 3,600 lbs. Meets OSHA 1926-502 and ANSI Class "A" Z359.14 standard.



FS-FSP1411-W

ITEM #	MARTIN #	SIZES	UOM	PRICE
<i>Single Leg SRL with Steel Snap Hook &amp; Carabiner</i>				
FS-FSP1411-W	EXCOFS-FSP1411-W	11'	EA	\$191.67
<i>Dual-Leg Web SRL with Tie-Back Hooks &amp; Carabiner</i>				
FS-FSP14075-W-TBH	EXCOFS-FSP14075WTBH	7'	EA	\$516.67

## SAFEWAZE™

### CLASS A CABLE RETRACTABLE

Designed to be used as a single person fall protection device. Features mobility enhancing swivel-top, rugged and high-strength polymer housing, and unique braking system that eases shock in the event of a fall. Includes galvanized steel cable and forged steel snap hook. 420-lb. Maximum working load. Meets OSHA 1926.502, ANSI Z359.14 and ANSI A10.32 standards.



SW-8008-10

ITEM #	MARTIN #	DESCRIPTION	SIZES	UOM	PRICE
SW-8008-10	EXCOSW-8008-10	Class A cable retractable	10'	EA	\$181.67



**LEADING EDGE  
RETRACTABLE LIFELINE**

Designed for use as a single person fall protection device. Features mobility-enhancing swivel top, rugged and durable housing, and unique braking system that eases shock in the event of a fall.



ITEM #	MARTIN #	DESCRIPTION	SIZES	UOM	PRICE
FS-FSP9030	EXCOFS-FSP9030	Leading edge retractable w/ integral shock pack	30'	EA	\$616.67



**3M™ DBI-SALA®  
FIXED BEAM ANCHOR**

Specifically designed for fall arrest anchorage, but can also be used as end point for some horizontal lifeline systems. Installs quickly to beam structure, tightens using built-in adjustment handle. Attaches to beam structure in any orientation or direction for added versatility. Fits flanges 1 1/2" thick and 2 1/2" to 12" wide. Rated 5,000 lbs. minimum strength in any direction. Meets or exceeds all applicable OSHA regulations and ANSI standards, including ANSI Z359.1.

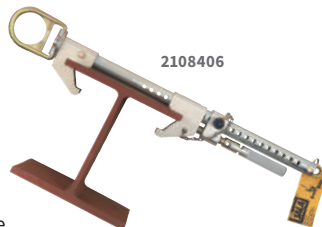

ITEM #	MARTIN #	DESCRIPTION	UOM	PRICE
2108406	DBI2108406	Fixed beam anchor	EA	\$431.08



**3M™ DBI-SALA®  
SLIDING BEAM ANCHOR**

Rugged, corrosion-resistant construction for all weather conditions. Hands-free 360° swiveling D-ring optimizes mobility on the beam. Visible dual ratcheting adjustment buttons are accessible above the beam, while locking mechanism is located on the side to reduce accidental engagement. Compact size and lightweight materials make transportation a breeze. Meets ANSI Z359.18, OSHA 1910.140 and OSHA 1926.502 standards.



ITEM #	MARTIN #	DESCRIPTION	UOM	PRICE
2104710	DBI2104710	Sliding Beam Anchor	EA	\$249.23



**3M™ DBI-SALA®  
TIE-OFF ADAPTERS**

Pass-through design for quick and easy attachment to anchorage. Standard adapter has 1 3/4" polyester strap with 5,000-lb. minimum tensile strength. Features 3" wide wear pad and coated steel hardware for added abrasion resistance and durability. Kevlar® tie-off adapter is ideal for welding or high-heat environments with zinc-plated steel hardware. i-Safe™ enabled with RFID technology. Meets or exceeds all applicable OSHA regulations and ANSI standards, including ANSI Z359.1.



ITEM #	MARTIN #	DESCRIPTION	SIZES	UOM	PRICE
1003000	DBI1003000	Tie-off adapter	3'	EA	\$52.62
1003006	DBI1003006	Tie-off adapter	6'	EA	\$60.46



**3M™ DBI-SALA® CONCRETE  
D-RING ANCHOR**

Simple, versatile and safe concrete anchor solution. Reusable D-ring assembly, just install a new bolt and use again. Rugged design for harsh environments with no moving or fragile parts. Safe "hook-up" indicator notifies user that anchor has been installed properly. Installs with standard drill bits, 11/16", 18 mm or 3/4". Rated 5,000 lbs. Connection point swivels 360° for safety and ease-of-use. Meets or exceeds all applicable OSHA regulations and ANSI standards, including ASTM E488 Standard Test Methods for Strength of Anchors.



ITEM #	MARTIN #	DESCRIPTION	UOM	PRICE
2104560	DBI2104560	D-ring anchor assembly w/ (1) bolt	EA	\$110.77



**3M™ PROTECTA® PRO  
CONCRETE WEDGE ANCHOR**

Concrete wedge anchor for 3/4" hole with swiveling D-ring. Installs into 3/4" concrete hole. Use vertically in wall or horizontally in ceiling. Portable and reusable, compact and lightweight design. High strength steel and aluminum construction with rugged, corrosion-resistant materials. Swiveling D-ring tie-off point. Easy grip trigger. Shielded load and chock release cables.

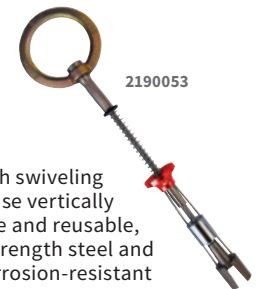

ITEM #	MARTIN #	DESCRIPTION	UOM	PRICE
2190053	DBI2190053	Concrete wedge anchor	EA	\$105.23

**WARNING**

Compliant fall protection and emergency rescue systems help prevent serious injury during fall arrest. Users must read and understand the *User Instructions* provided with the product and be properly trained by their employer prior to use per OSHA 1910.66 and 1926.503 or applicable local standards. **Misuse or failure to follow warnings and instructions may result in serious personal injury or death.** For proper use, see supervisor, *User Instructions*, or call Technical Service at 1-800-560-1094.



8183/6FTGN

### MILLER CROSS-ARM STRAP

Made of 2" polyester webbing with a 2" D-ring that passes through a 3" D-ring. 400-lb. Capacity. Meets all applicable OSHA, ANSI and CSA requirements.

ITEM #	MARTIN #	DESCRIPTION	SIZES	UOM	PRICE
8183/6FTGN	NTH8183/6FTGN	Cross-arm strap	6'	EA	\$42.58



FS830-C6

### CABLE CROSS ARM STRAP

Made with coated cable and pass-through O-rings. 310-lb. Weight capacity. Meets OSHA 1926.502, ANSI Z359.3 and ANSI A10.32 standards.

ITEM #	MARTIN #	DESCRIPTION	SIZES	UOM	PRICE
FS830-C6	EXCOFS830-C6	Cable cross arm strap	6'	EA	\$54.17



496

### MILLER GRIP™ PORTABLE/REUSABLE ANCHORAGE CONNECTOR

Designed as intermediary for securing connecting device to anchorage. Primarily used in concrete applications to attach lifeline or lanyard of single user. Portable, reusable anchorage device easily fastens by pulling spring-loaded trigger and fitting device through hole drilled in properly cured concrete. When anchor is in place, tapered wedges open inside hole and provide secure grip. Can be removed and simply reinstalled in new vertical or horizontal location. 400-lb. Capacity. 5,000-lb. Ultimate strength.

ITEM #	MARTIN #	DESCRIPTION	UOM	PRICE
496/	NTH496/	3/4" Anchorage connector	EA	\$138.74



FS870

### REUSABLE ROOF ANCHOR

Designed to be used as a single anchor point for no more than one person at a time. Will fit any roof pitch, wood or steel. Must use a minimum of 12 #8 x 2" wood screws and a minimum of 10 #8 x 3/4" long sheet metal screws per side on steel roofs 24 gauge or thicker. Meets OSHA 1926.502 regulation and ANSI Z359.1 and A10.32 standards.

ITEM #	MARTIN #	DESCRIPTION	UOM	PRICE
FS870	EXCOFS870	Reusable roof anchor	EA	\$21.67

TO SEE MORE OPTIONS, VISIT [WWW.MARTINSUPPLY.COM](http://WWW.MARTINSUPPLY.COM)

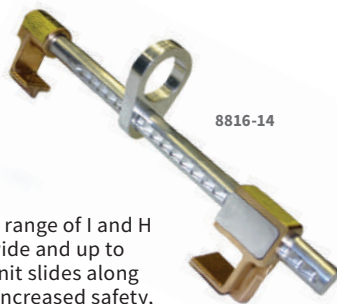

8816-14

### MILLER SHADOW® BEAM ANCHOR

Connects horizontally to wide range of I and H beam flanges from 3" to 14" wide and up to 2 1/2" thick. Once attached, unit slides along beam with worker to provide increased safety, mobility and productivity. Integral positive-lock engagement system eliminates need for loose connection pins which can be installed incorrectly or inadvertently disengaged. Meets all applicable OSHA regulations and ANSI standards.

ITEM #	MARTIN #	DESCRIPTION	UOM	PRICE
8816-14	NTH8816-14	Shadow beam anchor, adjustable aluminum	EA	\$236.78



FS-EX110

### 10K REMOVABLE CONCRETE CABLE ANCHOR

Easy to use removable and reusable concrete cable anchor is rated to maximum capacity of 10,000 lbs. Features 7x19 galvanized cable, coated eye and reusable bolt anchors that are designed for use in concrete substrate ONLY. Overall length: 13.75". Meets OSHA 1926.502, ANSI Z359.3 and ANSI A10.32 standards.

ITEM #	MARTIN #	DESCRIPTION	UOM	PRICE
FS-EX110	EXCOFS-EX110	10K Removable concrete cable anchor	EA	\$240.00



7605060

**3M™ DBI-SALA® EZ-LINE™ RETRACTABLE HORIZONTAL LIFELINE SYSTEM**

Innovative retractable design allows for quick and efficient set-up and disassembly of any length system. Retractable lifeline is simply pulled out for installation and retracted with built-in winch for dismantle. Entire 60' system is retracted into easy-to-carry case which eliminates large, bulky coils of cable. Weighs 25 lbs. Built-in pre-tension and impact indicators take guess work out of set-up and inspection. Provides hands-free horizontal mobility and continuous protection for (2) users per span, up to (6) users per system. Stanchions not included.



ITEM #	MARTIN #	DESCRIPTION	UOM	PRICE
7605060	DBI7605060	Retractable horizontal lifeline system	EA	\$1,514.77



**3M™ DBI-SALA® SAYFLINE™ ROPE HORIZONTAL LIFELINE SYSTEM**

Portable horizontal lifeline system is lightweight and easy to install with no special tools or equipment. Complete with kernmantle rope lifeline assembly, tensioning device, (2) tie-off adapters for anchoring to structures and carrying bag. Capacity: 2 workers. Available in 10' increments. Meets or exceeds all applicable OSHA regulations and ANSI standards.



ITEM #	MARTIN #	DESCRIPTION	SIZES	UOM	PRICE
7600506	DBI7600506	Rope lifeline system	60'	EA	\$767.08



**3M™ PROTECTA® PRO-LINE™ SYNTHETIC HORIZONTAL LIFELINE SYSTEM**

Lightweight, easy to install and extremely portable system installs in seconds, without special tools or equipment, maintaining optimum worker productivity. Simply attach the lifeline and tie-off adaptors to a suitable structure and tension the lifeline with the integrated ratchet. Built-in shock absorber limits arresting forces during a fall and provides the user with a visual impact indicator for added safety. Connection to the lifeline is made by attaching the hook of a shock absorbing lanyard directly to the lifeline for complete ease-of-use. Carrying bag included for easy transport and storage, and protects against dirt, moisture and UV degradation. Complete 60' system includes tensioner, energy absorber, lightweight 2" web lifeline, and (2) 6' tie-off adaptor anchors. Capacity: 2 workers.

ITEM #	MARTIN #	DESCRIPTION	SIZES	UOM	PRICE
1200101	DBI1200101	HLL system	60'	EA	\$408.92

7600506

FS806-60



**2-PERSON CABLE HORIZONTAL LIFELINE KITS**

310-lb. Weight capacity. Meets OSHA 1926.502, ANSI Z359.3 and ANSI A10.32 standards. Also available with 80' and 100' cable lengths.

**Kit includes:**

- 60' Cable line
- Turnbuckle
- (2) Carabiners
- (2) O-rings
- 5/16" Shackles
- (2) Cross arm straps
- Energy absorber
- Transport bag

ITEM #	MARTIN #	DESCRIPTION	SIZES	UOM	PRICE
FS806-60	EXCOFS806-60	2-Person cable horizontal lifeline kit	60'	EA	\$555.90



Compliant fall protection and emergency rescue systems help prevent serious injury during fall arrest. Users must read and understand the *User Instructions* provided with the product and be properly trained by their employer prior to use per OSHA 1910.66 and 1926.503 or applicable local standards. **Misuse or failure to follow warnings and instructions may result in serious personal injury or death.** For proper use, see supervisor, *User Instructions*, or call Technical Service at 1-800-560-1094.



### SAFELINK COME-A-LONG KIT

**Kit includes:**

- (1) FS-EX2510 Come-A-Long
- (1) FS-EX2503-SL StopLink brake assembly
- 65' of FS-EX2500-GA 5/16" galvanized steel cable with thimble eye
- (2) FS-EX2516 5/16" double saddle fist grips
- (3) FS1015 standard carabiners
- (1) FS-EX2505 adjustable safety strap
- (1) FS8175 extra-large bag

FS-EX10000



ITEM #	MARTIN #	DESCRIPTION	UOM	PRICE
FS-EX10000	EXCOFS-EX10000	SafeLink Come-A-Long kit	EA	\$1,133.33



### 3M™ DBI-SALA® ADVANCED™ 5-PIECE HOIST SYSTEM

Designed for manhole and other confined space entry and retrieval applications. Constructed of lightweight materials including high-strength aluminum. Davit pivots for ease of rescue and has an adjustment feature for overhead clearance restrictions. Lower base adjusts to fit most standard entries. The 5-piece hoist system comes equipped with 11 1/2" to 27 1/2" adjustable offset upper mast, 33" lightweight lower mast, 3-piece lightweight base and winch mount brackets. Winches and SRLs sold separately. Meets or exceeds all applicable OSHA regulations and ANSI standards.



8518000

ITEM #	MARTIN #	DESCRIPTION	UOM	PRICE
8518000	DBI8518000	Advanced 5-pc. hoist system	EA	\$5,614.15



### MILLER TRIPODS AND MATERIAL WINCHES

Miller® tripod is an anchorage connector solution for typical confined space and rescue systems. Extremely lightweight weighing only 42 lbs., features high-strength aluminum construction and withstands up to 5,000 lbs. of vertical pull. Adjustable legs with integral push pins are ideal for uneven surfaces. Independent leg locking feature will hold legs securely in place. Includes safety chain and comes with rubber skid pads and serrated edged tripod feet to prevent slippage in icy conditions. Material winches available in various lengths. Meets all applicable OSHA regulations and ANSI standards for hoist retrieval systems.



51/7FT

ITEM #	MARTIN #	DESCRIPTION	UOM	PRICE
51/7FT	NTH51/7FT	7' High-strength aluminum tripod	EA	\$1,020.28

▶ TO SEE MORE STYLES, VISIT [WWW.MARTINSUPPLY.COM](http://WWW.MARTINSUPPLY.COM)



### CONFINED SPACE SYSTEM

Includes 7' aluminum tripod, 65' 3-way recovery unit, material winch, carabiner and a carrying bag. Meets or exceeds all applicable OSHA regulations and ANSI standards.

ITEM #	MARTIN #	DESCRIPTION	UOM	PRICE
FS980	EXCOFS980	Confined space system	EA	\$3,500.00

FS980





9501403



**3M™ DBI-SALA® SUSPENSION TRAUMA SAFETY STRAPS**

Allows suspended worker to stand up in harness relieving pressure on arteries and veins around top of legs. Continuous loop design allows both sides of harness to relieve pressure. Strap provides increased comfort and improved circulation to one or both feet at a time while suspended. Safety accessories can be attached to most harness brands/styles right in the field. Installation is fast and efficient - just choke off to strap. Stows easily and stays out of worker's way. To deploy, simply unzip, hook straps together and step into. Sold as set of 2. Harness not included.

ITEM #	MARTIN #	DESCRIPTION	UOM	PRICE
9501403	DBI9501403	Suspension trauma safety straps	SET	\$35.54



9099



**MILLER RELIEF STEP™ SAFETY DEVICE**

Short-term solution alleviates effects of suspension trauma. When a fall occurs, the worker becomes suspended in harness, remaining vertical and sedentary for a long period of time. This causes blood to pool in leg veins, restricts flow to the brain and other major organs and may cause unconsciousness. Device attaches to any brand full-body harness. By utilizing one for each leg/foot, the worker is more comfortable until rescue is completed.

ITEM #	MARTIN #	DESCRIPTION	UOM	PRICE
9099X/12-H5	NTH9099X/12	Relief Step safety device	12/BX	\$281.78
9099/36BULK	NTH9099/36BULK	Relief Step safety device	36/CS	\$795.80



FS902



**SUSPENSION TRAUMA SUPPORT STEPS**

Web step system designed for suspension after a fall. Relieves body pressure in the event of a fall. Connect at D-ring. 6' Length.

ITEM #	MARTIN #	DESCRIPTION	UOM	PRICE
FS902	EXCOFS902	Suspension trauma support steps	EA	\$23.33



FS-EX243-BL



**RESCUE LADDER**

Equipped with a fast drop 18', nylon webbing ladder with a locking ANSI steel carabiner for quick attachment. Also available with 11.5 mm kernmantle rope belay. Stores in a ballistic nylon bag. Rated for 310 lbs.

ITEM #	MARTIN #	DESCRIPTION	UOM	PRICE
FS-EX243	EXCOFS-EX243	Extreme Rescue Ladder	EA	\$316.67
FS-EX243-BL	EXCOFS-EX243-BL	Extreme Rescue Ladder w/ rope belay	EA	\$658.33



**TOOLS@HEIGHT CUSTOMIZABLE TOOL BELT**

Optimized attachment points help maintain tool functionality and maximum productivity. Modularity allows user to personalize placement of tools on belt or harness. Independent tethering reduces transfers, which reduces drops. User can maintain three points of contact because tool can be used and put away without having to connect and disconnect. Scaffold builders open the box, put on the belt and go to work. Other Customizable Tool Belts are available to meet your needs.

ITEM #	MARTIN #	DESCRIPTION	SIZES	UOM	PRICE
WTHSCAFFSWLA	WMSWTHSCAFFSWLA	Scaffold building kit	L	EA	\$1,207.64
WTHSCAFFSWXLA	WMSWTHSCAFFSWXLA	Scaffold building kit	XL	EA	\$1,207.64



**TOOLS@HEIGHT SUPERCOMBO® COMBINATION WRENCHES**

1222SC-TH

High polish chrome or satin chrome finish with SUPERTORQUE® box end. Safety coil lanyard attachment is made of stainless steel and slides out of the way along wrench's handle to provide full use of handle and achieve greatest leverage.

ITEM #	MARTIN #	DESCRIPTION	SIZES	UOM	PRICE
1214SC-TH	WMS1214SC-TH	Combination wrench	7/16"	EA	\$36.82
1216SC-TH	WMS1216SC-TH	Combination wrench	1/2"	EA	\$37.64
1218SC-TH	WMS1218SC-TH	Combination wrench	9/16"	EA	\$38.95
1220SC-TH	WMS1220SC-TH	Combination wrench	5/8"	EA	\$40.58
1222SC-TH	WMS1222SC-TH	Combination wrench	11/16"	EA	\$42.05
1224SC-TH	WMS1224SC-TH	Combination wrench	3/4"	EA	\$43.69

**WARNING**

Compliant fall protection and emergency rescue systems help prevent serious injury during fall arrest. Users must read and understand the *User Instructions* provided with the product and be properly trained by their employer prior to use per OSHA 1910.66 and 1926.503 or applicable local standards. **Misuse or failure to follow warnings and instructions may result in serious personal injury or death.** For proper use, see supervisor, *User Instructions*, or call Technical Service at 1-800-560-1094.



## 409-PIECE TOOLS@HEIGHT MASTER MAINTENANCE TOOL SET

Provides a great assortment of tools for all types of maintenance applications. All tools are designed to be used with tethering and retention systems which maintain or enhance the tools' functionality when used at height or near critical assemblies. Ideal for any industry where a dropped tool could harm personnel, damage machinery or cost production time. Set includes:

- (17) Adjustable and miscellaneous wrenches
- (71) Combination, box and open end wrenches
- (12) Hammers
- (155) Hand sockets, ratchets and accessories
- (24) Hex keys and sockets
- (35) Impact sockets and accessories
- (15) Pliers
- (24) Pry bars, punches and chisels
- (27) Screwdrivers and nut drivers
- (2) Tool storage boxes
- (22) TOOLS@HEIGHT tethers, lanyards and specialties
- (15) Miscellaneous tools

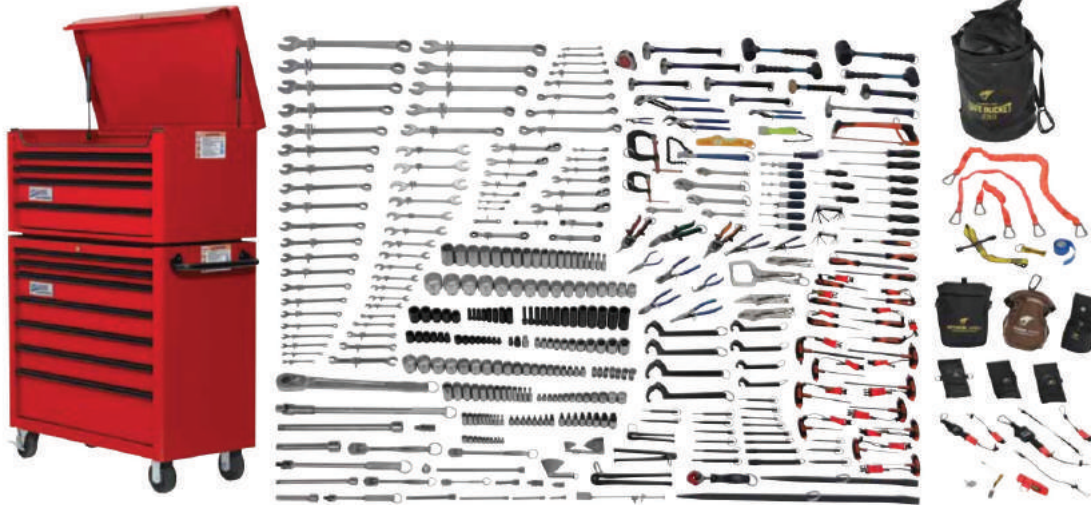

WSC-409-THTB

ITEM #	MARTIN #	DESCRIPTION	UOM	PRICE
WSC-409-THTB	WMSWSC-409-THTB	Master maintenance tool set w/ tool boxes (409-pieces)	EA	\$17,363.00
WSC-409-TH	WMSWSC-409-TH	Master maintenance tool set w/out tool boxes (407-pieces)	EA	\$14,587.00



## TOOLS@HEIGHT SCREWDRIVER SET

Comfort-grip handle with thumb stop allows for added turning power without discomfort or slippage. Blades are made from special alloy steel for extra strength, and hi-polish chrome to prevent corrosion and easy cleaning. Rotating screwdriver tab is located for secure retention and allows full use of the screwdriver handle.

### 5-Piece set includes:

- Slotted screwdriver, 3" blade—6 1/8" OAL
- Slotted screwdriver, 4" blade—7 7/8" OAL
- Slotted screwdriver, 6" blade—10 11/16" OAL
- #1 Phillips screwdriver, 3" blade—6 1/4" OAL
- #2 Phillips screwdriver, 4" blade—7 15/16" OAL

100P-5MD-TH



ITEM #	MARTIN #	DESCRIPTION	UOM	PRICE
100P-5MD-TH	WMS100P-5MD-TH	5-Piece screwdriver set	EA	\$120.44



## TOOLS@HEIGHT 3/8" DRIVE ENCLOSED HEAD RATCHETS

Enclosed head is sealed to protect from dust, dirt and liquids. Forged one-piece ratchet has smooth comfort-grip handle, 36 tooth gear with 10° of engagement, and easy access reverse lever. Single pawl ratchet design for tighter tolerances between pawl and gear.

B-52EHA-TH

BB-52EHA-TH

B-52EHLA-TH



ITEM #	MARTIN #	DESCRIPTION	SIZES	UOM	PRICE
B-52EHA-TH	WMSB-52EHA-TH	Enclosed head ratchet, chrome finish	8"	EA	\$81.16
BB-52EHA-TH	WMSBB-52EHA-TH	Enclosed head ratchet, black industrial finish	8"	EA	\$67.09
B-52EHLA-TH	WMSB-52EHLA-TH	Enclosed head ratchet, chrome finish, long	10 1/4"	EA	\$87.71



31216-TH

31208-TH

**TOOLS@HEIGHT  
3/8" DRIVE SHALLOW SOCKETS**

SUPERTORQUE® lobular openings for greater turning power without deforming the fastener. Designed for maximum engagement on 12-pt. fasteners. High-polished chrome finish. Features locking pin and locking holes on all four sides, for positive retention. This reduces the risk of misaligning the socket that occurs with typical sockets with one side hole.

ITEM #	MARTIN #	DESCRIPTION	SIZES	UOM	PRICE
31208-TH	WMS31208-TH	3/8" Drive shallow socket	1/4"	EA	\$19.80
31210-TH	WMS31210-TH	3/8" Drive shallow socket	5/16"	EA	\$20.13
31212-TH	WMS31212-TH	3/8" Drive shallow socket	3/8"	EA	\$20.13
31214-TH	WMS31214-TH	3/8" Drive shallow socket	7/16"	EA	\$20.13
31216-TH	WMS31216-TH	3/8" Drive shallow socket	1/2"	EA	\$20.29
31218-TH	WMS31218-TH	3/8" Drive shallow socket	9/16"	EA	\$20.29
31220-TH	WMS31220-TH	3/8" Drive shallow socket	5/8"	EA	\$20.29
31222-TH	WMS31222-TH	3/8" Drive shallow socket	11/16"	EA	\$20.29
31224-TH	WMS31224-TH	3/8" Drive shallow socket	3/4"	EA	\$20.45
31226-TH	WMS31226-TH	3/8" Drive shallow socket	13/16"	EA	\$20.78
31228-TH	WMS31228-TH	3/8" Drive shallow socket	7/8"	EA	\$20.95
31230-TH	WMS31230-TH	3/8" Drive shallow socket	15/16"	EA	\$21.60
31232-TH	WMS31232-TH	3/8" Drive shallow socket	1"	EA	\$21.76



1500063

**3M™ DBI-SALA® PYTHON SAFETY® COIL TETHERS**

Alternative to classic Bungee Tethers. Built with lightweight vinyl that's easy to clean. Coil tethers naturally and stays out of the way thanks to the ultra-compact design.

- **Hook2Hook Coil Tether:** Relaxed length 5"; stretched length 62"; stays out of the way when not in use.
- **Hook2Quick Ring Coil Tether with Tail:** Designed specifically for use with hammers and some other long-handled tools. Can also be purchased as a combo with the Python® Safety Hammer Holster.
- **Trigger2Trigger Coil Tether:** Compact design of the Double Trigger Coil Tether makes it the perfect lanyard to be used from Wristbands.

ITEM #	MARTIN #	DESCRIPTION	SIZES	UOM	PRICE
1500063	DBI1500063	Hook2Hook Coil Tether, 5-lb. load rating	5"-62"	EA	\$22.36
1500065	DBI1500065	Hook2Quick Ring Coil Tether w/ Tail, 2-lb. load rating	3"-62"	EA	\$22.36
1500067	DBI1500067	Trigger2Trigger Coil Tether, 5-lb. load rating	1 3/4"-24"	EA	\$16.36



1500003

**3M™ DBI-SALA® PYTHON SAFETY® D-RINGS**

Can be attached to virtually any tool under 5 lbs.—or 2 lbs. using Python® Safety Quick Wrap Tape. Creates an instant attachment point in less than a minute. Dual D-Rings allow for 100% tool tie-off during tool transfers.

ITEM #	MARTIN #	DESCRIPTION	UOM	PRICE
1500001	DBI1500001	Small dual D-rings, 2-lb. load rating	10/PK	\$52.91
1500003	DBI1500003	1/2" x 2 1/4" D-rings, 2-lb. load rating	10/PK	\$46.36
1500007	DBI1500007	1" x 3 1/2" D-rings, 5-lb. load rating	10/PK	\$49.64



1500042

**3M™ DBI-SALA® PYTHON SAFETY® HEAVY-DUTY QUICK WRAP TAPE**

Conforms to the shape of whatever it is applied to. Used with Python Safety D-Rings and Tool Cinch Attachments to create instant tethering points on virtually any tool. Made from a self-fusing silicone rubber that leaves no adhesive or residue behind. Inner fiberglass webbing increases strength and makes tape resistant to sharp objects.

ITEM #	MARTIN #	DESCRIPTION	UOM	PRICE
1500045	DBI1500045	Yellow, 1" x 108"	10/PK	\$233.45
1500036	DBI1500036	Blue, 1" x 108"	10/PK	\$233.45
1500042	DBI1500042	Green, 1" x 108"	10/PK	\$233.45
1500039	DBI1500039	Blue, 1" x 216"	10/PK	\$452.73



1500052

**3M™ DBI-SALA® PYTHON SAFETY® HOOK2RAIL LANYARD**

Features an aluminum double-action twist-lock carabiner to prevent accidental opens. Large double-action twist-lock rail carabiner. Works well with Python Tool Cinch Attachments. 72" length. 80-lb. load rating.

ITEM #	MARTIN #	DESCRIPTION	UOM	PRICE
1500052	DBI1500052	Heavy-duty Hook2Rail lanyard	EA	\$85.09

**SMALL PARTS POUCHES**



**3M™ DBI-SALA® PYTHON SAFETY® SMALL PARTS POUCHES**

Innovative self-closure system that traps objects inside, the pouch makes it nearly impossible for objects to fall out once placed in the bag. Easy to retrieve objects since no opening or closing is necessary. Compatible with most tool belts.

ITEM #	MARTIN #	DESCRIPTION	UOM	PRICE
1500122	DBI1500122	Pouch, vinyl yellow	EA	\$63.82
1500119	DBI1500119	Pouch, canvas black	EA	\$63.82
1500120	DBI1500120	Pouch, canvas camo	EA	\$63.82
1500121	DBI1500121	Pouch, canvas orange	EA	\$63.82
1500123	DBI1500123	Pouch, extra deep, canvas black	EA	\$67.64

**WARNING**

Compliant fall protection and emergency rescue systems help prevent serious injury during fall arrest. Users must read and understand the *User Instructions* provided with the product and be properly trained by their employer prior to use per OSHA 1910.66 and 1926.503 or applicable local standards. **Misuse or failure to follow warnings and instructions may result in serious personal injury or death.** For proper use, see supervisor, *User Instructions*, or call Technical Service at 1-800-560-1094.





### 3M™ DBI-SALA® PYTHON SAFETY® TOOL HOLSTERS

- Tape Measure Holster:** Designed to be used with virtually any tape measure, allowing Tape Measures to be safely tethered and holstered. Includes a Python Safety Retractor. The Tape Measure Sleeve conforms to the size of nearly every Tape Measure. Features Beacon™ Hi-Vis Reflectors.
- Pouch Holster with Retractor:** Quickly holster tape measures and other small tools. Includes a Python Safety Retractor.
- Scaffold Wrench Holster with Retractor:** Quickly holster scaffold wrenches while working at height. Features Beacon™ Hi-Vis Reflectors.
- Hammer Holster:** Allows for the safe holstering of virtually any hammer under 5 lbs. D-Ring on the side of the holster is load rated for 5 lbs. HOL-HAMMERCOMBO comes with a Hook2Quick Ring Coil Tether with Tail that is specially designed for use with the Hammer Holster. Hook2QuickRing Coil Tether is load rated for 2 lbs. During Transport, the Hammer Holster can be locked shut with a hook-and-loop strap. While being used, the strap can be locked up allowing for easy hammer access and holstering.
- Adjustable Radio Holster:** Holster adjusts to fit virtually any handheld radio, cell phone, and many other devices. Can be worn from Belt or Harness. A Micro D-Ring can be placed on the back of a device, and can then be tethered to a D-Ring on the front of the Adjustable Radio Holster using a Clip2Loop Coil Tether.
- Spray Can/Bottle Holster:** Flexible neoprene holster allows for quick tethering of bottles and spray cans. HOL-BOTTLECOMBO comes with Clip2Clip Coil Tether.
- Drill Battery Holster/Sleeve:** Unique sleeve design conforms to the size of virtually any drill battery. Sleeve is cinched to the drill, allowing the drill to be tethered off while being used at height. 10-lb. load rating.

ITEM #	MARTIN #	DESCRIPTION	UOM	PRICE
1500098	DBI1500098	Tape Measure Retractor Holster	EA	\$52.36
1500095	DBI1500095	Pouch Holster w/ Retractor	EA	\$75.82
1500096	DBI1500096	Scaffold Wrench Holster w/ Retractor	EA	\$52.36
1500093	DBI1500093	Hammer Holster	EA	\$40.36
1500088	DBI1500088	Adjustable Radio Holster	EA	\$29.45
1500091	DBI1500091	Spray Can/Bottle Holster	EA	\$14.18
1500090	DBI1500090	Drill Battery Holster/Sleeve	EA	\$33.27



### SQUIDS® 3001 RETRACTABLE SINGLE CARABINER WITH LOOP END



Retractable tool lanyard with stainless steel carabiner attachment and choking loop end. Locks into place at desired length preventing tangles and work under tension while securing tools.

#### Features:

- Extendable length up to 48"
- Modular connecting buckle for exchanging tools
- Plated swiveling ring for 360° rotation
- Loop and manual locking stainless carabiner
- Technora cord for ultimate strength and durability
- Self-setting pawls set desired lanyard length
- ABS thermoplastic housing for ultimate durability
- Maximum safe working capacity: 2 lbs.

ITEM #	MARTIN #	DESCRIPTION	UOM	PRICE
19301	ERGO19301	Retractable single carabiner w/ loop end	EA	\$36.82



### SQUIDS® 3109F(X) DOUBLE-LOCKING TOOL LANYARD



Shock absorbing tool lanyard with swiveling, locking carabiner on one end and loop on the other end. Prevents falling objects and reduces the force the anchor point sees if a drop occurs by absorbing the energy transmitted through the tool lanyard. Durable 1680-denier polyester elastic blended webbing extends from 38" to 48". Low profile lightweight design reduces snag hazards and added weight. Third party certified to a 25 lbs. maximum capacity. Orange.

ITEM #	MARTIN #	DESCRIPTION	UOM	PRICE
19809	ERGO19809	Double-locking tool lanyard	EA	\$27.18



### SQUIDS® 3193 TAPE MEASURE TETHERING KIT



Kit allows you to tether (1) standard 2 lb. (0.9 kg) tape measure. Kit includes 3100F(x) Single Carabiner Tool Lanyard and 3770 Tape Measure Trap. Meets ANSI/ISEA 121-2018 standards.

**⚠️ WARNING:** Cancer and reproductive harm. For more information go to [www.P65Warnings.ca.gov](http://www.P65Warnings.ca.gov).

ITEM #	MARTIN #	DESCRIPTION	UOM	PRICE
19663	ERGO19663	Tape measure tethering kit	EA	\$30.82



**SQUIDS® TOOL TETHERING KITS**

- **Squids 3180 Tool Tethering Kit** is ideal for telecommunications, construction and power generation. Kit includes 3700 4.5" Web Tool Tails (6/pack), 3755 Self-Adhering Tape and 3130S Coil Lanyard. This kit allows you to tether up to (6) 2-lb. tools.
- **Squids 3181 Tool Tethering Kit** includes a 3102 Detachable Single Carabiner Lanyard, a 12' roll of 3755 Self-Adhering Tape Trap, and (3) 3103 Detachable Elastic Tool Tails. This kit allows you to tether up to (4) 5-lb. (2.3 kg) tools.
- **Squids 3182 Tool Tethering Kit** includes a 3100F(x) Single Carabiner Tool Lanyard, a 12' roll of 3755 Self-Adhering Tape Trap, and (3) 3713 Swiveling Elastic Tool Tails. This kit allows you to tether up to (3) 10-lb. (4.5 kg) tools.
- **Squids 3191 Power Tool Tethering Kit** includes a 3100F(x) Single Carabiner Tool Lanyard and a 3780L Power Tool Trap. This kit allows you to tether (1) standard 6-lb. (2.7 kg) power tool.
- **Squids 3192 Wrist Lanyard Tethering Kit** includes a 3116 Pull-On Wrist Lanyard with Buckle, a 12' roll of 3755 Self-Adhering Tape Trap, and (3) 3103 Detachable Elastic Tool Tails. This kit allows you to tether up to (4) 3-lb. (1.4 kg) tools.
- **Squids 3190 Tape Measure Tethering Kit** includes a 3130S Coil Lanyard and a 3770 Tape Measure Trap. This kit allows you to tether (1) standard 2-lb. (0.9 kg) tape measure.



**⚠ WARNING:** Squids 3190 Tape Measure Tethering Kit can expose you to chemicals which are known to the State of California to cause cancer and birth defects or other reproductive harm. For more information go to [www.P65Warnings.ca.gov](http://www.P65Warnings.ca.gov).

ITEM #	MARTIN #	DESCRIPTION	UOM	PRICE
19650	ERGO19650	Tool tethering kit, 2-lb.	KIT	\$55.27
19651	ERGO19651	Tool tethering kit, 5-lb.	KIT	\$52.45
19652	ERGO19652	Tool tethering kit, 10-lb.	KIT	\$51.55

ITEM #	MARTIN #	DESCRIPTION	UOM	PRICE
19661	ERGO19661	Power tool tethering kit	KIT	\$27.55
19662	ERGO19662	Wrist lanyard tethering kit, 3-lb.	KIT	\$42.36
19660	ERGO19660	Tape measure tethering kit	KIT	\$36.82



**SQUIDS® 3115 WRIST TOOL LANYARDS**

Prevents injuries, reduces costs and eliminates lost productivity from dropped tools. Features poly webbing cuff that secures to wrist, tether length 7 1/2" and ribbed pull cord. Includes adjustable barrel lock for tool attachment. Maximum working capacity: 2 lbs. Black.



ITEM #	MARTIN #	DESCRIPTION	SIZES	UOM	PRICE
19042	ERGO19042	Wrist lanyard, wrist size 5"-7"	S/M	EA	\$2.73
19052	ERGO19052	Wrist lanyard, wrist size 7"-8 1/2"	L/XL	EA	\$2.73



**SQUIDS® 3540 LARGE LOCKING TIE HOOKS**

Super-duty, reusable locking tie hooks are great for organizing and cinching hoses, cords and pipes. Features cable lock for increased load capacity, adjustable sliding belt lock mechanism, high tensile strength and weather-resistant Nylon 66 design. Resistant to oil, salt, solvents and alkali. Hi-viz orange color. Temperature range: -40° F to 176° F. Recommended load limit: 44 lbs.

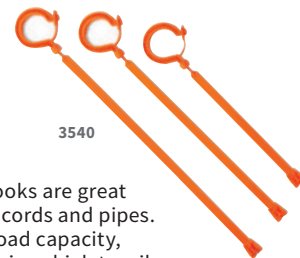

ITEM #	MARTIN #	DESCRIPTION	UOM	PRICE
33402	ERGO33402	Large locking tie hook w/ 11.8" belt	EA	\$4.36
33403	ERGO33403	Large locking tie hook w/ 15.8" belt	EA	\$4.64
33404	ERGO33404	Large locking tie hook w/ 19.7" belt	EA	\$5.00



**SQUIDS® 3130 COILED CABLE LANYARDS**

Coiled cable lanyard keeps the length of the lanyard close to the anchoring point, reducing snag hazards of traditional lanyards while preventing dropped objects. Swiveling design prevents tangles and headaches the coiled design can cause and reduces recoil force preventing aggressive snap back. Constructed with PU-covered aircraft cable for ultimate strength and durability. Stainless steel carabiners (#304) for corrosion resistance; captive eye carabiner with screw gate for locking connection. Choose from 6 1/2" coiled/50" extended length with 2-lb. working capacity or 7" coiled/51" extended length with 5-lb. working capacity.

**⚠ WARNING:** This product can expose you to chemicals including DEHP, which is known to the State of California to cause cancer. For more information go to [www.P65Warnings.ca.gov](http://www.P65Warnings.ca.gov).

ITEM #	MARTIN #	DESCRIPTION	COLOR	UOM	PRICE
19130	ERGO19130	6 1/2" Coiled cable lanyard, 2-lb. capacity	Lime	EA	\$18.91
19131	ERGO19131	7" Coiled cable lanyard, 5-lb. capacity	Orange	EA	\$20.82



# ▶ FACILITY CARE



These fine manufacturers help us bring you custom tailored solutions:



Under the Occupational Safety and Health Act of 1970, employers are responsible for providing safe and healthful workplaces for their employees. OSHA's role is to ensure conditions for workers are followed by setting and enforcing standards, and providing training, education and assistance. Employers can adhere to these standards by providing equipment such as instrumentation devices, first aid kits, signage, LOTO devices and materials to prevent slips, trips and falls.

Monitors & Instrumentation.....	114-121
First Aid.....	122-126
Matting .....	127-128
LOTO .....	129-136
Heat Stress .....	137-142
Signs.....	143-148
Spill Containment .....	149-154

# Dräger

## PAC® 6000 SINGLE-GAS DETECTORS

Disposable personal single-gas detection device. Measures CO, H2S, SO2 or O2 reliably and precisely, even in the toughest conditions. Robust design, quick sensor response times, and a powerful battery ensure maximum safety for up to 2 years with virtually no maintenance required. Features easy fastening crocodile clip, illuminating D-light, large display and 360° alarm signal. 2-Year warranty.

8326368



ITEM #	MARTIN #	DESCRIPTION	UOM	PRICE
8326369	DRSA8326369	PAC 6000, CO, 0-2000 ppm range, 1 ppm resolution	EA	\$208.68
8326368	DRSA8326368	PAC 6000, H2S, 0-100 ppm range, 0.1 ppm resolution	EA	\$208.68
8327612	DRSA8327612	PAC 6000, O2, 0-25% vol. range, 0.1% vol.	EA	\$208.68
8328273	DRSA8328273	PAC 6000, SO2, 0-100 ppm range, 0.1 ppm resolution	EA	\$208.68

# Dräger

## PAC® 8500 DUAL-GAS DETECTORS

Reliable and precise instrument even under the toughest of conditions. Can be equipped with a hydrogen-compensated CO sensor or dual sensor. Gives the option of measuring 2 gases at once: either H2S with CO or O2 with CO. Features easy fastening crocodile clip, illuminating D-light, robust housing, large display and 360° alarm signal. 2-Year warranty.

8328263



ITEM #	MARTIN #	DESCRIPTION	UOM	PRICE
8328263	DRSA8328263	PAC 8500, H2S/LC/CO LC, 0-2000 ppm CO range, 1 ppm CO resolution, 0-100 ppm H2S, 0.1 ppm H2S	EA	\$543.53
8328265	DRSA8328265	PAC 8500, O2/CO LC, 0-25% vol. O2 range, 0.1% vol. O2 resolution, 0-2000 ppm CO range, 1 ppm CO resolution	EA	\$660.00
8327617	DRSA8327617	PAC 8500, CO H2-CP, 0-2000 ppm range, 2 ppm resolution	EA	\$596.91

# Dräger

## PAC® 8000 SINGLE-GAS DETECTORS

Non-disposable, personal single-gas detection device is reliable and precise instrument. Detects hazardous concentrations of 29 different gases, including special gases like NO2, O3 or COCL2. Features easy fastening crocodile clip, illuminating D-light, robust housing, large display and 360° alarm signal. 1-Year warranty.

ITEM #	MARTIN #	DESCRIPTION	UOM	PRICE
8326350	DRSA8326350	PAC 8000, NO, 0-200 ppm range, 1 ppm resolution	EA	\$775.50
8328275	DRSA8328275	PAC 8000, NO2 LC, 0-50 ppm range, 0.02 ppm resolution	EA	\$672.62
8326351	DRSA8326351	PAC 8000, CO2, 0-5% vol., 0.1% vol.	EA	\$775.50
8326352	DRSA8326352	PAC 8000, CL2, 0-20 ppm range, 0.1 ppm resolution	EA	\$672.62
8328276	DRSA8328276	PAC 8000, Hydrogen Cyanide, 0-50 ppm range, 0.1 ppm resolution	EA	\$645.44
8328277	DRSA8328277	PAC 8000, NH3, 0-300 ppm range, 1 ppm resolution	EA	\$672.62

ITEM #	MARTIN #	DESCRIPTION	UOM	PRICE
8326355	DRSA8326355	PAC 8000, PH3, 0-20 ppm range, 0.1 ppm resolution	EA	\$672.62
8326356	DRSA8326356	PAC 8000, OV, 0-200 ppm range, 0.5 ppm resolution	EA	\$801.71
8326357	DRSA8326357	PAC 8000, OV-A, 0-200 ppm range, 1 ppm resolution	EA	\$801.71
8326359	DRSA8326359	PAC 8000, O3, 0-10 ppm range, 0.01 ppm resolution	EA	\$775.50
8326360	DRSA8326360	PAC 8000, COCL2, 0-10 ppm range, 0.01 ppm resolution	EA	\$775.50

8326350



# Dräger

## X-AM® 2500 MULTI-GAS DETECTOR

Accurately detects O2, CO, NO2, SO2 and combines reliable sensor technology with long battery life. Features Matrix large, easy-to-read liquid-crystal display and X-dock compatibility. Can operate for more than 12 hours with rechargeable NiMH batteries. Water- and dust-resistant in accordance with protection class IP67. Charger included.

ITEM #	MARTIN #	DESCRIPTION	UOM	PRICE
4542261	DRSA4542261	X-am 2500: Ex, O2, CO, H2S-LC	EA	\$932.65

4542261



# Dräger

## X-AM® 3500 MULTI-GAS MONITOR

Designed for clearance measurements. The 1-4 Gas Detector reliably detects flammable gases and vapors, as well as O2, CO, H2S, NO2 or SO2. Innovative design and extensive range of accessories ensure optimum safety and easy handling. Includes internal pump, pump adaptor and grip clip.

ITEM #	MARTIN #	DESCRIPTION	UOM	PRICE
8328419	DRSA8328419	X-am 3500, O2, CO LC, H2S LC	EA	\$266.76

8328419





## X-AM® 8000 MULTI-GAS DETECTOR

Measures up to 7 toxic as well as flammable gases, vapors and oxygen all at once, either in pump or diffusion mode. Signaling design and handy assistant functions ensure complete safety. Equipped with a powerful internal pump, battery, shoulder strap, pump adapter, inductive charger and power supply. Features glowing green D-light and easy-to-read color display.

8325800



ITEM #	MARTIN #	DESCRIPTION	UOM	PRICE
8325800	DRAS8325800	X-am 8000 multi-gas detector, configurable	EA	<b>Call for pricing</b>



## TOXIRAE PRO LEL SINGLE-GAS MONITORS FOR COMBUSTIBLE GASES, MODEL PGM-1820

Designed for the detection of combustible gases (LEL). This wireless, single-gas monitor is capable of 5-way local and remote alarm notification. Rugged, intrinsically safe and features three months of continuous datalogging, the largest display in their class, user-replaceable intelligent sensor, rechargeable battery and an automatic calibration option with AutoRAE 2.

### Unit includes:

- ToxiRAE Pro LEL monitor with sensor, alligator clip, protective rubber boot, and rechargeable battery installed
- Charging and PC communication cradle
- PC communication cable
- AC adapter (100 to 240 V, 50/60 Hz AC to 12 V DC)
- Calibration adapters
- CD with documentation
- ProRAE Studio II software for PC-based instrument configuration and data management
- Calibration card; quality certificate; packing list; and warranty/registration card
- Quick Start Guide

G02-B034-000

ITEM #	MARTIN #	DESCRIPTION	UOM	PRICE
G02-B034-000	RAEG02-B034-000	ToxiRAE Pro LEL: 0-100% LEL, wireless	EA	<b>\$1,069.12</b>

ITEM #	MARTIN #	DESCRIPTION	UOM	PRICE
G02-B030-000	RAEG02-B030-000	ToxiRAE Pro LEL: 0-100% LEL, non-wireless	EA	<b>\$772.06</b>



## X-DOCK® 5300 TEST AND CALIBRATION STATIONS

Provides automatic bump tests, calibration, reduced test gas consumption, short testing times and comprehensive documentation. Comes in multiple configurations to allow for flexibility depending on the type of detection instrumentation being used. The X-dock 5300 includes a master controller with a module for a single gas detection instrument in the X-am 1/2/5000 or Pac family of products; the X-dock 6300 and 6600 versions can be configured freely- a master controller and up to 10 modules for X-am 1/2/5000 and/or Pac single gas detection instruments.

### Features:

- Touchscreen operation at the master controller station
- Up to 3 configurable test routines
- Automatic permeability tests
- Automatic tests of all alarm elements (acoustic, visual and vibration alarms)
- Optional charging function for X-am 1/2/5x00
- Easy to replace seal cartridge
- 12 V operation (e.g., in vehicles) available
- Can be subsequently expanded with up to max. 10 modules (X-dock 6300/6600)
- Sensor performance testing



X-DOCK 5300 TEST AND CALIBRATION STATION

ITEM #	MARTIN #	DESCRIPTION	UOM	PRICE
8321880	DRSA8321880	Draeger X-dock 5300 X-am 125 set: incl. (1) master (3 gases) w/ power supply & (1) instrument module for Draeger X-am 125 (limit to 1 module; *order needed regulator(s) separately)	EA	<b>\$3,107.79</b>
8321881	DRSA8321881	Draeger X-dock 5300 PAC set: incl. (1) master (3 gases) w/ power supply & (1) instrument module for Draeger PAC 3500/5500 & Draeger PAC 7000 (limit to 1 module; *order needed regulator(s) separately)	EA	<b>\$3,107.79</b>



**TOXIRAE PRO SINGLE-GAS MONITORS FOR TOXIC GASES AND OXYGEN, MODEL PGM-1860**

A wireless personal single-gas monitor capable of 5-way local and remote alarm notification. Rugged, intrinsically safe instruments feature three months of continuous datalogging, the largest display in their class, user-replaceable intelligent sensor, rechargeable battery and an automatic calibration option with AutoRAE 2. Unit includes:ToxiRAE Pro monitor with sensor, alligator clip, protective rubber boot, and rechargeable battery installedCharging and PC communication cradlePC communication cableAC adapter (100-240 VAC, 50/60 Hz AC to 12 VDC)Calibration adaptersCD with documentationProRAE Studio II software for PC-based instrument configuration and data managementQuick Start Guide Ammonia (NH3) 0-00 ppm Carbon Dioxide (CO2) 0-50,000 ppm Carbon Monoxide (CO) Ext. Range 0-2,000 ppm Carbon Monoxide (CO) H2-comp.2 0-2,000 ppm Chlorine (CL2) 0-50 ppm Chlorine Dioxide (CLO2) 0-1 ppm Ethylene Oxide (ETO-A) 0-100 ppm Ethylene Oxide (ETO-B) 0-10 ppm Ethylene Oxide (ETO-C) 0-500 ppm Hydrogen (H2) 0-1,000 ppm Hydrogen Chloride (HCL) 0-15 ppm Hydrogen Cyanide 0-50 ppm Hydrogen Fluoride 0-10 ppm Hydrogen Sulfide (H2S) Extended Range 0-1,000 ppm Methyl Mercaptan (CH3-SH) 0-10 ppm Nitric Oxide (NO) 0-250 ppm Nitrogen Dioxide (NO2) 0-20 ppm Oxygen (O2) 0-30% vol. Phosgene (COCl2) 0-1 ppm Phosphine (PH3) 0-20 ppm Phosphine (PH3) Extended Range 0-1,000 ppm

G02-B214-100



ITEM #	MARTIN #	DESCRIPTION	UOM	PRICE
G02-BE14-100	RAEG02-BE14-100	ToxiRAE Pro: Oxygen, O2, 0 to 30% vol., wireless	EA	\$667.21
G02-BE10-100	RAEG02-BE10-100	ToxiRAE Pro: Oxygen, O2, 0 to 30% vol., non-wireless	EA	\$452.13
G02-B214-100	RAEG02-B214-100	ToxiRAE Pro: Carbon monoxide, CO, 0-500 ppm, wireless	EA	\$667.21
G02-B210-100	RAEG02-B210-100	ToxiRAE Pro: Carbon monoxide, CO, 0-500 ppm, non-wireless	EA	\$452.13
G02-B114-100	RAEG02-B114-100	ToxiRAE Pro: Hydrogen Sulfide, H2S, 0-100 ppm, wireless	EA	\$667.21
G02-B110-100	RAEG02-B110-100	ToxiRAE Pro: Hydrogen Sulfide, H2S, 0-100 ppm, non-wireless	EA	\$452.13
G02-B610-100	RAEG02-B610-100	ToxiRAE Pro: Chlorine, datalogging	EA	\$559.19

ITEM #	MARTIN #	DESCRIPTION	UOM	PRICE
G02-B710-100	RAEG02-B710-100	ToxiRAE Pro: Hydrogen cyanide, datalogging	EA	\$559.19
G02-B614-100	RAEG02-B614-100	ToxiRAE Pro: Chlorine, wireless	EA	\$774.26
G02-B714-100	RAEG02-B714-100	ToxiRAE Pro: Hydrogen cyanide, wireless	EA	\$774.26
G02-BM10-100	RAEG02-BM10-100	ToxiRAE Pro: Hydrogen, H2, non-wireless	EA	\$559.19
G02-BM14-100	RAEG02-BM14-100	ToxiRAE Pro: Hydrogen, H2, wireless	EA	\$774.26
G02-BQ10-100	RAEG02-BQ10-100	ToxiRAE Pro: Formaldehyde, HCHO, non-wireless	EA	\$774.26
G02-BQ14-100	RAEG02-BQ14-100	ToxiRAE Pro: Formaldehyde, HCHO, wireless	EA	\$989.34



**MICRORAE™ MULTI-GAS MONITOR**

Wireless multi-gas diffusion monitor simultaneously measures up to four gases, including hydrogen sulfide, carbon monoxide, oxygen and combustibles (LEL). With its multiple wireless connectivity options the MicroRAE can deliver real-time instrument readings, location, and alarm status to other wireless solutions such as ConneXt Plus, ConneXt Pro, ConneXt Loneworker and Safety Communicator.

M031-4111-200



**Features:**

- Honeywell ConneXt compatible with Mesh and Wi-Fi wireless configurations
- Real-time gas concentration reading, location, alarm and status enabled by state-of-the-art wireless technology
- Bluetooth® low energy connection to a Smart Phone device for uplink data communication and device configuration
- Compact and lightweight design
- IP-67 water- and dust-resistant case
- Strong, protective, concussion-proof design
- Unmistakable 5-way local and remote wireless notification of alarm conditions
- Short bump test and calibration time
- Filtered LEL sensor options to inhibit sensor poisoning
- Global approval for worldwide acceptance

ITEM #	MARTIN #	DESCRIPTION	UOM	PRICE
M031-1111-200	RAEM031-1111-200	MicroRAE (cCSAu): LEL, H2S, CO, O2 w/ Li-ion/ BLE	EA	\$1,072.06
M031-3111-200	RAEM031-3111-200	MicroRAE (cCSAu): LEL, H2S, CO, O2 w/ Li-ion/ BLE & 900MHz & GPS	EA	\$1,292.65
M031-4111-200	RAEM031-4111-200	MicroRAE (cCSAu): LEL, H2S, CO, O2 w/ Li-ion/ BLE & Wi-Fi & GPS	EA	\$1,329.41

ITEM #	MARTIN #	DESCRIPTION	UOM	PRICE
M031-1111-300	RAEM031-1111-300	MicroRAE (cCSAu) LEL, O2, CO, HCN w/ Li-ion/ BLE	EA	\$1,264.71
M031-3111-300	RAEM031-3111-300	MicroRAE (cCSAu) LEL, O2, CO, HCN w/ Li-ion/ BLE & 900MHz & GPS	EA	\$1,485.29
M031-4111-300	RAEM031-4111-300	MicroRAE (cCSAu) LEL, O2, CO, HCN w/ Li-ion/ BLE & Wi-Fi & GPS	EA	\$1,522.06



## ULTRARAE 3000

Photoionization Detector (PID) with extended range of 0.05 to 10000 ppm in VOC mode and 50 ppb to 200 ppm in benzene-specific mode makes it an ideal instrument for applications from entry pre-screening during refinery and plant maintenance to hazardous material response, marine spill response and refinery down-stream monitoring.

### Monitor only includes :

- UltraRAE 3000 monitor, Model PGM-7360
- Wireless communication in built, as specified
- Datalogging with ProRAE studio
- Travel download charger
- RAE UV 9.8 eV lamp with RAE-Sep™ tubes for Benzene
- Flex-I-Probe and short probe
- External filter
- Alkaline battery adapter
- Lamp cleaning and tool kit
- Li-ion battery with universal AC/DC adapter and international plug kit, if specified
- Resources CD-ROM and maintenance manual
- Soft leather carrying case

### Accessory kit includes:

- Hard case with pre-cut foam
- Charging/download cradle
- (5) Porous metal filters and O-rings
- Organic vapor zeroing kit

### Calibration kit includes:

- Calibration gas, 34 L, as specified
- Calibration regulator and flow controller



059-D310-000



## QRAE 3 MULTI-GAS MONITORS

Versatile, rugged, multi-sensor gas monitor that provides continuous exposure monitoring of combustibles and toxic gases, including hydrogen sulfide (H2S), sulfur dioxide (SO2), carbon monoxide (CO), hydrogen cyanide (HCN) and oxygen (O2). Unit is certified for use in hazardous environments where exposure to toxic gas is a constant safety threat. Wireless communication capability enables access to real-time, remote instrument readings and alarm status, including an innovative Man Down Alarm. Large graphical display, icon-driven user interface through intuitive, 2-button operation.



QRAE 3  
MULTI-GAS  
MONITOR

### Features:

- Extensive onboard gas library (dedicated 55 LEL correction factors)
- Easy maintenance with user-replaceable sensors, pump, and battery
- Fully-automated bump testing and calibration with AutoRAE 2
- IP Rating: pumped: IP-65, diffusion: IP-67
- Datalogging: Up to three months (4 sensors at 1-minute interval, 24/7), user-configurable
- LOW, HIGH, STEL (toxic) and TWA (toxic) alarms, user-configurable
- Alarms: bright visual alarm, 95dB audible alarm, vibration alarm
- Certifications: CSA Class I, Division 1, Groups A, B, C and D

ITEM #	MARTIN #	DESCRIPTION	UOM	PRICE
059-D310-000	RAE059-D310-000	UltraRAE 3000 w/ Li-ion battery & universal charger	EA	\$8,002.94
059-D310-200	RAE059-D310-200	UltraRAE 3000 w/ Li-ion battery & universal charger, accessories kit & calibration kit	EA	\$8,797.06
059-D311-200	RAE059-D311-200	UltraRAE 3000 w/ Li-ion battery & universal charger, accessories kit, calibration kit & wireless (Bluetooth®)	EA	\$9,267.65

ITEM #	MARTIN #	DESCRIPTION	UOM	PRICE
<i>QRAE 3 Pump, Non-Wireless with Accessory Kit</i>				
M020-11111-111	RAEM020-11111-111	QRAE 3: LEL, H2S, O2, CO	EA	\$1,369.12
<i>QRAE 3 Diffusion, Non-Wireless with Accessory Kit</i>				
M020-21111-111	RAEM020-21111-111	QRAE 3: LEL, H2S, O2, CO	EA	\$1,220.59
<i>QRAE 3 Pump, Wireless with Accessory Kit</i>				
M020-11211-111	RAEM020-11211-111	QRAE 3: LEL, H2S, O2, CO	EA	\$1,663.24
<i>QRAE 3 Diffusion, Wireless with Accessory Kit</i>				
M020-21211-111	RAEM020-21211-111	QRAE 3: LEL, H2S, O2, CO	EA	\$1,514.71



## MULTIRAE LITE MONITORS

Optimal one-to-six-gas monitor for personal protection and multi-gas leak detection applications. Available in pumped and diffusion versions with a broad selection of sensor options. Configurable to meet the needs and compliance requirements of various countries, industries and applications.

### Features:

- Unmistakable 5-way local and remote wireless notification of alarm conditions, including Man-Down Alarm
- 25+ Interchangeable intelligent sensors, including PID for VOCs, NDIR and catalytic LEL for combustibles, and NDIR for CO2
- Large graphical display with easy-to-use, icon-driven user interface and automatic "flip" feature
- Continuous datalogging (6 months for 5 sensors, 24x7)
- Easy maintenance with replaceable sensors, pump, and plug-and-play lithium-ion battery

MAB3-A2C112E-020



ITEM #	MARTIN #	DESCRIPTION	UOM	PRICE
MAB3-A2C112E-020	RAEMAB3-A2C112E-020	MultiRAE Lite: pumped, 10.6 eV PID, LEL, H2S, CO, O2, non-wireless	EA	\$3,245.59
MAB3-A2C112E-420	RAEMAB3-A2C112E-420	MultiRAE Lite: pumped, 10.6 eV PID, LEL, H2S, CO, O2, wireless	EA	\$3,686.76
MAB3-A2C1R3E-020	RAEMAB3-A2C1R3E-020	MultiRAE Lite: pumped, 10.6 eV PID, LEL, CO+H2S, SO2, O2, non-wireless	EA	\$3,701.47
MAB3-A2C1R3E-420	RAEMAB3-A2C1R3E-420	MultiRAE Lite: pumped, 10.6 eV PID, LEL, CO+H2S, SO2, O2, wireless	EA	\$4,142.65



**RAELINK 3 WIRELESS MODEM**

License-free, ISM band RF transmission with communication range up to 500' with optional RAELink 3 modem. RAELink 3 modem provides GPS capability to track and display readings from remote detectors and provide long-distance transmission. The unit is also a compatible wireless upgrade package for MiniRAE 2000, ppbRAE Plus and MultiRAE Plus detectors. It allows real-time monitoring information from these detector to be integrated into an existing AreaRAE system. This modem transmits readings and other information on a real-time basis to a remotely located AreaRAE base controller. Call for further ordering details.

RAELINK 3 WIRELESS MODEM



ITEM #	MARTIN #	DESCRIPTION	UOM	PRICE
029-0505-000	RAE029-0505-000	RAELink 3 kit multi-function modem w/ GPS	EA	\$3,750.00
029-0695-000	RAE029-0695-000	RAELink 3 Mesh modem kit multi-function modem w/ GPS	EA	\$3,750.00



F04R-B1111-000

**CONNEXT PACK  
CONFINED SPACE ENTRY KITS**

ConneXt Packs are a rapidly deployable confined space entry gas detection solution. Kits include 1-4 pumped or diffused gas monitors with sensing capabilities of CO, H2S, O2, LEL, a wireless host, and various accessories. The operation is simple, remove the devices from the case, press the on button, and the worker is ready to enter a confined space while the attendant is able to view toxic gas levels in real time from the wireless host, ensuring the confined space entrants are safe.



ITEM #	MARTIN #	DESCRIPTION	UOM	PRICE
<i>Connect Pak Kits with Pumped QRAE 3 Monitors</i>				
F04R-B1111-000	RAEF04R-B1111-000	ConneXt Pack, 1 Unit QRAE 3 LEL, O2, CO, H2S pumped, EchoView host & accessories	EA	\$3,507.35
F04R-B2111-000	RAEF04R-B2111-000	ConneXt Pack, 2 Units QRAE 3 LEL, O2, CO, H2S pumped, EchoView host & accessories	EA	\$4,676.47
F04R-B3111-000	RAEF04R-B3111-000	ConneXt Pack, 3 Units QRAE 3 LEL, O2, CO, H2S pumped, EchoView host & accessories	EA	\$6,139.71
<i>Connect Pak Kits with Diffused QRAE 3 Monitors</i>				
F04R-B2211-000	RAEF04R-B2211-000	ConneXt Pack, 2 Units QRAE 3 LEL, O2, CO, H2S diffused monitor, EchoView host & accessories	EA	\$4,382.35
F04R-B1211-000	RAEF04R-B1211-000	ConneXt Pack, 1 QRAE 3 Unit LEL, O2, CO, H2S Diffusion, 1 EchoView Host, Accessories	EA	\$3,360.29



**PRORAE GUARDIAN  
MOBILE COMMAND CENTER**

Represents an advanced generation of real-time wireless gas detection software and serves as a mobile command center for threat-detection needs. Allows incident commanders and safety managers to get constantly updated, real-time data anywhere and anytime. Software connects, integrates and relays data from RAE Systems' and select partners' wireless products to remote monitors. Accepts real-time detector data and instantly displays device status, alarm and sensor reading information, integrating all information on a single, dynamic map display. Monitors installation from anywhere in the world. Geographically dispersed teams can coordinate threat responses while simultaneously viewing the same situational data, all in real-time.



**Features:**

- Lower deployment costs
- Increased situational awareness
- 24/7 documentation of exposure conditions
- Early warning and tracking of hazardous threats
- Ideal for rapid deployment situations
- Real-time display of device status, sensor readings, and alarms
- Redesigned user interface with simultaneous on-screen instrument readings
- Integrated Google™ Maps show precise instrument locations with alarm status
- Remote alarming via email and text messages
- Datalogging in text and graphical formats, including boolean filters
- Open platform for third-party devices and systems
- Image overlay option

ITEM #	MARTIN #	DESCRIPTION	UOM	PRICE
S01-1000-000	RAES01-1000-000	ProRAE Guardian License - Tier 1 Concurrent Instruments qty 1-49	EA	\$27.21
S01-2000-000	RAES01-2000-000	ProRAE Guardian License - Tier 2 Concurrent Instruments qty 1-24	EA	\$551.47
S01-3000-000	RAES01-3000-000	ProRAE Guardian License - Tier 3 Concurrent Instruments qty 1-9	EA	\$1,102.94



SEE MORE PRODUCTS AT  
[WWW.MARTINSUPPLY.COM](http://WWW.MARTINSUPPLY.COM)

**GAS CYLINDERS**

Various mixtures and cylinder sizes available.

ITEM #	MARTIN #	DESCRIPTION	SIZES	UOM	PRICE
610-1082-000	RAE610-1082-000	Isobutylene 100 ppm, balance air	34 L	EA	\$110.29
610-0001-000	RAE610-0001-000	Isobutylene 100 ppm, balance air	116 L	EA	\$330.88
610-0050-007	RAE610-0050-007	4-Gas Calibration Mix: CO 50 ppm/H2S 10 ppm/CH4 50% LEL (2.5% vol)/O2 18%, balance N2	34 L	EA	\$264.71
610-0050-070	RAE610-0050-070	4-Gas Calibration Mix: CO 50 ppm/H2S 10 ppm/CH4 50% LEL (2.5% vol)/O2 18%, balance N2	54 L	EA	\$367.65
610-0004-000	RAE610-0004-000	4-Gas Calibration Mix: CO 50 ppm/H2S 10 ppm/CH4 50% LEL (2.5% vol)/O2 18%, balance N2	116 L	EA	\$617.65

GAS CYLINDERS



FACILITY CARE | MONITORS & INSTRUMENTS





## DEMAND-FLOW REGULATOR CGA-600

Demand-Flow Regulator for pumped instruments. Female threaded for use with 34 L steel cylinders. (Not for use with HCN or CL2 gases).



ITEM #	MARTIN #	DESCRIPTION	UOM	PRICE
002-3051-000	RAE002-3051-000	Demand-Flow Regulator	EA	\$617.65



## ALTAIR® 2X GAS DETECTORS

Rugged, intrinsically-safe gas detector is available in (3) models to fit all situations. Features tough over-molded rubber armor that can survive 25' drops onto concrete. Agency certified dust- and water-tight IP67 construction. Three-year warranty on instrument and most sensors (2-years on Cl2, NH3).



- **ALTAIR 2X single-gas detector** incorporates proven XCell® sensor technology and records hours of periodic data
- **ALTAIR 2XP single-gas detector** with XCell Pulse Technology features stand-alone bump test anytime, anywhere without specific calibration gas; records hours of periodic data

ITEM #	MARTIN #	DESCRIPTION	COLOR	UOM	PRICE
<i>ALTAIR 2X with XCell Sensor Technology</i>					
10153986	MSA10153986	ALTAIR 2X: CO	Charcoal	EA	\$395.35
10154185	MSA10154185	ALTAIR 2X: CO	Phosphorescent	EA	\$406.20
<i>ALTAIR 2XP with XCell Pulse Technology</i>					
10153984	MSA10153984	ALTAIR 2XP: H2S	Charcoal	EA	\$448.59
10154188	MSA10154188	ALTAIR 2XP: H2S	Phosphorescent	EA	\$458.45
10157955	MSA10157955	ALTAIR 2XP: H2S w/ alternate setpoints - low: 5 ppm, high: 10 ppm	Charcoal	EA	\$448.59
10157956	MSA10157956	ALTAIR 2XP: H2S w/ alternate setpoints - low: 5 ppm, high: 10 ppm	Phosphorescent	EA	\$458.45
<i>Calibration Gas</i>					
710882	MSA710882	CO 60 ppm, 34L		EA	\$271.13
10153800	MSA10153800	CO, 20 ppm H2S, 34L		EA	\$270.14
10153801	MSA10153801	CO, 20 ppm, H2S, 58L		EA	\$398.31
10153844	MSA10153844	H2S, 20 ppm, 34L		EA	\$196.20
10153845	MSA10153845	H2S, 20 ppm, 58L		EA	\$238.59
10153846	MSA10153846	H2S, 20 ppm 116L		EA	\$332.25
711070	MSA711070	SO2, 10 ppm, 34L		EA	\$196.20
808978	MSA808978	SO2, 10 ppm, 58L		EA	\$243.52



## ALTAIR® 2XT TWO-TOX GAS DETECTORS

Eliminates the need for a second detector by utilizing proven XCell Two-Tox Sensors. Detects 2 gases on distinct sensor channels with digital output that minimizes cross-channel interference. Real-time LED and on-screen visual indication of bump test compliance. Event, peak and calibration records data logged for full traceability. IP 67 ingress protection, 25' drop test. Only need 1 device to monitor 2 gases. Records 300+ alarm events and 850+ hours of periodic data, including bump and calibration records. Compatible with MSA Galaxy® GX2 Automated Test System and MSA Link Pro Software. Four-year expected instrument and sensor life. Three-year warranty on instrument and most sensors.



ITEM #	MARTIN #	DESCRIPTION	COLOR	UOM	PRICE
10153985	MSA101539	SO2/H2S-LC (SO2: 2, 5; H2S: 10, 15)	Charcoal	EA	\$526.48
10154040	MSA10154040	CO/H2S (CO:25, 100; H2S: 10, 15)	Charcoal	EA	\$526.48
10154071	MSA10154071	CO-H2/H2S	Charcoal	EA	\$526.48
10154072	MSA10154072	CO/H2S-LC	Charcoal	EA	\$526.48
10154073	MSA10154073	CO/NO2 (CO: 25, 100; NO2: 2.5, 5)	Charcoal	EA	\$526.48
10154181	MSA10154181	CO/H2S (CO:25, 100; H2S: 10, 15)	Glow-in-the-dark	EA	\$537.32
10154182	MSA10154182	CO-H2/H2S	Glow-in-the-dark	EA	\$537.32
10154183	MSA10154183	CO/H2S-LC	Glow-in-the-dark	EA	\$537.32
10154184	MSA10154184	CO/NO2 (CO: 25, 100; NO2: 2.5, 5)	Glow-in-the-dark	EA	\$537.32



## ALTAIR® 4XR MULTI-GAS DETECTORS

Sense gas 2X faster than the industry average with XCell® sensors. Quickly update MSA ALTAIR 4XR settings via the ALTAIR Connect app. Survives 25 drops from 4' (1.2 meters) (MIL-STD-810G drop protection). Dust- and waterproof IP68 rating (2 meters for at least 1 hour). Operating temperature range: -40° F to +140° F. Four-year instrument and sensor warranty. Charcoal case.



ITEM #	MARTIN #	DESCRIPTION	UOM	PRICE
10178356	MSA110178356	ALTAIR 4XR: LEL, O2, H2S & CO w/ 4-gas cylinder & regulator	EA	\$1,700.70
10178357	MSA10178357	ALTAIR 4XR: LEL, O2, H2S & CO w/ 4-gas cylinder, regulator & pump probe	EA	\$2,164.08
10178358	MSA10178358	ALTAIR 4XR: LEL, O2, H2S-LC & CO w/ 4-gas cylinder, regulator & pump probe	EA	\$2,164.08
10178557	MSA10178557	ALTAIR 4XR: LEL, O2, H2S & CO	EA	\$1,123.94
10178566	MSA1017856	ALTAIR 4XR: LEL, O2, & CO	EA	\$1,078.59
10178568	MSA10178568	ALTAIR 4XR: LEL & O2	EA	\$910.99
10178572	MSA10178572	ALTAIR 4XR: LEL, O2, H2S-LC & CO	EA	\$1,123.94
10179330	MSA10179330	ALTAIR 4XR: LEL, O2, H2S & CO-H2	EA	\$1,182.11



The Safety Company

10165445



**ALTAIR® 5X  
MULTI-GAS DETECTORS**

Measures up to 6 gases simultaneously and can be fitted with a wide range of both toxic and infrared sensors. Features MSA's XCell® sensors with extended range covering SO2, Cl2 and NH3. Offers superior stability, accuracy, repeatability, fast response and longevity. Standard sensors designed for average life of more than 4 years (more than 3 years for SO2, Cl2, and NH3); allow for faster response/clear times, bump tests in less than 10 seconds, and span calibration time of 60 seconds for common configurations; provide greater signal stability and repeatability under changing or extreme environmental conditions; are plug-and-play-capable. End-of-sensor-life indicator gives advanced warning to user, eliminating service outages. Event/data log records up to 500 events. MotionAlert™ triggers alarm if user remains motionless for 20 seconds. InstantAlert™ allows users to manually activate all alarms to alert others to potential hazards. Includes triple alarm system (visual, audible and vibration), large hi-res LCD screen (color or monochromatic), 24-hour bump test checkmark, rugged rubberized housing and ergonomic design, auto calibration, Li-polymer battery with up to 18 hours usage between charges, 10' sampling line and 1' probe. MSA Link™ software and Galaxy® system compatible. IP65 rated for dust and water ingress. Wireless Bluetooth included standard.



The Safety Company

10128642



**GALAXY® GX2  
AUTOMATED  
TEST SYSTEM**

Provides simple, intelligent testing and calibration of MSA ALTAIR® and ALTAIR PRO Single-Gas Detectors and ALTAIR 4X and ALTAIR 5X Multi-Gas Detectors. Easy-to-use automated test stand offers high performance as either stand-alone unit or integrated portable detector management system, enabling total data access and control of the MSA ALTAIR family Gas Detector fleet. New MSA Link™ Pro Software for proactive safety management; gas exposure email alerts, direct data input, live filtering, test and exposure queries, collecting and printing reports.

**Features:**

- Color touch screen for ease of setup and viewing
- Extremely simple to use; testing starts automatically without touching a single button
- Simultaneous testing of up to ten instruments
- Galaxy GX2 System is optimized for use with MSA's XCell® Sensors; provides up to 50% cost of ownership reduction
- At-a-glance indicators include low calibration gas volume, expiration warnings and test stand status
- MSA Link Pro Software provides proactive safety management, dashboard overview and total record-keeping
- 18 Languages available for test stand and MSA Link Pro Software that simplifies usage and reduces training

ITEM #	MARTIN #	DESCRIPTION	UOM	PRICE
<i>Economy Kits - Monochrome Display</i>				
10116924	MSA10116924	ALTAIR 5X: LEL, O2, CO & H2S	EA	\$2,231.13
10116925	MSA10116925	ALTAIR 5X: LEL, O2, CO, H2S & SO2	EA	\$2,819.72
<i>Industrial Kits - Monochrome Display with 10' Sampling Line and 1' Probe</i>				
10116926	MSA10116926	ALTAIR 5X: LEL, O2, CO & H2S	EA	\$2,523.94
10116927	MSA	ALTAIR 5X: LEL, O2, CO, H2S & SO2	EA	\$3,111.55
<i>Deluxe Kits - Color Display with 10' Sampling Line and 1' Probe</i>				
10116928	MSA10116928	ALTAIR 5X: LEL, O2, CO & H2S	EA	\$2,796.06
10116929	MSA10116929	ALTAIR 5X: LEL, O2, CO, H2S & SO2	EA	\$3,384.65
<i>Applicable Calibration Gases</i>				
10048280	MSA10048280	CO 60 ppm, O2 15%, Pentane 1.45%, H2S 20 ppm, balance N	EA	\$291.83
10098855	MSA10098855	CO 60 ppm, O2 15%, CH4 1.45%, H2S 20 ppm, SO2 10 ppm, balance N 34L	EA	\$377.46
<i>With Integrated PID Sensor for VOC Detection</i>				
10165445	MSA10165445	ALTAIR 5X: LEL, O2, CO, H2S, PID	EA	\$4,270.00
<i>Applicable Calibration Gases</i>				
10048279	MSA10048279	100 PPM Isobutylene, 34L RP Cyl	EA	\$291.83

ITEM #	MARTIN #	DESCRIPTION	UOM	PRICE
<i>Galaxy GX2 for ALTAIR 5/5X</i>				
10128625	MSA10128625	Automated test system w/ 4 valves & charger	EA	\$2,808.87
10128626	MSA10128626	Automated test system w/ 1 valve & charger	EA	\$2,496.34
10128627	MSA10128627	Automated test system w/ 4 valves	EA	\$2,626.48
10128628	MSA10128628	Automated test system w/ 1 valve	EA	\$2,314.93
<i>Galaxy GX2 for ALTAIR 4/4X</i>				
10128629	MSA10128629	Automated test system w/ 4 valves & charger	EA	\$2,808.87
10128630	MSA10128630	Automated test system w/ 1 valve & charger	EA	\$2,496.34
10128641	MSA10128641	Automated test system w/ 4 valves	EA	\$2,626.48
10128642	MSA10128642	Automated test system w/ 1 valve	EA	\$2,314.93
<i>Galaxy GX2 for ALTAIR/PRO</i>				
10128643	MSA10128643	Automated test system w/ 4 valves	EA	\$2,626.48
10128644	MSA10128644	Automated test system w/ 1 valve	EA	\$2,314.93
<i>Accessories</i>				
10125135	MSA1012513	Cylinder holder assembly, non-electronic	EA	\$271.13
10125907	MSA10125907	Test stand end cap	EA	\$15.77
10127111	MSA10127111	Memory card, SD/SDHC	EA	\$29.58
10105756	MSA10105756	Cylinder holder assembly, GX2	EA	\$1,170.28
<i>Chargers</i>				
10127422	MSA10127422	Multi-unit charger, ALTAIR 4X	EA	\$374.65
10127427	MSA10127427	Multi-unit charger, ALTAIR 5X	EA	\$374.65



## GAS MISER® DEMAND REGULATORS

Constructed of nickel-plated brass and polished aluminum (especially important for reactive gases). Regulator can supply gas flow from 0.1 lpm to 3.0 lpm. Designed for use with any MSA Model RP Calibration cylinder except chlorine and ammonia and features automatic ON/OFF valve that releases gas only on demand, using only amount of gas needed to calibrate your MSA instrument. When calibration is complete, regulator shuts off automatically. Regulator can stay connected to cylinder where it remains in ready state, making it ideal for fixed installations such as work benches and calibration stations. Eliminates need to change regulators to accommodate different instruments or flow rates. Supplied with calibration tubing and special fitting.

710288



ITEM #	MARTIN #	DESCRIPTION	UOM	PRICE
710288	MSA710288	Model RP Gas Miser regulator	EA	\$476.20
710289	MSA710289	Model BD-20 w/ CGA fitting	EA	\$529.44



## MSA FIXED FLOW REGULATORS

Available in the Model R and Model RP, each with fixed flow rates of 0.25 and 1.5 lpm. Fixed flow design provides constant and accurate flow to the instrument pump or aspirator. Approved for all MSA calibration gases.

467895



ITEM #	MARTIN #	DESCRIPTION	UOM	PRICE
467895	MSA467895	Model RP cylinder regulator, 0.25 lpm	EA	\$244.51
467896	MSA467896	Model RP cylinder regulator, 1.5 lpm	EA	\$244.51
459949	MSA459949	Model R cylinder regulator, 0.25 lpm	EA	\$244.51
459948	MSA459948	Model R cylinder regulator, 1.5 lpm	EA	\$244.51



## MODEL RP CALIBRATION CHECK KITS

Kits consist of regulating valve which includes gauge to measure container pressure, adapter hose, sensor adapter (where applicable), instructions and case fitted with room for (2) Model RP cylinders of calibration check gas.



**477149** Calibration check kit includes: regulator (0.25 lpm); tubing, 30' (without sampling line connection); calibration plug for MSA electrochemical sensors; zero plugs for MSA electrochemical sensors; calibration plug for MSA electrochemical sensors.

**477150** Calibration check kit includes: regulator (1.5 lpm) and (2) adapter hoses- (1) each with and without sampling line connection.

ITEM #	MARTIN #	DESCRIPTION	UOM	PRICE
477149	MSA477149	Calibration check kit w/ 0.25 lpm regulator	EA	\$411.27
477150	MSA477150	Calibration check kit w/ 1.5 lpm regulator	EA	\$370.70



## ECONO-CAL® CALIBRATION CYLINDERS—REACTIVE GASES, ALUMINUM CYLINDER

Aluminum cylinder has 500 psig and contains approximately 34 L at atmospheric pressure. Size: 13 3/4" x 3". Weighs 1 lb., 1 oz.

ECONO-CAL



ITEM #	MARTIN #	DESCRIPTION	UOM	PRICE
<i>Single Gas Cylinders</i>				
711078	MSA711078	NH3, balance air	EA	\$432.82
711066	MSA711066	Cl, balance N	EA	\$432.82
711062	MSA711062	H2S 40 ppm, balance N	EA	\$196.20
711064	MSA711064	H2S, balance N	EA	\$196.20
711060	MSA711060	H2S, balance N	EA	\$196.20
711074	MSA711074	NO, balance air	EA	\$291.83
711068	MSA711068	NO2, balance air	EA	\$291.83
711084	MSA711084	NO2, balance air	EA	\$432.82
711088	MSA711088	PH3, balance N	EA	\$465.35
711070	MSA711070	SO2 10 ppm, balance air	EA	\$196.20
<i>Multi-Gas Cylinders</i>				
711058	MSA711058	CO 300 ppm, O2 15%, Methane 1.45%, H2S 10 ppm, balance N	EA	\$291.83
711076	MSA711076	CO 300 ppm, O2 15%, Methane 2.5%, H2S 10 ppm, balance N	EA	\$291.83
10048280	MSA10048280	CO 60 ppm, O2 15%, Pentane 1.45%, H2S 20 ppm, balance N	EA	\$291.83
10098855	MSA10098855	CO 60 ppm, O2 15%, CH4 1.45%, H2S 20 ppm, SO2 10 ppm, balance N	EA	\$377.46



**SMARTCOMPLIANCE™ LARGE FIRST AID CABINET**

Solid steel case comes with a carrying handle and is wall mountable. Contents exceed the 2015 ANSI Class A requirements and are sufficient to treat 50 or more people. Measures: 13 1/2" x 14 1/2" x 3".



ITEM #	MARTIN #	DESCRIPTION	UOM	PRICE
746004	FA0746004	SmartCompliance large first aid cabinet	EA	\$202.38
746000	FA0746000	SmartCompliance large first aid cabinet w/ meds	EA	\$202.38

KIT CONTENTS DESCRIPTION	746004		746000	
	QTY	QTY	QTY	QTY
1 1/2" x 1 1/2" Patch Plastic Bandage	10	10		
1" x 3" Adhesive Fabric Bandage	25	25		
3/4" x 3" Adhesive Plastic Bandage	25	25		
Fingertip Fabric Bandage	10	10		
2" x 5 yd. Elastic Bandage Wrap	1	—		
Alcohol Wipe	20	20		
BZK Antiseptic Wipes	20	20		
Castile Soap Wipe	1	—		
Hand Sanitizer	10	10		
2" x 2" Gauze Pad	10	10		

KIT CONTENTS (cont'd) DESCRIPTION	746004		746000	
	QTY	QTY	QTY	QTY
3" x 3" Gauze Pad	10	10		
5" x 9" Trauma Pad	2	2		
1/2" x 5 yd First Aid Tape	2	2		
2" Gauze Roll	2	2		
40" x 40" x 56" Triangular Bandage	1	1		
Cold Pack, 4" x 5"	1	1		
2" x 2" Moleskin Blister Prevention	10	—		
CPR Mask	1	1		
Nitrile Gloves	4	4		
Eye Pad	2	2		

KIT CONTENTS (cont'd) DESCRIPTION	746004		746000	
	QTY	QTY	QTY	QTY
1 oz. Eyewash	1	1		
Aspirin Tablets	—	20		
Non-Aspirin Tablets	—	20		
Burn Cream	10	10		
4" x 4" Burn Dressing	1	1		
Ibuprofen Tablets	—	20		
Triple Antibiotic Ointment	10	10		
Forceps	1	1		
Scissors	1	1		
First Aid Guide	1	1		



**ANSI FIRST AID STATIONS WITH MEDICATIONS**

Solid steel case comes with a carrying handle and is wall mountable. Contents exceed the 2015 ANSI Class A requirements and are sufficient to treat 75 (2-shelf) or 100 or more people (3-shelf).



ITEM #	MARTIN #	DESCRIPTION	SIZES	UOM	PRICE
90572	FA090572	2-Shelf first aid station w/ meds	15 1/4" x 11" x 4 1/2"	EA	\$139.80
90574	FA090574	3-Shelf first aid station w/ meds	15 1/2" x 17" x 5 3/4"	EA	\$213.63

KIT CONTENTS DESCRIPTION	90572 QTY
1" x 3" Adhesive Fabric Bandage	50
Antibiotic Ointment Packet	10
4 oz. Antiseptic Spray	1
CPR Mask w/ One Way Valve	1
4" x 4" Burn Dressing	1
4 oz. Burn Spray	1
4" x 5" Cold Compress	1
Sterile Eye Pad & Strip	4
1 oz. Eyewash	1
2" Conforming Gauze Roll	2
Scissors	1
40" x 40" x 56" Triangular Bandage	1
Tweezers	1
3/4" x 3" Adhesive Plastic Bandage	100
Hand Sanitizer Packet	10
3" x 3" Gauze Dressing Pad	2
1/2" x 5 yd First Aid Tape	1
Knuckle Fabric Bandage	8
Fingertip Fabric Bandage	10
Alcohol Wipe	20
Aspirin Tablets	50
Non-Aspirin Tablets	50
5" x 9" Hema-Flex Trauma Pad in Gauze	1
5" x 9" Trauma Pad	1
Nitrile Gloves	4
First Aid Guide	1

KIT CONTENTS DESCRIPTION	90754 QTY
1" x 3" Fabric Bandages	100
1/2" x 5 yd. First Aid Tape	1
Nitrile Gloves	12
Triple Antibiotic Ointment	25
Antiseptic Spray, 4 oz.	1
CPR Mask w/ One Way Valve	1
4" x 4" Burn Dressing	1
Burn Spray, 4 oz.	1
6" x 9" Cold Compress	1
Sterile Eye Pads and Strips	2
Eyewash, 4 oz.	1
Hand Sanitizer	10
2" Conforming Gauze Roll	1
Scissors	1
3" x 3" Gauze Pad	10
Triangular Bandage	2
Tweezers	1
2" x 3" Fabric Bandages	10
Fabric Knuckle and Fingertip Bandage	50
2" x 2" Gauze Dressing Pads	10
4" x 4" Gauze Dressing Pads	10
Alcohol Pads	100
Non-Aspirin	100
3" Cotton Tipped Applicators	100
4" x yds. Elastic Bandage	1
5" x 9" Hema-Flex in 4" x 4" Trauma Pad	1
5" x 9" Trauma Pad	1
Antacid tablets	100
First Aid Guide	1

**FIRST AID ONLY**

**ANSI 2015 COMPLIANT FIRST AID KITS**

Complete first aid kit contains everything needed to maintain safety. Supplies feature bilingual labels in English and Spanish, for easy reading in an emergency. Class A ANSI-compliant.

90568



ITEM #	MARTIN #	DESCRIPTION	UOM	PRICE
90568	FA090568	25-Person/16-Unit unitized kit w/ Class A basic fill, metal	EA	\$68.75
90569	FA090569	25-Person/16-Unit unitized kit w/ Class A basic fill, plastic	EA	\$47.38

KIT CONTENTS		90568 & 90569
DESCRIPTION		QTY
Adhesive Strips		2
2" Gauze Rolls		2
3" x 3" Gauze Pads		4
5" x 9" Trauma Pads		2
Triangular Bandage		1
4" x 4" Burn Dressing		1

KIT CONTENTS (cont'd)		90568 & 90569
DESCRIPTION		QTY
1/2" x 5 yd First Aid Tape		1
Triple Antibiotic Ointment		12
BZK Antiseptic Wipes		10
Burn Cream		12
CPR Mask		1
Cold Pack		1

KIT CONTENTS (cont'd)		90568 & 90569
DESCRIPTION		QTY
Eye Pads		2
Eye Wash, 1 oz.		1
Hand Sanitizer		10
Nitrile Gloves		4
Scissors		1
First Aid Guide		1



90755

**FIRST AID ONLY**

**10-PERSON ANSI FIRST AID KITS**

71-Piece kits come with a carrying handle and are wall mountable. Contents meet 2015 ANSI Class A requirements and are sufficient to treat 10 or more people. Measures: 8" x 5" x 2 3/4".

ITEM #	MARTIN #	DESCRIPTION	UOM	PRICE
90754	FA090754	10-Person first aid kit, plastic case	EA	\$28.13
90755	FA090755	10-Person first aid kit, metal case	EA	\$44.88

KIT CONTENTS		90754 & 90755
DESCRIPTION		QTY
1" x 3" Adhesive Plastic Bandages		16
1/2" x 5 yd First Aid Tape		1
Triple Antibiotic Ointment		10
BZK Antiseptic Towelettes		10
CPR Mask w/ One Way Valve		1
4" x 4" Burn Dressing		1
Burn Cream Packets		10
4" x 5" Cold Compress		1
Sterile Eye Pads		2
1 oz. Eyewash		1
Hand Sanitizer Packets		6
Nitrile Gloves		4
2" Conforming Gauze Roll		1
Scissors		1
3" x 3" Gauze Dressing Pads		2
5" x 9" Trauma Pads		2
40" x 40" x 56" Triangular Bandage		1
First Aid Guide		1

9301-25P



**FIRST AID ONLY**

**25-PERSON CONTRACTOR'S FIRST AID KIT**

Plastic first aid kit is perfect for work vehicles and to have while on a jobsite. 179-Piece kit can treat 25 people.

ITEM #	MARTIN #	DESCRIPTION	UOM	PRICE
9301-25P	FA09301-25P	Contractor's first aid kit	EA	\$24.55

KIT CONTENTS		9301-25P
DESCRIPTION		QTY
1" x 3" Adhesive Plastic Bandages		100
Knuckle Fabric Bandages		2
Fingertip Fabric Bandages		2
3" Conforming Gauze roll		1
Triangular Sling Bandage		1
3" x 3" Gauze Dressing Pads		8
5" x 9" Trauma Pad		1
BZK Antiseptic Towelettes		42
Antibiotic Ointment		6
First Aid/Burn Cream		6
4" x 5" Cold Compress		1
1/2" x 10 yds First Aid Tape Roll		1
Scissors		1
Tweezers		1
Exam Quality Vinyl Gloves, 2 Pr.		4
Emergency First Aid Guide		1

**FIRST AID ONLY**

**25-PERSON CLASS A KITS**

Case comes with a carrying handle and is wall-mountable. Contents meet the 2015 ANSI Class A requirements and are sufficient to treat 25 or more people.



90588

ITEM #	MARTIN #	DESCRIPTION	UOM	PRICE
90588	FA090588	25-Person, Class A, Type I & II kit, plastic	EA	\$33.13
90560	FA090560	25-Person, Class A, Type III kit, metal	EA	\$49.88

KIT CONTENTS	90588	90560
DESCRIPTION	QTY	QTY
BZK Antiseptic Towelettes	10	10
Burn Cream	10	10
Triple Antibiotic Ointment	10	10
1" x 3" Adhesive Plastic Bandages	32	8
Hand Sanitizer	6	6
3" x 3" Gauze Pads	4	2
Nitrile Gloves	2	2
Sterile Eye Pads	2	2
5" x 9" Trauma Pads	2	2
4" x 4" Burn Dressing	1	1
4" x 5" Cold Compress	1	1
2" Conforming Gauze Roll	1	1
CPR Mask w/ One Way Valve	1	1
Eyewash, 1 oz.	1	1
1/2" x 5 yd First Aid Tape	1	1
Scissors	1	1
40" x 40" x 56" Triangular Bandage	1	1
First Aid Guide	1	1

**FIRST AID ONLY**

**50-PERSON CLASS A KITS**

Case comes with a carrying handle and is wall-mountable. Contents meet the 2015 ANSI Class A requirements and are sufficient to treat 50 or more people.



90564

ITEM #	MARTIN #	DESCRIPTION	UOM	PRICE
90597	FA090597	50-Person, Class A, Type I & II kit w/ dividers, plastic	EA	\$49.93
90564	FA090564	50-Person, Class A+, Type III kit, weatherproof metal	EA	\$71.88

KIT CONTENTS	90597	90564
DESCRIPTION	QTY	QTY
1" x 3" Plastic Bandages	45	60
1/2" x 5 yd. First Aid Tape	1	1
Triple Antibiotic Ointment	10	12
BZK Antiseptic Wipes	15	15
CPR Mask w/ One Way Valve	1	1
4" x 4" Burn Dressing	1	1
Burn Cream	10	12
4" x 5" Cold Compress	1	1
Sterile Eye Pads	2	2
Eyewash, 1 oz.	1	1
Hand Sanitizer Packets	8	10
Nitrile Gloves	4	4
2" Conforming Gauze Roll	2	2
Scissors	1	1
3" x 3" Gauze Pads	6	6
5" x 9" Trauma Pads	2	2
40" x 40" x 56" Triangular Bandage	1	1
4" Conforming Gauze Roll	1	1
Fabric Knuckle Bandages	4	10
Fabric Fingertip Bandages	4	10
Insect Sting Relief Wipe	—	3
Tweezers	1	1
Alcohol Wipes	15	20
Infection Control Wipes	—	4
2" x 5 yd. Elastic Bandage	—	1
First Aid Guide	1	1



90576

**FIRST AID ONLY**

**150-PERSON CLASS B KIT**

Solid steel case comes with a carrying handle and is wall-mountable. Measures: 15.19" H x 22.25" W x 5.56" D. Contents exceed the 2015 ANSI Class B requirements.

ITEM #	MARTIN #	DESCRIPTION	UOM	PRICE
90576	FA090576	150-Person, 4-shelf, Class B kit	EA	\$324.88

KIT CONTENTS	90576
DESCRIPTION	QTY
1" x 3" Fabric Bandages	100
Tri-cut Waterproof Tape	1
Triple Antibiotic Ointment	25
BZK Antiseptic Wipes	50
CPR Mask w/ One Way Valve	1
4" x 4" Burn Dressing	2
Burn Spray, 4 oz.	1
6" x 9" Cold Compress	2
Eyewash, 1 oz.	1
Sterile Eye Pads and Strips	2
Eyewash, 4 oz.	1
Hand Sanitizer, 4 oz.	1
Nitrile Gloves	12

KIT CONTENTS (cont'd)	90576
DESCRIPTION	QTY
2" Conforming Gauze Roll	10
Scissors	1
2" x 2" Gauze Pads	12
3" x 3" Gauze Pads	12
5" x 9" Trauma Pads	3
40" x 40" x 56" Triangular Bandage	2
4" x 4" Gauze Bandage	1
4" x 24" Padded Splint	1
Tourniquet	1
Antiseptic Spray, 4 oz.	1
Aspirin Tablets	250
Ibuprofen Tablets	250
Tweezers	1

KIT CONTENTS (cont'd)	90576
DESCRIPTION	QTY
4" x 5 yd. Elastic Bandage	1
Fabric Knuckle Bandages	40
Fabric Fingertip Bandages	40
Infection Control Wipes	50
1" x 3" Plastic Bandages	100
Alcohol Wipes	100
3" x 4" Non-Stick Pads	50
5" x 9" Hema-Flex in 4" x 4" Trauma Pad	1
Antacid Tablets	250
Elbow & Knee Bandages	25
Ammonia Inhalant	10
Antacid tablets	100



## CLASS A FIRST AID KITS

Available in 25-, 50- and 75-person sizes with a plastic or steel case. Compact size and carrying handle make it easy to transport. Ideal for small and low risk business environments. Steel cases are water-resistant and plastic cases are waterproof. Meets requirements for 2015 ANSI Class A specifications.



FAK25PL-CLSA

ITEM #	MARTIN #	DESCRIPTION	UOM	PRICE
FAK25PL-CLSA	NTHFAK25PL-CLSA	25-Person first aid kit, plastic case	EA	\$71.70
FAK25STL-CLSA	NTHFAK25STL-CLSA	25-Person first aid kit, steel case	EA	\$89.65
FAK50PL-CLSA	NTHFAK50PL-CLSA	50-Person first aid kit, plastic case	EA	\$119.48

ITEM #	MARTIN #	DESCRIPTION	UOM	PRICE
FAK50STL-CLSA	NTHFAK50STL-CLSA	50-Person first aid kit, steel case	EA	\$125.75
FAK75PL-CLSA	NTHFAK75PL-CLSA	75-Person first aid kit, plastic case	EA	\$153.98
FAK75STL-CLSA	NTHFAK75STL-CLSA	75-Person first aid kit, steel case	EA	\$204.85

KIT CONTENTS	FAK25	FAK50	FAK75
DESCRIPTION	QTY	QTY	QTY
4" x 2" Adhesive Bandage	1	2	3
1" x 3" Adhesive Bandage	32	100	100
Fingertip Bandage	3	4	8
Knuckle Bandage	2	3	6
40" x 40" x 56" Triangular Bandage	1	1	1
2" Roller Bandage	2	3	4
3" Roller Bandage	1	2	2
2" x 4.5 yds Elastic Bandage.	—	1	1
Neomycin Antibiotic	10	10	10
3" x 3" Gauze Pad	4	10	10
5" x 9" Trauma Pad	2	2	2
1/2" x 5 yds. Adhesive Tape	2	2	3
Burn Cream, 1.0 g	10	10	10

KIT CONTENTS (cont'd)	FAK25	FAK50	FAK75
DESCRIPTION	QTY	QTY	QTY
4" x 4" Burn Dressing	1	1	1
Eye Pads w/Adhesive Strips	4	4	4
Eye Wash, 1 oz.	1	1	2
Antiseptic Towelette	10	10	10
Hand Sanitizer, .9 g	10	10	15
Sting Relief Wipe	6	6	6
5" x 6" Cold Pack	1	1	2
Scissors	1	1	1
Tweezers	1	1	1
Exam Gloves, Pr.	2	4	6
Non-Aspirin Pain Reliever, 2/pouch	3	3	3
CPR Filtershield	1	1	1
First Aid Guide	1	1	1



## CLASS B INDUSTRIAL FIRST AID STATIONS

Steel first aid stations for industrial environments. Wall mountable with carrying handle. Ideal for use in warehouses, large retail outlets, construction sites and manufacturing facilities. Meets requirements for 2015 ANSI Class B specifications.



FAK4SHLF-CLSB

ITEM #	MARTIN #	DESCRIPTION	UOM	PRICE
FAK3SHLF-CLSB	NTHFAK3SHLF-CLSB	Industrial first aid station, 3-shelf	EA	\$392.18
FAK4SHLF-CLSB	NTHFAK4SHLF-CLSB	Industrial first aid station, 4-shelf	EA	\$392.18

KIT CONTENTS	FAK3SHLF	FAK4SHLF
DESCRIPTION	QTY	QTY
4" x 2" Adhesive Bandage	6	6
1" x 3" Adhesive Bandage, Plastic	100	100
1" x 3" Adhesive Bandage, Woven	100	100
Fingertip Bandage	40	40
Knuckle Bandage	40	40
40" x 40" x 56" Triangular Bandage	2	2
2" Roller Bandage	4	4
4" Roller Bandage	4	4
3" x 4.5 yds. Elastic Bandage	1	1
Neomycin Antibiotic	30	30
Blood Stopper Trauma Pad	4	4
2" x 2" Gauze Pad	10	10
3" x 3" Gauze Pad	25	25
1" x 5 yds. Adhesive Tape	2	2
2" x 3" Non Adherent pads	10	10
2 oz. Pump burn relief	1	1
4" x 4" Burn Dressing	2	2
Eye Pads w/ Adhesive Strips	8	8
Eyewash, 4 oz.	1	1

KIT CONTENTS (cont'd)	FAK3SHLF	FAK4SHLF
DESCRIPTION	QTY	QTY
Pump Antiseptic, 2 oz.	1	1
Alcohol prep pads	10	10
Hand Sanitizer, .9 g	10	10
5" x 6" Cold Pack	2	2
Scissors	1	1
Tweezers	1	1
Exam Gloves, Pr.	4	4
Tourniquet	1	1
Wire splint	1	1
CPR Filtershield	1	1
First Aid Guide	1	1
Cotton Tips	100	100
Ammonia Inhalants	10	10
Red Biohazard bag	2	2
Tongue Blades	6	6
Non-Aspirin Pain Reliever, 2/pouch	50	50
Miralac Tabs, 2/pouch	—	50
Sinus decongestant, 2/pouch	—	50
Cedaprin (Ibuprofen), 2/pouch	—	50

**Honeywell**



**CLASS B FIRST AID KITS**

Available in 100-, 150- and 200-person sizes with a steel case. Features carrying handle for transportation. Ideal for medium to large offices and manufacturing facilities. For indoor use only. Meets requirements for 2015 ANSI Class B specifications.

FAK150CAB-CLSB



ITEM #	MARTIN #	DESCRIPTION	UOM	PRICE
FAK100CAB-CLSB	NTHFAK100CAB-CLSB	100-Person first aid kit	EA	\$414.73
FAK150CAB-CLSB	NTHFAK150CAB-CLSB	150-Person first aid kit	EA	\$610.30
FAK200CAB-CLSB	NTHFAK200CAB-CLSB	200-Person first aid kit	EA	\$305.33

KIT CONTENTS DESCRIPTION	FAK100	FAK150	FAK200
	QTY	QTY	QTY
4" x 2" Adhesive Bandage	6	6	6
1" x 3" Adhesive Bandage	100	100	100
Fingertip Bandage	40	40	40
Knuckle Bandage	40	40	40
40" x 40" x 56" Triangular Bandage	2	2	3
2" Roller Bandage	4	6	8
4" Roller Bandage	4	6	8
3" x 4.5 yds. Elastic Bandage	1	3	4
Neomycin Antibiotic	30	30	30
Blood Stopper Trauma Pad	4	4	4
2" x 2" Gauze Pad	10	10	20
3" x 3" Gauze Pad	25	25	50
1" x 5 yds. Adhesive Tape	2	2	2
1/2" x 5 yds. Adhesive Tape	—	1	2
2" x 3" Non Adherent Pads	10	20	20
Pump Burn Relief, 2 oz.	1	2	2

KIT CONTENTS (cont'd) DESCRIPTION	FAK100	FAK150	FAK200
	QTY	QTY	QTY
4" x 4" Burn Dressing	2	2	3
Eye Pads w/Adhesive Strips	8	8	12
Eyewash, 4 oz.	1	1	2
Pump Antiseptic, 2 oz.	1	2	2
Alcohol Prep Pads	10	10	20
Hand Sanitizer, .9 g	10	20	30
5" x 6" Cold Pack	2	3	4
Scissors	1	1	1
Tweezers	1	1	1
Exam Gloves, Pr.	4	6	8
Non-Aspirin Pain Reliever, 2/pouch	50	50	100
Tourniquet	1	1	1
Wire Splint	1	1	1
CPR Filtershield	1	1	1
First Aid Guide	1	1	1

**Honeywell**



**SOFT PAK FIRST RESPONDER KIT**

Easily transportable kit is ideal for office employee first responders and work vehicles. Meets requirements for 2015 ANSI Class B specifications.

FRKSOFTPAK-CLSB



ITEM #	MARTIN #	DESCRIPTION	UOM	PRICE
FRKSOFTPAK-CLSB	NTHFRKSOFTPAK-CLSB	Soft Pak first responder kit, Class B	EA	\$296.08

KIT CONTENTS DESCRIPTION	FRKSOFTPAK-CLSB
	QTY
4" x 2" Adhesive Bandage	10
1" x 3" Adhesive Bandage	100
Fingertip Bandage	4
Knuckle Bandage	6
40" x 40" x 56" Triangular Bandage	2
2" Roller Bandage	2
4" Roller Bandage	1
2" Bandage Compress	4
3" x 4.5 yds. Elastic Bandage	1
Neomycin Antibiotic	30
Blood Stopper Trauma Pad	4
3" x 3" Gauze Pad	10
18" x 36" Gauze Compress	1
1" x 5 yds. Adhesive Tape	1
Pump Burn Relief, 2 oz.	1
4" x 4" Burn Dressing	2

KIT CONTENTS (cont'd) DESCRIPTION	FRKSOFTPAK-CLSB
	QTY
Eye Pads w/Adhesive Strips	8
Eyewash, 4 oz.	1
Pump Antiseptic, 2 oz.	1
Alcohol Prep Pads	10
Hand Sanitizer, .9 g	10
5" x 6" Cold Pack	2
Scissors	1
Tweezers	1
Exam Gloves, Pr.	4
Tourniquet	1
Wire Splint	1
CPR Filtershield	1
Rescue Blanket	1
Hydrocortisone, 1.0%	10
First Aid Guide	1



## WEARWELL

### ULTRASOFT DIAMOND-PLATE #414

Encourage employee productivity with the UltraSoft Diamond-Plate. Double-thick Nitricell® sponge base is a nitrile rubber composite that provides resilience and exceptional feel. Ideal for heavy-use areas, the diamond-plate surface resists abrasion and most chemical spills. Also available in solid gray. All edges are safety beveled. Overall thickness is 15/16". Custom sizes also available. Call for more information.

ITEM #	MARTIN #	SIZES	UOM	PRICE
<i>UltraSoft Diamond-Plate with Chevron Borders, Black/Yellow</i>				
414.1516x2x3CHV	WEAR414.1516x2x3CHV	2' x 3'	EA	\$90.33
414.1516x3x3CHV	WEAR414.1516x3x3CHV	3' x 3'	EA	\$247.67
414.1516x3x5CHV	WEAR414.1516x3x5CHV	3' x 5'	EA	\$224.98
414.1516x4x5CHV	WEAR414.1516x4x5CHV	4' x 5'	EA	\$330.24
414.1516x2x75CHV	WEAR414.1516x2x75CHV	2' x 75'	RL	\$2,259.76
414.1516x3x75CHV	WEAR414.1516x3x75CHV	3' x 75'	RL	\$3,227.49
414.1516x4x75CHV	WEAR414.1516x4x75CHV	4' x 75'	RL	\$4,303.07
<i>UltraSoft Diamond-Plate, Black</i>				
414.1516x2x3BK	WEAR414.1516x2x3BK	2' x 3'	EA	\$69.49
414.1516x3x3BK	WEAR414.1516x3x3BK	3' x 3'	EA	\$189.91
414.1516x3x5BK	WEAR414.1516x3x5BK	3' x 5'	EA	\$173.62
414.1516x4x5BK	WEAR414.1516x4x5BK	4' x 5'	EA	\$254.18
414.1516x5x5BK	WEAR414.1516x5x5BK	5' x 5'	EA	\$417.76
414.1516x2x75BK	WEAR414.1516x2x75BK	2' x 75'	RL	\$1,739.98

## WEARWELL

### DIAMOND-PLATE SPONGECOTE® #415

This favorite features 3/8" thick, super resilient, Nitricell® sponge base that enhances employee productivity and relieves fatigue. Nitricell is a special nitrile rubber/PVC compound designed for extreme comfort, immediate recovery and long life. The diamond-embossed, 100% vinyl surface provides extra traction, is self-extinguishing and resists chemicals and abrasion. Also available in solid gray. All sides are beveled for safety. Overall thickness is 9/16". Available in custom sizes. Call for more information. Made from 50% recycled content.

ITEM #	MARTIN #	SIZES	UOM	PRICE
<i>Diamond-Plate SpongeCote with Chevron Borders</i>				
415.916x2x3CHV	WEAR415.916x2x3CHV	2' x 3'	EA	\$70.73
415.916x3x3CHV	WEAR415.916x3x3CHV	3' x 3'	EA	\$193.78
415.916x3x5CHV	WEAR415.916x3x5CHV	3' x 5'	EA	\$177.00
415.916x4x5CHV	WEAR415.916x4x5CHV	4' x 5'	EA	\$258.38
415.916x2x75CHV	WEAR415.916x2x75CHV	2' x 75'	RL	\$1,769.25
415.916x3x75CHV	WEAR415.916x3x75CHV	3' x 75'	RL	\$2,526.80
415.916x4x75CHV	WEAR415.916x4x75CHV	4' x 75'	RL	\$3,370.02
<i>Diamond-Plate SpongeCote, Black</i>				
415.916x2x3BK	WEAR415.916x2x3BK	2' x 3'	EA	\$52.29
415.916x3x3BK	WEAR415.916x3x3BK	3' x 3'	EA	\$139.62
415.916x3x5BK	WEAR415.916x3x5BK	3' x 5'	EA	\$127.15
415.916x4x5BK	WEAR415.916x4x5BK	4' x 5'	EA	\$186.15
415.916x5x5BK	WEAR415.916x5x5BK	5' x 5'	EA	\$300.09
415.916x2x75BK	WEAR415.916x2x75BK	2' x 75'	RL	\$1,260.96

## WEARWELL

### DIAMOND-PLATE SELECT #495

High-tech industrial surface withstands heavy use while its specially formulated blown-vinyl Flex-Link sponge base lessens standing worker fatigue. 15/16" Thickness. Chemical and abrasion resistant. Used in dry industrial and commercial applications. 15/16" Thickness.

ITEM #	MARTIN #	COLOR	SIZES	UOM	PRICE
<i>Diamond-Plate Select #495</i>					
495.1516x2x3BK	WEAR495.1516x2x3BK	Black	2' x 3'	EA	\$61.78
495.1516x2x3BYL	WEAR495.1516x2x3BYL	Black/yellow	2' x 3'	EA	\$68.31
495.1516x3x5BK	WEAR495.1516x3x5BK	Black	3' x 5'	EA	\$156.25
495.1516x3x5BYL	WEAR495.1516x3x5BYL	Black/yellow	3' x 5'	EA	\$170.65
495.1516x2x75BK	WEAR495.1516x2x75BK	Black	2' x 75'	RL	\$1,565.53

 **WARNING:** These products can expose you to chemicals which are known to the state of California to cause cancer and other reproductive harm. For more information go to [www.P65Warnings.ca.gov](http://www.P65Warnings.ca.gov).

414.1516X2X3BYL



ITEM #	MARTIN #	SIZES	UOM	PRICE
414.1516x3x75BK	WEAR414.1516x3x75BK	3' x 75'	RL	\$2,484.98
414.1516x4x75BK	WEAR414.1516x4x75BK	4' x 75'	RL	\$3,312.40
414.1516x5x75BK	WEAR414.1516x5x75BK	5' x 75'	RL	\$5,821.29
414.1516x6x75BK	WEAR414.1516x6x75BK	6' x 75'	RL	\$6,473.07
<i>UltraSoft Diamond-Plate, Black/Yellow</i>				
414.1516x2x3BYL	WEAR414.1516x2x3BYL	2' x 3'	EA	\$75.87
414.1516x3x3BYL	WEAR414.1516x3x3BYL	3' x 3'	EA	\$209.29
414.1516x3x5BYL	WEAR414.1516x3x5BYL	3' x 5'	EA	\$189.53
414.1516x4x5BYL	WEAR414.1516x4x5BYL	4' x 5'	EA	\$279.65
414.1516x5x5BYL	WEAR414.1516x5x5BYL	5' x 5'	EA	\$450.15
414.1516x2x75BYL	WEAR414.1516x2x75BYL	2' x 75'	RL	\$1,897.16
414.1516x3x75BYL	WEAR414.1516x3x75BYL	3' x 75'	RL	\$2,709.98
414.1516x4x75BYL	WEAR414.1516x4x75BYL	4' x 75'	RL	\$3,612.93
414.1516x5x75BYL	WEAR414.1516x5x75BYL	5' x 75'	RL	\$6,279.49
414.1516x6x75BYL	WEAR414.1516x6x75BYL	6' x 75'	RL	\$6,981.31

415.916X2X3BYL



ITEM #	MARTIN #	SIZES	UOM	PRICE
415.916x3x75BK	WEAR415.916x3x75BK	3' x 75'	RL	\$1,801.27
415.916x4x75BK	WEAR415.916x4x75BK	4' x 75'	RL	\$2,402.02
415.916x5x75BK	WEAR415.916x5x75BK	5' x 75'	RL	\$4,181.20
415.916x6x75BK	WEAR415.916x6x75BK	6' x 75'	RL	\$4,648.02
<i>Diamond-Plate SpongeCote, Black/Yellow</i>				
415.916x2x3BYL	WEAR415.916x2x3BYL	2' x 3'	EA	\$59.58
415.916x3x3BYL	WEAR415.916x3x3BYL	3' x 3'	EA	\$157.76
415.916x3x5BYL	WEAR415.916x3x5BYL	3' x 5'	EA	\$137.18
415.916x4x5BYL	WEAR415.916x4x5BYL	4' x 5'	EA	\$210.36
415.916x5x5BYL	WEAR415.916x5x5BYL	5' x 5'	EA	\$339.47
415.916x2x75BYL	WEAR415.916x2x75BYL	2' x 75'	RL	\$1,439.02
415.916x3x75BYL	WEAR415.916x3x75BYL	3' x 75'	RL	\$2,055.16
415.916x4x75BYL	WEAR415.916x4x75BYL	4' x 75'	RL	\$2,739.87
415.916x5x75BYL	WEAR415.916x5x75BYL	5' x 75'	RL	\$4,736.87
415.916x6x75BYL	WEAR415.916x6x75BYL	6' x 75'	RL	\$5,267.33

495.1516X2X3BYL



ITEM #	MARTIN #	COLOR	SIZES	UOM	PRICE
495.1516x2x75BYL	WEAR495.1516x2x75BYL	Black/yellow	2' x 75'	RL	\$1,706.31
495.1516x3x75BK	WEAR495.1516x3x75BK	Black	3' x 75'	RL	\$2,237.09
495.1516x3x75BYL	WEAR495.1516x3x75BYL	Black/yellow	3' x 75'	RL	\$2,439.02
495.1516x4x75BK	WEAR495.1516x4x75BK	Black	4' x 75'	RL	\$2,980.96
495.1516x4x75BYL	WEAR495.1516x4x75BYL	Black/yellow	4' x 75'	RL	\$3,251.05

**WEARWELL**

**SMART DIAMOND-PLATE NO. 497**

Anti-fatigue mats designed to provide comfort and increase productivity of standing workers. Reduces the level of overall fatigue, decrease isolated lower body aches and pains, and absorbs the shock of walking on hard surfaces. An economical and "green" solution. Abrasion-resistant Diamond-Plate surface is bonded to 100% recycled urethane composite sponge base. Comfortable and functional in dry industrial applications. Available in UltraSoft 1" thickness. Lasts five times longer than traditional sponge mats. Made from 80% recycled content.

497.1X2X3BK



ITEM #	MARTIN #	COLOR	SIZES	UOM	PRICE
<i>SMART Diamond-Plate No. 497</i>					
497.1x2x3BK	WEAR497.1x2x3BK	Black	2' x 3'	EA	\$47.62
497.1x2x3BYL	WEAR497.1x2x3BYL	Black/yellow	2' x 3'	EA	\$52.60
497.1x2x75BK	WEAR497.1x2x75BK	Black	2' x 75'	RL	\$1,206.53
497.1x2x75BYL	WEAR497.1x2x75BYL	Black/yellow	2' x 75'	RL	\$1,315.42
497.1x3x5BK	WEAR497.1x3x5BK	Black	3' x 5'	EA	\$120.35

ITEM #	MARTIN #	COLOR	SIZES	UOM	PRICE
497.1x3x5BYL	WEAR497.1x3x5BYL	Black/yellow	3' x 5'	EA	\$130.62
497.1x3x75BK	WEAR497.1x3x75BK	Black	3' x 75'	RL	\$1,722.76
497.1x3x75BYL	WEAR497.1x3x75BYL	Black/yellow	3' x 75'	RL	\$1,879.04
497.1x4x75BK	WEAR497.1x4x75BK	Black	4' x 75'	RL	\$2,298.22
497.1x4x75BYL	WEAR497.1x4x75BYL	Black/yellow	4' x 75'	RL	\$2,505.36

**WEARWELL**

**ERGODECK® HEAVY-DUTY OPEN GRID #560**

For use in wet and non-greasy areas or in dry environments where small debris can drop through matting system. System of 7/8" thick, super-sized ergonomic tiles, ramps and corners. Quickly and easily covers large areas and requires less time and labor to install. Features LockSafe®, a patented and totally effective, interlocking system that quickly "locks" tiles together, and keeps them together despite constant use. Heavy-duty #560 provides flexibility underfoot and reduces fatigue, yet also withstands cart traffic and heavy usage. Tiles can endure up to 64 psi, the equivalent of a 300 lb. cart with 4" diameter wheels.

ERGODECK OPEN GRID

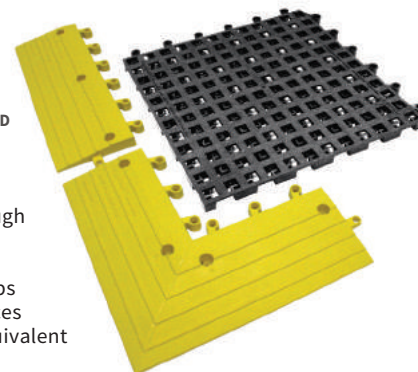

ITEM #	MARTIN #	DESCRIPTION	COLOR	SIZES	UOM	PRICE
560.78x18x18BK-CS10	WEAR560.78x18x18BK-CS10	ErgoDeck Heavy-Duty Open Grid 80 Durometer	Black	18" x 18"	10/CS	\$306.91
560.78x6x15x15YL-CS4	WEAR560.78x6x15x15YL-CS4	ErgoDeck outside corner	Yellow	6" x 15" x 15"	4/CS	\$175.89
560.78x6x18YL-CS10	WEAR560.78x6x18YL-CS10	ErgoDeck ramp	Yellow	6" x 18"	10/CS	\$120.60

**WEARWELL**

**24/SEVEN® OPEN #572**

Modular, anti-fatigue mats are designed to work 24/7 to keep employees comfortable. Hidden interlocking system works as a single workstation mat or to cover large areas. Drainage surface allows fluids and debris to freely flow through, preventing pooling of liquids. Available in (3) compounds: grease-resistant for all-purpose use, nitrile compound for exposure to petroleum based/industrial fluids, and CFR formulation for areas with mineral oil base cutting fluids and solvents. Available with optional safety borders. Overall thickness is 5/8".

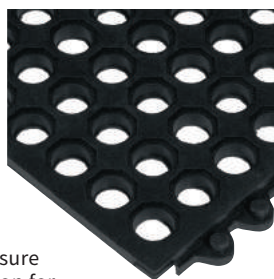

572.58X3X3GRBK



572.58X3X3CRFBK

ITEM #	MARTIN #	DESCRIPTION	COLOR	SIZES	UOM	PRICE
572.58x3x3GRBK	WEAR572.58x3x3GRBK	All-purpose mat	Black	3' x 3'	EA	\$58.53
572.58x3x3CRFBK	WEAR572.58x3x3CRFBK	CFR mat	Black	3' x 3'	EA	\$88.09
572.58x3x3NBRBK	WEAR572.58x3x3NBRBK	Nitrile mat	Black	3' x 3'	EA	\$97.56
572.EdgingFGRYL	WEAR572.EdgingFGRYL	All-purpose female edging	Yellow	3" x 39"	EA	\$17.15
572.EdgingMGRYL	WEAR572.EdgingMGRYL	All-purpose male edging	Yellow	3" x 39"	EA	\$17.15
572.EdgingFCFRYL	WEAR572.EdgingFCFRYL	CFR female edging	Yellow	3" x 39"	EA	\$27.09
572.EdgingMCFRYL	WEAR572.EdgingMCFRYL	CFR male edging	Yellow	3" x 39"	EA	\$27.09
572.EdgingFNBRYL	WEAR572.EdgingFNBRYL	Nitrile female edging	Yellow	3" x 39"	EA	\$30.44
572.EdgingMNBRYL	WEAR572.EdgingMNBRYL	Nitrile male edging	Yellow	3" x 39"	EA	\$30.44

**WARNING:** These products can expose you to chemicals which are known to the state of California to cause cancer and other reproductive harm. For more information go to [www.P65Warnings.ca.gov](http://www.P65Warnings.ca.gov).

## Master Lock

### ZENEX™ THERMOPLASTIC SAFETY PADLOCKS

Designed exclusively for lockout/tagout applications. Features 1/4" dia. metal shackle. The Zenex thermoplastic lock body provides durability while still being lightweight. Padlock features a reserved-for-safety, key retaining cylinder to ensure padlock is not accidentally left unlocked. Each padlock has a keyed-alike or keyed-different, 6-pin cylinder to reduce risk of key duplication within key system. Cylinder features over 40,000 key changes. Includes (1) key to comply with the "one employee, one lock, one key" industry guideline. Available in red, yellow, green, blue, orange, black, teal and purple.



**⚠️ WARNING:** This product can expose you to chemicals including Bisphenol A (BPA), which is known to the State of California to cause birth defects or other reproductive harm. For more information go to [www.P65Warnings.ca.gov](http://www.P65Warnings.ca.gov).

ITEM #	MARTIN #	DESCRIPTION	UOM	PRICE
410RED	ML410RED	Keyed-different, 1 3/4" tall body, 1 1/2" shackle clearance	EA	\$11.42
410KARED	ML410KARED	Keyed-alike, 1 3/4" tall body, 1 1/2" shackle clearance	EA	\$12.28

## Master Lock

### NON-SPARKING PADLOCKS

Nylon shackle helps prevent electrocution, arc flashing and electrical current from shackle to key. All components are non-sparking and non-magnetic. Designed exclusively for lockout/tagout applications. Durable, lightweight, non-conductive Zenex™ lock body. Key retaining ensures that padlock is not left unlocked. 1 1/2" W x 1 3/4" H Zenex™ thermoplastic lock body and nylon shackle shackle with 1 1/2" clearance.



**⚠️ WARNING:** This product can expose you to chemicals including Bisphenol A (BPA), which is known to the State of California to cause birth defects or other reproductive harm. For more information go to [www.P65Warnings.ca.gov](http://www.P65Warnings.ca.gov).

ITEM #	MARTIN #	DESCRIPTION	UOM	PRICE
406RED	ML406RED	Non-sparking padlock, keyed-different	EA	\$11.83
406KARED	ML406KARED	Non-sparking padlock, keyed-alike	EA	\$16.03

## AMERICAN LOCK ALUMINUM SAFETY PADLOCKS

Color-coded solid aluminum padlocks are perfect for lockout/tagout. Available with exclusive laser engraving. Helps comply with OSHA regulations. Padlocks have an anodized finish. Lightweight, corrosion-resistant padlock bodies have case-hardened, boron alloy steel shackles, and 5-pin solid brass cylinders. Approximately 10,000 key changes available, limiting the possibility for key duplication. Cylinders can be re-keyed.

ITEM #	MARTIN #	DESCRIPTION	COLOR	UOM	PRICE
A1106RED	MLA1106RED	Keyed-different, 1 1/2" shackle	Red	EA	\$12.43
A1106BLU	MLA1106BLU	Keyed-different, 1 1/2" shackle	Blue	EA	\$12.43
A1106BRN	MLA1106BRN	Keyed-different, 1 1/2" shackle	Brown	EA	\$12.43
A1106GRN	MLA1106GRN	Keyed-different, 1 1/2" shackle	Green	EA	\$12.43
A1106YLW	MLA1106YLW	Keyed-different, 1 1/2" shackle	Yellow	EA	\$12.43
A1106BLK	MLA1106BLK	Keyed-different, 1 1/2" shackle	Black	EA	\$12.43
A1106ORJ	MLA1106ORJ	Keyed-different, 1 1/2" shackle	Orange	EA	\$12.43
A1106CLR	MLA1106CLR	Keyed-different, 1 1/2" shackle	Silver	EA	\$12.43
A1106PRP	MLA1106PRP	Keyed-different, 1 1/2" shackle	Purple	EA	\$12.43

## BRADY

### REINFORCED NYLON SAFETY PADLOCK

Special 6-pin cylinder resists tampering and results in more unique key cuts, reducing the likelihood that one worker's key will open another's lock. Non-conductive red body resists sparking. Compact and lightweight, with 1 1/2" shackle. Constructed of reinforced nylon for chemical, corrosion and temperature resistance. Complies with all applicable OSHA lockout requirements.



**⚠️ WARNING:** This product can expose you to chemicals including lead, which is known to the State of California to cause cancer and birth defects or other reproductive harm. For more information go to [www.P65Warnings.ca.gov](http://www.P65Warnings.ca.gov).

ITEM #	MARTIN #	DESCRIPTION	UOM	PRICE
99552	BRA99552	Reinforced nylon padlock	EA	\$13.00

## BRADY

### STEEL GROUP LOCKOUT HASPS

Constructed of vinyl-coated high tensile steel with rust-resistant plating. Holds up to (6) locks at once. Lock holes measure 3/8" dia.



ITEM #	MARTIN #	DESCRIPTION	UOM	PRICE
65375	BRA65375	1" dia. jaws	12/PK	\$90.93
133162	BRA133162	1 1/2" dia. jaws	EA	\$6.88
65376	BRA65376	1 1/2" dia. jaws	12/PK	\$107.93

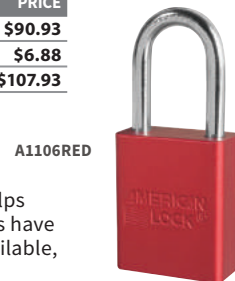

ITEM #	MARTIN #	DESCRIPTION	COLOR	UOM	PRICE
A1106KARED	MLA1106KARED	Keyed-alike, 1 1/2" shackle	Red	EA	\$13.30
A1106KABLU	MLA1106KABLU	Keyed-alike, 1 1/2" shackle	Blue	EA	\$13.30
A1106KABRN	MLA1106KABRN	Keyed-alike, 1 1/2" shackle	Brown	EA	\$13.30
A1106KAGRN	MLA1106KAGRN	Keyed-alike, 1 1/2" shackle	Green	EA	\$13.30
A1106KABLK	MLA1106KABLK	Keyed-alike, 1 1/2" shackle	Black	EA	\$13.30
A1106KAYLW	MLA1106KAYLW	Keyed-alike, 1 1/2" shackle	Yellow	EA	\$13.30
A1106KAORJ	MLA1106KAORJ	Keyed-alike, 1 1/2" shackle	Orange	EA	\$13.30
A1106KACLR	MLA1106KACLR	Keyed-alike, 1 1/2" shackle	Silver	EA	\$13.30
A1106KAPRP	MLA1106KAPRP	Keyed-alike, 1 1/2" shackle	Purple	EA	\$13.30



**STEEL GROUP LOCKOUT HASPS WITH TABS**

Case-hardened steel with rustproof plating and bright red vinyl insulation. Tamperproof interlocking tabs prevent unauthorized opening. Holds up to (6) locks at once. Lock holes measure 3/8" dia.

ITEM #	MARTIN #	DESCRIPTION	UOM	PRICE
105718	BRA105718	1" dia. jaws	EA	\$8.15
105719	BRA105719	1 1/2" dia. jaws	EA	\$9.43



**ECONOMY ALUMINUM HASPS**

Non-sparking, aluminum small hasp weighs only 1 1/2 oz. Features 5/8" holes for up to (6) padlocks with a maximum of 3/8" shackle diameter.

ITEM #	MARTIN #	DESCRIPTION	UOM	PRICE
105720	BRA105720	1" dia. jaws	EA	\$7.90
105721	BRA105721	1 1/2" dia. jaws	EA	\$9.00



**GATE VALVE LOCKOUTS**

Makes locking out valves safe and easy. Made of durable, non-adherent red plastic to resist chemicals and hot and cold temperatures. Stainless steel hinge design for added strength and security. Unique knockout feature accommodates Outside Screw & Yoke (OS&Y) or "rising stem" gate valves. Designed to accept all locks with up to 3/4" shackle diameter and 3/4" or greater vertical shackle clearance. Available in (4) sizes to fit valve handles from 2 1/2" to 13" in diameter.



65563



64057



**ADJUSTABLE GATE VALVE LOCKOUT**

Adjusts to fit valve handles from 1" to 6 1/2" wide. Made from durable plastic. Can stand up to extreme temperatures from -50° F to 360° F. Includes "Danger" labels in English, Spanish and French.

ITEM #	MARTIN #	DESCRIPTION	UOM	PRICE
64057	BRA64057	Adjustable gate valve lockout	EA	\$35.70



**LABELED LOCKOUT HASPS**

Constructed from tough 5052 anodized aluminum alloy. Allows a single employee to lock out a piece of equipment and begin servicing it. Label surface accepts pens, pencils and permanent markers. Printing from pens and pencils may be erased from lockout hasps. Tamper-proof locking tab. Hasp size: 7 1/14" x 3" x 3/16".



LABELED LOCKOUT HASPS

ITEM #	MARTIN #	DESCRIPTION	COLOR	UOM	PRICE
65960	BRA65960	Danger Do Not Operate hasps, reverse side #1	Red	5/PK	\$75.63
65961	BRA65961	Danger Do Not Operate hasps, reverse side #1	Silver	5/PK	\$75.63
65962	BRA65962	Danger Do Not Operate hasps, reverse side #1	Blue	5/PK	\$75.63
65963	BRA65963	Danger Do Not Operate hasps, reverse side #1	Green	5/PK	\$75.63
65964	BRA65964	Danger Do Not Operate hasps, reverse side #1	Gold	5/PK	\$75.63





### PNEUMATIC QUICK-DISCONNECT LOCKOUT

Lockout is applied to the male fitting, isolating equipment from all compressed air sources. Accommodates majority of 1/4", 3/8" and 1/2" male fittings. Hole in center of device allows for permanent storage on an air hose and loop on the side can be used to hang hose and lockout device. Lockout accepts padlocks with 1/4" or 9/32" shackles.

64221



ITEM #	MARTIN #	DESCRIPTION	UOM	PRICE
64221	BRA64221	Pneumatic quick-disconnect lockout	EA	\$22.52



### SMALL BALL VALVE LOCKOUTS

Designed to lock a wide range of valves. Unique, large ball valve lockout is both versatile and easy to use. Made from ultra-tough red polypropylene. Small ball valve lockout fits pipes from 1/2" to 1 1/4" in the "on" or "off" position, also locks out up to 2 1/2" dia. pipes in the "off" position. The large ball valve lockout is designed for valves on pipes from 2" to 8" diameter.

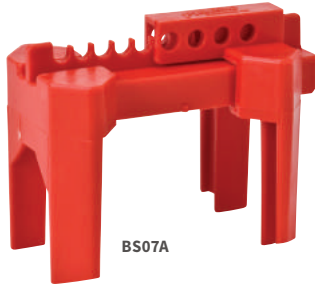

BS07A



50940



51442

ITEM #	MARTIN #	DESCRIPTION	UOM	PRICE
BS07A	BRABS07A	Small ball valve lockout	EA	\$24.98
BS08A	BRABS08A	Large ball valve lockout	EA	\$51.50



### MINI CABLE LOCKOUTS

Offers the versatility of traditional cable lockouts, but is small enough to fit in the palm of hand. Perfect lockout for electricians, contractors, mobile repair crews and other workers on the move. Designed for tough industrial applications. The 4" diameter body is constructed of durable nylon that resists impacts, chemicals and corrosion. Features a retractable 8' cable and includes (6) holes for padlocks, facilitating group lockouts without the need for hasps.

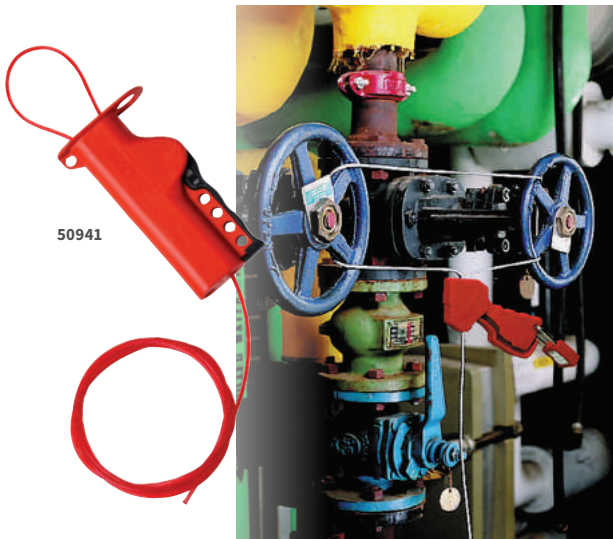

50941

65318

ITEM #	MARTIN #	DESCRIPTION	UOM	PRICE
50940	BRA50940	Mini cable lockout w/ steel cable	EA	\$38.23
51442	BRA51442	Mini cable lockout w/ nylon cable	EA	\$40.78



### DOUBLE LOOPED LOCKOUT CABLE

Plastic-coated steel cable is ideal for situations that require a flexible lockout device and a visual deterrent. Perfect for locking out large valves. Lightweight. 2' Length. Red.

ITEM #	MARTIN #	DESCRIPTION	UOM	PRICE
131063	BRA131063	Double looped lockout cable	EA	\$5.43

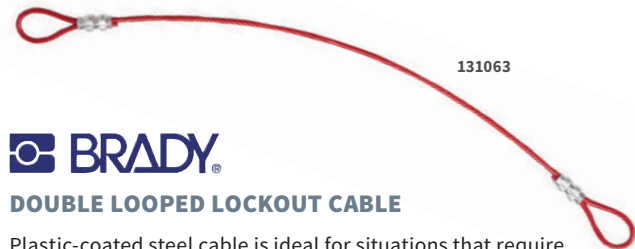

131063



### ALL-PURPOSE CABLE LOCKOUT DEVICES

Makes lock out of hazardous energy sources faster, more efficient, effective and easy-to-use. Unique design helps ensure switches and valves are locked down tight.

ITEM #	MARTIN #	DESCRIPTION	UOM	PRICE
50941	BRA50941	All-purpose cable lockout w/ 8' nylon cable	EA	\$47.58
65318	BRA65318	Cable lockout device w/ 6' cable	EA	\$42.48



**ELECTRICAL LOCKOUTS**

- Snap-On is designed for 120 V circuit breakers that have holes in switch tongue and accepts lock shackles up to 9/32" in diameter.
- Clamp-On uses a patented thumbscrew design and is made of rugged polypropylene and impact-modified nylon. Accepts lock shackles up to 9/32" in diameter.
- Universal Multi Pole is made of durable impact-modified nylon and is compatible with most 2 or 3 pole breakers.
- Plug Lockout is designed for heavy-duty applications. Made of durable polypropylene, the lockouts are available in 110 V and 220/500 V sizes.
- 3-in-1 Plug Lockout accommodates high and low-voltage plugs up to 3" in diameter and 5 1/2" in length. Made of bright yellow thermoplastic material.
- Stoppower™ Plug Lockout stops electrical cords from being plugged into outlet.

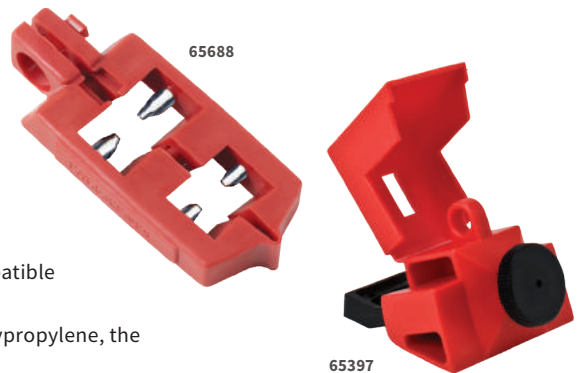

ITEM #	MARTIN #	DESCRIPTION	UOM	PRICE
65387	BRA65387	120 V Snap-on circuit breaker lockout	EA	\$4.92
65688	BRA65688	Single pole lockout	6/PK	\$25.48
65396	BRA65396	120/277 V Clamp-on breaker lockout	EA	\$9.85
65965	BRA65965	120/277 V Clamp-on breaker lockout	6/PK	\$53.53
65397	BRA65397	480/600 V Clamp-on breaker lockout	EA	\$10.95

ITEM #	MARTIN #	DESCRIPTION	UOM	PRICE
65966	BRA65966	480/600 V Clamp-on breaker lockout	6/PK	\$59.48
66321	BRA66321	Universal multi-pole breaker lockout	EA	\$9.85
66320	BRA66320	Universal multi-pole breaker lockout	6/PK	\$53.53
65673	BRA65673	Stoppower plug lockout	EA	\$19.53



**OVERSIZED BREAKER LOCKOUTS**

Ideal device for 480/600 V switches up to 2 1/4" wide and 7/8" thick. Made of durable polypropylene and glass-filled impact-modified nylon. Applies in seconds with thumbscrew mechanism; no screwdriver needed.

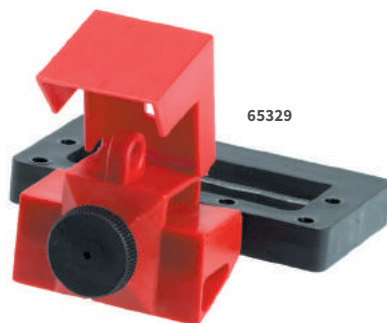

ITEM #	MARTIN #	DESCRIPTION	UOM	PRICE
65329	BRA65329	Oversized breaker lockout	EA	\$15.12
65321	BRA65321	Oversized breaker lockouts	6/PK	\$71.38



**HUBBELL PLUGOUTS®**

Fits the majority of heavier industrial plug applications. Large version accepts plugs with maximum 4 1/2" diameter and 0 3/20" length with 19/20" cord. Small version accepts plugs with maximum 2 3/4" diameter and 4 3/4" length with 1" cord.



ITEM #	MARTIN #	DESCRIPTION	UOM	PRICE
65695	BRA65695	Plugout, small	EA	\$28.88
65968	BRA65968	Plugout, large	EA	\$35.68



**WALL SWITCH LOCKOUTS**

May be used with most wall-mounted switches. Simple to install using existing plate screws. Available in hard-to-miss hi-viz red with a patented non-hinge design. Padlock sold separately.



ITEM #	MARTIN #	DESCRIPTION	UOM	PRICE
65392	BRA65392	Wall switch lockout	EA	\$11.13
65696	BRA65696	Wall switch lockouts	6/PK	\$59.48



**3-IN-1 PLUG LOCKOUT**

Accommodates high and low voltage plugs up to 3" in diameter and 5 1/2" in length. The (2) sliding top lids can be used individually or together to fit small, medium and large diameter cords up to 1 1/4". Made of bright yellow thermoplastic material.



ITEM #	MARTIN #	DESCRIPTION	UOM	PRICE
PLO23	BRAPLO23	3-In-1 Plug lockout, English/Spanish	EA	\$15.72



105967



### BREAKER LOCKOUT SAMPLER TOOLBOX KITS

Designed for 120/277 V and 480/600 V breakers in single- and multi-pole configurations.

**Kits include:**

- (1) 120 V/277 V Clamp-on breaker lockout with cleat
- (1) 480 V/600 V Clamp-on breaker lockout with cleat
- (1) Universal multi-pole breaker lockout
- (2) 1" Group lockout hasps
- (2) Heavy-duty lockout tags with nylon cable ties
- (1) Lockout belt pouch
- (2) Keyed-alike padlocks

**⚠️ WARNING:** This product can expose you to chemicals including lead, which is known to the State of California to cause cancer and birth defects or other reproductive harm. For more information go to [www.P65Warnings.ca.gov](http://www.P65Warnings.ca.gov).

ITEM #	MARTIN #	DESCRIPTION	UOM	PRICE
105967	BRA105967	Breaker lockout pouch kit w/ safety padlocks	KIT	\$103.35
105968	BRA105968	Breaker lockout pouch kit w/ steel padlocks	KIT	\$107.00



105969



### PERSONAL PADLOCK POUCHES

Easily transportable lockout/tagout kits include:

- (2) 1" Group lockout hasps
- (2) Heavy-duty lockout tags with ties
- (2) Keyed-alike safety padlocks
- Soft lockout belt pouch

**⚠️ WARNING:** This product can expose you to chemicals including lead, which is known to the State of California to cause cancer and birth defects or other reproductive harm. For more information go to [www.P65Warnings.ca.gov](http://www.P65Warnings.ca.gov).

ITEM #	MARTIN #	DESCRIPTION	UOM	PRICE
105969	BRA105969	Personal padlock pouch w/ safety padlocks	KIT	\$76.40
105970	BRA105970	Personal padlock pouch w/ steel padlocks	KIT	\$78.18



65289



### LOCKOUT TOOL BOX KIT

Everything needed to lock and mark equipment and prevent its use until repairs have been completed.

**Kit includes:**

- (1) Plastic lockout tool box with tray
- (1) 1"-2 1/2" Gate valve lockout
- (1) Small ball valve lockout
- (2) Blue padlocks, (1) 3/4" and (1) 2"
- (1) Labeled lockout hasp
- (5) Lockout tags
- (1) Universal multi-pole lockout
- (1) 277 V "No Hole" lockout
- (1) 480/600 V "No Hole" lockout
- (1) Wall switch lockout
- (1) Small Brady plug lockout

**⚠️ WARNING:** This product can expose you to chemicals including lead, which is known to the State of California to cause cancer and birth defects or other reproductive harm. For more information go to [www.P65Warnings.ca.gov](http://www.P65Warnings.ca.gov).

ITEM #	MARTIN #	DESCRIPTION	UOM	PRICE
65289	BRA65289	Lockout tool box	KIT	\$147.03



65699



### PORTABLE METAL LOCK BOX

Tamper-proof design is made of heavy-duty steel, powder-coated for extra rust resistance. Accommodates up to (13) padlocks and can store up to (40) padlocks. Measures: 6" H x 9" W x 3 1/2" D. Locks not included.

ITEM #	MARTIN #	DESCRIPTION	UOM	PRICE
65699	BRA65699	Portable metal lock box	EA	\$84.13



**GROUP LOCKOUT BOX**

Place item(s) for lockout in box and have each affected employee place padlock (up to 12) on box so that it cannot be opened until all padlocks have been removed.

LG096E



ITEM #	MARTIN #	DESCRIPTION	UOM	PRICE
LG096E	BRALG096E	Group lockout box	EA	\$46.73



**METAL WALL LOCK BOX**

Made of durable, powder-coated steel with key slot on top and clear window that slides out when locks are removed. Pre-drilled holes and hardware included for quick mounting. Seven key pegs hold (5) keys each; (7) lock holes along bottom. Measures: 7" H x 8" W x 2 1/4" D.



105714

ITEM #	MARTIN #	DESCRIPTION	UOM	PRICE
105714	BRA105714	Small wall lock box	EA	\$116.43

OTHER PRODUCTS AVAILABLE. VISIT [WWW.MARTINSUPPLY.COM](http://WWW.MARTINSUPPLY.COM)

S4810



**BOXED ROLL OF TAGS**

Durable polypropylene material withstands extreme environments. Attaches directly to padlock (up to 9/32" shackle width) and complies with OSHA's padlock identification standard. Box provides convenient storage and transportation between jobs and holds (100) tags. Tags measure: 6" x 3".



ITEM #	MARTIN #	DESCRIPTION	UOM	PRICE
S4810	MLS4810	Do Not Operate	100/RL	\$60.85

FACILITY CARE | LOCKOUT / TAGOUT



**GROUP LOCK BOX WITH WALL MOUNTING BRACKET**

Helps facilities manage the placement and movement of group lock boxes. Mount it using the bracket for routine, daily use; take it portable for remote lockouts; or move to a bracket in another area for large turnarounds. Secure to the bracket with the optional locking feature and prevent unwanted box removal from the wall. Easily monitor the status of group lockout at a glance with product features like rewritable tags and clear, impact-resistant window. Internal capacity of (15) safety padlocks and (8) lock holes for easy application and organization of padlocks or lockout hasps.



S3650

**⚠ WARNING:** This product can expose you to chemicals including Bisphenol A (BPA), which is known to the State of California to cause birth defects or other reproductive harm. For more information go to [www.P65Warnings.ca.gov](http://www.P65Warnings.ca.gov).

ITEM #	MARTIN #	DESCRIPTION	UOM	PRICE
S3650	MLS3650	Group lock box w/ wall mounting bracket	EA	\$100.17



**PADLOCK TAGS**

Made of calendared vinyl material that accepts pencil, pen or marker. Features 3/8" metal grommet that fits over most padlock shackles. Measures: 3" x 2", plus 1" for grommeted tab.

105722

105723



ITEM #	MARTIN #	DESCRIPTION	UOM	PRICE
105722	BRA105722	Danger Equipment Locked Out	EA	\$2.28
105723	BRA105723	Danger Do Not Operate	EA	\$2.28





## STANDARD LOCKOUT TAGS

Lockout tags comply with OSHA lockout standard. Feature a reinforcing brass grommet with 3/8" dia. to accept most padlocks. All tag material surfaces allow for easy personalization of tags with name, department and estimated completion information as required by regulations. Choose from two durable materials:

### Heavy-Duty Polyester (B-837):

Durable polyester laminate protects graphics and holds up against water, grease and extreme temperatures. Heavy-duty construction prevents accidental removal. Withstands up to 80 lbs. pullout force. 7/16" Diameter brass grommet. 5 1/2" x 3".

### Economy Polyester (B-851):

Rigid polyester surface is easy to write on and stays legible longer. Exceeds OSHA 50 lb. pullout requirement. 3/8" Diameter brass grommet. 5 3/4" x 3".

Side B: This energy source has been LOCKED OUT! Unauthorized removal of this lock/tag may result in immediate discharge.

Side F: This energy source has been LOCKED OUT! Only the individual who signed the reverse side may remove this lock/tag.

**⚠️ WARNING:** This product can expose you to chemicals including lead, which is known to the State of California to cause cancer and birth defects or other reproductive harm. For more information go to [www.P65Warnings.ca.gov](http://www.P65Warnings.ca.gov).



ITEM #	MARTIN #	DESCRIPTION	STYLE	MATERIAL	UOM	PRICE
65502	BRA65502	Do Not Operate	Side B	Heavy-duty polyester	25/PK	\$62.88
65535	BRA65535	Do Not Operate	Side F	Heavy-duty polyester	25/PK	\$62.88
65520	BRA65520	Do Not Operate, striped	Side B	Heavy-duty polyester	25/PK	\$62.88
65525	BRA65525	Do Not Operate, striped	Side F	Heavy-duty polyester	25/PK	\$62.88
65503	BRA65503	Do Not Operate/Maint Dept.	Side B	Heavy-duty polyester	25/PK	\$62.88
66050	BRA66050	Do Not Operate	Side B	Economy polyester	25/PK	\$37.38
66051	BRA66051	Do Not Operate	Side F	Economy polyester	25/PK	\$37.38
66063	BRA66063	Do Not Operate, striped	Side B	Economy polyester	25/PK	\$37.38
66064	BRA66064	Do Not Operate, striped	Side F	Economy polyester	25/PK	\$37.38
66066	BRA66066	Danger Locked Out	Side B	Economy polyester	25/PK	\$37.38
65501	BRA65501	Self-laminating tags, Danger Do Not Operate		Economy polyester	10/PK	\$22.08



## BALL VALVE LOCKOUTS

Stop valves from being turned with unique gull-wing design ball valve lockout.

- Quickly and simply secure over any closed ball valve handle
- Secure with padlock (sold separately)
- Bright red, plastic device works with ball valve handles either perpendicular or parallel to pipe
- Includes red "Danger Locked Out" label



KDD442

ITEM #	MARTIN #	DESCRIPTION	SIZES	UOM	PRICE
KDD442	ACUFGDD442	For 3/8"-1 1/4" Valves	3 1/8" x 4 1/2" x 4 1/2"	EA	\$14.52
KDD440	ACUFGDD440	For 1 1/2"-2" Valves	4 1/2" x 5 2/3" x 5 2/3"	EA	\$23.93



## GATE VALVE LOCKOUTS

Prevent gate valve handles from being turned without authority.

- Hinged clamshell housing fully encloses the valve handle and prevents unauthorized access
- Tough plastic octagon features three shackle holes for group lockout\*
- Unique pry guard edge
- Included safety label has space to write in lockout information



KDD470

\*KDD470 has only one padlock shackle hole.

ITEM #	MARTIN #	DESCRIPTION	SIZES	UOM	PRICE
KDD470	ACUFGDD470	For 1"-2 1/2" valves	3" x 1"	EA	\$10.18
KDD471	ACUFGDD471	For 2 1/2"-5" valves	5 1/2" x 2"	EA	\$15.50
KDD472	ACUFGDD472	For 5"-6 1/2" valves	7" x 2"	EA	\$21.87
KDD473	ACUFGDD473	For 6 1/2"-10" valves	10 1/2" x 3"	EA	\$27.07
KDD474	ACUFGDD474	For 10"-13" valves	13" x 3 1/2"	EA	\$42.88



**UNIVERSAL WALL SWITCH BLOCKOUT COVER**

KDD139

Flip the switch, flip the cover.

- Dual use blockout device works on both rocker/toggle and flat paddle switches
- Uses existing switch plate screws to attach the cover device
- Fold-down, living hinge blocks access to screws, preventing removal
- Secure with standard padlock (sold separately); tag available separately
- Measures 4 1/2" H x 1 5/8" W x 7/8" D
- Unique design allows the device to be applied in the direction of the desired off position



ITEM #	MARTIN #	DESCRIPTION	UOM	PRICE
KDD139	ACUFKDD139	STOPOUT® Wall Switch Lockout	EA	\$5.83



**CIRCUIT BREAKER LOCKOUTS**

Pump action of handle quickly secures lockouts to breaker switch. Unique design allows for fastest lockout application time and quick and easy removal as well. Unit uses metal jaws for optimum secure grip. Circuit breaker lockout is a visible safety red to call attention to locked out switch.



- Fast secure application, quick-release tab
- Easily apply with just one hand if needed
- Octagon peg allows specially designed Tab Tags (sold separately) to be secured directly to the device
- Accommodates up to 9/32" dia. padlock shackles (sold separately)

**⚠ WARNING:** This product can expose you to chemicals which are known to the state of California to cause birth defects and other reproductive harm and/or cancer. For more information go to [www.P65Warnings.ca.gov](http://www.P65Warnings.ca.gov).

ITEM #	MARTIN #	DESCRIPTION	SIZES	UOM	PRICE
KDD160	ACUFKDD160	Single Pole Circuit Breaker Lockout	15/16" W x 3 1/3" L x 1 1/2" D	EA	\$13.33
KDD161	ACUFKDD161	Double Pole Circuit Breaker Lockout	1 3/4" W x 3 1/3" L x 1 1/2" D	EA	\$15.93
KDD162	ACUFKDD162	Triple Pole Circuit Breaker Lockout	2 1/2" W x 3 1/3" L x 1 1/2" D	EA	\$16.90



**STOPPLUG™ LOCKOUT**

KDD230

Prevent unauthorized, accidental plug-in of power cord.

- Insert plug, close down, and secure with padlock (sold separately)
- Tamper-proof, pry-guard edge design
- Multi-Plug lockout fits most 110, 220, 550 or 600 VAC plugs – measures 3" H x 3" W x 6" L
- 110 Plug lockout fits most 110 VAC plugs – measures 2 1/4" H x 2 1/4" W x 3 1/2" L

**⚠ WARNING:** This product can expose you to chemicals which are known to the state of California to cause birth defects and other reproductive harm and/or cancer. For more information go to [www.P65Warnings.ca.gov](http://www.P65Warnings.ca.gov).

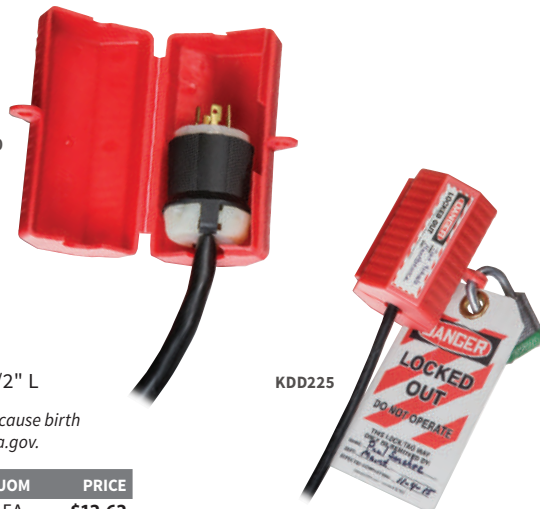

ITEM #	MARTIN #	DESCRIPTION	UOM	PRICE
KDD230	ACUFKDD230	Multi-Plug	EA	\$12.62
KDD225	ACUFKDD225	110 Plug	EA	\$11.07



## POWDER MIX

Replace lost fluids and electrolytes and avoid dangerous dehydration in high-heat environments. Quickly mixes with water and is convenient enough to take anywhere. Yield: 23.83 oz. powder mix makes 2 1/2 gals.

ITEM #	MARTIN #	DESCRIPTION	UOM	PRICE
016040-LA	SQW016040-LA	Lemonade	32/CS	\$139.64
016041-OR	SQW016041-OR	Orange	32/CS	\$139.64
016042-FP	SQW016042-FP	Fruit Punch	32/CS	\$139.64
016043-LL	SQW016043-LL	Lemon-Lime	32/CS	\$139.64
016044-AS	SQW016044-AS	Assorted	32/CS	\$139.64
016045-TE	SQW016045-TE	Tea	32/CS	\$139.64



016044-AS

ITEM #	MARTIN #	DESCRIPTION	UOM	PRICE
016046-GR	SQW016046-GR	Grape	32/CS	\$139.64
016047-CH	SQW016047-CH	Cherry	32/CS	\$139.64
016048-MB	SQW016048-MB	Mixed Berry	32/CS	\$139.64
016049-TC	SQW016049-TC	Tropical Cooler	32/CS	\$139.64
016050-CC	SQW016050-CC	Cool Citrus	32/CS	\$139.64



## POWDER MIX LITE

Replace lost fluids, lost electrolytes and avoid dangerous dehydration in high-heat environments. Sweetened with real sugar, lower calories and lower sugar than regular Squwincher®, and contains no added color. Quickly mixes with water and is convenient enough to take anywhere. Yield: 19.1 oz. package makes 3 gals.



016852-FP

016853-LL

ITEM #	MARTIN #	DESCRIPTION	UOM	PRICE
016850-GR	SQW016850-GR	Grape	20/CS	\$104.73
016851-OR	SQW016851-OR	Orange	20/CS	\$104.73
016852-FP	SQW016852-FP	Fruit Punch	20/CS	\$104.73
016853-LL	SQW016853-LL	Lemon-Lime	20/CS	\$104.73



## LIQUID CONCENTRATE ZERO

Low calorie, no sugar beverage, providing an ideal solution for diabetics or consumers monitoring their daily intake. Includes the same electrolyte content as regular Squwincher® (low sodium and great source of potassium to aid the body in replenishing essential elements lost to heat stress and fatigue). Mixes quickly and easily with water. Yield: 64 oz. concentrate makes 5 gals.



050106-MB

ITEM #	MARTIN #	DESCRIPTION	UOM	PRICE
050102-FP	SQW050102-FP	Fruit Punch	6/CS	\$65.24
050103-GR	SQW050103-GR	Grape	6/CS	\$65.24
050104-LL	SQW050104-LL	Lemon-Lime	6/CS	\$65.24
050106-MB	SQW050106-MB	Mixed Berry	6/CS	\$65.24
050107-OR	SQW050107-OR	Orange	6/CS	\$65.24



## LIQUID CONCENTRATE

Great tasting, scientifically formulated electrolyte replacement drink restores important mineral salts and fluids lost through dehydration, physical exertion and heat stress. More satisfying than water or soft drinks because it is readily absorbed by the body. Mixes quickly and easily with water. Yield: 64 oz. Liquid concentrate makes 5 gal.



030328-LL

ITEM #	MARTIN #	DESCRIPTION	UOM	PRICE
030319-SL	SQW030319-SL	Strawberry Lemonade	6/CS	\$67.09
030320-MB	SQW030320-MB	Mixed Berry	6/CS	\$67.09
030321-CH	SQW030321-CH	Cherry	6/CS	\$67.09
030322-GR	SQW030322-GR	Grape	6/CS	\$67.09
030323-LA	SQW030323-LA	Lemonade	6/CS	\$67.09
030324-OR	SQW030324-OR	Orange	6/CS	\$67.09
030325-FP	SQW030325-FP	Fruit Punch	6/CS	\$67.09
030328-LL	SQW030328-LL	Lemon-Lime	6/CS	\$67.09
030329-TC	SQW030329-TC	Tropical Cooler	6/CS	\$67.09
030330-CC	SQW030330-CC	Cool Citrus	6/CS	\$67.09



## POWDER MIX ZERO

Replace lost fluids, lost electrolytes and avoid dangerous dehydration in high-heat environments. Low calorie, no sugar beverage, providing an ideal solution for diabetics or any consumers monitoring their intake. Quickly mixes with water and is convenient enough to take anywhere. Yield: 1.76 oz. package makes 2 1/2 gals.



016802-AS

ITEM #	MARTIN #	DESCRIPTION	UOM	PRICE
016800-LL	SQW016800-LL	Lemon-Lime	32/CS	\$126.84
016801-OR	SQW016801-OR	Orange	32/CS	\$126.84
016803-FP	SQW016803-FP	Fruit Punch	32/CS	\$126.84
016804-GR	SQW016804-GR	Grape	32/CS	\$126.84
016805-SL	SQW016805-SL	Strawberry Lemonade	32/CS	\$126.84
016802-AS	SQW016802-AS	Assorted	32/CS	\$126.84



**SINGLE SERVE FAST PACK®**



FAST PACK®

Offers workers fluid and electrolyte replenishment anywhere, anytime. Mix water in packet and it becomes your drinking cup. Handy size is more convenient than carrying a cooler. Yield: 0.6 oz. packet makes 6 oz. drink.

ITEM #	MARTIN #	DESCRIPTION	UOM	PRICE
015300-MB	SQW015300-MB	Mixed Berry	200/CS	\$71.85
015301-CH	SQW015301-CH	Cherry	200/CS	\$71.85
015302-GR	SQW015302-GR	Grape	200/CS	\$71.85
015303-LA	SQW015303-LA	Lemonade	200/CS	\$71.85
015304-OR	SQW015304-OR	Orange	200/CS	\$71.85
015305-FP	SQW015305-FP	Fruit Punch	200/CS	\$71.85
015306-TE	SQW015306-TE	Tea	200/CS	\$71.85
015308-LL	SQW015308-LL	Lemon-Lime	200/CS	\$71.85
015309-TC	SQW015309-TC	Tropical Cooler	200/CS	\$71.85
015310-CC	SQW015310-CC	Cool Citrus	200/CS	\$71.85



**SQWEEZE® POPS**

Reduce core body temperature and protect from heat stress and fatigue. Scientifically developed formulation is absorbed at a significantly faster rate than water, allowing the body to replenish electrolytes and minerals needed for proper rehydration. Mixed case of Orange, Grape, Lemon-Lime, Cherry and Mixed Berry.



159200201

ITEM #	MARTIN #	DESCRIPTION	UOM	PRICE
159200201	SQW159200201	Assorted flavors	150/CS	\$47.27



**5-GAL. COOLER**

Durable insulated beverage cooler with rotating handles, screw-off lid and push-button spigot for easy product dispensing.



400104

ITEM #	MARTIN #	DESCRIPTION	UOM	PRICE
400104	SQW400104	5-Gal. cooler	EA	\$57.27



**SINGLE SERVE LITE STIKS**

Perfect for those looking for less calories, no color and no artificial flavor or additives. Contains the perfect electrolyte blend, sweetened with real sugar and contains no added color. 1 oz. Package yields 16.9-20 oz. drink.



SINGLE SERVE LITE STIKS

ITEM #	MARTIN #	DESCRIPTION	UOM	PRICE
060280-GR	SQW060280-GR	Grape	96/CS	\$63.27
060281-OR	SQW060281-OR	Orange	96/CS	\$63.27
060282-FP	SQW060282-FP	Fruit Punch	96/CS	\$63.27
060283-LL	SQW060283-LL	Lemon-Lime	96/CS	\$63.27

**SINGLE SERVE QWIK STIK® ZERO**



**SINGLE SERVE QWIK STIK® ZERO**

Offers the same great taste and electrolyte content as regular Squwincher® (low sodium and great source of potassium)—but with low calorie and no sugar. Simply tear open the convenient, single-serve pouch, add to bottled water, shake and enjoy. Individual packets yield 20 oz. drinks.



ITEM #	MARTIN #	DESCRIPTION	UOM	PRICE
060100-OR	SQW060100-OR	Orange	50/PK	\$213.27
060101-MB	SQW060101-MB	Mixed Berry	50/PK	\$213.27
060102-FP	SQW060102-FP	Fruit Punch	50/PK	\$213.27
060103-LA	SQW060103-LA	Lemonade	50/PK	\$213.27
060104-PT	SQW060104-PT	Peach Tea	50/PK	\$213.27
060105-RB	SQW060105-RB	Raspberry	50/PK	\$213.27
060106-LL	SQW060106-LL	Lemon-Lime	50/PK	\$213.27
060107-GR	SQW060107-GR	Grape	50/PK	\$213.27
060109-CC	SQW060109-CC	Cool Citrus	50/PK	\$213.27
060099-SL	SQW060099-SL	Strawberry Lemonade	50/PK	\$213.27



NIA24PK

**PURIFIED BOTTLED WATER**

Comes in an array of pack sizes. Lightweight Eco-Air Bottle® design ensures bottle doesn't weigh you or the planet down. Individual plastic bottles contain 16.9 oz. of water.



ITEM #	MARTIN #	DESCRIPTION	UOM	PRICE
NIA24PK	NIANIA24PK	Purified bottled water	24/PK	\$3.89



## G2 POWDER PACKS

Has all the electrolytes of original Gatorade with only 20 calories. Enhances athletic performance by stimulating fluid absorption, helping body maintain fluid balance and providing fuel to working muscles. Hydrates more effectively than water alone. Simply add (1) single-serving stick to 20 oz. of water and shake bottle to mix.



G2 POWDER PACKS

ITEM #	MARTIN #	DESCRIPTION	UOM	PRICE
13168	GAT13168	Fruit Punch	8/PK	\$42.47
13167	GAT13167	Grape	8/PK	\$42.47
13160	GAT13160	Glacier Freeze	8/PK	\$42.47



## THIRST QUENCHER INSTANT DRINK MIX

Helps replenish lost electrolytes and stimulates thirst, promoting proper hydration. The 6% carbohydrate solution delivers energy without carbonation or caffeine. Powder mixes quickly and easily with water. Assorted flavors and package sizes.

ITEM #	MARTIN #	DESCRIPTION	UOM	PRICE
<i>2.12 oz. Instant Powder Mix Makes 1 Qt.</i>				
03928	GAT03928	Lemon-Lime	144/CS	\$118.25
33808	GAT33808	Fruit Punch	144/CS	\$118.25
33675	GAT33675	Riptide Rush™	144/CS	\$118.25
<i>8.5 oz. Instant Powder Mix Makes 1 Gal.</i>				
03956	GAT03956	Lemon-Lime	40/CS	\$83.16
03966	GAT03966	Orange	40/CS	\$83.16
03808	GAT03808	Fruit Punch	40/CS	\$83.16
33665	GAT33665	Riptide Rush™	40/CS	\$83.16
<i>21 oz. Instant Powder Mix Makes 2 1/2 Gal.</i>				
13478	GAT13478	G2 Variety pack (Grape, Fruit Punch)	32/CS	\$157.45
03969	GAT03969	Lemon-Lime	32/CS	\$157.45
03970	GAT03970	Orange	32/CS	\$157.45
33691	GAT33691	Fruit Punch	32/CS	\$157.45
33677	GAT33677	Glacier Freeze®	32/CS	\$157.45
33673	GAT33673	Riptide Rush™	32/CS	\$157.45
03944	GAT03944	Variety Pack (Lemon-Lime, Fruit Punch, Orange, Riptide Rush™)	32/CS	\$157.45
<i>51 oz. Instant Powder Mix Makes 6 Gal.</i>				
03967	GAT03967	Lemon-Lime	14/CS	\$145.69
03968	GAT03968	Orange	14/CS	\$145.69
33690	GAT33690	Fruit Punch	14/CS	\$145.69
33676	GAT33676	Glacier Freeze®	14/CS	\$145.69
33672	GAT33672	Riptide Rush™	14/CS	\$145.69



## THIRST QUENCHER INSTANT POWDER PACKETS

Electrolyte and carbohydrate blend provides optimal rehydration. Single-serve packets are a portable and convenient solution for meeting on-the-go beverage needs. 1 oz. powder makes 20 oz. 8/Bx.



13165

ITEM #	MARTIN #	DESCRIPTION	UOM	PRICE
13163	GAT13163	Lemon-Lime	12 BX/CS	\$42.47
13165	GAT13165	Orange	12 BX/CS	\$42.47
13166	GAT13166	Fruit Punch	12 BX/CS	\$42.47



## THIRST QUENCHER LIQUID CONCENTRATE

Helps replenish lost electrolytes and stimulates thirst, promoting proper hydration. The 6% carbohydrate solution delivers energy without carbonation or caffeine. Liquid concentrate mixes instantly with water. Yield: 1 gal. liquid makes 6 gal. drink.



03984

ITEM #	MARTIN #	DESCRIPTION	UOM	PRICE
03984	GAT03984	Lemon-Lime	4/CS	\$51.02
03955	GAT03955	Orange	4/CS	\$51.02
33977	GAT33977	Fruit Punch	4/CS	\$51.02
33305	GAT33305	Fierce® Grape	4/CS	\$51.02
49044	GAT49044	Pump for liquid concentrate	EA	\$3.64



## THIRST QUENCHER COOLERS AND ACCESSORIES

Drink coolers, cups and accessories provide workers with re-hydrating drinks when and where needed.



ITEM #	MARTIN #	DESCRIPTION	SIZES	UOM	PRICE
49200	GAT49200	Cooler w/ fast flow spigot	3 gal.	EA	\$58.42
49134	GAT49134	Cooler w/ fast flow spigot, cup dispenser	7 gal.	EA	\$97.22
49602	GAT49602	Cooler w/ fast flow spigot, cup dispenser	10 gal.	EA	\$111.80
49037	GAT49037	Ice chest	48 qt.	EA	\$60.96
49136	GAT49136	Cooler truck bracket for 3, 5, 7 & 10 gal. cooler		EA	\$72.29
49191	GAT49191	Fast flow spigot		EA	\$12.09



**CHILL-ITS® 6700FR EVAPORATIVE FR COOLING BANDANA-TIE**

Evaporative cooling process helps workers stay cool when needed most. Lightweight, modacrylic cotton blend with super-absorbent acrylic polymers that provide cool comfort for hours after soaking in water 2-5 minutes. Reuse by re-soaking. Features tie closure. Universal. Fabric meets ASTM F1506 performance requirements (ATPV rating of 7.1 cal/cm²); classified CAT 1 per NFPA 70E. Meets ASTM F2302 for flame resistance.



ITEM #	MARTIN #	DESCRIPTION	COLOR	UOM	PRICE
12601	ERGO12601	6700FR Evaporative FR cooling bandana	Hi-vis lime	EA	\$5.64
12607	ERGO12607	6700FR Evaporative FR cooling bandana	Blue	EA	\$5.64



**CHILL-ITS® 5155 LOW-PROFILE HYDRATION PACKS**

Durable 600-denier water-resistant ripstop polyester shell construction with insulated 2 L bladder to keep water cool for hours. Features adjustable breakaway straps for added safety and an antimicrobial bite valve with cover to keep contaminants at bay.



ITEM #	MARTIN #	DESCRIPTION	COLOR	UOM	PRICE
13155	ERGO13155	5155 Low-profile hydration pack	Black	EA	\$62.27
13156	ERGO13156	5155 Low-profile hydration pack	Hi-vis lime	EA	\$69.27
13157	ERGO13157	5155 Low-profile hydration pack	Hi-vis orange	EA	\$69.27



**CHILL-ITS® 6710 EVAPORATIVE COOLING TRIANGLE HATS**

Evaporative cooling process helps workers stay cool when needed most. Lightweight cotton construction features super-absorbent acrylic polymer that activates easily and quickly when soaked in water for 2-5 minutes. Provides cool comfort for up to 4 hours. Re-soak to re-use. Tie closure for personal fit.



ITEM #	MARTIN #	DESCRIPTION	COLOR	UOM	PRICE
12323	ERGO12323	6710 Cooling triangle hat	Stars & Stripes	EA	\$5.00
12324	ERGO12324	6710 Cooling triangle hat	Camouflage	EA	\$5.00
12325	ERGO12325	6710 Cooling triangle hat	Red western	EA	\$5.00
12326	ERGO12326	6710 Cooling triangle hat	Navy western	EA	\$5.00
12327	ERGO12327	6710 Cooling triangle hat	Solid blue	EA	\$5.00
12328	ERGO12328	6710 Cooling triangle hat	Flames	EA	\$5.00
12331	ERGO12331	6710 Cooling triangle hat	Hi-vis lime	EA	\$5.00
12335	ERGO12335	6710 Cooling triangle hat	Black	EA	\$5.00
12359	ERGO12359	6710 Cooling triangle hat	Skulls	EA	\$5.00



**CHILL-ITS® 6700CT EVAPORATIVE COOLING BANDANA WITH COOLING TOWEL**

Advanced PVA material for keeping workers cool without the bulk. Lightweight and low-profile; perfect for under hard hats/helmets. Reusable, just re-wet. Features tie closure for personal fit. Universal, patented design.



ITEM #	MARTIN #	DESCRIPTION	COLOR	UOM	PRICE
12561	ERGO12561	6700CT Evaporative cooling bandana	Stars & Stripes	EA	\$4.36
12562	ERGO12562	6700CT Evaporative cooling bandana	Camouflage	EA	\$4.36
12563	ERGO12563	6700CT Evaporative cooling bandana	Red western	EA	\$4.36
12564	ERGO12564	6700CT Evaporative cooling bandana	Navy western	EA	\$4.36
12565	ERGO12565	6700CT Evaporative cooling bandana	Black	EA	\$4.67
12566	ERGO12566	6700CT Evaporative cooling bandana	Hi-vis lime	EA	\$4.36
12567	ERGO12567	6700CT Evaporative cooling bandana	Solid blue	EA	\$4.36
12568	ERGO12568	6700CT Evaporative cooling bandana	Flames	EA	\$4.36
12569	ERGO12569	6700CT Evaporative cooling bandana	Skulls	EA	\$4.67



**CHILL-ITS® 6710FR EVAPORATIVE FR COOLING TRIANGLE HATS**

Activated polymers bring cooling relief along with FR protection. Modacrylic cotton blend fabric. Soak in water 2-5 minutes to activate; remains hydrated for up to 4 hours and is re-usable. Fabric meets ASTM F1506 performance requirements (ATPV rating of 7.1 cal/cm²); classified CAT 1 per NFPA 70E. Meets ASTM F2302 for flame resistance.



ITEM #	MARTIN #	DESCRIPTION	COLOR	UOM	PRICE
12627	ERGO12627	6710FR Cooling triangle hat	Blue	EA	\$13.91
12621	ERGO12621	6710FR Cooling triangle hat	Hi-vis lime	EA	\$13.91



## CHILL-ITS® 6630 HIGH-PERFORMANCE CAPS

Design features Hi Cool® moisture management fabric with wide, absorbent terry headband. Caps are comfortable to use alone or under helmet. Elastic band for snug fit.

ITEM #	MARTIN #	DESCRIPTION	COLOR	UOM	PRICE
12505	ERGO12505	6630 High-performance cap	Hi-vis lime	EA	\$7.73
12506	ERGO12506	6630 High-performance cap	Stars & Stripes	EA	\$7.73
12507	ERGO12507	6630 High-performance cap	Camouflage	EA	\$7.73
12508	ERGO12508	6630 High-performance cap	Red western	EA	\$7.73
12509	ERGO12509	6630 High-performance cap	Navy western	EA	\$7.73
12510	ERGO12510	6630 High-performance cap	Blue	EA	\$7.73
12514	ERGO12514	6630 High-performance cap	Flames	EA	\$7.73
12516	ERGO12516	6630 High-performance cap	Black	EA	\$7.73
12529	ERGO12529	6630 High-performance cap	Skulls	EA	\$7.73

12505



12506



12508

12529



## CHILL-ITS® 6602 COOLING TOWELS

Dampen synthetic space age towel to create a super-evaporative cooling aid significantly colder than ambient air. Simply wet to activate. Advanced PVA material holds water without feeling heavy. Wear around neck for hours of cooling relief. Machine washable. Measures: 13" x 29 1/2".

ITEM #	MARTIN #	DESCRIPTION	COLOR	UOM	PRICE
12420	ERGO12420	6602 Cooling towel	Blue	EA	\$6.82
12438	ERGO12438	6602 Cooling towel	Gray	EA	\$6.82
12439	ERGO12439	6602 Cooling towel	Hi-vis lime	EA	\$6.82
12441	ERGO12441	6602 Cooling towel	Orange	EA	\$6.82
12442	ERGO12442	6602 Cooling towel	Pink	EA	\$6.82



6602 COOLING TOWELS



## EZ-COOL® EVAPORATIVE COOLING HARD HAT PAD

Made from 65% polyester/35% cotton poplin blend with cooling crystals at crown. Soak in water for 10-20 minutes and squeeze out excess to activate. Delivers effective cooling above suspension that lasts for hours. Securely attaches into hard hats with hook-and-loop attachment. Reusable. Universal size.



396-400-BLU

ITEM #	MARTIN #	DESCRIPTION	UOM	PRICE
396-400-BLU	PIP396-400-BLU	Hard hat cooling pad	EA	\$4.73



## EZ-COOL® EVAPORATIVE COOLING BANDANAS

Polyester and cotton blend fabric with cooling crystals. Soak in water for 20-30 minutes and squeeze out excess to activate. Place around head or neck to facilitate cooling sensation. Cooling effects last for hours. Reusable. Universal size.

ITEM #	MARTIN #	DESCRIPTION	COLOR	UOM	PRICE
393-100-BLU	PIP393-100-BLU	Evaporative cooling bandana	Blue	EA	\$2.56
393-100-CBL	PIP393-100-CBL	Evaporative cooling bandana	Cowboy blue	EA	\$2.56
393-100-CRD	PIP393-100-CRD	Evaporative cooling bandana	Cowboy red	EA	\$2.56
393-100-DGC	PIP393-100-DGC	Evaporative cooling bandana	Digital camo	EA	\$2.56
393-100-KHK	PIP393-100-KHK	Evaporative cooling bandana	Khaki	EA	\$2.56
393-100-NAVY	PIP393-100-NAVY	Evaporative cooling bandana	Navy	EA	\$2.56
393-100-PAT	PIP393-100-PAT	Evaporative cooling bandana	Patriot	EA	\$2.56



393-100-DGC



## EZ-COOL® EVAPORATIVE COOLING TOWELS

Ideal for use in hot environments for protection from the stress of high temperatures. Advanced Poly Vinyl Alcohol (PVA) material absorbs water and sweat efficiently. Activate with a small amount of water to keep cool for hours. Towel can be cut to size. Measures: 13" x 31".



396-602-B

396-602-L

ITEM #	MARTIN #	DESCRIPTION	COLOR	UOM	PRICE
396-602-B	PIP396-602-B	EZ-Cool evaporative cooling towel	Blue	EA	\$8.09
396-602-L	PIP396-602-L	EZ-Cool evaporative cooling towel	Hi-viz lime	EA	\$8.09
396-602-P	PIP396-602-P	EZ-Cool evaporative cooling towel	Pink	EA	\$8.09



**EZ-COOL® MAX EVAPORATIVE COOLING TOWELS**

Constructed of wicking hollow fiber to quickly reduce temperature when soaked in water and activated to provide cooling effect. Activates by waving towel or snapping it in air. Provides UV protection and resists odors. Reusable and machine washable. Retail-ready storage container can clip onto a belt or uniform. Measures: 12" x 40".

ITEM #	MARTIN #	DESCRIPTION	COLOR	UOM	PRICE
396-EZ900-NV	PIP396-EZ900-NV	EZ-Cool Max evaporative cooling towel	Navy	EA	\$12.40
396-EZ900-PK	PIP396-EZ900-PK	EZ-Cool Max evaporative cooling towel	Neon pink	EA	\$12.40
396-EZ900-LY	PIP396-EZ900-LY	EZ-Cool Max evaporative cooling towel	Neon yellow	EA	\$12.40
396-EZ900-GC	PIP396-EZ900-GC	EZ-Cool Max evaporative cooling towel	Camo	EA	\$12.40



396-EZ900



12418



**CHILL-ITS® 6603 EVAPORATIVE COOLING BAND**

Advanced PVA cooling technology; super-evaporative, feels significantly cooler than ambient air. Activates fast and easy: run under water for one minute and simply re-wet to reactivate. Only 1/3 the size of the Chill-Its® 6602 with the same cooling power. Use as a neck wrap by pulling end of wrap through slit. Wear for hours or for quick relief. Machine washable. Measures: 4" x 29 1/2". Blue.

ITEM #	MARTIN #	DESCRIPTION	UOM	PRICE
12418	ERGO12418	6603 Evaporative cooling band	EA	\$3.55



**CHILL-ITS® 6665 EVAPORATIVE COOLING VESTS**

Soak evaporative cooling vests in cold water, and enjoy cooling relief and comfort. Mesh side panels offer improved ventilation and stretch. Features a V-neck with zipper closure, quilted nylon outer layer with an activated, polymer-embedded fabric inside. Water-repellent liner and black cotton-poly elastic trim. Reusable, just re-wet. Remains hydrated for up to 4 hours. Lightweight, durable and washable. 100% Nylon.

ITEM #	MARTIN #	DESCRIPTION	COLOR	SIZES	UOM	PRICE
12533	ERGO12533	6665 Evaporative cooling vest	Hi-vis lime	M	EA	\$36.27
12534	ERGO12534	6665 Evaporative cooling vest	Hi-vis lime	L	EA	\$36.27
12535	ERGO12535	6665 Evaporative cooling vest	Hi-vis lime	XL	EA	\$36.27
12536	ERGO12536	6665 Evaporative cooling vest	Hi-vis lime	2XL	EA	\$36.27
12537	ERGO12537	6665 Evaporative cooling vest	Hi-vis lime	3XL	EA	\$36.27
12543	ERGO12543	6665 Evaporative cooling vest	Gray	M	EA	\$36.27
12544	ERGO12544	6665 Evaporative cooling vest	Gray	L	EA	\$36.27
12545	ERGO12545	6665 Evaporative cooling vest	Gray	XL	EA	\$36.27
12546	ERGO12546	6665 Evaporative cooling vest	Gray	2XL	EA	\$36.27
12547	ERGO12547	6665 Evaporative cooling vest	Gray	3XL	EA	\$36.27

12533



12543



**CHILL-ITS® 6685 DRY EVAPORATIVE COOLING VEST**

Patented vest provides immediate and long-lasting cooling with up to 3 days of cooling ability. Easy-to-us watertight filling cap. Fill vest with 13-20 oz. water to activate. Lightweight, durable and washable. V-neck style with zip closure. Mesh side panels provide additional ventilation and stretch. Lime.

ITEM #	MARTIN #	DESCRIPTION	SIZES	UOM	PRICE	ITEM #	MARTIN #	DESCRIPTION	SIZES	UOM	PRICE
12673	ERGO12673	6685 Cooling vest	M	EA	\$163.76	12676	ERGO12676	6685 Cooling vest	2XL	EA	\$163.76
12674	ERGO12674	6685 Cooling vest	L	EA	\$163.76	12677	ERGO12677	6685 Cooling vest	3XL	EA	\$163.76
12675	ERGO12675	6685 Cooling vest	XL	EA	\$163.76	12678	ERGO12678	6685 Cooling vest	4XL	EA	\$154.45

12674







### BBP®31 SIGN AND LABEL PRINTER

Easy to use and packed with functionalities. Can use as a stand-alone mobile unit or connected to PC.

Available with many material options to handle all labeling needs. Customize labels, tapes and signs from 1/2" to 4" on materials with up to 10-year outdoor grade durability. Includes power cord, USB cable, drivers CD, stylus, cleaning kit, cutter cleaning tool, quick-start guide and documentation holder.



142052

ITEM #	MARTIN #	DESCRIPTION	UOM	PRICE
142052	BRA142052	BBP31 sign & label maker	EA	\$1,799.00



### BBP®35 MULTICOLOR SIGN AND LABEL PRINTER

Creates colorful workplace visuals in seconds. Features touchscreen interface, automatic label setup and 20-second material change by simply setting or clicking into place without calibration or threading. Can use as stand-alone mobile unit or connected to PC. Includes power cord, network card, cleaning kit and quick-start guide.



143633

ITEM #	MARTIN #	DESCRIPTION	UOM	PRICE
143633	BRA143633	BBP35 multicolor sign & label printer	EA	\$2,750.00



### BBP®37 COLOR AND CUT SIGN AND LABEL PRINTER

Creates bright and colorful multicolor labels and signs quickly (5" per second print speed). Features touchscreen interface, automatic label setup, 20-second material change out and XY cutter that creates die-cut shapes and text. Can use as stand-alone mobile unit or connected to PC. Includes power cord, network card, cleaning kit, cutter cleaning tool and quick-start guide.



143638

ITEM #	MARTIN #	DESCRIPTION	UOM	PRICE
143638	BRA143638	BBP37 color & cut sign & label printer	EA	\$3,250.00



### BBP®30 SERIES ACCESSORIES

Various ribbons and labels that are compatible with BBP31, BBP35 and BBP37 printers.

ITEM #	MARTIN #	DESCRIPTION	COLOR	SIZES	UOM	PRICE
B30-R10000	BRAB30-R10000	Printer ribbon	Black	4.33" x 200'	RL	\$110.99
B30-R10000-WT	BRAB30-R10000-WT	Printer ribbon	White	4.33" x 200'	RL	\$110.99
B30C-4000-595-WT	BRAB30C-4000-595-WT	Continuous indoor/outdoor vinyl tape	White	4" x 100'	RL	\$245.99
B30C-4000-595-YL	BRAB30C-4000-595-YL	Continuous indoor/outdoor vinyl tape	Yellow	4" x 100'	RL	\$245.99
B30C-2250-595-YL	BRAB30C-2250-595-YL	Continuous indoor/outdoor vinyl tape	Yellow	2.25" x 100'	RL	\$163.99
B30C-2250-595-BL	BRAB30C-2250-595-BL	Continuous indoor/outdoor vinyl tape	Blue	2.25" x 100'	RL	\$163.99
B30C-2250-595-GN	BRAB30C-2250-595-GN	Continuous indoor/outdoor vinyl tape	Green	2.25" x 100'	RL	\$163.99
B30-261-7569-CLP1	BRAB30-261-7569-CLP1	Pre-printed GHS labels, 1 diamond		3" x 4"	RL	\$142.99
B30-261-7569-CLP2	BRAB30-261-7569-CLP2	Pre-printed GHS labels, 2 diamond		3" x 4"	RL	\$142.99
B30-261-7569-CLP3A	BRAB30-261-7569-CLP3A	Pre-printed GHS labels, 3 diamond		3" x 4"	RL	\$142.99
B30-261-7569-CLP4B	BRAB30-261-7569-CLP4B	Pre-printed GHS labels, 4 diamond		2.95" x 4.33"	RL	\$142.99
B30-25-595-OSHADA	BRAB30-25-595-OSHADA	Pre-printed die-cut labels, danger		4" x 6"	RL	\$245.99
B30-25-595-OSHACA	BRAB30-25-595-OSHACA	Pre-printed die-cut labels, caution		4" x 6"	RL	\$245.99
B30-25-595-ANSIWA	BRAB30-25-595-ANSIWA	Pre-printed die-cut labels, warning		4" x 6"	RL	\$245.99
B30-25-595-ANSINO	BRAB30-25-595-ANSINO	Pre-printed die-cut labels, notice		4" x 6"	RL	\$245.99

B30-25-595-ANSIWA



BMP21-PLUS



### BMP®21-PLUS LABEL PRINTER AND CARTRIDGES

Drop tested printer, super rugged with molded rubber bumpers provides protection from falls. All-in-one label printer for voice/data comm, electrical and general industrial crews. With label materials designed specifically for harsh environments, the portable printer can quickly and easily create clear, legible labels that stay stuck for years despite extreme temperatures and curved or highly textured surfaces. Printer includes a 2-year warranty.

ITEM #	MARTIN #	DESCRIPTION	COLOR	SIZES	UOM	PRICE
BMP21-PLUS	BRABMP21-PLUS	BMP21-PLUS label printer w/ M21-750-499 label cartridge, lanyard & Quick Start Guide			EA	\$99.00
M21-500-595-WT	BRAM21-500-595-WT	BMP21-PLUS label cartridge w/ black ribbon	White	0.5" W x 21' L	EA	\$21.99
M21-500-595-YL	BRAM21-500-595-YL	BMP21-PLUS label cartridge w/ black ribbon	Yellow	0.5" W x 21' L	EA	\$21.99
M21-500-595-OR	BRAM21-500-595-OR	BMP21-PLUS label cartridge w/ black ribbon	Orange	0.5" W x 21' L	EA	\$21.99
M21-750-595-WT	BRAM21-750-595-WT	BMP21-PLUS label cartridge w/ black ribbon	White	0.75" W x 21' L	EA	\$25.69
M21-750-595-YL	BRAM21-750-595-YL	BMP21-PLUS label cartridge w/ black ribbon	Yellow	0.75" W x 21' L	EA	\$24.99
M21-750-595-OR	BRAM21-750-595-OR	BMP21-PLUS label cartridge w/ black ribbon	Orange	0.75" W x 21' L	EA	\$24.99



**AISLE MARKING TAPES**

Quick way to identify aisles and walkways. Made of long-wearing vinyl. Applies quickly and sticks tightly to virtually any clean, dry surface.

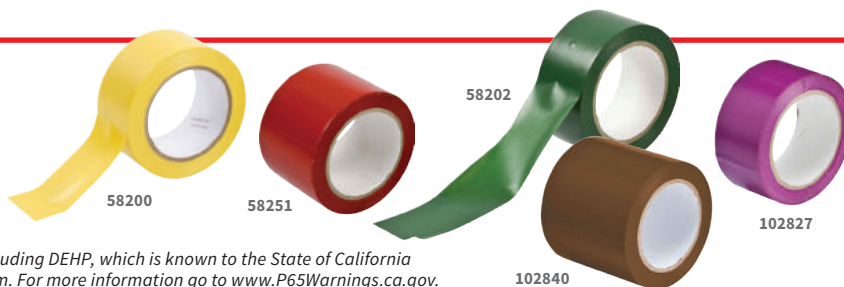

**⚠ WARNING:** This product can expose you to chemicals including DEHP, which is known to the State of California to cause cancer and birth defects or other reproductive harm. For more information go to [www.P65Warnings.ca.gov](http://www.P65Warnings.ca.gov).

ITEM #	MARTIN #	COLOR	SIZES	UOM	PRICE
<i>Aisle Marking Tape</i>					
58200	BRA58200	Yellow	2" x 36 yds.	RL	\$39.14
58250	BRA58250	Yellow	3" x 36 yds.	RL	\$59.18
102838	BRA102838	Yellow	4" x 36 yds.	RL	\$74.66
58201	BRA58201	Red	2" x 36 yds.	RL	\$39.14
58251	BRA58251	Red	3" x 36 yds.	RL	\$59.18
102836	BRA102836	Red	4" x 36 yds.	RL	\$74.66
58202	BRA58202	Green	2" x 36 yds.	RL	\$39.14
58252	BRA58252	Green	3" x 36 yds.	RL	\$59.18
102834	BRA102834	Green	4" x 36 yds.	RL	\$74.66
58203	BRA58203	White	2" x 36 yds.	RL	\$39.14
58253	BRA58253	White	3" x 36 yds.	RL	\$59.18
102837	BRA102837	White	4" x 36 yds.	RL	\$74.66

ITEM #	MARTIN #	COLOR	SIZES	UOM	PRICE
58220	BRA58220	Blue	2" x 36 yds.	RL	\$39.14
58221	BRA58221	Blue	3" x 36 yds.	RL	\$59.18
102833	BRA102833	Blue	4" x 36 yds.	RL	\$74.66
58222	BRA58222	Black	2" x 36 yds.	RL	\$39.14
58223	BRA58223	Black	3" x 36 yds.	RL	\$55.54
102839	BRA102839	Black	4" x 36 yds.	RL	\$74.66
102825	BRA102825	Orange	2" x 36 yds.	RL	\$39.14
102829	BRA102829	Orange	3" x 36 yds.	RL	\$59.18
102835	BRA102835	Orange	4" x 36 yds.	RL	\$74.66
102828	BRA102828	Brown	2" x 36 yds.	RL	\$39.14
102832	BRA102832	Brown	3" x 36 yds.	RL	\$59.18
102840	BRA102840	Brown	4" x 36 yds.	RL	\$74.66
102827	BRA102827	Purple	2" x 36 yds.	RL	\$39.14



**TOUGHSTRIPE® FLOOR MARKING TAPES**

Low-profile design minimizes tears and scratches from skids, pallet jacks, etc. Withstands forklift traffic without tearing or lifting. Made with rugged polyester and aggressive adhesive. Can be easily applied by one person working alone. Offers the same visibility as painted floor markings. Surface resists marks and smudges and cleans up like new.



ITEM #	MARTIN #	COLOR	SIZES	UOM	PRICE
<i>Floor Marking Tape, Solid Color</i>					
104310	BRA104310	Black	2" x 100'	RL	\$42.79
104311	BRA104311	White	2" x 100'	RL	\$42.79
104312	BRA104312	Yellow	2" x 100'	RL	\$42.79
104313	BRA104313	Red	2" x 100'	RL	\$42.79
104314	BRA104314	Blue	2" x 100'	RL	\$42.79
104315	BRA104315	Green	2" x 100'	RL	\$42.79
104316	BRA104316	Orange	2" x 100'	RL	\$42.79
134086	BRA134086	Purple	2" x 100'	RL	\$42.79
134089	BRA134089	Brown	2" x 100'	RL	\$42.79
134092	BRA134092	Gray	2" x 100'	RL	\$42.79
104340	BRA104340	Black	3" x 100'	RL	\$62.82
104341	BRA104341	White	3" x 100'	RL	\$62.82
104342	BRA104342	Yellow	3" x 100'	RL	\$62.82
104343	BRA104343	Red	3" x 100'	RL	\$62.82
104344	BRA104344	Blue	3" x 100'	RL	\$62.82
104345	BRA104345	Green	3" x 100'	RL	\$62.82
104346	BRA104346	Orange	3" x 100'	RL	\$62.82
134087	BRA134087	Purple	3" x 100'	RL	\$62.82
134090	BRA134090	Brown	3" x 100'	RL	\$59.18
134093	BRA134093	Gray	3" x 100'	RL	\$59.18
104370	BRA104370	Black	4" x 100'	RL	\$81.95
104371	BRA104371	White	4" x 100'	RL	\$81.95
104372	BRA104372	Yellow	4" x 100'	RL	\$81.95
104373	BRA104373	Red	4" x 100'	RL	\$81.95
104374	BRA104374	Blue	4" x 100'	RL	\$81.95
104375	BRA104375	Green	4" x 100'	RL	\$81.95
104376	BRA104376	Orange	4" x 100'	RL	\$81.95
134088	BRA134088	Purple	4" x 100'	RL	\$80.13
134091	BRA134091	Brown	4" x 100'	RL	\$80.13
134094	BRA134094	Gray	4" x 100'	RL	\$81.95

ITEM #	MARTIN #	COLOR	SIZES	UOM	PRICE
<i>Floor Marking Tape, Striped</i>					
132433	BRA132433	Orange/black	2" x 100'	RL	\$42.79
104317	BRA104317	Yellow/black	2" x 100'	RL	\$42.79
104319	BRA104319	White/black	2" x 100'	RL	\$42.79
104318	BRA104318	Red/white	2" x 100'	RL	\$42.79
132430	BRA132430	Red/yellow	2" x 100'	RL	\$42.79
132436	BRA132436	Green/white	2" x 100'	RL	\$42.79
132439	BRA132439	Blue/yellow	2" x 100'	RL	\$41.88
132434	BRA132434	Orange/black	3" x 100'	RL	\$62.82
104347	BRA104347	Yellow/black	3" x 100'	RL	\$62.82
104349	BRA104349	White/black	3" x 100'	RL	\$62.82
104348	BRA104348	Red/white	3" x 100'	RL	\$62.82
132431	BRA132431	Red/yellow	3" x 100'	RL	\$62.82
132437	BRA132437	Green/white	3" x 100'	RL	\$62.82
132440	BRA132440	Blue/yellow	3" x 100'	RL	\$59.18
132435	BRA132435	Orange/black	4" x 100'	RL	\$81.95
104377	BRA104377	Yellow/black	4" x 100'	RL	\$81.95
104379	BRA104379	White/black	4" x 100'	RL	\$81.95
104378	BRA104378	Red/white	4" x 100'	RL	\$81.95
132432	BRA132432	Red/yellow	4" x 100'	RL	\$81.95
132438	BRA132438	Green/white	4" x 100'	RL	\$81.95
132441	BRA132441	Blue/yellow	4" x 100'	RL	\$81.95
<i>Floor Marking Tape, Checkered</i>					
121913	BRA121913	Black/white	2" x 100'	RL	\$42.79
121916	BRA121916	Red/white	2" x 100'	RL	\$42.79
121914	BRA121914	Black/white	3" x 100'	RL	\$62.82
121917	BRA121917	Red/white	3" x 100'	RL	\$62.82
121915	BRA121915	Black/white	4" x 100'	RL	\$81.95
121928	BRA121928	Red/white	4" x 100'	RL	\$557.52
<i>Floor Corner Marks</i>					
104457	BRA104457	Yellow	4" x 10"	20/PK	\$56.45
104458	BRA104458	Black	4" x 10"	20/PK	\$56.45
104445	BRA104445	Yellow	3" x 8"	20/PK	\$39.14

FACILITY CARE | SIGNS





### SIGNS

A variety of signs and sign blanks are available. Choose from BradyTuff® plastic, aluminum, high performance polyester, premium fiberglass and high-performance vinyl.

- Plastic signs are made of polystyrene, have round corners with holes and have an Average Outdoor Durability of 3-5 years
- Aluminum signs have round corners with holes and have an Average Outdoor Durability of 5-8 years
- Polyester signs are pressure sensitive with a polyester overlaminate and have an Average Outdoor Durability of 5-8 years
- Fiberglass signs are reinforced polyester with protected graphics and have an Average Outdoor Durability of up to 25 years



84562, 84563 & 70249



84875 & 84876



43489



95468



40706



84907



85261



85270



90366



19527



43474



84859



85356



26582



26583



22635

ITEM #	MARTIN #	DESCRIPTION	MATERIAL	SIZES	UOM	PRICE
84562	BRA84562	Danger Confined Space Enter By Permit Only	Polyester	7" H x 10" W	EA	\$8.18
84563	BRA84563	Danger Confined Space Enter By Permit Only	Polyester	10" H x 14" W	EA	\$11.55
70249	BRA70249	Danger Confined Space Enter By Permit Only	Fiberglass	10" H x 14" W	EA	\$26.39
84875	BRA84875	Danger High Voltage	Polyester	3 1/2" H x 5" W	EA	\$2.27
84876	BRA84876	Danger High Voltage	Polyester	7" H x 10" W	EA	\$8.18
43489	BRA43489	Danger No Smoking, w/ pictogram	Aluminum	10" H x 14" W	EA	\$20.02
95468	BRA95468	Restricted Area Do Not Enter Authorized Personnel Only	Plastic	14" H x 20" W	EA	\$12.38
40706	BRA40706	Notice Authorized Personnel Only	Aluminum	10" H x 14" W	EA	\$20.02
84907	BRA84907	Notice No Firearms Allowed On Premises	Aluminum	10" H x 14" W	EA	\$19.57
85261	BRA85261	Fire Extinguisher	Polyester	14" H x 3 1/2" W	EA	\$6.46
85270	BRA85270	Fire Hose	Polyester	14" H x 5" W	EA	\$8.18
90366	BRA90366	Fire Alarm	Polyester	14" H x 5" W	EA	\$8.18
19527	BRA19527	Danger High Voltage	Plastic	14" H x 10" W	EA	\$11.55
43474	BRA43474	Danger Electrical Equipment Authorized Personnel only	Aluminum	10" H x 14" W	EA	\$20.02
84859	BRA84859	Danger Area In Front Of This Electrical Panel...	Polyester	7" H x 10" W	EA	\$8.18
85356	BRA85356	Fire Blanket, w/ 1st aid pictogram	Polyester	3 1/2" H x 10" W	EA	\$8.38
26582	BRA26582	Emergency Eye Wash Station Keep Area Clear	Plastic	10" H x 14" W	EA	\$12.38
26583	BRA26583	Emergency Safety Shower Keep Area Clear	Plastic	10" H x 14" W	EA	\$12.11
22635	BRA22635	Notice Breathing Air Emergency Use Only	Plastic	10" H x 14" W	EA	\$12.38



### HIGH-VISIBILITY V-STYLE SIGNS

Acrylic 45° signs are used to clearly mark safety equipment for quick and easy access in an emergency situation. Designed to be seen from all access points in your facility.

ITEM #	MARTIN #	DESCRIPTION	SIZES	UOM	PRICE
V1FE15A	BRAV1FE15A	Fire Extinguisher	6" H x 8" W	EA	\$14.84
V1FL15A	BRAV1FL15A	Fire Alarm	6" H x 9" W	EA	\$14.84
96907	BRA96907	Fire Alarm	12" H x 18" W	EA	\$21.84

V1FE15A





TAR110



**TAGS BY-THE-ROLL**

Safety Tags identify a temporary hazard until that hazard is eliminated or hazardous operation is complete. They comply in accordance with OSHA 29 CFR 1910.145 and ANSI Z535 requirements.

Tags By-The-Roll allow you to keep a large quantity of safety tags available. Features a 6 5/8" x 6 5/8" x 3 5/8" eye catching, octagon shaped disposable cardboard dispenser which includes a 1 1/2" perforated center hole for mounting with tags housed inside for portability. Simply pull out the 6 1/4" x 3" tag from the box to easily tear off. Made from pulp free cardstock which is more durable than traditional cardstock, and will not crack, distort, or shrink. Matte surface is scuff resistant and easy to write on with pen or marker.



ITEM #	MARTIN #	DESCRIPTION	UOM	PRICE
TAR110	ACUFTAR110	Danger Do Not Operate	100/RL	\$45.42
TAR121	ACUFTAR121	Danger Do Not Operate	250/RL	\$100.93
TAR412	ACUFTAR412	Danger, OSHA blank	100/RL	\$45.42
TAR423	ACUFTAR423	Danger, OSHA blank	250/RL	\$100.93
TAR128	ACUFTAR128	Danger Barricade Tag	100/RL	\$45.42
TAR158	ACUFTAR158	Danger Barricade Tag	250/RL	\$100.93

ITEM #	MARTIN #	DESCRIPTION	UOM	PRICE
TAR114	ACUFTAR114	Danger Do Not Operate	100/RL	\$45.42
TAR125	ACUFTAR125	Danger Do Not Operate	250/RL	\$100.93
TAR714	ACUFTAR714	Out Of Service	100/RL	\$45.42
TAR730	ACUFTAR730	Out Of Service	250/RL	\$100.93
TAR136	ACUFTAR136	Caution Barricade Tag	100/RL	\$45.42
TAR160	ACUFTAR160	Caution Barricade Tag	250/RL	\$100.93



**ACCIDENT PREVENTION SAFETY SIGNS**

Signs identify and indicate the potential, type, and degree of hazards that may lead to accidental injury or property damage. They comply in accordance with OSHA 29 CFR 1910.145 and ANSI Z535 requirements.

**Adhesive Vinyl (VS)**

Ideal for indoor and sheltered outdoor marking needs. Vinyl with printed matte surface. Permanent acrylic adhesive back with peel off liner.



**Plastic (VP)**

Durable plastic has slight flex that is ideal for indoor and sheltered outdoor environments. Printed surface has clear UV protective overcoat. Plastic has 50% recycled content with UV inhibitors and good impact resistance. Rounded corners with 3/16" mounting holes for installation.

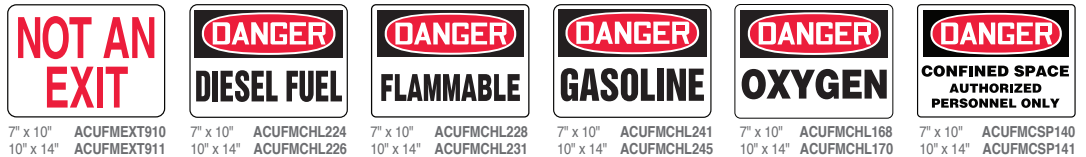

**Aluminum (VA)**

Withstands splashes and washdowns indoor and out. Provides the strength of metal, without rusting. Text is printed on rigid aluminum sheet with UV protective coating. Rounded corners with 3/16" mounting holes for installation.

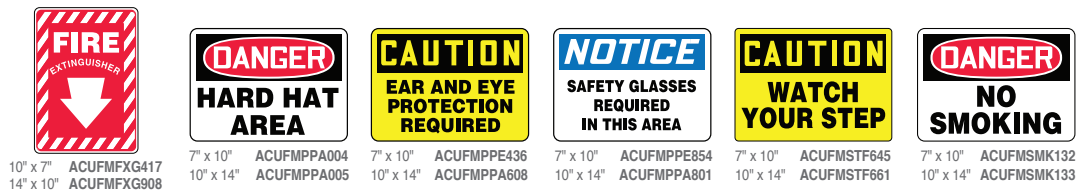

**HOW TO ORDER SIGNS**

- Select Sign; ACUFMADM006
- Select Material Code; Plastic - VP
- Order Part Number; ACUFMADM006VP

MATERIAL	MATERIAL CODE	7" x 10"	10" x 14"
Adhesive Vinyl	VS	\$7.62	\$11.42
Plastic	VP	\$8.30	\$12.40
Aluminum	VA	\$12.12	\$20.12



### ACCIDENT PREVENTION SAFETY LABELS

Labels identify and indicate the potential, type, and degree of hazards that may lead to accidental injury or property damage. They comply in accordance with OSHA 29 CFR 1910.145 and ANSI Z535 requirements. All labels measure: 3 1/2" x 5".

#### Adhesive Vinyl (VSP)

Flexible vinyl can be applied to curved surfaces such as pipes, poles, and secondary containers. It is moisture resistant for a variety of light-duty indoor and sheltered outdoor marking needs. The printed matte surface has permanent acrylic adhesive back. Finishing includes square corners and scored back liner for quick peel-off and application. Available in packs of 5.

#### Dura-Vinyl™ (XVE)

Printed image protected by a high-gloss UV protective coating for durability indoor and outdoor marking locations. Has permanent acrylic adhesive back. Dual-layer flexibility can be applied to curved areas such as pipes, poles, and secondary containers. Round corners and scored back liner for quick peel-off and application. Available each.

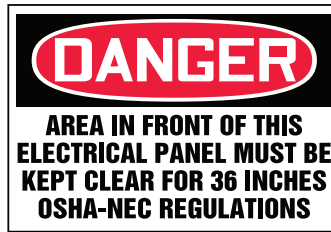

LELC002



LCSP280



LELC248



LEQM279



LEQM269



LELC164



LCHL675



LEQM780



LFXG440



LFSD509

ITEM #	MARTIN #	DESCRIPTION	MATERIAL	UOM	PRICE
LELC002VSP	ACUFLELC002VSP	Danger Area in Front of This Electrical Panel...	Adhesive vinyl	5/PK	\$11.28
LELC002XVE	ACUFLELC002XVE	Danger Area in Front of This Electrical Panel...	Adhesive Dura-Vinyl	EA	\$4.73
LCSP280VSP	ACUFLELCSP280VSP	Danger Confined Space Enter By Permit Only	Adhesive vinyl	5/PK	\$11.28
LCSP280XVE	ACUFLELCSP280XVE	Danger Confined Space Enter By Permit Only	Adhesive Dura-Vinyl	EA	\$4.73
LELC248VSP	ACUFLELC248VSP	Danger High Voltage	Adhesive vinyl	5/PK	\$11.28
LELC248XVE	ACUFLELC248XVE	Danger High Voltage	Adhesive Dura-Vinyl	EA	\$4.73
LEQM279VSP	ACUFLEQM279VSP	Danger Keep Hands Clear	Adhesive vinyl	5/PK	\$11.28
LEQM279XVE	ACUFLEQM279XVE	Danger Keep Hands Clear	Adhesive Dura-Vinyl	EA	\$4.73
LEQM269VSP	ACUFLEQM269VSP	Danger This Equipment Starts And Stops Automatically	Adhesive vinyl	5/PK	\$11.28
LEQM269XVE	ACUFLEQM269XVE	Danger This Equipment Starts And Stops Automatically	Adhesive Dura-Vinyl	EA	\$4.73
LELC164VSP	ACUFLELC164VSP	Danger 480 Volts	Adhesive vinyl	5/PK	\$11.28
LELC164XVE	ACUFLELC164XVE	Danger 480 Volts	Adhesive Dura-Vinyl	EA	\$4.73
LCHL675VSP	ACUFLCHL675VSP	Caution Hot	Adhesive vinyl	5/PK	\$11.28
LCHL675XVE	ACUFLCHL675XVE	Caution Hot	Adhesive Dura-Vinyl	EA	\$4.73
LEQM780VSP	ACUFLEQM780VSP	Caution Keep Hands Clear	Adhesive vinyl	5/PK	\$11.28
LEQM780XVE	ACUFLEQM780XVE	Caution Keep Hands Clear	Adhesive Dura-Vinyl	EA	\$4.73
LFXG440VSP	ACUFLFXG440VSP	Fire Extinguisher Inside	Adhesive vinyl	5/PK	\$11.28
LFXG440XVE	ACUFLFXG440XVE	Fire Extinguisher Inside	Adhesive Dura-Vinyl	EA	\$4.73
LFSD509VSP	ACUFLFSD509VSP	First Aid Kit Inside	Adhesive vinyl	5/PK	\$11.28
LFSD509XVE	ACUFLFSD509XVE	First Aid Kit Inside	Adhesive Dura-Vinyl	EA	\$4.73



**ACCIDENT PREVENTION SAFETY TAGS**

Safety Tags identify a temporary hazard until that hazard is eliminated or hazardous operation is complete. They comply in accordance with OSHA 29 CFR 1910.145 and ANSI Z535 requirements. All tags measure: 5 3/4" x 3 1/4".

**PF-Cardstock (CTP)**

Thin, flexible poly-based cardstock without wood content. Tear-resistant, waterproof, and will not crack, distort, or shrink. Matte surface with 3/8" hole.

**RP-Plastic (PTP)**

Durable plastic resists chemicals, tears, abrasions, dirt, and grease. 3/8" brass grogmet with 50-pull strength.

**HS-Laminated Plastic (LTP)**

Tear-proof, chemical-resistant, waterproof tags ideal for harsh conditions. Thick matte plastic with 3/8" brass grogmet with 50-pull strength.

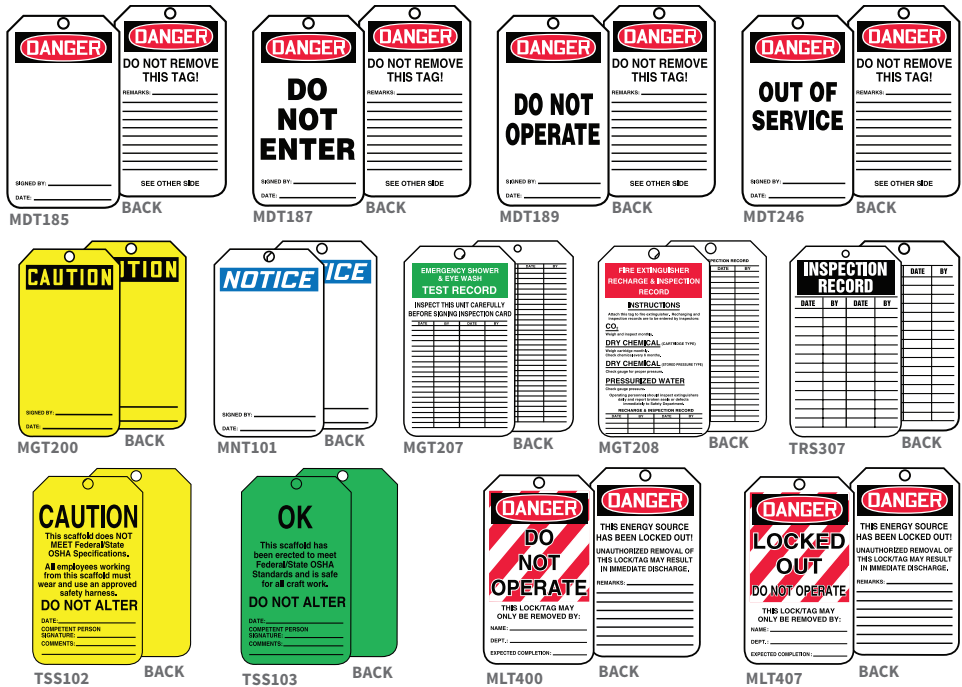

**⚠ WARNING:** RP-Plastic and HS-Laminate tags can expose you to chemicals which are known to the state of California to cause birth defects and other reproductive harm and/or cancer. For more information go to [www.P65Warnings.ca.gov](http://www.P65Warnings.ca.gov).

ITEM #	MARTIN #	DESCRIPTION	MATERIAL	UOM	PRICE
<i>Standard Back B</i>					
MDT185CTP	ACUFMDT185CTP	Danger	PF-Cardstock	25/PK	\$13.68
MDT185PTP	ACUFMDT185PTP	Danger	RP-Plastic	25/PK	\$37.15
MDT187CTP	ACUFMDT187CTP	Danger Do Not Enter	PF-Cardstock	25/PK	\$13.68
MDT187PTP	ACUFMDT187PTP	Danger Do Not Enter	RP-Plastic	25/PK	\$37.15
MDT189CTP	ACUFMDT189CTP	Danger Do Not Operate	PF-Cardstock	25/PK	\$13.68
MDT189PTP	ACUFMDT189PTP	Danger Do Not Operate	RP-Plastic	25/PK	\$37.15
MDT246CTP	ACUFMDT246CTP	Danger Out Of Service	PF-Cardstock	25/PK	\$13.68
MDT246PTP	ACUFMDT246PTP	Danger Out of Service	RP-Plastic	25/PK	\$37.15
<i>Blank With OSHA Header &amp; Repeat Back</i>					
MDT260CTP	ACUFMDT260CTP	Danger	PF-Cardstock	25/PK	\$13.68
MDT260PTP	ACUFMDT260PTP	Danger	RP-Plastic	25/PK	\$37.15
MGT200CTP	ACUFMGT200CTP	Caution	PF-Cardstock	25/PK	\$13.68
MGT200PTP	ACUFMGT200PTP	Caution	RP-Plastic	25/PK	\$37.15
MNT101CTP	ACUFMNT101CTP	Notice	PF-Cardstock	25/PK	\$13.68
MNT101PTP	ACUFMNT101PTP	Notice	RP-Plastic	25/PK	\$37.15
<i>Equipment Status Tags</i>					
MGT207CTP	ACUFMGT207CTP	Emergency Shower & Eyewash Test Record	PF-Cardstock	25/PK	\$13.68
MGT207PTP	ACUFMGT207PTP	Emergency Shower & Eyewash Test Record	RP-Plastic	25/PK	\$37.15
MGT208CTP	ACUFMGT208CTP	Fire Extinguisher Recharge & Inspection Record	PF-Cardstock	25/PK	\$13.68
MGT208PTP	ACUFMGT208PTP	Fire Extinguisher Recharge & Inspection Record	RP-Plastic	25/PK	\$37.15
TRS307CTP	ACUFTRS307CTP	Inspection Record	PF-Cardstock	25/PK	\$13.68

ITEM #	MARTIN #	DESCRIPTION	MATERIAL	UOM	PRICE
TRS307PTP	ACUFTRS307PTP	Inspection Record	RP-Plastic	25/PK	\$37.15
<i>Scaffold Status Tags</i>					
TSS101CTP	ACUFTSS101CTP	Danger Do Not Use This Scaffold Keep Off	PF-Cardstock	25/PK	\$13.68
TSS101PTP	ACUFTSS101PTP	Danger Do Not Use This Scaffold Keep Off	RP-Plastic	25/PK	\$37.15
TSS102CTP	ACUFTSS102CTP	Caution This Scaffold Does Not Meet Federal/State OSHA Specifications	PF-Cardstock	25/PK	\$13.68
TSS102PTP	ACUFTSS102PTP	Caution This Scaffold Does Not Meet Federal/State OSHA Specifications	RP-Plastic	25/PK	\$37.15
TSS103CTP	ACUFTSS103CTP	OK This Scaffold Has Been Erected To Meet Federal/State OSHA Standards	PF-Cardstock	25/PK	\$13.68
TSS103PTP	ACUFTSS103PTP	OK This Scaffold Has Been Erected To Meet Federal/State OSHA Standards	RP-Plastic	25/PK	\$37.15
<i>Lockout Tags</i>					
MLT400CTP	ACUFMLT400CTP	Danger Do Not Operate	PF-Cardstock	25/PK	\$13.68
MLT400PTP	ACUFMLT400PTP	Danger Do Not Operate	RP-Plastic	25/PK	\$37.15
MLT400LTP	ACUFMLT400LTP	Danger Do Not Operate	HS-Laminate	25/PK	\$53.05
MLT407CTP	ACUFMLT407CTP	Danger Locked Out	PF-Cardstock	25/PK	\$13.68
MLT407PTP	ACUFMLT407PTP	Danger Locked Out	RP-Plastic	25/PK	\$37.15
MLT407LTP	ACUFMLT407LTP	Danger Locked Out	HS-Laminate	25/PK	\$53.05

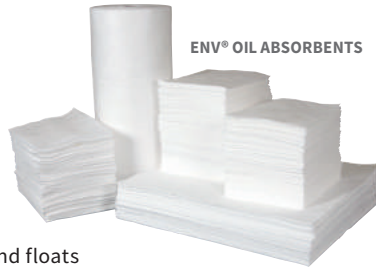

ENV® OIL ABSORBENTS

## ENV® OIL ABSORBENTS

Used for oil and petroleum-based fluids. Equally effective on land and water. Repels water and floats indefinitely, even when saturated. Pads and rolls are MAXX Enhanced for greater performance without extra weight.

ITEM #	MARTIN #	DESCRIPTION	SIZES	UOM	PRICE
ENV200	BRAENV200	Pads, lightweight	15" x 19"	200/BL	\$79.19
ENV300	BRAENV300	Pads, medium weight	15" x 19"	100/BL	\$62.36
ENV100	BRAENV100	Pads, heavyweight	15" x 19"	100/BL	\$74.24
ENV510	BRAENV510	Economy booms w/ blue sleeve	5" x 10'	4/BL	\$118.79
ENV810	BRAENV810	Economy booms w/ blue sleeve	8" x 10'	4/BL	\$153.44



SPC® OIL ABSORBENTS

## SPC® OIL ABSORBENTS

Convenient and cost-effective, oil sorbents will not absorb water: will float indefinitely, are wringable, dustless, unaffected by temperature, flame-resistant and impervious to both rot and mildew. Pads are dimpled and perforated. Rolls are impact bonded. Pillows and booms are lint-free. Product is also incinerable and leaves only .02% ash.

ITEM #	MARTIN #	DESCRIPTION	SIZES	UOM	PRICE
SPC100	BRASPC100	Pads, heavyweight	15" x 19"	100/BL	\$94.04
SPC200	BRASPC200	Pads, lightweight	15" x 19"	200/BL	\$103.94
SPC300	BRASPC300	Pads, medium weight	15" x 19"	100/BL	\$79.19
SPC150	BRASPC150	Roll, heavyweight	38" x 144'	1/BL	\$201.95



WFMF100

## FINE FIBER DIMPLED OIL-ONLY SORBENTS

Soft, super-sorbent fiber that resembles tissue paper. Thermally bonded thin layer on each side of MBT standard, coarse-fiber, meltblown polypropylene. Absorbs quickly, removes sheen, and grips cement floors. White.

ITEM #	MARTIN #	DESCRIPTION	SIZES	UOM	PRICE
WFMF100	MLTBWFMF100	White oil-only pads, heavyweight	15" x 18"	100/BL	\$69.44
WFMFL100	MLTBWFMFL100	White oil-only pads, medium weight	15" x 18"	100/BL	\$64.20
WFMF150	MLTBWFMF150	White oil-only roll, heavyweight	30" x 150'	1/RL	\$133.32
WFMF150S	MLTBWFMF150S	White oil-only rolls, heavyweight	15" x 150'	2/RL/CS	\$133.32
WFMF150S-1	MLTBWFMF150S-1	White oil-only roll, heavyweight	15" x 150'	1/RL	\$81.56
WFMFL150	MLTBWFMFL150	White oil-only roll, medium weight	30" x 150'	1/RL	\$113.21
WFMFL150S	MLTBWFMFL150S	White oil-only rolls, medium weight	15" x 150'	2/RL/CS	\$113.21
WFMFL150S-1	MLTBWFMFL150S-1	White oil-only roll, medium weight	15" x 150'	1/RL	\$70.53



WDM150



## MELTBLOWN DIMPLED OIL-ONLY SORBENTS

Similar to MBT standard meltblown products. Media is passed through a thermal bonder, which ties down loose fibers. Dimpled sorbents are also perforated, which minimizes waste. Selectively absorbs oil, repels water. Highly absorbent white products also show where liquids are absorbed.

ITEM #	MARTIN #	DESCRIPTION	SIZES	UOM	PRICE
WDM100	MLTBWDM100	White oil-only pads, heavyweight	15" x 18"	100/BL	\$56.82
WDM200	MLTBWDM200	White oil-only pads, lightweight	15" x 18"	200/BL	\$58.85
WDM50	MLTBWDM50	White oil-only pads, heavyweight	30" x 36"	50/BL	\$105.57
WDM200-HQ	MLTBWDM200-HQ	White oil-only pads, lightweight	15" x 18"	100/BL	\$36.38
WDML100	MLTBWDML100	White oil-only pads, medium weight	15" x 18"	100/CS	\$47.08
WDM150	MLTBWDM150	White oil-only roll, heavyweight	30" x 150'	1/RL	\$134.24
WDM150S	MLTBWDM150S	White oil-only rolls, heavyweight	15" x 150'	2/RL/CS	\$92.58
WDM144	MLTBWDM144	White oil-only roll, heavyweight	38" x 144'	1/RL	\$145.52
WDM143	MLTBWDM143	White oil-only roll, medium weight	38" x 144'	1/RL	\$126.26



CH100

## BRIGHTSORB™ HIGH-VISIBILITY CHEMICAL ABSORBENTS

All-purpose industrial absorbents feature a yellow caution color and printed message to visually warn workers of potential slips, trips and fall risks as well as easy separation for hazardous waste. Three-ply SMM construction and a low linting material that will not react to aggressive fluids.

ITEM #	MARTIN #	DESCRIPTION	SIZES	UOM	PRICE
CH100	BRACH100	Heavyweight pads	15" x 19"	100/CS	\$118.79
CH200	BRACH200	Lightweight pads	15" x 19"	200/CS	\$136.61
CH303	BRACH303	Medium weight roll, perfed every 15" & up center	30" x 300'	1/RL	\$212.84
CH30DP	BRACH30DP	Heavyweight roll, perfed every 15" & up center	30" x 150'	1/RL	\$197.00
CH15P	BRACH15P	Medium weight roll, perfed every 18"	15" x 150'	1/RL	\$128.69



YSMF100-HV



## HIGH-VISIBILITY HAZMAT ABSORBENTS

Provides protection against slips, trips and falls. Caution mat has the international symbol for slip hazard repeating throughout the mat making it ideal for use anywhere from factory to hospitality. Spunbond side is abrasion-resistant, great for foot traffic or heavy-duty wiping applications. Fine fiber side grips smooth surfaces (like cement) to reduce slips, trips & falls. Absorbs most fluids, including oil (hydrocarbon-based fluids), water, glycols, acids and caustics. A perforation helps reduce waste.

ITEM #	MARTIN #	DESCRIPTION	SIZES	UOM	PRICE
YSMF100-HV	MLTBYSMF100-HV	Hi-viz yellow heavyweight pads	15" x 18"	100/CS	\$109.14
YSMF150-HV	MLTBYSMF150-HV	Hi-viz yellow heavyweight roll	30" x 150'	1/RL	\$196.88
YSMF36150-HV	MLTBYSMF36150-HV	Hi-viz yellow heavyweight roll	36" x 150'	1/RL	\$276.09
YSMF24150-HV	MLTBYSMF24150-HV	Hi-viz yellow heavyweight roll	24" x 150'	1/RL	\$185.38



**BASIC OIL-ONLY PADS**

Durable absorbent for cleaning and containing petroleum-based spills and leaks. Proven to absorb liquids and repel water. Effective in both industrial and environmental applications. Fast, easy cleanup during emergency spills. Measures: 15" x 17".



BPO100

ITEM #	MARTIN #	DESCRIPTION	UOM	PRICE
BPO200	BRABPO200	Pads, lightweight	200/BL	\$57.41
BPO100	BRABPO100	Pads, heavyweight	100/BL	\$39.59



**BASIC UNIVERSAL PADS**

General purpose sorbents clean up oils, coolants, solvents and water-based fluids and absorb up to 20 times their weight. Ideal for use around assembly lines, printing equipment or any general manufacturing area. Measures: 15" x 17".



BPU100

ITEM #	MARTIN #	DESCRIPTION	UOM	PRICE
BPU100	BRABPU100	Pads, heavyweight	100/BL	\$44.54
BPU200	BRABPU200	Pads, heavyweight	200/BL	\$59.39



**GP MAXX ENHANCED PADS**

Economically priced and cleans up virtually any liquid. Constructed of 1-ply dimpled economy weight material. Gray color helps hide dirt. Utilizes the exclusive MAXX Enhanced technology for greater strength and absorbency. Measures: 15" x 19".

ITEM #	MARTIN #	DESCRIPTION	UOM	PRICE
GP200	BRAGP200	Pads, lightweight	200/BL	\$94.04
GP100	BRAGP100	Pads, heavyweight	100/BL	\$89.09



**GRAY DIMPLED PADS**

Gray dimpled meltblown polypropylene sorbents are single-layer, economical sorbents. Sorbents are passed through a thermal bonder, which ties down loose fibers. Dimpled sorbents are also perforated, which promotes waste minimization. Dimpled for fast wicking. Highly absorbent. Measures: 15" x 18".

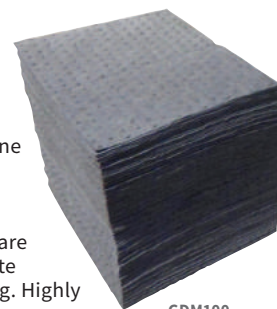

GDM100

ITEM #	MARTIN #	DESCRIPTION	UOM	PRICE
GDM100	MLTBGDM100	Heavyweight pads	100/CS	\$57.78
GDML100	MLTBGDML100	Medium weight pads	100/CS	\$47.08
GDM200	MLTBGDM200	Lightweight pads	200/CS	\$68.48



**GRAY FINE FIBER UNIVERSAL ABSORBENTS**

Fine fiber meltblown polypropylene sorbents have a soft, super-absorbent fiber that resembles tissue paper. Thermally bonded thin layer on each side of the standard, coarse-fiber, meltblown polypropylene. Composites absorb quickly, remove the sheen, and grip cement floors. Highest quality, fast wicking and great durability. Perforated.

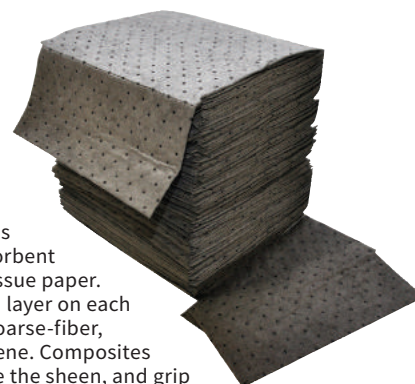

GFMF100

ITEM #	MARTIN #	DESCRIPTION	SIZES	UOM	PRICE
GFMF100	MLTBGFMF100	Heavyweight pads	15" x 18"	100/CS	\$68.48
GFMFL100	MLTBGFMFL100	Medium weight pads	15" x 18"	100/CS	\$63.67
GFMF150	MLTBGFMF150	Heavyweight roll	30" x 150'	CS	\$132.68
GFMF150S	MLTBGFMF150S	Heavyweight rolls	15" x 150'	2 RL/CS	\$132.68
GFMF150S-1	MLTBGFMF150S-1	Heavyweight roll	15" x 150'	CS	\$72.22
GFMFL150	MLTBGFMFL150	Medium weight roll	30" x 150'	CS	\$113.21
GFMFL150S	MLTBGFMFL150S	Medium weight rolls	15" x 150'	2 RL/CS	\$113.21
GFMFL150S-1	MLTBGFMFL150S-1	Medium weight roll	15" x 150'	CS	\$67.84

GP200







## MRO PLUS® ABSORBENTS

Medium and heavyweight, 3-ply dimpled material with enhanced thickness and strength. Suitable for virtually any industrial application. Low-linting and absorbs water, petroleum and chemical-based fluids.



MRO PLUS® ABSORBENTS

ITEM #	MARTIN #	DESCRIPTION	CAPACITY	SIZES	UOM	PRICE
<i>Heavyweight</i>						
MRO100	BRAMRO100	Pad, full size	26 gal./Cs	15" x 19"	100/CS	\$108.89
MRO15P	BRAMRO15P	Roll, perfed every 18"	25 gal./Cs	15" x 150'	RL	\$131.66
MRO30-DP	BRAMRO30-DP	Roll, perfed every 15" & up center	50 gal./RL	30" x 150'	RL	\$202.94
<i>Medium Weight</i>						
MRO300	BRAMRO300	Pad, perfed	20 1/2 gals./Cs	15" x 19"	100/CS	\$87.11
MRO350-DP	BRAMRO350-DP	Roll, perfed every 15" & up center	38 gal./Cs	30" x 150'	RL	\$143.54



## ALLWIK® PILLOWS

All-purpose polypropylene pillows are suitable for most industrial applications and are ideal for use under valves and other dripping applications. Gray color masks spills and stains. Measures: 18" x 18".



AW1818

ITEM #	MARTIN #	DESCRIPTION	UOM	PRICE
AW1818	BRAAW1818	Pillows	16/CS	\$102.95



## THIRSTY SOCK, PADS AND MEGA THIRSTY PADS

Ideal for tight spaces where buckets won't fit. Can be left in place to absorb leaks – no need for repeated mopping. Surfaces are quickly made safe from slip hazards. Maintain clean and dry working for public-access areas. Avoids lasting damage to flooring. Easy disposal in standard waste, liquid turns to gel – no drips or cross-contamination. Each pad can absorb 5 gallons. Each sock can absorb 2.5 gallons.



M001-U-TP-P

ITEM #	MARTIN #	DESCRIPTION	SIZES	UOM	PRICE
M001-U-TP-P	MLTBM001-U-TP-P	Thirsty Pads, 16 Pk/Cs	7.87" x 7.87"	CS	\$387.20
M001-U-TP-B	MLTBM001-U-TP-B	Thirsty Pads Pro Pack, 26 Pk/Cs	7.87" x 7.87"	CS	\$475.80
M001-U-MTP-P	MLTBM001-U-MTP-P	Mega Thirsty Pads, 16 Pk/Cs	14" x 14.4"	CS	\$312.80
M001-U-MTP-B	MLTBM001-U-MTP-B	Mega Thirsty Pro Pack, 26 Pk/Cs	14" x 14.4"	CS	\$475.80
M001-U-TS-P	MLTBM001-U-TS-P	Thirsty Sock, 30 Pk/Cs	4.72" x 39.37"	CS	\$352.50



## ALLWIK® SOCS

Dependable, flexible tubes contain and absorb liquid spills. SOCs mold around corners and conform to uneven surfaces to prevent spreading and soak up spills and drips around the workplace. Available in a variety of types and sizes for any application.



AW124

ITEM #	MARTIN #	DESCRIPTION	SIZES	UOM	PRICE
AW430	BRAAW430	SOCs, ALLWIK	3" x 4'	30/CS	\$141.56
AW124	BRAAW124	SOCs, ALLWIK	3" x 12'	4/CS	\$88.10



## INDUSTRIAL ABSORBENT SOCKS

Ideal for absorbing leaks and spills around machines, as well as helping to keep a facility in compliance. Absorbent socks provide great flexibility to bend or wrap the sock around equipment to catch leaks in tight spaces.

- White oil-only socks absorb hydrocarbon-based fluids and repel water. Great for outdoor applications. Also used near entrance ways to keep rain out.
- Gray universal socks absorb general fluids, such as oil, water, cutting fluids, glycols, etc. Used to line and protect walkways, drains, and entrances.
- Yellow hazmat socks are used in laboratory-type environments, or in spill kits, for emergency spill situations involving hazardous/aggressive chemicals such as acids.



GPS3144-10

ITEM #	MARTIN #	DESCRIPTION	COLOR	SIZES	UOM	PRICE
GPS3144-10	MLTBGPS3144-10	Universal absorbent socks	Gray	3" x 12'	10/CS	\$90.95
GPS348-30	MLTBGPS348-30	Universal absorbent socks	Gray	3" x 4'	30/CS	\$90.95
GPS396-15	MLTBGPS396-15	Universal absorbent socks	Gray	3" x 8'	15/CS	\$90.95
CS348-30	MLTBCS348-30	Universal absorbent socks	Camouflage	3" x 4'	30/CS	\$92.58
CS348-15	MLTBCS348-15	Universal absorbent socks	Camouflage	3" x 4'	15/CS	\$141.95
OS3144-10	MLTBOS3144-10	Oil-only absorbent socks	White	3" x 12'	10/CS	\$102.72
OS348-30	MLTBOS348-30	Oil-only absorbent socks	White	3" x 4'	30/CS	\$102.72
OS396-15	MLTBOS396-15	Oil-only absorbent socks	White	3" x 8'	15/CS	\$102.72
HZS348-30	MLTBHZS348-30	Hazmat absorbent socks	Yellow	3" x 4'	30/CS	\$99.51
HZS3144-10	MLTBHZS3144-10	Hazmat absorbent socks	Yellow	3" x 12'	10/CS	\$99.51



**TRI-FOLD ROLLS**

Can be used as a sock or unfolded and used as a pad. Available in universal gray that absorbs oils, coolants, solvents and water-based fluid; or oil-only white that selectively absorbs oils, while repelling water. Unfolds to 15" wide. Perfed every 17". Measures: 5" x 50'.

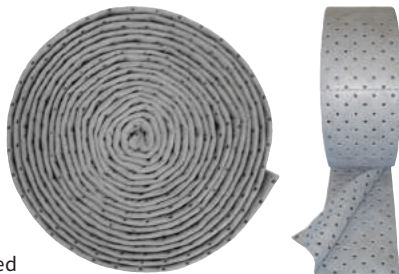

G750

ITEM #	MARTIN #	DESCRIPTION	COLOR	UOM	PRICE
G750	MLTBG750	Universal roll	Gray	CS	\$37.04
W750	MLTBW750	Oil-only roll	White	CS	\$34.72



**DRUM TOPPERS**

Keep drum tops clean. Pads mount on 55-gallon drums to eliminate messy drips and overflow when mixing or pumping liquids. Ideal for oil spill control and spill clean-up for messes around drums. Pads soak up oil, coolants, solvents and water. Two pre-cut bunghole cutouts to fit evenly on 55-gallon drums. Available in gray (universal) or white (oil-only) for indoor use. 22" dia.

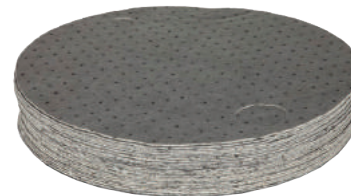

GDT22NL

ITEM #	MARTIN #	DESCRIPTION	COLOR	UOM	PRICE
GDT22NL	MLTBGDT22NL	Universal drum toppers	Gray	25/CS	\$57.78
WDT22NL	MLTBWDT22NL	Oil-only drum toppers	White	25/CS	\$57.78



**FLOOD BARRIERS**

For long term flooding or temporary flash floods. Lightweight, quick and ready-filled. Easy to store when not in use and easy to unroll in an emergency. Can be stacked for added height or curved round obstacles. Protects any door threshold. Great for driveways and gateways. 5' Barriers can absorb up to 4 gallons; 10' barriers can absorb up to 8 gallons.

ITEM #	MARTIN #	DESCRIPTION	SIZES	UOM	PRICE
M001-U-FB5F-P	MLTBM001-U-FB5F-P	5' Flood Barrier, 16 Pk/Cs	8.26" x 59.05"	CS	\$286.40
M001-U-FB5F-B	MLTBM001-U-FB5F-B	5' Flood Barrier Pro Pack, 24 Pk/Cs	8.26" x 59.05"	CS	\$326.40
M001-U-FB10F-P	MLTBM001-U-FB10F-P	10' Flood Barrier, 8 Pk/Cs	8.26" x 118.11"	CS	\$204.48
M001-U-FB10F-B	MLTBM001-U-FB10F-B	10' Flood Barrier Pro Pack, 10 Pk/Cs	8.26" x 118.11"	CS	\$271.50



M001-U-FB5F-P



**XTRA STICKY MATS**

Features sticky backing to help keep in place, but also allows for easy removal or replacement when no longer needed. Heavyweight mat provides great absorbency of oil, water and solvents. Helps prevent slipping and falling where water is present.

ITEM #	MARTIN #	DESCRIPTION	SIZES	UOM	PRICE
XSMB3650	MLTBXSMB3650	Adhesive floor mat	36" x 50'	CS	\$190.46
XSMB36100	MLTBXSMB36100	Adhesive floor mat	36" x 100'	CS	\$318.86
XSMB1850	MLTBXSMB1850	Adhesive floor mat	18" x 50'	CS	\$99.51
XSMB18100	MLTBXSMB18100	Adhesive floor mat	18" x 100'	CS	\$181.90



XSMB1850



**SPUNBOND FINE FIBER AND CAMO SORBENTS**

Industrial camouflage mats are great for hiding fluid stains and foot prints. Hi-viz orange infused into the camo pattern allows better visibility even in low light conditions, further preventing slips, trips, and falls. Stiff, durable, camouflage side faces up, and the soft, tacky, fine fiber side goes down. Perforated for ease of used.

ITEM #	MARTIN #	DESCRIPTION	SIZES	UOM	PRICE
GSMF100	MLTBGSMF100	Gray heavyweight pads	15" x 18"	100/CS	\$80.79
GSMFL100	MLTBGSMFL100	Gray medium weight pads	15" x 18"	100/CS	\$64.80
GSMF150	MLTBGSMF150	Gray heavyweight roll	30" x 150'	CS	\$179.33
GSMF150S	MLTBGSMF150S	Gray heavweight rolls	15" x 150'	2 RL/CS	\$179.33
GSMF150S-1	MLTBGSMF150S-1	Gray heavyweight roll	15" x 150'	CS	\$99.77
GSMFL150	MLTBGSMFL150	Gray medium weight roll	30" x 150'	CS	\$111.28
GSMF200	MLTBGSMF200	Gray light weight pads	15" x 18"	200/CS	\$85.39
GSMF300	MLTBGSMF300	Gray lightweight roll	30" x 300'	CS	\$179.76
GSMF300S	MLTBGSMF300S	Gray lightweight rolls	15" x 300'	2 RL/CS	\$179.76
GSMF300S-1	MLTBGSMF300S-1	Gray lightweight roll	15" x 300'	CS	\$89.88
CSMF150	MLTBSCMF150	Camo heavyweight roll	30" x 150'	CS	\$203.30
CSMF150S-1	MLTBSCMF150S-1	Camo heavyweight roll	15" x 150'	CS	\$103.79



CSMF150



## OIL-ONLY SPILLTRATION® ORIGINAL SMOOSHKIT™

SmooshKit is all about space savings. Smooshing technology solves the common space constraints that many fleet and remote industries face. Proprietary process compresses material into compact packages that can fit anywhere. Ideal for back seat of pickup trucks, glove boxes, toolboxes and other utility containers. A handy UnSmoosher is provided to easily open the SmooshKit.



### SPL046 and SPL054 kits contain:

- (30) White oil shammy towels
- (5) Gray Husky pads
- (1) Pair nitrile gloves
- (1) Yellow disposal bag

### SPL067 kit contains:

- (3) Gray Husky strips
- (3) Gray Husky pads
- (5) Yellow universal pads
- (1) Pair nitrile gloves
- (1) Yellow disposal bag

### SPL082 kit contains:

- (2) Gray Husky strips
- (5) Gray Husky pads
- (1) Pair nitrile gloves

ITEM #	MARTIN #	DESCRIPTION	SIZES	UOM	PRICE
SPL046	MLTBSPL046	Oil-Only Spiltration Original SmooshKit	5 gal.	CS	\$524.30
SPL054	MLTBSPL054	Oil-Only Spiltration Original SmooshKit	3 gal.	CS	\$625.96
SPL082	MLTBSPL082	Oil-Only Spiltration Original SmooshKit	5 gal.	CS	\$147.66
SPL067	MLTBSPL067	Universal All Fluids Vehicle Spiltration Original SmooshKit	4.5 gal.	CS	\$782.18



## EMERGENCY RESPONSE BAG SPILL KIT

Clear bag spill kit allows for quick access to absorbents for quick response to small to medium spills. Lightweight; fits almost anywhere. Absorbs up to 13 gallons per kit.

### Kit contains:

- (32) 15" x 18" Pads
- (5) 3" x 4' Socks
- (1) 18" x 18" Pillow
- (3) Disposal bags
- (1 pair) Goggles
- (1 pair) Nitrile gloves
- (1) Emergency Response Guidebook

ITEM #	MARTIN #	DESCRIPTION	UOM	PRICE
GPSK-CFB	MLTBGPSK-CFB	MRO bag spill kit	CS	\$112.97
OSSK-CFB	MLTBOSSK-CFB	Oil-only bag spill kit	CS	\$109.17
HZSK-CFB	MLTBHZSK-CFB	Hazmat bag spill kit	CS	\$143.38

SKA-PP



## ECONOMY SPILL KITS

Highly visible yellow PVC bag is just right for small spills. Absorbs up to 5 gals.

### Kit contains:

- (10) 15" x 19" Pads
- (2) 3" x 4' SOCs
- (1) Pair nitrile gloves
- (1) Disposal bag
- (1) Instruction sheet

**⚠️ WARNING:** This product can expose you to chemicals which are known to the State of California to cause birth defects or other reproductive harm. For more information go to [www.P65Warnings.ca.gov](http://www.P65Warnings.ca.gov).

ITEM #	MARTIN #	DESCRIPTION	UOM	PRICE
SKA-PP	BRASKA-PP	Spill kit, ALLWIK®	KIT	\$54.44
SKO-PP	BRASKO-PP	Spill kit, oil-only	KIT	\$54.44



## BUCKET SPILL KITS

Lightweight kit with large, easy-to-grab handle allows for easy carrying and quick response. Place in areas around workplace for fast response to small spills. Screw-on top twists off easily for quick access to sorbents. Clear bag allows for quick access to absorbents. Absorbs up to 15 gallons per kit. Reusable bucket is 14" dia. x 18" H.



### Kit contains:

- (10) 15" x 18" Pads
- (3) 3" x 4' Socks
- (2) Disposal bags
- (1 pair) Nitrile gloves
- (1) Instruction sheet

ITEM #	MARTIN #	DESCRIPTION	UOM	PRICE
GPSK-BKT	MLTBGPSK-BKT	MRO bucket kit	CS	\$59.92
OSSK-BKT	MLTBOSSK-BKT	Oil-only bucket kit	CS	\$63.45
HZSK-BKT	MLTBHZSK-BKT	Hazmat bucket kit	CS	\$72.01



**20-GAL. LAB PACK SPILL KITS**

Water- and chemical-resistant polyethylene lab pack with screw top lid for small to medium response situations. Can absorb up to 17 gals. Available in oil-only for oil and petroleum-based spills, ALLWIK® for oil, water-based and chemical spills, and HAZWIK® for aggressive liquid and hazardous material spills. UN Approved.



SKA-20

**Kit contains:**

- (12) 15" x 19" Pads
- (3) 3" x 12' SOCs
- (2) 18" x 18" Pillows
- (1) Pair goggles
- (1) Pair nitrile gloves
- (3) Disposal bags
- (1) Emergency response handbook

ITEM #	MARTIN #	DESCRIPTION	UOM	PRICE
SKA-20	BRASKA-20	Lab pack, ALLWIK	KIT	\$292.04
SKO-20	BRASKO-20	Lab pack, oil-only	KIT	\$292.04



**55-GAL. LAB PACKS**

Open and close this lever locking 55-gal. drum for fast spill response. Available in oil-only for oil and petroleum-based spills, ALLWIK® for oil, water-based and chemical spills, and HAZWIK® for aggressive liquid and hazardous material spills. Drum meets UN specifications. Absorbs up to 38 gals.



SKA-55

**Kit contains:**

- (50) 15" x 19" Pads
- (4) 3" x 12' SOCs
- (8) 18" x 18" Pillows
- (1) Pair goggles
- (1) Pair nitrile gloves
- (5) Disposal bags
- (1) Emergency response handbook

ITEM #	MARTIN #	DESCRIPTION	UOM	PRICE
SKA-55	BRASKA-55	Lab pack, ALLWIK	KIT	\$568.25
SKO-55	BRASKO-55	Lab pack, oil-only	KIT	\$568.25



HZSK-30



**30-GAL. OVERPACK SPILL KITS**

Tough, secure screw top spill kit is reusable and ideal for small to medium spills. A kit for everyday spills or absorb any type of spill fast with quality MBT sorbent. Absorbs up to 36 gallons per kit. UN-approved overpack. 21" dia. x 28 1/2" H. Complies with DOT CFR 173.3(c).

**Kit contains:**

- (25) 15" x 18" Pads
- (6) 3" x 12' Socks
- (6) 18" x 18" Pillows
- (3) Disposal bags
- (1 pair) Goggles
- (1 pair) Nitrile gloves
- (1) Emergency Response Guidebook

ITEM #	MARTIN #	DESCRIPTION	UOM	PRICE
GPSK-30	MLTBGPSK-30	MRO overpack kit	CS	\$262.32
OSSK-30	MLTBOSSK-30	Oil-only overpack kit	CS	\$322.92
HZSK-30	MLTBHZSK-30	Hazmat overpack kit	CS	\$357.63



**55-GAL. DRUM SPILL KITS**

Ideal for medium-sized spills. Easy-to-open lever lock ensures readiness and a fast response to any spill. Good size for most industrial response applications. Absorbs up to 38 gallons per kit. 24" dia. x 37" H. Drum meets UN specifications.



OSSK-55

**Kit contains:**

- (50) 15" x 18" Pads
- (4) 3" x 12' Socks
- (8) 18" x 18" Pillows
- (5) Disposal bags
- (1 pair) Goggles
- (1 pair) Nitrile gloves
- (1) Emergency Response Guidebook

ITEM #	MARTIN #	DESCRIPTION	UOM	PRICE
GPSK-55	MLTBGPSK-55	MRO drum kit	CS	\$468.66
OSSK-55	MLTBOSSK-55	Oil-only drum kit	CS	\$467.91
HZSK-55	MLTBHZSK-55	Hazmat drum kit	CS	\$468.66



DuPont  
Personal Protection





Absorbents.....	149-154	► <b>Fall Protection .....</b>	<b>96-112</b>
Accessories, eye protection .....	18	Accessories, fall protection.....	108
Accessories, fall protection.....	108	Anchors.....	105-105
Accessories, head protection .....	19-23	Beam anchor .....	105
Accessories, respiratory .....	32-34, 37	Cable anchor .....	105
Accident prevent tags .....	148	Carabiners & tools .....	108-112
Aisle marking tapes .....	144	Coil lanyards .....	112
Anchors .....	105-105	Confined space & rescue .....	107
Aprons.....	78, 81, 84	Cross arm strap.....	105
Arc flash kits .....	84-85	Harnesses.....	96-99
Automated test system.....	120	Hoists.....	107
Back support belts.....	76	Horizontal lifelines .....	106
Ball valves lockouts.....	131, 135	Lanyards .....	99-101
Bandanas .....	140-141	Lifeline systems .....	106-107
Beam anchor .....	105	Quick wrap tape.....	110
Breaker lockouts .....	132, 136	Ratchets.....	109
Cable anchor .....	105	Roof anchor.....	105
Cable lockouts .....	131	Safety straps .....	108
Calibration stations.....	115, 121	Screwdriver set.....	109
Carabiners & tools.....	108-112	SLRs .....	101-104
Cartridges and filters .....	32-34	Sockets.....	110
Chemical-resistant gloves.....	65-68	Tethers.....	110, 112
► <b>Clothing.....</b>	<b>75-94</b>	Tool holsters .....	111
Coil lanyards .....	112	Tool set.....	109
Confined space & rescue.....	107	Toolbelt.....	108
Confined space kits .....	118	Tripods .....	107
Coolers.....	138-139	► <b>Facility Care .....</b>	<b>113-154</b>
Cooling hats.....	140-141	Fall protection accessories .....	108
Cooling towels.....	141-142	First aid cabinets & stations.....	122, 125
Cooling vests.....	142	First aid kits.....	123-126
Coveralls.....	77-78	Fit test kit .....	37
Cross arm strap.....	105	Flame-resistant clothing .....	79-83
Cut-resistant gloves.....	48-56	Floor marking tapes .....	144
Disposable clothing .....	77-79	Floor matting .....	127-128
Disposable gloves .....	62-64	► <b>Footwear .....</b>	<b>91-93</b>
Disposable respirators.....	24-28	FR apparel.....	79-83
Drink mixes .....	138-139	FR coveralls.....	82-83
Earmuffs .....	44-46	FR jackets .....	79, 83
Earplug dispensers .....	41, 43-44	FR pants.....	80
Earplugs.....	38-44	FR shirts .....	81-82
Electrical lockouts .....	132	FR sleeves.....	83
Electrolyte drink mixes.....	138-139	Frocks .....	78
Ergonomics.....	76	Full facepiece respirators .....	30-32
Eye protection .....	8-18	Gas cylinders .....	118, 121
Eyewear accessories .....	18	Gate valve lockouts .....	130, 135
Faceshields .....	22	General purpose gloves .....	59-62

Glasses .....	8-15	Hard hat pads.....	141
▶ <b>Glasses &amp; Goggles</b> .....	<b>8-18</b>	Water, bottled .....	138
Accessories, eye protection.....	18	Hi-viz Clothing.....	85-88
Eye protection.....	8-18	Hi-viz jackets.....	88
Glasses.....	8-15	Hi-viz shirts.....	87
Gloves.....	48-74	Hoists.....	107
Goggles.....	15-18	Hoods, respiratory .....	36
Lens cleaning station .....	18	Horizontal lifelines .....	106
Lens towelettes .....	18	Jackets.....	79, 83, 88
Safety eyewear .....	8-18	Lab kits.....	153-154
Side shields .....	18	Lab coats.....	78-79
Goggles.....	15-18	Label printer .....	143
Group lockout box.....	133-134	Lanyards.....	99-101
Half facepiece respirators .....	28-30	Leather gloves .....	56-59
▶ <b>Hand Protection</b> .....	<b>48-74</b>	Lens cleaning station.....	18
Cut-resistant gloves.....	48-56	Lens towelettes.....	18
Leather gloves.....	56-59	Lifeline systems.....	106-107
General purpose gloves.....	59-62	Lockout kits.....	133
Disposable gloves .....	62-64	Lockout tags.....	134-135
Chemical-resistant gloves.....	65-68	Locks.....	129
Heat-resistant gloves .....	68-71	▶ <b>LOTO</b> .....	<b>129-136</b>
Welding gloves.....	71-74	Padlocks .....	129
Hard hat frames .....	19, 23	Ball valves lockouts.....	131, 135
▶ <b>Hard Hats</b> .....	<b>19-22</b>	Breaker lockouts.....	132, 136
Accessories, head protection .....	19-23	Cable lockouts .....	131
Faceshields.....	22	Electrical lockouts .....	132
Hard hat frames.....	19, 23	Gate valve lockouts .....	130, 135
Hard Hats .....	19-22	Group lockout box.....	133-134
Hard hat pads.....	141	Hasps .....	129-130
Hard Hats .....	19-22	Lockout kits.....	133
Headgear .....	23	Lockout tags .....	134-135
Head protection accessories.....	19-23	Plug lockouts.....	132, 136
▶ <b>Head &amp; Face Protection</b> .....	<b>8-46</b>	Safety locks.....	129
▶ <b>Hearing</b> .....	<b>38-46</b>	Wall switch lockouts.....	132, 136
Earmuffs .....	44-46	Matting .....	127-128
Earplug dispensers.....	41, 43-44	▶ <b>Monitors &amp; Instrumentation</b> .....	<b>114-121</b>
Earplugs.....	38-44	Automated test system.....	120
Visors .....	20, 22	Calibration stations.....	115, 121
Harnesses.....	96-99	Confined space kits .....	118
Hasps .....	129-130	Gas cylinders .....	118, 121
Heat-resistant gloves .....	68-71	Multi-gas detectors .....	114-117, 119-120
▶ <b>Heat Stress</b> .....	<b>137-142</b>	Regulators.....	119, 121
Bandanas.....	140-141	Single-gas detectors .....	114-116, 119
Coolers .....	138-139	Multi-gas detectors .....	114-117, 119-120
Cooling hats.....	140-141	Nomex hoods .....	81
Cooling towels.....	141-142	Padlocks.....	129
Cooling vests.....	142	Pads & rolls .....	149-154
Drink mixes .....	138-139	PAPRs .....	34-36



Plug lockouts.....	132, 136	Roof anchor .....	105
Printer ribbons & tapes .....	143	Safety eyewear .....	8-18
► <b>Protective Clothing.....</b>	<b>75-94</b>	Safety labels.....	146
Aprons.....	78, 81, 84	Safety locks.....	129
Arc flash kits.....	84-85	Safety signs.....	145-146
Back support belts .....	76	Safety straps .....	108
Clothing.....	75-94	Safety vests .....	85-86
Coveralls .....	77-78	SCBAs.....	37
Disposable clothing.....	77-79	Screwdriver set.....	109
Ergonomics .....	75-76	Shoe covers.....	79
Flame-resistant clothing.....	79-83	Side shields .....	18
Footwear.....	91-94	Sign & label printer .....	143
FR apparel.....	79-83	► <b>Signs .....</b>	<b>143-148</b>
FR coveralls.....	82-83	Accident prevent tags .....	148
FR jackets .....	79, 83	Aisle marking tapes .....	144
FR pants.....	80	Floor marking tapes .....	144
FR shirts .....	81-82	Label printer .....	143
FR sleeves.....	83	Printer ribbons & tapes .....	143
Frocks .....	78	Safety labels.....	146
Hi-viz Clothing.....	85-88	Safety signs .....	145-146
Hi-viz jackets.....	88	Sign & label printer .....	143
Hi-viz shirts.....	87	Signs.....	145-146
Jackets.....	79, 83, 88	Tags .....	146, 148
Lab coats .....	78-79	Tags by the roll .....	146
Nomex hoods.....	81	Single-gas detectors.....	114-116, 119
Rainwear.....	89-90	Sleeves .....	54-55, 83
Safety vests .....	85-86	SLRs .....	101-104
Shoe covers.....	79	Sockets.....	110
Specialty clothing.....	84-85	Specialty clothing .....	84-85
Vests.....	85-86	► <b>Spill Control .....</b>	<b>149-154</b>
Wrist supports .....	76	Absorbents.....	149-154
Protective sleeves.....	54-55, 83	Lab kits.....	153-154
Quick wrap tape.....	110	Pads & rolls .....	149-154
Rainwear.....	89-90	Spill containment .....	149-154
Ratchets.....	109	Tags .....	146, 148
Reading safety glasses .....	12	Tags by the roll .....	146
Regulators .....	119, 121	Tethers .....	110, 112
Respirator towelettes.....	37	Tool holsters .....	111
► <b>Respiratory .....</b>	<b>24-37</b>	Tool set.....	109
Accessories, respiratory .....	32-34, 37	Toolbelt.....	108
Cartridges and filters .....	32-34	Tripods .....	107
Disposable respirators.....	24-28	Vests.....	85-86
Fit test kit .....	37	Visors .....	20, 22
Full facepiece respirators .....	30-32	Wall switch lockouts.....	132, 136
Half facepiece respirators.....	28-30	Water, bottled.....	138
Hoods, respiratory.....	36	Welding gloves.....	71-74
PAPRs.....	34-36	Wrist supports .....	76
Respirator towelettes.....	37		
SCBAs.....	37		
Respiratory accessories.....	32-34, 37		

## CONTROLLING TERMS AND CONDITIONS

All purchases and sales of products (the "Products") and services (the "Services") between Buyer and Martin Inc. (or any affiliate thereof, "Martin Inc.") shall be made pursuant to and on the price terms indicated in Martin Inc.'s quote and/or order acknowledgment and shall be governed by these Terms and Conditions. These Terms and Conditions and Martin Inc.'s quote and/or order acknowledgment shall constitute the entire agreement between the parties pertaining to the subject matter hereof, and shall supersede all prior or contemporaneous oral or written negotiations, agreements, understanding or representations with respect thereto. These Terms and Conditions shall supersede any conflicting provision contained in any purchase order of Buyer. Unless otherwise agreed in writing, nothing contained in any purchase order of Buyer shall in any way modify or add any provision to these Terms and Conditions. These Terms and Conditions may not be amended or any provision hereof waived in any way except by an instrument in writing signed by both parties. If Martin Inc.'s quote is deemed an offer, Buyer agrees that its acceptance of such offer is expressly limited to provisions contained solely in these Terms and Conditions. Buyer's issuance of a purchase order shall solely be deemed to be an acceptance of these Terms and Conditions. If Martin Inc.'s order acknowledgment is deemed to be an acceptance of Buyer's purchase order, Martin Inc.'s acceptance of such purchase order is expressly made conditional on Buyer's assent to any additional and different terms contained herein, and failure by Buyer to specifically object to these Terms and Conditions in writing within twenty (20) days of receipt shall constitute an acceptance of these Terms and Conditions.

### PRICES

Prices displayed in all printed catalogs or printed promotional materials are effective as of the date of the publication and are subject to change without notification. Prices shown are for product only and do not contain any shipping, handling, sales tax, or other applicable charges. Once an order is accepted by Martin Inc., any cancellation of the order requires Martin Inc. authorization and may be subject to cancellation charges.

### SALES TAX

Buyer shall pay, where applicable, any and all such charges, assessments, levies, taxes, value added taxes or other governmental charges of any nature whatsoever now or hereafter imposed by or under the authority of any law, rule or regulation with respect to the Products and Services sold or with respect to the ownership, manufacture, importation, transportation, installation, purchase, sale or use of the Products or Services related thereto, except for income taxes owed by the Seller. For clarity, all prices are exclusive of any of the items set forth in the immediately preceding sentence. In the event Customer provides to Martin Inc. a valid sales tax exemption certificate prior to order acceptance, Martin Inc. may elect not to collect tax with respect to such order; when placing an order a customer shall indicate any and all items that are tax exempt.

## SHIPPING

All products are shipped F.O.B. shipping point with the cost of the shipping and handling paid by Martin Inc. and charged to Buyer. Delivery time is not of the essence. Delivery is accomplished when Products are released to the shipping agent. Shipment schedules indicated in Seller's quote and/or order acknowledgment are approximate, and Seller will use commercially reasonable efforts to deliver on the date specified or within a commercially reasonable period thereafter. Seller does not accept liability for any loss arising from delay in delivery. Buyer assumes all responsibility for risk of loss or damage to the Products upon the Products being made available to Buyer's freight agent at Seller's designated manufacturing facility.

## PAYMENT TERMS

Seller shall not be obligated to ship any Products or provide any Services unless Buyer has paid in full all prior invoices in accordance with the terms of payment. For purposes of payment, each order and shipment shall be considered a separate contract and Buyer shall not be entitled to set-off against payments owing any amounts owing or alleged to be owing from Seller to Buyer for adjustments, set-offs or claims hereunder. Martin Inc. accepts cash, money orders, Visa, American Express and MasterCard. No cash discounts are allowed for early payment. For customers with established Martin Inc. credit, payment terms are net 30 days from date of invoice.

If Buyer's credit standing or financial condition becomes unsatisfactory to Seller in its sole discretion, or if Buyer breaches this agreement, Seller reserves the right to (a) require advance payments and /or C.O.D. terms, or (b) withhold shipments of Products or provision of Services in whole or in part, (c) recall goods in transit. Buyer agrees to pay (a) interest on the unpaid portion of any past due invoices at the rate of one and one half (1.5%) percent per month, or the legal maximum allowed interest rate, if less, and (b) all reasonable and necessary costs and expenses incurred by Seller in collecting any amounts due and owing, including but not limited to reasonable attorney's fees and all litigation expenses.

## PRODUCT RETURNS

Buyer shall inspect and examine all Products upon delivery thereof, and such Products shall be deemed accepted by Buyer unless Seller receives a written notice specifically describing the purported defect or nonconformity within fifteen (15) days of delivery. Failure to provide such written notice within such time period shall be deemed an unqualified acceptance and waiver of any rights to return the Products. Contact your Martin Inc. representative for instructions relating to product returns or other claims. Returns require a Martin Inc. return goods authorization ("RGA"). Proof of purchase will be required. Returns may be subject to a restocking fee. All requests for an RGA or any other claims relating to material shipped must be made within 30 days from the date of product shipment.

Seller shall have the right to cancel or terminate any unfulfilled order or any part thereof in the event Buyer (a) threatens or files a petition for voluntary bankruptcy, (b) is threatened with or has filed against it a petition for involuntary bankruptcy, (c) has appointed on its behalf a receiver or trustee, (d) executes an assignment for the benefits of creditors, or (e) otherwise breaches these Terms and Conditions.

For standard, stock items, Buyer may terminate without charge any unfulfilled order at its convenience by written notice to Seller received and processed by Seller prior to shipment. For all other items, Buyer may terminate any unfulfilled order at its convenience by written notice to Seller received and processed by Seller prior to shipment, but Buyer agrees to pay a restocking fee equal to the greater of twenty five percent (25%) of the Product purchase price or Seller's costs and expenses (whether direct or indirect, general or administrative) incurred in performing and preparing to perform this agreement, and terminating the same, up to the full purchase price (e.g., if Seller is unable to return the Product to the manufacturer). If the restocking fee remains due and owing more than thirty (30) days after Seller's notification of the same, Buyer agrees to pay, all costs and expenses of collection, including but not limited to, reasonable attorney's fees. If requested, Seller will inform Buyer whether an order contains standard, stock items only.

## INDEMNIFICATION

The customer agrees to defend, indemnify and hold harmless Martin Inc. and its affiliates from and against any and all claims or costs, including attorney's fees arising from or related to the customer's use of any products contained herein.

## DISCLAIMER AND LIMITATION OF LIABILITY

All products contained herein have been manufactured by an unrelated third party and as such are sold by Martin Inc. "as is". Martin Inc. DISCLAIMS ALL WARRANTIES OF ANY KIND, EXPRESS OR IMPLIED, INCLUDING BUT NOT LIMITED TO WARRANTIES OF MERCHANTABILITY AND FITNESS OF USE FOR A PARTICULAR PURPOSE. Martin Inc. SHALL NOT BE LIABLE FOR ANY INDIRECT, INCIDENTAL, SPECIAL, PUNITIVE OR CONSEQUENTIAL DAMAGES INCURRED BY THE CUSTOMER OR A THIRD PARTY ARISING OUT OF THE PURCHASE OF THESE PRODUCTS. Martin Inc.'S LIABILITY IN ALL SUCH CIRCUMSTANCES SHALL NOT EXCEED THE PURCHASE PRICE PAID FOR THE AFFECTED PRODUCTS IRRESPECTIVE OF THE NATURE OF THE CLAIM.

## MANUFACTURER'S WARRANTY

Please contact your Martin Inc. representative with any questions relating to manufacturers' product warranties.

Printed in the USA. Produced by Safety Marketing Services. © 2018 Martin Inc.



Martin's Fastener division is a global sourcing and supply chain management company specializing in off the shelf class "C" components and per print specials. Our goal is to partner with our customers to provide a custom tailored solution for the procurement of these parts in order to lower your total cost.

## ▶ PRODUCTS

FASTENERS	COMPONENTS	LABELS
Nuts	CNC machined parts	Bar coded
Bolts	Molded rubber	Decals
Screws	Molded plastics	Diecut
Bearings	Turned parts	Tags
Threaded products	Stamped parts	RFID
Hardware	Cold formed parts	Thermal
Rods	Die Castings	Hang tags
Washers	Springs	
Pins	Extrusions	
Rivets	Tubing	
Plastic	Key stock	

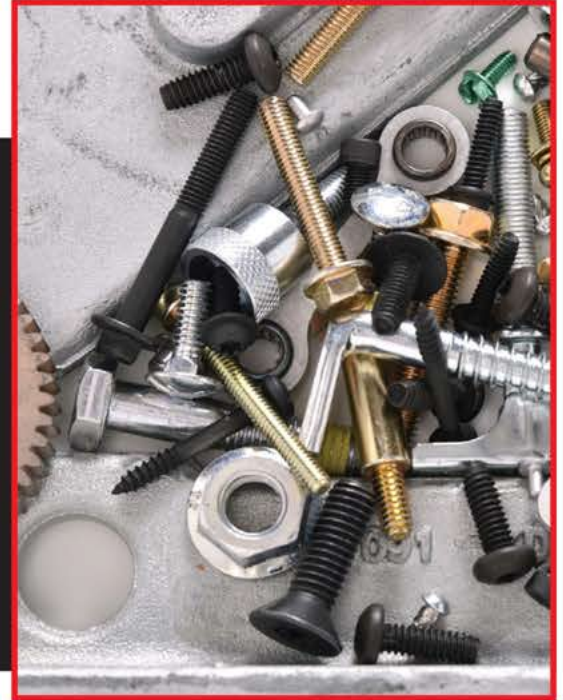

At Martin Integrated Supply, we help companies operate better by providing custom tailored supply chain solutions. Our on-site indirect materials management team optimizes storeroom performance through state of the art technology and processes while decreasing our customers total cost.

## ▶ FINANCIAL AND SERVICE BENEFITS

<p><b>STOCK PURCHASES</b></p> <ul style="list-style-type: none"> <li>Aggregate &amp; leverage</li> <li>Standardize</li> <li>Consumption reductions</li> <li>Freight</li> </ul> <p>UP TO <b>20%</b> SAVINGS</p>	<p><b>NON STOCK PURCHASES</b></p> <ul style="list-style-type: none"> <li>Purchase reductions</li> <li>Standardize</li> <li>Supply base consolidation</li> <li>Freight</li> </ul> <p>UP TO <b>40%</b> SAVINGS</p>	<p><b>OEM PURCHASES</b></p> <ul style="list-style-type: none"> <li>Convert to commercially available</li> <li>Long-term re-engineer</li> </ul> <p>UP TO <b>70%</b> SAVINGS</p>	
<p><b>SERVICE LEVEL</b></p> <ul style="list-style-type: none"> <li>Measured performance</li> <li>Root cause analytics-stock outs</li> <li>Order control management</li> </ul>	<p><b>WORKING CAPITAL</b></p> <ul style="list-style-type: none"> <li>Inventory right-size</li> <li>Consignment</li> <li>Invoice Consolidation</li> <li>Payment Terms</li> </ul>	<p><b>LABOR</b></p> <ul style="list-style-type: none"> <li>Core competency focused</li> <li>Sourcing controls</li> <li>Streamlined procurement</li> </ul>	

# MARTIN

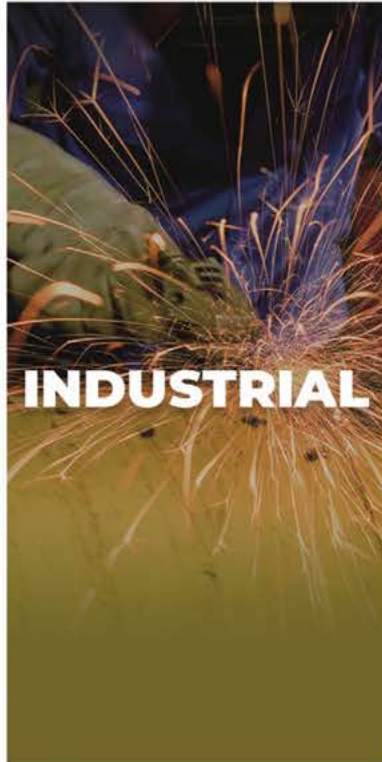

## ALABAMA

- ▶ **ANNISTON**  
1707 E HILLER ROBINSON PKWY  
OXFORD, AL 36203  
256.389.3365
- ▶ **BIRMINGHAM**  
141 COMMERCE CT  
PELHAM, AL 35124  
205.733.9292
- ▶ **DECATUR**  
313 N BELTLINE RD  
DECATUR, AL 35601  
256.355.6311
- ▶ **SHEFFIELD**  
200 APPLETON AVE  
SHEFFIELD, AL 35660  
256.383.3132
- ▶ **TUSCALOOSA**  
3718 11TH AVE  
TUSCALOOSA, AL 35401  
205.752.0421

## GEORGIA

- ▶ **ATLANTA**  
6215 FULTON INDUSTRIAL BLVD  
ATLANTA, GA 30336  
404.346.2141

## MISSISSIPPI

- ▶ **TUPELO**  
662.869.1800

## SOUTH CAROLINA

- ▶ **GREENVILLE**  
19 CONCOURSE WAY  
GREER, SC 29650  
864.848.1958

## TENNESSEE

- ▶ **JACKSON**  
120 JOHNSON ST  
JACKSON, TN 38302  
731.424.4300
- ▶ **MEMPHIS**  
3088 LAKEVIEW RD  
MEMPHIS, TN 38116  
901.620.2732
- ▶ **NASHVILLE**  
208 SPACE PARK N  
GOODLETTSVILLE, TN 37072  
615.851.8040

**MARTIN** 

**CORPORATE OFFICE**  
125 N COURT ST  
FLORENCE, AL 35630