



TRUSTED SINCE 1958

## LINEMAN'S TESTING LABORATORIES OF CANADA LIMITED

# PRODUCT CATALOGUE

LINEMAN'S TESTING LABORATORIES | LTL UTILITY SUPPLY

ltl.ca | ltlutilitysupply.com | 800-299-9769





TRUSTED SINCE 1958

## LINEMAN'S TESTING LABORATORIES OF CANADA

LINEMAN'S TESTING LABORATORIES OF CANADA ("LTL") is a privately owned Canadian company specializing in the utility, electrical, forestry and industrial sectors. Established in 1958 as a leading high voltage electrical service provider, LTL has diversified and expanded over the years to include the distribution of a vast selection of quality, brand name industry-related safety products, tools, and equipment. Representing national and international manufacturers, LTL stocks the largest inventory of insulating rubber goods, personal protective equipment, utility tools and equipment in Canada, while offering product recertification, fall arrest equipment inspection, factory-authorized tool repair and calibration in its full service NAIL-accredited high voltage testing centres.

LTL successfully maintains a loyal customer base across Canada and is recognized and respected for its integrity, and long-term business relationships. With an extensive inventory, sales offices, distribution centres, and high voltage testing and repair centres across Canada, our 6,000+ customers have come to rely on LTL for a turnkey solution including assistance with compliant product selection, timely delivery of brand name products, as well as accurate and reliable services.

Over 56 years of experience affords LTL customers the confidence knowing that we understand the risks and dangers associated with tasks in the electrical and arborist industries. The LTL team includes subject-matter experts, product specialists, knowledgeable customer care representatives, and professional facilitators with extensive industry experience. Our team knows the importance of staying apprised of changing legislation to assist our customers in the proper selection of tools and protective equipment required for the specific task, as well to support our customers in exercising due diligence, while ensuring compliance for the proper care, use and maintenance of this equipment.

Trusted since 1958, Lineman's Testing Laboratories has proven to be an industry leader for the provision of safety products, high voltage services, and specialized training. We have the skills, knowledge and tools to ensure you are compliant.

We welcome you to browse through the LTL UTILITY SUPPLY catalogue. Should you have any questions or suggestions, or are unable to find what you're looking for, please contact your local LTL branch and speak to a Product Specialist for assistance.

ON, QC & Maritime Provinces:	800-299-9769	Email: <a href="mailto:main@ltl.ca">main@ltl.ca</a>
AB, SK, MB, Northern Territories:	800-530-8640	Email: <a href="mailto:mainab@ltl.ca">mainab@ltl.ca</a>
British Columbia:	866-347-6911	Email: <a href="mailto:mainbc@ltl.ca">mainbc@ltl.ca</a>

Visit [www.ltl.ca](http://www.ltl.ca) | [ltlutilitysupply.com](http://ltlutilitysupply.com)

# TABLE OF CONTENTS

<b>LINEMAN'S TESTING LABORATORIES</b>	<b>1</b>	<b>CUTTERS &amp; CRIMPERS</b>	<b>217</b>	<b>LIGHTING &amp; ACCESSORIES</b>	<b>380</b>
LTL at a Glance		Wedge Tools		Lights	
Nail-Accredited Testing		Manual			
Services & Repair		Battery Powered		<b>STRINGING</b>	<b>392</b>
Training & Education		Hydraulic		Travellers	
Safety Programs		Compression Dies		Pulling Equipment	
LTL Utility Supply & Website				Swivels	
LTL Products		<b>UNDERGROUND/ CONFINED SPACE</b>	<b>251</b>	Dynamometer	
		Gas Detection		Ropes	
<b>HIGH VOLTAGE PRODUCTS &amp; SERVICES</b>	<b>11</b>	Tents & Shelters			
		Ladders		<b>POLE LINE HARDWARE/ HV EQUIPMENT</b>	<b>416</b>
<b>GLOVES - RUBBER &amp; WORK</b>	<b>19</b>			Grounding	
Gloves		<b>RIGGING</b>	<b>293</b>	Earth Anchors	
Sleeves		Grips		Pole Line Hardware	
Glove Bags		Hoists			
Glove Care		Hoist Accessories		<b>PAINTS &amp; CLEANERS</b>	<b>422</b>
		Slings			
<b>RUBBER &amp; FIBER COVERUP</b>	<b>32</b>	Nylon & Wire Rope		<b>NOVELTY ITEMS</b>	<b>426</b>
		Load Binders			
<b>LIVE LINE TOOLS</b>	<b>39</b>	Reel Lifting Device			
Grip-All Sticks, Switch Sticks,					
Link Sticks & Measuring Sticks		<b>FORESTRY</b>	<b>317</b>		
Live Line Platforms & Ladders		Carabiners			
Universal Tool Accessories		Pruners			
		Pole Saw Heads & Saw Blades			
<b>GROUNDING &amp; JUMPERS</b>	<b>72</b>	Fiberglass Sticks			
Live Line Jumpers		Couplers & Fittings			
Grounding Clamps		Rope			
Grounding Cables		Fall Protection			
Grounding Accessories		(refer to Fall Protection & Climbing)			
Pole Line Hardware		Chainsaw Protection			
Earth Anchors					
<b>PERSONAL PROTECTION</b>	<b>94</b>	<b>TRUCK</b>	<b>330</b>		
Arc Flash Clothing & Accessories		Custom Truck Kits			
Head, Face & Eye		Digger Derrick Truck Kit			
Footwear		Wheel Chocks			
Sunscreen & Insect Repellent		Outrigger Pads			
		Hinges & Rubber Accessories			
<b>FALL PROTECTION &amp; CLIMBING</b>	<b>119</b>	Truck Body Accessories			
Harnesses		Reels & Accessories			
Lanyards		Tool Organizers			
Belts		Safety Hooks			
Pole Chokers		Platform Tool Trays			
		Tool Boards			
<b>METERS &amp; TESTERS</b>	<b>150</b>	Platform Covers			
Potential Indicators		Liners & Scuff Pads			
Phasing Sticks		Tool Holders			
Contamination Meters		Temporary Ground Mats			
Digital Multi-Meters		Bags & Pouches			
Clamp Meters		Buckets & Accessories			
		Aprons			
<b>TOOLS</b>	<b>165</b>	Chainsaw Scabbard			
Lineman's Apprentice Starter Kit		Miscellaneous Platform Equipment			
Insulated Hand Tools					
Uninsulated Hand Tools		<b>TRAFFIC SAFETY</b>	<b>374</b>		
Loadbust /Spiking Tools		Traffic Cones			
Cable Scorers & Strippers		Signs, Paddles and Flags			
Shovels & Rakes		Apparel			
Hammers & Diggers		Delineators			
Accessories & Bits		Sign Systems			

# LTL at a Glance

**PROTECT WORKERS ~ IMPROVE SAFETY ~ INCREASE EFFICIENCY ~ ENSURE COMPLIANCE**



High Voltage Testing, Calibration and Factory-Authorized Warranty Tool Repair Centres



LTL UTILITY SUPPLY ~ EXTENSIVE INVENTORY  
3,000 Sq. Ft. Store & Clearance Area



Training & Education ~ Online & On-site



We bring the tools to you with our fully stocked mobile outfitting rig!



Substation/Engineering Services



GreenCycle Recovery & Sales

## NAIL-Accredited High Voltage Testing & Recertification Electrical Gloves & Rubber Goods

We take great pride in exceeding customer expectations for the supply, testing, calibration, repair of tools, and recertification of personal protective equipment. LTL's specialized technicians ensure proper handling of all equipment when in our facilities. To ensure compliance, all equipment is tested to applicable standards or as directed by our customers. We offer assistance in establishing both testing and calibration schedule intervals to ensure your equipment is reliable and ready to go when you are!

- Insulating Rubber Gloves
- Blankets
- Cover-Up
- Line Hose



## Canada's Largest NAIL-Accredited Centres

As advocates for safety in the workplace, LTL is represented on the NAIL for PET (North American Independent Laboratories for Protective Equipment Testing) Board of Directors.

NAIL is a not-for-profit organization dedicated to the development of uniformity and setting standards in testing, working in close association with ASTM and ANSI. To maintain accreditation, regular audits are conducted to ensure all industry accepted standards are strictly adhered to; the audit encompasses review of operational areas including but not limited to laboratory facility, equipment, training and knowledge of staff, quality control work procedures, and financial responsibility. Independent test facilities operating without NAIL-accreditation are not monitored to ensure industry best practices and standards are followed.



# Service & Repair Centres

## Live Line Tools & Ground Assemblies

### Certified Custom-Configured Ground Set Assembly and Annual Testing

- LTL builds and inventories an assortment of distribution and station grounding assembly units
- Grounding assembly clamps provide optimum support at the cable/ferrule connection when using a stress relief system
- Tinned copper threaded ferrules ensure low resistance connections
- Grounding cables are made with an extra strand of soft drawn #30 AWG (.01") copper, and are available in three jackets: yellow, clear, orange
- All grounding assembly components are tested to ASTM F855 by the manufacturer



### Live Line Tool Certification, Repair and Re-Stocking : Extend the life of your live line tools

#### Before and After Each Use:

- Inspect the surface of the tool for contaminants such as dirt, creosote, grease, oil, gas/fuel, moisture, or any other foreign material. If contaminated, a quick rag wipe may be required to improve the integrity of the fiberglass.
- Visually inspect the tool for a smooth glossy surface. Check for deep cuts, scratches, nicks, gouges or signs of bruising or crushing. Pay special attention to the tip or working section of the tool.

#### Field Inspection Results:

- Do not use if ANY defects are found on the tool surface. The tool should be tagged, removed from service, and sent to LTL for repair.
- Broken strands of fiberglass allow water to wick within the fiberglass stick itself, which promotes dielectric failure or reduced insulating values.

LTL recommends annual laboratory cleaning, inspection, waxing, and testing of fiberglass tools to ensure safety and to extend the life of your tools.

SEE IEEE STANDARD 978-1984 Guide for In-Service Maintenance and Electrical Testing of Live Line Tools, Section 4.2



## Metering, Instrumentation and Gas Detection Equipment Testing, Calibration & Repair

### Meter Manufacturing, Repair and Calibration : Auto-Notification Test-Calibration Due

LTL's Instrument Technologists test, repair, and calibrate electrical instruments and equipment including, but not limited to:

- Digital Multimeters
  - Potential Indicators
  - Clamp Meters
  - Meggers
  - Rotation Meters
  - Ground Thumpers
  - HiPot Testers
  - Decade Boxes
- LTL Technicians offer assistance in establishing both testing and calibration schedule intervals to ensure equipment is reliable and ready for use
  - Meter calibration and repair is traceable to NIST/NRC and in compliance with ISO 17025
  - LTL supplies brand name meters from industry-leading manufacturers
  - Also available, LTL-brand 361 contamination meters and potential indicators (7kV, 15kV, 30kV)

### Portable Gas Detection Equipment Calibration, Repair and Maintenance

- Certified Master Service Centre
- Calibration, repair and maintenance of gas detection equipment including industry-leading brands such as Honeywell, BW Technologies, Lumidor, BioSystems, MSA, Crowcon
- LTL representatives offer assistance with selecting the right gas detection product to suit your specific confined space application
- LTL factory-certified technicians ensure compliance with the Occupational Health & Safety Act Confined Space Regulations
- Training - Beyond the Canary: Understanding the Air in Confined Spaces. Highlights: ABC's of Gas Detection, Confined Space Regulations, Legal Obligations/Compliance, Product-Specific Operation/Use and Care

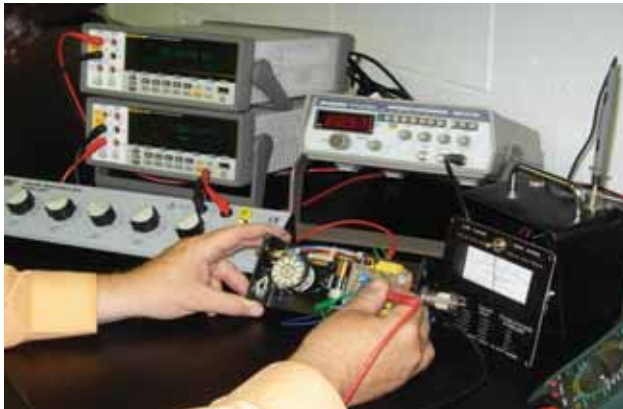

# Service & Repair Centres

## Factory Authorized Warranty Tool Testing & Repair Centres

- Load break tools
- All hydraulic and battery operated tool repair
- All hoist/chain jacks annual certification and repair
- Tools and replacement parts in stock
- Rental programs available

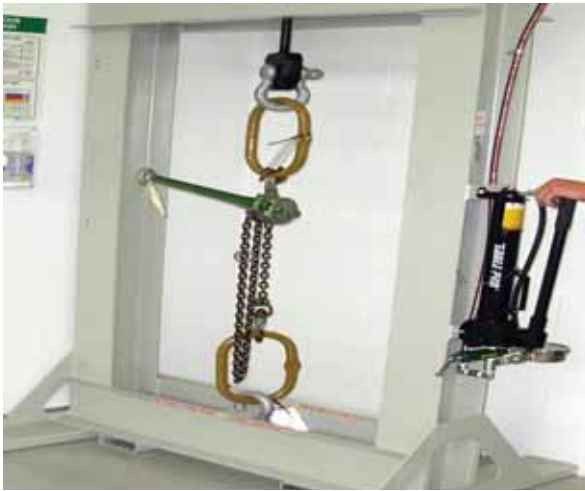



## Certified Fall Protection Inspection, Maintenance & Repair

- Industry best practices recommend field inspection of fall protection equipment prior to each use to ensure worker safety. As well, fall protection equipment should be thoroughly inspected annually by a certified laboratory. LTL's certified technicians offer inspection of harnesses, ropes, and slings to ensure the integrity of the fall arrest gear. Factory-Trained Miller & DBI Sala/Capital Safety Certified.
  - Harnesses
  - Ropes
  - Slings
  - Lanyards



# LTL UTILITY SUPPLY

## Insulating Rubber Gloves/PPE, Utility Tools and Related Equipment

- Largest stocking Canadian Distributor of Salisbury by Honeywell Insulating Rubber Gloves and related PPE
- Extensive product inventory; thousands of quality brand name products from the industry's leading manufacturers



## Mobile Outfitting Rig

- LTL UTILITY SUPPLY's mobile tool and equipment truck will be touring a city near you. We carry a wide selection of hand-picked specialty tools and equipment for the utility, forestry and industrial sectors.



Specialty tools and equipment for the Utility, Forestry & Industrial Sectors



## Utility Supply Store | 46 Meridian Road, Toronto | Hours of Operation: M-F 8:00am - 4:30pm

LTL Utility Supply store shelves are stocked and LTL Product Specialists are available to answer all questions as well as assist with compliant product selection and fitting. For your convenience, we offer insulating equipment and tools pre-certified and ready to go! Visit our Clearance Centre.



With over 56 years of industry-related technical expertise, LTL facilitators deliver specialized informational seminars. LTL's knowledgeable facilitators remain current with legislation relating to worker safety and personal protective equipment requirements, and have presented to numerous organizations in the electrical, industrial and health and safety fields.

Ensure you and your workers have the proper information necessary to promote a safe working environment while meeting legislated requirements. Seminars include instruction, training materials, and certificate of completion. We would be pleased to customize any of our sessions to best suit your specific requirements. Check back often for new topics, as well as seminars offered at LTL.

## Online Electrical Worker Safety Training



Lineman's Testing Laboratories is pleased to recommend this program as the most interactive, informative and easy-to-follow online electrical safety training system in the industry today!

This user-friendly, online electrical training program offers a convenient, cost-effective solution for establishing safe work practices to ensure personal safety when exposed to energized electrical equipment. Whether at work, home or play, this Electrical Safety Training System (ESTS) has been specifically designed to suit the needs of the electrical and non-electrical worker.



The ESTS is a multi-media based, highly interactive experience comprised of several modules with multiple lessons, knowledge checks and a final assessment. The ESTS uses 3-D "Virtual Electrical Workplace" scenarios and a unique digital electrical classroom as a learning aid to teach concepts. Each module includes a knowledge check that utilizes interactive elements that engage the student in the learning process. The ESTS for electrical worker is a four-hour course incorporating industry accepted best practice standards, while the non-electrical course is 45 minutes.

Visit [ltl.ca](http://ltl.ca) to get started.

## Classroom Safety Training at your location or ours...



LTL provides the following in-class training seminars:

- Electrical Insulating Rubber Gloves
- Arc Flash Awareness: Are you Covered?
- Beyond the Canary: Understanding the Air in Confined Spaces
- Live Line Tools: Field Care & Maintenance

Who should attend?

- Anyone working on or near live electrical apparatus
- Supervisors, Managers, Business Owners
- Health and Safety Representatives
- Any worker entering a confined space (Beyond the Canary Seminar)

For more information, or to book a safety training session at your workplace, e-mail [seminars@ltl.ca](mailto:seminars@ltl.ca) or call 800-299-9769.



Arc Flash Awareness



Live Line Tools:  
Field Care & Maintenance



Beyond the Canary:  
Air in Confined Spaces



Insulating Rubber Gloves

# LTL Arc Flash Safety Program

Protecting electrical workers since 1958, Lineman's Testing Laboratories is your single source for arc flash safety. Our complete Arc Flash Safety Program is managed and executed by our in-house electrical engineers, technicians, sales representatives and facilitators, and we inventory all applicable personal protective equipment (PPE). The program includes a CSA Z462-compliant Arc Flash Hazard Study, labeling of all applicable electrical equipment, supply of required PPE, and training.

Proper safety practices and on-going personnel training can minimize the likelihood of electrical injuries and fatalities due to shock, electrocution, arc flash and arc blast. At risk are employees who work on or near exposed energized electrical conductors or circuit parts including electrical maintenance personnel, operators, troubleshooters, electricians, linemen, engineers, site safety personnel, or anyone exposed to energized equipment.

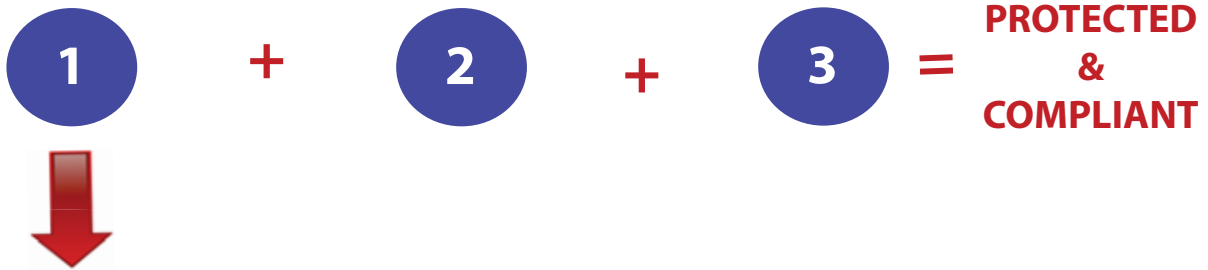

## CSA Z462 Compliant Arc Flash Hazard Study

Lineman's Testing Laboratories' comprehensive Arc Flash Studies determine potential arc flash incident energies and boundaries, shock hazard boundaries and proper personal protective equipment required for energized electrical equipment tasks for the system studied.

Performed by LTL's qualified engineers and technicians, LTL's Arc Flash Hazard Analysis includes:

- Complete engineering services
- Site assessment and data collection
- Short circuit and protective device coordination studies
- Labeling - warning labels identifying potential hazards and required safety equipment are affixed to all applicable electrical equipment
- Easy-to-read detailed Arc Flash Analysis reports
- Supply of personal protective equipment for arc flash protection
- Training - It is imperative that workers understand how and why the required PPE will help them, as well as how to properly care for and inspect this equipment to comply with legislation and ensure equipment integrity



## What sets us apart?

- Niche product and service provider all-in-one; we SERVICE what we SELL
- Over 56 years serving the Utility, Electrical, Forestry & Telecom industries
- Electrical Engineering/Substation Division team provides technical support to our product specialists when required
- Exceptional industry-experienced team including laboratory technicians, factory-authorized repair technicians, knowledgeable sales and customer care reps, linemen, electrical engineers and technologists, master electricians
- We have the knowledge, skills and tools to ensure you are compliant



## The Solution

- Canada's Largest Inventory of Insulating (Electrical) Rubber Gloves and PPE
- Utility Supply Store (Toronto location) - shelves stocked with thousands of brand name utility tools and related equipment
- Outfitting Rig - mobile tool truck
- Certified Custom Grounding Assemblies
- Hydraulic and Battery Operated Tool Repair
- Mobile Dielectric Truck Testing - Edmonton Facility
- Automatic Glove Replacement Program – ensures timely turnaround of failed gloves during testing
- Compliant Uniform Fitting and Recommendation by LTL Product Specialists
- Online and Classroom Electrical Safety Training
- Expedited/Rush Order Service
- Green Cycle Equipment Recovery & Sales - refurbished transformers, line hardware and surplus equipment
- Rental Tools and Equipment
- Emergency Inventory Availability - 24/7
- Canada's Largest NAIL-Accredited High Voltage Testing Centres
- Natural Disaster/Emergency Contingency Plans-Laboratory Redundancy (Edmonton & Toronto Facilities)
- Factory-Authorized Warranty Tool Repair Centre
- Honeywell Certified Master Service Centre - calibration, repair and maintenance of gas detection equipment

## STAY CONNECTED

### Hot Zone Specials, LTL Buzz and LTL.ca

Stay connected to the LTL community for product deals, specialized services, industry related news and information. Sign up for the LTL Buzz and Hot Zone Specials!



## SATISFACTION SURVEY

### Tell us how we're doing

At LTL, we are always striving to improve and enhance our customers' experience by offering the best in quality products and customer care. Please take a moment and let us know how we're doing by completing our online survey at [ltl.ca/contact-us/satisfaction-survey/](http://ltl.ca/contact-us/satisfaction-survey/)



All information collected is proprietary and will not be disclosed to external entities.

# Substation/Engineering Services

## At a glance...

- Electrical Design
- Service Work
- Preventative Maintenance Programs
- Infrared Scanning/Thermography
- Mobile Transformer Oil Regeneration & Exchange
- Field Transformer Repair Service
- CSA Z462 Compliant Arc Flash Hazard Analysis
- PCB Management & Decontamination
- Emergency Power Solutions
- Disaster Recovery | Emergency Contingency
- Extensive Inventory of New & Refurbished Transformers, Switchgear, Fuses, Lightning Arresters, Insulators, Towers, Poles and other related equipment
- 24 Hour Emergency Substation Services in Ontario

## Engineering

- Electrical power system specification/substation engineering/design engineered models
- High voltage engineered plan submissions to electrical utilities and Electrical Safety Authorities
- Short circuit current analysis and co-ordination studies
- Substation ground grid studies
- Electrical and electronic testing of high and low voltage substation components
- Power factor correction analysis and power quality studies
- Underground cable locating
- Transformer/Substation commissioning
- Arc Flash Hazard Studies in accordance to CSA Z462: includes site assessment and data collection, short circuit and protective device coordination, labeling, easy-to-read detailed arc flash analysis reports, and protective equipment supply and training

## Emergency Power Solutions

- 24-HR emergency services for commercial, industrial and utility sites: installations, repairs, splicing, terminations, fault locating, temporary cable supplies
- Generators and related equipment rentals: Transformers, metalclad switchgear, switches, towers, fuses

## Transformer Oil Services

- Environmentally friendly mobile transformer oil regeneration
- Regenerated oil performs as new or better
- On- or off-line oil regeneration
- Mode 60 oil sales and oil removal program
- Complete oil sampling with full report (five-way, gas, PCB, furans, water content)
- Degasification; vacuum fill; core dry out
- PCB management solutions

## Field Services

- Complete transformer commissioning and testing
- Transformer repair
- Transformer assemble/disassemble, transportation
- Fin replacement
- Bushing replacement
- Tap changer maintenance, repair and replacement
- Oil leak termination
- Painting
- Mobile Transformer oil regeneration
- Rewind service (shop only)
- Substation maintenance -- testing and calibration, inspection, adjustment, cleaning, repair and analysis of electrical insulating fluids
- Infrared Thermography (Scanning)
- New unit specification and supply



State-of-the-art mobile oil regeneration plant

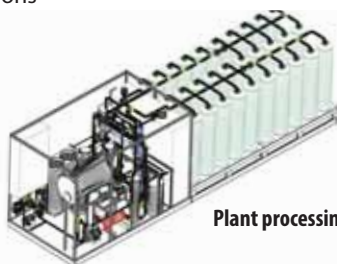

Plant processing and column view

## S&C Factory-Trained

With over 56 years of dedicated service, Lineman's Testing Laboratories has earned a reputation for accurate and professional execution of all electrical service work to established standards.

LTL's factory-trained technicians ensure in-service S&C equipment is maintained, in an expedient manner, to manufacturer specifications for design and safety, using original equipment parts. We service all switchgear, including, but not limited to, PMH and PME pad-mounted gear, offering complete restoration to near-new quality. LTL's full service offering includes pick-up of equipment at the customer site, removal from in-service yard locations, and tailored service to specific customer requirements.



## Transformer Field Services

- Complete transformer commissioning and testing
- Transformer repair
- Transformer assemble/disassemble, transportation
- Fin replacement
- Bushing replacement
- Tap changer maintenance, repair and replacement
- Oil leak termination
- Painting
- Mobile Transformer oil regeneration
- Refurbish/re-build
- Parts in stock
- Substation maintenance -- testing and calibration, inspection, adjustment, cleaning, repair and analysis of electrical insulating fluids
- Surplus equipment sales and purchase



Pole Mount Tx Refurbs



Station Class Tx Refurbs



Pad Mount Tx Refurbs



# LTL Products

## Lineman Gloves 3" & 6" Cuffs

- LTL-BRAND high grade leather
- Mustard yellow colour-fast
- Yellow Kevlar stitching
- Reinforced leather palm
- Fleece-lined winter style
- Unlined, water repellent summer style
- Sizes S-XXL



LTL426IMFL

## LTLGLVKE: LTL Glove Kit

LTLGLV0K-Size Class 0 Insulating Rubber Glove Kit Includes:

- E011Y-Size Gloves, Class 0, Yellow
- Available sizes: 7, 8, 8.5, 9, 9.5, 10, 10.5, 11, 12

LTLGLV2K-Size Class 2 Insulating Rubber Glove Kit Includes:

- E216YB-Size Gloves, Class 2, 16", Yellow /Black, Straight Cuff
- Available sizes: 9, 9.5, 10, 10.5, 11, 12

Both kits include the following:

- Leather Protectors (Class 0-L323-Size | Class 2-L2C814YS-Size)
- ML80K Cotton Glove Liner
- GP Glove Powder
- Glove Bag (Class 0-LTL112 | Class 2-LTL118)
- Kits are available in all classes



## GP/GP-1: Glove Powder

- A powder compounded especially for use in linemen's protective gloves to prevent sticking and binding. Powder will not deteriorate or lower the dielectric strength of rubber gloves
- Product Weight: Available in 100g or 900g (Part # GP-1) containers (available larger if needed)



## LTL Deerskin Leather Protectors Class 2 & 4

- Colour-fast, 100% Canadian premium deerskin leather glove protector
- To be worn over insulating rubber gloves to provide mechanical protection against cuts, abrasions, and punctures as well as protect the rubber gloves from possible physical damage while in use
- They are designed and are to be used solely for the purpose of protecting the rubber gloves
- The inner surface of the protectors should be inspected as often as that of the rubber gloves



LTL20DSY-9	Class 2, Size 9 - Yellow Cuff
LTL20DSY-10	Class 2, Size 10 - Yellow Cuff
LTL20DSY-11	Class 2, Size 11 - Yellow Cuff
LTL20DSY-12	Class 2, size 12 - Yellow Cuff
LTL40DSR-9	Class 4, Size 9 - Red Cuff
LTL40DSR-10	Class 4, Size 10 - Red Cuff
LTL40DSR-11	Class 4, Size 11 - Red Cuff
LTL40DSR-12	Class 4, Size 12 - Red Cuff

## LTL Glove Liners

- Cotton, machine knit parade liner
- Absorbs perspiration in the summer and provides added warmth in the winter





## 361 CONTAM MTR: Contamination Meter

- Complete with 30' Co-ax Cable Assembly
- Case sold separately: 361CASE
- Custom lengths available



## POTIND 7kV/15kV/30kV

- Used for identifying energized conductors
- 3 voltage ratings to choose from: 7kV, 15kV, 30kV
- Indicates line to ground voltage AC or DC
- Rugged polycarbonate tubing construction
- High dielectric value
- Protective carry case
- Lightweight
- C/W ground wire



## Grounding Cables

- Grounding Cable, 2/0 CU 1330 Strand Ground Cable, 600 Volts, Orange Jacket EPDM
- Grounding Cable, 4/0 1C CU 2109 Strand Ground Cable, 600 Volts, Orange Jacket EPDM
- Available in clusters and various configurations



## 350 MCM & 500 MCM Copper Grounding Cable

- For situations where you need a 5H or 7H rating

Caliber AWG	Conductor Diameter	No. of Strands	Cable Diameter	Capacity 15 Cycles	Capacity 30 Cycles	Temp. F	Separator	Weight/1000 (lbs)
350 MCM	0.77	3432 / 30	1.06	40 kA (IEC) 68 kA (ASTM)	51.3kA (ASTM)	-58 to 194	Paper	1369
500 MCM	0.95	5054 / 30	1.25	55 kA (IEC) 86.3kA (ASTM)	61kA (ASTM)	-58 to 194	Paper	1949

## P2MF-6: Male/Female Fittings

Set of male and female fittings for live line tools  
Live line tools with couplers available in various configurations



## Couplers



## Stick Bags

Vinyl bags for various lengths of live line tools



# LTL Products

## SKCA11(SIZE)-1200-CAN: LTL Pro-Wear Arc Flash Protection Kit-12 cal/cm<sup>2</sup>

INCLUDES:

- Arc Flash Navy Coveralls ATPV Rating of 12 cal/cm<sup>2</sup>
- Sizes: M, L & XL (2XL-3XL available at additional cost)
- AS1200HAT-weight balancing 12 cal/cm faceshield with helmet chin cup 2
- ATPV Rated AFHOOD 15
- ASBAG/D - helmet bag
- SKBAG/D - large storage bag
- UVEX Genesis Safety Glasses



## SWITCHMATBULK: Switchboard Matting

- Permanently placed in front of switchgear, motor control centres and other high voltage apparatus to provide personal protection for workers. It is also used when tending take-up and pay out reels and when adding or replacing conductors
- Made from high quality Type II rubber, Class 2 matting is 1/4" (6.4mm) thick and is tested to 20kV. Class 2 matting complies with ASTM D178 specifications
- The corrugated surface acts as safety tread while reducing the possibility of metal particles becoming embedded. Class 2 switchboard matting is available in 25 yard rolls or custom cut to specified lengths
- Maximum Use AC Voltage Class 2 is 17,000 volts
- Available in class 3 and 4



## LTL6000-5: Penta Socket

- T-handle with LTL logo



## Rope Block: LTLH1802-36SSR



## LTL6000-11: LTL Guy Wire Holder



- Four adjustable arms
- Holds guy wire with 1/2" diameters
- Driver or passenger site mounting options

## LTL Manual Ground Rod Drivers

- Driver made from 1.9" diameter extra heavy steel pipe 4' long with 4" PLUG doweled and welded in top end
- Extension made from 7/8" carbon steel rod doweled and welded into 1.9" diameter extra heavy steel pipe 9" long
- Hot dip galvanized



## 10-110: Nut and Bolt Bag Canvas w/Belt Loops



## Nut and Bolt Bag

- This bag, complete with hook and latch, hangs 6" from a belt; ideal for keeping nuts, bolts, and other small items handy on the job
- 9" x 8" x 3.75"



## LTLARCBAG: Heavy Reinforced Canvas Equipment Bags

- Made of heavy weight canvas or heavy weight orange vinyl
- The bottom of these bags are made of a special rubber blend that offers protection and solid support
- Molded rubber runners on bottom of bag protect it from wear
- Webbing handles are sewn completely around the bag for greater strength



## Camouflage Tool Bag

- Extremely durable
- Ideal for work or personal use
- Also available in canvas or vinyl
- Constructed of 1000-denier Cordura Plus with Realtree Advantage Camouflage Pattern



## 31-140: Tool Bucket Vinyl, w/Rope 8" x 12"



## 31-105: Tool Bucket Canvas, w/Rope and Snap



31-205: Tool Bucket Canvas, w/Rope and Snap 12" x 15"

31-206: Tool Bucket Canvas, w/Rope and Snap 1 Inside Pocket 12" x 15"

## 31-245: Tool Bucket Vinyl, w/ Rope and Snap 12" x 15"



## HANDLINE366M-50'

- Handline Assembly - 50' Working



# LTL Products

## HEAVY DUTY TEMPORARY ACCESS MAT

### The fast and safe way forward

#### Heavy Duty Temporary Access Mats

Supporting loads up to 80 tons, this mat is the ultimate, fast to install temporary access and ground protection mat for moving equipment and personnel over soft or sensitive ground.

#### Amazingly Tough & Flexible

Tough high density polyethylene (HDPE), the mat weighs only 35kg/77lbs and incorporates hand holds that make moving and installation easy.

#### Anti-Slip Surface

The engineered, unique chevron traction® surface delivers ultimate grip and dispels mud, dirt and snow when vehicles travel over the mats. The chevron nub design also reduces sideways movement and slippage and delivers optimal forward traction.

#### Connection Options

Multiple connection options are available to suit various applications.

- Fast and easy to install
- Unique chevron traction® surface
- Fast temporary access and working areas
- Low transport and handling costs
- Avoid property and environmental damage
- Avoid health and safety issues
- Reflective markings for night safety (optional extra)
- Multiple connection options for different terrain and equipment



EMS003

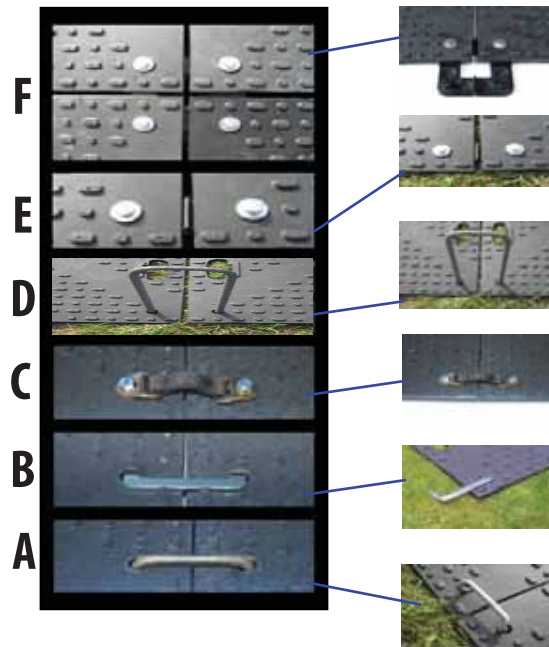

	Thickness	Dimension (WxL)	Weight per Mat
Standard	.47"	47" x 94.8"	77 lbs
Material	Premium recycled High Density Polyethylene (HDPE)		
Colours available	Black - recycled HDPE. Other colours available-minimum order quantity applies		
Connectivity	Standard connectors - 2 way and 4 way options		
	Metal connectors for heavy and tracked equipment		
	"Fast Fit" connectors for fast installation		
	Flex connectors for undulating ground		
	Metal U-pins for slopes and cambers		
Optional extras for night safety	Non-slip reflective markings and "cats eyes"		
Environmental features	Weather-proof, water and chemical resistant, usable in sub-zero temperatures. High Density Polyethylene is resistant to acids, alkalis and solvents		

	Part #	Description
A	EMC001A	Fast Connectors
B	EMC001B	Fast Connectors
C	EMC003	Flex Connectors
D	EMC008	Metal U Pin Connectors
E	EMC201	2-Way Connectors
F	EMC401	4-Way Connectors
	EMS003	EuroMat
G	LTLRACK	Transportation Rack 6'H x 8'L x 4'W

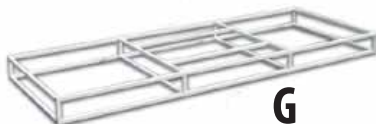

G

## LTLOUTRPAD

- LTL outrigger pads are ideal for use with radio boom derricks (RBD), digger derricks, single or double bucket trucks and cranes
- The outrigger pads are made from a high quality polyethylene (PE HD RKB regenerated multicolour), meaning they do not splinter or absorb water and can be used in all weather conditions
- Maintains its rigidity and original shape during use, each pad has a high resistance to vertical pressure
- Long lasting and have an extended life span compared to other materials
- Carry handles are made from durable nylon rope
- Handles on two sides make them easy to transport, install and store
- Easy to clean, chemical and oil resistant
- Dimensions: 2" x 14" x 28" (can customize to any size required)
- Weight: 26.45 lbs



## 85: Battery Cable Cutter



- For cutting Cu/Al cable and armored cable
- Powered by Li-ion battery, actuated by motor and controlled by MCU
- With a high pressure hydraulic system, LED light, LCD, error warning alarm and pressure showing function

## 400: Battery Crimping Tool



- For crimping Cu lugs with cables from 16-400 mm<sup>2</sup>
- Powered by Li-ion battery, actuated by motor and controlled by MCU
- With a high pressure hydraulic system, LED light, LCD, error warning alarm and pressure showing function

# Salisbury by Honeywell Linemen's Gloves & Sleeves

Insulating Rubber gloves are among the most important articles of personal protection for electrical workers. Incorporating high dielectric and physical strength, flexibility and durability, Salisbury by Honeywell insulating rubber gloves have earned the reputation for superior performance - meeting and exceeding the requirements of current ASTM D120 specifications and IEC EN60903 Standards.

## Protective Rubber Equipment Labeling Chart

Class Color	Proof Test Voltage AC / DC	Max. Use Voltage AC / DC*	Rubber Molded Products Label	Glove Label	Rubber Dipped Sleeve Label
00 Beige	2500 / 10,000	500 / 750*			
0 Red	5,000 / 20,000	1,000 / 1,500*			
1 White	10,000 / 40,000	7,500 / 11,250*			
2 Yellow	20,000 / 50,000	17,000 / 25,500*			
3 Green	30,000 / 60,000	26,500 / 39,750*			
4 Orange	40,000 / 70,000	36,000 / 54,000*			



### Salisbury Insulating Rubber Gloves - Low Voltage ASTM Class 00 Gloves

	Class	Length	Colour	Size
E	00	11	R, B, BL, Y or BLO	7, 8, 8H, 9,
E	00	14	R, B, BL, Y or BLO	9H, 10, 10H,
				11, 12

R= Red, B=Black, BL=Blue, BLO=Blue in, Orange out: Type II SALCOR®  
Example: E0011BL/8

### Salisbury Insulating Rubber Gloves - Low Voltage ASTM Class 0 Gloves

	Class	Length	Colour	Size
E	0	11	Y, B, R, BL, BLO* or BY	7, 8, 8H, 9, 9H,
E	0	14	Y, B, R, BL, BLO* or BY	10, 10H, 11, 12

R= Red, B=Black, Y=Yellow: Type I Natural Rubber  
BY: Black in, Yellow out: Type I Natural Rubber  
BL=Blue, BLO=Blue in, Orange out: Type II SALCOR®  
Example: E014R-9

\*The contrast between the outer orange colour and the inner blue colour makes inspecting for cuts and tears easier when the glove is inflated or stretched.



### Determine Your Glove Size

Measure the circumference of your palm (hand laying flat), following a line across your knuckles.  
Add 1" to this measurement, and this is your glove size.  
For example, if you measure 9", add 1", and your glove is size 10.

# Salisbury by Honeywell Linemen's Gloves & Sleeves

## Insulating Rubber Gloves - High Voltage ASTM Class 1, 2, 3, 4 Gloves

	Class	Length	Cuff Style***	Colour	Size
E	1	14, 16, or 18	FC, BC, C	B, YB, or RB	7, 8, 8H, 9, 9H,
E	2	14, 16, or 18	FC, BC, C	B, YB, or RB	10, 10H, 11,
E	3*	14, 16, or 18	FC, BC, C	B, YB, or RB	11H, 12
E	4**	14, 16, or 18	FC, BC, C	B, YB, or RB	

BC = Bell Cuff, C = Contour Cuff (straight cuff is the default style)

\* available in sizes 8-12 including half sizes only

\*\*available in sizes 9-12 including half sizes only

B=Black, YB = Yellow inside, Black out, RB = Red inside, Black out: Type I Natural Rubber

Example: E116FCYB-10

Example if ordering straight cuff: E116YB-10

\*\*\*bell cuff gloves available in sizes 9 through 12 including half sizes only



## Insulating Rubber Mittens - High Voltage ASTM Class 1, 2, 3, 4 Gloves

	Class	Length	Cuff Style	Colour	Size
EM	1	14, 16 or 18	BC	B, YB or RB	9, 10, 11
EM	2	14, 16 or 18	BC	B, YB or RB	9, 10, 11
EM	3	16 or 18	BC	B, YB or RB	9, 10, 11
EM	4	16 or 18	BC	B, YB or RB	9, 10, 11



## G99: Glove Inflator



- Simple and easy-to-use, portable glove inflator
- Provides a quality means of inspecting gloves in the field
- Glove is secured to the inflator using a nylon strap and fastened with a hook and pile closure
- Inflation is accomplished by pumping the bellows of the inflator against any surface

*Note: Gloves should be expanded no more than 1.5 times their normal size for Type 1, and 1.25 times normal for Type II SALCOR®*

## G100: Glove Inflator

### G100A: Low Voltage Glove Adapter



- Proper safety requires frequent inspection of gloves
- Simple and easy-to-use, portable glove inflator
- Operates exactly like the G99, but includes an additional G100 Adapter to inspect class 00 and 0, and smaller gloves
- To use the adapter, the glove is secured to the G100A adapter using a nylon strap with a hook and pile closure
- The adapter, with the glove attached, is then placed on top of the inflator to be inflated for inspection

## INF-6: Standard Sleeve Expander

- Proper safety requires frequent inspection of sleeves
- Provide an efficient way to conduct complete and thorough, visual inspections before and after use in the field
- Easy-to-install, simple to operate and accommodates all sleeves



# Salisbury by Honeywell Linemen's Gloves & Sleeves

## Sleeves

### Breakdown for Dipped Type I Sleeves

Voltage Class	Size	Colour
D0	S, R, L or XL	Y = Yellow
D1	S, R, L or XL	B = Black
D2	S, R, L or XL	YB = Y inside, B out
D3	S, R, L or XL	RB = R inside, B out
D4	S, R, L or XL	YR = Y inside, R out

S = Small  
 R = Regular  
 L = Large  
 XL = Extra Large  
 Add suffix -ST to order straight cuff or -EC to order extra-curved cuff



Straight arm  
D2RYB-ST



Extra-Curved Arm  
D2LYR-EC



Molded Black, Type I  
2RB



Molded Yellow, Type I  
3LY



Molded Orange, Type II  
2ROS

### Breakdown for Molded Type I Sleeves

Voltage Class	Size	Colour
1	R or L	Y
2	R, L or XL	B, Y, M
3	R or L	Y, M
4	R or L	M

R = Regular  
 L = Large  
 XL = Extra Large  
 B = Black  
 Y = Yellow  
 M = Maroon

### Breakdown for Molded Type II Sleeves

Voltage Class	Size	Colour
1	R or L	BS or OS
2	R, L or XL	BS or OS

R = Regular  
 L = Large  
 XL = Extra Large  
 BS = Black SALCOR®  
 OS = Orange SALCOR®

## Harness and Straps

- Four buttons, two straps, and one harness are required per pair of sleeves

H1 - Harness with 4 B2 buttons (right)  
 S1 - 5" Strap with 4 B2 buttons (below)



## Sleeve Buttons & Straps

- Sleeve buttons, straps, and harnesses are required to wear insulating rubber sleeves properly

B2 - 1-Piece Sleeve Button  
 B22 - 4 Screw Type Button



## Glove Liners

Glove liners enhance the comfort of wearing Insulating Rubber Gloves in every season. Liners provide warmth in the cold season and absorb perspiration in the warm months. Many styles and fabrics are available and include the option of either an open or knit wrist.

The knit wrist style grips the wrist rather than allowing the cuff to roll down and bunch at the palm. All liner gloves are for year round use with Insulating Rubber Gloves and Mittens. All liners are made from stretch fabric that can fit any hand size.

Part #	Description	Wrist style	Length (inches)	Weight (lbs)
L10JK	Jersey Style, lightweight Seams Out	Knit	10	.14
L10J	Jersey Style lightweight, Seams Out	Open	10	.12
L12J	Jersey Style, lightweight, Seams Out	Open	12	.14
L10MKC	Machine Knit, 100% Cotton	Knit	10	.12
L12MKC	Machine Knit, 100% Cotton	Knit	12	.12
L10MKW	Machine Knit, Wool Blend	Knit	10	.14
L12MKW	Machine Knit, Wool Blend	Knit	12	.14
89/1402	White Machine Knit, 100% Cotton	Knit	10	.12
89/4702	Rust Machine Knit, 100% Acrylic	Knit	10	.12





# Salisbury by Honeywell Leather Protectors



156-4



ILP10



ILP10A



ILP7C



ILPG3S



LPG4S

## Advantage Premium Series

- Made from specially tanned Grade A Red Boulevard buffed leather and an orange coloured SALCOR® "Super Cuff"
- Super Cuff does not absorb water and has greater track resistance and creepage than leather or vinyl cuffs
- Available in 4" straight cuff (12" overall) or 6" straight cuff (14" overall)
- SALCOR® cuff provides maximum protection
- Dual sizes: 8/8.5, 9/9.5, 10/10.5, 11/11.5, 12

*Warning: Do not use leather protectors alone for protection against electric shock. Serious injury or death will result. Always use a properly rated insulating glove for the voltage being worked on*

### 156 PREMIUM SERIES

Part #	Cuff Length (inches)	OAL Length (inches)	Weight Ea. (lbs)
156-4	4, Straight Cuff	12	1
156-6	6, Straight Cuff	14	1.2

**ILP SERIES - COWHIDE** Manufactured from top grain cowhide. Cuffs feature tough leather on palm side and orange vinyl on back.

Part #	OAL Length (inches)	Weight each (lbs)
ILP3S	12	1
ILP4S	13	1
ILP5S	14	1.2
ILP6S	15	1.2
ILP7C	16	1.5
ILP10	10	.7
ILP10A w/ pull strap	10	.7



### CLEARANCE TABLE FOR LEATHER PROTECTORS PER ASTM F496

Glove Class	Min. distance between Protectors & Rubber Gloves	
00, 0	1/2"	13mm
1	1	25mm
2	2	51mm
3	3	76mm
4	4	102mm

**LP SERIES - COWHIDE** Manufactured in the US from top grain cowhide. Cuffs feature adjustable straps with non-metallic buckles and are stitched with polyester thread for strong seams.

Part #	OAL Length (inches)	Weight each (lbs)
LP3S	12	1
LP4S	13	1
LP5S	14	1.2
LP6S	15	1.2
LP7C - contour cuff	16	1.5
LP10	10	.7
LP10A w/ pull strap	10	.7

**ILPM SERIES - COWHIDE** Mitten protectors are manufactured from top grain cowhide. Cuffs are tough leather on palm side and orange vinyl on back of hand side. Feature adjustable straps with non-metallic buckles and are stitched with polyester thread for strong seams.

Part #	OAL Length (inches)	Weight each (lbs)
ILPM3S	12	1
ILPM4S	13	1
ILPM5S	14	1.2



TRUSTED SINCE 1958

# Salisbury by Honeywell Gloves

## Winter Utility Gloves



UWG-WPGC/S	Small
UWG-WPGC/M	Medium
UWG-WPGC/L	Large
UWG-WPGC/XL	X Large
UWG-WPGC/XXL	2X Large

- Wool/fleece blend sportswool liner and 3M Thinsulate for extra insulation
- Gauntlet cuff with adjustable closure
- Waterproof, windproof, and breathable
- Non-slip saddle for gripping wet items

## Kevlar Utility Gloves



UWG-KLG/S	Small
UWG-KLG/M	Medium
UWG-KLG/L	Large
UWG-KLG/XL	X Large
UWG-KLG/XXL	2X Large

- A cut-resistant all-purpose glove
- Fully lined with 100% kevlar fiber
- Level 4 of 5 on EN388 Cut Test Standard
- Extensive PVC reinforcement for durability
- Double-stitched for extended life

## Pro Utility Gloves



UWG-HUXT/S	Small
UWG-HUXT/M	Medium
UWG-HUXT/L	Large
UWG-HUXT/XL	X Large
UWG-HUXT/XXL	2X Large

- The perfect utility worker glove
- Breathable stretch nylon on back of hand
- Extended cuff with asphalt reinforcement
- Non-slip saddle for gripping wet items
- Extensive PVC reinforcement for durability

## Winter Pro Gloves



UWG-WPSC/S	Small
UWG-WPSC/M	Medium
UWG-WPSC/L	Large
UWG-WPSC/XL	X Large
UWG-WPSC/XXL	2X Large

- All-purpose and abrasion resistant
- One piece back of hand with knuckle protection
- Supportive and breathable cuff
- Double-stitched for extended life

## LW2SPE: Lineman Cowhide Work Glove



- Linemen Work Gloves are designed specifically for use by linemen and offer many of the quality features found in our leather protectors
- The glove is soft and flexible, while still being highly abrasion and cut resistant for long wear
- Made from high quality grain cowhide and features a natural pigskin cuff
- Add "-M" for a size medium, "-L" for a size large, and a "-XL" for a size extra large

## SP-L: SALPOL Gloves

- SALPOL Gloves protect hands during cold weather jobs
- The black split cowhide leather has a 3M Thinsulate lining to keep hands warm
- For extra warmth, a long knit wrist is sewn into the safety cuff to keep out snow and ice
- The glove also has a full leather index finger, knuckle strap, leather finger tips, and pull patch

## I95/217 WHS: Driver Work Gloves



- Drivers Work Gloves set the standard for quality at an affordable price
  - Combining comfort, durability and economy, Salisbury leather Drivers Work Gloves meet the tough challenges of today's demanding workplace
  - Available in lined or unlined styles. The bindings are colour coded to indicate size: red-small, green-medium, brown-large, purple-extra large
- I95/217/WHS-SIZE (S/M/L/XL)**



# Chance - Lineman Grade Gloves

Featuring the ultimate protection you expect from the Chance name, these Lineman Grade Gloves also offer a new level of comfort and flexibility. Incorporating high dielectric and physical strength, these gloves exceed ASTM D120.

## Contour Cuff



ASTM classes: 2, 3 & 4  
Colours: Yellow under Black & Red under Black  
Sizes 8 to 12 and 8.5, 9.5 and 10.5  
Length: 18"

## Bell Cuff



ASTM classes: 1 & 2  
Colours: Red under Black & Yellow under Black  
Sizes: 9 to 12  
Length: Class 1 - 14" & 16", Class 2 - 14", 16" & 18"

ASTM classes: 3 & 4  
Colours: Red under Black & Yellow under Black  
Sizes: 9 to 12  
Length: 16" & 18"

## Straight Cuff (High Voltage)



ASTM classes: 1 & 2  
Colours: Black & Red under Black & Yellow under Black  
Sizes: 8 to 12 and 8.5, 9.5 and 10.5  
Length: Class 1 - 14" & 16", Class 2 - 14", 16" & 18"

ASTM classes: 3 & 4  
Colours: Red under Black & Yellow under Black  
Sizes: 8 (class 3 only) to 12 and 8.5 (class 3 only), 9.5 and 10.5  
Length: 16" & 18"

## Straight Cuff (Low Voltage)



ASTM classes: 00 & 0  
Colours: Red & Black & Yellow  
Sizes: 7 to 12 and 7.5, 8.5, 9.5 and 10.5  
Length: Class 00 - 11" & 14" (red available in 11" only), Class 0 - 11" & 14"

# Chance - Leather Protectors & Sleeves

## Low-Voltage Leather Protectors

- Goatskin-soft, flexible, strong
- Nylon strap with non-metallic buckle
- Note: 13" have polymeric/leather cuff



## High-Voltage Leather Protectors

- Cowhide - durable and flexible
- Hi-visibility polymeric/leather cuff
- Nylon Strap with non-metallic buckle
- Note: 16" fit straight and contour gloves



## Glove Liners

- 100% Cotton for warmth and comfort under rubber insulating gloves
- One size to fit most
- Two weight/length choices
- Reversible to fit either hand



## Sleeves

- The ultimate source of protection expected from the Chance name
- Offers a new level of comfort and flexibility
- Constructed for high dielectric and physical strength
- Exceed ASTM D1051
- Available in sizes Regular, Large and Extra Large
- Extra-Curved Sleeves are dipped
- Comes in yellow or two contrasting colours



Size	Class 2			Class 3			Class 4		
	Yellow	Red under Yellow	Yellow under Black	Yellow	Red under Yellow	Yellow under Black	Yellow	Red under Yellow	Yellow under Black
R	PSC2RYEC	PSC2RRYEC	PSC2RYBEC	PSC3RYEC	PSC3RRYEC	PSC3RYBEC	PSC4RYEC	PSC4RRYEC	PSC4RYBEC
L	PSC2LYEC	PSC2LRYEC	PSC2LYBEC	PSC3LYEC	PSC3LRYEC	PSC3LYBEC	PSC4LYEC	PSC4LRYEC	PSC4LYBEC
XL	PSC2XLYEC	PSC2XLRYEC	PSC2XLYBEC	PSC3XLYEC	PSC3XLRYEC	PSC3XLYBEC	PSC4XLYEC	PSC4XLRYEC	PSC4XLYBEC

### SLEEVE STRAPS & BUTTONS

- Two straps and four buttons are required to properly wear each pair of sleeves
- Straps are 15" in length
- Buttons are two-piece, screw-type



PSC4060610 Straps only



PSCS1 Strap Set: Includes 2 straps & 4 buttons



PSC4060600 Sleeve buttons: (Includes 4 pair)

### Sleeve Part Numbering System

- PSC** = Chance catalogue #
- Class (max. use voltage)** 2 = Class 2 ( 17kV), 3 = Class 3 (26.5 kV), 4 = Class 4 (36kV)
- Size** R = Regular, L = Large, XL = Extra Large
- Colour** YB = Yellow under Black, Y = Yellow, RY = Red under Yellow
- Style** EC = Extra Curved

EXAMPLE: PSC2RYBEC, Class 2, Size regular, Yellow under Black colour, Extra Curved style

## 20-1-1214: Performance Gloves

- Grain leather goatskin palm provides excellent comfort and durability
- Lightweight, breathable 4-way stretch fabric back
- Foam-padded palm for vibration resistance and tool use
- Neoprene knuckle provides excellent flexibility



## 20-1-10605B: Performance Gloves

- Vibration Resistance Gloves
- Synthetic leather palm combined with breathable 4-way stretch fabric
- Reinforced double palm with gel-packs for vibration absorption
- Neoprene knuckle provides excellent flexibility and comfort



## 20-1-10705: Performance Gloves

- Mesh and grain goatskin combination back hand for breathability and comfort
- Synthetic leather fourchette finger inserts with air holes for excellent comfort, mobility and breathability



## 20-1-10690: Performance Gloves

- Heavy Duty Gloves
- High visibility spandex back hand for breathability
- Heavy foam knuckle with silver rubber finger protectors for increased visibility
- Synthetic leather palm with reinforced Rubbertec® patches



## 20-1-10695: Performance Gloves

- Heavy Duty gloves
- Grain leather goatskin provides good dexterity, wear and abrasion
- Heavy rubber padded back hand and fingers for ultimate protection from abrasion and impact
- Double shirred elastic wrist
- Keystone thumb



## 30-1-W10EL-R: Split Leather Fitter Gloves

- Standard grade cowhide split leather
- Cotton/canvas back
- Fleece palm lining
- Rubberized safety cuff



## 40-1-1511PP: Grain Leather Fitter Gloves

- Industrial grade cowhide grain leather
- Cotton/canvas back
- Fleece palm lining
- Patch palm



## 40-1-281ECU: Grain Leather Fitter Gloves

- Industrial grade cowhide grain leather
- Cotton/canvas back
- Completely unlined



## 40-1-2525: Grain Leather Fitter Gloves

- Standard grade cowhide grain leather
- Full leather backhand
- Fleece palm lining
- 2.5" Gauntlet cuff



## 40-1-2510: Grain Leather Fitter Gloves

- Standard grade cowhide grain leather
- Full leather backhand
- Fleece palm lining
- 5" Gauntlet cuff



# Bob Dale Gloves

## 60-1-4100: Xtreme Welding Gloves

- Reinforced backhand patches
- Extended gauntlet cuff with reinforced inner wrist guard
- Kevlar® sewn throughout
- FR cotton liner on backhand and full cuff



## 60-1-4110: Ladies Xtreme Welding Gloves

- Reinforced backhand patches
- Extended gauntlet cuff with reinforced inner wrist guard
- Kevlar® sewn throughout
- FR cotton liner on backhand and full cuff



## 60-1-5200: Xtreme Welding Gloves

- Reinforced backhand patches
- FR cotton liner on backhand and full cuff
- Kevlar® sewn throughout
- Slip-on style with convenient pull-tab for ease of wear



## 60-1-1144P: Welding Gloves

- Premium deerskin for an extremely soft, snug fit
- Thumbstrap for extra durability
- Gauntlet cuff provides added protection
- Left hand heat patch
- Clute cut back



## 60-1-1634: Welding Gloves

- Split leather moosehide for heavy duty protection
- Heat patch on both hands for heat & spark protection
- Gauntlet cuff with gore for extra coverage
- Clute cut back
- Thumbstrap for extra durability



## 60-1-1705: Welding Gloves

- Premium deerskin for an extremely soft, snug fit
- Split leather back resists heat and sparks
- Welted thumb for increased durability
- Gauntlet cuff provides added protection



## 64-1-1065C: Welding Gloves

- Ruff Rigger
- Utility Gloves
- Premium deerskin/cowhide grain leather
- 5.5" Split cowhide leather cuff
- Outseam sewn
- Deerskin Utility



## 60-1-1280: Welding Gloves

- Welding Gloves
- Enhanced leather for water resistance
- 6.5" Gauntlet cuff
- Hi-Viz reflective strips



All Bob Dale gloves are available in a variety of sizes.  
Contact LTL for more information.

## 99-1-9800: Synthetic Gloves

- Seamless knit nylon shell offers excellent comfort and dexterity
- Nitrile foam coating provides a strong grip and resists oils and grease
- Treated with Actifresh® to eliminate bacteria
- Elastic wrist for secure fit and feel



## 99-1-9860: Ninja® Synthetic Gloves

- Flexible HPTTM coating resists punctures and abrasions
- Seamless nylon knit liner is exceptionally comfortable, lightweight and breathable
- Treated with Actifresh® to eliminate bacteria
- CFIA approved



## 99-1-9756: Synthetic Gloves

- Seamless Dyneema® knit for comfort and cut resistance
- Polyurethane coated palm for flexibility and breathability
- Elastic wrist for secure fit and feel
- Machine washable
- EN388 CE4543 cut level 5



## 99-1-9761: Synthetic Gloves

- Seamless knit blend of Dyneema® and synthetic yarns
- Hi-Viz fabric for the ultimate in safety protection
- Microfoam polyurethane coated palm for flexibility and breathability
- Elastic wrist for secure fit and feel
- EN388 CE cut level 5



## 99-1-9730: Ninja® 4X Synthetic Gloves

- Synthetic fiber/fiberglass shell
- Bi-Polymer coating provides softness and durability
- EN388 cut level 4
- Treated with Actifresh® to eliminate bacteria
- EN388 CE4432 cut level 4, ANSI cut level 2 CPPT 862 Grams



# Glove Bags



## LTL Glove Bags

- Made of heavy duty canvas fabric
- All bags have industrial type snaps and two ventilation eyelets in the bottom of bag
- Available for 12", 14" and 18" gloves
- Available with front pocket

LTL112 12" Canvas Glove Bag

LTL114 14" Canvas Glove Bag

LTL118 18" Canvas Glove Bag



LTL114VB Vinyl Glove Bag - Blue Two Pocket



LTL114VY Vinyl Glove Bag - Yellow

## Salisbury Glove Bags

Salisbury bags are constructed of heavy duty canvas duck and are double stitched and riveted at stress points for extra durability. Canvas bags feature a D ring for hanging in trucks or on work belts. Bags feature tapered gussets with wide opening tops for easy insertion.



Part #	For Glove Length (inches)	Dimensions
<b>26 oz. Canvas Glove Bags</b>		
GB112	11	9" x 14"
GB114	14	9" x 16"
GB116	16	9" x 16"
GB118	18	9" x 18"
<b>26 oz. Canvas Glove Bags w/ Goggle Case</b>		
GB114GC	14	9" x 16"
GB116GC	16	9" x 18"
GB118GC	18	9" x 20"
<b>26 oz. Canvas Glove &amp; Protector Bags</b>		
GPB112	12	9" x 14"
GBP114	14	9" x 16"
GBP116	16	9" x 18"
GBP118	18	9" x 20"
<b>Glove &amp; Protector Combo Bags</b>		
2C16	14, 16	9" x 18"
2C18	18	9" x 20"



## Sleeve Bags

- Constructed of heavy duty canvas, double stitched and riveted at stress points for extra durability
- Canvas bags feature a D ring for hanging in trucks or on work belts and tapered gussets
- Feature wide opening tops for easy insertion

**T31 - 30" x 9.5"**

**T32 - 30" x 13"**

*Proper storage extends the service life of linemen's gloves & sleeves. Folds and creases strain rubber and cause it to crack prematurely from ozone. By storing rubber sleeves in the right size bag, and never forcing more than one pair into each bag, equipment will lie flat thereby extending the life of the product.*



## Combination Sleeve & Glove Bags

- Made of heavy duty canvas fabric
- All bags have nickel plated industrial type snaps and two ventilation eyelets at the bottom of the bag
- Snap closure

**2C16 - 9"**

**2C18 - 9"**



## Canvas Double Glove Bags

- Made of heavy duty canvas fabric
- All bags have nickel plated industrial type snaps and two ventilation eyelets at the bottom of the bag
- Stores sets of high and low voltage gloves and leather protectors
- 19" x 8" x 6"



## Salisbury Glove Kits

- For every electrical worker's complete safety, Salisbury glove kits keep insulating rubber gloves in top condition, providing proper storage to ensure protection against cuts, abrasions and punctures



### Product Numbering Chart for Glove Kits

	Class	Length	Colour	Sizes
GK	00	11 or 14	B, RB, BL	7, 8, 9, 10, 11, 12
GK	0	11 or 14	R, BL, B, Y	7, 8, 9, 10, 11, 12
GK	2	14, 16, or 18	B, RB	7, 8, 9, 10, 11, 12

Example: GK011BL-9

Type I Natural Rubber Available in: R=Red, Y=Yellow, B=Black, RB=Red in, black out

Type II SALCOR® Rubber available in: BL = Blue

# Salisbury by Honeywell

## Ten-Four® Glove Dust



- A cooling, frictionless powder that absorbs moisture and perspiration when wearing rubber gloves
- Provides extra comfort while preventing gloves from getting sticky
- 5 oz. bottle easily fits into a pocket or glove bag
- Sold by the case

**10-4 - (12) 5 oz. Bottles per Case**  
**10-4-4QT - 3.8 Litres Bulk, Single**

## Rub-Out® Towelettes



1461

1460

- 10.5" x 12.25" pre-moistened heavy duty towelettes
- Loosens, dissolves, and absorbs dirt and grease
- Will not harm rubber gloves
- Remove tough to clean substances including lubricants, tar, oils, wax, and caulk

**1460 Bucket of 60, 6 Buckets/Case, 14 lbs**  
**1461 Single Packets, 100 Singles/Case, 3 lbs**

## Rub-Out® Hand Cleaner



- A non-petroleum based hand cleaner for workers who wear rubber gloves and sleeves
- Dissolves and removes grease, oil, ink, tar, pipe dope, creosote, paint, and more without harming natural rubber or SALCOR® rubber
- Cleans with or without water
- Contains natural skin conditioners and leaves a fresh citrus scent
- Sold by the case

**1451 - (12) 16 oz. Cans per Case, 16 lbs**

## Super Salco® Cleaner



- Concentrated detergent with a special grease release formula that removes oils, grease, and dirt from natural rubber and SALCOR® rubber equipment
- Suitable for use in commercial washing machines or by hand
- Works well on fiberglass and other materials

**S4 - (4) 1 Gallon Jugs, 54 lbs**  
**S5 - (1) 5 Gallon Drum, 49 lbs**

## SALCON® Silicone Spray



- Specially formulated to reduce friction on natural rubber products
- Reduces surface creepage on rubber gloves and sleeves
- Oxygen barrier helps reduce corona cutting and weather checking

**S99 - Aerosol Can, 16 oz.**

## Class 3 Conductor Covers



- 5' cover is ideal for covering long spans when weight is a consideration
- 26.4kV voltage rating
- 2" inside diameter
- May be connected with Salisbury 1.5" I.D. Class 3 or 4 flexible cover-up equipment
- Conductor covers connect easily with either plastic or rubber line hose

21172	5' Cover with Eye
21173	27kV, 5' Cover
21315	5' Cover with 4' Fiberglass Stick
21826	Lightweight 35kV, 6' Conductor Cover



## Straight Line Hose

- Orange Type II SALCOR® line hose with RIB-GRIP® locking system
- Hoses remain flexible even in cold weather and are not damaged by ozone or ultraviolet rays
- Other sizes and classes are available

Part #	Type	Class	I.D. x Length
OR125-3	II	2	1.25" x 3'
OR125-45	II	2	1.25" x 4.5'
OR125-6	II	2	1.25" x 6'
OR150-3	II	3	1.5" x 3'
OR150-6	II	3	1.5" x 6'

## Line Hose - Extended Lip SU System

- The Extended Lip SU System is the only complete flexible cover-up available for use on voltages through 34.5kV
- Extremely versatile, it may be installed by hand
- Manufactured from superior SALCOR® Type II elastomer it is resistant to the effects of ozone and ultraviolet deterioration
- It remains flexible even at sub-zero temperatures
- Salisbury's RIB GRIP® construction securely interlocks with its corresponding covers and connectors
- Tapered lips facilitate easy starting on the conductors
- The contour cut ends accommodate the skirts of pin type insulators and permit the hose to cover the line snug to a saddle or clamp
- Available as Straight Line Hose or with a Connector End for easier connection of line hose and covers

Part #	Type	Class	I.D. x Length
SU150-45C	II	4	1.5" x 4.5'
SU150-6C	II	4	1.5" x 6'



## Stinger Cover

- Protects against phase-to-phase and phase-to-ground wildlife contacts
- Track resistant
- May be installed without disconnecting the lead wire from the bushing
- Easy to cut to the necessary length
- Ozone and UV resistant SALCOR® elastomer

Part #	Description
38-50SC	3/8" x 50' 1 coil
38-12SC	3/8" x 12' 4 pcs
58-12SC	5/8" x 12' coil 4 pcs
34-12SC	3/4" x 12' coil 4 pcs



## Silicon Bushing Cover



- Ozone and UV resistant silicone rubber
- Protects against wildlife contacts between energized equipment and ground by insulating exposed energized bushing parts
- Interlock with the top weathershed of the bushing and are securely fastened by inserting lock buttons
- Cover is 3.87" diameter x 3.37" tall

Part #	Description
21116	Cover Only; 16kV
21116TC	Cover with Tube Closure; 16kV
21644	Tube Closure



# Salisbury by Honeywell

## 1370 & 1371: Crossarm Guards

- Available in two different styles: the 1370 pin type and the 1371 post type
- Used to prevent tie wires from contacting crossarms during hot line operations
- Two different tie downs provided: a neoprene and a polypropylene rope
- Both are secured in the slots provided in the eye fitting
- Post type model has an automatic gap closer which covers the insulator slot opening over the end of the arm
- Made from orange Type I ABS cold weather high impact plastic



## 736PH: Slide-On Crossarm Guard

- Applied by sliding the cover on to the arm from the end using the shotgun eye until the unit locks onto the insulator pins
- Cover overlaps on top and has notches to ease application and removal
- Made from orange Type I ABS cold weather high impact plastic

Part #	Description	Dimensions	ASTM Voltage Class	Weight (lbs)
1370	Crossarm or Pin Type Guard	9" x 9" x 25.5"	4	5.7
1371	Crossarm or Post Type Guard	Fits Crossarm: 5 x 6	4	6
736PH	Slide-On Crossarm Guard	7"	4	4.5



## Versa Guards® & Link Guards

- Make use of air as well as the dielectric strength of plastic to provide total insulating value
- Both guards have a 7" diameter and a hook shaped inner lip to keep the guard in place
- Versa Guards: voltage rating of 36.6kV are designed so that two guards can be coupled together to cover most 13kV single and double arm, pin and post constructions
- Link Guards: voltage rating of 72.5kV, have inner and outer shells that run full length to include male and female couple ends
- Two guards connected provide four overlapping thicknesses of plastic plus air at a joint
- Tee Connectors: used on horizontal and vertical posts and suspension insulator strings when plastic line guards are used on the conductor
- Available in two ratings: 72.5 kV and 48.3 kV



Part #	Description	Type	ASTM Voltage Class	Grade	Weight (lbs)
<b>VERSA GUARDS 4.5'</b>					
2373	ABS/PVC, Eye	III	4	2	8.8
2377	ABS/PVC, 4' Stick	III	4	1	10.8
2378	ABS/PVC, 6' Stick	III	4	1	11.8
<b>VERSA GUARDS 3.92'</b>					
2389	ABS/PVC, 4' Stick	III	4	1	6.1
2689	ABS/PVC, Eye	III	4	2	8.1
<b>LINK GUARDS 4.5'</b>					
2475	ABS/PVC, Eye	III	6	2	10.5
2476	ABS/PVC, 4' Stick	III	6	1	12.5
2477	ABS/PVC, 6' Stick	III	6	1	13.5

## Class 5 Air Gap® Pole Guards

- Rated max use voltage of 48.3 kV guarded phase to guarded phase or 27kV phase to ground
- Unique Air Gap® Design: uniformly spaced dimples help increase insulation and keep electrical leakage to a minimum
- Type I ABS Plastic: strong memory improves grip when applied to the utility pole

Part #	Diameter x Length	Weight
2486	9" x 6'	13.8 lbs
2478	12" x 6'	16 lbs



## Substation Cover-Up & Accessories

- Often used where outages are difficult to reach and the occurrence of accidental contact is high
- May be applied with rubber gloves or hot sticks
- Made from Type I orange ABS plastic
- Bus Guards: easily interlocked with each other, guard has voltage rating of 36.6kV
- Bus "T" Guards: interlock two or three bus guards at bus tap "T" connections and 90° angles. To interlock units, first position the bus guard then slide the "T" guard over the top interlocking the dimples. This guard has a voltage rating of 36.6kV
- Bus End Guards: cover the ends of a substation bus supported by station post insulators

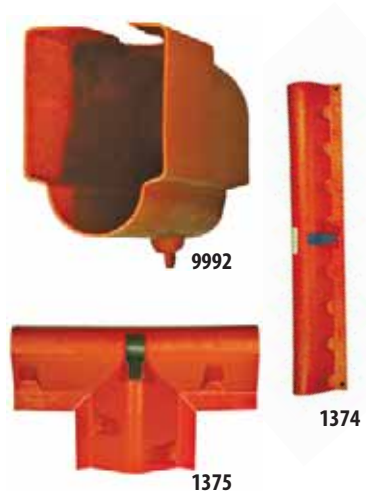

Part #	Dimensions	Description	ASTM Voltage Class	Weight (lbs)
Bus Guard 1374	5.25" x 9.5" x 4.5"	Impact Resistant ABS Plastic	4	6
Bus "T" Guard 1375	5" x 15" x 25"	Impact Resistant ABS Plastic	4	4
Bus End Guard 9992	8.5" x 12" x 24"	UV Resistant High Density Cross Linked Polyethylene	3	5
<b>GUARD ACCESSORIES</b>				
816	8" x 16"	Hot Cover	4	2.5
4314	15" x 14.25"	Underground Distribution Elbow Cover	3	2
4333	20" x 25"	Pole Bracket & Insulator Base	3	2.5

# Salisbury by Honeywell

## Post-Type Insulator Covers



- Covers interlock with 1.5" (38mm) Class 4 Extended Lip SU System or Conventional Line Hose
- The PTHL cover also has external ribs on the ears which secures 2.5" I.D. line hose
- Always use clamp pins to secure the device into position

Part #	Description
PTHL	For insulators up to 16"
PTHS	For insulators up to 12"

## Rubber Insulating Blanket - Slotted



- Ozone-resistant Type II orange SALCOR® is manufactured from a blend of prime EPDM, offering supreme flexibility
- Use for covering ridge pins, cross arms with insulators or any place a wire, pin or projection interferes with proper placement of other cover-up devices

1300	Class 4, 28 Eyelets, 36" x 36"
1302	Class 4, 2" Hole, 36" x 36"
1304	Class 4, 4.5" Hole, 36" x 36"

## Rubber Insulating Blanket - Solid



- Ozone-resistant Type II orange SALCOR® is manufactured from a blend of prime EPDM, offering supreme flexibility
- Will maintain colour, flexibility, physical properties, and dielectric strength in the field longer than any other blanket on the market
- Reinforced, beaded edge

**Salisbury 900E**      Class 4; 6 Eyelets; 36" x 36"

## Roll Blanket

- Salisbury's insulating Roll Blankets are made from a high strength fabric reinforced Type II rubber in unique colours making it easy to identify and highly visible in the work area
- All classes of Roll Blankets are easy to cut, and flexible to -40°F. Highly puncture and tear resistant, each class of blanket is also flame (self-extinguishing), oil, and ozone resistant

RLB00	ASTM 00, Type II, 3' x 30', Brown, 20 lbs
RLB0	ASTM 0, Type II, 3' x 30', Yellow, 26 lbs
RLB1	ASTM 1, Type II, 3' x 30', Yellow/Orange, 36 lbs
RLBPVC1	ASTM 1, 3' x 50', Clear, 60 lbs
RLBPVC1-48	ASTM 1, 4' x 30', Clear, 48 lbs



- The Roll Blankets can be easily custom-cut to fit each application at the job site
- This minimizes the number of different low voltage blanket sizes and shapes that would otherwise need to be carried from job to job. Each blanket comes in a convenient 36" wide roll
- Salisbury's insulating Type II rubber Roll Blankets and Insulating Aprons, meet ASTM F2320 standards

## Arc Protection Blankets

- Salisbury by Honeywell Arc Protection Blankets are now available in 4' x 5' and 4' x 8' sizes
- Each size is available in 15kA or 40kA ratings. The 15kA blankets include convenient loops and the 40kA blankets include grommets to easily keep the blanket in place
- These new blankets are sold individually or with a storage bag or storage bag and tie-strap kit
- The Arc Suppression Blanket is used as a barrier for protection from the explosive and incendiary effects of electrical arcs and flashes. These hazardous electrical discharges can be caused by faults in cables, in cable splices and joints, and at transformer terminals, or they may be generated by the operation of switchgear, circuit breakers and lightning arresters
- The blanket can be used for worker protection in underground vaults, switchyards, and other locations where electrical equipment poses a risk of exposure to explosive electrical discharges

*NOTE: These products do not eliminate or reduce requirements for proper PPE for arc flash protection*

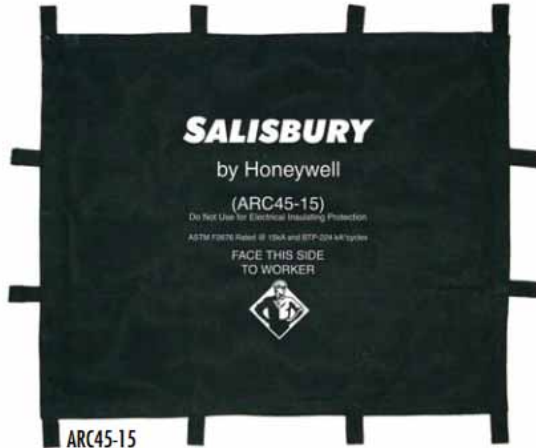

Part #	Dimensions	Description
ARC45-15	48" x 60"	15kA rating - navy blue
ARC45-40	48" x 60"	40kA rating - gray/khaki
ARC48-15	48" x 96"	15kA rating - navy blue
ARC48-40	48" x 96"	40kA rating - gray/khaki

## Blanket Pins



Salisbury 21

Salisbury HS21 For 90° Angle Applications

- In addition to other uses, blanket clamp pins can be used to hold insulating blankets in place
- Springs are used for tension while extra holes in the body of the pin are used to grip conductors and prevent line hose from sliding
- Opens to a full 5.5", making these pins the most versatile on the market
- Tapered ends to accommodate any clampstick
- Fiberglass reinforced nylon with rubber tipped pin boots
- Use HS21 for applications and removal where a 90° angle is necessary

## Blanket Buttons



Salisbury B1

- Designed to secure eyelet-style insulating blanket
- Made of yellow plastic, these buttons snap through the eyelet with thumb pressure on the large head

## Blanket Canisters



- 9" x 37"; holds up to six 36" blankets
- Molded in bright orange, high impact polyethylene with a tight fitting cap
- For easy retrieval, blankets can be rolled individually and stored in canister; a single blanket can then be removed without removing any others

P2	Fits Blanket Max Size: 36", Dimensions (in): 5 x 37, Capacity: 1-2 Blankets
P4	Fits Blanket Max Size: 36", Dimensions (in): 7 x 37, Capacity: 1-4 Blankets
P6	Fits Blanket Max Size: 36", Dimensions (in): 9 x 37, Capacity: 1-6 Blankets

# Chance - Rubber Insulating Covers

## 36" x 36" Rubber Insulating Blankets

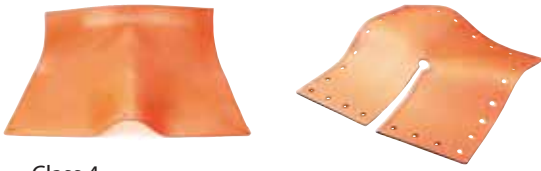

- Class 4
- Will retain its high-visibility orange colour
- May be used in applications which require a lower class or type
- Type II ozone/corona-resistant elastomer offers excellent performance properties in accordance with ASTM Standard Specification D-1048
- Offers superior resistance to long-term aging/checking

<b>C4060346</b>	<b>Solid Blanket</b>	<b>6 eyelets</b>
<b>C4060348</b>	<b>Slotted Blanket</b>	<b>28 eyelets</b>

## Straight Line Hose

- Does not absorb water
- Type II ozone/corona-resistant elastomer offers excellent performance properties in accordance with ASTM Standard Specification D-1050-90



<b>C4060296</b>	<b>Class 2, 1.25" diameter, 6' length, 4.55 lbs</b>
<b>C4060299</b>	<b>Class 3, 1.5" diameter, 6' length, 6.22 lbs.</b>

## Deadend Cover

- These covers provide a highly versatile system of covering up a wide variety of configurations on distribution systems
- The conductor covers couple with the insulator units and deadend units to cover pin-type or post-type insulator construction, virtually surrounding the hot parts and hardware to give line workers extra protection when rubber gloving or using hot sticks
- Each item is fitted with an adapter for multi-position handling by Grip-All clampsticks
- Covers couple with Chance 25kV covers, Classes 2, 3, and 4 of rubber line hose and major brands of rubber insulator hoods
- All covers are bright orange in colour
- All are made of high density polyethylene in a uniform wall thickness for excellent dielectric/puncture strength
- Performs well from -50° to 170°F
- Ultra-violet stabilizers in the material help inhibit degradation as a result of atmospheric exposure
- Deadend cover fits three 10" diameter porcelain bells or polymer deadend insulators and couples with the line cover
- To meet the Class 4 rating, the deadend cover must be used in conjunction with a rubber insulating blanket covering the coupler to the line cover
- Failure to use a blanket to cover the coupler may result in electrical shock, severe injury or death by electrocution

## Rubber Blanket Buttons



- Sold individually
  - For use with any rubber insulating blanket with perimeter eyelets
- C4060532**

## Clamp Pins

- C4060530 features eyes and special handle shape for easy placement by clampstick
- C4060531 features a special handle shape for easy placement by clampstick



<b>C4060530</b>	<b>Rubber Glove Use</b>
<b>C4060531</b>	<b>Hot Stick Use</b>

## Short-Lip Flexible Line Hose

- Does not absorb water
- Type II ozone/corona-resistant elastomer offers excellent performance properties in accordance with ASTM Standard Specification D-1050-90



<b>C4060306</b>	<b>Class 2, 1.25" diameter, 6' long coupler on one end; proof tested at 20kV AC RMS</b>
<b>C4060309</b>	<b>Class 3, 1.25" diameter, 6' long coupler on one end; proof tested at 30kV AC RMS</b>

## Spiral Conductor Cover

- Provides extra protection with a wide air space between two thicknesses of solid insulation
- Made of tough, durable ABS plastic
- Overall length of each cover is 53"
- All units interlock with each other to make up a chain of guards
- 15/36.6 kV units are formed on the ends to fit over most 15kV insulators, thus eliminating the need for an insulator cover
- A 4' or 6' long retractable Epoxiglas® handle or Clampstick adapter provides for ease of installation from a bucket or platform, in single units or linked together
- Each double-crossarm unit will fit over two 15kV pin-type insulators



**C4060082GA**    **46kV Phase-to-Phase**



**C4060537**    **36kV Phase-to-Phase**



# Chance - Rubber Insulating Covers

## Pole Covers

- Prolonged contact with an energized conductor must not be allowed
- Tested to ASTM F712
- Manufactured to ASTM F968 specifications
- Meet Class 4 requirements
- Made of high dielectric linear polyethylene material that will not flash flame
- Helps protect personnel when raising or lowering a pole between energized lines or to cover poles when rubber glove maintenance is performed in relatively confined areas
- This material will have some softening without deformation at approximately 170°F, and it will resist brittleness at temperatures to -50°F
- Chance covers are ribbed to reduce cover contact with the pole, thus minimizing creosote contamination
- Rope handles permit personnel to easily spread the covers and snap them around the pole; rubber gloves must be worn during this procedure



### 6" Diameter Pole Covers

**C4060550**      48" long  
**C4060551**      72" long

### 9" Diameter Pole Covers

**M4937-1**      12" long  
**M4937-2**      24" long  
**M4937-4**      48" long  
**M4937-6**      72" long

### 12" Diameter Pole Covers

**C4060029**      24" long  
**C4060030**      48" long  
**C4060000**      72" long

## Conductor Cover & Insulator Covers

- Bright orange in colour
- 5' long; 25 kV phase-to-phase
- Maximum conductor size: 666 kcmil ACSR
- Performs well from -50° to 170°F
- Available with adapter for hot stick application or without adapter for rubber glove application
- Provide a highly versatile system of covering up a wide variety of configurations on distribution systems; the units virtually surround the hot parts and hardware to give the linemen extra protection when rubber gloving or using hot sticks
- Made of high density polyethylene in a uniform wall thickness for excellent dielectric/puncture strength
- 5' long and are available with a Grip-All adapter for hot stick application or without adapter for rubber glove application
- Conductor covers mate with insulator covers to cover pin-type or post-type insulator construction; may also be used with the deadend cover
- Conductor cover will couple with major brands of rubber line hose and insulator covers of the 25kV class



### 25 kV Phase-to-Phase

**C4060181**      5' Cover, 4' Handle  
**C4060181GA**    5' Cover, Grip-All Adapter  
**P4060184**      5' Cover Only

### 36 kV Phase-to-Phase

**C4060514GA**    5' Cover, Grip-All Adapter

## Cross Arm Cover

- Prevents tie wires from contacting the crossarm when tying and untying insulators
- The material used is the same high-dielectric polyethylene used for Chance conductor and insulator covers
- Flanges above the slots shield the ends of the double-arming bolts
- Designed for single or double arm construction, with slots provided for double-arming bolts



## Insulator Covers

- Insulator covers come in two heights; 12" or 16.5"
- Cover fits 6.5" to 9" diameter pin or post insulators
- Special slits in the insulator covers help locate the conductor and hardware when installing the covers

**C4060557**      12" Tall      36 kV Phase-to-Phase  
**C4060557L**    16.5" Tall    36 kV Phase-to-Phase



## JIBS & EXTENSIONS WITH MATERIAL HANDLING ACCESSORIES

### Jib Extension with Wireholder 3" diameter round Epoxiglas® Insulation

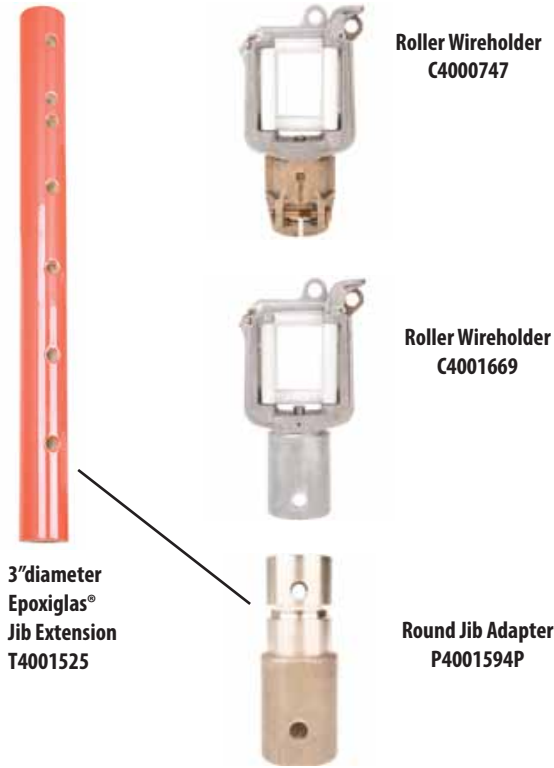

### Jib Extension with Wireholder 4" x 4" Square Epoxiglas® Insulation



## Jib Extensions & Storage Bag

- T4002415 features two adjustment holes; one hole is 2.5" from end; the second is 40 3/8" from the first adjustment hole; 3" diameter heavy wall jib extension x 60" long
- PST4002737 3" diameter heavy wall Jib Extension is 36.7" long and features 3 adjustment holes



## Jib Extensions with Wireholder

- PST4002818 features a wire holder
- PST4003059 features a wire holder on one end and a sheave (roller) on the other end
- 31" insulated rod connects both ends
- Clear coat on glass rod
- May be used in conjunction with material handler



## Jib Sleeve Adapter - 4" x 4"



PST4003111

# Chance - Conductor Support Equipment

## Epoxiglas® Extension Arm



- Designed for use on voltages up to and including 15kV where reconductoring or insulator replacement is necessary
- Epoxiglas® Extension Arm can be used on voltages up to 34.5kV providing the wireholders are fitted with insulators
- Maximum crossarm size: 3.75" x 4.75"
- Arm diameter: 2.5"
- Maximum vertical loading per wireholder: 150 lbs

H480060	5' long	1 wireholder
H480072	6' long	2 wireholders

## Chain Type Temporary Conductor Supports

- Used to hold energized distribution conductors during replacement of poles or repair/replacement of pole top and stand-off insulators
- Furnished with wheel tightener for poles up to 14" diameter
- Working load is 150 lbs per wireholder



H4001509 Two Conductor Supports



H4809W Single Conductor Support

## 35kV Tension Puller Switching Tool



C4001907

- Combines line tension disconnect switch with Epoxiglas® insulated tool
- Weathershed polymer skirts are bonded to 1.5" diameter pole
- Compression clamps secure switch hot parts to pole
- 1/2" bypass stud at each end accepts 3" wide jumper clamps
- Copper switch blade with silver-plated contacts opens to 90°, or 180° with stop pin removed
- Galvanized hooks provided for operation by loadbreak device
- With handling rings, this tool may be operated by either hot line tools or rubber glove techniques

## Nylon Strap Type Temporary Conductor Supports



- D-shaped buckle on the strap free end adds speed and convenience
- Polyester strap offers less stretch
- With 10,000 lbs rated tensile strength, 2" wide strap comes in 44" length to fit most structures
- Wide handle opening on rapid-action ratchet permits easy operation

T4001939 Double Conductor Support (top)



T4001940 Single Conductor Support (bottom)

# Chance - Conductor Support Tools

## Temporary Cutout Tools

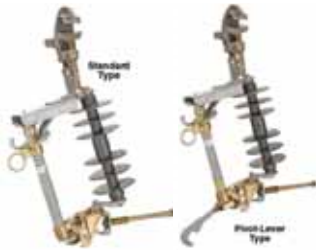

- Provides fuse protection during live-line maintenance
- Insulated bushing and hot parts are from Chance Type C-Polymer cutouts
- Upper contact with integral sleet shield and hooks are made of cast bronze
- Fusetube must be fitted with fuselink rated no larger than 100 AMP

## C4000574: 34.5 kV Hot Stick Tension Puller



- Equipped with rings for operation with Grip-All Clampstick or with rubber gloves
- Non-swiveling hook on each end for positive hot stick operation
- Spring-loaded gate will rotate 135° left or right from closed position
- Selector lever on the ratchet wrench accommodates hot sticks

## M4744: Crossarm Wire Tong Saddle



- Used on underbuilt arms when working space is limited or crowded with pole saddle(s)
- The pivoting action of the saddle swivel and pole clamp attachment provides a universal-joint action which allows complete freedom of movement of the wire tong in any direction and without binding
- Saddle does not include pole clamps
- Max. work load is 500 lbs.

## T4002272: Corner Restraint Bracket Tool



- Corner restraint bracket tool helps control each phase conductor while insulators are changed
- Acts as a load restraint for the hoist to pull the conductor back in for reconnection to the insulator string
- 2000 lbs max. load rating
- 2.5" diameter, 6" clear length

## Temporary Load Disconnect Tools



- Provides a temporary means of connecting and disconnecting equipment or circuits under load conditions
- Does not have a fuse and does not provide protection for fault or overcurrent conditions
- Insulated bushings and hot parts are from Chance Type-C Polymer cutouts, including the tubular copper disconnect blade
- An arc-chute type interrupter gives the tool its excellent loadbreak capability
- Tool clamps onto primary conductor with a Grip-All clampstick

PSC6010347 8.3/15kV

PSC6010348 15/27kV

## M47602: Lever Lift Arbor Tool Wire Tong Support



- Allows conversion of the single type lever lift to a double type when desired



TRUSTED SINCE 1958

# Chance - Conductor Support Tools

## Pole Wire Tong Saddle & Clamps



- Made of lightweight aluminum
- Will support a maximum of 1,000 lbs without the extension
- Clamp is set far enough away from the base to give ample clearance for most jobs
- Where additional clearance is required, the Chance Wire Tong Saddle Extension can be easily bolted to the saddle
- Heat treated aluminum-alloy extension is 4" long and has a tested working load rating of 800 lbs
- Wheel Type fasteners are easy to apply, hold the saddle firmly in place, and prevent riding down and excessive play
- Wheel Tightener has the advantage of being able to fit into close places such as between crossarm braces, under guy wires, etc.

<b>M4740-3W</b>	<b>Pole Wire Tong Saddle</b>
<b>M4741-3</b>	<b>Pole Clamp Only 2.5" Dia. Opening</b>
<b>M4741-2</b>	<b>Pole Clamp Only 2" Dia. Opening</b>

## H46461212' Wire Tong

- Made with Epoxiglas® poles
- Castings are made of heat treated aluminum alloy, separated by bronze wear rings
- Wide range jaws on the head can be clamped tightly on the conductor by turning the stick from a position beyond the minimum working clearances
- Designed for use in many applications: moving and holding live conductors clear of the working area, flat crossarm and/or ridge pin-construction, on horizontal post insulator structures, with all types of suspension insulator lines, for use as auxiliary arm braces, and in EHV construction for brace pole or ladder positioning guides
- Wire Size .16" - 2.25"



## M4742: Wire Tong Tower Saddle w/ Regular Hooks



- Used to support wire tongs or boom poles on towers
- Saddle is securely fastened to the angle iron tower leg by four hooks tightened by wing nuts
- A clevis which bolts through the pivot lug permits rope blocks to be fastened so that they will pivot with the wire tong or boom pole
- Saddle does not include pole clamps
- Fits angles 3" x 3" to 7" x 7"

## M48057: 35kV Epoxy Insulator



- Epoxy based
- Can be added to existing auxiliary arm wireholders to upgrade for 34.5 kV use

## M1846W: Rope Snubbing Bracket



- Provides an easy way to prevent line snarls by snubbing all hand or light block lines to this bracket, mounted at the base of the pole to the six different rings
- Bracket has a maximum total working load of 1,000 lbs

## M1847: 18" Extender Chain



- Increases length of the chain tightener so it may be used on large diameter poles

## Chain Binder Type Transformer Gin



C4000090 Standard Base

C4000315 Extended Base

- Versatile tool for hoisting distribution transformers and apparatus up the structure
- Standard base unit is for mounting on clear pole sections; 5" extended base model allows mounting to bridge up to 4" x 5" crossarms
- Gins are not intended for applications involving side pull on the hoist line, or with the lift load in a tagged out position
- Includes wheel tightener and 36" chain
- 2,000 lbs maximum rating, including hand pull force
- Pole length: 26"

## Strap Type Binder Transformer Gin



T4001937 Standard Base

T4001938 Extended Base

- Similar to the chain binder type transformer gin, but with a strap-type ratchet-action mounting mechanism
- 2" wide polyester strap features a 44" length to fit most structures
- Strap has a 10,000 lbs rated tensile strength
- Wide handle opening on rapid-action ratchet permits easy operation, even with rubber gloves and leather protectors
- Wheel tightener and 36" chain is part of each unit
- 2,000 lbs maximum rating, including load and fall-line pull
- Pole length: 26"; pole diameter: 3"

## T4000870: 56" Crossarm Gin



- Yoke casting fits over distribution crossarms, so this crossarm gin can be used with rope blocks or handline to lift conductors from their insulators
- Removable cadmium-plated steel pin allows crossarm adjustment - 3.5" x 4.5" to 4.75" x 5.75"
- At a 30° maximum angle from vertical, 56" gin has rated working load including pull force of 500 lbs
- Gins are not intended for applications involving side pull on either hoist line or load lines; therefore, load line must be parallel to the gin pole; lines must be within 5° of vertical

## C4000440: Swivel Top Gin



- Same application as the transformer gin, but the top eye casting can be swiveled to bypass secondary lines when necessary
- Cap is not intended to swivel while under load
- Includes wheel tightener and 36" chain
- 2,000 lbs maximum rating, including hand pull force
- Pole Length: 48"

## CLAMPSTICKS & ACCESSORIES

### Chance Grip-All Single Piece Style Hot stick

C4030291	1.25" x 4' 5"
C4030292	1.25" x 6' 5.5"
C4030293	1.25" x 8' 5.5"
C4030294	1.25" x 10' 5.5"
C4030295	1.25" x 12' 5.5"

- Chance Grip-All stick puts an easy-to-control finger on an insulated pole
  - Serves both overhead and underground circuits with various end fittings
  - Commonly called a shotgun, the operating mechanism incorporates a sliding hand grip that opens the hook to grasp a clamp eyescrew and retracts it into the tool head; a thumb latch then must be depressed to release the locked hand grip so it can open the hook
  - Easy to care for, Grip-All sticks do not require field stripping to clean; all insulated parts including the operating rod are outside the main pole, readily accessible to wipe dry
- CAUTION: Do not clean the plastic head with solvent*



# Chance - Clampsticks

## Chance Grip-All Hinged Style Hot Stick

- Ideal for troubleshooters with limited tool storage space in their vehicle, this folding version operates with the same features as the one-piece style

Part #	Folded	Extended
C4030296	3' 4"	0.25" x 6' 7"
C4030297	4' 4"	1.25" x 8' 6"
C4030298	5' 4"	1.25" x 10' 6"
C4030299	6' 4"	1.25" x 12' 6"
C4030342	7' 4"	1.25" x 14' 6"
C4030343	8' 4"	1.25" x 16' 6"



## M1867: Grip-All Hinged Style Hot Stick



- To convert any Grip-All stick to use all Universal Tool Accessories, adapter (M1867) secures the clampstick hook and head housing

## E4032543P: Grip-All Clampstick Assist Ring



- Provides a suspension midpoint for any Grip-All stick
- Particularly helpful on longer sticks, the assembly permits a support line to attach at the smaller ring
- To help maintain safe working clearances for hot line procedures, an insulated Strain Link Stick of proper size should be used in the hand line

## SafetyShield Hot Stick Barriers



- Mounts on a 1.25" or 1.5" diameter live-line tool
- Creates a 16", 21", or 24" diameter protective screen between a lineman and a potential electrical hazard
- Fits on clampsticks, hooksticks, elbow-puller tools
- Two flame-retardant transparent polycarbonate protective shields affixed with a nylon fastener to a nylon 33% glass-filled clamp
- Orange protective storage case included

PSC4170627	16" Grip-All
PSC4170628	21" Grip-All
PSC4170629	24" Grip-All

## Positive Grip Epoxiglas® Clampstick

- Made for use on eyescrew grounding on tap clamps
- Can be mounted on the line and tightened at angles up to 30°
- Fittings are aluminum and bronze
- The butt end of the tool is equipped with a combination tool hanger and universal head
- Extra long head for use with long eyescrew ground clamps

HG30302	Regular	1.25" x 8' 6"
HG303012	Extra Long	1.25" x 8' 6"
HG30422	Regular Head Only	
HG30425	Extra Long Head Only	





## 6' Ratchet Wirecutters

- High-performance design incorporates Delrin plastic rollers and a two-piece operating rod
- Roller mechanism travels smoothly along main Epoxiglas® pole
- Meet OSHA Electrical Rating subpart section 1926.951 (d).
- Insulated support pole is Chance orange 1 1/2" diameter Epoxiglas with Plastisol butt cap
- Operating shaft is 3/8" diameter solid fiberglass rod; lever handle is 1" diameter Epoxiglas with rubber cushion grip

**C4031381**      6' Soft Wire

**C4031382**      6' ACSR



## C4031384: 8' Ratchet Wirecutters

- High-performance design incorporates Delrin plastic rollers and a two-piece operating rod
- Roller mechanism travels smoothly along main Epoxiglas® pole
- Linked through the roller support unit, the hinged operating rod and larger Epoxiglas® pole reinforce each other
- Meet OSHA Electrical rating sub-part V-section 1926.951 (d)
- Insulated support pole is Chance orange 1 1/2" diameter Epoxiglas with Plastisol butt cap, operating shaft is 3/8" diameter solid fiberglass rod
- Lever handle is 1" diameter Epoxiglas with rubber cushion grip

## Epoxiglas® Wireholding Stick



- Used on or around energized lines for forming, bending and positioning jumper wires and for holding conductors during splicing operations
- The gripper, with an eye that allows other sticks to assist with heavy bending, accommodates #6 solid copper through 1590 kcmil ACSR
- The head of the tool locks in three stop positions so that the lineman can engage and position conductors easily from most angles
- The knurled screw handle below the jaw opening is used to adjust the head position from straight to right or left

**C4033068**      1.25" x 6' 5"

**C4033069**      1.25" x 8' 5"



## PSC4170630: SafetyShield Wirecutter Hot Stick Barrier



- Two flame-retardant transparent polycarbonate protective shields affixed with a nylon fastener to a nylon 33% glass-filled clamp
- Mounts on a 1 1/2" diameter ratchet wire-cutter handle in less than a minute
- Creates a 16" diameter protective screen between a lineman and a potential electrical hazard
- Orange protective storage case included

# Chance - Telescoping Live Line Sticks

## Telescoping Measuring & Disconnecting Stick - Metric & English

- Certified to OSHA dielectric requirements (Sub-part V, section 1926.951)
- Measures pole heights and conductor clearances from the ground
- Universal end fitting on the insulated top section accepts a wide variety of attachments so that the lineman can disconnect switches, replace cutout tubes and reclose, remove pole covers, prune trees, etc., with one tool
- Measuring scales are easy-to-read, with figures silk screened on orange fiberglass sections
- English scales are marked with each 1' increment designated in a box, each inch in bold numbers and half inches designated by intermediate bars
- Metric scales similarly display meters, decimeters and centimeters
- A positive spring-loaded locking-button mechanism and safety plug feature in each section prevent separation of the tool. Once snapped into place, the buttons securely lock into position
- Retract to approximately 5 ft. so that they can be carried on most trouble trucks, often in the cab section
- Heavy duty, spring-loaded plastic buttons keep the extended tool sections securely locked in position
- As each section is extended and twisted slightly, the buttons pop into place, allowing work to be done with complete control and confidence



A 35' STICK THAT FEATURES BOTH METRIC & ENGLISH UNITS OF MEASUREMENT

Part #	Extended Sections	Retracted/Extended Sections
C4031022EM	8	60"/35'

## Telescoping Grip-All Hot Sticks

- Chance Telescoping Grip-All sticks can replace several conventional clampsticks, reducing the number of clampsticks required on a line truck, saving limited storage space
- Engineered interface between sections ensures that the tool retracts with full control
- Close fit also helps keep out dirt and moisture
- Top section is made of foam-center Epoxiglas® insulated pole
- Basic clampstick functions of this telescoping style are identical to the fixed-length style
- All controls can be manipulated while wearing gloves
- Easy to disassemble, the Telescoping Grip-All stick must be kept clean and dry inside and out for maximum protection
- Available in two sizes, each readily locks at variable lengths



Part no.	Extended Lengths	Retracted Length
C4031035	5' 6.75", 6' 9.5", 8'	5' 2.75"
C4031036	8' 6.75", 10' 4.75", 12' 2.75", 14'	8' 3.75"

## Telescoping Style with Universal Fitting

- Readily locks at variable lengths
- Design features a rotating coupler and an engineered positive lock button with safety stop to keep the sections from parting or the hook from releasing while in use; the mechanism locks the sections into a solid and rattle-free tool



Part no.	Extended Lengths	Retracted Length
C4033060	5' 6.75", 6' 9.5", 8'	5' 2.75"
C4033061	8' 6.75", 10' 4.75", 12' 2.75", 14'	8' 3.75"

# Chance - Telescoping Live Line Sticks

## Telescoping Epoxiglas® Disconnect Tools

- Maximum convenience for the lineman because they allow the performance of many routine jobs from ground level
- Universal end fitting on the insulated top section accepts a wide variety of attachments so the lineman can disconnect switches, replace cutout tubes and reclose, remove pole covers, prune trees, replace bulbs and complete many other overhead tasks
- Retract to approximately 5' so that they can be carried on most trouble trucks, often in the cab section
- Heavy duty, spring-loaded plastic buttons keep the extended tool sections securely locked in position
- As each section is extended and twisted slightly, the buttons pop into place, allowing work to be done with complete control and confidence
- Offered in both standard and heavy duty models
- Both units use the same telescoping tube design
- Tip section of the heavy duty unit is slightly larger in diameter (1 1/4" versus 1 1/16") so that each telescoping tube is slightly larger, resulting in a more rigid tool when fully extended, important where additional weight may be frequently encountered on maintenance tasks
- Both tip sections employ time-proved Epoxiglas®, the unicellular® foam-core material where the epoxy reinforced fiberglass wall is built around the foam core to prevent any moisture trapping voids that could build up between foam and tool

### Standard Duty (1 1/16" Diameter Tip)

Part no.	Extended Lengths	Retracted Length	Base Diameter	Sections
C4031023	8'	56"	1.25"	2
C4031017	8'-12'	57"	1.5"	3
C4031018	12'-16'	59"	1 11/16"	4
C4031019	12.5', 16.5', 20'	61"	1 7/8"	5
C4031020	16.5', 20.5', 25'	63"	2 1/16"	6
C4031021	17.5', 21.5', 25.5', 30'	65"	2.25"	7
C4031022	22', 26', 30.5', 35'	67"	2.5"	8
T4033349	22', 28', 34', 40'	74.5"	2.5"	8

### Compact Standard Duty (1 1/16" Diameter Tip)

Part no.	Extended Lengths	Retracted Length	Base Diameter	Sections
T4032205	8'	26"	1 7/8"	5
C4031739	14', 17', 20', 23'	48"	2.5"	8
T4033350	12'	40"	1 11/16"	5
T4033240	11'	36"	1 11/16"	4

### Heavy Duty (1 1/4" Diameter Tip)

Part no.	Extended Lengths	Retracted Length	Base Diameter	Sections
C4031597	8'	56"	1.5"	2
C4031598	8', 12'	57"	1 11/16"	3
C4031599	12', 16'	59"	1 7/8"	4
C4031600	12.5', 16.5', 20'	61"	2 1/16"	5
C4031601	16.5', 20.5', 25'	63"	2.25"	6
C4031602	17.5', 21.5', 25.5', 30'	65"	2.5"	7



C4031023

# Chance - Disconnects & Universal Sticks

## Heavy Duty Adjustable Sticks

- Clearly marked at each 1' extension lock, one of these Chance tools can replace as many as eight single-length hot sticks
- Especially for such tight confines as substations, these adjustable sticks can be stored in standard-length canisters and avoid the difficulties of working extra-long sticks through buswork structures
- Classified as heavy-duty due to their large (1.25" diameter) insulated top section and 1/5" O.D. epoxy reinforced fiberglass base tube
- In each size, a 2' section of the Epoxiglas® foam core top section remains inside the base section at the longest locked, usable length
- At the shortest locked length, the insulated top section extends a full 2' beyond the base
- High-strength plastic buttons keep tools locked at specific lengths



### Disconnect-Style NEMA Head:

Part no.	Lockable Lengths	Collapsed
C4032600	10, 11, 12, 13, 14	8' 2.75"
C4032601	12, 13, 14, 15, 16, 17, 18	10' 2 3/4"

### Switch-Style NEMA Head:

Part no.	Lockable Lengths (feet)	Collapsed
C4032602	10, 11, 12, 13, 14	8' 2"
C4032603	12, 13, 14, 15, 16, 17, 18	10' 2"

### Universal Fitting Style:

Part no.	Lockable Lengths	Collapsed
C4032604	10, 11, 12, 13, 14'	8' 3 3/4"
C4032605	12, 13, 14, 15, 16, 17, 18'	10' 3/4"



Disconnect Style



Switch Style



Universal Disconnect Head



Extension Head Clearly marked at each hole for button engagement

# Chance - Disconnects & Universal Sticks

## Sectional Disconnect and Universal Tools

### 1.25" Diameter Poles

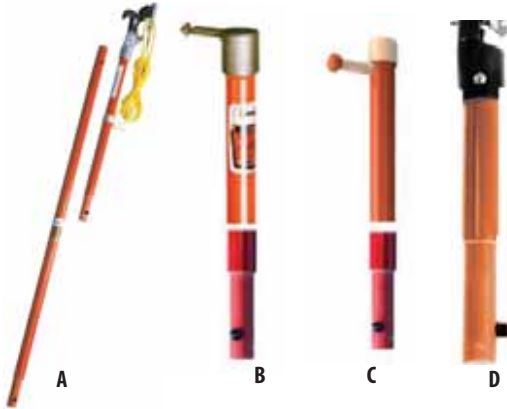

#### A) Tree Trimmer Head

Part no.	Description
C4032096	*2'
C4032097	*4'
<b>Base Cap</b>	
Part no.	Description
C4032069	5"

\*Length excludes trimmer head fitting

#### B) Standard Switch Head Disconnect

Part no.	Description
C4032073	6"
C4032053	4'
C4032054	6'
C4032055	8'

#### C) Non-Metallic Disconnect Head

Part no.	Description
C4032095	6"
C4032059	4'
C4032060	6'
C4032061	8'

#### D) Plastic Universal Head

Part no.	Description
C4032071	6"
C4032046	4'
C4032047	6'
C4032048	8'

#### Extension Section

Part no.	Description
C4032062	4'
C4032063	6'
C4032064	8'
C4032133	10'

### 1.5" Diameter Poles



#### Standard Disconnect Head

Part no.	Description
C4032074	6"
C4032056	6'
C4032057	8'
C4032058	10'

#### Standard Universal Head

Part no.	Description
C4032072	6"
C4032049	4'
C4032050	6'
C4032057	8'
C4032052	10'

#### Extension Section

Part no.	Description
C4032065	4'
C4032066	6'
C4032067	8'
C4032068	10'

#### Base Cap

Part no.	Description
C4032070	5"

# Chance - Disconnects & Universal Sticks

- Provide insulation safety for linemen in opening and closing disconnect switches and cutouts
- Poles are made of Epoxiglas® and NEMA-standard heads of cast bronze
- Splice disconnects are convenient for hauling, strong and rigid, easy to put together, and easy to take apart
- Fiberglass head disconnect stick gives the additional insulation required for work where bus and disconnect switch spacings are confined, as in indoor substations

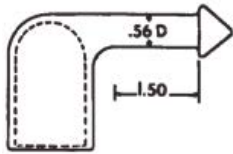

1.5" Disconnect Head

Part no.	Description
H3046-2	Head Only
H3046-22	1.5" x 6' 1"
H3046-23	1.5" x 8' 1"
H3046-24	1.5" x 10' 1"
H3046-15	1.5" x 12' 1"
H3046-16	1.5" x 16' 1"
H3046-18	1.5" x 18' 1"
H3046-20	1.5" x 20' 1"

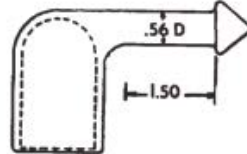

1.25" Switch Stick Head

Part no.	Description
H3046	Head Only
H3046-11	1.25" x 4'
H3046-12	1.25" x 6'
H3046-13	1.25" x 8'
H3046-14	1.25" x 10'
H3046-17	1.25" x 12'

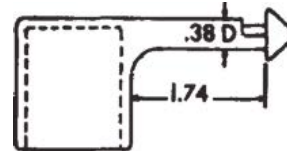

1.25" Spliced Disconnect Head

Part no.	Description
H3146-12	.25" x 6' 1.5" x 6' 1"
H3416-16	1.25" x 8' 1.5" x 8' 1"
H3146-18	1.25" x 8' 1.5" x 10' 1"
H3146-20	1.25" x 10' 1.5" x 10' 1"
H3146-24	1.25" x 12' 1.5" x 12' 1"



## Universal Poles



H1760-4

H1761

Hinged Pole

Spliced pole

Universal Fitting for Spliced Pole

### 1.5" Disconnect Head

Part no.	Description	Pole Diameter x Length
H1760	Pole; (1) universal head	1.25" x 8' 2"
H1760-1	Pole; (1) universal head	1.25" x 6' 1"
H1760-2	Rigid splice pole; (1) universal head	1.25" x 4' 1"
H1760-3	Pole; (2) universal heads	1.25" x 6' 3"
H1760-4	Pole; (2) universal heads	1.25" x 8' 3"
H1760-6	Rigid splice pole; (2) universal heads	1.25" x 4' 1"
H1760-10	Pole; (2) universal heads	1.25" x 10' 3"
H1760-12	Pole; (2) universal heads	1.25" x 12' 3"
H1760-14	Pole; (2) universal heads	1.25" x 14' 3"
H1761	Spline storm tool (2) skirts	1.25" x 8' 2"
H1770	Hinged pole; (2) universal heads	1.25" x 8' 2"
H1790-8	Pole; (2) universal heads, pole hanger	1.25" x 8' 3"
H1790-10	Pole; (2) universal heads	1.5" x 10' 3"
H1790-12	Pole; (2) universal heads	1.5" x 12' 3"
H4455	Universal head only	1.25"
H4455A	Universal head only	1.5"

- Designed for use as a hot stick handle for Universal Tools
- Made of Epoxiglas® and lightweight aluminum castings
- Universal Tools on this page fit under the thumbscrew of the spline on the Universal Pole for a rigid hot stick tool
- For job versatility, the splines allow angling of tool up to 90° in relation to the pole depending upon the individual tool design
- The Storm Tool, a Universal Pole with special rubber insulator skirts, is designed for emergency use, providing extra leakage distance and disrupting water paths when rain, sleet, or snow make regular tools hazardous
- Skirts break up streams that would otherwise run down the pole

# Chance - Elbow Puller Tools

## Impact Elbow-Puller

- 1.25" diameter orange Epoxiglas® pole; for balance, the 5 lbs slide hammer is Platisol coated and flared at both ends
- Tool and grippers help the operator control the elbow and stiff underground cable lead
- Employs a slide-hammer mechanism to easily disengage and assist in replacing elbows
- For secure handling, both front and rear handgrip areas of the pole are coated with Griptread, a grit-filled rubber-base paint
- The 6' and 8' units meet OSHA requirements with 25" and 48" of insulation respectively from the tool end to the handguard
- On the 4.5' unit (labeled "For Rubber Glove Use Only"), insulation length measures 5"



C4031822	6'
C4031850	8'
C4031857	4.5'

## Elbow Connector Tool Replacement Grippers

- Provide a sure grip for installing and disconnecting elbow terminators
- The tool grabs the elbow and has a special integral hook that fits through the rubber eye of an elbow or the metal hook of a bushing cap so that the lineman has complete, positive control, overcoming the resistance of the stiff underground cable

C4030704	15 kV Plastic-Coated
C4030613	25 kV Plastic-Coated
C4030614	25 kV Uncoated
C4030814	34.5 kV Plastic-Coated



## TROUBLE SHOOTER EQUIPMENT



C4031612	Complete Kit
C4032046	Top Section Epoxiglas® Pole
C4032062	Mid Section Epoxiglas® Pole
M4455-9	Aluminum Disconnect Head
E4031614	Non-Metallic Disconnect Head
M4455-29B	Clamp Stick Head
H2106-4	Tree Trimmer
C4032213	Pruning Saw
M4455-66	Pistol Grip Saw Handle
P4032996	Storage Case

## Multi-Duty Trouble Shooter Kit

- Includes (6) 4' sections of field proven 1 1/4" Epoxiglas® Universal Pole that snap together
- Butt section features a Platisol end cap
- Spring-loaded locking buttons permit uses at 4', 8', 12', 16', 20', and 24' lengths
- Fitting on top section with thumbscrew accepts the Universal Accessories included in the kit

### Kit Includes:

- Aluminum Disconnect Head for opening and closing switches, opening enclosed cutouts, etc.; has built in hanger hook
- Non-Metallic Disconnect Head provides additional insulation for indoor substations where buswork and switches are in close proximity. Platisol cap at top; 19" overall length with 15" long Epoxiglas® section
- Clamp Stick Head for use with 6" lone eyescrew ground clamps has locking ring with detent ball for on-off operation. Made from aluminum alloy
- Tree Trimmer adds 1.5' to reach with 3-to-1 mechanical advantage pulley and 25' of furnished rope. Offset universal fitting on trimmer accepts pruning saw
- Pruning Saw with deep-notched teeth for quick pullouts attaches directly to top pole, tree trimmer or pistol grip
- Pistol Grip Saw Handle for use when insulation is not needed. Made from aluminum alloy
- Storage Case of yellow heavy-duty vinyl-impregnated fabric has separate pockets for individual tools and Velcro flap closures



# Chance - Link Sticks

## H47163: Strain Link Stick

- On deadend structures and running corners, a Strain Link Stick is used as insulation between rope blocks and a cuma-long clamp
- To supplement wire tongs, a Strain Link Stick is attached to the conductor close to the wire tong and helps support the load
- Also used to support the middle conductor on H-frame structures during insulator or crossarm changes
- Hooks and ferrules are made of heat treated aluminum alloy for the best ratio of high strength to light weight
- Butt rings, for attaching rope blocks or hand lines, are forged of high quality steel
- Butt swivel spins freely on ball thrust bearing
- Edges of the jaws of Chance Link Sticks are rounded to prevent scarring of conductors
- 1.5" diameter x 6' long (overall length of 81")
- Duty - 6,500 lbs.
- Jaw Size - .44" to 1.06"



## H47146: Roller Link Stick

- Used to spread and hold conductors aside at midspan when relocating poles
- Used for measuring conductor-to-ground clearance by attaching a measuring tape or length of rope to the butt ring
- Poles for Roller Link Sticks are 1 3/4"; rotating the pole closes the hook, leaving the head free to roll along the conductor
- 82" overall length



## Spiral Link Stick

- Used in lieu of a strain link stick in close places where the lineman cannot safely install a strain link stick by hand
- A lifting eye on the head ferrule enables the lineman to guide the Spiral Link Stick to the conductor with a hot stick
- The pole of the Spiral Link Stick is made of 1.25" Epoxiglas®
- Ferrule castings are of heat treated aluminum alloy; spiral hook and butt ring of galvanized steel
- 1.25" diameter
- Duty - 3,500 lbs.
- Wire size: 1510.5 kcmil ACSR
- 3.43 lbs.



H4722 27.5" Overall Length  
C4000812 57.5" Overall Length

## C4012145: Adjustable Strain Pole

- Key to many transmission and EHV maintenance jobs
- Helps support conductors while insulators are removed and replaced
- May be used with yoke plates and hook assemblies at the conductor and structure ends of suspension, V-string or deadend insulator strings
- To support the hot-end trunnions or hooks, 5 stainless steel crosspins are located at 6" intervals on the 2" diameter Epoxiglas® poles
- To engage deadend and suspension yokes at the hot end also requires the adjustable pole clamp of heat treated aluminum; this pole clamp can be unlocked and positioned by hot sticks
- On the cold end, a high-strength steel strain-jack with bronze tongue provides take-up with a ratchet wrench and trunnions
- Wrench and trunnions must be ordered as separate items
- Standard strain jack furnished with each strain pole provides 12" of adjustment. Longer strain jacks (for 24" or 36" of take-up) and extra pole clamps also may be ordered
- 7' long (8' 8" overall length)
- Maximum voltage use: 169kV
- Insulated section: 48"



## H472084: Suspension Link Stick

- The Suspension Link Stick is for use on conductors from 1" to 2.5" diameter and can be used with various types of takeup devices at the structure end
- The lip of the hook, actuated by an eye screw, swivels to accommodate various conductor sizes
- The maximum load is 6,500 lbs
- 84" length



## C4002399: Insulated Link Stick

- Insulates hoists from energized conductors
- 1.25" diameter Epoxiglas® pole has a steel hook on one end and a butt swivel on the other
- The maximum load is 4,000 lbs
- 18" of glass





# Telescopic Hot Sticks & Cutters

## Tel-O-Pole Hot Sticks

- May be used for opening and closing disconnect switches, replacing fuses in porcelain-type cut-outs, pruning tree limbs, or replacing lamps in street circuits
- Made of reinforced high density electrical grade fiberglass laminate with unusual colour stability, greater strength and high dielectric properties
- Tubular sections are engineered to allow for air circulation; foam is applied with an exclusive process to eliminate voids between the foam and the tool wall, which eliminates trapped moisture
- Patented interlock feature allows it to be locked in lengths listed by means of one pin locking two or more sections
- The top section on all Tel-O-Pole Hot Sticks is insulated with a fire retardant polyurethane foam core
- Sure-lock joints and corona free discharge heads



### Standard Tel-O-Pole Hot Stick, 7/8" Tip Diameter

Hastings	Extended Length	Retracted Length	Base Dia.
S-212	12'	44"	1 5/8"
S-216	12'4" - 16"	56"	1 5/8"
S-220	17' - 20'	58"	1 7/8"
S-225	17' - 21' - 25.5'	61"	2 3/8"
S-230	17' - 21' - 26' - 30'	63 3/8"	2 11/16"
S-235	17' - 21 1/2' - 26' - 30' - 35'		

### Heavy Duty Tel-O-Pole Hot Stick, 1 3/32" Tip Diameter

SH-216	9' - 13' - 17'	58 1/8"	1 7/8"
SH-200	13' - 17.5' - 21.5'	60"	2 3/16"
SH-250	13' - 17.5' - 21.5' - 26'	61 5/8"	2 3/8"
SH-230	13' - 17.5' - 21.5' - 26' - 30'	63 3/8"	2 11/16"

### Tel-O-Pole Hot Stick with Tip Lock Feature

ST-220	17'-20'	58"	1 7/8"
ST-230	17' - 21.5' - 26' - 30'	61 5/8"	2 3/8"
ST-235	17' - 21.5' - 26' - 30' - 35'	63 3/8"	2 11/16"
ST-240	17' - 21.5' - 26' - 30' - 35' - 40'	63 3/8"	2 11/16"



## Tel-O-Pole II - "No Twist" Stick

- All models are heavy duty designed
- Triangle Shape enables each section to lock in automatically
- Fluorescent tip section (1.15" diameter) is highly visible and has a foam core
- Sections are 100% tested per OSHA and ASTM F-711
- Lock Buttons are large, easy to operate with or without gloves
- Design allows user to use only the number of required sections to perform each job, allowing for a lighter tool to perform the work more easily
- Easily disassemble by depressing the lock button and sliding the section, or sections, out
- Ergonomic design gives the operator a better gripping surface for improved control
- All sections have a smooth glossy surface for routine cleaning and waxing
- Strong aluminum alloy head incorporates corona discharge design and includes a captive Belleville washer to hold universal attachments securely

Hastings	Extended Length	Retracted Length	Base Dia.
HV-208	8'	26"	1.75"
HV-212	12' 7"	58"	1.45"
HV-216	16' 9"	60"	1.61"
HV-230	30'	66"	2.07"
HV-235	35'	68"	2.22"
HV-240	39' 6"	69"	2.38"

## 11-006: 6' Insulated Ratchet Cutters

- Lightweight and easy to handle
- For both overhead and underground applications
- Provides clean cuts for splicing conductors
- Cuts 666-54/7 ACSR, 1000 MCM aluminum, 500 MCM copper
- Handle folds and cutters store in 6" canister
- Operates in a 5" width trench
- Long reach, remote operation



## 12594: 6' Hot MD-6

- Lever handled compression tool
- Designed for live line crimping of sleeves and connectors
- Utilizes Burndy "W" dies
- Head features a fixed 5/8" nose die



## Combination Tel-O-Pole Measuring Stick



- Heavy duty Tel-O-Pole includes English scale measurement graduations for eye-level reading
- Painted graduations are silk-screen printed directly on the fiberglass sections, and will not chip or peel
- Surface is coated with a hard, high-gloss epoxy finish
- Foot markings are printed in large, easy to read numerals
- Graduations are marked to measure in feet, inches and 1/2" graduations
- 30' extended; 63 3/8" retracted
- 2 11/16" base diameter 1 3/32" tip diameter

EV-30	66" - 30'
EV-35	68" - 35'
EV-40	69" - 39'6"



# Hastings Shotgun & Link Sticks

## Shotgun Sticks & Carrying Case

- Constructed of electrical grade fiberglass
- Telescoping models can extend to match all stick lengths
- Extended length spear offers easy method of locating the eye of hot taps that are otherwise difficult to locate
- Larger opening 5" deep throat gives greater control on all hot taps, including the new longer stem taps
- New operating rod guide eliminates trapped dirt and moisture, allowing for easier cleaning of inside area of rod guide
- Handle body is made of melron polycarbonate, is non-conductive, extremely durable and unaffected by temperature extremes
- The plastic protective sleeve surrounding the fiberglass tube prevents scuffing
- Full open side hook offers unobstructed vision of the hook
- Hanger hook is molded in the head, eliminating metal parts
- Hook release trigger is shielded
- The precision case side offers 13 teeth per inch, giving complete control and an extra firm grip
- The insulated rubber cap protects the base and prevents wear



Telescopic Shotgun		
Hastings	Retracted Length	Operating Lengths
8158	5'1"	5'1", 6'6", 8'
81814	8'	8', 10', 12', 14'
Telescopic Shotgun with Universal Fitting on Handle		
8158-U	5'1"	5'1", 6'6", 8'
81814-U	8'	8', 10', 12', 14'
Folding Shotgun with External Operating Rod		
Hastings	Length	
13412	6'6"	
13413	8'6"	
13414	10'6"	
13415	12'6"	
Fixed Length Shotgun with External Operating Rod		
Hastings	Length	w/ Universal Fitting on Base End
8104	4'6"	8104-U
8106	6'6"	8106-U
8108	8'6"	8108-U
8110	10'6"	8110-U
8112	12'6"	8112-U

## C-35: Carrying Case for Shotgun Sticks

- Water repellant yellow vinyl nylon reinforced ducting
- Carrying strap attached
- Snap type flap on open end

## Insulated Spiral Link Stick



- Designed to isolate rope lines, hoists and rope blocks, providing insulation between energized conductors and pulling devices which might be attached to a different potential
- One-piece, 1" O.D. fiberglass stick has a solid unicellular foam core
- Spiral hook is made from high-strength, heat treated steel
- Maximum wire size: 795 ACSR
- Maximum working load: 2000 lbs

3480	1" x 12" F6 pole 24" overall length
3481	1" x 24' F6 pole 36" overall length
3482	1" x 36" F6 pole 48" overall length
3483	1" x 48" F6 pole 60" overall length

## Insulated Link Stick



- Designed to provide extra protection when using strap hoists on primary voltages
- Fiberglass links help overcome the loss of dielectric properties when the web straps become contaminated through field use
- Can be used with most strap hoists
- Pre-tested to 5,000 lbs before shipment and tested per OSHA and ASTM F-711
- 1" diameter fiberglass with solid foam core
- Insulated fiberglass shaft and operating rod allow maximum safety and durability

3413	6" length; 4000 lb rating
3414	12" length; 4000 lb rating

# Hastings Switch & Disconnect Sticks

## Spliced Switch and Disconnect Sticks

- These sticks eliminate storage problems and duplication of tools
- Switch and disconnect heads are made from high tensile cast bronze
- The insulated head is made of fiberglass
- Choose top section and base section and add extension sections as needed
- All stick sections have a solid unicellular foam core and are tested per OSHA and ASTM F-711



Universal Head	
55574-4	1 1/2" x 4'
55547-6	1 1/2" x 6'
55547-8	1 1/2" x 8'
55547-10	1 1/2" x 10'

Disconnect Head	
5541-6	1 1/2" x 6'
5541-8	1 1/2" x 8'
5541-10	1 1/2" x 10'

Insulated Head	
5462-2	1 1/4" x 2'
5462-4	1 1/4" x 4'
5462-6	1 1/4" x 6'
5462-8	1 1/4" x 8'

Switch Head	
5460-4	1 1/4" x 4'
5460-6	1 1/4" x 6'
5460-8	1 1/4" x 8'

Extension Sections	
546-4	1 1/4" x 4'
546-6	1 1/4" x 6'
546-8	1 1/4" x 8'
5546-4	1 1/2" x 4'
5546-6	1 1/2" x 6'
5546-8	1 1/2" x 8'
5546-10	1 1/2" x 10'



## Substation Adjustable Disconnect Sticks

- Designed for use in close confines of substations
- Eliminates the problem of threading long sticks through substation structures
- Adjustable to length in 1' increments; therefore multiple length stick requirements are eliminated
- Top section is a conventional 1 1/4" diameter hot stick with fire retardant unicellular core; the top section may also be removed for use as a single one piece hot stick
- Base section is 1 1/2" diameter
- Extended length is shown at each lock position for reference
- The top section must extend beyond the base before the lock will engage, giving full protection of fire retardant unicellular core
- Available with standard NEMA high tensile bronze disconnect head, switch head, or universal head "fit on type"

### NEMA Disconnect Head:

Hastings	Extended Length	Minimum Length	Collapsed Length
3114	14'	10'	8'4"
3118	18'	12'	10'4"

### NEMA Switch Head:

3115	14'	10'	8'4"
3119	18'	12'	10'4"

### Universal Head:

3116	14'	10'	8'4"
3120	18'	12'	10'4"

## Universal Hot Sticks

- Features a universal head on both ends which adapt to all standard universal fits on tools
- Constructed of a fine grade woven fiberglass material
- Contains a unicellular core, and are fabricated especially to withstand high torque and unusual strength requirements
- The colour of these sticks is standard safety yellow, and each universal hot stick has a hanger hook



4678-6	1 1/4" x 6'
4678-8	1 1/4" x 8'
4678-10	1 1/4" x 10'
4678-12	1 1/4" x 12'
4678-14	1 1/4" x 14'
4680-8	1 1/2" x 8'
4680-10	1 1/2" x 10'
4680-12	1 1/2" x 12'
4680-14	1 1/2" x 14'

## Multi-Purpose Holding Tool with Rigid or Adjustable Head

- For holding slack conductors during sleeving; provides positive control for shaping and bending jumpers, buss wires
- Main fiberglass portion is 1" diameter, and is fabricated with finely woven cloth, giving maximum strength with minimum weight and size; 5/8" operating rod is designed to withstand the highest torque obtainable by hand
- Foam filled to eliminate migration of contaminants and moisture
- Conductor capacity #6 - 1 1/16"; tested per OSHA and ASTM F-711
- Adjustable head models also offer the convenience of adjustment from straight to 30° both sides of center



4601	1" x 6' long	Rigid Head
4602	1" x 8' long	Rigid Head
4603	1" x 4' long	Adjustable Head
4604	1" x 6' long	Adjustable Head
4605	1" x 8' long	Adjustable Head



# Hastings Switch & Disconnect Sticks

## Switch or Disconnect Sticks

- Constructed of woven fiberglass materials
- A special manufacturing technique assures uniformity of fiberglass distribution and full elimination of resin-rich areas which cause chipping and fiber glass peel
- Unicellular core is self-extinguishing and resistant to cleaning fluids and solvents
- Safety bright yellow colour is an integral part of the laminate and will not chip or peel
- The hard-gloss, porosity-free epoxy finish is easy to keep clean
- Switch and disconnect heads are made of tough, high-tensile, cast bronze and are designed to NEMA standards
- Insulated head is made of fiberglass with a non-metallic NEMA shaped prong
- All sticks are tested per ASTM F-711 and OSHA

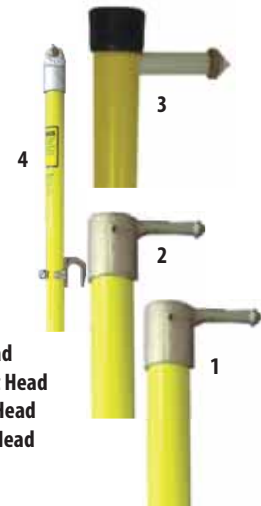

1) Switch Head  
2) Disconnect Head  
3) Insulated Head  
4) Universal Head

Hastings	Length	Weight
<b>Switch Head</b>		
460-4	1 1/4" x 4'	1 lb 9 oz
460-6	1 1/4" x 6'	2 lbs 5 oz
460-8	1 1/4" x 8'	3 lbs
460-10	1 1/4" x 10'	3 lbs 4 oz
460-12	1 1/4" x 12'	3 lbs 9 oz
P10036	Head Only	7 oz
<b>Disconnect Head</b>		
541-6	1 1/2" x 6'	3 lbs 3 oz
541-8	1 1/2" x 8'	3 lbs 12 oz
541-10	1 1/2" x 10'	4 lbs 15 oz
541-12	1 1/2" x 12'	6 lbs 10 oz
541-14	1 1/2" x 14'	7 lbs 7 oz
541-16	1 1/2" x 16'	8 lbs 6 oz
541-18	1 1/2" x 18'	9 lbs 4 oz
541-20	1 1/2" x 20'	10 lbs 3 oz
P10038	Head Only	13 oz
<b>Insulated Head</b>		
501-4	1 1/4" x 4'	1 lb 4 oz
501-6	1 1/4" x 6'	2 lbs 5 oz
501-8	1 1/4" x 8'	2 lbs 10 oz
501-10	1 1/4" x 10'	
501-12	1 1/4" x 12'	
<b>Universal head (Includes Hanger)</b>		
567-6	1 1/4" x 6'	
567-8	1 1/4" x 8'	

## P.V.C. Hot Stick Canister

- Includes universal mounting brackets for mounting on trucks, fences, etc.
- Constructed of top grade aluminum castings and heavy duty P.V.C. tubing to help prevent sag and the formation of aluminum oxide
- Aluminum end cap is designed to open by merely pulling a pin
- One end of the canister container is completely sealed; the opposite end has an "easy-open" aluminum cap with an "O" ring seal providing weather-tight protection for those many items that must be stored or transported outside



01-33350	7'
01-33351	9'
01-33352	11'
01-33353	13'
01-33354	15'
01-33355	17'
01-33356	19'
01-33357	21'

## Snap-On Adapters



- Can be used with extension sections for spliced switch and disconnect sticks
- Use of snap-on adapters with extension sections eliminates duplication of fixed sticks and storage problems

A18007	Base Cap for 1 1/4" Stick
A18008	Base Cap for 1 1/2" Stick
A10025	Universal Adapter for 1 1/2" Stick
5558	Disconnect Adapter for 1 1/2" Stick

## Spliced/Stepped Switch and Disconnect Sticks

- Features metal splice ferrules and solid unicellular foam core
- Stepped sections allow for long lengths and maintained rigidity
- Provides convenient storage, eliminating long one-piece sticks
- Two section switch stick with metal splice and disconnect head
- Tested per OSHA

Hastings	Length	Tip	Base
20923	12'	1 1/4" x 6'	1 1/2" x 6'
20925	16'	1 1/4" x 8'	1 1/2" x 8'
20926	18'	1 1/4" x 8'	1 1/2" x 10'
20927	20'	1 1/4" x 10'	1 1/2" x 10'

## FRP Clampsticks

Part #	Length		Weight	
	Feet	Meters	lbs	Kgs
<b>External Rod Clampstick</b>				
4007	4'8"	1.32	4.2	1.9
4008	5'8"	1.62	4.6	2.1
4009	6'8"	1.93	5.2	2.4
4010	8'8"	2.54	6.2	2.8
4011	10'8"	3.15	7	3.2
4012	12'8"	3.76	7.7	3.5
4013	14'8"	4.37	9.4	4.3
<b>External Rod Clampstick - Plain Cap</b>				
8106C	6'6"	1.98	5	2.27



## Conductor & Cleaning Tools

Tubular Brushes are preferred when rubber gloving or when working on de-energized conductors. The steel bristles are internal to prevent damaging rubber gloves. The 2.5" tubular brush is used in confined areas such as between two connectors or clamps. The "V" Type Wire Brushes are available with epoxy-coated handle or universal attachment that can be used with hotsticks.

Part #	Description	Weight ea. (lbs)
4108	Universal Tubular	1.3
4110	5" Tubular	0.4
4111	Universal "V" Line Cleaner	1
4112	"V" Type handle w/ brushes	1.2
4113	"V" Type carton of 10 replacement brushes	3
4337	2.5" Tubular	0.2



4108



4110



4337



4113



4112



4111



# Salisbury by Honeywell

## Storage for Hotsticks & Tools

SALCOR® Tool Holders secure tools to trailers, compartments and tool rooms. 12 per package.

Hotstick Bags are constructed of heavy vinyl with double stitched seams. Flaps snap closed. 6" wide and designed to hold sticks up to 4" shorter than bag length shown on chart.

Tubular PVC storage containers provide weather tight storage. Kit includes two mounting brackets and four steel bolts with each 6" I.D. or 4.1" tube. Sized for tools 12" shorter than tube. Four mounting bolts 3/8" x 1.5" are supplied with each container. Kit may be ordered without tubing or with mounting brackets only.



Part #	Description/Dimensions	Weight ea. (lbs)
1192	1.25" I.D. Tool Holder	3.5
9822	Kit for 6" I.D. 6'6" O.D.	8
9823	Kit for 4.1" I.D. 4'5" O.D.	6
C4007	I.D. 4" 7'	19
C4009	I.D. 4" 9'	22
C4011	I.D. 4" 11'	26
C4013	I.D. 4" 13'	29

Part #	Length		Weight (lbs)
	Feet	Meters	
<b>Hotstick Bags</b>			
4297	5	1.5	.7
4298	6	1.8	.8
4299	6'4"	1.9	.9
4300	7	2	1
4301	8'4"	2.5	1.1
4302	9	2.7	1.2
4303	10'4"	3	1.4
<b>4" I.D. Tubular PVC Storage Kit</b>			
4155	7	2.13	17
4156	9	2.74	20
<b>6" I.D. Tubular PVC Storage Kit</b>			
4167	6	1.82	20
4168	7	2.13	22
4169	9	2.74	26



Hotstick Bag

## Insulated Rescue Hook

- An invaluable tool for any workplace used to withdraw an injured worker out of a hazardous area
- Confined spaces, in vaults, or just near electrical cabinets and switch gear are some of the places where this tool is a must
- Featuring a foam-filled, fiberglass reinforced handle for superior electrical insulation and a coated heat treated body hook with an 18" opening
- The stick is available in the standard lengths of 6' and 8' lengths
- Handle meets the requirements of ASTM F711



Part #	Length	Weight
<b>Insulated Rescue Hook</b>		
24400	3'	3.4 lbs
24401	6'	4.5 lbs
24403	8'	5.5 lbs

## Static Discharge Stick

Designed to safely remove the static charge after de-energizing. This tool is pre-assembled and includes a copper "U" hook, closed cell foam-filled tubular fiberglass stick and 6' of copper grounding cable attached to a Salisbury 1814 bronze flat jaw serrated grade 3 clamp. Also available in a 1' length stick.

Part #	Length	Weight
<b>Static Discharge Stick OAL</b>		
20817	3' 8"	8 lbs
<b>Static Discharge Stick w/ Universal Attachment</b>		
22629	1'	.38 lbs



## Static Discharge Sticks

A **Discharge Hook** is used to drain capacitive voltage. The probe is first used to make contact, then the hook can be used to make direct contact bypassing the fuse. The fuse gives added protection in case initial contact is accidentally made on energized equipment. Fuse is rated at 8 kV maximum, 6 amperes continuous.

A Discharge Hook is a special discharging device used to de-energize capacitors and other voltage retaining components before maintenance work is performed. Mounting clip (1925MC) is included. Standard handle length is 2'. Other cable and handle lengths are available.

**Resistive Discharge Hooks/Probes** with resistors help eliminate initial surge current. Second hook bypasses resistors for residual discharge. Resistive discharge hooks and probes use #6 flexible copper, clear-jacketed cable, a hand guard, hook or probe, and a 1" diameter fiberglass insulating handle. The handle complies with ASTM F-711. All come with a clear PVC cover to protect resistors from damage from bumps and knocks. Not all resistors fit all hooks. Mounting clip (1925 MC) is included

*NOTE: For discharge only. Do not use as live line tool or grounding device.*



Part #	Description	Weight ea. (lbs)	
<b>FUSED DISCHARGE HOOK</b>			
1930535415Q	Fused Discharge Hook	10	
<b>DISCHARGE HOOK</b>			
1925	5'	2	
19257	7'	2.5	
19258	8'	3	
192510	10'	4.5	
192520	20'	5	
<b>RESISTIVE DISCHARGE HOOK/PROBE</b>			
	Handle Length	Ground Lead Length	
19250005	23"	5'	2
192500655	7'	10'	4.5
19250007	5'	7'	4
<b>Accessories</b>			
1925SSMC	Mounting Clip, Stainless Steel	3 oz	
1925MC	Mounting Clip	3 oz	
1925DMC	Mounting Clip with Hardware	4 oz	



# Utility Solutions

LIVE LINE TOOLS

## BREAK-SAFE® Load Break & Pick-up Tool



- Functions as portable in-field switch
- In order to keep personnel at a safe distance, the BREAK-SAFE® is operated with an insulated fiberglass hot stick
- The Yellow Safety Lock is operated by a hotstick and helps prevent the tool from an unintended load break or pickup operation
- Only tool with full load break and load pick-up capability
- 300 AMP loadbreak, load pick-up and continuous current duty
- Offered in 15kV, 27kV and 46kV voltage classes
- Available with either a Floating Head or Duckbill Head (full stick operation)
- Simple, easy method to establish parallel circuit
- Optional Hard Case or Soft Case

- USBS-15-1-PS** 15kV Rated, Gloved Operation; 300 AMP; Floating Head
- USBS-15-2-PS** 15kV Rated, Stick Operation; 300 AMP; Duckbill Head
- USBS-27-1-PS** 27kV Rated, Gloved Operation; 300 AMP; Floating Head
- USBS-27-2-PS** 27kV Rated, Stick Operation; 300 AMP; Duckbill Head
- USBS-46-1-PS** 46kV Rated, Gloved Operation; 200 AMP; Floating Head\*
- USBS-46-2-PS** 46kV Rated, Stick Operation; 200 AMP; Duckbill Head\*
- USBS-XX-X-PS** Soft Carrying Case

\*Note: the 46kV rated for 200 ampere loadbreak and 200 ampere load pickup



## BREAK-SAFE® 600 Load Break & Pick-Up Tool

- The industry's first portable switch rated at 600 AMP for load dropping, load pick-up and continuous current duty functions
- Tool is fully rated from 7.2kV to 27kV
- Features an extra large clamp capable of handling all wire sizes up to nearly 2" diameter
- Made of durable, electrical grade fiberglass housings and a glove friendly design
- Dual conductor bars allow for two mechanical jumper clamps to reach the 600 AMP rating
- This tool is designed with a patent pending internal safety lock, requiring the user to reset on each use
- Incorporates safety lock in pin and lock out pin feature



- USBS-600-1:** 7.2kV-27kV, Gloved Operation; 600 AMP; Floating Head
- USBS-600-1-S:** Soft Carrying Case

## Jack Jumper™ Cutout Bypass Tool

- Rated for 100 AMP continuous duty
- Permits a safe and quick method to bypass an overhead cutout without use of bulky jumper cables
- Indispensable for fuse coordination tasks and permits easy bypass of an underground dip
- Saves linemen time and eliminates risk of service interruption and prevents accidental cross phasing
- Features no moving parts to fail and utilizes a stainless steel external spring to provide many years of trouble-free service
- USJJ-001S, USJJ-002S, and USJJ-005 are supplied with soft storage cases standard; cases are not available for the USJJ-004S and the USJJ-007

- USJJ-001S** Designed for all 15kV rated standard cutouts
- USJJ-002S** Designed for all 27kV rated standard cutouts
- USJJ-004S** Designed for all 27kV rated loadbreak cutouts
- USJJ-005** Designed for 38kV rated standard cutouts
- USJJ-007** Designed for S&C™ SMD-20 38kV power fuse Cutouts with "V" design



## Klondike Clamp

- The Klondike Clamp tool series quickly and safely secures blankets in position on poles without damaging the blankets
- Eliminates the need for tie wrap, bungee cords, Velcro®, tape or any other means that are both time consuming to install and potentially damaging to the blanket
- The Klondike Clamp tool series can also be used in a myriad of padmount equipment situations where it is difficult to secure the blanket by conventional means
- Molded from a tough weather resistant polymer and assembled completely with stainless steel hardware, the Klondike Clamp tool series will provide a lineman with many years of maintenance free usage

- USCP-001** 7"-11" Diameter Range, 16" Long
- USCP-002** 11"-20" Diameter Range, 23" Long



Itlutilitysupply.com





# Chance - Live Line Tool Accessories

## M4455-67: Universal Insulator Fork Tool



- Designed to grasp 9" and 10" disk insulators used in deadend construction; will raise most pin type insulators up to 15 lbs
- Fiber jaws open and close by rotating screw
- Adjustable insulator forks
- 3" to 4.5" opening

## M4455-89: Ratchet Wrench Tool



- Designed for tightening square nuts on 5/8" pole line hardware, regardless of the length of the bolt running beyond it
- The long socket permits wrench handles to swing past crossarm when tightening top ridge pin nut

## C4000600: Tie Back Clamp



- Installs with a Grip-All clampstick
- Used with a Tension Puller to keep the tail of a conductor out of the work area by tying it back to the main line after it has been cut
- The clamp also may be used to hold a jumper on the main line while applying a compression connector

## M4455-84: Universal Tool Adapter



- When this adapter is mounted on a universal stick, and any universal tool is mounted on the adapter, the tool can be set at almost any angle to the stick
- Useful for working in tight places
- 90° universal tool

## C4031416: Tie Wire Claw Tool



- Hand-like hot line tool easily and neatly applies tie wires, both factory-formed and field-formed
- Claw controls wire with grip equal to pliers, permits securely wrapping tight coils onto conductors

## M4455-50: Skinning Knife



- For cutting or scraping insulation, cleaning conductors, etc., prior to making splices
- Use with a universal pole permits safe work near energized lines

## C4031417: Universal Utility Head Tool



- Gator-look shape makes Utility Head popular for many hotline jobs: placing and removing blocks, slings, circuit breakers, line hooks and strain breakers

## M4455-46: Flexible Wrench Head



- Made to fit standard wrench sockets
- Flexibility permits use at various angles

## M4455-85: Hammer Tool



- Used for many operations around energized conductors such as moving conductors, suspension clamps, and other pieces of hardware requiring a forceful blow

## H1760-5: Pole & Clamp Hanger



- Designed for use on 1.25" or 1.5" diameter Epoxiglas® poles
- Includes a black nylon-filled plastic hook and a steel hose clamp for easy attachment

# Chance - Live Line Tool Accessories

## 4455-17: Tie Stick Head



- Often preferred for manipulating tie wires which have looped ends
- Useful in close quarters where loose ends of the wire must be rolled up to prevent contact with crossarm or hardware while untying

## M4455-70: Tie Head



- For manipulating the wires with or without looped ends
- Heat treated aluminum alloy body design permits a swivel action
- Wire is wrapped or unwrapped without turning universal pole
- A V-notched carbon steel blade grasps tie wire securely

## M1948-3: Ratchet Wrench



- For use with strain jacks and trunnion

## M4455-69: Tie Head



- For placing insulator ties with looped ends
- Heat treated aluminum alloy body
- Prong swivels freely, permitting a full turn on the tie wire without releasing contact this minimizes the possibility of kinking or burning the wires

## E4010138P: 2" Pole Clamp



- Replacement pole clamp for adjustable strain pole

## M1860: Crossarm Tool Hanger



- Adjustable to crossarms ranging in width from 3.25" to 4.5" (depth of crossarm does not matter)
- Made of strong, lightweight aluminum alloy
- Features cadmium-plated steel hardware

## Assembly Trunnions

- Trunnions are bronze alloy
- Features ball-thrust bearing construction for use on adjustable strain poles
- Designed to equal the capacity of all Chance yokes and provide maximum efficiency for the lineman



E4012066



E4012068

## M4455-6: Ratchet Wrench



- This Ratchet Wrench is used for tightening bolts in substation equipment, hardware bolts on transmission and distribution lines, etc.

## M4455-63: Cleaning Brush



- V-position of brushes gives 2-sided cleaning action
- As brushes wear, they can be rotated by loosening the anchor screws so that unused bristles will come in contact with conductor

# Chance - Live Line Tool Accessories

## M4455-12: Cotter Key Removal Tool



- Hammer-like action makes it extremely useful in pulling out stuck cotter keys
- Release of the compression spring by a quick jerk of the pole deals the cotter key a hammer blow without disengaging the eye

## M4455-15: Locating Pin



- Used as a drift pin in aligning bolt holes as an aid in bolt and pin insertions
- It is recommended for making hardware connections on tower transmission lines and line deadends where aligning or hardware fitting is difficult

## Cotter Key Pulling Tool



- Used to partially withdraw a ball-socket cotter key so that the insulator can be removed from another insulator hanger
- This puller with its thin prong is preferred for prying out standard keys deeply set on long insulator strings

M4455-96

## M4455-82: Cotter Key Tool



- For pulling and replacing hump-type cotter keys
- Particularly suitable for use on clevis pins and ball socket insulators
- Easy guiding of cotter key provided by contoured slot and raised eye pin

## M4455-103: Cotter Key Holder Tool



- Used to install cotter keys into semi-recessed hardware this tool will hold the keys in position for proper insertion into clevis pins
- The tool will hold the key firmly, yet will readily release once engagement is made

## M4455-19: Cotter Key Tool



- For ball and socket insulator coupling
- Straight end of the tool enters the socket opening to force cotter key out
- Curved end forces cotter key back into position

## M4455-38: Mirror Tool



- Angle adjustment enables the operator to inspect insulators, switch bases, and other equipment which is difficult to see without coming in contact with energized conductors

## M4455-23: Hack Saw Tool



- Excellent for use at various angles where a hack saw is needed near energized conductors
- Comes with 10 blades

## M4455-2: Pin Holder Tool



- For replacing pins and bolts
- The bolt head fits into a slot and is held tight by spring action
- Will take bolts or pins up to 5/8" diameter
- Fits EEL and NEMA insulators

## T4000838: Steel Arm Bracket



- The steel arm bracket is used with C400-0445 (steel arm yoke) where the steel arm is not equipped with an end plate
- The bracket is made of heat treated aluminum and is complete with a wheel binder
- The steel arm bracket serves the same purpose as an end plate to support the yoke assembly

# Chance - Live Line Tool Accessories

## M4455-22: Adjuster Socket



- Useful in controlling the adapter between clevis clamps and ball and socket insulator pins

## M4455-36: Link Stick Head



- Use with light conductors
- The clamp will hook into a cum-a-long ring
- Jaw openings range from .750" to .22"
- Jaws have rounded edges to prevent scarring conductors
- The hook is made of heat treated aluminum alloy

## M4455-28: Screwdriver Tool



- Excellent for use at various angles where an insulated handle is needed

## M4455-39: Shepherd Hook



- The self-aligning shepherd hook is designed for pulling and lifting insulator strings
- Swivel action permits it to rotate and maintain its alignment with the insulator at all times
- Heat treated aluminum alloy

## M4455-77: Fuse Puller Tool



- The Chance Fuse Puller may be preset to any position desired and locked there by tightening the wing nut
- A spring assembly also permits the tool to be preset without locking, so that it will align with the fuse during the pulling operation
- Jaws are Plastisol covered

## Screw Jack Assembly



- ACME thread strain jack

V4010157 24" Length

V4010158 36" Length

## C4030799: Hand Guards



- Hand guards assist in maintaining minimum clearances between the hand and the working end of the hot line tool

## M4455-102: Clevis Pin Holder



- This tool has particular application on EHV hardware and insulators where the pin must be placed in semi-recessed areas
- The three-finger device is spring-loaded with cadmium plated music wire for positive grip

## C4031071: Super Hot Rodder Tool



- Ideal for applying line ties and other formed wire products on energized lines
- Adaptable to Super Top-Ties®
- The loop type work end permits rotational control which is difficult with conventional tying tools

## C4030177: All Angle Pliers



- Designed to grasp from any angle
- The jaws are held firmly in position with a wing-nut
- Used as a holding device for retaining bolt heads and loose hardware, adjusting arcing horns, replacing cotter keys, etc

# Chance - Live Line Tool Accessories

## M4455-79: Spiral Disconnect Tool



- Extremely effective in opening switches and removing and installing cutout doors on porcelain enclosed type cutouts
- Also called "Pigtail" Disconnect

## M4455-92: Conductor Cleaning Brush



- Semi-tubular shape allows linemen to clean 6" of entire circumference of conductor with two stick position

## M4455-87: Adjuster Socket



- Used on heavy socket clevises, particularly where aluminum suspension and deadend clamps are attached to ball and socket insulators

## C4030011: Universal Knocker Tool



- Designed to knock out and pull the cotter keys on fog-type insulators, the Knocker Tool is spring assisted for greater impact in restricted space and adverse working conditions
- The Knocker has a standard universal fitting on one end and a Universal fitting with wing nut on the other end

## M4742-1: Adjustable Hook Assembly



- Adjustable Hook Assembly can be used with the adjustable strain poles as a direct method of relieving the load on a suspension string
- Conductor clamp has a contoured seat with a trapping gripper and is operated by an eyescrew
- Conductor range is 1.125" to 25" dia.
- Hook can be positioned every 6" on the strain pole
- The hook is self-aligning within a range of 45° either side of vertical
- Maximum load is 3,500 lbs.

## PSC4033484: Universal 4-in-1 Cutout Tool



- Strong heat treated aluminum casting
- For hot sticks with splined universal fitting
- Gives a clear view of the cutout hinge while placing and removing a fuse holder
- Performs lift out, placement, opening, and closing of 100 Amp cutout fuse holders made by A.B. Chance, and S&C, as well as the Chance Electronic Sectionalizer
- Weighs only 1/4 lbs

## M4660: Hot Line Tool Rack



- Eliminates the need for rolls of canvas or other ground covering devices
- Compact, collapsible racks take up little space on the line truck or in the trailer
- Tools are protected against abrasion by soft, tough Plastisol coating over arms, center mast
- All metal parts below the Plastisol are galvanized or bronze for resistance to corrosion
- The folding tripod-like legs can be locked in the fully opened or fully closed position via an eyebolt, secured by a bead chain
- Will support up to 12 tools as there are 12 arms to a rack
- Poles of 3" diameter will easily fit on the arms

# Chance - Live Line Tool Accessories

## Epoxiglas® Spliced Ladders



- Available in combinations of up to 32'
- 1" diameter steel rods, 8" in diameter, are arched to hook over structural shapes and are furnished on all top section units
- Hooks are complete with steel chains
- Manufactured in short, easy to transport lengths and are joined with the Chance Rigid Ladder Splice to form an unshakable, rigid splice
- Two eye pins in each rail, with a klik pin in the end of each are supplied

**C4020404** 14' Top Section w/ 8" hook

**C4020418** 8' Bottom Section

**C4020421** 10' Bottom Section

**C4020422** 12' Bottom Section

## Epoxiglas® Hook Ladders



- Has many applications in high voltage maintenance to position linemen in the most advantageous working location, making line repairs possible at otherwise almost inaccessible places
- Hooks are formed from 1" diameter tempered steel and can be swiveled to best fit various angles on the structure
- Steel chains clip to the hooks to assist in securing the ladder to a support
- Rung material for both rated ladders are 1.25"

**H4905-14** 12' overall, 2.5" side rails  
14.5" below rails

## E4020525: Vertical Attachment for Towers



- Quick, easy rigging on most types of structure is the feature of the Chance ladder attachment sets, affording efficient use of the Chance Epoxiglas ladder as a platform for live-line maintenance
- Sets were designed to be attached to either steel or wood structures, vertical or horizontal, to support the structure-end of the ladder in a tagged-out position
- Designed for use on 2.5" diameter side rail ladders and can be ordered as sets or choosing the individual components

## C4020155: Ladder Attachment Kit

- Quick, easy rigging on most types of structure is the feature of the Chance ladder attachment sets, affording efficient use of the ladder as a platform for live-line maintenance
- Sets were designed to be attached to either steel or wood structures, vertical or horizontal, to support the structure-end of the ladder in a tagged-out position
- Designed for use on 2.5" diameter side rail ladders and can be ordered as sets or choosing the individual components

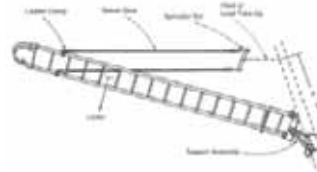

## H4964-6W: Standard Aerial Platform

- Designed to provide a convenient workstation on an aerial structure
- Quickly mount in position on the structure to place workers in the correct relationship to the work area
- These platforms are furnished with a Fixed Pole Mount for maintenance jobs that do not require frequent platform relocation
- Pivot Mounts (available as optional accessories) allow the platform to be swiveled on its horizontal plane to different positions for certain operations. For belt-on and as restraining guides for workers, Epoxiglas® Tripods or Railings may be added
- For improved footing, three strips of 2" non-skid tape extend the length of the platform working surface
- A bare section near the mounting end helps reduce moisture accumulation in inclement weather and provides an area between the working surface and the mount fittings that can be readily wiped clean of dirt and moisture when necessary



## E4020099: Spreader Bar



- Quick, easy rigging on most types of structure is the feature of the Chance ladder attachment sets, affording efficient use of the Chance Epoxiglas® ladder as a platform for live-line maintenance
- Designed to be attached to either steel or wood structures, vertical or horizontal, to support the structure-end of the ladder in a tagged-out position
- Designed for use on 2.5" diameter side rail ladders and can be ordered as sets or choosing the individual components

## C4020023: Railing for 6' Platform

- Epoxiglas® construction adds belt-on capability and restraining guide for lineworkers

# Hastings Live Line Accessories

## A30008: Rubber Glove Auxiliary Arm



- May be added to existing auxiliary arm
- For use up to 34.5 kV

## Universal Head - Splined



- Head adapts to all universal fit-on type tools for fitting to your existing sticks
- Includes cap and base

A10017 1 1/4"

A10018 1 1/2"

## A10019: Shotgun Universal Tool Adapter



- Adapts shotgun sticks to all universal attachments
- Made of high-quality bronze alloy
- May be used with all major brand tools

## A10022: Clamp Stick Head



- Use this head with universal sticks for installing and removing hot line clamps
- A quarter-turn of it's rotating cap locks the tool on the screw eye

## P10431: Universal Disconnect Hook



- Used for opening and closing switches
- Nickel-plated steel
- Disconnect hook comes equipped with extension for hanging stick from aerial structures

## A10020: Universal Rotary Prong with Tie Stick Head



- Prong is self-aligning, swivels freely
- Used for looped end tie wire

## A10021: Universal Rotary Blade with Tie Stick Head



- Blade has self-aligning swivel action for removal of ties without looped ends

## Conductor Cleaning Brushes



- All brushes have stainless steel bristles to allow the cleanest connection possible
- Stainless steel eliminates rust deterioration of bristles
- Compact "U" type brushes for tight clearances and easy storage in linemen's pouches
- Other models available

"U" 10-183

"V" 10-178

# Underwater Kinetics - Live Line Accessories

## 16001: LitFinger

- Bright, unbreakable 1-watt LED light.
- Pointed head for breaking off of ice or debris
- Notched straight arm to secure fuse while lowering or raising hot stick
- Curved arm for hanging
- HI-LOW switch for increased battery life
- Water-resistant battery compartment with sealed silicone rubber push button
- Sealed borosilicate window to resist heat and flash
- Passed 3000 V, 8000 A, 1/2 sec (30 cycles) arc blast test
- Easy access (no tools required) battery compartment door
- Universal splined slotted connector attaches to hot sticks
- Made in the USA



## 16002: LitLink

- Bright, unbreakable 1-watt LED light
- Light weight aluminum body, only 7 oz with batteries
- HI-LOW switch for increased battery life
- Water resistant battery compartment with sealed silicone rubber push button
- Sealed borosilicate window to resist heat and flash
- Passed 3000 V, 8000 A, (10 cycles) arc blast test at 7 inches from the 12 inch arc
- Easy access (no tools required) battery compartment door
- Universal splined slotted connector attaches to hot sticks
- Made in the USA





## C4002365: Epoxiglas® Cleaning Kit



- Includes essential items for the care and maintenance of Epoxiglas® tools and insulated boom sections of aerial lift trucks
- Proper use of these maintenance aids will ensure that maximum and useful life is obtained from Epoxiglas® products

### Kit consists of four parts:

**Moisture Eater II** - Should be used on contaminated Epoxiglas® during general tool maintenance and in preparation for reglossing a tool's surface. Moisture Eater removes moisture and a wide variety of contaminants such as dirt, tar, grease, tree sap, light metal rubbings and old surface coatings without harming the Epoxiglas® material.

**Abrasive Cleaning Pads** - Pads are used in conjunction with Moisture Eater to remove contamination that clings to the tool's surface. Gloss restorer must be applied after using these pads since cleaning with Moisture Eater II will remove the glossy finish on the tool as well as contamination. The pads may also be used on metal parts to remove oxides and surface corrosion.

**Gloss Restorer Kit** - When mixed and applied to the surface of a cleaned Epoxiglas® tool, they combine to form a clear, tough coating that replaces the original gloss and protects against contamination and moisture.

**Hot Stick Wiping Clothes** - Silicone impregnated cloths are used to wipe down mildly contaminated Epoxiglas®, removing dust and dirt, and depositing a thin protective film on the surface of the tool. They give an added measure of protection when used after recoating with gloss restorer.

**Warning:** Do not use on Gel-Coat or painted boom surfaces

## C4002364: Moisture Eater II Cleaner-Solvent



- Cleans contaminated Epoxiglas® found on hot line tools, line hose and blankets
- Consists of two solvents: one for oils, waxes and silicone-type contamination; one for moisture contamination
- Free of chlorinated hydrocarbons

## C4002538: Moisture Eater II Wipes



- Small pocket-size packets help utilities stay in compliance with OSHA 29 CFR 1910.269 (j)
- Sealed wipes mean no more rags to store or try to keep clean in the field; no more jugs to stow, big spills, evaporation losses or wasteful excesses just to wet large cloths
- The hanger box holds 50 wipes

## C4002568: Silicone Wipes for Hot Line Tools



- Small pocket-size packets help utilities stay in compliance with OSHA 29 CFR 1910.269 (j)
- The hanger box holds 50 wipes
- Sealed wipes mean no more rags to store or try to keep clean in the field
- Chance silicone 8"x10" wipes contain the same silicone that impregnates hot stick wiping cloths in the Epoxiglas® Cleaning Kit
- Removes dust and applies a thin protective coat

# Hastings Live Line Tools Cleaning & Repair

## 10-171: Fiberglass Cleaning & Refinishing Kit

- Kit includes (1) gallon All-Purpose Cleaner, (1) box of 20 Ultra Fine Non-Metallic Abrasive Pads, (1) Qt (2 parts) Clear Epoxy Refinishing Kit Silicone Treated Wiping Clothes
- Used to clean and/or restore fiberglass hot sticks, booms and buckets



## Hot Stick & Boom Wax

- 14 oz. can
- Protects hot sticks and booms



10-091 Single Can  
10-091-1 Case of 6

## 100-90: 18"x18" Silicone-Treated Wiping Cloth

- Deposits a water repellent film while removing dust and dirt particles from the surface of hot sticks and insulated tool handles
- 18"x18" cotton cloth features bound edges and has an open-type weave
- Regular replacement of the silicone-treated cloth will add to the life and safety of the tools



## H10-188: 50 Hot Stick Wipes



- Excellent for daily wiping of hot sticks
- Remove contaminants such as dirt, oils, creosote, and other undesirable matter
- Leaves a silicone moisture barrier which enables water to "bead up", eliminating the "blanket effect" when using hot sticks in wet conditions
- 50 wipes individually packaged in each heavy duty cardboard dispenser box
- Environmentally safe, the used wipes may be disposed of in normal waste containers

## 10-169: 1 Gallon All-Purpose Cleaner

- Excellent cleaner for the following items: Hot line tools, Platforms, Rubber Goods, Rigid Cover-ups, Shop Machinery, Hands, all Plastic Surfaces, Painted Surfaces, Aluminum
- This product is very safe, and is non-toxic, biodegradable, non-alkali, non-flammable, non-acid, and gentle on the skin



## Bucket Barricade

- Provides added protection from arcs and flashes while closing cutouts, from oil spray when working around transformers; as a barrier when working in close proximity to energized hardware, and from wind/weather when working in poor conditions
- Fits any bucket
- Handy tool board included
- Four height adjustments 10", 16", 22", and 28". Just lift and barricade locks in position automatically
- Barricade when stowed is down and out of the way

05-840 18" Wide

05-841 23" Wide

**WARNING:** Do not use Barricade as a replacement for primary personal protection, arc and blast protection, or any other safety equipment. Any attempt to do so may result in serious injury or death. This barricade is to be used along with all safety equipment and safe working practices required by your company and OSHA.



## Duck Bill Grounding Clamps



1793



1853



21030



21754

Part #	Eye & Clamp Description	ASTM Grade/ Class	Main Line Range	Rating	Weight (lbs)
<b>.96" SMOOTH JAW BRONZE DUCK BILL - GRAVITY ACTUATED - "V" THREAD</b>					
1793	Eye w/ strain relief sleeve, Smooth Jaw	4 / A		350 RMS AMP, 60 Hz	1.3
21080	Eye w/ strain relief sleeve, Smooth Jaw	4 / A	556 MCM ACSR to #6 .96" - .16" Dia.	350 RMS AMP, 60 Hz	1.1
1797*	Mounted w/ strain relief sleeve, Smooth Jaw	4 / A		350 RMS AMP, 60 Hz	4.63
2093	Hanger Stud only				0.4
<b>1.1" SMOOTH JAW ALUMINUM DUCK BILL - SPRING LOADED - "V" THREAD</b>					
21030	Eye w/ strain relief sleeve, Smooth Jaw	5 / A		400 RMS AMP, 60Hz	1.1
21059	Eye w/ strain relief sleeve, Smooth Jaw	5 / A	795 MCM ASR to #6 1.1" - .16" Dia.	400 RMS AMP, 60 Hz	1
21081	Mounted w/ strain relief sleeve, Smooth Jaw	5 / A		400 RMS AMP, 60 Hz	4.3
21754	Hanger Stud Only	5 / A		400 RMS AMP, 60 Hz	.3
<b>1.66" SERRATED JAW ALUMINUM DUCK BILL - ACME THREAD</b>					
1853	Eye w/ strain relief sleeve, Serrated Jaw	5 / B	1590 MCM ACSR to #6 1.66" - .16" Dia.	400 RMS AMP, 60 Hz	1.5

## "C" Type Grounding Clamps



2537



9985



4187

Part #	Eye & Clamp Description	ASTM Grade/ Class	Main Line Range	Rating	Weight (lbs)
<b>1.12" BRONZE "C" CLAMP - ACME THREAD</b>					
9985	Eye w/ strain relief sleeve, Smooth Jaw	5 / A		400 RMS AMP, 60 Hz	1.9
2937	Eye w/ strain relief sleeve, Smooth Jaw	5 / A	795 MCM 26" x 7" ACSR to #8	400 RMS AMP, 60 Hz	1.8
4280*	Mounted w/ strain relief sleeve, Smooth Jaw	5 / A	1.12" - .12" Dia	400 RMS AMP, 60 Hz	4.9
4187	Eye w/ strain relief sleeve, Serrated Jaw	5 / B		400 RMS AMP, 60 Hz	1.9
2537*	Hanger Stud Only				.4

\*Mounted: 1.25" dia. x 6' fiberglass Hotstick permanently mounted

# Salisbury by Honeywell

## "C" Type Grounding Clamps



9984



4279



9984



9983

Part #	Eye & Clamp Description	ASTM Grade/ Class	Main Line Range	Continuous Current Rating	Weight (lbs)
<b>1.25" BRONZE "C" CLAMP - ACME THREAD</b>					
9984	Eye w/ strain relief sleeve Smooth Jaw w/ Flat Lower Jaw	5 / A	1035.5 MCM ACSR to #6 1.25" - .16" Dia.	400 RMS AMP, 60 Hz	2.2
1897	Eye w/o strain relief sleeve Smooth Jaw w/ Flat Lower Jaw	5 / A		400 RMS AMP, 60 Hz	2.1
4255	Eye w/ strain relief sleeve Smooth Jaw w/ Curved Lower Jaw	5 / A		400 RMS AMP, 60 Hz	2.2
21069	Eye w/ strain relief sleeve Smooth Jaw w/ Flat Lower Jaw	5 / A		400 RMS AMP, 60 Hz	2.1
4279	Eye w/ strain relief sleeve Smooth Jaw w/ Curved Lower Jaw	5 / B		400 RMS AMP, 60 Hz	2.2
21070	Eye w/o strain relief sleeve Serrated Jaw w/ Flat Lower Jaw	5 / B		400 RMS AMP, 60 Hz	2.1
9983*	Hanger Stud Only				



21074



20882



4295

Part #	Eye & Clamp Description	ASTM Grade/ Class	Main Line Range	Continuous Current Rating	Weight (lbs)
<b>2" ALUMINUM "C" CLAMP W/ CURVED LOWER JAW - ACME THREAD</b>					
21074	Eye w/ strain relief sleeve, Smooth Jaw	5H / A	3000 MCM ACSR to #6 2" - .16" Dia.	400 RMS AMP, 60 Hz	2.1
21075	Eye w/o strain relief sleeve, Smooth Jaw	5H / A		400 RMS AMP, 60 Hz	2
20882	Eye w/ strain relief sleeve, Serrated Jaw	5H / B		400 RMS AMP, 60 Hz	2.1
21077	Eye w/o strain relief sleeve, Serrated Jaw	5H / B		400 RMS AMP, 60 Hz	2
<b>2.4" BRONZE "C" CLAMP W/ FLAT LOWER JAW - ACME THREAD</b>					
4295	Eye w/ strain relief sleeve, Smooth Jaw	5H / A	2" I.P. S. to #6 2.4" - .16" Dia.	400 RMS AMP, 60 Hz	4.1
4311	Eye w/ strain relief sleeve, Smooth Jaw	5H / A		400 RMS AMP, 60 Hz	4

## Grounding Clamps for Substation Buses



Part #	Eye & Clamp Description	ASTM Grade/ Class	Main Line Range	Continuous Current Rating	Weight (lbs)
<b>3.5" ALUMINUM "C" CLAMP FOR SUBSTATION BUSES - ACME THREAD</b>					
4282*	Eye w/ strain relief sleeve, Smooth Jaw w/ Flat Lower Jaw	5 / A		400 RMS AMP, 60 Hz	2.8
4283	Mounted w/ strain relief sleeve, Smooth Jaw w/ Flat Lower Jaw	5 / A		400 RMS AMP, 60 Hz	5.8
21953	Eye w/ strain relief sleeve Smooth Jaw w/ Flat Lower Jaw	5H / A	3" - 1.5" I.P.S.	400 RMS AMP, 60 Hz	2.9
4341	Long Eye Screw w/ strain relief sleeve, Smooth Upper Jaw w/ Flat Lower Serrated Jaw	5 / A	3.5" - 1.75" Dia.	400 RMS AMP, 60 Hz	2.9
21985**	Long Eye Screw w/ strain relief sleeve Serrated Jaw w/ Flat Lower Jaw	6 / B		400 RMS AMP, 60 Hz	3
<b>6.62" ADJUSTABLE ALUMINUM "C" CLAMP FOR ROUND, SQUARE, RECTANGLE OR "H" SECTION SUBSTATION BUSES - ACME THREAD</b>					
2991	Eye w/ strain relief sleeve, Serrated Jaw w/ Flat Lower Jaw	5H / A		400 RMS AMP, 60 Hz	6.9
2993***	Eye w/ welded single contact stud, Smooth Jaw w/ Flat Lower Jaw	5 / A	6.12" I.P.S.	400 RMS AMP, 60 Hz	7
9967***	Eye w/ welded double contact stud, Smooth Jaw w/ Flat Lower Jaw	5 / A	6.62" - 4" Dia.	400 RMS AMP, 60 Hz	7.3
4378	Oval Eye w/ strain relief sleeve, Smooth Jaw w/ Flat Lower Jaw	5 / A		400 RMS AMP, 60 Hz	6.9

\*Mounted: 1.25" dia x 6' Fiberglass Hotstick permanently mounted

\*\* Accepts 3/4 - 10 ferrule threads

\*\*\* No Ferrule Connection

# Salisbury by Honeywell

## Ground Clamps for Flats, Angles & Rounds



Part #	Eye & Clamp Description	ASTM Grade/ Class	Main Line Range	Continuous Current Rating	Weight (lbs)
<b>GRADE 2 BRONZE FLAT JAW GROUNDING CLAMPS - "V" THREAD</b>					
1815	Eye Screw w/ strain relief sleeve Serrated Jaw	3 / B	1.5" - .06" Flat or Square 1.26" - .06" Dia.	300 RMS AMP, 60 Hz	1.6
<b>GRADE 5 ALUMINUM FLAT JAW GROUNDING CLAMP - ACME THREAD</b>					
4369	Eye screw w/ strain relief sleeve, Serrated Jaw	5 / B	1.5" - .06" Flat or Square 1.26" - .06" Dia.	400 RMS AMP, 60 Hz	2
24441	Eye screw w/ strain relief sleeve, Serrated Jaw	5 / B	1.5" - .06" Flat or Square 1.26" - .06" Dia.	400 RMS AMP, 60 Hz	2

## Ball & Socket System - Socket Clamp & Ball Stud "C" Clamp

The Ball & Socket Grounding System allows for variable angle accessibility. This system is compact and lightweight. There are fixed grounding points on the socket clamp. The 21190 socket clamp, made from bronze alloy, has a socket size of 1" and a threaded bore boss of 5/8" - 11 UNC. The socket clamp has an integral cable support with strain relief sleeve.

The Ball Stud "C" Clamp is a universal clamp that can be used in substations and on overhead lines. This universal clamp can be used as a socket clamp on a 1" Ball Stud and as a 1 1/2" C-Clamp on overhead lines. The eye screw is not extended beyond the body of the clamp, minimizing possible thread damage during handling. Double lead V-thread allows for faster installation, minimizing worker fatigue. External and internal ball studs assembly can be used as a current carrying contact stud.

### Specifications for Ball Stud "C" Clamp

- Aluminum clamp body
- Double lead V-thread eye screw is bronze alloy
- ASTM Type 1, Class A, Grade 5 rating
- Fault current ratings: 43,000 AMP - 15 cycles, 30,000 AMP - 30 cycles
- Ferrule attachment: 5/8" x 11 UNC for Grade 5 rating
- Grounding cable: #2 min size to 4/0 max size



22675



21190

Part #	Description	ASTM Grade/ Class	Continuous Current Rating	Weight (lbs)
21190	w/ strain relief sleeve	5	400 AMP	1.2
21277	w/o strain relief sleeve	5	400 AMP	1.1
22675	1" Ball Stud C-Clamp w/ strain relief	5H	400 AMP	2.7
22704	1" Ball Stud C-Clamp w/o strain relief	5	400 AMP	2.6

# Salisbury by Honeywell

## Grounding Cables

Salisbury Grounding Cables are made with extra flexible strand of soft drawn #30 AWG (.01") copper and are available in three different jackets.

The yellow thermoplastic elastomer jacketed cable is the standard for grounding service. It provides a combination of economy, flexibility and durability. The service temperature ranges from 200° to -50°F. ASTM F 855 Type I.

The black thermoplastic elastomer jacketed cable has a smaller diameter and thinner jacket material giving it better flexibility than the yellow cable. The service temperature ranges from 200° to -50°F. ASTM F 855 Type I.

The PVC transparent flexible thermoplastic jacketed cable allows easy inspection for strand breakage. The flexibility decreases with low temperatures. The service temperature ranges from 140° to -40°F per ASTM F 855, Type III requirements.



Part #	Size	Strand Dia. (inches)	Jacket (inches)	Short Circuit Withstand AMP, RMS, 60 Hz		Continuous Current AMP, RMS, 60 Hz	Weight /1000ft (lbs)
				15 Cycles	30 Cycles		
<b>YELLOW JACKET</b>							
2136	#2-665W	.35	.5	14,500	10,000	200	282
2137	1/0-1064W	.45	.62	21,000	15,000	250	488
2138	2/0-1330W	.49	.65	27,000	20,000	300	537
2139	4/0-2109W	.62	.83	43,000	30,000	400	836
<b>BLACK JACKET</b>							
2636	#2-665W	.35	.47	14,500	10,000	200	263
2637	1/0-1064W	.45	.58	21,000	15,000	250	404
2638	2/0-1330W	.49	.63	27,000	20,000	300	497
2649	3/0-1672W	.55	.72	36,000	25,000	350	680
2639	4/0-2109W	.62	.78	43,000	30,000	400	770
<b>CLEAR-PVC JACKET</b>							
2128	#2-665W	.35	.53	14,500	10,000	200	289
2129	1/0-1064W	.45	.64	21,000	15,000	250	520
2133	2/0-1330W	.49	.70	27,000	20,000	300	546
2288	4/0-2109W	.62	.84	43,000	30,000	400	841

**Ask about our LTL 350 and 500 MCM grounding cables and ferrules for large ampacity applications (refer to page 14)**

# Salisbury by Honeywell

## Plain Shrouded & Unshrouded Ferrules

- **Plain ferrules** are designed for use with all grounding clamps that feature pressure terminals including the 1" duckbill and 1.5" flat jaw clamp.
- **Copper ferrules** are available in two different styles: unshrouded and shrouded. Shrouded ferrules are compressed on both the conductor and the jacket of the cable to reduce bending stress. Unshrouded ferrules are crimped on the conductor strands only. These ferrules are manufactured of tin plated, 99.5% pure copper.
- **Aluminum ferrules** are available in two different styles: unshrouded and shrouded. Shrouded ferrules are compressed on both the conductor and the jacket of the cable to reduce bending stress. Unshrouded ferrules are crimped on the conductor strands only.



Aluminum Plain Unshrouded Ferrules

Part #	Cable Size	Strand Die Codes T&B	Jacket Die Codes T&B	Burndy Die Number	Weight (lbs) ea. pair
<b>Copper Shrouded</b>					
24424	#2	50	71	-	0.30
24425	1/0	50	71	-	0.35
24426	2/0	60	76	-	0.40
24427	4/0	66	106	-	0.45
<b>Copper Unshrouded</b>					
24420	#2	50	-	-	0.30
24421	1/0	50	-	U243	0.30
24422	2/0	60	-	U245	0.35
24423	4/0	66	-	U247	0.35
<b>Aluminum Shrouded</b>					
24434	#2	50	71	-	0.1
24436	2/0	60	76	-	0.15
24437	4/0	71	106	-	0.15
<b>Aluminum Unshrouded</b>					
24430	#2	50	-	-	0.12
24431	1/0	50	-	-	0.12
24432	2/0	60	-	-	0.16
24433	4/0	71	-	-	0.16

## Threaded Grounding Ferrules

Salisbury compression Threaded Grounding Ferrules provide low resistant connection to cable strands with a threaded stud that securely screws into a clamp. Nut and lock washers increase contact pressure and secure the assembly. Tin plated copper ferrules can be used on either bronze or aluminum body clamps. All Salisbury threaded grounding ferrules are unshrouded and manufactured with a 5/8-11 UNC threaded stud and meet the requirements of ASTM F855.



Part #	ASTM Grade	Size	Installing Die Codes T&B	Burndy Die Numbers	Weight ea. pair (lbs)
<b>ALUMINUM THREADED GROUNDING FERRULE</b>					
2026	1	#2	50	-	.2
2027	2	1/0	50	-	.2
2620	3	2/0	60	-	.3
2640	5	4/0	71	-	.3
<b>COPPER THREADED GROUNDING FERRULES</b>					
2022	1	#2	50	U243	.5
2023	2	1/0	50	U243	.4
2024	3	2/0	60	U245	.4
4277	4	3/0	66	-t	.6
2025	5	4/0	66	U247	.6



## ASTM TABLES



**SALISBURY**  
by Honeywell

### ASTM F855-09 TABLE 1 - PROTECTIVE GROUNDING CLAMP RATINGS

**TABLE 1 Protective Ground Cable, Ferrule, Clamp and Assembly Ratings for Symmetrical Current**

Grade	Grounding Clamp Torque Strength, min				Short Circuit Properties <sup>A</sup>								Continuous Current Rating, A RMS, 60 Hz	
	Yield <sup>B</sup>		Ultimate		Withstand Rating, Symmetrical kA RMS, 60 Hz				Ultimate Rating Capacity <sup>C,D</sup> , Symmetrical kA RMS, 60 Hz					
					15 cycles (250 ms)		30 cycles (500 ms)		15 cycles (250 ms)		30 cycles (500 ms)			Maximum Copper Test Cable Size
	lbf-in.	n-m	lbf-in.	n-m	Copper Cable Size	Copper Cable Size	60 cycles (1 s)	60 cycles (1 s)						
1	280	32	330	37	14	10	#2	18	13	9	2/0	200		
2	280	32	330	37	21	15	1/0	29	21	14	4/0	250		
3	280	32	330	37	27	20	2/0	37	26	18	4/0	300		
4	330	37	400	45	34	25	3/0	47	33	23	250 kcmil	350		
5	330	37	400	45	43	30	4/0	59	42	29	250 kcmil	400		
6	330	37	400	45	54	39	250 kcmil or 2 2/0	70	49	35	350 kcmil	450		
7	330	37	400	45	74	54	350 kcmil or 2 4/0	98	69	48	550 kcmil	550		

<sup>A</sup> Withstand and ultimate short circuit properties are based on performance with surges not exceeding 20 % asymmetry factor (see 9.1 and 12.3.4.2).  
<sup>B</sup> Yield shall mean no permanent deformation such that the clamp cannot be reused throughout its entire range of application.  
<sup>C</sup> Ultimate rating represents a symmetrical current which the assembly or individual components shall carry for the specified time.  
<sup>D</sup> Ultimate values are based upon application of Onderdonk's equation to 98 % of nominal circular mil area allowed by Specifications B 172 and B 173.

Reprinted, with permission, from ASTM F 855-09 Standard Specification for Temporary Protective Grounds to Be Used on De-energized Electric Power Lines and Equipment Table 1, copyright ASTM International, 100 Barr Harbor Drive, West Conshohocken, PA 19428. A copy of the complete standard may be obtained from ASTM, www.astm.org

### ASTM F855-09 TABLE 2 - GROUNDING CABLE FERRULE AND ASSEMBLY RATINGS

**TABLE 2 Ultimate Assembly Rating for High X/R Ratio Applications**

Grade	Size	High Asymmetrical Test Requirements			Test Duration (cycles)
		Rating Rated Current (kA)	X/R = 30 1st Cycle Current Peak (kA) X 2.69	Last Cycle Current Peak (kA)	
1H	No. 2	15	41	23	15
2H	1/0	25	65	37	15
3H	2/0	31	84	46	15
4H	3/0	39	105	58	15
5H	4/0	47	126	70	15
6H	250 MCM	55	148	82	15
7H	350 MCM	68	183	101	15

NOTE 1—The above current values are based on electromechanical test values.  
 NOTE 2—Assemblies that have been subjected to these shall not be re-used.  
 NOTE 3—For use with currents exceeding 20 % asymmetry factor.  
 NOTE 4—See X4.7.2 for additional information.  
 NOTE 5—Alternate testing circuits are available for laboratories that cannot achieve the above requirements. See Appendix X4 for details.

Reprinted, with permission, from ASTM F 855-09 Standard Specification for Temporary Protective Grounds to Be Used on De-energized Electric Power Lines and Equipment Table 2, copyright ASTM International, 100 Barr Harbor Drive, West Conshohocken, PA 19428. A copy of the complete standard may be obtained from ASTM, www.astm.org



# Salisbury by Honeywell

## Ball & Socket System - Ball Studs

The Ball studs and the offset Nema Pad Ball Studs are made from tin-plated copper alloy or copper. They each have a 1" diameter ball. Recommended installation torque of 300 in. lbs. The short stud is used conventionally. The long stud can also be used as the grounding point for "C" or Duck bill clamps that have a jaw width of 2.75" or less. The Offset Nema Pad Ball Stud has the standard Nema bolt hole spacing and also comes in both long and short lengths. The Ball stud cover is made from Orange SALCOR® which allows for multiple angle application when installed using a clampstick.



Part #	Description	OAL	Dimensions (inches) thread	Shank	ASTM GRADE	Weight ea. (lbs)
<b>THREAD SIZE - 1/2" - 13 UNC - 2A</b>						
21191	Ball Stud Short, Tin-Plated Copper Alloy	4.38	2.12	1	5	.53
7542121BS	Ball Stud, Copper Alloy	4.7	2.25	1	5	9
21192	Ball Stud Long, Tin-Plated Copper Alloy	6.13	2.12	2.75	5	.81
7542123BST	Ball Stud, Tin-Plated Copper Alloy	6.78	2.5	2.875	5	13
7542123BS	Ball Stud, Copper Alloy	6.78	2.5	2.875	5	13
7542125BST	Ball Stud, Tin-Plated Copper Alloy	9	2.12	5.5	5	16
7542905BS	900 Ball Stud, Copper Alloy	7 x 5.2	2.12	5.5, 2	3	20
7542905BST	900 Ball Stud, Tin-Plated Copper Alloy	7 x 5.2	2.12	5.5, 2	3	20
<b>THREAD SIZE - 3/8" - 16 UNC - 2A</b>						
7542385BST	Ball Stud, Tin-Plated Copper Alloy	9	2.12	5.5	5	16
<b>NEMA PADS AND POTHEAD STUD</b>						
21846	90° Offset NEMA Pad, Tin-Plated Copper Alloy	5.75	-	2.7	5	1
21228	Offset NEMA Pad Short, Tin-Plated Copper Alloy	5.14	-	1	5	.84
24087	Offset NEMA Pad Long, Tin-Plated Copper Alloy	6.9	-	2.7	5	1
7542PHS	Pothead Stud, Spade, Brass	5.4	-	-	2	14
<b>INTERNAL THREAD - 1/2" - 13 UNC - 2A</b>						
24082	Internal Thread Ball Stud, Tin-Plated Copper Alloy	3.85	1.5	.75	5	.54
7542K	3/4" Ground Knob, Brass	1.4	1	.75	3	6
7542001BSF	Female Ball Stud, Brass	-	1.5	1	2	14
21236	Cover for Ball Stud	3	n/a	n/a	n/a	.09
<b>POLE BAND</b>			<b>Fault Duty (15 cycles)</b>		<b>Grade</b>	<b>Weight (lbs)</b>
760001PB	Aluminum Bar		27 kA		3	4

## Sure-Lok® Jumper Clamp

- Featuring a ratchet type locking mechanism
- Clamp tightens with a ratchet action using one hand, with no extra tools for a secure, positive connection
- Pull and turn the locking knob and it loosens like any traditional clamp
- Available in SALCOR® material and the industry's most durable single piece clear plastic jumper clamps
- SALCOR® Jumper Clamps are available in two main line sizes with a maximum use voltage of 35 kV

## Clear Plastic Jumper Clamps

- Compact, lightweight and virtually unbreakable
- Transparency allows easy inspection of the ferrule and cable inside of the handle
- Body and jaw are made from a copper base alloy
- Lower floating ring contact is bronze
- Handles should be cleaned only with mild detergent to maintain the transparency of the handle

## FRF Jumper Clamps

- Designed for maximum loads, voltage and cables
- Blunted points on the handle provide optimum grip, resist impact and will not soften with overloads
- Body and jaw are made from a copper based alloy
- Lower jaw is made of self-lubricating bronze



1786



2261



1610

Part #	Description	Main Line Range	Max AMP Continuous	Rating	OAL Length (inches)	Weight (lbs)
2261	SALCOR® Sure-Lok® Jumper Clamp	477 MCM (.9"-.162")	400	36 kV 0-0, 21 kV 0-GRD	11.5	10
2271	SALCOR® Sure-Lok® Jumper Clamp	954 MCM (1.25"-.162")	400	36 kV 0-0, 21 kV 0-GRD	11.5	11
1786	Clear Plastic Sure-Lok® Jumper Clamp	477 MCM (.9"-.162")	400	36 kV 0-0, 21 kV 0-GRD	11.5	8
2116	Clear Plastic Sure-Lok® Jumper Clamp	954 MCM (1.25"-.162")	400	36 kV 0-0, 21 kV 0-GRD	11.5	10
2260	SALCOR® Jumper Clamp	477 MCM (.9"-.162")	400	36 kV 0-0, 21 kV 0-GRD	11.5	10
2270	SALCOR® Jumper Clamp	954 MCM (1.25"-.162")	400	36 kV 0-0, 21 kV 0-GRD	11.5	11
1610	FRP Jumper Clamp	954 MCM (1.25"-.162")	400	36 kV 0-0, 21 kV 0-GRD	11	14
1785	Clear Plastic Jumper Clamp	477 MCM (.9"-.162")	400	36 kV 0-0, 21 kV 0-GRD	11.5	8
2115	Clear Plastic Jumper Clamp	954 MCM (1.25"-.162")	400	36 kV 0-0, 21 kV 0-GRD	11.5	10

# Salisbury by Honeywell

## Flexible Insulated Jumper Cables

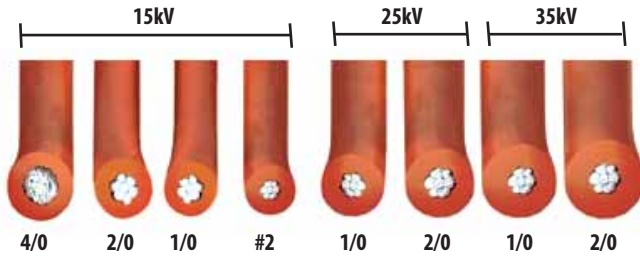

unshrouded



shrouded

FLEXIBLE INSULATED JUMPER CABLES							
Part #	Size & STR. AWG	KV RATING	NOMINAL Ø to GRD	STR. DIA. (inches)	O.A. DIA. (inches)	MAX AMP CONTINUOUS	WEIGHT PER 1000 ft. (lbs)
2754	#2-259W	15	10	.320	.75	200	440
2755	1/0-413W	15	10	.403	.83	250	600
2756	2/0-427W	15	10	.456	.90	300	710
2757	4/0-437W	15	10	.592	1.01	400	1050
21300	1/0-413W	25	15	.403	1.06	250	650
21060	2/0-427W	25	15	.456	1.10	300	750
2059	1/0-413W	35	20	.403	1.22	250	950
4370	2/0-427W	35	20	.48	1.31	300	1060

STICK INSTALLED FLEXIBLE JUMPERS					
Part #	Main Line Range	Max AMP Continuous	Components	Rating	Weight (ea)
2300	1431 ACSR to #6 Sol., 1.5" - .16"	250	2#1895 Alum "C" Clamp 1#1928A Hanger Stud 1#2027 Ferrule 10' #2755 1/0 15kV Cable	15 kV 0-0	16
2308	1431 ACSR to #6 Sol., 1.5" - .16"	200	2#1895 Alum "C" Clamp 1#1928A Hanger Stud 1#2026 Ferrule 12' #2754 #2 15kV Cable	15 kV 0-0	10.8
2317	1431 ACSR to #6 Sol., 1.5" - .16"	250	2#2195 Alum "C" Clamp 1#1928A Hanger Stud 1#2027 Alum Ferrule 12' #2059 1/0 35kV Cable	35 kV 0-0	16
2318	1431 ACSR to #6 Sol., 1.5" - .16"	300	2#2318 Alum "C" Clamp 1#1928A Hanger Stud 1#2620 Alum Ferrule 12' #2756 2/0 15 kV Cable	15 kV 0-0	15.6
2559	1033 ACSR to #6 Sol., 1.25" - .16"	250	2#1853 Alum Duckbill Clamp 1#1858A Hanger Stud 1#2027 Alum Ferrule 10' #2755 1/0 15kV Cable	15 kV 0-0	16
2877	795 ACSR to #8 Sol., 1.12" - .12"	250	2#2532 Alum "C" Clamp 1#2537A Hanger Stud 1#2027 Alum Ferrule 10' #2755 1/0 15kV Cable	15 kV 0-0	11
9976	795 ACSR to #8 Sol., 1.12" - .12"	250	2#9985 Brnz "C" Clamp 1#9983A Hanger Stud 1#2023 Cu Ferrule 10' 2755 1/0 15 kV Cable	15 kV 0-0	12
9977	795 ACSR to #8 Sol., 1.12" - .12"	250	2#2937 Brnz "C" Clamp 1#9983A Hanger Stud 1#2023 Cu Ferrule 10' #2059 1/0 35kV Cable	35 kV 0-0	12.5

## Dead Front Grounding Jumpers & Elbows

- Dead Front Ground Sets are supplied with an insulated grounding elbow, yellow jacketed copper grounding cable and a 1815 bronze flat jaw ground clamp for the ground connection. Grounding elbows are equipped with arc quenching tips as provided on standard load break elbows
- Both 15 kV and 25 kV elbows are available with connectors for 1/0 or 2/0 cable. Assembled sets for 15 kV and 25 kV are available for single phase or three phase grounding requirements. The fault duty rating for 200 AMP grounding elbows is 10 kA for 10 cycles per IEEE 386. Standard three phase sets have a 4 ft. tail connecting to a 2374 four wire connector with 2 ft. leads for the elbows



22630



2962

Part #	Description	Weight ea. (lbs)
<b>COMPLETE 3 PHASE DELTA</b>		
2910	15 kV Elbow w/ 1/0 Cable Connector	1.7
2912	15 kV Elbow 2/ 2/0 Cable Connector	1.7
2935	25 kV Elbow w/ 1/0 Cable Connector	2
2936	25 kV Elbow w/ 2/0 Cable Connector	2
2961	15 kV Single Phase, 6 ft 1/0 Cable w/ Bag	10
2962	15 kV Single, 6 ft 1/0 Cable w/o Bag	8
2963	15 kV Three Phase, 1/0 Cable w/ Bag	22
22630	15 kV Three Phase, 1/0 Cable w/o Bag	20
2971	25 kV Single Phase, 6 ft 1/0 Cable w/ Bag	13
22631	25 kV Single Phase, 6 ft 1/0 Cable w/o Bag	11
2973	25 kV Three Phase, 1/0 Cable w/ Bag	24
22632	25 kV Three Phase, 1/0 Cable w/o Bag	22

## FERRULES & JUMPER CLAMPS

### Grounding Ferrules

- Shrouded ferrules overlap onto the grounding cable jacket for stress relief to the terminal. Two crimps secure the ferrule against the bare strands and one crimp applies on the jacket
- Unshrouded ferrules are available with shrink tubing that overlaps the bare cable conductor and jacket for stress relief
- Available either factory-installed in pairs on any cable length specified or as separate individual units, the ferrules install simply with a hydraulic crimping tool. Complete illustrated installation instructions come with the ferrules and include a table for the crimping die sizes to use

### G4758 Jumper Clamp



- Handle length of 5.625" below the handguard
- The bearing type floating washer lower contact improves gripping action and prevents conductor scoring
- All metals parts are made of copper alloy to improve resistance to oxidation
- 300 AMP continuous current rating is based on using 2/0 jumper cable on the tap side
- Voltage class 15 kV
- Main Line Range: 0.162" to 0.721"
- Jumper Cable Range: #2 to 2/0 Cable
- 2.25lbs

**G4758**      **Pair**  
**T6010003**    **Individual Clamp**

### G4765 Jumper Clamp



- Features the same polyethylene material in the handle as other Chance jumper clamps
- The handle length below the handguard is 7.5"
- 400 AMP continuous current rating is based on using 4/0 jumper cable on the tap side
- Voltage Class 25kV
- Main Line Range: 0.162" to 0.883"
- Jumper Cable Range: #2 to 4/0 Cable
- 2.75lbs

**G4765**      **Pair**  
**T6010039**    **Individual Clamp**

### G4775 Jumper Clamp



- Features a larger contact opening for use on larger conductor distribution lines
- The handle length below the handguard is 8.375"
- Easy to assemble, the connector assemblies are interchangeable between the two sizes of 15kV Jumper Clamps
- 400 AMP continuous current rating is based on using 4/0 Jumper Cable on the tap side
- Voltage class 35 kV
- Main Line Range: 0.162" to 1.165"
- Jumper Cable Range: #2 to 4/0 Cable
- 3 lbs

**G4775**      **Pair**  
**T6010040**    **Individual Clamp**

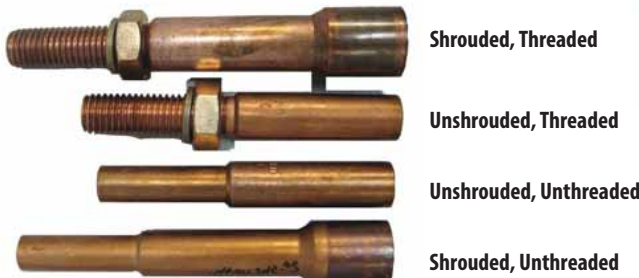

Shrouded Plain Copper Ferrules	
For Pressure Type Grounding Clamp Terminals	
C6002630	Cable size #2
C6002631	Cable size 1/0
C6002632	Cable size 2/0
C6002633	Cable size 4/0

Unshrouded Plain Copper Ferrules	
For Pressure Type Grounding Clamp Terminals	
C6002614	Cable size #2
C6002615	Cable size 1/0
C6002616	Cable Size 2/0
C6002617	Cable Size 4/0

Shrouded, Threaded-Stud Copper Ferrules	
For Tapped or Drilled Grounding Clamp Terminals	
C6002622	Cable size #2
C6002623	Cable size 1/0
C6002624	Cable Size 2/0
C6002625	Cable Size 4/0

Unshrouded, Threaded-Stud Copper Ferrules	
For Tapped or Drilled Grounding Clamp Terminals	
C6002606	Cable size #2
C6002607	Cable size 1/0
C6002608	Cable size 2/0
C6002609	Cable size 4/0

# Grounding & Mechanical Jumpers

## Ordering a Grounding or Jumper Assembly

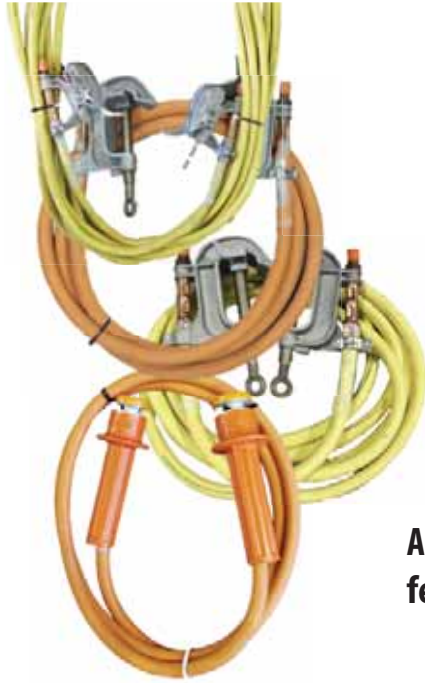

1. Specify Cable Type (600 Volt Grounding Cable is Yellow; 15 kV, 25 kV, 35 kV Jumper Cable is Orange)
2. Specify Cable Length
3. Specify Cable Size (#2, 1/0, 2/0, or 4/0)
4. Specify Ferrule Style (Shrouded, Unshrouded)
5. Specify Threaded or Unthreaded Ferrule
6. Specify Clamp Style (Standard C-Clamps, Duckbill, Barehand, Flat-faced, etc.)

Grounding assemblies are tested for resistance, tagged with resistance value, and dated. Heat shrink is applied to protect from water penetration, providing a barrier to resist moisture and corrosion and providing a positive stress relief of grounding cables at their terminations.

**Ask about our LTL 350 and 500 MCM grounding cables and ferrules for large ampacity applications (refer to Page 14)**

## Grounding Cable

Cable Size	Voltage Class	Stranding	Cable O.D.	Continuous Current	Weight
#2	600 Volts	19/35/30	0.475"	150 AMP 50' - 100' 100 AMP 100'+	270 lbs/1000'
1/0	600 Volts	19/55/30	0.575"	250 AMP 50'-100' 250 AMP 150'+	418 lbs/1000'
2/0	600 Volts	19/70/30	0.635"	300 AMP	542 lbs/1000'
4/0	600 Volts	19/111/30	0.78"	500 AMP	843 lbs/1000'



## Copper Mechanical Jumper Cable

Cable Size	Voltage Class	Stranding	Conductor Diameter	Cable O.D.	Continuous Current	Weight
#2	15 kV	259/#26	0.322"	0.779"	200 AMP	0.438 lbs
1/0	15 kV	413/#24	0.404"	0.863"	260 AMP	0.598 lbs
2/0	15 kV	273/#23	0.455"	0.914"	300 AMP	0.707 lbs
4/0	15 kV	473/#21	0.602"	1.065"	400 AMP	1.047 lbs
1/0	25 kV	413	0.404"	1.113"	260 AMP	0.801 lbs
2/0	25 kV	266	0.450"	1.160"	300 AMP	0.903 lbs
1/0	35 kV	413	0.404"	1.287"	260 AMP	0.985 lbs



# Grounding Equipment

## Hastings Clear Mechanical Jumper Clamps



- Clear, see-through, injection molded jumper clamps are manufactured from high impact polycarbonate material with ultraviolet inhibitors to retard discoloration
- Two sizes of clamps are available: 6 solid through 556.5 MCM and 6 solid through 954 ACSR
- Easy to install as clamps are the duck bill type in order that the jumper might be supported by the conductor while hand tightened
- Thrust bearing design provides low friction for tightening clamp
- Bronze clamping rings have serrated contact surface to insure a good electrical contact with conductors
- Both jumper clamps have molded in grip tabs for easy gripping with rubber gloves
- Machined from brass alloy bar stock; rated for 400 AMP
- Minimum main line range: 6 Solid (.162 dia.)

Hastings	Maximum Main Line Range	Jumper Cable Range
13765	556.5 MCM/477 ACSR	2 Str. 15kV to 4/0 Str. 15kV
13768	954 ACSR 36/1	2 Str. 15kV to 4/0 Str. 15k or 2/0 Str. 25kV or 1/0 Str. 35kV

## Hastings 4370: Screw Ground Rod



- Hastings Screw Ground Rod
- Provides a temporary ground where a system ground is not available
- 5/8" diameter copper weld rod
- 12" bronze handle
- 72" overall length
- C-head ground clamps and clusters with 5/8"
- 11C threaded terminals

## Bashlin 1590C: Traveling Ground



- This is a heavy duty traveling ground for conductors sized up to and including 1590 MCM
- The spring-loaded center sheave maintains tension
- The solid 1/2" aluminum rod is provided for attachment to the ground clamp

## Hastings 5755-6: 4-Way Terminal Block



- C-head ground clamps and clusters with 5/8" – 11 NC threaded terminals
- 4-Way cable splice
- Tested at 28,900 AMP for 15 cycles
- Used for connecting ground cables together

## Bashlin 336A: Grounding Saddle



- Lightweight, aluminum
- For grounding conductors up to and including 336 MCM
- Features graphite bushings, a spring-loaded tension arm, and offset sheaves for solid contact



## C-TYPE GROUNDING CLAMPS

### PSC6003412: C-Type Clamp



- Jaw Opening Size: 0.162" to 2"
- Fault Current Rating: ASTM Grade 5
- Material: Aluminum
- Terminal Type: Drilled for use with Threaded Ferrules
- Handle Type: Eyescrew
- Serrated Jaws
- Continuous Current: 400 AMP
- Fault Current:
  - 15 cycles 43,000 AMP
  - 30 cycles 30,000 AMP
- Recommended Torque: 250 in-lbs
- Jumper Range #2 to 4/0 Cable with Threaded Terminal
- 1.75 lbs

### C6001754: C-Type Clamp



- Jaw Opening Size: 0.128" to 0.998"
- Fault Current Rating: ASTM Grade 3
- Material: Aluminum
- Terminal Type: 5/8"-11 Thread
- Handle Type: Eyescrew
- Smooth Jaws
- Continuous Current: 300 AMP
- Fault Current:
  - 15 cycles 43,000 AMP
  - 30 cycles 30,000 AMP
- Recommended Torque: 250 in-lbs
- Jumper Range #2 to 2/0 Cable with Threaded Terminal
- 1 lb

### G3369: Bus-Bar Clamp



- Jaw Opening Size: 0.368" to 4.5"
- Fault Current Rating: ASTM Grade 5
- Material: Aluminum
- Terminal Type: Pressure
- Handle Type: Eyescrew
- Smooth Jaws
- Continuous Current: 400 AMP
- Fault Current:
  - 15 cycles 43,000 AMP
  - 30 cycles 30,000 AMP
- Recommended Torque: 300 in-lbs
- Jumper Range #2 with Plain Terminal to 4/0 Cable with Plain Terminal
- 5.145 lbs

### C6002271: C-Type Clamp



- Jaw Opening Size: 0.162" to 1.25"
- Fault Current Rating: ASTM Grade 5
- Material: Bronze
- Terminal Type: 5/8"-11 Thread
- Handle Type: Eyescrew
- Smooth Jaws
- Continuous Current: 400 AMP
- Fault Current:
  - 15 cycles 43,000 AMP
  - 30 cycles 30,000 AMP
- Recommended Torque: 250 in-lbs
- Jumper Range #2 Cable to 4/0 Cable with Threaded Terminal

### C6001959: C-Type Clamp



- Jaw Opening Size: 0.162" to 0.814"
- Fault Current Rating: ASTM Grade 2
- Material: Bronze
- Terminal Type: 5/8"-11 Thread
- Handle Type: Eyescrew
- Smooth Jaws
- Continuous Current: 250 AMP
- Fault Current:
  - 15 cycles 43,000 AMP
  - 30 cycles 30,000 AMP
- Recommended Torque: 200 in-lbs
- Jumper Range #2 to 1/0 Cable with Threaded Terminal
- 1 lb

### C6000434: Duckbill Clamp



- Jaw Opening Size: 1.506" to 0.162"
- Fault Current Rating: ASTM Grade 5
- Material: Aluminum
- Terminal Type: Pressure
- Handle Type: Eyescrew
- Serrated Jaws
- Continuous Current: 400 AMP
- Fault Current:
  - 15 cycles 43,000 AMP
  - 30 cycles 30,000 AMP
- Recommended Torque: 250 in-lbs
- Jumper Range #2 to 4/0 Cable with Plain Terminal
- 1.96 lbs

## C6002276: C-Type Clamp



- Jaw opening size: 0.128" to 1.25"
- Fault Current Rating: ASTM Grade 5
- Material: Aluminum
- Terminal Type: Pressure
- Handle Type: Eyescrew
- Serrated Jaws
- Continuous Current: 400 AMP
- Fault Current:
  - 15 cycles 43,000 AMP
  - 30 cycles 30,000 AMP
- Recommended Torque: 250 in-lbs
- Jumper Range #2 to 4/0 Cable with Plain Terminal
- 1.5 lbs

## C6002281: C-Type Clamp



- Jaw Opening Size: 0.162" to 2"
- Fault Current Rating: ASTM Grade 5
- Material: Aluminum
- Terminal Type: Pressure
- Handle Type: Eyescrew
- Smooth Jaws
- Continuous Current: 400 AMP
- Fault Current:
  - 15 cycles 43,000 AMP
  - 30 cycles 30,000 AMP
- Recommended Torque: 250 in-lbs
- Jumper Range #2 to 4/0 Cable with Plain Terminal
- 2.75 lbs

## C6001734: Duckbill Clamp



- Jaw Opening Size: 0.162" to 1.162"
- Fault Current Rating: ASTM Grade 5
- Material: Aluminum
- Terminal Type: 5/8"-11 Thread
- Handle Type: Eyescrew
- Smooth Jaws
- Continuous Current: 400 AMP
- Fault Current:
  - 15 cycles 43,000 AMP
  - 30 cycles 30,000 AMP
- Recommended Torque: 250 in-lbs
- Jumper Range #2 with Threaded Terminal to 4/0 Cable with Threaded Terminal
- 1.372 lbs

## C6002255: C-Type Clamp



- Jaw Opening Size: 0.162" to 2"
- Fault Current Rating: ASTM Grade 5
- Material: Aluminum
- Terminal Type: 5/8"-11 Thread
- Handle Type: Eyescrew
- Smooth Jaws
- Continuous Current: 400 AMP
- Fault Current:
  - 15 cycles 43,000 AMP
  - 30 cycles 30,000 AMP
- Recommended Torque: 250 in-lbs
- Jumper Range #2 Cable to 4/0 Cable with Threaded Terminal
- 2 lbs

## C6000197: Duckbill Clamp



- Jaw Opening Size: 0.162" to 1.506"
- Fault Current Rating: ASTM Grade 5
- Material: Aluminum
- Terminal Type: 5/8"-11 Thread
- Handle Type: Eyescrew
- Serrated Jaws
- Continuous Current: 400 AMP
- Fault Current:
  - 15 cycles 43,000 AMP
  - 30 cycles 30,000 AMP
- Recommended Torque: 250 in-lbs
- Jumper Range #2 with Threaded Terminal to 4/0 Cable with Threaded Terminal
- 1.862 lbs

## C6002282: C-Type Clamp



- Jaw Opening Size: 0.162" to 2"
- Fault Current Rating: ASTM Grade 5
- Material: Aluminum
- Terminal Type: Pressure
- Handle Type: Eyescrew
- Serrated Jaws
- Continuous Current: 400 AMP
- Fault Current:
  - 15 cycles 43,000 AMP
  - 30 cycles 30,000 AMP
- Recommended Torque: 250 in-lbs
- Jumper Range #2 to 4/0 Cable with Plain Terminal
- 2.5 lbs

## C6001735: Flat-Face Clamp



- Jaw Opening Size: 0.125" to 1.5"
- Fault Current Rating: ASTM Grade 3
- Material: Aluminum
- Terminal Type: 5/8"-11 Thread
- Handle Type: Eyescrew
- Serrated Jaws
- Continuous Current: 300 AMP
- Fault Current:
  - 15 cycles 27,000 AMP
  - 30 cycles 20,000 AMP
- Recommended Torque: 250 in-lbs
- Jumper Range #2 to 2/0 Cable with Threaded Terminal
- 1.5 lbs

## C6002100: Ball Stud Clamp



- Jaw Opening Size: 0.125" to 1.5"
- Fault Current Rating: ASTM Grade 5
- Material: Bronze
- Terminal Type: Drilled
- Handle Type: Eyescrew
- Serrated Jaws
- Continuous Current: 400 AMP
- Fault Current:
  - 15 cycles 43,000 AMP
  - 30 cycles 30,000 AMP
- Recommended Torque: 250 in-lbs
- Threaded terminal to 4/0 Cable with Threaded Terminal
- .95 lbs

## C6002232: Flat-Face Clamp



- Jaw Opening Size: 0.125" to 1.5"
- Fault Current Rating: ASTM Grade 5
- Material: Bronze
- Terminal Type: 5/8"-11 Thread
- Handle Type: Eyescrew
- Serrated Jaws
- Continuous Current: 400 AMP
- Fault Current:
  - 15 cycles 43,000 AMP
  - 30 cycles 30,000 AMP
- Recommended Torque: 250 in-lbs
- Jumper Range #2 to 4/0 Cable with Threaded Terminal
- 2.94 lbs

## C6002231: Flat-Face Clamp



- Jaw Opening Size: 0.125" to 1.5"
- Fault Current Rating: ASTM Grade 5
- Material: Bronze
- Terminal Type: 5/8"-11 Thread
- Handle Type: T-Handle
- Serrated Jaws
- Continuous Current: 400 AMP
- Fault Current:
  - 15 cycles 43,000 AMP
  - 30 cycles 30,000 AMP
- Recommended Torque: 250 in-lbs
- Jumper Range #2 to 4/0 Cable with Threaded Terminal
- 4 lbs

## T6001798: Grounding Clamp



- Jaw Opening Size: 0.125" to 1.5"
- Fault Current Rating: ASTM Grade 3
- Material: Aluminum
- Terminal Type: 5/8"-11 Thread
- Handle Type: T-Handle
- Serrated Jaws
- Continuous Current: 300 AMP
- Fault Current:
  - 15 cycles 27,000 AMP
  - 30 cycles 20,000 AMP
- Recommended Torque: 250 in-lbs
- Jumper Range #2 to 2/0 Cable with Threaded Terminal
- 1.5 lbs

## C60012256: Grounding Clamp



- Jaw Opening Size: 0.162" to 2"
- Fault Current Rating: ASTM Grade 5
- Material: Aluminum
- Terminal Type: 5/8"-11 Thread
- Handle Type: Eyescrew
- Serrated Jaws
- Continuous Current: 400 AMP
- Fault Current:
  - 15 cycles 43,000 AMP
  - 30 cycles 30,000 AMP
- Recommended Torque: 250 in-lbs
- Jumper Range #2 to 4/0 Cable with Threaded Terminal
- 1.75 lbs

## Apparatus Grounding Clamps



- C6002100** Drilled for 5/8-11 UNC Threaded Ferrule
- C6002101** Tapped for 5/8-11 UNC Threaded Ferrule
- T6002320** Tapped for 5/8-11 UNC Threaded Ferrule
- C6002300** Eyescrew with Pressure Terminal

- For restricted-space applications and as a truck-grounding system, this compact design delivers a high-current rating usually associated with only large clamps
- Applies to a wide range of switching equipment, including: industrial metalclad gear, indoor and outdoor substations, overhead and underground distribution
- For trucks, a ball stud permanently mounts on each body
- Clamp bodies and eyescrews are a bronze alloy
- C6002100, C6002101, T6002320 are designed for threaded stud ferrule on #2-4/0 grounding cable
- C6002300 is designed for plain-plug ferrule on #2 to 4/0 grounding cable

## 4-Way Terminal Block

- Used to attach ground leads from grounding clamps to a common ground
- Ideal where permanent temporary grounding sets are part of substation emergency equipment
- Accommodates 4/0 grounding cables with plain ferrules
- Continuous current: 400 AMP
- Fault Current:
  - 15 cycles 43,000 AMP
  - 30 cycles 30,000 AMP
- G4754-1 is for Plain Plug Ferrules
- T6001964 is for Threaded Ferrules



## Ball Studs

- For restricted-space applications and as a truck-grounding system, this compact design delivers a high-current rating usually associated with only large clamps
- Applies to a wide range of switching equipment, including industrial metal-clad gear, indoor and outdoor substations, overhead and under ground distribution
- For trucks, a ball stud permanently mounts on each body
- Ball-studs are bronze alloy and tin-plated; lockwasher and nut are silicone bronze
- Have nominal 1" diameter ball and stud to fit NEMA terminal pads

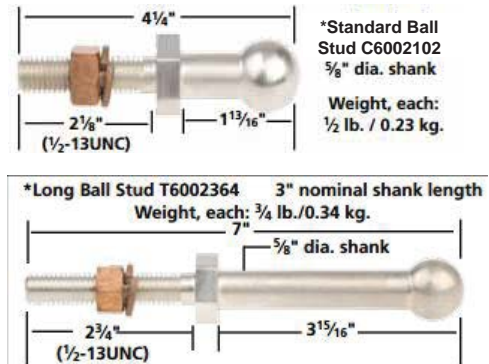

Part no.	Overall length	Stud length	Type
C6002102	4.25"	1 13/16"	Standard Ball Stud
T6002364	7"	3 15/16"	Long Ball Stud
T6002867	3.3"	1.8"	Female Threaded Ball Stud
C4060416	Ball Stud Cover		

## C4060416: Grounding Stud Cover

- May help prevent flashover on ball studs installed in enclosed switchgear, switchyards or substations
- An environmental protector to reduce corrosion and contamination on the ball-stud when energized cover is not intended for personnel protection
- Should not be considered as insulative cover-up equipment
- Provides 400 volts per mil puncture strength
- Resilient ozone/corona-resistant thermoplastic elastomer does not absorb water
- Resists aging/checking and retains high-visibility orange colour
- Snap-fit keeps cover in place
- The 5/8" I.D. loop at top permits hot-line tools to "pop" it on and off



## T6000865: Grounding Assembly Storage Bag

- Easy-to-see, bright yellow protective bag is made of double vinyl laminated open-weave polyester cloth
- Lightweight and durable with nylon stitching through out
- Plywood bottom is covered inside and out with metal skids on bottom of bag
- Full-separating closure constructed with heavy duty snaps and heavy webbing handles



## T6001549: Cluster Grounds

- Compact 5" aluminum-alloy bar (5/8" diameter)
- Accepts C-type or duckbill clamps for phase-to-phase grounding technique
- Adjustable wheel binder and 36" chain for wood-pole applications



## P6001593: Head Shrink Tube - 5" Length

- Clear heat-shrink tubes provide corrosion-inhibitor by excluding moisture and stress-relief for cable jacket and ferrule-to-stranding connection
- Visual inspection of cable condition through clear heat-shrink tube determines breakage or corrosion that other wise requires continuity test
- Units expose 1/2" of cable strands at junction point



## C6000000: Static Ground Set

- Eliminate the problem of electrostatic charge when working insulator strings
- Drains off the charge from the insulator string to the tower leg
- The adjustable jaws of the Static Ground fit insulator caps from 2.5" to 6"
- Overall length with a 1.25" x 19" Epoxiglas® pole is 30"



## Truck Grounding Set

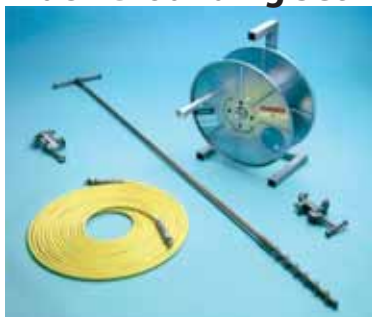

- Convenient set provides means to drain off capacitance or static charges from winch trucks and aerial devices
- Flat face clamp is for secure attachment to the truck bed at an area cleaned for electrical contact
- C-type clamp is for secure attachment to ground rod
- This grounding method should not be considered adequate protection to personnel against conductor contact

T6001971 Complete Assembly

Includes:

3370 Screw Ground Rod

T6001798 Flat Face Ground Clamp

C6001754 C-Type Ground Clamp

S6116 C-Type Ground Clamp

C6002618A Shrouded Aluminum Ferrules

C4176086 Storage Reel



# Clamps

## C Clamp

- Can be installed on all electrical facilities, apparatus, tubes and conductors as well as various equipment (trucks, pulling equipment, etc.)
- This universal clamp can also be used on a jumper cable
- Installation on conductor, round bus bar and grounding ball stud of 25mm
- Thermal shock indicator changes color (from white to red) when the clamp reaches a temperature of 200° F (93°C)
- Stress-relief to reduce cable damage and serve as a shock damper if fault occurs, which protects cable strands
- Locations on each side of the clamp for 20mm or 25mm grounding ball studs installation, which serve as support studs for either a grounding cluster or cascade assembly
- Fitted to receive a 5/8-11UNC threaded stud ferrule
- Lubrication chamber for upkeep of threads
- Installation eye for installing clamp with shotgun stick
- Double internal threads for fast installation and removal
- Material: Aluminum Clamp and Keeper, Bronze or Aluminum Eye Screw

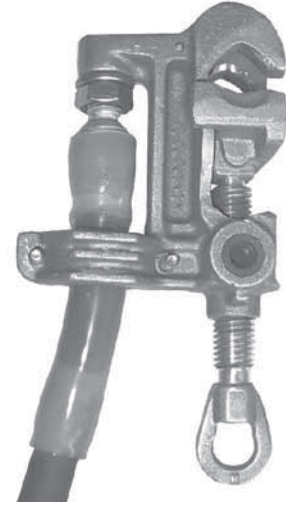

Capacity 15 Cycles	Capacity 30 Cycles	For Ground Stud	Jumper Cable Min.	Jumper Cable Max.	Main Conductor Min. (in)	Main Conductor Max. (in)	Jaw	Continuous Current Rating	Weight (lbs)
35kA (IEC) 43kA (ASTM)	30A (ASTM)	20mm	2 AWG	4/0 AWG	#8 (.16)	556 (.86)	1-3/8	400A	1.3
35A (IEC) 55 kA (ASTM)	39kA (ASTM)	25mm	2 AWG	4/0 AWG	#8 (.16)	795 (1.13)	1-3/8	400A	1.4

## Universal Clamp

- Can be installed on all electrical facilities, apparatus, tubes, and conductors as well as various equipment (trucks, pulling equipment, etc.)
- Installation on conductor, round bus bar and grounding ball stud of 30 mm
- Tested to 5H (HC-10041) and 7H (HC-10041-A)
- Tested and certified only with MPS components
- Stress relief to reduce cable damage and serve as a shock damper if fault occurs, which protects cable strands
- Fitted to receive a 5/8-11 or 3/4-10 UNC threaded stud ferrule
- Lubrication chamber for upkeep of threads
- Double internal threads for fast installation and removal
- No exposed threads for minimal maintenance
- Body and Eye Screw: Aluminum A356T6



**Ask about LTL's 350 and 500 MCM grounding cables and ferrules for large ampacity applications (refer to Page 14)**

Dimension	Capacity 15 Cycles	Jumper Cable Min.	Jumper Cable Max.	Main Conductor Max (in)	Main Conductor Max (in)	For Ground Stud	Jaw	Tested 15 Cycles	Max. Peak	Last Cycle Peak	Weight (lbs)	Standard Pack
15.5 x 6.5 x 3.25	55kA (IEC) 74kA (ASTM)	#2	4/0	1/0 (.40)	1796 (1.60)	30mm	2"	55kA (IEC) 47kA (ASTM)	126kA	70kA	3.9	6
15.5 x 6.5 x 3.25	55kA (IEC) 47kA (ASTM)	#2	350 MCM	1/0 (.40)		30mm	2"	5kA (IEC) 68k	183kA	101kA	3.9	8

## Chance G3370: Temporary Ground Rod

- The Chance Screw Ground Rod provides a temporary ground where a system ground is not available
- When installed, the 6' spiraled ground rod develops less resistance than straight ground rods, actual effectiveness depends upon soil properties
- The reusable Ground Rod is copper clad
- The helix (spiral), handle and wing nut are bronze
- Continuous Current 400 AMP
- Fault Current - 15 cycles 43,000 AMP
- Fault Current - 30 cycles 30,000 AMP
- Material Type Standard
- UPC Code 09635903820
- Standard Package 1
- Standard Package Unit Each
- Min Order Qty 1
- Weight / Ea. 7.595 lbs



## Grounds Warning Placard 16" x 18"

- Fluorescent orange identification marker
- Identification marker for temporary grounds
- Features a reflective striping for night time visibility
- Secured onto the ground with Velcro
- "Grounds" is stenciled onto the marker

13-526 Double-Sided

13-528 Single-Sided



## Grounding Reels with Cable

- Provides a simple, positive means for grounding line trucks or other vehicles parked in electrically hazardous areas
- Inverse loop design, silver-plated copper contact pressure under fault conditions
- Compression terminals connect the cable to the reel and ground clamp
- A removable plastic cover encases the shafts contacts to reduce contamination



## Grounding Reels without Cable

- Provides a simple, positive means for grounding line trucks or other vehicle parked in electrically hazardous areas
- Inverse loop design, silver-plated copper contact pressure under fault conditions
- Compression terminals connect the cable to the reel and ground clamp
- A removable plastic cover encases the shafts contacts to reduce contamination

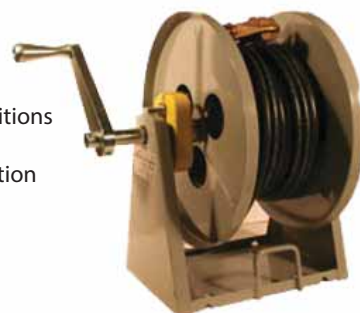

NOTE: Reels do NOT include cable

# Pfisterer

## Ball Pins

Part #	For Max. Cable Cross Section mm <sup>2</sup>	Max. Permissible Short Circuit Current I <sub>k</sub> 0,5 s in A	Key (SW)	Threaded Pin (d x l mm)	Weight (1/kg)
<b>Ø 20mm: E-Cu, ball pin electro-tinned; thread bolt of steel, for universal conductor screw clamp 360 330 002</b>					
360 382 004	95	26500	22	M12x28	0.15
360 382 005	95	26500	22	M12x38	0.16
360 382 006	95	26500	22	M12x48	0.17
<b>Angled, Ø 20mm: CuNiSi ball pin, electro-tinned, for universal conductor screw clamp 360 330 002</b>					
360 784 001	95	26500	24	M12x38	0.16
<b>Ø 25mm: Ball pin of E-Cu, electro-tinned; threaded bolt, steel nut and washer for universal conductor screw clamp 360 332 001 and multi purpose conductor screw clamp 360 333 002</b>					
360 384 002	120	33500	27	M12x28	0.22
360 384 003	120	33500	27	M12x38	0.23
360 384 004	120	33500	27	M16x48	0.24
360 938 095	120	33500	27	M16x25	0.28
360 938 939	120	33500	27	M16x55	0.31



360 382 004



360 784 001



360 384 002

## Universal Conductor Screw Clamp

Part #	For Max. Cable Cross Section (mm <sup>2</sup> )	Max. Permissible Short Circuit Current I <sub>k</sub> 0,5 s in A	Clamping Range (mm)	Clamp Width (mm)	Connecting Screw	Weight (1/kg)
<b>Universal: For the connection of cables up to 95mm<sup>2</sup> Suitable for connection to ball pins Ø 20mm, T-bolts width 30mm/Ø 15mm, circular conductors up to Ø 20mm, flat conductors up to 20 mm.</b>						
<b>Body of CuZn, electro-tinned, spindle and stainless steel A2 connecting screw</b>						
360 330 002	95	26500	20	34	M12	0.62
<b>Universal: For the connection of cable up to 120mm<sup>2</sup> Suitable for connection to ball pins Ø 25mm, T-bolts width 30mm/Ø 15mm, circular conductors up to Ø 20mm, flat conductors up to 20 mm.</b>						
<b>Body of CuNiSi, electro-tinned, spindle and stainless steel A2 connecting screw</b>						
360 332 001	120	33500	20	34	M12	0.63
<b>Multi-purpose: For the connection of cable up to 120mm<sup>2</sup> Suitable for connection to ball pins Ø 25mm and 30mm, T-bolts #360 386..., circular conductors up to Ø 25mm, flat conductors up to 20 mm.</b>						
<b>Body of copper alloy, electro-tinned, spindle and stainless steel A2 connecting screw</b>						
360 333 002	120	33500	2-25	50	M12	0.86



360 330 002



360 333 002



## Protection Hood



- Salisbury's Arc Flash Hoods (balaclava) create 360° head and neck protection from arc flash dangers when used with an AS2000, AS1200 or AS1000 Series Face Shield Unit w/Chin Cup. Each Arc Flash Hood is made from two layers of rib knit material and has an elastic face opening that maintains its shape and size

*CAUTION: Arc Flash Hoods must be worn in combination with a faceshield in order to comply with the requirements of NFPA 70E and will protect 360° inside the arc flash boundary*

**AFHOOD10 10 cal/cm<sup>2</sup> protection**

**AFHOOD15 15 cal/cm<sup>2</sup> protection**

**AFHOOD20 20 cal/cm<sup>2</sup> protection**

## ACB4030PLT: Arc Flash Protection Bib Overalls, Green



- 40 cal/cm<sup>2</sup>\* ATPV ratings
- Approximately 60% lighter fabric weight than standard 40 calorie garment
- 2 layers – 5 oz/yd<sup>2</sup> (141.747 g/m<sup>2</sup>) & 6 oz/yd<sup>2</sup> (170.097 g/m<sup>2</sup>) - Sewn with Nomex® thread
- Integrated heavy duty suspenders
- Relaxed cut for greater mobility
- 30" inseam
- Adjustable hook and pile waist straps
- Bib front for added protection
- Adjustable gussets on pant cuffs
- Meets current ASTM F1506 and NFPA 70E standards

Sizes S, M, L, XL, 2XL, and 3XL

**CONTACT LTL FOR  
SIZING CHART**

## ACC4032PLT: Arc Flash Protection Coats



- 40 cal/cm<sup>2</sup>\* ATPV ratings
- Approximately 60% lighter fabric weight than standard 40 calorie garment
- 2 layers – 5 oz/yd<sup>2</sup> (141.747 g/m<sup>2</sup>) & 6 oz/yd<sup>2</sup> (170.097 g/m<sup>2</sup>)
- Sewn with Nomex® thread
- 32" long
- Nomex® wristlets
- Expansion back for added comfort
- Dual stage front closure with high temperature plastic zipper on the - 31 - 100 cal/cm<sup>2</sup>\* coats
- FR hook and pile storm flap
- Coats are intended to be used with PRO-HOODS
- Meets current ASTM F1506 and NFPA 70E standards

Sizes S, M, L, XL, 2XL, and 3XL

*\*IMPORTANT - NFPA 70E DOES NOT HAVE A HAZARD RISK CATEGORY ABOVE 40 CAL/CM<sup>2</sup>. WORKING ON LEVELS ABOVE 40 CAL/CM<sup>2</sup> SHOULD BE AVOIDED BECAUSE OF THE BLAST HAZARDS CAUSED BY ARC FLASH*

## LFH40PLT & LFH40: Arc Flash Lift Front Hood - 40 cal/cm<sup>2</sup>



- 40 cal/cm<sup>2</sup>\*, premium lightweight, 2 layers, 5 oz/yd<sup>2</sup> over 6.32 oz/yd<sup>2</sup> arc flash protection hood w/ SA79R03 hardhat
- Optional FLKIT: attachable task light (1) & FLCLIP



- 40 cal/cm<sup>2</sup>\*, 2 layers, 9oz/yd<sup>2</sup> over 9oz/yd<sup>2</sup> arc flash protection hood, w/ SA79R03 hard hat

# Salisbury by Honeywell

## AS1000: Arc Flash Protection Face Shield



- 10 cal/cm<sup>2</sup> ATPV rating when used with the included chin cup
- 7.5" x 20" viewing area
- Extra light tint
- .06" thick
- Absorbs >99.9% of harmful UV radiation
- Resistant to fogging
- Shield meets current ANSI Z87.1 and tested to ASTM F2178 specifications
- 10 cal/cm<sup>2</sup>

## AS1200HAT: Arc Flash Protection Face Shield



- Stows in a balanced, compact position, centered over the top of the hard hat when not needed
- The AS1200HAT has an ATPV rating of 12cal/cm<sup>2</sup>\* and utilizes nanotechnology to provide a clearer, more transparent window for improved visibility. The shield/window is designed to be easily replaced without tools. The faceshield unit includes ventilation ribs that allow a natural convection air flow through the top of the face shield. This reduces fogging of the visor, lowers CO2 levels and improves comfort for the user
- AS1200HAT contains an AS1200 Face Shield with SA7R03 Hard Hat  
\*In order to achieve 360 degree 12 cal/cm<sup>2</sup> protection, a 12 cal/cm<sup>2</sup> balaclava must be worn.

## AS1200: Protective Face Shield - HRC2



- 7.5" x 20" viewing area
- Extra light tint
- .06" thick
- Absorbs >99.9% of harmful UV radiation
- Resistant to fogging
- Meets current ANSI Z87.1 and is CSA standard compliant
- Tested to ASTM F2178 specifications



BRACKET

ASSLB

FBBRACKET

## AS2000HAT: Arc Flash Protection Face Shield



- 20 cal/cm<sup>2</sup>\* ATPV rating
- 7.5" x 20" viewing area
- Extra light tint
- .06" thick
- Absorbs >99.9% of harmful UV radiation
- Resistant to fogging
- Shield meets current ANSI Z87.1 and tested to ASTM F2178 specifications 20 cal/cm<sup>2</sup>
- AS2000HAT contains an AS2000 Face Shield with SA79R03 Hard Hat  
\*In order to achieve 360 degree 20 cal/cm<sup>2</sup> protection, a 20 cal/cm<sup>2</sup> balaclava must be worn.

Part #	Description
AS2000HAT-CLR	AS2000HAT w/ transparent chin guard
AS2000FS	Replacement face shield/window for AS2000 Face Shield
AS2000FB	20 cal/cm <sup>2</sup> , universal fit, arc flash protection face shield unit for full brim hard hats
AS1000FS	Replacement face shield for AS1000HAT, AS1000FB, and AS1000U
AS1200HAT-CLR	12 cal/cm <sup>2</sup> , AS1200HAT w/ transparent chin guard
AS1200FB	12 cal/cm <sup>2</sup> , universal fit, arc flash protection face shield unit for full brim hard hats
AS1200U	12 cal/cm <sup>2</sup> , universal fit, arc flash protection face shield unit for front brim hard hats
AS12CLR-FB	Transparent chin guard for AS1200 series full brim
AS1200FS-FB	12 cal/cm <sup>2</sup> , replacement face shield/window for AS1200FB full brim
AS1200FS	12 cal/cm <sup>2</sup> , replacement face shield/window for AS1200 series
FLKIT	1 Attachable Task Light and 1 Flashlight Clip



FLCLIP



ASFL



AS12CLIP

## CCN-LGG6RB-RL: Deluxe FR 10 Pocket Coverall

- Oberon FR Deluxe CCN Coverall - 10 Pocket configuration (2 chest patch pockets (1 w/ FR mesh), 2 front pant "slash" pockets, 2 front "pass through" pockets, 2 rear patch pockets, 1 side tool pocket on pant leg, 1 pencil sleeve pocket). Zipper front with Velcro placard closure down front of coverall for easy use and removal. Collar has generous comfortable fit. Action Back design for improved range of motion at shoulders. Elastic waist band for more comfortable & attractive fit. Generous seat for comfort. FR Velcro button on sleeve for adjustment. Zipper pant legs to easily pull over boots.
- Deluxe I&E Arc Flash Coverall
- Meets NFPA 70E, CSA Z462 and ASTM F1930
- 10 Pocket Coverall w/ Reflective Striping
- Glen Guard - 6.4 oz (10 cal)
- Royal Blue
- Size RL (Regular L)



## CCV-LTS7OR-RL: Deluxe Industrial

- Lightweight fabric
- Inherently Flame Resistant fabric (IFR)
- 10 Pocket design
- (2) chest patch pockets with flap
- (1) FR mesh over-pocket on right
- (2) rear patch pockets
- (2) front in-seam pockets
- (2) front pass-through pockets
- (1) tool pocket on leg,
- (1) chest radio loop, and
- (1) pencil pocket
- Zipper front for easy don/doffing
- Zippered pant legs to expand to pull over heavy boots
- CSA Z96 Class 3 Level 2 Compliance
- Made in USA



## STD-LGG6NB-RL: Shirt Deluxe

- M-LGG W-6 C-NB Sz-RL
- Oberon Flame Resistant Work Shirts - 2 chest patch pockets with Pencil slot in one pocket. Button Down Collar. Yoke design shoulders for comfortable fit. Shirt is generously sized for comfortable fit around chest. 2.5" vented cuff with button
- 6 button down placard for attractive finish
- FR Work Shirt
- Meets NFPA 70E, CSA Z462 and ASTM F1930
- Button Down Collar & 2 Chest Pockets w/ Flaps
- Glen Guard - 6.4 oz (10 cal)
- Navy Blue
- Size RL (Regular L)



## STD-CBW9NB-RL: Shirt Deluxe

- M-CBW W-9 C-NB Sz-RL
- Oberon Flame Resistant Work Shirts - 2 chest patch pockets with Pencil slot in one pocket. Button Down Collar. Yoke design shoulders for comfortable fit. Shirt is generously sized for comfortable fit around chest. 2.5" vented cuff with button. 6 button down placard for attractive finish.
- FR Work Shirt
- Meets NFPA 70E, CSA Z462 and ASTM F1930
- Button Down Collar & 2 Chest Pockets w/ Flaps
- ITEX Banwear (88:12) - 9.5 oz (13 cal)
- Navy Blue
- Size RL (Regular L)



## KITBAG: KIT BAG FOR ARC FLASH CLOTHING



# Oberon

## IFR5B-XL: Arc Set IFR HRC

- Oberon Arc Flash Clothing Set - Inherently/Permanently FR (ARC) Series - ORC5 (65+ cal) - Contains a ARC65 Hood with Hard Cap (Ratchet Adjustable Suspension), ARC65 Bib-Overall & ARC65 Coat. Rubber Insulating Gloves and Storage Bags sold separately
- Oberon ARC Series Arc Flash PPE
- Inherently Flame Resistant
- Light Weight, Durable
- Hood w/ Hard Cap, Coat & Bib-Overall
- Arc Rating = 70 calories/cm<sup>2</sup>
- Size XL



## CAT11-BH-GR: Gray Balaclava

- NFPA 70E-2012
- CSA Z462-12
- HRC 2 (8+ cal)
- Made in USA



## ARC14-BH-NB: ARC 14 Balaclava Hood-Navy-Regular

- CSA Z462-12
- HRC 2 (8+ cal)
- Made in USA
- NFPA 70E-2012



## 21ARC12AF-C+500: Deluxe 12 cal ARC Shld w/Hard Cap

- NFPA 70E-2012
- CSA Z462-12
- ASTM F2178-08
- ANSI Z87.1-2010
- ANSI Z89.1-2009
- Made in USA



## CAT4-C+HVS

- Oberon Arc Flash Hood - CAT Series
- Arc Rating = HRC4 (40+ calories)
- Assembly = Oberon Ratchet Hard Cap
- Fabric = FR Treated Cotton
- Excellent Visibility, Best Visible Light Transmission (VLT)
- Add Hood Ventilation System (HVS) for additional ventilation



## 21AGR8AF-CC+500: True Colour Grey (TCG) ArcShield

- True Colour Grey (TCG) ArcShield
- Revolutionary Grey Infrared Arc Flash Faceshield
- See the true colours of your work - Reds are red, blues are blue
- Deluxe Scratch Resistant coated outside, Anti-fog inside
- Includes CSA Z94.1 Type 1 Ratchet Adjust Hard Cap



## SHLDBAG-NYLON

- Nylon Storage Bag for Oberon ArcShield
- Features draw string & carry strap



# Louis Hebert - FR/Arc Flash Gear

## V159F0: FR/Arc Flash Service Pant

- 9oz Twill, 88% Cotton 12% Nylon FR fabric base
- Long life \*VAT\* dye
- 7 waistband loops
- #5 brass fly zipper with Nomex® tape
- Melamine front button closure at waist and on left back pocket
- Double thickness waistband with 4 needle stitching
- 2 front quarter top pockets and 2 welted back pockets
- Pocketing and waistband linings with FR fabric
- 36" unfinished inseam
- Bar-tacked at all stress points
- Meets performance requirements to CGSB 155,2 Flash
- Fire, CSA Z462 for Electrical Arc Flash. Also meets Flame Resistance on ASTM F1506-08 and acceptable under OSHA Final rule 1910, 269
- **ATPV 12.4**
- Available colours: Navy and Orange



## V154F0: FR/Arc Flash Cargo Pant

- Flame retardant
- 9oz drill, 88% Cotton 12% Nylon FR
- Long life \*VAT\* dye
- 9 waistband loops
- #5 brass fly zipper with Nomex® tape
- Melamine front button closure at waist and on left back pocket
- Double thickness waistband with 4 needle stitching
- 2 front quarter top pockets and 2 welted backpockets front quarter top pockets and welted back pockets
- Pocketing and waistband linings with FR fabric
- 2 cargo pockets with flap and Velcro closure
- Side seams are two needles topstitched
- 34 1/2" inseam, bottoms not finished
- Bar-tacked at all stress points
- Meets performance requirements to CGSB 155,2 Flash
- Fire, NFPA 70E/CSA Z462 for Electrical Arc Flash. Also meets Flame Resistance on ASTM F1506-08 and acceptable under OSHA Final rule 1910,269
- **ATPV 12.4**
- Available colour: Navy



## V559A0: FR/Arc Flash Shirt w/ Flaps

- Flame retardant
- 7oz twill, 88% cotton 12% Nylon
- Long life \*VAT\* dye
- 2 Plastic reinforcement at collar
- Topstitched single piece collar with lining (1/16")
- 2 large breast pockets with flap and button/buttonhole closure left pocket with pencil divider
- Hemmed front placket
- Front closure with 7 button / buttonhole
- Long sleeves with single piece cuffs with lining and button / buttonhole closure
- Double back yoke
- Bar-tacked at all stress points
- **ATPV 8.7**
- Available colours: Medium Blue and Navy



# Louis Hebert - FR/Arc Flash Gear

## V-1187RBF0 & V-1187LBF0: Lined FR/Arc Flash Bib Overall

- YKK's Brass zippers front closure
- 23" YKK'S brass zipper at leg with storm flap
- Velcro tab closures at ankles
- 2 slanted front pockets with velcro closure
- Two rear pockets and flashlight pocket at right rear leg
- 3M Canada F.R. 2" triple trim reflectives at bottom of legs
- Lock stitch sewing technology
- Nomex sewing thread
- Bar-tacked all stress points
- Meets CGSB 155,20 Hydro Carbon Flash Fires
- Meets CSA Z462 Arc Flash Protection
- **ATPV 48.2**
- Available colours: Navy and Orange



## V1156RBA0: Unlined FR/Arc Flash Bib Overall

- 88% Cotton, 12% Nylon 9oz weight-FR
- Long life \*VAT\* dye
- Adjustable FR elastic shoulder straps
- Brass zipper front opening
- Two chest pockets
- Two front quarter pockets with inside pocket side access
- Two back patch pockets
- Tool pocket on right side
- 12" brass zipper at bottom leg opening
- Bar-tacked at all stress points
- 3M Canada triple trim reflectives; legs, waist, X on back, vertical front
- Meets performance requirements to CGSB 15,2 Flash
- Fire, NFPA 70E/CSA Z462 for Electrical Arc Flash
- Also meets Flame Resistance on ASTM F1506-08 and acceptable under OSHA Final rule 1910,269
- **ATPV 12.4**
- Available colours: Navy and Orange



# Louis Hebert - FR/Arc Flash Gear

## V11691RBF0 & V11691LBF0: Unlined FR/Arc Flash Coveralls

- Drill 9 oz, 88% Cotton 12% Nylon
- Superior colour retention with \*VAT\* dyes
- Topstitched single collar with lining
- 2 breast pockets with flaps and concealed snap closure, left pocket with pencil division
- Front #5 brass break-away zipper with Nomex tape (two-way)
- Lapel with concealed snap closure
- Front waistband with hidden snap closure, top-stitched
- Pocket with pencil division on the left sleeve
- 2 pieces cuffs with concealed snap closure, 2 front quarter pockets with FR fabric pocketing
- Inner clothing access side with concealed snap closure
- Single piece back with action pleats and inserted side elastics at the waist
- 2 double stitched back patch pockets with reinforced bottoms, left pocket with concealed snap closure and a tool pocket on right side
- Sewn with FR thread
- Bar-tacked at all stress points
- **ATPV 12.4**
- CSA-Z96, 2" yellow/silver/yellow reflective stripes
- Industrial grade non-FR coverall also available



## V-1127RBF0 & V-1127LBF0: Lined FR/Arc Flash Coveralls

- 9.4 oz Flame Resistant outershell
- 88% Cotton, 12% High Tenacity Nylon orange
- Quilted Flame Resistant lining (10oz FR Modacrylique interior batting)
- YKK's Brass zippers front closure
- 18" YKK'S brass zipper at leg
- Velcro tab closures at wrists and ankles
- Mesh outer front pocket for gas detector over right torso pocket. One left pocket with velcro closure
- Micro clip and velcro piece at front (name or Dept tag)
- Inserted side pockets, inner clothing access
- Two rear pockets and flashlight pocket at right rear leg
- Flame resistant 2" grey reflective band (CSA Z96)
- Lock stitch sewing technology
- Flame resistant sewing thread
- Bar-tacked all stress points
- **ATPV 40.6**
- Meets CGSB 155,20 Hydro Carbon Flash Fires
- Meets CSA Z462 Arc Flash Protection
- Meets F 1506-2010 Standard



### LTL Garment Customization - logos and personalization

Speak to your local LTL Product Specialist about adding logos and/or personalizing your garments!



# Louis Hebert - FR/Arc Flash Gear

## VE373RBA0: FR/Arc Flash 3 in 1 Bomber Jacket

- Shell: 7oz 88% cotton, 12% Nylon with FR membrane
- Wind and rain shield
- FR liner protecting membrane, 88% cotton, 12% nylon
- Mandarin collar
- 2 micro clips, one each side
- Front yoke with double stitch
- 2 chest pockets with flaps. Left side with pencil opening
- 2 lower front side and top entry pockets with flap closures
- Zippers at front closure with storm flap and concealed snaps
- Wrists with concealed snaps
- Action back
- 3M Canada reflectives (yellow-grey-yellow) compliant to CSA Z96-10 high visibility standard
- Bar-tacked at all stress points
- **ATPV 21.1**
- Available colours: Navy and Orange



## DF373: Zip In Zip Out Liner

- 88% cotton, 12% nylon
- 2 faces madaquilt quilted
- FR liner with 10oz FR modacrylic batting
- Brass front zipper to insert in parka VE373RBA0
- Clean finish with bias binding
- Bar-tacked at all stress points
- **ATPV 59.4**
- Available colour: Gray



## VE394BF0: FR/Arc Flash Parka

- Fabric : 7 oz, 88% Cotton, 12% Nylon with FR P.U. Membrane
- Lining: 10 oz, 100% FR MODACRYLIC
- Mandarin collar, with snap buttons at neck top for hood attachment
- 2 micro clips, one each side. 2 chest pockets with flaps. Left side with pencil opening
- 2 lower front side and top entry pockets with flap closures
- Flame resistant YKK Vislon zippers at front closure with storm flap and concealed snaps
- Wrists with concealed snaps
- Action back, elasticized back at waist
- Adjustable waist inside garment
- Reflective stripes (yellow-grey-Yellow) compliant to CSA Z96-10 high visibility standard
- Bar-tacked at all stress points
- Meets performance requirements to CGSB 155,2 Flash Fire, CSA Z462 for Electrical Arc Flash. Also meets Flame Resistance on ASTM F1506-09 and acceptable under OSHA
- **ATPV 40.6**
- Available colours: Navy and Orange





# Louis Hebert - Non-FR/Arc Flash Gear

## SAFETY WINTER GEAR

- 100% Nylon 450 Denier Fabric with P.U. Coating
- Wind and water resistant
- Complies to Hi-Viz standard CSA Z96-10

- Quilted lining made of 10oz polyester for very cold weather
- Non-FR rated

### M3013 BP034: Coverall

- Includes detachable hood
- 4" leg zipper closures
- Pencil pocket on left arm
- 2 hip level pockets
- 1 torso pocket with pencil space at front
- Knitted wrist closure



### M3012 BP034: Parka

- Includes detachable hood
- 2 large lower pockets
- 2 smaller torso pockets
- Inside pocket for cellular
- Knitted wrist closure



### M3011 BP034: 3 in 1 Bomber

- Includes a black 100% polyester polar fleece
- Elasticized waistband
- Mandarin collar
- Vizlon front closure/Storm flap
- Two entry side pockets
- Adjustable wrist closure



### M3010 BP034: Sleeveless Vest

- Elasticized sides
- Mandarin collar
- 4 pockets: 2 large, 2 small
- Can be worn with the 3 in 1 polar vest



### Winter Collection Back View



## LTL Garment Customization - logos and personalization

Speak to your local LTL Product Specialist about adding logos and/or personalizing your garments!



# Benchmark FR

## 4029FR: Feather Weight Coverall 2.0 (HRC 2 and NFPA 2112)

- Benchmark FR 2.0 Twill, 6.9 oz. HRC 2, ATPV = 8.5 cal/cm<sup>2</sup>
- Whether you are protecting against arc flash or flash fire, the Feather Weight 2.0 will meet the code
- It is UL certified to the voluntary NFPA 2112 standard for flash fire and it also meets the NFPA 70E HRC 2 requirement for arc flash; dual code compliance without sacrificing comfort
- Lightweight and breathable
- Two chest pockets, two side pockets, two pass-thru's, a tool pocket and a cell phone pocket
- 4029 coveralls will come standard with a Regular (32") inseam
- Sleeve cuff is tailor finished, back gusset with a comfortable back elastic waist
- This coverall is 6.9 oz which makes it light and comfortable for any season
- The Feather Weight 2.0 is skin safe and can be worn independently directly against the skin



## 1028FR Really Nice Shirt 2.0 (HRC 2 and NFPA 2112)

- Benchmark FR 2.0 Twill, 6.9 oz. HRC 2, ATPV = 8.5 cal/cm<sup>2</sup>
- The 2.0 version of the Really Nice shirt offers easy compliance, comfort and is proudly made in the USA
- The shirt offers dual compliance with both an HRC 2 rating for arc flash and UL certification to the voluntary code NFPA 2112 for flash fire
- It has less than 2% shrinkage and a class 4 colourfastness rating after multiple washings



## 2078FR Steve's Pants, Twill (HRC 2 and NFPA 2112)

- Benchmark FR 2.0 Twill, 6.9 oz. HRC 2, ATPV = 8.5 cal/cm<sup>2</sup>
- Steve's Pants are high quality FR pants with increased durability, classic jean styling and a professional appearance
- The pants are sized true to size and with the benefit of controlled shrinkage, they will fit comfortably
- The construction is similar to denim due to the reinforced chain stitched inseams and bar-tacks at stress points
- No exposed metal to the wearer and a dielectric shank in place of a button
- Reinforced belt loops are sewn into the waistband for additional strength
- They are certified to the voluntary code NFPA 2112



## 2810FR American Denim Pants

- Benchmark FR Modacrylic/Cotton Twill, 12 oz. HRC 2, ATPV = 14 cal/cm<sup>2</sup>
- American Denim 281 is the finest FR jean available representing American craftsmanship and ingenuity
- The denim is a unique blend of flame resistant fibers and high quality ring-spun cotton yarns
- The fabric has the same premium quality of high-end jeans found in department stores
- American Denim 281 does not shrink, is pre-washed for comfort, and is guaranteed to last



## 3025FR Zip Hooded Sweatshirt

- Benchmark FR Modacrylic/Cotton Fleece, 12 oz. HRC 2, Ebt = 19 cal/cm<sup>2</sup>
- The Hooded Sweatshirt is constructed like your favourite 'hoodie' with a generous fit, two hand warmers, and a three-piece lined drawstring hood
- The Benchmark FR symbol is noticeably located on the wearer's left wrist for easy identification
- The inner face of the knit fabric is fleeced, which holds body heat and insulates from the cold
- Sleeve cuffs are made using a circular knit process which eliminates seams; the cuff will keep its elasticity and shape throughout use
- Wear the sweatshirt as part of a layering system for greater insulation



## 3026FR Pullover Hooded Sweatshirt

- Benchmark FR Modacrylic/Cotton Fleece, 12 oz. HRC 2, Ebt = 19 cal/cm<sup>2</sup>
- The Pullover Sweatshirt is constructed like your favorite 'hoodie' with a generous fit, two hand warmers, and a three-piece lined drawstring hood
- The Benchmark FR symbol is noticeably located on the wearer's left wrist for easy identification
- The inner face of the knit fabric is fleeced, which holds body heat and insulates from the cold
- Sleeve cuffs are made using a circular knit process which eliminates seams; the cuff will keep its elasticity and shape throughout use
- Wear the sweatshirt as part of a layering system for greater insulation



## 4017FR Women's Coverall

- Benchmark FR Twill, 5.5 oz. HRC 1, ATPV = 6 cal/cm<sup>2</sup>
- The Women's Feather Weight offers the same comfort and compliance as the men's Feather Weight coverall but it is made to fit a woman's body
- Benchmark's flame resistant 5.5oz feather weight twill is made from combed cotton ring spun yarns, which yields a durable, lightweight and breathable material
- The Women's Feather Weight coverall was developed for the oil and gas industry
- The fabric is non-allergenic, skin safe and will not react with sweat
- Code compliance includes OSHA 1910, NFPA 70E HRC1, ASTM 1506, NESC 2007 and conforms to international health codes for toxicity



## 3034FR FR Skull Cap

- Benchmark FR Modacrylic/Cotton/Nylon Rib Knit, HRC 3, Ebt = 36 cal/cm<sup>2</sup>
- The FR skull cap, sometimes called a "toque," does not have a folding brim
- The close fitting double layers make it easier to wear with a hard hat or under a hood
- The Skull Cap is made from a circular knit with seamless construction for extra comfort
- The comfort and appearance of the FR Skull Cap is indistinguishable from a premium store bought knit cap



## 3035FR FR Beanie

- Benchmark FR Modacrylic/Cotton/Nylon Rib Knit, HRC 3, Ebt = 36 cal/cm<sup>2</sup>
- The FR Beanie has classic "ski hat" styling
- The double layered knit hat has a folding brim for additional warmth around the ears
- It is made from a circular knit with seamless construction for extra comfort
- The comfort and appearance of the FR Beanie is indistinguishable from a premium store bought beanie



## 3036FR FR Balaclava

- Benchmark FR Modacrylic/Cotton/Nylon Blend, 7.5 oz. HRC 2, Ebt = 9 cal/cm<sup>2</sup>
- The flame resistant Balaclava is made from a rib knit which will adjust to the wearer's head and face profile
- It fits comfortably under any helmet or hard hat
- The top section is constructed like a beanie and features an incorporated face mask which can pull down below the chin
- The soft breathable knit blend feels comfortable against the skin, never itchy or constrictive



# Bulwark

## Hi-Visibility Rainwear

- 9.5 oz. PVC/Kevlar/Nomex®
- Protection: JXN2 –Arc Rating ATPV 6.5 calories/cm<sup>2</sup> EBTAS 33 calories/cm<sup>2</sup> (HRC1)  
BXN2 –Arc Rating ATPV 40.0 calories/cm<sup>2</sup> EBTAS 33 calories/cm<sup>2</sup> (HRC4)
- Non-conductive durable hard wear
- 1 ½" reflective striping
- Stowaway hood and adjustable hood drawstring
- Two patch pockets with flaps
- Elasticized shoulder straps
- Vented back with "D" ring access
- Take-up tabs on cuffs
- 360° reflective trim for visibility
- Take-up tabs at ankles



### Jackets

JXN2-YG-S	Yellow/Green
JXN2-YG-M	Yellow/Green
JXN2-YG-L	Yellow/Green
JXN2-YG-XL	Yellow/Green
JXN2-YG-2XL	Yellow/Green
JXN2-YG-3XL	Yellow/Green

### Bibs

BXN2-YG-S	Yellow/Green
BXN2-YG-M	Yellow/Green
BXN2-YG-L	Yellow/Green
BXN2-YG-XL	Yellow/Green
BXN2-YG-2XL	Yellow/Green
BXN2-YG-3XL	Yellow/Green

## Hi-Visibility Flame-Resistant Work Shirt

- Blend: 7 oz. 48% Modacrylic/ 37% Lyocell/15% Para-aramid
- Care: Home Wash
- Protection: ATPV 8.4 calories/cm<sup>2</sup> (HRC 2)
- ANSI 107-2004 Class 2 Level 2 Compliant
- Two chest pockets without pocket flaps. Pencil stall in left chest pocket
- Garment meets NFPA 2112 & CGSB 155.20
- Colors: Yellow/Green (HV)
- Lined Collar and Cuffs to keep their shape during laundry
- 360° visibility with front and back
- 2" FR silver stripe and button through pockets, no pocket flaps (SMW4)
- Buttons will not melt or drip, conforming to the requirements of ASTM F1506
- Sewn with FR thread, conforming to the requirements of ASTM F1506
- Hemmed front to deter lint and soil redeposition
- Fabric: CoolTouch® 2



### REGULAR LENGTH

SMW4HV-YG-M-REG
SMW4HV-YG-L-REG
SMW4HV-YG-XL-REG
SMW4HV-YG-2XL-REG
SMW4HV-YG-3XL-REG

### LONG LENGTH

SMW4HV-YG-M-LONG
SMW4HV-YG-L-LONG
SMW4HV-YG-XL-LONG
SMW4HV-YG-2XL-LONG
SMW4HV-YG-3XL-LONG

## Hi-Visibility Flame-Resistant Long Sleeve T-Shirt

- Blend: 70% Modacrylic/ 15% FR Lenzing/ 15% Rayon
- Protection: ATPV 8.1 calories/cm<sup>2</sup> (HRC 2)
- ANSI 107 – 2010 Compliant Class 3 Level 2
- Features a self-fabric crew neck collar and hemmed sleeves
- Tagless, an added comfort benefit to the wearer
- Spade shaped chest pocket doesn't allow lint to get trapped which makes it laundry friendly
- Full side seam gusset allows the garment to move and prevents untucking
- 2" flame-resistant silver heat seal reflective meets ANSI 107-2010 Class 3 Level 2 compliancy
- Reflective is segmented for additional comfort
- Cover stitched hem allows movement with the knit without popping stitches
- Sewn with FR thread conforming to the requirements of ASTM F1506
- Color: Yellow/Green



SMK2YG-S-REG	Yellow/Green
SMK2YG-M-REG	Yellow/Green
SMK2YG-L-REG	Yellow/Green
SMK2YG-XL-REG	Yellow/Green
SMK2YG-2XL-REG	Yellow/Green
SMK2YG-3XL-REG	Yellow/Green
SMK2YG-4XL-REG	Yellow/Green

## SLUSOR FR High Visibility Shirt

- Banded top-stitched collar, two chest pockets with concealed gripper closure flaps and sewn-in pencil stall stitched cuffs with adjustable button closure, placket front with button closure and tailored sleeve placket
- 360° visibility with front and back 2" silver reflective striping. Striping configuration is CSA Z96-09 Class 2, Level 2 Compliant. Garment meets CGSB 155.20
- Fabric: 6oz EXCEL FR® ComforTouch® (205 g / m<sup>2</sup>) blend: 88% Cotton / 12% Nylon
- Protection: Arc Rating ATPV 8.7 calories/cm<sup>2</sup>
- Orange colour
- Men's sizes: Regular (S-4XL), Long (L-4XL)



## BLCSOR Deluxe Insulated Bib Overall w/ Reflective Trim

- Two-way, extra heavy-duty Nomex® taped brass zipper front with concealed flap
- Elasticized shoulder straps with non-conductive adjustable hardware
- Five large patch pockets
- Hip pocket with closure
- Reinforced double knees
- Full Nomex® taped ankle-to-hip brass zippers, concealed snap closure
- Elastic waist inserts
- Inside zipper guards on all zippers
- 360° visibility with front and back 2" silver reflective striping around calves
- Flame-resistant fabric, 100% cotton lining
- Arc Rating APTV 43.3 calories/cm<sup>2</sup>
- Men's sizes: Regular (S-3XL), Long (M-2XL)



## CTBBOR & CTBANV Ultra Soft® Coverall with CSA Reflective Trim

- Mandarin, stand-up, two-way safety collar
- Deep pleated action-back
- Two-way concealed Nomex® taped brass break-away zipper, concealed snap at top of zipper at neck
- Two top-stitched patch chest pockets with flaps and concealed snap closures
- Two inset lower front pockets are top-stitched and lined, side vent openings with snaps
- Two patch hip pockets with single concealed snap closures
- One patch pocket with pencil stall on left sleeve and one piece rule pocket on right leg
- Elastic waist inserts
- Ultra Soft® interior and exterior brand labeling
- Fabric: Flame-Resistant, 7 oz. (235 g / m<sup>2</sup>) 88% Cotton / 12% Nylon
- Protection: Arc Rating ATPV 8-7 calories/cm<sup>2</sup>
- Men's sizes: Regular (38-58), Long (42-58)



CTBBOR

### CTBBOR

- 360° visibility with front and back 2" silver reflective striping
- Striping configuration meets CAN/CSA Z96-09 Class 3, Level 2 Compliance

### CTBANV (Navy)/CTBARB (Royal Blue)

- 360° visibility with 3M 2" #RT80 yellow/silver/yellow reflective striping configuration meets CAN/CSA Z96-09 Class 1 Level FR Compliance



CTBANV

## LTL Garment Customization - logos and personalization

Speak to your local LTL Product Specialist about adding logos and/or personalizing your garments!



# Croc Bloc - Sunscreen

## 12-31010: Sunscreen 10mL SPF 30



- Croc Bloc Sunscreen 10mL CrocPac SPF 30 Broad Spectrum
- 3" x 5" packette
- Moisturizing aloe and vitamin E
- Water-resistant, unscented
- FDA and Health Canada approved
- Dermatologist Tested

## 12-31510: Sunscreen 10 mL SPF 50



- Croc Bloc Sunscreen 10mL CrocPac SPF 50 Broad Spectrum
- 3" x 5" packette
- Moisturizing aloe and vitamin E
- Water-resistant, unscented
- FDA and Health Canada approved
- Dermatologist Tested

## 12-34010: Sunscreen 4oz SPF 30



- Croc Bloc Sunscreen 4oz Bottle SPF 30 Broad Spectrum
- Provides 30 times your natural protection against the harmful effects of UV Rays
- Moisturizing aloe and vitamin E
- Water-resistant, unscented
- FDA and Health Canada approved
- Dermatologist Tested

## 12-32010: Sunscreen 1oz SPF 30



- Croc Bloc Sunscreen SPF 30, 1oz Tube Broad Spectrum
- Provides 30 times your natural protection against the harmful effects of UV Rays
- Moisturizing aloe and vitamin E
- Water-resistant, unscented
- FDA and Health Canada approved
- Dermatologist Tested

## 12-35010: Sunscreen 1L SPF 30



- Croc Bloc SPF 30 1L Sunscreen
- Broad Spectrum protection against UV rays
- Economical solution for larger groups
- 34oz/1L bottle with dispensing
- Wall mount bracket sold separately
- Moisturizing aloe & vitamin E
- Water-resistant, unscented
- FDA and Health Canada approved
- Dermatologist Tested

## 12-33010: Sunscreen SPF 30 Pump Spray



- Croc Bloc SPF 30 6oz Sunscreen Spray
- Broad Spectrum protection against UV rays
- Spray pump provides excellent coverage
- Small enough to fit in any carry bag
- 80ml/6oz
- Sunscreen applied without rubbing into the skin
- Moisturizing aloe and vitamin E
- Water-resistant, unscented
- FDA and Health Canada approved
- Dermatologist Tested

## 12-38010: Sunscreen 4oz SPF 50



- Greater Sun Protection Factor for longer lasting fun in the sun
- Broad spectrum protection against UV rays
- Odourless, moisturizing aloe and vitamin E
- Water resistant, dries quickly with no oily residue
- Hypoallergenic, dermatologist tested
- 4oz/120mL bottle with EZ open flip-top lid
- Integrated belt loop toddler

# Croc Bloc - Insect Repellent

## 12-42500: Insect Repellent Spray



- Croc Bloc Insect Repellent 4oz Spray 10% Deet (CDN Only)
- 10% Deet liquid spray provides over 3 hours of protection against insect bites
- 4 oz/120ml bottle with spray pump
- Net contents 5.58g
- PMRA approved

## 12-435A0: 30% DEET Liquid Pump Spray



- Croc Bloc Insect Repellent Liquid Spray
- Non-aerosol heavy-duty insect repellent for long-lasting protection against insect bites!
- Up to 6 hrs of protection
- Net Contents 120mL/4oz bottle
- PMRA approved

## 12-54500: Wasp & Hornet Killer



- Croc Bloc 325g Wasp & Hornet Killer (CDN Only)
- Effectively kills wasps, hornets, bees, ants, yellow jackets, and tent caterpillars in their nests from a distance without exposing yourself to the risk of being stung or bitten
- Packaged 14oz/325g
- Flash point of 226°F

## 12-43500: 28% DEET Heavy Duty Aerosol



- Croc Bloc Insect Repellent Heavy Duty Aerosol
- Up to 6 hrs of protection
- Effective control against a variety of insects in the toughest environments.
- Net contents 150g spray can
- PMRA approved

## 12-40500: 30% DEET Single Towellette



- Croc Bloc Insect Repellent Towelette
- 30% DEET
- Single use 6"x8" towel
- Formulated for effective control of a variety of insects in an economical format
- Up to 6 hrs of protection
- Net Contents 5.85g
- PMRA approved

## TopGard® Protective Caps and Hats

- Classification: Type I
- Application: General purpose, elevated temperature
- Shell Material: Polycarbonate
- Available styles: Slotted cap, non-slotted full-brim hat
- Sizes: Standard (6 1/2-8")
- Standards: ANSI/ISEA Z89.1-2009 (Class E), CSA Z94.1-2005 (Class E)
- Certification: Third party by SEI



DESCRIPTION	TOPGARD SLOTTED CAP ( STANDARD SIZE)		TOPGARD NON-SLOTTED HAT (STANDARD SIZE)	
	w/ 1-Touch Suspension	w/ Fas-Trac Suspension	w/ 1-Touch Suspension	w/ Fas-Trac Suspension
<b>TOPGARD ASSEMBLIES</b>				
White	454728	475385	454719	475393
Yellow	454721	475378	454712	475387
Gray	454722	475379	454713	-
Blue	454723	475380	-	-
Orange	454725	475382	-	-
Green	454726	475383	-	-
Red	454727	475384	-	-
Bright Orange	-	804396	-	804397
White w/ Lamp Bracket & Cord Holder	448914	-	-	-
<b>REPLACEMENT SUSPENSIONS</b>				
1-Touch Suspension (6 1/2-8)	10061127			
Fas-Trac Suspension (6 1/2 - 8)	473333			
Swing-Ratchet Suspension (6 1/2-7 5/8)	816648			



1-Touch Suspension



Fas-Trac Suspension



Swing-Ratchet Suspension



# Personal Safety Equipment & Accessories

## V-Gard Protective Cap



- Ratchet suspension adjusts size quickly and easily
- Nylon crown suspension straps fit comfortably
- Lightweight and balanced for all day wear
- Available in white and yellow

## Hard Hat Seat Rack



- Convenient hard hat holder for use on the back of a vehicle seat

## V-Gard Protective Hat



- Brim around entire cap helps keep rain and sun off wearer's neck and ears
- Short front brim allows unimpeded upward vision
- Ratchet suspension adjusts size quickly and easily
- Nylon crown suspension straps fit comfortably
- Lightweight and balanced for all day wear
- Available in white, yellow and orange

## Sun Shields



- These sun shields extend the brim of the hard hat all the way around to help protect the wearer's ears and neck from the sun's rays
- Made of polyurethane
- Front portion is Lexan with a smoke tint
- For V-Gard Protective Cap or Hat

## Cowboy Style Hard Hat



- Stylish and comfortable
- Meets ANSI Z89.1-2003, Type 1, Class E, G, & C
- Extra wide brim provides more UV protection than standard or full brim hard hats
- Fully adjustable 6-point ratchet suspension

## Knitted Tube Liner (flame resistant)



- 100% polyester; flame resistant
- Fits snugly over hard hat and blocks wind tunneling in the crown
- Traps warm air to keep head and ears warm
- Easily folds up on outside of hard hat
- Does not have ear barriers, reflective strip, gap eliminator, or warming pack pockets

## Shoulder Length Winter Liner



- Blue liner is flame resistant and features a 100% cotton twill shell and is lined with a heavy weight flame-resistant polyester fleece
- Grey liner is not flame resistant
- All materials (cotton twill, polyester fleece, and binding) are flame retardant until washed
- Features pockets near ears for warm packs

## Hard Hat Warming Tube Liners



- 100% Polyester
- Fits snugly over hard hat
- Blocks wind tunneling inside the crown
- Traps warmth to keep head and ears warm
- Folds up on the outside of a hardhat, when not needed during breaks
- Flame resistant

## Full Face Knitted Tube Liner



- 100% polyester
- Fits snugly over hard hat and blocks wind tunneling in the crown
- Traps warm air to keep head, face, nose, and ears warm
- Can be folded up outside of hard hat during breaks
- Does not have ear barriers, reflective strip, gap eliminator, or warming pack pockets

## Cooling Hard Hat Inserts



Hard Hat Pad



Hard Hat Pad w/  
Neck Shade



Cotton Terry Hard  
Hat Liner



Cotton Terry Hard  
Hat Band

- These liners are made with napped cotton terry, but also have cooling crystals encased within
- Crystals work in combination with the evaporation process
- When worn against the head or neck they create a cooling sensation that is passed to pulse points and carried throughout the body

## Hard Hat inserts

- Super absorbent double napped cotton terry
- Double layer of terry and a layer of foam around the rim catch more perspiration
- Blocks sun and keeps perspiration off face and neck



# Personal Safety Equipment & Accessories

## Cooling Vest

- Ideal for linemen, heavy equipment operators, or anyone working in a warm indoor or outdoor environment
- Designed to keep the user cool and alert
- Cooling crystals work in combination with the evaporation process
- These vests are also reversible for continuous cooling
- Soak in cold water for 10-20 minutes
- Reusable thousands of times
- Works without freezing or ice



## Cooling Bandana

- The cooling crystals encased within the 100% cotton fabric absorb and hold up to 1,000 times their weight in cool, refreshing water
- The crystals work in combination with the evaporation process
- When worn against the head, neck, or body, cooling sensations are passed to pulse points and carried throughout the body
- Soak in cold water for 10-20 minutes; stays hydrated for several days and is reusable thousands of times



## FAONTAPB: North Plastic First Aid Kit

Plastic bulk first aid kit #A. Ontario Regulation. Includes: 1- Triangular bandage, 12- Sterile plastic strips 3/4" x 3", 4- Gauze pad sterile 3" x 3", 2- Sterile pressure bandage 4", 2- Gauze bandage 2" x 5 yards, 12- Assorted safety pins, 1- Disposable glove pairs, 1- First Aid manual.

## FAONT2MB: North Plastic First Aid Kit

Plastic bulk first aid kit #A. Ontario Regulation. Includes: 1- Triangular bandage, 12- Sterile plastic strips 3/4" x 3", 4- Gauze pad sterile 3" x 3", 2- Sterile pressure bandage 4", 2- Gauze bandage 2" x 5 yards, 12- Assorted safety pins, 1- Disposable glove pairs, 1- First Aid manual.

## FA25: North Plastic First Aid Kit

Industrial kit #25, metal box (XF30) 15.5" x 12" x 4.5"

## FAONT1PB: North Plastic First Aid Kit

Plastic bulk first aid kit #1. Ontario Regulation. Includes: 6- Triangular bandage, 24- Sterile plastic strips 3/4" x 3", 12- Gauze pad sterile 3" x 3", 4- Sterile pressure bandage 4", 4- Gauze bandage 2" x 5 yards, 4- Gauze bandages 4" x 5 yards, 2- Splint padding, 1- Metal wire splint/Boxed, 12- Assorted safety pins, 1- Disposable glove pairs, 1- First Aid manual.

## FASOS1ESAFE

Vehicle, zippered nylon bag, 15 1/2" x 9" x 6" elastic fittings and compartments

## FA8TRP

Vehicle, bulk plastic kit, 16 unit box



## Water coolers

- Sturdy plastic water coolers help keep plenty of fresh drinking water on hand at the job site
- Constructed of durable plastic that won't rust or fade in direct sunlight



## Vinyl Safety Labels

- High visibility lettering
- Two versions: "FIRST AID KIT INSIDE" & "FIRE EXTINGUISHER"
- Heavy duty vinyl with peel off backing to expose adhesive



## North - Adaptec Series

- Efficient, full wrap coverage
- Available in 3 sizes for the perfect fit
- Fully adjustable nose piece and nose pads
- Temples adjust for inclination and width
- Quick-change lens replacement system
- Utilizes exclusive North 4A coating, protecting against fog, scratches, UV and static
- Meets ANSI Z87.1 and certified to the requirements of the CSA Z94.3 standards



<b>T5900LTK</b>	<b>Regular Size</b>	<b>Translucent-Black, clear lens</b>
<b>T5900LTKS</b>	<b>Regular Size</b>	<b>Translucent-Black, smoke lens</b>
<b>T5900NTK</b>	<b>Narrow Size</b>	<b>Translucent-Black, clear lens</b>

<b>T5900NTKS</b>	<b>Narrow Size</b>	<b>Translucent-Black, smoke lens</b>
<b>T5900WTK</b>	<b>Wide Size</b>	<b>Translucent-Black, clear lens</b>
<b>T5900WTKS</b>	<b>Wide Size</b>	<b>Translucent-Black, smoke lens</b>

## North - 180 Slimline Series

- Comfortable, low profile shape, 9-base full wrap polycarbonate lens, non-conductive dielectric design, soft, flexible temples
- Meets ANSI Z87.1 and is certified to the requirements of CSA Z94.3



<b>T1300</b>	<b>Clear with blue temple pad/Clear, not coated</b>
<b>T1301</b>	<b>Gray with Hi-Viz orange temple pad/Gray, not coated</b>
<b>T1302</b>	<b>Amber with gray temple pad/Amber, not coated</b>

## North - A900 Series

- Sporty, 8-base wraparound polycarbonate lens, non-slip rubber nose bridge and padded temples provide a comfortable fit, available with scratch-resistant hardcoat or optional Fog-Ban® anti-fog coating
- Meets ANSI Z87.1 standard, CSA version certified to requirements of CSA Z94.3 standard



<b>A900</b>	<b>Black/Clear, Lens coating: Hardcoat</b>
<b>A901CSA</b>	<b>Black/Clear, Lens coating: Fog-ban Anti-Fog</b>

## North - The Edge™

- Available in 2 frame colours: black or gray
- Single piece polycarbonate lens with a 9-base curve for maximum peripheral vision
- Comes with two sets of temples ends: curved and straight
- Lenses are coated with North's exclusive 4A coating (exception: mirror lenses are 3A)
- Replacement lenses available
- Certified to the requirements of CSA Z94.3 standards. Available only in Canada

<b>T56005B</b>	<b>Black/Clear, Lens coating: 4A</b>	<b>T56005GRYS</b>	<b>Gray/Smoke, Lens coating: 4A</b>
<b>T56005GRY</b>	<b>Gray/Clear, Lens coating: 4A</b>	<b>T56005BA</b>	<b>Black/Amber, Lens coating: 4A</b>
<b>T56005BS</b>	<b>Black/Smoke, Lens coating: 4A</b>	<b>T56005BM</b>	<b>Black/Mirror, Lens coating: 3A</b>



## North - V-Maxx® Goggles

- Sleek wrap-around styling for a 180°, clear field of vision
- Direct and indirect ventilation styles available for impact or splash applications
- Adjustable elastic or neoprene headband
- Pivoting headband clips to adjust strap around hard hats or hearing protection
- Peel-off goggle covers available to extend life of the lens
- Can be worn over most prescription eyewear (OTG compatible)
- Available in clear, 3.0 and 5.0 welding shades
- Available with scratch-resistant hardcoating or optional Fog-Ban anti-fog coating
- Meets ANSI Z87.1 and certified to requirements of CSA Z94.3 standards



<b>11250800</b>	<b>Body colour/lens tints: clear/clear, Lens coating: Fog-ban anti-fog</b> <b>Description: Direct vent with elastic headband</b>
<b>11250810</b>	<b>Body colour/lens tints: clear/clear, Lens coating: Fog-ban anti-fog</b> <b>Description: Indirect vent with neoprene headband</b>



# Safety Glasses

## North - Tornado™ F5 Series

- Optically-centered unilens with extended side coverage
- Adjustable temples available in models with curved and straight temples, utilizes exclusive North 4A coating, protecting against fog, scratches, UV and static
- Replacement lenses available
- Meets ANSI Z87.1 and certified to requirements of CSA Z94.3 standards

<b>T57505B</b>	<b>Black Red/Clear, Lens coating: 4A, Temple style: Curved</b>
<b>T57505BS</b>	<b>Black Red/Smoke, Lens coating: 4A, Temple style: Curved</b>
<b>T57505BL</b>	<b>Blue Gray/Clear, Lens coating: 4A, Temple style: Curved</b>
<b>T57505BLBLM</b>	<b>Blue Gray/Blue Mirror, Lens coating: 4A, Temple style: Curved</b>
<b>T58505B</b>	<b>Black Red/Clear, lens coating: 4A, Temple style: Straight</b>
<b>T58505BS</b>	<b>Black Red/Smoke, Lens coating: 4A, Temple style: Straight</b>
<b>T5805BL</b>	<b>Blue Gray/Clear, Lens coating: 4A, Temple style: Straight</b>
<b>T585005BLBLM</b>	<b>Blue Gray/Blue Mirror, Lens coating: 4A, Temple style: Straight</b>



## UVEX - Pheos

- Duo-spherical lens offers exceptional optical quality and features an integral brow guard for enhanced coverage, protection and performance
- Clear, Gray and Amber lens tints address the needs of most workplace environments
- Features high-performance Dura-streme® dual anti-fog/anti-scratch coating technology for lenses that stay clear in extreme environments and withstand scratches for 3x longer lens life\*
- Unique temple design provides increased airflow to further resist lens fogging
- Integral slot in temple tip simplifies attachment of hang cords or corded ear plugs
- Contains no metal parts for 100% dielectric performance
- Meets ANSI Z87.1-2010 standard
- Available in standard and slim sizing to comfortably fit most workers
- Frameless design is lightweight and easy to clean and maintain
- Innovative dual-material technology used on temples provides stability and cushioned comfort for all-day wear
- Temples feature an extremely thin profile and fit comfortably when worn with other PPE
- High-performance hinges open and close with a smooth, effortless motion
- Smooth, molded-in nose piece provides a comfortable and secure no-slip fit for almost any wearer

<b>S4120D</b>	<b>Clear Lens Black/Gray Frame, Dura-streme HC/AF</b>
<b>S4121D</b>	<b>Gray Lens Black/Gray Frame, Dura-streme HC/AF</b>
<b>S4122D</b>	<b>Amber Lens Black/Gray Frame, Dura-streme HC/AF</b>
<b>S4130D</b>	<b>Clear Lens Anthracite/Gray Frame, Dura-streme HC/AF</b>
<b>S4131D</b>	<b>Gray Lens Anthracite/Gray Frame, Dura-streme HC/AF</b>
<b>S4132D</b>	<b>Amber Lens Anthracite/Gray Frame, Dura-streme HC/AF</b>



*\*Composite lens life test performed using a Bayer Abrasion Test method and may vary between environment and application.*

## UVEX - Genesis

- Wrap-around lens provides exceptional peripheral vision and protection
- Flexible fingers adjust to most nasal profiles
- Elastomer browguard deflects impact
- Adjustable temples and lens inclination

<b>S3200</b>	<b>Black frame, clear lens, ultra-dura anti-scratch coating</b>
<b>S3200D</b>	<b>Black frame, clear lens, dura-streme</b>
<b>S3200-ADV</b>	<b>Black frame, clear Lens, Ultra-dura Anti-scratch Coating, Advanced TPE</b>
<b>S3200X</b>	<b>Black frame, clear Lens, UVextreme Anti-fog Coating</b>
<b>S3200X-ADV</b>	<b>Black frame, clear lens, UVextreme anti-fog coating, Advanced TPE</b>
<b>S3201</b>	<b>Black frame, espresso lens, ultra-dura anti-scratch coating</b>
<b>S3202</b>	<b>Back frame, amber lens, UVextreme anti-fog coating</b>



Hoffman Boots motto: Offer a high quality, functional product at a fair price. Hoffman's spends extra time and research to use the best quality materials in each and every pair of Hoffman boots. Hoffman brand lineman boots are made in the USA. From high quality industrial grade leather to exclusive dual steel shank system, the boots have stood the test of time.

## 10EH-CTPOWER: 10" Hoffman Powerline (steel toe optional)



The new 10" Powerline combines the comfort and fit of the 6" hiker with the support and feel of a regular work boot. The 10" Powerline features a leather/Cordura upper for lighter weight and breathability. The waterproof insert provides a waterproof barrier that helps keep you dry no matter what the weather is doing. A full cushion insole and padded leather collar add all-day comfort. Hoffman's unique dual steel shank system provides more climbing support than any boot on the market. For those needing a steel toe boot, the Powerline is available in both steel toe and plain toe. A Vibram sole provides long term wear and excellent traction.

### #LPower (Non-Steel Toe), #STPower (Steel Toe)

- Dual steel shanks for climbing support
- Available in plain or steel toe
- Leather/cordura upper for lighter weight
- Waterproof liner
- CSA approval pending
- D and EE widths available
- D: 7-12, 13w/ half sizes; EE: 8-12 w/ half sizes, 13

## 10STDL: All-Leather Powerline (safety toe optional)



The 10" Dri-line was built to keep your feet dry inside when conditions are wet on the outside. A highly advanced Sympatec waterproof membrane keeps water out and adds cushion and comfort to the boot. For climbing, the dual steel shanks are added to provide the extra arch support needed. Other quality features include a 7-7 1/2 oil tanned leather upper that provides support to your legs. A climber side patch, solid brass hooks and eyelets, supportive heel counter, Vibram lug sole and three rows of durable stitching help prolong the life of the boot. The 10" Hoffman Dri-Line is also available with an ANSI approved steel toe for added protection. For those looking for a quality waterproof climbing boot, look no further.

### #10DL (NON-Steel Toe)

### #10STDL (Steel Toe)

- Dual Steel Shanks for Climbing Support
- Waterproof Sympatec Liner Keeps Water Out
- Additional Lineman's Patch
- Optional Steel Toe with EH Rating Available
- D, E & EEE Widths Available
- Sizes 7-12 w/half sizes, 13
- Sizes 14, 15 (D width only)

**LINESWEAT-M/L/XL/2XL:  
Hoffman Boots Sweatshirt**

**LINET-M/L/XL/2XL:  
Hoffman Boots T-Shirt**



# Hoffman Boots

## ST MEINDL LINE: 6" & 10" Steel Toe Meindl Lineman Sole (Dual Climbing Shanks)

- 6" and 10" Steel Toe EH Rated Meindl Lineman Boots to our line of top quality footwear
- The German made Meindl boot has a very supportive upper that provides excellent leg support and stability
- A waterproof bootie helps insure dryness and a removable insole adds cushion to your every step
- Dual Steel Shanks have been added to the boot for all day climbing comfort
- A durable Vibram lug sole provides traction and longtime wear
- This boot will meet the F2413-11 standard for safety toe and EH rating
- Although waterproof liner failure is rare in the construction of this boot, neither Hoffman's nor Meindl will warranty the waterproofness of this boot
- Order 1/2 size smaller than usual

Sizes: 8-12



6" & 10" Steel Toe Meindl Lineman Sole

### 6STMeinREG: 6" Steel Toe Meindl Regular Sole (Single Shank)

- Easy to break in, the 6" Meindl Boot is ideal for those looking for a comfortable ground boot with outstanding support



6" Steel Toe Meindl Regular Sole

### 10STMeinREG: 10" Steel Toe Meindl Regular Sole (Single Shank)

- Easy to break in, the 10" Meindl Boot is ideal for those looking for a comfortable ground boot with a water proof liner

Sizes: 7-12 & 1/2 sizes, 13

# Salisbury by Honeywell

## Lineman's Rubber Overshoes

- Storm rubber overshoe; two buckles
- Ozone-resistant rubber is 100% waterproof
- Anti-skid bar tread outsole
- Shoe construction is hand layered in full-cut patterns to fit over work boots
- Fabric lining provides ease of putting on and taking off
- Provide extra safety when climbing ladders and poles where the deep heel cavity can lock onto the rungs

Linemen's Dielectric Footwear  
 100% tested to 20 kV per ASTM F1116  
 ASTM F1117 compliant  
**51511 - Non-Buckle Overshoe Bob Sole sizes 7-16**

Super Dielectric Storm Rubber Overshoe  
 100% tested to 20 kV per ASTM F2413-05 - revised standards  
**51530 - Deep Heel Overshoe, Anti-Skid Tread Outsole**



## 10-8601: Metal-Free Boots, Black



- Slip and oil resistant lightweight FLX™ rubber sole for improved flexibility
  - Non-metallic puncture resistant plate
  - Dielectric (ESR) protection
  - Sealed seams
  - Composite protective toecap
  - Soft PU footbed, for added comfort
  - Wear resistant TPU Pareshok™
  - Airflow waterproof and breathable membrane
  - Silverclear treated Taibrelle lining
  - 2.0 mm full grain polishable leather
  - This style meets CSA Z195-09, ASTM F2413-11 I/75, C/75, PR, EH quality standards
- Available sizes: 5, 6, 7-10 + 1/2, 11-15**

## 10-8400: Metal-Free Boots, Black



- Non-metallic puncture resistant plate
  - Dielectric (ESR) protection
  - Sealed seams
  - Slip and oil resistant lightweight FLX™ rubber sole for improved flexibility
  - Composite protective toecap
  - Wear resistant TPU Pareshok™ for more durability
  - Soft PU footbed, for added comfort
  - Airflow waterproof and breathable membrane
  - Silverclear treated Taibrelle lining
  - 2.0 mm full grain leather and Armortex fabric, abrasion resistant, water and wind proof
  - This style meets CSA Z195-09, ASTM F2413-11 I/75, C/75, PR, EH quality standards
- Available sizes: 5, 6, 7-10 + 1/2, 11-15**

## 8700: Linemen Boots, Black



- Dielectric (ESR) protection
  - Protective steel toecap
  - 2.0 mm full grain leather
  - Sealed seams
  - Tundra Poliyou footbed for added comfort
  - Isofix lining and waterproof membrane tested in factory
  - Vibram vulcanized and cemented rubber slip and oil resistant sole
  - Padded ankle protector to ease climber wear
  - Double dual-rib steel shank
  - Protective steel plate
  - This style meets CSA Z195-09, ASTM F2413-11 I/75, C/75, PR, EH quality standards
- Available sizes: 5-12 + 1/2, 13**

## 8614: Forestry Boots, Black & Orange



- Dielectric (ESR) protection
  - Poliyou footbed for added comfort
  - Stitching threads tested for strength
  - Vulcanized rubber track slip and oil resistant sole
  - Cambrelle liner and waterproof membrane tested in factory
  - Protective ballistic nylon, Kevlar® and 2.0 mm full grain leather
  - Protective steel plate
  - This style meets CSA Z195-09 quality standards
- Available sizes: 6-12 + 1/2, 13, 14**

## 10-8620 Metal-Free Boots, Brown, 8"



- Non-metallic puncture resistant plate
  - Dielectric (ESR) protection
  - Sealed seams
  - Slip and oil resistant lightweight FLX™ rubber sole for improved flexibility
  - Composite protective toecap
  - Wear resistant TPU Pareshok™ for more durability
  - Soft PU footbed, for added comfort
  - Airflow waterproof and breathable membrane
  - 2.0 mm Crazy Horse leather and Armortex fabric, abrasion resistant, water and wind proof
  - Silverclear treated Taibrelle lining
  - This style meets CSA Z195-09, ASTM F2413-11 I/75, C/75, PR, EH quality standards
- Available sizes: 5, 6, 7-10 + 1/2, 11-15**

## 10-8600 Metal-Free Boots, Black



- Non-metallic puncture resistant plate
  - Dielectric (ESR) protection
  - Sealed seams
  - Slip and oil resistant lightweight FLX™ rubber sole for improved flexibility
  - Composite protective toecap
  - Soft PU footbed, for added comfort
  - Pareshok™ and rubber heel counter resistant to chemicals, hydrocarbons, detergents
  - Airflow waterproof and breathable membrane
  - Silverclear treated Taibrelle lining
  - 2.0 mm full grain leather and Armortex fabric, abrasion resistant, water and wind proof
  - This style meets CSA Z195-09, ASTM F2413-11 I/75, C/75, PR, EH quality standards
- Available sizes: 5, 6, 7-10 + 1/2, 11-15**

## 10-8420 Metal-Free Boots, Brown



- Non-metallic puncture resistant plate
  - Dielectric (ESR) protection
  - Sealed seams
  - Slip and oil resistant lightweight FLX™ rubber sole for improved flexibility
  - Composite protective toecap
  - Wear resistant TPU Pareshok™ for more durability
  - Soft PU footbed, for added comfort
  - Airflow waterproof and breathable membrane
  - 2.0 mm Crazy Horse leather and Armortex fabric, abrasion resistant, water and wind proof
  - Silverclear treated Taibrelle lining
  - This style meets CSA Z195-09, ASTM F2413-11 I/75, C/75, PR, EH quality standards
- Available sizes: 5, 6, 7-10 + 1/2, 11-15**

## 10-6020 Metal-Free Boots, Brown



- Non-metallic puncture resistant plate
  - Dielectric (ESR) protection
  - Composite protective toecap
  - Wear resistant TPU Pareshok™ for more durability
  - Soft PU footbed, for added comfort
  - Taibrelle lining
  - Stitching threads tested for strength
  - Oil resistant 4-Density sole rubber inserts bonded to a PU midsole with a TPU lock sole
  - Thinsulate thermal insulation
  - 2.0 mm Crazy Horse leather
  - This style meets CSA Z195-09, ASTM F2413-11 I/75, C/75, PR, EH quality standards
- Available sizes: 7-10 + 1/2, 11, 12, 13**



## 10-8550: Metal-Free Boots, Black



- Non-metallic puncture resistant plate
  - Dielectric (ESR) protection
  - Sealed seams
  - Slip and oil resistant lightweight FLX™ rubber sole for improved flexibility
  - Composite protective toecap
  - Soft PU footbed, for added comfort
  - Wear resistant PU coated vamp, for more durability
  - Airflow waterproof and breathable membrane
  - Silverclear treated Taibrelle lining
  - Wear and tear resistant professional hockey grade nylon
  - This style meets CSA Z195-09, ASTM F2413-11 I/75, C/75, PR, EH quality standards
- Available sizes: 5, 6, 7-10 + 1/2, 11-15**

## 10-8610: Metal-Free Boots, Wheat



- Non-metallic puncture resistant plate
  - Dielectric (ESR) protection
  - Sealed seams
  - Slip and oil resistant lightweight FLX™ rubber sole for improved flexibility
  - Composite protective toecap
  - Wear resistant TPU Pareshok™ for more durability
  - Soft PU footbed, for added comfort
  - 2.0 mm Nubuck leather
  - Airflow waterproof and breathable membrane
  - Silverclear treated Taibrelle lining
  - This style meets CSA Z195-09, ASTM F2413-11 I/75, C/75, PR, EH quality standards
- Available sizes: 5, 6, 7-10 + 1/2, 11-15**

## 10-8604: Metal-Free Boots w/ Full Size Zipper, Black



- Non-metallic puncture resistant plate
  - Dielectric (ESR) protection
  - Sealed seams
  - Slip and oil resistant lightweight FLX™ rubber sole for improved flexibility
  - Composite protective toecap
  - Soft PU footbed, for added comfort
  - Airflow waterproof and breathable membrane
  - Silverclear treated Taibrelle lining
  - Superior quality YKK inside zipper
  - 2.0 mm full grain polishable leather
  - This style meets CSA Z195-09, ASTM F2413-11 I/75, C/75, PR, EH quality standards
- Available sizes: 5, 6, 7-10 + 1/2, 11-15**

## 10-6000: Metal-Free Boots, Black



- Non-metallic puncture resistant plate
  - Dielectric (ESR) protection
  - 2.0 mm full grain leather
  - Composite protective toecap
  - Wear resistant TPU Pareshok™ for more durability
  - Soft PU footbed, for added comfort
  - Taibrelle lining
  - Stitching threads tested for strength
  - Oil resistant 4-density sole rubber inserts bonded to a PU midsole with a TPU lock sole
  - Thinsulate thermal insulation
  - This style meets CSA Z195-09, ASTM F2413-11 I/75, C/75, PR, EH quality standards
- Available sizes: 7-10 + 1/2, 11, 12, 13**

## EVOTECH® Full Body Harness



- Breathable padding with moisture-wicking material keeps users cooler
- No binding edge on shoulder padding prevents neck chafing
- Sub-Pelvic Strap with patented variable width webbing provides 50% more surface area for improved weight distribution and improved comfort
- Patent-pending leg strap design keeps leg straps in place, increasing mobility and comfort
- Dual-colour webbing - red pattern on outside, black on inside - promotes easy identification of twisted webbing
- Patent-pending web management system provides means of storing excess webbing
- 3-position back D-ring allows users to determine optimal lanyard connection position
- Web finials prevent fraying on web ends and simplify threading through buckles
- NanoSphere® coating on webbing repels dirt, grease, moisture, etc.
- Available with Suspension Trauma Safety Step to improve post-fall comfort and help prevent suspension trauma
- Reflective webbing integrated into harness webbing increases visibility in low-light environment
- Construction harness features integral back pad and tool belt with dual-durometer padding for superior comfort in work positioning applications

**10105940** EVOTECH Harness, BACK D-ring, Qwik-Connect leg straps, Qwik-Connect chest strap, Shoulder Padding, Standard (STD)

**10112762** EVOTECH Tower Harness w/integral backpad, BACK, HIP & CHEST D-rings, Qwik-Connect leg straps, Qwik-Connect chest strap, Shoulder & Leg Padding, Standard (STD), Padded Saddle

**10112742** EVOTECH Construction Harness w/integral backpad, BACK & HIP D-rings, Qwik-Connect leg straps, Qwik-Connect chest strap, Shoulder Padding, Standard (STD)

## TechnaCurv® Harness



- The TechnaCurv® Full Body Harnesses offer features never seen before in full-body harnesses: Curvilinear comfort system, Visco-Elastic shoulder padding, and Sorbtek fabric on the shoulder and sub-pelvic pads
- The harness is designed with downward adjusting torso straps on most models to ease fitting
- Tower Harness model available with integral body belt and removable saddle
- Resists water, oil, grease, and dirt with Teflon fabric protected webbing which increases the life of the harness
- Uses Visco-Elastic shoulder padding for comfort
- Curvilinear Comfort System provides total comfort during use
- Integral belt and comfortable saddle assist with support, position, restraint, and climb movements

**10053001** TechnaCurv Harness, Vest-Style, BACK D-ring, Qwik-Fit leg straps, Qwik-Fit chest strap, Shoulder Padding, Tool Belt Loops, X-Large (XLG)

**10041611** TechnaCurv Harness, Vest-Style, BACK, HIP & CHEST D-rings, Tongue Buckle leg straps, Qwik-Fit chest strap, Shoulder Padding, Standard (STD)

## Gravity® Harness



- Available in vest and cross-over styles (varies by country) and rated to a 400 pound/180 kg capacity, Gravity Harnesses are suitable for controlled descent, positioning, ladder climbing, rescue, and fall arrest
- A variety of options are available to meet your specific needs
- All Gravity Harnesses now include a load-indicator to alert you when the harness has been involved in a fall event
- Colour-contrasting thigh and torso straps simplify donning
- Integral belt and comfortable saddle assist with support, position, restraint and climb movements
- Includes two lanyard keepers for added safety when lanyard leg is not in use
- Includes a load-indicator to alert you when the harness has been involved in a fall event

**SSH30420060** Gravity Harness Class A, Size Standard, Webbing Nylon Red/Blue, Leg Connection Mating Buckle

## Revolution Arc-Rated & Non Arc-Rated Harnesses

- Kevlar®/Nomex® Miller DualTech™ webbing – patent-pending 10,000 lb. tensile strength webbing is engineered with permanent fire retardant (FR) properties. The webbing offers the durability and FR properties of Kevlar on the outer side, with softer FR Nomex on the inside of the webbing for greater comfort. The webbing assures arc protection and durability that eclipses any nylon webbing
- PivotLink™ design allows unmatched freedom of motion and comfort, while the unique Cam Buckles provide easy two-finger adjustment
- Leather insulators under all metal hardware offer additional protection for the worker
- The Kevlar web loop on the back pad allows for a “metal-less” connection when used with a Kevlar shock-absorbing lanyard with a choke-off loop
- All Miller Revolution Arc-Rated Harnesses have bright red binding on every pad, making them easily identifiable as an arc-rated product



- Quick-Connect
  - Chest Buckles
  - Cam Buckles
  - ErgoArmor
  - Back Shield
  - Leather insulators; web back D-ring
  - Self-Contained
  - Label Pack
  - Web Finales
- RKNARRL-QC/UBK Arc-Rated Revolution Harness**



**RKN-QC/UBK Standard Revolution Harness**

## AirCore Tower Climbing Harnesses

- Up to 21% lighter than similar competitive harnesses – increased productivity and reduced fatigue
- Up to 16% less surface area than other padding used on the market – keeps workers cooler and working longer
- Rated to 400 lbs (181.4 kg) capacity
- Unique breathable, open-core padding technology provides optimal airflow and reduces heat and moisture build-up; up to 16% less surface area than other padding used on the market
- Contoured ergonomic padding design minimizes contact around a worker’s neck, lower back and inner thighs to reduce chafing and irritation
- Patented DuraFlex stretchable webbing provides greater flexibility
- Easy adjustability: Cam buckles provide easy one-hand adjustment; hold webbing firmly in place with no readjusting required
- Quick-connect buckles for easy donning
- Lightweight: Materials and components selected to reduce fatigue for all-day endurance and increased productivity; up to 10% lighter than similar competitive harnesses
- Unique and vibrant patterned webbing for easy identification



**ACF-QCBDPUG**

## 650KQC: Heavy Duty Welder Harnesses

- The Heavy-Duty Welder Harnesses are designed with rugged black Kevlar® webbing to withstand harsh welding environments
- They meet ASTM F887 Arc Test requirements and are rated for arc exposure
- Materials Webbing: 1-3/4" Kevlar
- Elastic Keepers: Kevlar, Elastic
- Thread (Stitching): Kevlar, Polyester
- Web Back D-Ring: Kevlar Webbing
- Metal Back D-Ring\*: Clear Chromate Finished Carbon Steel
- Buckles\*: Clear Chromate Finished Carbon Steel
- Grommets: Brass
- Connection Insulators: Leather

\* All hardware meets ASTM (50) fifty-hour salt spray test requirements



**805KQC**



TRUSTED SINCE 1958

# Miller

## P950/UGN: Duraflex Python Harness

- The DuraFlex Python Harness features wraparound comfort and is uniquely constructed with three types of performance webbing
- Cushioned tubular webbing shoulder straps
- DuraFlex webbing torso straps
- Non-stretch webbing leg straps



## E650-7/UGN: Duraflex Stretchable Harness

- Maximize Comfort
- DuraFlex Harnesses conform to the shape of the worker, stretching with every movement, so there is no bunching, binding or kinking
- With comfort unsurpassed, DuraFlex Harnesses offer wider end-user acceptance
- A comfortable harness is worn properly, enhancing compliance and safety on the jobsite
- Because DuraFlex Harnesses are stretchable, the worker has greater mobility with less fatigue



## 233MK-Z7: Manyard II Stretchable Shock-Absorbing Lanyard

- Specially-woven shock-absorbing inner core smoothly expands to reduce fall arrest forces
- Working load of 310 lbs (140.6 kg) and features a warning flag to indicate that it has arrested a fall
- A heavy-duty tubular outer jacket serves as a wear indicator and back-up strap to the red inner core for added safety



## StretchStop Lanyards w/SofStop Shock Absorber

- Unique stretchable design (4-ft. [1.2 m] to 6-ft. [1.8 m]), minimizes tripping, snagging and dragging
- SofStop Shock Absorber pack is designed with a specially-woven inner core that smoothly expands to reduce fall arrest forces
- Includes a heavy-duty back-up safety strap

940SS-E6/6FTGN One Leg

980SS-E6/6FTN Two Legs



## 216MK/6FTBK: Arc Rated Shock Absorbing Lanyards

- Specially-woven shock-absorbing inner core smoothly expands to reduce fall arrest forces
- Unique warning flag provides visual proof that a lanyard has been involved in a fall and must be removed from service
- Arc-rated Kevlar webbing in both single- and double-legged models
- Integral bright red core makes visual inspection easier and more reliable
- Available with choke-off loop or locking snap hooks with 3/4" (19 mm) or 2-1/2-in. (63 mm) gate openings
- Meets Stringent ASTM F887-05 Arc-Flash Standards



## Scorpion Fall Limiter

- The lightweight, compact design of the 9 ft (2.7 m) Miller Scorpion Personal Fall Limiter provides workers an affordable alternative to shock-absorbing lanyards
- In a head-to-head comparison with shock-absorbing lanyards, the Scorpion web retractable requires less fall clearance, offers greater mobility and prevents tripping hazards
- Greater versatility through dual operation: attach directly to the harness D-ring for use as a personal fall limiter, or use as a traditional retractable lifeline
- Small, lightweight design 2.9 lbs (1.3 kg)
- Quick-activating, high-strength stainless steel braking system – arrests free falls
- 9ft (2.7 m) of working capacity
- Variety of integral anchorage connectors available
  - No annual factory recertification required
  - Visual load indicator – indicates the unit must be removed from service



## StopFall Restraint Device

- Designed to easily and naturally climb wood poles in a position that's both comfortable and ergonomically accepted
- Automatic spring-loaded cinching feature - Miller Exclusive!
- Easy to use and adjust when hitchhiking wood poles
- For use on transmission and distribution poles
- 100% inspection
- Accommodates wood poles ranging from 20" to 60" circumference
- Unique gaffs provide excellent stopping power on dry, wet or icy poles
- The Miller StopFall™ Fall Restraint Device was created for linemen by linemen to make pole climbing as safe, comfortable and convenient as possible, eliminating room for error and increasing safety
- The only wood pole product of its type, it provides a straightforward solution allowing workers to climb naturally and instinctively
- The unique spring-loaded cinching feature of the Miller StopFall keeps the unit in constant contact around the pole
- Its minimal points of adjustment make worker training quick and easy



## GlideLoc Safe Climbing Ladder System (Rail)

- Continuous Fall Protection for Climbing Fixed Ladders
- New GlideLoc Vertical Height Access Ladder System Kits provide an innovative solution for vertical climbing that is easy-to-use, requires minimal maintenance and provides superior safety
- Kits are available in aluminum, galvanized or stainless steel construction
- Unique design keeps hands free for climbing
- Engineered for smooth operation for ascending/descending
- Durable construction for extended service life
- Accommodates multiple workers



Ideal for Permanent Ladder Applications:

- Wind Power/Turbines
- Drilling Rigs/Platforms
- Telecommunications
- Shipbuilding
- Utilities
- Crane Installation
- Industrial Facilities
- Confined Space

## Vi-Go Ladder Climbing Safety Systems (Cable)

- Continuous fall protection when climbing fixed ladders
- New Vi-Go™ Ladder Climbing Safety Systems provide the ultimate in safety with continuous fall protection when climbing fixed ladders
- Lower cost of ownership – Do-it-yourself kits for easy installation and inspection. No costly, annual manufacturer inspections often required by other systems
- Option to cut cable lengths on site for greater versatility
- Accommodate up to four (4) workers at a time: increasing productivity
- Select Automatic or Manual Personal Fall Arrester Cable Sleeves: both cable sleeves are designed to follow the user along the lifeline while ascending or descending, instantly locking in the event of a fall
- Uninterrupted fall protection: Uniquely-designed, patent-pending Vi-Go Cable Sleeve automatically bypasses intermediate cable guides, keeping both hands free for climbing; travels smoothly along cable and locks instantly in the event of a fall
- Easy, one-hand operation for attachment/detachment from the system
- Automatic pass-through cable guides secure lifeline to prevent cable wear and enable the system to accommodate curves
- Withstands harsh environments
- Attachment mechanism engineered to prevent incorrect installation, ensuring greater safety, unit will not open if attached incorrectly
- Cable sleeve integrated shock-absorbing element
- Provides a "dual shock-absorbing system" to further reduce fall forces, protects the system and ladder from damage
- Once a fall occurs, the deployed shock absorber indicates the unit must be taken out of service
- Accommodate 5/16" (8 mm) or 3/8" (10 mm) cable



# Miller

## MightEvac® Self-Retracting Lifeline with Emergency Retrieval Hoist

- The Miller MightEvac combines the superior performance and reliability of the best-selling MightyLite Self-Retracting Lifeline Series with a quick-activating retrieval mechanism for emergency evacuation
- Significant long-term savings/lower cost of ownership
- 20% lighter than competitive models
- Promotes quick and easy rescue with a 4:1 mechanical advantage (average speed of 25 ft [7.6 m] per minute)
- 310 lbs (1.4kN) weight capacity
- For emergency evacuation only
- Corrosion-resistant stainless steel/aluminum components
- Convenient, heavy-duty carrying handle
- Available in galvanized or stainless steel wire rope and Kevlar rope in lengths of 50 ft (15 m), 100 ft (30 m) and 130 ft (40 m), or Kevlar rope models in lengths of 40 ft (12.2 m) SKU MR40K/40FT, and 80 ft (24.4 m) SKU MR80K/80FT



## DH-1: Durahoist™ Safety Systems

- Designed for manhole and confined space entry/retrieval and fall arrest applications
- The modular design allows the use of components in various configurations and applications
- Multiple winches and/or lifeline systems may be mounted as required
- Lightweight, manageable components for easy storage, transport and set-up



## MR50GRC/50FT: Miller Tripod w/ MightEvac® Self-Retracting Lifeline/Emergency Retrieval Hoist

- Promotes quick and easy rescue with a 4:1 mechanical advantage (avg. speed of 25 ft per minute)
- 7 ft (2m) tripod; lightweight, high-strength aluminum construction
- Adjustable legs, safety chain, rubber skid pads/serrated edge tripod feet
- Corrosion-resistant stainless steel/aluminum components; 310 lbs capacity



## SE/75FT: Miller SafEscape® ELITE Controlled Descent/Self-Rescue System

- Used for vertical and angular controlled descent from overhead cranes, towers, aerial lifts, oil derricks, platforms and other elevated work areas
- Approved for multiple descents
- Includes lifeline, rescue harness, cross arm strap anchorage connector/carabiner, retrieval yoke and carrying bag
- SWHW/75FT comes with hoisting wheel



# Bashlin Climbing Equipment

Climbing is serious business, demanding dependable equipment for individuals to work safely in elevated work areas. Bashlin's products reflect that belief in safety and attention to the way the tools feel, work, and wear. Bashlin's craftsmen use the finest materials on the market today to manufacture the highest quality tool belts, pole straps, and climbers for professional linemen.

## The Floridian and the Maverick Tool Belts - Full Floating

- Superior design and performance make this belt the industry standard
- Combines a padded, contour cushion section with flares for shifting D-rings and a 5 1/2" back
- Gives excellent support and climbing comfort

Part #	Colour
Bashlin 88	Floridian Tan
Bashlin 88X	Maverick Black

## Hip-Grip Back Support Tool Belts - Full Floating

- Help relieve back strain and fatigue
- Standard belts are not padded, but padding is available

Part #	Colour
Bashlin 88G	Tan
Bashlin 88GX	Black

## Rest-A-Back Tool Belts - Full Floating

- Help relieve back strain and fatigue
- Standard belts are not padded, but padding is available

Part #	Colour
Bashlin 88B	Tan
Bashlin 88BX	Black

## 4 Dee Ring Tool Belt

- Excellent for use with secondary lanyards and/or wood pole fall restricting devices
- Features an arc-resistant cushion that allows cooling and ventilation
- This soft material requires no break-in
- Hip-hugging design gives back support in a lightweight belt

Part #	Colour
Q88GX4DMP	Black

## EZ Rider - Linemen's Tool Belt

- The new ergonomic, contoured design allows the belt to be worn comfortably and correctly, without compromising safety
- Supports the lower abdomen, reducing leg discomfort and numbness
- Dramatically improves "on the pole" comfort
- Easily connects Pole Lariats, Pole Chokers, Cynch-Loks and similar WPFRDs

Part #	Colour
88UX4DMP-DSIZE	Black



# Bashlin Climbing Equipment

## Steel Pole Climbers

- Steel alloy adjustable climber
- Offset design
- Features a replaceable gaff, roomy ankle area, and a triangular strap ring

<b>Bashlin BD16B-1N</b>	<b>Bottom Straps Attached</b>
<b>Bashlin BD16B-2N</b>	<b>Bottom and Top Straps Attached</b>
<b>Bashlin BD16B-3N</b>	<b>Straps with Pad 110D</b>
<b>Bashlin BD16B-4N</b>	<b>Straps with Pad 130D</b>
<b>Bashlin BD16B-5N</b>	<b>Straps with Pad 140DS</b>



Bashlin BD16

## Aluminum Alloy Pole Climbers

- Aluminum alloy offset climber features a replaceable, forged steel gaff
- Weigh 30% less than comparable steel climbers, reducing fatigue and adding climbing comfort

<b>Bashlin BD14-1N</b>	<b>Bottom Straps Attached</b>
<b>Bashlin BD14-2N</b>	<b>Bottom and Top Straps Attached</b>
<b>Bashlin BD14-3N</b>	<b>Straps with Pad 110D</b>
<b>Bashlin BD14-4N</b>	<b>Straps with Pad 130D</b>
<b>Bashlin BD14-5N</b>	<b>Straps with Pad 140DS</b>



Bashlin BD14

## Aluminum Alloy Tree Climbers

- Designed for tree climbing and features a 2 1/2" gaff
- Reduces fatigue and adds climbing comfort
- Comparable steel climbers weigh 30% more
- Climbers come with bottom straps attached, top straps and pads
- Weighs 5.75 lbs

<b>Bashlin BD14T-1N</b>
<b>Bashlin BD14T-2N</b>
<b>Bashlin BD14T-5N</b>



Bashlin BD14T

## Gaff Guards

- Made of leather with a hook/loop attachment
- These guards protect the gaff and the climber



Bashlin #2

## Nylon Climber Straps

- Durable, pliable, and comfortable
- Double riveted, featuring a protective buckle shield

<b>Bashlin 85N</b>	<b>Top Straps - 1 1/16"x24"</b>
<b>Bashlin 86N</b>	<b>One Piece Lower Straps - 1 1/16"x28"</b>
<b>Bashlin 87N</b>	<b>Two Piece Lower Straps - 1 1/16"x28"</b>
<b>Bashlin 89N</b>	<b>Two Piece Lower Straps w/ split ring 1 1/16"x28"</b>



Bashlin 85N



Bashlin 86N



Bashlin 87N



Bashlin 89N



# Bashlin Climbing Equipment

## Wing Pad

- This wing pad holds the shank more securely than other leather pads
- The climber shank fits inside the pad, reducing movement and adding comfort
- Available with or without padding

**Bashlin 140D**    Not Padded  
**Bashlin 140DS**    Padded



## 145 Series Climber Pads

- Features extreme comfort and gives increased climber support
- Double strap design with "spur stay irons"
- Fits Bashlin steel and aluminum climbers
- One pair climber straps included with pads

**145**    Without steel inserts  
**145 AC**    For Steel Climbers  
**145 BC**    For Aluminum Climbers



## Lineman's Holsters



**Bashlin 111HLS**

**Bashlin 111HLDS**

- Reinforced double backs for extra wear
- Available in tan or black
- 111HLS and 111HLSX will hold pliers, rule, screwdriver, Channellock, knife or wrench
- 111HLDS and 111HLDSX will hold pliers, rule, screwdriver, Channellock, ratchet driver, knife or wrench

<b>Bashlin 111HLS</b>	<b>4 Pockets</b>	<b>Tan</b>
<b>Bashlin 111HLSX</b>	<b>4 Pockets</b>	<b>Black</b>
<b>Bashlin 111HLDS</b>	<b>5 Pockets</b>	<b>Tan</b>
<b>Bashlin 111HLDSX</b>	<b>5 Pockets</b>	<b>Black</b>

## Hook-N-Loop Climber Pads



**Bashlin 145BCV**

- No straps and buckles for easy donning
- Comfortable wrap-around padding
- Fit most standard climbers
- 145 ACV AND 145 BCV feature a metal insert for positive climber control
- 150V features the standard "T" design

**Bashlin 150V**    Climber Pad

**Bashlin 145 ACV**    for Steel Climbers

**Bashlin 145 BCV**    for Aluminum Climbers

## Lowell Wrench Holster



- Reinforced double back for extra wear
- Designed to hold Lowell wrenches
- (tool not included)

**Bashlin 111LWH**    Tan

**Bashlin 111LWHX**    Black

## 25BS: Bashlin Bolt & Nut Bag



- Canvas
- Reinforced base
- Snap or thong attachment

## 78 Series Pole Straps



- 2 plies of pliable latigo leather straps featuring a nylon insert
- Stitching is deeply embedded in the leather for longer wear
- "HL" snap is very similar to the movements used with the single locking snap

**Bashlin 78X-2HL**    5'6" long

**Bashlin 78A-2HL**    6' long

**Bashlin 78B-2HL**    6'6" long

## 50 Series Pole Straps



- 6 ply 1 3/4" neoprene-coated nylon uses a tongue buckle adjustment
- "HL" Snap is similar to the movements used with the single locking snap

**Bashlin 51N-2HL**    5'6" long

**Bashlin 52N-2HL**    6' long

**Bashlin 53N-2HL**    6'6" long



# Buckingham

## SuperSqueeze

The SuperSqueeze offers superb Wood Pole Fall Restriction and offers the easiest adjustment on the market. With Buckingham's patent pending WebGrab, the SuperSqueeze can be adjusted with just a flick of the wrist. The SuperSqueeze can be configured to fit many climbing styles and needs, and its modular design makes it easy to change out worn or damaged components or straps in the field.



Featuring rope inner strap; features snap hooks on woven strap  
**Model 488RQ4 for Distribution**  
**Model 488RTQ4 for Transmission**  
 Featuring Rope Inner Strap and Carabiners:  
**Model 488R for Distribution**  
**Model 488RT for Transmission**



Featuring woven inner strap; features snap hooks on woven strap  
**Model 488W2Q3 for Distribution**  
**Model 488TW2Q3 for Transmission**  
 Featuring Woven Inner Strap and Carabiners:  
**Model 488W2 for Distribution**  
**Model 488TW2 for Transmission**

## 2011 482D BuckSqueeze Wood Pole Protection Device

Buckingham has yet again enhanced the BuckSqueeze by adding their WebGrab to the green strap for even easier adjustment. In production since 2000, the BuckSqueeze is the most widely used Wood Pole Fall Restriction Device in the U.S. With thousands in use and numerous documented saves, the BuckSqueeze provides Wood Pole Fall Protection during ascent and descent.



Featuring the Patent Pending Web-Grab for the Easiest Adjustment for the Circumference of the Pole

**2011 BuckSqueeze with WebGrab**  
**Model 482D - For Distribution Poles**  
**Model 482T - For Transmission Poles**  
**4305 Rainbow Cresote Remover (Case of 12)\***  
**4494 Brush (Case of 12)**  
 2010 BuckSqueeze models may be updated with webgrab.



WebGrab Adjustment

## 2010 483D BuckSqueeze Wood Pole Protection Device



BuckSqueeze is a Wood Pole Fall Restriction Device that provides:  
 Wood Pole Fall Protection during ascent and descent  
 With the use of a secondary lanyard like the BuckAdjuster, protects the user while climbing over obstacles  
 Designed to grip the pole if the user starts to fall  
 For distribution poles with a circumference up to 50" (16" diameter)

**483D Distribution (Max: 50" Circumference)**  
**484T Transmission (Max: 90" Circumference)**  
**4305 Rainbow Cresote Remover (Case of 12)**  
**4494 Brush/Case of 12**

## Ox Block

- A rope snatch block with an integrated friction bar used for hurt man rescue, lowering loads, snubbing loads, and raising loads
- Allows the rigging professional to handle loads with greater control
- When lowering loads, tension is transferred from the worker to the OX BLOCK™
- Replaces standard handline blocks, parted blocks, and various snatch blocks has greater working load limits than blocks of similar size



## SuperStrap

Buckingham's SuperStraps have the same, easy-to-use adjustment as the popular BuckAdjuster.

### Secondary Web Lanyard

- Features the patent pending WebGrab for easy adjustment
- Features all the benefits of web combined with the easy adjustment of rope
- Designed to use for climbing over obstructions



48129W2Y-6	6' length
48129W2Y-7	7' length
48129W2Y-8	8' length
48129W2Y-9	9' length
48129W2Y-10	10' length

### Secondary Web Lanyard / Positioning Strap

- Features the patent pending WebGrab for easy adjustment
- No more holes to find or run out of as with conventional positioning straps
- Made from 6 ply neoprene nylon with red warning core
- Available in any length with 2 snaps



336099E	6' length
336699E	6.5' length
337099E	7' length
337669E	7.5' length
338099E	8' length

## 4812Y-7: Positioning Strap



- Woven Nylon with Friction Buckle and 99E Locker
- Uses a friction buckle in conjunction with a carabiner
- Length - 7'

## 9-8: BackAdjuster



- Fully adjustable positioning rope lanyard
- 8' in length and 1/2" in diameter
- With a red core wear indicator
- Features the patent pending BuckGrab
- Clear protective tube lengthens rope life
- Stitched eye allows user to minimize length for easy storage
- Available in additional lengths upon request

## 2402: Handline Carrier



A nylon handline carrier that will straighten when approximately 14-18 lbs of pressure is applied, allowing the hand line to pull free

## C2019M: Stacked 4 Dee Dri-Lex® Body Belt with BackSaver

- A new version of the lightweight Dri-lex® lined body belt with stacked dee rings
- Ideal for use with a secondary lanyard
- 2 large full float double bar dees 2 small dees
- Back support; no gut strap
- Weight 6.35 lbs
- CSA Approved



C2019M D22	C2019M D27
C2019M D23	C2019M D28
C2019M D24	C2019M D29
C2019M D25	C2019M D30
C2019M D26	C2019M D31

## C2018M: Full Float 4 Dee Dri-Lex® Body Belt with BackSaver

The stacked 2018M 4 dee body belt features:

- Dri-lex® lining
- Stacked dee rings
- 2 large full float double bar dee
- 2 small dee rings
- Removable man rated gut strap (must be used with a Buckingham provided gut strap)
- CSA approved



C2018M D23	C2018M D28
C2018M D24	C2018M D29
C2018M D25	C2018M D30
C2018M D26	C2018M D31
C2018M D27	



# Buckingham

## C2000M: Full Float Leather Body Belt



- Leather belt strap with nylon center for strength
- Floating dees provide 4" lateral movement
- Hand crafted with 5 1/2" foam cushioned pad reinforced with rawhide lace
- Weight 7 lbs.
- Add suffix 'E' to order with 4 in line dee rings
- CSA Approved

Black	Brown
C2000M-BL D20	C2000M-BR D20
C2000M-BL D21	C2000M-BR D21
C2000M-BL D22	C2000M-BR D22
C2000M-BL D23	C2000M-BR D23
C2000M-BL D24	C2000M-BR D24
C2000M-BL D25	C2000M-BR D25
C2000M-BL D26	C2000M-BR D26
C2000M-BL D27	C2000M-BR D27
C2000M-BL D28	C2000M-BR D28

## 2100M: 4 Dee Body Belt

- The high-quality features of the 2000M with stacked dee rings
- Ideal for use when a secondary lanyard is used to climb over obstructions
- Highest quality leather with a 5 1/2" foam cushioned pad reinforced with rawhide lace, bridge pieces and belt straps crafted of leather with a nylon center to provide strength and longer life, and full floating primary dee rings that provide 4" lateral movement to reduce the wear on the pole strap
- 2 large full float double bar dee rings; 2 small dee rings
- 9" back pad
- Waist strap only; no upper gut strap
- Weighs 7.8 lbs

- 2100M D21
- 2100M D22
- 2100M D23
- 2100M D24
- 2100M D25
- 2100M D26
- 2100M D27
- 2100M D28



## 2107M-4: Dee Body Belt



- The high-quality features of the 2000M with stacked dee rings
- Ideal for use when a secondary lanyard is used to climb over obstructions
- Highest quality leather with a 5 1/2" foam cushioned pad reinforced with rawhide lace, bridge pieces and belt straps crafted of leather with a nylon center to provide strength and longer life, and full floating primary dee rings that provide 4" lateral movement to reduce the wear on the pole strap
- 2 large full float double bar dee rings; 2 small dee rings
- 9" back pad
- Waist strap only; no upper gut strap
- Weighs 9.2 lbs

## Buck ErgoBelt



Over the years, Linemen have had to adapt to the equipment they use causing stress and strain on their bodies. Buckingham teamed up with Ergonomic Specialists to design a line of products specifically designed for use by Linemen and Arborists that better fit the skeletal structure. The new Ergovation line from Buckingham makes hard work more comfortable, safe and productive.

- A. Abdominal Stabilizer System** - Elastic Abdominal Stabilizer belt maintains continual pressure and proper position of Lumbar Pad
- B. Dee Ring Distributing Pads** - Distributes pressure from the heel of dee by disbursing pressure over a greater area
- C. Equalization Strap** - When in work position, transfers users weight from back support to seat section or seat section to back support
- D. Lumbar Pocket** - Removable lumbar pad for ideal back support
- E. Harness Attachment Buckles** - Attach harness to belt with man rated straps. Specify 4C after harness model number
- F. Removable Seat** - Connects to upper belt using steel interlocking T buckles, BuckSqueeze can connect to the lower D rings for increased comfort, provides hip support for ultimate comfort and support, and seat D rings are adjustable for ideal placement and comfort of the individual while climbing

## C4200: Buck LineBacker

- Offers ergonomic advantages and turns a two dee belt into a four dee belt
- LineBackers feature an abdominal stabilizer, dee ring distributing pads, and lumbar support (removable in Model 4201, permanent in Model 4202)
- The deluxe Model 4201 also features harness attachment buckles to attach to a harness
- CSA approved



Model 4201 - Deluxe LineBacker



Model 4202 - Deluxe LineBacker



To size the Buck ErgoBelt, Buck LineBacker and the Buck LineBacker Deluxe for proper fit, the 'A' and 'B' measurements are required:

- Measurement 'A' is measured approximately 2" above waist and from center of hip bone (seam of shirt) around the small of the back to the center of hip bone (seam of shirt) on other side
- Measurement 'B' is from center of navel around the small of the back to the center of navel. Measurement 'B' is taken in the same location as measurement 'A'

## Man Rated Gut Straps

- Use with any two dee body belt
- Completely adjustable for user's comfort
- Belt features 5000 lbs man rated connections and leather-lined strap

Belt Size	Waist Size
Small	28-32
Medium	32-36
Large	36-40
X-Large	40-44



Model 6263 features a standard tongue buckle



Model 6264 features easy-to-use quick connect buckles



TRUSTED SINCE 1958

# Buckingham

## TB94089A: Titanium Replacement Gaff Pole Climbers



This popular choice Titanium Pole Climber offers:

- Contoured shank
- Off-set stirrup
- 16 degree dowel and screw replaceable gaffs
- 21391 nylon foot straps
- Includes standard length sleeves [9204] adjusting from 16 1/4" to 18 3/4". Long sleeves, adjusting from 19 1/4" to 21 3/4", may be ordered [9202]. Add suffix 'L' to the climber part number for long sleeves
- Climber with gaff weighs 1 lb 2 oz

## T94089A: Titanium Pole Climber - Non-Contoured Shank



- Non-contoured shank
- Off-set stirrup
- 16 degree dowel and screw replaceable gaffs
- 21391 nylon foot strap
- Includes standard length sleeves [9204] adjusting from 16 1/4" to 18 3/4". Long sleeves, adjusting from 19 1/4" to 21 3/4", may be ordered [9202]. Add suffix 'L' to the climber part number for long sleeves
- Climber with gaff weighs 1 lb 2 oz

## SB94089A - Steel Replaceable Gaff Pole Climbers

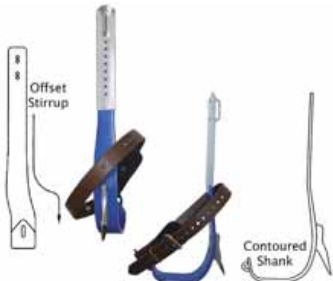

This popular choice Steel Pole Climber offers:

- Contoured shank
- Offset stirrup
- 16 degree dowel and screw replaceable gaffs
- 21391 nylon foot straps
- Includes standard length sleeves [9204] adjusting from 16 1/4" to 18 3/4". Long sleeves, adjusting from 19 1/4" to 21 3/4", may be ordered [9202]. Add suffix 'L' to the climber part number for long sleeves

## Buckingham 6909U: Universal Fit Gaff Guard



- Universal coated wire pole gaff guard made to fit all Buckingham, Bashlin, Klein and Stringer Brooks pole climbers

## Dowel & Screw Replaceable Climbers

- Buckingham Replaceable Climbers are now even easier to replace! The Dowel and Screw Replaceable Climber Gaffs are available for any climber issued after January 2011.



For use with all T, TB & SB replaceable gaff pole climbers  
**Model NB9106A CCA**



For use with all T, TB & SB replaceable gaff pole climbers  
**Model NB9206A**

## Buckingham 6909A: Snap On Gaff Guard

- Easy Snap On Gaff Guard fits all Buckingham replaceable pole gaffs with a 16° angle
- (A style)



## 35032: Climber Pad



- Leather 'C' pad designed with a metal insert and oversized felt liner for additional comfort
- Liner edge minimizes chafing on the leg. New improved inserts won't bend and insert loop has been modified to prevent sleeve roll out
- Requires a 26" strap (sold separately)

## 3502C: The Original Velcro® Wrap Pad with Insert



- An angled style Velcro® pad that features a continuous wrap with a metal insert
- Measures 4"W with 3/4" padding
- Rolled edge to prevent chafing
- Stitched tunnel for a secure fit
- Cinch loop provides tight fit

## 3500C: The Original Velcro® Wrap Pad with Cinch Loop

- A Velcro® pad that features a cinch loop
- No metal insert
- Measures 4"W with 3/4" padding
- Rolled edge to prevent chafing
- Stitched tunnel for a secure fit
- Cinch loop provides tight fit



## 3203C: Big Buck Wrap Pad



- The adjustability of the hook and loop wrap pad, the increased surface area of the Big Buck pad and a Dri-lex lining

## 3120: Leather Climber Pad

- A quality leather pad with 3 loops and a tunnel design to keep climber stationary
- All leather construction with 3/4" padding



## 3118: Big Buck Leather Climber Pad



- Utilizes a double strap system that fits 1" and 1 1/4" straps to secure the pad to the calf for superior support
- Angled metal insert keeps climber shank from shifting on calf and thick felt padding adds to the overall comfort
- Includes a pair of 2639 straps but requires two pairs
- Measures 9" H x 12 1/2" W

## 3126: Leather Climber Pad

- A comfortable 'L' pad that features a closed cell foam filler that prevents the climber shank from irritating the user's leg
- The rolled edges prevent chafing to the calf muscle
- A slightly heavier pad that provides maximum comfort
- Requires a 26" strap



## 2639: Nylon Leg Strap



1" W x 26" L

# Buckingham

## 8VV116+Z Buckyard Shock-Absorbing Lanyard



- For use with a full body harness with steel ring dorsal attachment
- Expands to 42". Interior materials stretch to reduce the arresting force to less than 900 lbs
- 17061 locking snap hook on both ends
- Length: 6 ft
- Meets ANSI Z359.1-2007 for a 3600 lbs gate

## 84V716 Buckyard Stretch Shock-Absorbing Lanyard

- Same benefits of the Buckyard but with the addition of an elastic bungee; this reduces the size of a 6' lanyard to about 44", greatly reducing the chance of tripping over it
- For full body harness w/web loop dorsal attachment
- 1706 locking snap hook on one end and web loop on the other end



## 64V7A26E+Z Tie Back Shock-Absorbing Lanyard

- Designed to be wrapped around a 5,000 lbs anchor and connected back to itself via an adjustable dee ring
- In a fall, force is reduced with a built-in shock pack
- May be ordered in lengths greater than 6' to allow the user to wrap to the anchor point and still have freedom of movement



## Tower & Rescue Harness



- 61995-M Medium
- 61995-L Large

- 'H' style full body harness with built in body belt
- Frontal dee adjusts independently
- Type 13 nylon webbing
- Vest like Dri-lex shell wicks moisture
- Dri-lex shoulder, leg pads for comfort
- PVC shoulder loops to stow lanyard hardware
- Quick connect buckles on chest / leg straps
- Steel dee dorsal attachment and spring-loaded friction buckles used for height adjustment

## 6393700 - 'H' Style Full Body Harness



- An 'H' style full body harness featuring a web dorsal loop attachment
- Hook and loop chest strap that meets ANSI Z359.1 requirements
- Interlocking leg strap buckles with leather chafes
- Standard friction buckle for height adjustment
- Made from Type 13 nylon webbing with orange upper and black lower sections.
- Meets ASTM F887 Electric Arc Performance Requirements

Kit: Includes large harness & 6' Length Buckyard Stretch Lanyard

## BuckFit Harness



- 68D7G8C600V9-L Large\*
- 68D7G8C600V9-XL X-Large

- 'H' style full body harness with steel dee for dorsal attachment
- Dri-lex shell for moisture control
- Padded Dri-lex shoulder and leg pads
- Spring loaded friction buckles for height adjustment
- ANSI approved
- Quick connect buckles with leather chafes
- Type 13 nylon webbing

## BuckFit FR Harness



- Steel Dorsal Dee. 'H' style full body harness
- Mesh shell for breathability
- FR foam pads
- Split tongue quick connect with leather chafes on the legs and chest straps
- ANSI approved
- Spring loaded friction buckles for height adjustment
- Meets ASTM F887 Electric Arc Performance Requirements

- 68D7G8C600K1-L Large
- 68D7G8C600K1-XL X-Large



## 3813: Hurt Man Bucket Truck Rescue System

- Ideal for lifting a hurt man easily and quickly
- Pulleys are made of stainless steel and have a 4:1 lifting advantage
- 95' of 7/16" diameter rope that can support a load up to 1700 lbs
- Designed to mount permanently and high up on the boom



## 105RS: Suspension Trauma Rescue System



- Designed to alleviate the effects of orthostatic intolerance known as suspension trauma
- Allows a victim to deploy a body support system that allows for improved blood circulation and the ability to move and flex muscles until rescue
- Attaches to any full body harness
- Adjustable for any sized user

## 355BT: Buck Ladder Lock System



- A ladder safety solution Includes ladder safety straps enclosed in weather resistant bags that are attached to your ladder
- Provides quick access to straps
- Includes top and bottom storage bags and straps

## 101SR-50: High Elevation Self Rescue System

- Provides all components necessary for self-rescue or aiding in rescuing a fellow worker
- The descender stops the user until the handle is compressed allowing for a smooth, controlled descent; also stops if the handle is compressed too hard (50' 1/2" braided rope)



## 301SR: Self Rescue System



- Features a new lightweight, compact design
- The lightweight descender is manufactured from aircraft grade aluminum and features an anti-panic release brake which will stop the descender if the user releases or compresses the descender all the way
- TVAC descent line measures 6.8mm and is compact and stands up to heat on long descents
- Weather-resistant nylon bag with a mesh bottom lets moisture escape
- Meets ANSI Z359.4 - 2007

301SR-50	37' and 40' Truck Self Rescue Kit, 50' of Rope
301SR-65	55' Truck Self Rescue Kit, 65' of Rope
301SR-110	100' Truck Self Rescue Kit, 110' of Rope
301SR-160	150' Truck Self Rescue Kit, 160' of Rope

# DBI Sala® - Harnesses

## ExoFit NEX™: Vest-Style Full Body Harness

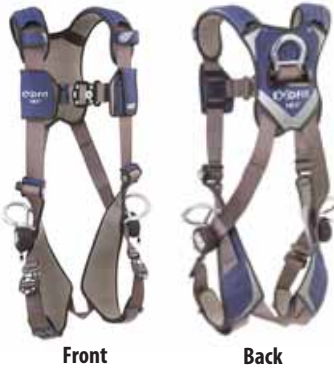

Front

Back

- Aluminum back and side D-rings, locking quick connect buckle leg straps, comfort padding
- Hybrid shoulder, back and leg comfort padding
- Stand-up Tech-Lite™ aluminum back D-ring
- Tech-Lite™ aluminum side D-rings
- Duo-Lok™ quick connect chest and leg straps
- Repel™ webbing
- Loops for body belt
- Protective shoulder caps
- Built-in lanyard keepers
- Revolver™ vertical torso adjusters
- Impact Indicator
- Integrated trauma straps
- Built-in reflective materials
- Protected labels, equipped with i-Safe™

## ExoFit NEX™ Arc Flash: Vest-Style Full Body Harness



Front

Back

- Tongue buckle style lineman body belt (size D25)
- Belt made with 100% top grain leather from Red Wing, MN
- PVC coated steel back D-ring, locking quick connect buckle leg straps, Nomex®/Kevlar® web and comfort padding (size large) with 100% top grain leather 2D lineman belt (size D25)
- Arc flash rated
- Nomex®/Kevlar® shoulder comfort padding
- Duo-Lok™ quick connect chest and leg straps
- Leather insulators
- Nomex®/Kevlar® webbing
- Built-in lanyard keepers
- Revolver™ vertical torso adjusters
- Impact Indicator
- Built-in reflective materials
- Protected labels, equipped with i-Safe™
- 2 large S-shaped full-floating D-rings at hips
- Built-in tool snaps, rings and tape thong
- Available in other harness sizes and belt sizes D18 through D30

## Exofit™ XP: Vest-Style Full Body Harness



Front

Back

- Back D-ring, tongue buckle leg straps, removable comfort padding
- Removable shoulder, back and leg comfort padding
- Stand-up back D-ring with impact indicator
- Quick connect chest strap
- Tongue buckle leg straps
- Soft, lightweight webbing
- Loops for body belt
- Built-in lanyard keepers
- Parachute torso adjusters
- Protected labels, equipped with i-Safe™

## Delta: Vest-Style Full Body Harness

- No-tangle design
- Stand-up back D-ring
- Front D-ring
- Tech-Lite™ quick connect buckle leg straps
- Repel™ webbing
- Built-in lanyard keepers
- Revolver™ vertical torso adjusters
- Impact Indicator
- Protected labels, equipped with i-Safe™



## Single Leg Tool Lanyard

- Tool lanyard with single leg
- Provides dropped object protection
- 15 lbs (6.8 kg) capacity
- Stretch design extends and automatically retracts
- Choker and carabiner connectors
- Fast and easy installation
- Extremely compact and lightweight design



## Twin Leg Tool Lanyard

- Tool lanyard with twin leg
- Provides dropped object protection for two tools
- 30 lbs (13.6 kg) capacity
- Stretch design extends and automatically retracts
- Carabiner connectors at both ends
- Fast and easy installation
- Extremely compact and lightweight design



## Shockwave™2 Lanyard

- 6 ft (1.8m) single-leg lanyard
- Stretches in reaction to your movements
- Abrasion resistant polyester tubular webbing
- User friendly self locking snap hooks at each end
- Energy absorbing design limits fall arrest forces
- Built-in impact indicator
- Protected labels, equipped with i-Safe™
- Also available in double-leg and web loop
- Available in E4 and E6 class



## Shockwave™2 Arc Flash Lanyard

- Arc flash rated
- 6 ft (1.8m) single-leg lanyard
- Stretches in reaction to your movements
- Nomex®/Kevlar® fire resistant webbing
- User friendly self locking snap hooks at each end
- Energy absorbing design limits fall arrest forces
- Built-in impact indicator
- Protected labels, equipped with i-Safe™
- Also available in double-leg and web loop
- Available in E4 and E6 class



## EZStop™II Shock Absorbing Lanyards

- 6 ft (1.8m) web single-leg with snap hooks at each end
- Extremely compact and lightweight
- Exclusive Hi-10™ Vectran™ energy absorption system
- Repel™ webbing
- User friendly self-locking snap hooks at each end
- Built-in reflective materials
- Impact indicator
- Protected labels, equipped with i-Safe™
- Also available in Tie-Back, Tie-Off and Polyurethane and Kevlar®



## EZStop™II Arc Flash Lanyards

- Arc flash rated
- 4 ft (1.2m) single-leg lanyard
- Durable, yet lightweight materials
- Nomex®/Kevlar® soft pack energy absorber
- Kevlar® fire resistant webbing
- Energy absorbing design limits fall arrest forces
- User friendly self locking snap hooks at each end
- Impact indicator
- Protected labels, equipped with i-Safe™



## Web Positioning Lanyard

- Single-leg lanyard
- Ideal for work positioning or restraint
- Abrasion resistant polyester webbing
- Built-in wear indicator
- User friendly self locking snap hooks at each end
- Equipped with i-Safe™
- Available in 2' to 9'



# DBI Sala® - Lanyards

## CynchLock Pole Climbing Device

- Lightweight pole climbing design
- For distribution pole sizes 5.5" dia./17.5" circ (14/45cm) min, 18.5" dia/58" circ. (47/147cm) max
- Extremely durable pole strap with wear indicator
- One-handed effortless adjustment
- Pinch-free ergonomic grips
- Stopping cleat and carabiner
- Durable polyester web
- Lightweight and durable rope adjuster
- Modular design with field replaceable straps
- Protected labels, equipped with i-Safe™



## Lanyard Hooks



One-hand operation makes DBI-SALA® snap hooks the most popular in the industry. You can even operate them with your gloves on. Open and close without getting your fingers in the way! All DBI-SALA® lanyards feature 3600 lb (16kN) rated gates, meeting the rigorous ANSI Z350 standard. Speak to an LTL Product Specialist about the complete line of DBI-SALA® lanyard hooks.

**Image shown: Standard Hook**

## Saflok™ Carabiners

Saflok™ carabiners are the unsung heroes of most safety systems. They securely attach one component to another and offer maximum strength - 5000 lb (22kN) minimum breaking strength and 3600 lb (16kN) gate strengths. Designed for easy securing, they are self closing and self locking to keep all components of your safety system firmly attached. Speak to an LTL Product Specialist about the complete line of Saflok™ Carabiners.



**Image shown: 11/16 in. (17.5mm) gate opening steel carabiner with self closing/locking gate**

## Ultra-Lok™ Self-Retracting Lifelines

- Rugged and extremely lightweight thermoplastic housing
- Semi-sealed design
- Available in 11' to 85'
- Stainless steel dynamic components
- Internal energy absorption system
- Anti-ratcheting twin disk brake system
- Constant moving brake system pawls
- Swiveling anchorage point
- Swiveling snap hook with impact indicator
- Reserve lifeline system
- Ergonomic cable handle equipped with i-Safe™



## Rollgliss Rescue & Descent Devices

- Emergency rescue and evacuation from a wide variety of elevated work areas
- Fully automatic controlled descent
- Bi-directional design enables multiple rescues
- Built-in rescue lifting wheel
- Compact and lightweight design
- High strength corrosion resistant construction
- Integrated rope ears
- Dual brake design
- Equipped with i-Safe™
- Kit also contains 4 ft. (1.2m) anchor sling, two carabiners and carrying bag
- Other standard and custom lengths are available
- Models also available without lifting wheel or add a humidity case
- Speak to an LTL Product Specialist about other Rollgliss Rescue and Descent devices



## Talon™ Quick Connect Self Retracting Lifeline

- Built-in connector for direct attachment to harness
- Available in 6' to 9'
- Compact, lightweight design
- Tough and impact resistant thermoplastic housing
- Anti-ratcheting design
- Extremely durable all metal braking system
- Velocity sensing brake
- Self-locking swivel snap hook
- Impact indicator
- Serviceable design
- i-Safe™ equipped



## RSQ™ Dual-Mode Built-in Rescue Operation

- Environmentally sealed dynamic components
- RSQ™ dual-mode design
- Extremely durable construction
- Available in 50', 85' and 130'
- Fast-Line™ lifeline system
- Anti-ratcheting locking system
- Built-in carrying handle
- Swiveling snap hook with impact indicator
- Large pivoting anchorage loop
- Saflok™ anchorage carabiner
- Cable tie-off adaptor x 4 ft. (1.2m) with carabiner
- Reserve lifeline system
- Ergonomic cable handle equipped with i-Safe™



## Pro™ Climbing Harness



- Back D-ring
- Front D-ring
- Tongue buckle leg straps
- Parachute torso adjusters
- Durable polyester web construction
- Built-in lanyard keepers
- Impact Indicator
- Protected labels
- Available sizes: S-XL

## Pro™ Vest-Style Harness with Comfort Padding



- Shoulder, back and leg comfort padding
- Back D-ring
- Side D-rings
- Quick connect buckle leg and chest straps
- Parachute torso adjusters
- Durable polyester web construction
- Built-in lanyard keepers
- Impact Indicator
- Protected labels
- Available sizes: S-XL

## Pro™ Adjustable Shock Absorbing Lanyard

- Single-leg lanyard
- Lightweight user friendly design
- PVC shock pack with protected label
- Abrasion resistant polyester webbing
- Energy absorbing design limits fall arrest forces
- User friendly self locking snap hooks at each end
- Impact indicator



## Pro™ 100% Tie-Off Shock Absorbing Lanyard

- Double-leg 100% tie-off lanyard
- Lightweight user friendly design
- PVC shock pack with protected label
- Abrasion resistant polyester webbing
- Energy absorbing design limits fall arrest forces
- User friendly self locking snap hook at center
- Self-locking steel rebar hook at leg ends
- Impact indicator



## Pro™ Elastic Shock Absorbing Lanyard - E4

- 6 ft. (1.8m) single-leg lanyard
- Stretches in reaction to your movements
- Lightweight user friendly design
- PVC shock pack with protected label
- Abrasion resistant polyester webbing
- Energy absorbing design limits fall arrest forces
- User friendly self locking snap hooks at each end
- Impact indicator
- Also available in E6



# Protecta

## Rebel™ Self Retracting Lifeline - Cable

- Rugged, lightweight thermoplastic housing
- Stackable housing design
- Built-in carrying handle
- Swiveling self-locking snap hook with impact indicator
- Speed sensing all metal brake system
- Internal energy absorption system
- Reserve lifeline system
- Side lifeline exit with ergonomic handle
- High strength, corrosion resistant components
- Swiveling anchorage point
- Self-locking anchorage carabiner
- Available sizes: 33', 50', 66', 85', 100'



## Rebel™ Self Retracting Lifeline - Cable

- Compact, lightweight design
- Rugged aluminum housing
- Swiveling anchorage point
- Swiveling self-locking snap hook on lifeline
- Speed sensing all metal brake system
- High strength, corrosion resistant components
- Kevlar®/Nomex® covered external energy absorber and impact indicator
- Self-locking anchorage carabiner
- Available in 6', 10', 15' and 20'



## AC203C-SA2: Cobra™ Rope Grab with Attached Lanyard

- Mobile and manual rope grab with 2 ft (0.6 m) PRO™ shock absorbing lanyard for use on 5/8" (16 mm) polyester/polypropylene blend rope lifeline
- Mobile design automatically follows user
- Manual option allows user to fix in place
- Cam locking system for safety
- Integral 2 ft. (0.6 m) PRO™ shock absorbing lanyard
- Detachable anywhere along the lifeline
- Durable and lightweight corrosion resistant construction
- For use with 5/8" (16 mm) diameter polyester/polypropylene blend rope lifeline



## AJ450C-6: Cable Tie-Off Adapter

- 6 ft (1.8m) pass-thru type tie-off adaptor
- Durable polyester construction
- Abrasion resistant polyester wear pad
- High strength steel hardware
- Compact and lightweight design



## Compliance in a Can™ Light Roofer's Fall Protection Kit

- Complete all purpose fall protection system in one handy container
- Kit includes 1191201C PRO™ harness, 1341001C PRO™ 6 ft (1.8m) single-leg shock absorbing lanyard and bucket
- Lightweight PRO™ harness with pass-thru buckle legs and 5-point adjustment (model 1191201C)
- PRO™ 6 ft (1.8m) single-leg shock absorbing lanyard (model 1341001C)
- Durable bucket with handle



## 03707: Pole Choker 4

- Wood pole climbing fall arrest
- The Choker Strap is a key component of the Jelco Pole Choker 4 Fall Prevention System
- This 1 3/4" wide, yellow nylon strap squeezes the pole. The roller's teeth dig in and you get the additional resistance provided by 2 sets of grippers
- All this provides the gripping force required to prevent you from falling down the pole
- **CSA certified Z259.14.01 Type AB**  
4.5': 3704, 5.25': 03705, 6.2': 03706



## 03727: Pole Choker 5

- The Choker Strap is a key component of the Jelco Pole Choker 5 Fall Prevention System
- The 1 3/4 inch wide yellow nylon strap squeezes the pole. The roller's teeth dig in to provide the gripping force required to prevent you from falling down the pole
- The difference between the Pole Choker 3 and the Pole Choker 5 is on the PC5; one Saphook has loops
- SIZES - 4.5': 3724, 5.25': 03725, 6.2': 03726**



## 87644: Pole Strap

- The Jelco Pole Strap is a positioning device that is an essential item for all lineman's gear
- The pole strap comes in various lengths, so you can find a size suitable for all situations
- The double-locking snap hooks featured on each end are "lineman friendly" and allow for ease of use even with the thickest rubber gloves
- Jelco offers the pole strap in two different materials; a nylon version and a neoprene impregnated nylon
- Our pole straps meet applicable ASTM F887, CSA Z259.11 and OSHA 1926.959 standards
- SIZES - 5'8": 87611, 6': 87622, 6.5': 87633**



## 549 Series 2 D-Ring Tradition 4" Belt

- This premium belt is characteristic of the high quality products that Jelco has to offer
- The all leather belt offers superior support, while providing a lineman with the softness, most comfortable, and lightweight (under 4 lbs) belt that money can buy
- It features a 4" backpad that fits and feels like your favorite "broken-in" lineman's belt that you have had for years, right out of the box. The Tradition belts' full floating design offers linemen the convenience of full range of motion, while performing all tasks and operations.
- Outside all natural leather for comfort and support
- Large forged, positioning D rings for easy clip on action. The belt features a glove bag ring, knife snap and tape thong
- All of our lineman's belts comply with CSA and ASTM linemen's belt sizing standards
- Colour: Caramel
- SIZES - 18: 80821, 19: 80822, 20: 80823, 21: 80824, 22: 80825, 23: 80826, 24: 80827, 25: 80828, 26: 80829, 27: 80830, 28: 80831, 29: 80832, 30: 80833**



## 550 Series 4 D-Ring Tradition Belt with Tongue Buckle and Quick Connect

- This belt has the same "broken-in" feel as our 2 D-Ring Tradition belt, but features 4 D-Rings
- The placement of the 4 D-Rings is two at the top of the belt, and two at the bottom of the belt, which is the traditional location
- The 2 additional D-Rings located at the top provide a place to park your secondary safety
- The all-leather lineman's belt not only has a leather exterior, but features a padded leather interior as well
- This style 4 D-Ring belt features two belts, at the top and the bottom
- The top belt features quick-connects, that once adjusted, can simply be quickly connected with the buckle - the bottom belt features the classic tongue buckle
- Colour: Black
- SIZES - 18: 86861, 19: 86862, 20: 86863, 21: 86864, 22: 86865, 23: 86866, 24: 86867, 25: 86868, 26: 86869, 27: 86870, 28: 86871, 29: 86872, 30: 86873**



## Lineman Combo Harness Grommets/Mating



- Issued from the 649H series, this linesman combo harness is one of Jelco's classics
- The chest strap is held in place by velcro

SIZES - 18: 43011, 19: 43012, 20: 43013, 21: 43014, 22: 43015, 23: 43016, 24: 43017, 25: 43018, 26: 43019, 27: 43020, 28: 43021, 29: 43022, 30: 43023

## Lineman Combo Harness Grommets/Quick



SIZES - 18-43901, 19-43902, 20-43903, 21-43904, 22-43905, 23-43906, 24-43907, 25-43908, 26-43909, 27-43910, 28-43911, 29-43912, 30-43913

## 21213: 7' Retractable Lanyard Mounted on a Swivel Plate and Number 17253 Auto-Locking Aluminium Carabiner with Pin on the End



## 21212: 7' Retractable Lanyard on Swivel Plate with Shock Absorber



- 7' retractable lanyard mounted on a swivel plate and has a shock absorbing lanyard on the other end
- It comes equipped with number 13150 double-locking carabiner on the shock absorbing end and an ultra light aluminium auto-locking carabiner number 13151 which is held in place by the pin on the retractable end

## 21450: Self-Retracting Lifeline



- The Jelco self-retracting lifeline automatically stops a person's fall
- The self-retracting lifeline is intended to connect to a structure while the user is moving directly under the self-retracting lifeline
- The device automatically takes up slack in the wire rope, keeping it out of the way while minimizing the free fall distance, should a fall occur
- In the event of a fall, the sudden jerk in the wire rope will activate the centrifugal locking mechanism, arresting the fall within 2 ft (0.6 m)



# Klein Climbing Equipment

## Pole Climbers with Gaffs - Sets



- 8" x 8" cushioned, high-grade leather climber pads
- Neoprene-impregnated nylon climber straps
- 4 7/16" wide stirrup provides greater foot support
- Contoured leg irons help position gaffs securely and comfortably
- CN1972AR and CN1972ARL are CCA pole gaffs, designed to penetrate the hardest salt-treated poles
- CN1986AR and CN1986ARL Gaffs are longer in length and wider in angle than 1 1/2" gaffs for exceptional resistance to cutouts
- To determine size needed, measure from in-step to 1" below knee; sold in pairs only

Part #	Gaff Size	Length
CN1972AR	1 1/2"	15"-19"
CN1972ARL	1 1/2"	17"-21"
CN1986AR	1 9/16"	15"-19"
CN1986ARL	1 9/16"	17"-21"
CN1907AR	2 3/4"	15"-19"
CN1907ARL	2 3/4"	17"-21"

## 1972G: Snap-On Gaff Guard



- Coil-spring, plastic coated guard quickly snaps onto pole climbers
- Sold in pairs only

## 1945G: Removable Gaff Guard



- Long-lasting leather construction with genuine velcro® brand touch fastener strap
- Sold in pairs only

## Gaff Sharpening Kit for Pole Tree Climbers



- Contains the following:
- (1) 8" fine-tooth file
  - (1) 3" honing stone
  - (1) Klein gaff gauge,
  - (1) fully-illustrated gaff sharpener instructions
  - (1) handy roll-up canvas case with tie

## 52006-8: Klein Polemaster



- Abrasion-resistant inner strap material for durability - includes red wear indicator
- Outer strap constructed of Klein-Kord material - a proven material for years with linemen
- Wood pole diameter range from 8" - 16"
- Cam bracket system for easy adjustments
- Connecting hardware conforms to ASTM F887, ANSI Z359.12 and CSA Z259-12, Class 1 requirements
- The Wood Pole Fall Restrict Device has been designed to meet CSA Z259.14-01 standard as a Type A Fall Restrict Device
- Do NOT use on icy poles
- Made in the USA

## 8220: Velcro Climber Pads



- 4" of Velcro provides the maximum amount of adjustability
- Continuous wrap with metal cinch loop for quick attachment and ease of use
- Extra wide cuff fastens around the calf
- Padded for additional comfort
- Klein Velcro® Climber Pads meet the requirements of ASTM F887

## Klein Positioning Strap

- Internal lock mechanism
- Elongated 6 1/2" snap hook is easy to use with even the thickest gloves and has a 5,000 lb. proof-loaded rating
- Meets or exceeds OSHA requirements and ASTM and CSA standards
- Red wear indicator alerts user when strap needs to be replaced
- 6-ply, 1 3/4" wide Klein-Kord®



KG5295L	5'8"
KG5295-6L	6'
KG5295-6-6L	6'6"
KG5295-7L	7'
KG5295-8L	8'



## ArcSafe® Harness



- Maintenance and utility workers are protected from the hazard of high-energy electric arc flash while wearing ArcSafe® Harnesses. This harness may also be used for retrieval from a confined space
- The nylon web loop that is included adds comfort by reducing overall harness weight and also reduces potential of electrical arc to the harness
- SEI-Certified to the requirements of the ASTM F887-05 standard for arc flash protection up to 40 cal/cm<sup>2</sup>
- Nylon web loop attachment points
- Certified to CSA Z259.10-06
- Integral load indicator
- 400lbs capacity
- Y-shaped back web loop locator pad provides comfort by moving the webbing away from the wearer's neck
- Colour-coded leg and torso straps simplify donning
- Downward-adjusting torso straps ease adjustment
- Meets all applicable OSHA regulations and ANSI Z359.1 standards

**10070439 ArcSafe Vest-Style Harness, BACK, HIP & BELAY WEB Loops, Qwik-Fit leg straps, Standard (STD)**

## ArcSafe® Lanyard

- Providing electrical arc flash protection, ArcSafe® Lanyards use a tear-tape design to keep fall arrest forces below 900 lbs ArcSafe® Energy Absorbing Lanyards connect the back (dorsal) D-ring of MSA full-body harnesses to a qualified anchorage and anchorage connector
- Limits average fall arrest forces to 900 pounds/6 kN or less
- Constructed of nylon webbing; length is adjustable
- Includes sewn loop on shock-absorber end and LS snaphook on lanyard leg
- Incorporates a protective cover over the energy



**10060139 ArcSafe Single-Leg Energy-Absorbing Lanyard, 6', Hitch Loop, 36C steel snaphook, CSA Z259.11**

## Workman® Energy-Absorbing Lanyard



- When free-fall distance can exceed two feet, use a lightweight, low-profile Workman® Energy-Absorbing Lanyard
- The energy absorber not only limits force on the body in a fall, but also on the anchor location. The shock absorber includes a clear, durable protective cover over the labels to increase service life and allow for easy inspection
- Tear-tape design to keep average fall arrest forces below 900 lbs/6kN
- Choice of single- or twin-leg configurations
- Choice of adjustable or tie-back configurations

**10072473 Workman Twin-Leg Energy-Absorbing Lanyard, 6', (2) 36C snaphooks, Tieback version, CSA Z259.11**

**10072475 Workman Twin-Leg Energy-Absorbing Lanyard, 6', 36C snaphook & (2) 36CL Rebar snaphooks, CSA Z259.11**

## Workman® Personal Fall Limiters



- The Workman Personal Fall Limiter (PFL) and the Workman Twin Leg Personal Fall Limiter are two of the most versatile fall protection devices available on the market today
- The Workman PFL has a fast acting brake mechanism, and the Workman Twin Leg PFL offers a great alternative to twin leg shock-absorbing lanyards

**10093358 Workman Web PFL, 0', 36C steel snaphook, Back D-ring connector, CSA Z259.2.2**

## Dyna-Lock® Self-Retracting Lanyard



- The MSA Dyna-Lock® Self-Retracting Lanyards (SRL) are fast-acting fall arresters that limit free-fall distance, deceleration distance and fall arrest forces while allowing user freedom of movement
- The Dyna-Lock SRL is ideal for climbing applications where vertical mobility is needed

**10006468 DYNA-LOCK SRL, Galvanized Wire Rope, Length 50'**

## I'D L: Self-Braking Descender with Anti-Panic Function

- Designed for rescue: lacks gated attachment hole
- Multi-functional handle allows the user to: unblock the rope and control the descent with the hand on the free end of the rope, move more easily on horizontal or low-angle terrain, thanks to the button on the handle, get into position without having to tie off the device
- Anti-panic function is engaged if the user pulls too strongly on the handle: brakes and stops the descent automatically
- Anti-error safety catch to reduce the risk of an accident due to incorrect installation of the device on the rope. The shape of the cam is designed to improve rope glide when ascending
- Pivoting cam facilitates taking up the slack in the rope. Can also be used to make a reversible haul system, and for short ascents (in conjunction with a FOOTPRO foot loop and an ASCENSION handled rope clamp)
- Lowers heavy loads up to 272 kg (only for expert users; consult the Instructions for Use for the device)
- Available in two colors

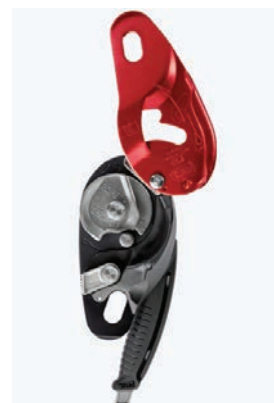

## I'D S: Self-Braking Descender with Anti-Panic Function

- Multi-functional handle allows the user to: unblock the rope and control the descent with the hand on the free end of the rope, move more easily on horizontal or low-angle terrain, thanks to the button on the handle, get into position without having to tie off the device
- Anti-panic function is engaged if the user pulls too strongly on the handle : brakes and stops the descent automatically
- Anti-error safety catch to reduce the risk of an accident due to incorrect installation of the device on the rope. The shape of the cam is designed to improve rope glide when ascending
- The safety gate on the moving side plate helps prevent dropping the device and facilitates installation of the rope when passing intermediate anchors
- Pivoting cam facilitates taking up the slack in the rope. Can also be used to make a reversible haul system, and for short ascents (in conjunction with a FOOTPRO foot loop and an ASCENSION handled rope clamp)
- The locking screw of the swinging side-plate allows the I'D S to be part of a rescue kit
- Lowers heavy loads up to 250 kg (only for expert users; consult the Instructions for Use for the device)
- Available in two colors

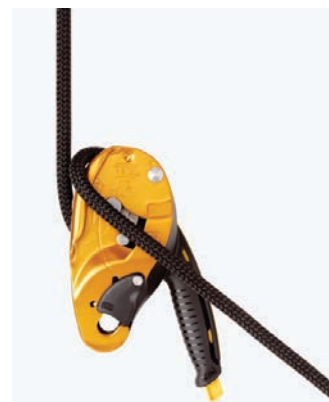

## RIG: Compact Self-Braking Descender

- Designed for rope access work (expert users only)
- Multi-functional handle allows the user to: unblock the rope and control the descent with the hand on the free end of the rope, get into position without having to tie off the device
- The automatic return system on the handle limits risks in case of an involuntary action by the user
- Handle storage position reduces the risk of snagging when the descender is being carried on the harness
- The safety gate on the moving side plate helps prevent dropping the device and facilitates installation of the rope when passing intermediate anchors
- Pivoting cam facilitates taking up the slack in the rope. Can also be used to make a reversible haul system, and for short ascents (in conjunction with a FOOTPRO foot loop and an ASCENSION handled rope clamp)
- Lowers heavy loads up to 200 kg (only for expert users; consult the Instructions for Use for the device)
- Available in two colors



# Petzl - Forestry Rigging

## Grillon: Temporary Horizontal Lifeline

- Allows a horizontal lifeline to be installed quickly when there is a large work surface
- The self-jamming device allows easy adjustment of the length and tension between the two anchor points (make a mule knot on the GRILLON to lock the anchor)
- Semi-static rope, resistant to aging and abrasion
- Sewn terminations on both ends with plastic sheath to keep the connector in position and protect the rope from abrasion
- Available in four lengths



## Grillon Hook

- Lanyard with fine adjustment system for precise work positioning,
- Used in double mode on the harness lateral attachment points to distribute the weight on the belt (user has weight on his feet); length is adjusted by pressing on the pivoting cam)
- Can be used in single mode on the harness ventral attachment point to distribute weight between the waistbelt and the leg loops (user is suspended); length is adjusted by operating the handle while holding the free end of the lanyard (it is necessary to open the device to remove the protective sheath)
- Removable protective sheath protects the rope from abrasive surfaces and allows smooth rope glide
- Available in several lengths



## Sequoia SRT: Tree Care Seat Harness

- For ascents on a single rope
- Designed for the arborist's comfort. The extra-wide, semi-rigid waistbelt and leg loops give excellent support

Built for comfort:

- semi-rigid, wide waistbelt and leg loops for excellent positioning; sculpted and lined with perforated foam for comfort during suspension
- foam on leg loops can be adjusted for perfect positioning
- mobile side attachment points allow the user to follow the orientation of the lanyard during lateral movement
- attachment bridge improves lateral mobility

Practical adjustment:

- waistbelt equipped with self-locking DoubleBack buckles for quick and easy adjustment
- leg loops equipped with FAST buckles for quick and easy opening and closing without the need to readjust them, even while wearing gloves
- buckles to adjust weight distribution between the waistbelt and the leg loops
- gated rings to adapt the length of the attachment bridge and to install accessories directly on the attachment bridge (RING, SWIVEL)

Facilitates carrying and organization of tools:

- seven pre-shaped equipment loops with protective sheath
- five slots for CARITool tool holder
- two slots for a carabiner to hold a chainsaw or handsaw
- elastic for attaching a first aid kit

Can be accessorized in order to adapt the harness to its use:

- seat improves comfort during prolonged suspension
- shoulder straps connect to the ventral attachment point and the two rear slots on the waistbelt to transfer the load from the waistbelt to the shoulders



## Accessories



Attachment bridge for SEQUOIA and SEQUOIA SRT harness



Shoulder Straps for SEQUOIA and SEQUOIA SRT harness



Seat for SEQUOIA and SEQUOIA SRT harness

## Caritool: Tool Holder

- Tools accessed and organized with one hand
- Flat top aids in sorting attached gear
- Small hole on top for attaching keeper cord, to prevent dropping critical gear
- Slips through the waistbelt slots or along the harness webbing and stays in place, thanks to its stabilizing clip
- Available in two sizes: P42, max load 5kg and P42 L max load 15kg



## Ascentree: Double-Handed Rope Clamp for Tree Care

- Designed for ascending double ropes in trees using the “footlock” technique or with two PANTIN foot ascenders
- Ergonomic molded handles allow a comfortable yet powerful grip
- Toothed cam with self-cleaning slot optimizes performance under any conditions (e.g. frozen or dirty ropes)
- Catch/cam combination is totally integrated into the body of the rope clamp to prevent rubbing
- Large handles can be used with thick gloves
- Lower holes for connecting a lanyard
- Upper holes for clipping a carabiner around the rope



## Pantin: Foot Ascender - right and left

- Designed to make rope ascents faster and less tiring
- Used to complement CROLL, ASCENSION or ASCENTREE rope clamps
- Cam facilitates passage of the rope through the device, even on the first few meters
- Toothed cam with self-cleaning slot optimizes performance under any conditions (e.g. rope that is icy, muddy, etc.). The stainless steel cam has better resistance to corrosion
- Mechanism is totally integrated into the body of the rope clamp to help prevent snagging
- Releases from the rope with a simple backwards movement of the foot
- Lower strap is 100% Dyneema® to resist abrasion
- Easy adjustment with DoubleBack buckle



## Ascension: Handled Rope Clamp - right and left-handed

- Molded grip provides even greater comfort with a more ergonomically shaped handle
- This shape keeps your hand from sliding to the bottom of the frame each time you pull on the Ascension
- The bi-material handle includes a rubber over-molded grip, increasing the comfort and grip in wet or icy conditions
- Chrome-plated steel cam with angled teeth and self-cleaning slot securely grips the rope, even in muddy or icy conditions
- Ergonomic trigger allows one-handed installation and removal
- Mono-frame construction eliminates weaknesses and keeps the ascender lightweight and durable for years of use
- The two attachment points allow for different uses (e.g., self-belaying, hauling systems, etc.)
- Anodized frames are colour coded for easy identification (black -left / gray -right)
- Safety catch prevents the cam from opening too far, helping to keep the rope captured for added safety
- 1 cm secondary hole at the bottom will accommodate a screw link for attaching aiders, slings, etc.



Left Hand



Right Hand

# Petzl - Forestry Rigging

## Oxan: Oval Steel Carabiner

- Steel adapted to difficult use conditions
- Keylock system helps prevent snagging of the carabiner during maneuvers
- Red indicator provides a visual warning when the carabiner is unlocked (on SCREW-LOCK version)
- CSA certified

## Vulcan: High Strength Steel Carabiner

- Steel adapted to difficult use conditions
- For use with heavy loads
- Large size allows easier connection of multiple elements
- Wide opening for connection to thick anchors
- Keylock system helps prevent snagging of the carabiner during maneuvers
- Red indicator provides a visual warning when the carabiner is unlocked (on SCREW-LOCK version)

## Freino: Locking Carabiner with Friction Spur for Descenders

- The spur helps increase the friction for improved control of the descent of a heavy load (e.g., two-person rescues)
- Rope is easily inserted into the spur, without opening the carabiner
- TWIST-LOCK automatic locking sleeve, unlocked by a simple rotation
- Keylock system helps prevent snagging of the carabiner during maneuvers
- Used, for example, with the I'D and RIG self-braking descenders

## Spirit: Non-Locking Progression Carabiner

- Should be used only for progression using climbing techniques
- Non-locking, clips easily
- Keylock system helps prevent snagging of the carabiner during maneuvers

## ZigZag®: Mechanical Prusik for Arborists

- Technique identical to classic Prusik pulley system
- Release lever mounted on spring for great precision when jamming/releasing the device. Varying the pressure on this lever controls the speed of the descent
- Friction links provide progressive braking action for fluidity when moving around
- Pulley mounted on sealed ball bearings to allow slack to be taken up easily
- Swivel always keeps the device in position for better rope glide through the device
- Steel construction for improved durability
- Upper connection point to easily connect the end of the double rope. It has a flexible ring that helps maintain the connector in the major axis position
- Only for use on double ropes

## Zillon: Adjustable Work Positioning Lanyard for Tree Care

- The adjustable Zillon lanyard is designed for arborist work positioning
- It is used doubled on the harness side attachment points to distribute load on the waistbelt
- It is easily adjusted with one hand thanks to the progressive locking/unlocking action of the device



## Treesbee & Treesbee Screwlink: False Crotch for Tree Care

- Protects the tree and improves rope glide at the anchor
- Can be retrieved from the ground
- Wide webbing limits twisting
- Triple thickness of termination on large ring side makes the webbing more rigid during retrieval

Available in two versions:

- Strap with large diameter ring and small ring for ropes with spliced terminations (the splice goes through the small ring)
- Strap with large diameter ring and quick link (triangle) for ropes with sewn terminations (the link opens to let the sewn termination through)
- Easily identifiable colour code



## Pro Traxion: Progress Capture Pulley

- The PRO TRAXION progress capture pulley was designed to allow rope installation while the pulley is connected to the anchor. With its large diameter sheave and great efficiency, it is particularly appropriate for hauling heavy loads on big walls. The side plate locks when loaded and prevents opening of the pulley during use.
- Loss-resistant pulley: allows a rope to be installed when the pulley is connected to the anchor
- Well suited for hauling heavy loads: large diameter aluminum sheave mounted on sealed ball bearings for excellent efficiency and side plate locks when loaded and prevents opening of the pulley during use
- Versatile: lower connection point for creating different types of hauling systems and toothed cam with self-cleaning slot optimizes performance under any conditions: frozen or dirty ropes
- May be used as simple pulley by locking the cam in the raised position



## Vertex Best: Helmet for Work at Height and Rescue

- Six-point mesh headband forms to the shape of the head for improved comfort. Shock absorption achieved through deformation of the outer shell
- CenterFit adjustment system ensures centering and optimal stability of the helmet on the head
- Side slots for mounting hearing protection
- Inserts for accepting a VIZIR visor
- Slot for mounting PIXA headlamp
- Four clips for mounting a headlamp with an elastic headband
- Chin strap designed to limit risk of losing helmet during a fall (strength greater than 50 daN)
- Non-ventilated helmet protecting against electrical hazard and molten metal splash
- Size: 53-63 cm / 20.9-24.8 "
- Weight: 445 g / 15,7 oz
- Colors: yellow, red, white, orange, black, blue
- Certification: CE\*
- ANSI Z89.1-2009 Type I Class E:
- CSA Z94.1-05 Type 1 Class E



## Vizir Shadow: Protective Face Shield for Vertex and Alveo Helmets

- Mounting inserts for easy installation on VERTEX (latest version) and ALVEO helmets
- Pivots quickly from "work" position to "storage" position on top of the helmet
- Scratch- and fog-resistant



# Petzl - Forestry Rigging

## Pixa 3R: Rechargeable Multi-Beam Headlamp with Configurable Performance

- Headlamp keeps the hands free for work: may be worn on the head with the headband, attached to a helmet with the included mount, or placed on the ground
- Rechargeable Lithium-Ion Polymer battery plugs into a quick charging dock (3 hours) for frequent use

Three possible configurations to adapt lighting performance to needs:

- 'STANDARD': power / battery life balance
- 'MAX AUTONOMY': battery life prioritized (12 hours)
- 'MAX POWER': power prioritized (55 lumens)

Three lighting modes:

- A mode adapted for close-range work: wide, uniform beam
- aA mode adapted for movement: mixed beam with focused component allows user to move around comfortably
- A mode adapted for long-range vision: highly focused beam
- Constant lighting, guaranteed lighting performance that does not diminish during its entire lifetime
- Reserve lighting for when battery is almost discharged: lights to 5 meters minimum for 2 hours
- Rotating selector dial is easy to use, even with gloves

Durable:

- Excellent resistance to falls (2m), to impacts and to crushing (80 kg)
- Storage position protects the glass and keeps headlamp from being turned on accidentally
- Comfortable adjustable headband, easily detached for washing
- Flashing battery charge indicator and red light
- Resistant to chemicals





## Full Range Auto Ranging Voltage Indicator for Overhead & URD Systems



PSC4032915

T4030428 15kV only Bushing Adapter

T4030856 15-35 kV Elbow Adapter

T4030857 15-35kV Bushing Adapter

- Full Range (600V to 500kV)
- Eliminates the need for a selector switch
- Automatic ranging function quickly displays the approximate line-to-line voltage class
- An easy, yet reliable means for the operator to determine if a line is:
  - a) de-energized; b) carrying less than normal system voltage from any source or induced charged from an adjacent live circuit; c) energized at full system voltage
- Attaches to an Epoxiglas® insulating universal handle of appropriate length
- For overhead testing, a Shepherd Hook probe is included
- This model adapts to both overhead lines as well as URD circuits with 200 and 600 AMP elbows, including those with or without capacitance test-points
- Includes the tester unit, a shepherd hook probe, instruction manual and hard shell padded case
- Complies with OSHA 1910.269 to Test for Absence of Nominal Voltage

## Multi-Range Voltage Detectors



- Confirms that a line is de-energized prior to performing maintenance on it
- Gives a metered readout capable of distinguishing actual line voltage from static or feedover from an adjacent line
- Readings from an MRVD can be compared with numeric certainty rather than the subjective judgments associated with “fuzz-sticking” or “glow-detecting”
- Since the MRVD is not a voltmeter, no specific accuracy is claimed by the manufacturer nor can be assumed by the user
- Includes (1) carrying case, (1) hook probe, (1) straight probe (only included in the C4030979)

C4030979 (1) 40kV MRVD

C4031029 (16) 161kV

## Multi-Range Voltage Detectors with Illuminated Dial

- The lighted-dial option sets this unit apart from features standard on Multi-Range Voltage Detector C4030979
- A field intensity meter, the MRVD is calibrated to read approximate line-to-line voltage when connected to any phase conductor, responding to the magnitude of the field gradient between its end probe and floating electrode
- The MRVD gives metered readout capable of distinguishing actual line voltage from static or feedover from an adjacent line
- Readings from an MRVD can be compared with numerical certainty rather than the subjective judgments associated with “fuzz-sticking” or “glow-detecting”
- Since the MRVD is not a voltmeter, no specific accuracy is claimed by the manufacturer or can be assumed by the user
- The MRVD must be mounted on proper length hot stick for the voltage class involved
- Complete instructions are furnished with easy, illustrated step-by-step procedures
- Internal circuit and push button permit check before and after each use to confirm operational condition of instrument/battery

T403-3228 Voltage Indicator with Illuminated Dial

H1876-6S Shepherd Hook Probe

H1876-6 Straight Probes

## H1876-2: Extension Resistor Pair Extends Chance 16kV Phasing Testers for 48 or 80 kV Applications

- Designed to extend any Chance 16kV phasing tester for 48 or 80kV applications
- Extension resistors simply thread in the field
- 32" long





## Voltage Detectors: Self-Testing Audio/Visual

- Salisbury's self-testing voltage detectors allow testing to be continuous and automatic
- An intermittent flash and beep confirms the detector is functioning properly
- Used to verify live or de-energized conductors
- Testers may be used with insulating rubber gloves or hotsticks using the splined universal end fitting
- Testers indicate voltage with an extra bright LED light and a distinctive audible signal
- It is recommended that the tester be moved closer to the conductor until a warning is indicated, or it touches the conductor, apparatus or test point
- Each tester includes three "C" batteries
- The need for additional PPE can be minimized by confirming that there is no electrical hazard present before work is performed
- This can be determined by using a Salisbury voltage detector attached to an insulating hotstick that is long enough to keep the worker outside of the arc flash boundary
- The Salisbury voltage detector alarms in the proximity of electric fields, so that it is not necessary to make physical contact with the equipment being checked
- Made of non-conductive materials, meaning that it will not conduct electricity nor will it cause an arc flash, even if contact with energized equipment is made



**WARNING:** do not assume conductors that have been tested de-energized will stay de-energized. Always install proper grounding devices before working. Failure to do so may result in serious injury or death.

PART #	DIMENSIONS (IN.)	SETTINGS PHASE TO PHASE	WEIGHT EA.
4544	11 x 3.5	Off / 240V / 4.2kV / 15kV / 25kV / 35kV / 69kV / 115kV / 230kV	15 oz.
4644	11 x 3.5	Off / 240V / 4.2kV / 35kV / 69kV / 115kV / 230kV / 345kV / 500kV	15 oz.
4744	11 x 3.5	Off / Test-240kV / Battery / URD:15kV / 25kV / 35kV Overhead: 4.2kV / 15kV / 25kV / 35kV / 46kV / 69kV	15 oz.
4745	11 x 3.5	Off / Test-240kV / Battery / URD: 4.8kV / 7.2kV / 16kV Overhead: 2.4/4.2kV / 4.8/8.3kV, 8/13.8-7.2 / 12.5kV / 14.4/25-16/27.6kV / 44kV	15 oz.
<b>Complete Kit</b>			
4556		1-4544 Detector 240 V to 230 kV, 1-21517 Case, 1-2500 Shotgun Adapter	2 lbs
4667		1-4644 Detector 240 V to 500 kV, 1-21517 Case, 1-2500 Shotgun Adapter	2 lbs
4769		1-4744 Detector 240 V to 69 kV, 1-21517 Case, 1-2500 Shotgun Adapter	2 lbs
<b>Accessories</b>			
2500		Shotgun Adapter	.4 lbs
21517	12 x 8 x 4.5	Storage Case	1 lbs

# Salisbury by Honeywell

## Voltage Detectors: Audio/Visual

- Used to verify live or de-energized conductors
- Testers may be used with rubber insulating gloves or hotsticks using the splined universal end fitting
- Testers indicate the presence of voltage with an extra bright LED light and a distinctive audible signal
- It is recommended that the tester be moved closer to the conductor until warning is indicated, or it touches conductor, apparatus or test point
- Test the unit on a nearby energized conductor
- Each tester requires three "C" batteries (included)
- The **4445 Voltage Detector Tester** provides the most convenient and reliable means of verifying operation of Salisbury Voltage Detectors
- Tester features instant push-button operation and requires a standard 9-volt battery (included)
- It's portable and lightweight
- To operate, push the button and move the tester toward the voltage detector being verified
- The tester generates an electric field that activates the detector verifying the audible and visual signals are operational

**WARNING:** do not assume conductors that have been tested de-energized will stay de-energized. Always install proper grounding devices before working. Failure to do so may result in serious injury or death.



### Test Procedures:

To assure unit is in operable condition, switch tester into "Test-240V" position. The tester may now be tested in several different ways:

- 1) Place head as marked against live wire outlet or equivalent above 110V AC.
- 2) Rub the head as marked on cloth or clothing to obtain static charge. Unit will only indicate intermittently.

PART #	DIMENSIONS (IN.)	SETTINGS PHASE TO PHASE	WEIGHT EA.
4244	11 x 3.5	Off / 240V / 4.2kV / 15kV / 25kV / 35kV / 69kV / 115kV / 230kV	15 oz.
4344	11 x 3.5	Off / 240V / 4.2kV / 35kV / 69kV / 115kV / 230kV / 345kV / 500kV	15 oz.
4444	11 x 3.5	Off / Test-240kV / Battery / URD:15kV / 25kV / 35kV Overhead: 4.2kV / 15kV/25kV / 35kV / 46kV / 69kV	15 oz.
<b>Complete Kit</b>			
4356		1-4244 Detector 240 V to 230 kV, 1-21517 Case, 1-2500 Shotgun Adapter	2 lbs
4367		1-4344 Detector 240 V to 500 kV, 1-21517 Case, 1-2500 Shotgun Adapter	2 lbs
4469		1-4444 Detector 240 V to 69 kV, 1-21517 Case, 1-2500 Shotgun Adapter	2 lbs
<b>Accessories</b>			
2500		Shotgun Adapter	.4 lbs
21517	12 x 8 x 4.5	Storage Case	1 lbs
4445		Voltage Detector Tester	1 lbs
21600		Replacement Handle	-

## 6709-1: Regulator Neutral Detector

- The RND insures that the operator has the regulator in its neutral position prior to disconnecting the regulator from the circuit
- Use of the RND eliminates high or low voltages caused by cycling the regulator to the upper or lower limits, then counting steps back to neutral
- Works with step type and induction type regulators
- 0-2000 volt range is showing in one volt increments
- Works with all regulators up to and including 34.5kV systems
- No range selector is required
- Digital display with 1/2" tall LCD digits for easy viewing
- Lighted meter can be switched on by the operator
- 9 volt battery included
- Low battery indicator
- RND verifies the step indicator has not slipped one step
- A female universal spline allows unit to be attached to all universal hot sticks
- Contact electrodes are knurled to aid in contact with conductors
- Complete with case, battery and instructions



## 7701: Non-Contact Voltage Detector

- Static discriminator technology exclusive in Live Tester provides more reliable detection on low voltage ranges, and now means no more false alarms
- Incorporates an all in one universal attachment and a shotgun adapter into the handle
- Electronic touchpad includes 11 range settings from 240V to 230kV and 2 URD settings, 15kV and 25kV
- Includes (3) C cell batteries
- Built in self test function, high quality beeper, water resistant design
- Auto power off, low battery indicator
- Operator feedback - both visual and audible
- Less than 1 lb
- The RND verifies the step indicator has not slipped one step
- Female universal spline allows unit to be attached to all universal hot sticks
- Contact electrodes are knurled to aid in contact with conductors



## 6793: Transformer & Capacitor Tester



- Utilized to test the condition of transformers and capacitors before placing them into service
- Test new transformers or capacitors, plus trouble shoot in-service units
- Provides operating personnel a safe and reliable method to verify that transformers or capacitors are not shorted or open prior to energizing
- Detects failures in equipment before loading and transporting to the job site
- Eliminates the blowing of cutout fuses to determine the condition of equipment
- Magnetized back allows hands to be free to install and remove cables and clips, lightweight, has built in push button test feature prior to applying it to the equipment. Four bright LED lights signal the condition of the equipment being tested
- Tester can be used to verify that secondary services are not shorted prior to energizing the transformer
- The T&C tester is powered by a 9 volt battery
- Can be used to -40°C
- Housing is weatherproof, high-impact resistant plastic
- Contact electrodes are knurled to aid in contact with conductors

## 6702: Digital Voltage Phasing Meter

- 0-40kV Digital Volt Meter
- Instrument for measuring overhead and underground voltages
- Model 6706 - Digital display reads directly in kilovolts with three 1/2" high digits; readout is given to the nearest 10 volts
- Model 6702 - Digital display reads directly in kilovolts with three 1/2" high digits; the readout is given to the nearest 100 volts
- Digital display has a lighted background that operates via a switch
- Powered by a 9 volt battery, included. Low battery indicator
- Meter shuts off automatically after 10 minutes without contacting live voltage
- Coiled self-retracting cable; 16" retracted, 10' fully extended
- Complete with storage case, which also accommodates a pair of add-on resistor extensions, 2 bushing adapters, and a Hi-Pot adapter (each sold separately)
- 6702 Unit includes: Digital volt meter, conductor hooks, carrying case, battery, and instructions



## PROFESSIONAL VOLTAGE/CONTINUITY TESTER

### ET200 Electronic Voltage/Continuity Tester



- Measures AC and DC voltage at 9 common levels up to 600V
- Bright LEDs indicate voltage reading without batteries installed
- Low impedance input reduces possibility of ghost voltages
- Permanently secured test leads are always there when they are needed
- Molded lead holders are perfect for easy measurements of tamper-proof outlets
- Vibration and sound alerts for dangerous voltage levels
- Modern solid-state construction provides CAT IV 600V safety rating

## PROFESSIONAL SERIES MULTI-METERS

### MM2000 Electrician's/HVAC TRMS Multimeter



- Display is brighter than most competitive units
- Bar graph measures fast moving readings
- Low impedance reduces ghost voltage
- uA setting for checking Flame sensors
- True RMS accurate readings for all signals
- 10A AC/DC Current
- Rubber molding for drop protection
- Lead storage protects leads
- 1000 voltage reading
- CAT IV Safety Rating - safest rating available

### MM200 Auto Ranging Multimeter



- Measures capacitance, temperature and frequency
- Features lighted display
- 10 AC/DC Current
- Lead storage protects leads
- Rubber molding for drop protection
- Measures up to 600V
- Cat III 600V Rating

## PROFESSIONAL SERIES CLAMP METERS

### CL1000 400A AC Clamp Meter



- Large clamp opening
- Capacitance great for HVAC work
- Display is brighter than most competitive units
- Worklight lights clamp area
- Magnetic mount secures meter and frees hands
- Side-mounted dial for ease of use
- Lead storage protects leads
- CAT III 600V Rating
- Frequency/duty cycle
- Bar graph measures fast moving readings
- Non-contact voltage tester

### CL2000 400A AC/DC True RMS Clamp Meter



- Large jaw sizes
- Worklights illuminate dark work spaces
- Data hold captures measurements in any situation
- Built-in magnetic mount for hands-free convenience
- Quick-response bar graph show elusive fluctuations
- CAT III 600V Rating
- Requires 2 AAA batteries

## HEATING, VENTILATION & AIR CONDITIONING CLAMP METERS

CMH-600    CMH-1000



FEATURES	CMH-600	CMH-1000
True RMS	AC	AC
Crest		×
Jaw Flashlight		×
Temperature (Type K)	×	×
Phase Sequence Test	×	×
Motor Rotation Test	×	×
Peak RMS	×	×
Backlight	×	×
Relative Offset Mode ( $\Delta$ )	×	×
AmpTip™	×	×
VFD ACV, Hz Measurement	×	×
Voltage Detection	×	×
Maximum/Minimum/Average	×	×
Frequency	×	×
Continuity/Diode Tests	×	×
Data Hold	×	×
Automatic Power Off (APO)	×	×
<b>RANGES</b>		
DC Microamps	2000	2000
Capacitance	2500 $\mu$ F	2500 $\mu$ F
AC Amps	600	1000
DC Volts	600	1000
AC Volts	600	1000
Resistance	60 k $\Omega$	60 k $\Omega$
Display Counts	6000	6000
Measurement Category Rating	CAT IV 300V CAT III 600V	CAT IV 600V CAT III 1000V

## INDUSTRIAL CLAMP METERS

CMI-660

CMI-1000

CMI-2000



FEATURES	CMI-600	CMI-1000	CMI-2000
True RMS	AC+DC	AC+DC	AC+DC
AutoCheck® Mode			×
Crest		×	×
Jaw Flashlight		×	
Phase Sequence Test	×	×	
Motor Rotation Test	×	×	
Peak RMS	×	×	
AmpTip™	×	×	
Maximum/Minumum/Average	×	×	
Temperature (Type K)	×	×	×
Backlight	×	×	×
Relative Offset Mode (Δ)	×	×	×
VFD ACV Hz Measurement	×	×	×
Voltage Detection	×	×	×
Frequency	×	×	×
Continuity/Diode Tests	×	×	×
Data Hold	×	×	×
Automatic Power Off (APO)	×	×	×
<b>RANGES</b>			
DC Microamps	2000	2000	-
Capacitance	2500 μF	2500 μF	2500 μF
DC Amps	600	1000	2000
AC Amps	600	1000	2000
DC Volts	600	1000	1000
AC Volts	600	1000	1000
Resistance	60 kΩ	60 kΩ	60 kΩ
Display Counts	6000	6000	6000
Measurement Category Rating	CAT IV 300V CAT III 600V	CAT IV 600V CAT III 1000V	CAT IV 1000V



## GENERAL PURPOSE CLAMP METERS

CM-660

CM-860

CM-960

CM-1360

CM-1560



FEATURES	CM-660	CM-860	CM-960	CM-1360	CM-1560
True RMS	AC	AC	AC+DC	AC	AC+DC
Peak RMS			×		×
Crest					×
Jaw Flashlight				×	×
Backlight		×	×	×	×
Relative Offset Mode		×	×	×	×
AmpTip™	×	×	×	×	×
VFD ACV, Hz Measurements	×	×	×	×	×
Non-Contact Voltage Detection	×	×	×	×	×
Maximum/Minimum/Average	×	×	×	×	×
Frequency	×	×	×	×	×
Continuity/Diode Tests	×	×	×	×	×
Data Hold	×	×	×	×	×
Automatic Power Off (APO)	×	×	×	×	×
<b>RANGES</b>					
Capacitance		2500 µF	2500 µF	2500 µF	2500 µF
DC Amps			600		1000
AC Amps	600	600	600	1000	1000
DC Volts	600	600	600	1000	1000
AC Volts	600	600	600	1000	1000
Resistance	60 kΩ	60 kΩ	60 kΩ	60 kΩ	60 kΩ
Display Counts	6000	6000	6000	6000	6000
Measurement Category Rating	CAT IV 300V CAT III 600V	CAT IV 300V CAT III 600V	CAT IV 300V CAT III 600V	CAT IV 600V CAT III 1000V	CAT IV 600V CAT III 1000V

## ELECTRICAL TEST EQUIPMENT

### GT-12A: Non-Contact Self-Testing Voltage Detector



- Designed and assembled in the USA
- Automatic self-test verifies the integrity of the unit
- Bright LEDs and audible alarm sound if voltage is present
- Silent-mode feature for use in quiet settings
- Used to detect voltage in outlets, lighting fixtures, circuit breakers, wires, and cables or to find a break in a wire
- Automatically turns off after five minutes of non-use to conserve battery life; low battery indicator
- Lifetime limited warranty

### GT-65: Voltage Tester



- AC/DC voltage and polarity measurement
- Continuity test and single probe detection of live conductors for added flexibility
- Overvoltage warning gives user visual notification that voltage levels have exceeded 1000V AC/380V DC
- Safe, non-contact voltage detection
- Auto-hold automatically activates when tester is removed from voltage reading
- Visual and audible continuity
- Voltage detection: 19 to 1000 VAC, 5 to 1000 VDC Frequency

### DM-200A, DM210A & DM-510A Digital Multi-Meter

- Measurement Category Rating CAT II 1000V, CAT III 600V, CAT IV 300V
- Auto-ranging or manual ranging selection
- BeepJack™ Safety Technology
- Two voltage detection modes – non-contact or using a single test lead
- Backlight
- Data Hold and Auto Power off features
- Computer interface capability
- Includes (2) AAA batteries and Test Leads

In addition to the DM-200A features, DM-210A also includes:

- Temperature and capacitance measurements
- Includes Type K thermocouple (200 C / 392 F max)

In addition to the DM-200A/DM-210A features, DM-510A includes:

- Low impedance AutoCheck™ mode—automatically selects AC or DC volts, resistance, or continuity. Low impedance masks “ghost” voltage pickup
- Min/Max/Average measurements
- Peak (crest) Hold – Max/Min
- AC True RMS



DM-200A  
DM-210A  
DM-510A

### DM-65: Digital Multi-Meter



- Designed for residential and light commercial use
- Includes elastomer boot to protect meter from damage
- AC/DC voltage (600V); AC/DC amperage measurement
- Audible continuity and diode tests
- Frequency measurement in voltage mode
- Data hold to capture measurement
- Max feature for added versatility
- Includes (1) 9V battery, test leads

### 09027: GT-95 Voltage Tester

- Visual and audible continuity
- LCD and dual colour LEDs
- Selectable SHAKER feature when measuring AC voltage
- Overvoltage warning gives visual notification that voltage levels have exceeded 1000V AC/380V DC
- Auto-hold automatically activates when tester is removed from voltage reading
- Continuity test and single probe detection of live conductors
- Safe, non-contact voltage detection
- GFCI test capability
- AC/DC voltage and polarity measurement
- Lifetime limited warranty
- Voltage Detection: 19 to 1000 VAC, 5 to 1000 VDC
- Frequency: 0 to 70 Hz
- GFCI: 7.5 mA at 120 VAC, +/- 10%
- Measurement Category: CAT IV, 600 V; CAT III, 1000 V



### DMSC-2U: Interface Kit

- Connects to a PC's USB or RS-232 (serial) port
- Allows real-time datalogging and graphing
- Export data to disk for analysis with any spreadsheet
- Includes RS-232 interface cable, USB converter, cable, and software



## CS-8000 Circuit Seeker™ Circuit Tracer



- Advanced patented non-directional sensing technology
- Superior sensitivity and functionality providing for accurate tracing and locating
- Traces concealed wiring, locates junction boxes, and finds breakers for live or open circuits
- Locates and identifies blown fuses
- Finds shorts and breaks in conductors
- Lifetime limited warranty

## DML-430A: Digital Logging Meter



- Measurement Category Rating CAT IV 1000V
- Low impedance AutoCheck™ mode - automatically selects AC or DC volts, resistance, or continuity
- Low impedance masks "ghost" voltage pickup
- AC+DC True RMS
- Two Temperature inputs using type K thermocouples
- Datalogging capability – stores 87,000 single-channel or 43,000 dual-channel measurements
- Dual digital display and analog graph
- 10,000 display counts
- Includes (1) 9V battery, test leads, and carrying case
- Includes Type K thermocouple (200°C / 392°F max)

## DM-810A, DM-820A & DM-830A: Multi-Meter Series



- Measurement Category Rating CAT IV 1000V
- AC True RMS capability
- BeepJack™ Safety Technology
- Auto-ranging or manual ranging selection
- Dual digital display and analog graph
- 10,000 display counts
- Computer interface capability
- Includes (1) 9V battery, test leads, and carrying case

In addition to the DM-810A features, the DM-820A also includes:

- One temperature mode using a type K thermocouple
- Two voltage detection modes – non-contact or using a single test lead
- Peak (crest) Hold – Max/Min
- Includes Type K thermocouple (200°C / 392°F max)

In addition to the DM-810A/DM-820A features, the DM-830A also includes:

- Low impedance AutoCheck™ mode—automatically selects AC or DC volts, resistance, or continuity
- Low impedance masks "ghost" voltage pickup
- Two Temperature inputs using type K thermocouples
- AC+DC True RMS

## DMSC-9U: Interface Kit

- Connects to a PC's USB or RS-232 (serial) port
- Allows real-time datalogging and graphing
- Export data to disk for analysis with any spreadsheet
- Retrieves stored data from DML-430A
- Includes USB interface cable and software



## DMHS-1

- A magnetic hanging strap for all Greenlee DMMs



## HVA-2000: High Voltage Digital Ammeter



- Quickly take current readings on conductors up to 500kV (phase-to-phase)
- Measures AC current up to 2000 amps, 25-500Hz
- Use in overhead and underground applications
- Take spot-load checks with ease
- Verify phases are balanced
- Read the measurement in real time from the large digit display
- Stores the last four current readings
- Display is easy to read in bright or dark conditions
- Auto shutoff with low battery function
- Small and lightweight, easy to manage on an extension hotstick - 1.8 lbs (0.82 kg)
- Dual hotstick connections – universal spline and clampstick
- Use on conductors up to 2.75" (7.0 cm)
- Accuracy 1% of reading
- Made in USA

## PRX-69D: Proximity Voltage Detector



- Sealed to resist water penetration in typical outdoor environments
- Seven standard voltage ranges from 120V up to 69kV
- Detects voltage on most elbow test points
- Detects voltages typically 10" (25 cm) from the source
- Rechargeable battery with quick recharge - 15 minutes for a full day of use
- Heartbeat signal assures that the PRX is ready to detect voltage
- Rugged, durable housing
- Dual hotstick connections - universal spline and shotgun stick
- Loud beeper and LED lights indicate voltage
- Weighs less than 1 pound (0.45 kg)
- Easy to use electronic touch pad with large buttons
- Custom voltage ranges available upon request
- Can be used on 50Hz and 60Hz systems
- Made in USA

## PRX-500: Proximity Voltage Detector



- Sealed to resist water penetration in typical outdoor environments
- Nine standard voltage ranges from 120V up to 500kV
- Detects voltage on most elbow test points
- Detects voltages 10" (25 cm) or greater from the source
- Rechargeable battery with quick recharge - 15 minutes for a full day of use
- Rugged, durable housing
- Dual hotstick connections - universal spline and shotgun stick
- Loud beeper and LED lights indicate voltage
- Weighs less than 1 pound (0.45 kg)
- Easy to use electronic touch pad with large buttons
- Custom voltage ranges available upon request
- Can be used on 50Hz and 60Hz systems
- Made in USA

## VW-20HFR: V-Watch™ Personal Voltage Detector



- Alerts user to proximity of high voltage
- Audible and visual alarms increase in frequency the closer the user gets to energized equipment
- Typical V-Watch initial warning distance is about 7ft (2.13 m) from a 4kVAC conductor (see instruction manual for more details)
- Warning distance increases with higher voltages
- Field replaceable 9V battery
- Lightweight, rugged protective housing
- Built-in self test
- Carrying case lanyard: High-visibility safety green shielded material with an outer layer of flame resistant material, black shielded material, electrically shielded, storage case when the V-Watch is not in use, lanyard allows user to adjust to optimum mid-torso position
- Made in USA

## DVI-100: Digital Voltage Indicator



- For use on system voltages up to 161kV (reads up to 99kV line-to-ground)
- Large auto-ranging LED display indicates the line-to-ground voltage level
- Audible indication when voltage is detected
- Voltage readout allows user to distinguish between nominal and induced voltage
- Measure Elbow Test Points with the DVI-100T (underground probe required)
- Use on overhead lines or in underground applications with bushing probe
- Built-in universal spline for standard hotstick attachment
- LED's operate in extreme temperatures
- Easy-to-read in bright or dark conditions
- Built-in self-test to verify proper operation
- Powered by a field-replaceable 9V alkaline battery
- No range selector switch or settings required
- Compact, rugged and lightweight polycarbonate housing
- Made in USA

## DVI-500: Digital Voltage Indicator



- For use on system voltages up to 800kV (reads up to 500kV line-to-ground)
- No range selector switch or settings required
- Large LED display indicates the line-to-ground voltage level
- Display is easy to read in bright or dark conditions
- Voltage readout allows the user to distinguish between nominal and induced voltages
- Audible indication when voltage is detected
- Measure elbow test points with the DVI-500T
- Built-in universal spline for standard hotstick attachment
- Built-in self test to verify proper operation
- Powered by a field replaceable 9V alkaline battery
- Compact, rugged and lightweight polycarbonate housing
- Kits are available, contact factory for details
- Made in USA

## DVM-80UVM: High Accuracy Digital Voltmeter and Phasing Set



- Digital Meter reads in kilovolts, 3.5 digits with decimal point
- Voltage Range - 5V-40kV, up to 80kV with add-on resistors
- Auto-Ranging - No range selector switch
- Highly accurate, within 1% of reading +/- 3 counts
- Meter Resolution: 0.005 - 1.999 range with 1 Volt resolution, 2.00 - 19.00 range with 10 Volt resolution, 19.0-40.0 range with 100 Volt resolution
- Backlit Display - For easy reading in bright or dark conditions
- Peak Hold Mode - Conveniently keeps the peak voltage reading on the display
- Measures AC and DC voltages through 1000Hz RMS
- Use on Secondary Voltages - Starting at 5 Volts
- Measure voltage on elbow test points - Meter displays system voltage
- Underground Cable Testing - Test underground cables for faults using the CFT-35
- Coiled Connecting Cord - 3.5' retracted, 12' extended
- Phase Accurate Technology makes all voltage readings, whether line-to-line or line-to-ground, accurate and repeatable to within 1%
- Powered by a standard 9V alkaline battery in an easy to change battery case - no tools required
- Weight of Voltmeter (w/o probes) - 2.25 lbs (1.02 kg)
- Made in USA



The DVM-80UVM Kit contains everything needed to:

- Perform voltmeter and phasing operations for virtually all overhead and underground applications
- Take measurements on secondary voltages starting at 5 Volts
- Take measurements on primary voltages up to 80 Kilovolts
- Take measurements on elbow test points with Test Point Feature
- Peak voltage reading can be held using the Peak Hold Feature
- Perform underground cable fault testing with Cable Fault Tester
- Test the voltmeter before and after use with Voltmeter Proof Tester

# Testers & Equipment

## HD Electric LV-5/K01: Stray Voltage Detector and Harness



- Low threshold voltage sensing design picks up voltages from 5VAC to 600VAC with direct contact and above 600VAC at a distance
- Ultra bright, long-lasting red LED indicates when voltage is present
- Detector is always on, ready to use and operates on two AA alkaline batteries
- Rugged, utility-grade design is waterproof
- Tester integrated into the holster provides a visual indication of the test. Supplies a low voltage
- AC signal for testing before and after use
- Operating Frequency 60Hz
- Made in USA

## HJA-469-SCO: HJ Arnett Super Beast - Secondary Service Conductor Tester



- Indicates issues on secondary service
- Detects open neutral quickly, accurately
- Isolates and identifies overhead or underground complaints on utility side
- Verifies condition of secondary conductors, associated connections

## Knopp K-3 Phase Sequence Indicator



- Identifies the phase sequence (A-B-C or C-B-A) of three-phase voltages
- Rotating disk design
- Internal connections are soldered
- Leads are colour-coded and 36" in length
- Operates from 25-60 hertz and from 60-600 volts

## Hastings Phase-Tell III Wireless Phasing Meter



6722 Phase-Tell III Wireless Phasing Meter  
266 URD Bushing Well Adapter

- Battery powered, two-piece wireless phasing tool
- Determines phase relationships on three phase power systems, overhead and URD applications; when contact is made with line voltage or elbow test points, the Phase-Tell III units compare transmitted data and then display the results via red or green LED lights and differentiated audible signals
- Flashing green lights indicate In-Phase. Flashing red lights indicate out-of-phase
- Wireless units communicate up to three hundred feet apart
- Both units are identical, no need to identify transmitter or receiver
- Voltage range from URD test points to 500kV
- Both units confirm the same phase readings
- Rugged extruded aluminum enclosure
- Each unit operates on two "AA" batteries, included
- FCC Compliant
- Automatic test cycle when placed in the "On" position
- Auto Shut-Off
- Includes carrying case and instructions
- URD bushing adapters and case available

## LIV-500: Line Isolation Verifier (2.4kV to 500kV)



- Line Isolation Verifiers (LIVs) are lightweight rugged devices that have been specifically designed to detect the presence of AC potentials on unshielded conductors
- Patented design utilizing a collimated signal frequency filter that provides maximum sensitivity to energized conductors that fall within 30 degrees of the instrument's centre-line
- This unique feature eliminates the adjacent conductor pick-up problem typically encountered with other potential indicating devices

## TIC 300CC, TIC 300HV: Tic Tracers AC Voltage Detectors



- TIC 300CC measures to 1500 V
- TIC 300HV with two measurement ranges, 1500 V, 122kV
- Used to check fuses, breaker panels, power outlets, loadbreak connectors, transmission lines, etc
- 9 VDC power supply
- Detects AC voltage without connection
- Audible signal
- Lightweight yet rugged
- Integrated switchguard
- Locates breaks in insulated wire
- Checks fuses and breaker panels
- Checks for proper grounding
- Made in USA
- Operating temperature 32° - 125°F (0°-52°C)
- MSHA Approved

- Water-tight, crush-proof, and dust-proof
- Easy open double throw latches
- Open cell core with solid wall design - strong, light weight
- O-ring seal
- Automatic pressure equalization valve
- Stainless steel hardware
- Pick N Pluck™ with convoluted lid foam
- Lifetime guarantee of excellence
- Available in black, silver, orange, yellow, OD green, desert tan



## 1200: Small Case with Pick N Pluck™ Foam

- Interior Dimensions: 9.25" x 7.12" x 4.12" (23.5 x 18.1 x 10.5 cm)



## 1400: Small Case, Black with Pick N Pluck™ Foam

- Interior Dimensions: 11.81" x 8.87" x 5.18" (30 x 22.5 x 13.2 cm)
- Stainless steel padlock protectors
- Comfortable rubber over-molded handle



## 1450: Medium Case, Black with Pick N Pluck™ Foam

- Interior Dimensions: 14.62" x 10.18" x 6.00" (37.1 x 25.8 x 15.2 cm)
- Stainless steel padlock protectors
- Comfortable rubber over-molded handle



## 1500: Medium Case, Black with Pick N Pluck™ Foam

- Interior Dimensions: 16.75" x 11.18" x 6.12" (42.5 x 28.4 x 15.5 cm)
- Stainless steel padlock protectors
- Comfortable rubber over-molded handle



## 1550: Medium Case, Black with Pick N Pluck™ Foam

- Interior Dimensions: 18.43" x 14.00" x 7.62" (46.8 x 35.5 x 19.3 cm)
- Stainless steel padlock protectors
- Comfortable rubber over-molded handle
- 2 level Pick N Pluck™ with convoluted lid foam



## 1650: Medium Case, Black with Pick N Pluck™ Foam

- Interior Dimensions: 28.57" x 17.52" x 10.65" (72.5 x 44.5 x 27 cm)
- Retractable extension handle
- 4 strong polyurethane wheels with stainless steel bearings
- Fold down handles
- 2 level Pick N Pluck with convoluted lid foam

# Lineman's Apprentice Starter Kit

TOOLS



A



B



C



D



E



F



G



H



I



J



K



L



M



N



O



P

A	C2000M-BL-SIZE	Buckingham Full Floating Body Belt
B	84540	Yellow Nut Bolt Bag
C	111HLSX	4 Pocket Belt Holster
D	11DC	Equipment Bag/Tool Bag
E	THH88	Tearaway Hook
F	803-32	Ball-Peen Hammer
G	81280	Rigid Fiberglass Folding 6' Ruler
H	D507-12	12" Adjustable Wrench
I	D507-10	10" Adjustable Wrench
J	600-8	3/8" x 8" Square Shank Screwdriver
K	7090	Skinning Knife
L	D502-12	12" Channel Lock Pliers
M	D-2000-9NE	9" High Leverage Side Cutting Pliers
N	CN1972AR	Pole Climber c/w Pads and Straps
O	A-1972G	Gaff Guard
P	LTL426MFL-SIZE	Lineman Glove 6" Cuff Fleece Lined
	LTL423MFL-SIZE	Lineman Glove 3" Cuff Fleece Lined

Visit [ltl.ca](http://ltl.ca) for our "Nice to Have" list



## 106-50: Buck Self Rescue System



- Ideal for the one man crew!
- Provides the means to safely and easily descend to the ground in the event of a fall from the bucket or the need to evacuate an inoperable bucket
- Combines a specially designed bag that, when deployed, releases a ladder, an ascender, descender and 50' of rope

## 3816: Tower Rescue Blocks

- Kit is designed to easily lift a victim on a tower or structure to disconnect their shock absorbing lanyard
- A 4-to-1 mechanical advantage eases the process
- Includes an anchor sling and micro grab to anchor to a life line
- Packed in a compact storage bag that can be easily attached to a harness or belt
- 10' lifting height



## 52993: Leather Nut & Bolt Bag



- Three inside pockets for speed wrenches
- Available in Brown, Black & Burgundy
- Measures 10 1/4" x 10"

52993BR Brown  
52993BL Black

## 42666-BL: Holster



- 5 pockets
- 2 way knife snap
- Measures 10 3/4" x 8"
- 4089 knife sheath attached

## 45911M2: Canvas Nut & Bolt Bag



- Canvas bag built with an inside pocket for organizing spare parts
- Web loops are strategically positioned to store cotter pins during work
- Features a powerful magnet
- Reinforced bottom to prevent premature wear
- Measures 3"H x 8"W x 9"L

## 7091: Buck ErgoBlade Knife



- A revolutionary lineman's skinning knife!
- 1 1/4" diameter rubber handle fits comfortably in a gloved hand
- Round handle allows the user to create the proper cutting angle by rotating the knife within the hand instead of constantly, and repetitively, turning the wrist
- 5 3/4" long handle extends beyond the palm reducing the force and wrist action needed to secure the knife while skinning cable
- Textured rubber handle increases gripping while working in inclement weather

# Greenlee - Tool Kits

## Professional Hand Tools

Designed with linemen, contractors, and cable technicians in mind, Greenlee professional hand tools are a natural extension to Greenlee's existing product lines. With a comprehensive assortment of custom-designed pliers, saws, screwdrivers, wrenches, drivers, tool bags, accessories, tool kits, and more, Greenlee hand tools meet and exceed quality expectations.

TOOLS

### 0159-11: Electrician's Tool Kit, 28 Piece

0151-09M	Side-Cutting Pliers 9" w/Molded Grip (Lineman's Pliers)	0254-11	Hex-Key Set 9 Piece
0251-08M	Diagonal Cutting Pliers 8" w/Molded Grip	0155-25A	Power-Return Tape Measure
0351-08M	Long Nose Pliers 8" w/Molded Grip	L107	Torpedo Level
0451-10M	Water Pump Pliers 10" w/Molded Grip	0156-11	Electricians Hammer
1955A	Wire Stripper	0158-12	18" Heavy Duty Multi-Pocket Bag
0252-11	NM Cable Ripper	9858-11	Leather Tool Belt 2"
1927A	Stripping/Crimping Combination Tool	0258-11	Heavy Duty 8 Pocket Leather Pouch
727	Cable Cutter	0358-14XL	Tradesman Gloves XL
0153-11C	Keystone Tip Screwdriver 1/4" x 6"	GT-12	Non-Contact Voltage Detector
0153-15C	Keystone Tip Screwdriver 5/16" x 4"	333A	Hacksaw
0153-21C	Cabinet Tip Screwdriver 3/16" x 6"		
0153-26C	Cabinet Tip Screwdriver 1/4" x 6"		
0153-31C	Phillips Screwdriver #1 x 3"		
0153-33C	Phillips Screwdriver #2 x 4"		
0453-14C	Screw-Holding Screwdriver 3/16" x 6"		
9753-12C	Scratch Awl 3"		
0154-10	Adjustable Wrench 10"		



0159-11 Complete Tool Kit

### 0159-13: Electrician's Tool Kit, 12 Piece

- 2" Leather Tool Belt
- 8-Pocket Leather Pouch
- 25' Tape Measure
- 9" Side-Cutting Pliers
- 8" Long Nose Pliers
- 10" Pump Pliers
- 8" Diagonal Cutting Pliers
- Pro Plus Wire Stripper 10-18 AWG
- Phillips Tip #1 - 3/16" x 3" Screwdriver
- Phillips Tip #2 - 1/4" x 4" Screwdriver
- Cabinet Tip Round Shank 3/16" x 6" Flat Blade Screwdriver
- Keystone Tip Square Shank 1/4" x 4" Flat Blade Screwdriver

### 0159-12: Journeyman's Tool Kit, 17 Piece

- 20-Pocket Tool Caddy
- 25' Tape Measure
- 8" Long Nose Pliers
- 10" Pump Pliers
- NM Cable Ripper
- 9" Side-Cutting Pliers
- 8" Diagonal Cutting Pliers
- 18 oz. Electrician's Hammer
- Pro Plus Wire Stripper 10-18 AWG
- Keystone Tip Square Shank 1/4" x 4" Flat Blade Screwdriver
- Cabinet Tip Round Shank 3/16" x 3" Flat Blade Screwdriver
- GT-11 Voltage Tester, Torpedo Level
- Phillips Tip #2 - 1/4" x 4" Screwdriver
- Phillips Tip #1 - 3/16" x 3" Screwdriver
- Stripping/Crimping Combination Tool and Cable Cutter

## Heavy Duty Leather Pouches

- For your tool storage and access needs, Greenlee has designed three top grain leather pouches that will not fade or stain
- Featuring a minimum of four compact pockets for tool organization, tapered compartments for tool stability, a tape chain, washer rivets for extra strength, and a metal tool clip, these pouches are what every lineman needs
- 0258-11 and 0258-13 feature large, divided main pockets for easy tool storage and access as well as a heavy duty tape measure holder that accepts and holds any size tape securely
- Each pouch will fit belts up to 3" wide

A) 0258-14 4 Pocket Leather Pouch

B) 0258-13 5 Pocket Leather Pouch

C) 0258-11 8 Pocket Leather Pouch



## 13" PVC Saw

- "V" tooth design enables straight cuts on both push and pull strokes
- Resharpenable blade
- Pointed blade nose makes drywall surface penetration easy
- Ergonomic handle is interchangeable with most PVC saw brands



00113

## 12" Heavy Duty Hacksaw

- Overmolded rugged design
- Alternative 45° blade mounting allows for flush cutting
- Mounting for most reciprocating saw blades for extra versatility
- Complete with bi-metal blade
- Fully adjustable blade tension up to 30,000 psi for longer blade life and faster, accurate cuts



333A

## Rothenberger Heavy Duty Pipe Wrenches

- One-handed ratchet-like use, self-clamping
- Monoblock cast body with high strength, double T profile; forged jaw and hook
- Fine polished teeth set against turning direction
- Induction hardened, tempered, and anti-slip adjustment screw
- Complies with US standard GGG-W-651 Type 1 Class A
- Quick and simple presetting



70152	12"	2" Max O.D.
70153	14"	2" Max O.D.
70154	18"	2.5" Max O.D.
70155	24"	3" Max O.D.
70156	36"	5" Max O.D.

## Scissors & Knife Kit with 2-Pocket Pouch

- Tough, tempered steel knife blade holds its edge longer
- Knife has a short, coping-type blade made of the finest cutlery steel
- Full-sized knife handle provides greater comfort
- Scissors have an upper blade with two stripping notches to strip most insulations from 19-24 AWG



PT-K01A

# Greenlee - Hand Tools

TOOLS

## Power Return Tape Measure



0155-25A 25' long  
0155-16A 16' long

- Double-sided tape with double foot can be read from above or below
- Easy to use Click Lock holds tape securely without moving the blade
- Stainless steel side panels
- Rigid 1" wide blade on all models
- Tough ABS case is over-molded with TPR for added protection
- Abrasion resistant nylon coated hardened steel blade
- Four rivets on foot resist pull-off, adjust for inside, outside readings
- 16" and 19.2" stud markings
- 0155-7MA contains a dual unit blade and metric units

## Electrician's Hammer



0156-11

- Elongated neck and narrow striking face for use in confined areas
- Long straight claws for electrical fixture removal
- Fiberglass handle for shock resistance
- Cushioned grip and flared handle end
- This is not an insulated tool

## Cushion-Grip Screwdriver Set, 5 Pc.

- Handle marked for size identification
- Precision machined black phosphate tips prevent chipping and slipping
- High grade, rust resistant, chrome finish
- 3/16" x 6" Cabinet, 1/4" x 4" Keystone, 1/4" x 6" Cabinet, 5/16" x 6" Keystone and #2 x 4" Phillips



0153-01C

## Cushion-Grip Screwdriver Set, 7 Pc.

- Handle marked for size identification
- Precision machined black phosphate tips
- High grade, rust-resistant, chrome finish
- 3/16" x 4" Cabinet, 3/16" x 6" Cabinet, 1/4" x 4" Keystone, 1/4" x 4" Cabinet, 5/16" x 6" Keystone, #1 x 3" Phillips and #2 x 4" Phillips



0153-02C

## Cushion-Grip Nut Driver Set, 7 Pc.

- Hollow shaft for screw clearance
- Heavy duty high grade, rust-resistant, satin chrome finish
- Precision heads for accurate fastener fit
- Includes 3" shank in sizes 3/16", 1/4", 5/16", 11/32", 3/8", 7/16", 1/2"



0253-01C

## Cushion-Grip Square Recess Tip Driver Set, 4 pc.

- Precision tip for accurate fastener fit
- Handle marked for easy identification
- High grade, rust resistant, chrome finish
- Contains #0, #1, #2, #3



0353-01C

## 3" Scratch Awl

- Heavy duty construction for piercing and scribing
- Cushion grip for extra comfort
- Steel cap for longer life
- High grade, rust-resistant, chrome-plated finish
- 7 7/8" long



9753-12C

## Folding Hex Key Set, 9 Key

- One-piece, powder-coated handle and case for corrosion resistance
- Heat-treated and tempered for extra strength and durability
- Exceeds ASME/ANSI specifications
- Includes sizes 5/64", 3/32", 7/64", 1/8", 9/64", 5/32", 3/16", 7/32", 1/4"



0254-11

## Ball End Folding Hex Key Set, 9 Key

- Ball-end design allows for angled use up to 30°
- Heat-treated and tempered
- Exceeds ASME/ANSI specifications
- Includes sizes 5/64", 3/32", 7/64", 1/8", 9/64", 5/32", 3/16", 7/32", 1/4"



0254-12

## 9-in-1 Multi-Tool

- Versatile multi-bit screwdriver, 9 tools in one
- Drive hex nuts, Phillips, Square-recess and slotted fasteners
- High-grade, rust-resistant, chrome-plated finish
- Precision machined, hardened steel bits
- Soft, cushioned grip for extra comfort and torque
- Lifetime limited warranty
- Note: This is not an insulated tool



0153-43C

9953-15

Replacement Bits

## High Leverage Diagonal Cutting Pliers

- Dual cutting edges for optimum performance
- Wider grip provides large load bearing area
- Effectively cuts most hardened wire, ACSR, bolts, screws and nails
- Forged from chrome vanadium steel



0251-08M

8" Molded Grip

0251-08AM

8" Angled Molded Grip

0251-08D

8" Dipped Grip

0251-08AD

8" Angled Dipped Grip

## Adjustable Wrench

- Patented lightweight ergonomic design
- Precision machined for smooth operation
- Wide capacity jaw provides versatility
- Exceeds ASME/ANSI specifications



0154-08D

8" Dipped Grip

0154-10D

10" Dipped Grip

0154-12D

12" Dipped Grip

## High Leverage Side-Cutting Pliers

- Location of handle ridge allows user to "choke up" for greater control
- Forged from chrome vanadium steel
- Effectively cuts most hardened wire, ACSR, bolts, screws, and nails
- Diamond serrated jaws



0151-09M

9" Molded Grip

0151-09D

9" Dipped Grip

## Long Nose Pliers/Side Cutters

- Flared handles for comfort and leverage
- Diamond serrated jaws and hardened cutting edges for optimum performance
- Forged from chrome vanadium steel
- Effectively cuts most hardened wire, ACSR, bolts, screws, and nails



0351-08M

Molded Grip

0351-08D

Dipped Grip

# Greenlee - Hand Tools

TOOLS

## Adjustable Wrench

- Precision machined for smooth operation
- Wide capacity jaw provides versatility
- Corrosion-resistant finish
- Exceeds ASME/ANSI specifications



0154-08 8"  
0154-10 10"  
0154-12 12"

## Double-Dipped Grip 16" Pump Pliers

- Double dipped grips for slip resistance
- Precision machined and through hardened for consistent performance
- Riveted process ensure joint integrity
- Right angled teeth for gripping in both directions



0451-16D

## Pump Pliers

- Precision machined and through hardened for consistent performance
- Right angled teeth for gripping in both directions
- Riveted process ensures joint integrity
- Slip-proof ergonomic grip
- User identification allowed on custom grip



0451-10M 10" Molded Grip  
0451-12M 12" Molded Grip  
0451-10D 10" Dipped Grip  
0451-12D 12" Dipped Grip

## Utility Knife

- Over-molded for secure grip
- Retractable, three position blade
- Easy front-loading design
- Pop-up holder for blade storage
- Packaged with 3 heavy duty blades



0652-11 Knife w/ 3 Blades  
9952-11 5 Replacement Blades

## Conduit-Reaming Screwdriver

- Deburs ID and OD of 1/2", 3/4" and 1" thin wall conduit
- Hooded, flat-tip driver used to fasten EMT fittings
- Soft, cushioned grip for extra torque
- 7 7/16" long



9753-11C Screwdriver  
9953-11 Replacement Blade

## 6" Keyhole Saw

- Integrated blade and handle design
- Hardened steel blade with clog-free teeth
- Pointed tip punches through drywall
- Blade cuts on both push and pull strokes
- Hole in handle may be used for lanyard or for convenient storage



301A

# Klein Tools - Tool Holders

## Pliers and Screwdriver Holder



- Features one pocket for side cutting pliers and one for a screwdriver
  - Slotted to fit belts up to 2" wide
  - Made of leather
- 5118S

## 8-Pocket Tool Pouch

- A roomy pouch for electricians, service and maintenance workers
- Five large utility pockets for a wide variety of tools such as pliers, wrenches and wire cutters
- Smaller pockets are great for screwdrivers and scratch awls
- Knife snap, chain tape thong, and tape rule holder are conveniently located on the front
- Tunnel loop fits belts up to 2 1/2" wide
- Made of chrome-tanned leather



5178

## Pliers, Rule, Screwdriver, & Wrench Holder

- Four pockets to hold pliers, rule, screwdriver, and adjustable wrench
- Also features a two-way knife snap
- No exposed rivets in back
- Slotted to fit belts up to 2" wide
- Made of leather



5118C

## 8-Pocket Tool Pouches

- Multi-purpose pouch provides space for an extraordinary number of tools
- Four large, gusseted utility pockets
- Two pliers pockets
- Two pockets for screwdrivers
- Knife snap
- Slotted fits belts up to 2" wide
- Tunnel loop fits belts up to 2 1/2" wide



5164  
Slotted



51647  
Tunnel loop

## 4-Pocket Tool Pouch

- Pouch with center pocket for 6' wood rule, front loop for pliers, and two side loops; knife snap on front
- Slotted to fit belts up to 2" wide
- Made of leather



5119

## 5-Pocket Tool Pouch

- A high-quality pouch with extra-large, gusseted utility pocket, two pliers pockets, two screwdriver pockets, and knife strap
- Slotted pouch
- Fits belts up to 1 3/4"
- Made of leather



5126

## 10-Pocket Tool Pouch

- Rugged, big-capacity pouch with 10 separate pockets
- Four large, gusseted utility pockets
- Two pliers pockets
- Four pockets for screwdrivers
- Knife snap
- Slotted pouch fits belts up to 2" wide
- Made of leather



5126

## 10-Pocket Riveted Tool Pouch

- Riveted throughout to assure long life
- Ten separate compartments provide places for a wide variety of pliers, screwdrivers and other tools
- Has ring and tape thong
- Slotted pouch fits belts up to 2" wide
- Made of leather



5166



5190

## 7-Pocket Multi-Purpose Tool Pouch

- Multi-purpose pouch, soft and pliable
- Moisture resistant to retain flexibility even after being wet and dried
- Has two large, gusseted utility pockets, two screwdriver pockets, hammer loop, three pliers pockets, and one chain tape thong
- Tunnel loop fits belts up to 2 1/4" wide
- Made of chrome-tanned leather



TRUSTED SINCE 1958

# Klein Tools - Pro Pack Tool Sets

## 92914: 14 Piece Tool Set

- J2000-9NETP 9" High-Leverage Side-Cutting Pliers - Fish Tape Pulling
- J2000-48 8" High-Leverage Diagonal-Cutting Pliers - Angled Head
- J203-8 8" Heavy-Duty Long-Nose Pliers - Side-Cutting
- 11055 Klein Kurve® Wire Stripper/Cutter
- J502-10 10" Pump Pliers
- 630-1/4 1/4" Cushion-Grip Nut Driver - 3" Shaft
- 630-5/16 5/16" Cushion-Grip Nut Driver - 3" Shaft
- 662 #2 Square Recess Tip Cushion-Grip Screwdriver - 3" Round Shank
- 605-4 1/4" Cabinet Tip Cushion-Grip Screwdriver - 4" Heavy Duty Round Shank
- 603-4 #2 Phillips Tip Cushion-Grip Screwdriver - 4" Round Shank
- 603-3 #1 Phillips Tip Cushion-Grip Screwdriver - 3" Round Shank
- 601-6 3/16" Cabinet Tip Cushion-Grip Screwdriver - 6" Round Shank
- 5720 12-Pocket Tool Pouch
- 5705 Adjustable Tool Belt



## 92911: 11 Piece Tool Set

- D213-9NETP 9" High-Leverage Side-Cutting Pliers - Fish Tape Pulling
- D248-8 8" High-Leverage Diagonal-Cutting Pliers - Angled Head
- D203-8 8" Heavy-Duty Long-Nose Pliers - Side-Cutting
- 11045 Wire Stripper/Cutter
- D502-10 10" Pump Pliers
- 605-4 1/4" Cabinet Tip Cushion-Grip Screwdriver  
4" Heavy Duty Round Shank
- 603-4 #2 Phillips Tip Cushion-Grip Screwdriver
- 603-3 #1 Phillips Tip Cushion-Grip Screwdriver - 3" Round Shank
- 601-6 3/16" Cabinet Tip Cushion-Grip Screwdriver - 6" Round Shank
- 5720 12-Pocket Tool Pouch
- 5705 Adjustable Tool Belt

## 92906: 6 Piece Tool Set

- D213-9NE 9" High-Leverage Side-Cutting Pliers
- D248-8 8" High-Leverage Diagonal-Cutting Pliers - Angled Head
- D203-8 8" Heavy-Duty Long-Nose Pliers - Side-Cutting
- 11045 Wire Stripper/Cutter
- 605-4 1/4" Cabinet Tip Cushion-Grip Screwdriver
- 603-4 #2 Phillips Tip Cushion-Grip Screwdriver - 4" Heavy Duty Round Shank

## 80118: 18-Piece Journeyman's Kit

- |                                    |                              |
|------------------------------------|------------------------------|
| Journeyman Side-Cutting Pliers     | (2) Cabinet-Tip Screwdrivers |
| Journeyman Diagonal-Cutting Pliers | Rapi-Driv Screwdriver        |
| Journeyman Long-Nose Pliers        | Adjustable Wrench            |
| Klein-Kurve Wire Stripper/Cutter   | (2) Nut Drivers              |
| Journeyman Pump Pliers             | Power-Return Rule            |
| Square-Recess Tip Screwdriver      | Protective Eyewear           |
| Phillips-Tip Screwdriver           | Powerline™ Work Belt         |
| Wire-Bending Screwdriver           | Ten-Pocket Tool Pouch        |

## Klein Hand Tools



## 80006: 6-Piece Trim-Out Set

- |                                      |  |
|--------------------------------------|--|
| Portable Solutions for Electricians: | No. 2 Phillips Tip Screwdriver; 4" Round Shank |
| Heavy Duty Side-Cutting Pliers       | 1/4" Cabinet Tip Screwdriver; 4" Round Shank   |
| Klein -Kurve Wire Stripper           |  |
| 4 Pocket Leather Tool                |  |
| Lightweight Utility Belt Pouch       |  |





## 63050-INS: Insulated High-Leverage Cable Cutter



- Cable-gripping shear-type jaws cut up to 4/0 aluminum, 2/0 soft copper, 100-pair, 24-gauge communications cable
- Compact design for easy portability and efficient work in confined spaces
- Not designed for cutting steel or ACSR
- Rated up to 1,000 volts
- 9 1/2" length

## D2000-9NE-INS: Insulated High Leverage NE-Type Side Cutter



- Flame retardant, impact resistant, bright orange outer coating
- Provides greater cutting and gripping power
- Smooth, streamlined nose with knurled jaws
- Rated up to 1000 volts
- 9 1/4" length

## Insulated Heavy-Duty Round Shank Keystone® Tip Screwdrivers



- Square edges fit screw openings securely and resist slippage
- Strong, durable black tips, precision forged and ground
- Rated up to 1000 volts

602-4-INS	1/4" x 4"	8 11/32"
602-6-INS	5/16" x 6"	10 15/16"

## D2000-28-INS: Insulated High-Leverage Diagonal Cutter



- Flame retardant, impact-resistant, bright orange outer coating
- Provides greater mechanical cutting and gripping power
- Standard-bevel cutting knives
- Rated up to 1000 volts
- 8" length

## Insulated Round Shank, Cabinet Tip, Cushion-Grip Screwdrivers



- Super comfortable, sure-grip handles
- Perfect for electrical, telephone and work in recessed holes and other tight spaces
- Rated up to 1000 volts

601-4-INS	3/16" x 4"	7 3/4"
601-6-INS	3/16" x 6"	9 3/4"

## D2000-48-INS: Insulated High-Leverage Diagonal Cutter with Angled Head



- Heavy duty design with angled head for easier work in confined areas
- Flame retardant, impact-resistant, bright orange outer coating
- Rated up to 1000 volts
- 8" length

## Insulated Round-Shank, Special Profilated Phillips-Tip Screwdrivers



- Profilated to provide a more consistent geometric symmetry than conventional Phillips-tip screwdrivers for more accurate fit and torque without slippage
- Rated up to 1000 volts

603-4-INS	No. 2 Point	4" shank length
-----------	-------------	-----------------

## D203-8-INS: Insulated Heavy-Duty Long-Nose Pliers with Side Cutters



- Extra-heavy design for easier and more comfortable cutting
- Rated up to 1000 volts
- 8 5/16" length

# Klein Tools - Hand Tools

## Cushion-Grip Screwdrivers

- Cushion-Grip screwdrivers are exceptionally strong and made of carefully heat treated and tempered steel
- The Cushion-Grip handle resists slippage which allows you to apply greater torque
- Bolster on blade at handle provides added strength and rigidity for heavy duty Cushion-Grip screwdrivers
- Blades are fully chrome-plated with black-tips
- Cushion-Grip is resistant to oil, gas, and water
- Available with Round or Square shank



605-4 Round-Shank Cabinet-Tip 1/4" x 4"  
605-6 Round-Shank Cabinet Tip 1/4" x 6"



603-4 Round-Shanks Phillips-Tip (Point Size) No. 2 x 4"  
603-6 Round-Shank Phillips-Tip (Point Size) No. 3 x 6"  
603-7 Round-Shank Phillips-Tip (Point Size) No. 2 x 7"



661 Round-Shank Square-Recess (Point Size) No. 1 x 4"  
662 Round-Shank Square-Recess (Point Size) No. 2 x 4"  
663 Round-Shank Square-Recess (Point Size) No. 3 x 4"



600-4 Square- Shank Keystone-Tip 1/4" x 4"  
600-6 Square-Shank Keystone-Tip 5/16" x 6"  
600-8 Square-Shank Keystone-Tip 3/8" x 8"  
600-12 Square-Shank Keystone-Tip 1/2" x 12"



620-4 Plastic-Coated Round-Shank Cabinet Tip 1/4" x 3 3/4"  
620-6 Plastic-Coated Round-Shank Cabinet Tip 5/16" x 5 3/4"



19543 Round Shank TORX T20 x 4"  
19544 Round Shank TORX T25 x 4"  
19546 Round Shank TORX T30 x 4"

## 85076: 7 Piece Cushion-Grip Screwdriver Set



- A convenient selection of popular screwdrivers including three cabinet tip, two Phillips tip and two keystone tip styles, all with Cushion-Grip high quality design and construction features
- Set is provided in recloseable seal tight vinyl pouch
- Cushion-Grip is resistant to oil, gas, and water

## 631: 7 Piece Cushion-Grip Nut-Driver Set



- These exceptionally strong drivers are made of carefully heat treated and tempered steel
- Cushion-Grip handle resists slippage which allows you to apply greater torque
- Shafts are fully chrome plated
- The handle grip is comfortable
- This set consists of seven nut drivers in a handy, roll-up plastic pouch with hang-hole
- Cushion-grip is resistant to oil, gas, and water
- Size is colour coded for easy identification

Sizes: 3/16", 1/4", 5/16", 11/32", 3/8", 7/16", 1/2"

## 631-M: 7 Piece Magnetic Tip Nut Driver Set with 3" Hollow Shafts



- Full hollow shaft design with Rare Earth magnetic tip
- Full hollow shafts facilitate work on long bolt applications
- Cushion Grip handles allow for greater torque and comfort
- Handle domes are colour coded for easy identification
- Internal flanges provide solid, twist resistant shaft anchor
- Chrome plated shaft prevents corrosion

Sizes: 3/16", 1/4", 5/16", 11/32", 3/8", 7/16", 1/2"  
3/16" does not have hollow shaft

# Klein Tools - Screwdrivers & Nut Drivers

## 85090: Klein 5-Piece Grip-It Screwdriver Set



- Patented, oil resistant, anti-slip, plastic flock on handle helps prevent slippage
- Made of special high-alloy steel for exceptionally strong blade and long life
- Rounded end virtually eliminates pressure points in the palm of the hand
- Triangular-shaped handle allows for more turning power
- This set contains a general purpose selection of the most frequently used Grip-It screwdrivers
- Includes two cabinet tip, one Phillips tip, and two keystone tip screwdrivers

## 32510: Magnetic Screwdriver with 32-Piece Tamperproof Bit Set



- Sturdy bit and screw holding magnet allows screws to fit securely in place
- Complete tamperproof bit set in block
- Non-ratcheting

## 32526: Magnetic 32-Piece Standard Tip Bit Set



- Clutch 5/32" and 3/16"
- Hex-5/64", 3/32", 7/64", 1/8", 9/64", 5/32", 3/16"
- Phillips - #0, #1, #2 (Qty 3), and #3
- Square recess #1, #2, and #3
- TORX - T6, T7, T8, T10, T15, T20, and T25
- Slotted screws sizes 3-4, 5-6, 6-8, 8-10, 10-12, 12-14
- 1/4" square to 1/4" hex adapter to drive sockets

## 32525: Magnetic 32-Piece Tamperproof Tip Bit Set



- Spanner - 4, 6, 8, 10
- Tri-Wing - 1, 2, 3, and 4
- TORQ-SET - 6, 8, and 10
- 1/4" square to 1/4" hex adapter to drive sockets
- Fraction Hex - 3/32", 7/64", 18", 9/64", 5/32", and 3/16", 1/4"
- TORX - T7, T8, T10, T15, T20, T25, T27, T30, and T40

## Journeyman Screwdrivers



JSDS01



JSDS02

- Journeyman™ represents the best of Klein quality, workmanship combined with the latest in product design
- JSDS01 includes (1) cabinet-tip, (2) Phillips-tip, (2) keystone-tip screwdrivers
- JSDS02 includes (2) cabinet-tip, (3) Phillips-tip, and (2) keystone-tip screwdrivers
- Advanced blade technology; maximum turning power
- Ultra-comfort tri-lobe handle for control, grip and balance
- Patented Tip-Ident™ quickly identifies screwdriver tip/orientation

## 85484: 4-Piece Mini Screwdriver Set

- Patented Tip-Ident® quickly identifies the type of screwdriver and tip orientation
- Precision tip for an exact fit
- Premium chrome-plated shafts for corrosion resistance



# Klein Tools - Pliers

## High Leverage NE-Type Side-Cutters

- Smooth, streamlined nose with knurled jaws
- High-leverage design
- Blue plastic-dipped handles



D213-9NE



HD213-9NE



D2000-9NE

## High-Leverage Diagonal Cutters



- High-leverage design
- Ultra-durable cutting knives
- Plastic-dipped handles

D2000-28

8" x 13/16" x 13/16" x 7/16"

D2000-48 Angled Head

8" x 13/16" x 13/16" x 7/16"

## High-Leverage Diagonal Cutters



- Soft, light blue handle material on outer surface for comfort and a firm grip
- Hard, black material on inner surface and handle ends for toughness and durability
- Hot-riveted joint for smooth action and no handle wobble

J2000-28 8 1/8" Length

J2000-48 8 1/8" Length, Angled Head

## High Leverage NE-Type Side-Cutters



- Smooth, streamlined nose with knurled jaws
- High-leverage design
- Blue plastic-dipped handles
- Soft, light blue handle material on outer surface for comfort and a firm grip
- Hard, black material on inner surface and handle ends for toughness and durability
- Hot-riveted joint for smooth action and no handle wobble

J2000-9NE 9 3/8" Overall Length

## Pump Pliers



- Wide range of jaw opening sizes
- Jaws cannot slip under heavy pressure
- Yellow plastic-dipped handles

D502-10 10" Long 1 3/4" Jaw

D502-12 12" Long 2 1/8" Jaw

## D213-9NETH: Bolt-Thread Holding Side-Cutters



- Hinge opening holds and cleans 5/8" pole line and hardware bolts or threaded rods
- High-leverage design. Rivet is closer to the cutting edge for 46% greater cutting and gripping power than other plier designs
- Streamlined design with rounded nose and sure-gripping, cross-hatched knurled jaws
- 9 3/8" Overall Length

## D2000-9NETH: High Leverage Side-Cutting Pliers - Lineman's Bolt Thread Holding



- Hinge opening holds and cleans 5/8" pole line and hardware bolts or threaded rods.
- High-leverage design. Rivet is closer to the cutting edge for 46% greater cutting and gripping power than other plier designs
- Streamlined design with rounded nose and sure-gripping, cross-hatched knurled jaws
- 2000 Series - Heavy-duty cutting knives; cuts ACSR, screws, nails and most hardened wire

**WARNING:** Plastic-dipped or slip-on plastic handles are NOT intended for protection against electrical shock. This warning includes heavy-duty plastic-dipped handles. Never use any pliers or cutters on live electrical circuits.

## 803-32: Ball Peen Hammer, 32 oz.



- High-carbon steel head, drop-forged and hardened
- Crowned face with uniform bevel
- Smoothly-rounded peen
- Straight-grain hickory handle, stained and lacquered

## 823-32: Lineman's Straight-Claw Hammer, 32 oz.



- Heavy duty, double-duty, drives lags and pulls big nails
- Special high-carbon steel head with solid, octagon-shaped driving end and thick, strong claw
- Blue painted finish
- Straight-grain lacquered hickory handle

## 10" Straight Jaw Locking Pliers



- Versatile 10" locking pliers
- Pliers adjust easily to lock to any size with desired amount of pressure
- Release lever opens jaws fully
- Alloy steel, heat treated with nickel-plated finish

## Cable Crimper - Fixed Die

- Rust-resistant
- Length: 21.42"
- Crimps #2, #4, and #6 connectors safely and easily
- Features extra-heavy duty fiberglass handles
- Molded rubber grip handles are ergonomically designed to fit the contour of the human hand for increased comfort and slip resistance
- Weight: 3.8 lbs



## Round Head Cable Cutter

- High leverage design provides excellent cutting capability
- Plastic coated handles
- Precision, one-hand shearing action
- Cuts up to 2/0 AWG
- Designed for use in confined spaces
- Hot-riveted joint ensures smooth action and no handle wobble
- Beveled jaw tips provide proper opening, closing, and cutting



## Ratcheting Cable Cutter

- With one hand operation, use can cleanly cut up to 350 MCM copper and aluminum cable
- Ratchet holds cable tight and allows straight cuts with minimal effort
- Large handles allow sure grip and handles are plastic coated for positive grip
- Quick release lever opens blade during operation
- Not designed for steel or ACSR

## Ratcheting Cable Cutter

- Fully ratcheting cable cutter features handles designed for comfort and positive grip
- Quick release lever opens blade during operation
- A professional tool for stranded and flexible copper and aluminum cable up to 750 MCM or diameter of 1.77"
- Not designed for steel or ACSR



## Long-Nose Multi-Purpose Tool

- Features an extended handle



## Plastic Gripping Pliers

- Rated up to 1,000 volts
- 3 1/8" opening
- 7 1/2" long



# Snap-On Industrial/Williams

TOOLS

## Combination Wrench Sets

SUPERCOMBO® open end has specially designed grooves that direct wrench force away from fastener corners  
SUPERTORQUE® box opening design allows application of higher torque without rounding or deforming hex fastener points. No contact is made at the corners. Instead, wrenching forces are placed on the flat surfaces behind the points. Meets or exceeds aerospace specification AS 954 for 12 point fasteners (as defined by AS 870) to provide accurate torque/tension relationship for precision application. May be used on all common hex (6 point) fasteners with considerable advantage over conventional box end wrenches to increase both hand tool flexibility and economy



**WS-1170SCA: 7 Pc Combo Wrench Set**



**WS-1171SCA: 11 Pc Combo Wrench Set**



**WS-1172SCA: 15 Pc Combo Wrench Set**

## High Polish Wrench Sets

High polish chrome textured finish provides great feel and extra gripping power. 12 point box end provides easy socket engagement and maximum versatility. Recessed corners in box end provide extra turning power. Sets are packed in a vinyl pouch.



**11003: 9 Pc Hi Pol-Wrench Set**



**11007: 11 Pc Hi Pol-Wrench Set**



**11008: 14 Pc Hi Pol-Wrench Set**

## 100P-5MD: 5 Piece Premium Mixed Screwdriver Set

- Contains 3 slotted and 2 Phillips screwdrivers
- Comfort-grip handle with thumb stop allow for added turning power without discomfort or slippage
- Chrome blades prevent corrosion and can be easily cleaned
- Blades are made from special alloy steel for extra strength
- Vapor-blasted tips grip fasteners and prevent chipping, extending tool life
- Hex bolsters on shafts allow a wrench to be used for extra turning power
- 3/16", 1/4", 5/16", #1 & #2 Phillips



## 100P-8MD: 8 Piece Premium Mixed Screwdriver Set

- 8 Piece Premium Screwdriver Set Phillips Slotted Tips
- Comfort-grip handle with thumb stop allow for added turning power without discomfort or slippage
- Chrome blades prevent corrosion and can be easily cleaned
- Blades are made from special alloy steel for extra strength
- Vapor-blasted tips grip fasteners and prevent chipping, extending tool life
- Hex bolsters on shafts allow a wrench to be used for extra turning power
- 1/4", 5/16", 3/8", #1, #2 & #3 Phillips tip, 3/16" electrician's tip 3", 3/16" electrician's tip 6"



# Snap-On Industrial/Williams

## 24004: 6 Piece Slotted Tip Screwdriver Set

- Bi-mold handles provide comfortable grip, reducing hand fatigue
- Set packed in a vinyl pouch
- Handle end shows size and style for easy identification
- Chrome blades prevent corrosion and can be easily cleaned
- (2) 3/16", (2) 1/4", 5/16", 3/8"



## 24050: 7 Piece Nutdriver Set in Carrying Caddy

- Hollow shaft accommodates long bolts or studs
- Precision machined socket end
- Cushion grip handle for comfort
- Size imprinted on colour coded ends for easy identification
- 3/16", 1/4", 5/16", 11/32", 3/8", 7/16", 1/2"



## WS-1168RC: Reversible Ratcheting Combination Wrench Set

- High-polished cleans easily
- Ratchet lever is easily accessible for quick direction changes
- Recessed corners in ends provide extra turning power
- 5/16", 3/8", 7/16", 1/2", 9/16", 5/8", 11/16", 3/4"



## PLS-6A: 6-Piece General Service Pliers Set

The set includes:

- PL-1519C 5" utility superjoint
- PL-1520C 10" utility superjoint
- PL-46C 6" diagonal cutting
- PL-76C 6 1/2" chain nose side cutters
- 23503 8 1/4" front end stripper
- 2628G-180 7" side cutting pliers
- This 6 piece set is packaged in a roll pouch



## 24006: 8 Piece Combination Screwdriver Set

- Contains 5 slotted and 3 Phillips® screwdrivers
- Bi-Mold handles provide comfortable grip, reducing hand fatigue
- Set packed in a vinyl pouch
- Handle end shows size and style for easy identification
- Chrome blades prevent corrosion and can be easily cleaned
- 3/16", (2) 1/4", 5/16", 3/8" #1, #2 Phillips® tips



## 24051: 9 Piece Nutdriver Set in Plastic Tray

- Solid shaft accommodates long bolts or studs
- Precision machined socket end
- Cushion grip handle for comfort
- Size imprinted on colour coded ends for easy identification
- 3/16", 1/4", 5/16", 11/32", 3/8", 7/16", 1/2", 9/16", 5/8"



## Adjustable Wrench

- Measurement scale on head conveniently shows fastener size
- Wrench heads are fully polished for easy clean-up
- Exceed ANSI specifications for strength
- Precision hardened and anti-corrosion treated



Part #	Overall Length	Max. Jaw Opening (not less than)	Head Thickness
13408A	8"	1 1/8"	9/16"
13410A	10"	1 5/16"	11/16"
13412A	12"	1 1/2"	13/16"



# Snap-On Industrial/Williams

TOOLS

## WSC-167TB: 167 Piece Electrical Maintenance Service Set

- Designed to satisfy electrical maintenance tool requirements, this set has both the standard hand tools and special tools needed to accomplish a wide variety of electrical maintenance and installation
- Start with 1/4" and 3/8" drive sockets and accessories, hammers, and hand wrenches, and add the special items needed for electrical work:
  - Insulated and non-insulated pliers and screwdrivers
  - An electrician's holesaw set and a 10-pack of assorted recip blades
  - A comprehensive assortment of electrical strippers / crimpers / cutters
  - Drywall, hacksaw, and toolbox saws
  - And a full-size roll cabinet to organize, store, and move your tool set
- Unique in the industry, this set will help you get those critical electrical maintenance tasks done quickly, efficiently, professionally, and safely

### SET INCLUDES:

PRODUCT CATEGORY	# OF PIECES
Electrical Specialty Tools	2
Hammers	3
Hand Sockets	28
Miscellaneous Tools	9
Pliers	8
Pliers - Electrical	12
Pliers - Insulated	5
Ratchets, Drive Tools & Accessories	7
Saws and Saw Blades	32
Screwdrivers	14
Screwdrivers - Insulated	11
Tool Box	1
Wrenches	35

Tool Set Only (166 pieces)

Tool Box: 40" Wide x 20" Deep  
7-Drawer Roll Cabinet

WSC-167

W40RC7





# Snap-On Industrial/Williams

## 8155-1/2: 1/2" Drive Ergo® One-Hand Reversing Ratchet

- Ergonomic, smooth, non-slip handle ensures maximum comfort in the hand
- Ring switch provides easy, one handed change of direction
- Easy access reverse lever allows user to change working direction quickly and easily with only one hand
- Built-in ratchet spinner disc for fast socket turn-down
- 72 tooth gear with 5° engagement allows engagement in tight working areas
- Nickel/Chrome plating provides increased protection from rust and corrosion
- Durable handle material withstands aggressive fluids and oils

Length	Number of Teeth
10 1/4"	60

## 1/2" Drive Enclosed Head Ratchets

- Enclosed head is sealed to prevent dust, dirt, and liquids from entering head, preserving internal lubrication
- Forged one-piece ratchet provide strength and safety for industrial applications
- Smooth comfort-grip handle permits all-day use without gloves
- 36 tooth gear with 10° of engagement allows engagement in tight working areas
- Nickel/Chrome plating provides increase protection from rust and corrosion
- Chrome finish models feature mirror-like exterior that can be easily cleaned after each use
- Single Pawl ratchet design:
  - 1) Designed for tighter tolerances between pawl and gear which reduces metal fatigue and slippage under load
  - 2) Does not require as many working parts, reducing possible breakage and parts to repair
- Easy access reverse lever allows user to change working direction quickly and easily with only one hand

Part #	Description	Length	Number of Teeth
S-52EHA	Chrome Finish Enclosed Head Ratchet	10 1/4"	36
S-52EHLA	Chrome Finish Enclosed Head Ratchet, Long	15"	36
SB-52EHLA	Black Industrial Finish Enclosed Head Ratchet, Long	15"	36
S-52EHFA	Chrome Finish Flex Head Ratchet	14 1/4"	36
SB-52EHA	Black Industrial Finish Enclosed Head Ratchet	10 1/4"	36
S-52EHRKA	Repair Kit "EHA" Model Enclosed Head Ratchets		
<b>BAHCO Fine-Tooth Bi-Mold Comfort Grip Handles</b>			
8150-1/2	Comfort Grip Enclosed Head Ratchet	10 1/5"	80



## 12" Drive Round Head Ratchets

- Double pawl design with 72 teeth action provides a 5° ratcheting angle
- Shift lever reverses action instantly
- Knurled handle provides a non-slip grip
- Chrome finish models provides increased protection from rust and corrosion

Part #	Description	Length	Number of Teeth
S-52A	Chrome Finish Round Head Ratchet	11 5/16"	72
S-53A	Chrome Finish Round Head Ratchet, Long	15"	72
BS-52A	Black Industrial Finish Round Head Ratchet	11 5/16"	72
S-52ARK	Repair Kit		



# Snap-On Industrial/Williams

## 1/2" Drive Hex to Square Shank Impact Extensions

- Specially heat treated for impact use to provide long life, safety, and durability
- Spring plunger provides secure socket retention for safety and convenience
- Suitable for use with pneumatic and electric impact wrenches

Part #	Hex Shank Size	Square Drive Size	Length
4-33B	7/16"	1/2"	2 3/4"
4-35B	7/16"	1/2"	5"
4-53B	5/8"	1/2"	2 3/4"



## 1/2" Drive Impact Extensions & Accessories

- Specially heat treated for impact use to provide long life, safety, and durability
- Spring plunger provides secure socket retention for safety and convenience
- Suitable for use with pneumatic and electric impact wrenches

Part #	Description	Length	Socket Retention
4-102	Impact Extension	3 1/2"	Lock Ring
4-105A	Impact Extension	5"	Spring Plunger
4-110A	Impact Extension	10"	Spring Plunger
4-140B	Impact Universal Joint	2 1/2"	Spring Plunger
4-2A	3/8" M x 1/2" F Adapter	2 1/4"	Spring Plunger
4-6	3/4" M x 1/2" F Adapter	1 1/4"	Through Hole



## 1/2" Drive Impact Extensions & Accessories

- Specially heat treated for impact use to provide long life, safety, and durability
- Ball socket retention for fast socket changes
- Suitable for use with pneumatic and electric impact wrenches
- Drive end features pin retention hole and groove

Part #	Hex Shank Size	Length	Socket Retention
37002	Impact Extension	3"	Ball
37003	Impact Extension	6"	Ball
37004	Impact Extension	10"	Ball
37001	Impact Universal Joint	2 9/16"	Ball
37005	1/2" F x 3/8" M Adapter	1 7/8"	Ball



# Snap-On Industrial/Williams

TOOLS

## 1/2" Drive Deep Sockets, Impact 6 Point

Part #	Size	OAL	Drive End Diameter	Working End Diameter	Broach Depth	Bolt Clearance Depth	Bolt Clearance Diameter	Nose Length
37312	3/8"	3 1/4"	15/16"	5/8"	1 3/32"	2 1/4"	11/32"	3/4"
37314	7/16"	3 1/4"	15/16"	11/16"	1"	2 3/8"	13/32"	3/4"
37316	1/2"	3 1/4"	15/16"	25/32"	1 3/32"	2 3/8"	7/16"	3/4"
37318	9/16"	3 1/4"	15/16"	7/8"	1 5/32"	2 11/32"	1/2"	3/4"
37320	5/8"	3 1/4"	1	31/32"	1 5/16"	2 7/16"	9/16"	3/4"
37322	11/16"	3 1/4"	1 1/8"	1"	1 3/8"	2 17/32"	21/32"	3/4"
37324	3/4"	3 1/4"	1 1/8"	1 1/8"	1 5/16"	2 9/16"	23/32"	-
37326	13/16"	3 1/4"	1 3/16"	1 3/16"	1 1/2"	2 11/32"	3/4"	-
37328	7/8"	3 1/2"	1 1/4"	1 1/4"	1 15/32"	2 21/32"	27/32"	-
37330	15/16"	3 1/2"	1 3/8"	1 3/8"	1 13/32"	2 19/32"	29/32"	-
37332	1"	3 1/2"	1 1/2"	1 1/2"	1 15/32"	2 5/8"	15/16"	-
37334	1-1/16"	3 1/2"	1 17/32"	1 17/32"	1 29/32"	2 17/32"	1 1/32"	-
37336	1-1/8"	3 1/2"	1 5/8"	1 5/8"	1 7/16"	2 7/16"	1 1/16"	-
37338	1-3/16"	3 1/2"	1 21/32"	1 21/32"	1 13/32"	2 27/32"	1 1/16"	-
37340	1-1/4"	3 1/2"	1 3/4"	1 3/4"	1 7/16"	2 3/4"	1 1/16"	-
37342	1 5/16"	3 1/2"	1 7/8"	1 7/8"	1 3/8"	2 43/64"	1 7/32"	-
37344	1 3/8"	3 1/2"	1 57/64"	1 57/64"	1 3/8"	2 43/64"	1 19/64"	-
37346	1 1/16"	3 1/2"	1 31/32"	1 31/32"	1 3/8"	2 43/64"	1 11/32"	-
37348	1 1/2"	3 1/2"	2 1/8"	2 1/8"	1 3/8"	2 43/64"	1 3/8"	-



37312, 37324

## 37906: 9 Piece 1/2" Drive Deep 6 Point Impact Socket Set on Clip Rail

Contents Include:

Part #	Size	Part #	Size	Part #	Size
37316	1/2"	37322	11/16"	37328	7/8"
37318	9/16"	37324	3/4"	37330	15/16"
37320	5/8"	37326	13/16"	37332	1"



37906

## 37908: 15 Piece 1/2" Drive Deep 6 Point Impact Socket Set on Clip Rail

Contents Include:

Part #	Size	Part #	Size	Part #	Size	Part #	Size
37312	3/8"	37320	5/8"	37328	7/8"	37336	1 1/8"
37314	7/16"	37322	11/16"	37330	15/16"	37338	1 3/16"
37316	1/2"	37324	3/4"	37332	1"	37340	1 1/4"
37318	9/16"	37326	13/16"	37334	1 1/16"		



37908

## 37909: 19 Piece 1/2" Drive Impact Deep 6 Point Socket Set on Clip Rail

Contents Include:

Part #	Size	Part #	Size	Part #	Size	Part #	Size
37312	3/8"	37322	11/16"	37332	1"	37342	1 5/16"
37314	7/16"	37324	3/4"	37334	1 1/16"	37344	1 3/8"
37316	1/2"	37326	13/16"	37336	1 1/8"	37346	1 7/16"
37318	9/16"	37328	7/8"	37338	1 3/16"	37348	1 1/2"
37320	5/8"	37330	15/16"	37340	1 1/4"		



37909



ltlutilitysupply.com

## Transmission Tower Wrenches

- Bolt-Thru Design
- Two Square Sizes = 1-5/16" and 1-1/2"
- Provides greater flexibility for linemen
- Coated with epoxy paint for durability, easy cleaning
- Designed for utility, construction, and maintenance
- Made in USA



Lowell 52	52901-95823	15" Cast Handle
Lowell 53	53901-95823	20" Cast Handle
Lowell 152	15201-95823	17" Riveted Handle

## 101TDE & 103TDE Triple Square Distribution Wrench

- Five socket sizes in one wrench
- Square = 3/4" (oversize), 1" & 1-1/8"
- Hex = 9/16" & 3/4" (3/4" hex also turns 5/8" square nuts)
- Two handle lengths: 101TDE 9" & 103TDE 12"
- Ergonomic handle shape makes the work more comfortable
- Reversing control at both ends
- Twice as strong as a standard ratcheting box wrench
- Fluorescent orange sockets make the wrenches harder to lose, easier to find
- Bolt-thru design lets bolts pass entirely through sockets and arm head so nuts can be secured on any threaded length



## 23-26908-9900: Triple Square Impact Socket Assembly w/ Adapter

- Three square openings in one socket
- 3/4" (oversize) for 1/2" hardware
- 1" for 5/8" hardware
- 1 1/8" for 3/4" hardware
- 13/16" diameter, 6" long hollow shaft allows use on long threaded bolts
- Narrowed center allows easy grip with or without gloves
- 7/16" hex quick-change adapter included
- Length 7 3/4", weight 2 lbs

## 21-T8T29-Q100: Triple Square Impact Socket w/ Adapter

- 6" deep, 1-1/16" diameter hollow shaft allows use on long threaded bolts
- 7/16 Hex Quick-Change Adapter included
- Length 10-3/8" (assembled), weight 3.5 lbs. (with adapter)
- Square socket openings 1-1/8" for 3/4" hardware 1-5/16" for 7/8" hardware 1-1/2" for 1" hardware
- Also fits 1-1/2" hex nuts



## 51T/151T Distribution Wrenches

- Ergonomic handle shapes
- Reversing control in head
- Enclosed ratchet mechanism on models 50T, 51T; semi-enclosed on models 101T, 150T, 151T
- Fluorescent orange sockets
- Bolt-thru design
- Made in USA



Lowell 51T	51901-94800	12" Cast Handle
Lowell 151T	88901-94800	12" Riveted Handle
Lowell 50T	50901-94800	10" Cast Handle
Lowell 150T	88901-94800	10" Riveted Handle

## 101T Mini Triple Square Distribution Wrench

- Fits most common utility pole fasteners: lag bolts, C-clamps, suspension bolts
- Reduced socket depth and short handle length designed for tight spaces
- Torque capacity of 150lb/ft
- Made in USA
- 8" length, 1.5 lbs, 3/4" x 1" x 1-1/8"



## 104T: Triple Square Tower Wrench

- Provides greater flexibility for linemen dealing with the most common nut sizes in tower fasteners
- The 1-1/8" x 1-5/16" x 1-1/2" triple square socket allows for tolerances on 1-1/8" square nuts (5/8" bolts), 1-1/4" square nuts (3/4" bolts) and 1-3/8" square nuts (7/8" bolts)
- Also fits 1-1/2" hex bolts
- The Bolt-Thru design allows threaded rod to pass through the socket so that nuts can be secured on any threaded length
- The 104T has a heavy duty stamped riveted metal handle with a vinyl grip

## Hexagonal Wrenches

- Unique "Bolt-Thru" design allows the user to tighten nuts on any threaded length
- Permanent socket will not fall off the handle
- Features a reversible ratchet
- 1 1/4" hexagonal socket

50901-94720	10" Cast Handle
87901-94720	10" Riveted Handle
51901-94720	12" Cast Handle



## Simplex Strap Wrench

- Single piece design; contoured handle
- The 6" straps are ribbed and uncoated; the larger models are latex-coated for increased gripping power
- Strap attaches to the wrench with a "pound-in" wedge



Model	Handle Length	Strap Length	Strap Width
S-6	6"	22"	1/2"
S-12	12"	17"	1 1/4"
S-18	18"	30"	1 3/4"
S-24	24"	54"	2 1/4"

## Warnock Strap Wrench

- The original strap wrench for handling highly polished and smooth surfaces
- Rugged shackle swings away from the handle, allowing quick adjustment of the strap
- Strap is latex coated for increased gripping power



Model	Handle Length	Strap Length	Strap Width
W-12	12"	17"	1 1/4"
W-18	18"	30"	1 3/4"
W-24	24"	54"	2 1/4"

## 101XRS: Wrench 7/8" Pentagon + 3/4" Hex

- Built for tough duty with a rugged one-piece design that incorporates gear, shaft and sockets
- The sturdy ratchet mechanism reverses with the flick of a lever
- There are 32 teeth which reduce the throw angle between teeth and make the tool a good choice for working in tight areas
- For extra strength, the head of the wrench is secured with a pin which also eliminates wobbling for better torque and reduced wear
- Torque has been tested to 90 ft lbs
- A cushioned grip improves comfort and reduces worker fatigue
- Handle length is 7" and the tool weighs 1-1/2 lbs



## 10-312: Hastings Hammer Head Wrench



- The perfect tool for power linemen, telecommunications linemen, construction workers, maintenance workers
- Reduces your inventory and replacement of standard adjustable wrenches due to breakage

## Q-1 FUSEBUDDY

### Fusebuddy...a Tool Designed for Linemen by Linemen

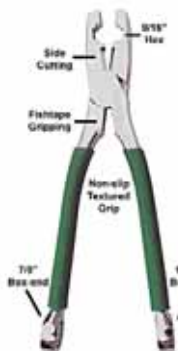

- FuseBuddy is a combination tool designed specifically for the electrical lineman
- Tool consists of three different common wrench sizes. One is positioned in the end of each handle and the third is positioned in the cutting head of the pliers
- Utilized most specifically for the re-fusing of open cut-out gates used in overhead power distribution
- The FuseBuddy eliminates the use of more than one tool to accomplish tasks
- Combination electrical lineman pliers
- 7/8" box end wrench at the end of one handle
- 13/16" box end wrench at the end of one handle
- 9/16" socket formed in the head of the pliers
- ACSR cutting capability



# ITL - Insulated Hand Tools

- ITL tools are insulated with injection molded Nylon 11
- Exceeds all the requirements of IEC 60900, including Category C (unaffected by extreme temperatures from +158°F/70°C down to minus 40°F/C)
- 100% test every product prior the shipment to ensure they meet the required standards
- Lifetime guarantee on the tools and the insulation
- 30-day no quibble money back guarantee

TOOLS

## UKC-02100: 7 Piece Screwdriver Set



- 02010: 1pt Phillips (02010)
- 02020: 2pt Phillips (02020)
- 01860: 3" Terminal driver
- 01880: 3" Electrical driver
- 01890: 6" Electrical driver
- 01940: 4" Engineers driver
- Tester
- Tool roll

## UKC-02150: 5 Piece Screwdriver Set



- 02020: 2pt Phillips
- 01860: 3" Terminal driver
- 01880: 3" Electrical driver
- 01890: 6" Electrical driver
- Tester
- Tool roll

## 02295: 7 Piece Nut Driver Kit



- 02305: 3/16" Nut Driver – 1" (25mm) stud clearance
- 02315: 1/4" Nut Driver – 1" (25mm) stud clearance
- 02331: 5/16" Nut Driver – 1" (25mm) stud clearance
- 02332: 11/32" AF Nut Driver (spinner) – 1" (25mm) stud clearance
- 02333: 3/8" AF Nut Driver (spinner) – 1" (25mm) stud clearance
- 02334: 7/16" AF Nut Driver (spinner) – 1" (25mm) stud clearance
- 02335: 1/2" AF Nut Driver (spinner) – 1" (25mm) stud clearance
- 03190: Tool Roll – 8 pockets

## 00017: Special Hydro Power Utility Kit



- 03005: 10" Adjustable wrench
- 01780: 3/8" Reversible Ratchet
- 01791: 5" Extension Bar
- 01792: 10" Extension Bar
- 01726: 3/8 Sq Dr. 9/16" Socket
- 01739: 3/8 Sq Dr. 3/4" Socket
- 02755: 3/8 Sq Dr. Male Hex 5/16" Socket
- 02756: 3/8 Sq Dr. Male Hex 3/8" Socket
- 02757: 3/8 Sq Dr. Male Hex 1/2" Socket
- 07053: Ratcheting Ring Wrench 9/16"
- 07056: Ratcheting Ring Wrench 3/4"
- 02742: T-Bar handle Wrench 5/16"
- 02743: T-Bar handle Wrench 3/8"
- 02745: T-Bar handle Wrench 1/2"

## 00008: 12 Piece General Utility Kit



- 00045: 9" Lineman Plier
- 00061: 8" Long Nose Plier
- 00115: High leverage Diagonal Cutting Nippers
- 01930: 4" Insulated Screwdriver 1/4" (6.5mm)
- 01940: 6" Insulated Screwdriver 5/16" (8mm)
- 01970: 10" Insulated Screwdriver 3/8" (10mm)
- 02010: No1 Phillips 3" Blade
- 02020: No2 Phillips 4" Blade
- 02030: No3 Phillips 6" Blade
- 00141: 10" Water Pump Plier
- 01726: 3/8 Sq Dr.
- 00125: 9" Cable Cutter
- 01830: 7" Cable Jointers Coring Knife
- 03200: Tool Case (19" x 14" x 6")

# Salisbury by Honeywell - Hand Tools

## Salisbury TK9: Salisbury Took Kit 9 Piece Basic Electrician Roll

- Slotted screwdrivers: 3/16 x 4", 3/16 x 6", 1/4 x 6"
- Phillips screwdrivers: #1 x 3", #2 x 4"
- 8" Needle nose pliers
- 7-1/2" Diagonal cutting pliers
- 9" Lineman pliers
- Combination stripper / crimper pliers
- In a tool roll bag



## Salisbury TK60:

- Slotted screwdrivers: 1/8 x 2", 3/16 x 4", 3/16 x 6", 1/4 x 6", 5/16 x 6"
- Phillips screwdrivers: #2 x 4", #2 x 8"
- Nutdrivers: 3/16", 1/4", 5/16", 11/32", 3/8", 7/16", 1/2"
- Torque wrench 30 - 150 in/lb;
- 3/8" dr, reversible ratchet
- 3" and 6" extensions, 3/8" dr
- 10 pcs. 5/16" to 7/8", 3/8" dr socket set
- 11 pcs. 3/8" to 1" box end wrench set
- 14 pcs. 1/16" to 1/2", 6" long arm, type "I" hexwrench set
- 7-1/2" diagonal cutting pliers
- 8" Needle nose pliers
- 9" lineman pliers
- 9-1/2" cable cutting pliers
- 10" water pump pliers
- Combination stripper/crimper pliers
- In a plastic box, including tool pouch rolls



# Cable Scorers & Stripping Kits

## Ripley Primary Distribution Tool Kit

- A convenient way to keep all tools together for performing all tasks associated with splicing and termination. This kit is suitable for all primary needs. Please note that you must call for bushings.
- Primary Distribution Tool Kit:
  - (1) URD Bag
  - (1) Ripley Banana Peeler (.750" - 1.25")
  - (1) WS64-U-E Adjustable Cable Stripper
  - (1) PIT-1T Load Break Elbow Probe Insertion Tool
  - WS5A-DA Adjustable End Stripper with Chuck Adapter(1) LBIT-1T Load Break Bushing Insertion Tool



## CPK-1: Speed Systems Combo Kit

- 1700SS Series Semi-Con Scorer allows for square and spiral cuts, and features an adjustable blade depth of .001" - .100", Leaf springs, and a Cable O.D. Range of 1/2" - 2"
- 1542-2CL stripper may be used on the following cables: kV Class Conductor Size, up to 5kV 1000 MCM, up to 15kV 750 MCM, up to 25kV 350 MCM, and up to 35kV 3/0; a wedge and spare straight blade are installed, and the tool features precise blade depth adjustment
- The kit also includes (1) scale gauge for measuring strip back and a 12" x 4.5" x 4" 20-gauge steel case



# Ripley Secondary Distribution Tool Kits

## WS 22A: Power Driven End Stripper

- Strips quickly, even in cold climates
- Uses standard WS 22 bushings
- Adjustable strip stop from 1" to 5"
- Guarded cutting blades ensure safety
- Tool designed to reduce working time and effort on repetitive stripping functions
- Precision stripping with no conductor damage
- Choice of Drill Drive or Socket Drive adapters available
- Ergonomic end stripping tool for 600V cables, 1/0 AWG to 1000 MCM - designed for use with low speed or variable speed power drill



WS 22A with 3/8" Drill Drive  
 WS 22A with 1/4" Hex Drive  
 WS 22A with 3/8" Square Socket Drive  
 WS 22A with 1/2" Square Socket Drive

## WS 68 SNAP: Power Drive End Stripper

- Guarded cutting blades ensure safety
- Strips quickly, even in cold climates
- 3/8" & 1/2" square socket adapters available
- Precision stripping with no conductor damage
- Designed for low speed or variable speed drills
- Features a bushing quick disconnect feature eliminating the need for a hex wrench
- Ergonomic end stripping tools for 600 volt secondary cable; designed for use with a low or variable speed power drill



- New adjustable strip stop with adjustment window allows easy setup for precise strip lengths from 0.625" to 2.5"
- Uses standard 2 x 2 and 4 x 4 bushings: #6 AWG to 500MCM (concentric, compressed, or compacted)
- Available with choice of drill drive or socket drive adapter



# Ripley - Scorers & Strippers

## WS 22: Double Ended End Stripper

- Precision stripping with no conductor damage
- For 600 volt cables, 1/0 AWG to 1000 MCM
- Square-cuts two specific cable sizes
- Stripping length preset at factory, special order
- Ergonomic end stripping tools for up to 600V secondary cable



## WS 68: Power Driven End Stripper

- Ergonomic end stripping tools for 600V secondary cable
- Designed for use with a low or variable speed power drill
- New adjustable strip stop with adjustment windows allows easy setup for precise strip lengths from 0.625" to 2.5"
- Uses standard 2x2 and 4x4 bushings: from #6 AWG to 500 MCM (concentric, compressed, or compacted)
- Plugs into chuck endings of cordless drills



## Ripley PIT-1T Load Break Elbow Probe Insertion Tool

- For insertion of probe into 15 to 34.5kV elbow - small interface
- Multiple drive system; 125 in lbs torque
- Prevents load break probe breakage and contamination; reduces cross threading
- Adjustable and removable "T" handle
- 1" steel drive and adjustable wrench
- 3/8" square drive socket



## Ripley WS 5A: Adjustable End Stripper

- Adjustable strip stop with rotary mechanism
- Adjustable window allows easy setting of stop
- Strip lengths from 0.625" up to 2.5"
- Ideal for primary URD cable
- For 600 volt to 35kV cables, 0.26" to 1.265" Cable O.D.
- Strips XLPE, polyethylene, EPR insulation up to 400 mils thick (insulation only or with semicon over insulation)



WS-5A End Stripper  
WS 5A-DA End Stripper w/ Chuck Adapter  
CB 7-2 Replacement Blade

## Ripley LBIT-1T Load Break Bushing Insertion Tool

- For 200 amp bushing inserts with internal hexagon socket drive
- Multiple drive system; preset 180 in-lb. torque rating
- Adjustable "T" handle; standard penta head
- 7/8" hexagon for wrench
- 1" square drive socket



## Ripley WS 64-U-E Adjustable Cable Stripper

- Universal tool for end stripping outer jackets up to 2.5" O.D. or insulation up to 1.5" O.D. with interchangeable blades
- Dual position jaw for cable sizes from 1/2" to 2 1/2"
- Spring loaded 'trigger-action' jaw
- Micro-adjustable blade and self feeding tool



# Scorers & Strippers

## 700FP: Ripley WS70 Wire End Stripper

- 1.9" to 3.65" O.D. cable range
- Self-feeding during stripping operation
- Fine adjustment feature on the blade
- Dual handle design gives greater leverage
- Blades can be replaced
- Strips out jacket or insulating material on 46 to 69kV cable



## Ripley 2 x 2 & 4 x 4 Plus Tool

- For 600 volt secondary cable
- Strips quickly, even in cold climates
- Guarded blades ensure safety
- Bushings change easily
- Precision stripping
- Strips 45 - 110 mil secondary insulations



## 1542-2CL: Speed Systems Stripper

- Use on the following cables: kV Class Conductor Size, up to 5kV 1000 MCM, up to 15kV 750 MCM, up to 25kV 350 MCM, and up to 35kV 3/0
- Wedge and spare straight blade installed
- Precise blade depth adjustment
- No bushings required



1562 Replacement Wedge Blade

1581 Replacement Straight Blade

## Ripley Banana Peeler

- Adjustable blade semi-con scoring tool
- Scoring depth from 1 to 90 mils
- Length: 9.4"
- Weight: 13 oz.



35250 .38" - .75"

BP1A .75" - 1.10"

BP2A 1.25" - 1.75"

BP3A 2" - 2.63"

Replacement blade

## 1700SS/1800SS: Speed Systems Semi-Con Scorer

- Adjustable blade depth (.001" - .100")
- Allows for square and spiral cuts
- 1700SS features leaf springs and Cable O.D. Range 1/2" - 2"
- 1800SS features coil springs and Cable O.D. Range 3/4" - 3"



## 2750 Secondary End Strip Stripper

- Cable O.D. .31" - 1.375"
- No bushings are required
- End strips 600V cable or insulation (45 mil to 110 mil thickness)
- Unlimited stripback length
- #4 thru 1000 MCM



# Greenlee - Scorers & Strippers

## 1935: Wire Strippers

- Strips insulation from most smaller gauge wire
- Strips up to 7/8" length
- Strips PVC and THHN insulation
- For use with solid and stranded wire
- Capacity: 20-10 AWG



## 1903: Pocket Cable Strippers

- Easy blade depth adjustment
- 90° blade rotation allows longitudinal, circular, and spiral slitting of insulation



## 1927-SS: Stripping/Crimping Tool

- Machine stripping stations feature a positive stop, providing precise stripping diameters
- Crimps 10-22 AWG insulated/non-insulated terminals
- Cuts #4-40, #5-40, #6-32, #8-32, #10-24, #10-32 screws
- Strips 10-22 AWG solid and stranded
- Long, curved cutting blade reduces force required by 25% and can cut NM in a single cut
- Screw cutting stations are collapsed around the pivot - 20% less force is required



## Wire Strippers/Cutters

- Precision ground blades ensure consistent stripping/cutting and are heat treated for long life
- Serrated nose grip for wire pulling/straightening
- Stamped from high carbon tool steel
- Pivot joints have hardened steel bushings
- Designed to cut PVC or THHN insulation



1916-SS 20-10 AWG Solid



1917-SS 26-16 AWG Solid



1955-SS 10-18 AWG Solid and 12-20 AWG Stranded conductors



1956-SS 6-14 AWG Solid and 8-14 AWG Stranded conductors

## GTS-1930: Saber™ Cable Stripper

- 14 bushing kit ranging from #6 AWG - 500 MCM THHN copper conductor
- One way ratchet handle – allows user to maintain control of the cutback throughout the stripping process, ensuring blade does not come into contact with the conductor
- Tension grip depth stop – Self contained 4" laser etched depth stop for precise articulation of cut back depth, no additional tools needed for depth stop set up
- Spring loaded retention pin – Quick attachment method of cable specific bushings, no additional tools needed for bushing attachment
- Safety factor – Replaces the need to use blades when stripping cable. Blade lacerations comprise approximately 40% of all recordable injuries on the jobsite.



## JRF-4: Universal Cable Stripper

- Large capacity clamp jaw – Wide range, 1/2" - 3" cable outside diameter, enabling productivity when working with a variety of cable sizes
- Tension trigger – 150 lbs of clamping force allows user to securely capture cable for precise blade setting
- Delrin ball bearing rollers – Reduces the amount of force needed for the tool to move around and up the cable during stripping
- Roller ball actuation - Allows user to maintain constant contact with the clamp as it move around the cable
- Precision adjustable cutting blades – EPR and XLPE design specific blades allow for ease and efficient cut back



TRUSTED SINCE 1958

## SIEVERT TORCH & ACCESSORIES

### 8710-01: Sievert Soft Flame Burner



- Soft flame design ideal for cable work and other heat shrinking applications
- Sweeping, powerful yellow and blue soot-free, windproof flames
- Fresh air sucks in and keeps the burner head cold to minimize the risk of burning the shrink material
- Heats the sleeves efficiently yet soft enough not to overheat the shrink material
- Work pressure 29 psi; burner diameter 1.5"
- Thick walled sleeves max 5.9"

### 3366-97: Sievert Universal Torch Handle



- Plastic composite handle reinforced with 30% glass for maximum durability
- Bayonet fitting for burners
- Valve for precise flame setting
- 7.1" long x 3.1" height
- Piezo ignitor with instant trigger on/off function
- Swivelling hose connection to avoid hose drag
- Combined suspension hook and footstand

### 3091-23: Sievert Gas Regulator



- High quality brass construction
- P.O.L. inlet for refillable propane cylinder
- LH 9/16" male outlet
- Preset regulator; 28 psi for 1 lb. disposable cylinder variable hose connection
- Manufactured in brass to ensure the highest quality and long service life
- Valves have a very high capacity and precise outlet pressure
- LTS valve is designed to detect minor leaks
- Regulator with LTS is always combined with a hose failure valve

### 3015-04: Sievert Hose/Preset Regulator Assembly



- 4 ft. hose/preset regulator assembly
- 28 psi (disposable cylinder)
- Hose is rubber/plastic composition
- 1/4" I.D. with LH 9/16" female connections on both ends
- U/L and CGA approved

### 1510IS: Sievert 10' Gas Hose



- Rubber/plastic composition
- 1/4" I.D. with LH 9/16" female connections on both ends
- U/L and CGA approved

## S&C 35kV Loadbuster



- Loadbuster is the original lightweight, easy-to-use portable loadbreak tool for use with disconnects, cutouts, power fuses, and fuse limiters. It brings load-switching capability through 34.5 kV and 600 amperes nominal, 900 amperes maximum to your over head distribution system
- Loadbuster cuts installation and operation costs. There's no need for load interrupters on each device
- Switching procedures are simplified too, minimizing the duration and scope of outages
- This rugged, reliable device interrupts with no external arc, meeting OSHA requirements for opening circuits under load

Part #	Description
5300R3	14.4/25kV Nominal, 27kV Maximum
5400R3	25/34.5 kV Nominal, 38kV Maximum

## S&C 4440: Talon Fuse Handling Fitting



- Two pronged fitting designed for use on overhead distribution systems for installing and removing S&C SMD-20 power fuses, fuse cutouts, and S&C Fault Tamer® fuse limiters from their mountings
- Talon can be used to open and close disconnects and interrupter switches
- High-strength, aluminum-bronze fitting

## SP-1/SP-2: SPIKE Tool

- SPIKE provides positive assurance that the lineman will not cut an energized cable
- SPIKE is operated remotely thereby removing the lineman from danger if a live cable is spiked
- SPIKE can be used on aluminum and lead sheathed cable and interlock armored cables
- SPIKE will accept single conductor cables ranging in diameter from 3/4" OD to 2 3/4" OD
- A larger tool accommodates cable sizes up to 3 1/2" OD
- Used on thermoplastic or thermosetting insulation and oil impregnated paper insulation
- Pierces cable through it's center core
- Creates minimal cable damage
- Uses low velocity loads for actuation
- Weight: 7 lbs



# RoboPaks® Battery Powered Tools

TOOLS

## XL 9280 RoboPak Kits

- Ultimate in portable power systems increases run-time of your tool 30 times
- Power all tools that require voltages from 6 - 28 Volts
- Power Huskie, Burndy, Greenlee, Milwaukee, DeWalt, Makita, and hundreds more
- Encased in a heavy-duty, all-weather high impact plastic case with shoulder strap
- All kits include (1) Robopak, (1) AC charger, and appropriate adapter for the tools they are designed to power
- Easily hangs via "S-hooks" in your bucket

- 5228 Powers Huskie Tools**
- 5060 Powers 14.4V Burndy, Makita, Stanley, Cembre Tools**
- 5061 Powers EK425 Greenlee Tools**



## 19.2 Li-Ion RobolImpact®

- Made for Linemen and other heavy-duty users, the 19.2v Cordless RobolImpact® is small, lightweight, powerful and durable
- It is the lightest-weight-to-power-ratio cordless impact wrench in the world
- The RobolImpact's lightweight combined with a proprietary cushioned handle and "gun like" design will increase job efficiency, reduce operator fatigue, and allow uses in an environment where hoses or cords are unsafe or inconvenient
- Voltage: 19.2v
- Ft./lbs of Torque: 350
- Impacts Per Minute: 0 - 2300
- Chuck: 7/16" Hex Quick-Change
- Cordless Battery: 19.2v Lithium-Ion
- Charging Options: AC
- Weight (Tool and Battery): 5.7 lbs

- 5600 Tool, Two Batteries, AC Charger, Case**
- 5601 Tool, One Battery, AC Charger, Case**
- 5602 Tool, One Battery, AC Charger, Inverter, Case**
- 5603 Tool, Two Batteries, AC Charger, Inverter, Case**
- 5604 Tool, Two Batteries, AC Charger 5040 Tool Bag**



## 5040: Lineman's Cordless Tool Bag

- Designed by linemen for linemen
- Allows you to easily carry, organize and store your cordless tool and accessories
- Can be securely mounted in your vehicle or bucket
- Made of heavy-duty vinyl
- Durable shoulder strap and mounting rings for vehicle or bucket
- Side impact holder for up to 18" L x 3/4" diameter impact bit
- Deep center pocket to securely hold and protect tool, extra battery and charger
- Two front pockets that can hold and protect needed accessories like hex adapters, sockets, etc.
- Overall Height 17" x Width 11"



## 36V Cordless RobolImpact®

- Unmatched in performance, the 36V RobolImpact® is the most powerful tool of its kind in the world
- 7/16" hex quick-change
- 2500 impacts per minute
- Powerful 30 AMP reversible motor provides in excess of 2500 impacts per minute and approximately 450+ ft./lbs. of torque for the most demanding drilling and hardware applications
- Tool can be used with superior quality Hilti cordless batteries
- Average drill time in 10" diameter pole is 9 seconds
- Average number holes per charge in 10" diameter pole is 20+

- 5309 Tool, (1) Lithium-Ion Battery, AC Charger**
- 5310 Tool, (2) Lithium-Ion Batteries, AC Charger**
- 2756 36V Lithium-Ion Battery**
- 4376 Lithium-Ion AC Battery Charger**



## 9296: Pole bit Holder

- Holds 4 bits any length and up to 1" diameter
- Extremely heavy-duty and weather resistant
- Will not rust and comes with lifetime warranty
- Mount on your vehicle or any vertical surface



# Greenlee - Impact Tools & Accessories

## HW1 & HW1V: Hydraulic Impact Wrench



- Impact and temperature-resistant polymer grip designed to dissipate heat from the handle
- Weight reduction of 14% to previous models
- Improved center-of-gravity for superior ergonomics
- Increased service life with the addition of back-up rings and larger O-rings
- Built-in hydraulic check valve to eliminate damage from an improperly connected tool
- Large and strong lifting eye for easy and secure storage
- Longer and wider trigger provides improved control with insulated gloves
- Discrete position torque adjustment control with 3 positions; HW1V features quick-change access
- Fast, easy change between open center systems and closed center systems; no disassembly required
- Higher breaking torque in reverse to ensure you can remove tightened bolts
- Cast motor enclosure better protects the impact mechanism operation versus competing models

**HW1** Standard Wrench

**HW1V** Wrench with 3 Position Torque Control

## H8508: Reversible Impact Wrench & Drill with 7/16" Hex Quick Change



- Includes (1) 1/2" HD square adapter with every wrench - a \$35 value!
- Operates on either an open or closed center hydraulic system
- Internal control prevents overspeeding and allows up to 12 gpm
- Features high torque for drilling salt-cured and creosoted poles
- Ergonomic, heat insulated handle
- Features a twin hammer impact mechanism
- Available with variable torque control that is adjustable from 80 to 400 ft. lbs.
- Operating pressure of 1,000 - 2,000 psi
- Flow range of 4 - 12 gpm; optimum flow range of 5 - 8 gpm

**H8508-1**

**H8505-IV\*** Adjustable Torque *\*only wrench on the market with this feature - dial down torque to protect hardware*

**H8508-3**

**H8508-3V**

## HID6506: Rotary Impact Hammer Drill



- Adjustable flow control prevents overspeeding and allows precise control of drilling speed
- Super Spool selector control for use on open and closed center hydraulic systems
- Depth gauge and auxiliary handle are removable for tight areas
- Selector for drill or hammer/drill
- Hammer drill in concrete, brick, rock, and other difficult-to-drill materials; drill in wood or steel with auxiliary chuck
- Built-in slip clutch to guard against over-torque
- Flow range of 5 - 10 gpm; RPM at 6.5 gpm is 775 - 1,100
- Operating pressure of 1,000 - 2,000 psi

## H6510: Impact Wrench 5/8" Hex & 3/4" Square Drive



- Added power and torque for heavy-duty jobs
- Operates on either an open or closed center hydraulic system
- Twin hammer design with adjustable torque control and auxiliary handle
- Flow range of 4-12 gpm
- Operating pressure of 1000 - 2000 psi
- Torque at 6 gpm is 1060 ft lbs
- Needle bearing, rugged gear motor design

## H6400C: Reversible Drill, 1/2" Key-Type Chuck

- Compact, lightweight - ideal for line construction applications
- Super Spool selector control for use on open and closed center hydraulic systems
- Rugged gear motor
- Weighs 6 lbs
- Operating pressure of 1000 - 2000 psi
- Flow range of 4-8 gpm



# Greenlee Nail Eater® Extreme Black

TOOLS

## Utility Auger Bits - the Easier and Faster Way to Drill in Utility Poles!



- Nail Eater® Extreme Black Teflon® coated Utility Auger Bits. Auger bits drill fast and smooth in most treated woods, including tough utility poles
- Patented cutting edge cuts nails and staples so these auger bits last much longer than other Teflon® coated bits on the market
- With less power required to drill holes—extending battery life up to 30%—these auger bits help save time and money
- Teflon® coating resists heat and friction for fast and smooth operation
- Over center flute design evacuates chips faster, no clogging or chip flyback
- Made in the USA

Cat no.	UPC no.	Description
66TF-9/16	02004	Impact Auger Bit, TF-9/16" x 18"
66TF-11/16	02005	Impact Auger Bit, TF-11/16" x 18"
66TF-13/16	02006	Impact Auger Bit, TF-13/16" x 18"
66TF-15/16	02007	Impact Auger Bit, TF-15/16" x 18"

## Nail Eater II® Extreme Impact Bits



- Quickly bore through creosote and salt-treated utility poles
- Resists wear, eats through nails and staples
- Self-feeding screw point draws the bit through the wood
- 7/16" hex shank to fit quick-change impact drivers

37868	9/16" x 18"
37869	11/16" x 18"
37870	13/16" x 18"
37871	15/16" x 18"

## Long Impact Bits



- Made from hardened alloy steel for added toughness
- Quickly bore through large creosote and salt-treated utility poles
- Self-feeding screw point draws the bit through the wood
- 7/16" hex shank to fit quick-change impact drivers
- Cutting edge can be re-sharpened multiple times and continues to self-feed

11097	11/16 x 24"
11100	11/16 x 30"
11098	13/16 x 24"
11099	15/16 x 24"
11101	13/16 x 30"
11102	15/16 x 30"

## NR1 Nut Runner



- For installing and tightening pole hardware
- Will work with 7/16" quick change chuck
- Accommodates bolts that extend up to 6" beyond the nut
- 9 1/2" long with adapter

45798	3/4", 13/16", 1", 1 1/8", 7/16" Hex Adapter
49782	Replacement Adapter

## NR2 Nut Runner



- Used for most transmission applications
- 11" long with adapter
- 1 5/16", 1 1/8", 1" square openings
- Socket can be turned end-to-end without removing the adapter from the tool
- Accommodates bolts that extend up to 6" beyond the nut
- 7/16" hex adapter for use with 1/2" impact wrenches

20920	Nut Runner Adapter
21111	Replacement Adapter

## 49314: Heavy Duty Square Adapter



- 7/16" x 1/2" drive shank
- Rated at 450 ft lbs of torque
- Not for use with nut runners



# Greenlee - Hydraulic Equipment

## F20: 20 HP Power Unit

- Variable oil flow to 10 gpm
- 20hp at 3,600 rpm
- Open center hydraulic system
- Rated flow: 5 -10 gpm
- Rated pressure of 2,000 psi
- Fuel: Gasoline 3.3 gallons (50.35 litres)
- Engine hour meter and tachometer
- Heavy duty lifting eye
- Sealed lead-acid battery
- HTMA flat face hydraulic couplers
- Integral grab rails for lifting into trucks and trailers
- Hydraulic oil level sight gauge and 10 micron oil filter
- Oversized oil cooler and electric fan ensures cool running
- Easy access service points for engine oil, fuel, battery, and oil filter
- Electric key-start 20 hp Honda Model GX620 engine with low-oil shutdown



## High Pressure Couplers



- 40647 Male Coupler, Nose Half 1/4 - 18 NPSM
- 40652 Female Coupler 1/4 - 18 NPSM
- 54169 Male Coupler, Nose Half 1/4 - 18 NPTM (Used on HB10)
- 42096 Female Coupler 1/4 - 18 NPTM (Used on HB10)
- 41941 Male Coupler, Nose Half 3/8 - 18 NPTF
- 41877 Female Coupler 3/8 - 18 NPTM

## HFC30 Flow Control Valve

- Operates off other equipment's hydraulic accessory circuit
- Variable flow adjustment (up to 30 gpm) allows precise flow control for tool operation
- Integral pressure relief valve helps protect hydraulic equipment and tools
- All tool ports have O-Ring boss and accept industry standard hoses and couplers
- All-aluminum body design provides better heat dissipation



## PVA Valves

- May be directly connected to the tool or used remotely with hoses
- Controlled advance; 4-way, 3 position valve
- Built-in hold feature
- 3,000 - 4,000 psi return line ground dump safety valve
- 3-8 gpm flow range
- Maximum operating pressure: 10,000 psi return relief
- Port size inlet: 1/4 - 18 NPTF; Tool: 1/4 - 18 NPSM



- PVA0021 For Single Acting Tool
- PVA0022 For Double Acting Tool
- PVA1122 For Coupled Double Acting Tools

## HB10: Dynapress Hydraulic Intensifier

- Small and compact, the HB10 operates 10,000 psi remote head tools
- Operates on open or closed center hydraulic systems
- Uses the versatile Dynapress remote control valves and hoses sets
- Supplied with pressure and return high pressure screw-type couplers (HTMA couplers available)
- Crimping at 10,000 psi is 120,000 lbs.
- Fast advance flow of 3,200 cubic inches per minute



	Input Pressure	Input Flow	Max Back Pressure	Port Sizes
Low Pressure	1000-2200 psi	4-8 gpm	200 psi	3/4 - 16 SAE O-ring
	Output Pressure	Output Flow	Relief Valve Setting	Port Sizes
High Pressure	10,000 psi	35 cu. in./min.	10,000 psi	1/4-18 NPSM*

\*Couplers Provided

## High Pressure Non-Conductive Hose

- Certified Non-Conductive High Pressure Dual Hose Set - Rated 10,000 psi (700 bar) Rated 10,000 psi (700 bar)
- For use between Dynapress® intensifier or electric pump and control valve
- Each pair includes 3/16" (4.8 mm) I.D. pressure hoses with one 1/4" NPT male fitting on one end and high-pressure quick-disconnect on the other end

138573/41107 6 ft.

138574/41108 10 ft.

- Certified Non-conductive High Pressure Hose - Rated 10,000 psi (700 bar)
- For use between control valve and tool
- 3/16" (4.8 mm) I.D. hose with 1/4 NPT male fittings on both ends
- Hoses are tested at 75kV per foot

F020721/41795 6 ft.

F020723/41796 10 ft.



# Hydraulic Tool Assemblies

TOOLS

## Impact Wrench Assembly

- (1) Greenlee Impact Wrench
- (1) 8' hose (non-conductive)
- (1) 3/8" HTMA Flush Face Male, Female Couplers
- (2) Swivel Adapters



## Impact Wrench Assembly

- (1) Greenlee HW1 Standard Impact Wrench
- (1) 8' hose (non-conductive)
- (1) 3/8" HTMA Flush Face Male, Female Couplers
- (2) Swivel Adapters



## Impact Wrench Assembly

- (1) Greenlee HW1V Adjustable Torque Impact Wrench
- (1) 8' hose (non-conductive)
- (1) 3/8" HTMA Flush Face Male, Female Couplers
- (2) Swivel Adapters



## Pole Puller Assembly

- (1) Pole Puller
- (2) Hose Fittings



## Ground Rod Driver Assembly

Greenlee HRD-58 Ground Rod Driver



- (1) 3/8" HTMA Flush Face Male & Female Couplers

9/16" UN/UNF x 3/8" Female NPSM Swivel

9/16" UN/UNF x 1/2" Female NPSM Swivel



# Hydraulic Tool Replacement Parts

## LPK1240 Assembly



(1) Fairmont LPK120



(1) 8' Hose (non-conductive)



(2) Swivel Adapters



3/8" HTMA Flush Face Male & Female Couplers

## 20" Chain Saw Assembly



(1) Greenlee HCS820 20" Standard Chain Saw



Hose Fittings



(1) Quick Release Coupling Set

## 62.5" Pole Saw Assembly

- (1) 62.5" Pole Saw
- (1) 8' Hose (non-conductive)
- (1) Straight Adapter
- (1) Swivel Adapter
- (1) Quick Release Coupling



62.5" Pole Saw



(1) 8' Hose Non-Conductive



(1) Straight Adapter  
(1) Swivel Adapter



(1) Quick Release Coupling Set

## 75" Pole Saw Assembly

- (1) 75" Pole Saw
- (1) 8' Hose (non-conductive)
- (1) Straight Adapter
- (1) Swivel Adapter
- (1) Quick Release Coupling Set



75" Pole Saw



(1) 8' Hose (non-conductive)



(1) Straight Adapter  
(1) Swivel Adapter



(1) Quick Release Coupling Set

## Pole Tamper Assembly

- (1) Greenlee Pole Tamper
- (2) Hose fittings
- (1) 3/8" HTMA Flush Face Male & Female Couplers



Pole Tamper



Hose fittings



(1) Quick Release Coupling Set

## 60" Pole Tamper Assembly

- (1) Greenlee H4802-5 60" Pole Tamper
- (2) Hose fittings
- (1) Quick Release Coupling



60" Pole Tamper



Hose fittings



(1) Quick Release Coupling Set

## TED-270PFR: Tanaka Reversible Gas Drill

- 26.9 cc, 1.4 hp PureFire® two-stroke engine meets emissions levels without sacrificing power, adding weight, or creating maintenance headaches
- 20:1 gear reduction
- Powered reversing feature
- Dual position padded front handle
- Heavy-duty fuel tank protector
- 12.3 lbs
- Covered by Tanaka's two-year commercial use warranty and seven-year consumer use warranty



## TED-270PFL: Tanaka Gas-Powered Drill

- 26.9 cc, 1.4 hp PureFire® two-stroke engine meets emissions levels without sacrificing power, adding weight, or creating maintenance headaches
- 24:1 gear reduction
- Manual gear lock
- Dual position padded front handle
- Heavy-duty fuel tank protector
- Easy access air filter
- 11.2 lbs
- Covered by Tanaka's two-year commercial use warranty and seven-year consumer use warranty



## TIA-350FPS: Tanaka One Man Post Hole Digger

- 32.2 cc, 1.6 HP two-stroke engine provides excellent throttle response, reliable starting and proven durability
- S-Start system reduces the amount of pull-force required by 40%
- Tall wrap-around handles protect the engine from damage and provide the operator with more leverage
- Sound reduction system
- Primer for fast starting
- 33.2 output torque (ft/lbs)
- 17.6 lbs
- Covered by Tanaka's two-year commercial use warranty and seven-year consumer use warranty



## OshKosh Lug Hooks



- Lug Hooks are made for the exclusive purpose of hand carrying poles
- The handles are made of sturdy hard maple. Hooks are forged out of high-carbon steel and attached to the handle with a swivel of malleable iron, which makes for easier operation of the tool
- The shape of the chisel point hooks and handle provide balanced weight distribution and assures positive gripping

Part #	Description	WT
295	Lug Hook 2 1/2" x 4'	8 #
593	Replacement Handle, 2 1/2" x 4'	4 #
296	Lug Hook, 2 1/2" x 4'-6"	10 #
594	Replacement Handle, 2 1/2" x 4'-6"	5 #
297	Lug Hook, 2 1/2" x 5'	10 #
595	Replacement Handle, 2 1/2" x 5'	5 #
298	Lug Hook, 3" x 5'	14 #
963	Replacement Handle, 3" x 5'	6 #
299	Lug Hook, 3" x 6'	17 #
964	Replacement Handle, 3" x 6'	7 #

## OshKosh Peavies



- Designed and constructed for balance and easy handling
- The handles are made of hardwood
- The Hooks and Pikes are made of high-carbon steel
- The stop is to prevent the hook from falling back onto the handle

Part #	Description	WT
137	2 1/2" x 4'	9 #
575T	Replacement Handle, 2 1/2" x 4'	
138	2 1/2" x 4'-6"	11 #
576T	Replacement Handle, 2 1/2" x 4'-6"	
139	2 1/2" x 5'	12 #
577T	Replacement Handle, 2 1/2" x 5'	
480	Replacement Hook, 1" x 1/2"	

## Cant Hooks

- OshKosh Cant Hooks are made with hard maple handles and high-carbon steel hooks which are heat treated for strength and durability
- The hook stop is designed to prevent the hook from falling back and damaging the handle. Any hook can be placed on any handle
- The #5 and #7 hooks are used to handle smaller size poles
- Sockets, Clasps, Clips and Toe Rings are made of high-grade malleable iron which is light in weight yet strong

## OshKosh Skidding Tongs



Skidding Tongs are made of round high-carbon steel and have heavy up-set, hammer-forged points or hooks. High carbon steel is noted for its stiffness and extra strength. The sides are flattened evenly where they pivot. This gives a larger bearing surface and allows for the pivot to be shorter and of a larger diameter. The tongs are shaped so that a good grip is obtained on anything they straddle. The hooks are heat treated to resist straightening. The tongs are made with ring only.

*NOTE: Skidding tongs are not load rated and should not be used for overhead lifting*

Part #	Non-rated Skidding Tongs	WT	Opening
384	1" x 24" Skidding Tong w/ Ring	14 #	Not rated 24"
385	1 1/8" x 32" Skidding Tong w/ Ring	22 #	Not rated 32"
386	1 1/4" x 36" Skidding Tong w/ Ring	31 #	Not rated 36"

## Hisco Cant Hooks



- HI48CHS-10 No. 10 Cant hook, Forged 10" Hook, Pencil Point, 48" Solid Fiberglass Handle
- HI48CHS-12 No. 12 Cant hook, Forged 12" Hook, Pencil Point, 48" Solid Fiberglass Handle
- HI72CHS-10 No. 10 Cant hook, Forged 10" Hook, Pencil Point, 72" Solid Fiberglass Handle
- HI72CHS-12 No.12 Cant hook, Forged 12" Hook, Pencil Point, 72" Solid Fiberglass Handle



## OshKosh Straight Shovels

- Made with hardwood handles and 10" wide high carbon steel blades
- The blade is forged in a straight pattern and heat treated
- The shovel blade and back strap are electrically seam welded to a front strap
- The shovel is completely straight from end to end for effective use in deep holes
- This shovel is also offered with a 6" blade
- The shovel straps and handle have footage markers to indicate hole depth
- Available with Ash or Maple handles
- Available with 6" or 10" blade



PART #	DESCRIPTION
2032	7' Ash Shovel
2036	7' Ash Shovel w/ 6" blade
1005	7' Ash Replacement Handle
2033	8' Ash Shovel
2033-6	8' Ash Shovel w/ 6" blade
1006	8' Ash Replacement Handle
2034	9' Ash Shovel
2034-6	9' Ash Shovel w/ 6" blade
1007	9' Ash Replacement Handle
2035	10' Ash Shovel
2035-6	10' Ash Shovel w/ 6" blade
1008	10" Ash Replacement Handle
2036	12' Ash Shovel
2036-6	12' Ash Shovel w/6" blade
1009	12' Ash Replacement Handle

## OshKosh Spoon Shovel Blades

- Made from the same high-carbon steel as the rest of the OshKosh shovel line
- Available in two unique styles - Eastern and Western
- Both designs have a scoop shape for lifting mud, water and backfill from deep holes
- The shovel straps and handle have footage markers to indicate hole depth
- Western pattern designed for harder, clay-like soils
- Eastern pattern designed for lighter, sandier soils
- Available with Ash or Maple handles
- Available with 7', 8', 9', 10', or 12' handles



PART #	DESCRIPTION
2023	7' Ash Spoon, Western
2023E	7' Ash Spoon, Eastern
1005	7' Ash Replacement Handle
2024	8' Ash Spoon, Western
2024E	8' Ash Spoon, Eastern
1006	8' Ash Replacement Handle
1006H	8' Maple Replacement Handle
2025	9' Ash Spoon, Western
2025E	9' Ash Spoon, Eastern
1007	9' Ash Replacement Handle
2026	10' Ash Spoon, Western
2026E	10' Ash Spoon, Eastern
1008	10' Ash Replacement Handle
2027	12' Ash Spoon, Western
2027E	12' Ash Spoon, Eastern
1009	12' Ash Replacement Handle

## OshKosh Digging Spud with Tamper

- The digging spud is made from 1" steel pipe for easy gripping, is well-balanced and easy to use
- The 3 1/2" blade is hammer forged from high carbon steel, press-fitted and welded onto the pipe
- Hardness is controlled to maintain sharpness of edges and point through many hours of use, yet not so hard as to promote chipping in ordinary service



- 852-6 6' Digging Spud w/ Tamper, 1" x 6"
- 852-8 8' Digging Spud w/ Tamper, 1" x 8"
- 852-9 9' Digging Spud w/ Tamper, 1" x 9"

## OshKosh Crow & Digging Bars

- These digging bars are made of high carbon steel, to resist bending deformation
- The crow and digging bars have a 2" chisel on one end and are pointed on the other end
- Primarily used for splitting or separating wood, concrete or metal forms
- Hardness is controlled to maintain sharpness of edges and point through many hours of use, yet not so hard as to promote chipping in ordinary service



- 1063 1" x 6" Crow & Digging Bar
- 1061 1" x 7" Crow & Digging Bar
- 1062 1" x 8" Crow & Digging Bar
- 1064 1 1/8" x 7" Crow & Digging Bar
- 1065 1 1/8" x 8" Crow & Digging Bar
- 1066 1 1/8" x 9" Crow & Digging Bar
- 1067 1 1/8" x 10" Crow & Digging Bar

## OshKosh Round Tamp & Digging Bars



- These digging bars are made of high carbon steel, to resist bending deformation
- The round tamp and digging bars have a 2" chisel on one end and a malleable iron tamper on the opposite end
- Hardness is controlled to maintain sharpness of edges and point through many hours of use, yet not so hard as to promote chipping in ordinary service

- 1071 1" x 7' Tamp & Digging Bar
- 1072 1" x 8' Tamp & Digging Bar
- 1074 1 1/8" x 7' Tamp & Digging Bar
- 1075 1 1/8" x 8' Tamp & Digging Bar

## OshKosh Skidding Tong



- Skidding tongs are intended for pulling or skidding material and are not load rated
- They must not be used for overhead lifting
- These skidding tongs are made from round, high-carbon steel bar stock, which is hammer forged and heat treated for consistent strength
- The tong sides are flattened evenly for a larger pivot bearing surface; this allows the pivot to be shorter and ensures the hooks stay in proper alignment
- Each tong unit is heat treated and 100% hardness tested to assure high quality
- The tongs are made in either "ring only" or "swivel hook and ring" style

- 384A Tong w/ Ring, 1" x 16"
- 384B Tong w/ Ring, 1" x 21"
- 384 Tong w/ Ring, 1" x 24"
- 385 Tong w/ Ring, 1 1/8" x 32"
- 386 Tong w/ Ring, 1 1/4" x 36"

# OshKosh

TOOLS

## OshKosh Lug Hooks



- Made exclusively for carrying poles by hand
- Handles are made of sturdy hard maple
- Hooks are made from high-carbon steel and attached to the handle with a malleable iron swivel to facilitate easy operation

295	Lug Hook, 2 1/2" x 4'
593	Replacement Handle 2 1/2" x 4'
296	Lug Hook, 2 1/2" x 4'6"
594	Replacement Handle 2 1/2" x 4'6"
297	Lug Hook, 2 1/2" x 5'
595	Replacement Handle 2 1/2" x 5'
298	Lug Hook, 3" x 5'
963	Replacement Handle, 3" x 5'
299	Lug Hook, 3" x 6'
964	Replacement Handle, 3" x 6'

## OshKosh Cant Hook



- Dimensions: 2 1/4" x 4 1/2'; weighs 8 lbs.
- Features a thick hardwood handle and a high carbon steel hook which is heat treated
- Designed to prevent the hook from falling back and damaging the handle
- Leather safety cuff has a reinforcing wrist pad

200-A	2 1/4" x 4'6"
573	Replacement Handle 2 1/4" x 4'6"
199	2 1/2" x 4'
575T	Replacement Handle, 2 1/2" x 4'
480	Replacement Hook, 1" x 1/2"
200	2 1/2" x 4'6"
576T	Replacement Handle, 2 1/2" x 4'6"
201	2 1/2" x 5'
577	Replacement Handle, 2 1/2" x 5'
206-4645	2 3/4" x 6'

## OshKosh Post Hole Digger (Split Handles)



- Alloy steel blades are attached by welding, making a durable joint
- Fulcrum members are made of heavily constructed, channel-shaped steel
- Produces 6" diameter holes

2050-8	8' Digger
2050A-8	8' Replacement Handles
2050-9	9' Digger
2050A-9	9' Replacement Handles
2050-103	Head Assembly

## OshKosh Post Hole Digger (Solid Handles)



- Alloy steel blades are attached by welding, making a durable joint
- Fulcrum members are made of heavily constructed, channel-shaped steel
- Produces 6" diameter holes

2051	8' Digger
2051-103	Head Assembly
2051A-8	8' Replacement Handles

## OshKosh Peavies



- Designed and constructed for balance and easy handling
- Handles are made of hardwood and the hooks and pikes are constructed of high-carbon steel
- Unique hook stop prevents the hook from falling back and damaging the wooden handle
- Peavies are intended to have only human force applied during their use
- Adding an extension or mechanical force on the handle can result in tool damage and serious injury to the user

137	2 1/2" x 4'
575T	Replacement Handle 2 1/2" x 4'
138	2 1/2" x 4'-6"
576T	Replacement Handle, 2 1/2" x 4'-6"
139	2 1/2" x 5'
577T	Replacement Handle, 2 1/2" x 5'
480	Replacement Hook, 1" x 1/2"



## OshKosh Tamp Bars



- These tamp bars are used to flatten and smooth dirt, stone, asphalt and other materials
- The tamp bars are available in either a light or heavy weight, with a variety of handle lengths
- Curved-head tamp bars are also available
- The curved head bars are designed and built to tamp closer to the wall of the hole or close to the pole itself
- The unique curved-head design helps to prevent “knuckle busting” on the pole
- Available with 7’, 8’, 9’, or 10’ handles
- Available with a light, heavy, or curved shoe

854	7' Light Tamp Bar	856	9' Light Tamp Bar	857	10' Light Tamp Bar
1054	7' Heavy Tamp Bar	1056	9' Heavy Tamp Bar	1057	10' Heavy Tamp Bar
3698-7	7' Curved Tamp Bar	3698-9	9' Curved Tamp Bar	3698-10	10' Curved Tamp Bar
2002	7' Heavy Replacement Handle	2003A	9' Heavy Replacement Handle	2003B	10' Heavy Replacement Handle
3698-A7	7' Curved Replacement Handle	3698A9	9' Curved Replacement Handle	3698-10	10' Curved Replacement Handle
855	8' Light Tamp Bar				
1055	8' Heavy Tamp Bar				
3698-8	8' Curved Tamp Bar				
2003	8' Heavy Replacement Handle				
3698A8	8' Curved Replacement Handle				

## OshKosh Pole Cradle



- Provides a simple method for lifting poles into position for framing
- Makes lifting poles a one-man operation
- Utilizes the simple cam principle of rocking the pole off the ground and lifting it up
- Made from aluminum
- Dimensions: 18" x 15" x 9"
- Handles poles with a diameter of up to 19"

## OshKosh Load Rated Lifting Tong



- Lifting tongs are signified by the yellow colour and are capable of lifting up to 5000 lbs
- All units are tested per ASTM B 30.20 © 1999
- Each unit is tagged with rated load and serial number
- Test data is supplied with each tong

384L	1" x 24"
384AL	1" x 16"
386L	1.25" x 36"

### Load Limit:

Tool Opening	75°	135°	180°
384L	2500	2000	1500
384AL	2500	2000	1500
386L	5000	4000	3000



## Hisco Cant Hooks



- Hardwood handles and high carbon steel hooks are heat-treated and tested
- Handles are made of selected air-seasoned hardwood
- They are designed and constructed for balance and easy handling and finished with a hard transparent lacquer
- The unique hook-stop prevents the hook from falling back and damaging the wooden handle
- Cant Hooks are for turning, rolling, and lifting logs or poles
- Each is equipped with a 1 1/4" solid fiberglass handle and a sharpened pencil point
- A flat point hook can be ordered, upon request
- Available in three sizes 8", 10", and 12"

<b>HI48CHS-8</b>	<b>8" Hook, 4'</b>
<b>HI72CHS-8</b>	<b>8" Hook, 6'</b>
<b>HI48CHS-10</b>	<b>10" Hook, 4'</b>
<b>HI72CHS-10</b>	<b>10" Hook, 6'</b>
<b>HI48CHS-12</b>	<b>12" Hook, 4'</b>
<b>HI72CHS-12</b>	<b>12" Hook, 6'</b>
<b>HI48CHS</b>	<b>Handle Assembly, No Hook, 4'</b>
<b>HI72CHS</b>	<b>Handle Assembly, No Hook, 6'</b>

## Hisco Post Hole Digger

- These post-hole diggers are offered with either a split-handle or a solid-handle
- The digger blades are made of heavy-gauge alloy steel designed for years of dependable service
- The fulcrum members are made of a heavy channel steel and are welded to the fulcrum bracket (no rivets to shear off)
- Two bolts hold each handle securely to the digger head making them easy to replace when necessary
- Digger produces approximately a 6" diameter hole
- These post-hole diggers have solid wood core fiber glass handles and have Seymour Hercules Heads
- They are designed for hard and compact soil
- A wider hole can be dug with the split handle design



<b>HIPHD8</b>	<b>8' Digger</b>
<b>HI96PHD</b>	<b>8' Replacement Handles</b>

## Wood-Handle Sledge Hammer

- This 10 lbS hammer has an 8 lbs double-faced head and features a heavy-duty wood handle
- The 30" hickory handle is constructed to be more split resistant and shock-absorbing, making this traditional style hammer the wood hammer of choice among contemporary users

**HIBD-10W**



## Fiberglass-Handle Sledge Hammer

- This 10 lb. hammer has an 8 lb. double-faced head and features a heavy-duty wood handle
- The 30" hickory handle is constructed to be more split-resistant and shock-absorbing, making this traditional style hammer the wood hammer of choice among contemporary users

**HIBD-10**



## Blunt-Tip Utility Probe

- Non-conductive, solid 1/2" fiberglass shaft
- Features a 3/4" steel tip blade
- 8 1/4" fiberglass "T" style handle
- Features a vinyl grip
- Weighs 1.5 lbs

**HIUP-42**



## Hisco Fiberglass Handle Shovels



- Hollow back blades are stamped from a single piece of steel which creates the hollow socket and adds strength to the blade
- A nylon socket supports and strengthens the neck
- Forward turned steps provide for secure and comfortable foot placement
- Handles are attached with a nylon collar and single rivet
- Available with D or straight handle

HISHISSH	Small Head Round Point 27"; D Handle
HISHISLH	Small Head Round Point 46"
HISS14D	Drain Spade/Sharp Shooter; 28"; D Handle
HISS14L	Drain Spade/Sharp Shooter; 47"
HISP2D	Square Point 27"; D Handle
HISP2L	Square Point 47"
HITS483LCD	Trench 4'
HITS721L	Trench 6'
HITS8	Straight Telegraph Shovel 8'
HITS10	Straight Telegraph Shovel 10'
HITS12	Straight Telegraph Shovel 12'
HI48LHS	Replacement Handle 4'
HI72LHS	Replacement Handle 6'
HI96LHS	Replacement Handle 8'

### HIRP-14L: Round Point Shovel

- Hollow back blade is stamped from a single piece of steel with forward turned steps for secure and comfortable foot placement
- Features a double dip grip
- 47" fiberglass handle
- Size: 2 round point
- Handles are attached with a single rivet
- Features a reinforcing metal collar at the neck
- Dimensions: 8 7/8" x 11 3/4"; weighs 5 lbs



### HISP-2L: Square Point Shovel

- Hollow back blade is stamped from a single piece of steel with forward turned steps for secure foot placement
- Features a double dip grip
- 47" fiberglass handle
- Flat shovel: 8 5/8" x 11 1/4"; round point: 8 7/8" x 11 3/4"



### HI57-APBS: All Purpose Bar

- Blade: Forged Wedge 2" x 9"
- Handle: 1 1/4" x 48" Steel Pipe
- Grip: Double-Dip
- Weight: 8 lbs



### HI24PLR

- Blade: 24" Molded Poly Head
- Handle: 48" Fiberglass
- Grip: Vinyl
- Weight: 2 lbs

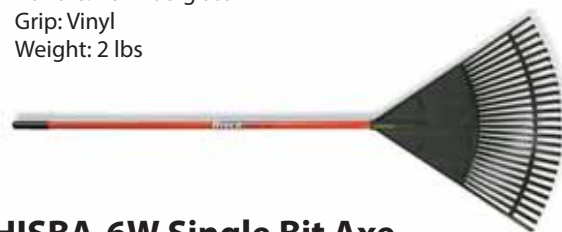

### HISBA-6 Sing Bit Axe

- Blade: 3 1/2 lb. Single Bit Head
- Handle: 36" Fiberglass
- Grip: None
- Weight: 6.50 lbs



### HISBA-6W Single Bit Axe

- Blade: 3 1/2 lb. Single Bit Head
- Handle: 36" Hickory
- Grip: None
- Weight: 5 lbs



### HIBR16T: Forged Head 16 Tine Bow Rake

- Features a sturdy and durable honeycomb core fiberglass handle with a polyvinyl grip
- Forged steel rake head is 16 3/4" wide with 16 tines
- Fiberglass handle is 5' long



## GPHR2FDS & GPHR2FLS: Round Point Shovels

- Industrial grade round point shovel
- Heavy-gauge tempered steel blade with extra-wide forward-turned footsteps for secure footing and maximum power
- Ultra-sturdy engineering material handle composed of a fiberglass core overmolded with TPE for more control and comfort
- One-piece D-grip for maximum sturdiness
- Double-rivet assembly
- Perfect for digging holes, planting trees and shrubs, digging up roots, and dividing perennials
- Limited lifetime warranty



GPHR2FDS: D Handle Shovel

GPHR2FLS: Long Handle Shovel

## GPHS2D & GPHS2C: Square Point Shovels

- Industrial grade square point shovel
- Heavy-gauge tempered steel blade with forward steps
- Ultra-sturdy engineering material long handle composed of a fiberglass core overmolded with TPE for more control and comfort
- One-piece D-grip for maximum sturdiness
- Double-rivet assembly
- Perfect for transporting small quantities of earth, sand, top soil, dirt or other bulk materials
- Limited lifetime warranty



GPHS2D: D Handle Shovel

GPHS2C: Long Handle Shovel

## GPDF0832: Double-Face Sledge Hammer

- Industrial quality sledge hammer, 8 lbs. double face drop-forged and tempered steel head, machine-finished face
- 32 in. high-density polypropylene overmolded fiberglass handle with rubberized non-slip grip
- Safe and durable mechanical assembly



## SPFR26 & SPFR30: 26" & 30" Poly Leaf Rake

- Light and durable, hardwood handle
- Ultralight, one-piece poly head
- Great for raking leaves and cut grass



## GLR22: 24" Springback Lawn Rake

- Industrial grade springback lawn rake, 24-inch tempered steel head with 22 tines, flexible reinforcing bar and socket with full welded plate to back for maximum sturdiness
- Premium varnished ash handle
- Ideal for grooming lawns in the spring and raking cut grass
- Back spring providing additional rigidity for deep-down grooming
- Limited lifetime warranty



## GPBSH30016: Blacksmith Hammer

- Industrial quality blacksmith (cross pein) hammer, 3 lbs. drop-forged and tempered steel head
- 16" high-density polypropylene overmolded fiberglass handle with rubberized non-slip grip, Garant Pro Series
- Safe and durable mechanical assembly
- Machined face finish for shaping, flattening and bending metal
- Wedge point striking face designed for general blacksmith work
- Limited lifetime warranty



## TIFS600: Wheelbarrow

- Industrial grade wheelbarrow, 6 cu. ft. high-visibility, rolled edge seamless steel tray, welded tray clips, funnel tray with easy pouring lip
- 64" square (1.75" x 2.25") hardwood handles, 4-ply 16" (40.6 cm) pneumatic tire with inner tube, oversized 3/4" (1.9 cm) steel axle and roller bearings with zert fitting
- Heavy-Duty undercarriage with tray braces, leg stabilizers, stays and leg shoe pads
- Maximum capacity: 600 lbs (272.1 kg)



## Featherlite 6200 Series: Super Heavy Duty Fiberglass Extension Ladder

- Durable, non-conductive fiberglass side rails in high visibility safety yellow
- Riveted rung to rail design maintains continuous strength of fibers and allows for easy repair
- Slip-resistant serrated rungs for safe climbing (available in round or "D" profile)
- Top crossover bar allows for ladder to be raised and lowered from front and provides torsional stiffness
- Premium heavy duty rung locks for durability
- Exclusive "1-piece" foot assembly with spur wheel provides unequalled strength, durability and torsion resistance
- CSA approved Grade 1, ANSI Type 1AA

Part #	Size	Max. Open Length	Weight
6224	24'	21'	57 lbs
6228	28'	25'	63 lbs
6232	32'	28'	71 lbs



## Featherlite 6400 Series: Extra Heavy-Duty Fiberglass Step

- Durable non-conductive "C" Channel side rails in high visibility safety yellow
- Super tough co-polymer utility top for strength and durability
- Slip-resistant serrated aluminum steps for safe climbing
- Inside spreader arms complete with "wrap-around" brackets to strengthen spreader to rail connection and protect spreader arms during storage/loading/transport
- Reinforced with Zinc coated steel diagonal braces on the front of every other step and double bracing on bottom step for added strength and stiffness
- Full rear "L" horizontal struts reinforced with Zinc coated steel diagonal braces offer maximum rigidity
- Extra large PVC rubber safety boots are heavy duty and provide increased rail protection and slip-resistance
- Meets or exceeds CSA Grade 1A, ANSI Type 1A



Part #	Size	Open Height	Weight
6404	4'	45"	17 lbs
6405	5'	56"	21 lbs
6406	6'	68"	24 lbs

## LTL Manual Ground Rod Drivers

- Driver made from 1.9" diameter extra heavy steel pipe 4' long with 4" PLUG doweled and welded in top end
- Extension made from 7/8" carbon steel rod doweled and welded into 1.9" diameter extra heavy steel pipe 9" long
- Hot dip galvanized



## 4241: OshKosh Pole Cradle



- Provides a simple method for lifting poles into position for framing
- Makes lifting poles a one-man operation
- Utilizes the simple cam principle of rocking the pole off the ground and lifting it up
- Made from aluminum
- Dimensions: 18" x 15" x 9"
- Handles poles with a diameter of up to 19"

## 10640: Greenlee SuperJack Pipe Stands with V-Heads

- Supports full lengths of pipe, 1/2" - 8", when using pipe threading machines
- Height capacity: 27" - 50"
- 2,500 lbs maximum capacity
- Folding stand includes carrying handle



# Impact Wrench & Drill Accessories

TOOLS

## 1/2" Drive 5 Point Penta Socket

### Williams SB-526:

5 point Penta-Socket services 5 point nuts found on tamper-resistant Buffalo covers used by gas, electric, and some water companies to protect shut-off gates



### Aircraft Dynamics 2775RPS

- Opening: 13/16"
- Drive: 1/2"
- Overall Length: 2"
- Inside Length: 1/2"
- Finish: Black Oxide

## Williams 4-33B & 4-35B: 1/2" Drive Hex to Square Shank Impact Extensions

- Specially heat treated for impact use to provide long life, safety, and durability
- Spring plunger provides secure socket retention for safety and convenience
- Suitable for use with pneumatic and electric impact wrenches



## Snap-On Industrial: Adapter



Part #	Hex Shank Size	Square Drive Size	Length
4-33B	7/16"	1/2"	2 3/4"
4-35B	7/16"	1/2"	5"
4-53B	5/8"	1/2"	2 3/4"

## Williams 6 Point (Double Square) 1/2" Drive Deep Impact Sockets



Part #	Size
14-612	3/8"
14-614	7/16"
14-616	1/2"
14-618	9/16"
14-620	5/8"
14-622	11/16"
14-624	3/4"
14-626	13/16"
14-628	7/8"
14-630	15/16"
14-632	1"
14-634	1 1/16"
14-636	1 1/8"

## Williams 1/2" Drive Hex to Square Shank Impact Extensions

Part #	Size
37002	3"
37003	6"
37004	10"



# Impact Wrench & Drill Accessories

## Aircraft Dynamics 2590: 1/2" 3 Jawed Chuck Kit



- Allows impact wrenches to use standard shank drill bits
- Includes specially treated Hex adapter
- Enable your impact to drill holes (up to 1/2" dia. max) with jobber bits in steel, wood, fiberglass and plastic, or use carbide tipped bits to drill into mortar, brick, etc.)

*Note: Adapter should not be used with any tool/accessory that results in continuous impacting*

## Greenlee NR1: Nut Runner

- Deep well accepts up to 6 IN (152 mm) excess bolt length
- 7/16" hex quick-change adapter included
- Slim profile for easy use and storage



## Williams Deep Sockets, Impact 6 Point

Part #	Size
37312	3/8"
37314	7/16"
37316	1/2"
37318	9/16"
37320	5/8"
37322	11/16"
37324	3/4"
37326	13/16"
37328	7/8"
37330	15/16"
37332	1"
37334	1-1/16"
37336	1-1/8"
37338	1-3/16"
37340	1-1/4"
37908	1/2 Drive 15 Pc



## Wood Owl Deep Cut Ship Augers (Quick-Change Impact Drill Bits)

Part #	Length	Diameter
08806	18"	9/16"
08808	18"	11/16"
08810	18"	13/16"
08812	18"	15/16"
08813	18"	1"
08814	18"	1 1/16"
08815	18"	1 1/8"
08817	18"	1 1/4"
08818	18"	1 3/8"
01004	24"	7/16"
01006	24"	9/16"
01008	24"	11/16"
01010	24"	13/16"
01012	24"	15/16"
01013	24"	1"
01014	24"	1 1/16"
01015	24"	1 1/8"
01017	24"	1 1/4"
01018	24"	1 3/8"
01019	24"	1 1/2"

- Spurred cutting edge for fast and even cutting
- Course, burr-free lead screw for quick, on-target starts without material build-up
- Unique twist design for clean chip removal, even in the deepest cuts
- Teflon® coated to resist heat and friction
- Perfectly concentric for even, easy cutting of accurate diameter holes
- Carbon Steel Construction
- Heat treated and hardened for durability



# Wood Owl

JAPANESE TRADITION OF MANUFACTURING EXCELLENCE.

Expertise in forging, casting and honing of high-quality steel and other metals dates back 2000 years to the days of feudal warfare. Under the protection of the reigning feudal lord in the 12th century, Miki City became the center of the blacksmith industry of Asia.

The skills of the craftsmen who were hidden in Miki City grew over the centuries from the design and manufacture of swords, armor and other arms of war to extremely precise carpentry tools used in Japan's wood-working industry. Today Miki City's 2000-year-old hardware industry is based on modern mass-production techniques, but relies on strict attention to design, engineering and precise manufacturing tolerances.

TOOLS

## Deep Cut Auger Bits

- Spurred cutting edge for fast and even cutting
- Course, burr-free lead screw for quick on-target starts without material build up
- **Unique twist design for clean chip removal, even in the deepest cuts**
- Teflon® coated to resist heat and friction
- Perfectly concentric for even, easy cutting of accurate diameter holes
- Carbon steel construction
- Heat treated and hardened for durability



## Standard Auger Bits

- Precision ground cutting edge for fast cutting of clean holes in wood
- Burr-free lead screw for easy starts and pull-through without material build up
- Perfectly concentric for even and easy cutting of accurate diameter holes
- Cuts nails and staples encountered in work
- Carbon steel construction
- Heat treated and hardened for durability



## Nail Chipper Auger Bits

- Tri-Cut® design with 3 precision ground edges for fast, smooth cutting without resistance
- Reduces nails to chips without grabbing and leaves a clean hole with minimal blowout
- Burr-free lead screw for easy starts and pull-through without material buildup
- Perfectly concentric for even and easy cutting of accurately sized holes
- Lighter weight than standard augers for safety and reduced fatigue without sacrificing strength
- Carbon steel construction with precise heat-treat and hardening process for strength and durability



Length: 7-1/2"	
Part #	Diameter
03703	3/8"
03704	7/16"
03705	1/2"
03706	9/16"
03707	5/8"
03708	11/16"
03709	3/4"
03710	13/16"
03711	7/8"
03712	15/16"
03713	1"
03715	1-1/8"
03717	1-1/4"
03718	1-3/8"
03719	1-1/2"
02390	Resharpening File

Length: 18"	
Part #	Diameter
03803	3/8"
03804	7/16"
03805	1/2"
03806	9/16"
03807	5/8"
03808	11/16"
03809	3/4"
03810	13/16"
03811	7/8"
03812	15/16"
03813	1"
03814	1-1/16"
03815	1-1/8"
03817	1-1/4"
03818	1-3/8"
03819	1-1/2"
02390	Resharpening File



## OverDrive Bits for Cordless Drills

- Brad point and unique chamfered lead-in edge for smooth starts and fast cuts
- Clean cutting finished holes with minimal “blow-out”
- Induction-hardened steel construction and precision ground cutting edges for durability and accuracy
- Perfectly concentric for even and easy cutting of accurately sized holes
- Performance superior to spade and other utility type bits
- Quick-change shank for fast, secure change-out
- Designed for cordless drills for extended battery life



Length: 6-1/2"	
Part #	Diameter
00708	3/8"
00700	1/2"
00701	5/8"
00702	3/4"
00703	7/8"
00704	1"
00705	1-1/4"
00706	6 pc kit includes all sizes 3 pc kit includes 5/8", 3/4", 1"

## Flat Wood Boring Bits

- Precision ground and spurred cutting edges for smooth, finished holes
- Brad point for quick and easy starts

Length: 4 3/4"	
Item #	Diameter
00405	1/2"
00409	3/4"
00413	1"
Length: 6"	
0601	1/4"
00602	5/16"
00603	3/8"
00604	7/16"
00605	1/2"
00606	9/16"
00607	5/8"
00608	11/16"
00609	3/4"

Length: 4 3/4"	
Item #	Diameter
00610	13/16"
00611	7/8"
00612	15/16"
00613	1"
00615	1 1/8"
00617	1 1/4"
00618	1 3/8"
00619	1 1/2"
Length: 16"	
01603	3/8"
01605	1/2"
01607	5/8"
01609	3/4"

Length: 4 3/4"	
Item #	Contents
01611	7/8"
01613	1"
Adjustable:	
00658	5/8" - 1 3/4"
00678	7/8" - 3"
Adjustable Kits:	
00430	3 pc Kit 4 3/4" long, 1/2", 3/4", 1" diameter
00630	3 pc Kit 6" long 1/2", 3/4", 1" diameter
00660	6 pc Kit 6" long 3/8", 1/2", 5/8", 3/4", 7/8", 1" diameter



## Self-Feed Wood Boring Bits

- Up to 50% wider cutting tooth surface for added stability and truer holes
- Chamfered back edge to easily extract the bit from the work
- Machined lead screw with burr-free threads feed the bit through wood at a consistent rate
- Machined, straight shaft for bit concentricity to eliminate wobble and leave a truer hole
- Quick-change shank for fast, secure change-out
- Heat treated and hardened for durability



Part #	Diameter
05101	1"
05102	1-1/8"
05103	1-1/4"
05104	1-3/8"
05105	1-1/2"
05106	1-3/4"
05202	2"
05205	2-1/8"
05206	2-9/16"
05301	3"
05302	3-5/8"
05303	4-5/8"
05304	5-1/2"
Extension	
05305	12" Extension
05306	18" Extension
05307	24" Extension

## Utility Socket Sets

- Double square black oxide coated
- High impact shock steel
- Quick-release secure mount system
- Sets include Blue Bully Hex Adapters
- Lifetime warranty on sockets



2758 9/16", 13/18", 1", 1 1/8" Sockets

2753 13/16", 7/8", 1", 1 1/8" Sockets

## 2590: 1/2" 3 Jawed Chuck Kit

- Allows impact wrenches to use standard shank drill bits
- Includes 7/16" Blue Bully Hex adapter - the most durable adapter available
- Kit includes key, holder, and attached 7/16" Blue Bully Hex drive adapter



## Utility Impact Sockets

- 1/2" square drive - double square
- 3 1/2" long
- Highest quality impact sockets available
- Black oxide finish
- Heavy-duty impact quality steel
- Aircraft Dynamics lifetime warranty

2492 13/16"

2493 7/8"

2494 1"

2489 1 1/8"

2490 9/16"

2491 3/4"



## 2779: Robotool Penta Socket "T" Wrench

- Penta Socket with black oxide finish and proprietary impact steel is securely attached to powder coated "T" handle for extra leverage
- 7.25" overall length; 13/16" penta opening, inside Length: 1/2"
- Easily remove and tighten Penta Bolts



## 2403: 7/16" Quick-Change Chuck

- Utilizing a proprietary multi-ball bearing system, this quick will hold your bits, adapters and sockets securely in place
- Most durable quick-change available



## 2775: Penta Socket

- The only impact socket available that uses impact quality steel
- Aircraft Dynamics lifetime warranty



## 2801: Blue Bully Hex Adapter

- 7/16" hex adapter for 1/2" square drive sockets; maximum mechanical properties
- Advanced impact resistant technology
- Aerospace quality engineered shock steel with advanced toughness and wear resistance
- Reduced deformation; increased torque yield points
- The most durable adapter available



## Ground Rod Driver System

- Eliminates problems with driving ground rods
- Kit includes hydraulic shoe and driver
- Driver mounts easily and securely to all rods
- Hydraulic shoe accepts hydraulic tampers and is used with the driver

5043 Ground Rod Driver Kit

5042 Hydraulic Shoe - Kidney Shaped

5008 Ground Rod Driver Adapter



5008



## Robotool Double Duty Deep Well Sockets

- Double Duty Utility Impact Sockets (2-sockets-in-1) with outside length of 5"
- Black Oxide finish and proprietary impact quality steel
- Aircraft Dynamics lifetime warranty

2751 13/16"/15/16" Openings

2757 1"/1 1/8" Openings

## Installation Tool



- Small tool for red, and blue-coded taps; aluminum wire combinations: #8 thru 350 kcmil
- Large tool for yellow-coded taps only; aluminum wire combinations: 336.4 thru 1192.5
- Auxiliary Platform is required to install red-coded standard taps with small tool

## Take-Off Clip



- RoHS and ELV compliant
- Not relevant for lead-free process
- Polyethylene
- Removes connector cap tap system tool

## Aluminum Tap System Tool



- RoHS and ELV compliant
- Not relevant for lead-free process
- Polyethylene; contains propellant and primer
- Colour-coded to match taps and stirrups
- Available in blue, yellow, red & white

## Heads



- RoHS and ELV compliant
- Not relevant for lead-free process
- Head; alloy steel
- Large head for use with yellow coded taps
- Small head for use with red, white, blue-code taps

## Cleaning Tool



- Cleans caps, breach assembly, threads, and any other part of the tool
- WD-40 or anything containing petroleum is not recommended to clean tools
- Use 3-in-1 oil or Hoppes Oil #9 to clean tools

# Greenlee - Manual Cutters & Crimpers

## Heavy Duty Ratchet Cable Cutters

- Extra thick blades, ground flat to reduce potential for breakage
- Ratchet action for heavy-duty cutting
- Two cutting actions – fast scissor cutting for small cable and insulation; converts automatically to ratchet mode
- Anti-slip mechanism for positive ratchet action
- Rubber boot protects ratchet mechanism
- Not for ACSR

**756**  
**Max Capacity**  
**Frequent Use Capacity**  
**Length 27 1/2" Long**  
**Jaw Opening 2"**  
**Weight 11.41 lbs**

<b>Copper</b>	<b>Aluminum</b>
<b>1500 kcmil (MCM)</b>	<b>1500 kcmil (MCM)</b>
<b>1000 kcmil (MCM)</b>	<b>1000 kcmil (MCM)</b>



## Two-hand Ratchet Cable Cutter

- Two-handed operation provides more leverage and makes cutting large cables easier
- Short fiberglass handles make it easy to use in tight places and to store in tool boxes
- Blade release allows blades to be opened in mid-cut
- Single speed ratchet mechanism
- Heavy duty forged steel blades provide long life

<b>761</b>	<b>Copper</b>	<b>Aluminum</b>	<b>Communications Cable</b>
<b>Cutting capacity</b>	<b>1000 kcmil (MCM)</b>	<b>1000 kcmil (MCM)</b>	<b>1 1/8" Diameter</b>
<b>Length 10 3/4" Long</b>			
<b>Weight 3.6 lbs</b>			



## High Performance Cable Cutters

- Two-speed mechanism saves cutting time by closing the blades rapidly and shifting to normal speed to perform the cut
- No more pushing on stubborn release buttons—the blades open automatically when the cut is complete
- Completely new ratchet mechanism improves durability
- Narrow profile permits use in deep boxes, against walls or on floors
- Durable, lightweight fiberglass handles
- U.S. Patent #6,766,581

<b>773</b>	<b>Copper</b>	<b>Aluminum</b>	<b>Communications Cable</b>
<b>Max Capacity</b>	<b>500 kcmil (MCM)</b>	<b>795 kcmil (MCM)</b>	<b>1 3/16" Diameter</b>
<b>Frequent Use Capacity</b>	<b>350 kcmil (MCM)</b>	<b>750 kcmil (MCM)</b>	
<b>Length 15 1/2"</b>			
<b>Weight 5.3 lbs</b>			



<b>774</b>	<b>Copper</b>	<b>Aluminum</b>	<b>Communications Cable</b>
<b>Max Capacity</b>	<b>750 kcmil (MCM)</b>	<b>795 kcmil (MCM)</b>	<b>1 3/16" Diameter</b>
<b>Frequent Use Capacity</b>	<b>500 kcmil (MCM)</b>	<b>750 kcmil (MCM)</b>	
<b>Length 1-1/28"</b>			
<b>Weight 5.38 lbs</b>			

## Performance Ratchet Cable Cutters

- Simple, one-hand operation
- Exclusive two-speed ratcheting mechanism adjusts for light/heavy cutting
- Well-suited for tight working spaces
- Blades can be opened mid-cycle
- Available with cushioned handles or with 1000V insulated cushioned handles

<b>45206</b>	<b>Copper</b>	<b>Aluminum</b>	<b>Communications Cable</b>
<b>Max Capacity</b>	<b>600 kcmil (MCM)</b>	<b>600 kcmil (MCM)</b>	<b>1 3/18" Diameter</b>
<b>Frequent Use Capacity</b>	<b>500 kcmil (MCM)</b>	<b>500 kcmil (MCM)</b>	
<b>Length 11"</b>			
<b>Jaw Opening 1 7/16"</b>			

<b>45207</b>	<b>Copper</b>	<b>Aluminum</b>	<b>Communications Cable</b>
<b>Max Capacity</b>	<b>750 kcmil (MCM)</b>	<b>1000 kcmil (MCM)</b>	<b>2" Diameter</b>
<b>Frequent Use Capacity</b>	<b>600 kcmil (MCM)</b>	<b>750 kcmil (MCM)</b>	
<b>Length 11"</b>			
<b>Jaw Opening 2"</b>			



# Greenlee - Manual Cutters & Crimpers

## Compact Ratchet Cable Cutters

- Simple, one-hand operation
- Compact – convenient for working in tight places and stores easily in tool pouches
- Single-speed ratchet mechanism
- Blade release allows blades to be opened in mid-cut
- Heavy-duty blades provide long life

759	Copper	Aluminum	Communications Cable
<b>Max Capacity</b>	500 kcmil (MCM)	750 kcmil (MCM)	1 1/8" Diameter
<b>Frequent Use Capacity</b>	400 kcmil (MCM)	600 kcmil (MCM)	
<b>Length</b>	10 1/2"		
<b>Weight</b>	1.4 lbs		
760	Copper	Aluminum	Communications Cable
<b>Max Capacity</b>	1000 kcmil (MCM)	1000 kcmil (MCM)	1 3/4" Diameter
<b>Frequent Use Capacity</b>	750 kcmil (MCM)	1000 kcmil (MCM)	
<b>Length</b>	11 3/4"		
<b>Weight</b>	1.75 lbs		



## Heavy Duty Cable Cutters

718F, 704, 705 and 706:

- Strong, lightweight fiberglass handles
- Adjustable pivot bolt provides for blade adjustment

704, 705 and 706:

- Replaceable, forged, heat-treated, and precision ground blades
- Made in USA

Capacities*	718F	704	705	706
<b>Copper</b>				
<b>Maximum Use</b>	350kcmil (MCM)	350 kcmil (MCM)	500 kcmil (MCM)	750 kcmil (MCM)
<b>Frequent Use</b>	4/0 AWG (95)	250 kcmil (MCM)	350 kcmil (MCM)	500 kcmil (MCM)
<b>Aluminum</b>				
<b>Maximum Use</b>		500 kcmil (MCM)	1000 kcmil (MCM)	1000 kcmil (MCM)
<b>Frequent Use</b>	350 kcmil (MCM)	350 kcmil (MCM)	750 kcmil (MCM)	750 kcmil (MCM)
<b>Communications Cable</b>				
<b>Maximum Use</b>	1" Diameter	1 1/4" Diameter	1 3/4" Diameter	1 1/2" Diameter
<b>Frequent Use</b>				
<b>Length</b>	17 1/2"	21"	25 1/2"	31 1/2"
<b>Weight</b>	2.8 lbs	3.01 lbs	5.5 lbs	6.2 lbs



\*Capacity may be less for compact or compressed cables.

## 727: Cable Cutters

- Easily cuts heavier copper and aluminum cables up to 2/0
- Precision-ground, shear-action, curved cutting blades
- 727 has PVC-covered, high-leverage handles for easier cuts
- 727M has cushion grip, high-leverage handles for added comfort
- Heat-treated for long life
- Made of heavy-duty forged steel
- Rust-resistant black oxide finish

727/727M	Copper	Aluminum	Communications Cable
<b>Max Capacity</b>	2/0		
<b>Frequent Use Capacity</b>	#1 AWG	2/0	100 pair
<b>Length</b>	9 1/4" long		
<b>Weight</b>	1 lb		



# Greenlee - Manual Cutters & Crimpers

## Hydraulic ACSR Cable Cutter

- Hydraulic cutter takes the effort out of cutting tough cables
- Flip-open head provides strength while making it easy to cut long lengths
- Head rotates 180°
- Thumb release lever for quick blade retraction

HK520

**Capacity**     **ACSR: 336.4 kcmil (MCM)**  
**Standard Guy Wire, Ground Rod: 1/2" (13mm)**  
**Soft Steel Bolts: 11/16" (17mm)**  
**Wire Rope: 3/4" (19mm)**  
**Rebar: 7/16" Dia. (Schedule 60)**

**Length**        **14.5" (368 mm)**

**Weight**        **5.7 lbs. (2.6 kg)**



## High Performance Ratchet ACSR Cable Cutter

- Two-speed mechanism saves cutting time by closing the blades rapidly and shifting to normal speed to perform the cut
- Patented mechanism opens the blades automatically when the cut is complete (U.S. Patent #6,766,581)
- Completely new ratchet mechanism provides excellent durability
- Short length fits easily into truck bins
- Durable, lightweight fiberglass handles

776

**Capacity:**                    **Cuts ACSR through 636 kcmil with steel core diameters less than 0.32"**

**Specifically Cuts**        **All 336.4 and Smaller ACSR plus:**  
**397.5 - Brant, Chickadee, Ibis; 477.0 - Pelican, Flicker, Hawk; 556.5 - Osprey, Parakeet**  
**605 - Peacock; 636.0 - Kingbird, Swift, Rook**

**Length**                        **20"**

**Weight**                        **6.2 lbs**



## Ratchet ACSR Cable Cutter

- Extra-thick blades, ground flat to reduce potential for breakage
- Ratchet action for increased cutting power
- Two cutting actions – fast scissor cutting for small cable; converts automatically to ratchet mode
- Anti-slip mechanism for positive ratchet action
- Rubber boot protects ratchet mechanism

757

**Capacity**                    **954 kcmil (MCM) ACSR, 1/2" Steel Rod**

**Length**                        **29 1/4"**

**Jaw Opening**            **1.18"**

**Weight**                        **12.22 lbs**



## Heavy-Duty Ratchet Guy Wire Cutter

- Cuts 1/2" Extra High Strength (EHS) and standard guy wire
- Cuts 1/2" (12.7 mm) mild steel rods and bolts
- Two cutting actions – single-motion cutting for small cable, ratchet action for heavy-duty cutting
- Anti-slip mechanism for positive ratchet action
- Suitable for cutting ACSR

758

**Capacity**                    **1/2" EHS and Standard Guy Wire, 1/2" Mild Steel Rods and Bolts**

**Length**                        **27 3/4"**

**Weight**                        **10 lbs. 12 oz**



# Greenlee - Manual Cutters & Crimpers

## ACSR Cable Cutter

- Precision-machined, forged steel blades
- Cuts ACSR service entrance cable
- Steel handles with rubber hand grips



749

Capacity	ACSR Cable 2/0, 7/16"
Piano Wire	2/0, 7/16"
Piano Wire	1/8"
Copper/Alum. Cable	350 kcmil (MCM)
Length	28"
Weight	5.66 lbs

## 45240: Telco Ratchet Cable Cutters

- This versatile cutter has a specially designed moving blade to handle the larger diameter telephone cable and soft drawn copper and aluminum
- Cuts up to 2,700 pair 3" telephone cable
- Blade release for safety and fast backout
- Ratchet lock
- Blades are manufactured from high carbon tool steel and heat-treated for long life
- Rust-resistant, black oxide finish
- Does NOT cut ACSR
- Length 11 1/2"
- Weight 2.8 lbs.



## Heavy Duty Manual Communications Cable Cutter

- Forged and heat-treated blades specially designed for communications cable
- Easily cuts cables up to 2 1/4" in diameter
- Makes clean cuts with minimal distortion on lead, rubber PVC and polyethylene-sheathed cables
- Blades and handles are replaceable in case of damage
- Precision-ground, shear-type blades
- Fiberglass handles with non-slip rubber grips

765

Cutting Capacity	2 1/4"
Communications Cable	900 pair, 24 AWG
Length	37"
Weight	7.2 lbs



## 52015: ROCUT® Professional 75TC Plastic Pipe Shears

- Precise cutting of PVC, PP, PE, PEX, PB, and PVDF up to 3" diameter
- Double-sided blade and ratchet support
- Precise force transfer and guided cutter feed
- Stainless steel blade



# Greenlee - Manual Cutters & Crimpers

## 12 Ton Hydraulic Crimping Tools

- Two crimping head choices: HK1230 with 1.20" opening, and HK1240 with 1.65" opening
- Accept Greenlee KC12, KA12 and KD12 crimping dies as well as industry "U" style dies
- Tested to 50,000 crimp cycles
- Two-speed pump to reduce cycle time
- Ram automatically retracts when crimp cycle is complete – a Greenlee exclusive
- Crimping heads rotate 360°
- Smaller and lighter than competitive tools
- Covered head models have two layers of PVC that total approximately 3/16" (4.8 mm) thick; the outer layer is black and the inner layer is red
- Includes carrying case
- U.S. Patent #6,206,663

Part no.	Length	Jaw Opening	Capacity*
HK1230	20 3/8"	1.2"	8 AWG to 750 kcmil Copper Colour-Coded Lugs and Splices Crimping Force to 24,000 lbs
HK1240	21 1/2"	1.65"	
		Lengths	Weight
		HK1230 - 20 3/8"	HK1230 - 12.2 lbs
		HK1240 - 21 1/2"	HK1240 - 13.2 lbs



\*HK1230 and HK1240 are UL and cUL classified with Anderson, Blackburn, FCI Burndy, ILSCO, Panduit, Penn-Union and Thomas & Betts copper and aluminum color-coded lugs and splices when used with Greenlee KC12 and KA12 crimping dies. The products listed above are registered trademarks of Anderson®, Blackburn®, FCI Burndy®, ILSCO®, Panduit®, Penn-Union® and Thomas & Betts®.

## 12-Ton Manual Hydraulic Crimping Tool

- Two-speed ram advances fast and shifts to lower speed to complete the crimp
- Strong, lightweight fiberglass handles
- Push button permits dies to be inserted and removed easily
- The "C" style head has a 1.4" (32 mm) opening for easy placement on connectors
- Tool is supplied in a durable, molded plastic carrying case
- Accepts Greenlee KC12, KA12 and KD12 as well as Industry "U" style dies

**HKL1232**  
**Capacity\* 8 AWG to 750 kcmil copper colour-coded lugs and splices**  
**Crimping Force 24,000 lbs.**  
**Length 24 1/4"**



\*UL and cUL classified with Anderson, Blackburn, FCI Burndy, ILSCO, Panduit, Penn-Union and Thomas & Betts copper and aluminum color-coded lugs and splices when used with Greenlee KC12 and KA12 crimping dies. The products listed above are registered trademarks of Anderson®, Blackburn®, FCI Burndy®, ILSCO®, Panduit®, Penn-Union® and Thomas & Betts®.

## K4250 & K425BG Crimping Tools

- Crimps a wide range of overhead service entrance connections, overhead splices, and overhead taps
- Easy-to-use MD-6 type "pop" tool
- K4250 and K425BG are equipped with D<sup>3</sup> die groove and either "BG" or "O" die groove
- K425K58 and K425KO are equipped with a die groove for Kearney® "O" dies and either a 5/8" or "O" die groove
- The D<sup>3</sup> die groove serves as a die seat for all Greenlee KD6 and industry "W" type dies
- Bent fiberglass handles provide a solid grip, good leverage and better durability than wood
- Teflon-impregnated bushings at pivot joints provide smooth operation and long life
- Complete crimps are assured with an over-center cam mechanism
- Tool can easily be checked visually for proper adjustment and can be adjusted with Allen wrenches

K4250	D <sup>3</sup> and "O" Grooves
K425BG	D <sup>3</sup> and "BG" Grooves
K425K58	Kearney "O" and 5/8" Groove
K425KO	Kearney "D" and "O" Die Grooves

### SPECIFICATIONS

INDUSTRIAL	OVERHEAD
Copper Lugs: 8-500	5/8" Service Ent Connectors: 10-1/0
Copper Splices: 8-500	.840 Service Ent. Connectors: 1/0-4/0
Aluminum Lugs: 8-4/0	Aluminum "H" Taps: 10-2
Aluminum Splices: 8-4/0	Copper Tension Splice: 6-2/0
Copper "C" Taps: 10-2	All Aluminum Tension Splice: 6-4/0
Aluminum "H" Taps: -	One Piece ACSR Tension Splice: 4-1/0
Aluminum Pin Adapters: 6-1/0 (3)	Two Piece ACSR Tension Splice: 2-477
	Aluminum Jumper Splice: 4-266.8
	Stirrups: 2-4/0
	Aluminum Lugs: 2-1/0
	Copper Lugs: 6-1/0





# Greenlee Selection Guide

## Copper & Aluminum Cable Cutters

	CABLE SIZE																			
	AWG	#8	#6	#4	#2	#1	1/0	2/0	3/0	4/0	250 kcmil	300 kcmil	350 kcmil	400 kcmil	500 kcmil	600 kcmil	750 kcmil	1000 kcmil	1500 kcmil	
	mm <sup>2</sup>	6	10	16	25	35	40	50	70	95	120	150	150	185	240	300	400	500	800	
<b>RATCHET</b>																				
759	Al Cu	• •	• •	• •	• •	• •	• •	• •	• •	• •	• •	• •	• •	• •	• •	• •	• •	• •	• •	• •
760 & 761	Al Cu	• •	• •	• •	• •	• •	• •	• •	• •	• •	• •	• •	• •	• •	• •	• •	• •	• •	• •	• •
45206	Al Cu	• •	• •	• •	• •	• •	• •	• •	• •	• •	• •	• •	• •	• •	• •	• •	• •	• •	• •	• •
45207	Al Cu	• •	• •	• •	• •	• •	• •	• •	• •	• •	• •	• •	• •	• •	• •	• •	• •	• •	• •	• •
773	Al Cu	• •	• •	• •	• •	• •	• •	• •	• •	• •	• •	• •	• •	• •	• •	• •	• •	• •	• •	• •
774	Al Cu	• •	• •	• •	• •	• •	• •	• •	• •	• •	• •	• •	• •	• •	• •	• •	• •	• •	• •	• •
756	Al Cu	• •	• •	• •	• •	• •	• •	• •	• •	• •	• •	• •	• •	• •	• •	• •	• •	• •	• •	• •
<b>MANUAL</b>																				
727 & 727M	Al Cu	• •	• •	• •	• •	• •	• •	• •	• •	• •	• •	• •	• •	• •	• •	• •	• •	• •	• •	• •
718F	Al Cu	• •	• •	• •	• •	• •	• •	• •	• •	• •	• •	• •	• •	• •	• •	• •	• •	• •	• •	• •
704	Al Cu	• •	• •	• •	• •	• •	• •	• •	• •	• •	• •	• •	• •	• •	• •	• •	• •	• •	• •	• •
705	Al Cu	• •	• •	• •	• •	• •	• •	• •	• •	• •	• •	• •	• •	• •	• •	• •	• •	• •	• •	• •
706	Al Cu	• •	• •	• •	• •	• •	• •	• •	• •	• •	• •	• •	• •	• •	• •	• •	• •	• •	• •	• •

Legend: • = Frequent Use Capacity x = Maximum Capacity

## For Greenlee ACSR, Guy Strand & Steel Cutters

	ACSR	Std. Guy Strand	HS Guy Strand	Ground Rod	Rebar (Schedule 60)
<b>HYDRAULIC-TYPE</b>					
HK520	336.4 kcmil	1/2" (13mm) dia.		1/2" (13 mm) dia.	7/16" (11mm)
<b>RATCHET-TYPE</b>					
776	636.0 kcmil*				
757	954.0 kcmil			1/2" (13mm) dia.	
758		1/2" (13 mm) dia.	1/2" (13 mm) dia.	1/2" (13 mm) dia.	
<b>MANUAL</b>					
749	20 AWG 203				
<b>CUTTER DIES</b>					
00949	477.0 kcmil	5/8" (16mm) dia.	5/8" (16mm) dia.	5/8" (16mm) dia.	5/8" (16mm) dia.
KD6-27	4/0 AWG				

\*For core diameters less than 0.32"

# Klein Tools - Manual Cutters & Crimpers

## 63607: Small ACSR Ratcheting Cable Cutters

- Unique ratchet action holds cable tight and allows rapid, straight cuts with minimum effort
- Quick-release lever opens blade at any time during operation
- Large, finger-formed handles have limit guards and bright yellow plastic covering for comfort and high visibility
- Hold-open spring speeds cutting action
- Cuts ACSR and triplex cable
- Also cuts copper up to 400 MCM, aluminum and multi-conductor cable up to 600 MCM



## Compact Cable Cutters

- Compact 12" design allows for one-handed use of the ratcheting cutter mechanism so other hand can position cable to ensure proper cut
- 63601 cleanly cuts up to 1000MCM Al, 600MCM CU, and 2 1/16" diameter communication cable
- 63602 cleanly cuts up to 1000MCM Al, 600MCM CU, up to 2 1/16" diameter communications cable, and up to 477 MCM ACSR
- Replacement cutting inserts are available (63858)
- Unique ratchet action holds cable tight and allows rapid, straight cuts with minimal effort
- Hold-open spring speeds cutting action
- Quick-release lever opens blade at any time during operation
- Lock in closed position for pouch carrying



**63601** Cuts up to 1000MCM Al, 600MCM CU, and 2 1/6" Diameter Communications Cable

**63602** Cuts up to 477MCM ACSR

## 63800ACSR: Ratcheting ACSR Cable Cutter

- Approximately 14" long
- Cutting blades/surfaces are replaceable without removing movable or stationary jaws
- High leverage ratchet mechanism for cutting ACSR cables up to and including 477 ACSR
- Quick release opens blades easily in every cutting position. (Allows removal of cable before completion of cut)
- Hardened steel cutting blades for lasting strength and sharpness (replaceable in case of damage)
- Precision ratcheting mechanism holds cable tight and allows rapid, straight cuts with minimal effort
- Plastic covered handles with hand guards for comfort, firm grip
- Locking lever keeps handles closed for easy transport



## Ratcheting Cable Cutters

- High leverage ratchet mechanism for single handed cutting of copper, aluminum cables; does not leave burrs or sharp edges
- Patented two-step ratchet mechanism requires fewer strokes per cut (63060/63750)
- Quick release opens blades easily in every cutting position
- Precision ratcheting mechanism holds cable tight and allows rapid, straight cuts with minimal effort



Part no.	Copper	Aluminum	Comm. Cable	Length
63060	400 kcmil	600 kcmil	1 1/8"	10 1/4"
63600	600 kcmil	600 kcmil	1 3/4"	9"
63750	750kcmil*	750 kcmil	2 1/16"	12 1/8"

\*Frequent use capacity; max. capacity is 1000 kcmil

## 63805: Cable Cutters - Drill-Operated ACSR

- Chucks into a corded, cordless or hydraulic drill for fast, clean cutting of large transmission, steel, and cable
- One hand operation
- Cleanly cuts Bluebird 2156 MCM (84x19), copper or aluminum up to 2"



- Replacement cutting inserts are available
- Tough, worm-drive gears are built to last through typical weather conditions
- Simply reverse drill to open cutting blades
- Lock in closed position for pouch carrying



# Klein Tools - Manual Cutters & Crimpers

## 63030 & 63028: Cable Cutter - Coaxial

- Cable-gripping jaws quickly score jacket and insulation, and easily cut through copper inner conductor
- Blades cleanly cut aluminum and copper coaxial cable without compression and frayed ends
- Forged body with heat-treated and precision-ground steel blades, withstands frequent cutting
- Hot-riveted design requires no adjustment while maintaining a smooth, precise operation
- Compact, lightweight design fits perfectly in any tool pouch
- Plastic-coated handles provide comfort and gripping power
- When cutting drop wire with an inner steel conductor, use Cat. No. D2000-28 diagonal-cutting pliers



## J63050: Journeyman High-Leverage Cable Cutter

- Features a state-of-the-art dual material molding that allows for a softer, more comfortable grip on the outer surface and a harder, more durable grip on the inner surface and handle ends
- Features a soft, red handle material on outer surface for comfort and a firm grip
- Cable-gripping, shear-type jaws cut up to 4/0 aluminum (not ACSR), up to 2/0 soft copper; up to 100 pair, 24-gauge communications cable
- Makes clean, efficient cuts
- Ideal for working in confined spaces; compact, only 9 1/2" long
- Features a hard, black material on inner surface and handle ends for toughness and durability



## 1010: Long-Nose All-Purpose Cutter

- All-purpose cutter/crimper designed for wire-cutting, bolt cutting, wire stripping and crimping including 7 to 8 mm ignition terminals
- Cutters and strippers are in front of the pivot for maximum ease-of-use in reaching into tight places
- Crimping dies for insulated and non-insulated connectors
- Narrow, serrated plier jaws to pull, loop and bend wire
- Plastic covered handles
- 8 1/4" long



## 63050: High-Leverage Cable Cutter

- This handy, economical tool handles most cable-cutting jobs with ease
- Cable-gripping, shear-type jaws cut up to 4/0 aluminum (not ACSR); up to 2/0 soft copper; up to 100 pair, 24-gauge communications cable
- Makes clean, efficient cuts. Ideal for working in confined spaces
- Special high-leverage design
- Tough, comfortable, red plastic-dipped handles
- Compact, only 9 1/2" long



## 11046: Wire Stripper/Cutter

- Compact, lightweight
- Black-oxide finish resists corrosion
- Narrow nose fits into tight places
- Wire looping and bending holes
- Do not use for cutting steel wire or bolts
- Spring-loaded action for self-opening
- Precision-ground stripping holes for easy removal of insulation
- Easy-to-read wire gauge markings on both sides for stripping in either direction
- Red handle indicates stranded wire, yellow handle indicates solid wire
- Textured handles provide a firm, comfortable grip



## 11057: Klein-Kurve® Wire Stripper/Cutter - Solid & Stranded wire

- Precision shear-type blades for clean cuts on solid and stranded copper wire
- Wire looping and bending holes
- Precision-ground stripping holes
- Easy-to-read markings on both sides
- Curved handles help reach into confined areas
- Coil spring provides fast self-opening action
- Strong-gripping serrated nose; for easy bending, shaping, and pulling of wire
- Screw-shearing holes
- Handy closure lock for convenient storage
- Double-dipped comfort grips



# Klein Tools - Manual Cutters & Crimpers

## Bolt Cutters

- Strong, lightweight, general purpose bolt cutters in three different sizes
- Heavy vinyl grips for comfort and slip resistance
- All-purpose, center cut jaws for soft, medium, and hard metals
- Drop forged, alloy steel jaws are precision ground for sure, efficient cutting and long life
- Lockplate reinforcement prevents jaw bolts from loosening or turning, keeps jaws in correct alignment
- One adjustment realigns cutting edges
- Three-point toggle joint multiplies 50 lbs of hand pressure on handles to 4000 lbs at cutting jaws

<b>63324</b>	<b>Steel 24" 5 1/4 lbs</b>
<b>63330</b>	<b>Steel 30" 8 1/2 lbs</b>
<b>63336</b>	<b>Steel 36" 12 3/4 lbs</b>
<b>63118</b>	<b>Fiberglass 18 1/4", 3 13/20 lbs</b>
<b>63124</b>	<b>Fiberglass 24 1/2", 4 1/2 lbs</b>
<b>63130</b>	<b>Fiberglass 30 1/2", 7 1/2 lbs</b>
<b>63136</b>	<b>Fiberglass 36 1/2", 11 1/2 lbs</b>



## 2006: Large Compound-Action Crimping Tool

- Crimps 6 - 4/0 AWG lugs and terminals
- All-in-one, integral crimp nest - without any removable parts or rotating dies to set
- High-leverage handles and compound action mechanism
- Adjustment screw allows user to control crimp depth
- 19 1/2" long, 2.8 lbs.

## 63035: Utility Cable Cutter

- Forged steel with black-oxide finish for long life; non-slip vinyl grips
- Beveled tips for positive mating
- Shear-type hook jaws grab and hold cable while shear-cutting action makes clean cuts
- Hinge bolt with pin-set nut for proper blade tension
- Not designed for cutting steel or ACSR



## Standard Cable Cutters

- Lightweight, efficient shear-type cable cutters
- Hook jaw shape forces cable into jaws
- Exceptionally strong fiberglass handles with heavy vinyl grips for comfort and slip resistance
- Heavy-duty pin in head serve as blade stops
- Beveled tips assure positive mating, and hinge on a rugged bolt with a pinset nut to maintain proper blade tension
- Cuts soft cable up to 1 3/4"
- Jaws are of drop-forged alloy tool steel
- Hook jaw shape forces cable into jaws
- Make a clean, even cut for ease in fitting lugs and terminals
- Cable cutting capacity: 1000 Copper, 1200 Aluminum
- 32" in length

**63041 26" Loppers, Cable Cutters**

**63045 32" Loppers, Cable Cutters**



# Burndy - Manual Crimping Tools

## MD6 HYTOOL™ Series - Manual Crimping

- Accepts the full line of Burndy "W" and "X" die inserts; #14-4/0 AWG
- Crimping force of 9,000 lbs
- Designed to provide over 90,000 reliable crimps installing full tension and non-tension connectors
- 25-3/8" long
- Hickory handles

**MD6** D3 & BG Grooves

**MD6-8** D3 & O Grooves



## MD7 HYTOOL™ Series - Manual Crimping

- Integral visual wear indicator
- Life cycle tested to over 99,000 crimp cycles
- Accepts the full line of "W" and "X" die inserts
- Positive-lock, spring loaded die retainer button
- Crimping force of 9,000 lbs
- Installs a full range of connectors (taps, splices, terminals)
- Conductor range: #14-4/0
- Lightweight, durable polymer handles

**MD7** D3 & BG Grooves

**MD7-8** D3 & O Grooves

## Y35 HYPRESS™ Series - 12 Ton Hydraulic

- Hook style head with extensive ram travel for easy tapping and splicing of overhead lines as well as HYGROUND® compression grounding systems
- Y35 body and handles are covered with 3/16" rubber for tool impact protection
- Y35-2 HYPRESS™ head, body, and handles are covered with 3/16" rubber for tool impact protection
- Versatile and economical tool works with all commonly used copper, aluminum #8-750 kcmil and ACSR conductors from #6 str.-556.5 kcmil

**Y35**

**Y35-2** Rubber Covered Head



## Y750 HYPRESS™ Series - 12 Ton Hydraulic

- Conductor range #14-750 kcmil Cu/Al and #4-556.5 kcmil ACSR; 1.65" wide jaw opening; C-shaped head rotates 355°
- Provides easy tapping, splicing and terminating of overhead lines, the full line of HYGROUND® compression grounding connectors, NEC cable connections and N30-N650 Navy cable connections
- Accepts all BURNDY "U" dies
- Y750CHSXT HYPRESS™ has a rubber covered head and handles for tool impact protection

**Y750HSXT**

**Y750CHSXT** Rubber Covered Head

# Burndy - Manual Cutting & Hand Tools

## RCC336, RCC556 & RCC954ACSR1K: Ratchet Cable Cutters

- High quality precision cutters designed to cut up to 954 ACSR and 1000 kcmil copper and aluminum
- Equipped with rugged steel blades and bi-directional ratchet (excluding RCC336) mechanism for positive blade control
- Rapid blade advance
- Comfortable tool operation and long life
- Easy cutting with minimal cable distortion
- Excellent cutting edge performance

Part #	Max Cutting Capacity
RCC336	350 kcmil Cu; 500 kcmil AL; 336 kcmil ACSR
RCC556	500 kcmil Cu; 500 kcmil AL; 556 ACSR
RCC954ACSR1K	1000 kcmil Cu; 1000 kcmil AL; 954 kcmil ACSR



## OUR840 HYTOOL™: Ratchet Crimping Tool

- One hand, full cycle ratchet tool for Cu, Al and ACSR
- Great for use in tight spaces where other tools can't fit
- #8-4/0 Al and #8-250 Cu terminals and splices on code conductor
- W28K cutter die permits use of tool as a cable cutter
- Uses reduced handle force on "X" and select "W" dies
- Proper crimps are assured with full cycle ratchet mechanism
- Connections are UL Listed when colour-coded dies are used to install recommended BURNDY® terminals and splices



## BTW30150 & BTW150750: Micro-Adjustable Ratchet Torque Wrenches

- Ratcheting, calibrated dual direction for ease of use in the field
- Positive lock with spring-loaded pull-down lock ring to assure that the torque setting is properly engaged and secure
- Scale settings on tool correspond to connector torque ratings (in-lb); fast, accurate and easy-to-set values
- Lightly knurled handle offers an ergonomic, non-slip grip
- Micro-adjustable design minimizes the need for several wrenches
- Individually serialized and calibrated traceable to N.I.S.T.
- BTW30150 designed for use on connectors requiring torque values from 30 to 150 in-lbs.
- BTW150750 designed for use on connectors requiring torque values 150 to 750 in-lbs.
- 3/8" drive



## OH25 HYTOOL™: Ratchet Crimping Tool

- Full cycle dieless ratchet tool
- Easy one-hand operation with spring loaded comfort grip handles
- Ratchet mechanism provides proper crimp, uniform installations
- Forged steel jaws and stainless steel indenter
- Installs 5/8" INSULINK™ and LINKIT™ service entrance connectors, conductor range #10-1/0 AWG with only one crimp



## Hastings 11-014: Hand held ACSR Ratchet Cutter

- Max cable 336 ACSR
- Release lever allows cutter jaws to be opened at any time
- Handles are plastic dipped for comfort and a non-slip grip
- Compact size allows cutter to be used under close working conditions



## Hastings 10-667: High Tensile Steel Bolt Cutters

- Replaceable insulated fiberglass handles
- Suitable for cutting hard material
- Capacities: 3/8" reinforced steel, 5/16" diameter bar steel or steel wire, and 9/32" diameter music wire
- Handles filled with unicellular foam core
- Cam hinge bolts for jaw alignment
- Replacement head available
- 24" long



## Hastings 954 ACSR Ratchet Cutters

- Allows for confined space cutting with offset cutting head
- Selection lever for "open" or "close" jaws
- Ratchet drive mechanism requires less force and leverage
- Handle plunger allows for "fast advance" or "fast retraction"
- Heat treated jaws with a keeper on the upper jaw to prevent blade separation while cutting



10-207

Ratchet Cutters

01-4002

Case

## Hastings Heavy Duty "EHS" Guy Strand Cutters

- Progressive cutting action - superior cutting of guy strand over typical bolt cutters
- Designed for cutting 1/2" EHS guy strand
- Fiberglass handles
- Release lever allows cutting jaw to be opened
- Cutting jaw retracts into main body and cuts guy strand as handles are opened and closed
- Weighs 11.25 lbs



10-260

## Chance C4032980: A.B. Chance Hydraulic Conductor Ratchet Cutters

- Half the size, weight of standard ratchet cutters
- Useful for confined workspaces such as manholes and hand holes
- Built to withstand punishing field conditions
- Open in less than half the space required for long-handled ratcheting cutters
- Guillotine, C-type jaws are heat-treated for lasting strength and sharpness
- Reinforced fiberglass handles are PVC-coated and protected by a vinyl sleeve
- Cuts up to 556 ACSR or 750 MCM AA/CU
- 18" long
- 4.4 lbs



## C18F Bolt Cutters with Fiberglass Handles

- Fiberglass handles tested to 100 kV per 12"
- Suitable for cutting up to 3/8" capacity high tensile material
- Short cutting edge for high tensile steel bolts, wire, rod, chain links, and case hardened chains



# H.K. Porter - Manual Cutters

## Center Cut Bolt Cutters

- Toggle joints turn 50 lbs. hand pressure to 4,000 lbs. cutting pressure
- Cuts soft, medium, and hard metals
- Lockplate keeps jaws from loosening
- Screw-type adjustment realigns edges
- Cuts hard materials up to 1/4"
- Cuts soft and medium materials up to 3/8"
- 18.25" long, 3.5 lbs



## 8690FH: 29 1/4" Ratchet-Type Hard Cable Cutters

- Jaw keeper prevents jaws from spreading while under a heavy load
- Cuts hard cable up to 1 3/16", ACSR, ACAR, ZEBRA, and self-supporting telephone cable
- Allows short strokes in confined spaces
- Ratchet and chain increase cutting pressure
- Shear-cut blades
- 29.25" long
- 10.5 lbs



## 8690FSK: 27 1/2" Ratchet-type, Soft Cable Cutter

- Jaw keeper prevents jaws from spreading while under heavy load
- Cuts copper and aluminum communications power cable up to 2"
- Improved heavy duty jaw design
- Built for tough conditions
- Ratchet provides up to 5 times the mechanical advantage over manual cutters
- Cuts all types of copper and aluminum cables up to 2500MCM
- Weight: 3 1/2 lbs
- Length: 27 1/2"



## General Purpose Bolt Cutter

- 0090FC 18 1/4" Fiberglass Handles
- 0190FC 24 1/2" Fiberglass Handles

## Heavy Duty Bolt Cutters

- 0390FCX 36" Fiberglass Handles

## Industrial Grade Bolt Cutters

- 0090MC 18" Steel Handles
- 0390MC 36 1/2" Steel Handles

## 8690TN: Guy Cutters

- Ratchet-type jaw with notched shear-cut blades
- Blades hold and lock material in place
- Cuts aircraft cable, EHS guy strand, wire rope and stainless steel cable
- Increased mechanical advantage over manual cutters
- Cuts all strands with minimal crushing or distortion
- 36" long



## 8690CK: 28" Ratchet-type Guy Strand Cutter

- Notched shear-cut blades hold material firmly in place
- Ratchet and chain produce easy, progressive cuts
- Cuts EHS guy strand, mild steel rods and bolts, and similar materials
- Makes clean, square cuts with minimal distortion
- Increased mechanical advantage over manual cutters
- Weight: 8 3/4 lbs
- Length: 28"

## 8613FH: Replacement Cutterhead for 8690FH Ratchet-type Hard Cable Cutter



# Greenlee - Battery Powered Tools



With industry-leading technology, ergonomic and easy-to-use designs, Gator® Tools help you work smarter on the job site. Cut cable, crimp lugs and splices, and punch holes all in lightning fast time. With smart features such as Intelli-Crimp™ and Auto Retraction Stop (ARS), you can always be sure that the job is done right.

## SAFE.

Gator® tools help line workers avoid repetitive motion injuries associated with manual cutters and crimpers.

## SECURE.

With UL certification and Intelli-CRIMP™ technology®, you can be sure that the crimp or cut was correct – and have the data to prove it.

## SIMPLE.

Designed for the lineman, Gator® tools feature industry leading center of gravity and single trigger designs – making them the easiest to use.

## SMART.

Whether it's Auto Retraction Stop, Retraction Stop Repeat (RSR), or Intelli-CRIMP™ technology, Gator® tools help get the job done Faster, Safer, and Easier™.



## Gator Eye

- **Detailed Work History:** Download, print and store work information such as operating pressure, number of crimps/cuts and battery information
- **Accountability:** Prove that the job was done correctly with operation and project specific documentation
- **Diagnostics:** Set and view maintenance intervals, and add user identifiable information to manage your inventory



Press Software Screenshot

## CP1: EK425 Pouch

- Fabricated out of durable vinyl
- Combine with "S" hooks to attach bag to the inside/outside of a platform (not included)
- Velcro closures keep the tool clean
- Crimping jaws do not need to be removed when storing the tool



# Greenlee - Battery Powered Tools

## EK425L Gator® Battery Powered Crimping Tool

### SPECIFICATIONS

Crimping Force	6-Tons (54 kN)
Length (with jaws)	18 1/2"
Width (head open)	4"
Weight (with jaws)	6.8 lbs
Battery	18V 3.0 Ah Li-ion
Est. Cycles per Charge	325
Crimp Cycle Time	4 Seconds
Battery Charge Time	28 Minutes



### CONNECTOR CAPACITY

5/8" Service Entrance Connectors	10-1/0 AWG
.840 Service Entrance Connectors	1/0-4/0 AWG
Aluminum "H" Taps	6-4/0 AWG
Copper "H" Taps	10-2 AWG
Copper Tension Splices	6-2/0 AWG
All Aluminum Tension Splices	6-4/0 AWG
One Piece ACSR Tension Splices	4-1/0 AWG
Two Piece ACSR Tension Splices	2 AWG-477 kcmil
Aluminum Jumper Splices	4 AWG-266.8 kcmil
Strirrup	2-4/0 AWG
Aluminum Colour-Coded Lugs & Splices	8-4/0 AWG

### CRIMPING JAW COMPATIBILITY

CRIMPING JAW COMPATIBILITY	BRAND	TYPE/SERIES
CJD3BG	Greenlee®	KD6 Series
CJD30	FCI Burndy®	W, X Series
CJD3	IlSCO®	ND Series
CJK*	Huskie®	HT-58 Series
*Requires F020735 Adapters	Panduit®	CD-2001 Series
CJK	Kearney®	Dies for Type "O" Tools
CJXPJ	Nicopress Connectors	Connectors that require the X, P or J tool grooves

### CUTTING JAW COMPATIBILITY

- CJB
- One time disposable lock hasps 4 AWG Alumoweld
  - ACSR 1/0



CJD3BG



CJD30



CJD3



CJK



CJB



CJXPJ

# Greenlee - Battery Powered Tools

## Gator® 22-Series 6-Ton Crimping Tool

- 18V Lithium-Ion battery provides more cycle times and faster cycles
- An exclusive pressure sensor monitors the crimping force of each crimp and provides the operator a visual and audible alert if the force is below specifications
- Automatic Retraction Stop (ARS) stops the ram retraction automatically at the correct position for the next crimp cycle reducing subsequent cycle times
- LED work light illuminates dark work areas
- One trigger controls all tool functions, ram automatically retracts when crimp is complete
- Over molded tacky grip areas make gripping the tool easier and more comfortable
- 6 ton crimping force, flip-style crimping head opens easily and rotates 35°
- Uses Greenlee K22 dies and industry "W" dies
- Includes (2) 18V 1.5 Ah Li-ion batteries, battery charger, molded carrying case, and die adapters for "W" dies



**EK622L11** Comes with 120 Volt Charger

**EK622L12** Comes with 12 Volt Charger

## Gator® L-Series 12-Ton Crimping Tools

- 18V Lithium-Ion battery provides more cycle times and faster cycles
- An exclusive pressure sensor monitors the crimping force of each crimp and provides the operator a visual and audible alert if the force is below specifications
- Automatic Retraction Stop (ARS) stops the ram retraction automatically at the correct position for the next crimp cycle reducing subsequent cycle times
- LED work light illuminates dark work areas
- 12 ton crimping force, crimping head rotates 350°
- One trigger controls all tool functions, ram automatically retracts when crimp is complete
- Over molded tacky grip areas make gripping the tool easier and more comfortable
- Uses Greenlee 12-ton dies and industry "U" dies
- Includes two 18V 3.0 Ah Li-ion batteries, battery charger, and molded carrying case

### PVC COVERED

**EK1240CL11** 12-Ton Battery-Powered Crimping Tool, 1.65" opening, 120V Charger

**EK1240CL12** 12-Ton Battery-Powered Crimping Tool, 1.65" opening, 12V Charger

**EK1240CL22** 12-Ton Battery-Powered Crimping Tool, 1.65" opening, 230V Charger



**EK1230L11** 120 Volt Charger

**EK1230L12** 12 Volt Charger

For industry "U" Style dies, jaw opening is 1.2"

**EK1240L11** 120 Volt Charger

**EK1240L12** 12 Volt Charger

For industry "U" Style dies, jaw opening is 1.65"

**EK1240KL11** 120 Volt Charger

**EK1240KL12** 12 Volt Charger

For use with Kearney PH2 style dies

## Gator® L-Series 6.2-Ton Crimping Tools

- 18V Lithium-Ion battery provides more cycle times and faster cycles
- An exclusive pressure sensor monitors the crimping force of each crimp and provides the operator a visual and audible alert if the force is below specifications
- Automatic Retraction Stop (ARS) stops the ram retraction automatically at the correct position for the next crimp cycle reducing subsequent cycle times
- LED work light illuminates dark work areas
- One trigger controls all tool functions, ram automatically retracts when crimp is complete
- Over molded tacky grip areas make gripping the tool easier and more comfortable
- 6.2 ton crimping force, crimping head rotates 350°
- Tools utilize 4 indenters to make a crimp
- Includes two 18V 3.0 Ah Li-ion batteries, battery charger, molded carrying case, test gauge, test slugs

**EK06ATL11** 120 Volt Charger Crimps Copper Lugs & Copper Splices: 4-500

**EK06ATL12** 12 Volt Charger Crimps Copper Lugs & Copper Splices: 4-500

**EK06FTL11** 120 Volt Charger Crimps Copper: 4-750; Aluminum: 6-750\*

**EK06FTL12** 12 Volt Charger Crimps Copper: 4-750; Aluminum: 6-750\*

\*Additional overhead specs: 58" service ent. connectors: 8-1/0; .840 Service Ent. Connectors: 4-350; Copper Tension Spliced: 6-4/0; One Piece ACSR Tension Splice: 4-477



TRUSTED SINCE 1958

# Greenlee - Battery Powered Tools

## Gator® L-Series 6-Ton Crimping Tool

- 18V Lithium-Ion battery provides more cycle times and faster cycles
- An exclusive pressure sensor monitors the crimping force of each crimp and provides the operator a visual and audible alert if the force is below specifications
- LED work light illuminates dark work areas
- One trigger controls all tool functions, ram automatically retracts when crimp is complete
- Over molded tacky grip areas make gripping the tool easier and more comfortable
- 6 ton crimping force, crimping rotate 350°
- Uses Greenlee KC22 dies for copper connectors 8 AWG – 600 kcmil and Greenlee KA22 dies for aluminum connectors 8 AWG – 350 kcmil
- Includes two 18V 1.5 Ah Li-ion batteries, battery charger, and molded carrying case

**EK628L11 w/ 120 Volt Charger**

**EK628L12 w/12 Volt Charger**



## Gator® L-Series Dieless Crimping Tool

- 18V Lithium-Ion battery provides more cycle times and faster cycles
- An exclusive pressure sensor monitors the crimping force of each crimp and provides the operator a visual and audible alert if the force is below specifications
- Automatic Retraction Stop (ARS) stops the ram retraction automatically at the correct position for the next crimp cycle reducing subsequent cycle times
- LED work light illuminates dark work areas
- One trigger controls all tool functions, ram automatically retracts when crimp is complete
- Over molded tacky grip areas make gripping the tool easier and more comfortable
- Indent style crimp, crimping head rotates 350°
- Flip-open crimping head allows crimping of 4 AWG – 1000 kcmil copper and 6 AWG -1000 kcmil aluminum with no dies to change
- Includes two 18V 3.0 Ah Li-ion batteries, battery charger, and molded carrying case

**EK12IDL11 w/ 120 Volt Charger**

**EK12IDL12 w/12 Volt Charger**



## Gator® 15-Ton Crimping Tool

- Crimps up to 1000 kcmil connectors
- Cutting head rotates 350° for making crimps in tight locations
- Two speed pump advances the ram quickly to start the crimp
- Side hand enhances operator control
- Retraction stop allows the operator to stop the ram retraction to make subsequent crimp cycle times faster
- Ram automatically retracts when the cut is complete
- Two batteries, battery charger, side handle, and steel carrying case included

**EK1550L11 w/ 120 Volt Charger**

**EK1550L12 w/ 12 Volt Charger**

### Replacement Batteries & Chargers for Gator "L" Series Tools

**52176 18V 3.0 Ah Li-ion Battery**

**52178 120V Charger Only**

**52180 12V Charger Only**



# Greenlee - Battery Powered Tools

## Gator® One-Time Lock Cutters

- Designed to cut disposable lock container seals, and small diameter bolts
- Lightweight in-line style tool is easy to maneuver
- Cutter head rotates 3500 for use in tight locations
- Ram retracts automatically when cut is complete
- Two 18V 1.5 Ah Li-Ion batteries, battery charger, and molded carrying case included

ETS12L11 w/ 120 Volt Charger

ETS12L12 w/ 12 Volt Charger



## Gator® Cable Cutters

### ESC105

- For cutting large diameter underground power and communications cables, including armored cables
- State of the art 18V lithium ion (Li-ion) battery provides 70% more cycles per charge and faster cycle times
- Retraction Stop allows the operator to stop the ram retraction at any point simply by tapping the trigger, and then starting the next cutting cycle from that point saving time and energy
- LED light provides the operator with the battery charge and tool maintenance status
- Two-stage hydraulic system provides fast advance and power speeds, saving time
- Scissor-style blades are easy to fit around cables
- Side handle enhances operator control
- Forward handle position improves tool balance
- One trigger controls all tool functions
- Cutting head rotates 350°
- Tools automatically retract when the cutting cycle is complete
- Overmolded tacky grip areas make gripping the tool easier and more comfortable
- LED work light illuminates dark work areas
- Greenlee battery-powered cutting tools now use bio-degradable oil
- Smart chargers control the charging current, charging voltage and battery temperature to maximize battery life
- Available with 120V, 12V or 230V battery charger or with 120V or 230V corded adapter in place of batteries and charger

ESC105L11 w/ 120 Volt Charger

ESC105L12 w/ 12 Volt Charger



### ESC85:

- Scissor style blades are easy to fit around cables and cutting head rotates 360° for making cuts in tight locations
- Side handle enhances operator control
- Designed for communications and underground power cable cutting
- Includes one-hour battery charger, steel carrying case and two batteries

ESC85L11 w/ 120 Volt Charger

ESC85L12 w/ 12 Volt Charger

02999 12V NiCd Battery Only

03046 120V Charger Only

## Gator® Plus ESG45GL11 ACSR Cutters

- Designed to cut steel cables, rods
- 2-speed pump advances the ram quickly to start the cut; ram automatically retracts after cut is complete
- Includes a 120V one hour battery charger, steel carrying case, and two batteries
- Also available with 12V or 230V chargers

### Replacement Batteries & Chargers for Gator "L" Series Tools

52176 18V 3.0 Ah Li-ion Battery (for all pistol grip style and EK425L tools)

52177 18V 1.5 Ah Li-ion Battery (for all in line style tools)

52178 120V Charger Only

52180 12V Charger Only



ESG45L11 w/ 120 Volt Charger

ESG45L12 w/ 12 Volt Charger



# Greenlee - Battery Powered Tools

## ES25 ACSR Cable Cutter

- Cuts up to 636 kcmil ACSR cables
- Approximately 50 cuts of Grosbeak or 120 cuts of Merlin per battery charge
- Includes one hour battery charger, one battery, and molded carrying case

<b>ES2511</b>	<b>w/ 120 Volt Charger</b>
<b>76807</b>	<b>Blade Kit</b>
<b>11851</b>	<b>14.4V NiCd Battery</b>
<b>11841</b>	<b>120V Battery Charger</b>



## ES32LU ACSR Cable Cutter

- State of the art 18V Lithium Ion (Li-ion) battery provides well over 200 cycles per charge and faster cycle times
- LED light provides the operator with the battery charge and indicates tool maintenance status
- In-line tool style is lightweight and very easy to control; one trigger controls all tool functions
- Cutting head rotates 350°
- Tool automatically retracts when the cutting cycle is complete
- Over molded tacky grip areas make gripping the tool easier and more comfortable
- LED work light illuminates dark work areas
- Greenlee battery-powered tools now use bio-degradable oil
- Smart chargers control the charging current, charging voltage and battery temperature to maximize battery life
- Available with 120V or 12V battery charger
- Includes (2) 18V 3.0 Ah Li-Ion batteries, a charger, and molded carrying case

<b>ES32LU11</b>	<b>w/ 120 Volt Charger</b>
<b>ES32LU12</b>	<b>w/ 12 Volt Charger</b>



## ES750 Cable Cutter

- Cuts 500 kcmil copper cable in less than 8 seconds
- Approximately 20 cuts in 750 kcmil per battery charge
- Includes a one hour battery charger, battery, and molded carrying case

<b>ES750-11</b>	<b>120 Volt Charger</b>
<b>ES750-22</b>	<b>230 Volt Charger</b>
<b>45378</b>	<b>12V NiCd Battery</b>
<b>45379</b>	<b>120V Charger Only</b>



## Gator® L-Series 6-Ton Multi-Purpose Tool

- 18V Lithium-Ion battery provides more cycle times and faster cycles
- LED work light illuminates dark work areas
- Uses a variety of easily interchanged cutting blades, crimping die adapters, and a knock-out punch adapter
- One trigger controls all tool functions, ram automatically retracts when crimp is complete
- Over-molded tacky grip areas make gripping the tool easier and more comfortable
- 6 ton crimping force, flip-style crimping head opens easily and rotates 350°
- Uses Greenlee K22 dies and industry "W" dies
- Includes two 18V 3.0 Ah batteries

### Multipurpose Tool Accessories:

<b>UAK</b>	<b>Adapter for Kearney "O", T&amp;B "6 Ton", &amp; Blackburn "OD" dies</b>	<b>ECCXL11</b>	<b>w/ 120 Volt Charger</b>
<b>UAW</b>	<b>Adapter for Burndy "W" and Panduit "CD-2001" dies</b>	<b>ECCXL12</b>	<b>w/ 12 Volt Charger</b>
<b>UC40</b>	<b>Cutter blades AL &amp; CU 1 1/2"</b>	<b>UA22</b>	<b>Adapter for Greenlee K22 Dies</b>
<b>UCACSR</b>	<b>Cutter blades for ACSR &amp; guy strand</b>	<b>UAK</b>	<b>Adapter for Kearney "O", T&amp;B "6 Ton", and Blackburn "OD" dies</b>



# Greenlee - Battery Powered Tools

## Gator® L-Series 12-Ton Multi-Purpose Tool

- Uses a variety of easily interchanged cutting blades, crimping die adapters, and a knock-out punch adapter
- 18V Lithium-Ion battery provides more cycle times and faster cycles
- LED work light illuminates dark work areas
- One trigger controls all tool functions, ram automatically retracts when crimp is complete
- Over molded tacky grip areas make gripping the tool easier and more comfortable
- 12 ton crimping force, flip-style crimping head opens easily and rotates 350°
- Uses Greenlee 12-ton dies and industry "U" dies
- Includes two 18V 3.0 Ah Li-ion batteries, battery charger, molded carrying case, and die adapters for "W" dies

**E12CCXL11 w/ 120 Volt Charger**

**E12CCXL12 w/ 12 Volt Charger**

*\*Adapters for "U" dies are included with 12 CCX tools. Other dies and blades must be purchased separately.*

*\*\* 6 ton dies are compatible with the CCX tools when paired with a die adapter*



## Cutting Capacities

- Copper and aluminum cable 1 1/2"
- ACSR: 954 kcmil
- Standard guy strand: 5/8"
- EHS guy strand: 1/2"
- Ground rod: 1/2"
- Rebar: 1/2"
- Threaded rod: 1/4", 3/8" 1/2", 4mm, 5mm, 6mm, 8mm, 10mm
- DIN rail: 35 x 7.5, 32 x 15 x 9, 35 x 15

## Punching Capacities

- Round: 5 5/8"
- Rectangular: 2.677" x 5.433"
- Square: 5.4333" x 5.4333"

## Crimping Capacities

- Copper, colour-coded lugs and splices: 750 kcmil\*
- Aluminum colour-coded lugs and splices: 750 kcmil\*\*
- 5/8" service entrance connectors: 10 - 1/0 AWG
- .840 service entrance connectors: 1/0 - 4/0 AWG
- Aluminum overhead "H" taps: 6 AWG - 500 kcmil
- One piece ACSR tension splicers: 4 AWG - 556.5 kcmil
- One piece ACSR tension splicers: 4 AWG - 556.5 kcmil

*\* When used with Greenlee KC12 dies in combination with Anderson, Blackburn, FCI Burndy, ILSCO, Panduit, Penn-Union, and Thomas & Betts copper colour-coded connectors, crimps on copper lugs up to 750 kcmil are UL and cUL classified.*

*\*\* When used with Greenlee KA12 dies in combination with Anderson, Blackburn, FCI Burndy, ILSCO, Panduit, Penn-Union, and Thomas & Betts, aluminum colour-coded connectors, crimps on copper lugs up to 750 kcmil are UL and cUL classified.*

### DIE ADAPTERS

**UAW Adapter for Burndy "W" and Panduit "CD-2001" Dies (equivalent to "D3" Die)**

### CABLE CUTTING BLADES

**UC26 Cutter Blades AL & CU 1" Capacity**

**UC40 Cutter Blades AL & CU 1 1/2" Capacity**

**UCACSR Cutter Blades for ACSR and Guy Strand**

### KNOCKOUT PUNCH ADAPTER

**UA12P Punch Driver Adapter (accepts 3/4" draw stud)**

### THREADED ROD CUTTING BLADES

**UCUNC14 Cutter Blades for 1/4" Threaded Rod**

**UCUNC38 Cutter Blades for 3/8" Threaded Rod**

**UCUNC12 Cutter Blades for 1/2" Threaded Rod**



The CCX 3 step, 10 second function changeover

Step 1: Push the release buttons and the blades slide right out of the easy opening CCX head

Step 2: Alternate die adapters, cutter blades or knockout punch adapters slide right in

Step 3: You are working again with no lost time

### Replacement Batteries & Chargers for Gator "L" Series Tools

52176	18V 3.0 Ah Li-ion Battery
52178	120V Charger
52180	12V Charger



# Greenlee - Battery Powered Tools

CUTTERS & CRIMPERS

## Cutting Tool Specifications



	ETS12L One-Time Lock Cutters	ES25 ACSR Cable Cutter	ES750 Cable Cutters	ES32LU ACSR Cable Cutters	ESC105L Cable Cutters	ESC85 Cable Cutters	EK1550 15 Ton Crimpers	ESG45L ACSR Cable Cutters
Kit	ETS12L11 ETS12L12	ES2511	ES75011 ES75022	ES32LU11 ES32LU12	ESC105L11 ESC105L12	ESC85L11 ESC85L12	EK1550L11 EK1550L12	ESG45L11 ESG45L12
Batteries included with Kit	18V 1.5 Ah Li-ion	14.4 Volt, NiCd	12 Volt, NiCd	18V 3.0 Ah Li-ion	12V, 2.6Ah, NiMH	18V 3.0 Ah Li-ion	18V 3.0 Ah Li-ion	12 Volt 2.0 Ah NiCd
Charger included with Kit	120 Volt Charger 12 Volt Charger	120 Volt Charger	120 Volt Charger 230 Volt Charger	120 Volt Charger 12 Volt Charger	120 Volt Charger 12 Volt Charger	120 Volt Charger 12 Volt Charger	120 Volt Charger 12 Volt Charger	120 Volt Charger 12 Volt Charger
Length	13 5/8"	14 3/4"	14 1/4"	21.62"	23.75"	21"	19 5/8"	15 1/2"
Width	2 7/8"	-	-	17.75"	-	2 7/8"	2 7/8"	2 7/8"
Height	4 1/2"	-	-	8"	23.75"	15 1/4"	15"	12 1/2"
Weight	4.4 lbs	7.7 lbs	12.95 lbs	14.99 lbs	22 lbs	6.85 lbs	19 lbs	12.8 lbs
Capacity	<ul style="list-style-type: none"> <li>• 1 Time Disposable Lock: 4 AWG Alumoweld</li> <li>• Common Bolt: 1/2"</li> <li>• Grade 5 Bolt: 7/16"</li> <li>• Grade 8 Bolt: 5/16"</li> <li>• Boa Lock: BL-9</li> </ul>	<ul style="list-style-type: none"> <li>• ACSR: 636 kcmil (except Egret)</li> <li>• Aluminum: 1500 kcmil</li> </ul>	<ul style="list-style-type: none"> <li>• 750 kcmil copper cable</li> <li>• 1000 kcmil aluminum cable</li> </ul>	<ul style="list-style-type: none"> <li>• 500 kcmil copper cable</li> <li>• 500 kcmil aluminum cable</li> </ul>	<ul style="list-style-type: none"> <li>• Not for cutting ACSR, guy strand, or other with cables with steel strands</li> <li>• 4" diameter Cu &amp; Al power cables including soft steel armored, lead sheathed, and communications cables</li> <li>• Cycles per Battery Charge: 40 (Approximate)</li> </ul>	<ul style="list-style-type: none"> <li>• 3 3/8" max. diameter copper, aluminum and communications cable</li> </ul>	<ul style="list-style-type: none"> <li>• Est. cycles per charge: 50</li> <li>• Colour-coded copper lugs and splices, 8 AWG to 1000 kcmil</li> <li>• Colour-coded aluminum lugs and splices, 8 AWG to 1000 kcmil</li> <li>• Crimping Force: 30,000 lbs</li> </ul>	<ul style="list-style-type: none"> <li>• ACSR: 1590 kcmil (MCM), (Falcon 54/19)</li> <li>• Standard Guy Strand: 5/8" diameter (16 mm diameter)</li> <li>• EHS Guy Strand: 1/2" diameter (13 mm diameter)</li> <li>• Ground Rod: 5/8" diameter (16 mm)</li> <li>• Rebar (schedule 60) 1/2" diameter (13 mm diameter)</li> <li>• Wire rope: 5/8" diameter (16 mm diameter)</li> <li>• Copper &amp; Aluminum cable: 1500 kcmil (MCM) (800 mm<sup>2</sup>)</li> <li>• Soft Steel Bolts: 5/8" diameter (16 mm)</li> </ul>



# Greenlee - Battery Powered Tools

	EK425L Crimping Tool	EK425L Crimping Tool	EK622L Crimping Tool	EK1230L Crimping Tool	EK1240L & EK1240KL Crimping Tools
<b>Kit</b>	EK425LD011 CJD30 Crimping Jaws EK425LDBG11 CJD3BG Crimping Jaws EK425LD11 CJD3 Crimping Jaws EK425LK11 CJK Crimping Jaws	EK425LD012 CJD30 Crimping Jaws EK425LDBG12 CJD3BG Crimping Jaws EK425LD12 CJD3 Crimping Jaws EK425LK12 CJK Crimping Jaws	EK622L11  EK622L12	For industry "U" style dies, jaw opening is 1.2":  EK1230L11  EK1230L12	For industry "U" style dies, jaw opening is 1.65": EK1240L11 EK1240L12  For use with Kearney PH2 style dies: EK1240KL11 EK1240KL12
<b>Batteries included with Kit</b>	18V 3.0 Ah Li-ion (30 minute charge time)				
<b>Charger included with Kit</b>	120 Volt Charger	12 Volt Charger	120 Volt Charger 12 Volt Charger	120 Volt Charger 12 Volt Charger	120 Volt Charger 12 Volt Charger
<b>Voltage</b>	18V		18V	18V	18V
<b>Crimping Force</b>	6 Ton		6 Ton	12 Ton	12 Ton
<b>Length</b>	18 1/2"		15 3/4"	14 1/2"	16 1/4"
<b>Width</b>	4" (head open)		2 7/8"	2 7/8"	2 7/8"
<b>Height</b>	-		4 1/2"	12"	12 1/2"
<b>Weight</b>	6.8 lbs		6.5 lbs	15.5 lbs	15 lbs
<b>Est. Cycles/Charge</b>	325		100	60	90
<b>INDUSTRIAL CRIMPING TOOL CAPACITIES</b>					
<b>Copper Lugs</b>	-	-	8-600	8-750	8-750
<b>Copper Slices</b>	-	-	8-600	8-400	8-750
<b>Aluminum Lugs</b>	-	-	8-350	8-750	8-750
<b>Aluminum Splices</b>	-	-	8-350	8-400	8-750
<b>Copper "C" Taps</b>	-	-	12-2	12-400	12-400
<b>Aluminum "H" Taps</b>	-	-	-	6-500	6-500
<b>Aluminum Pin</b>	-	-	6-1/0	6-500	6-750
<b>GROUNDING CRIMPING TOOL CAPACITIES</b>					
<b>Ground Grid</b>	-	-	6-3	6-500	6-500
<b>Connectors</b>	-	-	-	6-500	6-500
<b>Copper "E" Taps</b>	-	-	-	-	-
<b>OVERHEAD CRIMPING TOOL CAPACITIES</b>					
<b>5/8" Service Entrance Connectors</b>	10-1/0 AWG		10-1/0 AWG	10-1/0	10-1/0
<b>.840 Service Entrance Connectors</b>	1/0-4/0 AWG		1/0-4/0 AWG	1/0-4/0	1/0-4/0
<b>Aluminum "H" Taps</b>	6-4/0 AWG		6-4/0 AWG	6-500	6-500
<b>Copper "H" Taps</b>	10-2 AWG		12-2 AWG	12-4/0	12-4/0
<b>Copper Tension Splice</b>	6-2/0 AWG		6-2/0 AWG	6-500	6-500
<b>All Aluminum Tension Splice</b>	6-4/0 AWG		6-4/0 AWG	6-587.5	6-587.5
<b>One Piece ACSR Tension Splice</b>	4-1/0 AWG		4-1/0 AWG	4-556.5	4-556.5
<b>Two Piece ACSR Tension Splice</b>	2 AWG-477 kcmil		2-4/0	2-556.5	4-556.5
<b>Aluminum Jumper Splice</b>	4 AWG-266.8 kcmil		2 AWG-266.8 kcmil	4-556.5	4-556.5
<b>Stirrups</b>	2-4/0 AWG		6-4/0 AWG	6-500	6-500
<b>Aluminum Lugs</b>	8 AWG-500 kcmil		4-4/0	4-556.5	2-556.5
<b>Copper Lugs</b>	8-4/0 AWG		1/0-2/0	1/0-500	1/0-500

# Greenlee - Battery Powered Tools

	EK06ATL/EK06FTL L-Series Quad-Point Crimping Tool	EK12IDL Dieless Crimping Tool	EK628L 6 Ton Crimping Tool	ECCXL 6 Ton Multi-Purpose Tool
Kit	EK06ATL11 EK06ATL12 EK06FTL11 EK06FTL12	EK12IDL11 EKD12IDL12	EK628L11 EK628L12	ECCXL11 ECCXL12
Batteries included with Kit	18V 3.0 Ah Li-ion (30 minute charge time)			
Charger included with Kit	120 Volt Charger 12 Volt Charger 120 Volt Charger 12 Volt Charger	120 Volt Charger 12 Volt Charger	120 Volt Charger 12 Volt Charger	120 Volt Charger 12 Volt Charger
Voltage	18V			
Crimping Force	12,400 lbs	24,000 lbs	12,000 lbs	12,000 lbs
Length	14"	16 1/2"	18 1/2"	16 1/2"
Width	2 7/8"	2 7/8"	2 7/8"	2 7/8"
Height	14"	14 1/2"	4 1/2"	14 1/2"
Weight	12 lbs	15 lbs	6 lbs	14 lbs
Est. Cycles/Charge	100	90	150	300
<b>INDUSTRIAL CRIMPING TOOL CAPACITIES</b>				
Copper Lugs	4-750	4-1000	8-600	8-600
Copper Slices	4-400	4-1000	8-600	8-600
Aluminum Lugs	6-750	6-1000	8-350	8-350
Aluminum Splices	6-750	6-1000	8-350	8-350
Copper "C" Taps	-	-	-	12-2
Aluminum "H" Taps	-	-	-	-
Aluminum Pin	-	-	-	6/10
<b>GROUNDING CRIMPING TOOL CAPACITIES</b>				
Ground Grid	-	-	-	6-3
Connectors	-	-	-	-
Copper "E" Taps	-	-	-	-
<b>OVERHEAD CRIMPING TOOL CAPACITIES</b>				
5/8" Service Entrance Connectors	8-1/0 AWG	-	-	10-1/0 AWG
.840 Service Entrance Connectors	4-350	-	-	1/0-4/0
Aluminum "H" Taps	-	-	-	6-4/0
Copper "H" Taps	-	-	-	12-2
Copper Tension Splice	6-4/0 AWG	-	-	6-4/0 AWG
All Aluminum Tension Splice	-	-	-	6-4/0
One Piece ACSR Tension Splice	4-477	-	-	4-1/0
Two Piece ACSR Tension Splice	-	-	-	2-4/0
Aluminum Jumper Splice	-	-	-	4-266.8
Stirrups	-	-	-	6-4/0
Aluminum Lugs	-	-	-	4-4/0
Copper Lugs	-	-	-	1/0-2/0

## Remote Hydraulic Cutting

- Guillotine cutting heads provide additional safety and cutting control
- Precision blades provide clean cuts every time
- Dual position handles for easy operation and transport
- Lightweight, compact design for professional linemen

Part #	UPC No.	Description
SDG45	01555	Remote ACSR Cable Guillotine Cutter, 45mm
SDG55	01556	Remote ACSR Cable Guillotine Cutter, 55mm
SDG85	01522	Remote Cable Guillotine Cutter, 85mm
SDG105	01526	Remote Cable Guillotine Cutter, 105mm
SDK105	01870	Remote Cable Scissor Cutter, 105mm
01059	01059	Hose Assy, 1/4" x 6' 3/8M&3/8"F Filled
01058	01058	Hose Assy, 1/4" x 6' 3/8M&1/4"M Filled
05850	05850	Hose Assy, 1/4" x 10' 3/8M&3/8"F Filled
17707	17707	Hose Assy, 1/4" x 10' 3/8M&1/4"M Filled



SPECIFICATIONS	SDG45	SDG55	SDG85	SDG105	SDK105
Length	16-5/8" (423mm)	18-18" (460mm)	21" (533mm)	23-3/4" (604mm)	20" (510mm)
Weight	8.38 lbs (3.8 kg)	12.35 lbs (5.6 kg)	9.48 lbs (4.3 kg)	16.98 lbs (7.7 kg)	17 lbs (7.7 kg)
Connector	3/8" NPT Male (Screw-Type)	3/8" NPT Male (Screw-Type)	3/8" NPT Male (Screw-Type)	3/8" NPT Male (Screw-Type)	3/8" NPT Male (Screw-Type)
Communications	1-3/4" (50mm)	2-1/8" (55mm)	3-3/8" (85mm)	4" (105mm)	4" (105mm)
Cu & Al Power Cables ACSR	1590 kcmil (MCM)	2515 kcmil			
Standard Guy Strand	5/8" (16mm)	5/8" (16mm)			
EHS Guy Strand	1/2" (13mm)	9/16" (14mm)			
Ground Rod	5/8" (16mm)	3/4" (19mm)			
Rebar	1/2" (13mm)	5/8" (16mm)			
Wire Rope	5/8" (16mm)	5/8" (16mm)			
Copper & Aluminum Cable	1500 kcmil (MCM)	1500 kcmil (MCM)			

# Greenlee - Hydraulic Crimping Tools

## 12 Ton Crimping Tools

Greenlee LPK1230, LPK1240 & LPK1240K crimping tools do not require a high pressure intensifier and operate on either an open or closed center hydraulic system. A relief valve signals the operator when the crimp is complete. Their crimping force at 1,500 psi is 24,000 lbs. with an operating pressure range of 1,500 - 2,500 psi. Dies and couplers are not included.

### LPK1240K 12 Ton Crimping Tool

- Compatible with dies for Kearney PH-2 and PH-3 tools
- Flow range of 3-9 gpm
- 19.5 lbs



### LPK1230 12 Ton Crimping Tool

- 1.20" jaw opening
- Compatible with dies for Burndy Y35, Alcoa 12A, 12AC, 12HA, 12HAC; Anderson HC-12, HC-12H
- Accepts Standard "U" style dies
- Flow range of 3-9 gpm
- 18.5 lbs



### LPK1240 12 Ton Crimping Tool

- 1.65" jaw opening
- Flow range of 3-9 gpm
- 19.7 lbs.
- Crimps up to 750 MCM copper and aluminum
- Compatible with dies for Burndy Y35, Alcoa 12A, 12AC, 12HA, 12HAC; Anderson HC-12, HC-12H, Thomas & Betts 12-ton



### LPK1550: 15 Ton Crimping Tools

- No high pressure intensifier required
- Crimps cable 500 MCM and larger
- Dies and couplers not included
- 1,500 - 2,500 psi
- Flow range of 3-9 gpm
- Operates on either open or closed center hydraulic systems
- Relief valve signals operator when crimp is complete
- Compatible with dies for: Kearney PH2\*, PH4/PH14; Burndy Y35\*, Y46\*; Penn-Union TPU-15PH\*; Thomas & Betts TBM15PF\*
- May be converted (with adapters) for use with Burndy "U" style dies and Kearney PH2 and some WH2 dies



48820 Burndy Y46, Penn-Union TPU 15BH

48788 Thomas & Betts TBM 15PF

48802 12 Ton U-Die

48824 Kearney PH2

## 60 Ton Crimping Tool

- Accepts Burndy "L" dies and Alcoa "6000 Series" crimping dies
- After completing the connection, the top of the head easily swivels 90° and can be lifted from the tool to remove the connector
- Removing the tool from the stand exposes a lifting eye for when the tool must be used above ground level
- RK6040 requires 10,000 psi single-acting hydraulic power source
- DK6040 requires 10,000 psi double acting hydraulic power source
- Equipped with 3/8" male type hydraulic couplers
- Includes steel carrying case with storage space for dies
- Crimping force at 10,000 psi is 120,000 lbs



RK6040 Single Acting

DK6040 Double Acting

## EHP700LU: Battery-Powered Hydraulic Pump

- Loaded with intelligent features such as a multi-function pressure sensor, self-diagnostics, and a real-time LED readout
- Versatile battery pump can crimp, cut and punch with up to 10,000 psi of pressure
- Mode dial enables the user to select between three primary intelligent program settings: CRIMP, CUT and PUNCH
- Each setting provides specific pressure functionality for the job at hand
- Future proof settings allow for a variety of additional functions to be programmed into the pump via a bi-directional optical connection
- Intelli-CRIMP™ technology monitors the crimping process, ensuring the correct amount of pressure is applied for each crimp
- Real-Time Monitoring is displayed via LED screen and recorded for statistics
- Automatic Retraction detects pressure drop from completed action and releases pressure, preventing damage to head
- Manual Retraction allows user to retract head to starting position at any time

Part #	UPC No.	Description
EHP700LU11	00754	Power Pump, Bat 120V Charger
EHP700LU12	00755	Power Pump, Bat 12V Charger
EHP700LU22	00757	Power Pump, Bat 230V Charger
EHP700LU120	00756	Power Pump, 120V Adapter
EHP700LU230	00758	Power Pump, 230 V Adapter
EHP700LUB	01150	EHP700 Bare Pump
HTA4GL	00759	Remote Control
TG3	01054	Strap
EAC18120	52191	Adapter, AC - 120V to 18V
EAC18230	52192	Adapter, AC - 230V to 18V
52176	52176	Battery, 18V Li Ion 3.0Ah
52178	52178	Charger, Battery 120V
52179	52179	Charger, Battery 230V
52180	52180	Charger, Battery 12V
25766	25766	Adapter, Charger 18V Li to 12V Ni
EL122/32	02042	Hydraulic Fluid, Biodegradable
17707	17707	Hose Assy, 1/4" x 10' 3/8M&1/4M Filled
05850	05850	Hose Assy, 1/4" x 10' 3/8M&3/8F Filled
01058	01058	Hose Assy, 1/4" x 6' 3/8M&1/4M Filled
01059	01059	Hose Assy, 1/4" x 6' 3/8M&3/8F Filled



### SPECIFICATIONS

Operating Pressure:	10,000 psi
Oil Volume:	0.80 qt (0.76l)
Flow Rate of Double Stage Pump:	
Low Pressure Range	up to 0.9 l/min
At Full Pressure	0.3 l/min
Degree of Protection:	IP43
Battery Voltage:	18V
Battery Capacity:	3.0 Ah, Li-Ion

### SPECIFICATIONS

Number of Batteries:	2 - 1 Active, 1 Stored
Charging Time:	30 Minutes
Ambient Temperature:	10°F - 104°F (-12°C to 40°C)
Weight without Batteries:	10.8 lbs (4.9 kg)
Weight with 2 Batteries:	14.1 lbs
Length:	14"
Width:	6.5"
Height:	11.5"

# Compression Dies

BURNDY CSA "U" Dies	
PART #	DESCRIPTION
UCSA1	U-Die
UCSA2	U-Die
UCSA3	U-Die
UCSA20	U-Die
UCSA22	U-Die
USCA22CU	Hexagonal Twin Die
USCA24	U-Die
UCSA24CU	U-Die
UCSA26	U-Die
UCSA26CU	U-Die
UCSA28	U-Die
UCSA28CU	Hexagonal Twin Die
UCSA30	U-Die
UCSA30CU	Hexagonal Twin Die
USCAKIT12	UCSA Kit w/ Case & Dies

BURNDY CSA "L" Dies
LCSA1
LCSA2
LCSA3
LCSA22
LCSA24
LCSA26
LCSA28
LCSA30
LCSA30CU
LCSA32
LCSA32CU
LCSA34CU
LCSA36

RELIABLE CSA DIES	
12 TON DIES	15 TON DIES
UCSA20	UCSA32
UCSA22	UCSA34
UCSA24	
UCSA26	
UCSA28	
UCSA30	

HUSKIE CSA Dies	
HUSKIE	CSA
HTCSA-20	-
HTCSA-22	-
HTSCSA-24	-
HT41PA	CSA-20
HT41PB	CSA-22
HT41PC	CSA-24
HT41PD	CSA-26
HT41-PE	CSA-28
HT41PF	CSA-30W
HT41PL	CSA-20CU
HT41PG	CSA-22CU
HT41PI	CSA-26CU
HT41PJ	CSA-28CU
HT41PK	CSA-30WCU
HT41PM	CSA-1
HT41PN	CSA-2
HT58PA	CSA-20
HT58PB	CSA-22
HT58PC	CSA-24
HT61PF	CSA-30
HT61PK	CSA-30CU
HT61PO	CSA-32
HT61PP	CSA-32CU
HT61PQ	CSA-34
HT61PR	CSA-34CU

# Compression Dies

HUSKIE "HT" SERIES Equivalent to Kearney "O" Type Dies for 4-6 Ton Tools
HT-B
HT-D
HT-J
HT-K
HT-O
HT-P
HT-T
HT-737
HT-781
HT-840
HT-316
HT-14
HT-516
HT-38
HT-12
HT-916
HT-1932
HT-58-1
HT-1116
HT-D3
HT-510
HT-635
HT-747

KEARNEY "O" STYLE DIES For 4-6 Ton Tools
B (30554)
D (26994)
J (48410)
K (40495)
O (26993)
P (30611)
T (40493)
737 (30084)
781 (30450)
840 (30124)
3/16 (36181)
1/4 (30154)
1/3
3/8 (30042)
1/2 (30041)
4/7
19/32 (30914)
5/8 to 1 (26992)
11/16 (40114)
D3
510 (HEX) (100600)
635 (HEX) (100601)
747 (HEX) (100602)

"W" STYLE DIES Equivalent to Burndy "W" Type Dies for 4-6 Ton Tools		
HUSKIE	BURNDY	GREENLEE
HT58AE	W-K840	KD6-13
HT58BX	W-161	KD6-14
HT58BZ	W-162	KD6-15
HT58CB	W-163	KD6-16
HT58CD	W-164	KD6-22
HT58CE	W-165	KD6-17
HT58CF	W-166	KD6-18
HT58CG	W-167	-
HT58CM	W-171	-
HT58G	W-BG	KD6-10
HT58J	W-C	KD6-12
HT58AK	W-O	KD6-11
HT58CUT	CUTTER	-
HT58DE	W-236	-
-	W-237	KD6-24
HT58DG	W-238	-
HT58DH	W-239	KD6-25
HT58DK	W-241	-
HT58DM	W-243	KD6-19
HT58DP	W-245	-
HT58DT	W-247	KD6-20
HT58DV	W-248	-
HT58DW	W-249	KD6-21
HT58KA	W-687	-
HT58HK	W-702	-
HT58AF	W-L	-
-	W-28K	KD6-27

"U" STYLE DIES Equivalent ALCOA/HUSKIE "U" Type Dies for 12 Ton Tools	
HUSKIE	ALCOA
HT4107	74SH-035SH
HT4108	75SH-05SH
HT4109	76SH
HT4111	11AH
HT4120	20AH-14AH
HT4128	74AH-10AH
HT4129	75AH-12AH
HT4130	76AH
HT4131	72AH
HT4132	73AH-08AH
HT4140	07CD
HT4141	08CD
HT4142	09CD
HT4155	72SH-01SH
HT4156	73SH
HT4180	13AH-80EA

# Compression Dies

DIE SELECTION					
APPROXIMATE CONDUCTOR RANGE					
CU	AL	DIE COLOUR CODE	HUSKIE	BURNDY	GREENLEE
6 AWG	8 AWG	BLUE	HT41AT/HT41GL	U5CRT/U8CABT	KC12-6/KA12-8
4 AWG	6 AWG	GREY	HT41AU / HT41GE	U4CRT/U6CABT	KC12-4/KA12-6
2 AWG		BROWN	HT41AW	U2CRT	KC12-2
1 AWG	4 AWG	GREEN	HT41AX	U1CRT	KC12-1
	4 AWG	GREEN	HT41GM	U4CABT	KA12-4
1/0 AWG	2 AWG	PINK	HT41AY	U25RT	KC12-1/0
	2 AWG	PINK	HT41GF	U2CABT	KA12-2
2/0 AWG		BLACK	HT41AZ	U26RT	KC12-2/0
3/0 AWG		ORANGE	HT41BA	U27RT	KA12-3/0
	1/0 AWG	TAN	HT41EX	U25ART	KA12-1/0
4/0 AWG		PURPLE	HT41BC	U28RT	KC12-4/0
	2/0 AWG	OLIVE	HT41EY	U26ART	KA12-2/0
250 MCM		YELLOW	HT41BE	U29RT	KC12-250
	3/0 AWG	RUBY	HT41GW	U27ART	KA12-3/0
300 MCM		WHITE	HT41BF	U30RT	KC12-300
	4/0 AWG	WHITE	HT41EZ	U28ART	KA12-4/0
350 MCM		RED	HT41BJ	U32RT	KC12-350
	250MCM	RED	HT41FW	U29ART	KA12-250
400 MCM		BLUE	HT41BK	U32RT	KC12-400
	300 MCM	BLUE	HT41GZ	U30ART	KA12-300
500 MCM		BROWN	HT41BL	U34RT	KC12-500
	350 MCM	BROWN	HT41FA	U31ART	KA12-350
600 MCM	400 MCM	GREEN	HT41HH/HT41BM	U32ART/U36RT	KA12-400/KC12-600
	500 MCM	PINK	HT41FB	U34ART	KA12-500
750 MCM		BLACK	HT41BP	U39RT	KC12-750
	600 MCM	BLACK	HT41HG	U36ART	KA12-600
	700/750 MCM	YELLOW	HT41LJ	U39ART-2	KA12-750

BURNDY		
12 TON DIES		
WIRE SIZE	COPPER	ALUMINUM
Small #8 Str.	U8CRT	U8CABT
#6, #5 Str.	U5CRT	U6CABT
#4 Str.	U4CRT	U4CABT
#3 Str.	U3CRT	N/A
#2 Str.	U2CRT	U2CABT
#1 Str.	U1CRT-1	U1CART
1/0 Str.	U25RT	U25ART
2/0 Str.	U26RT	U26ART
3/0 Str.	U27RT	U27ART
4/0 Str.	U28RT	U28ART
250kcmil	U29RT	U29ART

BURNDY		
12 TON DIES		
WIRE SIZE	COPPER	ALUMINUM
300 kcmil	U30RT	U30ART
350 kcmil	U31RT	U31ART
400 kcmil	U32RT	U32ART
500 kcmil	U34RT	U34ART
535 Flex kcmil	U38XRT	N/A
600 kcmil	U36RT	U36ART
750 kcmil	U39RT	U39ART2
Large 777 Flex	U44XRT	N/A



# Compression Dies

"U" STYLE DIES Equivalent to Burndy & Kearney "U" Type Dies for 12 Ton Tools		
HUSKIE	BURNDY	GREENLEE
HT41G	U-BG	KD12-10
HT41J	U-C	KD12-12
HT41V	U-D	KD12-30
HT41X	U-D3	KD12-30
HT41Y	U-E	-
HT41Z	U-F	KD12-32
HT41AB	U-H	-
HT41AF	U-L	-
HT41AG	U-M	-
HT41AJ	U-N	-
HT41AK	U-O	KD12-11
HT41AM	U-R	-
HT41BX	U-161	KD12-14
HT41BZ	U-162	KD12-15
HT41CB	U-163	-
HT41CD	U-164	-
HT41CE	U-165	KD12-17
HT41CF	U-166	KD12-18
HT41CG	U-167	-
HT41CJ	U-168	-
HT41CK	U-169	-
HT41CL	U-170	-
HT41CT	U-203	-
HT41DE	U-236	-
HT41DF	U-237	-
HT41DG	U-238	KD12-35
HT41DH	U-239	-
HT41DL	U-242	-
HT41DM	U-243	KD12-19
HT41DP	U-245	-
HT41DT	U-247	KD12-20
HT41DV	U-248	-
HT41DW	U-249	KD12-21
HT41DY	U-251	-
HT41DZ	U-252	-
HT41EK	U-261	-
HT41FG	U-305	-
HT41FM	U-316	-
HT41FN	U-317	-
HT41FU	U-321	-
HT41FX	U-327	-
HT41GK	U-373	-
HT41GX	U-468	-
HT41HM	U-490	-
HT41JM	U-654	KD12-36
HT41JN	U-655	KD12-37

# Compression Dies

"U" STYLE DIES Equivalent to Burndy & Kearney "U" Type Dies for 12 Ton Tools		
HUSKIE	BURNDY	GREENLEE
HT41JP	U-658	KD12-38
HT41JR	U-659	KD12-39
HT41KJ	U-705	-
HT41LG	U-788	-
-	U-998	KD12-40
HT41AE	U-K840	-
HT41AX	U1CRT	KC12-1
HT41AW	U2CRT	KC12-2
HT41AV	U3CRT	-
HT41AU	U4CRT	KC12-4
HT41AT	U5CRT	-
HT41AY	U25RT	KC12-1/0
HT41AZ	U26RT	KC12-2/0
HT41BA	U27RT	KC12-3/0
HT41BC	U28RT	KC12-4/0
HT41BE	U29RT	KC12-250
HT41GF	U2CABT	KC12-1/0 / KA12-2
HT41GM	U4CABT	KA12-4
HT41GE	U6CABT	-
HT41GL	U8CABT	KA12-8
HT41BF	U30RT	KC12-300
HT41BJ	U31RT	KC12-350
HT41BK	U32RT	KC12-400
HT41BL	U34RT	KC12-500
HT41BM	U36RT	KC12-600
HT41BP	U39RT	KC12-750
HT41EX	U25ART	KC12-350/KA12-1/0
HT41EY	U26ART	KA12-2/0
HT41GW	U27ART	KA12-3/0
HT41EZ	U28ART	KC12-300 / KA12-4/0
HT41FW	U29ART	KA12-250 KC12-350
HT41GZ	U30ART	KA12-300 KC12-400
HT41FA	U31ART	KA12-350 KC12-500
HT41HH	U32ART	KA12-400 KC12-600
HT41FB	U34ART	KA12-500
HT41HG	U36ART	KA12-600
HT41LJ	U39ART2	KA12-750
HT41CUT	CUTTER DIES	-
HT41TEST	TEST DIES	-

# Compression Dies

HT41 SERIES Equivalent to Kearney "U" Type Dies for 12 Ton Tools	
HUSKIE	
HT41KA	
HT41KB	
HT41KC	
HT41 KD	
HT41KE	
HT41KF	
HT41KG	
HT41KH	
HT41KI	
HT41KK	
HT41KL	
HT41KM	
HT41KN	
HT41KO	
HT41KP	
HT41KQ	
HT41KR	
HT41KS	
HT41KT	
HT41KU	
HT41KV	
HT41AE	
HT41U	
HT41KX	

HT61 SERIES Equivalent to Burndy "P" Type Dies for 15 Ton Tools	
HUSKIE	BURNDY
HT61BP	P39RT
HT61BR	P40RT
HT61BU	P44RT
HT61BV	P46RT
HT61KX	P724
PU15	DIE ADAPTER
HT61FC	P39ART
HT61HJ	P40ART
HT61FD	P44ART
HT61AC	PKR
HT61AJ	PN

HTK SERIES Equivalent to Kearney "WH-2" (10.7 Ton) & "WH-3" (12 Ton) Type Dies	
HUSKIE	KEARNEY
HTK-BKT	BKT (36832)
HTK-C	C (36830)
HTK-D	D (36457)
HTK-N	N (36459)
HTK-O	O (36467)
HTK-P	P (36828)
HTK-U	U (36472)
HTK-510	510 (36838)
HTK-572	572 (36836)
HTK-635	365 (36482)
HTK-727	727 (40063)
HTK-737	737 (36480)
HTK-12	1/2 (36940)
HTK-747	747 (36834)
HTK-781	781 (36478)
HTK-840	840 (36476)
HTK-14	1/4 (36498)
HTK-516	5/16 (36496)
HTK-38	3/8 (36494)
HTK-12	1/2 (36490)
HTK-916	9/16 (36488)
HTK-1932	19/32 (36486)
HTK-58-1	5/8 to 1 (36484)
HTK-1116	11/6 (40151)
HTK-34H	3/4 (HEX) (49435)
HTK-2932H	19/32 (HEX) (49437)
HTK-1516	15/16 (36474)
HTK-1-2H	1-2 (HEX) (100399)
HTK-1-18-2H	1-1/8 (HEX) 36463 (-1) 100400 (-2)
HTK-1-516H	1-5/16 (HEX) (100433)
HTK-1-12H	1-1/2 (HEX) (100434)

# Compression Dies

HA60 SERIES Equivalent to ALCOA 60 Ton Dies
HUSKIE
HA60-01
HA60-02
HA60-03
HA60-04
HA60-05
HA60-06
HA60-07
HA60-08
HA60-09
HA60-20
HA60-21
HA60-22
HA60-23
HA60-24
HA60-25
HA60-26
HA60-27
HA60-28
HA60-29
HA60-30
HA60-40
HA60-41
HA60-42
HA60-43
HA60-44
HA60-45
HA60-46
HA60-47
HA60-48
HA60-49
HA60-50

ALCOA SERIES 60 Ton Dies
ALCOA
6010SH
6012SH
6014SH
6016SH
6018SH
6020SH
6074SH
6075SH
6076SH
6020AH
6024AH
6027AH
6030AH
6034AH
6036AH
6038AH
6040AH
6074AH
6075AH
6076AH
6007CD
6008CD
6009CD
6010CD
6011CD
6012CD
6013CD
6014CD
6015CD
6016CD
6017CD

HA610 SERIES Equivalent to ALCOA 100 Ton Dies
HUSKIE
HA100-01
HA100-02
HA100-03
HA100-04
HA100-05
HA100-06
HA100-07
HA100-08
HA100-20
HA100-21
HA100-22
HA100-23
HA100-24
HA100-25
HA100-26
HA100-27
HA100-28
HA100-29
HA100-30
HA100-34
HA100-36
HA100-37
HA100-38
HA100-40
HA100-41
HA100-42
HA100-43
HA100-44
HA100-45
HA100-46
HA100-47
HA100-48
HA100-49
HA100-50
HA100-51
HA100-52
HA100-53

ALCOA SERIES 100 Ton Dies
ALCOA
10010SH
10012SH
10014SH
10016SH
10018SH
10020SH
10074SH
10075SH
10020AH
10024AH
10027AH
10030AH
10034AH
10036AH
10038AH
10040AH
10074AH
10075AH
10076AH
10042AH
10044AH
10046AH
10048AH
10007CD
10008CD
10009CD
10010CD
10011CD
10012CD
10013CD
10014CD
10015CD
10016CD
10017CD
10018CD
10019CD
10020CD

# Compression Dies

R6 SERIES - 6 TON DIES	
R6-BG	R6-241
R6-C	R6-242
R6-K840	R6-243
R6-L	R6-245
R6-O	R6-247
R6-Q	R6-248
R6-161	R6-249
R6-162	R6-251
R6-163	R6-660
R6-164	R6-687
R6-165	R6-690
R6-167	R6-691
R6-171	R6-693
R6-236	R6-694
R6-237	R6-702
R6-238	R6-733
R6-239	R6-28K
R6-240	

R6K SERIES - 6 TON DIES KEARNEY "O" STYLES			
30554	B	30043	5/16
26994	D	30042	3/8
48410	J	30041	1/2
40495	K	26958	9/16
26993	O	30914	19/32
30611	P	26992	5/8-1
40493	T	40114	11/16
30084	737	26994	D3
30450	781	100600	510-HEX
30124	840	100601	635-HEX
36181	3/16	100602	747-HEX
30154	1/4	100606	980-HEX

R12K SERIES - 12 TON DIES KEARNEY "WH2" STYLES			
36832	KT	36498	1/4
36830	C	36496	5/16
36457	D	36494	3/8
36459	N	36490	1/2
36467	O	36488	9/16
36828	P	36486	19/32
36472	U	36484	5/8-1
36838	510	40151	11/16
36836	572	49435	3/4-H
36482	635	49437	29/32-H
40063	727	100370	15/16-H
36480	737	100399	1-2-H
36834	747	100400	1-1/8-2-H
36478	781	100433	1-5/16-H
36476	840	100434	1-1/2-H

R12 SERIES - 12 TON DIES	
R12-BG	R12-238
R12-C	R12-239
R12-D	R12-240
R12-D3	R12-241
R12-E	R12-242
R12-F	R12-243
R12-H	R12-245
R12-L	R12-247
R12-M	R12-248
R12-N	R12-249
R12-O	R12-250
R12-R	R12-251
R12-161	R12-252
R12-162	R12-253
R12-163	R12-255
R12-164	R12-257
R12-165	R12-261
R12-166	R12-267
R12-167	R12-276
R12-168	R12-304
R12-169	R12-305
R12-170	R12-308

R12-202	R12-313
R12-203	R12-316
R12-209	R12-317
R12-210	R12-321
R12-236	R12-327
R12-237	R12-329
R12-350	R12-5CRT
R12-373	R12-8CRT
R12-468	R12-25RT
R12-490	R12-26RT
R12-552	R12-27RT
R12-608	R12-28RT
R12-609	R12-29RT
R12-642	R12-30RT
R12-654	R12-31RT
R12-655	R12-32RT
R12-658	R12-34RT
R12-659	R12-36RT
R12-660	R12-39RT
R12-668	R12-25ART
R12-676	R12-26ART
R12-677	R12-27ART
R12-678	R12-28ART

R12-679	R12-29ART
R12-691	R12-30ART
R12-693	R12-31ART
R12-694	R12-32ART
R12-705	R12-34ART
R12-708	R12-36ART
R12-778	R12-39ART
R12-840	
R12-997	



# Greenlee - Tools & Accessories

## Ultra Glider™

- Automatically applies cable lube during a cable pull
- Includes a 3 speed pump unit, an applicator, and a dolly designed to transport a 5 gallon bucket of lubricant around the jobsite
- Reduces number of people needed at the feeding end of a cable pull
- Keeps operators' hands away from where the cable enters conduit or duct
- Applies lube more evenly around the cable and down the length of the cable, preventing cable jacket damage



- UG511T** Ultra-Glider 120V including Threaded Applicator Kit UGTAK
- UG511ST** Ultra-Glider 120V Including Slip-In Applicator Kit UGSAK and Threaded Applicator Kit UGTAK
- UG512S** Ultra-Glider 12V Including Slip-In Applicator Kit UGSAK and Threaded Applicator Kit UGTAK
- UG512T** Ultra-Glider 12V including Threaded Applicator Kit UGTAK
- UG512ST** Ultra-Glider 12V Slip-in Applicator Kit UGSAK and Threaded Applicator Kit UGTAK
- UG511** Ultra-Glider 120V Assembly without Applicators
- UG512** Ultra-Glider 12V Assembly without Applicators
- UGSAK** Slip-In Applicator Kit - Includes 2", 2.5", 3", 3.5", 4" Applicators with Case
- UGTAK** Threaded Applicator Kit - Includes 2", 2.5", 3", 3.5", 4" Applicators with Case

## 542-250: Fiberglass Fish Tape in Reel Stand - 250 ft Fish Tape

- High-impact nylon, one-piece handle for maximum durability and comfortable use
- Non-conductive fiberglass tape with low friction coating
- Unique non-coiling properties enable it to fish in large and small conduit equally well, even with wire or cable in place
- Fiberglass fish tape is the fastest manual fish tape available
- 3/16" diameter and 300 lbs maximum design strength



## 35213: Cable-Gel™ Cable Pulling Lubricant

- Polymer-based lubricant offers lower friction and easier pulling
- Environmentally safe and non-hazardous
- Compatible with all cable insulation types
- Higher lubricity than competitive products; will not cement itself to the pipe
- Dries slowly; apply by hand or pump
- Will not break down or separate after exposure to heat or cold
- Viscosity 8,000 - 12,000 CPS PH Range 7.0 - 8.0



## 430: Greenlee Poly Line - 6500 ft

- Use with power fishing systems directly from the container
- Resists tangling when dispensing
- Rot and mildew resistant
- Handy reusable plastic dispenser pail with handle keep the line dry
- Use to pull rope through conduit
- 210 lbs. average breaking strength



## 489: Cable Guide

- Helps protect cable from being damaged on sharp edges



## Manhole Sheave

- High strength aluminum alloy frame for easy setup
- Adjustable, a full range of sheave pin positions to accommodate most manhole setups
- 18" diameter aluminum alloy sheaves with 7" minimum radius and 5" width
- Self-lubricating bearings for easier cable pulling
- Select a sheave with maximum rated capacity that meets or exceeds the cable puller's maximum pulling force

**15345 10' (158 lbs.) Capacity 4,000 lbs.**

**31395 12' (190 lbs.) Capacity 6,500 lbs.**



## 800F1725: Hydraulic Cable Bender

- 600V
- 350 - 1000 kcmil capacity
- 350 - 750 kcmil compact cable
- One-shot bends up to 90° and automatically unloads cable
- Compact design bends in tight places
- Unit with foot pump keeps both hands free to hold cable
- Includes hydraulic cable bender with 1725a foot pump, high pressure hose unit and storage box



## 796: Ratchet Cable Bender

- Capacity: through 500 kcmil (MCM), 600V, copper or aluminum cable
- Simplifies and speeds cable installation
- 10" ratchet extension is furnished to simplify bending in deep enclosures
- Includes ratchet wrench, L-wrench, ratchet extension, bending shoe assembly and storage box



## Lube Spreader Swab

- Spreads a coat of wire lubricant in duct before installation of cable
- Cleans mud, dirt, and light debris from duct before pulling
- Will not damage inner walls of duct
- Maximum rated capacity 4800 lbs
- Tapered shape permits bi-directional use

**16854 2" 1 3/4"**

**16856 2 1/2" 2 1/4"**

**16857 3" 2 3/4"**



## Woven Aramid\* High Strength Conduit Measuring Tape

- Pull small cables or install pull rope for large cable pulling jobs
- Will not rot or deteriorate; can be left in ducts indefinitely for future use
- Low stretch properties make measurements accurate
- Printed measurements every foot from zero to 3000'

**39143 1/4" x 3000' 1250 lb Capacity**

**39144 3/8" x 3000' 1800 lb Capacity**

**39245 1/2" x 3000' 2500 lb Capacity**

**\* Woven Aramid material equivalent to Kevlar®**



# Greenlee - Tools & Accessories

## Conduit Pistons

- Use with blower or vacuum power fishing system to pioneer the line through the conduit run
- Colour coded end disk with embossed size markings for fast, easy selection
- Strong steel center rod with loops on both ends
- Pistons available for all types, sizes of conduit 1/2" to 6"
- Flexible foam body for an airtight seal



## 690-15: Power Fishing System

- Industrial 2-Stage Motor – Powerful, sustained suction and blowing that out-performs a typical shop vacuum
- Washable Stainless Steel Filter – Stainless steel mesh filter that, when maintained, never needs replacing
- Steel Transport Handle – Long handle to easily pull vacuum around the jobsite and up stairs
- Fully Equipped Power Fishing System – 690 system comes with all the accessories needed to fish a pulling line and a new locking storage box to hold it all
- Large Durable Tank – Large 12 gallon tank for wet or dry vacuum and storage for the available 10', 15', or 25' hoses
- Large 8" Wheels – Industrial wheel and axle system make transportation on rough ground or up stairs easy



Part #	Conduit Size	Conduit Type
608-5*	1/2"	All
609-5*	3/4"	All
610-5*	1"	All
611-3*	1 1/4"	All
612-2*	1 1/2"	All
613	2"	All
614	2 1/2"	IMC, Rigid
621	2 1/2"	EMT
615	3"	IMC, Rigid
622	3"	EMT
616	3 1/2"	IMC/Rigid
646	3 1/2"	EMT
617	4"	IMC/Rigid
623	4"	EMT
618	5"	All
619	6"	All
S2613	1/2"-2"	All
34317	2 1/2" - 4"	EMT

\*Multi-Packages

## UT-10 Ultra Tugger Cable Puller w/ Mobile VersiBoom

- 2 Speed Ultra Tugger (UT10-2S) is a one-stop-shop: The only 2 speed puller on the market that can shift from high speed/low load pulling to low speed/high load pulling with a simple double tap motion on the foot pedal control switch
- Use for cable pulls requiring high as well as low pulling loads
- The no-load high speed is 16 ft/min and is best suited for loads up to 4000 lbs where the speed will be 12 ft/min
- The no-load low speed is 9 ft/min and can be used on loads up to 8000 lbs where the speed will be 6 ft/min, or a momentary peak capacity of 10,000 lbs
- 2-Speed motor that delivers the fastest pulling time for all pulling needs over the widest (10,000 lbs) range
- Strong, rugged motor designed specifically for both big and small cable pulling applications up to 10,000 lbs
- Easy control features for increased productivity: On-board force gauge provides visual communication of pulling force and speed changes
- Quick speed change from high speed to low-speed by simply double tapping foot pedal
- Removable foot pedal for convenience
- Sets up in less than 2 minutes and can be used in every pulling situation
- This combination of speed and versatility can increase your productivity, equaling more pulls in a day and delivering greater benefit to your bottom line



## 591: Portable Power Blower Fishing System

- Powerful, will blow line or measuring tape in up to 4" conduit
- Portable, lightweight blower has a shoulder strap to make it easy to carry and allow the operator to have both hands free
- Efficient, includes the Mighty Mouser® blow gun for fast, easy line blowing

### System Includes:

<b>Mighty Mouser Blow Gun</b>	<b>Adapter Nozzle for Tape and Line</b>
<b>2150' of 85 lbs strength fish line</b>	<b>Portable Blower</b>
<b>Adapter Cone 1/2" - 1" conduit</b>	<b>Flexible Hose 1 1/2" dia. x 4'</b>
<b>Adapter Cone 1 1/4" - 2 1/2" conduit</b>	<b>1/2" conduit x 150' line pkg. 10 qty</b>
<b>Adapter Cone 3" - 4" conduit</b>	<b>3/4" conduit x 200' line pkg. 5 qty</b>
<b>Flexible Hose 1 1/2" dia. x 1'</b>	<b>3/4" conduit x 450' line pkg. 5 qty</b>
<b>Hose Clamp</b>	<b>1" conduit x 200' line pkg 5 qty</b>
<b>Storage Box</b>	<b>1" conduit x 450' line pkg 5 qty</b>
<b>Pistons 608-5 through 623</b>	



## GATOR Grips™ Crimp-On Cable Pulling Grips

- Maximize contractor productivity by reducing cable pull set-up times
- Fast installation in 2 minutes! Use the Greenlee EK12IDL or HK12ID crimping tool to crimp any size of regular, compressed compact copper and aluminum cable from 1 AWG to 1000 Kcmil without having to change dies
- Versatile - Use with copper and aluminum stranded cables (both regular, compressed and compact stranded)
- Only 6 grips needed to cover cable sizes from 1 AWG through 1000 Kcmil
- Parallel up to 5 conductors on the same reel with no overlap



Part #	Description	Overall Length
GG1-1/OS	Short	20 1/2"
GG1-1/OM	Medium	27 1/2"
GG1-1/OL	Long	34 1/2"
GG2/0-4/OS	Short	20 1/2"
GG2/0-4/OM	Medium	27 1/2"
GG2/0-4/OL	Long	34 1/2"
GG250-350S	Short	20 1/2"
GG250-350M	Medium	27 1/2"
GG250-350L	Long	34 1/2"
GG400-500S	Short	20 1/2"
GG400-500M	Medium	27 1/2"
GG400-500L	Long	34 1/2"
GG600-750S	Short	20 1/2"
GG600-750M	Medium	27 1/2"
GG600-750L	Long	34 1/2"
GG1000S	Short	20 1/2"
GG1000M	Medium	27 1/2"
GG1000L	Long	34 1/2"

# Greenlee

## Feeding Sheaves



- Yoke frame slides into the end of conduit and holds sheave, allowing cable being fed into the conduit to smoothly roll over the sheave
- 5" wide aluminum alloy sheave with self-lubricating bearings
- Split tube for easy removal after cable is installed

### SPECIFICATIONS

Part #	Description		Weight (lbs)	Width of Shaft Opening
441-2	Feeding Sheave for 2" Conduit	441-2	9	1.24"
441-2 1/2	Feeding Sheave for 2 1/2" Conduit	441-2 1/2	11	1.37"
441-3	Feeding Sheave for 3" Conduit	441-3	14	1.79"
441-3 1/2	Feeding Sheave for 3 1/2" Conduit	441-3 1/2	17	1.75"
441-4	Feeding Sheave for 4" Conduit	441-4	19	1.99"
441-5	Feeding Sheave for 5" Conduit	441-5	26	2.23"
441-6	Feeding Sheave for 6" Conduit	441-6	28	2.75"



## 1325P & 1400P: Electric Ventilators, Axial - Polyethylene

- The Model 1325P 120 VAC, electric ventilator is constructed of a durable, weather-resistant, high-impact polyethylene plastic
- The CSA and CEESI certified unit will accept any 8" ventilator duct or our AIRPAC series
- The unit also comes in 12 VDC (model 1400P). Weighing only 17 lbs, the unit provides as much as 921 CFM. This Model is CSA, CEESI Certified.



	1325P	1400P
<b>Power</b>	Electric - 1/3 HP 120 VAC, 3 AMP	1/4 HP 12 VDC, 15 AMP
<b>Certifications</b>	CSA, CEESI	CEESI
<b>Dimensions</b>	18" L x 14" W x 15" H	18" L x 14" W x 15" H
<b>Weight</b>	17 lbs	17 lbs
<b>Free Air (certified)</b>	921 cfm	814 cfm
<b>w/ one 90° bend</b>	575 cfm	478 cfm
<b>w/ two 90° bends</b>	546 cfm	479 cfm

## 1375P & 1475P: Electric Axial Ventilators with AIR-PAC, Polyethylene

- A Pelsue "Air-Pac" consists of an Axial Ventilator, High Retraction or SpaceMaker Hose and Storage Canister
- The models vary from 120 VAC, 60 Hz to 220 VAC, 50Hz; 15' or 25' of hose stored in canister or our special spacemaker hose
- All the models are third party certified by CEESI and CSA and all are constructed to CE requirements
- The light weight casing are made from a High-Density Polyethylene



	1375P	1475P
<b>Power</b>	Electric - 1/3 HP 120 VAC, 3 AMP	Electric - 1/4 HP 12 VDC, 15 AMP
<b>Certifications</b>	CSA, CEESI	CEESI
<b>Dimensions</b>	37" L x 13" W x 14.5" H	37" L x 13" W x 14.5" H
<b>Weight</b>	36 lbs	36 lbs
<b>w/ one 90° bend</b>	575 cfm	478 cfm
<b>w/ two 90° bends</b>	546 cfm	479 cfm

## 1325D & 1400D: Electric Axial Ventilators - Steel

- Models 1325D & 1400D are constructed with high a grade steel housing
- Model 1325D is a 120 VAC, 60Hz electric ventilator, Model 1400D is a 12VDC electric ventilator
- All the models are third party certified by CEESI and CSA and all are constructed to CE requirement



	1325D	1400D
<b>Power</b>	Electric - 1/3 HP 120 VAC, 3 AMP	Electric - 1/4 HP 12 VDC, 15 AMP
<b>Certifications</b>	CSA, CEESI	CEESI
<b>Dimensions</b>	14.5" L x 13" W x 14.5" H	14.5" L x 13" W x 14.5" H
<b>Weight</b>	20 lbs	20 lbs
<b>Free Air (certified)</b>	1075 cfm	922 cfm
<b>w/ one 90° bend</b>	668 cfm	541 cfm
<b>w/ two 90° bends</b>	585 cfm	518 cfm
<b>Static Pressure</b>	2.09" W.C.	1.46" W.C.

# Pelsue

## 1000, 1200 & 1240: Electric Centrifugal Ventilators

- The ventilator wheel, or “squirrel cage” design gives our centrifugal ventilators the ability to push air further, around bends in the hose, resulting in higher static pressures
- Centrifugal is preferable to Axial when more than 50’ of hose and/or more than three bends are required
- This ventilator is specifically designed to provide a convenient and portable source of air. Positive pressure ventilators are tested to AMCA PPV Standard 240-95, for use in extreme conditions
- This ventilator is designed for high powered air movement, propeller produces a greater intake of air and eliminates turbulence at the tips. Each blade is statically balanced for high efficiency and long life
- The 1200 models offer high static pressure ventilation with the ability to switch from high speed for purging to low speed for continuous ventilation. This Model is CEESI Certified
- The 1240 models offer high static pressure ventilation with the ability to switch from high speed for purging to low speed for continuous ventilation. This Model is CSA, CEESI Certified

	1000	1200 (High)	1200 (Low)	1240 (High)	1240 (Low)
<b>Power</b>	Electric - 1/3 HP 120 VAC, 60Hz	Electric 1/3 HP, 120 V AC, 60 Hz	Electric 1/9 HP, 120 V AC,	Electric 1 HP, 120V AC, 12 AMP	Electric 1/3 HP, 120V AC, 7 AMP
<b>Certification</b>		CEESI	CEESI	CSA, CEESI	CSA, CEESI
<b>Measurements</b>	15”H x 14 5/8”W x 15 1/4”L	15”H x 15.5”W x 15.5”L	15”H x 15.5”W x 15.5”L	17.5”H x 18.5”W x 18.5”L	17.5”H x 18.5”W x 18.5”L
<b>Weight</b>	35 lbs	45 lbs	45 lbs	54 lbs	54 lbs
<b>w/ one 90° bend</b>	924 cfm	853 cfm	581 cfm	810 cfm	526 cfm
<b>w/ two 90° bends</b>	807 cfm	761 cfm	489 cfm	805 cfm	506 cfm
<b>Features</b>	Low maintenance Specifically designed to provide a completely portable source of fresh air				
<b>Materials &amp; Construction</b>	Main structure: Steel Hardware: Plated Steel				
<b>Additional Requirements &amp; Notes</b>	Centrifugal Blower is a single-speed blower	Static Pressure: 2.03” W.C.	Static Pressure: 0.97” W.C.	Static Pressure: 1.69” W.C.	Static Pressure: .655” W.C.



1000



1200



1240

## 1450 & 1453: Gas-Powered Centrifugal Ventilator

- The models 1450 and 1453 provides total portability in a high volume ventilator. Compact and light weight, these ventilators are dampened against excessive vibration. The model 1450 uses a Briggs & Stratton engine. Model 1453 uses a Honda Motor. These models are CEESI Certified.



	1450	1453
<b>Power</b>	(Briggs & Stratton) Gasoline - 3.5 HP 3600 RPM	(Honda) Gasoline - 4 HP 3600 RPM
<b>Certifications</b>	CEESI	CEESI
<b>Dimensions</b>	18.5"L x 15.25"W x 14.5"H	18.5"L x 15.25"W x 14.5"H
<b>Weight</b>	55 lbs	55 lbs
<b>Free Air (certified)</b>	1526 cfm	1526 cfm
<b>w/ one 90° bend</b>	1360 cfm	1360 cfm
<b>w/ two 90° bends</b>	1255 cfm	1255 cfm
<b>Static Pressure</b>	5.71" W.C.	5.71" W.C.

## 2000 Series Ventilator Hoses: 2015HRT, 2025HRT, 2015HD, 2025HD, 2006N, 2015N & 2025N

- Three styles of high quality 8" dia. (20cm) ventilation hoses
- Hoses have cuff & strap at one end



MODEL	DESCRIPTION
2015HRT	Standard Wt. 15L (4.57 m)
2025HRT	Standard Wt. 25L (7.62 m)
2015HD	Heavy Duty Wt. 15L (4.57 m)
2025HD	Heavy Duty Wt. 25L (7.62 m)
2006-N	Insulated, 6L (1.82 m)
2015-N	Insulated, 15L (4.57 m)
2025-N	Insulated, 25 L (7.62 m)

# Pelsue

## 6506/08/10A: "A" Style Ground Tent

- "A" Model Tents include two screen windows with roll up flaps, three tie down cords through the hub, ground flaps, heavy duty frame, wide open front, dual zipper roll up door, ventilation hose entry sleeve, interior and exterior roof line loops for tie down, carrying case and three tent stakes



Part #	Size (in)	Weight (lbs)	Folded Dimensions (in)
6506A	70 x 70	20	6 x 56
6508A	94 x 94	31	7 x 66
6510A	118 x 118	34	8 x 76

## 6506D: "D" Style Ground Tent

- "D" Model tents include two screen windows with roll up flaps, three tie-down cords through the hub, ground flaps, heavy-duty-frame, wide open front, snap and D-rings with inter-connectable flaps (connect 2 tents together), ventilation hose entry sleeve, interior and exterior roof line loops for tie-down, carry case and three tent stakes



Part #	Size (in)	Weight (lbs)	Folded Dimensions (in)
6506D	70 x 70	21	6 x 56

## DuraHoist Portable Confined Space Systems

- DuraHoist Complete Four-Piece Confined Space Systems consist of a One-Piece Adjustable Mast (DH-3/) and Three-Piece Portable Base (DH-4/)

### Suggested applications:

- Public Utilities: Vault and manhole entry, pump/lift/valve stations, water treatment and wastewater industries
- General Industry (Food, Chemical, Pulp and Paper): Elevated manholes, storage tanks, platforms/mezzanines, underground vaults, clarifier tanks, pre-heaters

### Features:

- System breaks down into four lightweight aluminum components for easy storage, transport and set-up. No tools required for assembly
- Overall system height adjusts from 79" (2.01 m) to 100" (2.54 m)
- Modular design allows the use of various fixed and portable bases and an optional mast with extensions
- Multiple winches and/or lifeline systems may be mounted as required



# Underground Equipment



## Pelsue 3025A & 3035A: Ventilator Accessories - Hose Storage

- The "Pel Can" Hose Storage features steel construction and coated with a weather resistant, safety yellow powder coat finish
- Model 3025A holds all HRT & 2015HD hoses
- Model 3035A holds all "N" models & 2025HD hoses

## Pelsue Hose Storage

- The "Pel Can" Hose Storage features Steel construction, and coated with a weather resistant, safety yellow powder coat finish. Model 3025A holds all HRT & 2015HD hoses. Model 3035A holds all "N" models & 2025HD hoses.



## Pelsue 2775: Lid Lifter

- Model 2775 weighs only 12.5 lbs (5.6 kg) and has a special handle to allow for a better grip
- It is also designed to remove ice or dirt by using the built-in scraper
- This model features a heat treated hook that can lift manhole covers which are equipped with a hole
- The hook locks in the handle when not in use

## Featherlite 5300 Series: Super Heavy Duty Straight Ladders

- Durable non-conductive fiberglass side rails in high visibility safety yellow
- Riveted rung to rail design maintains continuous strength of fibers and allows for easy repair
- Slip-resistant serrated rungs for safe climbing
- Black ABS, high impact non-marring end caps
- 5300 features vinyl coated hoop ends, and 36" long rail sleeves that protect the ladder from rims and edges
- Compliance with ANSI A14.5 /OSHA (CSA Not Applicable)



Model	Size	Outside Width	Inside Width	Approximate Weight (lbs)
5308	8'	12 1/8"	9 3/4"	21
5310	10'	12 1/8"	9 3/4"	25
5312	12'	12 1/8"	9 3/4"	27
5314	14'	12 1/8"	9 3/4"	32
5316*	16'	12 1/8"	9 3/4"	36

\*300 lbs Load Rating

# General Machine Products

## MANHOLE ACCESS TOOLS

### 06867: Manhole Guard Rail

- Helps protect field crews when working in and around manhole vaults
- Folds into a compact 2 1/2" x 33 1/4" rectangle, yet opens easily into a large 32" wide by 32" deep by 42" high cube
- Features two "D" rings welded to the frame for attaching our Splicer's Combination Tent
- The guard is also compatible with GMP's Umbrella Tent



### 08172: Manhole Cover Hook

- For prying loose conventional manhole covers
- Made from octagon plated tool steel that's been specially hardened to prevent bending



### Utility Manhole Cover Lifter

- Designed for use with a wide variety of covers
- The plated steel tubular body has been made thicker for the typically heavier electric utility manhole covers
- Multiple hooks or "keys" are available to be placed on the shackle at the end of the lifter's galvanized chain, allowing one tool to remove multiple cover types



Part #	Lifter 70066	Small J-Hook	Medium L-Hook	Large J-Jook
70151	X	X	X	
70152		X		
70153	X		X	
70154	X			X
70155	X	X	X	
70156		X		X
70157	X	X	X	X

### Manhole Cover Lifter

- Simplifies the removal and replacement of typical telephone manhole covers while decreasing the strain on the user
- Long handle provides useful leverage when removing and replacing manhole covers
- Made of an all-steel handle, sleeve, shank, foot and heat-treated alloy steel hook
- The open end of the hook can be locked inside the handle as an added safety feature when not being used



01368	Manhole Cover Lifter
13681	Manhole Cover Lifter w/ Spiked Foot

## DUCT CLEANING, PROOFING & RODDING

### Heavy Duty Stiff Spine Conduit Cleaners



- Cleans stubborn foreign matter from a partially obstructed conduit
- Oil tempered, spring steel bristles are looped through a mounting plate, providing extreme durability and resistance to loss
- Hundreds of cutting edges line each side of the cleaner for thorough cleaning action throughout the conduit in either direction

Part #	Conduit ID	Body Length	Work Load Limit
10152	2"	4"	1250 lbs
10153	2.5"	4"	1250 lbs
10154	3"	5.25"	1250 lbs
10155	3.5"	5.25"	1250 lbs
10156	4"	5.25"	1250 lbs
10157	5"	5.25"	1250 lbs
10158	6"	5.25"	1250 lbs

### GMP Stiff Spine Conduit Brushes

- Help clean foreign matter in a lightly obstructed conduit before placing cable
- Hundreds of cutting edges line each side of the brush, so that you'll get cleaning in either direction
- Available in ranges of sizes for your different cleaning operations



Part #	Conduit ID	Weight	Work Load Limit
17091	2"	3 lbs	600 lbs
17025	2.5"	3 lbs	600 lbs
17092	3"	4.5 lbs	600 lbs
17093	3.5"	6 lbs	600 lbs
17094	4"	6 lbs	600 lbs
17050	5"	6.5 lbs	600 lbs



## GMP Rubber Duct Swabs

- Flexible cable is suitable for tight bends
- Rubber Duct Swabs are pulled through your duct system after conduit is installed to verify duct integrity, to clean dirt and residue from installation, to provide a clean raceway for ease of cable placement
- Assists in the spreading of lubricant throughout the duct



### Long Duct Swabs:

Part #	Conduit ID	Weight
10116	2"	2.5 lbs
10117	3"	4.1 lbs
10118	3 1/2"	5.8 lbs
10119	4"	6.8 lbs
10121	6"	13 lbs
10122	8"	22 lbs

### Short Duct Swabs:

Part #	Conduit ID	Weight
10123	2"	1.25 lbs
10124	2 1/2"	1.45 lbs
10125	3"	1.75 lbs
10126	3 1/2"	2.24 lbs
10127	4"	2.71 lbs
10128	5"	3.53 lbs
10129	6"	4.62 lbs
10130	8"	7.93 lbs

## GMP Washer Duct Cleaner

- Cleans conduit less abrasively
- Disks are made from tough leather in graduated sizes for wiping the inside of the conduit
- An alternative to Stiff Spine Cleaners

### Part # Conduit ID

10142	2 1/2"
10143	3"
10146	3 1/2"
10144	4"
10145	5"



## Aluminum Test Mandrels

- Test Mandrels are pulled through your duct system after conduit is installed to verify duct integrity and to comply with the ovality specification the owner may have
- Made from solid aluminum for durability and corrosion resistance
- Cable is suitable for tight bends



### Part # Conduit ID Weight

10109	2"	1 lb
10110	2 1/2"	1.5 lbs
10111	3"	2.5 lbs
10112	3 1/2"	3.5 lbs
10113	4"	6.5 lbs
10114	5"	10.5 lbs
10115	6"	15 lbs

## 89004: Powered Duct Rod Pusher

- With GMP's Powered Duct Rod Pusher and a 1/2" GMP Duct Rodder, the job of placing pulling lines or fiber cables just got that much easier with less personnel in old or occupied conduits
- Hydraulically powers GMP 1/2" Duct Rodders into and out of conduits
- Pushes and pulls with forces up to 300 lbs
- Rod speeds up to 130'/min (40 meters/min)
- Accurately measures footage and speed with an electronic monitoring system that works in either direction. The readout can be scaled to feet or meters
- When pulling back, the fiberglass rod is placed directly back onto the cassette
- Features rod access areas for wiping the rod clean during the pull back operation. Also comes with a package of rod wiper pads (GMP #32290)
- Duct Clamp on the machine, and the specially designed Duct Mounting
- Clamp Assembly (GMP #32221) provided on the rodder cassette, help stabilize both pieces of equipment during use
- Comes with a gasoline driven power pack and hoses
- Pusher is mounted on a lightweight, anti-corrosion treated, tubular-steel frame that can be tilted at a 30-degree angle to the manhole to reduce initial bending of the fiberglass rod
- Must order 1/2" Duct Rodder separately. Also, user must provide length of 1-1/4" innerduct between Rod Pusher and Rodder Cassette, and another length of 1-1/4" innerduct between the pusher and the duct to be rodDED
- Calibration in feet



# General Machine Products

## DUCT CLEANING, PROOFING & RODDING

### GMP Duct Rodders

- Fundamentally essential tools for underground tasks such as cleaning and locating ducts, threading lines or pulling cables
- Comes equipped with a male threaded end fitting and tapered head on the leading end and a female threaded fitting on the back end
- Carriers are made of tubular steel alloy and are powder coated or electro-galvanized for corrosion resistance; larger diameter carriers have inboard wheels for easier transport at the jobsite. Each carrier is fitted with a hand-operated brake to control payout
- Lightweight, durable and corrosion-resistant. The rod is coated with a tough UV stabilized safety orange polypropylene and are not affected by water
- They will not soften or lose tensile strength in hot weather, nor become brittle under cold conditions
- Each Duct Rodder Frame assists the pay-out/pay-in of the rod material by using an eyebolt with a nylon bushing. The bushing is designed to protect the duct rod from abrasion and premature wear



1/4" Duct Rodders		3/8" Duct Rodders		1/2" Duct Rodders	
Part #	Size	Part #	Size	Part #	Size
89202	1/4" x 100'	89222	3/8" x 200'	89252	1/2" x 200'
89204	1/4" x 200'	89224	3/8" x 300'	89254	1/2" x 300'
89206	1/4" x 300'	89226	3/8" x 400'	89256	1/2" x 400'
89208	1/4" x 400'	89228	3/8" x 500'	89258	1/2" x 500'
89210	1/4" x 500'	89230	3/8" x 600'	89260	1/2" x 600'
		89232	3/8" x 700'	89262	1/2" x 700'
		89234	3/8" x 800'	89264	1/2" x 800'
		89236	3/8" x 900'	89266	1/2" x 900'
		89238	3/8" x 1000'	89268	1/2" x 1000'
		89240	3/8" x 1100'	89270	1/2" x 1100'
		89242	3/8" x 1200'	89272	1/2" x 1200'

Nominal Size	End Fitting Threads	Rated Tensile Strength	Rated Pull Strength	Minimum Bend Radius
1/4"	5/16-18	6000 lbs	500 lbs	7.4"
3/8"	3/8-16	10,000 lbs	1400 lbs	9"
1/2"	3/8-16	21,000 lbs	1800 lbs	18"

## CABLE PULLING & REMOVAL EQUIPMENT

### 89801: Control Valve

- Utilizing a ball valve with a safety locking lever, the Control Valve allows control of air flow
- Equipped with a Chicago fitting for connecting to the air supply; also features a quick disconnect fitting at the end for attachment of seal-offs
- Comes standard with a solid plug in lieu of rope adapter for pressurizing ducts



### Rope Adapter

- Allows for a wide range of rope diameters to be used with the above control valve

29448	3/16"
29446	1/4"
29447	3/8"



## CABLE PULLING & REMOVAL EQUIPMENT

### Innerduct Seal-Off

- Featuring quick disconnects, these insert into the innerduct and twists tight for seal, utilizing the same buttress thread as our pulling eyes

- 89804 Duct Seal-Off 1"
- 89805 Duct Seal-Off 1 1/4"
- 89806 Duct Seal-Off 1 1/2"
- 89807 Duct Seal-Off 2"

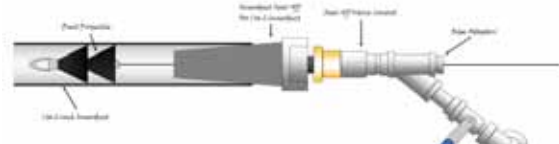

### Conduit Seal-Off

- Securely fits into a duct with a turn of the wing-nut handle, expanding the two rubber plugs for a firm seal
- 15 psi (1 bar) maximum

- 89808 Conduit Seal-Off 2"
- 89809 Conduit Seal-Off 3"
- 89810 Conduit Seal-Off 3 1/2"
- 89811 Conduit Seal-Off 4"
- 89812 Conduit Seal-Off 4 1/2"
- 89813 Conduit Seal-Off 5"



### Duct Projectiles

- Constructed of molded rubber cones fastened to a heavy duty metal rod with fastening rings
- Projectile is easily blown through duct with hand blower tool

- 70505 Duct Projectile for 1"
- 70506 Duct Projectile for 1 1/4"
- 70508 Duct Projectile for 1 3/8"
- 70509 Innerduct Projectile for 1 1/2"
- 70510 Duct Projectile for 1 1/2"
- 70511 Duct Projectile for 1 7/8"
- 70512 Innerduct Projectile for 2"
- 70513 Duct Projectile for 2"
- 70514 Duct Projectile for 2 1/2"
- 70515 Duct Projectile for 3"
- 70516 Duct Projectile for 4"
- 70517 Duct Projectile for 5"
- 70518 Duct Projectile for 6"



### 89820: Optional Carry Case for Conduit Seal-Offs

- This durable plastic box ensures that your conduit blowing accessories stay together and are protected from damage



### Construction Chain

- This chain is intended for use in general construction work
- Offered in two link sizes: 5/16" and 1/2"
- The 5/16" link size is furnished in a length of 4' 4" and is equipped with a ring at each end
- The 1/2" link size is furnished in a length of 6' and is equipped with a grab hook at one end and an end ring on the other end



63540 1/2" Link Size  
63541 5/16" Link Size

### Missile Line Carriers for 2" to 6" Conduit

- Fast blowing and vacuuming of 2" to 6" diameter conduit by low-friction plastic carriers
- Easily removed from conduit if stuck or jammed

- 70527 Missile for 2" conduit
- 70528 Missile for 3" conduit
- 70529 Missile for 4" conduit
- 70531 Missile for 5" conduit
- 70532 Missile for 6" conduit



# General Machine Products

## CABLE GUIDES & ACCESSORIES

### Heavy Duty Quadrant Block

- Used to guide the pulling line or cable during underground cable placement or removal
- Consists of six cast aluminum sheaves supported in an aluminum frame to provide a bending radius of 24"
- Each sheave has self-lubricating bushings for smooth movement and a long, maintenance-free life
- Available to accommodate 3" (84453), 4" (84454) or 5" (84455) cable diameters
- Each side plate has holes to insert a 1 1/4" digging bar to prevent the block from being knocked into the manhole
- Can also be used with a Cable Sheave Shackle, Pulling Frame or Jamb Skid to suspend in the manhole as an alternative method of use

Part #	Max Cable Size	Weight
84453	3"	60 lbs
84454	4"	75 lbs
84455	5"	90 lbs



### Cable Feeding Guide

- Cable Feeding Sheaves slide into the end of conduit in a manhole wall, allowing the cable being fed into the conduit to roll smoothly over the sheave from all angles
- The frame is made from steel for durability while the sheave is made from aluminum alloy or Nylatron® with self-lubricating bearings
- The sheaves have a split tube for easy removal after cable is installed



*Note: Cable feeding sheaves are not designed for use with fiberoptic cable due to bending radius limitations. Please contact our Sales team for specific product recommendations.*

#### Aluminum Alloy Roller Cable Feeding Sheaves

Part #	Description	Weight
70563	For 2" Duct Schedule 40	14 lbs
70564	For 3" Duct Schedule 40	17 lbs
70565	For 4" Duct Schedule 40	23 lbs
70566	For 4" Duct Schedule 40	23 lbs
70567	For 5" Duct Schedule 40	27 lbs

#### Nylatron® Roller Cable Feeding Sheaves

Part #	Max Cable Diameter	Weight
70581	For 3" Duct Schedule 40	11.4 lbs
70582	For 4" Duct Schedule 40	17.4 lbs
70583	For 4" Duct Schedule 80	17.4 lbs
70584	For 5" Duct Schedule 40	20 lbs
70585	For 6" Duct Schedule 40	38.9 lbs
70586	For 6" Duct Schedule 80	40.4 lbs



### 71130: Rope-To-Rope Connector

- This connector is used to connect two ropes of up to 7/8" (22 mm) diameter
- Rated @ 15,000 lbs. (6804 kg) max. load, this connector is made entirely from stainless steel, available only in the one size since it can also be used for smaller rope sizes
- Safety factor for load is 3:1 (horizontal pull only)
- Weight 2.7 lbs (1.2 kg)



### Rope to Swivel Connectors

- These Rope-to-Swivel Connectors achieve in two products what others do in four. These stainless steel connectors maximize usefulness by catering to the same rope capacity and using different ends to attach to the most popular swivel sizes. The sheaves run on clevis pins which are also available as spares
- Safety factor for load is 3:1 (horizontal pull only)

**71131 1/2 in. Connector**  
 Rated @ 7000 lbs. (3175 kg) max load  
 Weight 2.1 lbs (0.95 kg)  
 Can be used with GMP swivel 70137 and 70138

**71132 21/32 in. Connector**  
 Rated @ 15,000 lbs. (6804 kg) max load  
 Weight 2.3 lbs (1.0 kg)  
 Can be used with GMP swivel 70139

## CABLE PULLING & REMOVAL EQUIPMENT

### 5/8" Underground Handlines

- Intended for lowering tools and materials and for setting up cables when doing underground work
- Handlines come equipped with a 1" open hook spliced in one end and a 6' eye splice at the other

68592 5/8" X 20'  
68597 5/8" X 35'



### 3/8" Underground Handlines

- Intended for lowering tools and materials and for setting up cables when doing underground work
- Our 5/8" x 20 ft. (16 mm x 6 m) handline comes equipped with a 1 in. (25 mm) open hook spliced in one end and a 6" (152 mm) eye splice at the other end

68593 3/8" x 50'  
68595 3/8" x 100'



### Cable Feeding Sheaves

- Cable Feeding Sheaves slide into the end of conduit in a manhole wall, allowing the cable being fed into the conduit to roll smoothly over the sheave from all angles
- The frame is made from steel for durability while the sheave is made from aluminum alloy or Nylatron® with self-lubricating bearings
- The sheaves have a split tube for easy removal after cable is installed



### Cable Bending Shoes

- These easy-to-install bending shoes protect cables from sharp edges in and around manholes, conduit systems
- Cadmium-plated, 13 gauge steel with a protective polymer coating
- Tie off hole at either end for increased stability during the pulling of cables
- The trough-like steel section is bent into a 75° arc with an extended end for easier insertion into duct. This arc also provides a curved support for bending the cable around



86570 3"  
86571 3.5"



### 1/2" Utility Handlines

- Intended for general construction use
- 1/2" x 60' handline comes equipped with a crown splice on one end (no hardware) and a 6" eye splice on the other end and waxed linen cord served at both ends for approximately 1/2"

68596 1/2" X 60'



#### Important:

- When using handlines, whenever practical, raise and lower tools and materials while standing in a position where the movement of the load to its destination can be observed.
- Do not permit the rope to slip through the hands when lowering a load, but use the hand over hand procedure.
- Extreme care should be exercised when using a wet handline since it is more difficult to grip the rope securely.
- Stand clear as far as possible when raising and lowering heated material, such as solder pots, paraffin pots, etc. Ensure that no one is under a load while it is being positioned, raised, or lowered with a handline.
- Note: Do not use a wet handline where there is any chance that it may contact an electrical power source except in an emergency and then only when the craftsperson is protected by insulating gloves.
- Do not store handlines where they will come in contact with no paraffin or solder pots, furnaces or sharp edged tools. Inspect the rope before the handline is used to ensure that it is in good condition.

### Part # Description

#### Aluminum Alloy Roller Cable Feeding Sheave:

70564	For 3" Duct, Schedule 40
70565	For 4" Duct, Schedule 40
70566	For 4" Duct, Schedule 80
70567	For 5" Duct, Schedule 40

#### Nylatron® Roller Cable Feeding Sheave:

70581	For 3" Duct, Schedule 40
70582	For 4" Duct, Schedule 40
70583	For 4" Duct, Schedule 80
70584	For 5" Duct, Schedule 40
70585	For 6" Duct, Schedule 40
70586	For 6" Duct, Schedule 80

### Ball Bearing Swivels

- Tough swivels designed to handle higher thrust loads for extra cable safety and faster, straight pulls
- Precision-machined body is made of high quality stainless steel with higher working load ratings than comparably sized swivels available on the market
- These heavy-duty swivels are built with a thrust bearing for tensile load and a radial bearing for bending load

Part #	Load Width	Limit	Dia.	Length	Pin
70136	3/8"	2250 lbs	7/8"	3 3/8"	Slot
70137	17/32"	5000 lbs	1 1/4"	4 5/32"	Slot
70138	9/16"	7000 lbs	1 3/8"	4 19/32"	Slot
70139	11/16"	10,000 lbs	1 5/8"	5 7/16"	Hex
70140	1 1/32"	25,000 lbs	2 1/2"	9 5/8"	Hex

# General Machine Products

## Flexible Pulling Grips

- Manufactured from high-tensile, galvanized steel wire that is evenly woven in a single, double or triple wire weave according to pulling tension requirements

Part #	Diameter Range	Min Breaking Strength	Grip Length
<b>Single Weave - Single Flexible Eye</b>			
70660	.24" - .51"	1984 lbs	11.81"
70661	.47" - .75"	3505 lbs	21.65"
70662	.75" - .98"	4674 lbs	23.62"
70663	.98" - 1.5"	5644 lbs	27.56"
<b>Double Weave - Single Flexible Eye</b>			
70670	.39" - .79"	4101 lbs	23.62"
70671	.79" - 1.18"	4974 lbs	23.62"
70672	1.18" - 1.57"	8148 lbs	23.62"
70673	1.57" - 1.97"	12103 lbs	23.62"
70674	1.97" - 2.56"	12103 lbs	23.62"
70675	2.56" - 3.15"	16138 lbs	23.62"
70676	3.15" - 3.74"	16138 lbs	23.62"
70677	3.74" - 4.33"	23398 lbs	35.43"
<b>Triple Weave - Single Flexible Eye with Shoulders</b>			
70680	.24" - .51"	4960 lbs	25.59"
70681	.47" - .75"	7452 lbs	32.48"
70682	.75" - .98"	12214 lbs	40.35"
70683	.98" - 1.26"	21054 lbs	51.18"
70684	1.26" - 1.5"	25256 lbs	55.12"



## Innerduct Pulling Eyes

- Rugged chrome-plated steel pulling eyes allow innerduct placement to become a faster, safer operation
- Easy insertion by rotating the pulling eye into the innerduct allows the threads to make the connection
- A convenient hole in the threaded end of the pulling eye body is used to tie off the innerduct pulling line or tape keeping it from being lost during the pulling operation
- Eyes with swivel eliminate the need to use a separate swivel between the winch line and innerduct
- The hex portion of the pulling eye allows use of a wrench to make the final turns when inserting into innerduct

Part #	Nominal Duct Diameter	Innerduct inside Diameter Range	Max Pulling Eye Diameter
<b>Without Swivel:</b>			
60510	1" & 1 1/8"	1" - 1.18"	1.5"
60512	1 1/4" & 1 3/8"	1.25" - 1.43"	1.75"
60515	1 1/2"	1.5" - 1.68"	2"
60520	2"	2" - 2.18"	2.5"
<b>With Swivel:</b>			
61510	1" & 1 1/8"	1" - 1.18"	1.5"
61512	1 1/4" & 1 3/8"	1.25" - 1.43"	1.75"
61515	1 1/2"	1.5" - 1.68"	2"
61520	2"	2" - 2.18"	2.5"

## Cable Pulling Harnesses

- This convenient product will allow multiple pulls at one time by attaching 2 or 3 cables or ducts to the puller
- The "legs" are staggered in length so the individual connections are not interfering with each other
- Lead coupler can be easily dismantled to change out or add another leg
- Each leg is marked with load capacity and they are pull tested to 3 times that rating (based on equal pull on all cables, horizontal pull only)
- Manufactured from aircraft quality wire rope
- Other sling configurations are available upon request



Part #	Max Harness Width	Safe Working Load	Wire Rope Diameter
70298	2 1/4"	2000 lbs	1/8"
70299	3 1/8"	5800 lbs	1/4"
70300	3 1/2"	8400 lbs	3/8"

## 17022: Cable Bending Tool

- Easily bends up to 3 1/2" diameter cable into almost any shape
- The best cable bender to have whether you're setting up cables in manholes, making bends, straightening cable for sleeve placement during splicing, doing setups, off-sets or straightening in buildings, or even working from an aerial bucket
- The tool is made from zinc plated steel with aluminum saddles
- Seven position handle lets you bend cable easily, even when working in close quarters

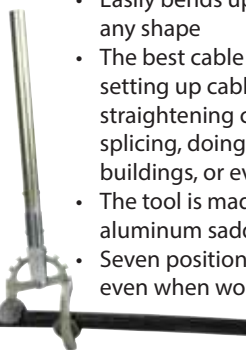

## B Connecting Links

- These time-tested, split "sister hooks" or "figure-8" links let you join two pulling lines together, and consist of two E-shaped, forged steel parts held together with a metal pin
- Swivel the two halves open to insert the looped end of each pulling line, then close and secure the link with a few turns of 2" friction tape around the center



Part #	Size	Width	Length	Eye dia.	Safe Load
80771	1/4"	1 5/16"	1 7/8"	3/8"	1000 lbs
80773	3/8"	1 5/16"	2 9/16"	1/2"	1000 lbs
80775	1/2"	1 5/8"	3 3/4"	5/8"	1000 lbs
80777	3/4"	2 1/2"	5"	15/16"	1000 lbs
80779	1"	3 3/4"	6 1/2"	1 1/4"	1000 lbs

## Manhole Sheaves

- The Manhole Sheave or "Pittsburgh" is used to guide pulling line or cable over the manhole edge when placing and removing cable in manholes which are equipped with pulling in irons to support a sheave and shackle assembly
- Consists of a reinforced, heat-treated wrought aluminum alloy frame with two self-lubricating, bronze bushed aluminum sheaves
- The frame also has a hole in each side plate so you can insert a 1 1/4" diameter digging bar parallel to the ground to keep the sheave from being knocked into the manhole
- Overall unit dimensions: 30" long x 12" wide x 22" high
- Standard units are rated at 36,000 lbs; the 80975 heavy duty 5" model is rated for 45,000 lbs.

<b>70283</b>	<b>3" Manhole Sheave</b>
<b>70284</b>	<b>4" Manhole Sheave</b>
<b>70285</b>	<b>5" Manhole Sheave</b>
<b>80975</b>	<b>5" Heavy Duty</b>



## Split Cable Feeders

- Same tough construction as our standard feeders with the added benefit of dividing in half for fast, easy removal without needing an end of the cable
- Style of feeder is ideal for pre-connected cables to avoid having to cut and splice cable to remove the feeder
- Excellent for particularly long runs of cable allowing "figure-8 types" of installation
- All exposed edges of both the 90" main split feeder and 36" extension split feeder have a protective plastic coating protecting the cable and user
- The series of latches allows for easy opening and closing of both the body and ends of the feeders

<b>88830</b>	<b>4" x 90" Main</b>
<b>88831</b>	<b>4" x 36" Ext.</b>



## Cable Feeders

- Solid feeders provide increased cable protection no matter how deep the manhole is and is an easy way to apply lubricant to the cable as it passes through the feeder
- Made from flexible spring steel hose
- Both the main section and extension section comes with a bronze bell mouth welded to one end
- The main section also has a connecting sleeve welded to the other end, while the extension section has a reducer welded to its other end to fit into the bell mouth of either the main section or another extension section
- The ability to add extension sections allows a user to make any length of hose required

<b>60580</b>	<b>4" x 90" Main Cable Feeder</b>
<b>60581</b>	<b>4" x 43 1/2" Extension Cable Feeder</b>
<b>60583</b>	<b>4" Main Cable Feeder*</b>
<b>60582</b>	<b>4" Extension Cable Feeder*</b>
<b>60585</b>	<b>5" Main Cable Feeder</b>
<b>60600</b>	<b>5" Extension Cable Feeder*</b>
<b>60587</b>	<b>6" Main Cable Feeder*</b>
<b>60586</b>	<b>6" Extension Cable Feeder*</b>

*\*Customer Specified Length*



## Cable Feeder Nozzles

- These simple split nozzles provide easy connections between our cable feeders and the conduit entered
- Each nozzle is made from high strength, thin-wall steel for a wider ID that permits use of larger pulling eyes
- Nozzles are available for either round or square conduit while still being compatible with round cable feeders
- The nozzles are split for easier removal after the cable has been placed and both halves are marked with the nozzle size
- The nozzles are available for straight connections (a 4" cable feeder going into a 4" conduit) or for reduced connections (a 4" cable feeder going into a 3" conduit)

Part #	Size	Conduit	Conduit Shape					
60590	4"	3"	Round	70004	6"	3 1/4"	Round	
60591	4"	3 1/4"	Round	70003	6"	3 1/2"	Round	
60592	4"	3 1/4"	Square	70002	6"	4"	Round	
60593	4"	3 1/2"	Round	70001	6"	5"	Round	
60584	4"	3 1/2"	Square	60598	6"	6"	Round	
60596	4"	4"	Round					
60597	4"	4"	Square					
70009	5"	3"	Round					
70008	5"	3 1/4"	Round					
70007	5"	3 1/2"	Round					
70006	5"	4"	Round					
60599	5"	5"	Round					
70005	6"	3"	Round					



# General Machine Products

## Cable Sheaves

- Used in placing and removing underground cables
- Constructed from high strength aluminum alloy, and has self-lubricating bushings for long, maintenance free lives
- All hole sizes are 1 3/8" diameter for 1 5/16" pin
- These units are available in 11", 20", and 26 1/2" diameter, and may be purchased for maximum 3", 4", or 5" cables



Part #	A	B	C	Weight
71723	3"	11"	8 1/2"	15 lbs
71726	4"	11"	7 7/8"	20 lbs
71729	5"	11"	6 7/8"	25 lbs
71722	3"	20"	17 1/2"	32 lbs
71725	4"	20"	16"	36 lbs
71728	5"	20"	16 1/2"	40 lbs
71721	3"	26 1/2"	24"	38 lbs
71724	4"	26 1/2"	22 1/2"	44 lbs
71727	5"	26 1/2"	23"	56 lbs

## Cable Sheave Shackle

- Used for supporting a cable sheave or quadrant block in place at a manhole equipped with pulling-in irons
- Contains a two-part clevis made of high strength structural steel, with two sets of sheave pin holes 1 3/8" diameter for accommodating either a cable sheave or quadrant block
- Forged steel hook attaches to the pulling-in irons with a standard 1/2" x 6' construction chain, while the support half has a shoulder eyebolt so you can tie it off to a support rope over the manhole
- Will accommodate any 11", 20", or 26 1/2" cable sheave with a 1 3/8" hole size for 3", 4" or 5" cable
- Each shackle includes a 1 5/16" diameter sheave pin and can with stand working loads up to 10,000 lbs.

71643	3" Cable Size
71644	4" Cable Size
71645	5" Cable Size



## Pulling Frames

- Used as a guide for the pulling line and cable when placing and removing cable in manholes that are not equipped with pulling irons
- 12' 6" frame is designed for use in manholes up to 11' 6" deep; 15' frame can be used in deeper manholes
- Each frame consists of two 6", high structural aluminum channels bolted back-to-back
- Sheave pin holes are at 6" centers, individual sheaves can be easily loaded or removed
- Two 1 5/16" diameter sheave pins come with each frame; the C pulling frame is used to support Cable Sheaves or the B operations

Part #	Sheave Size
71710	3" x 12' 6"
71711	4" x 12' 6"
71712	5" x 12' 6"
71713	3" x 15'
71714	4" x 15'
71715	5" x 15'



## GMP Jamb Skid

- Supports quadrant blocks and sheaves when pulling cable through underground conduit
- Lightweight, constructed primarily of aluminum
- Includes (2) 1 5/16" diameter locking pins to lock the jamb skid height and secure the sheave or quadrant block
- Accepts all GMP sheaves and quadrant blocks with widths up to 7"
- Includes a base unit to accept the upper extensions

70640	48" x 85"; Includes 43" Extension
70643	84" - 121"; Includes 76" Extension
70646	114" - 151"; Includes 109" Extension
31356	Optional Extension for 70643 or 70646 to 48"-85"
31357	Optional Extension for 70640 or 70646 to 84" - 121"
31358	Optional Extension for 70640 or 70643 to 114" - 151"





## FIBER OPTIC CABLE DEPLOYMENTS

### Mid-Assist Fiber Optic Capstan

- Lightweight aluminum alloy units mount on a standard 2 7/16" diameter drive shaft with either a bayonet or a cross-pin type of connection
- Capstans can be used as end pullers or mid-assist booster pullers that will allow long, straight-through, splice-free pulls
- Offered with a torque limiter between the drive spindle and the inner hub, factory set at standard 600 lbs force, but may be calibrated to other torque values, if requested
- Also available with a steel shaft and no torque limiter for no-slip applications with a maximum rated load of 1500 lbs
- Can also be used with Fiber Optic Cable Blowers in series to place longer lengths of cable without splicing



Part #	Diameter	Width	Lbs. Force
15472	25"	5"	600
15479	25"	5"	1000
15470	25"	5"	N/A
70338	25"	5"	750
70351	32"	7.5"	600
70381	32"	7.5"	750
70471	32"	7.5"	1000
70472	32"	7.5"	N/A
70473	40"	7.5"	600
70475	40"	7.5"	1000
70478	40"	7.5"	N/A

### Fiber Optic Cable Blower

- Safe, fast and effective, even on tough terrain, the "Tornado" cable blowing machine will move fiber optic cable of 0.23" to 1.25" diameter at speeds to 300' per min. into pre-installed innerduct or direct-buried duct
- Accommodates 1" to 2.48" innerduct
- A conversion kit allows the Tornado to place either 12/10 mm or 10/8 mm micro duct into the innerduct
- Comprised of an aluminum air box and cable pusher, the "Tornado" uses compressed air to install the cable with or without a missile
- The hydraulically powered, caterpillar belt drive system controls the cable as it is propelled by compressed air into the duct
- An electronic monitoring system provides read-outs of speed and distance, protects cable against duct obstructions, and includes an emergency stop facility
- Duct and cable sizes ODs are required at time of ordering



**89000 "Tornado" Cable Blowing Machine w/ Hydraulic Power Pack**

### 70605: Fiber Optic Pulling Trailer

- Exceed the requirements of installing telecommunications cables, employing a 32" diameter single capstan to provide a controlled force to the pulling rope or tape
- The single capstan allows the winch to be placed at the mid-point of a section to assist in the pull, thus enabling longer pulls to be achieved
- The winch is mounted on a sturdy all-steel fabricated chassis. It is equipped with torsional suspension axles, stabilizing prop legs, a front telescopic jockey wheel and a tow bar with a Lunette Ring
- Rope take-up drum is driven independently by a hydraulic motor



### Hydraulically Limited Cable Puller

- Designed to offer exceptional value while providing critical speed control and overload protection
- Adjustable pull control, up to 1000 lbs. maximum on a 40" diameter capstan
- Speeds up to 425' per minute at 15 gpm flow
- Control panel with pressure gauge, pressure adjustment knob and directional foot control valve
- Hydraulic hoses come with 1/2" non-spill quick-disconnect fittings for 2500 psi maximum hydraulic source input



70483	Hydraulically Limited Cable Puller Motor w/ Self-Support Frame, Foot Control Valve, and (2) Hydraulic Hoses
70484	Hydraulically Limited Cable Puller Motor w/ Vehicle Receiver Mount, Support Jack, Foot control Valve and (2) Hydraulic Hoses
70486	Hydraulically Limited Cable Puller Motor w/ Foot Control Valve and (2) Hydraulic Hoses for 2 1/2" Square Socket Mount
70487	Hydraulic Power Unit with (2) Hydraulic Hoses, 1/2" diameter x 20'



TRUSTED SINCE 1958

# General Machine Products

## Break-Away Swivels

- Swivels provide an inexpensive fracture point between the pulling line and cable avoiding costly cable damage if the cable's rated pulling capacity is exceeded
- Available in two diameters; 7/8", made from high quality aluminum and 5/8", made from steel
- The 5/8" size is designed for use when working with innerduct sizes below 1 5/8" diameter
- The design of the swivels incorporates a replaceable tension bolt that joins the barrel eye and swivel body. The bolt separates when pulling loads on the cable reach +/- 5%. The damaged bolt can then be replaced in seconds using an Allen wrench (included) and screwdriver
- Swivel and bolt head are colour-coded for fast load identification
- GMP uses a steel thrust washer and bushing in the larger break-away swivel and four ball bearings in the smaller version; both designs provide smooth rotation under load and help to keep twisting forces from reaching the cable

### Aluminum 7/8" Diameter Break-Away Swivel

Part #	Breaking Point (lbs)	Colour Code
53700	340	White
53701	450	Orange
53702	600	Yellow
53703	800	Blue
53704	1000	Green
53705	1200	Red



### Steel 5/8" Diameter Break-Away Swivel

Part #	Breaking Point (lbs)	Colour Code
71399	200	Orange/White
71400	220	Red/White
71401	295	Green/White
71402	340	White
71403	400	Blue/White
71404	420	Yellow/White
71405	435	Violet/White
71406	450	Orange
70188	500	Violet
71408	600	Yellow
70191	700	Brown



## Fiber Optic Sheave & Shackle

- This new "bicycle wheel" combination is designed to accommodate the special handling needs of pulling fiber optic cable
- One-size shackle
- 32" and 40" sizes are split to accommodate less than 32" diameter manhole
- Lightweight design, aluminum construction with self-lube bearings
- Captivating pins on shackles prevent cable damage when not under tension
- For overhead applications, 24" sheave with shackle provides generous bending radius for fiberoptic cable up to .6" diameter
- All removable hardware is retained for security

Part #	Description
71548	Underground Fiber Optic Shackle (requires Fiber Optic Sheave)
71549	Overhead Fiber Optic Shackle with 24" Fiber Optic Sheave
71550	24" Fiber Optic Sheave
71551	Underground 32" Split Fiber Optic Sheave
71552	Underground 40" Split Fiber Optic Sheave
71554	Overhead Fiber Optic Shackle (requires Fiber Optic Sheave)
71560	Underground 24" Fiber Optic Sheave & Shackle Assembly - Working Load 2000 lbs
71561	Underground 32" Split Fiber Optic Sheave & Shackle Assembly - Working Load 1250 lbs
71562	Underground 40" Split Fiber Optic Sheave & Shackle Assembly - Working Load 1250 lbs



## 10727: 7" Aluminum Capstan

- Cast from a high strength aluminum alloy
- Will fit on any 2 7/16" diameter winch extension shaft equipped with a bayonet or pin type mount
- The working surface is 7 1/4" diameter x 8" wide
- The maximum allowable pull is 4000 lbs



## Capstan Drive

- Gives your mobile hydraulic equipment the capacity to run GMP line of power reels and capstans
- Even when your vehicle doesn't have a winch, you can still achieve the benefits of GMP's highly productive cable placing tools using this economical device
- Capstan Drive features a Bell standard 2 7/16" bayonet shaft and a highly efficient planetary gear reduction that rotates on roller bearings and is powered by a compact, continuous duty single stage motor
- Multi-disc wet brake that's spring applied and hydraulically released is rated for the unit's full pulling load
- Features a built-in bi-directional counterbalance valve to give "feathering" control over the load movement in either direction
- At maximum flow of 15 gpm and operating pressure of 2250 psi, the capstan shaft can achieve 58 rpm and develops 13,000 in. lbs of torque



Device	Line Speed	Line Pull
7" Capstan	106 ft./min.	3250 lbs
C.R. Reel	304 ft./min.	1300 lbs
25" Capstan	380 ft./min.	900* lbs
32" Capstan	486 ft./min	700* lbs

\*Line pull limited to 600 lbs typical clutch setting

## REEL HANDLING EQUIPMENT

### B Cable Reel Jacks

- Two of these heavy-duty jacks can support cable reels weighing up to 12,000 lbs.
- Consists of a steel A-frame, a tee which accepts a 2 1/2" diameter spindle bar, a screw assembly and a three-hole adjusting nut with a detachable 36" lever bar
- Tee of the jack accepts a standard cable reel spindle 2 1/2" in diameter and has a 3/8" vertical locking pin hole in the center
- The height of the jack from the base to the center of the spindle ranges from a minimum of 29" to a maximum of 48" when fully extended
- The spindle is 63" long with a 3/8" diameter locking pin hole 4" from each end; the spindle must be ordered separately

74530

74531 Spindle



### Small Cable Reel Jacks

- The small cable reel jack is primarily used for block and building cable and strand reels
- The jack consists of a steel frame, a tee for accepting the spindle and a screw assembly
- The height of the jack from the base to the center of the spindle ranges from a minimum of 19" to a maximum of 30" when fully extended
- Holes are provided in the base for securing the jacks to planks or lags if required
- The jacks are sold in pairs with a 15" lever bar
- Features a durable black finish for extra corrosion protection

66050

66051 Spindle 1 1/2" x 48"



# General Machine Products

## 71669: Reel Buck

- A tough, easily maneuvered and portable frame that's ideal for supporting any reel up to 36" wide x 50" diameter
- Two welded, rectangular steel members make up the frame
- Designed for one-person handling
- Frame protected against corrosion
- The foot and handle design holds the main frame up and away from irregular surfaces
- Will accommodate the Corning FlexNap™ cable drums
- 1200 lbs load capacity
- 42" long spool bar included



## 70403: Reel Caddy

- Large diameter reel caddies
- May be used to support and dispense drop cable quickly and easily
- Lightweight; folds flat for compact storage
- Fabricated from durable steel tubing that's painted for years of dependable service
- Supports reels up to 30" in diameter and easily accommodates multi-port deployment on cardboard or plastic reels
- Quick and simple to set up with one hand
- Supports reels up to 200 lbs with at least a 1 1/2" spindle diameter



## MISCELLANEOUS UTILITY EQUIPMENT

### D Umbrella and Dielectric Umbrella

- Umbrella's tough plastic 68" diameter cover is safety yellow on the top
- A reflective white underside decreases interior heat absorption
- Vinyl-coated, nylon rid-end pockets keep the frame from tearing the cover
- Features self-sealing, waterproofed, waxed stitching and improved construction, using a nylon sleeve and rib retainers for attaching the frame's six collapsible ribs
- Frame's collapsible fiberglass ribs connect at a ring-type lock that slides along the pole as umbrella is opened or closed
- 43" long wooden pole features a male ferrule that may be attached to the 29" extension section for a 6' height
- When working near power lines, choose the dielectric umbrella to eliminate potential sources of electrical shock



- 80920 D Umbrella
- 70352 Dielectric Umbrella
- 28210 Holder (hardware not included)
- 71647 Adapter
- 80921 Nylon Storage Case

### Splicer's Knife & Scissors Kit

- A favourite of craft professionals everywhere, this kit joins GMP's Splicer's Scissors and Skinning Knife in a single sturdy, belting-quality leather pouch
- The heavy duty pouch is stitched throughout and riveted at all stress points; separate pockets for each tool and a slotted back that will fit any belt up to 2" width



- 15471 Kit
- 24470 Pouch Only
- 24471 Splicer's Knife
- 01008 Splicer's Scissors

### 15475: Knife and Scissors Sharpener

- Sharp cutlery is both easier and safer to use, and you can keep your cutlery at its keenest with this easy-to-use sharpener
- The two carbide bits in front are for sharpening knives; to sharpen scissors, draw the non-serrated edge of your scissors, along the sharpener's single side bit by resting the sharpener on a flat surface
- Draw the sharpener along the blade of your tool three or four times, and the original edge is restored in seconds
- The built-in finger guard protects your hand



## OVERHEAD ELECTRIC PLACING EQUIPMENT

### Cable Pulling Sled

- The Pulling Sled is used for aligning two or three cables in our multiple cable block when pulling overhead cable into position prior to lashing
- Incorporates either a 5000 or 7500 lbs swivel capacity on the front end and three 5000 lbs capacity swivels on the back end
- Generally used with any conventional winching device
- The 22" chain provides both alignment and stability



70649 Cable Pulling Sled

70626 Sled with Swivels

### 90° 3 Roller Inside Corner Cable Guide

- Often called the "Banana Bar", this guide consists of a curved steel frame that accommodates five 3 roller cable blocks that clamp to the frame
- Each block can handle up to three 2 1/2" diameter cables
- Cable bending radius of 25"

71563 Guide, complete with blocks

28249 Replacement block only

### 75268: 3 Roller Starter Guide Block

- Used as a starter block during the pulling in of heavy duty cable up to 6" diameter as it is pulled from a stationary or moving cable reel
- Has three rollers that guide the cable with minimal friction
- Cable pulled through the block has a minimum bending radius of 17"
- Designed for use with larger cables up to 6" in diameter, i.e., 750 MCM Tri-Plex Conductors
- Has a heavy duty aluminum frame with stainless hardware
- A 7/8" hex actuates a screw vise to grip the strand and keep the block in a stationary position
- Can be used on strand sizes 3/8" to 9/16"
- Capacity for up to 6" diameter cable and a safe working load of up 2000 lbs
- After cable and support rings are in place, the block has hinges that open at one side for easy removal



**MSA Respirator Fit Test Compliance**

29 CFR Part 1910.134



Advantage 200LS Respirator



Advantage 3000



Advantage 3200 Respirator



Advantage 420 Respirator



Ultravue Respirator



Advantage 4100 Respirator



Ultra Elite Respirator

<b>MSA RESPIRATOR FIT TEST KITS</b>	<b>697287</b>	<b>Saccharin Qualitative Fit Test Kit</b>
	<b>697444</b>	<b>Bitrex Qualitative Fit Test Kit</b>
	<b>697285</b>	<b>Replacement (Saccharin) Sensitivity Test</b>
	<b>697445</b>	<b>Solution, 55 ml Bottle (Bitrex)</b>
	<b>697286</b>	<b>Replacement Fit-Test (Saccharin) Solution, 55 ml Bottle</b>
	<b>697446</b>	<b>Replacement Fit-Test (Bitrex) Solution, 55ml Bottle</b>
	<b>697447</b>	<b>#1 Sensitivity Nebulizer</b>
	<b>697459</b>	<b>#2 Fit Test Nebulizer</b>
	<b>697448</b>	<b>Test Hood (Same for Both)</b>
	<b>697325</b>	<b>Using the Qualitative (Saccharin) Fit Test Kit Video</b>
	<b>697449</b>	<b>Using the Qualitative (Bitrex) Fit-Test Kit Video</b>
	<b>801628</b>	<b>Banana Oil Qualitative Fit Test Kit</b>

Respirator Description	Class	Material	APF	OSHA Acceptable Fit Test Methods	Required Fit Factor Quantitative	MSA Fit Test Adapter Required	Cartridge Type	Probed Facepiece P/N	Controlled negative Pressure (OHD) Quan Fit Test
Advantage 200LS	Half-Mask Negative Pressure	TPR	10	Qualitative or Quantitative	100	Advantage Adapter #10056424	Bayonet or threaded with adapter #809999	S (816515) M (8165130) L (816517)	OHD P/N 9513-0210
Advantage 420	Half-Mask Negative Pressure	Silicone	10	Qualitative or Quantitative	100	Advantage Adapter #10056424	Bayonet or threaded with adapter #809999	S (10107710) M (10107731) L (10107732)	OHD P/N 9513-0210
Comfo Classic	Full-Face Negative Pressure	Silicone	10	Qualitative or Quantitative	100	Quik Chek II Adapter #812022	Threaded	S (808255) M (808249) L (808261)	OHD P/N 9513-0109
Comfo Elite	Full-Face Negative Pressure	Hycar™	10	Qualitative or Quantitative	100	Quik Chek II Adapter #812022	Threaded	S (808253) M (808247) L (808259)	OHD P/N 9513-0109
Comfo Elite	Full-Face Negative Pressure	Silicone	10	Qualitative or Quantitative	100	Quik Chek II Adapter #812022	Threaded	S (491862) M (491860) L (491864)	OHD P/N 9513-0109
Advantage 3100	Full-Face Negative Pressure	Silicone	50	Qualitative or Quantitative*	500	Quik Chek III Adapter #805078	N/A	N/A	OHD P/N 9513-0210
Advantage 3200	Full-Face Negative Pressure	Silicone	50	Qualitative or Quantitative*	500	Advantage Adapter #10056424	Bayonet or threaded w/ adapter #809999	N/A	OHD P/N 9513-0210
Advantage 4100	Full-Face Negative Pressure	Silicone	50	Qualitative or Quantitative*	500	Quik Chek III Adapter #	N/A	N/A	OHD P/N 9513-0217
Advantage 4200	Full-Face Negative Pressure	Hycar or Silicone	50	Qualitative or Quantitative*	500	Advantage Adapter #10056424	Bayonet threaded w/ adapter #809999 @ NIOSH	N/A	OHD P/N 9513-0218
Advantage 1000	Full-Face Negative Pressure	Silicone	50	Qualitative or Quantitative*	500	Advantage Adapter #10056424	Bayonet	N/A	OHD P/N 9513-0219
Ultra-Twin	Full-Face Negative Pressure	Silicone	50	Qualitative or Quantitative*	500	Quik Chek II Adapter #812022	Threaded	S (482025) M (482024) L (482026)	OHD P/N 9513-0109

Ultra-Twin	Full-Face Negative Pressure	Hycar	50	Qualitative or Quantitative*	500	Quik Chek II Adapter #812022	Threaded	S (417683) M (465457) L (471684)	OHD P/N 9513-0109
Ultravue	Full-Face Negative Pressure	Silicone	50	Qualitative or Quantitative*	500	Quik Chek III Adapter #805078	N/A	S (482009) M (482008) L (482010)	OHD P/N 9513-0130
Ultravue	Full-Face Negative Pressure	Hycar	50	Qualitative or Quantitative*	500	Quik Chek III Adapter #805078	N/A	S (471681) M (465425) L (471682)	OHD P/N 9513-0130
Ultravue for use with 1/4 turn quick disconnect	Full-Face Negative Pressure	Hycar or Silicone	50	Qualitative or Quantitative*	500	Quik Chek IV Adapter #817446	N/A	N/A	OHD P/N 9513-0130
Ultra Elite	Full-Face Negative Pressure	Silicone	50	Qualitative or Quantitative*	500	Quik Chek III Adapter #805078	N/A	S (813210) M (813209) L (813213)	OHD P/N 9513-0210
Ultra Elite	Full-Face Negative Pressure	Hycar	50	Qualitative or Quantitative*	500	Quik Chek III Adapter #805078	N/A	S (813210) M (813218) L (813212)	OHD P/N 9513-0210
Millenium Facepiece	Full-Face Negative Pressure	Hycar	50	Qualitative or Quantitative*	500 2000±	Quik Chek III Adapter #805078	Threaded	Probe Assembly (10006227)	OHD P/N 9513-0130
Ultra Elite Pressure-Demand	Full-Face Positive Pressure	Silicone	10,000 SCBA  1000 Air-Line	Qualitative or Quantitative	500+	APR Fit Test Adapter Kit, 1/4 turn #10107257 (10029823 APR adapter only) APR Fit Test Adapter Kit, Slide Version #10107229 (100332511 APR adapter only) APR Fit Test Adapter Kit, Push-to-Connect #10107256 (10040052 APR adapter only) Quik Chek Adapter Kit, Firehawk #10044576±	Bayonet	Negative Pressure S (813211) M (813209) L (813213)	OHD P/N 9513-0380
Ultra Elite Pressure-De-mand	Full-Face Positive Pressure	Hycar	10,000 SCBA  1000 Air-Line	Qualitative or Quantitative	500+	APR Fit Test Adapter kit, 1/4 Turn #10107257 APR Fit Test Adapter Kit, Slide Version #10107229 APR Fit Test Adapter Kit, Push-to-Connect #10107256 Quik Chek Adapter Kit, Firehawk #10044576±	Bayonet	Negative Pressure S (813210) M (813218) L (813212)	OHD P/N 9513-0210
Ultra Elite Respirator	Full-Face Positive/Negative Pressure	Hycar	10,000 SCBA 50 APR	Qualitative or Quantitative	500+ SCBA 2000± APR	Responder Fit Test Kit #10082555	Threaded	N/A	N/A

## Repair, cleaning and inspection

LTL offers complete inspection, maintenance and repair program for breathing apparatus.

Please call for complete information on all your self-contained breathing application needs.



# MSA - Multigas Detectors

UNDERGROUND/CONFINED SPACE

## ALTAIR® 5X Multigas Detectors

- ALTAIR 5X is capable of measuring up to 6 gases simultaneously and is driven by advanced MSA XCell® Sensor Technology. These sensors offer superior response time, stability, accuracy, and reliability together with an extended service life
- Durable detector tests levels of combustible gases in LEL and/or volume percentage range, oxygen, carbon monoxide, carbon dioxide, hydrogen sulfide, sulfur dioxide, ammonia, chlorine and many others depending on sensor configuration
- A rugged polycarbonate housing provides unsurpassed durability, including the ability to survive a 10ft (3m) drop and is IP 65 certified
- Field-proven integral pump provides consistent gas flow without the problems of externally-attached components
- High performance XCell sensors last longer
- Typical life greater than four years for combustible, O<sub>2</sub>, CO/H<sub>2</sub>S, and SO<sub>2</sub> sensors
- Typical life greater than three years for NH<sub>3</sub>, and Cl<sub>2</sub> sensors
- Most sensor response and clear times <15 seconds
- Rapid bump test gives results in under 10 seconds for most common sensor configurations
- Span calibration time of 60 seconds for most common sensor configurations
- MotionAlert option tells others that user has become immobile
- InstantAlert provides manual alarm to alert others of a dangerous situation
- Large buttons and bright display provide easy operation, even when user is wearing gloves
- Exclusive end-of-sensor warning cautions user when unit's sensor is nearing end-of-life
- Versatile MSA Link™ allows user to transmit data to a computer
- GALAXY GX2 system compatible



PART #	ACCESSORIES	PART #	CONFIGURATION
		10115118	LEL O <sub>2</sub> , CO, H <sub>2</sub> S
10082834	USB IR Receiver	10115119	LEL O <sub>2</sub> , CO, H <sub>2</sub> S, SO <sub>2</sub>
10114837	Battery pack, Alkaline	1015120	LEL O <sub>2</sub> , CO, H <sub>2</sub> S
10088099	MSA Link Software CD	10115141	LEL O <sub>2</sub> , CO, H <sub>2</sub> S, SO <sub>2</sub>
		1011542	LEL O <sub>2</sub> , CO, H <sub>2</sub> S
		1011543	LEL O <sub>2</sub> , CO, H <sub>2</sub> S, SO <sub>2</sub>

## ALTAIR® 4X Multigas Detectors

- Dependable multigas detector tests for LEL, oxygen, carbon monoxide, hydrogen sulfide, and nitrogen dioxide
- Economical construction saves users more than 50% on calibration gas, replacement sensors and maintenance
- Four-year sensor life means detector lasts 60% longer than the industry average
- Unit uses 50% less calibration gas per minute than the average detectors within the industry
- Two-tox CO/H<sub>2</sub>S sensor removes practically all cross-channel interference
- Large buttons and high-contrast screen make operation easy in low-light conditions
- Ribbed rubber housing provides secure grip and high durability
- Unit features 95+ db alarm and ultra-bright LEDs
- Exclusive end-of-sensor warning cautions user when unit's sensor needs to be changed
- MotionAlert option tells others that user has become immobile
- InstantAlert provides manual alarm to alert others of a dangerous situation



PART #	CONFIGURATION	SENSORS & SPARE PARTS
10107602	LEL O <sub>2</sub> , CO, H <sub>2</sub> S, Charcoal	10106722 Sensor Kit, XCell Ex Combustible
10110443	LEL O <sub>2</sub> , CO, Charcoal	10106729 Sensor Kit, XCell O <sub>2</sub>
10110444	LEL O <sub>2</sub> , Charcoal O <sub>2</sub>	10106725 Sensor Kit, XCell CO/H <sub>2</sub> S Two-Tox
10107603	LEL O <sub>2</sub> , CO, H <sub>2</sub> S Phosphorescent	10121213 Sensor Kit, XCell CO/H <sub>2</sub> S
10110445	LEL O <sub>2</sub> , CO Phosphorescent	10121217 Sensor Kit, XCell, NO <sub>2</sub> /CO Two-Tox
10110446	LEL, O <sub>2</sub> Phosphorescent	ACCESSORIES
		10069894 Stainless Steel Suspender Clip
		10046528 Universal Pump Probe (UL)
		10088099 MSA Link™ Software CD-ROM
		10082834 JetEye IR Adapter with USB Connector
		10050333 Hand Aspirator Assembly

### POWER SUPPLY

10086639	Charging Cradle Components
10087913	North American Power Supply
10092233	Charging Cradle Assembly
10095774	Vehicle Charger



Itutilitysupply.com

# MSA - Multigas Detector Accessories

## ALTAIR® 5X MULTIGAS DETECTORS

### Replacement/Spare Parts

10114835	Battery pack assembly, rechargeable
10114837	Battery pack, alkaline (includes belt clip)
10114839	Battery pack, rechargeable, IR
10114949	Maintenance Kit
10050976	Retractable line with belt clip
10040586	Carrying case, Cordura, UL only

### Replacement Sensors

10106722	Kit, XCell Ex Sensor, Combustible
10106729	Kit, Xcell O <sub>2</sub> Sensor
10106725	Kit, XCell CO/H <sub>2</sub> S two-tox sensor
10106375	Kit, replacement, HCN
10106728	Kit, XCell Cl <sub>2</sub> Sensor replacement
10080222	Kit, replacement, ClO <sub>2</sub>
10106727	Kit, XCell SO <sub>2</sub> Sensor Replacement
10080224	Kit, replacement, NO <sub>2</sub>
10106726	Kit, XCell NH <sub>3</sub> Sensor replacement
10116638	Kit, replacement, PH <sub>3</sub>
10114750	Kit, replacement NO
10105650	XCell Sensor plug
10088192	Sensor plug, oxygen and toxics (20 mm)

## ALTAIR® 4X MULTIGAS DETECTORS

### Accessories

10088099	MSA Link™ Software CD-ROM
10082834	JetEye IR Adapter with USB connector

### Sensors/Spare Parts

10106722	Kit, XCell Ex combustible sensor
10106729	Kit, XCell O <sub>2</sub> Sensor
10106725	Kit, XCell, CO/H <sub>2</sub> S two-tox sensor
10121213	Kit, XCell CO/H <sub>2</sub> S-LC two-tox sensor
10121217	Kit, XCell CO/NO <sub>2</sub> two-tox sensor
10110030	Front housing with integrated dust filters (charcoal)
10110029	Front housing with integrated dust filters (phosphorescent)
10106621	Main board with battery pack
10110061	LCD frame assembly (frame, LCD, zebra strips, screws)
10110062	Sensors gasket, Phillips screws (4x), self-tapping (2x)
10106623	CD manual, ALTAIR 4X Multigas Detector

## SIRIUS MULTIGAS DETECTOR ACCESSORIES

### Long-term Storage Kit

10051176	Includes 4-Gas PID, Lithium-ion and alkaline battery packs, vehicle charger, 10' sampling line w/ 1' probe, retractable carrying line w/ belt clip, Cordura jacket and black boot, Econo-Cal kit, Data Link w/ software 4 replacement sensors and PID lamp, lamp cleaning kit, standard lamp cover and case
----------	---

### Replacement Lamps & Sensors

10049692	10.6 eV Lamp
10051717	4 Sensor Kit (LEL, O <sub>2</sub> , CO, H <sub>2</sub> S)
10049808	Combustible sensor (both LEL and CH <sub>4</sub> )
10049806	Oxygen Sensor
10049804	Carbon Monoxide Sensor
10049805	Hydrogen Sulfide Sensor
10049807	Long-term storage oxygen sensor (hermetically sealed for 2-year storage)

## SOLARIS MSHA MULTIGAS DETECTOR ACCESSORIES

### Sensors

10046944	Replacement CO Sensor
10046945	Replacement H <sub>2</sub> S Sensor
10059040	Replacement NO <sub>2</sub> Sensor
10046946	Replacement O <sub>2</sub> Sensor
10046947	Replacement Combustible Sensor
10049406	4 Sensor replacement kit (CO, H <sub>2</sub> S, O <sub>2</sub> , Comb)
10059039	4 Sensor replacement kit (No <sub>2</sub> , CO, O <sub>2</sub> , Comb)

# MSA - Single Gas Detectors

## ALTAIR® Pro Single-Gas Detector

- Innovative toxic gas and oxygen detectors are based upon ALTAIR Single-Gas Detector design, but with added features and functionality
- Tough rubberized housing
- One-button operation
- Accurately measures gas concentration or percent oxygen
- Displays information on a large, clear, backlit LCD
- Superior dust and water protection (rated IP67 except for O2-R)
- Event-logging and data-logging
- Excellent impact resistance
- Versions available for CO, H2S, O2, NH3, Cl2, ClO2, NO2, SO2, HCN, and PH3
- Great RFI performance
- Adjustable alarm set points are offered for LOW, HIGH, TWA, and STEL
- Alarms are indicated by flashing LEDs, audible alarm and internal vibrating alarm
- Replaceable battery and sensor

10074137	O <sub>2</sub>
10074135	CO
10076723	CO Fire
10076724	CO Steel
10074136	H <sub>2</sub> S
10076729	HCN
10076716	Cl <sub>2</sub>
10076717	ClO <sub>2</sub>
10076736	SO <sub>2</sub>
10076731	NO <sub>2</sub>
10076730	NH <sub>3</sub>
10076735	PH <sub>3</sub>
10076733	O <sub>2</sub> -R



## ALTAIR® Maintenance-Free Single-Gas Detector

- Designed for superior lifespan - patented sensors operate for over two years - and high performance, the ALTAIR Single-Gas Detector is the smart choice for market-leading cost-effective gas monitors
- Features sensor options for carbon monoxide, hydrogen sulfide, and oxygen coupled with ED/audible/vibrating alarms. Superior dust-water protection, high RFI resistance, and one-button operation provide heightened safety, plus increased durability and ease-of-use
- Sensor options for CO, H<sub>2</sub>S and O<sub>2</sub>
- Patented electrochemical sensors and MSA-built button sensors
- Stainless steel and solid electrolyte construction virtually eliminate sensor leakage
- Automatically records the last 25 alarm/test events and can communicate data by connecting to MSA Link via built-in IR communication port
- No-miss triple alarm system includes bright flashing LEDs, piercing audible alarm, and an internal vibrating alarm
- Rubberized armor housing and one-button operation for maximum durability and simplicity

10092522	CO
10092521	H <sub>2</sub> S
10092523	O <sub>2</sub>



# MSA - Multigas Detector Accessories

## ALTAIR® QuickCheck® Station

- The ALTAIR QuickCheck station uses several tests to make sure ALTAIR and ALTAIR Pro Detectors are fully ready for action. The station administers a bump test to make sure the detector responds to a specified concentration of gas. The station also uses a microphone and electronic check to ensure the detector's audible, visual and vibrating alarms are good to go. With easy-to-understand LEDs, the QuickCheck Station tells a user which test is being administered and whether the detector passed or failed
- Station administers a bump test and uses a microphone and electronic check to ensure a detector is ready for action. Station is compatible with all 3 ALTAIR detector versions (CO, H<sub>2</sub>S, O<sub>2</sub>) and with ALTAIR Pro O<sub>2</sub>, H<sub>2</sub>S, CO, CO Fire and CO Steel detectors. Station comes in manual and automatic versions. Easy-to-see LEDs give simple-to-understand test results



### Altair Quick-Check Station w/ Manual Regulator

10076692	Gas Type: O <sub>2</sub> /CO/H <sub>2</sub> S/SO <sub>2</sub> /NO <sub>2</sub>
10076701	Gas Type: Cl <sub>2</sub> /ClO <sub>2</sub>
10076695	Gas Type: NH <sub>3</sub>
10076698	Gas Type: HCN

### Altair Quick-Check Station w/ Automatic Regulator

10076704	Gas Type: O <sub>2</sub> /CO/H <sub>2</sub> S/SO <sub>2</sub> /NO <sub>2</sub>
10076713	Gas Type: Cl <sub>2</sub> /ClO <sub>2</sub>
10076707	Gas Type: NH <sub>3</sub>
10076710	Gas Type: HCN

## GALAXY® GX2 Automated Test System

- Color touch screen for ease of set up and viewing
- Extremely simple to use; testing starts automatically without touching a single button
- Simultaneous testing of up to ten instruments
- GALAXY GX2 System is optimized for use with MSA's XCell® Sensors; provides up to 50% cost of ownership reduction
- At-a-glance indicators include low calibration gas volume, expiration warnings and test stand status
- MSA Link Pro Software provides proactive safety management, dashboard overview and total record-keeping
- 18 languages available for test stand and MSA Link Pro Software that simplifies usage and reduces training



### System Stand/1 Valve for use with 1 Calibration Gas Cylinder

10128644	ALTAIR/ALTAIR Pro Single-Gas Detector, No-Charging
10128630	ALTAIR 4/4X Multigas Detector, Charging
10128642	ALTAIR 4/4X Multigas Detector, No-Charging
10128626	ALTAIR 5/5X Multigas Detector, Charging
10128628	ALTAIR 5/5X Multigas Detector, No-Charging

### System Stand/4 Valve For Use with 1-4 Calibration Gas Cylinders

10128643	ALTAIR/ALTAIR Pro Single-Gas Detector, No-Charging
10128629	ALTAIR 4/4X Multigas Detector, Charging
10128641	ALTAIR 4/4X Multigas Detector, No-Charging
10128625	ALTAIR 5/5X Multigas Detector, Charging
10128627	ALTAIR 5/5X Multigas Detector, No-Charging

## Impact & Impact Pro Multigas Detectors

- The Lumidor Impact multigas monitor is supplied complete with dry cell battery holders, 4 x AA batteries, belt clip, flow adaptor, multi-lingual quick start guide (printed) and operation instructions (on CD)
- Lumidor Impact Pro is supplied with integral pump and pump adaptor
- Reliable Operation
- Pre-calibrated plug-in sensor cartridge
- High specification sensors
- Patented Surecell™ toxic sensors
- Stable and accurate
- Easy-to-Use, one button on/off
- Multi-lingual, intuitive menu system
- On screen prompts guide user
- Built-in correction factors for flammable gases
- Minimal training required
- Plug-in operation for all serviceable parts
- Cartridge replacement in less than one minute
- Re-calibration in less than two minutes when using Enforcer
- Minimized cost of ownership
- Durable Housing
- Waterproof to IP67
- Rugged and impact-resistant
- Built for everyday use
- Alarm indication
- 3 levels of instantaneous alarm, time weighted average alarms on toxic
- Periodic confidence flash and bleep
- Increasingly rapid flashing, ultra-bright alarm LEDs
- Powerful two-tone audible alarm
- Vibrating alarm for noisy environments\*
- Safelink communications (Pro only)
- User friendly pre-entry check
- Peak hold function and drop line
- Hand aspiration
- Built-in automatic pump (Impact Pro only)
- Totally flexible



<b>2302B20008UE</b>	<b>Impact</b>
<b>2302B10009CA</b>	<b>Impact Pro</b>
<b>2302BCD40FCHO</b>	<b>Standard 4-Gas Cylinder</b>
<b>2302B0831</b>	<b>Enforcer with a Gas Cylinder</b>
<b>2302BCD40FCHO</b>	<b>4-Gas Detector Sensor</b>



2302B0831

## SafeLink

- Confined-space communications
- Connect two Impact Pro detectors together
- Gas readings and instrument status is repeated on the other unit
- Co-workers can remotely monitor each other in confined spaces and exchange messages
- Emergency assistance can easily be called by pressing and holding any button so that help is never far away

<b>2302B0735</b>	<b>30 ft. Safelink cable including 2 x cable restraints</b>
<b>2302B0737</b>	<b>164 ft Safelink cable including 2 x cable restraints</b>
<b>2302B0746</b>	<b>328 ft Safelink cable including 2 x cable restraints</b>



# BW Technologies

## GasAlert Clip Extreme

- As the world's most popular and widely used zero-maintenance gas detector, the GasAlertClip Extreme offers continuous, reliable protection. Available in two year or three year versions, this single gas detector requires no calibration, sensor replacement, battery replacement or battery charging. Compatible with the MicroDock II automatic test system, the simplicity of the GasAlertClip Extreme combined with minimal training requirements and negligible maintenance costs, make the GasAlertClip Extreme one of the most cost-effective PPE solutions for facility workers and on-site contractors
- Durable, reliable and easy-to-use with no downtime
- Record keeping is accurate and easy with automatic event logging
- Exceptionally low cost of ownership
- Water resistant

### 2 YEAR DETECTORS

GA24XT-H	H <sub>2</sub> S
GA24XT-M	CO
GA24XT-S	SO <sub>2</sub>
GA24XT-X	O <sub>2</sub>
GA24XT0X19.522.5	O <sub>2</sub>

### 3 YEAR DETECTORS

GA36XT-H	H <sub>2</sub> S
GA36XT-M	CO



### Carrying Accessories

GA-BSPASH-K	Splash guard filters, kit of 5 for use with concussion-proof boot (GA24-BALERT)
GA-CL-1	Belt Clip with Screw
GA-HC-1	Hard Hat Clip (non-conductive)
GA-AG-1	Alligator-Style Clip (non-conductive)
GA-AG-2	Alligator-Style Clip (stainless steel - included with detector)

### Event Logging Accessories

GA-USB2	IR DataLink USB Adaptor
---------	-------------------------

### Testing Equipment and Spares

GA-TC-1	Test Cap and Hose (1 ft/0.3m)
---------	-------------------------------

### MicroDock II Base Station and GasAlertClip Extreme Docking Module

DOCK2-2-IE-00-G	H <sub>2</sub> S
DOCK2-2-1F-00-G	SO <sub>2</sub>
DOCK2-2-1G-00-G	CO
DOCK2-2-1H-00-G	O <sub>2</sub>

### GasAlertClip Extreme MicroDock II Docking Module

DOCK2-0-IE-00-G	H <sub>2</sub> S
DOCK2-0-1F-00-G	SO <sub>2</sub>
DOCK2-0-1G-00-G	CO
Dock2-0-1H-00-G	O <sub>2</sub>

## GasAlert Extreme

- Designed with durability and comfort in mind, the GasAlert Extreme reliably monitors for any single gas hazard within its wide range of available toxic gas models. With easy on/off operation, this single gas detector offers extended longevity with a two year field-replaceable battery and sensor. Calibration is a simple automatic procedure and is compatible with BW Technologies by Honeywell's MicroDock II automatic test and calibration system. A wide range of user options, multi-language display and datalogging functionality make the GasAlert Extreme an ideal solution for many applications
- Direct, real-time readings on large LCD
- Operates through consecutive shifts—exceptional battery run-time
- Secure and accurate history with datalogging option
- Simple automatic calibration procedure; compatible with BW Technologies by Honeywell MicroDock II automatic test and calibration station
- Full function self-test of sensor, battery status, circuit integrity and audible/visual alarms on start up
- Bright wide-angled visual alarm bars
- Built-in concussion-proof boot
- Water-resistant

GAXT-H-DL	H <sub>2</sub> S
GAXT-M-DL	CO
GAXT-M2-DL	CO (H <sub>2</sub> resistant)
GAXT-X-DL-2	O <sub>2</sub>
GAXT-S-DL	SO <sub>2</sub>
GAXT-C-DL	Cl <sub>2</sub>
GAXT-Z-DL	HCN
GAXT-D-DL	NO <sub>2</sub>
GAXT-A-DL	NH <sub>3</sub>
GAXT-A2-DL	NH <sub>3</sub>
GAXT-P-DL	PH <sub>3</sub>
GAXT-G-DL	O <sub>3</sub>
GAXT-E-DL	C <sub>2</sub> H <sub>4</sub> O
GAXT-N-DL	NO <sub>2</sub>
GAXT-V-DL	ClO <sub>2</sub>

### Carrying Accessories

GA-HC-1	Hard Hat Clip (non-conductive)
GA-AG-1	Alligator Style Clip (non-conductive)
GA-AG-2	Alligator Style Clip (stainless steel - included with detector)
GA-CL-1	Belt Clip with Screw

### Datalogging Accessories & Spares

GA-USB2	IR Data Link USB Adaptor
---------	--------------------------

### Sampling/Testing Equipment and Spares

GA-TC-1	Test Cap and Hose (1 ft. /0.3 m) Replacement (included with detector)
DOCK2-2-ID-00-G	MicroDock II (not compatible with ClO <sub>2</sub> or O <sub>3</sub> ) Base Station plus GasAlert Extreme Docking Module
DOCK2-0-1D-00-G	MicroDock II (not compatible with ClO <sub>2</sub> or O <sub>3</sub> ) GasAlert Extreme Docking Module
GA-SPAK	SamplerPak Motorized Sampling Pack Kit
GA-AS02	Manual Aspirator Pump Kit with Probe (1 ft./0.3m)

### Power Spares

E25296	Battery-Lithium, 3V
--------	---------------------

### Sensor Spares/Replacement Parts

GAXT-SS	Replacement Sensor Screens with Gasket, Kit of 10
PS-RH04S	Replacement H <sub>2</sub> S Sensor
PS-RM04	Replacement CO Sensor
SR-M04-SC	Replacement CO Sensor, H <sub>2</sub> Resistant
SR-X10-C1	Replacement O <sub>2</sub> Sensor
SR-X10	Replacement O <sub>2</sub> Sensor



# BW Technologies

## GasAlertMicroClipXT

- Continuous LCD shows real-time gas concentrations
- Compact and lightweight design makes it comfortable to wear
- Water-resistant
- Simple automatic calibration procedure; compatible with BW MicroDock II automatic test and calibration station
- Full function self-test of sensor, battery status, circuit integrity and audible/visual alarms on start up
- Bright wide-angled visual alarm bars
- Built-in concussion-proof boot
- Conveniently manage your fleet using Fleet Manager II
- IntelliFlash verifies operation and compliance to both the user and supervisor
- Tamper-proof, one button operation
- Equipped with internal vibrating alarm for high noise areas
- Powered by a lithium polymer battery
- Multi-language support in English, French, German, Spanish and Portuguese



### GasAlertMicroClipXT 4-Gas Detector

MC2-XWHM-Y-NA                    %LEL, O<sub>2</sub>, H<sub>2</sub>S, CO

### GasAlertMicroClipXT 3-Gas Detector

MC2-XWH0-Y-NA                    %LEL, O<sub>2</sub>, H<sub>2</sub>S

MC2-XW0M-Y-NA                    %LEL, O<sub>2</sub>, CO

MC2-0WHM-Y-NA                    %LEL, H<sub>2</sub>S, CO

MC2-X0HM-Y-NA                    O<sub>2</sub>, H<sub>2</sub>S, CO

MC-CK-DL                    **GasAlertMicroClipXT Deluxe Confined Space Kit - includes manual aspirator kit, IR connectivity kit, calibration cap with 1 ft/0.3m hose, 1.5 LPM regulator, sampling probe, leather carrying case and auxiliary filter**

MC-CK-CC                    **Carrying Case for GasAlertMicroClipXT with foam and lid insert**

### Power Options and Spares

MC2-C01-MC5                    Multi-unit (5) cradle charger

GA-PA-1-MC5-NA                    Multi-unit (5) power adaptor

### Datalogging Accessories

GA-USB1-IR                    IR Connectivity kit with Fleet Manager II software

### Sampling/Testing Equipment and Spares

MC-TC-1                    Test cap and hose (1 ft/0.3m) replacement

DOCK2-2-1C1P-00-G                    MicroDock II Base station and GasAlertMicroClipXT docking module with charging cable

DOCK2-2-1P-00-G                    MicroDock II Base station and GasAlertMicroClipXT docking module without charging cable

DOCK2-0-1C1P-00-G                    MicroDock II GasAlertMicroClip XT docking module with charging cable

DOCK2-0-1P-00-G                    MicroDock II GasAlertMicroClip XT docking module without charging cable

### Sensor Spares

SR-W-MP75C                    Replacement MICROPel® combustible (LEL) sensor

SR-X10-C1                    Replacement O<sub>2</sub> sensor (for use with models MC2-)

SR-X-MC                    Replacement MICROCel® O<sub>2</sub> sensor (for use with models MC-)

SR-H-MC                    Replacement MICROCel® H<sub>2</sub>S sensor

SR-M-MC                    Replacement MICROCel® CO sensor



## GasAlertQuattro

- IntelliFlash verifies operation and compliance to both the user and supervisors from up to 20 ft. / 6.1 m
- One-button operational simplicity
- Easy to identify icons for onsite auditing and compliance
- Field-proven Surecell sensors offer unprecedented performance, even in the harshest environments
- Easy-to-read, multi-language LCD displays all four gas concentrations (H<sub>2</sub>S, CO, O<sub>2</sub> and combustibles) simultaneously
- Audible, visual and vibrating alarm
- Extended alarm bars
- Flexible, interchangeable battery options with extended runtimes
- Full function self-test is initiated upon activation and runs continuously during operation
- Heartbeat pulses continually during normal operation
- Extensive datalogging and event logging capability
- User-options, such as flip display, accessible through IR interface for tamper-proof operation
- Multi-language support in English, French, German, Spanish and Portuguese
- Compatible with MicroDock II automated test and calibration system



### GasAlertQuattro 4-Gas Detector

<b>Alkaline Version</b>	<b>Rechargeable Version</b>
QT-XWHM-A-Y-NA	QT-XWHM-R-Y-NA

**Configuration**  
%LEL, O<sub>2</sub>, H<sub>2</sub>S, CO

### GasAlertQuattro 3-Gas Detector

<b>Alkaline Version</b>	<b>Rechargeable Version</b>
QT-XWHO-A-Y-NA	QT-XWHO-R-Y-NA
QT-XWOM-A-Y-NA	QT-XWOM-R-Y-NA
QT-XOHM-A-Y-NA	QT-XOHM-R-Y-NA
QT-OWHM-A-Y-NA	QT-OWHM-R-Y-NA

**Configuration**  
%LEL, O<sub>2</sub>, H<sub>2</sub>S  
%LEL, O<sub>2</sub>, CO  
O<sub>2</sub>, H<sub>2</sub>S, CO  
%LEL, H<sub>2</sub>S, CO

### CONFINED SPACE KITS

QT-XWHM-R-Y-NA-CS	GasAlertQuattro confined Space Kit - includes GasAlertQuattro detector (%LEL, O <sub>2</sub> , H <sub>2</sub> S, CO) rechargeable version, manual aspirator kit, IR connectivity kit, calibration cap with 1 ft/0.3m hose, 0.5 LPM regulator, sampling probe, calibration gas (2.5% CH <sub>4</sub> , 18% O <sub>2</sub> , 25 ppm H <sub>2</sub> S, 100 ppm CO), rechargeable battery pack
QT-CK-DL	GasAlertQuattro Deluxe Confined Space Kit - includes manual aspirator kit, IR connectivity kit, calibration cap with 1 ft/0.3m hose, 0.5 LPM regulator, sampling probe, carrying holster and auxiliary filter
QT-CK-CC	Carrying Case for GasAlertQuattro with foam Insert
XT-AG-1	Replacement alligator-style clip (stainless steel with screw)

### Power Options & Spares

QT-BAT-R01	Rechargeable battery pack, yellow
QT-BAT-A01	Alkaline battery pack with batteries, yellow

### Datalogging Accessories

GA-USB1-IR	IR connectivity kit with Fleet Manager II software
------------	--

### Sampling/Testing Equipment and Spares

DOCK2-2-1C1N-00-G	MicroDock II Base station and GasAlertQuattro docking module with charging cable
DOCK2-2-1N-00-G	MicroDock II Base station and GasAlertQuattro docking module without charging cable
DOCK2-0-1N-000G	GasAlertQuattro docking module with charging cable
DOCK2-0-1C1N-00-G	GasAlertQuattro docking module without charging cable
GA-SPAK	Sampler Pak motorized sampling pump kit with alkaline batteries
QT-AS01	Manual aspirator pump
QT-TC-1	Replacement test cap and hose

### Sensor Spares

SR-W04-75C	Replacement combustible (LEL) sensor
SR-X10-C1	Replacement O <sub>2</sub> sensor
SR-H04-SC	Replacement H <sub>2</sub> S sensor
SR-M04-SC	Replacement CO sensor
SR-DUMM1	Dummy sensor for one O <sub>2</sub> , H <sub>2</sub> S or CO location
QT-SS	Replacement quad sensor screen, kit of 2



# BW Technologies

## GasAlertMax XT II

- GasAlertMax XT II is the smart, simple, economical way to compliance. Workers feel safe and incidents are minimized so everyone will be able to do more. That means savings realized from business continuity and productivity
- Simple operation with SmartSample pump
- GasAlertMax XT II reliably monitors up to four hazards and combines straightforward one-button operation with our robust, motorized pump for intelligent, remote sampling, ideal for confined spaces. The GasAlertMax XT II is fully compatible with Micro Dock II automated test and calibration system

### GasAlertMax XT II 4-Gas Detector

XT-XWHM-Y-NA      %LEL, O<sub>2</sub>, H<sub>2</sub>S, CO

### GasAlertMax XT II 3-Gas Detector

XT-XWHO-Y-NA      %LEL, O<sub>2</sub>, H<sub>2</sub>S

XT-XWOM-Y-NA      %LEL, O<sub>2</sub>, CO

XT-OWHM-Y-NA      %LEL, H<sub>2</sub>S, CO

XT-XOHM-Y-NA      O<sub>2</sub>, H<sub>2</sub>S, CO

XT-XWHM-Y-NA-CS      GasAlertMax XT II Confined Space Kit - includes GasAlertMax XT II detector (%LEL, O<sub>2</sub>, H<sub>2</sub>S, CO), IR Connectivity kit, 0.5 LPM regulator, sampling probe, calibration gas (2.5% CH<sub>4</sub>, 18% O<sub>2</sub>, 25 ppm H<sub>2</sub>S, 100 ppm CO)

XT-CK-DL      GasAlertMax XT II Deluxe Confined Space Kit - includes IR connectivity kit, 0.5 LPM regulator, 10 ft/3m hose, 3 ft /1m hose, sampling probe, concussion-proof boot, auxiliary filter and Fleet Manager II software CD

XT-CK-CC      Carrying case for GasAlertMax XT II with foam insert

### Datalogging Accessories

GA-USB1-IR      IR connectivity kit with Fleet Manager II software

### Sampling/Testing Equipment & Spares

DOCK2-2-1C1M-00-G      MicroDock II base station and GasAlertMax XT II docking module with charging cable

DOCK2-2-1M-00-G      MicroDock II base station and GasAlertMax XT II docking module without charging cable

DOCK2-0-1C1M-00-G      GasAlertMax XT II docking module with charging cable

DOCK2-0-1M-00-G      GasAlertMax XT II docking module without charging cable

XT-RF-H5      Hydrophobic pump filter replacement, kit of 5

XT-RF-H50      Hydrophobic pump filter replacement, kit of 50

XT-RF-H100      Hydrophobic pump filter replacement, kit of 100

GA-PFMAX      Particulate pump filter replacement, kit of 5

GA-PFMAX-50      Particulate pump filter replacement, kit of 50

GA-PFMAX-100      Particulate pump filter replacement, kit of 100

### Sensor Spares

SR-W-MP75C      Replacement MICROPel® combustible (LEL) sensor

SR-X10-C1      Replacement O<sub>2</sub> sensor

SR-X-MC      Replacement MICROCel® O<sub>2</sub> sensor

SR-H-MC      Replacement MICROCel® H<sub>2</sub>S sensor

SR-M-MC      Replacement MICROCel® CO sensor



## GasAlertMicro 5 Series

- Providing protection from up to five potential atmospheric hazards including oxygen, combustible and toxic gases, GasAlertMicro 5 is unparalleled in its versatility, capability and overall value
- BW Technologies by Honeywell's newest addition to its water-resistant line of portable gas detectors has transformed the market with its matchless array of features
- Continuously monitoring and displaying concentrations of up to five gases, the compact and lightweight GasAlertMicro 5 was designed and engineered with an extensive host of applications in mind
- Integral concussion-proof boot
- Optional integral motorized pump option for remote sampling
- Powered by three AA alkaline batteries or a hot-swappable rechargeable battery pack
- Triple alarms (audible, visual and vibrating)
- Multi-language support in English, French, German, Spanish and Portuguese
- Large, user selectable backlit LCD
- Four alarm levels: Low, High, TWA and STEL
- Compatible with MicroDock II Automatic Test and Calibration Station
- Datalogging models store and recall event information
- Wide range of user selectable field options including password protection, safe and stealth modes

### GasAlertMicro5 Detector

M5-XWSY-R-D-D-Y-N-00	%LEL, O <sub>2</sub> , CO, SO <sub>2</sub> - lithium polymer, yellow housing
M5-XWSY-R-P-D-Y-N-00	%LEL, O <sub>2</sub> , CO, SO <sub>2</sub> - lithium polymer and pump, yellow housing
M5-XWAY-R-D-D-Y-N-00	%LEL, O <sub>2</sub> , H <sub>2</sub> S, CO, NH <sub>3</sub> - lithium polymer battery, yellow housing
M5-XWAY-R-P-D-Y-N-00	%LEL, O <sub>2</sub> , H <sub>2</sub> S, CO, NH <sub>3</sub> - lithium polymer battery and pump, yellow housing
M5-XWCY-R-D-D-Y-N-00	%LEL, O <sub>2</sub> , H <sub>2</sub> S, CO, Cl <sub>2</sub> - lithium polymer battery, yellow housing
M5-XWCY-R-P-D-Y-N-00	%LEL, O <sub>2</sub> , H <sub>2</sub> S, CO, Cl <sub>2</sub> - lithium polymer battery and pump, yellow housing
M5-XWOY-A-P-D-Y-N-00	%LEL, O <sub>2</sub> , H <sub>2</sub> S, CO - alkaline batteries and pump, yellow housing
M5-XWOY-R-D-D-Y-N-00	%LEL, O <sub>2</sub> , H <sub>2</sub> S, CO - lithium polymer battery, yellow housing
M5-XWOY-R-P-D-Y-N-00	%LEL, O <sub>2</sub> , H <sub>2</sub> S, CO - lithium polymer battery and pump, yellow housing
M5-XWSY-R-D-D-B-N-00	%LEL, O <sub>2</sub> , H <sub>2</sub> S, CO, NH <sub>3</sub> - lithium polymer, black housing
M5-XWSY-R-P-D-B-N-00	%LEL, O <sub>2</sub> , H <sub>2</sub> S, CO, SO <sub>2</sub> - lithium polymer and pump, black housing
M5-XWAY-R-D-D-B-N-00	%LEL, O <sub>2</sub> , H <sub>2</sub> S, CO, NH <sub>3</sub> - lithium polymer battery, black housing
M5-XWAY-R-P-D-B-N-00	%LEL, O <sub>2</sub> , H <sub>2</sub> S, CO, NH <sub>3</sub> - lithium polymer battery and pump, black housing
M5-XWCY-R-D-D-B-N-00	%LEL, O <sub>2</sub> , H <sub>2</sub> S, CO, Cl <sub>2</sub> - lithium polymer battery, black housing
M5-XWCY-R-P-D-B-N-00	%LEL, O <sub>2</sub> , H <sub>2</sub> S, CO, Cl <sub>2</sub> - lithium polymer battery and pump, black housing
M5-XWOY-A-P-D-B-N-00	%LEL, O <sub>2</sub> , H <sub>2</sub> S, CO - alkaline batteries and pump, black housing
M5-XWOY-R-D-D-B-N-00	%LEL, O <sub>2</sub> , H <sub>2</sub> S, CO - lithium polymer battery, black housing
M5-XWOY-R-P-D-B-N-00	%LEL, O <sub>2</sub> , H <sub>2</sub> S, CO - lithium polymer battery and pump, black housing



# BW Technologies

- GasAlertMicro 5 IR portable gas detector simultaneously monitors up to five atmospheric hazards including carbon dioxide (CO<sub>2</sub>), oxygen (O<sub>2</sub>), combustible gas (%LEL), and a wide selection of toxic gases. Compact and lightweight, GasAlertMicro 5 IR activates audible, visual and vibrating alarms in the event of a low, high, TWA or STEL alarm condition
- 0-5% vol (0-50,000 ppm) measurement of carbon dioxide
- Integral concussion-proof enclosure for the most rugged environments
- Continuous LCD shows simultaneous gas concentrations for up to five gases
- Two power options: three AA alkaline batteries or a rechargeable battery pack
- Simple automatic calibration procedure; compatible with BW Technologies by Honeywell's MicroDock II system
- Provides 95 dB alarm tone, two bright wide-angled alarm bars and internal vibrating alarm for high noise areas
- Multi-language support in English, French, German, Spanish and Portuguese
- Full function self-test of sensor, battery and circuit integrity, and audible/visual alarms
- Two year warranty including sensors (1 year NH<sub>3</sub>)

## GasAlertMicro 5 PID Detector

M5PID-XWQY-A-P-D-Y-N-00	VOCs, %LEL, O <sub>2</sub> , H <sub>2</sub> S, CO - alkaline batteries and pump, yellow housing
M5PID-XWQY-R-P-D-Y-N-00	VOCs, %LEL, O <sub>2</sub> , H <sub>2</sub> S, CO - lithium polymer battery and pump, yellow housing
M5PID-XWQO-A-P-D-Y-N-00	VOCs, %LEL, O <sub>2</sub> - alkaline batteries and pump, yellow housing
M5PID-XWQO-R-P-D-Y-N-00	VOCs, %LEL, O <sub>2</sub> - lithium polymer battery and pump, yellow housing
M5PID-00QO-A-P-D-Y-N-00	VOCs - alkaline batteries and pump, yellow housing
M5PID-00QO-R-P-D-Y-N-00	VOCs - lithium polymer battery and pump, yellow housing
M5PID-XWQY-A-P-D-B-N-00	VOCs, %LEL, O <sub>2</sub> , H <sub>2</sub> S, CO - alkaline batteries and pump, black housing
M5PID-XWQY-R-P-D-B-N-00	VOCs, %LEL, O <sub>2</sub> , H <sub>2</sub> S, CO - lithium polymer battery and pump, black housing
M5PID-XWQO-A-P-D-B-N-00	VOCs, %LEL, O <sub>2</sub> - alkaline batteries and pump, black housing
M5PID-XWQO-R-P-D-B-N-00	VOCs, %LEL, O <sub>2</sub> , H <sub>2</sub> S, CO - lithium polymer battery and pump, black housing
M5PID-00QO-A-P-D-B-N-00	VOCs - alkaline batteries and pump, black housing
M5PID-00QO-R-P-D-B-N-00	VOCs - lithium polymer battery and pump, black housing

## GasAlertMicro 5 IR Detector

M5IR-XWBY-R-D-D-Y-N-00	CO <sub>2</sub> (IR), %LEL, O <sub>2</sub> , H <sub>2</sub> S, CO - lithium polymer battery, yellow housing
M5IR-XWBY-R-P-D-Y-N-00	CO <sub>2</sub> (IR), %LEL, O <sub>2</sub> , H <sub>2</sub> S, CO - lithium polymer battery and pump, yellow housing
M5IR-XWBH-R-D-D-Y-N-00	CO <sub>2</sub> (IR), %LEL, O <sub>2</sub> , H <sub>2</sub> S - lithium polymer battery, yellow housing
M5IR-XWBH-R-P-D-Y-N-00	CO <sub>2</sub> (IR), %LEL, O <sub>2</sub> , H <sub>2</sub> S - lithium polymer battery and pump, yellow housing
M5IR-XWB0-R-D-D-Y-N-00	CO <sub>2</sub> (IR), %LEL, O <sub>2</sub> - lithium polymer battery, yellow housing
M5IR-XWB0-R-P-D-Y-N-00	CO <sub>2</sub> (IR), %LEL, O <sub>2</sub> - lithium polymer battery and pump, yellow housing
M5IR-00B0-R-D-D-Y-N-00	CO <sub>2</sub> (IR) - lithium polymer battery, yellow housing
M5IR-00B0-R-P-D-Y-N-00	CO <sub>2</sub> (IR) - lithium polymer battery and pump, yellow housing
M5IR-XWBY-R-D-D-B-N-00	CO <sub>2</sub> (IR), %LEL, O <sub>2</sub> , H <sub>2</sub> S, CO - lithium polymer battery, black housing
M5IR-XWBY-R-P-D-B-N-00	CO <sub>2</sub> (IR), %LEL, O <sub>2</sub> , H <sub>2</sub> S, CO - lithium polymer battery and pump, black housing
M5IR-XWBH-R-D-D-B-N-00	CO <sub>2</sub> (IR), %LEL, O <sub>2</sub> , H <sub>2</sub> S - lithium polymer battery, black housing
M5IR-XWBH-R-P-D-B-N-00	CO <sub>2</sub> (IR), %LEL, O <sub>2</sub> , H <sub>2</sub> S - lithium polymer battery and pump, black housing
M5IR-XWB0-R-D-D-B-N-00	CO <sub>2</sub> (IR), %LEL, O <sub>2</sub> - lithium polymer battery, black housing
M5IR-XWB0-R-P-D-B-N-00	CO <sub>2</sub> (IR), %LEL, O <sub>2</sub> - lithium polymer battery and pump, black housing
M5IR-00B0-R-D-D-B-N-00	CO <sub>2</sub> (IR) - lithium polymer battery, black housing
M5IR-00B0-R-P-D-B-N-00	CO <sub>2</sub> (IR) - lithium polymer battery and pump, black housing
M5-CK-DL	GasAlertMicro 5 Series deluxe confined space kit includes manual aspirator kit, calibration cap, regulator, sampling probe with holster, detector holster, five spare auxiliary filters and three spare quick connect fitting
M5-CK-CC	Carrying case for GasAlertMicro 5 Series with foam and lid insert



## Carrying Accessories

**GA-AG-2** Alligator-style clip (stainless steel)

## Datalogging Accessories and Options

**M5-MMC** Multimedia card

**CR-MMC-USB1** USB memory card reader

## Power Accessories and Options

**M5-BAT0501** Alkaline battery pack, yellow

**M5-BAT08** Lithium polymer rechargeable battery pack, yellow

**M5-C01-BAT08** Cradle charger and rechargeable battery pack, yellow

**M5-C01** Cradle charger for rechargeable battery packs

**M5-BL-1** Battery latch, replacement

**GA-V-CHRG4** 12 VDC vehicle adaptor cable for use with cradle charger (M5-C01)

## MicroDock II

**DOCK2-2-1C1K-00-G** Base station and GasAlertMicro 5 Series docking module (charging) with charging cable

**DOCK2-2-1J-00-G** Base station and GasAlertMicro 5 Series docking module (non-charging)

**DOCK2-0-1K-00-G** GasAlertMicro 5 Series docking module (charging), no charging cable

**DOCK2-0-1J-00-G** GasAlertMicro 5 Series docking module (non-charging)

## Sensor Spares and Replacements

**M5-SS** Quad sensor screen filters, kit of 2

**POWER-UPS-01** Replacement power supply for chargers

**M5-PR-1** Replacement pump, yellow

**M5-PRB-1** Replacement pump, black

**M5-PN-1** Replacement pump nozzle (for use with new Generation 2 pump modules)

**M5-DC-1** Replacement diffusion cover, yellow

**M5-DCB-1** Replacement diffusion cover, black

**SR-B04** Replacement CO<sub>2</sub> IR sensor

**SR-Q07** Replacement volatile organic compounds (VOC) PID sensor, 10.6 eV

**M5PID-ES-1** Replacement electrode stacks for PID sensor (SR-Q07) kit of 2

**RL-PID10.6** Replacement PID lamp, (10.6 eV) for PID sensor (SR-Q07)

**M5PID-CLN-K1** Cleaning kit for PID sensor

**D4-RHM04** Replacement TwinTox sensor - CO and H<sub>2</sub>S

**PS-RH04S** Replacement H<sub>2</sub>S Sensor

**PS-RM04** Replacement CO sensor

**SR-M04-SC** Replacement CO sensor, H<sub>2</sub> resistant

# BW Technologies

## MicroDock II

- The most cost effective way to manage the calibration and bump testing of BW Technologies by Honeywell portable gas detectors is through the MicroDock II automated test and calibration system. Fully portable and easily expandable, the MicroDock II requires no computer and provides simultaneous management of up to ten modules. Minimize expenses and maximize productivity with the MicroDock II
- Quick and easy compliance - automatically maintain accurate records
- Automatic bump testing, calibration, record keeping and charging
- One base station with one AC outlet supports up to six modules to suit your application
- Verifies proper performance of detectors
- Reduces maintenance costs
- Multiple MicroDock II systems can be connected via a LAN
- Includes BW Technologies by Honeywell Fleet Manager software for easy data analysis
- Multi-language support in English, French, German, Spanish and Portuguese

<b>DOCK2-2-1E-00-G</b>	<b>Base station with GasAlertClip Extreme H<sub>2</sub>S module</b>
<b>DOCK2-2-1G-00-G</b>	<b>Base station with GasAlertClip Extreme CO module</b>
<b>DOCK2-2-1F-00-G</b>	<b>Base station with GasAlertClip Extreme SO<sub>2</sub> module</b>
<b>DOCK2-2-1H-00-G</b>	<b>Base station with GasAlertClip Extreme O<sub>2</sub> module</b>
<b>DOCK2-2-1D-00-G</b>	<b>Base station with GasAlert Extreme module</b>
<b>DOCK2-2-1C1P-00-G</b>	<b>Base station with GasAlertMicroClip XT module (charging) with power supply</b>
<b>DOCK2-2-1P-00-G</b>	<b>Base station with GasAlertMicroClip XT module (charging) without power supply</b>
<b>DOCK2-2-1N-00-G</b>	<b>Base station with GasAlertQuattro module (charging) without power supply</b>
<b>DOCK2-2-1C1N-00-G</b>	<b>Base station with GasAlertQuattro module (charging) with power supply</b>
<b>DOCK2-2-1C1M-00-G</b>	<b>Base station with GasAlertMax XT II module (charging) with power supply</b>
<b>DOCK2-2-1M-00-G</b>	<b>Base station with GasAlertMax XT II module (charging) without power supply</b>
<b>DOCKS2-2-1C1K-00-G</b>	<b>Base station with GasAlertMicro 5 Series module (charging) with power supply and 2 gas inlets</b>
<b>DOCKS2-3-1C1L-00-G</b>	<b>Base station with GasAlertMicro 5 Series module (charging) with power supply and 3 gas inlets</b>
<b>DOCKS2-2-1J-00-G</b>	<b>Base station with GasAlertMicro 5 Series module (non-charging) with 2 gas inlets</b>
<b>DOCKS2-3-1J-00-G</b>	<b>Base station with GasAlertMicro 5 Series module (non-charging) with 3 gas inlets</b>

### Accessory Docking Modules

<b>DOCK2-2-00-G</b>	<b>Base station with 2 gas inlets without power supply</b>
<b>DOCKS2-3-00-G</b>	<b>Base station with 3 gas inlets without power supply</b>
<b>DOCKS2-4-00-G</b>	<b>Base station with 4 gas inlets without power supply</b>
<b>DOCKS2-5-00-G</b>	<b>Base station with 5 gas inlets without power supply</b>
<b>DOCKS2-0-1E-00-G</b>	<b>GasAlertClip Extreme H<sub>2</sub>S docking module</b>
<b>DOCKS2-0-1G-00-G</b>	<b>GasAlertClip Extreme CO docking module</b>
<b>DOCKS2-0-1F-00-G</b>	<b>GasAlertClip Extreme SO<sub>2</sub> docking module</b>
<b>DOCKS2-0-1H-00-G</b>	<b>GasAlertClip Extreme O<sub>2</sub> docking module</b>
<b>DOCKS2-0-1D-00-G</b>	<b>GasAlert Extreme docking module</b>
<b>DOCKS2-0-1C1P-00-G</b>	<b>GasAlertMicroClip XT docking module (charging with power supply)</b>
<b>DOCKS2-0-1P-00-G</b>	<b>GasAlertMicroClip XT docking module (charging without power supply)</b>
<b>DOCKS2-0-1N-00-G</b>	<b>GasAlertQuattro docking module (charging without power supply)</b>
<b>DOCKS2-0-1C1N-00-G</b>	<b>GasAlertQuattro docking module (charging without power supply)</b>
<b>DOCKS2-0-1C1M-00-G</b>	<b>GasAlertMax XT II/GasAlertMax XT docking module (charging with power supply)</b>
<b>DOCKS2-0-1M-00-G</b>	<b>GasAlertMax XT II/GasAlertMax XT docking module (charging without power supply)</b>
<b>DOCKS2-0-1C1K-00-G</b>	<b>GasAlertMicro 5 Series docking module (charging with power supply)</b>
<b>DOCKS2-0-1K-00-G</b>	<b>GasAlertMicro 5 Series docking module (charging)</b>
<b>DOCKS2-0-1J-00-G</b>	<b>GasAlertMicro 5 Series docking module</b>

## Accessories & Spares

REG-DF-1	Demand flow regulator
REG-DF-2	Demand flow regulator for refillable cylinders, CGA connector
REG-DF-3	Demand flow regulator for disposable steel cylinders
WMA-DOCK	Wall mount adaptor (kit of 2) modules and base station
<b>SAMPLERPAK</b>	
GA-SPAK	SamplerPak motorized sampling pump kit with alkaline batteries
GA-SPAK-NA	Deluxe SamplerPak motorized sampling pump kit with alkaline batteries, rechargeable batteries and battery charger

## Sampling Accessories

SP-CPROB1	Collapsible sample probe (3.3 ft/1m)
SP-CPROB14	Collapsible sample probe (14 ft/4.3m)
SP-T1-2	Sample probe (1 ft/0.3m) for Sampler
GA-MFILTER	Metallic sintered particulate filter
GA-SP01	Replacement Sampler motorized sampling pump

## Carrying Accessories & Replacements

GA-HSAMP	Carrying holster for Sampler
SPAK-CC1	Replacement carrying case with foam for SamplerPak portable kits

## Calibration Equipment

Single Gas Cylinders	Cylinder Material	Regulator
CO <sub>2</sub> 1.0% vol. (10,000 ppm)	Steel	REG-DF-3 or REG2-0.5
N <sub>2</sub> 100% N <sub>2</sub>	Steel	REG-DF-3 or REG2-0.5



## Capstan Brackets without Chain Clamps

- Bolt-down bracket for 1,000 lb. hoists
- Does not include chain clamps
- 8.82 lbs

**E3081321P**



- Bolt-down bracket for 3,000 lb. hoists
- Does not include chain clamps
- 14 lbs

**E3081434P**



## Capstan Brackets with Chain Clamps



- All-purpose bracket Series 90 hoists
- Includes 2 chain clamps for poles, angles, or beams

**C3081335**     **1,000 lb. rating**

**C3081443**     **3,000 lb. rating**

## Universal Bracket/Chain Clamp for Capstan 1000 lb. Gas Hoist



- Recommended for use with Chance gasoline 1,000 lbs hoist
- C3080925 also fits other 1,000 lbs Series 90 and earlier 750 lbs Chance hoists
- C3080925 bolts down or uses two C4170346 chain clamps for mounting on poles, angles, or beams

**C3080925**     **Universal Bracket**

**C4170346**     **Chain Clamp for Universal Bracket**

## "C" Bracket for Hoist Storage



- To store hoist on C-bracket, simply remove four bolts
- The C-bracket also can be bolted down for fixed-angle

**C3080890**

## Rope Lock Device Tool



- Includes two mounting bolts, washers, and a release lanyard
  - Accepts 1/2", 5/8", and 3/4" rope
- C3080856**



## Kellems Multiple Strength Type Pulling Grips

- Designed for pulling ACSR, aluminum, or copper bare conductor, ground wires, messenger strands, wire rope, and insulated cables
- High-strength galvanized steel strand, featuring double-weave mesh for greater strength and added mesh contact for longer or heavier pulling jobs
- Endless weave grip end lies flat on the cable and will not snag
- Ideal for overhead transmission and distribution line stringing where moderate loading is anticipated

Part #	Range	Colour Code	Eye Length	Mesh Length	Approx. Breaking Strength
03302044	.25-.49"	Dark Green	9"	26"	6,800 lbs.
03302046	.50-.74"	Brown	9"	32"	10,000 lbs.
03302048	.75-.99"	Light Blue	11"	41"	14,400 lbs.
03302050	1-1.24"	Gold	12"	52"	24,600 lbs.
03302052	1.25-1.49"	Black	12"	56"	30,600 lbs.
03302054	1.5-1.74"	Red	12"	60"	30,600 lbs.



## Kellems DUA-Pull Type Pulling Grips

- DUA-Pull line accommodates ACSR, ACAR, and all aluminum and copper conductors
- The highest strength pulling grips manufactured for overhead transmission line stringing
- They may work both bare and insulated conductors, as well as synthetic rope
- Kellems' patented two-over, two-under weave design gives exceptional strength and gripping ability by putting more steel mesh in contact with the cable or rope surfaces
- Primarily used in overhead transmission line construction where loads and safety considerations require an extra high strength grip, and will mate with swivels and link-type connectors
- Also accommodates ground wires, messenger strands, wire ropes, and synthetic ropes
- Most commonly used for attaching pulling lines to conductors, conductors to running boards, and "double socking" for conductor-to-conductor connections

Part #	Range	Colour Code	Eye Length	Mesh Length	Approx. Breaking Strength
033271037	.19-.37"	Black	10"	24"	6,500 lbs.
033271038	.38-.62"	Dark Green	12"	36"	14,000 lbs.
033271039	.63-.87"	Red	13"	48"	20,000 lbs.
033271040	.88-1.12"	Blue	15"	60"	30,600 lbs.



## Kellems Pulling Grips

- High-strength galvanized steel strand, featuring double-weave mesh for greater strength and added mesh contact for longer or heavier pulling jobs
- Forged steel rotating eye mates with a swivel or shackle

Part #	Type	Range	Length
33041085	T-Type	1-1.49"	33"
03301027	K-Type	2-2.49"	45"



## Punch-Lok Bands for Kellems Pulling Grips

- Punch-Lok® Bands are applied over the tail of a grip to prevent the mesh from being tripped or pulled loose
- They assure full gripping action by locking the mesh of the tail in tight contact with the cable or rope
- When the tail of a grip is the leading end, the bands are particularly important to prevent accidental release caused by tripping on obstructions



Part no.	Grip Banding Range	Band Width	Band Inside Diameter
20320050	1/4" - 1 1/8"	3/8"	1 3/8"
20320051	1 1/8" - 1 5/8"	3/8"	2"
20320052	1 5/8" - 2 1/4"	5/8"	2 1/2"
20320054	3 1/2" - 5"	5/8"	6"



## Mechanical Ratchet Chain Hoists



- Compact and portable, this hoist operates easily in close clearance work spaces
- Forged-steel load hooks at both ends, swivel 360° for easy attachment and to help maintain axial alignment during use
- Two-way handle swings to either side
- Rounded stop at end helps keep hand on handle
- Standard lift is 5.5'

Part #	Rating	Handle Pull at Rating	Hook-to-Hook Minimum	Weight (lbs)
C3090438	0.75 ton	65 lbs.	11"	14
30115	1 ton	90 lbs.	11"	14
C3090439	1.5 ton	60 lbs.	16"	22
4012	2 ton	90 lbs.	11"	28.5
C3090440	3 ton	60 lbs.	19.75"	30.5
C3090441	4.5 ton	70 lbs.	24.5"	47
C3090442	6 ton	70 lbs.	24.5"	50

## Nylon Strap Ratchet Hoists



- Designed with special features, these hoists offer a choice of two handle options for utility maintenance and construction
- For rubber-glove work, select hoist with Plastisol cap on handle end
- For operation by hot line tools, specify hoist with swivel-eye on handle end
- Features hot stick rings on hooks and latches
- Single strap of 1-Ton units reach and lifts farther; 2-Ton units employ a sheave-mounted hook in a double-strap bucket

PSC3090323	1 Ton Hoist, Regular Handle
PSC3090467	1 Ton Hoist, Hot Stick Handle
PSC3090468	2 Ton Hoist, Hot Stick Handle

## Powered Hoists



C3081172

- Improved design features a multiple planetary drive/backstop clutch assembled on the center shaft of a steel gearcase with full-length internal teeth
- Handles more rugged jobs, extends service life and reduces maintenance
- Lightweight, powerful, and portable
- Moves many heavyweight tasks and can get into remote or difficult-access sites
- Designed for use with setting utility poles, pulling wheeled equipment over obstacles, raising transformers (even over fences in back lots), hoisting heavy insulators, stringing and tensioning conductors, pulling cable (indoors and underground)
- Operator effort remains low for typical loads simply by adding wraps on the capstan drum
- Control is so accurate, loads can be moved fractions of an inch
- Standard drum style

Part #	Power Source	Rope Speed at Rated Load	Source (min.)
C3081172	12 V DC	22' per min.	90 AMP
C3081170	115 V AC	40' per min.	14 AMP
C3081370	115 V AC	2' per min.	14 AMP



C3081170 & C3081370

## Hydraulically Driven Capstan Hoists



C3080900



C3081180

- Improved design features a multiple planetary drive/backstop clutch assembled on the center shaft of a steel gearcase with full-length internal teeth
- Handles more rugged jobs, extends service life and reduces maintenance
- Lightweight, powerful, and portable
- Moves many heavyweight tasks and can get into remote or difficult-access sites
- Designed for use with setting utility poles, pulling wheeled equipment over obstacles, raising transformers (even over fences in back lots), hoisting heavy insulators, stringing and tensioning conductors, pulling cable (indoors and underground)
- Operator effort remains low for typical loads simply by adding wraps on the capstan drum
- Control is so accurate, loads can be moved fractions of an inch
- Standard drum style

Part #	Rope Speed at Rated Load	Source (Gallons/min.)	Load Rating
C3081180	93' per min.	8 gal.: 1,000 psi	1000 lbs
C3080900	30' per min.	8 gal.; 1,000 psi	3000 lbs

## Capstan 1000 lb. Gas Hoist



C3081190

- Improved design features a multiple planetary drive/backstop-clutch assembled on the center shaft of a steel gearcase with full-length internal teeth
- This design handles more rugged jobs, extends service life and reduces maintenance
- Lightweight yet powerful, these portable hoists move many heavyweight tasks and can get into remote or difficult-access sites; for example, setting utility poles, pulling wheeled equipment over obstacles, raising transformers (even over fences in back lots), hoisting heavy insulators, stringing and tensioning conductors, pulling cable (indoors and underground)
- Operator effort remains low for typical loads simply by adding wraps on the capstan drum
- Control is so accurate, loads can be moved fractions of an inch
- Rope speed at 1000 lbs. rated working load is 40' per minute
- Engine speed of 8000 rpm

## Grips for Weatherproof Wire



- Round jaws provide maximum contact and gripping power to minimize conductor damage
- Notches in jaw provide firm grip on insulation
- Round inside jaw contour for weatherproof coated wire
- Maximum safe load for 1611-20 and 1611-30 is 4,500 lbs.
- Maximum safe load for 1611-40 and 1611-50 is 8,000 lbs.

*Note: Due to various types of weatherproof coatings available, selection of proper grips is determined by outside diameter of cable.*

<b>1611-20</b>	<b>0.2" x 0.4"</b>
<b>1611-30</b>	<b>0.31" x 0.53"</b>
<b>1611-40</b>	<b>0.53" x 0.74"</b>
<b>1611-50</b>	<b>0.78" x 0.88"</b>

## Grips for PVC-Covered Conductors



- The serpentine jaws of this grip series are specially machined to allow insertion of insulated conductors through the jaws, which reduces danger of slippage which might result in insulation damage
- Round inside-jaw contour
- Maximum safe load for 1659-20 and 1659-30 is 4,500 lbs.
- Maximum safe load for 1659-40 and 1659-50 is 8,000 lbs.

<b>1659-20</b>	<b>0.20" x 0.42"</b>
<b>1659-30</b>	<b>0.31" x 0.50"</b>
<b>1659-40</b>	<b>0.49" x 0.79"</b>
<b>1659-50</b>	<b>0.79" x 1.01"</b>

## Grips for Extra High-Strength Cables, Messenger, Guy Strand and Conductors



- A family of grips for cable sizes from 0.12" to 1.0"
- Double "V" grooves give four-point contact, reducing chance of slipping and providing proper alignment
- For larger conductors, see grips with round inside-jaw contour
- Maximum safe load for 1613-40 is 4,500 lbs.
- Maximum safe load for 1684-5, 1692-5, and 1684-5F is 8,000 lbs.
- Maximum safe load for 1628-16, 1628-17 and 1628-18 is 15,000 lbs.

<b>1613-40</b>	<b>0.12" x 0.37"</b>
<b>1684-5</b>	<b>0.218" x 0.55"</b>
<b>1692-5</b>	<b>0.218" x 0.55"</b>
<b>1684-5F</b>	<b>0.16" x 0.55"</b>
<b>1628-16</b>	<b>0.31" x 0.62"</b>
<b>1628-17</b>	<b>0.50" x 0.75"</b>
<b>1628-18</b>	<b>0.75" x 1.00"</b>

## Chicago Grip "Type B" Strand Puller



- Similar to Bell-System type "B" strand puller
- Designed to pull 1/4" figure-8 telephone cable
- Serpentine grooves grip insulation on strand, preventing slippage
- Equipped with chain, toggle, and shackle

1659-5AT

## Klein Curved-Jaw Grips for EHS Cable



- When pulling EHS (extra-high-strength) galvanized-steel cable, the galvanizing has a tendency to coat the jaws of any grip, causing the cable to slip; to reduce the possibility of slippage and damage to the cable, the jaws of this grip are milled on a curve with a double "V" contour
- Maximum safe load is 8,000 lbs.

1684-74 0.218" x 0.55"

## Chicago Grip Bell-System Type Grip



- Equipped with chain, toggle and shackle
- For support wire .134 and larger, use 1659-5AT
- Outside diameter of support wire includes thickness of polyethylene coating

Part #	Capacity	Jaw Length	Max Safe Load	Weight
1684-5AT	0.218" - 0.55" cable	5"	8000 lbs	6.25 lbs.
1628-16AT	0.31" - 0.62" cable	7.25"	15,000 lbs	15.5 lbs.
1692-5AT	0.218" - 0.55" cable	5"	8000 lbs	6 3/8 lbs

## Chicago Grip for Bare ACSR, Aluminum and Stranded Copper Cables



- Round, smooth inside jaw contour on this series of grips is ideal for bare ACSR, aluminum, and stranded copper cables
- Smooth jaws grip with maximum contact and are less likely to damage conductors

Part #	Wire Size	Capacity
1656-20	0.2" x .40"	4500 lbs
1656-30	.31" x .53"	4500 lbs
1656-40	.53" x .74"	8000 lbs
1656-50	.74" x .86"	8000 lbs
1656-60	.86" x .53"	8000 lbs

## Grips for Bare Wire



- A lightweight grip for working with solid and stranded bare wire from .08" to .20"
- Simple three-point jaws designed for use on small-diameter bare wire and cable
- Single "V" groove jaw
- Maximum safe load is 1500 lbs

1613-30 .08" x .20"

## Klein Parallel Jaw Grips

- Longer jaws achieve a firm hold, reducing possibility of slippage
- Design includes a latch, plus a large diameter eye that accommodates large hooks on hoists, winches and tackle blocks



1671-10



1685-20



1672-10



1685-31

1686-10

1686-20

Part #	Wire Size	Capacity
1671-10	.37" x .75"	10,000 lbs
1686-10	.20" x .40"	10,000 lbs.
1686-20	.20" x .40"	10,000 lbs.

### Features knurled jaws

1672-10	.37" x .75"	10,000 lbs.
1685-20	.157" x .886"	4500 lbs.

### Features round inside jaw contour and serrated lower jaw

1685-31	.625" x 1.250"	7500 lbs.
---------	----------------	-----------

### Features round inside jaw contour and serrated lower jaw

## Klein Grips Warnings

### CAUTION:

- 1) Proper maintenance and field inspection of all grips is necessary before each use
- 2) Check to be sure there is no accumulation of foreign material in the jaws which might cause slippage
- 3) Check mechanical condition of entire grip
- 4) Check grip to be sure it is the correct size and type for the application
- 5) Check and lubricate; DO NOT lubricate gripping surfaces of jaws
- 6) Check all parts for distortion or misalignment

### WARNING:

- Always match proper size and type grip to application
- Do not exceed rated capacity
- Before each use clean jaw area and inspect grip for proper operation to avoid slippage
- When used on or near energized lines, ground, insulate, or isolate grip before pulling
- Grips are to be used for temporary installation, not permanent anchorage

## KLEIN WIRE PULLING GRIPS

### KT4500 Series Parallel Jaw Grips

- Cable range from 0.180" to 0.600"
- KT4500 and KT4502 are supplied with hot latches
- 5,000 lbs. maximum safe load

<b>KT4500</b>	<b>Spring</b>
<b>KT4501</b>	<b>Hot latch, Spring, Locking Handle</b>
<b>KT4502</b>	<b>Hot Latch Only</b>



### KT4600 Series Parallel Jaw Grips

- KT4601 and 4602 and are supplied with hot latches
- 10,000 lbs. maximum safe load

<b>KT4600</b>	<b>Spring</b>
<b>KT4601</b>	<b>Hot latch, Spring, Locking Handle</b>
<b>KT4602</b>	<b>Hot Latch Only</b>

### KT4800 Series Parallel Jaw Grips

- KT4801 and KT4802 are supplied with hot latches
- 12,000 lbs. maximum safe load

<b>KT4800</b>	<b>Spring</b>
<b>KT4801</b>	<b>Hot latch, Spring, Locking Handle</b>
<b>KT4802</b>	<b>Hot Latch Only</b>

## KLEIN HAVE (BULL DOG) GRIPS

- Designed for use when light, compact grip is desired and where conductor damage is not a factor
- Gripping pressure of the knurled jaw is applied to 1/4" cable area
- 1604-20L features a swing latch to help hold cable in the jaw

<b>Part #</b>	<b>Wire size</b>	<b>Capacity</b>
<b>1604-10</b>	<b>.06" x .25"</b>	<b>2500 lbs.</b>
<b>1604-20L</b>	<b>.125" x .50"</b>	<b>5000 lbs.</b>
<b>1604-20</b>	<b>.125" x .50"</b>	<b>5000 lbs.</b>
<b>1625-20</b>	<b>.28" x .75"</b>	<b>8000 lbs.</b>



**1604-10**  
**1604-20**



**1604-20L**



**1625-20**

## 1628 Series Interchangeable Jaw Grips

- Klein Tools' new Interchangeable Jaw Grips feature three grip bodies with interchangeable liners for ACSR, ACSS, and AAC cable
- Simply replace the liners for the particular cable diameter with Klein's grip liners, and there is no need to carry additional grips.
- Fewer grips means less weight on the job site and more storage space!
- Constructed of high strength alloy steel, hot forged, heat treated, and galvanized for toughness, strength, and corrosion resistance
- Suitable for ACSR, ACSS, and AAC
- Offers a full range of interchangeable liners to be inserted between the upper and lower jaws of the grip
- Cable diameter range: .886" to 1.614"
- MCM cable range: 565.5 to 1780.0



### Interchangeable Grip Bodies:

1628-60	.886" to 1.614"	Cable Diameter, 565.5 to 1780 MCM 13,000 lbs.
1628-70	.236" to .906"	Cable Diameter, 2 AWG to 600 MCM 6,750 lbs.
1628-80	.236" to .906"	Cable Diameter, for OPGW, 6750 lbs.

## 1628-60 Series Grip Liners

Part #	Cable Range
1628-60N	.866" to .945"
1628-60P	.945" to 1.004"
1628-60R	1.004" to 1.063"
1628-60S	1.063" to 1.122"
1628-60T	1.122" to 1.181"
1628-60U	1.181" to 1.24"
1628-60W	1.24" to 1.299"
1628-60X	1.299" to 1.358"
1628-60Y	1.358" to 1.417"
1628-60Z	1.417" to 1.476"
1628-60A	1.476" to 1.535"
1628-60B	1.535" to 1.594"
1628-60C	1.594" to 1.614"

## 1628-70 Series Grip Liners

Part #	Cable Range
1628-70AA	.236" to .236"
1628-70BB	.256" to .315"
1628-70F	.315" to .374"
1628-70G	.374" to .433"
1628-70H	.433" to .492"
1628-70I	.492" to .551"
1628-70J	.551" to .610"
1628-70K	.610" to .669"
1628-70L	.669" to .728"
1628-70M	.728" to .787"
1628-70N	.787" to .846"
1628-70O	.846" to .906"

## 1628-80 OPGW Series Grip Liners

Part #	Cable Range
1628-80AA	.236"
1628-80BB	.315"
1628-80E	.354"
1628-80F	.433"
1628-80G	.512"
1628-80H	.591"
1628-80I	.669"
1628-80J	.748"
1628-80K	.787"
1628-80L	.827"
1628-80M	.866"
1628-80N	.906"



## Standard Spring-Loaded Grips



LMG4500  
LMG4600



LMG4800

- Handle eye opening 1.25" x 1.75"
- Accept standard hooks and easily attach to tackle blocks
- Forged steel construction with yellow chromate finish to protect from rust and corrosion

Part #	Capacity	Wire Size/Gauge
LMG4500	5000 lbs.	.18" - .60" (6AWG - 4/0AWG)
LMG4600	10,000 lbs	.30" - .80" (1AWG - 450MCM)
LMG4800	12,000 lbs	.70" - 1.25" (397MCM - 1130MCM)

## Hot Line Spring Loaded Grips, Notched Handles



LMG4501  
LMG4601



LMG4801

- Hot Line Models also feature spring loaded gate with locking mechanism

Part #	Capacity	Wire Size/Gauge
LMG4501	5000 lbs.	.18" - .60" (6AWG - 4/0AWG)
LMG4601	10,000 lbs	.30" - .80" (1AWG - 450MCM)
LMG4801	12,000 lbs	.70" - 1.25" (397MCM - 1130MCM)

## LSB Hoist

- 360° rotating handle provides versatile rigging options when used in confined spaces
- Impact-resistant stamped steel housing withstands years of rigorous use
- Low handle effort provided by double reduction gearing and short handle
- Free wheeling mechanism allows one-handed take up and positioning of slack chain
- Meets or exceeds minimum 4:1 design factor and all requirements of ASME/ANSI Standard B-30.21

Part #	Capacity	Hook to Hook (min)	Average Handle Efforts	Handle Length	Lift
LSB1500B-10	1500 lbs	11 5/8"	46 lbs.	9.25"	10'
LSB3000B-10	3000 lbs	13"	59 lbs.	14.56"	10'
LSB6000B-10	6000 lbs	16 5/16"	75 lbs.	14.56"	10'



## G Model Chain Hoists



- Malleable iron housings, key internal components made of heat treated alloy steel, riveted construction
- Free chain feature allows easy positioning and set-up; also features reversible handle
- 360° swivel hooks are equipped with safety latches for positive load engagement
- Double pawl models can be operated with half strokes of lever for use in close quarters

Model	Capacity	Lift	Strands of Load Chain	Min. Distance Between Hooks	Average Handle Effort	Minimum Increment	Pawl
AG	1500 lbs	56.5"	1	13"	56 lbs	.624/.313	Single
ATG	3000 lbs	57"	2	15"	60 lbs	.313/.156	Single
ATGI	3000 lbs	57"	2	15"	60 lbs	.313/.156	Double
FTG	6000 lbs	57"	2	17 5/8"	120 lbs	.500/.250	Single
ZG-6	12,000 lbs	53"	4	25"	124 lbs	.250	Single

## TB602 & TB603 Mini Hoists

- Performs just like the larger hoists, but small enough to fit in a hard hat
- Weston type load brake
- Forged upper and lower hooks with latches standard
- Plated load chain is standard
- Free wheeling feature serves to quickly attach the load
- Hardened link type steel load chain

TB-602 Models feature a 550 lb. capacity

TB602-5 5' Lift

TB602-10 10' Lift

TB-602 Models feature a 1100 lb capacity

TB603-5 5' Lift

TB603-10 10' Lift



# Coffing Hoists

## Model 344 Lineman's Strap Hoists



- 344B features standard hooks with safety latches
- 344DB features hot stick ring hooks with safety latches on all hooks, control surfaces, and quick disconnect shafts
- 344CB features standard hooks with heavy duty swivel gate latches
- 344DHB features hot stick ring hooks with hot stick ring safety latches on all hooks and control surfaces and quick disconnect shaft

Part #	Capacity	Single Line		Double Line		
		Lift	Min. Headroom	Capacity	Lift	Hook to Hook (Min)
344B	2000 lbs	11'	20"	4000 lbs	5.5'	23"
344DB	2000 lbs	11'	20"	4000 lbs	5.5'	23"
344CB	2000 lbs	11'	23"	4000 lbs	5.5'	27"
344DHB	2000 lbs	11'	22"	4000 lbs	5.5'	26"

## 6000 lbs. Series Lineman's Strap Hoist



- 6000A features standard hooks with safety latches, 6000DA features hot stick rings with safety latches on all hooks, control surfaces, and quick disconnect shaft
- 6000CA features standard hooks with heavy duty swivel gate latches

Part #	Capacity	Lift	Min. Headroom	Double Line		
				Web Strap Length	Handle Length	Net Weight
6000A	6000 lbs	5'	27"	12'	30"	26.5 lbs.
6000DA	6000 lbs	5'	27"	12'	30"	26.5 lbs.
6000CA	6000 lbs	5'	31 1/2"	12'	30"	26.5 lbs.

## Cable Hoist



- 360° swivel hooks are equipped with safety latches for positive load engagement
- Double-interlocking pawl mechanism assures one pawl is engaged at all times
- Special cast aluminum and zinc alloy housings with preformed, galvanized, extra-flexible aircraft cable

Part #	Capacity	Single Line		Double Line		
		Lift	Hook to Hook (Min)	Capacity	Lift	Hook to Hook (Min)
1155B	1000 lbs	23'	20"	---	---	---
115DB	1000 lbs	23'	20"	2000 lbs.	11.5'	27"
434WNB	1500 lbs	22'	20"	3000 lbs.	11'	27"

## RA Model Dual Ratchet and Pawl Design Hoist

- 360° swivel hooks are equipped with safety latches for positive load engagement
- Double-interlocking pawl mechanism assures one pawl is engaged with the ratchet during lifting or lowering operations
- Meets or exceeds minimum 4:1 design factor and all requirements of ASME/ANSI Standard B-30.21

Part #	Capacity	Hook to Hook (Min)	Handle Pull at Rated Load	Handle Length	Lift
RA15	1500 lbs	12.4375"	59 lbs	20.5"	60"
RA20	2000 lbs	12.4375"	79 lbs	20.5"	60"
RA30	3000 lbs	13.75"	82 lbs	20.5"	60"
RA40	4000 lbs	13.75"	110 lbs	20.5"	60"



## Model 250 Lineman's Strap Hoists



- 250A features standard hooks with safety latches, 250DA features hot stick ring hooks with safety latches, 250CA features standard hooks with heavy duty swivel gate latches, and 250DHA features hot stick ring hooks with hot stick ring safety latches
- Unsurpassed in load spotting due to a friction brake design and fine tooth pawl
- Safety gate latches have been added; designed with a 4:1 safety factor

Part #	Capacity	Lift	Hook to Hook	Capacity	Lift	Min. Headroom
250A	1000 lbs.	9'	21"	2000 lbs.	4.25'	25"
250DA	1000 lbs.	9.25'	18"	2000 lbs.	4.25'	25"
250CA	1000 lbs.	9'	21"	2000 lbs.	4.25'	25"
250DHA	1000 lbs.	9.25'	18"	2000 lbs.	4.25'	25"

## Model 300 Lineman's Strap Hoists



- Features fiberglass handle, polyester webbing, and 360° swivel hooks equipped with safety latches
- Double-locking pawl mechanism assures one pawl is engaged at all times
- Stainless steel springs and shafts are corrosion-resistant and the hoist itself is durable and portable
- Insulated fiberglass handle with overload protection and polyester webbing adds non-conductivity
- 300A features standard hooks with safety latches, 300DA features hot stick ring hooks with safety latches, 300CA features standard hooks with heavy-duty swivel gate latches, and 300DHA features hot stick ring hooks with hot stick ring safety latches on all hooks, control surfaces and quick disconnect shaft

Part #	Single Line			Double Line			Web Strap Length
	Capacity	Lift	Min. Headroom	Capacity	Lift	Min. Headroom	
300A	1500 lbs.	9'	21"	3000 lbs.	4.25'	25"	10'
300DA	1500 lbs.	9.25'	18"	3000 lbs.	4.25'	25"	10'
300CA	1500 lbs.	9'	21"	3000 lbs.	4.25'	25"	10'
300DHA*	1500 lbs.	9.25'	18"	3000 lbs.	4.25'	25"	10'

\*Includes Hot Stick Rings on All Hooks, Control Surfaces and Quick disconnect Shaft

## Model 322 Lineman's Strap Hoists



- Insulated fiberglass handle with overload protection and polyester webbing adds non-conductivity
- 322B features standard hooks with safety latches, 322DB features hot stick ring hooks with safety latches on all hooks and control surfaces and quick disconnect shaft, 322CB features standard hooks with heavy duty swivel gate latches
- 322DHB features hot stick ring hooks with hot stick ring safety latches on all hooks, control surfaces, and quick disconnect shaft

Part #	Single Line			Double Line		
	Capacity	Lift	Min. Headroom	Capacity	Lift	Hook to Hook (Min)
322B	1500 lbs.	14'	20"	3000 lbs.	7'	23"
322DB*	1500 lbs.	14'	20"	3000 lbs.	7'	23"
322CB	1500 lbs.	14'	23"	3000 lbs.	7'	27"
322DHB*	1500 lbs.	14'	22"	3000 lbs.	7'	26"

\*Meets or exceeds minimum 4:1 design design factor and all requirements of ASME/ANSI Standard B-30.21

# Lug-All

## Web Strap Pullers

- With LUG-ALL's new convertible web strap pullers, all the parts needed to switch from a double line to single line are on the hoist, lessening the possibility of misplacing or losing parts.
- Lighter weight and more headroom on medium frame convertible models



1.5 Ton Small Frame Convertible



1.5 Ton Medium Frame w/ Convertible Kit



2 Ton Medium Frame w/ Convertible Kit



### 5 Hook Styles

- A - Standard Latch Hooks
- B - Hot Stick Rings & Latching Hooks
- U - Gate Type Hooks
- UB - Gate Type Hooks & Hot Stick Rings
- HB - Hot Stick Rings & Hook Latches

- All models equipped with quick release pulley block
- LUG-ALL grups, straps and hooks are colour-coded by capacity

Part #	Capacity (Ton)	Single Pull Distance		Capacity (Ton)	Double Pull Distance		Strap Length	Handle Length	Net Weight
		Min.	Max.		Min.	Max.			
2-CA	3/4	20"	7'2"	1.5	18"	3'6"	8'	30"	9.5
2-CB	3/4	20"	7'2"	1.5	18"	3'6"	8'	32"	9.75
2-CU	3/4	22"	7'2"	1.5	20"	3'5"	8'	30"	10
2-CUB	3/4	22"	7'2"	1.5	20"	3'5"	8'	32"	10.25
2-CHB	3/4	22"	7'2"	1.5	20"	3'5"	8'	32"	10.25
2-CA-1000	3/4	20"	7'2"	1.5	18"	3'6"	8'	20"	9.25
2-CB-1000	3/4	20"	7'2"	1.5	18"	3'6"	8'	22"	9.5
2-CU-1000	3/4	22"	7'2"	1.5	20"	3'5"	8'	20"	9.75
2-CUB-1000	3/4	22"	7'2"	1.5	20"	3'5"	8'	22"	10
2-CHB-1000	3/4	22"	7'2"	1.5	20"	3'5"	8'	22"	10
3-CA	3/4	21"	11'1"	1.5	21"	5'4"	11'5"	30"	13.25
3-CB	3/4	21"	11'1"	1.5	21"	5'4"	11'5"	32"	13.5
3-CU	3/4	23"	11'1"	1.5	23"	5'3"	11'5"	30"	13.75
3-CUB	3/4	23"	11'1"	1.5	23"	5'3"	11'5"	32"	14
3-CHB	3/4	23"	11'1"	1.5	23"	5'3"	11'5"	32"	14
4-CA	1	21"	9'2"	2	21"	4'5"	10'	36"	14.5
4-CB	1	21"	9'2"	2	21"	4'5"	10'	38"	14.75
4-CU	1	23"	9'2"	2	23"	4'4"	10'	36"	15
4-CUB	1	23"	9'2"	2	23"	4'4"	10'	38"	15
4-CHB	1	23"	9'2"	2	23"	4'4"	10'	38"	15

## Standard Web Strap Pullers

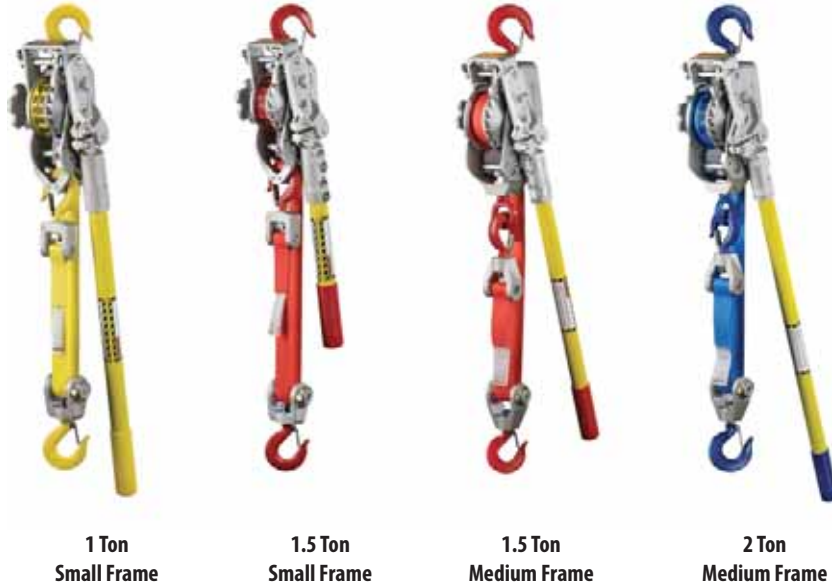

### 5 Hook Styles

- A - Standard Latching Hooks
- B - Hot Stick Rings & Latching Hooks
- U - Gate Type Hooks
- UB - Gate Type Hooks & Hot Stick Rings
- HB - Hot Stick Rings & Hook Latches

- All models equipped with quick release pulley block
- LUG-ALL grups, straps and hooks are colour-coded by capacity

Part #	Capacity (Ton)	Single Pull Distance		Capacity (Ton)	Double Pull Distance		Strap Length	Handle Length	Net Weight
		Min.	Max.		Min.	Max.			
2-A	0.5	16"	9'6"	1	21"	4'5"	10'	30"	10.25
2-B	0.5	16"	9'6"	1	21"	4'5"	10'	32"	10.5
2-U	0.5	18"	9'6"	1	24"	4'4"	10'	30"	10.75
2-UB	0.5	18"	9'6"	1	24"	4'4"	10'	32"	11
2-HB	0.5	18"	9'6"	1	24"	4'4"	10'	32"	11
25-A	0.75	16"	7'6"	1.5	21"	3'5"	8'	20"	10
25-B	0.75	16"	7'6"	1.5	21"	3'5"	8'	22"	10.5
25-U	0.75	18"	7'6"	1.5	24"	3'4"	8'	20"	10.5
25-UB	0.75	18"	7'6"	1.5	24"	3'4"	8'	22"	10.75
25-HB	0.75	18"	7'6"	1.5	24"	3'4"	8'	22"	11
3-A	0.75	19"	11'3"	1.5	27"	5'1"	11'5"	30"	14
3-B	0.75	19"	11'3"	1.5	27"	5'1"	11'5"	32"	14.5
3-U	0.75	21"	11'3"	1.5	30"	5'0"	11'5"	30"	15
3-UB	0.75	21"	11'3"	1.5	30"	5'0"	11'5"	32"	15
3-HB	0.75	20"	11'3"	1.5	29"	5'0"	11'5"	32"	15.25
4-A	1	19"	9'4"	2	27"	4'1"	10'	36"	15.5
4-B	1	19"	9'4"	2	27"	4'1"	10'	38"	16
4-U	1	21"	9'4"	2	31"	4'	10'	36"	16
4-UB	1	21"	9'4"	2	31"	4'	10'	38"	16.5
4-HB	1	20"	9'4"	2	29"	4'	10'	38"	16.25

## CM Bandit Ratchet Lever Hoist



- Capacities of 3/4 and 1-1/2 tons. Metric Rated. Standard lifts up to 20 feet
- Rugged, yet lightweight, design and construction allow for easy transport
- CM SmartID RFID option available on request
- Easy free chaining feature allows for quick take up and positioning of slack chain. Designed not to accidentally free chain while under load
- Available with load limiter option
- Enclosed Weston type load brake stays clean and dry for positive load positioning
- Upper and lower hooks feature extra wide throat openings to allow for easier attachment to pick points
- Lifetime Warranty
- Meets ASME B30.21

Part #	Capacity	Lift
BAN07505R	3/4 Ton	5'
BAN07510R	3/4 Ton	10'
BAN07515R	3/4 Ton	15'
BAN15005R	1 1/2 Ton	5'
BAN15010R	1 1/2 Ton	10'
BAN15015R	1 1/2 Ton	15'

## Screw Pin Midland Carbon Anchor Shackle



- Screw Pin Anchor Shackles allow quick and easy removal of the screw pin and can be useful in applications where the shackle is frequently removed, but not so much in applications where the pin is subject to torque or twisting
- Meet requirements of Federal Specification RR-C-271D Amendment 1
- All shackle pins are forged from alloy steel, heat treated and tempered to give greater strength
- Available in painted, galvanized and self-coloured finishes (Dacromate coating upon special request only)
- All shackles are marked with size (inches and millimeters) and working load limit in tons
- Ultimate strength equals 5 times working load limit
- All bolt, nut and cotter shackles have thread protected ends
- Galvanized per ASTM A153
- Standard industry tolerances apply
- Design factor 5:1
- Pin Type: Screw
- Industrial/Government Rated

CM	Capacity
MC649	1.5 Ton
MC650	2 Ton
MC651	3.25 Ton
MC652	4.75 Ton
MC654	8.5 Ton

## Alloy Web Sling Shackle



- Designed for use with web slings up to 6" in width and available in capacities up to 12 tons
- Web Sling Shackles can be used on web slings from 3 to 6 inches in width
- Utilize a bolt and nut with linch style pin to secure the assembly in place
- Galvanized for longer life
- Marked with working load limit (WLL) and size
- Pin Type: Bolt, Nut and Cotter

CM	Size	Capacity
M703A	.75"	13,500 lbs
M704A	.75"	14,500 lbs
M705A	1"	19,000 lbs
M706A	1 1/8"	22,500 lbs

## Carbon Web Sling Shackle



- Designed for use with web slings up to 6" in width and available in capacities up to 12 tons
- Finish: hot dip galvanized
- Klik pin (zinc plated) as shown
- Furnished as standard-cotter or hair pin can be furnished on special order
- Shackle body: carbon steel, heat treated
- Shackle pin: alloy steel, heat treated
- Tolerances: 11/32" unless otherwise indicated
- Design ultimate strength equals 4 times the working load limit

CM	Size	Size	Capacity
M702	5/8"	2"	8050 lbs
M703	3/4"	3"	13,050 lbs
M704	3/4"	4"	10,800 lbs
M705	7/8"	5"	18,000 lbs
M706	1"	6"	18,000 lbs

## Lewis Ring and Conduit Riser Grips

- Specially designed to suspend conductor by using the conduit as a means of support
- With the conductor approximately 1/2" above the "in-place" position, the grip is slipped into position and sits on the conduit edge, thus completing the installation
- The ring and its components are constructed of investment cast, powder coated bronze
- The plastic coated aircraft strand cable - plus the flexibility of design - permits a maximum of line surge without conductor damage
- Ring size permits conduit couplings to be used
- Patent Numbers 3,216,682 and 3,399,853



Conduit Size	Grip Size					
	.75" 0.75' - 1.125"	1.12" 1.125" - 1.625"	1.62" 1.625" - 2.5"	2.5" 2.5" - 3.5"	3.5" 3.5" - 4.5"	4.5" 4.5" - 5.5"
1.25"	LR 1.25 - .75 1000 lbs					
1.5"	LR 1.5 - .75 1000 lbs					
2"	LR 2 - .75 1000 lbs	LR 2 - 1.12 1250 lbs				
2.5"	LR 2.5 - .75 1000 lbs	LR 2.5 - 1.12 1250 lbs	LR 2.5 - 1.62 2250 lbs			
3"	LR 3 - .75 1000 lbs	LR 3 - 1.12 1250 lbs	LR 3 - 1.62 2250 lbs			
3.5"	LR 3.5 - .75 1000 lbs	LR 3.5 - 1.12 1250 lbs	LR 3.5 - 1.62 2250 lbs	LR 3.5 - 2.5 3000 lbs		
4"	LR 4 - .75 1000 lbs	LR 4 - 1.12 1250 lbs	LR 4 - 1.62 2250 lbs	LR 4 - 2.5 3000 lbs		
4.5"	LR 4.5 - .75 1000 lbs	LR 4.5 - 1.12 1250 lbs	LR 4.5 - 1.62 2250 lbs	LR 4.5 - 2.5 3000 lbs		
5"	LR 5 - .75 1000 lbs	LR 5 - 1.12 1250 lbs	LR 5 - 1.62 2250 lbs	LR 5 - 2.5 3000 lbs	LR 5 - 3.5 4500 lbs	
6"	LR 6 - .75 1000 lbs	LR 6 - 1.12 1250 lbs	LR 6 - 1.62 2250 lbs	LR 6 - 2.5 3000 lbs	LR 6 - 3.5 4500 lbs	LR 6 - 4.5 6000 lbs



## Multi-Purpose X-Series Pulling Grips

Voltage Class	Part #	Conductor Size AWG/ KCMIL	Rating	Name	Nominal O.D. (in.)	Grip Range (in.)	Working load (lbs)
Primary	XS-A-DW-24	#2	15kV (175 mil insul.)	N/A	1	.75-1.25	2000
Primary	XS-A-DW-24	#2	15kV (220 mil insul.)	N/A	1.09	.75-1.25	2000
Primary	XS-A-DW-24	1/0	15kV (175 mil insul.)	N/A	1.07	.75-1.25	2000
Primary	XS-A-DW-24	1/0	15kV (220 mil insul.)	N/A	1.17	.75-1.25	2000
Primary	XS-B-TW-26	1/0	25kV (260 mil insul.)	N/A	1.25	1.25-2	2500
Primary	XS-B-DW-26	1/0	35kV (345 mil insul.)	N/A	1.45	1.25-2	2500
Primary	XS-A-DW-24	2/0	15kV (175 mil insul.)	N/A	1.15	.75-1.25	2000
Primary	XS-A-DW-24	2/0	15kV (220 mil insul.)	N/A	1.24	.75-1.25	2000
Primary	XS-B-TW-26	2/0	25kV (260 mil insul.)	N/A	1.33	1.25-2	2500
Primary	XS-B-TW-26	2/0	35kV (345 mil insul.)	N/A	1.52	1.25-2	2500
Primary	XS-A-DW-24	4/0	15kV (175 mil insul.)	N/A	1.23	.75-1.25	2000
Primary	XS-B-TW-26	4/0	15kV (220 mil insul.)	N/A	1.32	1.25-2	2500
Primary	XS-B-TW-26	4/0	25kV (260 mil insul.)	N/A	1.43	1.25-2	2500
Primary	XS-B-TW-26	4/0	35kV (345 mil insul.)	N/A	1.6	1.25-2	2500
Primary	XS-B-TW-26	500	15kV (175 mil insul.)	N/A	1.57	1.25-2	2500
Primary	XS-B-TW-26	500	15kV (220 mil insul.)	N/A	1.73	1.25-2	2500
Primary	XS-B-TW-26	500	25kV (260 mil insul.)	N/A	1.81	1.25-2	2500
Primary	XS-C-TW-32	500	35kV (345 mil insul.)	N/A	2.02	2-2.75	3500
Primary	XS-B-TW-26	750	15kV (175 mil insul.)	N/A	1.87	1.25-2	2500
Primary	XS-B-TW-26	750	15kV (220 mil insul.)	N/A	1.96	1.25-2	2500
Primary	XS-C-TW-32	750	25kV (260 mil insul.)	N/A	2.08	2-2.75	3500
Primary	XS-C-TW-32	750	35kV (345 mil insul.)	N/A	2.25	2-2.75	3500
Primary	XS-C-TW-32	1000	15kV (175 mil insul.)	N/A	2.06	2-2.75	3500
Primary	XS-C-TW-32	1000	15kV (220 mil insul.)	N/A	2.15	2-2.75	3500
Primary	XS-C-TW-32	1000	25kV (260 mil insul.)	N/A	2.23	2-2.75	3500
Primary	XS-C-TW-32	1000	35kV (345 mil insul.)	N/A	2.4	2-2.75	3500
Secondary	XS-A-DW-24	#2 (#4 neutral)	600V (60 mil insul.)	Stephens	.84	.75-1.25	2000
Secondary	XS-A-DW-24	#2	600V (60 mil insul.)	Ramapo	.88	.75-1.25	2000
Secondary	XS-A-DW-24	1/0 (#2 neutral)	600V (60 mil insul.)	Brenau	1.06	.75-1.25	2000
Secondary	XS-A-DW-24	1/0	600V (80 mil insul.)	Bergen	1.14	.75-1.25	2000
Secondary	XS-A-DW-24	1/0	600V (80 mil insul.)	Hunter	1.23	.75-1.25	2000
Secondary	XS-B-TW-26	4/0 (2/0 neutral)	600V (80 mil insul.)	Sweetbriar	1.38	1.25-2	2500
Secondary	XS-B-TW-26	4/0	600V (80 mil insul.)	Monmouth	1.46	1.25-2	2500
Secondary	XS-B-TW-26	350 (4/0 neutral)	600V (80 mil insul.)	Wesleyan	1.72	1.25-2	2500
Secondary	XS-C-TW-32	500 (350 neutral)	600V (95 mil insul.)	Rider	2.03	2-2.75	3500

- May be used for overhead or underground applications
- Feature coated galvanized cable, reverse weave, and a single bail wire, but will not have metal shoulders
- Identified by tags beneath the heavy duty clear tubing





## JL-R Series Grips

- The JL-R Series Grips are designed to be used in secondary light duty cable pulls
- The neoprene cone at the front of the grip helps the grip and cable go around the bends easily and smoothly
- If installed properly, the cone can also help eliminate possible cable lubricant migration by sealing off the cable during a pull



Part #	Range	Work Load
50-2014	1/4" - 1/2"	600 lbs
50-2015	1/2" - 3/4"	1250 lbs
50-2011	3/4" - 1"	1400 lbs
50-2012	1" - 1 1/2"	2250 lbs

## X-Series Grips

- Plastic-coating increases the life of the grip, provides a more effective gripping surface, and helps reduce injuries due to frayed or mangled wire in the pulling grip itself
- The single wire eye allows a swivel to be attached to the grip easily and helps to alleviate any binding that may occur in the throat of the swivel during a pull
- Also offers a backwards weave that (1) adds pulling surface to the grip itself, and (2) allows the grip to pass through even the tightest of clearances
- Feature metal sleeves near the top of the grip to eliminate wear when pulling through clay conduit, gravel, or other abrasive pulling environments
- Constructed of galvanized wire



Part #	Range	Work Load
50-1895	3/4" - 1 1/4"	2000 lbs
50-1904	1 1/4" - 2"	2500 lbs
50-1910	2" - 2 3/4"	4500 lbs
50-1912	2 3/4" - 3 1/2"	5500 lbs
50-1915	3 1/2" - 4 1/4"	6500 lbs
50-1917	4 1/4" - 4 7/8"	7000 lbs

## Pulling Collars

- Use the pulling collar's staggering feature to eliminate conduit stress while pulling multiple cables and grips together
- These pulling collars allow you to attach various sized single grips together
- The grips are attached to each collar head with a swing link or swivel



Part #	# of Legs	Break Load
70-1006	3	5500 lbs
70-1007	4	5500 lbs
70-1010	3	8200 lbs
70-1011	4	8200 lbs
70-1014	3	9800 lbs
70-1015	4	9800 lbs

## Swing Link

- Drop forged steel swing links are fabricated from the same high quality steel as Lewis swivels
- Used for adapting swivels to grips and/or winch lines



Part #	Range
5118	5/16"
5119	7/16"
5120	9/16"

# Lewis Manufacturing

## Pulling Grip Selection Guide for Overhead Cable

Voltage Class	Part #	Conductor Size AWG/KCMIL	Stranding	Name	Nominal O.D. (in.)	Grip Range (in.)	Working load (lbs)
Primary	OH-DW-1/4"-1/2"	#2	ACSR (6/1)	Sparrow	.316	.25-.5	1500
Primary	OH-DW-1/4"-1/2"	#2	AAC (7)	Iris	.292	.25-.5	1200
Primary	OH-DW-1/4"-1/2"	1/0	ACSR (6/1)	Raven	.398	.25-.5	1200
Primary	OH-DW-1/4"-1/2"	1/0	AAC (7)	Poppy	.368	.25-.5	1200
Primary	OH-DW-1/4"-1/2"	2/0	ACSR (6/1)	Quail	.447	.25-.5	1200
Primary	OH-DW-1/4"-1/2"	2/0	AAC (7)	Aster	.414	.25-.5	1200
Primary	OH-TW-1/2"-7/8"	4/0	ACSR (6/1)	Penguin	.563	.5-.875	3200
Primary	OH-TW-1/2"-7/8"	4/0	AAC (7)	Oxlip	.522	.5-.875	3200
Primary	OH-TW-1/2"-7/8"	266.8	ACSR (18/1)	Waxwing	.609	.5-.875	3200
Primary	OH-TW-1/2"-7/8"	266.8	ACSR (26/7)	Partridge	.642	.5-.875	3200
Primary	OH-TW-1/2"-7/8"	336.4	ACSR (26/7)	Linnet	.721	.5-.875	3200
Primary	OH-TW-1/2"-7/8"	336.4	ACSR (30/7)	Oriole	.741	.5-.875	3200
Primary	OH-TW-1/2"-7/8"	397.5	ACSR (26/7)	Ibis	.783	.5-.875	3200
Primary	OH-TW-7/8"-1 1/4"	477	ACSR (18/1)	Pelican	.814	.875-1.25	4100
Primary	OH-TW-7/8"-1 1/4"	477	ACSR (26/7)	Hawk	.858	.875-1.25	4100
Primary	OH-TW-7/8"-1 1/4"	556.5	ACSR (18/1)	Osprey	.879	.875-1.25	4100
Primary	OH-TW-7/8"-1 1/4"	556.5	ACSR (26/7)	Dove	.927	.875-1.25	4100
Primary	OH-TW-7/8"-1 1/4"	605	ACSR (26/7)	Squab	.966	.875-1.25	4100
Primary	OH-TW-7/8"-1 1/4"	636	ACSR (26/7)	Grosbeak	.990	.875-1.25	4100
Primary	OH-TW-7/8"-1 1/4"	636	ACSR (30/19)	Egret	1.019	.875-1.25	4100
Primary	OH-TW-7/8"-1 1/4"	666	ACSR (26/7)	Gannet	1.014	.875-1.25	4100
Primary	OH-TW-7/8"-1 1/4"	715	ACSR (26/7)	Starling	1.051	.875-1.25	4100
Primary	OH-TW-7/8"-1 1/4"	795	ACSR (26/7)	Drake	1.108	.875-1.25	4100
Primary	OH-TW-7/8"-1 1/4"	795	ACSR (30/19)	Mallard	1.14	.875-1.25	4100
Primary	X-HDFE-7/8"-1 3/8"	954	ACSR (45/7)	Rail	1.165	.875-1.375	5700
Primary	X-HDFE-7/8"-1 3/8"	954	ACSR (54/7)	Cardinal	1.196	.875-1.375	5700
Secondary	XS-A-SW-24	#2 (#4 neutral)	600V (45 mil insul.)	Cockle	.760	.75-1.25	2000
Secondary	XS-A-SW-24	#2	600V (45 mil insul.)	Conch	.770	.75-1.25	2000
Secondary	XS-A-SW-24	1/0 (#2 neutral)	600V (60 mil insul.)	Janthina	.970	.75-1.25	2000
Secondary	XS-A-SW-24	1/0	600V (60 mil insul.)	Neritina	.980	.75-1.25	2000
Secondary	XS-A-SW-24	2/0	600V (60 mil insul.)	Runica	1.08	.75-1.25	2000
Secondary	XS-A-SW-24	3/0 (1/0 neutral)	600V (60 mil insul.)	Sanddollar	1.16	.75-1.25	2000
Secondary	XS-A-SW-24	3/0	600V (60 mil insul.)	Cherrystone	1.19	.75-1.25	2000
Secondary	XS-B-TW-26	4/0 (2/0 neutral)	600V (60 mil insul.)	Cuttlefish	1.27	1.25-2.0	2500
Secondary	XS-B-TW-26	4/0	600V (60 mil insul.)	Razor	1.31	1.25-2.0	2500



RIGGING

Itlutilitysupply.com



## Sealed Thrust Ball Bearing Swivel



- These directional boring swivels prevent equipment's rotational torque from interfering with the product being pulled
- In a typical boring application, the swivel is attached behind the reamer head and to the pipe or cable being pulled through the bore
- Permanently sealed to keep contaminants out, they never require lubrication

Part #	Work Load
40-1003	1500 lbs
40-1001	5400 lbs
40-1005	9000 lbs
40-1007	12,000 lbs

## LKJ-1: Knuckle Joint-1



Knuckle Joint



Knuckle Joint installed on a swivel and "Duckbill" directional boring bit

- Provides a way to adapt a pulling swivel (or any other device) to the popular "Duckbill" style directional bits
- Prevents premature wear and tear on both the swivel and bit
- The knuckle joint allows the swivel to be pulled back in a straight line
- Quickly attaches and detaches with one Allen head bolt

## Heavy Duty Ball Bearing Swivels



- Specifically designed for tension stringing; manufactured from high-grade pre-stressed steel
- Swivels assure that the conductor will remain in the neutral position during stringing of transmission and distribution lines
- Twin race ball bearing swivels; pins are removable with a screwdriver
- Proper placement of thrust and radial bearing allow thrust and shock loads to be absorbed without affecting rotation of swivel

Part #	Overall Length	Pin Diameter	Jaw Opening	Overall Diameter	Working Load	Approx. Breaking Strength
HD-00	4 1/8"	5/16"	3/8"	7/8"	1500 lbs	4500 lbs
HD-0	5 1/4"	7/16"	1/2"	1 1/8"	5400 lbs	16200 lbs
HD-1	6"	1/2"	5/8"	1 7/16"	9000 lbs	27000 lbs
HD-2	7 1/8"	5/8"	5/8"	1 5/8"	12000 lbs	36000 lbs
HD-3	8 5/8"	3/4"	3/4"	2"	21000 lbs	63000 lbs
HD-4	10"	7/8"	7/8"	2 3/8"	30000 lbs	90000 lbs

# Lewis Manufacturing

## Sealed Thrust Ball Bearing Swivels with Grease Zerk



- Designed for directional boring
- For overhead and underground applications that require a greasable swivel
- Swivel must be greased before and after each use



Part #	Overall Length	Pin Diameter	Jaw Opening	Overall Diameter	Working Load	Approx. Breaking Strength
HD-0-S-Z	5 1/16"	7/16"	1/2"	1 1/8"	5400 lbs	16,200 lbs
HD-1-S-Z	6 5/8"	1/2"	5/8"	1 7/16"	9000 lbs	27,000 lbs
HD-2-S-Z	7 3/4"	5/8"	5/8"	1 5/8"	12,000 lbs	36,000 lbs
HD-3-S-Z	9"	3/4"	3/4"	2"	21,000 lbs	63,000 lbs
HD-4-S-Z	10 1/4"	7/8"	7/8"	2 3/8"	30,000 lbs	90,000 lbs

## Ouchless Lewis Grips™



- Made of plastic coated Aramid Fiber strands
- Traditionally used in overhead or underground operations when pulling or suspending electric or fiber optic cables
- Grips do not have the metallic fraying as traditional grips do, thereby eliminating the chance of being injured from metallic strands that have been branded
- May also be used when metallic grip is unsuitable, such as when pulling in an energized environment
- Non-conductive, lighter, yet stronger than metal grips, easier to load and remove, no wire frays, no wire cuts and contusions

Single Eye



Double Eye



Model #	Size	Work Load	Breaking Strength	Weave	Eye
SE-LK-SW-1/4-3/4	1/4"-3/4"	830 lbs	2500 lbs	Single	Single
SE-LK-SW-3/4-1	3/4"-1"	1200 lbs	3600 lbs	Single	Single
SE-LK-SW-1-1 1/2	1"-1 1/2"	1665 lbs	5000 lbs	Single	Single
SE-LK-SW-1 1/2-2	1 1/2"-2"	1940 lbs	5825 lbs	Single	Single
SE-LK-DW-1-1 1/2	1"-1 1/2"	3300 lbs	9900 lbs	Double	Single
SE-LK-DW-1 1/2-2	1 1/2"-2"	3965 lbs	11,900 lbs	Double	Single
SE-LK-DW-2-2 1/2	2"-2 1/2"	5300 lbs	15,900 lbs	Double	Single
SE-LK-DW-2 1/2-3	2 1/2"-3"	5300 lbs	15,900 lbs	Double	Single
SE-LK-DW-3-4	3"-4"	5300 lbs	15,900 lbs	Double	Single

Model #	Size	Work Load	Breaking Strength	Weave	Eye
DLE-LK-SW-1/4-3/4	1/4"-3/4"	830 lbs	2500 lbs	Single	Double
DLE-LK-SW-3/4-1	3/4"-1"	1200 lbs	3600 lbs	Single	Double
DLE-LK-SW-1-1 1/2	1"-1 1/2"	1665 lbs	5000 lbs	Single	Double
DLE-LK-SW-1 1/2-2	1 1/2"-2"	1940 lbs	5825 lbs	Single	Double
DLE-LK-DW-1-1 1/2	1"-1 1/2"	3300 lbs	9900 lbs	Double	Double
DLE-LK-DW-1 1/2-2	1 1/2"-2"	3965 lbs	11,900 lbs	Double	Double
DLE-LK-DW-2-2 1/2	2"-2 1/2"	5300 lbs	15,900 lbs	Double	Double
DLE-LK-DW-2 1/2-3	2 1/2"-3"	5300 lbs	15,900 lbs	Double	Double
DLE-LK-DW-3-4	3"-4"	5300 lbs	15,900 lbs	Double	Double

# Chain Slings & Lifting Accessories

## Steel Choker with Loops on Both Ends

- Eye and eye wire rope sling
- Wire rope construction is 6 x 19, IWRC, Right Regular Lay (industry standard)

- 1/2" x 4'
- 1/2" x 6'
- 1/2" x 8'
- 3/8" x 4'
- 3/8" x 6'
- 3/8" x 8'



## 3/8" Pole Sling with Slide Hook

- Will not kink like cable or fray like rope
- Slides down pole easily
- Fittings are grade 8 alloy
- 4 - 1 design factor
- 5' long



## 2 Ply Nylon Slings

- Capacities: Vertical is 6400 lbs; Basket hitch - 12,800 lbs.; Choker - 5000 lbs
- Capacities are determined according to ANSI standard B30.9, Section 9-5.2
- Industry standard twisted eye and eye nylon web sling

- 2" x 4' Nylon Sling
- 2" x 6' Nylon Sling
- 2" x 8' Nylon Sling



## Utility Pole Specialized Rigging Sling

- 70" working length
- 1900 lb. rated capacity
- Designed to offer a good grip on the shaft of a tapered pole without rigging up a clamping device
- Designed by bonding patented slip-resistant polymer traction bars to a nylon sling, using a proprietary process
- When slipped around a pole and pulled taught, its polymer grippers are forced into the surface of the pole; more force produces an even tighter grip
- Saves time and manpower, because now crews can simply pick a spot anywhere above the pole's "tipping point," fasten the sling, and be ready to lift

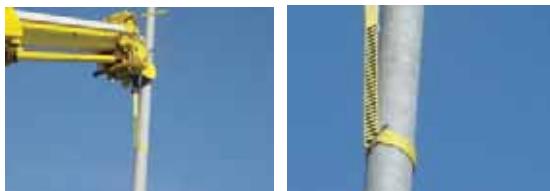

## Polyester Web Slings

- A light, versatile, flexible synthetic sling with eyes on both ends
- Wear points can continually be shifted for maximum sling life
- Vertical capacity: 3200 lbs
- Choker capacity: 2500 lbs
- Basket capacity: 6400 lbs



1" Wide x 9' Long  
1" Wide x 10' Long

## Endless Gel Round Slings

- 10' long
- Load stability and balance achieved by spreading sling legs
- Wear points may continually be shifted for maximum sling life



CAPACITIES		
Vertical	Choker	Basket
10,600 lbs	8500 lbs	21,200 lbs

## Endless Polyester Round Slings

- 6' long
- Light, versatile, flexible synthetic slings
- Wear points may continually be shifted for maximum sling life



CAPACITIES		
Vertical	Choker	Basket
2650 lbs	2120 lbs	5300 lbs
5300 lbs	4240 lbs	10,600 lbs



TRUSTED SINCE 1958

# Slings

## Salisbury Transformer Slings



Part #	Diameter	Tensile (Straight Pull)	WLL	Colour
S0190L0048	1/2"	7200 lbs	1225 lbs	Blue
S0191L0048	5/8"	12,000 lbs	2160 lbs	Red
S0194L0048	3/4"			Green

- Features eye on each end
- Adjustable from 3" to 15" to accommodate various sizes and types of transformers
- Chafe collar in middle of sling protects against abrasion and snagging
- Each end has a crown splice to prevent eye from pulling out while under load
- Standard length is 4 ft.; other lengths available
- Adjustable from 24" to 28"
- Rope is 100% high tenacity polyester, constructed in a single braid and coated with Rhino-Lote for increased abrasion resistance

## RNH 10-2: Unirope 2" Tie-Downs (Polyester Webbing)

- Complete with ratchet and end fittings
- 1/2" narrow wire hook at both ends
- Standard Length is 20 ft (2 ft Tail, 18 ft Strap)
- Rated capacity: 3300 lbs
- All tie-down systems come with a sturdy vinyl capacity tag stating safety precautions and load ratings at various tie-down angles
- Tag firmly sewn to strap (no flag)

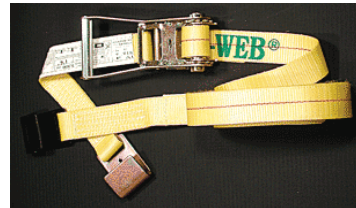

## Uni-Web® Nylon Eye & Eye Lifting Sling Type 3 (EE) Straight Eye; Type 4 (EE) Twisted Eye 1 and 2 Ply

- Slings with an eye at both ends
- Choice of straight or twisted eyes
- As standard, all eyes of 3" wide and up are tapered



Uni-Web® Nylon Eye & Eye Lifting Sling Type 3 - 2" Width  
 EE1-901-N-3: 1" Width  
 EE1-902-N-3: 2" Width



Uni-Web® Nylon Lifting Sling Type 5 - 2" Width  
 EN1-901-N: 1" Width  
 EN-902-N: 2" Width



## Unirope Transformer Sling

- This sling is used to lift transformer into place
- The elastic strap prevents the sling eyes from falling out of the lifting points

TS2-602-N-LENGTH  
 Available in 18-36" Length

## A-338: Grade 80 Alloy Fittings

- Alloy Steel – Quenched and Tempered
- Individually proof-tested at 2-1/2 times the working load limit with certification
- Pin locking requires no special tools
- The use of A-338 Clevis Grab Hook will result in a 20 percent reduction in chain capacity. When used to hook back to chain leg to form a choker, the angle of the choker must be 120° or greater. When used as a chain shortener, minimize twist of chain and ensure chain is fully engaged in hook



## A-1338: Crosby® Grade 100 Clevis Grab Hooks

- Forged Alloy Steel - Quenched and Tempered
- Innovative cradle design allows for 100% efficiency of Grade 100 chain
- Individually proof tested to 2-1/2 times the working load limit with certification
- Each hook has a Product Identification Code (PIC) for material traceability, along with the size and the name Crosby & USA in raised letters
- Suitable for use with Grade 100 and Grade 80 chain slings (per ANSI B30.1)
- The use of A-1338 Cradle Grab Hook will allow 100 percent of the chain sling capacity. When used to hook back to chain leg to form a choker, the angle of the choke must be 120° or greater
- When used as a chain shortener, minimize twist of chain and ensure chain is fully engaged in hook
- Fatigue rated at 1-1/2 times the working load limit at 20,000 cycles



## A-342: Alloy Master Links

- Alloy forged master link is 100% proof tested
- Drop forged using special bar quality alloy steel
- Quenched and tempered heat treatment for improved strength



## L-140: Lebus® Load Binders

- Upgraded for use with Grades 70, 80 and 100 Chain
- Utilizes standard Crosby A-323 Alloy Eye Grab Hooks
- New design “one piece” forged handle
- Continuous take-up feature provides finite adjustment to tie down load
- One piece assembly, no bolts or nuts to loosen
- Ratchet spring is rust proofed
- All load bearing or holding parts forged
- Easy operating positive ratchet



## L-150: Lebus® Load Binders

- Extra heavy construction at leverage point to prevent spreading
- Heel of binder toggles away from load, permitting easy release
- Ball and socket swivel joints at hook assemblies permit a straight line pull



## Spectrum 7® Drum Transport Chain

- High Tensile Carbon Steel
- Minimum Ultimate load is 4 times the working load limit
- Proof tested at 2 times the working load limit with certification
- Permanently embossed with CG® (Crosby Group) and 7 (Grade)
- Finish - yellow dichromate
- Standard container - fiber drum



## Stihl MS201 Chain Saw - 16" Bar



- Comes equipped with a low kickback 3/8" saw chain
- Patented captive bar nut on the chain sprocket cover
- Stainless steel muffler, diecast magnesium engine casing and a digital ignition system that ensures a smooth start every time
- Designed with a stratified charge engine to reduce fuel consumption and emissions
- Displacement (cc): 35.2
- Power output (kW/bhp): 1.8/2.4
- Weight: 8.2 lbs

## Stihl MS261 Chain Saw



- Features STIHL's electronic engine management system for optimum engine power at all times
- Cuts fuel consumption by 20% and exhaust emissions by 50% compared to its predecessor
- New long-life air filtration system, patented captive nuts on the sprocket cover and side-access chain tensioner
- Includes anti-vibration technology and a stainless steel muffler in a durable magnesium crank case
- Displacement (cc): 50.2
- Power output (kW/bhp): 2.9/3.9
- Weight: 11.5 lbs
- Featured price bar: 16"

## Stihl BT45 Wood Boring Drill

- Dependable, powerful and lightweight engine
- Anti-vibration system for comfortable use
- Two-speed gearbox, with a neutral position as well as a reverse gear
- Displacement 27.2 cc, power output: 0.8 kW
- Weight: 10.6 lbs



## Stihl Pole Pruner

Telescoping Pole Pruner:

- Ideal for hard-to-reach places
- Features a side mount chain
- Extendable shaft adjusts from tensioner 8' 8" to 12' 8", reaching branches up to 16' off the ground
- Powered by a proven low-emissions engine
- Automatic side bar and chain oiler
- Displacement: 31.4 cc
- Power output: 1.05 kW
- Weight: 16.8 lbs



HT 101 Telescoping



# STIHL - Chainsaw Accessories

## Oil & Lubricants

- STIHL chainsaws are made to deliver the kind of performance that professionals need
- STIHL bar and chain oil is made specifically for your STIHL chainsaw, keeping it protected and running smooth
- Without the proper lubricant, the average amount of use that a guide bar, saw chain and sprocket should be able to provide would certainly be shortened
- STIHL lubricants have been formulated to allow STIHL products to break in without any special procedures, such as running a rich oil mixture or operating at specific RPM for a certain amount of time



- Bar and Chain Oil
- BioPlus™ Bar and Chain Oil
- High Performance 2-Cycle Engine Oil
- HP Ultra 2-Cycle Engine Oil
- Winter Weight Bar and Chain Oil
- No-Spill® Fuel Containers

## Guide Bars

- STIHL guide bars have induction heat-treated edges to give high wear resistance. The heat treating process hardens the rails while allowing the rest of the bar to remain flexible. This makes it less likely for the bar to have a permanent bend if it were flexed during use. Guide bars are also symmetrical. Over time, they can be flipped over to spread out the wear, increasing the service life of the bar
  - STIHL guide bars range from 10" (found on our tree-trimming pole pruners) to 59" (used in extreme felling operations). STIHL manufactures over eighty bar configurations to match the unique cutting requirements of chainsaws
  - All are laser cut from tough, wear-resistant steel and feature exclusive Ematic™ Bar Lubrication System. This technology ensures pinpoint lubrication where it's needed most: the saw chain links and guide bar rails
  - When used with STIHL OILOMATIC® saw chains, guide bars provide maximum lubrication, longer wear and up to 50% less oil consumption than conventional chain lubrication methods
  - STIHL recommends using low-kickback, green-labeled chain and green-labeled reduced-kickback bars on all powerheads
- NOTE: The actual listed guide bar length can vary from the effective cutting length depending upon which power head it is installed.*



- Stihl Duromatic® C
- Stihl Duromatic® E
- Stihl Rollomatic® E Mini Light
- Stihl Rollomatic® E Mini
- Stihl Rollomatic® E Light
- Stihl Rollomatic® E Standard
- Stihl Rollomatic® ES Light

## Saw Chains

- Choosing the right saw chain is essential for effective use of a chain saw
- STIHL supplies the optimum chains for every application, every power class and every chain saw make. All chains are characterised by rugged first-class quality



# STIHL - Chainsaw Accessories

## Cases & Bar Scabbards

- Protect your investment with a heavy-duty STIHL carrying case and scabbard
- Made of heavy-duty polymers for long-lasting protection; great for easy transport and storage
- The handy slip-on scabbards accommodate various chainsaw bar lengths
- The rugged STIHL case includes built-in tool holders for carrying to the work site with a removable scabbard for easy storage



- Bar Scabbard
- Woodsman Chainsaw Carrying Case

## Sharpening Kit

- Includes file guide, depth gauge, round file, flat file and two file handles in tool pouch
- Kits available for the following chain types: STIHL PICCO™ Mini; 1/4" pitch chain; .325" pitch chain; 3/8" pitch chain; .404" pitch chain



# Gas-Powered Saw Accessories

## Buckingham Tearaway Chainsaw Lanyard



- Features a built-in bungee, designed to give users added safety and convenience
- Constructed with a tear-away safety pack that activates when 200 lbs. of force is applied
- Lanyard measures up to 50" when fully extended and contracts to 32" when relaxed
- The saw, if dropped, will fall below the user's feet without falling to the ground
- A 1 3/4" steel ring suspends the chain saw when not in use

## Buckingham Chain Saw Scabbard

- This chain saw scabbard prevents damage to the chain and fastens using a handy strap and buckle
- For use with bar lengths from 16" to 20"
- Available in high-quality top grain leather or rubberized belting material
- 18 1/4" overall length
- 17 3/4" pocket depth

## ROPES

### Prusik Loop



- Comes in 1/2" nylon, 3 strand with a locking snap spliced into the rope for versatility and ease of operation
- Tie into a Prusik knot as a safety device on a climbing line or as an adjustment for fliplines
- 20" length

### Hastings Rope Insulator



- This dielectrically tested insulator attaches between the pruner head and rope helping to prevent the rope from conducting electricity if contacted above the insulator
- Available in 8 1/2" and 12" lengths

### Buckingham Wire Core Flipline



- Available in 1/2" Safety Blue High-Vee braided over wire
- A tight, snag-free construction and the flipline's size allow use with most ascenders/adjusters
- A unique eye termination helps alleviate pivot point stress for increased service life
- Lightweight for improved performance and easier use
- Comes with eye on one end and locking snap on the other
- 8' and 10' long

### Flipline (Beranek Lanyard)



- Available in 1/2" Braided Safety Blue High-Vee
- This rope can be used as an adjustable flipline with Prusik Loop or a mechanical adjustment device
- The length can be adjusted by simply pulling on a "tail"
- This flipline has a backsplice on one end and a locking snap on the other
- 1/2" diameter, 8' long

## Standard Chain Saws

- Ideal for large trimming applications and cut-up removal jobs
- Reduced kickback bar and chain
- Rugged gear motor and expanded chip exit area
- Super Spool™ selector control for open and closed center systems
- The handle position on these saws can be oriented to horizontal, or to 60° or 30°, relative to bar and chain according to operator preference
- Safety features on these saws include: two-step safety trigger, high impact polymer front handle/shroud
- Wide lower handle protects hands/knuckles, chain catcher stops chain rotation
- Automatic chain oiler can be adjusted without tools
- Supplied with 12" steel braided whip hoses (couplers not included)
- Chain pitch of 3/8"; cut capacities range from 16" - 24"
- Flow range of 4 - 8 gpm; operating pressure: 1000 - 2000 psi



**HCS816** 16"

**HCS820** 20"

**L088009** 9" Blade

**43973** 9" Chain Blade

## HPS513: Pistol-Grip Chain Saw

- Ideal for cutting back or trimming from an aerial basket
- Reduced kickback bar and chain
- Rugged gear motor and expanded chip exit area
- Super Spool™ selector control for open and closed center systems
- The handle position on these saws can be oriented to horizontal, or to 60° or 30° relative to bar and chain according to operator preference
- Safety features on these saws include: two-step safety trigger, high impact polymer front handle/shroud
- Wide lower handle protects hands/knuckles, chain catcher stops chain rotation
- Automatic chain oiler can be adjusted without tools
- Includes 12" steel braided whip hoses (couplers not included)
- Sprocket cover is removed without tools for easy cleaning
- Chain, bar are adjustable without removing sprocket cover
- Chain pitch of .325"; cut capacity of 13"
- Flow range of 4-8 gpm; operating pressure of 1000-2000 psi



## 82" Overhead Circular Saw

- Designed for high production utility line clearing and general tree clearing applications
- Features hand stop safety collar, trigger guard, two-step safety trigger, branch stop
- Insulated fiberglass extension tube meets OSHA 1910.269
- 82" long with angular head design
- 9" blade diameter with cut capacity of 3.5"
- 1000 - 2000 psi; 4-6 gpm flow range
- Operates on open or closed center systems

**43180** Overhead Circular Saw

**L088009** 9" Blade

**43973** 9" Chain Blade



## Long Reach Chain Saw

- Designed for use from aerial platforms or the ground
- The insulated fiberglass extension tubes are tested to meet OSHA regulation 1910.269
- Operating pressure: 1000-2000 psi
- Chain size of 0.325" pitch; cut capacity of 13"
- Safety features include a two-step trigger, a trigger guard, a fully covered sprocket guard, anti-kickback chain, and an automatic chain oiler
- Super Spool™ selector control allows chain saws to be used on both open and closed center systems
- Flow range of 5-8 gpm



**43178** 62.5" long

**38568** 75" long

**43177** 88.5" long

## 48520: 86" Utility Pruner

- The insulated fiberglass extension tubes are tested to meet OSHA regulation 1910.269
- Operating pressure: 1,000 - 2,000 psi
- Designed for utility line clearing and selective pruning of shade trees
- Heavy cut capacity cuts branches up to 2"
- Trigger guard
- Flow range of 4-6 gpm
- Heat insulated handle; full power return



## LHFS-210003: 60" Orchard/Shade Tree Pruner

- Heavy duty large capacity pruner; only 7.7 lbs
- 360° swiveling extension
- Operating pressure: 1000-2000 psi
- Cutting capacity of 1 3/4"
- Flow range of 4-6 gpm
- Open centre with an aluminum extension type
- Not to be used near high voltage lines



### QCS: U-1R Saw Head w/ Adapter

- Marvin's pole saw heads are designed and built to meet the rigid requirements of tree service professionals. U-1R saw head with adapter
- Fits all Marvin poles with a female ferrule (base and mid poles)
- An assortment of saw blades attach to the head via a bolt and wing nut



### QCU2: Marvin's U2 saw head w/ adapter



### U-1R: Saw Head Only

- Marvin's U-1R universal saw head easily mounts octagonal wood or fiberglass poles without an adapter
- Saw head is designed to accommodate an assortment of blades. Fits all Marvin saw head poles and 1 1/4" octagonal wood poles



### U2: Cast Saw Head Only

- Marvin's cast saw head. Marvin's U2 saw head easily mount octagonal wood or fiberglass poles without an adapter
- Saw head is designed to accommodate an assortment of blades



### QCSF: U-1R Saw Head w/ Fiberglass Adapter

- U-1R Saw Head w/ 10" fiberglass adapter. Fits all Marvin poles with a female ferrule (base and mid poles)



### QCPP: Pole Pick Head with Adapter

- Great utility tool used to raise rope, pull hangars and guide tree fall



### QC20HB: Snap-Cut Saw Head w/ Adapter

Saw blade included: S11



### PP1R: Pole Pick only

- Great utility tool used to raise line, pull down loose tree branches and guide tree fall. Fits any Marvin saw head pole or 1 1/4" octagonal wood poles



# Fred Marvin

## HS2: Tri-Edge Hand Saw



- With a 13 inch blade and a custom marine plywood handle
- Replacement blade: S9

## HS9: Marvin/ARS Tri-Edge Hand Saw

- With a 12 inch blade and marine plywood handle
- Replacement blade: S17



## HS10: Marvin/ARS Tri-Edge Hand Saw

- With a 12 inch raker tooth blade and marine plywood handle
- Replacement blade: S18



## HS11: Marvin F-350 Tri-Edge Hand Saw

- With a 13 inch blade and a rubber handle
- Replacement blade: S22



## HS38: Heavy Duty Tri-Edge Hand Saw

- Marvin's newest hand saw, the HS-38 features 15 inches of razor sharp, tri-edge teeth, allowing for a smooth cut every time. This heavy duty, extra-firm blade can be used on harder, tougher woods, such as palm and even some cacti
- Replacement blade: S38



## HS3: Tri-Edge Hand Saw

- With a 13 inch blade and a rubber gripped handle



## HS17: Heavy-duty, commercial-grade hand saw

- This saw boasts an extra stiff 17 inch tri-edge blade and will easily tackle 5 inch limbs
- Replacement blade: S14



## HS18: Marvin Pony Saw

- With a raker tooth and a marine plywood handle
  - It is designed to be easily used upside down when need be
- Replacement blade: S18



## HS21: Marvin 8" Folding Hand Saw with Tri-Edge Blade

- Overall 17 inch length
- Great for camping or your tool belt



## HS47: Marvin Rhino Tri-Edge Hand Saw

- With 18 inch heavy duty blade (26 inch total length) and wooden handle
- Replacement blade: S47



## S-9: Heavy Duty Tri-Edge Saw Blade

- Fanno 12.5 inch tri-edge saw blade. This blade can be used as a pole saw blade or as the replacement blade for the HS2 hand saw



## S-14: 14" Tri-Edge Heavy Duty Saw Blade

- Can be used as a pole saw, or as a replacement blade for the HS17 hand saw



## S-17: 12" Turbocut Tri-Edge Saw Blade

- Can be used as a pole saw blade or as a replacement blade for the HS9 or HS18 hand saws



## S-18: 12" Turbocut Saw Blade

- Turbocut with wood chip relief gullets. Can be used as a pole saw blade or as a replacement blade for the HS10 or HS18 hand saws



## S-22: 13" Tri-Edge Replacement Saw Blade

- Marvin F-350 13 inch tri-edge replacement saw blade for the HS11 hand saw



## S-38: 15" Tri-Edge Heavy Duty Replacement Saw Blade

- For the HS38 hand saw



## S-47-RB: 18" Tri-Edge Replacement Saw Blade

- For the HS47 handsaw



# Hastings

## 4141 & 4142: Tree Trimming Kit

- Open the tool kit bag and you have your choice of tree trimming tools in the length you need, all in a convenient heavy duty vinyl tool bag that offers long wear and maximum protection for the tools. Kits are available with round or square pole sections in four or six foot lengths
- Each kit contains the following items: 1 Pruner Head Assembly - 2'4 Extension Sections with 1 Base Cap, 1 Universal Pruning Saw (A11000), 1 Saw Handle (A10016), 1 Saw Scabbard (A30007), 1 Universal Adapter (A10012), 1 Universal "S" Hook for pushing or pulling tree limbs (P10046), 1 Multiple Pocket Vinyl Tool Bag



**ROUND POLES 1/4" DIAMETER**  
**Length of Section: 4' - Part # 4141, 15lbs**  
**Length of Section: 6' - Part # 4142, 19lbs**



### Universal Pruning Saw

- Fast cutting 16" curved steel blade with 7 teeth per inch
- Adapts to all tools with universal heads
- Can be used as a hand saw by attaching handle accessory
- Scabbard is made of leather for safe storage of saw

Part #	Description	Lbs
A11000	Universal Pruning Saw	0.6
P11004	Replacement Blade	0.3
A30007	Saw Scabbard	1.0
A10016	Handle	0.5
A11005	Pole Head	0.8



### 10-019: Universal Tree Pruner



- Features drop forged steel blades and a two-pulley rope swing that can cut limbs up to 1 1/2" diameter
- A universal saw attachment may be used with this pruner; it is mounted on a 12" fiberglass shaft with a universal adapter and 25' of polypropylene rope

### 10016: Universal Saw Handle



- Lightweight aluminum saw handle is for use with a universal saw when limbs can be easily reached and insulation is not needed



# Pruner Tools & Accessories

## PKG9FFM: Foam-Filled Pruner Package

- PH4 pruner head, (2) 6' foam-filled fiberglass poles (head & base) w/ rope (unassembled)
- Up to 12 feet of reach is possible with this professional pole pruning package



## Z-140: Fiberglass Pruner Adapter with Eye Bolt



## Z-142: Aircraft Aluminum Pruner Adapter with Eye Bolt



## Z-143: Big Bite Pruner Head Adapter with U1R Sawhead Adapter



## QCB Marvins "Bull"

- Features a 1 3/4" cut, dual pulley system, adapter and 15' of 3/8" rope
- The QCB easily inserts into the female ferrule of your extension pole
- All parts are replaceable



## QCSP: Marvins PH-2 Swivel Pulley Head

- With "quick change" adapter. Fits any Marvin pole with a female ferrule (base poles and mid-poles)



## PKG9BFFM: Foam-Filled Pruner Package

- One of Marvin's most popular pruning packages, this combination package gives you 12 feet of pruning or 12 feet of sawing
- Both the pruning head pole and the saw pole easily insert into the base pole via a spring clip coupling
- The saw head fits an assortment of blades
- Parts included in this package: PH4 Pruner Head, U1R Saw Head, 6' Foam-Filled Fiberglass Head Pole (Batch Tested), 6' Foam-Filled Fiberglass Saw Head Pole (Batch Tested), 6' Foam-Filled Fiberglass Base Pole (Batch Tested), S-20 Saw Blade, Pruning Rope



## QCP: Marvins PH4 1/4" Cut Pruner Head

- With "quick change" adapter
- Fits all Marvin poles with a female ferrule (mid-poles and base poles)



## QCPF: Marvins PH4 Pruner Head

- With a 10" fiberglass adapter. Fits all Marvin poles with a female ferrule (mid-poles and base poles)



## QCP5: Marvins 1 3/4" Cut Single Pulley "Bull" Pruner Head with Adapter

- Head only: PH5



## QC16: Big Bite 1 3/4" Cut Pruner Head with Adapter

- Head only: PH16
- Rope included



# Pruner Tools & Accessories

## PH2: Marvin's Pruner Head with Swivel Pulley

- Fits all Marvin fiberglass "head" poles and 1 1/4" octagonal wood poles



## PH5: Marvin's PH5 Pruner Head

- Features a 1 3/4" cut and a single pulley
- All parts are replaceable



## PH4: Marvin's 1 1/4" Cut Pruner Head with Round Casting

- Fits all Marvin fiberglass "head" poles and 1 1/4" octagonal wood poles



## PH16: Big Bite Pruner Head

- 1 3/4" Cutting Capacity



6FB: 6' hollow fiberglass base pole (female coupling & rubber base)



6FM: 6' hollow fiberglass mid pole (male & female coupling)



6FH: 6' hollow fiberglass pruner head pole (male coupling & rope anchor)



6FFBM: 6' foam-filled fiberglass base pole



6FFM: 6' foam-filled fiberglass mid pole



12FFBLK-M: 12' foam-filled fiberglass pole with end cap only (minimum order of 12)

## Buckingham



6019C Rubberized belting material, use w/ 1 1/2" cutting capacity. 4 1/2" x 6 3/4"



6019 Leather, use w/ 1 1/2" cutting capacity, 4 1/2" x 6 3/4"



6017 Leather, use w/ 1" cutting capacity, 3 3/4" x 4 1/2"



6017C Rubberized belting material, use w/ 1" cutting capacity, 3 3/4" x 4 1/2"

## Tearaway Chainsaw Lanyard

This Chainsaw Lanyard features a 1 3/4" ring for suspension when not in use, an elastic bungee designed for safety and convenience that measures 50" fully extended and contracts to 32" when relaxed, and a tear away safety pack that activates when 200 lbs. of force is applied.



**25Y12-42A:** Features a 1 1/8" steel ring saddle end attachment



**25Y12-48A:** Features a #2 bronze snap saddle end attachment



**25Y12-50A:** Features a 3/4" carabiner loop saddle end attachment

## 6022 & 6022C Chainsaw Scabbard

A chainsaw scabbard that prevents damage to chain and other equipment. For use with bar lengths from 16" to 20"



**6022:** Overall length measures 18 1/4" with a 17 3/4" pocket depth  
**6022C:** Overall length measures 18 1/4" with 17 3/4" pocket depth

## 60212 & 60212C Chainsaw Scabbard

A leather chainsaw scabbard that prevents damage to chain and other equipment. Rubberized Material. For use with bar lengths from 12" to 14."



**60212:** Overall length measures 12 3/4" with a 12" pocket depth  
**60212C:** Overall length measures 12 3/4" with a 12" pocket depth

## P7J8A-V-26: Hip Prusik Loop

A leather chainsaw scabbard that prevents damage to chain and other equipment. Rubberized Material. For use with bar lengths from 12" to 14"



## Flipline



**9V08B110M4:** 10' stitched High Vee rope flipline with BuckGrab LAD (Length Adjusting Device)



**9V08B112M4:** 12' stitched Safety Blue rope flipline with BuckGrab LAD (Length Adjusting Device)



**9V08B114M4:** 14' stitched XTC Spearmint rope flipline with BuckGrab LAD (Length Adjusting Device)

## The Buck Rigidline

This 7/16" uniline rope lanyard with the BuckGrab Adjuster has the same rigidness as a wire core flipline without the metal core. Ideal for hitch-hiking and when climbing near energized lines. Features a red wear indicator to alert the user of excess wear



**7808R18M6:** Features a 1704 swivel snap and is available in different lengths

**7808R17GM6:** Features a 1704 swivel snap and a carabiner on the BuckGrab. Measures 7'

## Pruner Rope Insulator

Insulator provides protection for use near high voltage lines. Tested at 100kV per foot



Part #	Description	lbs
4005	Insulator is 1/2" diameter by 34" long	0.3
4004-1	Insulator is 1/2" diameter by 12" long	0.2



TRUSTED SINCE 1958

# Ropes

## Climbing Rope-Braided Safety Blue



- This rope offers a tightly plied, polyester
- 16-strand cover, providing a smooth, snag-free surface
- Polyolefin yarns in the core of each cover strand reduce weight and improve handling
- This rope greatly exceeds industry specifications of 5400 lbs
- Twisted parallel blue yarns, in a blue core, allow the rope to stay firm and round while in use
- Core also acts as a warning flag if the cover is ever cut
- The tough durable cover is treated with a protective finish that minimizes abrasion and maximizes rope life

Diameter	Length	Tensile Strength
1/2"	120'	7700 lbs
1/2"	150'	7700 lbs
1/2"	600'	7700 lbs
<b>Split Tail, eye in one end</b>		
1/2"	6'	

## Climbing Rope-Braided Safety Orange High Vee



- Offers the same performance qualities and construction as the Braided Safety Blue, but with a highly visible orange and white work cover pattern
- Greatly exceeds industry specifications of 5400 lbs
- High-Vee stands out in the workplace and can be designated as a critical life safety line

Diameter	Length	Tensile Strength
1/2"	120'	7700 lbs
1/2"	150'	7700 lbs
1/2"	600'	7700 lbs
<b>Spliced Eye</b>		
1/2"	120'	7000 lbs
1/2"	150'	7000 lbs
<b>Split Tail, eye in one end</b>		
1/2"	6'	



## 3-Strand Bull Rope

- This popular 3-strand bull rope is a composite rope made of polyester yarns wrapped around a core of polyolefin in each strand
- Spun polyester is added to the surface for better grip and chafe protection
- Multiline II can be identified by the two orange markers on the surface of one strand
- This rope can also be used as a safety and rescue rope



Diameter	Length	Tensile Strength
5/8"	150'	8200 lbs
5/8"	600'	8200 lbs
3/4"	150'	10,500 lbs
3/4"	600'	10,500 lbs

## Bull Rope-Industrial Polyester Double Braid

- This polyester double braid bull rope offers non-hocking, torque-free construction
- This rope is the strongest low stretch rope available for bull rope applications
- Recommended especially for applications where lowering devices are being used
- High strength allows increased safety factors and/or use of smaller diameter lines



Diameter	Length	Tensile Strength
5/8"	150'	14,400 lbs
5/8"	600'	14,400 lbs
3/4"	150'	20,000 lbs
3/4"	600'	20,000 lbs

# Customized Aerial Truck Kit

Part #	Description	Qty
30115	1 Ton Chain Hoist	1
C3090439	Chance 1-1/2 Ton Chain Hoist	1
1684-5F	File Grips	2
IWRC1/2X4FT	Wire Rope Sling, Eye Both Ends 4ft	2
IWRC1/2X6FT	Wire Rope Sling, Eye Both Ends 6FT	2
IWRC1/2X8FT	Wire Rope Sling, Eye Both Ends 8ft	2
EE2-902-3X8FT	Synthetic Lifting Sling, Eyed Both Ends, 8ft	2
EE2-902-3X4FT	Synthetic Lifting Sling, Eyed Both Ends, 4ft	2
EE2-902-3X6FT	Synthetic Lifting Sling, Eyed Both Ends, 6ft	2
384-CERT	1" x 24QT Skid Tong Certified	1
199	2-1/2" X 4' Cant Hook	1
EGRD34	Erico Ground Rod Driver	1
C3020003	Expanding Anchor and Tamping	1
HITSEP-10	Eastern Pattern Telegraph Spoon	1
852	Digging Spud with Tamper	1
Customgroundset	50' - 2/0 Truck Ground	1
outriggerfront	Pads, Outrigger Oak 14" X 28"	6
8690CK	Ratchet Guy Steel Cutter	1
C-18F	Bolt Cutter with Insulated FG Handles	1
0190MCX	24" HD Bolt Cutter	1
705	Manual HD 25" Cable Cutter	1
SK5	Spill Kit	1
Rel-2250-R-120-A	Greenlee Hydraulic Tamper c/w Fittings and Hoses	1
TS2-602-N-20	Transformer Sling	1
TED-270PFR	Gas Drill (TANAKA)	1
Rt-20	Reel Thing	1
RT-40	Reel Thing	1
RSDG-TC102b	Road Work Ahead	2
RSDG-TC103R	Right Lane Closed	1
RSDG-TC4L	Arrow	1
RSHI-RB91	Yield to Oncoming Traffic	1
SSS-BTMSC3F	Sign Stand with Flags	3
RIBS-90X90	Rib Set	3
RIBS-90X120	Rib Set	1
H4910A	Greenlee Hydraulic Pole Puller	1
HI24FBC	24" Floor Push Broom	1
HIRPLG	Round Mouth Shovel Pro Gold	2
HIPM-5H	Pick Mattock 5lb Head w/ #6 Eye	1
HIBD-12	12 lbs Sledge Hammer	1
EXFLR24	24" Fan Rake	1
50412	First Aid Kit Ontario Section 8	1
HISPLG	Square Point Shovel	1
333A	Greenlee Hack Saw	1
3295500	Triangle Reflector Kit	1
630011HD	Kelly bar adapter Hex (2.5"/4.25"/8.125")	1
C1021583	Hubbell Anchor Tool: 1-3/8" x 7'. Drive End	1
REL-PE	Pulling Eye	1
TC-H4U-28	28" Traffic Cone, w/4" Collar	10
H4802-3	Greenlee Fairmont Hydraulic Tamper Assembly	1



TRUCK

ltutilitysupply.com



# Customized Digger Derrick Truck Kit

TRUCK

Itlutilitysupply.com

Part #	Description	Qty
3282	Hiokoe digital clamp on meter	1
TFL-1	Fused leads	1
69611	Large AMPGun	1
69437	Small AMP gun	1
REL-BG	MD6 press with BG die	1
8690FH	Ratchet cutter	1
0190FCX	24" FG handle bolt cutters	1
8690CK	Guy steel ratchet cutters	1
0290FCS	25" FG handle cable cutters	1
NTP1874W	Chain saw chaps	1
SK5	spill kit	1
3295500	triangular reflector kit	1
PSC3090323	1 ton strap hoist	3
30115	1 ton chain hoist	1
H1802-30SSR	secondary service blocks	1
1702-20N	Howel wire tool	1
1684-5F	File grip	2
1656-20	20 grip	1
1656-30	30 grip	2
1656-40	40 grip	2
1656-50	50 grip	2
EE2-902-3X3Ft	3ft sling	1
EE2-902-3X4FT	4ft sling	1
ee2-902-3X6FT	6ft sling	1
TS2-602-N-20	Transformer sling	1
REL-PE	guy pulling eye	1
361 con. Meter	contamination meter	1
361-case1M2075	case for 361	1
1TB	tool tray	2
C4030292	6.5' Grip-all stick	2
P2MF-6	6' pin and sleeve switch stick	3
P2F-u	short adapters - pin and sleeve to universal fitting	1
P10431	P-2 head for universal fitting	1
3482	36" FG spiral link stick	2
Grounds 2/0 X 10'	Grounds 2/0 X 10'	2
Grounds 2/0 X 6'	Grounds 2/0 X 6'	1
Grounds 2/0 X 50	Grounds 2/0 X 50	1
1300	class 4 split blankets	3
900E	class 4 solid blankets	3
SU150-6C	class 4 line hose 6'	3
M4931	conductor cover	9
PTHL	class 4 hood	3
5041	Auxiliary Arm w/c 2 conductor holders and insulators	1
HW1	Greenlee Hydraulic drill	1
8810	Wood owl 13/16 x 18"	2
REL-2250-r-120-A	10' non conductive hoses	1
REL-ED-1618	framing socket	1
1829-DP	Tool Apron	1
1831	Bucket hooks	4

23	Nose bag	1
PD50	Phasing set	1
LIV500	potential indicator	1
P4	Blanket tubes	2
21	blanket clamp pins	21
PBS-7	4pc pinch and roll bar set	1
333A	Greenlee hack saw	1
50412	First aid kit Ontario section 8	1
MS-291	STHIL Chain saw	1
HIRPLG	round mouth shovel pro gold	2
H124FBC	24" floor push broom	1
HIBD-12	12lbs sledge hammer	1
RC450-S	wheel chocks	4
5300R3-su	Surplus load buster	1
REL-BG	MD6 press with BG die	1
3480	spiral link stick	1
TC-H4U-28	28" Traffic Cone, w/4" Collar	10
REL-510	Manual Hydraulic 12 Ton Crimping Tool	1



# Klein Tools - Tool Storage

TRUCK

## Heavy-Duty Top-Closing Buckets



- Top of bucket zips closed
- Load rated: 150 lbs
- Durable, steel rim
- Accommodates standard 5 gallon buckets
- Body constructed of heavy-duty no. 1 canvas
- Web strap extends down the side of the bucket
- Leather reinforced bottom extends 3" up the side
- Dimensions – 17"H x 14"D or 22"H x 14"D
- 14" diameter large enough to accommodate 5 gallon buckets

**SPLBUCKET-22, 22" High**  
**SPLBUCKET-17, 17" High**

## 5416TC: Top Closing Bolt Bag



- Same durability of Klein 5416 series bull pin & bolt pouch
- Now with durable drawstring closing top to prevent items from falling out of the pouch at height
- Pouch body constructed of heavy duty, #4 canvas
- 10"H x 9"W x 5"D
- Drawstring 3"

## 51829: Vinyl Tool Apron



- 24"L x 23"H
- Includes: ten hand tool pockets, two pouches, hammer loop and two vinyl drill bit pockets with plastic tubes
- Hooks sold separately

## 51829M: Aerial Apron with Magnet



- 24"L x 23"H
- Sewn-in magnet design won't catch on gloves
- Includes: ten hand tool pockets, two pouches, hammer loop and two vinyl drill bit pockets with plastic tubes
- Two pouches reinforced with heavy duty rivets

## 54445



- Number of Compartments: 16
- Compartment Sizes: 4-3/8" (111 mm) x 2-7/8" (73 mm)
- Length (Front to Back): 12" (305 mm)
- Height: 3" (76 mm)
- Weight (lbs): 7.55
- Width: 18" (457 mm)

## 54446



- Number of Compartments: 21
- Compartment Sizes: 20 each 2-3/4" (70 mm) x 2-7/8" (73 mm) and one 3-3/4" (95 mm) x 11-7/8" (302 mm)
- Length (Front to Back): 12" (305 mm)
- Height: 3" (76 mm)
- Weight (lbs): 7.60
- Width: 18" (457 mm)

## 5181ORA



- Exterior Pockets: 1
- Color: orange
- Length: 24" (610 mm)
- Height: 20" (508 mm)
- Weight (lbs): 7
- Width: 10" (254 mm)

## 55417-18



- Exterior Pockets: 25
- Interior Pockets: 53
- Length: 19" (483 mm)
- Height: 16" (406 mm)
- Weight (lbs): 9.51
- Width: 10.5" (267 mm)



lutilitysupply.com

# Klein Tools - Tool Storage

TRUCK

## Premium Orange Vinyl Equipment Bag



- 24"L x 18"H x 10"W
  - Nylon-web handles extend down the side of the bag for extra support
  - Hard rubber base
  - Two heavy duty slide-action buckles for convenient, secure bag closure
  - Convenient, Velcro fastening, water-proof flap for quick bag open and closure in the rain
  - Large outside pocket with Velcro enclosure
  - Comfort padded, adjustable shoulder strap
  - Wide opening steel frame is securely riveted in top of bag
- 5181ORA**

## Ultra Premium Black Vinyl Equipment Bag



- 24"L x 18"H x 10"W
  - Hard rubber base
  - Nylon-web handles extend down the side of the bag for extra support
  - Convenient, Velcro fastening, water-proof flap for quick bag open and closure in the rain
  - Two heavy duty slide-action buckles for convenient, secure bag closure
  - Two large outside pockets with Velcro enclosure
  - Comfort padded, adjustable shoulder strap
  - Wide opening steel frame is securely riveted in top of bag
- 5182BLA**

## Extra-Large Nylon Equipment Bag



- Bottom extends 3" up the sides
  - Bottom of bag is protected by metal studs
  - Extra flap for storm protection
  - Orange vinyl-coated nylon fabric bag
  - Bottom reinforced with 1/4" plywood
  - Stores and protects Klein Climbing Gear
  - Nylon-web handles extend around bag for extra support
  - Wide opening steel frame is securely riveted in top of bag
- 5180**

## Nut and Bolt Pouch



- Includes interior pocket
  - Top sides of pouch reinforced with leather to maintain shape of pouch opening
  - Inside bottom is reinforced with leather and ventilating eyelet
  - Metal snaps provided on loops for easy attachment to belts up to 3" (76 mm) wide
  - Top edge reinforced with 1/4" (6 mm) rope
- 51A**

## Orange Oval Hard Body Bucket



- 14"L x 7"W x 10"H
  - Features 15 interior pockets
  - Orange, non-conductive plastic exterior maintains bucket shape
  - Molded polypropylene base with drain holes
  - Hooks sold separately
- 5144BHB**

## Hard Body Oval Bucket



- Includes leather skinning knife sheath and 14 other interior pockets
  - Orange, non-conductive plastic exterior maintains bucket shape
  - Fabric constructed of rugged denier polyester to resist wear and tear on the jobsite
  - Black molded polypropylene bottom with drain holes
  - Hooks sold separately
- 5144HBS**

## Hard Body Oval Bucket w/ 15 Interior Pockets & Handles



- 14"L x 7"W x 10"H
  - Features 15 interior pockets
  - Orange, non-conductive plastic exterior maintains bucket shape
  - Black molded polypropylene bottom
  - Hooks sold separately
- 5144BHHB**

## Black Hard Body Tote Bucket



- 14"L x 7"W x 10"H
  - Features 15 inside pockets, 14 outside pockets and web handle
  - Constructed of rugged denier polyester to resist wear and tear on the jobsite
  - Black molded polypropylene bottom with drain holes
- 5144BHB140S**



## 05-829: Hastings Heavy Tool Tray Outside Mount



- One piece design fits both buckets with and without liners
- Special designed bracket enables the tool boards to be easily installed and removed without tools
- Each board has a four pocket leather tool pouch, leather knife pouch, nylon loops, and hammer loop
- Utility bag is made from heavy duty cordura
- A wide leather loop is riveted on the top of bag for easy access with rubber gloves
- Also available with lights above the cordura bag and lights along the entire bottom of board
- Ideal for night time and low light conditions
- Battery and switch operated. 2 AA batteries included
- Weight 4.6 lbs

## 05-951: Hastings Tool Tray Outside Mount



- Compact
- Lightweight polyethylene
- Outside mount
- Ideal for connectors, bolts, and nuts
- Fits buckets with and without liners
- 7.5" D x 6" W x 14" L
- Weight 8 lbs

## Hastings Heavy Duty Fiberglass Step



- Heavy duty fiberglass step makes it easier to get in and out of buckets
- Stepping surface has an anti-skid material to prevent foot slippage
- Tough durable, attractive, white plastic finish is easy to clean and maintain
- Dimensions: 26" x 8 1/2" x 8"
- Weight 8 lbs

05-961 Step for Buckets With Liners

05-960 Step for Buckets Without Liners

## Hastings Heavy Reinforced Canvas Tool Buckets

Workers will find dozens of uses for these rugged round and oval canvas tool buckets. These canvas buckets are made from US grade #4 canvas with brass grommets. A solid non-conductive PVC ring maintains bucket shape. Round tool buckets with polypropylene rope are offered with a brass swivel snap.

### 31-105: Tool Bucket Canvas w/Rope and Snap

31-205: Tool Bucket Canvas, w/Rope and Snap 12" x 15"

31-206: Tool Bucket Canvas, w/Rope and Snap 1 Inside Pocket 12" x 15"



### 31-140: Tool Bucket Vinyl w/ Rope 8" x 12"



### 10-110: Nut and Bolt Bag Canvas w/ Belt Loops



### 31-245: Tool Bucket Vinyl w/ Rope and Snap 12" x 15"



# Bucket Accessories

TRUCK

**35: 12" Round - Blackwrap**



**95: 15" Bottom with Frame Opening  
15" Length x 8" Width x 13" Height**



**10-185: Tool Pouch, 4 Inside Pockets, 2 Outside Pockets, Tape Thong**



**10-367: Tool Roll Up Black Vinyl, 13 Pockets**



**43-165: Aerial Apron Vinyl, 18 Pockets, Fully Re-inforced**



**43-155: Aerial Apron Vinyl, 16 Pockets**



**43-957: Aerial Apron Canvas, 2 Man Bucket**



**47-140: Aerial Bucket Hook Polymer for 2-Inch Lips Each**



**47-222: Aerial Bucket Hook Polymer for 3-Inch Lips**



**47-500: Aerial Bucket Hook Polymer for 3-Inch Lips Each**



Itlutilitysupply.com



# Equipment Storage Bags

TRUCK

## Estex 1498 & 1498-8: 4 Pocket Stick Bag

- Waterproof
- Heavy Duty Yellow Vinyl
- 2-Handles
- Accessory Pouch
- 1498: Holds 6-foot sticks: 20" Wx78"H, weight: 3 lbs 8 oz
- 1498-8: Holds 8-foot sticks: 20" W x 96"H, weight: 4 lbs



## Estex 2078: Tool Bucket 12" X 15" Vinyl Plastic Bottom with Snap

- Heavy duty canvas, steel top ring and molded top ring and bottom
- Leather rope holes, polypropylene handle, snap
- 12" dia X 15" H
- Weight 2lbs 13 oz



## Bashlin 11DC: Equipment Bag

- Equipment bag made of very tough waterproof polyester material and has nylon web handles
- It has a leatherette bottom and flap to cover the opening when exposed to weather
- The "S" model features a polyester web shoulder strap
- 24" X 19" X 11"



## Petzl Bucket Rope Bag

- Bag remains upright and has an exterior folding lid system that allows easy access to the contents of the bag
- External zippered pocket for personal effects
- Transparent external window for displaying an equipment identification card
- Two large, comfortable carrying handles
- Adjustable strap for carrying bandolier style
- Interior ring can be used as attachment point for rope
- Bottom is lined for longer wear
- Waterproof fabric
- Available in two versions



S41Y 025: 25 Litre Capacity



S41Y 035: 35 Litre Capacity

## Petzl Airline: Throwline

- Combines flexibility for a precise throw and stiffness for avoiding knot formation as it comes out of the bag
- Excellent sheath-core bond maintains a round cross section, ensuring good rope glide through the tree. The sheath is made of Dyneema for excellent abrasion resistance
- Lightweight, does not require a very heavy throw-bag
- Yellow for excellent visibility



## Petzl Jet: Throw-Bag

- Durable, two-layer construction prolongs throwbag life
- Streamlined shape facilitates passage through tree branches
- Different colored stitching on webbing differentiates the weights of the bags
- Secondary connection point for quick attachment of the rope
- Yellow for excellent visibility



lutilitysupply.com

# Buzzline

BUZZLINE® TOOL BUCKETS are made of heavy-duty canvas or yellow vinyl nylon and feature a solid round non-conductive injected molded top ring with a choice of bottom type. The bottom choices include plastic, rubber, or unitized. Tool buckets are equipped with either polypropylene rope handle or nylon webbing handle, which comes with or without a swivel snap. Rope holes are reinforced with brass grommets. All BUZZLINE® Tool Buckets are offered with Blackwrap™, plastic that reinforces the Tool Bucket.

TRUCK

**30-010: Mini Tool Bucket 5 Pockets, 5" x 6", White**



**30-021: Blackwrap Mini Tool Bucket 5 Pockets, 5" x 6", Black**



**30-023: Blackwrap Mini Tool Bucket, 5 Pockets, 5" x 6", Red**



**30-024: Mini Blackwrap Tool Bucket, 5 Pockets, 5" x 6", Yellow**



**1829-BH-1: Aerial Tool Board w/ Hook Holes**

- Made with 8-vinyl hand tool pockets, bit, knife, and utility pockets
- Loops for hammer and screw driver
- 16" W X 21" H X FLAT
- Weight 5 lbs 8 oz



**1829-BH-4: Aerial Tool Board w/ Hook Holes**

- Made with 4-pocket leather pouch, knife sheath, and 2-screwdriver/1-hammer loop, canvas pouch
- 16" W X 21" H X FLAT
- Weight 4 lbs 8 oz



**1829-BH-2: Aerial Tool Board w/ Hook Holes**

- Made with 7-vinyl pockets and 3-tool loops, a bit and large utility pocket, hammer loop & AMP pocket
- 16" W X 21" H X FLAT
- Weight 6 lbs



**1829-BL-1: Aerial Tool Board w/ Wide Lip**

- Made with 8-vinyl hand tool pockets, bit, knife, and utility pockets
- Loops for hammer & screwdriver
- 16" W X 21" H X FLAT
- Weight 5 lbs 10 oz



**1829-BL-2: Aerial Tool Board w/ Wide Lip**

- Made w/ 7-vinyl pockets and 3-tool loops, a bit and large utility pocket, hammer loop, AMP pocket
- 16" W X 21" H X FLAT
- Weight 6 lbs



**1829-BL-3: Aerial Tool Board w/ Wide Lip**

- Made w/ 4-pocket leather tool pouch, knife, and hammer loop, vinyl crimp tool holder with die pocket
- 16" W X 21" H X FLAT
- Weight 5 lbs 14 oz



**1829-BL-4: Aerial Tool Board w/ Wide Lip**

- Made with 4 pocket leather pouch, knife sheath, and 2-screwdriver 1-hammer loop, canvas pouch
- 16" W X 21" H X FLAT
- Weight 5 lbs 10 oz



## 1829-A-2: Aerial Vinyl Tool Apron, 2-Man Bucket

- Multiple hand tool pockets, tape sling and leather reinforcement
- 4 material pouches & 2 drill bit holders
- 28.5"L x 4"W x 26.5"H
- Weight 4 lbs 14 oz



## 1829-PSO: Aerial Vinyl Tool Apron

- Non-Conductive for safety
- Fits perfectly within Aerial Bucket
- 41.5"L x 26"H
- Weight 5 lbs 6 oz



## 1829-MLGW: Aerial 2-Man Vinyl Tool Apron

- Designed for kidney shaped buckets
- Multiple pocket configuration
- 38"L x 18"H
- Weight 5 lbs 7 oz



## 1829-DP-C: Aerial Canvas Tool Apron

- 10 hand tool pockets & 2 pouches, 3 socket pockets & 2 drill bit holders
- 23.8"L x 4"W x 21.25"H
- Weight 4lbs 12oz



## 1829-DP: Aerial Vinyl Tool Apron

- 10 hand tool pockets & 2 pouches
- Hammer loop and 2 pouches, 2 drill bit holders
- 23.8"L x 4"W x 21.25"H
- Weight 4 lbs 12 oz



## 1829-PG&E: Aerial 2-Man Canvas Apron

- 8 hand tool pockets, 2 pouches, 3 drill bit holders, 3 socket pockets, hammer loop & knife sheath
- 24"W x 33"H
- Weight 6 lbs 6 oz



## 1826: Aerial Canvas Tool Apron

- 8 hand tool pockets & 1 pouch
- 1 quick release snap
- 18"L x 4"W x 19.5"H
- Weight 3 lbs 2 oz



## 1825: Aerial Canvas Tool Apron

- 2 Pockets 6"x8"
- Heavy weight canvas
- 18"L x 4"W x 10"H
- Weight 2 lbs 10oz



## 1825-3: Aerial Canvas Tool Apron

- 3 Pockets 6"H x 8"W
- Heavy weight canvas
- 22"L x 4"W x 10"H
- Weight 1lb 4oz



## 1825-3-V: Aerial Vinyl Tool Apron

- 3 Pockets 6"H x 8"W
- 18 oz fire retardant vinyl
- 22"L x 4"W x 10"H
- Weight 1 lb 4oz



## 2651: Compression Tool & Bolt Cutter Bag

- Heavy vinyl coated nylon, 2 pockets
- 2 grommets for bucket attachment
- 10"L x 3"W x 19"H
- Weight 1 lb 7 oz



## 2651-AP-S1: Compression Tool & Bolt Cutter Bag with Closure

- Durable hook and loop fastener helps keep bag closed
- Diminish the risk of dropping your equipment with reliable closure
- 10"L x 4"W x 19"H
- Weight 2 lbs 2 oz



## 2651-2-XCEL: Compression Tool & Bolt Cutter Bag

- Heavy vinyl coated nylon, 3 pockets
- 3 grommets for bucket attachment
- 10"L x 3"W x 26"H
- Weight 2lbs 14oz



## 1061: Nut & Bolt Bag

- This olive drab nut and bolt bag has real leather reinforcements, an inside pocket for small items, and quick release snaps on the back for easy belt attachment
- Real leather top and bottom reinforcement
- Quick release snaps
- 8.5"W x 10"H x 3"D
- Weight 9 oz



## 181514HBHQ2: Oversized Splicer's Tool Bucket

- This oversized bucket has two handles, 15 inside and 14 outside pockets to organize all your tools
- The fabric is 1000 Denier Nylon Cordura which is extremely abrasion and cut resistant
- Hard body plastic liner that give it shape and makes it rigid
- Heavy PVC top ring to keep the bag open, two attachment holes reinforced by brass grommets and a molded plastic bottom
- 15"L x 9"W x 11"H
- Weight 3 lbs 4 oz



## 1815HB2G: Splicer's Tool Bucket

- Has two handles, 15 inside and 14 outside pockets to organize all your tools
- Heavy natural canvas fabric, extremely abrasion and cut resistant
- The bag has a hard body plastic liner that give it shape and makes it rigid
- There is a heavy PVC top ring to keep the bag open, two attachment holes reinforced by brass grommets and a molded plastic bottom
- 15"L x 7"W x 9"H
- Weight 2 lbs 10oz



## 1829-DP-MAG: Aerial Apron with Magnet

- Yellow vinyl, magnetic strip
- 24"L x 4"W x 21"H



## 1820-HB: Aerial Oval Bucket

- This oval shaped tool bag hangs on the aerial lift bucket with attachment hooks
- There is a PVC ring in the top to shape the opening and hard body plastic on the sides to keep the bag open and rigid
- 15 hand tool pockets on the inside of the bag organize tools for easy access
- Holes for attachment hooks are reinforced with brass grommets
- The bag has a sturdy plastic bottom with drainage holes



## 1820-HB-7: Rigid Aerial Apron with Inosil

- Estex has designed a series of tool aprons with multiple pocket configurations to fit inside the bucket
- They were designed to fit flat against the liner to minimize interference with line work yet maximize a lineman's ability to reach the necessary tools
- Each apron has a non-conductive rod in the top for support as well as two brass grommets
- These aprons also contain Inosil, a proprietary anti-corrosive shield to protect against rust and corrosion when used properly
- This apron also has another unique feature and that is the "hardbody" construction which gives these vinyl aprons the rigidity of a traditional board
- 23.9"L x 4"W x 21.25"H
- Weight 6 lbs 10 oz



## 1829-DP-LED: Aerial Tool Board with Lights

- This aerial bucket apron has many tool pockets and pouches dispersed over two rows, each illuminated by a compact, powerful LED flashlight for maximum visibility during night-time jobs
- Made of 18 oz vinyl. Flashlights powered by 3 AA batteries, and are water proof to 20 ft (6 m)
- Impact resistant. Meets NFPA Fire Resistant Requirements: 500°F (200°C) for 30 minutes
- 23.8" L x 4"W x 21.25" H
- Weight 5 lbs





## Polymer Hook



- These hooks are an injection molded part, which ensures strength and consistent quality. They have high break strength and are resistant to cold weather
- 11/16" Dia.

**1830:**  
**Weight 5 oz**  
**Fits All Standard Buckets**  
**Also Keeps Liners From Bouncing Out**

**1831:**  
**Weight 6 oz**  
**Fits All Buckets**  
**Engineered To Fit New High Load Lifts**



## 2070: 12x15 Canvas Tool Bucket

- All Estex tool buckets are made of heavy duty canvas or vinyl coated nylon for long wear and use
- The top ring is a single piece metallic material designed to stay open even under severe and continuous load
- The bottoms are made of high impact polymer resins or leather
- The bag has leather side supports at the rope holes and a unique Estex feature whereby the bottom is stitched on and the body of the bag is folded back over the stitches to protect the threads from abrasion and excessive wear
- This has the added benefit of providing a smooth padded area at the bucket bottom. Otherwise, your bucket becomes a rough sharp source of wear on the bucket truck and on the aerial bucket
- The bucket also has Strong UV and rot-resistant rope handle
- 12" dia. x 15" H
- Weight 2 lbs 15 oz

## 2117-1LOSP: 24" Vinyl Tool Bag w/ Outside Pocket



- 2117 series tool bags are wider than other bags and are made from canvas or heavy vinyl coated nylon which is water resistant and also very resistant to abrasion
- The bottom is made from molded polymer plastic which gives additional water resistance
- The 2" web handles wrap completely around the bag. There is a weather flap that covers the top of the bag to keep water out Box "X" stitches on the handles prevent tearing
- There is one large outside pocket covered with a flap with snap fasteners
- This bag also has a shoulder strap

## 2190: 24" Vinyl Tool Bag

- Made from heavy vinyl coated nylon; water-resistant and abrasion resistant
- There is a second layer of vinyl around the bottom of the bag for extra protection
- The bag has a hard wood bottom with six brass studs to protect the bottom surface from abrasion
- The 2" web handles wrap completely around the bag
- There is a weather flap that covers the top of the bag to keep water out
- Box "X" stitches on the handles prevent tearing



## 2629: Grounding Bag

- Grounds and jumpers storage bag use has increased over the years as utilities realize the protection from moisture, dirt, oil and other contaminants is important in the effectiveness of the equipment they are using
- These bags are designed so that the handles go all the way around the bag to support the entire contents of the bag
- They also take all the stress when the grounds are hung on a hook or a mandrel
- Fully customizable to your specifications



## 2735-12-22: Kneeling Pad

- The Estex Ergonomic Kneeling Pad has a non-skid surface and a closed cell foam base that will not absorb water. It was designed as a health aid to relieve lower back and leg stress for workers that work in network underground, URD, or on padmount transformers among other applications. This pad benefits workers in the Electric, Cable and Telecommunications Industry. This pad is also used as a thermal barrier to the ice cold ground
- 12"W x 22"L
- Weight 1 lb 4 oz



# Plastic Techniques (PTI)

The PTI tool tray, as with all PTI products has been designed with the lineman's needs in mind. It is built to withstand the harsh environments that linemen are subjected to on a daily basis, combining storage needs and durability in one great product! Available in white, yellow or orange.

## 1TB: Tool Tray, Standard w/ Brackets 19x8x8

- Dimensions 19" x 8" x 8"
- UV protected
- Weather-resistant
- Safe and convenient storage for tools and CATV meters
- Brackets fit virtually every aerial lift basket
- Mountable on buckets with or without liners
- Made of a rugged polymer making it impervious to motor oil, hydraulic oil and a broad range of chemicals



## 6TB-W-TP7: Deep Tool Box w/ 7 Pocket Omni Pouch

- Dimensions 15" x 10" x 13"
- White Color Only
- UV protected
- Cold-resistant
- Safe and convenient storage for tools and CATV meters
- 7 Pocket Omni Pouch Included
- Fits virtually every aerial lift basket
- Mountable on buckets with or without liners
- Made of a rugged polymer making it impervious to motor oil, hydraulic oil and a broad range of chemicals



## 2TB-W-TP9: Tool Tray - Double sized, Omni Pouch

- Dimensions 20" x 14" x 8"
- UV protected
- Weather resistant
- Safe and convenient storage for tools and CATV meters
- Brackets fit virtually every aerial lift basket
- Made of a rugged polymer making it impervious to motor oil, hydraulic oil and a broad range of chemicals
- Handy 9 Pocket Omni Pouch installed in tray



## 14DTB-319016: Deep Poly Tool Tray w/ 24" Tool Magnet

- Dimensions 19" x 7" x 24"
- UV protected
- Weather resistant
- Safe and convenient storage for tools
- Fits virtually every aerial lift basket
- Convenient tool magnet installed in tray
- Made of a rugged polymer blend making it impervious to motor oil, hydraulic oil and a broad range of chemicals
- This tray is extra deep at 24"



## 2TB: Tool Tray - Double sized, 20x14x8

- Dimensions 20" x 14" x 8"
- UV protected
- Weather resistant
- Available online in Natural/Gray only
- Safe and convenient storage for tools and CATV meters
- Brackets fit virtually every aerial lift basket
- Mountable on buckets with or without liners
- Made of a rugged polymer making it impervious to motor oil, hydraulic oil and a broad range of chemicals



## CSS: Chainsaw Scabbard - Fiberglass

- Durable reinforced fiberglass construction
- Sturdy reinforced back plate
- Non-corrosive pan-head brass post and screw fasteners for rapid sheath replacement
- Dimensional proportions optimized for gas or hydraulic saws
- Mountable on the inside or outside of the bucket
- PTI's chainsaw scabbard is designed to allow for easy access and storage of your chainsaw



## CSS-20: Chainsaw Scabbard - Polymer

- Designed to hold standard chainsaws
- Plastic construction is impervious to hydraulic, bar and motor oils
- Lightweight
- PTI's chainsaw scabbard is designed to allow for easy access and storage of your chainsaw
- The scabbard can be mounted on the inside or outside of the basket



## CSS-20WK: Chainsaw Scabbard with Wear Rollers

- Designed to hold standard chainsaws
- Plastic construction is impervious to hydraulic, bar and motor oils
- Lightweight
- Plastic wear rollers prolong the life of the scabbard
- PTI's chainsaw scabbard is designed to allow for easy access and storage of your chainsaw
- The scabbard can be mounted on the inside or outside of the basket



## CSS-24: Plastic Pruning Saw Scabbard

- Polymer construction is impervious to hydraulic, bar and motor oils
- Lightweight
- Colour is Black
- PTI's pruning saw scabbard is designed to allow for easy access and storage of your pruning saw
- The scabbard can be mounted on the inside of the basket



## BSH-4: Saw Holder Boom Mounted "Boom-Saver"

- Shovel-nose design eases tool entry
- Prevents tool from damaging boom when storing and removing the tool
- Fits virtually all standard aerial lift booms
- The holder mounts to the boom using a ratchet for a sure grip
- Made from a specially formulated polymer that has demonstrated superior resistance to weather
- Impervious to hydraulic oils
- Lightweight, durable, resistant to UV degradation
- Straps are around the outside of holder for extra safety
- The long reach chainsaw holder mounts to the boom of the truck eliminating work area interference when not in use (saw not included)

## CSH: Circular Stick Saw Holder

- Holds hydraulic circular stick saw
- Fits round and square booms
- Ratchet binder and strap attachment



# Platform Accessories

TRUCK

## Plastic Techniques LBH: LiteBox® Holder, Bucket Mount - Black

- Fully non-conductive wrap-around housing offers maximum protection
- Made from a special polymer blend
- Excellent cold weather characteristics
- Allows dual use of your rechargeable Litebox® as a bucket mount work light
- The design of this LiteBox® holder allows the light head to be aimed from 50° below horizontal to 20° past vertical, with nearly a full 360° side to side



## Plastic Techniques LBH2: LiteBox® Holder, Bucket Mount - Black

- For Streamlight models with rings
- Fully non-conductive wrap-around housing offers maximum protection
- Made from a special grade polymer blend
- Excellent cold weather characteristics
- Available in black, yellow or orange
- Allows dual use of your rechargeable Litebox® as a bucket mount work light
- The design of this LiteBox® holder allows the light head to be aimed from 50° below horizontal to 20° past vertical, with nearly a full 360° side to side



LBH2-0 - Orange



LBH2-Y - Yellow

## PTH: Tool Holder for Pruner

- Holds hydraulic and pneumatic stick pruners
- Fits round and square booms
- Ratchet binder and strap attachment



## Hastings 06-177: Boom Mounted Pruner/Saw Holder

- Boom mounted pruner/saw holder
- Pruner/saw holder provides an excellent method for storage of hydraulic tools during the clearance work
- Boom mounted tool holders are constructed with fiberglass laminates
- Ratchet load binders with 1" wide nylon straps secures holders firmly to boom
- Gravity type latch secures control end of tool and is easy to open and close
- Unit adapts to square, rectangular, round and oval booms
- 9.5 lbs

## Hastings 05-1001: Complete Boom Mounted Hot Stick Holder

- Boom mounted holders are made with durable molded fiberglass
- Ratchet load binders for attachment to the boom
- Will hold four hot sticks 1 1/4" - 2" diameter
- Adapts to square, rectangular, round, and oval booms
- 10" wide x 7" High, 12 lbs

## Hastings P30128: Individual Rubber Grips



## Hastings A19001: Tool Holder - Slotted End, 6 lbs



## Hastings A19001: Tool Holder - Grip End, 6 lbs



## 6TB: Tool Tray

- Dimensions 15"x10"x13"
- UV protected
- Weather-resistant
- Safe and convenient storage for tools and CATV meters
- Fits virtually every aerial lift basket
- Mountable on buckets with or without liners
- Made of a rugged polymer making it impervious to motor oil, hydraulic oil and a broad range of chemicals
- Available in white: 6TB-W



## 1TB-RA: Tool Tray - Curved

- Dimensions 19"x8"x8"
- UV protected
- Weather-resistant
- Safe and convenient storage for tools and CATV meters
- Fits 30" diameter round buckets with or without liner
- Made of a rugged polymer making it impervious to motor oil, hydraulic oil and a broad range of chemicals



## 321010: Tool Tray

- Dimensions 19x8x8
- UV protected
- Fits most 30" diameter round buckets
- Set of 2 tool trays
- Available in natural/gray only
- Weather resistant
- Safe and convenient storage for TOOLS and CATV meters
- Mountable on buckets with or without liners
- Made of a rugged polymer making it impervious to motor oil, hydraulic oil and a broad range of chemicals.



## 319119: Tool Tray, Semi-Oval

- Dimensions 18"x12"x10"
- Adjustable tool straps
- UV protected
- Weather-resistant
- ABH hooks included
- Safe and convenient storage for tools and equipment
- Fits virtually every aerial lift basket
- Made of a rugged polymer making it impervious to motor oil, hydraulic oil and a broad range of chemicals
- ABH hooks included. Soft and hard covers are available



## 319119-C: Tool Tray, Semi-Oval w/ Lid

- Dimensions 18"x12"x10" (same as 319119)
- Lid adds protection from weather and stores tools safely
- Lid has straps and buckle to safely secure it in place
- Attaches to your bucket using our ABH hooks
- Adjustable tool straps
- UV protected
- Weather-resistant
- ABH hooks included
- Safe and convenient storage for tools and equipment
- Fits virtually every aerial lift basket
- Made of a rugged polymer making it impervious to motor oil, hydraulic oil and a broad range of chemicals
- ABH hooks Included
- Soft and hard covers are available
- ABH hooks included. Soft and hard covers are available



# Plastic Techniques (PTI)

TRUCK

## IWH: Impact Wrench Holster, Inside Mount

- Field reversible bracket can be left or right-mounted
- 10" deep
- Fits wrench only
- Weather-resistant
- Offers maximum space efficiency
- Semi-flexible polymer construction
- Fits virtually every lift bucket
- Excellent dielectric, cold weather, chemical resistance and UV properties
- This model is field reversible



## IWH2: Impact Wrench Holster, Deep Outside Mount

- 13" deep
- Fits wrench with socket attached
- Offers maximum space efficiency
- Semi-flexible polymer construction
- Excellent dielectric, cold weather, chemical resistance and UV properties



## IWH3: Impact Wrench Holster w/ Bit Holder, Outside Mount

- Outside mount
- 13" deep
- 19" integrated bit holder
- Fits wrench with socket attached
- Offers maximum space efficiency
- Semi-flexible polymer construction
- Excellent dielectric, cold weather, chemical resistance and UV properties



## IWH4: Impact Wrench Holster, 27" Deep, Outside Mount

- 27" deep
- Fits wrench with bit attached
- Offers maximum space efficiency
- Semi-flexible polymer construction
- Excellent dielectric, cold weather, chemical resistance and UV properties



## 219030: Tool Holder, Burndy Long, Yellow

- Overall length of 13"
- Designed for longer nosed, pistol grip tools with overall length of 13"-18" such as Greenlee Gator-Pro, ECCX, the Huskie and REC-5440
- Offers maximum space efficiency
- Semi-flexible polymer construction
- Excellent dielectric, cold weather, chemical resistance and UV properties



## 210001: Tool Organizer Board

- Dimensions 18" x 20"
- 5 pocket tool holster
- 4 leather tool loops
- Scissor pouch
- Leather bug bag
- Offers the maximum in space efficiency
- Made of thick durable, polymer
- Won't bloom like fiberglass; eliminates cuts, scratches & irritation associated with fiberglass
- Replacement components available
- All of the utility components are made from high quality, heavy duty top grain saddle leather



## 210020: Tool Organizer Board

- Dimensions 18" x 20"
- TP-7 pouch
- 4 leather tool loops
- 3 way tool holster w/ knife snaps
- Leather Bug Bag
- Offers the maximum in space efficiency
- Made of thick durable, polymer
- Won't bloom like fiberglass; eliminates cuts, scratches & irritation associated with fiberglass
- Replacement components available
- All of the utility components are made from high quality, heavy duty top grain saddle leather



## TO-1: Tool Organizer Board

- Dimensions 18" x 20"
- 3 leather tool loops
- 3 way tool pouch with knife snaps
- Scissor pouch
- Leather bug bag
- Offers the maximum in space efficiency
- Made of a thick and durable polymer
- Won't bloom like fiberglass; eliminates cuts, scratches and irritation associated with fiberglass
- Replacement components available
- All of the utility components are made from high quality, heavy duty top grain saddle leather
- Available with canvas bug bag



TO-2: With auger bit holder and knife pouch



TO-3: With knife pouch

# Platform Equipment

TRUCK

## PTI EZ-2: Step, rated for 275 lbs

- Fits all standard 1 man and 2 man aerial buckets
- Strong and lightweight
- Impact resistant polycarbonate
- Dielectrically safe, no metal
- Rated for 275 lbs



## PTI SST-20: Splicer Seat, Large Opening, Gray

- 40% lighter than traditional wooden models
- UV protected
- Cold-resistant
- 12" x 28.5" opening to accommodate larger items
- Made of a rugged polymer making it impervious to motor oil, hydraulic oil and a broad range of chemicals
- The PTI splicer seat allows for storage of tools
- No longer does the technician have to rummage for the correct tool, it will be in plain sight and within easy reach



## PTI 318022: Splicer Seat, Large opening, Gray with Xtra Padded Seat

- 40% lighter than traditional wooden models
- The tool pouch has a large pocket that holds connectors, 3 tool pockets that store drivers, pliers and other small hand tools, and a leather knife sheath
- UV protected
- Cold-resistant
- 12" x 28.5" opening to accommodate larger items
- Made of a rugged polymer making it impervious to motor oil, hydraulic oil and a broad range of chemicals
- With the addition of a padded seat and handy tool pockets, the splicer seat will increase productivity



## PTI DS-1: Scuff Pad with Step

- Size 20" x 20" square shape
- Molded interior step for easy exit and added safety
- High quality fiberglass for strength and longevity
- Exclusive non-skid surface
- Longer bucket liner life
- Works with or without a liner
- Greater lineman safety
- PTI's fiberglass scuff pad is smooth on the outside to protect the bucket and/or liner. Inside, the pad's gritty surface provides the lineman with non-skid footing and greater safety



**DS-8: Scuff Pad 26" x 20" Rectangle**

**DS-11: Scuff Pad 43" x 20" Rectangle**

## D-20: Scuff Pad 20" Square

- 20" square scuff pad
- Exclusive non-skid surface
- Longer bucket liner life
- Works with or without a liner
- Greater lineman safety



**D-21: Scuff Pad w/ Step 21" Square**

**D-26: Scuff Pad 27" x 21" x 4" Rectangle**

**D-28: Scuff Pad 26" x 20" x 4" Rectangle**

**D-46: Scuff Pad 44" x 20" x 4" Rectangle**





## FITALL Soft Covers

- Fit Most 2-man buckets
- Made of heavy duty vinyl coated nylon
- Eliminates gathering of still water
- Reversible, gives you twice the life
- Available in black only

"Fit-All" soft covers were designed with safety and extended durability in mind. The soft covers will keep the inside of your bucket or tool tray dry from the elements, thus extending its useful life. It is also manufactured to allow for a doming of the cover, allowing water to run off rather than puddle. This helps to reduce mosquito breeding ground and the spreading of viruses.

Part #	Description	Fits Bucket Size
FITALL-I	Soft Cover Single Man w/ Foam	24" x 24"
FITALL-II	Soft Cover 2-Man w/ Foam	24" x 48"
FITALL-K	Soft Cover Kidney-Shaped w/ Foam	Fits Hi Ranger & Teco Kidney Styles
FITALL-V	Soft Cover 1.5 Man w/ Foam	24" x 30"



FITALL-II



FITALL-V

## Tru-Fit Lid w/ Strap

- Shaped to shed ice and snow
- Easily removed and replaced by one person
- Fits permanently: no shrinking, sagging or tearing
- These rigid, tough polymer covers seal your bucket against driving rain, ice and snow

Part #	Description	Size
28L32	Tru-Fit Lid w/ Strap, Rectangle Shape	28" x 32"
30L34	Tru-Fit Lid w/ Strap, Rectangle Shape	30" x 34"
2L28N	Tru-Fit Lid w/ Strap & Webbing	29.5" x 29.5"
5A30	Tru-Fit Lid w/ Strap	33" x 27"
5A48	Tru-Fit Lid, 2 Man w/ Straps	50.5" x 27"
5F48	Tru-Fit Lid, 2 Man w/ Straps, Hi Ranger	50.5" x 27"
5TD48	Tru-Fit Lid, 2 Man w/ Straps, High Ranger	50.5" x 28"
411041	Tru-Fit Lid, 2 Man w/ Straps	54.5" x 31"



28L32



5A30



411041

## 411048: Lid, Slide on Retrofit Kit for 1TB

- Lid only. Kit comes with lid, strap and fasteners to add to your existing 1TB model
- Made from a special grade of rugged, cold resistant polymer blend with UV protection added
- Protects tools from the weather
- Two straps support lid in open position and hold it in out of the way location while working
- Safe and convenient storage for tools and CATV meters

## Hastings 05-960: Fiberglass Step

- Heavy duty fiberglass step.
- Makes it easier to get into and out of buckets
- The HFGP accessory step is a one piece construction produced from high strength fiberglass materials
- Weight: 7.8 lbs

## Hastings 05-961: Fiberglass Step

- Heavy duty fiberglass step
- Makes it easier to get into and out of buckets
- The HFGP accessory step is a one piece construction produced from high strength fiberglass materials
- Weight: 8 lbs



# Cable Handling Accessories

TRUCK

## Aircraft Dynamics RoboReels

- Designed for linemen to provide a safe and easy means to unwind and rewind cumbersome wire and cable
- Extremely rugged, all-weather, heavy duty reels
- Made of steel and E-coated, RoboReels have adjustable arms that allow a secure means of loading, unwinding and rewinding various coils with different diameters
- Coils can simply be rolled into the stand and clamped into place with the adjustable arms
- Wire or cable is easily pulled or rewound through "smooth" center guides

## Aircraft Dynamics Guy Wire RoboReel

- Four adjustable arms
- Holds guy wire with 1/2" diameters
- 5276 holds coil diameter 22" to 31" with coil widths to 4.75"
- 5415 holds coil diameter 32" to 36" with coil widths to 8.75"
- Driver or passenger site mounting options
- 5276 Dimensions: 33 3/4" high x 9 1/4" deep x 32 1/4" wide
- Weight 41 lbs

5276 Universal Mounting  
5415 Universal Mounting



## LTL6000-11: LTL Guy Wire Holder



- Four adjustable arms
- Holds guy wire with 1/2" diameters
- Driver or passenger site mounting options

## Aircraft Dynamics 5478: Triplex RoboReel

- 8 adjustable arms
- Holds coils up to 10 1/4" wide
- Accepts coils with outside diameter 26" to 32" and inside 14" - 20"
- 34 1/2" high x 14" deep x 33 1/2" wide
- Weight: 58 lbs



## Aircraft Dynamics 5074: RoboReel Base Plate

- Securely, easily mount or remove reel
- Simply slide your RoboReel into the RoboReel base plate and a spring-loaded latching system will provide a secure means to hold your reel for all transportation needs
- Ideal accessory for those who want a quick means to remove or remount RoboReel



## Aircraft Dynamics 5479: Hitch Mount

- Allows the RoboReels to be mounted in any 2" receiver hitch
- Mounting plate swivels 360° to allow the cable to pay out in any direction
- Works well with the RoboReel quick change base plate, but may also be used without it



## Tulsa Power the REEL Thing

- With higher load ratings stamped right on the tool, you can use The Reel Thing for a greater range of reel weights
- With a new flipping feature, this multi-use tool gives you more flexibility in the warehouse and in the field
- The Reel Thing allows one person to lift, stack, and spin cable spools
- RT-20 and RT-40 allow you to safely flip a reel from rolling to non-rolling position
- RT-60 features a bearing swivel assembly to accommodate a weight of up to 12,000 lbs
- Independent laboratory tested with the ASME code stamped right on the toggle bar

Part #	Arbor Size	Capacity
RT-10	1.25"-2"	500 lbs.
RT-20	2"-4"	3000 lbs.
RT-40	3"-6"	4500 lbs.
RT-60	2 5/8"-6"	12000 lbs.



Itlutilitysupply.com



# Hannay Reels & Accessories

TRUCK

## GCR 10-17-19 Manual Rewind Grounding Reel

- Independently tested to 43 kVA for 30 cycles
- Helps meet OSHA requirements for vehicle grounding
- Offers manual rewind with hand crank permanently attached to disc
- Internal rotary device



BASE MODEL	CABLE CAPACITY OF REEL			APPROX. WEIGHT	
	Cable Size	ft	m	lb	kg
GCR10-17-19	#2	150	45.7	30	13.6
	1/0	90	27.4	30	13.6
	2/0	90	27.4	30	13.6

## GC 10-17-19 Manual Rewind Grounding Reel

- Storage only
- Manual rewind with hand crank permanently attached to disc



BASE MODEL	CABLE CAPACITY OF REEL			APPROX. WEIGHT	
	Cable Size	ft	m	lb	kg
GC10-17-19	#2	150	45.7	28	12.7
	1/0	90	27.4	28	12.7
	2/0	90	27.4	28	12.7

## SGCR 10-17-19 Spring Rewind Grounding Reel

- Independently tested to 43 kVA for 30 cycles
- Helps meet OSHA requirements for vehicle grounding
- Fast, convenient, automatic spring rewind
- Ratchet mechanism locks the reel
- Built-in cable hoop
- Internal rotary device



BASE MODEL	CABLE CAPACITY OF REEL			APPROX. WEIGHT	
	Cable Size	ft	m	lb	kg
SGCR10-17-19	#2	75	22.9	43	19.5
	1/0	75	22.9	43	19.5
	2/0	65	19.8	43	19.5

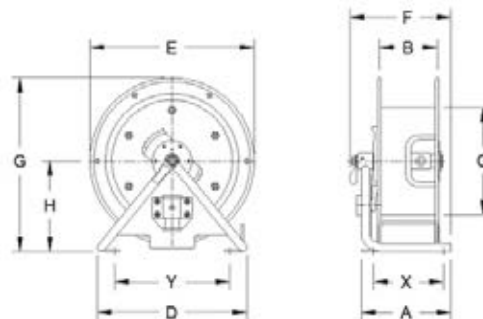

BASE MODEL	REEL DIMENSIONS (INCHES)									
	A	B	C	D	E	F	G	H	X	Y
GCR10-17-19	9	6	10.5	15	16.5	10.5	17.19	8.94	-	-
GC10-17-19	9	6	10.5	15	16.5	10.5	17.19	8.94	-	-
SGCR10-17-19	9	5.5	10.5	15	16.5	10.12	17.19	8.94	-	-

Itutilitysupply.com



# Reels & Accessories

TRUCK

## Hydraulic Reels & Hydraulic Hoses



- Because rewind power is self-contained, spring rewind reels are extremely versatile
- No power connections are required and the reels may be installed in almost any position and on all types of equipment
- Rewinds hose automatically when hose is pulled to release the ratchet
- The ratchet provides interval locking or may be detached for constant tension operation
- A declutching hub arbor prevents damage to the spring from reverse winding
- Heavy duty spring operates through thousands of cycles without power loss
- Each unit is equipped with rollers to protect the hose as it extends and retracts from the reel
- Equipped with two swivel joints, allowing use of two hoses simultaneously

## Power Cord Reels



- Designed for optimum performance and a long service life, this durable cord reel is perfect for a wide variety of applications including hoists, electric tools and moving equipment
- The unit is factory assembled and includes Type SO or W cable
- The reel's spring tension design allows it to lift or stretch cable with 10% sag
- Containerized main spring assures safety and easy handling
- Features include an adjustable cable guide with anti-cable "lock out", and a modular collector ring, cable included

## Hand Wind Reels



- This rugged hand wind reel is designed for heavy duty industrial storage applications, such as storing extension cords, power cables, and hoses
- Center cavity allows convenient access to the end of the conductor
- Capacity: for example, the unit can hold up to 100' of 3-conduit type SO cable, size #14 AWG
- Unit is UL listed

## Hydraulic Reel Ball Stop



- Recommended with spring rewind reels and 4-way roller assemblies
- Each stop is easily assembled with the fasteners provided, without any special tools
- Two-piece molded plastic spheres, custom drilled to the size you specify

## Hydraulic Reel Ball Swivel



- 1/2" swivel joint
- 90° - male to female
- Made from steel
- Rated to 3000 psi

## Chance C4176086: Portable Cable Reel 18 lbs



- Hole in outer flange for cable to feed through
- Rewind handle has galvanized-pipe extension for temporarily parking clamps
- Portable reel quickly pays-out/takes-up
- Helps keep ground sets clean and neat, ready for use
- Handles are comfortable, turned aluminum
- Lightweight unit can be carried to remote sites
- Tubular-steel frame can be U-bolted to deck of truck
- Galvanized drum has ribbed flanges to resist flexing and beaded rims to eliminate sharp edges
- Reel is for storage only
- Cable and clamps should be removed completely from reel before use
- Failure to do so could result in a dangerous voltage drop and violent mechanical reactions
- A label on the unit gives this warning

## Chance T6001971: Truck Grounding Set



- Provides means to drain off capacitance or static charges from winch trucks and aerial devices
- Flat-face clamp is for secure attachment to the truck bed at an area cleaned for electrical contact
- C-type clamp is for secure attachment to the ground rod
- This grounding method should not be considered adequate protection to personnel against conductor contact

Part #	Component	Qty
G3370	Screw Ground Rod	1
T6001798	Flat Face Ground Clamp	1
C6001754	C-Type Ground Clamp	1
S6116	#2 Copper Grounding Cable	50 ft
C6002618A	Shrouded Alum. Ferrules	2
C417-6086	Storage Reel	1

## Utility Tool & Trailer CR Collapsible Reel

- The CR collapsible reel is designed for picking up wire in neat coils
- The reel is simply pushed onto the winch shaft, compressing the spring and then turned to lock onto the shaft
- After the wire is coiled onto the reel, a quick-acting handle is used to collapse the outer rim of the pick-up reel, allowing the coiled wire to be removed

Drum Diameter	20"
Overall Diameter	28"
Throat (between flanges)	6"
Winch Shaft	2-7/16"
Weight	73 lbs



## Utility Tool & Trailer 132513: LD Payout Reel

- Utility Tool & Trailer designed the LD Payout Reel for both picking up wire cable in neat coils in addition to paying out. Unit expands and contracts and is designed to work in any position in-between
- Unit also comes with a rope brake made to drag in one direction to ensure ease of rewinding and which aids in evenly paying out wire or cable
- LD Payout Reel can be mounted on your truck using very limited space and is made of both high-strength steel and heat-treated aluminum

Max Paddle ID	21"
Minimum Paddle ID	14"
Paddle Width	12"
Unit Width	20"
Unit Height	39"
Unit Weight	46 lbs



# Reels & Accessories

TRUCK

## Hastings Grounding Reels

- Two models available to ensure adequate cable lengths to meet truck grounding requirements - small or large
- Compact design grounding reels provide an efficient and positive means to ground trucks working on or near energized lines
- Grounding reels have been tested for maximum fault current rating and can be tested without removing from the truck
- The ground connection from reel to the vehicle is made during the initial installation
- Reels are designed to be bolted to the vehicle so they can be removed easily for transfer to new trucks
- Spring rewind drum for controlled payout and take up
- 4-way cable guide rollers allow for one man operation and prevents excessive wear on the ground cable
- Weather-tight construction to prevent corrosion
- All catalogued ground reels with factory installed cables include a 6' length of 2/0 ground cable to connect the reel to the truck. Item A30205, a 4-way bronze tee connector is provided to connect one end of the cable to the ground stud on the reel. The other end must be connected to the truck frame by a suitable means



01-029

Part #	Description	Weight
21362	Retractable Grounding Reel only tested to 27KA @ 15 cycles	32 lbs
21363	21362 Reel with 40' of #2 Yellow Ground Cable Factory installed and 21307 Bronze clamp one end	47 lbs
21364	21362 Reel with 40' of 1/0 Yellow Ground Cable Factory installed and 21307 Bronze clamp one end	53 lbs
21365	21362 Reel with 40' of 2/0 Yellow Ground Cable Factory installed with 21307 Bronze Clamp one end	57 lbs
21366	Large Retractable Grounding Reel only tested to 43KA @ 15 cycles	83 lbs
21373	21362 reel with 50' of 2/0 Yellow Ground Cable Factory installed with 21307 Bronze Clamp one end	50 lbs
21374	21362 Reel with 50' of 1/0 Yellow Ground Cable Factory installed with 21307 Bronze Clamp one end	57 lbs
21375	21362 reel with 50' of 2/0 Yellow Ground Cable Factory Installed with 21307 Bronze Clamp one end	62 lbs
A30205	4-way Bronze Tee Connector	1.3 lbs
01-029	Cover, Yellow Vinyl, for 21362 Reel	2 lbs
01-030	Cover, Yellow Vinyl, for 21366 Reel	2.5 lbs

## Bashlin 902: Wire Basket

- A lightweight, compact wire dispenser that will accommodate reels up to 26" X 4 1/4"
- Specially handy for guy strand. It features a hanger for easy mounting on a truck and an eyelet for temporary pole attachment
- 902-30 is slightly larger and will accommodate a 30" coil

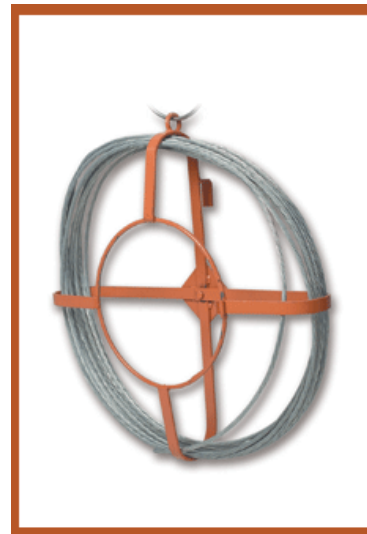

# Checkers Industrial Safety Wheel Chocks

TRUCK

## RC450 Series Wheel Chock (Black)

- Standard of the utility industry
- Durable recycled rubber construction
- Resistant to the elements
- Steel loop carrying handle
- Fits most chock storage compartments
- Allows either side to be positioned against the tire
- 7 lbs
- Height: 5.5 in
- Width: 8 in
- Length: 10 in
- Available with a Bottom Void (RC450), Solid Bottom (RC450-S), Bottom Void with Aluminum Ice Cleat (RC450-CL), or Bottom Void with 14 ga. Steel Grate for Ice (RC450-GR)



Part #	Weight
RC450	7 lbs
RC450-S	10 lbs
RC450-CL	8.5 lbs
RC450-GR	9.2 lbs

## UC1600 Wheel Chock (Orange)

- For tires with up to a 35" outside diameter
- Rated for vehicles with a gross operating weight up to 40,000 lbs
- Weather-resistant, lightweight polyurethane construction
- Resistant to oils, fuels, and solvents
- Recessed carrying handle
- Mounting hole for ropes or chains
- High visibility orange color
- 3.5 lbs
- Length: 11.25 in
- Width: 8 in
- Height: 8.25 in
- 7.5 lbs (pair of chocks)
- Available in singles or pairs, specify after model number S=Single or P=Pair



## Heavy Duty Dock Chain with Hardware

- Rated for 800 lb working load limit
- Standard lengths are 10, 12 and 15 ft
- Includes hardware
- Custom lengths available

Part #	Weight	Length
MS1602-5-10	4.1 lbs	10 ft
MS1602-5-12	4.9 lbs	12 ft
MS1602-5-15	5.8 lbs	15 ft



Itlutilitysupply.com



# Outrigger Pads

TRUCK

## LTLOUTRPAD

- LTL outrigger pads are ideal for use with radio boom derricks (RBD), digger derricks, single or double bucket trucks and cranes
- The outrigger pads are made from a high quality polyethylene (PE HD RKB regenerated multicolour), meaning they do not splinter or absorb water and can be used in all weather conditions
- Maintains its rigidity and original shape during use, each pad has a high resistance to vertical pressure
- Long lasting and have an extended life span compared to other materials
- Carry handles are made from durable nylon rope
- Handles on two sides make them easy to transport, install and store
- Easy to clean, chemical and oil resistant
- Dimensions: 1.97" x 13.98" x 28" (tolerance +0/ +0.02")
- Weight: 26.45 lbs





# Heavy Duty Temporary Access Mat

## The fast and safe way forward

### Heavy Duty Temporary Access Mats

Supporting loads up to 80 tons, this mat is the ultimate, fast to install temporary access and ground protection mat for moving equipment and personnel over soft or sensitive ground.

### Amazingly Tough & Flexible

Tough high density polyethylene (HDPE), the mat weighs only 35kg/77lbs and incorporates hand holds that make moving and installation easy.

### Anti-Slip Surface

The engineered, unique chevron traction® surface delivers ultimate grip and dispels mud, dirt and snow when vehicles travel over the mats. The chevron nub design also reduces sideways movement and slippage and delivers optimal forward traction.

### Connection Options

Multiple connection options are available to suit various applications.

- Fast and easy to install
- Unique chevron traction® surface
- Fast temporary access and working areas
- Low transport and handling costs
- Avoid property and environmental damage
- Avoid health and safety issues
- Reflective markings for night safety (optional extra)
- Multiple connection options for different terrain and equipment

	Thickness	Dimension (WxL)	Weight per Mat
Standard	.47"	47" x 94.8"	77 lbs
Material	Premium recycled High Density Polyethylene (HDPE)		
Colours Available	Black - recycled HDPE. Other colours available-minimum order quantity applies		
Connectivity	Standard connectors - 2-way and 4-way options		
	Metal connectors for heavy and tracked equipment		
	"Fast Fit" connectors for fast installation		
	Flex connectors for undulating ground		
Optional extras for night safety	Non-slip reflective markings and "cats eyes"		
Environmental features	Weather-proof, water and chemical resistant, usable in sub-zero temperatures. High Density Polyethylene is resistant to acids, alkalis and solvents		

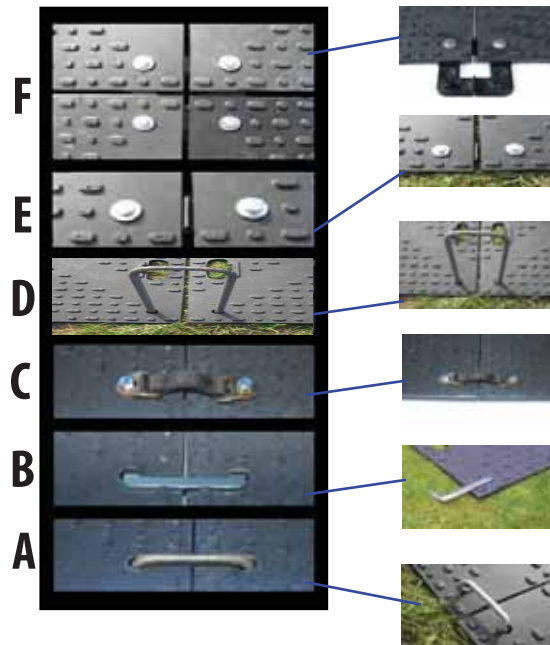
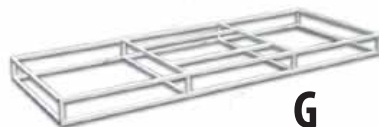

	Part #	Description
A	EMC001A	Fast Connectors
B	EMC001B	Fast Connectors
C	EMC003	Flex Connectors
D	EMC008	Metal U Pin Connectors
E	EMC201	2-Way Connectors
F	EMC401	4-Way Connectors
	EMS003	EuroMat
G	LTLRACK	Transportation Rack 6'H x 8'L x 4'W

TRUCK

ltutilitysupply.com



## TRUCK ACCESSORIES

### AUXILLIARY ARM ASSEMBLY

#### Complete Assembly

- Support arm for 3" diameter mast with solid Epoxirod® pole
- Designed for use on light construction when handling multiple conductors

**T4001857 Complete Auxiliary Assembly:**  
**3 Roller Wireholders, No Insulator, 2.5" opening**  
**1 Arm Clamp Assembly**  
**1 Solid Epoxirod, 2.5" x 10'**  
**1 Adapter**

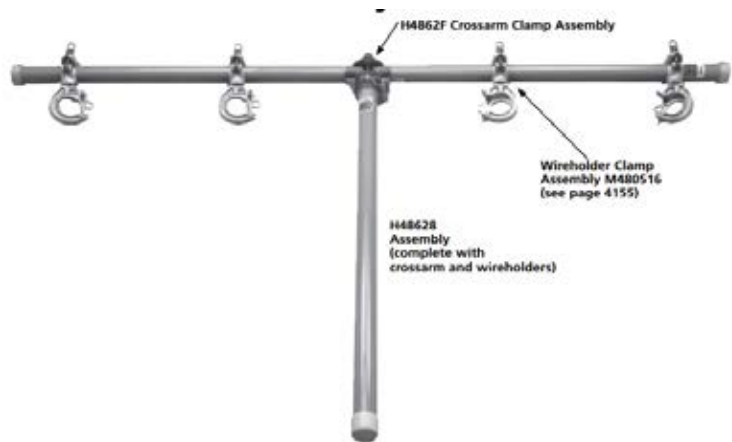

### AUXILLIARY ARM ASSEMBLY - BY COMPONENT

#### Roller Wireholder



- Offers protection to conductors while raising the conductor above the work area
- Fit on 2" or 2.5" solid Epoxirod®
- Does not feature an insulator

**C4000268 2" Opening**  
**C4000690 2.5" Opening**

#### Arm Clamp Assembly



- Connects the adapter to the solid 2.5" x 10' Epoxirod

**E4000757**

#### Jib Mounted Arm Attachment Round Adapter



- 3" diameter adapter
- Used to connect the jib extension to the arm clamp assembly

**P4001594P**

#### Solid Epoxirod®



**E4001569 2.5" x 10' Solid Epoxirod®**

# Chance - Truck Accessories

TRUCK

## JIB & EXTENSIONS WITH MATERIAL HANDLING ACCESSORIES

### Single Wireholder with Swivel



- Accommodates conductors up to and including 1.5" in diameter
- Gate is held closed by a spring loaded latch which must be manually opened
- Features seven Delrin plastic rollers
- 1.5" opening

**C4000747**

### Single Wireholder with Swivel



- For attachment to mast
- Accommodates conductors up to and including 2.5" in diameter opening
- Gate is held closed by a spring loaded latch which must be manually opened
- For 3" diameter round jib
- Seven Delrin plastic rollers offer protection to conductors while raising the conductor above the work area
- 800 lb. capacity

**C4001669**

### Wireholder/Sheave Combo (For Square Jib)



- 19" x 8" x 8" x 2.5"; 800 lbs max load
- For 4" square jib
- 2.5" x 3 3/8" opening
- 7" diameter sheave accepts up to .75" diameter rope
- Can be used in conjunction with material handler
- 7" sheave

**T4002530**

### Wireholder/Sheave Combo (For Round Jib)



- 19" x 8" x 8" x 2.5", 800 lbs max load
- 2.5" opening
- For 3" diameter round jib
- Can be used in conjunction with material handler
- 7" sheave

**T4002529**

### Wireholder without Sheave



- 800 lbs max load
- 2.5" opening
- For 4" square jib
- Can be used in conjunction with material handler

**PST4002856**



TRUSTED SINCE 1958

ltlutilitysupply.com

# Chance - Anchor Tools

TRUCK

## SCREW ANCHOR KIT - 10K SYSTEM

- This kit includes the specified Kelly bar adapter, locking dog assembly, and 7' drive-end wrench

C3030090 2.5" Kelly Bar Adapter

Includes: C3030070, C1021583, 630011HD

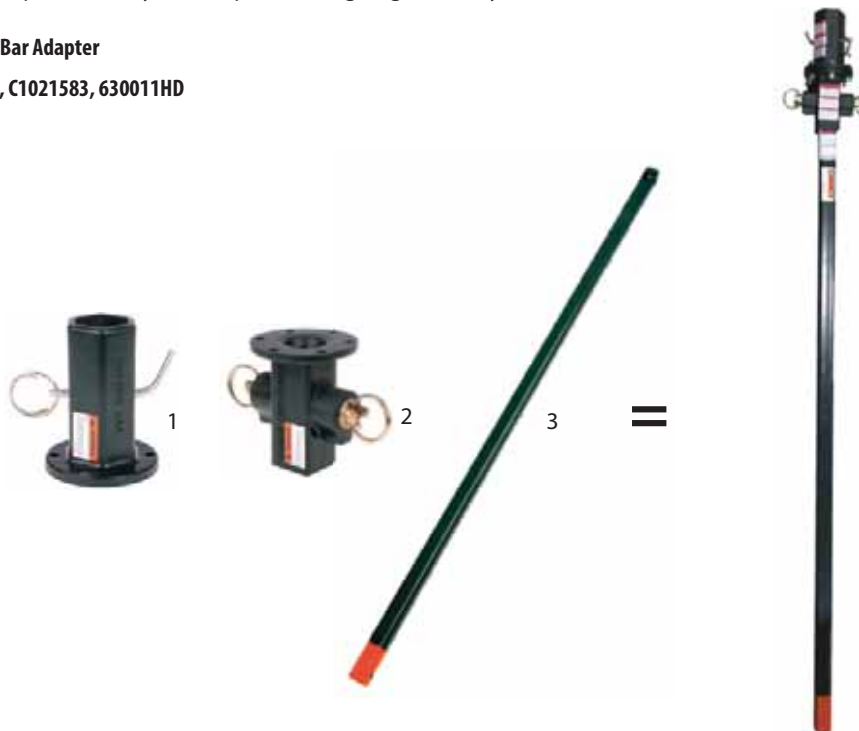

## SCREW ANCHOR EQUIPMENT - 10K SYSTEM

### 10K Locking Dog Assembly



- Features six 0.5" diameter holes on a 5.25" bolt circle
- Includes six 1/2" grade 5 bolts, nuts and lock washers

C3030069HD 10K Locking Dog Assembly  
C3030070 Repair Kit for 10K Assembly

### 10K - Kelly Bar Adapter with Bent Arm Pin



- Features six 1/2" diameter holes on a 5.25" bolt circle
- Includes six 1/2" bolts, nuts, lock washers and a bent arm pin with a coil lock

630017 Square, 2.5"  
630011HD Hex, 2.5"  
630013 Hex, 2"  
630012HD Hex, 2 5/8"

## ANCHOR WRENCHES

### 10K 1.5" Core Anchor Hybrid Drive-End Wrenches



- Installs PISA® 6000 & 7000 and 8000 ft. lb. (large hub) Tough One® Anchors

C3031063 3.5'  
C3031064 7'

### 10K 1 3/8" Standard Core Anchor Drive-End Wrenches



- Fits 1 3/8" core anchors
- Installs 8000 ft. lb. (small hub) Tough One® Anchors, 10,000 ft. lb. (small hub) Tough One® Anchors, standard strength and mid-strength anchors

C1021595 3.5'  
C1021583 7'

Itlutilitysupply.com



**ANCHORING TOOLS & ACCESSORIES**

**SCREW ANCHOR EQUIPMENT - 15K SYSTEM**

**Tough One® 15K - Locking Dog Assemblies**



- Features twelve 5/8" holes on a 7 5/8" bolt circle
- Includes twelve 5/8" grade 2 bolts, nuts and lockwashers
- C3031026 includes all parts in C3030981 except casting

- C3030981 Locking Dog Assembly**
- C3031026 Locking Dog Assembly Repair Kit for Tough One® 15K Assembly**

**Tough One® 15K Kelly Bar Adapter with Bent Arm Pin**



- Features twelve 5/8" holes on a 7 5/8" bolt circle
- Includes twelve 5/8" bolts, nuts, lock washers, and a bent arm pin with a coil lock

- C3030936 Hex, 2.5"**
- C3030937 Hex, 2 5/8"**
- C3031571 Square, 3.5"**

**Anchor Wrenches**



- Fits Tough One Anchors, 1.5" core anchors
- Installs Tough One Anchors, 8,000 ft lbs and 15,000 ft lbs (large hub)

- C3030982 3.5'**
- C3030983 7'**

**SCREW ANCHOR KIT 15K SYSTEM**

- This kit includes the specified kelly bar adapter, locking dog assembly and 7' drive-end wrench



- Kit: 2 1/2" Kelly Bar Adapter**
- Includes: (1) C3030981 (1) C3030983 (1) C3030936**
- Kit: 2 5/8" Kelly Bar Adapter**
- Includes: (1) C3030981 (1) C3030983 (1) C3030937**

## ANCHOR TOOLS

### Anchor Drive End Extension 10K



- Extends core anchor drive-end wrenches an additional 3.5' or 7'
- 10,000 ft lb torque rating

630027	3.5'	42 lbs
630028	7'	71 lbs

### Tough One Anchor Drive End Extension 15K



- Extends core anchor drive-end wrenches an additional 3.5' or 7'
- 15,000 ft. lb. torque rating

C3030987	3.5'	50 lbs
C3030988	7'	87 lbs

### Bolt Circle Adapter



C3030115  
T3030166

- Used to connect two tools with incompatible bolt circles
- C3030115 is for use between two tools having tapped 5.25" bolt circle
- T3030166 is for use between a tool having a 5 1/4" bolt circle and one having a 7 5/8" bolt circle
- Both are limited to 10,000 ft lbs

### Anchor Installing Tool Pin



- Plated-steel bent arm pins
- Designed to attach a Kelly bar adapter to a Kelly bar
- Used to secure SS, RR, and bumper post anchors to anchor drive tools
- Bent arm pins are included with new tools as required

C3031223	4.5" x 0.5"
C3031227	5" x 0.75"
C3031226	3" x 5/8"
C3031222	5" x 5/8" Coil Lock Assembly
P3031215P	Coil Keeper

### Adapter for Installation of SS or RR Anchors



- Slides into the C3030069HD locking dog adapter and is retained by a spring loaded dog
- Weighs approximately 8 lbs

C3030020

### Light Pole Anchor Plate



- Plates fit STL foundation anchors with 9" to 13.5" bolt circles
- C3030139 connects directly to a Kelly

- bar adapter with (6) 0.5" furnished bolts and features a torque rating of 10,000 ft. lbs
- C3030684 includes (12) 5/8" bolts and features a torque rating of 20,000 ft. lbs
- Coupling C3030684 to a Kelly bar adapter with a 5.25" bolt circle requires use of T3030166 adapter and limits tool's maximum torque rating to 10,000 ft. lbs

C3030139	5.25", (6) 1/2" Tapped Holes
C3030684	7 5/8" (6) 5/8" Drilled Holes

### Expanding & Tamping Bar



- Fiberglass handle
- Simplifies the job of expanding anchors
- The curved Expander and Tamper Head distributes the weight of the bar evenly around the anchor rod to reduce handle vibration
- The hook of the Expanding and Tamping Bar wraps around the anchor rod to keep the expanding head from slipping off the anchor top plate
- This tool is also effectively used for tamping in soil above the installed anchor
- The base casting is attached directly to the fiberglass handle

C3020004 12' 24 lbs

### Foundation Anchor Installing Tool



- Used for installing flange-drive foundations
- The drive tool has six 0.5" - 13 tapped holes on a 5.25" bolt circle and requires a Kelly Bar Adapter (sold separately)

C1300010

## How to Match CHANCE® Anchors and Installing Wrenches

PISA® 9 Anchor (formerly PISA® 5 Anchor)	PISA® 7 Anchor	Standard-Strength PISA® Anchor	Mid-Strength PISA® Anchor	C102-50XX Series Tough One® Anchor - Small Hub	C102-50XX Series Tough One® Anchor - Small Hub	C102-50XX Series Tough One® Anchor - Large Hub	C102-50XX Series Tough One® Anchor - Large Hub						
								0700-00066 *C102-1583	7'	10,000	2.16	1.46	Orange
								0700-00034 *C102-1595	3 1/2'	10,000	2.16	1.46	Orange
								8960-21700 *C303-1064	7'	10,000	2.44	1.54	Yellow
								0700-00031 *C303-1063	3 1/2'	10,000	2.44	1.54	Yellow
								0700-00054 **C303-0983	7'	15,000	2.44	1.54	Red
								9000-30982 **C303-0982	3 1/2'	15,000	2.44	1.54	Red
6,000	7,000	4,000	6,000	8,000	10,000	10,000	15,000	Maximum Installation Torque Rating (ft-lbs)					
								*Fits Locking Dog Assembly CC303-0069HD					
								** Fits Locking Dog Assembly CC303-0981					

Inside and outside dimensions correspond to the color coded end of installing wrench.

TRUCK

### TORQUE INDICATORS

#### C3031578: Digital Torque Indicator



- Allows you to install screw anchors to a pre-determined torque value which gives a positive indication of anchor holding capacity in any type soil
- This tool also helps your crew avoid excessive torsional loading which could cause damage to the anchor and/or other anchor tools during installation
- Indicator mounts between Kelly bar adapter and drive tool or locking dog assembly
- LED display is easy-to-read in full daylight and gives the operator a direct readout of installation torque at all times
- Solid one-piece spool, designed to withstand bending loads
- No shear pins to replace
- Operational temperature range: -40° to 80° C (-40° to 175° F)
- Accuracy: +/-500 ft. lb. at any reading
- Torque is measured using strain gauges
- Powered by a standard 9V battery
- Top and bottom flange - each provides: six holes tapped 1/2" - 13 on a 5 1/4" bolt circle and twelve holes tapped 5/8" - 11 on a 7 5/8" bolt circle

#### C3030044: Shear Pin Torque Indicator



- Designed for installing torques up to 10,000 ft. lbs.
- Offers protection for anchors and installing tools by disconnecting the power source from drive tools
- Durable; does not require special storage/handling
- Useable in very rocky soil
- Includes six 1/2" - 13 tapped holes on a 5.25" bolt circle, both ends

lTutilitysupply.com



# Greenlee - Hydraulic Paving Breakers

TRUCK

## HPB25: 25 lbs Paving Breaker



- "D" handle and an assist handle for both vertical and horizontal operation
- Simple construction with few parts provides easy maintenance and excellent durability
- Supplied with steel braided whip hoses
- Hydraulic cushioning of the ram return stroke helps to reduce operator fatigue
- Lever style latch for quick tool changes
- Open center system
- 7/8" x 3 1/4" chuck size
- Hydraulic flow of 3-7 gpm
- 1280 - 1850 psi operating pressure
- Maximum pressure of 3,000 psi
- 1,800 blows per minute at 5 gpm
- Whip hoses are 3/8" NPTF x 12"

## HPB25: 35 lbs Paving Breaker



- Vibration isolated and cushioned handles to reduce operator fatigue
- Simple construction with few parts provides easy maintenance and excellent durability
- Supplied with steel braided whip hoses
- Hydraulic cushioning of the ram return stroke helps to reduce operator fatigue
- Lever style latch for quick tool changes
- Open center system
- 1" x 4 1/4" chuck size
- Hydraulic flow of 5-8 gpm
- 2000 blows per minute at 7 gpm
- Whip hoses are 3/8" NPTF x 12"
- 1140 - 1700 psi (3000 psi max.) operating pressure

## 45 lb/55 lb Paving Breakers



- Great for breaking sidewalks and curbs or driving ground rod, and for other small demolition jobs
- Clean modular design with few protrusions to irritate operators' legs
- High blow energy provides maximum breaking power
- Integral rubber damper reduces chisel noise
- Low noise and vibration levels
- AVS tools have patented spring-dampened handles that reduce vibration transmitted to the operator by 80%-90%
- Two-step trigger
- Supplied with 12" steel braided whip hoses
- Open center hydraulic system
- 1/2" BSP pressure and return ports; 1/2" NPTF x 12" whip hoses

Part #	Tool Shank Size	Sound Power Level	Blow Energy	Blow Frequency	Oil Flow	Operating Pressure
HPB45-1AVS*	1 1/8" x 6" AVS	110 dB	63 ft lbs	2160/minute	5-8 gpm	1500-1800 PSI
HPB45-2AVS*	1" x 4 1/4" AVS	109 dB	63 ft lbs	2160/minute	5-8 gpm	1500-1800 PSI
HPB55-1AVS*	1 1/8" x 6" AVS	112 dB	81 ft lbs	1860/minute	5-8 gpm	1500-1800 PSI

			BREAKER COMPATIBILITY CHART				
			25 lbs	35 lbs	45 lbs		55 lbs
Cat #	UPC#	Description	HPB25	HPB35	HPB45-1AVS	HPB45-2AVS	HPB55-1AVS
F018451	41706	Moil Point - 1 1/8" x 6"			X		X
F018452	41707	3" Chisel - 1 1/8 x 6"			X		X
49138	49138	Moil Point - 1 x 4 1/4"		X		X	
46219	46219	3" Chisel 1 x 4 1/4"		X		X	
46221	46221	Asphalt Cutter - 1 x 4 1/4"		X		X	
46222	46222	5/8" Threadless Ground Rod Adapter - 1 x 4 1/4"		X		X	
46223	46223	1" Threadless Ground Rod Adapter - 1 x 4 1/4"		X		X	
F016769	41610	Moil Point - 7/8 x 3 1/4"	X				
F016770K	41611	3" Chisel - 7/8 x 3 1/4"	X				
113509	40349	1" Threadless Ground Rod Adapter - 7/8 x 3 1/4"	X				
137449	41070	5/8" Threadless Ground Rod Adapter - 7/8 x 3 1/4"	X				

Itlutilitysupply.com





## POLE TAMPERS

### H4802 Pole Tampers & Accessories



- Makes quick work of setting poles, asphalt patch, and general construction backfill compacting
- Reversible on/off valve allows tamper to be used with an open or closed center hydraulic system
- Only 3 moving parts for low maintenance
- Kidney shaped foot standard
- Flow range of 4 - 6 gpm
- Operating pressure of 1,000 - 2,000 psi

#### Pole Tampers w/ Hose End Valve (left):

H4802	60" Long
H4802-1	85" Long
H4802-6	60" Long, no valve

#### Pole Tampers with Valve on Tube (right):

H4802-5	60" Long
H4802-3	72" Long

## SIGN POST DRIVER & POLE PULLER

### HPD Series Sign Post Driver



- Can drive a variety of post sizes from small delineator posts up to 3 1/2" round posts including square, "U" channel, breakaway stubs, round, "T" fence, and wood
- Quick change front head design accommodates adapters for different types of posts
- Dual guide handles provide directional control
- A deep post opening and smooth operation ensures that the driver will not jump off of posts
- Flow range of 5-8 gpm
- 75 lbs. with UA adapter, hoses
- 1500 - 2000 psi operating pressure
- 9/16-18 SAE O-ring Boss; 1/2" NPTF
- Can be used with open and closed center hydraulic systems
- Available with integral trigger or remote on/off valve

**HPD-T-U/11183 - Internal Trigger; Universal Post Adapter**  
**RA96/49532 - Remote On/Off Valve; Universal Post Adapter**

#### Sign Post Driver Accessories

UA/49533	Universal head adapter
RA 96/49532	3.8" round head adapter
SA54/49534	2 1/8" square head adapter

### H4905A42237: Sign Post Puller



- Uses serrated jaws or wrap-around, high strength alloy chain
- Able to pull nearly any post size and shape
- Faster and easier than conventional manual methods
- Open center hydraulic system
- Lifting capacity of 9,800 lbs.
- Flow range of 4 - 6 gpm
- Operating pressure of 1000 - 2000 psi
- Weighs 70 lbs
- 5" stroke
- 9/32" alloy chain

## HRD-1 & HRD-58 Ground Rod Drivers

- Accommodates various sizes of ground rods
- May be used with single or stacked rods
- May be used on an open or closed center system
- Drivers come with built-in dual carrying handles and a lifting eye
- Flow range of 5 - 8 gpm
- Maximum input pressure 2,000 psi



## HIRD44A: Hydraulic Rock Drill

- Weighs 44 lbs
- Drills holes up to 2 1/2" diameter, 10' deep
- Vibration isolated and cushioned handles reduce operator fatigue
- Uses bits with 7/8" x 4 1/4" shanks
- On-board air compressor provides air to clean dust out of holes
- Drill rotation speed is adjustable from 0 to 400 rpm with a 4 positioning dial; tool can be operated without rotation
- Supplied with steel braided whip hoses



## H4910A: Hydraulic Pole Puller

- Pole puller works in confined areas, next to buildings, or out in the open
- Lifting capacity of 56,000 lbs.
- Designed for heavy-duty construction
- May be used on either an open or closed-center hydraulic system
- Comes standard with a 5/8" proof-certified 6' alloy chain
- Flow range of 4 - 15 gpm
- Operating pressure of 300 - 2,800 psi



# Greenlee - Compact Submersible Pumps

TRUCK

## H4665A: Submersible Pump

- Compact, lightweight design
- High impact strainer housing
- Up to 275 gpm
- Carrying handle
- Can draw water down to depth of 1 3/4"
- Can run dry without damage
- Open and closed center systems



## H4660B: 2 1/2" Submersible Pump

- High impact strainer housing
- Up to 400 gpm
- Carrying handle
- Self priming
- Can run dry without damage
- Can draw water down to depth of 2"
- Open and closed center systems



## H4635: 3" Submersible Pump

- Lighter than typical 3" water pumps
- Lightweight, durable all-aluminum body
- 12" diameter to fit in compact areas
- Self-priming submersible pump
- Can run dry without damage
- Passes up to 3" solids, minimizing pump blockage from debris
- Draws water down to depth of 2 3/4"
- Locking coupler for discharge hose included
- Open and closed center operation runs off of a variety of power sources



## H4670: 4" Submersible Pump

- No clog, self priming, abrasion-resistant impeller pump
- Up to 900 gpm
- Replaceable wear plate, carry handle
- Can run dry without damage
- 4" NPT discharge, will pass 3" solids
- Draws water down to depth of 3 1/4"
- Locking coupler for discharge hose included
- Open and closed center systems



## GREENLEE SUBMERSIBLE PUMP SPECIFICATIONS

	Intake Port	Discharge Port	Width	Height	Flow Range	Operating Pressure	Pressure Port Thread	Return Port Thread
H665A	1 5/16"	2" NPFT	7.5"	12.5"	5-8gpm	0-2000 psi	9/16 - 18 SAE O-Ring	3/4 - 16 SAE O-Ring
H4660B	1 1/2"	2.5" NPT	12"	16"	4-8 gpm	0-2000 psi	9/16 - 18 SAE O-Ring	3/4 - 16 SAE O-Ring
H4635	3.125"	3" Female NPT	11.87"	14.18"	8-10 gpm	0-2000 psi	1/2" Male NPTF	1/2" Make NPTF
H4670	4" NPT	4" NPT	14.5"	15.75"	5-9 gpm	0-2000 psi	1/2" Make NPTF	1/2" Make NPTF

## Submersible Pump Accessories - Discharge Hose/Couplings

Part #	Hose Assembly
156340	2" Diameter x 25' Discharge Hose Assembly for Use with Submersible Pump H4665A
F024772	2" Cam Lock Coupling for Discharge Hose 156340
156339	2.5" Diameter x 25' Discharge Hose Assembly for Use with Submersible Pump H4660B
F024775	2.5" Cam Lock Coupling for Discharge Hose 156339
49499	3" Diameter x 25' Discharge Hose Assembly for Use with Submersible Pump H4635
41189	4" Diameter x 25' Discharge Hose Assembly for Use with Submersible Pump H4670



lutilitysupply.com

# Hastings - Arm Assembly

TRUCK

## Complete Arm Assembly



- The boom-mounted lift arm may be utilized as a 1 or 3-phase lifting attachment when mounted to derrick trucks and aerial trucks that have lifting capabilities
- May be used for change- out of poles, cross-arms, insulators, and mid-span lifting requirements
- Lift arm can be mounted to a square, rectangular, round, or oval boom by ordering the proper boom adapters and blocks
- Total arc covered is 45°
- Metal components are steel or aluminum alloy
- Boom mounting assembly features a ratchet, which allows the arm to be positioned under the load
- Fiberglass arm and mast assembly is 3" O.D. with a solid foam core, which are tested per OSHA
- Fiberglass brace is 1 1/2" O.D. with solid foam core and tested per OSHA
- Load rating - balanced loading with brace is 1000 lbs maximum; with arm, unbalanced load is 200 lbs per conductor holder
- Rating is based on vertical lift; sideloading reduces rating
- Load rating - if mast only is used with self-aligning conductor holder or super-duty conductor holder, the load rating is 500 lbs maximum

## 11974: Swivel Support



- This support is used to connect the arm assembly to the mast

### Complete Assembly Includes:

9' x 3" O.D. Arm

Swivel Support

Brace Pole

2 Brace Clamps

3 Four-Way Conductor Holders

## 12006: Brace Pole



- For attachment to arm assembly and mast

## Brace Clamps



- For attachment of brace pole
- 11387: Fits 3" O.D. arm and mast assemblies
- 13495: Fits 3.80" O.D. arm and mast assemblies and allows use of Brace Pole

## 12666: Super Duty Conductor Holder



- For attachment to mast and jib adapters
- Accepts 2" diameter conductors
- Maximum working load 500 lbs

## 5034: Four Way Conductor Holder



- For mounting to 3" O.D. arm
- Opening is 1 1/2"
- Spring loaded latch is hot stick operable

## 21644: Jib Head Roller with Sheave



- Aluminum alloy housing with a steel wheel
- Opening is 3" diameter

## EX3-726: Super Duty Conductor Holder with Latch



- For attachment to mast and jib adapters
- Features a spring-loaded release latch
- Accepts 2" diameter conductors
- Maximum working load 500 lbs

# Hastings - Arm Assembly

## 3489: Square Jib Brace Adapter

- For attaching brace to pole
- 4" x 4" F.G. Jibs



## 11683: 5' x 3" O.D. Mast Assembly Only

- Features quick detach pin



## 3479: Jib Mounted Arm Attachment

- Mounts arm assemblies and attachments
- Enables attachments to rotate 360°

## 21642: Self-Aligning Conductor Holder

- For attachment to mast
- Opening is 1 1/2"
- Spring loaded latch is hot stick operable
- Maximum work load 300 lbs
- For a 3" diameter round jib



## 6729: Truck Safety Barricade Arm

- Barrier can be installed, positioned, or raised for moving truck and removed in minutes. Just drop in place in pre-located, permanently attached steel brackets
- Fiberglass arm is easily positioned to adjust barricade for proper height above the ground and to compensate for parking on uneven terrain
- Unique design of sector allows fiberglass arm to be quickly locked into 8 different positions
- Arm can also be moved to "vertical travel position" when movement of truck for a short distance is required



## Truck Safety Barricade Kit

- Installation, positioning, or removal are quick and simple
- Fiberglass arm is easily positioned to adjust barricade for proper height
- Arm can be moved to vertical travel position when short distance movement of a truck is required
- All metal components except for adapters are stainless steel or aluminum to reduce corrosion



Truck Safety Barrier kit with 4' Arms

Truck Safety Barrier Kit with 6' Arms

4' Fiberglass Arm with Bracket

6' Fiberglass Arm with Bracket



TRUCK

ltlutilitysupply.com

## POWER GENERATORS

### EM5000S: Deluxe Generator

- Portable power with premium features and traditional Honda durability and performance
- 5000 watts maximum AC output
- Home backup and commercial usage (for non-GFCI applications)
- Suitable for rental applications
- Powerful, easy-start Honda iGX390 commercial-grade engine
- Auto-throttle further extends running time by automatically adjusting engine speed to idle when under no load
- 12 VDC battery charging capability with optional charge cable
- Standard wheel kit with positive lock folding handles for easy transportation and convenient, compact storage
- Cold climate technology aids continuous running in cold weather conditions



### EM3000: Generator

- Ultra-compact and lightweight cycloconverter design, 30% lighter than conventional models
- Large muffler offers 68 dB(A) noise level at rated load
- 3000 watts of power, continuous-rated output of over 20 amps
- Full-frame design, 12 VDC battery-charging capability, convenient circuit-breaker construction, a 10.2-litre fuel tank that allows up to 6 hours of continuous running, and a rubber-mount system for smooth operation



### EU3000IS: Generator

- High-tech 2 layer enclosure and unique muffler design offers whis per quiet operation
- Reliable Honda GX200T2 OHV four-stroke engine
- Dependable 12 volt DC electric start with enclosed low maintenance battery
- Power for your furnace, fridge, microwave, most 13,500 BTU/h RV AC units, and more
- Large 13-litre tank gives 7.2 hours' continuous operation at rated load, 20 hours of continuous operation at 25% load



## WATER PUMPS

### WT-20: Trash Series

- Honda GX160, four-stroke, OHV, air cooled, single cylinder
- 50 mm (2 in) suction and discharge ports
- Pumps 710 litres per minute (156 Imp. gal. per minute)
- 50 mm (2 in) trash pump designed specifically for commercial users
- Heavy-duty, deep-vane impeller and extra-thick, cast-aluminum pump housing; it is capable of pumping water that contains rocks and debris
- An easy-access door is also standard so that the pump housing can be easily flushed
- Pumping capacity is 710 litres per minute
- Powered by a commercial-grade, GX160, 4-stroke, OHV Honda engine for dependable starts and long life
- Tubular steel frame and Oil Alert™



### WH20: High Pressure Series

- High output 500 litres per minute (110 Imp. gal. per minute), high pressure (61 psi)
- Honda GX160 OHV engine
- 50 mm (2 in) suction and discharge ports
- General water transfer, high pressure to irrigation
- Can be used with a fire hose nozzle for emergency back-up in remote areas
- A convenient carrying handle and hose strainer come standard



### WMP-20: Chemical Series

- Output 833 litres (183 Imp. gal.) / min capacity
- Honda GX160T2 OHV engine
- 50 mm (2 in) suction and discharge ports
- Designed for pumping a diversity of industrial and agricultural liquid chemicals
- Pump features EPDM seals (ethylene-propylene terpolymere) for chemical resistance, a reinforced thermoplastic pump housing and impeller and full-frame protection with vibration damping mounts
- This multi-purpose centrifugal self-priming 2" pump features Honda's commercial-grade engine with Honda Oil Alert to provide outstanding performance for chemical applications
- Maximum pumping is 833 litres (183 Imp. gal.) / min. capacity
- Other standard features include isolation mounted engine and pump, an easy starting Honda GX160T2 OHV commercial engine and a suction hose strainer



# Robolights

TRUCK

## Pole Bug



- Single bright LED is rated for 100,000 hours of heavy duty operation
- System provides the ultimate in pole-mount transportation safety
- LED features a 5-7 mile visibility range, includes four flash patterns: Comet, Single, Steady Burn and Flare Flicker
- Light module with dual front/angled reflectors is encapsulated for vibration and moisture resistance
- Three alkaline "C" batteries provide 100+ hours of continuous operation
- Easy-to-attach and deploy; heavy duty strap attaches to all type of poles and sizes
- Powder coated metal components and dual flag holders
- Includes batteries and two flags

**LED Strobe with Dual Flag Holder (shown):**      **Dual LED Strobes with Dual Flag Holder :**

<b>7015-R</b>	<b>Red LED</b>	<b>7026-R</b>	<b>Red LED</b>
<b>7015-A</b>	<b>Amber LED</b>	<b>7062-A</b>	<b>Amber LED</b>

## Robolight Cone Light



- Enhances the safety of workers, surrounding areas
- Small, versatile, and effective
- Easily placed over cones
- Durable, long-lasting weather-resistant LEDs
- Lights are attached to rust-proof plates that can be used with all cone sizes
- 4AA battery burn time is 50+ hours (blinking pattern)

<b>7036-R</b>	<b>(1) Red LED</b>
<b>7037-A</b>	<b>(1) Amber LED</b>
<b>7038-R</b>	<b>(4) Red LED Kit w/ Case</b>
<b>7039-A</b>	<b>(4) Amber LED Kit w/ Case</b>

## Pole Tacker



- Provides a simple, durable, effective means in maintaining pole transportation safety
- Utilizing super-bright, long-lasting (100,000 hours of heavy operation) LEDs; 5-7 mile visibility range
- Easy-to-mount with heavy duty super secure "T-Screw"
- Four optional flash patterns: Comet, Single, Steady Burn, and Flare Flicker
- LED is encapsulated for vibration and moisture resistance with dual front/angled reflectors

<b>7032-R</b>	<b>Red</b>
<b>7032-A</b>	<b>Amber</b>

## LED 360° STROBES

<b>7167-A</b>	<b>Amber</b>
<b>7167-R</b>	<b>Red</b>
<b>7175-A</b>	<b>Amber - Low Profile Model</b>
<b>7175-R</b>	<b>Red - Low Profile Model</b>

- 360° LED strobes utilize 24 long lasting LEDs to create a highly visible 60 flashes per minute strobe
- System is easy to attach and deploy, using a heavy duty strap that attaches to all types of poles and sizes
- Strobe is protected by a rugged cage and includes powder coated metal components
- These systems can be purchased with or without dual flag holders
- Batteries: Two alkaline "D"s
- Battery Run Time: 100+ hours
- Low profile model is great for mid-pole or rear protection

## GMP Pole Trailer Light Kits

- Features compact design, secure attachments and maximum visibility
- Allows easy transport of utility poles with greater visibility while meeting DOT requirements and only adding minimal width to the trailer
- Frame is made from an aluminum extruded weldment with a durable bright yellow polyester powder coating
- The kit uses a Reflexite label with 3" high lettering and a standard legend
- Shock mounts provide greater bulb life and simplify bulb replacement
- The unit comes with a 40' 18 gauge S.O. trailer cord with a heavy-duty 4-way or 6-way trailer plug
- The width of the unit is minimized with up-right flags and cordage storage arms located within the outer dimensions of the frame
- Attachment to the pole is done with an over-center chain binder that uses 5' of chain and hardened steel spikes that bury in the pole when the binder is tightened



<b>Part #</b>	<b>Description</b>	<b>Weight</b>
<b>70274</b>	<b>46" Wide; 4-Way</b>	<b>26 lbs</b>
<b>70276</b>	<b>46" Wide; 6-Way</b>	<b>26 lbs</b>
<b>70277</b>	<b>24" Wide; 4-Way</b>	<b>14 lbs</b>
<b>70278</b>	<b>24" Wide; 6-Way</b>	<b>14 lbs</b>
<b>26006</b>	<b>4-Way Socket</b>	<b>2 oz</b>
<b>26007</b>	<b>6-Way Socket</b>	<b>2 oz</b>

Itlutilitysupply.com





# SafeZone Series Roll-Up Signs and Overlays

## Bone Safety Signs

All signs are designed using the Standard Highway Signs Manual as specified in the Manual on Uniform Traffic Control Devices (MUTCD).

Bone Corner Pocket, Anti-Kiting Devices, Storage Strap and Reversible Snaps for Overlays option and Heavy Duty Fiberglass with Anti-Blooming are standard on all Roll-Up signs.

## Super Bright (SB) Signs

This is one of Reflexite's most popular products. Super Bright fluorescent prismatic sign blanks are used by our customers to create the work zone signs you see on the road. As a motorist, you benefit from maximum visibility at long distances, day and night. Reflexite's colour stability technology ensures a long and useful life. Super Bright colours are: fluorescent orange, non-fluorescent white, yellow and the new fluorescent pink colour recommended for Incident Management applications.



## Marathon (M) Signs

Reflexite's Roll-Up sign blanks which utilize Marathon Fluorescence take performance to a higher level. The longer lasting fluorescent colour gives the sign a longer useful life and offers outstanding visibility, day and night. Higher levels of photometric performance ensure superior reflectivity at night and in low light conditions. Reflexite High Performance Marathon Fluorescence signs are available in the following colours: fluorescent orange, fluorescent yellow-green (lime), non-fluorescent white, and the new fluorescent yellow.

## Common Sign Overlays

The Signs and the Overlays are designed so that the overlay may be attached to the back of the sign for easy storage. Velcro may be used upon request. Velcro Overlay cannot be attached to the back of the sign for storage.

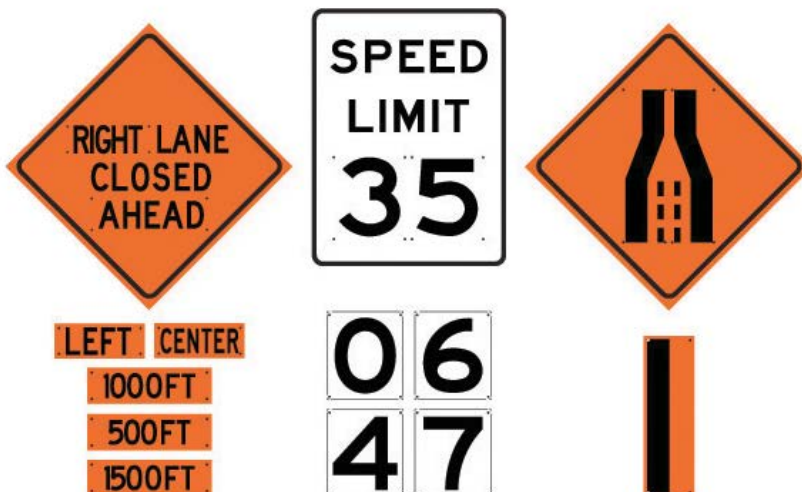

Common Overlays		
Legend	48" Premium Mesh Overlay	48" Super Bright Reflective Overlay
Left		
Right		
500 ft		
1000 ft		
1500 ft		
Merge		



# SafeZone Traffic Control & OSHA Signs

## Bone Tele-Pole

The SafeZone series STOP/SLOW paddle is designed to allow the worker to telescope the sign from 54" to 84" for ease of use controlling traffic through the temporary traffic control zone. It is available in reflective and non-reflective faces and comes in both 18" and 24" sizes.

## Safe

An ergonomically designed screw-type compression fitting on the telescopic mast, combined with a non-skid rubber cap on the bottom of the HI-VIZ orange fiberglass mast, makes the SafeZone Series paddle both simple and economical.

## Durable

The pultruded hollow fiberglass mast, coupled with the fiberglass reinforced plastic (FRP) sign face, makes the SafeZone series STOP/SLOW paddle both lightweight and durable even in extreme temperatures and harsh environments.



## Stop-N-Slow Paddles

Our Stop-N-Slow sign faces are made from the same BONELIGHT ACM used for our large construction signs or Reclaimed Aluminum and Virgin Aluminum. Available in 18" & 24" sizes and various reflective and non-reflective faces.



### Stop-N-Slow Paddle

- 24" Face
- Standard Reflective 84" Extendable Handle



### Stop-N-Slow Paddle

- 24" Hi-Intensity Reflective
- 84" Extendable Handle



### Stop-N-Slow Paddle

- Combination Model
- 24" Diamond Grade Hi-Intensity Reflective
- 84" Extendable Handle



### Stop-N-Slow Covers

- A fluorescent orange cover will add longer life to the paddles

## OSHA Signs

Helping you meet the federal OSHA guideline for 1910 or 1926 for indoor or outdoor use



# SafeZone Series Stands

## SafeZone Series Stand Features & Benefits

All SafeZone Series Sign Stands come with a patented Auto-Latch mechanism, unless the Universal Bracket is requested. The advantage of our Auto-Latch is the speed in which the sign is attached and released from our stands.

- Crash design breakaway base
- Exclusive Quick Release System for all modular attachments and accessories
- Compact and lightweight
- Bright orange, UV stabilized, powder coated legs for safety, durability & visibility
- Pull pin and kick release for fast setup by hand or foot
- Simple nut & bolt construction allows for fast repairs using basic hand tools
- Readily available replacement parts or assemblies
- 3 height adjustments on Legs for use on uneven terrain
- Skid resistant rubber feet



## Universal Bracket



Universal Bracket

Allows the use of the SafeZone Stands with most brands of roll-up signs

The SafeZone Series SZ-412 is a super lightweight compact springless sign stand for use with roll-up signs. Easy to use and easy to store, its single sign attachment point allows for quick deployment in the field.

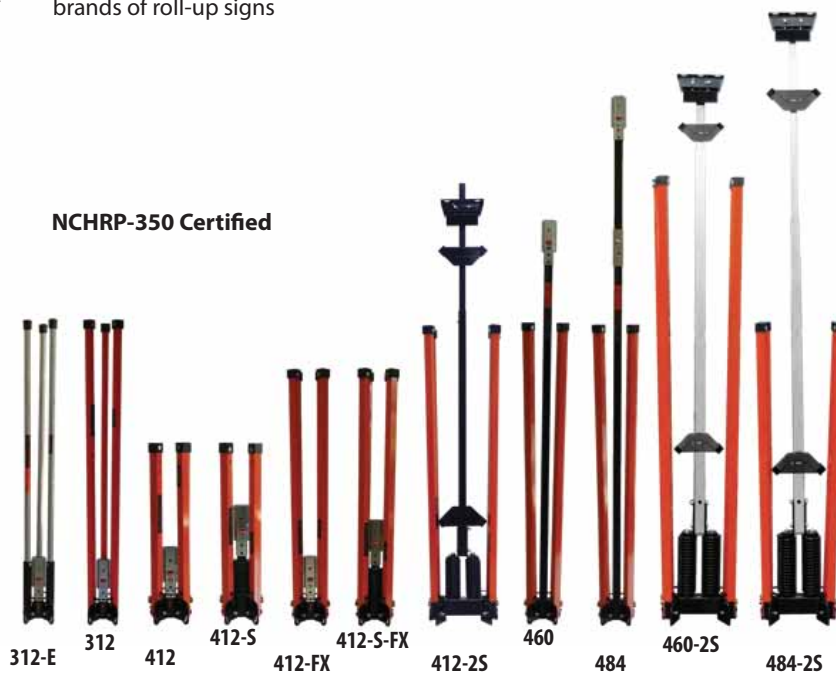

Standard Model	Springless	Springless with U Bracket	Single Spring	Single Spring with U-Bracket	Dual Spring (Rigid Sign Stand)	Dual Spring with Roll-Up Bracket (Rigid Sign Stand)
Model SZ-412 1' Stand (4 legs, 12" off ground)						
Model SZ-460 5' Stand (4 legs, 60" off ground)						
Model SZ-484 7' Stand (4 legs, 84" off ground)						

# Safety Equipment

Part #	Description
SSS-BTMS3F	Sign Stand System, Consists of Base, Telescoping Mast, 3 Warning Flags
RIBS-90X120	Rib Kit to Support 90cmx120cm Sign
RIBS-90X90	Rib Kit to Support 90cmx90cm Sign
RSDG-TC102B	90X90 Roadwork Ahead, DG
RSDG-TC103R	90X90 Right Lane Closed, DG
RSHI-RB91	90X120 Yield to Oncoming Traffic, HI
SV-LTT-LX	Standard Vest, Lime, Large/XLarge
SV-OTT-SM	Standard Vest, Orange, Small/Medium
TC-CBAR	Traffic Cone Bar - Telescoping
TC-H4U-28	28" Traffic Cone, w/ 4" Collar
TC-22-Complete	Stop/Slow Paddle c/w 5 ft Handle



## Single & Double Collar Traffic Cones

### TC-H4U-18

- 18" Cone (45cm) 8 lb
- HI-VIS PVC Traffic Cone with Black Base
- Meets MTO-Spec TC-51B
- with 4" Reflective Collar

### TC-SBB-36

- 36" Cone (91.44cm)
- HI-VIS PVC Traffic Cone
- 6" Lower Collar
- Meets MTO Spec

### TC-H6U-28

- 28" Cone (70 cm) 8 lb
- HI-VIS PVC Traffic Cone with Black Base
- Meets MTO-Spec TC-51B
- With 6" Reflective Collar

### TC-H6U4L-28

- 28" Cone (70cm) 8lb
- HI-VIS PVC Traffic Cone with Black Base
- Meets MTO-Spec TC-51B
- With 4" Lower Collar and 6" Upper Collar



## TC-CBAR: Retractable Cone Bar

- Lightweight and extremely portable
- Easy to set up or remove
- Providing an instant and inexpensive barrier to hazardous or controlled access areas
- Made with high quality industrial grade material
- Traffic cone bar special features:  
Black and yellow stripes for visual intensity  
Retractable from 1150MM to 2500MM  
Used in combination with traffic cones



## PCC-501-28: Pack N' Pop Cones & Tote

- 28"(70cm) Pack-A-Cone
- 4 LED Lights
- Collapsed height 2" weight 4.2 lbs
- Base - 13x13" 2-AAA batteries included
- Tough nylon material with polyethylene base
- 5-Pack with case



## WorkZone Standard Vest

- Exceeds all requirements set out in CSA Z96-09
- Class II / Level II
- 5 Point Tear-Away design with true tear-away capabilities
- Available in fluorescent orange or fluorescent yellow/green
- 2" glass bead reflective tape
- Two front pockets with hook and loop closure
- One radio clip
- Two pencil pockets
- Contrasting colour binding to enhance visibility



Part #	Size	Colour
SV-OTT-SM	Small	Orange
SV-OTT-LX	Large/XLarge	Orange
SV-OTT-23	2XL/3XL	Orange
SV-OTT-45	4XL/5XL	Orange

## WorkZone Deluxe Vest

- Exceeds requirements for CSA Z96-09 Class II / Level II
- 5 Point Tear-Away design with true tear-away capabilities
- Fluorescent orange or fluorescent yellow/green
- 4" wide contrasting trim with 2" glass bead reflective tape
- Two large, front "pouch" pockets, two radio clips
- Cell phone pocket with Velcro closure
- Front flagging tape pocket with hook and loop closure, grommet hole for access to tape and two pencil pockets
- Inside "safety" pocket with full hook and loop closure
- Two full size inside pockets
- Plan pocket across entire back of vest with zippered access
- Contrasting colour binding to enhance visibility



Part #	Size	Colour
DV-OTT-SM	Small	Orange
DV-OTT-LX	Large/XLarge	Orange
DV-OTT-23	2XL/3XL	Orange
DV-OTT-45	4XL/5XL	Orange

## WorkZone Premium Vest

- Exceeds all requirements for CSA Z96-09, Class II/Level II
- 5 Point Tear-Away design with true tear-away capabilities
- Fluorescent orange or fluorescent lime/yellow
- 4" wide contrasting trim with 2" glass bead retro-reflective
- Two front "safety" pockets with full hook and loop closure to lock in items
- Two radio clips
- Cell phone pocket with Velcro closure
- Two pencil pockets
- Inside "safety" pocket with full hook and loop closure
- Contrasting colour binding to enhance visibility



Part #	Size	Colour
PV-OTT-SM	Small	Orange
PV-OTT-LX	Large/XLarge	Orange
PV-OTT-23	2XL/3XL	Orange
PV-OTT-45	4XL/5XL	Orange

# Traffic Safety Equipment

## Safety Cones

- Rugged, brightly coloured safety cones
- Designed for many years of outside use
- Cones are constructed of day-glow red/orange PVC with two reflective collars
- 18", 28", and 36" tall cones available



18" Cone	Base 11" x 11"
28" Cone	Base 14" x 14"
36" Cone	Base 14.5" x 14.5"

## 18" & 28" Pack N' Pop Cones & Tote

- 13.5" x 13.5" x 8" plastic tote holds 4 cones
- Durable, bright orange, flexible nylon
- Rubber base grips the road for stability
- Meets MUTCD standards
- Collapses flat for easy storage
- Internal light endures over 100,000 flashes
- or 36 hours of steady burn



Qty of 4	18" Cones/Nylon Bag Set
Qty of 4	28" Cones/Nylon Bag Set

## Cortina 3295500: Emergency Warning Triangle Kit

- ORTINA Highway Warning Triangles quickly warn passersby of oncoming traffic hazards. High-visibility units snap together in minutes. Come complete with storage box that fits conveniently in your vehicle
- Sold in boxes of 3



## Safety Lightsticks



- Provides long distance illumination
- Visible in fog, rain, or snow
- Waterproof and windproof
- Non-toxic and non-flammable
- Easy Snaplight® activation
- 6" Snaplight 30 minute lightstick in white
- 10" Safety Glow lightstick with a stand in red

## EMERGENCY EQUIPMENT

### Fire Extinguishers for Electrical Equipment

- Dispense a precisely dispersed, rapidly evaporating liquid agent that is electrically non-conductive
- Does not cause thermoshock on sensitive electrical equipment
- Pressurized with argon
- The liquid agent is HydroChloroFluoroCarbon (blend B) for use in extinguishing class A, B, C type fires
- Ideal for extinguishing fires originating at or near delicate electronics and electrical equipment such as mobile units, computers, telephone switchgear, etc.



### Multi-Purpose Fire Extinguishers

- Designed to fight all common fires (Class ABC): wood, electrical, gas, oil, flammable liquids, paper and cloth
- Features easy-to-pull safety pin
- Capacities range from 2.5 lbs to 10 lbs
- Rust and impact-resistant nylon handle
- Easy-to-read gauge tells when extinguisher is charged and ready for use
- Quick, clear directions for ease of use
- Includes vehicle mounting bracket



## E-Flood® LiteBox®



	615 LUMENS	330 LUMENS
	8h	18h
	126m	93m
	4000 cd	2150 cd

- Six (6) C4® LEDs
- High: 615 Lumens, up to 8 hours; Low: 330 Lumens, up to 18 hours
- Fits existing Litebox® chargers
- IPX4 rated for weather-resistant operation
- Parabolic reflectors produce a smooth flood pattern
- Optimized electronics provide regulated intensity
- Jumper selectable high or low setting to allow higher light output or longer runtime

### Standard System (120V AC/12V DC):

- 45801 E-Flood - Orange
- 45821 E-Flood - Yellow

### Vehicle Mount:

- 45805 E-Flood LiteBox 12V - Orange
- 45825 E-Flood LiteBox 12V - Yellow

## E-Spot® LiteBox®

- Three C4® LEDs and deep-dish parabolic reflectors produce a large spot pattern
- High: 540 Lumens, up to 7 hours; Low: 330 Lumens, up to 15 hours
- Zero-maintenance 6V, 12 Ah sealed lead-acid battery
- Fits existing Litebox® mounting racks
- IPX4 rated for weather-resistant operation
- Jumper selectable high or low setting allows higher light output or longer run time



	540 LUMENS	330 LUMENS
	7h	15h
	469m	358m
	55,000cd	32,000cd

### Standard System (120V AC/12V DC):

- 45851 E-Spot - Orange
- 45871 E-Spot - Yellow

### Vehicle Mount:

- 45855 E-Spot 12V Orange
- 45875 E-Spot 12V Yellow

## Portable Scene Light

- Six C4® LEDs and wide reflectors produce a uniform flood pattern; selectable diffuser settings for two beam widths
- Three user-selectable outputs: High, 3600 lumens runs five hours, Medium, 2400 lumens runs 9 hours, Low, 1100 lumens runs 18 hours
- 90° swivel
- Sealed lead acid batteries rechargeable up to 500 times
- Easy setup, less than 30 seconds pole extends to 72"
- Weight: 25 lbs

- 45670 120V AC/DC
- 45671 230V AC/DC
- 45672 240V AC/DC
- 45673 100V AC/DC

## LiteBox® Rechargeable Lantern



- Rechargeable, completely portable lantern
- Output: 8 watt spot = 80,000 peak beam candle power, up to 9 hours per charge; 20 watt spot = 105,000 peak beam candle power, up to 3.5 hours per charge
- 7.4 lbs with 6 volt, 12 Ah sealed lead acid battery
- Standard system includes shoulder strap, AC and DC chargers, and charge rack
- Vehicle Mount Systems include truck-mountable 12 volt DC direct wire, mounting rack, and shoulder strap
- Locking device systems are available and are factory installed

### Standard System

- 45117 8 Watt Spot, Yellow
- 45116 8 Watt Spot, Orange
- 45109 20 Watt Spot, Yellow
- 45110 20 Watt Spot, Orange

### Vehicle Mount

- 45108 8 Watt Spot, Yellow
- 45107 8 Watt Spot, Orange
- 45104 20 Watt Spot, Yellow
- 45102 20 Watt Spot, Orange

### Locking Device System

- 40164 Keyed Alike
- 40163 Keyed Differently
- 45937 Replacement Battery



TRUSTED SINCE 1958

# Streamlight



## Knucklehead®

- Rechargeable, alkaline work light
- C4® premium LED technology delivers 200 lumens and 3.5 hour run time on high; 63 lumens and 6 hour run time on low
- Moonlight mode runs 20 days; flash runs 8 hours
- Features a 210 degree articulating head that rotates a full 360°
- Dual power source: accepts rechargeable NiCd battery pack or 4 "AA" alkaline batteries
- Removable magnet with 135 lb. pull strength
- Optimized electronics provide regulated intensity
- High-impact, super-tough nylon polymer construction
- IPX4 rated for water-resistance
- Available in black or yellow
- Rated Class I & II, Division 2

### Steady Charge Models (w/ AC/DC Charger/Holder)

90607\* Black 120V AC/DC

90627\* Yellow 120V AC/DC

### Alkaline Models

90641\* Black

90642\* Yellow

\*Other models available

FL1 STANDARD	HIGH	LOW
	200 LUMENS	63 LUMENS
	3h 30min	16h
	68m	37m
	1150 cd	350cd

## Survivor® LED

- Flash for signaling: runs 8 hours
- Moonlight mode provides low-level lighting for battery conservation: runs 20 days

### Rechargeable model:

- High for a super-bright beam that pierces through smoke: 36,000 candela; 175 lumens; 379m beam distance; runs 3.5 hours
- Low for bright light and longer run time: 12,000 candela; 60 lumens; 219m beam distance; runs 13 hours

### Alkaline model:

- High for a super-bright beam that pierces through smoke: 36,000 candela; 175 lumens; 379m beam distance; runs 4 hours
- Low for bright light and longer run time: 12,000 candela; 60 lumens; 219m beam distance; runs 15 hours

FL1 STANDARD	HIGH	LOW
	175 LUMENS	60 LUMENS
	3h 30min	13h
	379m	219m
	36,000cd	12000cd



## Waypoint®

- Powerful, long-reaching beam that illuminates a range of up to 678 meters
- Pistol-grip spotlight features 3 modes: high, low, and emergency signal
- C4® premium LED technology delivers 210 lumens and 8.5 hour runtime on high; 20 lumens and 120 hour run time on low
- Unlimited run time using 12V DC power cord (included)
- Optimized electronics provide regulated intensity
- IPX4 rated for water-resistance
- Integrated stand for hands-free scene lighting
- Requires four "C" sized alkaline batteries
- Available in black or yellow

44900 Yellow Waypoint with Storage Mount

44902 Black Waypoint with Storage Mount

44904 Yellow Waypoint without Storage Mount

44905 Black Waypoint without Storage Mount

FL1 STANDARD	HIGH	LOW
	210 LUMENS	20 LUMENS
	8h 30min	120h
	678m	245m
	115,000 cd	10000cd





## Fire Vulcan® LED



- C4® LED technology and 2 ultra-bright blue taillights
- Light output: high - 145 lumens; low - 70 lumens
- Run times: Steady High LED and taillights - up to 3 hours on high; up to 7 hours on low
- Recharges in 5 hours
- Fits existing Streamlight Vulcan chargers
- 1.85 lbs.; lantern floats
- 8 modes of operation

- 44450 Orange LED Standard System 120V w/ Quick Release Shoulder Strap - AC/DC
- 44451 Orange LED Vehicle Mount System 12V w/ Quick Release Shoulder Strap - DC
- 44454 Orange LED Standard System (w/o charger) w/ Quick Release Shoulder Strap

## H.I.D. LiteBox®



- 1,000,000 candela peak beam intensity
- Deep-dish parabolic reflector produces a long-range, high-intensity focused beam of light
- Up to 1.75 hours run time
- Fully articulating head
- 35 watt H.I.D. Xenon lamp
- High-impact ABS thermoplastic housing; weatherproof
- 12V, 7.2Ah sealed lead acid rechargeable up to 500 times
- Serialized for positive identification
- Kit includes 120 Volt AC charger and 12 Volt DC charger

- 45621 Black H.I.D. LiteBox® Kit
- 45601 Orange H.I.D. LiteBox® Kit
- 45637 Replacement H.I.D. Bulb Kit

## Vantage® Helmet Mount



### Fire & Industrial Headlight

- C4® LED technology combined with an ultra-bright blue LED taillight
- Lightweight, compact, low profile design easily attaches/detaches above or below brim on fire helmets and full brim hard hats
- Up to 7000 candela peak beam intensity; 115 lumens measured system output
- 6 hours of continuous run time
- Uses two 3V CR123A lithium batteries
- IPX7 rated; waterproof to 1 meter for 30 minutes
- Swivel clamp and insertable 5° angle adjuster to optimize beam location

69140

FLY STANDARD	VANTAGE
	100 LUMENS
	6h
	152m
	5,800cd

# Streamlight

## Headlamp Series

Streamlight offers a variety of ultra-compact headlamps. Designed for comfort and durability, the adjustable, flexible, lightweight straps can be worn on the head or around a hard hat. These high powered professional grade lights offer power, versatility and longevity to accomplish any task.



	Septor®	Enduro®	3AA HAZ-LO®	Argo®	Trident®
	61052	61400	61200	61301	61050
Battery	Three "AAA" Size alkaline batteries	Two 1.5 Volt "AAA" cells	Three "AA" Size alkaline batteries	Three "AAA" size alkaline batteries	Three "AAA" size alkaline batteries
Light Source	Seven ultra-bright white LEDs	.5W High-Flux LED	C4 LED	C4° LED	1C4 LED 3 White LED
Case Material	Water resistant lightweight thermoplastic construction	Impact resistant ABS case	Impact resistant ABS case	Water resistant lightweight thermoplastic construction	Water resistant lightweight thermoplastic construction
Colours	Yellow	Black (other colours available)	Yellow	Yellow	Yellow
Weight (w/ batteries)	5.50 oz (156 g)	2.75 oz (78.5 g)	7.1 oz (202 g)	5.50 oz (156 g)	4.64 oz (131.54 g)
Dimensions (L x W x H)	1.86" x 2.55" x 2.53"	1.3" x 2.25" x 1.6"	1.88" x 2.5" x 3.08"	2.15" x 2.9" x 2.25"	1.86" x 2.55" x 2.53"
Run Time	7 LEDs = 3.5 hrs 8-10h 1=55 hr	6 hours / 12 hours	11 hrs	3 hrs high 4.5 hrs medium 30 hrs low	C4 LED - 5 hours 3 LED - 10 hours 1 LED - 53 hours
Light Output	7 LED / 3 LED / 1 LED 120/45/13	14.5 / 6 lumens	120 lumens	150 lumens high 100 lumens medium 45 lumens low	CD LED - 80 lumens 3 LEDs - 35 lumens 1 LED - 11 lumens
Special Features	<ul style="list-style-type: none"> <li>• 3 lighting modes</li> <li>• Rubber &amp; elastic hard hat straps included</li> <li>• 90° tilting head</li> <li>• Low battery indicator</li> <li>• Flood beam for up close work</li> </ul>	<ul style="list-style-type: none"> <li>• Rubber/elastic combination headstrap</li> <li>• Water resistant</li> </ul>	<ul style="list-style-type: none"> <li>• Rubber &amp; elastic hard hat straps included</li> <li>• 90° tilting head</li> <li>• Water resistant</li> <li>• Intrinsically safe</li> <li>• Class 1, Div 1 and MSHA approved</li> </ul>	<ul style="list-style-type: none"> <li>• Rubber &amp; elastic hard hat straps included</li> <li>• Water resistant</li> <li>• LED battery indicator</li> <li>• 90° tilting head</li> <li>• Illuminate objects at distance</li> </ul>	<ul style="list-style-type: none"> <li>• 3 lighting modes</li> <li>• Rubber &amp; elastic hard hat straps included</li> <li>• 90° tilting head</li> <li>• Water resistant</li> <li>• Spot-to-flood focus - for close up and distance</li> </ul>

### 61304: ProTac HL® Headlamp



- Designed for maximum illumination with a wide beam to light an entire area
- Featured TEN-TAP® programming, which allows the choice of three programs 1) high/medium/low 2) high only 3) low/medium/high
- High for super-bright light; 540 lumens, 7400 candela; runs 1.75 hours
- Medium for bright light and longer run time 95 lumens, 1200 candela, runs 8 hours
- Low for extended run times and when a less intense beam is ideal: 18 lumens; 250 candela; runs 36 hours
- 90° tilting head prevents neck fatigue
- Includes two 3V CR123A lithium batteries rubber and elastic headstraps
- Durable, anodized aluminum construction; gasket-sealed, glass lens; IPX4 water-resistant, 1m impact resistance tested

### ClipMate® USB, Clip-On Light

- 61125 Light Only (w/o AC adapter), Black with White and Red LEDs
- 61126 120V AC adapter, Black with White and Red LEDs
- 61127 International AC adapter, Black with White and Red LEDs



## Polytac®



- High impact super tough nylon polymer
- Textured sure grip
- C4® LED technology
- 275 lumens
- Run time up to 3 hours
- Available in black, coyote tan, and yellow
- IPX7 rated design; waterproof to 1 meter
- Powered by two 3-volt CR123A lithium batteries (included)
- TENTAP® programmable switch
- Batteries included

Beam Spread	HIGH	LOW
	275 LUMENS	14 LUMENS
	3h	65h
	195m	45m
	9,500cd	500cd

- 88850 Black**
- 88851 Coyote**
- 88853 Yellow**
- 88854 Helmet Lighting Kit - Yellow**

## Polytac® HP



- C4® LED technology, impervious to shock with a 50,000 hour lifetime
- Up to 19,000 candela and 275 lumens
- Runs 3 hours on high
- Powered by two 3-volt CR123A lithium batteries
- High impact super tough nylon polymer
- Waterproof to 1 meter (IPX7 rated)
- TENTAP® programmable switch
- Textured sure grip

Beam Spread	HIGH	LOW
	275 LUMENS	14 LUMENS
	3h	56h
	275m	63m
	19,000cd	1,000cd

- 88860 Black w/ Lithium Batteries**
- 88861 Coyote w/ Lithium Batteries**
- 88863 Yellow w/ Lithium Batteries**

## Polytac 90® LED



- Super bright and compact right angle personal light
- Can clip onto turn-out gear or onto our new elastic head strap for a headlamp
- Fully rotatable/reversible/removable clip
- C4® LED technology, with a 50,000 hour lifetime
- Up to 7,000 candela and 170 lumens
- Run: 3.75 hours on high; 30 hours only
- Powered by two 3-volt CR123A lithium batteries
- 90° head
- Waterproof to 1 meter (IPX7 rated design)
- Optional Gear Keeper® system features a retractable attachment system with a high-strength nylon tether featuring a 36" extension and 6 oz of retraction force

Beam Spread	HIGH	LOW
	170 LUMENS	17 LUMENS
	3h 45min	30h
	167m	53m
	7,000cd	700cd

- 88830 Black**
- 88831 Yellow**
- 88834 Orange**
- 88832 Orange w / Gear Keeper**
- 88833 Gear Keeper**



# Streamlight

## PROTAC® TACTICAL SERIES

### ProTac® 2AA



C4® LED illumination output and run times:

- HIGH - 165 lumens/2 Hour
- LOW - 11 lumens/36 Hours
- Includes 2 AA alkaline batteries
- Waterproof to 1 meter

88033

### ProTac® 2L



C4® LED illumination output and run times:

- HIGH - 260 lumens/3 Hours
- LOW - 13 lumens/50 Hours
- Includes 2 CR123A lithium batteries
- Waterproof to 1 meter
- Features strobe mode
- TENTAP Programmable

88031

### ProTac® 1AA



C4® LED illumination output and run times:

- HIGH - 70 lumens/2 Hours
- LOW - 5 lumens/32 Hours
- Includes 1 AA alkaline battery
- Waterproof to 1 meter
- TENTAP Programmable

88032

### ProTac® 1L



C4® LED illumination output and run times:

- HIGH - 180 lumens/2 Hours
- LOW - 12 lumens/24 Hours
- Includes 1 CR123A lithium battery
- Waterproof to 1 meter
- Features strobe mode
- TENTAP Programmable

88030

ProTac HL® (High Lumen) 3 also available, part # 88047

## TACTICAL HAND-HELD SERIES

### Scorpion®



- Xenon gas bulb (spare bulb included)
- Up to 7900 candela (78 lumens measured system output)
- Adjustable spot-to-flood focus
- Two 3 volt lithium batteries (included)
- 1 meter impact-resistance tested

FLC STANDARD	SCORPION
	78 LUMENS
	1h 20min
	178m
	7,900cd

85001 Black

85004 Black w/ Belt Clip Attachment

### Scorpion® X



- C4 LED Technology, 50,000 hr lifetime
- 11,000 candela (200 lumens measured system output on high)
- Adjustable spot-to-flood focus
- Three 3 volt lithium batteries (included)
- 1 meter impact-resistant tested

FLC STANDARD	HIGH	LOW
	200 LUMENS	10 LUMENS
	2h 30min	50h
	210m	47m
	11,000cd	550cd

85011 Black

Scorpion HL® also available, part # 85400

### Super Tac® X



- C4® LED technology
- High - 200 lumens, 2.5 hours run time; Low - 10 lumens, 50 hours run time
- Two 3 volt lithium batteries (included)
- Operates with remote switches
- IPX4 rated for water-resistance

FLC STANDARD	HIGH	LOW
	200 LUMENS	10 LUMENS
	2h 30min	50h
	400m	89m
	40,000cd	2,000cd

88708 Black w/ Holster & Lithium Batteries, Box

88709 Black w/ Lithium Batteries

## STINGER® & POLYSTINGER® SERIES

The series of Stinger® rechargeable flashlights offer you the advantages of a full-size light in a case the length of your palm. The lights are made of a machined aircraft aluminum that is anodized against corrosion inside and out. Streamlight's PolyStinger® flashlights provide you with the features and brightness you expect from a Stinger, in a super-tough, non-conductive nylon polymer with non-slip rubberized comfort grip.

### STINGER® LED



- C4® LED technology with a 50,000 hour lifetime
- Run time: High - up to 2 continuous hours; Medium up to 3.75 hours; Low - up to 7.25 hours
- 3-cell, 3.6 Volt Ni-Cd sub-C battery, rechargeable up to 1000 times
- Fits existing Stinger snap-in chargers

FL 1 STANDARD	HIGH	MEDIUM	LOW
	350 LUMENS	175 LUMENS	85 LUMENS
	2h	3h 45min	7h 15min
	310m	219m	155m
	24,000cd	12,000cd	8,000cd

**75713 Black w/ AC/DC Standard Charger - 2 Holders**

**75735 Black w/ AC/DC Fast Charger - 2 Holders**

### ULTRASTINGER®



- High intensity, extremely bright rechargeable flashlight
- 35,000 candela peak beam intensity. 230 lumens typical
- 30 hour life xenon halogen gas-filled bi-pin bulb; variable spot-to-flood beam
- 5 cell, 6 Volt Ni-Cd sub-C battery is rechargeable up to 1,000 times

FL 1 STANDARD	ULTRASTINGER
	230 LUMENS
	1h
	374m
	35,000cd

**78014 UltraStinger® w/ AC/DC Charger - 2 Holders**

### POLYSTINGER® LED



- C4® LED rechargeable polycarbonate flashlight
- Fits existing Stinger snap in chargers (only DS models)
- Deep-dish parabolic reflector provides a long-range targeting beam with optimum peripheral illumination

FL 1 STANDARD	HIGH	MEDIUM	LOW
	385 LUMENS	195 LUMENS	95 LUMENS
	2h	3h 45min	7h 15min
	322m	228m	161m
	26,000cd	13,000cd	6,500cd

**PolyStinger® LED with 120V AC/DC Charger:**

**76113 Steady Charge Black - 2 Holders**

**76163 Steady Charge Yellow - 2 Holders**

**76132 Steady Charge PiggyBack Black**

**76135 Fast Charge Black**

**76116 Fast Charge PiggyBack Black**

### POLYSTINGER® LED HAZ-LO®



- High performance intrinsically safe rechargeable Class 1, Div. 1 flashlight
- C4® LED technology
- High - 130 lumens, 4 hour run time; Low - 50 lumens, 12 hour run time; also has a 20 hour moonlight mode
- Super-tough, non-conductive chemical and corrosion-resistant nylon polymer
- NiCd battery is rechargeable up to 1000 times
- IPX4 rated for water resistance

FL 1 STANDARD	HIGH	LOW
	130 LUMENS	50 LUMENS
	4h	12h
	245m	151m
	15000cd	5700cd

**76442 120 V AC/12VDC Black**

**76412 120 V AC/12VDC Yellow**

# Streamlight

## STREAMLIGHT JR.® LED & STRION® LED

### Streamlight Jr® LED



- Ultra-compact, lightweight flashlight
- C4® LED technology
- Up to 85 lumens output
- Run time: "AA" Alkaline batteries - 4 hours; "AA" (L91) Lithium batteries - 5.25 hours
- Removable pocket clip
- Powered by two "AA" alkaline batteries included

71500 **Streamlight Jr.® C4 LED w/ Holster**

71503 **Stand Alone Holster**

FL 1 STANDARD	STREAMLIGHT JR.
	85 LUMENS
	4h
	123m
	3800 cd

### STRION® LED



- C4® LED technology
- 3.75V, 2,000mAh minimum lithium ion battery, rechargeable up to 1000 times
- LED charge continuity indicator on charger base
- IPX4 rated design; water-resistant operation
- 2 meter impact resistance

74301 **Black 120V AC/12V DC (1) Holder**

74302 **Black 120V AC/12V DC (2) Holders**

FL 1 STANDARD	HIGH	MEDIUM	LOW
	260 LUMENS	130 LUMENS	65 LUMENS
	2h	4h	7h 30min
	200m	141m	100m
	10,000cd	5,000cd	2,500cd

### MICROSTREAM®



- Compact flashlight with C4® LED technology
- Powered by (1) "AAA" alkaline battery
- Delivers up to 28 lumens
- Up to 2.24 hours of regulated run time
- Combination pocket/hat clip

66318

FL 1 STANDARD	MICROSTREAM
	28 LUMENS
	2h 15min
	52m
	683cd

### STYLUS PRO®



- Sleek, compact flashlight the size of a pen
- C4® LED technology
- 48 lumens median output; 6.25 hours run time
- Powered by two "AAA" alkaline batteries (included)
- Tear-resistant nylon holster
- Unbreakable, removable pocket clip

66118 **Black w/ White LED**

66133 **120 AC - Black w/ White LED**

66135 **International AC - Black w/ White LED**

66134 **Stylus Pro USB w/ USB Cord & Nylon Holster  
Black w/ White LED**

FL 1 STANDARD	C4 WHITE LED	GREEN LED
	48 LUMENS	5 LUMENS
	6h 15min	11h
	64m	17m
	1033 cd	73 cd

## 9460 Remote Area Lighting System



- Using solid-state mounted LED's coupled with a thermally efficient light engine and our 1510 Pelican Protector™ Case, the RALS 9460 gives the user the ultimate maintenance free portable floodlight station
- Houses two of its light heads and it's multi-stage charger for that total self-contained convenience, and is equipped with a telescopic handle and rugged wheels for ease of transport
- Comes with convenient low battery warning system and waterproof activation switch
- High Flux LED with 50,000 expected hours
- 2 Lampheads with 6 LEDs each, 6000 lumens (high), 500 lumens (low)
- Intelligent control features LCD display with customizable run time and brightness
- Battery - up to 40 hours run time on low; 7 hours run time on high
- 110 Volt charger Included; 12V charger available

*CAUTION: The Pelican Products RALS models 9450, 9460 and 9470 contain sealed lead acid batteries that can generate hydrogen gas when charging. It is imperative that these products are charged, as instructed, with the case lid open to allow any gases to escape as charging with the lid closed poses a significant hazard. Failure to abide by this instruction could result in injury and/or damage to property. Please refer to the warnings provided in the instructions for the unit and on a decal affixed to the inside of the case adjacent to the cavity where the charger unit is packed.*

**9460 Safety Yellow, 110V Charging System (12V Charging System Available)**

**9460 Black, 110V Charging System (12V Charging System Available)**

## 9430 & 9430SL Remote Area Lighting Systems



- 9430 models each offer a wide 90° beam for large area coverage
- 9430SL models each offer a focused 10° beam with a 200 yard reach
- Polycarbonate Lens is lightweight and impact-resistant
- Maintenance free LED array; life expectancy of 50,000 hours
- Fully extendable mast with mast extension lock; 360° rotating head
- 110 Volt Charger Included; 12V charger available
- High Flux LED with 50,000 expected hours; 3000 lumens on High, and 1500 on Low (9430)
- High Flux LED with 50,000 expected hours; 2000 lumens on High, and 1000 on Low (9430SL)
- 1 Lamphead with 24 LEDs per head
- Battery - 15 hours run time on low; 8 hours run time on high
- Waterproof rubber activation switch
- 1 Year Warranty

**9430 With 110V Charging Station - 12V System is Available**

**9430 Wide Beam, Safety Yellow**

**9430 Wide Beam, Black**

**9430SL With 110V Charging Station - 12V System is Available**

**Focused Beam, Black**



## 9410L LED Lantern

- Four LEDs, powered by the latest generation Lithium-Ion batteries illuminate a distance of 475 yards (435 meters)
- Loaded with innovative technology and features
- 120° rotating head
- Run time: 9 hrs. (low)/3.75 hrs. (high)
- Battery status indicator
- 3 mode switch (High, Low, Flashing)
- 8.75" x 3.75" x 4.0" (22.2 x 9.5 10.2 cm) L x W x H
- Shoulder strap included



**9410L Safety Yellow, 110V**

**9410L Black, 110V**

# Pelican

## StealthLite™ 2410 LED™ & 2410PL LED Photoluminescent Flashlight

- Same features as the StealthLite 2410 LED Flashlight but outfitted with a lens ring that emits a bright glow in the dark
- Photoluminescent material in the plastic absorbs the energy from any light source - fluorescent lights, sun, the flashlight's own beam
- Powered by 4 AA alkaline cells (included); 7.5 hour battery burn time (included), submersible, and has an ABS resin body which resists chemicals, corrosion, and extreme temperatures
- ITS.09.0017X Ex ia IIC T4 Ga, Ex ia IIIC T83°C Da IP66
- Class I II III Div. 1 Grps. ABCDEFG Operating Temp. Class T4
- LED lamps have a life expectancy of 50,000 hrs.

2410

2410PL Photoluminescent Shroud



## 2360 LED Flashlight

- Aluminum with Type II Anodized Body
- 2 standard AA alkaline batteries in the 2360 LED emits a peak output of 250 lumens
- Run time of up to 2 hours: 3 output mode - High/Low/Strobe
- Impact-resistant LED lamp module
- High/Low light output is available with a push of the tail button
- Features a non-slip textured body for secure handling
- Removable two way pocket clip
- 6.2" Length
- Lumens: High 250, Low 24
- Run time: High 2.25 hrs, Low 19 hrs
- Water-resistant

2360 Black



## 3610 Little Ed® LED Flashlight



- Body Material: EXL Resin
- Body of tough ABS resin that's corrosion-proof and resistant to extreme temperatures
- Powered by 4 AA alkaline cells (included)
- 7.5 hour run time
- 126 lumens, 6500 cd with 161m beam distance on high
- Water-proof and submersible

3610-B Black Flashlight (carded)

3610-Y Yellow Flashlight (carded)

3610PL Recoil™ Flashlight w/ Photoluminescent Shroud

## HeadsUp Lite™ 2690 Flashlight

- With 60 lumens of LED light, 10 hours of battery run time and weighing in at 4.1 ounces, it's brighter, more efficient, compact and lighter than other headlamps in its class
- Rotary bezel switch is easy to operate, even when wearing bulky gloves
- Impact, chemical-resistant ABS; water-resistant for all-weather use
- Features an adjustable and comfortable cloth strap, as well as a heavy duty rubber strap that will not slip off your climbing helmet
- 3 AAA Alkaline (Included); 10 hour battery run time
- II 1 D/G Ex ia IIC T4, Ex iaD 20 IP65 T65° C Certificate: TRL 08ATEX11184X and CL I, II,III, DIV1 GRPS ABCDEFG CL 1, Zone 0, Groups IIA, IIB, IIC SGS E1052012



2690



2720 Black

## 2720 LED Headlight

- Body Material: ABS
- Gesture Activation Control
- Variable Light Output
- Dual Red LED Night Vision
- Variable light output 100%-10%
- Signaling red (S.O.S) beacon light
- Gloved hands, wet hands or oily hands are not an issue; turn on the light with a wave of a hand
- Low level red light preserves night vision, for night time applications
- Optical 4x magnification allows for a wide or penetrating beam
- 80 lumens, 8 hour run time and 790 cd with 56m beam distance (high); 5 lumens, 175 hour run time and 60cd with 15m beam distance (low)
- Water-resistant



## 3315: LED Flashlight - Compact LED Power, Black/Yellow

- The new 3315 LED flashlight: the lightweight compact design houses 3AA batteries that power a single LED for 113 lumens of super bright LED light
- Safety approved for the most volatile work environments, the 3315 LED flashlight is one of the most efficient flashlights on the market today



## 2350: Compact 1AA Flashlight, Black Only

- Pelican's new 2350 LED flashlight emits up to 100 lumens of concentrated light
- Powered by one AA alkaline battery, it's one of the brightest flashlights in its class
- 4.23" long
- Body Material: Aluminum with Type II Anodized



## 3610: Right Angle Light - Little Ed, Black/Yellow

- Uses "Deep Mount" LED technology, delivering impressive lumens and lux performance
- The stainless steel mounting clip allows for hands-free applications
- Powered by 4 AA alkaline cells (included)
- Body Material: EXL Resin, corrosion-proof and resistant to extreme temperatures
- Minimum Pack 1 ea
- Packaged Weight: 11.1 oz



## 9440: Remote Area Lighting System Black/Yellow

- The most innovative RALS unit to date, the 9440 moves fast to light up ravines, confined spaces, riverbanks and any place generator lights can't go
- Deployed, the mast extends 7 feet high, shining light over low obstructions encountered by traditional lantern style lights
- With a 120° beam spread and up to 2400 lumens
- Super tough LED lamp modules and NiMH batteries for up to 6 hours of continuous light
- Adjustable carrying strap included



## 2740: LED Headlight, Black/Translucent Blue/White

- Compact, reliable headlight for harsh conditions - the 2740 LED headlight features 3 LEDs, producing up to 35 lumens and a low level that gives an extended run time of 51 hours. Designed with weather-resistant casings which also allows for fast and easy battery change
- Body Material: PC



## 2610: HeadsUp Lite™ LED, Black

- Provides hands-free light where you need it, when you need it
- Dual mode button activates all 3 LEDs or full brightness, or just 1 to extend battery life
- The adjustable cloth strap fits comfortable and securely on your head, while rubber strap grips tightly to hard hats and helmets, both are included
- 3 AAA alkaline cell batteries included
- Ideal for reading maps and light duties around the campsite



# Petzl Lights

## Pixa 1

Easy to use headlamp for comfortable close-range work



## Pixa 2

Versatile headlamp allows comfortable close-range work and moving around in complete safety



## Pixa 3

This headlamp is designed to respond to all the needs on the terrain: close-range work, moving around and long-range vision



## Zipka® headlamp

The ZIPKA headlamp will accompany you wherever you go. Its exclusive retractable cord makes it extremely compact, practical to transport and versatile to wear. It offers comfortable proximity lighting that allows for some movement. Maximum brightness is 80 lumens, with a range of 50 meters. This headlamp has two lighting modes to adapt the brightness to each situation.

Ultra-compact format is easy to carry and wear:

- Petzl's exclusive adjustable retractable cord
- can be worn on the head, the wrist or attached to a tent pole, a seat post, etc.

Several proximity lighting modes adapt to each situation:

- proximity lighting mode: wide, comfortable beam for close-range vision
- mode for limited movement: wide beam allows movement over short distances

Easy to use:

- push-button for easy, quick lighting mode selection
- phosphorescent reflector allows the lamp to be located in the dark battery case; opens easily for changing batteries



## Duo Atex LED 5

- All-terrain, durable, headlamp that is waterproof to -5 meters

Two light sources to choose from, depending on the activity:

- One high-output LED for long-range, focused lighting with adjustable zoom
- Five LEDs for flood beam lighting with a long burn time

Comfortable and easy to use:

- adjustable and comfortable elastic headband
- on/off switch can be locked to prevent accidental operation - light body can be tilted
- Intrinsically safe rechargeable battery E61100 2 (Ni-MH, 2700 mAh), E65200 2 European and USA charger (110/240 V - 50/60 Hz compatible)
- ATEX certified: headlamp may be used in areas containing gas (zones 1 and 2) and in areas containing dust (zones 21 and 22) where the auto-combustion temperature is greater than 200° C at one atmosphere of pressure (200° C = maximum surface temperature of the lamp)



## Ultra Vario®

Constant lighting: guaranteed lighting performance that does not diminish during the entire rated battery life. Switches to reserve lighting when rechargeable battery is almost discharged: lights to 43 lumens for a minimum of 1 hour

Four modes adapt lighting to the activity:

- low intensity mode: wide beam with relatively low intensity favors a long battery life and prevents blinding others
- close-range work mode: wide beam with intensity adapted to comfortable close-range vision
- movement mode: mixed beam offers a focused component for easily moving around
- distance vision mode: highly focused beam for spotting (maximum range)

Simple and comfortable to use. Rotating selector knob is easy to use, even with gloves, allowing quick access to the different modes:

- quick connection system makes the battery easy to remove
- front and back comfort plates with adjustable elastic head band for an excellent fit on the head

High-performance rechargeable battery:

- 2600 mAh Lithium-Ion rechargeable battery offers excellent performance at low temperatures
- energy gauge allows monitoring of battery's charge level
- light flashes to signal switch to reserve lighting mode
- charger included; quick charge in 3 hours for frequent use



## PoleBoss™ System

- Performance 1000 lbs linepull @ 400 fpm based on hydraulic supply of 15 gpm @ 2000 psi
- Precise metering spring to neutral control valve
- Linepull limiting tension control valve
- Hydraulic pressure gauge
- Anti-rotation clutch
- 2 ratchet type web binder straps
- Manual rope levelwind
- Hydraulic quick disconnects
- Poleboss drive unit weight 215 lbs
- Payout Spindle:
  - Galvanized steel frame construction
  - Hot-stick adjustable disc brake
  - 300 lbs. maximum braking force
  - Ratchet type web binder strap
  - Payout spindle weight 35 lbs.
- Rope and Reel:
  - Reel capacity: 3000 ft. of 3/8 inch rope
  - Recommended rope: 3000 ft. of 3/8 inch TSE Superline
  - Reel weight: 119 lbs.



## DPT-40B: Puller Tensioner

- The TSE Model DPT-40B is a heavy duty drum puller designed for light transmission line stringing. The reel drive incorporates the latest in hydrostatic transmissions that allow the operator to infinitely vary the linespeed and linepull for safe, positive control during the pulling operation. The maximum desired linepull can be preset prior to pulling so that the reel drive will stall if a restriction to the line occurs avoiding damage to the conductor, towers and hardware. In the tensioning mode, the hydraulic system permits the line to be pulled at a steady and controlled tension with automatic pull back to keep the conductor suspended if the pulling force is reduced
- The central operator's console allows the operator to completely control the pulling operation with optimum visibility of the pulling rope. Operator controls include linepull, linespeed, holding brake, levelwind and engine controls
- A free wheel disconnect and bronze overspin brake are available for controlled pay out of the pulling rope
- Continuous Torque Rating 70,000 in.-lbs
- Intermittent Torque Rating 80,000 in.-lbs
- Continuous Linepull Rating 4,350 in.-lbs (with 6,000 ft. of 5/8" rope on the drum)
- 0-4 mph linespeed with infinite control

### STANDARD FEATURES

- Proven hydrostatic pulling and tensioning system with hydraulic oil cooler
- 49 HP water-cooled diesel engine
- Reel capacity up to 72" diameter, 54" wide and 6000 lbs
- Tandem axle with leaf spring suspension
- Infinite variable linespeed and linepull control
- Free wheeling disconnect for high speed rope pull out
- Spring-applied / hydraulic pressure released holding brake
- Central operator's position for maximum safety and visibility
- Quick change reel shaft with straight vertical lift
- Engraved operator's console
- Operator's seat
- Two rear mechanical jack
- Front hydraulic jack



## T30/36 DDVG RC: V-Groove Tensioner

- Continuous performance of 3000 lbs. tension at 4 mph
- Single "V" groove bullwheel direct drive through gear reducer and hydraulic motor
- Bolt on replaceable urethane lining segments
- 3 roller fairlead
- Pressure gauge and performance chart
- Open reeved for easy installation and removal of conductor
- Tongue and rear stabilizer jacks
- Tandem axle with leaf spring suspension
- Pintle hitch adjustable to four height positions
- 2-5/8" reel shaft with double drive arm and lifting loop
- Quick change reel shaft design



## 6707: Universal Stringing Block

- Gate latch is designed for safe, smooth, single motion hotstick operation allowing the conductor to be removed from the same side
- Gate opening latch is a one-hand operation
- Extended rope guards prevent rope from snagging between frame and sheave
- The top is enclosed to protect rope or conductor in case of uplift
- All edges are smoothly contoured to prevent damage to rope or conductor



## 6708-3/6711-3: Stringing Blocks

- Aluminum alloy cast sheaves with machined groove
- Roller bearings
- Aluminum alloy case side frames

	6708-3		6711-3	
Sheave Dimensions	Unlined	Lined	Unlined	Lined
Outside Dimensions	8"	8"	10 3/4"	10 3/4"
Root Diameter	6"	6 1/2"	8"	8 1/2"
Groove Radius	5/8"	1/2"	11/16"	9/16"
Groove Depth	1"	3/4"	1 3/8"	1 1/8"
*Weight	Approx. 15 lbs		Approx. 27 lbs	
Groove sides flared outwards at 15° on unlined sheave and at 30° on lined sheave				
*Basic block weight (not including base)				



## 4700 Series: Stringing Blocks

- Compact steel frame, zinc plated
- Cast nylon sheave
- Crosshead and type 'B' socket for suspension
- Lightweight construction
- Sealed ball bearings

Nominal Sheave Dimensions					
	4716-1Ny	4720-1Ny	4726-1Ny	4730-1Ny	4736-1Ny
A	16	20	26	31	36
B	14	16	22	26	31
C	1	2	2	2.5	2.5
D	.71	1	1.3	1.3	1.6
E	2	3	3.5	3.5	4.3
Weight (Approx.)	38 lbs	43 lbs	47 lbs	54 lbs	66 lbs



## KTA Adaptor

- Used for mounting on Universal-K Type Insulators



# Timberland Equipment Ltd.

STRINGING

## Gatortail Rope

- 12 braid synthetic construction, urethane saturated
- Available in 4 standard colors: orange, yellow, red and green
- Torque free (will not rotate under load)
- Excellent to handle (stays flexible). No kinking or hocking
- Open construction allows easy inspection for wear or damage
- Easy to splice without special tools



Rope Diameter	Average Tensile Strength	Maximum Work Load	Weight per ft.
3/8"	6600 lbs	1320 lbs	.045 lbs
7/16"	8800 lbs	1760 lbs	.062 lbs
1/2"	14600 lbs	2920 lbs	.08 lbs
9/16"	17000 lbs	3400 lbs	.098 lbs
5/8"	20100 lbs	4020 lbs	.143 lbs
3/4"	23000 lbs	4600 lbs	.175 lbs
7/8"	37800 lbs	7560 lbs	.231 lbs
1"	41900 lbs	8380 lbs	.330 lbs

## Breakaway Reels

Steel breakaway reels are specifically designed for winding in and banding old conductor on reconductoring operations. They may be used with take-up winders or puller tensioners and feature tapered barrels for ease of conductor removal in a compact banded coil. The unique flange lock feature provides complete flange security during pulling operations while permitting quick flange removal. Special sizes are available for special applications.



	BRS2814	BRS6030	BRS6632	BRS7236	BRS8436
Outside Dia.	28"	60"	66"	72"	84"
Outside Width	15"	35"	38"	42"	42"
Width b/w flanges	14"	30"	32"	36"	36"
Barrel type	split taper	tapered	tapered	tapered	tapered
Barrel dia.	16"	25"	32"	32"	34"
Maximum Linepull	1000 lbs	1500 lbs	1500 lbs	1500 lbs	1500 lbs
Weight	135 lbs	850 lbs	1000 lbs	1150 lbs	1350 lbs

## SW Series Line Swivels

Stainless steel construction. Intended for connecting the pull rope to the utility product in an overhead and underground application. The swivel permits rotation of the pull rope while protecting the product from twisting. Line swivels are not designed to run around bullwheels. Slotted clevis pins on SW-17 to SW-13. Hex clevis pins on swivels SW-14 to SW-38.

Part #	Safe Working Load	Ultimate Load	A	B	C	D	E	F	G	H	Net Weight
SW-7	750lbs.	2,250lbs.	5/8"	9/32"	3/16"	11/16"	1/4"	2"	2-1/2"	N/A	0.13lb
SW-9	2,250lbs.	6,750lbs.	7/8"	3/8"	5/16"	31/32"	7/16"	2-1/2"	3-3/8"	7/32"	0.33lb
SW-10	3,500lbs.	10,500lbs.	1"	13/32"	3/8"	1-3/32"	1/2"	2-7/8"	3-7/8"	1/4"	0.50lb
SW-13	5,000lbs.	15,000lbs.	1-1/4"	17/32"	13/32"	1-9/32"	17/32"	3-11/16"	4-3/4"	1/4"	1.0lb
SW-14	7,000lbs.	21,000lbs.	1-3/8"	9/16"	1/2"	1-3/8"	5/8"	3-7/8"	5-1/8"	5/16"	1.4lb
SW-15	9,000lbs.	27,000 lbs.	1-1/2"	19/32"	1/2"	1-9/16"	11/16"	4-1/4"	5-5/8"	5/16"	1.7lb
SW-17	10,000lbs.	30,000lbs.	1-5/8"	11/16"	5/8"	1-23/32"	3/4"	4-1/2"	6"	3/8"	2.1lb
SW-19	15,000lbs.	45,000lbs.	2"	25/32"	11/16"	2-1/16"	15/16"	5-1/8"	7"	7/16"	3.8lb
SW-26	30,000lbs.	90,000lbs.	2-3/8"	1-1/32"	7/8"	2-25/32"	1-3/16"	7-5/8"	10"	7/17"	7.6lb
SW-30	50,000lbs.	150,000lbs.	3"	1-3/16"	1-1/8"	3-5/8"	1-1/2"	10"	13"	7/17"	20lb
SW-38	62,500 lbs.	187,500lbs	3 3/4"	1 1/2"	1 1/4"	4 1/4"	1 7/8"	12 1/8"	15 7/8"	1/2"	34lb



Itlutilitysupply.com



## Complete Hand Line Sets with 1/2" Polypropylene Rope



- Complete handline sets available with rope lengths of 60', 80', and 100'
- Features selected length of 1/2" polypropylene rope, (1) handline block, (1) handline hook, and (1) swivel snap hook

3555	60' Overall Length
3556	80' Overall Length
3557	100' Overall Length

## Complete Hand Line Sets with 1/2" Soft Navy Braid Rope



- Complete handline sets available with rope lengths of 60' and 80'
- Features selected length of 1/2" soft navy braid rope, (1) handline block, (1) handline hook, and (1) swivel snap hook

CT01732	60' Overall Length
CT01733	80' Overall Length
CT01789	100' Overall Length

## P10060 Hand Line Hook



- Constructed from manganese bronze alloy
- Use with up to 1/2" diameter rope
- 600 lbs working capacity

## 3550 Hand Line Block



- Block and sheave constructed of rugged nylon fiberglass reinforced high di-electric material
- Side opening block with swivel hook and safety snap
- 4" block size
- Rated with a 3-1 safety factor

## P30142 Hand Line Snap



- Drop-forged snap opening of 5/8"
- Rated capacity of 5000 lbs.

## Insulated Tackle Blocks

- Designed for all types of hoisting-related jobs
- Especially ideal for hot-line use
- Bodies are made from high-impact, dielectric thermoplastic material
- All hooks have full swivel capabilities
- Sheaves are made with fiberglass reinforced nylon material
- Shafts are stainless steel
- Swivel hooks are plated and include hot eye for application with hot sticks
- Maximum loading of blocks should not exceed 2000 lbs

## 3551 Hand Line Block



- Block and sheave constructed of rugged nylon fiberglass reinforced high dielectric material
- Closed block with swivel hook and safety snap
- 4" block size
- Rated with a 3-1 safety factor

Part #	Description	Upper	Lower
11361	Blocks Only - No Rope	2 Sheave	2 Sheave
11362	Blocks with 120' 0.5" Polydacron Rope	2 Sheave	2 Sheave
11367	Block Only - No Rope	3 Sheave	2 Sheave
11368	Blocks with 150' 0.5" Polydacron Rope	3 Sheave	2 Sheave
11052	Single Block Only	2 Sheave	
11051	Single Block Only	3 Sheave	



# Klein Tools

STRINGING

## HANDLINE EQUIPMENT

### Klein Block & Tackle

- Maximum safe load is 750 lbs.
- 1802-30 is furnished with 25' of 3/8" rope, (1) 267 block with a snap hook and (1) detachable forged anchor hook on one end, and (1) block 268 with eye and rope tie-off hook on the other end
- 1802-30 S/R has the same features as 1802-30, but with rope spliced to the 268 block
- 1802-30S has the same features as 1802-30, except supplied with a detachable swivel anchor hook instead of hook 258
- 1802-30S S/R has the same features as 1802-30S, but with the rope spliced to the 268 block
- H1802-30 features 25' of 3/8" rope, (1) 267 block with guarded snap hook, (1) detachable forged anchor hook on one end, (1) block 268 with eye and rope tie-off hook on the other end
- H1802-30 S/R has the same features as H1802-30 but with the rope spliced to the 268 block

**Part #**

**1802-30**

**1802-30 S/R**

**1802-30S**

**1802-30S S/R**

**H1802-30**

**H1802-30S**

**H1802-30 SR Guarded Snap Hook**



### Klein Blocks

- Blocks without ropes and hooks
- Made of light galvanized steel and aluminum alloy
- Sheaves have bronze bushings
- 268 is a block with an eye to splice line to block and rope tie-off
- 268 and H268 feature an eye to splice line to block and rope tie-off hook
- Available with standard or guarded snap hooks
- Maximum safe load is 750 lbs.

- 267 Plain Block**
- 268 Standard Snap Hook**
- H268 Guarded Snap Hook**



267



268



H268

### 1702-20N Howe Wire Tool

- Strap is made of tough nylon webbing
- Swivel hook is forged steel with large opening
- Shank of hook lengthened to reach under insulator
- Other end has device to hold the load at any distance
- All metal parts are galvanized
- Maximum safe load is 500 lbs.



### Handline Swivel Snap Hook

- 750 lb. working load
- Swivel hook with plunger latch
- Forged steel construction
- For use with up to a 1/2" diameter rope



**CAUTION: These hooks are NOT intended for use with occupational protective equipment**

Itlutilitysupply.com





## Chance Block with Insulated Rope



- Shells and sheaves are made of high dielectric, fiber-filled natural nylon
- Shaft is of silicon bronze and the sheave bearings are oil impregnated bronze
- Dielectric rating in dry weather is 30,000 volts between the bearing and the mounting bolt nut
- Maximum 1/2" rope
- Maximum load is 3500 lbs for both double and triple blocks

**C4009019 Double Block with Becket**

**C4000918 Triple Block without Becket**

## Chance Double Nylon Rope Blocks



- The shells and sheaves are made of high dielectric, fiber-filled natural nylon
- Shaft is made of silicon bronze and sheave bearings are oil impregnated bronze
- Maximum 0.5" rope
- Blocks available with either polypropylene or Polydacron rope for minimum stretch and long service life
- Dielectric strength: dielectric rating in dry weather is 30,000 volts between the bearing and the mounting bolt nut

**C4000925 Double/Triple Blocks Set; 150' Rope**

**C4000924 Double Blocks Set; 120' Rope**

## Chance Snatch Blocks



- Light-weight cast-aluminum housing and sheave with a hinged, cotterlock yoke and either forged steel or steel meat hook, makes for quick, easy rigging in diversified applications
- Handline and block and tackle efficiency is increased with a forged steel swivel-eye suspension ring and a 3" sheave operating on bronze oilite bearings
- Maximum rope size is 5/8"
- Maximum load capacity is 1250 lbs

**2230-1 Single Block 2500 lbs capacity**

## Snatch Blocks

- Hook and shackle assemblies can be interchanged
- Opening feature permits insertion of rope while block is suspended from gin-pole
- Blocks have exclusive bolt retaining spring to assure no lost bolts
- Forged alloy heat treated hooks
- Forged steel swivel tees, yokes and shackles

**3" 2 Ton Capacity**  
**4 1/2" 4 Ton Capacity**  
**6" 8 Ton Capacity**  
**8" 8 Ton Capacity**



TRUSTED SINCE 1958

# Bethea Tool

## Bethea Tool Travelers



- Polished aluminum with a urethane lining
- Safe working load is based on single resultant vertical load on center (pulling line) sheave
- BTTV-31-UL18-12 features a working load of 15,000 lbs.
- BTTV-31-UL14-8 features a working load of 8,000 lbs.
- Major load supporting members are made from heat-treated aluminum alloy
- The ultimate in cost efficiency
- Precision ground, deep-groove Conrad type shielded ball bearings increase the efficiency of each traveler, and simplify the sagging operation
- Urethane of the highest grade and of the proper hardness is used for lining the conductor sheaves
- Pulling line sheaves are lined with high strength, wear-resistant urethane which under normal use outlasts most steel and iron linings
- Safe rapid attachment to supporting hardware is accomplished with captive pushbutton ball lock pins or safety pins
- These components are secured to the traveler with welded closed link chain
- All ferrous components are protected from corrosion, depending on application by hot dip galvanized, electro-cadmium plating, or rust-inhibiting enamel

**BTTV-31-UL18-12 22" diameter**

**BTTV-31-UL14-8 16" diameter**

## UB-1C: Universal Roller

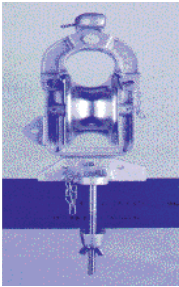

- Bethea's UB-1-C Universal Roller is the solution to your search for a quality engineered sheave that is lightweight (7.4 lbs), versatile, durable and dependable. It can be intermixed with similar stringing blocks and mounting attachments manufactured by others without affecting conductor sag and tension
- The quality of the UB-1-C roller is unsurpassed by any roller of its type. Its aluminum parts are cast from high strength A356 alloy, heat-treated to the T6 condition, giving it the capability of withstanding rough treatment under adverse conditions while supporting heavy loads
- The UB-1-C may be attached directly to ANSI Class 52-3 & 5 ball and socket insulators using the socket eye supplied as an integral part of the unit. If desired, the UB-1-C socket eye can be attached to optionally available fittings, i.e., our CB-55 Clevis Ball; YCB-65 Y-Clevis Ball; OEB-55 Oval Eye; BH-5L Ball Hook or SHB-1 Ball Safety Hook
- Other optional mounting adapters are also available: IA-1 for clamp top type post insulators; IA-2 for tie top post insulators and XA-1 for crossarms. These adapters must be ordered separately. The UB1-A has a 90° adapter mounting lugs on each side of the frame. These allow positioning the sheave horizontally, if desired, when used with the XA-1 crossarm adapter or the IA-2 when attached to a horizontal tie post insulator
- The transfer of conductor or rope from UB-1-C Universal Roller is quickly and easily accomplished by the removal of a single ball loc pin. This pin is designed for safe, smooth, single-motion hand operation. The ball loc pin is secured to the roller with a welded closed link chain. When released, the frame opens wide for conductor clipping
- The sheave groove is profile machined for centricity, thus permitting more precise sagging of the conductor. In addition, the universal roller is available with urethane sheave lining (UB-1-CUL) or neoprene lined sheave (UB-1-CNL)
- Conrad Type, ABEC precision ground, deep groove ball bearings are used in the sheave hub. They are permanently lubricated with Bethea BSG150 wide temperature range (-60F to 600F) synthetic lubricant

## ADSS FIBER OPTIC CABLE SOLUTIONS

### Typical Installation and Tools

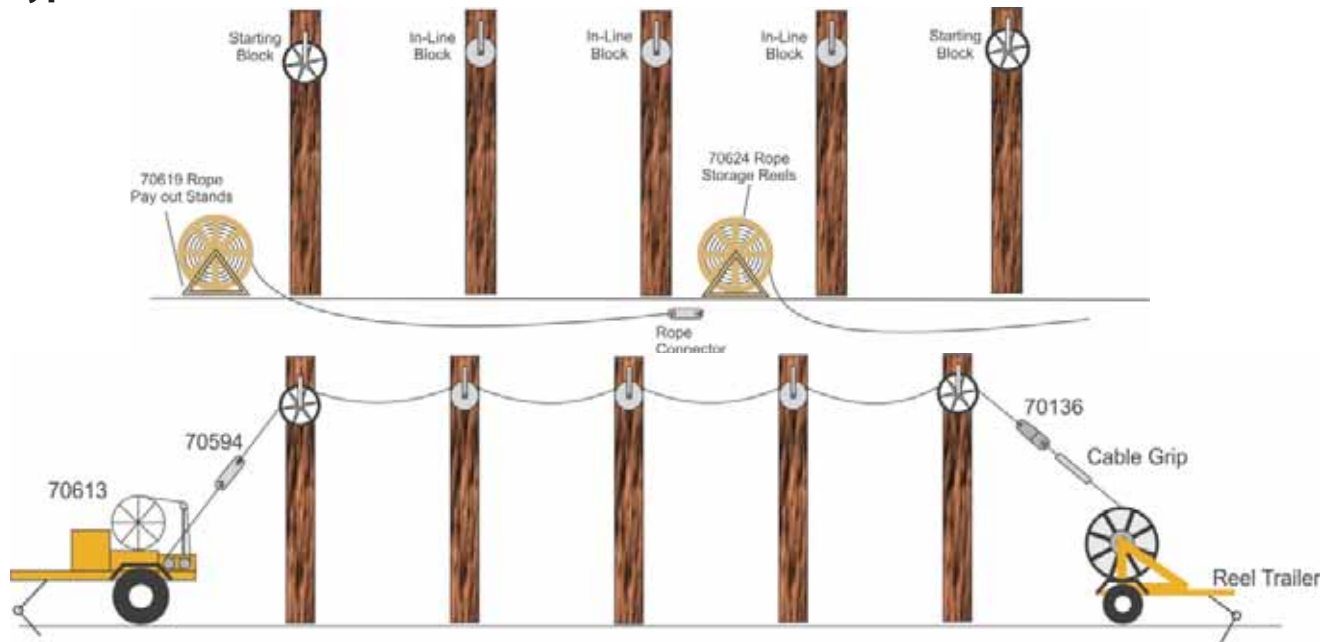

## RECOMMENDED INSTALLATION EQUIPMENT

### In Line Block

Split side frame and hooks make it easy to use. The side frame incorporates a guide ring to protect the fiber cable. The sheave rides on ball bearings



#### 70615

- O.D.: 7.87"
- Groove Width: 2.36"
- Root Dia.: 5.4"
- Wt.: 8.52 lbs
- W.L.L.: 660 lbs

#### 70616

- O.D.: 8.44"
- Groove Width: 2.36"
- Root Dia.: 6.0"
- Wt.: 9.5 lbs
- W.L.L.: 660 lbs

### 70595: Starting Block

- The block has a safety gate and steel side frames. The sheave rides on ball bearings
- O.D.: 11.8"
- Groove Width: 1.77"
- Root Dia.: 9.64"
- Wt.: 15.4 lbs
- W.L.L.: 2646 lbs



### Starting Block

The large diameter profiled groove helps protect the cable. The swivel oval eye, cable gate and cable retaining pin make it easy to use. The sheave rides on ball bearings.

#### 70621

- O.D.: 18.50"
- Groove Width: 2.17"
- Root Dia.: 15.16"
- Wt.: 30.8 lbs
- W.L.L.: 5291 lbs

#### 70614

- O.D.: 26.06"
- Groove Width: 2.36"
- Root Dia.: 23.62"
- Wt.: 33.1 lbs
- W.L.L.: 5291 lbs



# General Machine Products

STRINGING

## 70594: Rope Connector

- Rope connectors provide an effective method of joining pulling ropes
- W.L.L.: 2200 lbs



## 70136: Heavy Duty Ball Bearing Swivel

- These tough stainless steel swivels are designed to handle higher thrust loads for extra cable safety
- W.L.L.: 1350 lbs



## Flexible Pulling Grips

- Manufactured from high-tensile, galvanized steel wire that is evenly woven in a triple wire weave, grips are slipped over the outside sheath of a cable. When pulling tension is applied, the grip contracts applying its gripping force to the outside of the cable



GMP	Diameter Range	Minimum Breaking	Grip Length
70681	.47 to .75"	7452 lbs	32.48"
70682	.75 to .98"	12214 lbs	40.35"
70683	.98 to 1.26"	21054 lbs	51.18"

## 70624: Rope Storage Reel with 5/16 x 2000' of Rope

- Unique reel design that allows it to be used on both the payout stand and the Cable Pony. Holds up to 2,000' of 5/16" dia. pulling line
- W.L.L.: 2200 lbs



## 70619: Rope Pay Out Stand

- Supports the rope storage reels during the stringing process



## 70613: Cable Pony Hydraulic ADSS Winch

- The GMP Cable Pony winch offers the constant pulling tension of a double capstan drive and the flexibility of a direct drive drum in one machine
- Max. Pulling Capacity: 2200 lbs (1000 kg)
- Rope Speed Max.: 130 ft/min (40 meters/min) at capstan



Itlutilitysupply.com



## 70400: Apollo Lasher

- Under 39 lbs., (17.7 kgs) without wire, 12-1/2 in. (318 mm) diameter
- Lashes any telcom cable/innerduct combination up to 4 in. (10 cm) diameter
- Parallel-pull capability overcomes all terrain obstacles
- Interference-free over-lashing with no modifications
- Positive slip-free gear drive (no belts) tested in excess of 1 million cycles
- Lashes to strand sizes 1/4 in. to 3/8 in. (6 - 10 mm) diameter lasher in use
- Holds two coils of industry standard wire .045 in. x 1200 ft. (1.1 mm x 365 m) or .038 in. x 1600 ft. (1. mm x 488 m)
- Provides adjustable tension of lashing wire, affording tight or loose lash
- Wire tension constant regardless of amount on spool
- No lasher backroll when pulling force removed
- Front rollers guide cables through the machine
- All smooth edges throughout provide 360° protection against cable damage
- Ergonomic design makes it easy to handle



## 71422: C2 Lasher

- Lashes single or bundled cables up to 1-7/8 in. (46 mm) onto strand sizes 1/4 in. to 3/8 in. (6-10 mm) diameter
- New style strand lock swings out of the way for unobstructed over-lashing
- Simple wire routing yields either "normal" or "loose" wire tension
- Dual wire magazines for loading two coils of stainless steel lashing wire
- Typical wire dimensions: 1200 ft. x .045 in. (365 m x 1.1 mm) or 1600 ft. x .038 in. (487 m x 1 mm)
- Lightweight and compact: Unloaded weight 35 lbs. (16 kgs.); only 10 in. O.D. x 18.5 in. long (25 x 47 cm)
- The C2's tapered housing eases passage through treed areas
- The C2 Cable Lasher is furnished with a 6 ft. (1.6 m) bridle rope with snap hooks, an instruction manual and a rugged, lightweight storage chest



## 86070: J2 Lasher

- Will lash any single or multiple aerial cables up to 3 in. (76 mm) diameter across on any suspension strand from 1/4 in. (6 mm) to 7/16 in. (11 mm)
- Consists of a rotating drum supported on a carriage that provides the mounting for a driving mechanism, cable lifters, cable and strand rollers
- Each of two recessed magazines will hold a 1200 ft. coil of .045 in. (365 m of 1.1 mm wire) lashing wire (or 450 ft. of .065 in.). The Lashing Wire is fully recessed and covered by a gate
- Features a fast setup procedure, quick coil loading, and automatic drum lock for easy span transfers and smooth forward travel
- Easy lashing, push down on the strand roller knob, rotate it a quarter turn and you can lash additional cables together on previously lashed cable
- Positive internal gear-to-gear mechanism has no chains or belts to stretch, slip or break
- Constructed with heat-treated, plated steel, stainless steel, brass and aluminum components. Contains sealed and oilless bearings to minimize maintenance and assure durability
- Pre-drilled and tapped at the factory for mounting of the lasher guard or "halo". For use when lashing in overgrown areas
- The lasher is furnished with a rugged lightweight storage chest with corrosion resistant hardware, recessed latches and a moisture-proof, tongue-in-groove design for maximum protection when not in use
- Supplied with a 6 ft. bridle rope assembly and snap hooks, and an information and operation manual



# General Machine Products

STRINGING

## OVERHEAD ELECTRIC PLACING EQUIPMENT

### G Cable Lasher

- Lashes any cable from 2 1/2" to 5" diameter, on strand from 11/32" to 3/4" diameters with one or two left lay spiral wrappings of .065" diameter stainless steel wire
- Can be used for new installs or with existing cables in place
- Nominal spacing between wraps is 16 1/2"
- Each lasher includes a 6' bridle rope assembly with snap hooks, an information and operations manual, and a heavy duty storage chest

- 10500 G Cable Lasher Standard
- 10502 G Cable Lasher Modified for 1200' of .045" Wire
- 03165 Bridle Rope Assembly Only
- 10501 Chest Only
- 70190 Towing Lanyard 35 ft. (optional)



### 01051: G Cable Block

- Block is functionally similar to the D Cable Block
- This larger tool can be used with the G Cable Lasher to handle cable up to 5" diameter and features strand hooks to accommodate 3/8 - 3/4" diameter strand
- This heavy duty block is made from 100% heat treated aluminum alloy
- Contains two vertical side rollers in addition to the cable sheave to minimize cable friction during pulling in

### Stainless Steel Lashing Wire

- Used to lash an aerial cable or combination of cables to a supporting strand
- Packaged as 6 coils per carton for ordering convenience
- Available in a 430, 302, and 316 stainless steel alloy
- All lashing wire is wound in a straight hub configuration to fit all the standard GMP lashers

#### Type 430 Stainless

- Low carbon, 17% chromium wire
- Suitable for general use and in ordinary atmospheric exposure
- Will acquire only a dark surface stain
- Specifically not recommended for use within 25 miles of salt water or industrial operations which emit pollutants

#### Type 302 Stainless

- 18% chromium, 8% nickel analysis
- Excellent resistance to corrosion from industrial atmospheres
- Higher tensile strength and breaking load are an added benefit
- A .038 in. diameter Type 302 wire provides strength equal to a .045 in. type 430 wire with better ductility (easier bending and unwinding) and better elongation (less chance of wire breakage from stress)

#### Type 316 Stainless

- Modified 18-10 analysis containing approximately 2.5% molybdenum
- More resistant to the corrosive action of most chemicals, including chlorides and sulfides, than any other wire
- Particularly resistant to pitting and pin hole corrosion of the kind commonly caused by salt spray
- Its use provides the best insurance against failure under the most severe atmospheric conditions

#### Buying tip:

- When estimating the length of lashing wire required for a cable run, add the following amounts to the length of the run for single lashing:

Add:*	For Cables Up to:
5%	1 1/2" diameter
10%	1 1/2" to 3" diameter
20%	Over 3" diameter

\* For double lashing, double the quantity

#### Note:

- 1) Fits standard C2 Lasher, J2 Lasher, and Apollo Lasher
- 2) Fits G Lasher or Modified C2 and J2 Lashers



GMP	Alloy	Diameter	Ft./Coil	Coil Dia.	Coil Width	Coil Package	Note
71530	430	.045	1200	5.38"	1.81"	6	1
71532	430	.065	450	5.5"	1.69"	6	2
71533	302	.045	1200	5.38"	1.81"	6	1
71534	316	.045	1200	5.38"	1.81"	6	1
71535	302	.038	1600	5.38"	1.81"	6	1

## OVERHEAD ELECTRIC PLACING EQUIPMENT

### 07886: D Lashing Wire Clamp, 2 piece - 100/box



- Perfect for temporary and permanent terminations or grounds, this all steel clamp lets you securely attach two lashing wires or #6 ground wire on any size strand from 1/4" to 7/16" diameter

### 81460: E Lashing Wire Clamp, 7/16" Opening, 1 piece - 100/box



- Designed for permanent wire terminations, this clamp has the same hardware, construction and clamping range as the D Clamp, but with a one piece stamping formed to let both sides grip the messenger in perfect alignment

### 10553: 3 Sheave Cable Block



- Heavy duty multiple sheave cable Blocks are used to simultaneously support two, three, or four cables prior to lashing to a supporting suspension strand
- 3 sheave multiple cable block can keep up to three 2 1/2" diameter or smaller cables separate until you're ready for lashing to the messenger
- The 3 sheave block is ideal for triplexing cables in the electrical industry; lashing up to three 750 MCM cables together to a supporting strand
- Features heat treated aluminum alloy frame and sheave, with Oilite bearings on the sheave and steel inserts on the strand hooks for easier movement
- A bi-directional lever operated cam locks the block in place during pulling in, then automatically releases during lashing

### Multi-Roller Overhead Cable Guide



- The roller type aerial cable guide is used to guide and straighten cables as they are pulled into a lashing position from a stationary or moving cable reel
- With its three sheaves to guide cable with minimum friction, this is the best tool you can use when handling especially heavy cable, or when using an aerial basket for "drive-off" lashing
- The guide rides along the strand on a roller bearing for smooth movement
- A built-in grip prevents back-rolling during span transfers
- Also included with the guide is a safety chain to prevent the guide from coming off the strand

91605\* (3) Roller Guides for 4" Cable or Bundles to 4"

91606\* (3) Roller Guides for 2 3/4" Cable or Bundles to 2 3/4"

\*Above cable guides have 2 rollers instead of the rubber grip and they do not require the use of the hitch weldment or hitch field kit

91604 (3) Roller Overhead Cable Guide for 2 3/4" Cable

30140 Hitch Weldment for J2 Lashers

70125\*\* Hitch Field Kit for F, J, J2 Lashers Guide for 2 3/4" Cable

\*\*Only J2 Lashers with serial #91-0001 or higher are factory ready equipped with a Hitch Weldment. All other J2 Lashers should be retro-fitted with a Hitch Field kit

# Rope Accessories

## Crosby Swivels

- All swivels individually proof tested/certified
- Equipped with tapered roller thrust bearing
- Suitable for frequent rotation under load
- All hooks furnished with latches assembled
- All jaws complete with bolts, nuts, and cotter pins
- Pressure lube fitting provided
- Not to be used on demolition (wrecking) balls

Working Load Limit: 5 tons  
Wire Rope Size: 5/8"  
Weight: 15.51 lbs.  
297217



Working Load Limit: 8.5 tons  
Wire Rope Size: 3/4"  
Weight: 29.42 lbs.  
297413

Working Load Limit: 10 tons  
Wire Rope Size: 7/8"  
Weight: 42.5 lbs.  
297618

## 599533: Crosby L-160 Series Snatch-Block

- Heavy duty
- Hook is forged alloy steel - quenched and tempered
- Designed for fast, efficient line changes
- All parts are forged
- Beaded side plate prevents rope from jamming
- Blocks furnished with dual rated wireline sheaves
- Fatigue rated
- Shackle fitting
- Sheave diameter: 5"
- Working load limit: 6 tons
- Wire rope size: 3/8" - 1/2"
- Weight: 15 lbs



## Crosby 5 Ton & 8.5 Ton Swivel Hook

- All swivels individually proof tested with certification
- Suitable for frequent rotation under load
- Hooks furnished with latches assembled
- Other types and capacities, up to 600 tons, available to meet your requirements
- Suitable for digger derricks

297217 5 Tons  
29741 8.5 Tons



## 109037: Crosby Snatch Block

- 6" OL assembly for 1/2" wire line
- Forged alloy heat treated hooks
- Forged steel swivel tees, yokes and shackles
- Hook and shackle assemblies on 4 1/2" through 14" sizes can be interchanged
- Can be furnished with bronze bushings or roller bearings
- Opening feature permits insertion of rope while block is suspended from gin-pole
- 3" thru 18" 418 and 419 blocks have exclusive bolt retaining spring to assure no lost bolts
- Pressure lube fittings
- Fatigue rated
- 3" - 10" feature dual rated wireline sheaves



## Crosby Screw Pin Shackles

- Forged, quenched and tempered, with alloy pins
  - Working load limit permanently shown on shackle
  - Hot dip galvanized or self-coloured
  - Fatigue rated
  - Can meet DNV impact requirements of 42 joules at 20°C
  - Meet or exceed all requirements of ASME B30.26, including identification, ductility, design factor, proof load, and temperature requirements
- Also meets other critical performance requirements including fatigue life, impact properties, and material traceability, not addressed by ASME B30.26

1018446	7/16"	1 1/2 Ton Capacity, 1/2" Pin
1018464	1/2"	2 Ton Capacity, 5/8" Pin
1018482	5/8"	3 1/4" Ton Capacity, 3/4" Pin
1018507	3/4"	4 3/4 Ton Capacity, 7/8" Pin
1018525	7/8"	6 1/2 Ton Capacity, 1" Pin



## S-322CN/S-322AN:1 Ton Swivel Hook

- Suitable for frequent rotation under load
- Used for material handling aerial devices
- 1" diameter hook opening



## Crosby Replacement Latch Kit

- Heavy duty stamped latch interlocks with the hook tip
- High cycle, long life spring
- Can be made into a "positive locking" hook when proper cotter pin is utilized
- Latch kits shipped unassembled with instruction

1096562 for 234-21010 Crosby 5 Ton Swivel Hook





## Dillon Mechanical Model AP Dynamometers

- Accuracy +/- 0.5% of full scale capacity for precise data
- Broad temperature range for use in nearly any environment
- No batteries required
- Large safety factor for overload protection
- Anti-parallax dial and pointer produce accurate readings from any perspective
- Maximum hand retains peak load point and is easily reset
- Standard Model AP Dynamometer includes: Dynamometer, shackles and pins, maximum pointer, zero adjust for tear, carrying case (molded plastic on 5" models or rugged plywood crate for 10" models) and calibration certificate

Part#	Capacity & Dial Division in lbs	Diameter of Dial
30006-0027	1000x10	5"
30006-0035	2000x20	5"
30006-0084	10,000x100	5"
30006-0100	20,000x200	5"



## Dillon Digital ED Extreme Dynamometer

- Superior strength and corrosion resistance
- 5:1 safety factor
- Typical accuracy of 0.1% of full scale capacity
- Exclusive soft-key interface and wide angle LCD
- Powered by (2) standard C-cell batteries
- Backlit display

**AWT05-506312 2500 lb Capacity**



## Dillon Digital ED Junior Dynamometer

- Can be relied upon for simple, yet critical measurements of weight and force
- Shares the same base of research and testing that was conducted to match material characteristics and load cell technology
- Typical accuracy of 0.2% of full scale capacity
- Exclusive soft-key interface and wide angle LCD
- Powered by (2) standard C-cell batteries

**AWT05-506319 10,000 ft lbs x 10 lbs Dial Division**



# Ropes

## Double Braided Nylon Rope



All Double Braid Nylon is Fully Spliceable

- A double braid is a braid-over-braid construction where the load is shared equally by both braids
- This creates a strong, balanced rope that will not torque when loaded
- Double braided nylon is a strong supple rope that is resistant to abrasion, oil, alkalis, organic solvents, and most other chemicals
- It is not susceptible to mildew and has good abrasion resistance to UV deterioration
- It is used in applications where energy absorption at working load is required. For example, marine anchor lines and auger ropes

Stock Number	Diameter (in)	Spool Length (ft)	Approx. Weight per 100 ft (in)	Breaking Strength(lbs)
BNY3/16	3/16	1200	1.25	1,020
BNY1/4	1/4	1200	1.5	1,850
BNY5/16	5/16	600	2.4	2,850
BNY3/8	3/8	600	3.5	4,100
BNY7/16	7/16	600	4.7	5,500
BNY1/2	1/2	600	6.2	7,100
BNY5/8	5/8	600	10.9	12,500
BNY3/4	3/4	600	13.8	15,600
BNY7/8	7/8	600	20.6	23,000
BNY1	1	600	24.5	27,400
BNY1-1/4	1 1/4	600	38.4	42,000

## Double Braided Polyester Rope

- Double braided polyester is a strong, supple rope that has low stretch at working loads
- It has low shrinkage and resists acids, organic solvents and most chemicals
- It is not attacked by mildew and has the best UV resistance
- Double braid polyester will not torque when loaded
- It is used for marine rigging and industrial applications



Stock Number	Diameter (in)	Spool Length (ft)	Approx. Weight per 100 ft (in)	Breaking Strength (lbs)
BPE3/16	3/16	1200	1.4	950
BPE1/4	1/4	1200	1.85	2100
BPE5/16	5/16	600	2.9	3100
BPE3/8	3/8	600	4.2	4200
BPE7/16	7/16	600	5.7	5700
BPE1/2	1/2	600	7.5	8100
BPE5/8	5/8	600	13.2	12800
BPE3/4	3/4	600	16.5	16000
BPE7/8	7/8	600	25.0	23600
BPE1	1	600	29.7	28000
BPE1-1/4	1 1/4	600	46.5	43300
BPE1-1/2	1 1/2	600	66.8	61800
BPE2	2	600	119.0	95000

## Double Braided Polypropylene Rope



- Polypropylene double braid floats and resists deterioration from chemicals
- It is very lightweight and is commonly used for water safety throw lines

Stock Number	Diameter in Inches	Spool Length in Feet	Approximate Weight (lbs) per 100 Ft.	Breaking Strength (lbs)
BPP1/4	1/4	1200	1.2	970
BPP3/8	3/8	600	2.6	2000

## Three Strand Nylon Rope

- Long continuous fibers are twisted together to form larger strands. Three strands are twisted together in three strand construction creating a strong, abrasion resistant rope
- Three strand nylon is a strong, abrasion resistant rope with excellent shock absorbing characteristics at working loads
- It is resistant to alkalis, organic solvents, and most other chemicals. It is not susceptible to mildew and has good resistance to UV deterioration



Stock Number	Diameter in Inches	Spool Length in Feet	Approximate Weight/ Lbs Per 100 Feet	Breaking Strength in Pounds
TNY1/4	1/4	1200	1.9	1700
TNY5/16	5/16	600	3.0	2700
TNY3/8	3/8	600	4.0	3500
TNY7/16	7/16	600	5.0	4300
TNY1/2	1/2	600	7.0	5950
TNY5/8	5/8	600	10.8	8800
TNY3/4	3/4	600	15.4	12700
TNY1	1	600	27.5	22000
TNY1-1/2	1 1/2	400	62.0	47700
TNY2	2	300	108.5	81400

# Ropes

## Three Strand Polyester Rope

- Three strand polyester, under working load, has lower stretch and elongation properties than three strand nylon
- It is resistant to acids, organic solvents, and mildew. It has the best resistance to UV deterioration



Part #	Diameter (inches)	Spool Length (ft)	Approximate Weight (lbs) Per 100 Feet	Breaking Strength (lbs)
TPE1/4	1/4	1200	2.2	1,490
TPE5/16	5/16	600	3.3	2,300
TPE3/8	3/8	600	4.5	3,340
TPE1/2	1/2	600	7.7	5,200
TPE5/8	5/8	600	11.5	8,000
TPE3/4	3/4	600	16.6	10,500
TPE1	1 Coils	600	31.3	19,000

## Three Strand Polypropylene Rope

- Industrial and retail grade polypropylene rope is made from mono-filament polypropylene
- Polypropylene is resistant to deterioration from chemicals
- It makes a good general purpose rope that is lightweight and floats
- Retail grade polypropylene is an economical choice
- White polypropylene is commonly used in awnings and banners



Industrial Grade



Retail Grade

Part #	Diameter (in)	Approximate Weight/600 Ft in Pounds	Approximate Weight/1200 Ft in Pounds	Breaking Strength (lbs)
<b>Industrial Grade Three Strand Polypropylene - In Coils - Yellow with Green Stripe</b>				
TPPI38Y12C	3/8"	1200	35	2400
TPPI12Y12C	1/2"	1200	60	4200
TPPI12Y6C	1/2"	600	30	4200
TPPI58Y12C	5/8"	1200	90	5900
TPPI58Y6C	5/8"	600	45	5900
TPPI34Y12C	3/4"	1200	130	8500
TPPI34Y6C	3/4"	600	65	8500
TPPI1Y6C	1"	600	110	14000
TPPI114Y6C	1-1/4"	600	160	21500
TPPI112Y6R	1-1/2"	600	245	30500
TPP1-1/2Y	1 1/2	230	460	30500
TPP2Y	2	415	830	51000
<b>Three Strand Polypropylene - Retail Grade - No Cuts</b>				
TPPR316Y	3/16"	2125	15	
TPPR14Y	1/4"	1300	15	900
TPPR516Y	5/16"	975	15	1300
TPPR38Y	3/8"	630	15	1900
TPPR12Y	1/2"	335	15	3300
TPPR58Y	5/8"	175	15	4700
TPPR34Y	3/4"	125	15	6800

## Hollow Braid Polyethylene Rope



- Made from mono-filament polyethylene yarns, hollow braided construction, easy to splice
- Floats and lightweight
- Water and ice will not saturate the fibers, ideal for wet and icy conditions such as bump lines, water safety throw lines
- Also great for dogsledding gang, tug and neck lines and utility spider lines
- Available in: white, red, blue, green, black and yellow

Part #	Diameter	Reel Length (ft)	Spool Weight (lbs)	Breaking Strength (lbs)
HBE14	1/4"	1000	10	870
HBE516	5/16"	1000	16	1250
HBE38	3/8"	1000	22	1800
HBE12	1/2"	500	17	2200

## Nylon Braided Cord



- Diamond braid strands are tightly braided together
- Nylon braided cord is a durable high strength cord that resists deterioration from abrasion, oils, alkalis, organic solvents and most chemicals
- It is not susceptible to mildew and has good resistance to UV deterioration
- Nylon braided cord is a good general purpose cord

Part #	Diameter in Inches	Spool Length in Feet	Breaking Strength in Pounds
NY2 (#2)	1/16"	1000	140
NY3 (#3)	3/32"	1000	290
NY4 (#4)	1/8"	1000	600
NY5 (#5)	5/32"	600	730
NY6 (#6)	3/16"	500	900
NY8 (#8)	1/4"	250	1400
NY10 (#10)	5/16"	250	1800

## Polyester Braided Cord



- High strength cord that resists abrasion and deterioration from acids, organic solvents and most chemicals
- Has the best UV resistance
- Less stretch than nylon cord

Part #	Diameter (in.)	Length (ft.)	Breaking Strength (lbs.)
PE2	1/16"	2000	120
PE3	3/32"	1000	260
PE4	1/8"	1000	450
PE5	5/32"	600	650
PE6	3/16"	500	800
PE7	7/32"	500	960
PE8	1/4"	250	1220

# Ropes

## Spun Polyester Cord



- Spun polyester cord is made from durable spun polyester for a soft cotton-like finish that stays tied
- Available in matte black and white to reduce reflection

Part #	Diameter (in.)	Colour	Length (ft.)	Breaking Strength (lbs.)
PESP4BK	1/8"	Black	1000	200
PESP5BK	5/32"	Black	1000	300
PESP6BK	3/16"	Black	760	300
PESP8BK	1/4"	Black	500	670
PESP10BK	5/16"	Black	350	910
PESP12BK	3/8"	Black	240	1080

## Cotton Sash Cord



- Cotton sash cord is made from quality spun cotton yarns
- This cord has a firm, smooth feel

Part #	Diameter in Inches	Reel Length in Feet
BCS4	1/8 (#4)	1000
BCS5	5/32 (#5)	1000
BCS6	3/16 (#6)	760
BCS8	1/4 (#8)	500
BCS10	5/16 (#10)	350
BCS12	3/8 (#12)	240
BCS16	1/2 (#16)	170

## Polypropylene Tying Twine



- Polypropylene tying twine is made from mono-filament polypropylene
- It is also known as plastic twine. It is a good general purpose twine that is economical

Part #	Colour	Length (ft.)	Weight/Pkg (lbs)	Breaking Strength (lbs.)
TT140	White/Blue	9000	10	140
TT180	White/Blue	7000	10	180
TT240	White/Blue	5250	10	240
TT800	White/Blue	1450	10	800

## Silicone Insulators

Silicone Composite Insulators combine the technologies of a fiberglass reinforced rod, metal fittings and Salisbury's extensive knowledge of elastomeric insulation to produce a high quality composite insulator. Since 1980, thousands of silicone insulators have been installed by utilities worldwide in a variety of environments. Continued outstanding performance is proof of their superior quality and design.

**Design:** Unibody Design insulators are one-piece injection molded directly to the rod and sealed to the end fittings with a bead of silicone to give the insulator high dielectric strength and protect it from all environmental conditions. This design is used for standard distribution dead end/suspension insulators

**Fiberglass Rod:** A high quality fiberglass reinforced rod is the core of every insulator with ultimate mechanical strength at least twice the maximum work load

**End fittings:** Standard distribution dead/end suspension units are supplied with clevis and tongue fittings meeting ANSI C29 specifications. Ball, socket and eye fittings are also available. All are made of hot dipped galvanized high strength carbon steel and have an ultimate tensile strength rating of 15,000 pounds. All end fittings on dead/end suspension insulators are attached by compression. Every insulator is proof tested to verify the crimp

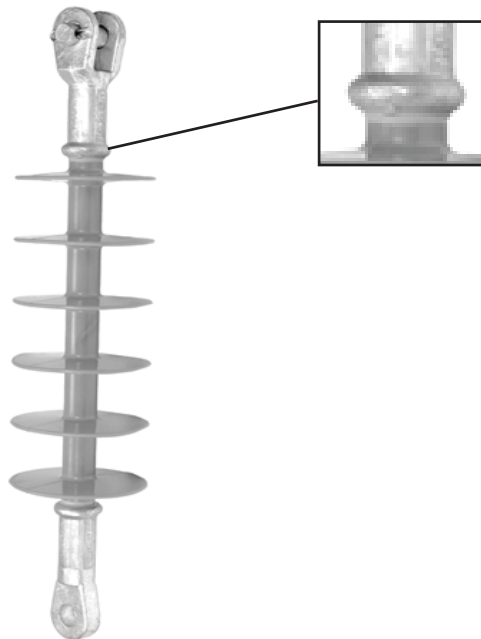

Unibody insulators have end fittings sealed with silicone to eliminate any possibility of moisture or contamination from reaching the fiberglass rod

INSULATOR SPECIFICATIONS					
Dimensions	Rated Voltage (kV)		15	25	35
	Section Length (mm)		345 ± 15	430 ± 35	525 ± 55
	Leakage Distance (mm)		430	640	850
	Minimum Arcing Distance (mm)		210	301	398
Electrical Ratings	Low Frequency Flashover	Dry	100	131	166
	Voltage Test (60 Hz) (kV)	Wet	82	111	138
	Critical Impulse Flashover	Positive	159	221	279
	Voltage Test (kV)	Negative	185	251	320
	Radio Influence Voltage Data (µV)	Max. Voltage	<1	<1	<1
Mechanical Ratings	Failing Load Test (KG)		>7000	>7000	>7000
	Number of Sheds		4	6	8

# Salisbury by Honeywell

STRINGING

The SI series of silicone insulators features a silicone formulation weathershed material. Salisbury combined the excellent hydrophobic and electrical qualities of silicone with an optimum weathershed design and corrosion-resistant fiberglass rod to produce a state-of-the-art insulator which meets or exceeds industry requirements. The insulators were tested in accordance with ANSI C29 and IEC1109. End fittings are hot dipped galvanized high strength carbon steel, providing a 15,000 pound ultimate tensile strength. 100% proof testing ensures trouble-free installation. RUS accepted.

		9501U-SI	9502U-SI	9503U-SI
<b>Class</b>		<b>DS-15</b>	<b>DS-28</b>	<b>DS-35</b>
<b># of Weathersheds</b>		<b>4</b>	<b>6</b>	<b>8</b>
<b>Length (inches)</b>		<b>13.5</b>	<b>17.5</b>	<b>21.3</b>
<b>Dia. of Weathersheds (inches)</b>		<b>3.8</b>	<b>3.8</b>	<b>3.8</b>
<b>Leakage Distance (inches)</b>		<b>17.1</b>	<b>26</b>	<b>35.1</b>
<b>Dry Arc Distance (inches)</b>		<b>8.4</b>	<b>12.13</b>	<b>16</b>
<b>Flash Over Voltage</b>	<b>Critical impulse, Pos</b>	<b>173</b>	<b>217</b>	<b>258</b>
	<b>Critical Impulse, Neg</b>	<b>250</b>	<b>310</b>	<b>340</b>
	<b>Dry, 60 Hz</b>	<b>97</b>	<b>145</b>	<b>168</b>
	<b>Wet, 60 Hz</b>	<b>67</b>	<b>115</b>	<b>137</b>
<b>Radio Influence</b>	<b>Test, kV Ground</b>	<b>15</b>	<b>25</b>	<b>25</b>
	<b>Max RIV-1000KhZ <math>\mu</math>V</b>	<b>1</b>	<b>1</b>	<b><math>\mu</math>V</b>
<b>Ultimate Strength</b>	<b>lbs</b>	<b>15,000</b>	<b>15,000</b>	<b>15,000</b>
<b>FRP Rod Dia. (inches)</b>		<b>.73</b>	<b>.73</b>	<b>.73</b>
<b>Typ. Appl-kV, 0-0</b>		<b>15</b>	<b>27</b>	<b>35</b>
<b>Net Weight ea. (lbs)</b>		<b>2.6</b>	<b>3.1</b>	<b>3.5</b>





## LTL Transformers

Equipment built for the electrical industry is made to last! We offer an extensive inventory of new and used transformers. Please call or email us; our Product Specialists will get you what you need.



## Lightning Arresters

LTL carries a wide selection of distribution, station class and intermediate lightning arresters. Call LTL for more information.

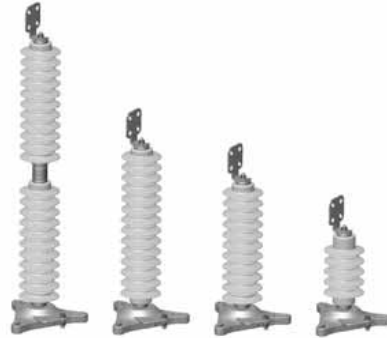

## S&C Omni-Rupter® Switches

Omni-Rupters provide long-life, high performance, no-external-arc circuit interruption, and are ideally suited for the following switching duties:

- Line switching, including sectionalizing and feeder switching
- Transformer switching
- Cable switching
- Omni-Rupter switches are rated 900 amperes continuous and interrupting in voltage ratings of 14.4kV and 25kV. These gang-operated interrupter switches are available in a number of mounting configurations to accommodate a wide variety of line configurations encountered on today's distribution systems



## S&C Scada-Mate® Switching Systems

- Scada-Mate Switches are integer style three-pole, group-operated load interrupter switches available in voltage ratings of 14.4 kV through 34.5 kV. They're factory-assembled on a one-piece base and include an integral stored-energy operating mechanism. Circuit making and breaking are accomplished within sealed interrupters, in a controlled SF6 environment
- All functions — sensing, control, and communication — are provided in one economical, completely self-contained, fully tested, integrated package



## S&C Fuses

- SM Power Fuses are especially suited for protecting transformers, capacitor banks, and cables in outdoor distribution substations through 34.5 kV. Their precision-engineered non-damageable silver or nickel-chrome fusible elements have time-current characteristics that are precise and permanently accurate - assuring not only dependable performance, but also continued reliability of system coordination plans
- With SM Power Fuses, source-side devices may be set for faster operation than practical with other power fuses or circuit breakers, thereby providing better system protection without compromising coordination
- SM-5, SMD-2C and SMU-40 are regularly stocked items. For all other fuses, please inquire with an LTL Product Specialist



SM Power Fuse



SMD Power Fuse

## Dominion Cutout Fuses

- We also carry a wide variety of Dominion Cutout Fuses
- Regularly stocked items include the: EPF461B- 46 KV and EBF341B- 34.5 KV
- Contact an LTL Product Specialist for more information

## ABB Cutout Fuses

- 15 kV cutout fuses

X1J CNN CA31	300 Amp
X1J CNN KA21	200 Amp
X1J CNN LM11	100 Amp



# Exiscan

## XIR-A-4-H-X: XIR Series Infrared Window

- Keep energized electrical equipment closed during inspection with Exiscan's XIR Series Infrared window, and easily comply with CSA Z462, OSHA, NFPA 70E, and similar electrical safety mandates

### More Structural Integrity

- Impact-resistant optic per UL and ANSI standards
- Body and cover machined from bar stock aluminum (stainless steel available)

### More Viewing Area

- 4" x 4" aperture is 66% larger than similar sized round windows
- Square aperture does not "clip" camera's squared display
- Camera lens can be placed on window optic (as opposed to 2" back) for fuller field of view

### More Accuracy

- Higher "flatter" LWIR Transmission curves for temperature accuracy
- Polymer optic remains stable over life of product without delicate sealants required

STRINGING



DIMENSION SPECS (NOM.)	
Body and Cover (LxH)	6" x 6"
Total Width (Body + Cover)	0.9"
Cover Thickness	0.4"
Aperture Dimension	4" x 4"
Aperture Area	16 sq. in.
TESTED/CERTIFIED	
UL 50V (IR Window Standard)	Yes
UL Type Rating / NEMA	Type 4
Ingress Protection (IP)	IP65
UL 746C (Impact & Flame Resistance)	Yes
ANSI/IEEE C37.20.2 Sec A.3.6 (Switchgear Window Impact Resistance)	Yes
ANSI/IEEE C37.20.7 Arc Resistance	Yes
CSA Compliant	Yes
MATERIAL SPECIFICATIONS	
Body and Cover Material	Aluminum: Anodized & Powder Coated
Backer Plate and Finger Guard	Stainless Steel
Hardware and Fasteners	Stainless Steel
Optic	Transmissive Polymer
Gaskets	Silicone & Neoprene
Cover Screws*	1/4-20Captive
TRANSMISSION COMPATIBILITY	
Mid wave and Long Wave Imagers	All Brands
Vibration	Unaffected
Broad Spectrum Acids / Alkalis	Unaffected
Humidity and Moisture	Unaffected
GENERAL	
Voltage Range	Low, Medium and High
Grounding	Automatically Grounds When Mounted to Grounded Panel/Door
Operating Temperature	-40°C to 150°C
Installation	Saw-Cut or Punch
Lifetime Warranty	Unconditional for Materials and Workmanship
Patent	Patent Pending: USA and International
Country of Origin	Made in the USA

## Double Arming Bolt



- Used to secure two cable suspension clamps or other attachments on opposite sides of utility pole
- Each double arming bolt is supplied with four attached square nuts
- Bolt provided with cone point at each end to ease starting
- Hot dip galvanized to meet ASTM Specification A153

Part Number	Description
59750	3/8" X 8" - Minimum Tensile Strength: 4,650 lbf
59755	1/2" X 18" - Minimum Tensile Strength: 8,500 lbf.
8395	1/2" X 8" - Minimum Tensile Strength: 5/8" – 13,550 lbf., 3/4" – 20,050 lbf., 7/8" - 27,700 lbf.
	5/8" X 10"/12/14/16/18/20/22/24/28/30/32/34/36/40/42/44/46/48
59780	3/4" x 6"/10/12/14/16/18/20/22/24/2/28/30/32/34/36/38/40/42

## Carriage Bolt



- Designed for use in square holes to keep the bolt from turning as the nut is tightened
- Once bolt is inserted in square hole, bolt is tightened without gripping the bolt head
- Manufactured from Grade 2 steel
- Hot dip galvanized to meet ASTM Specification A153
- Carriage Bolts are full threaded
- Supplied with attached square nut

### Available Sizes:

- 3/16" x 1, 1.25"
- 1/4" X 1.5, 2, 2.25, 2.5"
- 5/16" X 1-1/4, 3"
- 3/8" X 2-1/2, 3, 4, 4.5, 5, 5.5, 6, 7, 8, 10, 12, 14"
- 1/2" x 2-1/2, 4, 4.5, 4.75, 5, 5.5, 6, 7, 8"
- 5/8" x 2-1/2, 6"

## 5080: Cable Suspension Clamp



- Used to attach strand to straight line poles
- Accepts 1/4" (6.6M) to 7/16" (16M) strand
- Consists of two plates, and two 1/2"-13 track bolts with attached square nuts
- Plates are 1-11/16" wide and 5-3/4" long
- Center hole accepts 5/8" thru bolts
- Hot dip galvanized to meet ASTM Specification A153
- Conforms to Bell Specification CAO 8623

## 5080SS: Cable Suspension Clamp



- Used in high corrosive environments to attach strand to straight line poles
- All components constructed from high-strength 304 stainless steel

## 5082: Cable Suspension Clamp



- Used to attach strand to straight line poles
- Accepts 1/4" (6.6M) to 7/16" (16M) strand
- Consists of one hot rolled specialty shaped plate, one stamped flat plate, and two 1/2"-13 track bolts with attached square nuts
- Plates are 1-11/16" wide and 5-3/4" long
- Center hole accepts 5/8" thru bolts
- Hot dip galvanized to meet ASTM Specification A153

# Allied Bolt

## 648: Square Head Machine Bolt



- Used for fastening poleline hardware to crossarms, poles, and other structures
- Bolt head marking (ABI) appears on head of each bolt, and is registered with the U.S. Patent and Trademark Office, per the Fastener Insignia Register Act
- Hot dip galvanized to meet ASTM Specification A153
- Supplied with attached square nut
- Minimum tensile strength: 1,900 lb
- Minimum thread length is 1"

### Available Sizes:

1/4" x 1"

3/8" X 1, 1.25, 1.5, 2, 2.5, 3, 4, 4.5, 5, 5.5, 6, 7"

1/2" X 1, 1.25, 1.5, 1.75, 2, 2.5, 3, 4, 4.5, 5, 6, 7, 8, 8, 10, 12, 14, 16, 18, 20, 22, 24"

5/8" x 1, 1.25, 1.5, 1.75, 2, 2.5, 3, 3.5, 4, 4.5, 5, 5.5, 6, 7, 8, 9, 10, 12, 14, 16, 18, 20, 22, 24, 26, 28, 30, 32, 34, 36, 40"

3/4" X 2, 3, 4, 6, 7, 8, 10, 12, 14, 16, 18, 20, 22, 24, 26, 28, 30, 32, 34, 36,"

7/8" X 3, 12, 14, 16, 18, 20, 22, 24, 26, 28, 30, 32, 34, 36, 38, 40, 42, 44, 46, 48"

1" X 12, 14, 16, 18, 20, 22, 24, 26, 28, 30, 32, 34, 36"

**NOTE: Bolts over 6" long have a cone point**

## 2055: 3/4" Standard Eyelet



- Used with machine bolts for dead-ending
- Forged from High strength AISI 1018 Steel
- Slot size is 13/16" x 1-1/8"
- Height is 4-1/8"
- Hot dip galvanized to meet ASTM Specification A153

## 1429: Pole Plate and End Fitting for 2" Pipe Kit



- These malleable iron fittings are used with standard pipe near sidewalks and buildings where there is insufficient space for standard guying and where head clearance must be maintained
- Pole Plates consist of a Malleable Iron fitting, and a 1/2" x 1" bolt
- Pole Plates are provided with a curved flange and 9/16" mounting holes
- End Fitting for 2" pipe is provided with two malleable castings, two 1/2" x 2" Hex Bolts and one 1/2" x 1" Hex Bolt
- All components are hot dip galvanized to meet ASTM Specification A153

## 5060: 5/8" B Guy Hook



- Used as a means of attaching guy wire to poles
- Casted from ductile iron
- 45° ultimate strength of 10,000 lbs
- Conforms to Bell Specification CAO 7909
- Hot dip galvanized to meet ASTM Specification A153

## 5061: 3/4" B Guy Hook



- Used as a means of attaching guy wire to poles
- Casted from ductile iron
- 45° Ultimate Strength of 15,000 lbs
- Conforms to Bell Specification CAO 7909
- Hot dip galvanized to meet ASTM Specification A153

## 5875: 1/2"-13 Oval Eye Nut



- Used for dead-ending and guying from the threaded ends of crossarm bolts
- Forged from AISI 1018 steel
- Hot dip galvanized to meet ASTM Specification A153

## 9" Solid Square Hub Single Helix Power Driven Anchor 1-3/8" Hub 4000 lbs for 5/8" Rods



- Installation is performed using a power digger. An anchor wrench fits over the anchor hub and a torque measurement device is required to determine proper installation
- Correct installation is achieved only when the anchor is installed using the appropriate torque for the particular soil and anchor type (see reference charts)
- Proper anchor selection depends on the type of soil and guying requirements
- Installation torque is usually measured using a device connected in series with the wrench, digger, and Kelley Bar during installation
- Anchors are painted with rust-inhibiting blue paint after fabrication

8" SOLID SQUARE HUB SINGLE HELIX POWER DRIVEN ANCHOR 1-3/8" HUB 4000LB FOR 5/8" RODS

8" SOLID SQUARE HUB SINGLE HELIX POWER DRIVEN ANCHOR 1-3/8" HUB 4000LB FOR 3/4" & 1" RODS

10" SOLID SQUARE HUB SINGLE HELIX POWER DRIVEN ANCHOR 1-3/8" HUB 4000LB FOR 5/8" RODS

10" SOLID SQUARE HUB SINGLE HELIX POWER DRIVEN ANCHOR 1-3/8" HUB 4000LB FOR 3/4" & 1" RODS

12" SOLID SQUARE HUB SINGLE HELIX POWER DRIVEN ANCHOR 1-3/8" HUB 4000LB FOR 3/4" & 1" RODS

12" SOLID SQUARE HUB SINGLE HELIX POWER DRIVEN ANCHOR 1-3/8" HUB 4000LB FOR 5/8" RODS

8" SOLID SQUARE HUB SINGLE HELIX POWER DRIVEN ANCHOR 1-3/8" HUB 6000LB FOR 3/4" & 1" RODS

8" SOLID SQUARE HUB SINGLE HELIX POWER DRIVEN ANCHOR 1-3/8" HUB 6000LB FOR 5/8" RODS

10" SOLID SQUARE HUB SINGLE HELIX POWER DRIVEN ANCHOR 1-3/8" HUB 6000LB FOR 5/8" RODS

10" SOLID SQUARE HUB SINGLE HELIX POWER DRIVEN ANCHOR 1-3/8" HUB 6000LB FOR 3/4" & 1" RODS

12" SOLID SQUARE HUB SINGLE HELIX POWER DRIVEN ANCHOR 1-3/8" HUB 6000LB FOR 5/8" RODS



# Pole Line Hardware

## 3490: 8" Solid Square Hub Twin Helix Power Driven Anchor 1-3/8" Hub 4000 lb for 3/4" and 1" Rods



- Installation is performed using a power digger. An anchor wrench fits over the anchor hub and a torque measurement device is required to determine proper installation
- Correct installation is achieved only when the anchor is installed using the appropriate torque for the particular soil and anchor type (see reference charts)
- Proper anchor selection depends on the type of soil and guying requirements
- Installation torque is usually measured using a device connected in series with the wrench, digger, and Kelley Bar during installation
- Anchors are painted with rust-inhibiting blue paint after fabrication

## 3500: 2 1/4" Socket Anchor 8000 lb 8" Helix for 5/8" Rods



- Installation is performed using a drive wrench which fits into the anchor hub
- Proper anchor selection depends on the type of soil and guying requirements
- The anchors have a 3" helix pitch
- Installation uses standard tools
- Anchors are painted with rust-inhibiting blue paint after fabrication

## 5/8" Single Nut for Power Drive Anchor Rods



- Used in conjunction with anchor rods for helical anchors
- Eye nuts are forged from High Strength 1045 Steel
- Tapped .695"-11 UNS-2B
- Hot dip galvanized to meet ASTM Specification A153

## 19020: 6" Expanding Anchor for 1/2" or 5/8" Rod



- Offers excellent holding power with minimal soil disturbance
- A two-piece assembly that consists of a curved base plate and an integral unit with eight expanding blades
- Black paint is applied for maximum corrosion-resistance
- Formed metal cavity on the underside of the curved base unit accepts the nut of the guy rod when assembling the anchor
- The blades expand in a lateral motion by forcing the curved blades against the curved base
- Manufactured from AISI 1018 steel

## 3950: 16" Crossplate Anchor for 5/8" or 3/4" Rod



- Anchor is comprised of 2 stamped plates that are welded together  
Each plate has reinforcing ribs for extra strength  
A nut retainer is welded to the bottom plate for accepting the heavy square nuts of anchor rods  
Designed for use in holes made by power augers  
Holding power of the anchor is not affected by size of the hole  
Can be installed using the same auger used for the pole itself  
The anchor is installed in a diagonally bored hole so that the anchor is at a right angle to the guy  
Anchor is coated with paint for longevity

## Anchor Rod and Coupling Nut Assembly



- Used in conjunction with internally tapped earth anchors
- Anchor rods are forged from AISI 1045 steel to ensure high tensile strength
- Coupling nuts are forged from high strength 1045 steel
- Hot dip galvanized to meet ASTM Specification A123
- Butt of rod marked with "ABI" for identification

**5/8" X 3-1/2' ANCHOR ROD WITH ASSEMBLED COUPLING NUT**

**5/8" X 7' ANCHOR ROD WITH ASSEMBLED COUPLING NUT**

**3/4" X 3-1/2' ANCHOR ROD WITH ASSEMBLED COUPLING NUT**

**3/4" X 7' ANCHOR ROD WITH ASSEMBLED COUPLING NUT**

**1" X 3-1/2' ANCHOR ROD WITH ASSEMBLED COUPLING NUT**

**1" X 7' ANCHOR ROD WITH ASSEMBLED COUPLING NUT**

## Anchor Rod and Eye Nut Assemblies for Helical Anchors



Image shown: 3603

- Used in conjunction with internally tapped earth anchors
- Anchor rods are forged from AISI 1045 Steel to ensure high tensile strength
- Eye nuts are forged from high strength 1045 steel
- Hot dip galvanized to meet ASTM specification A123
- Butt of rod marked with "ABI" for identification

**5/8" X 3-1/2' ANCHOR ROD WITH ASSEMBLED SINGLE EYE NUT**

**5/8" X 3-1/2' ANCHOR ROD WITH ASSEMBLED TWIN EYE NUT**

**5/8" X 3-1/2' ANCHOR ROD WITH ASSEMBLED TRIPLE EYE NUT**

**5/8" X 7' ANCHOR ROD WITH ASSEMBLED SINGLE EYE NUT**

**5/8" X 7' ANCHOR ROD WITH ASSEMBLED TWIN EYE NUT**

**5/8" X 7' ANCHOR ROD WITH ASSEMBLED TRIPLE EYE NUT**

**3/4" X 3-1/2' ANCHOR ROD WITH ASSEMBLED SINGLE EYE NUT**

**3/4" X 3-1/2' ANCHOR ROD WITH ASSEMBLED TWIN EYE NUT**

**3/4" X 3-1/2' ANCHOR ROD WITH ASSEMBLED TRIPLE EYE NUT**

**3/4" X 7' ANCHOR ROD WITH ASSEMBLED SINGLE EYE NUT**

**3/4" X 7' ANCHOR ROD WITH ASSEMBLED TWIN EYE NUT**

**3/4" X 7' ANCHOR ROD WITH ASSEMBLED TRIPLE EYE NUT**

**1" X 3-1/2' ANCHOR ROD WITH ASSEMBLED SINGLE EYE NUT**

**1" X 3-1/2' ANCHOR ROD WITH ASSEMBLED TWIN EYE NUT**

**1" X 3-1/2' ANCHOR ROD WITH ASSEMBLED TRIPLE EYE NUT**

**1" X 7' ANCHOR ROD WITH ASSEMBLED SINGLE EYE NUT**

**1" X 7' ANCHOR ROD WITH ASSEMBLED TWIN EYE NUT**

**1" X 7' ANCHOR ROD WITH ASSEMBLED TRIPLE EYE NUT**

## Anchor Rod for Helical Anchors



Image shown: 3420

- Used in conjunction with internally tapped earth anchors and couplings or eye nuts
- Anchor rods are forged from AISI 1045 Steel to ensure high tensile strength
- Hot dip galvanized to meet ASTM Specification A123
- Butt of rod marked with "ABI" for identification

**3420 5/8" X 3-1/2' ANCHOR ROD FOR HELICAL ANCHORS**

**3423 5/8" X 7' ANCHOR ROD FOR HELICAL ANCHORS**

**3421 3/4" X 3-1/2' ANCHOR ROD FOR HELICAL ANCHORS**

**3424 3/4" X 7' ANCHOR ROD FOR HELICAL ANCHORS**

**3422 1" X 3-1/2' ANCHOR ROD FOR HELICAL ANCHORS**

**3425 1" X 7' ANCHOR ROD FOR HELICAL ANCHORS**

## Coupling Nut

- Used to join two Helical Anchor Rods
- Coupling nut is formed from AISI 4130 Seamless tubing
- Coupling nuts are 2" in length
- Hot dip galvanized to meet ASTM specification A153

**5052 COUPLING NUT FOR 5/8" ANCHOR RODS**

**5053 COUPLING NUT FOR 3/4" AND 1" ANCHOR RODS**



Image shown: 5053

# Rainbow Technology

## Pole Setting Foam

- A hydrophobic two-part polyurethane foam that expands to fill the peripheral void between a utility pole and the hole
- Displays excellent adhesion to all pole types without the use of primers, including wood, concrete, fiberglass, steel, and decorative street lighting
- Expanding foam fills in all voids
- Replaces traditional method of backfilling distribution and transmission poles during installation
- Low density, high strength foam can structurally support the pole and maintain its upright position
- Environmentally friendly; does not contain CFC's
- Sets the pole in 10-15 minutes with strengths 3-4 times that of tamped soil
- Foam expands 15 times its original volume and sets the pole in 3 minutes to create solid foundation material



Prepare hole for pole



Pour Part B container into Part A container



Mix together



Pour mixture into prepared hole with pole



Let sit for 15 minutes; hardware is ready to be strung

- 79698 Case of 5
- 79701 2 - 1 Cubic Foot kit
- 79702 1 - 2 Cubic Feet Kit
- 79703 1 - 3 Cubic Feet Kit
- 79705 1 - 5 Cubic Feet Kit
- 79706 1 - 6 Cubic Feet Kit
- 79707 1 - 7 Cubic Feet Kit
- 79709 1 - 9 Cubic Feet Kit



## 4305: Rainbow Cleaner & Degreaser



- Highly concentrated citrus formula
  - Ideal for general purpose cleaning on tools and equipment
  - Removes cable filling compounds, grease, oil, grime, printing inks, and more
  - Non-corrosive; safe for painted and non-painted surfaces
- 20 Oz. Aerosol Case of 12**

## 4480: Fire Ant & Insect Killer



- Granular insecticide protects equipment and personnel from insect damage and injury
- Non-conductive and non-corrosive
- Provides long lasting protection from ants, black widow spiders, brown recluse spiders, crickets, fire ants, fleas, millipedes, roaches, scorpions, silverfish, sowbugs, ticks, waterbugs, and soil-infesting insects

**100 - 4 oz. Single Application Bags**  
**5 Shaker Cans, 6 lbs Each**

## 87020: Fast Dry Contact Cleaner, 16 oz (case of 12)



- Rainbow's most powerful cleaner available
- Quickly and effectively cleans sensitive electric and electronic components
- Ideal for applications where lower flashpoint solvents may be used
- Flammable



## S-1™ Hot Stick Cleaner & Water Repellent Wipes



- Dual action - cleans, applies water repellent
- Does not remove or adversely affect glossy coat
- No "build-up" over time
- Evaporates quickly
- Removes grease, dirt, and grime
- Meets IEEE maintenance recommendations
- Convenient, pre-saturated, lint-free wipe
- Prevents continuous water film on stick in wet weather

**S-1C Hot Stick Cleaner/Water Repellent Wipes**

## Grime-Away™ Wipes



- Heavy-duty towelettes pre-moistened with a multi-purpose cleaning solution
- Features textured side to quickly remove grease, dirt and grime from items such as tools, transformers, work surfaces, equipment, service vehicles, machinery, etc., and a softer side that moisturizes and is gentle on skin
- Safe for linemen to clean hands prior to wearing insulated rubber gloves

**HTC-D72 Container of 72 Wipes**

- Quickly removes:
- PVC Pipe Cement
  - Transformer Oils
  - Cable Gels
  - Silicone Greases
  - Oxide Inhibitors
  - Dirt/Soil
  - Adhesives
  - Caulk
  - Lubricants
  - HDD Pipe Thread
  - Grease
  - Tar/Asphalt

## W-1™ Wax & Buff Wipes for Live Line Tool Maintenance



- Convenient, wax-saturated, lint-free wipe
- Dual action tandem pack includes dry buffing towel
- Superior quality, fast-hazing fiberglass wax
- Suitable for rubber and porcelain materials too
- Easy to apply
- Does not remove or adversely affect gel coat
- Leaves non-conductive water repellent coating
- Prevents continuous water film on stick in wet weather
- Designed for one time use and easy disposal
- Meets IEEE maintenance recommendations

**W-1C (72) Wax-Saturated Wipes with Dry Buffing Towel**

**W-16C (12) 16 oz. Fast-Hazing Fiberglass Wax**

## Rubber Goods Cleaner



- A specially formulated water-based cleaner for removing dirt, grease and grime from lineman's gloves, sleeves, jumper cables and other goods

**RBG-35LR One Quart Bottle With Sprayer**

**RBG-D72 Container of 72 Towels**

# American Polywater

## HP™ Multi-Purpose Cleaner/Degreaser



- Specially formulated solvent for multi-purpose, industrial and maintenance cleaning
- Effectively cleans industrial grimes, greases, lubrication fluids, silicone, tars, adhesives, and fluxes
- Evaporates without residue and is essentially non-conductive
- Cleans transformer oils, corrosion inhibitor compounds, silicone grease, semi-conducting paints, etc.
- For all electrical and communications cleaning needs
- Contains no CFC's, HCFC'S, chlorinated solvents, perchloroethylene, or other ozone-depleting solvents
- Harmless to most plastics, including polycarbonate and ABS
- Non-freezing
- Non-staining to metals

**HP-16LFC** 16 Fluid oz. Bottle; Flip Top

**HP-35LFC** 1 Quart Bottle; Flip Top

**HPY-12** 16 fl. oz. Aerosol Can

**ST-R** Trigger Sprayer for Bottles

## Boom™ Prewash Wipes for Electrical Safety



Removal of hydraulic fluid, pine pitch, road tar and other contaminants that build up during the normal exposure of the boom is vital to maintaining the dielectric properties of your boom

- Boom™ Prewash Wipes are cleaner-saturated towels that clean grease, tar, creosote, salt spray, hydraulic fluid, pine pitch, and road debris off fiberglass boom arms
- Water soluble; washes off during subsequent water rinsing
- Boom™ wipes do not adversely affect the gel coat on booms
- American Polywater cleaners do not contain abrasives and do not leave a residue. Others, like acetone, xylene and toluene, can cause permanent damage if left in contact with the surface for too long a period; these solvents are flammable, among other hazards

**B-1C** Individual 24" x 24" Wipes

**B-D72C** Container of 72 Wipes

## FD™ Electrical Contact Cleaner



- Multi-purpose industrial and maintenance cleaner evaporates quickly, without residue
- Replaces ozone-depleting CFC's, trichloroethane, HCFC's, perchloroethylene, and other carcinogenic chlorinated solvents
- Effectively dissolves industrial grimes, greases, lubrication fluids, silicone, tars, adhesives, and fluxes
- Suitable for use in electrical maintenance as a replacement for 1,1,1-trichloroethane
- Quickly cleans transformer oils, corrosion inhibitor compounds, silicone grease, semi-conducting paints, etc.
- No chlorinated solvents; non-conductive, non-staining

**FD-16LFC** 16 fluid oz. Bottle; flip top

**FD-35LFC** 1 quart bottle; flip top

**FD-9** 16 fl. oz. aerosol can

**ST-R** Trigger sprayer for bottles

## Polywater J Lubricant

- A high performance, clean, slow-drying, water based gel lubricant
- Provides maximum tension reduction in all types of cable pulling
- UL & CSA listed
- Recommended for long pulls, in a hot environment
- High cling factor and temperature stable
- Dries to form a thin film; retains its slip for months after use
- Compatible with all cables
- Available in cold weather (non-freezing) formula

Description	Regular Grade Part #	Winter Grade Part #
1-Quart Bottle	J-35	WJ-35
1-Gallon Pail	J-128	WJ-128
5-Gallon Pail	J-640	WJ-640



## Polywater F Lubricant

- A high performance, pourable liquid lubricant recommended for outside fiber optic cable pulls
- It also can be used for other types of communications cable, including coaxial and copper pair
- Slow drying; leaves a lubricating film after water-base has evaporated
- Compatible with a broad range of cable jackets, including the polyethylene types
- Easy to pour into innerducts and feeder tubes
- Superior friction reduction for lower tension pulls
- Available in cold weather (non-freezing) formula

Description	Regular Grade Part #	Winter Grade Part #
1-Quart Bottle	F-35	WF-35
1-Gallon Pail	F-128	WF-128
5-Gallon Pail	F-640	WF-640



# Krylon/Sprayon

## S03700: Quik-Mark™ Inverted Marking Paint



- Has a high solids formulation that gives the boldest, brightest and most visible markings in the industry
- These fast-drying products penetrate and adhere to hot surfaces, and deliver a line you can count on for all your locating, marking and surveying needs
- VOC compliant and free of lead hazards

## S03408: Quik-Mark™ Inverted Marking Paint



- Solvent-based
- Bright bold colors are easily identified for marking public utilities, survey and construction sites, and more
- Used to identify utilities or surfaces to dig
- Bright, bold colors
- Spray upside down
- Dry to touch: 20 minutes
- VOC compliant and free of lead hazards

## Krylon Marking Equipment



- From athletic fields to parking lots to underground utility repair, wherever bright, crisp lines and bold markings are required, Krylon marking equipment will do a professional job quickly and easily
- Creates bold, crisp lines
- For use on a variety of surfaces

## Krylon OSHA Colour Paint



- OSHA Colour Paint
- OSHA paint marks physical hazards and designates caution on the job site or at home
- Matches OSHA standard colors
- High visibility safety colors Ideal for signs, pipes, safety equipment and more
- Dry to touch: 15 minutes or less
- Dry to handle: 1 hour
- For use on wood, metal, wrought iron, paper

## LU™711: Sprayon All-Purpose Lubricant



- Penetrates and prevents rust
- Displaces moisture & lubricates
- Contains no silicone

## LU™103: Sprayon Rust Breaker



- Quickly loosens rust
- Will not harm painted surfaces
- Non-flammable
- A penetrant, water-displacer and rust inhibitor

## EL™749: Sprayon Electrical Cleaner/Degreaser



- Leaves no residue
- Use on non-energized equipment
- Replaces 1,1,1 trichloroethene

## 98002BT: Klein Beverage Tool

- Extremely handy bottle opener in the mold of a Klein Tools screwdriver
- Cushion-grip handle resists slippage and provides the comfort needed for frequent use
- Bottlecap tip-ident allows for quick identification in tool pouches or crowded drawers
- Makes a great gift
- High-quality stainless steel construction



## 5715: Mobile Phone Holder

- Fits most mobile phones
- Metal belt clip for simple mounting and removal from belts up to 2" wide
- Velcro flap and closed bottom for secure and convenient storage
- 6 1/2" length



## 44031: Money Clip Pocket Knife

- Brushed stainless steel case with rose wood insert
- Features a money clip, a 1 1/2" spearpoint blade and a 1 1/2" nail file
- Closed length: 2 1/8" x 7/8" x 1/4"



## 98288: Canvas Apron

- Great for the jobsite, workshop, or garage
- Durable 100% cotton canvas
- Large pocket is great for tools
- A large neck strap offers universal sizing, just knot to size

*WARNING: This product is NOT FLAME RESISTANT AND CAN BURN*

*WARNING: Users should be careful and always keep a minimum of three feet between themselves and the cooking surface*



## 1016: Tripsaver Multi-Purpose Tool



- Unique multi-tool addresses the special needs of electricians and maintenance professionals while providing many other handy features
- Combination cutting, stripping and crimping tool
- Compact, lightweight, and very sturdy
- Produced from high-carbon, rust-resistant stainless steel
- Features the following: needle-nose pliers, beveled wire cutter, toothed pipe grippers, files (coarse and fine), 5-slot wire stripper, wire-looping hole, scraper, awl/reamer, serrated sheeps foot knife, clip-point knife, standard/metric ruler, drywall socket, locking "L" handle, #1 and #2 phillips hex bits, small slotted hex bit, large slotted hex bit, 1/4" socket adapter, lanyard hole, nylon pouch

# Must-Haves

NOVELTY ITEMS

## Klein 98005: Insulated Beverage Hauler



- Popular Klein Tools cushion-grip design
- Double wall stainless steel insulation
- Durable stainless steel resists rust and corrosion
- Unique flow control cap opens and closes with a single touch
- Supersized cushion grip just like a Klein Tool
- Insulated lining keeps beverages hot or cold
- Makes a great gift for anyone who loves tools
- 24 oz. capacity with an integrated drink cup

## Klein 98554: 2 Fine Point Permanent Markers



- Permanent on most surfaces
- For precise marking
- Fast drying, water-resistant ink
- Long-lasting
- Replace cap after use

## LINESWEAT-M/L/XL/2XL: Hoffman Boots Sweatshirt

## LINET-M/L/XL/2XL: Hoffman Boots T-Shirt



# LTL at a Glance

**PROTECT WORKERS ~ IMPROVE SAFETY ~ INCREASE EFFICIENCY ~ ENSURE COMPLIANCE**



High Voltage Testing, Calibration and Factory-Authorized Warranty Tool Repair Centres



LTL UTILITY SUPPLY ~ EXTENSIVE INVENTORY  
3,000 Sq. Ft. Store & Clearance Area



Training & Education ~ Online & On-site



We bring the tools to you with our fully stocked mobile outfitting rig!



Substation/Engineering Services



GreenCycle Recovery & Sales

## NAIL-Accredited High Voltage Testing & Recertification Electrical Gloves & Rubber Goods

We take great pride in exceeding customer expectations for the supply, testing, calibration, repair of tools, and recertification of personal protective equipment. LTL's specialized technicians ensure proper handling of all equipment when in our facilities. To ensure compliance, all equipment is tested to applicable standards or as directed by our customers. We offer assistance in establishing both testing and calibration schedule intervals to ensure your equipment is reliable and ready to go when you are!

- Insulating Rubber Gloves
- Blankets
- Cover-Up
- Line Hose



## Canada's Largest NAIL-Accredited Centres

As advocates for safety in the workplace, LTL is represented on the NAIL for PET (North American Independent Laboratories for Protective Equipment Testing) Board of Directors.

NAIL is a not-for-profit organization dedicated to the development of uniformity and setting standards in testing, working in close association with ASTM and ANSI. To maintain accreditation, regular audits are conducted to ensure all industry accepted standards are strictly adhered to; the audit encompasses review of operational areas including but not limited to laboratory facility, equipment, training and knowledge of staff, quality control work procedures, and financial responsibility. Independent test facilities operating without NAIL-accreditation are not monitored to ensure industry best practices and standards are followed.





# Service & Repair Centres

## Live Line Tools & Ground Assemblies

### Certified Custom-Configured Ground Set Assembly and Annual Testing

- LTL builds and inventories an assortment of distribution and station grounding assembly units
- Grounding assembly clamps provide optimum support at the cable/ferrule connection when using a stress relief system
- Tinned copper threaded ferrules ensure low resistance connections
- Grounding cables are made with an extra strand of soft drawn #30 AWG (.01") copper, and are available in three jackets: yellow, clear, orange
- All grounding assembly components are tested to ASTM F855 by the manufacturer



### Live Line Tool Certification, Repair and Re-Stocking : Extend the life of your live line tools

#### Before and After Each Use:

- Inspect the surface of the tool for contaminants such as dirt, creosote, grease, oil, gas/fuel, moisture, or any other foreign material. If contaminated, a quick rag wipe may be required to improve the integrity of the fiberglass.
- Visually inspect the tool for a smooth glossy surface. Check for deep cuts, scratches, nicks, gouges or signs of bruising or crushing. Pay special attention to the tip or working section of the tool.

#### Field Inspection Results:

- Do not use if ANY defects are found on the tool surface. The tool should be tagged, removed from service, and sent to LTL for repair.
- Broken strands of fiberglass allow water to wick within the fiberglass stick itself, which promotes dielectric failure or reduced insulating values.

LTL recommends annual laboratory cleaning, inspection, waxing, and testing of fiberglass tools to ensure safety and to extend the life of your tools.

SEE IEEE STANDARD 978-1984 Guide for In-Service Maintenance and Electrical Testing of Live Line Tools, Section 4.2



## Metering, Instrumentation and Gas Detection Equipment Testing, Calibration & Repair

### Meter Manufacturing, Repair and Calibration : Auto-Notification Test-Calibration Due

LTL's Instrument Technologists test, repair, and calibrate electrical instruments and equipment including, but not limited to:

- Digital Multimeters
  - Potential Indicators
  - Clamp Meters
  - Meggers
  - Rotation Meters
  - Ground Thumpers
  - HiPot Testers
  - Decade Boxes
- LTL Technicians offer assistance in establishing both testing and calibration schedule intervals to ensure equipment is reliable and ready for use
  - Meter calibration and repair is traceable to NIST/NRC and in compliance with ISO 17025
  - LTL supplies brand name meters from industry-leading manufacturers
  - Also available, LTL-brand 361 contamination meters and potential indicators (7kV, 15kV, 30kV)

### Portable Gas Detection Equipment Calibration, Repair and Maintenance

- Certified Master Service Centre
- Calibration, repair and maintenance of gas detection equipment including industry-leading brands such as Honeywell, BW Technologies, Lumidor, BioSystems, MSA, Crowcon
- LTL representatives offer assistance with selecting the right gas detection product to suit your specific confined space application
- LTL factory-certified technicians ensure compliance with the Occupational Health & Safety Act Confined Space Regulations
- Training - Beyond the Canary: Understanding the Air in Confined Spaces. Highlights: ABC's of Gas Detection, Confined Space Regulations, Legal Obligations/Compliance, Product-Specific Operation/Use and Care

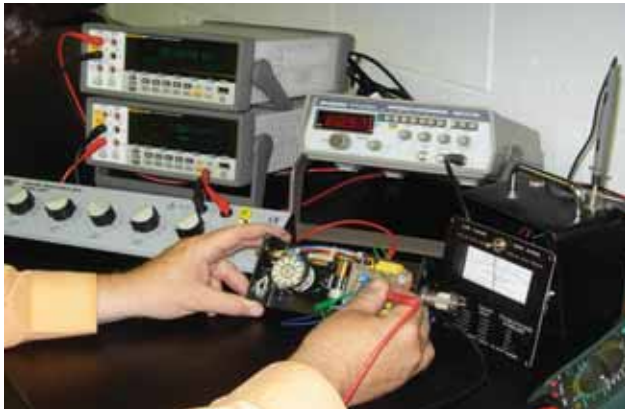

# Service & Repair Centres

## Factory Authorized Warranty Tool Testing & Repair Centres

- Load break tools
- All hydraulic and battery operated tool repair
- All hoist/chain jacks annual certification and repair
- Tools and replacement parts in stock
- Rental programs available

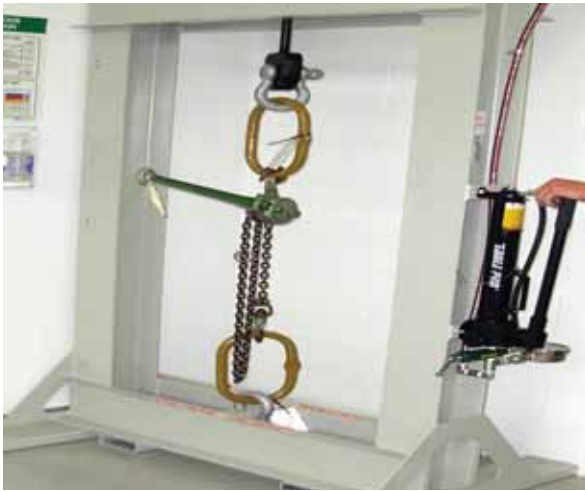

## Certified Fall Protection Inspection, Maintenance & Repair

- Industry best practices recommend field inspection of fall protection equipment prior to each use to ensure worker safety. As well, fall protection equipment should be thoroughly inspected annually by a certified laboratory. LTL's certified technicians offer inspection of harnesses, ropes, and slings to ensure the integrity of the fall arrest gear. Factory-Trained Miller & DBI Sala/Capital Safety Certified.
  - Harnesses
  - Ropes
  - Slings
  - Lanyards



# LTL UTILITY SUPPLY

## Insulating Rubber Gloves/PPE, Utility Tools and Related Equipment

- Largest stocking Canadian Distributor of Salisbury by Honeywell Insulating Rubber Gloves and related PPE
- Extensive product inventory; thousands of quality brand name products from the industry's leading manufacturers



## Mobile Outfitting Rig

- LTL UTILITY SUPPLY's mobile tool and equipment truck will be touring a city near you. We carry a wide selection of hand-picked specialty tools and equipment for the utility, forestry and industrial sectors.



Specialty tools and equipment for the Utility, Forestry & Industrial Sectors



## Utility Supply Store | 46 Meridian Road, Toronto | Hours of Operation: M-F 8:00am - 4:30pm

LTL Utility Supply store shelves are stocked and LTL Product Specialists are available to answer all questions as well as assist with compliant product selection and fitting. For your convenience, we offer insulating equipment and tools pre-certified and ready to go! Visit our Clearance Centre.



With over 56 years of industry-related technical expertise, LTL facilitators deliver specialized informational seminars. LTL's knowledgeable facilitators remain current with legislation relating to worker safety and personal protective equipment requirements, and have presented to numerous organizations in the electrical, industrial and health and safety fields.

Ensure you and your workers have the proper information necessary to promote a safe working environment while meeting legislated requirements. Seminars include instruction, training materials, and certificate of completion. We would be pleased to customize any of our sessions to best suit your specific requirements. Check back often for new topics, as well as seminars offered at LTL.

## Online Electrical Worker Safety Training



Lineman's Testing Laboratories is pleased to recommend this program as the most interactive, informative and easy-to-follow online electrical safety training system in the industry today!

This user-friendly, online electrical training program offers a convenient, cost-effective solution for establishing safe work practices to ensure personal safety when exposed to energized electrical equipment. Whether at work, home or play, this Electrical Safety Training System (ESTS) has been specifically designed to suit the needs of the electrical and non-electrical worker.

The ESTS is a multi-media based, highly interactive experience comprised of several modules with multiple lessons, knowledge checks and a final assessment. The ESTS uses 3-D "Virtual Electrical Workplace" scenarios and a unique digital electrical classroom as a learning aid to teach concepts. Each module includes a knowledge check that utilizes interactive elements that engage the student in the learning process. The ESTS for electrical worker is a four-hour course incorporating industry accepted best practice standards, while the non-electrical course is 45 minutes.

Visit [ltl.ca](http://ltl.ca) to get started.

## Classroom Safety Training at your location or ours...



LTL provides the following in-class training seminars:

- Electrical Insulating Rubber Gloves
- Arc Flash Awareness: Are you Covered?
- Beyond the Canary: Understanding the Air in Confined Spaces
- Live Line Tools: Field Care & Maintenance

Who should attend?

- Anyone working on or near live electrical apparatus
- Supervisors, Managers, Business Owners
- Health and Safety Representatives
- Any worker entering a confined space (Beyond the Canary Seminar)

For more information, or to book a safety training session at your workplace, e-mail [seminars@ltl.ca](mailto:seminars@ltl.ca) or call 800-299-9769.



Arc Flash Awareness



Live Line Tools:  
Field Care & Maintenance



Beyond the Canary:  
Air in Confined Spaces



Insulating Rubber Gloves

# LTL Arc Flash Safety Program

Protecting electrical workers since 1958, Lineman's Testing Laboratories is your single source for arc flash safety. Our complete Arc Flash Safety Program is managed and executed by our in-house electrical engineers, technicians, sales representatives and facilitators, and we inventory all applicable personal protective equipment (PPE). The program includes a CSA Z462-compliant Arc Flash Hazard Study, labeling of all applicable electrical equipment, supply of required PPE, and training.

Proper safety practices and on-going personnel training can minimize the likelihood of electrical injuries and fatalities due to shock, electrocution, arc flash and arc blast. At risk are employees who work on or near exposed energized electrical conductors or circuit parts including electrical maintenance personnel, operators, troubleshooters, electricians, linemen, engineers, site safety personnel, or anyone exposed to energized equipment.

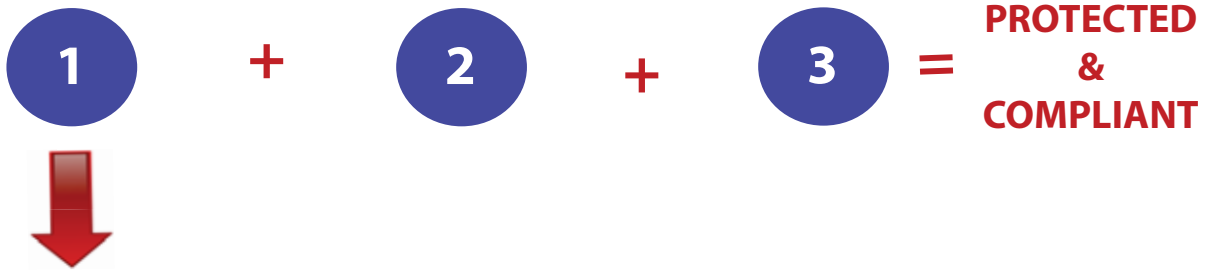

## CSA Z462 Compliant Arc Flash Hazard Study

Lineman's Testing Laboratories' comprehensive Arc Flash Studies determine potential arc flash incident energies and boundaries, shock hazard boundaries and proper personal protective equipment required for energized electrical equipment tasks for the system studied.

Performed by LTL's qualified engineers and technicians, LTL's Arc Flash Hazard Analysis includes:

- Complete engineering services
- Site assessment and data collection
- Short circuit and protective device coordination studies
- Labeling - warning labels identifying potential hazards and required safety equipment are affixed to all applicable electrical equipment
- Easy-to-read detailed Arc Flash Analysis reports
- Supply of personal protective equipment for arc flash protection
- Training - It is imperative that workers understand how and why the required PPE will help them, as well as how to properly care for and inspect this equipment to comply with legislation and ensure equipment integrity



## What sets us apart?

- Niche product and service provider all-in-one; we SERVICE what we SELL
- Over 56 years serving the Utility, Electrical, Forestry & Telecom industries
- Electrical Engineering/Substation Division team provides technical support to our product specialists when required
- Exceptional industry-experienced team including laboratory technicians, factory-authorized repair technicians, knowledgeable sales and customer care reps, linemen, electrical engineers and technologists, master electricians
- We have the knowledge, skills and tools to ensure you are compliant



## The Solution

- Canada's Largest Inventory of Insulating (Electrical) Rubber Gloves and PPE
- Utility Supply Store (Toronto location) - shelves stocked with thousands of brand name utility tools and related equipment
- Outfitting Rig - mobile tool truck
- Certified Custom Grounding Assemblies
- Hydraulic and Battery Operated Tool Repair
- Mobile Dielectric Truck Testing - Edmonton Facility
- Automatic Glove Replacement Program – ensures timely turnaround of failed gloves during testing
- Compliant Uniform Fitting and Recommendation by LTL Product Specialists
- Online and Classroom Electrical Safety Training
- Expedited/Rush Order Service
- Green Cycle Equipment Recovery & Sales - refurbished transformers, line hardware and surplus equipment
- Rental Tools and Equipment
- Emergency Inventory Availability - 24/7
- Canada's Largest NAIL-Accredited High Voltage Testing Centres
- Natural Disaster/Emergency Contingency Plans-Laboratory Redundancy (Edmonton & Toronto Facilities)
- Factory-Authorized Warranty Tool Repair Centre
- Honeywell Certified Master Service Centre - calibration, repair and maintenance of gas detection equipment

## STAY CONNECTED

### Hot Zone Specials, LTL Buzz and LTL.ca

Stay connected to the LTL community for product deals, specialized services, industry related news and information. Sign up for the LTL Buzz and Hot Zone Specials!



## SATISFACTION SURVEY

### Tell us how we're doing

At LTL, we are always striving to improve and enhance our customers' experience by offering the best in quality products and customer care. Please take a moment and let us know how we're doing by completing our online survey at [ltl.ca/contact-us/satisfaction-survey/](http://ltl.ca/contact-us/satisfaction-survey/)



All information collected is proprietary and will not be disclosed to external entities.



# Substation/Engineering Services

## At a glance...

- Electrical Design
- Service Work
- Preventative Maintenance Programs
- Infrared Scanning/Thermography
- Mobile Transformer Oil Regeneration & Exchange
- Field Transformer Repair Service
- CSA Z462 Compliant Arc Flash Hazard Analysis
- PCB Management & Decontamination
- Emergency Power Solutions
- Disaster Recovery | Emergency Contingency
- Extensive Inventory of New & Refurbished Transformers, Switchgear, Fuses, Lightning Arresters, Insulators, Towers, Poles and other related equipment
- 24 Hour Emergency Substation Services in Ontario

## Engineering

- Electrical power system specification/substation engineering/design engineered models
- High voltage engineered plan submissions to electrical utilities and Electrical Safety Authorities
- Short circuit current analysis and co-ordination studies
- Substation ground grid studies
- Electrical and electronic testing of high and low voltage substation components
- Power factor correction analysis and power quality studies
- Underground cable locating
- Transformer/Substation commissioning
- Arc Flash Hazard Studies in accordance to CSA Z462: includes site assessment and data collection, short circuit and protective device coordination, labeling, easy-to-read detailed arc flash analysis reports, and protective equipment supply and training

## Emergency Power Solutions

- 24-HR emergency services for commercial, industrial and utility sites: installations, repairs, splicing, terminations, fault locating, temporary cable supplies
- Generators and related equipment rentals: Transformers, metalclad switchgear, switches, towers, fuses

## Transformer Oil Services

- Environmentally friendly mobile transformer oil regeneration
- Regenerated oil performs as new or better
- On- or off-line oil regeneration
- Mode 60 oil sales and oil removal program
- Complete oil sampling with full report (five-way, gas, PCB, furans, water content)
- Degasification; vacuum fill; core dry out
- PCB management solutions

## Field Services

- Complete transformer commissioning and testing
- Transformer repair
- Transformer assemble/disassemble, transportation
- Fin replacement
- Bushing replacement
- Tap changer maintenance, repair and replacement
- Oil leak termination
- Painting
- Mobile Transformer oil regeneration
- Rewind service (shop only)
- Substation maintenance -- testing and calibration, inspection, adjustment, cleaning, repair and analysis of electrical insulating fluids
- Infrared Thermography (Scanning)
- New unit specification and supply



State-of-the-art mobile oil regeneration plant

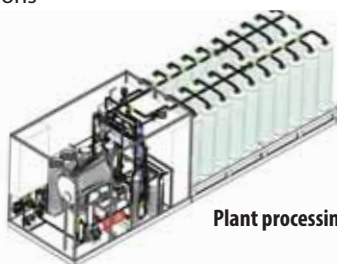

Plant processing and column view

## S&C Factory-Trained

With over 56 years of dedicated service, Lineman's Testing Laboratories has earned a reputation for accurate and professional execution of all electrical service work to established standards.

LTL's factory-trained technicians ensure in-service S&C equipment is maintained, in an expedient manner, to manufacturer specifications for design and safety, using original equipment parts. We service all switchgear, including, but not limited to, PMH and PME pad-mounted gear, offering complete restoration to near-new quality. LTL's full service offering includes pick-up of equipment at the customer site, removal from in-service yard locations, and tailored service to specific customer requirements.



## Transformer Field Services

- Complete transformer commissioning and testing
- Transformer repair
- Transformer assemble/disassemble, transportation
- Fin replacement
- Bushing replacement
- Tap changer maintenance, repair and replacement
- Oil leak termination
- Painting
- Mobile Transformer oil regeneration
- Refurbish/re-build
- Parts in stock
- Substation maintenance -- testing and calibration, inspection, adjustment, cleaning, repair and analysis of electrical insulating fluids
- Surplus equipment sales and purchase



Pole Mount Tx Refurbs



Station Class Tx Refurbs



Pad Mount Tx Refurbs



# LTL Products

## Lineman Gloves 3" & 6" Cuffs

- LTL-BRAND high grade leather
- Mustard yellow colour-fast
- Yellow Kevlar stitching
- Reinforced leather palm
- Fleece-lined winter style
- Unlined, water repellent summer style
- Sizes S-XXL



LTL426IMFL

## LTLGLVKE: LTL Glove Kit

LTLGLV0K-Size Class 0 Insulating Rubber Glove Kit Includes:

- E011Y-Size Gloves, Class 0, Yellow
- Available sizes: 7, 8, 8.5, 9, 9.5, 10, 10.5, 11, 12

LTLGLV2K-Size Class 2 Insulating Rubber Glove Kit Includes:

- E216YB-Size Gloves, Class 2, 16", Yellow /Black, Straight Cuff
- Available sizes: 9, 9.5, 10, 10.5, 11, 12

Both kits include the following:

- Leather Protectors (Class 0-L323-Size | Class 2-L2C814YS-Size)
- ML80K Cotton Glove Liner
- GP Glove Powder
- Glove Bag (Class 0-LTL112 | Class 2-LTL118)
- Kits are available in all classes



## GP/GP-1: Glove Powder

- A powder compounded especially for use in linemen's protective gloves to prevent sticking and binding. Powder will not deteriorate or lower the dielectric strength of rubber gloves
- Product Weight: Available in 100g or 900g (Part # GP-1) containers (available larger if needed)



## LTL Deerskin Leather Protectors Class 2 & 4

- Colour-fast, 100% Canadian premium deerskin leather glove protector
- To be worn over insulating rubber gloves to provide mechanical protection against cuts, abrasions, and punctures as well as protect the rubber gloves from possible physical damage while in use
- They are designed and are to be used solely for the purpose of protecting the rubber gloves
- The inner surface of the protectors should be inspected as often as that of the rubber gloves



LTL20DSY-9	Class 2, Size 9 - Yellow Cuff
LTL20DSY-10	Class 2, Size 10 - Yellow Cuff
LTL20DSY-11	Class 2, Size 11 - Yellow Cuff
LTL20DSY-12	Class 2, size 12 - Yellow Cuff
LTL40DSR-9	Class 4, Size 9 - Red Cuff
LTL40DSR-10	Class 4, Size 10 - Red Cuff
LTL40DSR-11	Class 4, Size 11 - Red Cuff
LTL40DSR-12	Class 4, Size 12 - Red Cuff

## LTL Glove Liners

- Cotton, machine knit parade liner
- Absorbs perspiration in the summer and provides added warmth in the winter



## 361 CONTAM MTR: Contamination Meter

- Complete with 30' Co-ax Cable Assembly
- Case sold separately: 361CASE
- Custom lengths available



## POTIND 7kV/15kV/30kV

- Used for identifying energized conductors
- 3 voltage ratings to choose from: 7kV, 15kV, 30kV
- Indicates line to ground voltage AC or DC
- Rugged polycarbonate tubing construction
- High dielectric value
- Protective carry case
- Lightweight
- C/W ground wire



## Grounding Cables

- Grounding Cable, 2/0 CU 1330 Strand Ground Cable, 600 Volts, Orange Jacket EPDM
- Grounding Cable, 4/0 1C CU 2109 Strand Ground Cable, 600 Volts, Orange Jacket EPDM
- Available in clusters and various configurations



## 350 MCM & 500 MCM Copper Grounding Cable

- For situations where you need a 5H or 7H rating

Caliber AWG	Conductor Diameter	No. of Strands	Cable Diameter	Capacity 15 Cycles	Capacity 30 Cycles	Temp. F	Separator	Weight/1000 (lbs)
350 MCM	0.77	3432 / 30	1.06	40 kA (IEC) 68 kA (ASTM)	51.3kA (ASTM)	-58 to 194	Paper	1369
500 MCM	0.95	5054 / 30	1.25	55 kA (IEC) 86.3kA (ASTM)	61kA (ASTM)	-58 to 194	Paper	1949

## P2MF-6: Male/Female Fittings

Set of male and female fittings for live line tools  
Live line tools with couplers available in various configurations



## Couplers



## Stick Bags

Vinyl bags for various lengths of live line tools



# LTL Products

## SKCA11(SIZE)-1200-CAN: LTL Pro-Wear Arc Flash Protection Kit-12 cal/cm<sup>2</sup>

**INCLUDES:**

- Arc Flash Navy Coveralls ATPV Rating of 12 cal/cm<sup>2</sup>
- Sizes: M, L & XL (2XL-3XL available at additional cost)
- AS1200HAT-weight balancing 12 cal/cm faceshield with helmet chin cup 2
- ATPV Rated AFHOOD 15
- ASBAG/D - helmet bag
- SKBAG/D - large storage bag
- UVEX Genesis Safety Glasses



## SWITCHMATBULK: Switchboard Matting

- Permanently placed in front of switchgear, motor control centres and other high voltage apparatus to provide personal protection for workers. It is also used when tending take-up and pay out reels and when adding or replacing conductors
- Made from high quality Type II rubber, Class 2 matting is 1/4" (6.4mm) thick and is tested to 20kV. Class 2 matting complies with ASTM D178 specifications
- The corrugated surface acts as safety tread while reducing the possibility of metal particles becoming embedded. Class 2 switchboard matting is available in 25 yard rolls or custom cut to specified lengths
- Maximum Use AC Voltage Class 2 is 17,000 volts
- Available in class 3 and 4



## LTL6000-5: Penta Socket

- T-handle with LTL logo



## Rope Block: LTLH1802-36SSR



## LTL6000-11: LTL Guy Wire Holder



- Four adjustable arms
- Holds guy wire with 1/2" diameters
- Driver or passenger site mounting options

## LTL Manual Ground Rod Drivers

- Driver made from 1.9" diameter extra heavy steel pipe 4' long with 4" PLUG doweled and welded in top end
- Extension made from 7/8" carbon steel rod doweled and welded into 1.9" diameter extra heavy steel pipe 9" long
- Hot dip galvanized



## 10-110: Nut and Bolt Bag Canvas w/Belt Loops



## Nut and Bolt Bag

- This bag, complete with hook and latch, hangs 6" from a belt; ideal for keeping nuts, bolts, and other small items handy on the job
- 9" x 8" x 3.75"



## LTLARCBAG: Heavy Reinforced Canvas Equipment Bags

- Made of heavy weight canvas or heavy weight orange vinyl
- The bottom of these bags are made of a special rubber blend that offers protection and solid support
- Molded rubber runners on bottom of bag protect it from wear
- Webbing handles are sewn completely around the bag for greater strength



## Camouflage Tool Bag

- Extremely durable
- Ideal for work or personal use
- Also available in canvas or vinyl
- Constructed of 1000-denier Cordura Plus with Realtree Advantage Camouflage Pattern



## 31-140: Tool Bucket Vinyl, w/Rope 8" x 12"



## 31-105: Tool Bucket Canvas, w/Rope and Snap



31-205: Tool Bucket Canvas, w/Rope and Snap 12" x 15"

31-206: Tool Bucket Canvas, w/Rope and Snap 1 Inside Pocket 12" x 15"

## 31-245: Tool Bucket Vinyl, w/ Rope and Snap 12" x 15"



## HANDLINE366M-50'

- Handline Assembly - 50' Working



# LTL Products

## HEAVY DUTY TEMPORARY ACCESS MAT

### The fast and safe way forward

#### Heavy Duty Temporary Access Mats

Supporting loads up to 80 tons, this mat is the ultimate, fast to install temporary access and ground protection mat for moving equipment and personnel over soft or sensitive ground.

#### Amazingly Tough & Flexible

Tough high density polyethylene (HDPE), the mat weighs only 35kg/77lbs and incorporates hand holds that make moving and installation easy.

#### Anti-Slip Surface

The engineered, unique chevron traction® surface delivers ultimate grip and dispels mud, dirt and snow when vehicles travel over the mats. The chevron nub design also reduces sideways movement and slippage and delivers optimal forward traction.

#### Connection Options

Multiple connection options are available to suit various applications.

- Fast and easy to install
- Unique chevron traction® surface
- Fast temporary access and working areas
- Low transport and handling costs
- Avoid property and environmental damage
- Avoid health and safety issues
- Reflective markings for night safety (optional extra)
- Multiple connection options for different terrain and equipment



EMS003

	Thickness	Dimension (WxL)	Weight per Mat
Standard	.47"	47" x 94.8"	77 lbs
Material	Premium recycled High Density Polyethylene (HDPE)		
Colours available	Black - recycled HDPE. Other colours available-minimum order quantity applies		
Connectivity	Standard connectors - 2 way and 4 way options		
	Metal connectors for heavy and tracked equipment		
	"Fast Fit" connectors for fast installation		
	Flex connectors for undulating ground		
	Metal U-pins for slopes and cambers		
Optional extras for night safety	Non-slip reflective markings and "cats eyes"		
Environmental features	Weather-proof, water and chemical resistant, usable in sub-zero temperatures. High Density Polyethylene is resistant to acids, alkalis and solvents		

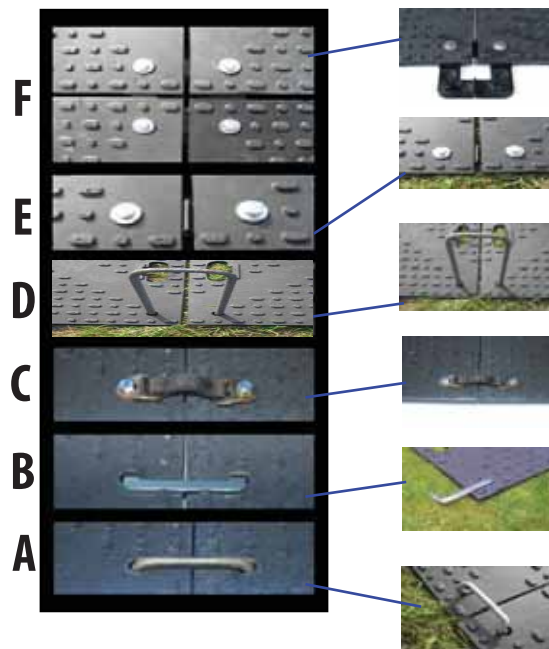

	Part #	Description
A	EMC001A	Fast Connectors
B	EMC001B	Fast Connectors
C	EMC003	Flex Connectors
D	EMC008	Metal U Pin Connectors
E	EMC201	2-Way Connectors
F	EMC401	4-Way Connectors
	EMS003	EuroMat
G	LTLRACK	Transportation Rack 6'H x 8'L x 4'W



G

## LTLOUTRPAD

- LTL outrigger pads are ideal for use with radio boom derricks (RBD), digger derricks, single or double bucket trucks and cranes
- The outrigger pads are made from a high quality polyethylene (PE HD RKB regenerated multicolour), meaning they do not splinter or absorb water and can be used in all weather conditions
- Maintains its rigidity and original shape during use, each pad has a high resistance to vertical pressure
- Long lasting and have an extended life span compared to other materials
- Carry handles are made from durable nylon rope
- Handles on two sides make them easy to transport, install and store
- Easy to clean, chemical and oil resistant
- Dimensions: 2" x 14" x 28" (can customize to any size required)
- Weight: 26.45 lbs



## 85: Battery Cable Cutter



- For cutting Cu/Al cable and armored cable
- Powered by Li-ion battery, actuated by motor and controlled by MCU
- With a high pressure hydraulic system, LED light, LCD, error warning alarm and pressure showing function

## 400: Battery Crimping Tool



- For crimping Cu lugs with cables from 16-400 mm<sup>2</sup>
- Powered by Li-ion battery, actuated by motor and controlled by MCU
- With a high pressure hydraulic system, LED light, LCD, error warning alarm and pressure showing function



# Salisbury by Honeywell Linemen's Gloves & Sleeves

Insulating Rubber gloves are among the most important articles of personal protection for electrical workers. Incorporating high dielectric and physical strength, flexibility and durability, Salisbury by Honeywell insulating rubber gloves have earned the reputation for superior performance - meeting and exceeding the requirements of current ASTM D120 specifications and IEC EN60903 Standards.

## Protective Rubber Equipment Labeling Chart

Class Color	Proof Test Voltage AC / DC	Max. Use Voltage AC / DC*	Rubber Molded Products Label	Glove Label	Rubber Dipped Sleeve Label
00 Beige	2500 / 10,000	500 / 750*			
0 Red	5,000 / 20,000	1,000 / 1,500*			
1 White	10,000 / 40,000	7,500 / 11,250*			
2 Yellow	20,000 / 50,000	17,000 / 25,500*			
3 Green	30,000 / 60,000	26,500 / 39,750*			
4 Orange	40,000 / 70,000	36,000 / 54,000*			



### Salisbury Insulating Rubber Gloves - Low Voltage ASTM Class 00 Gloves

	Class	Length	Colour	Size
E	00	11	R, B, BL, Y or BLO	7, 8, 8H, 9,
E	00	14	R, B, BL, Y or BLO	9H, 10, 10H, 11, 12

R= Red, B=Black, BL=Blue, BLO=Blue in, Orange out: Type II SALCOR®  
Example: E0011BL/8

### Salisbury Insulating Rubber Gloves - Low Voltage ASTM Class 0 Gloves

	Class	Length	Colour	Size
E	0	11	Y, B, R, BL, BLO* or BY	7, 8, 8H, 9, 9H,
E	0	14	Y, B, R, BL, BLO* or BY	10, 10H, 11, 12

R= Red, B=Black, Y=Yellow: Type I Natural Rubber  
BY: Black in, Yellow out: Type I Natural Rubber  
BL=Blue, BLO=Blue in, Orange out: Type II SALCOR®  
Example: E014R-9

\*The contrast between the outer orange colour and the inner blue colour makes inspecting for cuts and tears easier when the glove is inflated or stretched.

### Determine Your Glove Size



Measure the circumference of your palm (hand laying flat), following a line across your knuckles.  
Add 1" to this measurement, and this is your glove size.  
For example, if you measure 9", add 1", and your glove is size 10.

# Salisbury by Honeywell Linemen's Gloves & Sleeves

## Insulating Rubber Gloves - High Voltage ASTM Class 1, 2, 3, 4 Gloves

	Class	Length	Cuff Style***	Colour	Size
E	1	14, 16, or 18	FC, BC, C	B, YB, or RB	7, 8, 8H, 9, 9H,
E	2	14, 16, or 18	FC, BC, C	B, YB, or RB	10, 10H, 11,
E	3*	14, 16, or 18	FC, BC, C	B, YB, or RB	11H, 12
E	4**	14, 16, or 18	FC, BC, C	B, YB, or RB	

BC = Bell Cuff, C = Contour Cuff (straight cuff is the default style)

\* available in sizes 8-12 including half sizes only

\*\*available in sizes 9-12 including half sizes only

B=Black, YB = Yellow inside, Black out, RB = Red inside, Black out: Type I Natural Rubber

Example: E116FCYB-10

Example if ordering straight cuff: E116YB-10

\*\*\*bell cuff gloves available in sizes 9 through 12 including half sizes only



## Insulating Rubber Mittens - High Voltage ASTM Class 1, 2, 3, 4 Gloves

	Class	Length	Cuff Style	Colour	Size
EM	1	14, 16 or 18	BC	B, YB or RB	9, 10, 11
EM	2	14, 16 or 18	BC	B, YB or RB	9, 10, 11
EM	3	16 or 18	BC	B, YB or RB	9, 10, 11
EM	4	16 or 18	BC	B, YB or RB	9, 10, 11



## G99: Glove Inflator



- Simple and easy-to-use, portable glove inflator
- Provides a quality means of inspecting gloves in the field
- Glove is secured to the inflator using a nylon strap and fastened with a hook and pile closure
- Inflation is accomplished by pumping the bellows of the inflator against any surface

*Note: Gloves should be expanded no more than 1.5 times their normal size for Type 1, and 1.25 times normal for Type II SALCOR®*

## G100: Glove Inflator

### G100A: Low Voltage Glove Adapter



- Proper safety requires frequent inspection of gloves
- Simple and easy-to-use, portable glove inflator
- Operates exactly like the G99, but includes an additional G100 Adapter to inspect class 00 and 0, and smaller gloves
- To use the adapter, the glove is secured to the G100A adapter using a nylon strap with a hook and pile closure
- The adapter, with the glove attached, is then placed on top of the inflator to be inflated for inspection

## INF-6: Standard Sleeve Expander

- Proper safety requires frequent inspection of sleeves
- Provide an efficient way to conduct complete and thorough, visual inspections before and after use in the field
- Easy-to-install, simple to operate and accommodates all sleeves



# Salisbury by Honeywell Linemen's Gloves & Sleeves

## Sleeves

### Breakdown for Dipped Type I Sleeves

Voltage Class	Size	Colour
D0	S, R, L or XL	Y = Yellow
D1	S, R, L or XL	B = Black
D2	S, R, L or XL	YB = Y inside, B out
D3	S, R, L or XL	RB = R inside, B out
D4	S, R, L or XL	YR = Y inside, R out

S = Small  
 R = Regular  
 L = Large  
 XL = Extra Large  
 Add suffix -ST to order straight cuff or -EC to order extra-curved cuff



Straight arm  
D2RYB-ST



Extra-Curved Arm  
D2LYR-EC



Molded Black, Type I  
2RB



Molded Yellow, Type I  
3LY



Molded Orange, Type II  
2ROS

### Breakdown for Molded Type I Sleeves

Voltage Class	Size	Colour
1	R or L	Y
2	R, L or XL	B, Y, M
3	R or L	Y, M
4	R or L	M

R = Regular  
 L = Large  
 XL = Extra Large  
 B = Black  
 Y = Yellow  
 M = Maroon

### Breakdown for Molded Type II Sleeves

Voltage Class	Size	Colour
1	R or L	BS or OS
2	R, L or XL	BS or OS

R = Regular  
 L = Large  
 XL = Extra Large  
 BS = Black SALCOR®  
 OS = Orange SALCOR®

## Harness and Straps

- Four buttons, two straps, and one harness are required per pair of sleeves

H1 - Harness with 4 B2 buttons (right)  
 S1 - 5" Strap with 4 B2 buttons (below)



## Sleeve Buttons & Straps

- Sleeve buttons, straps, and harnesses are required to wear insulating rubber sleeves properly

B2 - 1-Piece Sleeve Button  
 B22 - 4 Screw Type Button



## Glove Liners

Glove liners enhance the comfort of wearing Insulating Rubber Gloves in every season. Liners provide warmth in the cold season and absorb perspiration in the warm months. Many styles and fabrics are available and include the option of either an open or knit wrist.

The knit wrist style grips the wrist rather than allowing the cuff to roll down and bunch at the palm. All liner gloves are for year round use with Insulating Rubber Gloves and Mittens. All liners are made from stretch fabric that can fit any hand size.

Part #	Description	Wrist style	Length (inches)	Weight (lbs)
L10JK	Jersey Style, lightweight Seams Out	Knit	10	.14
L10J	Jersey Style lightweight, Seams Out	Open	10	.12
L12J	Jersey Style, lightweight, Seams Out	Open	12	.14
L10MKC	Machine Knit, 100% Cotton	Knit	10	.12
L12MKC	Machine Knit, 100% Cotton	Knit	12	.12
L10MKW	Machine Knit, Wool Blend	Knit	10	.14
L12MKW	Machine Knit, Wool Blend	Knit	12	.14
89/1402	White Machine Knit, 100% Cotton	Knit	10	.12
89/4702	Rust Machine Knit, 100% Acrylic	Knit	10	.12



# Salisbury by Honeywell Leather Protectors



156-4



ILP10



ILP10A



ILP7C



ILPG3S



LPG4S

## Advantage Premium Series

- Made from specially tanned Grade A Red Boulevard buffed leather and an orange coloured SALCOR® "Super Cuff"
- Super Cuff does not absorb water and has greater track resistance and creepage than leather or vinyl cuffs
- Available in 4" straight cuff (12" overall) or 6" straight cuff (14" overall)
- SALCOR® cuff provides maximum protection
- Dual sizes: 8/8.5, 9/9.5, 10/10.5, 11/11.5, 12

*Warning: Do not use leather protectors alone for protection against electric shock. Serious injury or death will result. Always use a properly rated insulating glove for the voltage being worked on*

### 156 PREMIUM SERIES

Part #	Cuff Length (inches)	OAL Length (inches)	Weight Ea. (lbs)
156-4	4, Straight Cuff	12	1
156-6	6, Straight Cuff	14	1.2

**ILP SERIES - COWHIDE** Manufactured from top grain cowhide. Cuffs feature tough leather on palm side and orange vinyl on back.

Part #	OAL Length (inches)	Weight each (lbs)
ILP3S	12	1
ILP4S	13	1
ILP5S	14	1.2
ILP6S	15	1.2
ILP7C	16	1.5
ILP10	10	.7
ILP10A w/ pull strap	10	.7



### CLEARANCE TABLE FOR LEATHER PROTECTORS PER ASTM F496

Glove Class	Min. distance between Protectors & Rubber Gloves	
00, 0	1/2"	13mm
1	1	25mm
2	2	51mm
3	3	76mm
4	4	102mm

**LP SERIES - COWHIDE** Manufactured in the US from top grain cowhide. Cuffs feature adjustable straps with non-metallic buckles and are stitched with polyester thread for strong seams.

Part #	OAL Length (inches)	Weight each (lbs)
LP3S	12	1
LP4S	13	1
LP5S	14	1.2
LP6S	15	1.2
LP7C - contour cuff	16	1.5
LP10	10	.7
LP10A w/ pull strap	10	.7

**ILPM SERIES - COWHIDE** Mitten protectors are manufactured from top grain cowhide. Cuffs are tough leather on palm side and orange vinyl on back of hand side. Feature adjustable straps with non-metallic buckles and are stitched with polyester thread for strong seams.

Part #	OAL Length (inches)	Weight each (lbs)
ILPM3S	12	1
ILPM4S	13	1
ILPM5S	14	1.2



TRUSTED SINCE 1958

# Salisbury by Honeywell Gloves

## Winter Utility Gloves



UWG-WPGC/S	Small
UWG-WPGC/M	Medium
UWG-WPGC/L	Large
UWG-WPGC/XL	X Large
UWG-WPGC/XXL	2X Large

- Wool/fleece blend sportswool liner and 3M Thinsulate for extra insulation
- Gauntlet cuff with adjustable closure
- Waterproof, windproof, and breathable
- Non-slip saddle for gripping wet items

## Kevlar Utility Gloves



UWG-KLG/S	Small
UWG-KLG/M	Medium
UWG-KLG/L	Large
UWG-KLG/XL	X Large
UWG-KLG/XXL	2X Large

- A cut-resistant all-purpose glove
- Fully lined with 100% kevlar fiber
- Level 4 of 5 on EN388 Cut Test Standard
- Extensive PVC reinforcement for durability
- Double-stitched for extended life

## Pro Utility Gloves



UWG-HUXT/S	Small
UWG-HUXT/M	Medium
UWG-HUXT/L	Large
UWG-HUXT/XL	X Large
UWG-HUXT/XXL	2X Large

- The perfect utility worker glove
- Breathable stretch nylon on back of hand
- Extended cuff with asphalt reinforcement
- Non-slip saddle for gripping wet items
- Extensive PVC reinforcement for durability

## Winter Pro Gloves



UWG-WPSC/S	Small
UWG-WPSC/M	Medium
UWG-WPSC/L	Large
UWG-WPSC/XL	X Large
UWG-WPSC/XXL	2X Large

- All-purpose and abrasion resistant
- One piece back of hand with knuckle protection
- Supportive and breathable cuff
- Double-stitched for extended life

## LW2SPE: Lineman Cowhide Work Glove



- Linemen Work Gloves are designed specifically for use by linemen and offer many of the quality features found in our leather protectors
- The glove is soft and flexible, while still being highly abrasion and cut resistant for long wear
- Made from high quality grain cowhide and features a natural pigskin cuff
- Add "-M" for a size medium, "-L" for a size large, and a "-XL" for a size extra large

## SP-L: SALPOL Gloves

- SALPOL Gloves protect hands during cold weather jobs
- The black split cowhide leather has a 3M Thinsulate lining to keep hands warm
- For extra warmth, a long knit wrist is sewn into the safety cuff to keep out snow and ice
- The glove also has a full leather index finger, knuckle strap, leather finger tips, and pull patch

## I95/217 WHS: Driver Work Gloves



- Drivers Work Gloves set the standard for quality at an affordable price
  - Combining comfort, durability and economy, Salisbury leather Drivers Work Gloves meet the tough challenges of today's demanding workplace
  - Available in lined or unlined styles. The bindings are colour coded to indicate size: red-small, green-medium, brown-large, purple-extra large
- I95/217/WHS-SIZE (S/M/L/XL)**



# Chance - Lineman Grade Gloves

Featuring the ultimate protection you expect from the Chance name, these Lineman Grade Gloves also offer a new level of comfort and flexibility. Incorporating high dielectric and physical strength, these gloves exceed ASTM D120.

## Contour Cuff



ASTM classes: 2, 3 & 4  
Colours: Yellow under Black & Red under Black  
Sizes 8 to 12 and 8.5, 9.5 and 10.5  
Length: 18"

## Bell Cuff



ASTM classes: 1 & 2  
Colours: Red under Black & Yellow under Black  
Sizes: 9 to 12  
Length: Class 1 - 14" & 16", Class 2 - 14", 16" & 18"

ASTM classes: 3 & 4  
Colours: Red under Black & Yellow under Black  
Sizes: 9 to 12  
Length: 16" & 18"

## Straight Cuff (High Voltage)



ASTM classes: 1 & 2  
Colours: Black & Red under Black & Yellow under Black  
Sizes: 8 to 12 and 8.5, 9.5 and 10.5  
Length: Class 1 - 14" & 16", Class 2 - 14", 16" & 18"

ASTM classes: 3 & 4  
Colours: Red under Black & Yellow under Black  
Sizes: 8 (class 3 only) to 12 and 8.5 (class 3 only), 9.5 and 10.5  
Length: 16" & 18"

## Straight Cuff (Low Voltage)



ASTM classes: 00 & 0  
Colours: Red & Black & Yellow  
Sizes: 7 to 12 and 7.5, 8.5, 9.5 and 10.5  
Length: Class 00 - 11" & 14" (red available in 11" only), Class 0 - 11" & 14"

# Chance - Leather Protectors & Sleeves

## Low-Voltage Leather Protectors

- Goatskin-soft, flexible, strong
- Nylon strap with non-metallic buckle
- Note: 13" have polymeric/leather cuff



## High-Voltage Leather Protectors

- Cowhide - durable and flexible
- Hi-visibility polymeric/leather cuff
- Nylon Strap with non-metallic buckle
- Note: 16" fit straight and contour gloves



## Glove Liners

- 100% Cotton for warmth and comfort under rubber insulating gloves
- One size to fit most
- Two weight/length choices
- Reversible to fit either hand



## Sleeves

- The ultimate source of protection expected from the Chance name
- Offers a new level of comfort and flexibility
- Constructed for high dielectric and physical strength
- Exceed ASTM D1051
- Available in sizes Regular, Large and Extra Large
- Extra-Curved Sleeves are dipped
- Comes in yellow or two contrasting colours



Size	Class 2			Class 3			Class 4		
	Yellow	Red under Yellow	Yellow under Black	Yellow	Red under Yellow	Yellow under Black	Yellow	Red under Yellow	Yellow under Black
R	PSC2RYEC	PSC2RRYEC	PSC2RYBEC	PSC3RYEC	PSC3RRYEC	PSC3RYBEC	PSC4RYEC	PSC4RRYEC	PSC4RYBEC
L	PSC2LYEC	PSC2LRYEC	PSC2LYBEC	PSC3LYEC	PSC3LRYEC	PSC3LYBEC	PSC4LYEC	PSC4LRYEC	PSC4LYBEC
XL	PSC2XLYEC	PSC2XLRYEC	PSC2XLYBEC	PSC3XLYEC	PSC3XLRYEC	PSC3XLYBEC	PSC4XLYEC	PSC4XLRYEC	PSC4XLYBEC

### SLEEVE STRAPS & BUTTONS

- Two straps and four buttons are required to properly wear each pair of sleeves
- Straps are 15" in length
- Buttons are two-piece, screw-type



PSC4060610 Straps only



PSCS1 Strap Set: Includes 2 straps & 4 buttons



PSC4060600 Sleeve buttons: (Includes 4 pair)

### Sleeve Part Numbering System

- PSC** = Chance catalogue #
- Class (max. use voltage)** 2 = Class 2 ( 17kV), 3 = Class 3 (26.5 kV), 4 = Class 4 (36kV)
- Size** R = Regular, L = Large, XL = Extra Large
- Colour** YB = Yellow under Black, Y = Yellow, RY = Red under Yellow
- Style** EC = Extra Curved

EXAMPLE: PSC2RYBEC, Class 2, Size regular, Yellow under Black colour, Extra Curved style

## 20-1-1214: Performance Gloves

- Grain leather goatskin palm provides excellent comfort and durability
- Lightweight, breathable 4-way stretch fabric back
- Foam-padded palm for vibration resistance and tool use
- Neoprene knuckle provides excellent flexibility



## 20-1-10605B: Performance Gloves

- Vibration Resistance Gloves
- Synthetic leather palm combined with breathable 4-way stretch fabric
- Reinforced double palm with gel-packs for vibration absorption
- Neoprene knuckle provides excellent flexibility and comfort



## 20-1-10705: Performance Gloves

- Mesh and grain goatskin combination back hand for breathability and comfort
- Synthetic leather fourchette finger inserts with air holes for excellent comfort, mobility and breathability



## 20-1-10690: Performance Gloves

- Heavy Duty Gloves
- High visibility spandex back hand for breathability
- Heavy foam knuckle with silver rubber finger protectors for increased visibility
- Synthetic leather palm with reinforced Rubbertec® patches



## 20-1-10695: Performance Gloves

- Heavy Duty gloves
- Grain leather goatskin provides good dexterity, wear and abrasion
- Heavy rubber padded back hand and fingers for ultimate protection from abrasion and impact
- Double shirred elastic wrist
- Keystone thumb



## 30-1-W10EL-R: Split Leather Fitter Gloves

- Standard grade cowhide split leather
- Cotton/canvas back
- Fleece palm lining
- Rubberized safety cuff



## 40-1-1511PP: Grain Leather Fitter Gloves

- Industrial grade cowhide grain leather
- Cotton/canvas back
- Fleece palm lining
- Patch palm



## 40-1-281ECU: Grain Leather Fitter Gloves

- Industrial grade cowhide grain leather
- Cotton/canvas back
- Completely unlined



## 40-1-2525: Grain Leather Fitter Gloves

- Standard grade cowhide grain leather
- Full leather backhand
- Fleece palm lining
- 2.5" Gauntlet cuff



## 40-1-2510: Grain Leather Fitter Gloves

- Standard grade cowhide grain leather
- Full leather backhand
- Fleece palm lining
- 5" Gauntlet cuff





# Bob Dale Gloves

## 60-1-4100: Xtreme Welding Gloves

- Reinforced backhand patches
- Extended gauntlet cuff with reinforced inner wrist guard
- Kevlar® sewn throughout
- FR cotton liner on backhand and full cuff



## 60-1-4110: Ladies Xtreme Welding Gloves

- Reinforced backhand patches
- Extended gauntlet cuff with reinforced inner wrist guard
- Kevlar® sewn throughout
- FR cotton liner on backhand and full cuff



## 60-1-5200: Xtreme Welding Gloves

- Reinforced backhand patches
- FR cotton liner on backhand and full cuff
- Kevlar® sewn throughout
- Slip-on style with convenient pull-tab for ease of wear



## 60-1-1144P: Welding Gloves

- Premium deerskin for an extremely soft, snug fit
- Thumbstrap for extra durability
- Gauntlet cuff provides added protection
- Left hand heat patch
- Clute cut back



## 60-1-1634: Welding Gloves

- Split leather moosehide for heavy duty protection
- Heat patch on both hands for heat & spark protection
- Gauntlet cuff with gore for extra coverage
- Clute cut back
- Thumbstrap for extra durability



## 60-1-1705: Welding Gloves

- Premium deerskin for an extremely soft, snug fit
- Split leather back resists heat and sparks
- Weltd thumb for increased durability
- Gauntlet cuff provides added protection



## 64-1-1065C: Welding Gloves

- Ruff Rigger
- Utility Gloves
- Premium deerskin/cowhide grain leather
- 5.5" Split cowhide leather cuff
- Outseam sewn
- Deerskin Utility



## 60-1-1280: Welding Gloves

- Welding Gloves
- Enhanced leather for water resistance
- 6.5" Gauntlet cuff
- Hi-Viz reflective strips



All Bob Dale gloves are available in a variety of sizes.  
Contact LTL for more information.

## 99-1-9800: Synthetic Gloves

- Seamless knit nylon shell offers excellent comfort and dexterity
- Nitrile foam coating provides a strong grip and resists oils and grease
- Treated with Actifresh® to eliminate bacteria
- Elastic wrist for secure fit and feel



## 99-1-9860: Ninja® Synthetic Gloves

- Flexible HPTTM coating resists punctures and abrasions
- Seamless nylon knit liner is exceptionally comfortable, lightweight and breathable
- Treated with Actifresh® to eliminate bacteria
- CFIA approved



## 99-1-9756: Synthetic Gloves

- Seamless Dyneema® knit for comfort and cut resistance
- Polyurethane coated palm for flexibility and breathability
- Elastic wrist for secure fit and feel
- Machine washable
- EN388 CE4543 cut level 5



## 99-1-9761: Synthetic Gloves

- Seamless knit blend of Dyneema® and synthetic yarns
- Hi-Viz fabric for the ultimate in safety protection
- Microfoam polyurethane coated palm for flexibility and breathability
- Elastic wrist for secure fit and feel
- EN388 CE cut level 5



## 99-1-9730: Ninja® 4X Synthetic Gloves

- Synthetic fiber/fiberglass shell
- Bi-Polymer coating provides softness and durability
- EN388 cut level 4
- Treated with Actifresh® to eliminate bacteria
- EN388 CE4432 cut level 4, ANSI cut level 2 CPPT 862 Grams



# Glove Bags



## LTL Glove Bags

- Made of heavy duty canvas fabric
- All bags have industrial type snaps and two ventilation eyelets in the bottom of bag
- Available for 12", 14" and 18" gloves
- Available with front pocket

LTL112 12" Canvas Glove Bag

LTL114 14" Canvas Glove Bag

LTL118 18" Canvas Glove Bag



LTL114VB Vinyl Glove Bag - Blue Two Pocket



LTL114VY Vinyl Glove Bag - Yellow

## Salisbury Glove Bags

Salisbury bags are constructed of heavy duty canvas duck and are double stitched and riveted at stress points for extra durability. Canvas bags feature a D ring for hanging in trucks or on work belts. Bags feature tapered gussets with wide opening tops for easy insertion.



Part #	For Glove Length (inches)	Dimensions
<b>26 oz. Canvas Glove Bags</b>		
GB112	11	9" x 14"
GB114	14	9" x 16"
GB116	16	9" x 16"
GB118	18	9" x 18"
<b>26 oz. Canvas Glove Bags w/ Goggle Case</b>		
GB114GC	14	9" x 16"
GB116GC	16	9" x 18"
GB118GC	18	9" x 20"
<b>26 oz. Canvas Glove &amp; Protector Bags</b>		
GPB112	12	9" x 14"
GBP114	14	9" x 16"
GBP116	16	9" x 18"
GBP118	18	9" x 20"
<b>Glove &amp; Protector Combo Bags</b>		
2C16	14, 16	9" x 18"
2C18	18	9" x 20"

## Sleeve Bags

- Constructed of heavy duty canvas, double stitched and riveted at stress points for extra durability
- Canvas bags feature a D ring for hanging in trucks or on work belts and tapered gussets
- Feature wide opening tops for easy insertion

**T31 - 30" x 9.5"**

**T32 - 30" x 13"**

*Proper storage extends the service life of linemen's gloves & sleeves. Folds and creases strain rubber and cause it to crack prematurely from ozone. By storing rubber sleeves in the right size bag, and never forcing more than one pair into each bag, equipment will lie flat thereby extending the life of the product.*



## Combination Sleeve & Glove Bags

- Made of heavy duty canvas fabric
- All bags have nickel plated industrial type snaps and two ventilation eyelets at the bottom of the bag
- Snap closure

**2C16 - 9"**

**2C18 - 9"**



## Canvas Double Glove Bags

- Made of heavy duty canvas fabric
- All bags have nickel plated industrial type snaps and two ventilation eyelets at the bottom of the bag
- Stores sets of high and low voltage gloves and leather protectors
- 19" x 8" x 6"



## Salisbury Glove Kits

- For every electrical worker's complete safety, Salisbury glove kits keep insulating rubber gloves in top condition, providing proper storage to ensure protection against cuts, abrasions and punctures



### Product Numbering Chart for Glove Kits

	Class	Length	Colour	Sizes
GK	00	11 or 14	B, RB, BL	7, 8, 9, 10, 11, 12
GK	0	11 or 14	R, BL, B, Y	7, 8, 9, 10, 11, 12
GK	2	14, 16, or 18	B, RB	7, 8, 9, 10, 11, 12

Example: GK011BL-9

Type I Natural Rubber Available in: R=Red, Y=Yellow, B=Black, RB=Red in, black out

Type II SALCOR® Rubber available in: BL = Blue

# Salisbury by Honeywell

## Ten-Four® Glove Dust



- A cooling, frictionless powder that absorbs moisture and perspiration when wearing rubber gloves
- Provides extra comfort while preventing gloves from getting sticky
- 5 oz. bottle easily fits into a pocket or glove bag
- Sold by the case

**10-4 - (12) 5 oz. Bottles per Case**  
**10-4-4QT - 3.8 Litres Bulk, Single**

## Rub-Out® Towelettes



1461



1460

- 10.5" x 12.25" pre-moistened heavy duty towelettes
- Loosens, dissolves, and absorbs dirt and grease
- Will not harm rubber gloves
- Remove tough to clean substances including lubricants, tar, oils, wax, and caulk

**1460 Bucket of 60, 6 Buckets/Case, 14 lbs**  
**1461 Single Packets, 100 Singles/Case, 3 lbs**

## Rub-Out® Hand Cleaner



- A non-petroleum based hand cleaner for workers who wear rubber gloves and sleeves
- Dissolves and removes grease, oil, ink, tar, pipe dope, creosote, paint, and more without harming natural rubber or SALCOR® rubber
- Cleans with or without water
- Contains natural skin conditioners and leaves a fresh citrus scent
- Sold by the case

**1451 - (12) 16 oz. Cans per Case, 16 lbs**

## Super Salco® Cleaner



- Concentrated detergent with a special grease release formula that removes oils, grease, and dirt from natural rubber and SALCOR® rubber equipment
- Suitable for use in commercial washing machines or by hand
- Works well on fiberglass and other materials

**S4 - (4) 1 Gallon Jugs, 54 lbs**  
**S5 - (1) 5 Gallon Drum, 49 lbs**

## SALCON® Silicone Spray



- Specially formulated to reduce friction on natural rubber products
- Reduces surface creepage on rubber gloves and sleeves
- Oxygen barrier helps reduce corona cutting and weather checking

**S99 - Aerosol Can, 16 oz.**

## Class 3 Conductor Covers



- 5' cover is ideal for covering long spans when weight is a consideration
- 26.4kV voltage rating
- 2" inside diameter
- May be connected with Salisbury 1.5" I.D. Class 3 or 4 flexible cover-up equipment
- Conductor covers connect easily with either plastic or rubber line hose

21172	5' Cover with Eye
21173	27kV, 5' Cover
21315	5' Cover with 4' Fiberglass Stick
21826	Lightweight 35kV, 6' Conductor Cover



## Straight Line Hose

- Orange Type II SALCOR® line hose with RIB-GRIP® locking system
- Hoses remain flexible even in cold weather and are not damaged by ozone or ultraviolet rays
- Other sizes and classes are available

Part #	Type	Class	I.D. x Length
OR125-3	II	2	1.25" x 3'
OR125-45	II	2	1.25" x 4.5'
OR125-6	II	2	1.25" x 6'
OR150-3	II	3	1.5" x 3'
OR150-6	II	3	1.5" x 6'

## Line Hose - Extended Lip SU System

- The Extended Lip SU System is the only complete flexible cover-up available for use on voltages through 34.5kV
- Extremely versatile, it may be installed by hand
- Manufactured from superior SALCOR® Type II elastomer it is resistant to the effects of ozone and ultraviolet deterioration
- It remains flexible even at sub-zero temperatures
- Salisbury's RIB GRIP® construction securely interlocks with its corresponding covers and connectors
- Tapered lips facilitate easy starting on the conductors
- The contour cut ends accommodate the skirts of pin type insulators and permit the hose to cover the line snug to a saddle or clamp
- Available as Straight Line Hose or with a Connector End for easier connection of line hose and covers

Part #	Type	Class	I.D. x Length
SU150-45C	II	4	1.5" x 4.5'
SU150-6C	II	4	1.5" x 6'



## Stinger Cover

- Protects against phase-to-phase and phase-to-ground wildlife contacts
- Track resistant
- May be installed without disconnecting the lead wire from the bushing
- Easy to cut to the necessary length
- Ozone and UV resistant SALCOR® elastomer

Part #	Description
38-50SC	3/8" x 50' 1 coil
38-12SC	3/8" x 12' 4 pcs
58-12SC	5/8" x 12' coil 4 pcs
34-12SC	3/4" x 12' coil 4 pcs



## Silicon Bushing Cover



- Ozone and UV resistant silicone rubber
- Protects against wildlife contacts between energized equipment and ground by insulating exposed energized bushing parts
- Interlock with the top weathershed of the bushing and are securely fastened by inserting lock buttons
- Cover is 3.87" diameter x 3.37" tall

Part #	Description
21116	Cover Only; 16kV
21116TC	Cover with Tube Closure; 16kV
21644	Tube Closure



# Salisbury by Honeywell

## 1370 & 1371: Crossarm Guards

- Available in two different styles: the 1370 pin type and the 1371 post type
- Used to prevent tie wires from contacting crossarms during hot line operations
- Two different tie downs provided: a neoprene and a polypropylene rope
- Both are secured in the slots provided in the eye fitting
- Post type model has an automatic gap closer which covers the insulator slot opening over the end of the arm
- Made from orange Type I ABS cold weather high impact plastic



## 736PH: Slide-On Crossarm Guard

- Applied by sliding the cover on to the arm from the end using the shotgun eye until the unit locks onto the insulator pins
- Cover overlaps on top and has notches to ease application and removal
- Made from orange Type I ABS cold weather high impact plastic

Part #	Description	Dimensions	ASTM Voltage Class	Weight (lbs)
1370	Crossarm or Pin Type Guard	9" x 9" x 25.5"	4	5.7
1371	Crossarm or Post Type Guard	Fits Crossarm: 5 x 6	4	6
736PH	Slide-On Crossarm Guard	7"	4	4.5



## Versa Guards® & Link Guards

- Make use of air as well as the dielectric strength of plastic to provide total insulating value
- Both guards have a 7" diameter and a hook shaped inner lip to keep the guard in place
- Versa Guards: voltage rating of 36.6kV are designed so that two guards can be coupled together to cover most 13kV single and double arm, pin and post constructions
- Link Guards: voltage rating of 72.5kV, have inner and outer shells that run full length to include male and female couple ends
- Two guards connected provide four overlapping thicknesses of plastic plus air at a joint
- Tee Connectors: used on horizontal and vertical posts and suspension insulator strings when plastic line guards are used on the conductor
- Available in two ratings: 72.5 kV and 48.3 kV



Part #	Description	Type	ASTM Voltage Class	Grade	Weight (lbs)
<b>VERSA GUARDS 4.5'</b>					
2373	ABS/PVC, Eye	III	4	2	8.8
2377	ABS/PVC, 4' Stick	III	4	1	10.8
2378	ABS/PVC, 6' Stick	III	4	1	11.8
<b>VERSA GUARDS 3.92'</b>					
2389	ABS/PVC, 4' Stick	III	4	1	6.1
2689	ABS/PVC, Eye	III	4	2	8.1
<b>LINK GUARDS 4.5'</b>					
2475	ABS/PVC, Eye	III	6	2	10.5
2476	ABS/PVC, 4' Stick	III	6	1	12.5
2477	ABS/PVC, 6' Stick	III	6	1	13.5

## Class 5 Air Gap® Pole Guards

- Rated max use voltage of 48.3 kV guarded phase to guarded phase or 27kV phase to ground
- Unique Air Gap® Design: uniformly spaced dimples help increase insulation and keep electrical leakage to a minimum
- Type I ABS Plastic: strong memory improves grip when applied to the utility pole

Part #	Diameter x Length	Weight
2486	9" x 6'	13.8 lbs
2478	12" x 6'	16 lbs

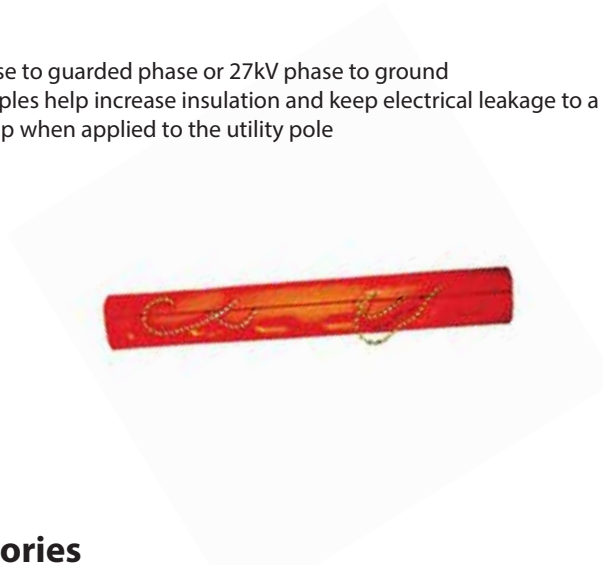

## Substation Cover-Up & Accessories

- Often used where outages are difficult to reach and the occurrence of accidental contact is high
- May be applied with rubber gloves or hot sticks
- Made from Type I orange ABS plastic
- Bus Guards: easily interlocked with each other, guard has voltage rating of 36.6kV
- Bus "T" Guards: interlock two or three bus guards at bus tap "T" connections and 90° angles. To interlock units, first position the bus guard then slide the "T" guard over the top interlocking the dimples. This guard has a voltage rating of 36.6kV
- Bus End Guards: cover the ends of a substation bus supported by station post insulators

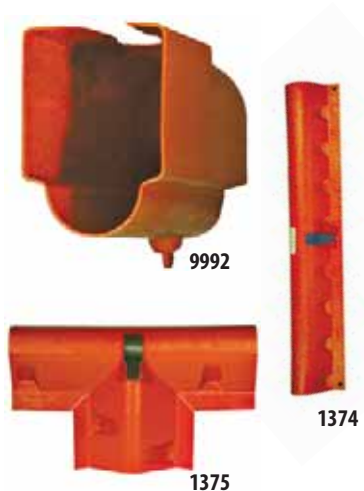

Part #	Dimensions	Description	ASTM Voltage Class	Weight (lbs)
Bus Guard 1374	5.25" x 9.5" x 4.5"	Impact Resistant ABS Plastic	4	6
Bus "T" Guard 1375	5" x 15" x 25"	Impact Resistant ABS Plastic	4	4
Bus End Guard 9992	8.5" x 12" x 24"	UV Resistant High Density Cross Linked Polyethylene	3	5
<b>GUARD ACCESSORIES</b>				
816	8" x 16"	Hot Cover	4	2.5
4314	15" x 14.25"	Underground Distribution Elbow Cover	3	2
4333	20" x 25"	Pole Bracket & Insulator Base	3	2.5



# Salisbury by Honeywell

## Post-Type Insulator Covers



- Covers interlock with 1.5" (38mm) Class 4 Extended Lip SU System or Conventional Line Hose
- The PTHL cover also has external ribs on the ears which secures 2.5" I.D. line hose
- Always use clamp pins to secure the device into position

Part #	Description
PTHL	For insulators up to 16"
PTHS	For insulators up to 12"

## Rubber Insulating Blanket - Slotted



- Ozone-resistant Type II orange SALCOR® is manufactured from a blend of prime EPDM, offering supreme flexibility
- Use for covering ridge pins, cross arms with insulators or any place a wire, pin or projection interferes with proper placement of other cover-up devices

1300	Class 4, 28 Eyelets, 36" x 36"
1302	Class 4, 2" Hole, 36" x 36"
1304	Class 4, 4.5" Hole, 36" x 36"

## Rubber Insulating Blanket - Solid



- Ozone-resistant Type II orange SALCOR® is manufactured from a blend of prime EPDM, offering supreme flexibility
- Will maintain colour, flexibility, physical properties, and dielectric strength in the field longer than any other blanket on the market
- Reinforced, beaded edge

**Salisbury 900E**      **Class 4; 6 Eyelets; 36" x 36"**

## Roll Blanket

- Salisbury's insulating Roll Blankets are made from a high strength fabric reinforced Type II rubber in unique colours making it easy to identify and highly visible in the work area
- All classes of Roll Blankets are easy to cut, and flexible to -40°F. Highly puncture and tear resistant, each class of blanket is also flame (self-extinguishing), oil, and ozone resistant

RLB00	ASTM 00, Type II, 3' x 30', Brown, 20 lbs
RLB0	ASTM 0, Type II, 3' x 30', Yellow, 26 lbs
RLB1	ASTM 1, Type II, 3' x 30', Yellow/Orange, 36 lbs
RLBPVC1	ASTM 1, 3' x 50', Clear, 60 lbs
RLBPVC1-48	ASTM 1, 4' x 30', Clear, 48 lbs



- The Roll Blankets can be easily custom-cut to fit each application at the job site
- This minimizes the number of different low voltage blanket sizes and shapes that would otherwise need to be carried from job to job. Each blanket comes in a convenient 36" wide roll
- Salisbury's insulating Type II rubber Roll Blankets and Insulating Aprons, meet ASTM F2320 standards

## Arc Protection Blankets

- Salisbury by Honeywell Arc Protection Blankets are now available in 4' x 5' and 4' x 8' sizes
- Each size is available in 15kA or 40kA ratings. The 15kA blankets include convenient loops and the 40kA blankets include grommets to easily keep the blanket in place
- These new blankets are sold individually or with a storage bag or storage bag and tie-strap kit
- The Arc Suppression Blanket is used as a barrier for protection from the explosive and incendiary effects of electrical arcs and flashes. These hazardous electrical discharges can be caused by faults in cables, in cable splices and joints, and at transformer terminals, or they may be generated by the operation of switchgear, circuit breakers and lightning arresters
- The blanket can be used for worker protection in underground vaults, switchyards, and other locations where electrical equipment poses a risk of exposure to explosive electrical discharges

*NOTE: These products do not eliminate or reduce requirements for proper PPE for arc flash protection*

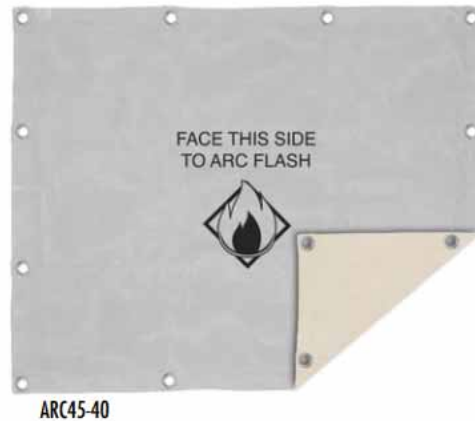
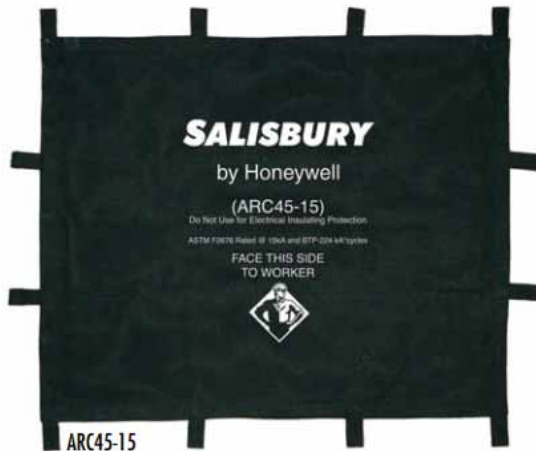

Part #	Dimensions	Description
ARC45-15	48" x 60"	15kA rating - navy blue
ARC45-40	48" x 60"	40kA rating - gray/khaki
ARC48-15	48" x 96"	15kA rating - navy blue
ARC48-40	48" x 96"	40kA rating - gray/khaki

## Blanket Pins



Salisbury 21

Salisbury HS21 For 90° Angle Applications

- In addition to other uses, blanket clamp pins can be used to hold insulating blankets in place
- Springs are used for tension while extra holes in the body of the pin are used to grip conductors and prevent line hose from sliding
- Opens to a full 5.5", making these pins the most versatile on the market
- Tapered ends to accommodate any clampstick
- Fiberglass reinforced nylon with rubber tipped pin boots
- Use HS21 for applications and removal where a 90° angle is necessary

## Blanket Buttons



Salisbury B1

- Designed to secure eyelet-style insulating blanket
- Made of yellow plastic, these buttons snap through the eyelet with thumb pressure on the large head

## Blanket Canisters



- 9" x 37"; holds up to six 36" blankets
- Molded in bright orange, high impact polyethylene with a tight fitting cap
- For easy retrieval, blankets can be rolled individually and stored in canister; a single blanket can then be removed without removing any others

P2	Fits Blanket Max Size: 36", Dimensions (in): 5 x 37, Capacity: 1-2 Blankets
P4	Fits Blanket Max Size: 36", Dimensions (in): 7 x 37, Capacity: 1-4 Blankets
P6	Fits Blanket Max Size: 36", Dimensions (in): 9 x 37, Capacity: 1-6 Blankets

# Chance - Rubber Insulating Covers

## 36" x 36" Rubber Insulating Blankets

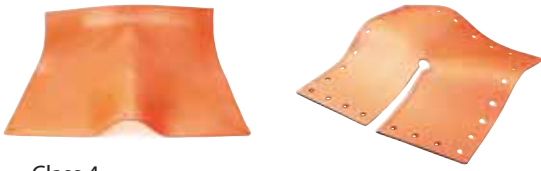

- Class 4
- Will retain its high-visibility orange colour
- May be used in applications which require a lower class or type
- Type II ozone/corona-resistant elastomer offers excellent performance properties in accordance with ASTM Standard Specification D-1048
- Offers superior resistance to long-term aging/checking

<b>C4060346</b>	<b>Solid Blanket</b>	<b>6 eyelets</b>
<b>C4060348</b>	<b>Slotted Blanket</b>	<b>28 eyelets</b>

## Straight Line Hose

- Does not absorb water
- Type II ozone/corona-resistant elastomer offers excellent performance properties in accordance with ASTM Standard Specification D-1050-90



<b>C4060296</b>	<b>Class 2, 1.25" diameter, 6' length, 4.55 lbs</b>
<b>C4060299</b>	<b>Class 3, 1.5" diameter, 6' length, 6.22 lbs.</b>

## Deadend Cover

- These covers provide a highly versatile system of covering up a wide variety of configurations on distribution systems
- The conductor covers couple with the insulator units and deadend units to cover pin-type or post-type insulator construction, virtually surrounding the hot parts and hardware to give line workers extra protection when rubber gloving or using hot sticks
- Each item is fitted with an adapter for multi-position handling by Grip-All clampsticks
- Covers couple with Chance 25kV covers, Classes 2, 3, and 4 of rubber line hose and major brands of rubber insulator hoods
- All covers are bright orange in colour
- All are made of high density polyethylene in a uniform wall thickness for excellent dielectric/puncture strength
- Performs well from -50° to 170°F
- Ultra-violet stabilizers in the material help inhibit degradation as a result of atmospheric exposure
- Deadend cover fits three 10" diameter porcelain bells or polymer deadend insulators and couples with the line cover
- To meet the Class 4 rating, the deadend cover must be used in conjunction with a rubber insulating blanket covering the coupler to the line cover
- Failure to use a blanket to cover the coupler may result in electrical shock, severe injury or death by electrocution

## Rubber Blanket Buttons



- Sold individually
  - For use with any rubber insulating blanket with perimeter eyelets
- C4060532**

## Clamp Pins

- C4060530 features eyes and special handle shape for easy placement by clampstick
- C4060531 features a special handle shape for easy placement by clampstick



<b>C4060530</b>	<b>Rubber Glove Use</b>
<b>C4060531</b>	<b>Hot Stick Use</b>

## Short-Lip Flexible Line Hose

- Does not absorb water
- Type II ozone/corona-resistant elastomer offers excellent performance properties in accordance with ASTM Standard Specification D-1050-90



<b>C4060306</b>	<b>Class 2, 1.25" diameter, 6' long coupler on one end; proof tested at 20kV AC RMS</b>
<b>C4060309</b>	<b>Class 3, 1.25" diameter, 6' long coupler on one end; proof tested at 30kV AC RMS</b>

## Spiral Conductor Cover

- Provides extra protection with a wide air space between two thicknesses of solid insulation
- Made of tough, durable ABS plastic
- Overall length of each cover is 53"
- All units interlock with each other to make up a chain of guards
- 15/36.6 kV units are formed on the ends to fit over most 15kV insulators, thus eliminating the need for an insulator cover
- A 4' or 6' long retractable Epoxiglas® handle or Clampstick adapter provides for ease of installation from a bucket or platform, in single units or linked together
- Each double-crossarm unit will fit over two 15kV pin-type insulators



**C4060082GA**    **46kV Phase-to-Phase**



**C4060537**    **36kV Phase-to-Phase**

# Chance - Rubber Insulating Covers

## Pole Covers

- Prolonged contact with an energized conductor must not be allowed
- Tested to ASTM F712
- Manufactured to ASTM F968 specifications
- Meet Class 4 requirements
- Made of high dielectric linear polyethylene material that will not flash flame
- Helps protect personnel when raising or lowering a pole between energized lines or to cover poles when rubber glove maintenance is performed in relatively confined areas
- This material will have some softening without deformation at approximately 170°F, and it will resist brittleness at temperatures to -50°F
- Chance covers are ribbed to reduce cover contact with the pole, thus minimizing creosote contamination
- Rope handles permit personnel to easily spread the covers and snap them around the pole; rubber gloves must be worn during this procedure



### 6" Diameter Pole Covers

**C4060550**      48" long  
**C4060551**      72" long

### 9" Diameter Pole Covers

**M4937-1**      12" long  
**M4937-2**      24" long  
**M4937-4**      48" long  
**M4937-6**      72" long

### 12" Diameter Pole Covers

**C4060029**      24" long  
**C4060030**      48" long  
**C4060000**      72" long

## Conductor Cover & Insulator Covers

- Bright orange in colour
- 5' long; 25 kV phase-to-phase
- Maximum conductor size: 666 kcmil ACSR
- Performs well from -50° to 170°F
- Available with adapter for hot stick application or without adapter for rubber glove application
- Provide a highly versatile system of covering up a wide variety of configurations on distribution systems; the units virtually surround the hot parts and hardware to give the linemen extra protection when rubber gloving or using hot sticks
- Made of high density polyethylene in a uniform wall thickness for excellent dielectric/puncture strength
- 5' long and are available with a Grip-All adapter for hot stick application or without adapter for rubber glove application
- Conductor covers mate with insulator covers to cover pin-type or post-type insulator construction; may also be used with the deadend cover
- Conductor cover will couple with major brands of rubber line hose and insulator covers of the 25kV class



### 25 kV Phase-to-Phase

**C4060181**      5' Cover, 4' Handle  
**C4060181GA**    5' Cover, Grip-All Adapter  
**P4060184**      5' Cover Only

### 36 kV Phase-to-Phase

**C4060514GA**    5' Cover, Grip-All Adapter

## Cross Arm Cover

- Prevents tie wires from contacting the crossarm when tying and untying insulators
- The material used is the same high-dielectric polyethylene used for Chance conductor and insulator covers
- Flanges above the slots shield the ends of the double-arming bolts
- Designed for single or double arm construction, with slots provided for double-arming bolts



M4933

## Insulator Covers

- Insulator covers come in two heights; 12" or 16.5"
- Cover fits 6.5" to 9" diameter pin or post insulators
- Special slits in the insulator covers help locate the conductor and hardware when installing the covers

**C4060557**      12" Tall      36 kV Phase-to-Phase  
**C4060557L**    16.5" Tall    36 kV Phase-to-Phase



## JIBS & EXTENSIONS WITH MATERIAL HANDLING ACCESSORIES

### Jib Extension with Wireholder 3" diameter round Epoxiglas® Insulation

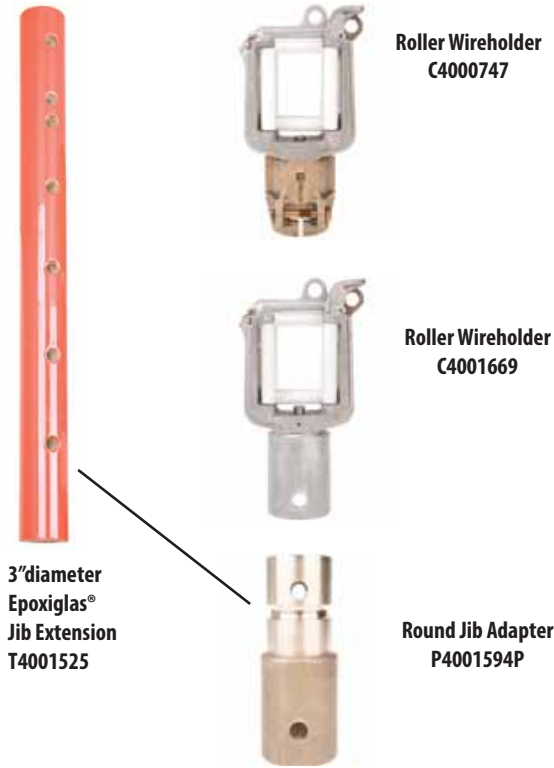

### Jib Extension with Wireholder 4" x 4" Square Epoxiglas® Insulation



## Jib Extensions & Storage Bag

- T4002415 features two adjustment holes; one hole is 2.5" from end; the second is 40 3/8" from the first adjustment hole; 3" diameter heavy wall jib extension x 60" long
- PST4002737 3" diameter heavy wall Jib Extension is 36.7" long and features 3 adjustment holes



## Jib Extensions with Wireholder

- PST4002818 features a wire holder
- PST4003059 features a wire holder on one end and a sheave (roller) on the other end
- 31" insulated rod connects both ends
- Clear coat on glass rod
- May be used in conjunction with material handler



## Jib Sleeve Adapter - 4" x 4"



PST4003111

# Chance - Conductor Support Equipment

## Epoxiglas® Extension Arm



- Designed for use on voltages up to and including 15kV where reconductoring or insulator replacement is necessary
- Epoxiglas® Extension Arm can be used on voltages up to 34.5kV providing the wireholders are fitted with insulators
- Maximum crossarm size: 3.75" x 4.75"
- Arm diameter: 2.5"
- Maximum vertical loading per wireholder: 150 lbs

H480060	5' long	1 wireholder
H480072	6' long	2 wireholders

## Chain Type Temporary Conductor Supports

- Used to hold energized distribution conductors during replacement of poles or repair/replacement of pole top and stand-off insulators
- Furnished with wheel tightener for poles up to 14" diameter
- Working load is 150 lbs per wireholder



H4001509 Two Conductor Supports



H4809W Single Conductor Support

## 35kV Tension Puller Switching Tool



C4001907

- Combines line tension disconnect switch with Epoxiglas® insulated tool
- Weathershed polymer skirts are bonded to 1.5" diameter pole
- Compression clamps secure switch hot parts to pole
- 1/2" bypass stud at each end accepts 3" wide jumper clamps
- Copper switch blade with silver-plated contacts opens to 90°, or 180° with stop pin removed
- Galvanized hooks provided for operation by loadbreak device
- With handling rings, this tool may be operated by either hot line tools or rubber glove techniques

## Nylon Strap Type Temporary Conductor Supports



- D-shaped buckle on the strap free end adds speed and convenience
- Polyester strap offers less stretch
- With 10,000 lbs rated tensile strength, 2" wide strap comes in 44" length to fit most structures
- Wide handle opening on rapid-action ratchet permits easy operation

T4001939 Double Conductor Support (top)



T4001940 Single Conductor Support (bottom)

# Chance - Conductor Support Tools

## Temporary Cutout Tools

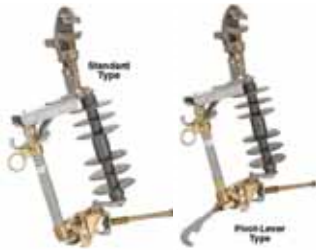

- Provides fuse protection during live-line maintenance
- Insulated bushing and hot parts are from Chance Type C-Polymer cutouts
- Upper contact with integral sleet shield and hooks are made of cast bronze
- Fusetube must be fitted with fuselink rated no larger than 100 AMP

## C4000574: 34.5 kV Hot Stick Tension Puller



- Equipped with rings for operation with Grip-All Clampstick or with rubber gloves
- Non-swiveling hook on each end for positive hot stick operation
- Spring-loaded gate will rotate 135° left or right from closed position
- Selector lever on the ratchet wrench accommodates hot sticks

## M4744: Crossarm Wire Tong Saddle



- Used on underbuilt arms when working space is limited or crowded with pole saddle(s)
- The pivoting action of the saddle swivel and pole clamp attachment provides a universal-joint action which allows complete freedom of movement of the wire tong in any direction and without binding
- Saddle does not include pole clamps
- Max. work load is 500 lbs.

## T4002272: Corner Restraint Bracket Tool



- Corner restraint bracket tool helps control each phase conductor while insulators are changed
- Acts as a load restraint for the hoist to pull the conductor back in for reconnection to the insulator string
- 2000 lbs max. load rating
- 2.5" diameter, 6" clear length

## Temporary Load Disconnect Tools



- Provides a temporary means of connecting and disconnecting equipment or circuits under load conditions
- Does not have a fuse and does not provide protection for fault or overcurrent conditions
- Insulated bushings and hot parts are from Chance Type-C Polymer cutouts, including the tubular copper disconnect blade
- An arc-chute type interrupter gives the tool its excellent loadbreak capability
- Tool clamps onto primary conductor with a Grip-All clampstick

PSC6010347 8.3/15kV

PSC6010348 15/27kV

## M47602: Lever Lift Arbor Tool Wire Tong Support



- Allows conversion of the single type lever lift to a double type when desired



TRUSTED SINCE 1958



# Chance - Conductor Support Tools

## Pole Wire Tong Saddle & Clamps



- Made of lightweight aluminum
- Will support a maximum of 1,000 lbs without the extension
- Clamp is set far enough away from the base to give ample clearance for most jobs
- Where additional clearance is required, the Chance Wire Tong Saddle Extension can be easily bolted to the saddle
- Heat treated aluminum-alloy extension is 4" long and has a tested working load rating of 800 lbs
- Wheel Type fasteners are easy to apply, hold the saddle firmly in place, and prevent riding down and excessive play
- Wheel Tightener has the advantage of being able to fit into close places such as between crossarm braces, under guy wires, etc.

<b>M4740-3W</b>	<b>Pole Wire Tong Saddle</b>
<b>M4741-3</b>	<b>Pole Clamp Only 2.5" Dia. Opening</b>
<b>M4741-2</b>	<b>Pole Clamp Only 2" Dia. Opening</b>

## H46461212' Wire Tong

- Made with Epoxiglas® poles
- Castings are made of heat treated aluminum alloy, separated by bronze wear rings
- Wide range jaws on the head can be clamped tightly on the conductor by turning the stick from a position beyond the minimum working clearances
- Designed for use in many applications: moving and holding live conductors clear of the working area, flat crossarm and/or ridge pin-construction, on horizontal post insulator structures, with all types of suspension insulator lines, for use as auxiliary arm braces, and in EHV construction for brace pole or ladder positioning guides
- Wire Size .16" - 2.25"



## M4742: Wire Tong Tower Saddle w/ Regular Hooks



- Used to support wire tongs or boom poles on towers
- Saddle is securely fastened to the angle iron tower leg by four hooks tightened by wing nuts
- A clevis which bolts through the pivot lug permits rope blocks to be fastened so that they will pivot with the wire tong or boom pole
- Saddle does not include pole clamps
- Fits angles 3" x 3" to 7" x 7"

## M48057: 35kV Epoxy Insulator



- Epoxy based
- Can be added to existing auxiliary arm wireholders to upgrade for 34.5 kV use

## M1846W: Rope Snubbing Bracket



- Provides an easy way to prevent line snarls by snubbing all hand or light block lines to this bracket, mounted at the base of the pole to the six different rings
- Bracket has a maximum total working load of 1,000 lbs

## M1847: 18" Extender Chain



- Increases length of the chain tightener so it may be used on large diameter poles

## Chain Binder Type Transformer Gin



C4000090 Standard Base

C4000315 Extended Base

- Versatile tool for hoisting distribution transformers and apparatus up the structure
- Standard base unit is for mounting on clear pole sections; 5" extended base model allows mounting to bridge up to 4" x 5" crossarms
- Gins are not intended for applications involving side pull on the hoist line, or with the lift load in a tagged out position
- Includes wheel tightener and 36" chain
- 2,000 lbs maximum rating, including hand pull force
- Pole length: 26"

## Strap Type Binder Transformer Gin



T4001937 Standard Base

T4001938 Extended Base

- Similar to the chain binder type transformer gin, but with a strap-type ratchet-action mounting mechanism
- 2" wide polyester strap features a 44" length to fit most structures
- Strap has a 10,000 lbs rated tensile strength
- Wide handle opening on rapid-action ratchet permits easy operation, even with rubber gloves and leather protectors
- Wheel tightener and 36" chain is part of each unit
- 2,000 lbs maximum rating, including load and fall-line pull
- Pole length: 26"; pole diameter: 3"

## T4000870: 56" Crossarm Gin



- Yoke casting fits over distribution crossarms, so this crossarm gin can be used with rope blocks or handline to lift conductors from their insulators
- Removable cadmium-plated steel pin allows crossarm adjustment - 3.5" x 4.5" to 4.75" x 5.75"
- At a 30° maximum angle from vertical, 56" gin has rated working load including pull force of 500 lbs
- Gins are not intended for applications involving side pull on either hoist line or load lines; therefore, load line must be parallel to the gin pole; lines must be within 5° of vertical

## C4000440: Swivel Top Gin



- Same application as the transformer gin, but the top eye casting can be swiveled to bypass secondary lines when necessary
- Cap is not intended to swivel while under load
- Includes wheel tightener and 36" chain
- 2,000 lbs maximum rating, including hand pull force
- Pole Length: 48"

## CLAMPSTICKS & ACCESSORIES

### Chance Grip-All Single Piece Style Hot stick

C4030291	1.25" x 4' 5"
C4030292	1.25" x 6' 5.5"
C4030293	1.25" x 8' 5.5"
C4030294	1.25" x 10' 5.5"
C4030295	1.25" x 12' 5.5"

- Chance Grip-All stick puts an easy-to-control finger on an insulated pole
  - Serves both overhead and underground circuits with various end fittings
  - Commonly called a shotgun, the operating mechanism incorporates a sliding hand grip that opens the hook to grasp a clamp eyescrew and retracts it into the tool head; a thumb latch then must be depressed to release the locked hand grip so it can open the hook
  - Easy to care for, Grip-All sticks do not require field stripping to clean; all insulated parts including the operating rod are outside the main pole, readily accessible to wipe dry
- CAUTION: Do not clean the plastic head with solvent*



# Chance - Clampsticks

## Chance Grip-All Hinged Style Hot Stick

- Ideal for troubleshooters with limited tool storage space in their vehicle, this folding version operates with the same features as the one-piece style

Part #	Folded	Extended
C4030296	3' 4"	0.25" x 6' 7"
C4030297	4' 4"	1.25" x 8' 6"
C4030298	5' 4"	1.25" x 10' 6"
C4030299	6' 4"	1.25" x 12' 6"
C4030342	7' 4"	1.25" x 14' 6"
C4030343	8' 4"	1.25" x 16' 6"



## M1867: Grip-All Hinged Style Hot Stick



- To convert any Grip-All stick to use all Universal Tool Accessories, adapter (M1867) secures the clampstick hook and head housing

## E4032543P: Grip-All Clampstick Assist Ring



- Provides a suspension midpoint for any Grip-All stick
- Particularly helpful on longer sticks, the assembly permits a support line to attach at the smaller ring
- To help maintain safe working clearances for hot line procedures, an insulated Strain Link Stick of proper size should be used in the hand line

## SafetyShield Hot Stick Barriers



- Mounts on a 1.25" or 1.5" diameter live-line tool
- Creates a 16", 21", or 24" diameter protective screen between a lineman and a potential electrical hazard
- Fits on clampsticks, hooksticks, elbow-puller tools
- Two flame-retardant transparent polycarbonate protective shields affixed with a nylon fastener to a nylon 33% glass-filled clamp
- Orange protective storage case included

PSC4170627	16" Grip-All
PSC4170628	21" Grip-All
PSC4170629	24" Grip-All

## Positive Grip Epoxiglas® Clampstick

- Made for use on eyescrew grounding on tap clamps
- Can be mounted on the line and tightened at angles up to 30°
- Fittings are aluminum and bronze
- The butt end of the tool is equipped with a combination tool hanger and universal head
- Extra long head for use with long eyescrew ground clamps

HG30302	Regular	1.25" x 8' 6"
HG303012	Extra Long	1.25" x 8' 6"
HG30422	Regular Head Only	
HG30425	Extra Long Head Only	



## 6' Ratchet Wirecutters

- High-performance design incorporates Delrin plastic rollers and a two-piece operating rod
- Roller mechanism travels smoothly along main Epoxiglas® pole
- Meet OSHA Electrical Rating subpart section 1926.951 (d).
- Insulated support pole is Chance orange 1 1/2" diameter Epoxiglas with Plastisol butt cap
- Operating shaft is 3/8" diameter solid fiberglass rod; lever handle is 1" diameter Epoxiglas with rubber cushion grip

**C4031381**      6' Soft Wire

**C4031382**      6' ACSR



## C4031384: 8' Ratchet Wirecutters

- High-performance design incorporates Delrin plastic rollers and a two-piece operating rod
- Roller mechanism travels smoothly along main Epoxiglas® pole
- Linked through the roller support unit, the hinged operating rod and larger Epoxiglas® pole reinforce each other
- Meet OSHA Electrical rating sub-part V-section 1926.951 (d)
- Insulated support pole is Chance orange 1 1/2" diameter Epoxiglas with Plastisol butt cap, operating shaft is 3/8" diameter solid fiberglass rod
- Lever handle is 1" diameter Epoxiglas with rubber cushion grip

## Epoxiglas® Wireholding Stick



- Used on or around energized lines for forming, bending and positioning jumper wires and for holding conductors during splicing operations
- The gripper, with an eye that allows other sticks to assist with heavy bending, accommodates #6 solid copper through 1590 kcmil ACSR
- The head of the tool locks in three stop positions so that the lineman can engage and position conductors easily from most angles
- The knurled screw handle below the jaw opening is used to adjust the head position from straight to right or left

**C4033068**      1.25" x 6' 5"

**C4033069**      1.25" x 8' 5"



## PSC4170630: SafetyShield Wirecutter Hot Stick Barrier



- Two flame-retardant transparent polycarbonate protective shields affixed with a nylon fastener to a nylon 33% glass-filled clamp
- Mounts on a 1 1/2" diameter ratchet wire-cutter handle in less than a minute
- Creates a 16" diameter protective screen between a lineman and a potential electrical hazard
- Orange protective storage case included

# Chance - Telescoping Live Line Sticks

## Telescoping Measuring & Disconnecting Stick - Metric & English

- Certified to OSHA dielectric requirements (Sub-part V, section 1926.951)
- Measures pole heights and conductor clearances from the ground
- Universal end fitting on the insulated top section accepts a wide variety of attachments so that the lineman can disconnect switches, replace cutout tubes and reclose, remove pole covers, prune trees, etc., with one tool
- Measuring scales are easy-to-read, with figures silk screened on orange fiberglass sections
- English scales are marked with each 1' increment designated in a box, each inch in bold numbers and half inches designated by intermediate bars
- Metric scales similarly display meters, decimeters and centimeters
- A positive spring-loaded locking-button mechanism and safety plug feature in each section prevent separation of the tool. Once snapped into place, the buttons securely lock into position
- Retract to approximately 5 ft. so that they can be carried on most trouble trucks, often in the cab section
- Heavy duty, spring-loaded plastic buttons keep the extended tool sections securely locked in position
- As each section is extended and twisted slightly, the buttons pop into place, allowing work to be done with complete control and confidence



A 35' STICK THAT FEATURES BOTH METRIC & ENGLISH UNITS OF MEASUREMENT

Part #	Extended Sections	Retracted/Extended Sections
C4031022EM	8	60"/35'

## Telescoping Grip-All Hot Sticks

- Chance Telescoping Grip-All sticks can replace several conventional clampsticks, reducing the number of clampsticks required on a line truck, saving limited storage space
- Engineered interface between sections ensures that the tool retracts with full control
- Close fit also helps keep out dirt and moisture
- Top section is made of foam-center Epoxiglas® insulated pole
- Basic clampstick functions of this telescoping style are identical to the fixed-length style
- All controls can be manipulated while wearing gloves
- Easy to disassemble, the Telescoping Grip-All stick must be kept clean and dry inside and out for maximum protection
- Available in two sizes, each readily locks at variable lengths



Part no.	Extended Lengths	Retracted Length
C4031035	5' 6.75", 6' 9.5", 8'	5' 2.75"
C4031036	8' 6.75", 10' 4.75", 12' 2.75", 14'	8' 3.75"

## Telescoping Style with Universal Fitting

- Readily locks at variable lengths
- Design features a rotating coupler and an engineered positive lock button with safety stop to keep the sections from parting or the hook from releasing while in use; the mechanism locks the sections into a solid and rattle-free tool



Part no.	Extended Lengths	Retracted Length
C4033060	5' 6.75", 6' 9.5", 8'	5' 2.75"
C4033061	8' 6.75", 10' 4.75", 12' 2.75", 14'	8' 3.75"

# Chance - Telescoping Live Line Sticks

## Telescoping Epoxiglas® Disconnect Tools

- Maximum convenience for the lineman because they allow the performance of many routine jobs from ground level
- Universal end fitting on the insulated top section accepts a wide variety of attachments so the lineman can disconnect switches, replace cutout tubes and reclose, remove pole covers, prune trees, replace bulbs and complete many other overhead tasks
- Retract to approximately 5' so that they can be carried on most trouble trucks, often in the cab section
- Heavy duty, spring-loaded plastic buttons keep the extended tool sections securely locked in position
- As each section is extended and twisted slightly, the buttons pop into place, allowing work to be done with complete control and confidence
- Offered in both standard and heavy duty models
- Both units use the same telescoping tube design
- Tip section of the heavy duty unit is slightly larger in diameter (1 1/4" versus 1 1/16") so that each telescoping tube is slightly larger, resulting in a more rigid tool when fully extended, important where additional weight may be frequently encountered on maintenance tasks
- Both tip sections employ time-proved Epoxiglas®, the unicellular® foam-core material where the epoxy reinforced fiberglass wall is built around the foam core to prevent any moisture trapping voids that could build up between foam and tool

### Standard Duty (1 1/16" Diameter Tip)

Part no.	Extended Lengths	Retracted Length	Base Diameter	Sections
C4031023	8'	56"	1.25"	2
C4031017	8'-12'	57"	1.5"	3
C4031018	12'-16'	59"	1 11/16"	4
C4031019	12.5', 16.5', 20'	61"	1 7/8"	5
C4031020	16.5', 20.5', 25'	63"	2 1/16"	6
C4031021	17.5', 21.5', 25.5', 30'	65"	2.25"	7
C4031022	22', 26', 30.5', 35'	67"	2.5"	8
T4033349	22', 28', 34', 40'	74.5"	2.5"	8

### Compact Standard Duty (1 1/16" Diameter Tip)

Part no.	Extended Lengths	Retracted Length	Base Diameter	Sections
T4032205	8'	26"	1 7/8"	5
C4031739	14', 17', 20', 23'	48"	2.5"	8
T4033350	12'	40"	1 11/16"	5
T4033240	11'	36"	1 11/16"	4

### Heavy Duty (1 1/4" Diameter Tip)

Part no.	Extended Lengths	Retracted Length	Base Diameter	Sections
C4031597	8'	56"	1.5"	2
C4031598	8', 12'	57"	1 11/16"	3
C4031599	12', 16'	59"	1 7/8"	4
C4031600	12.5', 16.5', 20'	61"	2 1/16"	5
C4031601	16.5', 20.5', 25'	63"	2.25"	6
C4031602	17.5', 21.5', 25.5', 30'	65"	2.5"	7



C4031023

# Chance - Disconnects & Universal Sticks

## Heavy Duty Adjustable Sticks

- Clearly marked at each 1' extension lock, one of these Chance tools can replace as many as eight single-length hot sticks
- Especially for such tight confines as substations, these adjustable sticks can be stored in standard-length canisters and avoid the difficulties of working extra-long sticks through buswork structures
- Classified as heavy-duty due to their large (1.25" diameter) insulated top section and 1/5" O.D. epoxy reinforced fiberglass base tube
- In each size, a 2' section of the Epoxiglas® foam core top section remains inside the base section at the longest locked, usable length
- At the shortest locked length, the insulated top section extends a full 2' beyond the base
- High-strength plastic buttons keep tools locked at specific lengths



### Disconnect-Style NEMA Head:

Part no.	Lockable Lengths	Collapsed
C4032600	10, 11, 12, 13, 14	8' 2.75"
C4032601	12, 13, 14, 15, 16, 17, 18	10' 2 3/4"

### Switch-Style NEMA Head:

Part no.	Lockable Lengths (feet)	Collapsed
C4032602	10, 11, 12, 13, 14	8' 2"
C4032603	12, 13, 14, 15, 16, 17, 18	10' 2"

### Universal Fitting Style:

Part no.	Lockable Lengths	Collapsed
C4032604	10, 11, 12, 13, 14'	8' 3 3/4"
C4032605	12, 13, 14, 15, 16, 17, 18'	10' 3/4"



Disconnect Style



Switch Style



Universal Disconnect Head



Extension Head Clearly marked at each hole for button engagement

# Chance - Disconnects & Universal Sticks

## Sectional Disconnect and Universal Tools

### 1.25" Diameter Poles

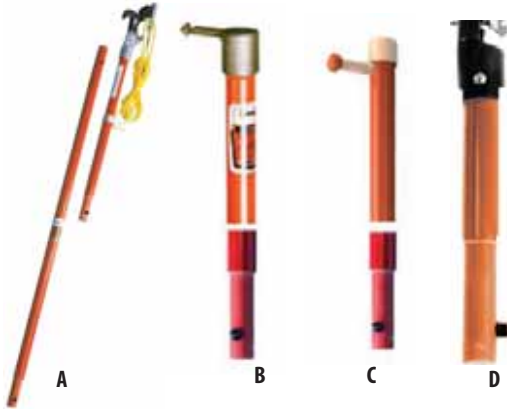

#### A) Tree Trimmer Head

Part no.	Description
C4032096	*2'
C4032097	*4'
<b>Base Cap</b>	
Part no.	Description
C4032069	5"

\*Length excludes trimmer head fitting

#### B) Standard Switch Head Disconnect

Part no.	Description
C4032073	6"
C4032053	4'
C4032054	6'
C4032055	8'

#### C) Non-Metallic Disconnect Head

Part no.	Description
C4032095	6"
C4032059	4'
C4032060	6'
C4032061	8'

#### D) Plastic Universal Head

Part no.	Description
C4032071	6"
C4032046	4'
C4032047	6'
C4032048	8'

#### Extension Section

Part no.	Description
C4032062	4'
C4032063	6'
C4032064	8'
C4032133	10'

### 1.5" Diameter Poles



#### Standard Disconnect Head

Part no.	Description
C4032074	6"
C4032056	6'
C4032057	8'
C4032058	10'

#### Standard Universal Head

Part no.	Description
C4032072	6"
C4032049	4'
C4032050	6'
C4032057	8'
C4032052	10'

#### Extension Section

Part no.	Description
C4032065	4'
C4032066	6'
C4032067	8'
C4032068	10'

#### Base Cap

Part no.	Description
C4032070	5"



# Chance - Disconnects & Universal Sticks

- Provide insulation safety for linemen in opening and closing disconnect switches and cutouts
- Poles are made of Epoxiglas® and NEMA-standard heads of cast bronze
- Splice disconnects are convenient for hauling, strong and rigid, easy to put together, and easy to take apart
- Fiberglass head disconnect stick gives the additional insulation required for work where bus and disconnect switch spacings are confined, as in indoor substations

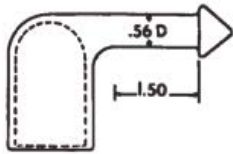

1.5" Disconnect Head

Part no.	Description
H3046-2	Head Only
H3046-22	1.5" x 6'1"
H3046-23	1.5" x 8'1"
H3046-24	1.5" x 10'1"
H3046-15	1.5" x 12'1"
H3046-16	1.5" x 16'1"
H3046-18	1.5" x 18'1"
H3046-20	1.5" x 20'1"

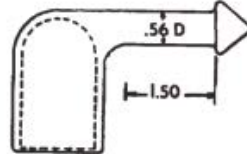

1.25" Switch Stick Head

Part no.	Description
H3046	Head Only
H3046-11	1.25" x 4'
H3046-12	1.25" x 6'
H3046-13	1.25" x 8'
H3046-14	1.25" x 10'
H3046-17	1.25" x 12'

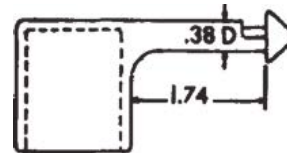

1.25" Spliced Disconnect Head

Part no.	Description
H3146-12	.25" x 6' 1.5" x 6'1"
H3416-16	1.25" x 8' 1.5" x 8'1"
H3146-18	1.25" x 8' 1.5" x 10'1"
H3146-20	1.25" x 10' 1.5" x 10'1"
H3146-24	1.25" x 12' 1.5" x 12'1"



## Universal Poles



H1760-4

H1761

Hinged Pole

### 1.5" Disconnect Head

Part no.	Description	Pole Diameter x Length
H1760	Pole; (1) universal head	1.25" x 8'2"
H1760-1	Pole; (1) universal head	1.25" x 6'1"
H1760-2	Rigid splice pole; (1) universal head	1.25" x 4'1"
H1760-3	Pole; (2) universal heads	1.25" x 6'3"
H1760-4	Pole; (2) universal heads	1.25" x 8'3"
H1760-6	Rigid splice pole; (2) universal heads	1.25" x 4'1"
H1760-10	Pole; (2) universal heads	1.25" x 10'3"
H1760-12	Pole; (2) universal heads	1.25" x 12'3"
H1760-14	Pole; (2) universal heads	1.25" x 14'3"
H1761	Spline storm tool (2) skirts	1.25" x 8'2"
H1770	Hinged pole; (2) universal heads	1.25" x 8'2"
H1790-8	Pole; (2) universal heads, pole hanger	1.25" x 8'3"
H1790-10	Pole; (2) universal heads	1.5" x 10'3"
H1790-12	Pole; (2) universal heads	1.5" x 12'3"
H4455	Universal head only	1.25"
H4455A	Universal head only	1.5"

- Designed for use as a hot stick handle for Universal Tools
- Made of Epoxiglas® and lightweight aluminum castings
- Universal Tools on this page fit under the thumbscrew of the spline on the Universal Pole for a rigid hot stick tool
- For job versatility, the splines allow angling of tool up to 90° in relation to the pole depending upon the individual tool design
- The Storm Tool, a Universal Pole with special rubber insulator skirts, is designed for emergency use, providing extra leakage distance and disrupting water paths when rain, sleet, or snow make regular tools hazardous
- Skirts break up streams that would otherwise run down the pole

# Chance - Elbow Puller Tools

## Impact Elbow-Puller

- 1.25" diameter orange Epoxiglas® pole; for balance, the 5 lbs slide hammer is Plastisol coated and flared at both ends
- Tool and grippers help the operator control the elbow and stiff underground cable lead
- Employs a slide-hammer mechanism to easily disengage and assist in replacing elbows
- For secure handling, both front and rear handgrip areas of the pole are coated with Griptread, a grit-filled rubber-base paint
- The 6' and 8' units meet OSHA requirements with 25" and 48" of insulation respectively from the tool end to the handguard
- On the 4.5' unit (labeled "For Rubber Glove Use Only"), insulation length measures 5"



C4031822	6'
C4031850	8'
C4031857	4.5'

## Elbow Connector Tool Replacement Grippers

- Provide a sure grip for installing and disconnecting elbow terminators
- The tool grabs the elbow and has a special integral hook that fits through the rubber eye of an elbow or the metal hook of a bushing cap so that the lineman has complete, positive control, overcoming the resistance of the stiff underground cable

C4030704	15 kV Plastic-Coated
C4030613	25 kV Plastic-Coated
C4030614	25 kV Uncoated
C4030814	34.5 kV Plastic-Coated



## TROUBLE SHOOTER EQUIPMENT



C4031612	Complete Kit
C4032046	Top Section Epoxiglas® Pole
C4032062	Mid Section Epoxiglas® Pole
M4455-9	Aluminum Disconnect Head
E4031614	Non-Metallic Disconnect Head
M4455-29B	Clamp Stick Head
H2106-4	Tree Trimmer
C4032213	Pruning Saw
M4455-66	Pistol Grip Saw Handle
P4032996	Storage Case

## Multi-Duty Trouble Shooter Kit

- Includes (6) 4' sections of field proven 1 1/4" Epoxiglas® Universal Pole that snap together
- Butt section features a Plastisol end cap
- Spring-loaded locking buttons permit uses at 4', 8', 12', 16', 20', and 24' lengths
- Fitting on top section with thumbscrew accepts the Universal Accessories included in the kit

### Kit Includes:

- Aluminum Disconnect Head for opening and closing switches, opening enclosed cutouts, etc.; has built in hanger hook
- Non-Metallic Disconnect Head provides additional insulation for indoor substations where buswork and switches are in close proximity. Plastisol cap at top; 19" overall length with 15" long Epoxiglas® section
- Clamp Stick Head for use with 6" lone eyescrew ground clamps has locking ring with detent ball for on-off operation. Made from aluminum alloy
- Tree Trimmer adds 1.5' to reach with 3-to-1 mechanical advantage pulley and 25' of furnished rope. Offset universal fitting on trimmer accepts pruning saw
- Pruning Saw with deep-notched teeth for quick pullouts attaches directly to top pole, tree trimmer or pistol grip
- Pistol Grip Saw Handle for use when insulation is not needed. Made from aluminum alloy
- Storage Case of yellow heavy-duty vinyl-impregnated fabric has separate pockets for individual tools and Velcro flap closures



# Chance - Link Sticks

## H47163: Strain Link Stick

- On deadend structures and running corners, a Strain Link Stick is used as insulation between rope blocks and a cuma-long clamp
- To supplement wire tongs, a Strain Link Stick is attached to the conductor close to the wire tong and helps support the load
- Also used to support the middle conductor on H-frame structures during insulator or crossarm changes
- Hooks and ferrules are made of heat treated aluminum alloy for the best ratio of high strength to light weight
- Butt rings, for attaching rope blocks or hand lines, are forged of high quality steel
- Butt swivel spins freely on ball thrust bearing
- Edges of the jaws of Chance Link Sticks are rounded to prevent scarring of conductors
- 1.5" diameter x 6' long (overall length of 81")
- Duty - 6,500 lbs.
- Jaw Size - .44" to 1.06"



## H47146: Roller Link Stick

- Used to spread and hold conductors aside at midspan when relocating poles
- Used for measuring conductor-to-ground clearance by attaching a measuring tape or length of rope to the butt ring
- Poles for Roller Link Sticks are 1 3/4"; rotating the pole closes the hook, leaving the head free to roll along the conductor
- 82" overall length



## Spiral Link Stick

- Used in lieu of a strain link stick in close places where the lineman cannot safely install a strain link stick by hand
- A lifting eye on the head ferrule enables the lineman to guide the Spiral Link Stick to the conductor with a hot stick
- The pole of the Spiral Link Stick is made of 1.25" Epoxiglas®
- Ferrule castings are of heat treated aluminum alloy; spiral hook and butt ring of galvanized steel
- 1.25" diameter
- Duty - 3,500 lbs.
- Wire size: 1510.5 kcmil ACSR
- 3.43 lbs.



H4722 27.5" Overall Length  
C4000812 57.5" Overall Length

## C4012145: Adjustable Strain Pole

- Key to many transmission and EHV maintenance jobs
- Helps support conductors while insulators are removed and replaced
- May be used with yoke plates and hook assemblies at the conductor and structure ends of suspension, V-string or deadend insulator strings
- To support the hot-end trunnions or hooks, 5 stainless steel crosspins are located at 6" intervals on the 2" diameter Epoxiglas® poles
- To engage deadend and suspension yokes at the hot end also requires the adjustable pole clamp of heat treated aluminum; this pole clamp can be unlocked and positioned by hot sticks
- On the cold end, a high-strength steel strain-jack with bronze tongue provides take-up with a ratchet wrench and trunnions
- Wrench and trunnions must be ordered as separate items
- Standard strain jack furnished with each strain pole provides 12" of adjustment. Longer strain jacks (for 24" or 36" of take-up) and extra pole clamps also may be ordered
- 7' long (8' 8" overall length)
- Maximum voltage use: 169kV
- Insulated section: 48"



## H472084: Suspension Link Stick

- The Suspension Link Stick is for use on conductors from 1" to 2.5" diameter and can be used with various types of takeup devices at the structure end
- The lip of the hook, actuated by an eye screw, swivels to accommodate various conductor sizes
- The maximum load is 6,500 lbs
- 84" length



## C4002399: Insulated Link Stick

- Insulates hoists from energized conductors
- 1.25" diameter Epoxiglas® pole has a steel hook on one end and a butt swivel on the other
- The maximum load is 4,000 lbs
- 18" of glass



# Telescopic Hot Sticks & Cutters

## Tel-O-Pole Hot Sticks

- May be used for opening and closing disconnect switches, replacing fuses in porcelain-type cut-outs, pruning tree limbs, or replacing lamps in street circuits
- Made of reinforced high density electrical grade fiberglass laminate with unusual colour stability, greater strength and high dielectric properties
- Tubular sections are engineered to allow for air circulation; foam is applied with an exclusive process to eliminate voids between the foam and the tool wall, which eliminates trapped moisture
- Patented interlock feature allows it to be locked in lengths listed by means of one pin locking two or more sections
- The top section on all Tel-O-Pole Hot Sticks is insulated with a fire retardant polyurethane foam core
- Sure-lock joints and corona free discharge heads



### Standard Tel-O-Pole Hot Stick, 7/8" Tip Diameter

Hastings	Extended Length	Retracted Length	Base Dia.
S-212	12'	44"	1 5/8"
S-216	12'4" - 16"	56"	1 5/8"
S-220	17' - 20'	58"	1 7/8"
S-225	17' - 21' - 25.5'	61"	2 3/8"
S-230	17' - 21' - 26' - 30'	63 3/8"	2 11/16"
S-235	17' - 21 1/2' - 26' - 30' - 35'		

### Heavy Duty Tel-O-Pole Hot Stick, 1 3/32" Tip Diameter

SH-216	9' - 13' - 17'	58 1/8"	1 7/8"
SH-200	13' - 17.5' - 21.5'	60"	2 3/16"
SH-250	13' - 17.5' - 21.5' - 26'	61 5/8"	2 3/8"
SH-230	13' - 17.5' - 21.5' - 26' - 30'	63 3/8"	2 11/16"

### Tel-O-Pole Hot Stick with Tip Lock Feature

ST-220	17'-20'	58"	1 7/8"
ST-230	17' - 21.5' - 26' - 30'	61 5/8"	2 3/8"
ST-235	17' - 21.5' - 26' - 30' - 35'	63 3/8"	2 11/16"
ST-240	17' - 21.5' - 26' - 30' - 35' - 40'	63 3/8"	2 11/16"



## Tel-O-Pole II - "No Twist" Stick

- All models are heavy duty designed
- Triangle Shape enables each section to lock in automatically
- Fluorescent tip section (1.15" diameter) is highly visible and has a foam core
- Sections are 100% tested per OSHA and ASTM F-711
- Lock Buttons are large, easy to operate with or without gloves
- Design allows user to use only the number of required sections to perform each job, allowing for a lighter tool to perform the work more easily
- Easily disassemble by depressing the lock button and sliding the section, or sections, out
- Ergonomic design gives the operator a better gripping surface for improved control
- All sections have a smooth glossy surface for routine cleaning and waxing
- Strong aluminum alloy head incorporates corona discharge design and includes a captive Belleville washer to hold universal attachments securely

Hastings	Extended Length	Retracted Length	Base Dia.
HV-208	8'	26"	1.75"
HV-212	12' 7"	58"	1.45"
HV-216	16' 9"	60"	1.61"
HV-230	30'	66"	2.07"
HV-235	35'	68"	2.22"
HV-240	39' 6"	69"	2.38"

## 11-006: 6' Insulated Ratchet Cutters

- Lightweight and easy to handle
- For both overhead and underground applications
- Provides clean cuts for splicing conductors
- Cuts 666-54/7 ACSR, 1000 MCM aluminum, 500 MCM copper
- Handle folds and cutters store in 6" canister
- Operates in a 5" width trench
- Long reach, remote operation



## 12594: 6' Hot MD-6

- Lever handled compression tool
- Designed for live line crimping of sleeves and connectors
- Utilizes Burndy "W" dies
- Head features a fixed 5/8" nose die



## Combination Tel-O-Pole Measuring Stick



- Heavy duty Tel-O-Pole includes English scale measurement graduations for eye-level reading
- Painted graduations are silk-screen printed directly on the fiberglass sections, and will not chip or peel
- Surface is coated with a hard, high-gloss epoxy finish
- Foot markings are printed in large, easy to read numerals
- Graduations are marked to measure in feet, inches and 1/2" graduations
- 30' extended; 63 3/8" retracted
- 2 11/16" base diameter 1 3/32" tip diameter

EV-30	66" - 30'
EV-35	68" - 35'
EV-40	69" - 39'6"



# Hastings Shotgun & Link Sticks

## Shotgun Sticks & Carrying Case

- Constructed of electrical grade fiberglass
- Telescoping models can extend to match all stick lengths
- Extended length spear offers easy method of locating the eye of hot taps that are otherwise difficult to locate
- Larger opening 5" deep throat gives greater control on all hot taps, including the new longer stem taps
- New operating rod guide eliminates trapped dirt and moisture, allowing for easier cleaning of inside area of rod guide
- Handle body is made of melron polycarbonate, is non-conductive, extremely durable and unaffected by temperature extremes
- The plastic protective sleeve surrounding the fiberglass tube prevents scuffing
- Full open side hook offers unobstructed vision of the hook
- Hanger hook is molded in the head, eliminating metal parts
- Hook release trigger is shielded
- The precision case side offers 13 teeth per inch, giving complete control and an extra firm grip
- The insulated rubber cap protects the base and prevents wear



Telescopic Shotgun		
Hastings	Retracted Length	Operating Lengths
8158	5'1"	5'1", 6'6", 8'
81814	8'	8', 10', 12', 14'
Telescopic Shotgun with Universal Fitting on Handle		
8158-U	5'1"	5'1", 6'6", 8'
81814-U	8'	8', 10', 12', 14'
Folding Shotgun with External Operating Rod		
Hastings	Length	
13412	6'6"	
13413	8'6"	
13414	10'6"	
13415	12'6"	
Fixed Length Shotgun with External Operating Rod		
Hastings	Length	w/ Universal Fitting on Base End
8104	4'6"	8104-U
8106	6'6"	8106-U
8108	8'6"	8108-U
8110	10'6"	8110-U
8112	12'6"	8112-U

## C-35: Carrying Case for Shotgun Sticks

- Water repellant yellow vinyl nylon reinforced ducting
- Carrying strap attached
- Snap type flap on open end

## Insulated Spiral Link Stick



- Designed to isolate rope lines, hoists and rope blocks, providing insulation between energized conductors and pulling devices which might be attached to a different potential
- One-piece, 1" O.D. fiberglass stick has a solid unicellular foam core
- Spiral hook is made from high-strength, heat treated steel
- Maximum wire size: 795 ACSR
- Maximum working load: 2000 lbs

3480	1" x 12" F6 pole 24" overall length
3481	1" x 24' F6 pole 36" overall length
3482	1" x 36" F6 pole 48" overall length
3483	1" x 48" F6 pole 60" overall length

## Insulated Link Stick



- Designed to provide extra protection when using strap hoists on primary voltages
- Fiberglass links help overcome the loss of dielectric properties when the web straps become contaminated through field use
- Can be used with most strap hoists
- Pre-tested to 5,000 lbs before shipment and tested per OSHA and ASTM F-711
- 1" diameter fiberglass with solid foam core
- Insulated fiberglass shaft and operating rod allow maximum safety and durability

3413	6" length; 4000 lb rating
3414	12" length; 4000 lb rating

# Hastings Switch & Disconnect Sticks

## Spliced Switch and Disconnect Sticks

- These sticks eliminate storage problems and duplication of tools
- Switch and disconnect heads are made from high tensile cast bronze
- The insulated head is made of fiberglass
- Choose top section and base section and add extension sections as needed
- All stick sections have a solid unicellular foam core and are tested per OSHA and ASTM F-711



Universal Head	
55574-4	1 1/2" x 4'
55547-6	1 1/2" x 6'
55547-8	1 1/2" x 8'
55547-10	1 1/2" x 10'

Disconnect Head	
5541-6	1 1/2" x 6'
5541-8	1 1/2" x 8'
5541-10	1 1/2" x 10'

Insulated Head	
5462-2	1 1/4" x 2'
5462-4	1 1/4" x 4'
5462-6	1 1/4" x 6'
5462-8	1 1/4" x 8'

Switch Head	
5460-4	1 1/4" x 4'
5460-6	1 1/4" x 6'
5460-8	1 1/4" x 8'

Extension Sections	
546-4	1 1/4" x 4'
546-6	1 1/4" x 6'
546-8	1 1/4" x 8'
5546-4	1 1/2" x 4'
5546-6	1 1/2" x 6'
5546-8	1 1/2" x 8'
5546-10	1 1/2" x 10'



## Substation Adjustable Disconnect Sticks

- Designed for use in close confines of substations
- Eliminates the problem of threading long sticks through substation structures
- Adjustable to length in 1' increments; therefore multiple length stick requirements are eliminated
- Top section is a conventional 1 1/4" diameter hot stick with fire retardant unicellular core; the top section may also be removed for use as a single one piece hot stick
- Base section is 1 1/2" diameter
- Extended length is shown at each lock position for reference
- The top section must extend beyond the base before the lock will engage, giving full protection of fire retardant unicellular core
- Available with standard NEMA high tensile bronze disconnect head, switch head, or universal head "fit on type"

### NEMA Disconnect Head:

Hastings	Extended Length	Minimum Length	Collapsed Length
3114	14'	10'	8'4"
3118	18'	12'	10'4"

### NEMA Switch Head:

3115	14'	10'	8'4"
3119	18'	12'	10'4"

### Universal Head:

3116	14'	10'	8'4"
3120	18'	12'	10'4"

## Universal Hot Sticks

- Features a universal head on both ends which adapt to all standard universal fits on tools
- Constructed of a fine grade woven fiberglass material
- Contains a unicellular core, and are fabricated especially to withstand high torque and unusual strength requirements
- The colour of these sticks is standard safety yellow, and each universal hot stick has a hanger hook



4678-6	1 1/4" x 6'
4678-8	1 1/4" x 8'
4678-10	1 1/4" x 10'
4678-12	1 1/4" x 12'
4678-14	1 1/4" x 14'
4680-8	1 1/2" x 8'
4680-10	1 1/2" x 10'
4680-12	1 1/2" x 12'
4680-14	1 1/2" x 14'

## Multi-Purpose Holding Tool with Rigid or Adjustable Head

- For holding slack conductors during sleeving; provides positive control for shaping and bending jumpers, buss wires
- Main fiberglass portion is 1" diameter, and is fabricated with finely woven cloth, giving maximum strength with minimum weight and size; 5/8" operating rod is designed to withstand the highest torque obtainable by hand
- Foam filled to eliminate migration of contaminants and moisture
- Conductor capacity #6 - 1 1/16"; tested per OSHA and ASTM F-711
- Adjustable head models also offer the convenience of adjustment from straight to 30° both sides of center



4601	1" x 6' long	Rigid Head
4602	1" x 8' long	Rigid Head
4603	1" x 4' long	Adjustable Head
4604	1" x 6' long	Adjustable Head
4605	1" x 8' long	Adjustable Head



# Hastings Switch & Disconnect Sticks

## Switch or Disconnect Sticks

- Constructed of woven fiberglass materials
- A special manufacturing technique assures uniformity of fiberglass distribution and full elimination of resin-rich areas which cause chipping and fiber glass peel
- Unicellular core is self-extinguishing and resistant to cleaning fluids and solvents
- Safety bright yellow colour is an integral part of the laminate and will not chip or peel
- The hard-gloss, porosity-free epoxy finish is easy to keep clean
- Switch and disconnect heads are made of tough, high-tensile, cast bronze and are designed to NEMA standards
- Insulated head is made of fiberglass with a non-metallic NEMA shaped prong
- All sticks are tested per ASTM F-711 and OSHA

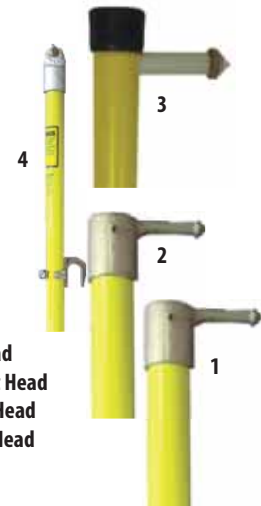

1) Switch Head  
2) Disconnect Head  
3) Insulated Head  
4) Universal Head

Hastings	Length	Weight
<b>Switch Head</b>		
460-4	1 1/4" x 4'	1 lb 9 oz
460-6	1 1/4" x 6'	2 lbs 5 oz
460-8	1 1/4" x 8'	3 lbs
460-10	1 1/4" x 10'	3 lbs 4 oz
460-12	1 1/4" x 12'	3 lbs 9 oz
P10036	Head Only	7 oz
<b>Disconnect Head</b>		
541-6	1 1/2" x 6'	3 lbs 3 oz
541-8	1 1/2" x 8'	3 lbs 12 oz
541-10	1 1/2" x 10'	4 lbs 15 oz
541-12	1 1/2" x 12'	6 lbs 10 oz
541-14	1 1/2" x 14'	7 lbs 7 oz
541-16	1 1/2" x 16'	8 lbs 6 oz
541-18	1 1/2" x 18'	9 lbs 4 oz
541-20	1 1/2" x 20'	10 lbs 3 oz
P10038	Head Only	13 oz
<b>Insulated Head</b>		
501-4	1 1/4" x 4'	1 lb 4 oz
501-6	1 1/4" x 6'	2 lbs 5 oz
501-8	1 1/4" x 8'	2 lbs 10 oz
501-10	1 1/4" x 10'	
501-12	1 1/4" x 12'	
<b>Universal head (Includes Hanger)</b>		
567-6	1 1/4" x 6'	
567-8	1 1/4" x 8'	

## P.V.C. Hot Stick Canister

- Includes universal mounting brackets for mounting on trucks, fences, etc.
- Constructed of top grade aluminum castings and heavy duty P.V.C. tubing to help prevent sag and the formation of aluminum oxide
- Aluminum end cap is designed to open by merely pulling a pin
- One end of the canister container is completely sealed; the opposite end has an "easy-open" aluminum cap with an "O" ring seal providing weather-tight protection for those many items that must be stored or transported outside



01-33350	7'
01-33351	9'
01-33352	11'
01-33353	13'
01-33354	15'
01-33355	17'
01-33356	19'
01-33357	21'

## Snap-On Adapters



- Can be used with extension sections for spliced switch and disconnect sticks
- Use of snap-on adapters with extension sections eliminates duplication of fixed sticks and storage problems

A18007	Base Cap for 1 1/4" Stick
A18008	Base Cap for 1 1/2" Stick
A10025	Universal Adapter for 1 1/2" Stick
5558	Disconnect Adapter for 1 1/2" Stick

## Spliced/Stepped Switch and Disconnect Sticks

- Features metal splice ferrules and solid unicellular foam core
- Stepped sections allow for long lengths and maintained rigidity
- Provides convenient storage, eliminating long one-piece sticks
- Two section switch stick with metal splice and disconnect head
- Tested per OSHA

Hastings	Length	Tip	Base
20923	12'	1 1/4" x 6'	1 1/2" x 6'
20925	16'	1 1/4" x 8'	1 1/2" x 8'
20926	18'	1 1/4" x 8'	1 1/2" x 10'
20927	20'	1 1/4" x 10'	1 1/2" x 10'

## FRP Clampsticks

Part #	Length		Weight	
	Feet	Meters	lbs	Kgs
<b>External Rod Clampstick</b>				
4007	4'8"	1.32	4.2	1.9
4008	5'8"	1.62	4.6	2.1
4009	6'8"	1.93	5.2	2.4
4010	8'8"	2.54	6.2	2.8
4011	10'8"	3.15	7	3.2
4012	12'8"	3.76	7.7	3.5
4013	14'8"	4.37	9.4	4.3
<b>External Rod Clampstick - Plain Cap</b>				
8106C	6'6"	1.98	5	2.27



## Conductor & Cleaning Tools

Tubular Brushes are preferred when rubber gloving or when working on de-energized conductors. The steel bristles are internal to prevent damaging rubber gloves. The 2.5" tubular brush is used in confined areas such as between two connectors or clamps. The "V" Type Wire Brushes are available with epoxy-coated handle or universal attachment that can be used with hotsticks.

Part #	Description	Weight ea. (lbs)
4108	Universal Tubular	1.3
4110	5" Tubular	0.4
4111	Universal "V" Line Cleaner	1
4112	"V" Type handle w/ brushes	1.2
4113	"V" Type carton of 10 replacement brushes	3
4337	2.5" Tubular	0.2





# Salisbury by Honeywell

## Storage for Hotsticks & Tools

SALCOR® Tool Holders secure tools to trailers, compartments and tool rooms. 12 per package.

Hotstick Bags are constructed of heavy vinyl with double stitched seams. Flaps snap closed. 6" wide and designed to hold sticks up to 4" shorter than bag length shown on chart.

Tubular PVC storage containers provide weather tight storage. Kit includes two mounting brackets and four steel bolts with each 6" I.D. or 4.1" tube. Sized for tools 12" shorter than tube. Four mounting bolts 3/8" x 1.5" are supplied with each container. Kit may be ordered without tubing or with mounting brackets only.



Part #	Description/Dimensions	Weight ea. (lbs)
1192	1.25" I.D. Tool Holder	3.5
9822	Kit for 6" I.D. 6'6" O.D.	8
9823	Kit for 4.1" I.D. 4'5" O.D.	6
C4007	I.D. 4" 7'	19
C4009	I.D. 4" 9'	22
C4011	I.D. 4" 11'	26
C4013	I.D. 4" 13'	29

Part #	Length		Weight (lbs)
	Feet	Meters	
<b>Hotstick Bags</b>			
4297	5	1.5	.7
4298	6	1.8	.8
4299	6'4"	1.9	.9
4300	7	2	1
4301	8'4"	2.5	1.1
4302	9	2.7	1.2
4303	10'4"	3	1.4
<b>4" I.D. Tubular PVC Storage Kit</b>			
4155	7	2.13	17
4156	9	2.74	20
<b>6" I.D. Tubular PVC Storage Kit</b>			
4167	6	1.82	20
4168	7	2.13	22
4169	9	2.74	26



Hotstick Bag

Container Kits		
C4000	Kit w/o Lock I.D. 4"	6
C4000L	Kit w/ Lock I.D. 4"	9

## Insulated Rescue Hook

- An invaluable tool for any workplace used to withdraw an injured worker out of a hazardous area
- Confined spaces, in vaults, or just near electrical cabinets and switch gear are some of the places where this tool is a must
- Featuring a foam-filled, fiberglass reinforced handle for superior electrical insulation and a coated heat treated body hook with an 18" opening
- The stick is available in the standard lengths of 6' and 8' lengths
- Handle meets the requirements of ASTM F711



Part #	Length	Weight
<b>Insulated Rescue Hook</b>		
24400	3'	3.4 lbs
24401	6'	4.5 lbs
24403	8'	5.5 lbs

## Static Discharge Stick

Designed to safely remove the static charge after de-energizing. This tool is pre-assembled and includes a copper "U" hook, closed cell foam-filled tubular fiberglass stick and 6' of copper grounding cable attached to a Salisbury 1814 bronze flat jaw serrated grade 3 clamp. Also available in a 1' length stick.

Part #	Length	Weight
<b>Static Discharge Stick OAL</b>		
20817	3' 8"	8 lbs
<b>Static Discharge Stick w/ Universal Attachment</b>		
22629	1'	.38 lbs

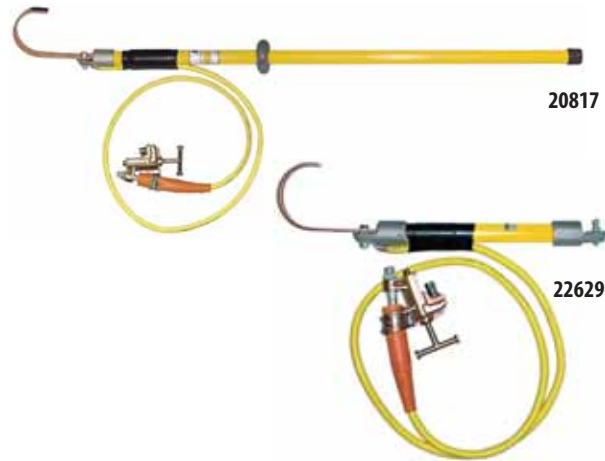

## Static Discharge Sticks

A **Discharge Hook** is used to drain capacitive voltage. The probe is first used to make contact, then the hook can be used to make direct contact bypassing the fuse. The fuse gives added protection in case initial contact is accidentally made on energized equipment. Fuse is rated at 8 kV maximum, 6 amperes continuous.

A Discharge Hook is a special discharging device used to de-energize capacitors and other voltage retaining components before maintenance work is performed. Mounting clip (1925MC) is included. Standard handle length is 2'. Other cable and handle lengths are available.

**Resistive Discharge Hooks/Probes** with resistors help eliminate initial surge current. Second hook bypasses resistors for residual discharge. Resistive discharge hooks and probes use #6 flexible copper, clear-jacketed cable, a hand guard, hook or probe, and a 1" diameter fiberglass insulating handle. The handle complies with ASTM F-711. All come with a clear PVC cover to protect resistors from damage from bumps and knocks. Not all resistors fit all hooks. Mounting clip (1925 MC) is included

*NOTE: For discharge only. Do not use as live line tool or grounding device.*



Part #	Description	Weight ea. (lbs)	
<b>FUSED DISCHARGE HOOK</b>			
1930535415Q	Fused Discharge Hook	10	
<b>DISCHARGE HOOK</b>			
1925	5'	2	
19257	7'	2.5	
19258	8'	3	
192510	10'	4.5	
192520	20'	5	
<b>RESISTIVE DISCHARGE HOOK/PROBE</b>			
	Handle Length	Ground Lead Length	
19250005	23"	5'	2
192500655	7'	10'	4.5
19250007	5'	7'	4
<b>Accessories</b>			
1925SSMC	Mounting Clip, Stainless Steel	3 oz	
1925MC	Mounting Clip	3 oz	
1925DMC	Mounting Clip with Hardware	4 oz	



# Utility Solutions

LIVE LINE TOOLS

## BREAK-SAFE® Load Break & Pick-up Tool



- Functions as portable in-field switch
- In order to keep personnel at a safe distance, the BREAK-SAFE® is operated with an insulated fiberglass hot stick
- The Yellow Safety Lock is operated by a hotstick and helps prevent the tool from an unintended load break or pickup operation
- Only tool with full load break and load pick-up capability
- 300 AMP loadbreak, load pick-up and continuous current duty
- Offered in 15kV, 27kV and 46kV voltage classes
- Available with either a Floating Head or Duckbill Head (full stick operation)
- Simple, easy method to establish parallel circuit
- Optional Hard Case or Soft Case



- USBS-15-1-PS** 15kV Rated, Gloved Operation; 300 AMP; Floating Head
- USBS-15-2-PS** 15kV Rated, Stick Operation; 300 AMP; Duckbill Head
- USBS-27-1-PS** 27kV Rated, Gloved Operation; 300 AMP; Floating Head
- USBS-27-2-PS** 27kV Rated, Stick Operation; 300 AMP; Duckbill Head
- USBS-46-1-PS** 46kV Rated, Gloved Operation; 200 AMP; Floating Head\*
- USBS-46-2-PS** 46kV Rated, Stick Operation; 200 AMP; Duckbill Head\*
- USBS-XX-X-PS** Soft Carrying Case

\*Note: the 46kV rated for 200 ampere loadbreak and 200 ampere load pickup

## BREAK-SAFE® 600 Load Break & Pick-Up Tool

- The industry's first portable switch rated at 600 AMP rating for load dropping, load pick-up and continuous current duty functions
- Tool is fully rated from 7.2kV to 27kV
- Features an extra large clamp capable of handling all wire sizes up to nearly 2" diameter
- Made of durable, electrical grade fiberglass housings and a glove friendly design
- Dual conductor bars allow for two mechanical jumper clamps to reach the 600 AMP rating
- This tool is designed with a patent pending internal safety lock, requiring the user to reset on each use
- Incorporates safety lock in pin and lock out pin feature



- USBS-600-1:** 7.2kV-27kV, Gloved Operation; 600 AMP; Floating Head
- USBS-600-1-S:** Soft Carrying Case

## Jack Jumper™ Cutout Bypass Tool

- Rated for 100 AMP continuous duty
- Permits a safe and quick method to bypass an overhead cutout without use of bulky jumper cables
- Indispensable for fuse coordination tasks and permits easy bypass of an underground dip
- Saves linemen time and eliminates risk of service interruption and prevents accidental cross phasing
- Features no moving parts to fail and utilizes a stainless steel external spring to provide many years of trouble-free service
- USJJ-001S, USJJ-002S, and USJJ-005 are supplied with soft storage cases standard; cases are not available for the USJJ-004S and the USJJ-007

- USJJ-001S** Designed for all 15kV rated standard cutouts
- USJJ-002S** Designed for all 27kV rated standard cutouts
- USJJ-004S** Designed for all 27kV rated loadbreak cutouts
- USJJ-005** Designed for 38kV rated standard cutouts
- USJJ-007** Designed for S&C™ SMD-20 38kV power fuse Cutouts with "V" design



## Klondike Clamp

- The Klondike Clamp tool series quickly and safely secures blankets in position on poles without damaging the blankets
- Eliminates the need for tie wrap, bungee cords, Velcro®, tape or any other means that are both time consuming to install and potentially damaging to the blanket
- The Klondike Clamp tool series can also be used in a myriad of padmount equipment situations where it is difficult to secure the blanket by conventional means
- Molded from a tough weather resistant polymer and assembled completely with stainless steel hardware, the Klondike Clamp tool series will provide a lineman with many years of maintenance free usage

- USCP-001** 7"-11" Diameter Range, 16" Long
- USCP-002** 11"-20" Diameter Range, 23" Long



Itlutilitysupply.com



# Chance - Live Line Tool Accessories

## M4455-67: Universal Insulator Fork Tool



- Designed to grasp 9" and 10" disk insulators used in deadend construction; will raise most pin type insulators up to 15 lbs
- Fiber jaws open and close by rotating screw
- Adjustable insulator forks
- 3" to 4.5" opening

## M4455-89: Ratchet Wrench Tool



- Designed for tightening square nuts on 5/8" pole line hardware, regardless of the length of the bolt running beyond it
- The long socket permits wrench handles to swing past crossarm when tightening top ridge pin nut

## C4000600: Tie Back Clamp



- Installs with a Grip-All clampstick
- Used with a Tension Puller to keep the tail of a conductor out of the work area by tying it back to the main line after it has been cut
- The clamp also may be used to hold a jumper on the main line while applying a compression connector

## M4455-84: Universal Tool Adapter



- When this adapter is mounted on a universal stick, and any universal tool is mounted on the adapter, the tool can be set at almost any angle to the stick
- Useful for working in tight places
- 90° universal tool

## C4031416: Tie Wire Claw Tool



- Hand-like hot line tool easily and neatly applies tie wires, both factory-formed and field-formed
- Claw controls wire with grip equal to pliers, permits securely wrapping tight coils onto conductors

## M4455-50: Skinning Knife



- For cutting or scraping insulation, cleaning conductors, etc., prior to making splices
- Use with a universal pole permits safe work near energized lines

## C4031417: Universal Utility Head Tool



- Gator-look shape makes Utility Head popular for many hotline jobs: placing and removing blocks, slings, circuit breakers, line hooks and strain breakers

## M4455-46: Flexible Wrench Head



- Made to fit standard wrench sockets
- Flexibility permits use at various angles

## M4455-85: Hammer Tool



- Used for many operations around energized conductors such as moving conductors, suspension clamps, and other pieces of hardware requiring a forceful blow

## H1760-5: Pole & Clamp Hanger



- Designed for use on 1.25" or 1.5" diameter Epoxiglas® poles
- Includes a black nylon-filled plastic hook and a steel hose clamp for easy attachment

# Chance - Live Line Tool Accessories

## 4455-17: Tie Stick Head



- Often preferred for manipulating tie wires which have looped ends
- Useful in close quarters where loose ends of the wire must be rolled up to prevent contact with crossarm or hardware while untying

## M4455-70: Tie Head



- For manipulating the wires with or without looped ends
- Heat treated aluminum alloy body design permits a swivel action
- Wire is wrapped or unwrapped without turning universal pole
- A V-notched carbon steel blade grasps tie wire securely

## M1948-3: Ratchet Wrench



- For use with strain jacks and trunnion

## M4455-69: Tie Head



- For placing insulator ties with looped ends
- Heat treated aluminum alloy body
- Prong swivels freely, permitting a full turn on the tie wire without releasing contact this minimizes the possibility of kinking or burning the wires

## E4010138P: 2" Pole Clamp



- Replacement pole clamp for adjustable strain pole

## M1860: Crossarm Tool Hanger



- Adjustable to crossarms ranging in width from 3.25" to 4.5" (depth of crossarm does not matter)
- Made of strong, lightweight aluminum alloy
- Features cadmium-plated steel hardware

## Assembly Trunnions

- Trunnions are bronze alloy
- Features ball-thrust bearing construction for use on adjustable strain poles
- Designed to equal the capacity of all Chance yokes and provide maximum efficiency for the lineman



E4012066



E4012068

## M4455-6: Ratchet Wrench



- This Ratchet Wrench is used for tightening bolts in substation equipment, hardware bolts on transmission and distribution lines, etc.

## M4455-63: Cleaning Brush



- V-position of brushes gives 2-sided cleaning action
- As brushes wear, they can be rotated by loosening the anchor screws so that unused bristles will come in contact with conductor

# Chance - Live Line Tool Accessories

## M4455-12: Cotter Key Removal Tool



- Hammer-like action makes it extremely useful in pulling out stuck cotter keys
- Release of the compression spring by a quick jerk of the pole deals the cotter key a hammer blow without disengaging the eye

## M4455-15: Locating Pin



- Used as a drift pin in aligning bolt holes as an aid in bolt and pin insertions
- It is recommended for making hardware connections on tower transmission lines and line deadends where aligning or hardware fitting is difficult

## Cotter Key Pulling Tool



- Used to partially withdraw a ball-socket cotter key so that the insulator can be removed from another insulator hanger
- This puller with its thin prong is preferred for prying out standard keys deeply set on long insulator strings

M4455-96

## M4455-82: Cotter Key Tool



- For pulling and replacing hump-type cotter keys
- Particularly suitable for use on clevis pins and ball socket insulators
- Easy guiding of cotter key provided by contoured slot and raised eye pin

## M4455-103: Cotter Key Holder Tool



- Used to install cotter keys into semi-recessed hardware this tool will hold the keys in position for proper insertion into clevis pins
- The tool will hold the key firmly, yet will readily release once engagement is made

## M4455-19: Cotter Key Tool



- For ball and socket insulator coupling
- Straight end of the tool enters the socket opening to force cotter key out
- Curved end forces cotter key back into position

## M4455-38: Mirror Tool



- Angle adjustment enables the operator to inspect insulators, switch bases, and other equipment which is difficult to see without coming in contact with energized conductors

## M4455-23: Hack Saw Tool



- Excellent for use at various angles where a hack saw is needed near energized conductors
- Comes with 10 blades

## M4455-2: Pin Holder Tool



- For replacing pins and bolts
- The bolt head fits into a slot and is held tight by spring action
- Will take bolts or pins up to 5/8" diameter
- Fits EEL and NEMA insulators

## T4000838: Steel Arm Bracket



- The steel arm bracket is used with C400-0445 (steel arm yoke) where the steel arm is not equipped with an end plate
- The bracket is made of heat treated aluminum and is complete with a wheel binder
- The steel arm bracket serves the same purpose as an end plate to support the yoke assembly

# Chance - Live Line Tool Accessories

## M4455-22: Adjuster Socket



- Useful in controlling the adapter between clevis clamps and ball and socket insulator pins

## M4455-36: Link Stick Head



- Use with light conductors
- The clamp will hook into a cum-a-long ring
- Jaw openings range from .750" to .22"
- Jaws have rounded edges to prevent scarring conductors
- The hook is made of heat treated aluminum alloy

## M4455-28: Screwdriver Tool



- Excellent for use at various angles where an insulated handle is needed

## M4455-39: Shepherd Hook



- The self-aligning shepherd hook is designed for pulling and lifting insulator strings
- Swivel action permits it to rotate and maintain its alignment with the insulator at all times
- Heat treated aluminum alloy

## M4455-77: Fuse Puller Tool



- The Chance Fuse Puller may be preset to any position desired and locked there by tightening the wing nut
- A spring assembly also permits the tool to be preset without locking, so that it will align with the fuse during the pulling operation
- Jaws are Plastisol covered

## Screw Jack Assembly



- ACME thread strain jack

V4010157 24" Length

V4010158 36" Length

## C4030799: Hand Guards



- Hand guards assist in maintaining minimum clearances between the hand and the working end of the hot line tool

## M4455-102: Clevis Pin Holder



- This tool has particular application on EHV hardware and insulators where the pin must be placed in semi-recessed areas
- The three-finger device is spring-loaded with cadmium plated music wire for positive grip

## C4031071: Super Hot Rodder Tool



- Ideal for applying line ties and other formed wire products on energized lines
- Adaptable to Super Top-Ties®
- The loop type work end permits rotational control which is difficult with conventional tying tools

## C4030177: All Angle Pliers



- Designed to grasp from any angle
- The jaws are held firmly in position with a wing-nut
- Used as a holding device for retaining bolt heads and loose hardware, adjusting arcing horns, replacing cotter keys, etc

# Chance - Live Line Tool Accessories

## M4455-79: Spiral Disconnect Tool



- Extremely effective in opening switches and removing and installing cutout doors on porcelain enclosed type cutouts
- Also called "Pigtail" Disconnect

## M4455-92: Conductor Cleaning Brush



- Semi-tubular shape allows linemen to clean 6" of entire circumference of conductor with two stick position

## M4455-87: Adjuster Socket



- Used on heavy socket clevises, particularly where aluminum suspension and deadend clamps are attached to ball and socket insulators

## C4030011: Universal Knocker Tool



- Designed to knock out and pull the cotter keys on fog-type insulators, the Knocker Tool is spring assisted for greater impact in restricted space and adverse working conditions
- The Knocker has a standard universal fitting on one end and a Universal fitting with wing nut on the other end

## M4742-1: Adjustable Hook Assembly



- Adjustable Hook Assembly can be used with the adjustable strain poles as a direct method of relieving the load on a suspension string
- Conductor clamp has a contoured seat with a trapping gripper and is operated by an eyescrew
- Conductor range is 1.125" to 25" dia.
- Hook can be positioned every 6" on the strain pole
- The hook is self-aligning within a range of 45° either side of vertical
- Maximum load is 3,500 lbs.

## PSC4033484: Universal 4-in-1 Cutout Tool



- Strong heat treated aluminum casting
- For hot sticks with splined universal fitting
- Gives a clear view of the cutout hinge while placing and removing a fuse holder
- Performs lift out, placement, opening, and closing of 100 Amp cutout fuse holders made by A.B. Chance, and S&C, as well as the Chance Electronic Sectionalizer
- Weighs only 1/4 lbs

## M4660: Hot Line Tool Rack



- Eliminates the need for rolls of canvas or other ground covering devices
- Compact, collapsible racks take up little space on the line truck or in the trailer
- Tools are protected against abrasion by soft, tough Plastisol coating over arms, center mast
- All metal parts below the Plastisol are galvanized or bronze for resistance to corrosion
- The folding tripod-like legs can be locked in the fully opened or fully closed position via an eyebolt, secured by a bead chain
- Will support up to 12 tools as there are 12 arms to a rack
- Poles of 3" diameter will easily fit on the arms



# Chance - Live Line Tool Accessories

## Epoxiglas® Spliced Ladders



- Available in combinations of up to 32'
- 1" diameter steel rods, 8" in diameter, are arched to hook over structural shapes and are furnished on all top section units
- Hooks are complete with steel chains
- Manufactured in short, easy to transport lengths and are joined with the Chance Rigid Ladder Splice to form an unshakable, rigid splice
- Two eye pins in each rail, with a klik pin in the end of each are supplied

**C4020404** 14' Top Section w/ 8" hook

**C4020418** 8' Bottom Section

**C4020421** 10' Bottom Section

**C4020422** 12' Bottom Section

## E4020525: Vertical Attachment for Towers



- Quick, easy rigging on most types of structure is the feature of the Chance ladder attachment sets, affording efficient use of the Chance Epoxiglas ladder as a platform for live-line maintenance
- Sets were designed to be attached to either steel or wood structures, vertical or horizontal, to support the structure-end of the ladder in a tagged-out position
- Designed for use on 2.5" diameter side rail ladders and can be ordered as sets or choosing the individual components

## H4964-6W: Standard Aerial Platform

- Designed to provide a convenient workstation on an aerial structure
- Quickly mount in position on the structure to place workers in the correct relationship to the work area
- These platforms are furnished with a Fixed Pole Mount for maintenance jobs that do not require frequent platform relocation
- Pivot Mounts (available as optional accessories) allow the platform to be swiveled on its horizontal plane to different positions for certain operations. For belt-on and as restraining guides for workers, Epoxiglas® Tripods or Railings may be added
- For improved footing, three strips of 2" non-skid tape extend the length of the platform working surface
- A bare section near the mounting end helps reduce moisture accumulation in inclement weather and provides an area between the working surface and the mount fittings that can be readily wiped clean of dirt and moisture when necessary



## Epoxiglas® Hook Ladders



- Has many applications in high voltage maintenance to position linemen in the most advantageous working location, making line repairs possible at otherwise almost inaccessible places
- Hooks are formed from 1" diameter tempered steel and can be swiveled to best fit various angles on the structure
- Steel chains clip to the hooks to assist in securing the ladder to a support
- Rung material for both rated ladders are 1.25"

**H4905-14** 12' overall, 2.5" side rails  
14.5" below rails

## C4020155: Ladder Attachment Kit

- Quick, easy rigging on most types of structure is the feature of the Chance ladder attachment sets, affording efficient use of the ladder as a platform for live-line maintenance
- Sets were designed to be attached to either steel or wood structures, vertical or horizontal, to support the structure-end of the ladder in a tagged-out position
- Designed for use on 2.5" diameter side rail ladders and can be ordered as sets or choosing the individual components

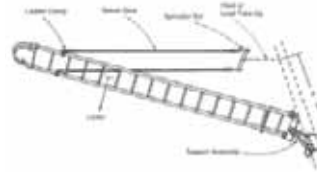

## E4020099: Spreader Bar



- Quick, easy rigging on most types of structure is the feature of the Chance ladder attachment sets, affording efficient use of the Chance Epoxiglas® ladder as a platform for live-line maintenance
- Designed to be attached to either steel or wood structures, vertical or horizontal, to support the structure-end of the ladder in a tagged-out position
- Designed for use on 2.5" diameter side rail ladders and can be ordered as sets or choosing the individual components

## C4020023: Railing for 6' Platform

- Epoxiglas® construction adds belt-on capability and restraining guide for lineworkers

# Hastings Live Line Accessories

## A30008: Rubber Glove Auxiliary Arm



- May be added to existing auxiliary arm
- For use up to 34.5 kV

## Universal Head - Splined



- Head adapts to all universal fit-on type tools for fitting to your existing sticks
- Includes cap and base

A10017 1 1/4"

A10018 1 1/2"

## A10019: Shotgun Universal Tool Adapter



- Adapts shotgun sticks to all universal attachments
- Made of high-quality bronze alloy
- May be used with all major brand tools

## A10022: Clamp Stick Head



- Use this head with universal sticks for installing and removing hot line clamps
- A quarter-turn of it's rotating cap locks the tool on the screw eye

## P10431: Universal Disconnect Hook



- Used for opening and closing switches
- Nickel-plated steel
- Disconnect hook comes equipped with extension for hanging stick from aerial structures

## A10020: Universal Rotary Prong with Tie Stick Head



- Prong is self-aligning, swivels freely
- Used for looped end tie wire

## A10021: Universal Rotary Blade with Tie Stick Head



- Blade has self-aligning swivel action for removal of ties without looped ends

## Conductor Cleaning Brushes



- All brushes have stainless steel bristles to allow the cleanest connection possible
- Stainless steel eliminates rust deterioration of bristles
- Compact "U" type brushes for tight clearances and easy storage in linemen's pouches
- Other models available

"U" 10-183

"V" 10-178

# Underwater Kinetics - Live Line Accessories

## 16001: LitFinger

- Bright, unbreakable 1-watt LED light.
- Pointed head for breaking off of ice or debris
- Notched straight arm to secure fuse while lowering or raising hot stick
- Curved arm for hanging
- HI-LOW switch for increased battery life
- Water-resistant battery compartment with sealed silicone rubber push button
- Sealed borosilicate window to resist heat and flash
- Passed 3000 V, 8000 A, 1/2 sec (30 cycles) arc blast test
- Easy access (no tools required) battery compartment door
- Universal splined slotted connector attaches to hot sticks
- Made in the USA



## 16002: LitLink

- Bright, unbreakable 1-watt LED light
- Light weight aluminum body, only 7 oz with batteries
- HI-LOW switch for increased battery life
- Water resistant battery compartment with sealed silicone rubber push button
- Sealed borosilicate window to resist heat and flash
- Passed 3000 V, 8000 A, (10 cycles) arc blast test at 7 inches from the 12 inch arc
- Easy access (no tools required) battery compartment door
- Universal splined slotted connector attaches to hot sticks
- Made in the USA



## C4002365: Epoxiglas® Cleaning Kit



- Includes essential items for the care and maintenance of Epoxiglas® tools and insulated boom sections of aerial lift trucks
- Proper use of these maintenance aids will ensure that maximum and useful life is obtained from Epoxiglas® products

### Kit consists of four parts:

**Moisture Eater II** - Should be used on contaminated Epoxiglas® during general tool maintenance and in preparation for reglossing a tool's surface. Moisture Eater removes moisture and a wide variety of contaminants such as dirt, tar, grease, tree sap, light metal rubbings and old surface coatings without harming the Epoxiglas® material.

**Abrasive Cleaning Pads** - Pads are used in conjunction with Moisture Eater to remove contamination that clings to the tool's surface. Gloss restorer must be applied after using these pads since cleaning with Moisture Eater II will remove the glossy finish on the tool as well as contamination. The pads may also be used on metal parts to remove oxides and surface corrosion.

**Gloss Restorer Kit** - When mixed and applied to the surface of a cleaned Epoxiglas® tool, they combine to form a clear, tough coating that replaces the original gloss and protects against contamination and moisture.

**Hot Stick Wiping Clothes** - Silicone impregnated cloths are used to wipe down mildly contaminated Epoxiglas®, removing dust and dirt, and depositing a thin protective film on the surface of the tool. They give an added measure of protection when used after recoating with gloss restorer.

**Warning:** Do not use on Gel-Coat or painted boom surfaces

## C4002364: Moisture Eater II Cleaner-Solvent



- Cleans contaminated Epoxiglas® found on hot line tools, line hose and blankets
- Consists of two solvents: one for oils, waxes and silicone-type contamination; one for moisture contamination
- Free of chlorinated hydrocarbons

## C4002538: Moisture Eater II Wipes



- Small pocket-size packets help utilities stay in compliance with OSHA 29 CFR 1910.269 (j)
- Sealed wipes mean no more rags to store or try to keep clean in the field; no more jugs to stow, big spills, evaporation losses or wasteful excesses just to wet large cloths
- The hanger box holds 50 wipes

## C4002568: Silicone Wipes for Hot Line Tools



- Small pocket-size packets help utilities stay in compliance with OSHA 29 CFR 1910.269 (j)
- The hanger box holds 50 wipes
- Sealed wipes mean no more rags to store or try to keep clean in the field
- Chance silicone 8"x10" wipes contain the same silicone that impregnates hot stick wiping cloths in the Epoxiglas® Cleaning Kit
- Removes dust and applies a thin protective coat

# Hastings Live Line Tools Cleaning & Repair

## 10-171: Fiberglass Cleaning & Refinishing Kit

- Kit includes (1) gallon All-Purpose Cleaner, (1) box of 20 Ultra Fine Non-Metallic Abrasive Pads, (1) Qt (2 parts) Clear Epoxy Refinishing Kit Silicone Treated Wiping Clothes
- Used to clean and/or restore fiberglass hot sticks, booms and buckets



## Hot Stick & Boom Wax

- 14 oz. can
- Protects hot sticks and booms



10-091 Single Can  
10-091-1 Case of 6

## 100-90: 18"x18" Silicone-Treated Wiping Cloth

- Deposits a water repellent film while removing dust and dirt particles from the surface of hot sticks and insulated tool handles
- 18"x18" cotton cloth features bound edges and has an open-type weave
- Regular replacement of the silicone-treated cloth will add to the life and safety of the tools



## H10-188: 50 Hot Stick Wipes



- Excellent for daily wiping of hot sticks
- Remove contaminants such as dirt, oils, creosote, and other undesirable matter
- Leaves a silicone moisture barrier which enables water to "bead up", eliminating the "blanket effect" when using hot sticks in wet conditions
- 50 wipes individually packaged in each heavy duty cardboard dispenser box
- Environmentally safe, the used wipes may be disposed of in normal waste containers

## 10-169: 1 Gallon All-Purpose Cleaner

- Excellent cleaner for the following items: Hot line tools, Platforms, Rubber Goods, Rigid Cover-ups, Shop Machinery, Hands, all Plastic Surfaces, Painted Surfaces, Aluminum
- This product is very safe, and is non-toxic, biodegradable, non-alkali, non-flammable, non-acid, and gentle on the skin



## Bucket Barricade

- Provides added protection from arcs and flashes while closing cutouts, from oil spray when working around transformers; as a barrier when working in close proximity to energized hardware, and from wind/weather when working in poor conditions
- Fits any bucket
- Handy tool board included
- Four height adjustments 10", 16", 22", and 28". Just lift and barricade locks in position automatically
- Barricade when stowed is down and out of the way

05-840 18" Wide  
05-841 23" Wide

**WARNING:** Do not use Barricade as a replacement for primary personal protection, arc and blast protection, or any other safety equipment. Any attempt to do so may result in serious injury or death. This barricade is to be used along with all safety equipment and safe working practices required by your company and OSHA.



## Duck Bill Grounding Clamps



1793



1853



21030



21754

Part #	Eye & Clamp Description	ASTM Grade/ Class	Main Line Range	Rating	Weight (lbs)
<b>.96" SMOOTH JAW BRONZE DUCK BILL - GRAVITY ACTUATED - "V" THREAD</b>					
1793	Eye w/ strain relief sleeve, Smooth Jaw	4 / A		350 RMS AMP, 60 Hz	1.3
21080	Eye w/ strain relief sleeve, Smooth Jaw	4 / A	556 MCM ACSR to #6 .96" - .16" Dia.	350 RMS AMP, 60 Hz	1.1
1797*	Mounted w/ strain relief sleeve, Smooth Jaw	4 / A		350 RMS AMP, 60 Hz	4.63
2093	Hanger Stud only				0.4
<b>1.1" SMOOTH JAW ALUMINUM DUCK BILL - SPRING LOADED - "V" THREAD</b>					
21030	Eye w/ strain relief sleeve, Smooth Jaw	5 / A		400 RMS AMP, 60Hz	1.1
21059	Eye w/ strain relief sleeve, Smooth Jaw	5 / A	795 MCM ASR to #6 1.1" - .16" Dia.	400 RMS AMP, 60 Hz	1
21081	Mounted w/ strain relief sleeve, Smooth Jaw	5 / A		400 RMS AMP, 60 Hz	4.3
21754	Hanger Stud Only	5 / A		400 RMS AMP, 60 Hz	.3
<b>1.66" SERRATED JAW ALUMINUM DUCK BILL - ACME THREAD</b>					
1853	Eye w/ strain relief sleeve, Serrated Jaw	5 / B	1590 MCM ACSR to #6 1.66" - .16" Dia.	400 RMS AMP, 60 Hz	1.5

## "C" Type Grounding Clamps



2537



9985



4187

Part #	Eye & Clamp Description	ASTM Grade/ Class	Main Line Range	Rating	Weight (lbs)
<b>1.12" BRONZE "C" CLAMP - ACME THREAD</b>					
9985	Eye w/ strain relief sleeve, Smooth Jaw	5 / A		400 RMS AMP, 60 Hz	1.9
2937	Eye w/ strain relief sleeve, Smooth Jaw	5 / A	795 MCM 26" x 7" ACSR to #8	400 RMS AMP, 60 Hz	1.8
4280*	Mounted w/ strain relief sleeve, Smooth Jaw	5 / A	1.12" - .12" Dia	400 RMS AMP, 60 Hz	4.9
4187	Eye w/ strain relief sleeve, Serrated Jaw	5 / B		400 RMS AMP, 60 Hz	1.9
2537*	Hanger Stud Only				.4

\*Mounted: 1.25" dia. x 6' fiberglass Hotstick permanently mounted

# Salisbury by Honeywell

## "C" Type Grounding Clamps



9984



4279



9984



9983

Part #	Eye & Clamp Description	ASTM Grade/ Class	Main Line Range	Continuous Current Rating	Weight (lbs)
<b>1.25" BRONZE "C" CLAMP - ACME THREAD</b>					
9984	Eye w/ strain relief sleeve Smooth Jaw w/ Flat Lower Jaw	5 / A	1035.5 MCM ACSR to #6 1.25" - .16" Dia.	400 RMS AMP, 60 Hz	2.2
1897	Eye w/o strain relief sleeve Smooth Jaw w/ Flat Lower Jaw	5 / A		400 RMS AMP, 60 Hz	2.1
4255	Eye w/ strain relief sleeve Smooth Jaw w/ Curved Lower Jaw	5 / A		400 RMS AMP, 60 Hz	2.2
21069	Eye w/ strain relief sleeve Smooth Jaw w/ Flat Lower Jaw	5 / A		400 RMS AMP, 60 Hz	2.1
4279	Eye w/ strain relief sleeve Smooth Jaw w/ Curved Lower Jaw	5 / B		400 RMS AMP, 60 Hz	2.2
21070	Eye w/o strain relief sleeve Serrated Jaw w/ Flat Lower Jaw	5 / B		400 RMS AMP, 60 Hz	2.1
9983*	Hanger Stud Only				



21074



20882



4295

Part #	Eye & Clamp Description	ASTM Grade/ Class	Main Line Range	Continuous Current Rating	Weight (lbs)
<b>2" ALUMINUM "C" CLAMP W/ CURVED LOWER JAW - ACME THREAD</b>					
21074	Eye w/ strain relief sleeve, Smooth Jaw	5H / A	3000 MCM ACSR to #6 2" - .16" Dia.	400 RMS AMP, 60 Hz	2.1
21075	Eye w/o strain relief sleeve, Smooth Jaw	5H / A		400 RMS AMP, 60 Hz	2
20882	Eye w/ strain relief sleeve, Serrated Jaw	5H / B		400 RMS AMP, 60 Hz	2.1
21077	Eye w/o strain relief sleeve, Serrated Jaw	5H / B		400 RMS AMP, 60 Hz	2
<b>2.4" BRONZE "C" CLAMP W/ FLAT LOWER JAW - ACME THREAD</b>					
4295	Eye w/ strain relief sleeve, Smooth Jaw	5H / A	2" I.P. S. to #6 2.4" - .16" Dia.	400 RMS AMP, 60 Hz	4.1
4311	Eye w/ strain relief sleeve, Smooth Jaw	5H / A		400 RMS AMP, 60 Hz	4

## Grounding Clamps for Substation Buses



Part #	Eye & Clamp Description	ASTM Grade/ Class	Main Line Range	Continuous Current Rating	Weight (lbs)
<b>3.5" ALUMINUM "C" CLAMP FOR SUBSTATION BUSES - ACME THREAD</b>					
4282*	Eye w/ strain relief sleeve, Smooth Jaw w/ Flat Lower Jaw	5 / A		400 RMS AMP, 60 Hz	2.8
4283	Mounted w/ strain relief sleeve, Smooth Jaw w/ Flat Lower Jaw	5 / A		400 RMS AMP, 60 Hz	5.8
21953	Eye w/ strain relief sleeve Smooth Jaw w/ Flat Lower Jaw	5H / A	3" - 1.5" I.P.S.	400 RMS AMP, 60 Hz	2.9
4341	Long Eye Screw w/ strain relief sleeve, Smooth Upper Jaw w/ Flat Lower Serrated Jaw	5 / A	3.5" - 1.75" Dia.	400 RMS AMP, 60 Hz	2.9
21985**	Long Eye Screw w/ strain relief sleeve Serrated Jaw w/ Flat Lower Jaw	6 / B		400 RMS AMP, 60 Hz	3
<b>6.62" ADJUSTABLE ALUMINUM "C" CLAMP FOR ROUND, SQUARE, RECTANGLE OR "H" SECTION SUBSTATION BUSES - ACME THREAD</b>					
2991	Eye w/ strain relief sleeve, Serrated Jaw w/ Flat Lower Jaw	5H / A		400 RMS AMP, 60 Hz	6.9
2993***	Eye w/ welded single contact stud, Smooth Jaw w/ Flat Lower Jaw	5 / A	6.12" I.P.S.	400 RMS AMP, 60 Hz	7
9967***	Eye w/ welded double contact stud, Smooth Jaw w/ Flat Lower Jaw	5 / A	6.62" - 4" Dia.	400 RMS AMP, 60 Hz	7.3
4378	Oval Eye w/ strain relief sleeve, Smooth Jaw w/ Flat Lower Jaw	5 / A		400 RMS AMP, 60 Hz	6.9

\*Mounted: 1.25" dia x 6' Fiberglass Hotstick permanently mounted

\*\* Accepts 3/4 - 10 ferrule threads

\*\*\* No Ferrule Connection



# Salisbury by Honeywell

## Ground Clamps for Flats, Angles & Rounds



Part #	Eye & Clamp Description	ASTM Grade/ Class	Main Line Range	Continuous Current Rating	Weight (lbs)
<b>GRADE 2 BRONZE FLAT JAW GROUNDING CLAMPS - "V" THREAD</b>					
1815	Eye Screw w/ strain relief sleeve Serrated Jaw	3 / B	1.5" - .06" Flat or Square 1.26" - .06" Dia.	300 RMS AMP, 60 Hz	1.6
<b>GRADE 5 ALUMINUM FLAT JAW GROUNDING CLAMP - ACME THREAD</b>					
4369	Eye screw w/ strain relief sleeve, Serrated Jaw	5 / B	1.5" - .06" Flat or Square 1.26" - .06" Dia.	400 RMS AMP, 60 Hz	2
24441	Eye screw w/ strain relief sleeve, Serrated Jaw	5 / B	1.5" - .06" Flat or Square 1.26" - .06" Dia.	400 RMS AMP, 60 Hz	2

## Ball & Socket System - Socket Clamp & Ball Stud "C" Clamp

The Ball & Socket Grounding System allows for variable angle accessibility. This system is compact and lightweight. There are fixed grounding points on the socket clamp. The 21190 socket clamp, made from bronze alloy, has a socket size of 1" and a threaded bore boss of 5/8" - 11 UNC. The socket clamp has an integral cable support with strain relief sleeve.

The Ball Stud "C" Clamp is a universal clamp that can be used in substations and on overhead lines. This universal clamp can be used as a socket clamp on a 1" Ball Stud and as a 1 1/2" C-Clamp on overhead lines. The eye screw is not extended beyond the body of the clamp, minimizing possible thread damage during handling. Double lead V-thread allows for faster installation, minimizing worker fatigue. External and internal ball studs assembly can be used as a current carrying contact stud.

### Specifications for Ball Stud "C" Clamp

- Aluminum clamp body
- Double lead V-thread eye screw is bronze alloy
- ASTM Type 1, Class A, Grade 5 rating
- Fault current ratings: 43,000 AMP - 15 cycles, 30,000 AMP - 30 cycles
- Ferrule attachment: 5/8" x 11 UNC for Grade 5 rating
- Grounding cable: #2 min size to 4/0 max size



22675



21190

Part #	Description	ASTM Grade/ Class	Continuous Current Rating	Weight (lbs)
21190	w/ strain relief sleeve	5	400 AMP	1.2
21277	w/o strain relief sleeve	5	400 AMP	1.1
22675	1" Ball Stud C-Clamp w/ strain relief	5H	400 AMP	2.7
22704	1" Ball Stud C-Clamp w/o strain relief	5	400 AMP	2.6

# Salisbury by Honeywell

## Grounding Cables

Salisbury Grounding Cables are made with extra flexible strand of soft drawn #30 AWG (.01") copper and are available in three different jackets.

The yellow thermoplastic elastomer jacketed cable is the standard for grounding service. It provides a combination of economy, flexibility and durability. The service temperature ranges from 200° to -50°F. ASTM F 855 Type I.

The black thermoplastic elastomer jacketed cable has a smaller diameter and thinner jacket material giving it better flexibility than the yellow cable. The service temperature ranges from 200° to -50°F. ASTM F 855 Type I.

The PVC transparent flexible thermoplastic jacketed cable allows easy inspection for strand breakage. The flexibility decreases with low temperatures. The service temperature ranges from 140° to -40°F per ASTM F 855, Type III requirements.



Part #	Size	Strand Dia. (inches)	Jacket (inches)	Short Circuit Withstand AMP, RMS, 60 Hz		Continuous Current AMP, RMS, 60 Hz	Weight /1000ft (lbs)
				15 Cycles	30 Cycles		
<b>YELLOW JACKET</b>							
2136	#2-665W	.35	.5	14,500	10,000	200	282
2137	1/0-1064W	.45	.62	21,000	15,000	250	488
2138	2/0-1330W	.49	.65	27,000	20,000	300	537
2139	4/0-2109W	.62	.83	43,000	30,000	400	836
<b>BLACK JACKET</b>							
2636	#2-665W	.35	.47	14,500	10,000	200	263
2637	1/0-1064W	.45	.58	21,000	15,000	250	404
2638	2/0-1330W	.49	.63	27,000	20,000	300	497
2649	3/0-1672W	.55	.72	36,000	25,000	350	680
2639	4/0-2109W	.62	.78	43,000	30,000	400	770
<b>CLEAR-PVC JACKET</b>							
2128	#2-665W	.35	.53	14,500	10,000	200	289
2129	1/0-1064W	.45	.64	21,000	15,000	250	520
2133	2/0-1330W	.49	.70	27,000	20,000	300	546
2288	4/0-2109W	.62	.84	43,000	30,000	400	841

**Ask about our LTL 350 and 500 MCM grounding cables and ferrules for large ampacity applications (refer to page 14)**

# Salisbury by Honeywell

## Plain Shrouded & Unshrouded Ferrules

- **Plain ferrules** are designed for use with all grounding clamps that feature pressure terminals including the 1" duckbill and 1.5" flat jaw clamp.
- **Copper ferrules** are available in two different styles: unshrouded and shrouded. Shrouded ferrules are compressed on both the conductor and the jacket of the cable to reduce bending stress. Unshrouded ferrules are crimped on the conductor strands only. These ferrules are manufactured of tin plated, 99.5% pure copper.
- **Aluminum ferrules** are available in two different styles: unshrouded and shrouded. Shrouded ferrules are compressed on both the conductor and the jacket of the cable to reduce bending stress. Unshrouded ferrules are crimped on the conductor strands only.



Aluminum Plain Unshrouded Ferrules

Part #	Cable Size	Strand Die Codes T&B	Jacket Die Codes T&B	Burndy Die Number	Weight (lbs) ea. pair
<b>Copper Shrouded</b>					
24424	#2	50	71	-	0.30
24425	1/0	50	71	-	0.35
24426	2/0	60	76	-	0.40
24427	4/0	66	106	-	0.45
<b>Copper Unshrouded</b>					
24420	#2	50	-	-	0.30
24421	1/0	50	-	U243	0.30
24422	2/0	60	-	U245	0.35
24423	4/0	66	-	U247	0.35
<b>Aluminum Shrouded</b>					
24434	#2	50	71	-	0.1
24436	2/0	60	76	-	0.15
24437	4/0	71	106	-	0.15
<b>Aluminum Unshrouded</b>					
24430	#2	50	-	-	0.12
24431	1/0	50	-	-	0.12
24432	2/0	60	-	-	0.16
24433	4/0	71	-	-	0.16

## Threaded Grounding Ferrules

Salisbury compression Threaded Grounding Ferrules provide low resistant connection to cable strands with a threaded stud that securely screws into a clamp. Nut and lock washers increase contact pressure and secure the assembly. Tin plated copper ferrules can be used on either bronze or aluminum body clamps. All Salisbury threaded grounding ferrules are unshrouded and manufactured with a 5/8-11 UNC threaded stud and meet the requirements of ASTM F855.



Part #	ASTM Grade	Size	Installing Die Codes T&B	Burndy Die Numbers	Weight ea. pair (lbs)
<b>ALUMINUM THREADED GROUNDING FERRULE</b>					
2026	1	#2	50	-	.2
2027	2	1/0	50	-	.2
2620	3	2/0	60	-	.3
2640	5	4/0	71	-	.3
<b>COPPER THREADED GROUNDING FERRULES</b>					
2022	1	#2	50	U243	.5
2023	2	1/0	50	U243	.4
2024	3	2/0	60	U245	.4
4277	4	3/0	66	-t	.6
2025	5	4/0	66	U247	.6

## ASTM TABLES



**SALISBURY**  
by Honeywell

### ASTM F855-09 TABLE 1 - PROTECTIVE GROUNDING CLAMP RATINGS

**TABLE 1 Protective Ground Cable, Ferrule, Clamp and Assembly Ratings for Symmetrical Current**

Grade	Grounding Clamp Torque Strength, min				Short Circuit Properties <sup>A</sup>								Continuous Current Rating, A RMS, 60 Hz	
	Yield <sup>B</sup>		Ultimate		Withstand Rating, Symmetrical kA RMS, 60 Hz				Ultimate Rating Capacity <sup>C,D</sup> , Symmetrical kA RMS, 60 Hz					
					15 cycles (250 ms)		30 cycles (500 ms)		15 cycles (250 ms)		30 cycles (500 ms)			Maximum Copper Test Cable Size
	lbf-in.	n-m	lbf-in.	n-m	Copper Cable Size	Copper Cable Size	60 cycles (1 s)	Maximum Copper Test Cable Size						
1	280	32	330	37	14	10	#2	18	13	9	2/0	200		
2	280	32	330	37	21	15	1/0	29	21	14	4/0	250		
3	280	32	330	37	27	20	2/0	37	26	18	4/0	300		
4	330	37	400	45	34	25	3/0	47	33	23	250 kcmil	350		
5	330	37	400	45	43	30	4/0	59	42	29	250 kcmil	400		
6	330	37	400	45	54	39	250 kcmil or 2 2/0	70	49	35	350 kcmil	450		
7	330	37	400	45	74	54	350 kcmil or 2 4/0	98	69	48	550 kcmil	550		

<sup>A</sup> Withstand and ultimate short circuit properties are based on performance with surges not exceeding 20 % asymmetry factor (see 9.1 and 12.3.4.2).  
<sup>B</sup> Yield shall mean no permanent deformation such that the clamp cannot be reused throughout its entire range of application.  
<sup>C</sup> Ultimate rating represents a symmetrical current which the assembly or individual components shall carry for the specified time.  
<sup>D</sup> Ultimate values are based upon application of Onderdonk's equation to 98 % of nominal circular mil area allowed by Specifications B 172 and B 173.

Reprinted, with permission, from ASTM F 855-09 Standard Specification for Temporary Protective Grounds to Be Used on De-energized Electric Power Lines and Equipment Table 1, copyright ASTM International, 100 Barr Harbor Drive, West Conshohocken, PA 19428. A copy of the complete standard may be obtained from ASTM, www.astm.org

### ASTM F855-09 TABLE 2 - GROUNDING CABLE FERRULE AND ASSEMBLY RATINGS

**TABLE 2 Ultimate Assembly Rating for High X/R Ratio Applications**

Grade	Size	High Asymmetrical Test Requirements			Test Duration (cycles)
		Rating Rated Current (kA)	X/R = 30 1st Cycle Current Peak (kA) X 2.69	Last Cycle Current Peak (kA)	
1H	No. 2	15	41	23	15
2H	1/0	25	65	37	15
3H	2/0	31	84	46	15
4H	3/0	39	105	58	15
5H	4/0	47	126	70	15
6H	250 MCM	55	148	82	15
7H	350 MCM	68	183	101	15

NOTE 1—The above current values are based on electromechanical test values.  
 NOTE 2—Assemblies that have been subjected to these shall not be re-used.  
 NOTE 3—For use with currents exceeding 20 % asymmetry factor.  
 NOTE 4—See X4.7.2 for additional information.  
 NOTE 5—Alternate testing circuits are available for laboratories that cannot achieve the above requirements. See Appendix X4 for details.

Reprinted, with permission, from ASTM F 855-09 Standard Specification for Temporary Protective Grounds to Be Used on De-energized Electric Power Lines and Equipment Table 2, copyright ASTM International, 100 Barr Harbor Drive, West Conshohocken, PA 19428. A copy of the complete standard may be obtained from ASTM, www.astm.org



# Salisbury by Honeywell

## Ball & Socket System - Ball Studs

The Ball studs and the offset Nema Pad Ball Studs are made from tin-plated copper alloy or copper. They each have a 1" diameter ball. Recommended installation torque of 300 in. lbs. The short stud is used conventionally. The long stud can also be used as the grounding point for "C" or Duck bill clamps that have a jaw width of 2.75" or less. The Offset Nema Pad Ball Stud has the standard Nema bolt hole spacing and also comes in both long and short lengths. The Ball stud cover is made from Orange SALCOR® which allows for multiple angle application when installed using a clampstick.

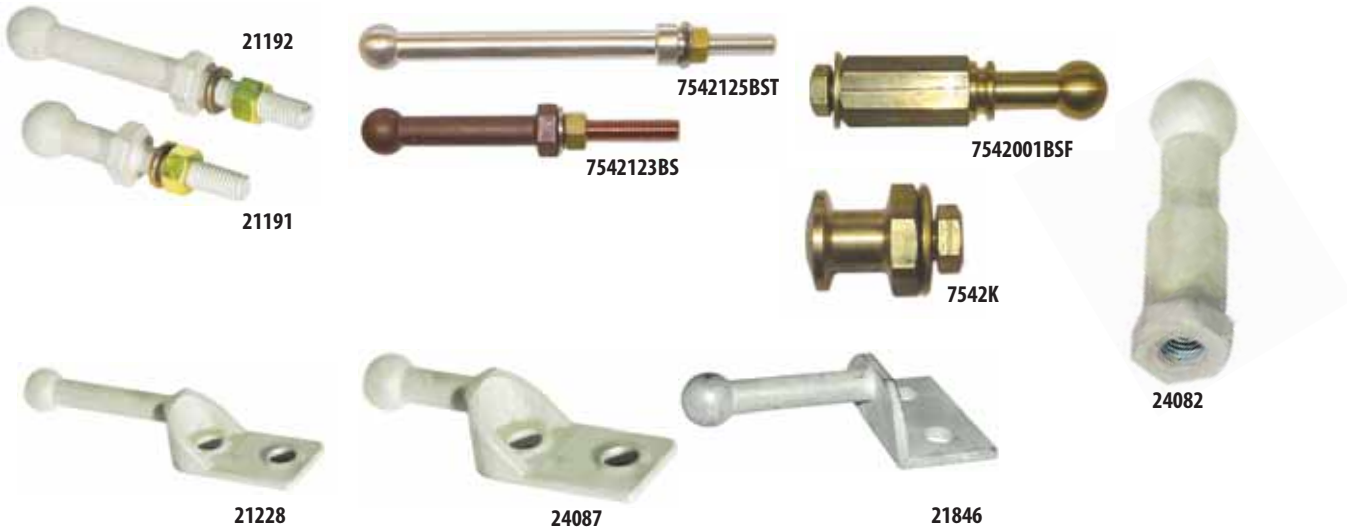

Part #	Description	OAL	Dimensions (inches) thread	Shank	ASTM GRADE	Weight ea. (lbs)
<b>THREAD SIZE - 1/2" - 13 UNC - 2A</b>						
21191	Ball Stud Short, Tin-Plated Copper Alloy	4.38	2.12	1	5	.53
7542121BS	Ball Stud, Copper Alloy	4.7	2.25	1	5	9
21192	Ball Stud Long, Tin-Plated Copper Alloy	6.13	2.12	2.75	5	.81
7542123BST	Ball Stud, Tin-Plated Copper Alloy	6.78	2.5	2.875	5	13
7542123BS	Ball Stud, Copper Alloy	6.78	2.5	2.875	5	13
7542125BST	Ball Stud, Tin-Plated Copper Alloy	9	2.12	5.5	5	16
7542905BS	900 Ball Stud, Copper Alloy	7 x 5.2	2.12	5.5, 2	3	20
7542905BST	900 Ball Stud, Tin-Plated Copper Alloy	7 x 5.2	2.12	5.5, 2	3	20
<b>THREAD SIZE - 3/8" - 16 UNC - 2A</b>						
7542385BST	Ball Stud, Tin-Plated Copper Alloy	9	2.12	5.5	5	16
<b>NEMA PADS AND POTHEAD STUD</b>						
21846	90° Offset NEMA Pad, Tin-Plated Copper Alloy	5.75	-	2.7	5	1
21228	Offset NEMA Pad Short, Tin-Plated Copper Alloy	5.14	-	1	5	.84
24087	Offset NEMA Pad Long, Tin-Plated Copper Alloy	6.9	-	2.7	5	1
7542PHS	Pothead Stud, Spade, Brass	5.4	-	-	2	14
<b>INTERNAL THREAD - 1/2" - 13 UNC - 2A</b>						
24082	Internal Thread Ball Stud, Tin-Plated Copper Alloy	3.85	1.5	.75	5	.54
7542K	3/4" Ground Knob, Brass	1.4	1	.75	3	6
7542001BSF	Female Ball Stud, Brass	-	1.5	1	2	14
21236	Cover for Ball Stud	3	n/a	n/a	n/a	.09
<b>POLE BAND</b>			<b>Fault Duty (15 cycles)</b>		<b>Grade</b>	<b>Weight (lbs)</b>
760001PB	Aluminum Bar		27 kA		3	4

## Sure-Lok® Jumper Clamp

- Featuring a ratchet type locking mechanism
- Clamp tightens with a ratchet action using one hand, with no extra tools for a secure, positive connection
- Pull and turn the locking knob and it loosens like any traditional clamp
- Available in SALCOR® material and the industry's most durable single piece clear plastic jumper clamps
- SALCOR® Jumper Clamps are available in two main line sizes with a maximum use voltage of 35 kV

## Clear Plastic Jumper Clamps

- Compact, lightweight and virtually unbreakable
- Transparency allows easy inspection of the ferrule and cable inside of the handle
- Body and jaw are made from a copper base alloy
- Lower floating ring contact is bronze
- Handles should be cleaned only with mild detergent to maintain the transparency of the handle

## FRF Jumper Clamps

- Designed for maximum loads, voltage and cables
- Blunted points on the handle provide optimum grip, resist impact and will not soften with overloads
- Body and jaw are made from a copper based alloy
- Lower jaw is made of self-lubricating bronze



1786



2261



1610

Part #	Description	Main Line Range	Max AMP Continuous	Rating	OAL Length (inches)	Weight (lbs)
2261	SALCOR® Sure-Lok® Jumper Clamp	477 MCM (.9"-.162")	400	36 kV 0-0, 21 kV 0-GRD	11.5	10
2271	SALCOR® Sure-Lok® Jumper Clamp	954 MCM (1.25"-.162")	400	36 kV 0-0, 21 kV 0-GRD	11.5	11
1786	Clear Plastic Sure-Lok® Jumper Clamp	477 MCM (.9"-.162")	400	36 kV 0-0, 21 kV 0-GRD	11.5	8
2116	Clear Plastic Sure-Lok® Jumper Clamp	954 MCM (1.25"-.162")	400	36 kV 0-0, 21 kV 0-GRD	11.5	10
2260	SALCOR® Jumper Clamp	477 MCM (.9"-.162")	400	36 kV 0-0, 21 kV 0-GRD	11.5	10
2270	SALCOR® Jumper Clamp	954 MCM (1.25"-.162")	400	36 kV 0-0, 21 kV 0-GRD	11.5	11
1610	FRP Jumper Clamp	954 MCM (1.25"-.162")	400	36 kV 0-0, 21 kV 0-GRD	11	14
1785	Clear Plastic Jumper Clamp	477 MCM (.9"-.162")	400	36 kV 0-0, 21 kV 0-GRD	11.5	8
2115	Clear Plastic Jumper Clamp	954 MCM (1.25"-.162")	400	36 kV 0-0, 21 kV 0-GRD	11.5	10

# Salisbury by Honeywell

## Flexible Insulated Jumper Cables

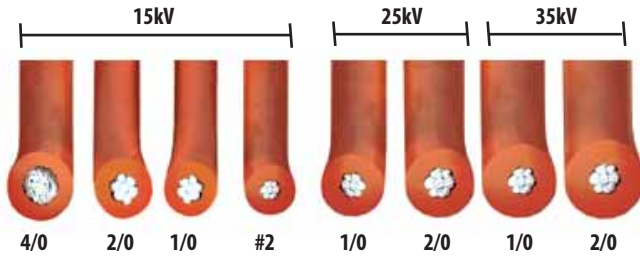

unshrouded



shrouded

FLEXIBLE INSULATED JUMPER CABLES							
Part #	Size & STR. AWG	KV RATING	NOMINAL Ø to GRD	STR. DIA. (inches)	O.A. DIA. (inches)	MAX AMP CONTINUOUS	WEIGHT PER 1000 ft. (lbs)
2754	#2-259W	15	10	.320	.75	200	440
2755	1/0-413W	15	10	.403	.83	250	600
2756	2/0-427W	15	10	.456	.90	300	710
2757	4/0-437W	15	10	.592	1.01	400	1050
21300	1/0-413W	25	15	.403	1.06	250	650
21060	2/0-427W	25	15	.456	1.10	300	750
2059	1/0-413W	35	20	.403	1.22	250	950
4370	2/0-427W	35	20	.48	1.31	300	1060

STICK INSTALLED FLEXIBLE JUMPERS					
Part #	Main Line Range	Max AMP Continuous	Components	Rating	Weight (ea)
2300	1431 ACSR to #6 Sol., 1.5" - .16"	250	2#1895 Alum "C" Clamp 1#1928A Hanger Stud 1#2027 Ferrule 10' #2755 1/0 15kV Cable	15 kV 0-0	16
2308	1431 ACSR to #6 Sol., 1.5" - .16"	200	2#1895 Alum "C" Clamp 1#1928A Hanger Stud 1#2026 Ferrule 12' #2754 #2 15kV Cable	15 kV 0-0	10.8
2317	1431 ACSR to #6 Sol., 1.5" - .16"	250	2#2195 Alum "C" Clamp 1#1928A Hanger Stud 1#2027 Alum Ferrule 12' #2059 1/0 35kV Cable	35 kV 0-0	16
2318	1431 ACSR to #6 Sol., 1.5" - .16"	300	2#2318 Alum "C" Clamp 1#1928A Hanger Stud 1#2620 Alum Ferrule 12' #2756 2/0 15 kV Cable	15 kV 0-0	15.6
2559	1033 ACSR to #6 Sol., 1.25" - .16"	250	2#1853 Alum Duckbill Clamp 1#1858A Hanger Stud 1#2027 Alum Ferrule 10' #2755 1/0 15kV Cable	15 kV 0-0	16
2877	795 ACSR to #8 Sol., 1.12" - .12"	250	2#2532 Alum "C" Clamp 1#2537A Hanger Stud 1#2027 Alum Ferrule 10' #2755 1/0 15kV Cable	15 kV 0-0	11
9976	795 ACSR to #8 Sol., 1.12" - .12"	250	2#9985 Brnz "C" Clamp 1#9983A Hanger Stud 1#2023 Cu Ferrule 10' 2755 1/0 15 kV Cable	15 kV 0-0	12
9977	795 ACSR to #8 Sol., 1.12" - .12"	250	2#2937 Brnz "C" Clamp 1#9983A Hanger Stud 1#2023 Cu Ferrule 10' #2059 1/0 35kV Cable	35 kV 0-0	12.5

## Dead Front Grounding Jumpers & Elbows

- Dead Front Ground Sets are supplied with an insulated grounding elbow, yellow jacketed copper grounding cable and a 1815 bronze flat jaw ground clamp for the ground connection. Grounding elbows are equipped with arc quenching tips as provided on standard load break elbows
- Both 15 kV and 25 kV elbows are available with connectors for 1/0 or 2/0 cable. Assembled sets for 15 kV and 25 kV are available for single phase or three phase grounding requirements. The fault duty rating for 200 AMP grounding elbows is 10 kA for 10 cycles per IEEE 386. Standard three phase sets have a 4 ft. tail connecting to a 2374 four wire connector with 2 ft. leads for the elbows



22630



2962

Part #	Description	Weight ea. (lbs)
<b>COMPLETE 3 PHASE DELTA</b>		
2910	15 kV Elbow w/ 1/0 Cable Connector	1.7
2912	15 kV Elbow 2/ 2/0 Cable Connector	1.7
2935	25 kV Elbow w/ 1/0 Cable Connector	2
2936	25 kV Elbow w/ 2/0 Cable Connector	2
2961	15 kV Single Phase, 6 ft 1/0 Cable w/ Bag	10
2962	15 kV Single, 6 ft 1/0 Cable w/o Bag	8
2963	15 kV Three Phase, 1/0 Cable w/ Bag	22
22630	15 kV Three Phase, 1/0 Cable w/o Bag	20
2971	25 kV Single Phase, 6 ft 1/0 Cable w/ Bag	13
22631	25 kV Single Phase, 6 ft 1/0 Cable w/o Bag	11
2973	25 kV Three Phase, 1/0 Cable w/ Bag	24
22632	25 kV Three Phase, 1/0 Cable w/o Bag	22



## FERRULES & JUMPER CLAMPS

### Grounding Ferrules

- Shrouded ferrules overlap onto the grounding cable jacket for stress relief to the terminal. Two crimps secure the ferrule against the bare strands and one crimp applies on the jacket
- Unshrouded ferrules are available with shrink tubing that overlaps the bare cable conductor and jacket for stress relief
- Available either factory-installed in pairs on any cable length specified or as separate individual units, the ferrules install simply with a hydraulic crimping tool. Complete illustrated installation instructions come with the ferrules and include a table for the crimping die sizes to use

### G4758 Jumper Clamp



- Handle length of 5.625" below the handguard
- The bearing type floating washer lower contact improves gripping action and prevents conductor scoring
- All metals parts are made of copper alloy to improve resistance to oxidation
- 300 AMP continuous current rating is based on using 2/0 jumper cable on the tap side
- Voltage class 15 kV
- Main Line Range: 0.162" to 0.721"
- Jumper Cable Range: #2 to 2/0 Cable
- 2.25lbs

**G4758**      **Pair**  
**T6010003**    **Individual Clamp**

### G4765 Jumper Clamp



- Features the same polyethylene material in the handle as other Chance jumper clamps
- The handle length below the handguard is 7.5"
- 400 AMP continuous current rating is based on using 4/0 jumper cable on the tap side
- Voltage Class 25kV
- Main Line Range: 0.162" to 0.883"
- Jumper Cable Range: #2 to 4/0 Cable
- 2.75lbs

**G4765**      **Pair**  
**T6010039**    **Individual Clamp**

### G4775 Jumper Clamp



- Features a larger contact opening for use on larger conductor distribution lines
- The handle length below the handguard is 8.375"
- Easy to assemble, the connector assemblies are interchangeable between the two sizes of 15kV Jumper Clamps
- 400 AMP continuous current rating is based on using 4/0 Jumper Cable on the tap side
- Voltage class 35 kV
- Main Line Range: 0.162" to 1.165"
- Jumper Cable Range: #2 to 4/0 Cable
- 3 lbs

**G4775**      **Pair**  
**T6010040**    **Individual Clamp**



**Shrouded, Threaded**

**Unshrouded, Threaded**

**Unshrouded, Unthreaded**

**Shrouded, Unthreaded**

Shrouded Plain Copper Ferrules	
For Pressure Type Grounding Clamp Terminals	
C6002630	Cable size #2
C6002631	Cable size 1/0
C6002632	Cable size 2/0
C6002633	Cable size 4/0

Unshrouded Plain Copper Ferrules	
For Pressure Type Grounding Clamp Terminals	
C6002614	Cable size #2
C6002615	Cable size 1/0
C6002616	Cable Size 2/0
C6002617	Cable Size 4/0

Shrouded, Threaded-Stud Copper Ferrules	
For Tapped or Drilled Grounding Clamp Terminals	
C6002622	Cable size #2
C6002623	Cable size 1/0
C6002624	Cable Size 2/0
C6002625	Cable Size 4/0

Unshrouded, Threaded-Stud Copper Ferrules	
For Tapped or Drilled Grounding Clamp Terminals	
C6002606	Cable size #2
C6002607	Cable size 1/0
C6002608	Cable size 2/0
C6002609	Cable size 4/0

# Grounding & Mechanical Jumpers

## Ordering a Grounding or Jumper Assembly

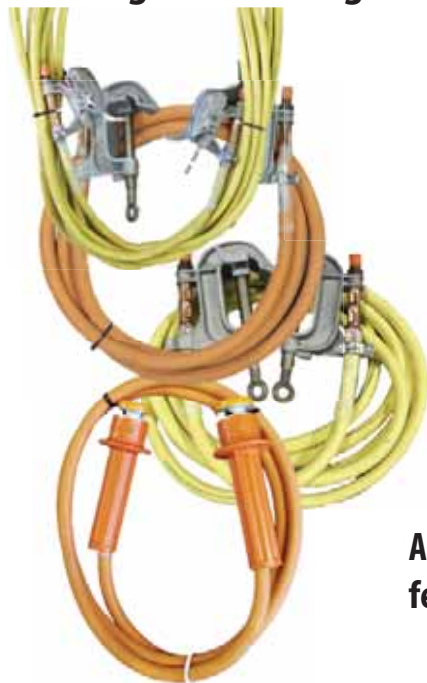

1. Specify Cable Type (600 Volt Grounding Cable is Yellow; 15 kV, 25 kV, 35 kV Jumper Cable is Orange)
2. Specify Cable Length
3. Specify Cable Size (#2, 1/0, 2/0, or 4/0)
4. Specify Ferrule Style (Shrouded, Unshrouded)
5. Specify Threaded or Unthreaded Ferrule
6. Specify Clamp Style (Standard C-Clamps, Duckbill, Barehand, Flat-faced, etc.)

Grounding assemblies are tested for resistance, tagged with resistance value, and dated. Heat shrink is applied to protect from water penetration, providing a barrier to resist moisture and corrosion and providing a positive stress relief of grounding cables at their terminations.

**Ask about our LTL 350 and 500 MCM grounding cables and ferrules for large ampacity applications (refer to Page 14)**

## Grounding Cable

Cable Size	Voltage Class	Stranding	Cable O.D.	Continuous Current	Weight
#2	600 Volts	19/35/30	0.475"	150 AMP 50' - 100' 100 AMP 100'+	270 lbs/1000'
1/0	600 Volts	19/55/30	0.575"	250 AMP 50'-100' 250 AMP 150'+	418 lbs/1000'
2/0	600 Volts	19/70/30	0.635"	300 AMP	542 lbs/1000'
4/0	600 Volts	19/111/30	0.78"	500 AMP	843 lbs/1000'



## Copper Mechanical Jumper Cable

Cable Size	Voltage Class	Stranding	Conductor Diameter	Cable O.D.	Continuous Current	Weight
#2	15 kV	259/#26	0.322"	0.779"	200 AMP	0.438 lbs
1/0	15 kV	413/#24	0.404"	0.863"	260 AMP	0.598 lbs
2/0	15 kV	273/#23	0.455"	0.914"	300 AMP	0.707 lbs
4/0	15 kV	473/#21	0.602"	1.065"	400 AMP	1.047 lbs
1/0	25 kV	413	0.404"	1.113"	260 AMP	0.801 lbs
2/0	25 kV	266	0.450"	1.160"	300 AMP	0.903 lbs
1/0	35 kV	413	0.404"	1.287"	260 AMP	0.985 lbs



# Grounding Equipment

## Hastings Clear Mechanical Jumper Clamps



- Clear, see-through, injection molded jumper clamps are manufactured from high impact polycarbonate material with ultraviolet inhibitors to retard discoloration
- Two sizes of clamps are available: 6 solid through 556.5 MCM and 6 solid through 954 ACSR
- Easy to install as clamps are the duck bill type in order that the jumper might be supported by the conductor while hand tightened
- Thrust bearing design provides low friction for tightening clamp
- Bronze clamping rings have serrated contact surface to insure a good electrical contact with conductors
- Both jumper clamps have molded in grip tabs for easy gripping with rubber gloves
- Machined from brass alloy bar stock; rated for 400 AMP
- Minimum main line range: 6 Solid (.162 dia.)

Hastings	Maximum Main Line Range	Jumper Cable Range
13765	556.5 MCM/477 ACSR	2 Str. 15kV to 4/0 Str. 15kV
13768	954 ACSR 36/1	2 Str. 15kV to 4/0 Str. 15k or 2/0 Str. 25kV or 1/0 Str. 35kV

## Hastings 4370: Screw Ground Rod



- Hastings Screw Ground Rod
- Provides a temporary ground where a system ground is not available
- 5/8" diameter copper weld rod
- 12" bronze handle
- 72" overall length
- C-head ground clamps and clusters with 5/8"
- 11C threaded terminals

## Bashlin 1590C: Traveling Ground



- This is a heavy duty traveling ground for conductors sized up to and including 1590 MCM
- The spring-loaded center sheave maintains tension
- The solid 1/2" aluminum rod is provided for attachment to the ground clamp

## Hastings 5755-6: 4-Way Terminal Block



- C-head ground clamps and clusters with 5/8" – 11 NC threaded terminals
- 4-Way cable splice
- Tested at 28,900 AMP for 15 cycles
- Used for connecting ground cables together

## Bashlin 336A: Grounding Saddle



- Lightweight, aluminum
- For grounding conductors up to and including 336 MCM
- Features graphite bushings, a spring-loaded tension arm, and offset sheaves for solid contact

## C-TYPE GROUNDING CLAMPS

### PSC6003412: C-Type Clamp



- Jaw Opening Size: 0.162" to 2"
- Fault Current Rating: ASTM Grade 5
- Material: Aluminum
- Terminal Type: Drilled for use with Threaded Ferrules
- Handle Type: Eyescrew
- Serrated Jaws
- Continuous Current: 400 AMP
- Fault Current:
  - 15 cycles 43,000 AMP
  - 30 cycles 30,000 AMP
- Recommended Torque: 250 in-lbs
- Jumper Range #2 to 4/0 Cable with Threaded Terminal
- 1.75 lbs

### C6001754: C-Type Clamp



- Jaw Opening Size: 0.128" to 0.998"
- Fault Current Rating: ASTM Grade 3
- Material: Aluminum
- Terminal Type: 5/8"-11 Thread
- Handle Type: Eyescrew
- Smooth Jaws
- Continuous Current: 300 AMP
- Fault Current:
  - 15 cycles 43,000 AMP
  - 30 cycles 30,000 AMP
- Recommended Torque: 250 in-lbs
- Jumper Range #2 to 2/0 Cable with Threaded Terminal
- 1 lb

### G3369: Bus-Bar Clamp



- Jaw Opening Size: 0.368" to 4.5"
- Fault Current Rating: ASTM Grade 5
- Material: Aluminum
- Terminal Type: Pressure
- Handle Type: Eyescrew
- Smooth Jaws
- Continuous Current: 400 AMP
- Fault Current:
  - 15 cycles 43,000 AMP
  - 30 cycles 30,000 AMP
- Recommended Torque: 300 in-lbs
- Jumper Range #2 with Plain Terminal to 4/0 Cable with Plain Terminal
- 5.145 lbs

### C6002271: C-Type Clamp



- Jaw Opening Size: 0.162" to 1.25"
- Fault Current Rating: ASTM Grade 5
- Material: Bronze
- Terminal Type: 5/8"-11 Thread
- Handle Type: Eyescrew
- Smooth Jaws
- Continuous Current: 400 AMP
- Fault Current:
  - 15 cycles 43,000 AMP
  - 30 cycles 30,000 AMP
- Recommended Torque: 250 in-lbs
- Jumper Range #2 Cable to 4/0 Cable with Threaded Terminal

### C6001959: C-Type Clamp



- Jaw Opening Size: 0.162" to 0.814"
- Fault Current Rating: ASTM Grade 2
- Material: Bronze
- Terminal Type: 5/8"-11 Thread
- Handle Type: Eyescrew
- Smooth Jaws
- Continuous Current: 250 AMP
- Fault Current:
  - 15 cycles 43,000 AMP
  - 30 cycles 30,000 AMP
- Recommended Torque: 200 in-lbs
- Jumper Range #2 to 1/0 Cable with Threaded Terminal
- 1 lb

### C6000434: Duckbill Clamp



- Jaw Opening Size: 1.506" to 0.162"
- Fault Current Rating: ASTM Grade 5
- Material: Aluminum
- Terminal Type: Pressure
- Handle Type: Eyescrew
- Serrated Jaws
- Continuous Current: 400 AMP
- Fault Current:
  - 15 cycles 43,000 AMP
  - 30 cycles 30,000 AMP
- Recommended Torque: 250 in-lbs
- Jumper Range #2 to 4/0 Cable with Plain Terminal
- 1.96 lbs

## C6002276: C-Type Clamp



- Jaw opening size: 0.128" to 1.25"
- Fault Current Rating: ASTM Grade 5
- Material: Aluminum
- Terminal Type: Pressure
- Handle Type: Eyescrew
- Serrated Jaws
- Continuous Current: 400 AMP
- Fault Current:
  - 15 cycles 43,000 AMP
  - 30 cycles 30,000 AMP
- Recommended Torque: 250 in-lbs
- Jumper Range #2 to 4/0 Cable with Plain Terminal
- 1.5 lbs

## C6002281: C-Type Clamp



- Jaw Opening Size: 0.162" to 2"
- Fault Current Rating: ASTM Grade 5
- Material: Aluminum
- Terminal Type: Pressure
- Handle Type: Eyescrew
- Smooth Jaws
- Continuous Current: 400 AMP
- Fault Current:
  - 15 cycles 43,000 AMP
  - 30 cycles 30,000 AMP
- Recommended Torque: 250 in-lbs
- Jumper Range #2 to 4/0 Cable with Plain Terminal
- 2.75 lbs

## C6001734: Duckbill Clamp



- Jaw Opening Size: 0.162" to 1.162"
- Fault Current Rating: ASTM Grade 5
- Material: Aluminum
- Terminal Type: 5/8"-11 Thread
- Handle Type: Eyescrew
- Smooth Jaws
- Continuous Current: 400 AMP
- Fault Current:
  - 15 cycles 43,000 AMP
  - 30 cycles 30,000 AMP
- Recommended Torque: 250 in-lbs
- Jumper Range #2 with Threaded Terminal to 4/0 Cable with Threaded Terminal
- 1.372 lbs

## C6002255: C-Type Clamp



- Jaw Opening Size: 0.162" to 2"
- Fault Current Rating: ASTM Grade 5
- Material: Aluminum
- Terminal Type: 5/8"-11 Thread
- Handle Type: Eyescrew
- Smooth Jaws
- Continuous Current: 400 AMP
- Fault Current:
  - 15 cycles 43,000 AMP
  - 30 cycles 30,000 AMP
- Recommended Torque: 250 in-lbs
- Jumper Range #2 Cable to 4/0 Cable with Threaded Terminal
- 2 lbs

## C6000197: Duckbill Clamp



- Jaw Opening Size: 0.162" to 1.506"
- Fault Current Rating: ASTM Grade 5
- Material: Aluminum
- Terminal Type: 5/8"-11 Thread
- Handle Type: Eyescrew
- Serrated Jaws
- Continuous Current: 400 AMP
- Fault Current:
  - 15 cycles 43,000 AMP
  - 30 cycles 30,000 AMP
- Recommended Torque: 250 in-lbs
- Jumper Range #2 with Threaded Terminal to 4/0 Cable with Threaded Terminal
- 1.862 lbs

## C6002282: C-Type Clamp



- Jaw Opening Size: 0.162" to 2"
- Fault Current Rating: ASTM Grade 5
- Material: Aluminum
- Terminal Type: Pressure
- Handle Type: Eyescrew
- Serrated Jaws
- Continuous Current: 400 AMP
- Fault Current:
  - 15 cycles 43,000 AMP
  - 30 cycles 30,000 AMP
- Recommended Torque: 250 in-lbs
- Jumper Range #2 to 4/0 Cable with Plain Terminal
- 2.5 lbs

## C6001735: Flat-Face Clamp



- Jaw Opening Size: 0.125" to 1.5"
- Fault Current Rating: ASTM Grade 3
- Material: Aluminum
- Terminal Type: 5/8"-11 Thread
- Handle Type: Eyescrew
- Serrated Jaws
- Continuous Current: 300 AMP
- Fault Current:
  - 15 cycles 27,000 AMP
  - 30 cycles 20,000 AMP
- Recommended Torque: 250 in-lbs
- Jumper Range #2 to 2/0 Cable with Threaded Terminal
- 1.5 lbs

## C6002100: Ball Stud Clamp



- Jaw Opening Size: 0.125" to 1.5"
- Fault Current Rating: ASTM Grade 5
- Material: Bronze
- Terminal Type: Drilled
- Handle Type: Eyescrew
- Serrated Jaws
- Continuous Current: 400 AMP
- Fault Current:
  - 15 cycles 43,000 AMP
  - 30 cycles 30,000 AMP
- Recommended Torque: 250 in-lbs
- Threaded terminal to 4/0 Cable with Threaded Terminal
- .95 lbs

## C6002232: Flat-Face Clamp



- Jaw Opening Size: 0.125" to 1.5"
- Fault Current Rating: ASTM Grade 5
- Material: Bronze
- Terminal Type: 5/8"-11 Thread
- Handle Type: Eyescrew
- Serrated Jaws
- Continuous Current: 400 AMP
- Fault Current:
  - 15 cycles 43,000 AMP
  - 30 cycles 30,000 AMP
- Recommended Torque: 250 in-lbs
- Jumper Range #2 to 4/0 Cable with Threaded Terminal
- 2.94 lbs

## C6002231: Flat-Face Clamp



- Jaw Opening Size: 0.125" to 1.5"
- Fault Current Rating: ASTM Grade 5
- Material: Bronze
- Terminal Type: 5/8"-11 Thread
- Handle Type: T-Handle
- Serrated Jaws
- Continuous Current: 400 AMP
- Fault Current:
  - 15 cycles 43,000 AMP
  - 30 cycles 30,000 AMP
- Recommended Torque: 250 in-lbs
- Jumper Range #2 to 4/0 Cable with Threaded Terminal
- 4 lbs

## T6001798: Grounding Clamp



- Jaw Opening Size: 0.125" to 1.5"
- Fault Current Rating: ASTM Grade 3
- Material: Aluminum
- Terminal Type: 5/8"-11 Thread
- Handle Type: T-Handle
- Serrated Jaws
- Continuous Current: 300 AMP
- Fault Current:
  - 15 cycles 27,000 AMP
  - 30 cycles 20,000 AMP
- Recommended Torque: 250 in-lbs
- Jumper Range #2 to 2/0 Cable with Threaded Terminal
- 1.5 lbs

## C60012256: Grounding Clamp



- Jaw Opening Size: 0.162" to 2"
- Fault Current Rating: ASTM Grade 5
- Material: Aluminum
- Terminal Type: 5/8"-11 Thread
- Handle Type: Eyescrew
- Serrated Jaws
- Continuous Current: 400 AMP
- Fault Current:
  - 15 cycles 43,000 AMP
  - 30 cycles 30,000 AMP
- Recommended Torque: 250 in-lbs
- Jumper Range #2 to 4/0 Cable with Threaded Terminal
- 1.75 lbs

## Apparatus Grounding Clamps



- C6002100** Drilled for 5/8-11 UNC Threaded Ferrule
- C6002101** Tapped for 5/8-11 UNC Threaded Ferrule
- T6002320** Tapped for 5/8-11 UNC Threaded Ferrule
- C6002300** Eyescrew with Pressure Terminal

- For restricted-space applications and as a truck-grounding system, this compact design delivers a high-current rating usually associated with only large clamps
- Applies to a wide range of switching equipment, including: industrial metalclad gear, indoor and outdoor substations, overhead and underground distribution
- For trucks, a ball stud permanently mounts on each body
- Clamp bodies and eyescrews are a bronze alloy
- C6002100, C6002101, T6002320 are designed for threaded stud ferrule on #2-4/0 grounding cable
- C6002300 is designed for plain-plug ferrule on #2 to 4/0 grounding cable

## 4-Way Terminal Block

- Used to attach ground leads from grounding clamps to a common ground
- Ideal where permanent temporary grounding sets are part of substation emergency equipment
- Accommodates 4/0 grounding cables with plain ferrules
- Continuous current: 400 AMP
- Fault Current:
  - 15 cycles 43,000 AMP
  - 30 cycles 30,000 AMP
- G4754-1 is for Plain Plug Ferrules
- T6001964 is for Threaded Ferrules



## Ball Studs

- For restricted-space applications and as a truck-grounding system, this compact design delivers a high-current rating usually associated with only large clamps
- Applies to a wide range of switching equipment, including industrial metal-clad gear, indoor and outdoor substations, overhead and under ground distribution
- For trucks, a ball stud permanently mounts on each body
- Ball-studs are bronze alloy and tin-plated; lockwasher and nut are silicone bronze
- Have nominal 1" diameter ball and stud to fit NEMA terminal pads

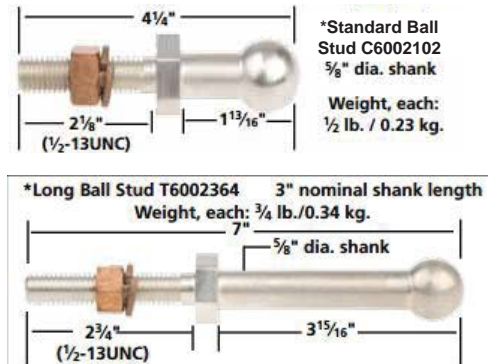

Part no.	Overall length	Stud length	Type
C6002102	4.25"	1 13/16"	Standard Ball Stud
T6002364	7"	3 15/16"	Long Ball Stud
T6002867	3.3"	1.8"	Female Threaded Ball Stud
C4060416	Ball Stud Cover		

## C4060416: Grounding Stud Cover

- May help prevent flashover on ball studs installed in enclosed switchgear, switchyards or substations
- An environmental protector to reduce corrosion and contamination on the ball-stud when energized cover is not intended for personnel protection
- Should not be considered as insulative cover-up equipment
- Provides 400 volts per mil puncture strength
- Resilient ozone/corona-resistant thermoplastic elastomer does not absorb water
- Resists aging/checking and retains high-visibility orange colour
- Snap-fit keeps cover in place
- The 5/8" I.D. loop at top permits hot-line tools to "pop" it on and off



## T6000865: Grounding Assembly Storage Bag

- Easy-to-see, bright yellow protective bag is made of double vinyl laminated open-weave polyester cloth
- Lightweight and durable with nylon stitching through out
- Plywood bottom is covered inside and out with metal skids on bottom of bag
- Full-separating closure constructed with heavy duty snaps and heavy webbing handles



## T6001549: Cluster Grounds

- Compact 5" aluminum-alloy bar (5/8" diameter)
- Accepts C-type or duckbill clamps for phase-to-phase grounding technique
- Adjustable wheel binder and 36" chain for wood-pole applications



## P6001593: Head Shrink Tube - 5" Length

- Clear heat-shrink tubes provide corrosion-inhibitor by excluding moisture and stress-relief for cable jacket and ferrule-to-stranding connection
- Visual inspection of cable condition through clear heat-shrink tube determines breakage or corrosion that other wise requires continuity test
- Units expose 1/2" of cable strands at junction point



## C6000000: Static Ground Set

- Eliminate the problem of electrostatic charge when working insulator strings
- Drains off the charge from the insulator string to the tower leg
- The adjustable jaws of the Static Ground fit insulator caps from 2.5" to 6"
- Overall length with a 1.25" x 19" Epoxiglas® pole is 30"



## Truck Grounding Set

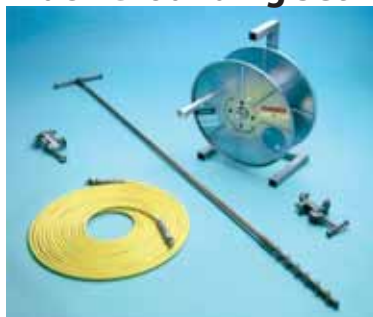

- Convenient set provides means to drain off capacitance or static charges from winch trucks and aerial devices
- Flat face clamp is for secure attachment to the truck bed at an area cleaned for electrical contact
- C-type clamp is for secure attachment to ground rod
- This grounding method should not be considered adequate protection to personnel against conductor contact

T6001971 Complete Assembly

Includes:

3370 Screw Ground Rod

T6001798 Flat Face Ground Clamp

C6001754 C-Type Ground Clamp

S6116 C-Type Ground Clamp

C6002618A Shrouded Aluminum Ferrules

C4176086 Storage Reel





# Clamps

## C Clamp

- Can be installed on all electrical facilities, apparatus, tubes and conductors as well as various equipment (trucks, pulling equipment, etc.)
- This universal clamp can also be used on a jumper cable
- Installation on conductor, round bus bar and grounding ball stud of 25mm
- Thermal shock indicator changes color (from white to red) when the clamp reaches a temperature of 200° F (93°C)
- Stress-relief to reduce cable damage and serve as a shock damper if fault occurs, which protects cable strands
- Locations on each side of the clamp for 20mm or 25mm grounding ball studs installation, which serve as support studs for either a grounding cluster or cascade assembly
- Fitted to receive a 5/8-11UNC threaded stud ferrule
- Lubrication chamber for upkeep of threads
- Installation eye for installing clamp with shotgun stick
- Double internal threads for fast installation and removal
- Material: Aluminum Clamp and Keeper, Bronze or Aluminum Eye Screw

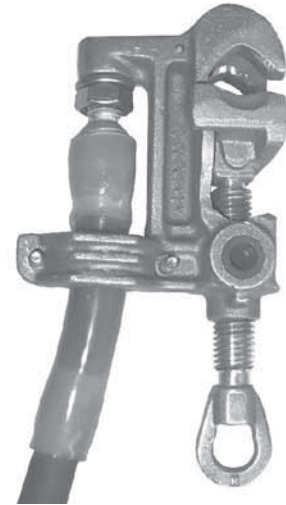

Capacity 15 Cycles	Capacity 30 Cycles	For Ground Stud	Jumper Cable Min.	Jumper Cable Max.	Main Conductor Min. (in)	Main Conductor Max. (in)	Jaw	Continuous Current Rating	Weight (lbs)
35kA (IEC) 43kA (ASTM)	30A (ASTM)	20mm	2 AWG	4/0 AWG	#8 (.16)	556 (.86)	1-3/8	400A	1.3
35A (IEC) 55 kA (ASTM)	39kA (ASTM)	25mm	2 AWG	4/0 AWG	#8 (.16)	795 (1.13)	1-3/8	400A	1.4

## Universal Clamp

- Can be installed on all electrical facilities, apparatus, tubes, and conductors as well as various equipment (trucks, pulling equipment, etc.)
- Installation on conductor, round bus bar and grounding ball stud of 30 mm
- Tested to 5H (HC-10041) and 7H (HC-10041-A)
- Tested and certified only with MPS components
- Stress relief to reduce cable damage and serve as a shock damper if fault occurs, which protects cable strands
- Fitted to receive a 5/8-11 or 3/4-10 UNC threaded stud ferrule
- Lubrication chamber for upkeep of threads
- Double internal threads for fast installation and removal
- No exposed threads for minimal maintenance
- Body and Eye Screw: Aluminum A356T6



**Ask about LTL's 350 and 500 MCM grounding cables and ferrules for large ampacity applications (refer to Page 14)**

Dimension	Capacity 15 Cycles	Jumper Cable Min.	Jumper Cable Max.	Main Conductor Max (in)	Main Conductor Max (in)	For Ground Stud	Jaw	Tested 15 Cycles	Max. Peak	Last Cycle Peak	Weight (lbs)	Standard Pack
15.5 x 6.5 x 3.25	55kA (IEC) 74kA (ASTM)	#2	4/0	1/0 (.40)	1796 (1.60)	30mm	2"	55kA (IEC) 47kA (ASTM)	126kA	70kA	3.9	6
15.5 x 6.5 x 3.25	55kA (IEC) 47kA (ASTM)	#2	350 MCM	1/0 (.40)		30mm	2"	5kA (IEC) 68k	183kA	101kA	3.9	8

## Chance G3370: Temporary Ground Rod

- The Chance Screw Ground Rod provides a temporary ground where a system ground is not available
- When installed, the 6' spiraled ground rod develops less resistance than straight ground rods, actual effectiveness depends upon soil properties
- The reusable Ground Rod is copper clad
- The helix (spiral), handle and wing nut are bronze
- Continuous Current 400 AMP
- Fault Current - 15 cycles 43,000 AMP
- Fault Current - 30 cycles 30,000 AMP
- Material Type Standard
- UPC Code 09635903820
- Standard Package 1
- Standard Package Unit Each
- Min Order Qty 1
- Weight / Ea. 7.595 lbs



## Grounds Warning Placard 16" x 18"

- Fluorescent orange identification marker
- Identification marker for temporary grounds
- Features a reflective striping for night time visibility
- Secured onto the ground with Velcro
- "Grounds" is stenciled onto the marker

13-526 Double-Sided

13-528 Single-Sided



## Grounding Reels with Cable

- Provides a simple, positive means for grounding line trucks or other vehicles parked in electrically hazardous areas
- Inverse loop design, silver-plated copper contact pressure under fault conditions
- Compression terminals connect the cable to the reel and ground clamp
- A removable plastic cover encases the shafts contacts to reduce contamination



## Grounding Reels without Cable

- Provides a simple, positive means for grounding line trucks or other vehicle parked in electrically hazardous areas
- Inverse loop design, silver-plated copper contact pressure under fault conditions
- Compression terminals connect the cable to the reel and ground clamp
- A removable plastic cover encases the shafts contacts to reduce contamination

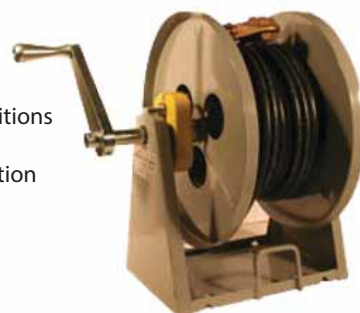

NOTE: Reels do NOT include cable

# Pfisterer

## Ball Pins

Part #	For Max. Cable Cross Section mm <sup>2</sup>	Max. Permissible Short Circuit Current I <sub>k</sub> 0,5 s in A	Key (SW)	Threaded Pin (d x l mm)	Weight (1/kg)
<b>Ø 20mm: E-Cu, ball pin electro-tinned; thread bolt of steel, for universal conductor screw clamp 360 330 002</b>					
360 382 004	95	26500	22	M12x28	0.15
360 382 005	95	26500	22	M12x38	0.16
360 382 006	95	26500	22	M12x48	0.17
<b>Angled, Ø 20mm: CuNiSi ball pin, electro-tinned, for universal conductor screw clamp 360 330 002</b>					
360 784 001	95	26500	24	M12x38	0.16
<b>Ø 25mm: Ball pin of E-Cu, electro-tinned; threaded bolt, steel nut and washer for universal conductor screw clamp 360 332 001 and multi purpose conductor screw clamp 360 333 002</b>					
360 384 002	120	33500	27	M12x28	0.22
360 384 003	120	33500	27	M12x38	0.23
360 384 004	120	33500	27	M16x48	0.24
360 938 095	120	33500	27	M16x25	0.28
360 938 939	120	33500	27	M16x55	0.31



360 382 004



360 784 001



360 384 002

## Universal Conductor Screw Clamp

Part #	For Max. Cable Cross Section (mm <sup>2</sup> )	Max. Permissible Short Circuit Current I <sub>k</sub> 0,5 s in A	Clamping Range (mm)	Clamp Width (mm)	Connecting Screw	Weight (1/kg)
<b>Universal: For the connection of cables up to 95mm<sup>2</sup> Suitable for connection to ball pins Ø 20mm, T-bolts width 30mm/Ø 15mm, circular conductors up to Ø 20mm, flat conductors up to 20 mm.</b>						
<b>Body of CuZn, electro-tinned, spindle and stainless steel A2 connecting screw</b>						
360 330 002	95	26500	20	34	M12	0.62
<b>Universal: For the connection of cable up to 120mm<sup>2</sup> Suitable for connection to ball pins Ø 25mm, T-bolts width 30mm/Ø 15mm, circular conductors up to Ø 20mm, flat conductors up to 20 mm.</b>						
<b>Body of CuNiSi, electro-tinned, spindle and stainless steel A2 connecting screw</b>						
360 332 001	120	33500	20	34	M12	0.63
<b>Multi-purpose: For the connection of cable up to 120mm<sup>2</sup> Suitable for connection to ball pins Ø 25mm and 30mm, T-bolts #360 386..., circular conductors up to Ø 25mm, flat conductors up to 20 mm.</b>						
<b>Body of copper alloy, electro-tinned, spindle and stainless steel A2 connecting screw</b>						
360 333 002	120	33500	2-25	50	M12	0.86



360 330 002



360 333 002

## Protection Hood



- Salisbury's Arc Flash Hoods (balaclava) create 360° head and neck protection from arc flash dangers when used with an AS2000, AS1200 or AS1000 Series Face Shield Unit w/Chin Cup. Each Arc Flash Hood is made from two layers of rib knit material and has an elastic face opening that maintains its shape and size

*CAUTION: Arc Flash Hoods must be worn in combination with a faceshield in order to comply with the requirements of NFPA 70E and will protect 360° inside the arc flash boundary*

**AFHOOD10 10 cal/cm<sup>2</sup> protection**

**AFHOOD15 15 cal/cm<sup>2</sup> protection**

**AFHOOD20 20 cal/cm<sup>2</sup> protection**

## ACB4030PLT: Arc Flash Protection Bib Overalls, Green



- 40 cal/cm<sup>2</sup>\* ATPV ratings
- Approximately 60% lighter fabric weight than standard 40 calorie garment
- 2 layers – 5 oz/yd<sup>2</sup> (141.747 g/m<sup>2</sup>) & 6 oz/yd<sup>2</sup> (170.097 g/m<sup>2</sup>) - Sewn with Nomex® thread
- Integrated heavy duty suspenders
- Relaxed cut for greater mobility
- 30" inseam
- Adjustable hook and pile waist straps
- Bib front for added protection
- Adjustable gussets on pant cuffs
- Meets current ASTM F1506 and NFPA 70E standards

Sizes S, M, L, XL, 2XL, and 3XL

**CONTACT LTL FOR SIZING CHART**

## ACC4032PLT: Arc Flash Protection Coats



- 40 cal/cm<sup>2</sup>\* ATPV ratings
- Approximately 60% lighter fabric weight than standard 40 calorie garment
- 2 layers – 5 oz/yd<sup>2</sup> (141.747 g/m<sup>2</sup>) & 6 oz/yd<sup>2</sup> (170.097 g/m<sup>2</sup>)
- Sewn with Nomex® thread
- 32" long
- Nomex® wristlets
- Expansion back for added comfort
- Dual stage front closure with high temperature plastic zipper on the - 31 - 100 cal/cm<sup>2</sup>\* coats
- FR hook and pile storm flap
- Coats are intended to be used with PRO-HOODS
- Meets current ASTM F1506 and NFPA 70E standards

Sizes S, M, L, XL, 2XL, and 3XL

*\*IMPORTANT - NFPA 70E DOES NOT HAVE A HAZARD RISK CATEGORY ABOVE 40 CAL/CM<sup>2</sup>. WORKING ON LEVELS ABOVE 40 CAL/CM<sup>2</sup> SHOULD BE AVOIDED BECAUSE OF THE BLAST HAZARDS CAUSED BY ARC FLASH*

## LFH40PLT & LFH40: Arc Flash Lift Front Hood - 40 cal/cm<sup>2</sup>



- 40 cal/cm<sup>2</sup>\*, premium lightweight, 2 layers, 5 oz/yd<sup>2</sup> over 6.32 oz/yd<sup>2</sup> arc flash protection hood w/ SA79R03 hardhat
- Optional FLKIT: attachable task light (1) & FLCLIP



- 40 cal/cm<sup>2</sup>\*, 2 layers, 9oz/yd<sup>2</sup> over 9oz/yd<sup>2</sup> arc flash protection hood, w/ SA79R03 hard hat

# Salisbury by Honeywell

## AS1000: Arc Flash Protection Face Shield



- 10 cal/cm<sup>2</sup> ATPV rating when used with the included chin cup
- 7.5" x 20" viewing area
- Extra light tint
- .06" thick
- Absorbs >99.9% of harmful UV radiation
- Resistant to fogging
- Shield meets current ANSI Z87.1 and tested to ASTM F2178 specifications
- 10 cal/cm<sup>2</sup>

## AS1200HAT: Arc Flash Protection Face Shield



- Stows in a balanced, compact position, centered over the top of the hard hat when not needed
- The AS1200HAT has an ATPV rating of 12cal/cm<sup>2</sup>\* and utilizes nanotechnology to provide a clearer, more transparent window for improved visibility. The shield/window is designed to be easily replaced without tools. The faceshield unit includes ventilation ribs that allow a natural convection air flow through the top of the face shield. This reduces fogging of the visor, lowers CO2 levels and improves comfort for the user
- AS1200HAT contains an AS1200 Face Shield with SA7R03 Hard Hat  
\*In order to achieve 360 degree 12 cal/cm<sup>2</sup> protection, a 12 cal/cm<sup>2</sup> balaclava must be worn.

## AS1200: Protective Face Shield - HRC2



- 7.5" x 20" viewing area
- Extra light tint
- .06" thick
- Absorbs >99.9% of harmful UV radiation
- Resistant to fogging
- Meets current ANSI Z87.1 and is CSA standard compliant
- Tested to ASTM F2178 specifications

## AS2000HAT: Arc Flash Protection Face Shield



- 20 cal/cm<sup>2</sup>\* ATPV rating
- 7.5" x 20" viewing area
- Extra light tint
- .06" thick
- Absorbs >99.9% of harmful UV radiation
- Resistant to fogging
- Shield meets current ANSI Z87.1 and tested to ASTM F2178 specifications 20 cal/cm<sup>2</sup>
- AS2000HAT contains an AS2000 Face Shield with SA79R03 Hard Hat  
\*In order to achieve 360 degree 20 cal/cm<sup>2</sup> protection, a 20 cal/cm<sup>2</sup> balaclava must be worn.



Part #	Description
AS2000HAT-CLR	AS2000HAT w/ transparent chin guard
AS2000FS	Replacement face shield/window for AS2000 Face Shield
AS2000FB	20 cal/cm <sup>2</sup> , universal fit, arc flash protection face shield unit for full brim hard hats
AS1000FS	Replacement face shield for AS1000HAT, AS1000FB, and AS1000U
AS1200HAT-CLR	12 cal/cm <sup>2</sup> , AS1200HAT w/ transparent chin guard
AS1200FB	12 cal/cm <sup>2</sup> , universal fit, arc flash protection face shield unit for full brim hard hats
AS1200U	12 cal/cm <sup>2</sup> , universal fit, arc flash protection face shield unit for front brim hard hats
AS12CLR-FB	Transparent chin guard for AS1200 series full brim
AS1200FS-FB	12 cal/cm <sup>2</sup> , replacement face shield/window for AS1200FB full brim
AS1200FS	12 cal/cm <sup>2</sup> , replacement face shield/window for AS1200 series
FLKIT	1 Attachable Task Light and 1 Flashlight Clip



## CCN-LGG6RB-RL: Deluxe FR 10 Pocket Coverall

- Oberon FR Deluxe CCN Coverall - 10 Pocket configuration (2 chest patch pockets (1 w/ FR mesh), 2 front pant "slash" pockets, 2 front "pass through" pockets, 2 rear patch pockets, 1 side tool pocket on pant leg, 1 pencil sleeve pocket). Zipper front with Velcro placard closure down front of coverall for easy use and removal. Collar has generous comfortable fit. Action Back design for improved range of motion at shoulders. Elastic waist band for more comfortable & attractive fit. Generous seat for comfort. FR Velcro button on sleeve for adjustment. Zipper pant legs to easily pull over boots.
- Deluxe I&E Arc Flash Coverall
- Meets NFPA 70E, CSA Z462 and ASTM F1930
- 10 Pocket Coverall w/ Reflective Striping
- Glen Guard - 6.4 oz (10 cal)
- Royal Blue
- Size RL (Regular L)



## CCV-LTS7OR-RL: Deluxe Industrial

- Lightweight fabric
- Inherently Flame Resistant fabric (IFR)
- 10 Pocket design
- (2) chest patch pockets with flap
- (1) FR mesh over-pocket on right
- (2) rear patch pockets
- (2) front in-seam pockets
- (2) front pass-through pockets
- (1) tool pocket on leg,
- (1) chest radio loop, and
- (1) pencil pocket
- Zipper front for easy don/doffing
- Zippered pant legs to expand to pull over heavy boots
- CSA Z96 Class 3 Level 2 Compliance
- Made in USA



## STD-LGG6NB-RL: Shirt Deluxe

- M-LGG W-6 C-NB Sz-RL
- Oberon Flame Resistant Work Shirts - 2 chest patch pockets with Pencil slot in one pocket. Button Down Collar. Yoke design shoulders for comfortable fit. Shirt is generously sized for comfortable fit around chest. 2.5" vented cuff with button
- 6 button down placard for attractive finish
- FR Work Shirt
- Meets NFPA 70E, CSA Z462 and ASTM F1930
- Button Down Collar & 2 Chest Pockets w/ Flaps
- Glen Guard - 6.4 oz (10 cal)
- Navy Blue
- Size RL (Regular L)



## STD-CBW9NB-RL: Shirt Deluxe

- M-CBW W-9 C-NB Sz-RL
- Oberon Flame Resistant Work Shirts - 2 chest patch pockets with Pencil slot in one pocket. Button Down Collar. Yoke design shoulders for comfortable fit. Shirt is generously sized for comfortable fit around chest. 2.5" vented cuff with button. 6 button down placard for attractive finish.
- FR Work Shirt
- Meets NFPA 70E, CSA Z462 and ASTM F1930
- Button Down Collar & 2 Chest Pockets w/ Flaps
- ITEX Banwear (88:12) - 9.5 oz (13 cal)
- Navy Blue
- Size RL (Regular L)



## KITBAG: KIT BAG FOR ARC FLASH CLOTHING



# Oberon

## IFR5B-XL: Arc Set IFR HRC

- Oberon Arc Flash Clothing Set - Inherently/Permanently FR (ARC) Series - ORC5 (65+ cal) - Contains a ARC65 Hood with Hard Cap (Ratchet Adjustable Suspension), ARC65 Bib-Overall & ARC65 Coat. Rubber Insulating Gloves and Storage Bags sold separately
- Oberon ARC Series Arc Flash PPE
- Inherently Flame Resistant
- Light Weight, Durable
- Hood w/ Hard Cap, Coat & Bib-Overall
- Arc Rating = 70 calories/cm<sup>2</sup>
- Size XL



## CAT11-BH-GR: Gray Balaclava

- NFPA 70E-2012
- CSA Z462-12
- HRC 2 (8+ cal)
- Made in USA



## ARC14-BH-NB: ARC 14 Balaclava Hood-Navy-Regular

- CSA Z462-12
- HRC 2 (8+ cal)
- Made in USA
- NFPA 70E-2012



## 21ARC12AF-C+500: Deluxe 12 cal ARC Shld w/Hard Cap

- NFPA 70E-2012
- CSA Z462-12
- ASTM F2178-08
- ANSI Z87.1-2010
- ANSI Z89.1-2009
- Made in USA



## CAT4-C+HVS

- Oberon Arc Flash Hood - CAT Series
- Arc Rating = HRC4 (40+ calories)
- Assembly = Oberon Ratchet Hard Cap
- Fabric = FR Treated Cotton
- Excellent Visibility, Best Visible Light Transmission (VLT)
- Add Hood Ventilation System (HVS) for additional ventilation



## 21AGR8AF-CC+500: True Colour Grey (TCG) ArcShield

- True Colour Grey (TCG) ArcShield
- Revolutionary Grey Infrared Arc Flash Faceshield
- See the true colours of your work - Reds are red, blues are blue
- Deluxe Scratch Resistant coated outside, Anti-fog inside
- Includes CSA Z94.1 Type 1 Ratchet Adjust Hard Cap



## SHLDBAG-NYLON

- Nylon Storage Bag for Oberon ArcShield
- Features draw string & carry strap



# Louis Hebert - FR/Arc Flash Gear

## V159F0: FR/Arc Flash Service Pant

- 9oz Twill, 88% Cotton 12% Nylon FR fabric base
- Long life \*VAT\* dye
- 7 waistband loops
- #5 brass fly zipper with Nomex® tape
- Melamine front button closure at waist and on left back pocket
- Double thickness waistband with 4 needle stitching
- 2 front quarter top pockets and 2 welted back pockets
- Pocketing and waistband linings with FR fabric
- 36" unfinished inseam
- Bar-tacked at all stress points
- Meets performance requirements to CGSB 155,2 Flash
- Fire, CSA Z462 for Electrical Arc Flash. Also meets Flame Resistance on ASTM F1506-08 and acceptable under OSHA Final rule 1910, 269
- **ATPV 12.4**
- Available colours: Navy and Orange



## V154F0: FR/Arc Flash Cargo Pant

- Flame retardant
- 9oz drill, 88% Cotton 12% Nylon FR
- Long life \*VAT\* dye
- 9 waistband loops
- #5 brass fly zipper with Nomex® tape
- Melamine front button closure at waist and on left back pocket
- Double thickness waistband with 4 needle stitching
- 2 front quarter top pockets and 2 welted backpockets front quarter top pockets and welted back pockets
- Pocketing and waistband linings with FR fabric
- 2 cargo pockets with flap and Velcro closure
- Side seams are two needles topstitched
- 34 1/2" inseam, bottoms not finished
- Bar-tacked at all stress points
- Meets performance requirements to CGSB 155,2 Flash
- Fire, NFPA 70E/CSA Z462 for Electrical Arc Flash. Also meets Flame Resistance on ASTM F1506-08 and acceptable under OSHA Final rule 1910,269
- **ATPV 12.4**
- Available colour: Navy



## V559A0: FR/Arc Flash Shirt w/ Flaps

- Flame retardant
- 7oz twill, 88% cotton 12% Nylon
- Long life \*VAT\* dye
- 2 Plastic reinforcement at collar
- Topstitched single piece collar with lining (1/16")
- 2 large breast pockets with flap and button/buttonhole closure left pocket with pencil divider
- Hemmed front placket
- Front closure with 7 button / buttonhole
- Long sleeves with single piece cuffs with lining and button / buttonhole closure
- Double back yoke
- Bar-tacked at all stress points
- **ATPV 8.7**
- Available colours: Medium Blue and Navy





# Louis Hebert - FR/Arc Flash Gear

## V-1187RBF0 & V-1187LBF0: Lined FR/Arc Flash Bib Overall

- YKK's Brass zippers front closure
- 23" YKK'S brass zipper at leg with storm flap
- Velcro tab closures at ankles
- 2 slanted front pockets with velcro closure
- Two rear pockets and flashlight pocket at right rear leg
- 3M Canada F.R. 2" triple trim reflectives at bottom of legs
- Lock stitch sewing technology
- Nomex sewing thread
- Bar-tacked all stress points
- Meets CGSB 155,20 Hydro Carbon Flash Fires
- Meets CSA Z462 Arc Flash Protection
- **ATPV 48.2**
- Available colours: Navy and Orange



## V1156RBA0: Unlined FR/Arc Flash Bib Overall

- 88% Cotton, 12% Nylon 9oz weight-FR
- Long life \*VAT\* dye
- Adjustable FR elastic shoulder straps
- Brass zipper front opening
- Two chest pockets
- Two front quarter pockets with inside pocket side access
- Two back patch pockets
- Tool pocket on right side
- 12" brass zipper at bottom leg opening
- Bar-tacked at all stress points
- 3M Canada triple trim reflectives; legs, waist, X on back, vertical front
- Meets performance requirements to CGSB 15,2 Flash
- Fire, NFPA 70E/CSA Z462 for Electrical Arc Flash
- Also meets Flame Resistance on ASTM F1506-08 and acceptable under OSHA Final rule 1910,269
- **ATPV 12.4**
- Available colours: Navy and Orange



# Louis Hebert - FR/Arc Flash Gear

## V11691RBF0 & V11691LBF0: Unlined FR/Arc Flash Coveralls

- Drill 9 oz, 88% Cotton 12% Nylon
- Superior colour retention with \*VAT\* dyes
- Topstitched single collar with lining
- 2 breast pockets with flaps and concealed snap closure, left pocket with pencil division
- Front #5 brass break-away zipper with Nomex tape (two-way)
- Lapel with concealed snap closure
- Front waistband with hidden snap closure, top-stitched
- Pocket with pencil division on the left sleeve
- 2 pieces cuffs with concealed snap closure, 2 front quarter pockets with FR fabric pocketing
- Inner clothing access side with concealed snap closure
- Single piece back with action pleats and inserted side elastics at the waist
- 2 double stitched back patch pockets with reinforced bottoms, left pocket with concealed snap closure and a tool pocket on right side
- Sewn with FR thread
- Bar-tacked at all stress points
- **ATPV 12.4**
- CSA-Z96, 2" yellow/silver/yellow reflective stripes
- Industrial grade non-FR coverall also available



## V-1127RBF0 & V-1127LBF0: Lined FR/Arc Flash Coveralls

- 9.4 oz Flame Resistant outershell
- 88% Cotton, 12% High Tenacity Nylon orange
- Quilted Flame Resistant lining (10oz FR Modacrylique interior batting)
- YKK's Brass zippers front closure
- 18" YKK'S brass zipper at leg
- Velcro tab closures at wrists and ankles
- Mesh outer front pocket for gas detector over right torso pocket. One left pocket with velcro closure
- Micro clip and velcro piece at front (name or Dept tag)
- Inserted side pockets, inner clothing access
- Two rear pockets and flashlight pocket at right rear leg
- Flame resistant 2" grey reflective band (CSA Z96)
- Lock stitch sewing technology
- Flame resistant sewing thread
- Bar-tacked all stress points
- **ATPV 40.6**
- Meets CGSB 155,20 Hydro Carbon Flash Fires
- Meets CSA Z462 Arc Flash Protection
- Meets F 1506-2010 Standard



### LTL Garment Customization - logos and personalization

Speak to your local LTL Product Specialist about adding logos and/or personalizing your garments!



# Louis Hebert - FR/Arc Flash Gear

## VE373RBA0: FR/Arc Flash 3 in 1 Bomber Jacket

- Shell: 7oz 88% cotton, 12% Nylon with FR membrane
- Wind and rain shield
- FR liner protecting membrane, 88% cotton, 12% nylon
- Mandarin collar
- 2 micro clips, one each side
- Front yoke with double stitch
- 2 chest pockets with flaps. Left side with pencil opening
- 2 lower front side and top entry pockets with flap closures
- Zippers at front closure with storm flap and concealed snaps
- Wrists with concealed snaps
- Action back
- 3M Canada reflectives (yellow-grey-yellow) compliant to CSA Z96-10 high visibility standard
- Bar-tacked at all stress points
- **ATPV 21.1**
- Available colours: Navy and Orange



## DF373: Zip In Zip Out Liner

- 88% cotton, 12% nylon
- 2 faces madaquilt quilted
- FR liner with 10oz FR modacrylic batting
- Brass front zipper to insert in parka VE373RBA0
- Clean finish with bias binding
- Bar-tacked at all stress points
- **ATPV 59.4**
- Available colour: Gray



## VE394BF0: FR/Arc Flash Parka

- Fabric : 7 oz, 88% Cotton, 12% Nylon with FR P.U. Membrane
- Lining: 10 oz, 100% FR MODACRYLIC
- Mandarin collar, with snap buttons at neck top for hood attachment
- 2 micro clips, one each side. 2 chest pockets with flaps. Left side with pencil opening
- 2 lower front side and top entry pockets with flap closures
- Flame resistant YKK Vislon zippers at front closure with storm flap and concealed snaps
- Wrists with concealed snaps
- Action back, elasticized back at waist
- Adjustable waist inside garment
- Reflective stripes (yellow-grey-Yellow) compliant to CSA Z96-10 high visibility standard
- Bar-tacked at all stress points
- Meets performance requirements to CGSB 155,2 Flash Fire, CSA Z462 for Electrical Arc Flash. Also meets Flame Resistance on ASTM F1506-09 and acceptable under OSHA
- **ATPV 40.6**
- Available colours: Navy and Orange



# Louis Hebert - Non-FR/Arc Flash Gear

## SAFETY WINTER GEAR

- 100% Nylon 450 Denier Fabric with P.U. Coating
- Wind and water resistant
- Complies to Hi-Viz standard CSA Z96-10

- Quilted lining made of 10oz polyester for very cold weather
- Non-FR rated

### M3013 BP034: Coverall

- Includes detachable hood
- 4" leg zipper closures
- Pencil pocket on left arm
- 2 hip level pockets
- 1 torso pocket with pencil space at front
- Knitted wrist closure



### M3012 BP034: Parka

- Includes detachable hood
- 2 large lower pockets
- 2 smaller torso pockets
- Inside pocket for cellular
- Knitted wrist closure



### M3011 BP034: 3 in 1 Bomber

- Includes a black 100% polyester polar fleece
- Elasticized waistband
- Mandarin collar
- Vizlon front closure/Storm flap
- Two entry side pockets
- Adjustable wrist closure



### M3010 BP034: Sleeveless Vest

- Elasticized sides
- Mandarin collar
- 4 pockets: 2 large, 2 small
- Can be worn with the 3 in 1 polar vest



### Winter Collection Back View



## LTL Garment Customization - logos and personalization

Speak to your local LTL Product Specialist about adding logos and/or personalizing your garments!



# Benchmark FR

## 4029FR: Feather Weight Coverall 2.0 (HRC 2 and NFPA 2112)

- Benchmark FR 2.0 Twill, 6.9 oz. HRC 2, ATPV = 8.5 cal/cm<sup>2</sup>
- Whether you are protecting against arc flash or flash fire, the Feather Weight 2.0 will meet the code
- It is UL certified to the voluntary NFPA 2112 standard for flash fire and it also meets the NFPA 70E HRC 2 requirement for arc flash; dual code compliance without sacrificing comfort
- Lightweight and breathable
- Two chest pockets, two side pockets, two pass-thru's, a tool pocket and a cell phone pocket
- 4029 coveralls will come standard with a Regular (32") inseam
- Sleeve cuff is tailor finished, back gusset with a comfortable back elastic waist
- This coverall is 6.9 oz which makes it light and comfortable for any season
- The Feather Weight 2.0 is skin safe and can be worn independently directly against the skin



## 1028FR Really Nice Shirt 2.0 (HRC 2 and NFPA 2112)

- Benchmark FR 2.0 Twill, 6.9 oz. HRC 2, ATPV = 8.5 cal/cm<sup>2</sup>
- The 2.0 version of the Really Nice shirt offers easy compliance, comfort and is proudly made in the USA
- The shirt offers dual compliance with both an HRC 2 rating for arc flash and UL certification to the voluntary code NFPA 2112 for flash fire
- It has less than 2% shrinkage and a class 4 colourfastness rating after multiple washings



## 2078FR Steve's Pants, Twill (HRC 2 and NFPA 2112)

- Benchmark FR 2.0 Twill, 6.9 oz. HRC 2, ATPV = 8.5 cal/cm<sup>2</sup>
- Steve's Pants are high quality FR pants with increased durability, classic jean styling and a professional appearance
- The pants are sized true to size and with the benefit of controlled shrinkage, they will fit comfortably
- The construction is similar to denim due to the reinforced chain stitched inseams and bar-tacks at stress points
- No exposed metal to the wearer and a dielectric shank in place of a button
- Reinforced belt loops are sewn into the waistband for additional strength
- They are certified to the voluntary code NFPA 2112



## 2810FR American Denim Pants

- Benchmark FR Modacrylic/Cotton Twill, 12 oz. HRC 2, ATPV = 14 cal/cm<sup>2</sup>
- American Denim 281 is the finest FR jean available representing American craftsmanship and ingenuity
- The denim is a unique blend of flame resistant fibers and high quality ring-spun cotton yarns
- The fabric has the same premium quality of high-end jeans found in department stores
- American Denim 281 does not shrink, is pre-washed for comfort, and is guaranteed to last



## 3025FR Zip Hooded Sweatshirt

- Benchmark FR Modacrylic/Cotton Fleece, 12 oz. HRC 2, Ebt = 19 cal/cm<sup>2</sup>
- The Hooded Sweatshirt is constructed like your favourite 'hoodie' with a generous fit, two hand warmers, and a three-piece lined drawstring hood
- The Benchmark FR symbol is noticeably located on the wearer's left wrist for easy identification
- The inner face of the knit fabric is fleeced, which holds body heat and insulates from the cold
- Sleeve cuffs are made using a circular knit process which eliminates seams; the cuff will keep its elasticity and shape throughout use
- Wear the sweatshirt as part of a layering system for greater insulation



## 3026FR Pullover Hooded Sweatshirt

- Benchmark FR Modacrylic/Cotton Fleece, 12 oz. HRC 2, Ebt = 19 cal/cm<sup>2</sup>
- The Pullover Sweatshirt is constructed like your favorite 'hoodie' with a generous fit, two hand warmers, and a three-piece lined drawstring hood
- The Benchmark FR symbol is noticeably located on the wearer's left wrist for easy identification
- The inner face of the knit fabric is fleeced, which holds body heat and insulates from the cold
- Sleeve cuffs are made using a circular knit process which eliminates seams; the cuff will keep its elasticity and shape throughout use
- Wear the sweatshirt as part of a layering system for greater insulation



## 4017FR Women's Coverall

- Benchmark FR Twill, 5.5 oz. HRC 1, ATPV = 6 cal/cm<sup>2</sup>
- The Women's Feather Weight offers the same comfort and compliance as the men's Feather Weight coverall but it is made to fit a woman's body
- Benchmark's flame resistant 5.5oz feather weight twill is made from combed cotton ring spun yarns, which yields a durable, lightweight and breathable material
- The Women's Feather Weight coverall was developed for the oil and gas industry
- The fabric is non-allergenic, skin safe and will not react with sweat
- Code compliance includes OSHA 1910, NFPA 70E HRC1, ASTM 1506, NESC 2007 and conforms to international health codes for toxicity



## 3034FR FR Skull Cap

- Benchmark FR Modacrylic/Cotton/Nylon Rib Knit, HRC 3, Ebt = 36 cal/cm<sup>2</sup>
- The FR skull cap, sometimes called a "toque," does not have a folding brim
- The close fitting double layers make it easier to wear with a hard hat or under a hood
- The Skull Cap is made from a circular knit with seamless construction for extra comfort
- The comfort and appearance of the FR Skull Cap is indistinguishable from a premium store bought knit cap



## 3035FR FR Beanie

- Benchmark FR Modacrylic/Cotton/Nylon Rib Knit, HRC 3, Ebt = 36 cal/cm<sup>2</sup>
- The FR Beanie has classic "ski hat" styling
- The double layered knit hat has a folding brim for additional warmth around the ears
- It is made from a circular knit with seamless construction for extra comfort
- The comfort and appearance of the FR Beanie is indistinguishable from a premium store bought beanie



## 3036FR FR Balaclava

- Benchmark FR Modacrylic/Cotton/Nylon Blend, 7.5 oz. HRC 2, Ebt = 9 cal/cm<sup>2</sup>
- The flame resistant Balaclava is made from a rib knit which will adjust to the wearer's head and face profile
- It fits comfortably under any helmet or hard hat
- The top section is constructed like a beanie and features an incorporated face mask which can pull down below the chin
- The soft breathable knit blend feels comfortable against the skin, never itchy or constrictive



# Bulwark

## Hi-Visibility Rainwear

- 9.5 oz. PVC/Kevlar/Nomex®
- Protection: JXN2 –Arc Rating ATPV 6.5 calories/cm<sup>2</sup> EBTAS 33 calories/cm<sup>2</sup> (HRC1)  
BXN2 –Arc Rating ATPV 40.0 calories/cm<sup>2</sup> EBTAS 33 calories/cm<sup>2</sup> (HRC4)
- Non-conductive durable hard wear
- 1 ½" reflective striping
- Stowaway hood and adjustable hood drawstring
- Two patch pockets with flaps
- Elasticized shoulder straps
- Vented back with "D" ring access
- Take-up tabs on cuffs
- 360° reflective trim for visibility
- Take-up tabs at ankles



### Jackets

JXN2-YG-S	Yellow/Green
JXN2-YG-M	Yellow/Green
JXN2-YG-L	Yellow/Green
JXN2-YG-XL	Yellow/Green
JXN2-YG-2XL	Yellow/Green
JXN2-YG-3XL	Yellow/Green

### Bibs

BXN2-YG-S	Yellow/Green
BXN2-YG-M	Yellow/Green
BXN2-YG-L	Yellow/Green
BXN2-YG-XL	Yellow/Green
BXN2-YG-2XL	Yellow/Green
BXN2-YG-3XL	Yellow/Green

## Hi-Visibility Flame-Resistant Work Shirt

- Blend: 7 oz. 48% Modacrylic/ 37% Lyocell/15% Para-aramid
- Care: Home Wash
- Protection: ATPV 8.4 calories/cm<sup>2</sup> (HRC 2)
- ANSI 107-2004 Class 2 Level 2 Compliant
- Two chest pockets without pocket flaps. Pencil stall in left chest pocket
- Garment meets NFPA 2112 & CGSB 155.20
- Colors: Yellow/Green (HV)
- Lined Collar and Cuffs to keep their shape during laundry
- 360° visibility with front and back
- 2" FR silver stripe and button through pockets, no pocket flaps (SMW4)
- Buttons will not melt or drip, conforming to the requirements of ASTM F1506
- Sewn with FR thread, conforming to the requirements of ASTM F1506
- Hemmed front to deter lint and soil redeposition
- Fabric: CoolTouch® 2



### REGULAR LENGTH

SMW4HV-YG-M-REG
SMW4HV-YG-L-REG
SMW4HV-YG-XL-REG
SMW4HV-YG-2XL-REG
SMW4HV-YG-3XL-REG

### LONG LENGTH

SMW4HV-YG-M-LONG
SMW4HV-YG-L-LONG
SMW4HV-YG-XL-LONG
SMW4HV-YG-2XL-LONG
SMW4HV-YG-3XL-LONG

## Hi-Visibility Flame-Resistant Long Sleeve T-Shirt

- Blend: 70% Modacrylic/ 15% FR Lenzing/ 15% Rayon
- Protection: ATPV 8.1 calories/cm<sup>2</sup> (HRC 2)
- ANSI 107 – 2010 Compliant Class 3 Level 2
- Features a self-fabric crew neck collar and hemmed sleeves
- Tagless, an added comfort benefit to the wearer
- Spade shaped chest pocket doesn't allow lint to get trapped which makes it laundry friendly
- Full side seam gusset allows the garment to move and prevents untucking
- 2" flame-resistant silver heat seal reflective meets ANSI 107-2010 Class 3 Level 2 compliancy
- Reflective is segmented for additional comfort
- Cover stitched hem allows movement with the knit without popping stitches
- Sewn with FR thread conforming to the requirements of ASTM F1506
- Color: Yellow/Green



SMK2YG-S-REG	Yellow/Green
SMK2YG-M-REG	Yellow/Green
SMK2YG-L-REG	Yellow/Green
SMK2YG-XL-REG	Yellow/Green
SMK2YG-2XL-REG	Yellow/Green
SMK2YG-3XL-REG	Yellow/Green
SMK2YG-4XL-REG	Yellow/Green

## SLUSOR FR High Visibility Shirt

- Banded top-stitched collar, two chest pockets with concealed gripper closure flaps and sewn-in pencil stall stitched cuffs with adjustable button closure, placket front with button closure and tailored sleeve placket
- 360° visibility with front and back 2" silver reflective striping. Striping configuration is CSA Z96-09 Class 2, Level 2 Compliant. Garment meets CGSB 155.20
- Fabric: 6oz EXCEL FR® ComforTouch® (205 g / m2) blend: 88% Cotton / 12% Nylon
- Protection: Arc Rating ATPV 8.7 calories/cm<sup>2</sup>
- Orange colour
- Men's sizes: Regular (S-4XL), Long (L-4XL)



## BLCSOR Deluxe Insulated Bib Overall w/ Reflective Trim

- Two-way, extra heavy-duty Nomex® taped brass zipper front with concealed flap
- Elasticized shoulder straps with non-conductive adjustable hardware
- Five large patch pockets
- Hip pocket with closure
- Reinforced double knees
- Full Nomex® taped ankle-to-hip brass zippers, concealed snap closure
- Elastic waist inserts
- Inside zipper guards on all zippers
- 360° visibility with front and back 2" silver reflective striping around calves
- Flame-resistant fabric, 100% cotton lining
- Arc Rating APTV 43.3 calories/cm<sup>2</sup>
- Men's sizes: Regular (S-3XL), Long (M-2XL)



## CTBBOR & CTBANV Ultra Soft® Coverall with CSA Reflective Trim

- Mandarin, stand-up, two-way safety collar
- Deep pleated action-back
- Two-way concealed Nomex® taped brass break-away zipper, concealed snap at top of zipper at neck
- Two top-stitched patch chest pockets with flaps and concealed snap closures
- Two inset lower front pockets are top-stitched and lined, side vent openings with snaps
- Two patch hip pockets with single concealed snap closures
- One patch pocket with pencil stall on left sleeve and one piece rule pocket on right leg
- Elastic waist inserts
- Ultra Soft® interior and exterior brand labeling
- Fabric: Flame-Resistant, 7 oz. (235 g / m2) 88% Cotton / 12% Nylon
- Protection: Arc Rating ATPV 8-7 calories/cm<sup>2</sup>
- Men's sizes: Regular (38-58), Long (42-58)



CTBBOR

### CTBBOR

- 360° visibility with front and back 2" silver reflective striping
- Striping configuration meets CAN/CSA Z96-09 Class 3, Level 2 Compliance

### CTBANV (Navy)/CTBARB (Royal Blue)

- 360° visibility with 3M 2" #RT80 yellow/silver/yellow reflective striping configuration meets CAN/CSA Z96-09 Class 1 Level FR Compliance



CTBANV

## LTL Garment Customization - logos and personalization

Speak to your local LTL Product Specialist about adding logos and/or personalizing your garments!





# Croc Bloc - Sunscreen

## 12-31010: Sunscreen 10mL SPF 30



- Croc Bloc Sunscreen 10mL CrocPac SPF 30 Broad Spectrum
- 3" x 5" packette
- Moisturizing aloe and vitamin E
- Water-resistant, unscented
- FDA and Health Canada approved
- Dermatologist Tested

## 12-31510: Sunscreen 10 mL SPF 50



- Croc Bloc Sunscreen 10mL CrocPac SPF 50 Broad Spectrum
- 3" x 5" packette
- Moisturizing aloe and vitamin E
- Water-resistant, unscented
- FDA and Health Canada approved
- Dermatologist Tested

## 12-34010: Sunscreen 4oz SPF 30



- Croc Bloc Sunscreen 4oz Bottle SPF 30 Broad Spectrum
- Provides 30 times your natural protection against the harmful effects of UV Rays
- Moisturizing aloe and vitamin E
- Water-resistant, unscented
- FDA and Health Canada approved
- Dermatologist Tested

## 12-32010: Sunscreen 1oz SPF 30



- Croc Bloc Sunscreen SPF 30, 1oz Tube Broad Spectrum
- Provides 30 times your natural protection against the harmful effects of UV Rays
- Moisturizing aloe and vitamin E
- Water-resistant, unscented
- FDA and Health Canada approved
- Dermatologist Tested

## 12-35010: Sunscreen 1L SPF 30



- Croc Bloc SPF 30 1L Sunscreen
- Broad Spectrum protection against UV rays
- Economical solution for larger groups
- 34oz/1L bottle with dispensing
- Wall mount bracket sold separately
- Moisturizing aloe & vitamin E
- Water-resistant, unscented
- FDA and Health Canada approved
- Dermatologist Tested

## 12-33010: Sunscreen SPF 30 Pump Spray



- Croc Bloc SPF 30 6oz Sunscreen Spray
- Broad Spectrum protection against UV rays
- Spray pump provides excellent coverage
- Small enough to fit in any carry bag
- 80ml/6oz
- Sunscreen applied without rubbing into the skin
- Moisturizing aloe and vitamin E
- Water-resistant, unscented
- FDA and Health Canada approved
- Dermatologist Tested

## 12-38010: Sunscreen 4oz SPF 50



- Greater Sun Protection Factor for longer lasting fun in the sun
- Broad spectrum protection against UV rays
- Odourless, moisturizing aloe and vitamin E
- Water resistant, dries quickly with no oily residue
- Hypoallergenic, dermatologist tested
- 4oz/120mL bottle with EZ open flip-top lid
- Integrated belt loop toddler

# Croc Bloc - Insect Repellent

## 12-42500: Insect Repellent Spray



- Croc Bloc Insect Repellent 4oz Spray 10% Deet (CDN Only)
- 10% Deet liquid spray provides over 3 hours of protection against insect bites
- 4 oz/120ml bottle with spray pump
- Net contents 5.58g
- PMRA approved

## 12-435A0: 30% DEET Liquid Pump Spray



- Croc Bloc Insect Repellent Liquid Spray
- Non-aerosol heavy-duty insect repellent for long-lasting protection against insect bites!
- Up to 6 hrs of protection
- Net Contents 120mL/4oz bottle
- PMRA approved

## 12-54500: Wasp & Hornet Killer



- Croc Bloc 325g Wasp & Hornet Killer (CDN Only)
- Effectively kills wasps, hornets, bees, ants, yellow jackets, and tent caterpillars in their nests from a distance without exposing yourself to the risk of being stung or bitten
- Packaged 14oz/325g
- Flash point of 226°F

## 12-43500: 28% DEET Heavy Duty Aerosol



- Croc Bloc Insect Repellent Heavy Duty Aerosol
- Up to 6 hrs of protection
- Effective control against a variety of insects in the toughest environments.
- Net contents 150g spray can
- PMRA approved

## 12-40500: 30% DEET Single Towellette



- Croc Bloc Insect Repellent Towelette
- 30% DEET
- Single use 6"x8" towel
- Formulated for effective control of a variety of insects in an economical format
- Up to 6 hrs of protection
- Net Contents 5.85g
- PMRA approved

## TopGard® Protective Caps and Hats

- Classification: Type I
- Application: General purpose, elevated temperature
- Shell Material: Polycarbonate
- Available styles: Slotted cap, non-slotted full-brim hat
- Sizes: Standard (6 1/2-8")
- Standards: ANSI/ISEA Z89.1-2009 (Class E), CSA Z94.1-2005 (Class E)
- Certification: Third party by SEI



DESCRIPTION	TOPGARD SLOTTED CAP ( STANDARD SIZE)		TOPGARD NON-SLOTTED HAT (STANDARD SIZE)	
	w/ 1-Touch Suspension	w/ Fas-Trac Suspension	w/ 1-Touch Suspension	w/ Fas-Trac Suspension
<b>TOPGARD ASSEMBLIES</b>				
White	454728	475385	454719	475393
Yellow	454721	475378	454712	475387
Gray	454722	475379	454713	-
Blue	454723	475380	-	-
Orange	454725	475382	-	-
Green	454726	475383	-	-
Red	454727	475384	-	-
Bright Orange	-	804396	-	804397
White w/ Lamp Bracket & Cord Holder	448914	-	-	-
<b>REPLACEMENT SUSPENSIONS</b>				
1-Touch Suspension (6 1/2-8)	10061127			
Fas-Trac Suspension (6 1/2 - 8)	473333			
Swing-Ratchet Suspension (6 1/2-7 5/8)	816648			



1-Touch Suspension



Fas-Trac Suspension



Swing-Ratchet Suspension

# Personal Safety Equipment & Accessories

## V-Gard Protective Cap



- Ratchet suspension adjusts size quickly and easily
- Nylon crown suspension straps fit comfortably
- Lightweight and balanced for all day wear
- Available in white and yellow

## Hard Hat Seat Rack



- Convenient hard hat holder for use on the back of a vehicle seat

## V-Gard Protective Hat



- Brim around entire cap helps keep rain and sun off wearer's neck and ears
- Short front brim allows unimpeded upward vision
- Ratchet suspension adjusts size quickly and easily
- Nylon crown suspension straps fit comfortably
- Lightweight and balanced for all day wear
- Available in white, yellow and orange

## Sun Shields



- These sun shields extend the brim of the hard hat all the way around to help protect the wearer's ears and neck from the sun's rays
- Made of polyurethane
- Front portion is Lexan with a smoke tint
- For V-Gard Protective Cap or Hat

## Cowboy Style Hard Hat



- Stylish and comfortable
- Meets ANSI Z89.1-2003, Type 1, Class E, G, & C
- Extra wide brim provides more UV protection than standard or full brim hard hats
- Fully adjustable 6-point ratchet suspension

## Knitted Tube Liner (flame resistant)



- 100% polyester; flame resistant
- Fits snugly over hard hat and blocks wind tunneling in the crown
- Traps warm air to keep head and ears warm
- Easily folds up on outside of hard hat
- Does not have ear barriers, reflective strip, gap eliminator, or warming pack pockets

## Shoulder Length Winter Liner



- Blue liner is flame resistant and features a 100% cotton twill shell and is lined with a heavy weight flame-resistant polyester fleece
- Grey liner is not flame resistant
- All materials (cotton twill, polyester fleece, and binding) are flame retardant until washed
- Features pockets near ears for warm packs

## Hard Hat Warming Tube Liners



- 100% Polyester
- Fits snugly over hard hat
- Blocks wind tunneling inside the crown
- Traps warmth to keep head and ears warm
- Folds up on the outside of a hardhat, when not needed during breaks
- Flame resistant

## Full Face Knitted Tube Liner



- 100% polyester
- Fits snugly over hard hat and blocks wind tunneling in the crown
- Traps warm air to keep head, face, nose, and ears warm
- Can be folded up outside of hard hat during breaks
- Does not have ear barriers, reflective strip, gap eliminator, or warming pack pockets

## Cooling Hard Hat Inserts



Hard Hat Pad



Hard Hat Pad w/  
Neck Shade



Cotton Terry Hard  
Hat Liner



Cotton Terry Hard  
Hat Band

- These liners are made with napped cotton terry, but also have cooling crystals encased within
- Crystals work in combination with the evaporation process
- When worn against the head or neck they create a cooling sensation that is passed to pulse points and carried throughout the body

## Hard Hat inserts

- Super absorbent double napped cotton terry
- Double layer of terry and a layer of foam around the rim catch more perspiration
- Blocks sun and keeps perspiration off face and neck



# Personal Safety Equipment & Accessories

## Cooling Vest

- Ideal for linemen, heavy equipment operators, or anyone working in a warm indoor or outdoor environment
- Designed to keep the user cool and alert
- Cooling crystals work in combination with the evaporation process
- These vests are also reversible for continuous cooling
- Soak in cold water for 10-20 minutes
- Reusable thousands of times
- Works without freezing or ice



## Cooling Bandana

- The cooling crystals encased within the 100% cotton fabric absorb and hold up to 1,000 times their weight in cool, refreshing water
- The crystals work in combination with the evaporation process
- When worn against the head, neck, or body, cooling sensations are passed to pulse points and carried throughout the body
- Soak in cold water for 10-20 minutes; stays hydrated for several days and is reusable thousands of times



## FAONTAPB: North Plastic First Aid Kit

Plastic bulk first aid kit #A. Ontario Regulation. Includes: 1- Triangular bandage, 12- Sterile plastic strips 3/4" x 3", 4- Gauze pad sterile 3" x 3", 2- Sterile pressure bandage 4", 2- Gauze bandage 2" x 5 yards, 12- Assorted safety pins, 1- Disposable glove pairs, 1- First Aid manual.

## FAONT2MB: North Plastic First Aid Kit

Plastic bulk first aid kit #A. Ontario Regulation. Includes: 1- Triangular bandage, 12- Sterile plastic strips 3/4" x 3", 4- Gauze pad sterile 3" x 3", 2- Sterile pressure bandage 4", 2- Gauze bandage 2" x 5 yards, 12- Assorted safety pins, 1- Disposable glove pairs, 1- First Aid manual.

## FA25: North Plastic First Aid Kit

Industrial kit #25, metal box (XF30) 15.5" x 12" x 4.5"

## FAONT1PB: North Plastic First Aid Kit

Plastic bulk first aid kit #1. Ontario Regulation. Includes: 6- Triangular bandage, 24- Sterile plastic strips 3/4" x 3", 12- Gauze pad sterile 3" x 3", 4- Sterile pressure bandage 4", 4- Gauze bandage 2" x 5 yards, 4- Gauze bandages 4" x 5 yards, 2- Splint padding, 1- Metal wire splint/Boxed, 12- Assorted safety pins, 1- Disposable glove pairs, 1- First Aid manual.

## FASOS1ESAFE

Vehicle, zippered nylon bag, 15 1/2" x 9" x 6" elastic fittings and compartments

## FA8TRP

Vehicle, bulk plastic kit, 16 unit box



## Water coolers

- Sturdy plastic water coolers help keep plenty of fresh drinking water on hand at the job site
- Constructed of durable plastic that won't rust or fade in direct sunlight



## Vinyl Safety Labels

- High visibility lettering
- Two versions: "FIRST AID KIT INSIDE" & "FIRE EXTINGUISHER"
- Heavy duty vinyl with peel off backing to expose adhesive



## North - Adaptec Series

- Efficient, full wrap coverage
- Available in 3 sizes for the perfect fit
- Fully adjustable nose piece and nose pads
- Temples adjust for inclination and width
- Quick-change lens replacement system
- Utilizes exclusive North 4A coating, protecting against fog, scratches, UV and static
- Meets ANSI Z87.1 and certified to the requirements of the CSA Z94.3 standards



<b>T5900LTK</b>	<b>Regular Size</b>	<b>Translucent-Black, clear lens</b>
<b>T5900LTKS</b>	<b>Regular Size</b>	<b>Translucent-Black, smoke lens</b>
<b>T5900NTK</b>	<b>Narrow Size</b>	<b>Translucent-Black, clear lens</b>

<b>T5900NTKS</b>	<b>Narrow Size</b>	<b>Translucent-Black, smoke lens</b>
<b>T5900WTK</b>	<b>Wide Size</b>	<b>Translucent-Black, clear lens</b>
<b>T5900WTKS</b>	<b>Wide Size</b>	<b>Translucent-Black, smoke lens</b>

## North - 180 Slimline Series

- Comfortable, low profile shape, 9-base full wrap polycarbonate lens, non-conductive dielectric design, soft, flexible temples
- Meets ANSI Z87.1 and is certified to the requirements of CSA Z94.3



<b>T1300</b>	<b>Clear with blue temple pad/Clear, not coated</b>
<b>T1301</b>	<b>Gray with Hi-Viz orange temple pad/Gray, not coated</b>
<b>T1302</b>	<b>Amber with gray temple pad/Amber, not coated</b>

## North - A900 Series

- Sporty, 8-base wraparound polycarbonate lens, non-slip rubber nose bridge and padded temples provide a comfortable fit, available with scratch-resistant hardcoat or optional Fog-Ban® anti-fog coating
- Meets ANSI Z87.1 standard, CSA version certified to requirements of CSA Z94.3 standard



<b>A900</b>	<b>Black/Clear, Lens coating: Hardcoat</b>
<b>A901CSA</b>	<b>Black/Clear, Lens coating: Fog-ban Anti-Fog</b>

## North - The Edge™

- Available in 2 frame colours: black or gray
- Single piece polycarbonate lens with a 9-base curve for maximum peripheral vision
- Comes with two sets of temples ends: curved and straight
- Lenses are coated with North's exclusive 4A coating (exception: mirror lenses are 3A)
- Replacement lenses available
- Certified to the requirements of CSA Z94.3 standards. Available only in Canada

<b>T56005B</b>	<b>Black/Clear, Lens coating: 4A</b>	<b>T56005GRYS</b>	<b>Gray/Smoke, Lens coating: 4A</b>
<b>T56005GRY</b>	<b>Gray/Clear, Lens coating: 4A</b>	<b>T56005BA</b>	<b>Black/Amber, Lens coating: 4A</b>
<b>T56005BS</b>	<b>Black/Smoke, Lens coating: 4A</b>	<b>T56005BM</b>	<b>Black/Mirror, Lens coating: 3A</b>



## North - V-Maxx® Goggles

- Sleek wrap-around styling for a 180°, clear field of vision
- Direct and indirect ventilation styles available for impact or splash applications
- Adjustable elastic or neoprene headband
- Pivoting headband clips to adjust strap around hard hats or hearing protection
- Peel-off goggle covers available to extend life of the lens
- Can be worn over most prescription eyewear (OTG compatible)
- Available in clear, 3.0 and 5.0 welding shades
- Available with scratch-resistant hardcoating or optional Fog-Ban anti-fog coating
- Meets ANSI Z87.1 and certified to requirements of CSA Z94.3 standards



<b>11250800</b>	<b>Body colour/lens tints: clear/clear, Lens coating: Fog-ban anti-fog Description: Direct vent with elastic headband</b>
<b>11250810</b>	<b>Body colour/lens tints: clear/clear, Lens coating: Fog-ban anti-fog Description: Indirect vent with neoprene headband</b>



# Safety Glasses

## North - Tornado™ F5 Series

- Optically-centered unilens with extended side coverage
- Adjustable temples available in models with curved and straight temples, utilizes exclusive North 4A coating, protecting against fog, scratches, UV and static
- Replacement lenses available
- Meets ANSI Z87.1 and certified to requirements of CSA Z94.3 standards

<b>T57505B</b>	<b>Black Red/Clear, Lens coating: 4A, Temple style: Curved</b>
<b>T57505BS</b>	<b>Black Red/Smoke, Lens coating: 4A, Temple style: Curved</b>
<b>T57505BL</b>	<b>Blue Gray/Clear, Lens coating: 4A, Temple style: Curved</b>
<b>T57505BLBLM</b>	<b>Blue Gray/Blue Mirror, Lens coating: 4A, Temple style: Curved</b>
<b>T58505B</b>	<b>Black Red/Clear, lens coating: 4A, Temple style: Straight</b>
<b>T58505BS</b>	<b>Black Red/Smoke, Lens coating: 4A, Temple style: Straight</b>
<b>T5805BL</b>	<b>Blue Gray/Clear, Lens coating: 4A, Temple style: Straight</b>
<b>T585005BLBLM</b>	<b>Blue Gray/Blue Mirror, Lens coating: 4A, Temple style: Straight</b>



## UVEX - Pheos

- Duo-spherical lens offers exceptional optical quality and features an integral brow guard for enhanced coverage, protection and performance
- Clear, Gray and Amber lens tints address the needs of most workplace environments
- Features high-performance Dura-streme® dual anti-fog/anti-scratch coating technology for lenses that stay clear in extreme environments and withstand scratches for 3x longer lens life\*
- Unique temple design provides increased airflow to further resist lens fogging
- Integral slot in temple tip simplifies attachment of hang cords or corded ear plugs
- Contains no metal parts for 100% dielectric performance
- Meets ANSI Z87.1-2010 standard
- Available in standard and slim sizing to comfortably fit most workers
- Frameless design is lightweight and easy to clean and maintain
- Innovative dual-material technology used on temples provides stability and cushioned comfort for all-day wear
- Temples feature an extremely thin profile and fit comfortably when worn with other PPE
- High-performance hinges open and close with a smooth, effortless motion
- Smooth, molded-in nose piece provides a comfortable and secure no-slip fit for almost any wearer

<b>S4120D</b>	<b>Clear Lens Black/Gray Frame, Dura-streme HC/AF</b>
<b>S4121D</b>	<b>Gray Lens Black/Gray Frame, Dura-streme HC/AF</b>
<b>S4122D</b>	<b>Amber Lens Black/Gray Frame, Dura-streme HC/AF</b>
<b>S4130D</b>	<b>Clear Lens Anthracite/Gray Frame, Dura-streme HC/AF</b>
<b>S4131D</b>	<b>Gray Lens Anthracite/Gray Frame, Dura-streme HC/AF</b>
<b>S4132D</b>	<b>Amber Lens Anthracite/Gray Frame, Dura-streme HC/AF</b>



*\*Composite lens life test performed using a Bayer Abrasion Test method and may vary between environment and application.*

## UVEX - Genesis

- Wrap-around lens provides exceptional peripheral vision and protection
- Flexible fingers adjust to most nasal profiles
- Elastomer browguard deflects impact
- Adjustable temples and lens inclination

<b>S3200</b>	<b>Black frame, clear lens, ultra-dura anti-scratch coating</b>
<b>S3200D</b>	<b>Black frame, clear lens, dura-streme</b>
<b>S3200-ADV</b>	<b>Black frame, clear Lens, Ultra-dura Anti-scratch Coating, Advanced TPE</b>
<b>S3200X</b>	<b>Black frame, clear Lens, UVextreme Anti-fog Coating</b>
<b>S3200X-ADV</b>	<b>Black frame, clear lens, UVextreme anti-fog coating, Advanced TPE</b>
<b>S3201</b>	<b>Black frame, espresso lens, ultra-dura anti-scratch coating</b>
<b>S3202</b>	<b>Black frame, amber lens, UVextreme anti-fog coating</b>



Hoffman Boots motto: Offer a high quality, functional product at a fair price. Hoffman's spends extra time and research to use the best quality materials in each and every pair of Hoffman boots. Hoffman brand lineman boots are made in the USA. From high quality industrial grade leather to exclusive dual steel shank system, the boots have stood the test of time.

## 10EH-CTPOWER: 10" Hoffman Powerline (steel toe optional)



The new 10" Powerline combines the comfort and fit of the 6" hiker with the support and feel of a regular work boot. The 10" Powerline features a leather/Cordura upper for lighter weight and breathability. The waterproof insert provides a waterproof barrier that helps keep you dry no matter what the weather is doing. A full cushion insole and padded leather collar add all-day comfort. Hoffman's unique dual steel shank system provides more climbing support than any boot on the market. For those needing a steel toe boot, the Powerline is available in both steel toe and plain toe. A Vibram sole provides long term wear and excellent traction.

### #LPower (Non-Steel Toe), #STPower (Steel Toe)

- Dual steel shanks for climbing support
- Available in plain or steel toe
- Leather/cordura upper for lighter weight
- Waterproof liner
- CSA approval pending
- D and EE widths available
- D: 7-12, 13w/ half sizes; EE: 8-12 w/ half sizes, 13

## 10STDL: All-Leather Powerline (safety toe optional)



The 10" Dri-line was built to keep your feet dry inside when conditions are wet on the outside. A highly advanced Sympatec waterproof membrane keeps water out and adds cushion and comfort to the boot. For climbing, the dual steel shanks are added to provide the extra arch support needed. Other quality features include a 7-7 1/2 oil tanned leather upper that provides support to your legs. A climber side patch, solid brass hooks and eyelets, supportive heel counter, Vibram lug sole and three rows of durable stitching help prolong the life of the boot. The 10" Hoffman Dri-Line is also available with an ANSI approved steel toe for added protection. For those looking for a quality waterproof climbing boot, look no further.

### #10DL (NON-Steel Toe)

### #10STDL (Steel Toe)

- Dual Steel Shanks for Climbing Support
- Waterproof Sympatec Liner Keeps Water Out
- Additional Lineman's Patch
- Optional Steel Toe with EH Rating Available
- D, E & EEE Widths Available
- Sizes 7-12 w/half sizes, 13
- Sizes 14, 15 (D width only)

**LINESWEAT-M/L/XL/2XL:  
Hoffman Boots Sweatshirt**

**LINET-M/L/XL/2XL:  
Hoffman Boots T-Shirt**





# Hoffman Boots

## ST MEINDL LINE: 6" & 10" Steel Toe Meindl Lineman Sole (Dual Climbing Shanks)

- 6" and 10" Steel Toe EH Rated Meindl Lineman Boots to our line of top quality footwear
- The German made Meindl boot has a very supportive upper that provides excellent leg support and stability
- A waterproof bootie helps insure dryness and a removable insole adds cushion to your every step
- Dual Steel Shanks have been added to the boot for all day climbing comfort
- A durable Vibram lug sole provides traction and longtime wear
- This boot will meet the F2413-11 standard for safety toe and EH rating
- Although waterproof liner failure is rare in the construction of this boot, neither Hoffman's nor Meindl will warranty the waterproofness of this boot
- Order 1/2 size smaller than usual

Sizes: 8-12



6" & 10" Steel Toe Meindl Lineman Sole

### 6STMeinREG: 6" Steel Toe Meindl Regular Sole (Single Shank)

- Easy to break in, the 6" Meindl Boot is ideal for those looking for a comfortable ground boot with outstanding support



6" Steel Toe Meindl Regular Sole

### 10STMeinREG: 10" Steel Toe Meindl Regular Sole (Single Shank)

- Easy to break in, the 10" Meindl Boot is ideal for those looking for a comfortable ground boot with a water proof liner

Sizes: 7-12 & 1/2 sizes, 13

# Salisbury by Honeywell

## Lineman's Rubber Overshoes

- Storm rubber overshoe; two buckles
- Ozone-resistant rubber is 100% waterproof
- Anti-skid bar tread outsole
- Shoe construction is hand layered in full-cut patterns to fit over work boots
- Fabric lining provides ease of putting on and taking off
- Provide extra safety when climbing ladders and poles where the deep heel cavity can lock onto the rungs

Linemen's Dielectric Footwear  
100% tested to 20 kV per ASTM F1116  
ASTM F1117 compliant  
51511 - Non-Buckle Overshoe Bob Sole sizes 7-16

Super Dielectric Storm Rubber Overshoe  
100% tested to 20 kV per ASTM F2413-05 - revised standards  
51530 - Deep Heel Overshoe, Anti-Skid Tread Outsole



## 10-8601: Metal-Free Boots, Black



- Slip and oil resistant lightweight FLX™ rubber sole for improved flexibility
  - Non-metallic puncture resistant plate
  - Dielectric (ESR) protection
  - Sealed seams
  - Composite protective toecap
  - Soft PU footbed, for added comfort
  - Wear resistant TPU Pareshok™
  - Airflow waterproof and breathable membrane
  - Silverclear treated Taibrelle lining
  - 2.0 mm full grain polishable leather
  - This style meets CSA Z195-09, ASTM F2413-11 I/75, C/75, PR, EH quality standards
- Available sizes: 5, 6, 7-10 + 1/2, 11-15**

## 10-8400: Metal-Free Boots, Black



- Non-metallic puncture resistant plate
  - Dielectric (ESR) protection
  - Sealed seams
  - Slip and oil resistant lightweight FLX™ rubber sole for improved flexibility
  - Composite protective toecap
  - Wear resistant TPU Pareshok™ for more durability
  - Soft PU footbed, for added comfort
  - Airflow waterproof and breathable membrane
  - Silverclear treated Taibrelle lining
  - 2.0 mm full grain leather and Armortex fabric, abrasion resistant, water and wind proof
  - This style meets CSA Z195-09, ASTM F2413-11 I/75, C/75, PR, EH quality standards
- Available sizes: 5, 6, 7-10 + 1/2, 11-15**

## 8700: Linemen Boots, Black



- Dielectric (ESR) protection
  - Protective steel toecap
  - 2.0 mm full grain leather
  - Sealed seams
  - Tundra Poliyou footbed for added comfort
  - Isofix lining and waterproof membrane tested in factory
  - Vibram vulcanized and cemented rubber slip and oil resistant sole
  - Padded ankle protector to ease climber wear
  - Double dual-rib steel shank
  - Protective steel plate
  - This style meets CSA Z195-09, ASTM F2413-11 I/75, C/75, PR, EH quality standards
- Available sizes: 5-12 + 1/2, 13**

## 8614: Forestry Boots, Black & Orange



- Dielectric (ESR) protection
  - Poliyou footbed for added comfort
  - Stitching threads tested for strength
  - Vulcanized rubber track slip and oil resistant sole
  - Cambrelle liner and waterproof membrane tested in factory
  - Protective ballistic nylon, Kevlar® and 2.0 mm full grain leather
  - Protective steel plate
  - This style meets CSA Z195-09 quality standards
- Available sizes: 6-12 + 1/2, 13, 14**

## 10-8620 Metal-Free Boots, Brown, 8"



- Non-metallic puncture resistant plate
  - Dielectric (ESR) protection
  - Sealed seams
  - Slip and oil resistant lightweight FLX™ rubber sole for improved flexibility
  - Composite protective toecap
  - Wear resistant TPU Pareshok™ for more durability
  - Soft PU footbed, for added comfort
  - Airflow waterproof and breathable membrane
  - 2.0 mm Crazy Horse leather and Armortex fabric, abrasion resistant, water and wind proof
  - Silverclear treated Taibrelle lining
  - This style meets CSA Z195-09, ASTM F2413-11 I/75, C/75, PR, EH quality standards
- Available sizes: 5, 6, 7-10 + 1/2, 11-15**

## 10-8600 Metal-Free Boots, Black



- Non-metallic puncture resistant plate
  - Dielectric (ESR) protection
  - Sealed seams
  - Slip and oil resistant lightweight FLX™ rubber sole for improved flexibility
  - Composite protective toecap
  - Soft PU footbed, for added comfort
  - Pareshok™ and rubber heel counter resistant to chemicals, hydrocarbons, detergents
  - Airflow waterproof and breathable membrane
  - Silverclear treated Taibrelle lining
  - 2.0 mm full grain leather and Armortex fabric, abrasion resistant, water and wind proof
  - This style meets CSA Z195-09, ASTM F2413-11 I/75, C/75, PR, EH quality standards
- Available sizes: 5, 6, 7-10 + 1/2, 11-15**

## 10-8420 Metal-Free Boots, Brown



- Non-metallic puncture resistant plate
  - Dielectric (ESR) protection
  - Sealed seams
  - Slip and oil resistant lightweight FLX™ rubber sole for improved flexibility
  - Composite protective toecap
  - Wear resistant TPU Pareshok™ for more durability
  - Soft PU footbed, for added comfort
  - Airflow waterproof and breathable membrane
  - 2.0 mm Crazy Horse leather and Armortex fabric, abrasion resistant, water and wind proof
  - Silverclear treated Taibrelle lining
  - This style meets CSA Z195-09, ASTM F2413-11 I/75, C/75, PR, EH quality standards
- Available sizes: 5, 6, 7-10 + 1/2, 11-15**

## 10-6020 Metal-Free Boots, Brown



- Non-metallic puncture resistant plate
  - Dielectric (ESR) protection
  - Composite protective toecap
  - Wear resistant TPU Pareshok™ for more durability
  - Soft PU footbed, for added comfort
  - Taibrelle lining
  - Stitching threads tested for strength
  - Oil resistant 4-Density sole rubber inserts bonded to a PU midsole with a TPU lock sole
  - Thinsulate thermal insulation
  - 2.0 mm Crazy Horse leather
  - This style meets CSA Z195-09, ASTM F2413-11 I/75, C/75, PR, EH quality standards
- Available sizes: 7-10 + 1/2, 11, 12, 13**

## 10-8550: Metal-Free Boots, Black



- Non-metallic puncture resistant plate
  - Dielectric (ESR) protection
  - Sealed seams
  - Slip and oil resistant lightweight FLX™ rubber sole for improved flexibility
  - Composite protective toecap
  - Soft PU footbed, for added comfort
  - Wear resistant PU coated vamp, for more durability
  - Airflow waterproof and breathable membrane
  - Silverclear treated Taibrelle lining
  - Wear and tear resistant professional hockey grade nylon
  - This style meets CSA Z195-09, ASTM F2413-11 I/75, C/75, PR, EH quality standards
- Available sizes: 5, 6, 7-10 + 1/2, 11-15**

## 10-8610: Metal-Free Boots, Wheat



- Non-metallic puncture resistant plate
  - Dielectric (ESR) protection
  - Sealed seams
  - Slip and oil resistant lightweight FLX™ rubber sole for improved flexibility
  - Composite protective toecap
  - Wear resistant TPU Pareshok™ for more durability
  - Soft PU footbed, for added comfort
  - 2.0 mm Nubuck leather
  - Airflow waterproof and breathable membrane
  - Silverclear treated Taibrelle lining
  - This style meets CSA Z195-09, ASTM F2413-11 I/75, C/75, PR, EH quality standards
- Available sizes: 5, 6, 7-10 + 1/2, 11-15**

## 10-8604: Metal-Free Boots w/ Full Size Zipper, Black



- Non-metallic puncture resistant plate
  - Dielectric (ESR) protection
  - Sealed seams
  - Slip and oil resistant lightweight FLX™ rubber sole for improved flexibility
  - Composite protective toecap
  - Soft PU footbed, for added comfort
  - Airflow waterproof and breathable membrane
  - Silverclear treated Taibrelle lining
  - Superior quality YKK inside zipper
  - 2.0 mm full grain polishable leather
  - This style meets CSA Z195-09, ASTM F2413-11 I/75, C/75, PR, EH quality standards
- Available sizes: 5, 6, 7-10 + 1/2, 11-15**

## 10-6000: Metal-Free Boots, Black



- Non-metallic puncture resistant plate
  - Dielectric (ESR) protection
  - 2.0 mm full grain leather
  - Composite protective toecap
  - Wear resistant TPU Pareshok™ for more durability
  - Soft PU footbed, for added comfort
  - Taibrelle lining
  - Stitching threads tested for strength
  - Oil resistant 4-density sole rubber inserts bonded to a PU midsole with a TPU lock sole
  - Thinsulate thermal insulation
  - This style meets CSA Z195-09, ASTM F2413-11 I/75, C/75, PR, EH quality standards
- Available sizes: 7-10 + 1/2, 11, 12, 13**

## EVOTECH® Full Body Harness



- Breathable padding with moisture-wicking material keeps users cooler
- No binding edge on shoulder padding prevents neck chafing
- Sub-Pelvic Strap with patented variable width webbing provides 50% more surface area for improved weight distribution and improved comfort
- Patent-pending leg strap design keeps leg straps in place, increasing mobility and comfort
- Dual-colour webbing - red pattern on outside, black on inside - promotes easy identification of twisted webbing
- Patent-pending web management system provides means of storing excess webbing
- 3-position back D-ring allows users to determine optimal lanyard connection position
- Web finials prevent fraying on web ends and simplify threading through buckles
- NanoSphere® coating on webbing repels dirt, grease, moisture, etc.
- Available with Suspension Trauma Safety Step to improve post-fall comfort and help prevent suspension trauma
- Reflective webbing integrated into harness webbing increases visibility in low-light environment
- Construction harness features integral back pad and tool belt with dual-durometer padding for superior comfort in work positioning applications

**10105940** EVOTECH Harness, BACK D-ring, Qwik-Connect leg straps, Qwik-Connect chest strap, Shoulder Padding, Standard (STD)

**10112762** EVOTECH Tower Harness w/integral backpad, BACK, HIP & CHEST D-rings, Qwik-Connect leg straps, Qwik-Connect chest strap, Shoulder & Leg Padding, Standard (STD), Padded Saddle

**10112742** EVOTECH Construction Harness w/integral backpad, BACK & HIP D-rings, Qwik-Connect leg straps, Qwik-Connect chest strap, Shoulder Padding, Standard (STD)

## TechnaCurv® Harness



- The TechnaCurv® Full Body Harnesses offer features never seen before in full-body harnesses: Curvilinear comfort system, Visco-Elastic shoulder padding, and Sorbtek fabric on the shoulder and sub-pelvic pads
- The harness is designed with downward adjusting torso straps on most models to ease fitting
- Tower Harness model available with integral body belt and removable saddle
- Resists water, oil, grease, and dirt with Teflon fabric protected webbing which increases the life of the harness
- Uses Visco-Elastic shoulder padding for comfort
- Curvilinear Comfort System provides total comfort during use
- Integral belt and comfortable saddle assist with support, position, restraint, and climb movements

**10053001** TechnaCurv Harness, Vest-Style, BACK D-ring, Qwik-Fit leg straps, Qwik-Fit chest strap, Shoulder Padding, Tool Belt Loops, X-Large (XLG)

**10041611** TechnaCurv Harness, Vest-Style, BACK, HIP & CHEST D-rings, Tongue Buckle leg straps, Qwik-Fit chest strap, Shoulder Padding, Standard (STD)

## Gravity® Harness



- Available in vest and cross-over styles (varies by country) and rated to a 400 pound/180 kg capacity, Gravity Harnesses are suitable for controlled descent, positioning, ladder climbing, rescue, and fall arrest
- A variety of options are available to meet your specific needs
- All Gravity Harnesses now include a load-indicator to alert you when the harness has been involved in a fall event
- Colour-contrasting thigh and torso straps simplify donning
- Integral belt and comfortable saddle assist with support, position, restraint and climb movements
- Includes two lanyard keepers for added safety when lanyard leg is not in use
- Includes a load-indicator to alert you when the harness has been involved in a fall event

**SSH30420060** Gravity Harness Class A, Size Standard, Webbing Nylon Red/Blue, Leg Connection Mating Buckle

## Revolution Arc-Rated & Non Arc-Rated Harnesses

- Kevlar®/Nomex® Miller DualTech™ webbing – patent-pending 10,000 lb. tensile strength webbing is engineered with permanent fire retardant (FR) properties. The webbing offers the durability and FR properties of Kevlar on the outer side, with softer FR Nomex on the inside of the webbing for greater comfort. The webbing assures arc protection and durability that eclipses any nylon webbing
- PivotLink™ design allows unmatched freedom of motion and comfort, while the unique Cam Buckles provide easy two-finger adjustment
- Leather insulators under all metal hardware offer additional protection for the worker
- The Kevlar web loop on the back pad allows for a “metal-less” connection when used with a Kevlar shock-absorbing lanyard with a choke-off loop
- All Miller Revolution Arc-Rated Harnesses have bright red binding on every pad, making them easily identifiable as an arc-rated product



- Quick-Connect
  - Chest Buckles
  - Cam Buckles
  - ErgoArmor
  - Back Shield
  - Leather insulators; web back D-ring
  - Self-Contained
  - Label Pack
  - Web Finials
- RKNARRL-QC/UBK Arc-Rated Revolution Harness**



**RKN-QC/UBK Standard Revolution Harness**

## AirCore Tower Climbing Harnesses

- Up to 21% lighter than similar competitive harnesses – increased productivity and reduced fatigue
- Up to 16% less surface area than other padding used on the market – keeps workers cooler and working longer
- Rated to 400 lbs (181.4 kg) capacity
- Unique breathable, open-core padding technology provides optimal airflow and reduces heat and moisture build-up; up to 16% less surface area than other padding used on the market
- Contoured ergonomic padding design minimizes contact around a worker’s neck, lower back and inner thighs to reduce chafing and irritation
- Patented DuraFlex stretchable webbing provides greater flexibility
- Easy adjustability: Cam buckles provide easy one-hand adjustment; hold webbing firmly in place with no readjusting required
- Quick-connect buckles for easy donning
- Lightweight: Materials and components selected to reduce fatigue for all-day endurance and increased productivity; up to 10% lighter than similar competitive harnesses
- Unique and vibrant patterned webbing for easy identification



**ACF-QCBDPUG**

## 650KQC: Heavy Duty Welder Harnesses

- The Heavy-Duty Welder Harnesses are designed with rugged black Kevlar® webbing to withstand harsh welding environments
- They meet ASTM F887 Arc Test requirements and are rated for arc exposure
- Materials Webbing: 1-3/4" Kevlar
- Elastic Keepers: Kevlar, Elastic
- Thread (Stitching): Kevlar, Polyester
- Web Back D-Ring: Kevlar Webbing
- Metal Back D-Ring\*: Clear Chromate Finished Carbon Steel
- Buckles\*: Clear Chromate Finished Carbon Steel
- Grommets: Brass
- Connection Insulators: Leather

\* All hardware meets ASTM (50) fifty-hour salt spray test requirements



**805KQC**



TRUSTED SINCE 1958

# Miller

## P950/UGN: Duraflex Python Harness

- The DuraFlex Python Harness features wraparound comfort and is uniquely constructed with three types of performance webbing
- Cushioned tubular webbing shoulder straps
- DuraFlex webbing torso straps
- Non-stretch webbing leg straps



## E650-7/UGN: Duraflex Stretchable Harness

- Maximize Comfort
- DuraFlex Harnesses conform to the shape of the worker, stretching with every movement, so there is no bunching, binding or kinking
- With comfort unsurpassed, DuraFlex Harnesses offer wider end-user acceptance
- A comfortable harness is worn properly, enhancing compliance and safety on the jobsite
- Because DuraFlex Harnesses are stretchable, the worker has greater mobility with less fatigue



## 233MK-Z7: Manyard II Stretchable Shock-Absorbing Lanyard

- Specially-woven shock-absorbing inner core smoothly expands to reduce fall arrest forces
- Working load of 310 lbs (140.6 kg) and features a warning flag to indicate that it has arrested a fall
- A heavy-duty tubular outer jacket serves as a wear indicator and back-up strap to the red inner core for added safety



## StretchStop Lanyards w/SofStop Shock Absorber

- Unique stretchable design (4-ft. [1.2 m] to 6-ft. [1.8 m]), minimizes tripping, snagging and dragging
- SofStop Shock Absorber pack is designed with a specially-woven inner core that smoothly expands to reduce fall arrest forces
- Includes a heavy-duty back-up safety strap

940SS-E6/6FTGN One Leg

980SS-E6/6FTN Two Legs



## 216MK/6FTBK: Arc Rated Shock Absorbing Lanyards

- Specially-woven shock-absorbing inner core smoothly expands to reduce fall arrest forces
- Unique warning flag provides visual proof that a lanyard has been involved in a fall and must be removed from service
- Arc-rated Kevlar webbing in both single- and double-legged models
- Integral bright red core makes visual inspection easier and more reliable
- Available with choke-off loop or locking snap hooks with 3/4" (19 mm) or 2-1/2-in. (63 mm) gate openings
- Meets Stringent ASTM F887-05 Arc-Flash Standards



## Scorpion Fall Limiter

- The lightweight, compact design of the 9 ft (2.7 m) Miller Scorpion Personal Fall Limiter provides workers an affordable alternative to shock-absorbing lanyards
- In a head-to-head comparison with shock-absorbing lanyards, the Scorpion web retractable requires less fall clearance, offers greater mobility and prevents tripping hazards
- Greater versatility through dual operation: attach directly to the harness D-ring for use as a personal fall limiter, or use as a traditional retractable lifeline
- Small, lightweight design 2.9 lbs (1.3 kg)
- Quick-activating, high-strength stainless steel braking system – arrests free falls
- 9ft (2.7 m) of working capacity
- Variety of integral anchorage connectors available
  - No annual factory recertification required
  - Visual load indicator – indicates the unit must be removed from service



## StopFall Restraint Device

- Designed to easily and naturally climb wood poles in a position that's both comfortable and ergonomically accepted
- Automatic spring-loaded cinching feature - Miller Exclusive!
- Easy to use and adjust when hitchhiking wood poles
- For use on transmission and distribution poles
- 100% inspection
- Accommodates wood poles ranging from 20" to 60" circumference
- Unique gaffs provide excellent stopping power on dry, wet or icy poles
- The Miller StopFall™ Fall Restraint Device was created for linemen by linemen to make pole climbing as safe, comfortable and convenient as possible, eliminating room for error and increasing safety
- The only wood pole product of its type, it provides a straightforward solution allowing workers to climb naturally and instinctively
- The unique spring-loaded cinching feature of the Miller StopFall keeps the unit in constant contact around the pole
- Its minimal points of adjustment make worker training quick and easy



## GlideLoc Safe Climbing Ladder System (Rail)

- Continuous Fall Protection for Climbing Fixed Ladders
- New GlideLoc Vertical Height Access Ladder System Kits provide an innovative solution for vertical climbing that is easy-to-use, requires minimal maintenance and provides superior safety
- Kits are available in aluminum, galvanized or stainless steel construction
- Unique design keeps hands free for climbing
- Engineered for smooth operation for ascending/descending
- Durable construction for extended service life
- Accommodates multiple workers



Ideal for Permanent Ladder Applications:

- Wind Power/Turbines
- Drilling Rigs/Platforms
- Telecommunications
- Shipbuilding
- Utilities
- Crane Installation
- Industrial Facilities
- Confined Space

## Vi-Go Ladder Climbing Safety Systems (Cable)

- Continuous fall protection when climbing fixed ladders
- New Vi-Go™ Ladder Climbing Safety Systems provide the ultimate in safety with continuous fall protection when climbing fixed ladders
- Lower cost of ownership – Do-it-yourself kits for easy installation and inspection. No costly, annual manufacturer inspections often required by other systems
- Option to cut cable lengths on site for greater versatility
- Accommodate up to four (4) workers at a time: increasing productivity
- Select Automatic or Manual Personal Fall Arrester Cable Sleeves: both cable sleeves are designed to follow the user along the lifeline while ascending or descending, instantly locking in the event of a fall
- Uninterrupted fall protection: Uniquely-designed, patent-pending Vi-Go Cable Sleeve automatically bypasses intermediate cable guides, keeping both hands free for climbing; travels smoothly along cable and locks instantly in the event of a fall
- Easy, one-hand operation for attachment/detachment from the system
- Automatic pass-through cable guides secure lifeline to prevent cable wear and enable the system to accommodate curves
- Withstands harsh environments
- Attachment mechanism engineered to prevent incorrect installation, ensuring greater safety, unit will not open if attached incorrectly
- Cable sleeve integrated shock-absorbing element
- Provides a "dual shock-absorbing system" to further reduce fall forces, protects the system and ladder from damage
- Once a fall occurs, the deployed shock absorber indicates the unit must be taken out of service
- Accommodate 5/16" (8 mm) or 3/8" (10 mm) cable





# Miller

## MightEvac® Self-Retracting Lifeline with Emergency Retrieval Hoist

- The Miller MightEvac combines the superior performance and reliability of the best-selling MightyLite Self-Retracting Lifeline Series with a quick-activating retrieval mechanism for emergency evacuation
- Significant long-term savings/lower cost of ownership
- 20% lighter than competitive models
- Promotes quick and easy rescue with a 4:1 mechanical advantage (average speed of 25 ft [7.6 m] per minute)
- 310 lbs (1.4kN) weight capacity
- For emergency evacuation only
- Corrosion-resistant stainless steel/aluminum components
- Convenient, heavy-duty carrying handle
- Available in galvanized or stainless steel wire rope and Kevlar rope in lengths of 50 ft (15 m), 100 ft (30 m) and 130 ft (40 m), or Kevlar rope models in lengths of 40 ft (12.2 m) SKU MR40K/40FT, and 80 ft (24.4 m) SKU MR80K/80FT



## DH-1: Durahoist™ Safety Systems

- Designed for manhole and confined space entry/retrieval and fall arrest applications
- The modular design allows the use of components in various configurations and applications
- Multiple winches and/or lifeline systems may be mounted as required
- Lightweight, manageable components for easy storage, transport and set-up



## MR50GRC/50FT: Miller Tripod w/ MightEvac® Self-Retracting Lifeline/Emergency Retrieval Hoist

- Promotes quick and easy rescue with a 4:1 mechanical advantage (avg. speed of 25 ft per minute)
- 7 ft (2m) tripod; lightweight, high-strength aluminum construction
- Adjustable legs, safety chain, rubber skid pads/serrated edge tripod feet
- Corrosion-resistant stainless steel/aluminum components; 310 lbs capacity



## SE/75FT: Miller SafEscape® ELITE Controlled Descent/Self-Rescue System

- Used for vertical and angular controlled descent from overhead cranes, towers, aerial lifts, oil derricks, platforms and other elevated work areas
- Approved for multiple descents
- Includes lifeline, rescue harness, cross arm strap anchorage connector/carabiner, retrieval yoke and carrying bag
- SWHW/75FT comes with hoisting wheel



# Bashlin Climbing Equipment

Climbing is serious business, demanding dependable equipment for individuals to work safely in elevated work areas. Bashlin's products reflect that belief in safety and attention to the way the tools feel, work, and wear. Bashlin's craftsmen use the finest materials on the market today to manufacture the highest quality tool belts, pole straps, and climbers for professional linemen.

## The Floridian and the Maverick Tool Belts - Full Floating

- Superior design and performance make this belt the industry standard
- Combines a padded, contour cushion section with flares for shifting D-rings and a 5 1/2" back
- Gives excellent support and climbing comfort

Part #	Colour
Bashlin 88	Floridian Tan
Bashlin 88X	Maverick Black

## Hip-Grip Back Support Tool Belts - Full Floating

- Help relieve back strain and fatigue
- Standard belts are not padded, but padding is available

Part #	Colour
Bashlin 88G	Tan
Bashlin 88GX	Black

## Rest-A-Back Tool Belts - Full Floating

- Help relieve back strain and fatigue
- Standard belts are not padded, but padding is available

Part #	Colour
Bashlin 88B	Tan
Bashlin 88BX	Black

## 4 Dee Ring Tool Belt

- Excellent for use with secondary lanyards and/or wood pole fall restricting devices
- Features an arc-resistant cushion that allows cooling and ventilation
- This soft material requires no break-in
- Hip-hugging design gives back support in a lightweight belt

Part #	Colour
Q88GX4DMP	Black

## EZ Rider - Linemen's Tool Belt

- The new ergonomic, contoured design allows the belt to be worn comfortably and correctly, without compromising safety
- Supports the lower abdomen, reducing leg discomfort and numbness
- Dramatically improves "on the pole" comfort
- Easily connects Pole Lariats, Pole Chokers, Cynch-Loks and similar WPF RDs

Part #	Colour
88UX4DMP-DSIZE	Black



# Bashlin Climbing Equipment

## Steel Pole Climbers

- Steel alloy adjustable climber
- Offset design
- Features a replaceable gaff, roomy ankle area, and a triangular strap ring

<b>Bashlin BD16B-1N</b>	<b>Bottom Straps Attached</b>
<b>Bashlin BD16B-2N</b>	<b>Bottom and Top Straps Attached</b>
<b>Bashlin BD16B-3N</b>	<b>Straps with Pad 110D</b>
<b>Bashlin BD16B-4N</b>	<b>Straps with Pad 130D</b>
<b>Bashlin BD16B-5N</b>	<b>Straps with Pad 140DS</b>



Bashlin BD16

## Aluminum Alloy Pole Climbers

- Aluminum alloy offset climber features a replaceable, forged steel gaff
- Weigh 30% less than comparable steel climbers, reducing fatigue and adding climbing comfort

<b>Bashlin BD14-1N</b>	<b>Bottom Straps Attached</b>
<b>Bashlin BD14-2N</b>	<b>Bottom and Top Straps Attached</b>
<b>Bashlin BD14-3N</b>	<b>Straps with Pad 110D</b>
<b>Bashlin BD14-4N</b>	<b>Straps with Pad 130D</b>
<b>Bashlin BD14-5N</b>	<b>Straps with Pad 140DS</b>



Bashlin BD14

## Aluminum Alloy Tree Climbers

- Designed for tree climbing and features a 2 1/2" gaff
- Reduces fatigue and adds climbing comfort
- Comparable steel climbers weigh 30% more
- Climbers come with bottom straps attached, top straps and pads
- Weighs 5.75 lbs

<b>Bashlin BD14T-1N</b>
<b>Bashlin BD14T-2N</b>
<b>Bashlin BD14T-5N</b>



Bashlin BD14T

## Gaff Guards

- Made of leather with a hook/loop attachment
- These guards protect the gaff and the climber



Bashlin #2

## Nylon Climber Straps

- Durable, pliable, and comfortable
- Double riveted, featuring a protective buckle shield

<b>Bashlin 85N</b>	<b>Top Straps - 1 1/16"x24"</b>
<b>Bashlin 86N</b>	<b>One Piece Lower Straps - 1 1/16"x28"</b>
<b>Bashlin 87N</b>	<b>Two Piece Lower Straps - 1 1/16"x28"</b>
<b>Bashlin 89N</b>	<b>Two Piece Lower Straps w/ split ring 1 1/16"x28"</b>



Bashlin 85N



Bashlin 86N



Bashlin 87N



Bashlin 89N

# Bashlin Climbing Equipment

## Wing Pad

- This wing pad holds the shank more securely than other leather pads
- The climber shank fits inside the pad, reducing movement and adding comfort
- Available with or without padding

**Bashlin 140D** Not Padded  
**Bashlin 140DS** Padded



## 145 Series Climber Pads

- Features extreme comfort and gives increased climber support
- Double strap design with "spur stay irons"
- Fits Bashlin steel and aluminum climbers
- One pair climber straps included with pads

**145** Without steel inserts  
**145 AC** For Steel Climbers  
**145 BC** For Aluminum Climbers



## Lineman's Holsters



**Bashlin 111HLS**

**Bashlin 111HLDS**

- Reinforced double backs for extra wear
- Available in tan or black
- 111HLS and 111HLSX will hold pliers, rule, screwdriver, Channellock, knife or wrench
- 111HLDS and 111HLDSX will hold pliers, rule, screwdriver, Channellock, ratchet driver, knife or wrench

<b>Bashlin 111HLS</b>	<b>4 Pockets</b>	<b>Tan</b>
<b>Bashlin 111HLSX</b>	<b>4 Pockets</b>	<b>Black</b>
<b>Bashlin 111HLDS</b>	<b>5 Pockets</b>	<b>Tan</b>
<b>Bashlin 111HLDSX</b>	<b>5 Pockets</b>	<b>Black</b>

## Hook-N-Loop Climber Pads



**Bashlin 145BCV**

- No straps and buckles for easy donning
- Comfortable wrap-around padding
- Fit most standard climbers
- 145 ACV AND 145 BCV feature a metal insert for positive climber control
- 150V features the standard "T" design

**Bashlin 150V** Climber Pad  
**Bashlin 145 ACV** for Steel Climbers  
**Bashlin 145 BCV** for Aluminum Climbers

## Lowell Wrench Holster



- Reinforced double back for extra wear
- Designed to hold Lowell wrenches
- (tool not included)

**Bashlin 111LWH** Tan  
**Bashlin 111LWHX** Black

## 25BS: Bashlin Bolt & Nut Bag



- Canvas
- Reinforced base
- Snap or thong attachment

## 78 Series Pole Straps



- 2 plies of pliable latigo leather straps featuring a nylon insert
- Stitching is deeply embedded in the leather for longer wear
- "HL" snap is very similar to the movements used with the single locking snap

**Bashlin 78X-2HL** 5'6" long  
**Bashlin 78A-2HL** 6' long  
**Bashlin 78B-2HL** 6'6" long

## 50 Series Pole Straps



- 6 ply 1 3/4" neoprene-coated nylon uses a tongue buckle adjustment
- "HL" Snap is similar to the movements used with the single locking snap

**Bashlin 51N-2HL** 5'6" long  
**Bashlin 52N-2HL** 6' long  
**Bashlin 53N-2HL** 6'6" long



# Buckingham

## SuperSqueeze

The SuperSqueeze offers superb Wood Pole Fall Restriction and offers the easiest adjustment on the market. With Buckingham's patent pending WebGrab, the SuperSqueeze can be adjusted with just a flick of the wrist. The SuperSqueeze can be configured to fit many climbing styles and needs, and its modular design makes it easy to change out worn or damaged components or straps in the field.



Featuring rope inner strap; features snap hooks on woven strap  
**Model 488RQ4 for Distribution**  
**Model 488RTQ4 for Transmission**  
 Featuring Rope Inner Strap and Carabiners:  
**Model 488R for Distribution**  
**Model 488RT for Transmission**



Featuring woven inner strap; features snap hooks on woven strap  
**Model 488W2Q3 for Distribution**  
**Model 488TW2Q3 for Transmission**  
 Featuring Woven Inner Strap and Carabiners:  
**Model 488W2 for Distribution**  
**Model 488TW2 for Transmission**

## 2011 482D BuckSqueeze Wood Pole Protection Device

Buckingham has yet again enhanced the BuckSqueeze by adding their WebGrab to the green strap for even easier adjustment. In production since 2000, the BuckSqueeze is the most widely used Wood Pole Fall Restriction Device in the U.S. With thousands in use and numerous documented saves, the BuckSqueeze provides Wood Pole Fall Protection during ascent and descent.

**2011 BuckSqueeze with WebGrab**  
**Model 482D - For Distribution Poles**  
**Model 482T - For Transmission Poles**  
**4305 Rainbow Cresote Remover (Case of 12)\***  
**4494 Brush (Case of 12)**

2010 BuckSqueeze models may be updated with webgrab.



Featuring the Patent Pending Web-Grab for the Easiest Adjustment for the Circumference of the Pole



WebGrab Adjustment

## 2010 483D BuckSqueeze Wood Pole Protection Device



BuckSqueeze is a Wood Pole Fall Restriction Device that provides:  
 Wood Pole Fall Protection during ascent and descent  
 With the use of a secondary lanyard like the BuckAdjuster, protects the user while climbing over obstacles  
 Designed to grip the pole if the user starts to fall  
 For distribution poles with a circumference up to 50" (16" diameter)

**483D Distribution (Max: 50" Circumference)**  
**484T Transmission (Max: 90" Circumference)**  
**4305 Rainbow Cresote Remover (Case of 12)**  
**4494 Brush/Case of 12**

## Ox Block

- A rope snatch block with an integrated friction bar used for hurt man rescue, lowering loads, snubbing loads, and raising loads
- Allows the rigging professional to handle loads with greater control
- When lowering loads, tension is transferred from the worker to the OX BLOCK™
- Replaces standard handline blocks, parted blocks, and various snatch blocks has greater working load limits than blocks of similar size



## SuperStrap

Buckingham's SuperStraps have the same, easy-to-use adjustment as the popular BuckAdjuster.

### Secondary Web Lanyard

- Features the patent pending WebGrab for easy adjustment
- Features all the benefits of web combined with the easy adjustment of rope
- Designed to use for climbing over obstructions



- 48129W2Y-6 6' length
- 48129W2Y-7 7' length
- 48129W2Y-8 8' length
- 48129W2Y-9 9' length
- 48129W2Y-10 10' length

### Secondary Web Lanyard / Positioning Strap

- Features the patent pending WebGrab for easy adjustment
- No more holes to find or run out of as with conventional positioning straps
- Made from 6 ply neoprene nylon with red warning core
- Available in any length with 2 snaps



- 336099E 6' length
- 336699E 6.5' length
- 337099E 7' length
- 337669E 7.5' length
- 338099E 8' length

## 4812Y-7: Positioning Strap



- Woven Nylon with Friction Buckle and 99E Locker
- Uses a friction buckle in conjunction with a carabiner
- Length - 7'

## 9-8: BackAdjuster



- Fully adjustable positioning rope lanyard
- 8' in length and 1/2" in diameter
- With a red core wear indicator
- Features the patent pending BuckGrab
- Clear protective tube lengthens rope life
- Stitched eye allows user to minimize length for easy storage
- Available in additional lengths upon request

## 2402: Handline Carrier



A nylon handline carrier that will straighten when approximately 14-18 lbs of pressure is applied, allowing the hand line to pull free

## C2019M: Stacked 4 Dee Dri-Lex® Body Belt with BackSaver

- A new version of the lightweight Dri-lex® lined body belt with stacked dee rings
- Ideal for use with a secondary lanyard
- 2 large full float double bar dees 2 small dees
- Back support; no gut strap
- Weight 6.35 lbs
- CSA Approved



- C2019M D22 C2019M D27
- C2019M D23 C2019M D28
- C2019M D24 C2019M D29
- C2019M D25 C2019M D30
- C2019M D26 C2019M D31

## C2018M: Full Float 4 Dee Dri-Lex® Body Belt with BackSaver

The stacked 2018M 4 dee body belt features:

- Dri-lex® lining
- Stacked dee rings
- 2 large full float double bar dee
- 2 small dee rings
- Removable man rated gut strap (must be used with a Buckingham provided gut strap)
- CSA approved



- C2018M D23 C2018M D28
- C2018M D24 C2018M D29
- C2018M D25 C2018M D30
- C2018M D26 C2018M D31
- C2018M D27

# Buckingham

## C2000M: Full Float Leather Body Belt



- Leather belt strap with nylon center for strength
- Floating dees provide 4" lateral movement
- Hand crafted with 5 1/2" foam cushioned pad reinforced with rawhide lace
- Weight 7 lbs.
- Add suffix 'E' to order with 4 in line dee rings
- CSA Approved

Black	Brown
C2000M-BL D20	C2000M-BR D20
C2000M-BL D21	C2000M-BR D21
C2000M-BL D22	C2000M-BR D22
C2000M-BL D23	C2000M-BR D23
C2000M-BL D24	C2000M-BR D24
C2000M-BL D25	C2000M-BR D25
C2000M-BL D26	C2000M-BR D26
C2000M-BL D27	C2000M-BR D27
C2000M-BL D28	C2000M-BR D28

## 2100M: 4 Dee Body Belt

- The high-quality features of the 2000M with stacked dee rings
- Ideal for use when a secondary lanyard is used to climb over obstructions
- Highest quality leather with a 5 1/2" foam cushioned pad reinforced with rawhide lace, bridge pieces and belt straps crafted of leather with a nylon center to provide strength and longer life, and full floating primary dee rings that provide 4" lateral movement to reduce the wear on the pole strap
- 2 large full float double bar dee rings; 2 small dee rings
- 9" back pad
- Waist strap only; no upper gut strap
- Weighs 7.8 lbs

- 2100M D21
- 2100M D22
- 2100M D23
- 2100M D24
- 2100M D25
- 2100M D26
- 2100M D27
- 2100M D28



## 2107M-4: Dee Body Belt



- The high-quality features of the 2000M with stacked dee rings
- Ideal for use when a secondary lanyard is used to climb over obstructions
- Highest quality leather with a 5 1/2" foam cushioned pad reinforced with rawhide lace, bridge pieces and belt straps crafted of leather with a nylon center to provide strength and longer life, and full floating primary dee rings that provide 4" lateral movement to reduce the wear on the pole strap
- 2 large full float double bar dee rings; 2 small dee rings
- 9" back pad
- Waist strap only; no upper gut strap
- Weighs 9.2 lbs

## Buck ErgoBelt



Over the years, Linemen have had to adapt to the equipment they use causing stress and strain on their bodies. Buckingham teamed up with Ergonomic Specialists to design a line of products specifically designed for use by Linemen and Arborists that better fit the skeletal structure. The new Ergovation line from Buckingham makes hard work more comfortable, safe and productive.

- A. Abdominal Stabilizer System** - Elastic Abdominal Stabilizer belt maintains continual pressure and proper position of Lumbar Pad
- B. Dee Ring Distributing Pads** - Distributes pressure from the heel of dee by disbursing pressure over a greater area
- C. Equalization Strap** - When in work position, transfers users weight from back support to seat section or seat section to back support
- D. Lumbar Pocket** - Removable lumbar pad for ideal back support
- E. Harness Attachment Buckles** - Attach harness to belt with man rated straps. Specify 4C after harness model number
- F. Removable Seat** - Connects to upper belt using steel interlocking T buckles, BuckSqueeze can connect to the lower D rings for increased comfort, provides hip support for ultimate comfort and support, and seat D rings are adjustable for ideal placement and comfort of the individual while climbing

## C4200: Buck LineBacker

- Offers ergonomic advantages and turns a two dee belt into a four dee belt
- LineBackers feature an abdominal stabilizer, dee ring distributing pads, and lumbar support (removable in Model 4201, permanent in Model 4202)
- The deluxe Model 4201 also features harness attachment buckles to attach to a harness
- CSA approved



Model 4201 - Deluxe LineBacker



Model 4202 - Deluxe LineBacker



To size the Buck ErgoBelt, Buck LineBacker and the Buck LineBacker Deluxe for proper fit, the 'A' and 'B' measurements are required:

- Measurement 'A' is measured approximately 2" above waist and from center of hip bone (seam of shirt) around the small of the back to the center of hip bone (seam of shirt) on other side
- Measurement 'B' is from center of navel around the small of the back to the center of navel. Measurement 'B' is taken in the same location as measurement 'A'

## Man Rated Gut Straps

- Use with any two dee body belt
- Completely adjustable for user's comfort
- Belt features 5000 lbs man rated connections and leather-lined strap

Belt Size	Waist Size
Small	28-32
Medium	32-36
Large	36-40
X-Large	40-44



Model 6263 features a standard tongue buckle



Model 6264 features easy-to-use quick connect buckles



TRUSTED SINCE 1958



# Buckingham

## TB94089A: Titanium Replacement Gaff Pole Climbers



This popular choice Titanium Pole Climber offers:

- Contoured shank
- Off-set stirrup
- 16 degree dowel and screw replaceable gaffs
- 21391 nylon foot straps
- Includes standard length sleeves [9204] adjusting from 16 1/4" to 18 3/4". Long sleeves, adjusting from 19 1/4" to 21 3/4", may be ordered [9202]. Add suffix 'L' to the climber part number for long sleeves
- Climber with gaff weighs 1 lb 2 oz

## T94089A: Titanium Pole Climber - Non-Contoured Shank



- Non-contoured shank
- Off-set stirrup
- 16 degree dowel and screw replaceable gaffs
- 21391 nylon foot strap
- Includes standard length sleeves [9204] adjusting from 16 1/4" to 18 3/4". Long sleeves, adjusting from 19 1/4" to 21 3/4", may be ordered [9202]. Add suffix 'L' to the climber part number for long sleeves
- Climber with gaff weighs 1 lb 2 oz

## SB94089A - Steel Replaceable Gaff Pole Climbers



This popular choice Steel Pole Climber offers:

- Contoured shank
- Offset stirrup
- 16 degree dowel and screw replaceable gaffs
- 21391 nylon foot straps
- Includes standard length sleeves [9204] adjusting from 16 1/4" to 18 3/4". Long sleeves, adjusting from 19 1/4" to 21 3/4", may be ordered [9202]. Add suffix 'L' to the climber part number for long sleeves

## Buckingham 6909U: Universal Fit Gaff Guard



- Universal coated wire pole gaff guard made to fit all Buckingham, Bashlin, Klein and Stringer Brooks pole climbers

## Buckingham 6909A: Snap On Gaff Guard

- Easy Snap On Gaff Guard fits all Buckingham replaceable pole gaffs with a 16° angle
- (A style)



## Dowel & Screw Replaceable Climbers

- Buckingham Replaceable Climbers are now even easier to replace! The Dowel and Screw Replaceable Climber Gaffs are available for any climber issued after January 2011.



For use with all T, TB & SB replaceable gaff pole climbers  
**Model NB9106A CCA**



For use with all T, TB & SB replaceable gaff pole climbers  
**Model NB9206A**

## 35032: Climber Pad



- Leather 'C' pad designed with a metal insert and oversized felt liner for additional comfort
- Liner edge minimizes chafing on the leg. New improved inserts won't bend and insert loop has been modified to prevent sleeve roll out
- Requires a 26" strap (sold separately)

## 3502C: The Original Velcro® Wrap Pad with Insert



- An angled style Velcro® pad that features a continuous wrap with a metal insert
- Measures 4"W with 3/4" padding
- Rolled edge to prevent chafing
- Stitched tunnel for a secure fit
- Cinch loop provides tight fit

## 3500C: The Original Velcro® Wrap Pad with Cinch Loop

- A Velcro® pad that features a cinch loop
- No metal insert
- Measures 4"W with 3/4" padding
- Rolled edge to prevent chafing
- Stitched tunnel for a secure fit
- Cinch loop provides tight fit



## 3203C: Big Buck Wrap Pad



- The adjustability of the hook and loop wrap pad, the increased surface area of the Big Buck pad and a Dri-lex lining

## 3120: Leather Climber Pad

- A quality leather pad with 3 loops and a tunnel design to keep climber stationary
- All leather construction with 3/4" padding



## 3118: Big Buck Leather Climber Pad



- Utilizes a double strap system that fits 1" and 1 1/4" straps to secure the pad to the calf for superior support
- Angled metal insert keeps climber shank from shifting on calf and thick felt padding adds to the overall comfort
- Includes a pair of 2639 straps but requires two pairs
- Measures 9" H x 12 1/2" W

## 3126: Leather Climber Pad

- A comfortable 'L' pad that features a closed cell foam filler that prevents the climber shank from irritating the user's leg
- The rolled edges prevent chafing to the calf muscle
- A slightly heavier pad that provides maximum comfort
- Requires a 26" strap



## 2639: Nylon Leg Strap



1" W x 26" L

# Buckingham

## 8VV116+Z Buckyard Shock-Absorbing Lanyard



- For use with a full body harness with steel ring dorsal attachment
- Expands to 42". Interior materials stretch to reduce the arresting force to less than 900 lbs
- 17061 locking snap hook on both ends
- Length: 6 ft
- Meets ANSI Z359.1-2007 for a 3600 lbs gate

## 84V716 Buckyard Stretch Shock-Absorbing Lanyard

- Same benefits of the Buckyard but with the addition of an elastic bungee; this reduces the size of a 6' lanyard to about 44", greatly reducing the chance of tripping over it
- For full body harness w/web loop dorsal attachment
- 1706 locking snap hook on one end and web loop on the other end



## 64V7A26E+Z Tie Back Shock-Absorbing Lanyard

- Designed to be wrapped around a 5,000 lbs anchor and connected back to itself via an adjustable dee ring
- In a fall, force is reduced with a built-in shock pack
- May be ordered in lengths greater than 6' to allow the user to wrap to the anchor point and still have freedom of movement



## Tower & Rescue Harness



61995-M Medium  
61995-L Large

- 'H' style full body harness with built in body belt
- Frontal dee adjusts independently
- Type 13 nylon webbing
- Vest like Dri-lex shell wicks moisture
- Dri-lex shoulder, leg pads for comfort
- PVC shoulder loops to stow lanyard hardware
- Quick connect buckles on chest / leg straps
- Steel dee dorsal attachment and spring-loaded friction buckles used for height adjustment

## 6393700 - 'H' Style Full Body Harness



- An 'H' style full body harness featuring a web dorsal loop attachment
- Hook and loop chest strap that meets ANSI Z359.1 requirements
- Interlocking leg strap buckles with leather chafes
- Standard friction buckle for height adjustment
- Made from Type 13 nylon webbing with orange upper and black lower sections.
- Meets ASTM F887 Electric Arc Performance Requirements

Kit: Includes large harness & 6' Length Buckyard Stretch Lanyard

## BuckFit Harness



68D7G8C600V9-L Large\*  
68D7G8C600V9-XL X-Large

- 'H' style full body harness with steel dee for dorsal attachment
- Dri-lex shell for moisture control
- Padded Dri-lex shoulder and leg pads
- Spring loaded friction buckles for height adjustment
- ANSI approved
- Quick connect buckles with leather chafes
- Type 13 nylon webbing

## BuckFit FR Harness



- Steel Dorsal Dee. 'H' style full body harness
- Mesh shell for breathability
- FR foam pads
- Split tongue quick connect with leather chafes on the legs and chest straps
- ANSI approved
- Spring loaded friction buckles for height adjustment
- Meets ASTM F887 Electric Arc Performance Requirements

68D7G8C600K1-L Large  
68D7G8C600K1-XL X-Large

## 3813: Hurt Man Bucket Truck Rescue System

- Ideal for lifting a hurt man easily and quickly
- Pulleys are made of stainless steel and have a 4:1 lifting advantage
- 95' of 7/16" diameter rope that can support a load up to 1700 lbs
- Designed to mount permanently and high up on the boom



## 105RS: Suspension Trauma Rescue System



- Designed to alleviate the effects of orthostatic intolerance known as suspension trauma
- Allows a victim to deploy a body support system that allows for improved blood circulation and the ability to move and flex muscles until rescue
- Attaches to any full body harness
- Adjustable for any sized user

## 355BT: Buck Ladder Lock System



- A ladder safety solution Includes ladder safety straps enclosed in weather resistant bags that are attached to your ladder
- Provides quick access to straps
- Includes top and bottom storage bags and straps

## 101SR-50: High Elevation Self Rescue System

- Provides all components necessary for self-rescue or aiding in rescuing a fellow worker
- The descender stops the user until the handle is compressed allowing for a smooth, controlled descent; also stops if the handle is compressed too hard (50' 1/2" braided rope)



## 301SR: Self Rescue System



- Features a new lightweight, compact design
- The lightweight descender is manufactured from aircraft grade aluminum and features an anti-panic release brake which will stop the descender if the user releases or compresses the descender all the way
- TVAC descent line measures 6.8mm and is compact and stands up to heat on long descents
- Weather-resistant nylon bag with a mesh bottom lets moisture escape
- Meets ANSI Z359.4 - 2007

301SR-50	37' and 40' Truck Self Rescue Kit, 50' of Rope
301SR-65	55' Truck Self Rescue Kit, 65' of Rope
301SR-110	100' Truck Self Rescue Kit, 110' of Rope
301SR-160	150' Truck Self Rescue Kit, 160' of Rope

# DBI Sala® - Harnesses

## ExoFit NEX™: Vest-Style Full Body Harness

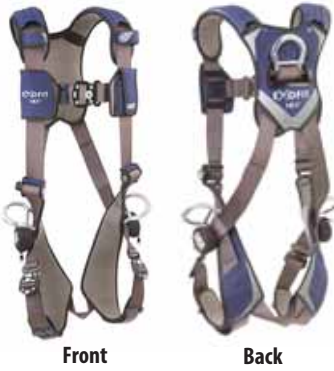

Front

Back

- Aluminum back and side D-rings, locking quick connect buckle leg straps, comfort padding
- Hybrid shoulder, back and leg comfort padding
- Stand-up Tech-Lite™ aluminum back D-ring
- Tech-Lite™ aluminum side D-rings
- Duo-Lok™ quick connect chest and leg straps
- Repel™ webbing
- Loops for body belt
- Protective shoulder caps
- Built-in lanyard keepers
- Revolver™ vertical torso adjusters
- Impact Indicator
- Integrated trauma straps
- Built-in reflective materials
- Protected labels, equipped with i-Safe™

## ExoFit NEX™ Arc Flash: Vest-Style Full Body Harness



Front

Back

- Tongue buckle style lineman body belt (size D25)
- Belt made with 100% top grain leather from Red Wing, MN
- PVC coated steel back D-ring, locking quick connect buckle leg straps, Nomex®/Kevlar® web and comfort padding (size large) with 100% top grain leather 2D lineman belt (size D25)
- Arc flash rated
- Nomex®/Kevlar® shoulder comfort padding
- Duo-Lok™ quick connect chest and leg straps
- Leather insulators
- Nomex®/Kevlar® webbing
- Built-in lanyard keepers
- Revolver™ vertical torso adjusters
- Impact Indicator
- Built-in reflective materials
- Protected labels, equipped with i-Safe™
- 2 large S-shaped full-floating D-rings at hips
- Built-in tool snaps, rings and tape thong
- Available in other harness sizes and belt sizes D18 through D30

## Exofit™ XP: Vest-Style Full Body Harness



Front

Back

- Back D-ring, tongue buckle leg straps, removable comfort padding
- Removable shoulder, back and leg comfort padding
- Stand-up back D-ring with impact indicator
- Quick connect chest strap
- Tongue buckle leg straps
- Soft, lightweight webbing
- Loops for body belt
- Built-in lanyard keepers
- Parachute torso adjusters
- Protected labels, equipped with i-Safe™

## Delta: Vest-Style Full Body Harness

- No-tangle design
- Stand-up back D-ring
- Front D-ring
- Tech-Lite™ quick connect buckle leg straps
- Repel™ webbing
- Built-in lanyard keepers
- Revolver™ vertical torso adjusters
- Impact Indicator
- Protected labels, equipped with i-Safe™



## Single Leg Tool Lanyard

- Tool lanyard with single leg
- Provides dropped object protection
- 15 lbs (6.8 kg) capacity
- Stretch design extends and automatically retracts
- Choker and carabiner connectors
- Fast and easy installation
- Extremely compact and lightweight design



## Twin Leg Tool Lanyard

- Tool lanyard with twin leg
- Provides dropped object protection for two tools
- 30 lbs (13.6 kg) capacity
- Stretch design extends and automatically retracts
- Carabiner connectors at both ends
- Fast and easy installation
- Extremely compact and lightweight design



## Shockwave™2 Lanyard

- 6 ft (1.8m) single-leg lanyard
- Stretches in reaction to your movements
- Abrasion resistant polyester tubular webbing
- User friendly self locking snap hooks at each end
- Energy absorbing design limits fall arrest forces
- Built-in impact indicator
- Protected labels, equipped with i-Safe™
- Also available in double-leg and web loop
- Available in E4 and E6 class



## Shockwave™2 Arc Flash Lanyard

- Arc flash rated
- 6 ft (1.8m) single-leg lanyard
- Stretches in reaction to your movements
- Nomex®/Kevlar® fire resistant webbing
- User friendly self locking snap hooks at each end
- Energy absorbing design limits fall arrest forces
- Built-in impact indicator
- Protected labels, equipped with i-Safe™
- Also available in double-leg and web loop
- Available in E4 and E6 class



## EZStop™II Shock Absorbing Lanyards

- 6 ft (1.8m) web single-leg with snap hooks at each end
- Extremely compact and lightweight
- Exclusive Hi-10™ Vectran™ energy absorption system
- Repel™ webbing
- User friendly self-locking snap hooks at each end
- Built-in reflective materials
- Impact indicator
- Protected labels, equipped with i-Safe™
- Also available in Tie-Back, Tie-Off and Polyurethane and Kevlar®



## EZStop™II Arc Flash Lanyards

- Arc flash rated
- 4 ft (1.2m) single-leg lanyard
- Durable, yet lightweight materials
- Nomex®/Kevlar® soft pack energy absorber
- Kevlar® fire resistant webbing
- Energy absorbing design limits fall arrest forces
- User friendly self locking snap hooks at each end
- Impact indicator
- Protected labels, equipped with i-Safe™



## Web Positioning Lanyard

- Single-leg lanyard
- Ideal for work positioning or restraint
- Abrasion resistant polyester webbing
- Built-in wear indicator
- User friendly self locking snap hooks at each end
- Equipped with i-Safe™
- Available in 2' to 9'



# DBI Sala® - Lanyards

## CynchLock Pole Climbing Device

- Lightweight pole climbing design
- For distribution pole sizes 5.5" dia./17.5" circ (14/45cm) min, 18.5" dia/58" circ. (47/147cm) max
- Extremely durable pole strap with wear indicator
- One-handed effortless adjustment
- Pinch-free ergonomic grips
- Stopping cleat and carabiner
- Durable polyester web
- Lightweight and durable rope adjuster
- Modular design with field replaceable straps
- Protected labels, equipped with i-Safe™



## Lanyard Hooks



One-hand operation makes DBI-SALA® snap hooks the most popular in the industry. You can even operate them with your gloves on. Open and close without getting your fingers in the way! All DBI-SALA® lanyards feature 3600 lb (16kN) rated gates, meeting the rigorous ANSI Z350 standard. Speak to an LTL Product Specialist about the complete line of DBI-SALA® lanyard hooks.

**Image shown: Standard Hook**

## Ultra-Lok™ Self-Retracting Lifelines

- Rugged and extremely lightweight thermoplastic housing
- Semi-sealed design
- Available in 11' to 85'
- Stainless steel dynamic components
- Internal energy absorption system
- Anti-ratcheting twin disk brake system
- Constant moving brake system pawls
- Swiveling anchorage point
- Swiveling snap hook with impact indicator
- Reserve lifeline system
- Ergonomic cable handle equipped with i-Safe™



## Talon™ Quick Connect Self Retracting Lifeline

- Built-in connector for direct attachment to harness
- Available in 6' to 9'
- Compact, lightweight design
- Tough and impact resistant thermoplastic housing
- Anti-ratcheting design
- Extremely durable all metal braking system
- Velocity sensing brake
- Self-locking swivel snap hook
- Impact indicator
- Serviceable design
- i-Safe™ equipped



## Saflok™ Carabiners

Saflok™ carabiners are the unsung heroes of most safety systems. They securely attach one component to another and offer maximum strength - 5000 lb (22kN) minimum breaking strength and 3600 lb (16kN) gate strengths. Designed for easy securing, they are self closing and self locking to keep all components of your safety system firmly attached. Speak to an LTL Product Specialist about the complete line of Saflok™ Carabiners.



**Image shown: 11/16 in. (17.5mm) gate opening steel carabiner with self closing/locking gate**

## Rollgliss Rescue & Descent Devices

- Emergency rescue and evacuation from a wide variety of elevated work areas
- Fully automatic controlled descent
- Bi-directional design enables multiple rescues
- Built-in rescue lifting wheel
- Compact and lightweight design
- High strength corrosion resistant construction
- Integrated rope ears
- Dual brake design
- Equipped with i-Safe™
- Kit also contains 4 ft. (1.2m) anchor sling, two carabiners and carrying bag
- Other standard and custom lengths are available
- Models also available without lifting wheel or add a humidity case
- Speak to an LTL Product Specialist about other Rollgliss Rescue and Descent devices



## RSQ™ Dual-Mode Built-in Rescue Operation

- Environmentally sealed dynamic components
- RSQ™ dual-mode design
- Extremely durable construction
- Available in 50', 85' and 130'
- Fast-Line™ lifeline system
- Anti-ratcheting locking system
- Built-in carrying handle
- Swiveling snap hook with impact indicator
- Large pivoting anchorage loop
- Saflok™ anchorage carabiner
- Cable tie-off adaptor x 4 ft. (1.2m) with carabiner
- Reserve lifeline system
- Ergonomic cable handle equipped with i-Safe™



## Pro™ Climbing Harness



- Back D-ring
- Front D-ring
- Tongue buckle leg straps
- Parachute torso adjusters
- Durable polyester web construction
- Built-in lanyard keepers
- Impact Indicator
- Protected labels
- Available sizes: S-XL

## Pro™ Vest-Style Harness with Comfort Padding



- Shoulder, back and leg comfort padding
- Back D-ring
- Side D-rings
- Quick connect buckle leg and chest straps
- Parachute torso adjusters
- Durable polyester web construction
- Built-in lanyard keepers
- Impact Indicator
- Protected labels
- Available sizes: S-XL

## Pro™ Adjustable Shock Absorbing Lanyard

- Single-leg lanyard
- Lightweight user friendly design
- PVC shock pack with protected label
- Abrasion resistant polyester webbing
- Energy absorbing design limits fall arrest forces
- User friendly self locking snap hooks at each end
- Impact indicator



## Pro™ 100% Tie-Off Shock Absorbing Lanyard

- Double-leg 100% tie-off lanyard
- Lightweight user friendly design
- PVC shock pack with protected label
- Abrasion resistant polyester webbing
- Energy absorbing design limits fall arrest forces
- User friendly self locking snap hook at center
- Self-locking steel rebar hook at leg ends
- Impact indicator



## Pro™ Elastic Shock Absorbing Lanyard - E4

- 6 ft. (1.8m) single-leg lanyard
- Stretches in reaction to your movements
- Lightweight user friendly design
- PVC shock pack with protected label
- Abrasion resistant polyester webbing
- Energy absorbing design limits fall arrest forces
- User friendly self locking snap hooks at each end
- Impact indicator
- Also available in E6





# Protecta

## Rebel™ Self Retracting Lifeline - Cable

- Rugged, lightweight thermoplastic housing
- Stackable housing design
- Built-in carrying handle
- Swiveling self-locking snap hook with impact indicator
- Speed sensing all metal brake system
- Internal energy absorption system
- Reserve lifeline system
- Side lifeline exit with ergonomic handle
- High strength, corrosion resistant components
- Swiveling anchorage point
- Self-locking anchorage carabiner
- Available sizes: 33', 50', 66', 85', 100'



## Rebel™ Self Retracting Lifeline - Cable

- Compact, lightweight design
- Rugged aluminum housing
- Swiveling anchorage point
- Swiveling self-locking snap hook on lifeline
- Speed sensing all metal brake system
- High strength, corrosion resistant components
- Kevlar®/Nomex® covered external energy absorber and impact indicator
- Self-locking anchorage carabiner
- Available in 6', 10', 15' and 20'



## AC203C-SA2: Cobra™ Rope Grab with Attached Lanyard

- Mobile and manual rope grab with 2 ft (0.6 m) PRO™ shock absorbing lanyard for use on 5/8" (16 mm) polyester/polypropylene blend rope lifeline
- Mobile design automatically follows user
- Manual option allows user to fix in place
- Cam locking system for safety
- Integral 2 ft. (0.6 m) PRO™ shock absorbing lanyard
- Detachable anywhere along the lifeline
- Durable and lightweight corrosion resistant construction
- For use with 5/8" (16 mm) diameter polyester/polypropylene blend rope lifeline



## AJ450C-6: Cable Tie-Off Adapter

- 6 ft (1.8m) pass-thru type tie-off adaptor
- Durable polyester construction
- Abrasion resistant polyester wear pad
- High strength steel hardware
- Compact and lightweight design



## Compliance in a Can™ Light Roofer's Fall Protection Kit

- Complete all purpose fall protection system in one handy container
- Kit includes 1191201C PRO™ harness, 1341001C PRO™ 6 ft (1.8m) single-leg shock absorbing lanyard and bucket
- Lightweight PRO™ harness with pass-thru buckle legs and 5-point adjustment (model 1191201C)
- PRO™ 6 ft (1.8m) single-leg shock absorbing lanyard (model 1341001C)
- Durable bucket with handle



## 03707: Pole Choker 4

- Wood pole climbing fall arrest
- The Choker Strap is a key component of the Jelco Pole Choker 4 Fall Prevention System
- This 1 3/4" wide, yellow nylon strap squeezes the pole. The roller's teeth dig in and you get the additional resistance provided by 2 sets of grippers
- All this provides the gripping force required to prevent you from falling down the pole
- **CSA certified Z259.14.01 Type AB**  
4.5': 3704, 5.25': 03705, 6.2': 03706



## 03727: Pole Choker 5

- The Choker Strap is a key component of the Jelco Pole Choker 5 Fall Prevention System
- The 1 3/4 inch wide yellow nylon strap squeezes the pole. The roller's teeth dig in to provide the gripping force required to prevent you from falling down the pole
- The difference between the Pole Choker 3 and the Pole Choker 5 is on the PC5; one Snaphook has loops
- SIZES - 4.5': 3724, 5.25': 03725, 6.2': 03726**



## 87644: Pole Strap

- The Jelco Pole Strap is a positioning device that is an essential item for all lineman's gear
- The pole strap comes in various lengths, so you can find a size suitable for all situations
- The double-locking snap hooks featured on each end are "lineman friendly" and allow for ease of use even with the thickest rubber gloves
- Jelco offers the pole strap in two different materials; a nylon version and a neoprene impregnated nylon
- Our pole straps meet applicable ASTM F887, CSA Z259.11 and OSHA 1926.959 standards
- SIZES - 5'8": 87611, 6': 87622, 6.5': 87633**



## 549 Series 2 D-Ring Tradition 4" Belt

- This premium belt is characteristic of the high quality products that Jelco has to offer
- The all leather belt offers superior support, while providing a lineman with the softness, most comfortable, and lightweight (under 4 lbs) belt that money can buy
- It features a 4" backpad that fits and feels like your favorite "broken-in" lineman's belt that you have had for years, right out of the box. The Tradition belts' full floating design offers linemen the convenience of full range of motion, while performing all tasks and operations.
- Outside all natural leather for comfort and support
- Large forged, positioning D rings for easy clip on action. The belt features a glove bag ring, knife snap and tape thong
- All of our lineman's belts comply with CSA and ASTM linemen's belt sizing standards
- Colour: Caramel
- SIZES - 18: 80821, 19: 80822, 20: 80823, 21: 80824, 22: 80825, 23: 80826, 24: 80827, 25: 80828, 26: 80829, 27: 80830, 28: 80831, 29: 80832, 30: 80833**



## 550 Series 4 D-Ring Tradition Belt with Tongue Buckle and Quick Connect

- This belt has the same "broken-in" feel as our 2 D-Ring Tradition belt, but features 4 D-Rings
- The placement of the 4 D-Rings is two at the top of the belt, and two at the bottom of the belt, which is the traditional location
- The 2 additional D-Rings located at the top provide a place to park your secondary safety
- The all-leather lineman's belt not only has a leather exterior, but features a padded leather interior as well
- This style 4 D-Ring belt features two belts, at the top and the bottom
- The top belt features quick-connects, that once adjusted, can simply be quickly connected with the buckle - the bottom belt features the classic tongue buckle
- Colour: Black
- SIZES - 18: 86861, 19: 86862, 20: 86863, 21: 86864, 22: 86865, 23: 86866, 24: 86867, 25: 86868, 26: 86869, 27: 86870, 28: 86871, 29: 86872, 30: 86873**



## Lineman Combo Harness Grommets/Mating



- Issued from the 649H series, this linesman combo harness is one of Jelco's classics
- The chest strap is held in place by velcro

SIZES - 18: 43011, 19: 43012, 20: 43013, 21: 43014, 22: 43015, 23: 43016, 24: 43017, 25: 43018, 26: 43019, 27: 43020, 28: 43021, 29: 43022, 30: 43023

## Lineman Combo Harness Grommets/Quick



SIZES - 18-43901, 19-43902, 20-43903, 21-43904, 22-43905, 23-43906, 24-43907, 25-43908, 26-43909, 27-43910, 28-43911, 29-43912, 30-43913

## 21213: 7' Retractable Lanyard Mounted on a Swivel Plate and Number 17253 Auto-Locking Aluminium Carabiner with Pin on the End



## 21212: 7' Retractable Lanyard on Swivel Plate with Shock Absorber



- 7' retractable lanyard mounted on a swivel plate and has a shock absorbing lanyard on the other end
- It comes equipped with number 13150 double-locking carabiner on the shock absorbing end and an ultra light aluminium auto-locking carabiner number 13151 which is held in place by the pin on the retractable end

## 21450: Self-Retracting Lifeline



- The Jelco self-retracting lifeline automatically stops a person's fall
- The self-retracting lifeline is intended to connect to a structure while the user is moving directly under the self-retracting lifeline
- The device automatically takes up slack in the wire rope, keeping it out of the way while minimizing the free fall distance, should a fall occur
- In the event of a fall, the sudden jerk in the wire rope will activate the centrifugal locking mechanism, arresting the fall within 2 ft (0.6 m)

# Klein Climbing Equipment

## Pole Climbers with Gaffs - Sets



- 8" x 8" cushioned, high-grade leather climber pads
- Neoprene-impregnated nylon climber straps
- 4 7/16" wide stirrup provides greater foot support
- Contoured leg irons help position gaffs securely and comfortably
- CN1972AR and CN1972ARL are CCA pole gaffs, designed to penetrate the hardest salt-treated poles
- CN1986AR and CN1986ARL Gaffs are longer in length and wider in angle than 1 1/2" gaffs for exceptional resistance to cutouts
- To determine size needed, measure from in-step to 1" below knee; sold in pairs only

Part #	Gaff Size	Length
CN1972AR	1 1/2"	15"-19"
CN1972ARL	1 1/2"	17"-21"
CN1986AR	1 9/16"	15"-19"
CN1986ARL	1 9/16"	17"-21"
CN1907AR	2 3/4"	15"-19"
CN1907ARL	2 3/4"	17"-21"

## 1972G: Snap-On Gaff Guard



- Coil-spring, plastic coated guard quickly snaps onto pole climbers
- Sold in pairs only

## 1945G: Removable Gaff Guard



- Long-lasting leather construction with genuine velcro® brand touch fastener strap
- Sold in pairs only

## Gaff Sharpening Kit for Pole Tree Climbers



- Contains the following:
- (1) 8" fine-tooth file
  - (1) 3" honing stone
  - (1) Klein gaff gauge,
  - (1) fully-illustrated gaff sharpener instructions
  - (1) handy roll-up canvas case with tie

## 52006-8: Klein Polemaster



- Abrasion-resistant inner strap material for durability - includes red wear indicator
- Outer strap constructed of Klein-Kord material - a proven material for years with linemen
- Wood pole diameter range from 8" - 16"
- Cam bracket system for easy adjustments
- Connecting hardware conforms to ASTM F887, ANSI Z359.12 and CSA Z259-12, Class 1 requirements
- The Wood Pole Fall Restrict Device has been designed to meet CSA Z259.14-01 standard as a Type A Fall Restrict Device
- Do NOT use on icy poles
- Made in the USA

## 8220: Velcro Climber Pads



- 4" of Velcro provides the maximum amount of adjustability
- Continuous wrap with metal cinch loop for quick attachment and ease of use
- Extra wide cuff fastens around the calf
- Padded for additional comfort
- Klein Velcro® Climber Pads meet the requirements of ASTM F887

## Klein Positioning Strap

- Internal lock mechanism
- Elongated 6 1/2" snap hook is easy to use with even the thickest gloves and has a 5,000 lb. proof-loaded rating
- Meets or exceeds OSHA requirements and ASTM and CSA standards
- Red wear indicator alerts user when strap needs to be replaced
- 6-ply, 1 3/4" wide Klein-Kord®



KG5295L	5'8"
KG5295-6L	6'
KG5295-6-6L	6'6"
KG5295-7L	7'
KG5295-8L	8'



## ArcSafe® Harness



- Maintenance and utility workers are protected from the hazard of high-energy electric arc flash while wearing ArcSafe® Harnesses. This harness may also be used for retrieval from a confined space
- The nylon web loop that is included adds comfort by reducing overall harness weight and also reduces potential of electrical arc to the harness
- SEI-Certified to the requirements of the ASTM F887-05 standard for arc flash protection up to 40 cal/cm<sup>2</sup>
- Nylon web loop attachment points
- Certified to CSA Z259.10-06
- Integral load indicator
- 400lbs capacity
- Y-shaped back web loop locator pad provides comfort by moving the webbing away from the wearer's neck
- Colour-coded leg and torso straps simplify donning
- Downward-adjusting torso straps ease adjustment
- Meets all applicable OSHA regulations and ANSI Z359.1 standards

**10070439 ArcSafe Vest-Style Harness, BACK, HIP & BELAY WEB Loops, Qwik-Fit leg straps, Standard (STD)**

## ArcSafe® Lanyard

- Providing electrical arc flash protection, ArcSafe® Lanyards use a tear-tape design to keep fall arrest forces below 900 lbs ArcSafe® Energy Absorbing Lanyards connect the back (dorsal) D-ring of MSA full-body harnesses to a qualified anchorage and anchorage connector
- Limits average fall arrest forces to 900 pounds/6 kN or less
- Constructed of nylon webbing; length is adjustable
- Includes sewn loop on shock-absorber end and LS snaphook on lanyard leg
- Incorporates a protective cover over the energy



**10060139 ArcSafe Single-Leg Energy-Absorbing Lanyard, 6', Hitch Loop, 36C steel snaphook, CSA Z259.11**

## Workman® Energy-Absorbing Lanyard



- When free-fall distance can exceed two feet, use a lightweight, low-profile Workman® Energy-Absorbing Lanyard
- The energy absorber not only limits force on the body in a fall, but also on the anchor location. The shock absorber includes a clear, durable protective cover over the labels to increase service life and allow for easy inspection
- Tear-tape design to keep average fall arrest forces below 900 lbs/6kN
- Choice of single- or twin-leg configurations
- Choice of adjustable or tie-back configurations

**10072473 Workman Twin-Leg Energy-Absorbing Lanyard, 6', (2) 36C snaphooks, Tieback version, CSA Z259.11**

**10072475 Workman Twin-Leg Energy-Absorbing Lanyard, 6', 36C snaphook & (2) 36CL Rebar snaphooks, CSA Z259.11**

## Workman® Personal Fall Limiters



- The Workman Personal Fall Limiter (PFL) and the Workman Twin Leg Personal Fall Limiter are two of the most versatile fall protection devices available on the market today
- The Workman PFL has a fast acting brake mechanism, and the Workman Twin Leg PFL offers a great alternative to twin leg shock-absorbing lanyards

**10093358 Workman Web PFL, 0', 36C steel snaphook, Back D-ring connector, CSA Z259.2.2**

## Dyna-Lock® Self-Retracting Lanyard



- The MSA Dyna-Lock® Self-Retracting Lanyards (SRL) are fast-acting fall arresters that limit free-fall distance, deceleration distance and fall arrest forces while allowing user freedom of movement
- The Dyna-Lock SRL is ideal for climbing applications where vertical mobility is needed

**10006468 DYNA-LOCK SRL, Galvanized Wire Rope, Length 50'**

## I'D L: Self-Braking Descender with Anti-Panic Function

- Designed for rescue: lacks gated attachment hole
- Multi-functional handle allows the user to: unblock the rope and control the descent with the hand on the free end of the rope, move more easily on horizontal or low-angle terrain, thanks to the button on the handle, get into position without having to tie off the device
- Anti-panic function is engaged if the user pulls too strongly on the handle: brakes and stops the descent automatically
- Anti-error safety catch to reduce the risk of an accident due to incorrect installation of the device on the rope. The shape of the cam is designed to improve rope glide when ascending
- Pivoting cam facilitates taking up the slack in the rope. Can also be used to make a reversible haul system, and for short ascents (in conjunction with a FOOTPRO foot loop and an ASCENSION handled rope clamp)
- Lowers heavy loads up to 272 kg (only for expert users; consult the Instructions for Use for the device)
- Available in two colors

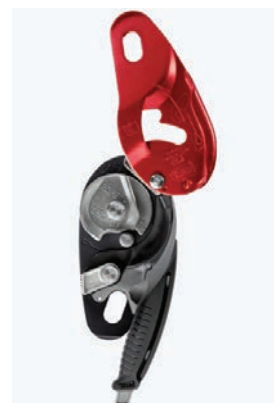

## I'D S: Self-Braking Descender with Anti-Panic Function

- Multi-functional handle allows the user to: unblock the rope and control the descent with the hand on the free end of the rope, move more easily on horizontal or low-angle terrain, thanks to the button on the handle, get into position without having to tie off the device
- Anti-panic function is engaged if the user pulls too strongly on the handle : brakes and stops the descent automatically
- Anti-error safety catch to reduce the risk of an accident due to incorrect installation of the device on the rope. The shape of the cam is designed to improve rope glide when ascending
- The safety gate on the moving side plate helps prevent dropping the device and facilitates installation of the rope when passing intermediate anchors
- Pivoting cam facilitates taking up the slack in the rope. Can also be used to make a reversible haul system, and for short ascents (in conjunction with a FOOTPRO foot loop and an ASCENSION handled rope clamp)
- The locking screw of the swinging side-plate allows the I'D S to be part of a rescue kit
- Lowers heavy loads up to 250 kg (only for expert users; consult the Instructions for Use for the device)
- Available in two colors

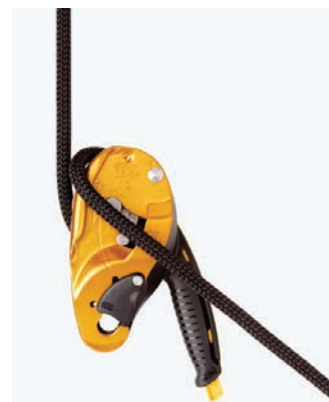

## RIG: Compact Self-Braking Descender

- Designed for rope access work (expert users only)
- Multi-functional handle allows the user to: unblock the rope and control the descent with the hand on the free end of the rope, get into position without having to tie off the device
- The automatic return system on the handle limits risks in case of an involuntary action by the user
- Handle storage position reduces the risk of snagging when the descender is being carried on the harness
- The safety gate on the moving side plate helps prevent dropping the device and facilitates installation of the rope when passing intermediate anchors
- Pivoting cam facilitates taking up the slack in the rope. Can also be used to make a reversible haul system, and for short ascents (in conjunction with a FOOTPRO foot loop and an ASCENSION handled rope clamp)
- Lowers heavy loads up to 200 kg (only for expert users; consult the Instructions for Use for the device)
- Available in two colors



# Petzl - Forestry Rigging

## Grillon: Temporary Horizontal Lifeline

- Allows a horizontal lifeline to be installed quickly when there is a large work surface
- The self-jamming device allows easy adjustment of the length and tension between the two anchor points (make a mule knot on the GRILLON to lock the anchor)
- Semi-static rope, resistant to aging and abrasion
- Sewn terminations on both ends with plastic sheath to keep the connector in position and protect the rope from abrasion
- Available in four lengths



## Grillon Hook

- Lanyard with fine adjustment system for precise work positioning,
- Used in double mode on the harness lateral attachment points to distribute the weight on the belt (user has weight on his feet); length is adjusted by pressing on the pivoting cam)
- Can be used in single mode on the harness ventral attachment point to distribute weight between the waistbelt and the leg loops (user is suspended); length is adjusted by operating the handle while holding the free end of the lanyard (it is necessary to open the device to remove the protective sheath)
- Removable protective sheath protects the rope from abrasive surfaces and allows smooth rope glide
- Available in several lengths



## Sequoia SRT: Tree Care Seat Harness

- For ascents on a single rope
- Designed for the arborist's comfort. The extra-wide, semi-rigid waistbelt and leg loops give excellent support

Built for comfort:

- semi-rigid, wide waistbelt and leg loops for excellent positioning; sculpted and lined with perforated foam for comfort during suspension
- foam on leg loops can be adjusted for perfect positioning
- mobile side attachment points allow the user to follow the orientation of the lanyard during lateral movement
- attachment bridge improves lateral mobility

Practical adjustment:

- waistbelt equipped with self-locking DoubleBack buckles for quick and easy adjustment
- leg loops equipped with FAST buckles for quick and easy opening and closing without the need to readjust them, even while wearing gloves
- buckles to adjust weight distribution between the waistbelt and the leg loops
- gated rings to adapt the length of the attachment bridge and to install accessories directly on the attachment bridge (RING, SWIVEL)

Facilitates carrying and organization of tools:

- seven pre-shaped equipment loops with protective sheath
- five slots for CARITool tool holder
- two slots for a carabiner to hold a chainsaw or handsaw
- elastic for attaching a first aid kit

Can be accessorized in order to adapt the harness to its use:

- seat improves comfort during prolonged suspension
- shoulder straps connect to the ventral attachment point and the two rear slots on the waistbelt to transfer the load from the waistbelt to the shoulders



## Accessories



Attachment bridge for SEQUOIA and SEQUOIA SRT harness



Shoulder Straps for SEQUOIA and SEQUOIA SRT harness



Seat for SEQUOIA and SEQUOIA SRT harness

## Caritool: Tool Holder

- Tools accessed and organized with one hand
- Flat top aids in sorting attached gear
- Small hole on top for attaching keeper cord, to prevent dropping critical gear
- Slips through the waistbelt slots or along the harness webbing and stays in place, thanks to its stabilizing clip
- Available in two sizes: P42, max load 5kg and P42 L max load 15kg



## Ascentree: Double-Handed Rope Clamp for Tree Care

- Designed for ascending double ropes in trees using the “footlock” technique or with two PANTIN foot ascenders
- Ergonomic molded handles allow a comfortable yet powerful grip
- Toothed cam with self-cleaning slot optimizes performance under any conditions (e.g. frozen or dirty ropes)
- Catch/cam combination is totally integrated into the body of the rope clamp to prevent rubbing
- Large handles can be used with thick gloves
- Lower holes for connecting a lanyard
- Upper holes for clipping a carabiner around the rope



## Pantin: Foot Ascender - right and left

- Designed to make rope ascents faster and less tiring
- Used to complement CROLL, ASCENSION or ASCENTREE rope clamps
- Cam facilitates passage of the rope through the device, even on the first few meters
- Toothed cam with self-cleaning slot optimizes performance under any conditions (e.g. rope that is icy, muddy, etc.). The stainless steel cam has better resistance to corrosion
- Mechanism is totally integrated into the body of the rope clamp to help prevent snagging
- Releases from the rope with a simple backwards movement of the foot
- Lower strap is 100% Dyneema® to resist abrasion
- Easy adjustment with DoubleBack buckle



## Ascension: Handled Rope Clamp - right and left-handed

- Molded grip provides even greater comfort with a more ergonomically shaped handle
- This shape keeps your hand from sliding to the bottom of the frame each time you pull on the Ascension
- The bi-material handle includes a rubber over-molded grip, increasing the comfort and grip in wet or icy conditions
- Chrome-plated steel cam with angled teeth and self-cleaning slot securely grips the rope, even in muddy or icy conditions
- Ergonomic trigger allows one-handed installation and removal
- Mono-frame construction eliminates weaknesses and keeps the ascender lightweight and durable for years of use
- The two attachment points allow for different uses (e.g., self-belaying, hauling systems, etc.)
- Anodized frames are colour coded for easy identification (black -left / gray -right)
- Safety catch prevents the cam from opening too far, helping to keep the rope captured for added safety
- 1 cm secondary hole at the bottom will accommodate a screw link for attaching aiders, slings, etc.



Left Hand



Right Hand



# Petzl - Forestry Rigging

## Oxan: Oval Steel Carabiner

- Steel adapted to difficult use conditions
- Keylock system helps prevent snagging of the carabiner during maneuvers
- Red indicator provides a visual warning when the carabiner is unlocked (on SCREW-LOCK version)
- CSA certified

## Vulcan: High Strength Steel Carabiner

- Steel adapted to difficult use conditions
- For use with heavy loads
- Large size allows easier connection of multiple elements
- Wide opening for connection to thick anchors
- Keylock system helps prevent snagging of the carabiner during maneuvers
- Red indicator provides a visual warning when the carabiner is unlocked (on SCREW-LOCK version)

## Freino: Locking Carabiner with Friction Spur for Descenders

- The spur helps increase the friction for improved control of the descent of a heavy load (e.g., two-person rescues)
- Rope is easily inserted into the spur, without opening the carabiner
- TWIST-LOCK automatic locking sleeve, unlocked by a simple rotation
- Keylock system helps prevent snagging of the carabiner during maneuvers
- Used, for example, with the I'D and RIG self-braking descenders

## Spirit: Non-Locking Progression Carabiner

- Should be used only for progression using climbing techniques
- Non-locking, clips easily
- Keylock system helps prevent snagging of the carabiner during maneuvers

## ZigZag®: Mechanical Prusik for Arborists

- Technique identical to classic Prusik pulley system
- Release lever mounted on spring for great precision when jamming/releasing the device. Varying the pressure on this lever controls the speed of the descent
- Friction links provide progressive braking action for fluidity when moving around
- Pulley mounted on sealed ball bearings to allow slack to be taken up easily
- Swivel always keeps the device in position for better rope glide through the device
- Steel construction for improved durability
- Upper connection point to easily connect the end of the double rope. It has a flexible ring that helps maintain the connector in the major axis position
- Only for use on double ropes

## Zillon: Adjustable Work Positioning Lanyard for Tree Care

- The adjustable Zillon lanyard is designed for arborist work positioning
- It is used doubled on the harness side attachment points to distribute load on the waistbelt
- It is easily adjusted with one hand thanks to the progressive locking/unlocking action of the device



## Treesbee & Treesbee Screwlink: False Crotch for Tree Care

- Protects the tree and improves rope glide at the anchor
- Can be retrieved from the ground
- Wide webbing limits twisting
- Triple thickness of termination on large ring side makes the webbing more rigid during retrieval

Available in two versions:

- Strap with large diameter ring and small ring for ropes with spliced terminations (the splice goes through the small ring)
- Strap with large diameter ring and quick link (triangle) for ropes with sewn terminations (the link opens to let the sewn termination through)
- Easily identifiable colour code



## Pro Traxion: Progress Capture Pulley

- The PRO TRAXION progress capture pulley was designed to allow rope installation while the pulley is connected to the anchor. With its large diameter sheave and great efficiency, it is particularly appropriate for hauling heavy loads on big walls. The side plate locks when loaded and prevents opening of the pulley during use.
- Loss-resistant pulley: allows a rope to be installed when the pulley is connected to the anchor
- Well suited for hauling heavy loads: large diameter aluminum sheave mounted on sealed ball bearings for excellent efficiency and side plate locks when loaded and prevents opening of the pulley during use
- Versatile: lower connection point for creating different types of hauling systems and toothed cam with self-cleaning slot optimizes performance under any conditions: frozen or dirty ropes
- May be used as simple pulley by locking the cam in the raised position



## Vertex Best: Helmet for Work at Height and Rescue

- Six-point mesh headband forms to the shape of the head for improved comfort. Shock absorption achieved through deformation of the outer shell
- CenterFit adjustment system ensures centering and optimal stability of the helmet on the head
- Side slots for mounting hearing protection
- Inserts for accepting a VIZIR visor
- Slot for mounting PIXA headlamp
- Four clips for mounting a headlamp with an elastic headband
- Chin strap designed to limit risk of losing helmet during a fall (strength greater than 50 daN)
- Non-ventilated helmet protecting against electrical hazard and molten metal splash
- Size: 53-63 cm / 20.9-24.8"
- Weight: 445 g / 15,7 oz
- Colors: yellow, red, white, orange, black, blue
- Certification: CE\*
- ANSI Z89.1-2009 Type I Class E:
- CSA Z94.1-05 Type 1 Class E



## Vizir Shadow: Protective Face Shield for Vertex and Alveo Helmets

- Mounting inserts for easy installation on VERTEX (latest version) and ALVEO helmets
- Pivots quickly from "work" position to "storage" position on top of the helmet
- Scratch- and fog-resistant



# Petzl - Forestry Rigging

## Pixa 3R: Rechargeable Multi-Beam Headlamp with Configurable Performance

- Headlamp keeps the hands free for work: may be worn on the head with the headband, attached to a helmet with the included mount, or placed on the ground
- Rechargeable Lithium-Ion Polymer battery plugs into a quick charging dock (3 hours) for frequent use

Three possible configurations to adapt lighting performance to needs:

- 'STANDARD': power / battery life balance
- 'MAX AUTONOMY': battery life prioritized (12 hours)
- 'MAX POWER': power prioritized (55 lumens)

Three lighting modes:

- A mode adapted for close-range work: wide, uniform beam
- aA mode adapted for movement: mixed beam with focused component allows user to move around comfortably
- A mode adapted for long-range vision: highly focused beam
- Constant lighting, guaranteed lighting performance that does not diminish during its entire lifetime
- Reserve lighting for when battery is almost discharged: lights to 5 meters minimum for 2 hours
- Rotating selector dial is easy to use, even with gloves

Durable:

- Excellent resistance to falls (2m), to impacts and to crushing (80 kg)
- Storage position protects the glass and keeps headlamp from being turned on accidentally
- Comfortable adjustable headband, easily detached for washing
- Flashing battery charge indicator and red light
- Resistant to chemicals



## Full Range Auto Ranging Voltage Indicator for Overhead & URD Systems



PSC4032915

T4030428 15kV only Bushing Adapter

T4030856 15-35 kV Elbow Adapter

T4030857 15-35kV Bushing Adapter

- Full Range (600V to 500kV)
- Eliminates the need for a selector switch
- Automatic ranging function quickly displays the approximate line-to-line voltage class
- An easy, yet reliable means for the operator to determine if a line is:
  - a) de-energized; b) carrying less than normal system voltage from any source or induced charged from an adjacent live circuit; c) energized at full system voltage
- Attaches to an Epoxiglas® insulating universal handle of appropriate length
- For overhead testing, a Shepherd Hook probe is included
- This model adapts to both overhead lines as well as URD circuits with 200 and 600 AMP elbows, including those with or without capacitance test-points
- Includes the tester unit, a shepherd hook probe, instruction manual and hard shell padded case
- Complies with OSHA 1910.269 to Test for Absence of Nominal Voltage

## Multi-Range Voltage Detectors



- Confirms that a line is de-energized prior to performing maintenance on it
- Gives a metered readout capable of distinguishing actual line voltage from static or feedover from an adjacent line
- Readings from an MRVD can be compared with numeric certainty rather than the subjective judgments associated with “fuzz-sticking” or “glow-detecting”
- Since the MRVD is not a voltmeter, no specific accuracy is claimed by the manufacturer nor can be assumed by the user
- Includes (1) carrying case, (1) hook probe, (1) straight probe (only included in the C4030979)

C4030979 (1) 40kV MRVD

C4031029 (16) 161kV

## Multi-Range Voltage Detectors with Illuminated Dial

- The lighted-dial option sets this unit apart from features standard on Multi-Range Voltage Detector C4030979
- A field intensity meter, the MRVD is calibrated to read approximate line-to-line voltage when connected to any phase conductor, responding to the magnitude of the field gradient between its end probe and floating electrode
- The MRVD gives metered readout capable of distinguishing actual line voltage from static or feedover from an adjacent line
- Readings from an MRVD can be compared with numerical certainty rather than the subjective judgments associated with “fuzz-sticking” or “glow-detecting”
- Since the MRVD is not a voltmeter, no specific accuracy is claimed by the manufacturer or can be assumed by the user
- The MRVD must be mounted on proper length hot stick for the voltage class involved
- Complete instructions are furnished with easy, illustrated step-by-step procedures
- Internal circuit and push button permit check before and after each use to confirm operational condition of instrument/battery

T403-3228 Voltage Indicator with Illuminated Dial

H1876-6S Shepherd Hook Probe

H1876-6 Straight Probes

## H1876-2: Extension Resistor Pair Extends Chance 16kV Phasing Testers for 48 or 80 kV Applications

- Designed to extend any Chance 16kV phasing tester for 48 or 80kV applications
- Extension resistors simply thread in the field
- 32" long





## Voltage Detectors: Self-Testing Audio/Visual

- Salisbury's self-testing voltage detectors allow testing to be continuous and automatic
- An intermittent flash and beep confirms the detector is functioning properly
- Used to verify live or de-energized conductors
- Testers may be used with insulating rubber gloves or hotsticks using the splined universal end fitting
- Testers indicate voltage with an extra bright LED light and a distinctive audible signal
- It is recommended that the tester be moved closer to the conductor until a warning is indicated, or it touches the conductor, apparatus or test point
- Each tester includes three "C" batteries
- The need for additional PPE can be minimized by confirming that there is no electrical hazard present before work is performed
- This can be determined by using a Salisbury voltage detector attached to an insulating hotstick that is long enough to keep the worker outside of the arc flash boundary
- The Salisbury voltage detector alarms in the proximity of electric fields, so that it is not necessary to make physical contact with the equipment being checked
- Made of non-conductive materials, meaning that it will not conduct electricity nor will it cause an arc flash, even if contact with energized equipment is made



**WARNING:** do not assume conductors that have been tested de-energized will stay de-energized. Always install proper grounding devices before working. Failure to do so may result in serious injury or death.

PART #	DIMENSIONS (IN.)	SETTINGS PHASE TO PHASE	WEIGHT EA.
4544	11 x 3.5	Off / 240V / 4.2kV / 15kV / 25kV / 35kV / 69kV / 115kV / 230kV	15 oz.
4644	11 x 3.5	Off / 240V / 4.2kV / 35kV / 69kV / 115kV / 230kV / 345kV / 500kV	15 oz.
4744	11 x 3.5	Off / Test-240kV / Battery / URD:15kV / 25kV / 35kV Overhead: 4.2kV / 15kV / 25kV / 35kV / 46kV / 69kV	15 oz.
4745	11 x 3.5	Off / Test-240kV / Battery / URD: 4.8kV / 7.2kV / 16kV Overhead: 2.4/4.2kV / 4.8/8.3kV, 8/13.8-7.2 / 12.5kV / 14.4/25-16/27.6kV / 44kV	15 oz.
<b>Complete Kit</b>			
4556		1-4544 Detector 240 V to 230 kV, 1-21517 Case, 1-2500 Shotgun Adapter	2 lbs
4667		1-4644 Detector 240 V to 500 kV, 1-21517 Case, 1-2500 Shotgun Adapter	2 lbs
4769		1-4744 Detector 240 V to 69 kV, 1-21517 Case, 1-2500 Shotgun Adapter	2 lbs
<b>Accessories</b>			
2500		Shotgun Adapter	.4 lbs
21517	12 x 8 x 4.5	Storage Case	1 lbs

# Salisbury by Honeywell

## Voltage Detectors: Audio/Visual

- Used to verify live or de-energized conductors
- Testers may be used with rubber insulating gloves or hotsticks using the splined universal end fitting
- Testers indicate the presence of voltage with an extra bright LED light and a distinctive audible signal
- It is recommended that the tester be moved closer to the conductor until warning is indicated, or it touches conductor, apparatus or test point
- Test the unit on a nearby energized conductor
- Each tester requires three "C" batteries (included)
- The **4445 Voltage Detector Tester** provides the most convenient and reliable means of verifying operation of Salisbury Voltage Detectors
- Tester features instant push-button operation and requires a standard 9-volt battery (included)
- It's portable and lightweight
- To operate, push the button and move the tester toward the voltage detector being verified
- The tester generates an electric field that activates the detector verifying the audible and visual signals are operational

**WARNING:** do not assume conductors that have been tested de-energized will stay de-energized. Always install proper grounding devices before working. Failure to do so may result in serious injury or death.



### Test Procedures:

To assure unit is in operable condition, switch tester into "Test-240V" position. The tester may now be tested in several different ways:

- 1) Place head as marked against live wire outlet or equivalent above 110V AC.
- 2) Rub the head as marked on cloth or clothing to obtain static charge. Unit will only indicate intermittently.

PART #	DIMENSIONS (IN.)	SETTINGS PHASE TO PHASE	WEIGHT EA.
4244	11 x 3.5	Off / 240V / 4.2kV / 15kV / 25kV / 35kV / 69kV / 115kV / 230kV	15 oz.
4344	11 x 3.5	Off / 240V / 4.2kV / 35kV / 69kV / 115kV / 230kV / 345kV / 500kV	15 oz.
4444	11 x 3.5	Off / Test-240kV / Battery / URD:15kV / 25kV / 35kV Overhead: 4.2kV / 15kV/25kV / 35kV / 46kV / 69kV	15 oz.
<b>Complete Kit</b>			
4356		1-4244 Detector 240 V to 230 kV, 1-21517 Case, 1-2500 Shotgun Adapter	2 lbs
4367		1-4344 Detector 240 V to 500 kV, 1-21517 Case, 1-2500 Shotgun Adapter	2 lbs
4469		1-4444 Detector 240 V to 69 kV, 1-21517 Case, 1-2500 Shotgun Adapter	2 lbs
<b>Accessories</b>			
2500		Shotgun Adapter	.4 lbs
21517	12 x 8 x 4.5	Storage Case	1 lbs
4445		Voltage Detector Tester	1 lbs
21600		Replacement Handle	-

## 6709-1: Regulator Neutral Detector

- The RND insures that the operator has the regulator in its neutral position prior to disconnecting the regulator from the circuit
- Use of the RND eliminates high or low voltages caused by cycling the regulator to the upper or lower limits, then counting steps back to neutral
- Works with step type and induction type regulators
- 0-2000 volt range is showing in one volt increments
- Works with all regulators up to and including 34.5kV systems
- No range selector is required
- Digital display with 1/2" tall LCD digits for easy viewing
- Lighted meter can be switched on by the operator
- 9 volt battery included
- Low battery indicator
- RND verifies the step indicator has not slipped one step
- A female universal spline allows unit to be attached to all universal hot sticks
- Contact electrodes are knurled to aid in contact with conductors
- Complete with case, battery and instructions



## 7701: Non-Contact Voltage Detector

- Static discriminator technology exclusive in Live Tester provides more reliable detection on low voltage ranges, and now means no more false alarms
- Incorporates an all in one universal attachment and a shotgun adapter into the handle
- Electronic touchpad includes 11 range settings from 240V to 230kV and 2 URD settings, 15kV and 25kV
- Includes (3) C cell batteries
- Built in self test function, high quality beeper, water resistant design
- Auto power off, low battery indicator
- Operator feedback - both visual and audible
- Less than 1 lb
- The RND verifies the step indicator has not slipped one step
- Female universal spline allows unit to be attached to all universal hot sticks
- Contact electrodes are knurled to aid in contact with conductors



## 6793: Transformer & Capacitor Tester



- Utilized to test the condition of transformers and capacitors before placing them into service
- Test new transformers or capacitors, plus trouble shoot in-service units
- Provides operating personnel a safe and reliable method to verify that transformers or capacitors are not shorted or open prior to energizing
- Detects failures in equipment before loading and transporting to the job site
- Eliminates the blowing of cutout fuses to determine the condition of equipment
- Magnetized back allows hands to be free to install and remove cables and clips, lightweight, has built in push button test feature prior to applying it to the equipment. Four bright LED lights signal the condition of the equipment being tested
- Tester can be used to verify that secondary services are not shorted prior to energizing the transformer
- The T&C tester is powered by a 9 volt battery
- Can be used to -40°C
- Housing is weatherproof, high-impact resistant plastic
- Contact electrodes are knurled to aid in contact with conductors

## 6702: Digital Voltage Phasing Meter

- 0-40kV Digital Volt Meter
- Instrument for measuring overhead and underground voltages
- Model 6706 - Digital display reads directly in kilovolts with three 1/2" high digits; readout is given to the nearest 10 volts
- Model 6702 - Digital display reads directly in kilovolts with three 1/2" high digits; the readout is given to the nearest 100 volts
- Digital display has a lighted background that operates via a switch
- Powered by a 9 volt battery, included. Low battery indicator
- Meter shuts off automatically after 10 minutes without contacting live voltage
- Coiled self-retracting cable; 16" retracted, 10' fully extended
- Complete with storage case, which also accommodates a pair of add-on resistor extensions, 2 bushing adapters, and a Hi-Pot adapter (each sold separately)
- 6702 Unit includes: Digital volt meter, conductor hooks, carrying case, battery, and instructions



6702



6702-1: 0-40kV Digital Volt Meter



6702-2: D.C. Hipot Adapter for up to 35kV



6702-3: 35kV Loadbreak bushing adapter





## PROFESSIONAL VOLTAGE/CONTINUITY TESTER

### ET200 Electronic Voltage/Continuity Tester



- Measures AC and DC voltage at 9 common levels up to 600V
- Bright LEDs indicate voltage reading without batteries installed
- Low impedance input reduces possibility of ghost voltages
- Permanently secured test leads are always there when they are needed
- Molded lead holders are perfect for easy measurements of tamper-proof outlets
- Vibration and sound alerts for dangerous voltage levels
- Modern solid-state construction provides CAT IV 600V safety rating

## PROFESSIONAL SERIES MULTI-METERS

### MM2000 Electrician's/HVAC TRMS Multimeter



- Display is brighter than most competitive units
- Bar graph measures fast moving readings
- Low impedance reduces ghost voltage
- uA setting for checking Flame sensors
- True RMS accurate readings for all signals
- 10A AC/DC Current
- Rubber molding for drop protection
- Lead storage protects leads
- 1000 voltage reading
- CAT IV Safety Rating - safest rating available

### MM200 Auto Ranging Multimeter



- Measures capacitance, temperature and frequency
- Features lighted display
- 10 AC/DC Current
- Lead storage protects leads
- Rubber molding for drop protection
- Measures up to 600V
- Cat III 600V Rating

## PROFESSIONAL SERIES CLAMP METERS

### CL1000 400A AC Clamp Meter



- Large clamp opening
- Capacitance great for HVAC work
- Display is brighter than most competitive units
- Worklight lights clamp area
- Magnetic mount secures meter and frees hands
- Side-mounted dial for ease of use
- Lead storage protects leads
- CAT III 600V Rating
- Frequency/duty cycle
- Bar graph measures fast moving readings
- Non-contact voltage tester

### CL2000 400A AC/DC True RMS Clamp Meter



- Large jaw sizes
- Worklights illuminate dark work spaces
- Data hold captures measurements in any situation
- Built-in magnetic mount for hands-free convenience
- Quick-response bar graph show elusive fluctuations
- CAT III 600V Rating
- Requires 2 AAA batteries

## HEATING, VENTILATION & AIR CONDITIONING CLAMP METERS

CMH-600    CMH-1000



FEATURES	CMH-600	CMH-1000
True RMS	AC	AC
Crest		×
Jaw Flashlight		×
Temperature (Type K)	×	×
Phase Sequence Test	×	×
Motor Rotation Test	×	×
Peak RMS	×	×
Backlight	×	×
Relative Offset Mode ( $\Delta$ )	×	×
AmpTip™	×	×
VFD ACV, Hz Measurement	×	×
Voltage Detection	×	×
Maximum/Minimum/Average	×	×
Frequency	×	×
Continuity/Diode Tests	×	×
Data Hold	×	×
Automatic Power Off (APO)	×	×
<b>RANGES</b>		
DC Microamps	2000	2000
Capacitance	2500 $\mu$ F	2500 $\mu$ F
AC Amps	600	1000
DC Volts	600	1000
AC Volts	600	1000
Resistance	60 k $\Omega$	60 k $\Omega$
Display Counts	6000	6000
Measurement Category Rating	CAT IV 300V CAT III 600V	CAT IV 600V CAT III 1000V

## INDUSTRIAL CLAMP METERS

CMI-660      CMI-1000      CMI-2000



FEATURES	CMI-600	CMI-1000	CMI-2000
True RMS	AC+DC	AC+DC	AC+DC
AutoCheck® Mode			×
Crest		×	×
Jaw Flashlight		×	
Phase Sequence Test	×	×	
Motor Rotation Test	×	×	
Peak RMS	×	×	
AmpTip™	×	×	
Maximum/Minumum/Average	×	×	
Temperature (Type K)	×	×	×
Backlight	×	×	×
Relative Offset Mode (Δ)	×	×	×
VFD ACV Hz Measurement	×	×	×
Voltage Detection	×	×	×
Frequency	×	×	×
Continuity/Diode Tests	×	×	×
Data Hold	×	×	×
Automatic Power Off (APO)	×	×	×
<b>RANGES</b>			
DC Microamps	2000	2000	-
Capacitance	2500 μF	2500 μF	2500 μF
DC Amps	600	1000	2000
AC Amps	600	1000	2000
DC Volts	600	1000	1000
AC Volts	600	1000	1000
Resistance	60 kΩ	60 kΩ	60 kΩ
Display Counts	6000	6000	6000
Measurement Category Rating	CAT IV 300V CAT III 600V	CAT IV 600V CAT III 1000V	CAT IV 1000V

## GENERAL PURPOSE CLAMP METERS

CM-660

CM-860

CM-960

CM-1360

CM-1560



FEATURES	CM-660	CM-860	CM-960	CM-1360	CM-1560
True RMS	AC	AC	AC+DC	AC	AC+DC
Peak RMS			×		×
Crest					×
Jaw Flashlight				×	×
Backlight		×	×	×	×
Relative Offset Mode		×	×	×	×
AmpTip™	×	×	×	×	×
VFD ACV, Hz Measurements	×	×	×	×	×
Non-Contact Voltage Detection	×	×	×	×	×
Maximum/Minimum/Average	×	×	×	×	×
Frequency	×	×	×	×	×
Continuity/Diode Tests	×	×	×	×	×
Data Hold	×	×	×	×	×
Automatic Power Off (APO)	×	×	×	×	×
<b>RANGES</b>					
Capacitance		2500 $\mu$ F	2500 $\mu$ F	2500 $\mu$ F	2500 $\mu$ F
DC Amps			600		1000
AC Amps	600	600	600	1000	1000
DC Volts	600	600	600	1000	1000
AC Volts	600	600	600	1000	1000
Resistance	60 k $\Omega$	60 k $\Omega$	60 k $\Omega$	60 k $\Omega$	60 k $\Omega$
Display Counts	6000	6000	6000	6000	6000
Measurement Category Rating	CAT IV 300V CAT III 600V	CAT IV 300V CAT III 600V	CAT IV 300V CAT III 600V	CAT IV 600V CAT III 1000V	CAT IV 600V CAT III 1000V

## ELECTRICAL TEST EQUIPMENT

### GT-12A: Non-Contact Self-Testing Voltage Detector



- Designed and assembled in the USA
- Automatic self-test verifies the integrity of the unit
- Bright LEDs and audible alarm sound if voltage is present
- Silent-mode feature for use in quiet settings
- Used to detect voltage in outlets, lighting fixtures, circuit breakers, wires, and cables or to find a break in a wire
- Automatically turns off after five minutes of non-use to conserve battery life; low battery indicator
- Lifetime limited warranty

### GT-65: Voltage Tester



- AC/DC voltage and polarity measurement
- Continuity test and single probe detection of live conductors for added flexibility
- Overvoltage warning gives user visual notification that voltage levels have exceeded 1000V AC/380V DC
- Safe, non-contact voltage detection
- Auto-hold automatically activates when tester is removed from voltage reading
- Visual and audible continuity
- Voltage detection: 19 to 1000 VAC, 5 to 1000 VDC Frequency

### DM-200A, DM210A & DM-510A Digital Multi-Meter

- Measurement Category Rating CAT II 1000V, CAT III 600V, CAT IV 300V
- Auto-ranging or manual ranging selection
- BeepJack™ Safety Technology
- Two voltage detection modes – non-contact or using a single test lead
- Backlight
- Data Hold and Auto Power off features
- Computer interface capability
- Includes (2) AAA batteries and Test Leads

In addition to the DM-200A features, DM-210A also includes:

- Temperature and capacitance measurements
- Includes Type K thermocouple (200 C / 392 F max)

In addition to the DM-200A/DM-210A features, DM-510A includes:

- Low impedance AutoCheck™ mode—automatically selects AC or DC volts, resistance, or continuity. Low impedance masks “ghost” voltage pickup
- Min/Max/Average measurements
- Peak (crest) Hold – Max/Min
- AC True RMS



DM-200A  
DM-210A  
DM-510A

### DM-65: Digital Multi-Meter



- Designed for residential and light commercial use
- Includes elastomer boot to protect meter from damage
- AC/DC voltage (600V); AC/DC amperage measurement
- Audible continuity and diode tests
- Frequency measurement in voltage mode
- Data hold to capture measurement
- Max feature for added versatility
- Includes (1) 9V battery, test leads

### 09027: GT-95 Voltage Tester

- Visual and audible continuity
- LCD and dual colour LEDs
- Selectable SHAKER feature when measuring AC voltage
- Overvoltage warning gives visual notification that voltage levels have exceeded 1000V AC/380V DC
- Auto-hold automatically activates when tester is removed from voltage reading
- Continuity test and single probe detection of live conductors
- Safe, non-contact voltage detection
- GFCI test capability
- AC/DC voltage and polarity measurement
- Lifetime limited warranty
- Voltage Detection: 19 to 1000 VAC, 5 to 1000 VDC
- Frequency: 0 to 70 Hz
- GFCI: 7.5 mA at 120 VAC, +/- 10%
- Measurement Category: CAT IV, 600 V; CAT III, 1000 V



### DMSC-2U: Interface Kit

- Connects to a PC's USB or RS-232 (serial) port
- Allows real-time datalogging and graphing
- Export data to disk for analysis with any spreadsheet
- Includes RS-232 interface cable, USB converter, cable, and software



## CS-8000 Circuit Seeker™ Circuit Tracer



- Advanced patented non-directional sensing technology
- Superior sensitivity and functionality providing for accurate tracing and locating
- Traces concealed wiring, locates junction boxes, and finds breakers for live or open circuits
- Locates and identifies blown fuses
- Finds shorts and breaks in conductors
- Lifetime limited warranty

## DML-430A: Digital Logging Meter



- Measurement Category Rating CAT IV 1000V
- Low impedance AutoCheck™ mode - automatically selects AC or DC volts, resistance, or continuity
- Low impedance masks "ghost" voltage pickup
- AC+DC True RMS
- Two Temperature inputs using type K thermocouples
- Datalogging capability – stores 87,000 single-channel or 43,000 dual-channel measurements
- Dual digital display and analog graph
- 10,000 display counts
- Includes (1) 9V battery, test leads, and carrying case
- Includes Type K thermocouple (200°C / 392°F max)

## DM-810A, DM-820A & DM-830A: Multi-Meter Series



- Measurement Category Rating CAT IV 1000V
- AC True RMS capability
- BeepJack™ Safety Technology
- Auto-ranging or manual ranging selection
- Dual digital display and analog graph
- 10,000 display counts
- Computer interface capability
- Includes (1) 9V battery, test leads, and carrying case

In addition to the DM-810A features, the DM-820A also includes:

- One temperature mode using a type K thermocouple
- Two voltage detection modes – non-contact or using a single test lead
- Peak (crest) Hold – Max/Min
- Includes Type K thermocouple (200°C / 392°F max)

In addition to the DM-810A/DM-820A features, the DM-830A also includes:

- Low impedance AutoCheck™ mode—automatically selects AC or DC volts, resistance, or continuity
- Low impedance masks "ghost" voltage pickup
- Two Temperature inputs using type K thermocouples
- AC+DC True RMS

## DMSC-9U: Interface Kit

- Connects to a PC's USB or RS-232 (serial) port
- Allows real-time datalogging and graphing
- Export data to disk for analysis with any spreadsheet
- Retrieves stored data from DML-430A
- Includes USB interface cable and software



## DMHS-1

- A magnetic hanging strap for all Greenlee DMMs



## HVA-2000: High Voltage Digital Ammeter



- Quickly take current readings on conductors up to 500kV (phase-to-phase)
- Measures AC current up to 2000 amps, 25-500Hz
- Use in overhead and underground applications
- Take spot-load checks with ease
- Verify phases are balanced
- Read the measurement in real time from the large digit display
- Stores the last four current readings
- Display is easy to read in bright or dark conditions
- Auto shutoff with low battery function
- Small and lightweight, easy to manage on an extension hotstick - 1.8 lbs (0.82 kg)
- Dual hotstick connections – universal spline and clampstick
- Use on conductors up to 2.75" (7.0 cm)
- Accuracy 1% of reading
- Made in USA

## PRX-69D: Proximity Voltage Detector



- Sealed to resist water penetration in typical outdoor environments
- Seven standard voltage ranges from 120V up to 69kV
- Detects voltage on most elbow test points
- Detects voltages typically 10" (25 cm) from the source
- Rechargeable battery with quick recharge - 15 minutes for a full day of use
- Heartbeat signal assures that the PRX is ready to detect voltage
- Rugged, durable housing
- Dual hotstick connections - universal spline and shotgun stick
- Loud beeper and LED lights indicate voltage
- Weighs less than 1 pound (0.45 kg)
- Easy to use electronic touch pad with large buttons
- Custom voltage ranges available upon request
- Can be used on 50Hz and 60Hz systems
- Made in USA

## PRX-500: Proximity Voltage Detector



- Sealed to resist water penetration in typical outdoor environments
- Nine standard voltage ranges from 120V up to 500kV
- Detects voltage on most elbow test points
- Detects voltages 10" (25 cm) or greater from the source
- Rechargeable battery with quick recharge - 15 minutes for a full day of use
- Rugged, durable housing
- Dual hotstick connections - universal spline and shotgun stick
- Loud beeper and LED lights indicate voltage
- Weighs less than 1 pound (0.45 kg)
- Easy to use electronic touch pad with large buttons
- Custom voltage ranges available upon request
- Can be used on 50Hz and 60Hz systems
- Made in USA

## VW-20HFR: V-Watch™ Personal Voltage Detector



- Alerts user to proximity of high voltage
- Audible and visual alarms increase in frequency the closer the user gets to energized equipment
- Typical V-Watch initial warning distance is about 7ft (2.13 m) from a 4kVAC conductor (see instruction manual for more details)
- Warning distance increases with higher voltages
- Field replaceable 9V battery
- Lightweight, rugged protective housing
- Built-in self test
- Carrying case lanyard: High-visibility safety green shielded material with an outer layer of flame resistant material, black shielded material, electrically shielded, storage case when the V-Watch is not in use, lanyard allows user to adjust to optimum mid-torso position
- Made in USA

## DVI-100: Digital Voltage Indicator



- For use on system voltages up to 161kV (reads up to 99kV line-to-ground)
- Large auto-ranging LED display indicates the line-to-ground voltage level
- Audible indication when voltage is detected
- Voltage readout allows user to distinguish between nominal and induced voltage
- Measure Elbow Test Points with the DVI-100T (underground probe required)
- Use on overhead lines or in underground applications with bushing probe
- Built-in universal spline for standard hotstick attachment
- LED's operate in extreme temperatures
- Easy-to-read in bright or dark conditions
- Built-in self-test to verify proper operation
- Powered by a field-replaceable 9V alkaline battery
- No range selector switch or settings required
- Compact, rugged and lightweight polycarbonate housing
- Made in USA

## DVI-500: Digital Voltage Indicator



- For use on system voltages up to 800kV (reads up to 500kV line-to-ground)
- No range selector switch or settings required
- Large LED display indicates the line-to-ground voltage level
- Display is easy to read in bright or dark conditions
- Voltage readout allows the user to distinguish between nominal and induced voltages
- Audible indication when voltage is detected
- Measure elbow test points with the DVI-500T
- Built-in universal spline for standard hotstick attachment
- Built-in self test to verify proper operation
- Powered by a field replaceable 9V alkaline battery
- Compact, rugged and lightweight polycarbonate housing
- Kits are available, contact factory for details
- Made in USA

## DVM-80UVM: High Accuracy Digital Voltmeter and Phasing Set



- Digital Meter reads in kilovolts, 3.5 digits with decimal point
- Voltage Range - 5V-40kV, up to 80kV with add-on resistors
- Auto-Ranging - No range selector switch
- Highly accurate, within 1% of reading +/- 3 counts
- Meter Resolution: 0.005 - 1.999 range with 1 Volt resolution, 2.00 - 19.00 range with 10 Volt resolution, 19.0-40.0 range with 100 Volt resolution
- Backlit Display - For easy reading in bright or dark conditions
- Peak Hold Mode - Conveniently keeps the peak voltage reading on the display
- Measures AC and DC voltages through 1000Hz RMS
- Use on Secondary Voltages - Starting at 5 Volts
- Measure voltage on elbow test points - Meter displays system voltage
- Underground Cable Testing - Test underground cables for faults using the CFT-35
- Coiled Connecting Cord - 3.5' retracted, 12' extended
- Phase Accurate Technology makes all voltage readings, whether line-to-line or line-to-ground, accurate and repeatable to within 1%
- Powered by a standard 9V alkaline battery in an easy to change battery case – no tools required
- Weight of Voltmeter (w/o probes) - 2.25 lbs (1.02 kg)
- Made in USA



The DVM-80UVM Kit contains everything needed to:

- Perform voltmeter and phasing operations for virtually all overhead and underground applications
- Take measurements on secondary voltages starting at 5 Volts
- Take measurements on primary voltages up to 80 Kilovolts
- Take measurements on elbow test points with Test Point Feature
- Peak voltage reading can be held using the Peak Hold Feature
- Perform underground cable fault testing with Cable Fault Tester
- Test the voltmeter before and after use with Voltmeter Proof Tester



# Testers & Equipment

## HD Electric LV-5/K01: Stray Voltage Detector and Harness



- Low threshold voltage sensing design picks up voltages from 5VAC to 600VAC with direct contact and above 600VAC at a distance
- Ultra bright, long-lasting red LED indicates when voltage is present
- Detector is always on, ready to use and operates on two AA alkaline batteries
- Rugged, utility-grade design is waterproof
- Tester integrated into the holster provides a visual indication of the test. Supplies a low voltage
- AC signal for testing before and after use
- Operating Frequency 60Hz
- Made in USA

## HJA-469-SCO: HJ Arnett Super Beast - Secondary Service Conductor Tester



- Indicates issues on secondary service
- Detects open neutral quickly, accurately
- Isolates and identifies overhead or underground complaints on utility side
- Verifies condition of secondary conductors, associated connections

## Knopp K-3 Phase Sequence Indicator



- Identifies the phase sequence (A-B-C or C-B-A) of three-phase voltages
- Rotating disk design
- Internal connections are soldered
- Leads are colour-coded and 36" in length
- Operates from 25-60 hertz and from 60-600 volts

## Hastings Phase-Tell III Wireless Phasing Meter



6722 Phase-Tell III Wireless Phasing Meter  
266 URD Bushing Well Adapter

- Battery powered, two-piece wireless phasing tool
- Determines phase relationships on three phase power systems, overhead and URD applications; when contact is made with line voltage or elbow test points, the Phase-Tell III units compare transmitted data and then display the results via red or green LED lights and differentiated audible signals
- Flashing green lights indicate In-Phase. Flashing red lights indicate out-of-phase
- Wireless units communicate up to three hundred feet apart
- Both units are identical, no need to identify transmitter or receiver
- Voltage range from URD test points to 500kV
- Both units confirm the same phase readings
- Rugged extruded aluminum enclosure
- Each unit operates on two "AA" batteries, included
- FCC Compliant
- Automatic test cycle when placed in the "On" position
- Auto Shut-Off
- Includes carrying case and instructions
- URD bushing adapters and case available

## LIV-500: Line Isolation Verifier (2.4kV to 500kV)



- Line Isolation Verifiers (LIVs) are lightweight rugged devices that have been specifically designed to detect the presence of AC potentials on unshielded conductors
- Patented design utilizing a collimated signal frequency filter that provides maximum sensitivity to energized conductors that fall within 30 degrees of the instrument's centre-line
- This unique feature eliminates the adjacent conductor pick-up problem typically encountered with other potential indicating devices

## TIC 300CC, TIC 300HV: Tic Tracers AC Voltage Detectors



- TIC 300CC measures to 1500 V
- TIC 300HV with two measurement ranges, 1500 V, 122kV
- Used to check fuses, breaker panels, power outlets, loadbreak connectors, transmission lines, etc
- 9 VDC power supply
- Detects AC voltage without connection
- Audible signal
- Lightweight yet rugged
- Integrated switchguard
- Locates breaks in insulated wire
- Checks fuses and breaker panels
- Checks for proper grounding
- Made in USA
- Operating temperature 32° - 125°F (0°-52°C)
- MSHA Approved

- Water-tight, crush-proof, and dust-proof
- Easy open double throw latches
- Open cell core with solid wall design - strong, light weight
- O-ring seal
- Automatic pressure equalization valve
- Stainless steel hardware
- Pick N Pluck™ with convoluted lid foam
- Lifetime guarantee of excellence
- Available in black, silver, orange, yellow, OD green, desert tan



## 1200: Small Case with Pick N Pluck™ Foam

- Interior Dimensions: 9.25" x 7.12" x 4.12" (23.5 x 18.1 x 10.5 cm)



## 1400: Small Case, Black with Pick N Pluck™ Foam

- Interior Dimensions: 11.81" x 8.87" x 5.18" (30 x 22.5 x 13.2 cm)
- Stainless steel padlock protectors
- Comfortable rubber over-molded handle



## 1450: Medium Case, Black with Pick N Pluck™ Foam

- Interior Dimensions: 14.62" x 10.18" x 6.00" (37.1 x 25.8 x 15.2 cm)
- Stainless steel padlock protectors
- Comfortable rubber over-molded handle



## 1500: Medium Case, Black with Pick N Pluck™ Foam

- Interior Dimensions: 16.75" x 11.18" x 6.12" (42.5 x 28.4 x 15.5 cm)
- Stainless steel padlock protectors
- Comfortable rubber over-molded handle



## 1550: Medium Case, Black with Pick N Pluck™ Foam

- Interior Dimensions: 18.43" x 14.00" x 7.62" (46.8 x 35.5 x 19.3 cm)
- Stainless steel padlock protectors
- Comfortable rubber over-molded handle
- 2 level Pick N Pluck™ with convoluted lid foam



## 1650: Medium Case, Black with Pick N Pluck™ Foam

- Interior Dimensions: 28.57" x 17.52" x 10.65" (72.5 x 44.5 x 27 cm)
- Retractable extension handle
- 4 strong polyurethane wheels with stainless steel bearings
- Fold down handles
- 2 level Pick N Pluck with convoluted lid foam

# Lineman's Apprentice Starter Kit

TOOLS



A



B



C



D



E



F



G



H



I



J



K



L



M



N



O



P

A	C2000M-BL-SIZE	Buckingham Full Floating Body Belt
B	84540	Yellow Nut Bolt Bag
C	111HLSX	4 Pocket Belt Holster
D	11DC	Equipment Bag/Tool Bag
E	THH88	Tearaway Hook
F	803-32	Ball-Peen Hammer
G	81280	Rigid Fiberglass Folding 6' Ruler
H	D507-12	12" Adjustable Wrench
I	D507-10	10" Adjustable Wrench
J	600-8	3/8" x 8" Square Shank Screwdriver
K	7090	Skinning Knife
L	D502-12	12" Channel Lock Pliers
M	D-2000-9NE	9" High Leverage Side Cutting Pliers
N	CN1972AR	Pole Climber c/w Pads and Straps
O	A-1972G	Gaff Guard
P	LTL426MFL-SIZE	Lineman Glove 6" Cuff Fleece Lined
	LTL423MFL-SIZE	Lineman Glove 3" Cuff Fleece Lined

Visit [ltl.ca](http://ltl.ca) for our "Nice to Have" list

## 106-50: Buck Self Rescue System



- Ideal for the one man crew!
- Provides the means to safely and easily descend to the ground in the event of a fall from the bucket or the need to evacuate an inoperable bucket
- Combines a specially designed bag that, when deployed, releases a ladder, an ascender, descender and 50' of rope

## 3816: Tower Rescue Blocks

- Kit is designed to easily lift a victim on a tower or structure to disconnect their shock absorbing lanyard
- A 4-to-1 mechanical advantage eases the process
- Includes an anchor sling and micro grab to anchor to a life line
- Packed in a compact storage bag that can be easily attached to a harness or belt
- 10' lifting height



## 52993: Leather Nut & Bolt Bag



- Three inside pockets for speed wrenches
- Available in Brown, Black & Burgundy
- Measures 10 1/4" x 10"

52993BR Brown  
52993BL Black

## 42666-BL: Holster



- 5 pockets
- 2 way knife snap
- Measures 10 3/4" x 8"
- 4089 knife sheath attached

## 45911M2: Canvas Nut & Bolt Bag



- Canvas bag built with an inside pocket for organizing spare parts
- Web loops are strategically positioned to store cotter pins during work
- Features a powerful magnet
- Reinforced bottom to prevent premature wear
- Measures 3"H x 8"W x 9"L

## 7091: Buck ErgoBlade Knife



- A revolutionary lineman's skinning knife!
- 1 1/4" diameter rubber handle fits comfortably in a gloved hand
- Round handle allows the user to create the proper cutting angle by rotating the knife within the hand instead of constantly, and repetitively, turning the wrist
- 5 3/4" long handle extends beyond the palm reducing the force and wrist action needed to secure the knife while skinning cable
- Textured rubber handle increases gripping while working in inclement weather

# Greenlee - Tool Kits

## Professional Hand Tools

Designed with linemen, contractors, and cable technicians in mind, Greenlee professional hand tools are a natural extension to Greenlee's existing product lines. With a comprehensive assortment of custom-designed pliers, saws, screwdrivers, wrenches, drivers, tool bags, accessories, tool kits, and more, Greenlee hand tools meet and exceed quality expectations.

TOOLS

### 0159-11: Electrician's Tool Kit, 28 Piece

0151-09M	Side-Cutting Pliers 9" w/Molded Grip (Lineman's Pliers)	0254-11	Hex-Key Set 9 Piece
0251-08M	Diagonal Cutting Pliers 8" w/Molded Grip	0155-25A	Power-Return Tape Measure
0351-08M	Long Nose Pliers 8" w/Molded Grip	L107	Torpedo Level
0451-10M	Water Pump Pliers 10" w/Molded Grip	0156-11	Electricians Hammer
1955A	Wire Stripper	0158-12	18" Heavy Duty Multi-Pocket Bag
0252-11	NM Cable Ripper	9858-11	Leather Tool Belt 2"
1927A	Stripping/Crimping Combination Tool	0258-11	Heavy Duty 8 Pocket Leather Pouch
727	Cable Cutter	0358-14XL	Tradesman Gloves XL
0153-11C	Keystone Tip Screwdriver 1/4" x 6"	GT-12	Non-Contact Voltage Detector
0153-15C	Keystone Tip Screwdriver 5/16" x 4"	333A	Hacksaw
0153-21C	Cabinet Tip Screwdriver 3/16" x 6"		
0153-26C	Cabinet Tip Screwdriver 1/4" x 6"		
0153-31C	Phillips Screwdriver #1 x 3"		
0153-33C	Phillips Screwdriver #2 x 4"		
0453-14C	Screw-Holding Screwdriver 3/16" x 6"		
9753-12C	Scratch Awl 3"		
0154-10	Adjustable Wrench 10"		



0159-11 Complete Tool Kit

### 0159-13: Electrician's Tool Kit, 12 Piece

- 
- 2" Leather Tool Belt
  - 8-Pocket Leather Pouch
  - 25' Tape Measure
  - 9" Side-Cutting Pliers
  - 8" Long Nose Pliers
  - 10" Pump Pliers
  - 8" Diagonal Cutting Pliers
  - Pro Plus Wire Stripper 10-18 AWG
  - Phillips Tip #1 - 3/16" x 3" Screwdriver
  - Phillips Tip #2 - 1/4" x 4" Screwdriver
  - Cabinet Tip Round Shank 3/16" x 6" Flat Blade Screwdriver
  - Keystone Tip Square Shank 1/4" x 4" Flat Blade Screwdriver

### 0159-12: Journeyman's Tool Kit, 17 Piece

- 
- 20-Pocket Tool Caddy
  - 25' Tape Measure
  - 8" Long Nose Pliers
  - 10" Pump Pliers
  - NM Cable Ripper
  - 9" Side-Cutting Pliers
  - 8" Diagonal Cutting Pliers
  - 18 oz. Electrician's Hammer
  - Pro Plus Wire Stripper 10-18 AWG
  - Keystone Tip Square Shank 1/4" x 4" Flat Blade Screwdriver
  - Cabinet Tip Round Shank 3/16" x 3" Flat Blade Screwdriver
  - GT-11 Voltage Tester, Torpedo Level
  - Phillips Tip #2 - 1/4" x 4" Screwdriver
  - Phillips Tip #1 - 3/16" x 3" Screwdriver
  - Stripping/Crimping Combination Tool and Cable Cutter

## Heavy Duty Leather Pouches

- For your tool storage and access needs, Greenlee has designed three top grain leather pouches that will not fade or stain
- Featuring a minimum of four compact pockets for tool organization, tapered compartments for tool stability, a tape chain, washer rivets for extra strength, and a metal tool clip, these pouches are what every lineman needs
- 0258-11 and 0258-13 feature large, divided main pockets for easy tool storage and access as well as a heavy duty tape measure holder that accepts and holds any size tape securely
- Each pouch will fit belts up to 3" wide

A) 0258-14 4 Pocket Leather Pouch

B) 0258-13 5 Pocket Leather Pouch

C) 0258-11 8 Pocket Leather Pouch



## 13" PVC Saw

- "V" tooth design enables straight cuts on both push and pull strokes
- Resharpenable blade
- Pointed blade nose makes drywall surface penetration easy
- Ergonomic handle is interchangeable with most PVC saw brands



00113

## 12" Heavy Duty Hacksaw

- Overmolded rugged design
- Alternative 45° blade mounting allows for flush cutting
- Mounting for most reciprocating saw blades for extra versatility
- Complete with bi-metal blade
- Fully adjustable blade tension up to 30,000 psi for longer blade life and faster, accurate cuts



333A

## Rothenberger Heavy Duty Pipe Wrenches

- One-handed ratchet-like use, self-clamping
- Monoblock cast body with high strength, double T profile; forged jaw and hook
- Fine polished teeth set against turning direction
- Induction hardened, tempered, and anti-slip adjustment screw
- Complies with US standard GGG-W-651 Type 1 Class A
- Quick and simple presetting



70152	12"	2" Max O.D.
70153	14"	2" Max O.D.
70154	18"	2.5" Max O.D.
70155	24"	3" Max O.D.
70156	36"	5" Max O.D.

## Scissors & Knife Kit with 2-Pocket Pouch

- Tough, tempered steel knife blade holds its edge longer
- Knife has a short, coping-type blade made of the finest cutlery steel
- Full-sized knife handle provides greater comfort
- Scissors have an upper blade with two stripping notches to strip most insulations from 19-24 AWG



PT-K01A

# Greenlee - Hand Tools

## Power Return Tape Measure



0155-25A 25' long  
0155-16A 16' long

- Double-sided tape with double foot can be read from above or below
- Easy to use Click Lock holds tape securely without moving the blade
- Stainless steel side panels
- Rigid 1" wide blade on all models
- Tough ABS case is over-molded with TPR for added protection
- Abrasion resistant nylon coated hardened steel blade
- Four rivets on foot resist pull-off, adjust for inside, outside readings
- 16" and 19.2" stud markings
- 0155-7MA contains a dual unit blade and metric units

## Electrician's Hammer



0156-11

- Elongated neck and narrow striking face for use in confined areas
- Long straight claws for electrical fixture removal
- Fiberglass handle for shock resistance
- Cushioned grip and flared handle end
- This is not an insulated tool

## Cushion-Grip Screwdriver Set, 5 Pc.

- Handle marked for size identification
- Precision machined black phosphate tips prevent chipping and slipping
- High grade, rust resistant, chrome finish
- 3/16" x 6" Cabinet, 1/4" x 4" Keystone, 1/4" x 6" Cabinet, 5/16" x 6" Keystone and #2 x 4" Phillips



0153-01C

## Cushion-Grip Screwdriver Set, 7 Pc.

- Handle marked for size identification
- Precision machined black phosphate tips
- High grade, rust-resistant, chrome finish
- 3/16" x 4" Cabinet, 3/16" x 6" Cabinet, 1/4" x 4" Keystone, 1/4" x 4" Cabinet, 5/16" x 6" Keystone, #1 x 3" Phillips and #2 x 4" Phillips



0153-02C

## Cushion-Grip Nut Driver Set, 7 Pc.

- Hollow shaft for screw clearance
- Heavy duty high grade, rust-resistant, satin chrome finish
- Precision heads for accurate fastener fit
- Includes 3" shank in sizes 3/16", 1/4", 5/16", 11/32", 3/8", 7/16", 1/2"



0253-01C

## Cushion-Grip Square Recess Tip Driver Set, 4 pc.

- Precision tip for accurate fastener fit
- Handle marked for easy identification
- High grade, rust resistant, chrome finish
- Contains #0, #1, #2, #3



0353-01C

## 3" Scratch Awl

- Heavy duty construction for piercing and scribing
- Cushion grip for extra comfort
- Steel cap for longer life
- High grade, rust-resistant, chrome-plated finish
- 7 7/8" long



9753-12C

## Folding Hex Key Set, 9 Key

- One-piece, powder-coated handle and case for corrosion resistance
- Heat-treated and tempered for extra strength and durability
- Exceeds ASME/ANSI specifications
- Includes sizes 5/64", 3/32", 7/64", 1/8", 9/64", 5/32", 3/16", 7/32", 1/4"



0254-11

## Ball End Folding Hex Key Set, 9 Key

- Ball-end design allows for angled use up to 30°
- Heat-treated and tempered
- Exceeds ASME/ANSI specifications
- Includes sizes 5/64", 3/32", 7/64", 1/8", 9/64", 5/32", 3/16", 7/32", 1/4"



0254-12

## 9-in-1 Multi-Tool

- Versatile multi-bit screwdriver, 9 tools in one
- Drive hex nuts, Phillips, Square-recess and slotted fasteners
- High-grade, rust-resistant, chrome-plated finish
- Precision machined, hardened steel bits
- Soft, cushioned grip for extra comfort and torque
- Lifetime limited warranty
- Note: This is not an insulated tool



0153-43C

9953-15

Replacement Bits

## High Leverage Diagonal Cutting Pliers

- Dual cutting edges for optimum performance
- Wider grip provides large load bearing area
- Effectively cuts most hardened wire, ACSR, bolts, screws and nails
- Forged from chrome vanadium steel



0251-08M

8" Molded Grip

0251-08AM

8" Angled Molded Grip

0251-08D

8" Dipped Grip

0251-08AD

8" Angled Dipped Grip

## Adjustable Wrench

- Patented lightweight ergonomic design
- Precision machined for smooth operation
- Wide capacity jaw provides versatility
- Exceeds ASME/ANSI specifications



0154-08D

8" Dipped Grip

0154-10D

10" Dipped Grip

0154-12D

12" Dipped Grip

## High Leverage Side-Cutting Pliers

- Location of handle ridge allows user to "choke up" for greater control
- Forged from chrome vanadium steel
- Effectively cuts most hardened wire, ACSR, bolts, screws, and nails
- Diamond serrated jaws



0151-09M

9" Molded Grip

0151-09D

9" Dipped Grip

## Long Nose Pliers/Side Cutters

- Flared handles for comfort and leverage
- Diamond serrated jaws and hardened cutting edges for optimum performance
- Forged from chrome vanadium steel
- Effectively cuts most hardened wire, ACSR, bolts, screws, and nails



0351-08M

Molded Grip

0351-08D

Dipped Grip



# Greenlee - Hand Tools

## Adjustable Wrench

- Precision machined for smooth operation
- Wide capacity jaw provides versatility
- Corrosion-resistant finish
- Exceeds ASME/ANSI specifications



0154-08 8"  
 0154-10 10"  
 0154-12 12"

## Double-Dipped Grip 16" Pump Pliers

- Double dipped grips for slip resistance
- Precision machined and through hardened for consistent performance
- Riveted process ensure joint integrity
- Right angled teeth for gripping in both directions



0451-16D

## Pump Pliers

- Precision machined and through hardened for consistent performance
- Right angled teeth for gripping in both directions
- Riveted process ensures joint integrity
- Slip-proof ergonomic grip
- User identification allowed on custom grip



0451-10M 10" Molded Grip  
 0451-12M 12" Molded Grip  
 0451-10D 10" Dipped Grip  
 0451-12D 12" Dipped Grip

## Utility Knife

- Over-molded for secure grip
- Retractable, three position blade
- Easy front-loading design
- Pop-up holder for blade storage
- Packaged with 3 heavy duty blades



0652-11 Knife w/ 3 Blades  
 9952-11 5 Replacement Blades

## Conduit-Reaming Screwdriver

- Deburs ID and OD of 1/2", 3/4" and 1" thin wall conduit
- Hooded, flat-tip driver used to fasten EMT fittings
- Soft, cushioned grip for extra torque
- 7 7/16" long



9753-11C Screwdriver  
 9953-11 Replacement Blade

## 6" Keyhole Saw

- Integrated blade and handle design
- Hardened steel blade with clog-free teeth
- Pointed tip punches through drywall
- Blade cuts on both push and pull strokes
- Hole in handle may be used for lanyard or for convenient storage



301A

# Klein Tools - Tool Holders

## Pliers and Screwdriver Holder



- Features one pocket for side cutting pliers and one for a screwdriver
  - Slotted to fit belts up to 2" wide
  - Made of leather
- 51185**

## 8-Pocket Tool Pouch

- A roomy pouch for electricians, service and maintenance workers
- Five large utility pockets for a wide variety of tools such as pliers, wrenches and wire cutters
- Smaller pockets are great for screwdrivers and scratch awls
- Knife snap, chain tape thong, and tape rule holder are conveniently located on the front
- Tunnel loop fits belts up to 2 1/2" wide
- Made of chrome-tanned leather



**5178**

## Pliers, Rule, Screwdriver, & Wrench Holder

- Four pockets to hold pliers, rule, screwdriver, and adjustable wrench
- Also features a two-way knife snap
- No exposed rivets in back
- Slotted to fit belts up to 2" wide
- Made of leather



**5118C**

## 8-Pocket Tool Pouches

- Multi-purpose pouch provides space for an extraordinary number of tools
- Four large, gusseted utility pockets
- Two pliers pockets
- Two pockets for screwdrivers
- Knife snap
- Slotted fits belts up to 2" wide
- Tunnel loop fits belts up to 2 1/2" wide



**5164  
Slotted**



**51647  
Tunnel loop**

## 4-Pocket Tool Pouch

- Pouch with center pocket for 6' wood rule, front loop for pliers, and two side loops; knife snap on front
- Slotted to fit belts up to 2" wide
- Made of leather



**5119**

## 5-Pocket Tool Pouch

- A high-quality pouch with extra-large, gusseted utility pocket, two pliers pockets, two screwdriver pockets, and knife strap
- Slotted pouch
- Fits belts up to 1 3/4"
- Made of leather



**5126**

## 10-Pocket Tool Pouch

- Rugged, big-capacity pouch with 10 separate pockets
- Four large, gusseted utility pockets
- Two pliers pockets
- Four pockets for screwdrivers
- Knife snap
- Slotted pouch fits belts up to 2" wide
- Made of leather



**5126**

## 10-Pocket Riveted Tool Pouch

- Riveted throughout to assure long life
- Ten separate compartments provide places for a wide variety of pliers, screwdrivers and other tools
- Has ring and tape thong
- Slotted pouch fits belts up to 2" wide
- Made of leather



**5190**

## 7-Pocket Multi-Purpose Tool Pouch

- Multi-purpose pouch, soft and pliable
- Moisture resistant to retain flexibility even after being wet and dried
- Has two large, gusseted utility pockets, two screwdriver pockets, hammer loop, three pliers pockets, and one chain tape thong
- Tunnel loop fits belts up to 2 1/4" wide
- Made of chrome-tanned leather



**5166**



# Klein Tools - Pro Pack Tool Sets

## 92914: 14 Piece Tool Set

- J2000-9NETP 9" High-Leverage Side-Cutting Pliers - Fish Tape Pulling
- J2000-48 8" High-Leverage Diagonal-Cutting Pliers - Angled Head
- J203-8 8" Heavy-Duty Long-Nose Pliers - Side-Cutting
- 11055 Klein Kurve® Wire Stripper/Cutter
- J502-10 10" Pump Pliers
- 630-1/4 1/4" Cushion-Grip Nut Driver - 3" Shaft
- 630-5/16 5/16" Cushion-Grip Nut Driver - 3" Shaft
- 662 #2 Square Recess Tip Cushion-Grip Screwdriver - 3" Round Shank
- 605-4 1/4" Cabinet Tip Cushion-Grip Screwdriver - 4" Heavy Duty Round Shank
- 603-4 #2 Phillips Tip Cushion-Grip Screwdriver - 4" Round Shank
- 603-3 #1 Phillips Tip Cushion-Grip Screwdriver - 3" Round Shank
- 601-6 3/16" Cabinet Tip Cushion-Grip Screwdriver - 6" Round Shank
- 5720 12-Pocket Tool Pouch
- 5705 Adjustable Tool Belt



## 92911: 11 Piece Tool Set

- D213-9NETP 9" High-Leverage Side-Cutting Pliers - Fish Tape Pulling
- D248-8 8" High-Leverage Diagonal-Cutting Pliers - Angled Head
- D203-8 8" Heavy-Duty Long-Nose Pliers - Side-Cutting
- 11045 Wire Stripper/Cutter
- D502-10 10" Pump Pliers
- 605-4 1/4" Cabinet Tip Cushion-Grip Screwdriver  
4" Heavy Duty Round Shank
- 603-4 #2 Phillips Tip Cushion-Grip Screwdriver
- 603-3 #1 Phillips Tip Cushion-Grip Screwdriver - 3" Round Shank
- 601-6 3/16" Cabinet Tip Cushion-Grip Screwdriver - 6" Round Shank
- 5720 12-Pocket Tool Pouch
- 5705 Adjustable Tool Belt

## 92906: 6 Piece Tool Set

- D213-9NE 9" High-Leverage Side-Cutting Pliers
- D248-8 8" High-Leverage Diagonal-Cutting Pliers - Angled Head
- D203-8 8" Heavy-Duty Long-Nose Pliers - Side-Cutting
- 11045 Wire Stripper/Cutter
- 605-4 1/4" Cabinet Tip Cushion-Grip Screwdriver
- 603-4 #2 Phillips Tip Cushion-Grip Screwdriver - 4" Heavy Duty Round Shank

## 80118: 18-Piece Journeyman's Kit

- |                                    |                              |
|------------------------------------|------------------------------|
| Journeyman Side-Cutting Pliers     | (2) Cabinet-Tip Screwdrivers |
| Journeyman Diagonal-Cutting Pliers | Rapi-Driv Screwdriver        |
| Journeyman Long-Nose Pliers        | Adjustable Wrench            |
| Klein-Kurve Wire Stripper/Cutter   | (2) Nut Drivers              |
| Journeyman Pump Pliers             | Power-Return Rule            |
| Square-Recess Tip Screwdriver      | Protective Eyewear           |
| Phillips-Tip Screwdriver           | Powerline™ Work Belt         |
| Wire-Bending Screwdriver           | Ten-Pocket Tool Pouch        |

## Klein Hand Tools



## 80006: 6-Piece Trim-Out Set

- |                                      |  |
|--------------------------------------|--|
| Portable Solutions for Electricians: | No. 2 Phillips Tip Screwdriver; 4" Round Shank |
| Heavy Duty Side-Cutting Pliers       | 1/4" Cabinet Tip Screwdriver; 4" Round Shank   |
| Klein -Kurve Wire Stripper           |  |
| 4 Pocket Leather Tool                |  |
| Lightweight Utility Belt Pouch       |  |



## 63050-INS: Insulated High-Leverage Cable Cutter



- Cable-gripping shear-type jaws cut up to 4/0 aluminum, 2/0 soft copper, 100-pair, 24-gauge communications cable
- Compact design for easy portability and efficient work in confined spaces
- Not designed for cutting steel or ACSR
- Rated up to 1,000 volts
- 9 1/2" length

## D2000-9NE-INS: Insulated High Leverage NE-Type Side Cutter



- Flame retardant, impact resistant, bright orange outer coating
- Provides greater cutting and gripping power
- Smooth, streamlined nose with knurled jaws
- Rated up to 1000 volts
- 9 1/4" length

## Insulated Heavy-Duty Round Shank Keystone® Tip Screwdrivers



- Square edges fit screw openings securely and resist slippage
- Strong, durable black tips, precision forged and ground
- Rated up to 1000 volts

602-4-INS	1/4" x 4"	8 11/32"
602-6-INS	5/16" x 6"	10 15/16"

## D2000-28-INS: Insulated High-Leverage Diagonal Cutter



- Flame retardant, impact-resistant, bright orange outer coating
- Provides greater mechanical cutting and gripping power
- Standard-bevel cutting knives
- Rated up to 1000 volts
- 8" length

## Insulated Round Shank, Cabinet Tip, Cushion-Grip Screwdrivers



- Super comfortable, sure-grip handles
- Perfect for electrical, telephone and work in recessed holes and other tight spaces
- Rated up to 1000 volts

601-4-INS	3/16" x 4"	7 3/4"
601-6-INS	3/16" x 6"	9 3/4"

## D2000-48-INS: Insulated High-Leverage Diagonal Cutter with Angled Head



- Heavy duty design with angled head for easier work in confined areas
- Flame retardant, impact-resistant, bright orange outer coating
- Rated up to 1000 volts
- 8" length

## Insulated Round-Shank, Special Profilated Phillips-Tip Screwdrivers



- Profilated to provide a more consistent geometric symmetry than conventional Phillips-tip screwdrivers for more accurate fit and torque without slippage
- Rated up to 1000 volts

603-4-INS	No. 2 Point	4" shank length
-----------	-------------	-----------------

## D203-8-INS: Insulated Heavy-Duty Long-Nose Pliers with Side Cutters



- Extra-heavy design for easier and more comfortable cutting
- Rated up to 1000 volts
- 8 5/16" length

# Klein Tools - Hand Tools

## Cushion-Grip Screwdrivers

- Cushion-Grip screwdrivers are exceptionally strong and made of carefully heat treated and tempered steel
- The Cushion-Grip handle resists slippage which allows you to apply greater torque
- Bolster on blade at handle provides added strength and rigidity for heavy duty Cushion-Grip screwdrivers
- Blades are fully chrome-plated with black-tips
- Cushion-Grip is resistant to oil, gas, and water
- Available with Round or Square shank



605-4 Round-Shank Cabinet-Tip 1/4" x 4"  
605-6 Round-Shank Cabinet Tip 1/4" x 6"



603-4 Round-Shanks Phillips-Tip (Point Size) No. 2 x 4"  
603-6 Round-Shank Phillips-Tip (Point Size) No. 3 x 6"  
603-7 Round-Shank Phillips-Tip (Point Size) No. 2 x 7"



661 Round-Shank Square-Recess (Point Size) No. 1 x 4"  
662 Round-Shank Square-Recess (Point Size) No. 2 x 4"  
663 Round-Shank Square-Recess (Point Size) No. 3 x 4"



600-4 Square- Shank Keystone-Tip 1/4" x 4"  
600-6 Square-Shank Keystone-Tip 5/16" x 6"  
600-8 Square-Shank Keystone-Tip 3/8" x 8"  
600-12 Square-Shank Keystone-Tip 1/2" x 12"



620-4 Plastic-Coated Round-Shank Cabinet Tip 1/4" x 3 3/4"  
620-6 Plastic-Coated Round-Shank Cabinet Tip 5/16" x 5 3/4"



19543 Round Shank TORX T20 x 4"  
19544 Round Shank TORX T25 x 4"  
19546 Round Shank TORX T30 x 4"

## 85076: 7 Piece Cushion-Grip Screwdriver Set



- A convenient selection of popular screwdrivers including three cabinet tip, two Phillips tip and two keystone tip styles, all with Cushion-Grip high quality design and construction features
- Set is provided in recloseable seal tight vinyl pouch
- Cushion-Grip is resistant to oil, gas, and water

## 631: 7 Piece Cushion-Grip Nut-Driver Set



- These exceptionally strong drivers are made of carefully heat treated and tempered steel
- Cushion-Grip handle resists slippage which allows you to apply greater torque
- Shafts are fully chrome plated
- The handle grip is comfortable
- This set consists of seven nut drivers in a handy, roll-up plastic pouch with hang-hole
- Cushion-grip is resistant to oil, gas, and water
- Size is colour coded for easy identification

Sizes: 3/16", 1/4", 5/16", 11/32", 3/8", 7/16", 1/2"

## 631-M: 7 Piece Magnetic Tip Nut Driver Set with 3" Hollow Shafts



- Full hollow shaft design with Rare Earth magnetic tip
- Full hollow shafts facilitate work on long bolt applications
- Cushion Grip handles allow for greater torque and comfort
- Handle domes are colour coded for easy identification
- Internal flanges provide solid, twist resistant shaft anchor
- Chrome plated shaft prevents corrosion

Sizes: 3/16", 1/4", 5/16", 11/32", 3/8", 7/16", 1/2"  
3/16" does not have hollow shaft

# Klein Tools - Screwdrivers & Nut Drivers

## 85090: Klein 5-Piece Grip-It Screwdriver Set



- Patented, oil resistant, anti-slip, plastic flock on handle helps prevent slippage
- Made of special high-alloy steel for exceptionally strong blade and long life
- Rounded end virtually eliminates pressure points in the palm of the hand
- Triangular-shaped handle allows for more turning power
- This set contains a general purpose selection of the most frequently used Grip-It screw drivers
- Includes two cabinet tip, one Phillips tip, and two keystone tip screwdrivers

## 32510: Magnetic Screwdriver with 32-Piece Tamperproof Bit Set



- Sturdy bit and screw holding magnet allows screws to fit securely in place
- Complete tamperproof bit set in block
- Non-ratcheting

## 32526: Magnetic 32-Piece Standard Tip Bit Set



- Clutch 5/32" and 3/16"
- Hex-5/64", 3/32", 7/64", 1/8", 9/64", 5/32", 3/16"
- Phillips - #0, #1, #2 (Qty 3), and #3
- Square recess #1, #2, and #3
- TORX - T6, T7, T8, T10, T15, T20, and T25
- Slotted screws sizes 3-4, 5-6, 6-8, 8-10, 10-12, 12-14
- 1/4" square to 1/4" hex adapter to drive sockets

## 32525: Magnetic 32-Piece Tamperproof Tip Bit Set



- Spanner - 4, 6, 8, 10
- Tri-Wing - 1, 2, 3, and 4
- TORQ-SET - 6, 8, and 10
- 1/4" square to 1/4" hex adapter to drive sockets
- Fraction Hex - 3/32", 7/64", 18", 9/64", 5/32", and 3/16", 1/4"
- TORX - T7, T8, T10, T15, T20, T25, T27, T30, and T40

## Journeyman Screwdrivers



JSDS01



JSDS02

- Journeyman™ represents the best of Klein quality, workmanship combined with the latest in product design
- JSDS01 includes (1) cabinet-tip, (2) Phillips-tip, (2) keystone-tip screwdrivers
- JSDS02 includes (2) cabinet-tip, (3) Phillips-tip, and (2) keystone-tip screwdrivers
- Advanced blade technology; maximum turning power
- Ultra-comfort tri-lobe handle for control, grip and balance
- Patented Tip-Ident™ quickly identifies screwdriver tip/orientation

## 85484: 4-Piece Mini Screwdriver Set

- Patented Tip-Ident® quickly identifies the type of screwdriver and tip orientation
- Precision tip for an exact fit
- Premium chrome-plated shafts for corrosion resistance



# Klein Tools - Pliers

## High Leverage NE-Type Side-Cutters

- Smooth, streamlined nose with knurled jaws
- High-leverage design
- Blue plastic-dipped handles



D213-9NE



HD213-9NE



D2000-9NE

## High-Leverage Diagonal Cutters



- High-leverage design
- Ultra-durable cutting knives
- Plastic-dipped handles

D2000-28

8" x 13/16" x 13/16" x 7/16"

D2000-48 Angled Head

8" x 13/16" x 13/16" x 7/16"

## High-Leverage Diagonal Cutters



- Soft, light blue handle material on outer surface for comfort and a firm grip
- Hard, black material on inner surface and handle ends for toughness and durability
- Hot-riveted joint for smooth action and no handle wobble

J2000-28 8 1/8" Length

J2000-48 8 1/8" Length, Angled Head

## High Leverage NE-Type Side-Cutters



- Smooth, streamlined nose with knurled jaws
- High-leverage design
- Blue plastic-dipped handles
- Soft, light blue handle material on outer surface for comfort and a firm grip
- Hard, black material on inner surface and handle ends for toughness and durability
- Hot-riveted joint for smooth action and no handle wobble

J2000-9NE 9 3/8" Overall Length

## Pump Pliers



- Wide range of jaw opening sizes
- Jaws cannot slip under heavy pressure
- Yellow plastic-dipped handles

D502-10 10" Long 1 3/4" Jaw

D502-12 12" Long 2 1/8" Jaw

## D213-9NETH: Bolt-Thread Holding Side-Cutters



- Hinge opening holds and cleans 5/8" pole line and hardware bolts or threaded rods
- High-leverage design. Rivet is closer to the cutting edge for 46% greater cutting and gripping power than other plier designs
- Streamlined design with rounded nose and sure-gripping, cross-hatched knurled jaws
- 9 3/8" Overall Length

## D2000-9NETH: High Leverage Side-Cutting Pliers - Lineman's Bolt Thread Holding



- Hinge opening holds and cleans 5/8" pole line and hardware bolts or threaded rods.
- High-leverage design. Rivet is closer to the cutting edge for 46% greater cutting and gripping power than other plier designs
- Streamlined design with rounded nose and sure-gripping, cross-hatched knurled jaws
- 2000 Series - Heavy-duty cutting knives; cuts ACSR, screws, nails and most hardened wire

**WARNING:** Plastic-dipped or slip-on plastic handles are NOT intended for protection against electrical shock. This warning includes heavy-duty plastic-dipped handles. Never use any pliers or cutters on live electrical circuits.

## 803-32: Ball Peen Hammer, 32 oz.



- High-carbon steel head, drop-forged and hardened
- Crowned face with uniform bevel
- Smoothly-rounded peen
- Straight-grain hickory handle, stained and lacquered

## 823-32: Lineman's Straight-Claw Hammer, 32 oz.



- Heavy duty, double-duty, drives lags and pulls big nails
- Special high-carbon steel head with solid, octagon-shaped driving end and thick, strong claw
- Blue painted finish
- Straight-grain lacquered hickory handle

## 10" Straight Jaw Locking Pliers



- Versatile 10" locking pliers
- Pliers adjust easily to lock to any size with desired amount of pressure
- Release lever opens jaws fully
- Alloy steel, heat treated with nickel-plated finish

## Cable Crimper - Fixed Die

- Rust-resistant
- Length: 21.42"
- Crimps #2, #4, and #6 connectors safely and easily
- Features extra-heavy duty fiberglass handles
- Molded rubber grip handles are ergonomically designed to fit the contour of the human hand for increased comfort and slip resistance
- Weight: 3.8 lbs



## Round Head Cable Cutter

- High leverage design provides excellent cutting capability
- Plastic coated handles
- Precision, one-hand shearing action
- Cuts up to 2/0 AWG
- Designed for use in confined spaces
- Hot-riveted joint ensures smooth action and no handle wobble
- Beveled jaw tips provide proper opening, closing, and cutting



## Ratcheting Cable Cutter

- With one hand operation, use can cleanly cut up to 350 MCM copper and aluminum cable
- Ratchet holds cable tight and allows straight cuts with minimal effort
- Large handles allow sure grip and handles are plastic coated for positive grip
- Quick release lever opens blade during operation
- Not designed for steel or ACSR

## Ratcheting Cable Cutter

- Fully ratcheting cable cutter features handles designed for comfort and positive grip
- Quick release lever opens blade during operation
- A professional tool for stranded and flexible copper and aluminum cable up to 750 MCM or diameter of 1.77"
- Not designed for steel or ACSR



## Long-Nose Multi-Purpose Tool

- Features an extended handle



## Plastic Gripping Pliers

- Rated up to 1,000 volts
- 3 1/8" opening
- 7 1/2" long





# Snap-On Industrial/Williams

TOOLS

## Combination Wrench Sets

SUPERCOMBO® open end has specially designed grooves that direct wrench force away from fastener corners  
SUPERTORQUE® box opening design allows application of higher torque without rounding or deforming hex fastener points. No contact is made at the corners. Instead, wrenching forces are placed on the flat surfaces behind the points. Meets or exceeds aerospace specification AS 954 for 12 point fasteners (as defined by AS 870) to provide accurate torque/tension relationship for precision application. May be used on all common hex (6 point) fasteners with considerable advantage over conventional box end wrenches to increase both hand tool flexibility and economy



WS-1170SCA: 7 Pc Combo Wrench Set



WS-1171SCA: 11 Pc Combo Wrench Set



WS-1172SCA: 15 Pc Combo Wrench Set

## High Polish Wrench Sets

High polish chrome textured finish provides great feel and extra gripping power. 12 point box end provides easy socket engagement and maximum versatility. Recessed corners in box end provide extra turning power. Sets are packed in a vinyl pouch.



11003: 9 Pc Hi Pol-Wrench Set



11007: 11 Pc Hi Pol-Wrench Set



11008: 14 Pc Hi Pol-Wrench Set

## 100P-5MD: 5 Piece Premium Mixed Screwdriver Set

- Contains 3 slotted and 2 Phillips screwdrivers
- Comfort-grip handle with thumb stop allow for added turning power without discomfort or slippage
- Chrome blades prevent corrosion and can be easily cleaned
- Blades are made from special alloy steel for extra strength
- Vapor-blasted tips grip fasteners and prevent chipping, extending tool life
- Hex bolsters on shafts allow a wrench to be used for extra turning power
- 3/16", 1/4", 5/16", #1 & #2 Phillips



## 100P-8MD: 8 Piece Premium Mixed Screwdriver Set

- 8 Piece Premium Screwdriver Set Phillips Slotted Tips
- Comfort-grip handle with thumb stop allow for added turning power without discomfort or slippage
- Chrome blades prevent corrosion and can be easily cleaned
- Blades are made from special alloy steel for extra strength
- Vapor-blasted tips grip fasteners and prevent chipping, extending tool life
- Hex bolsters on shafts allow a wrench to be used for extra turning power
- 1/4", 5/16", 3/8", #1, #2 & #3 Phillips tip, 3/16" electrician's tip 3", 3/16" electrician's tip 6"



# Snap-On Industrial/Williams

## 24004: 6 Piece Slotted Tip Screwdriver Set

- Bi-mold handles provide comfortable grip, reducing hand fatigue
- Set packed in a vinyl pouch
- Handle end shows size and style for easy identification
- Chrome blades prevent corrosion and can be easily cleaned
- (2) 3/16", (2) 1/4", 5/16", 3/8"



## 24050: 7 Piece Nutdriver Set in Carrying Caddy

- Hollow shaft accommodates long bolts or studs
- Precision machined socket end
- Cushion grip handle for comfort
- Size imprinted on colour coded ends for easy identification
- 3/16", 1/4", 5/16", 11/32", 3/8", 7/16", 1/2"



## WS-1168RC: Reversible Ratcheting Combination Wrench Set

- High-polished cleans easily
- Ratchet lever is easily accessible for quick direction changes
- Recessed corners in ends provide extra turning power
- 5/16", 3/8", 7/16", 1/2", 9/16", 5/8", 11/16", 3/4"



## PLS-6A: 6-Piece General Service Pliers Set

The set includes:

- PL-1519C 5" utility superjoint
- PL-1520C 10" utility superjoint
- PL-46C 6" diagonal cutting
- PL-76C 6 1/2" chain nose side cutters
- 23503 8 1/4" front end stripper
- 2628G-180 7" side cutting pliers
- This 6 piece set is packaged in a roll pouch

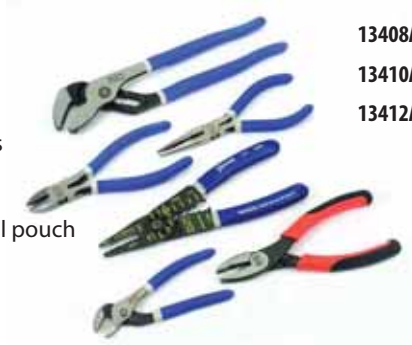

## 24006: 8 Piece Combination Screwdriver Set

- Contains 5 slotted and 3 Phillips® screwdrivers
- Bi-Mold handles provide comfortable grip, reducing hand fatigue
- Set packed in a vinyl pouch
- Handle end shows size and style for easy identification
- Chrome blades prevent corrosion and can be easily cleaned
- 3/16", (2) 1/4", 5/16", 3/8" #1, #2 Phillips® tips



## 24051: 9 Piece Nutdriver Set in Plastic Tray

- Solid shaft accommodates long bolts or studs
- Precision machined socket end
- Cushion grip handle for comfort
- Size imprinted on colour coded ends for easy identification
- 3/16", 1/4", 5/16", 11/32", 3/8", 7/16", 1/2", 9/16", 5/8"



## Adjustable Wrench

- Measurement scale on head conveniently shows fastener size
- Wrench heads are fully polished for easy clean-up
- Exceed ANSI specifications for strength
- Precision hardened and anti-corrosion treated



Part #	Overall Length	Max. Jaw Opening (not less than)	Head Thickness
13408A	8"	1 1/8"	9/16"
13410A	10"	1 5/16"	11/16"
13412A	12"	1 1/2"	13/16"



# Snap-On Industrial/Williams

## WSC-167TB: 167 Piece Electrical Maintenance Service Set

- Designed to satisfy electrical maintenance tool requirements, this set has both the standard hand tools and special tools needed to accomplish a wide variety of electrical maintenance and installation
- Start with 1/4" and 3/8" drive sockets and accessories, hammers, and hand wrenches, and add the special items needed for electrical work:
  - Insulated and non-insulated pliers and screwdrivers
  - An electrician's holesaw set and a 10-pack of assorted recip blades
  - A comprehensive assortment of electrical strippers / crimpers / cutters
  - Drywall, hacksaw, and toolbox saws
  - And a full-size roll cabinet to organize, store, and move your tool set
- Unique in the industry, this set will help you get those critical electrical maintenance tasks done quickly, efficiently, professionally, and safely

**SET INCLUDES:**

PRODUCT CATEGORY	# OF PIECES
Electrical Specialty Tools	2
Hammers	3
Hand Sockets	28
Miscellaneous Tools	9
Pliers	8
Pliers - Electrical	12
Pliers - Insulated	5
Ratchets, Drive Tools & Accessories	7
Saws and Saw Blades	32
Screwdrivers	14
Screwdrivers - Insulated	11
Tool Box	1
Wrenches	35

Tool Set Only (166 pieces)

Tool Box: 40" Wide x 20" Deep  
7-Drawer Roll Cabinet

WSC-167

W40RC7



# Snap-On Industrial/Williams

## 8155-1/2: 1/2" Drive Ergo® One-Hand Reversing Ratchet

- Ergonomic, smooth, non-slip handle ensures maximum comfort in the hand
- Ring switch provides easy, one handed change of direction
- Easy access reverse lever allows user to change working direction quickly and easily with only one hand
- Built-in ratchet spinner disc for fast socket turn-down
- 72 tooth gear with 5° engagement allows engagement in tight working areas
- Nickel/Chrome plating provides increased protection from rust and corrosion
- Durable handle material withstands aggressive fluids and oils

Length	Number of Teeth
10 1/4"	60

## 1/2" Drive Enclosed Head Ratchets

- Enclosed head is sealed to prevent dust, dirt, and liquids from entering head, preserving internal lubrication
- Forged one-piece ratchet provide strength and safety for industrial applications
- Smooth comfort-grip handle permits all-day use without gloves
- 36 tooth gear with 10° of engagement allows engagement in tight working areas
- Nickel/Chrome plating provides increase protection from rust and corrosion
- Chrome finish models feature mirror-like exterior that can be easily cleaned after each use
- Single Pawl ratchet design:
  - 1) Designed for tighter tolerances between pawl and gear which reduces metal fatigue and slippage under load
  - 2) Does not require as many working parts, reducing possible breakage and parts to repair
- Easy access reverse lever allows user to change working direction quickly and easily with only one hand

Part #	Description	Length	Number of Teeth
S-52EHA	Chrome Finish Enclosed Head Ratchet	10 1/4"	36
S-52EHLA	Chrome Finish Enclosed Head Ratchet, Long	15"	36
SB-52EHLA	Black Industrial Finish Enclosed Head Ratchet, Long	15"	36
S-52EHFA	Chrome Finish Flex Head Ratchet	14 1/4"	36
SB-52EHA	Black Industrial Finish Enclosed Head Ratchet	10 1/4"	36
S-52EHRKA	Repair Kit "EHA" Model Enclosed Head Ratchets		
<b>BAHCO Fine-Tooth Bi-Mold Comfort Grip Handles</b>			
8150-1/2	Comfort Grip Enclosed Head Ratchet	10 1/5"	80



## 12" Drive Round Head Ratchets

- Double pawl design with 72 teeth action provides a 5° ratcheting angle
- Shift lever reverses action instantly
- Knurled handle provides a non-slip grip
- Chrome finish models provides increased protection from rust and corrosion

Part #	Description	Length	Number of Teeth
S-52A	Chrome Finish Round Head Ratchet	11 5/16"	72
S-53A	Chrome Finish Round Head Ratchet, Long	15"	72
BS-52A	Black Industrial Finish Round Head Ratchet	11 5/16"	72
S-52ARK	Repair Kit		



# Snap-On Industrial/Williams

## 1/2" Drive Hex to Square Shank Impact Extensions

- Specially heat treated for impact use to provide long life, safety, and durability
- Spring plunger provides secure socket retention for safety and convenience
- Suitable for use with pneumatic and electric impact wrenches

Part #	Hex Shank Size	Square Drive Size	Length
4-33B	7/16"	1/2"	2 3/4"
4-35B	7/16"	1/2"	5"
4-53B	5/8"	1/2"	2 3/4"



## 1/2" Drive Impact Extensions & Accessories

- Specially heat treated for impact use to provide long life, safety, and durability
- Spring plunger provides secure socket retention for safety and convenience
- Suitable for use with pneumatic and electric impact wrenches

Part #	Description	Length	Socket Retention
4-102	Impact Extension	3 1/2"	Lock Ring
4-105A	Impact Extension	5"	Spring Plunger
4-110A	Impact Extension	10"	Spring Plunger
4-140B	Impact Universal Joint	2 1/2"	Spring Plunger
4-2A	3/8" M x 1/2" F Adapter	2 1/4"	Spring Plunger
4-6	3/4" M x 1/2" F Adapter	1 1/4"	Through Hole



## 1/2" Drive Impact Extensions & Accessories

- Specially heat treated for impact use to provide long life, safety, and durability
- Ball socket retention for fast socket changes
- Suitable for use with pneumatic and electric impact wrenches
- Drive end features pin retention hole and groove

Part #	Hex Shank Size	Length	Socket Retention
37002	Impact Extension	3"	Ball
37003	Impact Extension	6"	Ball
37004	Impact Extension	10"	Ball
37001	Impact Universal Joint	2 9/16"	Ball
37005	1/2" F x 3/8" M Adapter	1 7/8"	Ball



# Snap-On Industrial/Williams

TOOLS

## 1/2" Drive Deep Sockets, Impact 6 Point

Part #	Size	OAL	Drive End Diameter	Working End Diameter	Broach Depth	Bolt Clearance Depth	Bolt Clearance Diameter	Nose Length
37312	3/8"	3 1/4"	15/16"	5/8"	1 3/32"	2 1/4"	11/32"	3/4"
37314	7/16"	3 1/4"	15/16"	11/16"	1"	2 3/8"	13/32"	3/4"
37316	1/2"	3 1/4"	15/16"	25/32"	1 3/32"	2 3/8"	7/16"	3/4"
37318	9/16"	3 1/4"	15/16"	7/8"	1 5/32"	2 11/32"	1/2"	3/4"
37320	5/8"	3 1/4"	1	31/32"	1 5/16"	2 7/16"	9/16"	3/4"
37322	11/16"	3 1/4"	1 1/8"	1"	1 3/8"	2 17/32"	21/32"	3/4"
37324	3/4"	3 1/4"	1 1/8"	1 1/8"	1 5/16"	2 9/16"	23/32"	-
37326	13/16"	3 1/4"	1 3/16"	1 3/16"	1 1/2"	2 11/32"	3/4"	-
37328	7/8"	3 1/2"	1 1/4"	1 1/4"	1 15/32"	2 21/32"	27/32"	-
37330	15/16"	3 1/2"	1 3/8"	1 3/8"	1 13/32"	2 19/32"	29/32"	-
37332	1"	3 1/2"	1 1/2"	1 1/2"	1 15/32"	2 5/8"	15/16"	-
37334	1-1/16"	3 1/2"	1 17/32"	1 17/32"	1 29/32"	2 17/32"	1 1/32"	-
37336	1-1/8"	3 1/2"	1 5/8"	1 5/8"	1 7/16"	2 7/16"	1 1/16"	-
37338	1-3/16"	3 1/2"	1 21/32"	1 21/32"	1 13/32"	2 27/32"	1 1/16"	-
37340	1-1/4"	3 1/2"	1 3/4"	1 3/4"	1 7/16"	2 3/4"	1 1/16"	-
37342	1 5/16"	3 1/2"	1 7/8"	1 7/8"	1 3/8"	2 43/64"	1 7/32"	-
37344	1 3/8"	3 1/2"	1 57/64"	1 57/64"	1 3/8"	2 43/64"	1 19/64"	-
37346	1 1/16"	3 1/2"	1 31/32"	1 31/32"	1 3/8"	2 43/64"	1 11/32"	-
37348	1 1/2"	3 1/2"	2 1/8"	2 1/8"	1 3/8"	2 43/64"	1 3/8"	-



37312, 37324

## 37906: 9 Piece 1/2" Drive Deep 6 Point Impact Socket Set on Clip Rail

Contents Include:

Part #	Size	Part #	Size	Part #	Size
37316	1/2"	37322	11/16"	37328	7/8"
37318	9/16"	37324	3/4"	37330	15/16"
37320	5/8"	37326	13/16"	37332	1"



37906

## 37908: 15 Piece 1/2" Drive Deep 6 Point Impact Socket Set on Clip Rail

Contents Include:

Part #	Size	Part #	Size	Part #	Size	Part #	Size
37312	3/8"	37320	5/8"	37328	7/8"	37336	1 1/8"
37314	7/16"	37322	11/16"	37330	15/16"	37338	1 3/16"
37316	1/2"	37324	3/4"	37332	1"	37340	1 1/4"
37318	9/16"	37326	13/16"	37334	1 1/16"		



37908

## 37909: 19 Piece 1/2" Drive Impact Deep 6 Point Socket Set on Clip Rail

Contents Include:

Part #	Size	Part #	Size	Part #	Size	Part #	Size
37312	3/8"	37322	11/16"	37332	1"	37342	1 5/16"
37314	7/16"	37324	3/4"	37334	1 1/16"	37344	1 3/8"
37316	1/2"	37326	13/16"	37336	1 1/8"	37346	1 7/16"
37318	9/16"	37328	7/8"	37338	1 3/16"	37348	1 1/2"
37320	5/8"	37330	15/16"	37340	1 1/4"		



37909



lutilitysupply.com

## Transmission Tower Wrenches

- Bolt-Thru Design
- Two Square Sizes = 1-5/16" and 1-1/2"
- Provides greater flexibility for linemen
- Coated with epoxy paint for durability, easy cleaning
- Designed for utility, construction, and maintenance
- Made in USA



Lowell 52	52901-95823	15" Cast Handle
Lowell 53	53901-95823	20" Cast Handle
Lowell 152	15201-95823	17" Riveted Handle

## 101TDE & 103TDE Triple Square Distribution Wrench

- Five socket sizes in one wrench
- Square = 3/4" (oversize), 1" & 1-1/8"
- Hex = 9/16" & 3/4" (3/4" hex also turns 5/8" square nuts)
- Two handle lengths: 101TDE 9" & 103TDE 12"
- Ergonomic handle shape makes the work more comfortable
- Reversing control at both ends
- Twice as strong as a standard ratcheting box wrench
- Fluorescent orange sockets make the wrenches harder to lose, easier to find
- Bolt-thru design lets bolts pass entirely through sockets and arm head so nuts can be secured on any threaded length



## 23-26908-9900: Triple Square Impact Socket Assembly w/ Adapter

- Three square openings in one socket
- 3/4" (oversize) for 1/2" hardware
- 1" for 5/8" hardware
- 1 1/8" for 3/4" hardware
- 13/16" diameter, 6" long hollow shaft allows use on long threaded bolts
- Narrowed center allows easy grip with or without gloves
- 7/16" hex quick-change adapter included
- Length 7 3/4", weight 2 lbs

## 21-T8T29-Q100: Triple Square Impact Socket w/ Adapter

- 6" deep, 1-1/16" diameter hollow shaft allows use on long threaded bolts
- 7/16 Hex Quick-Change Adapter included
- Length 10-3/8" (assembled), weight 3.5 lbs. (with adapter)
- Square socket openings 1-1/8" for 3/4" hardware 1-5/16" for 7/8" hardware 1-1/2" for 1" hardware
- Also fits 1-1/2" hex nuts



## 51T/151T Distribution Wrenches

- Ergonomic handle shapes
- Reversing control in head
- Enclosed ratchet mechanism on models 50T, 51T; semi-enclosed on models 101T, 150T, 151T
- Fluorescent orange sockets
- Bolt-thru design
- Made in USA



Lowell 51T	51901-94800	12" Cast Handle
Lowell 151T	88901-94800	12" Riveted Handle
Lowell 50T	50901-94800	10" Cast Handle
Lowell 150T	88901-94800	10" Riveted Handle

## 101T Mini Triple Square Distribution Wrench

- Fits most common utility pole fasteners: lag bolts, C-clamps, suspension bolts
- Reduced socket depth and short handle length designed for tight spaces
- Torque capacity of 150lb/ft
- Made in USA
- 8" length, 1.5 lbs, 3/4" x 1" x 1-1/8"



## 104T: Triple Square Tower Wrench

- Provides greater flexibility for linemen dealing with the most common nut sizes in tower fasteners
- The 1-1/8" x 1-5/16" x 1-1/2" triple square socket allows for tolerances on 1-1/8" square nuts (5/8" bolts), 1-1/4" square nuts (3/4" bolts) and 1-3/8" square nuts (7/8" bolts)
- Also fits 1-1/2" hex bolts
- The Bolt-Thru design allows threaded rod to pass through the socket so that nuts can be secured on any threaded length
- The 104T has a heavy duty stamped riveted metal handle with a vinyl grip

## Hexagonal Wrenches

- Unique "Bolt-Thru" design allows the user to tighten nuts on any threaded length
- Permanent socket will not fall off the handle
- Features a reversible ratchet
- 1 1/4" hexagonal socket

50901-94720	10" Cast Handle
87901-94720	10" Riveted Handle
51901-94720	12" Cast Handle



## Simplex Strap Wrench

- Single piece design; contoured handle
- The 6" straps are ribbed and uncoated; the larger models are latex-coated for increased gripping power
- Strap attaches to the wrench with a "pound-in" wedge



Model	Handle Length	Strap Length	Strap Width
S-6	6"	22"	1/2"
S-12	12"	17"	1 1/4"
S-18	18"	30"	1 3/4"
S-24	24"	54"	2 1/4"

## Warnock Strap Wrench

- The original strap wrench for handling highly polished and smooth surfaces
- Rugged shackle swings away from the handle, allowing quick adjustment of the strap
- Strap is latex coated for increased gripping power



Model	Handle Length	Strap Length	Strap Width
W-12	12"	17"	1 1/4"
W-18	18"	30"	1 3/4"
W-24	24"	54"	2 1/4"

## 101XRS: Wrench 7/8" Pentagon + 3/4" Hex

- Built for tough duty with a rugged one-piece design that incorporates gear, shaft and sockets
- The sturdy ratchet mechanism reverses with the flick of a lever
- There are 32 teeth which reduce the throw angle between teeth and make the tool a good choice for working in tight areas
- For extra strength, the head of the wrench is secured with a pin which also eliminates wobbling for better torque and reduced wear
- Torque has been tested to 90 ft lbs
- A cushioned grip improves comfort and reduces worker fatigue
- Handle length is 7" and the tool weighs 1-1/2 lbs



## 10-312: Hastings Hammer Head Wrench



- The perfect tool for power linemen, telecommunications linemen, construction workers, maintenance workers
- Reduces your inventory and replacement of standard adjustable wrenches due to breakage

## Q-1 FUSEBUDDY

### Fusebuddy...a Tool Designed for Linemen by Linemen

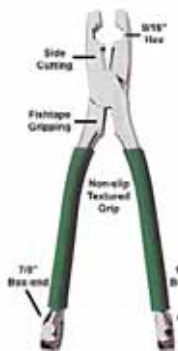

- FuseBuddy is a combination tool designed specifically for the electrical lineman
- Tool consists of three different common wrench sizes. One is positioned in the end of each handle and the third is positioned in the cutting head of the pliers
- Utilized most specifically for the re-fusing of open cut-out gates used in overhead power distribution
- The FuseBuddy eliminates the use of more than one tool to accomplish tasks
- Combination electrical lineman pliers
- 7/8" box end wrench at the end of one handle
- 13/16" box end wrench at the end of one handle
- 9/16" socket formed in the head of the pliers
- ACSR cutting capability





# ITL - Insulated Hand Tools

- ITL tools are insulated with injection molded Nylon 11
- Exceeds all the requirements of IEC 60900, including Category C (unaffected by extreme temperatures from +158°F/70°C down to minus 40°F/C)
- 100% test every product prior the shipment to ensure they meet the required standards
- Lifetime guarantee on the tools and the insulation
- 30-day no quibble money back guarantee

TOOLS

## UKC-02100: 7 Piece Screwdriver Set



- 02010: 1pt Phillips (02010)
- 02020: 2pt Phillips (02020)
- 01860: 3" Terminal driver
- 01880: 3" Electrical driver
- 01890: 6" Electrical driver
- 01940: 4" Engineers driver
- Tester
- Tool roll

## UKC-02150: 5 Piece Screwdriver Set



- 02020: 2pt Phillips
- 01860: 3" Terminal driver
- 01880: 3" Electrical driver
- 01890: 6" Electrical driver
- Tester
- Tool roll

## 02295: 7 Piece Nut Driver Kit



- 02305: 3/16" Nut Driver – 1" (25mm) stud clearance
- 02315: 1/4" Nut Driver – 1" (25mm) stud clearance
- 02331: 5/16" Nut Driver – 1" (25mm) stud clearance
- 02332: 11/32" AF Nut Driver (spinner) – 1" (25mm) stud clearance
- 02333: 3/8" AF Nut Driver (spinner) – 1" (25mm) stud clearance
- 02334: 7/16" AF Nut Driver (spinner) – 1" (25mm) stud clearance
- 02335: 1/2" AF Nut Driver (spinner) – 1" (25mm) stud clearance
- 03190: Tool Roll – 8 pockets

## 00017: Special Hydro Power Utility Kit



- 03005: 10" Adjustable wrench
- 01780: 3/8" Reversible Ratchet
- 01791: 5" Extension Bar
- 01792: 10" Extension Bar
- 01726: 3/8 Sq Dr. 9/16" Socket
- 01739: 3/8 Sq Dr. 3/4" Socket
- 02755: 3/8 Sq Dr. Male Hex 5/16" Socket
- 02756: 3/8 Sq Dr. Male Hex 3/8" Socket
- 02757: 3/8 Sq Dr. Male Hex 1/2" Socket
- 07053: Ratcheting Ring Wrench 9/16"
- 07056: Ratcheting Ring Wrench 3/4"
- 02742: T-Bar handle Wrench 5/16"
- 02743: T-Bar handle Wrench 3/8"
- 02745: T-Bar handle Wrench 1/2"

## 00008: 12 Piece General Utility Kit



- 00045: 9" Lineman Plier
- 00061: 8" Long Nose Plier
- 00115: High leverage Diagonal Cutting Nippers
- 01930: 4" Insulated Screwdriver 1/4" (6.5mm)
- 01940: 6" Insulated Screwdriver 5/16" (8mm)
- 01970: 10" Insulated Screwdriver 3/8" (10mm)
- 02010: No1 Phillips 3" Blade
- 02020: No2 Phillips 4" Blade
- 02030: No3 Phillips 6" Blade
- 00141: 10" Water Pump Plier
- 01726: 3/8 Sq Dr.
- 00125: 9" Cable Cutter
- 01830: 7" Cable Jointers Coring Knife
- 03200: Tool Case (19" x 14" x 6")

# Salisbury by Honeywell - Hand Tools

## Salisbury TK9: Salisbury Took Kit 9 Piece Basic Electrician Roll

- Slotted screwdrivers: 3/16 x 4", 3/16 x 6", 1/4 x 6"
- Phillips screwdrivers: #1 x 3", #2 x 4"
- 8" Needle nose pliers
- 7-1/2" Diagonal cutting pliers
- 9" Lineman pliers
- Combination stripper / crimper pliers
- In a tool roll bag



## Salisbury TK60:

- Slotted screwdrivers: 1/8 x 2", 3/16 x 4", 3/16 x 6", 1/4 x 6", 5/16 x 6"
- Phillips screwdrivers: #2 x 4", #2 x 8"
- Nutdrivers: 3/16", 1/4", 5/16", 11/32", 3/8", 7/16", 1/2"
- Torque wrench 30 - 150 in/lb;
- 3/8" dr, reversible ratchet
- 3" and 6" extensions, 3/8" dr
- 10 pcs. 5/16" to 7/8", 3/8" dr socket set
- 11 pcs. 3/8" to 1" box end wrench set
- 14 pcs. 1/16" to 1/2", 6" long arm, type "I" hexwrench set
- 7-1/2" diagonal cutting pliers
- 8" Needle nose pliers
- 9" lineman pliers
- 9-1/2" cable cutting pliers
- 10" water pump pliers
- Combination stripper/crimper pliers
- In a plastic box, including tool pouch rolls



# Cable Scorers & Stripping Kits

## Ripley Primary Distribution Tool Kit

- A convenient way to keep all tools together for performing all tasks associated with splicing and termination. This kit is suitable for all primary needs. Please note that you must call for bushings.
- Primary Distribution Tool Kit:
  - (1) URD Bag
  - (1) Ripley Banana Peeler (.750" - 1.25")
  - (1) WS64-U-E Adjustable Cable Stripper
  - (1) PIT-1T Load Break Elbow Probe Insertion Tool
  - WS5A-DA Adjustable End Stripper with Chuck Adapter(1) LBIT-1T Load Break Bushing Insertion Tool



## CPK-1: Speed Systems Combo Kit

- 1700SS Series Semi-Con Scorer allows for square and spiral cuts, and features an adjustable blade depth of .001" - .100", Leaf springs, and a Cable O.D. Range of 1/2" - 2"
- 1542-2CL stripper may be used on the following cables: kV Class Conductor Size, up to 5kV 1000 MCM, up to 15kV 750 MCM, up to 25kV 350 MCM, and up to 35kV 3/0; a wedge and spare straight blade are installed, and the tool features precise blade depth adjustment
- The kit also includes (1) scale gauge for measuring strip back and a 12" x 4.5" x 4" 20-gauge steel case



# Ripley Secondary Distribution Tool Kits

## WS 22A: Power Driven End Stripper

- Strips quickly, even in cold climates
- Uses standard WS 22 bushings
- Adjustable strip stop from 1" to 5"
- Guarded cutting blades ensure safety
- Tool designed to reduce working time and effort on repetitive stripping functions
- Precision stripping with no conductor damage
- Choice of Drill Drive or Socket Drive adapters available
- Ergonomic end stripping tool for 600V cables, 1/0 AWG to 1000 MCM - designed for use with low speed or variable speed power drill



WS 22A with 3/8" Drill Drive  
 WS 22A with 1/4" Hex Drive  
 WS 22A with 3/8" Square Socket Drive  
 WS 22A with 1/2" Square Socket Drive

## WS 68 SNAP: Power Drive End Stripper

- Guarded cutting blades ensure safety
- Strips quickly, even in cold climates
- 3/8" & 1/2" square socket adapters available
- Precision stripping with no conductor damage
- Designed for low speed or variable speed drills
- Features a bushing quick disconnect feature eliminating the need for a hex wrench
- Ergonomic end stripping tools for 600 volt secondary cable; designed for use with a low or variable speed power drill



- New adjustable strip stop with adjustment window allows easy setup for precise strip lengths from 0.625" to 2.5"
- Uses standard 2 x 2 and 4 x 4 bushings: #6 AWG to 500MCM (concentric, compressed, or compacted)
- Available with choice of drill drive or socket drive adapter

# Ripley - Scorers & Strippers

## WS 22: Double Ended End Stripper

- Precision stripping with no conductor damage
- For 600 volt cables, 1/0 AWG to 1000 MCM
- Square-cuts two specific cable sizes
- Stripping length preset at factory, special order
- Ergonomic end stripping tools for up to 600V secondary cable



## WS 68: Power Driven End Stripper

- Ergonomic end stripping tools for 600V secondary cable
- Designed for use with a low or variable speed power drill
- New adjustable strip stop with adjustment windows allows easy setup for precise strip lengths from 0.625" to 2.5"
- Uses standard 2x2 and 4x4 bushings: from #6 AWG to 500 MCM (concentric, compressed, or compacted)
- Plugs into chuck endings of cordless drills



## Ripley PIT-1T Load Break Elbow Probe Insertion Tool

- For insertion of probe into 15 to 34.5kV elbow - small interface
- Multiple drive system; 125 in lbs torque
- Prevents load break probe breakage and contamination; reduces cross threading
- Adjustable and removable "T" handle
- 1" steel drive and adjustable wrench
- 3/8" square drive socket



## Ripley WS 5A: Adjustable End Stripper

- Adjustable strip stop with rotary mechanism
- Adjustable window allows easy setting of stop
- Strip lengths from 0.625" up to 2.5"
- Ideal for primary URD cable
- For 600 volt to 35kV cables, 0.26" to 1.265" Cable O.D.
- Strips XLPE, polyethylene, EPR insulation up to 400 mils thick (insulation only or with semicon over insulation)



WS-5A End Stripper  
WS 5A-DA End Stripper w/ Chuck Adapter  
CB 7-2 Replacement Blade

## Ripley LBIT-1T Load Break Bushing Insertion Tool

- For 200 amp bushing inserts with internal hexagon socket drive
- Multiple drive system; preset 180 in-lb. torque rating
- Adjustable "T" handle; standard penta head
- 7/8" hexagon for wrench
- 1" square drive socket



## Ripley WS 64-U-E Adjustable Cable Stripper

- Universal tool for end stripping outer jackets up to 2.5" O.D. or insulation up to 1.5" O.D. with interchangeable blades
- Dual position jaw for cable sizes from 1/2" to 2 1/2"
- Spring loaded 'trigger-action' jaw
- Micro-adjustable blade and self feeding tool



# Scorers & Strippers

## 700FP: Ripley WS70 Wire End Stripper

- 1.9" to 3.65" O.D. cable range
- Self-feeding during stripping operation
- Fine adjustment feature on the blade
- Dual handle design gives greater leverage
- Blades can be replaced
- Strips out jacket or insulating material on 46 to 69kV cable



## Ripley 2 x 2 & 4 x 4 Plus Tool

- For 600 volt secondary cable
- Strips quickly, even in cold climates
- Guarded blades ensure safety
- Bushings change easily
- Precision stripping
- Strips 45 - 110 mil secondary insulations



## 1542-2CL: Speed Systems Stripper

- Use on the following cables: kV Class Conductor Size, up to 5kV 1000 MCM, up to 15kV 750 MCM, up to 25kV 350 MCM, and up to 35kV 3/0
- Wedge and spare straight blade installed
- Precise blade depth adjustment
- No bushings required



1562 Replacement Wedge Blade

1581 Replacement Straight Blade

## Ripley Banana Peeler

- Adjustable blade semi-con scoring tool
- Scoring depth from 1 to 90 mils
- Length: 9.4"
- Weight: 13 oz.



35250 .38" - .75"

BP1A .75" - 1.10"

BP2A 1.25" - 1.75"

BP3A 2" - 2.63"

Replacement blade

## 1700SS/1800SS: Speed Systems Semi-Con Scorer

- Adjustable blade depth (.001" - .100")
- Allows for square and spiral cuts
- 1700SS features leaf springs and Cable O.D. Range 1/2" - 2"
- 1800SS features coil springs and Cable O.D. Range 3/4" - 3"



## 2750 Secondary End Strip Stripper

- Cable O.D. .31" - 1.375"
- No bushings are required
- End strips 600V cable or insulation (45 mil to 110 mil thickness)
- Unlimited stripback length
- #4 thru 1000 MCM



# Greenlee - Scorers & Strippers

## 1935: Wire Strippers

- Strips insulation from most smaller gauge wire
- Strips up to 7/8" length
- Strips PVC and THHN insulation
- For use with solid and stranded wire
- Capacity: 20-10 AWG



## 1903: Pocket Cable Strippers

- Easy blade depth adjustment
- 90° blade rotation allows longitudinal, circular, and spiral slitting of insulation



## 1927-SS: Stripping/Crimping Tool

- Machine stripping stations feature a positive stop, providing precise stripping diameters
- Crimps 10-22 AWG insulated/non-insulated terminals
- Cuts #4-40, #5-40, #6-32, #8-32, #10-24, #10-32 screws
- Strips 10-22 AWG solid and stranded
- Long, curved cutting blade reduces force required by 25% and can cut NM in a single cut
- Screw cutting stations are collapsed around the pivot - 20% less force is required



## Wire Strippers/Cutters

- Precision ground blades ensure consistent stripping/cutting and are heat treated for long life
- Serrated nose grip for wire pulling/straightening
- Stamped from high carbon tool steel
- Pivot joints have hardened steel bushings
- Designed to cut PVC or THHN insulation



1916-SS 20-10 AWG Solid



1917-SS 26-16 AWG Solid



1955-SS 10-18 AWG Solid and 12-20 AWG Stranded conductors



1956-SS 6-14 AWG Solid and 8-14 AWG Stranded conductors

## GTS-1930: Saber™ Cable Stripper

- 14 bushing kit ranging from #6 AWG - 500 MCM THHN copper conductor
- One way ratchet handle – allows user to maintain control of the cutback throughout the stripping process, ensuring blade does not come into contact with the conductor
- Tension grip depth stop – Self contained 4" laser etched depth stop for precise articulation of cut back depth, no additional tools needed for depth stop set up
- Spring loaded retention pin – Quick attachment method of cable specific bushings, no additional tools needed for bushing attachment
- Safety factor – Replaces the need to use blades when stripping cable. Blade lacerations comprise approximately 40% of all recordable injuries on the jobsite.



## JRF-4: Universal Cable Stripper

- Large capacity clamp jaw – Wide range, 1/2" - 3" cable outside diameter, enabling productivity when working with a variety of cable sizes
- Tension trigger – 150 lbs of clamping force allows user to securely capture cable for precise blade setting
- Delrin ball bearing rollers – Reduces the amount of force needed for the tool to move around and up the cable during stripping
- Roller ball actuation - Allows user to maintain constant contact with the clamp as it move around the cable
- Precision adjustable cutting blades – EPR and XLPE design specific blades allow for ease and efficient cut back



## SIEVERT TORCH & ACCESSORIES

### 8710-01: Sievert Soft Flame Burner



- Soft flame design ideal for cable work and other heat shrinking applications
- Sweeping, powerful yellow and blue soot-free, windproof flames
- Fresh air sucks in and keeps the burner head cold to minimize the risk of burning the shrink material
- Heats the sleeves efficiently yet soft enough not to overheat the shrink material
- Work pressure 29 psi; burner diameter 1.5"
- Thick walled sleeves max 5.9"

### 3366-97: Sievert Universal Torch Handle



- Plastic composite handle reinforced with 30% glass for maximum durability
- Bayonet fitting for burners
- Valve for precise flame setting
- 7.1" long x 3.1" height
- Piezo ignitor with instant trigger on/off function
- Swivelling hose connection to avoid hose drag
- Combined suspension hook and footstand

### 3091-23: Sievert Gas Regulator



- High quality brass construction
- P.O.L. inlet for refillable propane cylinder
- LH 9/16" male outlet
- Preset regulator; 28 psi for 1 lb. disposable cylinder variable hose connection
- Manufactured in brass to ensure the highest quality and long service life
- Valves have a very high capacity and precise outlet pressure
- LTS valve is designed to detect minor leaks
- Regulator with LTS is always combined with a hose failure valve

### 3015-04: Sievert Hose/Preset Regulator Assembly



- 4 ft. hose/preset regulator assembly
- 28 psi (disposable cylinder)
- Hose is rubber/plastic composition
- 1/4" I.D. with LH 9/16" female connections on both ends
- U/L and CGA approved

### 1510IS: Sievert 10' Gas Hose



- Rubber/plastic composition
- 1/4" I.D. with LH 9/16" female connections on both ends
- U/L and CGA approved

## S&C 35kV Loadbuster



- Loadbuster is the original lightweight, easy-to-use portable loadbreak tool for use with disconnects, cutouts, power fuses, and fuse limiters. It brings load-switching capability through 34.5 kV and 600 amperes nominal, 900 amperes maximum to your over head distribution system
- Loadbuster cuts installation and operation costs. There's no need for load interrupters on each device
- Switching procedures are simplified too, minimizing the duration and scope of outages
- This rugged, reliable device interrupts with no external arc, meeting OSHA requirements for opening circuits under load

Part #	Description
5300R3	14.4/25kV Nominal, 27kV Maximum
5400R3	25/34.5 kV Nominal, 38kV Maximum

## S&C 4440: Talon Fuse Handling Fitting



- Two pronged fitting designed for use on overhead distribution systems for installing and removing S&C SMD-20 power fuses, fuse cutouts, and S&C Fault Tamer® fuse limiters from their mountings
- Talon can be used to open and close disconnects and interrupter switches
- High-strength, aluminum-bronze fitting

## SP-1/SP-2: SPIKE Tool

- SPIKE provides positive assurance that the lineman will not cut an energized cable
- SPIKE is operated remotely thereby removing the lineman from danger if a live cable is spiked
- SPIKE can be used on aluminum and lead sheathed cable and interlock armored cables
- SPIKE will accept single conductor cables ranging in diameter from 3/4" OD to 2 3/4" OD
- A larger tool accommodates cable sizes up to 3 1/2" OD
- Used on thermoplastic or thermosetting insulation and oil impregnated paper insulation
- Pierces cable through it's center core
- Creates minimal cable damage
- Uses low velocity loads for actuation
- Weight: 7 lbs





# RoboPaks® Battery Powered Tools

TOOLS

## XL 9280 RoboPak Kits

- Ultimate in portable power systems increases run-time of your tool 30 times
- Power all tools that require voltages from 6 - 28 Volts
- Power Huskie, Burndy, Greenlee, Milwaukee, DeWalt, Makita, and hundreds more
- Encased in a heavy-duty, all-weather high impact plastic case with shoulder strap
- All kits include (1) Robopak, (1) AC charger, and appropriate adapter for the tools they are designed to power
- Easily hangs via "S-hooks" in your bucket

- 5228 Powers Huskie Tools**
- 5060 Powers 14.4V Burndy, Makita, Stanley, Cembre Tools**
- 5061 Powers EK425 Greenlee Tools**



## 19.2 Li-Ion RobolImpact®

- Made for Linemen and other heavy-duty users, the 19.2v Cordless RobolImpact® is small, lightweight, powerful and durable
- It is the lightest-weight-to-power-ratio cordless impact wrench in the world
- The RobolImpact's lightweight combined with a proprietary cushioned handle and "gun like" design will increase job efficiency, reduce operator fatigue, and allow uses in an environment where hoses or cords are unsafe or inconvenient
- Voltage: 19.2v
- Ft./lbs of Torque: 350
- Impacts Per Minute: 0 - 2300
- Chuck: 7/16" Hex Quick-Change
- Cordless Battery: 19.2v Lithium-Ion
- Charging Options: AC
- Weight (Tool and Battery): 5.7 lbs

- 5600 Tool, Two Batteries, AC Charger, Case**
- 5601 Tool, One Battery, AC Charger, Case**
- 5602 Tool, One Battery, AC Charger, Inverter, Case**
- 5603 Tool, Two Batteries, AC Charger, Inverter, Case**
- 5604 Tool, Two Batteries, AC Charger 5040 Tool Bag**



## 5040: Lineman's Cordless Tool Bag

- Designed by linemen for linemen
- Allows you to easily carry, organize and store your cordless tool and accessories
- Can be securely mounted in your vehicle or bucket
- Made of heavy-duty vinyl
- Durable shoulder strap and mounting rings for vehicle or bucket
- Side impact holder for up to 18" L x 3/4" diameter impact bit
- Deep center pocket to securely hold and protect tool, extra battery and charger
- Two front pockets that can hold and protect needed accessories like hex adapters, sockets, etc.
- Overall Height 17" x Width 11"



## 36V Cordless RobolImpact®

- Unmatched in performance, the 36V RobolImpact® is the most powerful tool of its kind in the world
- 7/16" hex quick-change
- 2500 impacts per minute
- Powerful 30 AMP reversible motor provides in excess of 2500 impacts per minute and approximately 450+ ft./lbs. of torque for the most demanding drilling and hardware applications
- Tool can be used with superior quality Hilti cordless batteries
- Average drill time in 10" diameter pole is 9 seconds
- Average number holes per charge in 10" diameter pole is 20+

- 5309 Tool, (1) Lithium-Ion Battery, AC Charger**
- 5310 Tool, (2) Lithium-Ion Batteries, AC Charger**
- 2756 36V Lithium-Ion Battery**
- 4376 Lithium-Ion AC Battery Charger**



## 9296: Pole bit Holder

- Holds 4 bits any length and up to 1" diameter
- Extremely heavy-duty and weather resistant
- Will not rust and comes with lifetime warranty
- Mount on your vehicle or any vertical surface



# Greenlee - Impact Tools & Accessories

## HW1 & HW1V: Hydraulic Impact Wrench



- Impact and temperature-resistant polymer grip designed to dissipate heat from the handle
- Weight reduction of 14% to previous models
- Improved center-of-gravity for superior ergonomics
- Increased service life with the addition of back-up rings and larger O-rings
- Built-in hydraulic check valve to eliminate damage from an improperly connected tool
- Large and strong lifting eye for easy and secure storage
- Longer and wider trigger provides improved control with insulated gloves
- Discrete position torque adjustment control with 3 positions; HW1V features quick-change access
- Fast, easy change between open center systems and closed center systems; no disassembly required
- Higher breaking torque in reverse to ensure you can remove tightened bolts
- Cast motor enclosure better protects the impact mechanism operation versus competing models

**HW1** Standard Wrench

**HW1V** Wrench with 3 Position Torque Control

## H8508: Reversible Impact Wrench & Drill with 7/16" Hex Quick Change



- Includes (1) 1/2" HD square adapter with every wrench - a \$35 value!
- Operates on either an open or closed center hydraulic system
- Internal control prevents overspeeding and allows up to 12 gpm
- Features high torque for drilling salt-cured and creosoted poles
- Ergonomic, heat insulated handle
- Features a twin hammer impact mechanism
- Available with variable torque control that is adjustable from 80 to 400 ft. lbs.
- Operating pressure of 1,000 - 2,000 psi
- Flow range of 4 - 12 gpm; optimum flow range of 5 - 8 gpm

**H8508-1**

**H8505-IV\*** Adjustable Torque *\*only wrench on the market with this feature - dial down torque to protect hardware*

**H8508-3**

**H8508-3V**

## HID6506: Rotary Impact Hammer Drill



- Adjustable flow control prevents overspeeding and allows precise control of drilling speed
- Super Spool selector control for use on open and closed center hydraulic systems
- Depth gauge and auxiliary handle are removable for tight areas
- Selector for drill or hammer/drill
- Hammer drill in concrete, brick, rock, and other difficult-to-drill materials; drill in wood or steel with auxiliary chuck
- Built-in slip clutch to guard against over-torque
- Flow range of 5 - 10 gpm; RPM at 6.5 gpm is 775 - 1,100
- Operating pressure of 1,000 - 2,000 psi

## H6510: Impact Wrench 5/8" Hex & 3/4" Square Drive



- Added power and torque for heavy-duty jobs
- Operates on either an open or closed center hydraulic system
- Twin hammer design with adjustable torque control and auxiliary handle
- Flow range of 4-12 gpm
- Operating pressure of 1000 - 2000 psi
- Torque at 6 gpm is 1060 ft lbs
- Needle bearing, rugged gear motor design

## H6400C: Reversible Drill, 1/2" Key-Type Chuck

- Compact, lightweight - ideal for line construction applications
- Super Spool selector control for use on open and closed center hydraulic systems
- Rugged gear motor
- Weighs 6 lbs
- Operating pressure of 1000 - 2000 psi
- Flow range of 4-8 gpm



# Greenlee Nail Eater® Extreme Black

TOOLS

## Utility Auger Bits - the Easier and Faster Way to Drill in Utility Poles!



- Nail Eater® Extreme Black Teflon® coated Utility Auger Bits. Auger bits drill fast and smooth in most treated woods, including tough utility poles
- Patented cutting edge cuts nails and staples so these auger bits last much longer than other Teflon® coated bits on the market
- With less power required to drill holes—extending battery life up to 30%—these auger bits help save time and money
- Teflon® coating resists heat and friction for fast and smooth operation
- Over center flute design evacuates chips faster, no clogging or chip flyback
- Made in the USA

Cat no.	UPC no.	Description
66TF-9/16	02004	Impact Auger Bit, TF-9/16" x 18"
66TF-11/16	02005	Impact Auger Bit, TF-11/16" x 18"
66TF-13/16	02006	Impact Auger Bit, TF-13/16" x 18"
66TF-15/16	02007	Impact Auger Bit, TF-15/16" x 18"

## Nail Eater II® Extreme Impact Bits



- Quickly bore through creosote and salt-treated utility poles
- Resists wear, eats through nails and staples
- Self-feeding screw point draws the bit through the wood
- 7/16" hex shank to fit quick-change impact drivers

37868	9/16" x 18"
37869	11/16" x 18"
37870	13/16" x 18"
37871	15/16" x 18"

## Long Impact Bits



- Made from hardened alloy steel for added toughness
- Quickly bore through large creosote and salt-treated utility poles
- Self-feeding screw point draws the bit through the wood
- 7/16" hex shank to fit quick-change impact drivers
- Cutting edge can be re-sharpened multiple times and continues to self-feed

11097	11/16 x 24"
11100	11/16 x 30"
11098	13/16 x 24"
11099	15/16 x 24"
11101	13/16 x 30"
11102	15/16 x 30"

## NR1 Nut Runner



- For installing and tightening pole hardware
- Will work with 7/16" quick change chuck
- Accommodates bolts that extend up to 6" beyond the nut
- 9 1/2" long with adapter

45798	3/4", 13/16", 1", 1 1/8", 7/16" Hex Adapter
49782	Replacement Adapter

## NR2 Nut Runner



- Used for most transmission applications
- 11" long with adapter
- 1 5/16", 1 1/8", 1" square openings
- Socket can be turned end-to-end without removing the adapter from the tool
- Accommodates bolts that extend up to 6" beyond the nut
- 7/16" hex adapter for use with 1/2" impact wrenches

20920	Nut Runner Adapter
21111	Replacement Adapter

## 49314: Heavy Duty Square Adapter



- 7/16" x 1/2" drive shank
- Rated at 450 ft lbs of torque
- Not for use with nut runners

# Greenlee - Hydraulic Equipment

## F20: 20 HP Power Unit

- Variable oil flow to 10 gpm
- 20hp at 3,600 rpm
- Open center hydraulic system
- Rated flow: 5 -10 gpm
- Rated pressure of 2,000 psi
- Fuel: Gasoline 3.3 gallons (50.35 litres)
- Engine hour meter and tachometer
- Heavy duty lifting eye
- Sealed lead-acid battery
- HTMA flat face hydraulic couplers
- Integral grab rails for lifting into trucks and trailers
- Hydraulic oil level sight gauge and 10 micron oil filter
- Oversized oil cooler and electric fan ensures cool running
- Easy access service points for engine oil, fuel, battery, and oil filter
- Electric key-start 20 hp Honda Model GX620 engine with low-oil shutdown



## High Pressure Couplers



- 40647 Male Coupler, Nose Half 1/4 - 18 NPSM
- 40652 Female Coupler 1/4 - 18 NPSM
- 54169 Male Coupler, Nose Half 1/4 - 18 NPTM (Used on HB10)
- 42096 Female Coupler 1/4 - 18 NPTM (Used on HB10)
- 41941 Male Coupler, Nose Half 3/8 - 18 NPTF
- 41877 Female Coupler 3/8 - 18 NPTM

## HFC30 Flow Control Valve

- Operates off other equipment's hydraulic accessory circuit
- Variable flow adjustment (up to 30 gpm) allows precise flow control for tool operation
- Integral pressure relief valve helps protect hydraulic equipment and tools
- All tool ports have O-Ring boss and accept industry standard hoses and couplers
- All-aluminum body design provides better heat dissipation



## PVA Valves

- May be directly connected to the tool or used remotely with hoses
- Controlled advance; 4-way, 3 position valve
- Built-in hold feature
- 3,000 - 4,000 psi return line ground dump safety valve
- 3-8 gpm flow range
- Maximum operating pressure: 10,000 psi return relief
- Port size inlet: 1/4 - 18 NPTF; Tool: 1/4 - 18 NPSM



- PVA0021 For Single Acting Tool
- PVA0022 For Double Acting Tool
- PVA1122 For Coupled Double Acting Tools

## HB10: Dynapress Hydraulic Intensifier

- Small and compact, the HB10 operates 10,000 psi remote head tools
- Operates on open or closed center hydraulic systems
- Uses the versatile Dynapress remote control valves and hoses sets
- Supplied with pressure and return high pressure screw-type couplers (HTMA couplers available)
- Crimping at 10,000 psi is 120,000 lbs.
- Fast advance flow of 3,200 cubic inches per minute



	Input Pressure	Input Flow	Max Back Pressure	Port Sizes
Low Pressure	1000-2200 psi	4-8 gpm	200 psi	3/4 - 16 SAE O-ring
	Output Pressure	Output Flow	Relief Valve Setting	Port Sizes
High Pressure	10,000 psi	35 cu. in./min.	10,000 psi	1/4-18 NPSM*

\*Couplers Provided

## High Pressure Non-Conductive Hose

- Certified Non-Conductive High Pressure Dual Hose Set - Rated 10,000 psi (700 bar) Rated 10,000 psi (700 bar)
- For use between Dynapress® intensifier or electric pump and control valve
- Each pair includes 3/16" (4.8 mm) I.D. pressure hoses with one 1/4" NPT male fitting on one end and high-pressure quick-disconnect on the other end

138573/41107 6 ft.

138574/41108 10 ft.

- Certified Non-conductive High Pressure Hose - Rated 10,000 psi (700 bar)
- For use between control valve and tool
- 3/16" (4.8 mm) I.D. hose with 1/4 NPT male fittings on both ends
- Hoses are tested at 75kV per foot

F020721/41795 6 ft.

F020723/41796 10 ft.



# Hydraulic Tool Assemblies

TOOLS

## Impact Wrench Assembly

- (1) Greenlee Impact Wrench
- (1) 8' hose (non-conductive)
- (1) 3/8" HTMA Flush Face Male, Female Couplers
- (2) Swivel Adapters



## Impact Wrench Assembly

- (1) Greenlee HW1 Standard Impact Wrench
- (1) 8' hose (non-conductive)
- (1) 3/8" HTMA Flush Face Male, Female Couplers
- (2) Swivel Adapters



## Impact Wrench Assembly

- (1) Greenlee HW1V Adjustable Torque Impact Wrench
- (1) 8' hose (non-conductive)
- (1) 3/8" HTMA Flush Face Male, Female Couplers
- (2) Swivel Adapters



## Pole Puller Assembly

- (1) Pole Puller
- (2) Hose Fittings



## Ground Rod Driver Assembly

Greenlee HRD-58 Ground Rod Driver



- (1) 3/8" HTMA Flush Face Male & Female Couplers

9/16" UN/UNF x 3/8" Female NPSM Swivel

9/16" UN/UNF x 1/2" Female NPSM Swivel



# Hydraulic Tool Replacement Parts

## LPK1240 Assembly



(1) Fairmont LPK120



(1) 8' Hose (non-conductive)



(2) Swivel Adapters



3/8" HTMA Flush Face Male & Female Couplers

## 20" Chain Saw Assembly



(1) Greenlee HCS820 20" Standard Chain Saw



Hose Fittings



(1) Quick Release Coupling Set

## 62.5" Pole Saw Assembly

- (1) 62.5" Pole Saw
- (1) 8' Hose (non-conductive)
- (1) Straight Adapter
- (1) Swivel Adapter
- (1) Quick Release Coupling



62.5" Pole Saw



(1) 8' Hose Non-Conductive



(1) Straight Adapter  
(1) Swivel Adapter



(1) Quick Release Coupling Set

## 75" Pole Saw Assembly

- (1) 75" Pole Saw
- (1) 8' Hose (non-conductive)
- (1) Straight Adapter
- (1) Swivel Adapter
- (1) Quick Release Coupling Set



75" Pole Saw



(1) 8' Hose (non-conductive)



(1) Straight Adapter  
(1) Swivel Adapter



(1) Quick Release Coupling Set

## Pole Tamper Assembly

- (1) Greenlee Pole Tamper
- (2) Hose fittings
- (1) 3/8" HTMA Flush Face Male & Female Couplers



Pole Tamper



Hose fittings



(1) Quick Release Coupling Set

## 60" Pole Tamper Assembly

- (1) Greenlee H4802-5 60" Pole Tamper
- (2) Hose fittings
- (1) Quick Release Coupling



60" Pole Tamper



Hose fittings



(1) Quick Release Coupling Set

## TED-270PFR: Tanaka Reversible Gas Drill

- 26.9 cc, 1.4 hp PureFire® two-stroke engine meets emissions levels without sacrificing power, adding weight, or creating maintenance headaches
- 20:1 gear reduction
- Powered reversing feature
- Dual position padded front handle
- Heavy-duty fuel tank protector
- 12.3 lbs
- Covered by Tanaka's two-year commercial use warranty and seven-year consumer use warranty



## TED-270PFL: Tanaka Gas-Powered Drill

- 26.9 cc, 1.4 hp PureFire® two-stroke engine meets emissions levels without sacrificing power, adding weight, or creating maintenance headaches
- 24:1 gear reduction
- Manual gear lock
- Dual position padded front handle
- Heavy-duty fuel tank protector
- Easy access air filter
- 11.2 lbs
- Covered by Tanaka's two-year commercial use warranty and seven-year consumer use warranty



## TIA-350FPS: Tanaka One Man Post Hole Digger

- 32.2 cc, 1.6 HP two-stroke engine provides excellent throttle response, reliable starting and proven durability
- S-Start system reduces the amount of pull-force required by 40%
- Tall wrap-around handles protect the engine from damage and provide the operator with more leverage
- Sound reduction system
- Primer for fast starting
- 33.2 output torque (ft/lbs)
- 17.6 lbs
- Covered by Tanaka's two-year commercial use warranty and seven-year consumer use warranty



## OshKosh Lug Hooks



- Lug Hooks are made for the exclusive purpose of hand carrying poles
- The handles are made of sturdy hard maple. Hooks are forged out of high-carbon steel and attached to the handle with a swivel of malleable iron, which makes for easier operation of the tool
- The shape of the chisel point hooks and handle provide balanced weight distribution and assures positive gripping

Part #	Description	WT
295	Lug Hook 2 1/2" x 4'	8 #
593	Replacement Handle, 2 1/2" x 4'	4 #
296	Lug Hook, 2 1/2" x 4'-6"	10 #
594	Replacement Handle, 2 1/2" x 4'-6"	5 #
297	Lug Hook, 2 1/2" x 5'	10 #
595	Replacement Handle, 2 1/2" x 5'	5 #
298	Lug Hook, 3" x 5'	14 #
963	Replacement Handle, 3" x 5'	6 #
299	Lug Hook, 3" x 6'	17 #
964	Replacement Handle, 3" x 6'	7 #

## OshKosh Peavies



- Designed and constructed for balance and easy handling
- The handles are made of hardwood
- The Hooks and Pikes are made of high-carbon steel
- The stop is to prevent the hook from falling back onto the handle

Part #	Description	WT
137	2 1/2" x 4'	9 #
575T	Replacement Handle, 2 1/2" x 4'	
138	2 1/2" x 4'-6"	11 #
576T	Replacement Handle, 2 1/2" x 4'-6"	
139	2 1/2" x 5'	12 #
577T	Replacement Handle, 2 1/2" x 5'	
480	Replacement Hook, 1" x 1/2"	

## Cant Hooks

- OshKosh Cant Hooks are made with hard maple handles and high-carbon steel hooks which are heat treated for strength and durability
- The hook stop is designed to prevent the hook from falling back and damaging the handle. Any hook can be placed on any handle
- The #5 and #7 hooks are used to handle smaller size poles
- Sockets, Clasps, Clips and Toe Rings are made of high-grade malleable iron which is light in weight yet strong

## OshKosh Skidding Tongs



Skidding Tongs are made of round high-carbon steel and have heavy up-set, hammer-forged points or hooks. High carbon steel is noted for its stiffness and extra strength. The sides are flattened evenly where they pivot. This gives a larger bearing surface and allows for the pivot to be shorter and of a larger diameter. The tongs are shaped so that a good grip is obtained on anything they straddle. The hooks are heat treated to resist straightening. The tongs are made with ring only.

*NOTE: Skidding tongs are not load rated and should not be used for overhead lifting*

Part #	Non-rated Skidding Tongs	WT	Opening
384	1" x 24" Skidding Tong w/ Ring	14 #	Not rated 24"
385	1 1/8" x 32" Skidding Tong w/ Ring	22 #	Not rated 32"
386	1 1/4" x 36" Skidding Tong w/ Ring	31 #	Not rated 36"

## Hisco Cant Hooks



- HI48CHS-10 No. 10 Cant hook, Forged 10" Hook, Pencil Point, 48" Solid Fiberglass Handle
- HI48CHS-12 No. 12 Cant hook, Forged 12" Hook, Pencil Point, 48" Solid Fiberglass Handle
- HI72CHS-10 No. 10 Cant hook, Forged 10" Hook, Pencil Point, 72" Solid Fiberglass Handle
- HI72CHS-12 No.12 Cant hook, Forged 12" Hook, Pencil Point, 72" Solid Fiberglass Handle





## OshKosh Straight Shovels

- Made with hardwood handles and 10" wide high carbon steel blades
- The blade is forged in a straight pattern and heat treated
- The shovel blade and back strap are electrically seam welded to a front strap
- The shovel is completely straight from end to end for effective use in deep holes
- This shovel is also offered with a 6" blade
- The shovel straps and handle have footage markers to indicate hole depth
- Available with Ash or Maple handles
- Available with 6" or 10" blade



PART #	DESCRIPTION
2032	7' Ash Shovel
2036	7' Ash Shovel w/ 6" blade
1005	7' Ash Replacement Handle
2033	8' Ash Shovel
2033-6	8' Ash Shovel w/ 6" blade
1006	8' Ash Replacement Handle
2034	9' Ash Shovel
2034-6	9' Ash Shovel w/ 6" blade
1007	9' Ash Replacement Handle
2035	10' Ash Shovel
2035-6	10' Ash Shovel w/ 6" blade
1008	10" Ash Replacement Handle
2036	12' Ash Shovel
2036-6	12' Ash Shovel w/6" blade
1009	12' Ash Replacement Handle

## OshKosh Spoon Shovel Blades

- Made from the same high-carbon steel as the rest of the OshKosh shovel line
- Available in two unique styles - Eastern and Western
- Both designs have a scoop shape for lifting mud, water and backfill from deep holes
- The shovel straps and handle have footage markers to indicate hole depth
- Western pattern designed for harder, clay-like soils
- Eastern pattern designed for lighter, sandier soils
- Available with Ash or Maple handles
- Available with 7', 8', 9', 10', or 12' handles



PART #	DESCRIPTION
2023	7' Ash Spoon, Western
2023E	7' Ash Spoon, Eastern
1005	7' Ash Replacement Handle
2024	8' Ash Spoon, Western
2024E	8' Ash Spoon, Eastern
1006	8' Ash Replacement Handle
1006H	8' Maple Replacement Handle
2025	9' Ash Spoon, Western
2025E	9' Ash Spoon, Eastern
1007	9' Ash Replacement Handle
2026	10' Ash Spoon, Western
2026E	10' Ash Spoon, Eastern
1008	10' Ash Replacement Handle
2027	12' Ash Spoon, Western
2027E	12' Ash Spoon, Eastern
1009	12' Ash Replacement Handle

## OshKosh Digging Spud with Tamper

- The digging spud is made from 1" steel pipe for easy gripping, is well-balanced and easy to use
- The 3 1/2" blade is hammer forged from high carbon steel, press-fitted and welded onto the pipe
- Hardness is controlled to maintain sharpness of edges and point through many hours of use, yet not so hard as to promote chipping in ordinary service



- 852-6 6' Digging Spud w/ Tamper, 1" x 6"
- 852-8 8' Digging Spud w/ Tamper, 1" x 8"
- 852-9 9' Digging Spud w/ Tamper, 1" x 9"

## OshKosh Crow & Digging Bars

- These digging bars are made of high carbon steel, to resist bending deformation
- The crow and digging bars have a 2" chisel on one end and are pointed on the other end
- Primarily used for splitting or separating wood, concrete or metal forms
- Hardness is controlled to maintain sharpness of edges and point through many hours of use, yet not so hard as to promote chipping in ordinary service



- 1063 1" x 6" Crow & Digging Bar
- 1061 1" x 7" Crow & Digging Bar
- 1062 1" x 8" Crow & Digging Bar
- 1064 1 1/8" x 7" Crow & Digging Bar
- 1065 1 1/8" x 8" Crow & Digging Bar
- 1066 1 1/8" x 9" Crow & Digging Bar
- 1067 1 1/8" x 10" Crow & Digging Bar

## OshKosh Round Tamp & Digging Bars



- These digging bars are made of high carbon steel, to resist bending deformation
- The round tamp and digging bars have a 2" chisel on one end and a malleable iron tamper on the opposite end
- Hardness is controlled to maintain sharpness of edges and point through many hours of use, yet not so hard as to promote chipping in ordinary service

- 1071 1" x 7' Tamp & Digging Bar
- 1072 1" x 8' Tamp & Digging Bar
- 1074 1 1/8" x 7' Tamp & Digging Bar
- 1075 1 1/8" x 8' Tamp & Digging Bar

## OshKosh Skidding Tong



- Skidding tongs are intended for pulling or skidding material and are not load rated
- They must not be used for overhead lifting
- These skidding tongs are made from round, high-carbon steel bar stock, which is hammer forged and heat treated for consistent strength
- The tong sides are flattened evenly for a larger pivot bearing surface; this allows the pivot to be shorter and ensures the hooks stay in proper alignment
- Each tong unit is heat treated and 100% hardness tested to assure high quality
- The tongs are made in either "ring only" or "swivel hook and ring" style

- 384A Tong w/ Ring, 1" x 16"
- 384B Tong w/ Ring, 1" x 21"
- 384 Tong w/ Ring, 1" x 24"
- 385 Tong w/ Ring, 1 1/8" x 32"
- 386 Tong w/ Ring, 1 1/4" x 36"

# OshKosh

TOOLS

## OshKosh Lug Hooks



- Made exclusively for carrying poles by hand
- Handles are made of sturdy hard maple
- Hooks are made from high-carbon steel and attached to the handle with a malleable iron swivel to facilitate easy operation

295	Lug Hook, 2 1/2" x 4'
593	Replacement Handle 2 1/2" x 4'
296	Lug Hook, 2 1/2" x 4'6"
594	Replacement Handle 2 1/2" x 4'6"
297	Lug Hook, 2 1/2" x 5'
595	Replacement Handle 2 1/2" x 5'
298	Lug Hook, 3" x 5'
963	Replacement Handle, 3" x 5'
299	Lug Hook, 3" x 6'
964	Replacement Handle, 3" x 6'

## OshKosh Cant Hook



- Dimensions: 2 1/4" x 4 1/2'; weighs 8 lbs.
- Features a thick hardwood handle and a high carbon steel hook which is heat treated
- Designed to prevent the hook from falling back and damaging the handle
- Leather safety cuff has a reinforcing wrist pad

200-A	2 1/4" x 4'6"
573	Replacement Handle 2 1/4" x 4'6"
199	2 1/2" x 4'
575T	Replacement Handle, 2 1/2" x 4'
480	Replacement Hook, 1" x 1/2"
200	2 1/2" x 4'6"
576T	Replacement Handle, 2 1/2" x 4'6"
201	2 1/2" x 5'
577	Replacement Handle, 2 1/2" x 5'
206-4645	2 3/4" x 6'

## OshKosh Post Hole Digger (Split Handles)



- Alloy steel blades are attached by welding, making a durable joint
- Fulcrum members are made of heavily constructed, channel-shaped steel
- Produces 6" diameter holes

2050-8	8' Digger
2050A-8	8' Replacement Handles
2050-9	9' Digger
2050A-9	9' Replacement Handles
2050-103	Head Assembly

## OshKosh Post Hole Digger (Solid Handles)



- Alloy steel blades are attached by welding, making a durable joint
- Fulcrum members are made of heavily constructed, channel-shaped steel
- Produces 6" diameter holes

2051	8' Digger
2051-103	Head Assembly
2051A-8	8' Replacement Handles

## OshKosh Peavies



- Designed and constructed for balance and easy handling
- Handles are made of hardwood and the hooks and pikes are constructed of high-carbon steel
- Unique hook stop prevents the hook from falling back and damaging the wooden handle
- Peavies are intended to have only human force applied during their use
- Adding an extension or mechanical force on the handle can result in tool damage and serious injury to the user

137	2 1/2" x 4'
575T	Replacement Handle 2 1/2" x 4'
138	2 1/2" x 4'-6'
576T	Replacement Handle, 2 1/2" x 4'-6'
139	2 1/2" x 5'
577T	Replacement Handle, 2 1/2" x 5'
480	Replacement Hook, 1" x 1/2"

## OshKosh Tamp Bars



- These tamp bars are used to flatten and smooth dirt, stone, asphalt and other materials
- The tamp bars are available in either a light or heavy weight, with a variety of handle lengths
- Curved-head tamp bars are also available
- The curved head bars are designed and built to tamp closer to the wall of the hole or close to the pole itself
- The unique curved-head design helps to prevent “knuckle busting” on the pole
- Available with 7', 8', 9', or 10' handles
- Available with a light, heavy, or curved shoe

854	7' Light Tamp Bar	856	9' Light Tamp Bar	857	10' Light Tamp Bar
1054	7' Heavy Tamp Bar	1056	9' Heavy Tamp Bar	1057	10' Heavy Tamp Bar
3698-7	7' Curved Tamp Bar	3698-9	9' Curved Tamp Bar	3698-10	10' Curved Tamp Bar
2002	7' Heavy Replacement Handle	2003A	9' Heavy Replacement Handle	2003B	10' Heavy Replacement Handle
3698-A7	7' Curved Replacement Handle	3698A9	9' Curved Replacement Handle	3698-10	10' Curved Replacement Handle
855	8' Light Tamp Bar				
1055	8' Heavy Tamp Bar				
3698-8	8' Curved Tamp Bar				
2003	8' Heavy Replacement Handle				
3698A8	8' Curved Replacement Handle				

## OshKosh Pole Cradle



- Provides a simple method for lifting poles into position for framing
- Makes lifting poles a one-man operation
- Utilizes the simple cam principle of rocking the pole off the ground and lifting it up
- Made from aluminum
- Dimensions: 18" x 15" x 9"
- Handles poles with a diameter of up to 19"

## OshKosh Load Rated Lifting Tong



- Lifting tongs are signified by the yellow colour and are capable of lifting up to 5000 lbs
- All units are tested per ASTM B 30.20 © 1999
- Each unit is tagged with rated load and serial number
- Test data is supplied with each tong

384L	1" x 24"
384AL	1" x 16"
386L	1.25" x 36"

### Load Limit:

Tool Opening	75°	135°	180°
384L	2500	2000	1500
384AL	2500	2000	1500
386L	5000	4000	3000



## Hisco Cant Hooks



- Hardwood handles and high carbon steel hooks are heat-treated and tested
- Handles are made of selected air-seasoned hardwood
- They are designed and constructed for balance and easy handling and finished with a hard transparent lacquer
- The unique hook-stop prevents the hook from falling back and damaging the wooden handle
- Cant Hooks are for turning, rolling, and lifting logs or poles
- Each is equipped with a 1 1/4" solid fiberglass handle and a sharpened pencil point
- A flat point hook can be ordered, upon request
- Available in three sizes 8", 10", and 12"

<b>HI48CHS-8</b>	<b>8" Hook, 4'</b>
<b>HI72CHS-8</b>	<b>8" Hook, 6'</b>
<b>HI48CHS-10</b>	<b>10" Hook, 4'</b>
<b>HI72CHS-10</b>	<b>10" Hook, 6'</b>
<b>HI48CHS-12</b>	<b>12" Hook, 4'</b>
<b>HI72CHS-12</b>	<b>12" Hook, 6'</b>
<b>HI48CHS</b>	<b>Handle Assembly, No Hook, 4'</b>
<b>HI72CHS</b>	<b>Handle Assembly, No Hook, 6'</b>

## Hisco Post Hole Digger

- These post-hole diggers are offered with either a split-handle or a solid-handle
- The digger blades are made of heavy-gauge alloy steel designed for years of dependable service
- The fulcrum members are made of a heavy channel steel and are welded to the fulcrum bracket (no rivets to shear off)
- Two bolts hold each handle securely to the digger head making them easy to replace when necessary
- Digger produces approximately a 6" diameter hole
- These post-hole diggers have solid wood core fiber glass handles and have Seymour Hercules Heads
- They are designed for hard and compact soil
- A wider hole can be dug with the split handle design



<b>HIPHD8</b>	<b>8' Digger</b>
<b>HI96PHD</b>	<b>8' Replacement Handles</b>

## Wood-Handle Sledge Hammer

- This 10 lbS hammer has an 8 lbs double-faced head and features a heavy-duty wood handle
- The 30" hickory handle is constructed to be more split resistant and shock-absorbing, making this traditional style hammer the wood hammer of choice among contemporary users

**HIBD-10W**



## Fiberglass-Handle Sledge Hammer

- This 10 lb. hammer has an 8 lb. double-faced head and features a heavy-duty wood handle
- The 30" hickory handle is constructed to be more split-resistant and shock-absorbing, making this traditional style hammer the wood hammer of choice among contemporary users

**HIBD-10**



## Blunt-Tip Utility Probe

- Non-conductive, solid 1/2" fiberglass shaft
- Features a 3/4" steel tip blade
- 8 1/4" fiberglass "T" style handle
- Features a vinyl grip
- Weighs 1.5 lbs

**HIUP-42**



## Hisco Fiberglass Handle Shovels



- Hollow back blades are stamped from a single piece of steel which creates the hollow socket and adds strength to the blade
- A nylon socket supports and strengthens the neck
- Forward turned steps provide for secure and comfortable foot placement
- Handles are attached with a nylon collar and single rivet
- Available with D or straight handle

HISHISSH	Small Head Round Point 27"; D Handle
HISHISLH	Small Head Round Point 46"
HISS14D	Drain Spade/Sharp Shooter; 28"; D Handle
HISS14L	Drain Spade/Sharp Shooter; 47"
HISP2D	Square Point 27"; D Handle
HISP2L	Square Point 47"
HITS483LCD	Trench 4'
HITS721L	Trench 6'
HITS8	Straight Telegraph Shovel 8'
HITS10	Straight Telegraph Shovel 10'
HITS12	Straight Telegraph Shovel 12'
HI48LHS	Replacement Handle 4'
HI72LHS	Replacement Handle 6'
HI96LHS	Replacement Handle 8'

### HIRP-14L: Round Point Shovel

- Hollow back blade is stamped from a single piece of steel with forward turned steps for secure and comfortable foot placement
- Features a double dip grip
- 47" fiberglass handle
- Size: 2 round point
- Handles are attached with a single rivet
- Features a reinforcing metal collar at the neck
- Dimensions: 8 7/8" x 11 3/4"; weighs 5 lbs



### HISP-2L: Square Point Shovel

- Hollow back blade is stamped from a single piece of steel with forward turned steps for secure foot placement
- Features a double dip grip
- 47" fiberglass handle
- Flat shovel: 8 5/8" x 11 1/4"; round point: 8 7/8" x 11 3/4"



### HI57-APBS: All Purpose Bar

- Blade: Forged Wedge 2" x 9"
- Handle: 1 1/4" x 48" Steel Pipe
- Grip: Double-Dip
- Weight: 8 lbs



### HI24PLR

- Blade: 24" Molded Poly Head
- Handle: 48" Fiberglass
- Grip: Vinyl
- Weight: 2 lbs



### HISBA-6 Sing Bit Axe

- Blade: 3 1/2 lb. Single Bit Head
- Handle: 36" Fiberglass
- Grip: None
- Weight: 6.50 lbs



### HISBA-6W Single Bit Axe

- Blade: 3 1/2 lb. Single Bit Head
- Handle: 36" Hickory
- Grip: None
- Weight: 5 lbs



### HIBR16T: Forged Head 16 Tine Bow Rake

- Features a sturdy and durable honeycomb core fiberglass handle with a polyvinyl grip
- Forged steel rake head is 16 3/4" wide with 16 tines
- Fiberglass handle is 5' long



## GPHR2FDS & GPHR2FLS: Round Point Shovels

- Industrial grade round point shovel
- Heavy-gauge tempered steel blade with extra-wide forward-turned footsteps for secure footing and maximum power
- Ultra-sturdy engineering material handle composed of a fiberglass core overmolded with TPE for more control and comfort
- One-piece D-grip for maximum sturdiness
- Double-rivet assembly
- Perfect for digging holes, planting trees and shrubs, digging up roots, and dividing perennials
- Limited lifetime warranty



## GPHS2D & GPHS2C: Square Point Shovels

- Industrial grade square point shovel
- Heavy-gauge tempered steel blade with forward steps
- Ultra-sturdy engineering material long handle composed of a fiberglass core overmolded with TPE for more control and comfort
- One-piece D-grip for maximum sturdiness
- Double-rivet assembly
- Perfect for transporting small quantities of earth, sand, top soil, dirt or other bulk materials
- Limited lifetime warranty



## GPDF0832: Double-Face Sledge Hammer

- Industrial quality sledge hammer, 8 lbs. double face drop-forged and tempered steel head, machine-finished face
- 32 in. high-density polypropylene overmolded fiberglass handle with rubberized non-slip grip
- Safe and durable mechanical assembly



## SPFR26 & SPFR30: 26" & 30" Poly Leaf Rake

- Light and durable, hardwood handle
- Ultralight, one-piece poly head
- Great for raking leaves and cut grass



## GLR22: 24" Springback Lawn Rake

- Industrial grade springback lawn rake, 24-inch tempered steel head with 22 tines, flexible reinforcing bar and socket with full welded plate to back for maximum sturdiness
- Premium varnished ash handle
- Ideal for grooming lawns in the spring and raking cut grass
- Back spring providing additional rigidity for deep-down grooming
- Limited lifetime warranty



## GPBSH30016: Blacksmith Hammer

- Industrial quality blacksmith (cross pein) hammer, 3 lbs. drop-forged and tempered steel head
- 16" high-density polypropylene overmolded fiberglass handle with rubberized non-slip grip, Garant Pro Series
- Safe and durable mechanical assembly
- Machined face finish for shaping, flattening and bending metal
- Wedge point striking face designed for general blacksmith work
- Limited lifetime warranty



## TIFS600: Wheelbarrow

- Industrial grade wheelbarrow, 6 cu. ft. high-visibility, rolled edge seamless steel tray, welded tray clips, funnel tray with easy pouring lip
- 64" square (1.75" x 2.25") hardwood handles, 4-ply 16" (40.6 cm) pneumatic tire with inner tube, oversized 3/4" (1.9 cm) steel axle and roller bearings with zert fitting
- Heavy-Duty undercarriage with tray braces, leg stabilizers, stays and leg shoe pads
- Maximum capacity: 600 lbs (272.1 kg)



## Featherlite 6200 Series: Super Heavy Duty Fiberglass Extension Ladder

- Durable, non-conductive fiberglass side rails in high visibility safety yellow
- Riveted rung to rail design maintains continuous strength of fibers and allows for easy repair
- Slip-resistant serrated rungs for safe climbing (available in round or "D" profile)
- Top crossover bar allows for ladder to be raised and lowered from front and provides torsional stiffness
- Premium heavy duty rung locks for durability
- Exclusive "1-piece" foot assembly with spur wheel provides unequalled strength, durability and torsion resistance
- CSA approved Grade 1, ANSI Type 1AA

Part #	Size	Max. Open Length	Weight
6224	24'	21'	57 lbs
6228	28'	25'	63 lbs
6232	32'	28'	71 lbs



## Featherlite 6400 Series: Extra Heavy-Duty Fiberglass Step

- Durable non-conductive "C" Channel side rails in high visibility safety yellow
- Super tough co-polymer utility top for strength and durability
- Slip-resistant serrated aluminum steps for safe climbing
- Inside spreader arms complete with "wrap-around" brackets to strengthen spreader to rail connection and protect spreader arms during storage/loading/transport
- Reinforced with Zinc coated steel diagonal braces on the front of every other step and double bracing on bottom step for added strength and stiffness
- Full rear "L" horizontal struts reinforced with Zinc coated steel diagonal braces offer maximum rigidity
- Extra large PVC rubber safety boots are heavy duty and provide increased rail protection and slip-resistance
- Meets or exceeds CSA Grade 1A, ANSI Type 1A



Part #	Size	Open Height	Weight
6404	4'	45"	17 lbs
6405	5'	56"	21 lbs
6406	6'	68"	24 lbs

## LTL Manual Ground Rod Drivers

- Driver made from 1.9" diameter extra heavy steel pipe 4' long with 4" PLUG doweled and welded in top end
- Extension made from 7/8" carbon steel rod doweled and welded into 1.9" diameter extra heavy steel pipe 9" long
- Hot dip galvanized



## 4241: OshKosh Pole Cradle



- Provides a simple method for lifting poles into position for framing
- Makes lifting poles a one-man operation
- Utilizes the simple cam principle of rocking the pole off the ground and lifting it up
- Made from aluminum
- Dimensions: 18" x 15" x 9"
- Handles poles with a diameter of up to 19"

## 10640: Greenlee SuperJack Pipe Stands with V-Heads

- Supports full lengths of pipe, 1/2" - 8", when using pipe threading machines
- Height capacity: 27" - 50"
- 2,500 lbs maximum capacity
- Folding stand includes carrying handle





# Impact Wrench & Drill Accessories

TOOLS

## 1/2" Drive 5 Point Penta Socket

### Williams SB-526:

5 point Penta-Socket services 5 point nuts found on tamper-resistant Buffalo covers used by gas, electric, and some water companies to protect shut-off gates



### Aircraft Dynamics 2775RPS

- Opening: 13/16"
- Drive: 1/2"
- Overall Length: 2"
- Inside Length: 1/2"
- Finish: Black Oxide

## Williams 4-33B & 4-35B: 1/2" Drive Hex to Square Shank Impact Extensions

- Specially heat treated for impact use to provide long life, safety, and durability
- Spring plunger provides secure socket retention for safety and convenience
- Suitable for use with pneumatic and electric impact wrenches



## Snap-On Industrial: Adapter



Part #	Hex Shank Size	Square Drive Size	Length
4-33B	7/16"	1/2"	2 3/4"
4-35B	7/16"	1/2"	5"
4-53B	5/8"	1/2"	2 3/4"

## Williams 6 Point (Double Square) 1/2" Drive Deep Impact Sockets



Part #	Size
14-612	3/8"
14-614	7/16"
14-616	1/2"
14-618	9/16"
14-620	5/8"
14-622	11/16"
14-624	3/4"
14-626	13/16"
14-628	7/8"
14-630	15/16"
14-632	1"
14-634	1 1/16"
14-636	1 1/8"

## Williams 1/2" Drive Hex to Square Shank Impact Extensions

Part #	Size
37002	3"
37003	6"
37004	10"



# Impact Wrench & Drill Accessories

## Aircraft Dynamics 2590: 1/2" 3 Jawed Chuck Kit



- Allows impact wrenches to use standard shank drill bits
- Includes specially treated Hex adapter
- Enable your impact to drill holes (up to 1/2" dia. max) with jobber bits in steel, wood, fiberglass and plastic, or use carbide tipped bits to drill into mortar, brick, etc.)

*Note: Adapter should not be used with any tool/accessory that results in continuous impacting*

## Greenlee NR1: Nut Runner

- Deep well accepts up to 6 IN (152 mm) excess bolt length
- 7/16" hex quick-change adapter included
- Slim profile for easy use and storage



49782: Adapter for NR1

## Williams Deep Sockets, Impact 6 Point

Part #	Size
37312	3/8"
37314	7/16"
37316	1/2"
37318	9/16"
37320	5/8"
37322	11/16"
37324	3/4"
37326	13/16"
37328	7/8"
37330	15/16"
37332	1"
37334	1-1/16"
37336	1-1/8"
37338	1-3/16"
37340	1-1/4"
37908	1/2 Drive 15 Pc



## Wood Owl Deep Cut Ship Augers (Quick-Change Impact Drill Bits)

Part #	Length	Diameter
08806	18"	9/16"
08808	18"	11/16"
08810	18"	13/16"
08812	18"	15/16"
08813	18"	1"
08814	18"	1 1/16"
08815	18"	1 1/8"
08817	18"	1 1/4"
08818	18"	1 3/8"
01004	24"	7/16"
01006	24"	9/16"
01008	24"	11/16"
01010	24"	13/16"
01012	24"	15/16"
01013	24"	1"
01014	24"	1 1/16"
01015	24"	1 1/8"
01017	24"	1 1/4"
01018	24"	1 3/8"
01019	24"	1 1/2"

- Spurred cutting edge for fast and even cutting
- Course, burr-free lead screw for quick, on-target starts without material build-up
- Unique twist design for clean chip removal, even in the deepest cuts
- Teflon® coated to resist heat and friction
- Perfectly concentric for even, easy cutting of accurate diameter holes
- Carbon Steel Construction
- Heat treated and hardened for durability



# Wood Owl

JAPANESE TRADITION OF MANUFACTURING EXCELLENCE.

Expertise in forging, casting and honing of high-quality steel and other metals dates back 2000 years to the days of feudal warfare. Under the protection of the reigning feudal lord in the 12th century, Miki City became the center of the blacksmith industry of Asia.

The skills of the craftsmen who were hidden in Miki City grew over the centuries from the design and manufacture of swords, armor and other arms of war to extremely precise carpentry tools used in Japan's wood-working industry. Today Miki City's 2000-year-old hardware industry is based on modern mass-production techniques, but relies on strict attention to design, engineering and precise manufacturing tolerances.

TOOLS

## Deep Cut Auger Bits

- Spurred cutting edge for fast and even cutting
- Course, burr-free lead screw for quick on-target starts without material build up
- **Unique twist design for clean chip removal, even in the deepest cuts**
- Teflon® coated to resist heat and friction
- Perfectly concentric for even, easy cutting of accurate diameter holes
- Carbon steel construction
- Heat treated and hardened for durability



## Standard Auger Bits

- Precision ground cutting edge for fast cutting of clean holes in wood
- Burr-free lead screw for easy starts and pull-through without material build up
- Perfectly concentric for even and easy cutting of accurate diameter holes
- Cuts nails and staples encountered in work
- Carbon steel construction
- Heat treated and hardened for durability



## Nail Chipper Auger Bits

- Tri-Cut® design with 3 precision ground edges for fast, smooth cutting without resistance
- Reduces nails to chips without grabbing and leaves a clean hole with minimal blowout
- Burr-free lead screw for easy starts and pull-through without material buildup
- Perfectly concentric for even and easy cutting of accurately sized holes
- Lighter weight than standard augers for safety and reduced fatigue without sacrificing strength
- Carbon steel construction with precise heat-treat and hardening process for strength and durability



Length: 7-1/2"	
Part #	Diameter
03703	3/8"
03704	7/16"
03705	1/2"
03706	9/16"
03707	5/8"
03708	11/16"
03709	3/4"
03710	13/16"
03711	7/8"
03712	15/16"
03713	1"
03715	1-1/8"
03717	1-1/4"
03718	1-3/8"
03719	1-1/2"
02390	Resharpening File

Length: 18"	
Part #	Diameter
03803	3/8"
03804	7/16"
03805	1/2"
03806	9/16"
03807	5/8"
03808	11/16"
03809	3/4"
03810	13/16"
03811	7/8"
03812	15/16"
03813	1"
03814	1-1/16"
03815	1-1/8"
03817	1-1/4"
03818	1-3/8"
03819	1-1/2"
02390	Resharpening File

## OverDrive Bits for Cordless Drills

- Brad point and unique chamfered lead-in edge for smooth starts and fast cuts
- Clean cutting finished holes with minimal “blow-out”
- Induction-hardened steel construction and precision ground cutting edges for durability and accuracy
- Perfectly concentric for even and easy cutting of accurately sized holes
- Performance superior to spade and other utility type bits
- Quick-change shank for fast, secure change-out
- Designed for cordless drills for extended battery life



Length: 6-1/2"	
Part #	Diameter
00708	3/8"
00700	1/2"
00701	5/8"
00702	3/4"
00703	7/8"
00704	1"
00705	1-1/4"
00706	6 pc kit includes all sizes 3 pc kit
00707	includes 5/8", 3/4", 1"

## Flat Wood Boring Bits

- Precision ground and spurred cutting edges for smooth, finished holes
- Brad point for quick and easy starts

Length: 4 3/4"	
Item #	Diameter
00405	1/2"
00409	3/4"
00413	1"
Length: 6"	
0601	1/4"
00602	5/16"
00603	3/8"
00604	7/16"
00605	1/2"
00606	9/16"
00607	5/8"
00608	11/16"
00609	3/4"

Length: 4 3/4"	
Item #	Diameter
00610	13/16"
00611	7/8"
00612	15/16"
00613	1"
00615	1 1/8"
00617	1 1/4"
00618	1 3/8"
00619	1 1/2"
Length: 16"	
01603	3/8"
01605	1/2"
01607	5/8"
01609	3/4"

Length: 4 3/4"	
Item #	Contents
01611	7/8"
01613	1"
Adjustable:	
00658	5/8" - 1 3/4"
00678	7/8" - 3"
Adjustable Kits:	
00430	3 pc Kit 4 3/4" long, 1/2", 3/4", 1" diameter
00630	3 pc Kit 6" long 1/2", 3/4", 1" diameter
00660	6 pc Kit 6" long 3/8", 1/2", 5/8", 3/4", 7/8", 1" diameter



## Self-Feed Wood Boring Bits

- Up to 50% wider cutting tooth surface for added stability and truer holes
- Chamfered back edge to easily extract the bit from the work
- Machined lead screw with burr-free threads feed the bit through wood at a consistent rate
- Machined, straight shaft for bit concentricity to eliminate wobble and leave a truer hole
- Quick-change shank for fast, secure change-out
- Heat treated and hardened for durability



Part #	Diameter
05101	1"
05102	1-1/8"
05103	1-1/4"
05104	1-3/8"
05105	1-1/2"
05106	1-3/4"
05202	2"
05205	2-1/8"
05206	2-9/16"
05301	3"
05302	3-5/8"
05303	4-5/8"
05304	5-1/2"
Extension	
05305	12" Extension
05306	18" Extension
05307	24" Extension

## Utility Socket Sets

- Double square black oxide coated
- High impact shock steel
- Quick-release secure mount system
- Sets include Blue Bully Hex Adapters
- Lifetime warranty on sockets



2758 9/16", 13/18", 1", 1 1/8" Sockets

2753 13/16", 7/8", 1", 1 1/8" Sockets

## 2590: 1/2" 3 Jawed Chuck Kit

- Allows impact wrenches to use standard shank drill bits
- Includes 7/16" Blue Bully Hex adapter - the most durable adapter available
- Kit includes key, holder, and attached 7/16" Blue Bully Hex drive adapter



## Utility Impact Sockets

- 1/2" square drive - double square
- 3 1/2" long
- Highest quality impact sockets available
- Black oxide finish
- Heavy-duty impact quality steel
- Aircraft Dynamics lifetime warranty

2492 13/16"

2493 7/8"

2494 1"

2489 1 1/8"

2490 9/16"

2491 3/4"



## 2779: Robotool Penta Socket "T" Wrench

- Penta Socket with black oxide finish and proprietary impact steel is securely attached to powder coated "T" handle for extra leverage
- 7.25" overall length; 13/16" penta opening, inside Length: 1/2"
- Easily remove and tighten Penta Bolts



## 2403: 7/16" Quick-Change Chuck

- Utilizing a proprietary multi-ball bearing system, this quick will hold your bits, adapters and sockets securely in place
- Most durable quick-change available



## 2775: Penta Socket

- The only impact socket available that uses impact quality steel
- Aircraft Dynamics lifetime warranty



## 2801: Blue Bully Hex Adapter

- 7/16" hex adapter for 1/2" square drive sockets; maximum mechanical properties
- Advanced impact resistant technology
- Aerospace quality engineered shock steel with advanced toughness and wear resistance
- Reduced deformation; increased torque yield points
- The most durable adapter available



## Ground Rod Driver System

- Eliminates problems with driving ground rods
- Kit includes hydraulic shoe and driver
- Driver mounts easily and securely to all rods
- Hydraulic shoe accepts hydraulic tampers and is used with the driver

5043 Ground Rod Driver Kit

5042 Hydraulic Shoe - Kidney Shaped

5008 Ground Rod Driver Adapter



5008



## Robotool Double Duty Deep Well Sockets

- Double Duty Utility Impact Sockets (2-sockets-in-1) with outside length of 5"
- Black Oxide finish and proprietary impact quality steel
- Aircraft Dynamics lifetime warranty

2751 13/16"/15/16" Openings

2757 1"/1 1/8" Openings

## Installation Tool



- Small tool for red, and blue-coded taps; aluminum wire combinations: #8 thru 350 kcmil
- Large tool for yellow-coded taps only; aluminum wire combinations: 336.4 thru 1192.5
- Auxiliary Platform is required to install red-coded standard taps with small tool

## Take-Off Clip



- RoHS and ELV compliant
- Not relevant for lead-free process
- Polyethylene
- Removes connector cap tap system tool

## Aluminum Tap System Tool



- RoHS and ELV compliant
- Not relevant for lead-free process
- Polyethylene; contains propellant and primer
- Colour-coded to match taps and stirrups
- Available in blue, yellow, red & white

## Heads



- RoHS and ELV compliant
- Not relevant for lead-free process
- Head; alloy steel
- Large head for use with yellow coded taps
- Small head for use with red, white, blue-code taps

## Cleaning Tool



- Cleans caps, breach assembly, threads, and any other part of the tool
- WD-40 or anything containing petroleum is not recommended to clean tools
- Use 3-in-1 oil or Hoppes Oil #9 to clean tools

# Greenlee - Manual Cutters & Crimpers

## Heavy Duty Ratchet Cable Cutters

- Extra thick blades, ground flat to reduce potential for breakage
- Ratchet action for heavy-duty cutting
- Two cutting actions – fast scissor cutting for small cable and insulation; converts automatically to ratchet mode
- Anti-slip mechanism for positive ratchet action
- Rubber boot protects ratchet mechanism
- Not for ACSR

**756**  
**Max Capacity**  
**Frequent Use Capacity**  
**Length 27 1/2" Long**  
**Jaw Opening 2"**  
**Weight 11.41 lbs**

<b>Copper</b>	<b>Aluminum</b>
<b>1500 kcmil (MCM)</b>	<b>1500 kcmil (MCM)</b>
<b>1000 kcmil (MCM)</b>	<b>1000 kcmil (MCM)</b>



## Two-hand Ratchet Cable Cutter

- Two-handed operation provides more leverage and makes cutting large cables easier
- Short fiberglass handles make it easy to use in tight places and to store in tool boxes
- Blade release allows blades to be opened in mid-cut
- Single speed ratchet mechanism
- Heavy duty forged steel blades provide long life

<b>761</b>	<b>Copper</b>	<b>Aluminum</b>	<b>Communications Cable</b>
<b>Cutting capacity</b>	<b>1000 kcmil (MCM)</b>	<b>1000 kcmil (MCM)</b>	<b>1 1/8" Diameter</b>
<b>Length 10 3/4" Long</b>			
<b>Weight 3.6 lbs</b>			



## High Performance Cable Cutters

- Two-speed mechanism saves cutting time by closing the blades rapidly and shifting to normal speed to perform the cut
- No more pushing on stubborn release buttons—the blades open automatically when the cut is complete
- Completely new ratchet mechanism improves durability
- Narrow profile permits use in deep boxes, against walls or on floors
- Durable, lightweight fiberglass handles
- U.S. Patent #6,766,581

<b>773</b>	<b>Copper</b>	<b>Aluminum</b>	<b>Communications Cable</b>
<b>Max Capacity</b>	<b>500 kcmil (MCM)</b>	<b>795 kcmil (MCM)</b>	<b>1 3/16" Diameter</b>
<b>Frequent Use Capacity</b>	<b>350 kcmil (MCM)</b>	<b>750 kcmil (MCM)</b>	
<b>Length 15 1/2"</b>			
<b>Weight 5.3 lbs</b>			



<b>774</b>	<b>Copper</b>	<b>Aluminum</b>	<b>Communications Cable</b>
<b>Max Capacity</b>	<b>750 kcmil (MCM)</b>	<b>795 kcmil (MCM)</b>	<b>1 3/16" Diameter</b>
<b>Frequent Use Capacity</b>	<b>500 kcmil (MCM)</b>	<b>750 kcmil (MCM)</b>	
<b>Length 1-1/28"</b>			
<b>Weight 5.38 lbs</b>			

## Performance Ratchet Cable Cutters

- Simple, one-hand operation
- Exclusive two-speed ratcheting mechanism adjusts for light/heavy cutting
- Well-suited for tight working spaces
- Blades can be opened mid-cycle
- Available with cushioned handles or with 1000V insulated cushioned handles

<b>45206</b>	<b>Copper</b>	<b>Aluminum</b>	<b>Communications Cable</b>
<b>Max Capacity</b>	<b>600 kcmil (MCM)</b>	<b>600 kcmil (MCM)</b>	<b>1 3/18" Diameter</b>
<b>Frequent Use Capacity</b>	<b>500 kcmil (MCM)</b>	<b>500 kcmil (MCM)</b>	
<b>Length 11"</b>			
<b>Jaw Opening 1 7/16"</b>			

<b>45207</b>	<b>Copper</b>	<b>Aluminum</b>	<b>Communications Cable</b>
<b>Max Capacity</b>	<b>750 kcmil (MCM)</b>	<b>1000 kcmil (MCM)</b>	<b>2" Diameter</b>
<b>Frequent Use Capacity</b>	<b>600 kcmil (MCM)</b>	<b>750 kcmil (MCM)</b>	
<b>Length 11"</b>			
<b>Jaw Opening 2"</b>			



# Greenlee - Manual Cutters & Crimpers

## Compact Ratchet Cable Cutters

- Simple, one-hand operation
- Compact – convenient for working in tight places and stores easily in tool pouches
- Single-speed ratchet mechanism
- Blade release allows blades to be opened in mid-cut
- Heavy-duty blades provide long life

759	Copper	Aluminum	Communications Cable
<b>Max Capacity</b>	500 kcmil (MCM)	750 kcmil (MCM)	1 1/8" Diameter
<b>Frequent Use Capacity</b>	400 kcmil (MCM)	600 kcmil (MCM)	
<b>Length</b>	10 1/2"		
<b>Weight</b>	1.4 lbs		
760	Copper	Aluminum	Communications Cable
<b>Max Capacity</b>	1000 kcmil (MCM)	1000 kcmil (MCM)	1 3/4" Diameter
<b>Frequent Use Capacity</b>	750 kcmil (MCM)	1000 kcmil (MCM)	
<b>Length</b>	11 3/4"		
<b>Weight</b>	1.75 lbs		



## Heavy Duty Cable Cutters

718F, 704, 705 and 706:

- Strong, lightweight fiberglass handles
- Adjustable pivot bolt provides for blade adjustment

704, 705 and 706:

- Replaceable, forged, heat-treated, and precision ground blades
- Made in USA

Capacities*	718F	704	705	706
<b>Copper</b>				
<b>Maximum Use</b>	350kcmil (MCM)	350 kcmil (MCM)	500 kcmil (MCM)	750 kcmil (MCM)
<b>Frequent Use</b>	4/0 AWG (95)	250 kcmil (MCM)	350 kcmil (MCM)	500 kcmil (MCM)
<b>Aluminum</b>				
<b>Maximum Use</b>		500 kcmil (MCM)	1000 kcmil (MCM)	1000 kcmil (MCM)
<b>Frequent Use</b>	350 kcmil (MCM)	350 kcmil (MCM)	750 kcmil (MCM)	750 kcmil (MCM)
<b>Communications Cable</b>				
<b>Maximum Use</b>	1" Diameter	1 1/4" Diameter	1 3/4" Diameter	1 1/2" Diameter
<b>Frequent Use</b>				
<b>Length</b>	17 1/2"	21"	25 1/2"	31 1/2"
<b>Weight</b>	2.8 lbs	3.01 lbs	5.5 lbs	6.2 lbs



\*Capacity may be less for compact or compressed cables.

## 727: Cable Cutters

- Easily cuts heavier copper and aluminum cables up to 2/0
- Precision-ground, shear-action, curved cutting blades
- 727 has PVC-covered, high-leverage handles for easier cuts
- 727M has cushion grip, high-leverage handles for added comfort
- Heat-treated for long life
- Made of heavy-duty forged steel
- Rust-resistant black oxide finish

727/727M	Copper	Aluminum	Communications Cable
<b>Max Capacity</b>	2/0		
<b>Frequent Use Capacity</b>	#1 AWG	2/0	100 pair
<b>Length</b>	9 1/4" long		
<b>Weight</b>	1 lb		





# Greenlee - Manual Cutters & Crimpers

## Hydraulic ACSR Cable Cutter

- Hydraulic cutter takes the effort out of cutting tough cables
- Flip-open head provides strength while making it easy to cut long lengths
- Head rotates 180°
- Thumb release lever for quick blade retraction

HK520

**Capacity**     **ACSR: 336.4 kcmil (MCM)**  
**Standard Guy Wire, Ground Rod: 1/2" (13mm)**  
**Soft Steel Bolts: 11/16" (17mm)**  
**Wire Rope: 3/4" (19mm)**  
**Rebar: 7/16" Dia. (Schedule 60)**

**Length**        **14.5" (368 mm)**

**Weight**        **5.7 lbs. (2.6 kg)**



## High Performance Ratchet ACSR Cable Cutter

- Two-speed mechanism saves cutting time by closing the blades rapidly and shifting to normal speed to perform the cut
- Patented mechanism opens the blades automatically when the cut is complete (U.S. Patent #6,766,581)
- Completely new ratchet mechanism provides excellent durability
- Short length fits easily into truck bins
- Durable, lightweight fiberglass handles

776

**Capacity:**                    **Cuts ACSR through 636 kcmil with steel core diameters less than 0.32"**

**Specifically Cuts**        **All 336.4 and Smaller ACSR plus:  
 397.5 - Brant, Chickadee, Ibis; 477.0 - Pelican, Flicker, Hawk; 556.5 - Osprey, Parakeet  
 605 - Peacock; 636.0 - Kingbird, Swift, Rook**

**Length**                        **20"**

**Weight**                        **6.2 lbs**



## Ratchet ACSR Cable Cutter

- Extra-thick blades, ground flat to reduce potential for breakage
- Ratchet action for increased cutting power
- Two cutting actions – fast scissor cutting for small cable; converts automatically to ratchet mode
- Anti-slip mechanism for positive ratchet action
- Rubber boot protects ratchet mechanism

757

**Capacity**                    **954 kcmil (MCM) ACSR, 1/2" Steel Rod**

**Length**                        **29 1/4"**

**Jaw Opening**            **1.18"**

**Weight**                        **12.22 lbs**



## Heavy-Duty Ratchet Guy Wire Cutter

- Cuts 1/2" Extra High Strength (EHS) and standard guy wire
- Cuts 1/2" (12.7 mm) mild steel rods and bolts
- Two cutting actions – single-motion cutting for small cable, ratchet action for heavy-duty cutting
- Anti-slip mechanism for positive ratchet action
- Suitable for cutting ACSR

758

**Capacity**                    **1/2" EHS and Standard Guy Wire, 1/2" Mild Steel Rods and Bolts**

**Length**                        **27 3/4"**

**Weight**                        **10 lbs. 12 oz**



# Greenlee - Manual Cutters & Crimpers

## ACSR Cable Cutter

- Precision-machined, forged steel blades
- Cuts ACSR service entrance cable
- Steel handles with rubber hand grips



749

Capacity	ACSR Cable 2/0, 7/16"
Piano Wire	2/0, 7/16"
Piano Wire	1/8"
Copper/Alum. Cable	350 kcmil (MCM)
Length	28"
Weight	5.66 lbs

## 45240: Telco Ratchet Cable Cutters

- This versatile cutter has a specially designed moving blade to handle the larger diameter telephone cable and soft drawn copper and aluminum
- Cuts up to 2,700 pair 3" telephone cable
- Blade release for safety and fast backout
- Ratchet lock
- Blades are manufactured from high carbon tool steel and heat-treated for long life
- Rust-resistant, black oxide finish
- Does NOT cut ACSR
- Length 11 1/2"
- Weight 2.8 lbs.



## Heavy Duty Manual Communications Cable Cutter

- Forged and heat-treated blades specially designed for communications cable
- Easily cuts cables up to 2 1/4" in diameter
- Makes clean cuts with minimal distortion on lead, rubber PVC and polyethylene-sheathed cables
- Blades and handles are replaceable in case of damage
- Precision-ground, shear-type blades
- Fiberglass handles with non-slip rubber grips

765

Cutting Capacity	2 1/4"
Communications Cable	900 pair, 24 AWG
Length	37"
Weight	7.2 lbs



## 52015: ROCUT® Professional 75TC Plastic Pipe Shears

- Precise cutting of PVC, PP, PE, PEX, PB, and PVDF up to 3" diameter
- Double-sided blade and ratchet support
- Precise force transfer and guided cutter feed
- Stainless steel blade



# Greenlee - Manual Cutters & Crimpers

## 12 Ton Hydraulic Crimping Tools

- Two crimping head choices: HK1230 with 1.20" opening, and HK1240 with 1.65" opening
- Accept Greenlee KC12, KA12 and KD12 crimping dies as well as industry "U" style dies
- Tested to 50,000 crimp cycles
- Two-speed pump to reduce cycle time
- Ram automatically retracts when crimp cycle is complete – a Greenlee exclusive
- Crimping heads rotate 360°
- Smaller and lighter than competitive tools
- Covered head models have two layers of PVC that total approximately 3/16" (4.8 mm) thick; the outer layer is black and the inner layer is red
- Includes carrying case
- U.S. Patent #6,206,663

Part no.	Length	Jaw Opening	Capacity*
HK1230	20 3/8"	1.2"	8 AWG to 750 kcmil Copper Colour-Coded Lugs and Splices Crimping Force to 24,000 lbs
HK1240	21 1/2"	1.65"	
		Lengths	Weight
		HK1230 - 20 3/8"	HK1230 - 12.2 lbs
		HK1240 - 21 1/2"	HK1240 - 13.2 lbs



\*HK1230 and HK1240 are UL and cUL classified with Anderson, Blackburn, FCI Burndy, ILSCO, Panduit, Penn-Union and Thomas & Betts copper and aluminum color-coded lugs and splices when used with Greenlee KC12 and KA12 crimping dies. The products listed above are registered trademarks of Anderson®, Blackburn®, FCI Burndy®, ILSCO®, Panduit®, Penn-Union® and Thomas & Betts®.

## 12-Ton Manual Hydraulic Crimping Tool

- Two-speed ram advances fast and shifts to lower speed to complete the crimp
- Strong, lightweight fiberglass handles
- Push button permits dies to be inserted and removed easily
- The "C" style head has a 1.4" (32 mm) opening for easy placement on connectors
- Tool is supplied in a durable, molded plastic carrying case
- Accepts Greenlee KC12, KA12 and KD12 as well as Industry "U" style dies

**HKL1232**  
**Capacity\* 8 AWG to 750 kcmil copper colour-coded lugs and splices**  
**Crimping Force 24,000 lbs.**  
**Length 24 1/4"**



\*UL and cUL classified with Anderson, Blackburn, FCI Burndy, ILSCO, Panduit, Penn-Union and Thomas & Betts copper and aluminum color-coded lugs and splices when used with Greenlee KC12 and KA12 crimping dies. The products listed above are registered trademarks of Anderson®, Blackburn®, FCI Burndy®, ILSCO®, Panduit®, Penn-Union® and Thomas & Betts®.

## K4250 & K425BG Crimping Tools

- Crimps a wide range of overhead service entrance connections, overhead splices, and overhead taps
- Easy-to-use MD-6 type "pop" tool
- K4250 and K425BG are equipped with D<sup>3</sup> die groove and either "BG" or "O" die groove
- K425K58 and K425KO are equipped with a die groove for Kearney® "O" dies and either a 5/8" or "O" die groove
- The D<sup>3</sup> die groove serves as a die seat for all Greenlee KD6 and industry "W" type dies
- Bent fiberglass handles provide a solid grip, good leverage and better durability than wood
- Teflon-impregnated bushings at pivot joints provide smooth operation and long life
- Complete crimps are assured with an over-center cam mechanism
- Tool can easily be checked visually for proper adjustment and can be adjusted with Allen wrenches

K4250	D <sup>3</sup> and "O" Grooves
K425BG	D <sup>3</sup> and "BG" Grooves
K425K58	Kearney "O" and 5/8" Groove
K425KO	Kearney "D" and "O" Die Grooves

### SPECIFICATIONS

INDUSTRIAL	OVERHEAD
Copper Lugs: 8-500	5/8" Service Ent Connectors: 10-1/0
Copper Splices: 8-500	.840 Service Ent. Connectors: 1/0-4/0
Aluminum Lugs: 8-4/0	Aluminum "H" Taps: 10-2
Aluminum Splices: 8-4/0	Copper Tension Splice: 6-2/0
Copper "C" Taps: 10-2	All Aluminum Tension Splice: 6-4/0
Aluminum "H" Taps: -	One Piece ACSR Tension Splice: 4-1/0
Aluminum Pin Adapters: 6-1/0 (3)	Two Piece ACSR Tension Splice: 2-477
	Aluminum Jumper Splice: 4-266.8
	Stirrups: 2-4/0
	Aluminum Lugs: 2-1/0
	Copper Lugs: 6-1/0



# Greenlee Selection Guide

## Copper & Aluminum Cable Cutters

	CABLE SIZE																			
	AWG	#8	#6	#4	#2	#1	1/0	2/0	3/0	4/0	250 kcmil	300 kcmil	350 kcmil	400 kcmil	500 kcmil	600 kcmil	750 kcmil	1000 kcmil	1500 kcmil	
	mm <sup>2</sup>	6	10	16	25	35	40	50	70	95	120	150	150	185	240	300	400	500	800	
<b>RATCHET</b>																				
759	Al Cu	• •	• •	• •	• •	• •	• •	• •	• •	• •	• •	• •	• •	• •	• •	• •	• •	• •	• •	• •
760 & 761	Al Cu	• •	• •	• •	• •	• •	• •	• •	• •	• •	• •	• •	• •	• •	• •	• •	• •	• •	• •	• •
45206	Al Cu	• •	• •	• •	• •	• •	• •	• •	• •	• •	• •	• •	• •	• •	• •	• •	• •	• •	• •	• •
45207	Al Cu	• •	• •	• •	• •	• •	• •	• •	• •	• •	• •	• •	• •	• •	• •	• •	• •	• •	• •	• •
773	Al Cu	• •	• •	• •	• •	• •	• •	• •	• •	• •	• •	• •	• •	• •	• •	• •	• •	• •	• •	• •
774	Al Cu	• •	• •	• •	• •	• •	• •	• •	• •	• •	• •	• •	• •	• •	• •	• •	• •	• •	• •	• •
756	Al Cu	• •	• •	• •	• •	• •	• •	• •	• •	• •	• •	• •	• •	• •	• •	• •	• •	• •	• •	• •
<b>MANUAL</b>																				
727 & 727M	Al Cu	• •	• •	• •	• •	• •	• •	• •	• •	• •	• •	• •	• •	• •	• •	• •	• •	• •	• •	• •
718F	Al Cu	• •	• •	• •	• •	• •	• •	• •	• •	• •	• •	• •	• •	• •	• •	• •	• •	• •	• •	• •
704	Al Cu	• •	• •	• •	• •	• •	• •	• •	• •	• •	• •	• •	• •	• •	• •	• •	• •	• •	• •	• •
705	Al Cu	• •	• •	• •	• •	• •	• •	• •	• •	• •	• •	• •	• •	• •	• •	• •	• •	• •	• •	• •
706	Al Cu	• •	• •	• •	• •	• •	• •	• •	• •	• •	• •	• •	• •	• •	• •	• •	• •	• •	• •	• •

Legend: • = Frequent Use Capacity x = Maximum Capacity

## For Greenlee ACSR, Guy Strand & Steel Cutters

	ACSR	Std. Guy Strand	HS Guy Strand	Ground Rod	Rebar (Schedule 60)
<b>HYDRAULIC-TYPE</b>					
HK520	336.4 kcmil	1/2" (13mm) dia.		1/2" (13 mm) dia.	7/16" (11mm)
<b>RATCHET-TYPE</b>					
776	636.0 kcmil*				
757	954.0 kcmil			1/2" (13mm) dia.	
758		1/2" (13 mm) dia.	1/2" (13 mm) dia.	1/2" (13 mm) dia.	
<b>MANUAL</b>					
749	20 AWG 203				
<b>CUTTER DIES</b>					
00949	477.0 kcmil	5/8" (16mm) dia.	5/8" (16mm) dia.	5/8" (16mm) dia.	5/8" (16mm) dia.
KD6-27	4/0 AWG				

\*For core diameters less than 0.32"

# Klein Tools - Manual Cutters & Crimpers

## 63607: Small ACSR Ratcheting Cable Cutters

- Unique ratchet action holds cable tight and allows rapid, straight cuts with minimum effort
- Quick-release lever opens blade at any time during operation
- Large, finger-formed handles have limit guards and bright yellow plastic covering for comfort and high visibility
- Hold-open spring speeds cutting action
- Cuts ACSR and triplex cable
- Also cuts copper up to 400 MCM, aluminum and multi-conductor cable up to 600 MCM



## Compact Cable Cutters

- Compact 12" design allows for one-handed use of the ratcheting cutter mechanism so other hand can position cable to ensure proper cut
- 63601 cleanly cuts up to 1000MCM Al, 600MCM CU, and 2 1/16" diameter communication cable
- 63602 cleanly cuts up to 1000MCM Al, 600MCM CU, up to 2 1/16" diameter communications cable, and up to 477 MCM ACSR
- Replacement cutting inserts are available (63858)
- Unique ratchet action holds cable tight and allows rapid, straight cuts with minimal effort
- Hold-open spring speeds cutting action
- Quick-release lever opens blade at any time during operation
- Lock in closed position for pouch carrying



**63601** Cuts up to 1000MCM Al, 600MCM CU, and 2 1/6" Diameter Communications Cable

**63602** Cuts up to 477MCM ACSR

## 63800ACSR: Ratcheting ACSR Cable Cutter

- Approximately 14" long
- Cutting blades/surfaces are replaceable without removing movable or stationary jaws
- High leverage ratchet mechanism for cutting ACSR cables up to and including 477 ACSR
- Quick release opens blades easily in every cutting position. (Allows removal of cable before completion of cut)
- Hardened steel cutting blades for lasting strength and sharpness (replaceable in case of damage)
- Precision ratcheting mechanism holds cable tight and allows rapid, straight cuts with minimal effort
- Plastic covered handles with hand guards for comfort, firm grip
- Locking lever keeps handles closed for easy transport



## Ratcheting Cable Cutters

- High leverage ratchet mechanism for single handed cutting of copper, aluminum cables; does not leave burrs or sharp edges
- Patented two-step ratchet mechanism requires fewer strokes per cut (63060/63750)
- Quick release opens blades easily in every cutting position
- Precision ratcheting mechanism holds cable tight and allows rapid, straight cuts with minimal effort



Part no.	Copper	Aluminum	Comm. Cable	Length
63060	400 kcmil	600 kcmil	1 1/8"	10 1/4"
63600	600 kcmil	600 kcmil	1 3/4"	9"
63750	750kcmil*	750 kcmil	2 1/16"	12 1/8"

\*Frequent use capacity; max. capacity is 1000 kcmil

## 63805: Cable Cutters - Drill-Operated ACSR

- Chucks into a corded, cordless or hydraulic drill for fast, clean cutting of large transmission, steel, and cable
- One hand operation
- Cleanly cuts Bluebird 2156 MCM (84x19), copper or aluminum up to 2"



- Replacement cutting inserts are available
- Tough, worm-drive gears are built to last through typical weather conditions
- Simply reverse drill to open cutting blades
- Lock in closed position for pouch carrying



# Klein Tools - Manual Cutters & Crimpers

## 63030 & 63028: Cable Cutter - Coaxial

- Cable-gripping jaws quickly score jacket and insulation, and easily cut through copper inner conductor
- Blades cleanly cut aluminum and copper coaxial cable without compression and frayed ends
- Forged body with heat-treated and precision-ground steel blades, withstands frequent cutting
- Hot-riveted design requires no adjustment while maintaining a smooth, precise operation
- Compact, lightweight design fits perfectly in any tool pouch
- Plastic-coated handles provide comfort and gripping power
- When cutting drop wire with an inner steel conductor, use Cat. No. D2000-28 diagonal-cutting pliers



## J63050: Journeyman High-Leverage Cable Cutter

- Features a state-of-the-art dual material molding that allows for a softer, more comfortable grip on the outer surface and a harder, more durable grip on the inner surface and handle ends
- Features a soft, red handle material on outer surface for comfort and a firm grip
- Cable-gripping, shear-type jaws cut up to 4/0 aluminum (not ACSR), up to 2/0 soft copper; up to 100 pair, 24-gauge communications cable
- Makes clean, efficient cuts
- Ideal for working in confined spaces; compact, only 9 1/2" long
- Features a hard, black material on inner surface and handle ends for toughness and durability



## 1010: Long-Nose All-Purpose Cutter

- All-purpose cutter/crimper designed for wire-cutting, bolt cutting, wire stripping and crimping including 7 to 8 mm ignition terminals
- Cutters and strippers are in front of the pivot for maximum ease-of-use in reaching into tight places
- Crimping dies for insulated and non-insulated connectors
- Narrow, serrated plier jaws to pull, loop and bend wire
- Plastic covered handles
- 8 1/4" long



## 63050: High-Leverage Cable Cutter

- This handy, economical tool handles most cable-cutting jobs with ease
- Cable-gripping, shear-type jaws cut up to 4/0 aluminum (not ACSR); up to 2/0 soft copper; up to 100 pair, 24-gauge communications cable
- Makes clean, efficient cuts. Ideal for working in confined spaces
- Special high-leverage design
- Tough, comfortable, red plastic-dipped handles
- Compact, only 9 1/2" long



## 11046: Wire Stripper/Cutter

- Compact, lightweight
- Black-oxide finish resists corrosion
- Narrow nose fits into tight places
- Wire looping and bending holes
- Do not use for cutting steel wire or bolts
- Spring-loaded action for self-opening
- Precision-ground stripping holes for easy removal of insulation
- Easy-to-read wire gauge markings on both sides for stripping in either direction
- Red handle indicates stranded wire, yellow handle indicates solid wire
- Textured handles provide a firm, comfortable grip



## 11057: Klein-Kurve® Wire Stripper/Cutter - Solid & Stranded wire

- Precision shear-type blades for clean cuts on solid and stranded copper wire
- Wire looping and bending holes
- Precision-ground stripping holes
- Easy-to-read markings on both sides
- Curved handles help reach into confined areas
- Coil spring provides fast self-opening action
- Strong-gripping serrated nose; for easy bending, shaping, and pulling of wire
- Screw-shearing holes
- Handy closure lock for convenient storage
- Double-dipped comfort grips



# Klein Tools - Manual Cutters & Crimpers

## Bolt Cutters

- Strong, lightweight, general purpose bolt cutters in three different sizes
- Heavy vinyl grips for comfort and slip resistance
- All-purpose, center cut jaws for soft, medium, and hard metals
- Drop forged, alloy steel jaws are precision ground for sure, efficient cutting and long life
- Lockplate reinforcement prevents jaw bolts from loosening or turning, keeps jaws in correct alignment
- One adjustment realigns cutting edges
- Three-point toggle joint multiplies 50 lbs of hand pressure on handles to 4000 lbs at cutting jaws



63324	Steel 24" 5 1/4 lbs
63330	Steel 30" 8 1/2 lbs
63336	Steel 36" 12 3/4 lbs
63118	Fiberglass 18 1/4", 3 13/20 lbs
63124	Fiberglass 24 1/2", 4 1/2 lbs
63130	Fiberglass 30 1/2", 7 1/2 lbs
63136	Fiberglass 36 1/2", 11 1/2 lbs

## 2006: Large Compound-Action Crimping Tool

- Crimps 6 - 4/0 AWG lugs and terminals
- All-in-one, integral crimp nest - without any removable parts or rotating dies to set
- High-leverage handles and compound action mechanism
- Adjustment screw allows user to control crimp depth
- 19 1/2" long, 2.8 lbs.

## 63035: Utility Cable Cutter

- Forged steel with black-oxide finish for long life; non-slip vinyl grips
- Beveled tips for positive mating
- Shear-type hook jaws grab and hold cable while shear-cutting action makes clean cuts
- Hinge bolt with pin-set nut for proper blade tension
- Not designed for cutting steel or ACSR



## Standard Cable Cutters

- Lightweight, efficient shear-type cable cutters
- Hook jaw shape forces cable into jaws
- Exceptionally strong fiberglass handles with heavy vinyl grips for comfort and slip resistance
- Heavy-duty pin in head serve as blade stops
- Beveled tips assure positive mating, and hinge on a rugged bolt with a pinset nut to maintain proper blade tension
- Cuts soft cable up to 1 3/4"
- Jaws are of drop-forged alloy tool steel
- Hook jaw shape forces cable into jaws
- Make a clean, even cut for ease in fitting lugs and terminals
- Cable cutting capacity: 1000 Copper, 1200 Aluminum
- 32" in length

63041 26" Loppers, Cable Cutters

63045 32" Loppers, Cable Cutters



# Burndy - Manual Crimping Tools

## MD6 HYTOOL™ Series - Manual Crimping

- Accepts the full line of Burndy "W" and "X" die inserts; #14-4/0 AWG
- Crimping force of 9,000 lbs
- Designed to provide over 90,000 reliable crimps installing full tension and non-tension connectors
- 25-3/8" long
- Hickory handles

**MD6** D3 & BG Grooves

**MD6-8** D3 & O Grooves



## MD7 HYTOOL™ Series - Manual Crimping

- Integral visual wear indicator
- Life cycle tested to over 99,000 crimp cycles
- Accepts the full line of "W" and "X" die inserts
- Positive-lock, spring loaded die retainer button
- Crimping force of 9,000 lbs
- Installs a full range of connectors (taps, splices, terminals)
- Conductor range: #14-4/0
- Lightweight, durable polymer handles

**MD7** D3 & BG Grooves

**MD7-8** D3 & O Grooves

## Y35 HYPRESS™ Series - 12 Ton Hydraulic

- Hook style head with extensive ram travel for easy tapping and splicing of overhead lines as well as HYGROUND® compression grounding systems
- Y35 body and handles are covered with 3/16" rubber for tool impact protection
- Y35-2 HYPRESS™ head, body, and handles are covered with 3/16" rubber for tool impact protection
- Versatile and economical tool works with all commonly used copper, aluminum #8-750 kcmil and ACSR conductors from #6 str.-556.5 kcmil

**Y35**

**Y35-2** Rubber Covered Head



## Y750 HYPRESS™ Series - 12 Ton Hydraulic

- Conductor range #14-750 kcmil Cu/Al and #4-556.5 kcmil ACSR; 1.65" wide jaw opening; C-shaped head rotates 355°
- Provides easy tapping, splicing and terminating of overhead lines, the full line of HYGROUND® compression grounding connectors, NEC cable connections and N30-N650 Navy cable connections
- Accepts all BURNDY "U" dies
- Y750CHSXT HYPRESS™ has a rubber covered head and handles for tool impact protection

**Y750HSXT**

**Y750CHSXT** Rubber Covered Head



# Burndy - Manual Cutting & Hand Tools

## RCC336, RCC556 & RCC954ACSR1K: Ratchet Cable Cutters

- High quality precision cutters designed to cut up to 954 ACSR and 1000 kcmil copper and aluminum
- Equipped with rugged steel blades and bi-directional ratchet (excluding RCC336) mechanism for positive blade control
- Rapid blade advance
- Comfortable tool operation and long life
- Easy cutting with minimal cable distortion
- Excellent cutting edge performance

Part #	Max Cutting Capacity
RCC336	350 kcmil Cu; 500 kcmil AL; 336 kcmil ACSR
RCC556	500 kcmil Cu; 500 kcmil AL; 556 ACSR
RCC954ACSR1K	1000 kcmil Cu; 1000 kcmil AL; 954 kcmil ACSR



## OUR840 HYTOOL™: Ratchet Crimping Tool

- One hand, full cycle ratchet tool for Cu, Al and ACSR
- Great for use in tight spaces where other tools can't fit
- #8-4/0 Al and #8-250 Cu terminals and splices on code conductor
- W28K cutter die permits use of tool as a cable cutter
- Uses reduced handle force on "X" and select "W" dies
- Proper crimps are assured with full cycle ratchet mechanism
- Connections are UL Listed when colour-coded dies are used to install recommended BURNDY® terminals and splices



## BTW30150 & BTW150750: Micro-Adjustable Ratchet Torque Wrenches

- Ratcheting, calibrated dual direction for ease of use in the field
- Positive lock with spring-loaded pull-down lock ring to assure that the torque setting is properly engaged and secure
- Scale settings on tool correspond to connector torque ratings (in-lb); fast, accurate and easy-to-set values
- Lightly knurled handle offers an ergonomic, non-slip grip
- Micro-adjustable design minimizes the need for several wrenches
- Individually serialized and calibrated traceable to N.I.S.T.
- BTW30150 designed for use on connectors requiring torque values from 30 to 150 in-lbs.
- BTW150750 designed for use on connectors requiring torque values 150 to 750 in-lbs.
- 3/8" drive



## OH25 HYTOOL™: Ratchet Crimping Tool

- Full cycle dieless ratchet tool
- Easy one-hand operation with spring loaded comfort grip handles
- Ratchet mechanism provides proper crimp, uniform installations
- Forged steel jaws and stainless steel indenter
- Installs 5/8" INSULINK™ and LINKIT™ service entrance connectors, conductor range #10-1/0 AWG with only one crimp



## Hastings 11-014: Hand held ACSR Ratchet Cutter

- Max cable 336 ACSR
- Release lever allows cutter jaws to be opened at any time
- Handles are plastic dipped for comfort and a non-slip grip
- Compact size allows cutter to be used under close working conditions



## Hastings 10-667: High Tensile Steel Bolt Cutters

- Replaceable insulated fiberglass handles
- Suitable for cutting hard material
- Capacities: 3/8" reinforced steel, 5/16" diameter bar steel or steel wire, and 9/32" diameter music wire
- Handles filled with unicellular foam core
- Cam hinge bolts for jaw alignment
- Replacement head available
- 24" long



## Hastings 954 ACSR Ratchet Cutters

- Allows for confined space cutting with offset cutting head
- Selection lever for "open" or "close" jaws
- Ratchet drive mechanism requires less force and leverage
- Handle plunger allows for "fast advance" or "fast retraction"
- Heat treated jaws with a keeper on the upper jaw to prevent blade separation while cutting



10-207  
01-4002

Ratchet Cutters  
Case

## Hastings Heavy Duty "EHS" Guy Strand Cutters

- Progressive cutting action - superior cutting of guy strand over typical bolt cutters
- Designed for cutting 1/2" EHS guy strand
- Fiberglass handles
- Release lever allows cutting jaw to be opened
- Cutting jaw retracts into main body and cuts guy strand as handles are opened and closed
- Weighs 11.25 lbs



10-260

## Chance C4032980: A.B. Chance Hydraulic Conductor Ratchet Cutters

- Half the size, weight of standard ratchet cutters
- Useful for confined workspaces such as manholes and hand holes
- Built to withstand punishing field conditions
- Open in less than half the space required for long-handled ratcheting cutters
- Guillotine, C-type jaws are heat-treated for lasting strength and sharpness
- Reinforced fiberglass handles are PVC-coated and protected by a vinyl sleeve
- Cuts up to 556 ACSR or 750 MCM AA/CU
- 18" long
- 4.4 lbs



## C18F Bolt Cutters with Fiberglass Handles

- Fiberglass handles tested to 100 kV per 12"
- Suitable for cutting up to 3/8" capacity high tensile material
- Short cutting edge for high tensile steel bolts, wire, rod, chain links, and case hardened chains



# H.K. Porter - Manual Cutters

## Center Cut Bolt Cutters

- Toggle joints turn 50 lbs. hand pressure to 4,000 lbs. cutting pressure
- Cuts soft, medium, and hard metals
- Lockplate keeps jaws from loosening
- Screw-type adjustment realigns edges
- Cuts hard materials up to 1/4"
- Cuts soft and medium materials up to 3/8"
- 18.25" long, 3.5 lbs



## 8690FH: 29 1/4" Ratchet-Type Hard Cable Cutters

- Jaw keeper prevents jaws from spreading while under a heavy load
- Cuts hard cable up to 1 3/16", ACSR, ACAR, ZEBRA, and self-supporting telephone cable
- Allows short strokes in confined spaces
- Ratchet and chain increase cutting pressure
- Shear-cut blades
- 29.25" long
- 10.5 lbs



## 8690FSK: 27 1/2" Ratchet-type, Soft Cable Cutter

- Jaw keeper prevents jaws from spreading while under heavy load
- Cuts copper and aluminum communications power cable up to 2"
- Improved heavy duty jaw design
- Built for tough conditions
- Ratchet provides up to 5 times the mechanical advantage over manual cutters
- Cuts all types of copper and aluminum cables up to 2500MCM
- Weight: 3 1/2 lbs
- Length: 27 1/2"



## General Purpose Bolt Cutter

- 0090FC 18 1/4" Fiberglass Handles
- 0190FC 24 1/2" Fiberglass Handles

## Heavy Duty Bolt Cutters

- 0390FCX 36" Fiberglass Handles

## Industrial Grade Bolt Cutters

- 0090MC 18" Steel Handles
- 0390MC 36 1/2" Steel Handles

## 8690TN: Guy Cutters

- Ratchet-type jaw with notched shear-cut blades
- Blades hold and lock material in place
- Cuts aircraft cable, EHS guy strand, wire rope and stainless steel cable
- Increased mechanical advantage over manual cutters
- Cuts all strands with minimal crushing or distortion
- 36" long



## 8690CK: 28" Ratchet-type Guy Strand Cutter

- Notched shear-cut blades hold material firmly in place
- Ratchet and chain produce easy, progressive cuts
- Cuts EHS guy strand, mild steel rods and bolts, and similar materials
- Makes clean, square cuts with minimal distortion
- Increased mechanical advantage over manual cutters
- Weight: 8 3/4 lbs
- Length: 28"

## 8613FH: Replacement Cutterhead for 8690FH Ratchet-type Hard Cable Cutter

# Greenlee - Battery Powered Tools



With industry-leading technology, ergonomic and easy-to-use designs, Gator® Tools help you work smarter on the job site. Cut cable, crimp lugs and splices, and punch holes all in lightning fast time. With smart features such as Intelli-Crimp™ and Auto Retraction Stop (ARS), you can always be sure that the job is done right.

## SAFE.

Gator® tools help line workers avoid repetitive motion injuries associated with manual cutters and crimpers.

## SECURE.

With UL certification and Intelli-CRIMP™ technology®, you can be sure that the crimp or cut was correct – and have the data to prove it.

## SIMPLE.

Designed for the lineman, Gator® tools feature industry leading center of gravity and single trigger designs – making them the easiest to use.

## SMART.

Whether it's Auto Retraction Stop, Retraction Stop Repeat (RSR), or Intelli-CRIMP™ technology, Gator® tools help get the job done Faster, Safer, and Easier™.



## Gator Eye

- **Detailed Work History:** Download, print and store work information such as operating pressure, number of crimps/cuts and battery information
- **Accountability:** Prove that the job was done correctly with operation and project specific documentation
- **Diagnostics:** Set and view maintenance intervals, and add user identifiable information to manage your inventory



Press Software Screenshot

## CP1: EK425 Pouch

- Fabricated out of durable vinyl
- Combine with "S" hooks to attach bag to the inside/outside of a platform (not included)
- Velcro closures keep the tool clean
- Crimping jaws do not need to be removed when storing the tool



# Greenlee - Battery Powered Tools

## EK425L Gator® Battery Powered Crimping Tool

### SPECIFICATIONS

Crimping Force	6-Tons (54 kN)
Length (with jaws)	18 1/2"
Width (head open)	4"
Weight (with jaws)	6.8 lbs
Battery	18V 3.0 Ah Li-ion
Est. Cycles per Charge	325
Crimp Cycle Time	4 Seconds
Battery Charge Time	28 Minutes



### CONNECTOR CAPACITY

5/8" Service Entrance Connectors	10-1/0 AWG
.840 Service Entrance Connectors	1/0-4/0 AWG
Aluminum "H" Taps	6-4/0 AWG
Copper "H" Taps	10-2 AWG
Copper Tension Splices	6-2/0 AWG
All Aluminum Tension Splices	6-4/0 AWG
One Piece ACSR Tension Splices	4-1/0 AWG
Two Piece ACSR Tension Splices	2 AWG-477 kcmil
Aluminum Jumper Splices	4 AWG-266.8 kcmil
Strirrup	2-4/0 AWG
Aluminum Colour-Coded Lugs & Splices	8-4/0 AWG



### CRIMPING JAW COMPATIBILITY

CRIMPING JAW COMPATIBILITY	BRAND	TYPE/SERIES
CJD3BG	Greenlee®	KD6 Series
CJD30	FCI Burndy®	W, X Series
CJD3	IlSCO®	ND Series
CJK*	Huskie®	HT-58 Series
*Requires F020735 Adapters	Panduit®	CD-2001 Series
CJK	Kearney®	Dies for Type "O" Tools
CJXPJ	Nicopress Connectors	Connectors that require the X, P or J tool grooves

### CUTTING JAW COMPATIBILITY

- CJB
- One time disposable lock hasps 4 AWG Alumoweld
  - ACSR 1/0



CJD3BG



CJD30



CJD3



CJK



CJB



CJXPJ

# Greenlee - Battery Powered Tools

## Gator® 22-Series 6-Ton Crimping Tool

- 18V Lithium-Ion battery provides more cycle times and faster cycles
- An exclusive pressure sensor monitors the crimping force of each crimp and provides the operator a visual and audible alert if the force is below specifications
- Automatic Retraction Stop (ARS) stops the ram retraction automatically at the correct position for the next crimp cycle reducing subsequent cycle times
- LED work light illuminates dark work areas
- One trigger controls all tool functions, ram automatically retracts when crimp is complete
- Over molded tacky grip areas make gripping the tool easier and more comfortable
- 6 ton crimping force, flip-style crimping head opens easily and rotates 35°
- Uses Greenlee K22 dies and industry "W" dies
- Includes (2) 18V 1.5 Ah Li-ion batteries, battery charger, molded carrying case, and die adapters for "W" dies



**EK622L11** Comes with 120 Volt Charger

**EK622L12** Comes with 12 Volt Charger

## Gator® L-Series 12-Ton Crimping Tools

- 18V Lithium-Ion battery provides more cycle times and faster cycles
- An exclusive pressure sensor monitors the crimping force of each crimp and provides the operator a visual and audible alert if the force is below specifications
- Automatic Retraction Stop (ARS) stops the ram retraction automatically at the correct position for the next crimp cycle reducing subsequent cycle times
- LED work light illuminates dark work areas
- 12 ton crimping force, crimping head rotates 350°
- One trigger controls all tool functions, ram automatically retracts when crimp is complete
- Over molded tacky grip areas make gripping the tool easier and more comfortable
- Uses Greenlee 12-ton dies and industry "U" dies
- Includes two 18V 3.0 Ah Li-ion batteries, battery charger, and molded carrying case

### PVC COVERED

**EK1240CL11** 12-Ton Battery-Powered Crimping Tool, 1.65" opening, 120V Charger

**EK1240CL12** 12-Ton Battery-Powered Crimping Tool, 1.65" opening, 12V Charger

**EK1240CL22** 12-Ton Battery-Powered Crimping Tool, 1.65" opening, 230V Charger



**EK1230L11** 120 Volt Charger

**EK1230L12** 12 Volt Charger

For industry "U" Style dies, jaw opening is 1.2"

**EK1240L11** 120 Volt Charger

**EK1240L12** 12 Volt Charger

For industry "U" Style dies, jaw opening is 1.65"

**EK1240KL11** 120 Volt Charger

**EK1240KL12** 12 Volt Charger

For use with Kearney PH2 style dies

## Gator® L-Series 6.2-Ton Crimping Tools

- 18V Lithium-Ion battery provides more cycle times and faster cycles
- An exclusive pressure sensor monitors the crimping force of each crimp and provides the operator a visual and audible alert if the force is below specifications
- Automatic Retraction Stop (ARS) stops the ram retraction automatically at the correct position for the next crimp cycle reducing subsequent cycle times
- LED work light illuminates dark work areas
- One trigger controls all tool functions, ram automatically retracts when crimp is complete
- Over molded tacky grip areas make gripping the tool easier and more comfortable
- 6.2 ton crimping force, crimping head rotates 350°
- Tools utilize 4 indenters to make a crimp
- Includes two 18V 3.0 Ah Li-ion batteries, battery charger, molded carrying case, test gauge, test slugs

**EK06ATL11** 120 Volt Charger Crimps Copper Lugs & Copper Splices: 4-500

**EK06ATL12** 12 Volt Charger Crimps Copper Lugs & Copper Splices: 4-500

**EK06FTL11** 120 Volt Charger Crimps Copper: 4-750; Aluminum: 6-750\*

**EK06FTL12** 12 Volt Charger Crimps Copper: 4-750; Aluminum: 6-750\*

\*Additional overhead specs: 58" service ent. connectors: 8-1/0; .840 Service Ent. Connectors: 4-350; Copper Tension Spliced: 6-4/0; One Piece ACSR Tension Splice: 4-477



TRUSTED SINCE 1958

# Greenlee - Battery Powered Tools

## Gator® L-Series 6-Ton Crimping Tool

- 18V Lithium-Ion battery provides more cycle times and faster cycles
- An exclusive pressure sensor monitors the crimping force of each crimp and provides the operator a visual and audible alert if the force is below specifications
- LED work light illuminates dark work areas
- One trigger controls all tool functions, ram automatically retracts when crimp is complete
- Over molded tacky grip areas make gripping the tool easier and more comfortable
- 6 ton crimping force, crimping rotate 350°
- Uses Greenlee KC22 dies for copper connectors 8 AWG – 600 kcmil and Greenlee KA22 dies for aluminum connectors 8 AWG – 350 kcmil
- Includes two 18V 1.5 Ah Li-ion batteries, battery charger, and molded carrying case

**EK628L11 w/ 120 Volt Charger**

**EK628L12 w/12 Volt Charger**



## Gator® L-Series Dieless Crimping Tool

- 18V Lithium-Ion battery provides more cycle times and faster cycles
- An exclusive pressure sensor monitors the crimping force of each crimp and provides the operator a visual and audible alert if the force is below specifications
- Automatic Retraction Stop (ARS) stops the ram retraction automatically at the correct position for the next crimp cycle reducing subsequent cycle times
- LED work light illuminates dark work areas
- One trigger controls all tool functions, ram automatically retracts when crimp is complete
- Over molded tacky grip areas make gripping the tool easier and more comfortable
- Indent style crimp, crimping head rotates 350°
- Flip-open crimping head allows crimping of 4 AWG – 1000 kcmil copper and 6 AWG -1000 kcmil aluminum with no dies to change
- Includes two 18V 3.0 Ah Li-ion batteries, battery charger, and molded carrying case

**EK12IDL11 w/ 120 Volt Charger**

**EK12IDL12 w/12 Volt Charger**



## Gator® 15-Ton Crimping Tool

- Crimps up to 1000 kcmil connectors
- Cutting head rotates 350° for making crimps in tight locations
- Two speed pump advances the ram quickly to start the crimp
- Side hand enhances operator control
- Retraction stop allows the operator to stop the ram retraction to make subsequent crimp cycle times faster
- Ram automatically retracts when the cut is complete
- Two batteries, battery charger, side handle, and steel carrying case included

**EK1550L11 w/ 120 Volt Charger**

**EK1550L12 w/ 12 Volt Charger**

### Replacement Batteries & Chargers for Gator "L" Series Tools

**52176 18V 3.0 Ah Li-ion Battery**

**52178 120V Charger Only**

**52180 12V Charger Only**



# Greenlee - Battery Powered Tools

## Gator® One-Time Lock Cutters

- Designed to cut disposable lock container seals, and small diameter bolts
- Lightweight in-line style tool is easy to maneuver
- Cutter head rotates 3500 for use in tight locations
- Ram retracts automatically when cut is complete
- Two 18V 1.5 Ah Li-Ion batteries, battery charger, and molded carrying case included

ETS12L11 w/ 120 Volt Charger

ETS12L12 w/ 12 Volt Charger



## Gator® Cable Cutters

### ESC105

- For cutting large diameter underground power and communications cables, including armored cables
- State of the art 18V lithium ion (Li-ion) battery provides 70% more cycles per charge and faster cycle times
- Retraction Stop allows the operator to stop the ram retraction at any point simply by tapping the trigger, and then starting the next cutting cycle from that point saving time and energy
- LED light provides the operator with the battery charge and tool maintenance status
- Two-stage hydraulic system provides fast advance and power speeds, saving time
- Scissor-style blades are easy to fit around cables
- Side handle enhances operator control
- Forward handle position improves tool balance
- One trigger controls all tool functions
- Cutting head rotates 350°
- Tools automatically retract when the cutting cycle is complete
- Overmolded tacky grip areas make gripping the tool easier and more comfortable
- LED work light illuminates dark work areas
- Greenlee battery-powered cutting tools now use bio-degradable oil
- Smart chargers control the charging current, charging voltage and battery temperature to maximize battery life
- Available with 120V, 12V or 230V battery charger or with 120V or 230V corded adapter in place of batteries and charger

ESC105L11 w/ 120 Volt Charger

ESC105L12 w/ 12 Volt Charger

### ESC85:

- Scissor style blades are easy to fit around cables and cutting head rotates 360° for making cuts in tight locations
- Side handle enhances operator control
- Designed for communications and underground power cable cutting
- Includes one-hour battery charger, steel carrying case and two batteries



ESC85L11 w/ 120 Volt Charger

ESC85L12 w/ 12 Volt Charger

02999 12V NiCd Battery Only

03046 120V Charger Only

## Gator® Plus ESG45GL11 ACSR Cutters

- Designed to cut steel cables, rods
- 2-speed pump advances the ram quickly to start the cut; ram automatically retracts after cut is complete
- Includes a 120V one hour battery charger, steel carrying case, and two batteries
- Also available with 12V or 230V chargers

### Replacement Batteries & Chargers for Gator "L" Series Tools

52176 18V 3.0 Ah Li-ion Battery (for all pistol grip style and EK425L tools)

52177 18V 1.5 Ah Li-ion Battery (for all in line style tools)

52178 120V Charger Only

52180 12V Charger Only



ESG45L11 w/ 120 Volt Charger

ESG45L12 w/ 12 Volt Charger



TRUSTED SINCE 1958



# Greenlee - Battery Powered Tools

## ES25 ACSR Cable Cutter

- Cuts up to 636 kcmil ACSR cables
- Approximately 50 cuts of Grosbeak or 120 cuts of Merlin per battery charge
- Includes one hour battery charger, one battery, and molded carrying case

<b>ES2511</b>	<b>w/ 120 Volt Charger</b>
<b>76807</b>	<b>Blade Kit</b>
<b>11851</b>	<b>14.4V NiCd Battery</b>
<b>11841</b>	<b>120V Battery Charger</b>



## ES32LU ACSR Cable Cutter

- State of the art 18V Lithium Ion (Li-ion) battery provides well over 200 cycles per charge and faster cycle times
- LED light provides the operator with the battery charge and indicates tool maintenance status
- In-line tool style is lightweight and very easy to control; one trigger controls all tool functions
- Cutting head rotates 350°
- Tool automatically retracts when the cutting cycle is complete
- Over molded tacky grip areas make gripping the tool easier and more comfortable
- LED work light illuminates dark work areas
- Greenlee battery-powered tools now use bio-degradable oil
- Smart chargers control the charging current, charging voltage and battery temperature to maximize battery life
- Available with 120V or 12V battery charger
- Includes (2) 18V 3.0 Ah Li-Ion batteries, a charger, and molded carrying case

<b>ES32LU11</b>	<b>w/ 120 Volt Charger</b>
<b>ES32LU12</b>	<b>w/ 12 Volt Charger</b>



## ES750 Cable Cutter

- Cuts 500 kcmil copper cable in less than 8 seconds
- Approximately 20 cuts in 750 kcmil per battery charge
- Includes a one hour battery charger, battery, and molded carrying case

<b>ES750-11</b>	<b>120 Volt Charger</b>
<b>ES750-22</b>	<b>230 Volt Charger</b>
<b>45378</b>	<b>12V NiCd Battery</b>
<b>45379</b>	<b>120V Charger Only</b>



## Gator® L-Series 6-Ton Multi-Purpose Tool

- 18V Lithium-Ion battery provides more cycle times and faster cycles
- LED work light illuminates dark work areas
- Uses a variety of easily interchanged cutting blades, crimping die adapters, and a knock-out punch adapter
- One trigger controls all tool functions, ram automatically retracts when crimp is complete
- Over-molded tacky grip areas make gripping the tool easier and more comfortable
- 6 ton crimping force, flip-style crimping head opens easily and rotates 350°
- Uses Greenlee K22 dies and industry "W" dies
- Includes two 18V 3.0 Ah batteries

### Multipurpose Tool Accessories:

<b>UAK</b>	<b>Adapter for Kearney "O", T&amp;B "6 Ton", &amp; Blackburn "OD" dies</b>	<b>ECCXL11</b>	<b>w/ 120 Volt Charger</b>
<b>UAW</b>	<b>Adapter for Burndy "W" and Panduit "CD-2001" dies</b>	<b>ECCXL12</b>	<b>w/ 12 Volt Charger</b>
<b>UC40</b>	<b>Cutter blades AL &amp; CU 1 1/2"</b>	<b>UA22</b>	<b>Adapter for Greenlee K22 Dies</b>
<b>UCACSR</b>	<b>Cutter blades for ACSR &amp; guy strand</b>	<b>UAK</b>	<b>Adapter for Kearney "O", T&amp;B "6 Ton", and Blackburn "OD" dies</b>



# Greenlee - Battery Powered Tools

## Gator® L-Series 12-Ton Multi-Purpose Tool

- Uses a variety of easily interchanged cutting blades, crimping die adapters, and a knock-out punch adapter
- 18V Lithium-Ion battery provides more cycle times and faster cycles
- LED work light illuminates dark work areas
- One trigger controls all tool functions, ram automatically retracts when crimp is complete
- Over molded tacky grip areas make gripping the tool easier and more comfortable
- 12 ton crimping force, flip-style crimping head opens easily and rotates 350°
- Uses Greenlee 12-ton dies and industry "U" dies
- Includes two 18V 3.0 Ah Li-ion batteries, battery charger, molded carrying case, and die adapters for "W" dies

**E12CCXL11 w/ 120 Volt Charger**

**E12CCXL12 w/ 12 Volt Charger**

*\*Adapters for "U" dies are included with 12 CCX tools. Other dies and blades must be purchased separately.*

*\*\* 6 ton dies are compatible with the CCX tools when paired with a die adapter*



## Cutting Capacities

- Copper and aluminum cable 1 1/2"
- ACSR: 954 kcmil
- Standard guy strand: 5/8"
- EHS guy strand: 1/2"
- Ground rod: 1/2"
- Rebar: 1/2"
- Threaded rod: 1/4", 3/8" 1/2", 4mm, 5mm, 6mm, 8mm, 10mm
- DIN rail: 35 x 7.5, 32 x 15 x 9, 35 x 15

## Punching Capacities

- Round: 5 5/8"
- Rectangular: 2.677" x 5.433"
- Square: 5.4333" x 5.4333"

## Crimping Capacities

- Copper, colour-coded lugs and splices: 750 kcmil\*
- Aluminum colour-coded lugs and splices: 750 kcmil\*\*
- 5/8" service entrance connectors: 10 - 1/0 AWG
- .840 service entrance connectors: 1/0 - 4/0 AWG
- Aluminum overhead "H" taps: 6 AWG - 500 kcmil
- One piece ACSR tension splicers: 4 AWG - 556.5 kcmil
- One piece ACSR tension splicers: 4 AWG - 556.5 kcmil

*\* When used with Greenlee KC12 dies in combination with Anderson, Blackburn, FCI Burndy, ILSCO, Panduit, Penn-Union, and Thomas & Betts copper colour-coded connectors, crimps on copper lugs up to 750 kcmil are UL and cUL classified.*

*\*\* When used with Greenlee KA12 dies in combination with Anderson, Blackburn, FCI Burndy, ILSCO, Panduit, Penn-Union, and Thomas & Betts, aluminum colour-coded connectors, crimps on copper lugs up to 750 kcmil are UL and cUL classified.*

### DIE ADAPTERS

**UAW Adapter for Burndy "W" and Panduit "CD-2001" Dies (equivalent to "D3" Die)**

### CABLE CUTTING BLADES

**UC26 Cutter Blades AL & CU 1" Capacity**

**UC40 Cutter Blades AL & CU 1 1/2" Capacity**

**UCACSR Cutter Blades for ACSR and Guy Strand**

### KNOCKOUT PUNCH ADAPTER

**UA12P Punch Driver Adapter (accepts 3/4" draw stud)**

### THREADED ROD CUTTING BLADES

**UCUNC14 Cutter Blades for 1/4" Threaded Rod**

**UCUNC38 Cutter Blades for 3/8" Threaded Rod**

**UCUNC12 Cutter Blades for 1/2" Threaded Rod**



The CCX 3 step, 10 second function changeover

Step 1: Push the release buttons and the blades slide right out of the easy opening CCX head

Step 2: Alternate die adapters, cutter blades or knockout punch adapters slide right in

Step 3: You are working again with no lost time

### Replacement Batteries & Chargers for Gator "L" Series Tools

- 52176 18V 3.0 Ah Li-ion Battery**
- 52178 120V Charger**
- 52180 12V Charger**



# Greenlee - Battery Powered Tools

CUTTERS & CRIMPERS

## Cutting Tool Specifications



	ETS12L One-Time Lock Cutters	ES25 ACSR Cable Cutter	ES750 Cable Cutters	ES32LU ACSR Cable Cutters	ESC105L Cable Cutters	ESC85 Cable Cutters	EK1550 15 Ton Crimpers	ESG45L ACSR Cable Cutters
Kit	ETS12L11 ETS12L12	ES2511	ES75011 ES75022	ES32LU11 ES32LU12	ESC105L11 ESC105L12	ESC85L11 ESC85L12	EK1550L11 EK1550L12	ESG45L11 ESG45L12
Batteries included with Kit	18V 1.5 Ah Li-ion	14.4 Volt, NiCd	12 Volt, NiCd	18V 3.0 Ah Li-ion	12V, 2.6Ah, NiMH	18V 3.0 Ah Li-ion	18V 3.0 Ah Li-ion	12 Volt 2.0 Ah NiCd
Charger included with Kit	120 Volt Charger 12 Volt Charger	120 Volt Charger	120 Volt Charger 230 Volt Charger	120 Volt Charger 12 Volt Charger	120 Volt Charger 12 Volt Charger	120 Volt Charger 12 Volt Charger	120 Volt Charger 12 Volt Charger	120 Volt Charger 12 Volt Charger
Length	13 5/8"	14 3/4"	14 1/4"	21.62"	23.75"	21"	19 5/8"	15 1/2"
Width	2 7/8"	-	-	17.75"	-	2 7/8"	2 7/8"	2 7/8"
Height	4 1/2"	-	-	8"	23.75"	15 1/4"	15"	12 1/2"
Weight	4.4 lbs	7.7 lbs	12.95 lbs	14.99 lbs	22 lbs	6.85 lbs	19 lbs	12.8 lbs
Capacity	<ul style="list-style-type: none"> <li>• 1 Time Disposable Lock: 4 AWG Alumoweld</li> <li>• Common Bolt: 1/2"</li> <li>• Grade 5 Bolt: 7/16"</li> <li>• Grade 8 Bolt: 5/16"</li> <li>• Boa Lock: BL-9</li> </ul>	<ul style="list-style-type: none"> <li>• ACSR: 636 kcmil (except Egret)</li> <li>• Aluminum: 1500 kcmil</li> </ul>	<ul style="list-style-type: none"> <li>• 750 kcmil copper cable</li> <li>• 1000 kcmil aluminum cable</li> </ul>	<ul style="list-style-type: none"> <li>• 500 kcmil copper cable</li> <li>• 500 kcmil aluminum cable</li> </ul>	<ul style="list-style-type: none"> <li>• Not for cutting ACSR, guy strand, or other with cables with steel strands</li> <li>• 4" diameter Cu &amp; Al power cables including soft steel armored, lead sheathed, and communications cables</li> <li>• Cycles per Battery Charge: 40 (Approximate)</li> </ul>	<ul style="list-style-type: none"> <li>• 3 3/8" max. diameter copper, aluminum and communications cable</li> </ul>	<ul style="list-style-type: none"> <li>• Est. cycles per charge: 50</li> <li>• Colour-coded copper lugs and splices, 8 AWG to 1000 kcmil</li> <li>• Colour-coded aluminum lugs and splices, 8 AWG to 1000 kcmil</li> <li>• Crimping Force: 30,000 lbs</li> </ul>	<ul style="list-style-type: none"> <li>• ACSR: 1590 kcmil (MCM), (Falcon 54/19)</li> <li>• Standard Guy Strand: 5/8" diameter (16 mm diameter)</li> <li>• EHS Guy Strand: 1/2" diameter (13 mm diameter)</li> <li>• Ground Rod: 5/8" diameter (16 mm)</li> <li>• Rebar (schedule 60) 1/2" diameter (13 mm diameter)</li> <li>• Wire rope: 5/8" diameter (16 mm diameter)</li> <li>• Copper &amp; Aluminum cable: 1500 kcmil (MCM) (800 mm2)</li> <li>• Soft Steel Bolts: 5/8" diameter (16 mm)</li> </ul>

# Greenlee - Battery Powered Tools

	EK425L Crimping Tool	EK425L Crimping Tool	EK622L Crimping Tool	EK1230L Crimping Tool	EK1240L & EK1240KL Crimping Tools
<b>Kit</b>	EK425LD011 CJD30 Crimping Jaws EK425LDBG11 CJD3BG Crimping Jaws EK425LD11 CJD3 Crimping Jaws EK425LK11 CJK Crimping Jaws	EK425LD012 CJD30 Crimping Jaws EK425LDBG12 CJD3BG Crimping Jaws EK425LD12 CJD3 Crimping Jaws EK425LK12 CJK Crimping Jaws	EK622L11  EK622L12	For industry "U" style dies, jaw opening is 1.2":  EK1230L11  EK1230L12	For industry "U" style dies, jaw opening is 1.65": EK1240L11 EK1240L12  For use with Kearney PH2 style dies: EK1240KL11 EK1240KL12
<b>Batteries included with Kit</b>	18V 3.0 Ah Li-ion (30 minute charge time)				
<b>Charger included with Kit</b>	120 Volt Charger	12 Volt Charger	120 Volt Charger 12 Volt Charger	120 Volt Charger 12 Volt Charger	120 Volt Charger 12 Volt Charger
<b>Voltage</b>	18V		18V	18V	18V
<b>Crimping Force</b>	6 Ton		6 Ton	12 Ton	12 Ton
<b>Length</b>	18 1/2"		15 3/4"	14 1/2"	16 1/4"
<b>Width</b>	4" (head open)		2 7/8"	2 7/8"	2 7/8"
<b>Height</b>	-		4 1/2"	12"	12 1/2"
<b>Weight</b>	6.8 lbs		6.5 lbs	15.5 lbs	15 lbs
<b>Est. Cycles/Charge</b>	325		100	60	90
<b>INDUSTRIAL CRIMPING TOOL CAPACITIES</b>					
<b>Copper Lugs</b>	-	-	8-600	8-750	8-750
<b>Copper Slices</b>	-	-	8-600	8-400	8-750
<b>Aluminum Lugs</b>	-	-	8-350	8-750	8-750
<b>Aluminum Splices</b>	-	-	8-350	8-400	8-750
<b>Copper "C" Taps</b>	-	-	12-2	12-400	12-400
<b>Aluminum "H" Taps</b>	-	-	-	6-500	6-500
<b>Aluminum Pin</b>	-	-	6-1/0	6-500	6-750
<b>GROUNDING CRIMPING TOOL CAPACITIES</b>					
<b>Ground Grid</b>	-	-	6-3	6-500	6-500
<b>Connectors</b>	-	-	-	6-500	6-500
<b>Copper "E" Taps</b>	-	-	-	-	-
<b>OVERHEAD CRIMPING TOOL CAPACITIES</b>					
<b>5/8" Service Entrance Connectors</b>	10-1/0 AWG		10-1/0 AWG	10-1/0	10-1/0
<b>.840 Service Entrance Connectors</b>	1/0-4/0 AWG		1/0-4/0 AWG	1/0-4/0	1/0-4/0
<b>Aluminum "H" Taps</b>	6-4/0 AWG		6-4/0 AWG	6-500	6-500
<b>Copper "H" Taps</b>	10-2 AWG		12-2 AWG	12-4/0	12-4/0
<b>Copper Tension Splice</b>	6-2/0 AWG		6-2/0 AWG	6-500	6-500
<b>All Aluminum Tension Splice</b>	6-4/0 AWG		6-4/0 AWG	6-587.5	6-587.5
<b>One Piece ACSR Tension Splice</b>	4-1/0 AWG		4-1/0 AWG	4-556.5	4-556.5
<b>Two Piece ACSR Tension Splice</b>	2 AWG-477 kcmil		2-4/0	2-556.5	4-556.5
<b>Aluminum Jumper Splice</b>	4 AWG-266.8 kcmil		2 AWG-266.8 kcmil	4-556.5	4-556.5
<b>Stirrups</b>	2-4/0 AWG		6-4/0 AWG	6-500	6-500
<b>Aluminum Lugs</b>	8 AWG-500 kcmil		4-4/0	4-556.5	2-556.5
<b>Copper Lugs</b>	8-4/0 AWG		1/0-2/0	1/0-500	1/0-500

# Greenlee - Battery Powered Tools

	EK06ATL/EK06FTL L-Series Quad-Point Crimping Tool	EK12IDL Dieless Crimping Tool	EK628L 6 Ton Crimping Tool	ECCXL 6 Ton Multi-Purpose Tool
Kit	EK06ATL11 EK06ATL12 EK06FTL11 EK06FTL12	EK12IDL11 EKD12IDL12	EK628L11 EK628L12	ECCXL11 ECCXL12
Batteries included with Kit	18V 3.0 Ah Li-ion (30 minute charge time)			
Charger included with Kit	120 Volt Charger 12 Volt Charger 120 Volt Charger 12 Volt Charger	120 Volt Charger 12 Volt Charger	120 Volt Charger 12 Volt Charger	120 Volt Charger 12 Volt Charger
Voltage	18V			
Crimping Force	12,400 lbs	24,000 lbs	12,000 lbs	12,000 lbs
Length	14"	16 1/2"	18 1/2"	16 1/2"
Width	2 7/8"	2 7/8"	2 7/8"	2 7/8"
Height	14"	14 1/2"	4 1/2"	14 1/2"
Weight	12 lbs	15 lbs	6 lbs	14 lbs
Est. Cycles/Charge	100	90	150	300
<b>INDUSTRIAL CRIMPING TOOL CAPACITIES</b>				
Copper Lugs	4-750	4-1000	8-600	8-600
Copper Slices	4-400	4-1000	8-600	8-600
Aluminum Lugs	6-750	6-1000	8-350	8-350
Aluminum Splices	6-750	6-1000	8-350	8-350
Copper "C" Taps	-	-	-	12-2
Aluminum "H" Taps	-	-	-	-
Aluminum Pin	-	-	-	6/10
<b>GROUNDING CRIMPING TOOL CAPACITIES</b>				
Ground Grid	-	-	-	6-3
Connectors	-	-	-	-
Copper "E" Taps	-	-	-	-
<b>OVERHEAD CRIMPING TOOL CAPACITIES</b>				
5/8" Service Entrance Connectors	8-1/0 AWG	-	-	10-1/0 AWG
.840 Service Entrance Connectors	4-350	-	-	1/0-4/0
Aluminum "H" Taps	-	-	-	6-4/0
Copper "H" Taps	-	-	-	12-2
Copper Tension Splice	6-4/0 AWG	-	-	6-4/0 AWG
All Aluminum Tension Splice	-	-	-	6-4/0
One Piece ACSR Tension Splice	4-477	-	-	4-1/0
Two Piece ACSR Tension Splice	-	-	-	2-4/0
Aluminum Jumper Splice	-	-	-	4-266.8
Stirrups	-	-	-	6-4/0
Aluminum Lugs	-	-	-	4-4/0
Copper Lugs	-	-	-	1/0-2/0

## Remote Hydraulic Cutting

- Guillotine cutting heads provide additional safety and cutting control
- Precision blades provide clean cuts every time
- Dual position handles for easy operation and transport
- Lightweight, compact design for professional linemen

Part #	UPC No.	Description
SDG45	01555	Remote ACSR Cable Guillotine Cutter, 45mm
SDG55	01556	Remote ACSR Cable Guillotine Cutter, 55mm
SDG85	01522	Remote Cable Guillotine Cutter, 85mm
SDG105	01526	Remote Cable Guillotine Cutter, 105mm
SDK105	01870	Remote Cable Scissor Cutter, 105mm
01059	01059	Hose Assy, 1/4" x 6' 3/8M&3/8"F Filled
01058	01058	Hose Assy, 1/4" x 6' 3/8M&1/4"M Filled
05850	05850	Hose Assy, 1/4" x 10' 3/8M&3/8"F Filled
17707	17707	Hose Assy, 1/4" x 10' 3/8M&1/4"M Filled



SPECIFICATIONS	SDG45	SDG55	SDG85	SDG105	SDK105
Length	16-5/8" (423mm)	18-18" (460mm)	21" (533mm)	23-3/4" (604mm)	20" (510mm)
Weight	8.38 lbs (3.8 kg)	12.35 lbs (5.6 kg)	9.48 lbs (4.3 kg)	16.98 lbs (7.7 kg)	17 lbs (7.7 kg)
Connector	3/8" NPT Male (Screw-Type)	3/8" NPT Male (Screw-Type)	3/8" NPT Male (Screw-Type)	3/8" NPT Male (Screw-Type)	3/8" NPT Male (Screw-Type)
Communications	1-3/4" (50mm)	2-1/8" (55mm)	3-3/8" (85mm)	4" (105mm)	4" (105mm)
Cu & Al Power Cables ACSR	1590 kcmil (MCM)	2515 kcmil			
Standard Guy Strand	5/8" (16mm)	5/8" (16mm)			
EHS Guy Strand	1/2" (13mm)	9/16" (14mm)			
Ground Rod	5/8" (16mm)	3/4" (19mm)			
Rebar	1/2" (13mm)	5/8" (16mm)			
Wire Rope	5/8" (16mm)	5/8" (16mm)			
Copper & Aluminum Cable	1500 kcmil (MCM)	1500 kcmil (MCM)			

# Greenlee - Hydraulic Crimping Tools

## 12 Ton Crimping Tools

Greenlee LPK1230, LPK1240 & LPK1240K crimping tools do not require a high pressure intensifier and operate on either an open or closed center hydraulic system. A relief valve signals the operator when the crimp is complete. Their crimping force at 1,500 psi is 24,000 lbs. with an operating pressure range of 1,500 - 2,500 psi. Dies and couplers are not included.

### LPK1240K 12 Ton Crimping Tool

- Compatible with dies for Kearney PH-2 and PH-3 tools
- Flow range of 3-9 gpm
- 19.5 lbs



### LPK1230 12 Ton Crimping Tool

- 1.20" jaw opening
- Compatible with dies for Burndy Y35, Alcoa 12A, 12AC, 12HA, 12HAC; Anderson HC-12, HC-12H
- Accepts Standard "U" style dies
- Flow range of 3-9 gpm
- 18.5 lbs



### LPK1240 12 Ton Crimping Tool

- 1.65" jaw opening
- Flow range of 3-9 gpm
- 19.7 lbs.
- Crimps up to 750 MCM copper and aluminum
- Compatible with dies for Burndy Y35, Alcoa 12A, 12AC, 12HA, 12HAC; Anderson HC-12, HC-12H, Thomas & Betts 12-ton



### LPK1550: 15 Ton Crimping Tools

- No high pressure intensifier required
- Crimps cable 500 MCM and larger
- Dies and couplers not included
- 1,500 - 2,500 psi
- Flow range of 3-9 gpm
- Operates on either open or closed center hydraulic systems
- Relief valve signals operator when crimp is complete
- Compatible with dies for: Kearney PH2\*, PH4/PH14; Burndy Y35\*, Y46\*; Penn-Union TPU-15PH\*; Thomas & Betts TBM15PF\*
- May be converted (with adapters) for use with Burndy "U" style dies and Kearney PH2 and some WH2 dies



48820 Burndy Y46, Penn-Union TPU 15BH

48788 Thomas & Betts TBM 15PF

48802 12 Ton U-Die

48824 Kearney PH2

## 60 Ton Crimping Tool

- Accepts Burndy "L" dies and Alcoa "6000 Series" crimping dies
- After completing the connection, the top of the head easily swivels 90° and can be lifted from the tool to remove the connector
- Removing the tool from the stand exposes a lifting eye for when the tool must be used above ground level
- RK6040 requires 10,000 psi single-acting hydraulic power source
- DK6040 requires 10,000 psi double acting hydraulic power source
- Equipped with 3/8" male type hydraulic couplers
- Includes steel carrying case with storage space for dies
- Crimping force at 10,000 psi is 120,000 lbs



RK6040 Single Acting

DK6040 Double Acting

## EHP700LU: Battery-Powered Hydraulic Pump

- Loaded with intelligent features such as a multi-function pressure sensor, self-diagnostics, and a real-time LED readout
- Versatile battery pump can crimp, cut and punch with up to 10,000 psi of pressure
- Mode dial enables the user to select between three primary intelligent program settings: CRIMP, CUT and PUNCH
- Each setting provides specific pressure functionality for the job at hand
- Future proof settings allow for a variety of additional functions to be programmed into the pump via a bi-directional optical connection
- Intelli-CRIMP™ technology monitors the crimping process, ensuring the correct amount of pressure is applied for each crimp
- Real-Time Monitoring is displayed via LED screen and recorded for statistics
- Automatic Retraction detects pressure drop from completed action and releases pressure, preventing damage to head
- Manual Retraction allows user to retract head to starting position at any time

Part #	UPC No.	Description
EHP700LU11	00754	Power Pump, Bat 120V Charger
EHP700LU12	00755	Power Pump, Bat 12V Charger
EHP700LU22	00757	Power Pump, Bat 230V Charger
EHP700LU120	00756	Power Pump, 120V Adapter
EHP700LU230	00758	Power Pump, 230 V Adapter
EHP700LUB	01150	EHP700 Bare Pump
HTA4GL	00759	Remote Control
TG3	01054	Strap
EAC18120	52191	Adapter, AC - 120V to 18V
EAC18230	52192	Adapter, AC - 230V to 18V
52176	52176	Battery, 18V Li Ion 3.0Ah
52178	52178	Charger, Battery 120V
52179	52179	Charger, Battery 230V
52180	52180	Charger, Battery 12V
25766	25766	Adapter, Charger 18V Li to 12V Ni
EL122/32	02042	Hydraulic Fluid, Biodegradable
17707	17707	Hose Assy, 1/4" x 10' 3/8M&1/4M Filled
05850	05850	Hose Assy, 1/4" x 10' 3/8M&3/8F Filled
01058	01058	Hose Assy, 1/4" x 6' 3/8M&1/4M Filled
01059	01059	Hose Assy, 1/4" x 6' 3/8M&3/8F Filled



### SPECIFICATIONS

Operating Pressure:	10,000 psi
Oil Volume:	0.80 qt (0.76l)
Flow Rate of Double Stage Pump:	
Low Pressure Range	up to 0.9 l/min
At Full Pressure	0.3 l/min
Degree of Protection:	IP43
Battery Voltage:	18V
Battery Capacity:	3.0 Ah, Li-Ion

### SPECIFICATIONS

Number of Batteries:	2 - 1 Active, 1 Stored
Charging Time:	30 Minutes
Ambient Temperature:	10°F - 104°F (-12°C to 40°C)
Weight without Batteries:	10.8 lbs (4.9 kg)
Weight with 2 Batteries:	14.1 lbs
Length:	14"
Width:	6.5"
Height:	11.5"



# Compression Dies

BURNDY CSA "U" Dies	
PART #	DESCRIPTION
UCSA1	U-Die
UCSA2	U-Die
UCSA3	U-Die
UCSA20	U-Die
UCSA22	U-Die
USCA22CU	Hexagonal Twin Die
USCA24	U-Die
UCSA24CU	U-Die
UCSA26	U-Die
UCSA26CU	U-Die
UCSA28	U-Die
UCSA28CU	Hexagonal Twin Die
UCSA30	U-Die
UCSA30CU	Hexagonal Twin Die
USCAKIT12	UCSA Kit w/ Case & Dies

BURNDY CSA "L" Dies
LCSA1
LCSA2
LCSA3
LCSA22
LCSA24
LCSA26
LCSA28
LCSA30
LCSA30CU
LCSA32
LCSA32CU
LCSA34CU
LCSA36

RELIABLE CSA DIES	
12 TON DIES	15 TON DIES
UCSA20	UCSA32
UCSA22	UCSA34
UCSA24	
UCSA26	
UCSA28	
UCSA30	

HUSKIE CSA Dies	
HUSKIE	CSA
HTCSA-20	-
HTCSA-22	-
HTSCSA-24	-
HT41PA	CSA-20
HT41PB	CSA-22
HT41PC	CSA-24
HT41PD	CSA-26
HT41-PE	CSA-28
HT41PF	CSA-30W
HT41PL	CSA-20CU
HT41PG	CSA-22CU
HT41PI	CSA-26CU
HT41PJ	CSA-28CU
HT41PK	CSA-30WCU
HT41PM	CSA-1
HT41PN	CSA-2
HT58PA	CSA-20
HT58PB	CSA-22
HT58PC	CSA-24
HT61PF	CSA-30
HT61PK	CSA-30CU
HT61PO	CSA-32
HT61PP	CSA-32CU
HT61PQ	CSA-34
HT61PR	CSA-34CU

# Compression Dies

HUSKIE "HT" SERIES Equivalent to Kearney "O" Type Dies for 4-6 Ton Tools
HT-B
HT-D
HT-J
HT-K
HT-O
HT-P
HT-T
HT-737
HT-781
HT-840
HT-316
HT-14
HT-516
HT-38
HT-12
HT-916
HT-1932
HT-58-1
HT-1116
HT-D3
HT-510
HT-635
HT-747

KEARNEY "O" STYLE DIES For 4-6 Ton Tools
B (30554)
D (26994)
J (48410)
K (40495)
O (26993)
P (30611)
T (40493)
737 (30084)
781 (30450)
840 (30124)
3/16 (36181)
1/4 (30154)
1/3
3/8 (30042)
1/2 (30041)
4/7
19/32 (30914)
5/8 to 1 (26992)
11/16 (40114)
D3
510 (HEX) (100600)
635 (HEX) (100601)
747 (HEX) (100602)

"W" STYLE DIES Equivalent to Burndy "W" Type Dies for 4-6 Ton Tools		
HUSKIE	BURNDY	GREENLEE
HT58AE	W-K840	KD6-13
HT58BX	W-161	KD6-14
HT58BZ	W-162	KD6-15
HT58CB	W-163	KD6-16
HT58CD	W-164	KD6-22
HT58CE	W-165	KD6-17
HT58CF	W-166	KD6-18
HT58CG	W-167	-
HT58CM	W-171	-
HT58G	W-BG	KD6-10
HT58J	W-C	KD6-12
HT58AK	W-O	KD6-11
HT58CUT	CUTTER	-
HT58DE	W-236	-
-	W-237	KD6-24
HT58DG	W-238	-
HT58DH	W-239	KD6-25
HT58DK	W-241	-
HT58DM	W-243	KD6-19
HT58DP	W-245	-
HT58DT	W-247	KD6-20
HT58DV	W-248	-
HT58DW	W-249	KD6-21
HT58KA	W-687	-
HT58HK	W-702	-
HT58AF	W-L	-
-	W-28K	KD6-27

"U" STYLE DIES Equivalent ALCOA/HUSKIE "U" Type Dies for 12 Ton Tools	
HUSKIE	ALCOA
HT4107	74SH-035SH
HT4108	75SH-05SH
HT4109	76SH
HT4111	11AH
HT4120	20AH-14AH
HT4128	74AH-10AH
HT4129	75AH-12AH
HT4130	76AH
HT4131	72AH
HT4132	73AH-08AH
HT4140	07CD
HT4141	08CD
HT4142	09CD
HT4155	72SH-01SH
HT4156	73SH
HT4180	13AH-80EA

# Compression Dies

DIE SELECTION					
APPROXIMATE CONDUCTOR RANGE					
CU	AL	DIE COLOUR CODE	HUSKIE	BURNDY	GREENLEE
6 AWG	8 AWG	BLUE	HT41AT/HT41GL	U5CRT/U8CABT	KC12-6/KA12-8
4 AWG	6 AWG	GREY	HT41AU / HT41GE	U4CRT/U6CABT	KC12-4/KA12-6
2 AWG		BROWN	HT41AW	U2CRT	KC12-2
1 AWG	4 AWG	GREEN	HT41AX	U1CRT	KC12-1
	4 AWG	GREEN	HT41GM	U4CABT	KA12-4
1/0 AWG	2 AWG	PINK	HT41AY	U25RT	KC12-1/0
	2 AWG	PINK	HT41GF	U2CABT	KA12-2
2/0 AWG		BLACK	HT41AZ	U26RT	KC12-2/0
3/0 AWG		ORANGE	HT41BA	U27RT	KA12-3/0
	1/0 AWG	TAN	HT41EX	U25ART	KA12-1/0
4/0 AWG		PURPLE	HT41BC	U28RT	KC12-4/0
	2/0 AWG	OLIVE	HT41EY	U26ART	KA12-2/0
250 MCM		YELLOW	HT41BE	U29RT	KC12-250
	3/0 AWG	RUBY	HT41GW	U27ART	KA12-3/0
300 MCM		WHITE	HT41BF	U30RT	KC12-300
	4/0 AWG	WHITE	HT41EZ	U28ART	KA12-4/0
350 MCM		RED	HT41BJ	U32RT	KC12-350
	250MCM	RED	HT41FW	U29ART	KA12-250
400 MCM		BLUE	HT41BK	U32RT	KC12-400
	300 MCM	BLUE	HT41GZ	U30ART	KA12-300
500 MCM		BROWN	HT41BL	U34RT	KC12-500
	350 MCM	BROWN	HT41FA	U31ART	KA12-350
600 MCM	400 MCM	GREEN	HT41HH/HT41BM	U32ART/U36RT	KA12-400/KC12-600
	500 MCM	PINK	HT41FB	U34ART	KA12-500
750 MCM		BLACK	HT41BP	U39RT	KC12-750
	600 MCM	BLACK	HT41HG	U36ART	KA12-600
	700/750 MCM	YELLOW	HT41LJ	U39ART-2	KA12-750

BURNDY		
12 TON DIES		
WIRE SIZE	COPPER	ALUMINUM
Small #8 Str.	U8CRT	U8CABT
#6, #5 Str.	U5CRT	U6CABT
#4 Str.	U4CRT	U4CABT
#3 Str.	U3CRT	N/A
#2 Str.	U2CRT	U2CABT
#1 Str.	U1CRT-1	U1CART
1/0 Str.	U25RT	U25ART
2/0 Str.	U26RT	U26ART
3/0 Str.	U27RT	U27ART
4/0 Str.	U28RT	U28ART
250kcmil	U29RT	U29ART

BURNDY		
12 TON DIES		
WIRE SIZE	COPPER	ALUMINUM
300 kcmil	U30RT	U30ART
350 kcmil	U31RT	U31ART
400 kcmil	U32RT	U32ART
500 kcmil	U34RT	U34ART
535 Flex kcmil	U38XRT	N/A
600 kcmil	U36RT	U36ART
750 kcmil	U39RT	U39ART2
Large 777 Flex	U44XRT	N/A

# Compression Dies

CUTTERS & CRIMPERS

"U" STYLE DIES Equivalent to Burndy & Kearney "U" Type Dies for 12 Ton Tools		
HUSKIE	BURNDY	GREENLEE
HT41G	U-BG	KD12-10
HT41J	U-C	KD12-12
HT41V	U-D	KD12-30
HT41X	U-D3	KD12-30
HT41Y	U-E	-
HT41Z	U-F	KD12-32
HT41AB	U-H	-
HT41AF	U-L	-
HT41AG	U-M	-
HT41AJ	U-N	-
HT41AK	U-O	KD12-11
HT41AM	U-R	-
HT41BX	U-161	KD12-14
HT41BZ	U-162	KD12-15
HT41CB	U-163	-
HT41CD	U-164	-
HT41CE	U-165	KD12-17
HT41CF	U-166	KD12-18
HT41CG	U-167	-
HT41CJ	U-168	-
HT41CK	U-169	-
HT41CL	U-170	-
HT41CT	U-203	-
HT41DE	U-236	-
HT41DF	U-237	-
HT41DG	U-238	KD12-35
HT41DH	U-239	-
HT41DL	U-242	-
HT41DM	U-243	KD12-19
HT41DP	U-245	-
HT41DT	U-247	KD12-20
HT41DV	U-248	-
HT41DW	U-249	KD12-21
HT41DY	U-251	-
HT41DZ	U-252	-
HT41EK	U-261	-
HT41FG	U-305	-
HT41FM	U-316	-
HT41FN	U-317	-
HT41FU	U-321	-
HT41FX	U-327	-
HT41GK	U-373	-
HT41GX	U-468	-
HT41HM	U-490	-
HT41JM	U-654	KD12-36
HT41JN	U-655	KD12-37

ltutilitysupply.com



# Compression Dies

"U" STYLE DIES Equivalent to Burndy & Kearney "U" Type Dies for 12 Ton Tools		
HUSKIE	BURNDY	GREENLEE
HT41JP	U-658	KD12-38
HT41JR	U-659	KD12-39
HT41KJ	U-705	-
HT41LG	U-788	-
-	U-998	KD12-40
HT41AE	U-K840	-
HT41AX	U1CRT	KC12-1
HT41AW	U2CRT	KC12-2
HT41AV	U3CRT	-
HT41AU	U4CRT	KC12-4
HT41AT	U5CRT	-
HT41AY	U25RT	KC12-1/0
HT41AZ	U26RT	KC12-2/0
HT41BA	U27RT	KC12-3/0
HT41BC	U28RT	KC12-4/0
HT41BE	U29RT	KC12-250
HT41GF	U2CABT	KC12-1/0 / KA12-2
HT41GM	U4CABT	KA12-4
HT41GE	U6CABT	-
HT41GL	U8CABT	KA12-8
HT41BF	U30RT	KC12-300
HT41BJ	U31RT	KC12-350
HT41BK	U32RT	KC12-400
HT41BL	U34RT	KC12-500
HT41BM	U36RT	KC12-600
HT41BP	U39RT	KC12-750
HT41EX	U25ART	KC12-350/KA12-1/0
HT41EY	U26ART	KA12-2/0
HT41GW	U27ART	KA12-3/0
HT41EZ	U28ART	KC12-300 / KA12-4/0
HT41FW	U29ART	KA12-250 KC12-350
HT41GZ	U30ART	KA12-300 KC12-400
HT41FA	U31ART	KA12-350 KC12-500
HT41HH	U32ART	KA12-400 KC12-600
HT41FB	U34ART	KA12-500
HT41HG	U36ART	KA12-600
HT41LJ	U39ART2	KA12-750
HT41CUT	CUTTER DIES	-
HT41TEST	TEST DIES	-

# Compression Dies

HT41 SERIES Equivalent to Kearney "U" Type Dies for 12 Ton Tools	
HUSKIE	
HT41KA	
HT41KB	
HT41KC	
HT41 KD	
HT41KE	
HT41KF	
HT41KG	
HT41KH	
HT41KI	
HT41KK	
HT41KL	
HT41KM	
HT41KN	
HT41KO	
HT41KP	
HT41KQ	
HT41KR	
HT41KS	
HT41KT	
HT41KU	
HT41KV	
HT41AE	
HT41U	
HT41KX	

HT61 SERIES Equivalent to Burndy "P" Type Dies for 15 Ton Tools	
HUSKIE	BURNDY
HT61BP	P39RT
HT61BR	P40RT
HT61BU	P44RT
HT61BV	P46RT
HT61KX	P724
PU15	DIE ADAPTER
HT61FC	P39ART
HT61HJ	P40ART
HT61FD	P44ART
HT61AC	PKR
HT61AJ	PN

HTK SERIES Equivalent to Kearney "WH-2" (10.7 Ton) & "WH-3" (12 Ton) Type Dies	
HUSKIE	KEARNEY
HTK-BKT	BKT (36832)
HTK-C	C (36830)
HTK-D	D (36457)
HTK-N	N (36459)
HTK-O	O (36467)
HTK-P	P (36828)
HTK-U	U (36472)
HTK-510	510 (36838)
HTK-572	572 (36836)
HTK-635	365 (36482)
HTK-727	727 (40063)
HTK-737	737 (36480)
HTK-12	1/2 (36940)
HTK-747	747 (36834)
HTK-781	781 (36478)
HTK-840	840 (36476)
HTK-14	1/4 (36498)
HTK-516	5/16 (36496)
HTK-38	3/8 (36494)
HTK-12	1/2 (36490)
HTK-916	9/16 (36488)
HTK-1932	19/32 (36486)
HTK-58-1	5/8 to 1 (36484)
HTK-1116	11/6 (40151)
HTK-34H	3/4 (HEX) (49435)
HTK-2932H	19/32 (HEX) (49437)
HTK-1516	15/16 (36474)
HTK-1-2H	1-2 (HEX) (100399)
HTK-1-18-2H	1-1/8 (HEX) 36463 (-1) 100400 (-2)
HTK-1-516H	1-5/16 (HEX) (100433)
HTK-1-12H	1-1/2 (HEX) (100434)

# Compression Dies

HA60 SERIES Equivalent to ALCOA 60 Ton Dies
HUSKIE
HA60-01
HA60-02
HA60-03
HA60-04
HA60-05
HA60-06
HA60-07
HA60-08
HA60-09
HA60-20
HA60-21
HA60-22
HA60-23
HA60-24
HA60-25
HA60-26
HA60-27
HA60-28
HA60-29
HA60-30
HA60-40
HA60-41
HA60-42
HA60-43
HA60-44
HA60-45
HA60-46
HA60-47
HA60-48
HA60-49
HA60-50

ALCOA SERIES 60 Ton Dies
ALCOA
6010SH
6012SH
6014SH
6016SH
6018SH
6020SH
6074SH
6075SH
6076SH
6020AH
6024AH
6027AH
6030AH
6034AH
6036AH
6038AH
6040AH
6074AH
6075AH
6076AH
6007CD
6008CD
6009CD
6010CD
6011CD
6012CD
6013CD
6014CD
6015CD
6016CD
6017CD

HA610 SERIES Equivalent to ALCOA 100 Ton Dies
HUSKIE
HA100-01
HA100-02
HA100-03
HA100-04
HA100-05
HA100-06
HA100-07
HA100-08
HA100-20
HA100-21
HA100-22
HA100-23
HA100-24
HA100-25
HA100-26
HA100-27
HA100-28
HA100-29
HA100-30
HA100-34
HA100-36
HA100-37
HA100-38
HA100-40
HA100-41
HA100-42
HA100-43
HA100-44
HA100-45
HA100-46
HA100-47
HA100-48
HA100-49
HA100-50
HA100-51
HA100-52
HA100-53

ALCOA SERIES 100 Ton Dies
ALCOA
10010SH
10012SH
10014SH
10016SH
10018SH
10020SH
10074SH
10075SH
10020AH
10024AH
10027AH
10030AH
10034AH
10036AH
10038AH
10040AH
10074AH
10075AH
10076AH
10042AH
10044AH
10046AH
10048AH
10007CD
10008CD
10009CD
10010CD
10011CD
10012CD
10013CD
10014CD
10015CD
10016CD
10017CD
10018CD
10019CD
10020CD

# Compression Dies

R6 SERIES - 6 TON DIES	
R6-BG	R6-241
R6-C	R6-242
R6-K840	R6-243
R6-L	R6-245
R6-O	R6-247
R6-Q	R6-248
R6-161	R6-249
R6-162	R6-251
R6-163	R6-660
R6-164	R6-687
R6-165	R6-690
R6-167	R6-691
R6-171	R6-693
R6-236	R6-694
R6-237	R6-702
R6-238	R6-733
R6-239	R6-28K
R6-240	

R6K SERIES - 6 TON DIES KEARNEY "O" STYLES			
30554	B	30043	5/16
26994	D	30042	3/8
48410	J	30041	1/2
40495	K	26958	9/16
26993	O	30914	19/32
30611	P	26992	5/8-1
40493	T	40114	11/16
30084	737	26994	D3
30450	781	100600	510-HEX
30124	840	100601	635-HEX
36181	3/16	100602	747-HEX
30154	1/4	100606	980-HEX

R12K SERIES - 12 TON DIES KEARNEY "WH2" STYLES			
36832	KT	36498	1/4
36830	C	36496	5/16
36457	D	36494	3/8
36459	N	36490	1/2
36467	O	36488	9/16
36828	P	36486	19/32
36472	U	36484	5/8-1
36838	510	40151	11/16
36836	572	49435	3/4-H
36482	635	49437	29/32-H
40063	727	100370	15/16-H
36480	737	100399	1-2-H
36834	747	100400	1-1/8-2-H
36478	781	100433	1-5/16-H
36476	840	100434	1-1/2-H

R12 SERIES - 12 TON DIES	
R12-BG	R12-238
R12-C	R12-239
R12-D	R12-240
R12-D3	R12-241
R12-E	R12-242
R12-F	R12-243
R12-H	R12-245
R12-L	R12-247
R12-M	R12-248
R12-N	R12-249
R12-O	R12-250
R12-R	R12-251
R12-161	R12-252
R12-162	R12-253
R12-163	R12-255
R12-164	R12-257
R12-165	R12-261
R12-166	R12-267
R12-167	R12-276
R12-168	R12-304
R12-169	R12-305
R12-170	R12-308

R12-202	R12-313
R12-203	R12-316
R12-209	R12-317
R12-210	R12-321
R12-236	R12-327
R12-237	R12-329
R12-350	R12-5CRT
R12-373	R12-8CRT
R12-468	R12-25RT
R12-490	R12-26RT
R12-552	R12-27RT
R12-608	R12-28RT
R12-609	R12-29RT
R12-642	R12-30RT
R12-654	R12-31RT
R12-655	R12-32RT
R12-658	R12-34RT
R12-659	R12-36RT
R12-660	R12-39RT
R12-668	R12-25ART
R12-676	R12-26ART
R12-677	R12-27ART
R12-678	R12-28ART

R12-679	R12-29ART
R12-691	R12-30ART
R12-693	R12-31ART
R12-694	R12-32ART
R12-705	R12-34ART
R12-708	R12-36ART
R12-778	R12-39ART
R12-840	
R12-997	



# Greenlee - Tools & Accessories

## Ultra Glider™

- Automatically applies cable lube during a cable pull
- Includes a 3 speed pump unit, an applicator, and a dolly designed to transport a 5 gallon bucket of lubricant around the jobsite
- Reduces number of people needed at the feeding end of a cable pull
- Keeps operators' hands away from where the cable enters conduit or duct
- Applies lube more evenly around the cable and down the length of the cable, preventing cable jacket damage



- UG511T** Ultra-Glider 120V including Threaded Applicator Kit UGTAK
- UG511ST** Ultra-Glider 120V Including Slip-In Applicator Kit UGSAK and Threaded Applicator Kit UGTAK
- UG512S** Ultra-Glider 12V Including Slip-In Applicator Kit UGSAK and Threaded Applicator Kit UGTAK
- UG512T** Ultra-Glider 12V including Threaded Applicator Kit UGTAK
- UG512ST** Ultra-Glider 12V Slip-in Applicator Kit UGSAK and Threaded Applicator Kit UGTAK
- UG511** Ultra-Glider 120V Assembly without Applicators
- UG512** Ultra-Glider 12V Assembly without Applicators
- UGSAK** Slip-In Applicator Kit - Includes 2", 2.5", 3", 3.5", 4" Applicators with Case
- UGTAK** Threaded Applicator Kit - Includes 2", 2.5", 3", 3.5", 4" Applicators with Case

## 542-250: Fiberglass Fish Tape in Reel Stand - 250 ft Fish Tape

- High-impact nylon, one-piece handle for maximum durability and comfortable use
- Non-conductive fiberglass tape with low friction coating
- Unique non-coiling properties enable it to fish in large and small conduit equally well, even with wire or cable in place
- Fiberglass fish tape is the fastest manual fish tape available
- 3/16" diameter and 300 lbs maximum design strength



## 35213: Cable-Gel™ Cable Pulling Lubricant

- Polymer-based lubricant offers lower friction and easier pulling
- Environmentally safe and non-hazardous
- Compatible with all cable insulation types
- Higher lubricity than competitive products; will not cement itself to the pipe
- Dries slowly; apply by hand or pump
- Will not break down or separate after exposure to heat or cold
- Viscosity 8,000 - 12,000 CPS PH Range 7.0 - 8.0



## 430: Greenlee Poly Line - 6500 ft

- Use with power fishing systems directly from the container
- Resists tangling when dispensing
- Rot and mildew resistant
- Handy reusable plastic dispenser pail with handle keep the line dry
- Use to pull rope through conduit
- 210 lbs. average breaking strength



## 489: Cable Guide

- Helps protect cable from being damaged on sharp edges



## Manhole Sheave

- High strength aluminum alloy frame for easy setup
- Adjustable, a full range of sheave pin positions to accommodate most manhole setups
- 18" diameter aluminum alloy sheaves with 7" minimum radius and 5" width
- Self-lubricating bearings for easier cable pulling
- Select a sheave with maximum rated capacity that meets or exceeds the cable puller's maximum pulling force

**15345 10' (158 lbs.) Capacity 4,000 lbs.**

**31395 12' (190 lbs.) Capacity 6,500 lbs.**



## 800F1725: Hydraulic Cable Bender

- 600V
- 350 - 1000 kcmil capacity
- 350 - 750 kcmil compact cable
- One-shot bends up to 90° and automatically unloads cable
- Compact design bends in tight places
- Unit with foot pump keeps both hands free to hold cable
- Includes hydraulic cable bender with 1725a foot pump, high pressure hose unit and storage box



## 796: Ratchet Cable Bender

- Capacity: through 500 kcmil (MCM), 600V, copper or aluminum cable
- Simplifies and speeds cable installation
- 10" ratchet extension is furnished to simplify bending in deep enclosures
- Includes ratchet wrench, L-wrench, ratchet extension, bending shoe assembly and storage box



## Lube Spreader Swab

- Spreads a coat of wire lubricant in duct before installation of cable
- Cleans mud, dirt, and light debris from duct before pulling
- Will not damage inner walls of duct
- Maximum rated capacity 4800 lbs
- Tapered shape permits bi-directional use

**16854 2" 1 3/4"**

**16856 2 1/2" 2 1/4"**

**16857 3" 2 3/4"**



## Woven Aramid\* High Strength Conduit Measuring Tape

- Pull small cables or install pull rope for large cable pulling jobs
- Will not rot or deteriorate; can be left in ducts indefinitely for future use
- Low stretch properties make measurements accurate
- Printed measurements every foot from zero to 3000'

**39143 1/4" x 3000' 1250 lb Capacity**

**39144 3/8" x 3000' 1800 lb Capacity**

**39245 1/2" x 3000' 2500 lb Capacity**

**\* Woven Aramid material equivalent to Kevlar®**



# Greenlee - Tools & Accessories

## Conduit Pistons

- Use with blower or vacuum power fishing system to pioneer the line through the conduit run
- Colour coded end disk with embossed size markings for fast, easy selection
- Strong steel center rod with loops on both ends
- Pistons available for all types, sizes of conduit 1/2" to 6"
- Flexible foam body for an airtight seal



## 690-15: Power Fishing System

- Industrial 2-Stage Motor – Powerful, sustained suction and blowing that out-performs a typical shop vacuum
- Washable Stainless Steel Filter – Stainless steel mesh filter that, when maintained, never needs replacing
- Steel Transport Handle – Long handle to easily pull vacuum around the jobsite and up stairs
- Fully Equipped Power Fishing System – 690 system comes with all the accessories needed to fish a pulling line and a new locking storage box to hold it all
- Large Durable Tank – Large 12 gallon tank for wet or dry vacuum and storage for the available 10', 15', or 25' hoses
- Large 8" Wheels – Industrial wheel and axle system make transportation on rough ground or up stairs easy



Part #	Conduit Size	Conduit Type
608-5*	1/2"	All
609-5*	3/4"	All
610-5*	1"	All
611-3*	1 1/4"	All
612-2*	1 1/2"	All
613	2"	All
614	2 1/2"	IMC, Rigid
621	2 1/2"	EMT
615	3"	IMC, Rigid
622	3"	EMT
616	3 1/2"	IMC/Rigid
646	3 1/2"	EMT
617	4"	IMC/Rigid
623	4"	EMT
618	5"	All
619	6"	All
S2613	1/2"-2"	All
34317	2 1/2" - 4"	EMT

\*Multi-Packages

## UT-10 Ultra Tugger Cable Puller w/ Mobile VersiBoom

- 2 Speed Ultra Tugger (UT10-2S) is a one-stop-shop: The only 2 speed puller on the market that can shift from high speed/low load pulling to low speed/high load pulling with a simple double tap motion on the foot pedal control switch
- Use for cable pulls requiring high as well as low pulling loads
- The no-load high speed is 16 ft/min and is best suited for loads up to 4000 lbs where the speed will be 12 ft/min
- The no-load low speed is 9 ft/min and can be used on loads up to 8000 lbs where the speed will be 6 ft/min, or a momentary peak capacity of 10,000 lbs
- 2-Speed motor that delivers the fastest pulling time for all pulling needs over the widest (10,000 lbs) range
- Strong, rugged motor designed specifically for both big and small cable pulling applications up to 10,000 lbs
- Easy control features for increased productivity: On-board force gauge provides visual communication of pulling force and speed changes
- Quick speed change from high speed to low-speed by simply double tapping foot pedal
- Removable foot pedal for convenience
- Sets up in less than 2 minutes and can be used in every pulling situation
- This combination of speed and versatility can increase your productivity, equaling more pulls in a day and delivering greater benefit to your bottom line

## 591: Portable Power Blower Fishing System

- Powerful, will blow line or measuring tape in up to 4" conduit
- Portable, lightweight blower has a shoulder strap to make it easy to carry and allow the operator to have both hands free
- Efficient, includes the Mighty Mouser® blow gun for fast, easy line blowing

### System Includes:

<b>Mighty Mouser Blow Gun</b>	<b>Adapter Nozzle for Tape and Line</b>
<b>2150' of 85 lbs strength fish line</b>	<b>Portable Blower</b>
<b>Adapter Cone 1/2" - 1" conduit</b>	<b>Flexible Hose 1 1/2" dia. x 4'</b>
<b>Adapter Cone 1 1/4" - 2 1/2" conduit</b>	<b>1/2" conduit x 150' line pkg. 10 qty</b>
<b>Adapter Cone 3" - 4" conduit</b>	<b>3/4" conduit x 200' line pkg. 5 qty</b>
<b>Flexible Hose 1 1/2" dia. x 1'</b>	<b>3/4" conduit x 450' line pkg. 5 qty</b>
<b>Hose Clamp</b>	<b>1" conduit x 200' line pkg 5 qty</b>
<b>Storage Box</b>	<b>1" conduit x 450' line pkg 5 qty</b>
<b>Pistons 608-5 through 623</b>	



## GATOR Grips™ Crimp-On Cable Pulling Grips

- Maximize contractor productivity by reducing cable pull set-up times
- Fast installation in 2 minutes! Use the Greenlee EK12IDL or HK12ID crimping tool to crimp any size of regular, compressed compact copper and aluminum cable from 1 AWG to 1000 Kcmil without having to change dies
- Versatile - Use with copper and aluminum stranded cables (both regular, compressed and compact stranded)
- Only 6 grips needed to cover cable sizes from 1 AWG through 1000 Kcmil
- Parallel up to 5 conductors on the same reel with no overlap



Part #	Description	Overall Length
GG1-1/OS	Short	20 1/2"
GG1-1/OM	Medium	27 1/2"
GG1-1/OL	Long	34 1/2"
GG2/0-4/OS	Short	20 1/2"
GG2/0-4/OM	Medium	27 1/2"
GG2/0-4/OL	Long	34 1/2"
GG250-350S	Short	20 1/2"
GG250-350M	Medium	27 1/2"
GG250-350L	Long	34 1/2"
GG400-500S	Short	20 1/2"
GG400-500M	Medium	27 1/2"
GG400-500L	Long	34 1/2"
GG600-750S	Short	20 1/2"
GG600-750M	Medium	27 1/2"
GG600-750L	Long	34 1/2"
GG1000S	Short	20 1/2"
GG1000M	Medium	27 1/2"
GG1000L	Long	34 1/2"

# Greenlee

## Feeding Sheaves



- Yoke frame slides into the end of conduit and holds sheave, allowing cable being fed into the conduit to smoothly roll over the sheave
- 5" wide aluminum alloy sheave with self-lubricating bearings
- Split tube for easy removal after cable is installed

### SPECIFICATIONS

Part #	Description		Weight (lbs)	Width of Shaft Opening
441-2	Feeding Sheave for 2" Conduit	441-2	9	1.24"
441-2 1/2	Feeding Sheave for 2 1/2" Conduit	441-2 1/2	11	1.37"
441-3	Feeding Sheave for 3" Conduit	441-3	14	1.79"
441-3 1/2	Feeding Sheave for 3 1/2" Conduit	441-3 1/2	17	1.75"
441-4	Feeding Sheave for 4" Conduit	441-4	19	1.99"
441-5	Feeding Sheave for 5" Conduit	441-5	26	2.23"
441-6	Feeding Sheave for 6" Conduit	441-6	28	2.75"



## 1325P & 1400P: Electric Ventilators, Axial - Polyethylene

- The Model 1325P 120 VAC, electric ventilator is constructed of a durable, weather-resistant, high-impact polyethylene plastic
- The CSA and CEESI certified unit will accept any 8" ventilator duct or our AIRPAC series
- The unit also comes in 12 VDC (model 1400P). Weighing only 17 lbs, the unit provides as much as 921 CFM. This Model is CSA, CEESI Certified.



	1325P	1400P
Power	Electric - 1/3 HP 120 VAC, 3 AMP	1/4 HP 12 VDC, 15 AMP
Certifications	CSA, CEESI	CEESI
Dimensions	18" L x 14" W x 15" H	18" L x 14" W x 15" H
Weight	17 lbs	17 lbs
Free Air (certified)	921 cfm	814 cfm
w/ one 90° bend	575 cfm	478 cfm
w/ two 90° bends	546 cfm	479 cfm

## 1375P & 1475P: Electric Axial Ventilators with AIR-PAC, Polyethylene

- A Pelsue "Air-Pac" consists of an Axial Ventilator, High Retraction or SpaceMaker Hose and Storage Canister
- The models vary from 120 VAC, 60 Hz to 220 VAC, 50Hz; 15' or 25' of hose stored in canister or our special spacemaker hose
- All the models are third party certified by CEESI and CSA and all are constructed to CE requirements
- The light weight casing are made from a High-Density Polyethylene



	1375P	1475P
Power	Electric - 1/3 HP 120 VAC, 3 AMP	Electric - 1/4 HP 12 VDC, 15 AMP
Certifications	CSA, CEESI	CEESI
Dimensions	37" L x 13" W x 14.5" H	37" L x 13" W x 14.5" H
Weight	36 lbs	36 lbs
w/ one 90° bend	575 cfm	478 cfm
w/ two 90° bends	546 cfm	479 cfm

## 1325D & 1400D: Electric Axial Ventilators - Steel

- Models 1325D & 1400D are constructed with high a grade steel housing
- Model 1325D is a 120 VAC, 60Hz electric ventilator, Model 1400D is a 12VDC electric ventilator
- All the models are third party certified by CEESI and CSA and all are constructed to CE requirement



	1325D	1400D
Power	Electric - 1/3 HP 120 VAC, 3 AMP	Electric - 1/4 HP 12 VDC, 15 AMP
Certifications	CSA, CEESI	CEESI
Dimensions	14.5" L x 13" W x 14.5" H	14.5" L x 13" W x 14.5" H
Weight	20 lbs	20 lbs
Free Air (certified)	1075 cfm	922 cfm
w/ one 90° bend	668 cfm	541 cfm
w/ two 90° bends	585 cfm	518 cfm
Static Pressure	2.09" W.C.	1.46" W.C.

# Pelsue

## 1000, 1200 & 1240: Electric Centrifugal Ventilators

- The ventilator wheel, or “squirrel cage” design gives our centrifugal ventilators the ability to push air further, around bends in the hose, resulting in higher static pressures
- Centrifugal is preferable to Axial when more than 50’ of hose and/or more than three bends are required
- This ventilator is specifically designed to provide a convenient and portable source of air. Positive pressure ventilators are tested to AMCA PPV Standard 240-95, for use in extreme conditions
- This ventilator is designed for high powered air movement, propeller produces a greater intake of air and eliminates turbulence at the tips. Each blade is statically balanced for high efficiency and long life
- The 1200 models offer high static pressure ventilation with the ability to switch from high speed for purging to low speed for continuous ventilation. This Model is CEESI Certified
- The 1240 models offer high static pressure ventilation with the ability to switch from high speed for purging to low speed for continuous ventilation. This Model is CSA, CEESI Certified

	1000	1200 (High)	1200 (Low)	1240 (High)	1240 (Low)
<b>Power</b>	Electric - 1/3 HP 120 VAC, 60Hz	Electric 1/3 HP, 120 V AC, 60 Hz	Electric 1/9 HP, 120 V AC,	Electric 1 HP, 120V AC, 12 AMP	Electric 1/3 HP, 120V AC, 7 AMP
<b>Certification</b>		CEESI	CEESI	CSA, CEESI	CSA, CEESI
<b>Measurements</b>	15”H x 14 5/8”W x 15 1/4”L	15”H x 15.5”W x 15.5”L	15”H x 15.5”W x 15.5”L	17.5”H x 18.5”W x 18.5”L	17.5”H x 18.5”W x 18.5”L
<b>Weight</b>	35 lbs	45 lbs	45 lbs	54 lbs	54 lbs
<b>w/ one 90° bend</b>	924 cfm	853 cfm	581 cfm	810 cfm	526 cfm
<b>w/ two 90° bends</b>	807 cfm	761 cfm	489 cfm	805 cfm	506 cfm
<b>Features</b>	Low maintenance Specifically designed to provide a completely portable source of fresh air				
<b>Materials &amp; Construction</b>	Main structure: Steel Hardware: Plated Steel				
<b>Additional Requirements &amp; Notes</b>	Centrifugal Blower is a single-speed blower	Static Pressure: 2.03” W.C.	Static Pressure: 0.97” W.C.	Static Pressure: 1.69” W.C.	Static Pressure: .655” W.C.



1000



1200



1240

## 1450 & 1453: Gas-Powered Centrifugal Ventilator

- The models 1450 and 1453 provides total portability in a high volume ventilator. Compact and light weight, these ventilators are dampened against excessive vibration. The model 1450 uses a Briggs & Stratton engine. Model 1453 uses a Honda Motor. These models are CEESI Certified.



	1450	1453
<b>Power</b>	(Briggs & Stratton) Gasoline - 3.5 HP 3600 RPM	(Honda) Gasoline - 4 HP 3600 RPM
<b>Certifications</b>	CEESI	CEESI
<b>Dimensions</b>	18.5"L x 15.25"W x 14.5"H	18.5"L x 15.25"W x 14.5"H
<b>Weight</b>	55 lbs	55 lbs
<b>Free Air (certified)</b>	1526 cfm	1526 cfm
<b>w/ one 90° bend</b>	1360 cfm	1360 cfm
<b>w/ two 90° bends</b>	1255 cfm	1255 cfm
<b>Static Pressure</b>	5.71" W.C.	5.71" W.C.

## 2000 Series Ventilator Hoses: 2015HRT, 2025HRT, 2015HD, 2025HD, 2006N, 2015N & 2025N

- Three styles of high quality 8" dia. (20cm) ventilation hoses
- Hoses have cuff & strap at one end



MODEL	DESCRIPTION
2015HRT	Standard Wt. 15L (4.57 m)
2025HRT	Standard Wt. 25L (7.62 m)
2015HD	Heavy Duty Wt. 15L (4.57 m)
2025HD	Heavy Duty Wt. 25L (7.62 m)
2006-N	Insulated, 6L (1.82 m)
2015-N	Insulated, 15L (4.57 m)
2025-N	Insulated, 25 L (7.62 m)



# Pelsue

## 6506/08/10A: "A" Style Ground Tent

- "A" Model Tents include two screen windows with roll up flaps, three tie down cords through the hub, ground flaps, heavy duty frame, wide open front, dual zipper roll up door, ventilation hose entry sleeve, interior and exterior roof line loops for tie down, carrying case and three tent stakes



Part #	Size (in)	Weight (lbs)	Folded Dimensions (in)
6506A	70 x 70	20	6 x 56
6508A	94 x 94	31	7 x 66
6510A	118 x 118	34	8 x 76

## 6506D: "D" Style Ground Tent

- "D" Model tents include two screen windows with roll up flaps, three tie-down cords through the hub, ground flaps, heavy-duty-frame, wide open front, snap and D-rings with inter-connectable flaps (connect 2 tents together), ventilation hose entry sleeve, interior and exterior roof line loops for tie-down, carry case and three tent stakes



Part #	Size (in)	Weight (lbs)	Folded Dimensions (in)
6506D	70 x 70	21	6 x 56

## DuraHoist Portable Confined Space Systems

- DuraHoist Complete Four-Piece Confined Space Systems consist of a One-Piece Adjustable Mast (DH-3/) and Three-Piece Portable Base (DH-4/)

### Suggested applications:

- Public Utilities: Vault and manhole entry, pump/lift/valve stations, water treatment and wastewater industries
- General Industry (Food, Chemical, Pulp and Paper): Elevated manholes, storage tanks, platforms/mezzanines, underground vaults, clarifier tanks, pre-heaters

### Features:

- System breaks down into four lightweight aluminum components for easy storage, transport and set-up. No tools required for assembly
- Overall system height adjusts from 79" (2.01 m) to 100" (2.54 m)
- Modular design allows the use of various fixed and portable bases and an optional mast with extensions
- Multiple winches and/or lifeline systems may be mounted as required



# Underground Equipment



## Pelsue 3025A & 3035A: Ventilator Accessories - Hose Storage

- The "Pel Can" Hose Storage features steel construction and coated with a weather resistant, safety yellow powder coat finish
- Model 3025A holds all HRT & 2015HD hoses
- Model 3035A holds all "N" models & 2025HD hoses

## Pelsue Hose Storage

- The "Pel Can" Hose Storage features Steel construction, and coated with a weather resistant, safety yellow powder coat finish. Model 3025A holds all HRT & 2015HD hoses. Model 3035A holds all "N" models & 2025HD hoses.



## Pelsue 2775: Lid Lifter

- Model 2775 weighs only 12.5 lbs (5.6 kg) and has a special handle to allow for a better grip
- It is also designed to remove ice or dirt by using the built-in scraper
- This model features a heat treated hook that can lift manhole covers which are equipped with a hole
- The hook locks in the handle when not in use

## Featherlite 5300 Series: Super Heavy Duty Straight Ladders

- Durable non-conductive fiberglass side rails in high visibility safety yellow
- Riveted rung to rail design maintains continuous strength of fibers and allows for easy repair
- Slip-resistant serrated rungs for safe climbing
- Black ABS, high impact non-marring end caps
- 5300 features vinyl coated hoop ends, and 36" long rail sleeves that protect the ladder from rims and edges
- Compliance with ANSI A14.5 /OSHA (CSA Not Applicable)



Model	Size	Outside Width	Inside Width	Approximate Weight (lbs)
5308	8'	12 1/8"	9 3/4"	21
5310	10'	12 1/8"	9 3/4"	25
5312	12'	12 1/8"	9 3/4"	27
5314	14'	12 1/8"	9 3/4"	32
5316*	16'	12 1/8"	9 3/4"	36

\*300 lbs Load Rating



# General Machine Products

## MANHOLE ACCESS TOOLS

### 06867: Manhole Guard Rail

- Helps protect field crews when working in and around manhole vaults
- Folds into a compact 2 1/2" x 33 1/4" rectangle, yet opens easily into a large 32" wide by 32" deep by 42" high cube
- Features two "D" rings welded to the frame for attaching our Splicer's Combination Tent
- The guard is also compatible with GMP's Umbrella Tent



### 08172: Manhole Cover Hook

- For prying loose conventional manhole covers
- Made from octagon plated tool steel that's been specially hardened to prevent bending



### Utility Manhole Cover Lifter

- Designed for use with a wide variety of covers
- The plated steel tubular body has been made thicker for the typically heavier electric utility manhole covers
- Multiple hooks or "keys" are available to be placed on the shackle at the end of the lifter's galvanized chain, allowing one tool to remove multiple cover types



Part #	Lifter 70066	Small J-Hook	Medium L-Hook	Large J-Jook
70151	X	X	X	
70152		X		
70153	X		X	
70154	X			X
70155	X	X	X	
70156		X		X
70157	X	X	X	X

### Manhole Cover Lifter

- Simplifies the removal and replacement of typical telephone manhole covers while decreasing the strain on the user
- Long handle provides useful leverage when removing and replacing manhole covers
- Made of an all-steel handle, sleeve, shank, foot and heat-treated alloy steel hook
- The open end of the hook can be locked inside the handle as an added safety feature when not being used



01368	Manhole Cover Lifter
13681	Manhole Cover Lifter w/ Spiked Foot

## DUCT CLEANING, PROOFING & RODDING

### Heavy Duty Stiff Spine Conduit Cleaners



- Cleans stubborn foreign matter from a partially obstructed conduit
- Oil tempered, spring steel bristles are looped through a mounting plate, providing extreme durability and resistance to loss
- Hundreds of cutting edges line each side of the cleaner for thorough cleaning action throughout the conduit in either direction

Part #	Conduit ID	Body Length	Work Load Limit
10152	2"	4"	1250 lbs
10153	2.5"	4"	1250 lbs
10154	3"	5.25"	1250 lbs
10155	3.5"	5.25"	1250 lbs
10156	4"	5.25"	1250 lbs
10157	5"	5.25"	1250 lbs
10158	6"	5.25"	1250 lbs

### GMP Stiff Spine Conduit Brushes

- Help clean foreign matter in a lightly obstructed conduit before placing cable
- Hundreds of cutting edges line each side of the brush, so that you'll get cleaning in either direction
- Available in ranges of sizes for your different cleaning operations



Part #	Conduit ID	Weight	Work Load Limit
17091	2"	3 lbs	600 lbs
17025	2.5"	3 lbs	600 lbs
17092	3"	4.5 lbs	600 lbs
17093	3.5"	6 lbs	600 lbs
17094	4"	6 lbs	600 lbs
17050	5"	6.5 lbs	600 lbs

## GMP Rubber Duct Swabs

- Flexible cable is suitable for tight bends
- Rubber Duct Swabs are pulled through your duct system after conduit is installed to verify duct integrity, to clean dirt and residue from installation, to provide a clean raceway for ease of cable placement
- Assists in the spreading of lubricant throughout the duct



### Long Duct Swabs:

Part #	Conduit ID	Weight
10116	2"	2.5 lbs
10117	3"	4.1 lbs
10118	3 1/2"	5.8 lbs
10119	4"	6.8 lbs
10121	6"	13 lbs
10122	8"	22 lbs

### Short Duct Swabs:

Part #	Conduit ID	Weight
10123	2"	1.25 lbs
10124	2 1/2"	1.45 lbs
10125	3"	1.75 lbs
10126	3 1/2"	2.24 lbs
10127	4"	2.71 lbs
10128	5"	3.53 lbs
10129	6"	4.62 lbs
10130	8"	7.93 lbs

## GMP Washer Duct Cleaner

- Cleans conduit less abrasively
- Disks are made from tough leather in graduated sizes for wiping the inside of the conduit
- An alternative to Stiff Spine Cleaners

### Part # Conduit ID

10142	2 1/2"
10143	3"
10146	3 1/2"
10144	4"
10145	5"



## Aluminum Test Mandrels

- Test Mandrels are pulled through your duct system after conduit is installed to verify duct integrity and to comply with the ovality specification the owner may have
- Made from solid aluminum for durability and corrosion resistance
- Cable is suitable for tight bends



### Part # Conduit ID Weight

10109	2"	1 lb
10110	2 1/2"	1.5 lbs
10111	3"	2.5 lbs
10112	3 1/2"	3.5 lbs
10113	4"	6.5 lbs
10114	5"	10.5 lbs
10115	6"	15 lbs

## 89004: Powered Duct Rod Pusher

- With GMP's Powered Duct Rod Pusher and a 1/2" GMP Duct Rodder, the job of placing pulling lines or fiber cables just got that much easier with less personnel in old or occupied conduits
- Hydraulically powers GMP 1/2" Duct Rodders into and out of conduits
- Pushes and pulls with forces up to 300 lbs
- Rod speeds up to 130'/min (40 meters/min)
- Accurately measures footage and speed with an electronic monitoring system that works in either direction. The readout can be scaled to feet or meters
- When pulling back, the fiberglass rod is placed directly back onto the cassette
- Features rod access areas for wiping the rod clean during the pull back operation. Also comes with a package of rod wiper pads (GMP #32290)
- Duct Clamp on the machine, and the specially designed Duct Mounting
- Clamp Assembly (GMP #32221) provided on the rodder cassette, help stabilize both pieces of equipment during use
- Comes with a gasoline driven power pack and hoses
- Pusher is mounted on a lightweight, anti-corrosion treated, tubular-steel frame that can be tilted at a 30-degree angle to the manhole to reduce initial bending of the fiberglass rod
- Must order 1/2" Duct Rodder separately. Also, user must provide length of 1-1/4" innerduct between Rod Pusher and Rodder Cassette, and another length of 1-1/4" innerduct between the pusher and the duct to be rodDED
- Calibration in feet



# General Machine Products

## DUCT CLEANING, PROOFING & RODDING

### GMP Duct Rodders

- Fundamentally essential tools for underground tasks such as cleaning and locating ducts, threading lines or pulling cables
- Comes equipped with a male threaded end fitting and tapered head on the leading end and a female threaded fitting on the back end
- Carriers are made of tubular steel alloy and are powder coated or electro-galvanized for corrosion resistance; larger diameter carriers have inboard wheels for easier transport at the jobsite. Each carrier is fitted with a hand-operated brake to control payout
- Lightweight, durable and corrosion-resistant. The rod is coated with a tough UV stabilized safety orange polypropylene and are not affected by water
- They will not soften or lose tensile strength in hot weather, nor become brittle under cold conditions
- Each Duct Rodder Frame assists the pay-out/pay-in of the rod material by using an eyebolt with a nylon bushing. The bushing is designed to protect the duct rod from abrasion and premature wear



1/4" Duct Rodders		3/8" Duct Rodders		1/2" Duct Rodders	
Part #	Size	Part #	Size	Part #	Size
89202	1/4" x 100'	89222	3/8" x 200'	89252	1/2" x 200'
89204	1/4" x 200'	89224	3/8" x 300'	89254	1/2" x 300'
89206	1/4" x 300'	89226	3/8" x 400'	89256	1/2" x 400'
89208	1/4" x 400'	89228	3/8" x 500'	89258	1/2" x 500'
89210	1/4" x 500'	89230	3/8" x 600'	89260	1/2" x 600'
		89232	3/8" x 700'	89262	1/2" x 700'
		89234	3/8" x 800'	89264	1/2" x 800'
		89236	3/8" x 900'	89266	1/2" x 900'
		89238	3/8" x 1000'	89268	1/2" x 1000'
		89240	3/8" x 1100'	89270	1/2" x 1100'
		89242	3/8" x 1200'	89272	1/2" x 1200'

Nominal Size	End Fitting Threads	Rated Tensile Strength	Rated Pull Strength	Minimum Bend Radius
1/4"	5/16-18	6000 lbs	500 lbs	7.4"
3/8"	3/8-16	10,000 lbs	1400 lbs	9"
1/2"	3/8-16	21,000 lbs	1800 lbs	18"

## CABLE PULLING & REMOVAL EQUIPMENT

### 89801: Control Valve

- Utilizing a ball valve with a safety locking lever, the Control Valve allows control of air flow
- Equipped with a Chicago fitting for connecting to the air supply; also features a quick disconnect fitting at the end for attachment of seal-offs
- Comes standard with a solid plug in lieu of rope adapter for pressurizing ducts



### Rope Adapter

- Allows for a wide range of rope diameters to be used with the above control valve

29448	3/16"
29446	1/4"
29447	3/8"



## CABLE PULLING & REMOVAL EQUIPMENT

### Innerduct Seal-Off

- Featuring quick disconnects, these insert into the innerduct and twists tight for seal, utilizing the same buttress thread as our pulling eyes

- 89804 Duct Seal-Off 1"
- 89805 Duct Seal-Off 1 1/4"
- 89806 Duct Seal-Off 1 1/2"
- 89807 Duct Seal-Off 2"

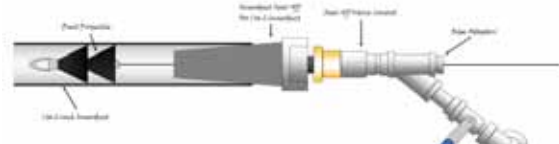

### Conduit Seal-Off

- Securely fits into a duct with a turn of the wing-nut handle, expanding the two rubber plugs for a firm seal
- 15 psi (1 bar) maximum

- 89808 Conduit Seal-Off 2"
- 89809 Conduit Seal-Off 3"
- 89810 Conduit Seal-Off 3 1/2"
- 89811 Conduit Seal-Off 4"
- 89812 Conduit Seal-Off 4 1/2"
- 89813 Conduit Seal-Off 5"



### Duct Projectiles

- Constructed of molded rubber cones fastened to a heavy duty metal rod with fastening rings
- Projectile is easily blown through duct with hand blower tool

- 70505 Duct Projectile for 1"
- 70506 Duct Projectile for 1 1/4"
- 70508 Duct Projectile for 1 3/8"
- 70509 Innerduct Projectile for 1 1/2"
- 70510 Duct Projectile for 1 1/2"
- 70511 Duct Projectile for 1 7/8"
- 70512 Innerduct Projectile for 2"
- 70513 Duct Projectile for 2"
- 70514 Duct Projectile for 2 1/2"
- 70515 Duct Projectile for 3"
- 70516 Duct Projectile for 4"
- 70517 Duct Projectile for 5"
- 70518 Duct Projectile for 6"



### 89820: Optional Carry Case for Conduit Seal-Offs

- This durable plastic box ensures that your conduit blowing accessories stay together and are protected from damage



### Construction Chain

- This chain is intended for use in general construction work
- Offered in two link sizes: 5/16" and 1/2"
- The 5/16" link size is furnished in a length of 4' 4" and is equipped with a ring at each end
- The 1/2" link size is furnished in a length of 6' and is equipped with a grab hook at one end and an end ring on the other end



63540 1/2" Link Size  
63541 5/16" Link Size

### Missile Line Carriers for 2" to 6" Conduit

- Fast blowing and vacuuming of 2" to 6" diameter conduit by low-friction plastic carriers
- Easily removed from conduit if stuck or jammed

- 70527 Missile for 2" conduit
- 70528 Missile for 3" conduit
- 70529 Missile for 4" conduit
- 70531 Missile for 5" conduit
- 70532 Missile for 6" conduit



# General Machine Products

## CABLE GUIDES & ACCESSORIES

### Heavy Duty Quadrant Block

- Used to guide the pulling line or cable during underground cable placement or removal
- Consists of six cast aluminum sheaves supported in an aluminum frame to provide a bending radius of 24"
- Each sheave has self-lubricating bushings for smooth movement and a long, maintenance-free life
- Available to accommodate 3" (84453), 4" (84454) or 5" (84455) cable diameters
- Each side plate has holes to insert a 1 1/4" digging bar to prevent the block from being knocked into the manhole
- Can also be used with a Cable Sheave Shackle, Pulling Frame or Jamb Skid to suspend in the manhole as an alternative method of use

Part #	Max Cable Size	Weight
84453	3"	60 lbs
84454	4"	75 lbs
84455	5"	90 lbs



### Cable Feeding Guide

- Cable Feeding Sheaves slide into the end of conduit in a manhole wall, allowing the cable being fed into the conduit to roll smoothly over the sheave from all angles
- The frame is made from steel for durability while the sheave is made from aluminum alloy or Nylatron® with self-lubricating bearings
- The sheaves have a split tube for easy removal after cable is installed



*Note: Cable feeding sheaves are not designed for use with fiberoptic cable due to bending radius limitations. Please contact our Sales team for specific product recommendations.*

#### Aluminum Alloy Roller Cable Feeding Sheaves

Part #	Description	Weight
70563	For 2" Duct Schedule 40	14 lbs
70564	For 3" Duct Schedule 40	17 lbs
70565	For 4" Duct Schedule 40	23 lbs
70566	For 4" Duct Schedule 40	23 lbs
70567	For 5" Duct Schedule 40	27 lbs

#### Nylatron® Roller Cable Feeding Sheaves

Part #	Max Cable Diameter	Weight
70581	For 3" Duct Schedule 40	11.4 lbs
70582	For 4" Duct Schedule 40	17.4 lbs
70583	For 4" Duct Schedule 80	17.4 lbs
70584	For 5" Duct Schedule 40	20 lbs
70585	For 6" Duct Schedule 40	38.9 lbs
70586	For 6" Duct Schedule 80	40.4 lbs



### 71130: Rope-To-Rope Connector

- This connector is used to connect two ropes of up to 7/8" (22 mm) diameter
- Rated @ 15,000 lbs. (6804 kg) max. load, this connector is made entirely from stainless steel, available only in the one size since it can also be used for smaller rope sizes
- Safety factor for load is 3:1 (horizontal pull only)
- Weight 2.7 lbs (1.2 kg)



### Rope to Swivel Connectors

- These Rope-to-Swivel Connectors achieve in two products what others do in four. These stainless steel connectors maximize usefulness by catering to the same rope capacity and using different ends to attach to the most popular swivel sizes. The sheaves run on clevis pins which are also available as spares
- Safety factor for load is 3:1 (horizontal pull only)

**71131 1/2 in. Connector**  
 Rated @ 7000 lbs. (3175 kg) max load  
 Weight 2.1 lbs (0.95 kg)  
 Can be used with GMP swivel 70137 and 70138

**71132 21/32 in. Connector**  
 Rated @ 15,000 lbs. (6804 kg) max load  
 Weight 2.3 lbs (1.0 kg)  
 Can be used with GMP swivel 70139

## CABLE PULLING & REMOVAL EQUIPMENT

### 5/8" Underground Handlines

- Intended for lowering tools and materials and for setting up cables when doing underground work
- Handlines come equipped with a 1" open hook spliced in one end and a 6' eye splice at the other

68592 5/8" X 20'  
68597 5/8" X 35'



### 3/8" Underground Handlines

- Intended for lowering tools and materials and for setting up cables when doing underground work
- Our 5/8" x 20 ft. (16 mm x 6 m) handline comes equipped with a 1 in. (25 mm) open hook spliced in one end and a 6" (152 mm) eye splice at the other end

68593 3/8" x 50'  
68595 3/8" x 100'



### Cable Feeding Sheaves

- Cable Feeding Sheaves slide into the end of conduit in a manhole wall, allowing the cable being fed into the conduit to roll smoothly over the sheave from all angles
- The frame is made from steel for durability while the sheave is made from aluminum alloy or Nylatron® with self-lubricating bearings
- The sheaves have a split tube for easy removal after cable is installed



### Cable Bending Shoes

- These easy-to-install bending shoes protect cables from sharp edges in and around manholes, conduit systems
- Cadmium-plated, 13 gauge steel with a protective polymer coating
- Tie off hole at either end for increased stability during the pulling of cables
- The trough-like steel section is bent into a 75° arc with an extended end for easier insertion into duct. This arc also provides a curved support for bending the cable around



86570 3"  
86571 3.5"



### 1/2" Utility Handlines

- Intended for general construction use
- 1/2" x 60' handline comes equipped with a crown splice on one end (no hardware) and a 6" eye splice on the other end and waxed linen cord served at both ends for approximately 1/2"

68596 1/2" X 60'

#### Important:

- When using handlines, whenever practical, raise and lower tools and materials while standing in a position where the movement of the load to its destination can be observed.
- Do not permit the rope to slip through the hands when lowering a load, but use the hand over hand procedure.
- Extreme care should be exercised when using a wet handline since it is more difficult to grip the rope securely.
- Stand clear as far as possible when raising and lowering heated material, such as solder pots, paraffin pots, etc. Ensure that no one is under a load while it is being positioned, raised, or lowered with a handline.
- Note: Do not use a wet handline where there is any chance that it may contact an electrical power source except in an emergency and then only when the craftsperson is protected by insulating gloves.
- Do not store handlines where they will come in contact with no paraffin or solder pots, furnaces or sharp edged tools. Inspect the rope before the handline is used to ensure that it is in good condition.



### Part # Description

#### Aluminum Alloy Roller Cable Feeding Sheave:

70564	For 3" Duct, Schedule 40
70565	For 4" Duct, Schedule 40
70566	For 4" Duct, Schedule 80
70567	For 5" Duct, Schedule 40

#### Nylatron® Roller Cable Feeding Sheave:

70581	For 3" Duct, Schedule 40
70582	For 4" Duct, Schedule 40
70583	For 4" Duct, Schedule 80
70584	For 5" Duct, Schedule 40
70585	For 6" Duct, Schedule 40
70586	For 6" Duct, Schedule 80

### Ball Bearing Swivels

- Tough swivels designed to handle higher thrust loads for extra cable safety and faster, straight pulls
- Precision-machined body is made of high quality stainless steel with higher working load ratings than comparably sized swivels available on the market
- These heavy-duty swivels are built with a thrust bearing for tensile load and a radial bearing for bending load

Part #	Load Width	Limit	Dia.	Length	Pin
70136	3/8"	2250 lbs	7/8"	3 3/8"	Slot
70137	17/32"	5000 lbs	1 1/4"	4 5/32"	Slot
70138	9/16"	7000 lbs	1 3/8"	4 19/32"	Slot
70139	11/16"	10,000 lbs	1 5/8"	5 7/16"	Hex
70140	1 1/32"	25,000 lbs	2 1/2"	9 5/8"	Hex



# General Machine Products

## Flexible Pulling Grips

- Manufactured from high-tensile, galvanized steel wire that is evenly woven in a single, double or triple wire weave according to pulling tension requirements

Part #	Diameter Range	Min Breaking Strength	Grip Length
<b>Single Weave - Single Flexible Eye</b>			
70660	.24" - .51"	1984 lbs	11.81"
70661	.47" - .75"	3505 lbs	21.65"
70662	.75" - .98"	4674 lbs	23.62"
70663	.98" - 1.5"	5644 lbs	27.56"
<b>Double Weave - Single Flexible Eye</b>			
70670	.39" - .79"	4101 lbs	23.62"
70671	.79" - 1.18"	4974 lbs	23.62"
70672	1.18" - 1.57"	8148 lbs	23.62"
70673	1.57" - 1.97"	12103 lbs	23.62"
70674	1.97" - 2.56"	12103 lbs	23.62"
70675	2.56" - 3.15"	16138 lbs	23.62"
70676	3.15" - 3.74"	16138 lbs	23.62"
70677	3.74" - 4.33"	23398 lbs	35.43"
<b>Triple Weave - Single Flexible Eye with Shoulders</b>			
70680	.24" - .51"	4960 lbs	25.59"
70681	.47" - .75"	7452 lbs	32.48"
70682	.75" - .98"	12214 lbs	40.35"
70683	.98" - 1.26"	21054 lbs	51.18"
70684	1.26" - 1.5"	25256 lbs	55.12"



## Innerduct Pulling Eyes

- Rugged chrome-plated steel pulling eyes allow innerduct placement to become a faster, safer operation
- Easy insertion by rotating the pulling eye into the innerduct allows the threads to make the connection
- A convenient hole in the threaded end of the pulling eye body is used to tie off the innerduct pulling line or tape keeping it from being lost during the pulling operation
- Eyes with swivel eliminate the need to use a separate swivel between the winch line and innerduct
- The hex portion of the pulling eye allows use of a wrench to make the final turns when inserting into innerduct

Part #	Nominal Duct Diameter	Innerduct inside Diameter Range	Max Pulling Eye Diameter
<b>Without Swivel:</b>			
60510	1" & 1 1/8"	1" - 1.18"	1.5"
60512	1 1/4" & 1 3/8"	1.25" - 1.43"	1.75"
60515	1 1/2"	1.5" - 1.68"	2"
60520	2"	2" - 2.18"	2.5"
<b>With Swivel:</b>			
61510	1" & 1 1/8"	1" - 1.18"	1.5"
61512	1 1/4" & 1 3/8"	1.25" - 1.43"	1.75"
61515	1 1/2"	1.5" - 1.68"	2"
61520	2"	2" - 2.18"	2.5"

## Cable Pulling Harnesses

- This convenient product will allow multiple pulls at one time by attaching 2 or 3 cables or ducts to the puller
- The "legs" are staggered in length so the individual connections are not interfering with each other
- Lead coupler can be easily dismantled to change out or add another leg
- Each leg is marked with load capacity and they are pull tested to 3 times that rating (based on equal pull on all cables, horizontal pull only)
- Manufactured from aircraft quality wire rope
- Other sling configurations are available upon request



Part #	Max Harness Width	Safe Working Load	Wire Rope Diameter
70298	2 1/4"	2000 lbs	1/8"
70299	3 1/8"	5800 lbs	1/4"
70300	3 1/2"	8400 lbs	3/8"

## 17022: Cable Bending Tool

- Easily bends up to 3 1/2" diameter cable into almost any shape
- The best cable bender to have whether you're setting up cables in manholes, making bends, straightening cable for sleeve placement during splicing, doing setups, off-sets or straightening in buildings, or even working from an aerial bucket
- The tool is made from zinc plated steel with aluminum saddles
- Seven position handle lets you bend cable easily, even when working in close quarters

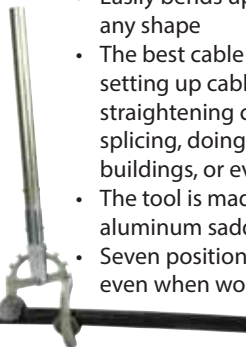

## B Connecting Links

- These time-tested, split "sister hooks" or "figure-8" links let you join two pulling lines together, and consist of two E-shaped, forged steel parts held together with a metal pin
- Swivel the two halves open to insert the looped end of each pulling line, then close and secure the link with a few turns of 2" friction tape around the center



Part #	Size	Width	Length	Eye dia.	Safe Load
80771	1/4"	1 5/16"	1 7/8"	3/8"	1000 lbs
80773	3/8"	1 5/16"	2 9/16"	1/2"	1000 lbs
80775	1/2"	1 5/8"	3 3/4"	5/8"	1000 lbs
80777	3/4"	2 1/2"	5"	15/16"	1000 lbs
80779	1"	3 3/4"	6 1/2"	1 1/4"	1000 lbs

## Manhole Sheaves

- The Manhole Sheave or "Pittsburgh" is used to guide pulling line or cable over the manhole edge when placing and removing cable in manholes which are equipped with pulling in irons to support a sheave and shackle assembly
- Consists of a reinforced, heat-treated wrought aluminum alloy frame with two self-lubricating, bronze bushed aluminum sheaves
- The frame also has a hole in each side plate so you can insert a 1 1/4" diameter digging bar parallel to the ground to keep the sheave from being knocked into the manhole
- Overall unit dimensions: 30" long x 12" wide x 22" high
- Standard units are rated at 36,000 lbs; the 80975 heavy duty 5" model is rated for 45,000 lbs.

<b>70283</b>	<b>3" Manhole Sheave</b>
<b>70284</b>	<b>4" Manhole Sheave</b>
<b>70285</b>	<b>5" Manhole Sheave</b>
<b>80975</b>	<b>5" Heavy Duty</b>



## Split Cable Feeders

- Same tough construction as our standard feeders with the added benefit of dividing in half for fast, easy removal without needing an end of the cable
- Style of feeder is ideal for pre-connected cables to avoid having to cut and splice cable to remove the feeder
- Excellent for particularly long runs of cable allowing "figure-8 types" of installation
- All exposed edges of both the 90" main split feeder and 36" extension split feeder have a protective plastic coating protecting the cable and user
- The series of latches allows for easy opening and closing of both the body and ends of the feeders

<b>88830</b>	<b>4" x 90" Main</b>
<b>88831</b>	<b>4" x 36" Ext.</b>



## Cable Feeders

- Solid feeders provide increased cable protection no matter how deep the manhole is and is an easy way to apply lubricant to the cable as it passes through the feeder
- Made from flexible spring steel hose
- Both the main section and extension section comes with a bronze bell mouth welded to one end
- The main section also has a connecting sleeve welded to the other end, while the extension section has a reducer welded to its other end to fit into the bell mouth of either the main section or another extension section
- The ability to add extension sections allows a user to make any length of hose required

<b>60580</b>	<b>4" x 90" Main Cable Feeder</b>
<b>60581</b>	<b>4" x 43 1/2" Extension Cable Feeder</b>
<b>60583</b>	<b>4" Main Cable Feeder*</b>
<b>60582</b>	<b>4" Extension Cable Feeder*</b>
<b>60585</b>	<b>5" Main Cable Feeder</b>
<b>60600</b>	<b>5" Extension Cable Feeder*</b>
<b>60587</b>	<b>6" Main Cable Feeder*</b>
<b>60586</b>	<b>6" Extension Cable Feeder*</b>

*\*Customer Specified Length*



## Cable Feeder Nozzles

- These simple split nozzles provide easy connections between our cable feeders and the conduit entered
- Each nozzle is made from high strength, thin-wall steel for a wider ID that permits use of larger pulling eyes
- Nozzles are available for either round or square conduit while still being compatible with round cable feeders
- The nozzles are split for easier removal after the cable has been placed and both halves are marked with the nozzle size
- The nozzles are available for straight connections (a 4" cable feeder going into a 4" conduit) or for reduced connections (a 4" cable feeder going into a 3" conduit)

Part #	Size	Conduit	Conduit Shape				
60590	4"	3"	Round	70004	6"	3 1/4"	Round
60591	4"	3 1/4"	Round	70003	6"	3 1/2"	Round
60592	4"	3 1/4"	Square	70002	6"	4"	Round
60593	4"	3 1/2"	Round	70001	6"	5"	Round
60584	4"	3 1/2"	Square	60598	6"	6"	Round
60596	4"	4"	Round				
60597	4"	4"	Square				
70009	5"	3"	Round				
70008	5"	3 1/4"	Round				
70007	5"	3 1/2"	Round				
70006	5"	4"	Round				
60599	5"	5"	Round				
70005	6"	3"	Round				



# General Machine Products

## Cable Sheaves

- Used in placing and removing underground cables
- Constructed from high strength aluminum alloy, and has self-lubricating bushings for long, maintenance free lives
- All hole sizes are 1 3/8" diameter for 1 5/16" pin
- These units are available in 11", 20", and 26 1/2" diameter, and may be purchased for maximum 3", 4", or 5" cables



Part #	A	B	C	Weight
71723	3"	11"	8 1/2"	15 lbs
71726	4"	11"	7 7/8"	20 lbs
71729	5"	11"	6 7/8"	25 lbs
71722	3"	20"	17 1/2"	32 lbs
71725	4"	20"	16"	36 lbs
71728	5"	20"	16 1/2"	40 lbs
71721	3"	26 1/2"	24"	38 lbs
71724	4"	26 1/2"	22 1/2"	44 lbs
71727	5"	26 1/2"	23"	56 lbs

## Cable Sheave Shackle

- Used for supporting a cable sheave or quadrant block in place at a manhole equipped with pulling-in irons
- Contains a two-part clevis made of high strength structural steel, with two sets of sheave pin holes 1 3/8" diameter for accommodating either a cable sheave or quadrant block
- Forged steel hook attaches to the pulling-in irons with a standard 1/2" x 6' construction chain, while the support half has a shoulder eyebolt so you can tie it off to a support rope over the manhole
- Will accommodate any 11", 20", or 26 1/2" cable sheave with a 1 3/8" hole size for 3", 4" or 5" cable
- Each shackle includes a 1 5/16" diameter sheave pin and can with stand working loads up to 10,000 lbs.

71643	3" Cable Size
71644	4" Cable Size
71645	5" Cable Size



## Pulling Frames

- Used as a guide for the pulling line and cable when placing and removing cable in manholes that are not equipped with pulling irons
- 12' 6" frame is designed for use in manholes up to 11' 6" deep; 15' frame can be used in deeper manholes
- Each frame consists of two 6", high structural aluminum channels bolted back-to-back
- Sheave pin holes are at 6" centers, individual sheaves can be easily loaded or removed
- Two 1 5/16" diameter sheave pins come with each frame; the C pulling frame is used to support Cable Sheaves or the B operations

Part #	Sheave Size
71710	3" x 12' 6"
71711	4" x 12' 6"
71712	5" x 12' 6"
71713	3" x 15'
71714	4" x 15'
71715	5" x 15'



## GMP Jamb Skid

- Supports quadrant blocks and sheaves when pulling cable through underground conduit
- Lightweight, constructed primarily of aluminum
- Includes (2) 1 5/16" diameter locking pins to lock the jamb skid height and secure the sheave or quadrant block
- Accepts all GMP sheaves and quadrant blocks with widths up to 7"
- Includes a base unit to accept the upper extensions

70640	48" x 85"; Includes 43" Extension
70643	84" - 121"; Includes 76" Extension
70646	114" - 151"; Includes 109" Extension
31356	Optional Extension for 70643 or 70646 to 48"-85"
31357	Optional Extension for 70640 or 70646 to 84" - 121"
31358	Optional Extension for 70640 or 70643 to 114" - 151"



## FIBER OPTIC CABLE DEPLOYMENTS

### Mid-Assist Fiber Optic Capstan

- Lightweight aluminum alloy units mount on a standard 2 7/16" diameter drive shaft with either a bayonet or a cross-pin type of connection
- Capstans can be used as end pullers or mid-assist booster pullers that will allow long, straight-through, splice-free pulls
- Offered with a torque limiter between the drive spindle and the inner hub, factory set at standard 600 lbs force, but may be calibrated to other torque values, if requested
- Also available with a steel shaft and no torque limiter for no-slip applications with a maximum rated load of 1500 lbs
- Can also be used with Fiber Optic Cable Blowers in series to place longer lengths of cable without splicing



Part #	Diameter	Width	Lbs. Force
15472	25"	5"	600
15479	25"	5"	1000
15470	25"	5"	N/A
70338	25"	5"	750
70351	32"	7.5"	600
70381	32"	7.5"	750
70471	32"	7.5"	1000
70472	32"	7.5"	N/A
70473	40"	7.5"	600
70475	40"	7.5"	1000
70478	40"	7.5"	N/A

### Fiber Optic Cable Blower

- Safe, fast and effective, even on tough terrain, the "Tornado" cable blowing machine will move fiber optic cable of 0.23" to 1.25" diameter at speeds to 300' per min. into pre-installed innerduct or direct-buried duct
- Accommodates 1" to 2.48" innerduct
- A conversion kit allows the Tornado to place either 12/10 mm or 10/8 mm micro duct into the innerduct
- Comprised of an aluminum air box and cable pusher, the "Tornado" uses compressed air to install the cable with or without a missile
- The hydraulically powered, caterpillar belt drive system controls the cable as it is propelled by compressed air into the duct
- An electronic monitoring system provides read-outs of speed and distance, protects cable against duct obstructions, and includes an emergency stop facility
- Duct and cable sizes ODs are required at time of ordering



**89000 "Tornado" Cable Blowing Machine w/ Hydraulic Power Pack**

### 70605: Fiber Optic Pulling Trailer

- Exceed the requirements of installing telecommunications cables, employing a 32" diameter single capstan to provide a controlled force to the pulling rope or tape
- The single capstan allows the winch to be placed at the mid-point of a section to assist in the pull, thus enabling longer pulls to be achieved
- The winch is mounted on a sturdy all-steel fabricated chassis. It is equipped with torsional suspension axles, stabilizing prop legs, a front telescopic jockey wheel and a tow bar with a Lunette Ring
- Rope take-up drum is driven independently by a hydraulic motor



### Hydraulically Limited Cable Puller

- Designed to offer exceptional value while providing critical speed control and overload protection
- Adjustable pull control, up to 1000 lbs. maximum on a 40" diameter capstan
- Speeds up to 425' per minute at 15 gpm flow
- Control panel with pressure gauge, pressure adjustment knob and directional foot control valve
- Hydraulic hoses come with 1/2" non-spill quick-disconnect fittings for 2500 psi maximum hydraulic source input



70483	Hydraulically Limited Cable Puller Motor w/ Self-Support Frame, Foot Control Valve, and (2) Hydraulic Hoses
70484	Hydraulically Limited Cable Puller Motor w/ Vehicle Receiver Mount, Support Jack, Foot control Valve and (2) Hydraulic Hoses
70486	Hydraulically Limited Cable Puller Motor w/ Foot Control Valve and (2) Hydraulic Hoses for 2 1/2" Square Socket Mount
70487	Hydraulic Power Unit with (2) Hydraulic Hoses, 1/2" diameter x 20'



TRUSTED SINCE 1958

# General Machine Products

## Break-Away Swivels

- Swivels provide an inexpensive fracture point between the pulling line and cable avoiding costly cable damage if the cable's rated pulling capacity is exceeded
- Available in two diameters; 7/8", made from high quality aluminum and 5/8", made from steel
- The 5/8" size is designed for use when working with innerduct sizes below 1 5/8" diameter
- The design of the swivels incorporates a replaceable tension bolt that joins the barrel eye and swivel body. The bolt separates when pulling loads on the cable reach +/- 5%. The damaged bolt can then be replaced in seconds using an Allen wrench (included) and screwdriver
- Swivel and bolt head are colour-coded for fast load identification
- GMP uses a steel thrust washer and bushing in the larger break-away swivel and four ball bearings in the smaller version; both designs provide smooth rotation under load and help to keep twisting forces from reaching the cable

### Aluminum 7/8" Diameter Break-Away Swivel

Part #	Breaking Point (lbs)	Colour Code
53700	340	White
53701	450	Orange
53702	600	Yellow
53703	800	Blue
53704	1000	Green
53705	1200	Red



### Steel 5/8" Diameter Break-Away Swivel

Part #	Breaking Point (lbs)	Colour Code
71399	200	Orange/White
71400	220	Red/White
71401	295	Green/White
71402	340	White
71403	400	Blue/White
71404	420	Yellow/White
71405	435	Violet/White
71406	450	Orange
70188	500	Violet
71408	600	Yellow
70191	700	Brown



## Fiber Optic Sheave & Shackle

- This new "bicycle wheel" combination is designed to accommodate the special handling needs of pulling fiber optic cable
- One-size shackle
- 32" and 40" sizes are split to accommodate less than 32" diameter manhole
- Lightweight design, aluminum construction with self-lube bearings
- Captivating pins on shackles prevent cable damage when not under tension
- For overhead applications, 24" sheave with shackle provides generous bending radius for fiberoptic cable up to .6" diameter
- All removable hardware is retained for security

Part #	Description
71548	Underground Fiber Optic Shackle (requires Fiber Optic Sheave)
71549	Overhead Fiber Optic Shackle with 24" Fiber Optic Sheave
71550	24" Fiber Optic Sheave
71551	Underground 32" Split Fiber Optic Sheave
71552	Underground 40" Split Fiber Optic Sheave
71554	Overhead Fiber Optic Shackle (requires Fiber Optic Sheave)
71560	Underground 24" Fiber Optic Sheave & Shackle Assembly - Working Load 2000 lbs
71561	Underground 32" Split Fiber Optic Sheave & Shackle Assembly - Working Load 1250 lbs
71562	Underground 40" Split Fiber Optic Sheave & Shackle Assembly - Working Load 1250 lbs



## 10727: 7" Aluminum Capstan

- Cast from a high strength aluminum alloy
- Will fit on any 2 7/16" diameter winch extension shaft equipped with a bayonet or pin type mount
- The working surface is 7 1/4" diameter x 8" wide
- The maximum allowable pull is 4000 lbs



## Capstan Drive

- Gives your mobile hydraulic equipment the capacity to run GMP line of power reels and capstans
- Even when your vehicle doesn't have a winch, you can still achieve the benefits of GMP's highly productive cable placing tools using this economical device
- Capstan Drive features a Bell standard 2 7/16" bayonet shaft and a highly efficient planetary gear reduction that rotates on roller bearings and is powered by a compact, continuous duty single stage motor
- Multi-disc wet brake that's spring applied and hydraulically released is rated for the unit's full pulling load
- Features a built-in bi-directional counterbalance valve to give "feathering" control over the load movement in either direction
- At maximum flow of 15 gpm and operating pressure of 2250 psi, the capstan shaft can achieve 58 rpm and develops 13,000 in. lbs of torque



Device	Line Speed	Line Pull
7" Capstan	106 ft./min.	3250 lbs
C.R. Reel	304 ft./min.	1300 lbs
25" Capstan	380 ft./min.	900* lbs
32" Capstan	486 ft./min	700* lbs

\*Line pull limited to 600 lbs typical clutch setting

## REEL HANDLING EQUIPMENT

### B Cable Reel Jacks

- Two of these heavy-duty jacks can support cable reels weighing up to 12,000 lbs.
- Consists of a steel A-frame, a tee which accepts a 2 1/2" diameter spindle bar, a screw assembly and a three-hole adjusting nut with a detachable 36" lever bar
- Tee of the jack accepts a standard cable reel spindle 2 1/2" in diameter and has a 3/8" vertical locking pin hole in the center
- The height of the jack from the base to the center of the spindle ranges from a minimum of 29" to a maximum of 48" when fully extended
- The spindle is 63" long with a 3/8" diameter locking pin hole 4" from each end; the spindle must be ordered separately

74530

74531 Spindle



### Small Cable Reel Jacks

- The small cable reel jack is primarily used for block and building cable and strand reels
- The jack consists of a steel frame, a tee for accepting the spindle and a screw assembly
- The height of the jack from the base to the center of the spindle ranges from a minimum of 19" to a maximum of 30" when fully extended
- Holes are provided in the base for securing the jacks to planks or lags if required
- The jacks are sold in pairs with a 15" lever bar
- Features a durable black finish for extra corrosion protection

66050

66051 Spindle 1 1/2" x 48"



# General Machine Products

## 71669: Reel Buck

- A tough, easily maneuvered and portable frame that's ideal for supporting any reel up to 36" wide x 50" diameter
- Two welded, rectangular steel members make up the frame
- Designed for one-person handling
- Frame protected against corrosion
- The foot and handle design holds the main frame up and away from irregular surfaces
- Will accommodate the Corning FlexNap™ cable drums
- 1200 lbs load capacity
- 42" long spool bar included



## 70403: Reel Caddy

- Large diameter reel caddies
- May be used to support and dispense drop cable quickly and easily
- Lightweight; folds flat for compact storage
- Fabricated from durable steel tubing that's painted for years of dependable service
- Supports reels up to 30" in diameter and easily accommodates multi-port deployment on cardboard or plastic reels
- Quick and simple to set up with one hand
- Supports reels up to 200 lbs with at least a 1 1/2" spindle diameter



## MISCELLANEOUS UTILITY EQUIPMENT

### D Umbrella and Dielectric Umbrella

- Umbrella's tough plastic 68" diameter cover is safety yellow on the top
- A reflective white underside decreases interior heat absorption
- Vinyl-coated, nylon rid-end pockets keep the frame from tearing the cover
- Features self-sealing, waterproofed, waxed stitching and improved construction, using a nylon sleeve and rib retainers for attaching the frame's six collapsible ribs
- Frame's collapsible fiberglass ribs connect at a ring-type lock that slides along the pole as umbrella is opened or closed
- 43" long wooden pole features a male ferrule that may be attached to the 29" extension section for a 6' height
- When working near power lines, choose the dielectric umbrella to eliminate potential sources of electrical shock



- 80920 **D Umbrella**
- 70352 **Dielectric Umbrella**
- 28210 **Holder (hardware not included)**
- 71647 **Adapter**
- 80921 **Nylon Storage Case**

### Splicer's Knife & Scissors Kit

- A favourite of craft professionals everywhere, this kit joins GMP's Splicer's Scissors and Skinning Knife in a single sturdy, belting-quality leather pouch
- The heavy duty pouch is stitched throughout and riveted at all stress points; separate pockets for each tool and a slotted back that will fit any belt up to 2" width



- 15471 **Kit**
- 24470 **Pouch Only**
- 24471 **Splicer's Knife**
- 01008 **Splicer's Scissors**

### 15475: Knife and Scissors Sharpener

- Sharp cutlery is both easier and safer to use, and you can keep your cutlery at its keenest with this easy-to-use sharpener
- The two carbide bits in front are for sharpening knives; to sharpen scissors, draw the non-serrated edge of your scissors, along the sharpener's single side bit by resting the sharpener on a flat surface
- Draw the sharpener along the blade of your tool three or four times, and the original edge is restored in seconds
- The built-in finger guard protects your hand



## OVERHEAD ELECTRIC PLACING EQUIPMENT

### Cable Pulling Sled

- The Pulling Sled is used for aligning two or three cables in our multiple cable block when pulling overhead cable into position prior to lashing
- Incorporates either a 5000 or 7500 lbs swivel capacity on the front end and three 5000 lbs capacity swivels on the back end
- Generally used with any conventional winching device
- The 22" chain provides both alignment and stability



70649 Cable Pulling Sled

70626 Sled with Swivels

### 90° 3 Roller Inside Corner Cable Guide

- Often called the "Banana Bar", this guide consists of a curved steel frame that accommodates five 3 roller cable blocks that clamp to the frame
- Each block can handle up to three 2 1/2" diameter cables
- Cable bending radius of 25"

71563 Guide, complete with blocks

28249 Replacement block only

### 75268: 3 Roller Starter Guide Block

- Used as a starter block during the pulling in of heavy duty cable up to 6" diameter as it is pulled from a stationary or moving cable reel
- Has three rollers that guide the cable with minimal friction
- Cable pulled through the block has a minimum bending radius of 17"
- Designed for use with larger cables up to 6" in diameter, i.e., 750 MCM Tri-Plex Conductors
- Has a heavy duty aluminum frame with stainless hardware
- A 7/8" hex actuates a screw vise to grip the strand and keep the block in a stationary position
- Can be used on strand sizes 3/8" to 9/16"
- Capacity for up to 6" diameter cable and a safe working load of up 2000 lbs
- After cable and support rings are in place, the block has hinges that open at one side for easy removal





**MSA Respirator Fit Test Compliance**

29 CFR Part 1910.134



Advantage 200LS Respirator



Advantage 3000



Advantage 3200 Respirator



Advantage 420 Respirator



Ultravue Respirator



Advantage 4100 Respirator



Ultra Elite Respirator

<b>MSA RESPIRATOR FIT TEST KITS</b>	<b>697287</b>	<b>Saccharin Qualitative Fit Test Kit</b>
	<b>697444</b>	<b>Bitrex Qualitative Fit Test Kit</b>
	<b>697285</b>	<b>Replacement (Saccharin) Sensitivity Test</b>
	<b>697445</b>	<b>Solution, 55 ml Bottle (Bitrex)</b>
	<b>697286</b>	<b>Replacement Fit-Test (Saccharin) Solution, 55 ml Bottle</b>
	<b>697446</b>	<b>Replacement Fit-Test (Bitrex) Solution, 55ml Bottle</b>
	<b>697447</b>	<b>#1 Sensitivity Nebulizer</b>
	<b>697459</b>	<b>#2 Fit Test Nebulizer</b>
	<b>697448</b>	<b>Test Hood (Same for Both)</b>
	<b>697325</b>	<b>Using the Qualitative (Saccharin) Fit Test Kit Video</b>
	<b>697449</b>	<b>Using the Qualitative (Bitrex) Fit-Test Kit Video</b>
	<b>801628</b>	<b>Banana Oil Qualitative Fit Test Kit</b>

Respirator Description	Class	Material	APF	OSHA Acceptable Fit Test Methods	Required Fit Factor Quantitative	MSA Fit Test Adapter Required	Cartridge Type	Probed Facepiece P/N	Controlled negative Pressure (OHD) Quan Fit Test
Advantage 200LS	Half-Mask Negative Pressure	TPR	10	Qualitative or Quantitative	100	Advantage Adapter #10056424	Bayonet or threaded with adapter #809999	S (816515) M (8165130) L (816517)	OHD P/N 9513-0210
Advantage 420	Half-Mask Negative Pressure	Silicone	10	Qualitative or Quantitative	100	Advantage Adapter #10056424	Bayonet or threaded with adapter #809999	S (10107710) M (10107731) L (10107732)	OHD P/N 9513-0210
Comfo Classic	Full-Face Negative Pressure	Silicone	10	Qualitative or Quantitative	100	Quik Chek II Adapter #812022	Threaded	S (808255) M (808249) L (808261)	OHD P/N 9513-0109
Comfo Elite	Full-Face Negative Pressure	Hycar™	10	Qualitative or Quantitative	100	Quik Chek II Adapter #812022	Threaded	S (808253) M (808247) L (808259)	OHD P/N 9513-0109
Comfo Elite	Full-Face Negative Pressure	Silicone	10	Qualitative or Quantitative	100	Quik Chek II Adapter #812022	Threaded	S (491862) M (491860) L (491864)	OHD P/N 9513-0109
Advantage 3100	Full-Face Negative Pressure	Silicone	50	Qualitative or Quantitative*	500	Quik Chek III Adapter #805078	N/A	N/A	OHD P/N 9513-0210
Advantage 3200	Full-Face Negative Pressure	Silicone	50	Qualitative or Quantitative*	500	Advantage Adapter #10056424	Bayonet or threaded w/ adapter #809999	N/A	OHD P/N 9513-0210
Advantage 4100	Full-Face Negative Pressure	Silicone	50	Qualitative or Quantitative*	500	Quik Chek III Adapter #	N/A	N/A	OHD P/N 9513-0217
Advantage 4200	Full-Face Negative Pressure	Hycar or Silicone	50	Qualitative or Quantitative*	500	Advantage Adapter #10056424	Bayonet threaded w/ adapter #809999 @ NIOSH	N/A	OHD P/N 9513-0218
Advantage 1000	Full-Face Negative Pressure	Silicone	50	Qualitative or Quantitative*	500	Advantage Adapter #10056424	Bayonet	N/A	OHD P/N 9513-0219
Ultra-Twin	Full-Face Negative Pressure	Silicone	50	Qualitative or Quantitative*	500	Quik Chek II Adapter #812022	Threaded	S (482025) M (482024) L (482026)	OHD P/N 9513-0109

Ultra-Twin	Full-Face Negative Pressure	Hycar	50	Qualitative or Quantitative*	500	Quik Chek II Adapter #812022	Threaded	S (417683) M (465457) L (471684)	OHD P/N 9513-0109
Ultravue	Full-Face Negative Pressure	Silicone	50	Qualitative or Quantitative*	500	Quik Chek III Adapter #805078	N/A	S (482009) M (482008) L (482010)	OHD P/N 9513-0130
Ultravue	Full-Face Negative Pressure	Hycar	50	Qualitative or Quantitative*	500	Quik Chek III Adapter #805078	N/A	S (471681) M (465425) L (471682)	OHD P/N 9513-0130
Ultravue for use with 1/4 turn quick disconnect	Full-Face Negative Pressure	Hycar or Silicone	50	Qualitative or Quantitative*	500	Quik Chek IV Adapter #817446	N/A	N/A	OHD P/N 9513-0130
Ultra Elite	Full-Face Negative Pressure	Silicone	50	Qualitative or Quantitative*	500	Quik Chek III Adapter #805078	N/A	S (813210) M (813209) L (813213)	OHD P/N 9513-0210
Ultra Elite	Full-Face Negative Pressure	Hycar	50	Qualitative or Quantitative*	500	Quik Chek III Adapter #805078	N/A	S (813210) M (813218) L (813212)	OHD P/N 9513-0210
Millenium Facepiece	Full-Face Negative Pressure	Hycar	50	Qualitative or Quantitative*	500 2000±	Quik Chek III Adapter #805078	Threaded	Probe Assembly (10006227)	OHD P/N 9513-0130
Ultra Elite Pressure-Demand	Full-Face Positive Pressure	Silicone	10,000 SCBA  1000 Air-Line	Qualitative or Quantitative	500+	APR Fit Test Adapter Kit, 1/4 turn #10107257 (10029823 APR adapter only) APR Fit Test Adapter Kit, Slide Version #10107229 (100332511 APR adapter only) APR Fit Test Adapter Kit, Push-to-Connect #10107256 (10040052 APR adapter only) Quik Chek Adapter Kit, Firehawk #10044576±	Bayonet	Negative Pressure S (813211) M (813209) L (813213)	OHD P/N 9513-0380
Ultra Elite Pressure-De-mand	Full-Face Positive Pressure	Hycar	10,000 SCBA  1000 Air-Line	Qualitative or Quantitative	500+	APR Fit Test Adapter kit, 1/4 Turn #10107257 APR Fit Test Adapter Kit, Slide Version #10107229 APR Fit Test Adapter Kit, Push-to-Connect #10107256 Quik Chek Adapter Kit, Firehawk #10044576±	Bayonet	Negative Pressure S (813210) M (813218) L (813212)	OHD P/N 9513-0210
Ultra Elite Respirator	Full-Face Positive/Negative Pressure	Hycar	10,000 SCBA 50 APR	Qualitative or Quantitative	500+ SCBA 2000± APR	Responder Fit Test Kit #10082555	Threaded	N/A	N/A

## Repair, cleaning and inspection

LTL offers complete inspection, maintenance and repair program for breathing apparatus.

Please call for complete information on all your self-contained breathing application needs.

# MSA - Multigas Detectors

UNDERGROUND/CONFINED SPACE

## ALTAIR® 5X Multigas Detectors

- ALTAIR 5X is capable of measuring up to 6 gases simultaneously and is driven by advanced MSA XCell® Sensor Technology. These sensors offer superior response time, stability, accuracy, and reliability together with an extended service life
- Durable detector tests levels of combustible gases in LEL and/or volume percentage range, oxygen, carbon monoxide, carbon dioxide, hydrogen sulfide, sulfur dioxide, ammonia, chlorine and many others depending on sensor configuration
- A rugged polycarbonate housing provides unsurpassed durability, including the ability to survive a 10ft (3m) drop and is IP 65 certified
- Field-proven integral pump provides consistent gas flow without the problems of externally-attached components
- High performance XCell sensors last longer
- Typical life greater than four years for combustible, O<sub>2</sub>, CO/H<sub>2</sub>S, and SO<sub>2</sub> sensors
- Typical life greater than three years for NH<sub>3</sub>, and Cl<sub>2</sub> sensors
- Most sensor response and clear times <15 seconds
- Rapid bump test gives results in under 10 seconds for most common sensor configurations
- Span calibration time of 60 seconds for most common sensor configurations
- MotionAlert option tells others that user has become immobile
- InstantAlert provides manual alarm to alert others of a dangerous situation
- Large buttons and bright display provide easy operation, even when user is wearing gloves
- Exclusive end-of-sensor warning cautions user when unit's sensor is nearing end-of-life
- Versatile MSA Link™ allows user to transmit data to a computer
- GALAXY GX2 system compatible



PART #	ACCESSORIES	PART #	CONFIGURATION
		10115118	LEL O <sub>2</sub> , CO, H <sub>2</sub> S
10082834	USB IR Receiver	10115119	LEL O <sub>2</sub> , CO, H <sub>2</sub> S, SO <sub>2</sub>
10114837	Battery pack, Alkaline	1015120	LEL O <sub>2</sub> , CO, H <sub>2</sub> S
10088099	MSA Link Software CD	10115141	LEL O <sub>2</sub> , CO, H <sub>2</sub> S, SO <sub>2</sub>
		1011542	LEL O <sub>2</sub> , CO, H <sub>2</sub> S
		1011543	LEL O <sub>2</sub> , CO, H <sub>2</sub> S, SO <sub>2</sub>

## ALTAIR® 4X Multigas Detectors

- Dependable multigas detector tests for LEL, oxygen, carbon monoxide, hydrogen sulfide, and nitrogen dioxide
- Economical construction saves users more than 50% on calibration gas, replacement sensors and maintenance
- Four-year sensor life means detector lasts 60% longer than the industry average
- Unit uses 50% less calibration gas per minute than the average detectors within the industry
- Two-tox CO/H<sub>2</sub>S sensor removes practically all cross-channel interference
- Large buttons and high-contrast screen make operation easy in low-light conditions
- Ribbed rubber housing provides secure grip and high durability
- Unit features 95+ db alarm and ultra-bright LEDs
- Exclusive end-of-sensor warning cautions user when unit's sensor needs to be changed
- MotionAlert option tells others that user has become immobile
- InstantAlert provides manual alarm to alert others of a dangerous situation



PART #	CONFIGURATION	SENSORS & SPARE PARTS
10107602	LEL O <sub>2</sub> , CO, H <sub>2</sub> S, Charcoal	10106722 Sensor Kit, XCell Ex Combustible
10110443	LEL O <sub>2</sub> , CO, Charcoal	10106729 Sensor Kit, XCell O <sub>2</sub>
10110444	LEL O <sub>2</sub> , Charcoal O <sub>2</sub>	10106725 Sensor Kit, XCell CO/H <sub>2</sub> S Two-Tox
10107603	LEL O <sub>2</sub> , CO, H <sub>2</sub> S Phosphorescent	10121213 Sensor Kit, XCell CO/H <sub>2</sub> S
10110445	LEL O <sub>2</sub> , CO Phosphorescent	10121217 Sensor Kit, XCell, NO <sub>2</sub> /CO Two-Tox
10110446	LEL, O <sub>2</sub> Phosphorescent	ACCESSORIES
		10069894 Stainless Steel Suspender Clip
		10046528 Universal Pump Probe (UL)
		10088099 MSA Link™ Software CD-ROM
		10082834 JetEye IR Adapter with USB Connector
		10050333 Hand Aspirator Assembly

### POWER SUPPLY

10086639	Charging Cradle Components
10087913	North American Power Supply
10092233	Charging Cradle Assembly
10095774	Vehicle Charger



Itutilitysupply.com

# MSA - Multigas Detector Accessories

## ALTAIR® 5X MULTIGAS DETECTORS

### Replacement/Spare Parts

10114835	Battery pack assembly, rechargeable
10114837	Battery pack, alkaline (includes belt clip)
10114839	Battery pack, rechargeable, IR
10114949	Maintenance Kit
10050976	Retractable line with belt clip
10040586	Carrying case, Cordura, UL only

### Replacement Sensors

10106722	Kit, XCell Ex Sensor, Combustible
10106729	Kit, Xcell O <sub>2</sub> Sensor
10106725	Kit, XCell CO/H <sub>2</sub> S two-tox sensor
10106375	Kit, replacement, HCN
10106728	Kit, XCell Cl <sub>2</sub> Sensor replacement
10080222	Kit, replacement, ClO <sub>2</sub>
10106727	Kit, XCell SO <sub>2</sub> Sensor Replacement
10080224	Kit, replacement, NO <sub>2</sub>
10106726	Kit, XCell NH <sub>3</sub> Sensor replacement
10116638	Kit, replacement, PH <sub>3</sub>
10114750	Kit, replacement NO
10105650	XCell Sensor plug
10088192	Sensor plug, oxygen and toxics (20 mm)

## ALTAIR® 4X MULTIGAS DETECTORS

### Accessories

10088099	MSA Link™ Software CD-ROM
10082834	JetEye IR Adapter with USB connector

### Sensors/Spare Parts

10106722	Kit, XCell Ex combustible sensor
10106729	Kit, XCell O <sub>2</sub> Sensor
10106725	Kit, XCell, CO/H <sub>2</sub> S two-tox sensor
10121213	Kit, XCell CO/H <sub>2</sub> S-LC two-tox sensor
10121217	Kit, XCell CO/NO <sub>2</sub> two-tox sensor
10110030	Front housing with integrated dust filters (charcoal)
10110029	Front housing with integrated dust filters (phosphorescent)
10106621	Main board with battery pack
10110061	LCD frame assembly (frame, LCD, zebra strips, screws)
10110062	Sensors gasket, Phillips screws (4x), self-tapping (2x)
10106623	CD manual, ALTAIR 4X Multigas Detector

## SIRIUS MULTIGAS DETECTOR ACCESSORIES

### Long-term Storage Kit

10051176	Includes 4-Gas PID, Lithium-ion and alkaline battery packs, vehicle charger, 10' sampling line w/ 1' probe, retractable carrying line w/ belt clip, Cordura jacket and black boot, Econo-Cal kit, Data Link w/ software 4 replacement sensors and PID lamp, lamp cleaning kit, standard lamp cover and case
----------	---

### Replacement Lamps & Sensors

10049692	10.6 eV Lamp
10051717	4 Sensor Kit (LEL, O <sub>2</sub> , CO, H <sub>2</sub> S)
10049808	Combustible sensor (both LEL and CH <sub>4</sub> )
10049806	Oxygen Sensor
10049804	Carbon Monoxide Sensor
10049805	Hydrogen Sulfide Sensor
10049807	Long-term storage oxygen sensor (hermetically sealed for 2-year storage)

## SOLARIS MSHA MULTIGAS DETECTOR ACCESSORIES

### Sensors

10046944	Replacement CO Sensor
10046945	Replacement H <sub>2</sub> S Sensor
10059040	Replacement NO <sub>2</sub> Sensor
10046946	Replacement O <sub>2</sub> Sensor
10046947	Replacement Combustible Sensor
10049406	4 Sensor replacement kit (CO, H <sub>2</sub> S, O <sub>2</sub> , Comb)
10059039	4 Sensor replacement kit (No <sub>2</sub> , CO, O <sub>2</sub> , Comb)

# MSA - Single Gas Detectors

## ALTAIR® Pro Single-Gas Detector

- Innovative toxic gas and oxygen detectors are based upon ALTAIR Single-Gas Detector design, but with added features and functionality
- Tough rubberized housing
- One-button operation
- Accurately measures gas concentration or percent oxygen
- Displays information on a large, clear, backlit LCD
- Superior dust and water protection (rated IP67 except for O2-R)
- Event-logging and data-logging
- Excellent impact resistance
- Versions available for CO, H2S, O2, NH3, Cl2, ClO2, NO2, SO2, HCN, and PH3
- Great RFI performance
- Adjustable alarm set points are offered for LOW, HIGH, TWA, and STEL
- Alarms are indicated by flashing LEDs, audible alarm and internal vibrating alarm
- Replaceable battery and sensor

10074137	O <sub>2</sub>
10074135	CO
10076723	CO Fire
10076724	CO Steel
10074136	H <sub>2</sub> S
10076729	HCN
10076716	Cl <sub>2</sub>
10076717	ClO <sub>2</sub>
10076736	SO <sub>2</sub>
10076731	NO <sub>2</sub>
10076730	NH <sub>3</sub>
10076735	PH <sub>3</sub>
10076733	O <sub>2</sub> -R



## ALTAIR® Maintenance-Free Single-Gas Detector

- Designed for superior lifespan - patented sensors operate for over two years - and high performance, the ALTAIR Single-Gas Detector is the smart choice for market-leading cost-effective gas monitors
- Features sensor options for carbon monoxide, hydrogen sulfide, and oxygen coupled with ED/audible/vibrating alarms. Superior dust-water protection, high RFI resistance, and one-button operation provide heightened safety, plus increased durability and ease-of-use
- Sensor options for CO, H<sub>2</sub>S and O<sub>2</sub>
- Patented electrochemical sensors and MSA-built button sensors
- Stainless steel and solid electrolyte construction virtually eliminate sensor leakage
- Automatically records the last 25 alarm/test events and can communicate data by connecting to MSA Link via built-in IR communication port
- No-miss triple alarm system includes bright flashing LEDs, piercing audible alarm, and an internal vibrating alarm
- Rubberized armor housing and one-button operation for maximum durability and simplicity

10092522	CO
10092521	H <sub>2</sub> S
10092523	O <sub>2</sub>



# MSA - Multigas Detector Accessories

## ALTAIR® QuickCheck® Station

- The ALTAIR QuickCheck station uses several tests to make sure ALTAIR and ALTAIR Pro Detectors are fully ready for action. The station administers a bump test to make sure the detector responds to a specified concentration of gas. The station also uses a microphone and electronic check to ensure the detector's audible, visual and vibrating alarms are good to go. With easy-to-understand LEDs, the QuickCheck Station tells a user which test is being administered and whether the detector passed or failed
- Station administers a bump test and uses a microphone and electronic check to ensure a detector is ready for action. Station is compatible with all 3 ALTAIR detector versions (CO, H<sub>2</sub>S, O<sub>2</sub>) and with ALTAIR Pro O<sub>2</sub>, H<sub>2</sub>S, CO, CO Fire and CO Steel detectors. Station comes in manual and automatic versions. Easy-to-see LEDs give simple-to-understand test results



### Altair Quick-Check Station w/ Manual Regulator

10076692	Gas Type: O <sub>2</sub> /CO/H <sub>2</sub> S/SO <sub>2</sub> /NO <sub>2</sub>
10076701	Gas Type: Cl <sub>2</sub> /ClO <sub>2</sub>
10076695	Gas Type: NH <sub>3</sub>
10076698	Gas Type: HCN

### Altair Quick-Check Station w/ Automatic Regulator

10076704	Gas Type: O <sub>2</sub> /CO/H <sub>2</sub> S/SO <sub>2</sub> /NO <sub>2</sub>
10076713	Gas Type: Cl <sub>2</sub> /ClO <sub>2</sub>
10076707	Gas Type: NH <sub>3</sub>
10076710	Gas Type: HCN

## GALAXY® GX2 Automated Test System

- Color touch screen for ease of set up and viewing
- Extremely simple to use; testing starts automatically without touching a single button
- Simultaneous testing of up to ten instruments
- GALAXY GX2 System is optimized for use with MSA's XCell® Sensors; provides up to 50% cost of ownership reduction
- At-a-glance indicators include low calibration gas volume, expiration warnings and test stand status
- MSA Link Pro Software provides proactive safety management, dashboard overview and total record-keeping
- 18 languages available for test stand and MSA Link Pro Software that simplifies usage and reduces training



### System Stand/1 Valve for use with 1 Calibration Gas Cylinder

10128644	ALTAIR/ALTAIR Pro Single-Gas Detector, No-Charging
10128630	ALTAIR 4/4X Multigas Detector, Charging
10128642	ALTAIR 4/4X Multigas Detector, No-Charging
10128626	ALTAIR 5/5X Multigas Detector, Charging
10128628	ALTAIR 5/5X Multigas Detector, No-Charging

### System Stand/4 Valve For Use with 1-4 Calibration Gas Cylinders

10128643	ALTAIR/ALTAIR Pro Single-Gas Detector, No-Charging
10128629	ALTAIR 4/4X Multigas Detector, Charging
10128641	ALTAIR 4/4X Multigas Detector, No-Charging
10128625	ALTAIR 5/5X Multigas Detector, Charging
10128627	ALTAIR 5/5X Multigas Detector, No-Charging

## Impact & Impact Pro Multigas Detectors

- The Lumidor Impact multigas monitor is supplied complete with dry cell battery holders, 4 x AA batteries, belt clip, flow adaptor, multi-lingual quick start guide (printed) and operation instructions (on CD)
- Lumidor Impact Pro is supplied with integral pump and pump adaptor
- Reliable Operation
- Pre-calibrated plug-in sensor cartridge
- High specification sensors
- Patented Surecell™ toxic sensors
- Stable and accurate
- Easy-to-Use, one button on/off
- Multi-lingual, intuitive menu system
- On screen prompts guide user
- Built-in correction factors for flammable gases
- Minimal training required
- Plug-in operation for all serviceable parts
- Cartridge replacement in less than one minute
- Re-calibration in less than two minutes when using Enforcer
- Minimized cost of ownership
- Durable Housing
- Waterproof to IP67
- Rugged and impact-resistant
- Built for everyday use
- Alarm indication
- 3 levels of instantaneous alarm, time weighted average alarms on toxic
- Periodic confidence flash and bleep
- Increasingly rapid flashing, ultra-bright alarm LEDs
- Powerful two-tone audible alarm
- Vibrating alarm for noisy environments\*
- Safelink communications (Pro only)
- User friendly pre-entry check
- Peak hold function and drop line
- Hand aspiration
- Built-in automatic pump (Impact Pro only)
- Totally flexible



<b>2302B20008UE</b>	<b>Impact</b>
<b>2302B10009CA</b>	<b>Impact Pro</b>
<b>2302BCD40FCHO</b>	<b>Standard 4-Gas Cylinder</b>
<b>2302B0831</b>	<b>Enforcer with a Gas Cylinder</b>
<b>2302BCD40FCHO</b>	<b>4-Gas Detector Sensor</b>



2302B0831

## SafeLink

- Confined-space communications
- Connect two Impact Pro detectors together
- Gas readings and instrument status is repeated on the other unit
- Co-workers can remotely monitor each other in confined spaces and exchange messages
- Emergency assistance can easily be called by pressing and holding any button so that help is never far away

<b>2302B0735</b>	<b>30 ft. Safelink cable including 2 x cable restraints</b>
<b>2302B0737</b>	<b>164 ft Safelink cable including 2 x cable restraints</b>
<b>2302B0746</b>	<b>328 ft Safelink cable including 2 x cable restraints</b>





# BW Technologies

## GasAlert Clip Extreme

- As the world's most popular and widely used zero-maintenance gas detector, the GasAlertClip Extreme offers continuous, reliable protection. Available in two year or three year versions, this single gas detector requires no calibration, sensor replacement, battery replacement or battery charging. Compatible with the MicroDock II automatic test system, the simplicity of the GasAlertClip Extreme combined with minimal training requirements and negligible maintenance costs, make the GasAlertClip Extreme one of the most cost-effective PPE solutions for facility workers and on-site contractors
- Durable, reliable and easy-to-use with no downtime
- Record keeping is accurate and easy with automatic event logging
- Exceptionally low cost of ownership
- Water resistant

### 2 YEAR DETECTORS

GA24XT-H	H <sub>2</sub> S
GA24XT-M	CO
GA24XT-S	SO <sub>2</sub>
GA24XT-X	O <sub>2</sub>
GA24XT0X19.522.5	O <sub>2</sub>

### 3 YEAR DETECTORS

GA36XT-H	H <sub>2</sub> S
GA36XT-M	CO



### Carrying Accessories

GA-BSPASH-K	Splash guard filters, kit of 5 for use with concussion-proof boot (GA24-BALERT)
GA-CL-1	Belt Clip with Screw
GA-HC-1	Hard Hat Clip (non-conductive)
GA-AG-1	Alligator-Style Clip (non-conductive)
GA-AG-2	Alligator-Style Clip (stainless steel - included with detector)

### Event Logging Accessories

GA-USB2	IR DataLink USB Adaptor
---------	-------------------------

### Testing Equipment and Spares

GA-TC-1	Test Cap and Hose (1 ft/0.3m)
---------	-------------------------------

### MicroDock II Base Station and GasAlertClip Extreme Docking Module

DOCK2-2-IE-00-G	H <sub>2</sub> S
DOCK2-2-1F-00-G	SO <sub>2</sub>
DOCK2-2-1G-00-G	CO
DOCK2-2-1H-00-G	O <sub>2</sub>

### GasAlertClip Extreme MicroDock II Docking Module

DOCK2-0-IE-00-G	H <sub>2</sub> S
DOCK2-0-1F-00-G	SO <sub>2</sub>
DOCK2-0-1G-00-G	CO
Dock2-0-1H-00-G	O <sub>2</sub>

## GasAlert Extreme

- Designed with durability and comfort in mind, the GasAlert Extreme reliably monitors for any single gas hazard within its wide range of available toxic gas models. With easy on/off operation, this single gas detector offers extended longevity with a two year field-replaceable battery and sensor. Calibration is a simple automatic procedure and is compatible with BW Technologies by Honeywell's MicroDock II automatic test and calibration system. A wide range of user options, multi-language display and datalogging functionality make the GasAlert Extreme an ideal solution for many applications
- Direct, real-time readings on large LCD
- Operates through consecutive shifts—exceptional battery run-time
- Secure and accurate history with datalogging option
- Simple automatic calibration procedure; compatible with BW Technologies by Honeywell MicroDock II automatic test and calibration station
- Full function self-test of sensor, battery status, circuit integrity and audible/visual alarms on start up
- Bright wide-angled visual alarm bars
- Built-in concussion-proof boot
- Water-resistant

GAXT-H-DL	H <sub>2</sub> S
GAXT-M-DL	CO
GAXT-M2-DL	CO (H <sub>2</sub> resistant)
GAXT-X-DL-2	O <sub>2</sub>
GAXT-S-DL	SO <sub>2</sub>
GAXT-C-DL	Cl <sub>2</sub>
GAXT-Z-DL	HCN
GAXT-D-DL	NO <sub>2</sub>
GAXT-A-DL	NH <sub>3</sub>
GAXT-A2-DL	NH <sub>3</sub>
GAXT-P-DL	PH <sub>3</sub>
GAXT-G-DL	O <sub>3</sub>
GAXT-E-DL	C <sub>2</sub> H <sub>4</sub> O
GAXT-N-DL	NO <sub>2</sub>
GAXT-V-DL	ClO <sub>2</sub>

### Carrying Accessories

GA-HC-1	Hard Hat Clip (non-conductive)
GA-AG-1	Alligator Style Clip (non-conductive)
GA-AG-2	Alligator Style Clip (stainless steel - included with detector)
GA-CL-1	Belt Clip with Screw

### Datalogging Accessories & Spares

GA-USB2	IR Data Link USB Adaptor
---------	--------------------------

### Sampling/Testing Equipment and Spares

GA-TC-1	Test Cap and Hose (1 ft. /0.3 m) Replacement (included with detector)
DOCK2-2-ID-00-G	MicroDock II (not compatible with ClO <sub>2</sub> or O <sub>3</sub> ) Base Station plus GasAlert Extreme Docking Module
DOCK2-0-1D-00-G	MicroDock II (not compatible with ClO <sub>2</sub> or O <sub>3</sub> ) GasAlert Extreme Docking Module
GA-SPAK	SamplerPak Motorized Sampling Pack Kit
GA-AS02	Manual Aspirator Pump Kit with Probe (1 ft./0.3m)

### Power Spares

E25296	Battery-Lithium, 3V
--------	---------------------

### Sensor Spares/Replacement Parts

GAXT-SS	Replacement Sensor Screens with Gasket, Kit of 10
PS-RH04S	Replacement H <sub>2</sub> S Sensor
PS-RM04	Replacement CO Sensor
SR-M04-SC	Replacement CO Sensor, H <sub>2</sub> Resistant
SR-X10-C1	Replacement O <sub>2</sub> Sensor
SR-X10	Replacement O <sub>2</sub> Sensor



# BW Technologies

## GasAlertMicroClipXT

- Continuous LCD shows real-time gas concentrations
- Compact and lightweight design makes it comfortable to wear
- Water-resistant
- Simple automatic calibration procedure; compatible with BW MicroDock II automatic test and calibration station
- Full function self-test of sensor, battery status, circuit integrity and audible/visual alarms on start up
- Bright wide-angled visual alarm bars
- Built-in concussion-proof boot
- Conveniently manage your fleet using Fleet Manager II
- IntelliFlash verifies operation and compliance to both the user and supervisor
- Tamper-proof, one button operation
- Equipped with internal vibrating alarm for high noise areas
- Powered by a lithium polymer battery
- Multi-language support in English, French, German, Spanish and Portuguese



### GasAlertMicroClipXT 4-Gas Detector

MC2-XWHM-Y-NA                    %LEL, O<sub>2</sub>, H<sub>2</sub>S, CO

### GasAlertMicroClipXT 3-Gas Detector

MC2-XWH0-Y-NA                    %LEL, O<sub>2</sub>, H<sub>2</sub>S

MC2-XW0M-Y-NA                    %LEL, O<sub>2</sub>, CO

MC2-0WHM-Y-NA                    %LEL, H<sub>2</sub>S, CO

MC2-X0HM-Y-NA                    O<sub>2</sub>, H<sub>2</sub>S, CO

MC-CK-DL                    **GasAlertMicroClipXT Deluxe Confined Space Kit - includes manual aspirator kit, IR connectivity kit, calibration cap with 1 ft/0.3m hose, 1.5 LPM regulator, sampling probe, leather carrying case and auxiliary filter**

MC-CK-CC                    **Carrying Case for GasAlertMicroClipXT with foam and lid insert**

### Power Options and Spares

MC2-C01-MC5                    Multi-unit (5) cradle charger

GA-PA-1-MC5-NA                    Multi-unit (5) power adaptor

### Datalogging Accessories

GA-USB1-IR                    IR Connectivity kit with Fleet Manager II software

### Sampling/Testing Equipment and Spares

MC-TC-1                    Test cap and hose (1 ft/0.3m) replacement

DOCK2-2-1C1P-00-G                    MicroDock II Base station and GasAlertMicroClipXT docking module with charging cable

DOCK2-2-1P-00-G                    MicroDock II Base station and GasAlertMicroClipXT docking module without charging cable

DOCK2-0-1C1P-00-G                    MicroDock II GasAlertMicroClip XT docking module with charging cable

DOCK2-0-1P-00-G                    MicroDock II GasAlertMicroClip XT docking module without charging cable

### Sensor Spares

SR-W-MP75C                    Replacement MICROPel® combustible (LEL) sensor

SR-X10-C1                    Replacement O<sub>2</sub> sensor (for use with models MC2-)

SR-X-MC                    Replacement MICROCel® O<sub>2</sub> sensor (for use with models MC-)

SR-H-MC                    Replacement MICROCel® H<sub>2</sub>S sensor

SR-M-MC                    Replacement MICROCel® CO sensor

## GasAlertQuattro

- IntelliFlash verifies operation and compliance to both the user and supervisors from up to 20 ft. / 6.1 m
- One-button operational simplicity
- Easy to identify icons for onsite auditing and compliance
- Field-proven Surecell sensors offer unprecedented performance, even in the harshest environments
- Easy-to-read, multi-language LCD displays all four gas concentrations (H<sub>2</sub>S, CO, O<sub>2</sub> and combustibles) simultaneously
- Audible, visual and vibrating alarm
- Extended alarm bars
- Flexible, interchangeable battery options with extended runtimes
- Full function self-test is initiated upon activation and runs continuously during operation
- Heartbeat pulses continually during normal operation
- Extensive datalogging and event logging capability
- User-options, such as flip display, accessible through IR interface for tamper-proof operation
- Multi-language support in English, French, German, Spanish and Portuguese
- Compatible with MicroDock II automated test and calibration system



### GasAlertQuattro 4-Gas Detector

<b>Alkaline Version</b>	<b>Rechargeable Version</b>
QT-XWHM-A-Y-NA	QT-XWHM-R-Y-NA

**Configuration**  
%LEL, O<sub>2</sub>, H<sub>2</sub>S, CO

### GasAlertQuattro 3-Gas Detector

<b>Alkaline Version</b>	<b>Rechargeable Version</b>
QT-XWHO-A-Y-NA	QT-XWHO-R-Y-NA
QT-XWOM-A-Y-NA	QT-XWOM-R-Y-NA
QT-XOHM-A-Y-NA	QT-XOHM-R-Y-NA
QT-OWHM-A-Y-NA	QT-OWHM-R-Y-NA

**Configuration**  
%LEL, O<sub>2</sub>, H<sub>2</sub>S  
%LEL, O<sub>2</sub>, CO  
O<sub>2</sub>, H<sub>2</sub>S, CO  
%LEL, H<sub>2</sub>S, CO

### CONFINED SPACE KITS

QT-XWHM-R-Y-NA-CS	GasAlertQuattro confined Space Kit - includes GasAlertQuattro detector (%LEL, O <sub>2</sub> , H <sub>2</sub> S, CO) rechargeable version, manual aspirator kit, IR connectivity kit, calibration cap with 1 ft/0.3m hose, 0.5 LPM regulator, sampling probe, calibration gas (2.5% CH <sub>4</sub> , 18% O <sub>2</sub> , 25 ppm H <sub>2</sub> S, 100 ppm CO), rechargeable battery pack
QT-CK-DL	GasAlertQuattro Deluxe Confined Space Kit - includes manual aspirator kit, IR connectivity kit, calibration cap with 1 ft/0.3m hose, 0.5 LPM regulator, sampling probe, carrying holster and auxiliary filter
QT-CK-CC	Carrying Case for GasAlertQuattro with foam Insert
XT-AG-1	Replacement alligator-style clip (stainless steel with screw)

### Power Options & Spares

QT-BAT-R01	Rechargeable battery pack, yellow
QT-BAT-A01	Alkaline battery pack with batteries, yellow

### Datalogging Accessories

GA-USB1-IR	IR connectivity kit with Fleet Manager II software
------------	--

### Sampling/Testing Equipment and Spares

DOCK2-2-1C1N-00-G	MicroDock II Base station and GasAlertQuattro docking module with charging cable
DOCK2-2-1N-00-G	MicroDock II Base station and GasAlertQuattro docking module without charging cable
DOCK2-0-1N-000G	GasAlertQuattro docking module with charging cable
DOCK2-0-1C1N-00-G	GasAlertQuattro docking module without charging cable
GA-SPAK	Sampler Pak motorized sampling pump kit with alkaline batteries
QT-AS01	Manual aspirator pump
QT-TC-1	Replacement test cap and hose

### Sensor Spares

SR-W04-75C	Replacement combustible (LEL) sensor
SR-X10-C1	Replacement O <sub>2</sub> sensor
SR-H04-SC	Replacement H <sub>2</sub> S sensor
SR-M04-SC	Replacement CO sensor
SR-DUMM1	Dummy sensor for one O <sub>2</sub> , H <sub>2</sub> S or CO location
QT-SS	Replacement quad sensor screen, kit of 2



# BW Technologies

## GasAlertMax XT II

- GasAlertMax XT II is the smart, simple, economical way to compliance. Workers feel safe and incidents are minimized so everyone will be able to do more. That means savings realized from business continuity and productivity
- Simple operation with SmartSample pump
- GasAlertMax XT II reliably monitors up to four hazards and combines straightforward one-button operation with our robust, motorized pump for intelligent, remote sampling, ideal for confined spaces. The GasAlertMax XT II is fully compatible with Micro Dock II automated test and calibration system

### GasAlertMax XT II 4-Gas Detector

XT-XWHM-Y-NA      %LEL, O<sub>2</sub>, H<sub>2</sub>S, CO

### GasAlertMax XT II 3-Gas Detector

XT-XWHO-Y-NA      %LEL, O<sub>2</sub>, H<sub>2</sub>S

XT-XWOM-Y-NA      %LEL, O<sub>2</sub>, CO

XT-OWHM-Y-NA      %LEL, H<sub>2</sub>S, CO

XT-XOHM-Y-NA      O<sub>2</sub>, H<sub>2</sub>S, CO

XT-XWHM-Y-NA-CS      GasAlertMax XT II Confined Space Kit - includes GasAlertMax XT II detector (%LEL, O<sub>2</sub>, H<sub>2</sub>S, CO), IR Connectivity kit, 0.5 LPM regulator, sampling probe, calibration gas (2.5% CH<sub>4</sub>, 18% O<sub>2</sub>, 25 ppm H<sub>2</sub>S, 100 ppm CO)

XT-CK-DL      GasAlertMax XT II Deluxe Confined Space Kit - includes IR connectivity kit, 0.5 LPM regulator, 10 ft/3m hose, 3 ft /1m hose, sampling probe, concussion-proof boot, auxiliary filter and Fleet Manager II software CD

XT-CK-CC      Carrying case for GasAlertMax XT II with foam insert

### Datalogging Accessories

GA-USB1-IR      IR connectivity kit with Fleet Manager II software

### Sampling/Testing Equipment & Spares

DOCK2-2-1C1M-00-G      MicroDock II base station and GasAlertMax XT II docking module with charging cable

DOCK2-2-1M-00-G      MicroDock II base station and GasAlertMax XT II docking module without charging cable

DOCK2-0-1C1M-00-G      GasAlertMax XT II docking module with charging cable

DOCK2-0-1M-00-G      GasAlertMax XT II docking module without charging cable

XT-RF-H5      Hydrophobic pump filter replacement, kit of 5

XT-RF-H50      Hydrophobic pump filter replacement, kit of 50

XT-RF-H100      Hydrophobic pump filter replacement, kit of 100

GA-PFMAX      Particulate pump filter replacement, kit of 5

GA-PFMAX-50      Particulate pump filter replacement, kit of 50

GA-PFMAX-100      Particulate pump filter replacement, kit of 100

### Sensor Spares

SR-W-MP75C      Replacement MICROPel® combustible (LEL) sensor

SR-X10-C1      Replacement O<sub>2</sub> sensor

SR-X-MC      Replacement MICROCel® O<sub>2</sub> sensor

SR-H-MC      Replacement MICROCel® H<sub>2</sub>S sensor

SR-M-MC      Replacement MICROCel® CO sensor



## GasAlertMicro 5 Series

- Providing protection from up to five potential atmospheric hazards including oxygen, combustible and toxic gases, GasAlertMicro 5 is unparalleled in its versatility, capability and overall value
- BW Technologies by Honeywell's newest addition to its water-resistant line of portable gas detectors has transformed the market with its matchless array of features
- Continuously monitoring and displaying concentrations of up to five gases, the compact and lightweight GasAlertMicro 5 was designed and engineered with an extensive host of applications in mind
- Integral concussion-proof boot
- Optional integral motorized pump option for remote sampling
- Powered by three AA alkaline batteries or a hot-swappable rechargeable battery pack
- Triple alarms (audible, visual and vibrating)
- Multi-language support in English, French, German, Spanish and Portuguese
- Large, user selectable backlit LCD
- Four alarm levels: Low, High, TWA and STEL
- Compatible with MicroDock II Automatic Test and Calibration Station
- Datalogging models store and recall event information
- Wide range of user selectable field options including password protection, safe and stealth modes

### GasAlertMicro5 Detector

M5-XWSY-R-D-D-Y-N-00	%LEL, O <sub>2</sub> , CO, SO <sub>2</sub> - lithium polymer, yellow housing
M5-XWSY-R-P-D-Y-N-00	%LEL, O <sub>2</sub> , CO, SO <sub>2</sub> - lithium polymer and pump, yellow housing
M5-XWAY-R-D-D-Y-N-00	%LEL, O <sub>2</sub> , H <sub>2</sub> S, CO, NH <sub>3</sub> - lithium polymer battery, yellow housing
M5-XWAY-R-P-D-Y-N-00	%LEL, O <sub>2</sub> , H <sub>2</sub> S, CO, NH <sub>3</sub> - lithium polymer battery and pump, yellow housing
M5-XWCY-R-D-D-Y-N-00	%LEL, O <sub>2</sub> , H <sub>2</sub> S, CO, Cl <sub>2</sub> - lithium polymer battery, yellow housing
M5-XWCY-R-P-D-Y-N-00	%LEL, O <sub>2</sub> , H <sub>2</sub> S, CO, Cl <sub>2</sub> - lithium polymer battery and pump, yellow housing
M5-XWOY-A-P-D-Y-N-00	%LEL, O <sub>2</sub> , H <sub>2</sub> S, CO - alkaline batteries and pump, yellow housing
M5-XWOY-R-D-D-Y-N-00	%LEL, O <sub>2</sub> , H <sub>2</sub> S, CO - lithium polymer battery, yellow housing
M5-XWOY-R-P-D-Y-N-00	%LEL, O <sub>2</sub> , H <sub>2</sub> S, CO - lithium polymer battery and pump, yellow housing
M5-XWSY-R-D-D-B-N-00	%LEL, O <sub>2</sub> , H <sub>2</sub> S, CO, NH <sub>3</sub> - lithium polymer, black housing
M5-XWSY-R-P-D-B-N-00	%LEL, O <sub>2</sub> , H <sub>2</sub> S, CO, SO <sub>2</sub> - lithium polymer and pump, black housing
M5-XWAY-R-D-D-B-N-00	%LEL, O <sub>2</sub> , H <sub>2</sub> S, CO, NH <sub>3</sub> - lithium polymer battery, black housing
M5-XWAY-R-P-D-B-N-00	%LEL, O <sub>2</sub> , H <sub>2</sub> S, CO, NH <sub>3</sub> - lithium polymer battery and pump, black housing
M5-XWCY-R-D-D-B-N-00	%LEL, O <sub>2</sub> , H <sub>2</sub> S, CO, Cl <sub>2</sub> - lithium polymer battery, black housing
M5-XWCY-R-P-D-B-N-00	%LEL, O <sub>2</sub> , H <sub>2</sub> S, CO, Cl <sub>2</sub> - lithium polymer battery and pump, black housing
M5-XWOY-A-P-D-B-N-00	%LEL, O <sub>2</sub> , H <sub>2</sub> S, CO - alkaline batteries and pump, black housing
M5-XWOY-R-D-D-B-N-00	%LEL, O <sub>2</sub> , H <sub>2</sub> S, CO - lithium polymer battery, black housing
M5-XWOY-R-P-D-B-N-00	%LEL, O <sub>2</sub> , H <sub>2</sub> S, CO - lithium polymer battery and pump, black housing



# BW Technologies

- GasAlertMicro 5 IR portable gas detector simultaneously monitors up to five atmospheric hazards including carbon dioxide (CO<sub>2</sub>), oxygen (O<sub>2</sub>), combustible gas (%LEL), and a wide selection of toxic gases. Compact and lightweight, GasAlertMicro 5 IR activates audible, visual and vibrating alarms in the event of a low, high, TWA or STEL alarm condition
- 0-5% vol (0-50,000 ppm) measurement of carbon dioxide
- Integral concussion-proof enclosure for the most rugged environments
- Continuous LCD shows simultaneous gas concentrations for up to five gases
- Two power options: three AA alkaline batteries or a rechargeable battery pack
- Simple automatic calibration procedure; compatible with BW Technologies by Honeywell's MicroDock II system
- Provides 95 dB alarm tone, two bright wide-angled alarm bars and internal vibrating alarm for high noise areas
- Multi-language support in English, French, German, Spanish and Portuguese
- Full function self-test of sensor, battery and circuit integrity, and audible/visual alarms
- Two year warranty including sensors (1 year NH<sub>3</sub>)

## GasAlertMicro 5 PID Detector

M5PID-XWQY-A-P-D-Y-N-00	VOCs, %LEL, O <sub>2</sub> , H <sub>2</sub> S, CO - alkaline batteries and pump, yellow housing
M5PID-XWQY-R-P-D-Y-N-00	VOCs, %LEL, O <sub>2</sub> , H <sub>2</sub> S, CO - lithium polymer battery and pump, yellow housing
M5PID-XWQO-A-P-D-Y-N-00	VOCs, %LEL, O <sub>2</sub> - alkaline batteries and pump, yellow housing
M5PID-XWQO-R-P-D-Y-N-00	VOCs, %LEL, O <sub>2</sub> - lithium polymer battery and pump, yellow housing
M5PID-00QO-A-P-D-Y-N-00	VOCs - alkaline batteries and pump, yellow housing
M5PID-00QO-R-P-D-Y-N-00	VOCs - lithium polymer battery and pump, yellow housing
M5PID-XWQY-A-P-D-B-N-00	VOCs, %LEL, O <sub>2</sub> , H <sub>2</sub> S, CO - alkaline batteries and pump, black housing
M5PID-XWQY-R-P-D-B-N-00	VOCs, %LEL, O <sub>2</sub> , H <sub>2</sub> S, CO - lithium polymer battery and pump, black housing
M5PID-XWQO-A-P-D-B-N-00	VOCs, %LEL, O <sub>2</sub> - alkaline batteries and pump, black housing
M5PID-XWQO-R-P-D-B-N-00	VOCs, %LEL, O <sub>2</sub> , H <sub>2</sub> S, CO - lithium polymer battery and pump, black housing
M5PID-00QO-A-P-D-B-N-00	VOCs - alkaline batteries and pump, black housing
M5PID-00QO-R-P-D-B-N-00	VOCs - lithium polymer battery and pump, black housing

## GasAlertMicro 5 IR Detector

M5IR-XWBY-R-D-D-Y-N-00	CO <sub>2</sub> (IR), %LEL, O <sub>2</sub> , H <sub>2</sub> S, CO - lithium polymer battery, yellow housing
M5IR-XWBY-R-P-D-Y-N-00	CO <sub>2</sub> (IR), %LEL, O <sub>2</sub> , H <sub>2</sub> S, CO - lithium polymer battery and pump, yellow housing
M5IR-XWBH-R-D-D-Y-N-00	CO <sub>2</sub> (IR), %LEL, O <sub>2</sub> , H <sub>2</sub> S - lithium polymer battery, yellow housing
M5IR-XWBH-R-P-D-Y-N-00	CO <sub>2</sub> (IR), %LEL, O <sub>2</sub> , H <sub>2</sub> S - lithium polymer battery and pump, yellow housing
M5IR-XWB0-R-D-D-Y-N-00	CO <sub>2</sub> (IR), %LEL, O <sub>2</sub> - lithium polymer battery, yellow housing
M5IR-XWB0-R-P-D-Y-N-00	CO <sub>2</sub> (IR), %LEL, O <sub>2</sub> - lithium polymer battery and pump, yellow housing
M5IR-00B0-R-D-D-Y-N-00	CO <sub>2</sub> (IR) - lithium polymer battery, yellow housing
M5IR-00B0-R-P-D-Y-N-00	CO <sub>2</sub> (IR) - lithium polymer battery and pump, yellow housing
M5IR-XWBY-R-D-D-B-N-00	CO <sub>2</sub> (IR), %LEL, O <sub>2</sub> , H <sub>2</sub> S, CO - lithium polymer battery, black housing
M5IR-XWBY-R-P-D-B-N-00	CO <sub>2</sub> (IR), %LEL, O <sub>2</sub> , H <sub>2</sub> S, CO - lithium polymer battery and pump, black housing
M5IR-XWBH-R-D-D-B-N-00	CO <sub>2</sub> (IR), %LEL, O <sub>2</sub> , H <sub>2</sub> S - lithium polymer battery, black housing
M5IR-XWBH-R-P-D-B-N-00	CO <sub>2</sub> (IR), %LEL, O <sub>2</sub> , H <sub>2</sub> S - lithium polymer battery and pump, black housing
M5IR-XWB0-R-D-D-B-N-00	CO <sub>2</sub> (IR), %LEL, O <sub>2</sub> - lithium polymer battery, black housing
M5IR-XWB0-R-P-D-B-N-00	CO <sub>2</sub> (IR), %LEL, O <sub>2</sub> - lithium polymer battery and pump, black housing
M5IR-00B0-R-D-D-B-N-00	CO <sub>2</sub> (IR) - lithium polymer battery, black housing
M5IR-00B0-R-P-D-B-N-00	CO <sub>2</sub> (IR) - lithium polymer battery and pump, black housing
M5-CK-DL	GasAlertMicro 5 Series deluxe confined space kit includes manual aspirator kit, calibration cap, regulator, sampling probe with holster, detector holster, five spare auxiliary filters and three spare quick connect fitting
M5-CK-CC	Carrying case for GasAlertMicro 5 Series with foam and lid insert



## Carrying Accessories

**GA-AG-2** Alligator-style clip (stainless steel)

## Datalogging Accessories and Options

**M5-MMC** Multimedia card

**CR-MMC-USB1** USB memory card reader

## Power Accessories and Options

**M5-BAT0501** Alkaline battery pack, yellow

**M5-BAT08** Lithium polymer rechargeable battery pack, yellow

**M5-C01-BAT08** Cradle charger and rechargeable battery pack, yellow

**M5-C01** Cradle charger for rechargeable battery packs

**M5-BL-1** Battery latch, replacement

**GA-V-CHRG4** 12 VDC vehicle adaptor cable for use with cradle charger (M5-C01)

## MicroDock II

**DOCK2-2-1C1K-00-G** Base station and GasAlertMicro 5 Series docking module (charging) with charging cable

**DOCK2-2-1J-00-G** Base station and GasAlertMicro 5 Series docking module (non-charging)

**DOCK2-0-1K-00-G** GasAlertMicro 5 Series docking module (charging), no charging cable

**DOCK2-0-1J-00-G** GasAlertMicro 5 Series docking module (non-charging)

## Sensor Spares and Replacements

**M5-SS** Quad sensor screen filters, kit of 2

**POWER-UPS-01** Replacement power supply for chargers

**M5-PR-1** Replacement pump, yellow

**M5-PRB-1** Replacement pump, black

**M5-PN-1** Replacement pump nozzle (for use with new Generation 2 pump modules)

**M5-DC-1** Replacement diffusion cover, yellow

**M5-DCB-1** Replacement diffusion cover, black

**SR-B04** Replacement CO<sub>2</sub> IR sensor

**SR-Q07** Replacement volatile organic compounds (VOC) PID sensor, 10.6 eV

**M5PID-ES-1** Replacement electrode stacks for PID sensor (SR-Q07) kit of 2

**RL-PID10.6** Replacement PID lamp, (10.6 eV) for PID sensor (SR-Q07)

**M5PID-CLN-K1** Cleaning kit for PID sensor

**D4-RHM04** Replacement TwinTox sensor - CO and H<sub>2</sub>S

**PS-RH04S** Replacement H<sub>2</sub>S Sensor

**PS-RM04** Replacement CO sensor

**SR-M04-SC** Replacement CO sensor, H<sub>2</sub> resistant



# BW Technologies

## MicroDock II

- The most cost effective way to manage the calibration and bump testing of BW Technologies by Honeywell portable gas detectors is through the MicroDock II automated test and calibration system. Fully portable and easily expandable, the MicroDock II requires no computer and provides simultaneous management of up to ten modules. Minimize expenses and maximize productivity with the MicroDock II
- Quick and easy compliance - automatically maintain accurate records
- Automatic bump testing, calibration, record keeping and charging
- One base station with one AC outlet supports up to six modules to suit your application
- Verifies proper performance of detectors
- Reduces maintenance costs
- Multiple MicroDock II systems can be connected via a LAN
- Includes BW Technologies by Honeywell Fleet Manager software for easy data analysis
- Multi-language support in English, French, German, Spanish and Portuguese

<b>DOCK2-2-1E-00-G</b>	<b>Base station with GasAlertClip Extreme H<sub>2</sub>S module</b>
<b>DOCK2-2-1G-00-G</b>	<b>Base station with GasAlertClip Extreme CO module</b>
<b>DOCK2-2-1F-00-G</b>	<b>Base station with GasAlertClip Extreme SO<sub>2</sub> module</b>
<b>DOCK2-2-1H-00-G</b>	<b>Base station with GasAlertClip Extreme O<sub>2</sub> module</b>
<b>DOCK2-2-1D-00-G</b>	<b>Base station with GasAlert Extreme module</b>
<b>DOCK2-2-1C1P-00-G</b>	<b>Base station with GasAlertMicroClip XT module (charging) with power supply</b>
<b>DOCK2-2-1P-00-G</b>	<b>Base station with GasAlertMicroClip XT module (charging) without power supply</b>
<b>DOCK2-2-1N-00-G</b>	<b>Base station with GasAlertQuattro module (charging) without power supply</b>
<b>DOCK2-2-1C1N-00-G</b>	<b>Base station with GasAlertQuattro module (charging) with power supply</b>
<b>DOCK2-2-1C1M-00-G</b>	<b>Base station with GasAlertMax XT II module (charging) with power supply</b>
<b>DOCK2-2-1M-00-G</b>	<b>Base station with GasAlertMax XT II module (charging) without power supply</b>
<b>DOCKS2-2-1C1K-00-G</b>	<b>Base station with GasAlertMicro 5 Series module (charging) with power supply and 2 gas inlets</b>
<b>DOCKS2-3-1C1L-00-G</b>	<b>Base station with GasAlertMicro 5 Series module (charging) with power supply and 3 gas inlets</b>
<b>DOCKS2-2-1J-00-G</b>	<b>Base station with GasAlertMicro 5 Series module (non-charging) with 2 gas inlets</b>
<b>DOCKS2-3-1J-00-G</b>	<b>Base station with GasAlertMicro 5 Series module (non-charging) with 3 gas inlets</b>
<b>Accessory Docking Modules</b>	
<b>DOCK2-2-00-G</b>	<b>Base station with 2 gas inlets without power supply</b>
<b>DOCKS2-3-00-G</b>	<b>Base station with 3 gas inlets without power supply</b>
<b>DOCKS2-4-00-G</b>	<b>Base station with 4 gas inlets without power supply</b>
<b>DOCKS2-5-00-G</b>	<b>Base station with 5 gas inlets without power supply</b>
<b>DOCKS2-0-1E-00-G</b>	<b>GasAlertClip Extreme H<sub>2</sub>S docking module</b>
<b>DOCKS2-0-1G-00-G</b>	<b>GasAlertClip Extreme CO docking module</b>
<b>DOCKS2-0-1F-00-G</b>	<b>GasAlertClip Extreme SO<sub>2</sub> docking module</b>
<b>DOCKS2-0-1H-00-G</b>	<b>GasAlertClip Extreme O<sub>2</sub> docking module</b>
<b>DOCKS2-0-1D-00-G</b>	<b>GasAlert Extreme docking module</b>
<b>DOCKS2-0-1C1P-00-G</b>	<b>GasAlertMicroClip XT docking module (charging with power supply)</b>
<b>DOCKS2-0-1P-00-G</b>	<b>GasAlertMicroClip XT docking module (charging without power supply)</b>
<b>DOCKS2-0-1N-00-G</b>	<b>GasAlertQuattro docking module (charging without power supply)</b>
<b>DOCKS2-0-1C1N-00-G</b>	<b>GasAlertQuattro docking module (charging without power supply)</b>
<b>DOCKS2-0-1C1M-00-G</b>	<b>GasAlertMax XT II/GasAlertMax XT docking module (charging with power supply)</b>
<b>DOCKS2-0-1M-00-G</b>	<b>GasAlertMax XT II/GasAlertMax XT docking module (charging without power supply)</b>
<b>DOCKS2-0-1C1K-00-G</b>	<b>GasAlertMicro 5 Series docking module (charging with power supply)</b>
<b>DOCKS2-0-1K-00-G</b>	<b>GasAlertMicro 5 Series docking module (charging)</b>
<b>DOCKS2-0-1J-00-G</b>	<b>GasAlertMicro 5 Series docking module</b>

## Accessories & Spares

REG-DF-1	Demand flow regulator
REG-DF-2	Demand flow regulator for refillable cylinders, CGA connector
REG-DF-3	Demand flow regulator for disposable steel cylinders
WMA-DOCK	Wall mount adaptor (kit of 2) modules and base station
<b>SAMPLERPAK</b>	
GA-SPAK	SamplerPak motorized sampling pump kit with alkaline batteries
GA-SPAK-NA	Deluxe SamplerPak motorized sampling pump kit with alkaline batteries, rechargeable batteries and battery charger

## Sampling Accessories

SP-CPROB1	Collapsible sample probe (3.3 ft/1m)
SP-CPROB14	Collapsible sample probe (14 ft/4.3m)
SP-T1-2	Sample probe (1 ft/0.3m) for Sampler
GA-MFILTER	Metallic sintered particulate filter
GA-SP01	Replacement Sampler motorized sampling pump

## Carrying Accessories & Replacements

GA-HSAMP	Carrying holster for Sampler
SPAK-CC1	Replacement carrying case with foam for SamplerPak portable kits

## Calibration Equipment

Single Gas Cylinders	Cylinder Material	Regulator
CO <sub>2</sub> 1.0% vol. (10,000 ppm)	Steel	REG-DF-3 or REG2-0.5
N <sub>2</sub> 100% N <sub>2</sub>	Steel	REG-DF-3 or REG2-0.5



## Capstan Brackets without Chain Clamps

- Bolt-down bracket for 1,000 lb. hoists
- Does not include chain clamps
- 8.82 lbs

**E3081321P**



- Bolt-down bracket for 3,000 lb. hoists
- Does not include chain clamps
- 14 lbs

**E3081434P**



## Capstan Brackets with Chain Clamps



- All-purpose bracket Series 90 hoists
- Includes 2 chain clamps for poles, angles, or beams

**C3081335**     **1,000 lb. rating**

**C3081443**     **3,000 lb. rating**

## Universal Bracket/Chain Clamp for Capstan 1000 lb. Gas Hoist



- Recommended for use with Chance gasoline 1,000 lbs hoist
- C3080925 also fits other 1,000 lbs Series 90 and earlier 750 lbs Chance hoists
- C3080925 bolts down or uses two C4170346 chain clamps for mounting on poles, angles, or beams

**C3080925**     **Universal Bracket**

**C4170346**     **Chain Clamp for Universal Bracket**

## "C" Bracket for Hoist Storage



- To store hoist on C-bracket, simply remove four bolts
- The C-bracket also can be bolted down for fixed-angle

**C3080890**

## Rope Lock Device Tool



- Includes two mounting bolts, washers, and a release lanyard
  - Accepts 1/2", 5/8", and 3/4" rope
- C3080856**

## Kellems Multiple Strength Type Pulling Grips

- Designed for pulling ACSR, aluminum, or copper bare conductor, ground wires, messenger strands, wire rope, and insulated cables
- High-strength galvanized steel strand, featuring double-weave mesh for greater strength and added mesh contact for longer or heavier pulling jobs
- Endless weave grip end lies flat on the cable and will not snag
- Ideal for overhead transmission and distribution line stringing where moderate loading is anticipated

Part #	Range	Colour Code	Eye Length	Mesh Length	Approx. Breaking Strength
03302044	.25-.49"	Dark Green	9"	26"	6,800 lbs.
03302046	.50-.74"	Brown	9"	32"	10,000 lbs.
03302048	.75-.99"	Light Blue	11"	41"	14,400 lbs.
03302050	1-1.24"	Gold	12"	52"	24,600 lbs.
03302052	1.25-1.49"	Black	12"	56"	30,600 lbs.
03302054	1.5-1.74"	Red	12"	60"	30,600 lbs.



## Kellems DUA-Pull Type Pulling Grips

- DUA-Pull line accommodates ACSR, ACAR, and all aluminum and copper conductors
- The highest strength pulling grips manufactured for overhead transmission line stringing
- They may work both bare and insulated conductors, as well as synthetic rope
- Kellems' patented two-over, two-under weave design gives exceptional strength and gripping ability by putting more steel mesh in contact with the cable or rope surfaces
- Primarily used in overhead transmission line construction where loads and safety considerations require an extra high strength grip, and will mate with swivels and link-type connectors
- Also accommodates ground wires, messenger strands, wire ropes, and synthetic ropes
- Most commonly used for attaching pulling lines to conductors, conductors to running boards, and "double socking" for conductor-to-conductor connections

Part #	Range	Colour Code	Eye Length	Mesh Length	Approx. Breaking Strength
033271037	.19-.37"	Black	10"	24"	6,500 lbs.
033271038	.38-.62"	Dark Green	12"	36"	14,000 lbs.
033271039	.63-.87"	Red	13"	48"	20,000 lbs.
033271040	.88-1.12"	Blue	15"	60"	30,600 lbs.



## Kellems Pulling Grips

- High-strength galvanized steel strand, featuring double-weave mesh for greater strength and added mesh contact for longer or heavier pulling jobs
- Forged steel rotating eye mates with a swivel or shackle

Part #	Type	Range	Length
33041085	T-Type	1-1.49"	33"
03301027	K-Type	2-2.49"	45"



## Punch-Lok Bands for Kellems Pulling Grips

- Punch-Lok® Bands are applied over the tail of a grip to prevent the mesh from being tripped or pulled loose
- They assure full gripping action by locking the mesh of the tail in tight contact with the cable or rope
- When the tail of a grip is the leading end, the bands are particularly important to prevent accidental release caused by tripping on obstructions



Part no.	Grip Banding Range	Band Width	Band Inside Diameter
20320050	1/4" - 1 1/8"	3/8"	1 3/8"
20320051	1 1/8" - 1 5/8"	3/8"	2"
20320052	1 5/8" - 2 1/4"	5/8"	2 1/2"
20320054	3 1/2" - 5"	5/8"	6"



## Mechanical Ratchet Chain Hoists



- Compact and portable, this hoist operates easily in close clearance work spaces
- Forged-steel load hooks at both ends, swivel 360° for easy attachment and to help maintain axial alignment during use
- Two-way handle swings to either side
- Rounded stop at end helps keep hand on handle
- Standard lift is 5.5'

Part #	Rating	Handle Pull at Rating	Hook-to-Hook Minimum	Weight (lbs)
C3090438	0.75 ton	65 lbs.	11"	14
30115	1 ton	90 lbs.	11"	14
C3090439	1.5 ton	60 lbs.	16"	22
4012	2 ton	90 lbs.	11"	28.5
C3090440	3 ton	60 lbs.	19.75"	30.5
C3090441	4.5 ton	70 lbs.	24.5"	47
C3090442	6 ton	70 lbs.	24.5"	50

## Nylon Strap Ratchet Hoists



- Designed with special features, these hoists offer a choice of two handle options for utility maintenance and construction
- For rubber-glove work, select hoist with Plastisol cap on handle end
- For operation by hot line tools, specify hoist with swivel-eye on handle end
- Features hot stick rings on hooks and latches
- Single strap of 1-Ton units reach and lifts farther; 2-Ton units employ a sheave-mounted hook in a double-strap bucket

PSC3090323	1 Ton Hoist, Regular Handle
PSC3090467	1 Ton Hoist, Hot Stick Handle
PSC3090468	2 Ton Hoist, Hot Stick Handle

## Powered Hoists



C3081172

- Improved design features a multiple planetary drive/backstop clutch assembled on the center shaft of a steel gearcase with full-length internal teeth
- Handles more rugged jobs, extends service life and reduces maintenance
- Lightweight, powerful, and portable
- Moves many heavyweight tasks and can get into remote or difficult-access sites
- Designed for use with setting utility poles, pulling wheeled equipment over obstacles, raising transformers (even over fences in back lots), hoisting heavy insulators, stringing and tensioning conductors, pulling cable (indoors and underground)
- Operator effort remains low for typical loads simply by adding wraps on the capstan drum
- Control is so accurate, loads can be moved fractions of an inch
- Standard drum style

Part #	Power Source	Rope Speed at Rated Load	Source (min.)
C3081172	12 V DC	22' per min.	90 AMP
C3081170	115 V AC	40' per min.	14 AMP
C3081370	115 V AC	2' per min.	14 AMP



C3081170 & C3081370

## Hydraulically Driven Capstan Hoists



C3080900



C3081180

- Improved design features a multiple planetary drive/backstop clutch assembled on the center shaft of a steel gearcase with full-length internal teeth
- Handles more rugged jobs, extends service life and reduces maintenance
- Lightweight, powerful, and portable
- Moves many heavyweight tasks and can get into remote or difficult-access sites
- Designed for use with setting utility poles, pulling wheeled equipment over obstacles, raising transformers (even over fences in back lots), hoisting heavy insulators, stringing and tensioning conductors, pulling cable (indoors and underground)
- Operator effort remains low for typical loads simply by adding wraps on the capstan drum
- Control is so accurate, loads can be moved fractions of an inch
- Standard drum style

Part #	Rope Speed at Rated Load	Source (Gallons/min.)	Load Rating
C3081180	93' per min.	8 gal.: 1,000 psi	1000 lbs
C3080900	30' per min.	8 gal.; 1,000 psi	3000 lbs

## Capstan 1000 lb. Gas Hoist



C3081190

- Improved design features a multiple planetary drive/backstop-clutch assembled on the center shaft of a steel gearcase with full-length internal teeth
- This design handles more rugged jobs, extends service life and reduces maintenance
- Lightweight yet powerful, these portable hoists move many heavyweight tasks and can get into remote or difficult-access sites; for example, setting utility poles, pulling wheeled equipment over obstacles, raising transformers (even over fences in back lots), hoisting heavy insulators, stringing and tensioning conductors, pulling cable (indoors and underground)
- Operator effort remains low for typical loads simply by adding wraps on the capstan drum
- Control is so accurate, loads can be moved fractions of an inch
- Rope speed at 1000 lbs. rated working load is 40' per minute
- Engine speed of 8000 rpm

## Grips for Weatherproof Wire



- Round jaws provide maximum contact and gripping power to minimize conductor damage
- Notches in jaw provide firm grip on insulation
- Round inside jaw contour for weatherproof coated wire
- Maximum safe load for 1611-20 and 1611-30 is 4,500 lbs.
- Maximum safe load for 1611-40 and 1611-50 is 8,000 lbs.

*Note: Due to various types of weatherproof coatings available, selection of proper grips is determined by outside diameter of cable.*

<b>1611-20</b>	<b>0.2" x 0.4"</b>
<b>1611-30</b>	<b>0.31" x 0.53"</b>
<b>1611-40</b>	<b>0.53" x 0.74"</b>
<b>1611-50</b>	<b>0.78" x 0.88"</b>

## Grips for PVC-Covered Conductors



- The serpentine jaws of this grip series are specially machined to allow insertion of insulated conductors through the jaws, which reduces danger of slippage which might result in insulation damage
- Round inside-jaw contour
- Maximum safe load for 1659-20 and 1659-30 is 4,500 lbs.
- Maximum safe load for 1659-40 and 1659-50 is 8,000 lbs.

<b>1659-20</b>	<b>0.20" x 0.42"</b>
<b>1659-30</b>	<b>0.31" x 0.50"</b>
<b>1659-40</b>	<b>0.49" x 0.79"</b>
<b>1659-50</b>	<b>0.79" x 1.01"</b>

## Grips for Extra High-Strength Cables, Messenger, Guy Strand and Conductors



- A family of grips for cable sizes from 0.12" to 1.0"
- Double "V" grooves give four-point contact, reducing chance of slipping and providing proper alignment
- For larger conductors, see grips with round inside-jaw contour
- Maximum safe load for 1613-40 is 4,500 lbs.
- Maximum safe load for 1684-5, 1692-5, and 1684-5F is 8,000 lbs.
- Maximum safe load for 1628-16, 1628-17 and 1628-18 is 15,000 lbs.

<b>1613-40</b>	<b>0.12" x 0.37"</b>
<b>1684-5</b>	<b>0.218" x 0.55"</b>
<b>1692-5</b>	<b>0.218" x 0.55"</b>
<b>1684-5F</b>	<b>0.16" x 0.55"</b>
<b>1628-16</b>	<b>0.31" x 0.62"</b>
<b>1628-17</b>	<b>0.50" x 0.75"</b>
<b>1628-18</b>	<b>0.75" x 1.00"</b>

## Chicago Grip "Type B" Strand Puller



- Similar to Bell-System type "B" strand puller
- Designed to pull 1/4" figure-8 telephone cable
- Serpentine grooves grip insulation on strand, preventing slippage
- Equipped with chain, toggle, and shackle

1659-5AT

## Klein Curved-Jaw Grips for EHS Cable



- When pulling EHS (extra-high-strength) galvanized-steel cable, the galvanizing has a tendency to coat the jaws of any grip, causing the cable to slip; to reduce the possibility of slippage and damage to the cable, the jaws of this grip are milled on a curve with a double "V" contour
- Maximum safe load is 8,000 lbs.

1684-74 0.218" x 0.55"

## Chicago Grip Bell-System Type Grip



- Equipped with chain, toggle and shackle
- For support wire .134 and larger, use 1659-5AT
- Outside diameter of support wire includes thickness of polyethylene coating

Part #	Capacity	Jaw Length	Max Safe Load	Weight
1684-5AT	0.218" - 0.55" cable	5"	8000 lbs	6.25 lbs.
1628-16AT	0.31" - 0.62" cable	7.25"	15,000 lbs	15.5 lbs.
1692-5AT	0.218" - 0.55" cable	5"	8000 lbs	6 3/8 lbs

## Chicago Grip for Bare ACSR, Aluminum and Stranded Copper Cables



- Round, smooth inside jaw contour on this series of grips is ideal for bare ACSR, aluminum, and stranded copper cables
- Smooth jaws grip with maximum contact and are less likely to damage conductors

Part #	Wire Size	Capacity
1656-20	0.2" x .40"	4500 lbs
1656-30	.31" x .53"	4500 lbs
1656-40	.53" x .74"	8000 lbs
1656-50	.74" x .86"	8000 lbs
1656-60	.86" x .53"	8000 lbs

## Grips for Bare Wire



- A lightweight grip for working with solid and stranded bare wire from .08" to .20"
- Simple three-point jaws designed for use on small-diameter bare wire and cable
- Single "V" groove jaw
- Maximum safe load is 1500 lbs

1613-30 .08" x .20"



## Klein Parallel Jaw Grips

- Longer jaws achieve a firm hold, reducing possibility of slippage
- Design includes a latch, plus a large diameter eye that accommodates large hooks on hoists, winches and tackle blocks



1671-10



1685-20



1672-10



1685-31

1686-10

1686-20

Part #	Wire Size	Capacity
1671-10	.37" x .75"	10,000 lbs
1686-10	.20" x .40"	10,000 lbs.
1686-20	.20" x .40"	10,000 lbs.

### Features knurled jaws

1672-10	.37" x .75"	10,000 lbs.
1685-20	.157" x .886"	4500 lbs.

### Features round inside jaw contour and serrated lower jaw

1685-31	.625" x 1.250"	7500 lbs.
---------	----------------	-----------

### Features round inside jaw contour and serrated lower jaw

## Klein Grips Warnings

### CAUTION:

- 1) Proper maintenance and field inspection of all grips is necessary before each use
- 2) Check to be sure there is no accumulation of foreign material in the jaws which might cause slippage
- 3) Check mechanical condition of entire grip
- 4) Check grip to be sure it is the correct size and type for the application
- 5) Check and lubricate; DO NOT lubricate gripping surfaces of jaws
- 6) Check all parts for distortion or misalignment

### WARNING:

- Always match proper size and type grip to application
- Do not exceed rated capacity
- Before each use clean jaw area and inspect grip for proper operation to avoid slippage
- When used on or near energized lines, ground, insulate, or isolate grip before pulling
- Grips are to be used for temporary installation, not permanent anchorage

## KLEIN WIRE PULLING GRIPS

### KT4500 Series Parallel Jaw Grips

- Cable range from 0.180" to 0.600"
- KT4500 and KT4502 are supplied with hot latches
- 5,000 lbs. maximum safe load

<b>KT4500</b>	<b>Spring</b>
<b>KT4501</b>	<b>Hot latch, Spring, Locking Handle</b>
<b>KT4502</b>	<b>Hot Latch Only</b>



### KT4600 Series Parallel Jaw Grips

- KT4601 and 4602 and are supplied with hot latches
- 10,000 lbs. maximum safe load

<b>KT4600</b>	<b>Spring</b>
<b>KT4601</b>	<b>Hot latch, Spring, Locking Handle</b>
<b>KT4602</b>	<b>Hot Latch Only</b>

### KT4800 Series Parallel Jaw Grips

- KT4801 and KT4802 are supplied with hot latches
- 12,000 lbs. maximum safe load

<b>KT4800</b>	<b>Spring</b>
<b>KT4801</b>	<b>Hot latch, Spring, Locking Handle</b>
<b>KT4802</b>	<b>Hot Latch Only</b>

## KLEIN HAVE (BULL DOG) GRIPS

- Designed for use when light, compact grip is desired and where conductor damage is not a factor
- Gripping pressure of the knurled jaw is applied to 1/4" cable area
- 1604-20L features a swing latch to help hold cable in the jaw

Part #	Wire size	Capacity
<b>1604-10</b>	<b>.06" x .25"</b>	<b>2500 lbs.</b>
<b>1604-20L</b>	<b>.125" x .50"</b>	<b>5000 lbs.</b>
<b>1604-20</b>	<b>.125" x .50"</b>	<b>5000 lbs.</b>
<b>1625-20</b>	<b>.28" x .75"</b>	<b>8000 lbs.</b>



**1604-10**  
**1604-20**



**1604-20L**



**1625-20**

## 1628 Series Interchangeable Jaw Grips

- Klein Tools' new Interchangeable Jaw Grips feature three grip bodies with interchangeable liners for ACSR, ACSS, and AAC cable
- Simply replace the liners for the particular cable diameter with Klein's grip liners, and there is no need to carry additional grips.
- Fewer grips means less weight on the job site and more storage space!
- Constructed of high strength alloy steel, hot forged, heat treated, and galvanized for toughness, strength, and corrosion resistance
- Suitable for ACSR, ACSS, and AAC
- Offers a full range of interchangeable liners to be inserted between the upper and lower jaws of the grip
- Cable diameter range: .886" to 1.614"
- MCM cable range: 565.5 to 1780.0



### Interchangeable Grip Bodies:

1628-60	.886" to 1.614"	Cable Diameter, 565.5 to 1780 MCM 13,000 lbs.
1628-70	.236" to .906"	Cable Diameter, 2 AWG to 600 MCM 6,750 lbs.
1628-80	.236" to .906"	Cable Diameter, for OPGW, 6750 lbs.

## 1628-60 Series Grip Liners

Part #	Cable Range
1628-60N	.866" to .945"
1628-60P	.945" to 1.004"
1628-60R	1.004" to 1.063"
1628-60S	1.063" to 1.122"
1628-60T	1.122" to 1.181"
1628-60U	1.181" to 1.24"
1628-60W	1.24" to 1.299"
1628-60X	1.299" to 1.358"
1628-60Y	1.358" to 1.417"
1628-60Z	1.417" to 1.476"
1628-60A	1.476" to 1.535"
1628-60B	1.535" to 1.594"
1628-60C	1.594" to 1.614"

## 1628-70 Series Grip Liners

Part #	Cable Range
1628-70AA	.236" to .236"
1628-70BB	.256" to .315"
1628-70F	.315" to .374"
1628-70G	.374" to .433"
1628-70H	.433" to .492"
1628-70I	.492" to .551"
1628-70J	.551" to .610"
1628-70K	.610" to .669"
1628-70L	.669" to .728"
1628-70M	.728" to .787"
1628-70N	.787" to .846"
1628-70O	.846" to .906"

## 1628-80 OPGW Series Grip Liners

Part #	Cable Range
1628-80AA	.236"
1628-80BB	.315"
1628-80E	.354"
1628-80F	.433"
1628-80G	.512"
1628-80H	.591"
1628-80I	.669"
1628-80J	.748"
1628-80K	.787"
1628-80L	.827"
1628-80M	.866"
1628-80N	.906"

## Standard Spring-Loaded Grips



LMG4500  
LMG4600



LMG4800

- Handle eye opening 1.25" x 1.75"
- Accept standard hooks and easily attach to tackle blocks
- Forged steel construction with yellow chromate finish to protect from rust and corrosion

Part #	Capacity	Wire Size/Gauge
LMG4500	5000 lbs.	.18" - .60" (6AWG - 4/0AWG)
LMG4600	10,000 lbs	.30" - .80" (1AWG - 450MCM)
LMG4800	12,000 lbs	.70" - 1.25" (397MCM - 1130MCM)

## Hot Line Spring Loaded Grips, Notched Handles



LMG4501  
LMG4601



LMG4801

- Hot Line Models also feature spring loaded gate with locking mechanism

Part #	Capacity	Wire Size/Gauge
LMG4501	5000 lbs.	.18" - .60" (6AWG - 4/0AWG)
LMG4601	10,000 lbs	.30" - .80" (1AWG - 450MCM)
LMG4801	12,000 lbs	.70" - 1.25" (397MCM - 1130MCM)

## LSB Hoist

- 360° rotating handle provides versatile rigging options when used in confined spaces
- Impact-resistant stamped steel housing withstands years of rigorous use
- Low handle effort provided by double reduction gearing and short handle
- Free wheeling mechanism allows one-handed take up and positioning of slack chain
- Meets or exceeds minimum 4:1 design factor and all requirements of ASME/ANSI Standard B-30.21

Part #	Capacity	Hook to Hook (min)	Average Handle Efforts	Handle Length	Lift
LSB1500B-10	1500 lbs	11 5/8"	46 lbs.	9.25"	10'
LSB3000B-10	3000 lbs	13"	59 lbs.	14.56"	10'
LSB6000B-10	6000 lbs	16 5/16"	75 lbs.	14.56"	10'



## G Model Chain Hoists



- Malleable iron housings, key internal components made of heat treated alloy steel, riveted construction
- Free chain feature allows easy positioning and set-up; also features reversible handle
- 360° swivel hooks are equipped with safety latches for positive load engagement
- Double pawl models can be operated with half strokes of lever for use in close quarters

Model	Capacity	Lift	Strands of Load Chain	Min. Distance Between Hooks	Average Handle Effort	Minimum Increment	Pawl
AG	1500 lbs	56.5"	1	13"	56 lbs	.624/.313	Single
ATG	3000 lbs	57"	2	15"	60 lbs	.313/.156	Single
ATGI	3000 lbs	57"	2	15"	60 lbs	.313/.156	Double
FTG	6000 lbs	57"	2	17 5/8"	120 lbs	.500/.250	Single
ZG-6	12,000 lbs	53"	4	25"	124 lbs	.250	Single

## TB602 & TB603 Mini Hoists

- Performs just like the larger hoists, but small enough to fit in a hard hat
- Weston type load brake
- Forged upper and lower hooks with latches standard
- Plated load chain is standard
- Free wheeling feature serves to quickly attach the load
- Hardened link type steel load chain

TB-602 Models feature a 550 lb. capacity

TB602-5 5' Lift

TB602-10 10' Lift

TB-602 Models feature a 1100 lb capacity

TB603-5 5' Lift

TB603-10 10' Lift



# Coffing Hoists

## Model 344 Lineman's Strap Hoists



- 344B features standard hooks with safety latches
- 344DB features hot stick ring hooks with safety latches on all hooks, control surfaces, and quick disconnect shafts
- 344CB features standard hooks with heavy duty swivel gate latches
- 344DHB features hot stick ring hooks with hot stick ring safety latches on all hooks and control surfaces and quick disconnect shaft

Part #	Capacity	Single Line		Double Line		
		Lift	Min. Headroom	Capacity	Lift	Hook to Hook (Min)
344B	2000 lbs	11'	20"	4000 lbs	5.5'	23"
344DB	2000 lbs	11'	20"	4000 lbs	5.5'	23"
344CB	2000 lbs	11'	23"	4000 lbs	5.5'	27"
344DHB	2000 lbs	11'	22"	4000 lbs	5.5'	26"

## 6000 lbs. Series Lineman's Strap Hoist



- 6000A features standard hooks with safety latches, 6000DA features hot stick rings with safety latches on all hooks, control surfaces, and quick disconnect shaft
- 6000CA features standard hooks with heavy duty swivel gate latches

Part #	Capacity	Lift	Min. Headroom	Double Line		
				Web Strap Length	Handle Length	Net Weight
6000A	6000 lbs	5'	27"	12'	30"	26.5 lbs.
6000DA	6000 lbs	5'	27"	12'	30"	26.5 lbs.
6000CA	6000 lbs	5'	31 1/2"	12'	30"	26.5 lbs.

## Cable Hoist



- 360° swivel hooks are equipped with safety latches for positive load engagement
- Double-interlocking pawl mechanism assures one pawl is engaged at all times
- Special cast aluminum and zinc alloy housings with preformed, galvanized, extra-flexible aircraft cable

Part #	Capacity	Single Line		Double Line		
		Lift	Hook to Hook (Min)	Capacity	Lift	Hook to Hook (Min)
1155B	1000 lbs	23'	20"	---	---	---
115DB	1000 lbs	23'	20"	2000 lbs.	11.5'	27"
434WNB	1500 lbs	22'	20"	3000 lbs.	11'	27"

## RA Model Dual Ratchet and Pawl Design Hoist

- 360° swivel hooks are equipped with safety latches for positive load engagement
- Double-interlocking pawl mechanism assures one pawl is engaged with the ratchet during lifting or lowering operations
- Meets or exceeds minimum 4:1 design factor and all requirements of ASME/ANSI Standard B-30.21

Part #	Capacity	Hook to Hook (Min)	Handle Pull at Rated Load	Handle Length	Lift
RA15	1500 lbs	12.4375"	59 lbs	20.5"	60"
RA20	2000 lbs	12.4375"	79 lbs	20.5"	60"
RA30	3000 lbs	13.75"	82 lbs	20.5"	60"
RA40	4000 lbs	13.75"	110 lbs	20.5"	60"



## Model 250 Lineman's Strap Hoists



- 250A features standard hooks with safety latches, 250DA features hot stick ring hooks with safety latches, 250CA features standard hooks with heavy duty swivel gate latches, and 250DHA features hot stick ring hooks with hot stick ring safety latches
- Unsurpassed in load spotting due to a friction brake design and fine tooth pawl
- Safety gate latches have been added; designed with a 4:1 safety factor

Part #	Capacity	Lift	Hook to Hook	Capacity	Lift	Min. Headroom
250A	1000 lbs.	9'	21"	2000 lbs.	4.25'	25"
250DA	1000 lbs.	9.25'	18"	2000 lbs.	4.25'	25"
250CA	1000 lbs.	9'	21"	2000 lbs.	4.25'	25"
250DHA	1000 lbs.	9.25'	18"	2000 lbs.	4.25'	25"

## Model 300 Lineman's Strap Hoists



- Features fiberglass handle, polyester webbing, and 360° swivel hooks equipped with safety latches
- Double-locking pawl mechanism assures one pawl is engaged at all times
- Stainless steel springs and shafts are corrosion-resistant and the hoist itself is durable and portable
- Insulated fiberglass handle with overload protection and polyester webbing adds non-conductivity
- 300A features standard hooks with safety latches, 300DA features hot stick ring hooks with safety latches, 300CA features standard hooks with heavy-duty swivel gate latches, and 300DHA features hot stick ring hooks with hot stick ring safety latches on all hooks, control surfaces and quick disconnect shaft

Part #	Single Line			Double Line			Web Strap Length
	Capacity	Lift	Min. Headroom	Capacity	Lift	Min. Headroom	
300A	1500 lbs.	9'	21"	3000 lbs.	4.25'	25"	10'
300DA	1500 lbs.	9.25'	18"	3000 lbs.	4.25'	25"	10'
300CA	1500 lbs.	9'	21"	3000 lbs.	4.25'	25"	10'
300DHA*	1500 lbs.	9.25'	18"	3000 lbs.	4.25'	25"	10'

\*Includes Hot Stick Rings on All Hooks, Control Surfaces and Quick disconnect Shaft

## Model 322 Lineman's Strap Hoists



- Insulated fiberglass handle with overload protection and polyester webbing adds non-conductivity
- 322B features standard hooks with safety latches, 322DB features hot stick ring hooks with safety latches on all hooks and control surfaces and quick disconnect shaft, 322CB features standard hooks with heavy duty swivel gate latches
- 322DHB features hot stick ring hooks with hot stick ring safety latches on all hooks, control surfaces, and quick disconnect shaft

Part #	Single Line			Double Line		
	Capacity	Lift	Min. Headroom	Capacity	Lift	Hook to Hook (Min)
322B	1500 lbs.	14'	20"	3000 lbs.	7'	23"
322DB*	1500 lbs.	14'	20"	3000 lbs.	7'	23"
322CB	1500 lbs.	14'	23"	3000 lbs.	7'	27"
322DHB*	1500 lbs.	14'	22"	3000 lbs.	7'	26"

\*Meets or exceeds minimum 4:1 design design factor and all requirements of ASME/ANSI Standard B-30.21

# Lug-All

## Web Strap Pullers

- With LUG-ALL's new convertible web strap pullers, all the parts needed to switch from a double line to single line are on the hoist, lessening the possibility of misplacing or losing parts.
- Lighter weight and more headroom on medium frame convertible models



1.5 Ton Small Frame Convertible

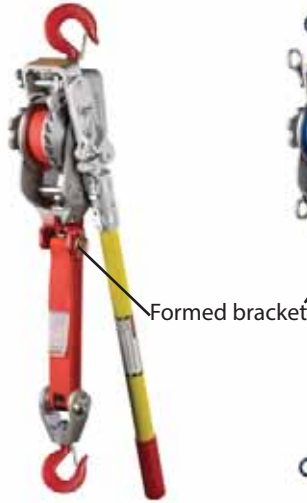

1.5 Ton Medium Frame w/ Convertible Kit



2 Ton Medium Frame w/ Convertible Kit



### 5 Hook Styles

- A - Standard Latch Hooks
- B - Hot Stick Rings & Latching Hooks
- U - Gate Type Hooks
- UB - Gate Type Hooks & Hot Stick Rings
- HB - Hot Stick Rings & Hook Latches

- All models equipped with quick release pulley block
- LUG-ALL grups, straps and hooks are colour-coded by capacity

Part #	Capacity (Ton)	Single Pull Distance		Capacity (Ton)	Double Pull Distance		Strap Length	Handle Length	Net Weight
		Min.	Max.		Min.	Max.			
2-CA	3/4	20"	7'2"	1.5	18"	3'6"	8'	30"	9.5
2-CB	3/4	20"	7'2"	1.5	18"	3'6"	8'	32"	9.75
2-CU	3/4	22"	7'2"	1.5	20"	3'5"	8'	30"	10
2-CUB	3/4	22"	7'2"	1.5	20"	3'5"	8'	32"	10.25
2-CHB	3/4	22"	7'2"	1.5	20"	3'5"	8'	32"	10.25
2-CA-1000	3/4	20"	7'2"	1.5	18"	3'6"	8'	20"	9.25
2-CB-1000	3/4	20"	7'2"	1.5	18"	3'6"	8'	22"	9.5
2-CU-1000	3/4	22"	7'2"	1.5	20"	3'5"	8'	20"	9.75
2-CUB-1000	3/4	22"	7'2"	1.5	20"	3'5"	8'	22"	10
2-CHB-1000	3/4	22"	7'2"	1.5	20"	3'5"	8'	22"	10
3-CA	3/4	21"	11'1"	1.5	21"	5'4"	11'5"	30"	13.25
3-CB	3/4	21"	11'1"	1.5	21"	5'4"	11'5"	32"	13.5
3-CU	3/4	23"	11'1"	1.5	23"	5'3"	11'5"	30"	13.75
3-CUB	3/4	23"	11'1"	1.5	23"	5'3"	11'5"	32"	14
3-CHB	3/4	23"	11'1"	1.5	23"	5'3"	11'5"	32"	14
4-CA	1	21"	9'2"	2	21"	4'5"	10'	36"	14.5
4-CB	1	21"	9'2"	2	21"	4'5"	10'	38"	14.75
4-CU	1	23"	9'2"	2	23"	4'4"	10'	36"	15
4-CUB	1	23"	9'2"	2	23"	4'4"	10'	38"	15
4-CHB	1	23"	9'2"	2	23"	4'4"	10'	38"	15

## Standard Web Strap Pullers



**1 Ton  
Small Frame**

**1.5 Ton  
Small Frame**

**1.5 Ton  
Medium Frame**

**2 Ton  
Medium Frame**



### 5 Hook Styles

- A** - Standard Latching Hooks
- B** - Hot Stick Rings & Latching Hooks
- U** - Gate Type Hooks
- UB** - Gate Type Hooks & Hot Stick Rings
- HB** - Hot Stick Rings & Hook Latches

- All models equipped with quick release pulley block
- LUG-ALL grups, straps and hooks are colour-coded by capacity

Part #	Capacity (Ton)	Single Pull Distance		Capacity (Ton)	Double Pull Distance		Strap Length	Handle Length	Net Weight
		Min.	Max.		Min.	Max.			
2-A	0.5	16"	9'6"	1	21"	4'5"	10'	30"	10.25
2-B	0.5	16"	9'6"	1	21"	4'5"	10'	32"	10.5
2-U	0.5	18"	9'6"	1	24"	4'4"	10'	30"	10.75
2-UB	0.5	18"	9'6"	1	24"	4'4"	10'	32"	11
2-HB	0.5	18"	9'6"	1	24"	4'4"	10'	32"	11
25-A	0.75	16"	7'6"	1.5	21"	3'5"	8'	20"	10
25-B	0.75	16"	7'6"	1.5	21"	3'5"	8'	22"	10.5
25-U	0.75	18"	7'6"	1.5	24"	3'4"	8'	20"	10.5
25-UB	0.75	18"	7'6"	1.5	24"	3'4"	8'	22"	10.75
25-HB	0.75	18"	7'6"	1.5	24"	3'4"	8'	22"	11
3-A	0.75	19"	11'3"	1.5	27"	5'1"	11'5"	30"	14
3-B	0.75	19"	11'3"	1.5	27"	5'1"	11'5"	32"	14.5
3-U	0.75	21"	11'3"	1.5	30"	5'0"	11'5"	30"	15
3-UB	0.75	21"	11'3"	1.5	30"	5'0"	11'5"	32"	15
3-HB	0.75	20"	11'3"	1.5	29"	5'0"	11'5"	32"	15.25
4-A	1	19"	9'4"	2	27"	4'1"	10'	36"	15.5
4-B	1	19"	9'4"	2	27"	4'1"	10'	38"	16
4-U	1	21"	9'4"	2	31"	4'	10'	36"	16
4-UB	1	21"	9'4"	2	31"	4'	10'	38"	16.5
4-HB	1	20"	9'4"	2	29"	4'	10'	38"	16.25



## CM Bandit Ratchet Lever Hoist



- Capacities of 3/4 and 1-1/2 tons. Metric Rated. Standard lifts up to 20 feet
- Rugged, yet lightweight, design and construction allow for easy transport
- CM SmartID RFID option available on request
- Easy free chaining feature allows for quick take up and positioning of slack chain. Designed not to accidentally free chain while under load
- Available with load limiter option
- Enclosed Weston type load brake stays clean and dry for positive load positioning
- Upper and lower hooks feature extra wide throat openings to allow for easier attachment to pick points
- Lifetime Warranty
- Meets ASME B30.21

Part #	Capacity	Lift
BAN07505R	3/4 Ton	5'
BAN07510R	3/4 Ton	10'
BAN07515R	3/4 Ton	15'
BAN15005R	1 1/2 Ton	5'
BAN15010R	1 1/2 Ton	10'
BAN15015R	1 1/2 Ton	15'

## Screw Pin Midland Carbon Anchor Shackle



- Screw Pin Anchor Shackles allow quick and easy removal of the screw pin and can be useful in applications where the shackle is frequently removed, but not so much in applications where the pin is subject to torque or twisting
- Meet requirements of Federal Specification RR-C-271D Amendment 1
- All shackle pins are forged from alloy steel, heat treated and tempered to give greater strength
- Available in painted, galvanized and self-coloured finishes (Dacromate coating upon special request only)
- All shackles are marked with size (inches and millimeters) and working load limit in tons
- Ultimate strength equals 5 times working load limit
- All bolt, nut and cotter shackles have thread protected ends
- Galvanized per ASTM A153
- Standard industry tolerances apply
- Design factor 5:1
- Pin Type: Screw
- Industrial/Government Rated

CM	Capacity
MC649	1.5 Ton
MC650	2 Ton
MC651	3.25 Ton
MC652	4.75 Ton
MC654	8.5 Ton

## Alloy Web Sling Shackle



- Designed for use with web slings up to 6" in width and available in capacities up to 12 tons
- Web Sling Shackles can be used on web slings from 3 to 6 inches in width
- Utilize a bolt and nut with linch style pin to secure the assembly in place
- Galvanized for longer life
- Marked with working load limit (WLL) and size
- Pin Type: Bolt, Nut and Cotter

CM	Size	Capacity
M703A	.75"	13,500 lbs
M704A	.75"	14,500 lbs
M705A	1"	19,000 lbs
M706A	1 1/8"	22,500 lbs

## Carbon Web Sling Shackle



- Designed for use with web slings up to 6" in width and available in capacities up to 12 tons
- Finish: hot dip galvanized
- Klik pin (zinc plated) as shown
- Furnished as standard-cotter or hair pin can be furnished on special order
- Shackle body: carbon steel, heat treated
- Shackle pin: alloy steel, heat treated
- Tolerances: 11/32" unless otherwise indicated
- Design ultimate strength equals 4 times the working load limit

CM	Size	Size	Capacity
M702	5/8"	2"	8050 lbs
M703	3/4"	3"	13,050 lbs
M704	3/4"	4"	10,800 lbs
M705	7/8"	5"	18,000 lbs
M706	1"	6"	18,000 lbs

## Lewis Ring and Conduit Riser Grips

- Specially designed to suspend conductor by using the conduit as a means of support
- With the conductor approximately 1/2" above the "in-place" position, the grip is slipped into position and sits on the conduit edge, thus completing the installation
- The ring and its components are constructed of investment cast, powder coated bronze
- The plastic coated aircraft strand cable - plus the flexibility of design - permits a maximum of line surge without conductor damage
- Ring size permits conduit couplings to be used
- Patent Numbers 3,216,682 and 3,399,853



Conduit Size	Grip Size					
	.75" 0.75' - 1.125"	1.12" 1.125" - 1.625"	1.62" 1.625" - 2.5"	2.5" 2.5" - 3.5"	3.5" 3.5" - 4.5"	4.5" 4.5" - 5.5"
1.25"	LR 1.25 - .75 1000 lbs					
1.5"	LR 1.5 - .75 1000 lbs					
2"	LR 2 - .75 1000 lbs	LR 2 - 1.12 1250 lbs				
2.5"	LR 2.5 - .75 1000 lbs	LR 2.5 - 1.12 1250 lbs	LR 2.5 - 1.62 2250 lbs			
3"	LR 3 - .75 1000 lbs	LR 3 - 1.12 1250 lbs	LR 3 - 1.62 2250 lbs			
3.5"	LR 3.5 - .75 1000 lbs	LR 3.5 - 1.12 1250 lbs	LR 3.5 - 1.62 2250 lbs	LR 3.5 - 2.5 3000 lbs		
4"	LR 4 - .75 1000 lbs	LR 4 - 1.12 1250 lbs	LR 4 - 1.62 2250 lbs	LR 4 - 2.5 3000 lbs		
4.5"	LR 4.5 - .75 1000 lbs	LR 4.5 - 1.12 1250 lbs	LR 4.5 - 1.62 2250 lbs	LR 4.5 - 2.5 3000 lbs		
5"	LR 5 - .75 1000 lbs	LR 5 - 1.12 1250 lbs	LR 5 - 1.62 2250 lbs	LR 5 - 2.5 3000 lbs	LR 5 - 3.5 4500 lbs	
6"	LR 6 - .75 1000 lbs	LR 6 - 1.12 1250 lbs	LR 6 - 1.62 2250 lbs	LR 6 - 2.5 3000 lbs	LR 6 - 3.5 4500 lbs	LR 6 - 4.5 6000 lbs



## Multi-Purpose X-Series Pulling Grips

Voltage Class	Part #	Conductor Size AWG/ KCMIL	Rating	Name	Nominal O.D. (in.)	Grip Range (in.)	Working load (lbs)
Primary	XS-A-DW-24	#2	15kV (175 mil insul.)	N/A	1	.75-1.25	2000
Primary	XS-A-DW-24	#2	15kV (220 mil insul.)	N/A	1.09	.75-1.25	2000
Primary	XS-A-DW-24	1/0	15kV (175 mil insul.)	N/A	1.07	.75-1.25	2000
Primary	XS-A-DW-24	1/0	15kV (220 mil insul.)	N/A	1.17	.75-1.25	2000
Primary	XS-B-TW-26	1/0	25kV (260 mil insul.)	N/A	1.25	1.25-2	2500
Primary	XS-B-DW-26	1/0	35kV (345 mil insul.)	N/A	1.45	1.25-2	2500
Primary	XS-A-DW-24	2/0	15kV (175 mil insul.)	N/A	1.15	.75-1.25	2000
Primary	XS-A-DW-24	2/0	15kV (220 mil insul.)	N/A	1.24	.75-1.25	2000
Primary	XS-B-TW-26	2/0	25kV (260 mil insul.)	N/A	1.33	1.25-2	2500
Primary	XS-B-TW-26	2/0	35kV (345 mil insul.)	N/A	1.52	1.25-2	2500
Primary	XS-A-DW-24	4/0	15kV (175 mil insul.)	N/A	1.23	.75-1.25	2000
Primary	XS-B-TW-26	4/0	15kV (220 mil insul.)	N/A	1.32	1.25-2	2500
Primary	XS-B-TW-26	4/0	25kV (260 mil insul.)	N/A	1.43	1.25-2	2500
Primary	XS-B-TW-26	4/0	35kV (345 mil insul.)	N/A	1.6	1.25-2	2500
Primary	XS-B-TW-26	500	15kV (175 mil insul.)	N/A	1.57	1.25-2	2500
Primary	XS-B-TW-26	500	15kV (220 mil insul.)	N/A	1.73	1.25-2	2500
Primary	XS-B-TW-26	500	25kV (260 mil insul.)	N/A	1.81	1.25-2	2500
Primary	XS-C-TW-32	500	35kV (345 mil insul.)	N/A	2.02	2-2.75	3500
Primary	XS-B-TW-26	750	15kV (175 mil insul.)	N/A	1.87	1.25-2	2500
Primary	XS-B-TW-26	750	15kV (220 mil insul.)	N/A	1.96	1.25-2	2500
Primary	XS-C-TW-32	750	25kV (260 mil insul.)	N/A	2.08	2-2.75	3500
Primary	XS-C-TW-32	750	35kV (345 mil insul.)	N/A	2.25	2-2.75	3500
Primary	XS-C-TW-32	1000	15kV (175 mil insul.)	N/A	2.06	2-2.75	3500
Primary	XS-C-TW-32	1000	15kV (220 mil insul.)	N/A	2.15	2-2.75	3500
Primary	XS-C-TW-32	1000	25kV (260 mil insul.)	N/A	2.23	2-2.75	3500
Primary	XS-C-TW-32	1000	35kV (345 mil insul.)	N/A	2.4	2-2.75	3500
Secondary	XS-A-DW-24	#2 (#4 neutral)	600V (60 mil insul.)	Stephens	.84	.75-1.25	2000
Secondary	XS-A-DW-24	#2	600V (60 mil insul.)	Ramapo	.88	.75-1.25	2000
Secondary	XS-A-DW-24	1/0 (#2 neutral)	600V (60 mil insul.)	Brenau	1.06	.75-1.25	2000
Secondary	XS-A-DW-24	1/0	600V (80 mil insul.)	Bergen	1.14	.75-1.25	2000
Secondary	XS-A-DW-24	1/0	600V (80 mil insul.)	Hunter	1.23	.75-1.25	2000
Secondary	XS-B-TW-26	4/0 (2/0 neutral)	600V (80 mil insul.)	Sweetbriar	1.38	1.25-2	2500
Secondary	XS-B-TW-26	4/0	600V (80 mil insul.)	Monmouth	1.46	1.25-2	2500
Secondary	XS-B-TW-26	350 (4/0 neutral)	600V (80 mil insul.)	Wesleyan	1.72	1.25-2	2500
Secondary	XS-C-TW-32	500 (350 neutral)	600V (95 mil insul.)	Rider	2.03	2-2.75	3500

- May be used for overhead or underground applications
- Feature coated galvanized cable, reverse weave, and a single bail wire, but will not have metal shoulders
- Identified by tags beneath the heavy duty clear tubing



## JL-R Series Grips

- The JL-R Series Grips are designed to be used in secondary light duty cable pulls
- The neoprene cone at the front of the grip helps the grip and cable go around the bends easily and smoothly
- If installed properly, the cone can also help eliminate possible cable lubricant migration by sealing off the cable during a pull



Part #	Range	Work Load
50-2014	1/4" - 1/2"	600 lbs
50-2015	1/2" - 3/4"	1250 lbs
50-2011	3/4" - 1"	1400 lbs
50-2012	1" - 1 1/2"	2250 lbs

## X-Series Grips

- Plastic-coating increases the life of the grip, provides a more effective gripping surface, and helps reduce injuries due to frayed or mangled wire in the pulling grip itself
- The single wire eye allows a swivel to be attached to the grip easily and helps to alleviate any binding that may occur in the throat of the swivel during a pull
- Also offers a backwards weave that (1) adds pulling surface to the grip itself, and (2) allows the grip to pass through even the tightest of clearances
- Feature metal sleeves near the top of the grip to eliminate wear when pulling through clay conduit, gravel, or other abrasive pulling environments
- Constructed of galvanized wire



Part #	Range	Work Load
50-1895	3/4" - 1 1/4"	2000 lbs
50-1904	1 1/4" - 2"	2500 lbs
50-1910	2" - 2 3/4"	4500 lbs
50-1912	2 3/4" - 3 1/2"	5500 lbs
50-1915	3 1/2" - 4 1/4"	6500 lbs
50-1917	4 1/4" - 4 7/8"	7000 lbs

## Pulling Collars

- Use the pulling collar's staggering feature to eliminate conduit stress while pulling multiple cables and grips together
- These pulling collars allow you to attach various sized single grips together
- The grips are attached to each collar head with a swing link or swivel



Part #	# of Legs	Break Load
70-1006	3	5500 lbs
70-1007	4	5500 lbs
70-1010	3	8200 lbs
70-1011	4	8200 lbs
70-1014	3	9800 lbs
70-1015	4	9800 lbs

## Swing Link

- Drop forged steel swing links are fabricated from the same high quality steel as Lewis swivels
- Used for adapting swivels to grips and/or winch lines



Part #	Range
5118	5/16"
5119	7/16"
5120	9/16"

# Lewis Manufacturing

## Pulling Grip Selection Guide for Overhead Cable

Voltage Class	Part #	Conductor Size AWG/KCMIL	Stranding	Name	Nominal O.D. (in.)	Grip Range (in.)	Working load (lbs)
Primary	OH-DW-1/4"-1/2"	#2	ACSR (6/1)	Sparrow	.316	.25-.5	1500
Primary	OH-DW-1/4"-1/2"	#2	AAC (7)	Iris	.292	.25-.5	1200
Primary	OH-DW-1/4"-1/2"	1/0	ACSR (6/1)	Raven	.398	.25-.5	1200
Primary	OH-DW-1/4"-1/2"	1/0	AAC (7)	Poppy	.368	.25-.5	1200
Primary	OH-DW-1/4"-1/2"	2/0	ACSR (6/1)	Quail	.447	.25-.5	1200
Primary	OH-DW-1/4"-1/2"	2/0	AAC (7)	Aster	.414	.25-.5	1200
Primary	OH-TW-1/2"-7/8"	4/0	ACSR (6/1)	Penguin	.563	.5-.875	3200
Primary	OH-TW-1/2"-7/8"	4/0	AAC (7)	Oxlip	.522	.5-.875	3200
Primary	OH-TW-1/2"-7/8"	266.8	ACSR (18/1)	Waxwing	.609	.5-.875	3200
Primary	OH-TW-1/2"-7/8"	266.8	ACSR (26/7)	Partridge	.642	.5-.875	3200
Primary	OH-TW-1/2"-7/8"	336.4	ACSR (26/7)	Linnet	.721	.5-.875	3200
Primary	OH-TW-1/2"-7/8"	336.4	ACSR (30/7)	Oriole	.741	.5-.875	3200
Primary	OH-TW-1/2"-7/8"	397.5	ACSR (26/7)	Ibis	.783	.5-.875	3200
Primary	OH-TW-7/8"-1 1/4"	477	ACSR (18/1)	Pelican	.814	.875-1.25	4100
Primary	OH-TW-7/8"-1 1/4"	477	ACSR (26/7)	Hawk	.858	.875-1.25	4100
Primary	OH-TW-7/8"-1 1/4"	556.5	ACSR (18/1)	Osprey	.879	.875-1.25	4100
Primary	OH-TW-7/8"-1 1/4"	556.5	ACSR (26/7)	Dove	.927	.875-1.25	4100
Primary	OH-TW-7/8"-1 1/4"	605	ACSR (26/7)	Squab	.966	.875-1.25	4100
Primary	OH-TW-7/8"-1 1/4"	636	ACSR (26/7)	Grosbeak	.990	.875-1.25	4100
Primary	OH-TW-7/8"-1 1/4"	636	ACSR (30/19)	Egret	1.019	.875-1.25	4100
Primary	OH-TW-7/8"-1 1/4"	666	ACSR (26/7)	Gannet	1.014	.875-1.25	4100
Primary	OH-TW-7/8"-1 1/4"	715	ACSR (26/7)	Starling	1.051	.875-1.25	4100
Primary	OH-TW-7/8"-1 1/4"	795	ACSR (26/7)	Drake	1.108	.875-1.25	4100
Primary	OH-TW-7/8"-1 1/4"	795	ACSR (30/19)	Mallard	1.14	.875-1.25	4100
Primary	X-HDFE-7/8"-1 3/8"	954	ACSR (45/7)	Rail	1.165	.875-1.375	5700
Primary	X-HDFE-7/8"-1 3/8"	954	ACSR (54/7)	Cardinal	1.196	.875-1.375	5700
Secondary	XS-A-SW-24	#2 (#4 neutral)	600V (45 mil insul.)	Cockle	.760	.75-1.25	2000
Secondary	XS-A-SW-24	#2	600V (45 mil insul.)	Conch	.770	.75-1.25	2000
Secondary	XS-A-SW-24	1/0 (#2 neutral)	600V (60 mil insul.)	Janthina	.970	.75-1.25	2000
Secondary	XS-A-SW-24	1/0	600V (60 mil insul.)	Neritina	.980	.75-1.25	2000
Secondary	XS-A-SW-24	2/0	600V (60 mil insul.)	Runica	1.08	.75-1.25	2000
Secondary	XS-A-SW-24	3/0 (1/0 neutral)	600V (60 mil insul.)	Sanddollar	1.16	.75-1.25	2000
Secondary	XS-A-SW-24	3/0	600V (60 mil insul.)	Cherrystone	1.19	.75-1.25	2000
Secondary	XS-B-TW-26	4/0 (2/0 neutral)	600V (60 mil insul.)	Cuttlefish	1.27	1.25-2.0	2500
Secondary	XS-B-TW-26	4/0	600V (60 mil insul.)	Razor	1.31	1.25-2.0	2500



## Sealed Thrust Ball Bearing Swivel



- These directional boring swivels prevent equipment's rotational torque from interfering with the product being pulled
- In a typical boring application, the swivel is attached behind the reamer head and to the pipe or cable being pulled through the bore
- Permanently sealed to keep contaminants out, they never require lubrication

Part #	Work Load
40-1003	1500 lbs
40-1001	5400 lbs
40-1005	9000 lbs
40-1007	12,000 lbs

## LKJ-1: Knuckle Joint-1



Knuckle Joint



Knuckle Joint installed on a swivel and "Duckbill" directional boring bit

- Provides a way to adapt a pulling swivel (or any other device) to the popular "Duckbill" style directional bits
- Prevents premature wear and tear on both the swivel and bit
- The knuckle joint allows the swivel to be pulled back in a straight line
- Quickly attaches and detaches with one Allen head bolt

## Heavy Duty Ball Bearing Swivels



- Specifically designed for tension stringing; manufactured from high-grade pre-stressed steel
- Swivels assure that the conductor will remain in the neutral position during stringing of transmission and distribution lines
- Twin race ball bearing swivels; pins are removable with a screwdriver
- Proper placement of thrust and radial bearing allow thrust and shock loads to be absorbed without affecting rotation of swivel

Part #	Overall Length	Pin Diameter	Jaw Opening	Overall Diameter	Working Load	Approx. Breaking Strength
HD-00	4 1/8"	5/16"	3/8"	7/8"	1500 lbs	4500 lbs
HD-0	5 1/4"	7/16"	1/2"	1 1/8"	5400 lbs	16200 lbs
HD-1	6"	1/2"	5/8"	1 7/16"	9000 lbs	27000 lbs
HD-2	7 1/8"	5/8"	5/8"	1 5/8"	12000 lbs	36000 lbs
HD-3	8 5/8"	3/4"	3/4"	2"	21000 lbs	63000 lbs
HD-4	10"	7/8"	7/8"	2 3/8"	30000 lbs	90000 lbs

# Lewis Manufacturing

## Sealed Thrust Ball Bearing Swivels with Grease Zerk



- Designed for directional boring
- For overhead and underground applications that require a greasable swivel
- Swivel must be greased before and after each use



Part #	Overall Length	Pin Diameter	Jaw Opening	Overall Diameter	Working Load	Approx. Breaking Strength
HD-0-S-Z	5 1/16"	7/16"	1/2"	1 1/8"	5400 lbs	16,200 lbs
HD-1-S-Z	6 5/8"	1/2"	5/8"	1 7/16"	9000 lbs	27,000 lbs
HD-2-S-Z	7 3/4"	5/8"	5/8"	1 5/8"	12,000 lbs	36,000 lbs
HD-3-S-Z	9"	3/4"	3/4"	2"	21,000 lbs	63,000 lbs
HD-4-S-Z	10 1/4"	7/8"	7/8"	2 3/8"	30,000 lbs	90,000 lbs

## Ouchless Lewis Grips™



- Made of plastic coated Aramid Fiber strands
- Traditionally used in overhead or underground operations when pulling or suspending electric or fiber optic cables
- Grips do not have the metallic fraying as traditional grips do, thereby eliminating the chance of being injured from metallic strands that have been branded
- May also be used when metallic grip is unsuitable, such as when pulling in an energized environment
- Non-conductive, lighter, yet stronger than metal grips, easier to load and remove, no wire frays, no wire cuts and contusions

Single Eye



Double Eye



Model #	Size	Work Load	Breaking Strength	Weave	Eye
SE-LK-SW-1/4-3/4	1/4"-3/4"	830 lbs	2500 lbs	Single	Single
SE-LK-SW-3/4-1	3/4"-1"	1200 lbs	3600 lbs	Single	Single
SE-LK-SW-1-1 1/2	1"-1 1/2"	1665 lbs	5000 lbs	Single	Single
SE-LK-SW-1 1/2-2	1 1/2"-2"	1940 lbs	5825 lbs	Single	Single
SE-LK-DW-1-1 1/2	1"-1 1/2"	3300 lbs	9900 lbs	Double	Single
SE-LK-DW-1 1/2-2	1 1/2"-2"	3965 lbs	11,900 lbs	Double	Single
SE-LK-DW-2-2 1/2	2"-2 1/2"	5300 lbs	15,900 lbs	Double	Single
SE-LK-DW-2 1/2-3	2 1/2"-3"	5300 lbs	15,900 lbs	Double	Single
SE-LK-DW-3-4	3"-4"	5300 lbs	15,900 lbs	Double	Single

Model #	Size	Work Load	Breaking Strength	Weave	Eye
DLE-LK-SW-1/4-3/4	1/4"-3/4"	830 lbs	2500 lbs	Single	Double
DLE-LK-SW-3/4-1	3/4"-1"	1200 lbs	3600 lbs	Single	Double
DLE-LK-SW-1-1 1/2	1"-1 1/2"	1665 lbs	5000 lbs	Single	Double
DLE-LK-SW-1 1/2-2	1 1/2"-2"	1940 lbs	5825 lbs	Single	Double
DLE-LK-DW-1-1 1/2	1"-1 1/2"	3300 lbs	9900 lbs	Double	Double
DLE-LK-DW-1 1/2-2	1 1/2"-2"	3965 lbs	11,900 lbs	Double	Double
DLE-LK-DW-2-2 1/2	2"-2 1/2"	5300 lbs	15,900 lbs	Double	Double
DLE-LK-DW-2 1/2-3	2 1/2"-3"	5300 lbs	15,900 lbs	Double	Double
DLE-LK-DW-3-4	3"-4"	5300 lbs	15,900 lbs	Double	Double

# Chain Slings & Lifting Accessories

## Steel Choker with Loops on Both Ends

- Eye and eye wire rope sling
- Wire rope construction is 6 x 19, IWRC, Right Regular Lay (industry standard)

- 1/2" x 4'
- 1/2" x 6'
- 1/2" x 8'
- 3/8" x 4'
- 3/8" x 6'
- 3/8" x 8'



## 3/8" Pole Sling with Slide Hook

- Will not kink like cable or fray like rope
- Slides down pole easily
- Fittings are grade 8 alloy
- 4 - 1 design factor
- 5' long



## 2 Ply Nylon Slings

- Capacities: Vertical is 6400 lbs; Basket hitch - 12,800 lbs.; Choker - 5000 lbs
- Capacities are determined according to ANSI standard B30.9, Section 9-5.2
- Industry standard twisted eye and eye nylon web sling

- 2" x 4' Nylon Sling
- 2" x 6' Nylon Sling
- 2" x 8' Nylon Sling



## Utility Pole Specialized Rigging Sling

- 70" working length
- 1900 lb. rated capacity
- Designed to offer a good grip on the shaft of a tapered pole without rigging up a clamping device
- Designed by bonding patented slip-resistant polymer traction bars to a nylon sling, using a proprietary process
- When slipped around a pole and pulled taught, its polymer grippers are forced into the surface of the pole; more force produces an even tighter grip
- Saves time and manpower, because now crews can simply pick a spot anywhere above the pole's "tipping point," fasten the sling, and be ready to lift

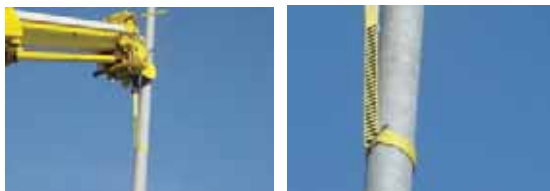

## Polyester Web Slings

- A light, versatile, flexible synthetic sling with eyes on both ends
- Wear points can continually be shifted for maximum sling life
- Vertical capacity: 3200 lbs
- Choker capacity: 2500 lbs
- Basket capacity: 6400 lbs



1" Wide x 9' Long  
1" Wide x 10' Long

## Endless Gel Round Slings

- 10' long
- Load stability and balance achieved by spreading sling legs
- Wear points may continually be shifted for maximum sling life



CAPACITIES		
Vertical	Choker	Basket
10,600 lbs	8500 lbs	21,200 lbs

## Endless Polyester Round Slings

- 6' long
- Light, versatile, flexible synthetic slings
- Wear points may continually be shifted for maximum sling life



CAPACITIES		
Vertical	Choker	Basket
2650 lbs	2120 lbs	5300 lbs
5300 lbs	4240 lbs	10,600 lbs



# Slings

## Salisbury Transformer Slings



Part #	Diameter	Tensile (Straight Pull)	WLL	Colour
S0190L0048	1/2"	7200 lbs	1225 lbs	Blue
S0191L0048	5/8"	12,000 lbs	2160 lbs	Red
S0194L0048	3/4"			Green

- Features eye on each end
- Adjustable from 3" to 15" to accommodate various sizes and types of transformers
- Chafe collar in middle of sling protects against abrasion and snagging
- Each end has a crown splice to prevent eye from pulling out while under load
- Standard length is 4 ft.; other lengths available
- Adjustable from 24" to 28"
- Rope is 100% high tenacity polyester, constructed in a single braid and coated with Rhino-Lote for increased abrasion resistance

## RNH 10-2: Unirope 2" Tie-Downs (Polyester Webbing)

- Complete with ratchet and end fittings
- 1/2" narrow wire hook at both ends
- Standard Length is 20 ft (2 ft Tail, 18 ft Strap)
- Rated capacity: 3300 lbs
- All tie-down systems come with a sturdy vinyl capacity tag stating safety precautions and load ratings at various tie-down angles
- Tag firmly sewn to strap (no flag)

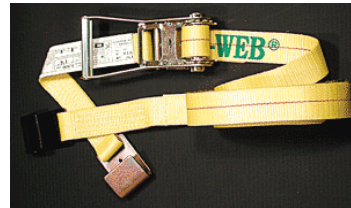

## Uni-Web® Nylon Eye & Eye Lifting Sling Type 3 (EE) Straight Eye; Type 4 (EE) Twisted Eye 1 and 2 Ply

- Slings with an eye at both ends
- Choice of straight or twisted eyes
- As standard, all eyes of 3" wide and up are tapered



Uni-Web® Nylon Eye & Eye Lifting Sling Type 3 - 2" Width  
 EE1-901-N-3: 1" Width  
 EE1-902-N-3: 2" Width



Uni-Web® Nylon Lifting Sling Type 5 - 2" Width  
 EN1-901-N: 1" Width  
 EN-902-N: 2" Width



## Unirope Transformer Sling

- This sling is used to lift transformer into place
- The elastic strap prevents the sling eyes from falling out of the lifting points

TS2-602-N-LENGTH  
 Available in 18-36" Length

## A-338: Grade 80 Alloy Fittings

- Alloy Steel – Quenched and Tempered
- Individually proof-tested at 2-1/2 times the working load limit with certification
- Pin locking requires no special tools
- The use of A-338 Clevis Grab Hook will result in a 20 percent reduction in chain capacity. When used to hook back to chain leg to form a choker, the angle of the choker must be 120° or greater. When used as a chain shortener, minimize twist of chain and ensure chain is fully engaged in hook



## A-1338: Crosby® Grade 100 Clevis Grab Hooks

- Forged Alloy Steel - Quenched and Tempered
- Innovative cradle design allows for 100% efficiency of Grade 100 chain
- Individually proof tested to 2-1/2 times the working load limit with certification
- Each hook has a Product Identification Code (PIC) for material traceability, along with the size and the name Crosby & USA in raised letters
- Suitable for use with Grade 100 and Grade 80 chain slings (per ANSI B30.1)
- The use of A-1338 Cradle Grab Hook will allow 100 percent of the chain sling capacity. When used to hook back to chain leg to form a choker, the angle of the choke must be 120° or greater
- When used as a chain shortener, minimize twist of chain and ensure chain is fully engaged in hook
- Fatigue rated at 1-1/2 times the working load limit at 20,000 cycles



## A-342: Alloy Master Links

- Alloy forged master link is 100% proof tested
- Drop forged using special bar quality alloy steel
- Quenched and tempered heat treatment for improved strength



## L-140: Lebus® Load Binders

- Upgraded for use with Grades 70, 80 and 100 Chain
- Utilizes standard Crosby A-323 Alloy Eye Grab Hooks
- New design "one piece" forged handle
- Continuous take-up feature provides finite adjustment to tie down load
- One piece assembly, no bolts or nuts to loosen
- Ratchet spring is rust proofed
- All load bearing or holding parts forged
- Easy operating positive ratchet



## L-150: Lebus® Load Binders

- Extra heavy construction at leverage point to prevent spreading
- Heel of binder toggles away from load, permitting easy release
- Ball and socket swivel joints at hook assemblies permit a straight line pull



## Spectrum 7® Drum Transport Chain

- High Tensile Carbon Steel
- Minimum Ultimate load is 4 times the working load limit
- Proof tested at 2 times the working load limit with certification
- Permanently embossed with CG® (Crosby Group) and 7 (Grade)
- Finish - yellow dichromate
- Standard container - fiber drum



## Stihl MS201 Chain Saw - 16" Bar



- Comes equipped with a low kickback 3/8" saw chain
- Patented captive bar nut on the chain sprocket cover
- Stainless steel muffler, diecast magnesium engine casing and a digital ignition system that ensures a smooth start every time
- Designed with a stratified charge engine to reduce fuel consumption and emissions
- Displacement (cc): 35.2
- Power output (kW/bhp): 1.8/2.4
- Weight: 8.2 lbs

## Stihl MS261 Chain Saw



- Features STIHL's electronic engine management system for optimum engine power at all times
- Cuts fuel consumption by 20% and exhaust emissions by 50% compared to its predecessor
- New long-life air filtration system, patented captive nuts on the sprocket cover and side-access chain tensioner
- Includes anti-vibration technology and a stainless steel muffler in a durable magnesium crank case
- Displacement (cc): 50.2
- Power output (kW/bhp): 2.9/3.9
- Weight: 11.5 lbs
- Featured price bar: 16"

## Stihl BT45 Wood Boring Drill

- Dependable, powerful and lightweight engine
- Anti-vibration system for comfortable use
- Two-speed gearbox, with a neutral position as well as a reverse gear
- Displacement 27.2 cc, power output: 0.8 kW
- Weight: 10.6 lbs



## Stihl Pole Pruner

Telescoping Pole Pruner:

- Ideal for hard-to-reach places
- Features a side mount chain
- Extendable shaft adjusts from tensioner 8' 8" to 12' 8", reaching branches up to 16' off the ground
- Powered by a proven low-emissions engine
- Automatic side bar and chain oiler
- Displacement: 31.4 cc
- Power output: 1.05 kW
- Weight: 16.8 lbs



HT 101 Telescoping

# STIHL - Chainsaw Accessories

## Oil & Lubricants

- STIHL chainsaws are made to deliver the kind of performance that professionals need
- STIHL bar and chain oil is made specifically for your STIHL chainsaw, keeping it protected and running smooth
- Without the proper lubricant, the average amount of use that a guide bar, saw chain and sprocket should be able to provide would certainly be shortened
- STIHL lubricants have been formulated to allow STIHL products to break in without any special procedures, such as running a rich oil mixture or operating at specific RPM for a certain amount of time



- Bar and Chain Oil
- BioPlus™ Bar and Chain Oil
- High Performance 2-Cycle Engine Oil
- HP Ultra 2-Cycle Engine Oil
- Winter Weight Bar and Chain Oil
- No-Spill® Fuel Containers

## Guide Bars

- STIHL guide bars have induction heat-treated edges to give high wear resistance. The heat treating process hardens the rails while allowing the rest of the bar to remain flexible. This makes it less likely for the bar to have a permanent bend if it were flexed during use. Guide bars are also symmetrical. Over time, they can be flipped over to spread out the wear, increasing the service life of the bar
  - STIHL guide bars range from 10" (found on our tree-trimming pole pruners) to 59" (used in extreme felling operations). STIHL manufactures over eighty bar configurations to match the unique cutting requirements of chainsaws
  - All are laser cut from tough, wear-resistant steel and feature exclusive Ematic™ Bar Lubrication System. This technology ensures pinpoint lubrication where it's needed most: the saw chain links and guide bar rails
  - When used with STIHL OILOMATIC® saw chains, guide bars provide maximum lubrication, longer wear and up to 50% less oil consumption than conventional chain lubrication methods
  - STIHL recommends using low-kickback, green-labeled chain and green-labeled reduced-kickback bars on all powerheads
- NOTE: The actual listed guide bar length can vary from the effective cutting length depending upon which power head it is installed.*



- Stihl Duromatic® C
- Stihl Duromatic® E
- Stihl Rollomatic® E Mini Light
- Stihl Rollomatic® E Mini
- Stihl Rollomatic® E Light
- Stihl Rollomatic® E Standard
- Stihl Rollomatic® ES Light

## Saw Chains

- Choosing the right saw chain is essential for effective use of a chain saw
- STIHL supplies the optimum chains for every application, every power class and every chain saw make. All chains are characterised by rugged first-class quality



# STIHL - Chainsaw Accessories

## Cases & Bar Scabbards

- Protect your investment with a heavy-duty STIHL carrying case and scabbard
- Made of heavy-duty polymers for long-lasting protection; great for easy transport and storage
- The handy slip-on scabbards accommodate various chainsaw bar lengths
- The rugged STIHL case includes built-in tool holders for carrying to the work site with a removable scabbard for easy storage



- Bar Scabbard
- Woodsman Chainsaw Carrying Case

## Sharpening Kit

- Includes file guide, depth gauge, round file, flat file and two file handles in tool pouch
- Kits available for the following chain types: STIHL PICCO™ Mini; 1/4" pitch chain; .325" pitch chain; 3/8" pitch chain; .404" pitch chain



# Gas-Powered Saw Accessories

## Buckingham Tearaway Chainsaw Lanyard



- Features a built-in bungee, designed to give users added safety and convenience
- Constructed with a tear-away safety pack that activates when 200 lbs. of force is applied
- Lanyard measures up to 50" when fully extended and contracts to 32" when relaxed
- The saw, if dropped, will fall below the user's feet without falling to the ground
- A 1 3/4" steel ring suspends the chain saw when not in use

## Buckingham Chain Saw Scabbard

- This chain saw scabbard prevents damage to the chain and fastens using a handy strap and buckle
- For use with bar lengths from 16" to 20"
- Available in high-quality top grain leather or rubberized belting material
- 18 1/4" overall length
- 17 3/4" pocket depth

## ROPES

### Prusik Loop



- Comes in 1/2" nylon, 3 strand with a locking snap spliced into the rope for versatility and ease of operation
- Tie into a Prusik knot as a safety device on a climbing line or as an adjustment for fliplines
- 20" length

### Hastings Rope Insulator



- This dielectrically tested insulator attaches between the pruner head and rope helping to prevent the rope from conducting electricity if contacted above the insulator
- Available in 8 1/2" and 12" lengths

### Buckingham Wire Core Flipline



- Available in 1/2" Safety Blue High-Vee braided over wire
- A tight, snag-free construction and the flipline's size allow use with most ascenders/adjusters
- A unique eye termination helps alleviate pivot point stress for increased service life
- Lightweight for improved performance and easier use
- Comes with eye on one end and locking snap on the other
- 8' and 10' long

### Flipline (Beranek Lanyard)



- Available in 1/2" Braided Safety Blue High-Vee
- This rope can be used as an adjustable flipline with Prusik Loop or a mechanical adjustment device
- The length can be adjusted by simply pulling on a "tail"
- This flipline has a backsplice on one end and a locking snap on the other
- 1/2" diameter, 8' long

## Standard Chain Saws

- Ideal for large trimming applications and cut-up removal jobs
- Reduced kickback bar and chain
- Rugged gear motor and expanded chip exit area
- Super Spool™ selector control for open and closed center systems
- The handle position on these saws can be oriented to horizontal, or to 60° or 30°, relative to bar and chain according to operator preference
- Safety features on these saws include: two-step safety trigger, high impact polymer front handle/shroud
- Wide lower handle protects hands/knuckles, chain catcher stops chain rotation
- Automatic chain oiler can be adjusted without tools
- Supplied with 12" steel braided whip hoses (couplers not included)
- Chain pitch of 3/8"; cut capacities range from 16" - 24"
- Flow range of 4 - 8 gpm; operating pressure: 1000 - 2000 psi



**HCS816** 16"

**HCS820** 20"

**L088009** 9" Blade

**43973** 9" Chain Blade

## HPS513: Pistol-Grip Chain Saw

- Ideal for cutting back or trimming from an aerial basket
- Reduced kickback bar and chain
- Rugged gear motor and expanded chip exit area
- Super Spool™ selector control for open and closed center systems
- The handle position on these saws can be oriented to horizontal, or to 60° or 30° relative to bar and chain according to operator preference
- Safety features on these saws include: two-step safety trigger, high impact polymer front handle/shroud
- Wide lower handle protects hands/knuckles, chain catcher stops chain rotation
- Automatic chain oiler can be adjusted without tools
- Includes 12" steel braided whip hoses (couplers not included)
- Sprocket cover is removed without tools for easy cleaning
- Chain, bar are adjustable without removing sprocket cover
- Chain pitch of .325"; cut capacity of 13"
- Flow range of 4-8 gpm; operating pressure of 1000-2000 psi



## 82" Overhead Circular Saw

- Designed for high production utility line clearing and general tree clearing applications
- Features hand stop safety collar, trigger guard, two-step safety trigger, branch stop
- Insulated fiberglass extension tube meets OSHA 1910.269
- 82" long with angular head design
- 9" blade diameter with cut capacity of 3.5"
- 1000 - 2000 psi; 4-6 gpm flow range
- Operates on open or closed center systems

**43180** Overhead Circular Saw

**L088009** 9" Blade

**43973** 9" Chain Blade



## Long Reach Chain Saw

- Designed for use from aerial platforms or the ground
- The insulated fiberglass extension tubes are tested to meet OSHA regulation 1910.269
- Operating pressure: 1000-2000 psi
- Chain size of 0.325" pitch; cut capacity of 13"
- Safety features include a two-step trigger, a trigger guard, a fully covered sprocket guard, anti-kickback chain, and an automatic chain oiler
- Super Spool™ selector control allows chain saws to be used on both open and closed center systems
- Flow range of 5-8 gpm



**43178** 62.5" long

**38568** 75" long

**43177** 88.5" long

## 48520: 86" Utility Pruner

- The insulated fiberglass extension tubes are tested to meet OSHA regulation 1910.269
- Operating pressure: 1,000 - 2,000 psi
- Designed for utility line clearing and selective pruning of shade trees
- Heavy cut capacity cuts branches up to 2"
- Trigger guard
- Flow range of 4-6 gpm
- Heat insulated handle; full power return



## LHFS-210003: 60" Orchard/Shade Tree Pruner

- Heavy duty large capacity pruner; only 7.7 lbs
- 360° swiveling extension
- Operating pressure: 1000-2000 psi
- Cutting capacity of 1 3/4"
- Flow range of 4-6 gpm
- Open centre with an aluminum extension type
- Not to be used near high voltage lines



### QCS: U-1R Saw Head w/ Adapter

- Marvin's pole saw heads are designed and built to meet the rigid requirements of tree service professionals. U-1R saw head with adapter
- Fits all Marvin poles with a female ferrule (base and mid poles)
- An assortment of saw blades attach to the head via a bolt and wing nut



### U-1R: Saw Head Only

- Marvin's U-1R universal saw head easily mounts octagonal wood or fiberglass poles without an adapter
- Saw head is designed to accommodate an assortment of blades. Fits all Marvin saw head poles and 1 1/4" octagonal wood poles



### QCU2: Marvin's U2 saw head w/ adapter



### U2: Cast Saw Head Only

- Marvin's cast saw head. Marvin's U2 saw head easily mount octagonal wood or fiberglass poles without an adapter
- Saw head is designed to accommodate an assortment of blades



### QCSF: U-1R Saw Head w/ Fiberglass Adapter

- U-1R Saw Head w/ 10" fiberglass adapter. Fits all Marvin poles with a female ferrule (base and mid poles)



### QCPP: Pole Pick Head with Adapter

- Great utility tool used to raise rope, pull hangars and guide tree fall



### QC20HB: Snap-Cut Saw Head w/ Adapter

Saw blade included: S11



### PP1R: Pole Pick only

- Great utility tool used to raise line, pull down loose tree branches and guide tree fall. Fits any Marvin saw head pole or 1 1/4" octagonal wood poles





# Fred Marvin

## HS2: Tri-Edge Hand Saw



- With a 13 inch blade and a custom marine plywood handle
- Replacement blade: S9

## HS9: Marvin/ARS Tri-Edge Hand Saw

- With a 12 inch blade and marine plywood handle
- Replacement blade: S17



## HS10: Marvin/ARS Tri-Edge Hand Saw

- With a 12 inch raker tooth blade and marine plywood handle
- Replacement blade: S18



## HS11: Marvin F-350 Tri-Edge Hand Saw

- With a 13 inch blade and a rubber handle
- Replacement blade: S22



## HS38: Heavy Duty Tri-Edge Hand Saw

- Marvin's newest hand saw, the HS-38 features 15 inches of razor sharp, tri-edge teeth, allowing for a smooth cut every time. This heavy duty, extra-firm blade can be used on harder, tougher woods, such as palm and even some cacti
- Replacement blade: S38



## HS3: Tri-Edge Hand Saw

- With a 13 inch blade and a rubber gripped handle



## HS17: Heavy-duty, commercial-grade hand saw

- This saw boasts an extra stiff 17 inch tri-edge blade and will easily tackle 5 inch limbs
- Replacement blade: S14



## HS18: Marvin Pony Saw

- With a raker tooth and a marine plywood handle
  - It is designed to be easily used upside down when need be
- Replacement blade: S18



## HS21: Marvin 8" Folding Hand Saw with Tri-Edge Blade

- Overall 17 inch length
- Great for camping or your tool belt



## HS47: Marvin Rhino Tri-Edge Hand Saw

- With 18 inch heavy duty blade (26 inch total length) and wooden handle
- Replacement blade: S47



## S-9: Heavy Duty Tri-Edge Saw Blade

- Fanno 12.5 inch tri-edge saw blade. This blade can be used as a pole saw blade or as the replacement blade for the HS2 hand saw



## S-14: 14" Tri-Edge Heavy Duty Saw Blade

- Can be used as a pole saw, or as a replacement blade for the HS17 hand saw



## S-17: 12" Turbocut Tri-Edge Saw Blade

- Can be used as a pole saw blade or as a replacement blade for the HS9 or HS18 hand saws



## S-18: 12" Turbocut Saw Blade

- Turbocut with wood chip relief gullets. Can be used as a pole saw blade or as a replacement blade for the HS10 or HS18 hand saws



## S-22: 13" Tri-Edge Replacement Saw Blade

- Marvin F-350 13 inch tri-edge replacement saw blade for the HS11 hand saw



## S-38: 15" Tri-Edge Heavy Duty Replacement Saw Blade

- For the HS38 hand saw



## S-47-RB: 18" Tri-Edge Replacement Saw Blade

- For the HS47 handsaw



# Hastings

## 4141 & 4142: Tree Trimming Kit

- Open the tool kit bag and you have your choice of tree trimming tools in the length you need, all in a convenient heavy duty vinyl tool bag that offers long wear and maximum protection for the tools. Kits are available with round or square pole sections in four or six foot lengths
- Each kit contains the following items: 1 Pruner Head Assembly - 2'4 Extension Sections with 1 Base Cap, 1 Universal Pruning Saw (A11000), 1 Saw Handle (A10016), 1 Saw Scabbard (A30007), 1 Universal Adapter (A10012), 1 Universal "S" Hook for pushing or pulling tree limbs (P10046), 1 Multiple Pocket Vinyl Tool Bag



**ROUND POLES 1/4" DIAMETER**  
**Length of Section: 4' - Part # 4141, 15lbs**  
**Length of Section: 6' - Part # 4142, 19lbs**



### Universal Pruning Saw

- Fast cutting 16" curved steel blade with 7 teeth per inch
- Adapts to all tools with universal heads
- Can be used as a hand saw by attaching handle accessory
- Scabbard is made of leather for safe storage of saw

Part #	Description	Lbs
A11000	Universal Pruning Saw	0.6
P11004	Replacement Blade	0.3
A30007	Saw Scabbard	1.0
A10016	Handle	0.5
A11005	Pole Head	0.8



### 10-019: Universal Tree Pruner



- Features drop forged steel blades and a two-pulley rope swing that can cut limbs up to 1 1/2" diameter
- A universal saw attachment may be used with this pruner; it is mounted on a 12" fiberglass shaft with a universal adapter and 25' of polypropylene rope

### 10016: Universal Saw Handle



- Lightweight aluminum saw handle is for use with a universal saw when limbs can be easily reached and insulation is not needed

# Pruner Tools & Accessories

## PKG9FFM: Foam-Filled Pruner Package

- PH4 pruner head, (2) 6' foam-filled fiberglass poles (head & base) w/ rope (unassembled)
- Up to 12 feet of reach is possible with this professional pole pruning package



## Z-140: Fiberglass Pruner Adapter with Eye Bolt



## Z-142: Aircraft Aluminum Pruner Adapter with Eye Bolt



## Z-143: Big Bite Pruner Head Adapter with U1R Sawhead Adapter



## QCB Marvins "Bull"

- Features a 1 3/4" cut, dual pulley system, adapter and 15' of 3/8" rope
- The QCB easily inserts into the female ferrule of your extension pole
- All parts are replaceable



## QCSP: Marvins PH-2 Swivel Pulley Head

- With "quick change" adapter. Fits any Marvin pole with a female ferrule (base poles and mid-poles)



## PKG9BFFM: Foam-Filled Pruner Package

- One of Marvin's most popular pruning packages, this combination package gives you 12 feet of pruning or 12 feet of sawing
- Both the pruning head pole and the saw pole easily insert into the base pole via a spring clip coupling
- The saw head fits an assortment of blades
- Parts included in this package: PH4 Pruner Head, U1R Saw Head, 6' Foam-Filled Fiberglass Head Pole (Batch Tested), 6' Foam-Filled Fiberglass Saw Head Pole (Batch Tested), 6' Foam-Filled Fiberglass Base Pole (Batch Tested), S-20 Saw Blade, Pruning Rope



## QCP: Marvins PH4 1/4" Cut Pruner Head

- With "quick change" adapter
- Fits all Marvin poles with a female ferrule (mid-poles and base poles)



## QCPF: Marvins PH4 Pruner Head

- With a 10" fiberglass adapter. Fits all Marvin poles with a female ferrule (mid-poles and base poles)



## QCP5: Marvins 1 3/4" Cut Single Pulley "Bull" Pruner Head with Adapter

- Head only: PH5



## QC16: Big Bite 1 3/4" Cut Pruner Head with Adapter

- Head only: PH16
- Rope included



# Pruner Tools & Accessories

## PH2: Marvin's Pruner Head with Swivel Pulley

- Fits all Marvin fiberglass "head" poles and 1 1/4" octagonal wood poles



## PH5: Marvin's PH5 Pruner Head

- Features a 1 3/4" cut and a single pulley
- All parts are replaceable



## PH4: Marvin's 1 1/4" Cut Pruner Head with Round Casting

- Fits all Marvin fiberglass "head" poles and 1 1/4" octagonal wood poles



## PH16: Big Bite Pruner Head

- 1 3/4" Cutting Capacity



6FB: 6' hollow fiberglass base pole (female coupling & rubber base)



6FM: 6' hollow fiberglass mid pole (male & female coupling)



6FH: 6' hollow fiberglass pruner head pole (male coupling & rope anchor)



6FFBM: 6' foam-filled fiberglass base pole



6FFM: 6' foam-filled fiberglass mid pole



12FFBLK-M: 12' foam-filled fiberglass pole with end cap only (minimum order of 12)

## Buckingham



6019C Rubberized belting material, use w/ 1 1/2" cutting capacity. 4 1/2" x 6 3/4"



6019 Leather, use w/ 1 1/2" cutting capacity, 4 1/2" x 6 3/4"



6017 Leather, use w/ 1" cutting capacity, 3 3/4" x 4 1/2"



6017C Rubberized belting material, use w/ 1" cutting capacity, 3 3/4" x 4 1/2"

## Tearaway Chainsaw Lanyard

This Chainsaw Lanyard features a 1 3/4" ring for suspension when not in use, an elastic bungee designed for safety and convenience that measures 50" fully extended and contracts to 32" when relaxed, and a tear away safety pack that activates when 200 lbs. of force is applied.



**25Y12-42A:** Features a 1 1/8" steel ring saddle end attachment



**25Y12-48A:** Features a #2 bronze snap saddle end attachment



**25Y12-50A:** Features a 3/4" carabiner loop saddle end attachment

## 6022 & 6022C Chainsaw Scabbard

A chainsaw scabbard that prevents damage to chain and other equipment. For use with bar lengths from 16" to 20"



**6022:** Overall length measures 18 1/4" with a 17 3/4" pocket depth  
**6022C:** Overall length measures 18 1/4" with 17 3/4" pocket depth

## 60212 & 60212C Chainsaw Scabbard

A leather chainsaw scabbard that prevents damage to chain and other equipment. Rubberized Material. For use with bar lengths from 12" to 14."



**60212:** Overall length measures 12 3/4" with a 12" pocket depth  
**60212C:** Overall length measures 12 3/4" with a 12" pocket depth

## P7J8A-V-26: Hip Prusik Loop

A leather chainsaw scabbard that prevents damage to chain and other equipment. Rubberized Material. For use with bar lengths from 12" to 14"



## Flipline



**9V08B110M4:** 10' stitched High Vee rope flipline with BuckGrab LAD (Length Adjusting Device)



**9V08B112M4:** 12' stitched Safety Blue rope flipline with BuckGrab LAD (Length Adjusting Device)



**9V08B114M4:** 14' stitched XTC Spearmint rope flipline with BuckGrab LAD (Length Adjusting Device)

## The Buck Rigidline

This 7/16" uniline rope lanyard with the BuckGrab Adjuster has the same rigidness as a wire core flipline without the metal core. Ideal for hitch-hiking and when climbing near energized lines. Features a red wear indicator to alert the user of excess wear



**7808R18M6:** Features a 1704 swivel snap and is available in different lengths

**7808R17GM6:** Features a 1704 swivel snap and a carabiner on the BuckGrab. Measures 7'

## Pruner Rope Insulator

Insulator provides protection for use near high voltage lines. Tested at 100kV per foot



Part #	Description	lbs
4005	Insulator is 1/2" diameter by 34" long	0.3
4004-1	Insulator is 1/2" diameter by 12" long	0.2



TRUSTED SINCE 1958

# Ropes

## Climbing Rope-Braided Safety Blue



- This rope offers a tightly plied, polyester
- 16-strand cover, providing a smooth, snag-free surface
- Polyolefin yarns in the core of each cover strand reduce weight and improve handling
- This rope greatly exceeds industry specifications of 5400 lbs
- Twisted parallel blue yarns, in a blue core, allow the rope to stay firm and round while in use
- Core also acts as a warning flag if the cover is ever cut
- The tough durable cover is treated with a protective finish that minimizes abrasion and maximizes rope life

Diameter	Length	Tensile Strength
1/2"	120'	7700 lbs
1/2"	150'	7700 lbs
1/2"	600'	7700 lbs
<b>Split Tail, eye in one end</b>		
1/2"	6'	

## Climbing Rope-Braided Safety Orange High Vee



- Offers the same performance qualities and construction as the Braided Safety Blue, but with a highly visible orange and white work cover pattern
- Greatly exceeds industry specifications of 5400 lbs
- High-Vee stands out in the workplace and can be designated as a critical life safety line

Diameter	Length	Tensile Strength
1/2"	120'	7700 lbs
1/2"	150'	7700 lbs
1/2"	600'	7700 lbs
<b>Spliced Eye</b>		
1/2"	120'	7000 lbs
1/2"	150'	7000 lbs
<b>Split Tail, eye in one end</b>		
1/2"	6'	



## 3-Strand Bull Rope

- This popular 3-strand bull rope is a composite rope made of polyester yarns wrapped around a core of polyolefin in each strand
- Spun polyester is added to the surface for better grip and chafe protection
- Multiline II can be identified by the two orange markers on the surface of one strand
- This rope can also be used as a safety and rescue rope



Diameter	Length	Tensile Strength
5/8"	150'	8200 lbs
5/8"	600'	8200 lbs
3/4"	150'	10,500 lbs
3/4"	600'	10,500 lbs

## Bull Rope-Industrial Polyester Double Braid

- This polyester double braid bull rope offers non-hocking, torque-free construction
- This rope is the strongest low stretch rope available for bull rope applications
- Recommended especially for applications where lowering devices are being used
- High strength allows increased safety factors and/or use of smaller diameter lines



Diameter	Length	Tensile Strength
5/8"	150'	14,400 lbs
5/8"	600'	14,400 lbs
3/4"	150'	20,000 lbs
3/4"	600'	20,000 lbs

# Customized Aerial Truck Kit

Part #	Description	Qty
30115	1 Ton Chain Hoist	1
C3090439	Chance 1-1/2 Ton Chain Hoist	1
1684-5F	File Grips	2
IWRC1/2X4FT	Wire Rope Sling, Eye Both Ends 4ft	2
IWRC1/2X6FT	Wire Rope Sling, Eye Both Ends 6FT	2
IWRC1/2X8FT	Wire Rope Sling, Eye Both Ends 8ft	2
EE2-902-3X8FT	Synthetic Lifting Sling, Eyed Both Ends, 8ft	2
EE2-902-3X4FT	Synthetic Lifting Sling, Eyed Both Ends, 4ft	2
EE2-902-3X6FT	Synthetic Lifting Sling, Eyed Both Ends, 6ft	2
384-CERT	1" x 24QT Skid Tong Certified	1
199	2-1/2" X 4' Cant Hook	1
EGRD34	Erico Ground Rod Driver	1
C3020003	Expanding Anchor and Tamping	1
HITSEP-10	Eastern Pattern Telegraph Spoon	1
852	Digging Spud with Tamper	1
Customgroundset	50' - 2/0 Truck Ground	1
outriggerfront	Pads, Outrigger Oak 14" X 28"	6
8690CK	Ratchet Guy Steel Cutter	1
C-18F	Bolt Cutter with Insulated FG Handles	1
0190MCX	24" HD Bolt Cutter	1
705	Manual HD 25" Cable Cutter	1
SK5	Spill Kit	1
Rel-2250-R-120-A	Greenlee Hydraulic Tamper c/w Fittings and Hoses	1
TS2-602-N-20	Transformer Sling	1
TED-270PFR	Gas Drill (TANAKA)	1
Rt-20	Reel Thing	1
RT-40	Reel Thing	1
RSDG-TC102b	Road Work Ahead	2
RSDG-TC103R	Right Lane Closed	1
RSDG-TC4L	Arrow	1
RSHI-RB91	Yield to Oncoming Traffic	1
SSS-BTMSC3F	Sign Stand with Flags	3
RIBS-90X90	Rib Set	3
RIBS-90X120	Rib Set	1
H4910A	Greenlee Hydraulic Pole Puller	1
HI24FBC	24" Floor Push Broom	1
HIRPLG	Round Mouth Shovel Pro Gold	2
HIPM-5H	Pick Mattock 5lb Head w/ #6 Eye	1
HIBD-12	12 lbs Sledge Hammer	1
EXFLR24	24" Fan Rake	1
50412	First Aid Kit Ontario Section 8	1
HISPLG	Square Point Shovel	1
333A	Greenlee Hack Saw	1
3295500	Triangle Reflector Kit	1
630011HD	Kelly bar adapter Hex (2.5"/4.25"/8.125")	1
C1021583	Hubbell Anchor Tool: 1-3/8" x 7'. Drive End	1
REL-PE	Pulling Eye	1
TC-H4U-28	28" Traffic Cone, w/4" Collar	10
H4802-3	Greenlee Fairmont Hydraulic Tamper Assembly	1



TRUCK

ltutilitysupply.com





# Customized Digger Derrick Truck Kit

TRUCK

Itlutilitysupply.com

Part #	Description	Qty
3282	Hiokoe digital clamp on meter	1
TFL-1	Fused leads	1
69611	Large AMPGun	1
69437	Small AMP gun	1
REL-BG	MD6 press with BG die	1
8690FH	Ratchet cutter	1
0190FCX	24" FG handle bolt cutters	1
8690CK	Guy steel ratchet cutters	1
0290FCS	25" FG handle cable cutters	1
NTP1874W	Chain saw chaps	1
SK5	spill kit	1
3295500	triangular reflector kit	1
PSC3090323	1 ton strap hoist	3
30115	1 ton chain hoist	1
H1802-30SSR	secondary service blocks	1
1702-20N	Howel wire tool	1
1684-5F	File grip	2
1656-20	20 grip	1
1656-30	30 grip	2
1656-40	40 grip	2
1656-50	50 grip	2
EE2-902-3X3Ft	3ft sling	1
EE2-902-3X4FT	4ft sling	1
ee2-902-3X6FT	6ft sling	1
TS2-602-N-20	Transformer sling	1
REL-PE	guy pulling eye	1
361 con. Meter	contamination meter	1
361-case1M2075	case for 361	1
1TB	tool tray	2
C4030292	6.5' Grip-all stick	2
P2MF-6	6' pin and sleeve switch stick	3
P2F-u	short adapters - pin and sleeve to universal fitting	1
P10431	P-2 head for universal fitting	1
3482	36" FG spiral link stick	2
Grounds 2/0 X 10'	Grounds 2/0 X 10'	2
Grounds 2/0 X 6'	Grounds 2/0 X 6'	1
Grounds 2/0 X 50	Grounds 2/0 X 50	1
1300	class 4 split blankets	3
900E	class 4 solid blankets	3
SU150-6C	class 4 line hose 6'	3
M4931	conductor cover	9
PTHL	class 4 hood	3
5041	Auxiliary Arm w/c 2 conductor holders and insulators	1
HW1	Greenlee Hydraulic drill	1
8810	Wood owl 13/16 x 18"	2
REL-2250-r-120-A	10' non conductive hoses	1
REL-ED-1618	framing socket	1
1829-DP	Tool Apron	1
1831	Bucket hooks	4

23	Nose bag	1
PD50	Phasing set	1
LIV500	potential indicator	1
P4	Blanket tubes	2
21	blanket clamp pins	21
PBS-7	4pc pinch and roll bar set	1
333A	Greenlee hack saw	1
50412	First aid kit Ontario section 8	1
MS-291	STHIL Chain saw	1
HIRPLG	round mouth shovel pro gold	2
H124FBC	24" floor push broom	1
HIBD-12	12lbs sledge hammer	1
RC450-S	wheel chocks	4
5300R3-su	Surplus load buster	1
REL-BG	MD6 press with BG die	1
3480	spiral link stick	1
TC-H4U-28	28" Traffic Cone, w/4" Collar	10
REL-510	Manual Hydraulic 12 Ton Crimping Tool	1



# Klein Tools - Tool Storage

TRUCK

## Heavy-Duty Top-Closing Buckets



- Top of bucket zips closed
- Load rated: 150 lbs
- Durable, steel rim
- Accommodates standard 5 gallon buckets
- Body constructed of heavy-duty no. 1 canvas
- Web strap extends down the side of the bucket
- Leather reinforced bottom extends 3" up the side
- Dimensions – 17"H x 14"D or 22"H x 14"D
- 14" diameter large enough to accommodate 5 gallon buckets

**SPLBUCKET-22, 22" High**  
**SPLBUCKET-17, 17" High**

## 5416TC: Top Closing Bolt Bag



- Same durability of Klein 5416 series bull pin & bolt pouch
- Now with durable drawstring closing top to prevent items from falling out of the pouch at height
- Pouch body constructed of heavy duty, #4 canvas
- 10"H x 9"W x 5"D
- Drawstring 3"

## 51829: Vinyl Tool Apron



- 24"L x 23"H
- Includes: ten hand tool pockets, two pouches, hammer loop and two vinyl drill bit pockets with plastic tubes
- Hooks sold separately

## 51829M: Aerial Apron with Magnet



- 24"L x 23"H
- Sewn-in magnet design won't catch on gloves
- Includes: ten hand tool pockets, two pouches, hammer loop and two vinyl drill bit pockets with plastic tubes
- Two pouches reinforced with heavy duty rivets

## 54445



- Number of Compartments: 16
- Compartment Sizes: 4-3/8" (111 mm) x 2-7/8" (73 mm)
- Length (Front to Back): 12" (305 mm)
- Height: 3" (76 mm)
- Weight (lbs): 7.55
- Width: 18" (457 mm)

## 54446



- Number of Compartments: 21
- Compartment Sizes: 20 each 2-3/4" (70 mm) x 2-7/8" (73 mm) and one 3-3/4" (95 mm) x 11-7/8" (302 mm)
- Length (Front to Back): 12" (305 mm)
- Height: 3" (76 mm)
- Weight (lbs): 7.60
- Width: 18" (457 mm)

## 5181ORA



- Exterior Pockets: 1
- Color: orange
- Length: 24" (610 mm)
- Height: 20" (508 mm)
- Weight (lbs): 7
- Width: 10" (254 mm)

## 55417-18



- Exterior Pockets: 25
- Interior Pockets: 53
- Length: 19" (483 mm)
- Height: 16" (406 mm)
- Weight (lbs): 9.51
- Width: 10.5" (267 mm)



lutilitysupply.com

# Klein Tools - Tool Storage

TRUCK

## Premium Orange Vinyl Equipment Bag



- 24"L x 18"H x 10"W
  - Nylon-web handles extend down the side of the bag for extra support
  - Hard rubber base
  - Two heavy duty slide-action buckles for convenient, secure bag closure
  - Convenient, Velcro fastening, water-proof flap for quick bag open and closure in the rain
  - Large outside pocket with Velcro enclosure
  - Comfort padded, adjustable shoulder strap
  - Wide opening steel frame is securely riveted in top of bag
- 5181ORA**

## Ultra Premium Black Vinyl Equipment Bag



- 24"L x 18"H x 10"W
  - Hard rubber base
  - Nylon-web handles extend down the side of the bag for extra support
  - Convenient, Velcro fastening, water-proof flap for quick bag open and closure in the rain
  - Two heavy duty slide-action buckles for convenient, secure bag closure
  - Two large outside pockets with Velcro enclosure
  - Comfort padded, adjustable shoulder strap
  - Wide opening steel frame is securely riveted in top of bag
- 5182BLA**

## Extra-Large Nylon Equipment Bag



- Bottom extends 3" up the sides
  - Bottom of bag is protected by metal studs
  - Extra flap for storm protection
  - Orange vinyl-coated nylon fabric bag
  - Bottom reinforced with 1/4" plywood
  - Stores and protects Klein Climbing Gear
  - Nylon-web handles extend around bag for extra support
  - Wide opening steel frame is securely riveted in top of bag
- 5180**

## Nut and Bolt Pouch



- Includes interior pocket
  - Top sides of pouch reinforced with leather to maintain shape of pouch opening
  - Inside bottom is reinforced with leather and ventilating eyelet
  - Metal snaps provided on loops for easy attachment to belts up to 3" (76 mm) wide
  - Top edge reinforced with 1/4" (6 mm) rope
- 51A**

## Orange Oval Hard Body Bucket



- 14"L x 7"W x 10"H
  - Features 15 interior pockets
  - Orange, non-conductive plastic exterior maintains bucket shape
  - Molded polypropylene base with drain holes
  - Hooks sold separately
- 5144BHB**

## Hard Body Oval Bucket



- Includes leather skinning knife sheath and 14 other interior pockets
  - Orange, non-conductive plastic exterior maintains bucket shape
  - Fabric constructed of rugged denier polyester to resist wear and tear on the jobsite
  - Black molded polypropylene bottom with drain holes
  - Hooks sold separately
- 5144HBS**

## Hard Body Oval Bucket w/ 15 Interior Pockets & Handles



- 14"L x 7"W x 10"H
  - Features 15 interior pockets
  - Orange, non-conductive plastic exterior maintains bucket shape
  - Black molded polypropylene bottom
  - Hooks sold separately
- 5144BHHB**

## Black Hard Body Tote Bucket



- 14"L x 7"W x 10"H
  - Features 15 inside pockets, 14 outside pockets and web handle
  - Constructed of rugged denier polyester to resist wear and tear on the jobsite
  - Black molded polypropylene bottom with drain holes
- 5144BHB140S**

## 05-829: Hastings Heavy Tool Tray Outside Mount



- One piece design fits both buckets with and without liners
- Special designed bracket enables the tool boards to be easily installed and removed without tools
- Each board has a four pocket leather tool pouch, leather knife pouch, nylon loops, and hammer loop
- Utility bag is made from heavy duty cordura
- A wide leather loop is riveted on the top of bag for easy access with rubber gloves
- Also available with lights above the cordura bag and lights along the entire bottom of board
- Ideal for night time and low light conditions
- Battery and switch operated. 2 AA batteries included
- Weight 4.6 lbs

## 05-951: Hastings Tool Tray Outside Mount



- Compact
- Lightweight polyethylene
- Outside mount
- Ideal for connectors, bolts, and nuts
- Fits buckets with and without liners
- 7.5" D x 6" W x 14" L
- Weight 8 lbs

## Hastings Heavy Duty Fiberglass Step



- Heavy duty fiberglass step makes it easier to get in and out of buckets
- Stepping surface has an anti-skid material to prevent foot slippage
- Tough durable, attractive, white plastic finish is easy to clean and maintain
- Dimensions: 26" x 8 1/2" x 8"
- Weight 8 lbs

05-961 Step for Buckets With Liners

05-960 Step for Buckets Without Liners

## Hastings Heavy Reinforced Canvas Tool Buckets

Workers will find dozens of uses for these rugged round and oval canvas tool buckets. These canvas buckets are made from US grade #4 canvas with brass grommets. A solid non-conductive PVC ring maintains bucket shape. Round tool buckets with polypropylene rope are offered with a brass swivel snap.

### 31-105: Tool Bucket Canvas w/Rope and Snap

31-205: Tool Bucket Canvas, w/Rope and Snap 12" x 15"

31-206: Tool Bucket Canvas, w/Rope and Snap 1 Inside Pocket 12" x 15"



### 31-140: Tool Bucket Vinyl w/ Rope 8" x 12"



### 10-110: Nut and Bolt Bag Canvas w/ Belt Loops



### 31-245: Tool Bucket Vinyl w/ Rope and Snap 12" x 15"



# Bucket Accessories

TRUCK

**35: 12" Round - Blackwrap**



**95: 15" Bottom with Frame Opening  
15" Length x 8" Width x 13" Height**



**10-185: Tool Pouch, 4 Inside Pockets, 2 Outside Pockets, Tape Thong**



**10-367: Tool Roll Up Black Vinyl, 13 Pockets**



**43-165: Aerial Apron Vinyl, 18 Pockets, Fully Re-inforced**



**43-155: Aerial Apron Vinyl, 16 Pockets**



**43-957: Aerial Apron Canvas, 2 Man Bucket**



**47-140: Aerial Bucket Hook Polymer for 2-Inch Lips Each**



**47-222: Aerial Bucket Hook Polymer for 3-Inch Lips**



**47-500: Aerial Bucket Hook Polymer for 3-Inch Lips Each**



Itlutilitysupply.com



# Equipment Storage Bags

TRUCK

## Estex 1498 & 1498-8: 4 Pocket Stick Bag

- Waterproof
- Heavy Duty Yellow Vinyl
- 2-Handles
- Accessory Pouch
- 1498: Holds 6-foot sticks: 20" Wx78"H, weight: 3 lbs 8 oz
- 1498-8: Holds 8-foot sticks: 20" W x 96"H, weight: 4 lbs



## Estex 2078: Tool Bucket 12" X 15" Vinyl Plastic Bottom with Snap

- Heavy duty canvas, steel top ring and molded top ring and bottom
- Leather rope holes, polypropylene handle, snap
- 12" dia X 15" H
- Weight 2lbs 13 oz



## Bashlin 11DC: Equipment Bag

- Equipment bag made of very tough waterproof polyester material and has nylon web handles
- It has a leatherette bottom and flap to cover the opening when exposed to weather
- The "S" model features a polyester web shoulder strap
- 24" X 19" X 11"



## Petzl Bucket Rope Bag

- Bag remains upright and has an exterior folding lid system that allows easy access to the contents of the bag
- External zippered pocket for personal effects
- Transparent external window for displaying an equipment identification card
- Two large, comfortable carrying handles
- Adjustable strap for carrying bandolier style
- Interior ring can be used as attachment point for rope
- Bottom is lined for longer wear
- Waterproof fabric
- Available in two versions



S41Y 025: 25 Litre Capacity



S41Y 035: 35 Litre Capacity

## Petzl Airline: Throwline

- Combines flexibility for a precise throw and stiffness for avoiding knot formation as it comes out of the bag
- Excellent sheath-core bond maintains a round cross section, ensuring good rope glide through the tree. The sheath is made of Dyneema for excellent abrasion resistance
- Lightweight, does not require a very heavy throw-bag
- Yellow for excellent visibility



## Petzl Jet: Throw-Bag

- Durable, two-layer construction prolongs throwbag life
- Streamlined shape facilitates passage through tree branches
- Different colored stitching on webbing differentiates the weights of the bags
- Secondary connection point for quick attachment of the rope
- Yellow for excellent visibility



lTutilitysupply.com



# Buzzline

BUZZLINE® TOOL BUCKETS are made of heavy-duty canvas or yellow vinyl nylon and feature a solid round non-conductive injected molded top ring with a choice of bottom type. The bottom choices include plastic, rubber, or unitized. Tool buckets are equipped with either polypropylene rope handle or nylon webbing handle, which comes with or without a swivel snap. Rope holes are reinforced with brass grommets. All BUZZLINE® Tool Buckets are offered with Blackwrap™, plastic that reinforces the Tool Bucket.

TRUCK

**30-010: Mini Tool Bucket 5 Pockets, 5" x 6", White**



**30-021: Blackwrap Mini Tool Bucket 5 Pockets, 5" x 6", Black**



**30-023: Blackwrap Mini Tool Bucket, 5 Pockets, 5" x 6", Red**



**30-024: Mini Blackwrap Tool Bucket, 5 Pockets, 5" x 6", Yellow**



**1829-BH-1: Aerial Tool Board w/ Hook Holes**

- Made with 8-vinyl hand tool pockets, bit, knife, and utility pockets
- Loops for hammer and screw driver
- 16" W X 21" H X FLAT
- Weight 5 lbs 8 oz



**1829-BH-4: Aerial Tool Board w/ Hook Holes**

- Made with 4-pocket leather pouch, knife sheath, and 2-screwdriver/1-hammer loop, canvas pouch
- 16" W X 21" H X FLAT
- Weight 4 lbs 8 oz



**1829-BH-2: Aerial Tool Board w/ Hook Holes**

- Made with 7-vinyl pockets and 3-tool loops, a bit and large utility pocket, hammer loop & AMP pocket
- 16" W X 21" H X FLAT
- Weight 6 lbs



**1829-BL-1: Aerial Tool Board w/ Wide Lip**

- Made with 8-vinyl hand tool pockets, bit, knife, and utility pockets
- Loops for hammer & screwdriver
- 16" W X 21" H X FLAT
- Weight 5 lbs 10 oz



**1829-BL-2: Aerial Tool Board w/ Wide Lip**

- Made w/ 7-vinyl pockets and 3-tool loops, a bit and large utility pocket, hammer loop, AMP pocket
- 16" W X 21" H X FLAT
- Weight 6 lbs



**1829-BL-3: Aerial Tool Board w/ Wide Lip**

- Made w/ 4-pocket leather tool pouch, knife, and hammer loop, vinyl crimp tool holder with die pocket
- 16" W X 21" H X FLAT
- Weight 5 lbs 14 oz



**1829-BL-4: Aerial Tool Board w/ Wide Lip**

- Made with 4 pocket leather pouch, knife sheath, and 2-screwdriver 1-hammer loop, canvas pouch
- 16" W X 21" H X FLAT
- Weight 5 lbs 10 oz





## 1829-A-2: Aerial Vinyl Tool Apron, 2-Man Bucket

- Multiple hand tool pockets, tape sling and leather reinforcement
- 4 material pouches & 2 drill bit holders
- 28.5"L x 4"W x 26.5"H
- Weight 4 lbs 14 oz



## 1829-PSO: Aerial Vinyl Tool Apron

- Non-Conductive for safety
- Fits perfectly within Aerial Bucket
- 41.5"L x 26"H
- Weight 5 lbs 6 oz



## 1829-MLGW: Aerial 2-Man Vinyl Tool Apron

- Designed for kidney shaped buckets
- Multiple pocket configuration
- 38"L x 18"H
- Weight 5 lbs 7 oz



## 1829-DP-C: Aerial Canvas Tool Apron

- 10 hand tool pockets & 2 pouches, 3 socket pockets & 2 drill bit holders
- 23.8"L x 4"W x 21.25"H
- Weight 4lbs 12oz



## 1829-DP: Aerial Vinyl Tool Apron

- 10 hand tool pockets & 2 pouches
- Hammer loop and 2 pouches, 2 drill bit holders
- 23.8"L x 4"W x 21.25"H
- Weight 4 lbs 12 oz



## 1829-PG&E: Aerial 2-Man Canvas Apron

- 8 hand tool pockets, 2 pouches, 3 drill bit holders, 3 socket pockets, hammer loop & knife sheath
- 24"W x 33"H
- Weight 6 lbs 6 oz



## 1826: Aerial Canvas Tool Apron

- 8 hand tool pockets & 1 pouch
- 1 quick release snap
- 18"L x 4"W x 19.5"H
- Weight 3 lbs 2 oz



## 1825: Aerial Canvas Tool Apron

- 2 Pockets 6"x8"
- Heavy weight canvas
- 18"L x 4"W x 10"H
- Weight 2 lbs 10oz



## 1825-3: Aerial Canvas Tool Apron

- 3 Pockets 6"H x 8"W
- Heavy weight canvas
- 22"L x 4"W x 10"H
- Weight 1lb 4oz



## 1825-3-V: Aerial Vinyl Tool Apron

- 3 Pockets 6"H x 8"W
- 18 oz fire retardant vinyl
- 22"L x 4"W x 10"H
- Weight 1 lb 4oz



## 2651: Compression Tool & Bolt Cutter Bag

- Heavy vinyl coated nylon, 2 pockets
- 2 grommets for bucket attachment
- 10"L x 3"W x 19"H
- Weight 1 lb 7 oz



## 2651-AP-S1: Compression Tool & Bolt Cutter Bag with Closure

- Durable hook and loop fastener helps keep bag closed
- Diminish the risk of dropping your equipment with reliable closure
- 10"L x 4"W x 19"H
- Weight 2 lbs 2 oz



## 2651-2-XCEL: Compression Tool & Bolt Cutter Bag

- Heavy vinyl coated nylon, 3 pockets
- 3 grommets for bucket attachment
- 10"L x 3"W x 26"H
- Weight 2lbs 14oz



## 1061: Nut & Bolt Bag

- This olive drab nut and bolt bag has real leather reinforcements, an inside pocket for small items, and quick release snaps on the back for easy belt attachment
- Real leather top and bottom reinforcement
- Quick release snaps
- 8.5"W x 10"H x 3"D
- Weight 9 oz



## 181514HBHQ2: Oversized Splicer's Tool Bucket

- This oversized bucket has two handles, 15 inside and 14 outside pockets to organize all your tools
- The fabric is 1000 Denier Nylon Cordura which is extremely abrasion and cut resistant
- Hard body plastic liner that give it shape and makes it rigid
- Heavy PVC top ring to keep the bag open, two attachment holes reinforced by brass grommets and a molded plastic bottom
- 15"L x 9"W x 11"H
- Weight 3 lbs 4 oz



## 1815HB2G: Splicer's Tool Bucket

- Has two handles, 15 inside and 14 outside pockets to organize all your tools
- Heavy natural canvas fabric, extremely abrasion and cut resistant
- The bag has a hard body plastic liner that give it shape and makes it rigid
- There is a heavy PVC top ring to keep the bag open, two attachment holes reinforced by brass grommets and a molded plastic bottom
- 15"L x 7"W x 9"H
- Weight 2 lbs 10oz



## 1829-DP-MAG: Aerial Apron with Magnet

- Yellow vinyl, magnetic strip
- 24"L x 4"W x 21"H



## 1820-HB: Aerial Oval Bucket

- This oval shaped tool bag hangs on the aerial lift bucket with attachment hooks
- There is a PVC ring in the top to shape the opening and hard body plastic on the sides to keep the bag open and rigid
- 15 hand tool pockets on the inside of the bag organize tools for easy access
- Holes for attachment hooks are reinforced with brass grommets
- The bag has a sturdy plastic bottom with drainage holes



## 1820-HB-7: Rigid Aerial Apron with Inosil

- Estex has designed a series of tool aprons with multiple pocket configurations to fit inside the bucket
- They were designed to fit flat against the liner to minimize interference with line work yet maximize a lineman's ability to reach the necessary tools
- Each apron has a non-conductive rod in the top for support as well as two brass grommets
- These aprons also contain Inosil, a proprietary anti-corrosive shield to protect against rust and corrosion when used properly
- This apron also has another unique feature and that is the "hardbody" construction which gives these vinyl aprons the rigidity of a traditional board
- 23.9"L x 4"W x 21.25"H
- Weight 6 lbs 10 oz



## 1829-DP-LED: Aerial Tool Board with Lights

- This aerial bucket apron has many tool pockets and pouches dispersed over two rows, each illuminated by a compact, powerful LED flashlight for maximum visibility during night-time jobs
- Made of 18 oz vinyl. Flashlights powered by 3 AA batteries, and are water proof to 20 ft (6 m)
- Impact resistant. Meets NFPA Fire Resistant Requirements: 500°F (200°C) for 30 minutes
- 23.8" L x 4"W x 21.25" H
- Weight 5 lbs



## Polymer Hook



- These hooks are an injection molded part, which ensures strength and consistent quality. They have high break strength and are resistant to cold weather
- 11/16" Dia.

**1830:**  
**Weight 5 oz**  
**Fits All Standard Buckets**  
**Also Keeps Liners From Bouncing Out**

**1831:**  
**Weight 6 oz**  
**Fits All Buckets**  
**Engineered To Fit New High Load Lifts**



## 2070: 12x15 Canvas Tool Bucket

- All Estex tool buckets are made of heavy duty canvas or vinyl coated nylon for long wear and use
- The top ring is a single piece metallic material designed to stay open even under severe and continuous load
- The bottoms are made of high impact polymer resins or leather
- The bag has leather side supports at the rope holes and a unique Estex feature whereby the bottom is stitched on and the body of the bag is folded back over the stitches to protect the threads from abrasion and excessive wear
- This has the added benefit of providing a smooth padded area at the bucket bottom. Otherwise, your bucket becomes a rough sharp source of wear on the bucket truck and on the aerial bucket
- The bucket also has Strong UV and rot-resistant rope handle
- 12" dia. x 15" H
- Weight 2 lbs 15 oz

## 2117-1LOSP: 24" Vinyl Tool Bag w/ Outside Pocket



- 2117 series tool bags are wider than other bags and are made from canvas or heavy vinyl coated nylon which is water resistant and also very resistant to abrasion
- The bottom is made from molded polymer plastic which gives additional water resistance
- The 2" web handles wrap completely around the bag. There is a weather flap that covers the top of the bag to keep water out Box "X" stitches on the handles prevent tearing
- There is one large outside pocket covered with a flap with snap fasteners
- This bag also has a shoulder strap

## 2190: 24" Vinyl Tool Bag

- Made from heavy vinyl coated nylon; water-resistant and abrasion resistant
- There is a second layer of vinyl around the bottom of the bag for extra protection
- The bag has a hard wood bottom with six brass studs to protect the bottom surface from abrasion
- The 2" web handles wrap completely around the bag
- There is a weather flap that covers the top of the bag to keep water out
- Box "X" stitches on the handles prevent tearing



## 2629: Grounding Bag

- Grounds and jumpers storage bag use has increased over the years as utilities realize the protection from moisture, dirt, oil and other contaminants is important in the effectiveness of the equipment they are using
- These bags are designed so that the handles go all the way around the bag to support the entire contents of the bag
- They also take all the stress when the grounds are hung on a hook or a mandrel
- Fully customizable to your specifications



## 2735-12-22: Kneeling Pad

- The Estex Ergonomic Kneeling Pad has a non-skid surface and a closed cell foam base that will not absorb water. It was designed as a health aid to relieve lower back and leg stress for workers that work in network underground, URD, or on padmount transformers among other applications. This pad benefits workers in the Electric, Cable and Telecommunications Industry. This pad is also used as a thermal barrier to the ice cold ground
- 12"W x 22"L
- Weight 1 lb 4 oz



# Plastic Techniques (PTI)

The PTI tool tray, as with all PTI products has been designed with the lineman's needs in mind. It is built to withstand the harsh environments that linemen are subjected to on a daily basis, combining storage needs and durability in one great product! Available in white, yellow or orange.

## 1TB: Tool Tray, Standard w/ Brackets 19x8x8

- Dimensions 19" x 8" x 8"
- UV protected
- Weather-resistant
- Safe and convenient storage for tools and CATV meters
- Brackets fit virtually every aerial lift basket
- Mountable on buckets with or without liners
- Made of a rugged polymer making it impervious to motor oil, hydraulic oil and a broad range of chemicals



## 6TB-W-TP7: Deep Tool Box w/ 7 Pocket Omni Pouch

- Dimensions 15" x 10" x 13"
- White Color Only
- UV protected
- Cold-resistant
- Safe and convenient storage for tools and CATV meters
- 7 Pocket Omni Pouch Included
- Fits virtually every aerial lift basket
- Mountable on buckets with or without liners
- Made of a rugged polymer making it impervious to motor oil, hydraulic oil and a broad range of chemicals



## 2TB-W-TP9: Tool Tray - Double sized, Omni Pouch

- Dimensions 20" x 14" x 8"
- UV protected
- Weather resistant
- Safe and convenient storage for tools and CATV meters
- Brackets fit virtually every aerial lift basket
- Made of a rugged polymer making it impervious to motor oil, hydraulic oil and a broad range of chemicals
- Handy 9 Pocket Omni Pouch installed in tray



## 14DTB-319016: Deep Poly Tool Tray w/ 24" Tool Magnet

- Dimensions 19" x 7" x 24"
- UV protected
- Weather resistant
- Safe and convenient storage for tools
- Fits virtually every aerial lift basket
- Convenient tool magnet installed in tray
- Made of a rugged polymer blend making it impervious to motor oil, hydraulic oil and a broad range of chemicals
- This tray is extra deep at 24"



## 2TB: Tool Tray - Double sized, 20x14x8

- Dimensions 20" x 14" x 8"
- UV protected
- Weather resistant
- Available online in Natural/Gray only
- Safe and convenient storage for tools and CATV meters
- Brackets fit virtually every aerial lift basket
- Mountable on buckets with or without liners
- Made of a rugged polymer making it impervious to motor oil, hydraulic oil and a broad range of chemicals



## CSS: Chainsaw Scabbard - Fiberglass

- Durable reinforced fiberglass construction
- Sturdy reinforced back plate
- Non-corrosive pan-head brass post and screw fasteners for rapid sheath replacement
- Dimensional proportions optimized for gas or hydraulic saws
- Mountable on the inside or outside of the bucket
- PTI's chainsaw scabbard is designed to allow for easy access and storage of your chainsaw



## CSS-20: Chainsaw Scabbard - Polymer

- Designed to hold standard chainsaws
- Plastic construction is impervious to hydraulic, bar and motor oils
- Lightweight
- PTI's chainsaw scabbard is designed to allow for easy access and storage of your chainsaw
- The scabbard can be mounted on the inside or outside of the basket



## CSS-20WK: Chainsaw Scabbard with Wear Rollers

- Designed to hold standard chainsaws
- Plastic construction is impervious to hydraulic, bar and motor oils
- Lightweight
- Plastic wear rollers prolong the life of the scabbard
- PTI's chainsaw scabbard is designed to allow for easy access and storage of your chainsaw
- The scabbard can be mounted on the inside or outside of the basket



## CSS-24: Plastic Pruning Saw Scabbard

- Polymer construction is impervious to hydraulic, bar and motor oils
- Lightweight
- Colour is Black
- PTI's pruning saw scabbard is designed to allow for easy access and storage of your pruning saw
- The scabbard can be mounted on the inside of the basket



## BSH-4: Saw Holder Boom Mounted "Boom-Saver"

- Shovel-nose design eases tool entry
- Prevents tool from damaging boom when storing and removing the tool
- Fits virtually all standard aerial lift booms
- The holder mounts to the boom using a ratchet for a sure grip
- Made from a specially formulated polymer that has demonstrated superior resistance to weather
- Impervious to hydraulic oils
- Lightweight, durable, resistant to UV degradation
- Straps are around the outside of holder for extra safety
- The long reach chainsaw holder mounts to the boom of the truck eliminating work area interference when not in use (saw not included)

## CSH: Circular Stick Saw Holder

- Holds hydraulic circular stick saw
- Fits round and square booms
- Ratchet binder and strap attachment



# Platform Accessories

TRUCK

## Plastic Techniques LBH: LiteBox® Holder, Bucket Mount - Black

- Fully non-conductive wrap-around housing offers maximum protection
- Made from a special polymer blend
- Excellent cold weather characteristics
- Allows dual use of your rechargeable Litebox® as a bucket mount work light
- The design of this LiteBox® holder allows the light head to be aimed from 50° below horizontal to 20° past vertical, with nearly a full 360° side to side



## Plastic Techniques LBH2: LiteBox® Holder, Bucket Mount - Black

- For Streamlight models with rings
- Fully non-conductive wrap-around housing offers maximum protection
- Made from a special grade polymer blend
- Excellent cold weather characteristics
- Available in black, yellow or orange
- Allows dual use of your rechargeable Litebox® as a bucket mount work light
- The design of this LiteBox® holder allows the light head to be aimed from 50° below horizontal to 20° past vertical, with nearly a full 360° side to side



LBH2-0 - Orange



LBH2-Y - Yellow

## PTH: Tool Holder for Pruner

- Holds hydraulic and pneumatic stick pruners
- Fits round and square booms
- Ratchet binder and strap attachment



## Hastings 06-177: Boom Mounted Pruner/Saw Holder

- Boom mounted pruner/saw holder
- Pruner/saw holder provides an excellent method for storage of hydraulic tools during the clearance work
- Boom mounted tool holders are constructed with fiberglass laminates
- Ratchet load binders with 1" wide nylon straps secures holders firmly to boom
- Gravity type latch secures control end of tool and is easy to open and close
- Unit adapts to square, rectangular, round and oval booms
- 9.5 lbs

## Hastings 05-1001: Complete Boom Mounted Hot Stick Holder

- Boom mounted holders are made with durable molded fiberglass
- Ratchet load binders for attachment to the boom
- Will hold four hot sticks 1 1/4" - 2" diameter
- Adapts to square, rectangular, round, and oval booms
- 10" wide x 7" High, 12 lbs

## Hastings P30128: Individual Rubber Grips



## Hastings A19001: Tool Holder - Slotted End, 6 lbs



## Hastings A19001: Tool Holder - Grip End, 6 lbs



## 6TB: Tool Tray

- Dimensions 15"x10"x13"
- UV protected
- Weather-resistant
- Safe and convenient storage for tools and CATV meters
- Fits virtually every aerial lift basket
- Mountable on buckets with or without liners
- Made of a rugged polymer making it impervious to motor oil, hydraulic oil and a broad range of chemicals
- Available in white: 6TB-W



## 1TB-RA: Tool Tray - Curved

- Dimensions 19"x8"x8"
- UV protected
- Weather-resistant
- Safe and convenient storage for tools and CATV meters
- Fits 30" diameter round buckets with or without liner
- Made of a rugged polymer making it impervious to motor oil, hydraulic oil and a broad range of chemicals



## 321010: Tool Tray

- Dimensions 19x8x8
- UV protected
- Fits most 30" diameter round buckets
- Set of 2 tool trays
- Available in natural/gray only
- Weather resistant
- Safe and convenient storage for TOOLS and CATV meters
- Mountable on buckets with or without liners
- Made of a rugged polymer making it impervious to motor oil, hydraulic oil and a broad range of chemicals.



## 319119: Tool Tray, Semi-Oval

- Dimensions 18"x12"x10"
- Adjustable tool straps
- UV protected
- Weather-resistant
- ABH hooks included
- Safe and convenient storage for tools and equipment
- Fits virtually every aerial lift basket
- Made of a rugged polymer making it impervious to motor oil, hydraulic oil and a broad range of chemicals
- ABH hooks included. Soft and hard covers are available



## 319119-C: Tool Tray, Semi-Oval w/ Lid

- Dimensions 18"x12"x10" (same as 319119)
- Lid adds protection from weather and stores tools safely
- Lid has straps and buckle to safely secure it in place
- Attaches to your bucket using our ABH hooks
- Adjustable tool straps
- UV protected
- Weather-resistant
- ABH hooks included
- Safe and convenient storage for tools and equipment
- Fits virtually every aerial lift basket
- Made of a rugged polymer making it impervious to motor oil, hydraulic oil and a broad range of chemicals
- ABH hooks Included
- Soft and hard covers are available
- ABH hooks included. Soft and hard covers are available





# Plastic Techniques (PTI)

TRUCK

## IWH: Impact Wrench Holster, Inside Mount

- Field reversible bracket can be left or right-mounted
- 10" deep
- Fits wrench only
- Weather-resistant
- Offers maximum space efficiency
- Semi-flexible polymer construction
- Fits virtually every lift bucket
- Excellent dielectric, cold weather, chemical resistance and UV properties
- This model is field reversible



## IWH2: Impact Wrench Holster, Deep Outside Mount

- 13" deep
- Fits wrench with socket attached
- Offers maximum space efficiency
- Semi-flexible polymer construction
- Excellent dielectric, cold weather, chemical resistance and UV properties



## IWH3: Impact Wrench Holster w/ Bit Holder, Outside Mount

- Outside mount
- 13" deep
- 19" integrated bit holder
- Fits wrench with socket attached
- Offers maximum space efficiency
- Semi-flexible polymer construction
- Excellent dielectric, cold weather, chemical resistance and UV properties



## IWH4: Impact Wrench Holster, 27" Deep, Outside Mount

- 27" deep
- Fits wrench with bit attached
- Offers maximum space efficiency
- Semi-flexible polymer construction
- Excellent dielectric, cold weather, chemical resistance and UV properties



## 219030: Tool Holder, Burndy Long, Yellow

- Overall length of 13"
- Designed for longer nosed, pistol grip tools with overall length of 13"-18" such as Greenlee Gator-Pro, ECCX, the Huskie and REC-5440
- Offers maximum space efficiency
- Semi-flexible polymer construction
- Excellent dielectric, cold weather, chemical resistance and UV properties



## 210001: Tool Organizer Board

- Dimensions 18" x 20"
- 5 pocket tool holster
- 4 leather tool loops
- Scissor pouch
- Leather bug bag
- Offers the maximum in space efficiency
- Made of thick durable, polymer
- Won't bloom like fiberglass; eliminates cuts, scratches & irritation associated with fiberglass
- Replacement components available
- All of the utility components are made from high quality, heavy duty top grain saddle leather



## 210020: Tool Organizer Board

- Dimensions 18" x 20"
- TP-7 pouch
- 4 leather tool loops
- 3 way tool holster w/ knife snaps
- Leather Bug Bag
- Offers the maximum in space efficiency
- Made of thick durable, polymer
- Won't bloom like fiberglass; eliminates cuts, scratches & irritation associated with fiberglass
- Replacement components available
- All of the utility components are made from high quality, heavy duty top grain saddle leather



## TO-1: Tool Organizer Board

- Dimensions 18" x 20"
- 3 leather tool loops
- 3 way tool pouch with knife snaps
- Scissor pouch
- Leather bug bag
- Offers the maximum in space efficiency
- Made of a thick and durable polymer
- Won't bloom like fiberglass; eliminates cuts, scratches and irritation associated with fiberglass
- Replacement components available
- All of the utility components are made from high quality, heavy duty top grain saddle leather
- Available with canvas bug bag



TO-2: With auger bit holder and knife pouch



TO-3: With knife pouch

# Platform Equipment

TRUCK

## PTI EZ-2: Step, rated for 275 lbs

- Fits all standard 1 man and 2 man aerial buckets
- Strong and lightweight
- Impact resistant polycarbonate
- Dielectrically safe, no metal
- Rated for 275 lbs



## PTI SST-20: Splicer Seat, Large Opening, Gray

- 40% lighter than traditional wooden models
- UV protected
- Cold-resistant
- 12" x 28.5" opening to accommodate larger items
- Made of a rugged polymer making it impervious to motor oil, hydraulic oil and a broad range of chemicals
- The PTI splicer seat allows for storage of tools
- No longer does the technician have to rummage for the correct tool, it will be in plain sight and within easy reach



## PTI 318022: Splicer Seat, Large opening, Gray with Xtra Padded Seat

- 40% lighter than traditional wooden models
- The tool pouch has a large pocket that holds connectors, 3 tool pockets that store drivers, pliers and other small hand tools, and a leather knife sheath
- UV protected
- Cold-resistant
- 12" x 28.5" opening to accommodate larger items
- Made of a rugged polymer making it impervious to motor oil, hydraulic oil and a broad range of chemicals
- With the addition of a padded seat and handy tool pockets, the splicer seat will increase productivity



## PTI DS-1: Scuff Pad with Step

- Size 20" x 20" square shape
- Molded interior step for easy exit and added safety
- High quality fiberglass for strength and longevity
- Exclusive non-skid surface
- Longer bucket liner life
- Works with or without a liner
- Greater lineman safety
- PTI's fiberglass scuff pad is smooth on the outside to protect the bucket and/or liner. Inside, the pad's gritty surface provides the lineman with non-skid footing and greater safety



DS-8

**DS-8: Scuff Pad 26" x 20" Rectangle**

**DS-11: Scuff Pad 43" x 20" Rectangle**

## D-20: Scuff Pad 20" Square

- 20" square scuff pad
- Exclusive non-skid surface
- Longer bucket liner life
- Works with or without a liner
- Greater lineman safety



D-20



D-21

**D-21: Scuff Pad w/ Step 21" Square**

**D-26: Scuff Pad 27" x 21" x 4" Rectangle**

**D-28: Scuff Pad 26" x 20" x 4" Rectangle**

**D-46: Scuff Pad 44" x 20" x 4" Rectangle**



D-28

## FITALL Soft Covers

- Fit Most 2-man buckets
- Made of heavy duty vinyl coated nylon
- Eliminates gathering of still water
- Reversible, gives you twice the life
- Available in black only

"Fit-All" soft covers were designed with safety and extended durability in mind. The soft covers will keep the inside of your bucket or tool tray dry from the elements, thus extending its useful life. It is also manufactured to allow for a doming of the cover, allowing water to run off rather than puddle. This helps to reduce mosquito breeding ground and the spreading of viruses.

Part #	Description	Fits Bucket Size
FITALL-I	Soft Cover Single Man w/ Foam	24" x 24"
FITALL-II	Soft Cover 2-Man w/ Foam	24" x 48"
FITALL-K	Soft Cover Kidney-Shaped w/ Foam	Fits Hi Ranger & Teco Kidney Styles
FITALL-V	Soft Cover 1.5 Man w/ Foam	24" x 30"



FITALL-II



FITALL-V

## Tru-Fit Lid w/ Strap

- Shaped to shed ice and snow
- Easily removed and replaced by one person
- Fits permanently: no shrinking, sagging or tearing
- These rigid, tough polymer covers seal your bucket against driving rain, ice and snow

Part #	Description	Size
28L32	Tru-Fit Lid w/ Strap, Rectangle Shape	28" x 32"
30L34	Tru-Fit Lid w/ Strap, Rectangle Shape	30" x 34"
2L28N	Tru-Fit Lid w/ Strap & Webbing	29.5" x 29.5"
5A30	Tru-Fit Lid w/ Strap	33" x 27"
5A48	Tru-Fit Lid, 2 Man w/ Straps	50.5" x 27"
5F48	Tru-Fit Lid, 2 Man w/ Straps, Hi Ranger	50.5" x 27"
5TD48	Tru-Fit Lid, 2 Man w/ Straps, High Ranger	50.5" x 28"
411041	Tru-Fit Lid, 2 Man w/ Straps	54.5" x 31"



28L32



5A30



411041

## 411048: Lid, Slide on Retrofit Kit for 1TB

- Lid only. Kit comes with lid, strap and fasteners to add to your existing 1TB model
- Made from a special grade of rugged, cold resistant polymer blend with UV protection added
- Protects tools from the weather
- Two straps support lid in open position and hold it in out of the way location while working
- Safe and convenient storage for tools and CATV meters

## Hastings 05-960: Fiberglass Step

- Heavy duty fiberglass step.
- Makes it easier to get into and out of buckets
- The HFGP accessory step is a one piece construction produced from high strength fiberglass materials
- Weight: 7.8 lbs

## Hastings 05-961: Fiberglass Step

- Heavy duty fiberglass step
- Makes it easier to get into and out of buckets
- The HFGP accessory step is a one piece construction produced from high strength fiberglass materials
- Weight: 8 lbs



# Cable Handling Accessories

TRUCK

## Aircraft Dynamics RoboReels

- Designed for linemen to provide a safe and easy means to unwind and rewind cumbersome wire and cable
- Extremely rugged, all-weather, heavy duty reels
- Made of steel and E-coated, RoboReels have adjustable arms that allow a secure means of loading, unwinding and rewinding various coils with different diameters
- Coils can simply be rolled into the stand and clamped into place with the adjustable arms
- Wire or cable is easily pulled or rewound through "smooth" center guides

## Aircraft Dynamics Guy Wire RoboReel

- Four adjustable arms
- Holds guy wire with 1/2" diameters
- 5276 holds coil diameter 22" to 31" with coil widths to 4.75"
- 5415 holds coil diameter 32" to 36" with coil widths to 8.75"
- Driver or passenger site mounting options
- 5276 Dimensions: 33 3/4" high x 9 1/4" deep x 32 1/4" wide
- Weight 41 lbs

5276 Universal Mounting  
5415 Universal Mounting



## LTL6000-11: LTL Guy Wire Holder



- Four adjustable arms
- Holds guy wire with 1/2" diameters
- Driver or passenger site mounting options

## Aircraft Dynamics 5478: Triplex RoboReel

- 8 adjustable arms
- Holds coils up to 10 1/4" wide
- Accepts coils with outside diameter 26" to 32" and inside 14" - 20"
- 34 1/2" high x 14" deep x 33 1/2" wide
- Weight: 58 lbs



## Aircraft Dynamics 5074: RoboReel Base Plate

- Securely, easily mount or remove reel
- Simply slide your RoboReel into the RoboReel base plate and a spring-loaded latching system will provide a secure means to hold your reel for all transportation needs
- Ideal accessory for those who want a quick means to remove or remount RoboReel



## Aircraft Dynamics 5479: Hitch Mount

- Allows the RoboReels to be mounted in any 2" receiver hitch
- Mounting plate swivels 360° to allow the cable to pay out in any direction
- Works well with the RoboReel quick change base plate, but may also be used without it



## Tulsa Power the REEL Thing

- With higher load ratings stamped right on the tool, you can use The Reel Thing for a greater range of reel weights
- With a new flipping feature, this multi-use tool gives you more flexibility in the warehouse and in the field
- The Reel Thing allows one person to lift, stack, and spin cable spools
- RT-20 and RT-40 allow you to safely flip a reel from rolling to non-rolling position
- RT-60 features a bearing swivel assembly to accommodate a weight of up to 12,000 lbs
- Independent laboratory tested with the ASME code stamped right on the toggle bar

Part #	Arbor Size	Capacity
RT-10	1.25"-2"	500 lbs.
RT-20	2"-4"	3000 lbs.
RT-40	3"-6"	4500 lbs.
RT-60	2 5/8"-6"	12000 lbs.



Itlutilitysupply.com



# Hannay Reels & Accessories

TRUCK

## GCR 10-17-19 Manual Rewind Grounding Reel

- Independently tested to 43 kVA for 30 cycles
- Helps meet OSHA requirements for vehicle grounding
- Offers manual rewind with hand crank permanently attached to disc
- Internal rotary device



BASE MODEL	CABLE CAPACITY OF REEL			APPROX. WEIGHT	
	Cable Size	ft	m	lb	kg
GCR10-17-19	#2	150	45.7	30	13.6
	1/0	90	27.4	30	13.6
	2/0	90	27.4	30	13.6

## GC 10-17-19 Manual Rewind Grounding Reel

- Storage only
- Manual rewind with hand crank permanently attached to disc



BASE MODEL	CABLE CAPACITY OF REEL			APPROX. WEIGHT	
	Cable Size	ft	m	lb	kg
GC10-17-19	#2	150	45.7	28	12.7
	1/0	90	27.4	28	12.7
	2/0	90	27.4	28	12.7

## SGCR 10-17-19 Spring Rewind Grounding Reel

- Independently tested to 43 kVA for 30 cycles
- Helps meet OSHA requirements for vehicle grounding
- Fast, convenient, automatic spring rewind
- Ratchet mechanism locks the reel
- Built-in cable hoop
- Internal rotary device



BASE MODEL	CABLE CAPACITY OF REEL			APPROX. WEIGHT	
	Cable Size	ft	m	lb	kg
SGCR10-17-19	#2	75	22.9	43	19.5
	1/0	75	22.9	43	19.5
	2/0	65	19.8	43	19.5

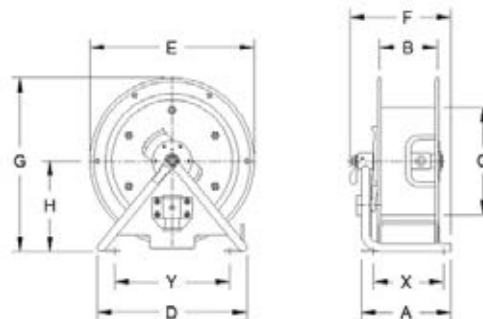

BASE MODEL	REEL DIMENSIONS (INCHES)									
	A	B	C	D	E	F	G	H	X	Y
GCR10-17-19	9	6	10.5	15	16.5	10.5	17.19	8.94	-	-
GC10-17-19	9	6	10.5	15	16.5	10.5	17.19	8.94	-	-
SGCR10-17-19	9	5.5	10.5	15	16.5	10.12	17.19	8.94	-	-

Itutilitysupply.com



# Reels & Accessories

TRUCK

## Hydraulic Reels & Hydraulic Hoses



- Because rewind power is self-contained, spring rewind reels are extremely versatile
- No power connections are required and the reels may be installed in almost any position and on all types of equipment
- Rewinds hose automatically when hose is pulled to release the ratchet
- The ratchet provides interval locking or may be detached for constant tension operation
- A declutching hub arbor prevents damage to the spring from reverse winding
- Heavy duty spring operates through thousands of cycles without power loss
- Each unit is equipped with rollers to protect the hose as it extends and retracts from the reel
- Equipped with two swivel joints, allowing use of two hoses simultaneously

## Power Cord Reels



- Designed for optimum performance and a long service life, this durable cord reel is perfect for a wide variety of applications including hoists, electric tools and moving equipment
- The unit is factory assembled and includes Type SO or W cable
- The reel's spring tension design allows it to lift or stretch cable with 10% sag
- Containerized main spring assures safety and easy handling
- Features include an adjustable cable guide with anti-cable "lock out", and a modular collector ring, cable included

## Hand Wind Reels



- This rugged hand wind reel is designed for heavy duty industrial storage applications, such as storing extension cords, power cables, and hoses
- Center cavity allows convenient access to the end of the conductor
- Capacity: for example, the unit can hold up to 100' of 3-conduit type SO cable, size #14 AWG
- Unit is UL listed

## Hydraulic Reel Ball Stop



- Recommended with spring rewind reels and 4-way roller assemblies
- Each stop is easily assembled with the fasteners provided, without any special tools
- Two-piece molded plastic spheres, custom drilled to the size you specify

## Hydraulic Reel Ball Swivel



- 1/2" swivel joint
- 90° - male to female
- Made from steel
- Rated to 3000 psi

## Chance C4176086: Portable Cable Reel 18 lbs



- Hole in outer flange for cable to feed through
- Rewind handle has galvanized-pipe extension for temporarily parking clamps
- Portable reel quickly pays-out/takes-up
- Helps keep ground sets clean and neat, ready for use
- Handles are comfortable, turned aluminum
- Lightweight unit can be carried to remote sites
- Tubular-steel frame can be U-bolted to deck of truck
- Galvanized drum has ribbed flanges to resist flexing and beaded rims to eliminate sharp edges
- Reel is for storage only
- Cable and clamps should be removed completely from reel before use
- Failure to do so could result in a dangerous voltage drop and violent mechanical reactions
- A label on the unit gives this warning

## Chance T6001971: Truck Grounding Set



- Provides means to drain off capacitance or static charges from winch trucks and aerial devices
- Flat-face clamp is for secure attachment to the truck bed at an area cleaned for electrical contact
- C-type clamp is for secure attachment to the ground rod
- This grounding method should not be considered adequate protection to personnel against conductor contact

Part #	Component	Qty
G3370	Screw Ground Rod	1
T6001798	Flat Face Ground Clamp	1
C6001754	C-Type Ground Clamp	1
S6116	#2 Copper Grounding Cable	50 ft
C6002618A	Shrouded Alum. Ferrules	2
C417-6086	Storage Reel	1

## Utility Tool & Trailer CR Collapsible Reel

- The CR collapsible reel is designed for picking up wire in neat coils
- The reel is simply pushed onto the winch shaft, compressing the spring and then turned to lock onto the shaft
- After the wire is coiled onto the reel, a quick-acting handle is used to collapse the outer rim of the pick-up reel, allowing the coiled wire to be removed

Drum Diameter	20"
Overall Diameter	28"
Throat (between flanges)	6"
Winch Shaft	2-7/16"
Weight	73 lbs



## Utility Tool & Trailer 132513: LD Payout Reel

- Utility Tool & Trailer designed the LD Payout Reel for both picking up wire cable in neat coils in addition to paying out. Unit expands and contracts and is designed to work in any position in-between
- Unit also comes with a rope brake made to drag in one direction to ensure ease of rewinding and which aids in evenly paying out wire or cable
- LD Payout Reel can be mounted on your truck using very limited space and is made of both high-strength steel and heat-treated aluminum

Max Paddle ID	21"
Minimum Paddle ID	14"
Paddle Width	12"
Unit Width	20"
Unit Height	39"
Unit Weight	46 lbs





# Reels & Accessories

TRUCK

## Hastings Grounding Reels

- Two models available to ensure adequate cable lengths to meet truck grounding requirements - small or large
- Compact design grounding reels provide an efficient and positive means to ground trucks working on or near energized lines
- Grounding reels have been tested for maximum fault current rating and can be tested without removing from the truck
- The ground connection from reel to the vehicle is made during the initial installation
- Reels are designed to be bolted to the vehicle so they can be removed easily for transfer to new trucks
- Spring rewind drum for controlled payout and take up
- 4-way cable guide rollers allow for one man operation and prevents excessive wear on the ground cable
- Weather-tight construction to prevent corrosion
- All catalogued ground reels with factory installed cables include a 6' length of 2/0 ground cable to connect the reel to the truck. Item A30205, a 4-way bronze tee connector is provided to connect one end of the cable to the ground stud on the reel. The other end must be connected to the truck frame by a suitable means



Part #	Description	Weight
21362	Retractable Grounding Reel only tested to 27KA @ 15 cycles	32 lbs
21363	21362 Reel with 40' of #2 Yellow Ground Cable Factory installed and 21307 Bronze clamp one end	47 lbs
21364	21362 Reel with 40' of 1/0 Yellow Ground Cable Factory installed and 21307 Bronze clamp one end	53 lbs
21365	21362 Reel with 40' of 2/0 Yellow Ground Cable Factory installed with 21307 Bronze Clamp one end	57 lbs
21366	Large Retractable Grounding Reel only tested to 43KA @ 15 cycles	83 lbs
21373	21362 reel with 50' of 2/0 Yellow Ground Cable Factory installed with 21307 Bronze Clamp one end	50 lbs
21374	21362 Reel with 50' of 1/0 Yellow Ground Cable Factory installed with 21307 Bronze Clamp one end	57 lbs
21375	21362 reel with 50' of 2/0 Yellow Ground Cable Factory Installed with 21307 Bronze Clamp one end	62 lbs
A30205	4-way Bronze Tee Connector	1.3 lbs
01-029	Cover, Yellow Vinyl, for 21362 Reel	2 lbs
01-030	Cover, Yellow Vinyl, for 21366 Reel	2.5 lbs

## Bashlin 902: Wire Basket

- A lightweight, compact wire dispenser that will accommodate reels up to 26" X 4 1/4"
- Specially handy for guy strand. It features a hanger for easy mounting on a truck and an eyelet for temporary pole attachment
- 902-30 is slightly larger and will accommodate a 30" coil

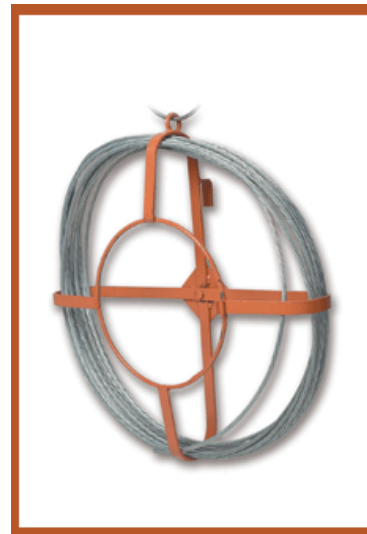

# Checkers Industrial Safety Wheel Chocks

TRUCK

## RC450 Series Wheel Chock (Black)

- Standard of the utility industry
- Durable recycled rubber construction
- Resistant to the elements
- Steel loop carrying handle
- Fits most chock storage compartments
- Allows either side to be positioned against the tire
- 7 lbs
- Height: 5.5 in
- Width: 8 in
- Length: 10 in
- Available with a Bottom Void (RC450), Solid Bottom (RC450-S), Bottom Void with Aluminum Ice Cleat (RC450-CL), or Bottom Void with 14 ga. Steel Grate for Ice (RC450-GR)



Part #	Weight
RC450	7 lbs
RC450-S	10 lbs
RC450-CL	8.5 lbs
RC450-GR	9.2 lbs

## UC1600 Wheel Chock (Orange)

- For tires with up to a 35" outside diameter
- Rated for vehicles with a gross operating weight up to 40,000 lbs
- Weather-resistant, lightweight polyurethane construction
- Resistant to oils, fuels, and solvents
- Recessed carrying handle
- Mounting hole for ropes or chains
- High visibility orange color
- 3.5 lbs
- Length: 11.25 in
- Width: 8 in
- Height: 8.25 in
- 7.5 lbs (pair of chocks)
- Available in singles or pairs, specify after model number S=Single or P=Pair



## Heavy Duty Dock Chain with Hardware

- Rated for 800 lb working load limit
- Standard lengths are 10, 12 and 15 ft
- Includes hardware
- Custom lengths available

Part #	Weight	Length
MS1602-5-10	4.1 lbs	10 ft
MS1602-5-12	4.9 lbs	12 ft
MS1602-5-15	5.8 lbs	15 ft



Itlutilitysupply.com



# Outrigger Pads

TRUCK

## LTLOUTRPAD

- LTL outrigger pads are ideal for use with radio boom derricks (RBD), digger derricks, single or double bucket trucks and cranes
- The outrigger pads are made from a high quality polyethylene (PE HD RKB regenerated multicolour), meaning they do not splinter or absorb water and can be used in all weather conditions
- Maintains its rigidity and original shape during use, each pad has a high resistance to vertical pressure
- Long lasting and have an extended life span compared to other materials
- Carry handles are made from durable nylon rope
- Handles on two sides make them easy to transport, install and store
- Easy to clean, chemical and oil resistant
- Dimensions: 1.97" x 13.98" x 28" (tolerance +0/ +0.02")
- Weight: 26.45 lbs



# Heavy Duty Temporary Access Mat

## The fast and safe way forward

### Heavy Duty Temporary Access Mats

Supporting loads up to 80 tons, this mat is the ultimate, fast to install temporary access and ground protection mat for moving equipment and personnel over soft or sensitive ground.

### Amazingly Tough & Flexible

Tough high density polyethylene (HDPE), the mat weighs only 35kg/77lbs and incorporates hand holds that make moving and installation easy.

### Anti-Slip Surface

The engineered, unique chevron traction® surface delivers ultimate grip and dispels mud, dirt and snow when vehicles travel over the mats. The chevron nub design also reduces sideways movement and slippage and delivers optimal forward traction.

### Connection Options

Multiple connection options are available to suit various applications.

- Fast and easy to install
- Unique chevron traction® surface
- Fast temporary access and working areas
- Low transport and handling costs
- Avoid property and environmental damage
- Avoid health and safety issues
- Reflective markings for night safety (optional extra)
- Multiple connection options for different terrain and equipment

	Thickness	Dimension (WxL)	Weight per Mat
Standard	.47"	47" x 94.8"	77 lbs
Material	Premium recycled High Density Polyethylene (HDPE)		
Colours Available	Black - recycled HDPE. Other colours available-minimum order quantity applies		
Connectivity	Standard connectors - 2-way and 4-way options		
	Metal connectors for heavy and tracked equipment		
	"Fast Fit" connectors for fast installation		
	Flex connectors for undulating ground		
	Metal U-pins for slopes and cambers		
Optional extras for night safety	Non-slip reflective markings and "cats eyes"		
Environmental features	Weather-proof, water and chemical resistant, usable in sub-zero temperatures. High Density Polyethylene is resistant to acids, alkalis and solvents		

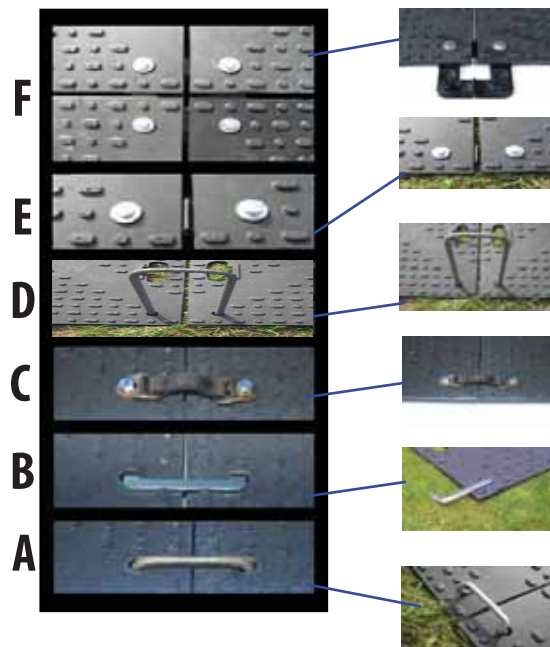
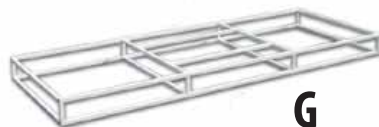

	Part #	Description
A	EMC001A	Fast Connectors
B	EMC001B	Fast Connectors
C	EMC003	Flex Connectors
D	EMC008	Metal U Pin Connectors
E	EMC201	2-Way Connectors
F	EMC401	4-Way Connectors
	EMS003	EuroMat
G	LTLRACK	Transportation Rack 6'H x 8'L x 4'W

TRUCK

ltutilitysupply.com



## TRUCK ACCESSORIES

### AUXILLIARY ARM ASSEMBLY

#### Complete Assembly

- Support arm for 3" diameter mast with solid Epoxirod® pole
- Designed for use on light construction when handling multiple conductors

**T4001857 Complete Auxiliary Assembly:**  
**3 Roller Wireholders, No Insulator, 2.5" opening**  
**1 Arm Clamp Assembly**  
**1 Solid Epoxirod, 2.5" x 10'**  
**1 Adapter**

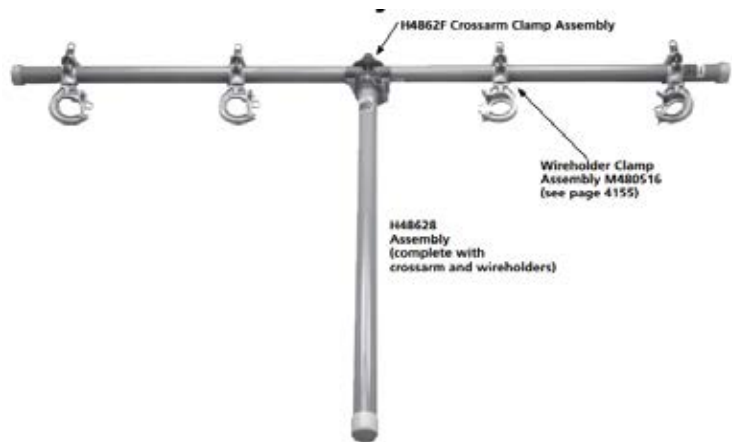

### AUXILLIARY ARM ASSEMBLY - BY COMPONENT

#### Roller Wireholder



- Offers protection to conductors while raising the conductor above the work area
- Fit on 2" or 2.5" solid Epoxirod®
- Does not feature an insulator

**C4000268 2" Opening**  
**C4000690 2.5" Opening**

#### Arm Clamp Assembly



- Connects the adapter to the solid 2.5" x 10' Epoxirod

**E4000757**

#### Jib Mounted Arm Attachment Round Adapter



- 3" diameter adapter
- Used to connect the jib extension to the arm clamp assembly

**P4001594P**

#### Solid Epoxirod®



**E4001569 2.5" x 10' Solid Epoxirod®**

# Chance - Truck Accessories

TRUCK

## JIB & EXTENSIONS WITH MATERIAL HANDLING ACCESSORIES

### Single Wireholder with Swivel



- Accommodates conductors up to and including 1.5" in diameter
- Gate is held closed by a spring loaded latch which must be manually opened
- Features seven Delrin plastic rollers
- 1.5" opening

**C4000747**

### Single Wireholder with Swivel



- For attachment to mast
- Accommodates conductors up to and including 2.5" in diameter opening
- Gate is held closed by a spring loaded latch which must be manually opened
- For 3" diameter round jib
- Seven Delrin plastic rollers offer protection to conductors while raising the conductor above the work area
- 800 lb. capacity

**C4001669**

### Wireholder/Sheave Combo (For Square Jib)



- 19" x 8" x 8" x 2.5"; 800 lbs max load
- For 4" square jib
- 2.5" x 3 3/8" opening
- 7" diameter sheave accepts up to .75" diameter rope
- Can be used in conjunction with material handler
- 7" sheave

**T4002530**

### Wireholder/Sheave Combo (For Round Jib)



- 19" x 8" x 8" x 2.5", 800 lbs max load
- 2.5" opening
- For 3" diameter round jib
- Can be used in conjunction with material handler
- 7" sheave

**T4002529**

### Wireholder without Sheave



- 800 lbs max load
- 2.5" opening
- For 4" square jib
- Can be used in conjunction with material handler

**PST4002856**



TRUSTED SINCE 1958

ltlutilitysupply.com

# Chance - Anchor Tools

TRUCK

## SCREW ANCHOR KIT - 10K SYSTEM

- This kit includes the specified Kelly bar adapter, locking dog assembly, and 7' drive-end wrench

C3030090 2.5" Kelly Bar Adapter

Includes: C3030070, C1021583, 630011HD

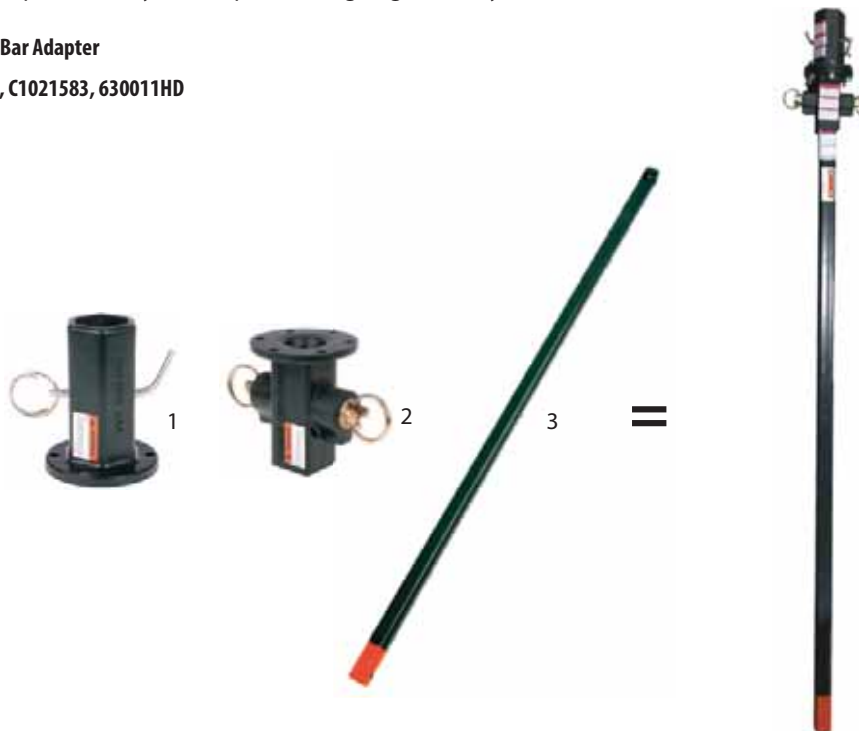

## SCREW ANCHOR EQUIPMENT - 10K SYSTEM

### 10K Locking Dog Assembly



- Features six 0.5" diameter holes on a 5.25" bolt circle
- Includes six 1/2" grade 5 bolts, nuts and lock washers

C3030069HD 10K Locking Dog Assembly  
C3030070 Repair Kit for 10K Assembly

### 10K - Kelly Bar Adapter with Bent Arm Pin



- Features six 1/2" diameter holes on a 5.25" bolt circle
- Includes six 1/2" bolts, nuts, lock washers and a bent arm pin with a coil lock

630017 Square, 2.5"  
630011HD Hex, 2.5"  
630013 Hex, 2"  
630012HD Hex, 2 5/8"

## ANCHOR WRENCHES

### 10K 1.5" Core Anchor Hybrid Drive-End Wrenches



- Installs PISA® 6000 & 7000 and 8000 ft. lb. (large hub) Tough One® Anchors

C3031063 3.5'  
C3031064 7'

### 10K 1 3/8" Standard Core Anchor Drive-End Wrenches



- Fits 1 3/8" core anchors
- Installs 8000 ft. lb. (small hub) Tough One® Anchors, 10,000 ft. lb. (small hub) Tough One® Anchors, standard strength and mid-strength anchors

C1021595 3.5'  
C1021583 7'

**ANCHORING TOOLS & ACCESSORIES**

**SCREW ANCHOR EQUIPMENT - 15K SYSTEM**

**Tough One® 15K - Locking Dog Assemblies**



- Features twelve 5/8" holes on a 7 5/8" bolt circle
- Includes twelve 5/8" grade 2 bolts, nuts and lockwashers
- C3031026 includes all parts in C3030981 except casting

- C3030981 Locking Dog Assembly**
- C3031026 Locking Dog Assembly Repair Kit for Tough One® 15K Assembly**

**Tough One® 15K Kelly Bar Adapter with Bent Arm Pin**



- Features twelve 5/8" holes on a 7 5/8" bolt circle
- Includes twelve 5/8" bolts, nuts, lock washers, and a bent arm pin with a coil lock

- C3030936 Hex, 2.5"**
- C3030937 Hex, 2 5/8"**
- C3031571 Square, 3.5"**

**Anchor Wrenches**



- Fits Tough One Anchors, 1.5" core anchors
- Installs Tough One Anchors, 8,000 ft lbs and 15,000 ft lbs (large hub)

- C3030982 3.5'**
- C3030983 7'**

**SCREW ANCHOR KIT 15K SYSTEM**

- This kit includes the specified kelly bar adapter, locking dog assembly and 7' drive-end wrench



- Kit: 2 1/2" Kelly Bar Adapter**
- Includes: (1) C3030981 (1) C3030983 (1) C3030936**
- Kit: 2 5/8" Kelly Bar Adapter**
- Includes: (1) C3030981 (1) C3030983 (1) C3030937**



## ANCHOR TOOLS

### Anchor Drive End Extension 10K



- Extends core anchor drive-end wrenches an additional 3.5' or 7'
- 10,000 ft lb torque rating

630027	3.5'	42 lbs
630028	7'	71 lbs

### Tough One Anchor Drive End Extension 15K



- Extends core anchor drive-end wrenches an additional 3.5' or 7'
- 15,000 ft. lb. torque rating

C3030987	3.5'	50 lbs
C3030988	7'	87 lbs

### Bolt Circle Adapter



C3030115  
T3030166

- Used to connect two tools with incompatible bolt circles
- C3030115 is for use between two tools having tapped 5.25" bolt circle
- T3030166 is for use between a tool having a 5 1/4" bolt circle and one having a 7 5/8" bolt circle
- Both are limited to 10,000 ft lbs

### Anchor Installing Tool Pin



- Plated-steel bent arm pins
- Designed to attach a Kelly bar adapter to a Kelly bar
- Used to secure SS, RR, and bumper post anchors to anchor drive tools
- Bent arm pins are included with new tools as required

C3031223	4.5" x 0.5"
C3031227	5" x 0.75"
C3031226	3" x 5/8"
C3031222	5" x 5/8" Coil Lock Assembly
P3031215P	Coil Keeper

### Adapter for Installation of SS or RR Anchors



- Slides into the C3030069HD locking dog adapter and is retained by a spring loaded dog
- Weighs approximately 8 lbs

C3030020

### Light Pole Anchor Plate



- Plates fit STL foundation anchors with 9" to 13.5" bolt circles
- C3030139 connects directly to a Kelly

- bar adapter with (6) 0.5" furnished bolts and features a torque rating of 10,000 ft. lbs
- C3030684 includes (12) 5/8" bolts and features a torque rating of 20,000 ft. lbs
- Coupling C3030684 to a Kelly bar adapter with a 5.25" bolt circle requires use of T3030166 adapter and limits tool's maximum torque rating to 10,000 ft. lbs

C3030139	5.25", (6) 1/2" Tapped Holes
C3030684	7 5/8" (6) 5/8" Drilled Holes

### Expanding & Tamping Bar



- Fiberglass handle
- Simplifies the job of expanding anchors
- The curved Expander and Tamper Head distributes the weight of the bar evenly around the anchor rod to reduce handle vibration
- The hook of the Expanding and Tamping Bar wraps around the anchor rod to keep the expanding head from slipping off the anchor top plate
- This tool is also effectively used for tamping in soil above the installed anchor
- The base casting is attached directly to the fiberglass handle

C3020004 12' 24 lbs







### Foundation Anchor Installing Tool

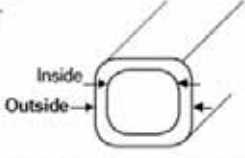
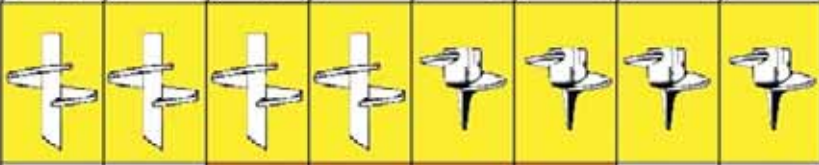

- Used for installing flange-drive foundations
- The drive tool has six 0.5" - 13 tapped holes on a 5.25" bolt circle and requires a Kelly Bar Adapter (sold separately)

C1300010

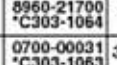
## How to Match CHANCE® Anchors and Installing Wrenches

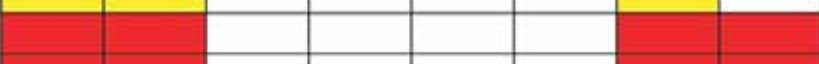
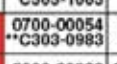
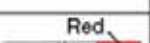
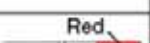
PISA® 9 Anchor (formerly PISA® 5 Anchor)	PISA® 7 Anchor	Standard-Strength PISA® Anchor	Mid-Strength PISA® Anchor	C102-50XX Series Tough One® Anchor - Small Hub	C102-50XX Series Tough One® Anchor - Small Hub	C102-50XX Series Tough One® Anchor - Large Hub	C102-50XX Series Tough One® Anchor - Large Hub											
								Installing Wrench Altec PIN & Hubbell PIN	Length (ft.)	Maximum Installing Torque Rating (ft-lbs)	Outside Dim. (inches)	Inside Dim. (inches)						
												0700-00066 *C102-1583	7'	10,000	2.16	1.46	Orange	
												0700-00034 *C102-1595	3 1/2'	10,000	2.16	1.46	Orange	
												8960-21700 *C303-1064	7'	10,000	2.44	1.54	Yellow	
												0700-00031 *C303-1063	3 1/2'	10,000	2.44	1.54	Yellow	
												0700-00054 **C303-0983	7'	15,000	2.44	1.54	Red	
												9000-30982 **C303-0982	3 1/2'	15,000	2.44	1.54	Red	
6,000	7,000	4,000	6,000	8,000	10,000	10,000	15,000	<b>Maximum Installation Torque Rating (ft-lbs)</b> *Fits Locking Dog Assembly CC303-0069HD ** Fits Locking Dog Assembly CC303-0981										

## TORQUE INDICATORS

### C3031578: Digital Torque Indicator



- Allows you to install screw anchors to a pre-determined torque value which gives a positive indication of anchor holding capacity in any type soil
- This tool also helps your crew avoid excessive torsional loading which could cause damage to the anchor and/or other anchor tools during installation
- Indicator mounts between kelly bar adapter and drive tool or locking dog assembly
- LED display is easy-to-read in full daylight and gives the operator a direct readout of installation torque at all times
- Solid one-piece spool, designed to withstand bending loads
- No shear pins to replace
- Operational temperature range: -40° to 80° C (-40° to 175° F)
- Accuracy: +/-500 ft. lb. at any reading
- Torque is measured using strain gauges
- Powered by a standard 9V battery
- Top and bottom flange - each provides: six holes tapped 1/2" - 13 on a 5 1/4" bolt circle and twelve holes tapped 5/8" - 11 on a 7 5/8" bolt circle

### C3030044: Shear Pin Torque Indicator



- Designed for installing torques up to 10,000 ft. lbs.
- Offers protection for anchors and installing tools by disconnecting the power source from drive tools
- Durable; does not require special storage/handling
- Useable in very rocky soil
- Includes six 1/2" - 13 tapped holes on a 5.25" bolt circle, both ends

# Greenlee - Hydraulic Paving Breakers

TRUCK

## HPB25: 25 lbs Paving Breaker



- "D" handle and an assist handle for both vertical and horizontal operation
- Simple construction with few parts provides easy maintenance and excellent durability
- Supplied with steel braided whip hoses
- Hydraulic cushioning of the ram return stroke helps to reduce operator fatigue
- Lever style latch for quick tool changes
- Open center system
- 7/8" x 3 1/4" chuck size
- Hydraulic flow of 3-7 gpm
- 1280 - 1850 psi operating pressure
- Maximum pressure of 3,000 psi
- 1,800 blows per minute at 5 gpm
- Whip hoses are 3/8" NPTF x 12"

## HPB25: 35 lbs Paving Breaker



- Vibration isolated and cushioned handles to reduce operator fatigue
- Simple construction with few parts provides easy maintenance and excellent durability
- Supplied with steel braided whip hoses
- Hydraulic cushioning of the ram return stroke helps to reduce operator fatigue
- Lever style latch for quick tool changes
- Open center system
- 1" x 4 1/4" chuck size
- Hydraulic flow of 5-8 gpm
- 2000 blows per minute at 7 gpm
- Whip hoses are 3/8" NPTF x 12"
- 1140 - 1700 psi (3000 psi max.) operating pressure

## 45 lb/55 lb Paving Breakers



- Great for breaking sidewalks and curbs or driving ground rod, and for other small demolition jobs
- Clean modular design with few protrusions to irritate operators' legs
- High blow energy provides maximum breaking power
- Integral rubber damper reduces chisel noise
- Low noise and vibration levels
- AVS tools have patented spring-dampened handles that reduce vibration transmitted to the operator by 80%-90%
- Two-step trigger
- Supplied with 12" steel braided whip hoses
- Open center hydraulic system
- 1/2" BSP pressure and return ports; 1/2" NPTF x 12" whip hoses

Part #	Tool Shank Size	Sound Power Level	Blow Energy	Blow Frequency	Oil Flow	Operating Pressure
HPB45-1AVS*	1 1/8" x 6" AVS	110 dB	63 ft lbs	2160/minute	5-8 gpm	1500-1800 PSI
HPB45-2AVS*	1" x 4 1/4" AVS	109 dB	63 ft lbs	2160/minute	5-8 gpm	1500-1800 PSI
HPB55-1AVS*	1 1/8" x 6" AVS	112 dB	81 ft lbs	1860/minute	5-8 gpm	1500-1800 PSI

			BREAKER COMPATIBILITY CHART				
			25 lbs	35 lbs	45 lbs		55 lbs
Cat #	UPC#	Description	HPB25	HPB35	HPB45-1AVS	HPB45-2AVS	HPB55-1AVS
F018451	41706	Moil Point - 1 1/8" x 6"			X		X
F018452	41707	3" Chisel - 1 1/8 x 6"			X		X
49138	49138	Moil Point - 1 x 4 1/4"		X		X	
46219	46219	3" Chisel 1 x 4 1/4"		X		X	
46221	46221	Asphalt Cutter - 1 x 4 1/4"		X		X	
46222	46222	5/8" Threadless Ground Rod Adapter - 1 x 4 1/4"		X		X	
46223	46223	1" Threadless Ground Rod Adapter - 1 x 4 1/4"		X		X	
F016769	41610	Moil Point - 7/8 x 3 1/4"	X				
F016770K	41611	3" Chisel - 7/8 x 3 1/4"	X				
113509	40349	1" Threadless Ground Rod Adapter - 7/8 x 3 1/4"	X				
137449	41070	5/8" Threadless Ground Rod Adapter - 7/8 x 3 1/4"	X				

Itlutilitysupply.com



## POLE TAMPERS

### H4802 Pole Tampers & Accessories



- Makes quick work of setting poles, asphalt patch, and general construction backfill compacting
- Reversible on/off valve allows tamper to be used with an open or closed center hydraulic system
- Only 3 moving parts for low maintenance
- Kidney shaped foot standard
- Flow range of 4 - 6 gpm
- Operating pressure of 1,000 - 2,000 psi

#### Pole Tampers w/ Hose End Valve (left):

H4802	60" Long
H4802-1	85" Long
H4802-6	60" Long, no valve

#### Pole Tampers with Valve on Tube (right):

H4802-5	60" Long
H4802-3	72" Long

## SIGN POST DRIVER & POLE PULLER

### HPD Series Sign Post Driver



- Can drive a variety of post sizes from small delineator posts up to 3 1/2" round posts including square, "U" channel, breakaway stubs, round, "T" fence, and wood
- Quick change front head design accommodates adapters for different types of posts
- Dual guide handles provide directional control
- A deep post opening and smooth operation ensures that the driver will not jump off of posts
- Flow range of 5-8 gpm
- 75 lbs. with UA adapter, hoses
- 1500 - 2000 psi operating pressure
- 9/16-18 SAE O-ring Boss; 1/2" NPTF
- Can be used with open and closed center hydraulic systems
- Available with integral trigger or remote on/off valve

**HPD-T-U/11183 - Internal Trigger; Universal Post Adapter**  
**RA96/49532 - Remote On/Off Valve; Universal Post Adapter**

#### Sign Post Driver Accessories

UA/49533	Universal head adapter
RA 96/49532	3.8" round head adapter
SA54/49534	2 1/8" square head adapter

### H4905A42237: Sign Post Puller



- Uses serrated jaws or wrap-around, high strength alloy chain
- Able to pull nearly any post size and shape
- Faster and easier than conventional manual methods
- Open center hydraulic system
- Lifting capacity of 9,800 lbs.
- Flow range of 4 - 6 gpm
- Operating pressure of 1000 - 2000 psi
- Weighs 70 lbs
- 5" stroke
- 9/32" alloy chain

## HRD-1 & HRD-58 Ground Rod Drivers

- Accommodates various sizes of ground rods
- May be used with single or stacked rods
- May be used on an open or closed center system
- Drivers come with built-in dual carrying handles and a lifting eye
- Flow range of 5 - 8 gpm
- Maximum input pressure 2,000 psi



## HIRD44A: Hydraulic Rock Drill

- Weighs 44 lbs
- Drills holes up to 2 1/2" diameter, 10' deep
- Vibration isolated and cushioned handles reduce operator fatigue
- Uses bits with 7/8" x 4 1/4" shanks
- On-board air compressor provides air to clean dust out of holes
- Drill rotation speed is adjustable from 0 to 400 rpm with a 4 positioning dial; tool can be operated without rotation
- Supplied with steel braided whip hoses



## H4910A: Hydraulic Pole Puller

- Pole puller works in confined areas, next to buildings, or out in the open
- Lifting capacity of 56,000 lbs.
- Designed for heavy-duty construction
- May be used on either an open or closed-center hydraulic system
- Comes standard with a 5/8" proof-certified 6' alloy chain
- Flow range of 4 - 15 gpm
- Operating pressure of 300 - 2,800 psi



# Greenlee - Compact Submersible Pumps

TRUCK

## H4665A: Submersible Pump

- Compact, lightweight design
- High impact strainer housing
- Up to 275 gpm
- Carrying handle
- Can draw water down to depth of 1 3/4"
- Can run dry without damage
- Open and closed center systems



## H4660B: 2 1/2" Submersible Pump

- High impact strainer housing
- Up to 400 gpm
- Carrying handle
- Self priming
- Can run dry without damage
- Can draw water down to depth of 2"
- Open and closed center systems



## H4635: 3" Submersible Pump

- Lighter than typical 3" water pumps
- Lightweight, durable all-aluminum body
- 12" diameter to fit in compact areas
- Self-priming submersible pump
- Can run dry without damage
- Passes up to 3" solids, minimizing pump blockage from debris
- Draws water down to depth of 2 3/4"
- Locking coupler for discharge hose included
- Open and closed center operation runs off of a variety of power sources



## H4670: 4" Submersible Pump

- No clog, self priming, abrasion-resistant impeller pump
- Up to 900 gpm
- Replaceable wear plate, carry handle
- Can run dry without damage
- 4" NPT discharge, will pass 3" solids
- Draws water down to depth of 3 1/4"
- Locking coupler for discharge hose included
- Open and closed center systems



## GREENLEE SUBMERSIBLE PUMP SPECIFICATIONS

	Intake Port	Discharge Port	Width	Height	Flow Range	Operating Pressure	Pressure Port Thread	Return Port Thread
H665A	1 5/16"	2" NPFT	7.5"	12.5"	5-8gpm	0-2000 psi	9/16 - 18 SAE O-Ring	3/4 - 16 SAE O-Ring
H4660B	1 1/2"	2.5" NPT	12"	16"	4-8 gpm	0-2000 psi	9/16 - 18 SAE O-Ring	3/4 - 16 SAE O-Ring
H4635	3.125"	3" Female NPT	11.87"	14.18"	8-10 gpm	0-2000 psi	1/2" Male NPTF	1/2" Make NPTF
H4670	4" NPT	4" NPT	14.5"	15.75"	5-9 gpm	0-2000 psi	1/2" Make NPTF	1/2" Make NPTF

## Submersible Pump Accessories - Discharge Hose/Couplings

Part #	Hose Assembly
156340	2" Diameter x 25' Discharge Hose Assembly for Use with Submersible Pump H4665A
F024772	2" Cam Lock Coupling for Discharge Hose 156340
156339	2.5" Diameter x 25' Discharge Hose Assembly for Use with Submersible Pump H4660B
F024775	2.5" Cam Lock Coupling for Discharge Hose 156339
49499	3" Diameter x 25' Discharge Hose Assembly for Use with Submersible Pump H4635
41189	4" Diameter x 25' Discharge Hose Assembly for Use with Submersible Pump H4670



TRUSTED SINCE 1958

lutilitysupply.com

# Hastings - Arm Assembly

TRUCK

## Complete Arm Assembly



- The boom-mounted lift arm may be utilized as a 1 or 3-phase lifting attachment when mounted to derrick trucks and aerial trucks that have lifting capabilities
- May be used for change-out of poles, cross-arms, insulators, and mid-span lifting requirements
- Lift arm can be mounted to a square, rectangular, round, or oval boom by ordering the proper boom adapters and blocks
- Total arc covered is 45°
- Metal components are steel or aluminum alloy
- Boom mounting assembly features a ratchet, which allows the arm to be positioned under the load
- Fiberglass arm and mast assembly is 3" O.D. with a solid foam core, which are tested per OSHA
- Fiberglass brace is 1 1/2" O.D. with solid foam core and tested per OSHA
- Load rating - balanced loading with brace is 1000 lbs maximum; with arm, unbalanced load is 200 lbs per conductor holder
- Rating is based on vertical lift; sideloading reduces rating
- Load rating - if mast only is used with self-aligning conductor holder or super-duty conductor holder, the load rating is 500 lbs maximum

## 11974: Swivel Support



- This support is used to connect the arm assembly to the mast

### Complete Assembly Includes:

9' x 3" O.D. Arm

Swivel Support

Brace Pole

2 Brace Clamps

3 Four-Way Conductor Holders

## 12006: Brace Pole



- For attachment to arm assembly and mast

## Brace Clamps



- For attachment of brace pole
- 11387: Fits 3" O.D. arm and mast assemblies
- 13495: Fits 3.80" O.D. arm and mast assemblies and allows use of Brace Pole

## 12666: Super Duty Conductor Holder



- For attachment to mast and jib adapters
- Accepts 2" diameter conductors
- Maximum working load 500 lbs

## 5034: Four Way Conductor Holder



- For mounting to 3" O.D. arm
- Opening is 1 1/2"
- Spring loaded latch is hot stick operable

## 21644: Jib Head Roller with Sheave



- Aluminum alloy housing with a steel wheel
- Opening is 3" diameter

## EX3-726: Super Duty Conductor Holder with Latch



- For attachment to mast and jib adapters
- Features a spring-loaded release latch
- Accepts 2" diameter conductors
- Maximum working load 500 lbs

# Hastings - Arm Assembly

TRUCK

## 3489: Square Jib Brace Adapter

- For attaching brace to pole
- 4" x 4" F.G. Jibs



## 11683: 5' x 3" O.D. Mast Assembly Only

- Features quick detach pin



## 3479: Jib Mounted Arm Attachment

- Mounts arm assemblies and attachments
- Enables attachments to rotate 360°



## 21642: Self-Aligning Conductor Holder

- For attachment to mast
- Opening is 1 1/2"
- Spring loaded latch is hot stick operable
- Maximum work load 300 lbs
- For a 3" diameter round jib



## 6729: Truck Safety Barricade Arm

- Barrier can be installed, positioned, or raised for moving truck and removed in minutes. Just drop in place in pre-located, permanently attached steel brackets
- Fiberglass arm is easily positioned to adjust barricade for proper height above the ground and to compensate for parking on uneven terrain
- Unique design of sector allows fiberglass arm to be quickly locked into 8 different positions
- Arm can also be moved to "vertical travel position" when movement of truck for a short distance is required



## Truck Safety Barricade Kit

- Installation, positioning, or removal are quick and simple
- Fiberglass arm is easily positioned to adjust barricade for proper height
- Arm can be moved to vertical travel position when short distance movement of a truck is required
- All metal components except for adapters are stainless steel or aluminum to reduce corrosion



Truck Safety Barrier kit with 4' Arms

Truck Safety Barrier Kit with 6' Arms

4' Fiberglass Arm with Bracket

6' Fiberglass Arm with Bracket



ltlutilitysupply.com



## POWER GENERATORS

### EM5000S: Deluxe Generator

- Portable power with premium features and traditional Honda durability and performance
- 5000 watts maximum AC output
- Home backup and commercial usage (for non-GFCI applications)
- Suitable for rental applications
- Powerful, easy-start Honda iGX390 commercial-grade engine
- Auto-throttle further extends running time by automatically adjusting engine speed to idle when under no load
- 12 VDC battery charging capability with optional charge cable
- Standard wheel kit with positive lock folding handles for easy transportation and convenient, compact storage
- Cold climate technology aids continuous running in cold weather conditions



### EM3000: Generator

- Ultra-compact and lightweight cycloconverter design, 30% lighter than conventional models
- Large muffler offers 68 dB(A) noise level at rated load
- 3000 watts of power, continuous-rated output of over 20 amps
- Full-frame design, 12 VDC battery-charging capability, convenient circuit-breaker construction, a 10.2-litre fuel tank that allows up to 6 hours of continuous running, and a rubber-mount system for smooth operation



### EU3000IS: Generator

- High-tech 2 layer enclosure and unique muffler design offers whis per quiet operation
- Reliable Honda GX200T2 OHV four-stroke engine
- Dependable 12 volt DC electric start with enclosed low maintenance battery
- Power for your furnace, fridge, microwave, most 13,500 BTU/h RV AC units, and more
- Large 13-litre tank gives 7.2 hours' continuous operation at rated load, 20 hours of continuous operation at 25% load



## WATER PUMPS

### WT-20: Trash Series

- Honda GX160, four-stroke, OHV, air cooled, single cylinder
- 50 mm (2 in) suction and discharge ports
- Pumps 710 litres per minute (156 Imp. gal. per minute)
- 50 mm (2 in) trash pump designed specifically for commercial users
- Heavy-duty, deep-vane impeller and extra-thick, cast-aluminum pump housing; it is capable of pumping water that contains rocks and debris
- An easy-access door is also standard so that the pump housing can be easily flushed
- Pumping capacity is 710 litres per minute
- Powered by a commercial-grade, GX160, 4-stroke, OHV Honda engine for dependable starts and long life
- Tubular steel frame and Oil Alert™



### WH20: High Pressure Series

- High output 500 litres per minute (110 Imp. gal. per minute), high pressure (61 psi)
- Honda GX160 OHV engine
- 50 mm (2 in) suction and discharge ports
- General water transfer, high pressure to irrigation
- Can be used with a fire hose nozzle for emergency back-up in remote areas
- A convenient carrying handle and hose strainer come standard



### WMP-20: Chemical Series

- Output 833 litres (183 Imp. gal.) / min capacity
- Honda GX160T2 OHV engine
- 50 mm (2 in) suction and discharge ports
- Designed for pumping a diversity of industrial and agricultural liquid chemicals
- Pump features EPDM seals (ethylene-propylene terpolymere) for chemical resistance, a reinforced thermoplastic pump housing and impeller and full-frame protection with vibration damping mounts
- This multi-purpose centrifugal self-priming 2" pump features Honda's commercial-grade engine with Honda Oil Alert to provide outstanding performance for chemical applications
- Maximum pumping is 833 litres (183 Imp. gal.) / min. capacity
- Other standard features include isolation mounted engine and pump, an easy starting Honda GX160T2 OHV commercial engine and a suction hose strainer



# Robolights

TRUCK

## Pole Bug



- Single bright LED is rated for 100,000 hours of heavy duty operation
- System provides the ultimate in pole-mount transportation safety
- LED features a 5-7 mile visibility range, includes four flash patterns: Comet, Single, Steady Burn and Flare Flicker
- Light module with dual front/angled reflectors is encapsulated for vibration and moisture resistance
- Three alkaline "C" batteries provide 100+ hours of continuous operation
- Easy-to-attach and deploy; heavy duty strap attaches to all type of poles and sizes
- Powder coated metal components and dual flag holders
- Includes batteries and two flags

**LED Strobe with Dual Flag Holder (shown):**      **Dual LED Strobes with Dual Flag Holder :**

<b>7015-R</b>	<b>Red LED</b>	<b>7026-R</b>	<b>Red LED</b>
<b>7015-A</b>	<b>Amber LED</b>	<b>7062-A</b>	<b>Amber LED</b>

## Robolight Cone Light



- Enhances the safety of workers, surrounding areas
- Small, versatile, and effective
- Easily placed over cones
- Durable, long-lasting weather-resistant LEDs
- Lights are attached to rust-proof plates that can be used with all cone sizes
- 4AA battery burn time is 50+ hours (blinking pattern)

<b>7036-R</b>	<b>(1) Red LED</b>
<b>7037-A</b>	<b>(1) Amber LED</b>
<b>7038-R</b>	<b>(4) Red LED Kit w/ Case</b>
<b>7039-A</b>	<b>(4) Amber LED Kit w/ Case</b>

## Pole Tacker



- Provides a simple, durable, effective means in maintaining pole transportation safety
- Utilizing super-bright, long-lasting (100,000 hours of heavy operation) LEDs; 5-7 mile visibility range
- Easy-to-mount with heavy duty super secure "T-Screw"
- Four optional flash patterns: Comet, Single, Steady Burn, and Flare Flicker
- LED is encapsulated for vibration and moisture resistance with dual front/angled reflectors

<b>7032-R</b>	<b>Red</b>
<b>7032-A</b>	<b>Amber</b>

## LED 360° STROBES

<b>7167-A</b>	<b>Amber</b>
<b>7167-R</b>	<b>Red</b>
<b>7175-A</b>	<b>Amber - Low Profile Model</b>
<b>7175-R</b>	<b>Red - Low Profile Model</b>

- 360° LED strobes utilize 24 long lasting LEDs to create a highly visible 60 flashes per minute strobe
- System is easy to attach and deploy, using a heavy duty strap that attaches to all types of poles and sizes
- Strobe is protected by a rugged cage and includes powder coated metal components
- These systems can be purchased with or without dual flag holders
- Batteries: Two alkaline "D"s
- Battery Run Time: 100+ hours
- Low profile model is great for mid-pole or rear protection

## GMP Pole Trailer Light Kits

- Features compact design, secure attachments and maximum visibility
- Allows easy transport of utility poles with greater visibility while meeting DOT requirements and only adding minimal width to the trailer
- Frame is made from an aluminum extruded weldment with a durable bright yellow polyester powder coating
- The kit uses a Reflexite label with 3" high lettering and a standard legend
- Shock mounts provide greater bulb life and simplify bulb replacement
- The unit comes with a 40' 18 gauge S.O. trailer cord with a heavy-duty 4-way or 6-way trailer plug
- The width of the unit is minimized with up-right flags and cordage storage arms located within the outer dimensions of the frame
- Attachment to the pole is done with an over-center chain binder that uses 5' of chain and hardened steel spikes that bury in the pole when the binder is tightened



<b>Part #</b>	<b>Description</b>	<b>Weight</b>
<b>70274</b>	<b>46" Wide; 4-Way</b>	<b>26 lbs</b>
<b>70276</b>	<b>46" Wide; 6-Way</b>	<b>26 lbs</b>
<b>70277</b>	<b>24" Wide; 4-Way</b>	<b>14 lbs</b>
<b>70278</b>	<b>24" Wide; 6-Way</b>	<b>14 lbs</b>
<b>26006</b>	<b>4-Way Socket</b>	<b>2 oz</b>
<b>26007</b>	<b>6-Way Socket</b>	<b>2 oz</b>

Itlutilitysupply.com



# SafeZone Series Roll-Up Signs and Overlays

## Bone Safety Signs

All signs are designed using the Standard Highway Signs Manual as specified in the Manual on Uniform Traffic Control Devices (MUTCD).

Bone Corner Pocket, Anti-Kiting Devices, Storage Strap and Reversible Snaps for Overlays option and Heavy Duty Fiberglass with Anti-Blooming are standard on all Roll-Up signs.

## Super Bright (SB) Signs

This is one of Reflexite's most popular products. Super Bright fluorescent prismatic sign blanks are used by our customers to create the work zone signs you see on the road. As a motorist, you benefit from maximum visibility at long distances, day and night. Reflexite's colour stability technology ensures a long and useful life. Super Bright colours are: fluorescent orange, non-fluorescent white, yellow and the new fluorescent pink colour recommended for Incident Management applications.



## Marathon (M) Signs

Reflexite's Roll-Up sign blanks which utilize Marathon Fluorescence take performance to a higher level. The longer lasting fluorescent colour gives the sign a longer useful life and offers outstanding visibility, day and night. Higher levels of photometric performance ensure superior reflectivity at night and in low light conditions. Reflexite High Performance Marathon Fluorescence signs are available in the following colours: fluorescent orange, fluorescent yellow-green (lime), non-fluorescent white, and the new fluorescent yellow.

## Common Sign Overlays

The Signs and the Overlays are designed so that the overlay may be attached to the back of the sign for easy storage. Velcro may be used upon request. Velcro Overlay cannot be attached to the back of the sign for storage.

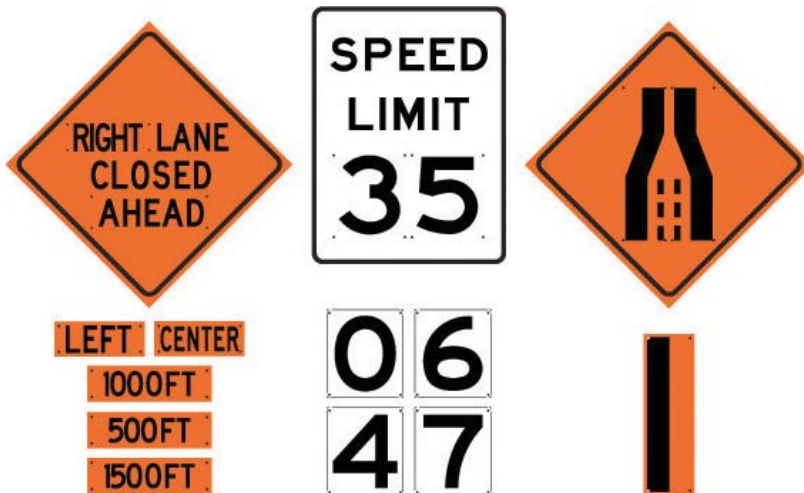

Common Overlays		
Legend	48" Premium Mesh Overlay	48" Super Bright Reflective Overlay
Left		
Right		
500 ft		
1000 ft		
1500 ft		
Merge		



# SafeZone Traffic Control & OSHA Signs

## Bone Tele-Pole

The SafeZone series STOP/SLOW paddle is designed to allow the worker to telescope the sign from 54" to 84" for ease of use controlling traffic through the temporary traffic control zone. It is available in reflective and non-reflective faces and comes in both 18" and 24" sizes.

## Safe

An ergonomically designed screw-type compression fitting on the telescopic mast, combined with a non-skid rubber cap on the bottom of the HI-VIZ orange fiberglass mast, makes the SafeZone Series paddle both simple and economical.

## Durable

The pultruded hollow fiberglass mast, coupled with the fiberglass reinforced plastic (FRP) sign face, makes the SafeZone series STOP/SLOW paddle both lightweight and durable even in extreme temperatures and harsh environments.



## Stop-N-Slow Paddles

Our Stop-N-Slow sign faces are made from the same BONELIGHT ACM used for our large construction signs or Reclaimed Aluminum and Virgin Aluminum. Available in 18" & 24" sizes and various reflective and non-reflective faces.



### Stop-N-Slow Paddle

- 24" Face
- Standard Reflective 84" Extendable Handle



### Stop-N-Slow Paddle

- 24" Hi-Intensity Reflective
- 84" Extendable Handle



### Stop-N-Slow Paddle

- Combination Model
- 24" Diamond Grade Hi-Intensity Reflective
- 84" Extendable Handle



### Stop-N-Slow Covers

- A fluorescent orange cover will add longer life to the paddles

## OSHA Signs

Helping you meet the federal OSHA guideline for 1910 or 1926 for indoor or outdoor use



# SafeZone Series Stands

## SafeZone Series Stand Features & Benefits

All SafeZone Series Sign Stands come with a patented Auto-Latch mechanism, unless the Universal Bracket is requested. The advantage of our Auto-Latch is the speed in which the sign is attached and released from our stands.

- Crash design breakaway base
- Exclusive Quick Release System for all modular attachments and accessories
- Compact and lightweight
- Bright orange, UV stabilized, powder coated legs for safety, durability & visibility
- Pull pin and kick release for fast setup by hand or foot
- Simple nut & bolt construction allows for fast repairs using basic hand tools
- Readily available replacement parts or assemblies
- 3 height adjustments on Legs for use on uneven terrain
- Skid resistant rubber feet



## Universal Bracket



Universal Bracket

Allows the use of the SafeZone Stands with most brands of roll-up signs

The SafeZone Series SZ-412 is a super lightweight compact springless sign stand for use with roll-up signs. Easy to use and easy to store, its single sign attachment point allows for quick deployment in the field.

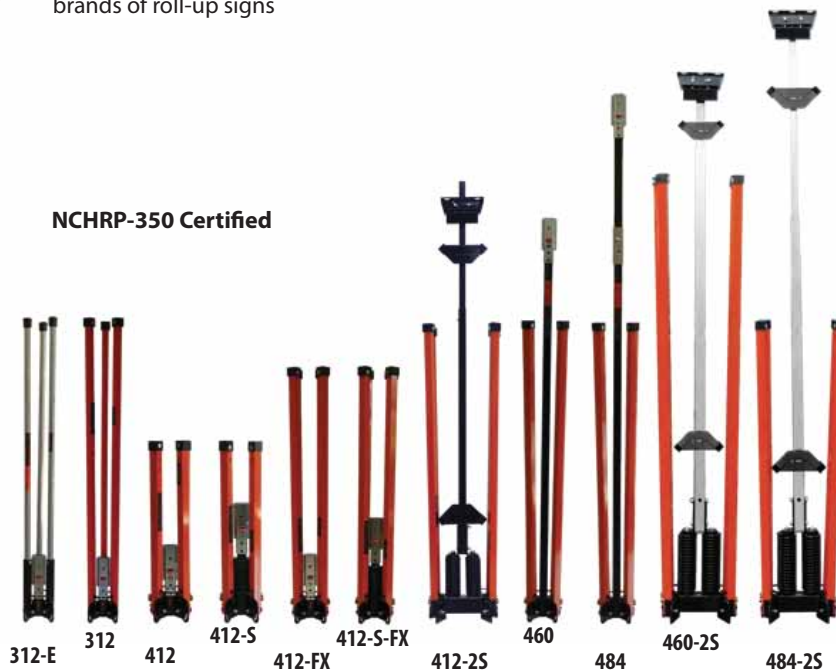

Standard Model	Springless	Springless with U Bracket	Single Spring	Single Spring with U-Bracket	Dual Spring (Rigid Sign Stand)	Dual Spring with Roll-Up Bracket (Rigid Sign Stand)
Model SZ-412 1' Stand (4 legs, 12" off ground)						
Model SZ-460 5' Stand (4 legs, 60" off ground)						
Model SZ-484 7' Stand (4 legs, 84" off ground)						



TRUSTED SINCE 1958

# Safety Equipment

Part #	Description
SSS-BTMS3F	Sign Stand System, Consists of Base, Telescoping Mast, 3 Warning Flags
RIBS-90X120	Rib Kit to Support 90cmx120cm Sign
RIBS-90X90	Rib Kit to Support 90cmx90cm Sign
RSDG-TC102B	90X90 Roadwork Ahead, DG
RSDG-TC103R	90X90 Right Lane Closed, DG
RSHI-RB91	90X120 Yield to Oncoming Traffic, HI
SV-LTT-LX	Standard Vest, Lime, Large/XLarge
SV-OTT-SM	Standard Vest, Orange, Small/Medium
TC-CBAR	Traffic Cone Bar - Telescoping
TC-H4U-28	28" Traffic Cone, w/ 4" Collar
TC-22-Complete	Stop/Slow Paddle c/w 5 ft Handle



## Single & Double Collar Traffic Cones

### TC-H4U-18

- 18" Cone (45cm) 8 lb
- HI-VIS PVC Traffic Cone with Black Base
- Meets MTO-Spec TC-51B
- with 4" Reflective Collar

### TC-SBB-36

- 36" Cone (91.44cm)
- HI-VIS PVC Traffic Cone
- 6" Lower Collar
- Meets MTO Spec

### TC-H6U-28

- 28" Cone (70 cm) 8 lb
- HI-VIS PVC Traffic Cone with Black Base
- Meets MTO-Spec TC-51B
- With 6" Reflective Collar

### TC-H6U4L-28

- 28" Cone (70cm) 8lb
- HI-VIS PVC Traffic Cone with Black Base
- Meets MTO-Spec TC-51B
- With 4" Lower Collar and 6" Upper Collar



## TC-CBAR: Retractable Cone Bar

- Lightweight and extremely portable
- Easy to set up or remove
- Providing an instant and inexpensive barrier to hazardous or controlled access areas
- Made with high quality industrial grade material
- Traffic cone bar special features:  
Black and yellow stripes for visual intensity  
Retractable from 1150MM to 2500MM  
Used in combination with traffic cones



## PCC-501-28: Pack N' Pop Cones & Tote

- 28"(70cm) Pack-A-Cone
- 4 LED Lights
- Collapsed height 2" weight 4.2 lbs
- Base - 13x13" 2-AAA batteries included
- Tough nylon material with polyethylene base
- 5-Pack with case



## WorkZone Standard Vest

- Exceeds all requirements set out in CSA Z96-09
- Class II / Level II
- 5 Point Tear-Away design with true tear-away capabilities
- Available in fluorescent orange or fluorescent yellow/green
- 2" glass bead reflective tape
- Two front pockets with hook and loop closure
- One radio clip
- Two pencil pockets
- Contrasting colour binding to enhance visibility



Part #	Size	Colour
SV-OTT-SM	Small	Orange
SV-OTT-LX	Large/XLarge	Orange
SV-OTT-23	2XL/3XL	Orange
SV-OTT-45	4XL/5XL	Orange

## WorkZone Deluxe Vest

- Exceeds requirements for CSA Z96-09 Class II / Level II
- 5 Point Tear-Away design with true tear-away capabilities
- Fluorescent orange or fluorescent yellow/green
- 4" wide contrasting trim with 2" glass bead reflective tape
- Two large, front "pouch" pockets, two radio clips
- Cell phone pocket with Velcro closure
- Front flagging tape pocket with hook and loop closure, grommet hole for access to tape and two pencil pockets
- Inside "safety" pocket with full hook and loop closure
- Two full size inside pockets
- Plan pocket across entire back of vest with zippered access
- Contrasting colour binding to enhance visibility



Part #	Size	Colour
DV-OTT-SM	Small	Orange
DV-OTT-LX	Large/XLarge	Orange
DV-OTT-23	2XL/3XL	Orange
DV-OTT-45	4XL/5XL	Orange

## WorkZone Premium Vest

- Exceeds all requirements for CSA Z96-09, Class II/Level II
- 5 Point Tear-Away design with true tear-away capabilities
- Fluorescent orange or fluorescent lime/yellow
- 4" wide contrasting trim with 2" glass bead retro-reflective
- Two front "safety" pockets with full hook and loop closure to lock in items
- Two radio clips
- Cell phone pocket with Velcro closure
- Two pencil pockets
- Inside "safety" pocket with full hook and loop closure
- Contrasting colour binding to enhance visibility



Part #	Size	Colour
PV-OTT-SM	Small	Orange
PV-OTT-LX	Large/XLarge	Orange
PV-OTT-23	2XL/3XL	Orange
PV-OTT-45	4XL/5XL	Orange



# Traffic Safety Equipment

## Safety Cones

- Rugged, brightly coloured safety cones
- Designed for many years of outside use
- Cones are constructed of day-glow red/orange PVC with two reflective collars
- 18", 28", and 36" tall cones available



18" Cone	Base 11" x 11"
28" Cone	Base 14" x 14"
36" Cone	Base 14.5" x 14.5"

## 18" & 28" Pack N' Pop Cones & Tote

- 13.5" x 13.5" x 8" plastic tote holds 4 cones
- Durable, bright orange, flexible nylon
- Rubber base grips the road for stability
- Meets MUTCD standards
- Collapses flat for easy storage
- Internal light endures over 100,000 flashes
- or 36 hours of steady burn



Qty of 4	18" Cones/Nylon Bag Set
Qty of 4	28" Cones/Nylon Bag Set

## Cortina 3295500: Emergency Warning Triangle Kit

- ORTINA Highway Warning Triangles quickly warn passersby of oncoming traffic hazards. High-visibility units snap together in minutes. Come complete with storage box that fits conveniently in your vehicle
- Sold in boxes of 3



## Safety Lightsticks



- Provides long distance illumination
- Visible in fog, rain, or snow
- Waterproof and windproof
- Non-toxic and non-flammable
- Easy Snaplight® activation
- 6" Snaplight 30 minute lightstick in white
- 10" Safety Glow lightstick with a stand in red

## EMERGENCY EQUIPMENT

### Fire Extinguishers for Electrical Equipment

- Dispense a precisely dispersed, rapidly evaporating liquid agent that is electrically non-conductive
- Does not cause thermoshock on sensitive electrical equipment
- Pressurized with argon
- The liquid agent is HydroChloroFluoroCarbon (blend B) for use in extinguishing class A, B, C type fires
- Ideal for extinguishing fires originating at or near delicate electronics and electrical equipment such as mobile units, computers, telephone switchgear, etc.



### Multi-Purpose Fire Extinguishers

- Designed to fight all common fires (Class ABC): wood, electrical, gas, oil, flammable liquids, paper and cloth
- Features easy-to-pull safety pin
- Capacities range from 2.5 lbs to 10 lbs
- Rust and impact-resistant nylon handle
- Easy-to-read gauge tells when extinguisher is charged and ready for use
- Quick, clear directions for ease of use
- Includes vehicle mounting bracket



## E-Flood® LiteBox®



	615 LUMENS	330 LUMENS
	8h	18h
	126m	93m
	4000 cd	2150 cd

- Six (6) C4® LEDs
- High: 615 Lumens, up to 8 hours; Low: 330 Lumens, up to 18 hours
- Fits existing Litebox® chargers
- IPX4 rated for weather-resistant operation
- Parabolic reflectors produce a smooth flood pattern
- Optimized electronics provide regulated intensity
- Jumper selectable high or low setting to allow higher light output or longer runtime

### Standard System (120V AC/12V DC):

- 45801 E-Flood - Orange
- 45821 E-Flood - Yellow

### Vehicle Mount:

- 45805 E-Flood LiteBox 12V - Orange
- 45825 E-Flood LiteBox 12V - Yellow

## E-Spot® LiteBox®

- Three C4® LEDs and deep-dish parabolic reflectors produce a large spot pattern
- High: 540 Lumens, up to 7 hours; Low: 330 Lumens, up to 15 hours
- Zero-maintenance 6V, 12 Ah sealed lead-acid battery
- Fits existing Litebox® mounting racks
- IPX4 rated for weather-resistant operation
- Jumper selectable high or low setting allows higher light output or longer run time



	540 LUMENS	330 LUMENS
	7h	15h
	469m	358m
	55,000cd	32,000cd

### Standard System (120V AC/12V DC):

- 45851 E-Spot - Orange
- 45871 E-Spot - Yellow

### Vehicle Mount:

- 45855 E-Spot 12V Orange
- 45875 E-Spot 12V Yellow

## Portable Scene Light

- Six C4® LEDs and wide reflectors produce a uniform flood pattern; selectable diffuser settings for two beam widths
- Three user-selectable outputs: High, 3600 lumens runs five hours, Medium, 2400 lumens runs 9 hours, Low, 1100 lumens runs 18 hours
- 90° swivel
- Sealed lead acid batteries rechargeable up to 500 times
- Easy setup, less than 30 seconds pole extends to 72"
- Weight: 25 lbs

- 45670 120V AC/DC
- 45671 230V AC/DC
- 45672 240V AC/DC
- 45673 100V AC/DC

## LiteBox® Rechargeable Lantern



- Rechargeable, completely portable lantern
- Output: 8 watt spot = 80,000 peak beam candle power, up to 9 hours per charge; 20 watt spot = 105,000 peak beam candle power, up to 3.5 hours per charge
- 7.4 lbs with 6 volt, 12 Ah sealed lead acid battery
- Standard system includes shoulder strap, AC and DC chargers, and charge rack
- Vehicle Mount Systems include truck-mountable 12 volt DC direct wire, mounting rack, and shoulder strap
- Locking device systems are available and are factory installed

### Standard System

- 45117 8 Watt Spot, Yellow
- 45116 8 Watt Spot, Orange
- 45109 20 Watt Spot, Yellow
- 45110 20 Watt Spot, Orange

### Vehicle Mount

- 45108 8 Watt Spot, Yellow
- 45107 8 Watt Spot, Orange
- 45104 20 Watt Spot, Yellow
- 45102 20 Watt Spot, Orange

### Locking Device System

- 40164 Keyed Alike
- 40163 Keyed Differently
- 45937 Replacement Battery



TRUSTED SINCE 1958

# Streamlight



## Knucklehead®

- Rechargeable, alkaline work light
- C4® premium LED technology delivers 200 lumens and 3.5 hour run time on high; 63 lumens and 6 hour run time on low
- Moonlight mode runs 20 days; flash runs 8 hours
- Features a 210 degree articulating head that rotates a full 360°
- Dual power source: accepts rechargeable NiCd battery pack or 4 "AA" alkaline batteries
- Removable magnet with 135 lb. pull strength
- Optimized electronics provide regulated intensity
- High-impact, super-tough nylon polymer construction
- IPX4 rated for water-resistance
- Available in black or yellow
- Rated Class I & II, Division 2

### Steady Charge Models (w/ AC/DC Charger/Holder)

90607\* Black 120V AC/DC

90627\* Yellow 120V AC/DC

### Alkaline Models

90641\* Black

90642\* Yellow

\*Other models available

FL1 STANDARD	HIGH	LOW
	200 LUMENS	63 LUMENS
	3h 30min	16h
	68m	37m
	1150 cd	350cd

## Survivor® LED

- Flash for signaling: runs 8 hours
- Moonlight mode provides low-level lighting for battery conservation: runs 20 days

### Rechargeable model:

- High for a super-bright beam that pierces through smoke: 36,000 candela; 175 lumens; 379m beam distance; runs 3.5 hours
- Low for bright light and longer run time: 12,000 candela; 60 lumens; 219m beam distance; runs 13 hours

### Alkaline model:

- High for a super-bright beam that pierces through smoke: 36,000 candela; 175 lumens; 379m beam distance; runs 4 hours
- Low for bright light and longer run time: 12,000 candela; 60 lumens; 219m beam distance; runs 15 hours

FL1 STANDARD	HIGH	LOW
	175 LUMENS	60 LUMENS
	3h 30min	13h
	379m	219m
	36,000cd	12000cd



## Waypoint®

- Powerful, long-reaching beam that illuminates a range of up to 678 meters
- Pistol-grip spotlight features 3 modes: high, low, and emergency signal
- C4® premium LED technology delivers 210 lumens and 8.5 hour runtime on high; 20 lumens and 120 hour run time on low
- Unlimited run time using 12V DC power cord (included)
- Optimized electronics provide regulated intensity
- IPX4 rated for water-resistance
- Integrated stand for hands-free scene lighting
- Requires four "C" sized alkaline batteries
- Available in black or yellow

44900 Yellow Waypoint with Storage Mount

44902 Black Waypoint with Storage Mount

44904 Yellow Waypoint without Storage Mount

44905 Black Waypoint without Storage Mount

FL1 STANDARD	HIGH	LOW
	210 LUMENS	20 LUMENS
	8h 30min	120h
	678m	245m
	115,000 cd	10000cd



## Fire Vulcan® LED



- C4® LED technology and 2 ultra-bright blue taillights
- Light output: high - 145 lumens; low - 70 lumens
- Run times: Steady High LED and taillights - up to 3 hours on high; up to 7 hours on low
- Recharges in 5 hours
- Fits existing Streamlight Vulcan chargers
- 1.85 lbs.; lantern floats
- 8 modes of operation

44450 Orange LED Standard System 120V w/ Quick Release Shoulder Strap - AC/DC

44451 Orange LED Vehicle Mount System 12V w/ Quick Release Shoulder Strap - DC

44454 Orange LED Standard System (w/o charger) w/ Quick Release Shoulder Strap

## H.I.D. LiteBox®



- 1,000,000 candela peak beam intensity
- Deep-dish parabolic reflector produces a long-range, high-intensity focused beam of light
- Up to 1.75 hours run time
- Fully articulating head
- 35 watt H.I.D. Xenon lamp
- High-impact ABS thermoplastic housing; weatherproof
- 12V, 7.2Ah sealed lead acid rechargeable up to 500 times
- Serialized for positive identification
- Kit includes 120 Volt AC charger and 12 Volt DC charger

45621 Black H.I.D. LiteBox® Kit

45601 Orange H.I.D. LiteBox® Kit

45637 Replacement H.I.D. Bulb Kit





## Vantage® Helmet Mount



### Fire & Industrial Headlight

- C4® LED technology combined with an ultra-bright blue LED taillight
- Lightweight, compact, low profile design easily attaches/detaches above or below brim on fire helmets and full brim hard hats
- Up to 7000 candela peak beam intensity; 115 lumens measured system output
- 6 hours of continuous run time
- Uses two 3V CR123A lithium batteries
- IPX7 rated; waterproof to 1 meter for 30 minutes
- Swivel clamp and insertable 5° angle adjuster to optimize beam location

69140

FLY STANDARD	VANTAGE
	100 LUMENS
	6h
	152m
	5,800cd

# Streamlight

## Headlamp Series

Streamlight offers a variety of ultra-compact headlamps. Designed for comfort and durability, the adjustable, flexible, lightweight straps can be worn on the head or around a hard hat. These high powered professional grade lights offer power, versatility and longevity to accomplish any task.



	Septor®	Enduro®	3AA HAZ-LO®	Argo®	Trident®
	61052	61400	61200	61301	61050
Battery	Three "AAA" Size alkaline batteries	Two 1.5 Volt "AAA" cells	Three "AA" Size alkaline batteries	Three "AAA" size alkaline batteries	Three "AAA" size alkaline batteries
Light Source	Seven ultra-bright white LEDs	.5W High-Flux LED	C4 LED	C4° LED	1C4 LED 3 White LED
Case Material	Water resistant lightweight thermoplastic construction	Impact resistant ABS case	Impact resistant ABS case	Water resistant lightweight thermoplastic construction	Water resistant lightweight thermoplastic construction
Colours	Yellow	Black (other colours available)	Yellow	Yellow	Yellow
Weight (w/ batteries)	5.50 oz (156 g)	2.75 oz (78.5 g)	7.1 oz (202 g)	5.50 oz (156 g)	4.64 oz (131.54 g)
Dimensions (L x W x H)	1.86" x 2.55" x 2.53"	1.3" x 2.25" x 1.6"	1.88" x 2.5" x 3.08"	2.15" x 2.9" x 2.25"	1.86" x 2.55" x 2.53"
Run Time	7 LEDs = 3.5 hrs 8-10h 1=55 hr	6 hours / 12 hours	11 hrs	3 hrs high 4.5 hrs medium 30 hrs low	C4 LED - 5 hours 3 LED - 10 hours 1 LED - 53 hours
Light Output	7 LED / 3 LED / 1 LED 120/45/13	14.5 / 6 lumens	120 lumens	150 lumens high 100 lumens medium 45 lumens low	CD LED - 80 lumens 3 LEDs - 35 lumens 1 LED - 11 lumens
Special Features	<ul style="list-style-type: none"> <li>• 3 lighting modes</li> <li>• Rubber &amp; elastic hard hat straps included</li> <li>• 90° tilting head</li> <li>• Low battery indicator</li> <li>• Flood beam for up close work</li> </ul>	<ul style="list-style-type: none"> <li>• Rubber/elastic combination headstrap</li> <li>• Water resistant</li> </ul>	<ul style="list-style-type: none"> <li>• Rubber &amp; elastic hard hat straps included</li> <li>• 90° tilting head</li> <li>• Water resistant</li> <li>• Intrinsically safe</li> <li>• Class 1, Div 1 and MSHA approved</li> </ul>	<ul style="list-style-type: none"> <li>• Rubber &amp; elastic hard hat straps included</li> <li>• Water resistant</li> <li>• LED battery indicator</li> <li>• 90° tilting head</li> <li>• Illuminate objects at distance</li> </ul>	<ul style="list-style-type: none"> <li>• 3 lighting modes</li> <li>• Rubber &amp; elastic hard hat straps included</li> <li>• 90° tilting head</li> <li>• Water resistant</li> <li>• Spot-to-flood focus - for close up and distance</li> </ul>

### 61304: ProTac HL® Headlamp



- Designed for maximum illumination with a wide beam to light an entire area
- Featured TEN-TAP® programming, which allows the choice of three programs 1) high/medium/low 2) high only 3) low/medium/high
- High for super-bright light; 540 lumens, 7400 candela; runs 1.75 hours
- Medium for bright light and longer run time 95 lumens, 1200 candela, runs 8 hours
- Low for extended run times and when a less intense beam is ideal: 18 lumens; 250 candela; runs 36 hours
- 90° tilting head prevents neck fatigue
- Includes two 3V CR123A lithium batteries rubber and elastic headstraps
- Durable, anodized aluminum construction; gasket-sealed, glass lens; IPX4 water-resistant, 1m impact resistance tested

### ClipMate® USB, Clip-On Light

- 61125 Light Only (w/o AC adapter), Black with White and Red LEDs
- 61126 120V AC adapter, Black with White and Red LEDs
- 61127 International AC adapter, Black with White and Red LEDs



## Polytac®



- High impact super tough nylon polymer
- Textured sure grip
- C4® LED technology
- 275 lumens
- Run time up to 3 hours
- Available in black, coyote tan, and yellow
- IPX7 rated design; waterproof to 1 meter
- Powered by two 3-volt CR123A lithium batteries (included)
- TENTAP® programmable switch
- Batteries included

Beam Spread	HIGH	LOW
	275 LUMENS	14 LUMENS
	3h	65h
	195m	45m
	9,500cd	500cd

- 88850**    **Black**
- 88851**    **Coyote**
- 88853**    **Yellow**
- 88854**    **Helmet Lighting Kit - Yellow**

## Polytac® HP



- C4® LED technology, impervious to shock with a 50,000 hour lifetime
- Up to 19,000 candela and 275 lumens
- Runs 3 hours on high
- Powered by two 3-volt CR123A lithium batteries
- High impact super tough nylon polymer
- Waterproof to 1 meter (IPX7 rated)
- TENTAP® programmable switch
- Textured sure grip

Beam Spread	HIGH	LOW
	275 LUMENS	14 LUMENS
	3h	56h
	275m	63m
	19,000cd	1,000cd

- 88860**    **Black w/ Lithium Batteries**
- 88861**    **Coyote w/ Lithium Batteries**
- 88863**    **Yellow w/ Lithium Batteries**

## Polytac 90® LED



- Super bright and compact right angle personal light
- Can clip onto turn-out gear or onto our new elastic head strap for a headlamp
- Fully rotatable/reversible/removable clip
- C4® LED technology, with a 50,000 hour lifetime
- Up to 7,000 candela and 170 lumens
- Run: 3.75 hours on high; 30 hours only
- Powered by two 3-volt CR123A lithium batteries
- 90° head
- Waterproof to 1 meter (IPX7 rated design)
- Optional Gear Keeper® system features a retractable attachment system with a high-strength nylon tether featuring a 36" extension and 6 oz of retraction force

Beam Spread	HIGH	LOW
	170 LUMENS	17 LUMENS
	3h 45min	30h
	167m	53m
	7,000cd	700cd

- 88830**    **Black**
- 88831**    **Yellow**
- 88834**    **Orange**
- 88832**    **Orange w / Gear Keeper**
- 88833**    **Gear Keeper**



# Streamlight

LIGHTING

## PROTAC® TACTICAL SERIES

### ProTac® 2AA



C4® LED illumination output and run times:

- HIGH - 165 lumens/2 Hour
- LOW - 11 lumens/36 Hours
- Includes 2 AA alkaline batteries
- Waterproof to 1 meter

88033

### ProTac® 2L



C4® LED illumination output and run times:

- HIGH - 260 lumens/3 Hours
- LOW - 13 lumens/50 Hours
- Includes 2 CR123A lithium batteries
- Waterproof to 1 meter
- Features strobe mode
- TENTAP Programmable

88031

### ProTac® 1AA



C4® LED illumination output and run times:

- HIGH - 70 lumens/2 Hours
- LOW - 5 lumens/32 Hours
- Includes 1 AA alkaline battery
- Waterproof to 1 meter
- TENTAP Programmable

88032

### ProTac® 1L



C4® LED illumination output and run times:

- HIGH - 180 lumens/2 Hours
- LOW - 12 lumens/24 Hours
- Includes 1 CR123A lithium battery
- Waterproof to 1 meter
- Features strobe mode
- TENTAP Programmable

88030

ProTac HL® (High Lumen) 3 also available, part # 88047

## TACTICAL HAND-HELD SERIES

### Scorpion®



- Xenon gas bulb (spare bulb included)
- Up to 7900 candela (78 lumens measured system output)
- Adjustable spot-to-flood focus
- Two 3 volt lithium batteries (included)
- 1 meter impact-resistance tested

FLC STANDARD	SCORPION
	78 LUMENS
	1h 20min
	178m
	7,900cd

85001 Black

85004 Black w/ Belt Clip Attachment

### Scorpion® X



- C4 LED Technology, 50,000 hr lifetime
- 11,000 candela (200 lumens measured system output on high)
- Adjustable spot-to-flood focus
- Three 3 volt lithium batteries (included)
- 1 meter impact-resistant tested

FLC STANDARD	HIGH	LOW
	200 LUMENS	10 LUMENS
	2h 30min	50h
	210m	47m
	11,000cd	550cd

85011 Black

Scorpion HL® also available, part # 85400

### Super Tac® X



- C4® LED technology
- High - 200 lumens, 2.5 hours run time; Low - 10 lumens, 50 hours run time
- Two 3 volt lithium batteries (included)
- Operates with remote switches
- IPX4 rated for water-resistance

FLC STANDARD	HIGH	LOW
	200 LUMENS	10 LUMENS
	2h 30min	50h
	400m	89m
	40,000cd	2,000cd

88708 Black w/ Holster & Lithium Batteries, Box

88709 Black w/ Lithium Batteries

## STINGER® & POLYSTINGER® SERIES

The series of Stinger® rechargeable flashlights offer you the advantages of a full-size light in a case the length of your palm. The lights are made of a machined aircraft aluminum that is anodized against corrosion inside and out. Streamlight's PolyStinger® flashlights provide you with the features and brightness you expect from a Stinger, in a super-tough, non-conductive nylon polymer with non-slip rubberized comfort grip.

### STINGER® LED



- C4® LED technology with a 50,000 hour lifetime
- Run time: High - up to 2 continuous hours; Medium up to 3.75 hours; Low - up to 7.25 hours
- 3-cell, 3.6 Volt Ni-Cd sub-C battery, rechargeable up to 1000 times
- Fits existing Stinger snap-in chargers

	350 LUMENS	175 LUMENS	85 LUMENS
☀️	350 LUMENS	175 LUMENS	85 LUMENS
🕒	2h	3h 45min	7h 15min
📏	310m	219m	155m
🎯	24,000cd	12,000cd	8,000cd

**75713 Black w/ AC/DC Standard Charger - 2 Holders**

**75735 Black w/ AC/DC Fast Charger - 2 Holders**

### ULTRASTINGER®



- High intensity, extremely bright rechargeable flashlight
- 35,000 candela peak beam intensity. 230 lumens typical
- 30 hour life xenon halogen gas-filled bi-pin bulb; variable spot-to-flood beam
- 5 cell, 6 Volt Ni-Cd sub-C battery is rechargeable up to 1,000 times

FL 1 STANDARD	ULTRASTINGER
☀️	230 LUMENS
🕒	1h
📏	374m
🎯	35,000cd

**78014 UltraStinger® w/ AC/DC Charger - 2 Holders**

### POLYSTINGER® LED



- C4® LED rechargeable polycarbonate flashlight
- Fits existing Stinger snap in chargers (only DS models)
- Deep-dish parabolic reflector provides a long-range targeting beam with optimum peripheral illumination

FL 1 STANDARD	HIGH	MEDIUM	LOW
☀️	385 LUMENS	195 LUMENS	95 LUMENS
🕒	2h	3h 45min	7h 15min
📏	322m	228m	161m
🎯	26,000cd	13,000cd	6,500cd

**PolyStinger® LED with 120V AC/DC Charger:**

**76113 Steady Charge Black - 2 Holders**

**76163 Steady Charge Yellow - 2 Holders**

**76132 Steady Charge PiggyBack Black**

**76135 Fast Charge Black**

**76116 Fast Charge PiggyBack Black**

### POLYSTINGER® LED HAZ-LO®



- High performance intrinsically safe rechargeable Class 1, Div. 1 flashlight
- C4® LED technology
- High - 130 lumens, 4 hour run time; Low - 50 lumens, 12 hour run time; also has a 20 hour moonlight mode
- Super-tough, non-conductive chemical and corrosion-resistant nylon polymer
- NiCd battery is rechargeable up to 1000 times
- IPX4 rated for water resistance

FL 1 STANDARD	HIGH	LOW
☀️	130 LUMENS	50 LUMENS
🕒	4h	12h
📏	245m	151m
🎯	15000cd	5700cd

**76442 120 V AC/12VDC Black**

**76412 120 V AC/12VDC Yellow**



# Streamlight

## STREAMLIGHT JR.® LED & STRION® LED

### Streamlight Jr® LED



- Ultra-compact, lightweight flashlight
- C4® LED technology
- Up to 85 lumens output
- Run time: "AA" Alkaline batteries - 4 hours; "AA" (L91) Lithium batteries - 5.25 hours
- Removable pocket clip
- Powered by two "AA" alkaline batteries included

71500 **Streamlight Jr.® C4 LED w/ Holster**

71503 **Stand Alone Holster**

FL 1 STANDARD	STREAMLIGHT JR.
	85 LUMENS
	4h
	123m
	3800 cd

### STRION® LED



- C4® LED technology
- 3.75V, 2,000mAh minimum lithium ion battery, rechargeable up to 1000 times
- LED charge continuity indicator on charger base
- IPX4 rated design; water-resistant operation
- 2 meter impact resistance

74301 **Black 120V AC/12V DC (1) Holder**

74302 **Black 120V AC/12V DC (2) Holders**

FL 1 STANDARD	HIGH	MEDIUM	LOW
	260 LUMENS	130 LUMENS	65 LUMENS
	2h	4h	7h 30min
	200m	141m	100m
	10,000cd	5,000cd	2,500cd

### MICROSTREAM®



- Compact flashlight with C4® LED technology
- Powered by (1) "AAA" alkaline battery
- Delivers up to 28 lumens
- Up to 2.24 hours of regulated run time
- Combination pocket/hat clip

66318

FL 1 STANDARD	MICROSTREAM
	28 LUMENS
	2h 15min
	52m
	683cd

### STYLUS PRO®



- Sleek, compact flashlight the size of a pen
- C4® LED technology
- 48 lumens median output; 6.25 hours run time
- Powered by two "AAA" alkaline batteries (included)
- Tear-resistant nylon holster
- Unbreakable, removable pocket clip

66118 **Black w/ White LED**

66133 **120 AC - Black w/ White LED**

66135 **International AC - Black w/ White LED**

66134 **Stylus Pro USB w/ USB Cord & Nylon Holster  
Black w/ White LED**

FL 1 STANDARD	C4 WHITE LED	GREEN LED
	48 LUMENS	5 LUMENS
	6h 15min	11h
	64m	17m
	1033 cd	73 cd

## 9460 Remote Area Lighting System



- Using solid-state mounted LED's coupled with a thermally efficient light engine and our 1510 Pelican Protector™ Case, the RALS 9460 gives the user the ultimate maintenance free portable floodlight station
- Houses two of its light heads and it's multi-stage charger for that total self-contained convenience, and is equipped with a telescopic handle and rugged wheels for ease of transport
- Comes with convenient low battery warning system and waterproof activation switch
- High Flux LED with 50,000 expected hours
- 2 Lampheads with 6 LEDs each, 6000 lumens (high), 500 lumens (low)
- Intelligent control features LCD display with customizable run time and brightness
- Battery - up to 40 hours run time on low; 7 hours run time on high
- 110 Volt charger Included; 12V charger available

*CAUTION: The Pelican Products RALS models 9450, 9460 and 9470 contain sealed lead acid batteries that can generate hydrogen gas when charging. It is imperative that these products are charged, as instructed, with the case lid open to allow any gases to escape as charging with the lid closed poses a significant hazard. Failure to abide by this instruction could result in injury and/or damage to property. Please refer to the warnings provided in the instructions for the unit and on a decal affixed to the inside of the case adjacent to the cavity where the charger unit is packed.*

**9460 Safety Yellow, 110V Charging System (12V Charging System Available)**

**9460 Black, 110V Charging System (12V Charging System Available)**

## 9430 & 9430SL Remote Area Lighting Systems



- 9430 models each offer a wide 90° beam for large area coverage
- 9430SL models each offer a focused 10° beam with a 200 yard reach
- Polycarbonate Lens is lightweight and impact-resistant
- Maintenance free LED array; life expectancy of 50,000 hours
- Fully extendable mast with mast extension lock; 360° rotating head
- 110 Volt Charger Included; 12V charger available
- High Flux LED with 50,000 expected hours; 3000 lumens on High, and 1500 on Low (9430)
- High Flux LED with 50,000 expected hours; 2000 lumens on High, and 1000 on Low (9430SL)
- 1 Lamphead with 24 LEDs per head
- Battery - 15 hours run time on low; 8 hours run time on high
- Waterproof rubber activation switch
- 1 Year Warranty

**9430 With 110V Charging Station - 12V System is Available**

**9430 Wide Beam, Safety Yellow**

**9430 Wide Beam, Black**

**9430SL With 110V Charging Station - 12V System is Available**

**Focused Beam, Black**



## 9410L LED Lantern

- Four LEDs, powered by the latest generation Lithium-Ion batteries illuminate a distance of 475 yards (435 meters)
- Loaded with innovative technology and features
- 120° rotating head
- Run time: 9 hrs. (low)/3.75 hrs. (high)
- Battery status indicator
- 3 mode switch (High, Low, Flashing)
- 8.75" x 3.75" x 4.0" (22.2 x 9.5 10.2 cm) L x W x H
- Shoulder strap included



**9410L Safety Yellow, 110V**

**9410L Black, 110V**

# Pelican

## StealthLite™ 2410 LED™ & 2410PL LED Photoluminescent Flashlight

- Same features as the StealthLite 2410 LED Flashlight but outfitted with a lens ring that emits a bright glow in the dark
- Photoluminescent material in the plastic absorbs the energy from any light source - fluorescent lights, sun, the flashlight's own beam
- Powered by 4 AA alkaline cells (included); 7.5 hour battery burn time (included), submersible, and has an ABS resin body which resists chemicals, corrosion, and extreme temperatures
- ITS.09.0017X Ex ia IIC T4 Ga, Ex ia IIIC T83°C Da IP66
- Class I II III Div. 1 Grps. ABCDEFG Operating Temp. Class T4
- LED lamps have a life expectancy of 50,000 hrs.

2410

2410PL Photoluminescent Shroud



## 2360 LED Flashlight

- Aluminum with Type II Anodized Body
- 2 standard AA alkaline batteries in the 2360 LED emits a peak output of 250 lumens
- Run time of up to 2 hours: 3 output mode - High/Low/Strobe
- Impact-resistant LED lamp module
- High/Low light output is available with a push of the tail button
- Features a non-slip textured body for secure handling
- Removable two way pocket clip
- 6.2" Length
- Lumens: High 250, Low 24
- Run time: High 2.25 hrs, Low 19 hrs
- Water-resistant

2360 Black



## 3610 Little Ed® LED Flashlight



- Body Material: EXL Resin
- Body of tough ABS resin that's corrosion-proof and resistant to extreme temperatures
- Powered by 4 AA alkaline cells (included)
- 7.5 hour run time
- 126 lumens, 6500 cd with 161m beam distance on high
- Water-proof and submersible

3610-B Black Flashlight (carded)

3610-Y Yellow Flashlight (carded)

3610PL Recoil™ Flashlight w/ Photoluminescent Shroud

## HeadsUp Lite™ 2690 Flashlight

- With 60 lumens of LED light, 10 hours of battery run time and weighing in at 4.1 ounces, it's brighter, more efficient, compact and lighter than other headlamps in its class
- Rotary bezel switch is easy to operate, even when wearing bulky gloves
- Impact, chemical-resistant ABS; water-resistant for all-weather use
- Features an adjustable and comfortable cloth strap, as well as a heavy duty rubber strap that will not slip off your climbing helmet
- 3 AAA Alkaline (Included); 10 hour battery run time
- II 1 D/G Ex ia IIC T4, Ex iaD 20 IP65 T65° C Certificate: TRL 08ATEX11184X and CL I, II,III,DIV1 GRPS ABCDEFG CL 1, Zone 0, Groups IIA, IIB, IIC SGS E1052012



2690



2720 Black

## 2720 LED Headlight

- Body Material: ABS
- Gesture Activation Control
- Variable Light Output
- Dual Red LED Night Vision
- Variable light output 100%-10%
- Signaling red (S.O.S) beacon light
- Gloved hands, wet hands or oily hands are not an issue; turn on the light with a wave of a hand
- Low level red light preserves night vision, for night time applications
- Optical 4x magnification allows for a wide or penetrating beam
- 80 lumens, 8 hour run time and 790 cd with 56m beam distance (high); 5 lumens, 175 hour run time and 60cd with 15m beam distance (low)
- Water-resistant

## 3315: LED Flashlight - Compact LED Power, Black/Yellow

- The new 3315 LED flashlight: the lightweight compact design houses 3AA batteries that power a single LED for 113 lumens of super bright LED light
- Safety approved for the most volatile work environments, the 3315 LED flashlight is one of the most efficient flashlights on the market today



## 2350: Compact 1AA Flashlight, Black Only

- Pelican's new 2350 LED flashlight emits up to 100 lumens of concentrated light
- Powered by one AA alkaline battery, it's one of the brightest flashlights in its class
- 4.23" long
- Body Material: Aluminum with Type II Anodized



## 3610: Right Angle Light - Little Ed, Black/Yellow

- Uses "Deep Mount" LED technology, delivering impressive lumens and lux performance
- The stainless steel mounting clip allows for hands-free applications
- Powered by 4 AA alkaline cells (included)
- Body Material: EXL Resin, corrosion-proof and resistant to extreme temperatures
- Minimum Pack 1 ea
- Packaged Weight: 11.1 oz



## 9440: Remote Area Lighting System Black/Yellow

- The most innovative RALS unit to date, the 9440 moves fast to light up ravines, confined spaces, riverbanks and any place generator lights can't go
- Deployed, the mast extends 7 feet high, shining light over low obstructions encountered by traditional lantern style lights
- With a 120° beam spread and up to 2400 lumens
- Super tough LED lamp modules and NiMH batteries for up to 6 hours of continuous light
- Adjustable carrying strap included



## 2740: LED Headlight, Black/Translucent Blue/White

- Compact, reliable headlight for harsh conditions - the 2740 LED headlight features 3 LEDs, producing up to 35 lumens and a low level that gives an extended run time of 51 hours. Designed with weather-resistant casings which also allows for fast and easy battery change
- Body Material: PC



## 2610: HeadsUp Lite™ LED, Black

- Provides hands-free light where you need it, when you need it
- Dual mode button activates all 3 LEDs or full brightness, or just 1 to extend battery life
- The adjustable cloth strap fits comfortable and securely on your head, while rubber strap grips tightly to hard hats and helmets, both are included
- 3 AAA alkaline cell batteries included
- Ideal for reading maps and light duties around the campsite



# Petzl Lights

## Pixa 1

Easy to use headlamp for comfortable close-range work



## Pixa 2

Versatile headlamp allows comfortable close-range work and moving around in complete safety



## Pixa 3

This headlamp is designed to respond to all the needs on the terrain: close-range work, moving around and long-range vision



## Zipka® headlamp

The ZIPKA headlamp will accompany you wherever you go. Its exclusive retractable cord makes it extremely compact, practical to transport and versatile to wear. It offers comfortable proximity lighting that allows for some movement. Maximum brightness is 80 lumens, with a range of 50 meters. This headlamp has two lighting modes to adapt the brightness to each situation.

Ultra-compact format is easy to carry and wear:

- Petzl's exclusive adjustable retractable cord
- can be worn on the head, the wrist or attached to a tent pole, a seat post, etc.

Several proximity lighting modes adapt to each situation:

- proximity lighting mode: wide, comfortable beam for close-range vision
- mode for limited movement: wide beam allows movement over short distances

Easy to use:

- push-button for easy, quick lighting mode selection
- phosphorescent reflector allows the lamp to be located in the dark battery case; opens easily for changing batteries



## Duo Atex LED 5

- All-terrain, durable, headlamp that is waterproof to -5 meters

Two light sources to choose from, depending on the activity:

- One high-output LED for long-range, focused lighting with adjustable zoom
- Five LEDs for flood beam lighting with a long burn time

Comfortable and easy to use:

- adjustable and comfortable elastic headband
- on/off switch can be locked to prevent accidental operation - light body can be tilted
- Intrinsically safe rechargeable battery E61100 2 (Ni-MH, 2700 mAh), E65200 2 European and USA charger (110/240 V - 50/60 Hz compatible)
- ATEX certified: headlamp may be used in areas containing gas (zones 1 and 2) and in areas containing dust (zones 21 and 22) where the auto-combustion temperature is greater than 200° C at one atmosphere of pressure (200° C = maximum surface temperature of the lamp)



## Ultra Vario®

Constant lighting: guaranteed lighting performance that does not diminish during the entire rated battery life. Switches to reserve lighting when rechargeable battery is almost discharged: lights to 43 lumens for a minimum of 1 hour

Four modes adapt lighting to the activity:

- low intensity mode: wide beam with relatively low intensity favors a long battery life and prevents blinding others
- close-range work mode: wide beam with intensity adapted to comfortable close-range vision
- movement mode: mixed beam offers a focused component for easily moving around
- distance vision mode: highly focused beam for spotting (maximum range)

Simple and comfortable to use. Rotating selector knob is easy to use, even with gloves, allowing quick access to the different modes:

- quick connection system makes the battery easy to remove
- front and back comfort plates with adjustable elastic head band for an excellent fit on the head

High-performance rechargeable battery:

- 2600 mAh Lithium-Ion rechargeable battery offers excellent performance at low temperatures
- energy gauge allows monitoring of battery's charge level
- light flashes to signal switch to reserve lighting mode
- charger included; quick charge in 3 hours for frequent use



## PoleBoss™ System

- Performance 1000 lbs linepull @ 400 fpm based on hydraulic supply of 15 gpm @ 2000 psi
- Precise metering spring to neutral control valve
- Linepull limiting tension control valve
- Hydraulic pressure gauge
- Anti-rotation clutch
- 2 ratchet type web binder straps
- Manual rope levelwind
- Hydraulic quick disconnects
- Poleboss drive unit weight 215 lbs
- Payout Spindle:
  - Galvanized steel frame construction
  - Hot-stick adjustable disc brake
  - 300 lbs. maximum braking force
  - Ratchet type web binder strap
  - Payout spindle weight 35 lbs.
- Rope and Reel:
  - Reel capacity: 3000 ft. of 3/8 inch rope
  - Recommended rope: 3000 ft. of 3/8 inch TSE Superline
  - Reel weight: 119 lbs.



## DPT-40B: Puller Tensioner

- The TSE Model DPT-40B is a heavy duty drum puller designed for light transmission line stringing. The reel drive incorporates the latest in hydrostatic transmissions that allow the operator to infinitely vary the linespeed and linepull for safe, positive control during the pulling operation. The maximum desired linepull can be preset prior to pulling so that the reel drive will stall if a restriction to the line occurs avoiding damage to the conductor, towers and hardware. In the tensioning mode, the hydraulic system permits the line to be pulled at a steady and controlled tension with automatic pull back to keep the conductor suspended if the pulling force is reduced
- The central operator's console allows the operator to completely control the pulling operation with optimum visibility of the pulling rope. Operator controls include linepull, linespeed, holding brake, levelwind and engine controls
- A free wheel disconnect and bronze overspin brake are available for controlled pay out of the pulling rope
- Continuous Torque Rating 70,000 in.-lbs
- Intermittent Torque Rating 80,000 in.-lbs
- Continuous Linepull Rating 4,350 in.-lbs (with 6,000 ft. of 5/8" rope on the drum)
- 0-4 mph linespeed with infinite control

### STANDARD FEATURES

- Proven hydrostatic pulling and tensioning system with hydraulic oil cooler
- 49 HP water-cooled diesel engine
- Reel capacity up to 72" diameter, 54" wide and 6000 lbs
- Tandem axle with leaf spring suspension
- Infinite variable linespeed and linepull control
- Free wheeling disconnect for high speed rope pull out
- Spring-applied / hydraulic pressure released holding brake
- Central operator's position for maximum safety and visibility
- Quick change reel shaft with straight vertical lift
- Engraved operator's console
- Operator's seat
- Two rear mechanical jack
- Front hydraulic jack



## T30/36 DDVG RC: V-Groove Tensioner

- Continuous performance of 3000 lbs. tension at 4 mph
- Single "V" groove bullwheel direct drive through gear reducer and hydraulic motor
- Bolt on replaceable urethane lining segments
- 3 roller fairlead
- Pressure gauge and performance chart
- Open reeved for easy installation and removal of conductor
- Tongue and rear stabilizer jacks
- Tandem axle with leaf spring suspension
- Pintle hitch adjustable to four height positions
- 2-5/8" reel shaft with double drive arm and lifting loop
- Quick change reel shaft design



## 6707: Universal Stringing Block

- Gate latch is designed for safe, smooth, single motion hotstick operation allowing the conductor to be removed from the same side
- Gate opening latch is a one-hand operation
- Extended rope guards prevent rope from snagging between frame and sheave
- The top is enclosed to protect rope or conductor in case of uplift
- All edges are smoothly contoured to prevent damage to rope or conductor



## 6708-3/6711-3: Stringing Blocks

- Aluminum alloy cast sheaves with machined groove
- Roller bearings
- Aluminum alloy case side frames

	6708-3		6711-3	
Sheave Dimensions	Unlined	Lined	Unlined	Lined
Outside Dimensions	8"	8"	10 3/4"	10 3/4"
Root Diameter	6"	6 1/2"	8"	8 1/2"
Groove Radius	5/8"	1/2"	11/16"	9/16"
Groove Depth	1"	3/4"	1 3/8"	1 1/8"
*Weight	Approx. 15 lbs		Approx. 27 lbs	
Groove sides flared outwards at 15° on unlined sheave and at 30° on lined sheave				
*Basic block weight (not including base)				



## 4700 Series: Stringing Blocks

- Compact steel frame, zinc plated
- Cast nylon sheave
- Crosshead and type 'B' socket for suspension
- Lightweight construction
- Sealed ball bearings

Nominal Sheave Dimensions					
	4716-1Ny	4720-1Ny	4726-1Ny	4730-1Ny	4736-1Ny
A	16	20	26	31	36
B	14	16	22	26	31
C	1	2	2	2.5	2.5
D	.71	1	1.3	1.3	1.6
E	2	3	3.5	3.5	4.3
Weight (Approx.)	38 lbs	43 lbs	47 lbs	54 lbs	66 lbs



## KTA Adaptor

- Used for mounting on Universal-K Type Insulators





# Timberland Equipment Ltd.

STRINGING

## Gatortail Rope

- 12 braid synthetic construction, urethane saturated
- Available in 4 standard colors: orange, yellow, red and green
- Torque free (will not rotate under load)
- Excellent to handle (stays flexible). No kinking or hocking
- Open construction allows easy inspection for wear or damage
- Easy to splice without special tools



Rope Diameter	Average Tensile Strength	Maximum Work Load	Weight per ft.
3/8"	6600 lbs	1320 lbs	.045 lbs
7/16"	8800 lbs	1760 lbs	.062 lbs
1/2"	14600 lbs	2920 lbs	.08 lbs
9/16"	17000 lbs	3400 lbs	.098 lbs
5/8"	20100 lbs	4020 lbs	.143 lbs
3/4"	23000 lbs	4600 lbs	.175 lbs
7/8"	37800 lbs	7560 lbs	.231 lbs
1"	41900 lbs	8380 lbs	.330 lbs

## Breakaway Reels

Steel breakaway reels are specifically designed for winding in and banding old conductor on reconductoring operations. They may be used with take-up winders or puller tensioners and feature tapered barrels for ease of conductor removal in a compact banded coil. The unique flange lock feature provides complete flange security during pulling operations while permitting quick flange removal. Special sizes are available for special applications.



	BRS2814	BRS6030	BRS6632	BRS7236	BRS8436
Outside Dia.	28"	60"	66"	72"	84"
Outside Width	15"	35"	38"	42"	42"
Width b/w flanges	14"	30"	32"	36"	36"
Barrel type	split taper	tapered	tapered	tapered	tapered
Barrel dia.	16"	25"	32"	32"	34"
Maximum Linepull	1000 lbs	1500 lbs	1500 lbs	1500 lbs	1500 lbs
Weight	135 lbs	850 lbs	1000 lbs	1150 lbs	1350 lbs

## SW Series Line Swivels

Stainless steel construction. Intended for connecting the pull rope to the utility product in an overhead and underground application. The swivel permits rotation of the pull rope while protecting the product from twisting. Line swivels are not designed to run around bullwheels. Slotted clevis pins on SW-17 to SW-13. Hex clevis pins on swivels SW-14 to SW-38.

Part #	Safe Working Load	Ultimate Load	A	B	C	D	E	F	G	H	Net Weight
SW-7	750lbs.	2,250lbs.	5/8"	9/32"	3/16"	11/16"	1/4"	2"	2-1/2"	N/A	0.13lb
SW-9	2,250lbs.	6,750lbs.	7/8"	3/8"	5/16"	31/32"	7/16"	2-1/2"	3-3/8"	7/32"	0.33lb
SW-10	3,500lbs.	10,500lbs.	1"	13/32"	3/8"	1-3/32"	1/2"	2-7/8"	3-7/8"	1/4"	0.50lb
SW-13	5,000lbs.	15,000lbs.	1-1/4"	17/32"	13/32"	1-9/32"	17/32"	3-11/16"	4-3/4"	1/4"	1.0lb
SW-14	7,000lbs.	21,000lbs.	1-3/8"	9/16"	1/2"	1-3/8"	5/8"	3-7/8"	5-1/8"	5/16"	1.4lb
SW-15	9,000lbs.	27,000 lbs.	1-1/2"	19/32"	1/2"	1-9/16"	11/16"	4-1/4"	5-5/8"	5/16"	1.7lb
SW-17	10,000lbs.	30,000lbs.	1-5/8"	11/16"	5/8"	1-23/32"	3/4"	4-1/2"	6"	3/8"	2.1lb
SW-19	15,000lbs.	45,000lbs.	2"	25/32"	11/16"	2-1/16"	15/16"	5-1/8"	7"	7/16"	3.8lb
SW-26	30,000lbs.	90,000lbs.	2-3/8"	1-1/32"	7/8"	2-25/32"	1-3/16"	7-5/8"	10"	7/17"	7.6lb
SW-30	50,000lbs.	150,000lbs.	3"	1-3/16"	1-1/8"	3-5/8"	1-1/2"	10"	13"	7/17"	20lb
SW-38	62,500 lbs.	187,500lbs	3 3/4"	1 1/2"	1 1/4"	4 1/4"	1 7/8"	12 1/8"	15 7/8"	1/2"	34lb



Itlutilitysupply.com



## Complete Hand Line Sets with 1/2" Polypropylene Rope



- Complete handline sets available with rope lengths of 60', 80', and 100'
- Features selected length of 1/2" polypropylene rope, (1) handline block, (1) handline hook, and (1) swivel snap hook

3555	60' Overall Length
3556	80' Overall Length
3557	100' Overall Length

## Complete Hand Line Sets with 1/2" Soft Navy Braid Rope



- Complete handline sets available with rope lengths of 60' and 80'
- Features selected length of 1/2" soft navy braid rope, (1) handline block, (1) handline hook, and (1) swivel snap hook

CT01732	60' Overall Length
CT01733	80' Overall Length
CT01789	100' Overall Length

## P10060 Hand Line Hook



- Constructed from manganese bronze alloy
- Use with up to 1/2" diameter rope
- 600 lbs working capacity

## 3550 Hand Line Block



- Block and sheave constructed of rugged nylon fiberglass reinforced high di-electric material
- Side opening block with swivel hook and safety snap
- 4" block size
- Rated with a 3-1 safety factor

## P30142 Hand Line Snap



- Drop-forged snap opening of 5/8"
- Rated capacity of 5000 lbs.

## Insulated Tackle Blocks

- Designed for all types of hoisting-related jobs
- Especially ideal for hot-line use
- Bodies are made from high-impact, dielectric thermoplastic material
- All hooks have full swivel capabilities
- Sheaves are made with fiberglass reinforced nylon material
- Shafts are stainless steel
- Swivel hooks are plated and include hot eye for application with hot sticks
- Maximum loading of blocks should not exceed 2000 lbs

## 3551 Hand Line Block



- Block and sheave constructed of rugged nylon fiberglass reinforced high dielectric material
- Closed block with swivel hook and safety snap
- 4" block size
- Rated with a 3-1 safety factor

Part #	Description	Upper	Lower
11361	Blocks Only - No Rope	2 Sheave	2 Sheave
11362	Blocks with 120' 0.5" Polydacron Rope	2 Sheave	2 Sheave
11367	Block Only - No Rope	3 Sheave	2 Sheave
11368	Blocks with 150' 0.5" Polydacron Rope	3 Sheave	2 Sheave
11052	Single Block Only	2 Sheave	
11051	Single Block Only	3 Sheave	



# Klein Tools

STRINGING

## HANDLINE EQUIPMENT

### Klein Block & Tackle

- Maximum safe load is 750 lbs.
- 1802-30 is furnished with 25' of 3/8" rope, (1) 267 block with a snap hook and (1) detachable forged anchor hook on one end, and (1) block 268 with eye and rope tie-off hook on the other end
- 1802-30 S/R has the same features as 1802-30, but with rope spliced to the 268 block
- 1802-30S has the same features as 1802-30, except supplied with a detachable swivel anchor hook instead of hook 258
- 1802-30S S/R has the same features as 1802-30S, but with the rope spliced to the 268 block
- H1802-30 features 25' of 3/8" rope, (1) 267 block with guarded snap hook, (1) detachable forged anchor hook on one end, (1) block 268 with eye and rope tie-off hook on the other end
- H1802-30 S/R has the same features as H1802-30 but with the rope spliced to the 268 block

**Part #**

**1802-30**

**1802-30 S/R**

**1802-30S**

**1802-30S S/R**

**H1802-30**

**H1802-30S**

**H1802-30 SR Guarded Snap Hook**



### Klein Blocks

- Blocks without ropes and hooks
- Made of light galvanized steel and aluminum alloy
- Sheaves have bronze bushings
- 268 is a block with an eye to splice line to block and rope tie-off
- 268 and H268 feature an eye to splice line to block and rope tie-off hook
- Available with standard or guarded snap hooks
- Maximum safe load is 750 lbs.

- 267 Plain Block**
- 268 Standard Snap Hook**
- H268 Guarded Snap Hook**



267



268



H268

### 1702-20N Howe Wire Tool

- Strap is made of tough nylon webbing
- Swivel hook is forged steel with large opening
- Shank of hook lengthened to reach under insulator
- Other end has device to hold the load at any distance
- All metal parts are galvanized
- Maximum safe load is 500 lbs.



### Handline Swivel Snap Hook

- 750 lb. working load
- Swivel hook with plunger latch
- Forged steel construction
- For use with up to a 1/2" diameter rope



**CAUTION: These hooks are NOT intended for use with occupational protective equipment**

Itlutilitysupply.com



## Chance Block with Insulated Rope



- Shells and sheaves are made of high dielectric, fiber-filled natural nylon
- Shaft is of silicon bronze and the sheave bearings are oil impregnated bronze
- Dielectric rating in dry weather is 30,000 volts between the bearing and the mounting bolt nut
- Maximum 1/2" rope
- Maximum load is 3500 lbs for both double and triple blocks

**C4009019 Double Block with Becket**

**C4000918 Triple Block without Becket**

## Chance Double Nylon Rope Blocks



- The shells and sheaves are made of high dielectric, fiber-filled natural nylon
- Shaft is made of silicon bronze and sheave bearings are oil impregnated bronze
- Maximum 0.5" rope
- Blocks available with either polypropylene or Polydacron rope for minimum stretch and long service life
- Dielectric strength: dielectric rating in dry weather is 30,000 volts between the bearing and the mounting bolt nut

**C4000925 Double/Triple Blocks Set; 150' Rope**

**C4000924 Double Blocks Set; 120' Rope**

## Chance Snatch Blocks



- Light-weight cast-aluminum housing and sheave with a hinged, cotterlock yoke and either forged steel or steel meat hook, makes for quick, easy rigging in diversified applications
- Handline and block and tackle efficiency is increased with a forged steel swivel-eye suspension ring and a 3" sheave operating on bronze oilite bearings
- Maximum rope size is 5/8"
- Maximum load capacity is 1250 lbs

**2230-1 Single Block 2500 lbs capacity**

## Snatch Blocks

- Hook and shackle assemblies can be interchanged
- Opening feature permits insertion of rope while block is suspended from gin-pole
- Blocks have exclusive bolt retaining spring to assure no lost bolts
- Forged alloy heat treated hooks
- Forged steel swivel tees, yokes and shackles

**3" 2 Ton Capacity**

**4 1/2" 4 Ton Capacity**

**6" 8 Ton Capacity**

**8" 8 Ton Capacity**



TRUSTED SINCE 1958

# Bethea Tool

## Bethea Tool Travelers



- Polished aluminum with a urethane lining
- Safe working load is based on single resultant vertical load on center (pulling line) sheave
- BTTV-31-UL18-12 features a working load of 15,000 lbs.
- BTTV-31-UL14-8 features a working load of 8,000 lbs.
- Major load supporting members are made from heat-treated aluminum alloy
- The ultimate in cost efficiency
- Precision ground, deep-groove Conrad type shielded ball bearings increase the efficiency of each traveler, and simplify the sagging operation
- Urethane of the highest grade and of the proper hardness is used for lining the conductor sheaves
- Pulling line sheaves are lined with high strength, wear-resistant urethane which under normal use outlasts most steel and iron linings
- Safe rapid attachment to supporting hardware is accomplished with captive pushbutton ball lock pins or safety pins
- These components are secured to the traveler with welded closed link chain
- All ferrous components are protected from corrosion, depending on application by hot dip galvanized, electro-cadmium plating, or rust-inhibiting enamel

**BTTV-31-UL18-12 22" diameter**

**BTTV-31-UL14-8 16" diameter**

## UB-1C: Universal Roller

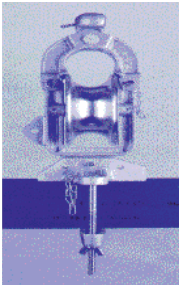

- Bethea's UB-1-C Universal Roller is the solution to your search for a quality engineered sheave that is lightweight (7.4 lbs), versatile, durable and dependable. It can be intermixed with similar stringing blocks and mounting attachments manufactured by others without affecting conductor sag and tension
- The quality of the UB-1-C roller is unsurpassed by any roller of its type. Its aluminum parts are cast from high strength A356 alloy, heat-treated to the T6 condition, giving it the capability of withstanding rough treatment under adverse conditions while supporting heavy loads
- The UB-1-C may be attached directly to ANSI Class 52-3 & 5 ball and socket insulators using the socket eye supplied as an integral part of the unit. If desired, the UB-1-C socket eye can be attached to optionally available fittings, i.e., our CB-55 Clevis Ball; YCB-65 Y-Clevis Ball; OEB-55 Oval Eye; BH-5L Ball Hook or SHB-1 Ball Safety Hook
- Other optional mounting adapters are also available: IA-1 for clamp top type post insulators; IA-2 for tie top post insulators and XA-1 for crossarms. These adapters must be ordered separately. The UB1-A has a 90° adapter mounting lugs on each side of the frame. These allow positioning the sheave horizontally, if desired, when used with the XA-1 crossarm adapter or the IA-2 when attached to a horizontal tie post insulator
- The transfer of conductor or rope from UB-1-C Universal Roller is quickly and easily accomplished by the removal of a single ball loc pin. This pin is designed for safe, smooth, single-motion hand operation. The ball loc pin is secured to the roller with a welded closed link chain. When released, the frame opens wide for conductor clipping
- The sheave groove is profile machined for centricity, thus permitting more precise sagging of the conductor. In addition, the universal roller is available with urethane sheave lining (UB-1-CUL) or neoprene lined sheave (UB-1-CNL)
- Conrad Type, ABEC precision ground, deep groove ball bearings are used in the sheave hub. They are permanently lubricated with Bethea BSG150 wide temperature range (-60F to 600F) synthetic lubricant

## ADSS FIBER OPTIC CABLE SOLUTIONS

### Typical Installation and Tools

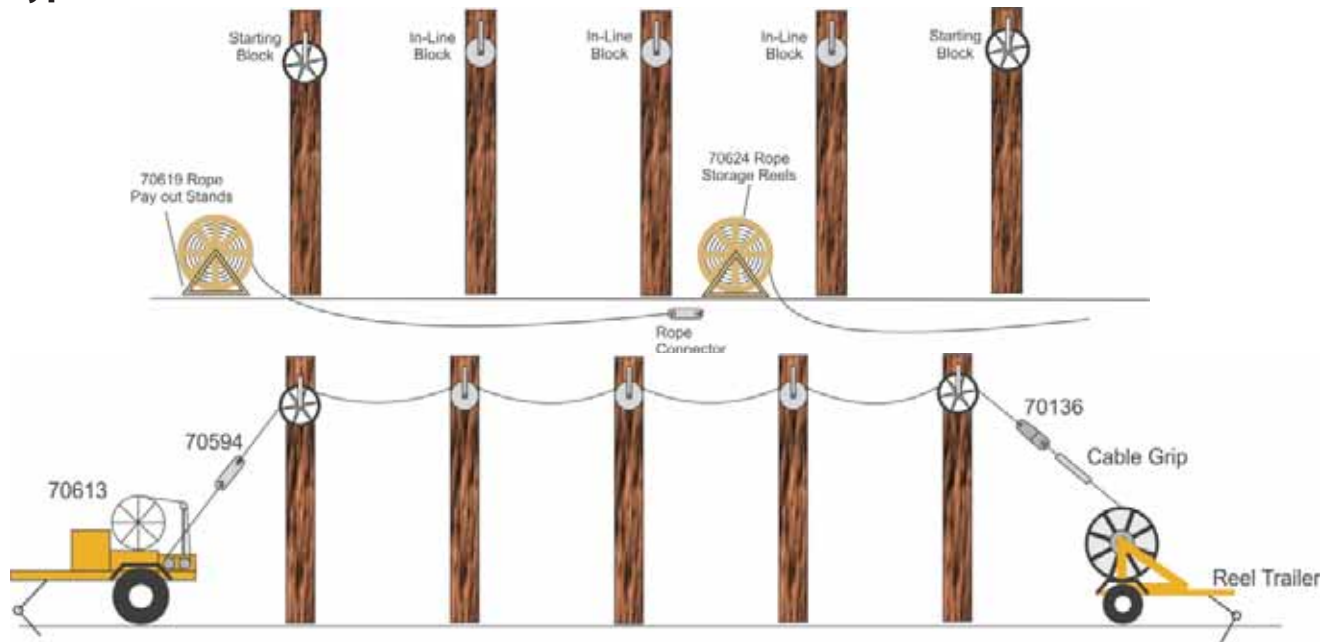

## RECOMMENDED INSTALLATION EQUIPMENT

### In Line Block

Split side frame and hooks make it easy to use. The side frame incorporates a guide ring to protect the fiber cable. The sheave rides on ball bearings



#### 70615

- O.D.: 7.87"
- Groove Width: 2.36"
- Root Dia.: 5.4"
- Wt.: 8.52 lbs
- W.L.L.: 660 lbs

#### 70616

- O.D.: 8.44"
- Groove Width: 2.36"
- Root Dia.: 6.0"
- Wt.: 9.5 lbs
- W.L.L.: 660 lbs

### 70595: Starting Block

- The block has a safety gate and steel side frames. The sheave rides on ball bearings
- O.D.: 11.8"
- Groove Width: 1.77"
- Root Dia.: 9.64"
- Wt.: 15.4 lbs
- W.L.L.: 2646 lbs



### Starting Block

The large diameter profiled groove helps protect the cable. The swivel oval eye, cable gate and cable retaining pin make it easy to use. The sheave rides on ball bearings.

#### 70621

- O.D.: 18.50"
- Groove Width: 2.17"
- Root Dia.: 15.16"
- Wt.: 30.8 lbs
- W.L.L.: 5291 lbs

#### 70614

- O.D.: 26.06"
- Groove Width: 2.36"
- Root Dia.: 23.62"
- Wt.: 33.1 lbs
- W.L.L.: 5291 lbs



# General Machine Products

STRINGING

## 70594: Rope Connector

- Rope connectors provide an effective method of joining pulling ropes
- W.L.L.: 2200 lbs



## 70136: Heavy Duty Ball Bearing Swivel

- These tough stainless steel swivels are designed to handle higher thrust loads for extra cable safety
- W.L.L.: 1350 lbs



## Flexible Pulling Grips

- Manufactured from high-tensile, galvanized steel wire that is evenly woven in a triple wire weave, grips are slipped over the outside sheath of a cable. When pulling tension is applied, the grip contracts applying its gripping force to the outside of the cable



GMP	Diameter Range	Minimum Breaking	Grip Length
70681	.47 to .75"	7452 lbs	32.48"
70682	.75 to .98"	12214 lbs	40.35"
70683	.98 to 1.26"	21054 lbs	51.18"

## 70624: Rope Storage Reel with 5/16 x 2000' of Rope

- Unique reel design that allows it to be used on both the payout stand and the Cable Pony. Holds up to 2,000' of 5/16" dia. pulling line
- W.L.L.: 2200 lbs



## 70619: Rope Pay Out Stand

- Supports the rope storage reels during the stringing process



## 70613: Cable Pony Hydraulic ADSS Winch

- The GMP Cable Pony winch offers the constant pulling tension of a double capstan drive and the flexibility of a direct drive drum in one machine
- Max. Pulling Capacity: 2200 lbs (1000 kg)
- Rope Speed Max.: 130 ft/min (40 meters/min) at capstan



## 70400: Apollo Lasher

- Under 39 lbs., (17.7 kgs) without wire, 12-1/2 in. (318 mm) diameter
- Lashes any telcom cable/innerduct combination up to 4 in. (10 cm) diameter
- Parallel-pull capability overcomes all terrain obstacles
- Interference-free over-lashing with no modifications
- Positive slip-free gear drive (no belts) tested in excess of 1 million cycles
- Lashes to strand sizes 1/4 in. to 3/8 in. (6 - 10 mm) diameter lasher in use
- Holds two coils of industry standard wire .045 in. x 1200 ft. (1.1 mm x 365 m) or .038 in. x 1600 ft. (1. mm x 488 m)
- Provides adjustable tension of lashing wire, affording tight or loose lash
- Wire tension constant regardless of amount on spool
- No lasher backroll when pulling force removed
- Front rollers guide cables through the machine
- All smooth edges throughout provide 360° protection against cable damage
- Ergonomic design makes it easy to handle



## 71422: C2 Lasher

- Lashes single or bundled cables up to 1-7/8 in. (46 mm) onto strand sizes 1/4 in. to 3/8 in. (6-10 mm) diameter
- New style strand lock swings out of the way for unobstructed over-lashing
- Simple wire routing yields either "normal" or "loose" wire tension
- Dual wire magazines for loading two coils of stainless steel lashing wire
- Typical wire dimensions: 1200 ft. x .045 in. (365 m x 1.1 mm) or 1600 ft. x .038 in. (487 m x 1 mm)
- Lightweight and compact: Unloaded weight 35 lbs. (16 kgs.); only 10 in. O.D. x 18.5 in. long (25 x 47 cm)
- The C2's tapered housing eases passage through treed areas
- The C2 Cable Lasher is furnished with a 6 ft. (1.6 m) bridle rope with snap hooks, an instruction manual and a rugged, lightweight storage chest



## 86070: J2 Lasher

- Will lash any single or multiple aerial cables up to 3 in. (76 mm) diameter across on any suspension strand from 1/4 in. (6 mm) to 7/16 in. (11 mm)
- Consists of a rotating drum supported on a carriage that provides the mounting for a driving mechanism, cable lifters, cable and strand rollers
- Each of two recessed magazines will hold a 1200 ft. coil of .045 in. (365 m of 1.1 mm wire) lashing wire (or 450 ft. of .065 in.). The Lashing Wire is fully recessed and covered by a gate
- Features a fast setup procedure, quick coil loading, and automatic drum lock for easy span transfers and smooth forward travel
- Easy lashing, push down on the strand roller knob, rotate it a quarter turn and you can lash additional cables together on previously lashed cable
- Positive internal gear-to-gear mechanism has no chains or belts to stretch, slip or break
- Constructed with heat-treated, plated steel, stainless steel, brass and aluminum components. Contains sealed and oilless bearings to minimize maintenance and assure durability
- Pre-drilled and tapped at the factory for mounting of the lasher guard or "halo". For use when lashing in overgrown areas
- The lasher is furnished with a rugged lightweight storage chest with corrosion resistant hardware, recessed latches and a moisture-proof, tongue-in-groove design for maximum protection when not in use
- Supplied with a 6 ft. bridle rope assembly and snap hooks, and an information and operation manual





# General Machine Products

STRINGING

## OVERHEAD ELECTRIC PLACING EQUIPMENT

### G Cable Lasher

- Lashes any cable from 2 1/2" to 5" diameter, on strand from 1 1/32" to 3/4" diameters with one or two left lay spiral wrappings of .065" diameter stainless steel wire
- Can be used for new installs or with existing cables in place
- Nominal spacing between wraps is 16 1/2"
- Each lasher includes a 6' bridle rope assembly with snap hooks, an information and operations manual, and a heavy duty storage chest

- 10500 G Cable Lasher Standard
- 10502 G Cable Lasher Modified for 1200' of .045" Wire
- 03165 Bridle Rope Assembly Only
- 10501 Chest Only
- 70190 Towing Lanyard 35 ft. (optional)



### 01051: G Cable Block

- Block is functionally similar to the D Cable Block
- This larger tool can be used with the G Cable Lasher to handle cable up to 5" diameter and features strand hooks to accommodate 3/8 - 3/4" diameter strand
- This heavy duty block is made from 100% heat treated aluminum alloy
- Contains two vertical side rollers in addition to the cable sheave to minimize cable friction during pulling in

### Stainless Steel Lashing Wire

- Used to lash an aerial cable or combination of cables to a supporting strand
- Packaged as 6 coils per carton for ordering convenience
- Available in a 430, 302, and 316 stainless steel alloy
- All lashing wire is wound in a straight hub configuration to fit all the standard GMP lashers

#### Type 430 Stainless

- Low carbon, 17% chromium wire
- Suitable for general use and in ordinary atmospheric exposure
- Will acquire only a dark surface stain
- Specifically not recommended for use within 25 miles of salt water or industrial operations which emit pollutants

#### Type 302 Stainless

- 18% chromium, 8% nickel analysis
- Excellent resistance to corrosion from industrial atmospheres
- Higher tensile strength and breaking load are an added benefit
- A .038 in. diameter Type 302 wire provides strength equal to a .045 in. type 430 wire with better ductility (easier bending and unwinding) and better elongation (less chance of wire breakage from stress)

#### Type 316 Stainless

- Modified 18-10 analysis containing approximately 2.5% molybdenum
- More resistant to the corrosive action of most chemicals, including chlorides and sulfides, than any other wire
- Particularly resistant to pitting and pin hole corrosion of the kind commonly caused by salt spray
- Its use provides the best insurance against failure under the most severe atmospheric conditions

#### Buying tip:

- When estimating the length of lashing wire required for a cable run, add the following amounts to the length of the run for single lashing:

Add:*	For Cables Up to:
5%	1 1/2" diameter
10%	1 1/2" to 3" diameter
20%	Over 3" diameter

\* For double lashing, double the quantity

#### Note:

- 1) Fits standard C2 Lasher, J2 Lasher, and Apollo Lasher
- 2) Fits G Lasher or Modified C2 and J2 Lashers



GMP	Alloy	Diameter	Ft./Coil	Coil Dia.	Coil Width	Coil Package	Note
71530	430	.045	1200	5.38"	1.81"	6	1
71532	430	.065	450	5.5"	1.69"	6	2
71533	302	.045	1200	5.38"	1.81"	6	1
71534	316	.045	1200	5.38"	1.81"	6	1
71535	302	.038	1600	5.38"	1.81"	6	1

## OVERHEAD ELECTRIC PLACING EQUIPMENT

### 07886: D Lashing Wire Clamp, 2 piece - 100/box



- Perfect for temporary and permanent terminations or grounds, this all steel clamp lets you securely attach two lashing wires or #6 ground wire on any size strand from 1/4" to 7/16" diameter

### 81460: E Lashing Wire Clamp, 7/16" Opening, 1 piece - 100/box



- Designed for permanent wire terminations, this clamp has the same hardware, construction and clamping range as the D Clamp, but with a one piece stamping formed to let both sides grip the messenger in perfect alignment

### 10553: 3 Sheave Cable Block



- Heavy duty multiple sheave cable Blocks are used to simultaneously support two, three, or four cables prior to lashing to a supporting suspension strand
- 3 sheave multiple cable block can keep up to three 2 1/2" diameter or smaller cables separate until you're ready for lashing to the messenger
- The 3 sheave block is ideal for triplexing cables in the electrical industry; lashing up to three 750 MCM cables together to a supporting strand
- Features heat treated aluminum alloy frame and sheave, with Oilite bearings on the sheave and steel inserts on the strand hooks for easier movement
- A bi-directional lever operated cam locks the block in place during pulling in, then automatically releases during lashing

### Multi-Roller Overhead Cable Guide



- The roller type aerial cable guide is used to guide and straighten cables as they are pulled into a lashing position from a stationary or moving cable reel
- With its three sheaves to guide cable with minimum friction, this is the best tool you can use when handling especially heavy cable, or when using an aerial basket for "drive-off" lashing
- The guide rides along the strand on a roller bearing for smooth movement
- A built-in grip prevents back-rolling during span transfers
- Also included with the guide is a safety chain to prevent the guide from coming off the strand

91605\* (3) Roller Guides for 4" Cable or Bundles to 4"

91606\* (3) Roller Guides for 2 3/4" Cable or Bundles to 2 3/4"

\*Above cable guides have 2 rollers instead of the rubber grip and they do not require the use of the hitch weldment or hitch field kit

91604 (3) Roller Overhead Cable Guide for 2 3/4" Cable

30140 Hitch Weldment for J2 Lashers

70125\*\* Hitch Field Kit for F, J, J2 Lashers Guide for 2 3/4" Cable

\*\*Only J2 Lashers with serial #91-0001 or higher are factory ready equipped with a Hitch Weldment. All other J2 Lashers should be retro-fitted with a Hitch Field kit

# Rope Accessories

## Crosby Swivels

- All swivels individually proof tested/certified
- Equipped with tapered roller thrust bearing
- Suitable for frequent rotation under load
- All hooks furnished with latches assembled
- All jaws complete with bolts, nuts, and cotter pins
- Pressure lube fitting provided
- Not to be used on demolition (wrecking) balls

Working Load Limit: 5 tons  
Wire Rope Size: 5/8"  
Weight: 15.51 lbs.  
297217



Working Load Limit: 8.5 tons  
Wire Rope Size: 3/4"  
Weight: 29.42 lbs.  
297413

Working Load Limit: 10 tons  
Wire Rope Size: 7/8"  
Weight: 42.5 lbs.  
297618

## 599533: Crosby L-160 Series Snatch-Block

- Heavy duty
- Hook is forged alloy steel - quenched and tempered
- Designed for fast, efficient line changes
- All parts are forged
- Beaded side plate prevents rope from jamming
- Blocks furnished with dual rated wireline sheaves
- Fatigue rated
- Shackle fitting
- Sheave diameter: 5"
- Working load limit: 6 tons
- Wire rope size: 3/8" - 1/2"
- Weight: 15 lbs



## Crosby 5 Ton & 8.5 Ton Swivel Hook

- All swivels individually proof tested with certification
- Suitable for frequent rotation under load
- Hooks furnished with latches assembled
- Other types and capacities, up to 600 tons, available to meet your requirements
- Suitable for digger derricks

297217 5 Tons  
29741 8.5 Tons



## 109037: Crosby Snatch Block

- 6" OL assembly for 1/2" wire line
- Forged alloy heat treated hooks
- Forged steel swivel tees, yokes and shackles
- Hook and shackle assemblies on 4 1/2" through 14" sizes can be interchanged
- Can be furnished with bronze bushings or roller bearings
- Opening feature permits insertion of rope while block is suspended from gin-pole
- 3" thru 18" 418 and 419 blocks have exclusive bolt retaining spring to assure no lost bolts
- Pressure lube fittings
- Fatigue rated
- 3" - 10" feature dual rated wireline sheaves



## Crosby Screw Pin Shackles

- Forged, quenched and tempered, with alloy pins
  - Working load limit permanently shown on shackle
  - Hot dip galvanized or self-coloured
  - Fatigue rated
  - Can meet DNV impact requirements of 42 joules at 20°C
  - Meet or exceed all requirements of ASME B30.26, including identification, ductility, design factor, proof load, and temperature requirements
- Also meets other critical performance requirements including fatigue life, impact properties, and material traceability, not addressed by ASME B30.26

1018446	7/16"	1 1/2 Ton Capacity, 1/2" Pin
1018464	1/2"	2 Ton Capacity, 5/8" Pin
1018482	5/8"	3 1/4" Ton Capacity, 3/4" Pin
1018507	3/4"	4 3/4 Ton Capacity, 7/8" Pin
1018525	7/8"	6 1/2 Ton Capacity, 1" Pin



## S-322CN/S-322AN:1 Ton Swivel Hook

- Suitable for frequent rotation under load
- Used for material handling aerial devices
- 1" diameter hook opening



## Crosby Replacement Latch Kit

- Heavy duty stamped latch interlocks with the hook tip
- High cycle, long life spring
- Can be made into a "positive locking" hook when proper cotter pin is utilized
- Latch kits shipped unassembled with instruction

1096562 for 234-21010 Crosby 5 Ton Swivel Hook



## Dillon Mechanical Model AP Dynamometers

- Accuracy +/- 0.5% of full scale capacity for precise data
- Broad temperature range for use in nearly any environment
- No batteries required
- Large safety factor for overload protection
- Anti-parallax dial and pointer produce accurate readings from any perspective
- Maximum hand retains peak load point and is easily reset
- Standard Model AP Dynamometer includes: Dynamometer, shackles and pins, maximum pointer, zero adjust for tear, carrying case (molded plastic on 5" models or rugged plywood crate for 10" models) and calibration certificate

Part#	Capacity & Dial Division in lbs	Diameter of Dial
30006-0027	1000x10	5"
30006-0035	2000x20	5"
30006-0084	10,000x100	5"
30006-0100	20,000x200	5"



## Dillon Digital ED Extreme Dynamometer

- Superior strength and corrosion resistance
- 5:1 safety factor
- Typical accuracy of 0.1% of full scale capacity
- Exclusive soft-key interface and wide angle LCD
- Powered by (2) standard C-cell batteries
- Backlit display

**AWT05-506312 2500 lb Capacity**



## Dillon Digital ED Junior Dynamometer

- Can be relied upon for simple, yet critical measurements of weight and force
- Shares the same base of research and testing that was conducted to match material characteristics and load cell technology
- Typical accuracy of 0.2% of full scale capacity
- Exclusive soft-key interface and wide angle LCD
- Powered by (2) standard C-cell batteries

**AWT05-506319 10,000 ft lbs x 10 lbs Dial Division**



# Ropes

## Double Braided Nylon Rope



All Double Braid Nylon is Fully Spliceable

- A double braid is a braid-over-braid construction where the load is shared equally by both braids
- This creates a strong, balanced rope that will not torque when loaded
- Double braided nylon is a strong supple rope that is resistant to abrasion, oil, alkalis, organic solvents, and most other chemicals
- It is not susceptible to mildew and has good abrasion resistance to UV deterioration
- It is used in applications where energy absorption at working load is required. For example, marine anchor lines and auger ropes

Stock Number	Diameter (in)	Spool Length (ft)	Approx. Weight per 100 ft (in)	Breaking Strength(lbs)
BNY3/16	3/16	1200	1.25	1,020
BNY1/4	1/4	1200	1.5	1,850
BNY5/16	5/16	600	2.4	2,850
BNY3/8	3/8	600	3.5	4,100
BNY7/16	7/16	600	4.7	5,500
BNY1/2	1/2	600	6.2	7,100
BNY5/8	5/8	600	10.9	12,500
BNY3/4	3/4	600	13.8	15,600
BNY7/8	7/8	600	20.6	23,000
BNY1	1	600	24.5	27,400
BNY1-1/4	1 1/4	600	38.4	42,000

## Double Braided Polyester Rope

- Double braided polyester is a strong, supple rope that has low stretch at working loads
- It has low shrinkage and resists acids, organic solvents and most chemicals
- It is not attacked by mildew and has the best UV resistance
- Double braid polyester will not torque when loaded
- It is used for marine rigging and industrial applications



Stock Number	Diameter (in)	Spool Length (ft)	Approx. Weight per 100 ft (in)	Breaking Strength (lbs)
BPE3/16	3/16	1200	1.4	950
BPE1/4	1/4	1200	1.85	2100
BPE5/16	5/16	600	2.9	3100
BPE3/8	3/8	600	4.2	4200
BPE7/16	7/16	600	5.7	5700
BPE1/2	1/2	600	7.5	8100
BPE5/8	5/8	600	13.2	12800
BPE3/4	3/4	600	16.5	16000
BPE7/8	7/8	600	25.0	23600
BPE1	1	600	29.7	28000
BPE1-1/4	1 1/4	600	46.5	43300
BPE1-1/2	1 1/2	600	66.8	61800
BPE2	2	600	119.0	95000

## Double Braided Polypropylene Rope



- Polypropylene double braid floats and resists deterioration from chemicals
- It is very lightweight and is commonly used for water safety throw lines

Stock Number	Diameter in Inches	Spool Length in Feet	Approximate Weight (lbs) per 100 Ft.	Breaking Strength (lbs)
BPP1/4	1/4	1200	1.2	970
BPP3/8	3/8	600	2.6	2000

## Three Strand Nylon Rope

- Long continuous fibers are twisted together to form larger strands. Three strands are twisted together in three strand construction creating a strong, abrasion resistant rope
- Three strand nylon is a strong, abrasion resistant rope with excellent shock absorbing characteristics at working loads
- It is resistant to alkalis, organic solvents, and most other chemicals. It is not susceptible to mildew and has good resistance to UV deterioration



Stock Number	Diameter in Inches	Spool Length in Feet	Approximate Weight/ Lbs Per 100 Feet	Breaking Strength in Pounds
TNY1/4	1/4	1200	1.9	1700
TNY5/16	5/16	600	3.0	2700
TNY3/8	3/8	600	4.0	3500
TNY7/16	7/16	600	5.0	4300
TNY1/2	1/2	600	7.0	5950
TNY5/8	5/8	600	10.8	8800
TNY3/4	3/4	600	15.4	12700
TNY1	1	600	27.5	22000
TNY1-1/2	1 1/2	400	62.0	47700
TNY2	2	300	108.5	81400

# Ropes

## Three Strand Polyester Rope

- Three strand polyester, under working load, has lower stretch and elongation properties than three strand nylon
- It is resistant to acids, organic solvents, and mildew. It has the best resistance to UV deterioration



Part #	Diameter (inches)	Spool Length (ft)	Approximate Weight (lbs) Per 100 Feet	Breaking Strength (lbs)
TPE1/4	1/4	1200	2.2	1,490
TPE5/16	5/16	600	3.3	2,300
TPE3/8	3/8	600	4.5	3,340
TPE1/2	1/2	600	7.7	5,200
TPE5/8	5/8	600	11.5	8,000
TPE3/4	3/4	600	16.6	10,500
TPE1	1 Coils	600	31.3	19,000

## Three Strand Polypropylene Rope

- Industrial and retail grade polypropylene rope is made from mono-filament polypropylene
- Polypropylene is resistant to deterioration from chemicals
- It makes a good general purpose rope that is lightweight and floats
- Retail grade polypropylene is an economical choice
- White polypropylene is commonly used in awnings and banners



Industrial Grade



Retail Grade

Part #	Diameter (in)	Approximate Weight/600 Ft in Pounds	Approximate Weight/1200 Ft in Pounds	Breaking Strength (lbs)
<b>Industrial Grade Three Strand Polypropylene - In Coils - Yellow with Green Stripe</b>				
TPPI38Y12C	3/8"	1200	35	2400
TPPI12Y12C	1/2"	1200	60	4200
TPPI12Y6C	1/2"	600	30	4200
TPPI58Y12C	5/8"	1200	90	5900
TPPI58Y6C	5/8"	600	45	5900
TPPI34Y12C	3/4"	1200	130	8500
TPPI34Y6C	3/4"	600	65	8500
TPPI1Y6C	1"	600	110	14000
TPPI114Y6C	1-1/4"	600	160	21500
TPPI112Y6R	1-1/2"	600	245	30500
TPP1-1/2Y	1 1/2	230	460	30500
TPP2Y	2	415	830	51000
<b>Three Strand Polypropylene - Retail Grade - No Cuts</b>				
TPPR316Y	3/16"	2125	15	
TPPR14Y	1/4"	1300	15	900
TPPR516Y	5/16"	975	15	1300
TPPR38Y	3/8"	630	15	1900
TPPR12Y	1/2"	335	15	3300
TPPR58Y	5/8"	175	15	4700
TPPR34Y	3/4"	125	15	6800

## Hollow Braid Polyethylene Rope



- Made from mono-filament polyethylene yarns, hollow braided construction, easy to splice
- Floats and lightweight
- Water and ice will not saturate the fibers, ideal for wet and icy conditions such as bump lines, water safety throw lines
- Also great for dogsledding gang, tug and neck lines and utility spider lines
- Available in: white, red, blue, green, black and yellow

Part #	Diameter	Reel Length (ft)	Spool Weight (lbs)	Breaking Strength (lbs)
HBE14	1/4"	1000	10	870
HBE516	5/16"	1000	16	1250
HBE38	3/8"	1000	22	1800
HBE12	1/2"	500	17	2200

## Nylon Braided Cord



- Diamond braid strands are tightly braided together
- Nylon braided cord is a durable high strength cord that resists deterioration from abrasion, oils, alkalis, organic solvents and most chemicals
- It is not susceptible to mildew and has good resistance to UV deterioration
- Nylon braided cord is a good general purpose cord

Part #	Diameter in Inches	Spool Length in Feet	Breaking Strength in Pounds
NY2 (#2)	1/16"	1000	140
NY3 (#3)	3/32"	1000	290
NY4 (#4)	1/8"	1000	600
NY5 (#5)	5/32"	600	730
NY6 (#6)	3/16"	500	900
NY8 (#8)	1/4"	250	1400
NY10 (#10)	5/16"	250	1800

## Polyester Braided Cord



- High strength cord that resists abrasion and deterioration from acids, organic solvents and most chemicals
- Has the best UV resistance
- Less stretch than nylon cord

Part #	Diameter (in.)	Length (ft.)	Breaking Strength (lbs.)
PE2	1/16"	2000	120
PE3	3/32"	1000	260
PE4	1/8"	1000	450
PE5	5/32"	600	650
PE6	3/16"	500	800
PE7	7/32"	500	960
PE8	1/4"	250	1220



# Ropes

## Spun Polyester Cord



- Spun polyester cord is made from durable spun polyester for a soft cotton-like finish that stays tied
- Available in matte black and white to reduce reflection

Part #	Diameter (in.)	Colour	Length (ft.)	Breaking Strength (lbs.)
PESP4BK	1/8"	Black	1000	200
PESP5BK	5/32"	Black	1000	300
PESP6BK	3/16"	Black	760	300
PESP8BK	1/4"	Black	500	670
PESP10BK	5/16"	Black	350	910
PESP12BK	3/8"	Black	240	1080

## Cotton Sash Cord



- Cotton sash cord is made from quality spun cotton yarns
- This cord has a firm, smooth feel

Part #	Diameter in Inches	Reel Length in Feet
BCS4	1/8 (#4)	1000
BCS5	5/32 (#5)	1000
BCS6	3/16 (#6)	760
BCS8	1/4 (#8)	500
BCS10	5/16 (#10)	350
BCS12	3/8 (#12)	240
BCS16	1/2 (#16)	170

## Polypropylene Tying Twine



- Polypropylene tying twine is made from mono-filament polypropylene
- It is also known as plastic twine. It is a good general purpose twine that is economical

Part #	Colour	Length (ft.)	Weight/Pkg (lbs)	Breaking Strength (lbs.)
TT140	White/Blue	9000	10	140
TT180	White/Blue	7000	10	180
TT240	White/Blue	5250	10	240
TT800	White/Blue	1450	10	800

## Silicone Insulators

Silicone Composite Insulators combine the technologies of a fiberglass reinforced rod, metal fittings and Salisbury's extensive knowledge of elastomeric insulation to produce a high quality composite insulator. Since 1980, thousands of silicone insulators have been installed by utilities worldwide in a variety of environments. Continued outstanding performance is proof of their superior quality and design.

**Design:** Unibody Design insulators are one-piece injection molded directly to the rod and sealed to the end fittings with a bead of silicone to give the insulator high dielectric strength and protect it from all environmental conditions. This design is used for standard distribution dead end/suspension insulators

**Fiberglass Rod:** A high quality fiberglass reinforced rod is the core of every insulator with ultimate mechanical strength at least twice the maximum work load

**End fittings:** Standard distribution dead/end suspension units are supplied with clevis and tongue fittings meeting ANSI C29 specifications. Ball, socket and eye fittings are also available. All are made of hot dipped galvanized high strength carbon steel and have an ultimate tensile strength rating of 15,000 pounds. All end fittings on dead/end suspension insulators are attached by compression. Every insulator is proof tested to verify the crimp

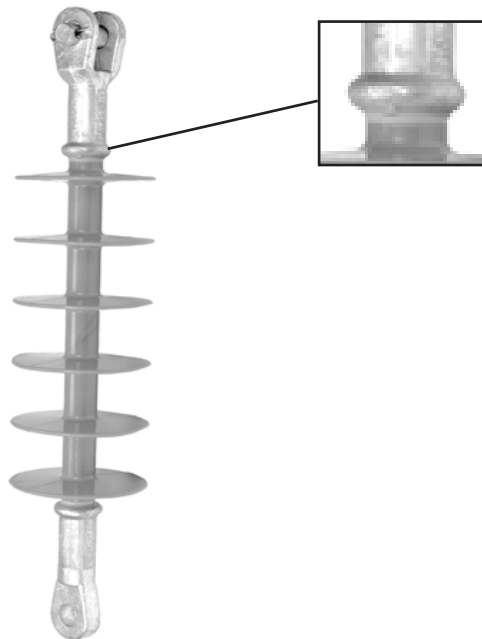

Unibody insulators have end fittings sealed with silicone to eliminate any possibility of moisture or contamination from reaching the fiberglass rod

INSULATOR SPECIFICATIONS					
Dimensions	Rated Voltage (kV)		15	25	35
	Section Length (mm)		345 ± 15	430 ± 35	525 ± 55
	Leakage Distance (mm)		430	640	850
	Minimum Arcing Distance (mm)		210	301	398
Electrical Ratings	Low Frequency Flashover	Dry	100	131	166
	Voltage Test (60 Hz) (kV)	Wet	82	111	138
	Critical Impulse Flashover	Positive	159	221	279
	Voltage Test (kV)	Negative	185	251	320
	Radio Influence Voltage Data (µV)	Max. Voltage	<1	<1	<1
Mechanical Ratings	Failing Load Test (KG)		>7000	>7000	>7000
	Number of Sheds		4	6	8

# Salisbury by Honeywell

The SI series of silicone insulators features a silicone formulation weathershed material. Salisbury combined the excellent hydrophobic and electrical qualities of silicone with an optimum weathershed design and corrosion-resistant fiberglass rod to produce a state-of-the-art insulator which meets or exceeds industry requirements. The insulators were tested in accordance with ANSI C29 and IEC1109. End fittings are hot dipped galvanized high strength carbon steel, providing a 15,000 pound ultimate tensile strength. 100% proof testing ensures trouble-free installation. RUS accepted.

STRINGING

		9501U-SI	9502U-SI	9503U-SI
<b>Class</b>		<b>DS-15</b>	<b>DS-28</b>	<b>DS-35</b>
<b># of Weathersheds</b>		<b>4</b>	<b>6</b>	<b>8</b>
<b>Length (inches)</b>		<b>13.5</b>	<b>17.5</b>	<b>21.3</b>
<b>Dia. of Weathersheds (inches)</b>		<b>3.8</b>	<b>3.8</b>	<b>3.8</b>
<b>Leakage Distance (inches)</b>		<b>17.1</b>	<b>26</b>	<b>35.1</b>
<b>Dry Arc Distance (inches)</b>		<b>8.4</b>	<b>12.13</b>	<b>16</b>
<b>Flash Over Voltage</b>	<b>Critical impulse, Pos</b>	<b>173</b>	<b>217</b>	<b>258</b>
	<b>Critical Impulse, Neg</b>	<b>250</b>	<b>310</b>	<b>340</b>
	<b>Dry, 60 Hz</b>	<b>97</b>	<b>145</b>	<b>168</b>
	<b>Wet, 60 Hz</b>	<b>67</b>	<b>115</b>	<b>137</b>
<b>Radio Influence</b>	<b>Test, kV Ground</b>	<b>15</b>	<b>25</b>	<b>25</b>
	<b>Max RIV-1000KhZ <math>\mu</math>V</b>	<b>1</b>	<b>1</b>	<b><math>\mu</math>V</b>
<b>Ultimate Strength</b>	<b>lbs</b>	<b>15,000</b>	<b>15,000</b>	<b>15,000</b>
<b>FRP Rod Dia. (inches)</b>		<b>.73</b>	<b>.73</b>	<b>.73</b>
<b>Typ. Appl-kV, 0-0</b>		<b>15</b>	<b>27</b>	<b>35</b>
<b>Net Weight ea. (lbs)</b>		<b>2.6</b>	<b>3.1</b>	<b>3.5</b>



## LTL Transformers

Equipment built for the electrical industry is made to last! We offer an extensive inventory of new and used transformers. Please call or email us; our Product Specialists will get you what you need.



## Lightning Arresters

LTL carries a wide selection of distribution, station class and intermediate lightning arresters. Call LTL for more information.

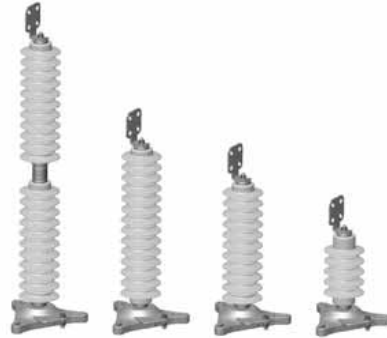

## S&C Omni-Rupter® Switches

Omni-Rupters provide long-life, high performance, no-external-arc circuit interruption, and are ideally suited for the following switching duties:

- Line switching, including sectionalizing and feeder switching
- Transformer switching
- Cable switching
- Omni-Rupter switches are rated 900 amperes continuous and interrupting in voltage ratings of 14.4kV and 25kV. These gang-operated interrupter switches are available in a number of mounting configurations to accommodate a wide variety of line configurations encountered on today's distribution systems



## S&C Scada-Mate® Switching Systems

- Scada-Mate Switches are integer style three-pole, group-operated load interrupter switches available in voltage ratings of 14.4 kV through 34.5 kV. They're factory-assembled on a one-piece base and include an integral stored-energy operating mechanism. Circuit making and breaking are accomplished within sealed interrupters, in a controlled SF6 environment
- All functions — sensing, control, and communication — are provided in one economical, completely self-contained, fully tested, integrated package



## S&C Fuses

- SM Power Fuses are especially suited for protecting transformers, capacitor banks, and cables in outdoor distribution substations through 34.5 kV. Their precision-engineered non-damageable silver or nickel-chrome fusible elements have time-current characteristics that are precise and permanently accurate - assuring not only dependable performance, but also continued reliability of system coordination plans
- With SM Power Fuses, source-side devices may be set for faster operation than practical with other power fuses or circuit breakers, thereby providing better system protection without compromising coordination
- SM-5, SMD-2C and SMU-40 are regularly stocked items. For all other fuses, please inquire with an LTL Product Specialist



SM Power Fuse



SMD Power Fuse

## Dominion Cutout Fuses

- We also carry a wide variety of Dominion Cutout Fuses
- Regularly stocked items include the: EPF461B- 46 KV and EBF341B- 34.5 KV
- Contact an LTL Product Specialist for more information

## ABB Cutout Fuses

- 15 kV cutout fuses

X1J CNN CA31	300 Amp
X1J CNN KA21	200 Amp
X1J CNN LM11	100 Amp



# Exiscan

## XIR-A-4-H-X: XIR Series Infrared Window

- Keep energized electrical equipment closed during inspection with Exiscan's XIR Series Infrared window, and easily comply with CSA Z462, OSHA, NFPA 70E, and similar electrical safety mandates

### More Structural Integrity

- Impact-resistant optic per UL and ANSI standards
- Body and cover machined from bar stock aluminum (stainless steel available)

### More Viewing Area

- 4" x 4" aperture is 66% larger than similar sized round windows
- Square aperture does not "clip" camera's squared display
- Camera lens can be placed on window optic (as opposed to 2" back) for fuller field of view

### More Accuracy

- Higher "flatter" LWIR Transmission curves for temperature accuracy
- Polymer optic remains stable over life of product without delicate sealants required

DIMENSION SPECS (NOM.)	
Body and Cover (LxH)	6" x 6"
Total Width (Body + Cover)	0.9"
Cover Thickness	0.4"
Aperture Dimension	4" x 4"
Aperture Area	16 sq. in.
TESTED/CERTIFIED	
UL 50V (IR Window Standard)	Yes
UL Type Rating / NEMA	Type 4
Ingress Protection (IP)	IP65
UL 746C (Impact & Flame Resistance)	Yes
ANSI/IEEE C37.20.2 Sec A.3.6 (Switchgear Window Impact Resistance)	Yes
ANSI/IEEE C37.20.7 Arc Resistance	Yes
CSA Compliant	Yes
MATERIAL SPECIFICATIONS	
Body and Cover Material	Aluminum: Anodized & Powder Coated
Backer Plate and Finger Guard	Stainless Steel
Hardware and Fasteners	Stainless Steel
Optic	Transmissive Polymer
Gaskets	Silicone & Neoprene
Cover Screws*	1/4-20Captive
TRANSMISSION COMPATIBILITY	
Mid wave and Long Wave Imagers	All Brands
Vibration	Unaffected
Broad Spectrum Acids / Alkalis	Unaffected
Humidity and Moisture	Unaffected
GENERAL	
Voltage Range	Low, Medium and High
Grounding	Automatically Grounds When Mounted to Grounded Panel/Door
Operating Temperature	-40°C to 150°C
Installation	Saw-Cut or Punch
Lifetime Warranty	Unconditional for Materials and Workmanship
Patent	Patent Pending: USA and International
Country of Origin	Made in the USA



## Double Arming Bolt



- Used to secure two cable suspension clamps or other attachments on opposite sides of utility pole
- Each double arming bolt is supplied with four attached square nuts
- Bolt provided with cone point at each end to ease starting
- Hot dip galvanized to meet ASTM Specification A153

Part Number	Description
59750	3/8" X 8" - Minimum Tensile Strength: 4,650 lbf
59755	1/2" X 18" - Minimum Tensile Strength: 8,500 lbf.
8395	1/2" X 8" - Minimum Tensile Strength: 5/8" – 13,550 lbf., 3/4" – 20,050 lbf., 7/8" - 27,700 lbf.
	5/8" X 10"/12/14/16/18/20/22/24/28/30/32/34/36/40/42/44/46/48
59780	3/4" x 6"/10/12/14/16/18/20/22/24/2/28/30/32/34/36/38/40/42

## Carriage Bolt



- Designed for use in square holes to keep the bolt from turning as the nut is tightened
- Once bolt is inserted in square hole, bolt is tightened without gripping the bolt head
- Manufactured from Grade 2 steel
- Hot dip galvanized to meet ASTM Specification A153
- Carriage Bolts are full threaded
- Supplied with attached square nut

### Available Sizes:

- 3/16" x 1, 1.25"
- 1/4" X 1.5, 2, 2.25, 2.5"
- 5/16" X 1-1/4, 3"
- 3/8" X 2-1/2, 3, 4, 4.5, 5, 5.5, 6, 7, 8, 10, 12, 14"
- 1/2" x 2-1/2, 4, 4.5, 4.75, 5, 5.5, 6, 7, 8"
- 5/8" x 2-1/2, 6"

## 5080: Cable Suspension Clamp



- Used to attach strand to straight line poles
- Accepts 1/4" (6.6M) to 7/16" (16M) strand
- Consists of two plates, and two 1/2"-13 track bolts with attached square nuts
- Plates are 1-11/16" wide and 5-3/4" long
- Center hole accepts 5/8" thru bolts
- Hot dip galvanized to meet ASTM Specification A153
- Conforms to Bell Specification CAO 8623

## 5080SS: Cable Suspension Clamp



- Used in high corrosive environments to attach strand to straight line poles
- All components constructed from high-strength 304 stainless steel

## 5082: Cable Suspension Clamp



- Used to attach strand to straight line poles
- Accepts 1/4" (6.6M) to 7/16" (16M) strand
- Consists of one hot rolled specialty shaped plate, one stamped flat plate, and two 1/2"-13 track bolts with attached square nuts
- Plates are 1-11/16" wide and 5-3/4" long
- Center hole accepts 5/8" thru bolts
- Hot dip galvanized to meet ASTM Specification A153

# Allied Bolt

## 648: Square Head Machine Bolt



- Used for fastening poleline hardware to crossarms, poles, and other structures
- Bolt head marking (ABI) appears on head of each bolt, and is registered with the U.S. Patent and Trademark Office, per the Fastener Insignia Register Act
- Hot dip galvanized to meet ASTM Specification A153
- Supplied with attached square nut
- Minimum tensile strength: 1,900 lb
- Minimum thread length is 1"

### Available Sizes:

1/4" x 1"

3/8" X 1, 1.25, 1.5, 2, 2.5, 3, 4, 4.5, 5, 5.5, 6, 7"

1/2" X 1, 1.25, 1.5, 1.75, 2, 2.5, 3, 4, 4.5, 5, 6, 7, 8, 8, 10, 12, 14, 16, 18, 20, 22, 24"

5/8" x 1, 1.25, 1.5, 1.75, 2, 2.5, 3, 3.5, 4, 4.5, 5, 5.5, 6, 7, 8, 9, 10, 12, 14, 16, 18, 20, 22, 24, 26, 28, 30, 32, 34, 36, 40"

3/4" X 2, 3, 4, 6, 7, 8, 10, 12, 14, 16, 18, 20, 22, 24, 26, 28, 30, 32, 34, 36,"

7/8" X 3, 12, 14, 16, 18, 20, 22, 24, 26, 28, 30, 32, 34, 36, 38, 40, 42, 44, 46, 48"

1" X 12, 14, 16, 18, 20, 22, 24, 26, 28, 30, 32, 34, 36"

**NOTE: Bolts over 6" long have a cone point**

## 2055: 3/4" Standard Eyelet



- Used with machine bolts for dead-ending
- Forged from High strength AISI 1018 Steel
- Slot size is 13/16" x 1-1/8"
- Height is 4-1/8"
- Hot dip galvanized to meet ASTM Specification A153

## 1429: Pole Plate and End Fitting for 2" Pipe Kit



- These malleable iron fittings are used with standard pipe near sidewalks and buildings where there is insufficient space for standard guying and where head clearance must be maintained
- Pole Plates consist of a Malleable Iron fitting, and a 1/2" x 1" bolt
- Pole Plates are provided with a curved flange and 9/16" mounting holes
- End Fitting for 2" pipe is provided with two malleable castings, two 1/2" x 2" Hex Bolts and one 1/2" x 1" Hex Bolt
- All components are hot dip galvanized to meet ASTM Specification A153

## 5060: 5/8" B Guy Hook



- Used as a means of attaching guy wire to poles
- Casted from ductile iron
- 45° ultimate strength of 10,000 lbs
- Conforms to Bell Specification CAO 7909
- Hot dip galvanized to meet ASTM Specification A153

## 5061: 3/4" B Guy Hook



- Used as a means of attaching guy wire to poles
- Casted from ductile iron
- 45° Ultimate Strength of 15,000 lbs
- Conforms to Bell Specification CAO 7909
- Hot dip galvanized to meet ASTM Specification A153

## 5875: 1/2"-13 Oval Eye Nut



- Used for dead-ending and guying from the threaded ends of crossarm bolts
- Forged from AISI 1018 steel
- Hot dip galvanized to meet ASTM Specification A153

## 9" Solid Square Hub Single Helix Power Driven Anchor 1-3/8" Hub 4000 lbs for 5/8" Rods



- Installation is performed using a power digger. An anchor wrench fits over the anchor hub and a torque measurement device is required to determine proper installation
- Correct installation is achieved only when the anchor is installed using the appropriate torque for the particular soil and anchor type (see reference charts)
- Proper anchor selection depends on the type of soil and guying requirements
- Installation torque is usually measured using a device connected in series with the wrench, digger, and Kelley Bar during installation
- Anchors are painted with rust-inhibiting blue paint after fabrication

- 8" SOLID SQUARE HUB SINGLE HELIX POWER DRIVEN ANCHOR 1-3/8" HUB 4000LB FOR 5/8" RODS
- 8" SOLID SQUARE HUB SINGLE HELIX POWER DRIVEN ANCHOR 1-3/8" HUB 4000LB FOR 3/4" & 1" RODS
- 10" SOLID SQUARE HUB SINGLE HELIX POWER DRIVEN ANCHOR 1-3/8" HUB 4000LB FOR 5/8" RODS
- 10" SOLID SQUARE HUB SINGLE HELIX POWER DRIVEN ANCHOR 1-3/8" HUB 4000LB FOR 3/4" & 1" RODS
- 12" SOLID SQUARE HUB SINGLE HELIX POWER DRIVEN ANCHOR 1-3/8" HUB 4000LB FOR 3/4" & 1" RODS
- 12" SOLID SQUARE HUB SINGLE HELIX POWER DRIVEN ANCHOR 1-3/8" HUB 4000LB FOR 5/8" RODS
- 8" SOLID SQUARE HUB SINGLE HELIX POWER DRIVEN ANCHOR 1-3/8" HUB 6000LB FOR 3/4" & 1" RODS
- 8" SOLID SQUARE HUB SINGLE HELIX POWER DRIVEN ANCHOR 1-3/8" HUB 6000LB FOR 5/8" RODS
- 10" SOLID SQUARE HUB SINGLE HELIX POWER DRIVEN ANCHOR 1-3/8" HUB 6000LB FOR 5/8" RODS
- 10" SOLID SQUARE HUB SINGLE HELIX POWER DRIVEN ANCHOR 1-3/8" HUB 6000LB FOR 3/4" & 1" RODS
- 12" SOLID SQUARE HUB SINGLE HELIX POWER DRIVEN ANCHOR 1-3/8" HUB 6000LB FOR 5/8" RODS





# Pole Line Hardware

## 3490: 8" Solid Square Hub Twin Helix Power Driven Anchor 1-3/8" Hub 4000 lb for 3/4" and 1" Rods



- Installation is performed using a power digger. An anchor wrench fits over the anchor hub and a torque measurement device is required to determine proper installation
- Correct installation is achieved only when the anchor is installed using the appropriate torque for the particular soil and anchor type (see reference charts)
- Proper anchor selection depends on the type of soil and guying requirements
- Installation torque is usually measured using a device connected in series with the wrench, digger, and Kelley Bar during installation
- Anchors are painted with rust-inhibiting blue paint after fabrication

## 3500: 2 1/4" Socket Anchor 8000 lb 8" Helix for 5/8" Rods



- Installation is performed using a drive wrench which fits into the anchor hub
- Proper anchor selection depends on the type of soil and guying requirements
- The anchors have a 3" helix pitch
- Installation uses standard tools
- Anchors are painted with rust-inhibiting blue paint after fabrication

## 5/8" Single Nut for Power Drive Anchor Rods



- Used in conjunction with anchor rods for helical anchors
- Eye nuts are forged from High Strength 1045 Steel
- Tapped .695"-11 UNS-2B
- Hot dip galvanized to meet ASTM Specification A153

## 19020: 6" Expanding Anchor for 1/2" or 5/8" Rod



- Offers excellent holding power with minimal soil disturbance
- A two-piece assembly that consists of a curved base plate and an integral unit with eight expanding blades
- Black paint is applied for maximum corrosion-resistance
- Formed metal cavity on the underside of the curved base unit accepts the nut of the guy rod when assembling the anchor
- The blades expand in a lateral motion by forcing the curved blades against the curved base
- Manufactured from AISI 1018 steel

## 3950: 16" Crossplate Anchor for 5/8" or 3/4" Rod



- Anchor is comprised of 2 stamped plates that are welded together  
Each plate has reinforcing ribs for extra strength  
A nut retainer is welded to the bottom plate for accepting the heavy square nuts of anchor rods  
Designed for use in holes made by power augers  
Holding power of the anchor is not affected by size of the hole  
Can be installed using the same auger used for the pole itself  
The anchor is installed in a diagonally bored hole so that the anchor is at a right angle to the guy  
Anchor is coated with paint for longevity

## Anchor Rod and Coupling Nut Assembly



- Used in conjunction with internally tapped earth anchors
- Anchor rods are forged from AISI 1045 steel to ensure high tensile strength
- Coupling nuts are forged from high strength 1045 steel
- Hot dip galvanized to meet ASTM Specification A123
- Butt of rod marked with "ABI" for identification

**5/8" X 3-1/2' ANCHOR ROD WITH ASSEMBLED COUPLING NUT**

**5/8" X 7' ANCHOR ROD WITH ASSEMBLED COUPLING NUT**

**3/4" X 3-1/2' ANCHOR ROD WITH ASSEMBLED COUPLING NUT**

**3/4" X 7' ANCHOR ROD WITH ASSEMBLED COUPLING NUT**

**1" X 3-1/2' ANCHOR ROD WITH ASSEMBLED COUPLING NUT**

**1" X 7' ANCHOR ROD WITH ASSEMBLED COUPLING NUT**

## Anchor Rod and Eye Nut Assemblies for Helical Anchors



Image shown: 3603

- Used in conjunction with internally tapped earth anchors
- Anchor rods are forged from AISI 1045 Steel to ensure high tensile strength
- Eye nuts are forged from high strength 1045 steel
- Hot dip galvanized to meet ASTM specification A123
- Butt of rod marked with "ABI" for identification

**5/8" X 3-1/2' ANCHOR ROD WITH ASSEMBLED SINGLE EYE NUT**

**5/8" X 3-1/2' ANCHOR ROD WITH ASSEMBLED TWIN EYE NUT**

**5/8" X 3-1/2' ANCHOR ROD WITH ASSEMBLED TRIPLE EYE NUT**

**5/8" X 7' ANCHOR ROD WITH ASSEMBLED SINGLE EYE NUT**

**5/8" X 7' ANCHOR ROD WITH ASSEMBLED TWIN EYE NUT**

**5/8" X 7' ANCHOR ROD WITH ASSEMBLED TRIPLE EYE NUT**

**3/4" X 3-1/2' ANCHOR ROD WITH ASSEMBLED SINGLE EYE NUT**

**3/4" X 3-1/2' ANCHOR ROD WITH ASSEMBLED TWIN EYE NUT**

**3/4" X 3-1/2' ANCHOR ROD WITH ASSEMBLED TRIPLE EYE NUT**

**3/4" X 7' ANCHOR ROD WITH ASSEMBLED SINGLE EYE NUT**

**3/4" X 7' ANCHOR ROD WITH ASSEMBLED TWIN EYE NUT**

**3/4" X 7' ANCHOR ROD WITH ASSEMBLED TRIPLE EYE NUT**

**1" X 3-1/2' ANCHOR ROD WITH ASSEMBLED SINGLE EYE NUT**

**1" X 3-1/2' ANCHOR ROD WITH ASSEMBLED TWIN EYE NUT**

**1" X 3-1/2' ANCHOR ROD WITH ASSEMBLED TRIPLE EYE NUT**

**1" X 7' ANCHOR ROD WITH ASSEMBLED SINGLE EYE NUT**

**1" X 7' ANCHOR ROD WITH ASSEMBLED TWIN EYE NUT**

**1" X 7' ANCHOR ROD WITH ASSEMBLED TRIPLE EYE NUT**

## Anchor Rod for Helical Anchors



Image shown: 3420

- Used in conjunction with internally tapped earth anchors and couplings or eye nuts
- Anchor rods are forged from AISI 1045 Steel to ensure high tensile strength
- Hot dip galvanized to meet ASTM Specification A123
- Butt of rod marked with "ABI" for identification

**3420 5/8" X 3-1/2' ANCHOR ROD FOR HELICAL ANCHORS**

**3423 5/8" X 7' ANCHOR ROD FOR HELICAL ANCHORS**

**3421 3/4" X 3-1/2' ANCHOR ROD FOR HELICAL ANCHORS**

**3424 3/4" X 7' ANCHOR ROD FOR HELICAL ANCHORS**

**3422 1" X 3-1/2' ANCHOR ROD FOR HELICAL ANCHORS**

**3425 1" X 7' ANCHOR ROD FOR HELICAL ANCHORS**

## Coupling Nut

- Used to join two Helical Anchor Rods
- Coupling nut is formed from AISI 4130 Seamless tubing
- Coupling nuts are 2" in length
- Hot dip galvanized to meet ASTM specification A153

**5052 COUPLING NUT FOR 5/8" ANCHOR RODS**

**5053 COUPLING NUT FOR 3/4" AND 1" ANCHOR RODS**



Image shown: 5053

# Rainbow Technology

## Pole Setting Foam

- A hydrophobic two-part polyurethane foam that expands to fill the peripheral void between a utility pole and the hole
- Displays excellent adhesion to all pole types without the use of primers, including wood, concrete, fiberglass, steel, and decorative street lighting
- Expanding foam fills in all voids
- Replaces traditional method of backfilling distribution and transmission poles during installation
- Low density, high strength foam can structurally support the pole and maintain its upright position
- Environmentally friendly; does not contain CFC's
- Sets the pole in 10-15 minutes with strengths 3-4 times that of tamped soil
- Foam expands 15 times its original volume and sets the pole in 3 minutes to create solid foundation material



Prepare hole for pole



Pour Part B container into Part A container



Mix together



Pour mixture into prepared hole with pole



Let sit for 15 minutes; hardware is ready to be strung

- 79698 Case of 5
- 79701 2 - 1 Cubic Foot kit
- 79702 1 - 2 Cubic Feet Kit
- 79703 1 - 3 Cubic Feet Kit
- 79705 1 - 5 Cubic Feet Kit
- 79706 1 - 6 Cubic Feet Kit
- 79707 1 - 7 Cubic Feet Kit
- 79709 1 - 9 Cubic Feet Kit



## 4305: Rainbow Cleaner & Degreaser



- Highly concentrated citrus formula
- Ideal for general purpose cleaning on tools and equipment
- Removes cable filling compounds, grease, oil, grime, printing inks, and more
- Non-corrosive; safe for painted and non-painted surfaces

**20 Oz. Aerosol Case of 12**

## 4480: Fire Ant & Insect Killer



- Granular insecticide protects equipment and personnel from insect damage and injury
- Non-conductive and non-corrosive
- Provides long lasting protection from ants, black widow spiders, brown recluse spiders, crickets, fire ants, fleas, millipedes, roaches, scorpions, silverfish, sowbugs, ticks, waterbugs, and soil-infesting insects

**100 - 4 oz. Single Application Bags**  
**5 Shaker Cans, 6 lbs Each**

## 87020: Fast Dry Contact Cleaner, 16 oz (case of 12)



- Rainbow's most powerful cleaner available
- Quickly and effectively cleans sensitive electric and electronic components
- Ideal for applications where lower flashpoint solvents may be used
- Flammable

## S-1™ Hot Stick Cleaner & Water Repellent Wipes



- Dual action - cleans, applies water repellent
- Does not remove or adversely affect glossy coat
- No "build-up" over time
- Evaporates quickly
- Removes grease, dirt, and grime
- Meets IEEE maintenance recommendations
- Convenient, pre-saturated, lint-free wipe
- Prevents continuous water film on stick in wet weather

**S-1C Hot Stick Cleaner/Water Repellent Wipes**

## Grime-Away™ Wipes



- Heavy-duty towelettes pre-moistened with a multi-purpose cleaning solution
- Features textured side to quickly remove grease, dirt and grime from items such as tools, transformers, work surfaces, equipment, service vehicles, machinery, etc., and a softer side that moisturizes and is gentle on skin
- Safe for linemen to clean hands prior to wearing insulated rubber gloves

**HTC-D72 Container of 72 Wipes**

- Quickly removes:
- PVC Pipe Cement
  - Transformer Oils
  - Cable Gels
  - Silicone Greases
  - Oxide Inhibitors
  - Dirt/Soil
  - Adhesives
  - Caulk
  - Lubricants
  - HDD Pipe Thread
  - Grease
  - Tar/Asphalt

## W-1™ Wax & Buff Wipes for Live Line Tool Maintenance



- Convenient, wax-saturated, lint-free wipe
- Dual action tandem pack includes dry buffing towel
- Superior quality, fast-hazing fiberglass wax
- Suitable for rubber and porcelain materials too
- Easy to apply
- Does not remove or adversely affect gel coat
- Leaves non-conductive water repellent coating
- Prevents continuous water film on stick in wet weather
- Designed for one time use and easy disposal
- Meets IEEE maintenance recommendations

**W-1C (72) Wax-Saturated Wipes with Dry Buffing Towel**

**W-16C (12) 16 oz. Fast-Hazing Fiberglass Wax**

## Rubber Goods Cleaner



- A specially formulated water-based cleaner for removing dirt, grease and grime from lineman's gloves, sleeves, jumper cables and other goods

**RBG-35LR One Quart Bottle With Sprayer**

**RBG-D72 Container of 72 Towels**

# American Polywater

## HP™ Multi-Purpose Cleaner/Degreaser



- Specially formulated solvent for multi-purpose, industrial and maintenance cleaning
- Effectively cleans industrial grimes, greases, lubrication fluids, silicone, tars, adhesives, and fluxes
- Evaporates without residue and is essentially non-conductive
- Cleans transformer oils, corrosion inhibitor compounds, silicone grease, semi-conducting paints, etc.
- For all electrical and communications cleaning needs
- Contains no CFC's, HCFC'S, chlorinated solvents, perchloroethylene, or other ozone-depleting solvents
- Harmless to most plastics, including polycarbonate and ABS
- Non-freezing
- Non-staining to metals

**HP-16LFC**      **16 Fluid oz. Bottle; Flip Top**

**HP-35LFC**      **1 Quart Bottle; Flip Top**

**HPY-12**        **16 fl. oz. Aerosol Can**

**ST-R**            **Trigger Sprayer for Bottles**

## Boom™ Prewash Wipes for Electrical Safety



Removal of hydraulic fluid, pine pitch, road tar and other contaminants that build up during the normal exposure of the boom is vital to maintaining the dielectric properties of your boom

- Boom™ Prewash Wipes are cleaner-saturated towels that clean grease, tar, creosote, salt spray, hydraulic fluid, pine pitch, and road debris off fiberglass boom arms
- Water soluble; washes off during subsequent water rinsing
- Boom™ wipes do not adversely affect the gel coat on booms
- American Polywater cleaners do not contain abrasives and do not leave a residue. Others, like acetone, xylene and toluene, can cause permanent damage if left in contact with the surface for too long a period; these solvents are flammable, among other hazards

**B-1C**            **Individual 24" x 24" Wipes**

**B-D72C**        **Container of 72 Wipes**

## FD™ Electrical Contact Cleaner



- Multi-purpose industrial and maintenance cleaner evaporates quickly, without residue
- Replaces ozone-depleting CFC's, trichloroethane, HCFC's, perchloroethylene, and other carcinogenic chlorinated solvents
- Effectively dissolves industrial grimes, greases, lubrication fluids, silicone, tars, adhesives, and fluxes
- Suitable for use in electrical maintenance as a replacement for 1,1,1-trichloroethane
- Quickly cleans transformer oils, corrosion inhibitor compounds, silicone grease, semi-conducting paints, etc.
- No chlorinated solvents; non-conductive, non-staining

**FD-16LFC**      **16 fluid oz. Bottle; flip top**

**FD-35LFC**      **1 quart bottle; flip top**

**FD-9**            **16 fl. oz. aerosol can**

**ST-R**            **Trigger sprayer for bottles**

## Polywater J Lubricant

- A high performance, clean, slow-drying, water based gel lubricant
- Provides maximum tension reduction in all types of cable pulling
- UL & CSA listed
- Recommended for long pulls, in a hot environment
- High cling factor and temperature stable
- Dries to form a thin film; retains its slip for months after use
- Compatible with all cables
- Available in cold weather (non-freezing) formula

Description	Regular Grade Part #	Winter Grade Part #
1-Quart Bottle	J-35	WJ-35
1-Gallon Pail	J-128	WJ-128
5-Gallon Pail	J-640	WJ-640



## Polywater F Lubricant

- A high performance, pourable liquid lubricant recommended for outside fiber optic cable pulls
- It also can be used for other types of communications cable, including coaxial and copper pair
- Slow drying; leaves a lubricating film after water-base has evaporated
- Compatible with a broad range of cable jackets, including the polyethylene types
- Easy to pour into innerducts and feeder tubes
- Superior friction reduction for lower tension pulls
- Available in cold weather (non-freezing) formula

Description	Regular Grade Part #	Winter Grade Part #
1-Quart Bottle	F-35	WF-35
1-Gallon Pail	F-128	WF-128
5-Gallon Pail	F-640	WF-640



# Krylon/Sprayon

## S03700: Quik-Mark™ Inverted Marking Paint



- Has a high solids formulation that gives the boldest, brightest and most visible markings in the industry
- These fast-drying products penetrate and adhere to hot surfaces, and deliver a line you can count on for all your locating, marking and surveying needs
- VOC compliant and free of lead hazards

## S03408: Quik-Mark™ Inverted Marking Paint



- Solvent-based
- Bright bold colors are easily identified for marking public utilities, survey and construction sites, and more
- Used to identify utilities or surfaces to dig
- Bright, bold colors
- Spray upside down
- Dry to touch: 20 minutes
- VOC compliant and free of lead hazards

## Krylon Marking Equipment



- From athletic fields to parking lots to underground utility repair, wherever bright, crisp lines and bold markings are required, Krylon marking equipment will do a professional job quickly and easily
- Creates bold, crisp lines
- For use on a variety of surfaces

## Krylon OSHA Colour Paint



- OSHA Colour Paint
- OSHA paint marks physical hazards and designates caution on the job site or at home
- Matches OSHA standard colors
- High visibility safety colors Ideal for signs, pipes, safety equipment and more
- Dry to touch: 15 minutes or less
- Dry to handle: 1 hour
- For use on wood, metal, wrought iron, paper

## LU™711: Sprayon All-Purpose Lubricant



- Penetrates and prevents rust
- Displaces moisture & lubricates
- Contains no silicone

## LU™103: Sprayon Rust Breaker



- Quickly loosens rust
- Will not harm painted surfaces
- Non-flammable
- A penetrant, water-displacer and rust inhibitor

## EL™749: Sprayon Electrical Cleaner/Degreaser



- Leaves no residue
- Use on non-energized equipment
- Replaces 1,1,1 trichloroethene

## 98002BT: Klein Beverage Tool

- Extremely handy bottle opener in the mold of a Klein Tools screwdriver
- Cushion-grip handle resists slippage and provides the comfort needed for frequent use
- Bottlecap tip-ident allows for quick identification in tool pouches or crowded drawers
- Makes a great gift
- High-quality stainless steel construction



## 5715: Mobile Phone Holder

- Fits most mobile phones
- Metal belt clip for simple mounting and removal from belts up to 2" wide
- Velcro flap and closed bottom for secure and convenient storage
- 6 1/2" length



## 44031: Money Clip Pocket Knife

- Brushed stainless steel case with rose wood insert
- Features a money clip, a 1 1/2" spearpoint blade and a 1 1/2" nail file
- Closed length: 2 1/8" x 7/8" x 1/4"



## 98288: Canvas Apron

- Great for the jobsite, workshop, or garage
- Durable 100% cotton canvas
- Large pocket is great for tools
- A large neck strap offers universal sizing, just knot to size

*WARNING: This product is NOT FLAME RESISTANT AND CAN BURN*

*WARNING: Users should be careful and always keep a minimum of three feet between themselves and the cooking surface*



## 1016: Tripsaver Multi-Purpose Tool



- Unique multi-tool addresses the special needs of electricians and maintenance professionals while providing many other handy features
- Combination cutting, stripping and crimping tool
- Compact, lightweight, and very sturdy
- Produced from high-carbon, rust-resistant stainless steel
- Features the following: needle-nose pliers, beveled wire cutter, toothed pipe grippers, files (coarse and fine), 5-slot wire stripper, wire-looping hole, scraper, awl/reamer, serrated sheeps foot knife, clip-point knife, standard/metric ruler, drywall socket, locking "L" handle, #1 and #2 phillips hex bits, small slotted hex bit, large slotted hex bit, 1/4" socket adapter, lanyard hole, nylon pouch



# Must-Haves

NOVELTY ITEMS

## Klein 98005: Insulated Beverage Hauler



- Popular Klein Tools cushion-grip design
- Double wall stainless steel insulation
- Durable stainless steel resists rust and corrosion
- Unique flow control cap opens and closes with a single touch
- Supersized cushion grip just like a Klein Tool
- Insulated lining keeps beverages hot or cold
- Makes a great gift for anyone who loves tools
- 24 oz. capacity with an integrated drink cup

## Klein 98554: 2 Fine Point Permanent Markers



- Permanent on most surfaces
- For precise marking
- Fast drying, water-resistant ink
- Long-lasting
- Replace cap after use

## LINESWEAT-M/L/XL/2XL: Hoffman Boots Sweatshirt

## LINET-M/L/XL/2XL: Hoffman Boots T-Shirt

