



PanelView Plus 7 Performance Terminals

Catalog Numbers 2711P-T7C22D9P, 2711P-T7C22D9P-B, 2711P-T7C22A9P, 2711P-T7C22A9P-B, 2711P-B7C22D9P, 2711P-B7C22D9P-B, 2711P-B7C22A9P, 2711P-B7C22A9P-B, 2711P-T9W22D9P, 2711P-T9W22D9P-B, 2711P-T9W22A9P, 2711P-T9W22A9P-B, 2711P-10C22D9P, 2711P-10C22D9P-B, 2711P-T10C22A9P, 2711P-T10C22A9P-B, 2711P-B10C22D9P, 2711P-B10C22D9P-B, 2711P-B10C22A9P, 2711P-B10C22A9P-B, 2711P-T12W22D9P, 2711P-T12W22D9P-B, 2711P-T12W22A9P, 2711P-T12W22A9P-B, 2711P-15C22D9P, 2711P-15C22D9P-B, 2711P-T15C22A9P, 2711P-T15C22A9P-B, 2711P-B15C22D9P, 2711P-B15C22D9P-B, 2711P-B15C22A9P, 2711P-B15C22A9P-B, 2711P-T19C22D9P, 2711P-T19C22D9P-B, 2711P-T19C22A9P, 2711P-T19C22A9P-B, 2711P-T9W22D9P-BSHK, 2711P-T12W22D9P-BSHK, 2711P-T7C22D9PK, 2711P-T9W22D9PK, 2711P-T10C22D9PK, 2711P-T12W22D9PK, 2711P-T15C22D9PK, 2711P-T19C22D9PK, 2711P-B15C22D9PK, 2711P-T12W22D9P-BM001, 2711P-T12W22D9P-BM002, 2711P-T12W22D9P-BM003, 2711P-T12W22D9P-BM004, 2711P-T12W22D9P-BM005, 2711P-T12W22D9P-BM006, 2711P-T12W22D9P-BM007, 2711P-T12W22D9P-BM008, 2711P-T12W22D9P-BM009, 2711P-T12W22D9P-BM010, 2711P-T12W22D9P-BM011, 2711P-T12W22D9P-BM012, 2711P-T12W22D9P-BM013, 2711P-T12W22D9P-BM014, 2711P-T12W22D9P-BM015, 2711P-T12W22D9P-BM016



Allen-Bradley

by **ROCKWELL AUTOMATION**

Important User Information

Read this document and the documents listed in the additional resources section about installation, configuration, and operation of this equipment before you install, configure, operate, or maintain this product. Users are required to familiarize themselves with installation and wiring instructions in addition to requirements of all applicable codes, laws, and standards.

Activities including installation, adjustments, putting into service, use, assembly, disassembly, and maintenance are required to be carried out by suitably trained personnel in accordance with applicable code of practice.

If this equipment is used in a manner not specified by the manufacturer, the protection provided by the equipment may be impaired.

In no event will Rockwell Automation, Inc. be responsible or liable for indirect or consequential damages resulting from the use or application of this equipment.

The examples and diagrams in this manual are included solely for illustrative purposes. Because of the many variables and requirements associated with any particular installation, Rockwell Automation, Inc. cannot assume responsibility or liability for actual use based on the examples and diagrams.

No patent liability is assumed by Rockwell Automation, Inc. with respect to use of information, circuits, equipment, or software described in this manual.

Reproduction of the contents of this manual, in whole or in part, without written permission of Rockwell Automation, Inc., is prohibited.

Throughout this manual, when necessary, we use notes to make you aware of safety considerations.



WARNING: Identifies information about practices or circumstances that can cause an explosion in a hazardous environment, which may lead to personal injury or death, property damage, or economic loss.



ATTENTION: Identifies information about practices or circumstances that can lead to personal injury or death, property damage, or economic loss. Attentions help you identify a hazard, avoid a hazard, and recognize the consequence.

IMPORTANT Identifies information that is critical for successful application and understanding of the product.

These labels may also be on or inside the equipment to provide specific precautions.



SHOCK HAZARD: Labels may be on or inside the equipment, for example, a drive or motor, to alert people that dangerous voltage may be present.



BURN HAZARD: Labels may be on or inside the equipment, for example, a drive or motor, to alert people that surfaces may reach dangerous temperatures.



ARC FLASH HAZARD: Labels may be on or inside the equipment, for example, a motor control center, to alert people to potential Arc Flash. Arc Flash will cause severe injury or death. Wear proper Personal Protective Equipment (PPE). Follow ALL Regulatory requirements for safe work practices and for Personal Protective Equipment (PPE).

The following icon may appear in the text of this document.



Identifies information that is useful and can help to make a process easier to do or easier to understand.

Overview

Preface

Summary of Changes 9
 Package Contents 9
 Product Firmware and Release Notes 10
 Additional Resources 11

Chapter 1

About the PanelView Plus 7 Performance Terminals 13
 Hardware Features 14
 Operator Control 16
 Touch Gestures 17
 Software Support 17
 Windows Operating System 18
 Open Versus Closed System 19
 Series A Terminals 19
 Series B Terminals 19
 Desktop Access 19
 Series A Terminals 19
 Series B Terminals 19
 Start-up Options 20
 EtherNet/IP Communication 20
 Typical Configuration 20
 Catalog Number Explanation 21
 Product Selections 22
 Accessories 23
 Ethernet Cables 24

Install the PanelView Plus 7 Performance Terminal

Chapter 2

Hazardous Locations 27
 Required Circuit Port Parameters for USB Peripheral Devices. 28
 Mounting Considerations 29
 Mounting Clearances 30
 Panel Guidelines 30
 Panel Cutout Dimensions 30
 Prepare For Panel Mounting 31
 Mount the Aluminum Terminal in a Panel 35
 Mount the Stainless Steel Terminal in a Panel 38
 Outdoor Installation 41
 Remove and Replace Power Terminal Block 42
 Connect to DC Power 43
 Connect to AC Power 44
 Connect to a Network 45
 Ethernet Ports 45
 Device Level Ring Network Topology 48
 Linear Network Topology 49

Star Network Topology 50
 Initial Startup — Series A Terminals 50
 Initial Startup — Series B Terminals 52
 Calibrate the PanelView Terminal 52
 Update the System Firmware 57
 Enter a Password 69
 Transfer Runtime Files (.mer) 71

Chapter 3

Configure Terminal Settings

FactoryTalk View ME Station 73
 Terminal Settings 76
 Soft Keyboard 77
 Load and Run Application 78
 Windows CE Desktop Access — Series A Terminals 79
 Enable Desktop Access 79
 Disable Desktop Access 80
 Set a Desktop Password 82
 Reset the Desktop Password 83
 Configure Start-up Options 84
 Disable FactoryTalk View ME Station on Startup 84
 Enter Configuration Mode on Startup 85
 Run the Loaded Application on Startup 86
 Configure Controller Address 87
 Configure Ethernet Settings 87
 Set the Ethernet Address of the Terminal 88
 Set the Ethernet Link Speed 89
 Define Name Server Addresses 90
 Configure the Ethernet Ports 90
 View the Network Diagnostic Data 91
 Modify Device Name of Terminal 92
 Copy Files on Terminal 93
 Delete Files from Terminal 94
 Delete Log Files 94
 Display Settings 95
 Adjust Display Intensity 95
 Configure the Screen Saver 95
 Disable the Screen Cursor 96
 Input Device Settings 97
 Configure Keyboard or Keypad Settings 97
 Calibrate the Touch Screen 98
 Set the Double-tap Sensitivity for a Touch Screen 99
 Change the Popup for String Entry 99
 Change Popup Input Color Settings 100
 Configure Print Options 102
 Configure Diagnostics 105
 Check Integrity of Application Files 106
 View and Clear the System Event Log 107

Enable or Disable the Alarm Display 107

Display System Information 108

 View Terminal Information 108

 View FactoryTalk View ME Station Information 110

Time and Date Settings 111

 Change the Time Zone on Terminal 111

 Change the Current Date on Terminal 112

 Change the Current Time on Terminal 112

Regional Settings 113

 Change the Decimal Separator 113

 Change the Time Format for a Language 114

 Change the Short Date Format for a Language 115

 Change the Long Date Format for a Language 115

KEPServer Driver Configuration (Series B Only) 116

Certificate Management (Series B Only) 118

Chapter 4

**Windows CE Operating System —
Series A Terminals**

Operating System Features 121

 Application Support 122

 Scripting Support 122

 Network Support 122

 Server Support 123

 Extended Features 123

Windows Explorer 124

Taskbar 124

Soft Input Panels 124

Windows Control Panel 125

Backup and Restore 126

 Perform a Backup 126

 Restore a Back-up Image 128

Display Properties 129

 Desktop Background 129

 Desktop Appearance 130

 Backlight Intensity 130

 Screen Saver 130

 Cursor 131

 Screen Rotation 131

Hardware Monitor 132

 Processes 132

 System Event Log 132

 Monitors 133

Logo Manager 134

User Accounts 136

Services 137

Network Server Configuration 138

 VNC Server Configuration 138

 Web Server Configuration 146

 FTP Server Configuration 148

File Server.....	151
KEPServer Configuration	152
System Information	152
General Information.....	152
Startup Options.....	153
Device Name.....	155
Touch Properties.....	156
Calibration	156
Double-tap.....	156
PDF Reader	157
Command Prompt Parameters	158

Chapter 5

Windows 10 IOT Core Operating System — Series B Terminals

System Features	159
Windows Control Panel	160
Menu Icons	160
Navigation Icons	161
Start Menu.....	162
Device Info Menu	165
Web Browser Menu	166
Account Management Menu	167
Menu Settings Screen	168
System Screen	169
Network & Wi-Fi Screen.....	170
Firmware Updates Screen	171
Power Options Screen	172
Touch Screen	173
Services Screen	174
Event Log Screen	175

Chapter 6

Install and Replace Components

Connect to USB Ports.....	178
USB Cables	179
Install a USB Printer	179
Series A Terminals.....	179
Plug-and-Play Installation	180
Manual Printer Installation.....	181
Series B Terminals	182
Insert an SD Card	183
Connect a Speaker	184
Replace the Battery.....	185
Install a Protective Overlay.....	187
Clean the Overlay	189
Remove the Overlay	189
Replace the Stainless Steel Terminal Gasket	189

Update Firmware	Chapter 7	
	Terminal Firmware.....	193
	Download Firmware Files (Series A Terminals Only).....	194
	Firmware Upgrade Wizard (Series A Terminals Only).....	195
	Upgrade Terminal Firmware from a Storage Device (Series A Terminals Only)	195
	Create a Firmware Update Card	195
	Update Terminal Firmware by Using Firmware Update Card	198
	Update Terminal Firmware Over the Network (Series A Terminals Only)	199
	Update System Firmware (Series B Terminals Only)	203
	USB Storage Device	203
	ControlFLASH Client.....	205
	Using ControlFLASH Plus.....	207
	Update DLR Network Switch Firmware (Series B Terminals Only) ..	213
	Chapter 8	
Troubleshooting	View System Information	217
	Status Indicators	218
	View Network Status Information	219
	Series A Terminals Only	219
	Series A and Series B Terminals (Series C for Stainless Steel terminals).....	220
	Terminal Does Not Start Up.....	220
	Terminal Restarts Intermittently	220
	Touch Screen Issues	221
	Display Issues	221
	Ethernet Issues.....	222
	Performance Is Slow.....	222
	Resistance to Chemicals	222
	Clean the Terminal Display	223
	Remove Paint and Grease	223
	Equipment Wash Downs	223
	Ship the Terminal.....	224
	Maintenance Mode Operations — Series A Terminals	224
	Maintenance Mode Operations — Series B Terminals.....	225
	Appendix A	
Fonts Resident on Terminal	True Type Fonts	227
	Appendix B	
Languages Supported	Available Languages	231

Notes:

Summary of Changes

This manual describes how to install, configure, operate, and troubleshoot the PanelView™ Plus 7 Performance terminals. It does not provide procedures on how to create applications that run on the terminals or ladder logic that runs in the controller.

This manual contains new and updated information as indicated in the following table.

Topic	Page
Updated the Additional Resources table.	11
Added an Important note to the section entitled Update the Firmware Using ControlFLASH.	66

Other tasks that you must do include:

- Create a human machine interface (HMI) application for the terminal by using FactoryTalk® View Machine Edition (ME) software, version 8.x or later.
- Create ladder logic for the controller by using the Studio 5000 Logix Designer® application.

Note: This document does not provide instructions on how to install and configure components of the ArmorView Plus 7 product. For instructions on how to do that, see the ArmorView Plus 7 Installation Instructions, publication [2711P-IN013](#).

Package Contents

This product is shipped with these items:

- PanelView Plus 7 Performance terminal
 - Series A: With FactoryTalk View ME Station runtime software installed and activated
 - Series B: With factory default firmware (must be updated with FactoryTalk View ME Station runtime software prior to deploying to production network)
- Removable power terminal block
- Product information
- Cutout template
- Quick start guide (Series B only⁽¹⁾)
- Mounting levers for panel installation (for aluminum terminals)
- Mounting clamps for panel installation (for stainless steel terminals)
- Backing plate (for stainless steel terminals)
- Hygienic gasket, blue (for stainless steel terminals)

For information on what is shipped with the ArmorView Plus 7 terminal, see the ArmorView Plus 7 Installation Instructions, publication [2711P-IN013](#).

(1) Series C for PanelView Plus 7 Performance Stainless Steel terminals.

Product Firmware and Release Notes

Product firmware and release notes are available online within the Product Compatibility and Download Center.

1. On the <http://ab.rockwellautomation.com> website, click Downloads.

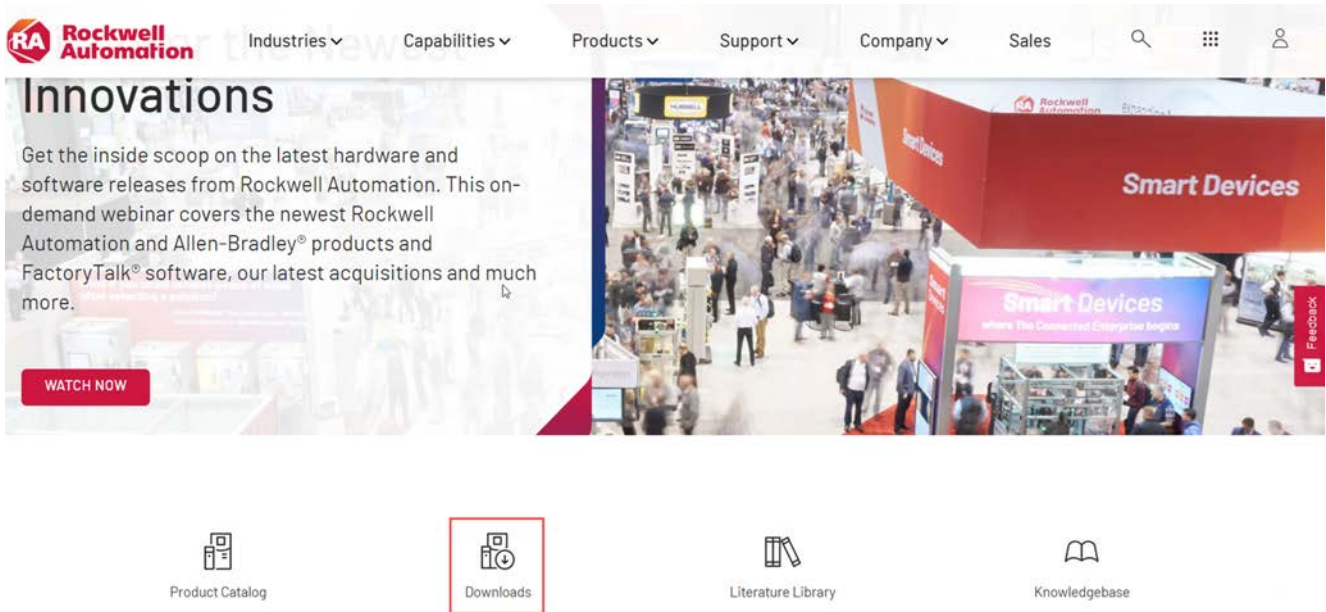

2. In the Search field, type the name of your product, and then click the Search icon to search for your product.

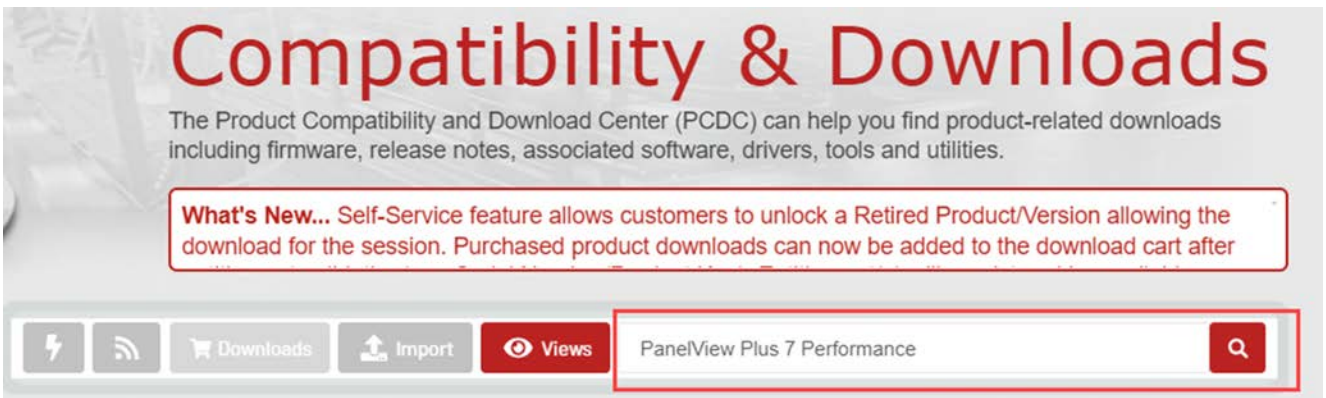

3. On the search results page, find the firmware and release notes for your product.
4. See the Product Compatibility and Download Center Quick Start Guide, publication [PCDC-QS001](#), for instructions on how to find and download firmware and release notes for the terminal.

Additional Resources

These documents contain additional information concerning related products from Rockwell Automation.

Resource	Description
PanelView Plus 7 Performance Specifications, publication 2711P-TD009	Provides technical specifications, environmental specifications, and certifications for the performance models of the PanelView Plus 7 Performance terminals.
PanelView Plus 7 Performance Series B Terminals Quick Start, publication 2711P-QS002	Provides instructions on how to configure and install the PanelView Plus 7 Performance Series B terminals. Also describes how to update the firmware for these terminals.
PanelView Plus 7 Performance Series B Terminals Important Information, publication 2711P-RN005	Lists the functions of the PanelView Plus 7 Performance Series A terminals that are not included in the initial version of the PanelView Plus 7 Performance Series B terminals. Also indicates which of these functions will be available in a future release.
2711P PanelView Plus 7 Performance 12.101 Release Notes, publication 2711P-RN006	Describes the new features, feature enhancements, and anomalies fixed in firmware release 12.101 for the PanelView Plus 7 Performance Series B terminals.
EtherNet/IP Device Level Ring Application Technique, publication ENET-AT007	Provides information on how to install, configure, and maintain linear and Device Level Ring (DLR) networks using Rockwell Automation® EtherNet/IP devices with embedded switch technology.
ArmorView Plus 7 Installation Instructions, publication 2711P-IN013	Provides instructions on how to install, configure, troubleshoot, and maintain the ArmorView Plus 7 terminal.
Industrial Automation Wiring and Grounding Guidelines, publication 1770-4.1	Provides general guidelines for installing a Rockwell Automation industrial system.
Guidelines for Handling Lithium Batteries Technical Data, publication AG-5.4	Provides guidelines for how to store handle, install, and dispose of lithium batteries.
Product Certifications website: rok.auto/certifications	Provides declarations of conformity, certificates, and other certification details.

You can view or download publications at <http://www.rockwellautomation.com/global/literature-library/overview.page>.

Notes:

Overview

Topic	Page	Topic	Page
About the PanelView Plus 7 Performance Terminals	13	Start-up Options	20
Hardware Features	14	EtherNet/IP Communication	20
Operator Control	16	Typical Configuration	20
Software Support	17	Catalog Number Explanation	21
Windows Operating System	18	Product Selections	22
Open Versus Closed System	19	Accessories	23
Desktop Access	19	Ethernet Cables	24

About the PanelView Plus 7 Performance Terminals



The PanelView™ Plus 7 Performance terminals are operator interface devices. They monitor and control devices that are attached to ControlLogix® and CompactLogix™ controllers on an EtherNet/IP™ network. Animated graphic and text displays provide operators a view into the operating state of a machine or process. Operators interact with the control system by using touch screen or keypad input.

Features include the following:

- FactoryTalk® View Machine Edition software provides a familiar environment for creating HMI applications.
- Microsoft® Windows® operating system:
 - Series A (and Stainless Steel Series A and B): Windows CE 6.0
 - Series B (and Stainless Steel Series C): Windows 10 IoT Core
- Ethernet communication that can support Device Level Ring (DLR), linear, or star network topologies.
- Web browser, Microsoft file viewers, text editor, PDF viewer, remote connection capabilities.
- Conformal-coating available for all DC power, touch-only terminals and the 15-inch DC power, touch and keypad terminal.

- Stainless steel, hygienic, brandless, DC-power, and conformal-coating are available for the 9-in. wide-screen, touch-only units and the 12-in. wide-screen, touch- only units.
- On-machine mounting available for the 12-in. terminal. For information on the options available, see the ArmorView™ Plus 7 Installation Instructions, publication [2711P-IN013](#).

Hardware Features

The PanelView Plus 7 Performance terminals feature fixed hardware configurations with a range of display sizes and operator input options.

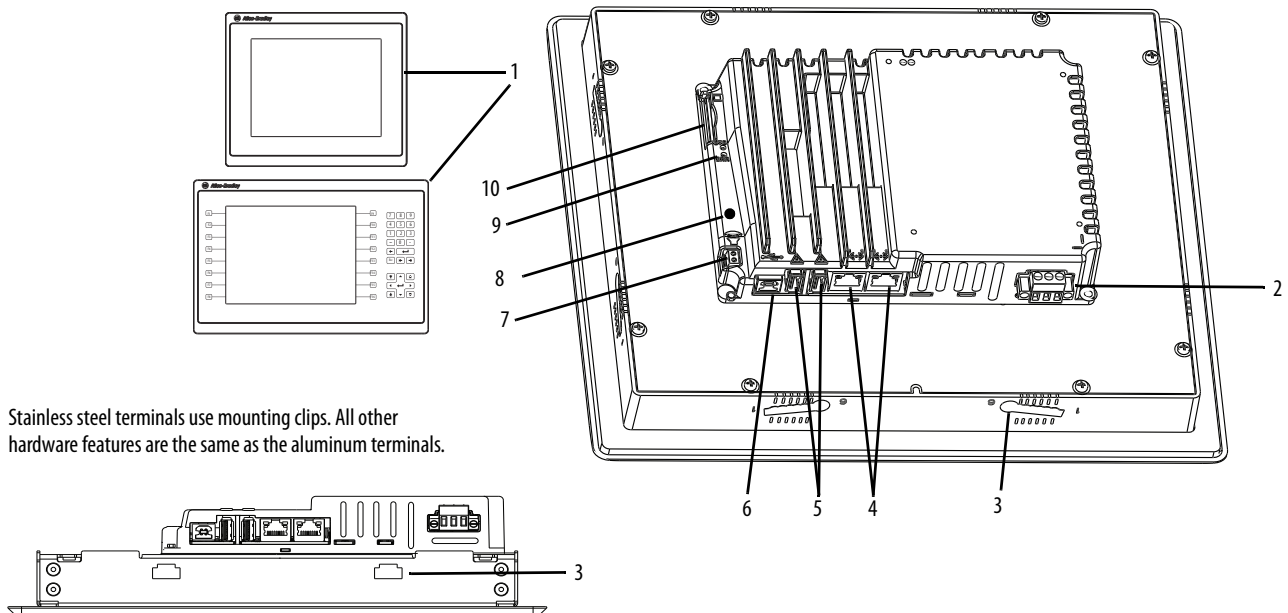

Table 1 - Hardware Features⁽¹⁾

Item	Feature	Description
1	Display/Keypad	TFT color graphic displays with a touch screen and navigation button in a range of sizes. Some models also have a keypad and function keys providing additional operator input options: <ul style="list-style-type: none"> • 6.5-in. touch, or touch with keypad • 9-in. widescreen touch • 10.4-in. touch, or touch with keypad • 12.1-in. widescreen touch • 15-in. touch, or touch with keypad • 19-in. touch
2	Power	AC or DC ⁽³⁾ power input: <ul style="list-style-type: none"> • 18...30V DC (isolated), aluminum and stainless steel terminals • 100...240V AC (nom), only aluminum terminals (Series A terminals only)
3	Mounting slot (aluminum terminals)	Slots on top, bottom, and sides of terminal are for mounting levers to mount the device to a panel or enclosure. The number of slots varies by terminal size.
	Mounting slot (stainless steel terminals)	Slots on top, bottom, and sides of terminal are for mounting clips to mount the device to a panel or enclosure. The number of slots varies by terminal size.
4	Ethernet ports	Two 10/100Base-T, Auto MDI/MDI-X, Ethernet ports for controller communication supporting Device Level Ring (DLR) network topology.

Table 1 - Hardware Features⁽¹⁾ (Continued)

Item	Feature	Description
5	USB host ports	Series A: Two 2.0 USB ports Series B (Series C for Stainless Steel terminals): One 2.0 USB port and one 3.0 USB port
6	USB device port	IMPORTANT: The device port is not functional. Do not use this port.
7	Audio out ⁽²⁾	One audio out port supports connection to a 4 Ω or 8 Ω speaker or amplifier (not initially supported on Series B (Series C for Stainless Steel terminals), however USB audio is supported).
8	Maintenance Mode button	Only available on Series B terminals (Series C for Stainless Steel terminals), this button allows you to enter maintenance menu mode, which is used to restore factory defaults, backup and restore terminal settings, and calibrate the touchscreen, etc.
9	Status indicators	Light-emitting diodes on the back of the terminals provide status and fault conditions.
10	Secure Digital (SD) card slot	One SD card slot supports catalog number 1784-SDx and 1784-SDHCx, hot-swappable, SD card for external storage.

(1) For information about the hardware features of the ArmorView Plus 7 terminal, see the ArmorView Plus 7 Installation Instructions, publication [2711P-IN013](#).

(2) Series A: The speaker works in the Windows CE operating system (Windows Media Player). FactoryTalk View ME Station software does not support the speaker. Series B (Series C for Stainless Steel terminals): The USB audio works in the Windows 10 IoT operating system through the Edge web browser.

(3) Series A terminals are available with AC or DC power. Series B terminals (Series C for Stainless Steel terminals) are available only with DC power.

Operator Control

All terminals have a color display with a touch screen, or touch screen and keypad, for operator control.

- Analog resistive touch screens provide accurate and durable touch control for industrial applications.
- Keypad models are similar except for the number of function keys to the left and right of the display. Larger models have more keys.



ATTENTION: The keypad and touch screen accept input from a finger, stylus, and gloved-hand for operation in dry or wet environments. The plastic stylus must have a minimum tip radius of 1.3 mm (0.051 in.). Any other object or tool can damage the keypad or touch screen.



ATTENTION: To help prevent unintended operation, do not conduct multiple operations simultaneously.

- Touch only one operating element on the touch screen with one finger at one time.
- Press only one key on the terminal at one time.

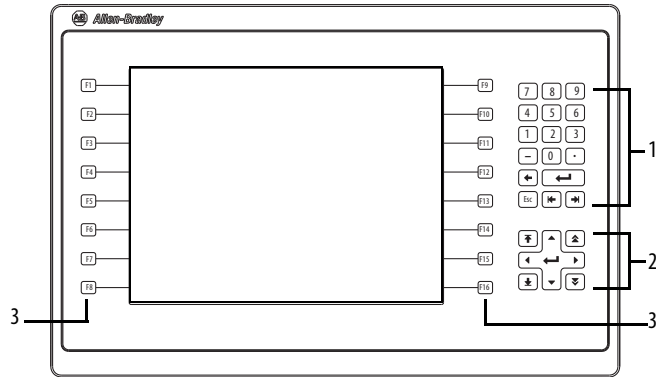
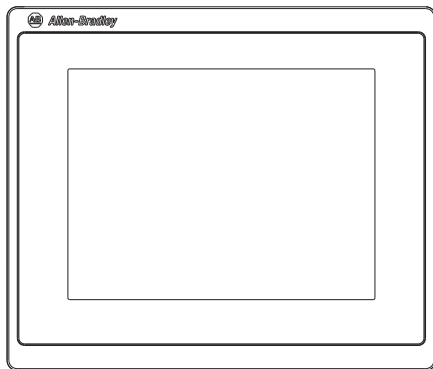

Table 2 - Terminal Keypad

Item	Feature	Description
1	Numeric keypad	Contains numeric, decimal, minus, and the following keys: <ul style="list-style-type: none"> • Backspace - deletes the character to the left of the insertion point. • Enter - inputs the currently highlighted key or enters a blank line if the insertion point is in the text box of the virtual keyboard. • Tab-left, Tab-right - selects the previous or next control or input element. • Esc - cancels or dismisses a dialog.
2	Navigation keys	Provides navigation control. <ul style="list-style-type: none"> • Arrow keys - selects a key on the virtual keyboard that is above, below, left, or right of the selected key. Moves the cursor in selected direction if in the text box. • Home/End - moves the insertion point to the beginning or end of a text or numeric entry field. • Page up/Page down - goes to the next or previous pages of a list.
3	Function keys 6.5-in. terminal 10-in. terminal 15-in. terminal	Performs specific commands if events are configured for a screen or any of its graphic elements. For example, F1 can be configured to navigate to another screen. <ul style="list-style-type: none"> • F1...F6 and F7...F12 • F1...F8 and F9...F16 • F1...F10 and F11...F20

Touch Gestures

The touch screen supports touch gestures to interact with screen elements during runtime. Standard touch gestures include:

- **Tap** – Briefly touch the target on the screen with your fingertip.
- **Double-tap** – Touch the target on the screen twice quickly with your fingertip.
- **Drag** – Touch the target and move your fingertip across the screen without losing contact.
- **Long press** – Touch and hold the target on the screen for several seconds.

Software Support

IMPORTANT It is the responsibility of the customer to be sure that any third-party software, updates, patches, or firmware that is installed is free of malicious programs, spyware, and so on.











Table 3 - PanelView Plus 7 Performance Software Support

Software	Description	Version
FactoryTalk View Machine Edition (ME) Station	Runtime environment of terminal: <ul style="list-style-type: none"> • Runs FactoryTalk View ME applications. • Provides options to view and configure terminal settings. Machine Edition Station is pre-loaded on each terminal and does not require activation.	8.x or later
FactoryTalk View Studio for Machine Edition	Software for developing HMI applications that run on terminal. RSLinx® software is included with FactoryTalk View Studio software and loaded during installation.	8.x or later
FactoryTalk ViewPoint	A web server application that lets remote users access and control the HMI application running on a terminal by using an internet browser. One license is embedded with each terminal to support one client connection to a terminal.	8.x or later

Windows Operating System

Series A terminals run the Windows CE 6.0 operating system, and Series B⁽¹⁾ terminals run the Windows 10 IoT Core operating system. These terminals both run the same FactoryTalk View Machine Edition applications.

Table 4 - Features

Standard Features		Series A	Series B ⁽³⁾
FTP server	–	Yes	–
Secure FTP server	–	No	Yes
VNC client and server	–	Yes	–
Secure VNC server	–	No	Yes
ActiveX controls ^{(1) (2)}	–	Yes	Yes
Third-party controller support	–	Yes	Yes
PDF reader	 	Foxit	Foxit and Microsoft Edge
Web browser	 	Internet Explorer 6	Microsoft Edge
Remote desktop client		Yes	No
Media player	 	Windows Media Player 9	Microsoft Edge
Microsoft Office file viewers			
<ul style="list-style-type: none"> • PowerPoint • Excel • Word • Image viewer 	  	Yes	Yes ⁽⁴⁾
WordPad text editor		Yes	No

(1) For a complete list of ActiveX controls, go to <https://rockwellautomation.custhelp.com> and search the Knowledgebase for keywords 'ActiveX Support for PanelView Plus Terminals'.

(2) See [View FactoryTalk View ME Station Information on page 110](#) to view a list of ActiveX controls installed on terminal.

(3) Series C for Stainless Steel terminals.

(4) Not available on the initial release.

(1) Series C for Stainless Steel terminals.

Open Versus Closed System **Series A Terminals**

On Series A terminals, you can configure a terminal to run an open or closed desktop environment:

- An open system launches the Windows CE desktop on startup.
- A closed system launches a FactoryTalk View Machine Edition application or FactoryTalk View Machine Edition Station on startup. Desktop access is restricted.

Series A terminals are shipped as closed systems with desktop access disabled. The first time that you start the system, the terminal launches FactoryTalk View ME Station Configuration mode. At this point, you can change the start-up option and allow desktop access.

Series B Terminals⁽¹⁾

Series B terminals are shipped as closed systems and there is no desktop available on the Windows 10 IoT Core operating system.

Desktop Access

Series A Terminals

On Series A terminals, you can allow or restrict access to the Windows desktop on the terminal. From the desktop, you can perform system and control panel operations, use Microsoft® file viewers, run third-party applications, and launch the web browser. You can also provide temporary access to perform specific tasks, then disable desktop access to help prevent unauthorized changes.

TIP All terminals are initially shipped with desktop access disabled.

See [Windows CE Desktop Access — Series A Terminals on page 79](#) for details on how to modify desktop access.

Series B Terminals⁽¹⁾

Series B terminals do not have a desktop. When you exit Machine Edition, a Windows 10 Control Panel launches.

(1) Series C for Stainless Steel terminals.

Start-up Options

The terminal can perform one of three actions at startup:

- Launch a FactoryTalk View Machine Edition HMI application.
- Launch FactoryTalk View Machine Edition Station in Configuration mode. This mode lets you configure terminal settings and start-up options, load applications to run, and so on.
- Launch the Windows desktop (available on Series A terminals only).

The factory default state and start-up option following a firmware update is to launch the terminal in Configuration mode. See [Configure Start-up Options on page 84](#) for details on how to change the start-up option.

For a list of actions you can perform using touch gestures, see the FactoryTalk View Machine Edition help.

EtherNet/IP Communication

The PanelView Plus 7 Performance terminals use an EtherNet/IP embedded switch. These terminals communicate with ControlLogix and CompactLogix controllers over an Ethernet connection with DLR, linear, or star network topologies.

The terminals can reside on EtherNet/IP networks that run integrated motion and CIP Sync™ applications without affecting performance. The terminal is not a consumer or producer of CIP Sync or motion packets.

Typical Configuration

Traditional DLR, linear, and star network topologies are supported. See these topics for examples:

- [Device Level Ring Network Topology on page 48](#)
- [Linear Network Topology on page 49](#)
- [Star Network Topology on page 50](#)

Catalog Number Explanation

This section provides an explanation of the catalog numbers.

Bulletin	Input Type	Display Size	Display Type	Network	Power	Operating System	Model	-	Option
2711P-	T = Touch	7 = 6.5-in.	C = Color	22 = Ethernet DLR ports	A = AC (Series A only)	9 = Windows CE 6.0 (Series A and Series B for Stainless Steel)) or 9 = Windows 10 IoT Core (Series B and Series C for Stainless Steel Terminals)	P = Performance	-	B = No brand identity
	B = Key and Touch	9 = 9-in.	W = Wide aspect ratio color		D = DC			-	BSHK ⁽¹⁾ = No brand identity, stainless steel, hygienic, conformal coated
		10 = 10.4-in.							K = Conformal coated
		12 = 12.1-in.							BM001– BM016 ⁽²⁾ = ArmorView Plus 7 terminal
		15 = 15-in.							
		19 = 19-in.							

(1) The -BSHK terminals are available in 9-in. and 12.1-in. touch screen terminals, with DC power, and without the Allen-Bradley logo.

(2) The ArmorView Plus 7 product includes a 12.1-in. PanelView Plus 7 Performance terminal and a 1732E ArmorBlock® EtherNet/IP I/O module. Both products are enclosed in a cast aluminum assembly that can be mounted on a machine, an arm mount system, a VESA-compatible bracket (with the optional VESA kit), or a pedestal. To order an ArmorView Plus 7 terminal, add BM001...BM016 to the 12.1-in. PanelView Plus 7 Performance touch terminal, 2711P-T12W22D9P. For explanations of the ArmorView Plus 7 catalog numbers, see the ArmorView Plus 7 Installation Instructions, publication [2711P-IN013](#).

Product Selections

[Table 5](#) provides a description of the product selections by catalog number.

Table 5 - PanelView Plus 7 Performance Terminal Product Selections

Cat. No. ⁽¹⁾		Display		Ethernet	Power	Memory			
Touch	Key and Touch	Size	Type	DLR	AC or DC	RAM	User ⁽⁶⁾		
2711P-T7C22D9P	2711P-B7C22D9P	6.5-in.	VGA TFT Color	Yes	DC	Series A 512 MB	Series A 80 MB		
2711P-T7C22D9PK ⁽²⁾	–				AC ⁽⁴⁾				
2711P-T7C22A9P	2711P-B7C22A9P				AC ⁽⁴⁾				
2711P-T9W22D9P	–	9-in. (wide)	WVGA TFT Color		DC				
2711P-T9W22D9PK ⁽²⁾					AC ⁽⁴⁾				
2711P-T9W22D9P-BSHK					DC				
2711P-T9W22A9P					AC ⁽⁴⁾				
2711P-T10C22D9P	2711P-B10C22D9P	10.4-in.	SVGA TFT Color		DC			Series B⁽⁵⁾ 4 GB	Series B⁽⁵⁾ 2 GB
2711P-T10C22D9PK ⁽²⁾	–				AC ⁽⁴⁾				
2711P-T10C22A9P	2711P-B10C22A9P				AC ⁽⁴⁾				
2711P-T12W22D9P ⁽³⁾	–	12.1-in. (wide)	WXGA TFT Color		DC				
2711P-T12W22D9PK ⁽²⁾					AC ⁽⁴⁾				
2711P-T12W22D9P-BSHK					DC				
2711P-T12W22A9P					AC ⁽⁴⁾				
2711P-T15C22D9P	2711P-B15C22D9P	15-in.	XGA TFT Color		DC				
2711P-T15C22D9PK ⁽²⁾	2711P-B15C22D9PK ⁽²⁾			AC ⁽⁴⁾					
2711P-T15C22A9P	2711P-B15C22A9P			AC ⁽⁴⁾					
2711P-T19C22D9P	–	19-in.	SXGA TFT Color	DC					
2711P-T19C22D9PK ⁽²⁾				AC ⁽⁴⁾					
2711P-T19C22A9P				AC ⁽⁴⁾					

(1) Add -B to the end of a catalog number to order a terminal without the Allen-Bradley logo and product identification, for example, 2711P-T9W22D9P-B.

(2) This terminal includes conformal coating.

(3) To order an ArmorView Plus 7 terminal, add BM001...BM016 to the 12.1-in. PanelView Plus 7 Performance touch terminal, 2711P-T12W22D9P. For explanations of the ArmorView Plus 7 catalog numbers, see the ArmorView Plus 7 Installation Instructions, publication [2711P-IN013](#).

(4) AC power is only available on Series A terminals.

(5) Series C for stainless steel terminals.

(6) Memory available for user to store applications.

Accessories

[Table 6...Table 10](#) list accessories for the PanelView Plus 7 Performance terminals.

For a list of accessories that are available for the ArmorView Plus 7 terminal, see the Visualization Solutions Selection Guide, publication [VIEW-SG001](#).

Table 6 - Protective Overlays

Cat. No. ⁽¹⁾	Display Size	Operator Input		Quantity
		Touch	Key and Touch	
2711P-RGT7SP	6.5-in.	•		3
2711P-RGB7P			•	
2711P-RGT9SP	9-in. (wide)	•		
2711P-RGT10SP	10.4-in.	•		
2711P-RGB10P			•	
2711P-RGT12SP	12.1-in. (wide)	•		
2711P-RGT15SP	15-in.	•		
2711P-RGB15P			•	
2711P-RGT19P	19-in.	•		

(1) The use of protective overlays may not be compatible in all hygienic applications. Consult the standards and protocols for your hygienic applications before you use a protective overlay on a stainless steel terminal.

Table 7 - Power Supplies and Power Terminal Blocks

Cat. No.	Description	Quantity
1606-XLP95E	DIN rail power supply, 24...28V DC output voltage, 95 W	1
1606-XLP100E	DIN rail power supply, 24...28V DC output voltage, 100 W	1
2711P-RSACDIN	DIN rail power supply, AC-to-DC, 85...265V AC, 47...63 Hz	1
2711P-RTBAP	3-pin AC power terminal block (gray with black labels for L1, L2N, and )	10
2711P-RTBDSP	3-pin DC power terminal block (black with white labels for +, -, and GND)	10

Table 8 - Mounting Hardware

Cat. No.	Description	Quantity
2711P-RMCP ⁽¹⁾	Mounting levers (black)	16
2711P-RTMC ⁽²⁾	Mounting clips	8

(1) Catalog number 2711P-RMCP mounting levers are used with PanelView Plus 7 Performance terminals. Do not use gray mounting levers; they are not compatible with PanelView Plus 7 Performance terminals.

(2) Catalog number 2711P-RTMC mounting clips are used for stainless steel terminals, catalog numbers 2711P-T9W22D9P-BSHK, or 2711P-T12W22D9P-BSHK. Catalog number 2711P-T12W22D9P-BSHK requires 10 mounting clips. If you need more than eight clips, order two 2711P-RTMC mounting clip kits.

Table 9 - Secure Digital (SD) Cards⁽¹⁾

Cat. No.	Description	Quantity
1784-SD1	1 GB SD card	1
1784-SD2	2 GB SD card	1
1784-SDHC8	8 GB High Capacity SD card	1
1784-SDHC32	32 GB High Capacity SD card	1
2711C-RCSA	USB to SD adapter for SD card	1

(1) To help reduce the chance of corruption when you use SD Cards or USB drives with the terminal, Rockwell Automation recommends that you use only the above SD card catalog numbers.

Table 10 - Battery Replacement

Cat. No.	Description	Quantity
2711P-RY2032	Lithium coin-cell battery, CR2032 equivalent	1

IMPORTANT Before you select the appropriate replacement gasket, you must identify the series of the PanelView Plus 7 Performance Stainless Steel terminal. The terminal's series information is located on the terminal's product nameplate label. In the following table, gaskets that are listed for use on Series B or C terminals are not certified for use on Series A terminals, and gaskets that are listed for use on Series A terminals are not certified for use on Series B or C terminals.

Table 11 - Hygienic Gasket Replacement Kits for Stainless Steel Terminals

Cat. No.	Description ⁽¹⁾	Terminal Series	Quantity
2711P-RGST9W	Hygienic gasket, blue silicone For 9-in. Series A Stainless Steel Terminals	A	1
2711P-RGST12W	Hygienic gasket, blue silicone For 12-in. Series A Stainless Steel Terminals	A	1
2711P-RGST9WB	Hygienic gasket, blue, silicone, with ribs For 9-in. Series B or C Stainless Steel Terminals	B or C	1
2711P-RGST12WB	Hygienic gasket, blue, silicone, with ribs For 12-in. Series B or C Stainless Steel Terminals	B or C	1

(1) Gasket material is compliant with FDA 21 CFR 177.2600.

Ethernet Cables

See the Industrial Ethernet Media Brochure, publication [1585-BR001](#), for recommended Ethernet cables and media solutions.

See the USB to Serial Adapter Quick Start Guide, publication [GMSC10-QS003](#), for information on USB to serial port adapters.

Install the PanelView Plus 7 Performance Terminal

Topic	Page
Hazardous Locations	27
Mounting Considerations	29
Mounting Clearances	30
Panel Guidelines	30
Panel Cutout Dimensions	30
Prepare For Panel Mounting	31
Mount the Aluminum Terminal in a Panel	35
Mount the Stainless Steel Terminal in a Panel	38
Outdoor Installation	41
Remove and Replace Power Terminal Block	42
Connect to DC Power	43
Connect to AC Power	44
Connect to a Network	45
Initial Startup — Series A Terminals	50
Initial Startup — Series B Terminals	52

This chapter describes how to install a PanelView® terminal in the door or wall of a NEMA rated, UL Type rated, or IP rated enclosure. For instructions on how to install the PanelView terminal on a machine, pedestal, or wall, see the ArmorView™ Plus 7 Installation Instructions, publication [2711P-IN013](#).



ATTENTION: Do not use a PanelView Plus 7 Performance terminal for emergency stops or other controls critical to the safety of personnel or equipment. Use separate hard-wired operator interface devices that do not depend on solid-state electronics. Some configurations of the ArmorView Plus 7 terminal include a separate emergency stop button that can be hard-wired.

**ATTENTION: Environment and Enclosure**

This equipment is intended for use in a Pollution Degree 2 industrial environment, in overvoltage Category II applications (as defined in IEC 60664-1), at altitudes up to 2000 m (6561 ft) without derating.

The terminals are intended for use with programmable logic controllers. Terminals that are AC powered must be connected to the secondary of an isolating transformer.

This equipment is considered Group 1, Class A industrial equipment according to IEC CISPR 11. Without appropriate precautions, there may be difficulties with electromagnetic compatibility in residential and other environments due to conducted or radiated disturbances.

Korean Radio Wave Suitability Registration - When so marked this equipment is registered for Electromagnetic Conformity Registration as business equipment (A), not home equipment. Sellers or users are required to take caution in this regard.

이 기기는 업무용 (A 급) 전자파적합기기로서 판 매자 또는 사용자는 이 점을 주의하시기 바라 며 , 가정외의 지역에서 사용하는 것을 목적으로 합니다 .

This equipment is supplied as open-type equipment. It must be mounted within an enclosure that is suitably designed for those specific environmental conditions that will be present and appropriately designed to prevent personal injury resulting from accessibility to live parts. The interior of the enclosure must be accessible only by the use of a tool. The terminals meet specified NEMA, UL Type, and IEC ratings only when mounted in a panel or enclosure with the equivalent rating. Subsequent sections of this publication may contain additional information regarding specific enclosure type ratings that are required to comply with certain product safety certifications.

In addition to this publication, see the following:

- Industrial Automation Wiring and Grounding Guidelines, publication [1770-4.1](#), for additional installation requirements.
- NEMA 250 and IEC 60529, as applicable, for explanations of the degrees of protection provided by different types of enclosure.

**ATTENTION: Wiring and Safety Guidelines**



Use publication NFPA 70E, Electrical Safety Requirements for Employee Workplaces, IEC 60364 Electrical Installations in Buildings, or other applicable wiring safety requirements for the country of installation when wiring the devices. In addition to the NFPA guidelines, here are some other guidelines to follow:

- Employ only qualified electricians to wire the device in accordance with local, state, and national codes.
- Connect the device and other similar electronic equipment to its own branch circuit.
- Protect the input power by a fuse or circuit breaker rated at no more than 15 A.
- Route incoming power to the device by a separate path from the communication lines.
- Cross power and communication lines at right angles if they must cross.
- Communication lines can be installed in the same conduit as low-level DC I/O lines (less than 10V).
- Shield and ground cables appropriately to avoid electromagnetic interference (EMI). Grounding minimizes noise from EMI and is a safety measure in electrical installations.

For more information on grounding recommendations, see the National Electrical Code published by the National Fire Protection Association.

Hazardous Locations

This section provides information for hazardous locations.

The following information applies when operating this equipment in hazardous locations.	Informations sur l'utilisation de cet équipement en environnements dangereux.
<p>When marked, these products are suitable for use in "Class I, Division 2, Groups A, B, C, D"; Class I, Zone 2, Group IIC hazardous locations and nonhazardous locations only. Each product is supplied with markings on the rating nameplate indicating the hazardous location temperature code. When combining products within a system, the most adverse temperature code (lowest "T" number) may be used to help determine the overall temperature code of the system. Combinations of equipment in your system are subject to investigation by the local Authority Having Jurisdiction at the time of installation.</p>	<p>Les produits marqués "CL I, DIV 2, GP A, B, C, D" ne conviennent qu'à une utilisation en environnements de Classe I Division 2 Groupes A, B, C, D dangereux et non dangereux. Chaque produit est livré avec des marquages sur sa plaque d'identification qui indiquent le code de température pour les environnements dangereux. Lorsque plusieurs produits sont combinés dans un système, le code de température le plus défavorable (code de température le plus faible) peut être utilisé pour déterminer le code de température global du système. Les combinaisons d'équipements dans le système sont sujettes à inspection par les autorités locales qualifiées au moment de l'installation.</p>
<div style="display: flex; align-items: center;">  <div> <p>WARNING: EXPLOSION HAZARD</p> <ul style="list-style-type: none"> • Do not disconnect equipment unless power has been removed or the area is known to be nonhazardous. • Do not disconnect connections to this equipment unless power has been removed or the area is known to be nonhazardous. Secure any external connections that mate to this equipment by using screws, sliding latches, threaded connectors, or other means provided with this product. • Substitution of components may impair suitability for Class I, Division 2. • Peripheral equipment must be suitable for the location in which it is used. • The battery in this product must be changed only in an area known to be nonhazardous. • All wiring must be in accordance with Class I, Division 2 wiring methods of Article 501 of the National Electrical Code and/or in accordance with Section 18-1J2 of the Canadian Electrical Code, and in accordance with the authority having jurisdiction. </div> </div>	<div style="display: flex; align-items: center;">  <div> <p>AVERTISSEMENT : RISQUE D'EXPLOSION</p> <ul style="list-style-type: none"> • Couper le courant ou s'assurer que l'environnement est classé non dangereux avant de débrancher l'équipement. • Couper le courant ou s'assurer que l'environnement est classé non dangereux avant de débrancher les connecteurs. Fixer tous les connecteurs externes reliés à cet équipement à l'aide de vis, loquets coulissants, connecteurs filetés ou autres moyens fournis avec ce produit. • La substitution de composants peut rendre cet équipement inadapté à une utilisation en environnement de Classe I, Division 2. • Les équipements périphériques doivent s'adapter à l'environnement dans lequel ils sont utilisés. • S'assurer que l'environnement est classé non dangereux avant de changer la pile ou le module horloge temps réel de ce produit. • Tous les systèmes de câblage doivent être de Classe I, Division 2, conformément aux méthodes de câblage indiquées dans les Articles 501 du National Electrical Code (Code Electrique National) et/ou conformément à la Section 18-1J2 du Canadian Electrical Code (Code Electrique Canadien), et en fonction de l'autorité de juridiction. </div> </div>

The terminals⁽¹⁾ have a temperature code of T4 when operating in a 55 °C (131 °F) maximum ambient temperature. Do not install product in environments where atmospheric gases have ignition temperatures less than 135 °C (275 °F).

(1) The ArmorView Plus 7 terminal is not certified for use in hazardous locations.

Required Circuit Port Parameters for USB Peripheral Devices

This product contains USB host ports that comply with hazardous location environments. Field wiring compliance requirements are provided in compliance with the National Electrical Code, Article 500.

Figure 1 - PanelView Plus 7 Performance Terminal Control Drawing

Associated Nonincendive Field Wiring Apparatus

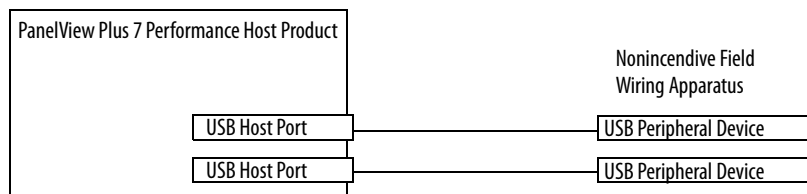

PanelView Plus 7 Performance terminals provide two, separately powered USB host ports. [Table 12](#) defines the circuit parameters of these USB host ports.

Table 12 - Circuit Parameters for USB Host Ports

Parameter	Value	Parameter Definition	
$V_{oc(USB)}$	5.25V DC	Open circuit voltage of each host USB port. The maximum applied voltage rating, $V_{max(peripheral)}$, of each USB peripheral device shall be greater than or equal to $V_{oc(USB)}$.	$V_{max(peripheral)} \geq V_{oc(USB)}$ (as appropriate)
$I_{oc(USB)}$	1.25 A	Maximum output current of each host USB port. The maximum current, $I_{max(peripheral)}$, to which each USB peripheral device can be subjected shall be greater than or equal to $I_{oc(USB)}$.	$I_{max(peripheral)} \geq I_{oc(USB)}$
$C_{a(USB)}$	10 μ F	This value is the maximum total capacitance that can be connected to each USB host port. The total capacitance of each USB peripheral device and its associated cable must not exceed the indicated value. The maximum total capacitance, $C_{i(peripheral)}$, and cable capacitance of each separate USB peripheral device shall be less than or equal to $C_{a(USB)}$.	$C_{i(peripheral)} + C_{cable(USB)} \leq C_{a(USB)}$
$L_{a(USB)}$	15 μ H	This value is the maximum total inductance that can be connected to each USB host port. The total inductance of each USB peripheral device and its associated cable must not exceed the indicated value. The maximum total inductance, $L_{i(peripheral)}$, and cable inductance of each separate USB peripheral device shall be less than or equal to $L_{a(USB)}$.	$L_{i(peripheral)} + L_{cable} \leq L_{a(USB)}$

Application Information

Per the National Electrical Code, the circuit parameters of associated field-wiring apparatus for use in hazardous locations shall be coordinated with the host product such that their combination remains nonincendive. PanelView Plus 7 Performance terminals and the USB peripheral devices shall be treated in this manner.

The USB peripheral devices and their associated cabling shall have circuit parameters with the limits given in [Table 12](#) for them to remain nonincendive when used with the PanelView Plus 7 Performance terminal USB host ports.

If cable capacitance and inductance are not known, use the following values from ANSI/ISA-RP 12.06.01-2003:

$$C_{cable} = 197 \text{ pF/m (60 pF/ft)}$$

$$L_{cable} = 0.7 \text{ } \mu\text{H/m (0.20 } \mu\text{H/ft)}$$

Nonincendive field wiring must be wired and separated in accordance with 501.10(B)(3) of the National Electrical Code, ANSI/NFPA 70, or other local codes as applicable. This associated nonincendive field wiring apparatus has not been evaluated for use in combination with another associated nonincendive field wiring apparatus.

Mounting Considerations

Consider the following when mounting the terminal:

- Mount the terminal at a height suitable for most operators. You can mount the cabinet at a different level than the operator floor.
- Use appropriate lighting. Do not operate the terminal in direct sunlight.
- Terminals are rated to operate at mounting angles between 0...180°.

Since the ArmorView Plus 7 terminals are pre-mounted in a custom enclosure for easy deployment, you may skip the following sections about mounting. For instructions on how to mount the ArmorView Plus 7 terminal, see the ArmorView Plus 7 Installation Instructions, publication [2711P-IN013](#).

Figure 2 - Acceptable and Unacceptable Mounting Positions

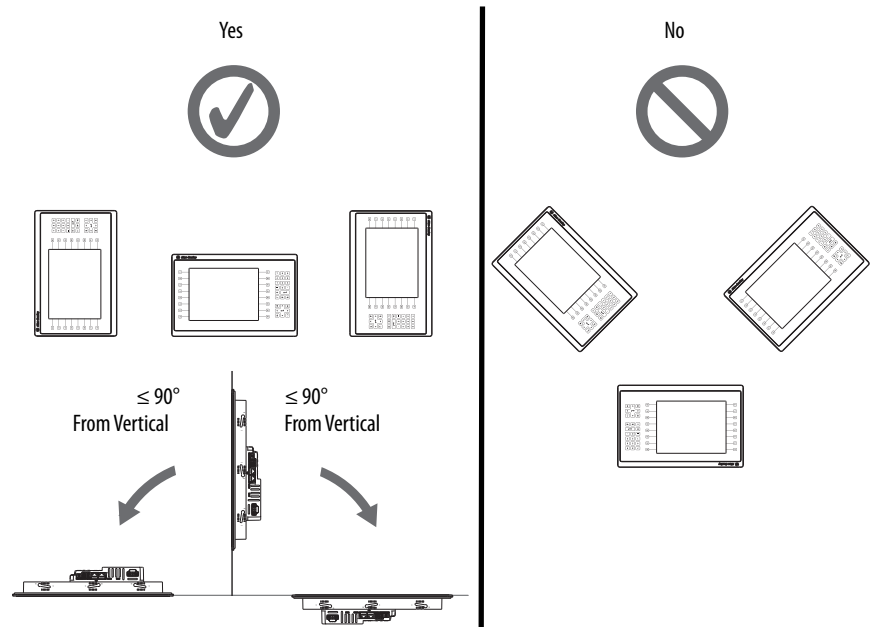

ATTENTION: Failure to follow these guidelines can result in personal injury or damage to the panel components.

Mounting Clearances

Plan for adequate space around the terminal, inside the enclosure, for ventilation and cabling. Consider heat that is produced by other devices in the enclosure.

The ambient temperature around the terminal must be 0...55 °C (32...131 °F), except for the 19-in. Series A terminal, which has an ambient temperature requirement of 0...50 °C (32...122 °F). The ambient temperature for the 19-in. Series B terminal (Series C for the Stainless Steel terminals) is 0...55 °C (32...131 °F).

Table 13 - Minimum Required Clearances

Product Area	Minimum Clearance
Top	51 mm (2 in.)
Bottom	102 mm (4 in.)
Sides	25 mm (1 in.) on side without an SD card 102 mm (4 in.) on side with an SD card
Back	0 mm (0 in.) ⁽¹⁾

(1) When mounting a stainless steel terminal on a panel thicker than 3.66 mm (0.144 in.), the minimum clearance is from the mounting clip, not the back of the terminal.

Panel Guidelines

The terminals are panel-mount devices that mount in the door or wall of a NEMA rated, UL Type rated, or IP rated enclosure:

- Panels must have a thickness of 1.5...4.8 mm (0.060...0.188 in.).
- The material strength and stiffness of the panel must be sufficient to hold the terminal and maintain an appropriate seal against water and dust.
- The panel surface must be flat and free of imperfections to maintain an adequate seal, and NEMA and UL Type ratings.

Panel Cutout Dimensions

Use the template that is shipped with your terminal to mark the cutout dimensions.

Table 14 - Panel Cutout Dimensions - PanelView Plus 7 Performance Terminals

Terminal Size	Input Type	Height, mm (in.)	Width, mm (in.)
6.5-in.	Keypad and touch	142 (5.59)	237 (9.33)
	Touch	142 (5.59)	184 (7.24)
9-in.	Touch	162 (6.38)	252 (9.92)
10.4-in.	Keypad and touch	224 (8.82)	335 (13.19)
	Touch	224 (8.82)	269 (10.59)
12.1-in.	Touch	218 (8.58)	312 (12.28)
15-in.	Keypad and touch	290 (11.42)	418 (16.46)
	Touch	290 (11.42)	353 (13.90)
19-in.	Touch	383 (15.08)	457 (17.99)

Prepare For Panel Mounting

IMPORTANT To mount a stainless steel terminal, skip this section and continue with [Mount the Stainless Steel Terminal in a Panel on page 38](#).

Before mounting a terminal in a panel, read this section and the entire installation procedure on [page 35](#).

IMPORTANT Catalog number 2711P-RMCP mounting levers (black) are used with the PanelView Plus 7 Performance terminals. Do not use gray mounting levers; they are not compatible with PanelView Plus 7 Performance terminals.

Mounting levers insert into the slots around the bezel to secure the terminal in the panel. The number of levers varies by terminal size.

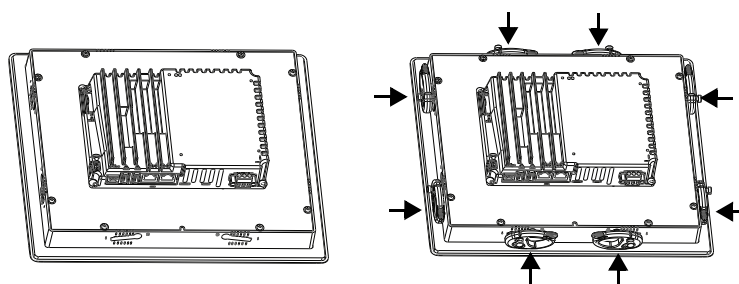

Each slot has six notches with alignment marks that are locking positions for a lever. The thickness of the panel in which you mount the terminal determines the locking position that is required to maintain a NEMA/UL Type seal.

Table 15 - Lever Locking Positions

Mounting Slot	Lever Lock Position	Panel Thickness Range	Typical Gauge
<p>Orientation of Slot Varies</p>	1	1.50...2.01 mm (0.060...0.079 in.)	16
	2	2.03...2.64 mm (0.080...0.104 in.)	14
	3	2.67...3.15 mm (0.105...0.124 in.)	12
	4	3.17...3.66 mm (0.125...0.144 in.)	10
	5	3.68...4.16 mm (0.145...0.164 in.)	8/9
	6	4.19...4.80 mm (0.165...0.188 in.)	7

Always orient a mounting lever vertically before inserting it into a slot. This method is the only way to slide the mounting lever knob within the slot for positioning. After sliding the mounting lever to a specific notch, rotate the mounting lever toward the panel to lock it in position. The flat side of the mounting lever must come into contact with the panel.

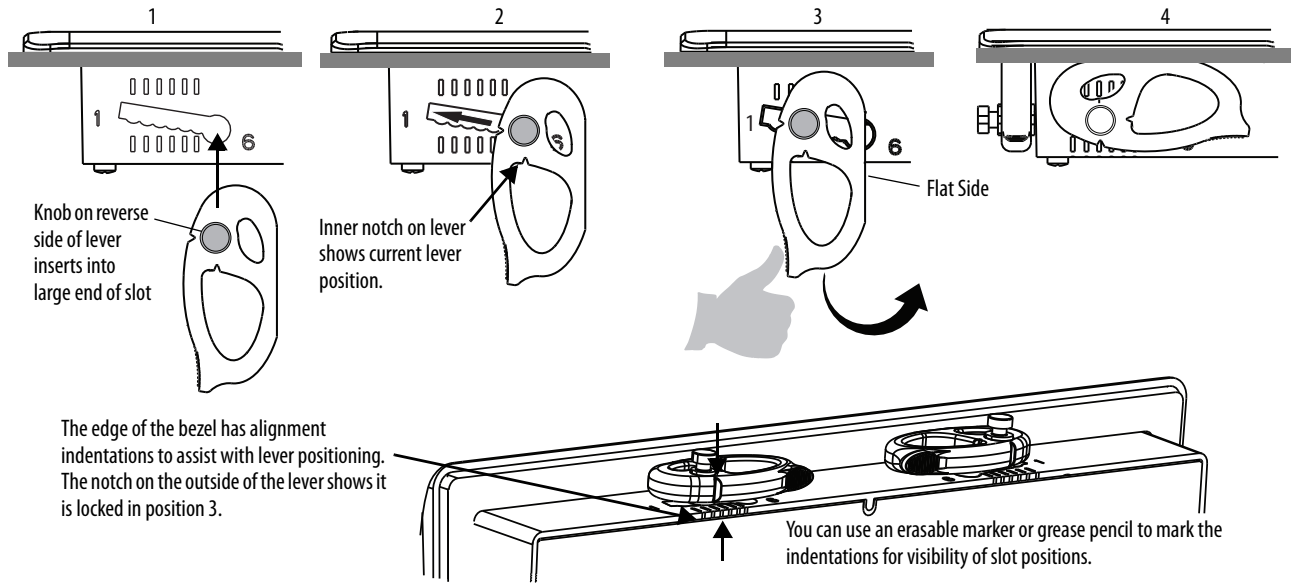

Initially, you secure the terminal in the panel by sliding each mounting lever to a position that is one or two notches greater than the final lock position. For example, if the final lock position is 3, slide each mounting lever to position 4 or 5. Follow the sequence specific to the terminal size shown in [Figure 3 on page 34](#).

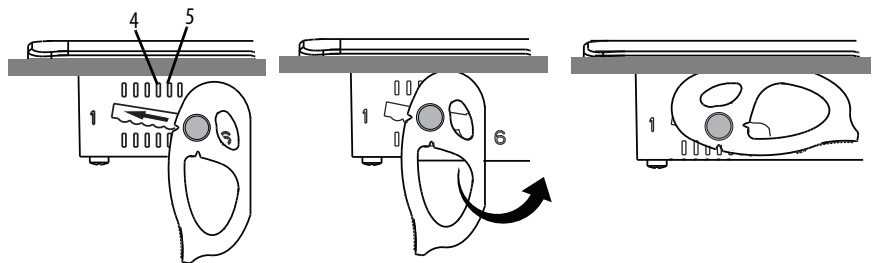

TIP If the lock position is 6, slide lever to large end of slot or insertion hole.

You then adjust each lever to its final lock position in the same sequence. See [Figure 3 on page 34](#).

IMPORTANT This process equalizes the pressure of the levers against the panel at a gradual rate reducing the probability of broken clamps.

This figure shows the lever orientation and lock sequence for a 10.4-in. touch terminal.

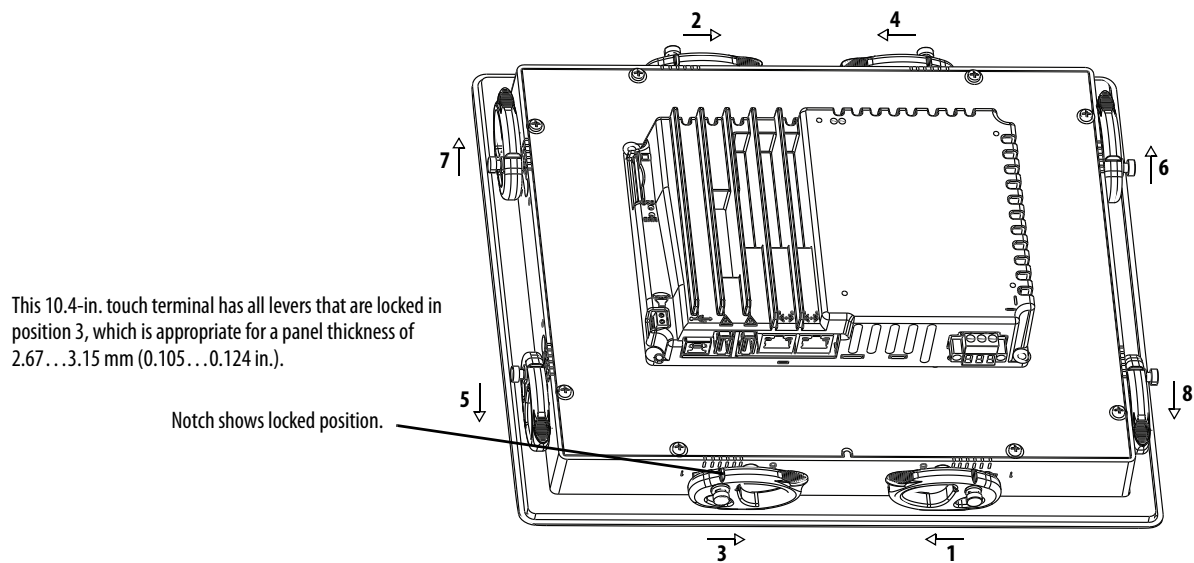
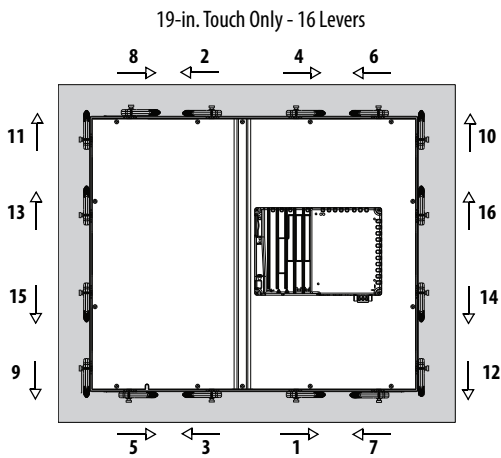
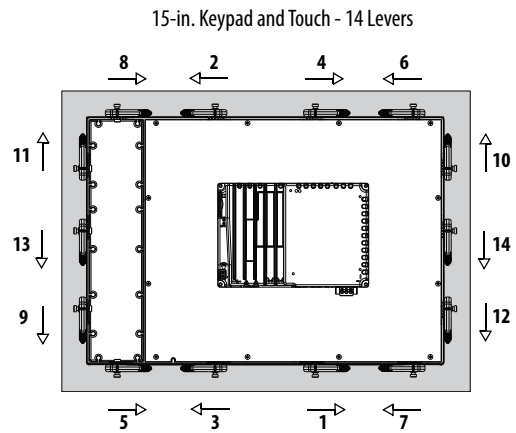
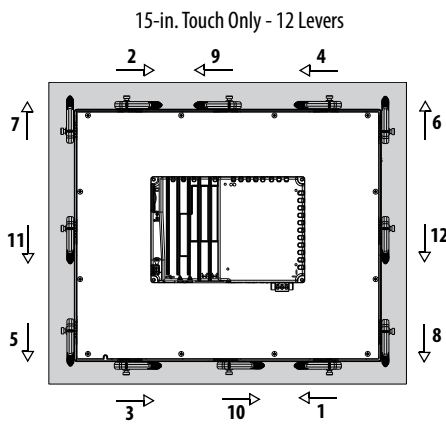
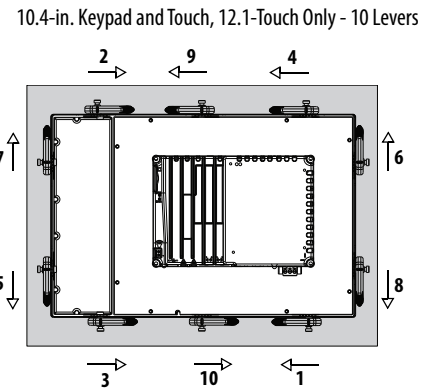
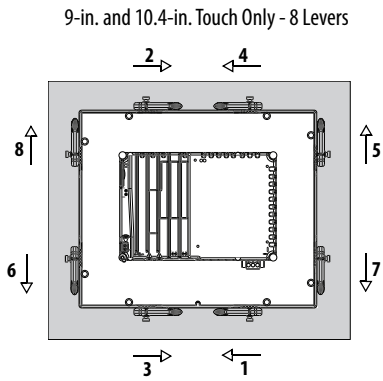
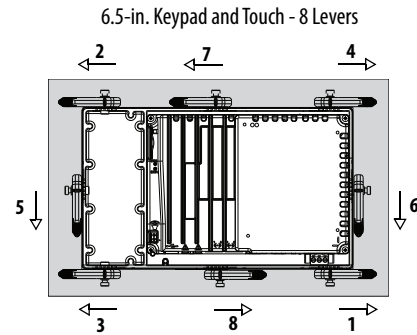
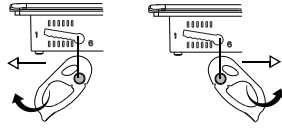
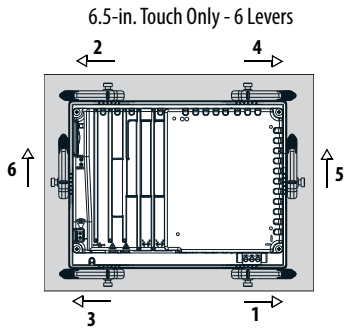

Figure 3 - Lever Orientation and Lock Sequence



IMPORTANT: The mounting lever orientations that are shown are required to maintain NEMA, UL Type, and IP seals. If you require a NEMA, UL Type, or IP seal, do not use a mounting lever in a different orientation than shown.

Mount the Aluminum Terminal in a Panel

IMPORTANT To mount a stainless steel terminal, skip this section and continue with [Mount the Stainless Steel Terminal in a Panel on page 38](#).

The terminals are designed for single-person installation. No tools are required except for the tools that are used to make the panel cutout.

To mount the terminal in a panel, follow these steps.



ATTENTION:

Disconnect all electric power from the panel before making the panel cutout.

Make sure that the area around the panel cutout is clear and that the panel is clean of any debris, oil, or other chemicals.

Make sure that metal cuttings do not enter any components that are installed in the panel, and that the edges of the cutout have no burrs or sharp edges.

Failure to follow these warnings can result in personal injury or damage to panel components.

1. Cut an opening in the panel by using the panel cutout template that shipped with the terminal, or the cutout dimensions in [Table 14 on page 30](#).
2. Verify that the sealing gasket is present on the terminal.

This gasket forms a compression seal. Do not use sealing compounds.

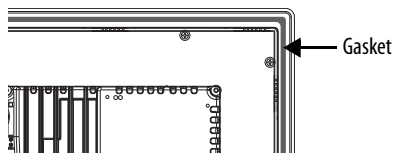

3. Insert and stabilize the terminal in the panel cutout.
 - a. Insert levers in the top corner slots by using the orientation in [Figure 3 on page 34](#), and rotate the curved side of the levers toward the panel.

TIP The mounting levers for PanelView Plus 7 Performance terminals are black (catalog number 2711P-RMCP).

Do not use gray mounting levers; they are not compatible with PanelView Plus 7 Performance terminals.

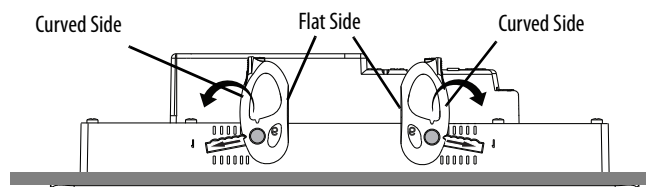
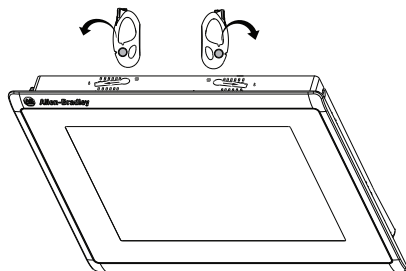

- b. Tilt the terminal into the panel cutout and guide upward into the cutout so that the levers are behind the panel.

TIP The levers help to prevent the terminal from falling out of the panel.

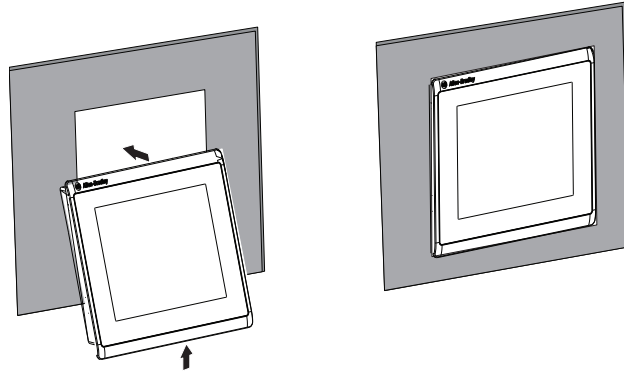

- c. Pull the top of the terminal toward you to verify that the levers are still in place and the terminal is stabilized in the panel.

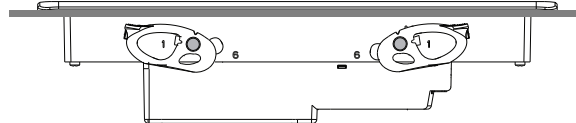

- d. Insert the remaining levers in the slots by using the orientations for your terminal in [Figure 3 on page 34](#).

The direction that you rotate the levers varies for each terminal size.

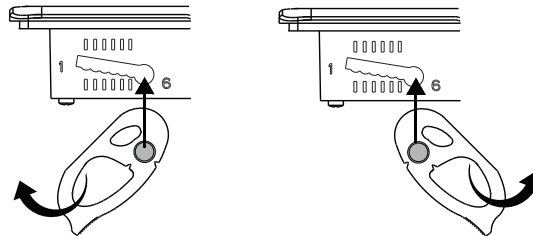

- 4. Slide and rotate each lever to a notch that is one or two positions greater than the final lock position, starting with the first lever in the sequence. For example, if the final lock position is 3, slide the lever to notch 4 or 5.

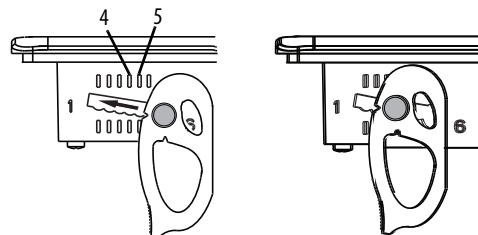

TIP Use the alignment marks or previous marks you made on the bezel to help position the levers and identify the final slot position.

- a. See [Figure 15 on page 31](#) to get the final lock position of the levers.
- b. See [Figure 3 on page 34](#) to get the locking sequence.

- c. Rotate each lever until its flat side comes in contact with the panel.

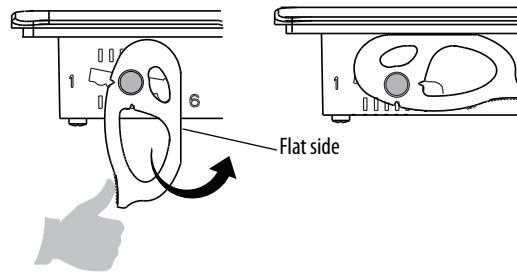

5. Adjust each lever to its final lock position by using the same locking sequence in [Figure 3 on page 34](#).
- a. Unlock lever one in the sequence by rotating it away from the bezel.

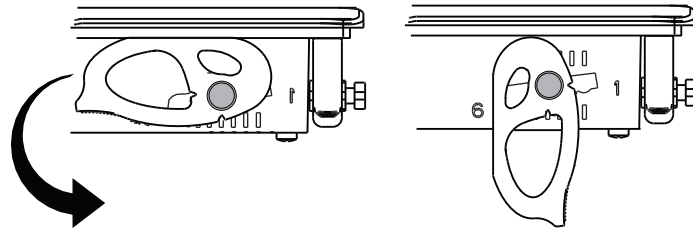

- b. With the lever positioned vertically to the slot, slide the lever to the final locking position in [Table 15 on page 31](#).

The outer notch of the lever aligns with the bezel indentation.

- c. Carefully rotate the lever back toward panel.

IMPORTANT Do not use tools or excessive force to rotate the mounting levers. The mounting levers are rotated and secured by hand.

TIP A broken mounting lever does not damage the terminal. The mounting levers are designed to break off the pin if they are over torqued. This breakage helps to prevent damage to the terminal bezel. If a pin is broken, you can turn the lever around and use the lever in another location. See [Figure 3 on page 34](#) for details and restrictions.

- d. Lock the remaining levers to their final position.

- Verify that all levers are in the correct locked position.



ATTENTION: All levers must be in the correct and same locked position to provide an adequate gasket seal between the terminal and the panel. Rockwell Automation assumes no responsibility for water or chemical damage to the terminal or other equipment within the enclosure because of improper installation.

The notch on the outside of lever shows its locked position.

These two views show levers that are locked in position 3.

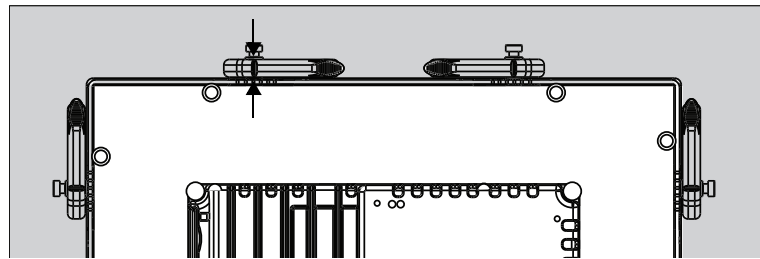
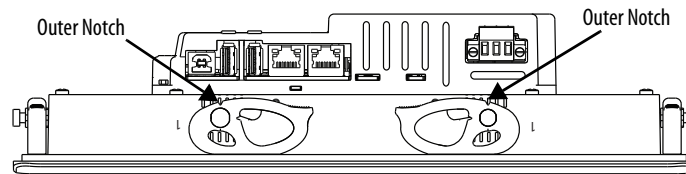

Mount the Stainless Steel Terminal in a Panel

Mounting clips secure the stainless steel terminals in a panel. The number of clips varies by terminal size. Tools that are required for installation include panel cutout tools, a large slotted or Phillips screwdriver, and a torque wrench for tightening the mounting clips.



ATTENTION:

Disconnect all electric power from the panel before making the panel cutout. Make sure that the area around the panel cutout is clear and that the panel is clean of any debris, oil, or other chemicals.

Make sure that metal cuttings do not enter any components that are installed in the panel, and that the edges of the cutout have no burrs or sharp edges.

Failure to follow these warnings can result in personal injury or damage to panel components.

To mount the stainless steel terminal in a panel, follow these steps.

- Cut an opening in the panel by using the panel cutout template that shipped with the terminal, or the cutout dimensions in [Table 14 on page 30](#).
- Place the terminal screen-down on a clean, flat surface.
Be careful not to scratch or damage the terminal screen.

3. Position the gasket on the bezel, with the gasket alignment plugs facing the bezel alignment features.

This gasket forms a compression seal. Do not use sealing compounds.

IMPORTANT Slip the inside corners of the gasket under the corners of the bezel shroud.

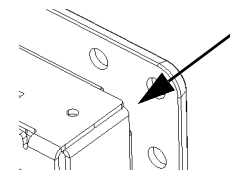

4. Press each gasket alignment plug into the bezel alignment feature.

The alignment plugs hold the gasket to the bezel.

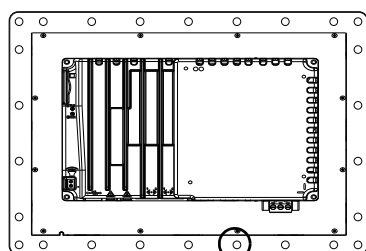

Back of Bezel with Alignment Features

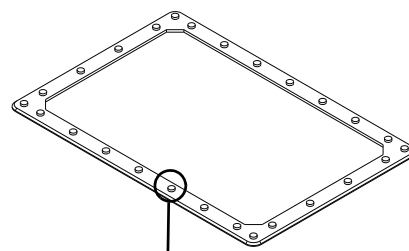

Gasket with Alignment Plugs

5. Place the terminal in the panel cutout.

Hold the terminal so it does not fall out of the panel.

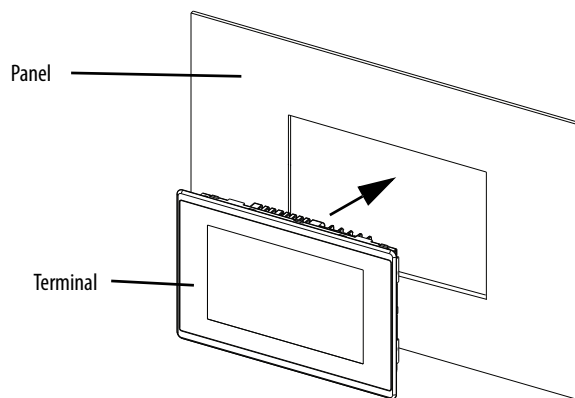

- Position the backing plate over the terminal.

IMPORTANT Make sure that the flat side of the backing plate faces away from the panel, as shown in the drawing.

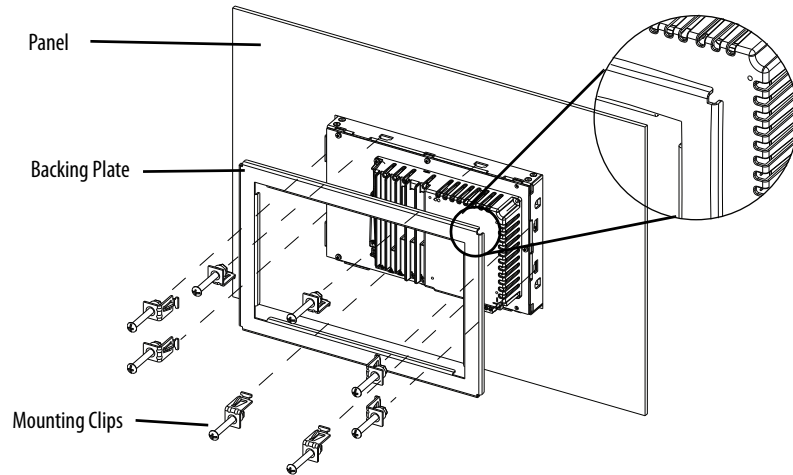

- Slide the ends of the mounting clips into the slots on the terminal.
- Tighten the mounting clip screws by hand until the backing plate contacts the panel uniformly.
- Torque the mounting clip screws to 2.3...2.6 N•m (20...23 lb•in) by using the specified sequence.
The clips will loosen as the adjacent clip is tightened.
- Repeat [step 9](#) until all the mounting clips are at the specified torque.

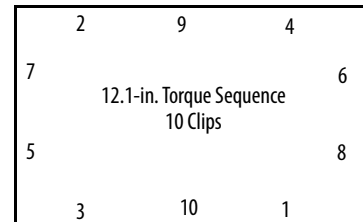
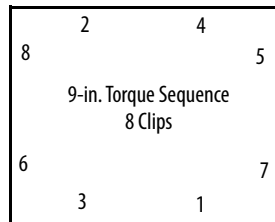

ATTENTION: Tighten the mounting clips to the specified torque to provide a proper seal and to prevent damage to the product. Rockwell Automation assumes no responsibility for water or chemical damage to the product or other equipment within the enclosure because of improper installation.

Outdoor Installation



ATTENTION: Failure to follow the recommended installation practices for outdoor use will substantially reduce product life and void product warranty.

When using a 2711P terminal outdoors, you must follow the recommendations outlined below to maximize the field life of the front bezel and display:

- Add UV protection and shielding (sun shade or sun visor)
- Manage terminal temperature
- Install a protective overlay
- Consider terminal orientation
- Select a proper enclosure

Ultraviolet (UV) and infrared radiation can reduce the field life of any electronic terminal. While the materials used in the terminal bezels provide long field life, that life can be improved by proper installation and by following the suggested guidelines.

UV radiation from the sun causes all plastics to fade or yellow and become brittle over time. Using a sacrificial antiglare overlay (see [Table 6 on page 23](#)) helps protect the front of the terminal from direct exposure to UV radiation, and by avoiding direct sunlight exposure, this overlay greatly increases its field life. Another recommendation for UV protection is a shield to shade the terminal from the direct rays of the sun. This also helps reduce the solar heating caused by direct sun exposure. When installing a sun shield that closes over the display, the temperature between the sun shield and the display cannot exceed the maximum temperature of the display, which is 55 °C (131°F). Adequately ventilate all sun shields to help prevent excess heat rise on the terminal display.

Use stirring fans or active cooling in high altitude and high ambient temperature locations to keep the internal enclosure temperature below 55 °C (131 °F).

Ensure the ambient temperature the product is operating in does not fall below its minimum rated 0°C (32°F).

The temperature differential between the inside of the terminal enclosure and the front panel must be minimized to reduce the potential for condensation and possible pressure variation between the inside and outside of the product.

Avoid placing the terminal on the south (north in the southern hemisphere) or west side of the cabinet. This reduces the heat rise due to solar heating during the hottest part of the day.

Mount the terminal vertically to minimize solar heating on the display. Do not mount the terminal in a sloped enclosure if it exposes the terminal to direct sunlight.

Protect the terminal from water and dust by mounting it in a proper enclosure following the instructions in the PanelView Plus 7 Performance Terminals Product Information, publication [2711P-PC007](#). The terminals meet specified NEMA, UL Type, and IEC ratings only when properly mounted in a panel or enclosure with the equivalent rating. Other sections of this publication may contain additional information regarding specific enclosure type ratings that are required to comply with certain product safety certifications.

Remove and Replace Power Terminal Block

The product has a three-pin terminal block for power connections. You can remove the terminal block for ease of installation, wiring, and maintenance.



WARNING: Explosion Hazard

If you connect or disconnect wiring while the power is on, an electric arc can occur. An electric arc can cause an explosion in hazardous location installations. Verify that the power is off and the area is nonhazardous before proceeding. Failure to turn power off can result in electric shock or damage to the terminal.

The terminal block has different markings for AC and DC power connections. Use a 0.6 x 3.5 mm screwdriver for terminal block wiring.

Table 16 - Wire Specifications for Power Input Terminal Block

Wire Type	Dual-wire Size ⁽¹⁾	Single-wire Size	Strip Length	Wire Torque	Mounting Torque
Stranded or solid Cu 90 °C (194 °F)	0.3...1.3 mm ² 22...16 AWG	0.3...2.1 mm ² (22...14 AWG)	7 mm (0.28 in.)	0.4...0.5 N·m (3.5...4.4 lb-in)	0.15...0.2 N·m (1.3...1.8 lb-in)

(1) Two-wire maximum per terminal.

To remove the terminal block, follow these steps.

1. Loosen the two screws that secure the terminal block.

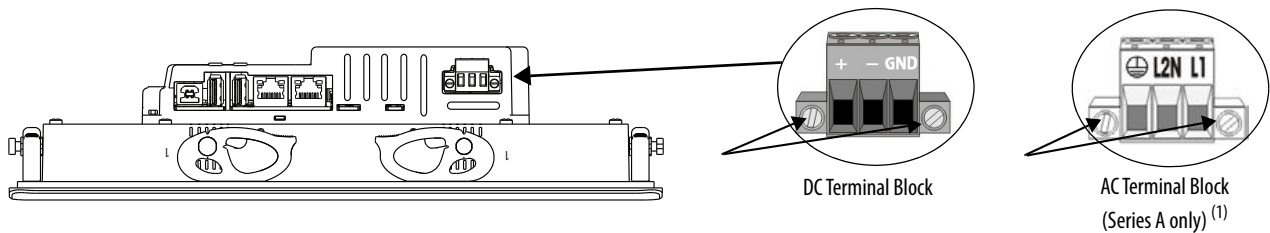

2. Gently pull the terminal block away from the connector.

⁽¹⁾ Series C for PanelView Plus 7 Performance Stainless Steel terminals.

To install the terminal block, follow these steps.

1. Reattach the terminal block to the connector until seated.



ATTENTION: Do not use excessive force to press the terminal block into position. The terminal blocks are keyed to fit the DC or AC connector. If the terminal block does not fit into the connector, verify that you have the correct terminal block. See [Table 7 on page 23](#).

2. Tighten the two screws that secure the terminal block to the connector.

Connect to DC Power

Terminals with a 24V DC power supply have these power ratings:

- 24V DC nominal (18...30V DC)
- 50 W maximum (2.1 A at 24V DC)



ATTENTION: The power supply is internally protected against reverse polarity. To avoid damage to the terminal:

- Do not connect DC+ or DC- to the earth ground terminal.
- Do not connect AC power, or more than 30V DC, to the power terminal block.

Terminals with a DC power input support operation from a safety extra low voltage (SELV) or protective extra-low voltage (PELV) 24V DC power supply. Supported power supplies include catalog numbers 1606-XLP95E, 1606-XLP100E, or 2711P-RSACDIN.



ATTENTION: Use a SELV or PELV supply as required by local wiring codes for your installation. The SELV and PELV power sources provide protection so that under normal and single fault conditions, the voltage between conductors and earth ground does not exceed a safe value.

You can power the terminal from the same power source as other equipment by using a DC power bus.

To connect the operator terminal to a DC power source, follow these steps.

1. Verify that the wiring is not connected to a power source.
2. Strip 7 mm (0.28 in.) of insulation from the ends of the wires.

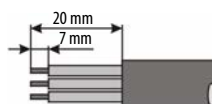

- Secure the DC power wires to the marked terminals (+ and -) on the terminal block.

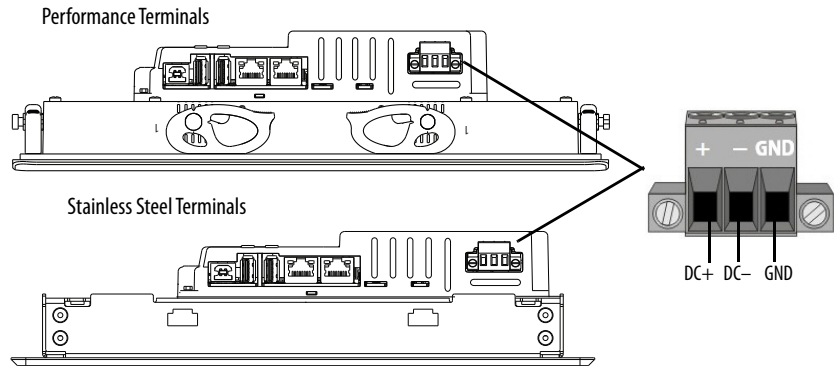

- Secure the earth ground wire to the GND terminal on the terminal block.

The GND terminal must be connected to a low-impedance earth ground.



ATTENTION: The earth ground connection to ground is mandatory. This connection is required for noise immunity, reliability, and Electromagnetic Compliance (EMC) with the European Union (EU) EMC Directive for CE marking conformance. This connection is required for safety by Underwriters Laboratory.

- Apply power to the operator terminal.

Connect to AC Power⁽¹⁾

Terminals with an AC power supply have these power ratings:

- 100...240V AC (50...60 Hz)
- 105VA maximum



ATTENTION: Improper wiring of the power terminals can result in voltage at the communication connector shells.

Do not apply power to the terminal until all wiring connections have been made. Failure to do so can result in electric shock.

Do not connect stainless steel terminals to AC power. Stainless steel terminals are only compatible with DC power.

To connect the operator terminal to an AC power source, follow these steps.

- Verify that the wiring is not connected to a power source.
- Strip 7 mm (0.28 in.) of insulation from the ends of the wire.

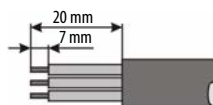

(1) Available on Series A terminals only.

- Secure the AC power wires to the marked terminals (L1 and L2N) on the terminal block.

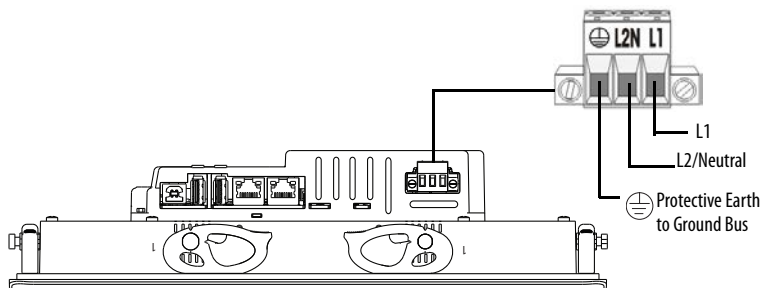

- Secure the protective earth ground wire to the marked terminal on the terminal block.

The protective earth terminal must be connected to a low-impedance earth ground.



ATTENTION: The earth ground connection to ground is mandatory. This connection is required for noise immunity, reliability, and Electromagnetic Compliance (EMC) with the European Union (EU) EMC Directive for CE marking conformance. This connection is required for safety by Underwriters Laboratory.

- Apply power to the operator terminal.

Connect to a Network

The two Ethernet ports connect to controllers on an EtherNet/IP network by using standard Ethernet connections. These network types are supported:

- [Device Level Ring Network Topology on page 48](#)
- [Linear Network Topology on page 49](#)
- [Star Network Topology on page 50](#)

Each of these EtherNet/IP network topologies supports applications that use Integrated Motion over an EtherNet/IP network, if necessary.

IMPORTANT The terminal has dual-Ethernet ports but only one device IP address.

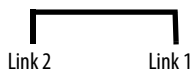

Ethernet Ports

The Ethernet port has two 10/100Base-T connectors for network communication and supports MDI/MDI-X connections and DLR network topology as indicated by the DLR network icon.

The terminal connects to an EtherNet/IP network by using a CAT5, CAT5E, or CAT6 twisted-pair, Ethernet cable with RJ45 connectors.

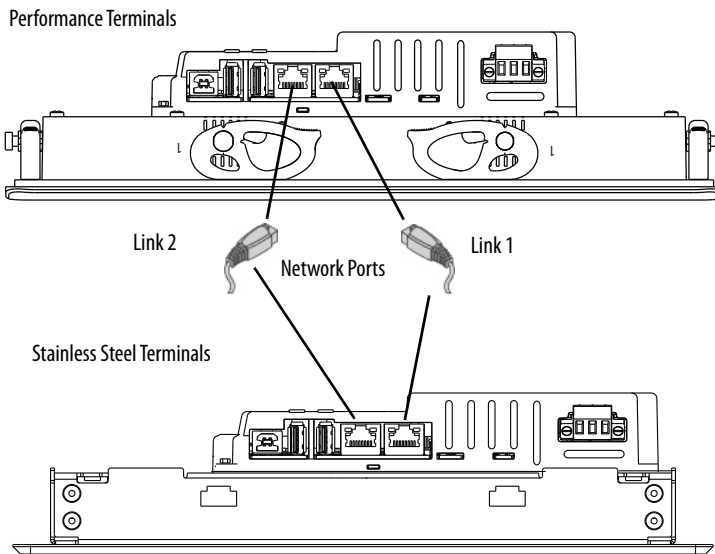

IMPORTANT To help prevent accidental disconnection of the Ethernet cable, follow these steps:

- Secure the Ethernet cable to minimize vibration at the connector, and reduce the chance that personnel working inside the panel can accidentally disconnect the cable.
- Do not install the Ethernet cable too tightly. Leave some slack in the cable to help prevent pulling on the cable when the panel door is opened and closed.

The maximum cable length between the Ethernet ports and a 10/100Base-T port on an Ethernet hub (without repeaters or fiber) is 100 m (328 ft).



WARNING: In hazardous locations, do not connect or disconnect any communication cable with power that is applied to this device or any device on the network. An electric arc can cause an explosion in hazardous location installations. Make sure that the power is off or the area is nonhazardous before proceeding.

Table 17 - Ethernet Connector Pinout

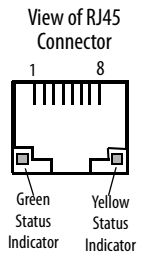
Connector	Pin	Pin Name
<p>View of RJ45 Connector</p> 	1	TD+
	2	TD-
	3	RD+
	4	Unused
	5	Unused
	6	RD-
	7	Unused
	8	Unused
	Shield Connection	No direct connection (AC coupled to chassis GND)

Each Ethernet port has two indicators that provide the status of activity.

Table 18 - Ethernet Status Indicators

Indicator	Color	Description
Link Integrity	Green	On when a link is present.
Activity	Yellow	Blinks when activity is detected on Ethernet link.

Device Level Ring Network Topology

A DLR network is a single-fault tolerant ring network that is intended for the interconnection of automation devices. This topology is also implemented at the device level. No additional switches are required.

TIP A DLR network has supervisor nodes and ring nodes. The PanelView Plus 7 Performance terminal operates only as a ring node on the network.

DLR network topologies automatically convert to linear network topologies when a fault is detected. The conversion to the new network topology maintains communication of data on the network. The fault condition is typically detected and corrected.

For more information on DLR network topology, see the EtherNet/IP Embedded Switch Technology Application Guide, publication [ENET-AP005](#).

Figure 4 - PanelView Plus 7 Performance Terminal in a DLR Topology Network

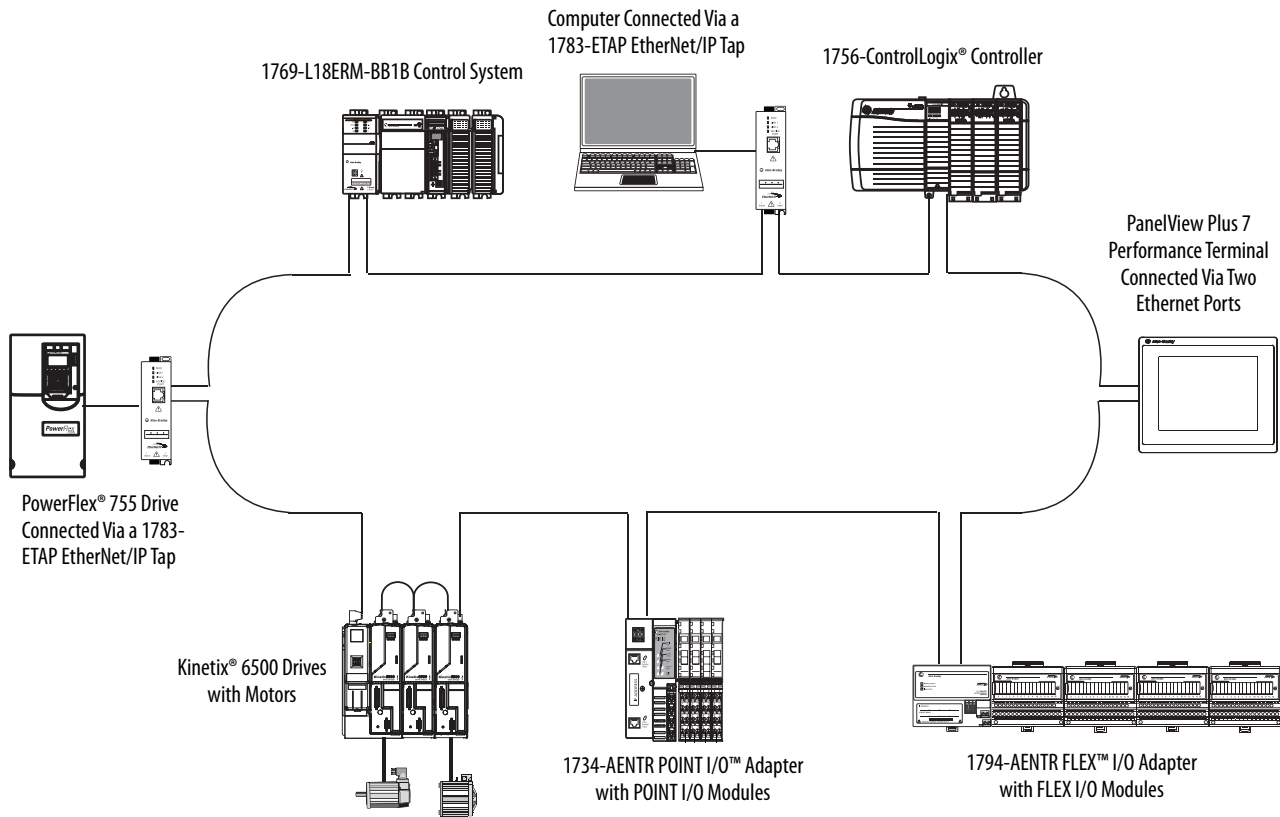

Linear Network Topology

A linear network topology is a collection of devices that are daisy-chained together across an EtherNet/IP network. Devices capable of connecting to a linear network topology use embedded switch technology to remove the need for a separate switch, as required in Star network topologies.

TIP The PanelView Plus 7 Performance terminal with dual Ethernet ports can be attached in the middle, or at the end, of a linear network.

Figure 5 - PanelView Plus 7 Performance Terminal in a Linear Topology Network

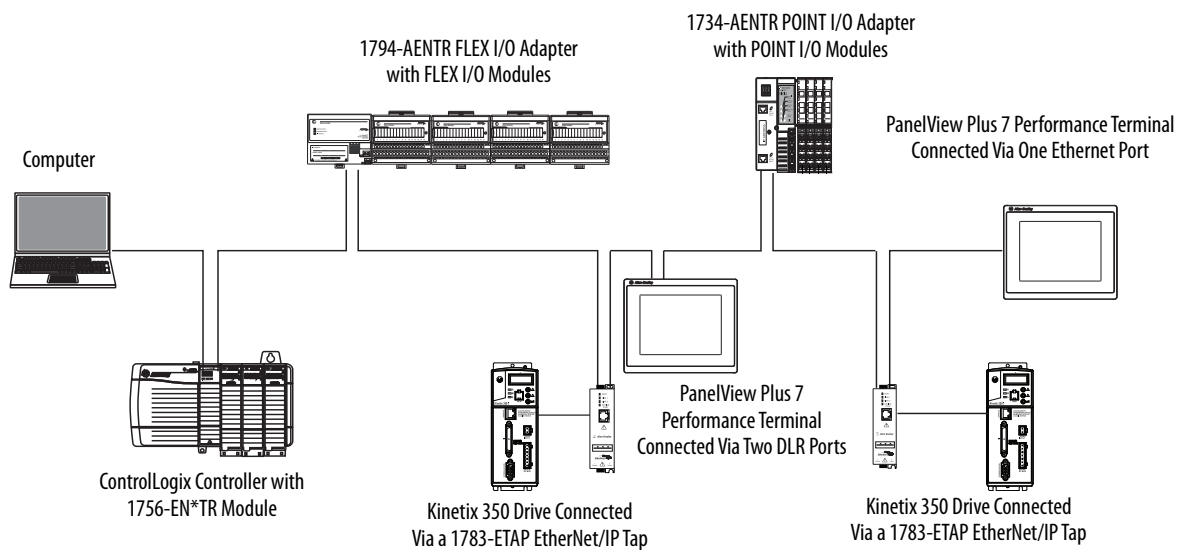

Star Network Topology

A star network topology is a traditional EtherNet/IP network that has multiple devices that are connected to each other via an Ethernet switch.

Figure 6 - PanelView Plus 7 Performance Terminal in a Star Topology Network

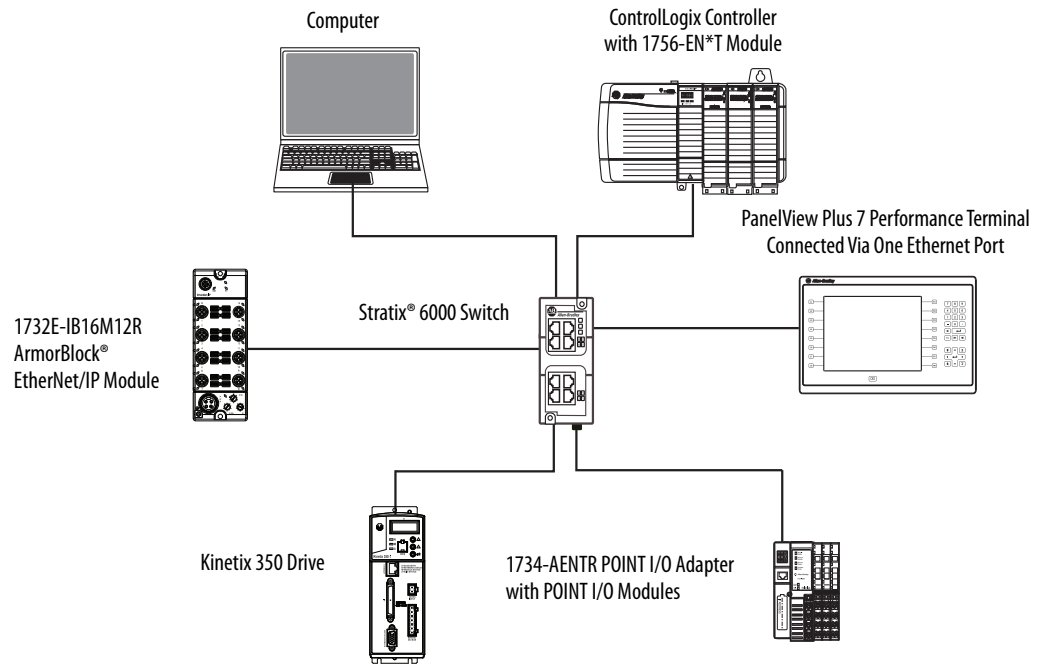

Initial Startup — Series A Terminals

The first time that you start the system, the terminal goes through its startup sequence and launches FactoryTalk® View ME Station in Configuration mode.

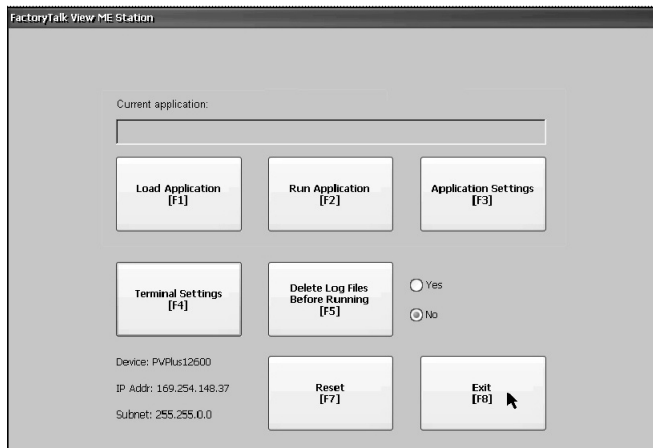

To change the action that occurs at startup, follow these steps.

1. Press Terminal Settings.
2. Tap Startup Options.

You can configure these options:

- Launch a FactoryTalk View Machine Edition HMI application.
- Launch FactoryTalk View ME Station in Configuration mode (default).
- Launch the Windows desktop. (This functionality is available on series A terminals only. Series B terminals (Series C for Stainless Steel terminals) launch the Control Panel).

TIP Terminals are initially shipped with desktop access disabled. You can also configure the terminal to allow desktop access.

For more information on how to change the start-up option and desktop access, see [Configure Start-up Options on page 84](#).

Initial Startup — Series B Terminals⁽¹⁾

Initial startup for Series B terminals (Series C for Stainless Steel terminals) differs from initial startup for Series A terminals. To complete initial startup for Series B terminals (Series C for Stainless Steel terminals), complete the steps shown in the following sections. For more information about initial startup of Series B terminals (Series C for Stainless Steel terminals), see the PanelView Plus 7 Performance Series B Terminals Quick Start, publication [2711P-QS002](#).

Calibrate the PanelView Terminal

1. Connect the terminal to an appropriately-rated DC power source.



WARNING: Series B terminals (Series C for Stainless Steel terminals) are designed for use with DC power only. Do not apply AC power or attempt to insert an AC terminal block (gray in color) into a Series B terminal (Series C for Stainless Steel terminals).

For additional information about how to connect to DC Power, see [Connect to DC Power on page 43](#).

After the initial power up, the terminal displays the Calibration Menu screen.

TIP For the following steps, if you do not have a keyboard or mouse connected to your terminal, you can tap commands and icons on the screen.

2. On the Calibration Menu screen, tap Touch Screen Calibration.

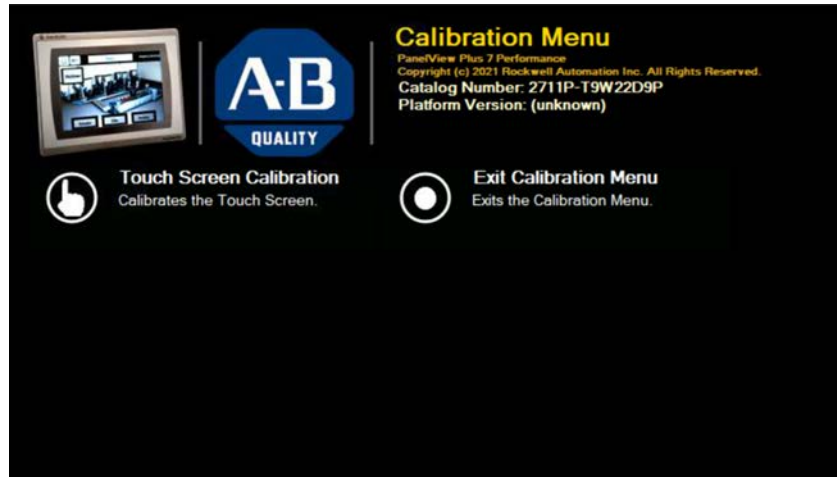

3. In the Touch Screen Calibration dialog box, tap Yes.

4. On the first calibration screen, calibrate the touch screen boundaries as prompted.

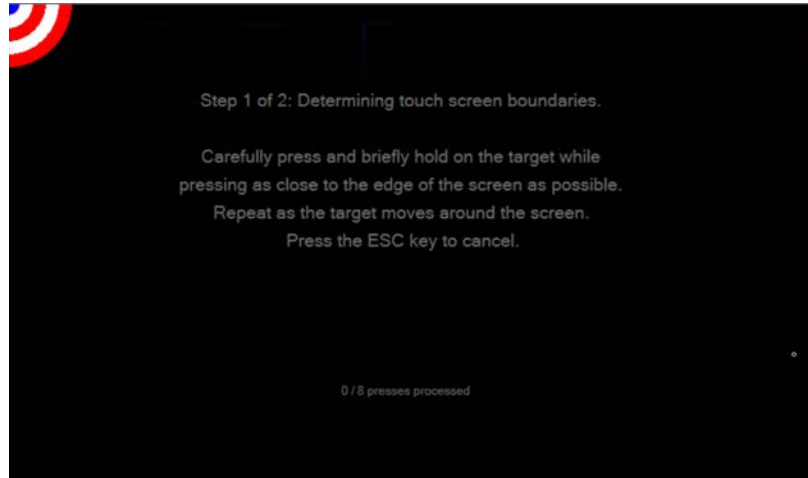

- a. Carefully tap the blue portion of the target as close to the edge as possible and slide it off the edge of the display.

The target moves after your finger slides off the display.

- b. Repeat as the target moves around the screen.

The terminal saves these settings and then displays the second calibration screen.

5. On the second calibration screen, calibrate the touch screen as prompted:

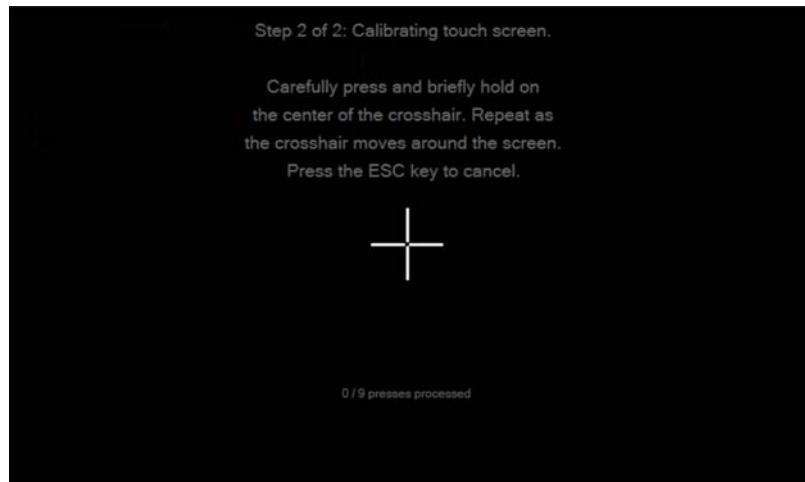

- a. Carefully tap and hold the center of the target for at least 1 second.

The target moves after you do this.

- b. Repeat as the target moves around the screen.

6. To save the calibration settings, tap the screen, as prompted.

IMPORTANT If this is not done within 30 seconds, the settings are not saved.

7. In the Success dialog box, tap OK.
8. Tap Exit Calibration Menu.
9. In the Exit Calibration Menu dialog box, tap Yes.

The terminal reboots and displays the first Welcome to PanelView Plus screen.

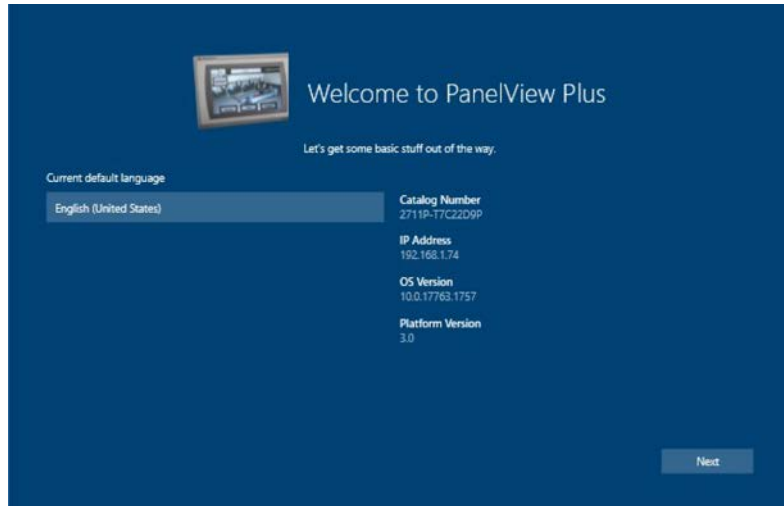

10. Review the information on this screen, and then tap the Next button.

The terminal displays the second Welcome to PanelView Plus screen.

TIP For all of the following PanelView screens, if you do not have a keyboard or mouse connected to your terminal, tap inside a field to display an on-screen keyboard. On the keyboard, tap each character for the information you want to enter. When you are finished entering the information, tap the X in the upper-right corner of the keyboard. The keyboard closes and the information appears in the appropriate field.

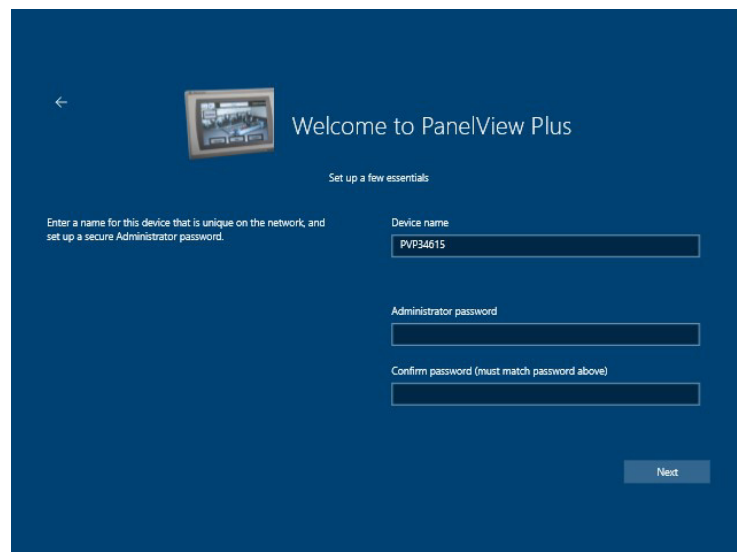

11. In the Administrator password field, type a password for the PanelView Plus Windows 10 IoT Core Control Panel.

The only requirement for the password is that it must be between 1 and 64 characters.

12. Retype the password in the Confirm password (must match password above) field.
13. Tap Next.

The terminal displays the Network Adapters setup screen.

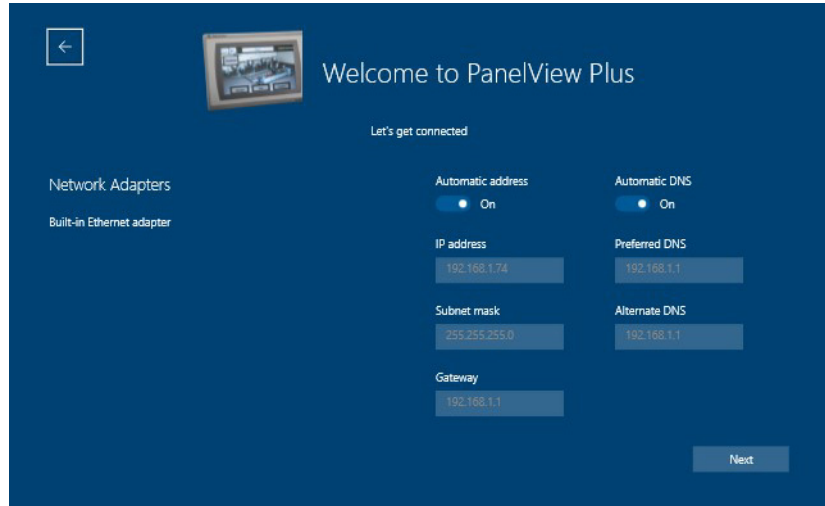

14. Type information about your network into the following fields:
 - Automatic address—The default setting is On, which means that the system provides dynamic IP addresses. If you prefer to use a static IP address, turn this field Off by tapping the button indicator and sliding it to the left. The Automatic DNS field becomes inactive, and the following fields become active so that you can type your information into them:
 - IP address
 - Subnet Mask
 - Gateway
 - Automatic DNS—The default setting is On, which means that the system generates DNS information for you. If you prefer to specify your own DNS information, turn this field Off by tapping the button indicator and sliding it to the left. The following fields become active so that you can type your information into them:
 - Preferred DNS
 - Alternate DNS
- TIP** If the Automatic DNS field is inactive, you may first need to turn the Automatic address field On by tapping that button indicator and sliding it to the right. Then slide the Automatic DNS button indicator to the right to turn that field Off.

15. Tap the Next button.

The terminal displays a verification screen.

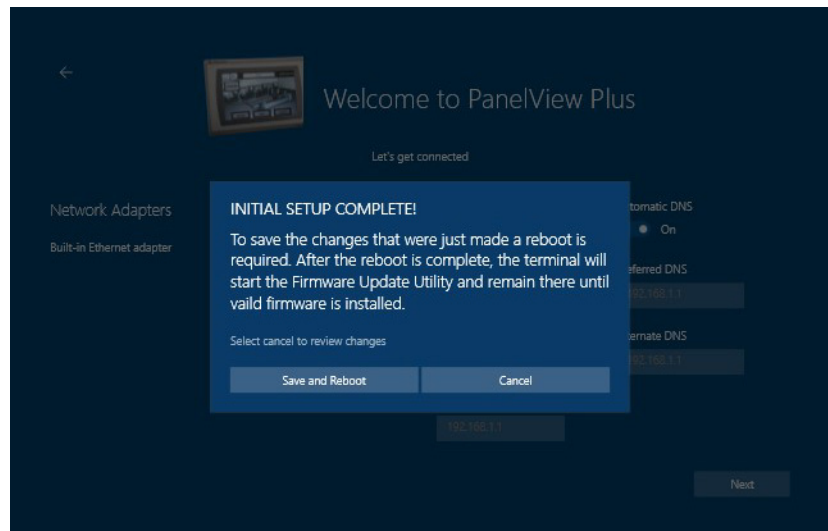

16. Tap Save and Reboot.

TIP If you need to change your network settings after this initial setup, you can do that in FactoryTalk View ME Station by tapping Terminal Settings [F4] > Networks and Communications > Network Connections > Network Adapters.

The terminal restarts and displays the PanelView Plus Firmware Update Utility screen.

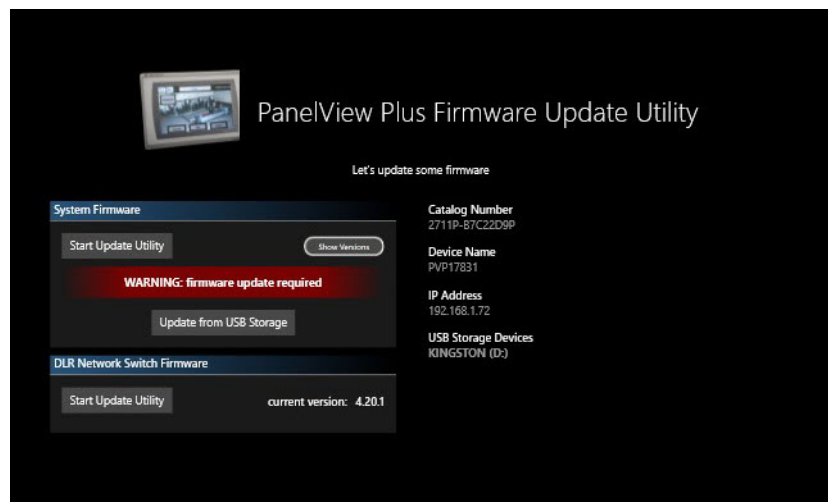

IMPORTANT If a USB Storage Device is not plugged into the terminal, the Update from USB Storage button is not visible on the screen. Plug in a USB storage device and the button is automatically added.

17. Continue with [Update the System Firmware on page 57](#).

Update the System Firmware

You can update the firmware on your terminal by using one of the following methods:

- USB storage device
- ControlFLASH™ client, which is available in the following formats:
 - ControlFLASH Plus™
 - ControlFLASH

Update the Firmware Using a USB Storage Device

1. Access the Rockwell Automation Product Compatibility and Download Center (PCDC) at rok.auto/pcdc.
2. On the home page, click Available Versions.

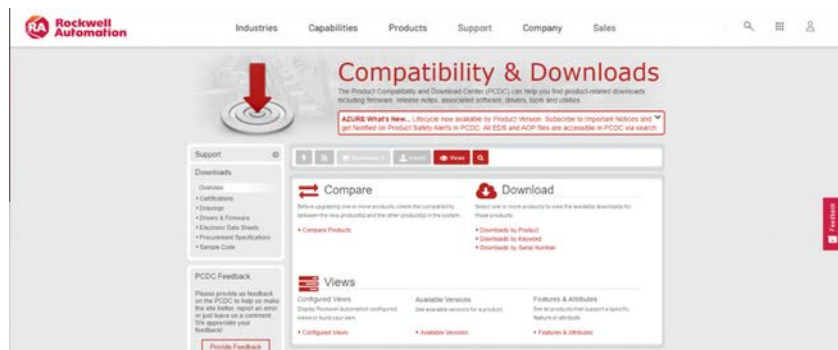

3. Click the Select a Product link, and in the Select a Product dialog box, type PanelView Plus 7 Performance in the search field, and then click the Search button.
4. Select PanelView Plus 7 Performance, and then select B for the Series B (Series C for Stainless Steel terminals) firmware.
5. Click the Show Downloads icon for the desired firmware version for PanelView Plus 7 Performance (Series B (Series C for Stainless Steel terminals)).

TIP Firmware for Series B terminals (Series C for Stainless Steel terminals) start at version 12.XXX.

6. Select and download the CAB Files for the desired firmware version.



IMPORTANT Do not download the DMK file. It does not work to update firmware via a USB Storage Device.

7. After the .ZIP file has downloaded, extract the contents to the root of the USB Storage Device.
TIP Use a USB Storage Device with at least 8 GB of storage available. Any Windows file system (including FAT32 or NTFS) is acceptable.
8. Insert the removable storage device into one of the USB ports located at the bottom of the PanelView terminal.
9. Tap Update from USB Storage and wait for the firmware update to complete.

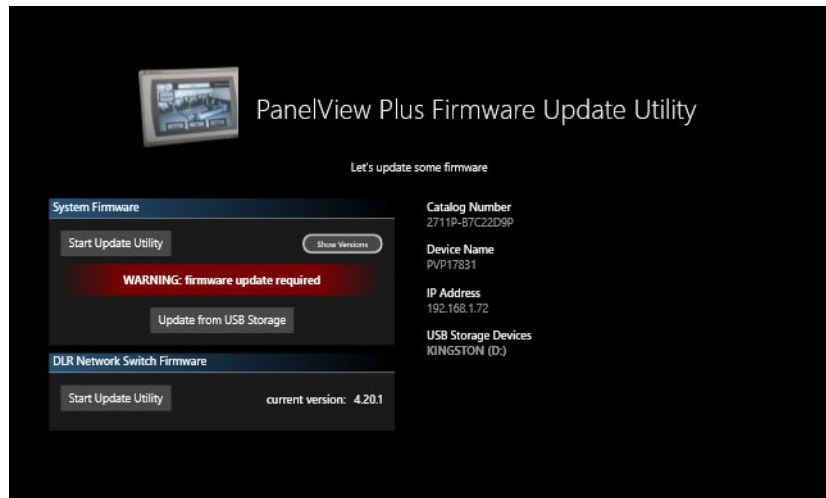

Before the update starts, the terminal displays the warning message shown in the following graphic. As the message states, do not remove the USB storage device while the file is being copied. Wait until you are prompted to remove the USB storage device.

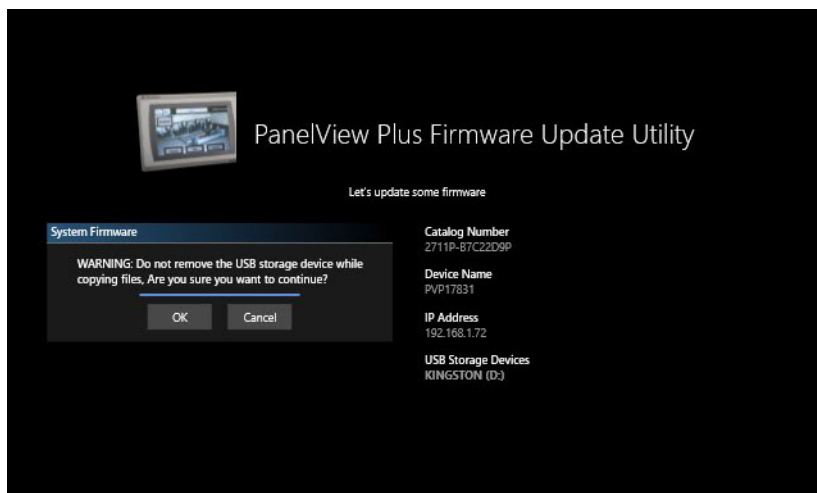

10. Tap OK when you are ready to continue.

While the firmware is updating, the terminal displays the update status. When the update is complete, the terminal displays the message shown in the following graphic.

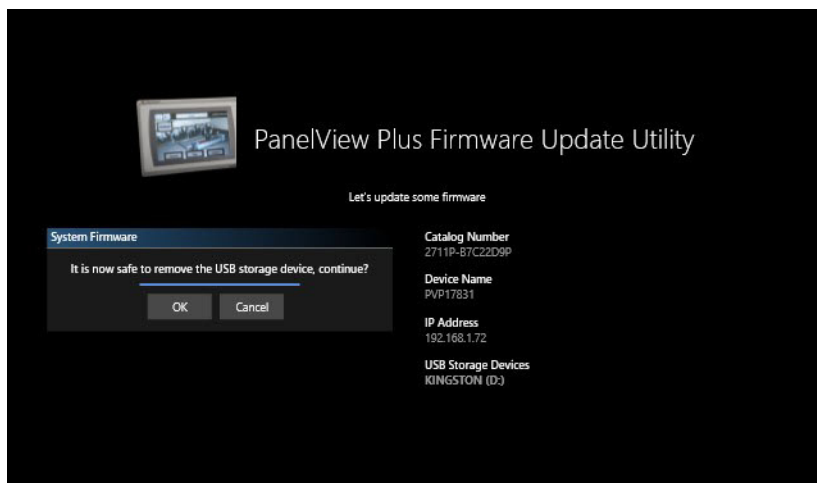

It is recommended that you remove the USB Storage device when prompted with the message shown in the image.

11. Tap OK to continue.

When the update is complete, the terminal reboots again and then displays the Password Entry screen.

12. Continue with [Enter a Password on page 69](#).

Update the Firmware Using ControlFLASH Client

The following ControlFLASH clients are available to update the firmware:

- ControlFLASH Plus
- ControlFLASH

Before you can use ControlFLASH Plus or ControlFLASH, you must download the DMK file from the Product Compatibility and Download Center (PCDC).

Download the ControlFLASH or ControlFLASH File

1. Access the Rockwell Automation Product Compatibility and Download Center (PCDC) at rok.auto/pcdc.
2. On the home page, click Available Versions.

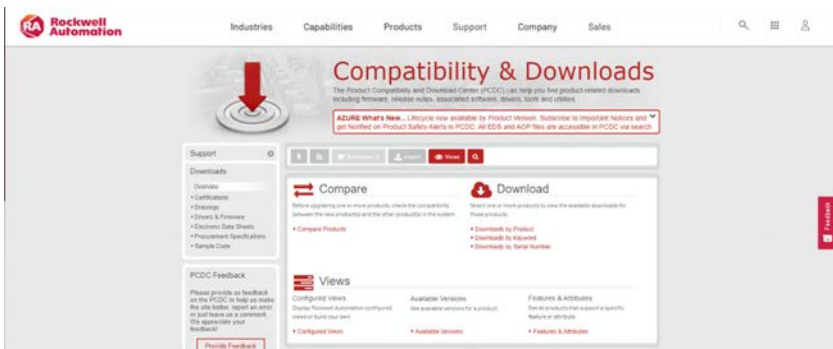

3. Click the Select a Product link, and in the Select a Product dialog box, type PanelView Plus 7 Performance in the search field, and then click the Search button.
4. Select PanelView Plus 7 Performance, and then select B for the Series B firmware (C for Series C Stainless Steel terminals).
5. Click the Show Downloads icon for the desired firmware version for PanelView Plus 7 Performance (Series B (Series C for Stainless Steel terminals)).

TIP Firmware for Series B terminals (Series C for Stainless Steel terminals) start at version 12.XXX.

- Select and download the DMK file for the desired firmware version.



- Save the DMK file in the desired Firmware Kits location.

The default location is

C:\Users\Public\Documents\RockwellAutomation\Firmware Kits

- On the PanelView terminal, under System Firmware, tap the Start Update Utility button.

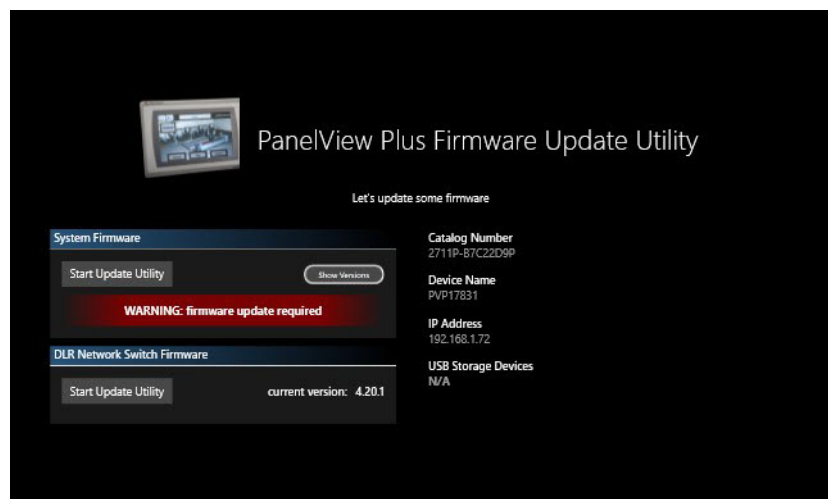

Update the Firmware Using ControlFLASH Plus

For details about how to install ControlFLASH Plus software, see the ControlFLASH Plus Quick Start Guide, publication [CFP-QS001](#).

IMPORTANT Use ControlFLASH Plus, version 4, or higher. The following procedure uses ControlFLASH Plus, version 4.

- After you save the DMK file in the desired Firmware Kits location, launch ControlFLASH Plus.
- Browse to and select the PanelView Plus 7 Performance Series B terminal (series C if it is a Stainless Steel terminal).

3. Click Next.

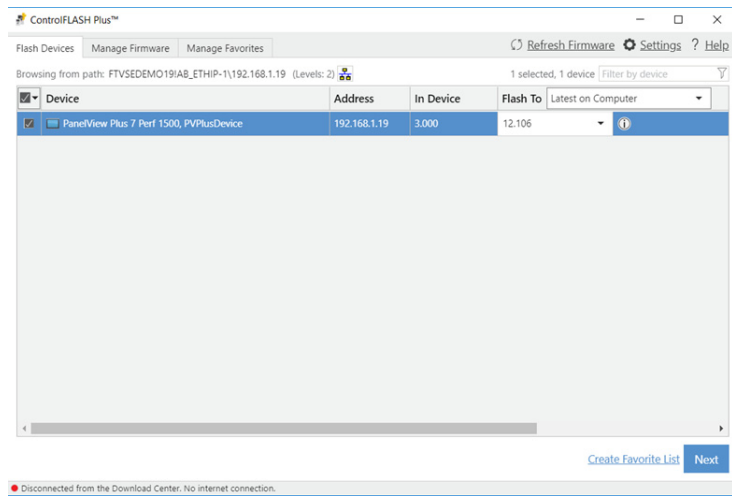

4. Confirm that the information is correct, and then click Flash.

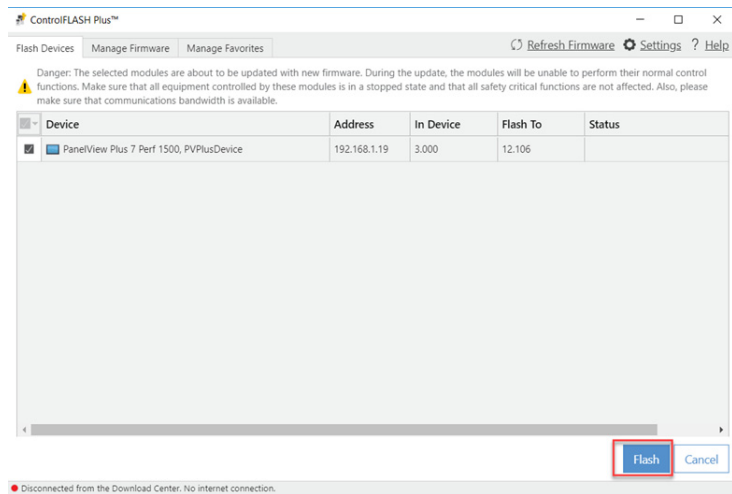

A series of status changes occur on the ControlFLASH Plus screen and on the PanelView terminal.

On the ControlFLASH Plus screen, the Status field displays the Transmitting update status.

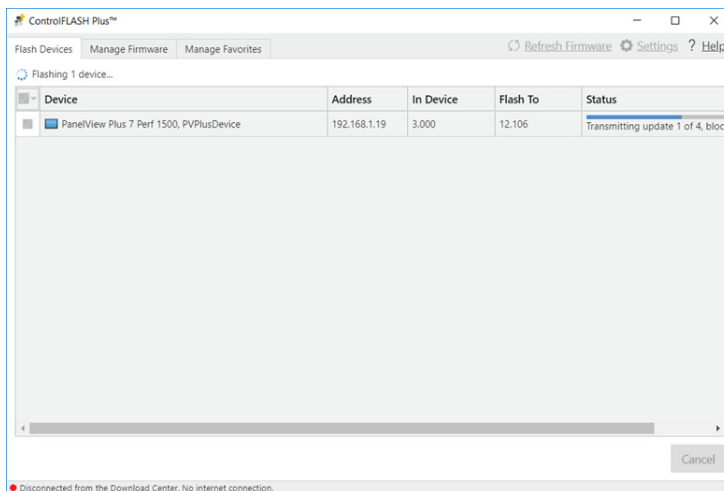

On the PanelView terminal, the status changes to CONNECTED: transferring updates... .

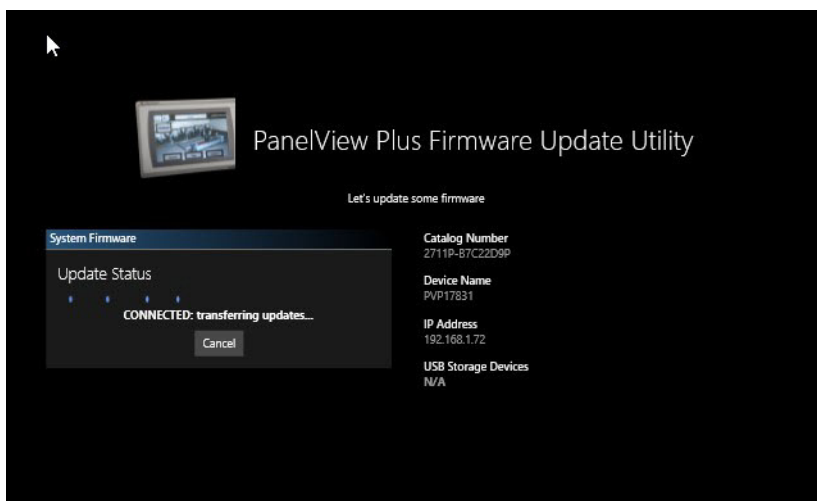

Once the firmware file transmission is complete, on the ControlFLASH Plus screen, the Status field displays the Polling for power-up status.

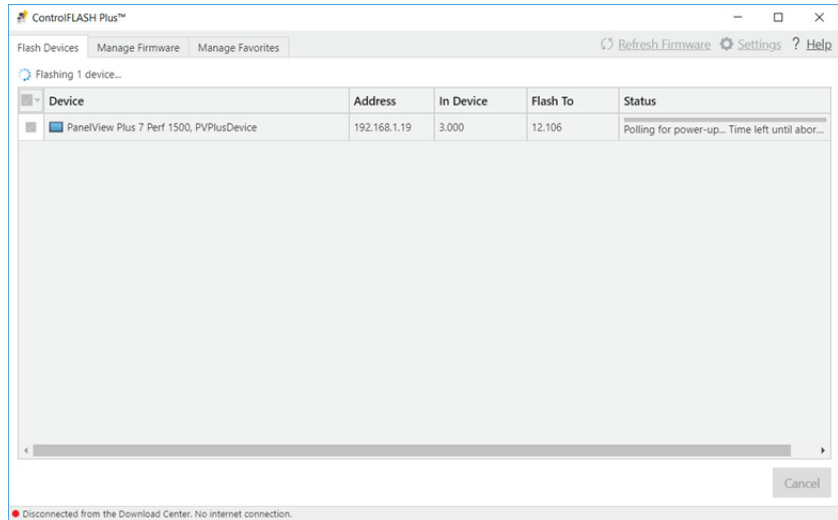

On the PanelView terminal, the status changes to PLEASE WAIT: verifying and preparing updates... .



The PanelView terminal reboots, and on the ControlFLASH Plus screen, the Flash Results dialog box displays a Succeeded message.

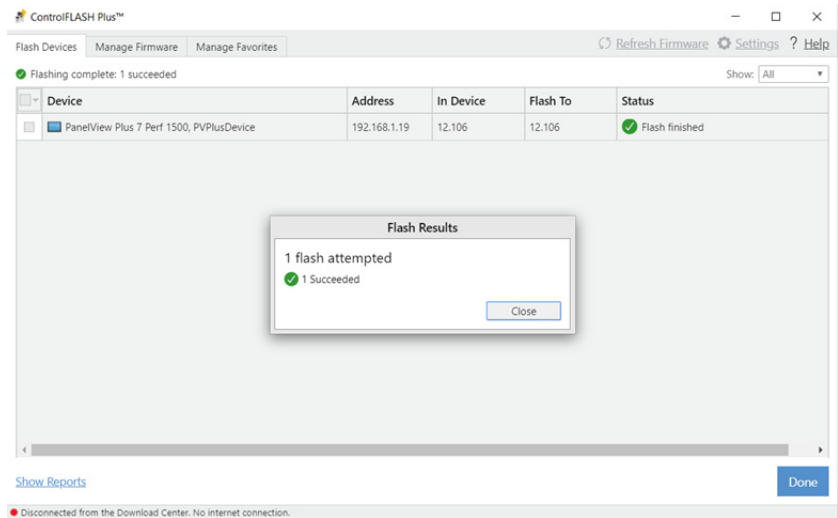

5. Click Close, and then click Done.

When the firmware update is complete, the terminal reboots and displays moving gears while the update installs.



6. Continue with [Enter a Password on page 69](#).

Update the Firmware Using ControlFLASH

For information on how to install ControlFLASH, see the ControlFLASH User Manual, publication [1756-UM105](#).

IMPORTANT Use ControlFLASH, version 15.05, or higher. The following procedure uses ControlFLASH, version 15.05.

To use the ControlFLASH software to update the firmware in a PanelView Plus 7 Performance Series B terminal (Series C for Stainless Steel terminals), follow these steps.

1. Click Start>Programs>FLASH Programming Tools>ControlFLASH.
2. Make sure that you know the required information in the Welcome dialog box, then click Next.



3. Select the catalog number of the PanelView Plus 7 Performance Series B terminal (Series C for Stainless Steel terminals) that you want to update and click Next.

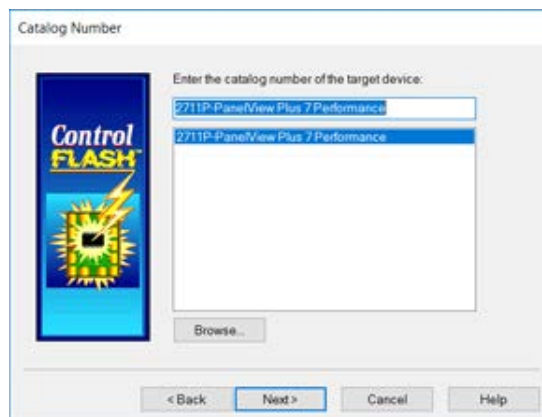

4. Browse to and select the device to update on the EtherNet/IP™ network and click OK.

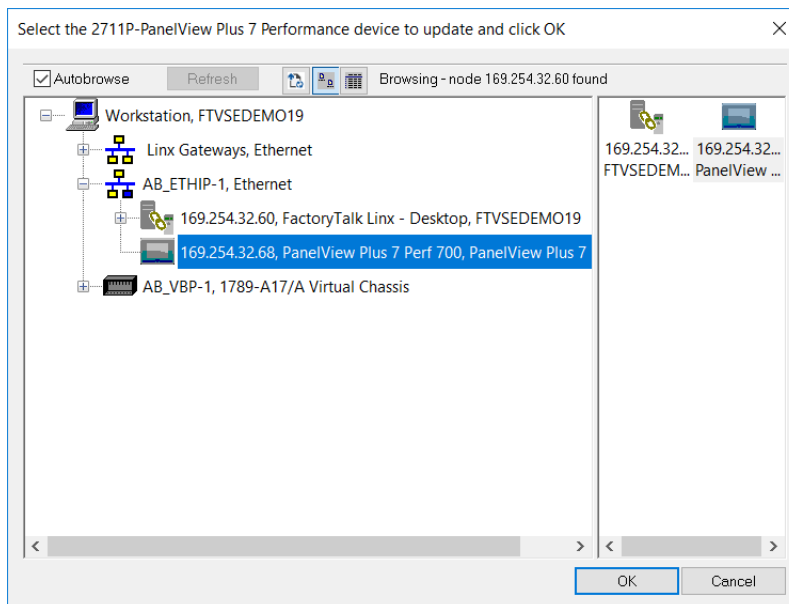

5. Select the firmware revision to install and click Next.

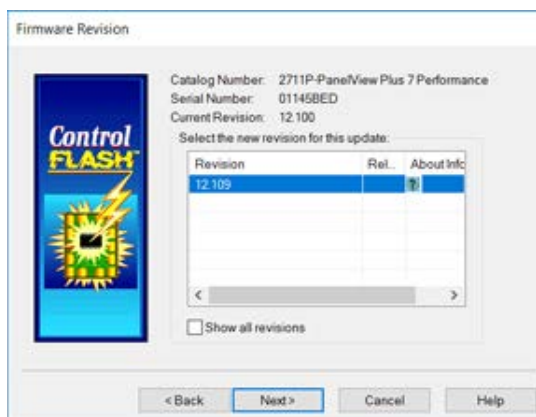

6. Read the Danger information in the Summary dialog, then click Finish.

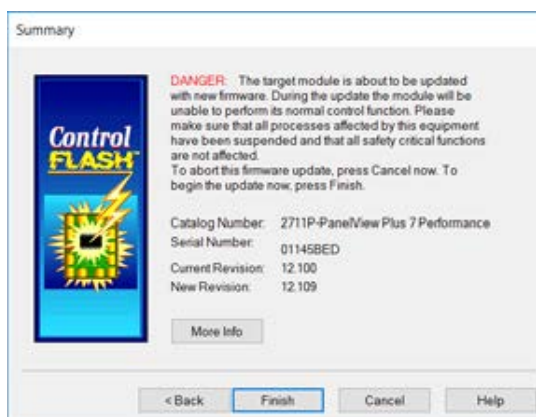

- Click Yes to confirm that you want to update the target device.

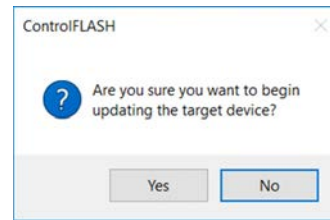

The update starts and can take several minutes to complete.

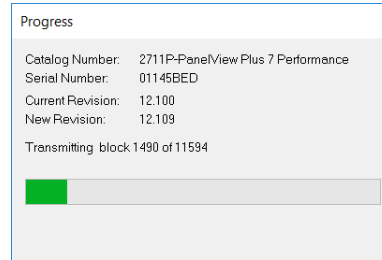

IMPORTANT Do not cycle power to the terminal during this process or the firmware update does not complete successfully.

When the firmware is sent to the terminal, the terminal resets and performs diagnostics.

The Update Status dialog box opens when the update is complete. If the update was successful, the Status area is green.

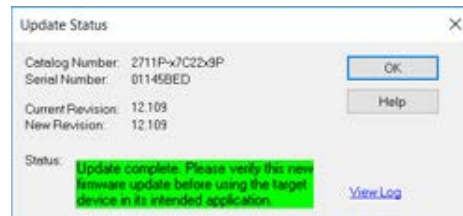

- Click OK.

If the update fails, the status area is red and reads Update failure. For troubleshooting information, see the ControlFLASH User Manual, publication [1756-UM105](#).

- Close the ControlFLASH software.
- Continue with [Enter a Password on page 69](#).

Enter a Password

After the PanelView terminal is updated with the desired firmware version, the terminal displays the Change Desktop Access Password screen. The password that you enter here is used to exit ME Station and access the Windows 10 IoT Core Control Panel menu.

TIP If you need to change (reset) your password after this initial setup, you can do that in FactoryTalk View ME Station by clicking or tapping Terminal Settings [F4] > Desktop Access Setup > Reset Password [F4].

1. On the Change Desktop Access Password screen, in the Password field, type a password that meets the following criteria:
 - Contains from 8 to 20 characters
 - Contains at least one lowercase and one uppercase character
 - Contains at least one numerical or special character
 - Is not any form of the word password

TIP If you do not have a keyboard or mouse connected to your terminal, tap the Set Password button to display an on-screen keyboard. On the keyboard, tap each character for your password. When you are finished typing the password, tap the Enter button. The password appears in the Password field.

TIP The buttons that appear next to the other fields on the Change Desktop Access Password screen, for example, Confirm Password, Set Challenge, and Set Response, display the same on-screen keyboard. Use the on-screen keyboard for these fields as described in the previous Note.

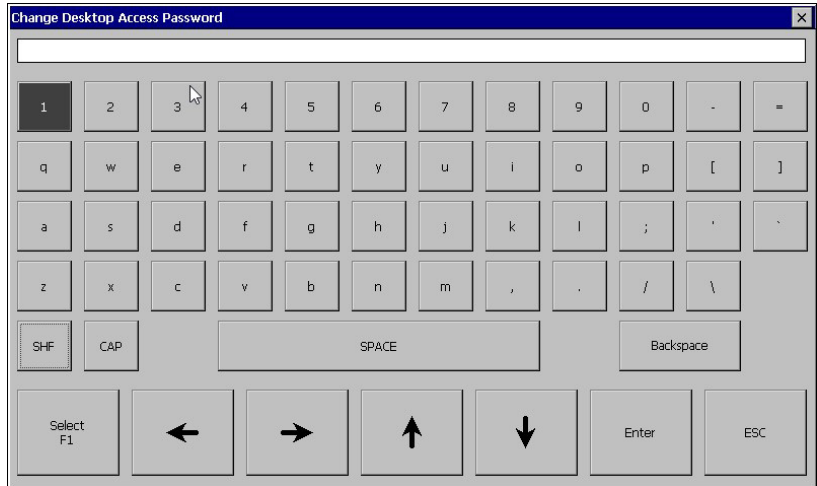

2. Tap the Confirm password field, and type the password again.
3. Tap the Challenge question field, and type a question.

TIP The challenge question is used to reset the password.

4. Tap the Challenge response field, and type the answer to the challenge question.

The response needs to be a minimum of 6 characters.

5. Tap OK.

The terminal displays the FactoryTalk View ME Station startup screen.

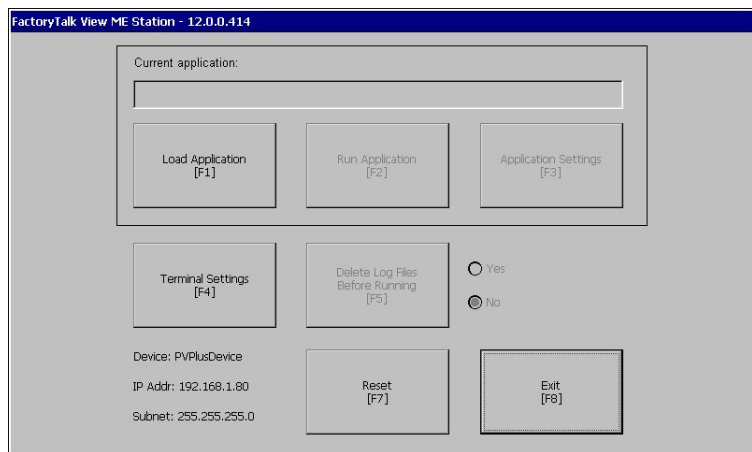

6. Continue with [Transfer Runtime Files \(.mer\) on page 71](#).

Transfer Runtime Files (.mer)

You can transfer project files (.mer) to your terminal by using one of the following methods:

- Transfer Utility (via ethernet)
- Removable storage (USB drive or SD card)

Transfer Utility

To transfer runtime files (.mer) by using the Transfer utility, complete the following steps:

1. From the FactoryTalk View Studio application on your PC, click Tools, and then click Transfer Utility.

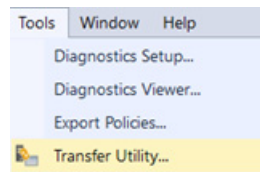

2. In the Transfer Utility dialog box, click the ellipsis to the right of the Source file field, browse to the location of the .mer file, and select the .mer file.

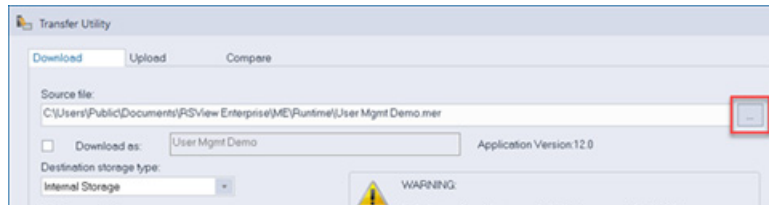

3. In the Select destination terminal field, browse to the location of the PanelView Plus 7 Series B terminal (Series C for Stainless Steel), and select it.

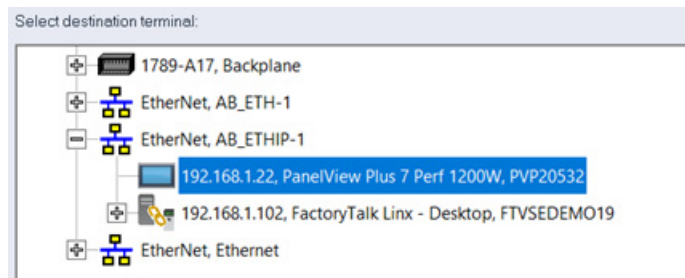

4. Click Download.



The runtime file (.mer) file is downloaded to your PanelView terminal.

Configure Terminal Settings

Topic	Page	Topic	Page
FactoryTalk View ME Station	73	Display Settings	95
Terminal Settings	76	Input Device Settings	97
Soft Keyboard	77	Configure Print Options	102
Load and Run Application	78	Configure Diagnostics	105
Windows CE Desktop Access — Series A Terminals	79	Check Integrity of Application Files	106
Configure Start-up Options	84	View and Clear the System Event Log	107
Configure Controller Address	87	Enable or Disable the Alarm Display	107
Configure Ethernet Settings	87	Display System Information	108
Modify Device Name of Terminal	92	Time and Date Settings	111
Copy Files on Terminal	93	Regional Settings	113
Delete Files from Terminal	94		

FactoryTalk View ME Station

FactoryTalk® View ME Station is the runtime environment of the terminal. This environment lets you configure start-up options, load and run HMI applications, adjust terminal settings, access the Windows desktop (Series A terminals only), and perform other terminal operations.

When you restart the terminal, one of these actions occurs depending on the configured start-up option:

- FactoryTalk View ME Station launches in Configuration mode (factory default).
- FactoryTalk View ME .mer application runs.
- Windows desktop launches (Series A terminals only).

- IMPORTANT**
- To access Configuration mode from an HMI application on the terminal, press Goto Configuration Mode. This button is added to application screens in FactoryTalk View Studio software during application development. The application stops running but is still loaded.
 - If your application does not have a Goto Configuration Mode button, see [Enter Configuration Mode on Startup on page 85](#) for details on how to access Configuration mode.
 - To access Configuration mode from the Windows desktop (available only on Series A terminals), double-click the FTViewME Station icon



Figure 7 - FactoryTalk View ME Station Configuration Menu

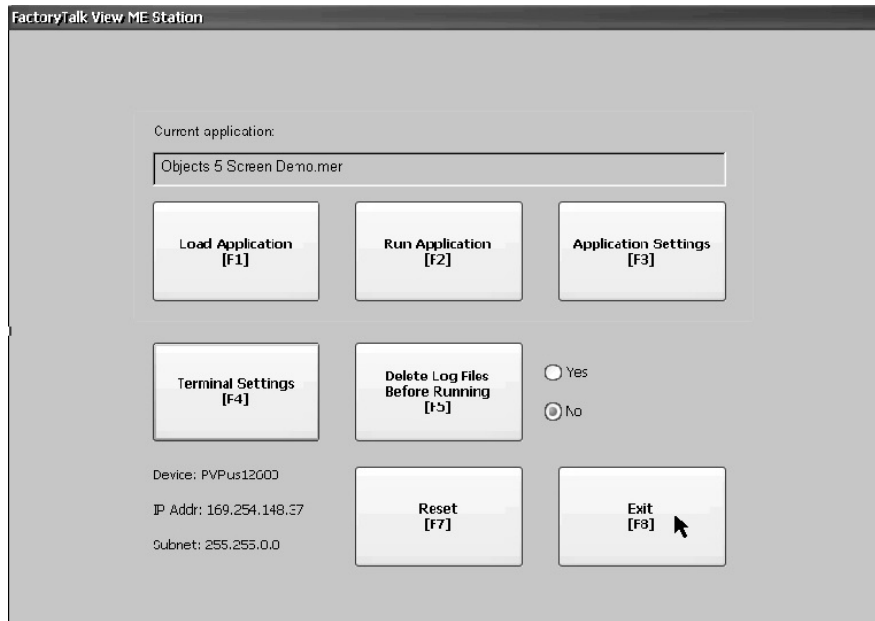

Table 19 - Terminal Operations

Press	To
Load Application [F1]	Open a dialog box where you select a .mer application to load in the device. You must load an application before you can run it. The name of the loaded application appears under Current Application.
Run Application [F2]	Run the .mer application that is loaded in the terminal.
Application Settings [F3]	Open a menu of application-specific settings, such as device shortcuts defined for the loaded .mer application. Device shortcuts are read only. For example, CLX is the device shortcut for a ControlLogix® controller.
Terminal Settings [F4]	Open a menu of options to modify terminal settings.
Delete Log Files Before Running [F5]	Toggle between Yes and No. <ul style="list-style-type: none"> • Select Yes to delete all data log files, alarm history, and alarm status files before running the application. • Select No to run the application without deleting log files.

Table 19 - Terminal Operations (Continued)

Press	To
Reset [F7]	Reset the terminal and launch an HMI application, FactoryTalk View ME Station software, or the Windows CE desktop (Series A terminals only). The action that occurs depends on the configured startup-option.
Exit [F8]	Exit FactoryTalk View ME Station. If desktop access is allowed, you can access the desktop (series A terminals only).
Device, IP Address, Subnet (Display only)	Identifies the device name, IP address, and subnet of the terminal on a connected Ethernet network. The network information is updated every 60 seconds. If the terminal is disconnected from the network, the IP address and subnet appear as 0.0.0.0.

TIP On devices with a keypad and a touch screen, you can press a function key or the touch screen button to access an operation. For example, to access terminal settings:

- Press the F4 function key, or
- Press the Terminal Settings touch screen button

Terminal Settings

The terminal has settings that you can adjust that are not specific to the application.

1. Press Terminal Settings from the FactoryTalk View ME Station dialog box.
2. Select an option by using the up and down cursor.
 - On touch screen terminals, touch the up or down cursor.
 - On keypad terminals, press the corresponding key on the keypad.
3. Press Enter to access the selected function.

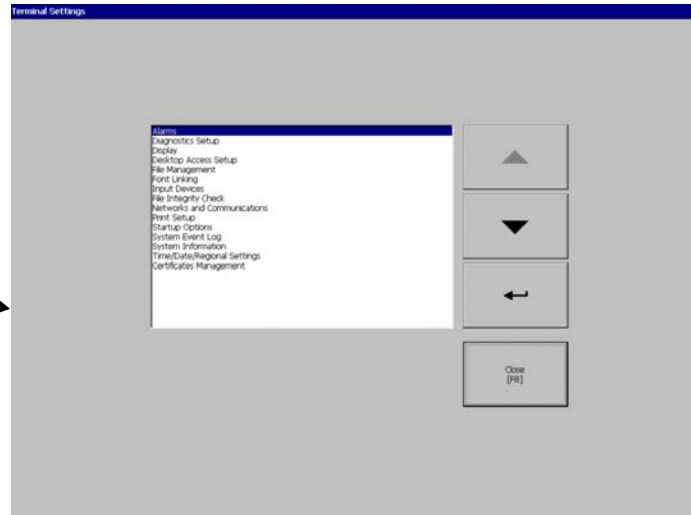
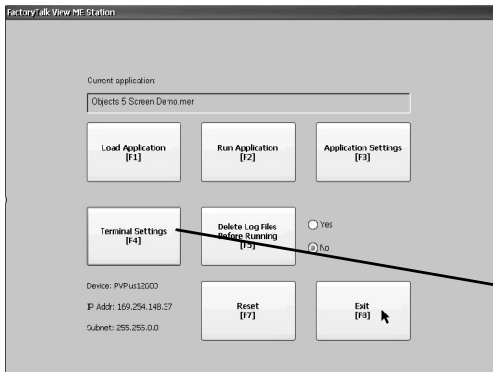

Table 20 - Terminal Settings

Select This Option:	If You Want to:
Alarms	Close the alarm display on the terminal when an operator acknowledges the newest alarm. By default, the alarm display is closed.
Diagnostics Setup	Forward diagnostic messages from a remote log destination to a computer that runs diagnostics.
Display	Adjust the brightness of the display, configure the screen saver, and enable/disable the touch screen cursor.
Desktop Access Setup	Allow or restrict access to the desktop. Set or reset the desktop password (Series A terminals exit to the desktop. Series B terminals (Series C for Stainless Steel terminals) exit to the Control Panel).
File Management	Copy application files and font files to the terminal, an SD card, or a USB drive. You can also delete application files or log files.
Font Linking	Link a font file to a base font loaded on the terminal.
Input Devices	Configure settings for the keypad, attached keyboard, mouse, or touch screen, including touch screen calibration. You can also choose between a popup character input or popup keyboard for string input.
File Integrity Check	Check the integrity of the .mer application file and runtime files by logging details to a file integrity check log. You can view and clear this log at any time.
Networks and Communications	Configure Ethernet and other communication settings for an application. KEPServer Driver Configuration is a new option available on both Series A and Series B terminals (Series C for Stainless Steel terminals).
Print Setup	Configure settings to print displays, alarm messages, or diagnostics messages generated by the application.
Startup Options	Specify whether the terminal launches the desktop, an application, or FactoryTalk View ME Station Configuration mode on startup.
System Event Log	Display system events that are logged by the terminal, and clear events from the log.
System Information	Display power, temperature, battery, and memory details for the terminal. You can also view the firmware revision for FactoryTalk View ME Station, and other software loaded on the terminal. Technical support information.
Time/Date/Regional Settings	Set the date, time, language, and numeric format used by terminal and applications.
Certificates Management	Import and view certificates on the terminal.

Soft Keyboard

When you activate a data entry field, a keyboard opens. For fields that require numeric values only, 0...9 and the decimals are enabled.

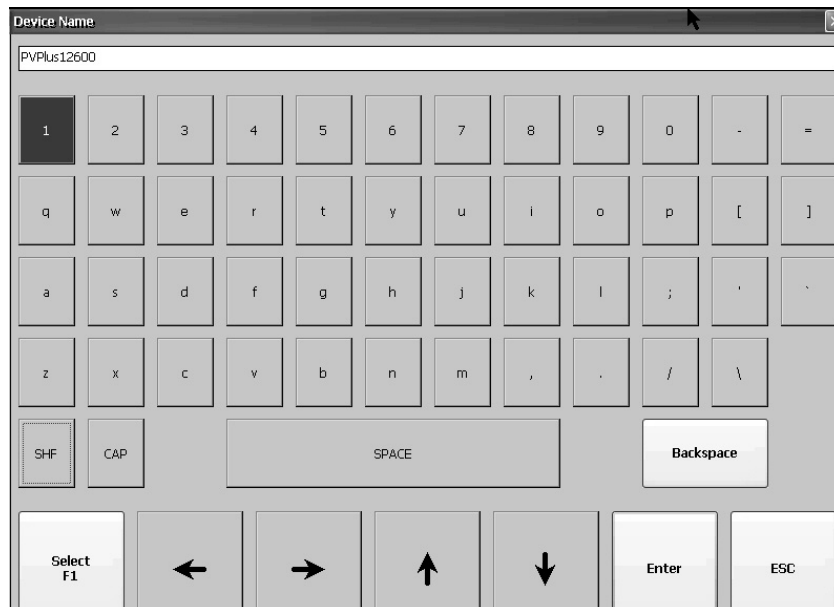

Table 21 - Soft Keyboard Controls

Select This Key:	To:
SHF	Switch keys between their shifted and unshifted state.
CAP	Switch between lowercase and uppercase characters.
SPACE	Enter a space between characters in the Display Area.
Backspace	Delete the previous character (to the left of the cursor) in the Display Area.
Select	Select a character and enter it in the Display Area.
Left, Right, Up, Down Arrow	Select the character to the left, right, above, or below the currently selected character.
Enter	Accept the entered characters and return to the previous dialog box.
ESC	Cancel the current operation and return to the previous dialog box.

To enter characters in the display area above the keyboard, follow these steps.

1. Select a character on the keyboard:
 - On a touch screen terminal, touch a key.
 - On a keypad terminal, press the arrow keys to navigate to a key.
2. Press Select to copy the character to the display area.
3. Press Enter when done to exit the keyboard.

Load and Run Application

To run a FactoryTalk View ME .mer application on the terminal, you must first load the application. You can load the application from internal storage (nonvolatile memory) in the terminal, an SD card, or a USB drive.

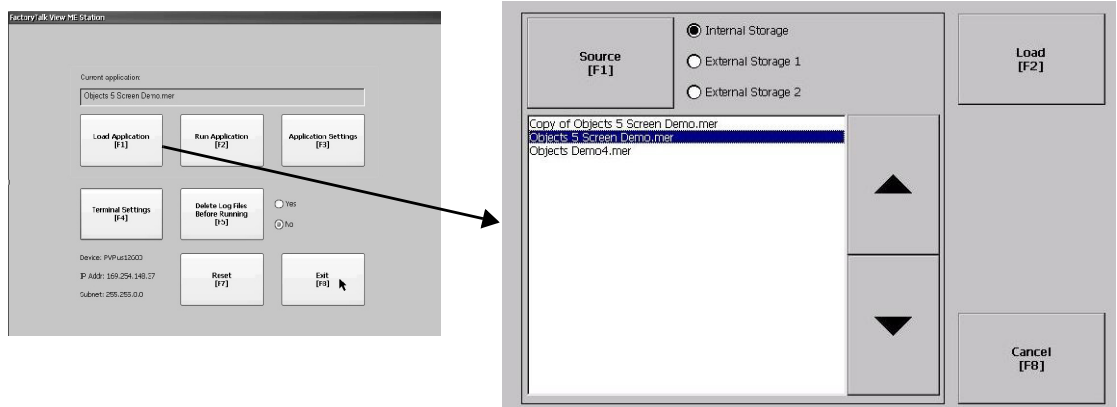

To load and run an application on the terminal, follow these steps.

1. Press Load Application from the FactoryTalk View ME Station dialog box.
2. Press Source to select the location of the file to load:
 - Internal Storage - nonvolatile memory of the terminal.
 - External Storage 1 - SD card that is loaded in the card slot.
 - External Storage 2 - USB drive that is loaded in the USB host port.

TIP The path for Machine Edition files on the terminal is My Device\Application Data\Rockwell Software\RSViewME\Runtime.

The path for Machine Edition files on the SD card or USB drive is \Rockwell Software\RSViewME\Runtime.

3. Select an .mer file from list by using the up and down cursor keys.
4. To load the selected application, press Load.

You are asked if you want to replace the current communication settings for the terminal with the settings that are defined in the application.

5. Select Yes or No.
 - Select Yes to use the communication settings in the application.
 - Select No to use the communication settings of the terminal.

The application loads and the application name appears at the top of the FactoryTalk View ME Station dialog box.

6. To run the application that you loaded, press Run Application on the FactoryTalk View ME Station dialog box.

TIP Applications generate log files. You can delete log files from the FactoryTalk View ME Station dialog box before running the application. Delete log files to reclaim memory in the terminal.

To set the application to run on startup or reset, see [Run the Loaded Application on Startup on page 86](#).

Windows CE Desktop Access — Series A Terminals

You can allow or restrict desktop access on the terminal (Series A⁽¹⁾ terminals allow Windows CE desktop access. Series B terminals exit to the Control Panel). From the desktop, you can perform system and control panel operations, use file viewers, the web browser, and the media player. You can allow temporary access, then disable desktop access to help prevent unauthorized changes.

TIP Terminals are shipped from the factory with desktop access disabled.

With restricted access, the only way to access the desktop is to enter a password. Each terminal has a default password and challenge question.

Default Password Credentials	Values
Password	password (case sensitive)
Challenge question	What is the opposite of lock?
Challenge answer	unlock (case sensitive)

TIP Rockwell Automation recommends that you change the default password and challenge question and answer to something unique for your installation.

Enable Desktop Access

To enable desktop access, follow these steps.

1. Press Terminal Settings, then choose Desktop Access Setup.
2. To select Allow, press Desktop Access.

The Enter Password dialog box opens.

Each time that you change desktop access from disallow to allow, you must enter a password. The default password is 'password'.

3. To type the password, press Password.
4. Press Enter.

(1) Series B on Stainless Steel terminals.

- To return to Desktop Access Management, press Enter again.

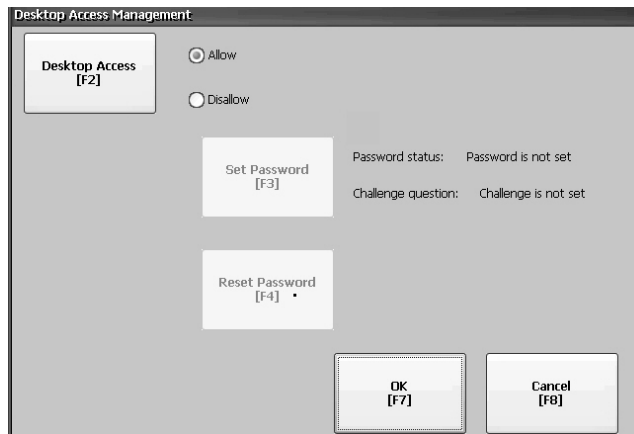

Notice that the password is no longer set.

- Press OK to exit Desktop Access Management, then Close to exit terminal settings and return to the FactoryTalk View ME Station dialog box.
- To access the desktop, press Exit.

When desktop access is enabled, you are not required to enter a password.

Disable Desktop Access

IMPORTANT To restrict desktop access, the start-up option must be set to either Go to Configuration Mode or Run Current Application. See [page 84](#) for details.

To restrict desktop access, define a desktop password and challenge question:

- The password lets you access the desktop from FactoryTalk View ME Station when pressing Exit.
- The challenge question and response lets you change the password with the Reset function.

To disable desktop access, follow these steps.

1. Press Terminal Settings, then choose Desktop Access Setup.
2. To select Disallow, press Desktop Access.

The Set Password button is enabled.

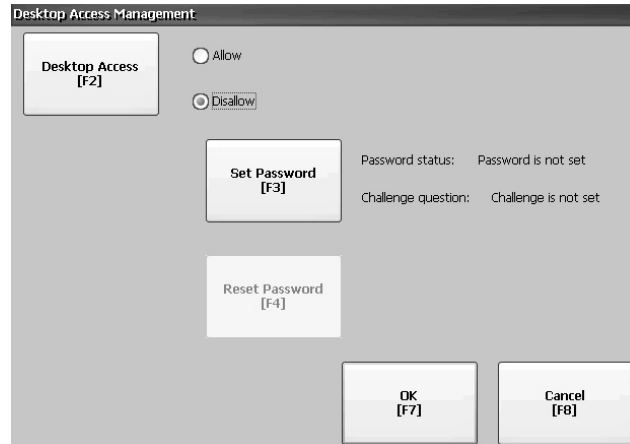

IMPORTANT If an error message displays, you can change the startup option to Go to Configuration Mode or Run Current Application. You cannot restrict access to the desktop if Startup Options is configured for Do not start FactoryTalk View ME Station.

3. See [Set a Desktop Password on page 82](#) to define a new password and challenge question.

Set a Desktop Password

On Series B terminals (Series C for Stainless Steel terminals), the desktop password is used to exit ME into the Windows Control Panel.

IMPORTANT When you restrict access to the desktop, you must define a new password and challenge question.

To define a new desktop password, follow these steps.

1. Press Set Password.

The Desktop Access Set Password dialog box opens.

2. Press Set Password, enter an 8...20 character password, then press Enter.

IMPORTANT You must correctly enter this password before accessing the desktop.

3. Press Set Challenge to enter a challenge question that you must correctly respond to when resetting the desktop password.
4. Press Set Response to enter a response to the challenge question, then press Enter.
5. Press OK.

The Desktop Access Management Dialog shows that a password and challenge question are set.

6. Press OK to return to terminal settings.

IMPORTANT Secure your password and challenge question for future use. To clear and reset the password, you must correctly respond to the challenge question. If you forget the response, the only way to clear the password is to restore the factory default settings on the terminal. See [Factory default on page 224](#).

Reset the Desktop Password

To clear and change the current password, you must correctly respond to the current challenge question. If you do not remember the response, you must restore the terminal to its factory defaults. See [Maintenance Mode Operations — Series A Terminals on page 224](#).

IMPORTANT You can reset the password and challenge questions if access to the desktop is restricted or set to disallow.

To reset the desktop password, follow these steps.

1. Press Reset Password from the Desktop Access Management dialog box.

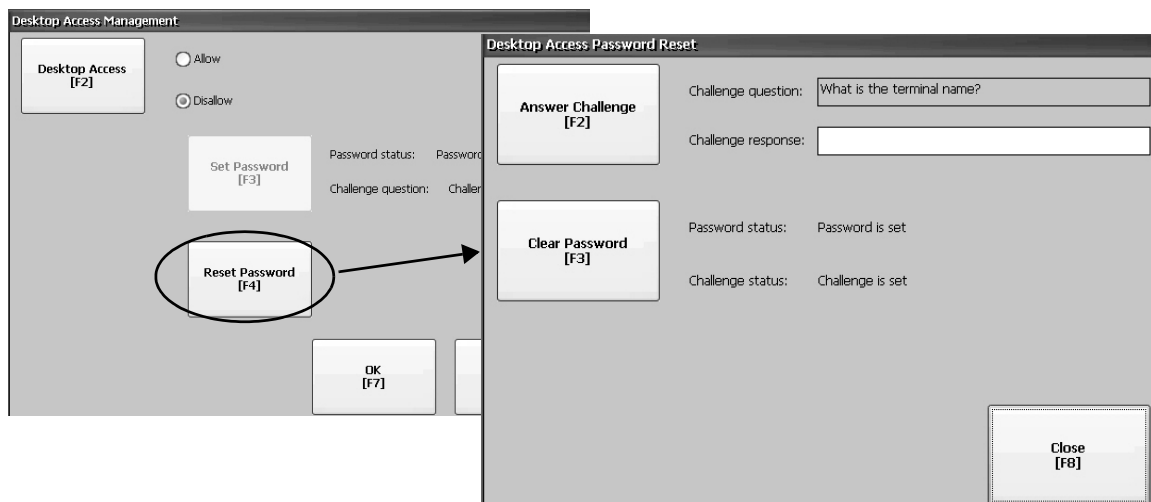

2. Press Answer Challenge and enter the correct response to the current challenge question.
3. Press Clear Password to clear the current password and challenge question.

The dialog box shows the updated status of the password and challenge information.

4. Press Close.
5. Refer to [Set a Desktop Password on page 82](#) to set a new password and challenge question.

After clearing the password, you must set a new desktop password or change the desktop access to allow.

Configure Start-up Options

You can specify what action the terminal takes on startup or a reset.

This Start-up Option	Performs This Action	Typical System
Do not start FactoryTalk View ME Station	Launches the Windows desktop on startup (available only on Series A terminals. This option is not available on Series B terminals. (Series C for Stainless Steel terminals)).	Open
Go to Configuration Mode	Launches FactoryTalk View ME Station in Configuration mode on startup (factory default).	Closed
Run Current Application	Runs the FactoryTalk View ME application that is loaded in the terminal on startup.	Closed

IMPORTANT When desktop access is restricted, the start-up option must be set to Run Current Application or Go to Configuration Mode (default). See [page 79](#) for details on how to allow or restrict desktop access.

Disable FactoryTalk View ME Station on Startup

To launch the desktop on startup, you must disable FactoryTalk View ME Station.

TIP You can also launch the desktop by pressing Exit on the FactoryTalk View ME Station dialog box.

To disable FactoryTalk View ME Station on startup, follow these steps.

1. Press Terminal Settings, then choose Startup Options.

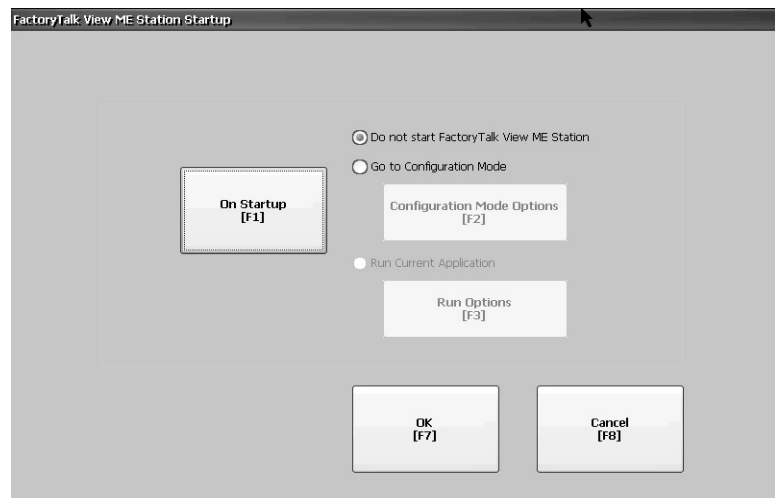

2. Press On Startup until 'Do not start FactoryTalk View ME Station' is selected.

TIP On Series A terminals only, desktop access must be set to allow or you get a warning. See [Enable Desktop Access on page 79](#).

3. Press OK.

Enter Configuration Mode on Startup

To launch FactoryTalk View ME Station in Configuration mode on startup, follow these steps.

1. Press Terminal Settings, then choose Startup Options.
2. To select Go to Configuration Mode, press On Startup.
3. To view or change optional settings, press Configuration Mode Options.

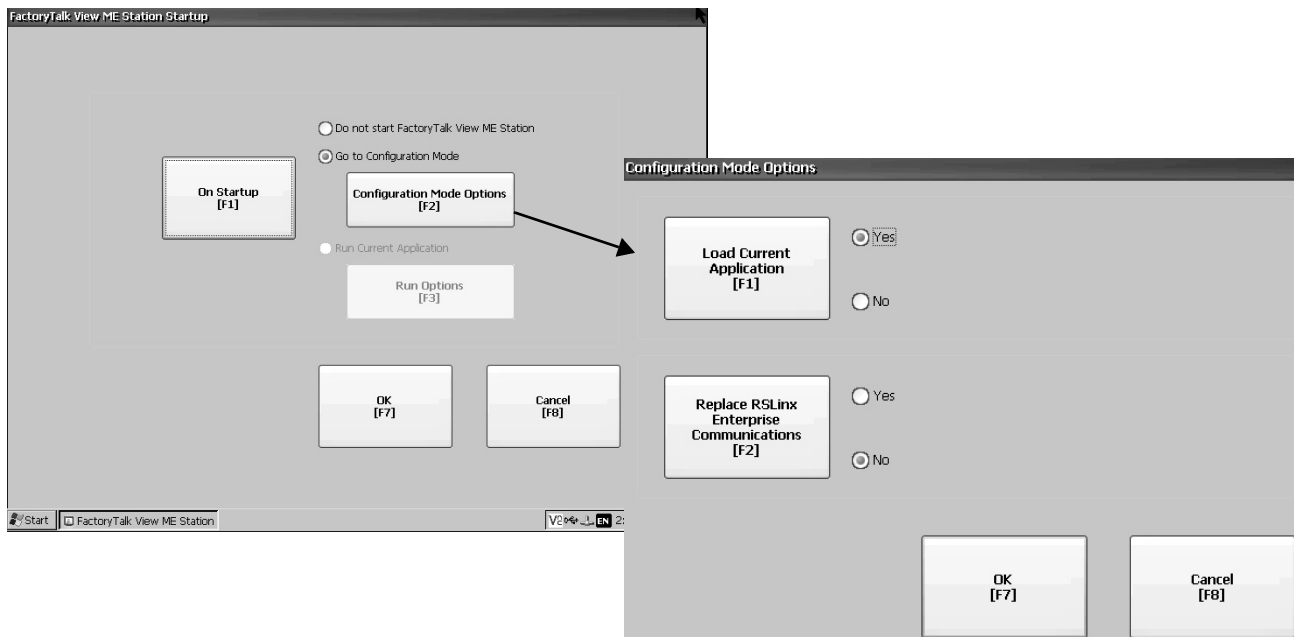

TIP On Series B terminals, the Do not start FactoryTalk View ME Station option is not available and is grayed out.⁽¹⁾

(1) Series C for Stainless Steel terminals.

4. To specify whether you want to load the current application on startup, press Load Current Application.
5. To specify what configuration settings are used when the loaded application is run, press Replace RSLinx® Enterprise Communications:
 - To use the RSLinx communication settings in the terminal, select No.
 - To replace the terminal settings with the communication settings in the application, select Yes. Any changes to RSLinx device addresses or driver properties on the terminal are lost.
6. To return to the previous dialog box, press OK.
7. To return to terminal settings, press OK.

Run the Loaded Application on Startup

To run the FactoryTalk View .mer application that is loaded in the terminal on startup, follow these steps.

1. Press Terminal Settings, then choose Startup Options.
2. To select Run Current Application, press On Startup.
3. To view or change optional settings, press Run Options.

If the application is not loaded, the options are disabled.

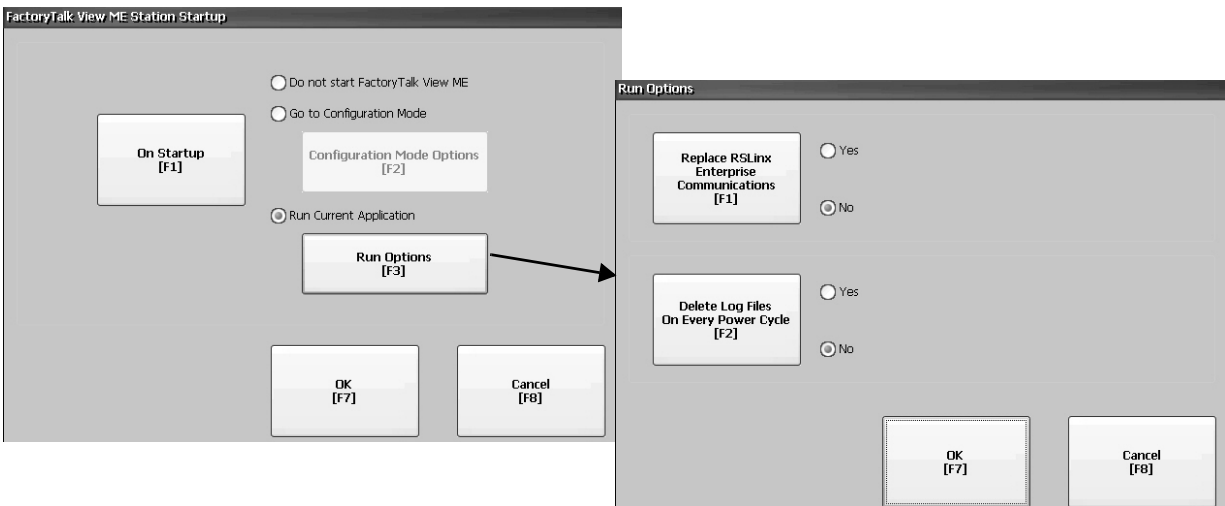

4. To specify what configuration settings are used when running the application, press Replace FactoryTalk Linx Communications:
 - To use the RSLinx communication settings in the terminal, select No.
 - To replace the terminal settings with the communication settings in the application, select Yes. Any changes to RSLinx device addresses or driver properties on the terminal are lost.
5. To specify what action to take with the log files on startup, press Delete Log Files On Every Power Cycle:
 - To delete all log files (data, alarm history, alarm status) generated by the terminal before running the application, select Yes. The files are deleted from the system default location.
 - To retain all log files, select No.
6. To return to the previous dialog box, press OK.
7. To return to terminal settings, press OK.

Configure Controller Address

You can configure communication information for your application and controller by using FactoryTalk® Linx software.

TIP You can also configure communication information for your application and controller by using FactoryTalk View Studio software.

To edit the device address of the controller, follow these steps.

1. Press Terminal Settings, then choose Networks and Communications>FactoryTalk Linx Communications.

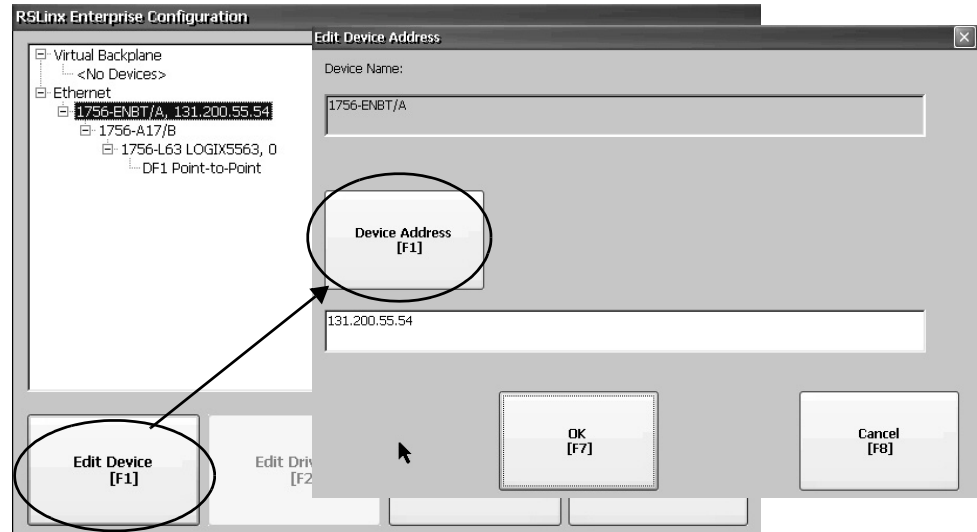

2. Select the controller in the tree.
3. To view the device name and current address, press Edit Device.
4. To modify the address, press Device Address.
The input panel opens with the current address.
5. Enter the address in the input panel and press Enter.
6. Press OK.

Updates do not take effect until the terminal is restarted.

Configure Ethernet Settings

The terminal has a built-in Ethernet driver. You can modify the Ethernet information for your device:

- IP address of terminal on network including link speed
- Device name that identifies terminal on network
- User name and password to access network resources
- Enable or disable either Ethernet port to configure for DLR, star, or linear network topologies

Set the Ethernet Address of the Terminal

Some networks automatically assign an IP address to Ethernet devices if Dynamic Host Configuration Protocol (DHCP) is enabled. If DHCP is disabled, you can manually enter an IP address.

To view or enter an IP address for your terminal, follow these steps.

1. Press Terminal Settings, then choose Networks and Communications>Network Connections>Network Adapters.

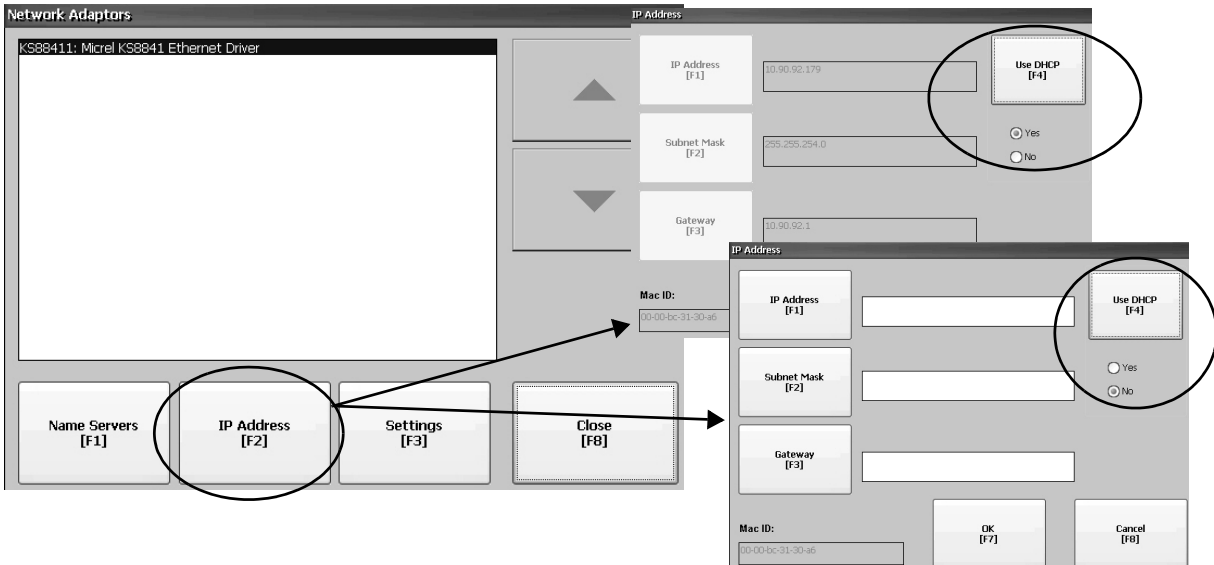

2. To view or modify the IP address, press IP Address.
3. To enable or disable DHCP assignment of addresses, press Use DHCP.
 - If DHCP is enabled or set to Yes, IP addresses are automatically assigned to newly attached devices on the network.
 - If DHCP is disabled or set to No, you can manually enter the IP address. Press IP Address, Subnet Mask, and Gateway to enter IP formatted addresses.

- TIP**
- IP Address - The format of the IP address is xxx.xxx.xxx.xxx, for example, 10.90.95.15. The first set of decimal numbers is in the range 1...255; the last three sets in the range 0...255. The default is 000.000.000.000.
 - Subnet Mask - Address must be identical to the server subnet mask.
 - Gateway - optional address.
 - MAC ID - read-only field.

4. Press OK when done.

If prompted, reset the device from the FactoryTalk View ME Station dialog box.

5. Press Close.

Set the Ethernet Link Speed

You can change the rate and mode at which data is transmitted on the Ethernet network. The default setting is Auto. The Auto option automatically configures the speed of the device to match the speed on the local network.

TIP The Auto option is preferred because it determines the actual speed and duplex setting of the connected device on the Ethernet network.

If you select a manual option, make sure that the speed and duplex setting for the connected device on the Ethernet network is identical. If the settings are different, there can be decreased network performance and errors.

1. Press Terminal Settings, then choose Networks and Communications>Network Connections>Network Adapters.

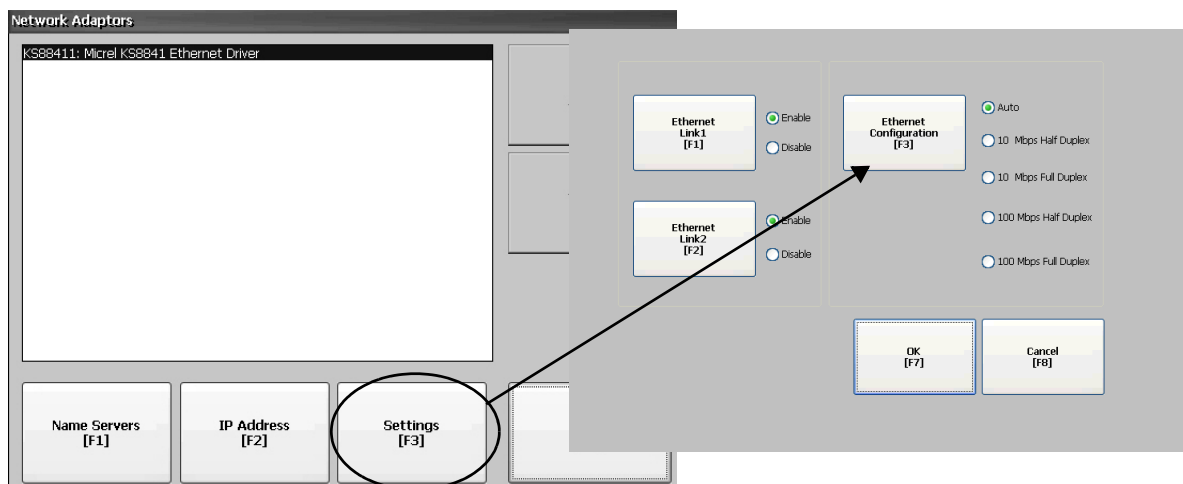

2. To access the Ethernet link settings, press Settings.
3. To change the rate at which data is transmitted over the Ethernet network, press Ethernet Configuration.
4. To return to the Network Adaptors dialog box, press OK.

Define Name Server Addresses

You can define Name Servers addresses for the EtherNet/IP network adapter. These addresses are automatically assigned if DHCP is enabled for the adapter.

1. Press Terminal Settings, then choose Networks and Communications>Network Connections>Network Adapters.

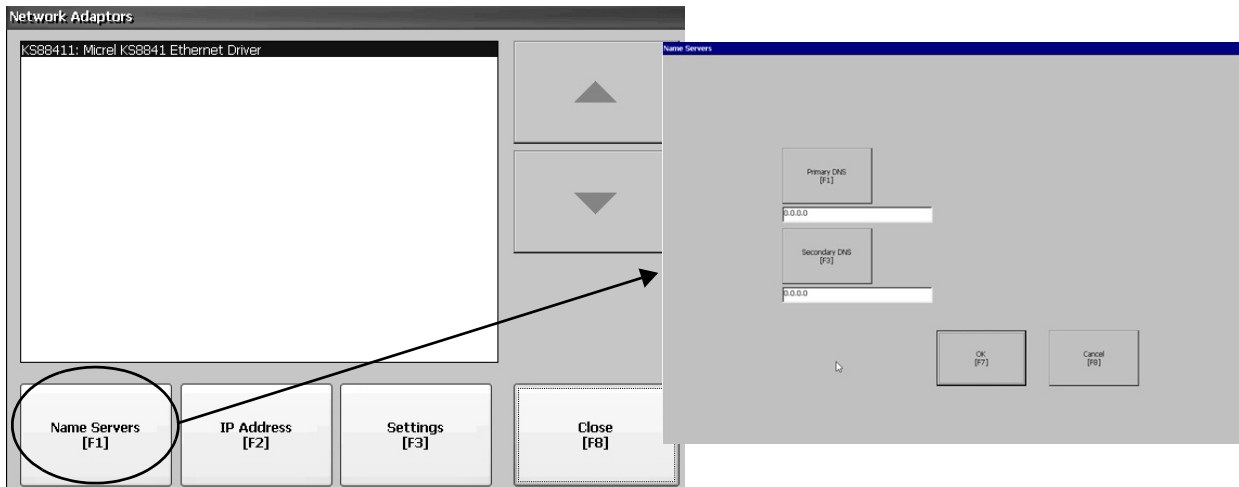

TIP Primary WINS and Secondary WINS are not available on Series B terminals (Series C for Stainless Steel terminals).

2. Press Name Servers.
3. To enter a corresponding name server address, press a button.
4. Press OK when done.

Configure the Ethernet Ports

To configure the Ethernet ports of the terminal, follow these steps.

1. Press Terminal Settings, then choose Networks and Communications>Network Connections>Network Adapters.
2. To access the Ethernet link settings, press Settings.

- To enable or disable the ports that you want to use for your network configuration, press Ethernet Link1 and Ethernet Link2.

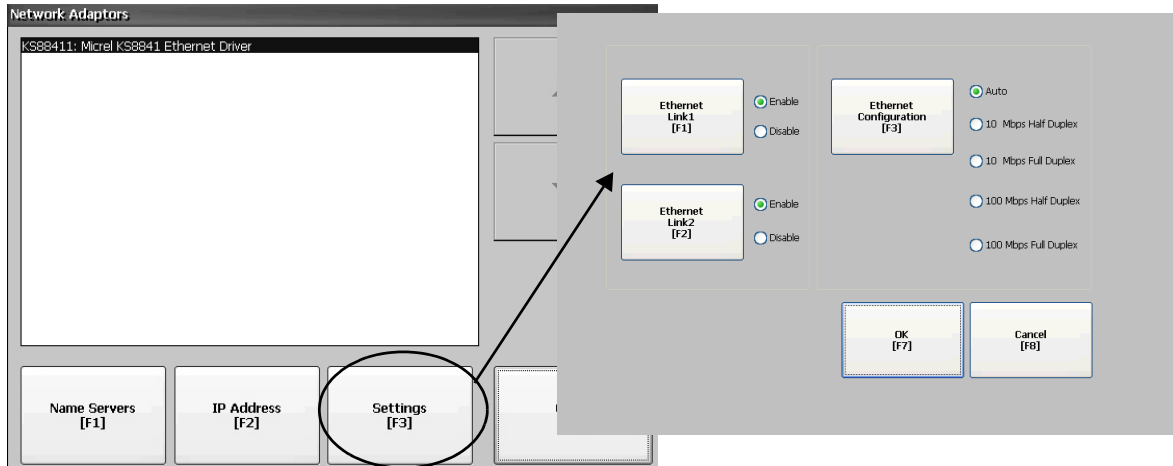

- To select Auto, press Ethernet Configuration.
- To save the configuration, press OK.
- Restart the terminal for the changes to take effect.

You can also configure the Ethernet ports as a system default for a closed system. See [Configure the Ethernet Ports on page 154](#).

View the Network Diagnostic Data

To view the network data, follow these steps.

- Press Terminal Settings, then choose Networks and Communications>Network Connections>Network Adaptors>Network Diagnostics.

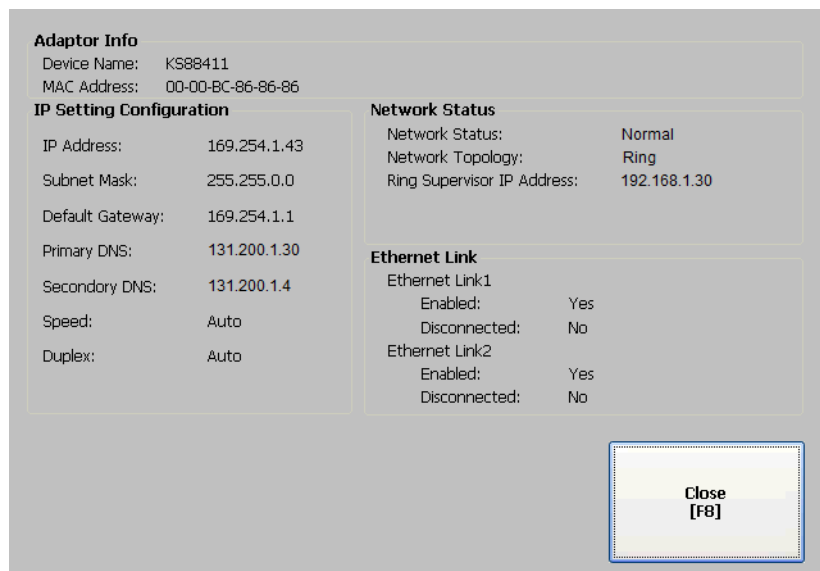

The table provides a description of Network Status text.

Status Text	Description
Network Status	
Normal	If network topology is Linear/Star, the network status is always normal.
Ring Fault	A non-fatal error condition exists.
Loop Detected	This value can only occur in a Linear/Star topology. This status occurs when an unexpected loop occurs in the network. It may not be possible for the terminal to report this condition (the terminal may not be capable of detecting frames that it has sent).
Network Topology	Identifies the network configuration as Linear/Star or Ring.

2. Press Close to exit the Network Diagnostic data.

Modify Device Name of Terminal

Each terminal has a unique name that identifies it on the network.

1. Press Terminal Settings, then choose Networks and Communications>Network Connections>Device Name.
2. To view or edit the default device name, press Device Name.

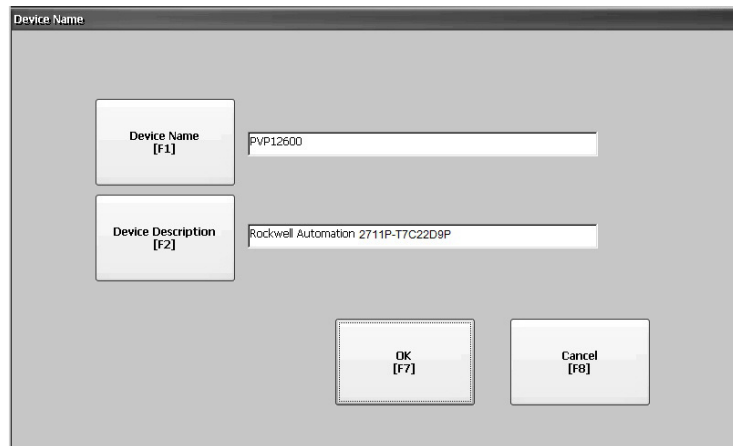

TIP The device name has 1...15 characters:

- First character must be an upper or lowercase letter a...z, A...Z.
- The other characters can be a...z, A...Z, 0...9, or - (hyphen).

3. To modify the description for the device, press Device Description.

TIP The description is a maximum of 50 characters. The default description is Rockwell Automation plus the device catalog number.

4. Press OK.

Copy Files on Terminal

You can copy FactoryTalk View ME application (.mer) files or font files between nonvolatile memory of the terminal and a USB drive, or SD card.

1. Press Terminal Settings, then choose File Management>Copy Files>Copy Applications or Copy Fonts.

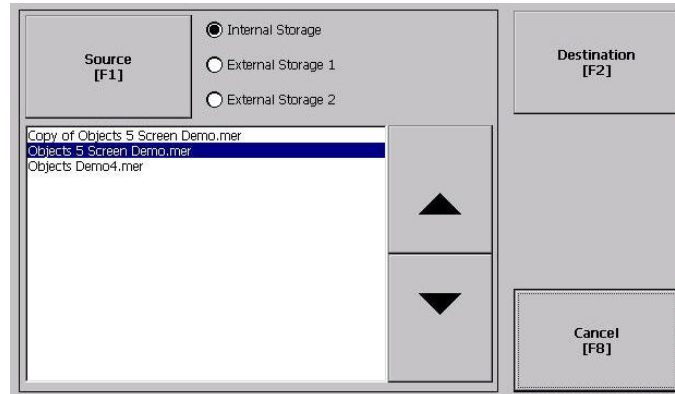

2. To select the location of the file you want to copy, press Source:
 - Internal Storage - nonvolatile memory of the terminal.
 - External Storage 1 - SD card that is loaded in card slot of terminal.
 - External Storage 2 - USB drive that is loaded in USB host port of terminal.
3. Select a file that appears in the list for the selected storage area.
4. Press Destination on the same dialog box.

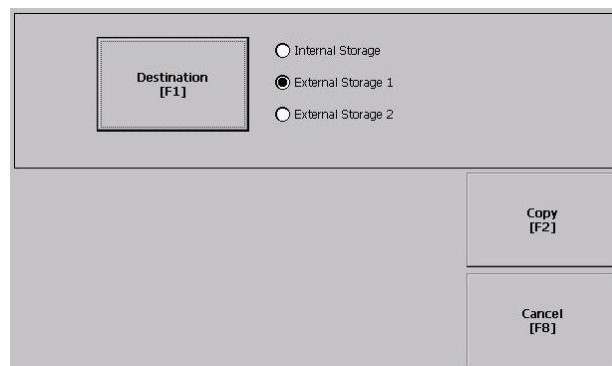

5. To select the storage location to copy the file, press Destination. The destination must be different than the source location.
6. To copy the selected file to the target location, press Copy. If the file exists, you are asked if it is okay to overwrite the file. Respond by selecting Yes or No.

TIP FactoryTalk View ME Station software looks for .mer files in the folder My Device\Application Data\Rockwell Software\RSViewME\Runtime\ and font files in the folder \Rockwell Software\RSViewME\Fonts\.

Delete Files from Terminal

You can delete FactoryTalk View ME application .mer files or font files that reside in nonvolatile memory of the terminal, a USB drive, or an SD card.

1. Press Terminal Settings, then choose File Management>Delete Files>Delete Applications or Delete Fonts.

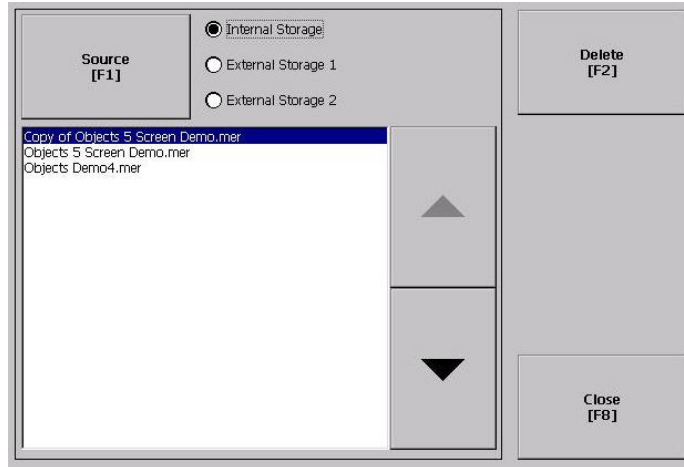

2. To select the storage location of the application or font file you want to delete, press Source:
 - Internal Storage - nonvolatile memory of the terminal.
 - External Storage 1 - SD card that is loaded in card slot of terminal.
 - External Storage 2 - USB drive that is loaded in USB host port of terminal.
3. Select a file that appears in the list for the selected storage area.
4. Press Delete.
5. Select Yes or No when asked if you want to delete the selected application or font file.

Delete Log Files

You can delete log files, alarm history files, and alarm status files from the System Default location of the terminal. The application generates these files during runtime.

1. Press Terminal Settings>File Management>Delete Files>Delete Log Files.

You are asked to confirm the deletion of the files.

Do you want to delete all FactoryTalk View ME Station Log Files?

2. Select Yes or No.

Log files not in the System Default location are not deleted.

Display Settings

For the terminal display, you can change its brightness, configure the screen saver, or disable the screen cursor.

Adjust Display Intensity

You can adjust the intensity of the backlight in 10% increments from 0...100%. At 0%, the backlight is minimally visible. You can use the default intensity of 100% or adjust the intensity for runtime operations.

1. Press Terminal Settings, then choose Display>Display Intensity.

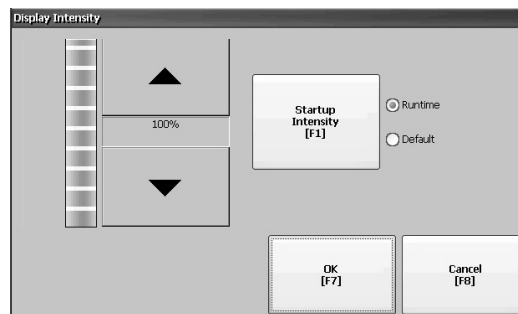

TIP Startup Intensity is not available on Series B terminals (Series C for Stainless Steel terminals).

2. To switch between Default intensity and Runtime intensity, press Startup Intensity.
 - If you select Runtime, the start-up screens use the runtime intensity.
 - If you select Default, the start-up screens use the default setting of 100%.
3. To increase or decrease the intensity for runtime operations, press the up or down cursors.
4. To save changes, press OK.

Configure the Screen Saver

TIP Screensaver is not available in the initial Series B release (Series C for Stainless Steel terminals); it will be added at a later date.

A screen saver image appears on the terminal display when no user activity has been sensed for a certain time. The default idle time is 10 minutes. You can adjust the idle time and intensity level of the screen saver, disable the screen saver, or disable the screen saver image.

1. Press Terminal Settings, then choose Display>Screen Saver.

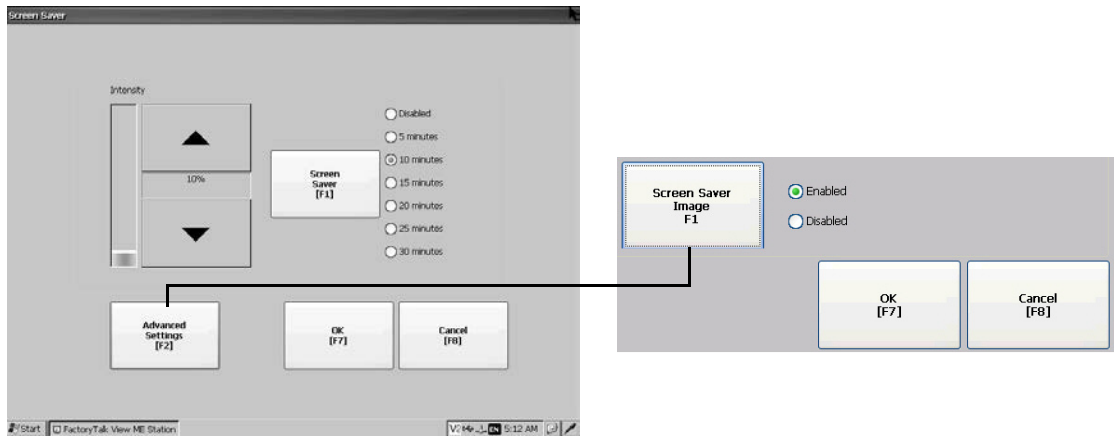

2. To change the idle period for activating the screen saver, press Screen Saver.
To disable the screen saver, select Disabled.
3. To increase or decrease the brightness intensity of the screen saver, press the up and down cursors.
4. To access the screen saver image setting, press Advanced Settings.
 - a. To disable or enable the current screen saver, press Screen Saver Image.
See [Screen Saver on page 130](#) for details on how to change the screen saver image.
 - b. To return to the Screen Saver dialog box, press OK.
5. To exit and return to terminal settings, press OK.

Disable the Screen Cursor

TIP This is an unsupported feature on Series B terminals (Series C for Stainless Steel terminals).

The terminal has a screen cursor that you can disable or enable.

1. Press Terminal Settings, then choose Display>Cursor.

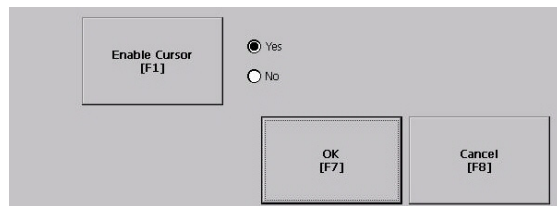

2. To disable or enable the cursor, press Enable Cursor.
3. To exit and return to terminal settings, press OK.

Input Device Settings

You can adjust settings for input devices that are used by the terminal including the keypad, touch screen, attached keyboard or mouse, and string entry popup.

Configure Keyboard or Keypad Settings

TIP This is an unsupported feature on Series B terminals (Series C for Stainless Steel terminals). The Keyboard/Keypad configuration page is removed from Series B terminals (Series S for Stainless Steel terminal).

You can adjust settings for keys on the terminal or an attached keyboard.

1. Press Terminal Settings, then choose Input Devices>Keyboard/Keypad.

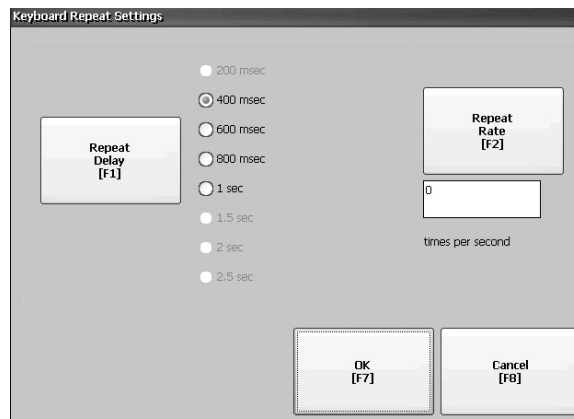

2. Press Repeat Rate to specify the number of times a key repeats itself per second when held down.
Valid values are 0, 2...30. Values are device-dependent for an attached keyboard, but typically the same.
3. Press Repeat Delay to select the time that elapses per second before a key is repeated.
Values are device-dependent. Unsupported values are dimmed.
4. Press OK when done.

Calibrate the Touch Screen

To calibrate PanelView Plus 7 Performance Series A terminals with a touch screen, follow these steps. For information on how to calibrate the Series B terminals (Series C for Stainless Steel terminals), see [Initial Startup — Series B Terminals on page 52](#).

IMPORTANT Use a plastic stylus with a minimum tip radius of 1.3 mm (0.051 in.) A stylus is more precise than a finger and also helps to protect the screen.

1. Press Terminal Settings, then choose Input Devices>touch screen>Calibration.

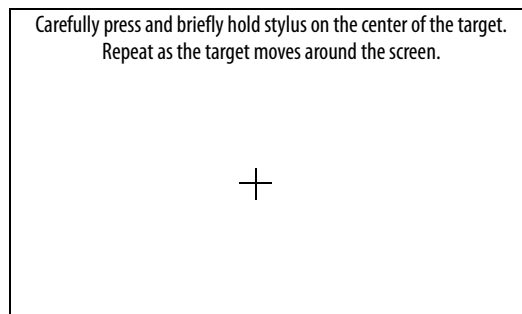

2. Follow the instructions on the screen.

When the calibration is complete, a message appears to indicate the measurement of new calibration settings.

On This Type of Terminal:	Do This:
Touch screen only	<ul style="list-style-type: none"> • Press the screen to register saved data. • Wait for 30 seconds to cancel saved data and keep the current settings.
Keypad and touch screen	<ul style="list-style-type: none"> • Press the Enter key to accept new settings. • Press the Esc key to cancel and keep the current settings.

Set the Double-tap Sensitivity for a Touch Screen

You can set and test the sensitivity of both speed and physical distance between touch screen presses.

TIP The process is identical for setting and testing the sensitivity of mouse clicks. To adjust the sensitivity of mouse clicks, press Terminal Settings, then choose Input Devices>Mouse.

1. Press Terminal Settings, then choose Input Devices>touch screen>Double Tap Sensitivity.

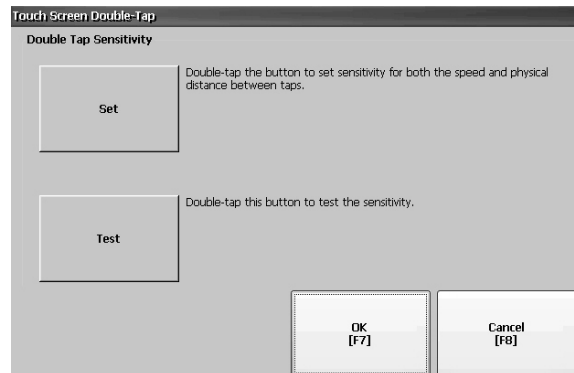

2. To set the sensitivity of touch screen presses, double-tap Set.
3. To test the sensitivity of touch screen presses, double-tap Test. The Test button reverses its foreground and background colors.
4. Press OK when done.

Change the Popup for String Entry

You can use a string popup for character input instead of the popup keyboard or input panel.

1. Press Terminal Settings, then choose Input Devices>String Popup.

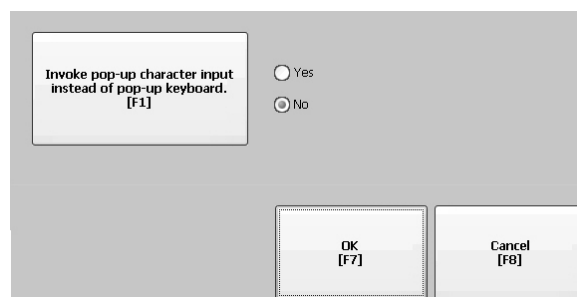

2. To select the preferred method for character input, press Invoke pop-up character input instead of pop-up keyboard.
3. Press OK.

Change Popup Input Color Settings

You can change the popup input color settings for your terminal.

1. Press Terminal Settings, then choose Input Devices.

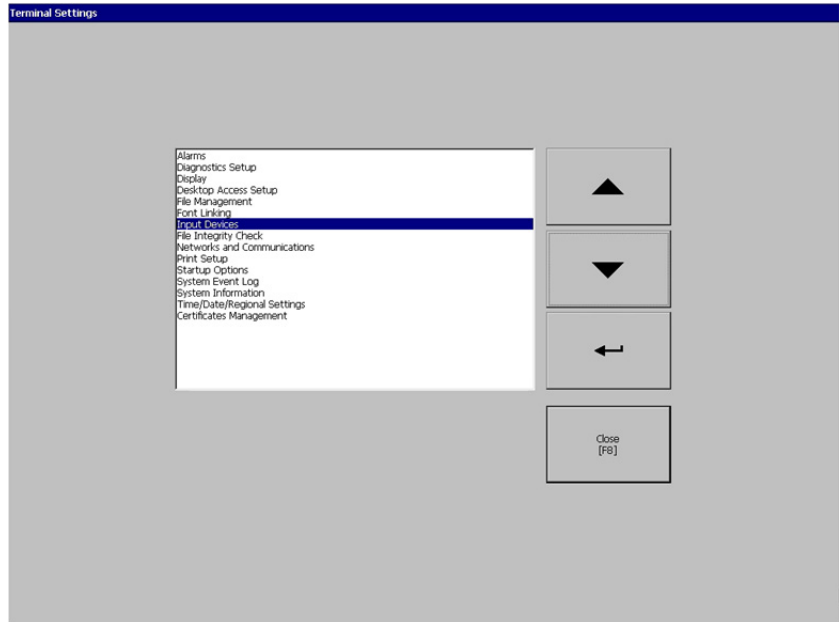

2. In the Input Devices dialog box, choose Pop-Up Input Color Settings.

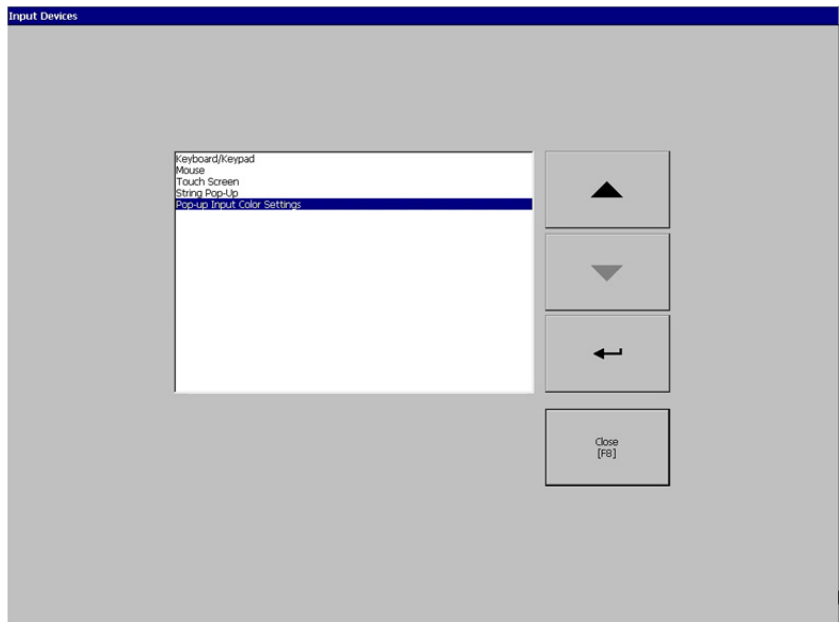

- In the Pop-up Input Color Settings dialog box, choose the input element for which you want to change the color: Keypad, Keyboard, or Character input.

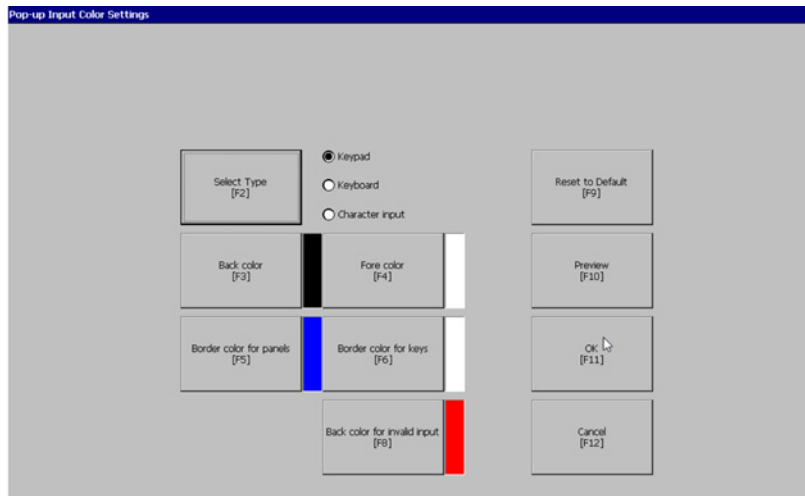

- Choose each of the color areas you want to modify for the input element, for example, Back color, and then select a color for that area.
- To save the color changes, click OK.

The new colors are changed for that input element, as shown in the following example.



Configure Print Options

You can configure settings to print displays, alarm messages, or diagnostic messages from FactoryTalk View ME applications. The setup to print displays and messages are the same; advanced settings are different.

TIP The following information applies to PanelView Plus 7 Performance Series A terminals. Series B terminals (Series C for Stainless Steel terminals) support the Internet Printing Protocol (IPP). On Series B terminals (Series C for Stainless Steel terminals), if a network printer is plugged in at terminal startup, the printer will be automatically detected and there is no requirement to configure printer drivers. However, the IPP service needs to be enabled for this automatic detection to work. See [Services Screen on page 174](#) for information on how to enable this service.

PanelView™ Plus 7 Performance Series A terminals support selected printers. For a list of supported printers, go to <https://rockwellautomation.custhelp.com> and search the Knowledgebase for keywords 'Printers Supported on PanelView Plus'.

PanelView Plus 7 Performance Series A terminals support selected Canon, Epson, Hewlett-Packard, and Brother printers. Printer installation is plug-and-play. Supported printers are automatically mapped to appropriate driver. Printers that do not configure automatically to the appropriate driver can be installed manually.

To access the print setup, follow these steps.

1. Press Terminal Settings, then choose a Print Setup> option:
 - Alarm Print Setup
 - Diagnostic Setup
 - Display Print Setup

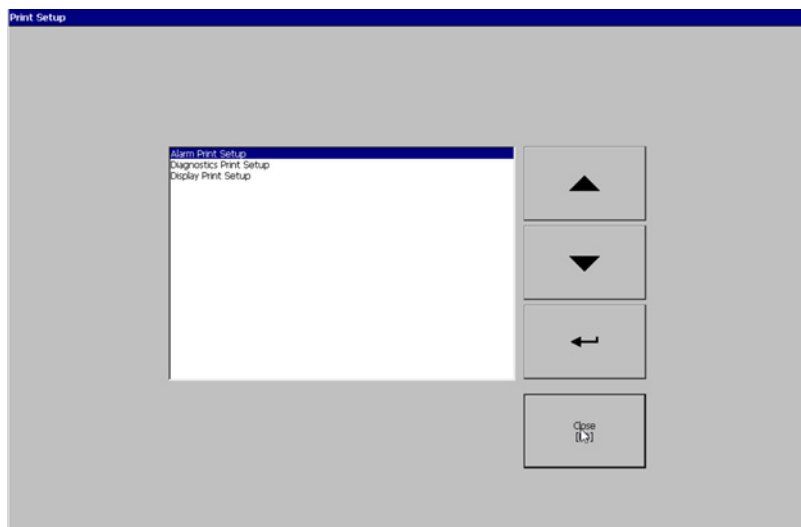

The Print Setup dialog box shows installed printers that are available to the FactoryTalk View ME application. The list of printers that shows depends on what printers you install.

The terminals are not shipped with pre-configured printers so initially the dialog box is empty.

TIP Series B terminals (Series C for Stainless Steel terminals) have a pre-configured printer driver. With the IPP service enabled on Series B terminals (Series C for Stainless Steel terminals), if an IPP printer is detected it automatically appears in the printer selection list.

The PDF printer driver is available by default on Series A and Series B terminals (Series C for Stainless Steel terminals).

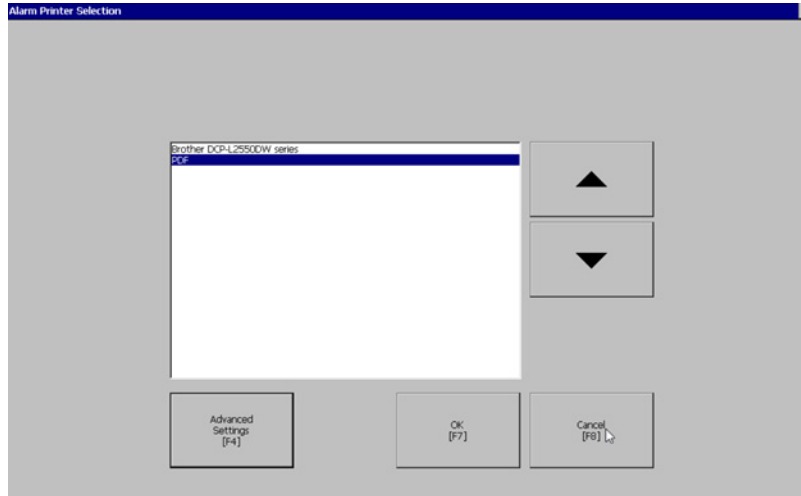

2. Select an installed printer.

TIP The printer you select must be in the control panel Printers applet. A failed attempt to automatically install a printer is reported in the system event log. A printer that does not install automatically can be installed manually by using the control panel in Windows Explorer.

3. To access these options, press Advanced Settings:
 - Options to print displays include print orientation, draft mode, and color.
 - Options to print diagnostic and alarm messages determine when to print messages that are sent to the network or USB port.

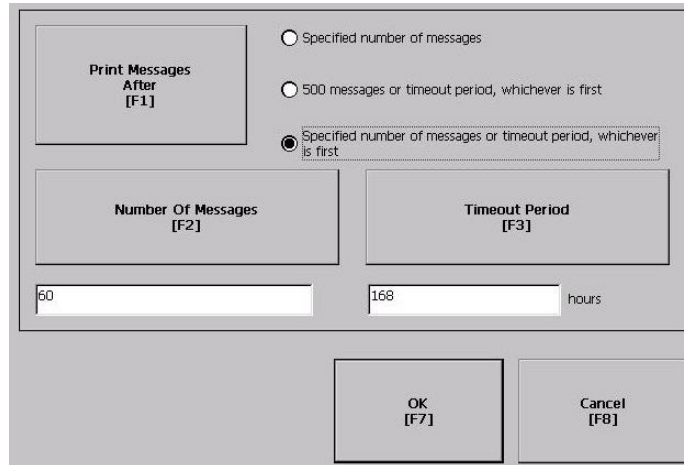

Print Messages After	Default Value	Example
Specified number of messages	60 messages	When the queue has 60 messages, the messages are printed regardless of how long they have been in the queue. You can change the number of messages.
500 messages or timeout period, whichever is first	168 hours (7 days)	If the queue has 350 messages after 168 hours, the 350 messages are printed. You can change the timeout period.
Specified number of messages or timeout period, whichever is first.	60 messages 168 hours (7 days)	If the queue has 60 messages after 24 hours, then the 60 messages are printed. You can change the number of messages and the timeout period. For example, the number of messages is set to 75 and the timeout period is set to 48 hours. <ul style="list-style-type: none"> • If the queue has 75 messages after 24 hours, then the 75 messages are printed before the set timeout of 48 hours. • If the queue has 15 messages after 48 hours, the 15 messages are printed after the set timeout period.

4. Press OK when done.
5. Press OK to return to terminal settings.

Configure Diagnostics

You can log diagnostics to a remote computer for troubleshooting.

To configure and forward diagnostics to a computer, follow these steps.

1. Press Terminal Settings, then choose Diagnostic Setup.

A list of diagnostic nodes appears.

TIP To access Remote Log or Message Routing setup, select the node then press Edit.

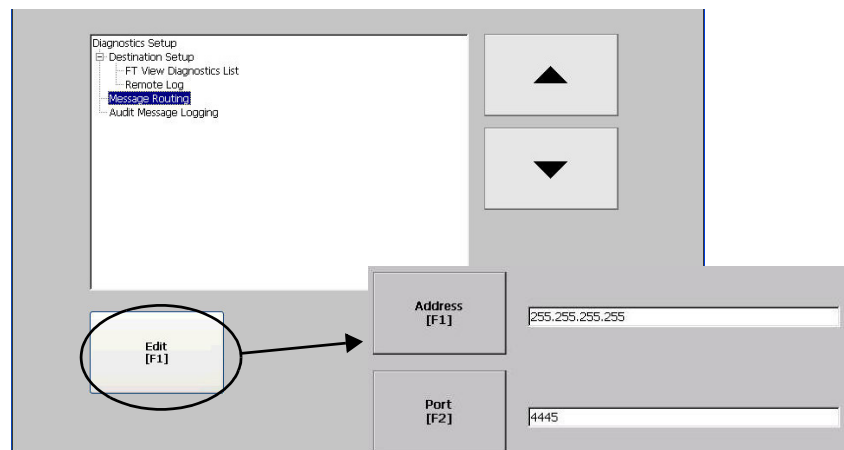

The Remote Log destination forwards messages to a Windows computer that runs diagnostics. The IP address and port number identify the computer.

Field	Description	Valid Values
Address	IP address of the remote Windows computer.	xxx.xxx.xxx.xxx
Port	The port that is used to communicate with the remote Windows computer.	4445 (default)

Select Message Routing to access the following dialog boxes:

- Remote Log
- FactoryTalk View Diagnostics List

Each dialog box shows a list of message that can be sent to a destination. Cursor to a message, then press On/Off to enable or disable the message. Messages with checked boxes are enabled. Messages with cleared boxes are disabled.

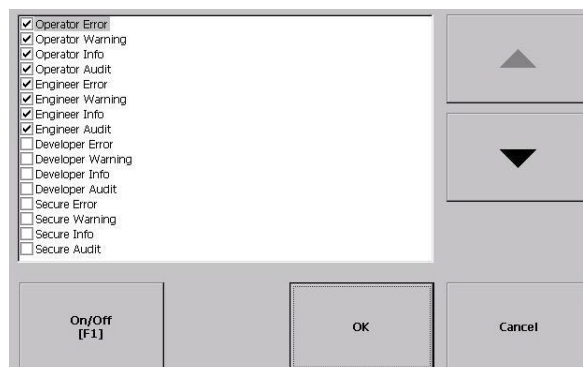

Audit Message Logging lets you log messages as Audit or Information.

Check Integrity of Application Files

It is good practice to periodically check the integrity of the .mer application that is loaded in the terminal and the runtime files. Errors, warnings, and information messages are logged to a file. You can view the log and clear items from the log.

TIP Runtime files allow applications to run on the terminal. If the terminal is not functioning correctly, a review of the logs can identify an error in a runtime file.

1. Press Terminal Settings, then choose File Integrity Check.

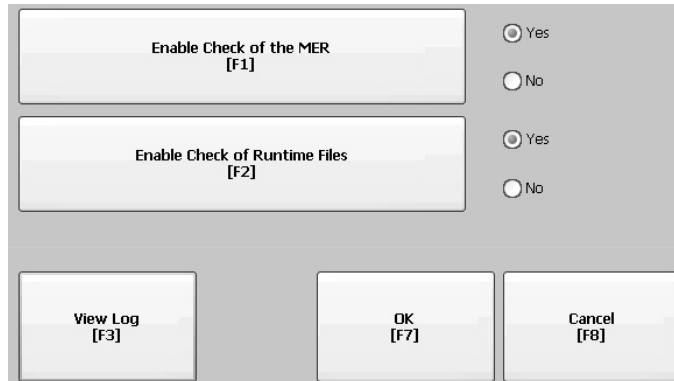

2. Press either of the Enable options to disable integrity checks of the .mer application or the runtime files.

Integrity checks are automatically performed on the application .mer file and runtime files. If you disable either of these functions, the files are not checked and the log file is not updated.

3. To save changes, press OK.

To view the log generated by runtime files, follow these steps.

1. Press View Log from the File Integrity Check dialog box.

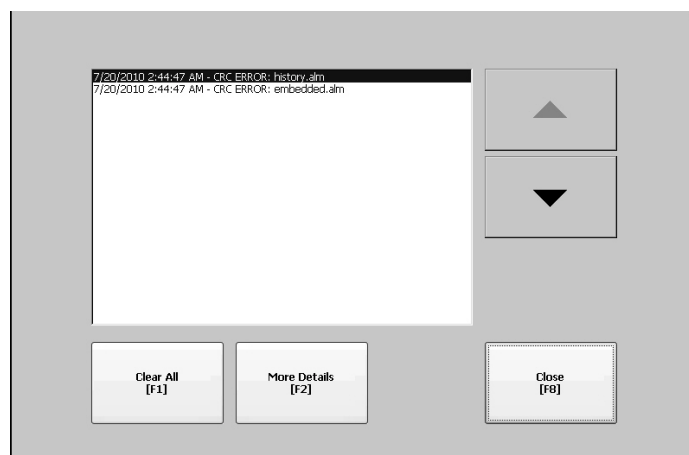

2. To display details for that event, select an event and press More Details.
3. To clear all details from the log, press Clear All.
4. To return to previous dialog box, press Close.

View and Clear the System Event Log

Note: The following information applies to PanelView Plus 7 Performance Series A terminals. For Series B terminals (Series C for Stainless Steel terminals), the Control Panel contains the System Event Log.

The System Event Log displays warnings, errors, and events logged by the terminal. The log provides a time stamp of when each event occurred and text that describes the event. If the event log is full when a new event occurs, the oldest entry is removed to accommodate the new event.

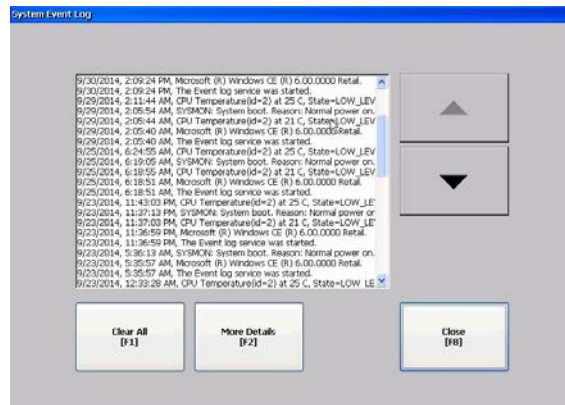

1. Press Terminal Settings>System Event Log.
2. To display details for the event, select an event and press More Details.
3. Press Clear All clear all events in the log.
4. Press Close.

Enable or Disable the Alarm Display

The terminal displays each alarm as it occurs in the alarm display or alarm banner. When the operator acknowledges the most recent alarm, the alarm display closes or remains open. The default is to close the alarm display.

1. Press Terminal Settings, then choose Alarms.

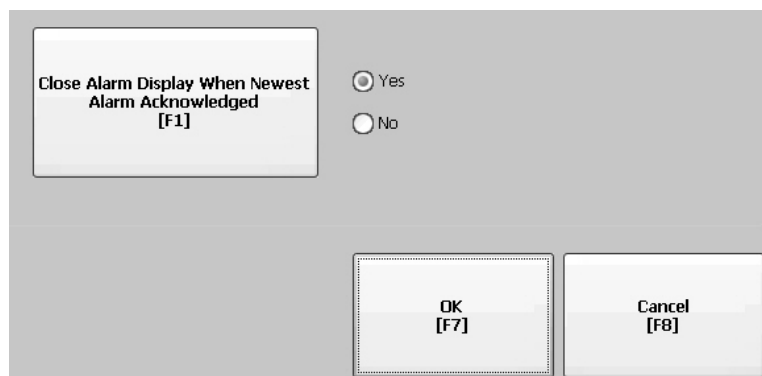

2. Press “Close Alarm Display When Newest Alarm Acknowledged” to toggle between Yes or No.
 - Yes closes the alarm display when the newest alarm is acknowledged.
 - No leaves the alarm display open when newest alarm is acknowledged.
3. Press OK.

Display System Information

You can view terminal and firmware revision information for software that is installed on a terminal.

View Terminal Information

You can view the following read-only information:

- Total power on time in minutes
- Processor temperature
- Battery voltage and state
- Memory that is allocated and used
- Random access memory (RAM) memory usage during runtime

To view status information for your terminal, follow these steps.

1. Press Terminal Settings, then choose System Information>Terminal Information.

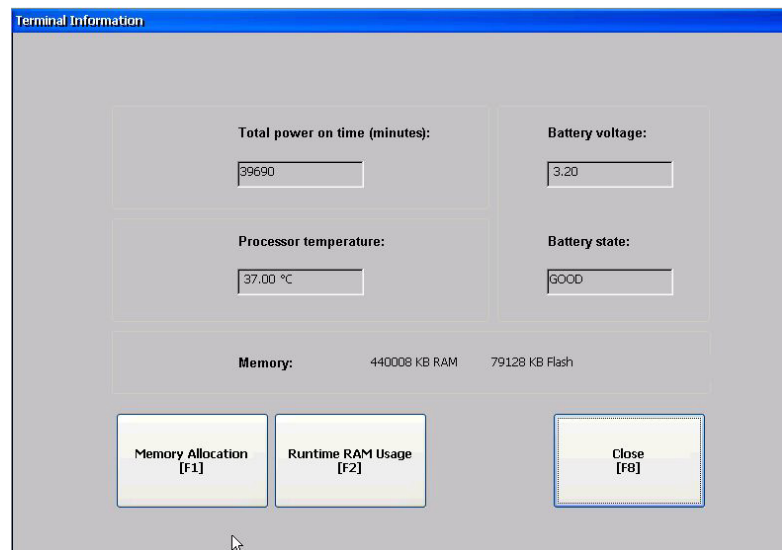

Processor temperature must be less than 90 °C (194 °F).

IMPORTANT Over-temperature messages are recorded in the system event log:

- 85 °C (185 °F) issues a warning message.
- 90 °C (194 °F) issues an error message.

Battery voltage must be at least 2.75V DC.

Battery State	Description
GOOD	Good battery condition.
FAILING	Low battery. Replace the battery.
BAD	Battery is missing or bad. Replace the battery.

- To view information about storage RAM, program RAM, and available nonvolatile memory, press Memory Allocation.

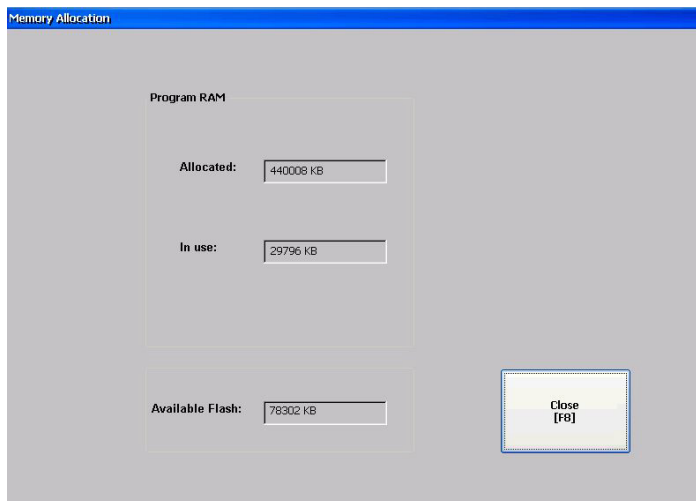

- To return to previous dialog box, press Close.
- To troubleshoot anomalies by showing RAM used by the application at runtime, press Runtime RAM Usage.

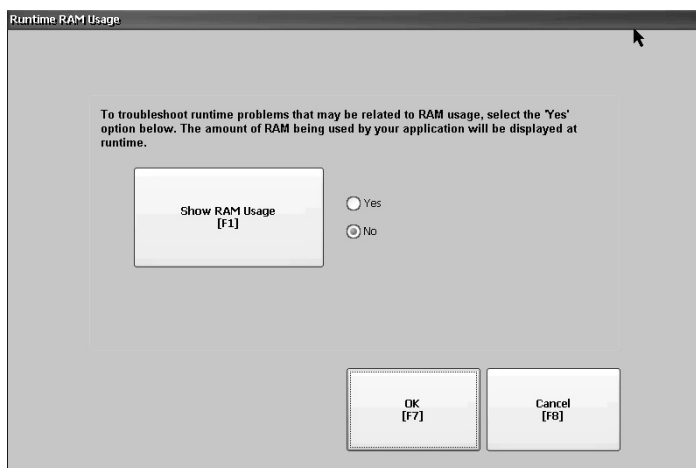

- To return to the previous dialog, press OK.
- Press Close until you return to terminal settings.

View FactoryTalk View ME Station Information

You can view firmware and version information for components that are installed on your terminal and access technical support information.

1. Press Terminal Settings, then choose System Information>About FactoryTalk View ME Station.

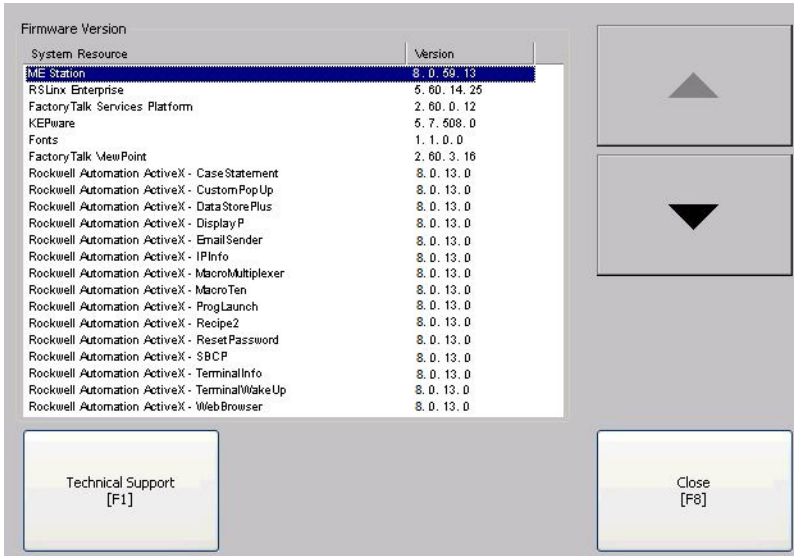

2. To display the support telephone number and website, press Technical Support.
3. Press Close until you return to terminal settings.

Time and Date Settings

You can change the date, time, time zone, and regional settings for terminal operations.

TIP Set the time zone before you change the current date and time on the terminal.

Change the Time Zone on Terminal

You can view or modify the current time zone on the terminal. Time zones are installed with the operating system. Changing the time zone adjusts the current time and date to match the time zone.

The clock in the terminal records the time when files are created or modified on the terminal. You can change the time and time zone of the clock.

1. Select Terminal Settings, then choose Time/Date/Regional Settings>Time Zone.

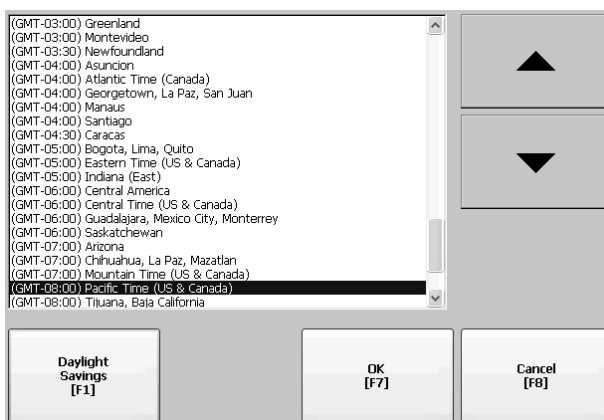

2. To select a time zone, press the up or down cursor.

Daylight Saving Time is enabled for all time zones except Japanese, which does not, support daylight savings. The clock is adjusted automatically when Daylight Saving Time changes.

3. Optionally, press Daylight Savings to enable or disable Daylight Saving Time for a time zone.

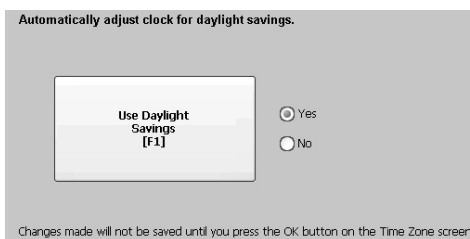

Changes are not permanent until you close the Time Zone dialog box.

4. Press Close when done.
5. To return to the previous dialog box, press OK.

Change the Current Date on Terminal

To adjust the date on the terminal, follow these steps.

1. Select Terminal Settings, then choose Time/Date/Regional Settings>Date.

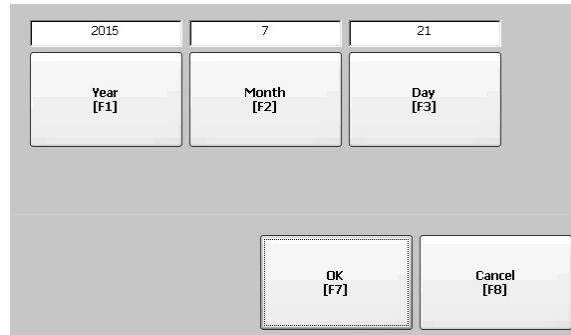

The screenshot shows a dialog box for setting the date. At the top, there are three input fields containing the values 2015, 7, and 21. Below these fields are three buttons labeled 'Year [F1]', 'Month [F2]', and 'Day [F3]'. At the bottom of the dialog are two buttons labeled 'OK [F7]' and 'Cancel [F8]'.

2. To change the current values above the button, press Year, Month, and Day:
 - Year is four digits in the range 1980...2099
 - Month is in the range 1...12
 - Day is in the range 1...31 and validated by month
3. Press OK when done.

Change the Current Time on Terminal

To adjust the time on the terminal, follow these steps.

1. Select Terminal Settings, then choose Time/Date/Regional Settings>Time.

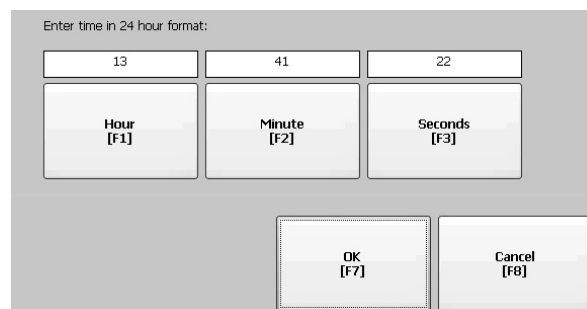

The screenshot shows a dialog box for setting the time. At the top, it says 'Enter time in 24 hour format:'. Below this are three input fields containing the values 13, 41, and 22. Below these fields are three buttons labeled 'Hour [F1]', 'Minute [F2]', and 'Seconds [F3]'. At the bottom of the dialog are two buttons labeled 'OK [F7]' and 'Cancel [F8]'.

2. To change the current values, press Hour, Minute, and Seconds:
 - Hour range is 0...23 (24-hour format)
 - Minute and second range is 0...59
3. Press OK when done.

Regional Settings

You can change the format to display dates, times, and numerics to match the standards of a country or region. Languages are installed with the operating system. Before changing regional settings, you must select a language.

To select a language that is installed on the terminal, follow these steps.

1. Select Terminal Settings, then choose Time/Date/Regional Settings>Language.

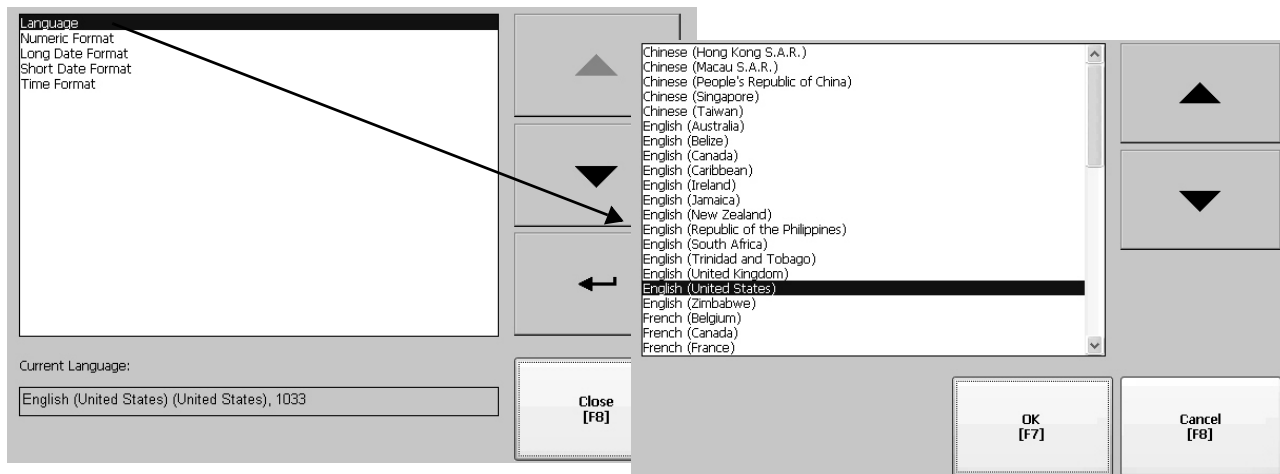

2. To select a language, press the up and down cursors.
3. Press OK.

The selected language shows under Current Language on the Regional Settings dialog box.

Change the Decimal Separator

You can change the decimal separator that is used in numeric formats for the selected language. The default separator is a period.

1. Select Terminal Settings, then choose Time/Date/Regional Settings>Numeric Format.

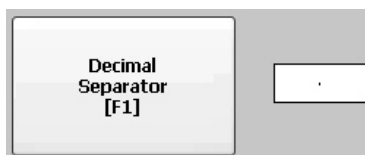

The default separator is shown.

2. Enter a maximum of three characters for the new separator.
3. Press OK.

Change the Time Format for a Language

To change the format of the time for the selected language, follow these steps.

1. Select Terminal Settings, then choose Time/Date/Regional Settings>Time Format.

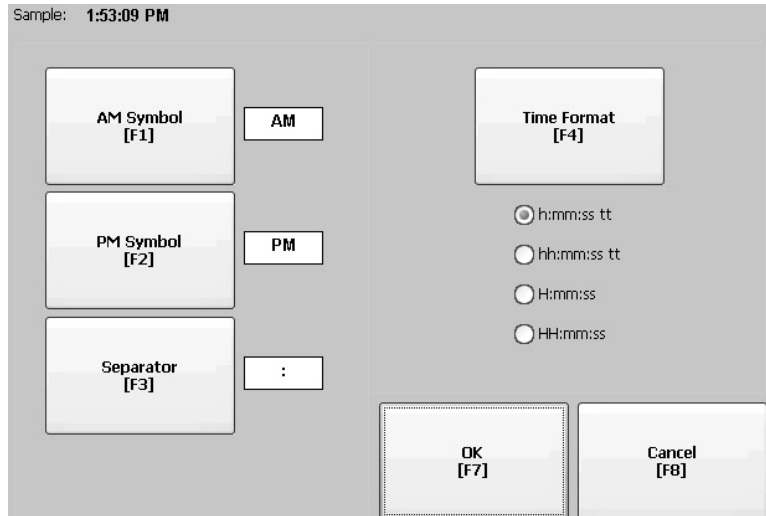

The current time appears in the selected format.

3. To adjust the formats, press the appropriate selections.

The sample format changes as you make selections.

Field	Description	Example
Time Format 12 hour	h:mm:ss tt (default) h = 12-hour time display, no leading zero tt = AM or PM symbol	7:23:02 AM or 1:13:31 PM 11:43:59 AM
	hh:mm:ss tt hh = 12-hour time display with leading zero tt = AM or PM symbol	07:23:02 AM or 01:13:31 PM 11:43:59 PM
Time Format 24 hour	H:mm:ss H = 24-hour time display, no leading zero	7:03:42 or 1:13:32 23:43:59
	HH:mm:ss HH = 24-hour time display with leading zero	07:03:42 or 01:13:22 23:43:59
AM Symbol	Characters to indicate AM. If the time format is set to a 12-hour time display (h:mm:ss tt or hh:mm:ss tt), you can modify the AM symbol.	AM (default) 12 character max
PM Symbol	Characters to indicate PM. If the time format is set to a 12-hour time display (h:mm:ss tt or hh:mm:ss tt), you can modify the PM symbol.	PM (default) 12 character max
Separator	Characters that separate fields in time format.	: (default) 3 character max

4. Press OK.

Change the Short Date Format for a Language

To change the short date format for the selected language, follow these steps.

1. Select Terminal Settings, then choose Time/Date/Regional Settings>Short Date Format.

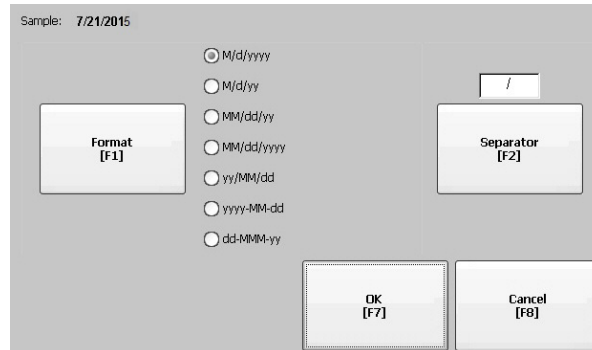

2. To change the short date format, press Format.
The date updates in the Sample area as you make changes.
3. To change the character between date elements, press Separator.
The separator can be three characters. The default separator is – or /.
4. Press OK when done.

Change the Long Date Format for a Language

To change the long date format for the selected language, follow these steps.

1. Select Terminal Settings, then choose Time/Date/Regional Settings>Long Date Format.

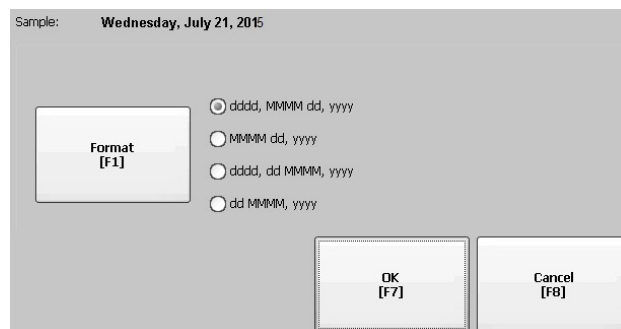

2. To change the long date format, press Format.
The date updates in the Sample area as you make changes.
3. Press OK when done.

KEPServer Driver Configuration (Series B Only)⁽¹⁾

The PanelView Plus 7 Performance Series B terminals (Series C for Stainless Steel terminals) allow you to select a KEPServer driver.

1. Select Terminal Settings.

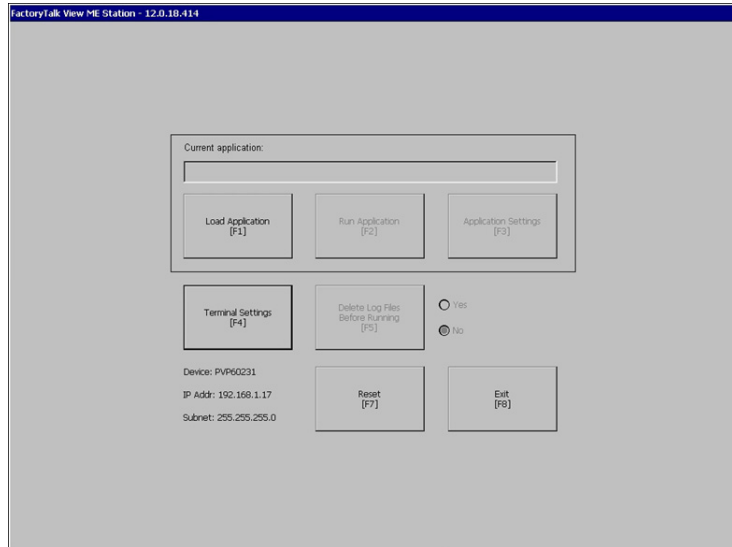

2. In the Terminal Settings dialog box, select Networks and Communications.

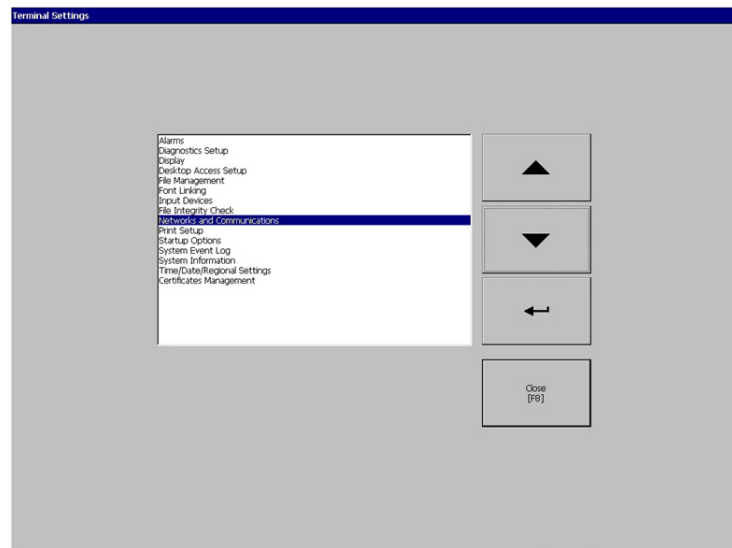

(1) (Series C for Stainless Steel terminals)

3. In the Networks and Communications dialog box, select KEPServer Driver Configuration.

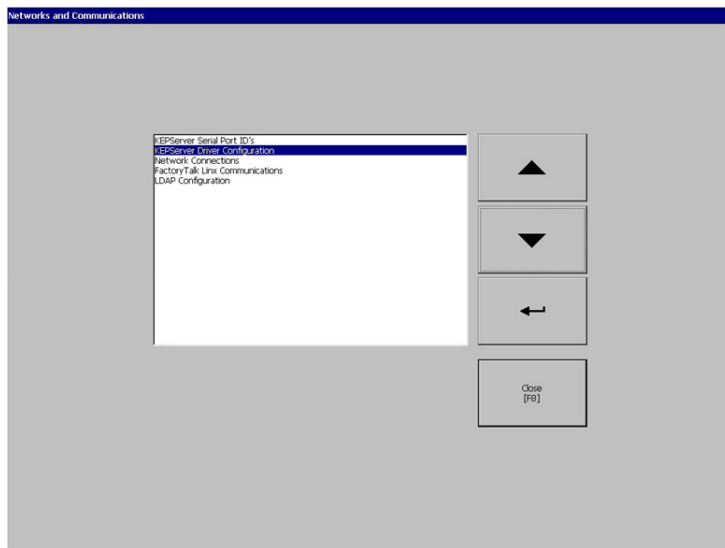

4. Use the arrow keys to highlight the desired drivers, and then click the On/Off button to select the drivers.

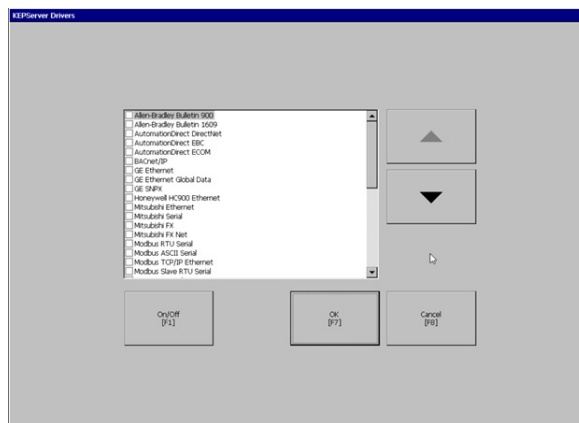

5. Click OK when you are finished.

IMPORTANT A terminal reset is necessary for the settings to take effect.



6. Click Yes and Restart your computer.

Certificate Management (Series B Only)⁽¹⁾

The PanelView Plus 7 Performance Series B terminals (Series C for Stainless Steel terminals) allow you to import and update certificates for your terminal.

Before you can use the Certificate Import tool, you need to copy the certificates to the Certificates folder by. You can do this by using Control Panel>Explore>File Explorer.

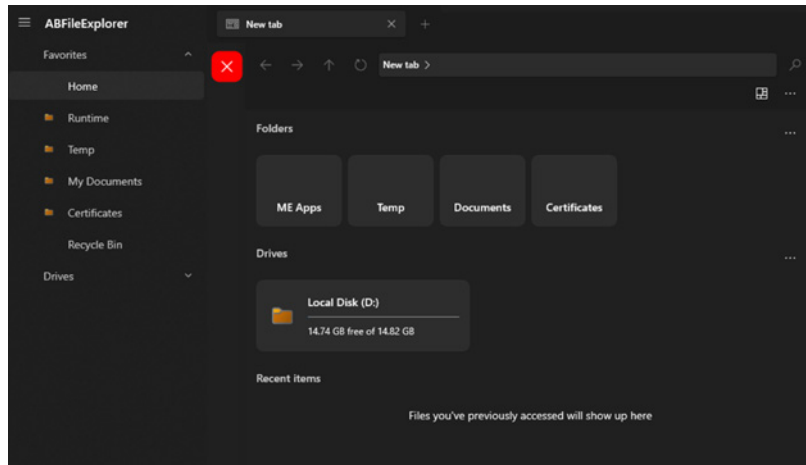

(1) (Series C for Stainless Steel terminals)

After you copy the certificates to the Certificates folder, complete the following steps to copy the certificates to your terminal.

1. Select Terminal Setting, and then select Certificates Management.

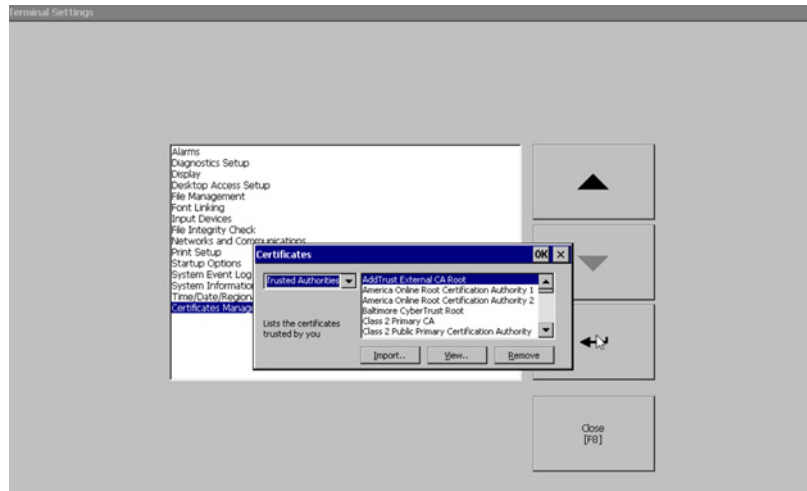

2. In the Certificates dialog box, select the certificate in the list, and then click the Import button.

The certificates are imported to your PanelView terminal.

Notes:

Windows CE Operating System — Series A Terminals

Topic	Page
Operating System Features	121
Windows Explorer	124
Taskbar	124
Soft Input Panels	124
Windows Control Panel	125
Backup and Restore	126
Display Properties	129
Hardware Monitor	132
Logo Manager	134
User Accounts	136
Services	137
Network Server Configuration	138
System Information	152
Touch Properties	156
PDF Reader	157

Operating System Features

The PanelView™ Plus 7 Performance terminals run the Windows CE 6.0 operating system (OS) providing the following features:

- Command shell
- Command processor
- Console window
- Windows Explorer shell
- Common dialog box
- Control panel
- Network user interface
- Soft keyboard input panels
- PDF reader
- Mouse and touch screen support with right-click support.

TIP Touch the screen for 1 second or longer for a right-click.

- VNC server and client viewer

-
- IMPORTANT** The platform distributes two VNC client viewers:
- Vncviewer.exe is in the /Windows folder on the terminal desktop. You can deploy this viewer to a personal computer to connect, view, and control a PanelView Plus 7 Performance terminal.
 - Another viewer on the terminal lets you establish a VNC connection between two PanelView Plus 7 Performance terminals. To access this viewer, choose Start>Programs>VNC Viewer.
-

Application Support

The Windows CE operating system supports these applications:

- .NET Compact Framework, version 3.5 or later
- C++ libraries and runtimes
- Component services DCOM/COM/OLE
- Message queuing MSMQ
- MSXML, version 3.0 or later
- Microsoft foundation classes (MFC) for devices, version 9.0 or later
- Active template library (ATL)
- ActiveSync
- Cabinet (CAB) file installer/uninstaller
- ToolHelp application programming interface (API)
- Error reports (generator, transfer driver, control panel)

Scripting Support

The Windows CE operating system supports these scripting features:

- Batch/Command (BAT and Cmd files)
- CS-Script
- JScript

Network Support

The Windows CE 6.0 operating system supports these network features:

- Winsock support
- Network utilities - ipconfig, ping, route
- Network Driver Architecture (NDIS)
- Windows Networking API/Redirector
- Wired Local Area Network, 802.3, 802.5

Server Support

The Windows CE 6.0 operating system supports these servers.







Table 22 - Windows CE 6.0 Server Support

Server	Default State	Description
Web server	Enabled	The web server delivers content, such as web pages, by using the HTTP protocol over the web.
FTP server	Enabled	File Transfer Protocol (FTP) is a standard network protocol for exchanging files over the Internet (TCP/IP-based network).
UPnP server	Enabled	Universal Plug and Play (UPnP) is a set of networking protocols that lets devices install and connect to a network.
File Server	Disabled	A network protocol that provides shared access to files, printers, serial ports, and miscellaneous communication between computers on a network.
VNC server	Disabled	Virtual Network Computing (VNC) is a graphical desktop sharing system that you can use to remotely control another computer. It transmits keyboard/mouse events from one computer to another, over a network.
ViewPoint Server	Enabled	A web server application that provides remote user access via a web browser to the FactoryTalk® View Machine Edition HMI application that is running on the terminal. ViewPoint software is a Rockwell Automation product.

Extended Features

The PanelView Plus 7 Performance terminals support these additional desktop applications that are not available on the PanelView Plus 7 Standard terminals.

Table 23 - Operating System with Extended Features

Icon	Software	Icon	Software
	Microsoft Internet Explorer 6 web browser with Silverlight 2		Microsoft Office 2003 PowerPoint file viewer
–	Adobe Flash Lite 3.1 ActiveX plug-in for Internet Explorer 6		Microsoft Office 2003 Word file viewer
	Microsoft Remote Desktop Connection		Microsoft Office 2003 Excel file viewer
	Microsoft media player 6.4 and 7.0 OCX	–	Westtek JETCET PDF viewer
	Microsoft WordPad text editor	–	Image viewer

Windows Explorer



Use one of these methods to access Windows Explorer from the desktop:

- Open the My Device icon.
- Choose Start>Programs>Windows Explorer.

A few folders contain items specific to the PanelView Plus 7 Performance platform.

Folder	Content
Application Data	Contains FactoryTalk View Machine Edition application files. Path: \Application Data\Rockwell Software\RSViewME
VFS (Virtual File System)	Contains firmware files and backup/restore files for the current system image. Path: \VFS\Platform Firmware

Taskbar

From the taskbar, you can access the Start menu, device IP information, the current language and time, input panels, and open programs.



To turn the taskbar on or off, follow these steps:

1. Choose Start>Settings>Taskbar>Start Menu.
2. Clear or check the Auto Hide checkbox.

TIP On touch screen terminals, touch the bottom of the display to recover the taskbar when in Auto Hide mode.

Soft Input Panels



The operating system offers different input panels for entering data. You can access the input panels from the taskbar or the control panel. From the taskbar, click the input panel icon and choose the input panel (keyboard) that you want to use:

- CHT Chajei IM (Chinese)
- CHT Phonetic IM (Chinese)
- Keyboard (small keyboard)
- LargeKB (large keyboard)
- MS Kana IM (Japanese)
- MS Roma IM (Japanese)
- Hide Input Panel (closes the keyboard)

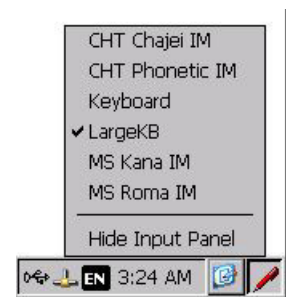

TIP The input panel icon changes depending on which input panel you select.

Windows Control Panel

Applications in the Windows control panel let you view and configure system and terminal settings. For example, you can monitor hardware performance, perform a touch screen calibration, or adjust screen saver settings.

TIP Most terminal settings are also available in FactoryTalk View ME Station Configuration mode.

The language of the control panel applications is based on the language set for the operating system. English is the default.



Use one of these methods to access the control panel:

- Choose Start>Settings>Control Panel.
- Open My Device on the desktop, then double-click Control Panel.

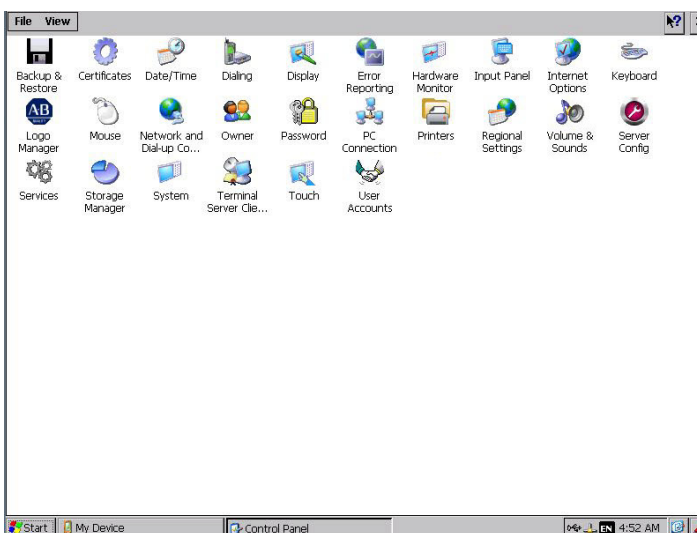

This chapter covers control panel applications specific to the terminal.

TIP From the View menu, you can change the size of the icons or see a brief description of each.

TIP Many control panel applications have scroll bars to allow you to view information on smaller displays.

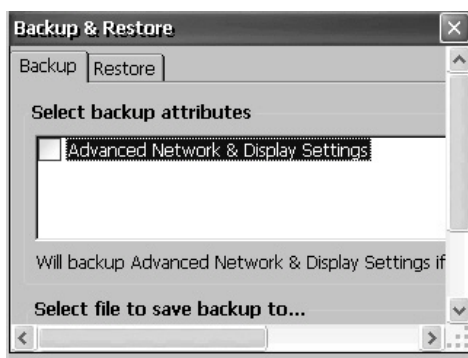

Backup and Restore



The Backup and Restore application lets you back up the current system image on the terminal, then restore that image to the same terminal or other HMI devices. This function is useful if you want to copy the same system image to multiple HMI devices.

TIP You can back up a system image to a USB drive or SD card. Rockwell Automation recommends using a USB drive or SD card with a minimum of 1 GB of available space. For applications with a large file system, use a minimum of 2 GB of available space.

A typical backup image includes the following items:

- File system
- Firmware image
- Windows registry
- Optional user configuration data

To include user configuration data in the backup image, click Advanced Network & Display Settings in the Backup & Restore dialog box.

Table 24 - Advanced Network Display Settings

Setting	Description
Ethernet Network	<ul style="list-style-type: none"> • DHCP-enabled or fixed IP address • Primary and secondary DNS • Primary and secondary WNS • Speed and duplex settings
USB network	USB IP address and subnet mask, Gateway, DHCP-enabled or fixed IP address
Network	Device name
Display	<ul style="list-style-type: none"> • Display brightness • Screen saver dimmer timeout

Perform a Backup

To perform a backup, follow these steps.

1. Insert a USB drive or SD card into the appropriate slot on the terminal.
2. In the control panel, double-click the Backup & Restore icon.

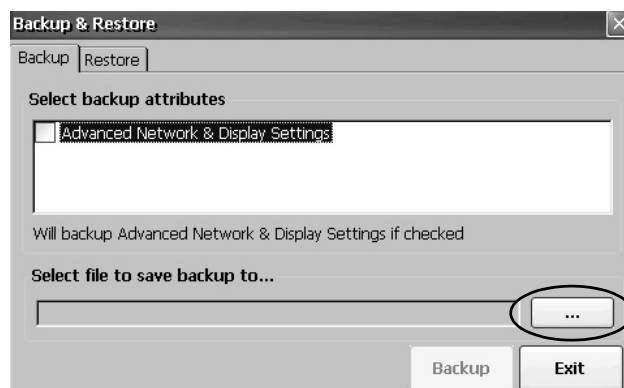

- Click the browse ... button on the Backup tab.

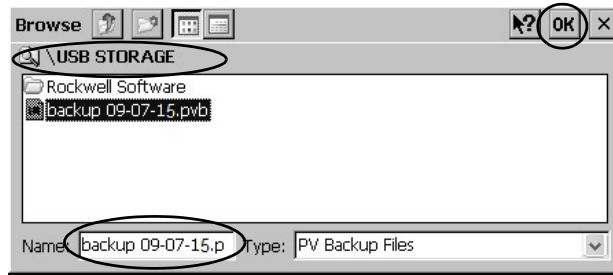

- Select the target location for the back-up file:
 - USB Storage if you use a USB drive
 - Storage Card2 if you use an SD card
 - Target folder if you back up the file to the terminal
- Type a name for the back-up file.
Back-up files have the .pvb file type.
- Click OK.



- Click Backup to start the process.

A progress bar shows the status of the operation. The backup can take a few minutes. You receive notification when the backup completes.

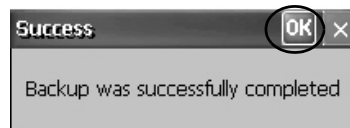

- Click OK.

If a file exists, you are asked if you want to overwrite the current file.

- To close the Backup & Restore dialog box, click Exit.

TIP To verify the .pvb file was successfully created, double-click My Device and select the target location for the backup. If the .pvb file was not successfully created, use a USB drive or SD card with more available space.

Rockwell Automation recommends using a USB drive or SD card with a minimum of 1 GB of available space. For applications with a large file system, use a minimum of 2 GB of available space.

Restore a Back-up Image

To restore or clone a back-up image to a storage device, follow these steps.

1. Insert the USB drive or SD card into the appropriate slot of the target device.
2. In the control panel, double-click Backup & Restore.

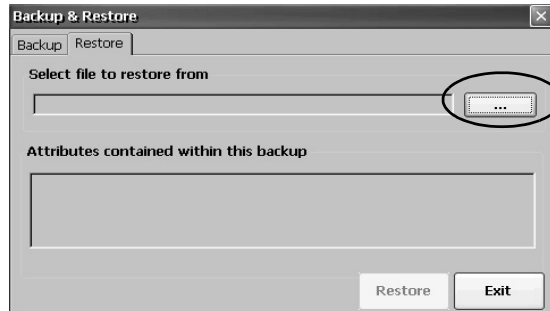

3. Click the Restore tab.
4. To select the back-up file to restore, click the...browse button.

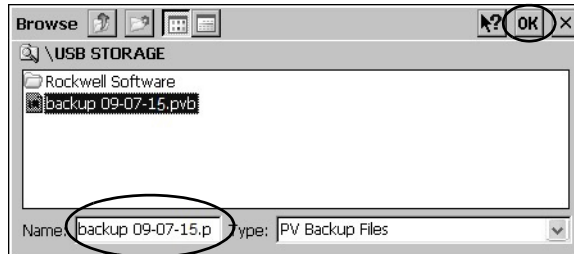

5. Select the location of the back-up file:
 - USB Storage if you use a USB drive
 - StorageCard2 if you use an SD card
6. Select the .pvb back-up file that you want to restore.
7. Click OK.

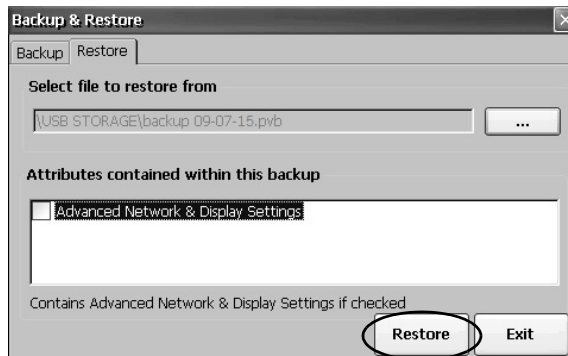

8. Click Restore.

The restore includes advanced network and display settings if you selected this option when performing the backup.
9. To start the restore, click Yes.

The terminal starts the restore process, which takes few minutes.

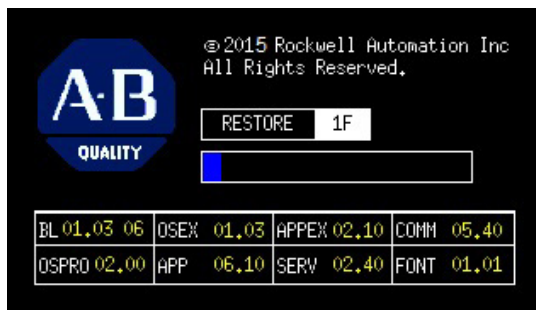

IMPORTANT Do not remove the USB drive, SD card, or power off the terminal during a restore. These actions can corrupt the firmware.
If the restore fails, reset the terminal from the maintenance menu.
See [Maintenance Mode Operations — Series A Terminals on page 224](#) for details.

When the restore completes successfully, the terminal restarts.

Display Properties

Use Display Properties to control the desktop background image and appearance, the brightness of the backlight, and screen saver settings.

Desktop Background

The Background tab in Display Properties controls the background bitmap on the desktop. The default bitmap is 'abclocknight'.



You can select another image from the pull-down menu or browse the system for a bitmap image. Custom images are in the \\Windows folder.

Desktop Appearance

The Appearance tab in Display Properties controls the visual style and colors of the desktop and other window elements.

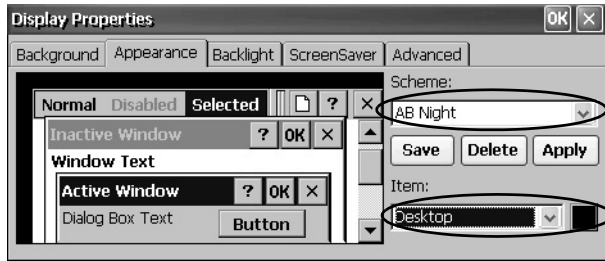

Two custom schemes and images provide for day or night viewing. When you change schemes, you must also change the image on the background tab.

Scheme	Desktop Color	Background Logo
AB Day	Blue	abclocknight
AB Night	Black	abclockday

Backlight Intensity

You can adjust the intensity of the backlight in 10% increments from 0...100%. At 0%, the backlight is minimally visible.

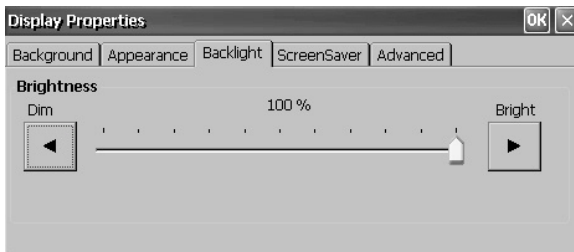

Screen Saver

The screen saver extends the life of the display. When the terminal is idle for a continuous period, the screen saver dims the backlight and displays a moving image. When deactivated, the display brightness returns to its normal level.

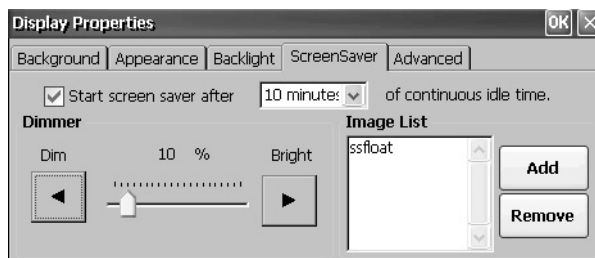

The Screen Saver tab in Display Properties lets you perform these actions:

- Change the idle timeout for the screen saver. The default is 10 minutes.

When the screen saver activates, the dimmer controls the backlight intensity. You set the brightness of the dimmer in range 0...100%. The default intensity is 10%. At 0%, the backlight is minimally visible.

- Browse the system for another screen saver bitmap. The default screen saver is SSFloat.bmp. Click Add or Remove to change screen saver bitmap. The system recognizes bitmaps in the \Windows folder.
- Disable the screen saver by clearing the 'Start screen saver after' checkbox.

Cursor

The Advanced tab in Display Properties lets you enable or disable the visible cursor that you see on the display. The cursor is visible by default.

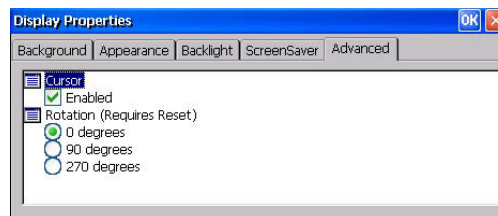

Screen Rotation

The Advanced tab in Display Properties lets you rotate the screen on the terminal. The default is 0°.

After you change the screen rotation, you have to calibrate the Touch Screen.

1. Plug in a USB mouse to the terminal.
2. Restart the terminal.
3. Use the mouse to calibrate the Touch Screen.
4. See [Calibrate the Touch Screen on page 98](#) for calibration details.

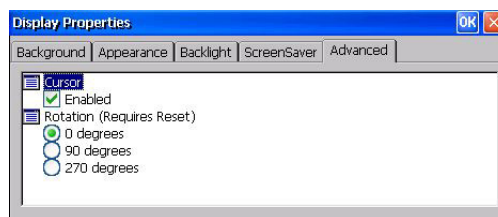

Hardware Monitor

The Hardware Monitor provides continuous voltage, and temperature, load information for the terminal.

Processes

The Processes tab in the Hardware Monitor shows all processes that are running on the terminal, and the memory usage of each process.

ProcessName	ProcessId	Thr	BaseAddr	HeapSize	TotalMem	Commit	Reserved
NK.EXE	00400002	74	80225000	3238704	0	0	0
udevice.exe	01D80002	7	00010000	18560	2273280	1699840	573440
udevice.exe	0085000A	1	00010000	2624	1818624	1634304	184320
udevice.exe	02040002	1	00010000	4928	1818624	1634304	184320
udevice.exe	03360006	1	00010000	1536	1818624	1630208	188416
wtSportm.exe	055D0006	4	00010000	12160	2211840	1851392	360448
servicesd.exe	05F40006	45	00010000	353040	9658368	5791744	3866624
udevice.exe	07180002	1	00010000	2560	1953792	1646592	307200
explorer.exe	07490002	6	00010000	49280	2703360	2007040	696320
fselect.exe	07B1000A	1	00010000	2048	1822720	1634304	188416
RSLinxNG.exe	065F000E	19	00010000	1522336	5158864	3436544	1720320
Rsvchost.exe	07BD000E	13	00010000	108832	2793472	1908736	884736
control.exe	07CC000A	1	00010000	22880	1822720	1675264	147456
PanelViewHardwareMonitor	0614054E	5	00010000	877680	6002368	9928704	50133856

Memory load 3704852480/413700096 [2%]

System Event Log

The System Event Log in the Hardware Monitor shows warnings, errors, events, and information.

Type	Date	Time	Category	MsgId	Message
Error	4/9/2014	3:15:33 PM	None	65537	Backlight Temperature(id=2) at 55 C,
Error	4/9/2014	3:13:33 PM	None	65537	Backlight Temperature(id=2) at 55 C,
Error	4/9/2014	2:55:33 PM	None	65537	Backlight Temperature(id=2) at 56 C,
Information	4/9/2014	2:54:49 PM	PVP	16777218	SYSMON: System boot. Reason: Software
Information	4/9/2014	2:54:32 PM	None	65537	FPGAPWUPDATE: Successfully updated
Information	4/9/2014	2:54:31 PM	None	65539	Microsoft (R) Windows CE (R) 6.00.0000
Information	4/9/2014	2:54:31 PM	None	65540	The Event log service was started.
Information	4/9/2014	2:52:41 PM	PVP	16777218	SYSMON: System boot. Reason: Software
Information	4/9/2014	2:52:23 PM	None	65537	FPGAPWUPDATE: Successfully updated
Information	4/9/2014	2:52:22 PM	None	65539	Microsoft (R) Windows CE (R) 6.00.0000
Information	4/9/2014	2:52:22 PM	None	65540	The Event log service was started.
Error	4/9/2014	10:27:59 AM	None	65537	Backlight Temperature(id=2) at 58 C,

Cpu load 22%

The log provides a date and time stamp of each event, and text that describes the event. The maximum size of the log is 1 MB, approximately 4,000 records. If the log exceeds 1 MB, the oldest 512K of information is removed. You can perform these operations on the log file:

- Press Export Log to export the log file to a CSV file (*.csv) in the \Windows folder. The default file name is SystemLog.csv.
- To clear all events from the log, press Clear Log.
- To view more details on a selected event, press Details.

Monitors

The Monitors tab in the Hardware Monitor provides continuous voltage, temperature, and load information for the terminal.

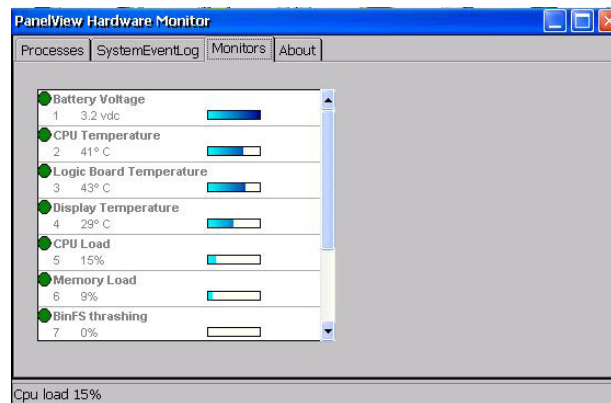

Battery Voltage

The Monitors tab gives a visual status and voltage reading of the battery for the real-time clock. The battery voltage updates at powerup, then every hour.

Table 25 - Battery Conditions

Condition	Battery
Depleted	Less than 2.0V indicates a dead battery or no power.
Low	2.0...2.74V
Normal	2.75V or higher

An event is logged to the system event log for a low or depleted battery.

Temperatures

The Monitors tab gives a visual status and reading of the current temperature of the logic board. The temperature updates every ten minutes.

Table 26 - Temperature Conditions

Condition	Logic Board
Low	–
Normal	25...94 °C (77...201 °F)
High	95 °C (203 °F) and higher

An event is logged to the system event log for a failed temperature sensor.

IMPORTANT A high temperature condition causes an automatic restart attempt. Restart attempts continue indefinitely until the system is cool enough to resume normal operation. High temperature conditions are logged to the system event log.

Logo Manager



Use the Logo Manager to change the logo that appears on the splash screen at startup and the default screen saver image. The default splash-screen image is the Allen-Bradley logo (ablogo.bmp).

The logo can be a .bmp, .jpg, .gif, or .png image. A 90 x 90 pixel, 16-bit color image provides a good result.

Before applying the new logo, you can do the following:

- Preview the logo on the splash screen.
- Resize image to fit the fixed area of the splash screen.

To apply a new logo the splash screen and the screen saver, follow these steps.

1. Double-click Logo Manager in the control panel.

The Logo Manager opens with the current logo.



2. Click Load.

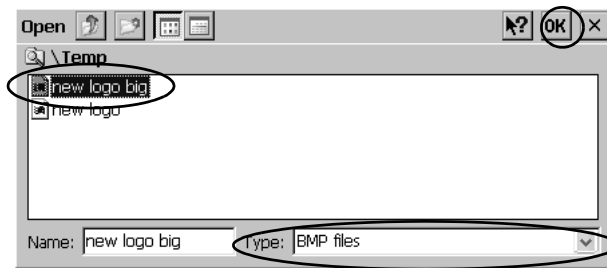

3. Select the location of the new image you want to load:
 - A folder on the terminal.
 - Storage Card2 - SD card
 - USB Storage - USB drive
4. Select the image file to load.
5. Verify that the file type is correct.
6. Click OK.

The new logo appears in the Logo Manager dialog box.

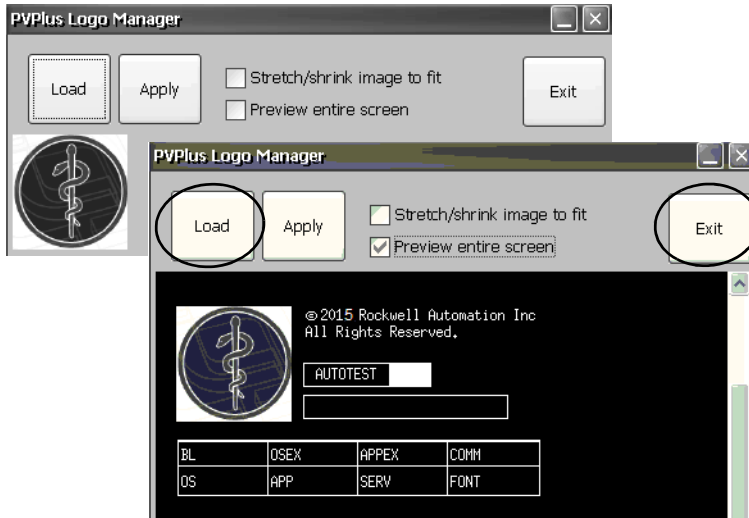

7. Check 'Preview entire screen' to view the logo on the splash screen.
If the logo is truncated or too small, check 'Stretch/shrink image to fit' to resize the logo to fit the area.
8. If satisfied with the preview, click Apply.
A dialog box confirms that the splash screen was updated. The default screen saver, ssfloat.bmp, is updated with the new image.
9. Click OK, then click Exit to close the Logo Manager.

User Accounts

User Accounts let you create NT LAN manager (NTLM) user accounts to authenticate client connections when using the FTP, web, and file servers. A user account consists of a user name and a password.

TIP NTLM is the security protocol that provides authentication, integrity, and confidentiality to users on Windows operating systems. NTLM is still included to support Windows 2000, 2002, and 2003 server systems.

To add a user account, follow these steps.



1. Double-click User Accounts in the control panel.

2. In the user name field, type a name.
3. To clear the field and type a password, click in the Password field. Asterisks display as you type the password.
4. Reenter the password in the Confirm pwd field.

5. Click Add User.

6. Click OK to acknowledge the new user account.

The new user name is added to the list.

7. Repeat steps 1 through 6 to add additional user accounts.
8. When done, click X to close the dialog box.

To remove a user account, follow these steps.



1. Select a name from the user name list.
2. Click Remove User.



3. To confirm the removal of the selected user account, click Yes.
The user account list is permanently deleted from the list.
4. To close the User Account Manager, click X.

TIPU Users who are entered in authentication lists of FTP, web, or file server configurations are removed when user accounts are deleted.

Services



The Services application shows servers the PanelView Plus 7 Performance platform supports. You can enable (start) or disable (stop) each server.

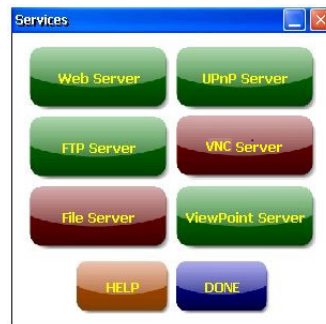

The buttons are color-coded:

- Green indicates that the server is running and automatically started at system startup.
- Red indicates that the server is not running.
- Gray indicates that the server is not available on the platform.

To enable or disable a server, press the corresponding button and the color changes accordingly.

Network Server Configuration

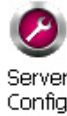

The Network Server Configuration application configures settings for VNC, FTP, web, Kepware, and file server activities on an Ethernet network.

VNC Server Configuration

The terminal provides two VNC client viewers:

- Vncviewer.exe is in the /Windows folder on the terminal desktop. You can deploy this viewer to a personal computer to connect, view, and control a PanelView Plus 7 terminal. See these sections for details:
 - [VNC Connection Requiring a Password for View-only Operations on page 139](#)
 - [VNC Connection with Separate Passwords for View and Control Operations on page 141](#)
- Another viewer on the terminal lets you establish a VNC connection to another PanelView Plus 7 terminal. To access this viewer, click Start>Programs>VNC Viewer. See these sections for details:
 - [Establish a VNC Connection Between a Local Terminal and a Remote Terminal on page 143](#)
 - [Close a VNC Connection to a Remote Terminal on page 144](#)
 - [Make a New VNC Connection to a Remote Terminal on page 145](#)
 - [Transfer Files Between a Local and a Remote Terminal on page 145](#)

The VNC Server tab in the Network Server Configuration dialog box configures settings for a client device to view or control the terminal over a VNC connection.

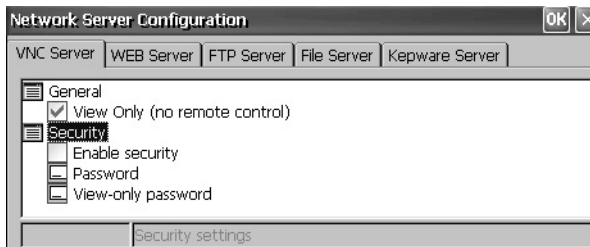

TIP Click OK in the title bar of the dialog box to apply new settings. You are asked if you want to restart the service immediately.

Table 27 - VNC Server Parameters

VNC Parameter	Description	Default
General		
View Only (no remote control)	Check this option to let users view terminal displays over a VNC connection. If you uncheck View Only, users can control and view terminal displays over a VNC connection. If security is disabled, users are not required to enter a password when connecting to the terminal.	Enabled for view only

Table 27 - VNC Server Parameters (Continued)

VNC Parameter	Description	Default
Security		
Enable security	Check this option to require password protection for VNC connections to the terminal. Users must enter a valid password before viewing or controlling terminal displays. If you enable security, you must supply a password for one of these parameters: <ul style="list-style-type: none"> • Password - for control and view operations • View-only password - for view only operations 	Disabled (unchecked)
Password	Specifies a password that a user must enter when establishing a VNC connection to control terminal displays. Select the box, then type a password in the field at the bottom of the dialog box. The password is a maximum of seven characters. Password protection is required to control terminal displays if: <ul style="list-style-type: none"> • View Only is unchecked (allows control access) • Security is enabled 	No password
View-only password	Specifies a password that a user must enter when establishing a VNC connection to view terminal displays. Select the box, then type a password in the field at the bottom of the dialog box. The password is a maximum of seven characters. <p>TIP: If you uncheck the View Only parameter, you have control and view access to the terminal. With control access enabled, you can restrict one or more users to view-only access by providing a View-only password. View-only password protection is required to view terminal displays if security is enabled:</p> <ul style="list-style-type: none"> • View Only is checked or unchecked • Security is enabled 	No password

VNC Connection Requiring a Password for View-only Operations

The default VNC configuration enables view-only access to the terminal without requiring a password. This configuration requires the VNC viewer that you copy from your terminal to a computer.

TIP Copy `vncviewer.exe`, in the `/Windows` folder on the terminal, to your computer and install the TightVNC software.

To configure a VNC connection that requires a password to view terminal displays, follow these steps.

1. From the control panel, click Server Config.



Server
Config

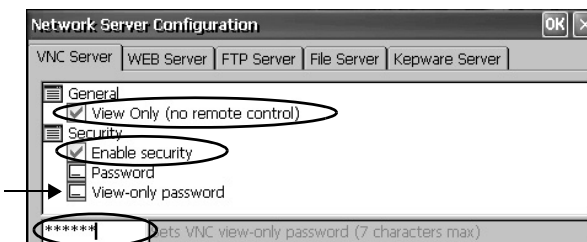

2. On the VNC Server tab, check these items:
 - View only (no remote control)
 - Enable security

3. Select View-only password, then enter a seven-character password in the field that opens.
4. Click OK
5. Restart the server when prompted to apply new settings.

To launch a VNC connection to view terminal operations, follow these steps.

1. On your computer, choose Start>Programs>TightVNC>TightVNC Viewer.

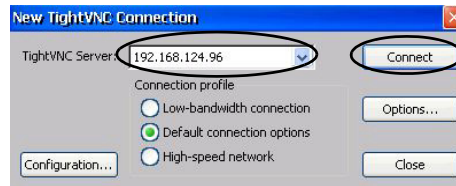

2. Enter the IP address of your terminal and click Connect.



TIP Click the network connection icon in the system tray to view the IP address of the terminal.

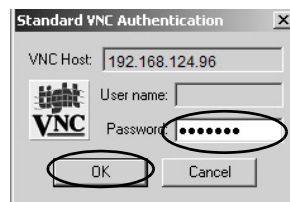

3. Enter the View-only password that is defined on the terminal and click OK.

The PanelView VNC Server opens the current view of the terminal on your desktop. You can view but not control terminal operations.

4. When finished, close the PanelView VNC Server.

VNC Connection with Separate Passwords for View and Control Operations

You can configure the VNC server to require separate passwords for view-only and control operations. This example uses the VNC viewer that is deployed to a computer to connect to the terminal.

TIP Copy `vncviewer.exe`, in the `/Windows` folder on the terminal, to your computer and install the TightVNC software.

To configure the VNC server to require a separate password for view-only and control operations, follow these steps.

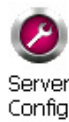

1. From the control panel, click Server Config.



2. On the VNC Server tab, do the following:
 - Clear View only (no remote control).
 - Check Enable security.
3. Select Password, then enter a password for control privileges.

Passwords are a maximum of seven characters.



4. Select View-only password, then enter a password for view-only privileges.
5. Click OK, then restart the service when prompted to apply new settings.

To launch a VNC connection to enable control of the terminal, follow these steps.

TIP To launch a VNC connection on your computer that requires a password for view-only operations, see [VNC Connection Requiring a Password for View-only Operations on page 139](#) and follow steps 1 through 4.

1. On your computer, choose Start>Programs>TightVNC>TightVNC Viewer.

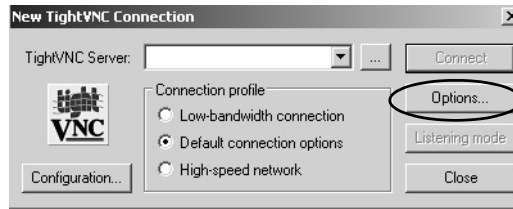

2. Click Options.

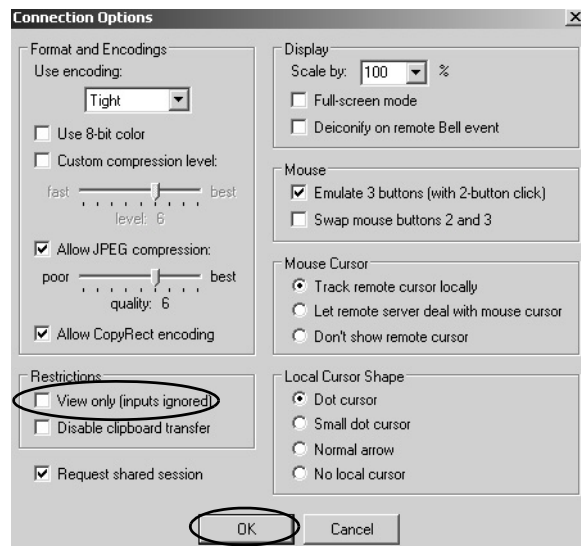

3. Clear View only (inputs ignored).
4. Click OK.

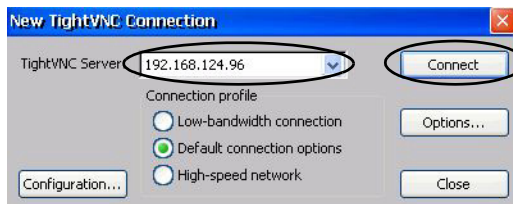

5. Enter the IP address of your terminal and click Connect.



TIP Click the network connection icon in the system tray to view the IP address of the terminal.

The Standard VNC Authentication dialog box opens.

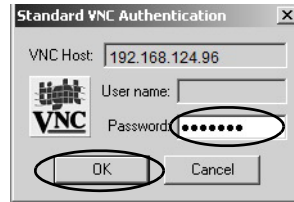

6. Enter the control password that is defined on the terminal and click OK.
7. On your computer, perform some actions to verify that you have control of the terminal.
8. When finished, close the PanelView VNC Server.

Establish a VNC Connection Between a Local Terminal and a Remote Terminal

To establish a VNC connection from a local terminal to a remote terminal, follow these steps.

1. Access the Windows desktop of the local terminal.
2. On the local terminal (viewer) desktop, choose Start>Programs>VNC Viewer.

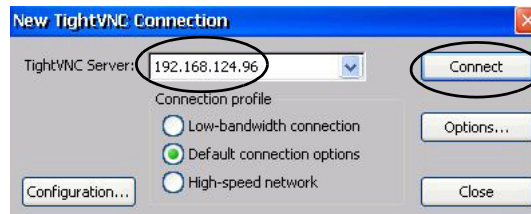

3. Enter the IP address of the remote terminal that you want to connect to and click Connect.

TIP Select an IP address from the pull-down menu, or enter an IP address by using a USB keyboard or soft input panel (see [Soft Input Panels on page 124](#)).

A Status message displays while the connection is being made. The messages can cycle as the status changes.

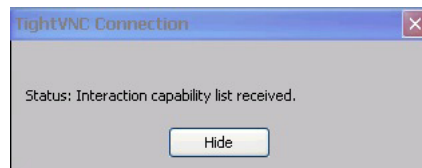

The message 'Please wait - initial screen loading' can also display after the connection has been made and while the desktop of the remote terminal is loading.

After the screen has loaded, the desktop of the remote terminal displays on the local terminal. You can now access the features and functions of the remote terminal.

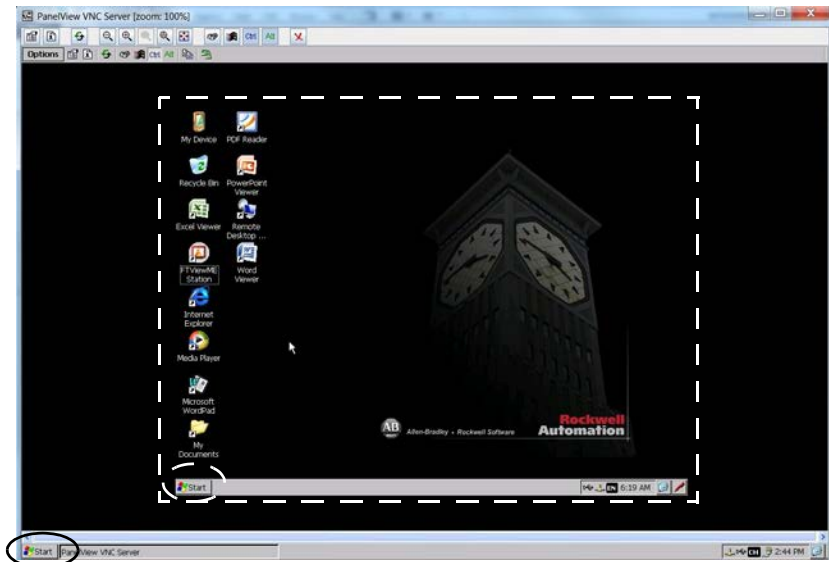

The white dotted line indicates the remote terminal and is only for reference (the dotted line does not actually appear on the local terminal). Note the two Start buttons: circled in white is the remote terminal; circled in black is the local terminal.

Close a VNC Connection to a Remote Terminal

To close a VNC connection between a local terminal and a remote terminal, follow these steps.

1. Establish a VNC connection from a local terminal to a remote terminal (see [page 143](#)).
2. On the local terminal, right-click PanelView VNC Server.

TIP Touch the screen for 1 second or longer for a right-click.

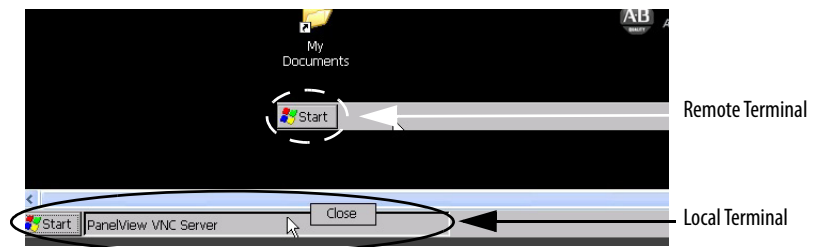

4. Click Close.

The VNC connection to the remote terminal is closed.

TIP Click PanelView VNC Server to toggle between the remote terminal (server) and local terminal (viewer) views.



Make a New VNC Connection to a Remote Terminal

To make a new VNC connection to another terminal, follow these steps.

1. Establish a VNC connection from a local terminal to a remote terminal (see [page 143](#)).
2. Click the New connection icon in the menu bar.

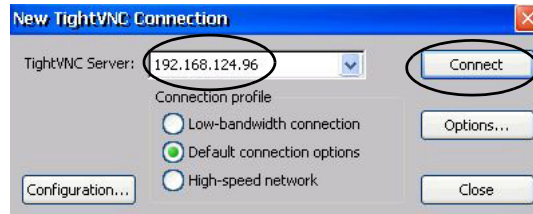

3. Enter the IP address of the new remote terminal that you want to connect to and click Connect.

TIP Select an IP address from the pull-down menu, or enter an IP address by using a USB keyboard or soft input panel on the local terminal (viewer) (see [Soft Input Panels on page 124](#)).

The local terminal creates a VNC connection to the new terminal.



Transfer Files Between a Local and a Remote Terminal

You can perform these tasks with the TightVNC File Transfer dialog box:

- Transfer files and folders between connected terminals
- Rename a selected file or folder
- Create a folder
- Delete a selected file or folder

To transfer files between the local terminal and the remote terminal, follow these steps.

1. Establish a VNC connection from a local terminal to a remote terminal (see [page 143](#)).
2. Click the Transfer files icon in the menu bar.
3. Select the folder or files that you want to transfer.
4. Click the upload (>>) or download (<<) files icon.
5. Click Yes.

6. Click Refresh to view the change (in needed).

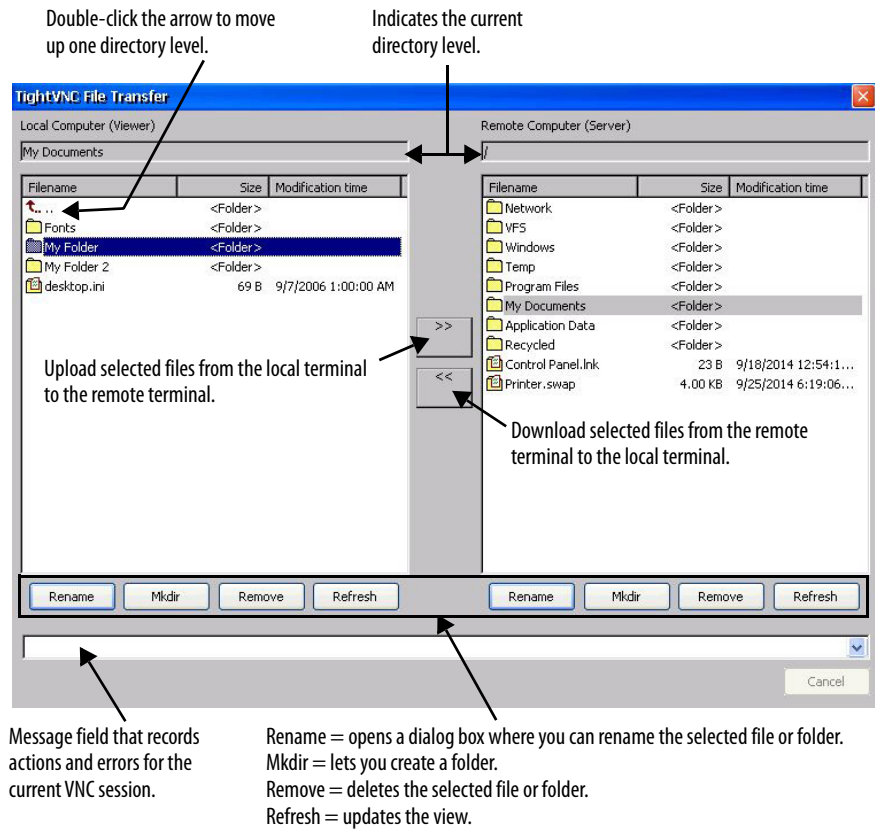

Web Server Configuration

The web server tab in the Network Server Configuration application configures settings that are used for HTTP web activities. These parameters are standard Microsoft Windows CE parameters.

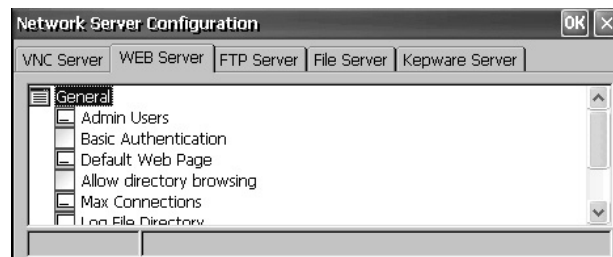

TIP Click OK in the title bar of the dialog box to apply new settings. You are asked if you want to restart the service immediately.

Table 28 - Web Server Parameters

Parameter	Description	Default
Admin Users	Specifies a list of users who are allowed to administer web activities. When selected, enter a list of user names, which are separated by semicolons, in the field that opens at the bottom of the dialog box.	ADMIN
Basic Authentication	Check this option to require a user name and password to access the web server.	Disabled (unchecked)
Default Web Page	Specifies default web pages that users can access.	default.htm; index.htm
Allow Directory Browsing	Check this option to let users browse directories on a web server.	Disabled (unchecked)
Max Connections	Specifies the maximum number of incoming web connections.	256
Log File Directory	Specifies the path where the log file is stored. This file logs web activity.	\windows\www
Max Log Size	Specifies the maximum size of the log file that is stored in the log file directory. A new log file is created, when the current log file reaches its maximum size.	32768 bytes
NTLM Authentication	Check this option to require a valid user name and password to access the web server. If NTLM Authentication is enabled, you must enter a valid user name in the Admin Users field. NTLM user accounts are defined in the User Account Manager of the control panel.	Enabled (checked)

FTP Server Configuration

The FTP Server tab in Network Server Configuration defines settings that are used to exchange files over a network. These parameters are standard Microsoft Windows CE parameters.

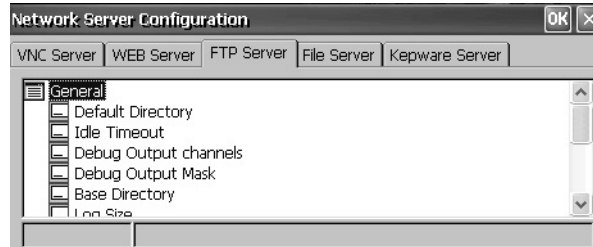

TIP Click OK in the title bar of the dialog box to apply new settings. You are asked if you want to restart the service immediately.

Table 29 - FTP Server Parameters

FTP Parameters	Description	Default
General		
Default Directory	Specifies a storage location on the terminal where users can transfer files. The directory that users come to when they first connect to the FTP server.	\\Temp\
Idle Timeout	Specifies an idle period after which inactive control connections are closed during a data transfer. An FTP session requires one control connection, plus one data connection, during file transfers. Without a timeout, the FTP server process can be left pending indefinitely if the corresponding client crashes without closing the control connection.	300 seconds (5 minutes)
Debug Output Channels	Specifies the number of debug output channels.	2
Debug Output Mask	Specifies the port number of the output mask that is used for debugging.	23
Base Directory	Specifies the path where the FTP log file and other support files are stored.	\\Windows
Log Size	Specifies the maximum size of the file that logs FTP activities. The log file is stored in the base directory. A new log file is created, when the current log file reaches its maximum size.	4096 bytes
Security Parameters		
Use Authentication	Check this option to require a valid NTLM user name and password to access the FTP server. If authentication is enabled, you must enter one or more valid user names in the User List field. NTLM user accounts are defined in the User Account Manager of the control panel.	Enabled (checked)
Allow Anonymous Logins	Check this option to let anyone connect to the FTP server. Anonymous logins do not require a user name and password.	Enabled (checked)
Allow Anonymous Uploads	Check this option to let users logged on anonymously to upload (or write) files to the FTP server (or default directory). If unchecked, users that are logged on anonymously can download (or copy) files from the server.	Disabled (unchecked)
Allow Anonymous VRoots	Check this option to let users logged on anonymously to access virtual roots.	Disabled (unchecked)
User List	Specifies the NTLM users that can access the FTP server and exchange files to or from the default directory. When selected, you can enter a list of NTLM user names, which are separated by semicolons, in the field that opens at the bottom of the dialog box. User names and passwords are defined in the User Account Manager of the control panel.	None

FTP Anonymous Login and Upload

With the default FTP security options, you can log on anonymously to the terminal and copy files between your computer and the default FTP folder on the terminal.

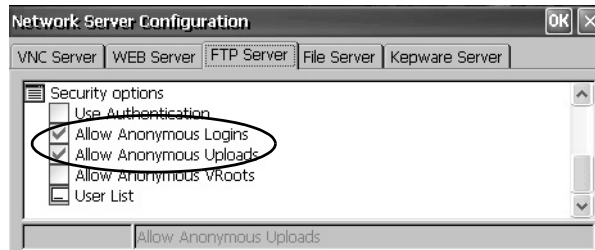

TIP If Allow Anonymous Uploads is unchecked, you can copy files from the default FTP folder on the terminal but not to the folder.

To establish an FTP connection to the terminal by using anonymous logins and file transfers to and from the FTP folder, follow these steps.



1. On your computer, open the web browser or any folder.
2. To determine the IP address of your terminal, click the Network Connection icon in the system tray.
3. Type the terminal IP address in the address field.

EXAMPLE Use this syntax for the IP address:
`ftp://ipaddress_of_the_terminal.`
 For example, `ftp://192.168.124.96`

A connection is established to the \Temp folder, the default FTP directory on the terminal. The terminal shows two files.

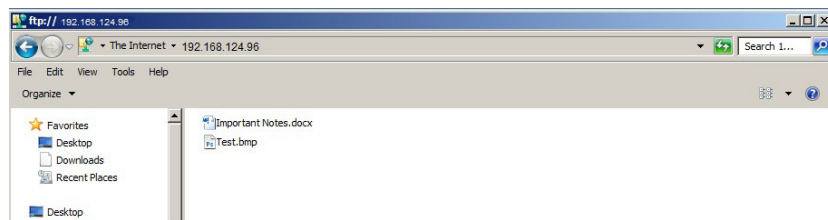

If you launch the FTP connection from your web browser, this view can appear.



To see the folder view, choose Open FTP site in Windows Explorer from the Page pull-down menu.

4. Transfer files between your computer and the FTP folder on the terminal:
 - Drag or copy a file from the FTP folder to your computer.
 - Drag or copy a file from the computer to your FTP folder.

FTP Connection Requiring User Authentication

You can require a user name and password before establishing an FTP connection. On the FTP Server tab, check Use Authentication. Select User List and enter a valid user name in the field that opens at the bottom of tab.

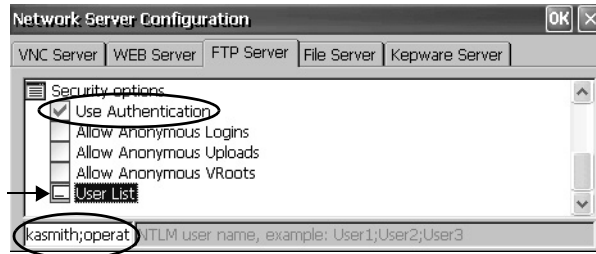

TIP You can create user names and passwords in the User Accounts application of the control panel. See [User Accounts on page 136](#).

To establish an FTP connection to the terminal by first entering a valid user name and password, follow these steps.



1. On your computer, open any folder or the browser.
2. Determine the IP address of your terminal by clicking the Network Connection icon in the system tray.
3. Type the terminal IP address in the Windows Explorer address field.

EXAMPLE Use this syntax for the IP address:
 ftp://ipaddress_of_the_terminal.
 For example, ftp://192.168.124.96

4. Click OK if the FTP Folder Error dialog box appears.
5. From the File menu, choose Login As.

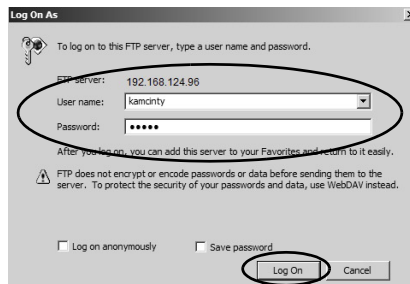

TIP The user name must be in the User List of the FTP configuration and previously configured as a valid account in the User Accounts application.

6. Type a valid user name and password.
7. Click Log On.

The default FTP directory on the terminal opens. You can transfer files to or from this folder.



File Server

The File Server tab in Network Server Configuration has settings that allow shared access to files, printers, serial ports, and miscellaneous communication between computers on a network. These parameters are standard Microsoft Windows CE parameters.

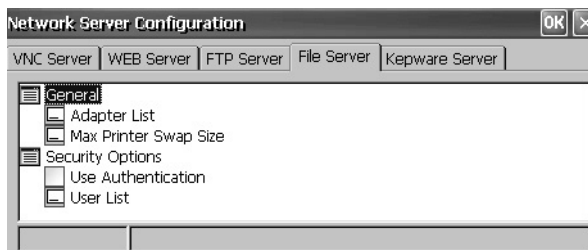

TIP Click OK in the title bar of the dialog box to apply new settings. You are asked if you want to restart the service immediately.

Table 30 - File Server Configuration

Parameter	Description	Default
General		
Adapter List	Provides a list of valid adapters.	*(all adapters)
Max Printer Swap Size	Specifies the maximum size of the printer swap file.	4096 bytes
Security Options		
Use Authentication	Check this option to require a valid NTLM user name and password to access the file server. If authentication is enabled, you must enter one or more valid user names in the User List field. NTLM user accounts are defined in the User Account Manager of the control panel.	Disabled (unchecked)
User List	Specifies a list of valid NTLM users who are allowed to access the file server. When selected, you can enter a list of NTLM user names, which are separated by semicolons, in the field that opens at the bottom of the dialog box. User names and passwords are defined in the User Account Manager of the control panel.	None

KEPServer Configuration

The Kepware Server tab in Network Server Configuration lets you select Kepware communication drivers for connected devices.

TIP For a complete list of Kepware drivers, go to <http://www.rockwellautomation.com/knowledgebase> and search the Knowledgebase for keywords 'Kepware Drivers for PanelView Plus'.

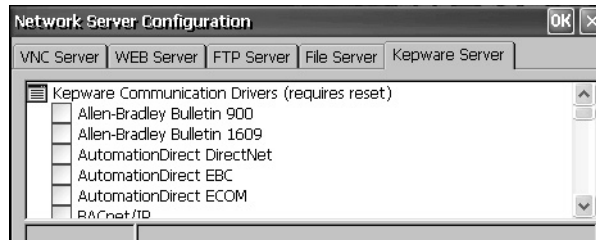

IMPORTANT Click OK in the title bar to apply new settings. You are asked if you want to restart the service immediately. **You must also restart the terminal.**

System Information

The System Information application provides tabs to view and set system-wide properties for your terminal.

General Information

The General tab of System Information shows the current version of the Windows CE operating system, the processor type, speed, and available memory.



Startup Options

The Startup Options tab of System Information lets you set these start-up options:

- Show or hide the battery warning
- Launch the terminal as open or closed
- Configure the Ethernet ports for DLR, star, or linear topology
- Disable or enable Safe mode
- Show or hide system watchdog errors



Battery Warnings



If the battery is low, missing, or depleted, a warning appears each time that the terminal starts up.

- TIP**• The terminal can operate without a battery if the accuracy of the date and time is not critical.
- When replacing the battery, you can verify the accuracy of the system date and time from the desktop control panel or the terminal settings in FactoryTalk View ME Station.

You have three options for handling the battery.

Battery Warning Startup Options	Description
Always show at startup (continue with startup)	Shows the battery warning at startup with ME Station software running behind it (default).
Always show at startup (halt startup)	Shows the battery warning at startup but halts the boot process until you press OK.
Never show at startup	Hides the battery warning at startup.

Startup Options

Use the Shell options to launch an open or closed desktop at startup and to set the visual appearance of button controls.



Shell Startup Options	Description
Type	<p>Launches the terminal as an open or closed system at startup:</p> <ul style="list-style-type: none"> • (Open system) – launches the Windows CE desktop on startup. • (Closed system) (default) – launches FactoryTalk View ME Station Configuration mode on startup. <p>You can also allow or restrict desktop access within FactoryTalk View ME Station Configuration mode by pressing Terminal Settings>Desktop Access Setup. See Windows CE Desktop Access — Series A Terminals on page 79.</p>
User Interface Button Controls	<p>Sets the visual appearance of control buttons at startup:</p> <ul style="list-style-type: none"> • Windows XP Style (default) • Windows 95 Style

Boot Option

The boot options provide a way for you to enter Safe mode at startup.



Safe Mode Options	Description
Do not detect Safe mode request at startup	Disables Safe mode detection during startup (default).
Detect Safe mode request at startup	<p>Displays a small white box in the lower left corner of the terminal display during startup. Press and hold the white box to enter Safe mode. Safe mode lets you bypass a loaded FactoryTalk View ME application and go directly to Configuration mode. If you do not press the white box, the system boots up normally.</p> <p>Another way to enter Safe mode is to access Maintenance mode. See Maintenance Mode Operations — Series A Terminals on page 224.</p>

Configure the Ethernet Ports

The ‘Network (On-board Embedded Ethernet Switch - DLR)’ provides options to configure the on-board Ethernet switch of the terminal for the network topology. You can also configure the Ethernet ports from the terminal menus. See [Configure the Ethernet Ports on page 90](#).

After changing the selections, restart the terminal.

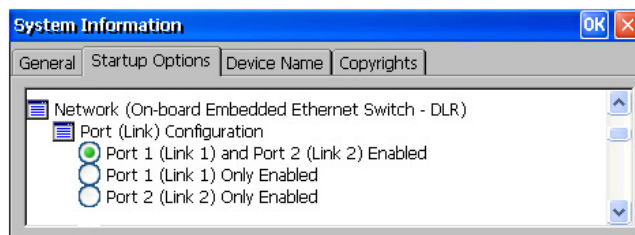

Port (Link) Configuration	Description
Port 1 (Link 1) and Port 2 (Link 2) Enabled	Enables Link 1 and Link 2 Ethernet connections for DLR configuration.
Port 1 (Link 1) Only Enabled	Enables Link 1 Ethernet connection for star or linear configuration.
Port 2 (Link 2) Only Enabled	Enables Link 2 Ethernet connection for star or linear configuration.

Watchdog Errors

You can show or hide watchdog errors at startup.



Watchdog Error Options	Description
Always show watchdog errors at startup	Shows the fatal watchdog error (error 02) at startup and halts the normal boot process (default). The system launches the maintenance window with the watchdog error displayed. You can continue booting from this window. See Maintenance Mode Operations — Series A Terminals on page 224 for details. The error is logged to the System Event log.
Never show watchdog errors at startup	Hides the errors at startup and adds the error to the system event log.

Advanced Diagnostics

Advanced diagnostics are for technical support use to diagnose and resolve system errors. They are not for use in a normal production environment.

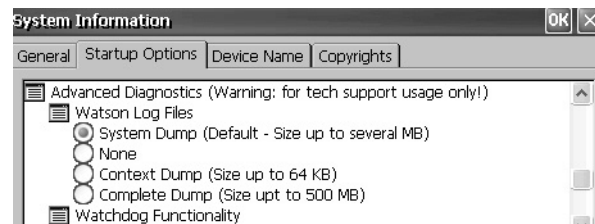

Device Name

The Device Name tab of System Information identifies your terminal to other devices on the network by providing a device name and description.



TIP Device names must be unique. Duplicate names conflict and cause network problems.

Touch Properties



Touch Properties is accessible on devices with a touch screen. It lets you calibrate the touch screen and set the sensitivity of touch screen taps.

Calibration

The Calibration tab lets you recalibrate the touch screen if your device is not responding appropriately to taps. Follow the instructions in the dialog box to recalibrate.

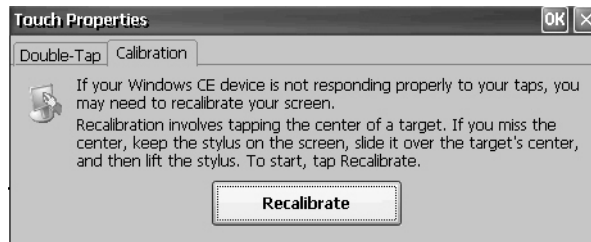

Double-tap

The Double-Tap tab lets you set and test the double-tap sensitivity of the touch screen taps.

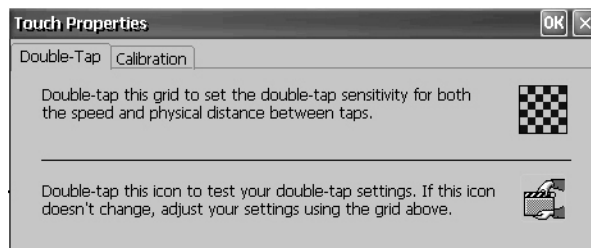

PDF Reader



The PDF reader provides typical view and search functions. You can run this reader from the Windows desktop or a command prompt.

When viewing a PDF document, you can initiate functions from the menu or toolbar. Bookmarks created in the original PDF appear under bookmarks.

Figure 8 - PDF Reader Workspace

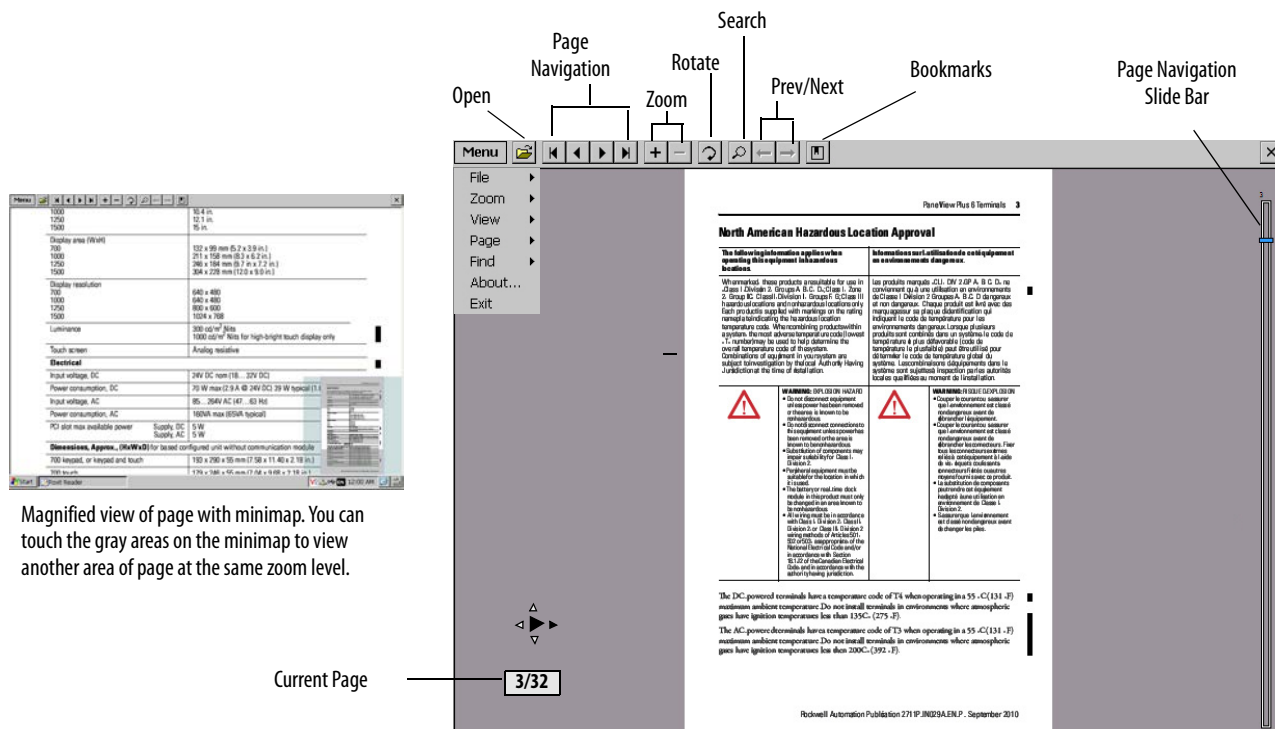



Magnified view of page with minimap. You can touch the gray areas on the minimap to view another area of page at the same zoom level.

Current Page 3/32

Some viewing functions can be initiated on touch screen terminals by touching or dragging.

Table 31 - Touch Screen Operations

To	Do This	Indicator
Zoom In or Out	Tap the screen once to zoom in. Tap the screen again to zoom out. If Menu>View>Minimap is chosen, a miniview of the page appears in lower right of workspace. You can tap the gray areas to change view.	
Navigate pages	<ul style="list-style-type: none"> Drag your stylus or finger to the right or left to view next and previous pages. An indicator shows the direction your are dragging. A box shows the current page/total page count. Drag up or down the screen to activate the page navigation bar on the right. Move slide bar up or down to navigate pages. 	 3/32 See page navigation bar in Figure 8 .
Rotate	Drag in a circular, clockwise or counterclockwise direction to rotate the page.	

Command Prompt Parameters

To run the PDF reader from the Windows Command Prompt, choose Start>Programs>Command Prompt, and execute the command parameters in [Table 32](#).

Command Prompt Syntax

Foxitreader "file_path/file-name.pdf" *parameter parameter_value*

- Enclose the file path and file name in double quotes and use forward slashes to separate the file path directories and file name.
- Use spaces to separate the parameter from the file name and optional parameter value.

Command Prompt Example

Foxitreader "windows/desktop/example.pdf" -p 4

This command prompt opens example.pdf in Foxit Reader at page 4.

Table 32 - Command Prompt Parameters

Parameter	Parameter Function	Example	Description
-p	Go to page	Foxitreader "file_path/file.pdf" -p 2	Opens the PDF file to page 2.
-zw	Fit width	Foxitreader "file_path/file.pdf" -zw	Opens the PDF file and fits the view to the page width.
-zp	Fit page	Foxitreader "file.pdf" -zp	Opens the PDF file and shows the full page.
-z	Zoom to	Foxitreader "file.pdf" -z 150	Opens the PDF file and zooms to 150%.
Multiple parameters	Enter empty spaces between parameters and parameter values	Foxitreader "file_path/file.pdf" -p 2 -zw	Opens the PDF file to page 2 and fits the view to the page width.
-b	Go to bookmark	Foxitreader "file_path/file.pdf" -b "Bookmark1"	Opens the PDF file to the location specified within Bookmark1.
-d	Go to named destination	Foxitreader "file_path/file.pdf" -b "Destination1"	Opens the PDF file to the location specified within Destination 1.
-g	Disable the File>Open command on the Menu and the Open folder button.	Foxitreader "file_path/file.pdf" -g	Opens the PDF file and dims the Menu, File>Open command and the Open button.

Windows 10 IoT Core Operating System — Series B Terminals

Topic	Page
System Features	159
Windows Control Panel	160
Menu Icons	160
Navigation Icons	161
Start Menu	162
Device Info Menu	165
Web Browser Menu	166
Account Management Menu	167
Menu Settings Screen	168
System Screen	169
Network & Wi-Fi Screen	170
Firmware Updates Screen	171
Power Options Screen	172
Touch Screen	173
Services Screen	174
Event Log Screen	175

System Features

The PanelView™ Plus 7 Performance Series B⁽¹⁾ terminals run the Windows 10 IoT Core operating system (OS), which provides the following features:

- VNC Server (with SSH encryption⁽²⁾)
- PDF reader
- Microsoft Office Viewers
- SFTP Server
- Microsoft Edge Web browser
- FactoryTalk ViewPoint
- Internet Printing Protocols (IPP)
- File Explorer

(1) Series C for Stainless Steel terminals.

(2) SSH encryption is not available on the initial release for the following items: VNC Server and Microsoft Office Viewers.

Windows Control Panel

The following sections describe the functionality that is available from the Control Panel. To access the Control Panel, click Exit on the FactoryTalk View ME Station startup screen.

Menu Icons

The main Menu displays icons that allow you to configure various features of your PanelView Plus 7 Performance Series B terminal (Series C for Stainless Steel terminals).



Table 33 - Menu Icons







Icon	Name	Description
	Menu	When pressed, this button expands the menu bar. Displays the following menus that are available in the Control Panel: <ul style="list-style-type: none"> • System • Network & Wi-Fi • Firmware Updates • Power Options • Touch • Services • Event Log
	Start	Displays tiles for the following programs: <ul style="list-style-type: none"> • Web Browser • Notifications • File Explorer

Table 33 - Menu Icons (Continued)

Icon	Name	Description
	Device Info	Displays the following information about your terminal: <ul style="list-style-type: none"> • Device Name • Network • IP Address • OS Version • Platform Version • Bootloader Version • DLR Network Switch • Connected Devices The following Network information is displayed: <ul style="list-style-type: none"> • IPv4 • Status
	Web Browser	Launches the web browser you specified on the Menu Settings screen.
	Account Management	Displays the Account Management page, which allows you to change your password.
	Settings	Displays the Menu Settings page, which allows you to set a default page, a web browser home page, and the size, color and scaling of tiles.
	Exit	Closes the Control Panel and launches Machine Edition (ME).

Navigation Icons

All screens that you access through the Control Panel display a navigation bar at bottom of the screen.



Table 34 - Navigation Icons







Icon	Description
	Moves to the previous screen.
	Moves to the next screen.
	Moves to the top of the current screen.
	Moves to the bottom of the current screen.

Table 34 - Navigation Icons (Continued)

Icon	Description
	Displays the following information about your terminal: <ul style="list-style-type: none"> • IP Address • OS Version • ControlPanels Version
	Allows you to toggle between full screen view and partial screen view.
	Displays a menu with the following options: <ul style="list-style-type: none"> • Set Default Page • Quick-Save Log • Session Log

Start Menu

The Start menu displays the applications available on the terminal.

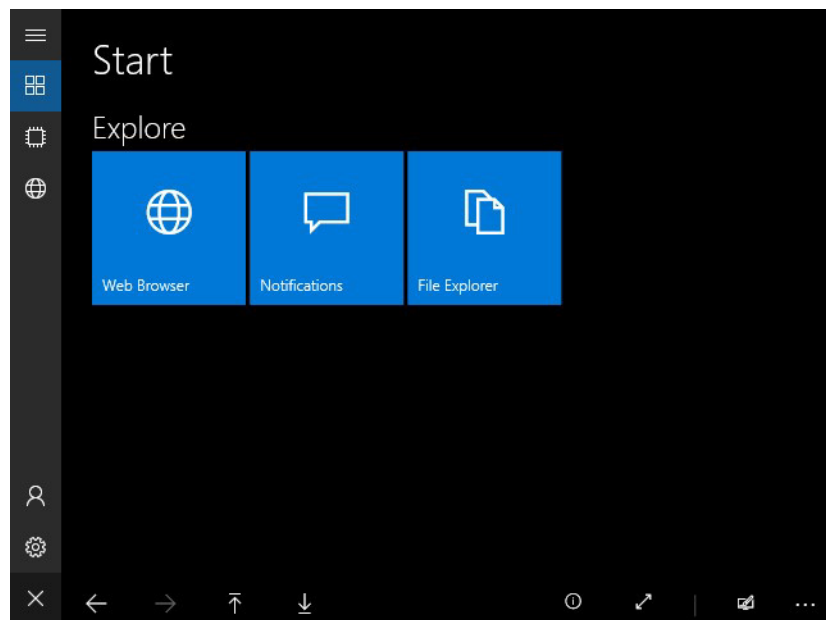

Table 35 - Start Menu Icons



Section	Icon	Description
Explore		Opens a web browser. See Web Browser Menu on page 166
		Lists notifications that have occurred since the Control Panel started running (see Figure 9). Exiting out of the Control Panel (by going to ME Station or by resetting the terminal) clears the list. The list is limited to 20 items.
		Opens File Explorer, which can be used to view files on the device or copy/move files to and from the terminal to USB storage devices. Each page in File Explorer includes a close button (red button with white X) and an address bar. For more information, see the following illustrations: <ul style="list-style-type: none"> • Figure 10 shows the main File Explorer page. • Figure 11 shows the contents of a folder. • Figure 12 shows an empty folder.

Figure 9 - Notifications page

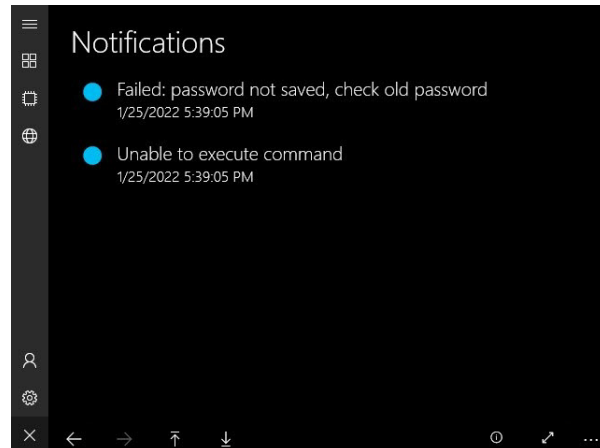
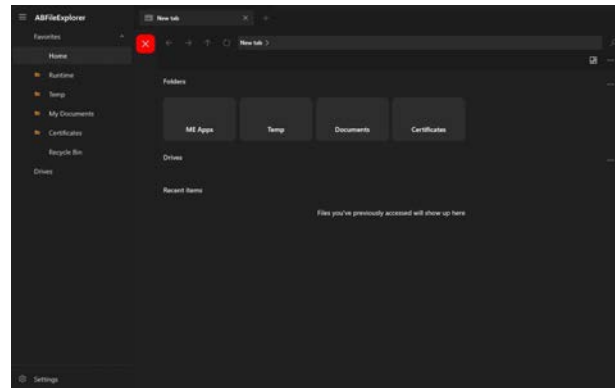

Figure 10 - File Explorer - Main Page



The Folders section displays important folders you may need to use. Clicking a folder displays its contents. The following folders are available:

- ME Apps—contains your runtime .mer files
- Temp—contains any temporary files that are generated as you work in PanelView
- Documents—contains document files such as PDFs, text files, etc.
- Certificates—contains any certificates you have acquired, for example, ViewPoint if you use HTTPS, or domain authentication if you use SSL

The Drives section displays a removable storage device (USB or SD card) that you plugged in to the terminal.

Figure 11 - File Explorer - Folder Contents

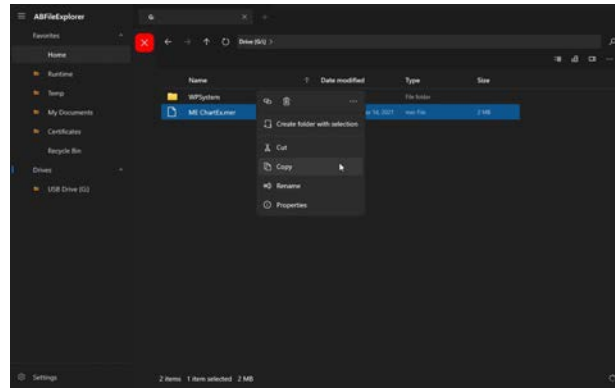

If you click on a folder, a list of its contents is displayed. Right-clicking a file displays a menu of common operations, such as Copy, Cut, or Rename.

TIP You need to have a mouse plugged into the terminal in order to use these commands.

Figure 12 - File Explorer - Empty Folder

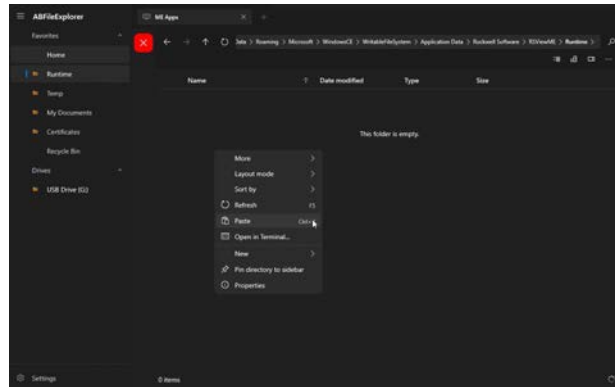

Right-clicking inside a folder displays a menu of operations, such as Move, Sort by, or Refresh, that help you organize your folder. (The Open in Terminal is not functional at this release).

TIP You need to have a mouse plugged into the terminal in order to use these commands.

Device Info Menu

The Device Info menu displays name, network, and version information about your PanelView terminal.



Table 36 - Device Info

Field	Description
Network Information	If the network cable is not plugged in, there is no information displayed here. If a network cable is plugged in, the following information is shown: <ul style="list-style-type: none"> IPv4—Displays the IPv4 address currently assigned to the terminal. Status—Displays the type of access available. Displays Local network access only or Local and Internet access, depending on the internet access availability.
Device Name	Displays the name of the device given by the user. This can be set-up on the out of box first power up or in ME Station - Terminal Settings > Networks and Communications > Network Connections > Device Name.
Network	Displays Ethernet if connected to a network. If no connection is identified, it displays No Internet Connection.
IP Address	Displays the IP address currently assigned to the terminal. If the network cable is not plugged in, the IP Address displays as 0.0.0.0
OS Version	Displays the Microsoft Windows 10 IoT Core OS version.
Platform Version	Displays the version of bundled firmware from Rockwell Automation. The more... button displays a page that shows versions of additional components.
Copyright Info	Displays the copyright year of the terminal. The more... button displays a complete copyright page.
Bootloader Version	Displays the version of Bootloader that is loaded on the terminal.
DLR Network Switch Version	Displays the firmware version of the Device Level Ring Network Switch.
Connected Devices	Displays the device name of any connected USB devices.

Web Browser Menu

The web browser is a Microsoft Edge browser that supports HTML5. You can view web pages and PDFs by using this browser. The default homepage can be set by going to Settings > Menu Settings > Web Browser > Home page.



TIP Local files cannot be opened with this web browser.

Account Management Menu

The administrator password is used to turn services on/off. The administrator password is also used for the Secure File Transfer Protocol (SFTP) and file server access. This password is different from the password used to exit ME station into the Control Panel (Desktop Access Password).

The initial administrator password is set up as a part of the out of box experience (OOBE). See [step 11](#) on [page 55](#) for this initial setup.

When changing the administrator password, the new password cannot be blank. It must be between 1 and 64 characters. There are no special character requirements; any special characters can be used if desired. We recommend following best practices for passwords to ensure they are as secure as possible.

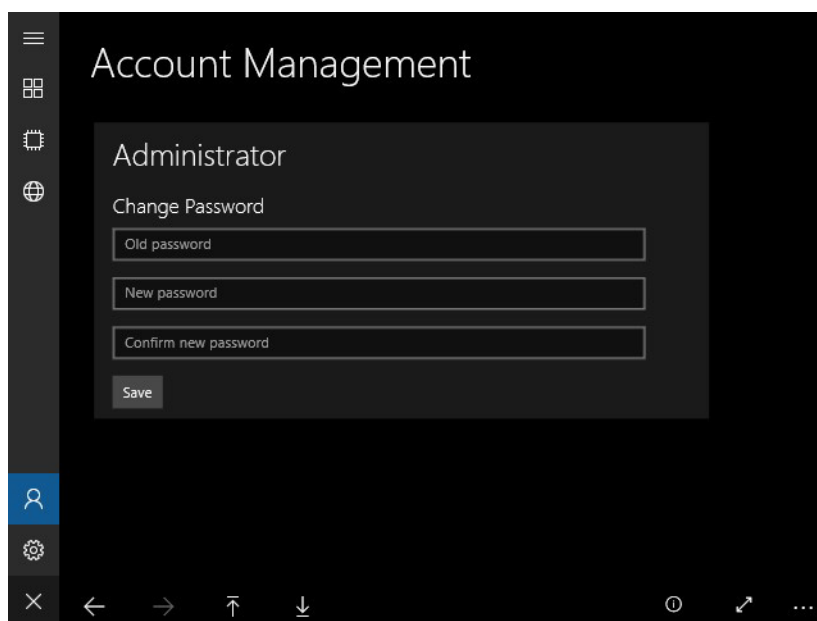
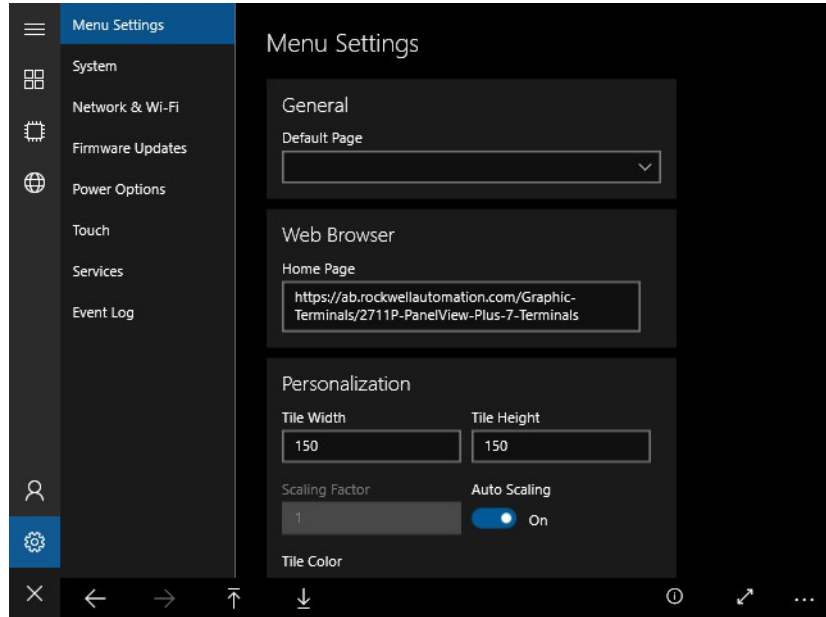

Table 37 - Account Management Screen

Section	Field	Description
Administrator—Change Password	Old password	This field is where you type your current password.
	New password	This field is where you type a new password.
	Confirm new password	This field is where you re-type the new password.

Menu Settings Screen

The Menu Settings screen allows you to select which application page and home page you want to use as a default. This screen also allows you to set the size and color of the tiles that are displayed on the terminal.



Use the scroll bar at the right of the screen to view all of the available fields on this screen.

Table 38 - Menu Settings Screen

Section	Field	Description
General	Default Page	Allows you to set the application page you want to use as your default page.
Web Browser	Home Page	Allows you to set the web page you want to use as your default web page.
Personalization	Tile Width	Allows you to type a number (representing pixels) that defines the width of a tile.
	Tile Height	Allows you to type a number (representing pixels) that defines the height of a tile.
	Scaling Factor	Allows you to type a number (when the Auto Scaling toggle switch is Off) to define how the tiles are scaled.
	Auto Scaling	Allows the application to define (when the toggle switch is On) how the are scaled.
	Tile Color	Provides the following fields that you can use to determine the color of the tiles on your terminal: <ul style="list-style-type: none"> Color scale--lets you select the color by sliding a RGB/HSV field--toggles between RGB and HSV values. Select RGB to type numerical values in the Red, Green, and Blue fields. Select HSV to type numerical values in the Hue, Saturation, and Value fields. Hexadecimal field--lets you type in a hexadecimal value to define a color.

System Screen

The System screen allows you to set the language for your terminal. In addition, you can select the language for your soft keyboard, and the time zone you work in.

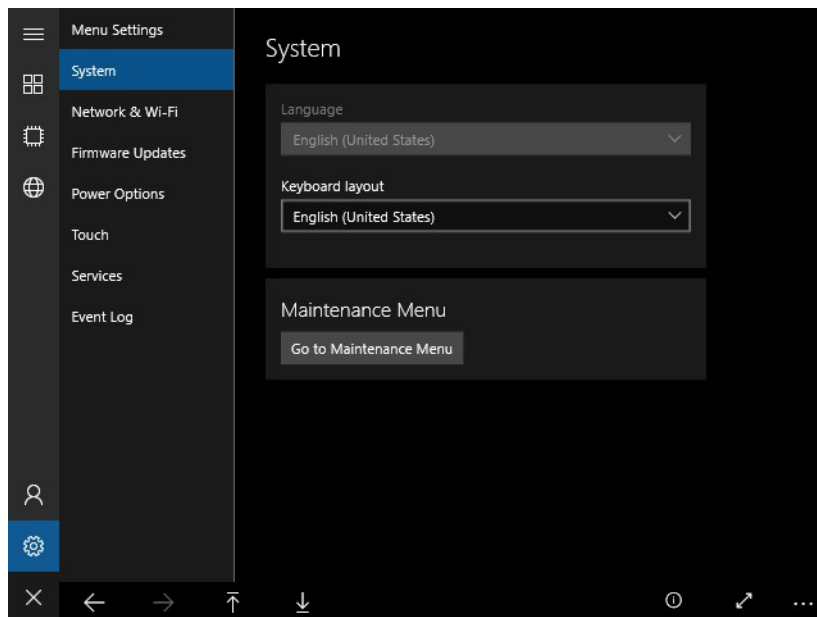

Table 39 - System Screen

Section	Field	Description
–	Language	Provides a drop-down list that allows you to select the language that is displayed in the Windows Configuration Menu. This has no impact on the language displayed in Machine Edition (ME) Station
–	Keyboard layout	Provides a drop-down list that allows you to select the language used for the soft keyboard on your terminal.
Maintenance Menu	–	Contains the Go to Maintenance Menu button, which allows you to return to the Maintenance Menu.

Network & Wi-Fi Screen

The Network & Wi-Fi screen displays information about the direct and wi-fi connections of your terminal.

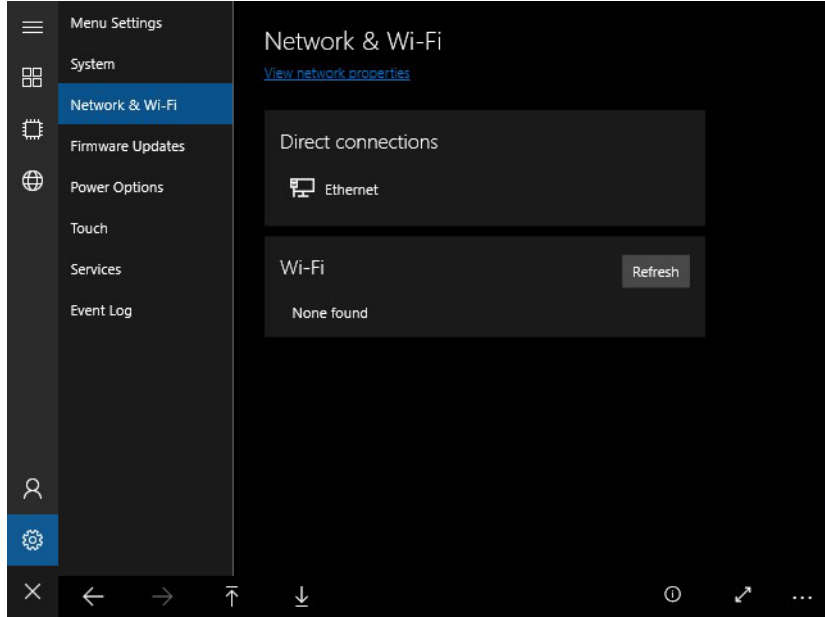
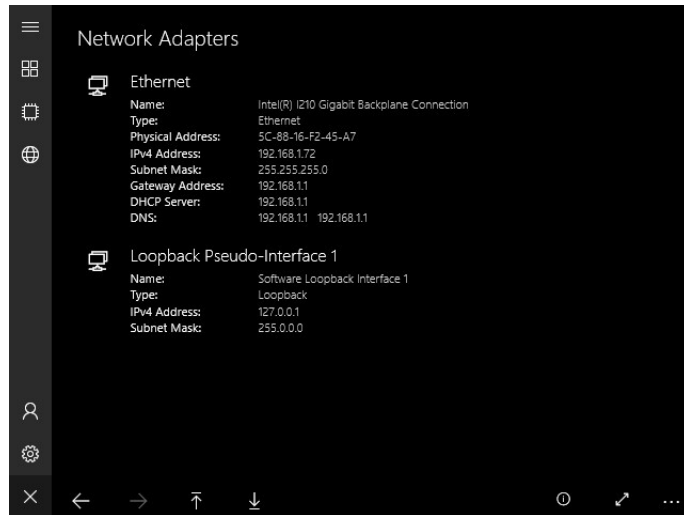

Table 40 - Network & Wi-Fi Screen

Section	Field	Description
–	View network properties	Displays the network properties of your terminal, as shown in the following screen capture.
Direct Connections	–	Displays the connection type of the terminal.
Wi-Fi	–	Displays information about the Wi-Fi connection available for your terminal. Includes a Refresh button that allows you to refresh the Wi-Fi information.



Firmware Updates Screen

The App Updates screen allows you to obtain updates for the operating system, as well as for applications that you use on the terminal.

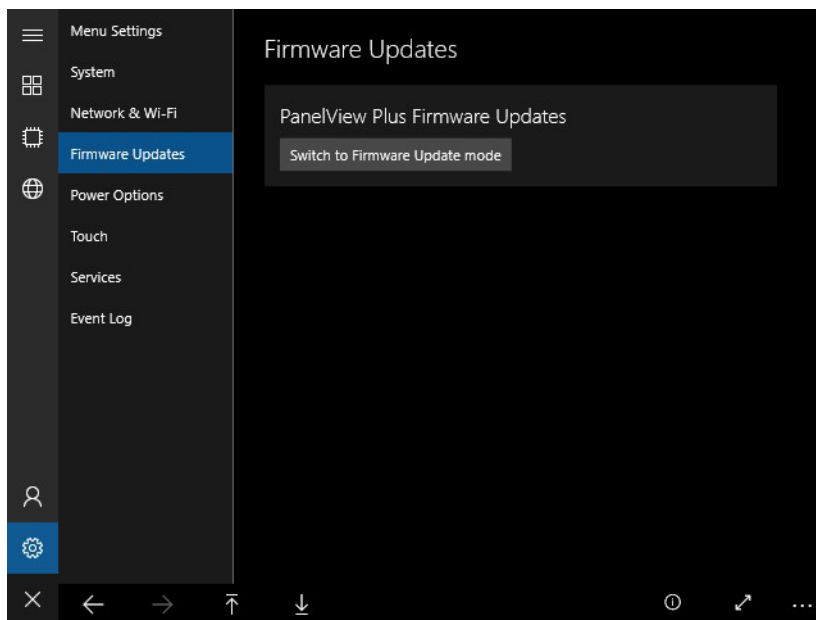

Use the scroll bar at the right of the screen to view all of the available fields on this screen.

Table 41 - Firmware Updates Screen

Section	Field	Description
PanelView Plus Firmware Updates	—	Contains the Switch to Firmware Update mode button, which allows you to use Control Flash to obtain the latest version of the FactoryTalk View ME Station software.

When you press Switch to Firmware Update mode, a system warning box appears. Click yes to continue into the firmware update mode. The firmware update mode is then displayed, as shown in the following graphic.

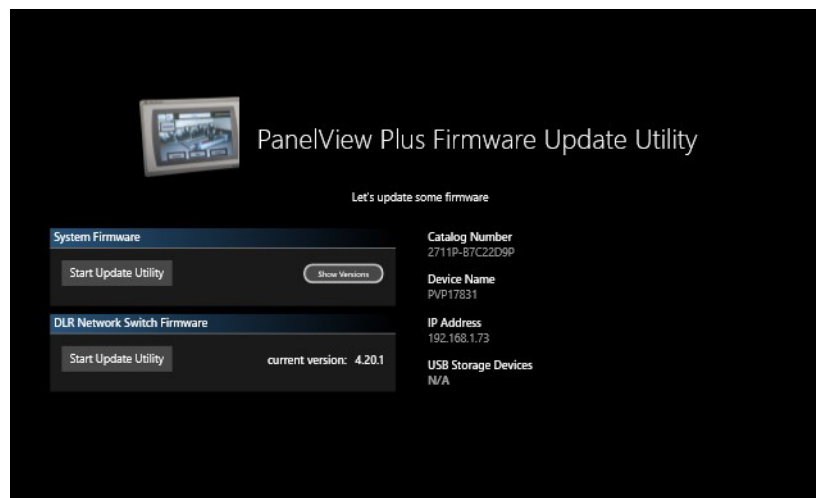

The System Firmware section includes information about the operating system and ME station. This can be updated via ControlFlash or a USB storage device. When updating via ControlFlash, a .dmk file is used. When updating via a USB Storage Device, .CAB file are used.

The Update from USB Storage button is visible only when a USB storage device is plugged in.

For instructions on how to update the firmware, [Update the System Firmware on page 57](#).

The DLR Network Switch Firmware section is new for Series B terminals (Series C for Stainless Steel terminals). This firmware is for the DLR functionality of the terminal.

Power Options Screen

The Power Options screen allows you to choose whether to restart or shut down your terminal.

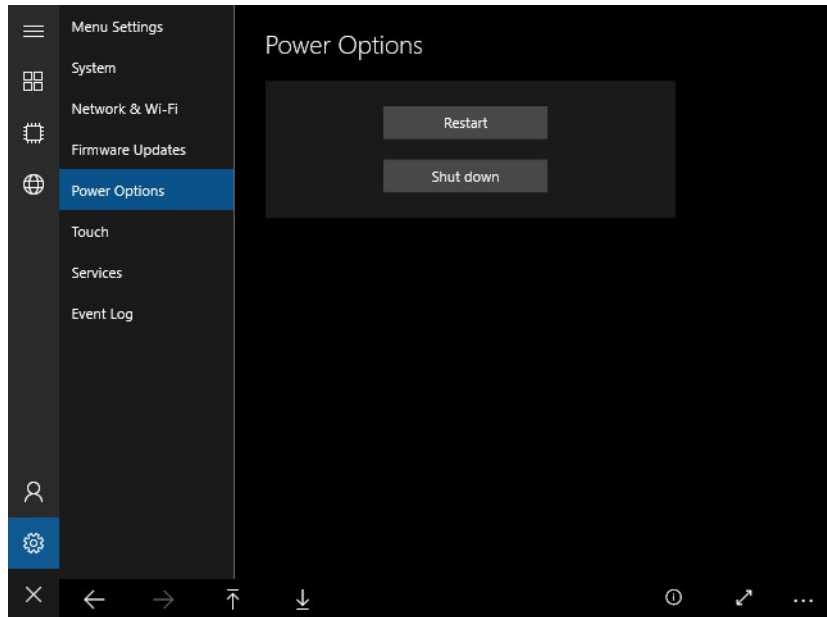

Table 42 - Power Options Screen

Section	Button	Description
–	Restart	Restarts the terminal into ME Station or loads the ME application (if configured to do so).
–	Shut down	Shuts down the terminal.

Touch Screen

The Touch screen allows you to recalibrate the touch screen of your terminal if your device does not respond appropriately to taps.

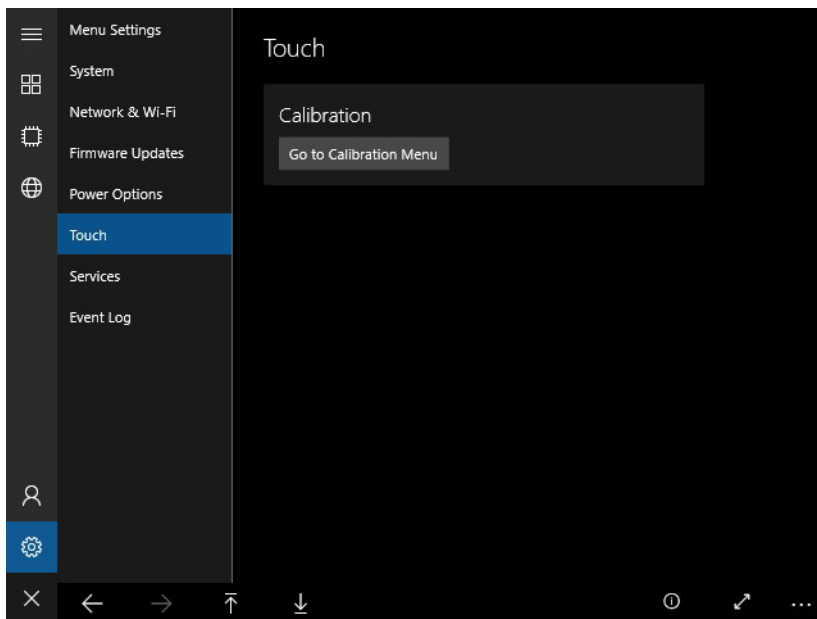

Table 43 - Touch Screen

Section	Button	Description
Calibration	Go to Calibration Menu	Reboots the terminal and then launches the Calibration menu, which allows you to re-calibrate the sensitivity of the touch screen.

Services Screen

The Services Screen allows you to specify whether or not you want to access various file servers.

IMPORTANT The default setting for all toggle switches on this screen is Off. To turn a service On, slide the toggle switch to the right. To turn a service Off, slide the toggle switch to the left.

If you turn any setting on or off, you must enter the administrator password.

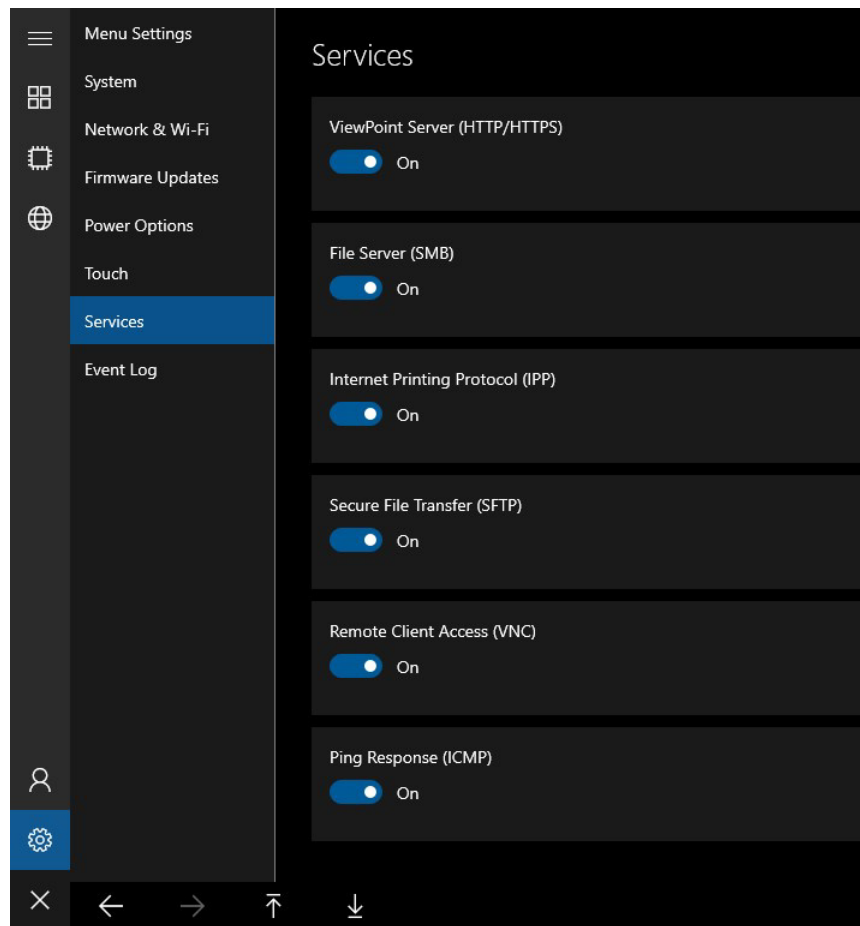

Table 44 - Services Screen

Section	Button	Description
–	ViewPoint Server (HTTP/HTTPS)	Set this switch On to enable the FactoryTalk ViewPoint server. Set this switch Off to disable the FactoryTalk ViewPoint server. This functionality is not available in the initial release.
–	File Server (SMB)	Set this switch On to enable file sharing. Set this switch Off to disable file sharing.
–	Internet Printing Protocol (IPP)	Set this switch On to enable printing (if this switch is not set to On, the printer is not recognized in the list of available printers within ME Station). Set this switch Off to disable printing.

Table 44 - Services Screen (Continued)

Section	Button	Description
–	Secure File Transfer (SFTP)	Set this switch On to turn on the secure FTP server. Set this switch Off to turn off the secure FTP server.
–	Remote Client Access (VNC)	Set this switch ON to turn on the VNC server. Set this switch Off to turn off the VNC server. This functionality is not available in the initial release.
–	Ping Response (ICMP)	Set this switch On to allow the terminal to reply to pings. Set this switch Off to disable ping replies.

Event Log Screen

The Event Log screen lets you select which event logs to generate for your terminal.

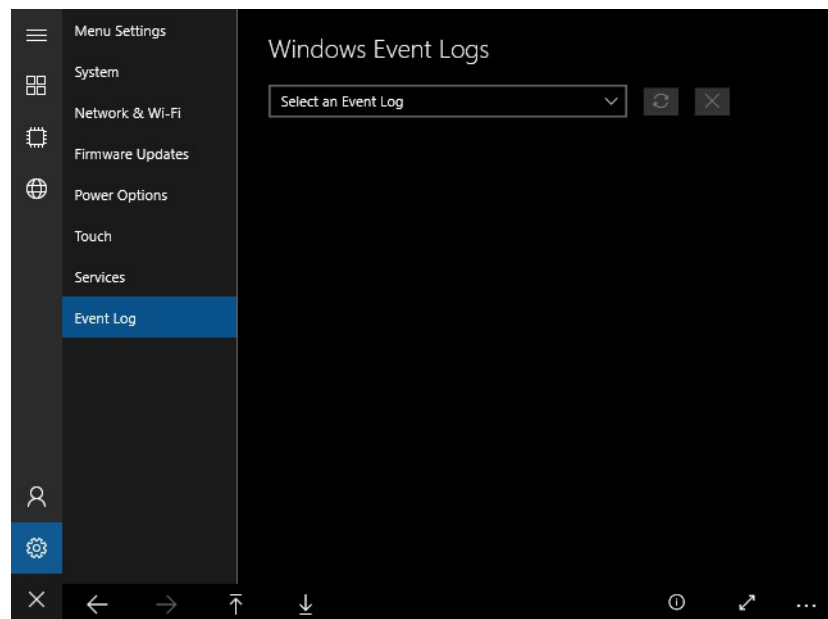
**Table 45 - Event Log Screen**

Section	Field	Description
–	–	Displays a drop-down list that allows you to select an event log to display. The following choices are available. <ul style="list-style-type: none"> • Application—displays events related to software installed on the Windows 10 IoT Core. • Parameters—displays the Parameter log. • System—displays events related to the Windows 10 IoT Core system. • WinCEApplication—displays events related to software installed in the Windows CE App Container. • WinCESystem—displays events related to the Windows CE App Container system.

Notes:

Install and Replace Components

Topic	Page
Connect to USB Ports	178
Install a USB Printer	179
Insert an SD Card	183
Connect a Speaker	184
Replace the Battery	185
Install a Protective Overlay	187
Replace the Stainless Steel Terminal Gasket	189
Install and Replace Components in the ArmorView Plus 7 Performance terminal.	See the ArmorView Plus 7 Installation Instructions, publication 2711P-IN013 .



ATTENTION: Prevent Electrostatic Discharge (ESD)

This equipment is sensitive to electrostatic discharge, which can cause internal damage and affect normal operation.

Follow these guidelines when you handle this equipment:

- Touch a grounded object to discharge potential static.
- Wear an approved grounding wrist strap.
- Do not touch connectors or pins on component boards.
- Use a static-safe workstation, if available.



ATTENTION: Disconnect all power before installing or replacing any components. Failure to remove power can result in electrical shock or damage to the terminal.



At the end of its life, this equipment should be collected separately from any unsorted municipal waste.

TIP For a complete list of supported devices, go to <https://rockwellautomation.custhelp.com> and search the Knowledgebase for keywords 'PanelView Plus Hardware Compatibility List'.

Connect to USB Ports

The PanelView Plus 7 Performance Series A terminals have two USB 2.0 (type A) host ports. The Series B terminals (Series C for Stainless Steel terminals) have one USB 2.0 port and one USB 3.0 host port. The USB host ports support removable USB drives and a USB printer.

IMPORTANT See [Required Circuit Port Parameters for USB Peripheral Devices on page 28](#) for information on how to use the USB host ports and USB peripheral devices in hazardous locations.

IMPORTANT The USB host connections are intended for temporary use. Do not use the USB host connections for runtime operations.

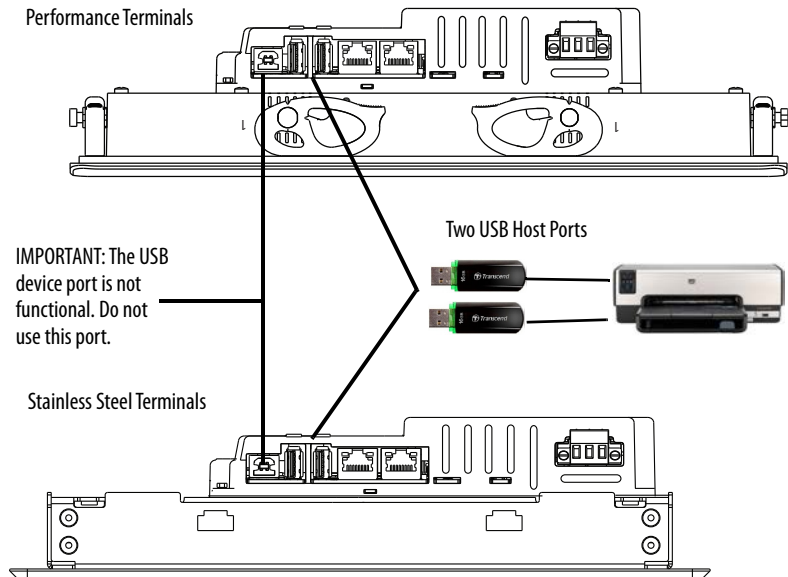

Icons identify the USB host connections. The USB host connection supports 0.5 A at 5V DC. Connected USB devices must not exceed this power load.

Table 46 - USB Connector Pinout

USB Port	USB Icon	USB Connector	Pin	Signal	Description
Host			1	VCC	+5V
			2	D-	Data -
			3	D+	Data +
			4	GND	Ground



WARNING: USB devices that are not powered by the USB port must be within the same enclosure as the terminal. The USB devices must be connected to a ground system common with the terminal or used with a USB hub that provides galvanic isolation.

Connect only externally powered USB hubs to the terminal that are USB 2.0 compatible. Before you attach devices to a USB hub, make sure that the power adapter is connected and powered on.

USB Cables

Use only hi-speed, USB 2.0 or higher certified cables for error-free transmissions.

Install a USB Printer

Series A Terminals

PanelView Plus 7 Performance Series A terminals support the connection of one USB printer such as Canon, Epson, Hewlett-Packard, and Brother. The printers support plug-and-play installation and manual installation if a suitable driver is available. You can connect a printer to a USB port on the terminal.

TIP For more information on supported printers, go to <https://rockwellautomation.custhelp.com> and search the Knowledgebase for keywords 'Printers Supported on PanelView Plus'.

Note: Series B terminals (Series C for Stainless Steel terminals) do not support USB printers. They support only network printing via IPP.

Printers are configured and managed from the Printers application  in the desktop control panel. A wizard is supported for each printer type.

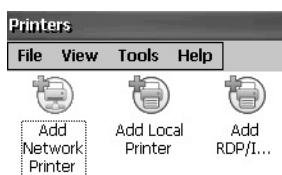

Table 47 - Support for Printers

Printer Type	Description
Local USB	You can connect a JETCET supported printer to a USB host port. The printer that is attached to the USB host port can be shared by a remote terminal when configured as a network printer on the remote terminal.
Network	The terminal supports a remote printer that is connected to the network via the Ethernet port. The printer address can be its device name or IP address.
RDP/ICA	A local printer can be made available to a Windows server application that is running in an RDP (Remote Desktop Protocol) session on the terminal.

After configuring a printer, you can access it from desktop applications or from FactoryTalk® View Machine Edition Station. Press Terminal Settings, then choose Print Setup. Applications can also select and share printers.

Plug-and-Play Installation

To install a plug-and-play printer from the Windows desktop, follow these steps. For manual printer installation, see [Manual Printer Installation on page 181](#).

TIP This procedure shows a plug-and-play installation for the Hewlett Packard HP Deskjet 5650 printer.

1. Connect the printer to a USB host port on the terminal.
2. Plug the power cord of the printer into an outlet and turn on the printer.

Windows automatically detects your plug-and-play printer, and in most cases, without requiring you to make any selections.

The printer is ready to print.

IMPORTANT If automatic plug-and-play installation is not supported for a printer, this error is logged to the System Event log in the Hardware Monitor.
For example, *JETCET PRINT was unable to auto-configure printer. To manually configure printer, go to the Printers folder from the Control Panel.*

3. Verify printer installation from the desktop control panel by opening the Printers  application.

Notice the icon for the Deskjet 5650C printer. The check mark indicates that this printer is the default.

4. From the File menu, choose Properties to view the properties of the printer.

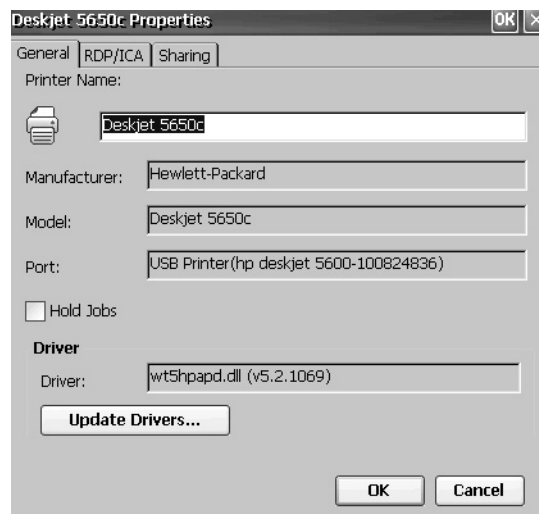

Printer properties include the printer name, manufacturer and model, print driver, and port-specific parameters.

- TIP**
- New printer configurations are retained through a power cycle.
 - Printers that are configured through the desktop control panel are also available within FactoryTalk View ME Station when pressing Terminal Settings>Print Setup.

5. To verify installation, right-click the printer and print a test page.

When printing from an application such as WordPad, a Print dialog box opens where you can adjust settings.

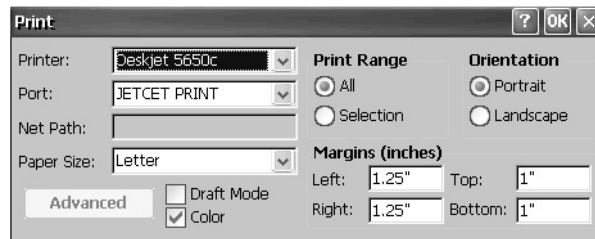

Manual Printer Installation

To configure a supported printer, follow these steps.

1. Connect the printer to a USB port of the terminal.
2. Plug the power cord of the printer into an outlet and turn on the printer.
3. From the desktop control panel, open Printers .
4. Click Add Local Printer.

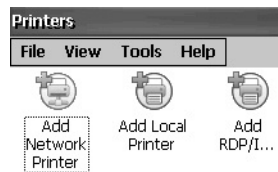

5. To configure the printer, follow the Add Local Printer Wizard instructions:
 - a. Verify that the connected printer appears on the USB printer port.
 - b. Select the manufacture and model of the JETCET printer.
 - c. Accept the default printer name or enter another.
 - d. To verify the installed printer, print a test page.
 - e. Specify whether you want the printer to be shared on the network.

Series B Terminals⁽¹⁾

To enable printing on Series B terminals (Series C for Stainless Steel terminals), the Internet Printing Protocol (IPP) service needs to be turned on. By default, this service is turned off.

To enable the Internet Printing Protocol (IPP) Service:

1. Navigate to the Windows Control Panel.
2. Select the Settings Menu (Gear Icon).
3. Select Services.
4. Under Internet Printing Protocol (IPP), move the slider to the right to turn the service on.
5. Enter the Administrator password when prompted.
6. Verify that the slider is on the right in the on position.

For instructions on how to set up the printing in the Machine Edition environment on the terminal, see [Configure Print Options on page 102](#).

(1) Series C for Stainless Steel terminals.

Insert an SD Card

An SD card provides extra storage when inserted into the SD card slot of the terminal. Supported cards include catalog numbers 1784-SD1, 1784-SD2, 1784-SDHC8, and 1784-SDHC32. The SD cards are hot-swappable; they can be inserted and removed while the terminal is powered on and running.



WARNING: Explosion Hazard

If you remove or insert an SD card while the power is on, an electric arc can occur. This arc can cause an explosion in hazardous location installations.

Do not remove and insert the SD card unless power has been removed or the area is known to be nonhazardous.

The SD card slot is accessible from the inside of the panel on the back of the terminal when installed.

To install an SD card in the card slot, follow these steps.

1. Verify that the SD card is locked or unlocked according to your preference.
 - If unlocked, the terminal can write data to or read data from the card.
 - If locked, the terminal can only read data from the card.

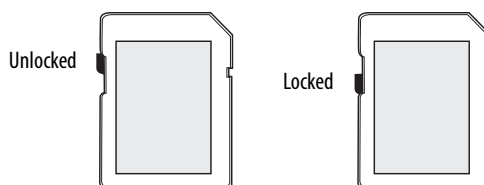

ATTENTION: Orient the SD card correctly before you insert the card into the slot. If you force the card into the slot, you can damage the card or the terminal.

2. Insert the SD card firmly into the slot until you hear a click.

When you hear the click, the card has locked into place.

To remove the card, push the SD card in slightly and remove then it from the slot.

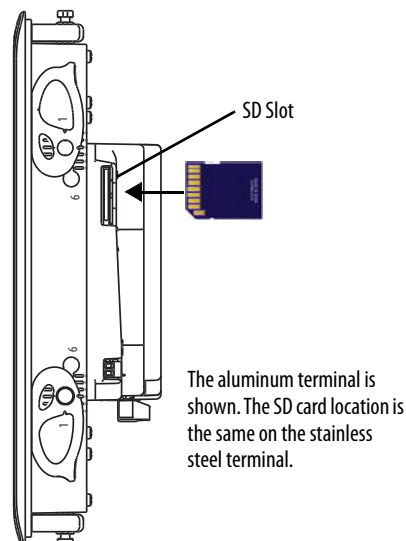

Connect a Speaker

You can connect a speaker or audio amplifier to the terminal to announce alarms, provide feedback of operator actions, and provide sound during video playback.

TIP On Series A terminals, the speaker works in the Windows CE operating system (Windows Media Player). On Series B terminals (Series C for Stainless Steel terminals), the speaker works in the Windows 10 operating system (Microsoft Edge Browser). FactoryTalk View ME Station software does not support the speaker.

Note: Series B terminals (Series C for Stainless Steel terminals) support audio through the audio out port and USB audio.

Selecting a Speaker for a Class D Amplifier

Speaker Impedance Ω	Test Frequency (KHz)	THD + N (%)	Output Power (W)	
			Series A	Series B ⁽¹⁾
4	1	1	2.2	2
4	1	10	2.7	2.5
8	1	1	1.3	1.42
8	1	10	1.6	1.8

(1) Series C for Stainless Steel terminals.



ATTENTION: The audio port is nonisolated. Follow these guidelines:

- A connected speaker must be within the same enclosure as the terminal. Amplified speakers must be connected to a ground system common with the terminal.
- The audio is provided as a terminal block connection for use in hazardous locations. Connect and tighten wires securely.

The audio port is a class D amplifier output. It has a two-pin terminal block for connecting a 4 ohm or 8 ohm speaker. The audio port can also drive externally amplified speakers.

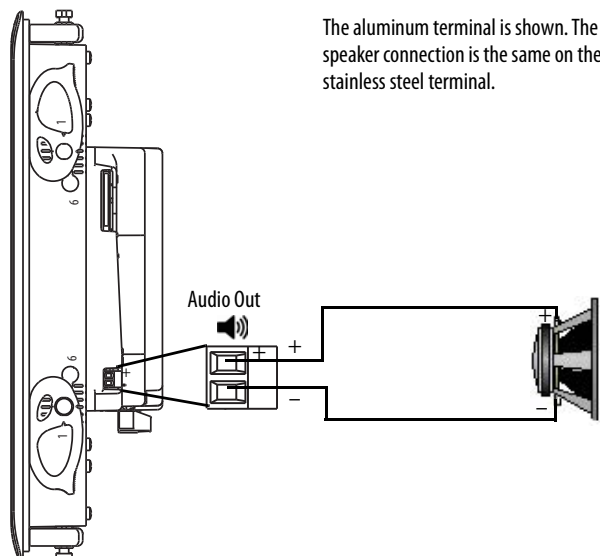
**Table 48 - Audio Port Wiring**

Wire Type	Wire Size	Strip Length	Torque Min...Max
Stranded or solid Cu 90 °C (194 °F)	0.05...1.3 mm ² 30...16 AWG	5 mm (0.2 in.)	0.22...0.25 N·m (1.95...2.2 lb·in)

Use a 0.4 x 2.5 mm screwdriver for terminal block wiring. The wire length must not exceed 1 m (39 in.).

To connect a speaker to the audio port, follow these steps.

1. Use wire strippers and remove about 5 mm (0.2 in.) of insulation from the ends of the wire.
2. Attach one of the newly exposed wires to the positive (+) terminal and the other to the negative (-) terminal on the operator device.
3. Connect the opposite exposed ends of the wire to the positive (+) and negative (-) terminals on the speaker or amplified speakers.

Replace the Battery

The product has a lithium battery that provides back-up power for the real-time clock and static RAM. The battery can be replaced while the product is mounted in the panel. You need a #1 Phillips screwdriver (#1 Phillips bit) to remove the logic module and access the battery.



This product contains a sealed lithium battery that may need to be replaced during the life of the product.

At the end of its life, the battery contained in this product should be collected separately from any unsorted municipal waste.

The collection and recycling of batteries helps to protect the environment and contributes to the conservation of natural resources as valuable materials are recovered.



ATTENTION: There is a danger of explosion if the lithium battery or real-time clock module in this product is incorrectly replaced. Do not replace the battery or real-time clock module unless power has been removed and the area is known to be nonhazardous.

Replace the battery only with catalog number 2711P-RY2032 or an equivalent CR2032 coin-cell battery.

Do not dispose of the lithium battery or real-time clock module in a fire or incinerator. Dispose of used batteries in accordance with local regulations.

For safety information on the handling of lithium batteries, including handling and disposal of leaking batteries, see Guidelines for Handling Lithium Batteries, publication [AG 5-4](#).

Perchlorate material – special handling may apply. See www.dtsc.ca.gov/hazardouswaste/perchlorate.

This perchlorate warning only applies to primary Lithium Manganese Dioxide (LiMnO₂) cells or batteries, and products containing these cells or batteries, sold or distributed in California, USA.

To replace the battery, follow these steps.

1. Remove power from the terminal.
2. Loosen the screws that secure the logic module to the back of the display.

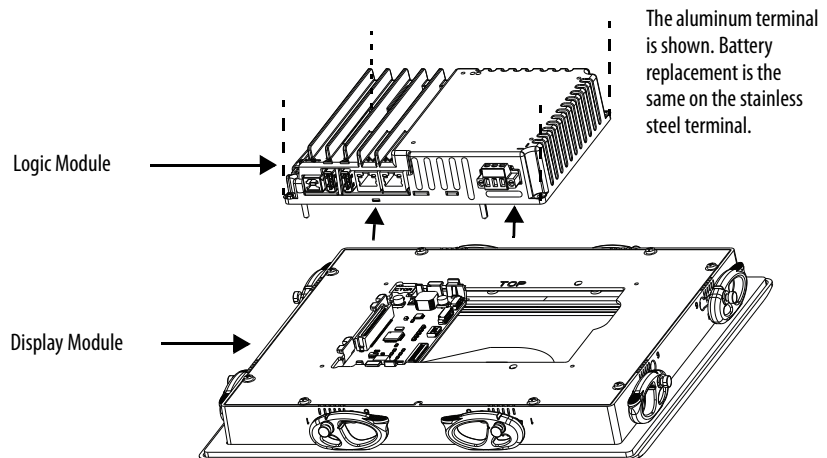

This equipment is sensitive to Electrostatic Discharge (ESD).
Follow ESD prevention guidelines when handling this equipment.

3. Carefully lift the logic module away from the display module and turn over to expose the circuit board.

4. Locate the coin-cell battery on the circuit board.

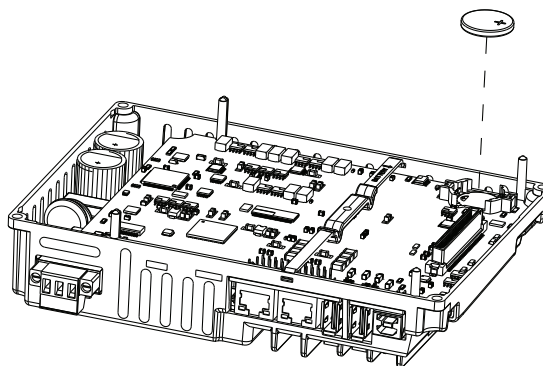

5. To remove the battery, lift the side of the battery.
6. Insert the new battery with the positive (+) polarity up.
7. Reattach the logic module by aligning the connector on the bottom of the logic module with the connector on the back of the display module.

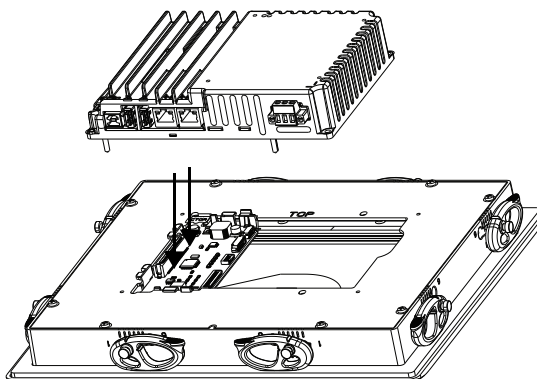

8. Push down on the logic module and make sure it is fully seated.
9. Tighten the screws to a torque of 0.68...0.90 N•m (6...8 lb•in).

Install a Protective Overlay

IMPORTANT Do not use protective overlays with the stainless steel terminals. The protective overlays are not compatible in hygienic applications.

The 12-inch overlay may be used on an ArmorView Plus 7 terminal, but it will only fit the touchscreen portion of the product.

The overlay helps to protect the touch screen and keys from scratches, dust, fingerprints, and external damage from chemicals or abrasive materials. See [Table 6 on page 23](#) for a list of available overlays.

IMPORTANT Follow these guidelines when installing the overlay:

- Make sure that your hands are clean and dry.
 - Handle the overlay by its edges to prevent fingerprints or lint. If you do get marks or lint on the overlay, remove them before proceeding.
 - Do not touch the adhesive ring.
 - Do not use Isopropyl Alcohol, chemicals that contain silicone, or soap to clean the surface of the terminal. Doing so may cause the overlay to not adhere properly to the terminal surface.
 - Denatured cleaning ethanol (95%) or a mild glass cleaner is recommended to clean the terminal surface before applying the protective overlay.
-

The protective overlay covers the entire surface of the terminal bezel inside the aluminum perimeter. The overlay has a protective liner that is removed by pulling back on a tab. Do not remove the liner until you are ready to install the overlay.

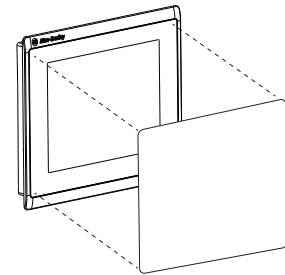

Before installing the overlay, use a lint-free cloth and a mild glass cleaner or denatured cleaning ethanol (95%) to clean the touch screen surface, and keys, if present. Remove all fingerprints, grease, or dust. Marks that are not removed are trapped underneath the overlay. Grease also affects the adhesion of the overlay.

To apply the protective overlay, follow these steps.

1. Pull the tab from one of the short sides and partially peel the liner away from the adhesive layer.

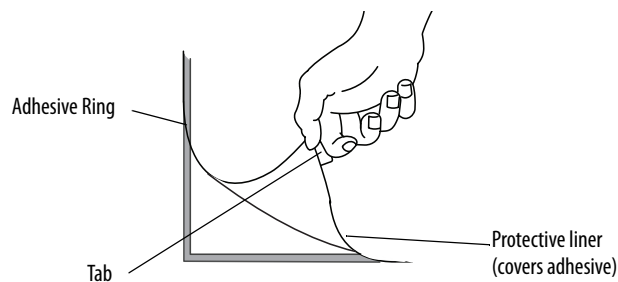

Hold the peeled back portion of the protective liner out of the way as you perform the next step.

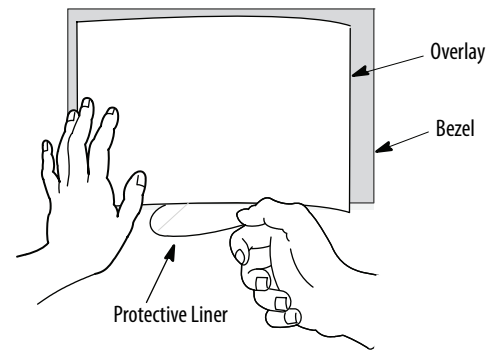

2. Center the overlay over the bezel and carefully position the adhesive surface on the terminal.

While the protective liner is still covering the rest of the overlay, verify that it is properly centered.

3. Slowly peel off the rest of the liner while using a soft cloth to press the overlay on the screen.

Make sure that the overlay lies flat with no bubbles or warps.

4. With a soft cloth or finger, press around the edges of the overlay to seal it, and remove any air bubbles trapped in the adhesive.

Clean the Overlay

Use a clean, lint-free cloth, and a mild glass cleaner that leaves no streaks to clean the overlay. Windex or an eye glass cleaner is recommended. Do not use cleaners that contain abrasives.

Remove the Overlay

Remove the overlay if it is damaged or needs replacement. Lift a corner and slowly pull off the overlay. Use isopropyl alcohol to remove any residual adhesive. Do not reuse the overlay.

Replace the Stainless Steel Terminal Gasket

The hygienic gasket for the stainless steel terminal is blue.

To replace the stainless steel terminal gasket, follow these steps.

1. Remove power from the terminal.
2. Label all wiring and connections so you can attach them correctly later.
3. Remove all wiring and connections.

4. Remove the mounting clips and backing plate.
Hold the terminal so it does not fall out of the panel.

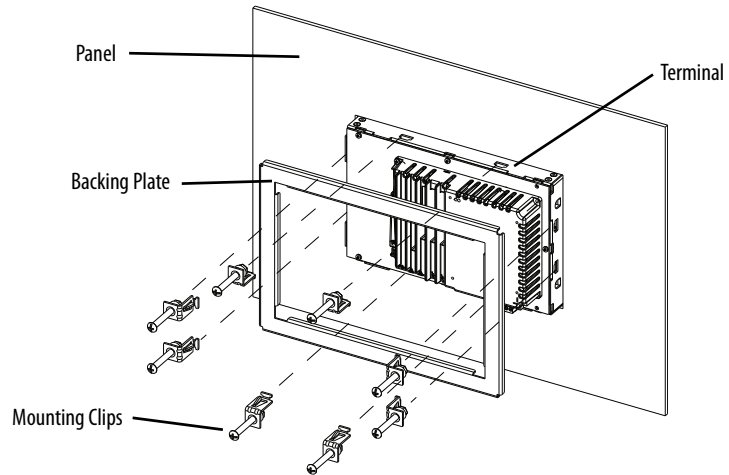

5. Remove the terminal from the panel.
6. Place the terminal screen-down on a clean, flat surface.
Be careful not to scratch or damage the terminal screen.
7. Remove the old gasket from the bezel.
8. Clean any dirt or residue from the bezel.
9. Position the new gasket on the bezel, with the gasket alignment plugs facing the bezel alignment features.

This gasket forms a compression seal. Do not use sealing compounds.

IMPORTANT Slip the inside corners of the gasket under the corners of the bezel shroud.

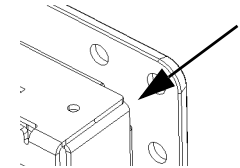

10. Press each gasket alignment plug into the bezel alignment feature.

The alignment plugs hold the gasket to the bezel.

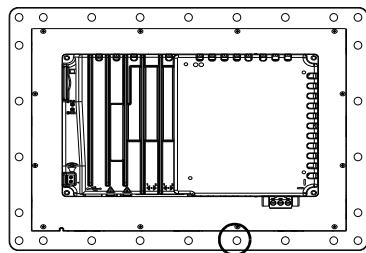

Back of Bezel with Alignment Features

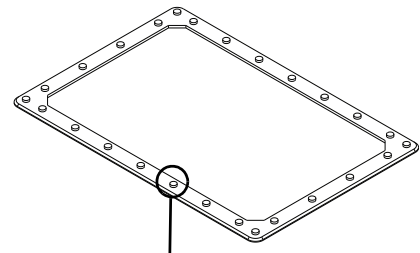

Gasket with Alignment Plugs

11. Place the terminal in the panel cutout.
Hold the terminal so it does not fall out of the panel.

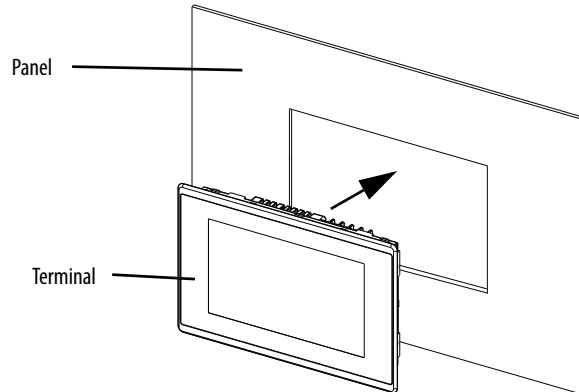

12. Position the backing plate over the terminal.

IMPORTANT Make sure that the flat side of the backing plate faces away from the panel, as shown in the drawing.

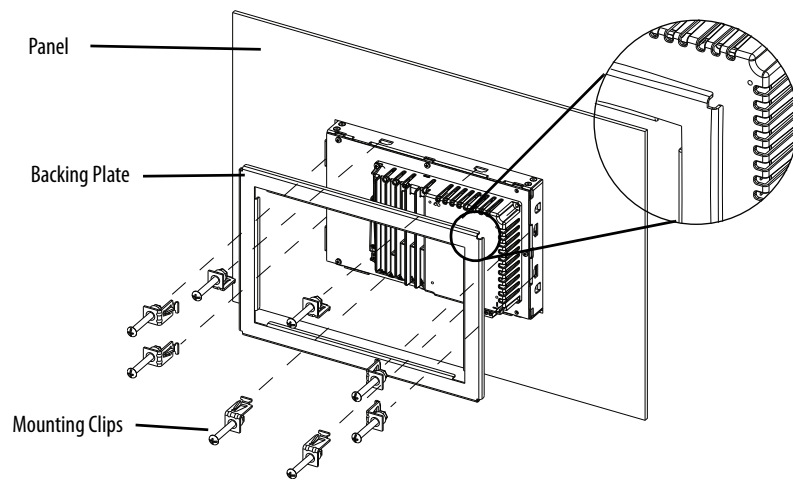

13. Slide the ends of the mounting clips into the slots on the terminal.
14. Tighten the mounting clip screws by hand until the backing plate contacts the panel uniformly.
15. Torque the mounting clip screws to 2.3...2.6 N•m (20...23 lb•in) by using the specified sequence.
The clips will loosen as the adjacent clip is tightened.

16. Repeat [step 15](#) until all the mounting clips are at the specified torque.

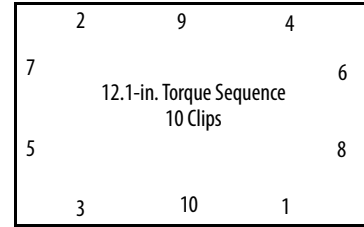
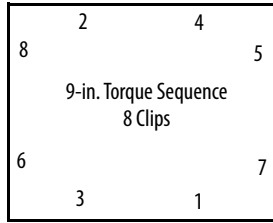

ATTENTION: Tighten the mounting clips to the specified torque to provide a proper seal and to prevent damage to the product. Rockwell Automation assumes no responsibility for water or chemical damage to the product or other equipment within the enclosure because of improper installation.

17. Reattach all wiring and connections.

Update Firmware

Topic	Page
Terminal Firmware	193
Download Firmware Files (Series A Terminals Only)	194
Firmware Upgrade Wizard (Series A Terminals Only)	195
Upgrade Terminal Firmware from a Storage Device (Series A Terminals Only)	195
Update Terminal Firmware Over the Network (Series A Terminals Only)	199
Update System Firmware (Series B Terminals Only)	203
Update DLR Network Switch Firmware (Series B Terminals Only)	213

Terminal Firmware

Firmware components are packaged as execute-in-place (XIP) regions in a System Code (SC) .img file. When the SC .img file is copied to the Virtual File System (VFS) on the terminal, the terminal XIP regions are updated and the terminal restarts automatically. These firmware components are affected during an update:

- FactoryTalk® View Machine Edition Station software
- Communication protocols and drivers including Kepware drivers
- Windows fonts
- Windows CE components
- FactoryTalk components
- User extensions

Note: The description of XIP and VFS is only applicable to PanelView Plus 7 Performance Series A terminals.

A firmware update does not affect these terminal components or settings:

- Windows registry
- File system including the FactoryTalk View Machine Edition application that is loaded⁽¹⁾ in the terminal
- Network parameters including the network device name, DHCP-enabled and static⁽²⁾ IP addressing, speed, and duplex setting
- Display settings and screen saver configuration
- Touch screen calibration

(1) In some cases, the FactoryTalk View ME application can be missing after a firmware update.

(2) In some cases, static IP addresses have been changed to DHCP-enabled IP address after a firmware update.

Download Firmware Files (Series A Terminals Only)

Note: The following description applies to PanelView Plus 7 Performance Series A terminals only. Series B terminals (Series C for Stainless Steel terminals) use ControlFlash to update firmware (files downloaded from the web are in .dmk format).

Download the appropriate firmware installation package from the Rockwell Automation website. The package is named:

PVP7_<terminal family>_x.xx-yyyymmdd.exe, where:



- <terminal family> is the terminal name
- x.xx is the FactoryTalk View ME software version that is contained in the package
- yyyymmdd is the date that the package was created

This installation package contains the following:

- Firmware Update Package (FUP) contains an autorun executable and the new firmware files.
- Firmware Upgrade Wizard (FUW), version 6.10 or later, is used to update the terminal firmware by using the contents of the FUP.

The FUP and FUW are copied to your computer during the download.

To download firmware installation files to your computer, follow these steps.

1. Click <http://ab.rockwellautomation.com> and choose Compatibility and Downloads. (See [Product Firmware and Release Notes on page 10](#).)
2. Click the Get Downloads tab.
3. Click Find Product Downloads.
4. From the All Families pull-down menu, choose PanelView™ Plus 7 Performance terminal.
5. Select a firmware revision, then click Find Downloads.
6. Download   the update file (.exe) to a temporary folder on the same drive as FactoryTalk View Machine Edition (ME) software.
7. Run the update file (.exe) installation procedure:
 - The FUW is installed in the FactoryTalk View ME folder.
 - The firmware update package file (.fup) is installed into the folder that is specified during the installation procedure.

TIP The FUP name is ME_PVP7xX_6=8.xx-yyyymmdd

 - yyyymmdd is the date the firmware package was created
 - 8.xx is the version of ME contained in this package

You are now ready to run the FUW to update the terminal firmware from a USB drive or SD card or by using a network connection.

Firmware Upgrade Wizard (Series A Terminals Only)

Note: The following description applies to PanelView Plus 7 Performance Series A terminals only. Series B (Series C for Stainless Steel terminals) terminals use ControlFlash to update the firmware.

The Firmware Upgrade Wizard (FUW) is used to update the terminal firmware. Two methods are provided to update the firmware:

- Create a firmware update card with the contents of the FUP file that you can then load in the terminal to update the firmware.

The firmware update card can be a USB drive or an SD card, catalog number 1784-SD x .

- Update firmware in a terminal that is connected to a computer over a direct network connection. The network connection requires a computer running RSLinx® Enterprise software, version 5.0 or later. In the FactoryTalk Linx software, you select the terminal that you want to update.

You can run the FUW from within FactoryTalk View Studio software or from the Programs menu on your computer:

- In FactoryTalk View Studio software, from the Tools menu, choose Firmware Upgrade Wizard.
- Choose Start>Programs>Rockwell Software>FactoryTalk View>Tools>ME Firmware Upgrade Wizard.

Upgrade Terminal Firmware from a Storage Device (Series A Terminals Only)

There are two steps to upgrade firmware from a storage device.

1. Create a firmware update card with the required firmware files.
2. To update the firmware, load the card in the target terminal.

The firmware update card can be a USB drive or an SD card.

Create a Firmware Update Card

Note: The following procedure is only available for PanelView Plus 7 Performance Series A terminals.

To copy firmware files to a USB drive or SD card, follow these steps.

1. Insert either a USB drive or an SD card into the appropriate slot on your computer.
2. Run the Firmware Upgrade Wizard:
 - In FactoryTalk View Studio software, from the Tools menu, choose Firmware Upgrade Wizard.
 - Choose Start>Programs>Rockwell Software>FactoryTalk View>Tools>ME Firmware Upgrade Wizard.

3. Follow these steps from the initial Firmware Upgrade Wizard dialog box.
 - a. Click Create firmware update card.

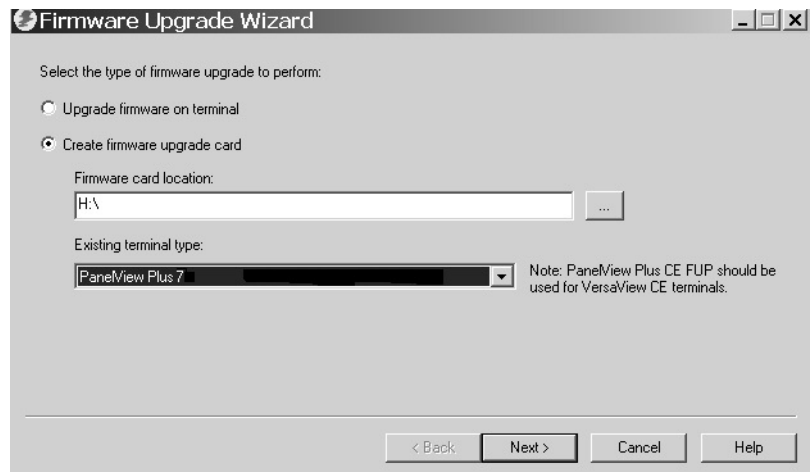

- b. Select the location of the firmware card by browsing to the root directory of the storage card that is loaded in your computer, for example, E:\.

The firmware files are copied to this location. You can also specify a folder on the hard disk.
 - c. From the Existing terminal type pull-down menu, select a PanelView Plus 7 terminal.
 - d. Click Next.
4. Follow these steps from this dialog box.
 - a. Browse to the location of the firmware source files on your computer, where the FUP was installed.

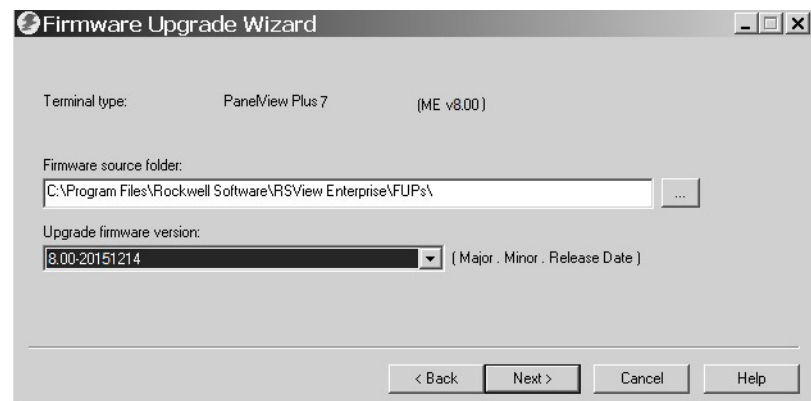

- b. Choose the firmware revision for the update.
 - c. Click Next.

It can take several seconds for the next dialog box to appear while the FUP is being retrieved.

- From this dialog box, optionally select the KEPServer drivers that you want included with the firmware, then click Next.

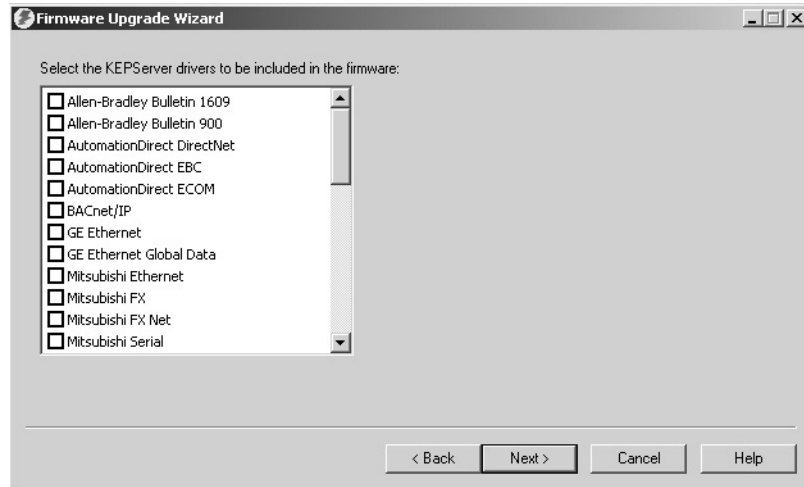

Keeware drivers are already installed on the PanelView Plus 7 Performance terminals.

The final dialog box summarizes your choices for creating the firmware update card.

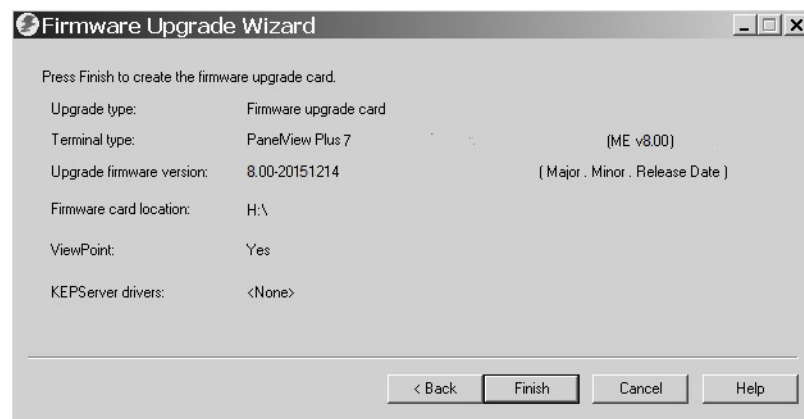

- Click Finish to copy the firmware files to the firmware update card.

A progress bar automatically updates as files are copied to the USB drive or SD card.

- Click OK when the firmware update completes successfully.

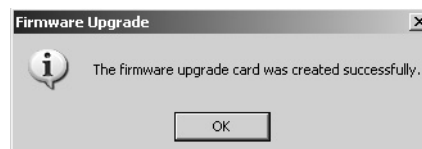

TIP If the firmware files were copied to the hard disk, copy the files to the root directory of the USB drive or SD card.

- Remove the USB drive or SD card from your computer.
- Go ahead to the next section to use this firmware update card to update the terminal firmware.

Update Terminal Firmware by Using Firmware Update Card

The following procedure is only available for PanelView Plus 7 Performance Series A terminals.

IMPORTANT For information on how to use a USB drive or SD card with the ArmorView Plus 7 terminal, see the ArmorView Plus 7 Installation Instructions, publication [2711P-IN013](#).

To transfer firmware files from the USB drive or SD card to the terminal, follow these steps. Use the firmware update drive or card that you created in the previous section.

IMPORTANT

- Do not remove or accidentally disconnect the USB drive or SD card while a firmware update is in process. This action can corrupt the firmware and make the terminal unstable.
- Do not power off the terminal during a firmware update.
- USB hubs can produce unexpected behavior and are not recommended.

1. Insert the USB drive or SD card into the appropriate slot on your terminal.

The firmware update automatically starts and displays this dialog box.

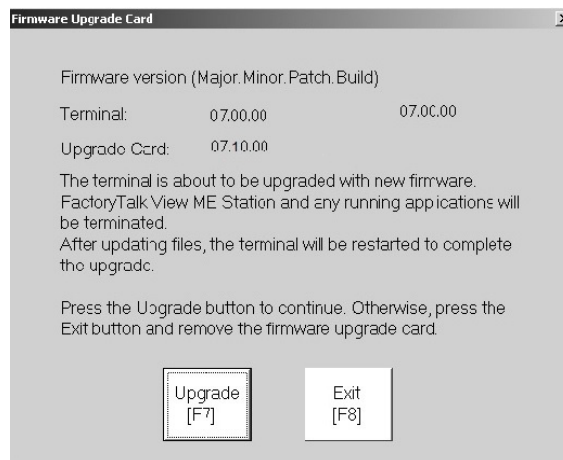

2. To start the firmware update, press update or [F7] on the terminal.

The terminal restarts and displays a progress bar during the update.

When the update is complete, the terminal restarts, and executes the new firmware.

3. Remove the USB drive or SD card from the terminal.

IMPORTANT If the firmware update fails because of a power loss or the firmware update card is inadvertently removed, you can restore the terminal to the factory default firmware. See [Maintenance Mode Operations — Series A Terminals on page 224](#) for details on how to restore the factory default settings.

Update Terminal Firmware Over the Network (Series A Terminals Only)

Note: The following procedure is only available for PanelView Plus 7 Performance Series A terminals.

You can update firmware in a terminal that is connected to a computer over a direct network connection. The network connection requires a computer with the Firmware Upgrade Wizard (FUW) and FactoryTalk Linx software, version 5.0 or later.

FactoryTalk Linx software is required so that you can select the terminal on the network.

To copy firmware files to the terminal over a network by using FactoryTalk Linx software and Ethernet communication, follow these steps.

1. Run the Firmware Upgrade Wizard:
 - In FactoryTalk View Studio software, from the Tools menu, choose Firmware Upgrade Wizard.
 - Choose Start>Programs>Rockwell Software>FactoryTalk View>Tools>ME Firmware Upgrade Wizard.



2. Click update firmware on terminal and click Next.
3. Click Yes to continue.

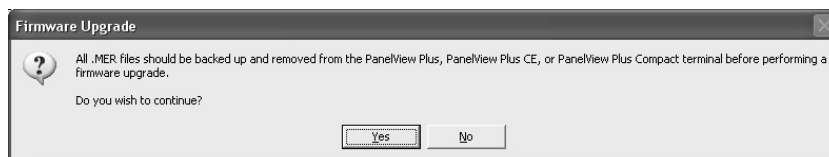

It is not necessary to back up files on PanelView Plus 7 Performance terminals.

- Click 'Network connection (using FactoryTalk Linx)' and click Next.

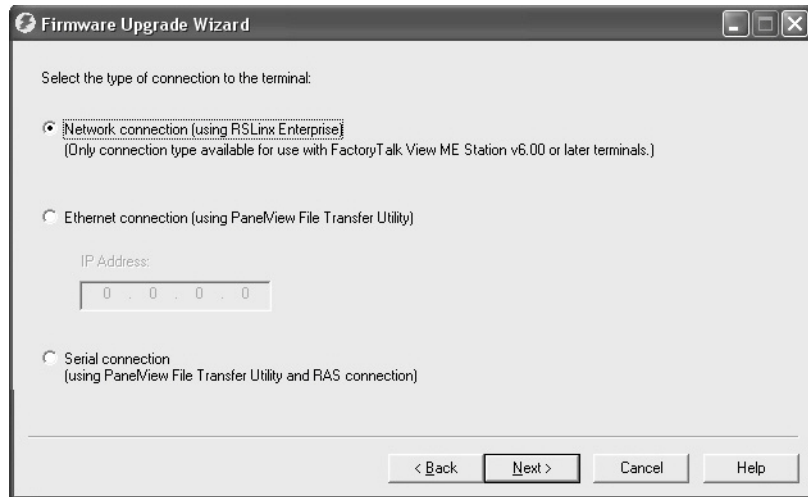

This connection is the only valid selection for PanelView Plus 7 Performance terminals.

- Select the terminal for the firmware update.
- Click Next.

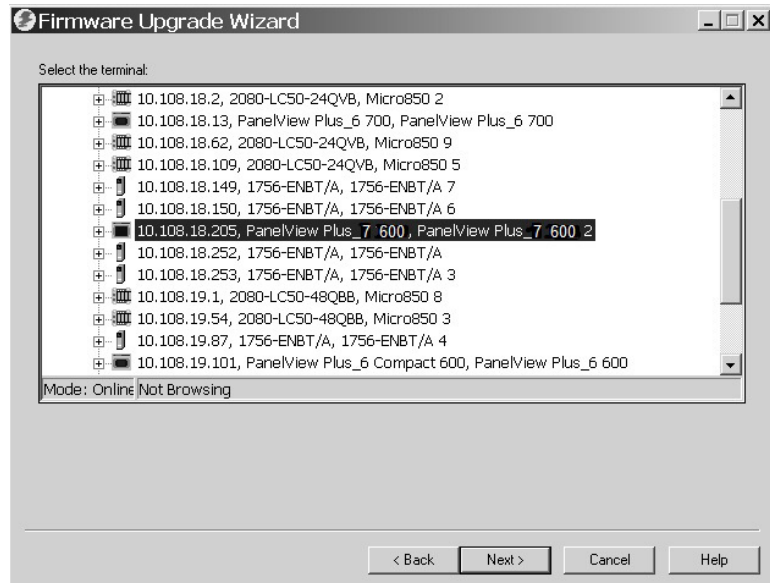

7. Follow these steps from this dialog box.

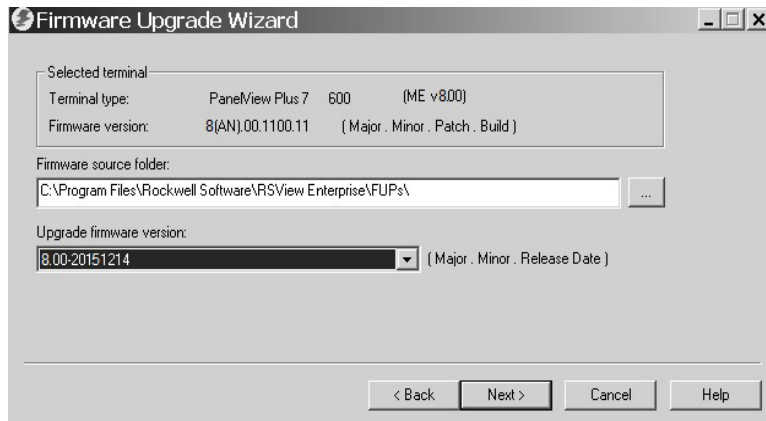

- a. Browse to the location of the firmware source files on your computer, where the FUP was installed.
The default location is shown.
 - b. Choose the version of the update firmware from the pull-down menu.
 - c. Click Next.
It can take several seconds for the next dialog box to appear while the FUP is being retrieved.
8. From this dialog box, optionally select the KEPServer drivers that you want included in the firmware, then click Next.

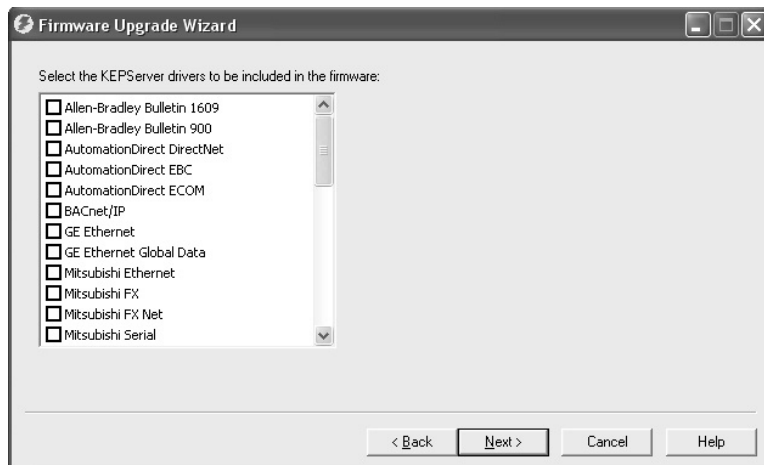

Keypare drivers are already installed on the PanelView Plus 7 Performance terminals.

The final dialog box summarizes your choices for upgrading the terminal firmware.

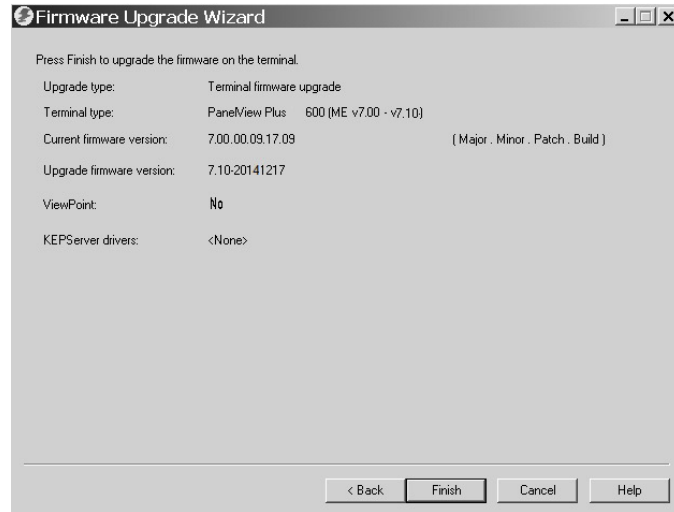

9. Click Finish to update the firmware in the terminal.
10. Click Yes to continue with the update.

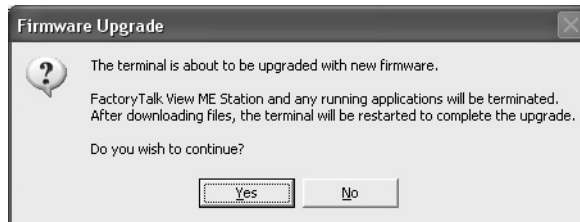

A progress bar updates as firmware files are copied to the terminal.

11. Click OK when the firmware update is complete.



The terminal restarts and executes the new firmware.

IMPORTANT If the firmware update fails because of a power loss or the firmware update card is inadvertently removed, you can restore the terminal to the factory default firmware. See [Maintenance Mode Operations — Series A Terminals on page 224](#) for details on how to restore the factory default settings.

Update System Firmware (Series B Terminals Only)⁽¹⁾

You can update the firmware on your terminal by using one of the following methods:

- USB storage device
- ControlFLASH™ client, which is available in the following formats:
 - ControlFLASH Plus™
 - ControlFLASH

USB Storage Device

1. Access the Rockwell Automation Product Compatibility and Download Center (PCDC) at rok.auto/pcdc.
2. On the home page, click Available Versions.

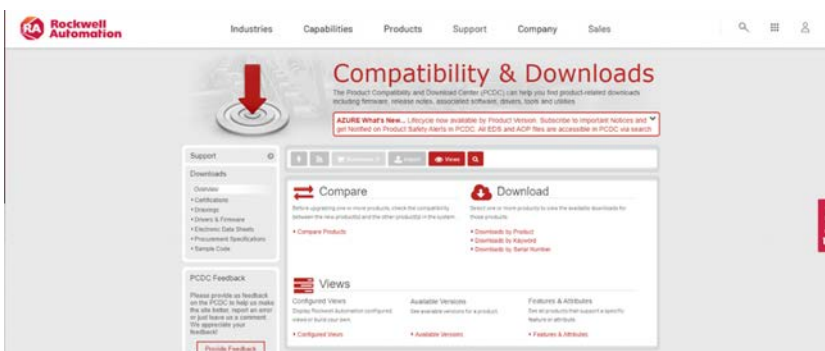

3. Click the Select a Product link, and in the Select a Product dialog box, type PanelView Plus 7 Performance in the search field, and then click the Search button.
4. Select PanelView Plus 7 Performance, and then select B for the Series B firmware (C for Series C for Stainless Steel terminals).
5. Click the Show Downloads icon for the desired firmware version for PanelView Plus 7 Performance (Series B (Series C for Stainless Steel terminals)).

TIP Firmware for Series B terminals (Series C for Stainless Steel terminals) start at version 12.XXX.

6. Select and download the CAB Files for the desired firmware version.



(1) Series C for Stainless Steel terminals.

IMPORTANT Do not download the DMK file. It does not work to update firmware via a USB Storage Device.

- After the .ZIP file has downloaded, extract the contents to the root of the USB Storage Device.

TIP Use a USB Storage Device with at least 8 GB of storage available. Any Windows file system (including FAT32 or NTFS) is acceptable.

- Insert the removable storage device into one of the USB ports located at the bottom of the PanelView terminal.
- On the PanelView terminal, in the Control Panel, select Settings, Firmware Updates, Switch to Firmware Update mode.
- Tap Update from USB Storage and wait for the firmware update to complete.

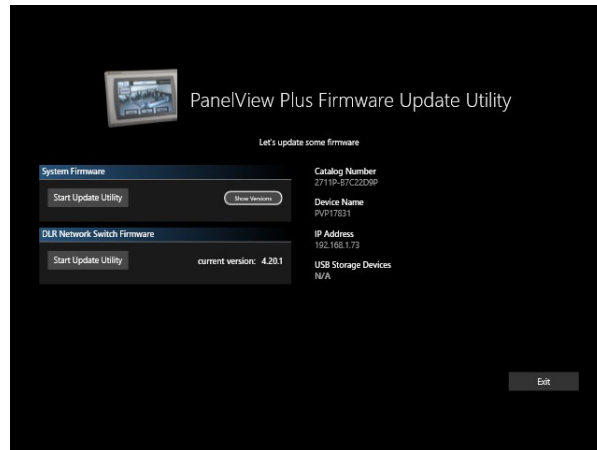

Before the update starts, the terminal displays the warning message shown in the following graphic. As the message states, do not remove the USB storage device while the file is being copied. Wait until you are prompted to remove the USB storage device.

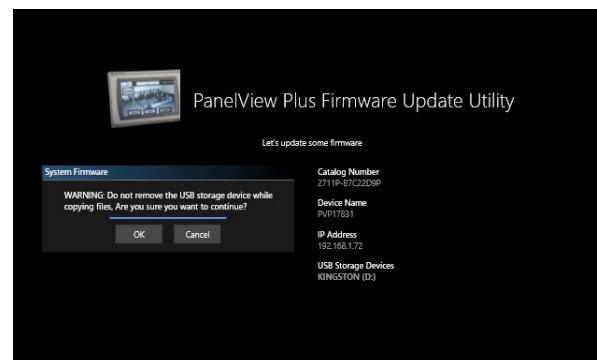

11. Tap OK when you are ready to continue.

While the firmware is updating, the terminal displays the update status. When the update is complete, the terminal displays the message shown in the following graphic.

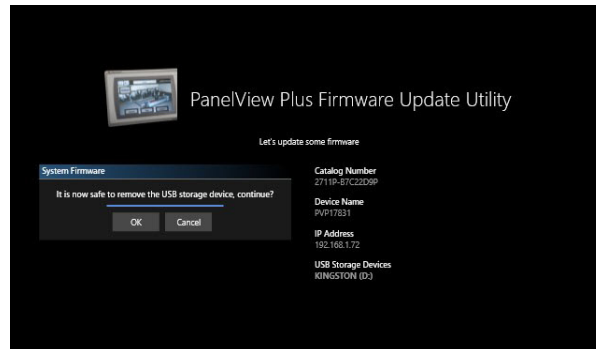

It is recommended that you remove the USB Storage device when prompted with the message shown in the image.

12. Tap OK to continue.

When the update is complete, the terminal reboots again and then displays the Password Entry screen.

13. Continue with [Enter a Password on page 69](#).

ControlFLASH Client

The following ControlFLASH clients are available to update the firmware:

- ControlFLASH Plus
- ControlFLASH

Before you can use ControlFLASH Plus or ControlFLASH, you must download the DMK file from the Product Compatibility and Download Center (PCDC).

Downloading the ControlFLASH Plus or ControlFLASH File

1. Access the Rockwell Automation Product Compatibility and Download Center (PCDC) at rok.auto/pcdc.

- On the home page, click Available Versions.

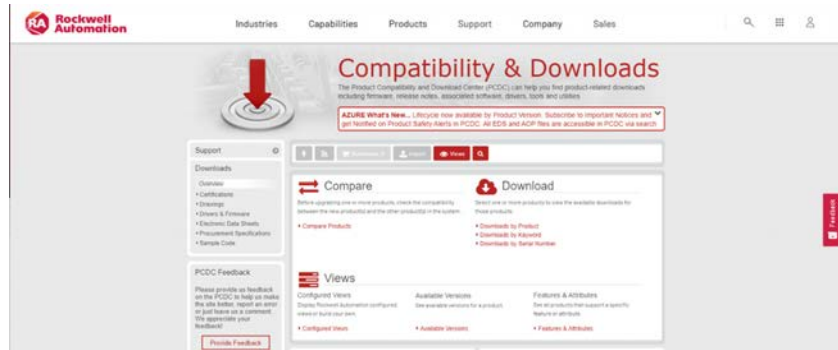

- Click the Select a Product link, and in the Select a Product dialog box, type PanelView Plus 7 Performance in the search field, and then click the Search button.
- Select PanelView Plus 7 Performance, and then select B for the Series B firmware (C for Series C for Stainless Steel terminals).
- Click the Show Downloads icon for the desired firmware version for PanelView Plus 7 Performance (Series B (Series C for Stainless Steel terminals)).

TIP Firmware for Series B terminals (Series C for Stainless Steel terminals) start at version 12.XXX.

- Select and download the DMK file for the desired firmware version.



- Save the DMK file in the desired Firmware Kits location.

The default location is

C:\Users\Public\Documents\RockwellAutomation\Firmware Kits

- On the PanelView terminal, in the Control Panel, select Settings, Firmware Updates, Switch to Firmware Update mode.

- Under System Firmware, tap the Start Update Utility button.

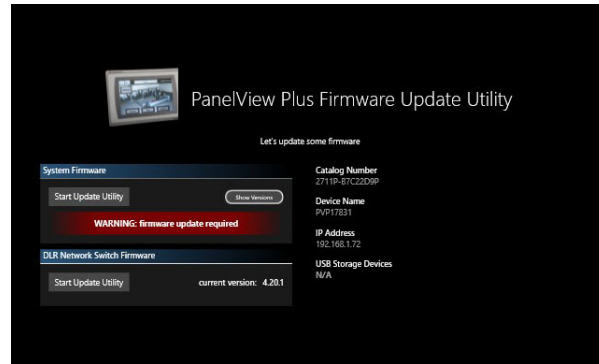

Using ControlFLASH Plus

For details about how to install ControlFLASH Plus software, see the ControlFLASH Plus Quick Start Guide, publication [CFP-QS001](#).

IMPORTANT Use ControlFLASH Plus, version 4, or higher. The following procedure uses ControlFLASH Plus, version 4.

- After you save the DMK file in the desired Firmware Kits location, launch ControlFLASH Plus.
- Browse to and select the PanelView Plus 7 Performance Series B terminal (series C if it is a Stainless Steel terminal).
- Click Next.

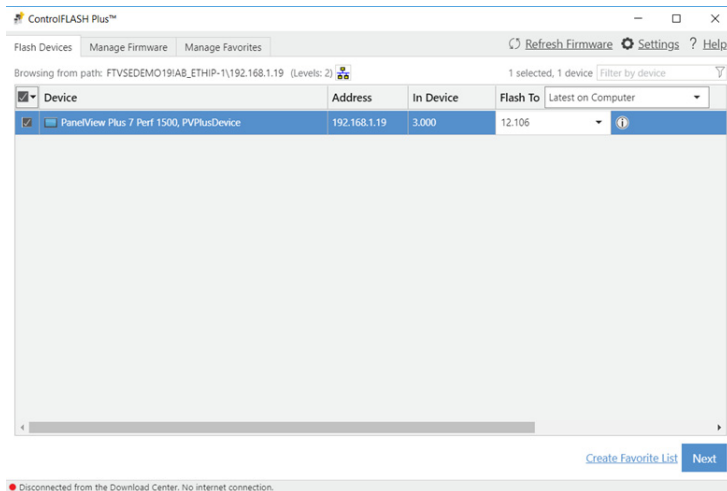

4. Confirm that the information is correct, and then click Flash.

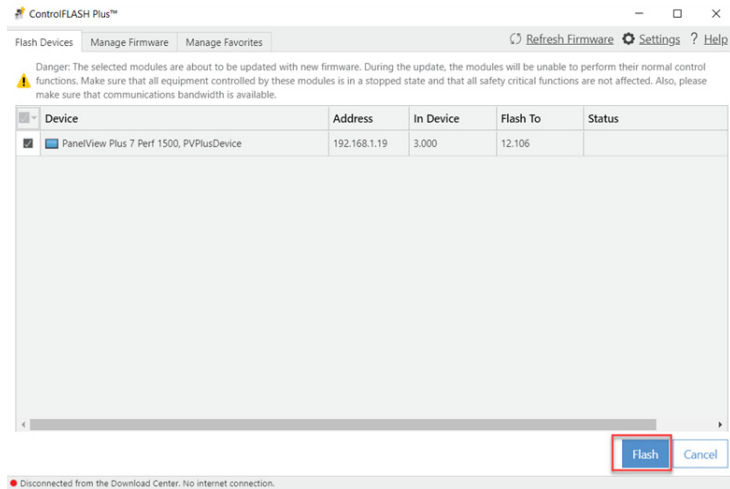

A series of status changes occur on the ControlFLASH Plus screen and on the PanelView terminal.

On the ControlFLASH Plus screen, the Status field displays the Transmitting update status.

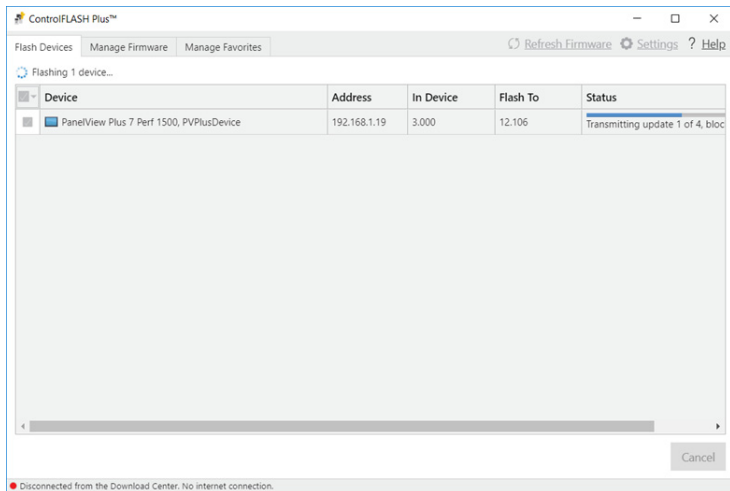

On the PanelView terminal, the status changes to CONNECTED: transferring updates... .

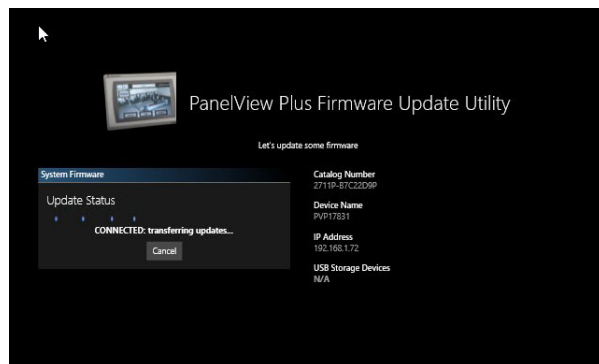

Once the firmware file transmission is complete, on the ControlFLASH Plus screen, the Status field displays the Polling for power-up status.

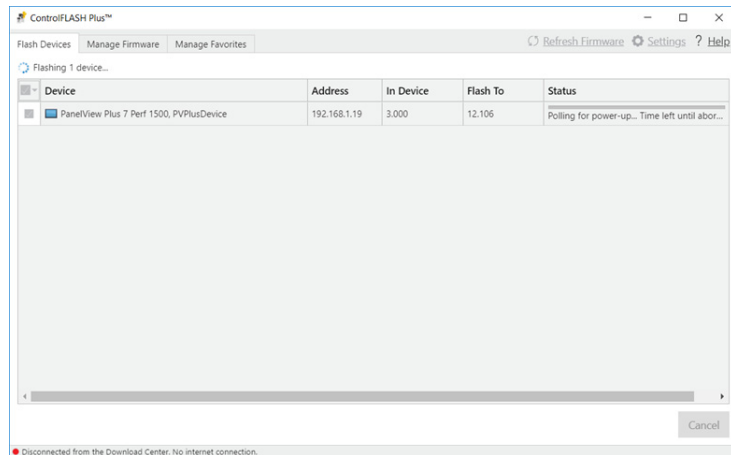

On the PanelView terminal, the status changes to PLEASE WAIT: verifying and preparing updates...

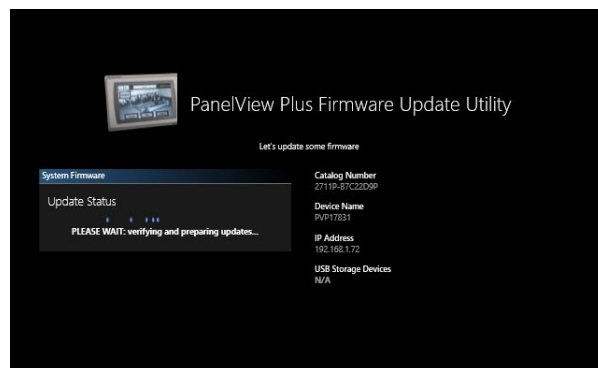

The PanelView terminal reboots, and on the ControlFLASH Plus screen, the Flash Results dialog box displays a Succeeded message.

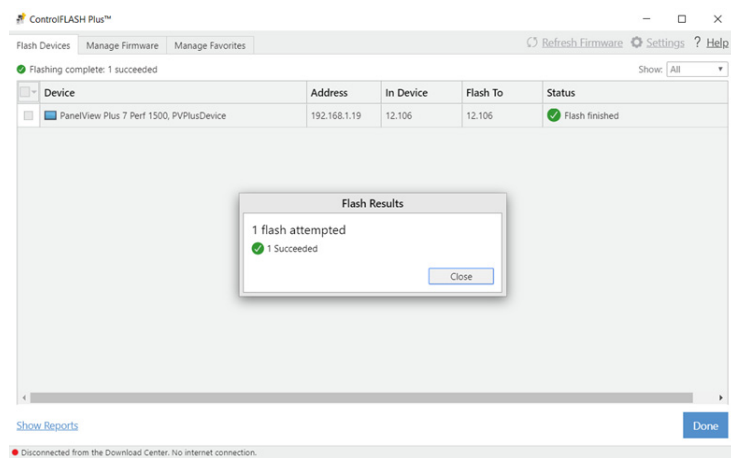

- Click Close, and then click Done.

When the firmware update is complete, the terminal reboots and displays moving gears while the update installs.



- Continue with [Enter a Password on page 69](#).

Using ControlFLASH

For information on how to install ControlFLASH, see the ControlFLASH User Manual, publication [1756-UM105](#).

To use the ControlFLASH software to update the firmware in a PanelView Plus 7 Performance Series B terminal (Series C for Stainless Steel terminals), follow these steps.

- Click Start>Programs>FLASH Programming Tools>ControlFLASH.
- Make sure that you know the required information in the Welcome dialog box, then click Next.



- Select the catalog number of the PanelView Plus 7 Performance Series B (Series C for Stainless Steel terminals) terminal that you want to update and click Next.

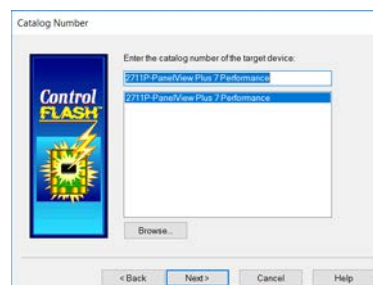

4. Browse to and select the device to update on the EtherNet/IP™ network and click OK.

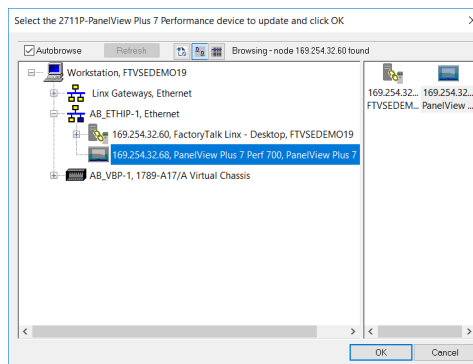

5. Select the firmware revision to install and click Next.

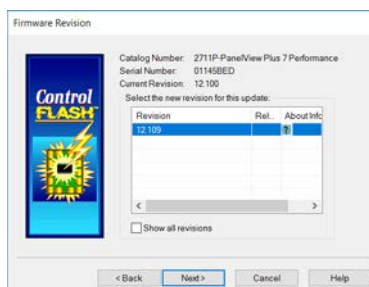

6. Read the Danger information in the Summary dialog, then click Finish.

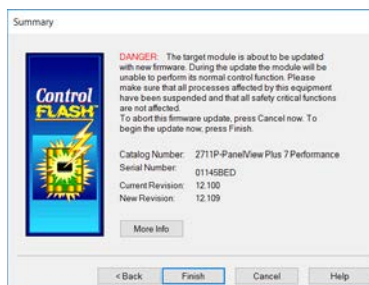

- Click Yes to confirm that you want to update the target device.

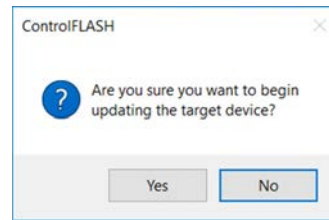

The update starts and can take several minutes to complete.

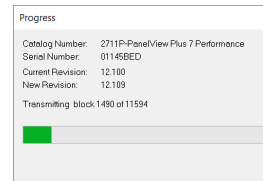

IMPORTANT Do not cycle power to the terminal during this process or the firmware update does not complete successfully.

When the firmware is sent to the terminal, the terminal resets and performs diagnostics.

The Update Status dialog box opens when the update is complete. If the update was successful, the Status area is green.



- Click OK.
- If the update fails, the status area is red and reads Update failure. For troubleshooting information, see the ControlFLASH User Manual, publication 1756-UM105.
- Close the ControlFLASH software.
- Continue with [Enter a Password on page 69](#).

Update DLR Network Switch Firmware (Series B Terminals Only)⁽¹⁾

The DLR Network Switch Firmware Update is new for Series B terminals (Series C for Stainless Steel terminals). This firmware is for the DLR functionality of the terminal and is separate from the System Firmware update. If the DLR functionality changes in the future, the update must be done using this process. If there is an update available, the .dmk file would be posted on the Product Compatibility and Download Center (PCDC) at rok.auto/pcdc.

This update must be done using Control Flash. It is not possible to do this update via USB flash drive as can be done with the System Firmware update

To update the DLR Network Switch firmware, follow these steps.

1. On the PanelView terminal, in the Control Panel, select Settings Firmware Updates / Switch to Firmware Update mode.
2. In the DLR Network Switch Firmware section, click Start Update Utility.

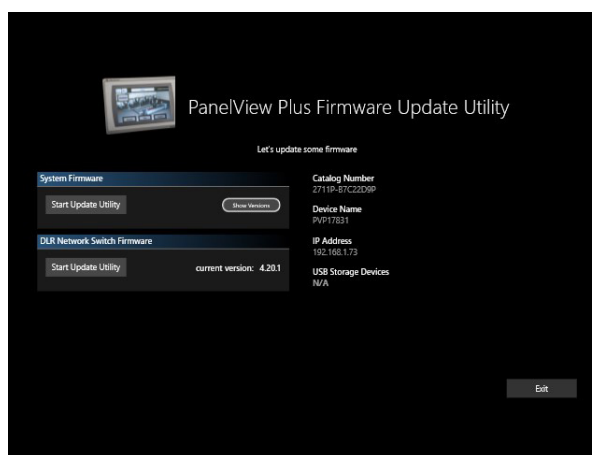

3. In the Warning dialog box, click the OK button to proceed with the firmware update.

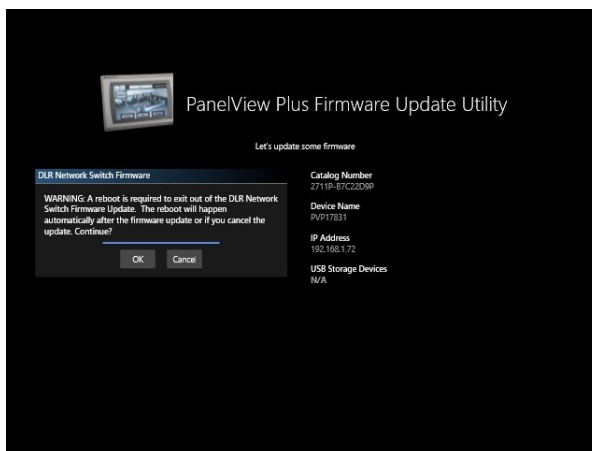

(1) Series C for Stainless Steel terminals.

The first progress message appears briefly and indicates that the terminal is connecting to the DLR network switch.

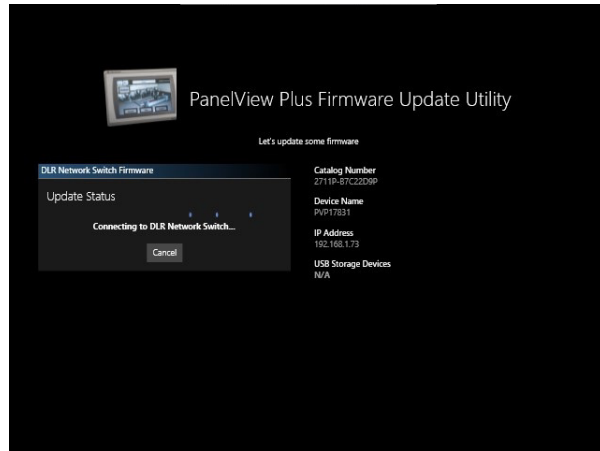

The second progress message appears when the terminal is connected to ControlFLASH and the new firmware is being downloaded to the DLR Network Switch.

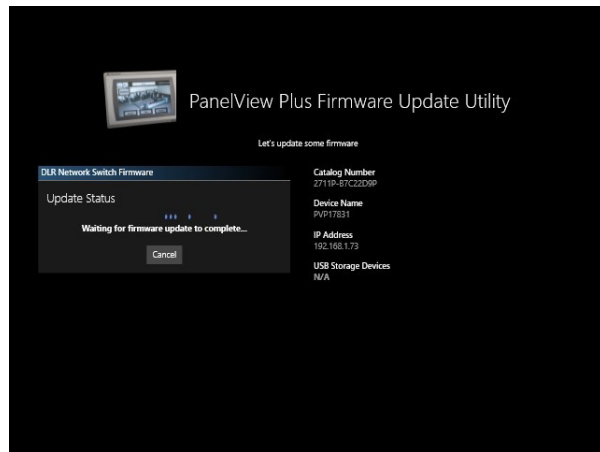

The third progress message appears when the download is complete. The terminal then automatically reboots.

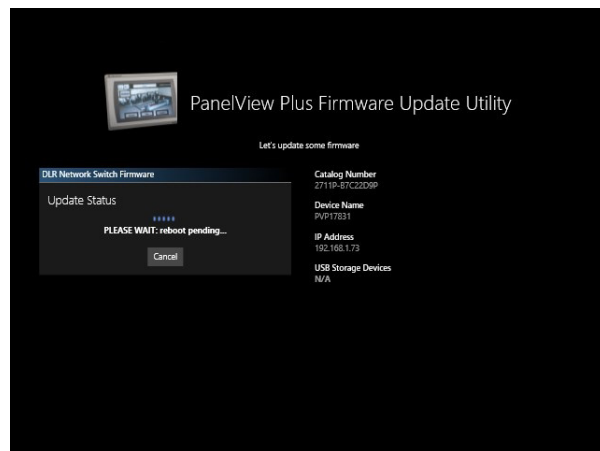

4. On your PC, browse to and select the PanelView Plus 7 Performance Series B terminal⁽¹⁾.

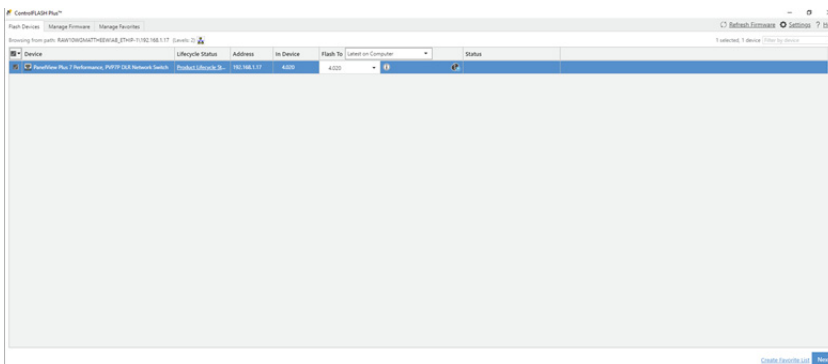

TIP The Device description states PanelView Plus 7 Performance, PVP7P DLR Network Switch.

5. Click Next.
6. Confirm that the information is correct, and then click Flash.

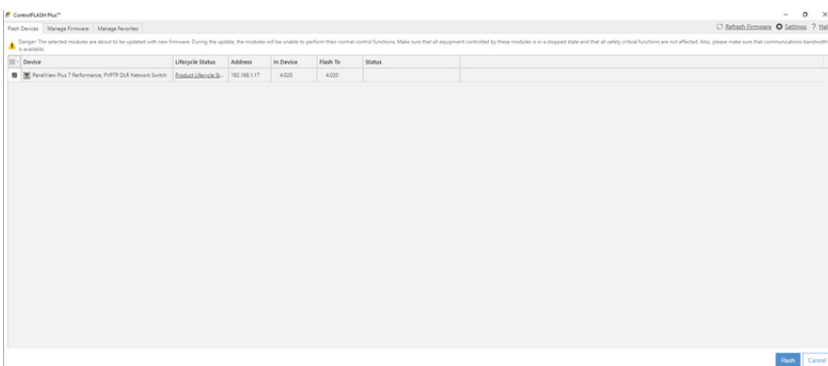

On the ControlFLASH Plus screen, the Status field displays the Transmitting update status.

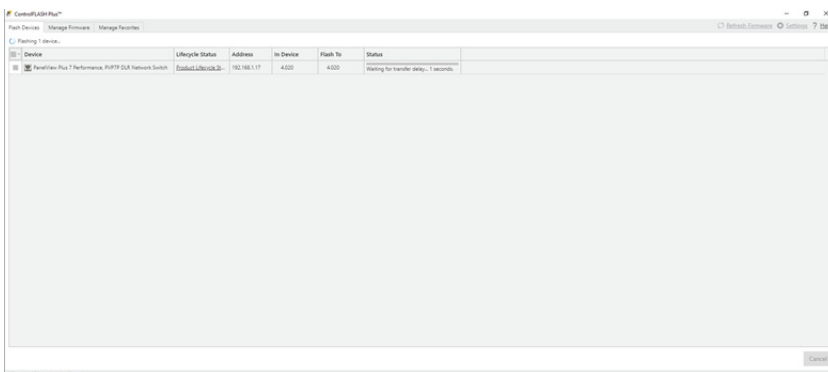

(1) Series C if it is a Stainless Steel terminal

Once the firmware file transmission is complete, on the ControlFLASH Plus screen, the Flash Results dialog box displays a Succeeded message.

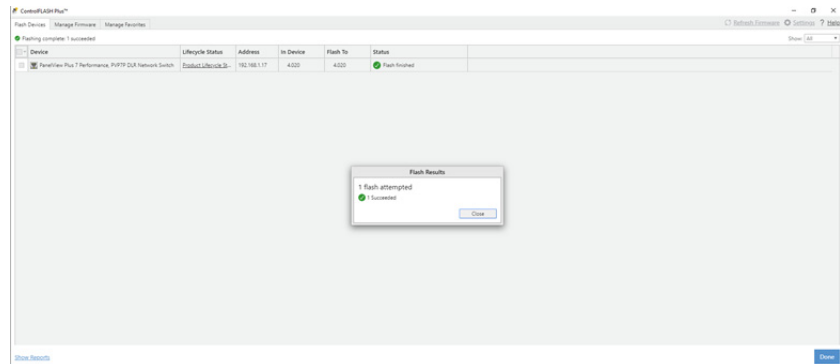

7. Click Close.

Troubleshooting

Topic	Page
View System Information	217
Status Indicators	218
View Network Status Information	219
Terminal Does Not Start Up	220
Terminal Restarts Intermittently	220
Touch Screen Issues	221
Display Issues	221
Ethernet Issues	222
Performance Is Slow	222
Resistance to Chemicals	222
Clean the Terminal Display	223
Ship the Terminal	224
Maintenance Mode Operations — Series A Terminals	224
Maintenance Mode Operations — Series B Terminals	225

View System Information

IMPORTANT This document describes troubleshooting procedures for the PanelView® Plus 7 Performance terminal only.

If your terminal is part of the ArmorView Plus 7 product, see the ArmorView Plus 7 Installation Instructions, publication [2711P-IN013](#), for instructions on how to gain physical access to the PanelView Plus 7 Performance terminal. After you gain access, follow the instructions in this chapter for troubleshooting the PanelView Plus 7 Performance terminal.

View system information for the terminal from FactoryTalk® View ME Station runtime or from the Hardware Monitor (Series A only) in the control panel.

To view system information for the installed components, follow these steps.

1. Access FactoryTalk View ME Station runtime.
2. Tap Terminal Settings, then choose System Information>About FactoryTalk View ME Station.

Status Indicators

The back of the terminal has two indicators to identify system status:

- STS indicator (green) indicates that the terminal is on and running
- ERR indicator (red) indicates hardware and firmware faults

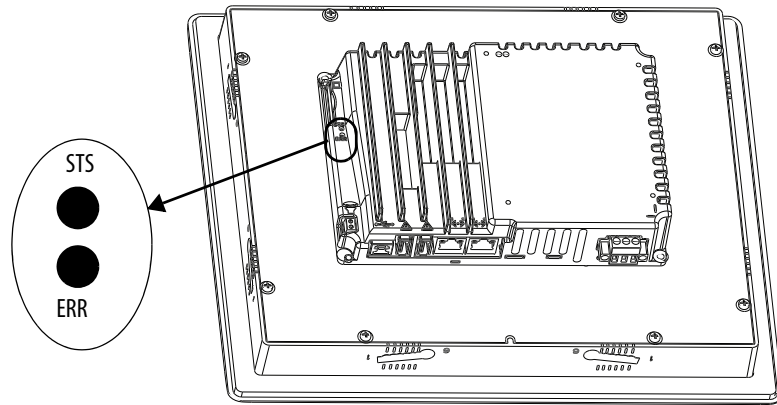

The aluminum terminal is shown. The status indicators are the same on the stainless steel terminal.

At startup, the STS and ERR indicators flash on and off, then the STS indicator flashes to signal progress during startup. If the indicators remain off, check the power cable.

After a successful startup, the STS indicator remains on. Under normal operation, for Series A terminals, the STS indicator will stay on. For Series B terminals (Series C for Stainless Steel terminals), the STS indicator will blink.

[Table 49](#) shows indicator states if the terminal stops during startup.

Table 49 - Fault Indicator States During Terminal Startup

ERR (red)	STS (green)	Description	Recommended Action
Blinking	Off	Recoverable firmware error.	Reload the firmware.
		Recoverable configuration failure.	Restore the terminal to its factory default image. See Restore a Back-up Image on page 128 .
On	On	Fatal hardware error.	Replace the terminal.
	Blinking	Fatal display hardware error.	Replace the terminal.

View Network Status Information

Note: The system tray and Network Status Information dialog box described in the following procedure are available only to PanelView Plus 7 Performance Series A terminals.

Series A Terminals Only

To access network status information from the system tray, follow these steps.



1. Double-click the network icon in the system tray.



2. To view the network status, click the Network Status Information tab.

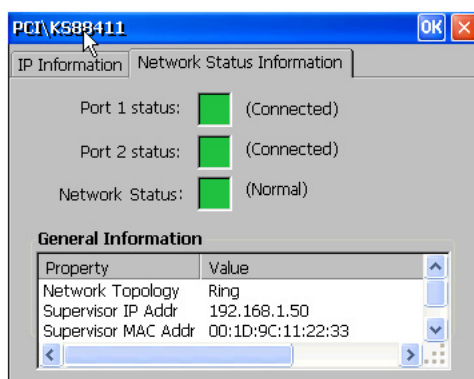

Status Indicator	Description
Port 1 status and Port 2 status	
Gray	Disabled or unknown.
Green	Enabled and operating normally.
Yellow	A non-fatal error condition exists.
Red	An error condition exists that requires some manual intervention.
Network Status	
Normal (green color)	If network topology is Linear/Star, the network status is always normal.
Ring Fault (yellow color)	A non-fatal error condition exists.
Loop Detected (red color)	This value can only occur in a Linear/Star topology. It occurs when an unexpected loop occurs in the network. It may not be possible for the terminal to report this condition (the terminal may not be capable of detecting frames that it has sent).
Partial Fault (yellow color)	A non-fatal error condition exists.
Rapid Fault (red color)	An error condition exists that requires some manual intervention.
General Information	
Network Topology	Linear/Star Ring

Status Indicator	Description
Supervisor IP Addr	xxx.xxx.xxx.xxx format (not applicable if in Linear/Star topology)
Supervisor MAC Addr	xx:xx:xx:xx:xx:xx format (not applicable if in Linear/Star topology)
Supervisor VLAN ID	8 bit numeric (not applicable if in Linear/Star topology)

Series A and Series B Terminals (Series C for Stainless Steel terminals)

To access network status information from ME Station, see [View the Network Diagnostic Data on page 91](#).

Terminal Does Not Start Up

If the terminal does not start up normally, check the table for possible causes.

Table 50 - Terminal Does Not Start Up Properly

Check For	What to Do	See This Page
Insufficient power	Make sure that device is receiving adequate power. <ul style="list-style-type: none"> Check the DC power requirements. Check the AC power requirements 	page 43 page 44
Improper power wiring	Verify that the power wiring is correct. <ul style="list-style-type: none"> Check the wiring specifications. Check the DC power wiring. Check the AC power wiring. 	page 42 page 43 page 44
Status indicators	Check the status indicators during startup.	page 218
Stalled progress indicator	If a terminal stalls at the progress indicator and does not load an application or configuration screens, reload the firmware or restore factory defaults.	page 128
Object touching the display	Verify that nothing is pressing against the display or that you are not touching the display during startup.	Not applicable

Terminal Restarts Intermittently

If the terminal restarts intermittently, check the table for possible causes.

Table 51 - Terminal Restarts Intermittently

Check For	What to Do	See This Page
Improper power wiring	Verify that the power wiring is correct. <ul style="list-style-type: none"> Check the wiring specifications. Check the DC power wiring. Check the AC power wiring. 	page 42 page 43 page 44
Over-temperature conditions	Make sure that the processor is not exceeding temperatures for normal terminal operations. <ul style="list-style-type: none"> Check the processor temperature. Check the System Event log for over-temperature conditions. Check for adequate clearances around the terminal in the panel. Check for proper operating temperature. 	page 108 or page 133 page 107 or page 132 page 30 page 133

Touch Screen Issues

If the touch screen is not responding correctly to touches with a finger or stylus, check the table.

Table 52 - Touch Screen Not Responding

Check For	What to Do	See This Page
Improper calibration	Check for activation points that are offset from touch points. Calibrate the touch screen.	page 98 or page 156
Non-functioning touch screen	Check the touch screen for damage, such as cuts or excessive wear. If there is damage, replace the terminal.	Not applicable
Touching multiple input elements	Application screens contain graphic input elements that are configured in the Machine Edition application. When touched, these elements perform operations in a predictable manner. For example, an input element is configured to navigate to a specific screen in the application or start a motor when touched. Multiple operations cannot be conducted simultaneously. Doing so results in an unintended operation. <ul style="list-style-type: none"> Do not touch multiple input elements simultaneously. Do not rest a hand or multiple fingers on the display. 	Not applicable

Display Issues

The display is unreadable or dims unexpectedly.



ATTENTION: If the display darkens, or if the backlight is not functioning properly, the screen can be difficult to read and use of this touch screen could result in a potentially hazardous outcome. **Do not use the touch screen under these circumstances.** The design of the system must take into account the possibility of the touch screen losing functionality and unable to be used to maintain or change control of the system. The touch screen shall not be the single point of control of critical functions and is not intended to replace an E-stop.

Design of the system should follow all applicable code and good engineering practice. Factors to consider include:

- The possibility of an unreadable touch screen
- The possibility of an inoperable touch screen
- Unexpected communication errors or delays
- Operator error in the control of the system
- Proper use of E-stops and other safety practices

The user shall provide means to achieve a safe state during anomalies and make sure the system has adequate redundancy for critical functions.

Failure to follow these instructions can result in death, serious injury, or equipment damage.

Table 53 - Dim Display

Check For	See These Pages
Low display brightness setting	page 95 or page 130
Low brightness level of screen saver	page 95 or page 130
Temperatures outside the operating range	page 108 or page 133

TIP Extend the life of the backlight by reducing the display brightness, by using the screen saver with reduced brightness, or operating at lower temperatures.

Ethernet Issues

[Table 54](#) provides tips for isolating Ethernet anomalies.

Table 54 - Ethernet Connection Issues

Check for These Issues	What to Do
Status of invalid Ethernet connection	<ul style="list-style-type: none"> Green indicator is on when a link is established. Yellow indicator blinks when activity is detected. Verify network connections.
Poor cable connections	Check the Ethernet cabling for the following: <ul style="list-style-type: none"> Make sure that cables are fully connected. Check for cable crimping. Check the Ethernet switch connections. Check the Uplink ports.
Invalid IP address of terminal	Go to Set the Ethernet Address of the Terminal on page 88 . If DHCP is enabled, the terminal automatically acquires a valid IP address from the network after startup. The TCP/IP protocol automatically assigns 169.254.xxx.xxx when it fails to acquire an IP address from the network. In general, an IP address that begins with 169 does not support a network connection.
Conflicting IP addresses	If DHCP is not enabled and a static IP address is specified, make sure that the IP address does not conflict with the address of another device on the network.

Performance Is Slow

If the response time of the application is slow, for example screen changes or text display changes, check for the following issues:

- Application screens contain too many elements.
- If the controller is programmed for feedback, it can cause delays.
- Slow network performance or noise can result in retries.

Resistance to Chemicals

The outer surfaces of the terminal including the bezel, touch screen overlay, and panel gasket seal are tested for chemical resistance. Some of the chemicals can cause discoloration, but they do not interfere with the operation of the terminal.

TIP For more information on chemical resistance of the product, go to <https://rockwellautomation.custhelp.com> and search the Knowledgebase for keywords 'Chemical Resistance PanelView Plus'.

IMPORTANT Do not operate the terminal in direct sunlight. Direct exposure to ultraviolet light can discolor the touch screen.

Clean the Terminal Display

A protective overlay can help extend the life of the terminal and make it easier to clean the display. [Table 6 on page 23](#) provides catalog numbers for overlays.



ATTENTION: Do not use abrasive cleaners or solvents, they can damage the display. Do not scrub or use brushes.

Do not apply cleaning solution directly on the terminal screen. The solution can drip or seep onto the gasket. Apply cleaning solution to a clean sponge or soft cloth, and gently wipe the screen to remove the dirt and grime.

To clean the display, follow these steps.

1. Remove power from the terminal.
2. To clean the display and to help prevent scratches, use a clean sponge or soft cloth with mild soap or detergent.
3. To avoid water spots, dry the display with a chamois or moist cellulose sponge.

Remove Paint and Grease

To remove paint or grease from the bezel that is properly mounted in a NEMA, UL Type, or IP rated enclosure, follow these steps.

1. Rub lightly with isopropyl alcohol (70% concentration).
2. Use a mild soap or detergent solution to remove residue.
3. Rinse with clean water.

Equipment Wash Downs



ATTENTION: Do not use a high-pressure washer for cleaning the front bezel of the terminal. A high-pressure washer can damage the terminal.

Do not use a high-pressure washer for cleaning vented enclosures. Water can enter the enclosure and damage the terminal and other equipment.

Remove power from the terminal before performing any wash downs. It is possible for screen objects to activate during equipment wash downs if the terminal is powered on.

See [Resistance to Chemicals on page 222](#) for information about exposure to chemicals.

Ship the Terminal

If you ship the enclosure with the terminal installed, make sure that the terminal is properly secured and protected against damage from impact, sharp objects, or abrasive materials.



ATTENTION: Rockwell Automation is not responsible for damage to a product that is shipped or transported while installed in a panel or enclosure.

Maintenance Mode Operations — Series A Terminals

To start the system in Maintenance Mode for diagnostics and repairs, press and hold the white box that shows in the lower left corner of the display during startup.

TIP You can also access the Maintenance Mode menu if you attach a USB keyboard and hold down the F1 key.

If an ME application is set to run at terminal startup, press and hold the white box during startup to put the terminal into Safe Mode.

Table 55 - Maintenance Mode Operations

Operation	Description
None	Exits Maintenance mode and continues with a normal restart.
Safe mode	Starts the system in Safe Operating mode. This mode is a diagnostic mode with reduced functionality that lets you recovery from a software anomaly. In Safe mode, you can repair applications or changes that caused the anomaly. Important: FactoryTalk View ME Station software does not run the HMI .mer application on startup if one is loaded, but instead enters Configuration mode. The HMI application runs the next time that the system is reset.
Clear all data	Restores all user-accessible storage and configuration data on the terminal to its default state. The current firmware revision is retained. Important: All storage media is returned to its original state when purchased except for the firmware. The latest FactoryTalk View ME image is retained. All user data changes or additions are lost.
Factory default	Restores all storage media on the terminal to its initial factory default state, including firmware, registry, file system, and configuration data. Typically, this option is used to recover from a failed firmware update. Important: All storage media is returned to its original state when purchased. All user-installed, firmware updates are removed. See Restore a Back-up Image on page 128 for details on how to perform a restore.

Perform maintenance operation in this order to diagnose and repair problems:

- **Safe mode** – stops an application from starting automatically.
- **Clear all data** – removes user-installed applications, user-configuration changes, and user accessible data.
- **Factory default** – returns the terminal to its out-of-box state.

Maintenance Mode Operations — Series B Terminals⁽¹⁾

To enter maintenance mode on your Series B terminal (Series C for Stainless Steel terminals), press the Maintenance button that is located on the back of your terminal any time while the terminal is powered up (see [Hardware Features on page 14](#)). This button is only available on Series B terminals (Series C for Stainless Steel terminals). It brings up the Maintenance Menu, which you use to restore factory defaults, backup and restore terminal settings, change the display orientation, and calibrate the touchscreen, etc.

Alternatively, the Maintenance Menu can be accessed in the Windows Control Panel, under Settings / System / Go To Maintenance Menu.



Maintenance Menu

Menu Item	Description
Exit Maintenance Menu	Exits Maintenance mode and continues with a normal restart.
Restore Terminal	Restores a snapshot of a terminal's state from a USB storage device. The USB storage device must contain a file named PVP7P_Snapshot.wim on the root directory. This operation overwrites existing settings in the OS, FactoryTalk View ME Station, and user accounts.
Export Audit Logs	Exports logs of terminal information to a USB storage device. Creates a compressed file named PVP7P_AuditLogs.zip on the root of the USB storage device.
Factory Default	Restores the terminal to the original out-of-box condition.
Reinitialize Terminal	Resets all data and settings on the terminal.
Calibrate Touch Screen	Restarts the terminal and boots into the Calibration Menu.
Backup Terminal	Saves a snapshot of the current state of the terminal to a USB storage device. The USB storage device must be formatted to NTFS and have at least 16 GB of free space. The snapshot includes the OS, FactoryTalk View ME Station, all files, user accounts, programs, settings and data. It creates a file named PVP7P_Snapshot.wim on the root directory of the USB storage device. If this file already exists, it is overwritten.
Safe Mode	Reboots the terminal to the FactoryTalk View ME Station Configuration Mode. Rebooting the terminal again takes the terminal out of safe mode, and any ME app that was set to run at startup resumes running at startup.
Change Display Orientation	Changes the display orientation to either landscape (default), portrait, or portrait-flipped. Requires a terminal reboot to take effect.

(1) Series C for Stainless Steel terminals.

Notes:

Fonts Resident on Terminal

True Type Fonts

The table lists TrueType fonts that are pre-installed on the terminals. The default system font is Tahoma.

TIP The Arial Unicode MS font contains almost 50,000 characters and provides default language support for many non-Latin languages and scripts including Arabic, Hebrew, Vietnamese, Thai, Hindi (Devanagari), and other Indic languages. The font also includes Chinese, Japanese, and Korean (CJK) support.

On Series A terminals, you can load additional fonts on the system by copying the font files to the \Windows\Fonts folder on the terminal desktop. To access this folder, open the My Device icon on the terminal desktop or choose Start>Programs>Windows Explorer.

IMPORTANT OpenType fonts (.otf) can contain many extra symbols and characters and can have large files sizes. If you install OpenType fonts, it can result in a reduction in available memory for applications. We recommend that you install only TrueType fonts. If you need an OpenType font, install only the font family that you want to use.

Table 56 - TrueType Fonts (.ttf and .ttc)

Font Type	Font Name	File Name
Latin Fonts	Arial Unicode MS version 1.01	arialuni.ttf
	Arial	
	Arial (Subset 1_30)	arial_1_30.ttf
	Arial Black	arialk.ttf
	Arial Bold	arialbd.ttf
	Arial Bold Italic	arialbi.ttf
	Arial Italic	ariali.ttf
	Comic Sans MS	
	Comic Sans MS	comic.ttf
	Comic Sans MS Bold	comicbd.ttf
	Courier New	
	Courier New (Subset 1_30)	cour_1_30.ttf
	Courier New Bold	courbd.ttf
	Courier New Bold Italic	courbi.ttf
	Courier New Italic	couri.ttf

Table 56 - TrueType Fonts (.ttf and .ttc) (Continued)

Font Type	Font Name	File Name
Latin Fonts	Georgia	
	Georgia	georgia.ttf
	Georgia Bold	georgiab.ttf
	Georgia Bold Italic	georgiaz.ttf
	Georgia Italic	georgiai.ttf
	Impact	impact.ttf
	Kino	kino.ttf
	Microsoft Logo	mslogo.ttf
	Symbol	symbol.ttf
	Tahoma	
	Tahoma (Subset 1_07)	tahoma_1_07.ttf
	Tahoma Bold	tahomabd.ttf
	Times New Roman	
	Times New Roman (Subset 1_30)	times_1_30.ttf
	Times New Roman Bold	timesbd.ttf
	Times New Roman Bold Italic	timesbi.ttf
	Times New Roman Italic	timesi.ttf
	Trebuchet MS	
	Trebuchet MS	trebuc.ttf
	Trebuchet MS Bold	trebucbd.ttf
	Trebuchet MS Bold Italic	trebucbi.ttf
	Trebuchet MS Italic	trebucit.ttf
	Verdana	
	Verdana	verdana.ttf
	Verdana Bold	verdanab.ttf
	Verdana Bold Italic	verdanaz.ttf
Verdana Italic	verdanai.ttf	
Symbols	Webdings	webdings.ttf
	Wingding	wingding.ttf

Table 56 - TrueType Fonts (.ttf and .ttc) (Continued)

Font Type	Font Name	File Name
PanelView™ Fonts	PV 12 x 24, PV 12 x 8	PV12x24.ttf, PV12x8.ttf
	PV 16 x 24	PV16x24.ttf
	PV 18 x 16, PV 18 x 8	PV18x16.ttf, PV18x8.ttf
	PV 24 x 32	PV24x32.ttf
	PV 32 x 40, PV 32 x 64	PV32x40.ttf, PV32x64.ttf
	PV 4 x 6	PV4x6.ttf
	PV 6 x 16, PV 6 x 24, PV 6 x 8, PV 6 x 9	PV6x16.ttf, PV6x24.ttf, PV6x8.ttf, PV6x9.ttf
	PV 8 x 16, PV 8 x 20, PV 8 x 24	PV8x16.ttf, PV8x20.ttf, PV8x24.ttf
	PV Double High	PVdouble_high.ttf
	PV Double Wide	PVdouble_wide.ttf
	PV Extra Large	PVextra_large.ttf
	PV Large	PVlarge.ttf
	PV Small	PVsmall.ttf
	PV Tiny	PVtiny.ttf
PV Very Tiny	PVvery_tiny.ttf	
East Asian Fonts	Gulim version 2.21 - Korean	gulim.ttc
	MS Gothic version 2.30 - Japanese	gulim.ttc

Notes:

Languages Supported

Available Languages

On Series B terminals (Series C for Stainless Steel terminals), the Maintenance Menu and Windows 10 Control Panel are only available in English. The Windows 10 Control Panel will be updated in the future to support additional languages.

The following languages are supported in Machine Edition (ME) Station:

Table 57 - Available Languages

Language	Series A	Series B ⁽¹⁾
Afrikaans (South Africa)	√	√
Albanian (Albania)	√	√
Arabic (Algeria)	√	√
Arabic (Bahrain)	√	√
Arabic (Egypt)	√	√
Arabic (Iraq)	√	√
Arabic (Jordan)	√	√
Arabic (Kuwait)	√	√
Arabic (Lebanon)	√	√
Arabic (Libya)	√	√
Arabic (Morocco)	√	√
Arabic (Oman)	√	√
Arabic (Qatar)	√	√
Arabic (Saudi Arabia)	√	√
Arabic (Syria)	√	√
Arabic (Tunisia)	√	√
Arabic (U.A.E.)	√	√
Arabic (Yemen)	√	√
Armenian (Armenia)	√	√
Azeri (Cyrillic) (Azerbaijan)	√	√
Azeri (Latin) (Azerbaijan)	√	√
Basque (Spain)	√	√
Belorussian (Belarus)	√	√
Bulgarian (Bulgaria)	√	√
Catalan (Spain)	√	√
Chinese (Hong Kong S.A.R.)	√	√
Chinese (Macau S.A.R.)	√	√
Chinese (People's Republic of China)	√	√

Table 57 - Available Languages (Continued)

Language	Series A	Series B⁽¹⁾
Chinese (Singapore)	√	√
Chinese (Taiwan)	√	√
Croatian (Croatia)	√	√
Czech (Czech Republic)	√	√
Danish (Denmark)	√	√
Dutch (Belgium)	√	√
Dutch (Netherlands)	√	√
English (Australia)	√	√
English (Belize)	√	√
English (Canada)	√	√
English (Caribbean)	√	√
English (Ireland)	√	√
English (Jamaica)	√	√
English (New Zealand)	√	√
English (Republic of the Philippines)	√	√
English (South Africa)	√	√
English (Trinidad and Tobago)	√	√
English (United Kingdom)	√	√
English (United States)	√	√
English (Zimbabwe)	√	√
Estonian (Estonia)	√	√
Faroese (Faroe Islands)	√	√
Farsi (Iran) (also known as Persian)	√	
Finnish (Finland)	√	√
French (Belgium)	√	√
French (Canada)	√	√
French (France)	√	√
French (Luxembourg)	√	√
French (Principality of Monaco)	√	√
French (Switzerland)	√	√
FYRO Macedonian (Former Yugoslav Republic of Macedonia)	√	√
Georgian (Georgia)	√	√
German (Austria)	√	√
German (Germany)	√	√
German (Liechtenstein)	√	√
German (Luxembourg)	√	√
German (Switzerland)	√	√
Greek (Greece)	√	√
Gujarati (India)	√	√

Table 57 - Available Languages (Continued)

Language	Series A	Series B ⁽¹⁾
Hebrew (Israel)	√	√
Hindi (India)	√	√
Hungarian (Hungary)	√	√
Icelandic (Iceland)	√	√
Indonesian (Indonesia)	√	√
Italian (Italy)	√	√
Italian (Switzerland)	√	√
Japanese (Japan)	√	√
Kannada (India)	√	√
Kazakh (Kazakhstan)	√	√
Konkani (India)	√	√
Korean (Korea)	√	√
Kyrgyz (Kyrgyzstan)	√	√
Latvian (Latvia)	√	√
Lithuanian (Lithuania)	√	√
Malay (Brunei Darussalam)	√	√
Malay (Malaysia)	√	√
Marathi (India)	√	√
Mongolian (Mongolia)	√	√
Norwegian (Bokmål) (Norway)	√	√
Norwegian (Nynorsk) (Norway)	√	√
Polish (Poland)	√	√
Portuguese (Brazil)	√	√
Portuguese (Portugal)	√	√
Punjabi (India)	√	√
Romanian (Romania)	√	√
Russian (Russia)	√	√
Sanskrit (India)	√	√
Serbian (Cyrillic) (Serbia and Montenegro)	√	√
Serbian (Latin) (Serbia and Montenegro)	√	√
Slovak (Slovakia)	√	√
Slovenian (Slovenia)	√	√
Spanish (Argentina)	√	√
Spanish (Bolivia)	√	√
Spanish (Chile)	√	√
Spanish (Colombia)	√	√
Spanish (Costa Rica)	√	√
Spanish (Dominican Republic)	√	√
Spanish (Ecuador)	√	√

Table 57 - Available Languages (Continued)

Language	Series A	Series B ⁽¹⁾
Spanish (El Salvador)	√	√
Spanish (Guatemala)	√	√
Spanish (Honduras)	√	√
Spanish (Mexico)	√	√
Spanish (Nicaragua)	√	√
Spanish (Panama)	√	√
Spanish (Paraguay)	√	√
Spanish (Peru)	√	√
Spanish (Puerto Rico)	√	√
Spanish (Spain)	√	√
Spanish (Uruguay)	√	√
Spanish (Venezuela)	√	√
Swahili (Kenya) (also known as Kiswahili)	√	√
Swedish (Finland)	√	√
Swedish (Sweden)	√	√
Tamil (India)	√	√
Tatar (Russia)	√	√
Telugu (India)	√	√
Thai (Thailand)	√	√
Turkish (Turkey)	√	√
Ukrainian (Ukraine)	√	√
Urdu (Islamic Republic of Pakistan)	√	√
Uzbek (Cyrillic) (Uzbekistan)	√	√
Uzbek (Latin) (Uzbekistan)	√	√
Vietnamese (Viet Nam)	√	√

(1) Series C for Stainless Steel terminals.

Symbols

.mer application 73, 74, 78, 86

A

access configuration mode

- from an HMI application 74
- from the Windows desktop 74
- Goto Configuration Mode button 74

accessories 23

ActiveX controls 18, 123

alarms 107

application

- backup 126
- checking integrity 106
- restore 126

atmospheric gases ignition temperature 27

authenticating client connections 136

B

back-up image 128

back-up power 185

battery

- back-up power 185
- conditions 133
- lithium 185
- replacement 186
- view voltage 133
- voltage 108
- warnings 153

boot options 154

branch circuit 26

button styles 154

C

cable

- capacitance 28
- inductance 28
- length between the Ethernet ports 46

calibration

- touch screen 98, 156

catalog numbers

- accessories 23
- battery replacement 24
- mounting hardware 23
- PanelView Plus 7 performance terminals 22
- power supplies 23
- power terminal blocks 23
- protective overlays 23
- SD cards 24

circuit breaker rating 26

clear all data 224

closed system 19, 154

command prompt

- Foxitreader 158
- parameters 158
- syntax 158

configuration mode 19

control panel

- touch screen calibration 156

cutout dimensions 30

D

date

- settings
 - date 112

DC power bus 43

desktop

- rotate 131

desktop access

- disable 81
- enable 79
- factory default state 19
- open versus closed 19
- reset password 83
- restrict 80, 82
- set password 82

device name

- terminal 92

DHCP 88

diagnostics

- advanced 155
- configure 105

display settings

- control panel 129

E

earth ground

- AC 45
- DC 44

electrostatic discharge 177

environment and enclosure notice 26

error indicator 218

ESD

- preventing 177

Ethernet

- connector pinout 47
- driver 87
- duplex setting 89
- link speed 87
- status indicators 47

Ethernet cables 24

event log

- errors 132
- events 132
- warnings 132

explosion hazard 42, 183, 186

F

FactoryTalk View ME

- check file integrity 106
- diagnostics 106

fault indicators

- firmware 218
- hardware 218

file server

- configuration 151

firmware upgrades

- fail 202
- firmware upgrade wizard 195
- over network 199
- using storage device 195

fonts 227**Foxitreader** 158**FTP security options** 149**FTP server**

- configuration 148
- parameters 148
- security 148

FUP 194**fuse rating** 26**FUW** 194**G****galvanic isolation** 178**H****hardware specifications**

- audio out 15
- Ethernet ports 14
- mounting slot 14
- SD card slot 15
- status indicators 15
- USB device port 15
- USB host ports 15

I**indicator**

- ERR 218
- STS 218

input panels 124**IP address**

- assign 88

K**KEPServer drivers** 152, 197, 201**L****ladder logic** 9**language** 113

- setting 113

lithium batteries

- handling 153

logs

- application files 106
- runtime files 106

M**maintenance mode** 224**ME** 9**mount the terminal**

- ambient temperature 27
- in a panel 30
- location considerations 27
- minimum clearances 30
- preparation 31

N**network**

- file servers 151
- FTP servers 148
- topologies 20
- VNC servers 138

network topology

- device-level ring 48
- linear 49
- star 50

O**open system** 19**open versus closed system** 19**P****PDF reader** 157**power**

- AC
 - connection 44
 - ratings 14, 44
 - terminal block 42

- DC
 - connection 43
 - ratings 14, 43
 - terminal block 42

- PELV 43

- SELV 43

- supplies 23

print setup 102**printers** 179**product compatibility and download center**

- 10

protective overlay

- catalog numbers 23
- cleaning 189
- installing 188
- removing 189

publications

- download 11

R**release notes** 10**RJ45 connector** 46**S****safe mode** 154, 224

safety notices

- earth ground 43, 44
- electrical arc 42, 46
- electrical shock 42, 44, 177
- emergency stops 25
- explosion hazard 27, 42, 46
- wiring and safety guidelines 26

screen

- rotate 131

screen saver 95**SD card**

- installing 183

server

- addresses 90
- enable/disable 137
- file 151
- ftp 148

settings

- appearance 130
- background image 129
- backlight intensity 130
- cursor 131
- language 113
- screen saver 130
- time 112
- time zone 111

shell options 153**soft keyboard controls** 77**software versions**

- FactoryTalk View Machine Edition (ME)
 - Station 17
- FactoryTalk View Studio for Machine Edition
 - 17
- FactoryTalk ViewPoint 17

startup

- configure 19
- options 20
- sequence 50

startup options 20**static-safe workstation** 177**status indicators** 218**system**

- information 217
- status 218

system event log 107**T****technical support** 110**temperature**

- code T4 27
- over-temperature messages 108
- view 108
- view current temperature 133

time 112**time zone** 111**touch screen**

- calibrate 156
- calibration 98
- gestures
 - double-tap 17
 - drag 17

- long press 17

- tap 17

- set sensitivity 99, 156

touch screen calibration 156**troubleshooting** 217**U****USB**

- cables 179
- host ports 28, 178
- hubs 179
- printer 179

USB ports

- installation 28

USB to serial port adapters 24**user accounts** 136**V****virtual keyboard** 16**VNC**

- configure 138
- connection password 139
- connection passwords 139
- control passwords 141
- server parameters 138
- view-only password 141

W**watchdog errors** 155**Web server parameters** 147**wiring and safety guidelines** 26

Notes:

Rockwell Automation Support

Use these resources to access support information.

Technical Support Center	Find help with how-to videos, FAQs, chat, user forums, and product notification updates.	rok.auto/support
Knowledgebase	Access Knowledgebase articles.	rok.auto/knowledgebase
Local Technical Support Phone Numbers	Locate the telephone number for your country.	rok.auto/phonesupport
Literature Library	Find installation instructions, manuals, brochures, and technical data publications.	rok.auto/literature
Product Compatibility and Download Center (PCDC)	Download firmware, associated files (such as AOP, EDS, and DTM), and access product release notes.	rok.auto/pcdc

Documentation Feedback

Your comments help us serve your documentation needs better. If you have any suggestions on how to improve our content, complete the form at rok.auto/docfeedback.

Waste Electrical and Electronic Equipment (WEEE)



At the end of life, this equipment should be collected separately from any unsorted municipal waste.

Rockwell Automation maintains current product environmental compliance information on its website at rok.auto/pec.

Allen-Bradley, ArmorBlock, ArmorView, CompactLogix, ControlLogix, expanding human possibility, FactoryTALK, FLEX, Kinetix, PanelView, POINT/POINT/P, PowerFlex, Rockwell Automation, RSLinx, Stratix, and Studio 5000 Logix Designer are trademarks of Rockwell Automation, Inc.





CIP Sync EtherNet/IP are trademarks of ODVA, Inc.

Microsoft and Windows are trademarks of Microsoft Corporation.

SD and SDHC are trademarks of SD-3C LLC.

Trademarks not belonging to Rockwell Automation are property of their respective companies.

Rockwell Otomasyon Ticaret A.Ş. Kar Plaza İş Merkezi E Blok Kat:6 34752, İçerenköy, İstanbul, Tel: +90 (216) 5698400 EEE Yönetmeliğine Uygundur

Connect with us.    

rockwellautomation.com ————— expanding **human possibility**[®]

AMERICAS: Rockwell Automation, 1201 South Second Street, Milwaukee, WI 53204-2496 USA, Tel: (1) 414.382.2000, Fax: (1) 414.382.4444

EUROPE/MIDDLE EAST/AFRICA: Rockwell Automation NV, Pegasus Park, De Kleetlaan 12a, 1831 Diegem, Belgium, Tel: (32) 2 663 0600, Fax: (32) 2 663 0640

ASIA PACIFIC: Rockwell Automation, Level 14, Core F, Cyberport 3, 100 Cyberport Road, Hong Kong, Tel: (852) 2887 4788, Fax: (852) 2508 1846