

RELION® REB500

Distributed busbar protection REB500

Version 8.3 IEC

Operation manual





Document ID: 1MRK 500 132-UEN
Issued: May 2019
Revision: B
Product version: 8.3

© Copyright 2019 ABB. All rights reserved

Copyright

This document and parts thereof must not be reproduced or copied without written permission from ABB, and the contents thereof must not be imparted to a third party, nor used for any unauthorized purpose.

The software and hardware described in this document is furnished under a license and may be used or disclosed only in accordance with the terms of such license.

This product includes software developed by the OpenSSL Project for use in the OpenSSL Toolkit. (<http://www.openssl.org/>) This product includes cryptographic software written/developed by: Eric Young (eay@cryptsoft.com) and Tim Hudson(tjh@cryptsoft.com).

Trademarks

ABB and Relion are registered trademarks of the ABB Group. All other brand or product names mentioned in this document may be trademarks or registered trademarks of their respective holders.

Warranty

Please inquire about the terms of warranty from your nearest ABB representative.

Disclaimer

The data, examples and diagrams in this manual are included solely for the concept or product description and are not to be deemed as a statement of guaranteed properties. All persons responsible for applying the equipment addressed in this manual must satisfy themselves that each intended application is suitable and acceptable, including that any applicable safety or other operational requirements are complied with. In particular, any risks in applications where a system failure and /or product failure would create a risk for harm to property or persons (including but not limited to personal injuries or death) shall be the sole responsibility of the person or entity applying the equipment, and those so responsible are hereby requested to ensure that all measures are taken to exclude or mitigate such risks.

This document has been carefully checked by ABB but deviations cannot be completely ruled out. In case any errors are detected, the reader is kindly requested to notify the manufacturer. Other than under explicit contractual commitments, in no event shall ABB be responsible or liable for any loss or damage resulting from the use of this manual or the application of the equipment.

Conformity

This product complies with the directive of the Council of the European Communities on the approximation of the laws of the Member States relating to electromagnetic compatibility (EMC Directive 2004/108/EC) and concerning electrical equipment for use within specified voltage limits (Low-voltage directive 2006/95/EC). This conformity is the result of tests conducted by ABB in accordance with the product standards EN 50263 and EN 60255-26 for the EMC directive, and with the product standards EN 60255-1 and EN 60255-27 for the low voltage directive. The product is designed in accordance with the international standards of the IEC 60255 series.

Table of contents

Section 1	Introduction.....	5
1.1	This manual.....	5
1.2	Intended audience.....	5
1.3	Product documentation.....	5
1.4	Symbols and conventions.....	5
1.4.1	Symbols.....	5
1.4.2	Document conventions.....	6
Section 2	Safety information.....	7
Section 3	System overview.....	9
Section 4	HMI500.....	11
4.1	Introduction.....	11
4.2	Safety instructions.....	11
4.3	Basic setup.....	11
4.3.1	Installation.....	11
4.3.2	Uninstallation.....	12
4.3.3	Starting HMI500.....	12
4.3.4	Window structure.....	13
4.3.5	Main window.....	14
4.4	File menu.....	15
4.4.1	Download to protection system.....	16
4.4.2	Compare.....	17
4.5	View menu.....	18
4.5.1	Single-line diagram.....	18
4.5.2	Protection zone measurements.....	20
4.5.2.1	Overview.....	20
4.5.2.2	Detailed view.....	21
4.5.3	Analogue input measurements.....	22
4.5.4	Binary input/output status.....	22
4.5.5	Switchgear objects.....	23
4.5.6	Protection zone circuit-breakers.....	24
4.5.7	Disturbance recorder	25
4.5.7.1	Overview.....	25
4.5.7.2	Upload disturbance recorder records.....	26
4.5.7.3	Detailed view (Open window).....	27
4.5.7.4	Disturbance recorder file (Detailed view/ Upload).....	27
4.5.8	Event list.....	28
4.5.8.1	Classification of events.....	28
4.5.8.2	Load events.....	29
4.5.8.3	Deleting events.....	29

- 4.5.8.4 Deleting the PC list..... 29
- 4.5.8.5 Deleting the system list..... 29
- 4.5.8.6 Deleting events that have been viewed..... 30
- 4.5.8.7 System events when starting..... 30
- 4.5.9 Security event list..... 30
- 4.5.10 Reset latching relays..... 30
- 4.6 Configuration menu..... 30
 - 4.6.1 Communication..... 31
 - 4.6.1.1 SCS Configuration..... 31
 - 4.6.1.2 SCS Diff Current Parameters..... 32
 - 4.6.1.3 Ethernet communication settings..... 32
 - 4.6.2 Device structure..... 32
 - 4.6.3 Binary inputs/outputs..... 33
 - 4.6.3.1 Overview..... 33
 - 4.6.3.2 Inputs..... 34
 - 4.6.3.3 Inputs Overview tab 34
 - 4.6.3.4 Inputs Details tab..... 36
 - 4.6.3.5 Outputs..... 37
 - 4.6.3.6 Outputs Overview tab..... 38
 - 4.6.3.7 Outputs Details tab..... 39
 - 4.6.4 GOOSE input support..... 41
 - 4.6.4.1 Interface to System engineering tool 42
 - 4.6.4.2 Enabling GOOSE Client..... 44
 - 4.6.4.3 Export IID/CID file..... 45
 - 4.6.4.4 Import GOOSE attributes..... 46
 - 4.6.4.5 GOOSE input mapping..... 47
 - 4.6.4.6 Requirements to GOOSE input signals..... 48
 - 4.6.4.7 Disabling GOOSE client..... 48
 - 4.6.5 GOOSE send support..... 48
 - 4.6.5.1 Configure GOOSE control blocks..... 50
 - 4.6.5.2 Defining signals for GOOSE send 52
 - 4.6.6 Event text configuration..... 53
 - 4.6.7 LMI LEDs..... 54
 - 4.6.7.1 New signal..... 54
 - 4.6.7.2 Delete signal..... 55
 - 4.6.7.3 Caption..... 55
 - 4.6.7.4 Mode..... 55
 - 4.6.8 Disturbance recorder..... 56
 - 4.6.8.1 Analogue inputs..... 56
 - 4.6.8.2 Recording..... 57
 - 4.6.8.3 Signals..... 57
- 4.7 Settings menu..... 61
- 4.8 Testing menu..... 62
 - 4.8.1 Test mode..... 62
 - 4.8.1.1 Using the test generator..... 63
 - 4.8.1.2 Shutting down the test generator..... 64

4.8.2	Installation mode.....	64
4.9	Tools menu.....	65
4.9.1	Version.....	65
4.9.2	File verification.....	66
4.9.3	Reports.....	67
4.9.4	Export SCS data.....	67
4.9.5	Settings.....	67
4.9.5.1	HMI500 settings.....	67
4.9.5.2	Communication.....	68
4.9.5.3	Parameters for reading and exporting event data.....	68
4.9.5.4	Database locations.....	68
4.9.5.5	DRR viewer support (optional).....	68
4.9.6	Security account management.....	69
4.9.7	Change password.....	69
4.9.8	Security options.....	69
4.9.9	Security log servers.....	69
4.9.10	Close all sessions.....	69
4.9.11	Set system time.....	69
Section 5	Local HMI.....	71
5.1	Introduction.....	71
5.2	Safety instructions.....	71
5.3	Operation.....	71
5.3.1	Introduction.....	71
5.3.2	Viewing data on the local HMI.....	72
5.3.3	Protection indicator LEDs.....	72
5.3.4	LED signals.....	73
5.3.5	LCD backlight.....	73
5.3.6	Buttons.....	73
5.3.7	Menu structure.....	74
5.3.7.1	Menu structure of the central unit.....	74
5.3.7.2	Menu structure of the bay unit.....	75
5.4	Alarms.....	77
5.5	Trips.....	78
5.6	Test Trip.....	79
5.6.1	Configuration.....	80
5.6.2	Usage.....	80
Section 6	Web HMI.....	87
6.1	Introduction.....	87
6.2	Accessing the WebHMI.....	87
Section 7	Troubleshooting.....	89
7.1	Safety Instructions.....	89
7.2	List of faults and corrective actions.....	89
7.2.1	Useful LEDs on the IEDs and switches.....	89
7.2.1.1	Switches.....	89

7.2.1.2	Bay Units/ Central Unit.....	89
7.2.2	Faults during startup.....	90
7.2.3	Alarm and Event list entries.....	91
7.2.4	Optical fiber connections faults.....	91
7.2.5	Electrical connection faults.....	92
7.3	Diagnostic (DIA) system - error handling.....	92

Section 1 Introduction

1.1 This manual

The operation manual contains instructions on how to operate the IED once it has been commissioned. The manual provides instructions for monitoring, controlling and setting the IED. The manual also provides trouble shooting instructions.

1.2 Intended audience

This manual addresses the operator, who operates the IED on a daily basis.

The operator must be trained in and have a basic knowledge of how to operate protection equipment. The manual contains terms and expressions commonly used to describe this kind of equipment.

1.3 Product documentation

For an introduction into REB500, it is recommended to study the *Product guide* and/or the *Application manual*.

REB500 manuals	Document numbers
Product guide	1MRK 505 402-BEN
Application manual	1MRK 505 399-UEN
Technical manual	1MRK 505 400-UEN
Operation manual	1MRK 500 132-UEN
Engineering manual	1MRK 511 452-UEN
Commissioning manual	1MRK 505 401-UEN
Application manual for bay protection functions	1MRK 505 403-UEN
Technical manual for bay protection functions	1MRK 505 406-UEN
Cyber security deployment guideline	1MRK 511 453-UEN
Communication protocol manual IEC61850	1MRK 511 450-UEN
Communication protocol manual IEC60870-5-103	1MRK 511 451-UEN
Getting started guide	1MRK 505 404-UEN

1.4 Symbols and conventions

1.4.1 Symbols



The electrical warning icon indicates the presence of a hazard which could result in electrical shock.



The warning icon indicates the presence of a hazard which could result in personal injury.



The caution icon indicates important information or warning related to the concept discussed in the text. It might indicate the presence of a hazard which could result in corruption of software or damage to equipment or property.



The information icon alerts the reader of important facts and conditions.





The tip icon indicates advice on, for example, how to design your project or how to use a certain function.

Although warning hazards are related to personal injury, it is necessary to understand that under certain operational conditions, operation of damaged equipment may result in degraded process performance leading to personal injury or death. Therefore, comply fully with all warning and caution notices.

1.4.2 Document conventions

A particular convention may not be used in this manual.

- Abbreviations and acronyms in this manual are spelled out in the glossary. The glossary also contains definitions of important terms.
- Push button navigation in the LHMI menu structure is presented by using the push button icons.
For example, to navigate the options, use  and .
- HMI menu paths are presented in bold.
For example, select **Main menu/Settings**.
- Signal names are presented in bold.
The signal **21120_EXT_TEST_TRIP** can be set and reset via the LHMI **Test Trip** menu.
- Parameter names and parameter values are presented in italics.
For example, the default value of the *Operation* setting is *Not inverted*.
- Section references are presented with the respective section numbers.
For example, see [Section 1.4.2](#) for more details about document conventions.

Section 2 Safety information

The busbar protection system REB500 corresponds to the latest practices and guidelines and complies with the recognized safety rules. Nevertheless, care must always be taken to avoid danger.

Only use the busbar protection system when it is in perfect working order and in strict accordance with these operating instructions.

Dangerous situations can arise if the equipment is used improperly, especially if the user changes the configuration.



Live electrical equipment is in the immediate vicinity of the REB500 system. Before working on the system, always ensure that it is impossible to come into contact with, or even close to live parts.



The IEDs of the REB500 system can initiate operation of items of electrical plant (circuit-breakers and isolators). Before working on the equipment, always ensure that unwanted operation is inhibited or has no effect on persons or plant.



Strictly observe all safety precautions (interlocks, locks and blocking devices), especially those issued for the specific station.



Only properly authorized, professionally qualified and correspondingly trained personnel, who have also read and understood the operating instructions, may work on the system.



Dangerous voltages can occur on the connectors, even though the auxiliary voltage has been disconnected.



Non-observance can result in death, personal injury or substantial property damage.



Only a competent electrician is allowed to carry out the electrical installation.



National and local electrical safety regulations must always be followed.



The frame of the IEDs has to be carefully earthed.



Whenever changes are made in the IEDs, measures should be taken to avoid inadvertent tripping.



The IEDs contain components which are sensitive to electrostatic discharge. Unnecessary touching of electronic components must therefore be avoided.



Take care never to open the secondary circuits of CTs conducting current.



There is a danger of contact with live parts when opening REB500 cubicle doors.



Electrostatic discharge can destroy components in the equipment.



Other safety instructions pertaining to particular operations are contained in the respective chapters of the operating instructions.

Section 3 System overview

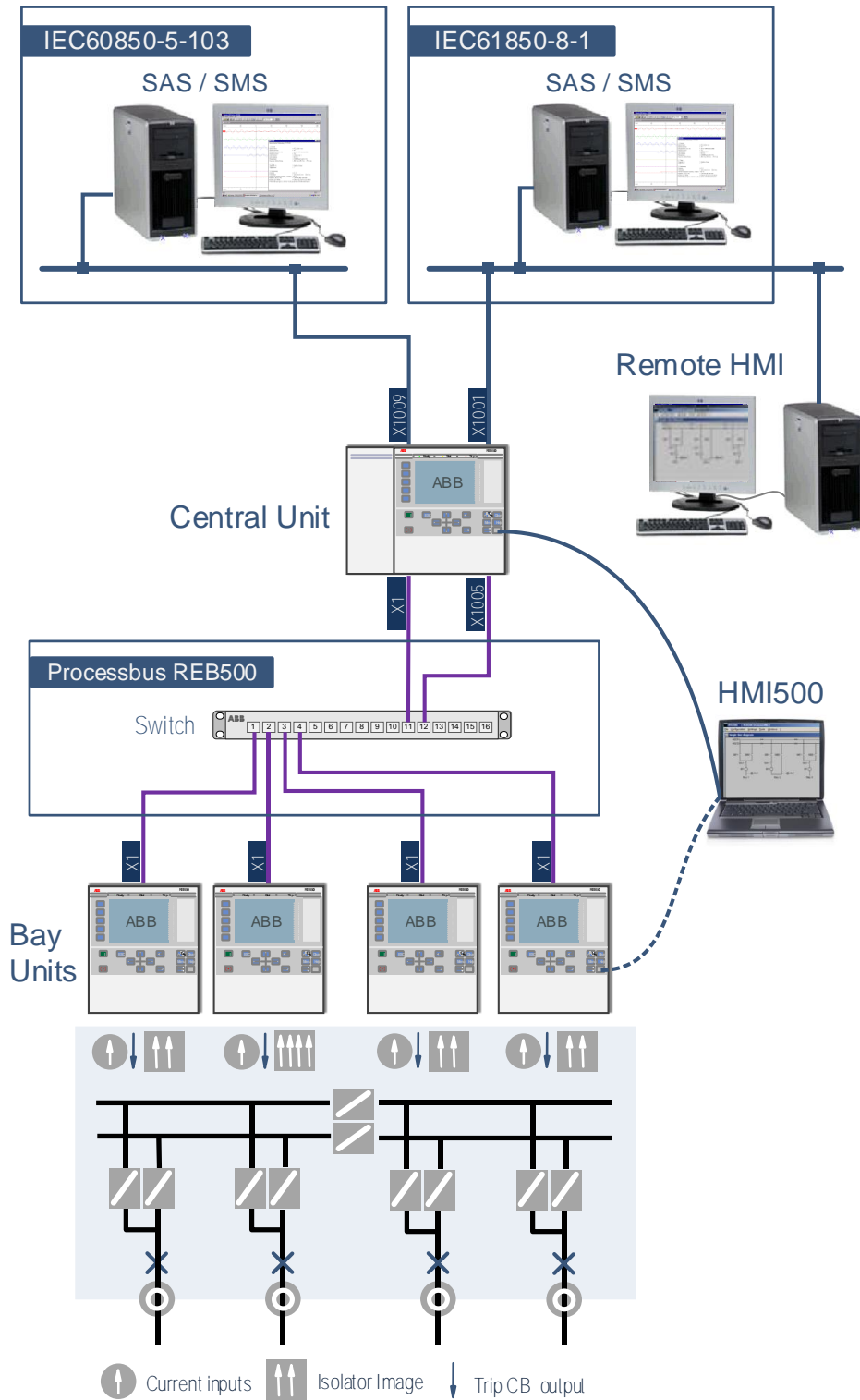

12000185-IEC18000287-1-en.vsdX

Figure 1: System overview

The digital busbar protection REB500 is divided into several hardware units. Bay units measure the line and bus-tie breaker currents and may be installed close to the respective CTs. They communicate with the central unit via a process bus. The central unit processes the current signals measured by the bay units and distributes the tripping signals back to the bay units in the event of an internal busbar fault. The system can be controlled by a local HMI (LHMI) on the Central unit and Bay units, by comprehensive external HMI software, or a remote HMI over a station bus connection. Communication with the station automation system (SAS) is possible via the central unit.



When configuring the IP-address for the LHMI Ethernet port to the fixed value of 192.168.0.1, a DHCP server functionality will be activated on this port. A maximum of 10 IP addresses will be assigned automatically, when connected. This functionality is available on the LHMI port only. Information on how to configure different IP-addresses can be found in [Section 4.9.5.2](#).

Section 4 HMI500

4.1 Introduction

This section describes the human/machine interface (HMI) for the protection systems REB500. For a detailed explanation of signals and parameters, see *Technical manual*. For a description of fault finding actions, see [Section 7](#). For details on security settings, see *Cyber security deployment guideline*.

HMI500 is a convenient human-machine interface which permits the operator to view measurements and statuses, to set protection functions, to configure the system, to download the latter data to REB500, and to control the disturbance recorder and event memory integrated in the system.

The data are transferred between the PC and REB500 via an Ethernet interface attached to the front of the central or bay units. The PC can be connected of the station bus as well.



Any changes (for example, settings and configuration) made using HMI500 are stored in a specific customer database (MS Access database file) on the PC and not in the protection system. The database then has to be downloaded from the PC to the protection system (see [Section 4.4.1](#)).

4.2 Safety instructions



HMI500 permits circuit-breakers and isolators to be operated. Every program operation and the possible consequences must be considered carefully beforehand. If switching operations have to be carried out, the same precautions must be taken as when performing them manually.



Earlier HMI500 versions are incompatible with version 8.00 of the protection system software.



When the HMI500 software establishes communication with a REB500 system initially user must enter a password. For details about security management, passwords and security options refer to *Cyber security Deployment Guideline*.

4.3 Basic setup

4.3.1 Installation

The human-machine interface program HMI500 is supplied on an installation CD. It can be installed on Windows XP or Windows 7.

During this installation procedure you are requested to read and confirm your acceptance of the license conditions. The installation program proposes an installation directory. Either confirm the proposed directory or enter a desired one. Make sure that you have appropriate access rights to the respective directory. Clicking **Next** starts the installation. An HMI500 directory and program icon **HMI500 x.xxll** are created in the Windows start menu, *x.xx* signifying the program version and //the language.

1. Insert the CD-ROM in the drive.
The CD Navigator starts then automatically
2. Should the auto-start function on your PC be disabled, select and run the program autostart.exe on the CD to start the CD-Navigator.
3. Select the preferred language and enter the HMI500 link, which is placed under the **CD-Navigator** section Software.
The software installation procedure should start now.

4.3.2 Uninstallation

1. Open Windows control panel and select **Add/remove programs**.
2. In the list of programs, select the entry for HMI500 and click **OK** to remove the program.

4.3.3 Starting HMI500



The program screens in this section are based on a typical application. Depending on the power system configuration and the options configured while engineering your system, certain menus may be missing or the display appears different

The first screen to appear after starting the operator program is the **System login** dialog box:



15000019-IEC18000288-1-en.vsdX

Figure 2: System login dialog box

The program can be run in a read only mode by ticking the **Read only** check box, that is. the data can be viewed but not changed.



When the HMI500 software establishes communication with a REB500 system initially user must enter a password. For details about security management, passwords and security options, see *Cyber security Deployment Guideline*.

HMI500 obtains the specific device data from a database in a file, which is stored both in the PC and the protection system. Database files on the PC have the extension .mdb.

Click **OK** to continue start-up or **Cancel** to close the program.

When you click **OK**, HMI500 tests communication with the protection system and starts in the on-line mode if communication can be established. Otherwise it starts either in off-line or simulation mode (see [Section 4.9.5](#)).

Some of the dialogs used by the program are standard Windows dialogs, whose language depends on the language setting of the operating system.



The database that was open during the last session opens automatically. If no database was open before, select **Open** in the **File** menu and then the desired file. An error message is displayed if an attempt is made to open an incompatible file. An existing file in the protection system can also be opened using the **Upload** function in the **File** menu.

4.3.4 Window structure

The structure and handling of the windows in the operator program is similar to other Windows applications.



12000072-IEC18000289-1-en.vsdX

Figure 3: Dialog box buttons

[Table 1](#) summarizes the meaning of buttons that appear in many dialog boxes:

Table 1: Meaning of common buttons in dialogs

Button	Description
OK	The new settings are saved in the database on the PC and the dialog closes.
Apply	The new settings are saved in the database on the PC and the dialog stays open.
Restore	The changes that have been made are ignored and the old settings restored. The dialog stays open.
Cancel	The new settings are not saved and the dialog closes.
Scroll (arrow) buttons	In windows permitting the selection of several bays (or isolators, circuit-breakers etc.), there are four scroll buttons at the bottom for scrolling through the bays.
Close	The window or dialog is closed and a warning is displayed, if changes have been made which have not been saved.

In many dialog boxes for setting parameters, there are two tabs:

- Overview: Lists all bays and enables selecting one.
- Details: Shows the settings.

You can view the details of a bay by double-clicking on the bay in **Overview** or by selecting the bay and clicking **Details**.

4.3.5 Main window

The title bar is at the top of the main program window and displays the station name. The menu bar is located immediately below the title bar.

Table 2: Main menu items

Menu Item	Description
File	Permits databases to be opened and saved and a database to be uploaded from the protection or downloaded to it.
View	Contains menu items for viewing the plant diagram, the measurements of each protection zone, inputs and outputs, switchgear statuses, the event list and any tripping that has taken place.
Configuration	Concerns the definition of the licensed bay protection functions, the communication parameters, the binary input/ output configuration, the event text configuration, the configuration of the LEDs on the local HMI and the disturbance recorder configuration.
Settings	Setting the operating values for the various protection functions, the parameters of the primary system objects (for example, current transformers, voltage transformers, etc.) and the system parameters including the system behavior.
Testing	Enabling/disabling either the test or installation mode.
Tools	Functions for editing data file versions, producing reports, exporting SCS communication data, changing passwords, setting of security options and security account management, selecting operator program options and setting the system time.
Windows	Provides facilities for arranging open windows (cascade, tile vertically, tile horizontally, arrange icons).
? (Help)	Information details of the software version.

Status information is displayed on the bar at the bottom of the main window as shown in [Figure 4](#).

Field							
1	2	3	4	5	6	7	8
Operator	Online	HMI: 10.41.140.115:8401	Edit			C:\Data\HMI500\Projects\8.000\Setfiles\REB500\8-FW022-TestSystem-28U-Prototype.mdb	///

12000074-IEC18000290-1-en.vsdX

Figure 4: Status bar

Table 3: Status bar content

Field	Content	Description
1	Configurator	indicates that configurator mode is active (no target communication possible)
	Operator	indicates that operator mode is active (target communication possible)
2	Online	Successfully established contact with the protection system.
	Offline	No connection to protection system.
	Simulation	All the functions can be executed without being connected to a protection device. Random values are generated when viewing protection unit data, for example, event lists or measurements. Simulated faults can also be viewed.
3	HMI: [IP:Port]	Active Ethernet interface (on the device front), the IP address and the port connected for the target communication
	LAN0: [IP:Port]	Active Ethernet interface communication over station bus, the IP address and the port connected for the target communication
4	Edit	Permits settings to be saved in a file or downloaded to the protection system.
	Read-Only	It is only possible to read data.
5	Test	Test generator is activated.
		Test generator not active
6	Install	Installation mode is active (debug mode is inactive)
	Install/Debug	Installation mode and Debug mode are active
	Debug	Debug mode is active (Installation mode is inactive)
7	<Setfile>	Path and name of the currently open setfile.
8	<action>	short message of an ongoing action

4.4 File menu

Table 4 summarizes the options available in this menu. The subsequent subsections describe the menu items **Download to protection system...** and **Compare...** in greater detail.

Table 4: Menu items in menu file

Menu Item	Description
Open...	Opens a database file stored on the computer's file system.
Save as...	Saves the currently open database to the computer's file system.
Upload from protection system...	Saves a database from the protection system to the computer's file system.
Download to protection system...	Sends a database file from the computer's file system to the protection system.
Compare...	Compares a database file on the computer's file system to the database of the protection system or to another database file on the computer's file system.
Exit	Terminates the program; displays a warning if there are changes that have not been saved. You then have the choice of saving or discarding them.

4.4.1 Download to protection system

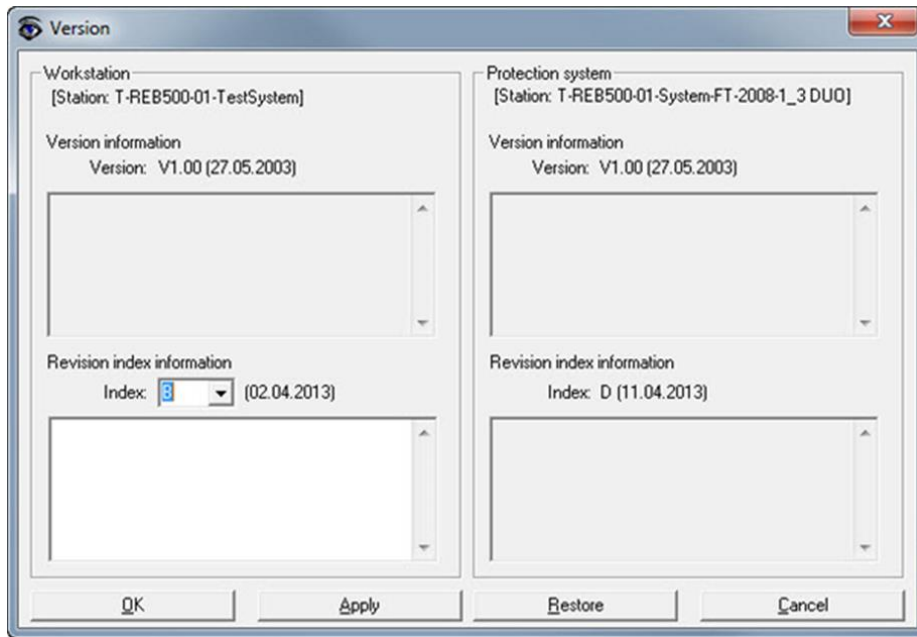

12000075-IEC 18000291-1-en.vsdX

Figure 5: Download to protection system and comparison of versions

Before downloading proceeds, the tool compares and displays the versions of the new database with the one in the protection system. You may also enter an index and a comment beforehand in menu **Tools/Version** (see [Section 4.9.1](#)). Data will only be saved if they are different or the version index is different.



Data can be correctly downloaded as soon as the user has been logged-in to the target device.

After the downloading procedure is complete, the protection system restarts. The valid version can then be verified on the HMI.

The progress of the downloading procedure is shown on the screen in window **Download to protection system** see [Figure 6](#). The correct time format must be set via the control panel on the PC for the procedure to be presented correctly. The procedure can be interrupted by the user as far as **Archive data in the protection system**.

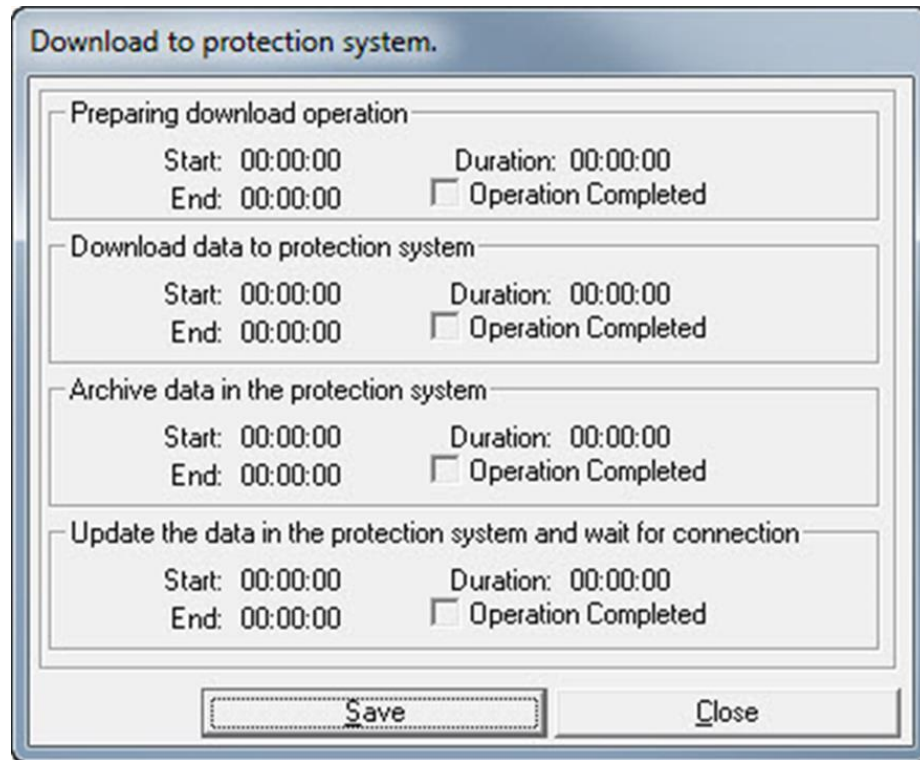

13000078-IEC18000455-1-en.vsdX

Figure 6: Download to protection system

Various check sums are calculated to establish the integrity of the data in the database and these are examined after the transfer of data has been completed.

Only after all the data have been successfully transferred they are saved in the non-volatile memory. The auxiliary supply of the central unit must not be interrupted during this part of the procedure.

4.4.2 Compare

When selecting this menu item, the dialog box shown in [Figure 7](#) appears. See [Table 5](#) for an explanation of all items in this dialog box.

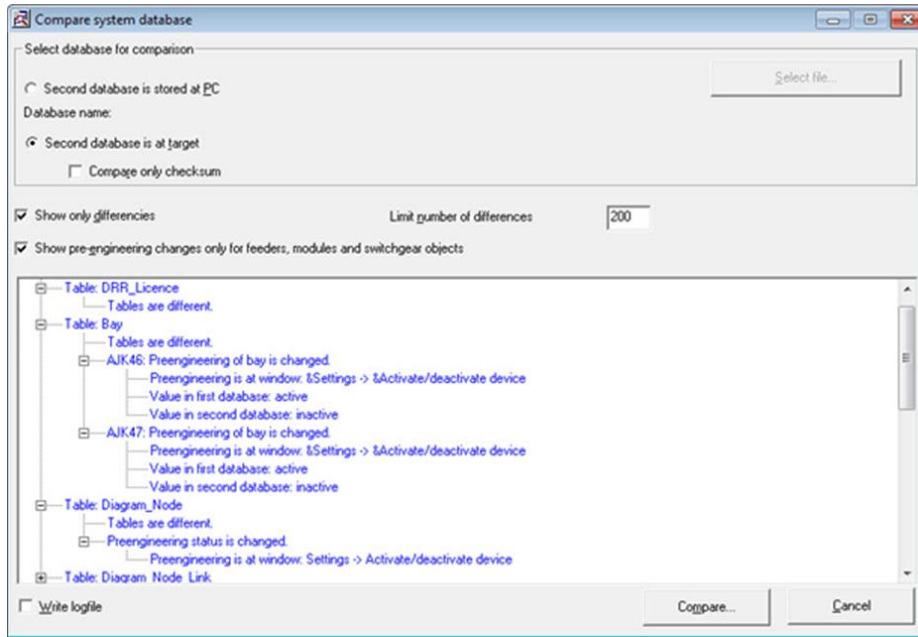

12000079-IEC18000488-1-en.vsdX

Figure 7: Comparison of system databases

Table 5: Dialog items of Compare system database

Dialog Item	Description
Second database is stored at PC	Compares the currently open system database with another database in the PC, which can be chosen by clicking on Select file...
Second database is at target	Compares the currently open system database with the database in the protection system. For a faster but less detailed check, tick Only compare checksum .
Show only differences	Limits the scope of the report to the differences actually found.
Limit number of differences	The number entered here determines the number of differences that can be found before the current comparison operation is aborted.
Show pre-engineering changes only for feeders and switchgear objects	When this box is checked (default setting), the comparison is restricted to determining whether changes have taken place in relation to the pre-engineering data for bays and switchgear. Generally, the default settings should be retained as otherwise the number of differences that will be discovered increases considerably (events, signals etc., are then also taken into account)
Write log file	The results of the comparison are stored in a file.
Compare...	Starts the comparison operation

4.5 View menu

4.5.1 Single-line diagram

This menu item displays a diagram of the plant corresponding to the layout of the connection diagrams created by ABB. The screenshot in [Figure 8](#) shows an example of a single-line diagram.

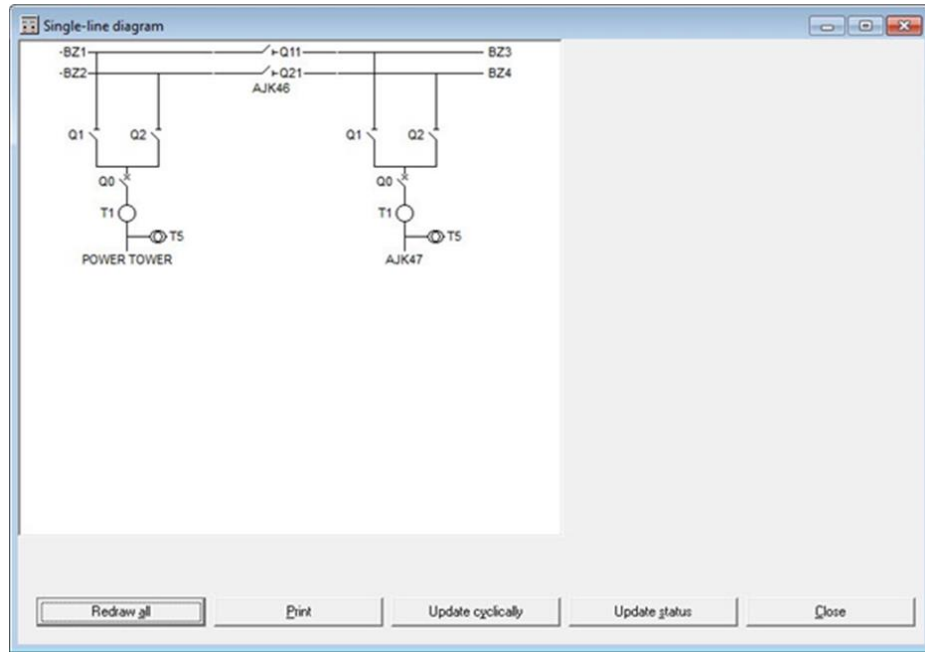

12000080-IEC18000489-1-en.vsd.x

Figure 8: Typical single-line diagram

The name of every item of a plant can be changed by pointing at its symbol and clicking the right mouse button. This opens the **Change label** context menu to open the corresponding dialog box. After entering the new name, click **OK** to confirm.

Click the button **Update Status** or **Update Cyclically** to show the actual bay measurements and the state symbols of the configured breakers and isolators.

It is also possible to display the differential currents of the selected busbar zone. Point on the end of a busbar zone (for example, BZ1) and click the right mouse button to get the corresponding context menu.

Click the right mouse button in an empty field in the single-line diagram to view a dialog with a list of the symbols used (see [Figure 9](#)). The buttons on the right provide facility for changing the default colors for open, closed or invalid objects to suit your needs.

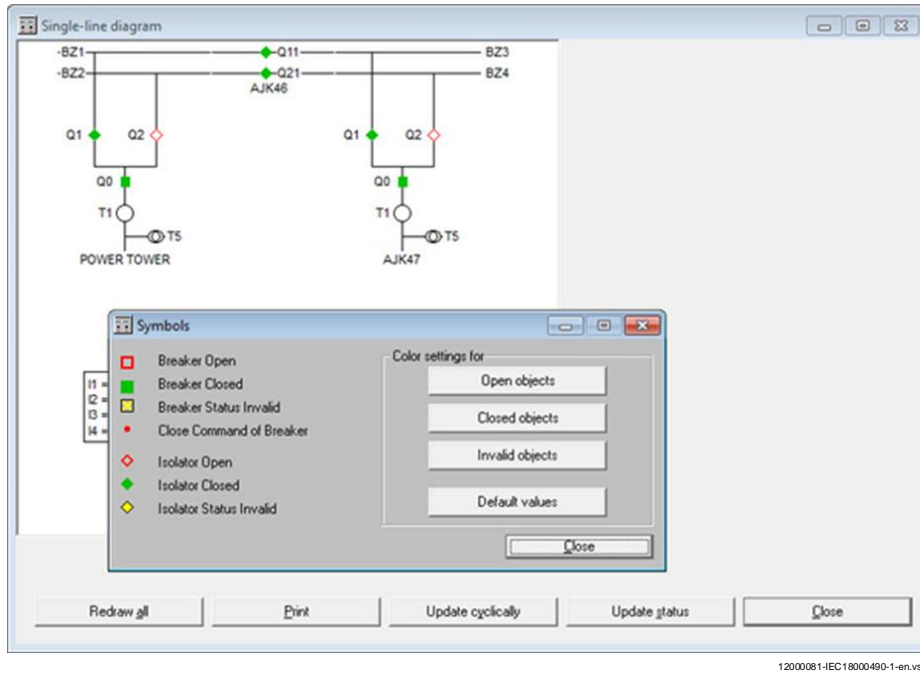

Figure 9: Updated single-line diagram

4.5.2 Protection zone measurements

This dialog displays the actual values of measured variables for each protection zone (restrained differential current of the bus bar protection function). The protection zones are determined by the positions of the isolators and the bus-tie breakers (bus bar image).

4.5.2.1 Overview

The currently active protection zones are listed in order showing the associated sections of busbar and the differential current per phase or in the neutral. The overview is not updated automatically. Click **Refresh** to update the list.

A protection zone to which no measurement has been assigned, that is no bay unit current is processed by the busbar protection algorithm, is shown as invalid.

Protection zones that have been connected, for example, via a pair of feeder isolators or a longitudinal isolator, are also presented.

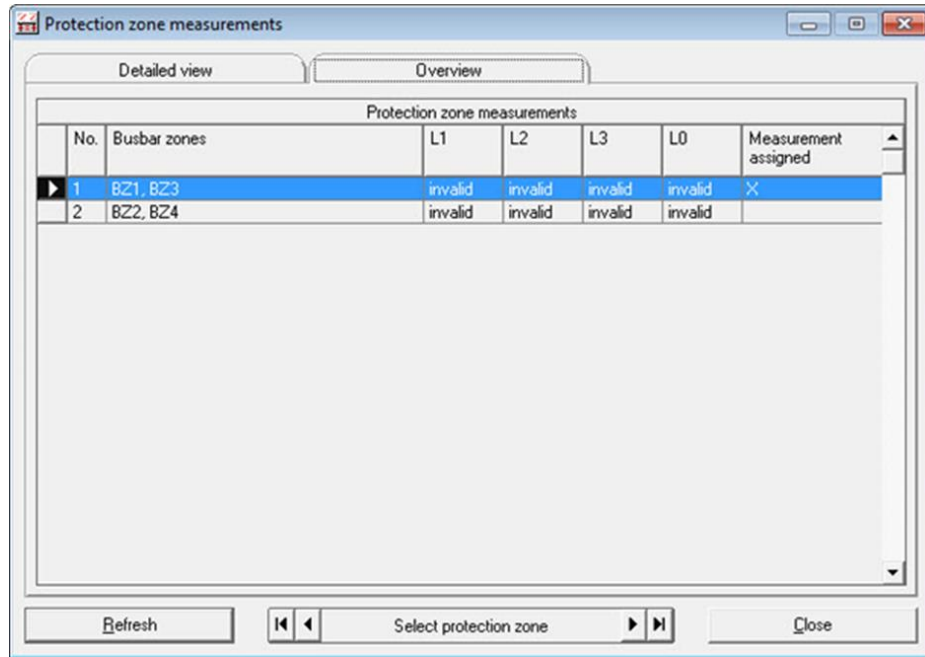

1200082-IEC18000491-1-en.vsdX

Figure 10: Overview dialog box for protection zone measurements

4.5.2.2 Detailed view

The feeders assigned to individual protection zones are listed in the detailed views of the relevant zones. The differential current, the restraint current and the stability factor are also displayed.

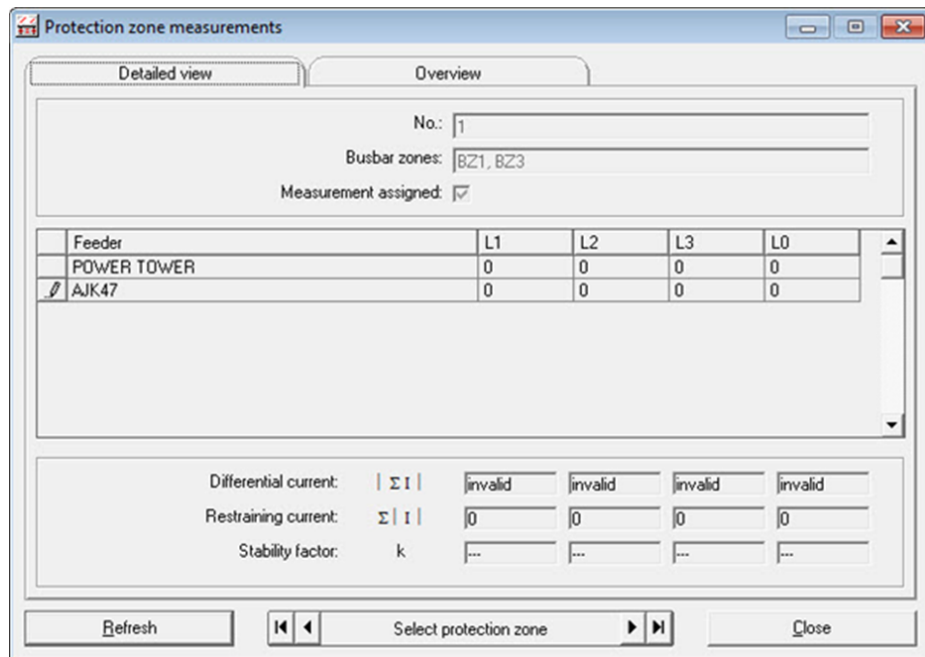

1200083-IEC18000492-1-en.vsdX

Figure 11: Detailed view of measurements per zone

4.5.3 Analogue input measurements

The bay units and their labels are listed in the **Overview** dialog box.

To display the values of measured variables select a device (row) and click on **Open measurements window**, or double-click on the device (row). Up to eight measurement windows can be open at the same time. **Arrange windows** arranges the windows below each other.

The display can be updated either manually by clicking on **Update measurement** or automatically by clicking on **Update cyclically**. This updates all open measurement windows.

A warning appears in the measurement window if measurements cannot be obtained correctly. Closing the overview window closes all the measurement windows as well.

For the selected bay unit, the phase-angles as well as the analogue measurements (see [Figure 12](#)) are displayed. The currently valid reference channel, that is reference point for displaying phase-angles, is highlighted yellow. The user can change the reference channel by double-clicking on the desired one. The phase-angle display is not available on the other types of bay unit.

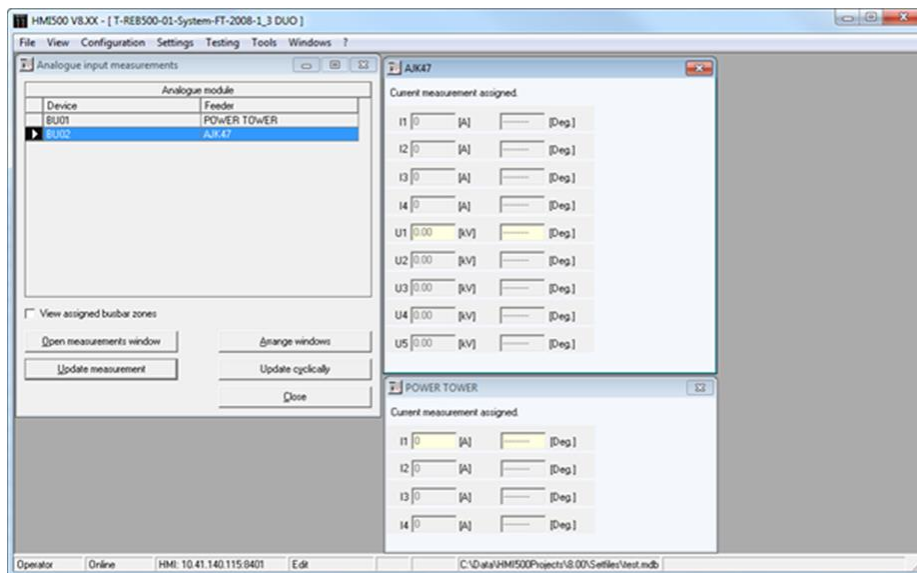

12000084-IEC 18000493-1-en.vsdX

Figure 12: Overview dialog box for protection zone measurements

4.5.4 Binary input/output status

The binary inputs and outputs are listed in the overview dialog together with their bay labels (see [Figure 13](#)).

To view a signal status, select the corresponding device (row) and click **Open status window**, or double-click on the device (row). Up to eight status windows can be open at the same time. **Arrange windows** arranges the windows below each other.

The display can be updated either manually by clicking on **Update status** or automatically by clicking on **Update cyclically**. This updates all open status windows.

A status window shows either inputs or outputs. Two windows can be opened to view the inputs and outputs of a bay at the same time.

The number 1 indicates that the respective input or output is set, and 0 that it is reset. The statuses of all valid values are green; the status of an input or output that has been impressed is yellow (see [Section 4.8](#)); and the statuses of inputs that the supervision function has tagged as being invalid are red. This can also occur briefly when the window is opened.

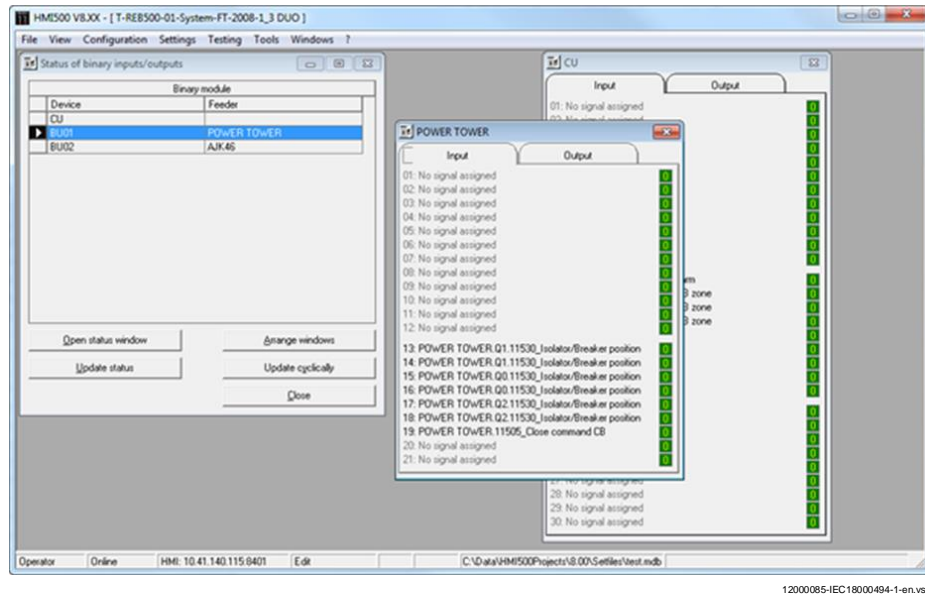

Figure 13: Binary input/output status

The signals assigned to each physical channel while configuring the binary inputs/outputs are displayed in the status window. Channels to which no signals were assigned are marked **No signal assigned**.

Closing the overview window closes all the status windows as well.



Further details of the signals assigned to the various binary inputs and outputs can be viewed by opening the **Configuration** menu and selecting **Binary inputs/outputs** (see [Section 4.6.3](#)).

4.5.5 Switchgear objects

The detailed view shows the statuses of circuit-breakers and isolators. If neither a closed nor an open position is defined, the status **invalid** is displayed.

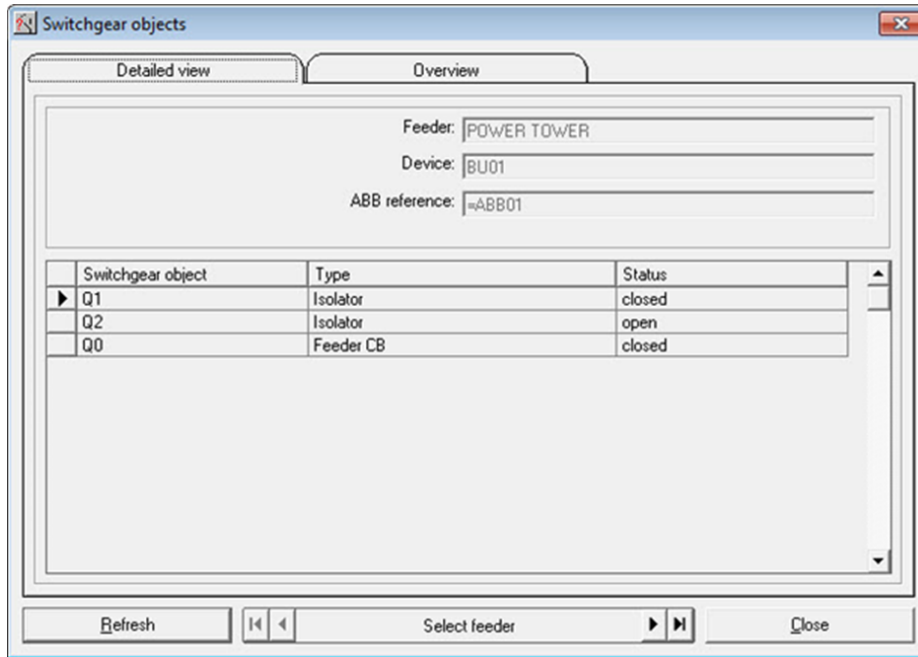

12000086-IEC18000495-1-en.vsdX

Figure 14: Switchgear objects

4.5.6 Protection zone circuit-breakers

The detailed view shows all the circuit-breakers belonging to the respective protection zone.

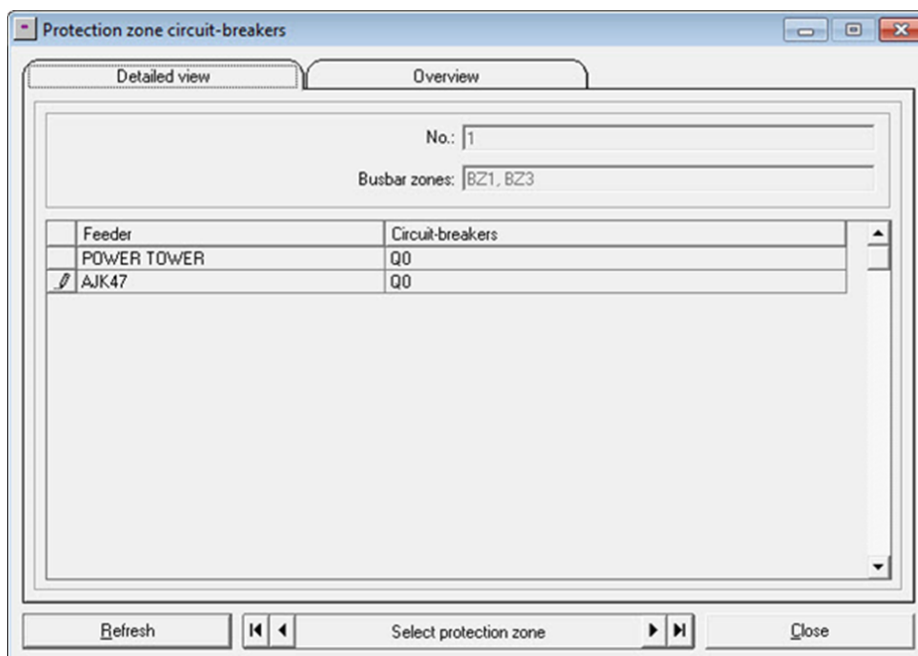

12000087-IEC18000496-1-en.vsdX

Figure 15: Protection zone circuit-breakers, detailed view

These circuit-breakers are intertripped, for example, in the event of a busbar fault in the respective protection zone.

4.5.7 Disturbance recorder

A disturbance recorder is integrated in every bay unit and in the central unit of the system. In the bay units, it records the current measurements, the voltage measurements and up to 32 binary input and output signals. In the central unit, it records the differential and the restraint currents and optional the phase differences of every bus zone and up to 32 binary output signals. Up to 40 recording periods are supported (depending on the selected sample rate and recording time).

4.5.7.1 Overview

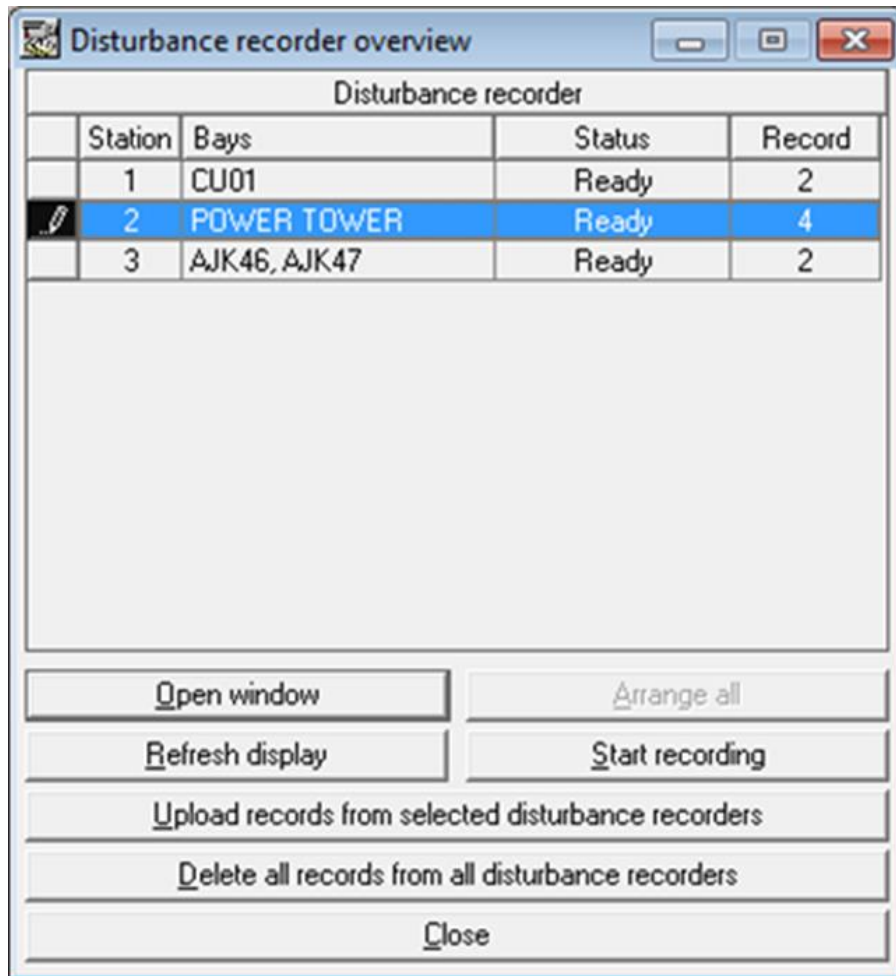

12000089-IEC18000497-1-en.vsdX

Figure 16: Disturbance recorder overview

This tab displays the number of records and the current status of the devices. The column **Bays** indicates the bay names of the individual records. The record of the central unit can be seen from the bays entry **CU01**. See [Table 6](#) for an explanation of the device statuses.

Table 6: Disturbance recorder statuses

Status	Description
Ready	Disturbance recorder is ready to record disturbances.
Memory full	Disturbance recorder memory is full
Not available	Disturbance recorder function is not active for the bay

Press SHIFT and click on the desired fields to select several fields at once. By clicking on the respective buttons below, you can apply a command to all selected bay units at once:

1. Open detailed views (button **Open window**)
2. Start recording
3. Upload records from selected disturbance recorders (Transfer disturbance records to computer)
4. Delete all disturbance records

4.5.7.2 Upload disturbance recorder records

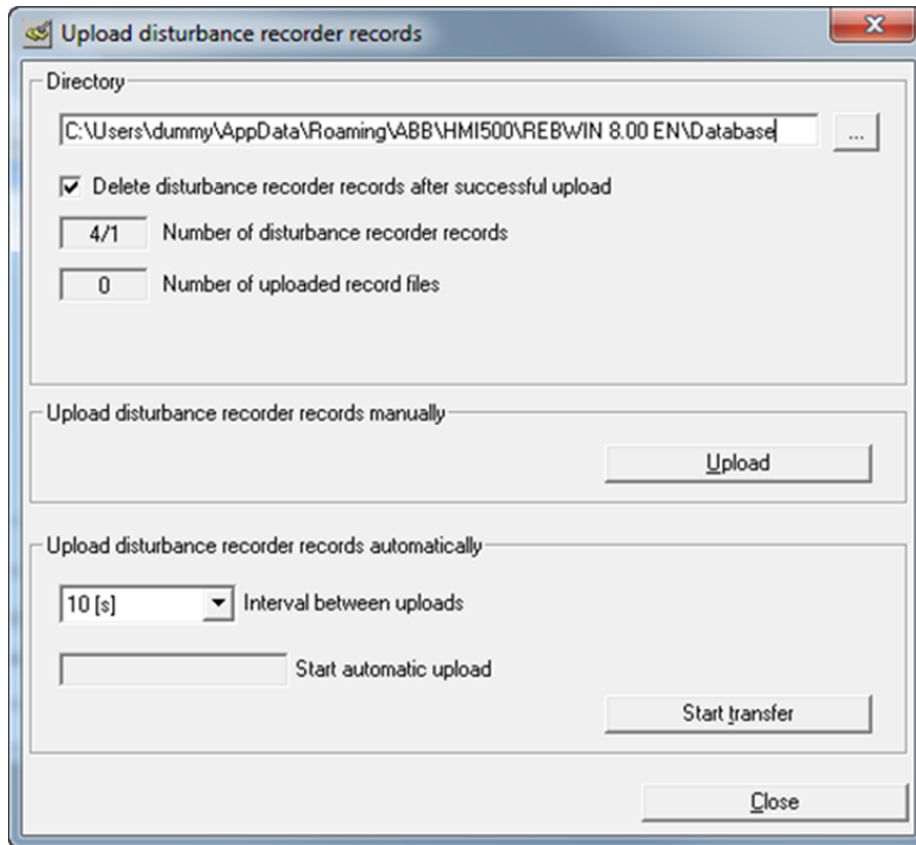

Figure 17: Transferring disturbance records

In this dialog box, you can specify a directory for storing the records on your computer, and whether the disturbance records are to be deleted after successful transfer. By pressing **Upload**, you initiate a single transfer.

In the lower part you can specify a repeated transfer at regular intervals. This part is only available if **Delete disturbance recorder data** is checked.



In case the maximum number of disturbance records has been reached, an ongoing upload of the oldest record could be interrupted by a trigger initiating a new recording.

4.5.7.3 Detailed view (Open window)

Dialog box for viewing individual devices and processing records.

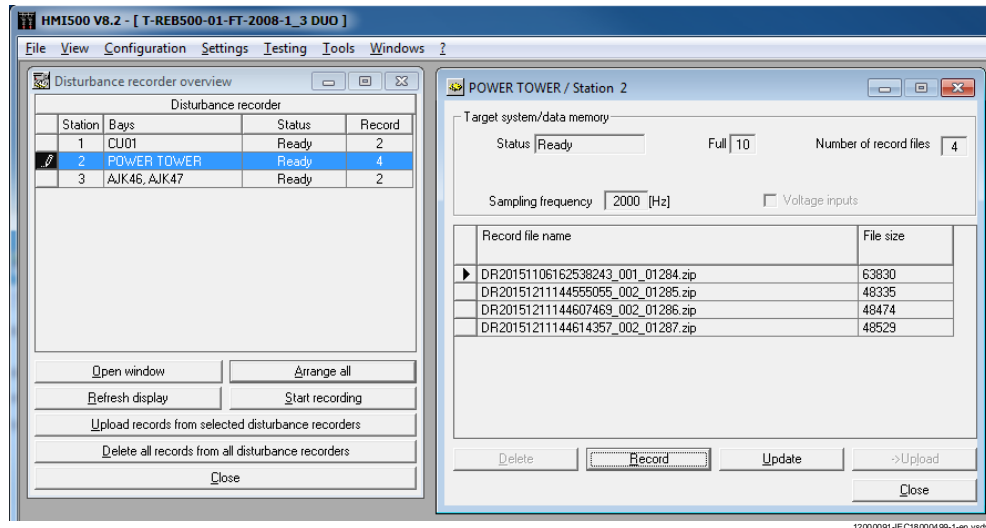

Figure 18: Disturbance recorder detailed view

The following data are displayed:

- Status (defined in the overview)
- Number of records available
- Number of free records
- Sampling frequency (see [Section 4.6.8](#))
- Record file name
- File size

The dialog provides the following facilities:

- Delete disturbance record
- Start disturbance recording
- Upload disturbance records
- Update disturbance records

4.5.7.4 Disturbance recorder file (Detailed view/ Upload)

The disturbance records are available in a zipped Comtrade file. The involved disturbance recorder files has the naming convention:

DRyyyyMMddhhmmssfff_aaa_nnnnn.ZIP

Table 7: Disturbance file names

Item	Description
yyyy	Year of the recording (Trigger time)
MM	Month of the recording (Trigger time)
dd	Day of the recording (Trigger time)
hh	Hour of the recording (Trigger time)
mm	Minute of the recording (Trigger time)
ss	Second of the recording (Trigger time)
Table continues on next page	

Item	Description
fff	Miliseconds of the recording (Trigger time)
aaa	Station number (1-999)
nnnnn	Fault number (0-65535)

The name of the file can be changed if the records are transferred manually.

4.5.8 Event list

Protection system events are shown in chronological order. By correspondingly setting the event filter, just protection events, system events or test events can be viewed separately. Events with an invalid time tag can be excluded from the display. You can choose between **User-defined** and **System-defined** event texts.

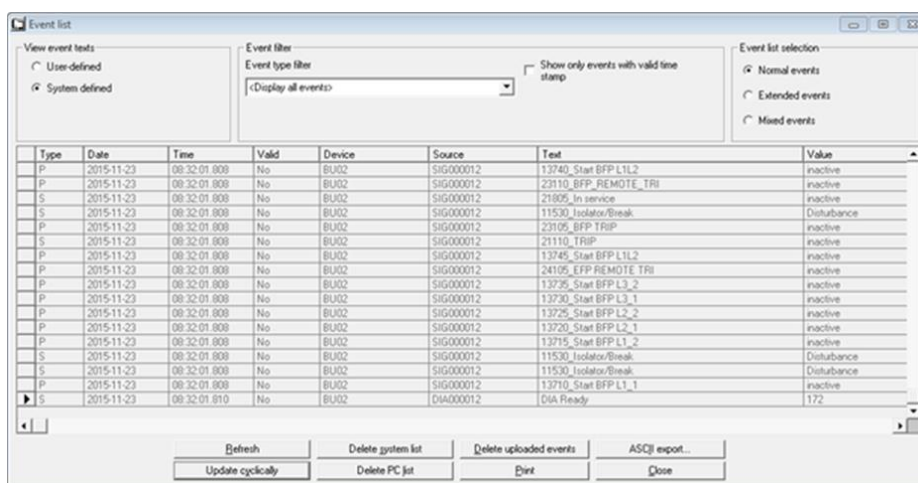

12000092-IEC1800500-1-en.vsd

Figure 19: Event list

The central unit event list has a maximum length of 1000 records; the bay units 100. In the event of a supply failure, the events stored in the REB500 central unit remain intact for at least 24 hours.

4.5.8.1 Classification of events

The REB500 system includes two different event lists, the normal and the extended events. The HMI view **Event List** enables the selection of the respective class (see [Figure 19](#)).

- normal** The normal event list shows mainly protection and system events including diagnosis events in case of major/minor errors which are relevant for the user. For normal operation of a REB500 system, it is recommended to use the **normal event list** view.
- extended** The extended event list shows further events for diagnosis and error cause analysis. The vast majority of minor errors falls into this group. The **extended event list** view can be helpful for error diagnosis and support activities.
- mixed** The mixed event list shows both, the entries of the normal and the extended view.

4.5.8.2 Load events

The protection system has an event memory for every unit (central unit and bay units).

To upload the latest events to the PC, open the **View** menu and select **Event list**. This opens the **Event list** dialog box (HMI500 must be in the on-line mode). Click on the **Refresh** button to upload the events. The protection system stores the events until they are explicitly deleted.

The list viewed on the PC is refreshed either on command or cyclically.

There is no indication should the event memory overflow before the events have been uploaded. The events are updated as determined by the system response setting (see *Technical Manual*).

The following information is shown for every event:

- Type of event
 - P = Protection function event
 - S = System event
 - T = Test generator event
- Date event occurred
- Time event occurred
- Time tag valid (yes / no)
- Source of event with application device ID in the format *FFF444444* (for example, BPD000011):
 - *FFF*: English function designation
 - *444444*: Address of the hardware unit that generated the event.



The source data are important for locating hardware defects.

- Text as entered via **Configuration/Binary inputs/outputs** (user defined) or alternatively, the name assigned by the system (system defined)
- Value, for example, ON or OFF.

The width of the columns can be adjusted by dragging the border with the mouse in the table header.

Providing a printer is connected to the PC, you can print the event list by clicking **Print**. The event list can be saved in a text file on the PC with the aid of **ASCII export**.

4.5.8.3 Deleting events

An event is marked by clicking on it. Several events can be marked by holding the mouse button and moving the pointer over them. Clicking in the blank field at the top left of the window (next to **Type**) marks all the events in the list.

4.5.8.4 Deleting the PC list

Single events, groups of events or all events can be deleted. Mark events you wish to delete and click **Delete PC list**. Deleting can take several seconds.

4.5.8.5 Deleting the system list

All the events stored in the protection system are deleted.

4.5.8.6 Deleting events that have been viewed

All the protection events viewed since opening the window are deleted.

4.5.8.7 System events when starting

A number of system signals that are generated when starting the system are recorded as events. Up to the instant that system clocks are automatically synchronized, events may have an incorrect date and time. These events are not displayed if **Only events with a valid time tag** is selected.

4.5.9 Security event list

It is possible to upload the security events stored on the protection system devices. The security events can be uploaded by using the **Refresh** button or using the **Update cyclically** button to get the data every four seconds from the target device. For details see *Cyber security guideline*.

4.5.10 Reset latching relays

All latched signals are reset and the corresponding display on the local control unit is deleted.

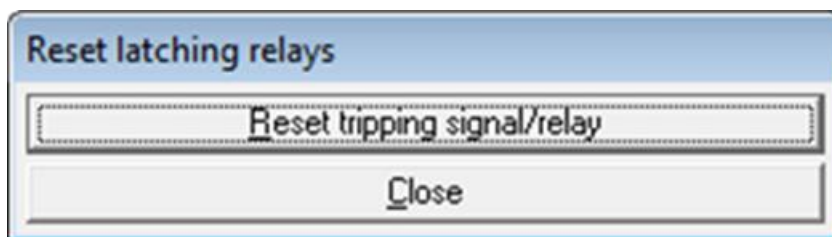

12000093-IEC18000501-1-en.vsdX

Figure 20: Reset latching relays

4.6 Configuration menu

Menu Item	See section	Description
Communication	4.6.1	Providing the communication option is selected, the protection system can be connected with a station automation system (SAS) or station monitoring system (SMS) via an interbay bus (IBB) connection.
Device structure	4.6.2	Opens a new window that gives an overview of the configured devices with its details.
Binary inputs/ outputs	4.6.3	Used to configure the binary inputs/outputs while engineering the protection system. The data entered are normally provided in the questionnaire filled in by the user. This dialog has three tabs: Overview, Inputs, and Outputs.
Table continues on next page		

Menu Item	See section	Description
Event text configuration	4.6.6	In this window, all the event signals configured in the REB500 are displayed. For each event signal a user specific text can be configured (32 characters). The user can sort the list as per ABB reference or the standard text.
LHMI LED...	4.6.7	The local HMI of the REB500 IEDs has a certain number of LEDs. Each of them can be assigned to an input or output signal.
Disturbance recorder	4.6.8	Used to configure the disturbance recording of currents and binary inputs and outputs in each bay and the central unit, respectively. In addition, voltages can be recorded in the bay units and the phase difference in the central unit.

4.6.1 Communication

4.6.1.1 SCS Configuration

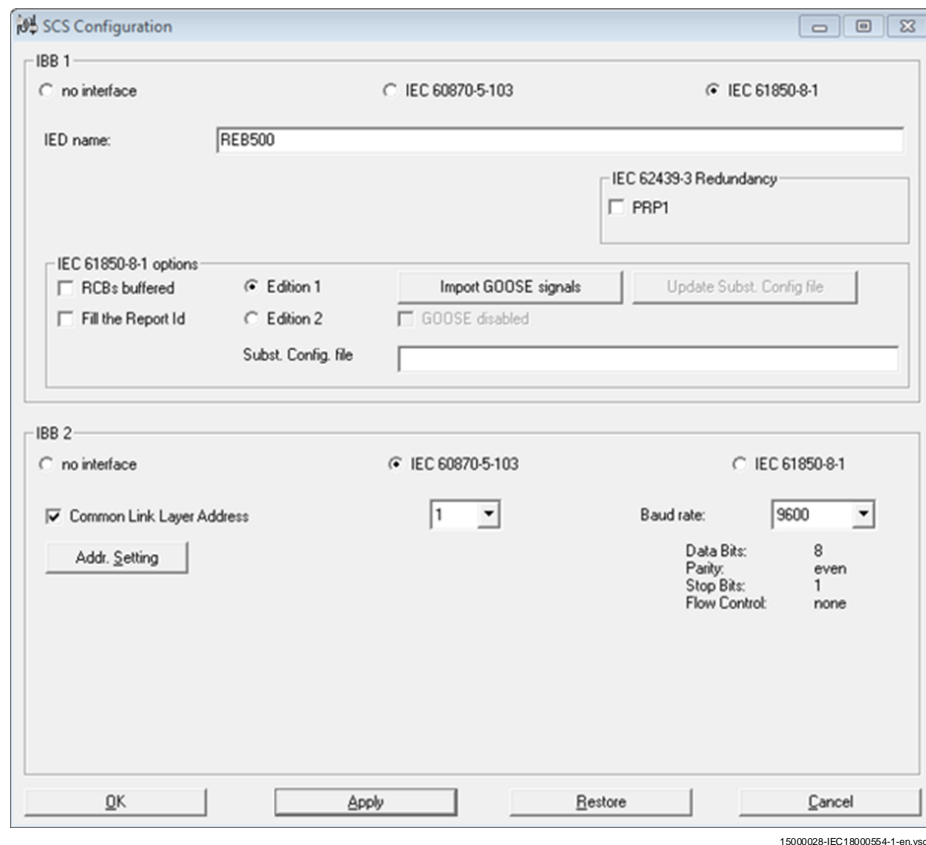
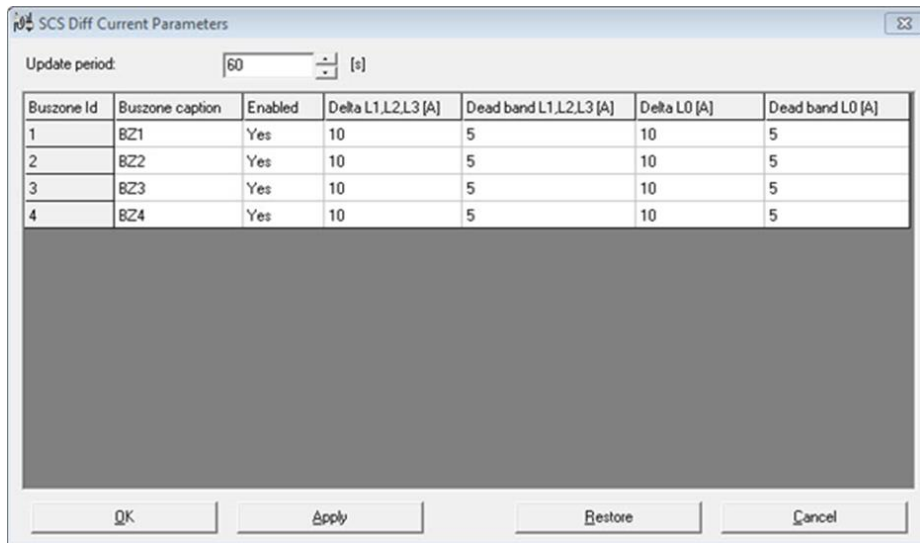

Figure 21: Configuration/ Communication/ SCS Configuration

This dialog box contains station control system (SCS) settings to define the interbay bus (IBB) connection. For communication details, see *Communication Protocol Manual*.

4.6.1.2 SCS Diff Current Parameters



12000190-IEC18000536-1-en.vsdX

Figure 22: Configuration/ Communication/ SCS Diff Current Parameters

This input mask contains the parameters for sending differential current to station control system (SCS). Specific setting for bus zones is possible.

4.6.1.3 Ethernet communication settings

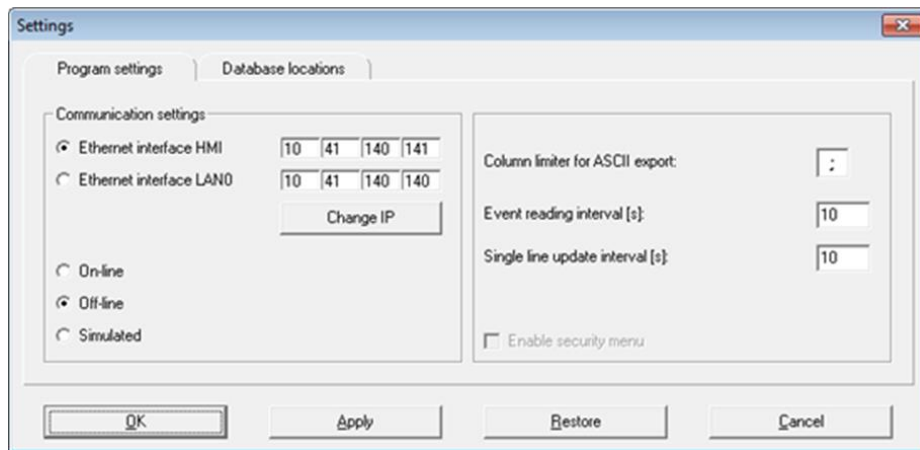

13000021-IEC18000550-1-en.vsdX

Figure 23: Configuration/ Communication/ Ethernet communication settings

This input mask for setting the connection parameters of the Ethernet devices.

4.6.2 Device structure

The device structure is configured by ABB when engineering the system. This dialog box is only for information as the configuration cannot be changed.

The **Overview** tab lists the central unit and all the bay units along with their device label and device type.

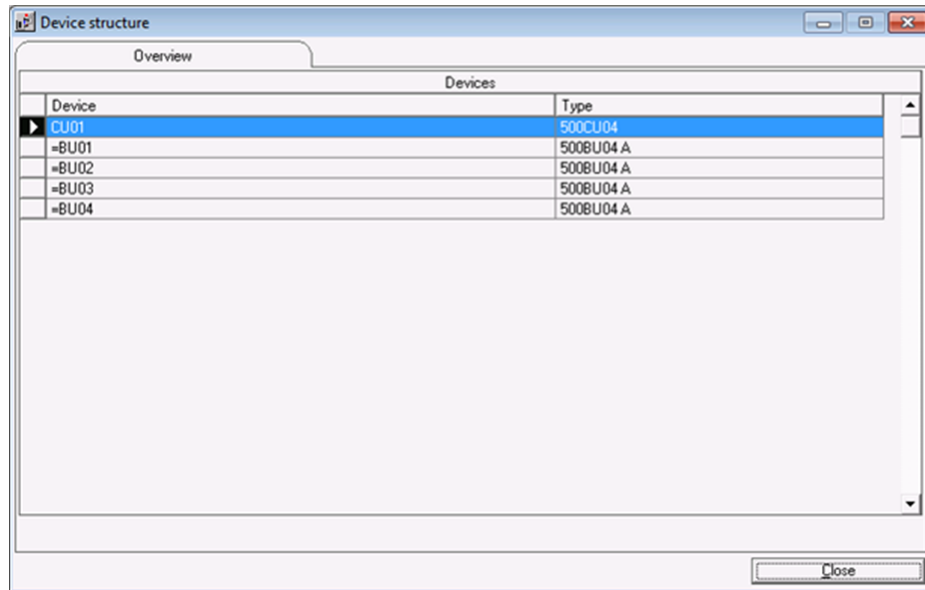

17000002-IEC18000563-1-en.vsdX

Figure 24: Configuration/ Device structure

4.6.3 Binary inputs/outputs

4.6.3.1 Overview

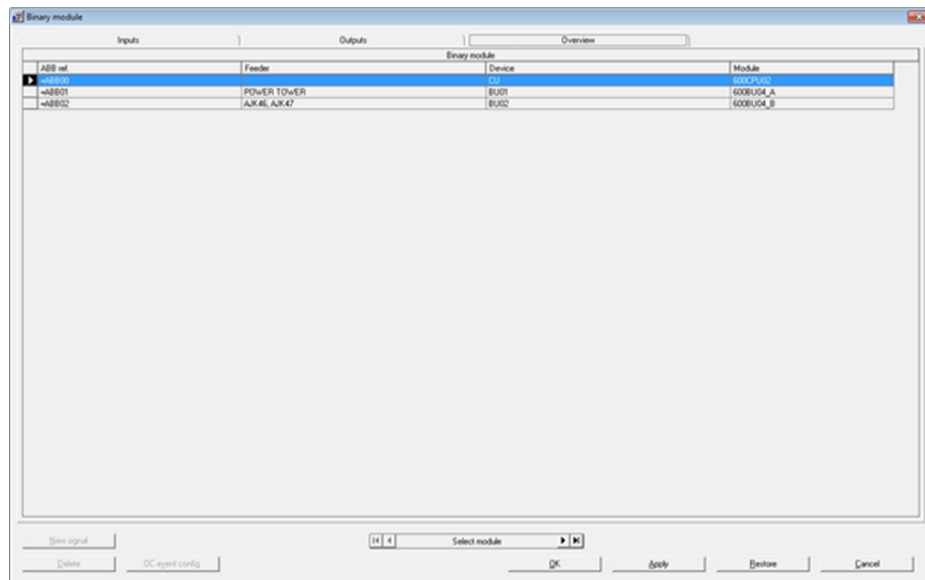

13000004-IEC18000537-1-en.vsdX

Figure 25: Configuration/ Binary module - Overview

The **Overview** tab shows a list with all configured devices providing binary inputs/outputs. See [Table 8](#) for an explanation of the columns.

Table 8: Binary inputs/outputs overview columns

Column	Description
ABB ref.	Internal designation for the bay or central unit
Feeder	in which the bay unit is located, user's label for the bay
Device	IED device label
Module	IED device type

For further information about the input or output configuration, see [Section 4.6.3.2](#) or [Section 4.6.3.5](#).

4.6.3.2 Inputs

This tab contains another two sub tabs **Overview** and **Details**. The additional buttons **New signal**, **Delete** and **OC event config** are enabled when the **Overview** tab is active. When the **Details** tab is active, only the **New signal** button is enabled.

4.6.3.3 Inputs Overview tab

The upper part of this tab contains the general input layout. The auxiliary supply voltage for each group of optocouplers (with a common pole) is placed below this.

The combo box is used to select a new value for the auxiliary supply voltage (battery voltage).

In the matrix below, all the input signals assigned to the device are listed.

Delete a Signal: Select a row in the list and click the button **Delete**.

Optocoupler event configuration: Select a column (for example, OC08) and click the button **OC event config**.

In addition to events generated by function signals, a physical input can also be configured as an event. This is of advantage, for example, when several signals are assigned to a physical input or when ambivalent signals from isolators or circuit-breakers need to be recorded.

To configure a physical input as an event select it in the list and click on **OC event config**. to open the **Configuration of events** window.

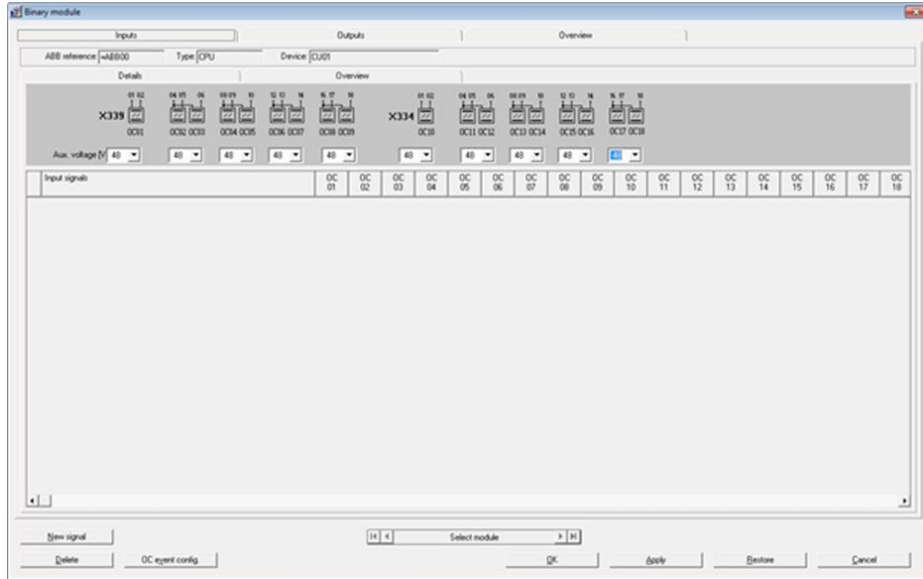

13000005-IEC18000538-1-en.vsdX

Figure 26: Configuration / Binary module - Central unit inputs

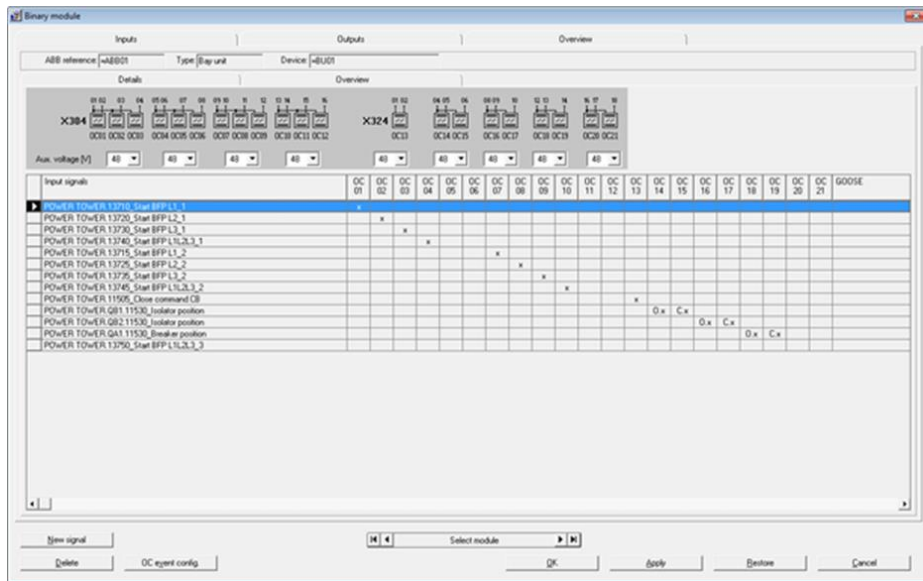

13000006-IEC18000539-1-en.vsdX

Figure 27: Configuration / Binary module - Bay unit inputs

4.6.3.4 Inputs Details tab

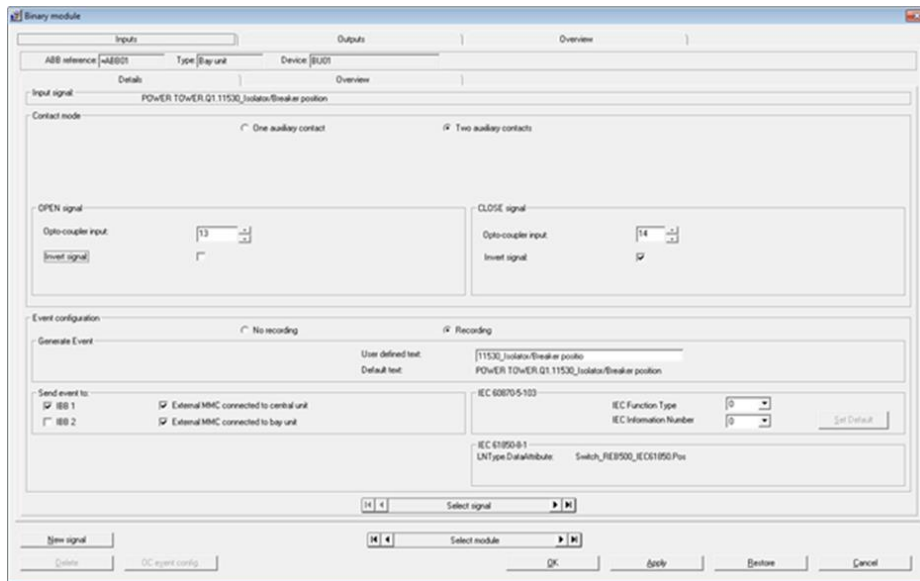

1300007-IEC18000551-1-en.vsdX

Figure 28: Configuration/ Binary module/ Inputs/ Details

Signal allocation

The **Details** dialog box provides facility for allocating optocoupler inputs to the logical input signals and the event memory of every input/output.

The abbreviations C.x and O.x denote the CLOSE and OPEN auxiliary contacts on the isolator or circuit-breaker respectively as they appear in the **Details** dialog box. Where an isolator or a circuit-breaker is only equipped with a single auxiliary contact, the **One auxiliary contact** mode must be selected.

This mode is not recommended because the status of the isolator or circuit-breaker cannot be properly monitored with just one auxiliary contact.

The signals are configured at the time the protection system is engineered and are generally not changed subsequently.

Only the CLOSED signal field is visible when the **One auxiliary contact** mode is selected. The function of the OPEN signal is achieved by inverting the CLOSED signal. In this case, we recommend connecting the auxiliary contact supply to the corresponding input so that its integrity is supervised.

Inversion

The signals of optocoupler inputs can also be inverted.

Configuring events

Every signal can also be saved as an event in one or more event memories (see *Technical Manual*).

More check boxes and input fields appear when the **Recording** radio button is selected. They determine whether the event is recorded on the positive or negative-going edge or on both edges. The user can enter a text (up to 32 characters) defining the event, but if none is entered the system assigns a default event text. At least one event memory in the **Send event to** (= save event in) field must also be selected either in the CU and/or BU event memories. Furthermore, events can be assigned to the event lists of IEC 60870-5-103 interbay bus (IBB) 1

or 2. As the 61850 model is implemented as defined by the standard, no custom assignments can be made for the IBB associated with 61850.

Minimum input signal duration

Provision is made for prolonging the input signals in steps of 1 ms (reset delay).

New signal

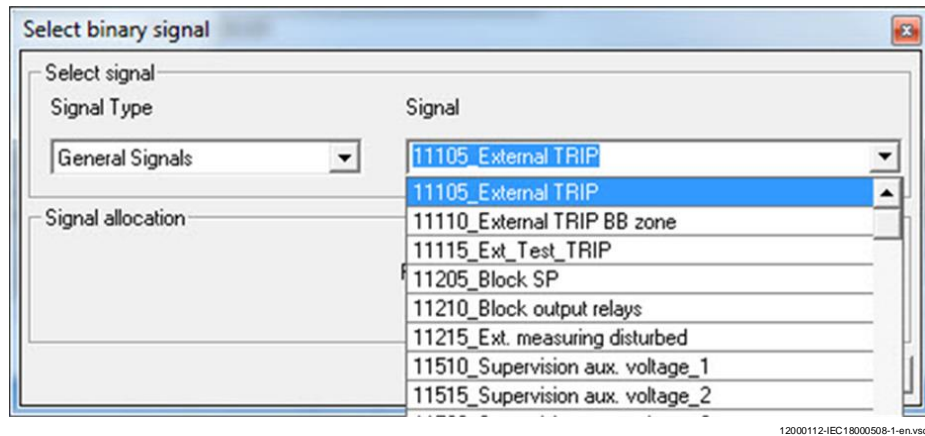

Figure 29: Configuration/ Binary module/ Inputs/ New signal

The button **New signal** opens a dialog box with a list for selecting and adding a new signal.

Clicking on the arrow to the right of the **Signal type** field opens a list of available signals. The effective list depends on the functions ordered by the user. The list can include as a maximum the following groups:

- General signals
- Busbar protection (BBP)
- Breaker failure protection (BFP)
- End fault protection (EFP)
- Time-overcurrent protection (OCDT)
- Disturbance recorder (DR)
- CB pole discrepancy protection (PDF)
- Voltage release (UV)

Clicking on the arrow button to the right of the signal name field opens a list of the signals available according to the filter group and device selected.

Signals that can only be assigned once will disappear from the list as soon as the user has assigned them.

The new signal can be configured as described in [Section 4.6.3](#).

4.6.3.5 Outputs

The procedures for configuring binary inputs and outputs are almost identical, in particular creating new signals and deleting existing ones. Therefore only the differences are dealt with in this section.



Most of the CU signals only occur once. There is an output signal **Trip BB zone** for each section of busbar (bus zone), therefore the respective zone must be given when selecting this signal.

4.6.3.6 Outputs Overview tab

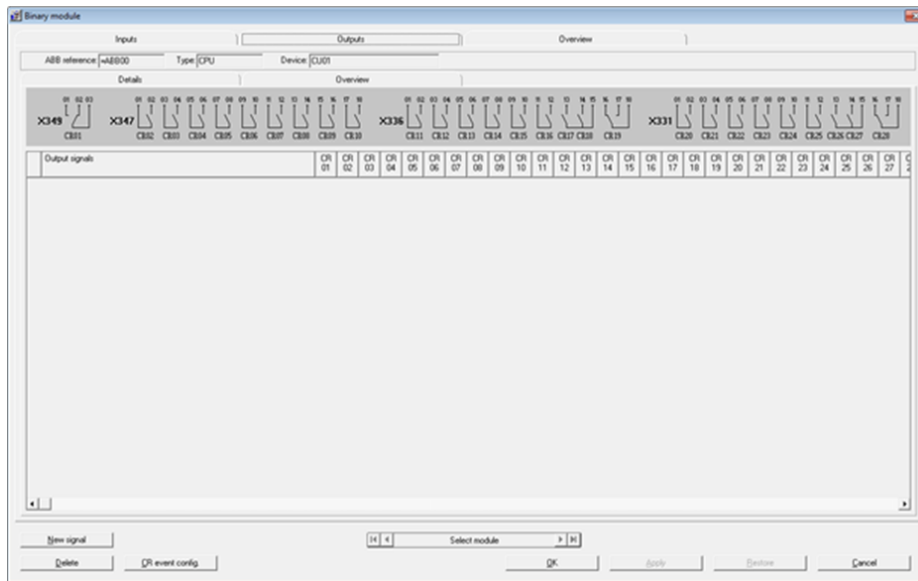

13000008-IEC18000540-1-en.vsdX

Figure 30: Configuration/ Binary module/ Outputs/ Overview – CU

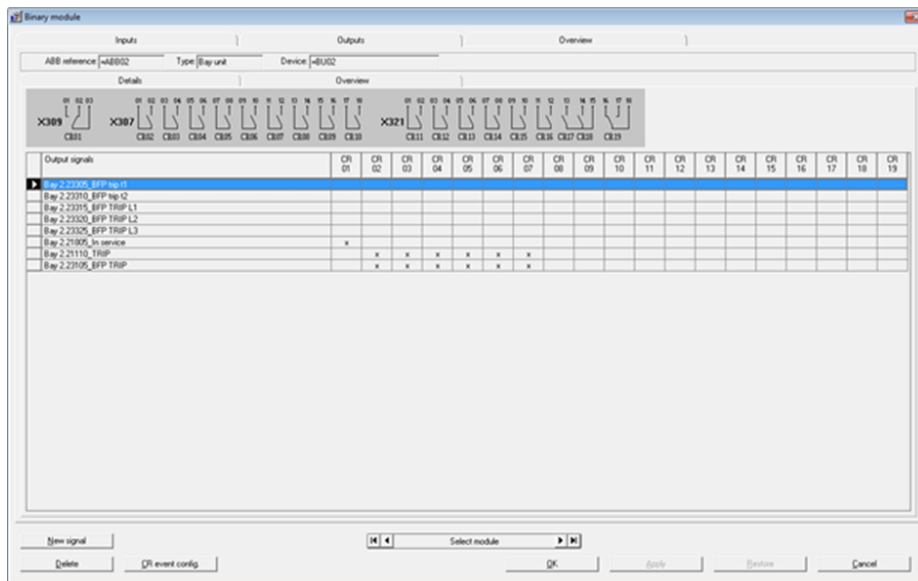

13000009-IEC18000541-1-en.vsdX

Figure 31: Configuration/ Binary module/ Outputs/ Overview – BU

The overview of the BU outputs shows which signals are assigned to which output relays. An output relay can be controlled by several signals (for example, relay CR02 by **TRIP** and **BFP TRIP**).

For reasons of safety, it is impossible to mix tripping commands and signals, that is tripping commands can only be combined with tripping commands and control signals with control signals.

Tripping commands:

- 21105_EXTERNAL TRIP
- 21110_TRIP
- 23105_BFP TRIP
- 25105_OCDT TRIP
- 27105_PDF TRIP

The remaining signals and all the CU signals are control signals.



It is recommended to configure tripping signals for operating circuit-breakers either to latch or to operate with a reset delay of at least 100 ms.

4.6.3.7 Outputs Details tab

13000010-IEC18000542-1-en.vsdX

Figure 32: Configuration/ Binary module/ Outputs/ Details - CU

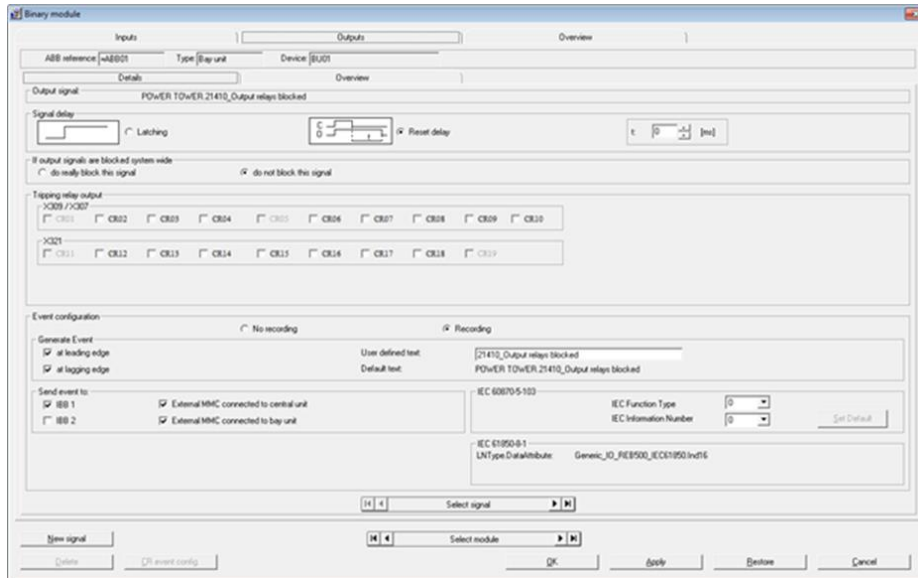

13000011-IEC18000543-1-en.vsdX

Figure 33: Configuration/ Binary module/ Outputs/ Details - BU

Signal delay

Every output signal can be configured either to latch (until reset by a signal) or to have a defined reset delay. A reset delay can be entered in the field **t** and can be changed by clicking with the mouse.

Blocking output signals throughout the system

In the case of all the output signals being blocked by the self-supervision function or a signal applied to the blocking CU or BU input **Block output relays**, the statuses of the selected output signals cannot change. This setting determines whether a signal is really blocked or is generated anyway.

Relay output

The current signal is assigned to the output relays with checked check boxes. Other signals of the same type (tripping command or control signal) may also be assigned to the same relay.

Unavailable output relays (grey) already have signals of the other type assigned to them. The remaining relays are available for other signals.

Event configuration

The configuration of an output signal event is the same as for an input signal event. An event is generated when the output signal is set, respectively reset.

Configuring output relay events

An event is generated when an output relay picks up or resets, that is this type of event takes any reset delay that has been set or blocking by another signal into account. As in the case of the binary input signals in [Section 4.6.3.2](#), the binary output signals are configured at the works.

1. Select an output relay in the **overview** dialog box first by clicking on its label above the signal list (its column is then highlighted).
2. Click **CR event config** to open the event configuration dialog box.

4.6.4 GOOSE input support

GOOSE indications from protection IED's (for example, Line protection trip) can be used as input signals for REB500 functions (for example, Start breaker failure protection).

Figure 34 illustrates a line fault combined with a breaker failure condition, and the resulting information (trip signal) flow assumed that the REB500 starting input is based on a GOOSE indication.

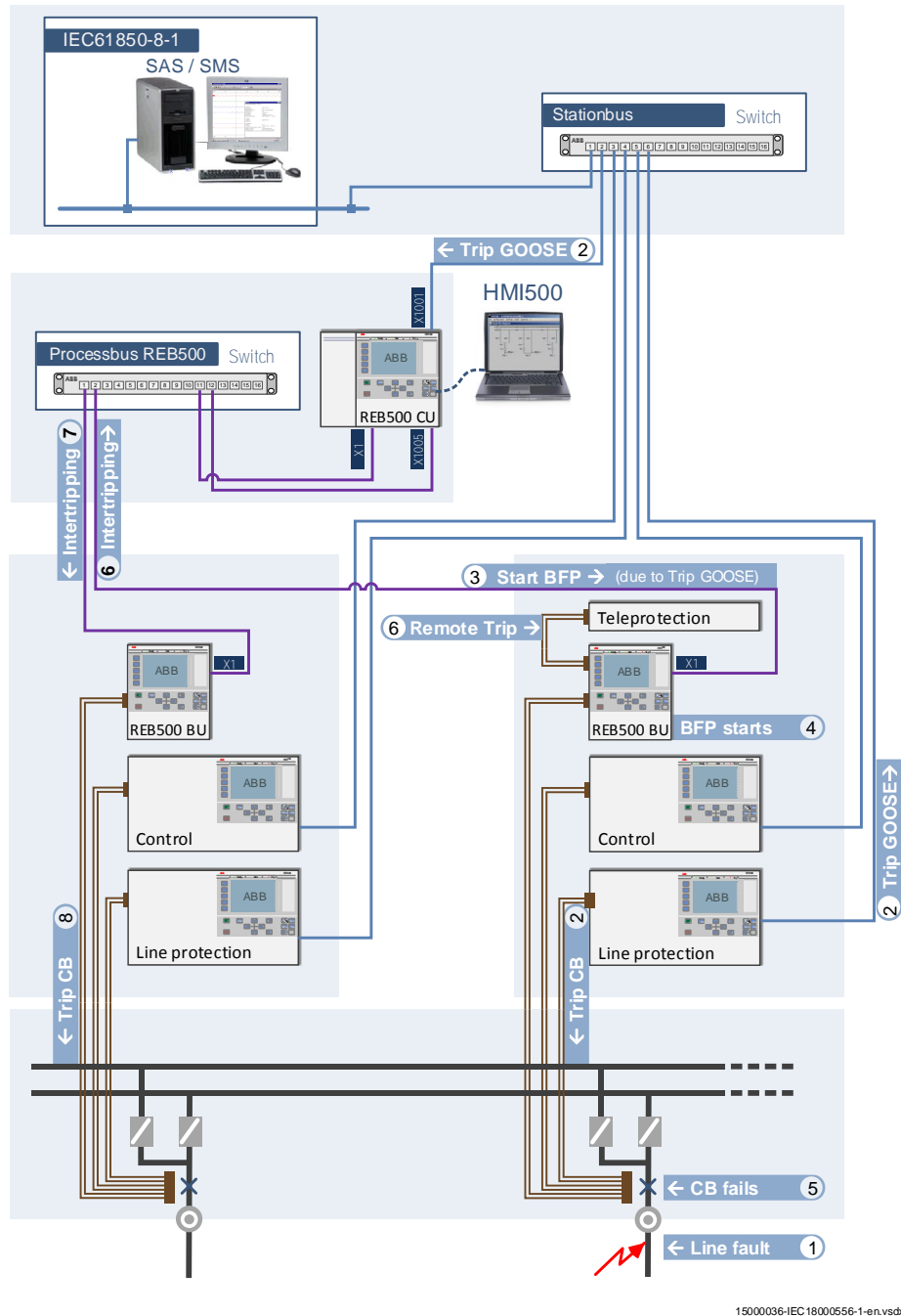

Figure 34: GOOSE input support - Information flow

Table 9: Explanations of information flow using GOOSE as input

Step	Description
1	Fault on line side
2	The line protection IED detects a fault, issues a trip command to the CB and indicates the issued trip on the station bus by GOOSE. The GOOSE DA is received by the REB500 Central unit.
3	The REB500 central unit forwards the information to the bay unit (see Table 10). Due to the REB500 configuration (made with the HMI500 tool) the GOOSE data attributes of the issued trip is mapped to the breaker failure start signal(s).
4	The bay unit starts the breaker failure protection
5	The circuit breaker fails to trip (trip issued by line protection IED (see Step 2).
6	If circuit breaker tripping is not successful after BFP timers have passed: <ul style="list-style-type: none"> • a remote tripping command is sent (via teleprotection) • intertripping is sent to the central unit
7	The Central unit performs the intertripping to the respective bay units
9	The bay units of the respective zone issue a trip command and consequently clear the fault

4.6.4.1 Interface to System engineering tool

Using GOOSE input signals for protection functions requires interaction between the REB500 configurator (HMI500) and the System engineering tool. [Table 10](#) provides an overall view of the engineering process.

Table 10: GOOSE engineering process

Step	REB500 configuration tool HMI500	System engineering tool	Remark
1	Pre-configuration: <ul style="list-style-type: none"> REB500 System must be configured System name must be defined GOOSE client must be enabled 	-	Enabling GOOSE Client (see Figure 35)
2	The REB500 IEC 61850-8-1 model is exported in an ICD file.	-	See Figure 36 and Figure 37 In addition to the ICD file that describes the IED functions, the project-specific configuration file is also exported: <ul style="list-style-type: none"> Edition 1: CID file (.cid) Edition 2: IID file (.iid) Selection of the Edition Configuration/Communication/SCS Configuration/IEC 61850-8-1 options/Edition x (see Figure 38) This Export SCS data process is used initially and after a configuration change.  Each time the export is started, the original values of REB500 setting parameters are implemented.
3	The REB500 ICD file is transferred to the system engineering tool	-	The IED name of the REB500 in the System engineering tool must match the System name in the REB500 configuration tool.
4	-	The REB500 ICD file is imported	
5	-	The data flow engineering is made in the System engineering tool	Setting instruction: For correct operation the GOOSE max repetition time should be set to 1 second.
6	-	Export of the Station configuration description (SCD file) and transfer to the HMI500	Containing GOOSE data set, report control block, source IED and destination IED
7	The available GOOSE data attributes are imported (from SCD file)	-	Configuration/Communication/SCS Configuration/IEC 61850-8-1 options/Import GOOSE data attributes button (see Figure 38).
Table continues on next page			

Step	REB500 configuration tool HMI500	System engineering tool	Remark
8	Final configuration: The assignment of GOOSE data attributes from selection list Unassigned GOOSE data attributes to REB500 input signals is made	-	See Figure 40 .
9	Download the configuration to the REB500 system	-	CCF creator uses the information of the Station configuration description (SCD) and of the REB500 configuration to create the configuration of the REB500 GOOSE client Sending IED: <ul style="list-style-type: none"> • Communication section • GSEC Control • DataSet  This configuration is automatically created during setfile download and the same time, the CID/IID file is updated.
10	Post-configuration: Transfer of the updated CID/IID file (see remark under item 9) to the system engineering tool	-	Used source IED data attributes are marked.
11	-	Post-configuration: Import of the updated CID/IID file	Prevents removing used GOOSE data attributes from the source IED.



If any further configuration changes affect the IEC61850 model or IEC61850 communication, then the information should be transferred by repeating steps 2 through 11.

4.6.4.2 Enabling GOOSE Client

This section describes the pre-configuration of the GOOSE Client.

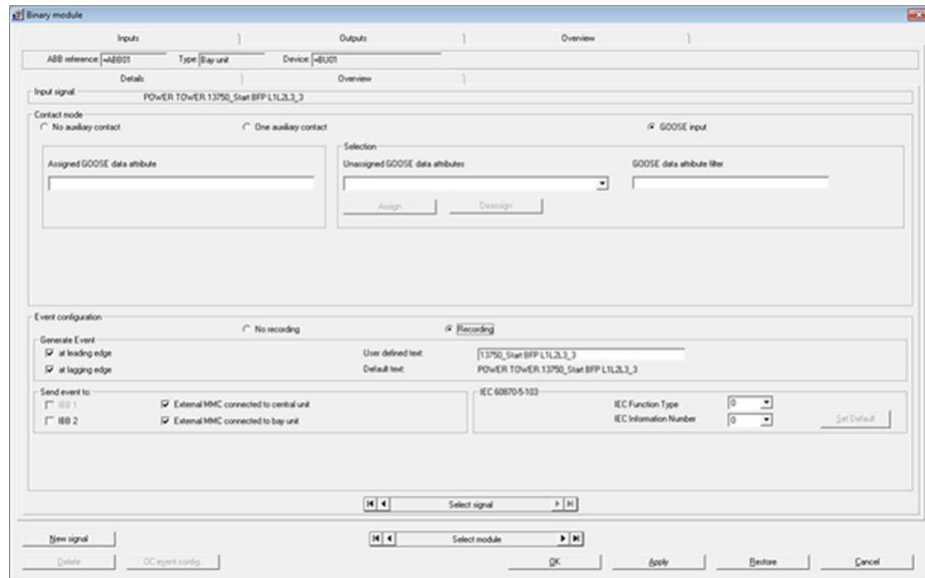

15000040-IEC18000560-1-en.vsd.x

Figure 35: Configuration/ Binary module/ Inputs/ Details - Contact mode

The GOOSE Client is enabled if at least one of the REB500 input signals has been configured as **GOOSE input**. The radio button **GOOSE input** is only available for specific REB500 signals. The **Assign** button is enabled after the Station configuration file (SCD) has been imported.

4.6.4.3 Export IID/CID file

The configuration file which is passed to the system configuration tool can be created from the **Tools/Export SCS data** menu. The **Export** button starts the export.

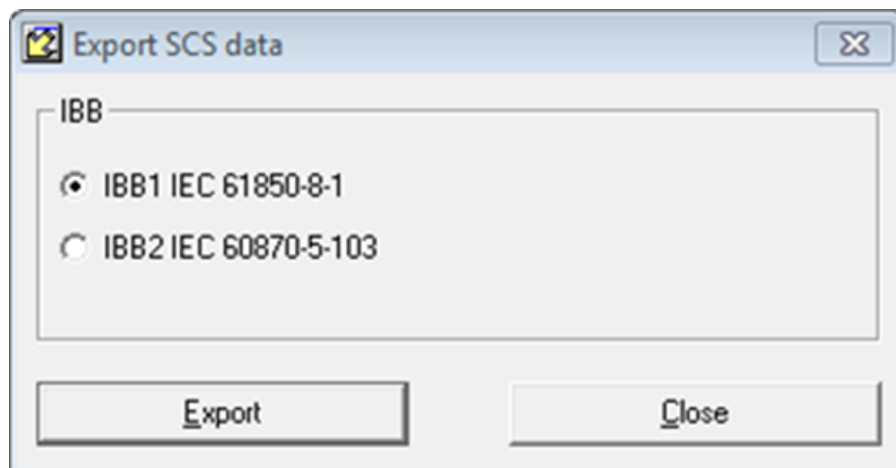

15000039-IEC18000559-1-en.vsd.x

Figure 36: Tools/ Export SCS data

A successful export is indicated by the SCS data exported message box. Additionally the location of the configuration file is shown.

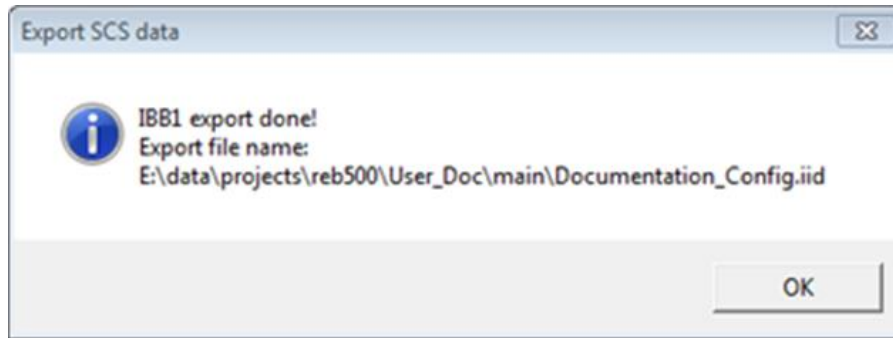

15000041-IEC18000561-1-en.vsdX

Figure 37: SCS Data exported

4.6.4.4 Import GOOSE attributes

The **Configuration/SCS Configuration/IEC 61850-8-1 options/Import GOOSE data attributes** button opens a file open dialog box. It is used to select the Station Configuration File (SCD), which has been created by a system engineering tool. GOOSE data attributes, which can be mapped to REB500 signals, are imported from the Station Configuration File.

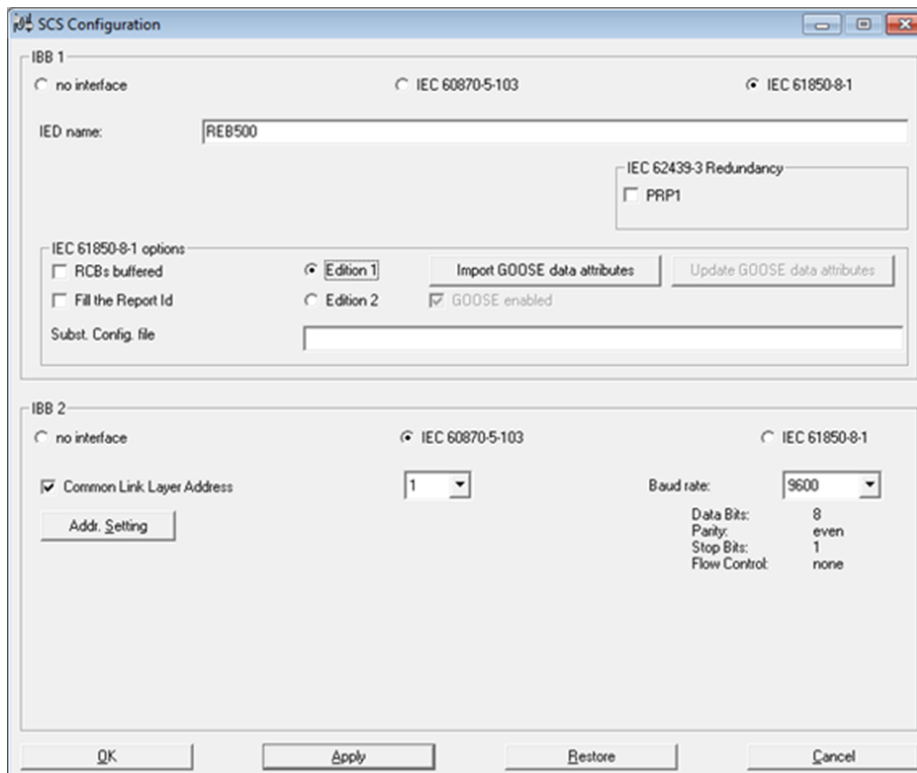

15000028_2-IEC18000553-1-en.vsdX

Figure 38: Configuration/ SCS Configuration/ IEC 61850-8-1 options

Once the SCD file is imported to the HMI500, the **Import GOOSE data attribute** button changes the text label to **Delete GOOSE data attributes**.

A successful import is indicated by the GOOSE data attributes imported message box. The number of imported attributes is shown in the box.



15000037-IEC18000557-1-en.vsdX

Figure 39: GOOSE data attributes imported



To simplify GOOSE engineering in REB500, the import of GOOSE signals is limited to specific logical nodes (for example, PTRC).

4.6.4.5 GOOSE input mapping

This section describes the configuration process of GOOSE input mapping in HMI500 menu **Configuration/Binary Module/Inputs/Details**.

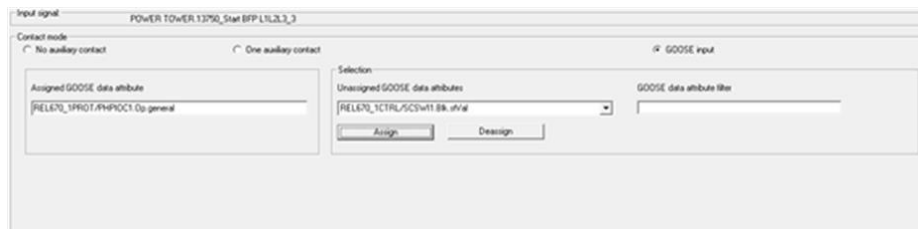

15000042-IEC18000562-1-en.vsdX

Figure 40: Configuration/ Binary module/ Inputs/ Details/ Contact mode – GOOSE Input

Table 11: GOOSE Input menu items

Menu Items	Description
Assigned GOOSE data Attribute	If a REB500 Signal has assigned to a GOOSE data attribute then the name of the attribute is listed in this field
Selection – Unassigned GOOSE data Attributes	List of GOOSE data attributes which can be assigned to the selected Input signal. See Figure 41 .
Selection – Assign	Confirms the mapping of the selected attribute to the REB500 Signal. The Assign button is enabled after the Station configuration file (SCD) has been imported.
Selection – Deassign	Breaks the connection between the GOOSE data attribute and the REB500 input signal. The GOOSE data attribute can be assigned to another REB500 Signal.
Selection – GOOSE data attribute filter	See Table 12

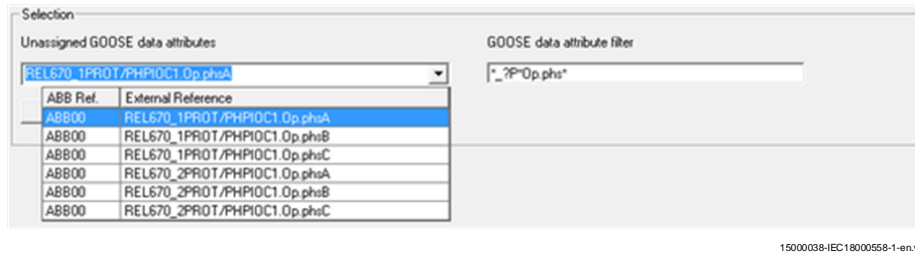

Figure 41: Configuration/ Binary module/ Inputs/ Details/ Contact mode/ GOOSE Input - Selection

Table 12: Selection elements

Menu Items	Description
Unassigned GOOSE Attribute – ABB Ref	REB500 Internal designation for the bay or central unit.
Unassigned GOOSE Attribute – External Reference	Full name of the GOOSE data attribute. The full name comprises: IED name, Logical Device Instance, Prefix, Logical Node Class, logical Node instance, Data Object name and Data attribute Name
Selection – GOOSE attribute filter	Regular expression which limits the number of GOOSE data attribute in the list of Unassigned GOOSE attributes: ? = any character * = none, one or any number of characters The comparison is case insensitive. examples: “*_1*Op*”, “*_?P*Op*”, “*_?P*Op.phs*”

4.6.4.6 Requirements to GOOSE input signals



The REB500 GOOSE input signals have to comply with the requirements for the corresponding standard input signal. Non-conformance may lead into unwanted operation of the protection system.

Example: The breaker failure protection remote trip (timer t1) and the intertripping to all bay units of a bus zone (timer t2) implies that the fault still persists at the end of the respective timer. Consequently, the GOOSE input signal (trip from line protection) mapped to the BFP start signal must therefore be reliably present during both time steps.

4.6.4.7 Disabling GOOSE client

The GOOSE client is disabled if none of the REB500 input signals have been configured as **GOOSE input** and GOOSE data attributes have been deleted in the **Configuration/SCS Configuration/IEC 61850-8-1 options**.

4.6.5 GOOSE send support

The REB500 can be configured to send trip information by GOOSE to other IEDs connected to station bus via central unit interface X1001 (PRP LineA) and X1002 (PRP LineB) respectively.

Figure 42 illustrates a busbar fault and the resulting information (trip signal) flow assumed that the control IED receives the trip information by GOOSE.

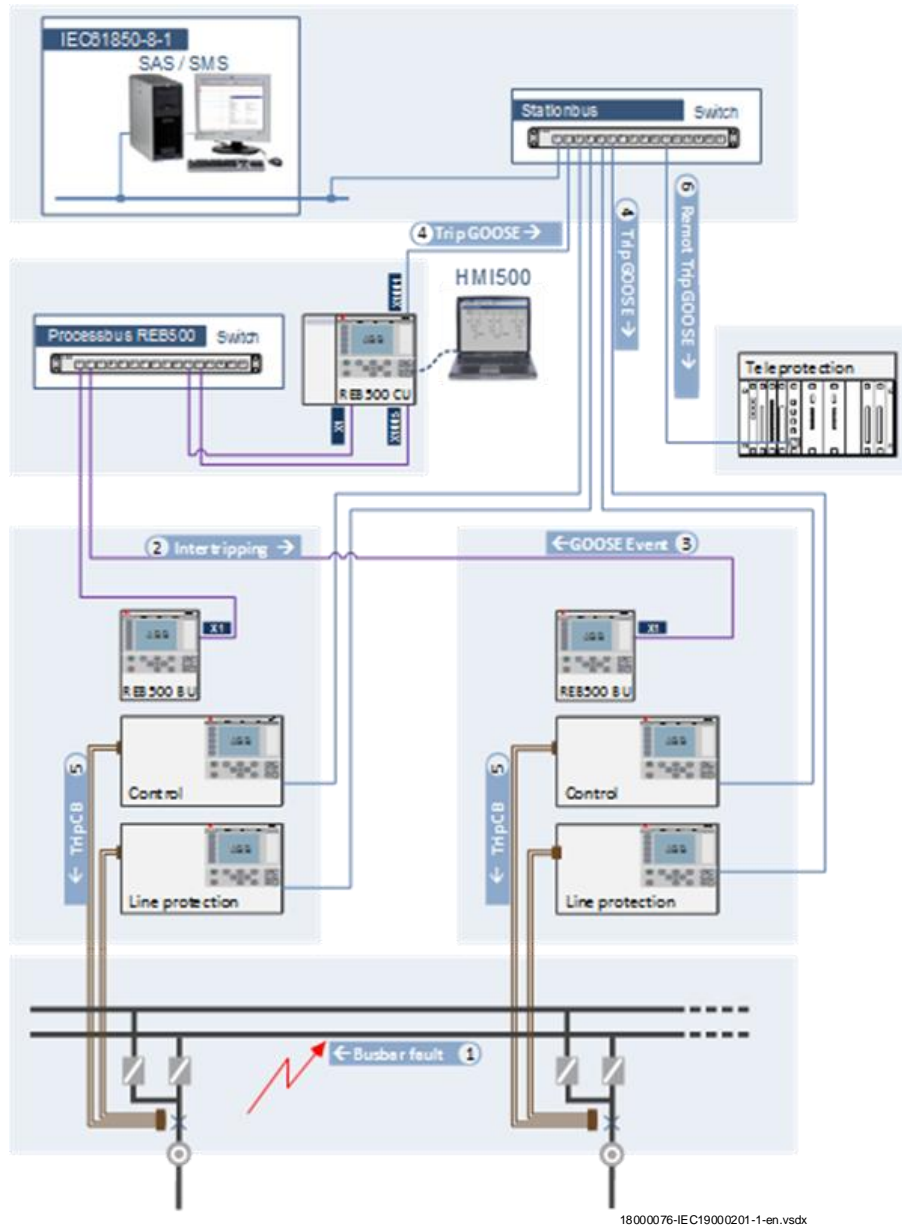

Figure 42: GOOSE send support -Information flow

Table 13: Explanations of information flow using GOOSE send

Step	Description
1	Fault on busbar.
2	The central unit detects the fault and issues an intertripping to the bay units of the associated protection zone.
3	The bay unit creates a high priority event which is transferred to the central unit. A high priority event is also created in case of a trip of the bay local protection functions that is BFP, EFP, BP, See section <i>Combined tripping commands</i> in the <i>Technical Manual</i> .
Table continues on next page	

Step	Description
4	The high priority event is mapped to IEC 61850 LN PTRC and PSCH respectively. If a GOOSE control block has been mapped to the trip signals then GOOSE messages are sent according to the definition. Section Mapping of the REB500 signals to logical nodes, table Mapping from REB500 signals to IEC 61850 data attributes in the Communication Protocol Manual IEC 61850 provides a list of the signals which are mapped to a IEC 61850 data attribute.
5	The control IED trip the circuit breaker.
6	In case of a remote trip a tele protection device can transfer the PSCH information to a remote substation.



The IEC 61850 communication stack and the application startup of REB500 are independent and at times parallel processes. Depending on the system size and the number of configured protection functions, the number of logical nodes differs considerably. Because the number of logical nodes has a significant impact on the startup time of the communication stack, it may be that the protection functions are already available before the information is sent via GOOSE. Therefore the presence of an active GOOSE communication should be checked in the receiver IED.

The configuration of GOOSE send is divided into two steps. First the GOOSE control block has to be defined which describes the destination for the GOOSE messages. As a second step, specific REB500 signals can be assigned to a previously defined GOOSE control block. The state of such a signal is continuously transmitted as a GOOSE multicast event.

4.6.5.1 Configure GOOSE control blocks

This section describes the configuration of the GOOSE control block. Depending on the requirement up to 12 GOOSE control blocks can be defined.

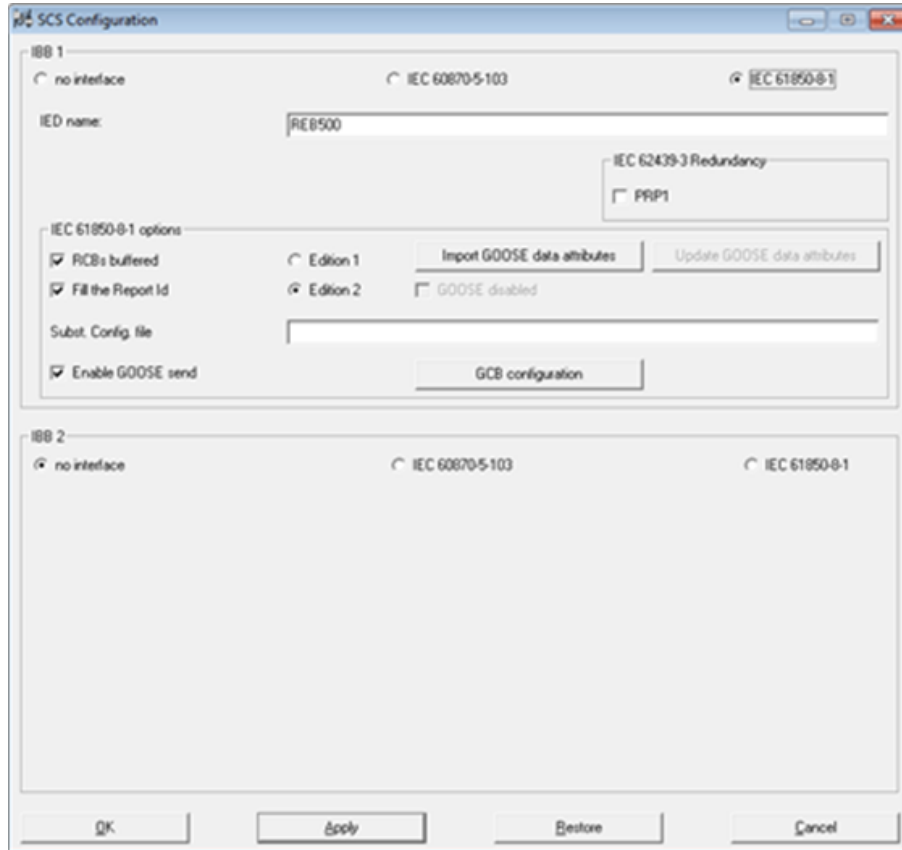

18000077-IEC19000202-1-en.vsdX

Figure 43: Configuration / SCS Configuration – IEC 61850-8-1 options

When the **Enable GOOSE send** check box is ticked then the **GCB configuration** button can be used to open the **GOOSE control block configuration** dialog box.

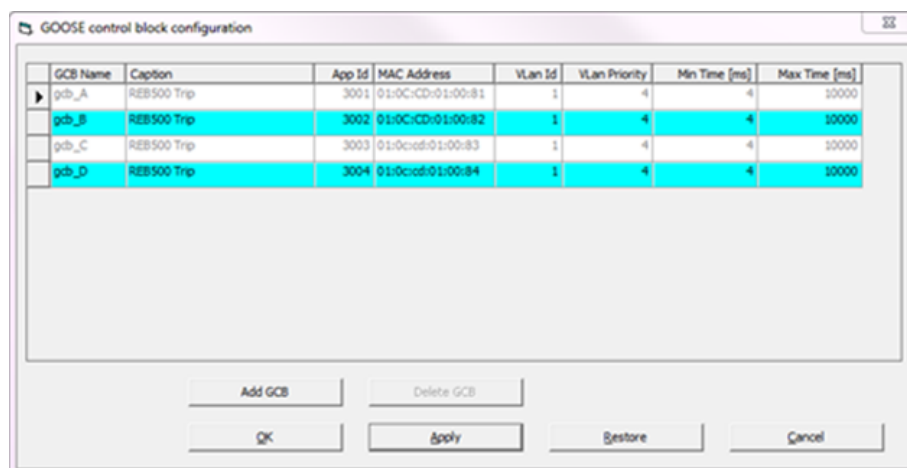

18000081-IEC19000203-1-en.vsdX

Figure 44: Configuration / SCS Configuration – IEC 61850-8-1 options / GCB configuration

Fields of the GOOSE control blocks are used according to IEC 61850-7-2 and IEC 61850-8-1.

Table 14: GCB configuration Menu Items

Menu items	Description	IEC 61850 identification	Default
GCB Name	Unambiguously identification of the GCB within the scope of the LLN0. Defined by the System.	GoCBName	
Caption	Attribute that allows a user to assign an identification for the GOOSE message.	GoID (Ed 2) appID (Ed1)	
App ID	Unique Identifier of GOOSE messages according to IEC 61850-8-1 Appendix C.	APPID	0
MAC Address	MAC address to which the GOOSE message is to be sent. The address shall be an Ethernet address that has the multicast bit set TRUE.	DstAddress.Addr	
VLAN ID	Range of values from 0 to 4095 according to IEEE 802.1Q.	DstAddress.VID	0
VLAN Priority	Range of values 0 to 7 according to IEEE 802.1Q.	DstAddress.PRIORITY	4
Min Time	As defined in IEC 61850-6 the sending delay on a data change between the first immediate sending of the change and the first repetition in ms.	MinTime	4
Max Time	As defined in IEC 61850-6 the source supervision time in ms (supervision heartbeat cycle time).	MaxTime	10000
Add GCB	Insert a new item at the end of the list.		
Delete GCB	Deletes the selected item		

4.6.5.2 Defining signals for GOOSE send

This section describes the configuration of the “GOOSE output” mapping which is done in HMI500 menu in **Configuration/Binary Module/Outputs/Details**.



Only signals which are mapped to a GOOSE control block are sent in GOOSE messages.



For all mapped signals the name of the GCB Name is listed in the GOOSE column in the Overview tab of the **Binary module/ Outputs** dialog box.

RESTRICTION:

The combined tripping signals are less flexible than the tripping logic of the **Trip relays output** assignment in the Details Tab of **Configuration /Binary Module — Outputs**.

If a phase selective function trips that is **23315_BFP TRIP L1** (PTRC.phsA on GOOSE) then also system internally the **23315_BFP TRIP L1** is set. As a consequence for GOOSE the PTRC.general is always TRUE on a trip. This in parallel with the phase specific PTRC.phsx (x = A,B,C,neut) on GOOSE.

Only specific Signals can be assigned to GOOSE. In the Details Tab of the **Binary Module/ Outputs** the menu item **GOOSE control block assignment** is only shown for these specific signals.

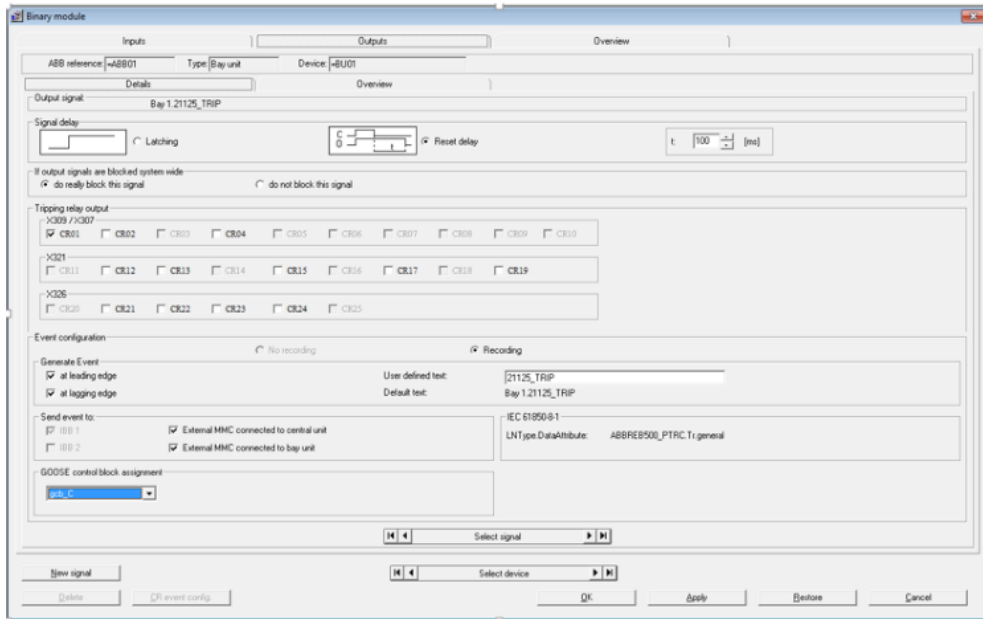

18000078-IEC190002 13-1-en.vsdK

Figure 45: Configuration / Binary module - Outputs - Details – BU

Table 15: GCB configuration Menu Items

Menu Items	Description
GOOSE control block assignment	List of defined GOOSE control blocks (GCB's). The list is only shown for signals which can be assigned to GOOSE. See <i>Combined tripping commands</i> in the <i>Technical manual</i> .

4.6.6 Event text configuration

In this window, all the event signals configured for REB500 are displayed. For each event signal, a user specific text can be defined (maximal 32 characters). The user can sort the list as per ABB reference or the standard text.

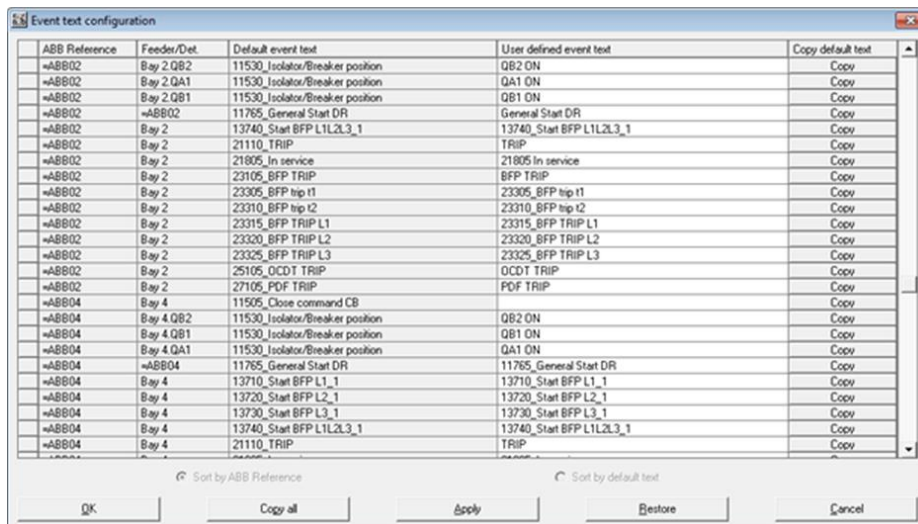

12000117-IEC18000509-1-en.vsdK

Figure 46: Event text configuration

4.6.7 LMI LEDs

This dialog box contains the list of bay units and the central unit (**LMI LED configuration**). The unit specific configuration dialog box (**Status LED on LMI**) is opened by selecting the desired bay unit or central unit with the left mouse button and then clicking on **Continue** or directly by simply double-clicking on the unit line.

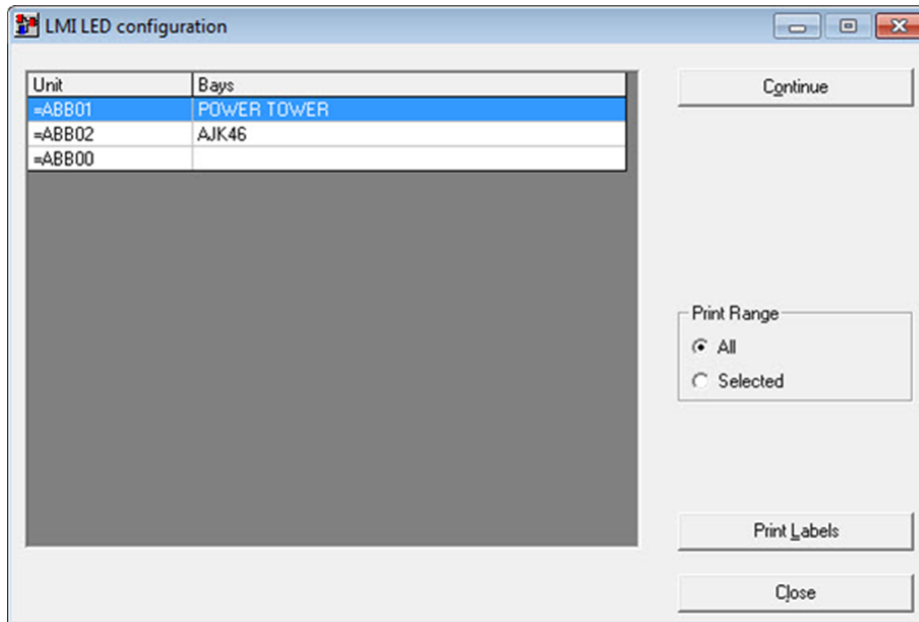

12000118-IEC18000510-1-en.vsdX

Figure 47: LMI LED configuration (List of units/ Print dialog box)

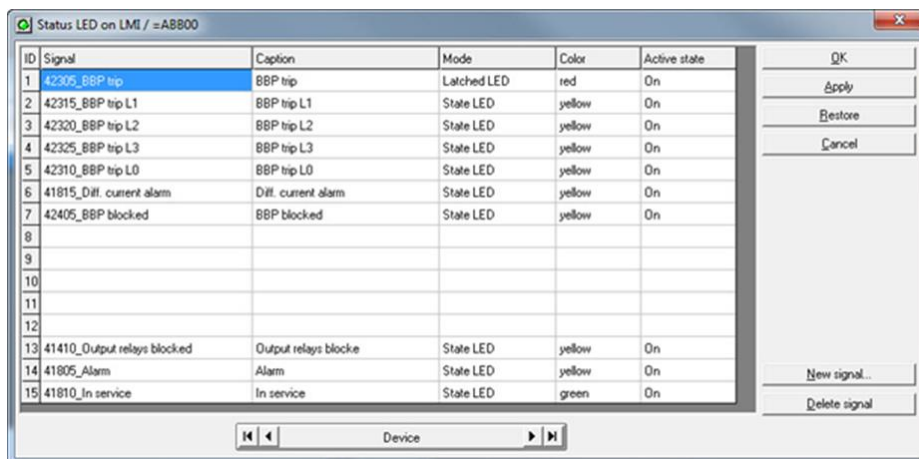

12000119-IEC18000511-1-en.vsdX

Figure 48: Status LED on the LMI (LED Configuration dialog box)

Under the **Status LED on LMI** dialog box, the number of the LED on the LMI is given in the **ID** column.

4.6.7.1 New signal

A LED is assigned to a signal by marking it in the dialog and clicking on **New signal** or alternatively by double-clicking on the LED line. A list of possible signals is then presented to

enable one to be chosen. Several signals can be assigned to one LED. Then the LED reflects the state of configured signals (combined in an OR function).



In case of breaker and isolator position signals only one position signal can be assigned.
The caption, mode, color and active state configuration can be set once for each LED.

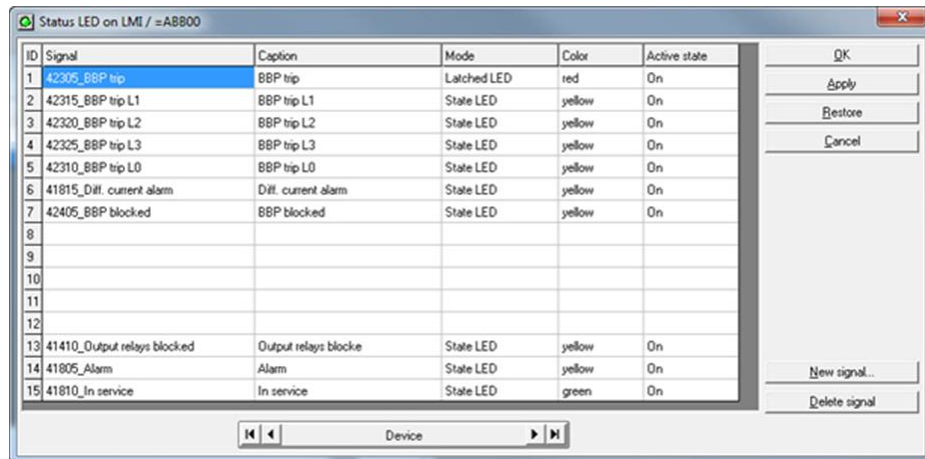

12000119-HEC18000511-1-en.vsdX

Figure 49: New signal (list of available signals)

4.6.7.2 Delete signal

The assignment of a signal is cancelled by marking it in the dialog box and clicking on **Delete signal**.

4.6.7.3 Caption

The name in the **Caption** column proposed by the program can be edited by selecting it with the mouse. A caption can have a maximum of 20 characters.

4.6.7.4 Mode

The user can determine the response of the LED by clicking in the **Mode** column. The following modes are possible:

- Status: The current status of the signal is displayed.
- Latching: The status of a LED is stored until one of the following occurs:
 - A bay protection function picks up
 - A station protection function trips
 - It is reset via the local HMI
 - It is reset by HMI500
 - It is reset by a binary signal
- Switch closed green: For a defined ON or OFF state of a switch (breaker/ isolator binary input signals 0 1 or 1 0) the closed position is indicated by a green LED and the open position by a red LED. All other (undefined) combinations of the binary input signals (0 0 or 1 1) are indicated by a yellow LED.
- Switch open green: For a defined ON or OFF state of a switch (breaker/ isolator binary input signals 0 1 or 1 0) the closed position is indicated by a red LED and the open position

by a green LED. All other (undefined) combinations of the binary input signals (0 0 or 1 1) are indicated by a yellow LED.

The **Status LED on LMI** dialog box is saved by clicking **OK**. The dialog box **LMI LED configuration** is active again and a print of the LED labels can be started by clicking **Print Labels** now. Before initiating a print job, the **Print Range** as well as the **Label Orientation** shall be adjusted.

4.6.8 Disturbance recorder

4.6.8.1 Analogue inputs

Bay Units

The currents measured by the four analogue inputs are always recorded. The five voltage inputs may only be recorded providing they have been licensed and engineered (optional).

The recording time is doubled if the voltage channels are not activated.

Central Unit

The differential and restraint currents and in addition the phase angle difference (hereinafter referred to as phase difference) of the currents are recorded per phase (L1..L3, L0) and bus zone. In the event that several bus zones are interconnected to (L1..L3, L0) and bus zone. In the event that several bus zones are interconnected to one protection zone, each bus zone shows the same measurement values.

The phase difference is only recorded, if it is enabled in the **Recording** tab of the CU disturbance recorder configuration (see [Figure 52](#))

The following diagram is an example of a phase difference record where no BBP trip occurred (since phase difference value is constantly above the trip range).

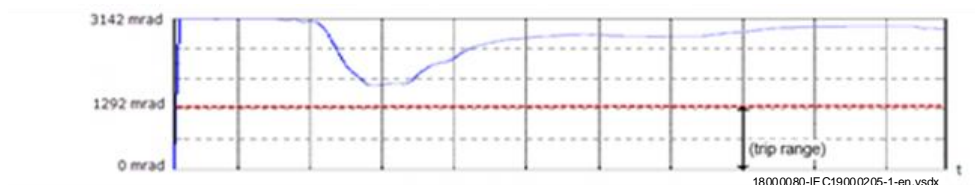

Figure 50: Example of a phase difference record

For more information about the phase comparison algorithm, see *REB500 Application manual*, section *Phase comparison*.



Remarks concerning the phase difference recording:

If the phase difference is activated, maximal four additional analogue channels per bus zone are recorded. (The maximal amount of recorded analogue channels per bus zone for currents and phase difference is 12). For larger systems this will cause a considerable amount of data which must be handled by a disturbance recorder evaluation program.

Particular display situations:

- If in a protection zone all phase measurements are invalid (for example, because the currents are below the phase comparison settings), the value -1 is recorded.
- If in a protection zone only one phase measurement is valid, the value "0" is recorded.
- The measuring range of the phase difference is 0 .. 3142 mrad (0° .. 180°).

The differential and restraint currents for each buszone are always recorded.

The dialog box has three tabs:

Overview

The overview shows all devices and their basic disturbance recorder configurations. A device is selected by clicking on it with the mouse.

The column **ABB ref.** indicates an internal designation for the devices. The reference =**ABB00** is always assigned to the central unit. The references =**ABB01-xx** are assigned to the bay units.

License status

This dialog box lists all the licensed devices and the duration of recording (see [Figure 55](#)).

Configuration

The configuration dialog box shows a device together with its recording mode and signals.

4.6.8.2 Recording

Bay Units

The following disturbance recorder settings can be made (see [Figure 51](#)).

Sampling frequency (50 Hz/60 Hz): 1000/1200 Hz, 2000/2400 Hz or 4000/4800 Hz. The maximum recording time is automatically adjusted to suit.

- Number of records (n): The maximum recording time available is divided by this setting into n equal time periods. For example, assuming 3 records have to be made for a sampling frequency of 2000 Hz, then 13.33 s each can be recorded.
- Acquisition time: This setting determines how much time before the triggering point is included in the record. The recording time must be at least 0.2 s to record the pre-fault and 0.3 s for the post-fault history.

Central Unit

The following disturbance recorder settings can be made (see [Figure 52](#)).

- Number of records n : The maximum recording time available is divided by this setting into n equal time periods. For example, assuming 3 records have to be made, then 6.67 seconds each can be recorded.
- Acquisition time: This setting determines how much time before the triggering point is included in the record. The recording time must be at least 0.2 s to record the pre-fault and 0.3 s for the post-fault history.

4.6.8.3 Signals

Bay Units

All binary signals (input, output or internal signal) can be recorded. For this purpose, they must be configured for recording and identified by their signal labels.

Up to 32 binary signals per bay can be selected for recording. Of these, up to 12 can be configured to trigger the start of recording. Triggering can take place on the lagging or leading edge of a signal. If **both edges** is selected, both lagging and leading edges are active (see [Figure 53](#)).

Once recording has been started, the complete recording period that has been set is recorded.

In addition to the normal bay unit binary signals, there are up to ten general purpose input signals that can be configured for recording and for triggering the disturbance recorder (**16705... 16750_Start DR_x**).

Central Unit

Some binary output signals can be recorded (see the following list). For this purpose, they must be configured for recording and identified by their signal labels.

- 41305_Trip BB zone41305_Trip BB zone
- 41815_Diff. current alarm
- 42305_BBP trip
- 42330_Check Zone Operated
- 46705_DR general started

Up to 32 signals can be selected for recording. Triggering can take place on the lagging or leading edge of a signal. If **both edges** is selected, both lagging and leading edges are active (see [Figure 53](#)).

Once recording has been started, the complete recording period that has been set is recorded.

Unlike the bay units, there are no dedicated general purpose input signals for recording and triggering.

Sorting binary signals

The order of the binary signals in the list can be changed by clicking on the **Signal ID** column of the respective signal and moving it to a new position. All other signals are sorted automatically in relation to the signal that has been moved.

The order of the signals in the list is the order in which they are transferred when uploading disturbance data.



Since circuit-breakers and isolators equipped with two auxiliary contacts (CLOSE and OPEN) can have more than two statuses (open, in motion, closed and undefined), the disturbance recorder does not record their positions. The disturbance recorder and the evaluation software can only process binary signals (that is with two possible values).

Possible solution: Configure one of the **x.Start DR** signals to be connected in parallel to the CLOSE auxiliary contact on the isolator.

Trigger operation

Recording commences when at least one of the triggering conditions is fulfilled. The trigger then remains disabled until the record has been completed and is then enabled again. You must therefore set the recording period such that all the signals you want to record can be recorded.



The trigger inputs are scanned every 16 ms. A trigger signal must have a pulse duration of at least 16 ms to be certain that it will be detected.

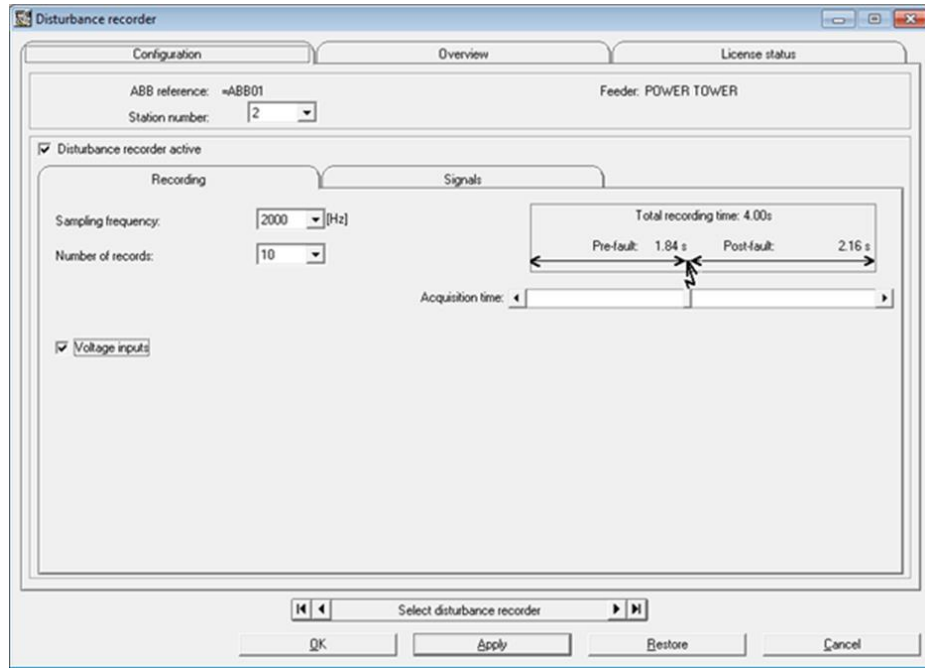

13000012-IEC18000544-1-en.vsdX

Figure 51: Disturbance recorder – Configuration (Bay Unit)

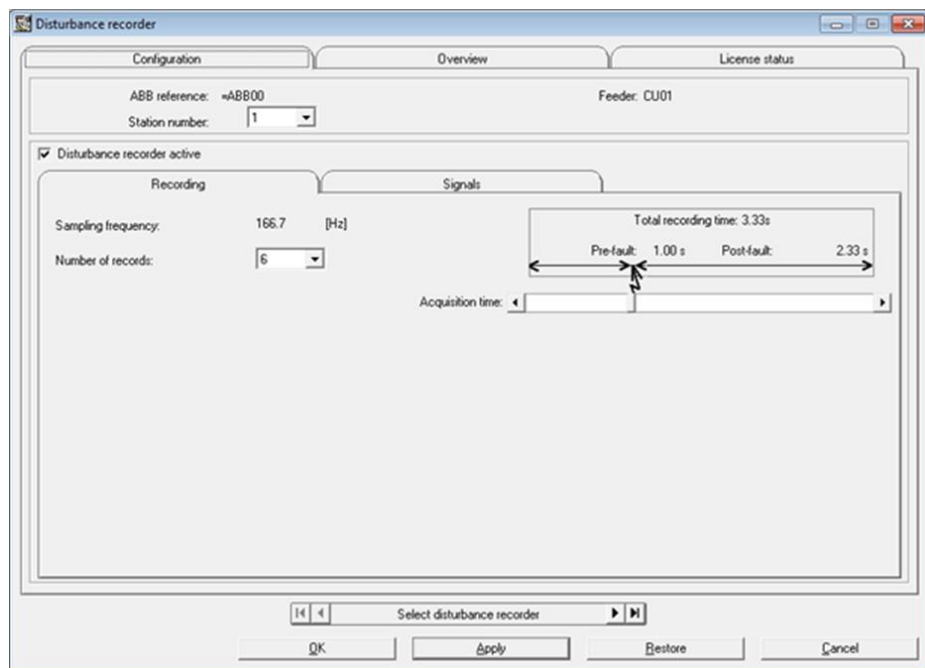

15000033-IEC18000555-1-en.vsdX

Figure 52: Disturbance recorder – Configuration (Central Unit)

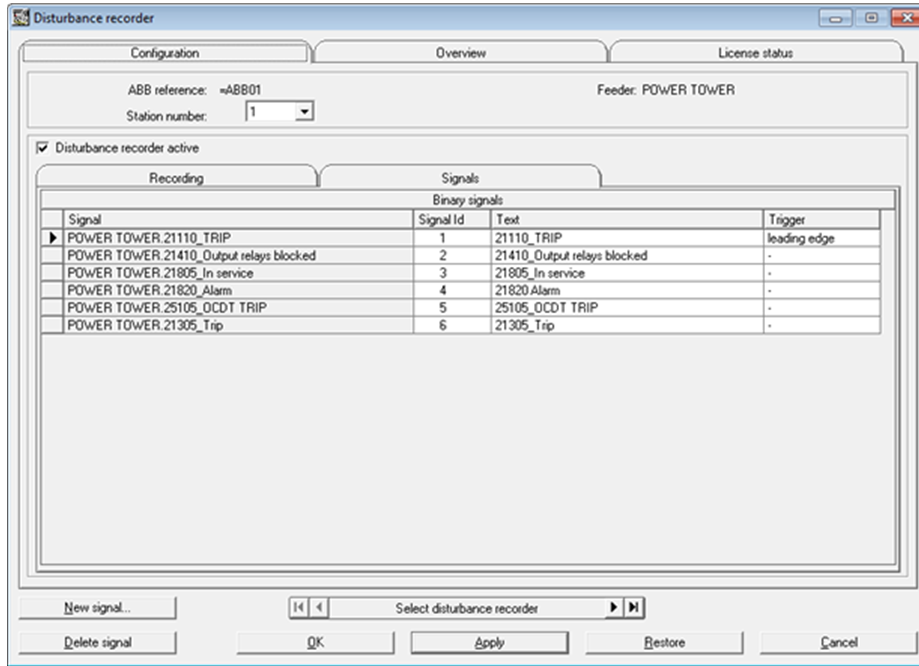

13000013-IEC18000545-1-en.vsdX

Figure 53: Disturbance recorder/ Configuration/ Signals

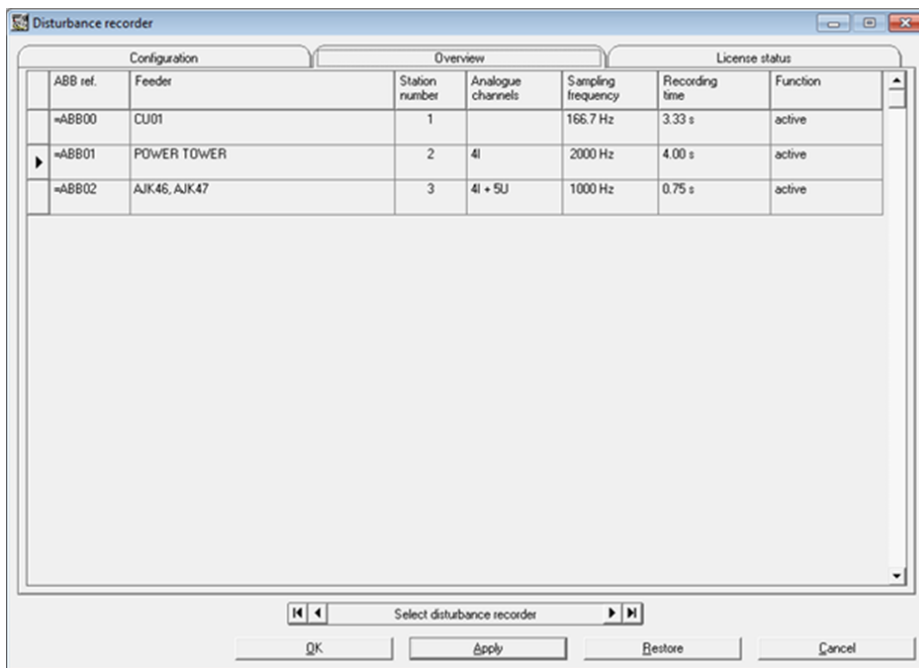

13000014-IEC18000546-1-en.vsdX

Figure 54: Disturbance recorder – Overview

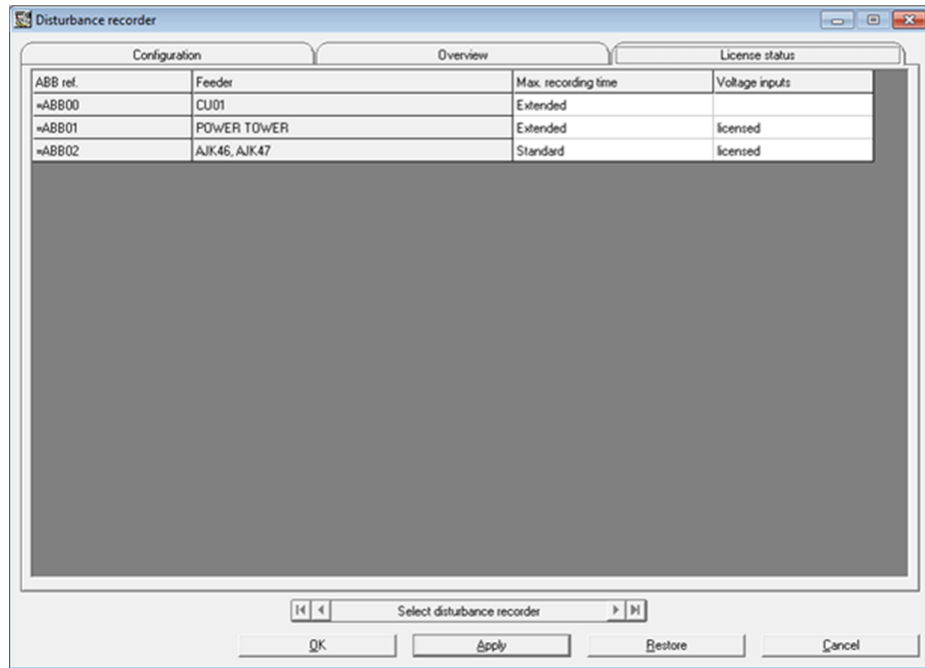

13000015-IEC18000547-1-en.vsdX

Figure 55: Disturbance recorder – License status

4.7 Settings menu

In general, the settings are described in the *Technical Manual*. Detailed explanations and examples can be found in the *Application Manual*. [Table 16](#) provides pointers to the respective sections in the *Technical Manual* and in the *Application Manual*.

Not all settings are available for all systems. Some settings depend on the scope of supply (marked \circ in column Av) while others are always available (\bullet).

Table 16: Settings menu items

Setting menu item	Av	Technical Manual section	Application Manual section
Breaker failure protection	\circ	<i>Breaker failure protection</i>	<i>Breaker failure protection</i>
Time overcurrent protection	\circ	<i>Overcurrent definite time protection</i>	-
End fault protection	\circ	<i>End fault protection</i>	-
CB pole discrepancy	\circ	<i>Breaker pole discrepancy protection</i>	-
Overcurrent release	\circ	<i>Overcurrent release of the trip command</i>	-
Voltage release	\circ	<i>Voltage release</i>	-
Circuit-breakers	\bullet	<i>Circuit-breakers</i>	-
Isolators	\bullet	<i>Isolators</i>	-
Current transformers	\bullet	<i>Current transformers</i>	-
Voltage transformers	\circ	<i>Voltage transformers</i>	-
Busbar protection	\bullet	<i>Busbar protection</i>	<i>Busbar protection</i>

Table continues on next page

Setting menu item	Av	Technical Manual section	Application Manual section
Release logic/matrix	•	<i>Release logic/matrix</i>	-
System response	•	<i>System response</i>	-
Activate/deactivate device	•	see <i>Commissioning Manual</i>	-
CB inspection	•	see <i>Commissioning Manual</i>	-
Event memory	•	<i>Event memory</i>	-
Time	•	<i>Time synchronization</i>	-

4.8 Testing menu

4.8.1 Test mode



Switching to the test mode while the protection is in operation should only be undertaken by especially trained personnel. Incorrect manipulations can cause false tripping, for example, by inadvertently operating a tripping relay, simulating an incorrect isolator or circuit-breaker status or activating a tripping input (for example, **External TRIP**).

The test generator is activated by opening the **Testing** menu, selecting **Test mode**. A tick appears next to the menu item, **Test mode** is added to the status line at the bottom of the screen and the **Test mode** dialog box opens.

The test generator is used in conjunction with the **Status of binary inputs/outputs** dialog box (has to be opened by the operator), (see [Section 4.5.4](#)).

When the test generator is active, the statuses of the tripping commands cannot change.

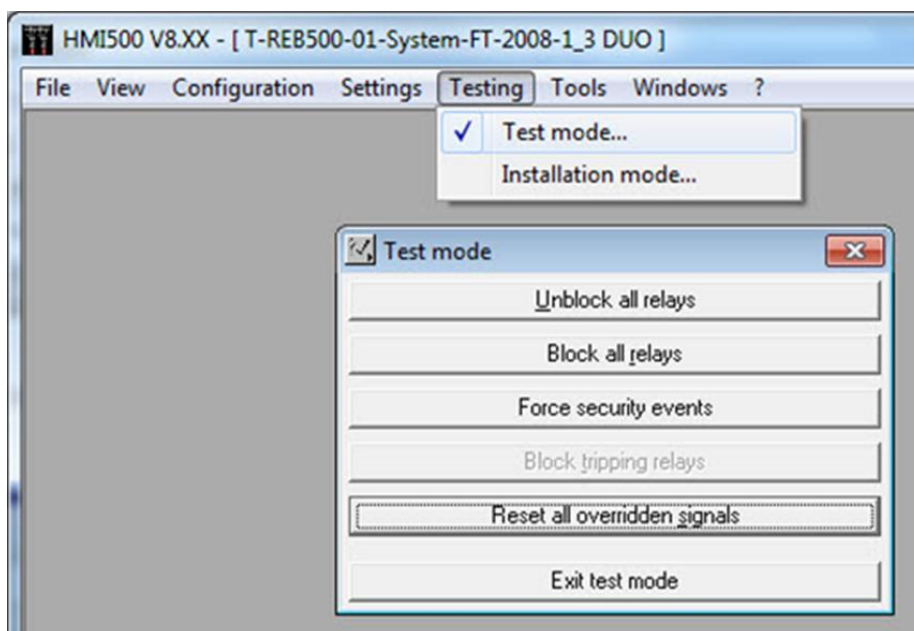

12000095-IEC18000502-1-en.vsdX

Figure 56: Test mode

Table 17: Buttons in Test mode dialog box

Button	Description
Unblock all relays	Restores the relays to normal operation and their statuses can change again.
Block all relays	Prevents the statuses of all relays for which outputs have been configured from being changed.
Force security events	See <i>Cyber security guideline</i> .
Block all tripping relays	Prevents the statuses of all relays from being changed with the exception of 41810_In service , 41835_Test generator active , 41410_Output relays blocked , 21805_In service and 21410_Output relays blocked . ¹⁾
Reset all overridden relays	Returns all inputs and outputs which had statuses impressed on them for test purposes to their original states.

- 1) These listed signals have precedence compared to other signals configured to the same output channel, that us the channel is not blocked after a test generator activation.



An output relay can be set or reset either directly (for example, by setting an output relay) or indirectly (for example, via an input or by a protection function).

The greatest care must be taken when using the test mode, especially when the protection system is in operation.



Blocking by the test generator takes precedence over all other functions, that is neither a protection function nor an External **TRIP** signal can initiate a trip.

Unblocking by the test generator takes precedence over all other functions, that is blocking by an isolator or differential current alarm or a signal applied to an optocoupler input is cancelled.

4.8.1.1 Using the test generator

In order to set or reset binary inputs and outputs using the test generator, it is necessary to open the **Status of binary inputs/outputs** dialog box. Providing the test mode is active, the status of an input or output can be changed by simply double-clicking on it.

Regardless of whether they are logical 0 or logical 1, inputs and outputs are normally green, those with impressed statuses yellow and invalid ones red. Impressed statuses are green after the display is refreshed.

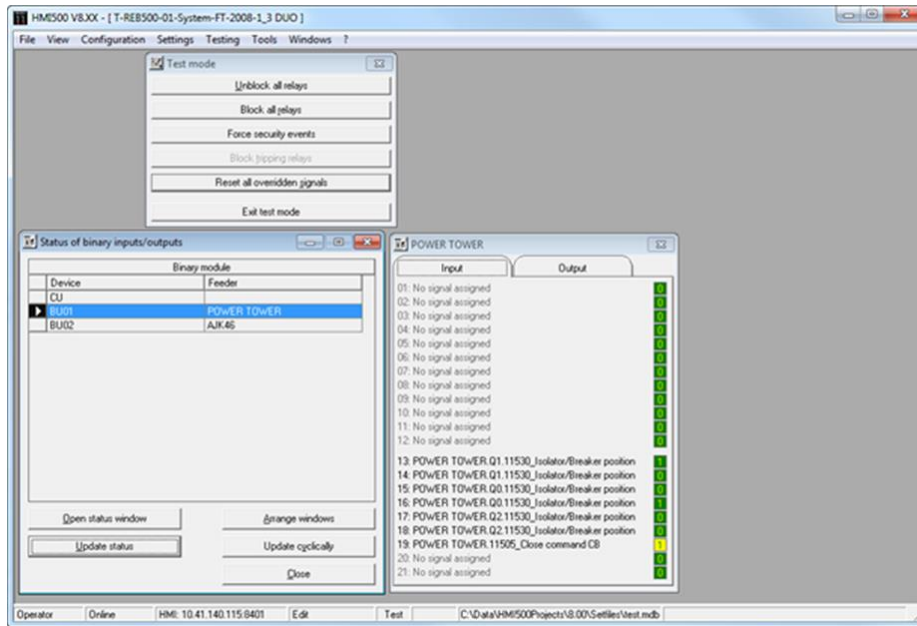

13000018-IEC18000549-1-en.vsdX

Figure 57: Statuses of binary inputs and outputs in the test mode13000018

4.8.1.2 Shutting down the test generator

The test generator is deactivated by clicking on the menu item **Test mode** a second time. All the relays are then restored to their original statuses, any latching is reset and blocking by the test generator is cancelled.

4.8.2 Installation mode

This mode is activated by opening the **Testing** menu, selecting **Installation mode**.

A tick appears next to the menu item, **Installation mode** is displayed on the status line at the bottom of the screen and the **Installation mode** dialog box opens.

Click on **Installation mode** in the **Testing** menu to reset the installation mode. The tick in the menu item is reset.

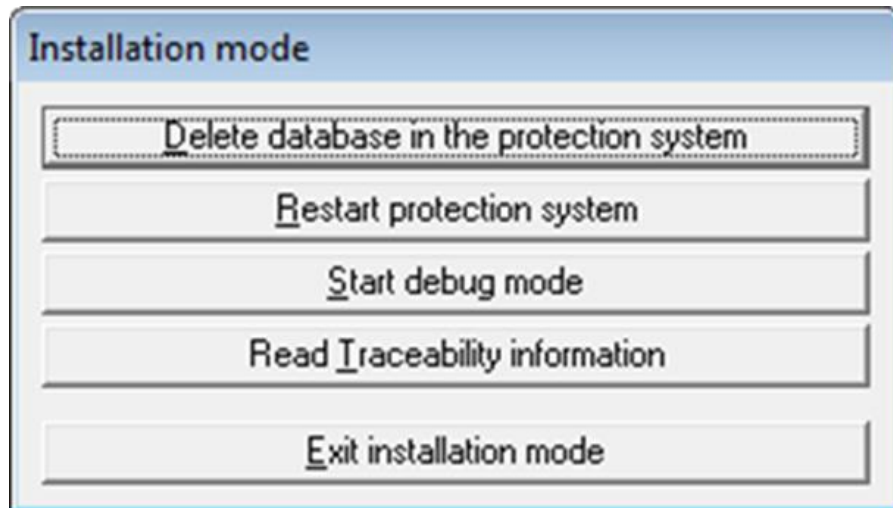

13000018_2-IEC18000548-1-en.vsd.x

Figure 58: Installation mode menu

Table 18: Buttons in Installation mode menu

Button	Description
Delete data base in the protection system	All the data in the protection system are deleted, that is the project database (MDB file) in the protection system is deleted.
Restart the protection system	Reinitializes the protection (CU and all BU's)
Debug mode	In the debug mode, the protection system generates additional internal program events. As a rule, the debug mode is only used by the ABB engineering department for test purposes.
Read Traceability information	The system info, the order codes of the central unit and the bay units (the decoding of the order code is shown in chapter <i>Ordering for customized IED</i> in the <i>REB500 Product Guide</i>), the hardware data (type, serial number, revision index, date of manufacture etc.) and the software data (version) are uploaded from the protection equipment and added to the HMI500 report section (see menu item Tools/Reports/Traceability data).

4.9 Tools menu

4.9.1 Version

This menu item is for administering the database for the specific protection system, which contains information such as settings, event texts, configuration of the binary inputs and outputs etc. Parts of the database can be edited on the PC using HMI500 and then downloaded to the protection. The database has a version number and index that are displayed in the HMI main menu.

Version: X.YY, date of the last change, description The version is purely numerical, that is X (0...9) and Y (0...9). It is assigned by ABB while processing the contract and determined at the time the system is accepted by the user. The user cannot change it subsequently.

Index: XX, date of the last change, description The index only comprises letters, that is X {A...Z}. The user must change the index and its description if he changes the REB500 settings in order

to document and distinguish different sets of settings. When a new index is assigned, the current date on the PC is recorded as the date of the last change.

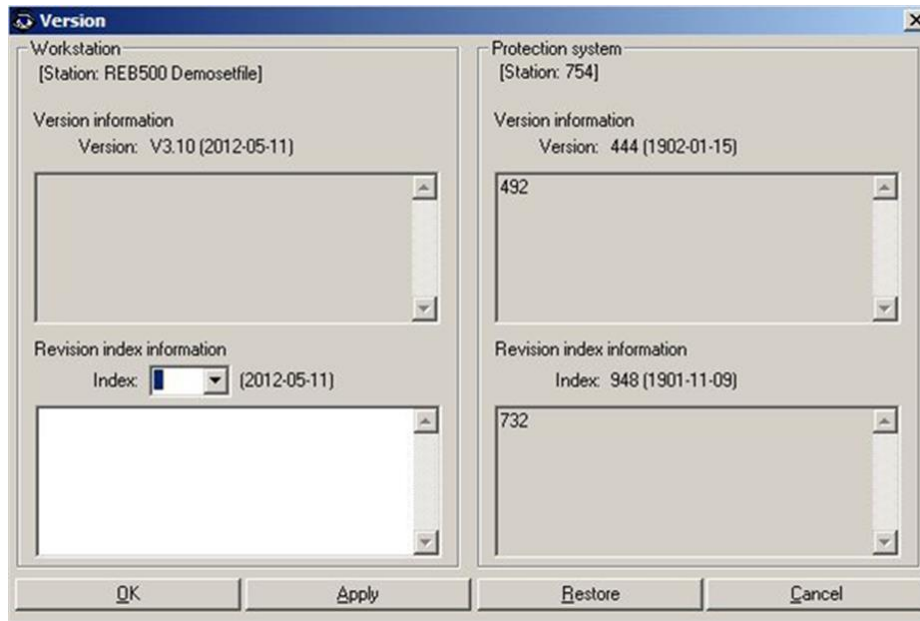

12000099-IEC18000503-1-en.vsdX

Figure 59: Version

4.9.2 File verification

Starts the file verification procedure, that checks data consistency within several tables of the project file. The result is displayed in a separate window.

4.9.3 Reports

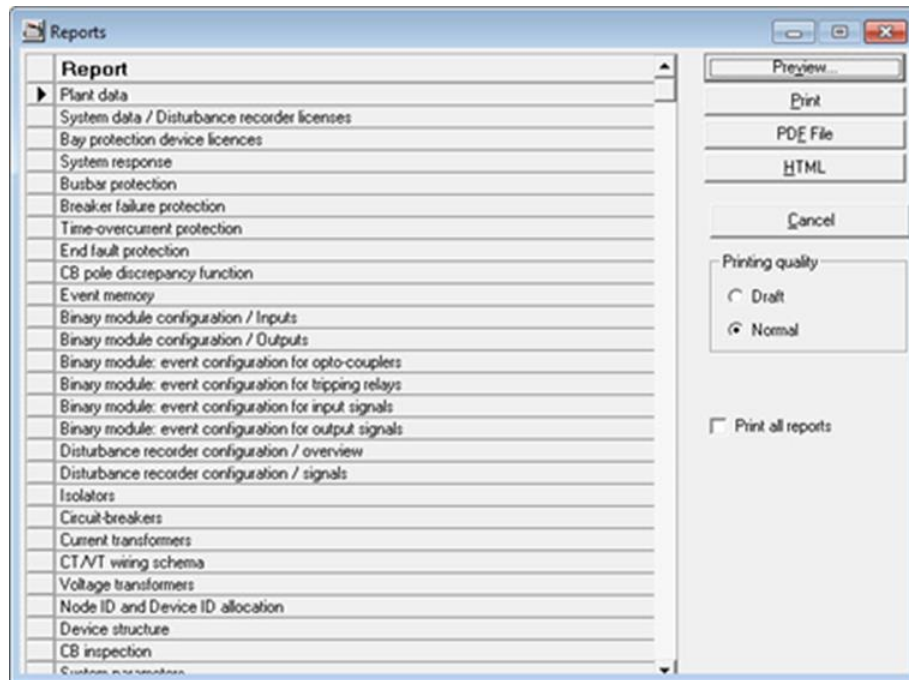

12000100-IEC18000504-1-en.vsdX

Figure 60: Reports

The **Reports** dialog box is opened by selecting **Reports** in the **Tools** menu. It contains a list of the various kinds of reports.

Either a desired report can be printed on its own or all the reports can be printed by activating the **Print all reports** check box.

The difference between the options in the **Printing quality** field is that the data are presented in tabular form if the **Normal** radio button is active.

Unless a printer is actually installed on the PC, the **Reports** menu item is grey and inactive. A printer does not, however, have to be connected.

4.9.4 Export SCS data

This menu item exports any communication data contained in the database. The menu is only active if under menu **Configuration Communication**, a SCS interface is configured (see [Section 4.6.1](#)).

In the case of the optional IEC 61850-8-1 and IEC 60870-5-103 communication protocols, the **Export** button creates files that can be used to configure the communication interface at the remote end

4.9.5 Settings

4.9.5.1 HMI500 settings

Some of the operator program functions can be customized.

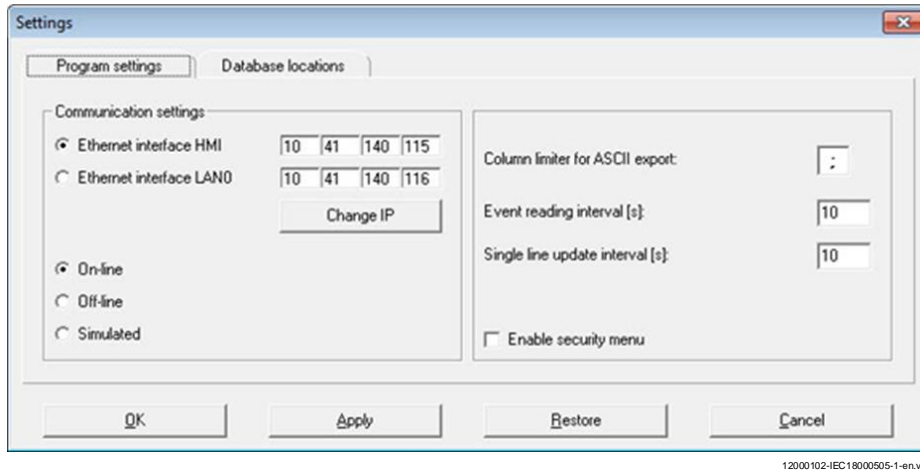

12000102-IEC18000505-1-en.vsd

Figure 61: HMI500 settings

4.9.5.2 Communication

Communication can be established with a REB500 system either via HMI front connector or via the station bus.

Settings are provided for the TCP/IP address of the REB system to which communication is being established.

It is possible to change between the communication modes On-line, Off-line and Simulation. Selecting **On-line** causes HMI500 to check whether communication with REB500 system can be established.

The check box **Enable security menu** and its influence to the sub-menus **Tools/Security option** and **Tools/Security account management** is described under *Cyber security deployment guideline*.

4.9.5.3 Parameters for reading and exporting event data

Settings are provided for the period for cyclically reading events and the separator for an ASCII file when exporting events.

4.9.5.4 Database locations

HMI500 creates a number of configuration databases. The following dialog provides facility for defining the directories where the databases are located and changing the database names. Default directories are created during the installation of HMI500 and it is recommended that these not be changed.

4.9.5.5 DRR viewer support (optional)

HMI500 automatically displays the **DRR viewer support** tab when WaveWin ABB is installed on the PC (the version H.G.24 installation file is available on REB500 product CD).

1. Use **Select viewer** button to change WaveWin ABB's installation path if it has been changed or select the installation path of E_wineve (if installed and preferred).
2. Activate the **Evaluate after manual upload** check box to start the selected viewer for evaluating disturbance recorder data after they have been uploaded from device.

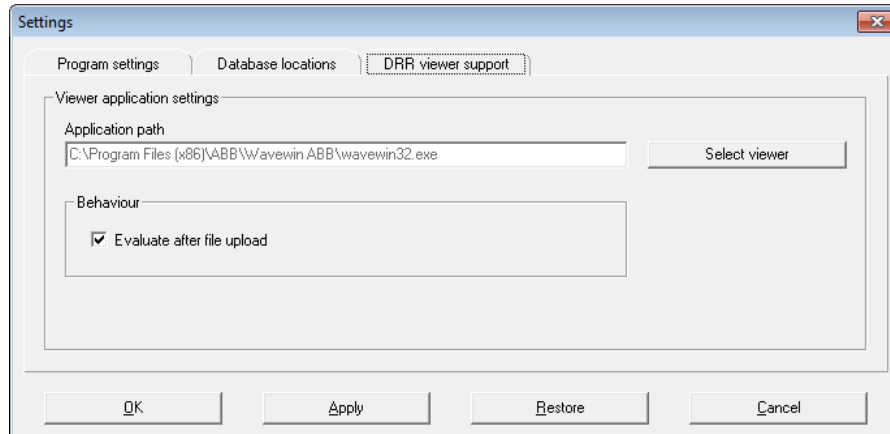

19000001-IEC19000479-1-en.vsdX

Figure 62: DRR viewer support settings

4.9.6 Security account management

The menu is only active if the HMI500 communication is online with the protection system. See *Cyber security deployment guideline*.

4.9.7 Change password

See *Cyber security deployment guideline*.

4.9.8 Security options

See *Cyber security deployment guideline*.

4.9.9 Security log servers

See *Cyber security deployment guideline*.

4.9.10 Close all sessions

This menu command closes all open sessions on the target device.

4.9.11 Set system time

The system clock in the protection system is equipped with a standby battery and runs independently with an accuracy of 50 ppm (4.3 s per day) if not synchronized periodically by an external reference. In this case, this menu is used for setting the date and time of the protection system. Initially, the date and time displayed in this menu item are those effective on the PC. The settings in the fields can be incremented or decremented by clicking on the appropriate arrow to the right of the value. Click on **Set time** to set the new date and time on the protection system.

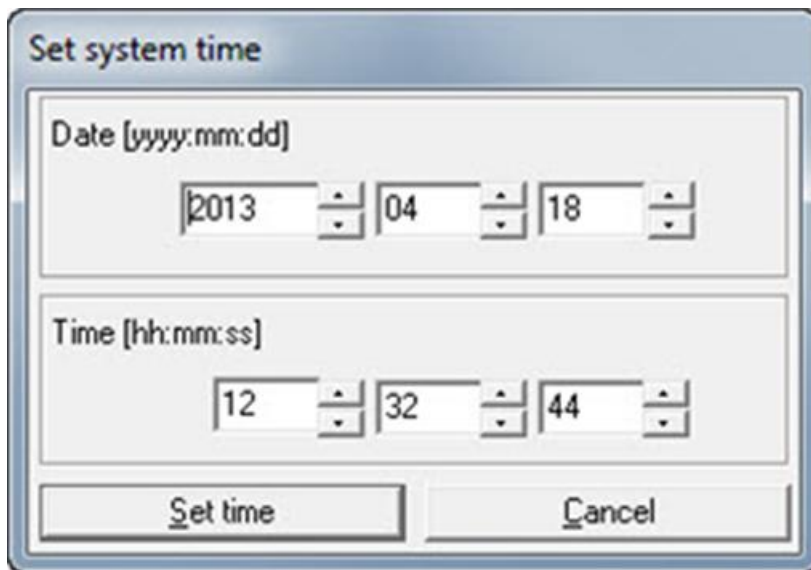

12000105-IEC18000507-1-en.vsdX

Figure 63: Setting the system time

Section 5 Local HMI

5.1 Introduction

REB500 includes continuous comprehensive self-supervision and diagnosis of the software and hardware components. By setting up a proper signaling scheme while commissioning the system, most failures are signaled externally (see [Section 4.6.3](#)). They can include internal REB500 as well as external failures in primary and secondary systems that influence the response of the protection. Other failures that are not detected (for example, interrupted tripping circuit) are located and cleared while carrying out periodic inspection and maintenance (see *Commissioning manual*). Checks and measurements while the system is in normal operation (no active alarms) are therefore unnecessary.



Normal operation without any faults is also indicated by the fact that only the green protection LED is lit and the alarm page LED is not lit on the local HMI.

An alarm (external or on the local HMI) can concern a failure in the REB500 system (for example, hardware failure) or in the associated primary plant (for example, incorrect isolator status signal).



Should the system generate an alarm, inform the trained maintenance personnel responsible.

5.2 Safety instructions



Checks and maintenance on the REB500 system may only be carried out by properly trained personnel.



Only properly trained and authorized personnel should be in possession of the HMI500 password.

5.3 Operation

5.3.1 Introduction

Operation in the case of the busbar protection system is confined to supervising the proper function of the system and assessing the system data.

There are different ways of viewing operating, disturbance and tripping data:

- Local HMI
- PC running HMI500
- Remote HMI
- Station automation system (SCS)

see [Section 3](#).

5.3.2 Viewing data on the local HMI

The local HMI provides a quick overview of the status of the protection (normal operation, alarms and trips) without having to connect a PC.

It is fitted in every central unit and as an option in the bay units. On the front, it has a 320 by 240 pixel display, three protection LEDs, 19 pushbuttons and 15 signalization/alarm LEDs. The local HMI enable the equipment to be operated and controlled simply and conveniently where it is installed. An interface is also provided for connecting a PC via RS45.

Whether on the central unit or a bay unit, the local HMI enables the following to be viewed:

- Current and voltage measurements
- Statuses of inputs and outputs
- Alarms (generated by the respective bay unit)
- System (or respective bay unit) settings
- Settings of all the specific bay unit protection functions



12000146-IEC18000535-1-en.vsdX

Figure 64: Local human-machine-interface (LHMI)

5.3.3 Protection indicator LEDs

There are three LEDs on top of the display: green, yellow, and red.

Table 19: Local HMI Protection Indicator LEDs

LED	IEC label	ANSI label	Description
green	Ready	Normal	Flashes while the system is being initialized. Continuously lit during normal operation.
yellow	Start	Pickup	Not used.
red	Trip	Trip	Indicates a trip. Remains lit until applying a binary signal to the reset input or selecting the HMI function Reset latching .

5.3.4 LED signals

The local HMI contains 15 additional LEDs, each of which can be assigned to any output signal and configured to latch or not to latch as required.

See [Section 4.6.7](#).

5.3.5 LCD backlight











If none of the buttons are operated for a time corresponding to the backlight timeout, the display backlight switches off and the main menu is displayed with the cursor at the topmost menu position. It switches on again automatically as soon as a button is pressed.

The currently configured backlight supervision timeout can be viewed and modified in menu **Display Settings**.

5.3.6 Buttons





lists the nine supported buttons. They are used primarily to navigate through the menu structure. Any of them switches the display backlight on again if it was switched off.

Table 20: Local HMI - Used buttons

Button	Name	Purpose
	Up	Move up and down in menu tree and in pages. Move selection in dialogs and alarm panel.
	Down	Scroll active digits, characters, or enumerators of a parameter when entering a new setting value, user name or password.
	Left	Move left and right in menu tree (change menu tree level) and in pages.
	Right	Change the active digit or character in parameter when entering a new value, user name or password.
	Enter	Enter the setting mode of a parameter. Confirm a new value of a setting parameter, user name or password. Confirm selection in dialogs.
	Escape	Cancel currently ongoing operation.
	Menu	Navigate directly to the main menu.
	Clear	Navigate to the view for clearing or acknowledging alarms, trips and LEDs.
	Multi-page	At first push it navigates to the alarm page. At second push it navigates to the alarm LED panel, which displays the text associated with the corresponding signalization LED on the right panel side. For setting the LED signals see Section 4.6.7 .
	Login	Certain LMI menus require a user authentication, for example, the LMI Test Trip menu requires a user login to access the menu. After a failed authentication this button re-opens the login window.

The following buttons are not used on the local HMI:

Table 21: Local HMI - Unused buttons

Button	Name
	Open
	Close
	LR
	Help
	Function Key

5.3.7 Menu structure

The menu structures of central unit and bay unit are similar. The central unit has additional menu items for system settings and specific bay units.

5.3.7.1 Menu structure of the central unit

- Alarms
- Trips
- Clear
 - Reset all relays, lists and LEDs
 - Acknowledge Alarms
 - Reset Permanent Blocking
- Measurements
 - Bus zones
 - BZ 1..N
 - Diff. current
 - Binary inputs
 - OC01..OCxx
 - Binary outputs
 - CR01..CRxx
- Settings
 - System response
 - Busbar protection
- Configuration
 - LAN IP settings
 - Process bus
 - HMI
 - IEC61850
 - System Information
 - Station Name
 - System frequency
 - DB Version
 - Date of last DB change
 - Index to last DB change
 - LED Text

- LED Text 1..15
- Display settings
 - Language
 - LHMI
 - Display Timeout
 - Contrast Level
 - Key Parameters
- Test
 - LED Test
- Diagnostic Information
 - Product Identifiers
 - IEDProdType
 - Firmware Version
 - Serial Number
 - Production Date
 - Ordering Number
 - Order Code
 - CPU Load
 - Module Check
 - System Logger
- Bay units
 - Bay unit 1..N
 - Measurements
 - Currents
 - Voltages
 - Binary inputs
 - OC01..OCxx
 - Binary outputs
 - CR01..CRxx
 - Switchgear objects
 - Settings
 - Busbar Protection
 - Breaker Failure Protection
 - Overcurrent Protection
 - End Fault Protection
 - Pole Discrepancy Protection

5.3.7.2 Menu structure of the bay unit

- Menu Alarms
- Trips
- Clear
 - Reset all relays, lists and LEDs
 - Acknowledge Alarms
 - Reset Permanent Blocking
 - Reset blocking signals
- Measurements
 - Currents
 - Voltages
 - Binary inputs

- OC01..OCxx
- Binary outputs
 - CR01..CRxx
- Switchgear objects
- Settings
 - Busbar protection
 - Breaker Failure Protection
 - Overcurrent Protection
 - End Fault Protection
 - Pole Discrepancy Protection
- Configuration
 - LAN IP settings
 - Process bus
 - HMI
 - System Information
 - Station Name
 - System frequency
 - DB Version
 - Date of last DB change
 - Index to last DB change
 - LED Text
- Display settings
 - Language
 - LHMI
 - Display Timeout
 - Contrast Level
 - Key Parameters
- Test
 - LED Test
 - Test Trip
- Diagnostic information
 - Product Identifiers
 - IEDProdType
 - Firmware Version
 - Serial Number
 - Production Date
 - Ordering Number
 - Order Code
 - CPU Load
 - System Logger
- Central unit
 - Measurements
 - Bus zones
 - Binary inputs
 - Binary outputs
 - Settings
 - System response
 - Busbar protection

5.4 Alarms

The yellow LED on the **Multipage** button signals the alarm state:

- Off: No pending alarm in list
- On: Pending alarms in list, acknowledged
- Flashing: New alarm in list, not yet acknowledged



Eventual system alarms can be viewed in the alarm list (Menu **Alarms**).

The operator can acknowledge an alarm using the menu item **Clear/Acknowledge Alarm** or equivalently by pressing the **CLEAR** button.

The following alarms can be displayed:

- Busbar protection blocked
- Breaker failure protection blocked
- End fault protection blocked
- OCDT blocked Overcurrent protection blocked
- Pole discrepancy protection blocked
- Bay unit alarm
- Contacts blocked
- Inspection/Maintenance
- Inspection alarm
- Auxiliary voltage failed
- Trip transferred
- Circuit breaker alarm
- Isolator alarm
- Test generator active
- Contacts blocked
- HW configuration mismatch
- Pow.sup. fault
- Power supply 2 failed
- AC Fail
- Major error
- BU problem
- CU problem
- General alarm



Viewing the event list and disturbance records is recommended should an alarm occur. The corresponding procedure is described in [Section 4.5.7](#) and [Section 4.5.8](#) respectively.



Avoid performing switching operations in the event of the following alarms before the failure has been analyzed by correspondingly trained personnel:

- Isolator alarm
- Switch inhibit
- Differential current alarm
- Inspection and maintenance

Non-observance of this precaution can cause maloperation in normal operation or a failure to trip in response to a fault.



Isolator alarm may only be acknowledged by appropriately trained and authorized personnel. Non-observance of this precaution can cause maloperation in normal operation or a failure to trip in response to a fault.

5.5 Trips



The trips generated by REB500 can be viewed in the trip list together with the protection functions that caused them (Menu **Trips**/ first column of list). In addition the corresponding date/time information, source and values (if existing) can be displayed.

The following trips can appear on the local HMI:

TRIP(ITT):	Trip: corresponding bus zones
BBP Trip:	Differential current Id Restraint current Ih Max. phase difference Ph-Diff
BFP TRIP T1:	Current of each phase
BFP TRIP T2:	Current of each phase
OCDT TRIP:	Current
PDF TRIP:	Current
EFP TRIP:	Current
EXTERNAL TRIP	
DIST TRIP:	Zone (Zone 1,2,3,4, or Zone 5 for the final zone), impedance and fault location Further trip signal of Bay Protection (if existing)

All these information can be seen in the trip list by navigation via the right and left arrow keys on the LHMI.

Table 22: Navigation within LHMI trip list

			
Trip ²⁾	Date	Source	Value ³⁾⁴⁾

- 1) Navigation via the right and left arrow keys on the LHMI (Value can have entries in several columns)
- 2) Trip signals column is fixed on left side of the trip list
- 3) Value: information (number of columns) depends on the information content of the trip signal
- 4) Current value indications are generally instantaneous values

Table 23: Example for a trip list viewed on Bay Unit

Trip	Date	Source	Value			
			L1 3604A	L2 0A	L3 0A	L0 3604A
BFP TRIP T1	2015-11-23 09:05:46	Bayname 1	L1 3604A	L2 0A	L3 0A	L0 3604A
OCDT TRIP	2015-11-23 09:05:46	Bayname 1	3604A	-	-	-
OCDT TRIP ¹⁾	2015-11-23 09:05:46	Bayname 1	-	-	-	-
TRIP	2015-11-23 09:05:46	Bayname 1	-	-	-	-

- 1) Second OCDT TRIP is caused by the Bay Protection function (no value entry available for this type of functions)

Table 24: Example for a trip list viewed on Central Unit

Trip	Date	Source	Value ¹⁾²⁾³⁾		
			Id =	Ih =	Ph-Diff =
BBP TRIP L1	2015-11-23 09:05:46	Zone BB01	3604A	4240A	175mrad
BFP TRIP T1	2015-11-23 09:05:46	Bayname 1	3604A	-	-
OCDT TRIP	2015-11-23 09:05:46	Bayname 1			

- 1) If all feeders in a protection zone are excluded from phase comparison then the value *-I* is shown for the phase differences (see section *Phase comparison*) in the REB500 *Application manual*
- 2) If only one feeders in a protection zone is included for phase comparison then the value *0* is shown for the phase differences (see section *Phase comparison*) in the REB500 *Application manual*
- 3) The measuring range of the phase difference is 0..3142 mrad (0° .. 180°)

The red Protection indicator LED signals the trip state:

- Off: No pending trip in list
- On: Pending or latched trips in list

The protection system and all signals can be reset by choosing **Clear/Reset all latched LEDs and Lists** on the LHMI, or equivalently by setting the signal **31810_External reset**, for example, generated by pressing the **RESET** button.

5.6 Test Trip

The REB500 system provides a test facility to activate and deactivate a test trip per bay. For this purpose the signal **21120_EXT_TEST_TRIP** can be set and reset via bay. For this purpose the signal **21120_EXT_TEST_TRIP** can be set and reset via the LHMI Test Trip menu.

The LHMI Test Trip can be combined with a current criteria, so that the test trip is only issued if the current of one phase does not exceed a certain factor of the rated current.



If the signal **11115_Ext_Test_TRIP** and LHMI Test Trip function are configured and used simultaneously, the signal **21120_EXT_TEST_TRIP** results from an OR function of both possible inputs.



To enter LHMI Test Trip menu a user authentication is mandatory in case that user account management is enabled. For details about the user account management see *Cyber security guideline*.

5.6.1 Configuration

The configuration of the LHMI Test Trip function includes the following two steps:

1. Configuration of the tripping output signal:
Add (configure) the tripping signal **21120_EXT_TEST_TRIP** HMI500 menu **Configuration/Binary module/Outputs** to the bay specific binary output configuration see *Tripping Command* [Section 4.6.3.6](#)
2. Select the **Enable the Test Trip** check box from HMI menu **Settings/Circuit-breakers/Details** window.

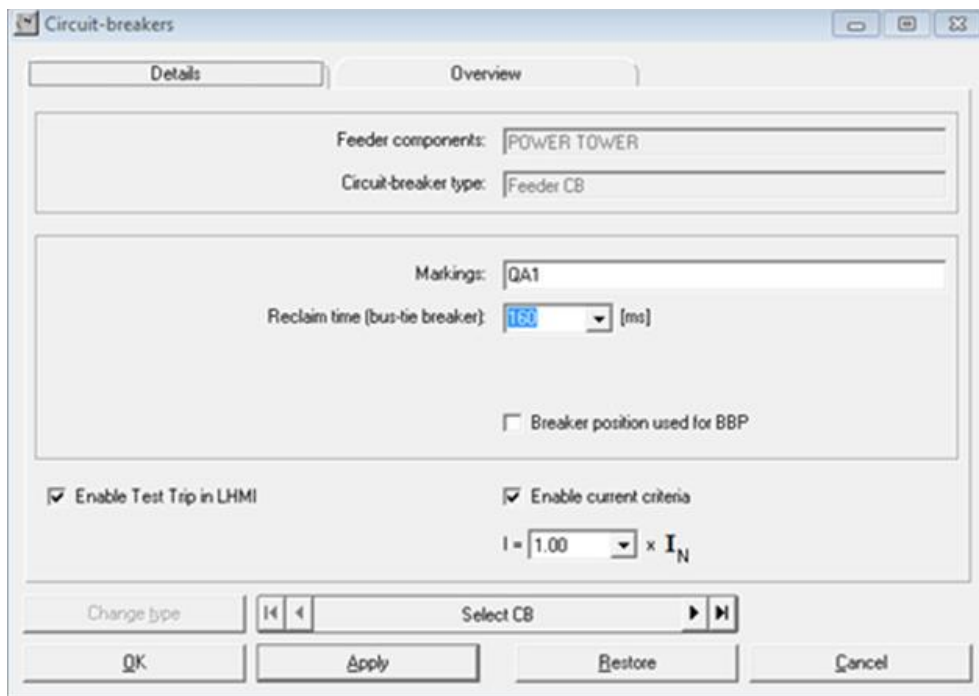

18000068-IEC19000206-1-en.vsdX

Figure 65: LHMI Test Trip Configuration per Circuit Breaker

The current criteria can be enabled by selecting the **Enable current criteria** check box . The current criteria value can be set to a value between 0.05 and 1.0 in steps of 0.05.



Changed configuration settings take effect after downloaded to the REB500 system (see [Section 4.4.1](#)).

5.6.2 Usage

After configuring the LHMI Test Trip, the functionality can be used on a particular feeder's LHMI. Use down and right arrow keys in the LHMI menu **Test** to find the **Test Trip** menu.



18000069-IEC19000207-1-en.vsdX

Figure 66: LHMI Test Trip Menu

The Test Trip menu can be entered by pressing the right arrow key, which opens first the logon window to authenticate the user (see [Figure 67](#)).

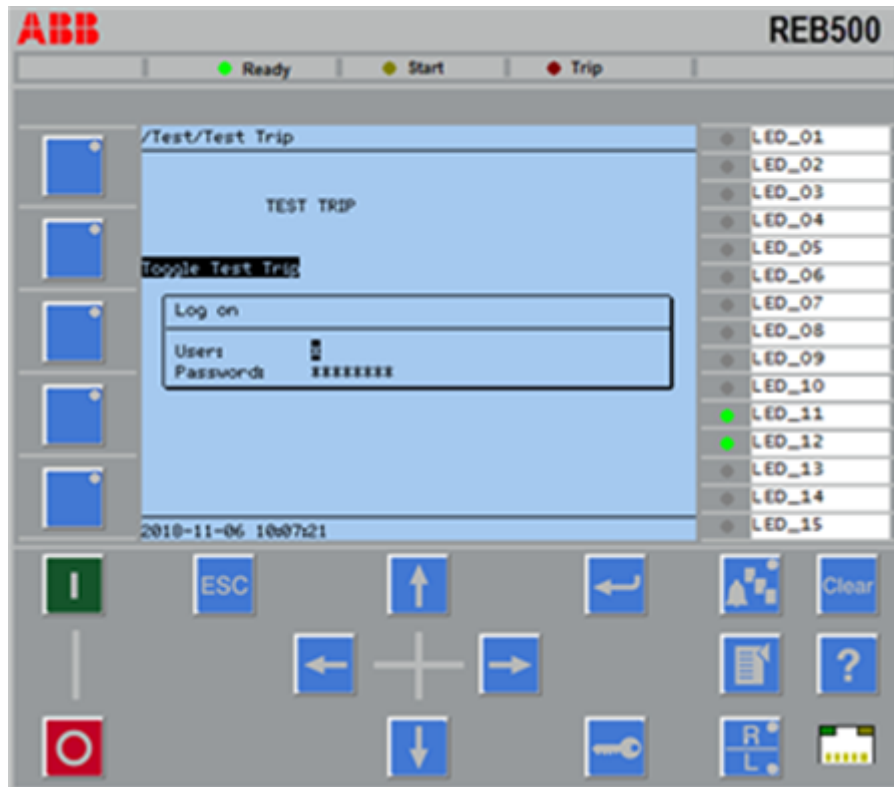

1800074-IEC19000208-1-en.vsdX

Figure 67: LHMI Test Trip Menu Initial Logon Window



Only users assigned with the predefined roles **Installer** or **Engineer**, or any other role that includes the permission **forceInOutputs@REB500** are allowed to enter the Test Trip menu. For details about the user account management see *Cyber security deployment guideline*.



If the user account management is switched off, the logon window does not appear.

To enter the user name and password, each letter needs to be selected by pressing the up or down arrow key at the current cursor position, with the following sequence of characters:
**ABCDEFGHIJKLMNOPQRSTUVWXYZabcdefghijklmnopqrstuvwxyz0123456789!"#\$%&()*
 +,-./:;<=>?@[\] ^ _ ` { | } ~**



The sequence of characters may differ depending on the configured LHMI language.

Each selected letter needs to be confirmed by pressing the right arrow key. To confirm the user name and/or password, press the **Enter** key.

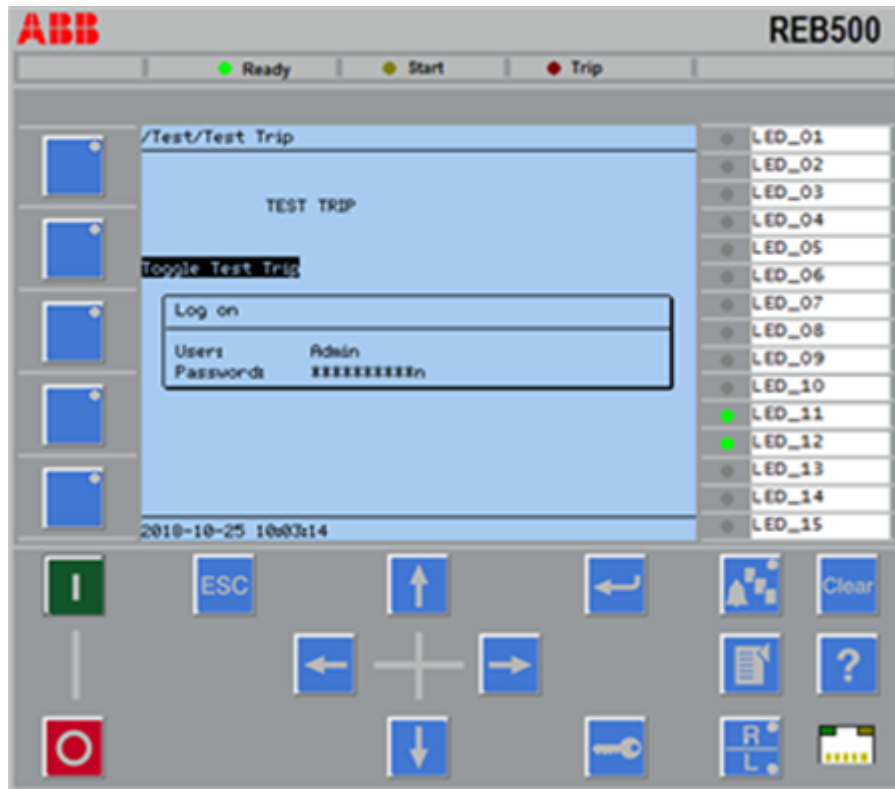

18000070-IEC19000209-1-en.vsdX

Figure 68: LHM Test Trip Logon Window



In case of an unsuccessful user authentication, the logon window can be re-opened by pressing the **LogIn** key.

After a successful login the **Toggle Test Trip** menu item is available, and can be executed by pressing the **Enter** key.

The current state of the signal **21120_EXT_TEST_TRIP** is shown in the **Test Trip** menu. The initial is OFF under the condition that the LHM Test Trip is not combined with the external Test Trip (**11115_Ext_Test_TRIP**). In combination with the external Test Trip input, it might be in the *ON* state (if the state of input signal **11115_Ext_Test_TRIP** is set to ON) .



18000071-IEC19000210-1-en.vsdX

Figure 69: LHMl Test Trip inactive

Every requested Test Trip change requires a confirmation by the user. A cancellation of the initiated change is possible by navigation with the right arrow key to the **Cancel** menu item and pressing the **Enter** key.

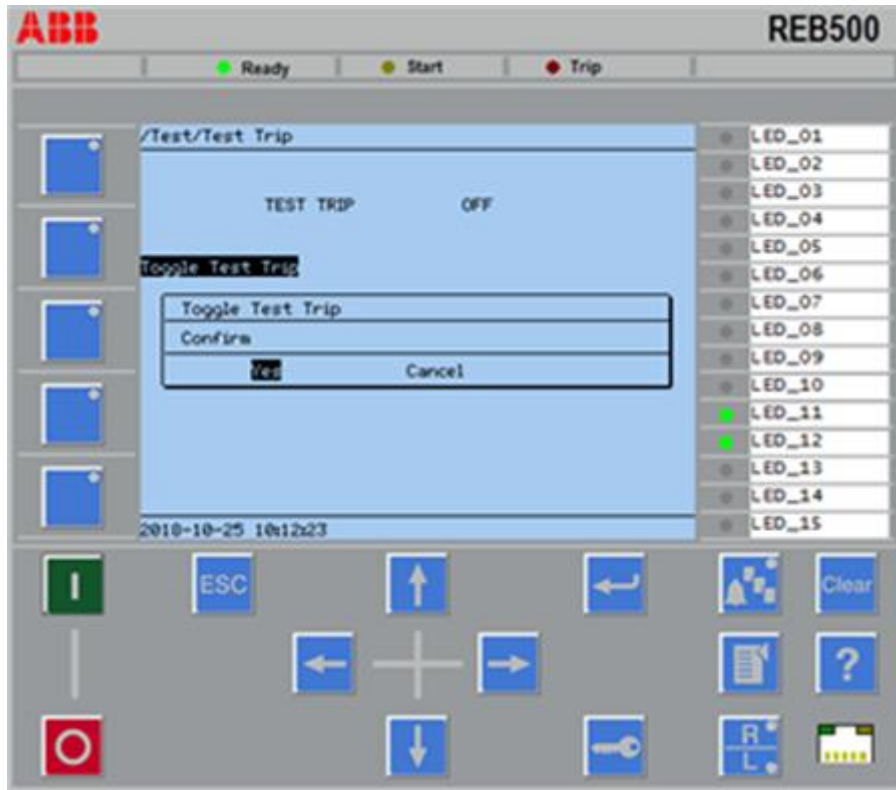

18000072-IEC19000211-1-en.vsdX

Figure 70: LHMUI Test Trip confirmation

The following figure shows the LHMUI Test Trip in active state.



IEC19000212-IEC19000212-1-en.vsdX

Figure 71: LHMUI Test Trip active



When the Test Trip state changes from OFF to ON, the tripping command **21120_EXT_TEST_TRIP** is activated and depending on the binary output configuration see *Tripping Command* [Section 4.6.3.6](#) a trip command is sent to the respective circuit breaker.



The Test Trip state can be toggled as many times as possible as long as the menu will not be left.



If the Test Trip menu will be left, the Test Trip state changes back to OFF if no combination with an external test trip input exists. In combination with the external Test Trip input it might remain in the *ON* state (if state of input signal **11115_Ext_Test_TRIP** is set to ON).



Leaving the Test Trip menu will require a re-logout to authenticate the user every time.



The Test Trip menu will be left automatically after the configured display timeout, which can be changed in the LHMUI menu **Display settings/LHMUI/Display Timeout**.

Section 6 Web HMI

6.1 Introduction

The WebHMI allows easy read-only access to all relevant details of a running REB500 system, such as:

- Switchgear status
- Event lists
- Analogue measurements
- System data

6.2 Accessing the WebHMI

To access the WebHMI, browse to the following URL via the station bus (LAN0):

https://LAN_0_IP/reb500.html

Information: Access to the WebHMI is protected by the user management. For required permissions, see *Cyber Security Deployment Guideline*.

Section 7 Troubleshooting

7.1 Safety Instructions



All work on the REB500 busbar protection system must be carefully planned. Errors when manipulating the system cannot only destroy components, they can also cause false tripping and serious interruption to the power supply.



Precautions must be taken in the immediate area when working on the central unit or one of the bay units to exclude any possibility of persons coming into contact with live parts. A danger of electrical shock also exists when measuring currents and voltages.



When replacing electronic modules, take the necessary precautions to prevent damage to components due to electrostatic discharge (ESD).

7.2 List of faults and corrective actions

7.2.1 Useful LEDs on the IEDs and switches

7.2.1.1 Switches

The Fault and Power (P) LED of the Switch are found on the left side of the switch. The green link LED for optical and electrical connection is located on the electrical connector. The same LEDs are also available on the back side of the switch.

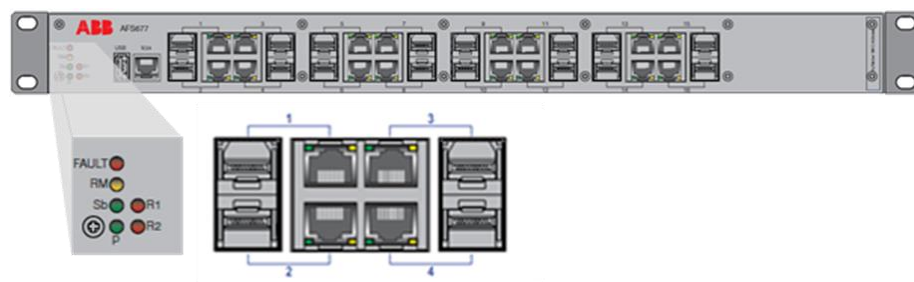

14000041-IEC18000552-1-en.vsd.x

Figure 72: LED Indication on the back side of the switch

7.2.1.2 Bay Units/ Central Unit

Front side

The Ready LED is on the top of the BU/CU. The Alarm Indicator LED is located in the right lower corner of the IED, integrated within the alarm button (see [Section 5.3.3](#) and [Section 5.3.6](#)).

For details about fault indications and corrective actions, see [Section 7.2.2](#).

Rear side

The yellow LED **bat1(2)** signals the availability of the station battery.

- *On*: The station battery is available and the voltage is within the tolerance.
- *Off*: The input voltage from the station battery is not in range, or not available.
Corrective Action: Check the battery voltage on input side of BU/ CU and the state of the MCB if necessary.

The green LED **rdy1(2)** signals the availability of the BU/CU internal voltages:

- *On*: All BU/CU inherent voltages are within tolerance (power supply is *in Service*).
- *Off*: Short-circuit or overload of one or several internal voltage(s) of BU/CU (Supposing the station battery is available and the yellow LED is On).
Corrective Action: The voltage supply is defective, BU/CU shall be replaced.

If the green Ready LED on front side of a BU/CU is *On* and there are no system alarms from this IED, while the green LED **rdy1(2)** on the rear side is *Off*, this discrepancy may point to a LED indication defect.

Corrective Action: A LED indication is defective, the respective BU/CU shall be replaced.

7.2.2 Faults during startup

	Description	Possible Cause	Corrective Action
1	CU/BU → Green Ready LED Off	Power missing	Check power supply of CU/BU
		Hardware failure	Replace CU/BU
2	CU/BU → Green Ready LED Flashing	System is starting	Wait up to 3 minutes for Startup
		Hardware failure	Replace CU/BU
3	CU/BU → Alarm Indicator LED On	Check Section 7.2.3	Check Section 7.2.3
4	CU/BU → System Restart	Erroneous Setfile	Verify Setfile
		Hardware failure	Replace CU/BU
5	CU/BU → No LHMI activity, all LEDs off	Ethernet cable plugged into X0	Remove cable from X0
		Hardware failure	Replace CU/BU
6	Switch → Power LED Off	Power missing	Check power supply of the switch
		Hardware failure	Replace switch
7	Switch → Power Fault LED On	Redundant power missing	Check power supplies of the Switch
		Wrong Ethernet connect. between switches	Check Section 7.2.4
8	14205_Block EFP always On	Signal 11505_Close command CB missing	Configure signal 11505

7.2.3 Alarm and Event list entries

	Description	Possible Cause	Corrective Action
1	General alarm CU/BU	Check Section 7.2.4	Check Section 7.2.4
		Wrong BU address	Correct BU address
2	Differential current alarm CU	CT circuit fault	Check Section 7.2.5
		Busbar image error	Check isolator image
		Hardware failure	Replace CU/BU
3	Isolator alarm BU	Wrong binary connection to auxiliary contacts	Check connection dia-grams and connections to the auxiliary contacts
		Wrong battery voltage configured	Correct setting (setfile)
		Hardware failure	Replace BU
4	Invalid Time Stamps	Wrong time synchronization type and/or parameter	Check time synchronization type and/or parameter
		Wrong time master configuration	Check time master configuration
		Wrong LWL connections	Check LWL connections to time master
5	Hardware Mismatch Alarm	Wrong hardware installed	Replace Hardware with configured type.
		Wrong hardware type configured	Change the configuration
6	IP address conflict	Ethernet interface LAN0 has address configured which already exists in the network connected to this interface	Change configured IP address
7	RPB Interruption Alarm on BU	Process Bus connection interrupted	Check process bus connection (see Section 3)
		CU is offline (for example, during a CU restart)	Wait until CU is up and running again (up to 3 Minutes)
		BU is stuck in standalone mode	Restart the BU
8	RPB Interruption Alarm on CU	At least one of the two process bus links of the CU is interrupted	Check both process bus links (see Section 3)

7.2.4 Optical fiber connections faults

	Description	Possible Cause	Corrective Action
1	Process Bus: No link LED for a connected BU	Optical fiber defect, or wrong type	Check, replace optical fibers
		Optical fiber wrong connection	Check connection
2	IEC 61850 Bus No link LED for a connected station control system	Optical fiber defect, or wrong type	Check, replace optical fibers
		Optical fiber wrong connection	Check connection
3	IEC 103 RX/TX LED dose not blink	Optical fiber defect, or wrong type	Check optical fibers
		Optical fiber wrong connection	Check optical fiber connections
		Wrong IEC103 Configuration	Check IEC103 Configuration

7.2.5 Electrical connection faults

	Description	Possible Cause	Corrective Action
1	Binary inputs on CU/BU do not work	Wrong battery voltage configured	Correct setting (setfile)
		HW Failure	Replace CU/BU
2	Binary Output do not work	Blocking inputs of the IED set	Reset blocking inputs
		Hardware failure	Replace CU/BU
3	Wrong current or voltage values	CT VT settings	Check CT VT settings
		Wrong CT/VT connections	Check connection diagram
4	Analogue measurement supervision alarm	Wrong CT connections	Check wiring of BU analogue inputs
		Bay Unit (analogue part) is defective	Replace BU

7.3 Diagnostic (DIA) system - error handling

The Error Handling detects the start-up and repetitive error causes listed under [Table 25](#). If one of these errors/failures is detected by a target (CIM, CPC or BU) the permanently blocked state (see [Table 26](#)) is activated on the particular target with the following effects:

- The target is running and can be accessed by the HMI500.
- All protection functions (subsystems) are blocked and will not be processed.
- The target will show the corresponding alarms and sent distinct Major Error events (see [Section 4.5.8](#)).

The permanent blocking state can only be reset by the LHMI menu on the affected target:

Clear/Reset Permanent Blocking

Table 25: Start-up and repetitive error causes

Alarm	Event	Detection setting	Description
Version check failed	Major_Error 013	once ²⁾	In case the target version does not match the version of the CU CIM target, the target blocks permanently
License check failed	Major_Error 014	once ²⁾	In case the license check during start-up failed (that is some features are activated that are not licensed on this target), the target blocks permanently
Repetitive BBP blocked	Major_Error 016	30 per 600 sec	If a Repetitive BBP blocked alarm is activated, the target blocks permanently
Repetitive BFP blocked	Major_Error 017	30 per 600 sec	If a Repetitive BFP blocked alarm is activated, the target blocks permanently
Repetitive Diff Current Alarm	Major_Error 018	60 per 3'600 sec	If a Repetitive Diff Current Alarm is activated, the target blocks permanently
Repetitive Invalid BU Currents	Major_Error 019	30 per 60 sec	If a Repetitive Invalid BU Currents alarm is activated, the target blocks permanently
Repetitive Output Relays blocked	Major_Error 020	30 per 600 sec	If a Repetitive Output Relays blocked alarm is activated, the target blocks permanently
Repetitive BU restarts	Major_Error 021	3 per 600 sec	In case of Repetitive BU restarts , the target blocks permanently

Table continues on next page

Alarm	Event	Detection setting	Description
Repetitive CU restarts	Major_Error 022	3 per 600 sec	In case of Repetitive CU restarts , the target blocks permanently
CIM HW Failure	Major_Error 023	once ¹⁾	If the diagnosis detects any HW related failure, the CIM blocks permanently
CPC HW Failure	Major_Error 024	once ¹⁾	If the diagnosis detects any HW related failure, the CPC blocks permanently
BU HW Failure	Major_Error 025	once ¹⁾	If the diagnosis detects any HW related failure, the BU blocks permanently
Missing PSM HW Module	Major_Error 026	once ²⁾	If the required PSM HW module is missing, the target blocks permanently
Missing Red. PSM HW Module	Major_Error 027	once ²⁾	If the configured/required redundant PSM HW module is missing, the target blocks permanently
Missing BIO HW Module	Major_Error 028	once ²⁾	If the configured/required BIO HW module is missing, the target blocks permanently
Missing TRM HW Module	Major_Error 029	once ²⁾	If the required TRM HW module is missing, the target blocks permanently
Missing PIO HW Module	Major_Error 030	once ²⁾	If the configured/required PIO HW module is missing, the target blocks permanently
Wrong TRM HW Module	Major_Error 031	once ²⁾	If the configured and physical assembled TRM HW module do not match, the target blocks permanently
Wrong PSM HW Module	Major_Error 032	once ²⁾	If the configured and physical assembled PSM HW module do not match, the target blocks permanently
Wrong Red. PSM HW Module	Major_Error 033	once ²⁾	If the configured and physical assembled redundant PSM HW module do not match, the target blocks permanently
BIO channels mismatch	Major_Error 034	once ²⁾	If binary input or output channels configured on physical channels that are not available, the target blocks permanently
IP address conflict	Major_Error 075	once ²⁾	If an IP address configuration problem occurs (The main reason is that two interfaces are configured with the same IP address), the target blocks permanently
1) only once during start-up or normal running state 2) only once during start-up			

Table 26: Permanently blocked state

Alarm	Event	Detection setting	Description
Permanently Blocked	Major_Error 176	-	If the error handling detects start-up or repetitive error causes (see Table 15), the permanently blocked state is set

ABB AB
Grid Automation Products
SE-721 59 Västerås, Sweden
Phone +46 (0) 21 32 50 00

www.abb.com/protection-control



Scan this QR code to visit our website