

Electrical installation solutions for buildings

Subdistribution boards

Index

**Compact distribution boards
for wall mounting AT/AL Cabinets** 18/2

**Compact distribution boards for flush and
hollow wall mounting U/UL cabinets** 18/12

Media enclosures and media panels 18/24

Accessories 18/29

Wall Cabinets 18/40

TwinLine N 44 18/60

TwinLine N 55 18/80

Wall cabinets IP55 18/80

Standing cabinets IP55 18/90

Interior fittings

with CombiLine N modules 18/131

CombiLine N module for... 18/136

System parts 18/210

Interior fittings with distribution
panels/combination sets 18/241

Fire protection housing 18/254

Complete cabinet system in all sizes –

TwinLine S 43 18/292

Distribution panel system – CombiLine S 18/312

AT wall-mounting compact distribution board

With distribution panels and sheet steel doors



AT wall-mounting compact distribution board with distribution panels and sheet steel door

125 mm or 150 mm DIN rail spacing

I_{nA} to 125 A

DIN EN 61439-1/-3 (VDE 0660-600-1/-3)

IP43 protection class

IK07 shock resistance rating

Protection class II, double insulated

Protection class I, earthed in combination with earthing set ZE11 (accessories)

The installed panels can be pulled out for assembly and wiring

The covers are made from plastic

Panels without device assembly

Sheet steel housing and doors, 1 mm

Color: White, RAL 9016

3 or more panels wide: Double-wing doors

With integrated N/PE Quick plug-in terminals on fields for modular installation devices

Without N/PE Quick plug-in terminals on fields with -terminal spaces or mounting plates

Panels for terminals, DIN rails mounted insulated (without N/PE Quick-terminals) (K)

Panels with mounting plate (without N/PE Quick-terminals) (M)

With cable fastening/strain relief rail









A ZB43 membrane flange installed on top per field

With labeling system

Cable entry covers (accessories)

AT wall-mounting compact distribution board

With distribution panels and sheet steel doors

	PW	GU	SU	External dimensions		Type	Order code
				H x W x D in mm			
For rail mounting devices, 125 mm DIN rail spacing							
 AT31	1	3	36	524 x 324 x 140		AT31	2CPX030099R9999
		4	48	674 x 324 x 140		AT41	2CPX030121R9999
		5	60	824 x 324 x 140		AT51	2CPX030124R9999
		6	72	974 x 324 x 140		AT61	2CPX030130R9999
 AT42	2	2	48	374 x 574 x 140		AT22	2CPX071740R9999
		3	72	524 x 574 x 140		AT32	2CPX030120R9999
		4	96	674 x 574 x 140		AT42	2CPX030122R9999
		5	120	824 x 574 x 140		AT52	2CPX030125R9999
		6	144	974 x 574 x 140		AT62	2CPX030131R9999
		7	168	1124 x 574 x 140		AT72	2CPX030134R9999
 AT42/2	2 (1/1)	4	96	674 x 574 x 140		AT42/2	2CPX030138R9999
		5	120	824 x 574 x 140		AT52/2	2CPX030139R9999
 AT53	3 (2/1)	4	144	674 x 824 x 140		AT43	2CPX030123R9999
		5	180	824 x 824 x 140		AT53	2CPX030127R9999
		6	216	974 x 824 x 140		AT63	2CPX071751R9999
 AT54	4 (2/2)	5	240	824 x 1074 x 140		AT54	2CPX071748R9999
For rail mounting devices, 150 mm DIN rail spacing							
 AT41R3	1	3	36	674 x 324 x 140		AT41R3	2CPX071681R9999
		4	48	824 x 324 x 140		AT51R4	2CPX071684R9999
		5	60	974 x 324 x 140		AT61R5	2CPX071688R9999
 AT42R3	2	2	48	524 x 574 x 140		AT32R2	2CPX071680R9999
		3	72	674 x 574 x 140		AT42R3	2CPX071682R9999
		4	96	824 x 574 x 140		AT52R4	2CPX071685R9999
		5	120	974 x 574 x 140		AT62R5	2CPX071689R9999
		6	144	1124 x 574 x 140		AT72R6	2CPX071691R9999
		 AT53R4	3 (2/1)	3	108	674 x 824 x 140	
4	144			824 x 824 x 140		AT53R4	2CPX071686R9999
5	180			974 x 824 x 140		AT63R5	2CPX071690R9999
6	216			1124 x 824 x 140		AT73R6	2CPX071692R9999
 AT54R4	4 (2/2)	4	192	824 x 1074 x 140		AT54R4	2CPX071687R9999

AT wall-mounting compact distribution boards

With distribution panels and sheet steel doors



AT52K



AT53K



AT64K



AT42M



AT53M

PW	GU	SU	External dimensions		Type	Order code
			H	W x D in mm		
For rail mounting devices and terminals, 125 mm DIN rail spacing						
2	5	120	824	574 x 140	AT52K	2CPX030126R9999
	6	144	974	574 x 140	AT62K	2CPX030132R9999
	7	168	1124	574 x 140	AT72K	2CPX030135R9999
3 (2/1)	5	180	824	824 x 140	AT53K	2CPX030128R9999
	6	216	974	824 x 140	AT63K	2CPX030133R9999
	7	252	1124	824 x 140	AT73K	2CPX030136R9999
4 (2/2)	5	240	824	1074 x 140	AT54K	2CPX030129R9999
	6	288	974	1074 x 140	AT64K	2CPX030137R9999
For rail mounting devices and terminals, 150 mm DIN rail spacing						
2 (1/1)	4	96	674	574 x 140	AT42M	2CPX030148R9999
3 (2/1)	5	180	824	824 x 140	AT53M	2CPX030149R9999

AT wall-mounting compact distribution boards

With distribution panels and transparent doors



AT wall-mounting compact distribution board with distribution panels and sheet steel door

125 mm or 150 mm DIN rail spacing

I_{na} to 125 A

DIN EN 61439-1/-3 (VDE 0660-600-1/-3)

IP43 protection class

IK07 shock resistance rating

Protection class II, double insulated

Protection class I, earthed in combination with earthing set ZE11 (accessories)

The installed panels can be pulled out for assembly and wiring

The covers are made from plastic

Panels without device assembly

Sheet steel housing and doors, 1 mm

Color: White, RAL 9016

3 or more panels wide: Double-wing doors

With integrated N/PE Quick plug-in terminals on fields for modular installation devices

Without N/PE Quick plug-in terminals on fields with -terminal spaces or mounting plates

Panels for terminals, DIN rails mounted insulated (without N/PE Quick-terminals) (K)

With cable fastening/strain relief rail

A ZB43 membrane flange installed on top per field

With labeling system

Cable entry covers (accessories)

AT wall-mounting compact distribution boards

With panels and transparent doors



AT41TE



AT32TE



AT52TE



AT41TR3



AT52TR4



AT63TR5



AT54TR4

PW	GU	SU	External dimensions		Type	Order code
			H x W x D in mm			
For rail mounting devices, 125 mm DIN rail spacing						
1	4	48	674 x 324 x 140		AT41TE	2CPX071585R9999
		60	824 x 324 x 140		AT51TE	2CPX071587R9999
		72	974 x 324 x 140		AT61TE	2CPX071589R9999
2 (1/1)	3	72	524 x 574 x 140		AT32TE	2CPX071584R9999
2	4	96	674 x 574 x 140		AT42TE	2CPX071586R9999
		120	824 x 574 x 140		AT52TE	2CPX071588R9999
		144	974 x 574 x 140		AT62TE	2CPX071590R9999
For rail mounting devices, 150 mm DIN rail spacing						
1	3	36	674 x 324 x 140		AT41TR3	2CPX071695R9999
		48	824 x 324 x 140		AT51TR4	2CPX071698R9999
		60	974 x 324 x 140		AT61TR5	2CPX071702R9999
2	2	48	524 x 574 x 140		AT32TR2	2CPX071694R9999
		72	674 x 574 x 140		AT42TR3	2CPX071696R9999
		96	824 x 574 x 140		AT52TR4	2CPX071699R9999
		120	974 x 574 x 140		AT62TR5	2CPX071703R9999
		144	1124 x 574 x 140		AT72TR6	2CPX071705R9999
3 (2/1)	3	108	674 x 824 x 140		AT43TR3	2CPX071697R9999
		144	824 x 824 x 140		AT53TR4	2CPX071700R9999
		180	974 x 824 x 140		AT63TR5	2CPX071704R9999
		216	1124 x 824 x 140		AT73TR6	2CPX071706R9999
4 (2/2)	4	192	82 x 1074 x 140		AT54TR4	2CPX071701R9999

AL wall-mounting compact distribution boards

Empty cabinets without door



AL wall-mounting compact distribution boards - Empty cabinets without doors

Suitable and prepared to be fitted with CombiLine modules, distribution panels and media panels

I_{nA} to 125 A

DIN EN 61439-1/-3 (VDE 0660-600-1/-3)

Protection class without door IP30*

Protection class with door IP43

Protection class II, double insulated

Protection class I, earthed in combination with earthing set (accessories)

Sheet steel housing, 1 mm

Color: White, RAL 9016

Media panels (accessories)

Sheet steel and transparent doors (accessories)

Cable entry covers (accessories)

Without N/PE Quick-terminals

With cable fastening/strain relief rail

A ZB43 membrane flange installed on top per field

* For expansion as installation subdistribution with panels or CombiLine modules

AL wall-mounting compact distribution boards

Empty cabinets without door



AL31



AL42



AL53



AL64

PW	GU	SU	External dimensions		Type	Order code
			H	W x D in mm		
1	3	36	524	324 x 140	AL31	2CPX030770R9999
	4	72	674	324 x 140	AL41	2CPX030772R9999
	5	60	824	324 x 140	AL51	2CPX030775R9999
	6	72	974	324 x 140	AL61	2CPX030779R9999
2	2	48	374	574 x 140	AL22	2CPX030769R9999
	3	72	524	574 x 140	AL32	2CPX030771R9999
	4	96	674	574 x 140	AL42	2CPX030773R9999
	5	120	824	574 x 140	AL52	2CPX030776R9999
	6	144	974	574 x 140	AL62	2CPX030780R9999
	7	168	1124	574 x 140	AL72	2CPX030783R9999
	3	4	144	674	842 x 140	AL43
5		180	824	824 x 140	AL53	2CPX030777R9999
6		216	974	824 x 140	AL63	2CPX030781R9999
7		252	1124	824 x 140	AL73	2CPX030784R9999
4	5	240	824	1074 x 140	AL54	2CPX030778R9999
	6	288	974	1074 x 140	AL64	2CPX030782R9999

> For expansion with distribution panels or CombiLine modules leave 2 SU free in lock area

AL wall-mounting compact distribution boards

Accessories cabinet doors



T20

PW	GU	Suitable for ...	Type	Order code
Sheet steel doors*2				
Single door				
1	3	AL31	T100	2CPX062057R9999
	4	AL41	T10	2CPX062059R9999
	5	AL51	T11	2CPX062062R9999
	6	AL61	T12	2CPX062066R9999
2	2	AL22	T220	2CPX062056R9999
	3	AL32	T200	2CPX062058R9999
	4	AL42	T20	2CPX062060R9999
	5	AL52	T21	2CPX062063R9999
	6	AL62	T22	2CPX062067R9999
	7	AL72	T23	2CPX062070R9999
Right double door				
3 ^{*1}	4	AL43	T30R	2CPX062195R9999
	5	AL53	T31R	2CPX062199R9999
	6	AL63	T32R	2CPX062203R9999
	7	AL73	T33R	2CPX062207R9999
4 ^{*1}	5	AL54	T31R	2CPX062199R9999
	6	AL64	T32R	2CPX062203R9999
Left double door				
3 ^{*1}	4	AL43	T30L	2CPX062196R9999
	5	AL53	T31L	2CPX062200R9999
	6	AL63	T32L	2CPX062204R9999
	7	AL73	T33L	2CPX062208R9999
4 ^{*1}	5	AL54	T51L	2CPX062202R9999
	6	AL64	T52L	2CPX062206R9999
Transparent doors*2				
1	3	AL31	TTS100	2CPX062021R9999
	4	AL41	TTS10	2CPX062026R9999
	5	AL51	TTS11	2CPX062031R9999
	6	AL61	TTS12	2CPX062036R9999
2	3	AL32	TTS200	2CPX062022R9999
	4	AL42	TTS20	2CPX062027R9999
	5	AL52	TTS21	2CPX062032R9999
	6	AL62	TTS22	2CPX062037R9999
	7	AL72	TTS23	2CPX062042R9999
	3 ^{*1}	4	AL43	TTS30
5		AL53	TTS31	2CPX062033R9999
6		AL63	TTS32	2CPX062038R9999
7		AL73	TTS33	2CPX062043R9999
4 ^{*1}	5	AL54	TTS41	2CPX062034R9999
	6	AL64	TTS42	2CPX062039R9999



TTS20

*1 3 or more panels wide: double-wing doors

*2 Leave not less than 2 space units (SU) for DIN rail devices behind the closure

AT and AL wall-mounting compact distribution boards

Accessories cable entry covers



KB19



KB219



KB59



KBW1

Article	Pieces	Type	Order code
Cable entry covers			
With end plates and mounting bracket Color RAL9016 adapted to the color of the cabinets			
Panel width 1, width 300 mm	1	KB19	2CPX044049R9999
Panel width 2, width 550 mm	1	KB29	2CPX044050R9999
Panel width 3, width 800 mm	1	KB39	2CPX044051R9999
Panel width 4, width 1050 mm	1	KB49	2CPX044052R9999
Profile Color RAL 9016, width 2000 mm	1	KB219	2CPX044055R9999
End plate left/right Color RAL 9016	2	KB59	2CPX044057R9999
Mounting bracket	1	KBW1	2CPX044058R9999

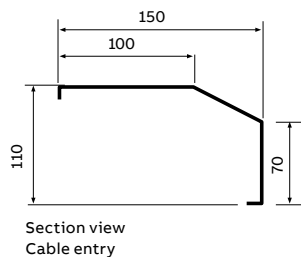

U compact distribution boards for flush- and hollow-wall mounting

With distribution panels and sheet steel door



U compact distribution board with distribution panels and sheet steel door

125 mm or 150 mm DIN rail spacing

I_{nA} to 125 A

DIN EN 61439-1/-3 (VDE 0660-600-1/-3)

IP31 protection class

IK08 shock resistance rating

Protection class II, double insulated

Protection class I, earthed in combination with earthing set ZE12 (accessories)

The installed panels can be pulled out for assembly and wiring

The covers are made from plastic

Panels without device assembly

Sheet steel housing and doors, 1 mm

Color: White, RAL 9016

Panel width 3 and over: Double doors

With integrated N/PE Quick plug-in terminals on fields for modular installation devices

Without N/PE Quick plug-in terminals on fields with -terminal spaces or mounting plates

Panels for terminals, top-hat rails mounted insulated (without N/PE Quick plug-in terminals) (K)

Panels with mounting plate (without N/PE Quick plug-in terminals) (M)

Hollow wall installation set for flush mount distributor (accessories)

With cable fastening/strain relief rail

A ZB40 nipple flange attached on top per field

With labeling system

Trim frame with flush mount

* In combination with hollow wall set ZKV200P4

U compact distribution boards for flush- and hollow-wall mounting

With distribution panels and sheet steel door



U41



U52



U42/2



U53



U54



U41R3



U42R3



U53R4



U54R4

PW	GU	SU	Wall cut-out dimension	Trim frame dimension	Type	Order code
			H x W x D in mm	H x W x D in mm		
For rail mounting devices, 125 mm DIN rail spacing						
1	4	48	684 x 310 x 120	694 x 354 x 27	U41	2CPX030101R9999
	5	60	834 x 310 x 120	844 x 354 x 27	U51	2CPX030104R9999
	6	72	984 x 310 x 120	994 x 354 x 27	U61	2CPX030110R9999
2	4	96	684 x 560 x 120	694 x 604 x 27	U42	2CPX030102R9999
	5	120	834 x 560 x 120	844 x 604 x 27	U52	2CPX030105R9999
	6	144	984 x 560 x 120	994 x 604 x 27	U62	2CPX030111R9999
	7	168	1134 x 560 x 120	1144 x 604 x 27	U72	2CPX030114R9999
2 (1/1)	3	72	534 x 560 x 120	544 x 604 x 27	U32	2CPX030100R9999
	4	96	684 x 560 x 120	694 x 604 x 27	U42/2	2CPX030118R9999
	5	120	834 x 560 x 120	844 x 604 x 27	U52/2	2CPX030119R9999
3 (2/1)	4	144	684 x 810 x 120	694 x 854 x 27	U43	2CPX030103R9999
	5	180	834 x 810 x 120	844 x 854 x 27	U53	2CPX030107R9999
	6	216	984 x 810 x 120	994 x 854 x 27	U63	2CPX071787R9999
4 (2/2)	5	240	834 x 1060 x 120	844 x 1104 x 27	U54	2CPX071784R9999
For rail mounting devices, 150 mm DIN rail spacing						
1	3	36	684 x 310 x 120	694 x 354 x 27	U41R3	2CPX071708R9999
	4	48	834 x 310 x 120	844 x 354 x 27	U51R4	2CPX071711R9999
	5	60	984 x 310 x 120	994 x 354 x 27	U61R5	2CPX071715R9999
2	2	48	534 x 560 x 120	544 x 604 x 27	U32R2	2CPX071707R9999
	3	72	684 x 560 x 120	694 x 604 x 27	U42R3	2CPX071709R9999
	4	96	834 x 560 x 120	844 x 604 x 27	U52R4	2CPX071712R9999
	5	120	984 x 560 x 120	994 x 604 x 27	U62R5	2CPX071716R9999
	6	144	1134 x 560 x 120	1144 x 604 x 27	U72R6	2CPX071718R9999
	3 (2/1)	3	108	684 x 810 x 120	694 x 854 x 27	U43R3
4		144	834 x 810 x 120	844 x 854 x 27	U53R4	2CPX071713R9999
5		180	984 x 810 x 120	994 x 854 x 27	U63R5	2CPX071717R9999
6		216	1134 x 810 x 120	1144 x 854 x 27	U73R6	2CPX071719R9999
4 (2/2)	4	192	834 x 1060 x 120	844 x 1104 x 27	U54R4	2CPX071714R9999

U compact distribution boards for flush- and hollow-wall mounting

With distribution panels and sheet steel door



U52K



U53K



U54K



U42M



U53M

PW	GU	SU	Wall cut-out dimension	Trim frame dimension	Type	Order code
			H x W x D in mm	H x W x D in mm		
For rail mounting devices and terminals, 125 mm DIN rail spacing						
2	5	120	834 x 560 x 120	844 x 604 x 27	U52K	2CPX030106R9999
	6	144	984 x 560 x 120	994 x 604 x 27	U62K	2CPX030112R9999
	7	168	1134 x 560 x 120	1144 x 604 x 27	U72K	2CPX030115R9999
3 (2/1)	5	180	834 x 810 x 120	844 x 854 x 27	U53K	2CPX030108R9999
	6	216	984 x 810 x 120	994 x 854 x 27	U63K	2CPX030113R9999
	7	252	1134 x 810 x 120	1144 x 854 x 27	U73K	2CPX030116R9999
4 (2/2)	5	240	834 x 1060 x 120	844 x 1104 x 27	U54K	2CPX030109R9999
	6	288	984 x 1060 x 120	994 x 1104 x 27	U64K	2CPX030117R9999
For rail mounting devices and terminals, 150 mm DIN rail spacing						
2 (1/1)	4	96	684 x 560 x 120	694 x 604 x 27	U42M	2CPX030146R9999
3 (2/1)	5	180	834 x 810 x 120	844 x 854 x 27	U53M	2CPX030147R9999

U compact distribution boards for flush- and hollow-wall mounting

With distribution panels and transparent door



U compact distribution board with distribution panels and sheet steel door

125 mm or 150 mm DIN rail spacing

I_{nA} to 125 A

DIN EN 61439-1/-3 (VDE 0660-600-1/-3)

IP31 protection class

IK08 shock resistance rating

Protection class II, double insulated

Protection class I, earthed in combination with earthing set ZE12 (accessories)

The installed distributor fields can be pulled out for assembly and wiring

The covers are made from plastic

Panels without device assembly

Sheet steel housing and doors, 1 mm

Color: White, RAL 9016

Panel width 3 and over: Double doors

With integrated N/PE Quick plug-in terminals on fields for modular installation devices

Without N/PE Quick plug-in terminals on fields with -terminal spaces or mounting plates

Hollow wall installation set for flush mounting version (accessories)

With cable fastening/strain relief rail

A ZB40 nipple flange attached on top per field

With labeling system

Trim frame with flush mount

* In combination with hollow wall set ZKV200P4

U compact distribution boards for flush- and hollow-wall mounting

With distribution panels and transparent door



U41TE



U32TE



U42TE



U41TR3



U42TR3



U53TR4



U54TR4

PW	GU	SU	Wall cut-out dimension	Trim frame dimension	Type	Order code
			H x W x D in mm	H x W x D in mm		
For rail mounting devices, 125 mm DIN rail spacing						
1	4	48	684 x 310 x 120	694 x 354 x 27	U41TE	2CPX071592R9999
	5	60	834 x 310 x 120	844 x 354 x 27	U51TE	2CPX071594R9999
	6	72	984 x 310 x 120	994 x 354 x 27	U61TE	2CPX071596R9999
2 (1/1)	3	72	534 x 560 x 120	544 x 604 x 27	U32TE	2CPX071591R9999
2	4	96	684 x 560 x 120	694 x 604 x 27	U42TE	2CPX071593R9999
	5	120	834 x 560 x 120	844 x 604 x 27	U52TE	2CPX071595R9999
	6	144	984 x 560 x 120	994 x 604 x 27	U62TE	2CPX071597R9999
For rail mounting devices, 150 mm DIN rail spacing						
1	3	36	684 x 310 x 120	694 x 354 x 27	U41TR3	2CPX071722R9999
	4	48	834 x 310 x 120	844 x 354 x 27	U51TR4	2CPX071725R9999
	5	60	984 x 310 x 120	994 x 354 x 27	U61TR5	2CPX071729R9999
2	2	48	534 x 560 x 120	544 x 604 x 27	U32TR2	2CPX071721R9999
	3	72	684 x 560 x 120	694 x 604 x 27	U42TR3	2CPX071723R9999
	4	96	834 x 560 x 120	844 x 604 x 27	U52TR4	2CPX071726R9999
	5	120	984 x 560 x 120	994 x 604 x 27	U62TR5	2CPX071730R9999
	6	144	1134 x 560 x 120	1144 x 604 x 27	U72TR6	2CPX071733R9999
3 (2/1)	3	108	684 x 810 x 120	694 x 854 x 27	U43TR3	2CPX071724R9999
	4	144	834 x 810 x 120	844 x 854 x 27	U53TR4	2CPX071727R9999
	5	180	984 x 810 x 120	994 x 854 x 27	U63TR5	2CPX071731R9999
	6	216	1134 x 810 x 120	1144 x 854 x 27	U73TR6	2CPX071734R9999
4 (2/2)	4	192	834 x 1060 x 120	844 x 1104 x 27	U54TR4	2CPX071728R9999

U compact distribution boards for flush- and hollow-wall mounting

With distribution panels and transparent door



U42D



U42FPT

PW	GU	SU	Wall cut-out dimension	Panel frame dimension	Type	Order code
			H x W x D in mm	H x W x D in mm		
With picture frame door, anodized aluminum, row distance 125 mm						
2	4	96	684 x 560 x 120	716 x 625 x 25	U42D	2CPX038152R9999
With control panel, unprinted and not wired, distribution panel without cover and N/PE rail						
2	4	96	684 x 560 x 120	716 x 625 x 25	U42FPT	2CPX038151R9999



Example of picture frame door with decorative image (delivered without picture)



Example control panel with layout and control lights (delivery unprinted/ not wired)

UL compact distribution boards for flush- and hollow-wall mounting

Empty cabinets without door



UL compact distribution boards - empty cabinets without doors

Prepared to be fitted with CombiLine modules, distribution panels and media panels

I_{nA} to 125 A

DIN EN 61439-1/-3 (VDE 0660-600-1/-3)

Protection class without door IP30*¹

Protection class with door IP31

Protection class II, double insulated

Protection class I, earthed in combination with earthing set ZE12 (accessories)

Sheet steel housing, 1 mm

Color: White, RAL 9016

Media panels (accessories)

Trim frame with sheet steel or transparent door (accessories)

Hollow-wall mounting set for flush-mounting versions (accessory)

Without N/PE Quick-terminals

With cable fastening/strain relief rail

A ZB40 nipple flange attached on top per field

*¹ For an extension as compact distribution board with distribution panels or CombiLine modules

* Leave not less than 2 SU for DIN rail devices behind the closure

UL compact distribution boards for flush- and hollow-wall mounting

Empty cabinets without door



UL41



UL42



UL53



UL64

PW	GU	SU	Wall cut-out dimension		Type	Order code
			H	W x D in mm		
Empty cabinets without door						
1	4	72	684	310 x 120	UL41	2CPX030756R9999
	5	60	834	310 x 120	UL51	2CPX030759R9999
	6	72	984	310 x 120	UL61	2CPX030763R9999
2	3	72	534	560 x 120	UL32	2CPX030755R9999
	4	96	684	560 x 120	UL42	2CPX030757R9999
	5	120	834	560 x 120	UL52	2CPX030760R9999
	6	144	984	560 x 120	UL62	2CPX030764R9999
	7	168	1134	560 x 120	UL72	2CPX030767R9999
3	4	144	684	810 x 120	UL43	2CPX030758R9999
	5	180	834	810 x 120	UL53	2CPX030761R9999
	6	216	984	810 x 120	UL63	2CPX030765R9999
	7	252	1134	810 x 120	UL73	2CPX030768R9999
4	5	240	834	1060 x 120	UL54	2CPX030762R9999
	6	288	984	1060 x 120	UL64	2CPX030766R9999

> For expansion with distributor panels or CombiLine modules leave 2 SU free in lock area

UL subdistribution boards for flush and hollow wall mounting

Accessories cabinet doors*²



BLU42



BLT42

PW	GU	Panel frame dimension		Type	Order code
		H x W x D in mm	Suitable for ...		
Trim frame with sheet steel door*², powder-coated white RAL 9016					
1	4	694 x 354 x 27	UL41	BLU41	2CPX031501R9999
	5	844 x 354 x 27	UL51	BLU51	2CPX031504R9999
	6	994 x 354 x 27	UL61	BLU61	2CPX031508R9999
2	3	544 x 604 x 27	UL32	BLU32	2CPX031500R9999
	4	694 x 604 x 27	UL42	BLU42	2CPX031502R9999
	5	844 x 604 x 27	UL52	BLU52	2CPX031505R9999
	6	994 x 604 x 27	UL62	BLU62	2CPX031509R9999
	7	1144 x 604 x 27	UL72	BLU72	2CPX031511R9999
3* ¹	4	694 x 854 x 27	UL43	BLU43	2CPX031503R9999
	5	844 x 854 x 27	UL53	BLU53	2CPX031506R9999
	6	994 x 854 x 27	UL63	BLU63	2CPX031510R9999
	7	1144 x 854 x 27	UL73	BLU73	2CPX031512R9999
4* ¹	5	844 x 1104 x 27	UL54	BLU54	2CPX031507R9999
	6	994 x 1104 x 27	UL64	BLU64	2CPX031513R9999
Trim frame with transparent door*²					
1	4	694 x 354 x 27	UL41	BLT41	2CPX030786R9999
	5	844 x 354 x 27	UL51	BLT51	2CPX030789R9999
	6	994 x 354 x 27	UL61	BLT61	2CPX030793R9999
2	3	544 x 604 x 27	UL32	BLT32	2CPX030785R9999
	4	694 x 604 x 27	UL42	BLT42	2CPX030787R9999
	5	844 x 604 x 27	UL52	BLT52	2CPX030790R9999
	6	994 x 604 x 27	UL62	BLT62	2CPX030794R9999
	7	1144 x 604 x 27	UL72	BLT72	2CPX030797R9999
3* ¹	4	694 x 854 x 27	UL43	BLT43	2CPX030788R9999
	5	844 x 854 x 27	UL53	BLT53	2CPX030791R9999
	6	994 x 854 x 27	UL63	BLT63	2CPX030795R9999
	7	1144 x 854 x 27	UL73	BLT73	2CPX030798R9999
4* ¹	5	844 x 1104 x 27	UL54	BLT54	2CPX030792R9999
	6	994 x 1104 x 27	UL64	BLT64	2CPX030796R9999

*¹ 3 or more panels wide: double-wing doors

*² Leave not less than 2 space units (SU) for DIN rail devices behind the closure

N/PE Quick-terminals accessories

Accessories for assembling the compact distribution boards AT/U



ZK113B



ZK50BT



ZK113G



ZK10P10

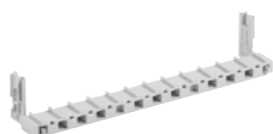

ZK13



ZK15

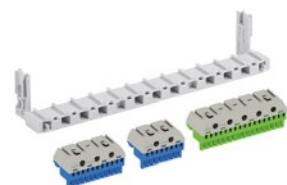

ZK220

Article	Number of terminals 1.5 - 4 mm ²	Number of terminals 2.5 - 25 mm ²	External dimensions H x W x D in mm	Pieces	Type	Order code
N Quick-terminals For Quick carrier	5 x 1.5 - 4	0 x 25	23 x 32 x 21	1	ZK50B	2CPX062750R9999
	5 x 1.5 - 4	1 x 25	32 x 32 x 31	1	ZK51B	2CPX062751R9999
	8 x 1.5 - 4	2 x 25	32 x 49 x 31	1	ZK82B	2CPX062752R9999
	11 x 1.5 - 4	3 x 25	32 x 65 x 31	1	ZK113B	2CPX062753R9999
	14 x 1.5 - 4	4 x 25	32 x 82 x 31	1	ZK144B	2CPX062754R9999
	17 x 1.5 - 4	5 x 25	32 x 98 x 31	1	ZK175B	2CPX062755R9999
	20 x 1.5 - 4	6 x 25	32 x 115 x 31	1	ZK206B	2CPX062756R9999
	23 x 1.5 - 4	7 x 25	32 x 132 x 31	1	ZK237B	2CPX063163R9999
26 x 1.5 - 4	8 x 25	32 x 149 x 31	1	ZK268B	2CPX063164R9999	
N Quick-terminal with adapter ZK15 For lateral assembly to the UK5... , A3...or for fastening on the DIN-Rail	5 x 1.5 - 4	0 x 25	28 x 39 x 25	1	ZK50BT	2CPX062745R9999
PE Quick-terminals For Quick carrier	5 x 1.5 - 4	1 x 25	32 x 32 x 31	1	ZK51G	2CPX062757R9999
	8 x 1.5 - 4	2 x 25	32 x 49 x 31	1	ZK82G	2CPX062758R9999
	11 x 1.5 - 4	3 x 25	32 x 65 x 31	1	ZK113G	2CPX062759R9999
	14 x 1.5 - 4	4 x 25	32 x 82 x 31	1	ZK144G	2CPX062760R9999
	17 x 1.5 - 4	5 x 25	32 x 98 x 31	1	ZK175G	2CPX062761R9999
	20 x 1.5 - 4	6 x 25	32 x 115 x 31	1	ZK206G	2CPX062762R9999
	23 x 1.5 - 4	7 x 25	32 x 132 x 31	1	ZK237G	2CPX063165R9999
26 x 1.5 - 4	8 x 25	32 x 149 x 31	1	ZK268G	2CPX063166R9999	
Connecting bridges For Quick-terminals				10	ZK10P10	2CPX062763R9999
Quick carrier For consumer units AT/U Usable width for Quick-terminals 214 mm				1	ZK13	2CPX064982R9999
Adapter for ZK50B By snapping in the N Quick plug-in terminal ZK50B into the ZK15 adapter, you obtain a ZK50BT which can be snapped onto the top-hat rail				1	ZK15	2CPX064984R9999
N/PE quick-terminal set for compact distribution boards Consisting of the following: Quick carrier: ZK13, 13 units and Quick-terminals: ZK113B: N 3 x 25 + 11 x 4 mm ² ZK82B: N 2 x 25 + 8 x 4 mm ² ZK175G: PE 5 x 25 + 17 x 4 mm ²				1	ZK220	2CPX063132R9999

Media enclosures and media panels

Complete media enclosures and panels for empty compact distribution boards



Technical specifications
Enclosures with media panel and distribution panel
Media panels for the AL and UL cabinet series
With perforated mounting plate without cover
Choice of three different doors
With mounted DIN rail
Wire holder included
Quick installation of devices without the need for drilling
The protection class depends on the respective expansion

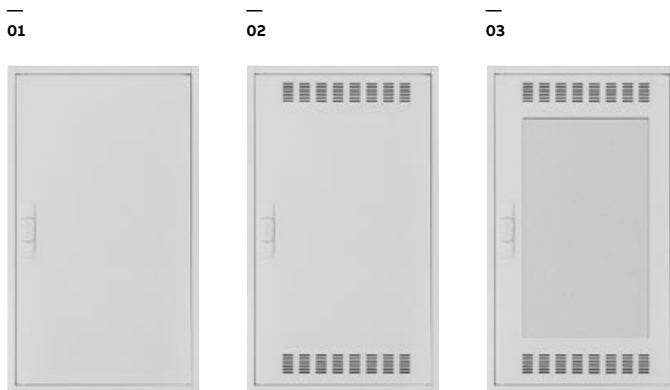

— 01
Trim frame with sheet steel door

— 02
Trim frame with a sheet steel door and ventilation slots

— 03
Trim frame with a sheet steel door ventilation slots and white plastic insert for an improved WiFi signal

— 04
Clean cable conduit and quick wiring thanks to wire holders

— 05
Device carrier (rubber) for fast and simple mounting of devices

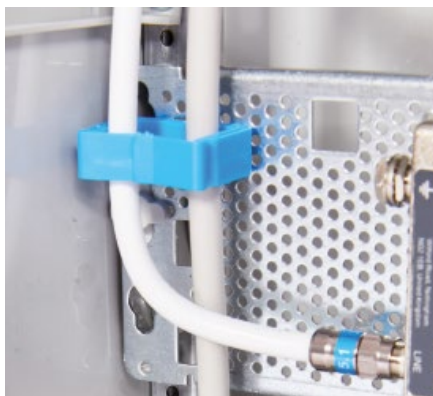

— 04



— 05

Media enclosures and media panels

Complete media enclosures and panels for empty subdistribution boards



AT42MM



AT53MML



U42MM

PW	GU	SU	Equipment	Panel frame dimensions	External dimensions	Type	Order code		
				H x W x D in mm	H x W x D in mm				
Media enclosures for wall mounting, with integrated media panel, 125 mm DIN rail spacing									
2	3	72	With sheet steel door IP31		524 x 574 x 140	AT32MM	2CPX030086R9999		
		96			674 x 574 x 140	AT42MM	2CPX030157R9999		
		120			824 x 574 x 140	AT52MM	2CPX030158R9999		
		144			974 x 574 x 140	AT62MM	2CPX030159R9999		
	4	96	Door with ventilation slots IP30		674 x 574 x 140	AT42MML	2CPX030285R9999		
		120			824 x 574 x 140	AT52MML	2CPX030286R9999		
		144			974 x 574 x 140	AT62MML	2CPX030287R9999		
	4	96	Sheet steel door IP30 ventilated with white plastic insert for an improved WiFi signal on the left and right s		674 x 574 x 140	AT42MMW	2CPX030678R9999		
					824 x 574 x 140	AT52MMW	2CPX030679R9999		
974 x 574 x 140					AT62MMW	2CPX030680R9999			
3 (2/1)	5	180	Door with ventilation slot IP30		824 x 824 x 140	AT53MML	2CPX030288R9999		
		216			974 x 824 x 140	AT63MML	2CPX030289R9999		
	5	180	Sheet steel door IP30 ventilated with white plastic insert 30% transparent for an improved wi-fi signal to the left and right		824 x 824 x 140	AT53MMW	2CPX030681R9999		
					216	974 x 824 x 140	AT63MMW	2CPX030682R9999	
	Media panel for flush and hollow wall mounting*, with integrated media panel, 125 mm DIN rail spacing								
	2	3	72	With IP31 steel-sheet door		984 x 310 x 120	994 x 354 x 27	U32MM	2CPX030088R9999
4						684 x 560 x 120	694 x 604 x 27	U42MM	2CPX030160R9999
5						884 x 560 x 120	844 x 604 x 27	U52MM	2CPX030161R9999
6						984 x 560 x 120	994 x 604 x 27	U62MM	2CPX030162R9999
4		96	Door with ventilation slot IP30		684 x 560 x 120	694 x 604 x 27	U42MML	2CPX030290R9999	
					5	884 x 560 x 120	844 x 604 x 27	U52MML	2CPX030291R9999
					6	984 x 560 x 120	994 x 604 x 27	U62MML	2CPX030292R9999
4		96	Sheet steel door IP30 ventilated with white plastic insert 30% transparent for an improved wi-fi signal to the left and right		684 x 560 x 120	694 x 604 x 27	U42MMW	2CPX030683R9999	
					5	884 x 560 x 120	844 x 604 x 27	U52MMW	2CPX030684R9999
					6	984 x 560 x 120	994 x 604 x 27	U62MMW	2CPX030685R9999

Media enclosures

Sheet steel doors with plastic insert and ventilation slots (WiFi door)



LT20



WT20

PW	GU	Suitable for ...	Type	Order code
Sheet steel door with ventilation slots*²				
Single door				
1	3	AT31	LT100	2CPX063419R9999
	4	AT41	LT10	2CPX063421R9999
	5	AT51	LT11	2CPX063424R9999
	6	AT61	LT12	2CPX063427R9999
2	3	AT32	LT200	2CPX063420R9999
	4	AT42	LT20	2CPX063422R9999
	5	AT52	LT21	2CPX063425R9999
	6	AT62	LT22	2CPX063428R9999
	7	AT72	LT23	2CPX063431R9999
Right double door				
3 ¹	4	AT43	LT30R	2CPX063423R9999
	5	AT53, AT54	LT31R	2CPX063426R9999
	6	AT63, AT64	LT32R	2CPX063429R9999
	7	AT73	LT33R	2CPX063432R9999
Sheet steel doors with plastic insert 30% transparent and ventilation slots (WiFi door)*²				
1	3	AT31	WT100	2CPX063400R9999
	4	AT41	WT10	2CPX063402R9999
	5	AT51	WT11	2CPX063405R9999
	6	AT61	WT12	2CPX063408R9999
2	3	AT32	WT200	2CPX063401R9999
	4	AT42	WT20	2CPX063403R9999
	5	AT52	WT21	2CPX063406R9999
	6	AT62	WT22	2CPX063409R9999
	7	AT72	WT23	2CPX063412R9999
Right double door				
3 ¹	4	AT43	WT30R	2CPX063404R9999
	5	AT53, AT54	WT31R	2CPX063407R9999
	6	AT63, AT64	WT32R	2CPX063410R9999
	7	AT73	WT33R	2CPX063413R9999

*¹ Double-wing doors in all cabinets of a width of 3 panels and more

*² Leave not less than 2 space units (SU) for DIN rail devices behind the closure

Media enclosures

Trim frame with door, plastic insert and ventilation slots (WiFi door)



BLL52



BLW52

PW	GU	Trim frame dimension H x W x D in mm	Suitable for ...	Type	Order code
Trim frame with sheet steel door with ventilation slots*2					
1	4	694 x 354 x 27	U41	BLL41	2CPX063451R9999
	5	844 x 354 x 27	U51	BLL51	2CPX063452R9999
	6	994 x 354 x 27	U61	BLL61	2CPX063453R9999
2	3	544 x 604 x 27	U32	BLL32	2CPX063454R9999
	4	694 x 604 x 27	U42	BLL42	2CPX063455R9999
	5	844 x 604 x 27	U52	BLL52	2CPX063456R9999
	6	994 x 604 x 27	U62	BLL62	2CPX063457R9999
	7	1144 x 604 x 27	U72	BLL72	2CPX063458R9999
3*1	4	694 x 854 x 27	U43	BLL43	2CPX063459R9999
	5	844 x 854 x 27	U53	BLL53	2CPX063460R9999
	6	994 x 854 x 27	U63	BLL63	2CPX063461R9999
	7	1144 x 854 x 27	U73	BLL73	2CPX063462R9999
4*1	5	844 x 1104 x 27	U54	BLL54	2CPX063463R9999
	6	994 x 1104 x 27	U64	BLL64	2CPX063464R9999
Trim frame with door, plastic insert 30% transparent and ventilation slots (WiFi door)*2					
1	5	844 x 354 x 27	U51	BLW51	2CPX063438R9999
	6	994 x 354 x 27	U61	BLW61	2CPX063439R9999
2	3	544 x 604 x 27	U32	BLW32	2CPX063440R9999
	4	694 x 604 x 27	U42	BLW42	2CPX063441R9999
	5	844 x 604 x 27	U52	BLW52	2CPX063442R9999
	6	994 x 604 x 27	U62	BLW62	2CPX063443R9999
	7	1144 x 604 x 27	U72	BLW72	2CPX063444R9999
3*1	4	694 x 854 x 27	U43	BLW43	2CPX063445R9999
	5	844 x 854 x 27	U53	BLW53	2CPX063446R9999
	6	994 x 854 x 27	U63	BLW63	2CPX063447R9999
	7	1144 x 854 x 27	U73	BLW73	2CPX063448R9999
4*1	5	844 x 1104 x 27	U54	BLW54	2CPX063449R9999
	6	994 x 1104 x 27	U64	BLL64	2CPX063464R9999

Media enclosures

Media panels and combination panels with perforated plate mounting

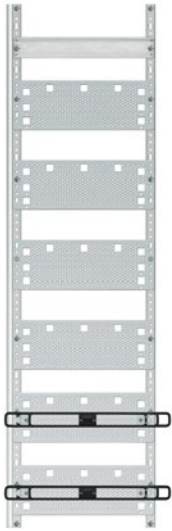

1MM2

PW	GU	height x width	Pieces	Type	Order code
Media panels for empty compact distribution boards					
1	3	450 x 250	1	1MM00	2CPX037485R9999
	4	600 x 250	1	1MM0	2CPX037486R9999
	5	750 x 250	1	1MM1	2CPX037487R9999
	6	900 x 250	1	1MM2	2CPX037488R9999
	7	1050 x 250	1	1MM3	2CPX037489R9999
2	4	600 x 500	1	2MM0	2CPX037490R9999
	5	750 x 500	1	2MM1	2CPX037491R9999
	6	900 x 500	1	2MM2	2CPX037492R9999
	7	1050 x 500	1	2MM3	2CPX037493R9999



1MMC22

PW	GU	height x width	PLE	Additional RE for multimedia	Pieces	Type	Order code
Media combination panels for empty compact distribution boards							
1	5	750 x 250	24	3	1	1MMC12	2CPX037494R9999
		750 x 250	36	2	1	1MMC13	2CPX037495R9999
2	6	900 x 250	24	4	1	1MMC22	2CPX037496R9999
		900 x 250	36	3	1	1MMC23	2CPX037497R9999
3	7	1050 x 250	24	5	1	1MMC32	2CPX037498R9999
		1050 x 250	36	4	1	1MMC33	2CPX037466R9999
		1050 x 250	48	3	1	1MMC34	2CPX037467R9999

Media enclosures

Accessories

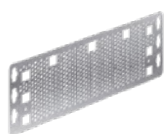

UZM61M



ZX340



ZE336



ZE338



ZE225



ZX29



ZE227



ZE339

Article	Pieces	Type	Order code
Perforated mounting plate			
From sheet steel			
Panel width 1	1	UZM61M	2CPX031421R9999
Panel width 2	1	UZM62M	2CPX031432R9999
Device carrier (rubber)			
Elastic strap for assembly of devices on the perforated sheet steel mounting plate without tools with 2 clips for assembly			
Patch panel			
Empty for communications modules, e.g. RJ45 connector, KOAX module, etc. For direct or insulated installation on the EDF rail, top-hat rail or on the mounting plate			
For 6 keystone modules	1	ZE335	2CPX031423R9999
1-panel wide for 12 keystone modules	1	ZE336	2CPX031424R9999
2-panel wide for 24 keystone modules	1	ZE337	2CPX031425R9999
Patch panel holder			
1			
ZE338			
2CPX031426R9999			
Dual socket			
230 V AC voltage, with EURO insert for mounting on the ZX29 mounting bracket			
1			
ZE225			
2CPX061177R9999			
Mounting bracket for Dual socket ZE225			
For snap-on installation on the terminal base or for mounting onto the perforated plate of the UK... media distributors and the 1MM... media fields			
1			
ZX29			
2CPX061178R9999			
Triple socket			
230 V AC voltage, 120° swiveling with EURO insert to be snapped on to the cable inlet or DIN rail; to be screwed to the mounting plate			
1			
ZE227			
2CPX061211R9999			
Media extension set			
Set including device carrier (rubber) with 2 clips for assembly Patch panel for 12 keystone modules Rotatable triple socket with EURO inserts and wire holders			
1			
ZE339			
2CPX038146R9999			

Media enclosures

Accessories



ED44P10

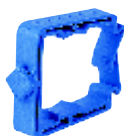

ED45P10



ZX287P10



ZE311



ZE312



ZE316



ZE317



ZE318



ZE319



ZE310

Article	Pieces	Type	Order code
Wire holder For cable routing, to be inserted into the perforated mounting plate			
Installation depth 28.5 mm	10	ED44P10	2CPX062335R9999
Installation depth 55 mm	10	ED45P10	2CPX062336R9999
Screws M4 x 14 thread rolling for the perforated sheet steel mounting plate 3.9 x 13 mm	10	ZX287P10	2CPX061180R9999
Keystone modules for installation in the patch panel			
RJ45 modules			
Plastic	1	ZE311	2CPX038612R9999
Metal	1	ZE312	2CPX038613R9999
COAX module F-jack/F-jack	1	ZE316	2CPX039246R9999
COAX module F-jack/EC-jack	1	ZE317	2CPX039247R9999
COAX module F-jack/IEC plug	1	ZE318	2CPX039248R9999
LC module Duplex jack/duplex jack For multi-mode fiber Phosphor bronze sleeve	1	ZE319	2CPX039249R9999
Patch module RJ45 For snap-on onto the top-hat rail, 1 PLE	1	ZE310	2CPX038625R9999

N/PE Quick-terminals

Standardized, clear, flexible

Configure as needed

The modularity and the extensive range make it possible for you to configure the products individually and exactly to your practical needs. A variety of Quick-terminals can be combined on a shared Quick carrier as needed.

If a larger N or PE terminal block is needed, two Quick-terminal blocks can be connected with the ZK10P10 connection bridge.

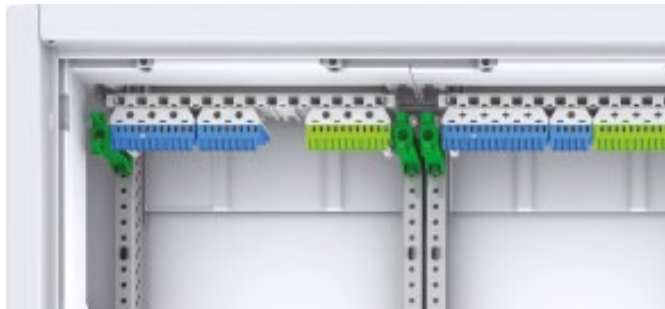

Product advantages

- Flexible terminal system for several N potentials: Screw connection technology: 2.5 to 25 mm² for rigid conductors; for flexible conductors up to 25 mm² (wire end sleeves required)
- Spring terminal technology: 1.5 to 4 mm² for rigid conductors; for flexible conductors up to 2.5 mm² (end sleeves required)
- Optimal for the use of several residual current circuit breakers (RCDs)
- Easy expansion of the Quick-terminals using connection bridges
- Precise assignment of the terminal blocks thanks to clear color coding: N = blue, PE = yellow-green
- Easy labeling of the terminal points with preprinted self-adhesive number strips
- Wide range of applications: In the UK600 series and Mistral consumer unit series, in all compact distribution boards, and with all meter cabinets, wall-mounting and floor-standing cabinets



Quick terminal carrier type ZK13

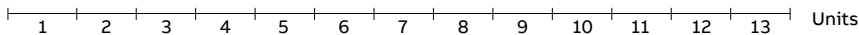

N/PE terminal blocks with units	N Quick-terminals	Screw connection system	Spring terminal system	PE Quick-terminals	Screw connection system	Spring terminal system
		ZK50B	0 x 25 mm ²	-	-	-
		ZK50BT	0 x 25 mm ²	-	-	-
		ZK51B	1 x 25 mm ²		ZK51G	1 x 25 mm ²
		ZK82B	2 x 25 mm ²		ZK82G	2 x 25 mm ²
		ZK113B	3 x 25 mm ²		ZK113G	3 x 25 mm ²
		ZK144B	4 x 25 mm ²		ZK144G	4 x 25 mm ²
		ZK175B	5 x 25 mm ²		ZK175G	5 x 25 mm ²
		ZK206B	6 x 25 mm ²		ZK206G	6 x 25 mm ²

N/PE Quick-terminals

Accessories



ZK113B



ZK50BT



ZK113G



ZK10P10



ZK13



ZK15

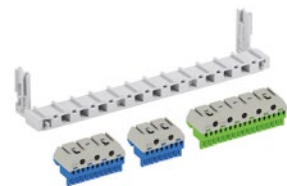

ZK220

Article	Number of terminals 1.5 - 4 mm ²	Number of terminals 2.5 - 25 mm ²	External dimensions H x W x D in mm	Pieces	Type	Order code
N Quick-terminals For Quick carrier	5 x 1.5 - 4	0 x 25	23 x 32 x 21	1	ZK50B	2CPX062750R9999
	5 x 1.5 - 4	1 x 25	32 x 32 x 31	1	ZK51B	2CPX062751R9999
	8 x 1.5 - 4	2 x 25	32 x 49 x 31	1	ZK82B	2CPX062752R9999
	11 x 1.5 - 4	3 x 25	32 x 65 x 31	1	ZK113B	2CPX062753R9999
	14 x 1.5 - 4	4 x 25	32 x 82 x 31	1	ZK144B	2CPX062754R9999
	17 x 1.5 - 4	5 x 25	32 x 98 x 31	1	ZK175B	2CPX062755R9999
	20 x 1.5 - 4	6 x 25	32 x 115 x 31	1	ZK206B	2CPX062756R9999
N Quick-terminal with ZK15 adapter For lateral installation in UK5..., A3... or to snap onto the DIN rail	5 x 1.5 - 4	0 x 25	28 x 39 x 25	1	ZK50BT	2CPX062745R9999
PE Quick-terminals For Quick carrier	5 x 1.5 - 4	1 x 25	32 x 32 x 31	1	ZK51G	2CPX062757R9999
	8 x 1.5 - 4	2 x 25	32 x 49 x 31	1	ZK82G	2CPX062758R9999
	11 x 1.5 - 4	3 x 25	32 x 65 x 31	1	ZK113G	2CPX062759R9999
	14 x 1.5 - 4	4 x 25	32 x 82 x 31	1	ZK144G	2CPX062760R9999
	17 x 1.5 - 4	5 x 25	32 x 98 x 31	1	ZK175G	2CPX062761R9999
	20 x 1.5 - 4	6 x 25	32 x 115 x 31	1	ZK206G	2CPX062762R9999
Connecting bridges For Quick-terminals				10	ZK10P10	2CPX062763R9999
Quick carrier For AT/U compact distribution boards Usable width for Quick-terminals 214 mm, 13 units				1	ZK13	2CPX064982R9999
Adapter for ZK50B By snapping in the N Quick-terminal ZK50B into the ZK15 adapter, you obtain a ZK50BT which can be snapped onto the DIN rail				1	ZK15	2CPX064984R9999
N/PE Quick-terminal set for subdistribution boards Consisting of the following: Quick carrier: ZK13, 13 units and Quick-terminals: ZK113B: N 3 x 25 + 11 x 4 mm ² ZK82B: N 2 x 25 + 8 x 4 mm ² ZK175G: PE 5 x 25 + 17 x 4 mm ²				1 Set	ZK220	2CPX063132R9999

Compact distribution boards

Accessories



ZB113



ZB111

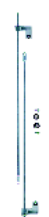

ZX456

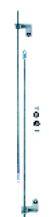

ZX440



ZH800



ZH801



ZH220



ZH130



ZH132



ZH134



ZH137

Article	Piece	Type	Order code
Standard lock Included in the scope of delivery	1	ZB113	2CPX038478R9999
Safety lock With 2 keys	1	ZB111	2CPX038479R9999
Espagnolette lock In combination with standard closure ZB113*1 or safety lock ZB111			
For installation height 4 RE	1	ZX456	2CPX039586R9999
For installation height 5 RE	1	ZX457	2CPX039587R9999
For installation height 6 RE	1	ZX458	2CPX039588R9999
For installation height 7 RE	1	ZX459	2CPX039589R9999
Espagnolette lock In combination with ZH203, ZH220, ZH221, ZH222, ZH227, ZH228			
For installation height 4 RE	1	ZX440	2CPX039570R9999
For installation height 5 RE	1	ZX441	2CPX039571R9999
For installation height 6 RE	1	ZX442	2CPX039572R9999
For installation height 7 RE	1	ZX443	2CPX039573R9999
Installation set**1 **2 of actuation options in combination with ZH220/ZH221/ZH222	1	ZH800	2CPX038544R9999
Additional lock tongue for rod lock In combination with U cabinet as a hollow wall distributor	1	ZH801	2CPX038549R9999
Key plate			
Double-bit actuating rod 3 mm standard and 5 mm (ZH800 must be ordered additionally)	1	ZH220	2CPX045700R9999
For triangular and rectangular actuating rod, as well as for Daimler-Benz insert (ZH800 must be ordered additionally)	1	ZH221	2CPX045701R9999
For T-handle or L-handle (ZH800 must be ordered additionally).	1	ZH222	2CPX045702R9999
Actuation pin			
Double bit 3 mm	1	ZH130	2CPX060490R9999
Double bit 5 mm	1	ZH131	2CPX060491R9999
Triangle 7 mm	1	ZH132	2CPX060492R9999
Triangle 8 mm	1	ZH133	2CPX060493R9999
Rectangle 6 mm	1	ZH134	2CPX060494R9999
Rectangle 7 mm	1	ZH135	2CPX060495R9999
Rectangle 8 mm	1	ZH136	2CPX060496R9999
Daimler-Benz insert	1	ZH137	2CPX060497R9999

*1 Leave not less than 2 space units (SU) for DIN rail devices behind the closure

*2 Use ZH801 lock tongue when using espagnolette lock and hollow wall distribution board

Compact distribution boards

Accessories



ZH157



ZH91



ZH138



ZH139



ZH140



ZH141



ZH228



ZH227



ZH203



ZH142

Article	Piece	Type	Order code
Actuation key			
Triangle 7 mm	1	ZH157	2CPX060657R9999
Triangle 8 mm	1	ZH158	2CPX060658R9999
Double bit 3 mm	1	ZH160	2CPX060660R9999
Double bit 5 mm	1	ZH161	2CPX060661R9999
Rectangle 6 mm	1	ZH162	2CPX060662R9999
Rectangle 7 mm	1	ZH163	2CPX060663R9999
Rectangle 8 mm	1	ZH164	2CPX060664R9999
Daimler-Benz insert	1	ZH165	2CPX060665R9999
Universal key Double bit 3 and 5 mm Triangle 8 mm Rectangle 6 and 8 mm	1	ZH91	2CPX066091R9999
T-handle*¹			
Without lock	1	ZH138	2CPX060498R9999
With lock	1	ZH139	2CPX060499R9999
L-handle*¹			
Without lock	1	ZH140	2CPX060500R9999
With lock	1	ZH141	2CPX060501R9999
Swivel handle with sealing cap*¹ *² For profile half cylinder 40 mm (30/10)	1	ZH228	2CPX045709R9999
Swivel handle with sealing cap*¹ *² With Senatsschloss Berlin, simultaneous locking	1	ZH227	2CPX045708R9999
Swivel handle with sealing cap*¹ *² With E0 12 closure	1	ZH203	2CPX045707R9999
Shutter insert Instead of a profile half cylinder for swivel handle ZH228	1	ZH142	2CPX060502R9999

*¹ Leave not less than 2 space units (SU) for DIN rail devices behind the closure*² Use ZH801 lock tongue when using espagnolette lock and hollow wall distribution board

Compact distribution boards

Accessories



ZKV200P4



ZE11



ZE12

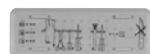

ZB43



ZB40



ZX69K



ZA1P5



ZA6



ZA5



ZX139LR

Article	Piece	Type	Order code
Hollow-wall set For later conversion of a flush-mounted distribution board to a hollow-wall distribution board Wall thickness min. 14 mm, max. 58 mm	1	ZKV200P4	2CPX062446R9999
Earthing set for wall-mounting enclosures For conversion to protection class 1	1	ZE11	2CPX038143R9999
Earthing set for flush-mounting enclosures For conversion to protection class 1	1	ZE12	2CPX038144R9999
Membrane flange For inserting the cable from the bottom	1	ZB43	2CPX038183R9999
Nipple flange	1	ZB40	2CPX038195R9999
Vertical partitions Between distribution panels, not arc-resistant			
Height 3 RE	1	ZX69K	2CPX039332R9999
Height 4 RE	1	ZX70K	2CPX039333R9999
Height 5 RE	1	ZX71K	2CPX039334R9999
Height 6 RE	1	ZX72K	2CPX039335R9999
Height 7 RE	1	ZX73K	2CPX039336R9999
Blocking plate Color RAL 7035, for 12 space units, can be broken off	5	ZA1P5	2CPX062384R9999
	50	ZA1P50	2CPX062378R9999
DIN A4 document holder Self-adhesive with transparent sleeve	1	ZA6	2CPX038227R9999
	10	ZA6P10	2CPX062380R9999
Self-adhesive with transparent sleeve and reinforced back	10	ZA61P10	2CPX062375R9999
DIN A4 document holder Self-adhesive	1	ZA13	2CPX038233R9999
	10	ZA13P10	2CPX062381R9999
DIN A5 document holder Self-adhesive	1	ZA5	2CPX038228R9999
	10	ZA5P10	2CPX062382R9999
Door hinge (plastic) Year of manufacture 2010	2	ZX139LR	2CPX039139R9999

Compact distribution boards

Accessories



ZX464

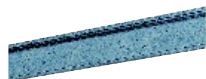

ZX371



ZK90P2



ZX372P2



ZX21



ZB32P20



ED137P4



ED50P12

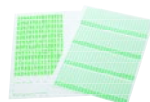

ZKV201

Article	Piece	Type	Order code
Door bolt for double-wiring doors For cabinets with three or more panel widths	1	ZX464	2CPX039596R9999
DIN rail for terminals 35 x 7.5 mm For recessed installation in combination with mounting bracket ZX372P2 and ZK90P2 insulator			
1 panel width	1	ZX371	2CPX068076R9999
2 panels width	1	ZX389	2CPX068190R9999
Insulator for DIN rails 35 x 7.5 mm including fastening material	2	ZK90P2	2CPX062426R9999
Mounting bracket for ZK90P2	2	ZX372P2	2CPX062544R9999
DIN rail 35 x 7.5 mm			
1 panel width	1	ZX21	2CPX039021R9999
2 panels width	1	ZX22	2CPX039022R9999
Fastening screws for DIN rails			
T25- torx screw	20	ZB32P20	2CPX062651R9999
T25- torx screw	500	ZB32P500	2CPX062652R9999
Cover holder, 45 mm high For fastening (inserting, turning) onto EDF profile rails as well as for snap-on installation of a partition. Only use this cover holder for DIN-Rails 35 x 7.5 mm	4 40	ED137P4 ED137P40	2CPX062600R9999 2CPX062601R9999
Press-and-turn fixing To cover distribution panels	12	ED50P12	2CPX062337R9999
Labeling system Self-adhesive for AT and U distribution board	1	ZKV201	2CPX038148R9999

Compact distribution boards

Accessories



ZK300



ZX518



ZX400



ZA122



ZA20



ZA120

Article	Pieces	Type	Order code
Busbar system for N/PE			
Cu 12 x 5 mm, max. connection 95 mm ²			
1 panel wide	1	ZK300	2CPX038551R9999
2 panels wide	1	ZK301	2CPX038552R9999
N/PE busbar carrier			
For copper busbars 12 x 5 mm, 20 x 5 mm, 30 x 5 mm			
	1	ZX518	2CPX067805R9999
	10	ZX518P10	2CPX062551R9999
Copper busbars			
12 x 5 mm = 250 A			
1 m long		ZX400	2CPX061400R9999
2 m long		ZX401	2CPX061401R9999
3 m long		ZX402	2CPX061402R9999
4 m long		ZX350	2CPX061350R9999
Cleaner			
For distribution board panel covers, spray dispenser, 500 ml			
	1	ZA122	2CPX038293R9999
Spray paint can			
Color RAL 9016, 150 ml			
	1	ZA20	2CPX038229R9999
Touch-up applicator			
Color RAL 9016, 12 ml			
	1	ZA120	2CPX039043R9999

A-Wall Cabinets IP43

For indoor use 



A-Wall cabinets IP43 , cabinet depth 215 mm

IP31 protection class

DIN VDE 0603-1

Protection class II, double insulated

Cabinet depth 215 mm

Enclosure and door made of sheet steel, with recessed plastic profile for double insulation

Rear wall made of plastic

RAL 9016, powder-coated

IK07 shock resistance rating

Prepared for the installation of meter and distribution panels/combination sets

Prepared for installation with CombiLine modules on EDF mounting frame

Double-wing doors on cabinets with three or more panel widths

Door opening angle 130 degrees

Equipped with ZB113 standard closure

Flange openings are provided on the bottom and sides

Membrane flanges are mounted in the upper connection area

A ZB40 nipple flange is additionally included

Knockouts for cable entry points on the back

Cable inlets are located in the lower and upper connection area (per panel width)



A-Wall Cabinets IP43

For indoor use 



3/2A

OH	GU	Height in mm	PW	SU	External dimensions H x W x D mm	A-Wall cabinets IP43 	
						Type	Order code
00	3	500	1	36	500 x 300 x 215	1/00A	2CPX036061R9999
			2	72	500 x 550 x 215	2/00A	2CPX036062R9999
			3	108	500 x 800 x 215	3/00A	2CPX036063R9999
			4	144	500 x 1050 x 215	4/00A	2CPX036064R9999
			5	180	500 x 1300 x 215	5/00A	2CPX036065R9999
0	4	650	1	48	650 x 300 x 215	1/0A	2CPX036001R9999
			2	96	650 x 550 x 215	2/0A	2CPX036002R9999
			3	144	650 x 800 x 215	3/0A	2CPX036003R9999
			4	192	650 x 1050 x 215	4/0A	2CPX036004R9999
			5	240	650 x 1300 x 215	5/0A	2CPX036005R9999
1	5	800	1	60	800 x 300 x 215	1/1A	2CPX036011R9999
			2	120	800 x 550 x 215	2/1A	2CPX036012R9999
			3	180	800 x 800 x 215	3/1A	2CPX036013R9999
			4	240	800 x 1050 x 215	4/1A	2CPX036014R9999
			5	300	800 x 1300 x 215	5/1A	2CPX036015R9999
2	6	950	1	72	950 x 300 x 215	1/2A	2CPX036021R9999
			2	144	950 x 550 x 215	2/2A	2CPX036022R9999
			3	216	950 x 800 x 215	3/2A	2CPX036023R9999
			4	288	950 x 1050 x 215	4/2A	2CPX036024R9999
			5	360	950 x 1300 x 215	5/2A	2CPX036025R9999
3	7	1100	1	84	1100 x 300 x 215	1/3A	2CPX036031R9999
			2	168	1100 x 550 x 215	2/3A	2CPX036032R9999
			3	252	1100 x 800 x 215	3/3A	2CPX036033R9999
			4	336	1100 x 1050 x 215	4/3A	2CPX036034R9999
			5	420	1100 x 1300 x 215	5/3A	2CPX036035R9999
4	8	1250	1	96	1250 x 300 x 215	1/4A	2CPX036041R9999
			2	192	1250 x 550 x 215	2/4A	2CPX036042R9999
			3	288	1250 x 800 x 215	3/4A	2CPX036043R9999
			4	384	1250 x 1050 x 215	4/4A	2CPX036044R9999
			5	480	1250 x 1300 x 215	5/4A	2CPX036045R9999
5	9	1400	1	108	1400 x 300 x 215	1/5A	2CPX036051R9999
			2	216	1400 x 550 x 215	2/5A	2CPX036052R9999
			3	324	1400 x 800 x 215	3/5A	2CPX036053R9999
			4	432	1400 x 1050 x 215	4/5A	2CPX036054R9999
			5	540	1400 x 1300 x 215	5/5A	2CPX036055R9999

A-Wall Cabinets IP43

Accessories

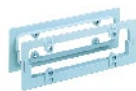

ZX455



ZX454



ZX206P4

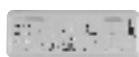

ZB43



ZB40



ZB113

ZB111

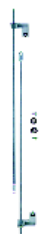

ZX456



ZH800



ZH220



ZH130

Article	Pieces	Type	Order code
Insulating frame for cabinet to cabinet connection For the side flange cut-outs (to maintain double insulation when cabinets are assembled next to each other) (with connection material)	1	ZX455	2CPX039192R9999
Insulating frame for cabinet to cabinet connection For the top/bottom flange cut-outs (to maintain double insulation when cabinets are assembled one above the other)	1	ZX454	2CPX039199R9999
External mounting brackets	4	ZX206P4	2CPX062491R9999
Membrane flange* For inserting cables	1	ZB43	2CPX038183R9999
Nipple flange* For cable diameters 1 x 12 to 47 mm, 1 x 12 to 29 mm, 3 x 8 to 15 mm, 20 x 7 to 13 mm	1	ZB40	2CPX038195R9999
Standard lock*	1	ZB113	2CPX038478R9999
Safety lock With 2 keys	1	ZB111	2CPX038479R9999
Espagnolette closure In conjunction with the standard lock and safety lock for subsequent installation in A-, B- and U-cabinets			
For overall height 0 (4 GU)	1	ZX456	2CPX039586R9999
For overall height 1 (5 GU)	1	ZX457	2CPX039587R9999
For overall height 2 (6 GU)	1	ZX458	2CPX039588R9999
For overall height 3 (7 GU)	1	ZX459	2CPX039589R9999
For overall height 4 (8 GU)	1	ZX460	2CPX039590R9999
For overall height 5 (9 GU)	1	ZX461	2CPX039591R9999
Installation set for actuation options in conjunction with ZH220/ZH221/ZH222	1	ZH800	2CPX038544R9999
Latch plate for double-bit operating pin (order installation set ZH800 separately) 3 mm and 5 mm	1	ZH220	2CPX045700R9999
Operating pins			
Double-bit 3 mm	1	ZH130	2CPX060490R9999
Double-bit 5 mm	1	ZH131	2CPX060491R9999

* Spare part included in the scope of delivery.

A-Wall Cabinets IP43

Accessories



ZH221



ZH132



ZH134



ZH137



ZH222



ZH138



ZH139



ZH140



ZH141



ZH228



ZH142



ZH227



ZH203

Article	Pieces	Type	Order code
Latch plate For triangular, square and Daimler-Benz operating pins (also order ZH800 installation set for A or U cabinets)	1	ZH221	2CPX045701R9999
Operating pins			
Triangle 7 mm	1	ZH132	2CPX060492R9999
Triangle 8 mm	1	ZH133	2CPX060493R9999
Square 6 mm	1	ZH134	2CPX060494R9999
Square 7 mm	1	ZH135	2CPX060495R9999
Square 8 mm	1	ZH136	2CPX060496R9999
Daimler-Benz	1	ZH137	2CPX060497R9999
Latch plate For T-handle or L-handle (Additionally order installation set ZH800)	1	ZH222	2CPX045702R9999
T-handle			
Without lock	1	ZH138	2CPX060498R9999
With lock	1	ZH139	2CPX060499R9999
L-handle			
Without lock	1	ZH140	2CPX060500R9999
With lock	1	ZH141	2CPX060501R9999
Swivel handle for semi-cylinder 40 mm (30/10) with lead sealable cap	1	ZH228	2CPX045709R9999
Dummy insert Instead of semi-cylinder	1	ZH142	2CPX060502R9999
Swivel handle with Senate closure Berlin	1	ZH227	2CPX045708R9999
Swivel handle With E0 12 closure	1	ZH203	2CPX045707R9999

A-Wall Cabinets IP43

Accessories



ZX456



ZX139LR



ZX464



KB219



KBS9



KBW1



ZA20



ZA120

Article	Pieces	Type	Order code
Espagnolette closure			
In conjunction with ZH203, ZH220, ZH221, ZH222, ZH227 and ZH228 lock system			
For overall height 0 (4 GU)	1	ZX440	2CPX039570R9999
For overall height 1 (5 GU)	1	ZX441	2CPX039571R9999
For overall height 2 (6 GU)	1	ZX442	2CPX039572R9999
For overall height 3 (7 GU)	1	ZX443	2CPX039573R9999
For overall height 4 (8 GU)	1	ZX444	2CPX039574R9999
For overall height 5 (9 GU)	1	ZX445	2CPX039575R9999
Door hinge (plastic)*	2	ZX139LR	2CPX039139R9999
Door bolt for double-wing doors* For cabinets with three or more panel widths	1	ZX464	2CPX039596R9999
Cable entry covers with end plates and mounting brackets Colour RAL9016 adapted to the colour of the cabinets			
1 panel wide, width 300 mm	1	KB19	2CPX044049R9999
2 panel wide, width 550 mm	1	KB29	2CPX044050R9999
3 panel wide, width 800 mm	1	KB39	2CPX044051R9999
4 panel wide, width 1050 mm	1	KB49	2CPX044052R9999
5 panel wide, width 1300 mm	1	KB59	2CPX044053R9999
Profile Plastic, color RAL 9016 Width 2000 mm	1	KB219	2CPX044055R9999
End plate left/right Plastic, color RAL 9016 1 set, 2 pieces	1	KBS9	2CPX044057R9999
Fixing bracket From plastic with holding magnet for mounting on cabinet	1	KBW1	2CPX044058R9999
Spray cans Color RAL 9016, 150 ml	1	ZA20	2CPX038229R9999
Touch-up applicator Color RAL 9016, 12 ml	1	ZA120	2CPX039043R9999

* Spare part included in the scope of delivery.

A-Wall Cabinets IP43

Accessories



ZA6



ZA5

Article	Pieces	Type	Order code
General accessories for all cabinets			
DIN A4 document holder	1	ZA6	2CPX038227R9999
Self-adhesive with transparent sleeve	10	ZA6P10	2CPX062380R9999
Self-adhesive with transparent sleeve and reinforced back	10	ZA61P10	2CPX062375R9999
DIN A5 document holder	1	ZA5	2CPX038228R9999
Self-adhesive	10	ZA5P10	2CPX062382R9999

A-Wall Cabinets IP43

Sheet steel doors



T31R

PW	OH	Compatible with cabinet	Left door*		Right door*	
			Type	Order code	Type	Order code
1	00	1/00A	-	-	T100	2CPX062057R9999
2	00	2/00A	-	-	T200	2CPX062058R9999
3	00	3/00A	T300L	2CPX062192R9999	T300R	2CPX062191R9999
4	00	4/00A	T500L	2CPX062194R9999	T300R	2CPX062191R9999
5	00	5/00A	T500L	2CPX062194R9999	T500R	2CPX062193R9999
1	0	1/0A	-	-	T10	2CPX062059R9999
2	0	2/0A	-	-	T20	2CPX062060R9999
3	0	3/0A	T30L	2CPX062196R9999	T30R	2CPX062195R9999
4	0	4/0A	T50L	2CPX062198R9999	T30R	2CPX062195R9999
5	0	5/0A	T50L	2CPX062198R9999	T50R	2CPX062197R9999
1	1	1/1A	-	-	T11	2CPX062062R9999
2	1	2/1A	-	-	T21	2CPX062063R9999
3	1	3/1A	T31L	2CPX062200R9999	T31R	2CPX062199R9999
4	1	4/1A	T51L	2CPX062202R9999	T31R	2CPX062199R9999
5	1	5/1A	T51L	2CPX062202R9999	T51R	2CPX062201R9999
1	2	1/2A	-	-	T12	2CPX062066R9999
2	2	2/2A	-	-	T22	2CPX062067R9999
3	2	3/2A	T32L	2CPX062204R9999	T32R	2CPX062203R9999
4	2	4/2A	T52L	2CPX062206R9999	T32R	2CPX062203R9999
5	2	5/2A	T52L	2CPX062206R9999	T52R	2CPX062205R9999
1	3	1/3A	-	-	T13	2CPX062079R9999
2	3	2/3A	-	-	T23	2CPX062070R9999
3	3	3/3A	T33L	2CPX062208R9999	T33R	2CPX062207R9999
4	3	4/3A	T53L	2CPX062210R9999	T33R	2CPX062207R9999
5	3	5/3A	T53L	2CPX062210R9999	T53R	2CPX062209R9999
1	4	1/4A	-	-	T14	2CPX062082R9999
2	4	2/4A	-	-	T24	2CPX062083R9999
3	4	3/4A	T34L	2CPX062212R9999	T34R	2CPX062211R9999
4	4	4/4A	T54L	2CPX062214R9999	T34R	2CPX062211R9999
5	4	5/4A	T54L	2CPX062214R9999	T54R	2CPX062213R9999
1	5	1/5A	-	-	T15	2CPX062087R9999
2	5	2/5A	-	-	T25	2CPX062088R9999
3	5	3/5A	T35L	2CPX062216R9999	T35R	2CPX062215R9999
4	5	4/5A	T55L	2CPX062218R9999	T35R	2CPX062215R9999
5	5	5/5A	T55L	2CPX062218R9999	T55R	2CPX062217R9999

* Double-wing doors in all cabinets of a width of 3 panels and more

A-Wall Cabinets IP43

Transparent doors



TTS20

PW	OH	Compatible with cabinet	Left door*		Right door*	
			Type	Order code	Type	Order code
1	00	1/00A	-	-	TTS100	2CPX062021R9999
2	00	2/00A	-	-	TTS200	2CPX062022R9999
3	00	3/00A	TTS300L	2CPX062248R9999	TTS300R	2CPX062247R9999
4	00	4/00A	TTS500L	2CPX062250R9999	TTS300R	2CPX062247R9999
5	00	5/00A	TTS500L	2CPX062250R9999	TTS500R	2CPX062249R9999
1	0	1/0A	-	-	TTS10	2CPX062026R9999
2	0	2/0A	-	-	TTS20	2CPX062027R9999
3	0	3/0A	TTS30L	2CPX062252R9999	TTS30R	2CPX062251R9999
4	0	4/0A	TTS50L	2CPX062254R9999	TTS30R	2CPX062251R9999
5	0	5/0A	TTS50L	2CPX062254R9999	TTS50R	2CPX062253R9999
1	1	1/1A	-	-	TTS11	2CPX062031R9999
2	1	2/1A	-	-	TTS21	2CPX062032R9999
3	1	3/1A	TTS31L	2CPX062256R9999	TTS31R	2CPX062255R9999
4	1	4/1A	TTS51L	2CPX062258R9999	TTS31R	2CPX062255R9999
5	1	5/1A	TTS51L	2CPX062258R9999	TTS51R	2CPX062257R9999
1	2	1/2A	-	-	TTS12	2CPX062036R9999
2	2	2/2A	-	-	TTS22	2CPX062037R9999
3	2	3/2A	TTS32L	2CPX062260R9999	TTS32R	2CPX062259R9999
4	2	4/2A	TTS52L	2CPX062262R9999	TTS32R	2CPX062259R9999
5	2	5/2A	TTS52L	2CPX062262R9999	TTS52R	2CPX062261R9999
1	3	1/3A	-	-	TTS13	2CPX062041R9999
2	3	2/3A	-	-	TTS23	2CPX062042R9999
3	3	3/3A	TTS33L	2CPX062264R9999	TTS33R	2CPX062263R9999
4	3	4/3A	TTS53L	2CPX062266R9999	TTS33R	2CPX062263R9999
5	3	5/3A	TTS53L	2CPX062266R9999	TTS53R	2CPX062265R9999
1	4	1/4A	-	-	TTS14	2CPX062046R9999
2	4	2/4A	-	-	TTS24	2CPX062047R9999
3	4	3/4A	TTS34L	2CPX062268R9999	TTS34R	2CPX062267R9999
4	4	4/4A	TTS54L	2CPX062270R9999	TTS34R	2CPX062267R9999
5	4	5/4A	TTS54L	2CPX062270R9999	TTS54R	2CPX062269R9999
1	5	1/5A	-	-	TTS15	2CPX062051R9999
2	5	2/5A	-	-	TTS25	2CPX062052R9999
3	5	3/5A	TTS35L	2CPX062272R9999	TTS35R	2CPX062271R9999
4	5	4/5A	TTS55L	2CPX062274R9999	TTS35R	2CPX062271R9999
5	5	5/5A	TTS55L	2CPX062274R9999	TTS55R	2CPX062273R9999

* Double-wing doors in all cabinets of a width of 3 panels and more

A-Wall Cabinets IP43

Technical description

1. The A wall-mounting cabinet is made of sheet steel and is powder-coated (RAL 9016). The exceptional stability of the cabinet is achieved by the profiled cabinet frame. This enables easy installation (surface mounting, partially recessed or flush mounting).
2. The protective insulation is guaranteed by an inserted plastic profile.
3. Plastic rear wall.
4. The sheet steel door provides a high level of stability thanks to its special shape in the hinge area and on the closing side.
5. The door can be readjusted using the special hinge.
6. Using a special set of accessories, the standard closure can be converted into a three-point espagnolette closure or into a swivel handle for semi-cylinder.
7. The flange openings on top are closed ex-factory with the membrane flange. The scope of delivery includes a ZB40 nipple flange for the cable entry from the bottom.
8. Knockouts are prepunched to the sides for busbar connections from cabinet to cabinet and to the bottom.
9. The cabinet sides have knockouts on the left and right for connecting the cabinets next to each other. Captive cover caps maintain double insulation (accessories).
10. Thanks to the individual panel holders, the cabinet provides an optimal connection space.
11. The cabinet can be installed with internal fastenings or external mounting brackets (accessories).
12. Prepunched knockouts are provided for inserting cables from the rear.

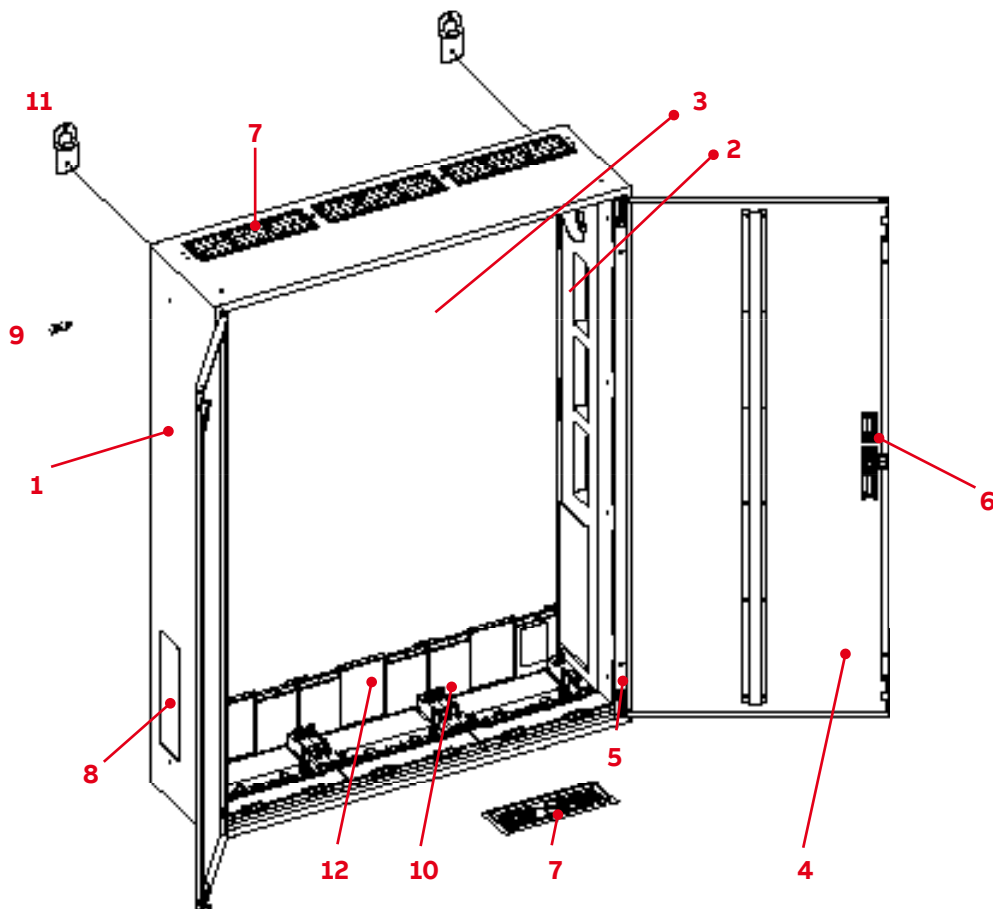

A-Wall Cabinets IP43

Interior configuration dimensions

Cross section with distribution panels and combination sets

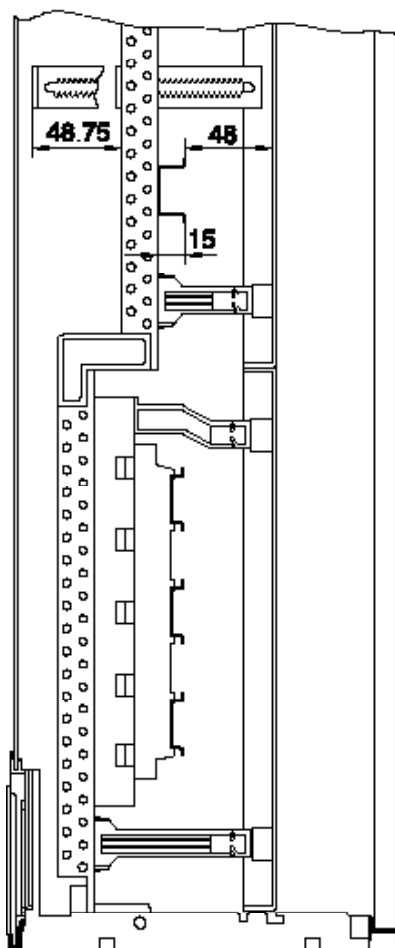
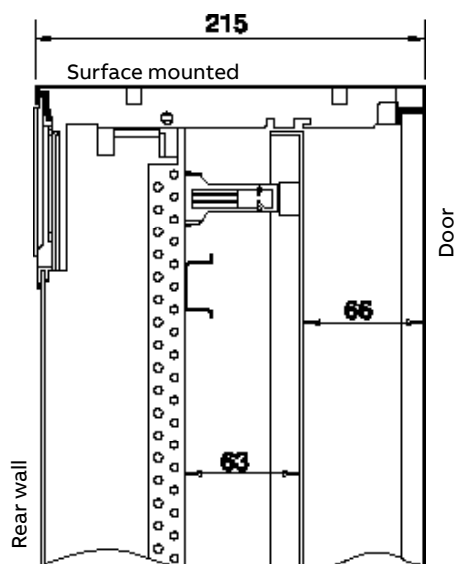

> Dimensions in mm

A-Wall Cabinets IP43

Dimensions, weights, power loss

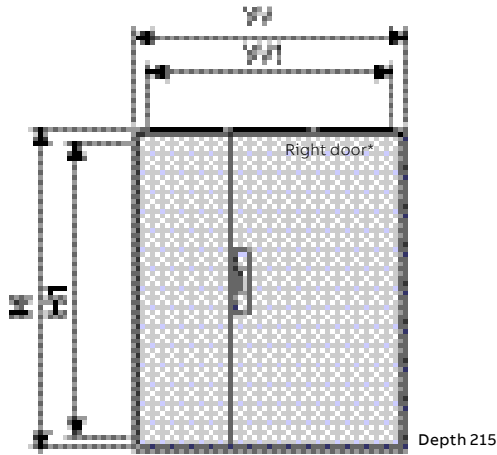

Type	OH	PW	SU	GU	Ext. dimensions		Int. dimensions		Left door*	Right door*	Weight	Power loss**
					H	W	H1	W1	H x W	H x W	in kg	in watts
1/00A	00	1	36	3	500	300	452	252		471.4 x 272	6.20	28.80
2/00A		2	72		500	550	452	502		471.4 x 522	8.40	47.40
3/00A		3	108		500	800	452	752	471.4 x 260	471.4 x 510	12.20	67.10
4/00A		4	144		500	1050	452	1002	471.4 x 510	471.4 x 510	15.80	66.20
5/00A		5	180		500	1300	452	1252	471.4 x 510	471.4 x 760	19.60	83.60
1/0A	0	1	48	4	650	300	602	252		621.4 x 272	7.80	35.20
2/0A		2	96		650	550	602	502		621.4 x 522	11.40	56.20
3/0A		3	144		650	800	602	752	621.4 x 260	621.4 x 510	15.60	59.80
4/0A		4	192		650	1050	602	1002	621.4 x 510	621.4 x 510	16.80	80.90
5/0A		5	240		650	1300	602	1252	621.4 x 510	621.4 x 760	24.00	105.60
1/1A	1	1	60	5	800	300	752	252		771.4 x 272	9.80	41.60
2/1A		2	120		800	550	752	502		771.4 x 522	13.40	65.30
3/1A		3	180		800	800	752	752	771.4 x 260	771.4 x 510	18.00	69.70
4/1A		4	240		800	1050	752	1002	771.4 x 510	771.4 x 510	23.80	96.80
5/1A		5	300		800	1300	752	1252	771.4 x 510	771.4 x 760	28.00	128.40
1/2A	2	1	72	6	950	300	902	252		921.4 x 272	10.80	48.10
2/2A		2	144		950	550	902	502		921.4 x 522	15.60	51.90
3/2A		3	216		950	800	902	752	921.4 x 260	921.4 x 510	21.00	79.20
4/2A		4	288		950	1050	902	1002	921.4 x 510	921.4 x 510	26.80	112.60
5/2A		5	360		950	1300	902	1252	921.4 x 510	921.4 x 760	31.20	150.90
1/3A	3	1	84	7	1100	300	1052	252		1071.4 x 272	12.00	54.50
2/3A		2	168		1100	550	1052	502		1071.4 x 522	17.60	60.70
3/3A		3	252		1100	800	1052	752	1071.4 x 260	1071.4 x 510	23.60	87.50
4/3A		4	336		1100	1050	1052	1002	1071.4 x 510	1071.4 x 510	30.00	131.30
5/3A		5	420		1100	1300	1052	1252	1071.4 x 510	1071.4 x 760	35.20	171.20
1/4A	4	1	96	8	1250	300	1202	252		1221.4 x 272	14.00	60.80
2/4A		2	192		1250	550	1202	502		1221.4 x 522	19.20	68.30
3/4A		3	288		1250	800	1202	752	1221.4 x 260	1221.4 x 510	26.00	101.50
4/4A		4	384		1250	1050	1202	1002	1221.4 x 510	1221.4 x 510	32.40	147.40
5/4A		5	480		1250	1300	1202	1252	1221.4 x 510	1221.4 x 760	40.20	190.50
1/5A	5	1	108	9	1400	300	1352	252		1371.4 x 272	15.00	67.20
2/5A		2	216		1400	550	1352	502		1371.4 x 522	22.40	77.80
3/5A		3	324		1400	800	1352	752	1371.4 x 260	1371.4 x 510	29.20	118.10
4/5A		4	432		1400	1050	1352	1002	1371.4 x 510	1371.4 x 510	35.20	156.00
5/5A		5	540		1400	1300	1352	1252	1371.4 x 510	1371.4 x 760	44.00	205.60

> Dimensions in mm | * Double-wing doors on cabinets with three or more panel widths | ** Power loss in watts at overtemperature Δt 20K

A-Wall Cabinets IP43

Mounting dimensions

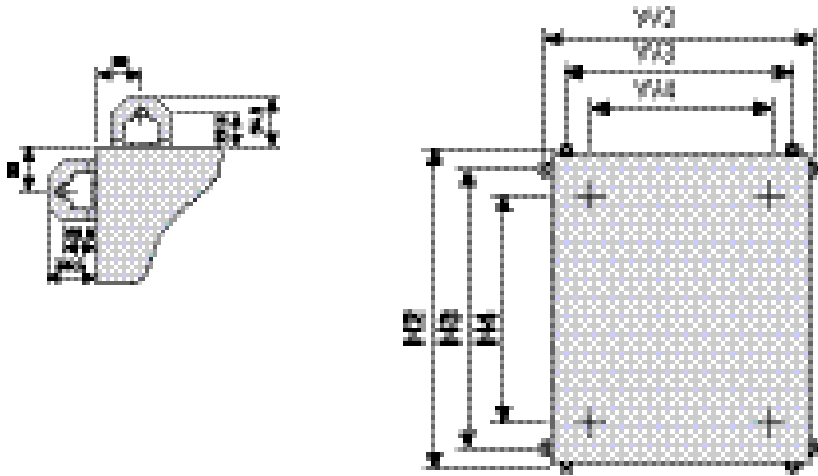

Type	OH	PW	SU	GU	External mounting				Internal mounting		Weight in kg	Power loss* in watts
					H2	H3	W2	W3	H4	W4		
1/00A	00	1	36	3	547	436	347	236	402	170	6.20	28.80
2/00A		2	72		547	436	597	486	402	420	8.40	47.40
3/00A		3	108		547	436	847	736	402	670	12.20	67.10
4/00A		4	144		547	436	1097	986	402	920	15.80	66.20
5/00A		5	180		547	436	1347	1236	402	1170	19.60	83.60
1/0A	0	1	48	4	697	586	347	236	552	170	7.80	35.20
2/0A		2	96		697	586	597	486	552	420	11.40	56.20
3/0A		3	144		697	586	847	736	552	670	15.60	59.80
4/0A		4	192		697	586	1097	986	552	920	16.80	80.90
5/0A		5	240		697	586	1347	1236	552	1170	24.00	105.60
1/1A	1	1	60	5	847	736	347	236	702	170	9.80	41.60
2/1A		2	120		847	736	597	486	702	420	13.40	65.30
3/1A		3	180		847	736	847	736	702	670	18.00	69.70
4/1A		4	240		847	736	1097	986	702	920	23.80	96.80
5/1A		5	300		847	736	1347	1236	702	1170	28.00	128.40
1/2A	2	1	72	6	997	886	347	236	852	170	10.80	48.10
2/2A		2	144		997	886	597	486	852	420	15.60	51.90
3/2A		3	216		997	886	847	736	852	670	21.00	79.20
4/2A		4	288		997	886	1097	986	852	920	26.80	112.60
5/2A		5	360		997	886	1347	1236	852	1170	31.20	150.90
1/3A	3	1	84	7	1147	1036	347	236	1002	170	12.00	54.50
2/3A		2	168		1147	1036	597	486	1002	420	17.60	60.70
3/3A		3	252		1147	1036	847	736	1002	670	23.60	87.50
4/3A		4	336		1147	1036	1097	986	1002	920	30.00	131.30
5/3A		5	420		1147	1036	1347	1236	1002	1170	35.20	171.20
1/4A	4	1	96	8	1297	1186	347	236	1152	170	14.00	60.80
2/4A		2	192		1297	1186	597	486	1152	420	19.20	68.30
3/4A		3	288		1297	1186	847	736	1152	670	26.00	101.50
4/4A		4	384		1297	1186	1097	986	1152	920	32.40	147.40
5/4A		5	480		1297	1186	1347	1236	1152	1170	40.20	190.50
1/5A	5	1	108	9	1447	1336	347	236	1302	170	15.00	67.20
2/5A		2	216		1447	1336	597	486	1302	420	22.40	77.80
3/5A		3	324		1447	1336	847	736	1302	670	29.20	118.10
4/5A		4	432		1447	1336	1097	986	1302	920	35.20	156.00
5/5A		5	540		1447	1336	1347	1236	1302	1170	44.00	205.60

> Dimensions in mm | * Power dissipation in watts at overtemperature Δt 20K

A-Wall Cabinets IP43

Dimensions transparent doors

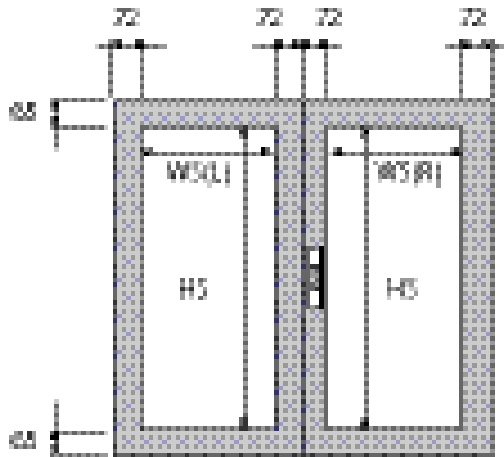

Cabinet				Left door			Right door		
Type	BH	FB	RE	Type	H x W	Viewing window WS(L) HS x WS	Type	H x W	Viewing window WS(R) HS x WS
1/00A	00	1	3	-	-	-	TTS100	471.4 x 272	341.4 x 128
2/00A		2		-	-	-	TTS200	471.4 x 522	341.4 x 378
3/00A		3		TTS300L	471.4 x 260	341.4 x 116	TTS300R	471.4 x 510	341.4 x 366
4/00A		4		TTS500L	471.4 x 510	341.4 x 366	TTS300R	471.4 x 510	341.4 x 366
5/00A		5		TTS500L	471.4 x 510	341.4 x 366	TTS500R	471.4 x 760	341.4 x 616
1/0A	0	1	4	-	-	-	TTS10	621.4 x 272	491.4 x 128
2/0A		2		-	-	-	TTS20	621.4 x 522	491.4 x 378
3/0A		3		TTS30L	621.4 x 260	491.4 x 116	TTS30R	621.4 x 510	491.4 x 366
4/0A		4		TTS50L	621.4 x 510	491.4 x 366	TTS30R	621.4 x 510	491.4 x 366
5/0A		5		TTS50L	621.4 x 510	491.4 x 366	TTS50R	621.4 x 760	491.4 x 616
1/1A	1	1	5	-	-	-	TTS11	771.4 x 272	641.4 x 128
2/1A		2		-	-	-	TTS21	771.4 x 522	641.4 x 378
3/1A		3		TTS31L	771.4 x 260	641.4 x 116	TTS31R	771.4 x 510	641.4 x 366
4/1A		4		TTS51L	771.4 x 510	641.4 x 366	TTS31R	771.4 x 510	641.4 x 366
5/1A		5		TTS51L	771.4 x 510	641.4 x 366	TTS51R	771.4 x 760	641.4 x 616
1/2A	2	1	6	-	-	-	TTS12	921.4 x 272	791.4 x 128
2/2A		2		-	-	-	TTS22	921.4 x 522	791.4 x 378
3/2A		3		TTS32L	921.4 x 260	791.4 x 116	TTS32R	921.4 x 510	791.4 x 366
4/2A		4		TTS52L	921.4 x 510	791.4 x 366	TTS32R	921.4 x 510	791.4 x 366
5/2A		5		TTS52L	921.4 x 510	791.4 x 366	TTS52R	921.4 x 760	791.4 x 616
1/3A	3	1	7	-	-	-	TTS13	1071.4 x 272	941.4 x 128
2/3A		2		-	-	-	TTS23	1071.4 x 522	941.4 x 378
3/3A		3		TTS33L	1071.4 x 260	941.4 x 116	TTS33R	1071.4 x 510	941.4 x 366
4/3A		4		TTS53L	1071.4 x 510	941.4 x 366	TTS33R	1071.4 x 510	941.4 x 366
5/3A		5		TTS53L	1071.4 x 510	941.4 x 366	TTS53R	1071.4 x 760	941.4 x 616
1/4A	4	1	8	-	-	-	TTS14	1221.4 x 272	1091.4 x 128
2/4A		2		-	-	-	TTS24	1221.4 x 522	1091.4 x 378
3/4A		3		TTS34L	1221.4 x 260	1091.4 x 116	TTS34R	1221.4 x 510	1091.4 x 366
4/4A		4		TTS54L	1221.4 x 510	1091.4 x 366	TTS34R	1221.4 x 510	1091.4 x 366
5/4A		5		TTS54L	1221.4 x 510	1091.4 x 366	TTS54R	1221.4 x 760	1091.4 x 616
1/5A	5	1	9	-	-	-	TTS15	1371.4 x 272	1241.4 x 128
2/5A		2		-	-	-	TTS25	1371.4 x 522	1241.4 x 378
3/5A		3		TTS35L	1371.4 x 260	1241.4 x 116	TTS35R	1371.4 x 510	1241.4 x 366
4/5A		4		TTS55L	1371.4 x 510	1241.4 x 366	TTS35R	1371.4 x 510	1241.4 x 366
5/5A		5		TTS55L	1371.4 x 510	1241.4 x 366	TTS55R	1371.4 x 760	1241.4 x 616

> Dimensions in mm

B-Wall Cabinets IP43

For interior area IP43



B-Wall Cabinets IP43 IP43 , cabinet depth 215 mm

Enclosure and door made of sheet steel

Rear wall made of plastic

RAL 9016 powder-coated

IK07 shock resistance rating

Prepared for installation of a installation plate from galvanized sheet steel

Prepared for the installation of distribution panels/combination sets

Prepared for installation with CombiLine modules on EDF mounting frame

Double-wing doors on cabinets with three or more panel widths

Door opening angle 130 degrees

Equipped with ZB113 standard closure

Flange openings are provided on the sides, open on the bottom. Nipple flanges ZB40 included.

Membrane flanges are mounted in the upper connection area

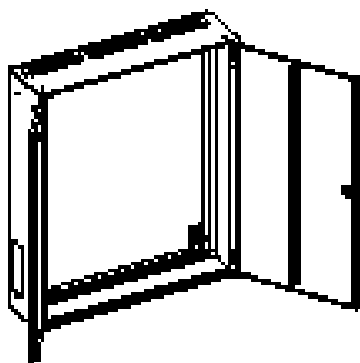

B-Wall Cabinets
IP43 IP43 , cabinet depth 215 mm

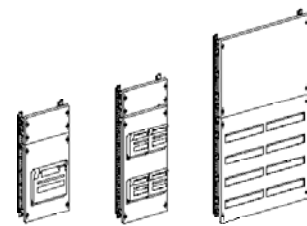

Distribution panels/combination sets
For CombiLine N modules
on EDF mounting frame see
Interior Configuration Systems chapter

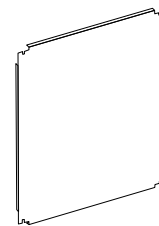

Mounting plate

B-Wall Cabinets IP43/mounting plates

For interior area \perp



3/2B



GM32

GU	OH	Height		External dimensions		B-Wall Cabinets IP43 \perp		External dimensions		Mounting plates	
		in mm	PW	SU	H x W x D mm	Type	Order code	H x W x D mm	Type	Order code	
3	00	500	1	36	500 x 300 x 215	1/00B	2CPX036360R9999	-	-	-	-
			2	72	500 x 550 x 215	2/00B	2CPX036361R9999	-	-	-	-
			3	108	500 x 800 x 215	3/00B	2CPX036362R9999	-	-	-	-
4	0	650	1	48	650 x 300 x 215	1/0B	2CPX036370R9999	-	-	-	-
			2	96	650 x 550 x 215	2/0B	2CPX036371R9999	600 x 500	GM20	2CPX034473R9999	
			3	144	650 x 800 x 215	3/0B	2CPX036372R9999	600 x 750	GM30	2CPX034474R9999	
			4	192	650 x 1050 x 215	4/0B	2CPX036373R9999	600 x 1000	GM40	2CPX034475R9999	
			5	240	650 x 1300 x 215	5/0B	2CPX036374R9999	600 x 1250	GM50	2CPX034476R9999	
5	1	800	1	60	800 x 300 x 215	1/1B	2CPX036380R9999	-	-	-	-
			2	120	800 x 550 x 215	2/1B	2CPX036381R9999	-	-	-	-
			3	180	800 x 800 x 215	3/1B	2CPX036382R9999	-	-	-	-
			4	240	800 x 1050 x 215	4/1B	2CPX036383R9999	-	-	-	-
			5	300	800 x 1300 x 215	5/1B	2CPX036384R9999	-	-	-	-
6	2	950	1	72	950 x 300 x 215	1/2B	2CPX036390R9999	900 x 250	GM12	2CPX034482R9999	
			2	144	950 x 550 x 215	2/2B	2CPX036391R9999	900 x 500	GM22	2CPX034483R9999	
			3	216	950 x 800 x 215	3/2B	2CPX036392R9999	900 x 750	GM32	2CPX034484R9999	
			4	288	950 x 1050 x 215	4/2B	2CPX036393R9999	900 x 1000	GM42	2CPX034485R9999	
			5	360	950 x 1300 x 215	5/2B	2CPX036394R9999	900 x 1250	GM52	2CPX034486R9999	
7	3	1100	1	84	1100 x 300 x 215	1/3B	2CPX036400R9999	-	-	-	-
			2	168	1100 x 550 x 215	2/3B	2CPX036401R9999	-	-	-	-
			3	252	1100 x 800 x 215	3/3B	2CPX036402R9999	-	-	-	-
			4	336	1100 x 1050 x 215	4/3B	2CPX036403R9999	-	-	-	-
			5	420	1100 x 1300 x 215	5/3B	2CPX036404R9999	-	-	-	-
8	4	1250	1	96	1250 x 300 x 215	1/4B	2CPX036410R9999	-	-	-	-
			2	192	1250 x 550 x 215	2/4B	2CPX036411R9999	1200 x 500	GM24	2CPX034488R9999	
			3	288	1250 x 800 x 215	3/4B	2CPX036412R9999	1200 x 750	GM34	2CPX034489R9999	
			4	384	1250 x 1050 x 215	4/4B	2CPX036413R9999	1200 x 1000	GM44	2CPX034490R9999	
			5	480	1250 x 1300 x 215	5/4B	2CPX036414R9999	1200 x 1250	GM54	2CPX034491R9999	
9	5	1400	1	108	1400 x 300 x 215	1/5B	2CPX036420R9999	-	-	-	-
			2	216	1400 x 550 x 215	2/5B	2CPX036421R9999	1350 x 500	GM25	2CPX034493R9999	
			3	324	1400 x 800 x 215	3/5B	2CPX036422R9999	1350 x 750	GM35	2CPX034494R9999	
			4	432	1400 x 1050 x 215	4/5B	2CPX036423R9999	1350 x 1000	GM45	2CPX034495R9999	
			5	540	1400 x 1300 x 215	5/5B	2CPX036424R9999	1350 x 1250	GM55	2CPX034496R9999	

B-Wall Cabinets IP43

Accessories



ZP74P4



ZX131

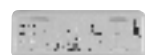

ZB43



ZB40

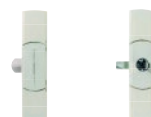

ZB113 ZB111



ZE10



ZX456



ZH800



ZH227



ZH203



ZH228

Article	Piece	Type	Order code
External mounting brackets	4	ZP74P4	2CPX062636R9999
Connection set for connecting cabinets in series, 1 set	1	ZX131	2CPX039131R9999
Membrane flange* For inserting cables	1	ZB43	2CPX038183R9999
Nipple flange* For cable diameters 1 x 12 to 47 mm, 1 x 12 to 29 mm, 3 x 8 to 15 mm, 20 x 7 to 13 mm	1	ZB40	2CPX038195R9999
Standard lock*	1	ZB113	2CPX038478R9999
Safety lock with 2 keys	1	ZB111	2CPX038479R9999
Door earthing set For a single door. For double doors (3 panels wide and more) 2 sets are required.	1	ZE10	2CPX060586R9999
Espagnolette closure In conjunction with standard lock and safety lock (ZB113, ZB111)			
For overall height 0 (4 GU)	1	ZX456	2CPX039586R9999
For overall height 1 (5 GU)	1	ZX457	2CPX039587R9999
For overall height 2 (6 GU)	1	ZX458	2CPX039588R9999
For overall height 3 (7 GU)	1	ZX459	2CPX039589R9999
For overall height 4 (8 GU)	1	ZX460	2CPX039590R9999
For overall height 5 (9 GU)	1	ZX461	2CPX039591R9999
Installation set for actuation options in conjunction with ZH220/ZH221/ZH222	1	ZH800	2CPX038544R9999
Swivel handle Senate closure Berlin	1	ZH227	2CPX045708R9999
Swivel handle E0 12 closure	1	ZH203	2CPX045707R9999
Swivel handle For semi-cylinder, 40 mm (30/10), with lead sealable cap	1	ZH228	2CPX045709R9999

* Spare part included in the scope of delivery

B-Wall Cabinets IP43

Accessories



ZX440



ZA20



ZA120



KB19



KB219



KBS9



KBW1



ZA6



ZA5

Article	Piece	Type	Order code
B-Wall cabinet			
Espagnolette closure In conjunction with ZH203, ZH220, ZH221, ZH222, ZH227 and ZH228, lock system			
For overall height 0 (4 GU)	1	ZX440	2CPX039570R9999
For overall height 1 (5 GU)	1	ZX441	2CPX039571R9999
For overall height 2 (6 GU)	1	ZX442	2CPX039572R9999
For overall height 3 (7 GU)	1	ZX443	2CPX039573R9999
For overall height 4 (8 GU)	1	ZX444	2CPX039574R9999
For overall height 5 (9 GU)	1	ZX445	2CPX039575R9999
Spray cans Color RAL 9016, 150 ml	1	ZA20	2CPX038229R9999
Touch-up applicator Color RAL 9016, 12 ml	1	ZA120	2CPX039043R9999
Cable entry covers With end plates and mounting bracket Color RAL9016 adapted to the color of the cabinets			
1 panel wide, width 300 mm	1	KB19	2CPX044049R9999
2 panel wide, width 550 mm	1	KB29	2CPX044050R9999
3 panel wide, width 800 mm	1	KB39	2CPX044051R9999
4 panel wide, width 1050 mm	1	KB49	2CPX044052R9999
5 panel wide, width 1300 mm	1	KB59	2CPX044053R9999
Profile Plastic, color RAL 9016 Width 2000 mm	1	KB219	2CPX044055R9999
Left/right end plate Plastic, color RAL 9016 1 set, 2 pieces	1	KBS9	2CPX044057R9999
Fixing bracket From plastic with holding magnet	1	KBW1	2CPX044058R9999
DIN A4 document holder Self-adhesive with transparent sleeve	1	ZA6	2CPX038227R9999
	10	ZA6P10	2CPX062380R9999
Self-adhesive with transparent sleeve and reinforced back	10	ZA61P10	2CPX062375R9999
DIN A5 document holder Self-adhesive	1	ZA5	2CPX038228R9999
	10	ZA5P10	2CPX062382R9999

B-Wall Cabinets IP43

Sheet steel doors



T31R

PW	OH	Compatible with cabinet	Left door*		Right door*	
			Type	Order code	Type	Order code
1	00	1/00B	-	-	T100	2CPX062057R9999
2	00	2/00B	-	-	T200	2CPX062058R9999
3	00	3/00B	T300L	2CPX062192R9999	T300R	2CPX062191R9999
1	0	1/0B	-	-	T10	2CPX062059R9999
2	0	2/0B	-	-	T20	2CPX062060R9999
3	0	3/0B	T30L	2CPX062196R9999	T30R	2CPX062195R9999
4	0	4/0B	T50L	2CPX062198R9999	T30R	2CPX062195R9999
5	0	5/0B	T50L	2CPX062198R9999	T50R	2CPX062197R9999
1	1	1/1B	-	-	T11	2CPX062062R9999
2	1	2/1B	-	-	T21	2CPX062063R9999
3	1	3/1B	T31L	2CPX062200R9999	T31R	2CPX062199R9999
4	1	4/1B	T51L	2CPX062202R9999	T31R	2CPX062199R9999
5	1	5/1B	T51L	2CPX062202R9999	T51R	2CPX062201R9999
1	2	1/2B	-	-	T12	2CPX062066R9999
2	2	2/2B	-	-	T22	2CPX062067R9999
3	2	3/2B	T32L	2CPX062204R9999	T32R	2CPX062203R9999
4	2	4/2B	T52L	2CPX062206R9999	T32R	2CPX062203R9999
5	2	5/2B	T52L	2CPX062206R9999	T52R	2CPX062205R9999
1	3	1/3B	-	-	T13	2CPX062079R9999
2	3	2/3B	-	-	T23	2CPX062070R9999
3	3	3/3B	T33L	2CPX062208R9999	T33R	2CPX062207R9999
4	3	4/3B	T53L	2CPX062210R9999	T33R	2CPX062207R9999
5	3	5/3B	T53L	2CPX062210R9999	T53R	2CPX062209R9999
1	4	1/4B	-	-	T14	2CPX062082R9999
2	4	2/4B	-	-	T24	2CPX062083R9999
3	4	3/4B	T34L	2CPX062212R9999	T34R	2CPX062211R9999
4	4	4/4B	T54L	2CPX062214R9999	T34R	2CPX062211R9999
5	4	5/4B	T54L	2CPX062214R9999	T54R	2CPX062213R9999
1	5	1/5B	-	-	T15	2CPX062087R9999
2	5	2/5B	-	-	T25	2CPX062088R9999
3	5	3/5B	T35L	2CPX062216R9999	T35R	2CPX062215R9999
4	5	4/5B	T55L	2CPX062218R9999	T35R	2CPX062215R9999
5	5	5/5B	T55L	2CPX062218R9999	T55R	2CPX062217R9999

> For ZE10 earthing set see accessories

* Double-wing doors in all cabinets of a width of 3 panels and more

B-Wall Cabinets IP43

Transparent doors



TTS20

PW	OH	Compatible with cabinet	Left door*		Right door*	
			Type	Order code	Type	Order code
1	00	1/00B	-	-	TTS100	2CPX062021R9999
2	00	2/00B	-	-	TTS200	2CPX062022R9999
3	00	3/00B	TTS300L	2CPX062248R9999	TTS300R	2CPX062247R9999
1	0	1/0B	-	-	TTS10	2CPX062026R9999
2	0	2/0B	-	-	TTS20	2CPX062027R9999
3	0	3/0B	TTS30L	2CPX062252R9999	TTS30R	2CPX062251R9999
4	0	4/0B	TTS50L	2CPX062254R9999	TTS30R	2CPX062251R9999
5	0	5/0B	TTS50L	2CPX062254R9999	TTS50R	2CPX062253R9999
1	1	1/1B	-	-	TTS11	2CPX062031R9999
2	1	2/1B	-	-	TTS21	2CPX062032R9999
3	1	3/1B	TTS31L	2CPX062256R9999	TTS31R	2CPX062255R9999
4	1	4/1B	TTS51L	2CPX062258R9999	TTS31R	2CPX062255R9999
5	1	5/1B	TTS51L	2CPX062258R9999	TTS51R	2CPX062257R9999
1	2	1/2B	-	-	TTS12	2CPX062036R9999
2	2	2/2B	-	-	TTS22	2CPX062037R9999
3	2	3/2B	TTS32L	2CPX062260R9999	TTS32R	2CPX062259R9999
4	2	4/2B	TTS52L	2CPX062262R9999	TTS32R	2CPX062259R9999
5	2	5/2B	TTS52L	2CPX062262R9999	TTS52R	2CPX062261R9999
1	3	1/3B	-	-	TTS13	2CPX062041R9999
2	3	2/3B	-	-	TTS23	2CPX062042R9999
3	3	3/3B	TTS33L	2CPX062264R9999	TTS33R	2CPX062263R9999
4	3	4/3B	TTS53L	2CPX062266R9999	TTS33R	2CPX062263R9999
5	3	5/3B	TTS53L	2CPX062266R9999	TTS53R	2CPX062265R9999
1	4	1/4B	-	-	TTS14	2CPX062046R9999
2	4	2/4B	-	-	TTS24	2CPX062047R9999
3	4	3/4B	TTS34L	2CPX062268R9999	TTS34R	2CPX062267R9999
4	4	4/4B	TTS54L	2CPX062270R9999	TTS34R	2CPX062267R9999
5	4	5/4B	TTS54L	2CPX062270R9999	TTS54R	2CPX062269R9999
1	5	1/5B	-	-	TTS15	2CPX062051R9999
2	5	2/5B	-	-	TTS25	2CPX062052R9999
3	5	3/5B	TTS35L	2CPX062272R9999	TTS35R	2CPX062271R9999
4	5	4/5B	TTS55L	2CPX062274R9999	TTS35R	2CPX062271R9999
5	5	5/5B	TTS55L	2CPX062274R9999	TTS55R	2CPX062273R9999

> For ZE10 earthing set see accessories

* Double-wing doors in all cabinets of a width of 3 panels and more

TwinLine N 44 floor-standing cabinets



TwinLine N 44 floor-standing cabinets

Specifications and product features

Specifications for TwinLine H	
Standards/regulations	DIN EN 61439-1/-2/-3, DIN VDE 0660-600-1/-2/-3*
Protection class	I, earthed II, insulated
Degree of protection	with IP44 door Without IP30 door, when expanded as an installation distributor with meter and distributor fields, combination sets or CombiLine modules
Mechanical impact strength	IK08 for the cabinet housing with steel-sheet door IK07 in the area of flange knock-outs
Ambient conditions	Indoor installation Ambient temperature max. + 40 °C Ambient temperature min. - 5 °C Operating temperature max. + 55 °C Storage temperature max. + 55 °C Storage temperature min. - 40 °C

Product features for TwinLine H	
Housing and doors	Made of sheet steel, color RAL 7035, powder-coated A flange opening is cut out for each field width, knock-outs are on the bottom Door opening angle 180 degrees Double door cabinets with field width 4 and over Doors with rod lock Standard closure, double-bit 3 mm
Assembly options*	Prepared for expansion with meter and distributor fields, combination sets or CombiLine modules on EDF mounting frame
Forms of delivery	Housing with door External mounting lugs are included in the scope of delivery Support elements for each field width are included in the scope of delivery Touch protection included in the scope of delivery Middle support rail included in the scope of delivery
Accessories	Flanges must be ordered separately Base must be ordered separately

*The permissible heating for switchgear combinations (SK) up to 630 A rated current can be verified using the procedure according to 10.10.4.2; The required values of the power dissipation capacity for TwinLine N 44 standing cabinets refer to the tables on page ; above 630 A rated current, the procedure in accordance with 10.10.4.3 (DIN EN 61439-1 supplementary sheet 2, DIN VDE 0660-600-1 supplementary sheet 2) must be applied

TwinLine N 44 floor-standing cabinets

Delivery condition and expansion variants



TH312G

- Support components for each field width are pre-assembled
- Middle support rail and touch protection are included in the scope of delivery

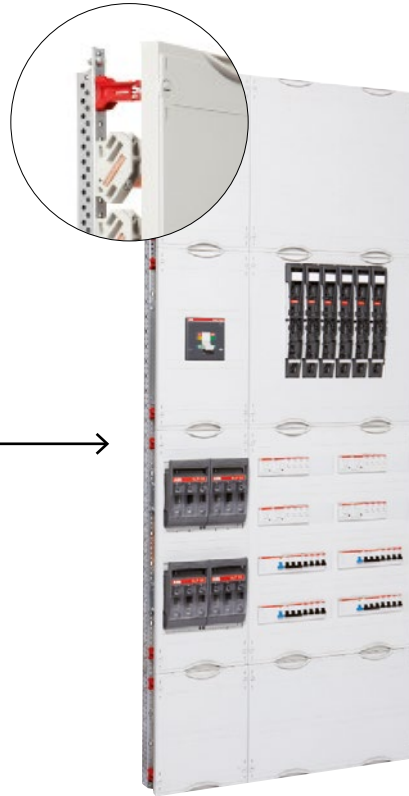

EDFmounting frame installation

Expansion to an installation distributor with meter and distributor fields, combination sets or CombiLine modules on EDF mounting frame possible

TwinLine N 44 floor-standing cabinets

TwinLine-H, cabinet depth 225 mm, \perp \square



TH312G

Included in the scope of delivery

- External mounting brackets
- Supports for expansion with EDF mounting frame
- Middle support rail
- Touch protection

Order accessories separately

- Flanges
- Base

Height		Width		External dimensions	Floor-standing cabinets with door IP44	
RE	BH	FB	PLE	H x W in mm	Type	Order code
TwinLine-H, cabinet depth 225 mm \perp						
12	8	1	144	1850 x 300	TH112G	2CPX010948R9999
		2	288	1850 x 550	TH212G	2CPX010950R9999
		3	432	1850 x 800	TH312G	2CPX010952R9999
		4	576	1850 x 1050	TH412G	2CPX010954R9999
		5	720	1850 x 1300	TH512G	2CPX010957R9999
TwinLine-H, cabinet depth 225 mm \square						
12	8	1	144	1850 x 300	TH112S	2CPX010949R9999
		2	288	1850 x 550	TH212S	2CPX010951R9999
		3	432	1850 x 800	TH312S	2CPX010953R9999
		4	576	1850 x 1050	TH412S	2CPX010955R9999
		5	720	1850 x 1300	TH512S	2CPX010958R9999

TwinLine N 44 floor-standing cabinets

Flanges



TZ101



TZ102



TZ103



TZ110



TZ111

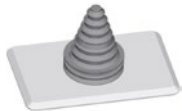

TZ112

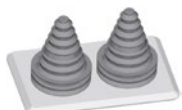

TZ104



TZ105



TZ107



TZ106

Article	Unit	Type	Order code
Membrane flange	1	TZ101	2CPX010450R9999
Material plastic for cable diameter 2 x 6 - 32.5 mm, 2 x 6 - 25 mm, 4 x 6 - 19 mm, 10 x 6 - 15 mm, 2 x 6 - 12 mm, 31 x 6 - 11 mm, 1 x 6 - 7 mm	10	TZ101P10	2CPX010451R9999
	100	TZ101P100	2CPX010826R9999
Flanges for M-screw joints			
Material plastic			
1 x M63/M50, 2 x M32/M20, 5 x M25, 5 x M20	1	TZ102	2CPX010452R9999
	10	TZ102P10	2CPX010453R9999
4 x M20/M25, 18 x M20	1	TZ103	2CPX010454R9999
	10	TZ103P10	2CPX010455R9999
Flanges with cable sleeves			
Material Plastic			
Flange with 8 cable sleeves	1	TZ110	2CPX010850R9999
For cable diameter 8 x 13 to 34 mm	10	TZ110P10	2CPX010934R9999
Flange with 11 cable sleeves	1	TZ111	2CPX010851R9999
For cable diameters 1 x 14 to 54 mm, 3 x 13 to 34 mm, 3 x 13 to 26.5 mm, 4 x 5 bis 21 mm	10	TZ111P10	2CPX010935R9999
Flange with 1 cable sleeve	1	TZ112	2CPX010852R9999
For cable diameter 1 x 14 to 68 mm			
Flange with 2 cable sleeves	1	TZ104	2CPX010456R9999
For cable diameter 2 x 14 to 68 mm	10	TZ104P10	2CPX010932R9999
Flange with 3 cable sleeves	1	TZ105	2CPX010457R9999
For cable diameter 3 x 14 to 54 mm	10	TZ105P10	2CPX010933R9999
Locking flanges			
Material Plastic	1	TZ107	2CPX010460R9999
	10	TZ107P10	2CPX010461R9999
Material steel sheet	1	TZ106	2CPX010458R9999
For earthed cabinets	10	TZ106P10	2CPX010459R9999

TwinLine N 44 floor-standing cabinets

Base



TZG305



TZG310



TZ627P2



TZ323



ZK143

Article	Depth		Width		Unit	Type	Order code
	mm	FB	mm				
Base, height 50 mm, color RAL 9005							
For TwinLine H*	225	1	300		1	TZG105	2CPX010571R9999
	225	2	550		1	TZG205	2CPX010573R9999
	225	3	800		1	TZG305	2CPX010575R9999
	225	4	1050		1	TZG405	2CPX010577R9999
	225	5	1300		1	TZG505	2CPX010579R9999
Base, height 100 mm, color RAL 9005							
For TwinLine H*	225	1	300		1	TZG110	2CPX010572R9999
Side knock-outs 1 x M32/M50 or 80 x 80 mm	225	2	550		1	TZG210	2CPX010574R9999
	225	3	800		1	TZG310	2CPX010576R9999
	225	4	1050		1	TZG410	2CPX010578R9999
	225	5	1300		1	TZG510	2CPX010580R9999
Base mounting lug					2	TZ627P2	2CPX010853R9999
To fasten the base to the cabinet from the outside For base height 50 mm and 100 mm							
Cable clamp rail							
For base, height 100 mm			1	250	1	TZ321	2CPX010473R9999
			2	500	1	TZ322	2CPX010474R9999
			3	750	1	TZ323	2CPX010475R9999
			4	1000	1	TZ324	2CPX010476R9999
			5	1250	1	TZ325	2CPX010477R9999
Clamp clip							
For cable clamp rail							
From 22 to 28 mm					1	ZK143	2CPX060005R9999
From 40 to 46 mm					1	ZK144	2CPX060006R9999
From 64 to 70 mm					1	ZK145	2CPX060007R9999

* For sockets for field widths of 4 or more, a base stiffener is included in the scope of delivery

TwinLine N 44 floor-standing cabinets

Lock replacement parts



TZ507

TZ508



ZH130

ZH132



ZH134

ZH137



TZ503

TZ504



TZ505

TZ506



TZ510



ZH142

Article	Unit	Type	Order code
Key plates for actuation pins			
For actuation pin 3 mm (standard)* and 5 mm (similar to RAL 9005)	1	TZ507	2CPX010491R9999
For triangular and rectangular actuator pin, as well as for Daimler-Benz insert	1	TZ508	2CPX010492R9999
Actuating pins			
Double bit 3 mm*	1	ZH130	2CPX060490R9999
Double bit 5 mm	1	ZH131	2CPX060491R9999
Triangle 7 mm	1	ZH132	2CPX060492R9999
Triangle 8 mm	1	ZH133	2CPX060493R9999
Rectangular 6 mm	1	ZH134	2CPX060494R9999
Rectangular 7 mm	1	ZH135	2CPX060495R9999
Rectangular 8 mm	1	ZH136	2CPX060496R9999
Daimler-Benz	1	ZH137	2CPX060497R9999
L-handle			
With key plate, with lock	1	TZ503	2CPX010487R9999
With key plate, without lock	1	TZ504	2CPX010488R9999
T-handle			
With key plate, with lock	1	TZ505	2CPX010489R9999
With key plate, without lock	1	TZ506	2CPX010490R9999
Swivel handle	1	TZ510	2CPX010494R9999
For profile half cylinder 40 mm (30/10) with sealing cap			
Shutter insert	1	ZH142	2CPX060502R9999
Instead of a profile half cylinder for swivel handle TZ510			

* Replacement part included in the scope of delivery

TwinLine N 44 floor-standing cabinets

Lock replacement parts



ZH91



ZH160



ZH157



ZH162



ZH165



TZ206



TZ511



TZ501



TZ502

Article	Unit	Type	Order code
Universal key Double bit 3 mm/5 mm Triangular 8 mm, square 6 mm/8 mm	1	ZH91	2CPX066091R9999
Double bit 3 mm*	1	ZH160	2CPX060660R9999
Double bit 5 mm	1	ZH161	2CPX060661R9999
Triangle 7 mm	1	ZH157	2CPX060657R9999
Triangle 8 mm	1	ZH158	2CPX060658R9999
Rectangular 6 mm	1	ZH162	2CPX060662R9999
Rectangular 7 mm	1	ZH163	2CPX060663R9999
Rectangular 8 mm	1	ZH164	2CPX060664R9999
Daimler-Benz	1	ZH165	2CPX060665R9999
Rod lock 12 RE = 1800 mm with lock body*	1	TZ212	2CPX010468R9999
Rod guide*	1	TZ511	2CPX010495R9999
Bumper shoe* For rod lock	1	TZ501	2CPX010485R9999
Rubber seal * For double door	1	TZ502	2CPX010486R9999

* Replacement part included in the scope of delivery

TwinLine N 44 floor-standing cabinets

General accessories



TZ433



TZ601



ZW125P4



TZ615P4



TZ607



TZ630P10

Article	Unit	Unmounted	
		Type	Order code
Middle support rail* For mounting in the cabinet, mounting brackets are included in the scope of delivery In addition, 2 mounting strips TZ601 are required			
Field width 1 = 250 mm	1	TZ431	2CPX010960R9999
Field width 2 = 500 mm	1	TZ432	2CPX010961R9999
Field width 3 = 750 mm	1	TZ433	2CPX010962R9999
Field width 4 = 1000 mm	1	TZ434	2CPX010963R9999
Field width 5 = 1250 mm	1	TZ435	2CPX010964R9999
Mounting rails* For fastening the middle support rail			
	1	TZ601	2CPX010779R9999
	10	TZ601P10	2CPX010814R9999
	100	TZ601P100	2CPX010815R9999
External mounting lugs* To mount the cabinet on the wall	4	ZW125P4	2CPX062461R9999
Transport eye bolts	4	TZ615P4	2CPX010510R9999
Door hinge 180 degrees* Color RAL 9005	1	TZ607	2CPX010502R9999
Pin* For door hinge 180 degrees	10	TZ630P10	2CPX010929R9999

TwinLine N 44 floor-standing cabinets

General accessories



ZL8



TZ617P10



TZ628P10



ZA6



ZA5



ZA123



TZ650



ZA16



ZA116

Article	Unit	Type	Order code
Door earthing set 10 mm ²	1	ZL8	2CPX038001R9999
Sealing plugs/connection plugs*	10	TZ617P10	2CPX010512R9999
Blind plug* For hinge break	10	TZ628P10	2CPX010854R9999
DIN A4 plan pocket Self-adhesive with transparent sleeve and reinforced back	1	ZA6	2CPX038227R9999
	10	ZA6P10	2CPX062380R9999
Self-adhesive with transparent sleeve	10	ZA61P10	2CPX062375R9999
DIN A4 plan pocket Self-adhesive	1	ZA13	2CPX038233R9999
	10	ZA13P10	2CPX062381R9999
DIN A5 plan pocket Self-adhesive	1	ZA5	2CPX038228R9999
	10	ZA5P10	2CPX062382R9999
Plan pocket holder			
For ZA13 plan pocket to be screwed to the door reinforcing elements	1	ZA123	2CPX038471R9999
For ZA5 plan pocket to be screwed to the door reinforcing elements	1	ZA125	2CPX038472R9999
LED control cabinet light		TZ650	2CPX010972R9999
Spray can Color RAL 7035, 150 ml	1	ZA16	2CPX038235R9999
Touch-up stick Color RAL 7035, 12 ml	1	ZA116	2CPX039042R9999

* Included in the scope of delivery

TwinLine N 44 floor-standing cabinets

Accessories and meter applications



TZ612



TZ610

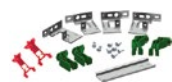

TZ616



TZ618

Article	Unit	Unmounted		Installed in the cabinet*	
		Type	Order code	Type	Order code
Cover strip*¹ For meter field installation to cover the mounting points of the middle support rail in the insulated standing cabinet					
For TwinLine H	1	TZ612	2CPX010507R9999	TZ612A	2CPX010796R9999
Inner cladding*¹ For meter fields, depth = 225 mm Additional profile for meter fields with 150 mm connection compartment at the top, in the insulated cabinet	1	TZ610	2CPX010505R9999	TZ610A	2CPX010795R9999
Mounting set For installation of meter fields in standing cabinets per field width (250 mm) additionally order 1 x TZ616	1	TZ616	2CPX010511R9999	TZ616A	2CPX010799R9999
Touch protection for earthed cabinets					
For single-level meter fields	1	TZ618	2CPX010673R9999	TZ618A	2CPX010800R9999
For dual-level meter fields	1	TZ619	2CPX010674R9999	TZ619A	2CPX010801R9999

* Only in conjunction with the factory-installed meter and distributor fields, combination kits or CombiLine modules.

TwinLine N 44 floor-standing cabinets

Meter applications



TZ612

Cover strip TZ612

Required for installation of meter fields in insulated cabinets for compliance with protection class IPXXB in the area of unnecessary fastening points for the middle support rail



TZ610

Inner cladding TZ610

For meter fields, depth = 225

Additional profile for meter fields with 150 mm connection compartment in the insulated cabinet

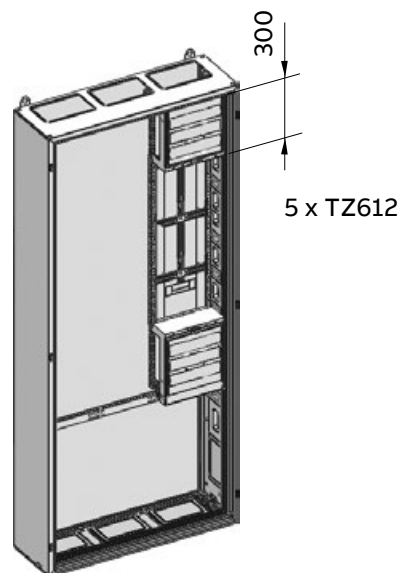
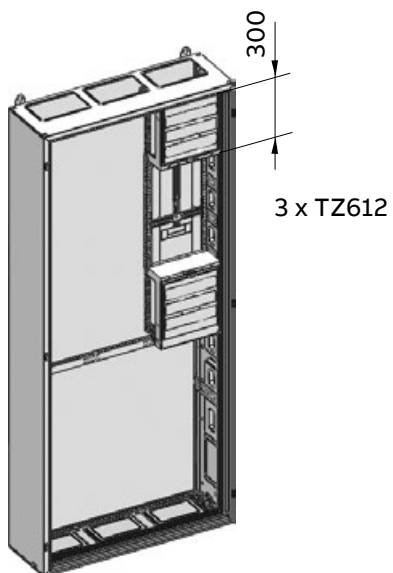

TwinLine N 44 floor-standing cabinets

Dimensions, weights, power dissipation

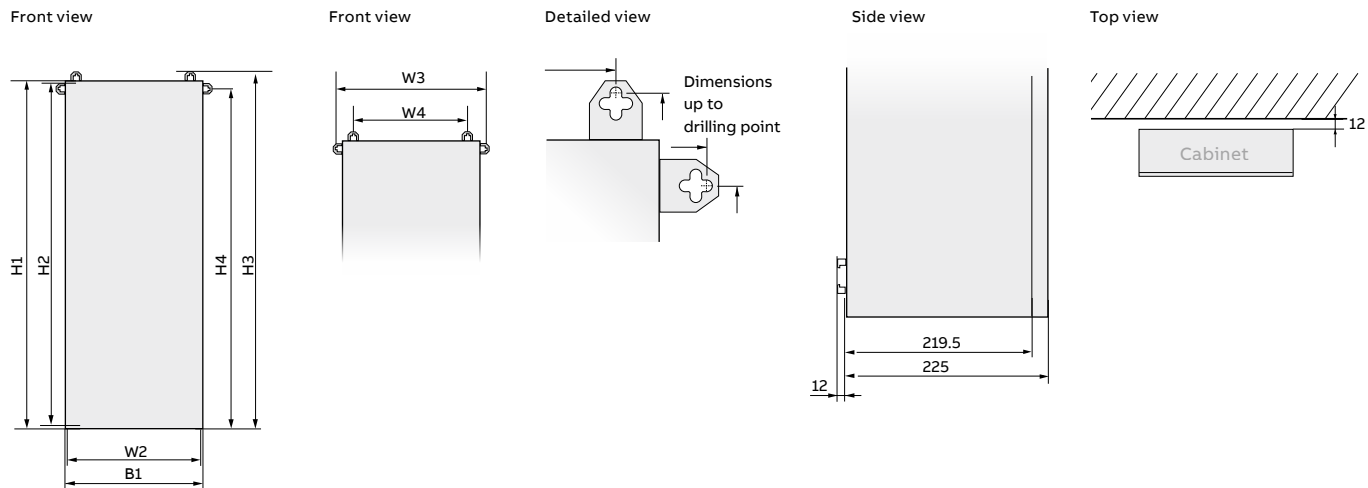

Height		Width		External dimensions in mm		Internal dimensions in mm		Wall mounting dimensions in mm			
RE	BH	FB	Type	H1	B1	H2	W2	H3	W3	H4	W4
TwinLine H standing cabinets											
12	8	1	TH112	1850	300	1802	252	1872	328	1796	192
		2	TH212	1850	550	1802	502	1872	578	1796	442
		3	TH312	1850	800	1802	752	1872	828	1796	692
		4	TH412	1850	1050	1802	1002	1872	1078	1796	942
		5	TH512	1850	1300	1802	1252	1872	1328	1796	1192

Height		Width		Power dissipation in watts* at overtemperature Δt 20K	Cabinet weight With door in kg	Cabinet weight With door in kg	Max. installation weight in kg
RE	BH	FB	Type				
TwinLine H standing cabinets							
12	8	1	TH112	64.00	25.65	27.33	45
		2	TH212	113.00	39.44	41.77	90
		3	TH312	162.60	50.88	53.86	135
		4	TH412	202.10	64.70	69.72	180
		5	TH512	230.80	75.82	80.21	225

* General remarks on the determination of the power dissipation: Values in accordance with DIN EN 61439-1 section 10.10.4.2.2; ambient temperature 35 °C, internal temperature 55 °C, it must be guaranteed that the permissible operating medium temperature is not exceeded; height of the installation location ≤ 2000 m above sea level; shape of inner divider = 1; side walls not covered

TwinLine N 44 floor-standing cabinets

Base - dimensions and weights

Top view

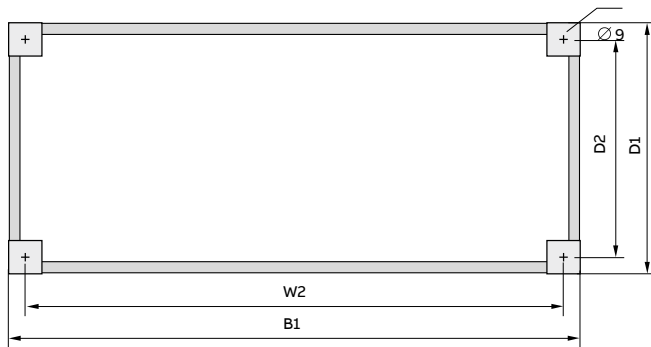

Side view

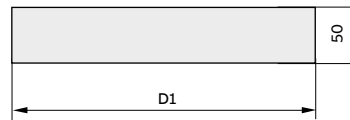

Side view

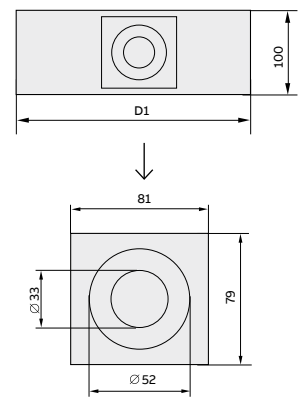

Height mm	Depth mm	Width		External dimensions Width x depth in mm		Internal dimensions Width x depth in mm		Weight in kg
		FB	Type	B1	D1	W2	D2	
TwinLine-H, base 50 mm								
50	225	1	TZG105	300	203.50	270	173.50	1.37
		2	TZG205	550	203.50	520	173.50	1.91
		3	TZG305	800	203.50	770	173.50	2.41
		4	TZG405	1050	203.50	1020	173.50	2.93
		5	TZG505	1300	203.50	1270	173.50	3.44
TwinLine-H, base 100 mm								
100	225	1	TZG110	300	203.50	270	173.50	2.22
		2	TZG210	550	203.50	520	173.50	3.06
		3	TZG310	800	203.50	770	173.50	3.87
		4	TZG410	1050	203.50	1020	173.50	4.67
		5	TZG510	1300	204.50	1270	173.50	5.47

TwinLine N 44 floor-standing cabinets

Door height 8 RE - dimensions and weights

External dimensions
Cabinets with field width 4 and over
Double doors

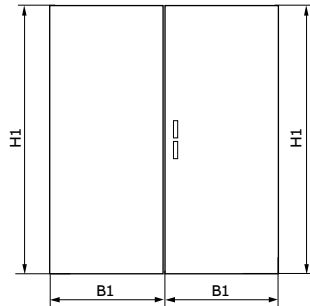

Usable installation space
Cabinets with field width 4 and over
Double doors

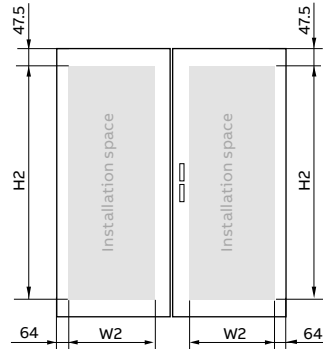

RE	Height		Width		Remark	External dimensions Height x width in mm		Installation space Height x width in mm		Weight in kg	Max. installation weight in kg
	BH	FB	Type	Type		H1	B1	H2	W2		
TwinLine standing cabinets, doors											
12	8	1	TH112			1843	289	1748	123	7.85	5.00
		2	TH212			1843	539	1748	373	13.37	5.00
		3	TH312			1843	789	1748	623	18.88	7.50
		4*	TH412	Left door		1843	526 ^{*2}	1748	373	12.52	5.00
				Right door		1843	539	1748	373	13.38	5.00
		5*	TH512	Left door		1843	776 ^{*2}	1748	623	18.02	7.50
				Right door		1843	539	1748	373	13.38	5.00

* Double doors field width 4 and over

*2 Dimensions including door center bar

TwinLine N 44 floor-standing cabinets

Flange openings at the top and knock-outs at the bottom

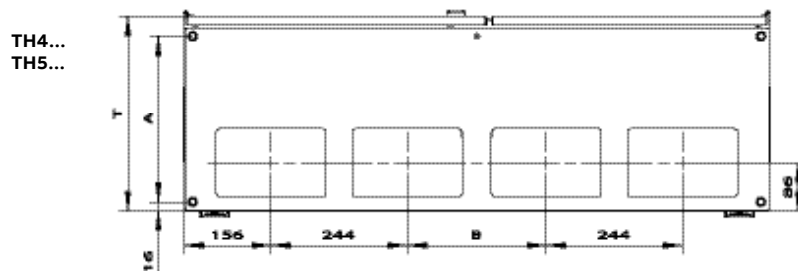
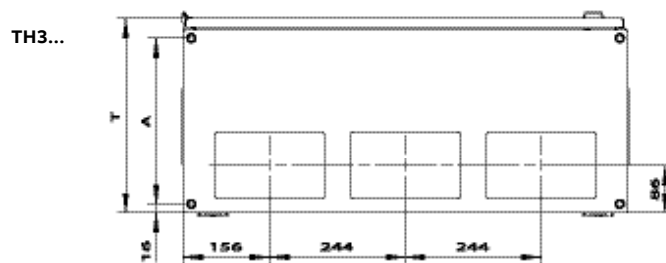
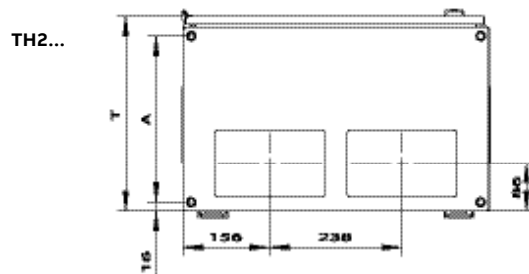
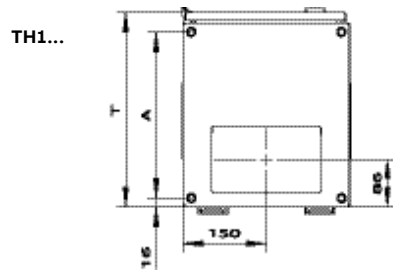

Cabinet series	Depth in mm	A in mm	B in mm/field width 4	B in mm/field width 5
TwinLine-H	225.00	173.50	1 x 250 (250)	2 x 250 (500)

> Dimensions in mm

TwinLine N 44 floor-standing cabinets

Installation of CombiLine N modules on EDF mounting frame

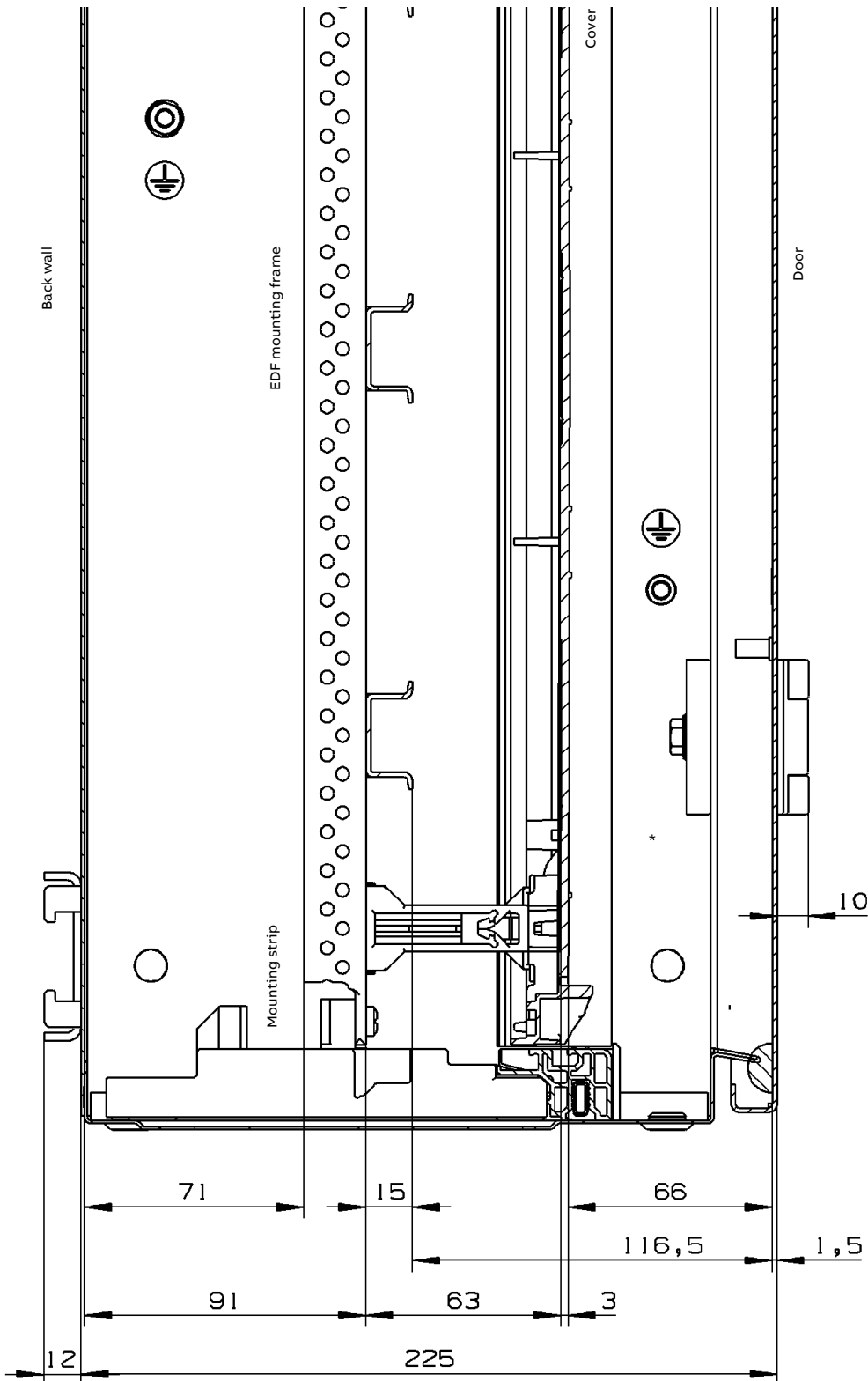

TwinLine N 44 floor-standing cabinets

Installation with meter field for TwinLine-H 

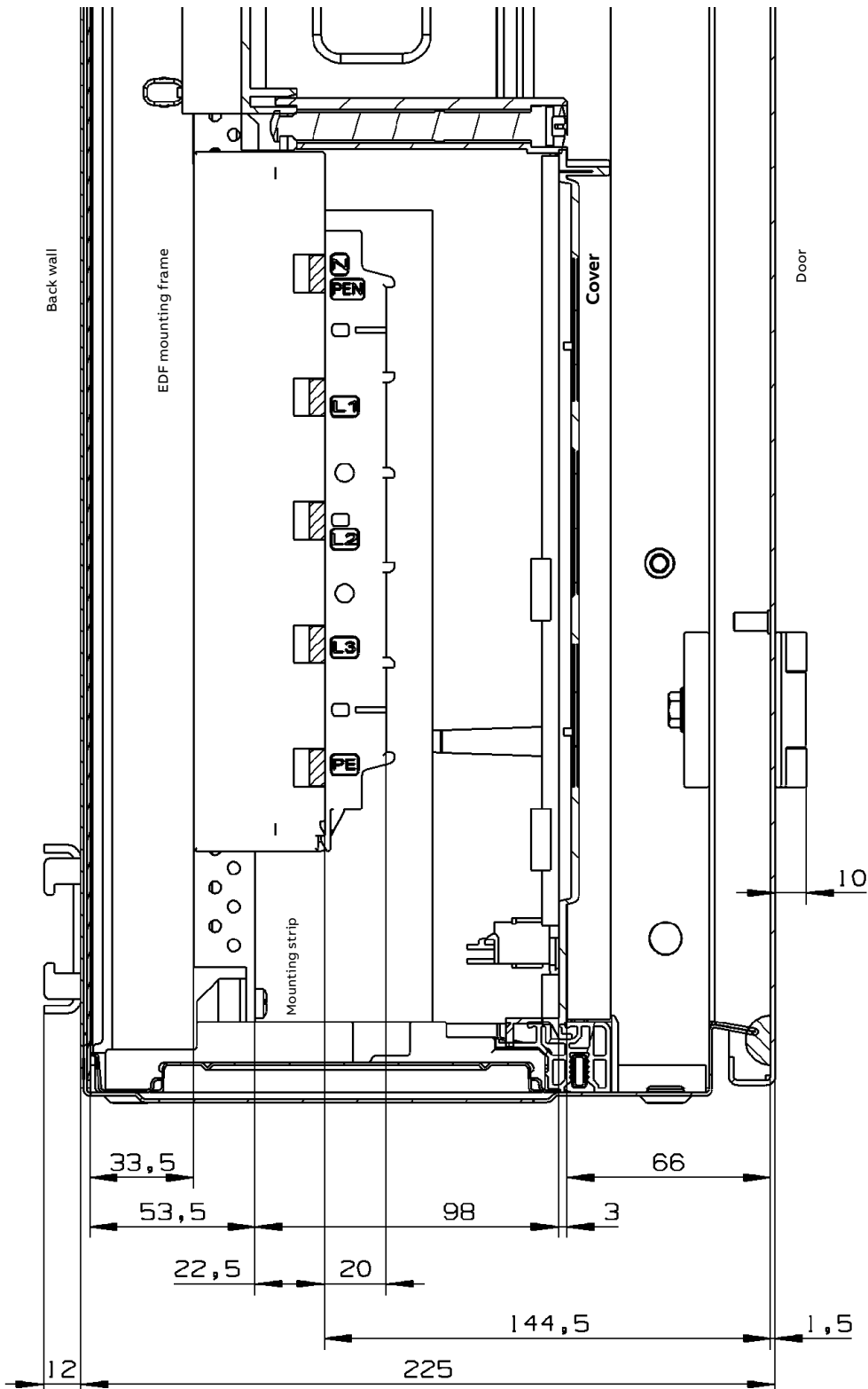

> Dimensions in mm

TwinLine N 44 floor-standing cabinets

LED control cabinet lights TZ650

Technical specifications	
Operating voltage	24 V – 265 V AC / DC
Power consumption	6 W
Light output	700 lm
Lighting level	1200 lx, 0.5 m 450 lx, 1.0 m
Color temperature	5,000 K
Degree of protection	IP 20
Protection class	II
Lifetime [std. at 20 °C]	50,000 h
Terminal	Push-in connector
Housing material	Polycarbonate
Weight	140 g
Max. humidity [% rH]	90 %
Operating temperature [° C]	- 20 °C to + 60 °C
Ambient temperature (storage)	- 40 °C to + 85 °C
Approvals	CE

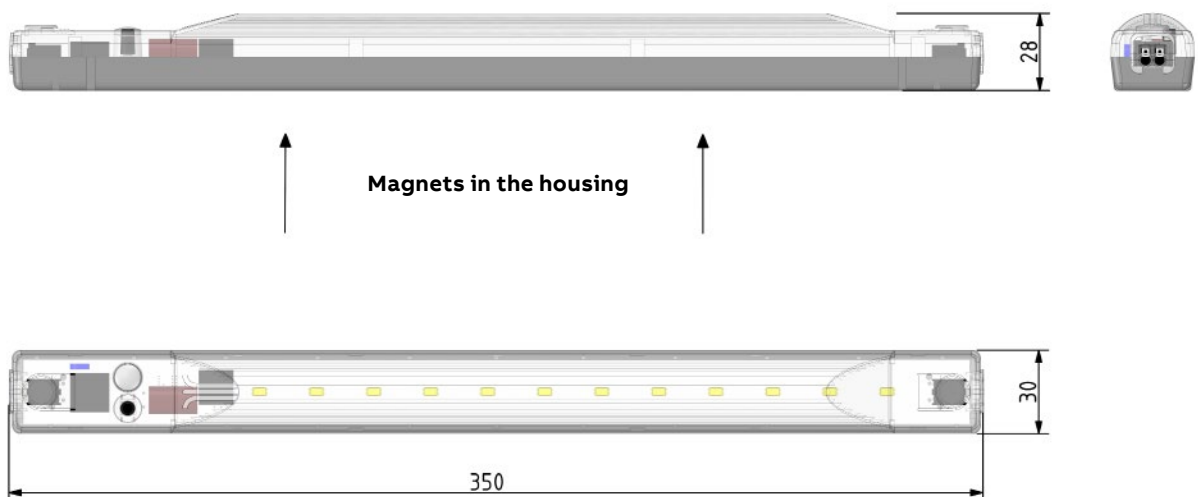

TwinLine N 44 floor-standing cabinets

Crane transport

The lifting of the TwinLine housing is possible in accordance with the information given. Here it is imperative that transport eye bolts from ABB STRIEBEL & JOHN with order code TZ615P4 are used. Crane transport must be provided exclusively for individual cabinets! Furthermore, the maximum installation weights of the cabinets must be observed.

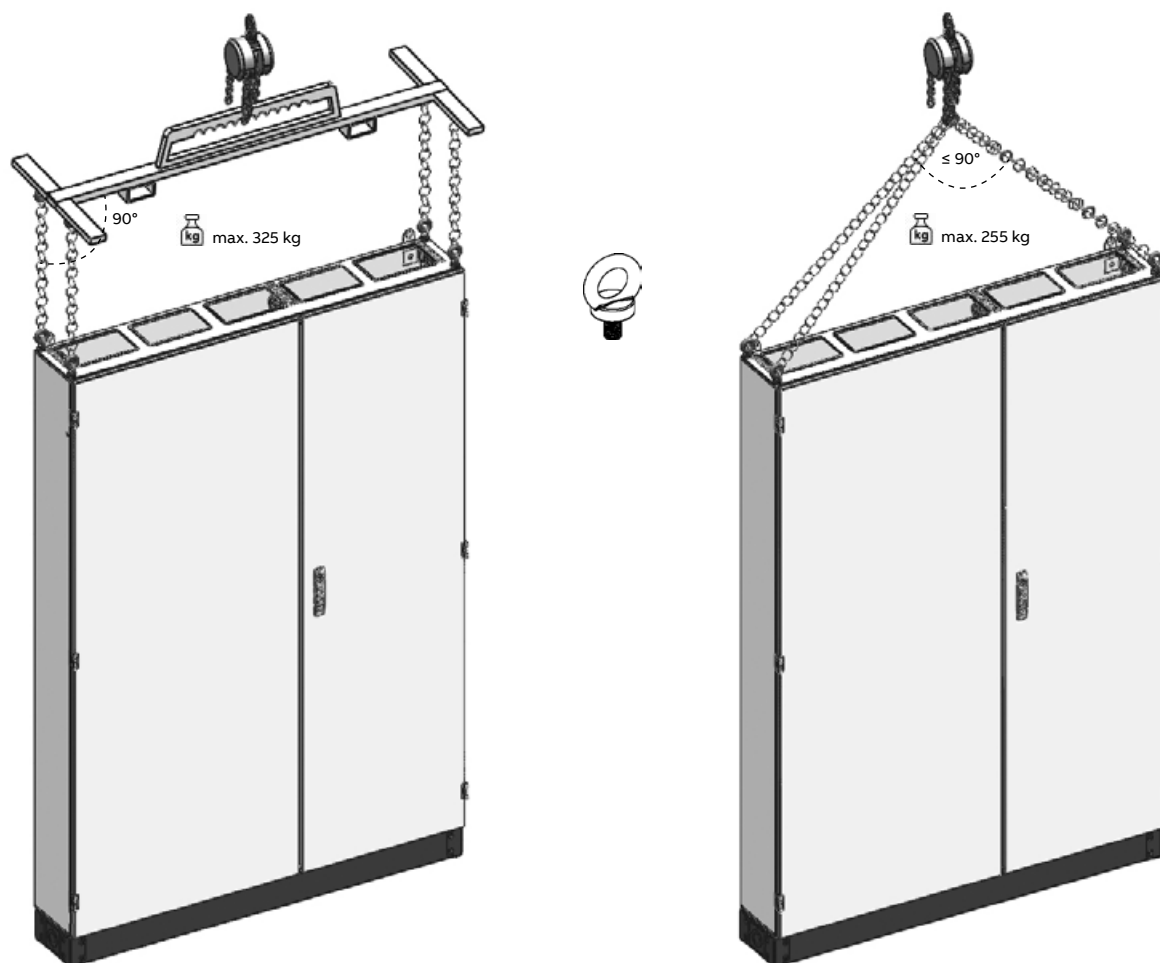

TwinLine N 55 wall cabinets and floor-standing cabinets

Wall cabinets



TwinLine N 55 wall cabinets and floor-standing cabinets

Wall cabinets/specifications and product features

Specifications for TwinLine-G, -L and -W	
Standards/regulations	DIN EN 61439-1/-2/-3, DIN VDE 0660-600-1/-2/-3*1
Protection class	I, earthed II, insulated
Degree of protection	with IP55 door Without IP30 door, when expanded as an installation distributor with meter and distributor fields, combination sets or CombiLine modules
Mechanical impact strength	IK08 for the cabinet housing with steel-sheet door IK07 in the area of flange knock-outs and for transparent doors
Ambient conditions	Indoor installation Ambient temperature max. + 40 °C Ambient temperature min. - 5 °C Operating temperature max. + 55 °C Storage temperature max. + 55 °C Storage temperature min. - 40 °C

Product features for TwinLine-G, -L and -W	
Housing and doors	Made of sheet steel, color RAL 7035, powder-coated A flange opening is cut out for each field width, knock-outs are on the side and bottom Door opening angle 180 degrees Double door cabinets with field width 4 and over Doors with rod lock Standard closure, double-bit 3 mm
Assembly options*	Prepared for expansion with meter and distributor fields, combination sets or CombiLine modules on EDF mounting frame Prepared for expansion with CombiLine modules on the WRmounting frame and mounting plates, by removing the EDF adapter
Forms of delivery	Housing with door Housing without door External mounting lugs are included in the scope of delivery Mounting strips with left and right mounting frame brackets, as well as an additional mounting strip for field width 4 and above cabinets, are included in the scope of delivery Touch protection for the insulated cabinet is included in the scope of delivery Touch protection for the earthed cabinet must be ordered separately as an accessory
Accessories	For housings without doors, the door can be ordered separately, as needed Flanges must be ordered separately Touch protection for the earthed cabinet must be ordered separately

*1 The permissible heating for switchgear combinations (SK) up to 630 A rated current can be verified using the procedure according to 10.10.4.2; for the required values of the power dissipation capacity, please refer to the tables on page above 630 A rated current, the procedure according to 10.10.4.3 (DIN EN 61439-1 supplementary sheet 2, DIN VDE 0660-600-1 supplementary sheet 2) must be applied

* For detailed description of the assembly options of floor-standing cabinets see next pages in this chapter.

TwinLine N 55 wall cabinets and floor-standing cabinets

Wall cabinets/assembly options \perp



TG306G

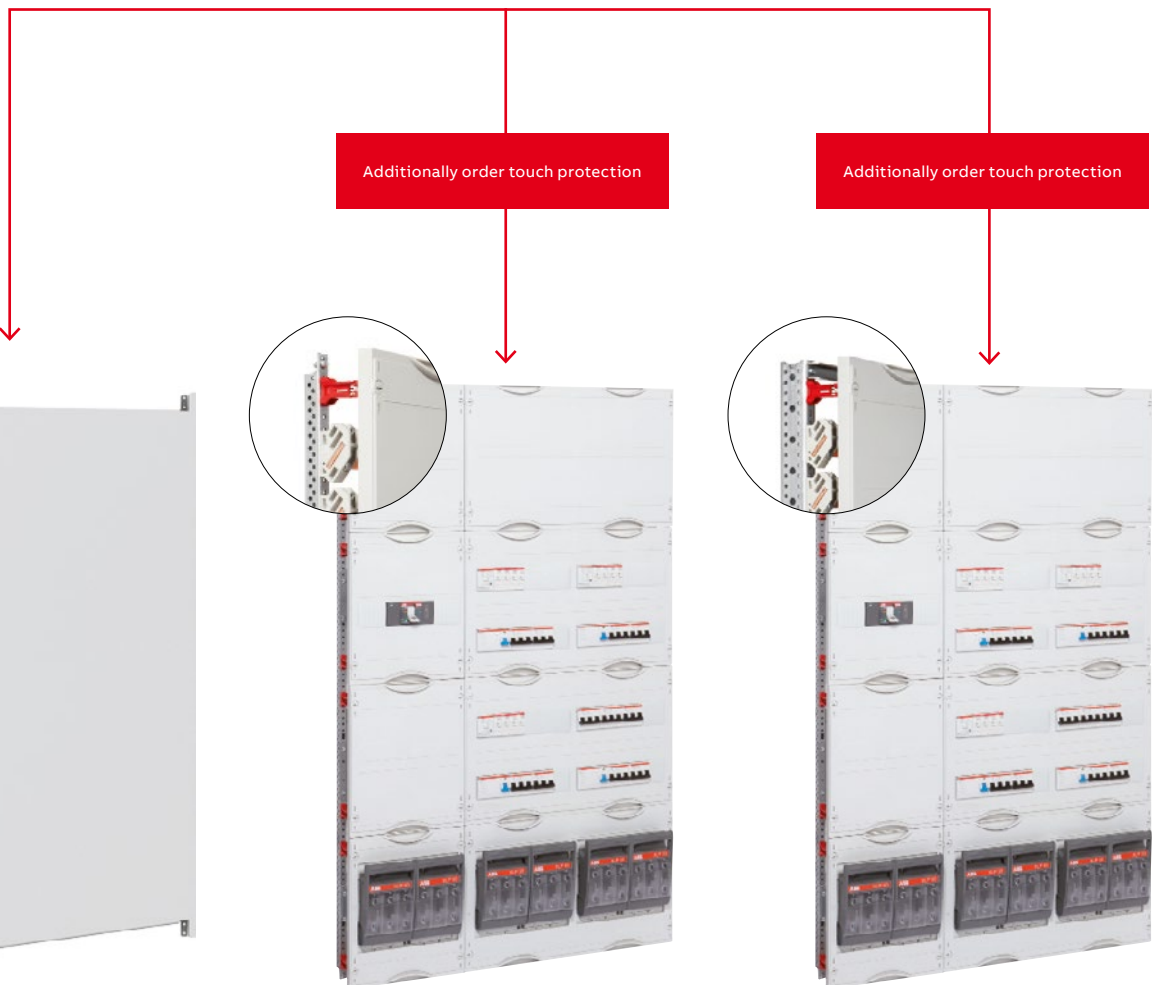

Additionally order touch protection

Additionally order touch protection

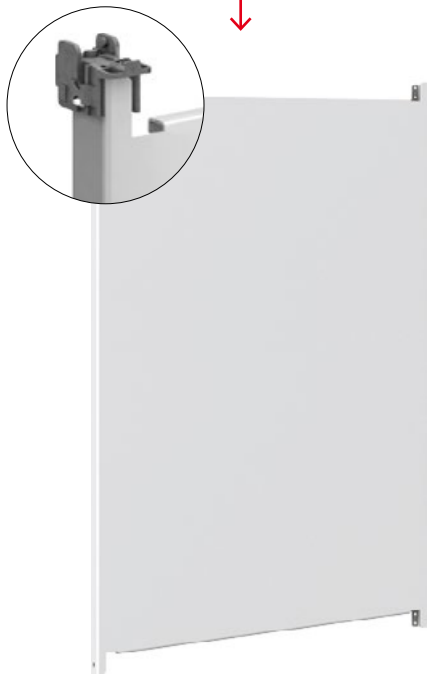

Mounting plate installation
Expansion for the control technology with mounting plate, by removing the EDF adapter



EDF mounting frame installation
Expansion as an installation distributor with meter and distributor fields, combination sets or CombiLine modules on EDF mounting frame



Installation of WR mounting frame
Expansion as an installation distributor with CombiLine modules on WR mounting frame, by removing the EDF Adapter

A combination of the individual expansion variants next to each other is possible.

TwinLine N 55 wall cabinets and floor-standing cabinets

Wall cabinets/assembly options 



TG306S

Touch protection included
in the scope of delivery

Touch protection included
in the scope of delivery



EDF mounting frame installation
Expansion as an installation distributor
with meter and distributor fields,
combination sets or CombiLine
modules on EDF mounting frame



Installation of WR mounting frame
Expansion as an installation
distributor with CombiLine
modules on WR mounting frame,
by removing the EDF Adapter

A combination of the individual expansion variants next to each other is possible.

TwinLine N 55 wall cabinets and floor-standing cabinets

TwinLine-G wall cabinet, cabinet depth 225 mm \perp



TG306G

Included in the scope of delivery

- External mounting brackets
- Mounting rails with left and right mounting frame brackets, as well as an additional mounting rail for cabinets with field width 4 and above
- Supports for expansion with meter and distributor fields, combination sets or CombiLine modules on EDF mounting frame
- Support for expansion with CombiLine modules on WRmounting frame and mounting plates, by removing the EDF Adapter

Order accessories separately

- Flanges
- Touch protection for expansion with meter and distributor fields, combination sets or CombiLine modules

Height		Width		External dimensions* ²	Wall cabinets with door IP55		Wall cabinets without door IP30	
RE	BH	FB	PLE		Type	Order code	Type	Order code
4	0	1	48	650 x 300	TG104G	2CPX010000R9999	TG104GB	2CPX010221R9999
		2	96	650 x 550	TG204G	2CPX010001R9999	TG204GB	2CPX010222R9999
		3	144	650 x 800	TG304G	2CPX010002R9999	TG304GB	2CPX010223R9999
		4	192	650 x 1050	TG404G	2CPX010003R9999	TG404GB	2CPX010224R9999
		5	240	650 x 1300	TG504G	2CPX010004R9999	TG504GB	2CPX010225R9999
5	1	1	60	800 x 300	TG105G	2CPX010005R9999	TG105GB	2CPX010226R9999
		2	120	800 x 550	TG205G	2CPX010006R9999	TG205GB	2CPX010227R9999
		3	180	800 x 800	TG305G	2CPX010007R9999	TG305GB	2CPX010228R9999
		4	240	800 x 1050	TG405G	2CPX010008R9999	TG405GB	2CPX010229R9999
		5	300	800 x 1300	TG505G	2CPX010009R9999	TG505GB	2CPX010230R9999
6	2	1	72	950 x 300	TG106G	2CPX010010R9999	TG106GB	2CPX010231R9999
		2	144	950 x 550	TG206G	2CPX010011R9999	TG206GB	2CPX010232R9999
		3	216	950 x 800	TG306G	2CPX010012R9999	TG306GB	2CPX010233R9999
		4	288	950 x 1050	TG406G	2CPX010013R9999	TG406GB	2CPX010234R9999
		5	360	950 x 1300	TG506G	2CPX010014R9999	TG506GB	2CPX010235R9999
7	3	1	84	1100 x 300	TG107G	2CPX010015R9999	TG107GB	2CPX010236R9999
		2	168	1100 x 550	TG207G	2CPX010016R9999	TG207GB	2CPX010237R9999
		3	252	1100 x 800	TG307G	2CPX010017R9999	TG307GB	2CPX010238R9999
		4	336	1100 x 1050	TG407G	2CPX010018R9999	TG407GB	2CPX010239R9999
		5	420	1100 x 1300	TG507G	2CPX010019R9999	TG507GB	2CPX010240R9999
8	4	1	96	1250 x 300	TG108G	2CPX010020R9999	TG108GB	2CPX010241R9999
		2	192	1250 x 550	TG208G	2CPX010021R9999	TG208GB	2CPX010242R9999
		3	288	1250 x 800	TG308G	2CPX010022R9999	TG308GB	2CPX010243R9999
		4	384	1250 x 1050	TG408G	2CPX010023R9999	TG408GB	2CPX010244R9999
		5	480	1250 x 1300	TG508G	2CPX010024R9999	TG508GB	2CPX010245R9999
9	5	1	108	1400 x 300	TG109G	2CPX010025R9999	TG109GB	2CPX010246R9999
		2	216	1400 x 550	TG209G	2CPX010026R9999	TG209GB	2CPX010247R9999
		3	324	1400 x 800	TG309G	2CPX010027R9999	TG309GB	2CPX010248R9999
		4	432	1400 x 1050	TG409G	2CPX010028R9999	TG409GB	2CPX010249R9999
		5	540	1400 x 1300	TG509G	2CPX010029R9999	TG509GB	2CPX010250R9999

*¹ When expanding as an installation distributor with meter and distributor fields, combination sets or CombiLine modules

*² External dimensions are without flange embossing.

TwinLine N 55 wall cabinets and floor-standing cabinets

TwinLine-G wall cabinet, cabinet depth 225 mm 



TG306S

Included in the scope of delivery

- External mounting brackets
- Touch protection
- Mounting rails with left and right mounting frame brackets, as well as an additional mounting rail for cabinets with field width 4 and above
- Supports for expansion with meter and distributor fields, combination sets or CombiLine modules on EDF mounting frame
- Support for expansion with CombiLine modules on WR mounting frame, by removing the EDF Adapter

Order accessories separately

- Flanges

Height		Width		External dimensions*2	Wall cabinets with door IP55		Wall cabinets without door IP30*1	
RE	BH	FB	PLE	H x W in mm	Type	Order code	Type	Order code
4	0	1	48	650 x 300	TG104S	2CPX010035R9999	TG104SB	2CPX010256R9999
		2	96	650 x 550	TG204S	2CPX010036R9999	TG204SB	2CPX010257R9999
		3	144	650 x 800	TG304S	2CPX010037R9999	TG304SB	2CPX010258R9999
		4	192	650 x 1050	TG404S	2CPX010038R9999	TG404SB	2CPX010259R9999
		5	240	650 x 1300	TG504S	2CPX010039R9999	TG504SB	2CPX010260R9999
5	1	1	60	800 x 300	TG105S	2CPX010040R9999	TG105SB	2CPX010261R9999
		2	120	800 x 550	TG205S	2CPX010041R9999	TG205SB	2CPX010262R9999
		3	180	800 x 800	TG305S	2CPX010042R9999	TG305SB	2CPX010263R9999
		4	240	800 x 1050	TG405S	2CPX010043R9999	TG405SB	2CPX010264R9999
		5	300	800 x 1300	TG505S	2CPX010044R9999	TG505SB	2CPX010265R9999
6	2	1	72	950 x 300	TG106S	2CPX010045R9999	TG106SB	2CPX010266R9999
		2	144	950 x 550	TG206S	2CPX010046R9999	TG206SB	2CPX010267R9999
		3	216	950 x 800	TG306S	2CPX010047R9999	TG306SB	2CPX010268R9999
		4	288	950 x 1050	TG406S	2CPX010048R9999	TG406SB	2CPX010269R9999
		5	360	950 x 1300	TG506S	2CPX010049R9999	TG506SB	2CPX010270R9999
7	3	1	84	1100 x 300	TG107S	2CPX010050R9999	TG107SB	2CPX010271R9999
		2	168	1100 x 550	TG207S	2CPX010051R9999	TG207SB	2CPX010272R9999
		3	252	1100 x 800	TG307S	2CPX010052R9999	TG307SB	2CPX010273R9999
		4	336	1100 x 1050	TG407S	2CPX010053R9999	TG407SB	2CPX010274R9999
		5	420	1100 x 1300	TG507S	2CPX010054R9999	TG507SB	2CPX010275R9999
8	4	1	96	1250 x 300	TG108S	2CPX010055R9999	TG108SB	2CPX010276R9999
		2	192	1250 x 550	TG208S	2CPX010056R9999	TG208SB	2CPX010277R9999
		3	288	1250 x 800	TG308S	2CPX010057R9999	TG308SB	2CPX010278R9999
		4	384	1250 x 1050	TG408S	2CPX010058R9999	TG408SB	2CPX010279R9999
		5	480	1250 x 1300	TG508S	2CPX010059R9999	TG508SB	2CPX010280R9999
9	5	1	108	1400 x 300	TG109S	2CPX010060R9999	TG109SB	2CPX010281R9999
		2	216	1400 x 550	TG209S	2CPX010061R9999	TG209SB	2CPX010282R9999
		3	324	1400 x 800	TG309S	2CPX010062R9999	TG309SB	2CPX010283R9999
		4	432	1400 x 1050	TG409S	2CPX010063R9999	TG409SB	2CPX010284R9999
		5	540	1400 x 1300	TG509S	2CPX010064R9999	TG509SB	2CPX010285R9999

*1 When expanding as an installation distributor with meter and distributor fields, combination sets or CombiLine modules

*2 External dimensions are without flange embossing.

TwinLine N 55 wall cabinets and floor-standing cabinets

TwinLine-L wall cabinets, cabinet depth 275 mm \perp



TL306G

Included in the scope of delivery

- External mounting brackets
- Mounting rails with left and right mounting frame brackets, as well as an additional mounting rail for cabinets with field width 4 and above
- Supports for expansion with meter and distributor fields, combination sets or CombiLine modules on EDF mounting frame
- Support for expansion with CombiLine modules on WR mounting frame and mounting plates, by removing the EDF Adapter

Order accessories separately

- Flanges
- Touch protection for expansion with meter and distributor fields, combination sets or CombiLine modules

Height		Width		External dimensions* ²	Wall cabinets with door IP55		Wall cabinets without door IP30* ¹	
RE	BH	FB	PLE	H x W in mm	Type	Order code	Type	Order code
4	0	1	48	650 x 300	TL104G	2CPX010070R9999	TL104GB	2CPX010291R9999
		2	96	650 x 550	TL204G	2CPX010071R9999	TL204GB	2CPX010292R9999
		3	144	650 x 800	TL304G	2CPX010072R9999	TL304GB	2CPX010293R9999
		4	192	650 x 1050	TL404G	2CPX010073R9999	TL404GB	2CPX010294R9999
		5	240	650 x 1300	TL504G	2CPX010074R9999	TL504GB	2CPX010295R9999
5	1	1	60	800 x 300	TL105G	2CPX010075R9999	TL105GB	2CPX010296R9999
		2	120	800 x 550	TL205G	2CPX010076R9999	TL205GB	2CPX010297R9999
		3	180	800 x 800	TL305G	2CPX010077R9999	TL305GB	2CPX010298R9999
		4	240	800 x 1050	TL405G	2CPX010078R9999	TL405GB	2CPX010299R9999
		5	300	800 x 1300	TL505G	2CPX010079R9999	TL505GB	2CPX010300R9999
6	2	1	72	950 x 300	TL106G	2CPX010080R9999	TL106GB	2CPX010301R9999
		2	144	950 x 550	TL206G	2CPX010081R9999	TL206GB	2CPX010302R9999
		3	216	950 x 800	TL306G	2CPX010082R9999	TL306GB	2CPX010303R9999
		4	288	950 x 1050	TL406G	2CPX010083R9999	TL406GB	2CPX010304R9999
		5	360	950 x 1300	TL506G	2CPX010084R9999	TL506GB	2CPX010305R9999
7	3	1	84	1100 x 300	TL107G	2CPX010085R9999	TL107GB	2CPX010306R9999
		2	168	1100 x 550	TL207G	2CPX010086R9999	TL207GB	2CPX010307R9999
		3	252	1100 x 800	TL307G	2CPX010087R9999	TL307GB	2CPX010308R9999
		4	336	1100 x 1050	TL407G	2CPX010088R9999	TL407GB	2CPX010309R9999
		5	420	1100 x 1300	TL507G	2CPX010089R9999	TL507GB	2CPX010310R9999
8	4	1	96	1250 x 300	TL108G	2CPX010090R9999	TL108GB	2CPX010311R9999
		2	192	1250 x 550	TL208G	2CPX010091R9999	TL208GB	2CPX010312R9999
		3	288	1250 x 800	TL308G	2CPX010092R9999	TL308GB	2CPX010313R9999
		4	384	1250 x 1050	TL408G	2CPX010093R9999	TL408GB	2CPX010314R9999
		5	480	1250 x 1300	TL508G	2CPX010094R9999	TL508GB	2CPX010315R9999
9	5	1	108	1400 x 300	TL109G	2CPX010095R9999	TL109GB	2CPX010316R9999
		2	216	1400 x 550	TL209G	2CPX010096R9999	TL209GB	2CPX010317R9999
		3	324	1400 x 800	TL309G	2CPX010097R9999	TL309GB	2CPX010318R9999
		4	432	1400 x 1050	TL409G	2CPX010098R9999	TL409GB	2CPX010319R9999
		5	540	1400 x 1300	TL509G	2CPX010099R9999	TL509GB	2CPX010320R9999

*¹ When expanding as an installation distributor with meter and distributor fields, combination sets or CombiLine modules

*² External dimensions are without flange embossing.

TwinLine N 55 wall cabinets and floor-standing cabinets

TwinLine-L wall cabinets, cabinet depth 275 mm \perp



TL306S

Included in the scope of delivery

- External mounting brackets
- Touch protection
- Mounting rails with left and right mounting frame brackets, as well as an additional mounting rail for cabinets with field width 4 and above
- Supports for expansion with meter and distributor fields, combination sets or CombiLine modules on EDFmounting frame
- Support for expansion with CombiLine modules on WRmounting frame, by removing the EDF Adapter

Order accessories separately

- Flanges

Height		Width		External dimensions* ²	Wall cabinets with door IP55		Wall cabinets without door IP30* ¹	
RE	BH	FB	PLE	H x W in mm	Type	Order code	Type	Order code
4	0	1	48	650 x 300	TL104S	2CPX010105R9999	TL104SB	2CPX010326R9999
		2	96	650 x 550	TL204S	2CPX010106R9999	TL204SB	2CPX010327R9999
		3	144	650 x 800	TL304S	2CPX010107R9999	TL304SB	2CPX010328R9999
		4	192	650 x 1050	TL404S	2CPX010108R9999	TL404SB	2CPX010329R9999
		5	240	650 x 1300	TL504S	2CPX010109R9999	TL504SB	2CPX010330R9999
5	1	1	60	800 x 300	TL105S	2CPX010110R9999	TL105SB	2CPX010331R9999
		2	120	800 x 550	TL205S	2CPX010111R9999	TL205SB	2CPX010332R9999
		3	180	800 x 800	TL305S	2CPX010112R9999	TL305SB	2CPX010333R9999
		4	240	800 x 1050	TL405S	2CPX010113R9999	TL405SB	2CPX010334R9999
		5	300	800 x 1300	TL505S	2CPX010114R9999	TL505SB	2CPX010335R9999
6	2	1	72	950 x 300	TL106S	2CPX010115R9999	TL106SB	2CPX010336R9999
		2	144	950 x 550	TL206S	2CPX010116R9999	TL206SB	2CPX010337R9999
		3	216	950 x 800	TL306S	2CPX010117R9999	TL306SB	2CPX010338R9999
		4	288	950 x 1050	TL406S	2CPX010118R9999	TL406SB	2CPX010339R9999
		5	360	950 x 1300	TL506S	2CPX010119R9999	TL506SB	2CPX010340R9999
7	3	1	84	1100 x 300	TL107S	2CPX010120R9999	TL107SB	2CPX010341R9999
		2	168	1100 x 550	TL207S	2CPX010121R9999	TL207SB	2CPX010342R9999
		3	252	1100 x 800	TL307S	2CPX010122R9999	TL307SB	2CPX010343R9999
		4	336	1100 x 1050	TL407S	2CPX010123R9999	TL407SB	2CPX010344R9999
		5	420	1100 x 1300	TL507S	2CPX010124R9999	TL507SB	2CPX010345R9999
8	4	1	96	1250 x 300	TL108S	2CPX010125R9999	TL108SB	2CPX010346R9999
		2	192	1250 x 550	TL208S	2CPX010126R9999	TL208SB	2CPX010347R9999
		3	288	1250 x 800	TL308S	2CPX010127R9999	TL308SB	2CPX010348R9999
		4	384	1250 x 1050	TL408S	2CPX010128R9999	TL408SB	2CPX010349R9999
		5	480	1250 x 1300	TL508S	2CPX010129R9999	TL508SB	2CPX010350R9999
9	5	1	108	1400 x 300	TL109S	2CPX010130R9999	TL109SB	2CPX010351R9999
		2	216	1400 x 550	TL209S	2CPX010131R9999	TL209SB	2CPX010352R9999
		3	324	1400 x 800	TL309S	2CPX010132R9999	TL309SB	2CPX010353R9999
		4	432	1400 x 1050	TL409S	2CPX010133R9999	TL409SB	2CPX010354R9999
		5	540	1400 x 1300	TL509S	2CPX010134R9999	TL509SB	2CPX010355R9999

*¹ When expanding as an installation distributor with meter and distributor fields, combination sets or CombiLine modules

*² External dimensions are without flange embossing.

TwinLine N 55 wall cabinets and floor-standing cabinets

TwinLine-W wall cabinets, cabinet depth 350 mm \perp



TW306G

Included in the scope of delivery

- External mounting brackets
- Mounting rails with left and right mounting frame brackets, as well as an additional mounting rail for cabinets with field width 4 and above
- Supports for expansion with meter and distributor fields, combination sets or CombiLine modules on EDF mounting frame
- Support for expansion with CombiLine modules on WR mounting frame and mounting plates, by removing the EDF Adapter

Order accessories separately

- Flanges
- Touch protection for expansion with meter and distributor fields, combination sets or CombiLine modules

Height		Width		External dimensions*2	Wall cabinets with door IP55		Wall cabinets without door IP30*1	
RE	BH	FB	PLE	H x W in mm	Type	Order code	Type	Order code
4	0	1	48	650 x 300	TW104G	2CPX010140R9999	TW104GB	2CPX010361R9999
		2	96	650 x 550	TW204G	2CPX010141R9999	TW204GB	2CPX010362R9999
		3	144	650 x 800	TW304G	2CPX010142R9999	TW304GB	2CPX010363R9999
		4	192	650 x 1050	TW404G	2CPX010143R9999	TW404GB	2CPX010364R9999
		5	240	650 x 1300	TW504G	2CPX010144R9999	TW504GB	2CPX010365R9999
5	1	1	60	800 x 300	TW105G	2CPX010202R9999	TW105GB	2CPX010366R9999
		2	120	800 x 550	TW205G	2CPX010203R9999	TW205GB	2CPX010367R9999
		3	180	800 x 800	TW305G	2CPX010204R9999	TW305GB	2CPX010368R9999
		4	240	800 x 1050	TW405G	2CPX010205R9999	TW405GB	2CPX010369R9999
		5	300	800 x 1300	TW505G	2CPX010206R9999	TW505GB	2CPX010370R9999
6	2	1	72	950 x 300	TW106G	2CPX010145R9999	TW106GB	2CPX010371R9999
		2	144	950 x 550	TW206G	2CPX010146R9999	TW206GB	2CPX010372R9999
		3	216	950 x 800	TW306G	2CPX010147R9999	TW306GB	2CPX010373R9999
		4	288	950 x 1050	TW406G	2CPX010148R9999	TW406GB	2CPX010374R9999
		5	360	950 x 1300	TW506G	2CPX010149R9999	TW506GB	2CPX010375R9999
7	3	1	84	1100 x 300	TW107G	2CPX010150R9999	TW107GB	2CPX010376R9999
		2	168	1100 x 550	TW207G	2CPX010151R9999	TW207GB	2CPX010377R9999
		3	252	1100 x 800	TW307G	2CPX010152R9999	TW307GB	2CPX010378R9999
		4	336	1100 x 1050	TW407G	2CPX010153R9999	TW407GB	2CPX010379R9999
		5	420	1100 x 1300	TW507G	2CPX010154R9999	TW507GB	2CPX010380R9999
8	4	1	96	1250 x 300	TW108G	2CPX010155R9999	TW108GB	2CPX010381R9999
		2	192	1250 x 550	TW208G	2CPX010156R9999	TW208GB	2CPX010382R9999
		3	288	1250 x 800	TW308G	2CPX010157R9999	TW308GB	2CPX010383R9999
		4	384	1250 x 1050	TW408G	2CPX010158R9999	TW408GB	2CPX010384R9999
		5	480	1250 x 1300	TW508G	2CPX010159R9999	TW508GB	2CPX010385R9999
9	5	1	108	1400 x 300	TW109G	2CPX010160R9999	TW109GB	2CPX010386R9999
		2	216	1400 x 550	TW209G	2CPX010161R9999	TW209GB	2CPX010387R9999
		3	324	1400 x 800	TW309G	2CPX010162R9999	TW309GB	2CPX010388R9999
		4	432	1400 x 1050	TW409G	2CPX010163R9999	TW409GB	2CPX010389R9999
		5	540	1400 x 1300	TW509G	2CPX010164R9999	TW509GB	2CPX010390R9999

*1 When expanding as an installation distributor with meter and distributor fields, combination sets or CombiLine modules

*2 External dimensions are without flange embossing.

TwinLine N 55 wall cabinets and floor-standing cabinets

TwinLine-W wall cabinets, cabinet depth 350 mm \perp



TW306S

Included in the scope of delivery

- External mounting brackets
- Touch protection
- Mounting rails with left and right mounting frame brackets, as well as an additional mounting rail for cabinets with field width 4 and above
- Supports for expansion with meter and distributor fields, combination sets or CombiLine modules on EDF mounting frame
- Support for expansion with CombiLine modules on WR mounting frame, by removing the EDF Adapter

Order accessories separately

- Flanges

Height		Width		External dimensions* ²	Wall cabinets with door IP55		Wall cabinets without door IP30* ¹	
RE	BH	FB	PLE	H x W in mm	Type	Order code	Type	Order code
4	0	1	48	650 x 300	TW104S	2CPX010171R9999	TW104SB	2CPX010397R9999
		2	96	650 x 550	TW204S	2CPX010172R9999	TW204SB	2CPX010398R9999
		3	144	650 x 800	TW304S	2CPX010173R9999	TW304SB	2CPX010399R9999
		4	192	650 x 1050	TW404S	2CPX010174R9999	TW404SB	2CPX010400R9999
		5	240	650 x 1300	TW504S	2CPX010175R9999	TW504SB	2CPX010401R9999
5	1	1	60	800 x 300	TW105S	2CPX010207R9999	TW105SB	2CPX010402R9999
		2	120	800 x 550	TW205S	2CPX010208R9999	TW205SB	2CPX010403R9999
		3	180	800 x 800	TW305S	2CPX010209R9999	TW305SB	2CPX010404R9999
		4	240	800 x 1050	TW405S	2CPX010210R9999	TW405SB	2CPX010405R9999
		5	300	800 x 1300	TW505S	2CPX010211R9999	TW505SB	2CPX010406R9999
6	2	1	72	950 x 300	TW106S	2CPX010176R9999	TW106SB	2CPX010407R9999
		2	144	950 x 550	TW206S	2CPX010177R9999	TW206SB	2CPX010408R9999
		3	216	950 x 800	TW306S	2CPX010178R9999	TW306SB	2CPX010409R9999
		4	288	950 x 1050	TW406S	2CPX010179R9999	TW406SB	2CPX010410R9999
		5	360	950 x 1300	TW506S	2CPX010180R9999	TW506SB	2CPX010411R9999
7	3	1	84	1100 x 300	TW107S	2CPX010181R9999	TW107SB	2CPX010412R9999
		2	168	1100 x 550	TW207S	2CPX010182R9999	TW207SB	2CPX010413R9999
		3	252	1100 x 800	TW307S	2CPX010183R9999	TW307SB	2CPX010414R9999
		4	336	1100 x 1050	TW407S	2CPX010184R9999	TW407SB	2CPX010415R9999
		5	420	1100 x 1300	TW507S	2CPX010185R9999	TW507SB	2CPX010416R9999
8	4	1	96	1250 x 300	TW108S	2CPX010186R9999	TW108SB	2CPX010417R9999
		2	192	1250 x 550	TW208S	2CPX010187R9999	TW208SB	2CPX010418R9999
		3	288	1250 x 800	TW308S	2CPX010188R9999	TW308SB	2CPX010419R9999
		4	384	1250 x 1050	TW408S	2CPX010189R9999	TW408SB	2CPX010420R9999
		5	480	1250 x 1300	TW508S	2CPX010190R9999	TW508SB	2CPX010421R9999
9	5	1	108	1400 x 300	TW109S	2CPX010191R9999	TW109SB	2CPX010422R9999
		2	216	1400 x 550	TW209S	2CPX010192R9999	TW209SB	2CPX010423R9999
		3	324	1400 x 800	TW309S	2CPX010193R9999	TW309SB	2CPX010424R9999
		4	432	1400 x 1050	TW409S	2CPX010194R9999	TW409SB	2CPX010425R9999
		5	540	1400 x 1300	TW509S	2CPX010195R9999	TW509SB	2CPX010426R9999

*¹ When expanding as an installation distributor with meter and distributor fields, combination sets or CombiLine modules

*² External dimensions are without flange embossing.

TwinLine N 55 wall cabinets and floor-standing cabinets

Floor-standing cabinets



TwinLine N 55 wall cabinets and floor-standing cabinets

Floor-standing cabinets/technical specifications and product features

Specifications for TwinLine-G, -L and -W	
Standards/regulations	DIN EN 61439-1/-2/-3, DIN VDE 0660-600-1/-2/-3*1
Protection class	I, earthed II, insulated
Degree of protection	with IP55 door Without IP30 door, when expanded as an installation distributor with meter and distributor fields, combination sets or CombiLine modules
Mechanical impact strength	IK08 for the cabinet housing with steel-sheet door IK07 in the area of flange knock-outs and for transparent doors
Ambient conditions	Indoor installation Ambient temperature max. + 40 °C Ambient temperature min. - 5 °C Operating temperature max. + 55 °C Storage temperature max. + 55 °C Storage temperature min. - 40 °C
Product features for TwinLine-G, -L and -W	
Housing and doors	Made of sheet steel, color RAL 7035, powder-coated A flange opening is cut out for each field width, knock-outs are on the side and bottom Door opening angle 180 degrees Double door cabinets with field width 4 and over Doors with rod lock Standard closure, double-bit 3 mm
Assembly options*	Prepared for expansion with CombiLine modules on WRmounting frame and mounting plates Prepared for expansion with meter and distributor fields, combination sets or CombiLine modules on EDF mounting frame, EDF adapter and middle support rails must be ordered separately as accessories
Forms of delivery	Housing with door Housing without door External mounting lugs are included in the scope of delivery Mounting strips with left and right mounting frame brackets, as well as an additional mounting strip for field width 4 and above cabinets, are included in the scope of delivery Touch protection for the insulated cabinet is included in the scope of delivery Touch protection for the earthed cabinet must be ordered separately as an accessory
Accessories	For housings without doors, the door can be ordered separately, as needed Flanges must be ordered separately Base must be ordered separately Touch protection for the earthed cabinet must be ordered separately EDF adapter must be ordered separately if required* Middle support rails must be ordered separately if required*

*1 The permissible heating for switchgear combinations (SK) up to 630 A rated current can be verified using the procedure according to 10.10.4.2; for the required values of the power dissipation capacity, please refer to the tables starting on page ; above 630 A rated current, the procedure according to 10.10.4.3 (DIN EN 61439-1 supplementary sheet 2, DIN VDE 0660-600-1 supplementary sheet 2) must be applied

* For detailed description of the assembly options of floor-standing cabinets see next pages in this chapter.

TwinLine N 55 wall cabinets and floor-standing cabinets

Floor-standing cabinets/assembly options \perp



TW312G

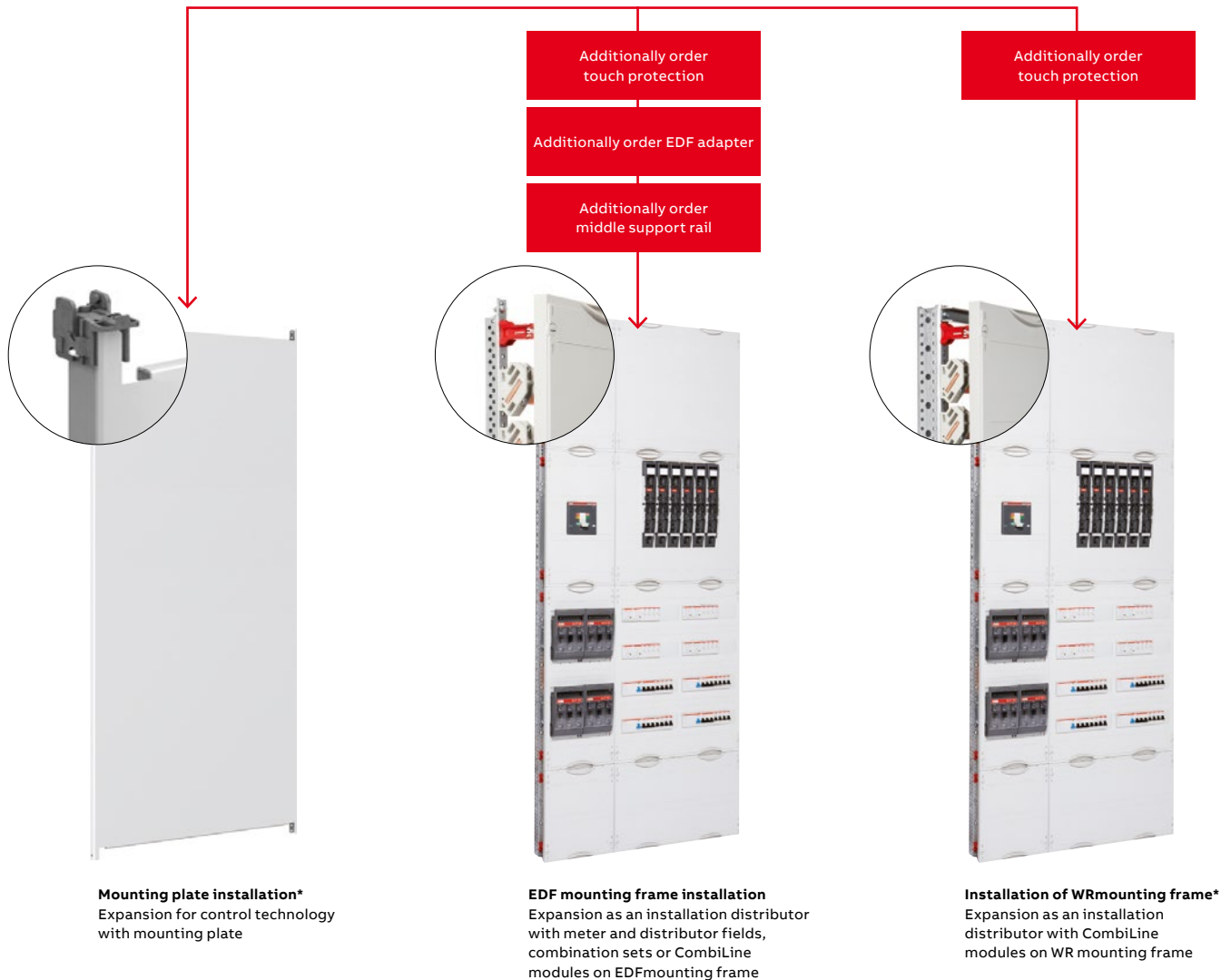

Mounting plate installation*
Expansion for control technology with mounting plate

EDF mounting frame installation
Expansion as an installation distributor with meter and distributor fields, combination sets or CombiLine modules on EDF mounting frame

Installation of WR mounting frame*
Expansion as an installation distributor with CombiLine modules on WR mounting frame

* The combination of mounting plate and WR mounting frame next to each other is possible.

TwinLine N 55 wall cabinets and floor-standing cabinets

Floor-standing cabinets/assembly options 



TW312S

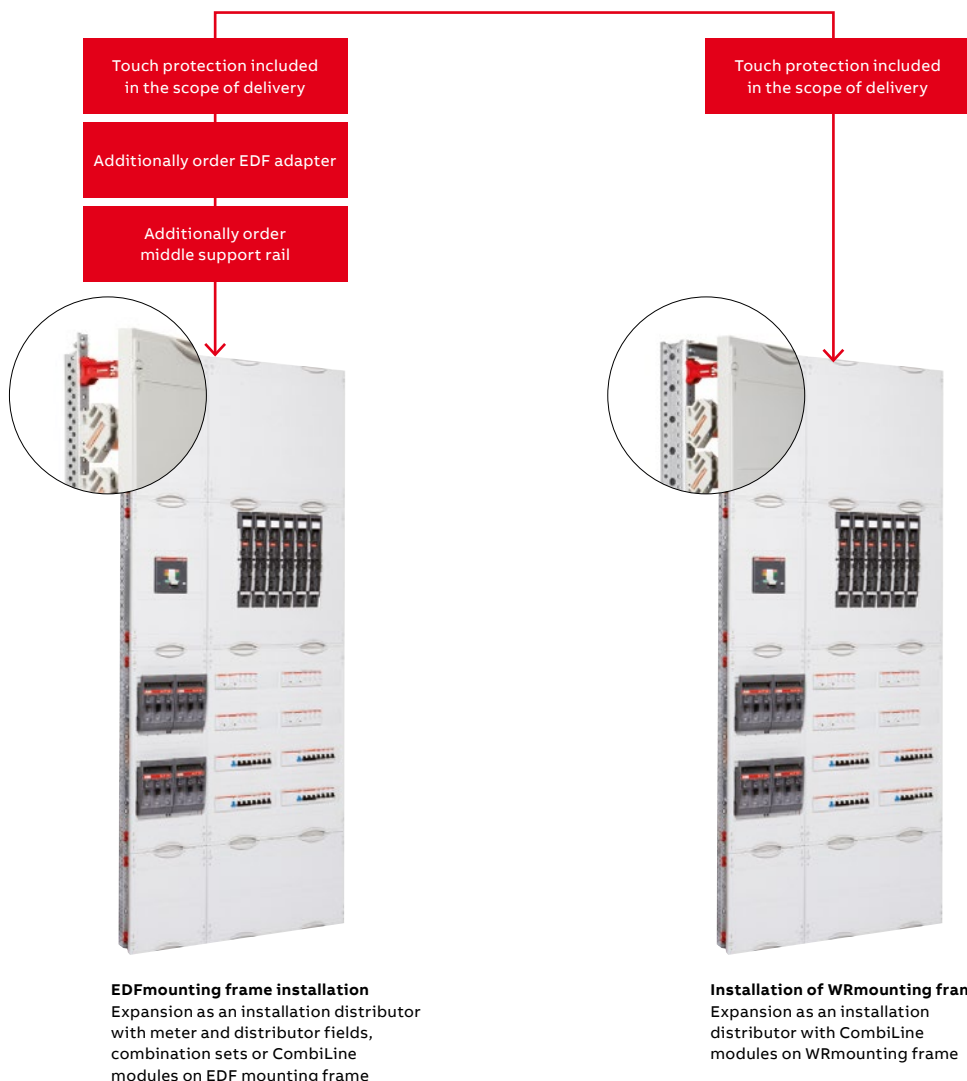

TwinLine N 55 wall cabinets and floor-standing cabinets

Floor-standing cabinets/cabinet depth 225/275/350 mm \perp



TG312G

Included in the scope of delivery

- External mounting brackets
- Mounting rails with left and right mounting frame brackets, as well as an additional mounting rail for cabinets with field width 4 and above
- Supports for expansion with CombiLine modules on WR mounting frame and mounting plates

Order accessories separately

- Flanges
- Base
- Touch protection for expansion with CombiLine modules
- EDF adapters, middle support rails and touch protection for expansion with meter and distributor fields, combination sets or CombiLine modules on EDF mounting frame

Height		Width		External dimensions*2		Standing cabinets with door IP55		Standing cabinets without door IP30*1	
RE	BH	FB	PLE	H x W in mm		Type	Order code	Type	Order code
TwinLine-G, cabinet depth 225 mm \perp									
12	8	1	144	1850 x 300		TG112G	2CPX010030R9999	TG112GB	2CPX010251R9999
		2	288	1850 x 550		TG212G	2CPX010031R9999	TG212GB	2CPX010252R9999
		3	432	1850 x 800		TG312G	2CPX010032R9999	TG312GB	2CPX010253R9999
		4	576	1850 x 1050		TG412G	2CPX010033R9999	TG412GB	2CPX010254R9999
		5	720	1850 x 1300		TG512G	2CPX010034R9999	TG512GB	2CPX010255R9999
TwinLine-L, cabinet depth 275 mm \perp									
12	8	1	144	1850 x 300		TL112G	2CPX010100R9999	TL112GB	2CPX010321R9999
		2	288	1850 x 550		TL212G	2CPX010101R9999	TL212GB	2CPX010322R9999
		3	432	1850 x 800		TL312G	2CPX010102R9999	TL312GB	2CPX010323R9999
		4	576	1850 x 1050		TL412G	2CPX010103R9999	TL412GB	2CPX010324R9999
		5	720	1850 x 1300		TL512G	2CPX010104R9999	TL512GB	2CPX010325R9999
TwinLine-W cabinet depth 350 mm \perp									
12	8	1	144	1850 x 300		TW112G	2CPX010165R9999	TW112GB	2CPX010391R9999
		2	288	1850 x 550		TW212G	2CPX010166R9999	TW212GB	2CPX010392R9999
		3	432	1850 x 800		TW312G	2CPX010167R9999	TW312GB	2CPX010393R9999
		4	576	1850 x 1050		TW412G	2CPX010168R9999	TW412GB	2CPX010394R9999
		5	720	1850 x 1300		TW512G	2CPX010169R9999	TW512GB	2CPX010395R9999
		6	864	1850 x 1550		TW612G	2CPX010170R9999	TW612GB	2CPX010396R9999

*1 When expanding as an installation distributor with meter and distributor fields, combination sets or CombiLine modules

*2 External dimensions are without flange embossing.

TwinLine N 55 wall cabinets and floor-standing cabinets

Floor-standing cabinets/cabinet depth 225/275/350 mm 





TG312S

Included in the scope of delivery

- External mounting brackets
- Touch protection
- Mounting rails with left and right mounting frame brackets, as well as an additional mounting rail for cabinets with field width 4 and above
- Supports for expansion with CombiLine modules on WRmounting frame

Order accessories separately

- Flanges
- Base
- EDF adapters and middle support rails for expansion with meter and distributor fields, combination sets or CombiLine modules on EDF mounting frame

Height		Width		External dimensions* ²		Standing cabinets with door IP55		Standing cabinets without door IP30* ¹	
RE	BH	FB	PLE	H x W in mm		Type	Order code	Type	Order code
TwinLine-G, cabinet depth 225 mm 									
12	8	1	144	1850 x 300		TG112S	2CPX010065R9999	TG112SB	2CPX010286R9999
		2	288	1850 x 550		TG212S	2CPX010066R9999	TG212SB	2CPX010287R9999
		3	432	1850 x 800		TG312S	2CPX010067R9999	TG312SB	2CPX010288R9999
		4	576	1850 x 1050		TG412S	2CPX010068R9999	TG412SB	2CPX010289R9999
		5	720	1850 x 1300		TG512S	2CPX010069R9999	TG512SB	2CPX010290R9999
TwinLine-L, cabinet depth 275 mm 									
12	8	1	144	1850 x 300		TL112S	2CPX010135R9999	TL112SB	2CPX010356R9999
		2	288	1850 x 550		TL212S	2CPX010136R9999	TL212SB	2CPX010357R9999
		3	432	1850 x 800		TL312S	2CPX010137R9999	TL312SB	2CPX010358R9999
		4	576	1850 x 1050		TL412S	2CPX010138R9999	TL412SB	2CPX010359R9999
		5	720	1850 x 1300		TL512S	2CPX010139R9999	TL512SB	2CPX010360R9999
TwinLine-W cabinet depth 350 mm 									
12	8	1	144	1850 x 300		TW112S	2CPX010196R9999	TW112SB	2CPX010427R9999
		2	288	1850 x 550		TW212S	2CPX010197R9999	TW212SB	2CPX010428R9999
		3	432	1850 x 800		TW312S	2CPX010198R9999	TW312SB	2CPX010429R9999
		4	576	1850 x 1050		TW412S	2CPX010199R9999	TW412SB	2CPX010430R9999
		5	720	1850 x 1300		TW512S	2CPX010200R9999	TW512SB	2CPX010431R9999
		6	864	1850 x 1550		TW612S	2CPX010201R9999	TW612SB	2CPX010432R9999

*¹ When expanding as an installation distributor with meter and distributor fields, combination sets or CombiLine modules

*² External dimensions are without flange embossing.

TwinLine N 55 wall cabinets and floor-standing cabinets

IP55 flanges



TZ101



TZ102



TZ103



TZ110



TZ111

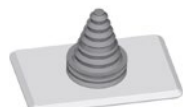

TZ112

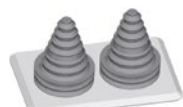

TZ104



TZ105



TZ107



TZ106

Article	Unit	Type	Order code
Membrane flange	1	TZ101	2CPX010450R9999
Material plastic for cable diameter 2 x 6 - 32.5 mm, 2 x 6 - 25 mm, 4 x 6 - 19 mm, 10 x 6 - 15 mm, 2 x 6 - 12 mm, 31 x 6 - 11 mm, 1 x 6 - 7 mm	10	TZ101P10	2CPX010451R9999
	100	TZ101P100	2CPX010826R9999
Flanges for M-screw joints			
Material plastic			
1 x M63/M50, 2 x M32/M20, 5 x M25, 5 x M20	1	TZ102	2CPX010452R9999
	10	TZ102P10	2CPX010453R9999
4 x M20/M25, 18 x M20	1	TZ103	2CPX010454R9999
	10	TZ103P10	2CPX010455R9999
Flanges with cable sleeves			
Material Plastic			
Flange with 8 cable sleeves	1	TZ110	2CPX010850R9999
For cable diameter 8 x 13 to 34 mm	10	TZ110P10	2CPX010934R9999
Flange with 11 cable sleeves	1	TZ111	2CPX010851R9999
For cable diameters 1 x 14 to 54 mm, 3 x 13 to 34 mm, 3 x 13 to 26.5 mm, 4 x 5 bis 21 mm	10	TZ111P10	2CPX010935R9999
Flange with 1 cable sleeve	1	TZ112	2CPX010852R9999
For cable diameter 1 x 14 to 68 mm			
Flange with 2 cable sleeves	1	TZ104	2CPX010456R9999
For cable diameter 2 x 14 to 68 mm	10	TZ104P10	2CPX010932R9999
Flange with 3 cable sleeves	1	TZ105	2CPX010457R9999
For cable diameter 3 x 14 to 54 mm	10	TZ105P10	2CPX010933R9999
Locking flanges			
Material Plastic	1	TZ107	2CPX010460R9999
	10	TZ107P10	2CPX010461R9999
Material steel sheet	1	TZ106	2CPX010458R9999
For earthed cabinets	10	TZ106P10	2CPX010459R9999

TwinLine N 55 wall cabinets and floor-standing cabinets

Socket for wall cabinets and standing cabinets



TZW305



TZW310



TZ627P2



TZ323



ZK143

Article	Depth		Width		Unit	Type	Order code		
	mm	FB	mm						
Base, height 50 mm, color RAL 9005									
For TwinLine-G	225	1	300	1	TZG105	2CPX010571R9999			
	225	2	550	1	TZG205	2CPX010573R9999			
	225	3	800	1	TZG305	2CPX010575R9999			
	225	4	1050	1	TZG405	2CPX010577R9999			
	225	5	1300	1	TZG505	2CPX010579R9999			
For TwinLine-L*	275	1	300	1	TZL105	2CPX010581R9999			
	275	2	550	1	TZL205	2CPX010583R9999			
	275	3	800	1	TZL305	2CPX010585R9999			
	275	4	1050	1	TZL405	2CPX010587R9999			
	275	5	1300	1	TZL505	2CPX010589R9999			
For TwinLine-W*	350	1	300	1	TZW105	2CPX010661R9999			
	350	2	550	1	TZW205	2CPX010663R9999			
	350	3	800	1	TZW305	2CPX010665R9999			
	350	4	1050	1	TZW405	2CPX010667R9999			
	350	5	1300	1	TZW505	2CPX010669R9999			
	350	6	1550	1	TZW605	2CPX010671R9999			
Base, height 100 mm, color RAL 9005									
For TwinLine-G	225	1	300	1	TZG110	2CPX010572R9999			
Side knock-outs 1 x M32/M50 or 80 x 80 mm	225	2	550	1	TZG210	2CPX010574R9999			
	225	3	800	1	TZG310	2CPX010576R9999			
	225	4	1050	1	TZG410	2CPX010578R9999			
	225	5	1300	1	TZG510	2CPX010580R9999			
	For TwinLine-L*	275	1	300	1	TZL110	2CPX010582R9999		
Side knock-outs 1 x M32/M50 or 80 x 80 mm	275	2	550	1	TZL210	2CPX010584R9999			
	275	3	800	1	TZL310	2CPX010586R9999			
	275	4	1050	1	TZL410	2CPX010588R9999			
	275	5	1300	1	TZL510	2CPX010590R9999			
	For TwinLine-W*	350	1	300	1	TZW110	2CPX010662R9999		
Side knock-outs 2 x M32/M50 or 2 x 80 x 80 mm	350	2	550	1	TZW210	2CPX010664R9999			
	350	3	800	1	TZW310	2CPX010666R9999			
	350	4	1050	1	TZW410	2CPX010668R9999			
	350	5	1300	1	TZW510	2CPX010670R9999			
	350	6	1550	1	TZW610	2CPX010672R9999			
	Base mounting lug					2	TZ627P2	2CPX010853R9999	
To fasten the base to the cabinet from the outside For base height 50 mm and 100 mm									
Cable clamp rail					1	250	1	TZ321	2CPX010473R9999
For base, height 100 mm									
					2	500	1	TZ322	2CPX010474R9999
					3	750	1	TZ323	2CPX010475R9999
					4	1000	1	TZ324	2CPX010476R9999
					5	1250	1	TZ325	2CPX010477R9999
					6	1500	1	TZ326	2CPX010478R9999
Bolt clamp									
For cable clamp rail									
From 22 to 28 mm					1	ZK143	2CPX060005R9999		
From 40 to 46 mm					1	ZK144	2CPX060006R9999		
From 64 to 70 mm					1	ZK145	2CPX060007R9999		

* For sockets for field widths of 4 or more, a base stiffener is included in the scope of delivery

TwinLine N 55 wall cabinets and floor-standing cabinets

Lock replacement parts



TZ507

TZ508



ZH130

ZH132



ZH134

ZH137



TZ503

TZ504



TZ505

TZ506



TZ510



ZH142

Article	Unit	Type	Order code
Key plates for actuation pins			
For actuation pin 3 mm (standard)* and 5 mm (similar to RAL 9005)	1	TZ507	2CPX010491R9999
For triangular and rectangular actuator pin, as well as for Daimler-Benz insert	1	TZ508	2CPX010492R9999
Actuating pins			
Double bit 3 mm*	1	ZH130	2CPX060490R9999
Double bit 5 mm	1	ZH131	2CPX060491R9999
Triangle 7 mm	1	ZH132	2CPX060492R9999
Triangle 8 mm	1	ZH133	2CPX060493R9999
Rectangular 6 mm	1	ZH134	2CPX060494R9999
Rectangular 7 mm	1	ZH135	2CPX060495R9999
Rectangular 8 mm	1	ZH136	2CPX060496R9999
Daimler-Benz	1	ZH137	2CPX060497R9999
L-handle			
With key plate, with lock	1	TZ503	2CPX010487R9999
With key plate, without lock	1	TZ504	2CPX010488R9999
T-handle			
With key plate, with lock	1	TZ505	2CPX010489R9999
With key plate, without lock	1	TZ506	2CPX010490R9999
Swivel handle	1	TZ510	2CPX010494R9999
For profile half cylinder 40 mm (30/10) with sealing cap			
Shutter insert	1	ZH142	2CPX060502R9999
Instead of a profile half cylinder for swivel handle TZ510			

* Replacement part included in the scope of delivery

TwinLine N 55 wall cabinets and floor-standing cabinets

Lock replacement parts



ZH91



ZH160



ZH157



ZH162



ZH165



TZ206



TZ511



TZ501



TZ502

Article	Unit	Type	Order code
Universal key	1	ZH91	2CPX066091R9999
Double bit 3 mm/5 mm			
Triangular 8 mm, square 6 mm/8 mm			
Double bit 3 mm*	1	ZH160	2CPX060660R9999
Double bit 5 mm	1	ZH161	2CPX060661R9999
Triangle 7 mm	1	ZH157	2CPX060657R9999
Triangle 8 mm	1	ZH158	2CPX060658R9999
Rectangular 6 mm	1	ZH162	2CPX060662R9999
Rectangular 7 mm	1	ZH163	2CPX060663R9999
Rectangular 8 mm	1	ZH164	2CPX060664R9999
Daimler-Benz	1	ZH165	2CPX060665R9999
Rod lock			
4 RE = 600 mm with lock body*	1	TZ204	2CPX010462R9999
5 RE = 750 mm with lock body*	1	TZ205	2CPX010463R9999
6 RE = 900 mm with lock body*	1	TZ206	2CPX010464R9999
7 RE = 1050 mm with lock body*	1	TZ207	2CPX010465R9999
8 RE = 1200 mm with lock body*	1	TZ208	2CPX010466R9999
9 RE = 1350 mm with lock body*	1	TZ209	2CPX010467R9999
12 RE = 1800 mm with lock body*	1	TZ212	2CPX010468R9999
Rod guide*	1	TZ511	2CPX010495R9999
Bumper shoe*	1	TZ501	2CPX010485R9999
For rod lock			
Rubber seal *	1	TZ502	2CPX010486R9999
For double door			

* Replacement part included in the scope of delivery

TwinLine N 55 wall cabinets and floor-standing cabinets

General accessories



TZ601



TZ604



TZ605



TZ606



TZ631P10



TZ632P10

Article	Unit	Unmounted		Installed in the cabinet*	
		Type	Order code	Type	Order code
Mounting strips*¹					
For mounting frame holder					
For TwinLine-G	1	TZ601	2CPX010779R9999	TZ601A	2CPX010787R9999
	10	TZ601P10	2CPX010814R9999	-	-
	100	TZ601P100	2CPX010815R9999	-	-
For TwinLine-L	1	TZ602	2CPX010780R9999	TZ602A	2CPX010788R9999
	10	TZ602P10	2CPX010816R9999	-	-
	100	TZ602P100	2CPX010817R9999	-	-
For TwinLine-W	1	TZ603	2CPX010781R9999	TZ603A	2CPX010789R9999
	10	TZ603P10	2CPX010818R9999	-	-
	100	TZ603P100	2CPX010819R9999	-	-
Mounting frame holder middle*¹, incl. mounting bolts					
For expansion with WR and EDF mounting frame or mounting plates side by side					
	1	TZ604	2CPX010782R9999	TZ604A	2CPX010790R9999
	10	TZ604P10	2CPX010820R9999	-	-
	100	TZ604P100	2CPX010821R9999	-	-
Mounting frame holder*¹ left or right, incl. mounting bolts					
For expansion with WR and EDF mounting frame or mounting plates or middle support rails					
	1	TZ605	2CPX010783R9999	TZ605A	2CPX010791R9999
	10	TZ605P10	2CPX010822R9999	-	-
	100	TZ605P100	2CPX010823R9999	-	-
EDF adapter*¹					
For mounting frame holder					
For expansion with EDF mounting frame	1	TZ606	2CPX010784R9999	TZ606A	2CPX010792R9999
	100	TZ606P100	2CPX010825R9999	-	-
Mounting bolt*²					
For TZ604 mounting frame holder in the middle					
	10	TZ631P10	2CPX010930R9999	-	-
Mounting bolt*²					
For TZ605 mounting frame holder right or left					
	10	TZ632P10	2CPX010931R9999	-	-

* Only in conjunction with the factory-installed meter and distributor fields, combination kits or CombiLine modules

*¹ Additionally required depending on the expansion; see below for details

*² Included in the scope of delivery

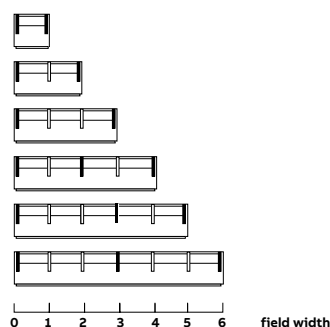

Position of the mounting strips with mounting frame holder
Top view

Factory-installed
Mounting strips with left and right mounting frame brackets, as well as an additional mounting strip for cabinets with field width 4 and above

Can be retrofitted
Depending on the expansion, additional mounting strips, mounting frame holder and EDF adapter are required

TwinLine N 55 wall cabinets and floor-standing cabinets

General accessories



TZ313



TZ433

Article	Unit	Unmounted		Installed in the cabinet*	
		Type	Order code	Type	Order code
Cable clamp rails					
For mounting in the cabinet For TwinLine-L and TwinLine-W					
Field width 1 = 250 mm	1	TZ311	2CPX010469R9999	TZ311A	2CPX010808R9999
Field width 2 = 500 mm	1	TZ312	2CPX010470R9999	TZ312A	2CPX010809R9999
Field width 3 = 750 mm	1	TZ313	2CPX010471R9999	TZ313A	2CPX010810R9999
Field width 4 = 1000 mm	1	TZ314	2CPX010472R9999	TZ314A	2CPX010811R9999
Field width 5 = 1250 mm	1	TZ315	2CPX010785R9999	TZ315A	2CPX010812R9999
Field width 6 = 1500 mm	1	TZ316	2CPX010786R9999	TZ316A	2CPX010813R9999
Middle support rails					
For mounting in the cabinet, mounting brackets are included in the scope of delivery 2 mounting strips are additionally needed (TZ601, TZ602 or TZ603, depending on the cabinet depth).					
Field width 1 = 250 mm	1	TZ431	2CPX010960R9999	TZ431A	2CPX010966R9999
Field width 2 = 500 mm	1	TZ432	2CPX010961R9999	TZ432A	2CPX010967R9999
Field width 3 = 750 mm	1	TZ433	2CPX010962R9999	TZ433A	2CPX010968R9999
Field width 4 = 1000 mm	1	TZ434	2CPX010963R9999	TZ434A	2CPX010969R9999
Field width 5 = 1250 mm	1	TZ435	2CPX010964R9999	TZ435A	2CPX010970R9999
Field width 6 = 1500 mm	1	TZ436	2CPX010965R9999	TZ436A	2CPX010971R9999

* Only in conjunction with the factory-installed meter and distributor fields, combination kits or CombiLine modules



ZW125P4



TZ615P4



TZ609



TZ608



TZ607



TZ630P10

Article	Unit	Type	Order code
External mounting lugs* To mount the cabinet on the wall	4	ZW125P4	2CPX062461R9999
Transport eye bolts	4	TZ615P4	2CPX010510R9999
IP55 protective frame for cabinet stacking			
Required for insulated cabinets	1	TZ609	2CPX010504R9999
Required for earthed cabinets	1	TZ626	2CPX010778R9999
IP55 Connection set for cabinet stacking			
For wall cabinets side by side or on top of each other order 1 x TZ608 For standing cabinets order 2 x TZ608	1	TZ608	2CPX010503R9999
Door hinge 180 degrees* Color RAL 9005	1	TZ607	2CPX010502R9999
Pin for door hinge 180 degrees*	10	TZ630P10	2CPX010929R9999

* Included in the scope of delivery

TwinLine N 55 wall cabinets and floor-standing cabinets

General accessories



ZL8



TZB004



TZ617P10



TZ628P10



ZA6



ZA5



ZA123



TZ650



ZA16



ZA116

Article	Unit	Type	Order code
Door earthing set 10 mm ²	1	ZL8	2CPX038001R9999
Door stiffening profile For cabinet height 4 and 5 RE	1	TZB004	2CPX010856R9999
Sealing plugs/connection plugs*1	10	TZ617P10	2CPX010512R9999
Blind plug* For hinge break	10	TZ628P10	2CPX010854R9999
DIN A4 plan pocket Self-adhesive with transparent sleeve and reinforced back	1	ZA6	2CPX038227R9999
	10	ZA6P10	2CPX062380R9999
	10	ZA61P10	2CPX062375R9999
DIN A4 plan pocket Self-adhesive	1	ZA13	2CPX038233R9999
	10	ZA13P10	2CPX062381R9999
DIN A5 plan pocket Self-adhesive	1	ZA5	2CPX038228R9999
	10	ZA5P10	2CPX062382R9999
Plan pocket holder For ZA13 plan pocket to be screwed to the door reinforcing elements	1	ZA123	2CPX038471R9999
For ZA5 plan pocket to be screwed to the door reinforcing elements	1	ZA125	2CPX038472R9999
LED control cabinet light		TZ650	2CPX010972R9999
Spray can Color RAL 7035, 150 ml	1	ZA16	2CPX038235R9999
Touch-up stick Color RAL 7035, 12 ml	1	ZA116	2CPX039042R9999

* Included in the scope of delivery

TwinLine N 55 wall cabinets and floor-standing cabinets

Accessories meter applications



TZ614



TZ610



TZ616



TZ618

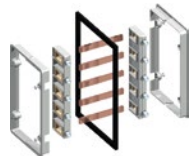



TZ620



TZ622



TZ623

Article	Unit	Unmounted		Installed in the cabinet*	
		Type	Order code	Type	Order code
Cover strip*¹ For meter field installation to cover the mounting points of the middle support rail in the insulated standing cabinet					
For TwinLine-G	1	TZ612	2CPX010507R9999	TZ612A	2CPX010796R9999
For TwinLine-L	1	TZ613	2CPX010508R9999	TZ613A	2CPX010797R9999
For TwinLine-W	1	TZ614	2CPX010509R9999	TZ614A	2CPX010798R9999
Inner cladding*¹ For meter fields, depth = 225 - 350 mm Additional profile for meter fields with 150 mm connection compartment at the top, in the insulated cabinet	1	TZ610	2CPX010505R9999	TZ610A	2CPX010795R9999
Mounting set For installation of meter fields in standing cabinets per field width (250 mm) additionally order 1 x TZ616	1	TZ616	2CPX010511R9999	TZ616A	2CPX010799R9999
Touch protection for earthed cabinets					
For single-level meter fields	1	TZ618	2CPX010673R9999	TZ618A	2CPX010800R9999
For dual-level meter fields	1	TZ619	2CPX010674R9999	TZ619A	2CPX010801R9999
Cabinet-cabinet connector					
5-pole for Cu 12 x 5 mm	1	TZ620	2CPX010793R9999	-	-
5-pole for Cu 2 x 12 x 5 mm	1	TZ621	2CPX010794R9999	-	-
Steel-sheet feed-in housing IP55, RAL7035  For TwinLine meter cabinets, bottom mounted For cables up to max. 120 mm ² For splicing the access lines With cable clamp rail H x W x D: 500 x 300 x 225 mm	1	TZ622	2CPX010448R9999	-	-
Steel-sheet feed-in housing IP55, RAL7035  For TwinLine meter cabinets, side mounted For cables up to max. 120 mm ² For splicing the access lines With cable clamp rail H x W x D: 500 x 300 x 225 mm Busbar system Cu 12 x 5 mm, 5-pole with 1 connector to the busbar system of the meter field	1	TZ623	2CPX010449R9999	-	-

> For further information on feed-in housings, see chapter on meter cabinets

* Only in conjunction with the factory-installed meter and distributor fields, combination kits or CombiLine modules

TwinLine N 55 wall cabinets and floor-standing cabinets

Steel-sheet doors with door hinges 180 degrees

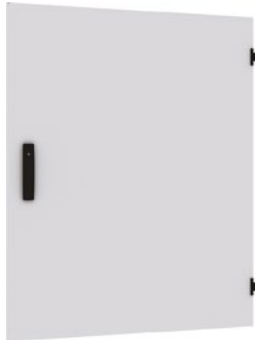

TZB306

Height		Width		Remark	Type	Order code
RE	BH	FB				
4	0	1			TZB104	2CPX010528R9999
		2			TZB204	2CPX010535R9999
		3			TZB304	2CPX010542R9999
		4*	Left door	TZB204L	2CPX010549R9999	
			Right door	TZB204R	2CPX010550R9999	
		5*	Left door	TZB304L	2CPX010563R9999	
Right door	TZB204R		2CPX010550R9999			
5	1	1			TZB105	2CPX010529R9999
		2			TZB205	2CPX010536R9999
		3			TZB305	2CPX010543R9999
		4*	Left door	TZB205L	2CPX010551R9999	
			Right door	TZB205R	2CPX010552R9999	
		5*	Left door	TZB305L	2CPX010564R9999	
Right door	TZB205R		2CPX010552R9999			
6	2	1			TZB106	2CPX010530R9999
		2			TZB206	2CPX010537R9999
		3			TZB306	2CPX010544R9999
		4*	Left door	TZB206L	2CPX010553R9999	
			Right door	TZB206R	2CPX010554R9999	
		5*	Left door	TZB306L	2CPX010565R9999	
Right door	TZB206R		2CPX010554R9999			
7	3	1			TZB107	2CPX010531R9999
		2			TZB207	2CPX010538R9999
		3			TZB307	2CPX010545R9999
		4*	Left door	TZB207L	2CPX010555R9999	
			Right door	TZB207R	2CPX010556R9999	
		5*	Left door	TZB307L	2CPX010566R9999	
Right door	TZB207R		2CPX010556R9999			
8	4	1			TZB108	2CPX010532R9999
		2			TZB208	2CPX010539R9999
		3			TZB308	2CPX010546R9999
		4*	Left door	TZB208L	2CPX010557R9999	
			Right door	TZB208R	2CPX010558R9999	
		5*	Left door	TZB308L	2CPX010567R9999	
Right door	TZB208R		2CPX010558R9999			
9	5	1			TZB109	2CPX010533R9999
		2			TZB209	2CPX010540R9999
		3			TZB309	2CPX010547R9999
		4*	Left door	TZB209L	2CPX010559R9999	
			Right door	TZB209R	2CPX010560R9999	
		5*	Left door	TZB309L	2CPX010568R9999	
Right door	TZB209R		2CPX010560R9999			
12	8	1			TZB112	2CPX010534R9999
		2			TZB212	2CPX010541R9999
		3			TZB312	2CPX010548R9999
		4*	Left door	TZB212L	2CPX010561R9999	
			Right door	TZB212R	2CPX010562R9999	
		5*	Left door	TZB312L	2CPX010569R9999	
			Right door	TZB212R	2CPX010562R9999	
		6*	Left door	TZB312L	2CPX010569R9999	
Right door	TZB312R		2CPX010570R9999			

*Double doors field width 4 and over

TwinLine N 55 wall cabinets and floor-standing cabinets

Doors with viewing glass and door hinges 180 degrees



TZT206

Height		Width		Remark*1	Type	Order code
RE	BH	FB				
4	0	2			TZT204	2CPX010860R9999
		3			TZT304	2CPX010867R9999
		4*		Left door	TZT204L	2CPX010874R9999
				Right door	TZT204R	2CPX010875R9999
		5*		Left door	TZT304L	2CPX010888R9999
				Right door	TZT204R	2CPX010875R9999
5	1	2			TZT205	2CPX010861R9999
		3			TZT305	2CPX010868R9999
		4*		Left door	TZT205L	2CPX010876R9999
				Right door	TZT205R	2CPX010877R9999
		5*		Left door	TZT305L	2CPX010889R9999
				Right door	TZT205R	2CPX010877R9999
6	2	2			TZT206	2CPX010862R9999
		3			TZT306	2CPX010869R9999
		4*		Left door	TZT206L	2CPX010878R9999
				Right door	TZT206R	2CPX010879R9999
		5*		Left door	TZT306L	2CPX010890R9999
				Right door	TZT206R	2CPX010879R9999
7	3	2			TZT207	2CPX010863R9999
		3			TZT307	2CPX010870R9999
		4*		Left door	TZT207L	2CPX010880R9999
				Right door	TZT207R	2CPX010881R9999
		5*		Left door	TZT307L	2CPX010891R9999
				Right door	TZT207R	2CPX010881R9999
8	4	2			TZT208	2CPX010864R9999
		3			TZT308	2CPX010871R9999
		4*		Left door	TZT208L	2CPX010882R9999
				Right door	TZT208R	2CPX010883R9999
		5*		Left door	TZT308L	2CPX010892R9999
				Right door	TZT208R	2CPX010883R9999
9	5	2			TZT209	2CPX010865R9999
		3			TZT309	2CPX010872R9999
		4*		Left door	TZT209L	2CPX010884R9999
				Right door	TZT209R	2CPX010885R9999
		5*		Left door	TZT309L	2CPX010893R9999
				Right door	TZT209R	2CPX010885R9999
12	8	2			TZT212	2CPX010866R9999
		3			TZT312	2CPX010873R9999
		4*		Left door	TZT212L	2CPX010886R9999
				Right door	TZT212R	2CPX010887R9999
		5*		Left door	TZT312L	2CPX010894R9999
				Right door	TZT212R	2CPX010887R9999
		6*		Left door	TZT312L	2CPX010894R9999
				Right door	TZT312R	2CPX010895R9999

*Double doors field width 4 and over

TwinLine N 55 wall cabinets and floor-standing cabinets

Touch protection

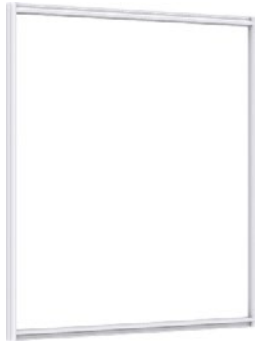

TZP306

Height		Width	Touch protection not mounted		Touch protection Installed in the cabinet*		
RE	BH		FB	Type	Order code	Type	Order code
4	0		1	TZP104	2CPX010625R9999	TZP104A	2CPX010708R9999
			2	TZP204	2CPX010632R9999	TZP204A	2CPX010715R9999
			3	TZP304	2CPX010639R9999	TZP304A	2CPX010722R9999
			4	TZP404	2CPX010646R9999	TZP404A	2CPX010729R9999
			5	TZP504	2CPX010653R9999	TZP504A	2CPX010736R9999
5	1		1	TZP105	2CPX010626R9999	TZP105A	2CPX010709R9999
			2	TZP205	2CPX010633R9999	TZP205A	2CPX010716R9999
			3	TZP305	2CPX010640R9999	TZP305A	2CPX010723R9999
			4	TZP405	2CPX010647R9999	TZP405A	2CPX010730R9999
			5	TZP505	2CPX010654R9999	TZP505A	2CPX010737R9999
6	2		1	TZP106	2CPX010627R9999	TZP106A	2CPX010710R9999
			2	TZP206	2CPX010634R9999	TZP206A	2CPX010717R9999
			3	TZP306	2CPX010641R9999	TZP306A	2CPX010724R9999
			4	TZP406	2CPX010648R9999	TZP406A	2CPX010731R9999
			5	TZP506	2CPX010655R9999	TZP506A	2CPX010738R9999
7	3		1	TZP107	2CPX010628R9999	TZP107A	2CPX010711R9999
			2	TZP207	2CPX010635R9999	TZP207A	2CPX010718R9999
			3	TZP307	2CPX010642R9999	TZP307A	2CPX010725R9999
			4	TZP407	2CPX010649R9999	TZP407A	2CPX010732R9999
			5	TZP507	2CPX010656R9999	TZP507A	2CPX010739R9999
8	4		1	TZP108	2CPX010629R9999	TZP108A	2CPX010712R9999
			2	TZP208	2CPX010636R9999	TZP208A	2CPX010719R9999
			3	TZP308	2CPX010643R9999	TZP308A	2CPX010726R9999
			4	TZP408	2CPX010650R9999	TZP408A	2CPX010733R9999
			5	TZP508	2CPX010657R9999	TZP508A	2CPX010740R9999
9	5		1	TZP109	2CPX010630R9999	TZP109A	2CPX010713R9999
			2	TZP209	2CPX010637R9999	TZP209A	2CPX010720R9999
			3	TZP309	2CPX010644R9999	TZP309A	2CPX010727R9999
			4	TZP409	2CPX010651R9999	TZP409A	2CPX010734R9999
			5	TZP509	2CPX010658R9999	TZP509A	2CPX010741R9999
12	8		1	TZP112	2CPX010631R9999	TZP112A	2CPX010714R9999
			2	TZP212	2CPX010638R9999	TZP212A	2CPX010721R9999
			3	TZP312	2CPX010645R9999	TZP312A	2CPX010728R9999
			4	TZP412	2CPX010652R9999	TZP412A	2CPX010735R9999
			5	TZP512	2CPX010659R9999	TZP512A	2CPX010742R9999
			6	TZP612	2CPX010660R9999	TZP612A	2CPX010743R9999

* Only in conjunction with the factory-installed meter and distributor fields, combination kits or CombiLine modules
 > The touch protection in the insulated cabinet is included in the scope of delivery

TwinLine N 55 wall cabinets and floor-standing cabinets

Mounting plates, sheet steel 2 mm, galvanized

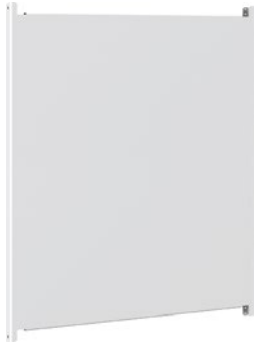

TZM306

Height		Width	Mounting plate not mounted		Mounting plate mounted in the cabinet*1	
RE	BH	FB	Type	Order code	Type	Order code
4	0	1	TZM104	2CPX010591R9999	TZM104A	2CPX010744R9999
		2	TZM204	2CPX010598R9999	TZM204A	2CPX010750R9999
		3	TZM304	2CPX010605R9999	TZM304A	2CPX010756R9999
		4	TZM404	2CPX010612R9999	TZM404A	2CPX010762R9999
		5	TZM504	2CPX010619R9999	TZM504A	2CPX010768R9999
5	1	1	TZM105	2CPX010592R9999	TZM105A	2CPX010745R9999
		2	TZM205	2CPX010599R9999	TZM205A	2CPX010751R9999
		3	TZM305	2CPX010606R9999	TZM305A	2CPX010757R9999
		4	TZM405	2CPX010613R9999	TZM405A	2CPX010763R9999
		5	TZM505	2CPX010620R9999	TZM505A	2CPX010769R9999
6	2	1	TZM106	2CPX010593R9999	TZM106A	2CPX010746R9999
		2	TZM206	2CPX010600R9999	TZM206A	2CPX010752R9999
		3	TZM306	2CPX010607R9999	TZM306A	2CPX010758R9999
		4	TZM406	2CPX010614R9999	TZM406A	2CPX010764R9999
		5	TZM506	2CPX010621R9999	TZM506A	2CPX010770R9999
7	3	1	TZM107	2CPX010594R9999	TZM107A	2CPX010747R9999
		2	TZM207	2CPX010601R9999	TZM207A	2CPX010753R9999
		3	TZM307	2CPX010608R9999	TZM307A	2CPX010759R9999
		4	TZM407	2CPX010615R9999	TZM407A	2CPX010765R9999
		5	TZM507	2CPX010622R9999	TZM507A	2CPX010771R9999
8	4	1	TZM108	2CPX010595R9999	TZM108A	2CPX010748R9999
		2	TZM208	2CPX010602R9999	TZM208A	2CPX010754R9999
		3	TZM308	2CPX010609R9999	TZM308A	2CPX010760R9999
		4	TZM408	2CPX010616R9999	TZM408A	2CPX010766R9999
		5	TZM508	2CPX010623R9999	TZM508A	2CPX010772R9999
9	5	1	TZM109	2CPX010596R9999	TZM109A	2CPX010749R9999
		2	TZM209	2CPX010603R9999	TZM209A	2CPX010755R9999
		3	TZM309	2CPX010610R9999	TZM309A	2CPX010761R9999
		4	TZM409	2CPX010617R9999	TZM409A	2CPX010767R9999
		5	TZM509	2CPX010624R9999	TZM509A	2CPX010773R9999
12	8	1	TZM112	2CPX010940R9999	TZM112A	2CPX010944R9999
		2	TZM212	2CPX010941R9999	TZM212A	2CPX010945R9999
		3	TZM312	2CPX010942R9999	TZM312A	2CPX010946R9999
		4	TZM412	2CPX010943R9999	TZM412A	2CPX010947R9999
		5*	TZM212	2CPX010941R9999	TZM212A	2CPX010945R9999
			TZM312	2CPX010942R9999	TZM312A	2CPX010946R9999
		6*	TZM312	2CPX010942R9999	TZM312A	2CPX010946R9999
	TZM312	2CPX010942R9999	TZM312A	2CPX010946R9999		

* In a cabinet with field width 5 and above, two separate mounting plates

*1 Mounting plate installed at the factory, only in conjunction with empty cabinet

TwinLine N 55 wall cabinets and floor-standing cabinets

Dimensions Twin Line-G, cabinet depth 225 mm, \perp \square

Front view
Wall cabinet and standing cabinet
External dimensions/
internal dimensions

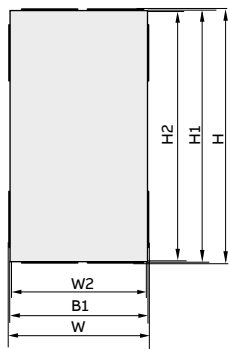

Front view
Wall cabinet
Dimensions wall mounting

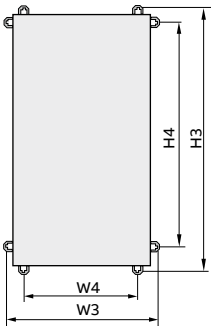

Front view
Standalone cabinet
Dimensions wall mounting

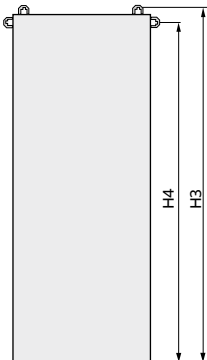

Front view
External mounting
Detail

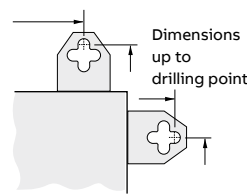

Side view
With/without door

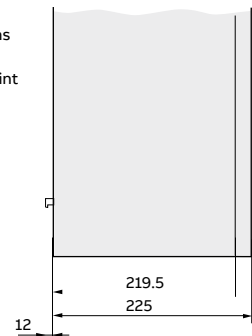

Height	Width		Type	External dimensions		Internal dimensions		External dimensions with flange knock-out		Dimensions wall mounting			
	RE	BH		FB	H1	B1	H2	W2	H	W	H3	W3	H4
Twin Line-G cabinets \perp \square													
4	0	1	TG104	650	300	602	252	654	304	693.5	328	542	192
		2	TG204	650	550	602	502	654	554	693.5	578	542	442
		3	TG304	650	800	602	752	654	804	693.5	828	542	692
		4	TG404	650	1050	602	1002	654	1054	693.5	1078	542	942
		5	TG504	650	1300	602	1252	654	1304	693.5	1328	542	1192
5	1	1	TG105	800	300	752	252	804	304	843.5	328	692	192
		2	TG205	800	550	752	502	804	554	843.5	578	692	442
		3	TG305	800	800	752	752	804	804	843.5	828	692	692
		4	TG405	800	1050	752	1002	804	1054	843.5	1078	692	942
		5	TG505	800	1300	752	1252	804	1304	843.5	1328	692	1192
6	2	1	TG106	950	300	902	252	954	304	993.5	328	842	192
		2	TG206	950	550	902	502	954	554	993.5	578	842	442
		3	TG306	950	800	902	752	954	804	993.5	828	842	692
		4	TG406	950	1050	902	1002	954	1054	993.5	1078	842	942
		5	TG506	950	1300	902	1252	954	1304	993.5	1328	842	1192
7	3	1	TG107	1100	300	1052	252	1104	304	1143.5	328	992	192
		2	TG207	1100	550	1052	502	1104	554	1143.5	578	992	442
		3	TG307	1100	800	1052	752	1104	804	1143.5	828	992	692
		4	TG407	1100	1050	1052	1002	1104	1054	1143.5	1078	992	942
		5	TG507	1100	1300	1052	1252	1104	1304	1143.5	1328	992	1192
8	4	1	TG108	1250	300	1202	252	1254	304	1293.5	328	1142	192
		2	TG208	1250	550	1202	502	1254	554	1293.5	578	1142	442
		3	TG308	1250	800	1202	752	1254	804	1293.5	828	1142	692
		4	TG408	1250	1050	1202	1002	1254	1054	1293.5	1078	1142	942
		5	TG508	1250	1300	1202	1252	1254	1304	1293.5	1328	1142	1192
9	5	1	TG109	1400	300	1352	252	1404	304	1443.5	328	1292	192
		2	TG209	1400	550	1352	502	1404	554	1443.5	578	1292	442
		3	TG309	1400	800	1352	752	1404	804	1443.5	828	1292	692
		4	TG409	1400	1050	1352	1002	1404	1054	1443.5	1078	1292	942
		5	TG509	1400	1300	1352	1252	1404	1304	1443.5	1328	1292	1192
Twin Line-G standing cabinets \perp \square													
12	8	1	TG112	1850	300	1802	252	1854	304	1872	328	1796	192
		2	TG212	1850	550	1802	502	1854	554	1872	578	1796	442
		3	TG312	1850	800	1802	752	1854	804	1872	828	1796	692
		4	TG412	1850	1050	1802	1002	1854	1054	1872	1078	1796	942
		5	TG512	1850	1300	1802	1252	1854	1304	1872	1328	1796	1192

> Dimensions in mm

TwinLine N 55 wall cabinets and floor-standing cabinets

Weights power loss TwinLine-G, cabinet depth 225 mm, $\frac{\perp}{\square}$

Type of installation
Cabinet on the wall

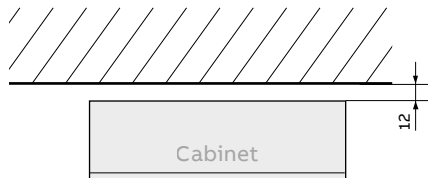

Type of installation
Cabinet combination
side by side

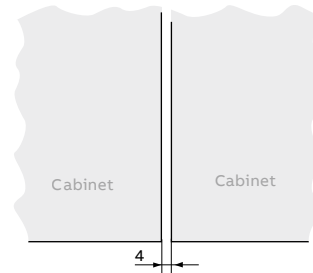

Type of installation
Cabinet combination
one on top of the other

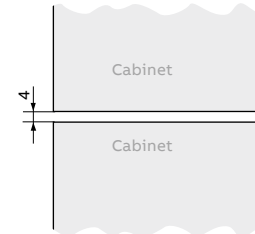

Height		Width		$\frac{\perp}{\square}$ Power dissipation in watts* at overtemperature Δt 20K	$\frac{\perp}{\square}$ Cabinet weight in kg		\square Cabinet weight in kg		Max. installation weight in kg
RE	BH	FB	Type		With door	Without door	With door	Without door	
Twin Line-G cabinets $\frac{\perp}{\square}$									
4	0	1	TG104	35.80	11.40	7.43	12.89	8.92	15.00
		2	TG204	57.00	16.17	9.95	17.80	11.59	30.00
		3	TG304	61.00	21.02	12.47	22.80	14.25	45.00
		4	TG404	82.30	28.03	15.54	29.95	17.46	60.00
		5	TG504	107.80	32.86	18.07	34.92	20.13	75.00
5	1	1	TG105	42.30	13.17	8.40	14.86	10.10	20.50
		2	TG205	66.10	18.72	11.22	20.60	13.11	41.00
		3	TG305	71.00	24.29	14.03	26.37	16.11	61.50
		4	TG405	99.00	32.45	17.40	34.71	19.67	82.50
		5	TG505	131.20	38.03	20.22	40.49	22.68	103.00
6	2	1	TG106	48.80	14.89	9.37	16.78	11.26	26.00
		2	TG206	52.60	21.23	12.43	23.36	14.61	52.50
		3	TG306	80.90	27.55	15.59	29.92	17.37	78.50
		4	TG406	115.10	36.84	19.25	39.46	21.86	105.00
		5	TG506	153.70	43.18	22.36	46.03	25.09	131.00
7	3	1	TG107	55.40	17.14	10.72	19.23	12.81	31.50
		2	TG207	61.40	24.36	14.25	26.74	16.64	63.50
		3	TG307	93.50	31.56	17.79	34.23	20.46	95.50
		4	TG407	133.70	42.23	21.87	45.19	24.83	127.50
		5	TG507	174.30	49.44	25.41	52.69	28.66	159.00
8	4	1	TG108	61.80	18.90	11.68	21.20	13.98	37.50
		2	TG208	69.30	26.87	15.51	29.50	18.15	75.00
		3	TG308	102.90	34.82	19.34	37.80	22.31	112.50
		4	TG408	150.30	46.64	23.72	50.01	27.10	150.00
		5	TG508	193.30	54.59	27.55	58.31	31.27	187.50
9	5	1	TG109	68.20	20.66	12.65	23.15	15.14	43.00
		2	TG209	79.10	29.38	16.77	32.23	19.65	86.00
		3	TG309	119.30	38.08	20.89	41.35	24.16	129.00
		4	TG409	157.50	51.04	25.57	54.77	29.31	172.50
		5	TG509	208.80	59.74	29.69	63.87	33.82	215.50
TwinLine-G standing cabinets $\frac{\perp}{\square}$									
12	8	1	TG112	64.00	26.17	15.78	28.89	18.50	60.00
		2	TG212	113.00	40.22	23.81	43.73	27.31	120.00
		3	TG312	162.60	51.87	29.54	56.17	33.84	180.00
		4	TG412	202.10	69.40	36.27	74.59	41.46	240.00
		5	TG512	230.80	80.19	41.11	86.17	47.09	300.00

* General remarks on the determination of the power dissipation: Values in accordance with DIN EN 61439-1 section 10.10.4.2.2; ambient temperature 35 °C, internal temperature 55 °C, it must be guaranteed that the permissible operating medium temperature is not exceeded; height of the installation location \leq 2000 m above sea level; shape of inner divider = 1; side walls not covered

TwinLine N 55 wall cabinets and floor-standing cabinets

Dimensions TwinLine-L, cabinet depth 275 mm, $\perp \square$

Front view
Wall cabinet and standing cabinet
External dimensions/
internal dimensions

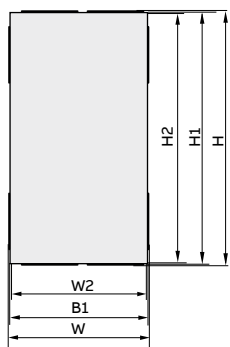

Front view
Wall cabinet
Dimensions wall mounting

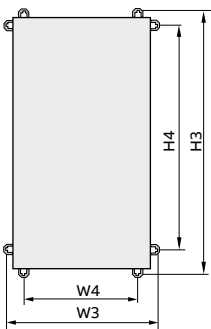

Front view
Standalone cabinet
Dimensions wall mounting

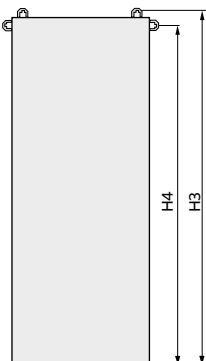

Front view
External mounting
Detail

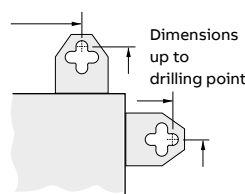

Side view
With/without door

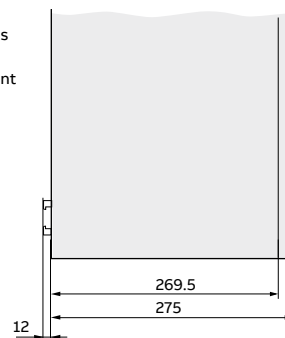

				External dimensions									
Height		Width		External dimensions		Internal dimensions		with flange knock-out		Dimensions wall mounting			
RE	BH	FB	Type	H1	B1	H2	W2	H	W	H3	W3	H4	W4
TwinLine-L wall cabinets $\perp \square$													
4	0	1	TL104	650	300	602	252	654	304	693.5	328	542	192
		2	TL204	650	550	602	502	654	554	693.5	578	542	442
		3	TL304	650	800	602	752	654	804	693.5	828	542	692
		4	TL404	650	1050	602	1002	654	1054	693.5	1078	542	942
		5	TL504	650	1300	602	1252	654	1304	693.5	1328	542	1192
5	1	1	TL105	800	300	752	252	804	304	843.5	328	692	192
		2	TL205	800	550	752	502	804	554	843.5	578	692	442
		3	TL305	800	800	752	752	804	804	843.5	828	692	692
		4	TL405	800	1050	752	1002	804	1054	843.5	1078	692	942
		5	TL505	800	1300	752	1252	804	1304	843.5	1328	692	1192
6	2	1	TL106	950	300	902	252	954	304	993.5	328	842	192
		2	TL206	950	550	902	502	954	554	993.5	578	842	442
		3	TL306	950	800	902	752	954	804	993.5	828	842	692
		4	TL406	950	1050	902	1002	954	1054	993.5	1078	842	942
		5	TL506	950	1300	902	1252	954	1304	993.5	1328	842	1192
7	3	1	TL107	1100	300	1052	252	1104	304	1143.5	328	992	192
		2	TL207	1100	550	1052	502	1104	554	1143.5	578	992	442
		3	TL307	1100	800	1052	752	1104	804	1143.5	828	992	692
		4	TL407	1100	1050	1052	1002	1104	1054	1143.5	1078	992	942
		5	TL507	1100	1300	1052	1252	1104	1304	1143.5	1328	992	1192
8	4	1	TL108	1250	300	1202	252	1254	304	1293.5	328	1142	192
		2	TL208	1250	550	1202	502	1254	554	1293.5	578	1142	442
		3	TL308	1250	800	1202	752	1254	804	1293.5	828	1142	692
		4	TL408	1250	1050	1202	1002	1254	1054	1293.5	1078	1142	942
		5	TL508	1250	1300	1202	1252	1254	1304	1293.5	1328	1142	1192
9	5	1	TL109	1400	300	1352	252	1404	304	1443.5	328	1292	192
		2	TL209	1400	550	1352	502	1404	554	1443.5	578	1292	442
		3	TL309	1400	800	1352	752	1404	804	1443.5	828	1292	692
		4	TL409	1400	1050	1352	1002	1404	1054	1443.5	1078	1292	942
		5	TL509	1400	1300	1352	1252	1404	1304	1443.5	1328	1292	1192
TwinLine-L standing cabinets $\perp \square$													
12	8	1	TL112	1850	300	1802	252	1854	304	1872	328	1796	192
		2	TL212	1850	550	1802	502	1854	554	1872	578	1796	442
		3	TL312	1850	800	1802	752	1854	804	1872	828	1796	692
		4	TL412	1850	1050	1802	1002	1854	1054	1872	1078	1796	942
		5	TL512	1850	1300	1802	1252	1854	1304	1872	1328	1796	1192

> Dimensions in mm

18

TwinLine N 55 wall cabinets and floor-standing cabinets

Weights and power dissipation TwinLine-L, cabinet depth 275 mm, \perp \square

Type of installation
Cabinet on the wall

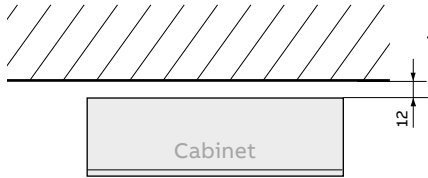

Type of installation
Cabinet combination
side by side

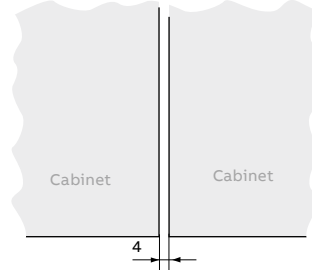

Type of installation
Cabinet combination
one on top of the other

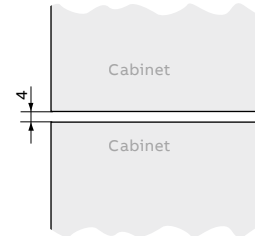

Height RE	Width		Type	\perp / \square Power dissipation in watts* at overtemperature Δt 20K	\perp Cabinet weight in kg		\square Cabinet weight in kg		Max. installation weight in kg
	BH	FB			With door	Without door	With door	Without door	
TwinLine-L wall cabinets \perp \square									
4	0	1	TL104	38.80	12.25	8.28	13.80	9.83	15.00
		2	TL204	60.80	17.23	10.97	18.94	12.72	30.00
		3	TL304	67.10	22.30	13.75	24.16	15.61	45.00
		4	TL404	89.70	29.54	17.06	31.54	19.08	60.00
		5	TL504	116.80	34.59	19.79	36.76	21.97	75.00
5	1	1	TL105	45.80	14.13	9.37	15.89	11.13	20.50
		2	TL205	70.20	19.90	12.40	21.86	14.36	41.00
		3	TL305	78.00	25.68	15.43	27.86	17.60	61.50
		4	TL405	108.90	34.08	19.03	36.45	21.38	82.50
		5	TL505	145.10	39.87	22.06	42.46	24.64	103.00
6	2	1	TL106	52.80	15.97	10.45	17.94	12.35	26.00
		2	TL206	59.90	22.53	13.78	24.75	16.00	52.50
		3	TL306	89.80	29.06	17.10	31.54	19.58	78.50
		4	TL406	128.10	38.59	21.00	41.32	23.73	105.00
		5	TL506	168.00	45.14	24.32	48.09	27.28	131.00
7	3	1	TL107	59.80	18.34	11.89	20.51	14.09	31.50
		2	TL207	65.20	25.77	15.67	28.25	18.15	63.50
		3	TL307	102.80	33.19	19.41	35.97	22.20	95.50
		4	TL407	145.70	44.10	23.74	47.19	27.14	127.50
		5	TL507	189.20	51.51	27.48	54.91	30.88	159.00
8	4	1	TL108	66.70	20.22	13.00	22.61	15.39	37.50
		2	TL208	74.40	28.40	17.04	31.14	19.78	75.00
		3	TL308	117.80	36.57	21.09	39.66	24.18	112.50
		4	TL408	163.70	48.62	25.70	52.14	29.22	150.00
		5	TL508	207.70	56.79	29.75	60.65	33.61	187.50
9	5	1	TL109	52.20	22.39	14.09	24.69	16.68	43.00
		2	TL209	86.00	31.03	18.42	34.03	21.42	86.00
		3	TL309	126.00	39.95	22.76	43.35	26.16	129.00
		4	TL409	179.10	53.14	27.68	57.02	31.55	172.50
		5	TL509	222.10	62.05	32.01	66.34	36.29	215.50
TwinLine-L standing cabinets \perp \square									
12	8	1	TL112	69.60	27.96	17.57	30.84	20.45	60.00
		2	TL212	120.90	42.23	25.81	45.91	29.49	120.00
		3	TL312	171.90	54.09	31.76	58.58	36.24	180.00
		4	TL412	207.00	71.86	38.72	77.25	44.12	240.00
		5	TL512	250.30	83.46	44.37	89.66	50.57	300.00

* General remarks on the determination of the power dissipation: Values in accordance with DIN EN 61439-1 section 10.10.4.2.2; ambient temperature 35 °C, internal temperature 55 °C, it must be guaranteed that the permissible operating medium temperature is not exceeded; height of the installation location \leq 2000 m above sea level; shape of inner divider = 1; side walls not covered

TwinLine N 55 wall cabinets and floor-standing cabinets

Dimensions TwinLine-W, cabinet depth 350 mm, \perp \square

Front view
Wall cabinet and standing cabinet
External dimensions/
internal dimensions

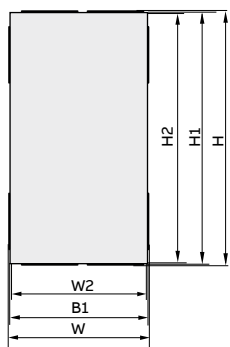

Front view
Wall cabinet
Dimensions wall mounting

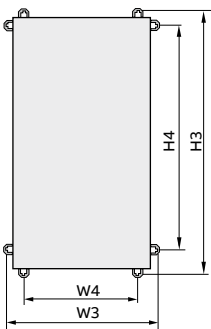

Front view
Standalone cabinet
Dimensions wall mounting

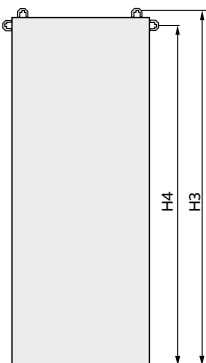

Front view
External mounting
Detail

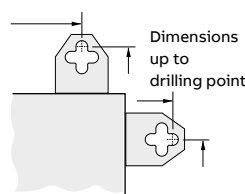

Side view
With/without door

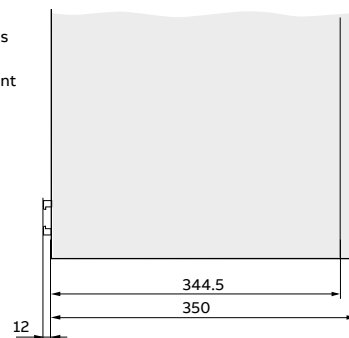

				External dimensions									
Height		Width		External dimensions		Internal dimensions		with flange knock-out		Dimensions wall mounting			
RE	BH	FB	Type	H1	B1	H2	W2	H	W	H3	W3	H4	W4
TwinLine-W wall cabinets \perp \square													
4	0	1	TW104	650	300	602	252	654	304	693.5	328	542	192
		2	TW204	650	550	602	502	654	554	693.5	578	542	442
		3	TW304	650	800	602	752	654	804	693.5	828	542	692
		4	TW404	650	1050	602	1002	654	1054	693.5	1078	542	942
		5	TW504	650	1300	602	1252	654	1304	693.5	1328	542	1192
5	1	1	TW105	800	300	752	252	804	304	843.5	328	692	192
		2	TW205	800	550	752	502	804	554	843.5	578	692	442
		3	TW305	800	800	752	752	804	804	843.5	828	692	692
		4	TW405	800	1050	752	1002	804	1054	843.5	1078	692	942
		5	TW505	800	1300	752	1252	804	1304	843.5	1328	692	1192
6	2	1	TW106	950	300	902	252	954	304	993.5	328	842	192
		2	TW206	950	550	902	502	954	554	993.5	578	842	442
		3	TW306	950	800	902	752	954	804	993.5	828	842	692
		4	TW406	950	1050	902	1002	954	1054	993.5	1078	842	942
		5	TW506	950	1300	902	1252	954	1304	993.5	1328	842	1192
7	3	1	TW107	1100	300	1052	252	1104	304	1143.5	328	992	192
		2	TW207	1100	550	1052	502	1104	554	1143.5	578	992	442
		3	TW307	1100	800	1052	752	1104	804	1143.5	828	992	692
		4	TW407	1100	1050	1052	1002	1104	1054	1143.5	1078	992	942
		5	TW507	1100	1300	1052	1252	1104	1304	1143.5	1328	992	1192
8	4	1	TW108	1250	300	1202	252	1254	304	1293.5	328	1142	192
		2	TW208	1250	550	1202	502	1254	554	1293.5	578	1142	442
		3	TW308	1250	800	1202	752	1254	804	1293.5	828	1142	692
		4	TW408	1250	1050	1202	1002	1254	1054	1293.5	1078	1142	942
		5	TW508	1250	1300	1202	1252	1254	1304	1293.5	1328	1142	1192
9	5	1	TW109	1400	300	1352	252	1404	304	1443.5	328	1292	192
		2	TW209	1400	550	1352	502	1404	554	1443.5	578	1292	442
		3	TW309	1400	800	1352	752	1404	804	1443.5	828	1292	692
		4	TW409	1400	1050	1352	1002	1404	1054	1443.5	1078	1292	942
		5	TW509	1400	1300	1352	1252	1404	1304	1443.5	1328	1292	1192
TwinLine-W standing cabinets \perp \square													
12	8	1	TW112	1850	300	1802	252	1854	304	1872	328	1796	192
		2	TW212	1850	550	1802	502	1854	554	1872	578	1796	442
		3	TW312	1850	800	1802	752	1854	804	1872	828	1796	692
		4	TW412	1850	1050	1802	1002	1854	1054	1872	1078	1796	942
		5	TW512	1850	1300	1802	1252	1854	1304	1872	1328	1796	1192
		6	TW612	1850	1550	1802	1502	1854	1554	1872	1578	1796	1442

> Dimensions in mm

TwinLine N 55 wall cabinets and floor-standing cabinets

Weights and power dissipation TwinLine-W, cabinet depth 350 mm, $\frac{\pm}{\square}$

Type of installation
Cabinet on the wall

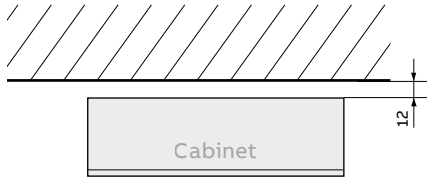

Type of installation
Cabinet combination
side by side

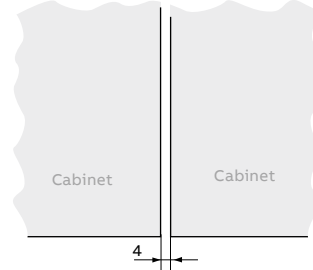

Type of installation
Cabinet combination
one on top of the other

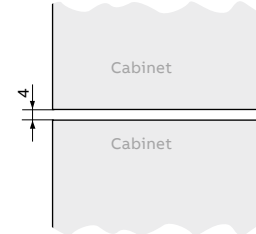

Height		Width		$\frac{\pm}{\square}$ Power dissipation in watts* at overtemperature Δt 20K	$\frac{\pm}{\square}$ Cabinet weight in kg		\square Cabinet weight in kg		Max. installation weight in kg
RE	BH	FB	Type		With door	Without door	With door	Without door	
TwinLine-W wall cabinets $\frac{\pm}{\square}$									
4	0	1	TW104	43.00	13.50	9.47	15.13	11.16	15.00
		2	TW204	65.90	18.79	12.58	20.60	14.38	30.00
		3	TW304	75.90	24.17	15.62	26.16	17.61	45.00
		4	TW404	100.10	31.76	19.27	33.92	21.44	60.00
		5	TW504	129.30	37.12	22.32	39.46	24.66	75.00
5	1	1	TW105	50.50	15.56	10.80	17.41	12.65	20.50
		2	TW205	59.80	21.64	14.14	23.72	16.21	41.00
		3	TW305	87.70	27.74	17.48	30.04	19.78	61.50
		4	TW405	121.30	36.47	21.42	39.00	23.95	82.50
		5	TW505	158.90	42.58	24.77	45.33	27.52	103.00
6	2	1	TW106	58.20	17.58	12.06	19.65	14.13	26.00
		2	TW206	68.20	24.44	15.69	26.79	18.04	52.50
		3	TW306	102.80	31.29	19.33	33.91	21.95	78.50
		4	TW406	144.80	41.16	23.57	44.06	26.46	105.00
		5	TW506	185.80	48.02	27.20	51.19	30.07	131.00
7	3	1	TW107	65.80	20.12	13.70	22.41	15.99	31.50
		2	TW207	75.70	27.87	17.76	30.48	20.38	63.50
		3	TW307	116.50	35.59	21.82	38.53	24.76	95.50
		4	TW407	163.60	46.84	26.48	50.11	29.75	127.50
		5	TW507	209.30	54.58	30.55	58.16	34.13	159.00
8	4	1	TW108	52.00	22.18	14.96	24.81	17.48	37.50
		2	TW208	82.70	30.67	19.32	33.56	22.20	75.00
		3	TW308	132.60	39.15	23.67	42.42	26.93	112.50
		4	TW408	180.80	51.55	28.63	55.25	32.33	150.00
		5	TW508	227.50	60.03	32.98	64.10	37.06	187.50
9	5	1	TW109	58.60	24.23	16.22	26.96	18.95	43.00
		2	TW209	93.90	33.48	20.87	36.63	24.03	86.00
		3	TW309	146.40	42.71	25.52	46.29	29.10	129.00
		4	TW409	197.10	56.24	30.77	60.32	34.85	172.50
		5	TW509	238.20	65.47	35.42	69.97	39.93	215.50
TwinLine-W standing cabinets $\frac{\pm}{\square}$									
12	8	1	TW112	78.90	30.62	20.24	33.72	23.33	60.00
		2	TW212	131.70	45.10	28.69	49.02	32.60	120.00
		3	TW312	181.50	57.38	35.05	62.12	39.79	180.00
		4	TW412	226.00	75.29	42.15	80.95	47.82	240.00
		5	TW512	269.40	87.20	48.12	93.70	54.61	300.00
		6	TW612	354.50	99.02	53.98	106.34	61.30	360.00

* General remarks on the determination of the power dissipation: Values in accordance with DIN EN 61439-1 section 10.10.4.2.2; ambient temperature 35 °C, internal temperature 55 °C, it must be guaranteed that the permissible operating medium temperature is not exceeded; height of the installation location \leq 2000 m above sea level; shape of inner divider = 1; side walls not covered

TwinLine N 55 wall cabinets and floor-standing cabinets

Dimensions and weight – base, height 50 mm

External dimensions/internal dimensions

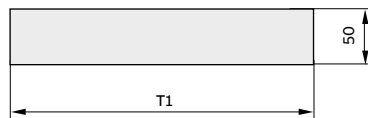
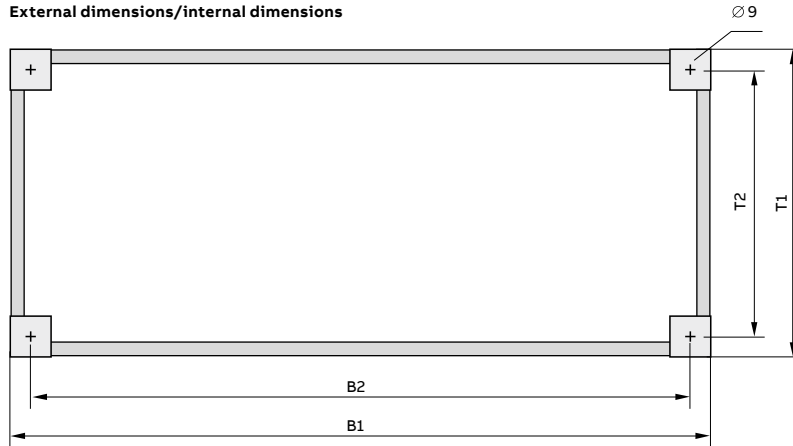

Height	Width		Type	External dimensions Width x depth		Internal dimensions Width x depth		Weight in kg
	Depth	FB		B1	D1	W2	D2	
TwinLine-G, base 50 mm								
50	225	1	TZG105	300	203.50	270	173.50	1.37
		2	TZG205	550	203.50	520	173.50	1.91
		3	TZG305	800	203.50	770	173.50	2.41
		4	TZG405	1050	203.50	1020	173.50	2.93
		5	TZG505	1300	203.50	1270	173.50	3.44
TwinLine-L, base 50 mm								
50	275	1	TZL105	300	253.50	270	223.50	1.49
		2	TZL205	550	253.50	520	223.50	2.03
		3	TZL305	800	253.50	770	223.50	2.54
		4	TZL405	1050	253.50	1020	223.50	3.34
		5	TZL505	1300	253.50	1270	223.50	5.78
TwinLine-W, base 50 mm								
50	350	1	TZW105	300	328.50	270	298.50	1.67
		2	TZW205	550	328.50	520	298.50	2.21
		3	TZW305	800	328.50	770	298.50	2.72
		4	TZW405	1050	328.50	1020	298.50	5.03
		5	TZW505	1300	328.50	1270	298.50	5.97
		6	TZW605	1550	328.50	1520	298.50	6.90

TwinLine N 55 wall cabinets and floor-standing cabinets

Dimensions and weight – base, height 100 mm

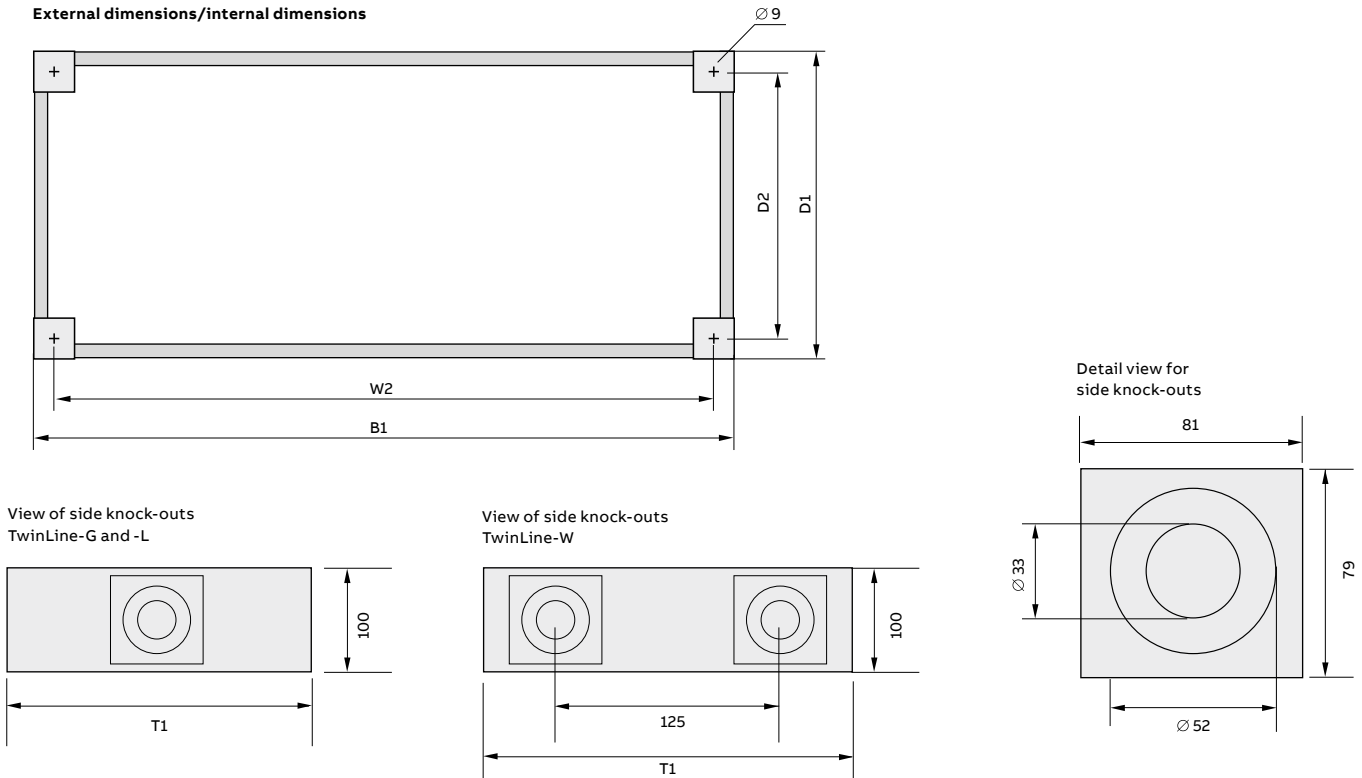

Height	Depth	Width		External dimensions		Internal dimensions		Weight in kg
		FB	Type	Width x depth	D1	Width x depth	D2	
TwinLine-G, base 100 mm								
100	225	1	TZG110	300	203.50	270	173.50	2.22
		2	TZG210	550	203.50	520	173.50	3.06
		3	TZG310	800	203.50	770	173.50	3.87
		4	TZG410	1050	203.50	1020	173.50	4.67
		5	TZG510	1300	204.50	1270	173.50	5.47
TwinLine-L, base 100 mm								
100	275	1	TZL110	300	253.50	270	223.50	2.41
		2	TZL210	550	253.50	520	223.50	3.24
		3	TZL310	800	253.50	770	223.50	4.05
		4	TZL410	1050	253.50	1020	223.50	6.71
		5	TZL510	1300	254.50	1270	223.50	7.95
TwinLine-W, base 100 mm								
100	350	1	TZW110	300	328.50	270	298.50	2.68
		2	TZW210	550	328.50	520	298.50	3.52
		3	TZW310	800	328.50	770	298.50	4.32
		4	TZW410	1050	328.50	1020	298.50	6.98
		5	TZW510	1300	329.50	1270	298.50	8.22
		6	TZW610	1550	329.50	1520	298.50	9.45

> Dimensions in mm

TwinLine N 55 wall cabinets and floor-standing cabinets

Dimensions and weights - doors, height 4 to 7 RE

External dimensions

Cabinets with field width 4 and over
Double doors

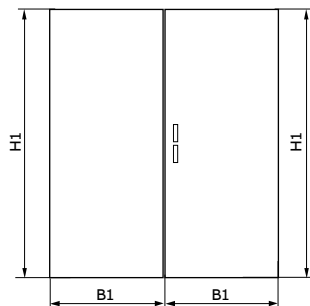

Usable installation space

Cabinets with field width 4 and over
Double doors

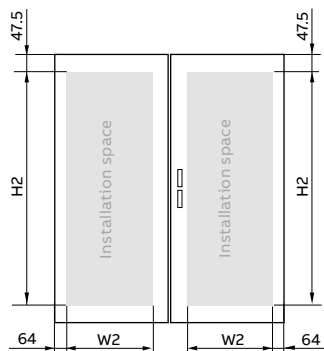

Height RE	Width		Type	Remark	External dimensions Height x width		Installation space Height x width		Weight in kg
	BH	FB			H1	B1	H2	W2	
TwinLine wall cabinets, doors									
4	0	1	TZB104		643	289	548	123	5.46
		2	TZB204		643	539	548	373	7.75
		3	TZB304		643	789	548	623	10.11
		4*1	TZB204L	Left door	643	526 *2	548	373	7.77
			TZB204R	Right door	643	539	548	373	7.78
		5*1	TZB304L	Left door	643	776 *2	548	623	10.11
			TZB204R	Right door	643	539	548	373	7.78
5	1	1	TZB105		793	289	698	123	6.27
		2	TZB205		793	539	698	373	9.05
		3	TZB305		793	789	698	623	11.85
		4*1	TZB205L	Left door	793	526 *2	698	373	9.10
			TZB205R	Right door	793	539	698	373	9.05
		5*1	TZB305L	Left door	793	776 *2	698	623	11.89
			TZB205R	Right door	793	539	698	373	9.05
6	2	1	TZB106		943	289	848	123	7.03
		2	TZB206		943	539	848	373	10.32
		3	TZB306		943	789	848	623	13.58
		4*1	TZB206L	Left door	943	526 *2	848	373	10.41
			TZB206R	Right door	943	539	848	373	10.32
		5*1	TZB306L	Left door	943	776 *2	848	623	13.68
			TZB206R	Right door	943	539	848	373	10.32
7	3	1	TZB107		1093	289	998	123	7.94
		2	TZB207		1093	539	998	373	11.69
		3	TZB307		1093	789	998	623	15.42
		4*1	TZB207L	Left door	1093	526 *2	998	373	11.85
			TZB207R	Right door	1093	539	998	373	11.69
		5*1	TZB307L	Left door	1093	776 *2	998	623	15.57
			TZB207R	Right door	1093	539	998	373	11.69

*1 Double doors field width 4 and over

*2 Dimensions including door center bar

TwinLine N 55 wall cabinets and floor-standing cabinets

Dimensions and weights – doors, height 8 to 12 RE

External dimensions
Cabinets with field width 4 and over
Double doors

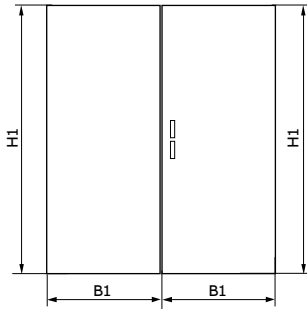

Usable installation space
Cabinets with field width 4 and over
Double doors

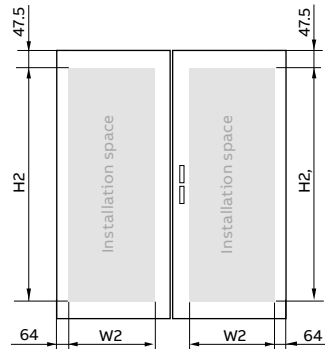

Height RE	Width		Type	Remark	External dimensions Height x width		Installation space Height x width		Weight in kg	Max. installation weight in kg
	BH	FB			H1	B1	H2	W2		
TwinLine wall cabinets, doors										
8	4	1	TZB108		1243	289	1148	123	8.75	5.00
		2	TZB208		1243	539	1148	373	12.96	5.00
		3	TZB308		1243	789	1148	623	17.15	7.50
		4*	TZB208L	Left door	1243	526 * ²	1148	373	13.17	5.00
			TZB208R	Right door	1243	539	1148	373	12.96	5.00
		5*	TZB308L	Left door	1243	776 * ²	1148	623	17.36	7.50
			TZB208R	Right door	1243	539	1148	373	12.96	5.00
9	5	1	TZB109		1393	289	1298	123	9.55	5.00
		2	TZB209		1393	539	1298	373	14.23	5.00
		3	TZB309		1393	789	1298	623	18.88	7.50
		4*	TZB209L	Left door	1393	526 * ²	1298	373	14.49	5.00
			TZB209R	Right door	1393	539	1298	373	14.23	5.00
		5*	TZB309L	Left door	1393	776 * ²	1298	623	19.14	7.50
			TZB209R	Right door	1393	539	1298	373	14.23	5.00
TwinLine standing cabinets, doors										
12	8	1	TZB112		1843	289	1748	123	11.96	5.00
		2	TZB212		1843	539	1748	373	18.07	5.00
		3	TZB312		1843	789	1748	623	24.08	7.50
		4*	TZB212L	Left door	1843	526 * ²	1748	373	18.45	5.00
			TZB212R	Right door	1843	539	1748	373	18.03	5.00
		5*	TZB312L	Left door	1843	776 * ²	1748	623	24.49	7.50
			TZB212R	Right door	1843	539	1748	373	18.03	5.00
		6*	TZB312L	Left door	1843	776 * ²	1748	623	24.49	7.50
			TZB312R	Right door	1843	789	1748	623	24.08	7.50

* Double doors field width 4 and over

*² Dimensions including door center bar

TwinLine N 55 wall cabinets and floor-standing cabinets

Dimensions and weights – doors with viewing window, height 4 to 7 RE

External dimensions
Cabinets with field width 4 and over
Double doors

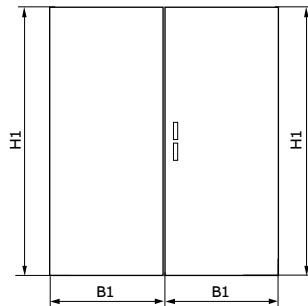

Dimensions of field of view
Cabinets with field width 4 and over
Double doors

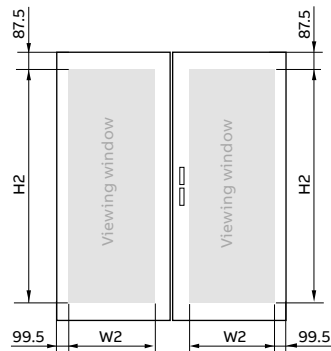

Height RE	Width		Type	Remark	External dimensions Height x width		Field of view Height x width		Weight in kg
	BH	FB			H1	B1	H2	W2	
TwinLine wall cabinets, doors									
4	0	2	TZT204		643	539	468	340	6.40
		3	TZT304		643	789	468	590	8.70
		4 ^{*1}	TZT204L	Left door	643	526 ^{*2}	468	340	6.50
			TZT204R	Right door	643	539	468	340	6.50
		5 ^{*1}	TZT304L	Left door	643	776 ^{*2}	468	590	8.40
			TZT204R	Right door	643	539	468	340	6.50
5	1	2	TZT205		793	539	618	340	7.60
		3	TZT305		793	789	618	590	10.20
		4 ^{*1}	TZT205L	Left door	793	526 ^{*2}	618	340	7.40
			TZT205R	Right door	793	539	618	340	7.50
		5 ^{*1}	TZT305L	Left door	793	776 ^{*2}	618	590	9.90
			TZT205R	Right door	793	539	618	340	7.50
6	2	2	TZT206		943	539	768	340	8.70
		3	TZT306		943	789	768	590	11.50
		4 ^{*1}	TZT206L	Left door	943	526 ^{*2}	768	340	8.50
			TZT206R	Right door	943	539	768	340	8.60
		5 ^{*1}	TZT306L	Left door	943	776 ^{*2}	768	590	11.40
			TZT206R	Right door	943	539	768	340	8.60
7	3	2	TZT207		1093	539	918	340	10.00
		3	TZT307		1093	789	918	590	13.00
		4 ^{*1}	TZT207L	Left door	1093	526 ^{*2}	918	340	9.70
			TZT207R	Right door	1093	539	918	340	9.80
		5 ^{*1}	TZT307L	Left door	1093	776 ^{*2}	918	590	13.00
			TZT207R	Right door	1093	539	918	340	9.80

^{*1} Double doors field width 4 and over

^{*2} Dimensions including door center bar

TwinLine N 55 wall cabinets and floor-standing cabinets

Dimensions and weights - doors with viewing window, height 8 to 12 RE

External dimensions
Cabinets with field width 4 and over
Double doors

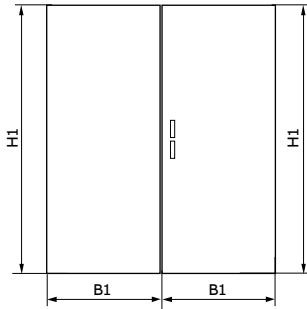

Dimensions of field of view
Cabinets with field width 4 and over
Double doors

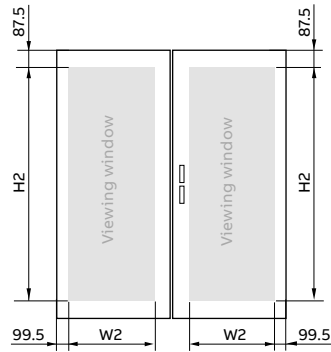

RE	Width		Type	Remark	External dimensions Height x width		Field of view Height x width		Weight in kg
	BH	FB			H1	B1	H2	W2	
TwinLine wall cabinets, doors									
8	4	2	TZT208		1243	539	1068	340	11.10
		3	TZT308		1243	789	1068	590	14.60
	4*	TZT208L	Left door	1243	526 ^{*2}	1068	340	10.90	
		TZT208R	Right door	1243	539	1068	340	11.10	
	5*	TZT308L	Left door	1243	776 ^{*2}	1068	590	14.60	
		TZT208R	Right door	1243	539	1068	340	11.10	
9	5	2	TZT209		1393	539	1218	340	12.20
		3	TZT309		1393	789	1218	590	16.10
	4*	TZT209L	Left door	1393	526 ^{*2}	1218	340	12.00	
		TZT209R	Right door	1393	539	1218	340	11.50	
	5*	TZT309L	Left door	1393	776 ^{*2}	1218	590	16.00	
		TZT209R	Right door	1393	539	1218	340	11.50	
TwinLine standing cabinets, doors									
12	8	2	TZT212		1843	539	1668	340	15.60
		3	TZT312		1843	789	1668	590	20.70
	4*	TZT212L	Left door	1843	526 ^{*2}	1668	340	15.60	
		TZT212R	Right door	1843	539	1668	340	15.40	
	5*	TZT312L	Left door	1843	776 ^{*2}	1668	590	20.70	
		TZT212R	Right door	1843	539	1668	340	15.40	
6*	TZT312L	Left door	1843	776 ^{*2}	1668	590	20.70		
	TZT312R	Right door	1843	789	1668	590	19.90		

* Double doors field width 4 and over

*2 Dimensions including door center bar

TwinLine N 55 wall cabinets and floor-standing cabinets

Dimensions and weights – mounting plates

External dimensions/usable installation space
Mounting plate

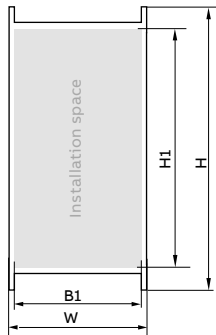

Height RE	Width		External dimensions			Installation space		Weight in kg
	BH	FB	Type	H	W	H1	B1	
Mounting plates for TwinLine wall cabinets ±								
4	0	1	TZM104	600	246	522	160	3.51
		2	TZM204	600	496	522	410	5.79
		3	TZM304	600	746	522	660	8.07
		4	TZM404	600	996	522	910	10.35
		5	TZM504	600	1246	522	1160	12.62
5	1	1	TZM105	750	246	672	160	4.43
		2	TZM205	750	496	672	410	7.30
		3	TZM305	750	746	672	660	10.17
		4	TZM405	750	996	672	910	13.03
		5	TZM505	750	1246	672	1160	15.90
6	2	1	TZM106	900	246	822	160	5.35
		2	TZM206	900	496	822	410	8.80
		3	TZM306	900	746	822	660	12.26
		4	TZM406	900	996	822	910	15.72
		5	TZM506	900	1246	822	1160	19.20
7	3	1	TZM107	1050	246	972	160	6.26
		2	TZM207	1050	496	972	410	10.31
		3	TZM307	1050	746	972	660	14.36
		4	TZM407	1050	996	972	910	18.40
		5	TZM507	1050	1246	972	1160	22.45
8	4	1	TZM108	1200	246	1122	160	7.18
		2	TZM208	1200	496	1122	410	11.82
		3	TZM308	1200	746	1122	660	16.45
		4	TZM408	1200	996	1122	910	21.09
		5	TZM508	1200	1246	1122	1160	25.72
9	5	1	TZM109	1350	246	1272	160	8.10
		2	TZM209	1350	496	1272	410	13.33
		3	TZM309	1350	746	1272	660	18.55
		4	TZM409	1350	996	1272	910	23.77
		5	TZM509	1350	1246	1272	1160	29.00
Mounting plates for TwinLine standing cabinets ±								
12	8	1	TZM112	1800	246	1722	160	10.80
		2	TZM212	1800	496	1722	410	17.80
		3	TZM312	1800	746	1722	660	21.00
		4	TZM412	1800	996	1722	910	31.80

> Dimensions in mm

TwinLine N 55 wall cabinets and floor-standing cabinets

Installation using mounting plate

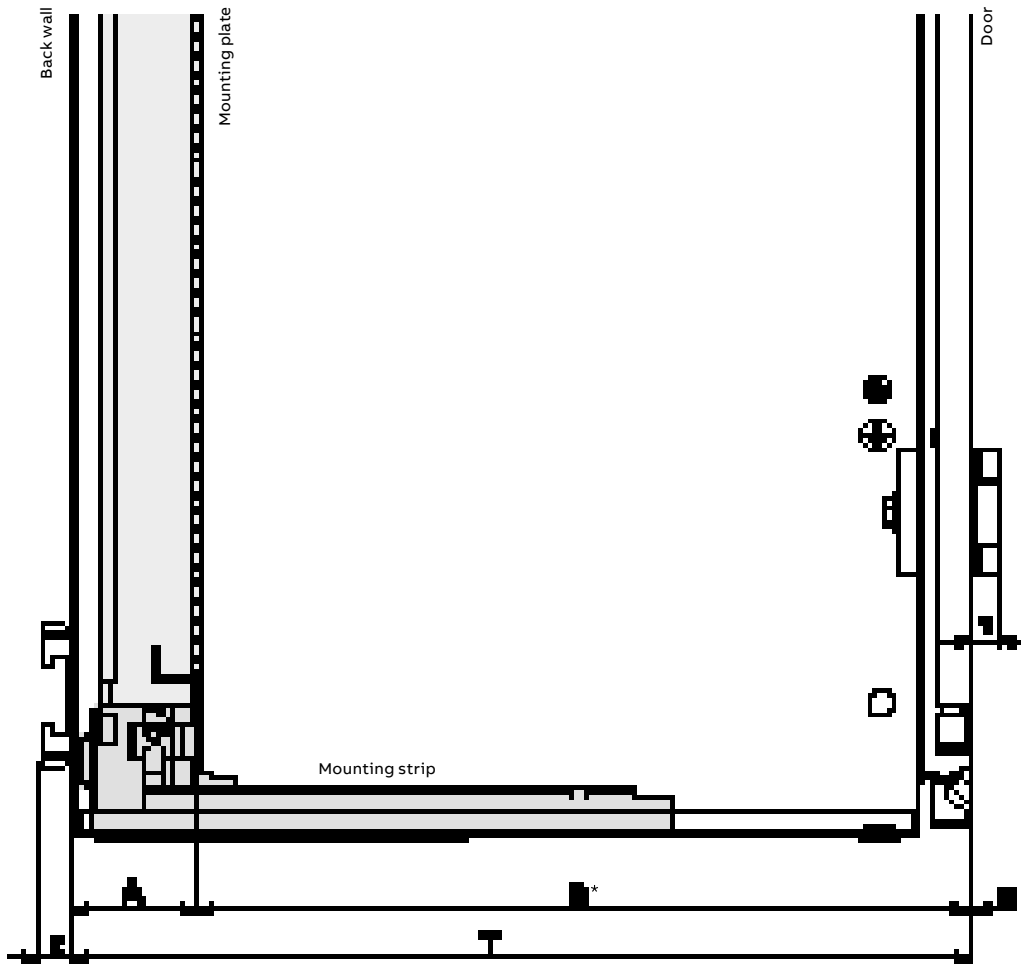

Mounting strip
Top view

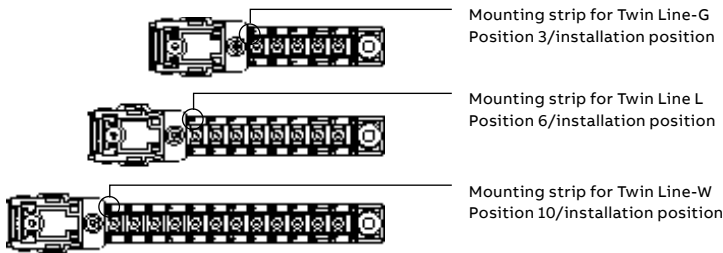

Dimension A at installation position														
Cabinet series	Depth	10	9	8	7	6	5	4	3	2	1	0	-1	-2
TwinLine G	225.00	-	-	-	-	-	-	-	52.50	65.00	77.50	90.00	102.50	115.00
TwinLine L	275.00	-	-	-	-	50.00	62.50	75.00	87.50	100.00	112.50	125.00	137.50	150.00
TwinLine W	350.00	48.50	61.00	73.50	86.00	98.50	111.00	123.50	136.00	148.50	161.00	173.50	186.00	198.50
Dimension B at installation position *														
TwinLine G	225.00	-	-	-	-	-	-	-	170.00	157.50	145.00	132.50	120.00	107.50
TwinLine L	275.00	-	-	-	-	222.50	210.00	197.50	185.00	172.50	160.00	147.50	135.00	122.50
TwinLine W	350.00	299.00	286.50	274.00	261.50	249.00	236.50	224.00	211.50	199.00	186.50	174.00	161.50	149.00

* Related to the area of the installation space (see page 116) outside the installation space, this dimension is reduced by 35 mm due to door installation components
> Dimensions in mm

TwinLine N 55 wall cabinets and floor-standing cabinets

CombiLine N modules on EDF mounting frame

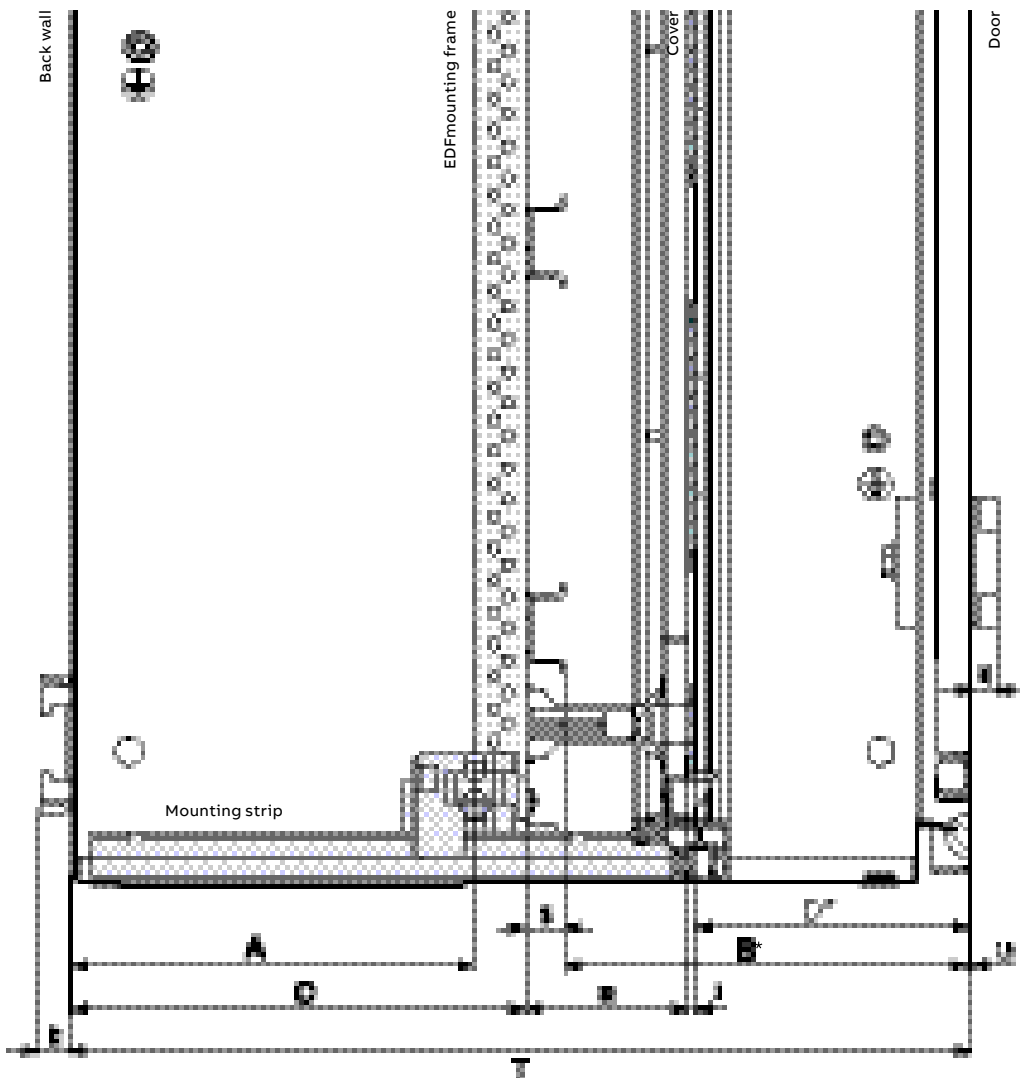

Mounting strip
Top view

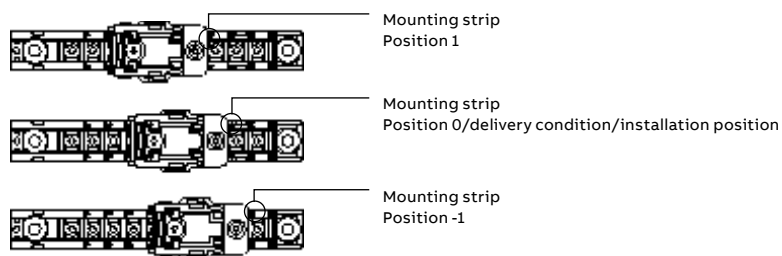

Cabinet series	Depth	Dimension A at installation position			Dimension B at installation position*			Dimension C at installation position			Dimension D at installation position*		
		1	0	-1	1	0	-1	1	0	-1	1	0	-1
TwinLine-G	225.00	60.00	72.50	85.00	127.50	115.00	102.50	80.00	92.50	105.00	76.50	64.00	51.50
TwinLine-L	275.00	95.00	107.50	120.00	142.50	130.00	117.50	115.00	127.50	140.00	91.50	79.00	66.50
TwinLine-W	350.00	143.50	156.00	168.50	169.00	156.50	144.00	163.50	176.00	188.50	117.50	105.00	92.50

* Related to the area of the installation space (see page 116); outside the installation space, this dimension is reduced by 35 mm due to door installation components
> Dimensions in mm

TwinLine N 55 wall cabinets and floor-standing cabinets

CombiLine N modules on WR mounting frame

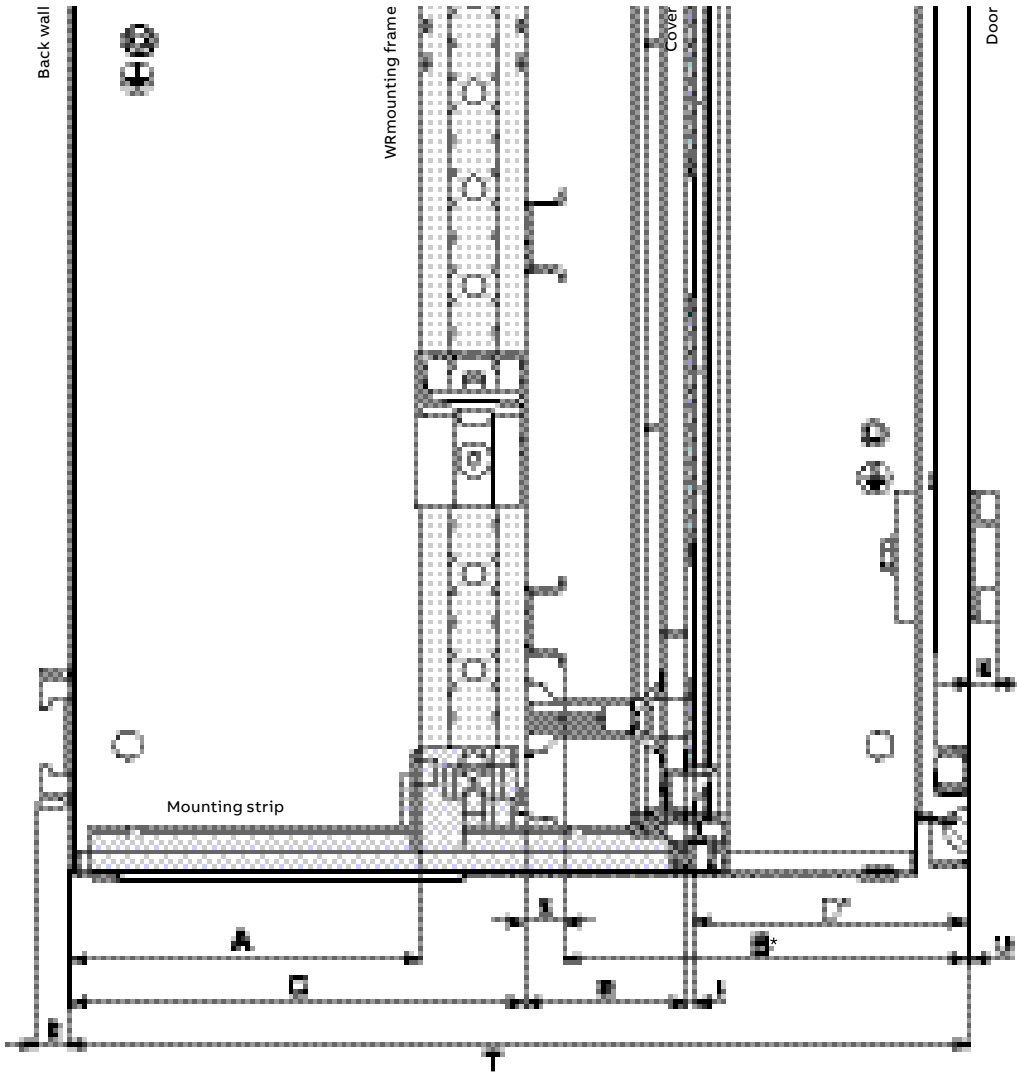

Mounting strip
Top view

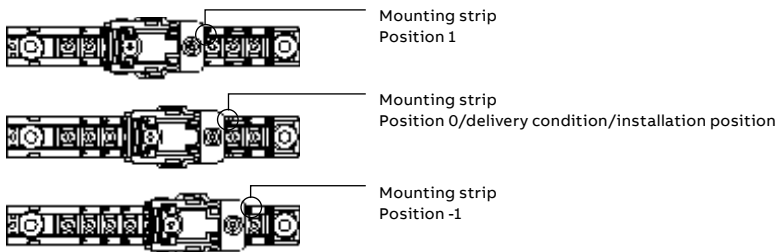

Cabinet series	Depth	Dimension A at installation position			Dimension B at installation position*			Dimension C at installation position			Dimension D at installation position*		
		1	0	-1	1	0	-1	1	0	-1	1	0	-1
TwinLine-G	225.00	40.00	52.50	65.00	127.50	115.00	102.50	80.00	92.50	105.00	76.50	64.00	51.50
TwinLine-L	275.00	75.00	87.50	100.00	142.50	130.00	117.50	115.00	127.50	140.00	91.50	79.00	66.50
TwinLine-W	350.00	123.50	136.00	148.50	169.00	156.50	144.00	163.50	176.00	188.50	117.50	105.00	92.50

* Related to the area of the installation space (see page 116) outside the installation space, this dimension is reduced by 35 mm due to door installation components
> Dimensions in mm

TwinLine N 55 wall cabinets and floor-standing cabinets

Installation with EDF mounting frame on WR mounting frame

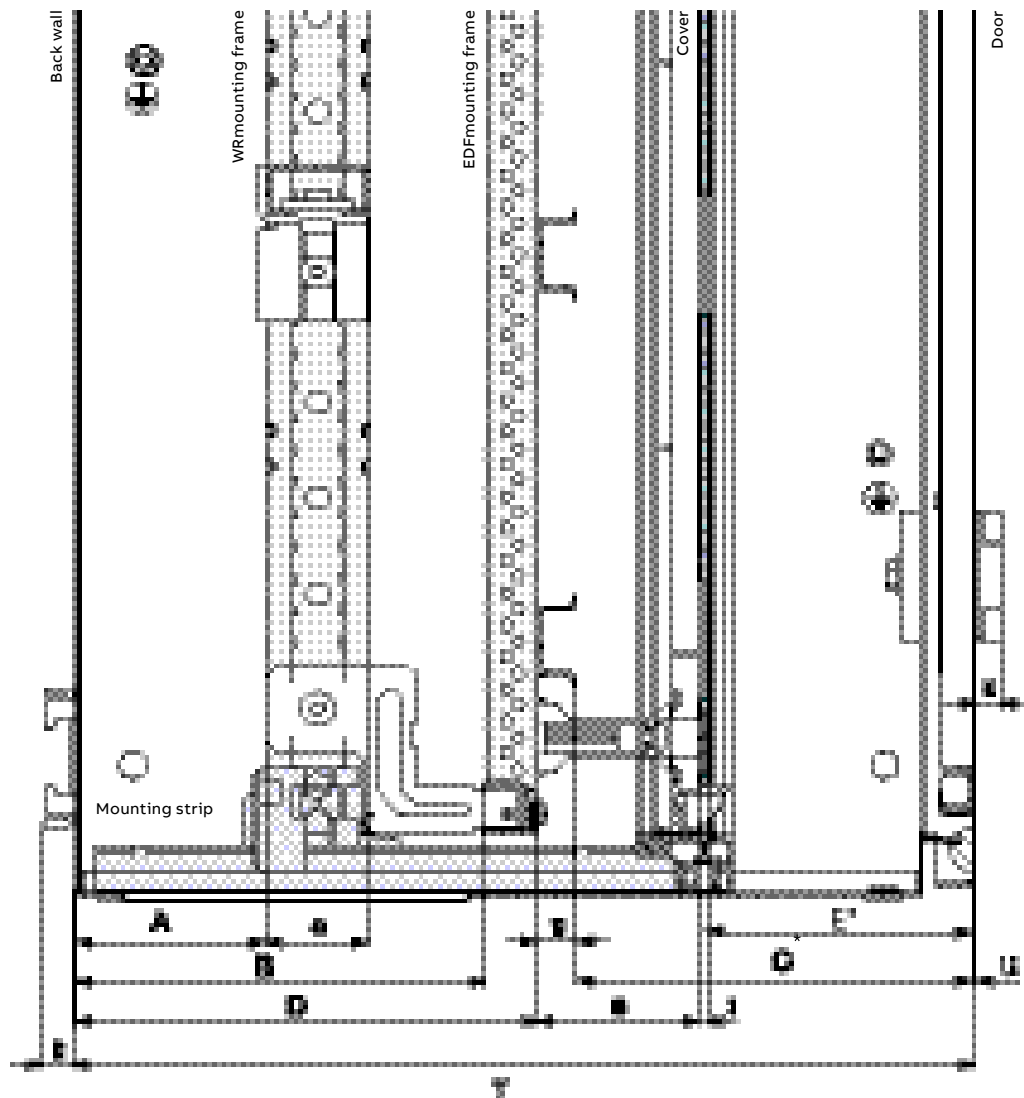

Mounting strip
Top view

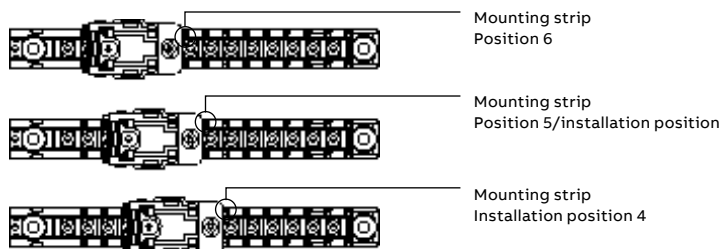

Cabinet series	Depth	Dimension A at installation position			Dimension B at installation position			Dimension C at installation position*			Dimension D at installation position			Dimension E at installation position*		
		6	5	4	6	5	4	6	5	4	6	5	4	6	5	4
TwinLine-L	275.00	12.50	25.00	37.50	98.00	110.50	123.00	139.50	127.00	114.50	117.50	130.00	142.50	88.50	76.00	63.50
TwinLine-W	350.00	61.00	73.50	86.00	146.50	159.00	171.50	165.50	153.00	140.50	166.50	179.00	191.50	114.50	102.00	89.50

* Related to the area of the installation space (see page 116); outside the installation space, this dimension is reduced by 35 mm due to door installation components
> Dimensions in mm

TwinLine N 55 wall cabinets and floor-standing cabinets

Installation with meter field for TwinLine-G 

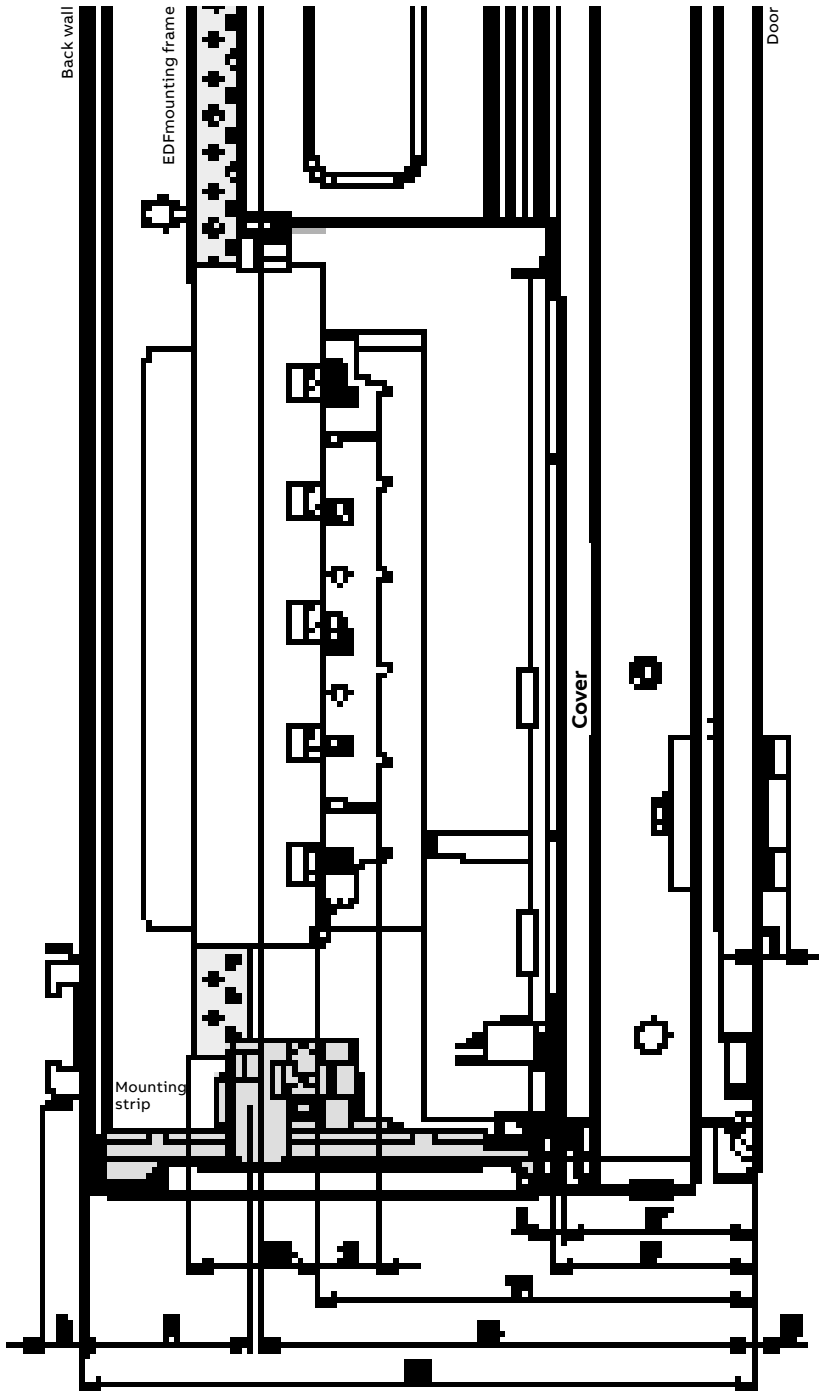

Mounting strip
Top view

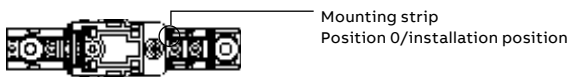

* Related to the area of the installation space (see page 116) outside the installation space, this dimension is reduced by 35 mm due to door installation components
> Dimensions in mm

TwinLine N 55 wall cabinets and floor-standing cabinets

Top view of flange knock-out bottom and top

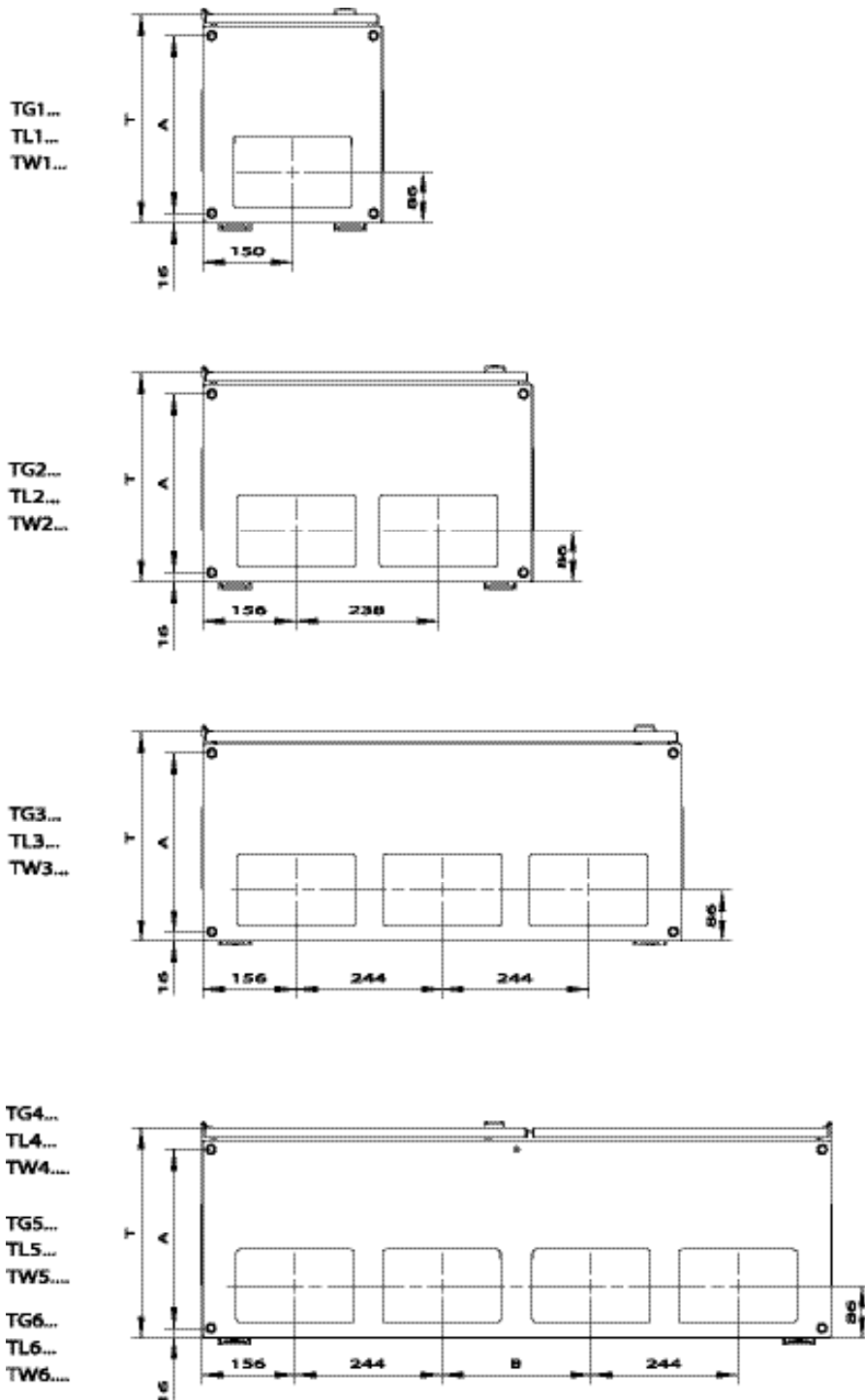

Cabinet series	Depth	A	B (field width 4)	B (field width 5)	B (field width 6)
TwinLine-G	225.00	173.50			
TwinLine-L	275.00	223.50	1 x 250 (250)	2 x 250 (500)	3 x 250 (750)
TwinLine-W	350.00	298.50			

> Dimensions in mm

TwinLine N 55 wall cabinets and floor-standing cabinets

Side view of flange knock-out bottom and top

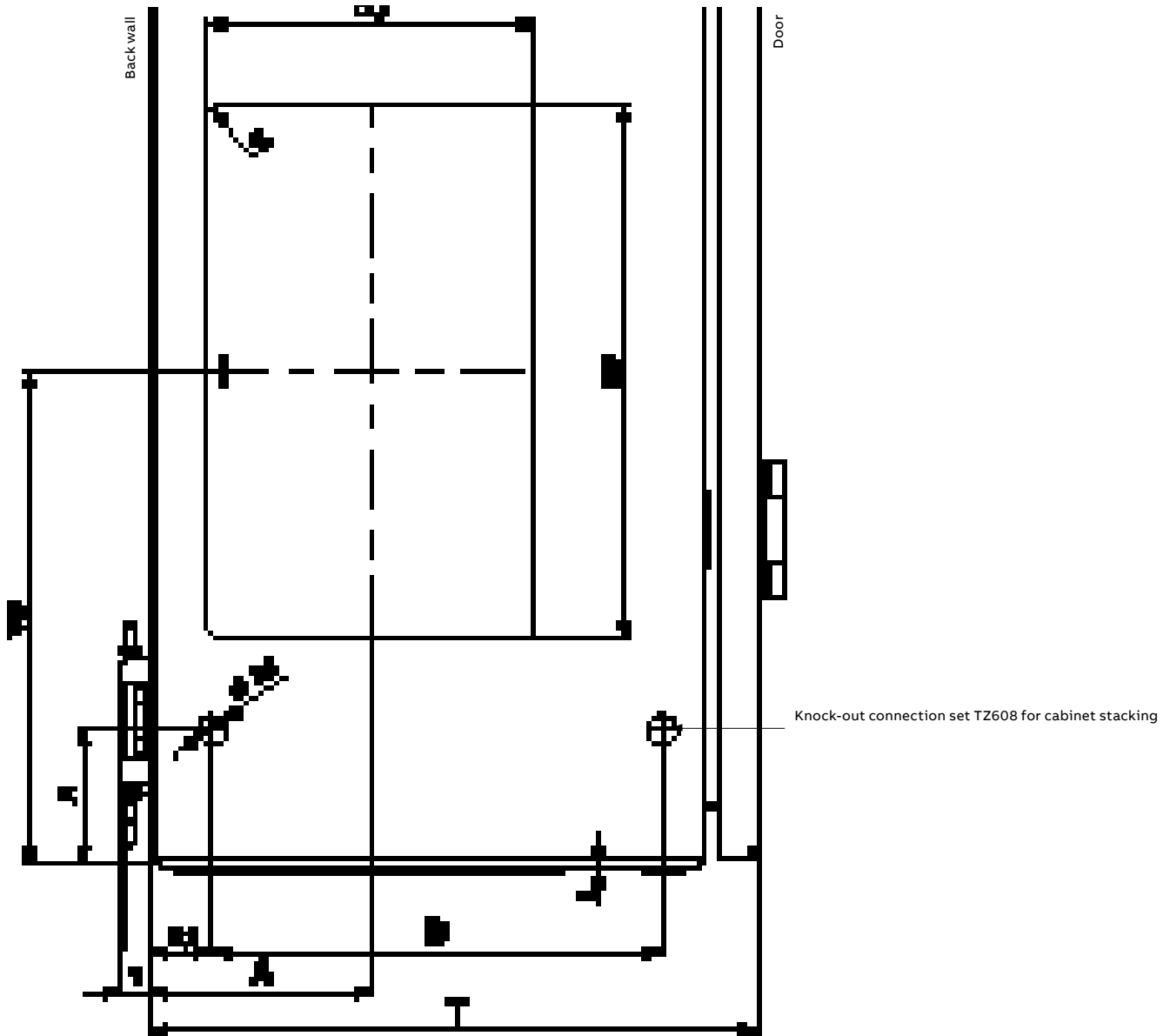

Cabinet series	Depth	A	B
TwinLine-G	225.00	80.50	167.00
TwinLine-L	275.00	106.50	217.00
TwinLine-W	350.00	154.50	292.00

> Dimensions in mm

TwinLine N 55 wall cabinets and floor-standing cabinets

Crane transport

The TwinLine housing can be lifted in accordance with the information given. Here it is imperative that transport eye bolts from ABB STRIEBEL & JOHN with order code TZ615P4 are used. Crane transport must be provided exclusively for individual cabinets! Furthermore, the maximum installation weights of the cabinets must be observed.

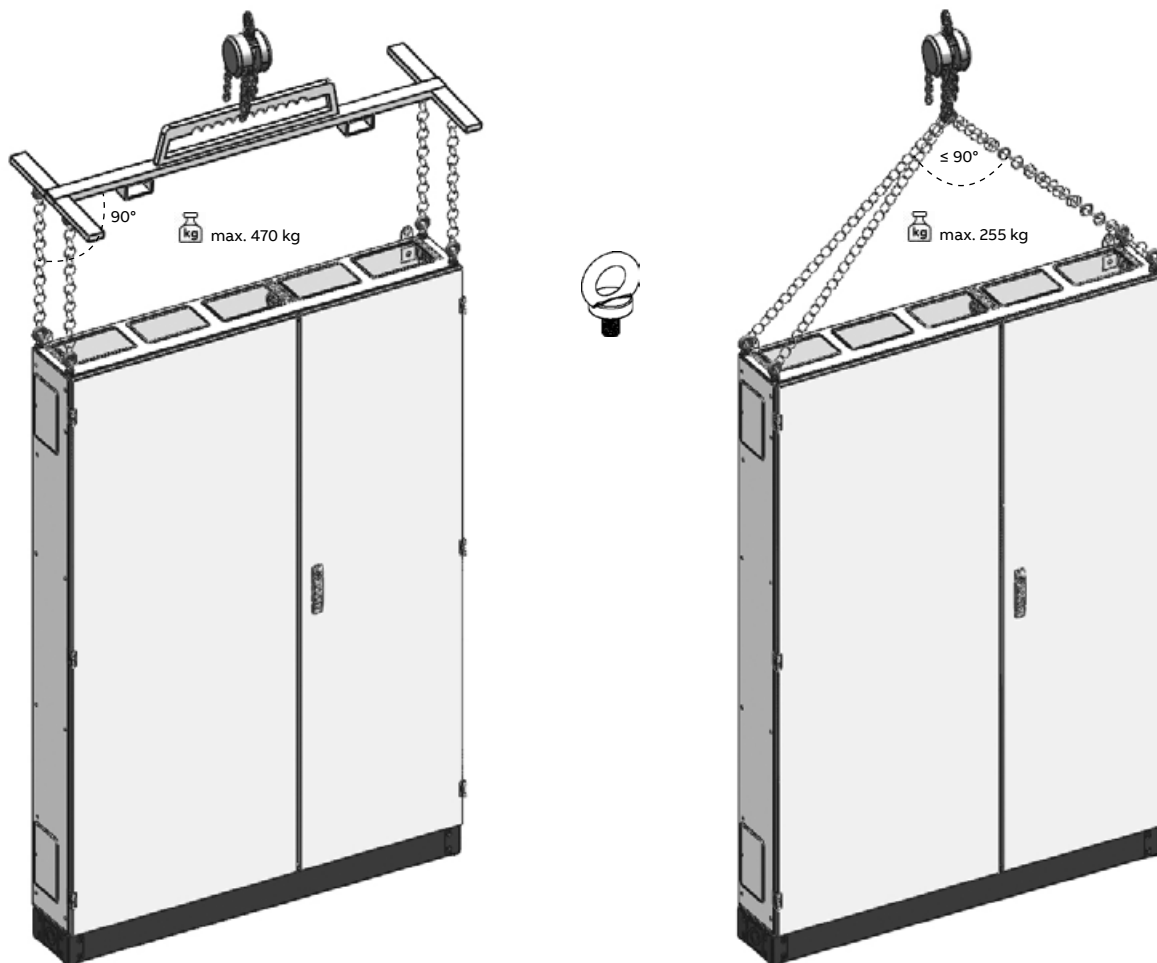

TwinLine N 55 wall cabinets and floor-standing cabinets

Meter applications



TZ610

Inner cladding TZ610

For meter fields, depth = 225 - 350 mm

Additional profile for meter fields with 150 mm connection compartment in the insulated cabinet



TZ614

Cover strip TZ612-614

Required for installation of meter fields in insulated cabinets for compliance with protection class IPXXB in the area of unnecessary fastening points for the middle support rail

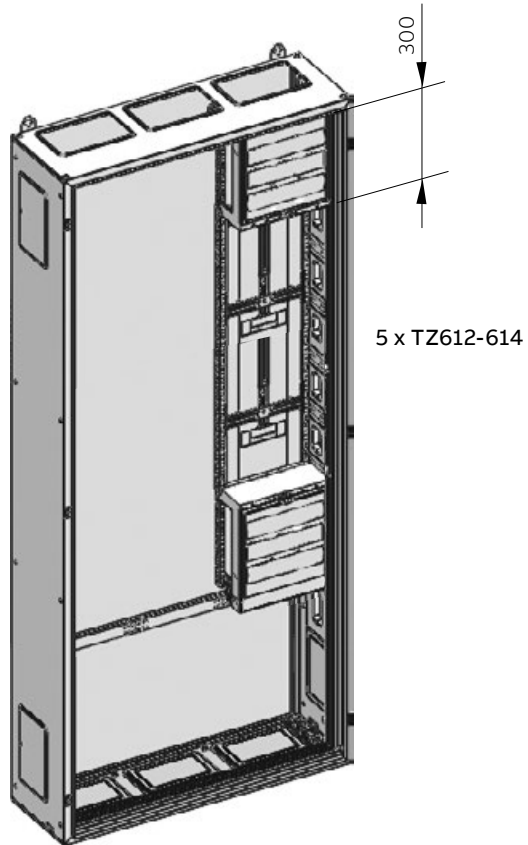
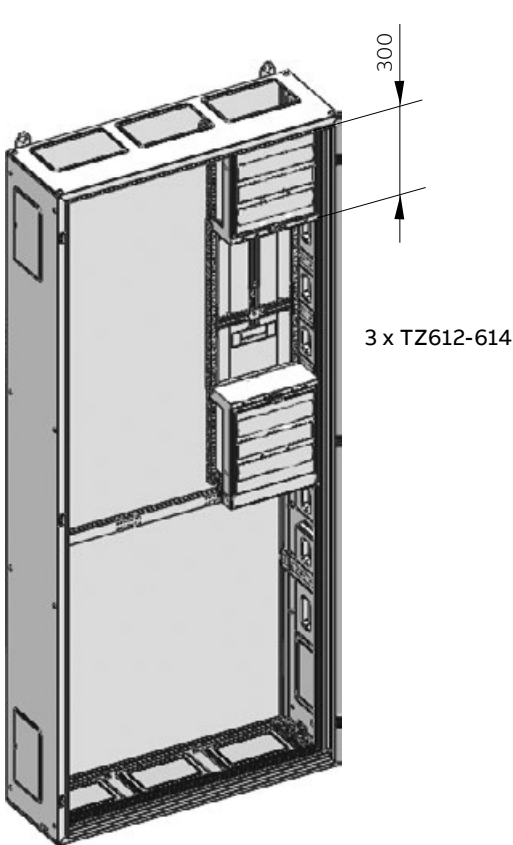

> Dimensions in mm

TwinLine N 55 floor-standing cabinets

LED control cabinet lights TZ650

Technical specifications	
Operating voltage	24 V – 265 V AC / DC
Power consumption	6 W
Light output	700 lm
Lighting level	1200 lx, 0.5 m 450 lx, 1.0 m
Color temperature	5,000 K
Degree of protection	IP 20
Protection class	II
Lifetime (std. at 20 °C)	50,000 h
Terminal	Push-in connector
Housing material	Polycarbonate
Weight	140 g
Max. humidity [% rH]	90 %
Operating temperature [° C]	- 20 °C to + 60 °C
Ambient temperature (storage)	- 40 °C to + 85 °C
Approvals	CE

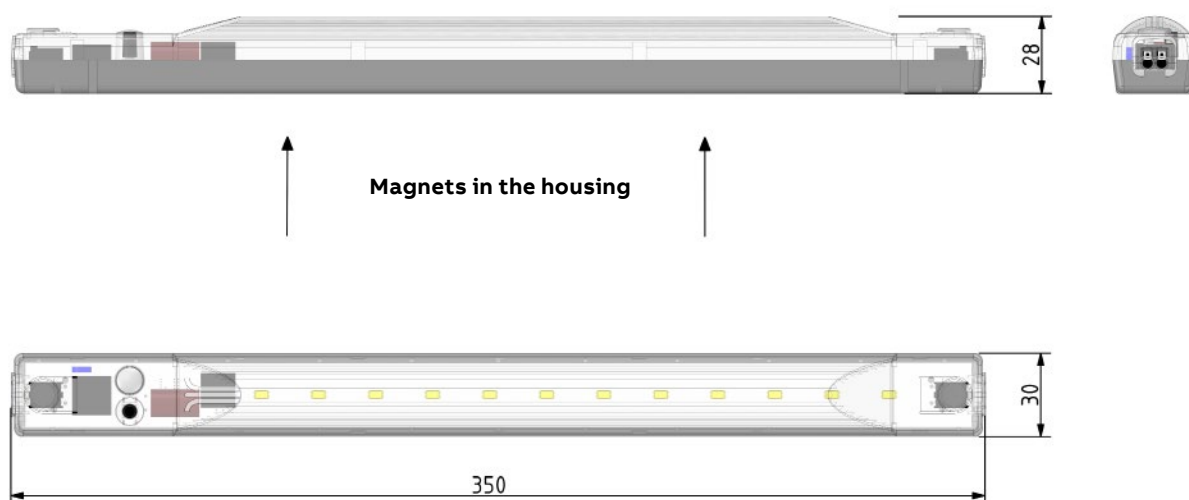

Interior expansion system CombiLine N

Expansion with EDF or WR mounting frame



Empty cabinets for expansion with EDF mounting frame

Small distributor

UL and AL \square

Wall-mounted cabinets

U and A \square , B \perp

TwinLine-G, TwinLine-L and TwinLine-W \perp \square

Standalone cabinets

TwinLine-H \square \perp

TwinLine-G, TwinLine-L and TwinLine-W \perp \square

Series switching cabinets

TriLine[®], System pro E power \perp

Fire protection housing

UF, AF and SF \perp

Empty cabinets for expansion with WR mounting frame

Wall-mounted cabinets

TwinLine-G, TwinLine-L and TwinLine-W \perp \square

Standalone cabinets

TwinLine-G, TwinLine-L and TwinLine-W \perp \square

Series switching cabinets

TriLine[®], System pro E power \perp



EDF mounting frame up to 400 A



WR mounting frame up to 850 A

Interior expansion system CombiLine N

Possible applications with EDF mounting frame

Small distributor of the UL series, AL/wall-mounted cabinets of the series U, A and TwinLine-G, -L and -W

Fire protection housing of the series UF, AF

Example: Expansion with modules (mounted) on EDF mounting frame in the TwinLine-G wall-mounted cabinet

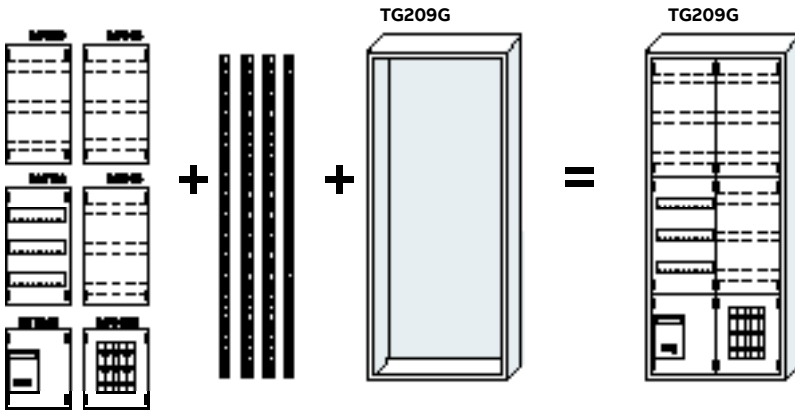

Delivery form
Modules are delivered ex works assembled on the EDF mounting frame (installed in the cabinet).

Modules (mounted) + EDF mounting frame + empty cabinet = wall-mounted distributor

Standalone cabinets of the series TwinLine-H as well as TwinLine-G, -L and -W

Series switching cabinets of the series TriLine®, pro E power system/fire protection housing of the series SF

Example: Expansion with modules (unassembled as a kit) and EDF mounting frame in the TwinLine-L standalone cabinet

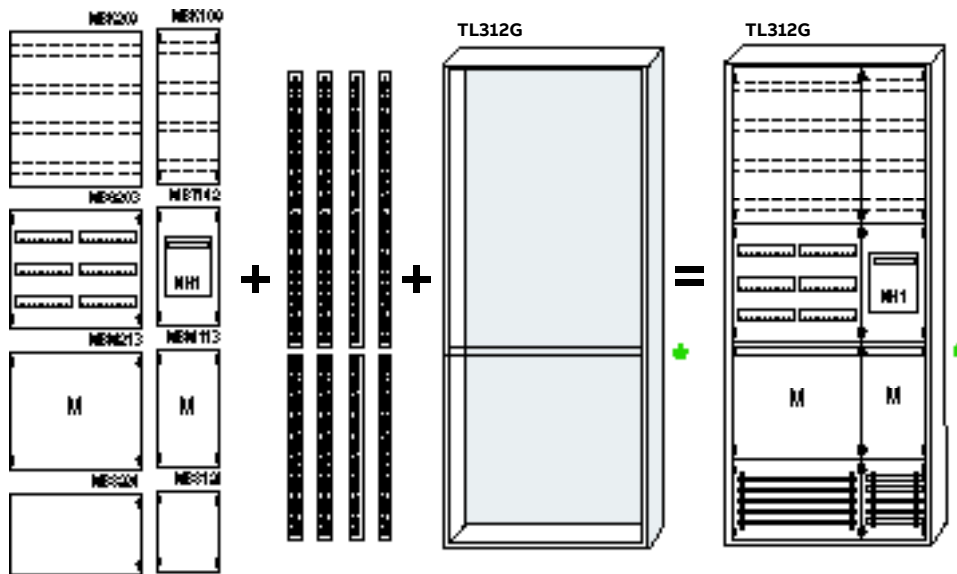

Delivery form
Kits, EDF profiles, copper rails and empty cabinet are each delivered packaged individually.

+ 5 pcs. ZX1001 + 5 pcs. ZX1002
copper rail copper rail

Modules (kit) + EDF mounting frame + empty cabinet = standalone distributor

* The EDF mounting frame may not exceed a maximum height of 1350 mm (installation height 5) at once. For structural reasons in standalone cabinets (prepared for EDF mounting frame), that is why a central supporting rail is mounted ex works, which can be moved up and down in the grid 150 mm.

Interior expansion system CombiLine N

Possible applications with WR mounting frame

Standalone cabinets of the series TwinLine-G, -L, -W/series switching cabinets of the series TriLine®, System pro E power

Example: Expansion with modules (mounted) on WR mounting frame in the TwinLine- L standalone cabinet

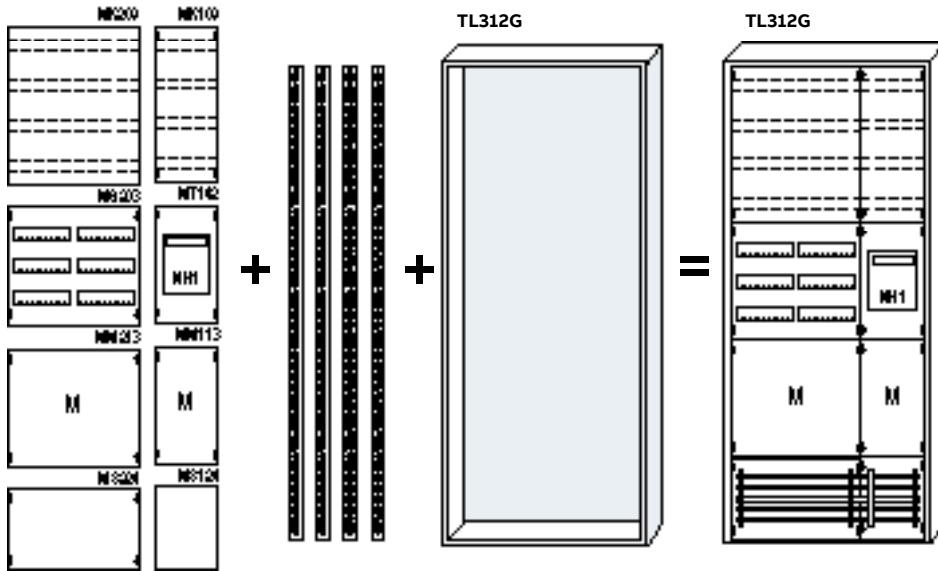

+ 5 pcs. ZXM1003 copper rail

Modules (mounted) + WR mounting frame + empty cabinet = standalone distributor

Delivery form
 Modules are delivered ex works
 assembled on the WR mounting
 frame and installed in the cabinet.

Interior expansion system CombiLine N

The three delivery forms

The interior expansion of modular cabinet series can be effortlessly mastered with the perfectly sophisticated quick-assembly system from ABB STRIEBEL & JOHN. Easy, quick and safe – these are the system's three product properties that speak for themselves. You choose which delivery form is right for you: Choose the complete delivery if you would like to have the modules installed in the empty cabinet ex works, the kit with instructions for assembly in order to set up the modules yourself on the mounting frame or the delivery with individual parts.

Complete delivery

The module system panel is completely assembled on the mounting frame with all modules and is delivered installed in the distributor cabinet. The mounting frame must be ordered separately.

Advantage: From the list of CombiLine N modules, you choose the modules that are tailored to your object, thereby getting the correct low-voltage distribution in the easiest way. The module control panel you have thus planned is delivered installed in the cabinet ex works. This way you do not have to spend time looking for system accessories, such as angle brackets, screws or retaining elements. All you need to do is choose the appropriate mounting frame. Our selection StriePlan can take care of this if desired.

Delivery as a kit

All of the individual parts required to assemble a module are delivered individually packaged as a kit with instructions for assembly. All you need to do is choose the appropriate mounting frame. The mounting frame must be ordered separately. Our software StriePlan will take care of choosing the mounting frame if desired.

Advantage: The kits allow you to be flexible when it comes to warehousing. You do not have to spend time looking for system accessories, such as angle brackets, screws or retaining elements. The enclosed instructions make assembly a breeze. Software support from StriePlan makes planning and calculation perfectly quick and clear.

Delivery in individual parts

The desired expansion parts are purchased individually in order to set up, expand or convert a module on your own.

Advantage: With a manageable number of individual parts, if necessary you can remain quick and flexible when it comes to setting up, expanding or converting distribution.



Complete delivery

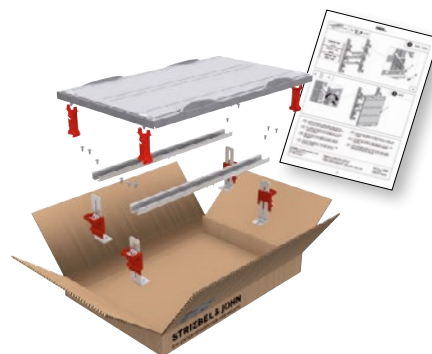

Delivery as a kit

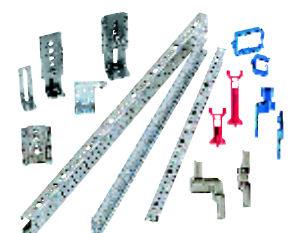

Delivery in individual parts

Interior expansion system CombiLine N

Technical specifications

Standards/provisions			
DIN EN 61439-1/-2/-3 (VDE 0660-600-1/-2/-3)*1	X		
DIN 43880 (rail-mounted devices)	X		
Protection class	IP2XC		
Electrical characteristics			
Rated impulse withstand voltage (U_{imp})	6 kV		
Overvoltage category	III		
Degree of contamination	3		
Protection class	I/II		
Rated current of the switchgear combination (I_{nA})	bis 850 A		
	Rail-mounted devices DIN 43880	NH-fuse switch disconnecter	Busbar systems
Rated impulse withstand voltage (I_{pk})	25 kA	to 52 kA	to 74 kA
Rated short-time withstand current (I_{cw})	12.5 kA	to 25 kA	to 35 kA
	-	Values by request	see the chapter Busbar systems
Rated frequency (f)	50 Hz		
Rated insulation voltage (U)	690 V AC		
Rated operating voltage (U_o)	400 V AC		

*1 The permissible heating for switchgear combinations (SK) up to 630 A rated current can be verified using the procedure according to 10.10.4.2. The required power dissipation capacities can be found in the tables of the respective cabinet series. Above 630 A rated current, the procedure according to 10.10.4.3 (DIN EN 61439-1 supplementary sheet 2, DIN VDE 0660-600-1 supplementary sheet 2) must be applied

Interior expansion system CombiLine N

Rail-mounted devices row spacing 125 mm/150 mm



MG303



MG433

- Expansion with DIN rails 35 x 15 mm
- DIN rails with field width 3 and over, with additional stabilization rail
- For installation devices according to DIN 43880
- The mounting frame must be ordered separately

Height		Width					From cabinet depth	Kit not installed		Mounted and installed in the cabinet	
RE	mm	FB	mm	PLE	EDF*1	WR*2	mm	Type	Order code	Type	Order code
Row spacing 125 mm											
1	150	1	250	12	●	●	120	MBG101	2CPX041650R9999	MG101	2CPX041200R9999
		2	500	24	●	●	120	MBG201	2CPX041651R9999	MG201	2CPX041201R9999
		3	750	36	●	●	120	MBG301	2CPX041652R9999	MG301	2CPX041202R9999
2	300	1	250	24	●	●	120	MBG102	2CPX041653R9999	MG102	2CPX041203R9999
		2	500	48	●	●	120	MBG202	2CPX041655R9999	MG202	2CPX041205R9999
		3	750	72	●	●	120	MBG302	2CPX041657R9999	MG302	2CPX041207R9999
3	450	1	250	36	●	●	120	MBG103	2CPX041659R9999	MG103	2CPX041209R9999
		2	500	72	●	●	120	MBG203	2CPX041661R9999	MG203	2CPX041211R9999
		3	750	108	●	●	120	MBG303	2CPX041663R9999	MG303	2CPX041213R9999
4	600	1	250	48	●	●	120	MBG104	2CPX041665R9999	MG104	2CPX041215R9999
		2	500	96	●	●	120	MBG204	2CPX041667R9999	MG204	2CPX041217R9999
		3	750	144	●	●	120	MBG304	2CPX041669R9999	MG304	2CPX041219R9999
5	750	1	250	60	●	●	120	MBG105	2CPX041671R9999	MG105	2CPX041221R9999
		2	500	120	●	●	120	MBG205	2CPX041673R9999	MG205	2CPX041223R9999
		3	750	180	●	●	120	MBG305	2CPX041675R9999	MG305	2CPX041225R9999
Row spacing 150 mm											
1	150	1	250	12	●	●	120	MBG101	2CPX041650R9999	MG101	2CPX041200R9999
		2	500	24	●	●	120	MBG201	2CPX041651R9999	MG201	2CPX041201R9999
		3	750	36	●	●	120	MBG301	2CPX041652R9999	MG301	2CPX041202R9999
2	300	1	250	24	●	●	120	MBG412	2CPX041654R9999	MG412	2CPX041204R9999
		2	500	48	●	●	120	MBG422	2CPX041656R9999	MG422	2CPX041206R9999
		3	750	72	●	●	120	MBG432	2CPX041658R9999	MG432	2CPX041208R9999
3	450	1	250	36	●	●	120	MBG413	2CPX041660R9999	MG413	2CPX041210R9999
		2	500	72	●	●	120	MBG423	2CPX041662R9999	MG423	2CPX041212R9999
		3	750	108	●	●	120	MBG433	2CPX041664R9999	MG433	2CPX041214R9999
4	600	1	250	48	●	●	120	MBG414	2CPX041666R9999	MG414	2CPX041216R9999
		2	500	96	●	●	120	MBG424	2CPX041668R9999	MG424	2CPX041218R9999
		3	750	144	●	●	120	MBG434	2CPX041670R9999	MG434	2CPX041220R9999
5	750	1	250	60	●	●	120	MBG415	2CPX041672R9999	MG415	2CPX041222R9999
		2	500	120	●	●	120	MBG425	2CPX041674R9999	MG425	2CPX041224R9999
		3	750	180	●	●	120	MBG435	2CPX041676R9999	MG435	2CPX041226R9999

*1Expansion on EDF mounting frame | *2Expansion on WR mounting frame

Interior expansion system CombiLine N

Touch protection



MB218

- Module as touch protection or to expand with system parts
- The mounting frame must be ordered separately

Height		Width					From cabinet depth			Kit not installed		Mounted and installed in the cabinet	
RE	mm	FB	mm	PLE	EDF* ¹	WR* ²	mm	Type	Order code	Type	Order code		
1	150	1	250	12	●	●	120	MBB116	2CPX041722R9999	MB116	2CPX041257R9999		
		2	500	24	●	●	120	MBB216	2CPX041723R9999	MB216	2CPX041258R9999		
		3	750	36	●	●	120	MBB316	2CPX041724R9999	MB316	2CPX041259R9999		
2	300	1	250	24	●	●	120	MBB117	2CPX041725R9999	MB117	2CPX041260R9999		
		2	500	48	●	●	120	MBB217	2CPX041726R9999	MB217	2CPX041261R9999		
		3	750	72	●	●	120	MBB317	2CPX041727R9999	MB317	2CPX041262R9999		
3	450	1	250	36	●	●	120	MBB118	2CPX041728R9999	MB118	2CPX041263R9999		
		2	500	72	●	●	120	MBB218	2CPX041729R9999	MB218	2CPX041264R9999		
		3	750	108	●	●	120	MBB318	2CPX041730R9999	MB318	2CPX041265R9999		
4	600	1	250	48	●	●	120	MBB119	2CPX041731R9999	MB119	2CPX041266R9999		
		2	500	96	●	●	120	MBB219	2CPX041732R9999	MB219	2CPX041267R9999		
		3	750	144	●	●	120	MBB319	2CPX041733R9999	MB319	2CPX041268R9999		
5	750	1	250	60	●	●	120	MBB120	2CPX041734R9999	MB120	2CPX041269R9999		
		2	500	120	●	●	120	MBB220	2CPX041735R9999	MB220	2CPX041270R9999		
		3	750	180	●	●	120	MBB320	2CPX041736R9999	MB320	2CPX041271R9999		



MB200

- Touch protection cover, including cover bracket
- Covers are not in the 150 mm grid
- 2 pieces must always be used per module control panel in order to get back to a grid unit
- The mounting frame must be ordered separately

Height		Width					From cabinet depth			Kit not installed		Mounted and installed in the cabinet	
RE	mm	FB	mm	PLE	EDF* ¹	WR* ²	mm	Type	Order code	Type	Order code		
0.5	75	1	250	6	●	●	120	MBB100	2CPX041427R9999	MB100	2CPX041422R9999		
		2	500	12	●	●	120	MBB200	2CPX041428R9999	MB200	2CPX041423R9999		

*1 Expansion on EDF mounting frame | *2 Expansion on WR mounting frame

Interior expansion system CombiLine N

Mounting plates



MM213

- Mounting plates made of sheet steel, 2 mm
- Mounting plates that are variably adjustable in depth via the deep angle piece ZW59P2
- Usable depth from 103 mm to 158 mm
- Usable width for equipment: 1-field width 188 mm, 2-field width 438 mm, 3-field width 688 mm
- The mounting frame must be ordered separately

Height RE	Width		From cabinet depth				Kit not installed		Mounted and installed in the cabinet		
	mm	FB	mm	PLE	EDF* ¹	WR* ²	mm	Type	Order code	Type	Order code
1	150	1	250	12	●	●	200	MBM111	2CPX041707R9999	MM111	2CPX041242R9999
		2	500	24	●	●	200	MBM211	2CPX041708R9999	MM211	2CPX041243R9999
		3	750	36	●	●	200	MBM311	2CPX041709R9999	MM311	2CPX041244R9999
2	300	1	250	24	●	●	200	MBM112	2CPX041710R9999	MM112	2CPX041245R9999
		2	500	48	●	●	200	MBM212	2CPX041711R9999	MM212	2CPX041246R9999
		3	750	72	●	●	200	MBM312	2CPX041712R9999	MM312	2CPX041247R9999
3	450	1	250	36	●	●	200	MBM113	2CPX041713R9999	MM113	2CPX041248R9999
		2	500	72	●	●	200	MBM213	2CPX041714R9999	MM213	2CPX041249R9999
		3	750	108	●	●	200	MBM313	2CPX041715R9999	MM313	2CPX041250R9999
4	600	1	250	48	●	●	200	MBM114	2CPX041716R9999	MM114	2CPX041251R9999
		2	500	96	●	●	200	MBM214	2CPX041717R9999	MM214	2CPX041252R9999
		3	750	144	●	●	200	MBM314	2CPX041718R9999	MM314	2CPX041253R9999
5	750	1	250	60	●	●	200	MBM115	2CPX041719R9999	MM115	2CPX041254R9999
		2	500	120	●	●	200	MBM215	2CPX041720R9999	MM215	2CPX041255R9999
		3	750	180	●	●	200	MBM315	2CPX041721R9999	MM315	2CPX041256R9999



MM113K

- Mounting plates made of sheet steel, 2 mm
- Mounting plate firmly attached
- Usable depth of 82 mm
- Usable width for equipment: 1-field width 200 mm
- The mounting frame must be ordered separately

Height RE	Width		From cabinet depth				Kit not installed		Mounted and installed in the cabinet		
	mm	FB	mm	PLE	EDF* ¹	WR* ²	mm	Type	Order code	Type	Order code
2	300	1	250	24	●	●	120	MBM112K	2CPX041640R9999	MM112K	2CPX041117R9999
3	450	1	250	36	●	●	120	MBM113K	2CPX041641R9999	MM113K	2CPX041118R9999
4	600	1	250	48	●	●	120	MBM114K	2CPX041642R9999	MM114K	2CPX041119R9999

*1 Expansion on EDF mounting frame | *2 Expansion on WR mounting frame

Interior expansion system CombiLine N

Horizontal terminal blocks



MK208

- With horizontally-arranged DIN rails 35 x 15 mm
- DIN rails variably-adjustable in depth
- Usable depth for ZW39P2 from 68 mm to 115 mm
- Usable depth for ZW59P2 from 90 mm to 145 mm
- Usable width for terminal blocks: 1-field width 188 mm, 2-field width 438 mm, 3-field width 688 mm
- Tiered delivery state
- Row spacing 150 mm (can be moved when it is needed)
- For grounded and insulated setup \perp
- The mounting frame must be ordered separately
- **Note:** The upper DIN rail is attached with at least a shorter deep angle piece (ZW39P2)
- **Modules setup:**
 - 1 row: 1 X ZW39P2
 - 2 rows: 1 X ZW39P2, 1 X ZW59P2
 - 3 rows: 2 X ZW39P2, 1 X ZW59P2
 - 4 rows: 2 X ZW39P2, 2 X ZW59P2
 - 5 rows: 2 X ZW39P2, 3 X ZW59P2

Height RE	Width		PLE	EDF*1	WR*2	From cabinet depth mm	Kit not installed		Mounted and installed in the cabinet		
	mm	FB mm					Type	Order code	Type	Order code	
1	150	1	250	12	●	●	200	MBK106	2CPX041677R9999	MK106	2CPX041227R9999
		2	500	24	●	●	200	MBK206	2CPX041679R9999	MK206	2CPX041228R9999
		3	750	36	●	●	200	MBK306	2CPX041681R9999	MK306	2CPX041229R9999
2	300	1	250	24	●	●	200	MBK107	2CPX041683R9999	MK107	2CPX041230R9999
		2	500	48	●	●	200	MBK207	2CPX041685R9999	MK207	2CPX041231R9999
		3	750	72	●	●	200	MBK307	2CPX041687R9999	MK307	2CPX041232R9999
3	450	1	250	36	●	●	200	MBK108	2CPX041689R9999	MK108	2CPX041233R9999
		2	500	72	●	●	200	MBK208	2CPX041691R9999	MK208	2CPX041234R9999
		3	750	108	●	●	200	MBK308	2CPX041693R9999	MK308	2CPX041235R9999
4	600	1	250	48	●	●	200	MBK109	2CPX041695R9999	MK109	2CPX041236R9999
		2	500	96	●	●	200	MBK209	2CPX041697R9999	MK209	2CPX041237R9999
		3	750	144	●	●	200	MBK309	2CPX041699R9999	MK309	2CPX041238R9999
5	750	1	250	60	●	●	200	MBK110	2CPX041701R9999	MK110	2CPX041239R9999
		2	500	120	●	●	200	MBK210	2CPX041703R9999	MK210	2CPX041240R9999
		3	750	180	●	●	200	MBK310	2CPX041705R9999	MK310	2CPX041241R9999

Interior expansion system CombiLine N

Horizontal / vertical terminal blocks



MK108K

- With horizontally-arranged DIN rails 35 x 7.5 mm
- DIN rails firmly attached via insulator piece ZK90P2
- Usable depth of 51 mm
- Usable width for terminal blocks: 1-field width 214 mm, 2-field width 464 mm
- Tiered delivery state
- Row spacing 150 mm (can be moved when it is needed)
- For insulated setup ☐
- The mounting frame must be ordered separately

Height	Width						From cabinet depth	Kit not installed		Mounted and installed in the cabinet	
	RE	mm	FB	mm	PLE	EDF* ¹		WR* ²	Type	Order code	Type
1	150	1	250	12	●	●	120	MBK106K	2CPX041632R9999	MK106K	2CPX041112R9999
		2	500	24	●	●	120	MBK206K	2CPX041633R9999	MK206K	2CPX041113R9999
2	300	1	250	24	●	●	120	MBK107K	2CPX041634R9999	MK107K	2CPX041114R9999
		2	500	48	●	●	120	MBK207K	2CPX041635R9999	MK207K	2CPX041115R9999
3	450	1	250	36	●	●	120	MBK108K	2CPX041636R9999	MK108K	2CPX041116R9999

*¹Expansion on EDF mounting frame | *²Expansion on WR mounting frame



MK213

- With vertically-arranged DIN rails 35 x 15 mm
- DIN rails that are variably adjustable in depth via the deep angle piece ZW39P2
- Usable depth from 66 mm to 113 mm
- Usable height for terminal blocks: 2 RE 244 mm, 3 RE 438 mm, 4 RE 591 mm
- For grounded and insulated setup ⊥
- The mounting frame must be ordered separately

Height	Width						From cabinet depth	Kit not installed		Mounted and installed in the cabinet	
	RE	mm	FB	mm	PLE	EDF* ¹		WR* ²	Type	Order code	Type
2	300	1	250	24	●	●	200	MBK112	2CPX041837R9999	MK112	2CPX041127R9999
		2	500	48	●	●	200	MBK212	2CPX041838R9999	MK212	2CPX041128R9999
		3	750	72	●	●	200	MBK312	2CPX041839R9999	MK312	2CPX041129R9999
3	450	1	250	36	●	●	200	MBK113	2CPX041840R9999	MK113	2CPX041130R9999
		2	500	72	●	●	200	MBK213	2CPX041841R9999	MK213	2CPX041131R9999
		3	750	108	●	●	200	MBK313	2CPX041842R9999	MK313	2CPX041132R9999
4	600	1	250	48	●	●	200	MBK114	2CPX041843R9999	MK114	2CPX041133R9999
		2	500	96	●	●	200	MBK214	2CPX041844R9999	MK214	2CPX041134R9999
		3	750	144	●	●	200	MBK314	2CPX041845R9999	MK314	2CPX041135R9999

*¹Expansion on EDF mounting frame | *²Expansion on WR mounting frame

Interior expansion system CombiLine N

Busbar system 40 mm, horizontal, M(B)S...24



MS324

- Busbar center distance 40 mm
- For maximum 5-pole busbars, see below
- With busbar bracket type ZB5
- With end cover type ZX172
- Additionally braced in the middle from 3-field width
- Rated current (I_n) max. 360 A
- **Important:** note the possibility to combine modules with the TwinLine cabinet row mountings
- The mounting frame must be ordered separately

Height RE	Width		PLE	EDF* ¹	WR* ²	From cabinet depth mm	Kit not installed		Mounted and installed in the cabinet		
	mm	FB					Type	Order code	Type	Order code	
2	300	1	250	24	●	●	200* ¹	MBS124	2CPX041737R9999	MS124	2CPX041272R9999
		2	500	48	●	●	200* ¹	MBS224	2CPX041738R9999	MS224	2CPX041273R9999
		3	750	72	●	●	225* ¹	MBS324	2CPX041739R9999	MS324	2CPX041274R9999

*¹Expansion on EDF mounting frame | *²Expansion on WR mounting frame

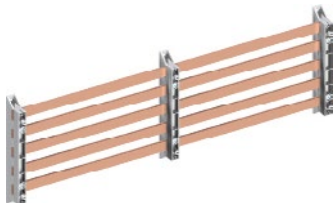

ZX2015

- Busbars for individual cabinet installation
- It is possible to combine different module widths within the cabinet with continuous busbars
- A maximum of 5 copper rails are required per module

Copper rail mm	I_n A	Width		Unit	Kit not installed		Mounted and installed in the cabinet	
		FB	mm		Type	Order code	Type	Order code
12 x 5	250	1	181	1	ZX2001	2CPX042200R9999	ZXM2001	2CPX042300R9999
		2	431	1	ZX2002	2CPX042201R9999	ZXM2002	2CPX042301R9999
		3	681	1	ZX2003	2CPX042202R9999	ZXM2003	2CPX042302R9999
		4	931	1	ZX2004	2CPX042203R9999	ZXM2004	2CPX042303R9999
		5	1181	1	ZX2005	2CPX042204R9999	ZXM2005	2CPX042304R9999
		6	1431	1	ZX2006	2CPX042792R9999	ZXM2006	2CPX042814R9999
12 x 10	360	1	181	1	ZX2007	2CPX042205R9999	ZXM2007	2CPX042305R9999
		2	431	1	ZX2008	2CPX042206R9999	ZXM2008	2CPX042306R9999
		3	681	1	ZX2009	2CPX042207R9999	ZXM2009	2CPX042307R9999
		4	931	1	ZX2010	2CPX042208R9999	ZXM2010	2CPX042308R9999
		5	1181	1	ZX2011	2CPX042209R9999	ZXM2011	2CPX042309R9999
		6	1431	1	ZX2012	2CPX042793R9999	ZXM2012	2CPX042815R9999
20 x 5	320	1	181	1	ZX2013	2CPX042210R9999	ZXM2013	2CPX042310R9999
		2	431	1	ZX2014	2CPX042211R9999	ZXM2014	2CPX042311R9999
		3	681	1	ZX2015	2CPX042212R9999	ZXM2015	2CPX042312R9999
		4	931	1	ZX2016	2CPX042213R9999	ZXM2016	2CPX042313R9999
		5	1181	1	ZX2017	2CPX042214R9999	ZXM2017	2CPX042314R9999
		6	1431	1	ZX2018	2CPX042794R9999	ZXM2018	2CPX042816R9999

Interior expansion system CombiLine N

Busbar system 60 mm, horizontal, M(B)S...27



MS327

- Busbar center distance 60 mm
- For 3-pole busbars, see below
- With busbar bracket type ZX151
- Additionally braced in the middle from 3-field width
- Rated current (I_n) max. 630 A
- **Important:** note the possibility to combine modules with the TwinLine cabinet row mountings
- The mounting frame must be ordered separately

Height RE	Width		From cabinet depth				Kit not installed		Mounted and installed in the cabinet		
	mm	FB	mm	PLE	EDF* ¹	WR* ²	mm	Type	Order code	Type	Order code
2	300	1	250	24	●	●	215* ¹	MBS127	2CPX041740R9999	MS127	2CPX041275R9999
		2	500	48	●	●	215* ¹	MBS227	2CPX041741R9999	MS227	2CPX041276R9999
		3	750	72	●	●	225* ¹	MBS327	2CPX041742R9999	MS327	2CPX041277R9999

*¹Expansion on EDF mounting frame | *²Expansion on WR mounting frame



ZX2027

- Busbars for individual cabinet installation
- It is possible to combine different module widths within the cabinet with continuous busbars
- 3 copper rails are required per module

Copper rail mm	I_n A	Width		Unit	Kit not installed		Mounted and installed in the cabinet	
		FB	mm		Type	Order code	Type	Order code
30 x 5	440	1	184	1	ZX2019	2CPX042215R9999	ZXM2019	2CPX042315R9999
		2	434	1	ZX2020	2CPX042216R9999	ZXM2020	2CPX042316R9999
		3	684	1	ZX2021	2CPX042217R9999	ZXM2021	2CPX042317R9999
		4	934	1	ZX2022	2CPX042218R9999	ZXM2022	2CPX042318R9999
		5	1184	1	ZX2023	2CPX042219R9999	ZXM2023	2CPX042319R9999
		6	1434	1	ZX2024	2CPX042795R9999	ZXM2024	2CPX042817R9999
30 x 10	630	1	184	1	ZX2025	2CPX042220R9999	ZXM2025	2CPX042320R9999
		2	434	1	ZX2026	2CPX042221R9999	ZXM2026	2CPX042321R9999
		3	684	1	ZX2027	2CPX042222R9999	ZXM2027	2CPX042322R9999
		4	934	1	ZX2028	2CPX042223R9999	ZXM2028	2CPX042323R9999
		5	1184	1	ZX2029	2CPX042224R9999	ZXM2029	2CPX042324R9999
		6	1434	1	ZX2030	2CPX042796R9999	ZXM2030	2CPX042818R9999

Interior expansion system CombiLine N

Busbar system 100 mm, horizontal, M(B)S...31

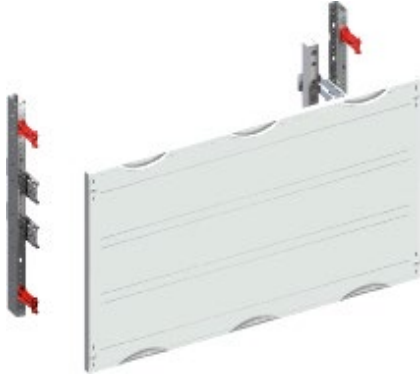

MS331

- Busbar center distance 100 mm
- For 3-pole busbars, see below
- With busbar bracket type ZX520
- Rated current (I_n) 850 A
- The mounting frame must be ordered separately
- Not suitable for fire protection housing

Height RE	Width						From cabinet depth mm	Kit not installed		Mounted and installed in the cabinet	
	mm	FB	mm	PLE	EDF* ¹	WR* ²		Type	Order code	Type	Order code
3	450	1	250	36	●	275	MBS131	2CPX041743R9999	MS131	2CPX041278R9999	
		2	500	72	●	275	MBS231	2CPX041744R9999	MS231	2CPX041279R9999	
		3	750	108	●	275	MBS331	2CPX041745R9999	MS331	2CPX041280R9999	

*¹ Expansion on EDF mounting frame | *² Expansion on WR mounting frame

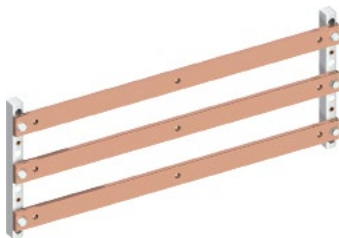

ZX2033

- Busbars for individual cabinet installation
- It is possible to combine different module widths within the cabinet with continuous busbars
- 3 copper rails are required per module

Copper rail mm	I_n A	Width			Unit	Kit not installed		Mounted and installed in the cabinet	
		FB	mm			Type	Order code	Type	Order code
40 x 10	850	1	184		1	ZX2031	2CPX042225R9999	ZXM2031	2CPX042325R9999
		2	434		1	ZX2032	2CPX042226R9999	ZXM2032	2CPX042326R9999
		3	684		1	ZX2033	2CPX042227R9999	ZXM2033	2CPX042327R9999
		4	934		1	ZX2034	2CPX042228R9999	ZXM2034	2CPX042328R9999
		5	1184		1	ZX2035	2CPX042229R9999	ZXM2035	2CPX042329R9999
		6	1434		1	ZX2036	2CPX042797R9999	ZXM2036	2CPX042819R9999

Interior expansion system CombiLine N

Busbar system, vertical, M(B)S...28, MBW250A



MS128

- With 4-pole busbars 30 x 5 mm, bores with M6 thread as well as connection with M8 press-in nuts for access
- With busbar bracket type ZX518
- Rated current (I_n) 440 A
- The mounting frame must be ordered separately
- Not suitable for fire protection housing

Height		Width						From cabinet depth	Kit not installed		Mounted and installed in the cabinet	
Re	mm	FB	mm	PLE	EDF* ¹	WR* ²	mm	Type	Order code	Type	Order code	
2	300	1	250	24	●	●	200	MBS128	2CPX041648R9999	MS128	2CPX041123R9999	
3	450	2	500	72	●	●	200	MBS228	2CPX041649R9999	MS228	2CPX041124R9999	

*¹Expansion on EDF mounting frame | *²Expansion on WR mounting frame

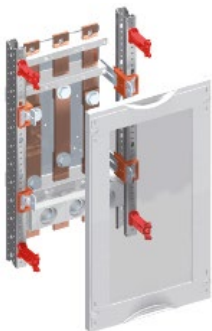

MBW250A

- With 3-pole busbars 30 x 5 mm and removable transformer supports
- With busbar bracket ZX146
- With deep angle piece ZW59P2
- With bus-mounting fuse socket E27, width 42 mm, 3-pole
- With cover with transparent panel
- Rated current (I_n) 250 A
- The mounting frame must be ordered separately
- Not suitable for fire protection housing

Height		Width						From cabinet depth	Kit not installed		Mounted and installed in the cabinet	
Re	mm	FB	mm	PLE	EDF* ¹	WR* ²	mm	Type	Order code	Type	Order code	
3	450	1	250	36	●	●	215	MBW250A	2CPX042102R9999	-	-	

*¹Expansion on EDF mounting frame | *²Expansion on WR mounting frame

Interior expansion system CombiLine N

N/PE busbar system, horizontal, M(B)N...69



MN369

- For 2-pole busbars, see below
- With busbar bracket type ZX518
- Additionally braced in the middle from 3-field width
- Rated current (I_n) max. 320 A
- The mounting frame must be ordered separately

Height		Width		From cabinet depth				Kit not installed		Mounted and installed in the cabinet	
RE	mm	FB	mm	PLE	EDF* ¹	WR* ²	mm	Type	Order code	Type	Order code
1	150	1	250	12	●	●	200	MBN169	2CPX041424R9999	MN169	2CPX041419R9999
		2	500	24	●	●	200	MBN269	2CPX041425R9999	MN269	2CPX041420R9999
		3	750	36	●	●	200	MBN369	2CPX041426R9999	MN369	2CPX041421R9999

*¹Expansion on EDF mounting frame | *²Expansion on WR mounting frame



ZX2066

- Busbars for individual cabinet installation
- It is possible to combine different module widths within the cabinet with continuous busbars
- 2 copper rails are required per module

Copper rail		Width		From cabinet depth				Kit not installed		Mounted and installed in the cabinet	
mm	I_n A	FB	mm	Unit				Type	Order code	Type	Order code
12 x 5	250	1	204	1				ZX2046	2CPX042538R9999	ZXM2046	2CPX042458R9999
		2	454	1				ZX2047	2CPX042539R9999	ZXM2047	2CPX042459R9999
		3	704	1				ZX2048	2CPX042540R9999	ZXM2048	2CPX042460R9999
		4	954	1				ZX2049	2CPX042541R9999	ZXM2049	2CPX042461R9999
		5	1204	1				ZX2050	2CPX042542R9999	ZXM2050	2CPX042462R9999
		6	1454	1				ZX2051	2CPX042798R9999	ZXM2051	2CPX042820R9999
20 x 5	320	1	204	1				ZX2064	2CPX042553R9999	ZXM2064	2CPX042473R9999
		2	454	1				ZX2065	2CPX042554R9999	ZXM2065	2CPX042474R9999
		3	704	1				ZX2066	2CPX042555R9999	ZXM2066	2CPX042475R9999
		4	954	1				ZX2067	2CPX042556R9999	ZXM2067	2CPX042476R9999
		5	1204	1				ZX2068	2CPX042557R9999	ZXM2068	2CPX042477R9999
		6	1454	1				ZX2069	2CPX042799R9999	ZXM2069	2CPX042821R9999

Interior expansion system CombiLine N

N/PE busbar system and terminal blocks, M(B)N...74+75



- For 2-pole busbars, see below
- With busbar bracket type ZX518
- With end cover type ZX519
- Additionally braced in the middle from 3-field width
- DIN rail that is variably adjustable in depth via the deep angle piece ZW59P2
- Usable depth from 90 mm to 145 mm
- Usable width for terminal blocks: 1-field width 188 mm, 2-field width 438 mm, 3-field width 688 mm
- Rated current (I_n) max. 440 A
- **Important:** note the possibility to combine modules with the TwinLine cabinet row mountings
- The mounting frame must be ordered separately

With one additional DIN rail for terminal blocks

Height	Width						From cabinet depth	Kit not installed		Mounted and installed in the cabinet		
	RE	mm	FB	mm	PLE	EDF* ¹		WR* ²	mm	Type	Order code	Type
2	300	1	250	24	●	●	200	MBN174	2CPX041746R9999	MN174	2CPX041281R9999	
		2	500	48	●	●	200	MBN274	2CPX041748R9999	MN274	2CPX041282R9999	
		3	750	72	●	●	200	MBN374	2CPX041750R9999	MN374	2CPX041283R9999	
With two additional DIN rails for terminal blocks												
3	450	1	250	36	●	●	200	MBN175	2CPX041752R9999	MN175	2CPX041284R9999	
		2	500	72	●	●	200	MBN275	2CPX041754R9999	MN275	2CPX041285R9999	
		3	750	108	●	●	200	MBN375	2CPX041756R9999	MN375	2CPX041286R9999	

*1 Expansion on EDF mounting frame | *2 Expansion on WR mounting frame



- Busbars for individual cabinet installation
- It is possible to combine different module widths within the cabinet with continuous busbars
- 2 copper rails are required per module

Copper rail	I _n	Width			Unit	Kit not installed		Mounted and installed in the cabinet	
		mm	A	FB		mm	Type	Order code	Type
12 x 5	250	1	246		1	ZX1001	2CPX041870R9999	ZXM1001	2CPX041480R9999
		2	496		1	ZX1002	2CPX041871R9999	ZXM1002	2CPX041481R9999
		3	746		1	ZX1003	2CPX041872R9999	ZXM1003	2CPX041482R9999
		4	996		1	ZX1004	2CPX041873R9999	ZXM1004	2CPX041483R9999
		5	1246		1	ZX1005	2CPX041874R9999	ZXM1005	2CPX041484R9999
		6	1496		1	ZX1006	2CPX042800R9999	ZXM1006	2CPX042822R9999
20 x 5	320	1	246		1	ZX1013	2CPX041882R9999	ZXM1013	2CPX041492R9999
		2	496		1	ZX1014	2CPX041883R9999	ZXM1014	2CPX041493R9999
		3	746		1	ZX1015	2CPX041884R9999	ZXM1015	2CPX041494R9999
		4	996		1	ZX1016	2CPX041885R9999	ZXM1016	2CPX041495R9999
		5	1246		1	ZX1017	2CPX041886R9999	ZXM1017	2CPX041496R9999
		6	1496		1	ZX1018	2CPX042801R9999	ZXM1018	2CPX042823R9999
30 x 5	440	1	246		1	ZX1019	2CPX041888R9999	ZXM1019	2CPX041498R9999
		2	496		1	ZX1020	2CPX041889R9999	ZXM1020	2CPX041499R9999
		3	746		1	ZX1021	2CPX041890R9999	ZXM1021	2CPX041500R9999
		4	996		1	ZX1022	2CPX041891R9999	ZXM1022	2CPX041501R9999
		5	1246		1	ZX1023	2CPX041892R9999	ZXM1023	2CPX041502R9999
		6	1496		1	ZX1024	2CPX042802R9999	ZXM1024	2CPX042824R9999

Interior expansion system CombiLine N

N/PE busbar system and terminal blocks, M(B)N...62+63



MN362

MN363

- For 2-pole busbars, see below
- With busbar bracket type ZX149
- Additionally braced in the middle from 3-field width
- DIN rail that is variably adjustable in depth via the deep angle piece ZW59P2
- Usable depth from 90 mm to 145 mm
- Usable width for terminal blocks: 1-field width 188 mm, 2-field width 438 mm, 3-field width 688 mm
- Rated current (I_n) 630 A
- **Important:** note the possibility to combine modules with the TwinLine cabinet row mountings
- The mounting frame must be ordered separately
- Not suitable for fire protection housing

With one additional DIN rail for terminal blocks

Height RE	Width				EDF* ¹	WR* ²	From cabinet depth mm	Kit not installed		Mounted and installed in the cabinet	
	mm	FB	mm	PLE				Type	Order code	Type	Order code
2	300	1	250	24	●	275	MBN162	2CPX041758R9999	MN162	2CPX041287R9999	
		2	500	48	●	275	MBN262	2CPX041760R9999	MN262	2CPX041288R9999	
		3	750	72	●	275	MBN362	2CPX041762R9999	MN362	2CPX041289R9999	

With two additional DIN rails for terminal blocks

3	450	1	250	36	●	275	MBN163	2CPX041764R9999	MN163	2CPX041290R9999
		2	500	72	●	275	MBN263	2CPX041766R9999	MN263	2CPX041291R9999
		3	750	108	●	275	MBN363	2CPX041768R9999	MN363	2CPX041292R9999

*¹Expansion on EDF mounting frame | *²Expansion on WR mounting frame



ZX2084

- Busbars for individual cabinet installation
- It is possible to combine different module widths within the cabinet with continuous busbars
- 2 copper rails are required per module

Copper rail mm	I_n A	Width			Unit	Kit not installed		Mounted and installed in the cabinet	
		FB	mm			Type	Order code	Type	Order code
30 x 10	630	1	201		1	ZX2082	2CPX042568R9999	ZXM2082	2CPX042488R9999
		2	451		1	ZX2083	2CPX042569R9999	ZXM2083	2CPX042489R9999
		3	701		1	ZX2084	2CPX042570R9999	ZXM2084	2CPX042490R9999
		4	951		1	ZX2085	2CPX042571R9999	ZXM2085	2CPX042491R9999
		5	1201		1	ZX2086	2CPX042572R9999	ZXM2086	2CPX042492R9999
		6	1451		1	ZX2087	2CPX042803R9999	ZXM2087	2CPX042825R9999

Interior expansion system CombiLine N

Busbar system 60 mm, horizontal, M(B)R...02(B)



MR302B



MR302

- Busbar center distance 60 mm
- For 3-pole busbars
- 32 mm spacing between copper rail and cover
- With busbar bracket type ZX146
- With end cover ZX172
- Additionally braced in the middle from 3-field width
- Rated current (I_n) max. 440 A
- Bus-mounting fuse socket, see below
- **Important:** note the possibility to combine modules with the TwinLine cabinet row mountings
- The mounting frame must be ordered separately
- Not suitable for fire protection housing

Populated module for equipment with vertically installed 3-pole bus-mounting fuse socket, I_n up to max. 250 A

Height	Width		Elements					From cabinet depth	Kit not installed		Mounted and installed in the cabinet	
	mm	FB	mm	D02	PLE	EDF* ¹	WR* ²		mm	Type	Order code	Type
2	300	1	250	5* ⁴	24	●	●	120	-	-	MR102B	2CPX041409R9999
		2	500	14* ⁴	48	●	●	200	-	-	MR202B	2CPX041410R9999
		3	750	24* ⁴	72	-	●	225	-	-	MR302B	2CPX041411R9999

Unpopulated module for equipment, for vertical installation of bus-mounting fuse sockets, D0 fuse switch disconnectors or NH00 fuse switch disconnectors*³, I_n up to max. 440 A

Height	Width		Useful width			PLE	EDF* ¹	WR* ²	From cabinet depth	Kit not installed		Mounted and installed in the cabinet		
	mm	FB	mm	mm	mm					Type	Order code	Type	Order code	
2	300	1	250	1 x 215* ⁴			24	●	●	120* ³	MBR102	2CPX041825R9999	MR102	2CPX041406R9999
		2	500	1 x 465* ⁴			48	●	●	200* ³	MBR202	2CPX041826R9999	MR202	2CPX041407R9999
		3	750	2 x 320* ⁴			72	-	●	225* ³	MBR302	2CPX041827R9999	MR302	2CPX041408R9999

*¹ Expansion on EDF mounting frame | *² Expansion on WR mounting frame | *³ The cabinet depth depends on the depth dimensions of the equipment (comparison of cabinet views with dimensions of the equipment) | *⁴ The change useable width should be considered in the TwinLine busbar arrangement 242



ZE60



ZE61



ZE62



ZA4P10

Article	Unit	Type	Order code
Neozed bus-mounting fuse socket E18, width 26 mm	1	ZE60	2CPX061045R9999
For gauge ring inserts, 3-pole, with covers and nameplates, with E18 thread, safety fuse max. 63 A	10	ZE60P10	2CPX062400R9999
Diazed bus-mounting fuse socket E27, width 42 mm	1	ZE61	2CPX061046R9999
For gauge ring inserts, 3-pole, with covers and nameplates, with E27 thread, safety fuse max. 25 A			
Diazed bus-mounting fuse socket E33, width 56 mm	1	ZE62	2CPX061047R9999
For gauge ring inserts, 3-pole, with covers and nameplates, with E33 thread, safety fuse max. 63 A			
Shutters instead of bus-mounting fuse socket	10	ZA4P10	2CPX062374R9999
Color similar to RAL 7035, for compliance with the contact protection IPXXC Usable width from 16 mm to 34 mm			

Interior expansion system CombiLine N

Busbar system 60 mm horizontal, M(B)R...02



ZX1015

- Busbars for individual cabinet installation
- It is possible to combine different module widths within the cabinet with continuous busbars
- 3 copper rails are required per module

Copper rail mm	I _n A	Width		Unit	Kit not installed		Mounted and installed in the cabinet	
		FB	mm		Type	Order code	Type	Order code
12 x 5	(100)* 250	1	246	1	ZX1001	2CPX041870R9999	ZXM1001	2CPX041480R9999
		2	496	1	ZX1002	2CPX041871R9999	ZXM1002	2CPX041481R9999
		3	746	1	ZX1003	2CPX041872R9999	ZXM1003	2CPX041482R9999
		4	996	1	ZX1004	2CPX041873R9999	ZXM1004	2CPX041483R9999
		5	1246	1	ZX1005	2CPX041874R9999	ZXM1005	2CPX041484R9999
		6	1496	1	ZX1006	2CPX042800R9999	ZXM1006	2CPX042822R9999
20 x 5	(250)* 320	1	246	1	ZX1013	2CPX041882R9999	ZXM1013	2CPX041492R9999
		2	496	1	ZX1014	2CPX041883R9999	ZXM1014	2CPX041493R9999
		3	746	1	ZX1015	2CPX041884R9999	ZXM1015	2CPX041494R9999
		4	996	1	ZX1016	2CPX041885R9999	ZXM1016	2CPX041495R9999
		5	1246	1	ZX1017	2CPX041886R9999	ZXM1017	2CPX041496R9999
		6	1496	1	ZX1018	2CPX042801R9999	ZXM1018	2CPX042823R9999
30 x 5	(250)* 440	1	246	1	ZX1019	2CPX041888R9999	ZXM1019	2CPX041498R9999
		2	496	1	ZX1020	2CPX041889R9999	ZXM1020	2CPX041499R9999
		3	746	1	ZX1021	2CPX041890R9999	ZXM1021	2CPX041500R9999
		4	996	1	ZX1022	2CPX041891R9999	ZXM1022	2CPX041501R9999
		5	1246	1	ZX1023	2CPX041892R9999	ZXM1023	2CPX041502R9999
		6	1496	1	ZX1024	2CPX042802R9999	ZXM1024	2CPX042824R9999

* For expansion with bus-mounting fuse socket

Interior expansion system CombiLine N

Busbar system 60 mm horizontal, M(B)R...03

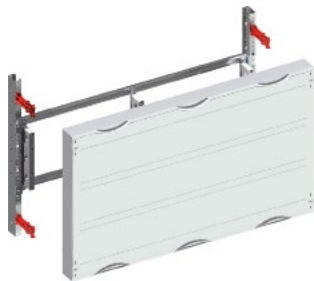

MR303

- Unpopulated for equipment for the vertical installation of D0 and NH fuse switch disconnectors or bus-mounting fuse sockets
- For 3-pole busbars, see below
- Spacing between copper rail and cover:
For the equipment Efen and K'Electric 68 mm*³,
Jean Müller and Wöhner 60.5 mm*³
- Cover without cutout, including extension frame
- With busbar bracket type ZX146
- Additionally braced in the middle from 3-field width
- Rated current (I_n) max. 630 A
- The mounting frame must be ordered separately
- Not suitable for fire protection housing

Height	Width	Useful width			From cabinet depth			Kit not installed		Mounted and installed in the cabinet		
		RE	mm	FB	mm	mm	PLE	EDF* ¹	WR* ²	mm	Type	Order code
3	450	1	250	165	36	-	●	275* ³	MBR103	2CPX041830R9999	MR103	2CPX041414R9999
		2	500	415	72	-	●	275* ³	MBR203	2CPX041831R9999	MR203	2CPX041415R9999
		3	750	665	108	-	●	275* ³	MBR303	2CPX041832R9999	MR303	2CPX041416R9999

*¹ Expansion on EDF mounting frame | *² Expansion on WR mounting frame | *³ The cabinet depth depends on the depth dimensions of the equipment (comparison of cabinet views with dimensions of the equipment)

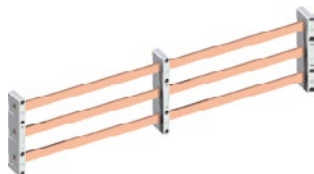

ZX2060

- Busbars for individual cabinet installation
- It is possible to combine different module widths within the cabinet with continuous busbars
- 3 copper rails are required per module

Copper rail	I _n	Width		Unit	Kit not installed		Mounted and installed in the cabinet	
		mm	FB		Type	Order code	Type	Order code
12 x 5	250	1	195	1	ZX2040	2CPX042533R9999	ZXM2040	2CPX042453R9999
		2	445	1	ZX2041	2CPX042534R9999	ZXM2041	2CPX042454R9999
		3	695	1	ZX2042	2CPX042535R9999	ZXM2042	2CPX042455R9999
		4	945	1	ZX2043	2CPX042536R9999	ZXM2043	2CPX042456R9999
		5	1195	1	ZX2044	2CPX042537R9999	ZXM2044	2CPX042457R9999
		6	1445	1	ZX2045	2CPX042804R9999	ZXM2045	2CPX042826R9999
12 x 10	360	1	195	1	ZX2052	2CPX042543R9999	ZXM2052	2CPX042463R9999
		2	445	1	ZX2053	2CPX042544R9999	ZXM2053	2CPX042464R9999
		3	695	1	ZX2054	2CPX042545R9999	ZXM2054	2CPX042465R9999
		4	945	1	ZX2055	2CPX042546R9999	ZXM2055	2CPX042466R9999
		5	1195	1	ZX2056	2CPX042547R9999	ZXM2056	2CPX042467R9999
		6	1445	1	ZX2057	2CPX042805R9999	ZXM2057	2CPX042827R9999
20 x 5	320	1	195	1	ZX2058	2CPX042548R9999	ZXM2058	2CPX042468R9999
		2	445	1	ZX2059	2CPX042549R9999	ZXM2059	2CPX042469R9999
		3	695	1	ZX2060	2CPX042550R9999	ZXM2060	2CPX042470R9999
		4	945	1	ZX2061	2CPX042551R9999	ZXM2061	2CPX042471R9999
		5	1195	1	ZX2062	2CPX042552R9999	ZXM2062	2CPX042472R9999
		6	1445	1	ZX2063	2CPX042806R9999	ZXM2063	2CPX042828R9999
30 x 5	440	1	195	1	ZX2070	2CPX042558R9999	ZXM2070	2CPX042478R9999
		2	445	1	ZX2071	2CPX042559R9999	ZXM2071	2CPX042479R9999
		3	695	1	ZX2072	2CPX042560R9999	ZXM2072	2CPX042480R9999
		4	945	1	ZX2073	2CPX042561R9999	ZXM2073	2CPX042481R9999
		5	1195	1	ZX2074	2CPX042562R9999	ZXM2074	2CPX042482R9999
		6	1445	1	ZX2075	2CPX042807R9999	ZXM2075	2CPX042829R9999
30 x 10	630	1	195	1	ZX2076	2CPX042563R9999	ZXM2076	2CPX042483R9999
		2	445	1	ZX2077	2CPX042564R9999	ZXM2077	2CPX042484R9999
		3	695	1	ZX2078	2CPX042565R9999	ZXM2078	2CPX042485R9999
		4	945	1	ZX2079	2CPX042566R9999	ZXM2079	2CPX042486R9999
		5	1195	1	ZX2080	2CPX042567R9999	ZXM2080	2CPX042487R9999
		6	1445	1	ZX2081	2CPX042808R9999	ZXM2081	2CPX042830R9999

Interior expansion system CombiLine N

Busbar system 60 mm vertical, M(B)R...H



MR102H

- Unpopulated for equipment for the horizontal installation of bus-mounting fuse sockets, see below
- For 3-pole busbars, see below
- 32 mm spacing between copper rail and cover
- With busbar bracket type ZX146
- Rated current (I_n) max. 250 A
- The mounting frame must be ordered separately
- Not suitable for fire protection housing

Height	Width		Cutout height in		From cabinet depth			Kit not installed		Mounted and installed in the cabinet		
	RE	mm	FB	mm	mm	PLE	EDF* ¹	WR* ²	Type	Order code	Type	Order code
2	300	1	250	1 x 134	24	●	●	120	MBR102H	2CPX041828R9999	MR102H	2CPX041412R9999
3	450	1	250	1 x 295	36	●	●	200	MBR103H	2CPX041829R9999	MR103H	2CPX041413R9999

*¹Expansion on EDF mounting frame | *²Expansion on WR mounting frame



ZX2506

- Combinations of different module heights (see information in RE height) are possible within the cabinet with continuous busbars.
- 3 copper rails are required per module

Copper rail	I_n	Height		Unit	Kit not installed		Mounted and installed in the cabinet	
		mm	RE		Type	Order code	Type	Order code
12x5,	100	2	178	1	ZX2500	2CPX042877R9999	ZXM2500	2CPX042867R9999
		3	328	1	ZX2501	2CPX042878R9999	ZXM2501	2CPX042868R9999
		4 (2RE + 2RE)	478	1	ZX2502	2CPX042879R9999	ZXM2502	2CPX042869R9999
		5 (2RE + 3RE)	628	1	ZX2503	2CPX042880R9999	ZXM2503	2CPX042870R9999
		6 (3RE + 3RE)	778	1	ZX2504	2CPX042881R9999	ZXM2504	2CPX042871R9999
		20x5	250	2	178	1	ZX2505	2CPX042882R9999
3	328			1	ZX2506	2CPX042883R9999	ZXM2506	2CPX042873R9999
4 (2RE + 2RE)	478			1	ZX2507	2CPX042884R9999	ZXM2507	2CPX042874R9999
5 (2RE + 3RE)	628			1	ZX2508	2CPX042885R9999	ZXM2508	2CPX042875R9999
6 (3RE + 3RE)	778			1	ZX2509	2CPX042886R9999	ZXM2509	2CPX042876R9999



ZE60



ZE61



ZE62



ZA4P10

Article	Unit	Type	Order code
Neozed bus-mounting fuse socket E18, width 26 mm	1	ZE60	2CPX061045R9999
For gauge ring inserts, 3-pole, with covers and nameplates, with E18 thread, safety fuse max. 63 A	10	ZE60P10	2CPX062400R9999
Diazed bus-mounting fuse socket E27, width 42 mm	1	ZE61	2CPX061046R9999
For gauge ring inserts, 3-pole, with covers and nameplates, with E27 thread, safety fuse max. 25 A			
Diazed bus-mounting fuse socket E33, width 56 mm	1	ZE62	2CPX061047R9999
For gauge ring inserts, 3-pole, with covers and nameplates, with E33 thread, safety fuse max. 63 A			
Shutters instead of bus-mounting fuse socket	10	ZA4P10	2CPX062374R9999
Color similar to RAL 7035, for compliance with the contact protection IPXXC			

Interior expansion system CombiLine N

NH00-fuse switch disconnecter, M(B)T...35+36+37(B)



MT337B

- Populated with NH00 fuse switch disconnecter 160 A type ZH411, with separator shutters
- With 320 A busbar system, 3-pole, M8 connection screws
- Rated current (I_n) max. 320 A
- **Important:** note the cabinet depth in the lock area
- Spacing from the front edge of the equipment to the cover: 37 mm
- The mounting frame must be ordered separately
- Not suitable for fire protection housing, except for module MT135B

Height	Width		With disconnecter				From cabinet depth	Kit not installed		Mounted and installed in the cabinet		
	RE	mm	FB	mm	NH00	PLE		EDF* ¹	WR* ²	mm	Type	Order code
2	300	1	250	1	24	●	●	200	-	-	MT135B	2CPX042451R9999
				2	24	●	●		-	-	MT136B	2CPX041293R9999
				4	48	●	●		-	-	MT236B	2CPX041294R9999
				6	72	●	●		-	-	MT336B	2CPX041295R9999
4	600	1	250	4	48	●	●	200	-	-	MT137B	2CPX041296R9999
				8	96	●	●		-	-	MT237B	2CPX041297R9999
				12	144	-	●		-	-	MT337B	2CPX041298R9999

*¹Expansion on EDF mounting frame | *²Expansion on WR mounting frame



MT337

- Unpopulated for NH00 fuse switch disconnecters 160 A, Makes: ABB (ZH411, ZH412), without separator shutters
- For 320 A busbar system, 3-pole
- Rated current (I_n) max. 320 A
- **Important:** note the cabinet depth in the lock area
- The mounting frame must be ordered separately
- Not suitable for fire protection housing, except for modules MBT135 and MT135

Height	Width		For disconnecter				From cabinet depth	Kit not installed		Mounted and installed in the cabinet		
	RE	mm	FB	mm	NH00	PLE		EDF* ¹	WR* ²	mm	Type	Order code
2	300	1	250	1	24	●	●	200	MBT135	2CPX042452R9999	MT135	2CPX042450R9999
				2	24	●	●		MBT136	2CPX041770R9999	MT136	2CPX041299R9999
				4	48	●	●		MBT236	2CPX041771R9999	MT236	2CPX041300R9999
				6	72	●	●		MBT336	2CPX041772R9999	MT336	2CPX041301R9999
4	600	1	250	4	48	●	●	200	MBT137	2CPX041773R9999	MT137	2CPX041302R9999
				8	96	●	●		MBT237	2CPX041774R9999	MT237	2CPX041303R9999
				12	144	-	●		MBT337	2CPX041775R9999	MT337	2CPX041304R9999

*¹Expansion on EDF mounting frame | *²Expansion on WR mounting frame

Interior expansion system CombiLine N

Accessories for NH00-fuse switch disconnecter modules

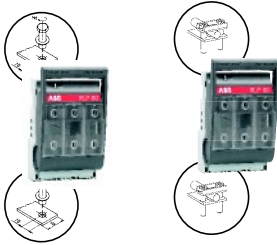

ZH411

ZH412



ZH311

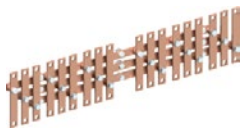

ZH312



ZH427



ZH430



ZX148

Article	Suitable for module	Unit	Type	Order code
NH00 fuse switch disconnecter				
Rated current (I_n) max. 160 A, without separator shutters				
With M8 connection screws	M(B)T135 - M(B)T337	1	ZH411	2CPX062947R9999
With U-clamp terminals up to 50 mm ²	M(B)T135 - M(B)T337	1	ZH412	2CPX062948R9999
NH00 busbar system				
Copper rails 20 x 5 mm, 3-pole	M(B)T136	1	ZH214	2CPX060443R9999
Rated current (I_n) 320 A	M(B)T236	1	ZH211	2CPX060440R9999
Single-story with M8 connection screws	M(B)T336	1	ZH311	2CPX060450R9999
NH00 busbar system				
Copper rails 20 x 5 mm, 3-pole	M(B)T137	1	ZH216	2CPX060445R9999
Rated current (I_n) 320 A	M(B)T237	1	ZH212	2CPX060441R9999
Double-story with M8 connection screws	M(B)T337	1	ZH312	2CPX060451R9999
Separator shutters				
For NH fuse switch disconnecter, color similar to RAL 7035, for compliance with the contact protection IPXXC				
Single shutter	1 x M(B)T135 *	1	ZH425	2CPX062952R9999
Double shutter	1 x M(B)T136 * 2 x M(B)T236 * 2 x M(B)T137 * 4 x M(B)T237 *	1	ZH426	2CPX062953R9999
Triple shutter	2 x M(B)T336 * 4 x M(B)T337 *	1	ZH427	2CPX062954R9999
Separator shutters, closed				
Instead of NH fuse switch disconnecter, color similar to RAL 7035, for compliance with the contact protection IPXXC				
Single shutter	M(B)T135 - M(B)T337	1	ZH428	2CPX062955R9999
Double shutter	M(B)T236 - M(B)T337	1	ZH429	2CPX062956R9999
Triple shutter	M(B)T336 - M(B)T337	1	ZH430	2CPX062957R9999
Insulation plate	M(B)T135 - M(B)T337	1	ZX148	2CPX044018R9999
For non-allocated busbar ends with NH00 fuse switch disconnecter				

*Quantity per module when fully assembled

Interior expansion system CombiLine N

NH1-fuse switch disconnecter, M(B)T...42+43(B)



MT343B

- Populated with NH1 fuse switch disconnecter 250 A type ZH431, with separator shutters
- With 3-pole busbar system, M10 connection screws
- Rated current (I_n) max. 440 A, single-story
- Rated current (I_n) max. 630 A, double-story
- **Important:** note the cabinet depth in the lock area
- Spacing from the front edge of the equipment to the cover: 43 mm
- The mounting frame must be ordered separately
- Not suitable for fire protection housing

Height	Width		With disconnecter				From cabinet depth	Kit not installed		Mounted and installed in the cabinet			
	RE	mm	FB	mm	NH1	PLE		EDF* ¹	WR* ²	mm	Type	Order code	Type
3	450	1	250	1	36	●	●	200	-	-	-	MT142B	2CPX041305R9999
		2	500	2	72	●	●	200	-	-	-	MT242B	2CPX041306R9999
		3	750	3	108	-	●	225	-	-	-	MT342B	2CPX041307R9999
5	750	1	250	2	60	●	●	200	-	-	-	MT143B	2CPX041308R9999
		2	500	4	120	-	●	225	-	-	-	MT243B	2CPX041309R9999
		3	750	6	180	-	●	225	-	-	-	MT343B	2CPX041310R9999

*1 Expansion on EDF mounting frame | *2 Expansion on WR mounting frame



MT343

- Unpopulated for NH1 fuse switch disconnectors 250 A, Makes: ABB (ZH431), without separator shutters
- For busbar system, 3-pole
- Rated current (I_n) max. 440 A, single-story
- Rated current (I_n) max. 630 A, double-story
- **Important:** note the cabinet depth in the lock area
- The mounting frame must be ordered separately
- Not suitable for fire protection housing

Height	Width		For disconnecter				From cabinet depth	Kit not installed		Mounted and installed in the cabinet		
	RE	mm	FB	mm	NH1	PLE		EDF* ¹	WR* ²	mm	Type	Order code
3	450	1	250	1	36	●	●	200	MBT142	2CPX041776R9999	MT142	2CPX041311R9999
		2	500	2	72	●	●	200	MBT242	2CPX041777R9999	MT242	2CPX041312R9999
		3	750	3	108	-	●	225	MBT342	2CPX041778R9999	MT342	2CPX041313R9999
5	750	1	250	2	60	●	●	200	MBT143	2CPX041779R9999	MT143	2CPX041314R9999
		2	500	4	120	-	●	225	MBT243	2CPX041780R9999	MT243	2CPX041315R9999
		3	750	6	180	-	●	225	MBT343	2CPX041781R9999	MT343	2CPX041316R9999

*1 Expansion on EDF mounting frame | *2 Expansion on WR mounting frame

Interior expansion system CombiLine N

Accessories for NH1-fuse switch disconnecter modules



ZH431



ZH317

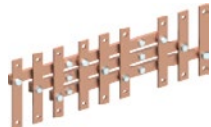

ZH318



ZH438



ZH440



ZX128

Article	Intended use	Unit	Type	Order code
NH1 fuse switch disconnecter Rated current (I_n) max. 250 A, without separator shutters, with M10 connection screws	M(B)T142 - M(B) T343	1	ZH431	2CPX062958R9999
NH1/NH2 busbar system Copper rails 30 x 5 mm, 3-pole Rated current (I_n) 440 A Single-story with M10 connection screws	M(B)T242	1	ZH217	2CPX060446R9999
	M(B)T342	1	ZH317	2CPX060456R9999
NH1/NH2 busbar system Copper rails 30 x 10 mm, 3-pole Rated current (I_n) 630 A Double-story with M10 connection screws	M(B)T243	1	ZH218	2CPX060447R9999
	M(B)T343	1	ZH318	2CPX060457R9999
Separator shutter Single shutter for NH fuse switch disconnecter, color similar to RAL 7035, for compliance with the contact protection IPXXC	1 x M(B)T142 * 2 x M(B)T242 * 3 x M(B)T342 * 2 x M(B)T143 * 4 x M(B)T243 * 6 x M(B)T343 *	1	ZH438	2CPX062961R9999
Separator shutter, closed Single shutter instead of NH fuse switch disconnecter, color similar to RAL 7035, for compliance with the contact protection IPXXC	M(B)T142 - M(B) T343	1	ZH440	2CPX062963R9999
Insulation plate For non-allocated busbar ends with NH1 fuse switch disconnecter	M(B)T142 - M(B) T343	1	ZX128	2CPX039128R9999

*Quantity per module when fully assembled

Interior expansion system CombiLine N

NH2-fuse switch disconnecter, M(B)T...44+45(B)



MT345B

- Populated with NH2 fuse switch disconnecter 400 A type ZH441, with separator shutters
- With 3-pole busbar system, M10 connection screws
- Rated current (I_n) max. 440 A, single-story
- Rated current (I_n) max. 630 A, double-story
- **Important:** note the cabinet depth in the lock area
- Spacing from the front edge of the equipment to the cover: 43 mm
- The mounting frame must be ordered separately
- Not suitable for fire protection housing

Height	Width		With disconnecter				From cabinet depth	Kit not installed		Mounted and installed in the cabinet		
	RE	mm	FB	mm	NH2	PLE		EDF* ¹	WR* ²	mm	Type	Order code
3	450	1	250	1	36	●	●	215	-	-	MT144B	2CPX041317R9999
		2	500	2	72	●	●	215	-	-	MT244B	2CPX041318R9999
		3	750	3	108	-	●	225	-	-	MT344B	2CPX041319R9999
5	750	1	250	2	60	●	●	215	-	-	MT145B	2CPX041320R9999
		2	500	4	120	-	●	225	-	-	MT245B	2CPX041321R9999
		3	750	6	180	-	●	225	-	-	MT345B	2CPX041322R9999

*¹ Expansion on EDF mounting frame | *² Expansion on WR mounting frame



MT345

- Unpopulated for NH2 fuse switch disconnecters 400 A, Makes: ABB (ZH441), without separator shutters
- For busbar system, 3-pole
- Rated current (I_n) max. 440 A, single-story
- Rated current (I_n) max. 630 A, double-story
- **Important:** note the cabinet depth in the lock area
- The mounting frame must be ordered separately
- Not suitable for fire protection housing

Height	Width		For disconnecter				From cabinet depth	Kit not installed		Mounted and installed in the cabinet		
	RE	mm	FB	mm	NH2	PLE		EDF* ¹	WR* ²	mm	Type	Order code
3	450	1	250	1	36	●	●	215	MBT144	2CPX041782R9999	MT144	2CPX041323R9999
		2	500	2	72	●	●	215	MBT244	2CPX041783R9999	MT244	2CPX041324R9999
		3	750	3	108	-	●	225	MBT344	2CPX041784R9999	MT344	2CPX041325R9999
5	750	1	250	2	60	●	●	215	MBT145	2CPX041785R9999	MT145	2CPX041326R9999
		2	500	4	120	-	●	225	MBT245	2CPX041786R9999	MT245	2CPX041327R9999
		3	750	6	180	-	●	225	MBT345	2CPX041787R9999	MT345	2CPX041328R9999

*¹ Expansion on EDF mounting frame | *² Expansion on WR mounting frame

Interior expansion system CombiLine N

Accessories for NH2-fuse switch disconnecter modules



ZH441



ZH317

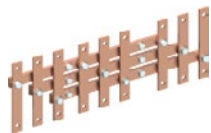

ZH318



ZH448



ZH442



ZX129

Article	Intended use	Unit	Type	Order code
NH2 fuse switch disconnecter Rated current (I_n) max. 400 A, without separator shutters, with M12 connection screws	M(B)T144 - M(B) T345	1	ZH441	2CPX062964R9999
NH1/NH2 busbar system Copper rails 30 x 5 mm, 3-pole Rated current (I_n) 440 A Single-story with M10 connection screws	M(B)T244 M(B)T344	1 1	ZH217 ZH317	2CPX060446R9999 2CPX060456R9999
NH1/NH2 busbar system Copper rails 30 x 10 mm, 3-pole Rated current (I_n) 630 A Double-story with M10 connection screws	M(B)T245 M(B)T345	1 1	ZH218 ZH318	2CPX060447R9999 2CPX060457R9999
Separator shutters For NH fuse switch disconnecter, color similar to RAL 7035, for compliance with the contact protection IPXXC				
Single shutter	1 x M(B)T144 * 2 x M(B)T145 *	1	ZH447	2CPX039842R9999
Single shutter	1 x M(B)T344 * 2 x M(B)T345 *	1	ZH448	2CPX062965R9999
Double shutter	1 x M(B)T244 * 1 x M(B)T344 * 2 x M(B)T245 * 2 x M(B)T345 *	1	ZH449	2CPX062966R9999
Separator shutter, closed Single shutter instead of NH fuse switch disconnecter, color similar to RAL 7035, for compliance with the contact protection IPXXC	M(B)T144 - M(B) T345	1	ZH442	2CPX062939R9999
Insulation plate For non-allocated busbar ends with NH2 fuse switch disconnecter	M(B)T144 - M(B) T345	1	ZX129	2CPX039129R9999

*Quantity per module when fully assembled

Interior expansion system CombiLine N

Busbar system 100 mm, NH00 switch disconnecter, M(B)D...52(B)



MD352B

- Populated with InLine II NH00-100 fuse switch disconnection rails 160 A, Make: ABB
- Busbar center distance 100 mm
- For 3-pole, horizontally arranged busbars
- With busbar bracket type ZX520
- Rated current (I_n) max. 850 A
- **Important:**
 1. The cabinet depth is to be noted in the lock area
Spacing from the front edge of the equipment to the cover: 29 mm
 2. The cable connection when using a middle rail or cross-profile rail in the direct connection is only possible to a limited extent with the use of a bridge clamp (plan for connection space, empty module)
- The mounting frame must be ordered separately
- The busbars must be ordered separately from the module
- Not suitable for fire protection housing
- Take additional connection room of at least 150 mm into consideration

Height	Width		Equipment	PLE	EDF* ¹	WR* ²	From cabinet depth	Kit not installed		Mounted and installed in the cabinet		
	RE	FB						Type	Order code	Type	Order code	
3	450	1	250	3 x NH00	36	●	●	215	-	-	MD152B	2CPX042110R9999
		2	500	8 x NH00	72	●	●	215	-	-	MD252B	2CPX042111R9999
		3	750	12 x NH00	108	-	●	225	-	-	MD352B	2CPX042112R9999

*1 Expansion on EDF mounting frame | *2 Expansion on WR mounting frame

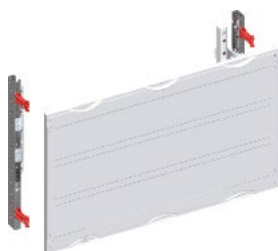

MBD352

- Unpopulated for InLine II NH00-100 fuse switch disconnection rails 160 A, Make: ABB
- Busbar center distance 100 mm
- For 3-pole, horizontally arranged busbars
- With busbar bracket type ZX520 mounted on 3-stage assembly bracket ZW480
- Cover without cutout
- Rated current (I_n) max. 850 A
- Equipment, see catalog ABB STOTZ-KONTAKT InLine II
- **Important:** See remarks above

Height	Width		Useful width	PLE	EDF* ¹	WR* ²	From cabinet depth	Kit not installed		Mounted and installed in the cabinet		
	RE	FB						Type	Order code	Type	Order code	
3	450	1	250	150	36	●	●	215	MBD152	2CPX042116R9999	MD152	2CPX042113R9999
		2	500	300	72	●	●	215	MBD252	2CPX042117R9999	MD252	2CPX042114R9999
		3	750	500	108	-	●	225	MBD352	2CPX042118R9999	MD352	2CPX042115R9999

*1 Expansion on EDF mounting frame | *2 Expansion on WR mounting frame

Interior expansion system CombiLine N

Busbar system 100 mm, NH00 switch disconnecter, M(B)D...52(B)



ZXM1215

- Busbars for individual cabinet installation
- With the EDF and WR mounting frame, defined combinations (see info FB width) are possible within the cabinet. The different busbars can be connected via a connection set
- The NH00 fuse switch disconnection rails are mounted directly on the copper rails prepared with press-in nuts
- Set positions are specified for feeding in on copper rails
- 3 copper rails are required per module

Copper rail mm	I _n A	Width			Kit not installed		Mounted and installed in the cabinet	
		FB	mm	Unit	Type	Order code	Type	Order code
30 x 10	630	1	184	1	ZX1210	2CPX042121R9999	ZXM1210	2CPX042230R9999
		2	434	1	ZX1211	2CPX042122R9999	ZXM1211	2CPX042231R9999
		3	684	1	ZX1212	2CPX042123R9999	ZXM1212	2CPX042232R9999
40 x 10	850	1	184	1	ZX1213	2CPX042124R9999	ZXM1213	2CPX042233R9999
		2	434	1	ZX1214	2CPX042125R9999	ZXM1214	2CPX042234R9999
		3	684	1	ZX1215	2CPX042126R9999	ZXM1215	2CPX042235R9999

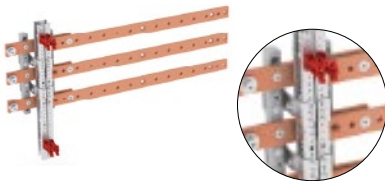

ZXM1217

- Busbar connection set (panel-panel connector)
- **Important:** Note the depth from the cabinet for the connection set
- 3 copper connection sets are required per connection
- The connection set is not possible for a cabinet depth of 215 mm

Copper rail mm	I _n A	Width mm	Unit	Kit not installed		Mounted and installed in the cabinet	
				Type	Order code	Type	Order code
30 x 10	630	230	1	ZX1216	2CPX042119R9999	ZXM1216	2CPX042236R9999
40 x 10	850	230	1	ZX1217	2CPX042120R9999	ZXM1217	2CPX042237R9999



ZE591M



ZX964

Article	Width in mm	Suitable for ...	Unit	Type	Order code
ZLBM00-100	50	MD...(H)B, M(B)D...	1	ZE591M	2CPX042959R9999
Blanking panels for sealing off reserve spaces 100 mm busbar center distance 50 mm width for sealing NH00 strips			1	ZX964	2CPX042238R9999

Interior expansion system CombiLine N

Busbar system 185 mm, NH switch disconnectors, M(B)D...21-300(B)



MD300B

- Populated with InLine II fuse switch disconnection rails **ZLBM**, Make: ABB
- NH00 in-line fused load break switches up to 160 A/ NH1 to 250 A
- Busbar center distance 185 mm
- For 3-pole, horizontally arranged busbars
- With busbar bracket type ZX522
- Rated current (I_n) max. 850 A
- **Important:** Plan for connection space or empty module and note the cabinet depth in the lock area*
- Spacing from the front edge of the equipment to the cover: NH00 – 60 mm/NH1-3 – 65 mm
- The busbars must be ordered separately from the module

Height	Width		Equipment	PLE	EDF* ¹	WR* ²	From cabinet depth	Kit not installed		Mounted and installed in the cabinet* ³		
	RE	FB						Type	Order code	Type	Order code	
5	750	1	250	4 x NH00	60	-	●	275*	-	-	MD100B	2CPX042240R9999
		2	500	8 x NH00	120	-	●	275*	-	-	MD200B	2CPX042241R9999
		3	750	12 x NH00	180	-	●	275*	-	-	MD300B	2CPX042242R9999
5	750	2	500	4 x NH1	120	-	●	275*	-	-	MD21B	2CPX042243R9999
		3	750	6 x NH1	180	-	●	275*	-	-	MD31B	2CPX042244R9999

* For double doors, a minimum cabinet depth of 325 mm is required | *¹Expansion on EDF mounting frame | *²Expansion on WR mounting frame

*³The module frame must be ordered separately | Not suitable for fire protection housing



MD300HB

- Populated with InLine II fuse switch disconnection rails **ZHBM**, Make: ABB NH00 in-line fused load break switches up to 160 A/NH1 up to 250 A
- Busbar center distance 185 mm
- For 3-pole, horizontally arranged busbars
- With busbar bracket type ZX522
- Rated current (I_n) max. 850 A
- **Important:** Plan for connection space or empty module and note the cabinet depth in the lock area*
- The busbars must be ordered separately from the module

Height	Width		Useful width	PLE	EDF* ¹	WR* ²	From cabinet depth	Kit not installed		Mounted and installed in the cabinet* ³		
	RE	FB						Type	Order code	Type	Order code	
5	750	1	250	4 x NH00	60	-	●	350*	-	-	MD100HB	2CPX042245R9999
		2	500	8 x NH00	120	-	●	350*	-	-	MD200HB	2CPX042246R9999
		3	750	12 x NH00	180	-	●	350*	-	-	MD300HB	2CPX042247R9999
5	750	2	500	4 x NH1	120	-	●	350*	-	-	MD21HB	2CPX042248R9999
		3	750	6 x NH1	180	-	●	350*	-	-	MD31HB	2CPX042249R9999

*¹Expansion on EDF mounting frame | *²Expansion on WR mounting frame

*³The module frame must be ordered separately | Not suitable for fire protection housing

Interior expansion system CombiLine N

Busbar system 185 mm, NH switch disconnectors, M(B)D...21-300(B)



MBD300

- Unpopulated for NH00 to NH3 fuse switch disconnection rails 160 A– 630 A, Make: ABB, **ZLBM** with 275 mm depth, ABB **ZHBM** with 350 mm depth
- Busbar center distance 185 mm
- For 3-pole, horizontally arranged busbars
- With busbar bracket type ZX522 mounted on 2-stage assembly bracket ZW481
- Cover without cutout
- Rated current (I_n) max. 850 A
- Equipment, see catalog ABB STOTZ-KONTAKT InLine II
- **Important:** See remarks on page 8/41

Height RE	Width		Useful width			From cabinet depth			Kit not installed		Mounted and installed in the cabinet	
	mm	FB	mm	mm	PLE	EDF* ¹	WR* ²	mm	Type	Order code	Type	Order code
5	750	1	250	199.5	60	-	●	275/350*	MBD100	2CPX042255R9999	MD100	2CPX042258R9999
		2	500	399.5	120	-	●	275/350*	MBD200	2CPX042256R9999	MD200	2CPX042259R9999
		3	750	649	180	-	●	275/350*	MBD300	2CPX042257R9999	MD300	2CPX042260R9999

* For double doors, a minimum cabinet depth of 325 mm is required | *¹Expansion on EDF mounting frame | *² Expansion on WR mounting frame



ZX1228

- Busbars for individual cabinet installation
- It is possible to combine different module widths within the cabinet with continuous busbars
- With press-in nuts for connecting NH fuse switch disconnection rails
- The module sequence is defined by the press-in nuts from 3-field ready and greater (see info FB width)
- 3 copper rails are required per module

Copper rail mm	I_n A	Width			Kit not installed		Mounted and installed in the cabinet	
		FB	mm	Unit	Type	Order code	Type	Order code
30 x 10	630	1	215	1	ZX1220	2CPX042267R9999	ZXM1220	2CPX042285R9999
		2	465	1	ZX1221	2CPX042268R9999	ZXM1221	2CPX042286R9999
		3	715	1	ZX1222	2CPX042269R9999	ZXM1222	2CPX042287R9999
		4 (2FB+2FB)	965	1	ZX1223	2CPX042270R9999	ZXM1223	2CPX042288R9999
		5 (3FB+2FB)	1215	1	ZX1224	2CPX042271R9999	ZXM1224	2CPX042289R9999
		6 (3FB+3FB)	1465	1	ZX1225	2CPX042272R9999	ZXM1225	2CPX042290R9999
40 x 10	850	1	215	1	ZX1226	2CPX042273R9999	ZXM1226	2CPX042291R9999
		2	465	1	ZX1227	2CPX042274R9999	ZXM1227	2CPX042292R9999
		3	715	1	ZX1228	2CPX042275R9999	ZXM1228	2CPX042293R9999
		4 (2FB+2FB)	965	1	ZX1229	2CPX042276R9999	ZXM1229	2CPX042294R9999
		5 (3FB+2FB)	1215	1	ZX1230	2CPX042277R9999	ZXM1230	2CPX042295R9999
		6 (3FB+3FB)	1465	1	ZX1231	2CPX042278R9999	ZXM1231	2CPX042296R9999

* For double doors, a minimum cabinet depth of 325 mm is required | *¹Expansion on EDF mounting frame | *² Expansion on WR mounting frame

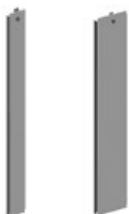

ZX960 ZX961

Article	Unit	Type	Order code
Blanking panels for sealing off reserve spaces			
185 mm busbar center distance			
50 mm width for sealing NH00 strips	1	ZX960	2CPX043180R9999
100 mm width for sealing NH1-3 strips	1	ZX961	2CPX043181R9999

Interior expansion system CombiLine N

Busbar system 185 mm, NH switch disconnectors + EFM, M(B)D...21-300(B)



MD300EB

- Populated with InLine II fuse switch disconnection rails ZHBM, Make: ABB ZHBM + Electronic Fuse Monitoring (EFM)
NH00 fuse switch disconnectors up to 160 A
NH1 fuse-switch disconnectors up to 250 A
- Busbar center distance 185 mm
- For 3-pole, horizontally arranged busbars
- With busbar bracket type ZX522
- Rated current (I_n) max. 850 A
- **Important:** Plan for connection space or empty module and note the cabinet depth in the lock area*
- Spacing from the front edge of the equipment to the cover: NH00 – 60 mm/NH1-3 – 65 mm
- The mounting frame must be ordered separately
- The busbars must be ordered separately from the module
- Not suitable for fire protection housing

Height	Width		Useful width			From cabinet depth			Kit not installed		Mounted and installed in the cabinet		
	RE	mm	FB	mm	mm	PLE	EDF*1	WR*2	mm	Type	Order code	Type	Order code
6	900	1	250	4 x NH00	60	-	●	350	-	-	-	MD100EB	2CPX042250R9999
		2	500	8 x NH00	120	-	●	350	-	-	-	MD200EB	2CPX042251R9999
		3	750	12 x NH00	180	-	●	350	-	-	-	MD300EB	2CPX042252R9999
6	900	2	250	4 x NH1	120	-	●	350	-	-	-	MD21EB	2CPX042253R9999
		3	750	6 x NH1	180	-	●	350	-	-	-	MD31EB	2CPX042254R9999

*1 Expansion on EDF mounting frame | *2 Expansion on WR mounting frame



ZE551M



ZE561M



ZE553M



ZE563M

Article	Width in mm	Suitable for ...	Unit	Type	Order code
ZLBM00	50	MD...(H)B, M(B)D...	1	ZE551M	2CPX042955R9999
ZLBM1	100	MD...(H)B, M(B)D...	1	ZE561M	2CPX042956R9999
ZLBM2	100	MD...(H)B, M(B)D...	1	ZE571M	2CPX042957R9999
ZLBM3	100	MD...(H)B, M(B)D...	1	ZE581M	2CPX042958R9999
ZHBM00	50	MD...(H)B, M(B)D...	1	ZE552M	2CPX042960R9999
ZHBM1	100	MD...(H)B, M(B)D...	1	ZE562M	2CPX042961R9999
ZHBM2	100	MD...(H)B, M(B)D...	1	ZE572M	2CPX042962R9999
ZHBM3	100	MD...(H)B, M(B)D...	1	ZE582M	2CPX042963R9999
ZHBM+EFM00	50	MD...(H)EB, M(B)D...E	1	ZE553M	2CPX042964R9999
ZHBM+EFM1	100	MD...(H)EB, M(B)D...E	1	ZE563M	2CPX042965R9999
ZHBM+EFM2	100	MD...(H)EB, M(B)D...E	1	ZE573M	2CPX042966R9999
ZHBM+EFM3	100	MD...(H)EB, M(B)D...E	1	ZE583M	2CPX042967R9999

Interior expansion system CombiLine N

Busbar system 185 mm, NH switch disconnectors + EFM, M(B)D...21-300(B)



MBD300E

- Unpopulated for NH00 to NH3 fuse switch disconnection rails + EFM 160 A– 630 A, Make: ABB
- Busbar center distance 185 mm
- For 3-pole, horizontally arranged busbars
- With busbar bracket type ZX522 mounted on 3-stage assembly bracket ZW480
- Cover without cutout
- Rated current (I_n) max. 850 A
- Equipment, see catalog ABB STOTZ-KONTAKT InLine II
- **Important:** See remarks on page 8/43

Height	Width		Useful width		From cabinet depth				Kit not installed		Mounted and installed in the cabinet	
	RE	mm	FB	mm	mm	PLE	EDF* ¹	WR* ²	mm	Type	Order code	Type
6	900	1	250	199.5	60	-	●	350	MBD100E	2CPX042261R9999	MD100E	2CPX042264R9999
		2	500	399.5	120	-	●	350	MBD200E	2CPX042262R9999	MD200E	2CPX042265R9999
		3	750	649	180	-	●	350	MBD300E	2CPX042263R9999	MD300E	2CPX042266R9999

*¹ Expansion on EDF mounting frame | *² Expansion on WR mounting frame



ZX1228

- Busbars for individual cabinet installation
- It is possible to combine different module widths within the cabinet with continuous busbars
- With press-in nuts for connecting NH fuse switch disconnection rails
- The module sequence is defined by the press-in nuts from 3-field ready and greater (see info FB width)
- 3 copper rails are required per module

Copper rail	I_n	Width			Kit not installed		Mounted and installed in the cabinet			
		mm	A	FB	mm	Unit	Type	Order code	Type	Order code
30 x 10	630	1		215		1	ZX1220	2CPX042267R9999	ZXM1220	2CPX042285R9999
		2		465		1	ZX1221	2CPX042268R9999	ZXM1221	2CPX042286R9999
		3		715		1	ZX1222	2CPX042269R9999	ZXM1222	2CPX042287R9999
		4 (2FB+2FB)		965		1	ZX1223	2CPX042270R9999	ZXM1223	2CPX042288R9999
		5 (3FB+2FB)		1215		1	ZX1224	2CPX042271R9999	ZXM1224	2CPX042289R9999
		6 (3FB+3FB)		1465		1	ZX1225	2CPX042272R9999	ZXM1225	2CPX042290R9999
40 x 10	850	1		215		1	ZX1226	2CPX042273R9999	ZXM1226	2CPX042291R9999
		2		465		1	ZX1227	2CPX042274R9999	ZXM1227	2CPX042292R9999
		3		715		1	ZX1228	2CPX042275R9999	ZXM1228	2CPX042293R9999
		4 (2FB+2FB)		965		1	ZX1229	2CPX042276R9999	ZXM1229	2CPX042294R9999
		5 (3FB+2FB)		1215		1	ZX1230	2CPX042277R9999	ZXM1230	2CPX042295R9999
		6 (3FB+3FB)		1465		1	ZX1231	2CPX042278R9999	ZXM1231	2CPX042296R9999

* For double doors, a minimum cabinet depth of 325 mm is required | *¹ Expansion on EDF mounting frame | *² Expansion on WR mounting frame

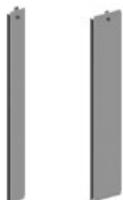

ZX962 ZX963

Article	Unit	Type	Order code
Blanking panels for sealing off reserve spaces with height (EFM)			
185 mm busbar center distance			
50 mm width for sealing NH00 strips	1	ZX962	2CPX042193R9999
100 mm width for sealing NH1-3 strips	1	ZX963	2CPX042194R9999

Interior expansion system CombiLine N

Busbar system 185 mm for NH load break switch, M(B)L...5



ML35

- Unpopulated for load break switch NH00 to NH3 fuses 160 A to 630 A
- For make ABB SlimLine XR and Jean Müller Sasil
- Busbar center distance 185 mm
- For 3-pole horizontally arranged busbars, see below
- With busbar bracket type ZX523
- Cover without cutout
- Rated current (I_n) max. 850 A
- **Important:** Plan for connection space or empty module and note the cabinet depth in the lock area
- Spacing from the front edge of the equipment to the cover: 138 mm
- The mounting frame must be ordered separately
- Not suitable for fire protection housing

Height RE	Width		Useful width			From cabinet depth			Kit not installed		Mounted and installed in the cabinet	
	mm	FB	mm	mm	PLE	EDF* ¹	WR* ²	mm	Type	Order code	Type	Order code
5	750	2	500	400	120	-	●	625	MBL25	2CPX041801R9999	ML25	2CPX041368R9999
		3	750	600	180	-	●	625	MBL35	2CPX041802R9999	ML35	2CPX041369R9999

*¹ Expansion on EDF mounting frame | *² Expansion on WR mounting frame



ZX1033

- Busbars for individual cabinet installation
- It is possible to combine different module widths within the cabinet with continuous busbars
- With clamping pins for affixing the busbars
- 3 copper rails are required per module

Copper rail mm	I_n A	Width			Unit	Kit not installed		Mounted and installed in the cabinet	
		FB	mm			Type	Order code	Type	Order code
40 x 10	850	2	496		1	ZX1032	2CPX041901R9999	ZXM1032	2CPX041511R9999
		3	746		1	ZX1033	2CPX041902R9999	ZXM1033	2CPX041512R9999
		4	996		1	ZX1034	2CPX041903R9999	ZXM1034	2CPX041513R9999
		5	1246		1	ZX1035	2CPX041904R9999	ZXM1035	2CPX041514R9999

Interior expansion system CombiLine N

Busbar system 40 mm for S700 and S750, M(B)H

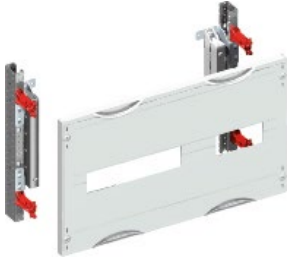

MH250

- Unpopulated for main circuit breakers
- For make ABB S700, 1 to 4-pole (width per pole 35 mm)
- Busbar center distance 40 mm
- For 4-pole horizontally arranged busbars, see below
- With busbar bracket type ZB5
- Additionally braced in the middle from 3-field width
- Covers with cutout
- Rated current (I_n) max. 250 A
- The remaining cutout is closed with cover strips
- The mounting frame must be ordered separately
- The modules MBH350 and MH350 are not suitable for fire protection housing

Height	Width		Useful width			From cabinet depth			Kit not installed		Mounted and installed in the cabinet	
	RE	mm	FB	mm	mm	PLE	EDF* ¹	WR* ²	mm	Type	Order code	Type
2	300	1	250	105	24	●	●	200	MBH150	2CPX041792R9999	MH150	2CPX041337R9999
		2	500	210/105	48	●	●	200	MBH250	2CPX041793R9999	MH250	2CPX041338R9999
		3	750	315/210	72	●	●	200	MBH350	2CPX041794R9999	MH350	2CPX041339R9999

*¹Expansion on EDF mounting frame | *²Expansion on WR mounting frame



MH251

- Unpopulated for main circuit breakers
- For make ABB S750, 1 to 3-pole (width per pole 27 mm)
- For modules with 1-field width, the feed-in occurs directly via the SH-switch with a maximum connection cross-section of 35 mm²/max. 100 A
- Busbar center distance 40 mm
- For 4-pole horizontally arranged busbars, see below
- With busbar bracket type ZB5
- Additionally braced in the middle from 3-field width
- Covers with cutout
- Rated current (I_n) max. 250 A
- The remaining cutout is closed with cover strips
- The mounting frame must be ordered separately
- The modules MBH351 and MH351 are not suitable for fire protection housing

2	300	1	250	161	24	●	●	200	MBH151	2CPX042031R9999	MH151	2CPX042026R9999
		2	500	161/161	48	●	●	200	MBH251	2CPX042032R9999	MH251	2CPX042027R9999
		3	750	322/242	72	●	●	200	MBH351	2CPX042033R9999	MH351	2CPX042028R9999

*¹Expansion on EDF mounting frame | *²Expansion on WR mounting frame

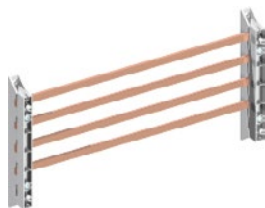

ZX2041

- Busbar within the module
- A maximum of 5 copper rails are required per module

Copper rail	I_n	Width			Unit	Kit not installed		Mounted and installed in the cabinet	
		mm	A	FB		mm	Type	Order code	Type
12 x 5	250	1		195	1	ZX2040	2CPX042533R9999	ZXM2040	2CPX042453R9999
		2		445	1	ZX2041	2CPX042534R9999	ZXM2041	2CPX042454R9999
		3		695	1	ZX2042	2CPX042535R9999	ZXM2042	2CPX042455R9999

Interior expansion system CombiLine N

Power switch Tmax populated, MA...ALXB, MA...ALSB



MA250ALXB

- Populated with power switches, Make: ABB, Tmax XT1, XT3 and T5, 3-pole
- Fixed installation with rocker arm drive
- With thermomagnetic tripping device
- Covers with cutout
- Mounting on mounting cross beam
- **Note:** When directly using a center support rail or cross-profile rail, the cable connection can be realized with terminals (FC-CUAL). This and other accessories are to be ordered via ABB STOTZ-KONTAKT
- The mounting frame must be ordered separately
- Not suitable for fire protection housing, except for module MA100ALXB

Height RE	Width		I _n A	Equipment				From cabinet depth mm	Kit not installed		Mounted and installed in the cabinet		
	mm	FB		mm	Type	PLE	EDF* ¹		WR* ²	Type	Order code	Type	Order code
2	300	1	250	100	XT1B160R100	24	●	●	120	-	-	MA100ALXB	2CPX041471R9999
				160	XT1N160R160	24	●	●	200	-	-	MA160ALXB	2CPX041472R9999
				200	XT3N250R200	24	●	●	200	-	-	MA200ALXB	2CPX041473R9999
				250	XT3N250R250	24	●	●	200	-	-	MA250ALXB	2CPX041474R9999
3	450	2	500	400	T5N400R400	72	●	●	215	-	-	MA400ALSB	2CPX041384R9999

*¹ Expansion on EDF mounting frame | *² Expansion on WR mounting frame



MA630ALSB

- Populated with power switches, Make: ABB, Tmax T5 and T6, 3-pole
- Fixed installation with rocker arm drive
- With electronic tripping device PR221 DS-LS/I
- Covers with cutout
- Mounting on mounting cross beam
- **Note:** When directly using a center support rail or cross-profile rail, the cable connection can be realized with terminals (FC-CUAL). This and other accessories are to be ordered via ABB STOTZ-KONTAKT
- The mounting frame must be ordered separately
- Not suitable for fire protection housing

3	450	2	500	630	T5N630R630	72	-	●	275	-	-	MA630ALSB	2CPX041385R9999
4	600	2	500	800	T6N800R800	96	-	●	325	-	-	MA800ALSB	2CPX041386R9999

*¹ Expansion on EDF mounting frame | *² Expansion on WR mounting frame

Interior expansion system CombiLine N

Power switch Tmax unpopulated, M(B)A...T

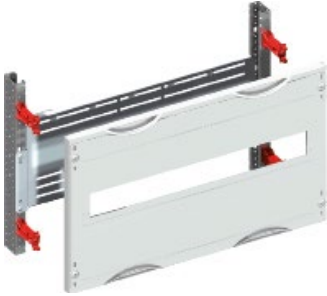

MA290T

- Unpopulated for make ABB, fix-mounted installation
Tmax XT1, 3-/4-pole, (76.2 mm/101.2 mm) or
Tmax XT3, 3/4-pole, (105 mm/140 mm)
- Covers with cutout, remaining cutout must be closed
with cover strips
- Rated current (I_n) max. 250 A
- With mounting cross beam, including slide nuts M4
- The mounting frame must be ordered separately
- Not suitable for fire protection housing, except for
modules MBA190T and MA190T

Height RE	Width		Equipment Type	Cutout width mm	Useful width mm	PLE	EDF ^{*1}	WR ^{*2}	From cabinet depth mm	Kit not installed		Mounted and installed in the cabinet		
	mm	FB mm								Type	Order code	Type	Order code	
2	300	1	250	XT1/XT3	216	199	24	●	●	120 ^{*3}	MBA190T	2CPX041643R9999	MA190T	2CPX041120R9999
		2	500	XT1/XT3	421	449	48	●	●	215	MBA290T	2CPX041644R9999	MA290T	2CPX041417R9999
		3	750	XT1/XT3	687	699	72	-	●	275	MBA390T	2CPX041645R9999	MA390T	2CPX041418R9999

*¹Expansion on EDF mounting frame | *² Expansion on WR mounting frame | *³ In the small distributor only 1 x Tmax XT1 with rocker arm and max. I_n up to 100 A

Interior expansion system CombiLine N

Power switch Tmax unpopulated, M(B)A...T



MA191T

- Unpopulated for make ABB, fix-mounted installation, Tmax XT2, 3-/4-pole, 90 mm/120 mm
Tmax XT4, 3-/4-pole, 105 mm/140 mm
- Covers with cutout
- With mounting cross beam, including slide nuts M4
- The mounting frame must be ordered separately
- Not suitable for fire protection housing, except for modules MBA191T and MA191T

Height	Width		I _n	Equipment				From cabinet depth	Kit not installed		Mounted and installed in the cabinet			
	RE mm	FB mm		A	Type	Polarity	PLE		EDF* ¹	WR* ²	Type	Order code	Type	Order code
2	300	1	250	160	XT2	3-poles	24	●	●	200	MBA191T	2CPX042841R9999	MA191T	2CPX042837R9999
2	300	1	250	160	XT2	4-poles	24	●	●	200	MBA194T	2CPX042906R9999	-	-
3	450	1	250	250	XT4	3-poles	36	●	●	200	MBA193T	2CPX042844R9999	MA193T	2CPX042840R9999
3	450	1	250	250	XT4	4-poles	36	●	●	200	MBA196T	2CPX042908R9999	-	-



MA291T

- Unpopulated for make ABB, fix-mounted installation, Tmax XT2, 3-/4-pole, 90 mm/120 mm
- Covers without cutout
- With mounting cross beam, including slide nuts M4
- The mounting frame must be ordered separately
- Not suitable for fire protection housing

Height	Width		I _n	Equipment				Useful width	From cabinet depth	Kit not installed		Mounted and installed in the cabinet			
	RE mm	FB mm		A	Type	Polarity	mm			PLE	EDF* ¹	WR* ²	Type	Order code	Type
2	300	2	500	250	XT2	3/4-pole	449	48	●	●	215	MBA291T	2CPX042842R9999	MA291T	2CPX042838R9999
2	300	3	750	250	XT2	3/4-pole	669	72	-	●	260	MBA391T	2CPX042843R9999	MA391T	2CPX042839R9999

*¹Expansion on EDF mounting frame | *²Expansion on WR mounting frame

Interior expansion system CombiLine N

Power switch Tmax unpopulated, M(B)A...T



MBA195T

- Unpopulated for make ABB, fix-mounted installation, Tmax XT2, 4-pole + 4-pole + RC Sel, 120 mm
Tmax XT4, 4-pole + 4-pole + RC Sel, 140 mm
- Covers with cutout
- With mounting cross beam, including slide nuts M4
- The mounting frame must be ordered separately
- Not suitable for fire protection housing

Height	Width		I _n	Equipment						From cabinet depth	Kit not installed		Mounted and installed in the cabinet	
	RE	FB		mm	A	Type	Polarity	PLE	EDF ^{*1}		WR ^{*2}	mm	Type	Order code
3	450	1	250	160	XT2	4-pole RC Sel	36	●	●	200	MBA195T	2CPX042907R9999	-	-
3	450	1	250	250	XT4	4-pole RC Sel	36	●	●	200	MBA197T	2CPX042909R9999	-	-



MA292T

- Unpopulated for make ABB, fix-mounted installation, Tmax T4, 3-/4-pole, 105 mm/140 mm
Tmax T5, 3/4-pole, 139.5 mm/186 mm
- Covers with cutout
- Mounting cross beam, including mounting holes with thread
- The mounting frame must be ordered separately
- Not suitable for fire protection housing

3	450	1	250	320	T4	3-/4-pole	36	●	●	215	MBA192T	2CPX041646R9999	MA192T	2CPX041121R9999
		1	250	400	T5	3-poles	36	●	●	215	MBA192T	2CPX041646R9999	MA192T	2CPX041121R9999
	2	500	630	T5	3-/4-pole	72	●	●	215	MBA292T	2CPX041647R9999	MA292T	2CPX041122R9999	

*1 Expansion on EDF mounting frame | *2 Expansion on WR mounting frame

Interior expansion system CombiLine N

Load break switch OT populated, MA...ALAB



MA160ALAB

- Populated with load break switches, make ABB type OT160G, 3-pole
- Covers with cutout
- Assembly on DIN rails 35 x 15 mm
- The mounting frame must be ordered separately

Height RE	Width		I _n A	Equipment				From cabinet depth mm	Kit not installed		Mounted and installed in the cabinet		
	mm	FB		Type	PLE	EDF* ¹	WR* ²		Type	Order code	Type	Order code	
2	300	1	250	160	OT160G	24	●	●	200	-	-	MA160ALAB	2CPX041370R9999

*¹Expansion on EDF mounting frame | *²Expansion on WR mounting frame



MA630ALAB

- Equipped with load break switches, make ABB OT, type OT... E03P
- Covers with cutout
- Mounting on mounting cross beam
- The mounting frame must be ordered separately
- Not suitable for fire protection housing, except for modules MA200ALAB and MA250ALAB

2	300	1	250	200	OT200E03P	24	●	●	200	-	-	MA200ALAB	2CPX041371R9999
			250	OT250E03P	24	●	●	200	-	-	MA250ALAB	2CPX041372R9999	
3	450	2	500	400	OT400E03P	72	●	●	215	-	-	MA400ALAB	2CPX041373R9999
			630	OT630E03P	72	-	●	275	-	-	MA630ALAB	2CPX041374R9999	
4	600	2	500	800	OT800E03P	72	-	●	325	-	-	MA800ALAB	2CPX041375R9999

*¹Expansion on EDF mounting frame | *²Expansion on WR mounting frame

Interior expansion system CombiLine N

Load break switch OT/OS/S750DR unpopulated, M(B)A...AL...



MA160ALA

- Unpopulated for load break switch, make ABB OT160M3 or main automatic fuse, make ABB S750DR
- 3-pole or 4-pole
- Covers without cutout
- Assembly on DIN rails 35 x 15 mm
- The mounting frame must be ordered separately

Height	Width		I_n	Useful width				From cabinet depth	Kit not installed		Mounted and installed in the cabinet		
	RE	mm		FB	mm	A	mm		PLE	EDF* ¹	WR* ²	mm	Type
2	300	1	250	160	216	24	●	●	200	MBA160ALA	2CPX041803R9999	MA160ALA	2CPX041376R9999

*¹Expansion on EDF mounting frame | *²Expansion on WR mounting frame



MA250ALA

- Unpopulated for load break switch, make ABB OT200E...P – OT630E...P
- 3-pole or 4-pole
- Covers without cutout
- Mounting on mounting cross beam
- The mounting frame must be ordered separately
- Not suitable for fire protection housing, except for modules MBA250ALA and MA250ALA

2	300	1	250	250	-	24	●	●	200	MBA250ALA	2CPX041804R9999	MA250ALA	2CPX041377R9999
3	450	2	500	630	-	72	-	●	275	MBA630ALA	2CPX041805R9999	MA630ALA	2CPX041378R9999

*¹Expansion on EDF mounting frame | *²Expansion on WR mounting frame



MBA250ALO

- Unpopulated for load break switch, make ABB OS
- Type OS160GD03PN3P for cabinet depth of 215 mm and above
- Type OS250GD03PN3P for cabinet depth of 225 mm and above
- Covers with cutout for rotary drive
- The mounting frame must be ordered separately
- Not suitable for fire protection housing

3	450	1	250	250	-	36	●	●	215/225	MBA250ALO	2CPX042101R9999	-	-
---	-----	---	-----	-----	---	----	---	---	---------	-----------	-----------------	---	---

*¹Ausbau auf EDF-Montagegerüst | *²Ausbau auf WR-Montagegerüst

Interior expansion system CombiLine N

Universal switch modules, M(B)A...A/line connection M(B)V...



MA630A

MA800A

- Unpopulated, universally usable for different equipment
- Cover without cutout
- With deep cross beams for variable adjustment
- Attachment of equipment via cage nuts
- The mounting frame must be ordered separately
- Not suitable for fire protection housing, except for modules MBA250A and MA250A

Height	Width		I _n	Useful width	Useful depth				From cabinet depth	Kit not installed		Mounted and installed in the cabinet		
	RE	mm				FB	mm	A		mm	mm	PLE	EDF* ¹	WR* ²
2	300	1	250	250	170	122	24	●	●	200	MBA250A	2CPX041807R9999	MA250A	2CPX041387R9999
3	450	2	500	630	420	122	72	●	●	215	MBA630A	2CPX041808R9999	MA630A	2CPX041388R9999
4	600	2	500	800	420	147	96	-	●	275	MBA800A	2CPX041806R9999	MA800A	2CPX041389R9999

*1 Expansion on EDF mounting frame | *2 Expansion on WR mounting frame

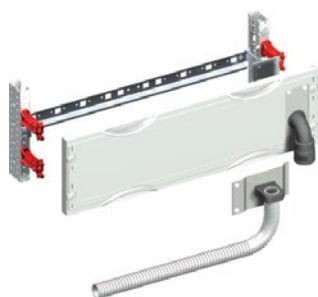

MV281

- For the line link from the module to the switch cabinet door
- Covers with cutout for line connection
- With DIN rail and connection hose
- With accessories for securing the hose to the module and the switch cabinet door
- Note the door stop
- The mounting frame must be ordered separately
- Not suitable for fire protection housing
- Cannot be used in the H/HS cabinet

Height	Width		Hose diameter				From cabinet depth	Kit not installed		Mounted and installed in the cabinet		
	RE	mm		FB	mm	∅		PLE	EDF* ¹	WR* ²	mm	Type
1	150	1	250	M20	12	●	●	225	MBV180	2CPX041815R9999	MV180	2CPX041396R9999
				M32	12	●	●	225	MBV181	2CPX041816R9999	MV181	2CPX041397R9999
				M40	12	●	●	225	MBV182	2CPX041817R9999	MV182	2CPX041398R9999
				M32	24	●	●	225	MBV281	2CPX041818R9999	MV281	2CPX041399R9999
				M40	24	●	●	225	MBV282	2CPX041819R9999	MV282	2CPX041400R9999

*1 Expansion on EDF mounting frame | *2 Expansion on WR mounting frame

Interior expansion system CombiLine N

Measuring devices/switch cabinet lighting, M(B)U...



MU257

- Unpopulated for 4 measuring devices with installation size 96 x 96 mm
- Arrangement of horizontal measuring devices
- Covers with cutout
- Mounting on mounting cross beam
- The mounting frame must be ordered separately

Height	Width		Measurement devices			From cabinet depth	Kit not installed		Mounted and installed in the cabinet			
	RE	mm	FB	mm	Unit		PLE	EDF* ¹	WR* ²	mm	Type	Order code
1	150	2	500	4	24	●	●	225	MBU257	2CPX041809R9999	MU257	2CPX041390R9999
		3	750	4	36	●	●	225	MBU357	2CPX041810R9999	MU357	2CPX041391R9999

*¹Expansion on EDF mounting frame | *²Expansion on WR mounting frame

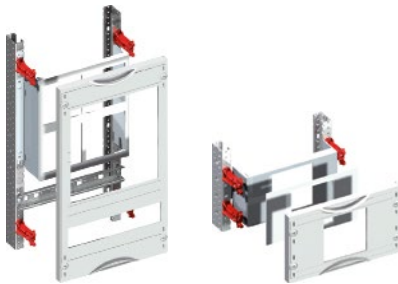

MU158

MU156

- Unpopulated for 1 or 4 measuring devices with installation size 96 x 96 mm
- At a height of 450 mm with additional DIN rail for rail-mounted devices 12 PLE
- Covers with cutout
- Mounting on mounting cross beam
- The mounting frame must be ordered separately

1	150	1	250	1	12	●	●	225	MBU156	2CPX042043R9999	MU156	2CPX042042R9999
2	300	1	250	4	24	●	●	225	MBU157	2CPX041811R9999	MU157	2CPX041392R9999
3	450	1	250	4	36	●	●	225	MBU158	2CPX041812R9999	MU158	2CPX041393R9999

*¹Expansion on EDF mounting frame | *²Expansion on WR mounting frame

Interior expansion system CombiLine N

Cable clamp rails, M(B)F...83+84



MF283

- With cable clamp rail for relieving the strain on cables and lines
- Including a cable clamp rail for bolt clamps, see below
- Covers without cutout
- For cabinet depths up to 275 mm
- Cable clamp rail that is variably adjustable in depth via the deep angle piece ZW59P2
- Usable depth from 87 mm to 142 mm
- The mounting frame must be ordered separately

Height	Width						From cabinet depth	Kit not installed		Mounted and installed in the cabinet	
	RE	mm	FB	mm	PLE	EDF* ¹		WR* ²	mm	Type	Order code
1	150	1	250	12	●	●	200	MBF183	2CPX041822R9999	MF183	2CPX041403R9999
		2	500	24	●	●	200	MBF283	2CPX041823R9999	MF283	2CPX041404R9999
		3	750	36	●	●	200	MBF383	2CPX041824R9999	MF383	2CPX041405R9999

*¹Expansion on EDF mounting frame | *²Expansion on WR mounting frame



MF284

- With cable clamp rail for relieving the strain on cables and lines
- Including a cable clamp rail for bolt clamps, see below
- Covers without cutout
- For cabinet depths up to 425 mm
- Cable clamp rail that is variably adjustable in depth via the deep angle piece ZW79P2
- Usable depth from 122 mm to 177 mm
- The mounting frame must be ordered separately

1	150	1	250	12	●	●	325	MBF184	2CPX041846R9999	MF184	2CPX041466R9999
		2	500	24	●	●	325	MBF284	2CPX041847R9999	MF284	2CPX041467R9999
		3	750	36	●	●	325	MBF384	2CPX041848R9999	MF384	2CPX041468R9999

*¹Expansion on EDF mounting frame | *²Expansion on WR mounting frame



ZK143

ZK1431P100

Article	Unit	Type	Order code
Boltclamp			
For cable clamp rails			
from 22-28 mm	1	ZK143	2CPX060005R9999
from 40-46 mm	1	ZK144	2CPX060006R9999
from 64-70 mm	1	ZK145	2CPX060007R9999
Saddle clamps for bolt clamps			
For ZK143	100	ZK1431P100	2CPX060251R9999
For ZK144	100	ZK1441P100	2CPX060252R9999
For ZK145	50	ZK1451P50	2CPX060253R9999

Interior expansion system CombiLine N

Meter with three-point attachment and eHZ meter

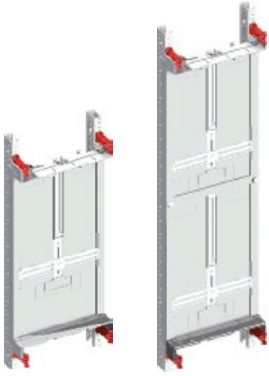

MZ160

MZ161

- For meter with three-point attachment on counter carrying plate
- Only suitable for intermediate measurement
- With head part above and below
- Partitions may be necessary, single-story ZX70, double-story ZX72, see below
- The mounting frame must be ordered separately
- Not suitable for fire protection housing
- Observe planning information below

Height	Width		Meter					From cabinet depth	Kit not installed		Mounted and installed in the cabinet	
	RE	mm	FB	mm	Unit	PLE	EDF* ¹		WR* ²	Type	Order code	Type
3	450	1	250	1	36	-	●	225	MBZ160	2CPX041820R9999	MZ160	2CPX041401R9999
5	750	1	250	2	60	-	●	225	MBZ161	2CPX041821R9999	MZ161	2CPX041402R9999

*¹Expansion on EDF mounting frame | *²Expansion on WR mounting frame



MZ162

MZ163

- For eHZ meter
- Only suitable for intermediate measurement
- For receiving eHZ cartridge (BKE-I), see below
- With head part above and below
- ZX69 partitions may be necessary, see below
- The mounting frame must be ordered separately
- Not suitable for fire protection housing
- Observe planning information below

2	300	1	250	1	24	-	●	225	MBZ162	2CPX042034R9999	MZ162	2CPX042029R9999
2	300	1	250	2	24	-	●	225	MBZ163	2CPX042035R9999	MZ163	2CPX042030R9999

*¹Expansion on EDF mounting frame *²Expansion on WR mounting frame

Planning information: Note the switch cabinet depth, distance between meter support plate and door at:

TwinLine-G, 225 mm depth = 126.5 - 139 mm, TwinLine-L, 275 mm depth = 141.5 - 154 mm, TwinLine-W, 350 mm depth = 168 - 180.5 mm

TriLine[®], 325 mm depth = 148 mm, TriLine[®], 425 mm depth = 198 mm

Important: Plan at least one module each with a width of 250 mm above and below the meter support plate



ZX70



VS659

Article	Height				Type	Order code
	RE	BH	mm	Unit		
Vertical partitions, plastic Not fault arc-proof, separation from adjacent module, distribution panel, meter panel, partition is inserted in adjacent module in the cover bracket, color similar to RAL 7035	3	00	450	1	ZX69	2CPX039069R9999
	4	0	600	1	ZX70	2CPX039070R9999
	6	2	900	1	ZX72	2CPX039072R9999
eHZ cartridge (BKE-I) with long inlet and outlet lines For electronic household meter (eHZ) With inlet lines 10 mm ² L1, L2, L3 and N, length 1000 mm without ferrules With outlet lines 10 mm ² L1, L2 and L3, length 1000 mm without ferrules				1	VS659	2CPX039932R9999

Interior expansion system CombiLine N

Module combinations for busbars TwinLine row mountings

The busbar systems for cabinet row mounting of the TwinLine cabinet system can be interconnected for various installation positions, the possible CombiLine N modules. There are modules that are interconnected in front of or behind the mounting frame due to the location of the busbar bracket.

If, for example, an N/PE busbar module is needed in the **top** of the cabinet and a busbar module is needed at the **bottom**, the possibility of combining the different modules must be taken into account. The different adjustment possibilities of the installation positions (1/0/-1) can be taken from the opposite side.

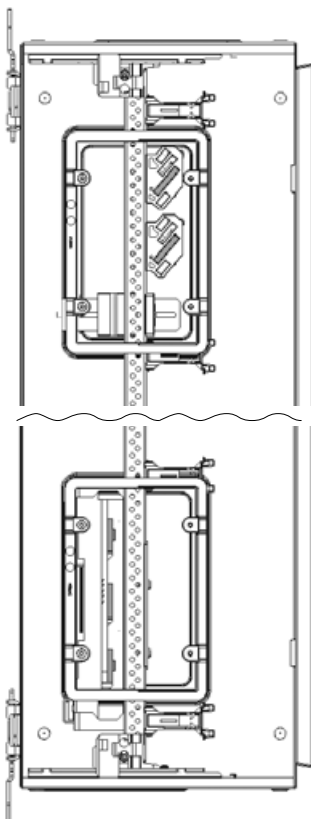
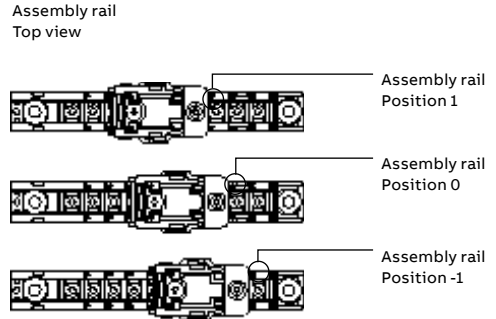

CombiLine N module M(B)N...74 above

CombiLine N module M(B)S...27 below

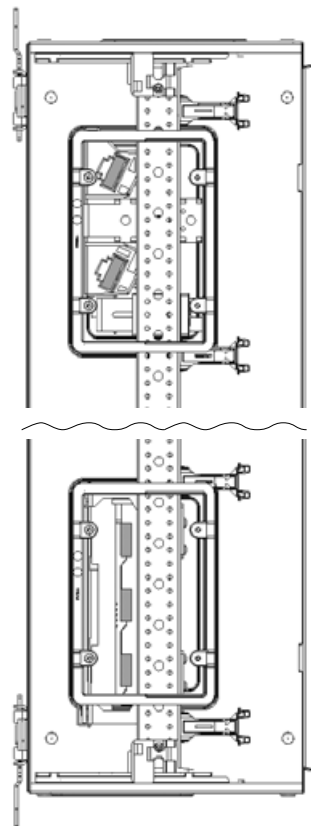

CombiLine N module M(B)N...62 above

CombiLine N module M(B)S...27 below

Example structure on EDF mounting frame On mounting position 1 above and below in the TwinLine-L cabinet, depth 275 mm

Example structure on WR mounting frame On mounting position -1 above and below in the TwinLine-L cabinet, depth 275 mm

Interior expansion system CombiLine N

Module combinations for busbars TwinLine row mountings

Possible combinations on EDF mounting frame

Module type, below	Module type, above	M(B)S...24			M(B)S...27			M(B)N...74 M(B)N...75			M(B)N...62 M(B)N...63			M(B)R...02			
		Suitable for TwinLine	G	L	W	G	L	W	G	L	W	G	L	W	G	L	W
M(B)S...24	G		1/0/-1			1/0/-1			1/0						1		
	L			1/0/-1			1/0/-1			1						1	
	W				1/0/-1			1/0/-1			1						1
M(B)S...27	G		1/0/-1			0/-1			1/0						1		
	L			1/0/-1			1/0/-1			1*						1	
	W				1/0/-1			1/0/-1			1						1
M(B)N...74 M(B)N...75	G		1/0			1/0			1/0						1		
	L			1			1			1						1	
	W				1			1			1						1
M(B)N...62 M(B)N...63	G																
	L																
	W																
M(B)R...02	G		1			1			1						1		
	L			1			1			1						1	
	W				1			1			1						1

> Cabinet depths TwinLine-G = 225 mm / TwinLine-L = 275 mm / TwinLine-W = 350 mm

* Mounting position of the example setup of the opposite side

Possible combinations on WR mounting frame

Module type, below	Module type, above	M(B)S...24			M(B)S...27			M(B)N...74 M(B)N...75			M(B)N...62 M(B)N...63			M(B)R...02			
		Suitable for TwinLine	G	L	W	G	L	W	G	L	W	G	L	W	G	L	W
M(B)S...24	G		-			-			-						-		
	L			-1			-1			-			-1			-	
	W				-1			-1			-			-1			-
M(B)S...27	G		-			-1			-						-		
	L			-1			-1			-			-1*			-	
	W				-1			-1			-			-1			-
M(B)N...74 M(B)N...75	G		-			-			1/0						1		
	L			-			-			1				-		1	
	W				-			-			1				-		1
M(B)N...62 M(B)N...63	G																
	L			-1			-1			-				-1			-
	W				-1			-1			-				-1		-
M(B)R...02	G		-			-			1						1		
	L			-			-			1				-		1	
	W				-			-			1				-		1

> Cabinet depths TwinLine-G = 225 mm / TwinLine-L = 275 mm / TwinLine-W = 350 mm

Legend for the tables

- 0 = Installation position 0 is possible
- 1 = Installation position 1 is possible
- 1 = Installation position -1 is possible
- 1/0 = Installation positions 1 or 0 are possible
- 0/-1 = Installation positions 0 or -1 are possible
- 1/0/-1 = Installation positions 1 and 0 and -1 are possible

TwinLine busbars

Row mounting for modules M(B)S...24

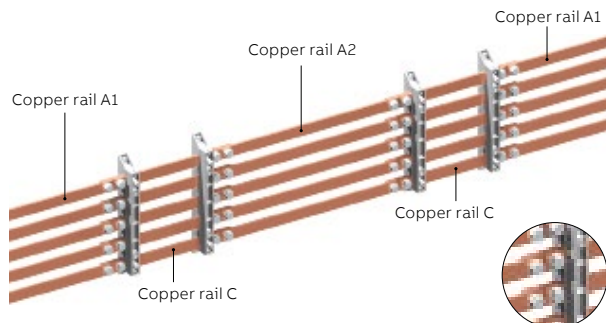

- It is possible to combine different module widths within the cabinet with continuous busbars
- Busbars for cabinet row mounting (copper rail A1/A2) are delivered on the connection side with copper transport pieces and attachment material
- A connector (copper rail C) is required for each busbar connection
- **Important:** note the possibility to combine modules with the TwinLine cabinet row mountings
- A max. of 5 copper rails A1/A2 and C are required per module

Copper rail mm	I _n A	Width		Unit	Kit not installed		Mounted and installed in the cabinet	
		FB	mm		Type	Order code	Type	Order code
Copper rail A1, busbars for TwinLine cabinet row mounting right or left								
20 x 5	320	1	138 + 43	1	ZX2224	2CPX042630R9999	ZXM2224	2CPX042672R9999
		2	388 + 43	1	ZX2225	2CPX042631R9999	ZXM2225	2CPX042673R9999
		3	638 + 43	1	ZX2226	2CPX042632R9999	ZXM2226	2CPX042674R9999
		4	888 + 43	1	ZX2227	2CPX042633R9999	ZXM2227	2CPX042675R9999
		5	1138 + 43	1	ZX2228	2CPX042634R9999	ZXM2228	2CPX042676R9999
		6	1388 + 43	1	ZX2229	2CPX042635R9999	ZXM2229	2CPX042677R9999
Copper rail A2, busbars for TwinLine cabinet row mounting right and left								
20 x 5	320	1	43 + 95 + 43	1	ZX2324	2CPX042714R9999	ZXM2324	2CPX042750R9999
		2	43 + 345 + 43	1	ZX2325	2CPX042715R9999	ZXM2325	2CPX042751R9999
		3	43 + 595 + 43	1	ZX2326	2CPX042716R9999	ZXM2326	2CPX042752R9999
		4	43 + 845 + 43	1	ZX2327	2CPX042717R9999	ZXM2327	2CPX042753R9999
		5	43 + 1095 + 43	1	ZX2328	2CPX042718R9999	ZXM2328	2CPX042754R9999
		6	43 + 1345 + 43	1	ZX2329	2CPX042719R9999	ZXM2329	2CPX042755R9999
Copper rail C, connector for TwinLine cabinet row mounting right or left								
20 x 5	320	-	208	1	ZX2405	2CPX042787R9999	-	-

TwinLine busbars

Row mounting for modules M(B)S...27

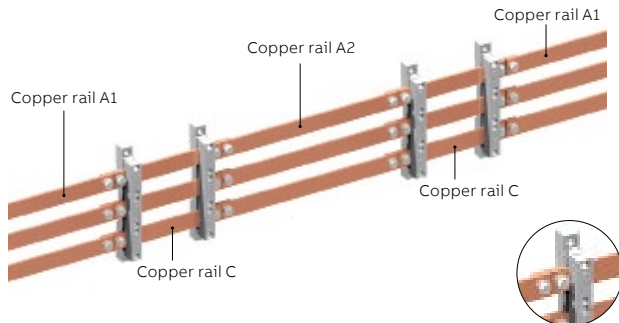

- It is possible to combine different module widths within the cabinet with continuous busbars
- Busbars for cabinet row mounting (copper rail A1/A2) are delivered on the connection side with copper transport pieces and attachment material
- A connector (copper rail C) is required for each busbar connection
- **Important:** note the possibility to combine modules with the TwinLine cabinet row mountings
- 3 copper rails A1/A2 and C are required per module

Copper rail	l _n	Width			Unit	Kit not installed		Mounted and installed in the cabinet	
		mm	A	FB		mm	Type	Order code	Type
Copper rail A1, busbars for TwinLine cabinet row mounting right or left									
30 x 5	440	1		138 + 43	1	ZX2236	2CPX042642R9999	ZXM2236	2CPX042684R9999
		2		388 + 43	1	ZX2237	2CPX042643R9999	ZXM2237	2CPX042685R9999
		3		638 + 43	1	ZX2238	2CPX042644R9999	ZXM2238	2CPX042686R9999
		4		888 + 43	1	ZX2239	2CPX042645R9999	ZXM2239	2CPX042687R9999
		5		1138 + 43	1	ZX2240	2CPX042646R9999	ZXM2240	2CPX042688R9999
		6		1388 + 43	1	ZX2241	2CPX042647R9999	ZXM2241	2CPX042689R9999
30 x 10	630	1		138 + 43	1	ZX2248	2CPX042654R9999	ZXM2248	2CPX042696R9999
		2		388 + 43	1	ZX2249	2CPX042655R9999	ZXM2249	2CPX042697R9999
		3		638 + 43	1	ZX2250	2CPX042656R9999	ZXM2250	2CPX042698R9999
		4		888 + 43	1	ZX2251	2CPX042657R9999	ZXM2251	2CPX042699R9999
		5		1138 + 43	1	ZX2252	2CPX042658R9999	ZXM2252	2CPX042700R9999
		6		1388 + 43	1	ZX2253	2CPX042659R9999	ZXM2253	2CPX042701R9999
Copper rail A2, busbars for TwinLine cabinet row mounting right and left									
30 x 5	440	1		43 + 95 + 43	1	ZX2336	2CPX042726R9999	ZXM2336	2CPX042762R9999
		2		43 + 345 + 43	1	ZX2337	2CPX042727R9999	ZXM2337	2CPX042763R9999
		3		43 + 595 + 43	1	ZX2338	2CPX042728R9999	ZXM2338	2CPX042764R9999
		4		43 + 845 + 43	1	ZX2339	2CPX042729R9999	ZXM2339	2CPX042765R9999
		5		43 + 1095 + 43	1	ZX2340	2CPX042730R9999	ZXM2340	2CPX042766R9999
		6		43 + 1345 + 43	1	ZX2341	2CPX042731R9999	ZXM2341	2CPX042767R9999
30 x 10	630	1		43 + 95 + 43	1	ZX2348	2CPX042738R9999	ZXM2348	2CPX042774R9999
		2		43 + 345 + 43	1	ZX2349	2CPX042739R9999	ZXM2349	2CPX042775R9999
		3		43 + 595 + 43	1	ZX2350	2CPX042740R9999	ZXM2350	2CPX042776R9999
		4		43 + 845 + 43	1	ZX2351	2CPX042741R9999	ZXM2351	2CPX042777R9999
		5		43 + 1095 + 43	1	ZX2352	2CPX042742R9999	ZXM2352	2CPX042778R9999
		6		43 + 1345 + 43	1	ZX2353	2CPX042743R9999	ZXM2353	2CPX042779R9999
Copper rail C, connector for TwinLine cabinet row mounting right or left									
30 x 5	440			208	1	ZX2407	2CPX042789R9999	-	-
30 x 10	630			208	1	ZX2408	2CPX042790R9999	-	-

TwinLine busbars

Row mounting for modules M(B) N..74+75

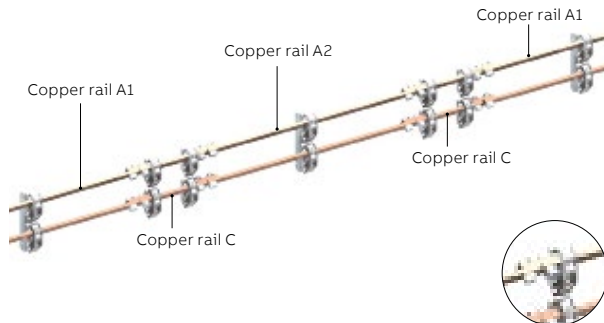

- It is possible to combine different module widths within the cabinet with continuous busbars
- Busbars for cabinet row mounting (copper rail A1/A2) are delivered on the connection side with copper transport pieces and attachment material
- A connector (copper rail C) is required for each busbar connection
- **Important:** note the possibility to combine modules with the TwinLine cabinet row mountings
- 2 copper rails A1/A2 and C are required per module

Copper rail	l _n	Width			Unit	Kit not installed		Mounted and installed in the cabinet	
		mm	A	FB		mm	Type	Order code	Type
Copper rail A1, busbars for TwinLine cabinet row mounting right or left									
20 x 5	320	1		200 + 43	1	ZX2230	2CPX042636R9999	ZXM2230	2CPX042678R9999
		2		450 + 43	1	ZX2231	2CPX042637R9999	ZXM2231	2CPX042679R9999
		3		700 + 43	1	ZX2232	2CPX042638R9999	ZXM2232	2CPX042680R9999
		4		950 + 43	1	ZX2233	2CPX042639R9999	ZXM2233	2CPX042681R9999
		5		1200 + 43	1	ZX2234	2CPX042640R9999	ZXM2234	2CPX042682R9999
		6		1450 + 43	1	ZX2235	2CPX042641R9999	ZXM2235	2CPX042683R9999
30 x 5	440	1		200 + 43	1	ZX2242	2CPX042648R9999	ZXM2242	2CPX042690R9999
		2		450 + 43	1	ZX2243	2CPX042649R9999	ZXM2243	2CPX042691R9999
		3		700 + 43	1	ZX2244	2CPX042650R9999	ZXM2244	2CPX042692R9999
		4		950 + 43	1	ZX2245	2CPX042651R9999	ZXM2245	2CPX042693R9999
		5		1200 + 43	1	ZX2246	2CPX042652R9999	ZXM2246	2CPX042694R9999
		6		1450 + 43	1	ZX2247	2CPX042653R9999	ZXM2247	2CPX042695R9999
Copper rail A2, busbars for TwinLine cabinet row mounting right and left									
20 x 5	320	1		43 + 154 + 43	1	ZX2330	2CPX042720R9999	ZXM2330	2CPX042756R9999
		2		43 + 404 + 43	1	ZX2331	2CPX042721R9999	ZXM2331	2CPX042757R9999
		3		43 + 654 + 43	1	ZX2332	2CPX042722R9999	ZXM2332	2CPX042758R9999
		4		43 + 904 + 43	1	ZX2333	2CPX042723R9999	ZXM2333	2CPX042759R9999
		5		43 + 1154 + 43	1	ZX2334	2CPX042724R9999	ZXM2334	2CPX042760R9999
		6		43 + 1404 + 43	1	ZX2335	2CPX042725R9999	ZXM2335	2CPX042761R9999
30 x 5	440	1		43 + 154 + 43	1	ZX2342	2CPX042732R9999	ZXM2342	2CPX042768R9999
		2		43 + 404 + 43	1	ZX2343	2CPX042733R9999	ZXM2343	2CPX042769R9999
		3		43 + 654 + 43	1	ZX2344	2CPX042734R9999	ZXM2344	2CPX042770R9999
		4		43 + 904 + 43	1	ZX2345	2CPX042735R9999	ZXM2345	2CPX042771R9999
		5		43 + 1154 + 43	1	ZX2346	2CPX042736R9999	ZXM2346	2CPX042772R9999
		6		43 + 1404 + 43	1	ZX2347	2CPX042737R9999	ZXM2347	2CPX042773R9999
Copper rail C, connector for TwinLine cabinet row mounting right or left									
20 x 5	320	-		149	1	ZX2404	2CPX042786R9999	-	-
30 x 5	440	-		149	1	ZX2406	2CPX042788R9999	-	-

TwinLine busbars

Row mounting for modules M(B) N..62+63

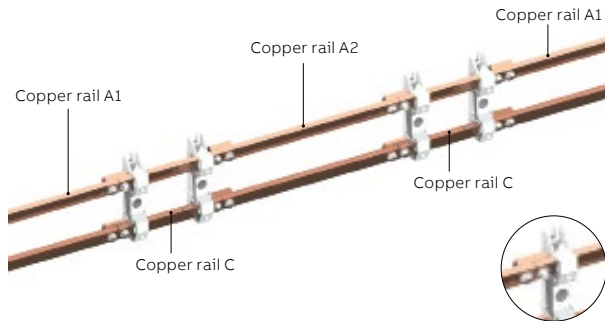

- It is possible to combine different module widths within the cabinet with continuous busbars
- Busbars for cabinet row mounting (copper rail A1/A2) are delivered on the connection side with copper transport pieces and attachment material
- A connector (copper rail C) is required for each busbar connection
- **Important:** note the possibility to combine modules with the TwinLine cabinet row mountings
- 2 copper rails A1/A2 and C are required per module

Copper rail	I _n	Width			Unit	Kit not installed		Mounted and installed in the cabinet	
		mm	A	FB		mm	Type	Order code	Type
Copper rail A1, busbars for TwinLine cabinet row mounting right or left									
30 x 10	630	1		149 + 43	1	ZX2254	2CPX042660R9999	ZXM2254	2CPX042702R9999
		2		399 + 43	1	ZX2255	2CPX042661R9999	ZXM2255	2CPX042703R9999
		3		649 + 43	1	ZX2256	2CPX042662R9999	ZXM2256	2CPX042704R9999
		4		899 + 43	1	ZX2257	2CPX042663R9999	ZXM2257	2CPX042705R9999
		5		1149 + 43	1	ZX2258	2CPX042664R9999	ZXM2258	2CPX042706R9999
		6		1399 + 43	1	ZX2259	2CPX042665R9999	ZXM2259	2CPX042707R9999
Copper rail A2, busbars for TwinLine cabinet row mounting right and left									
30 x 10	630	1		43 + 95 + 43	1	ZX2348	2CPX042738R9999	ZXM2348	2CPX042774R9999
		2		43 + 345 + 43	1	ZX2349	2CPX042739R9999	ZXM2349	2CPX042775R9999
		3		43 + 595 + 43	1	ZX2350	2CPX042740R9999	ZXM2350	2CPX042776R9999
		4		43 + 845 + 43	1	ZX2351	2CPX042741R9999	ZXM2351	2CPX042777R9999
		5		43 + 1095 + 43	1	ZX2352	2CPX042742R9999	ZXM2352	2CPX042778R9999
		6		43 + 1345 + 43	1	ZX2353	2CPX042743R9999	ZXM2353	2CPX042779R9999
Copper rail C, connector for TwinLine cabinet row mounting right or left									
30 x 10	630			208	1	ZX2408	2CPX042790R9999	-	-

TwinLine busbars

Row mounting for modules M(B)R...02(B)

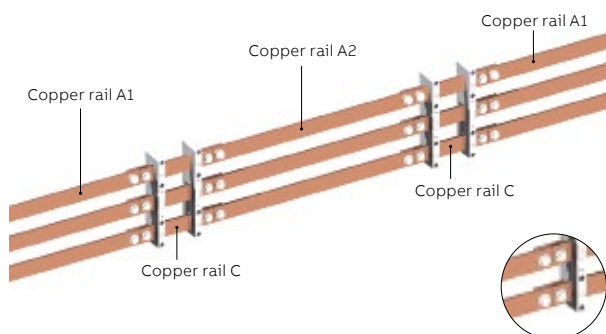

- It is possible to combine different module widths within the cabinet with continuous busbars
- Busbars for cabinet row mounting (copper rail A1/A2) are delivered on the connection side with copper transport pieces and attachment material
- A connector (copper rail C) is required for each busbar connection
- **Important:** For populated modules MR...02B, the external bus-mounting fuse socket may be omitted, for:
 - MR102B for connection left, 1 unit,
 - MR202B for connection left, 1 unit,
 - MR302B for connection left or right, 2 units each;
 these must be replaced by empty space covers ZA4P10 in the cover
- **Important:** note the possibility to combine modules with the TwinLine cabinet row mountings
- 3 copper rails A1/A2 and C are required per module

Copper rail	I _n	Width		Unit	Kit not installed		Mounted and installed in the cabinet	
		mm	FB		Type	Order code	Type	Order code
Copper rail A1, busbars for TwinLine cabinet row mounting right or left								
20 x 5	320	1	200 + 43	1	ZX2230	2CPX042636R9999	ZXM2230	2CPX042678R9999
		2	450 + 43	1	ZX2231	2CPX042637R9999	ZXM2231	2CPX042679R9999
		3	700 + 43	1	ZX2232	2CPX042638R9999	ZXM2232	2CPX042680R9999
		4	950 + 43	1	ZX2233	2CPX042639R9999	ZXM2233	2CPX042681R9999
		5	1200 + 43	1	ZX2234	2CPX042640R9999	ZXM2234	2CPX042682R9999
		6	1450 + 43	1	ZX2235	2CPX042641R9999	ZXM2235	2CPX042683R9999
30 x 5	440	1	200 + 43	1	ZX2242	2CPX042648R9999	ZXM2242	2CPX042690R9999
		2	450 + 43	1	ZX2243	2CPX042649R9999	ZXM2243	2CPX042691R9999
		3	700 + 43	1	ZX2244	2CPX042650R9999	ZXM2244	2CPX042692R9999
		4	950 + 43	1	ZX2245	2CPX042651R9999	ZXM2245	2CPX042693R9999
		5	1200 + 43	1	ZX2246	2CPX042652R9999	ZXM2246	2CPX042694R9999
		6	1450 + 43	1	ZX2247	2CPX042653R9999	ZXM2247	2CPX042695R9999
Copper rail A2, busbars for TwinLine cabinet row mounting right and left								
20 x 5	320	1	43 + 154 + 43	1	ZX2330	2CPX042720R9999	ZXM2330	2CPX042756R9999
		2	43 + 404 + 43	1	ZX2331	2CPX042721R9999	ZXM2331	2CPX042757R9999
		3	43 + 654 + 43	1	ZX2332	2CPX042722R9999	ZXM2332	2CPX042758R9999
		4	43 + 904 + 43	1	ZX2333	2CPX042723R9999	ZXM2333	2CPX042759R9999
		5	43 + 1154 + 43	1	ZX2334	2CPX042724R9999	ZXM2334	2CPX042760R9999
		6	43 + 1404 + 43	1	ZX2335	2CPX042725R9999	ZXM2335	2CPX042761R9999
30 x 5	440	1	43 + 154 + 43	1	ZX2342	2CPX042732R9999	ZXM2342	2CPX042768R9999
		2	43 + 404 + 43	1	ZX2343	2CPX042733R9999	ZXM2343	2CPX042769R9999
		3	43 + 654 + 43	1	ZX2344	2CPX042734R9999	ZXM2344	2CPX042770R9999
		4	43 + 904 + 43	1	ZX2345	2CPX042735R9999	ZXM2345	2CPX042771R9999
		5	43 + 1154 + 43	1	ZX2346	2CPX042736R9999	ZXM2346	2CPX042772R9999
		6	43 + 1404 + 43	1	ZX2347	2CPX042737R9999	ZXM2347	2CPX042773R9999
Copper rail C, connector for TwinLine cabinet row mounting right or left								
20 x 5	320	-	149	1	ZX2404	2CPX042786R9999	-	-
30 x 5	440	-	149	1	ZX2406	2CPX042788R9999	-	-

Busbars TriLine system and pro E power system

Row mounting for modules M(B)S...24

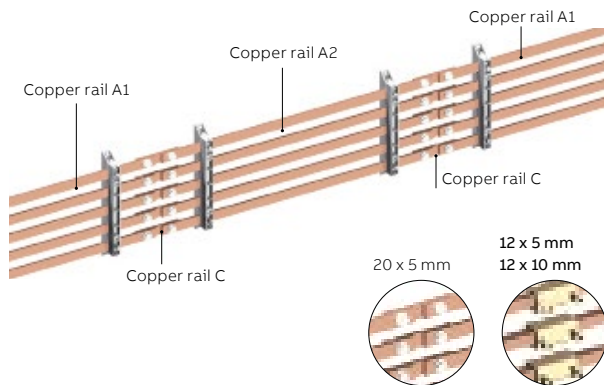

- It is possible to combine different module widths within the cabinet with continuous busbars
- A connector is required for cabinet row mounting for each busbar connection
- The busbar connection is realized outside the module
- Busbar connector for copper 12 x 5 mm and 12 x 10 mm, including connection terminals
- Busbar connector for copper 20 x 5 mm, including press-in nuts and fastening screws
- A max. of 5 copper rails A1/A2 and C are required per module

Copper rail mm	l _n A	Width		Unit	Kit not installed		Mounted and installed in the cabinet		
		FB	mm		Type	Order code	Type	Order code	
Copper rail A1, busbars for cabinet row mounting right or left									
12 x 5	250	1	293	1	ZX1040	2CPX041906R9999	ZXM1040	2CPX041516R9999	
		2	543	1	ZX1041	2CPX041907R9999	ZXM1041	2CPX041517R9999	
		3	793	1	ZX1042	2CPX041908R9999	ZXM1042	2CPX041518R9999	
		4	1043	1	ZX1043	2CPX041909R9999	ZXM1043	2CPX041519R9999	
		5	1293	1	ZX1044	2CPX041910R9999	ZXM1044	2CPX041520R9999	
12 x 10	360	1	293	1	ZX1046	2CPX041912R9999	ZXM1046	2CPX041522R9999	
		2	543	1	ZX1047	2CPX041913R9999	ZXM1047	2CPX041523R9999	
		3	793	1	ZX1048	2CPX041914R9999	ZXM1048	2CPX041524R9999	
		4	1043	1	ZX1049	2CPX041915R9999	ZXM1049	2CPX041525R9999	
		5	1293	1	ZX1050	2CPX041916R9999	ZXM1050	2CPX041526R9999	
20 x 5	320	1	293	1	ZX1052	2CPX041918R9999	ZXM1052	2CPX041528R9999	
		2	543	1	ZX1053	2CPX041919R9999	ZXM1053	2CPX041529R9999	
		3	793	1	ZX1054	2CPX041920R9999	ZXM1054	2CPX041530R9999	
		4	1043	1	ZX1055	2CPX041921R9999	ZXM1055	2CPX041531R9999	
		5	1293	1	ZX1056	2CPX041922R9999	ZXM1056	2CPX041532R9999	
Copper rail A2, busbars for cabinet row mounting right and left									
12 x 5	250	1	345	1	ZX1080	2CPX041942R9999	ZXM1080	2CPX041552R9999	
		2	595	1	ZX1081	2CPX041943R9999	ZXM1081	2CPX041553R9999	
		3	845	1	ZX1082	2CPX041944R9999	ZXM1082	2CPX041554R9999	
		4	1095	1	ZX1083	2CPX041945R9999	ZXM1083	2CPX041555R9999	
		5	1345	1	ZX1084	2CPX041946R9999	ZXM1084	2CPX041556R9999	
12 x 10	360	1	340	1	ZX1086	2CPX041948R9999	ZXM1086	2CPX041558R9999	
		2	590	1	ZX1087	2CPX041949R9999	ZXM1087	2CPX041559R9999	
		3	840	1	ZX1088	2CPX041950R9999	ZXM1088	2CPX041560R9999	
		4	1090	1	ZX1089	2CPX041951R9999	ZXM1089	2CPX041561R9999	
		5	1340	1	ZX1090	2CPX041952R9999	ZXM1090	2CPX041562R9999	
20 x 5	320	1	340	1	ZX1092	2CPX041954R9999	ZXM1092	2CPX041564R9999	
		2	590	1	ZX1093	2CPX041955R9999	ZXM1093	2CPX041565R9999	
		3	840	1	ZX1094	2CPX041956R9999	ZXM1094	2CPX041566R9999	
		4	1090	1	ZX1095	2CPX041957R9999	ZXM1095	2CPX041567R9999	
		5	1340	1	ZX1096	2CPX041958R9999	ZXM1096	2CPX041568R9999	
Copper rail C, connector for TwinLine cabinet row mounting right or left									
12 x 5	250		44	1	ZX1180	2CPX042020R9999	-	-	
12 x 10	360		44	1	ZX1181	2CPX042021R9999	-	-	
20 x 5	320		94	1	ZX1182	2CPX042022R9999	-	-	
Copper rail C, connector for the pro E power system cabinet row mounting right or left									
12 x 5	250		44	1	ZX1180	2CPX042020R9999	-	-	
12 x 10	360		44	1	ZX1181	2CPX042021R9999	-	-	
20 x 5	320		74	1	ZX1192	2CPX042105R9999	-	-	

Busbars TriLine system and pro E power system

Row mounting for modules M(B)S...27

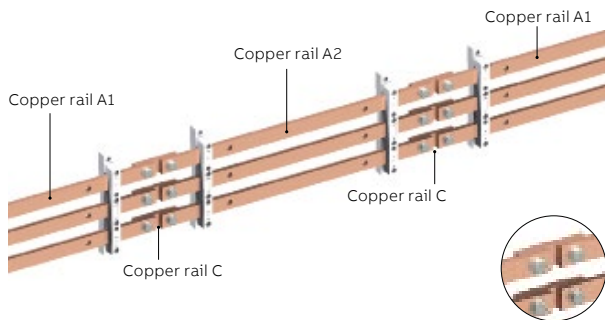

- It is possible to combine different module widths within the cabinet with continuous busbars
- A connector is required for cabinet row mounting for each busbar connection
- The busbar connection is realized outside the module
- Busbar connector, including press-in nuts and attachment material
- 3 copper rails A1/A2 and C are required per module

Copper rail	l _n	Width			Unit	Kit not installed		Mounted and installed in the cabinet	
		A	FB	mm		Type	Order code	Type	Order code
Copper rail A1, busbars for cabinet row mounting right or left									
30 x 5	440	1	293	1	ZX1058	2CPX041924R9999	ZXM1058	2CPX041534R9999	
		2	543	1	ZX1059	2CPX041925R9999	ZXM1059	2CPX041535R9999	
		3	793	1	ZX1060	2CPX041926R9999	ZXM1060	2CPX041536R9999	
		4	1043	1	ZX1061	2CPX041927R9999	ZXM1061	2CPX041537R9999	
		5	1293	1	ZX1062	2CPX041928R9999	ZXM1062	2CPX041538R9999	
30 x 10	630	1	293	1	ZX1064	2CPX041930R9999	ZXM1064	2CPX041540R9999	
		2	543	1	ZX1065	2CPX041931R9999	ZXM1065	2CPX041541R9999	
		3	793	1	ZX1066	2CPX041932R9999	ZXM1066	2CPX041542R9999	
		4	1043	1	ZX1067	2CPX041933R9999	ZXM1067	2CPX041543R9999	
		5	1293	1	ZX1068	2CPX041934R9999	ZXM1068	2CPX041544R9999	
Copper rail A2, busbars for cabinet row mounting right and left									
30 x 5	440	1	340	1	ZX1098	2CPX041960R9999	ZXM1098	2CPX041570R9999	
		2	590	1	ZX1099	2CPX041961R9999	ZXM1099	2CPX041571R9999	
		3	840	1	ZX1100	2CPX041962R9999	ZXM1100	2CPX041572R9999	
		4	1090	1	ZX1101	2CPX041963R9999	ZXM1101	2CPX041573R9999	
		5	1340	1	ZX1102	2CPX041964R9999	ZXM1102	2CPX041574R9999	
30 x 10	630	1	340	1	ZX1104	2CPX041966R9999	ZXM1104	2CPX041576R9999	
		2	590	1	ZX1105	2CPX041967R9999	ZXM1105	2CPX041577R9999	
		3	840	1	ZX1106	2CPX041968R9999	ZXM1106	2CPX041578R9999	
		4	1090	1	ZX1107	2CPX041969R9999	ZXM1107	2CPX041579R9999	
		5	1340	1	ZX1108	2CPX041970R9999	ZXM1108	2CPX041580R9999	
Copper rail C, connector for TwinLine cabinet row mounting right or left									
30 x 5	250		94	1	ZX1183	2CPX042023R9999	-	-	
30 x 10	360		94	1	ZX1184	2CPX042024R9999	-	-	
Copper rail C, connector for the pro E power system cabinet row mounting right or left									
30 x 5	250		74	1	ZX1193	2CPX042106R9999	-	-	
30 x 10	360		74	1	ZX1194	2CPX042107R9999	-	-	

Busbars TriLine system and pro E power system

Row mounting for modules M(B)S...31

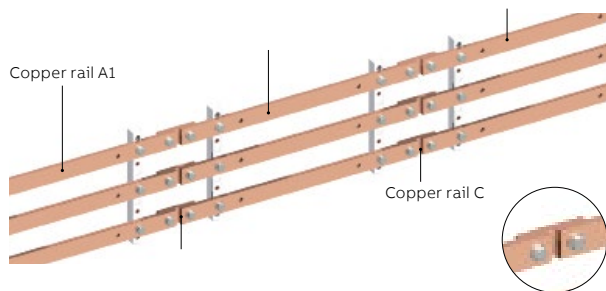

- It is possible to combine different module widths within the cabinet with continuous busbars
- A connector is required for cabinet row mounting for each busbar connection
- The busbar connection is realized outside the module
- Busbar connector, including press-in nuts and attachment material
- 3 copper rails A1/A2 and C are required per module

Copper rail	l _n	Width			Unit	Kit not installed		Mounted and installed in the cabinet	
		mm	A	FB		mm	Type	Order code	Type
Copper rail A1, busbars for cabinet row mounting right or left									
40 x 10	850	1		293	1	ZX1070	2CPX041936R9999	ZXM1070	2CPX041546R9999
		2		543	1	ZX1071	2CPX041937R9999	ZXM1071	2CPX041547R9999
		3		762	1	ZX1072	2CPX041938R9999	ZXM1072	2CPX041548R9999
		4 (2FB+2FB)		1043	1	ZX1073	2CPX041939R9999	ZXM1073	2CPX041549R9999
		5 (3FB+2FB)		1293	1	ZX1074	2CPX041940R9999	ZXM1074	2CPX041550R9999
Copper rail A2, busbars for cabinet row mounting right and left									
40 x 10	850	1		340	1	ZX1110	2CPX041972R9999	ZXM1110	2CPX041582R9999
		2		590	1	ZX1111	2CPX041973R9999	ZXM1111	2CPX041583R9999
		3		840	1	ZX1112	2CPX041974R9999	ZXM1112	2CPX041584R9999
		4 (2FB+2FB)		1090	1	ZX1113	2CPX041975R9999	ZXM1113	2CPX041585R9999
		5 (3FB+2FB)		1340	1	ZX1114	2CPX041976R9999	ZXM1114	2CPX041586R9999
Copper rail C, connector for TwinLine cabinet row mounting right or left									
40 x 10	850			94	1	ZX1185	2CPX042025R9999	-	-
Copper rail C, connector for the pro E power system cabinet row mounting right or left									
40 x 10	850			74	1	ZX1195	2CPX042108R9999	-	-

Busbars TriLine system and pro E power system

Row mounting for modules M(B)N...69

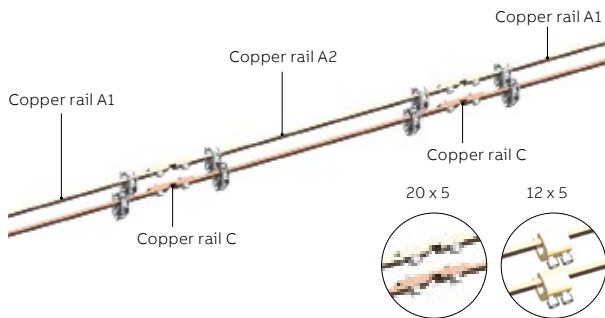

- It is possible to combine different module widths within the cabinet with continuous busbars
- A connector is required for cabinet row mounting for each busbar connection
- The busbar connection is realized outside the module
- Busbar connector, including press-in nuts and attachment material
- 2 copper rails A1/A2 and C are required per module

Copper rail	I _n	Width			Unit	Kit not installed		Mounted and installed in the cabinet	
		mm	A	FB		mm	Type	Order code	Type
Copper rail A1, busbars for cabinet row mounting right or left									
12 x 5	250	1		272	1	ZX2094	2CPX042578R9999	ZXM2094	2CPX042498R9999
		2		522	1	ZX2095	2CPX042579R9999	ZXM2095	2CPX042499R9999
		3		772	1	ZX2096	2CPX042580R9999	ZXM2096	2CPX042500R9999
		4		1022	1	ZX2097	2CPX042581R9999	ZXM2097	2CPX042501R9999
		5		1272	1	ZX2098	2CPX042582R9999	ZXM2098	2CPX042502R9999
20 x 5	320	1		272	1	ZX2112	2CPX042593R9999	ZXM2112	2CPX042513R9999
		2		522	1	ZX2113	2CPX042594R9999	ZXM2113	2CPX042514R9999
		3		772	1	ZX2114	2CPX042595R9999	ZXM2114	2CPX042515R9999
		4		1022	1	ZX2115	2CPX042596R9999	ZXM2115	2CPX042516R9999
		5		1272	1	ZX2116	2CPX042597R9999	ZXM2116	2CPX042517R9999
Copper rail A2, busbars for cabinet row mounting right and left									
12 x 5	250	1		345	1	ZX1080	2CPX041942R9999	ZXM1080	2CPX041552R9999
		2		595	1	ZX1081	2CPX041943R9999	ZXM1081	2CPX041553R9999
		3		845	1	ZX1082	2CPX041944R9999	ZXM1082	2CPX041554R9999
		4		1095	1	ZX1083	2CPX041945R9999	ZXM1083	2CPX041555R9999
		5		1345	1	ZX1084	2CPX041946R9999	ZXM1084	2CPX041556R9999
20 x 5	320	1		340	1	ZX1092	2CPX041954R9999	ZXM1092	2CPX041564R9999
		2		590	1	ZX1093	2CPX041955R9999	ZXM1093	2CPX041565R9999
		3		840	1	ZX1094	2CPX041956R9999	ZXM1094	2CPX041566R9999
		4		1090	1	ZX1095	2CPX041957R9999	ZXM1095	2CPX041567R9999
		5		1340	1	ZX1096	2CPX041958R9999	ZXM1096	2CPX041568R9999
Copper rail C, connector for TwinLine cabinet row mounting right or left									
12 x 5	250			94	1	ZX1180	2CPX042020R9999	-	-
20 x 5	320			94	1	ZX1182	2CPX042022R9999	-	-
Copper rail C, connector for the pro E power system cabinet row mounting right or left									
12 x 5	250			74	1	ZX1180	2CPX042020R9999	-	-
20 x 5	320			74	1	ZX1192	2CPX042105R9999	-	-

Busbars TriLine system and pro E power system

Row mounting for modules M(B)N...74+75

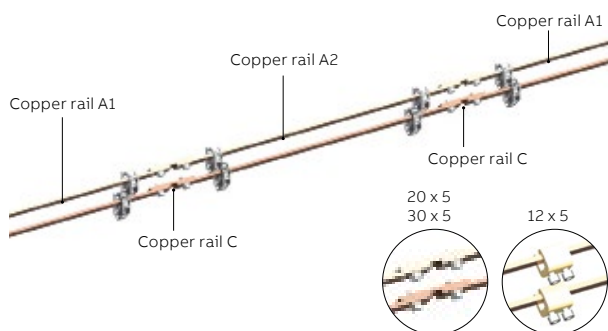

- It is possible to combine different module widths within the cabinet with continuous busbars
- A connector is required for cabinet row mounting for each busbar connection
- The busbar connection is realized outside the module
- Busbar connector, including press-in nuts and attachment material
- 2 copper rails A1/A2 and C are required per module

Copper rail	l _n	Width			Unit	Kit not installed		Mounted and installed in the cabinet	
		mm	A	FB		mm	Type	Order code	Type
Copper rail A1, busbars for cabinet row mounting right or left									
12 x 5	250	1		293	1	ZX1040	2CPX041906R9999	ZXM1040	2CPX041516R9999
		2		543	1	ZX1041	2CPX041907R9999	ZXM1041	2CPX041517R9999
		3		793	1	ZX1042	2CPX041908R9999	ZXM1042	2CPX041518R9999
		4		1043	1	ZX1043	2CPX041909R9999	ZXM1043	2CPX041519R9999
		5		1293	1	ZX1044	2CPX041910R9999	ZXM1044	2CPX041520R9999
20 x 5	320	1		293	1	ZX1052	2CPX041918R9999	ZXM1052	2CPX041528R9999
		2		543	1	ZX1053	2CPX041919R9999	ZXM1053	2CPX041529R9999
		3		793	1	ZX1054	2CPX041920R9999	ZXM1054	2CPX041530R9999
		4		1043	1	ZX1055	2CPX041921R9999	ZXM1055	2CPX041531R9999
		5		1293	1	ZX1056	2CPX041922R9999	ZXM1056	2CPX041532R9999
30 x 5	440	1		293	1	ZX1058	2CPX041924R9999	ZXM1058	2CPX041534R9999
		2		543	1	ZX1059	2CPX041925R9999	ZXM1059	2CPX041535R9999
		3		793	1	ZX1060	2CPX041926R9999	ZXM1060	2CPX041536R9999
		4		1043	1	ZX1061	2CPX041927R9999	ZXM1061	2CPX041537R9999
		5		1293	1	ZX1062	2CPX041928R9999	ZXM1062	2CPX041538R9999
Copper rail A2, busbars for cabinet row mounting right and left									
12 x 5	250	1		345	1	ZX1080	2CPX041942R9999	ZXM1080	2CPX041552R9999
		2		595	1	ZX1081	2CPX041943R9999	ZXM1081	2CPX041553R9999
		3		845	1	ZX1082	2CPX041944R9999	ZXM1082	2CPX041554R9999
		4		1090	1	ZX1083	2CPX041945R9999	ZXM1083	2CPX041555R9999
		5		1340	1	ZX1084	2CPX041946R9999	ZXM1084	2CPX041556R9999
20 x 5	320	1		340	1	ZX1092	2CPX041954R9999	ZXM1092	2CPX041564R9999
		2		590	1	ZX1093	2CPX041955R9999	ZXM1093	2CPX041565R9999
		3		840	1	ZX1094	2CPX041956R9999	ZXM1094	2CPX041566R9999
		4		1090	1	ZX1095	2CPX041957R9999	ZXM1095	2CPX041567R9999
		5		1340	1	ZX1096	2CPX041958R9999	ZXM1096	2CPX041568R9999
30 x 5	440	1		350	1	ZX1098	2CPX041960R9999	ZXM1098	2CPX041570R9999
		2		600	1	ZX1099	2CPX041961R9999	ZXM1099	2CPX041571R9999
		3		850	1	ZX1100	2CPX041962R9999	ZXM1100	2CPX041572R9999
		4		1100	1	ZX1101	2CPX041963R9999	ZXM1101	2CPX041573R9999
		5		1350	1	ZX1102	2CPX041964R9999	ZXM1102	2CPX041574R9999
Copper rail C, connector for TwinLine cabinet row mounting right or left									
12 x 5	250		44	1	ZX1180	2CPX042020R9999	-	-	
20 x 5	320		94	1	ZX1182	2CPX042022R9999	-	-	
30 x 5	440		94	1	ZX1183	2CPX042023R9999	-	-	
Copper rail C, connector for the pro E power system cabinet row mounting right or left									
12 x 5	250		44	1	ZX1180	2CPX042020R9999	-	-	
20 x 5	320		74	1	ZX1192	2CPX042105R9999	-	-	
30 x 5	440		74	1	ZX1193	2CPX042106R9999	-	-	

Busbars TriLine system and pro E power system

Row mounting for modules M(B)N...62+63

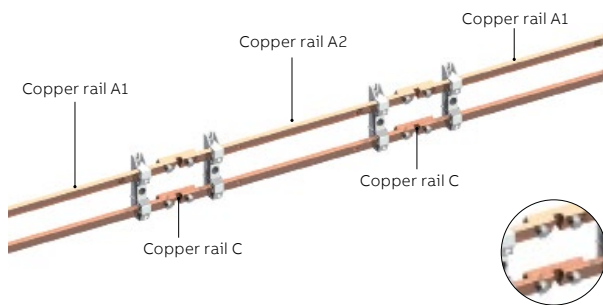

- It is possible to combine different module widths within the cabinet with continuous busbars
- A connector is required for cabinet row mounting for each busbar connection
- The busbar connection is realized outside the module
- Busbar connector, including press-in nuts and attachment material
- 2 copper rails A1/A2 and C are required per module

Copper rail	I _n	Width			Unit	Kit not installed		Mounted and installed in the cabinet	
		mm	A	FB		mm	Type	Order code	Type
Copper rail A1, busbars for cabinet row mounting right or left									
30 x 10	630	1		270	1	ZX2130	2CPX042608R9999	ZXM2130	2CPX042528R9999
		2		520	1	ZX2131	2CPX042609R9999	ZXM2131	2CPX042529R9999
		3		770	1	ZX2132	2CPX042610R9999	ZXM2132	2CPX042530R9999
		4		1020	1	ZX2133	2CPX042611R9999	ZXM2133	2CPX042531R9999
		5		1270	1	ZX2134	2CPX042612R9999	ZXM2134	2CPX042532R9999
Copper rail A2, busbars for cabinet row mounting right and left									
30 x 10	630	1		340	1	ZX1104	2CPX041966R9999	ZXM1104	2CPX041576R9999
		2		590	1	ZX1105	2CPX041967R9999	ZXM1105	2CPX041577R9999
		3		840	1	ZX1106	2CPX041968R9999	ZXM1106	2CPX041578R9999
		4		1090	1	ZX1107	2CPX041969R9999	ZXM1107	2CPX041579R9999
		5		1340	1	ZX1108	2CPX041970R9999	ZXM1108	2CPX041580R9999
Copper rail C, connector for TwinLine cabinet row mounting right or left									
30 x 10	360			94	1	ZX1184	2CPX042024R9999	-	-
Copper rail C, connector for the pro E power system cabinet row mounting right or left									
30 x 10	360			74	1	ZX1194	2CPX042107R9999	-	-

Busbars TriLine system and pro E power system

Row mounting for modules M(B)R...03

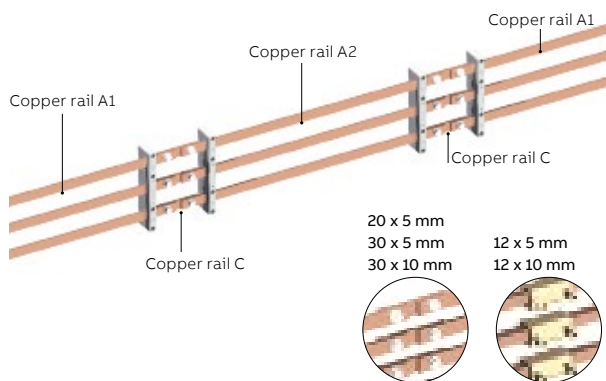

- It is possible to combine different module widths within the cabinet with continuous busbars
- A connector is required for cabinet row mounting for each busbar connection
- The busbar connection is realized outside the module
- Busbar connector for copper 12 x 5 mm and 12 x 10 mm, including connection terminals
- Busbar connector for copper 20 x 5 mm, including press-in nuts and fastening screws
- 3 copper rails A1/A2 and C are required per module

Copper rail mm	I _n A	Width			Unit	Kit not installed		Mounted and installed in the cabinet	
		A	FB	mm		Type	Order code	Type	Order code
Copper rail A1, busbars for TriLine cabinet row mounting right or left									
12 x 5	250	1		267	1	ZX2088	2CPX042573R9999	ZXM2088	2CPX042493R9999
		2		517	1	ZX2089	2CPX042574R9999	ZXM2089	2CPX042494R9999
		3		767	1	ZX2090	2CPX042575R9999	ZXM2090	2CPX042495R9999
		4		1017	1	ZX2091	2CPX042576R9999	ZXM2091	2CPX042496R9999
		5		1267	1	ZX2092	2CPX042577R9999	ZXM2092	2CPX042497R9999
12 x 10	360	1		267	1	ZX2100	2CPX042583R9999	ZXM2100	2CPX042503R9999
		2		517	1	ZX2101	2CPX042584R9999	ZXM2101	2CPX042504R9999
		3		767	1	ZX2102	2CPX042585R9999	ZXM2102	2CPX042505R9999
		4		1017	1	ZX2103	2CPX042586R9999	ZXM2103	2CPX042506R9999
		5		1267	1	ZX2104	2CPX042587R9999	ZXM2104	2CPX042507R9999
20 x 5	320	1		267	1	ZX2106	2CPX042588R9999	ZXM2106	2CPX042508R9999
		2		517	1	ZX2107	2CPX042589R9999	ZXM2107	2CPX042509R9999
		3		767	1	ZX2108	2CPX042590R9999	ZXM2108	2CPX042510R9999
		4		1017	1	ZX2109	2CPX042591R9999	ZXM2109	2CPX042511R9999
		5		1267	1	ZX2110	2CPX042592R9999	ZXM2110	2CPX042512R9999
30 x 5	440	1		267	1	ZX2118	2CPX042598R9999	ZXM2118	2CPX042518R9999
		2		517	1	ZX2119	2CPX042599R9999	ZXM2119	2CPX042519R9999
		3		767	1	ZX2120	2CPX042600R9999	ZXM2120	2CPX042520R9999
		4		1017	1	ZX2121	2CPX042601R9999	ZXM2121	2CPX042521R9999
		5		1267	1	ZX2122	2CPX042602R9999	ZXM2122	2CPX042522R9999
30 x 10	630	1		267	1	ZX2124	2CPX042603R9999	ZXM2124	2CPX042523R9999
		2		517	1	ZX2125	2CPX042604R9999	ZXM2125	2CPX042524R9999
		3		767	1	ZX2126	2CPX042605R9999	ZXM2126	2CPX042525R9999
		4		1017	1	ZX2127	2CPX042606R9999	ZXM2127	2CPX042526R9999
		5		1267	1	ZX2128	2CPX042607R9999	ZXM2128	2CPX042527R9999

Busbars TriLine system and pro E power system

Row mounting for modules M(B)R...03

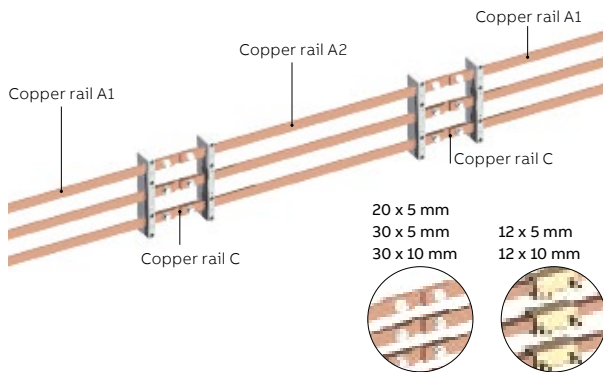

- It is possible to combine different module widths within the cabinet with continuous busbars
- A connector is required for cabinet row mounting for each busbar connection
- The busbar connection is realized outside the module
- Busbar connector for copper 12 x 5 mm and 12 x 10 mm, including connection terminals
- Busbar connector for copper 20 x 5 mm, including press-in nuts and fastening screws
- 3 copper rails A1/A2 and C are required per module

Copper rail mm	I _n A	Width		Unit	Kit not installed		Mounted and installed in the cabinet		
		FB	mm		Type	Order code	Type	Order code	
Copper rail A2, busbars for cabinet row mounting right and left									
12 x 5	250	1	345	1	ZX1080	2CPX041942R9999	ZXM1080	2CPX041552R9999	
		2	595	1	ZX1081	2CPX041943R9999	ZXM1081	2CPX041553R9999	
		3	845	1	ZX1082	2CPX041944R9999	ZXM1082	2CPX041554R9999	
		4	1095	1	ZX1083	2CPX041945R9999	ZXM1083	2CPX041555R9999	
		5	1345	1	ZX1084	2CPX041946R9999	ZXM1084	2CPX041556R9999	
12 x 10	360	1	340	1	ZX1086	2CPX041948R9999	ZXM1086	2CPX041558R9999	
		2	590	1	ZX1087	2CPX041949R9999	ZXM1087	2CPX041559R9999	
		3	840	1	ZX1088	2CPX041950R9999	ZXM1088	2CPX041560R9999	
		4	1090	1	ZX1089	2CPX041951R9999	ZXM1089	2CPX041561R9999	
		5	1340	1	ZX1090	2CPX041952R9999	ZXM1090	2CPX041562R9999	
20 x 5	320	1	340	1	ZX1092	2CPX041954R9999	ZXM1092	2CPX041564R9999	
		2	590	1	ZX1093	2CPX041955R9999	ZXM1093	2CPX041565R9999	
		3	840	1	ZX1094	2CPX041956R9999	ZXM1094	2CPX041566R9999	
		4	1090	1	ZX1095	2CPX041957R9999	ZXM1095	2CPX041567R9999	
		5	1340	1	ZX1096	2CPX041958R9999	ZXM1096	2CPX041568R9999	
30 x 5	440	1	340	1	ZX1098	2CPX041960R9999	ZXM1098	2CPX041570R9999	
		2	590	1	ZX1099	2CPX041961R9999	ZXM1099	2CPX041571R9999	
		3	840	1	ZX1100	2CPX041962R9999	ZXM1100	2CPX041572R9999	
		4	1090	1	ZX1101	2CPX041963R9999	ZXM1101	2CPX041573R9999	
		5	1340	1	ZX1102	2CPX041964R9999	ZXM1102	2CPX041574R9999	
30 x 10	630	1	340	1	ZX1104	2CPX041966R9999	ZXM1104	2CPX041576R9999	
		2	590	1	ZX1105	2CPX041967R9999	ZXM1105	2CPX041577R9999	
		3	840	1	ZX1106	2CPX041968R9999	ZXM1106	2CPX041578R9999	
		4	1090	1	ZX1107	2CPX041969R9999	ZXM1107	2CPX041579R9999	
		5	1340	1	ZX1108	2CPX041970R9999	ZXM1108	2CPX041580R9999	
Copper rail C, connector for TwinLine cabinet row mounting right or left									
12 x 5	250		44	1	ZX1180	2CPX042020R9999	-	-	
12 x 10	360		44	1	ZX1181	2CPX042021R9999	-	-	
20 x 5	320		94	1	ZX1182	2CPX042022R9999	-	-	
30 x 5	440		94	1	ZX1183	2CPX042023R9999	-	-	
30 x 10	630		94	1	ZX1184	2CPX042024R9999	-	-	
Copper rail C, connector for the pro E power system cabinet row mounting right or left									
12 x 5	250		44	1	ZX1180	2CPX042020R9999	-	-	
12 x 10	360		44	1	ZX1181	2CPX042021R9999	-	-	
20 x 5	320		74	1	ZX1192	2CPX042105R9999	-	-	
30 x 5	440		74	1	ZX1193	2CPX042106R9999	-	-	
30 x 10	630		74	1	ZX1194	2CPX042107R9999	-	-	

Busbars TriLine system and pro E power system

Row mounting of modules 100 mm, NH00 switch disconnectors, M(B)D...52(B)



ZXM1215

- Busbars for individual cabinet installation
- With the EDF and WR mounting frame, defined combinations (see info FB width) are possible within the cabinet. The different busbars can be connected via a connection set
- The NH00 fuse switch disconnection rails are mounted directly on the copper rails prepared with press-in nuts
- Set positions are specified for feeding in on copper rails
- 3 copper rails are required per module

Copper rail mm	I_n A	Width		Unit	Kit not installed		Mounted and installed in the cabinet	
		FB	mm		Type	Order code	Type	Order code
30 x 10	630	1	184	1	ZX1210	2CPX042121R9999	ZXM1210	2CPX042230R9999
		2	434	1	ZX1211	2CPX042122R9999	ZXM1211	2CPX042231R9999
		3	684	1	ZX1212	2CPX042123R9999	ZXM1212	2CPX042232R9999
40 x 10	850	1	184	1	ZX1213	2CPX042124R9999	ZXM1213	2CPX042233R9999
		2	434	1	ZX1214	2CPX042125R9999	ZXM1214	2CPX042234R9999
		3	684	1	ZX1215	2CPX042126R9999	ZXM1215	2CPX042235R9999

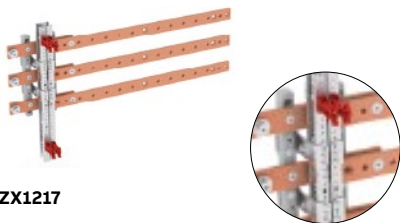

ZX1217

- Busbars connection set (cabinet-cabinet)
- **Important:** Note the cabinet depth when using a connection set
- A ZX22... P3 set with 3 connectors is required per connection

Copper rail mm	I_n A	Width		Unit	Kit not installed		Mounted and installed in the cabinet	
		FB	mm		Type	Order code	Type	Order code
Copper rail C, connector for the cabinet row mounting right or left for the TriLine system								
30 x 10	630		230	3	ZX2216P3	on request	-	-
40 x 10	850		230	3	ZX2217P3	on request	-	-
Copper rail C, connector for the cabinet row mounting right or left for the pro E power system								
30 x 10	630		230	3	ZX2218P3	on request	-	-
40 x 10	850		230	3	ZX2219P3	on request	-	-

Busbars TriLine system and pro E power system

Row mounting of modules 185 mm, switch disconnectors, M(B)D..21-300(B)

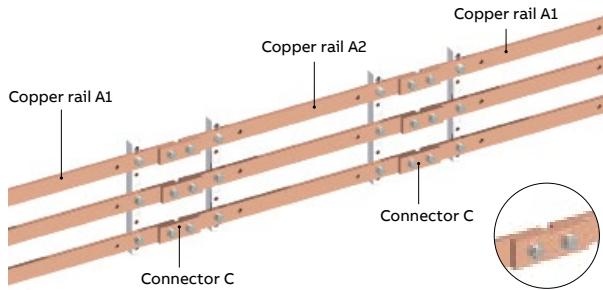

- Combinations of different module widths are possible within a cabinet with continuous busbars.
- The busbars A1 and A2 are provided with press-in nuts to assemble the NH-in-line fused load break switches.
- The busbar connection is realized outside the module
- 3 copper rails A1 or A2 and 3 or 6 copper connectors C are required per module
- The busbars A1 are required for cabinet row mounting right or left (right extension)
- The busbars A2 are required for cabinet row mounting right and left (both sides extension)
- A busbar connector C is required for each busbar connection
- The busbar connector is delivered with the press-in nuts and attachment material

Copper rail	I _n	Width			Unit	Kit not installed		Mounted and installed in the cabinet	
		A	FB	mm		Type	Order code	Type	Order code
Copper rail A1, busbars for the cabinet row mounting right or left (right extension) for the TriLine and pro E power systems									
30 x 10	630	1		274	1	ZX2520	2CPX042968R9999	ZXM2520	2CPX043316R9999
		2		524	1	ZX2521	2CPX042969R9999	ZXM2521	2CPX043317R9999
		3		774	1	ZX2522	2CPX042970R9999	ZXM2522	2CPX043318R9999
		4 (2FB+2FB)		1024	1	ZX2523	2CPX042971R9999	ZXM2523	2CPX043319R9999
		5 (3FB+2FB)		1274	1	ZX2524	2CPX042972R9999	ZXM2524	2CPX043320R9999
4 x 10	850	1		274	1	ZX2525	2CPX042973R9999	ZXM2525	2CPX043321R9999
		2		524	1	ZX2526	2CPX042974R9999	ZXM2526	2CPX043322R9999
		3		774	1	ZX2527	2CPX042975R9999	ZXM2527	2CPX043323R9999
		4 (2FB+2FB)		1024	1	ZX2528	2CPX042976R9999	ZXM2528	2CPX043324R9999
		5 (3FB+2FB)		1274	1	ZX2529	2CPX042977R9999	ZXM2529	2CPX043325R9999
Copper rail A2, busbars for the cabinet row mounting right and left (both sides extension) for the TriLine and pro E power systems									
30 x 10	630	1		333	1	ZX2530	2CPX042978R9999	ZXM2530	2CPX043326R9999
		2		583	1	ZX2531	2CPX042979R9999	ZXM2531	2CPX043327R9999
		3		833	1	ZX2532	2CPX042980R9999	ZXM2532	2CPX043328R9999
		4 (2FB+2FB)		1083	1	ZX2533	2CPX042981R9999	ZXM2533	2CPX043329R9999
		5 (3FB+2FB)		1333	1	ZX2534	2CPX042982R9999	ZXM2534	2CPX043330R9999
40 x 10	850	1		333	1	ZX2535	2CPX042983R9999	ZXM2535	2CPX043331R9999
		2		583	1	ZX2536	2CPX042984R9999	ZXM2536	2CPX043332R9999
		3		833	1	ZX2537	2CPX042985R9999	ZXM2537	2CPX043333R9999
		4 (2FB+2FB)		1083	1	ZX2538	2CPX042986R9999	ZXM2538	2CPX043334R9999
		5 (3FB+2FB)		1333	1	ZX2539	2CPX042987R9999	ZXM2539	2CPX043335R9999
Copper rail C, connector for the cabinet row mounting right and/or left for the TriLine pro E power systems									
30 x 10	630			100	1	ZX2540	2CPX042988R9999	ZXM2540	2CPX043336R9999
40 x 10	850			100	1	ZX2541	2CPX042989R9999	ZXM2541	2CPX043337R9999

Busbars TriLine system and pro E power system

Row mounting for modules M(B)R...02(B)

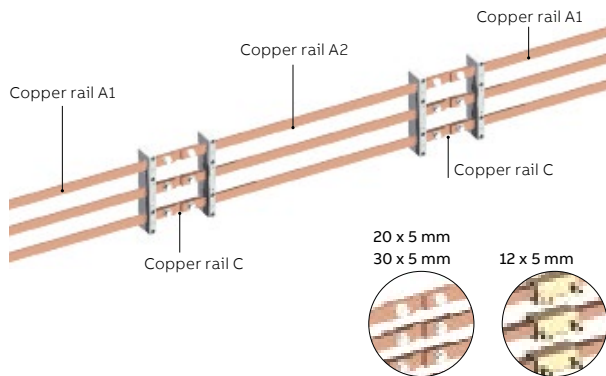

- It is possible to combine different module widths within the cabinet with continuous busbars
- A connector is required for cabinet row mounting for each busbar connection
- The busbar connection is realized outside the module
- Busbar connector for copper 12 x 5 mm and 12 x 10 mm, including connection terminals
- Busbar connector for copper 20 x 5 mm, including press-in nuts and fastening screws
- 3 copper rails A1/A2 and C are required per module

Copper rail	I _n	Width		Unit	Kit not installed		Mounted and installed in the cabinet	
		mm	FB		Type	Order code	Type	Order code
Copper rail A1, busbars for cabinet row mounting right or left								
12 x 5	250	1	293	1	ZX1040	2CPX041906R9999	ZXM1040	2CPX041516R9999
		2	543	1	ZX1041	2CPX041907R9999	ZXM1041	2CPX041517R9999
		3	793	1	ZX1042	2CPX041908R9999	ZXM1042	2CPX041518R9999
		4	1043	1	ZX1043	2CPX041909R9999	ZXM1043	2CPX041519R9999
		5	1293	1	ZX1044	2CPX041910R9999	ZXM1044	2CPX041520R9999
20 x 5	320	1	293	1	ZX1052	2CPX041918R9999	ZXM1052	2CPX041528R9999
		2	543	1	ZX1053	2CPX041919R9999	ZXM1053	2CPX041529R9999
		3	793	1	ZX1054	2CPX041920R9999	ZXM1054	2CPX041530R9999
		4	1043	1	ZX1055	2CPX041921R9999	ZXM1055	2CPX041531R9999
		5	1293	1	ZX1056	2CPX041922R9999	ZXM1056	2CPX041532R9999
30 x 5	440	1	293	1	ZX1058	2CPX041924R9999	ZXM1058	2CPX041534R9999
		2	543	1	ZX1059	2CPX041925R9999	ZXM1059	2CPX041535R9999
		3	793	1	ZX1060	2CPX041926R9999	ZXM1060	2CPX041536R9999
		4	1043	1	ZX1061	2CPX041927R9999	ZXM1061	2CPX041537R9999
		5	1293	1	ZX1062	2CPX041928R9999	ZXM1062	2CPX041538R9999
Copper rail A2, busbars for cabinet row mounting right and left								
12 x 5	250	1	345	1	ZX1080	2CPX041942R9999	ZXM1080	2CPX041552R9999
		2	595	1	ZX1081	2CPX041943R9999	ZXM1081	2CPX041553R9999
		3	845	1	ZX1082	2CPX041944R9999	ZXM1082	2CPX041554R9999
		4	1095	1	ZX1083	2CPX041945R9999	ZXM1083	2CPX041555R9999
		5	1345	1	ZX1084	2CPX041946R9999	ZXM1084	2CPX041556R9999
20 x 5	320	1	340	1	ZX1092	2CPX041954R9999	ZXM1092	2CPX041564R9999
		2	590	1	ZX1093	2CPX041955R9999	ZXM1093	2CPX041565R9999
		3	840	1	ZX1094	2CPX041956R9999	ZXM1094	2CPX041566R9999
		4	1090	1	ZX1095	2CPX041957R9999	ZXM1095	2CPX041567R9999
		5	1340	1	ZX1096	2CPX041958R9999	ZXM1096	2CPX041568R9999
30 x 5	440	1	340	1	ZX1098	2CPX041960R9999	ZXM1098	2CPX041570R9999
		2	590	1	ZX1099	2CPX041961R9999	ZXM1099	2CPX041571R9999
		3	840	1	ZX1100	2CPX041962R9999	ZXM1100	2CPX041572R9999
		4	1090	1	ZX1101	2CPX041963R9999	ZXM1101	2CPX041573R9999
		5	1340	1	ZX1102	2CPX041964R9999	ZXM1102	2CPX041574R9999
Copper rail C, connector for TwinLine cabinet row mounting right or left								
12 x 5	250		44	1	ZX1180	2CPX042020R9999	-	-
20 x 5	320		94	1	ZX1182	2CPX042022R9999	-	-
30 x 5	440		94	1	ZX1183	2CPX042023R9999	-	-
Copper rail C, connector for the pro E power system cabinet row mounting right or left								
12 x 5	250		44	1	ZX1180	2CPX042020R9999	-	-
20 x 5	320		74	1	ZX1192	2CPX042105R9999	-	-
30 x 5	440		74	1	ZX1193	2CPX042106R9999	-	-

Busbars TriLine system and pro E power system

Row mounting for modules M(B)T...50+51(B)

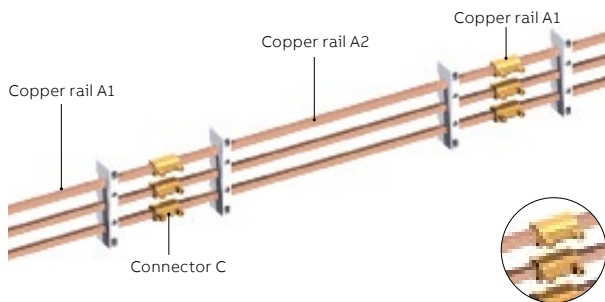

- It is possible to combine different module widths within the cabinet with continuous busbars
- A connector is required for cabinet row mounting for each busbar connection
- The busbar connection is realized outside the module
- Busbar connector, including connection terminals
- 3 copper rails A1/A2 and C are required per module

Copper rail	I _n	Width		Unit	Kit not installed		Mounted and installed in the cabinet		
		A	FB		mm	Type	Order code	Type	Order code
Copper rail A1, busbars for cabinet row mounting right or left									
12 x 5	250	2	543	1	ZX1041	2CPX041907R9999	ZXM1041	2CPX041517R9999	
		3	793	1	ZX1042	2CPX041908R9999	ZXM1042	2CPX041518R9999	
		4	1043	1	ZX1043	2CPX041909R9999	ZXM1043	2CPX041519R9999	
		5	1293	1	ZX1044	2CPX041910R9999	ZXM1044	2CPX041520R9999	
12 x 10	360	2	543	1	ZX1047	2CPX041913R9999	ZXM1047	2CPX041523R9999	
		3	793	1	ZX1048	2CPX041914R9999	ZXM1048	2CPX041524R9999	
		4	1043	1	ZX1049	2CPX041915R9999	ZXM1049	2CPX041525R9999	
		5	1293	1	ZX1050	2CPX041916R9999	ZXM1050	2CPX041526R9999	
Copper rail A2, busbars for cabinet row mounting right and left									
12 x 5	250	2	595	1	ZX1081	2CPX041943R9999	ZXM1081	2CPX041553R9999	
		3	845	1	ZX1082	2CPX041944R9999	ZXM1082	2CPX041554R9999	
		4	1095	1	ZX1083	2CPX041945R9999	ZXM1083	2CPX041555R9999	
		5	1345	1	ZX1084	2CPX041946R9999	ZXM1084	2CPX041556R9999	
12 x 10	360	2	590	1	ZX1087	2CPX041949R9999	ZXM1087	2CPX041559R9999	
		3	840	1	ZX1088	2CPX041950R9999	ZXM1088	2CPX041560R9999	
		4	1090	1	ZX1089	2CPX041951R9999	ZXM1089	2CPX041561R9999	
		5	1340	1	ZX1090	2CPX041952R9999	ZXM1090	2CPX041562R9999	
Copper rail C, connector for TwinLine cabinet row mounting right or left									
12 x 5	250		44	1	ZX1180	2CPX042020R9999	-	-	
12 x 10	360		44	1	ZX1181	2CPX042021R9999	-	-	
Copper rail C, connector for the pro E power system cabinet row mounting right or left									
12 x 5	250		44	1	ZX1180	2CPX042020R9999	-	-	
12 x 10	360		44	1	ZX1181	2CPX042021R9999	-	-	

Busbars TriLine system and pro E power system

Row mounting for modules M(B)L...5

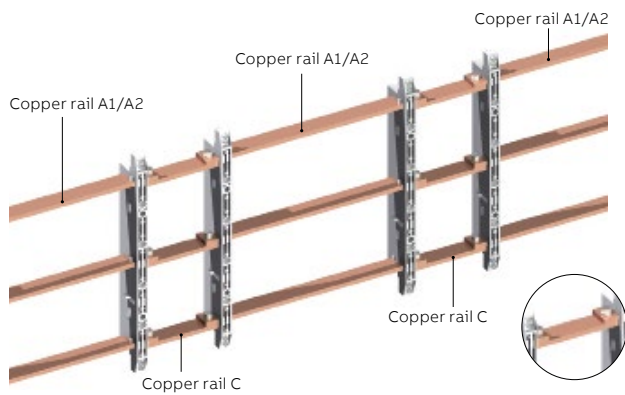

- It is possible to combine different module widths within the cabinet with continuous busbars
- A connector is required for cabinet row mounting for each busbar connection
- The busbar connection is realized outside the module
- Busbar connector, including press-in nuts and attachment material
- 3 copper rails A1/A2 and C are required per module

Copper rail mm	I_n A	Width		Unit	Kit not installed		Mounted and installed in the cabinet		
		FB	mm		Type	Order code	Type	Order code	
Copper rail A1/A2, busbars for TriLine cabinet row mounting right or left									
40 x 10	850	2	496	1	ZX1032	2CPX041901R9999	ZXM1032	2CPX041511R9999	
		3	746	1	ZX1033	2CPX041902R9999	ZXM1033	2CPX041512R9999	
		4	996	1	ZX1034	2CPX041903R9999	ZXM1034	2CPX041513R9999	
		5	1246	1	ZX1035	2CPX041904R9999	ZXM1035	2CPX041514R9999	
Copper rail A1/A2, busbars for cabinet row mounting right and left									
40 x 10	850	2	496	1	ZX1032	2CPX041901R9999	ZXM1032	2CPX041511R9999	
		3	746	1	ZX1033	2CPX041902R9999	ZXM1033	2CPX041512R9999	
		4	996	1	ZX1034	2CPX041903R9999	ZXM1034	2CPX041513R9999	
		5	1246	1	ZX1035	2CPX041904R9999	ZXM1035	2CPX041514R9999	
Copper rail C, connector for TwinLine cabinet row mounting right or left									
40 x 10	850		165	1	ZX1186	2CPX042887R9999	-	-	
Copper rail C, connector for the pro E power system cabinet row mounting right or left									
40 x 10	850		165	1	ZX1196	2CPX042109R9999	-	-	

Interior expansion system CombiLine N

EDF mounting frame parts

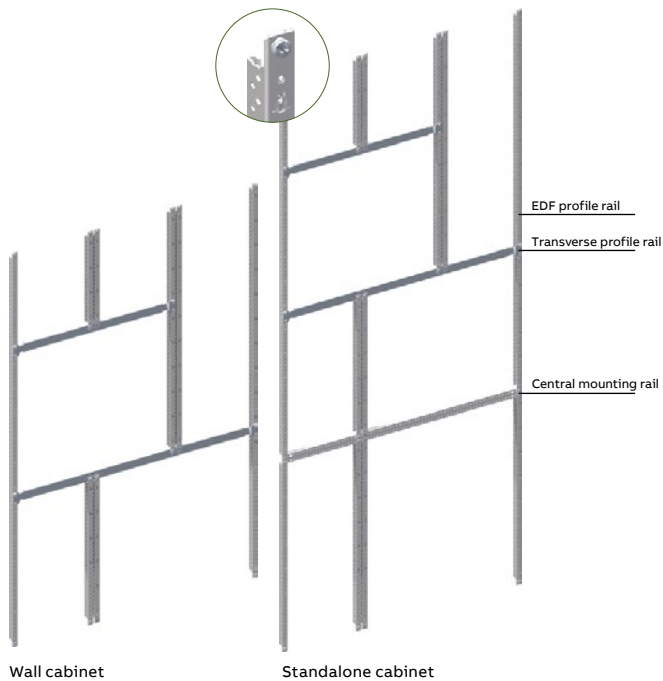

Wall cabinet

Standalone cabinet

Setup possibilities with EDF mounting frame parts in the variable setup with transverse profile rails

The vertical EDF profile rails are prepared for receiving modules. The use of a transverse profile rail is necessary to connect different field widths.

The TwinLine wall cabinets are prepared for the setup with the EDF mounting frame parts. In the TwinLine standalone cabinet, it is necessary to use a central mounting rail and EDF adapters (see TwinLine chapter).

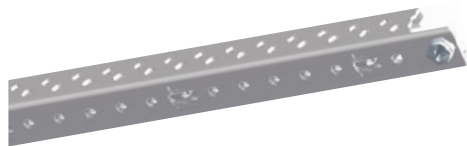

EDM9

- Vertical EDF profile rail
- Including fastening screws
- To set up the modules up to 400 A

Description	Height			Kit not installed		Mounted and installed in the cabinet	
	RE	mm	Unit	Type	Order code	Type	Order code
Vertical EDF profile rail	1	150	1	ED7	2CPX041865R9999	EDM7	2CPX041455R9999
			20	ED7P20	2CPX041866R9999	-	-
	2	300	1	ED8	2CPX039208R9999	EDM8	2CPX041456R9999
			20	ED8P20	2CPX062311R9999	-	-
	3	450	1	ED9	2CPX039209R9999	EDM9	2CPX041457R9999
			20	ED9P20	2CPX062312R9999	-	-
	4	600	1	ED10	2CPX039210R9999	EDM10	2CPX041458R9999
			20	ED10P20	2CPX062313R9999	-	-
	5	750	1	ED11	2CPX039211R9999	EDM11	2CPX041459R9999
			20	ED11P20	2CPX062314R9999	-	-
	6	900	1	ED12	2CPX039212R9999	EDM12	2CPX041460R9999
			20	ED12P20	2CPX062315R9999	-	-
	7	1050	1	ED13	2CPX039213R9999	EDM13	2CPX041461R9999
			20	ED13P20	2CPX062316R9999	-	-
	8	1200	1	ED14	2CPX039214R9999	EDM14	2CPX041462R9999
			20	ED14P20	2CPX062317R9999	-	-
	9	1350	1	ED15	2CPX039215R9999	EDM15	2CPX041463R9999
			20	ED15P20	2CPX062318R9999	-	-
Vertical EDF profile rail For holding touch protection covers during free removal	12	1800	1	ED18	2CPX039216R9999	-	-
			20	ED18P20	2CPX062325R9999	-	-
	14	2100	1	ED20	2CPX039218R9999	-	-

Interior expansion system CombiLine N

EDF mounting frame parts



ED112

- Horizontal transverse profile rails for field distribution upwards **and** downwards
- Including fastening screws

Description	Width			Kit not installed		Mounted and installed in the cabinet	
	FB	mm	Unit	Type	Order code	Type	Order code
Transverse profile rail	2	500	1	ED112	2CPX068572R9999	EDM112	2CPX041464R9999
			10	ED112P10	2CPX062736R9999	-	-
	3	750	1	ED113	2CPX068573R9999	EDM113	2CPX041465R9999
			10	ED113P10	2CPX062737R9999	-	-



ED122

- Horizontal transverse profile rails for field distribution upwards **or** downwards
- Including fastening screws

Description	Width			Kit not installed		Mounted and installed in the cabinet	
	FB	mm	Unit	Type	Order code	Type	Order code
Transverse profile rail	2	500	1	ED122	2CPX042847R9999	EDM122	2CPX042845R9999
			10	ED122P10	2CPX062738R9999	-	-
	3	750	1	ED123	2CPX042848R9999	EDM123	2CPX042846R9999
			10	ED123P10	2CPX062739R9999	-	-



ED403

- EDF profile rails for stabilizing the DIN rails with each other
- Included in the scope of delivery by default with 3-field width modules

Description	Height			Kit not installed		Mounted and installed in the cabinet	
	RE	mm	Unit	Type	Order code	Type	Order code
For rail-mounted device modules with a rail spacing 125 mm	2	152	1	ED402	2CPX042615R9999	-	-
	3	276	1	ED403	2CPX042616R9999	-	-
	4	401	1	ED404	2CPX042617R9999	-	-
	5	527	1	ED405	2CPX042618R9999	-	-
For rail-mounted device modules with a rail spacing 150 mm	2	177	1	ED412	2CPX042619R9999	-	-
	3	327	1	ED413	2CPX042620R9999	-	-
	4	477	1	ED414	2CPX042621R9999	-	-
	5	627	1	ED415	2CPX042622R9999	-	-

Interior expansion system CombiLine N

WR mounting frame parts

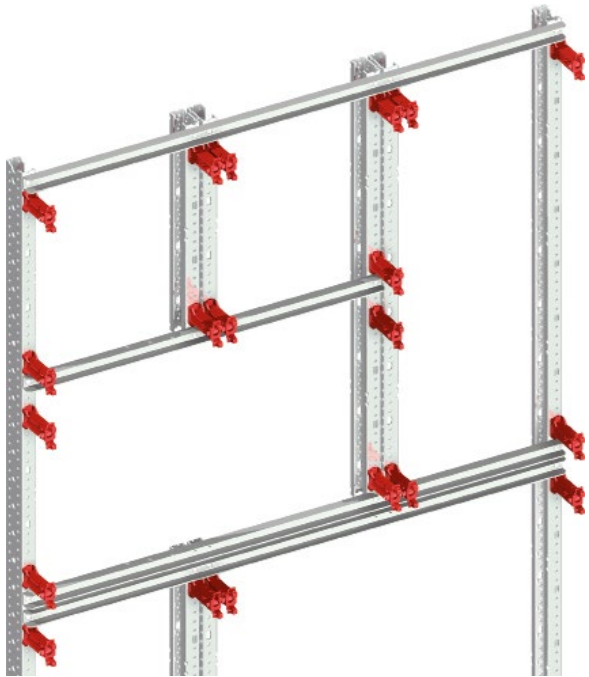

Setup possibilities with WR mounting frame parts in the variable setup with transverse profile rails.

The vertical WR profile rails are prepared for receiving modules. The use of a transverse profile rail is necessary to connect different field widths. The WR mounting frame is used in the TwinLine standalone cabinet. The EDF adapters of the mounting frame holder are removed for assembly in the TwinLine wall cabinet.



- WR mounting frame, complete
- WR profile rail, vertical with transverse profile rail
- To set up the modules up to 850 A

WRM281

Description	Width			Kit not installed		Mounted and installed in the cabinet	
	FB	mm	Unit	Type	Order code	Type	Order code
WR mounting frame For all standalone and series switching cabinets from a depth of 225 mm Height 12 RE, 1800 mm	1	250	1	WR181	2CPX042858R9999	WRM181	2CPX042849R9999
	2	500	1	WR281	2CPX042859R9999	WRM281	2CPX042850R9999
	3	750	1	WR381	2CPX042860R9999	WRM381	2CPX042851R9999
	4	1000	1	WR481	2CPX042861R9999	WRM481	2CPX042852R9999
WR mounting frame For series switching cabinets from a depth of 325 mm Height 14 RE, 2100 mm	1	250	1	WR1101	2CPX042862R9999	WRM1101	2CPX042853R9999
	2	500	1	WR2101	2CPX042863R9999	WRM2101	2CPX042854R9999
	3	750	1	WR3101	2CPX042864R9999	WRM3101	2CPX042855R9999
	4	1000	1	WR4101	2CPX042865R9999	WRM4101	2CPX042856R9999

Interior expansion system CombiLine N

WR mounting frame parts



ZW213

- Vertical WR profile rail
- For the height compensation when using transverse profile rails

Description	Height			Kit not installed		Mounted and installed in the cabinet	
	RE	mm	Unit	Type	Order code	Type	Order code
Vertical WR profile rail	1	150	1	ZW367	2CPX041850R9999	ZWM367	2CPX041432R9999
	2	300	1	ZW368	2CPX041851R9999	ZWM368	2CPX041433R9999
	3	450	1	ZW369	2CPX041852R9999	ZWM369	2CPX041434R9999
	4	600	1	ZW370	2CPX041853R9999	ZWM370	2CPX041435R9999
	5	750	1	ZW371	2CPX041854R9999	ZWM371	2CPX041436R9999
	6	900	1	ZW372	2CPX041855R9999	ZWM372	2CPX041437R9999
	7	1050	1	ZW373	2CPX041856R9999	ZWM373	2CPX041438R9999
	8	1200	1	ZW374	2CPX041857R9999	ZWM374	2CPX041439R9999
	9	1350	1	ZW375	2CPX041858R9999	ZWM375	2CPX041440R9999
	10	1500	1	ZW376	2CPX041859R9999	ZWM376	2CPX041441R9999
	11	1650	1	ZW377	2CPX041860R9999	ZWM377	2CPX041442R9999
	12	1800	1	ZW213	2CPX060141R9999	ZWM213	2CPX041430R9999
			10	ZW213P10	2CPX062641R9999	-	-
			300	ZW213P300	2CPX062714R9999	-	-
13	1950	1	ZW378	2CPX041861R9999	ZWM378	2CPX041443R9999	
14	2100	1	ZW214	2CPX060142R9999	ZWM214	2CPX041431R9999	
		10	ZW214P10	2CPX062642R9999	-	-	



ZW165

- Horizontal transverse profile rails for field distribution
- Including fastening screws
- Two transverse profile rails are required for field distribution upwards and downwards

Description	Width			Kit not installed		Mounted and installed in the cabinet	
	FB	mm	Unit	Type	Order code	Type	Order code
Horizontal transverse profile rail	1	250	1	ZW164	2CPX042866R9999	ZWM164	2CPX042857R9999
			10	ZW164P10	2CPX062710R9999	-	-
	2	500	1	ZW165	2CPX041862R9999	ZWM165	2CPX041444R9999
			10	ZW165P10	2CPX062711R9999	-	-
	3	750	1	ZW166	2CPX041863R9999	ZWM166	2CPX041445R9999
			10	ZW166P10	2CPX062712R9999	-	-
	4	1000	1	ZW167	2CPX041864R9999	ZWM167	2CPX041446R9999
			10	ZW167P10	2CPX062713R9999	-	-
	5	1250	1	ZW168	2CPX042950R9999	-	-
	6	1500	1	ZW163	2CPX042951R9999	-	-



ZW209

- As transverse profile rails in the WR mounting frame

Horizontal WR profile rail	1	186	1	ZW209	2CPX039207R9999	-	-
	2	436	1	ZW210	2CPX060138R9999	-	-
	3	686	1	ZW211	2CPX060139R9999	-	-
	4	936	1	ZW212	2CPX060140R9999	-	-

Interior expansion system CombiLine N

Plastic partitions



ZX69

Article	Height			Type	Order code
	RE	BH	Unit		
Vertical partitions, plastic	3	00	1	ZX69	2CPX039069R9999
Not fault arc-proof, separation from adjacent module, distribution panel, meter panel, partition is inserted in adjacent module in the cover bracket, color similar to RAL 7035	4	0	1	ZX70	2CPX039070R9999
	5	1	1	ZX71	2CPX039071R9999
	6	2	1	ZX72	2CPX039072R9999
	7	3	1	ZX73	2CPX039073R9999
	8	4	1	ZX74	2CPX039074R9999
	9	5	1	ZX75	2CPX039075R9999



ZX86

Article	Width		Unit	Type	Order code
	FB	mm			
Horizontal partitions, plastic	1	250	1	ZX86	2CPX039086R9999
Not fault arc-proof, separation from adjacent module, distribution panel, meter panel, partition is inserted in adjacent module in the cover bracket, color similar to RAL 7035	2	500	1	ZX87	2CPX039087R9999

Interior expansion system CombiLine N

Sheet steel partitions

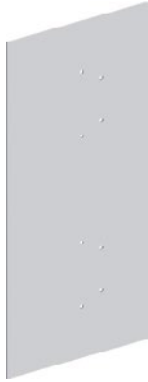

ZX820

Article	Height			Type	Order code
	RE	BH	Unit		
For TwinLine-G cabinets					
Vertical partitions, sheet steel Not fault arc-proof, separation from the adjacent module, distribution panel, meter panel, partition is riveted to WR profile / EDF profile; the partition is provided for the attachment position 0*	3	00	1	ZX810	2CPX010675R9999
	4	0	1	ZX811	2CPX010676R9999
	5	1	1	ZX812	2CPX010677R9999
	6	2	1	ZX813	2CPX010678R9999
	7	3	1	ZX814	2CPX010679R9999
	8	4	1	ZX815	2CPX010680R9999
	9	5	1	ZX816	2CPX010681R9999
	12	8	1	ZX817	2CPX010682R9999
For TwinLine-L cabinets					
Vertical partitions, sheet steel Not fault arc-proof, separation from the adjacent module, distribution panel, meter panel, partition is riveted to WR profile / EDF profile; the partition is provided for the attachment position 0*	3	00	1	ZX820	2CPX010683R9999
	4	0	1	ZX821	2CPX010684R9999
	5	1	1	ZX822	2CPX010685R9999
	6	2	1	ZX823	2CPX010686R9999
	7	3	1	ZX824	2CPX010687R9999
	8	4	1	ZX825	2CPX010688R9999
	9	5	1	ZX826	2CPX010689R9999
	12	8	1	ZX827	2CPX010690R9999
For TwinLine-W cabinets					
Vertical partitions, sheet steel Not fault arc-proof, separation from the adjacent module, distribution panel, meter panel, partition is riveted to WR profile / EDF profile; the partition is provided for the attachment position 0*	3	00	1	ZX830	2CPX010691R9999
	4	0	1	ZX831	2CPX010692R9999
	5	1	1	ZX832	2CPX010693R9999
	6	2	1	ZX833	2CPX010694R9999
	7	3	1	ZX834	2CPX010695R9999
	8	4	1	ZX835	2CPX010696R9999
	9	5	1	ZX836	2CPX010697R9999
	12	8	1	ZX837	2CPX010698R9999



ZX840

Article	Width			Type	Order code
	FB	mm	Unit		
For TwinLine-G-, TwinLine-L,- and TwinLine-W cabinets					
Horizontal partitions, sheet steel Not fault arc-proof, separation from the adjacent module, distribution panel, meter panel, partition is screwed to WR profile / EDF profile via additional mounting rail; the partition is provided for the attachment position 0*	1	250	1	ZX840	2CPX010699R9999
	2	500	1	ZX841	2CPX010700R9999
	3	750	1	ZX842	2CPX010701R9999

Interior expansion system CombiLine N

Partitions made of sheet steel for EDF mounting frame



ZX469

Article	Height		Unit	Type	Order code
	RE	BH			
For U-, A- and B cabinets					
Vertical partitions, sheet steel	3	00	1	ZX469	2CPX039541R9999
Not fault arc-proof, separation from adjacent module	4	0	1	ZX470	2CPX039542R9999
Distribution panel, meter panel	5	1	1	ZX471	2CPX039543R9999
Partition wall is riveted to EDF mounting frame	6	2	1	ZX472	2CPX039544R9999
	7	3	1	ZX473	2CPX039545R9999
	8	4	1	ZX474	2CPX039546R9999
	9	5	1	ZX475	2CPX039547R9999
For TwinLine H cabinets					
Vertical partitions, sheet steel	3	00	1	ZX479	2CPX039549R9999
Not fault arc-proof, separation from adjacent module	4	0	1	ZX480	2CPX039550R9999
Distribution panel to distribution panel	5	1	1	ZX481	2CPX039551R9999
Partition wall is riveted to EDF mounting frame	6	2	1	ZX482	2CPX039552R9999
	7	3	1	ZX483	2CPX039553R9999
	8	4	1	ZX484	2CPX039554R9999
	9	5	1	ZX485	2CPX039555R9999



ZX502

Article	Width		Unit	Type	Order code
	FB	mm			
For U-, A- and B cabinets					
Horizontal partitions, sheet steel	1	250	1	ZX502	2CPX039567R9999
Not fault arc-proof, pushed between the cover brackets when used with EDF mounting frame	2	500	1	ZX503	2CPX039568R9999
For TwinLine H cabinets					
Horizontal partitions, sheet steel	1	250	1	ZX497	2CPX039563R9999
Not fault arc-proof, pushed between the cover brackets when used with EDF mounting frame	2	500	1	ZX498	2CPX039564R9999

Interior expansion system CombiLine N

Partitions made of sheet steel for WR mounting frame



RZ151

Article	Height		Depth		Unit	Type	Order code
	RE	BH	mm	mm			
For TriLine® cabinets							
Vertical partitions, sheet steel	12	8	425	1	RZ151	2CPX046561R9999	
Not fault arc-proof, WR mounting frame to	14	10	425	1	RZ155	2CPX046565R9999	
WR mounting frame	12	8	625	1	RZ152	2CPX046562R9999	
Partition wall is riveted to WR mounting frame	14	10	625	1	RZ156	2CPX046566R9999	

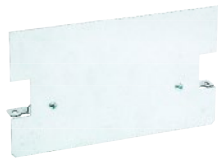

RZ161

Article	Width		Depth		Unit	Type	Order code
	FB	mm	mm	mm			
For TriLine® cabinets							
Horizontal partitions, sheet steel	1	250	425	1	RZ161	2CPX046571R9999	
Not fault arc-proof, with additional mounting profile for assembly on the WR mounting frame	2	500	425	1	RZ162	2CPX046572R9999	
	3	750	425	1	RZ163	2CPX046573R9999	
	1	250	625	1	RZ164	2CPX046574R9999	
	2	500	625	1	RZ165	2CPX046575R9999	
	3	750	625	1	RZ166	2CPX046576R9999	

Interior expansion system CombiLine N

General accessories



ZX66P4



ED44P10

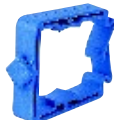

ED45P10



ED59P10



ED57P10



ED42P10



ED43P10



ED47



ZA1P5



ZA122

Article	Unit	Type	Order code
Device carrier connector For connecting EDF and WR mounting frames	4	ZX66P4	2CPX062562R9999
	50	ZX66P50	2CPX068614R9999
Wire holder For wire guidance, installation depth 28.5 mm, to be inserted into the DIN rail from the rear	10	ED44P10	2CPX062335R9999
	50	ED44P50	2CPX062308R9999
	1000	ED44P1000	2CPX062703R9999
Wire holder For the wire guidance or receiving a plastic tube of \varnothing 38 mm, installation depth 55 mm, to be inserted in the DIN rail from the rear	10	ED45P10	2CPX062336R9999
	50	ED45P50	2CPX062310R9999
	1000	ED45P1000	2CPX062704R9999
DIN rails adapter For ED44 and ED45, to be snapped onto the DIN rail from the front	10	ED59P10	2CPX062339R9999
Adapter To assemble the wire holders ED44 and ED45 on the perforated mounting plate	10	ED57P10	2CPX061179R9999
Console for the ED44 and ED45 wire holders To be inserted in the DIN rail from the rear	10	ED42P10	2CPX062333R9999
Console for the ED44 and ED45 wire holders To be snapped onto the DIN rail from the front	10	ED43P10	2CPX062334R9999
Cover As a view shutter for wire guidance in the wire holder ED44 and ED45, 1 m long	1	ED47	2CPX039309R9999
Blanking plates For 12 space units, breakable Color RAL 7035	5	ZA1P5	2CPX062384R9999
	50	ZA1P50	2CPX062378R9999
Running meter Color RAL 7035	1	ZA2	2CPX038231R9999
	20	ZA2P20	2CPX062379R9999
Cleaning agent for covers Pump spray bottle, 500 ml	1	ZA122	2CPX038293R9999

Interior expansion system CombiLine N

General accessories



ZA8



ZA71



ZA27



ZA73



ZA74



ZA78

































ZA79

Article	Unit	Type	Order code
Marking stripes			
20 mm, self-adhesive, 1-field width	1	ZA8	2CPX060200R9999
	5	ZA8P5	2CPX062598R9999
	40	ZA8P40	2CPX062731R9999
20 mm, self-adhesive, 2-field width	1	ZA9	2CPX060201R9999
	5	ZA9P5	2CPX062599R9999
	50	ZA9P50	2CPX062732R9999
20 mm, self-adhesive, 3-field width	1	ZA7	2CPX060004R9999
	5	ZA7P5	2CPX062597R9999
20 mm, self-adhesive, per running meter	1	ZA10	2CPX038241R9999
	10	ZA10P10	2CPX062706R9999
20 mm, self-adhesive, with additional transparent film, per running meter	1	ZA11	2CPX038230R9999
	10	ZA11P10	2CPX062707R9999
16 mm, self-adhesive, per running meter	1	ZA12	2CPX038242R9999
	10	ZA12P10	2CPX062708R9999
Labeling system for busbars L1, L2, L3, N, PE, 1 sheet = 120 different stickers	1	ZA71	2CPX038458R9999
Labeling system Self-adhesive, for manual or automatic labeling, comprising: 1 sheet with 10 strips	1	ZA27	2CPX038495R9999
Labeling system For distribution panel, up to 6 RE	1	ZA73	2CPX038497R9999
Labeling system For distribution panel, up to 9 RE	1	ZA74	2CPX038498R9999
Labeling system For 8 x 12 PLE	1	ZA78	2CPX031569R9999
Legend for 72 devices PLE	1	ZA79	2CPX031570R9999

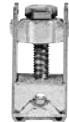
Interior expansion system CombiLine N

Connecting terminals for copper rails

		Article	Copper rails Dimensions in mm	Connection cross- section in mm ²	Unit	Type	Order code		
		Connecting terminals for latching onto copper rails With retaining spring	5	1.5 - 16	1	ZK79	2CPX064879R9999		
					4	ZK79P4	2CPX062421R9999		
			5	4 - 35	5	ZK79P5	2CPX062631R9999		
					50	ZK79P50	2CPX062429R9999		
			5	4 - 35	1	ZK81	2CPX064881R9999		
					4	ZK81P4	2CPX062422R9999		
			5	4 - 35	5	ZK81P5	2CPX062632R9999		
					50	ZK81P50	2CPX062431R9999		
			5	2.5 - 50	1	ZK150	2CPX064860R9999		
					4	ZK150P4	2CPX062427R9999		
			5	2.5 - 50	5	ZK150P5	2CPX062633R9999		
					50	ZK150P50	2CPX062432R9999		
			5	16 - 70	1	ZK178	2CPX064978R9999		
					50	ZK178P50	2CPX062622R9999		
			5	16 - 120	1	ZK157	2CPX064867R9999		
					50	ZK157P50	2CPX062437R9999		
			10	1.5 - 16	1	ZK87	2CPX064887R9999		
					4	ZK87P4	2CPX062424R9999		
			10	1.5 - 16	50	ZK87P50	2CPX062430R9999		
					10	16 - 70	1	ZK156	2CPX064866R9999
			10	16 - 70	50	ZK156P50	2CPX062438R9999		
					10	16 - 120	1	ZK154	2CPX064864R9999
			10	16 - 120	50	ZK154P50	2CPX062435R9999		
					Connecting terminals with insertion part for assembly from the front		12 x 5	16 - 95	1
			12 x 10	16 - 70	4	ZK83P4	2CPX062423R9999		
					5	ZK83P5	2CPX062655R9999		
			30 x 5	50 - 120	50	ZK83P50	2CPX062433R9999		
					30 x 10	50 - 120	1	ZK152	2CPX064862R9999
			30 x 10	50 - 120	20	ZK152P20	2CPX062444R9999		
					Frame terminals for sliding onto copper rails		12 x 5	16 - 150	4
			12 x 10	16 - 150	12 x 5	35 - 185	1	ZK86	2CPX064886R9999
					12 x 10	35 - 120	20	ZK86P20	2CPX062434R9999
		Attachment clamp For fastening on copper rail	5/10	10 - 95	1	ZK302	2CPX062645R9999		
					20	ZK302P20	2CPX062648R9999		
			5/10	16 - 150	1	ZK303	2CPX062646R9999		
					20	ZK303P20	2CPX062649R9999		
			5/10	35 - 240	1	ZK304	2CPX062647R9999		
					20	ZK304P20	2CPX062650R9999		
		Busbar connection terminal for connecting with insulating cap		25	1	ZK75	2CPX038220R9999		

ZK75

Interior expansion system parts

DIN rails and DIN rail accessories



ED1



ED51



ZX21



ZX371



ZK90P2



ZX372P2

Article	Use for...	Unit	Type	Order code
DIN rail 35 x 15 mm				
Wide rail 1: for assembly on the mounting frame				
For EDF and WR mounting frame, with hole pattern for wire holders ED44/ED45				
1-field width, length 244 mm	M(B)K...12/M(B)G1... M(B)G41.../ M(B) A160ALA	1 30	ED1 ED1P30	2CPX039381R9999 2CPX062319R9999
2-field width, length 494 mm	M(B)U270 M(B)G2.../M(B)G42...	1 30	ED2 ED2P30	2CPX039382R9999 2CPX062320R9999
3-field width, length 744 mm	M(B)U370 M(B)G3.../M(B)G43...	1 30	ED3 ED3P30	2CPX039383R9999 2CPX062321R9999
4-field width, length 994 mm	-	1 30	ED4 ED4P30	2CPX039384R9999 2CPX062735R9999
By meter	-	1	ED6	2CPX039386R9999
Length 2000 mm	-	10	ED6P10	2CPX062705R9999
DIN rail 35 x 15 mm				
Wide rail 2: for assembly between the mounting frame				
1-field width, length 188 mm	M(B)V1.../ M(B)K1... M(B)N1...	1 30	ED51 ED51P30	2CPX039251R9999 2CPX062322R9999
2-field width, length 438 mm	M(B)V2.../ M(B)K2... M(B)K...13/M(B)C2...HS M(B)N2...	1 30	ED52 ED52P30	2CPX039252R9999 2CPX062323R9999
3-field width, length 688 mm	M(B)K3... M(B)C3...HS/M(B)N3...	1 30	ED53 ED53P30	2CPX039253R9999 2CPX062324R9999
4-field width, length 938 mm	-	1	ED54	2CPX039254R9999
DIN rail 35 x 15 mm	M(B)K...14	1	ED74	2CPX042185R9999
For terminal block modules, vertical, length 591 mm, module height 600 mm/4RE				
DIN rail 35 x 7.5 mm				
For assembly on the mounting frame				
1-field width, length 244 mm	M(B)K1...K	1 30	ZX21 ZX21P30	2CPX039021R9999 2CPX062554R9999
2-field width, length 494 mm	M(B)K2...K	1 30	ZX22 ZX22P30	2CPX039022R9999 2CPX062555R9999
DIN rail 35 x 7.5 mm				
For assembly between the mounting frame				
1-field width, length 188 mm	M(B)K1...K	1	ZX371	2CPX068076R9999
2-field width, length 438 mm	-	1	ZX389	2CPX068190R9999
Insulator piece	M(B)K...K	2	ZK90P2	2CPX062426R9999
For DIN rails 35 x 7.5 and 35 x 15 mm including attachment material		100	ZK90P100	2CPX068613R9999
Mounting bracket	M(B)K1...K	2	ZX372P2	2CPX062544R9999
For ZK90P2				

Interior expansion system parts

Wide rails for EDF or WR mounting frame



ZW223



ZW228

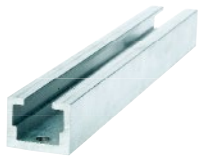

ZW233

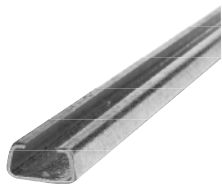

ZW248

Article	Unit	Type	Order code
Aluminum profile rail profile no. 1 25 x 14 mm, mounting hole \varnothing 6.2 mm			
Wide rail 1: for assembly on the mounting frame			
1-field width, length 244 mm	1	ZW11	2CPX039411R9999
2-field width, length 494 mm	1	ZW12	2CPX039412R9999
3-field width, length 744 mm	1	ZW13	2CPX039413R9999
4-field width, length 994 mm	1	ZW14	2CPX039414R9999
Wide rail 2: for assembly between the mounting frame			
1-field width, length 186 mm	1	ZW223	2CPX060323R9999
2-field width, length 436 mm	1	ZW224	2CPX060324R9999
3-field width, length 686 mm	1	ZW225	2CPX060325R9999
Aluminum profile rail profile no. 2 25 x 20 mm, mounting hole \varnothing 6.2 mm			
Wide rail 1: for assembly on the mounting frame			
3-field width, length 744 mm	1	ZW216	2CPX060144R9999
4-field width, length 994 mm	1	ZW217	2CPX060145R9999
Wide rail 2: for assembly between the mounting frame			
1-field width, length 186 mm	1	ZW228	2CPX060328R9999
2-field width, length 436 mm	1	ZW229	2CPX060329R9999
3-field width, length 686 mm	1	ZW230	2CPX060330R9999
4-field width, length 936 mm	1	ZW231	2CPX060331R9999
Aluminum profile rail profile no. 3 32 x 25 mm, mounting hole \varnothing 8.2 mm			
Wide rail 1: for assembly on the mounting frame			
1-field width, length 244 mm	1	ZW16	2CPX039416R9999
2-field width, length 494 mm	1	ZW17	2CPX039417R9999
3-field width, length 744 mm	1	ZW18	2CPX039418R9999
4-field width, length 994 mm	1	ZW19	2CPX039419R9999
Wide rail 2: for assembly between the mounting frame			
1-field width, length 186 mm	1	ZW233	2CPX060333R9999
2-field width, length 436 mm	1	ZW234	2CPX060334R9999
3-field width, length 686 mm	1	ZW235	2CPX060335R9999
4-field width, length 936 mm	1	ZW236	2CPX060336R9999
Cable clamp rail profile no. 10 35 x 19 mm, galvanized sheet steel, mounting hole \varnothing 6.2 mm			
Wide rail 1: for assembly on the mounting frame			
1-field width, length 244 mm	1	ZW219	2CPX060198R9999
2-field width, length 494 mm	1	ZW220	2CPX060146R9999
3-field width, length 744 mm	1	ZW221	2CPX060147R9999
4-field width, length 994 mm	1	ZW222	2CPX060148R9999
Wide rail 2: for assembly between the mounting frame			
1-field width, length 186 mm	1	ZW248	2CPX060199R9999
2-field width, length 436 mm	1	ZW249	2CPX060349R9999
3-field width, length 686 mm	1	ZW250	2CPX060350R9999
4-field width, length 936 mm	1	ZW251	2CPX060351R9999

> Bolt clamps and saddle clamps for profile no. 10 page 49

> Slide nuts and flat nuts 97

Wide rails representation for EDF or WR mounting frame



Wide rail 1
For assembly on the mounting frame



Wide rail 2
For assembly between the mounting frame

Interior expansion system parts

Profile rails and mounting bracket



ZW395



ZW396



ZX343

ZX334



ZW480

ZW481



ZW482



ZX321LR

ZW389LR



ZX342

ZW349

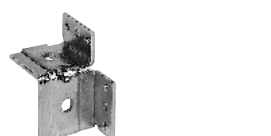

ZW64

Article	Use for...	Unit	Type	Order code
Transverse rail 3-field width* Busbar carrier Fixed position	M(B)T350(B) M(B)T351(B) M(B)H350(B) M(B)H351(B) M(B)R302(B)	1	ZW395	2CPX041136R9999
Transverse rail 3-field width* Busbar carrier position can be moved if necessary	M(B)R303 M(B)S324 M(B)S327	1	ZW396	2CPX041137R9999
Assembly bracket For busbar modules S700 and S750 For EDF or WR mounting frame	M(B)H...50	1	ZX343	2CPX064152R9999
For modules for line connection For lowering DIN rails For EDF or WR mounting frame	M(B)V...80 M(B)V...81	1	ZX334	2CPX064166R9999
Deep angle piece For busbar module equipment 100 mm With 3-stage adjustability For EDF or WR mounting frame	M(B)D...52(B)	4	ZW480	2CPX042239R9999
For busbar module equipment 185 mm With 2-stage adjustability For WR mounting frame	M(B)D...21-300(B)	4	ZW481	2CPX042195R9999
Bracket with NH + EFM cover For busbar module equipment 185 mm For WR mounting frame	M(B)D...21-300(B)	2	ZW482	2CPX042196R9999
45° inclined for busbar module For EDF or WR mounting frame	M(B)S...28	1	ZX321LR	2CPX064160R9999
For busbar module 40/60 mm When using ZB5/ZX151 For WR mounting frame	M(B)S...24 M(B)S...27	1	ZW389LR	2CPX062635R9999
For busbar carrier ZX520 For WR mounting frame	-	1	ZX342	2CPX062661R9999
For busbar module equipment 185 mm For WR mounting frame	ML100 - ML300 ML21B - ML33B	1 10	ZW349 ZW349P10	2CPX067951R9999 2CPX062485R9999
For attaching transverse profiles on the WR frame	WR...8 WR...10	1 40	ZW64 ZW64P40	2CPX039464R9999 2CPX062475R9999

Interior expansion system parts

T Deep angle piece for EDF or WR mounting frame



ZW39P2



ZW59P2



ZW79P2



ZW259P2



ED33P2



ZW60P2















ZW142P2

Article	Use for...	Unit	Type	Order code
Deep angle piece*, adjustment range 42 mm Distance between deep angle piece and cover of 83 - 125 mm* ² For EDF or WR profile For variable assembly ⚡	M(B)K106 to M(B)K310	2	ZW39P2	2CPX062681R9999
	M(B)K112 to M(B)K314	100	ZW39P100	2CPX062715R9999
Deep angle piece*, adjustment range 71 mm Distance between deep angle piece and cover of 106 - 153 mm* ² For EDF or WR profile For variable assembly ⚡	M(B)K107 to M(B)K310	2	ZW59P2	2CPX062660R9999
	M(B)M111 to M(B)M315	100	ZW59P100	2CPX062716R9999
	M(B)F183 to M(B)F383			
Deep angle piece*, adjustment range 107 mm Distance between deep angle piece and cover of 142 - 190 mm* ² For EDF or WR profile For variable assembly ⚡	M(B)F184 to M(B)F384	2	ZW79P2	2CPX062688R9999
		100	ZW79P100	2CPX062717R9999
Deep angle piece*, adjustment range 64 mm Distance between deep angle piece and cover of 99 - 147 mm* ² for interconnecting copper rails For EDF or WR profile For variable assembly ⚡	M(B)T250 to M(B)T351	2	ZW259P2	2CPX062679R9999
Deep angle piece, adjustment range 62 mm Distance between deep angle piece and cover of 77 - 139 mm* ² For EDF profile For variable assembly ⚡	Distributor panels with mounting plate	2	ED33P2	2CPX062305R9999
		100	ED33P100	2CPX062307R9999
Deep angle piece, adjustment range 60 mm Distance between deep angle piece and cover of 119 - 179 mm* ² For WR profile For assembly in the 15 mm grid ⚡	Free expansion	2	ZW60P2	2CPX062454R9999
		100	ZW60P100	2CPX062476R9999
Deep angle piece, adjustment range 88 mm Distance between deep angle piece and cover of 128 - 216 mm* ² For WR profile For variable assembly ⚡	M(B)L100 to M(B)L300	2	ZW142P2	2CPX062463R9999
	M(B)S131 to M(B)S331	40	ZW142P40	2CPX062477R9999

*² When using cover bracket ED138 with a height of 52.5 mm

Interior expansion system parts

Mounting cross-beams busbar modules / universal application

	Article	Use for...	Unit	Type	Order code
	ZW253				
	Mounting cross-bars for busbar modules				
	For busbar modules Equipment 40 mm	M(B)T350/M(B)T351	1	ZW253	2CPX062680R9999
	ZW252				
	For busbar module 40/60 mm For busbar carrier ZX151 for additional support	M(B)S327 M(B)S324/M(B)H350	1	ZW252	2CPX062664R9999
	ZW255				
	For busbar module equipment 60 mm For busbar carrier ZX146 for additional support	M(B)R302(B)	1	ZW255	2CPX064151R9999
	ZW256				
	For busbar module equipment 60 mm For busbar carrier ZX146 for additional support	M(B)R303(B)	1	ZW256	2CPX062678R9999
	ZW399				
	For busbar module equipment 60 mm For busbar carrier ZX146 For EDF or WR mounting frame	M(B)R...H	1	ZW399	2CPX062972R9999
	ZW384				
	For busbar module 40/60 mm For busbar carrier ZX151 For EDF mounting frame	M(B)S...24 M(B)S...27	1	ZW384	2CPX062748R9999
	ZW403LR				
	For busbar module equipment 60 mm For busbar carrier ZX146, deep-installed For WR mounting frame	M(B)R...03	1	ZW403LR	2CPX062974R9999
	Mounting cross-bars for busbar carrier ZX518				
	ZX322				
	45° inclined for busbar module 1-field width	M(B)S128	1	ZX322	2CPX064159R9999
	ZX333				
	45° inclined for busbar module 2-field width	M(B)S228	1	ZX333	2CPX064163R9999
	ZW386				
	For N/PE busbar module Indented for busbar carrier	M(B)N...69	1	ZW386	2CPX062749R9999
	ZW390P2				
	For N/PE busbar module For additional support	M(B)N274, M(B)N275 M(B)N374, M(B)N375	2	ZW390P2	2CPX062486R9999
	Mounting cross-beam for terminal blocks module				
	ZW322				
	195 mm	M(B)K112-114	1	ZW322	2CPX068541R9999
	435 mm	M(B)K212-214	1	ZW323	2CPX068542R9999
	685 mm	M(B)K312-314	1	ZW324	2CPX068543R9999

Interior expansion system parts

Mounting cross-bars for power switch and load break switch

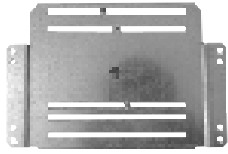

ED160



ED166



ED167



ED162



ED163

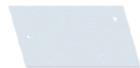

ED168



ED155



ED173

Article	Use for...	Unit	Type	Order code
Mounting cross-beams for power switches				
Make: ABB, series: Tmax XT Including M4 sliding nuts				
1-field width, Tmax XT1, XT3 useful width of 199 mm	MA100ALXB - MA250ALXB M(B)A190T	1	ED160	2CPX068773R9999
2-field width, Tmax XT1, XT3 useful width of 449 mm	M(B)A290T	1	ED260	2CPX062977R9999
3-field width, Tmax XT1, XT3 useful width of 699 mm	M(B)A390T	1	ED360	2CPX062978R9999
1-field width, Tmax XT2 useful width of 199 mm	M(B)A191T	1	ED170	2CPX068388R9999
2-field width, Tmax XT2 useful width of 449 mm	M(B)A291T	1	ED270	2CPX068390R9999
3-field width, Tmax XT2 useful width of 699 mm	M(B)A391T	1	ED370	2CPX068391R9999
1-field width, Tmax XT4 useful width of 199 mm	M(B)A193T	1	ED171	2CPX068389R9999
1-field width Tmax T4, 3-pole Tmax T5 (400), 3-pole	M(B)A192T	1	ED166	2CPX064155R9999
2-field width Tmax T4, 4-pole, Tmax T5, 3- and 4-pole	M(B)A292T	1	ED167	2CPX064156R9999
Mounting cross-beam for load break switch				
1-field width For OT200E03P and OT250E03P	MA200ALAB - MA250ALAB MA250ALA	1	ED162	2CPX068807R9999
2-field width For OT400E03P and OT630E03P	MA400ALAB - MA630ALAB MA630ALA	1	ED163	2CPX068808R9999
1-field width For OS160GD03PN3P and OS250GD03PN3P	MBA250ALO MBW250A	1	ED168	2CPX039312R9999
Universal mounting cross-beams with fastening screws and cage nuts M4, M5, M6, M8 (2 cross-beams are required per switch) Useful width/depth				
For switch 250 A, 1-field width Cage nut each 2 x M4, M5, M6 170 mm / 135 mm	M(B)A250A	1	ED155	2CPX067963R9999
For switch 630 A, 2-field width Cage nut each 2 x M5, M6 420 mm / 153 mm	M(B)A630A MA400ALSB - MA630ALSB	1	ED158	2CPX067969R9999
For switch 800 A, 2-field width Cage nut each 2 x M5, M6, M8 420 mm/161 mm	M(B)A800A	1	ED173	2CPX067998R9999

Interior expansion system parts

Mounting cross-beam for disconnecter mounting



ZX31



ZX34



ZW162



ZH235



ZH238



ZW159

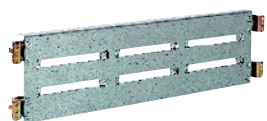

ZW160

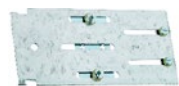

ZH418



ZX35



ZX297P10

Article	Use for...	Unit	Type	Order code
Mounting cross-beam for disconnecter mounting				
With fastening screws and cage nuts for:				
1/2 disconnecter NH00 1-field width	M(B)T135(B) M(B)T136(B) M(B)T137(B)	1 10	ZX31 ZX31P10	2CPX039031R9999 2CPX062480R9999
4 disconnecter NH00 2-field width	M(B)T236(B) M(B)T237(B)	1 10	ZX34 ZX34P10	2CPX039034R9999 2CPX062481R9999
6 disconnecter NH00 3-field width	M(B)T336(B) M(B)T337(B)	1	ZW162	2CPX039458R9999
1 disconnecter NH1 1-field width	M(B)T142(B) M(B)T143(B)	1	ZH235	2CPX039841R9999
1 disconnecter NH2 1-field width	M(B)T144(B) M(B)T145(B)	1	ZH238	2CPX039837R9999
2 disconnecters NH1 or NH2 2-field width	M(B)T242(B) M(B)T243(B) M(B)T244(B) M(B)T245(B)	1	ZW159	2CPX039455R9999
3 disconnecters NH1 or NH2 3-field width	M(B)T345(B) M(B)T343(B) M(B)T344(B) M(B)T345(B)	1	ZW160	2CPX039456R9999
Mounting cross-beam for disconnecter mounting	-	1	ZH418	2CPX062968R9999
For NH00 disconnecter for setup on a DIN rail				
Mounting cross-beam for installation without holes				
Without fastening screws and cage nuts				
Field width 1	1MK..A	1	ZX35	2CPX060638R9999
Field width 2	2MK..A	1	ZX39	2CPX060213R9999
Cage nuts				
For disconnecter cross-beams and telecom technology				
M4	ED160 - ED360 ED170 - ED370 ED171/ZX35	10	ZX299P10	2CPX060639R9999
M6	ZX31/ZX34/ZW162	10	ZX297P10	2CPX062541R9999
M8	ZH235/ZH238 ZW159/ZW160	10	ZX298P10	2CPX062542R9999

Interior expansion system parts

Assembly plates for depressed and fitted assembly



ZW365

Article	Use for...	Unit	Type	Order code
Mounting plates for assembly between the mounting frame				
For depressed assembly with deep angle piece Deep angle pieces are to be ordered separately				
H x W				
1-field width				
1 RE, 116 x 188 mm	M(B)M111	1	ZW365	2CPX068073R9999
2 RE, 266 x 188 mm	M(B)M112	1	ZW338	2CPX067938R9999
3 RE, 416 x 188 mm	M(B)M113	1	ZW341	2CPX067941R9999
4 RE, 566 x 188 mm	M(B)M114	1	ZW344	2CPX067944R9999
5 RE, 716 x 188 mm	M(B)M115	1	ZW362	2CPX068070R9999
2-field width				
1 RE, 116 x 438 mm	M(B)M211	1	ZW336	2CPX067936R9999
2 RE, 266 x 438 mm	M(B)M212	1	ZW339	2CPX067939R9999
3 RE, 416 x 438 mm	M(B)M213	1	ZW342	2CPX067942R9999
4 RE, 566 x 438 mm	M(B)M214	1	ZW345	2CPX067945R9999
5 RE, 716 x 438 mm	M(B)M215	1	ZW363	2CPX068071R9999
3-field width				
1 RE, 116 x 688 mm	M(B)M311	1	ZW337	2CPX067937R9999
2 RE, 266 x 688 mm	M(B)M312	1	ZW340	2CPX067940R9999
3 RE, 416 x 688 mm	M(B)M313	1	ZW343	2CPX067943R9999
4 RE, 566 x 688 mm	M(B)M314	1	ZW346	2CPX067946R9999
5 RE, 716 x 688 mm	M(B)M315	1	ZW364	2CPX068072R9999
Mounting plates for assembly on the mounting frame				
For fitted assembly in the small distributor without deep angle piece				
1-field width 2 RE, 266 x 200 mm	M(B)M112K	1	ZX605	2CPX067776R9999
1-field width 3 RE, 416 x 200 mm	M(B)M113K	1	ZX606	2CPX067777R9999
1-field width 4 RE, 566 x 200 mm	M(B)M114K	1	ZX607	2CPX064154R9999



ZX605

Interior expansion system parts

Mounting frame/meter support plates/switch cabinet lighting



ZX382



ZX381



ZX379



ZX380



ZX390



ZX24



ZX304



ZX305



ZX574



ZX378P20

Article	Use for...	Unit	Type	Order code
Mounting frame for measuring devices 96 x 96 mm				
1-field width	M(B)U156	1	ZX382	2CPX068186R9999
	M(B)U157 M(B)U158	1	ZX381	2CPX068086R9999
2-field width	M(B)U257	1	ZX379	2CPX068084R9999
3-field width	M(B)U357	1	ZX380	2CPX068085R9999
Mounting frame for NH load break switches Make ABB SlimLine				
2-field width	M(B)L25	1	ZX390	2CPX068560R9999
3-field width	M(B)L35	1	ZX391	2CPX068561R9999
Line protective hose				
Installation kit M 20	M(B)V180	1	ZX24	2CPX068538R9999
Installation kit M 32	M(B)V181, M(B)V281	1	ZX25	2CPX068539R9999
Installation kit M 40	M(B)V182, M(B)V282	1	ZX26	2CPX068540R9999
Meter support plates for WR profile				
1-field width, height 450 mm, For a meter, without head part	M(B)Z160	1	ZX304	2CPX060294R9999
1-field width, height 750 mm, For two meters, without head part	M(B)Z161	1	ZX305	2CPX060295R9999
Head part for meter support plates Including mounting material 1-field width	M(B)Z160 M(B)Z161	1	ZX574	2CPX068781R9999
Spacer piece for meter support plates	M(B)Z160 M(B)Z161	20	ZX378P20	2CPX062547R9999

Interior expansion system parts

Yard goods busbars

ZX400

Article	Unit	Type	Order code
Rated current (I_n) 250 A			
Copper rail 12 x 5 mm			
1 m	1	ZX400	2CPX061400R9999
2 m	1	ZX401	2CPX061401R9999
3 m	1	ZX402	2CPX061402R9999
4 m	1	ZX350	2CPX061350R9999

ZX406

Rated current (I_n) 320 A			
Copper rail 20 x 5 mm			
1 m	1	ZX406	2CPX061406R9999
2 m	1	ZX407	2CPX061407R9999
3 m	1	ZX408	2CPX061408R9999
4 m	1	ZX351	2CPX061351R9999

ZX403

Rated current (I_n) 360 A			
Copper rail 12 x 10 mm			
1 m	1	ZX403	2CPX061403R9999
2 m	1	ZX404	2CPX061404R9999
3 m	1	ZX405	2CPX061405R9999
4 m	1	ZX354	2CPX061354R9999

ZX365

Rated current (I_n) 390 A			
Copper rails 25 x 5 mm			
1 m	1	ZX365	2CPX061365R9999
2 m	1	ZX366	2CPX061366R9999
3 m	1	ZX367	2CPX061367R9999
4 m	1	ZX352	2CPX061352R9999

ZX409

Rated current (I_n) 440 A			
Copper rails 30 x 5 mm			
1 m	1	ZX409	2CPX061409R9999
2 m	1	ZX410	2CPX061410R9999
3 m	1	ZX411	2CPX061411R9999
4 m	1	ZX353	2CPX061353R9999

ZX362

Rated current (I_n) 500 A			
Copper rails 20 x 10 mm			
1 m	1	ZX362	2CPX061362R9999
2 m	1	ZX363	2CPX061363R9999
3 m	1	ZX364	2CPX061364R9999
4 m	1	ZX355	2CPX061355R9999

ZX412

Rated current (I_n) 630 A			
Copper rails 30 x 10 mm			
1 m	1	ZX412	2CPX061412R9999
2 m	1	ZX413	2CPX061413R9999
3 m	1	ZX414	2CPX061414R9999
4 m	1	ZX356	2CPX061356R9999

ZX415

Rated current (I_n) 850 A			
Copper rails 40 x 10 mm			
1 m	1	ZX415	2CPX061415R9999
2 m	1	ZX416	2CPX061416R9999
3 m	1	ZX417	2CPX061417R9999
4 m	1	ZX357	2CPX061357R9999

Interior expansion system parts

Busbar brackets and accessories



ZB5



ZX147



ZX146



ZX172



ZX157



ZX151



ZX158



ZX520



ZX523

Article	Use for...	Unit	Type	Order code
Busbar bracket 5-pole Busbar center distance 40 mm For copper rails 12 x 5 mm, 12 x 10 mm and 20 x 5 mm	M(B)H...50	1	ZB5	2CPX038459R9999
	M(B)S...24	10	ZB5P10	2CPX062556R9999
Busbar bracket 1-pole Busbar center distance 60 mm For copper rails 12 x 5 mm to 30 x 10 mm For adding in a row on ZX146	-	1	ZX147	2CPX044011R9999
	-	10	ZX147P10	2CPX062719R9999
Busbar bracket 3-pole Busbar center distance 60 mm For copper rails 12 x 5 mm to 30 x 10 mm	M(B)R...02(B)	1	ZX146	2CPX044010R9999
	M(B)R...H	10	ZX146P10	2CPX062718R9999
	M(B)R...03	10	ZX146P10	2CPX062718R9999
End cover For busbar carrier ZX146/ZB5	M(B)H...50	1	ZX172	2CPX060232R9999
	M(B)R...02(B) M(B)S...24	10	ZX172P10	2CPX062724R9999
N/PE busbar carrier For copper rails 12 x 5 mm to 30 x 5 mm And 12 x 10 mm to 20 x 10 mm For adding in a row on ZX151	-	1	ZX157	2CPX044009R9999
	-	10	ZX157P10	2CPX062722R9999
Busbar bracket 3-pole Busbar center distance 60 mm For copper rails 12 x 5 mm to 30 x 10 mm	M(B)S...27	1	ZX151	2CPX044006R9999
	M(B)S...27	10	ZX151P10	2CPX062721R9999
End cover For busbar carrier ZX151	-	1	ZX158	2CPX060208R9999
	-	10	ZX158P10	2CPX062723R9999
Busbar bracket 3-pole Busbar center distance 60 mm/100 mm For copper rails 30 x 10 mm to 60 x 10 mm	M(B)L...52(B)	1	ZX520	2CPX067861R9999
	M(B)S...31	10	ZX520P10	2CPX062552R9999
Busbar center distance 100 mm/ 185 mm For copper rails 30 x 10 mm to 100 x 10 mm	M(B)L...00(B)	1	ZX522	2CPX067909R9999
	ML...B	10	ZX522P10	2CPX062553R9999
Busbar bracket 3-/4-pole Busbar center distance 185 mm For copper rails 40 x 10 mm	M(B)L25	1	ZX523	2CPX068553R9999
	M(B)L35	1	ZX523	2CPX068553R9999

Interior expansion system parts

Busbar brackets and accessories



ZX518



ZX519



ZX149



ZB19



ZX50

Article	Use for...	Unit	Type	Order code
N/PE busbar carrier For copper rails 12 x 5 mm, 20 x 5 mm and 30 x 5 mm	M(B)N...69	1	ZX518	2CPX067805R9999
	M(B)N...74	10	ZX518P10	2CPX062551R9999
	M(B)N...75			
	M(B)S...28			
End cover For busbar carrier ZX518	M(B)N...74	1	ZX519	2CPX062687R9999
	M(B)N...75	10	ZX519P10	2CPX062686R9999
N/PE busbar carrier For copper rails 12 x 5 mm to 30 x 10 mm	M(B)N...62	1	ZX149	2CPX044019R9999
	M(B)N...63	10	ZX149P10	2CPX062720R9999
Cover profile for latching For copper rails 12 x 5 mm and 12 x 10 mm Length 1 m	-	1	ZB19	2CPX038187R9999
	-	10	ZB19P10	2CPX062709R9999
Support insulators with wrench flat Diameter x length				
30 x 30 mm, thread on both sides: M6 Wrench size: 30 mm	-	1	ZX50	2CPX039050R9999
	-	20	ZX50P20	2CPX062725R9999
30 x 30 mm, thread on both sides: M8 Wrench size: 30 mm	-	1	ZX51	2CPX039051R9999
	-	20	ZX51P20	2CPX062726R9999
40 x 40 mm, thread on both sides: M10 Wrench size: 40 mm	-	1	ZX52	2CPX039052R9999
	-	20	ZX52P20	2CPX062560R9999
50 x 60 mm, thread on both sides: M12 Wrench size: 50 mm	-	1	ZX53	2CPX039053R9999
	-	20	ZX53P20	2CPX062559R9999
40 x 50 mm, thread on one side: M12 Threaded bolts on one side: M12 x 65 mm	-	1	ZX54	2CPX039054R9999
	-	20	ZX54P20	2CPX062727R9999

Interior expansion system parts

Attachment material



ZW62



ZX256P10



ZX230P10



ZB70















ZW99

Article	Unit	Type	Order code
Inlay nuts for WR profile	1	ZW62	2CPX039462R9999
M 8	50	ZW62P50	2CPX062479R9999
Inlay nut for profile rails, profile no. 1 and 2			
L x W x D in mm			
20 x 11 x 4, M5	10	ZX256P10	2CPX062515R9999
20 x 14 x 4, M5	10	ZX248P10	2CPX062509R9999
20 x 14 x 4, M6	10	ZX249P10	2CPX062510R9999
20 x 14 x 4, M8	10	ZX250P10	2CPX062511R9999
Slide nut for profile rails, profile no. 1 and 2			
L x W x D in mm			
20 x 20 x 4, M3	10	ZX226P10	2CPX062494R9999
20 x 20 x 4, M4	10	ZX227P10	2CPX062495R9999
20 x 20 x 4, M5	10	ZX228P10	2CPX062496R9999
20 x 20 x 4, M6	10	ZX229P10	2CPX062497R9999
20 x 20 x 4, M8	10	ZX230P10	2CPX062498R9999
Slide nut for profile rails, for profile no. 3			
L x W x D in mm			
25 x 25 x 8, M5	10	ZX235P10	2CPX062639R9999
25 x 25 x 6, M6	10	ZX231P10	2CPX062499R9999
25 x 25 x 8, M8	10	ZX232P10	2CPX062500R9999
25 x 25 x 8, M10	10	ZX233P10	2CPX062501R9999
25 x 25 x 8, M12	10	ZX234P10	2CPX062502R9999
Plastic spacer pieces			
For high or low installation of fastening parts			
Yard goods, length 1 m	1	ZB70	2CPX038570R9999
Vibration damper			
For vibration-free installation of mounting plates and devices			
M6 external thread and M 6 internal thread	1	ZW98	2CPX060124R9999
M10 internal thread	1	ZW99	2CPX060125R9999

Interior expansion system parts

Attachment material

	Article	Unit	Type	Order code	
 ZB21P4	Lens screw with cross-slot Pozidriv PZ2, M5 x 8 mm	4	ZB21P4	2CPX062663R9999	
		20	ZB21P20	2CPX068585R9999	
 ZB36P20	Lens screw with cross-slot and slot Pozidriv PZ2, M5 x 12 mm	20	ZB36P20	2CPX062390R9999	
 ZB37P20	Lens screw with hexalobular socket and slit M5 x 12 mm/Torx T25	20	ZB37P20	2CPX060202R9999	
 ZB22P20	Cylinder head screw with slit M5 x 20 mm	20	ZB22P20	2CPX068586R9999	
 ZB32P4	Lens-tapping screw with hexalobular socket and slit Torx T25	M4.8 x 9.5 mm	4	ZB32P4	2CPX064149R9999
			20	ZB32P20	2CPX062651R9999
			500	ZB32P500	2CPX062652R9999
		M4.8 x 11.5 mm	20	ZB27P20	2CPX062588R9999
			500	ZB27P500	2CPX062689R9999
 ZX273P4	M4.8 x 32 mm	4	ZX273P4	2CPX064153R9999	
 ZX910P10	Flat head screws with hexalobular socket	M6 x 20 mm/Torx T30	10	ZX910P10	2CPX060203R9999
		M6 x 30 mm/Torx T30	10	ZX912P10	2CPX060204R9999
		M6 x 45 mm/Torx T30	10	ZX915P10	2CPX060205R9999
 ZX260P10	Cylinder head screw with hexalobular socket	M5 x 10 mm	10	ZX260P10	2CPX062517R9999
		M6 x 20 mm	10	ZX261P10	2CPX062518R9999
		M6 x 30 mm	20	ZX257P20	2CPX068588R9999
		M6 x 45 mm	20	ZX259P20	2CPX068589R9999
 ZX263P10	Cylinder head screw with hexalobular socket	M8 x 16 mm	10	ZX263P10	2CPX062520R9999
		M8 x 20 mm	10	ZX264P10	2CPX062521R9999
		M8 x 30 mm	10	ZX265P10	2CPX062522R9999
 ZX258P10	Cylinder head screw with hexalobular socket and captive spring washer M6 x 12 mm	10	ZX258P10	2CPX062516R9999	
 ZX270P10	Cylinder head screw with hexalobular socket, thread-forming For hole diameter 5.5 mm M6 x 20	10	ZX270P10	2CPX062527R9999	
 ZX283P10	Washer 6 mm	10	ZX283P10	2CPX060281R9999	

Interior expansion system parts

Covers for rail-mounted devices, row spacing 125 mm



AS11



AS12



AS13



AS14



AS15



AS21



AS22



AS23

Article	Unit	Type	Order code
Cover 1-field width, with 90° press-and-turn lock			
Height x width			
150 x 250 mm without slit	1	AG11	2CPX062801R9999
150 x 250 mm with slit	1	AS11	2CPX062802R9999
<hr/>			
300 x 250 mm without slit	1	AG12	2CPX062803R9999
300 x 250 mm with slit	1	AS12	2CPX062804R9999
<hr/>			
450 x 250 mm without slit	1	AG13	2CPX062805R9999
450 x 250 mm with slit	1	AS13	2CPX062806R9999
<hr/>			
600 x 250 mm without slit	1	AG14	2CPX062807R9999
600 x 250 mm with slit	1	AS14	2CPX062808R9999
<hr/>			
750 x 250 mm without slit	1	AG15	2CPX062809R9999
750 x 250 mm with slit	1	AS15	2CPX062810R9999
<hr/>			
Cover 2-field width, with 90° press-and-turn lock			
Height x width			
150 x 500 mm without slit	1	AG21	2CPX062811R9999
150 x 500 mm with slit	1	AS21	2CPX062812R9999
<hr/>			
300 x 500 mm without slit	1	AG22	2CPX062813R9999
300 x 500 mm with slit	1	AS22	2CPX062814R9999
<hr/>			
450 x 500 mm without slit	1	AG23	2CPX062815R9999
450 x 500 mm with slit	1	AS23	2CPX062816R9999

Interior expansion system parts

Covers for rail-mounted devices, row spacing 125 mm



AS24



AS25



AS31



AS32



AS33



AS34



AS35

Article	Unit	Type	Order code
Cover 2-field width, with 90° press-and-turn lock			
Height x width			
600 x 500 mm without slit	1	AG24	2CPX062817R9999
600 x 500 mm with slit	1	AS24	2CPX062818R9999
<hr/>			
750 x 500 mm without slit	1	AG25	2CPX062819R9999
750 x 500 mm with slit	1	AS25	2CPX062820R9999
<hr/>			
Cover 3-field width, with 90° press-and-turn lock			
Height x width			
150 x 750 mm without slit	1	AG31	2CPX062821R9999
150 x 750 mm with slit	1	AS31	2CPX062822R9999
<hr/>			
300 x 750 mm without slit	1	AG32	2CPX062823R9999
300 x 750 mm with slit	1	AS32	2CPX062824R9999
<hr/>			
450 x 750 mm without slit	1	AG33	2CPX062825R9999
450 x 750 mm with slit	1	AS33	2CPX062826R9999
<hr/>			
600 x 750 mm without slit	1	AG34	2CPX062827R9999
600 x 750 mm with slit	1	AS34	2CPX062828R9999
<hr/>			
750 x 750 mm without slit	1	AG35	2CPX062829R9999
750 x 750 mm with slit	1	AS35	2CPX062830R9999

Interior expansion system parts

Covers for rail-mounted devices, row spacing 150 mm



AH1



AS11



AS212



AS213



AS214



AS215



AH2



AS21



AS222



AS223

Article	Unit	Type	Order code
Cover 1-field width, with 90° press-and-turn lock			
Height x width			
75 x 250 mm without slit	1	AH1	2CPX070387R9999
150 x 250 mm without slit	1	AG11	2CPX062801R9999
150 x 250 mm with slit	1	AS11	2CPX062802R9999
300 x 250 mm without slit	1	AG212	2CPX062831R9999
300 x 250 mm with slit	1	AS212	2CPX062832R9999
450 x 250 mm without slit	1	AG213	2CPX062833R9999
450 x 250 mm with slit	1	AS213	2CPX062834R9999
600 x 250 mm without slit	1	AG214	2CPX062835R9999
600 x 250 mm with slit	1	AS214	2CPX062836R9999
750 x 250 mm without slit	1	AG215	2CPX062837R9999
750 x 250 mm with slit	1	AS215	2CPX062838R9999
Cover 2-field width, with 90° press-and-turn lock			
Height x width			
75 x 500 mm without slit	1	AH2	2CPX070388R9999
150 x 500 mm without slit	1	AG21	2CPX062811R9999
150 x 500 mm with slit	1	AS21	2CPX062812R9999
300 x 500 mm without slit	1	AG222	2CPX062839R9999
300 x 500 mm with slit	1	AS222	2CPX062840R9999
450 x 500 mm without slit	1	AG223	2CPX062841R9999
450 x 500 mm with slit	1	AS223	2CPX062842R9999

Interior expansion system parts

Covers for rail-mounted devices, row spacing 150 mm



AS224



AS225



AS31



AS232



AS233



AS234



AS235

Article	Unit	Type	Order code
Cover 2-field width, with 90° press-and-turn lock			
Height x width			
600 x 500 mm without slit	1	AG224	2CPX062843R9999
600 x 500 mm with slit	1	AS224	2CPX062844R9999
<hr/>			
750 x 500 mm without slit	1	AG225	2CPX062845R9999
750 x 500 mm with slit	1	AS225	2CPX062846R9999
<hr/>			
Cover 3-field width, with 90° press-and-turn lock			
Height x width			
150 x 750 mm without slit	1	AG31	2CPX062821R9999
150 x 750 mm with slit	1	AS31	2CPX062822R9999
<hr/>			
300 x 750 mm without slit	1	AG232	2CPX062847R9999
300 x 750 mm with slit	1	AS232	2CPX062848R9999
<hr/>			
450 x 750 mm without slit	1	AG233	2CPX062849R9999
450 x 750 mm with slit	1	AS233	2CPX062850R9999
<hr/>			
600 x 750 mm without slit	1	AG234	2CPX062851R9999
600 x 750 mm with slit	1	AS234	2CPX062852R9999
<hr/>			
750 x 750 mm without slit	1	AG235	2CPX062853R9999
750 x 750 mm with slit	1	AS235	2CPX062854R9999

Interior expansion system parts

Covers, 1-field width with cutout



AG71



AG65



AG73



AG72



AG173



AG161



AG174



AG200

Article	Use for...	Unit	Type	Order code
Cover , 1-field width, with 90° press-and-turn lock				
Height x width				
300 x 250 mm, with cutout For 1 x NH-fuse switch disconnecter NH00	M(B)T135(B)	1	AG71	2CPX062873R9999
300 x 250 mm, with cutout For 2 x NH-fuse switch disconnecter NH00	M(B)T136(B)	1	AG65	2CPX062870R9999
600 x 250 mm, with cutout For 4 x NH-fuse switch disconnecter NH00	M(B)T137(B)	1	AG73	2CPX062875R9999
450 x 250 mm, with cutout For 1 x NH-fuse switch disconnecter NH1	M(B)T142(B)	1	AG72	2CPX062874R9999
750 x 250 mm, with cutout For 2 x NH-fuse switch disconnecter NH1	M(B)T143(B)	1	AG173	2CPX062899R9999
450 x 250 mm, with cutout For 1 x NH-fuse switch disconnecter NH2	M(B)T144(B)	1	AG161	2CPX062887R9999
750 x 250 mm, with cutout For 2 x NH-fuse switch disconnecter NH2	M(B)T145(B)	1	AG174	2CPX062900R9999
300 x 250 mm, with cutout				
For OT-circuit OT160M3	MA160ALAB	1	AG200	2CPX062931R9999
For OT-circuit OT200E03P, OT250E03P	MA200ALAB MA250ALAB	1	AG201	2CPX062932R9999

Interior expansion system parts

Covers, 1-field width with cutout



AG205



AG208



AG206



AG207



AG1304



AG127



AG175



AG160



AG121



AG131

Article	Use for...	Unit	Type	Order code
Cover , 1-field width, with 90° press-and-turn lock				
Height x width				
300 x 250 mm, with cutout For Tmax circuit XT1, XT3	M(B)A190T	1	AG205	2CPX062936R9999
300 x 250 mm, with cutout				
For Tmax circuit XT1	MA100ALXB MA160ALXB	1	AG208	2CPX062993R9999
For Tmax circuit XT3	MA200ALXB MA250ALXB	1	AG209	2CPX062994R9999
300 x 250 mm, with cutout For Tmax circuit XT2	M(B)A191T	1	AG206	2CPX062855R9999
450 x 250 mm, with cutout For Tmax circuit XT4	M(B)A193T	1	AG207	2CPX062856R9999
450 x 250 mm, with cutout For Tmax circuit T4, 3-pole For Tmax circuit T5 (400), 3-pole	M(B)A192T	1	AG1304	2CPX064157R9999
300 x 250 mm, with cutout				
For S700	M(B)H150	1	AG127	2CPX062986R9999
For S750	M(B)H151	1	AG128	2CPX062989R9999
150 x 250 mm, with cutout For protective hose	M(B)V180 M(B)V181 M(B)V182	1	AG175	2CPX062901R9999
300 x 250 mm, with cutout For bus-mounting fuse socket 5 x 3 x D02	M(B)R102(B)	1	AG160	2CPX062886R9999
300 x 250 mm, with cutout For bus-mounting fuse socket Space for horizontal installation devices 134 mm	M(B)R102H	1	AG121	2CPX062969R9999
450 x 250 mm, with cutout For bus-mounting fuse socket Space for horizontal installation devices 295 mm	M(B)R103H	1	AG131	2CPX062970R9999

Interior expansion system parts

Covers, 1-field width with cutout/with viewing window



AG132



AG164



AG165



AG240



AG243



AG246



AG125

Article	Use for...	Unit	Type	Order code
Cover , 1-field width, with 90° press-and-turn lock				
Height x width				
150 x 250 mm, with cutout For measuring devices, 96 x 96 mm	M(B)U156	1	AG132	2CPX062992R9999
300 x 250 mm, with cutout For measuring devices, 96 x 96 mm	M(B)U157	1	AG164	2CPX062890R9999
450 x 250 mm, with cutout For measuring devices, 96 x 96 mm	M(B)U158	1	AG165	2CPX062891R9999
450 x 250 mm, with cutout For 3 x NH-fuse switch disconnecter NH00 100 mm busbar center distance	MD152B	1	AG240	2CPX042127R9999
750 x 250 mm, with cutout For 4 x NH-fuse switch disconnecter NH00 185 mm busbar center distance	MD100B	1	AG243	2CPX042187R9999
900 x 250 mm, with cutout For 4 x NH-fuse switch disconnecter NH00 + EFM 185 mm busbar center distance	MBD100E	1	AG246	2CPX042190R9999
Covers with viewing window				
1-field width, with 90° press-and-turn lock				
300 x 250 mm, with viewing window	-	1	AG12S	2CPX062228R9999
450 x 250 mm, with viewing window	-	1	AG13S	2CPX062230R9999
600 x 250 mm, with viewing window	-	1	AG14S	2CPX062232R9999

Interior expansion system parts

Covers, 2-field width with cutout



AG75



AG79



AG82



AG83



AG92



AG66



AG259



AG1404



AG227

Article	Use for...	Unit	Type	Order code
Covers, 2-field width, with 90° press-and-turn lock				
Height x width				
300 x 500 mm, with cutout For 4 x NH-fuse switch disconnecter NH00	M(B)T236(B)	1	AG75	2CPX062876R9999
600 x 500 mm, with cutout For 8 x NH-fuse switch disconnecter NH00	M(B)T237(B)	1	AG79	2CPX062877R9999
450 x 500 mm, with cutout For 2 x NH-fuse switch disconnecter NH1	M(B)T242(B)	1	AG82	2CPX062878R9999
750 x 500 mm, with cutout For 4 x NH-fuse switch disconnecter NH1	M(B)T243(B)	1	AG83	2CPX062879R9999
450 x 500 mm, with cutout For 2 x NH-fuse switch disconnecter NH2	M(B)T244(B)	1	AG92	2CPX062884R9999
750 x 500 mm, with cutout For 4 x NH-fuse switch disconnecter NH2	M(B)T245(B)	1	AG66	2CPX062871R9999
300 x 500 mm, with cutout For Tmax circuit XT1, XT3	M(B)A290T	1	AG259	2CPX062979R9999
450 x 500 mm, with cutout For Tmax circuit T4/T5, 3 and 4-pole	M(B)A292T	1	AG1404	2CPX064158R9999
For Tmax circuit T5	MA400ALSB MA630ALSB	1	AG198	2CPX062929R9999
300 x 500 mm, with cutout For S700	M(B)H250	1	AG227	2CPX062987R9999
For S750	M(B)H251	1	AG228	2CPX062990R9999

Interior expansion system parts

Covers, 2-field width with cutout



AG176



AG172



AG162



AG241



AG244



AG247



AG179



AG22S

Article	Use for...	Unit	Type	Order code
Covers, 2-field width, with 90° press-and-turn lock				
Height x width				
150 x 500 mm, with cutout For protective hose	M(B)V281 M(B)V282	1	AG176	2CPX062902R9999
300 x 500 mm, with cutout For bus-mounting fuse socket 14 x 3 x D02	M(B)R202(B)	1	AG172	2CPX062898R9999
150 x 500 mm, with cutout For measuring devices, 96 x 96 mm	M(B)U257	1	AG162	2CPX062888R9999
450 x 500 mm, with cutout For 6 x NH-fuse switch disconnectors NH00 100 busbar center distance	MD252B	1	AG241	2CPX042128R9999
750 x 500 mm, with cutout For 8 x NH-fuse switch disconnectors NH00	MD200B	1	AG244	2CPX042188R9999
For load break switches with fuse, ABB SlimLine XR Cutout 300 mm width 185 busbar center distance	-	1	AG177	2CPX062903R9999
900 x 500 mm, with cutout For 8 x NH-fuse switch disconnection rails NH00 + EFM 185 mm busbar center distance	MBD200E	1	AG247	2CPX042191R9999
750 x 500 mm, with cutout For 4 x NH-fuse switch disconnection rail NH1-3	MD21B MD22B	1	AG244	2CPX042188R9999
750 x 500 mm, with cutout For load break switches with fuse, ABB SlimLine XR Cutout 400 mm width	-	1	AG179	2CPX062905R9999
Covers with viewing window, 2-field width, with 90° press-and-turn lock				
300 x 500 mm, with viewing window	-	1	AG22S	2CPX062229R9999
450 x 500 mm, with viewing window	-	1	AG23S	2CPX062231R9999
600 x 500 mm, with viewing window	-	1	AG24S	2CPX062233R9999

Interior expansion system parts

Covers, 3-field width with cutout



AG84



AG85



AG90



AG91



AG93



AG67



AG359



AG327

Article	Use for...	Unit	Type	Order code
Covers with cutout 3-field width, with 90° press-and-turn lock				
Height x width				
300 x 750 mm, with cutout For 6 x NH-fuse switch disconnectors Gr. 00	M(B)T336(B)	1	AG84	2CPX062880R9999
600 x 750 mm, with cutout For 12 x NH-fuse switch disconnectors Gr. 00	M(B)T337(B)	1	AG85	2CPX062881R9999
450 x 750 mm, with cutout For 3 x NH-fuse switch disconnectors Gr. 1	M(B)T342B	1	AG90	2CPX062882R9999
750 x 750 mm, with cutout For 6 x NH-fuse switch disconnectors Gr. 1	M(B)T343(B)	1	AG91	2CPX062883R9999
450 x 750 mm, with cutout For 3 x NH-fuse switch disconnectors Gr. 2	M(B)T344(B)	1	AG93	2CPX062885R9999
750 x 750 mm, with cutout For 6 x NH-fuse switch disconnectors Gr. 2	M(B)T345(B)	1	AG67	2CPX062872R9999
300 x 750 mm, with cutout For Tmax circuit XT1, XT3	M(B)A390T	1	AG359	2CPX062980R9999
300 x 750 mm, with cutout				
For S700	M(B)H350	1	AG327	2CPX062988R9999
For S750	M(B)H351	1	AG328	2CPX062991R9999

Interior expansion system parts

Covers, 3-field width with cutout



AG321



AG163



AG242



AG245



AG180



AG248

Article	Use for...	Unit	Type	Order code
Covers with cutout, 3-field width, with 90° press-and-turn lock				
Height x width				
300 x 750 mm, with cutout For bus-mounting fuse socket 24 x 3 x D02	M(B)R302(B)	1	AG321	2CPX062971R9999
150 x 750 mm, with cutout For measuring devices, 96 x 96 mm	M(B)U357	1	AG163	2CPX062889R9999
450 x 750 mm, with cutout For 12 x NH-fuse switch disconnection rails, 100 mm busbar center distance	MD352B	1	AG242	2CPX042129R9999
750 x 750 mm, with cutout For 12 x NH-fuse switch disconnection rails, 185 mm busbar center distance	MD300B	1	AG245	2CPX042189R9999
750 x 750 mm, with cutout For load break switches with fuse, ABB SlimLine XR Cutout 2 x 250 mm width 185 mm busbar center distance	-	1	AG178	2CPX062904R9999
750 x 750 mm, with cutout For load break switches with fuse, ABB SlimLine XR Cutout 600 mm width	-	1	AG180	2CPX062906R9999
900 x 750 mm, with cutout For 12 x NH-fuse switch disconnection rails NH00 + EFM 185 mm busbar center distance	MBD300E	1	AG248	2CPX042192R9999

Interior expansion system parts

Cover parts



ED137P4



ED138P4



ED139P4



ED135P4



ED110



ED58P10



ED50P12



ED136P4



ED41P4



ZB35P5

Article	Use for...	Unit	Type	Order code
Cover bracket 45 mm tall For fastening (inserting, turning) on EDF profile rails as well as latching a bulkhead; For DIN rails 35 x 7.5 mm, only use this cover bracket	M(B)R...03	4	ED137P4	2CPX062600R9999
		40	ED137P40	2CPX062601R9999
Cover bracket 52.5 mm tall For fastening (inserting, turning) on EDF and WR profile rails, as well as for latching a partition wall, for DIN rails, 35 x 15 mm, only use this cover bracket	All modules	4	ED138P4	2CPX062630R9999
		12	ED138P12	2CPX062602R9999
		40	ED138P40	2CPX062603R9999
		1600	ED138P1600	2CPX062702R9999
Cover bracket 88 mm tall For fastening (inserting, turning) on EDF and WR profile rails, as well as for latching a partition wall; to be used when installing devices at greater depths or with busbar systems		4	ED139P4	2CPX062604R9999
		40	ED139P40	2CPX062734R9999
Spacer piece To extend the cover holder by 25 mm	M(B)R...03	4	ED135P4	2CPX062610R9999
		40	ED135P40	2CPX062733R9999
Cover bracket 1 set left / right		1	ED110	2CPX039320R9999
DIN rails adapter For cover brackets ED138 and ED139 to be snapped onto the DIN rail from the front		10	ED58P10	2CPX062338R9999
90 degree press-and-turn lock	All covers	12	ED50P12	2CPX062337R9999
Screw insert Fr metric thread, M5, for mounting macrolon, sheet metal or aluminum plates on the EDF cover brackets		4	ED136P4	2CPX062611R9999
90 degree press-and-turn lock For mounting macrolon, sheet metal or aluminum plates on the cover brackets		4	ED41P4	2CPX062332R9999
Sealing nipple for subsequent installation in standard field covers (6 mm hole must be drilled)		5	ZB35P5	2CPX062392R9999

Interior expansion system parts

Extension frame/safety terminal cover



ED212

Article	Use for...	Unit	Type	Order code
Extension frame for covers				
For fields with cover brackets 52.5 mm (ED138, etc.), plastic frame to pre-set the cover by 25 or 35 mm External dimensions in mm				
1-field width				
300 x 250	AG12	1	ED212	2CPX062782R9999
450 x 250	AG13	1	ED213	2CPX062783R9999
600 x 250	AG14	1	ED214	2CPX062784R9999
750 x 250	AG15	1	ED215	2CPX062785R9999
2-field width				
300 x 500	AG22	1	ED222	2CPX062787R9999
450 x 500	AG23	1	ED223	2CPX062788R9999
600 x 500	AG24	1	ED224	2CPX062789R9999
750 x 500	AG25	1	ED225	2CPX062790R9999
3-field width				
300 x 750	AG32	1	ED232	2CPX062792R9999
450 x 750	AG33	1	ED233	2CPX062793R9999
600 x 750	AG34	1	ED234	2CPX062794R9999
750 x 750	AG35	1	ED235	2CPX062795R9999

The following is also required per frame:

for 25 mm, increase 1 x ED135P4

for 35 mm, increase 1 x ED139P4

Interior expansion system parts

Busbar systems for NH-fuse switch disconnectors

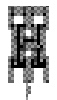

ZH55



ZH214



ZH211



ZH311

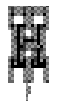

ZH216



ZH212



ZH312

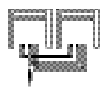

ZH217

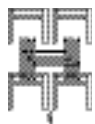

ZH218

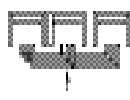

ZH317

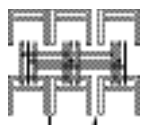

ZH318

Size NH..	Rated current I _n	Copper rail in mm	Terminal	Load break switch St.	Use for...	Unit	Type	Order code
Busbar systems with access line, line cross-section 35 mm², Line length 500 mm								
NH00	320 A	20 x 5 mm	M8	4	-	1	ZH55	2CPX038559R9999
Busbar systems without access line								
NH00	320 A	20 x 5	M8	2	MT136B	1	ZH214	2CPX060443R9999
NH00	320 A	20 x 5	M8	4	MT236B	1	ZH211	2CPX060440R9999
NH00	320 A	20 x 5	M8	6	MT336B	1	ZH311	2CPX060450R9999
NH00	320 A	20 x 5	M8	4	MT137B	1	ZH216	2CPX060445R9999
NH00	320 A	20 x 5	M8	8	MT237B	1	ZH212	2CPX060441R9999
NH00	320 A	20 x 5	M8	12	MT337B	1	ZH312	2CPX060451R9999
NH1/NH2	440 A	30 x 5	M10	2	MT242B MT244B	1	ZH217	2CPX060446R9999
NH1/NH2	630 A	30 x 10	M10	4	MT243B MT245B	1	ZH218	2CPX060447R9999
NH1/NH2	440 A	30 x 5	M10	3	MT342B MT344B	1	ZH317	2CPX060456R9999
NH1/NH2	630 A	30 x 10	M10	6	MT343B MT345B	1	ZH318	2CPX060457R9999

> **Important note:** If arranged in a single row, use 3 straight or 3 angled cable lugs to connect to the supply line. If arranged in two rows, 3 angled cable lugs to connect to the supply line.

Interior expansion system parts

Separator shutters and insulating plates for NH fuse switch disconnectors



ZH425



ZH426



ZH427



ZH428



ZH439



ZH440



ZH447



ZH449



ZH442



ZX148



ZH53

Article	Use for...	Unit	Type	Order code
NH00 fuse switch disconnector				
Single shutter	MT135B	1	ZH425	2CPX062952R9999
Double shutter	MT136B MT137B MT236B MT237B	1	ZH426	2CPX062953R9999
Triple shutter	MT336B MT337B	1	ZH427	2CPX062954R9999
Single shutter closed	-	1	ZH428	2CPX062955R9999
Double shutter closed	-	1	ZH429	2CPX062956R9999
Triple shutter closed	-	1	ZH430	2CPX062957R9999
NH1 fuse switch disconnector				
Single shutter	MT...42B MT...43B MT...51B	1	ZH438	2CPX062961R9999
Double shutter	-	1	ZH439	2CPX062962R9999
Single shutter closed	-	1	ZH440	2CPX062963R9999
NH2 fuse switch disconnector				
Single shutter For 1-field width modules	MT144B MT145B	1	ZH447	2CPX039842R9999
Single shutter For 3-field width modules	MT344B MT345B	1	ZH448	2CPX062965R9999
Double shutter	MT244B MT245B MT344B MT345B	1	ZH449	2CPX062966R9999
Single shutter closed	-	1	ZH442	2CPX062939R9999
Insulating plates for non-allocated busbar ends for...				
Fuse switch disconnectors including attachment material				
NH00	-	1	ZX148	2CPX044018R9999
NH1	-	1	ZX128	2CPX039128R9999
NH2	-	1	ZX129	2CPX039129R9999
N/PE rails for attaching behind the disconnector cross-beams for				
NH00 fuse switch disconnector Copper 20 x 4 mm, including attachment material	-	1	ZH53	2CPX038557R9999

Interior expansion system parts

NH fuse switch disconnecter



ZH411



ZH412



ZH431



ZH441



ZH414



ZH415

Article	Use for...	Unit	Type	Order code
NH fuse switch disconnecter				
For mounting with EDF and WR mounting frame on disconnecter cross-beam				
NH00 fuse switch disconnecter Rated current (I_n) max. 160 A, with screw connection M8, without shutter	MT135B MT...36B MT...37B	1	ZH411	2CPX062947R9999
NH00 fuse switch disconnecter Rated current (I_n) max. 160 A, with U-clamp terminals up to 50 mm ² without shutter	-	1	ZH412	2CPX062948R9999
NH1 fuse switch disconnecter Rated current (I_n) max. 250 A, with screw connection M10, without shutter	MT...42B MT...43B	1	ZH431	2CPX062958R9999
NH2 fuse switch disconnecter Rated current (I_n) max. 400 A, with screw connection M12, without shutter	MT...44B MT...45B	1	ZH441	2CPX062964R9999
NH fuse switch-disconnector for mounting with EDF mounting frame on busbar systems, copper 12 x 5 mm or copper 12 x 10 mm, busbar distance 40 mm				
NH00 fuse switch disconnecter Rated current (I_n) max. 160 A, with U-clamp terminals up to 50 mm ² without shutter	ED...TA	1	ZH414	2CPX062950R9999
NH00 fuse switch disconnecter Rated current (I_n) max. 160 A, with triple terminals up to 10 mm ² without shutter	-	1	ZH415	2CPX062951R9999

Interior expansion system parts

NH fuse switch disconnecter



ZE60



ZE61



ZE62



ZA4P10

Article	Use for...	Unit	Type	Order code
Neozed bus-mounting fuse socket E18, width 26 mm For gauge ring inserts, 3-pole, with covers and nameplates, with E18 thread, safety fuse max. 63 A		1	ZE60	2CPX061045R9999
		10	ZE60P10	2CPX062400R9999
Diazed bus-mounting fuse socket E27, width 42 mm For gauge ring inserts, 3-pole, with covers and nameplates, with E27 thread, safety fuse max. 25 A		1	ZE61	2CPX061046R9999
Diazed bus-mounting fuse socket E33, width 56 mm For gauge ring inserts, 3-pole, with covers and nameplates, with E33 thread, safety fuse max. 63 A		1	ZE62	2CPX061047R9999
Shutters instead of bus-mounting fuse socket Color similar to RAL 7035, For complying with the contact protection IPXXC		10	ZA4P10	2CPX062374R9999

Interior expansion system with distribution panels/combination sets

Possible applications for wall-mounted and standalone cabinets

Wall-mounted cabinets of the series U, A, B and TwinLine-G, TwinLine-L and TwinLine-W

Example: Expansion with distribution panels/combination sets in the TwinLine-G wall-mounted cabinet

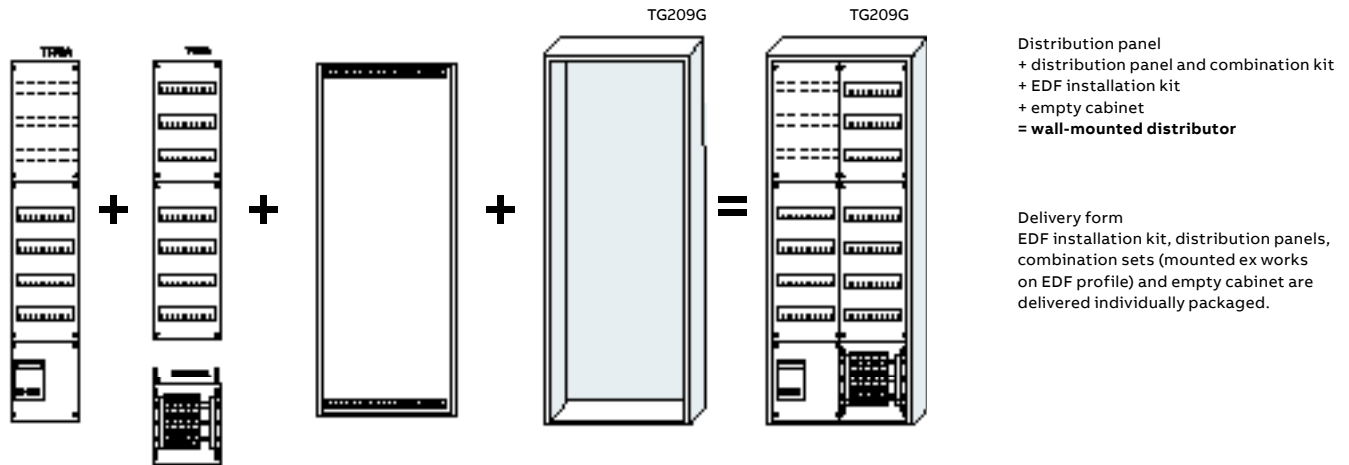

Standalone cabinets of the series TwinLine H and TwinLine-G, TwinLine-L and TwinLine-W

Series switching cabinets of the series TriLine®, Pro E Power system/fire protection housing of the series SF

Example: Expansion with distribution panels/combination sets in the TwinLine- L standalone cabinet

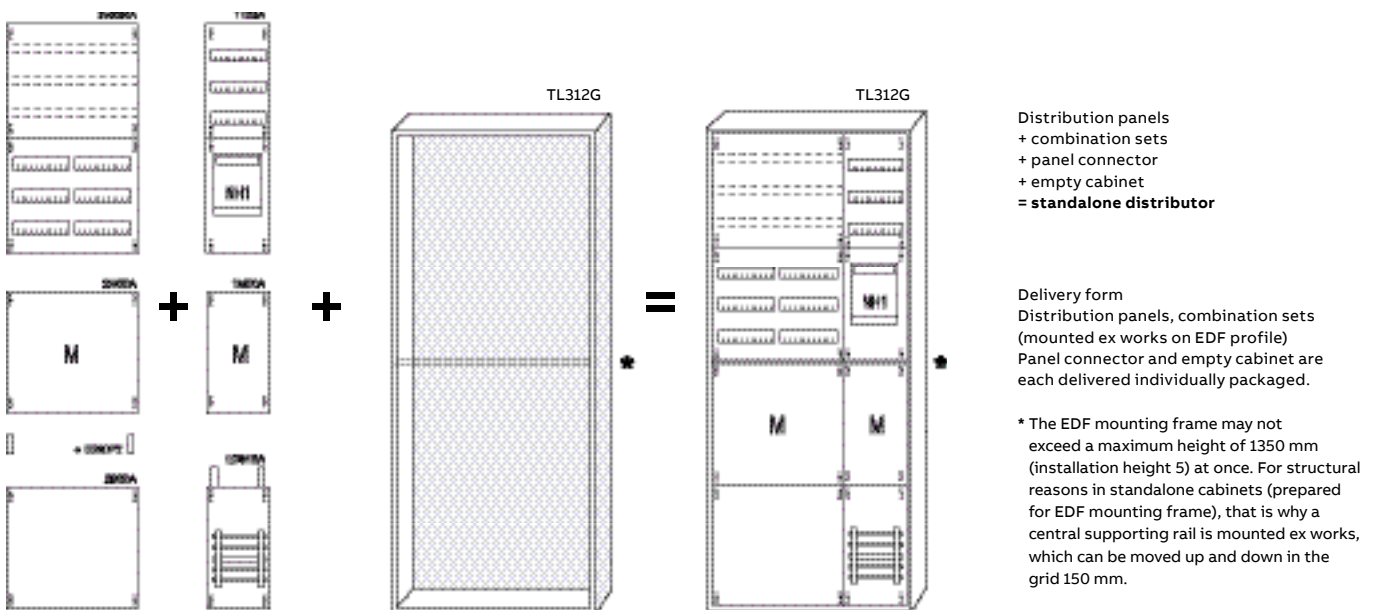

+ panel connector ED30P2

Internal expansion system with distribution panels

Population of the distribution panels

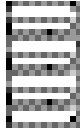

Distribution panels with DIN rails for rail-mounted devices

Equipment: DIN rail 35 x 15 mm for device installation and with hole pattern for the wiring system, row spacing 125 mm, with plastic covers, cutouts for rail-mounted devices DIN 43880 for 12 PLE (216 mm) per field width

> Wire holder and locking strips see page 127



Distribution panels with DIN rails for terminal blocks

Equipment: DIN rail 35 x 15 mm for terminal blocks with hole pattern for the wiring system, row spacing 125 mm, with plastic covers; for a protection-insulated design, use insulators ZK90; To mount the DIN rails to the rear, use ED33 deep angle piece and DIN rails for installation between the mounting frame

> Insulators page 85

> Deep angle piece page 88

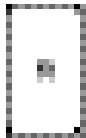

Distribution panels with mounting plates

Equipment: Steel sheet metal mounting plate, Sendzimir galvanized surface, material thickness 2 mm; the mounting plate is mounted on deep angle piece ED33 and can be variably adjusted in depth; maximum installation depth between mounting plate and cover 143 mm, with plastic covers (cover closed)



Distribution panels with mounting cross-beams for device installation without holes

Equipment: For every 150 mm, a mounting cross-beam ZX35 is mounted on ED33 deep angle piece and can be variably adjusted in depth; the maximum installation depth between the cross-beam and cover is 143 mm, with plastic covers (cover closed)



Distribution panels as touch protection (or to expand with assembly parts)

Equipment: Empty panel without installation parts, with plastic covers (covers closed)



Distribution panels with busbars

Equipment: 5-Pole busbar system copper 12 x 5 mm, busbar spacing 40 mm, with plastic covers (covers closed)

> Busbar connection terminals page 83

Internal expansion system - Distribution panels

Rail-mounted devices

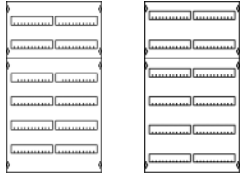

2V2A

2V2-150

- Expansion with DIN rails 35 x 15 mm
- Distribution panels or field combinations must have the same grid units as the cabinets, in which they are installed
- For standalone and row switching cabinets, two fields or field combinations must be installed one above the other
- Without N/PE quick plug-in terminals
- The EDF profile rails are included in the scope of delivery

Height		Width			Distribution of the covers in mm			From a cabinet		
RE	mm	FB	mm	PLE	top	middle	bottom	depth in mm	Type	Order code
Row spacing 125 mm										
3	450	1	250	36	450	-	-	120	1V00A	2CPX037580R9999
		2	500	72	450	-	-	120	2V00A	2CPX037581R9999
4	600	1	250	48	600	-	-	120	1V0A	2CPX037591R9999
		2	500	96	600	-	-	120	2V0A	2CPX037592R9999
5	750	1	250	60	300	-	450	120	1V1A	2CPX037610R9999
		2	500	120	300	-	450	120	2V1A	2CPX037611R9999
6	900	1	250	72	300	-	600	120	1V2A	2CPX037622R9999
		2	500	144	300	-	600	120	2V2A	2CPX037623R9999
6	900	1	250	72	450	-	450	120	1V23A	2CPX037634R9999
		2	500	144	450	-	450	120	2V23A	2CPX037635R9999
7	1050	1	250	84	450	-	600	120	1V3A	2CPX037639R9999
		2	500	168	450	-	600	120	2V3A	2CPX037640R9999
8	1200	1	250	96	450	-	750	120	1V4A	2CPX037651R9999
		2	500	192	450	-	750	120	2V4A	2CPX037652R9999
9	1350	1	250	108	450	450	450	120	1V5A	2CPX037665R9999
		2	500	216	450	450	450	120	2V5A	2CPX037666R9999
Row spacing 150 mm										
3	450	1	250	36	450	-	-	120	1V00-150	2CPX077800R9999
		2	500	72	450	-	-	120	2V00-150	2CPX077801R9999
4	600	1	250	48	600	-	-	120	1V0-150	2CPX077802R9999
		2	500	96	600	-	-	120	2V0-150	2CPX077803R9999
5	750	1	250	60	300	-	450	120	1V1-150	2CPX077804R9999
		2	500	120	300	-	450	120	2V1-150	2CPX077805R9999
6	900	1	250	72	300	-	600	120	1V2-150	2CPX077808R9999
		2	500	144	300	-	600	120	2V2-150	2CPX077809R9999

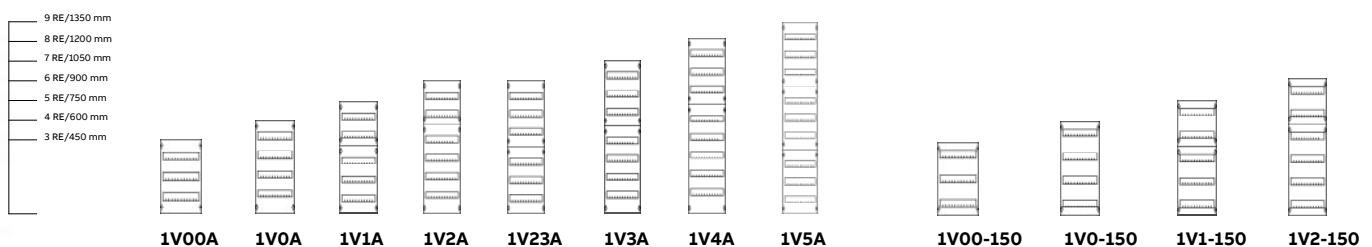

Internal expansion system - Distribution panels

Rail-mounted devices and terminal blocks

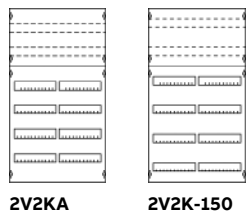

- DIN rails for terminal blocks directly mounted on the mounting frame
- DIN rails for terminal blocks and rail-mounted devices 35 x 15 mm
- Distribution panels or field combinations must have the same grid units as the cabinets, in which they are installed
- For standalone and row switching cabinets, two fields or field combinations must be installed one above the other
- Without N/PE quick plug-in terminals
- The EDF profile rails are included in the scope of delivery

Height	Width				Distribution of the covers in mm			From a cabinet depth in mm	Type	Order code
	RE	mm	FB	mm	PLE	top	middle			
Row spacing 125 mm										
4	600	1	250	48	150	-	450	120	1V0KA	2CPX037593R9999
		2	500	96	150	-	450	120	2V0KA	2CPX037594R9999
5	750	1	250	60	300	-	450	120	1V1KA	2CPX037612R9999
		2	500	120	300	-	450	120	2V1KA	2CPX037613R9999
6	900	1	250	72	300	-	600	120	1V2KA	2CPX037624R9999
		2	500	144	300	-	600	120	2V2KA	2CPX037625R9999
6	900	1	250	72	450	-	450	120	1V23KA	2CPX037637R9999
		2	500	144	450	-	450	120	2V23KA	2CPX037638R9999
7	1050	1	250	84	450	-	600	120	1V3KA	2CPX037641R9999
		2	500	168	450	-	600	120	2V3KA	2CPX037642R9999
8	1200	1	250	96	450	-	750	120	1V4KA	2CPX037653R9999
		2	500	192	450	-	750	120	2V4KA	2CPX037654R9999
9	1350	1	250	108	450	450	450	120	1V5KA	2CPX037667R9999
		2	500	216	450	450	450	120	2V5KA	2CPX037668R9999
Row spacing 150 mm										
5	750	1	250	60	300	-	450	120	1V1K-150	2CPX077806R9999
		2	500	120	300	-	450	120	2V1K-150	2CPX077807R9999
6	900	1	250	72	300	-	600	120	1V2K-150	2CPX077810R9999
		2	500	144	300	-	600	120	2V2K-150	2CPX077811R9999

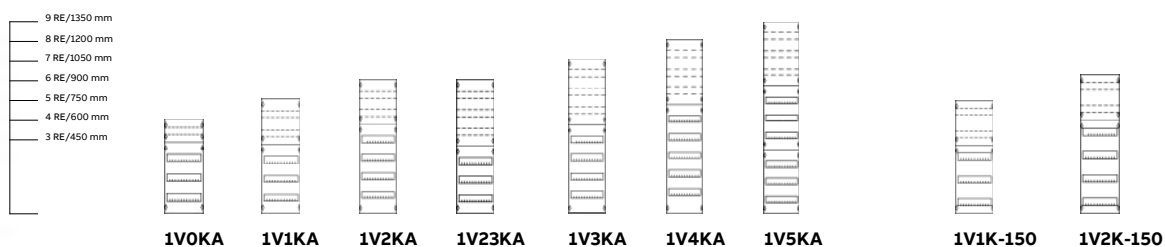

Internal expansion system - Distribution panels

Busbars 40 mm, terminal blocks and contact protection

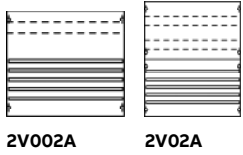

- Busbar center distance 40 mm
- With 5-pole busbars 12 x 5 mm
- With busbar bracket type ZX2BP2
- Rated current (I_n) max. 360 A (max. 12 x 10 mm)
- Distribution panels or field combinations must have the same grid units as the cabinets, in which they are installed
- For standalone and row switching cabinets, two fields or field combinations must be installed one above the other
- The EDF profile rails are included in the scope of delivery

Height	Width			Distribution of the covers in mm			From a cabinet		Type	Order code	
	RE	mm	FB	mm	PLE	top	middle	bottom			depth in mm
3	450	1	250	36	450	-	-	-	120	1V002A	2CPX037590R9999
		2	500	72	450	-	-	-	120	2V002A	2CPX037609R9999
4	600	1	250	48	300	-	300	-	120	1V02A	2CPX037606R9999
		2	500	96	300	-	300	-	120	2V02A	2CPX037607R9999

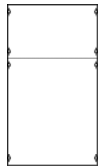

- Distribution panels or field combinations must have the same grid units as the cabinets, in which they are installed
- For standalone and row switching cabinets, two fields or field combinations must be installed one above the other
- The EDF profile rails are included in the scope of delivery

2B2A

3	450	1	250	36	450	-	-	-	120	1B00A	2CPX037585R9999
		2	500	72	450	-	-	-	120	2B00A	2CPX037586R9999
4	600	1	250	48	600	-	-	-	120	1B0A	2CPX037601R9999
		2	500	96	600	-	-	-	120	2B0A	2CPX037602R9999
5	750	1	250	60	750	-	-	-	120	1B1A	2CPX037620R9999
		2	500	120	750	-	-	-	120	2B1A	2CPX037621R9999
6	900	1	250	72	300	-	600	-	120	1B2A	2CPX037632R9999
		2	500	144	300	-	600	-	120	2B2A	2CPX037633R9999
7	1050	1	250	84	450	-	600	-	120	1B3A	2CPX037649R9999
		2	500	168	450	-	600	-	120	2B3A	2CPX037650R9999
8	1200	1	250	96	450	-	750	-	120	1B4A	2CPX037661R9999
		2	500	192	450	-	750	-	120	2B4A	2CPX037662R9999
9	1350	1	250	108	450	450	450	-	120	1B5A	2CPX037675R9999
		2	500	216	450	450	450	-	120	2B5A	2CPX037676R9999

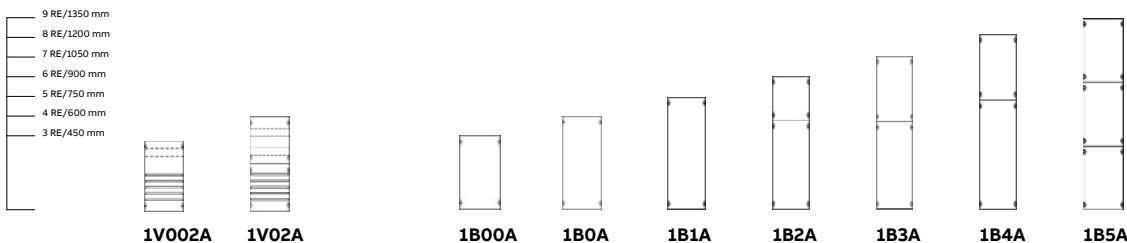

Internal expansion system - Distribution panels

Mounting plates and mounting cross-beams

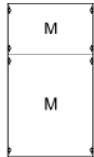

2M2A

- Mounting plates that are variably adjustable in depth via the deep angle piece ED33
- Distribution panels or field combinations must have the same grid units as the cabinets, in which they are installed
- For standalone and row switching cabinets, two fields or field combinations must be installed one above the other
- The EDF profile rails are included in the scope of delivery

Height RE	Width			Distribution of the covers in mm			From a cabinet depth in mm	Type	Order code	
	mm	FB	mm	PLE	top	middle				bottom
3	450	1	250	36	450	-	-	120	1M00A	2CPX037582R9999
		2	500	72	450	-	-	120	2M00A	2CPX037583R9999
4	600	1	250	48	600	-	-	120	1M0A	2CPX037595R9999
		2	500	96	600	-	-	120	2M0A	2CPX037596R9999
5	750	1	250	60	300	-	450	120	1M1A	2CPX037614R9999
		2	500	120	300	-	450	120	2M1A	2CPX037615R9999
6	900	1	250	72	300	-	600	120	1M2A	2CPX037626R9999
		2	500	144	300	-	600	120	2M2A	2CPX037627R9999
7	1050	1	250	84	450	-	600	120	1M3A	2CPX037643R9999
		2	500	168	450	-	600	120	2M3A	2CPX037644R9999
8	1200	1	250	96	450	-	750	120	1M4A	2CPX037655R9999
		2	500	192	450	-	750	120	2M4A	2CPX037656R9999
9	1350	1	250	108	450	450	450	120	1M5A	2CPX037669R9999
		2	500	216	450	450	450	120	2M5A	2CPX037670R9999



1MK2A

- Mounting cross-beams that are variably adjustable in depth via the deep angle piece ED33
- For contact-free mounting with M4 cage nuts
- Distribution panels or field combinations must have the same grid units as the cabinets, in which they are installed
- For standalone and row switching cabinets, two fields or field combinations must be installed one above the other
- The EDF profile rails are included in the scope of delivery

3	450	1	250	36	450	-	-	120	1MK00A	2CPX037179R9999
4	600	1	250	48	600	-	-	120	1MK0A	2CPX037180R9999
5	750	1	250	60	300	-	450	120	1MK1A	2CPX037181R9999
6	900	1	250	72	300	-	600	120	1MK2A	2CPX037182R9999

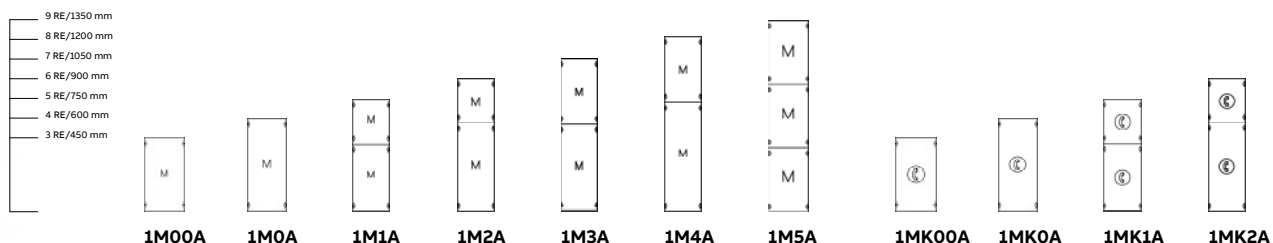

Internal expansion system - Combination sets

Busbars 40 mm/60 mm for operating equipment

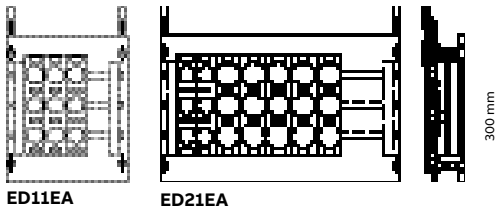
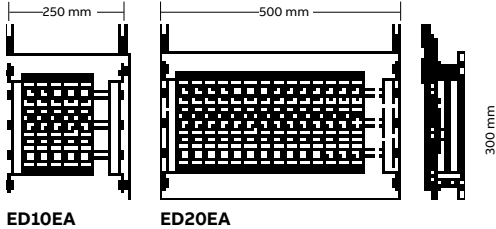

- With 3-pole bus-mounting fuse sockets
- Busbar center distance 60 mm
- With 3-pole busbars 12 x 5 mm
- With busbar bracket type ZX151
- Rated current (I_n) max. 100 A
- Combination sets are plugged into the distribution panel at the top or bottom and mounted on the other side of the cabinet

Height	Width			Equipment					
	RE	mm	FB	mm	PLE	Version	Number	From cabinet depth	Type
2	300	1	250	24	D02 (ZE60)	5	200	ED10EA	2CPX037800R9999
			500	48	D02 (ZE60)	14	200	ED20EA	2CPX037804R9999
2	300	1	250	24	Diazed E27 (ZE61)	3	200	ED11EA	2CPX037801R9999
			500	48	Diazed E27 (ZE61)/ Diazed E33N (ZE62)	2/5	200	ED21EA	2CPX037805R9999

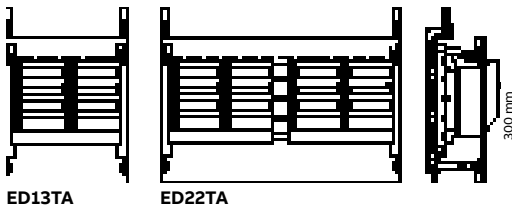
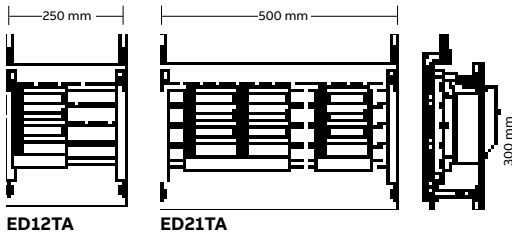

- With NH fuse switch disconnecter 3-pole
- Busbar center distance 40 mm
- With 3-pole busbars 12 x 5 mm
- With busbar bracket type ZX2BP2
- Rated current (I_n) max. 250 A
- Combination sets are plugged into the distribution panel at the top or bottom and mounted on the other side of the cabinet

2	300	1	250	24	NH00 (ZH414)	1	200	ED12TA	2CPX037802R9999
			500	48	NH00 (ZH414)	3	200	ED21TA	2CPX037806R9999
2	300	1	250	24	NH00 (ZH414)	2	200	ED13TA	2CPX037803R9999
			500	48	NH00 (ZH414)	4	200	ED22TA	2CPX037807R9999

Internal expansion system - Combination sets

Busbars

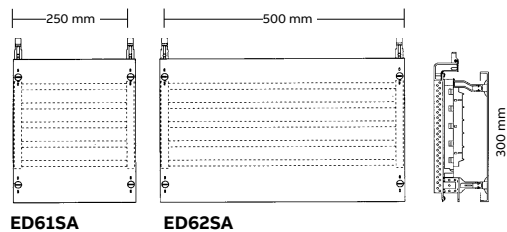

- Busbar center distance 40 mm
- With 5-pole busbars 12 x 5 mm
- With busbar bracket type ZX2BP2
- Rated current (I_n) max. 250 A
- Combination sets are plugged into the distribution panel at the top or bottom and mounted on the other side of the cabinet

Height	Width		PLE	From cabinet depth	Type	Order code
	RE	mm				
2	300	1	250	24	ED61SA	2CPX037810R9999
		2	500	48	ED62SA	2CPX037811R9999

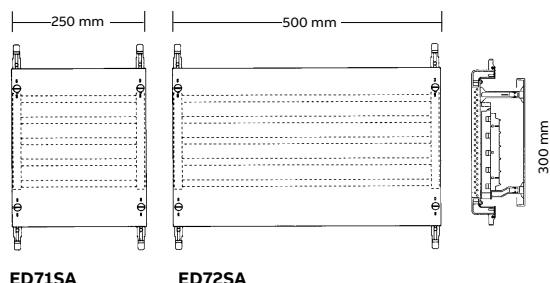

- Busbar center distance 40 mm
- With 5-pole busbars 12 x 5 mm
- With busbar bracket type ZX2BP2
- Rated current (I_n) max. 250 A
- Combination sets are plugged into distribution panels at the top and bottom and thus are provided as an interim installation

2	300	1	250	24	ED71SA	2CPX037812R9999
		2	500	48	ED72SA	2CPX037813R9999

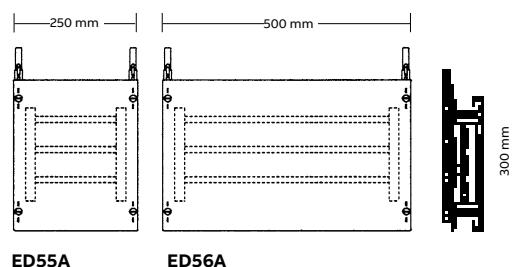

- Busbar center distance 60 mm
- With 3-pole busbars 12 x 5 mm
- With busbar bracket type ZX151
- Rated current (I_n) max. 250 A (for expansion with bus-mounting fuse socket max. 100 A)
- Combination sets are plugged into the distribution panel at the top or bottom and mounted on the other side of the cabinet

2	300	1	250	24	ED55A	2CPX037808R9999
		2	500	48	ED56A	2CPX037809R9999

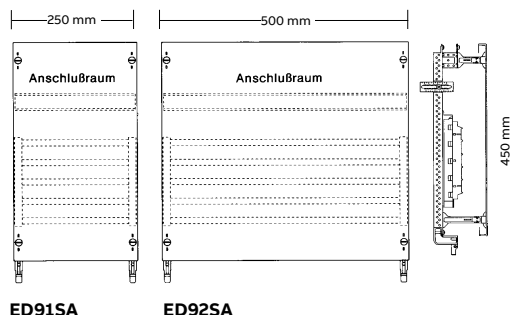

- Busbar center distance 40 mm
- With 5-pole busbars 12 x 5 mm
- With busbar bracket type ZX2BP2
- Rated current (I_n) max. 250 A
- In addition, mounted with a DIN rail on a deep angle piece ED33P2
- Combination sets are plugged into the distribution panel at the top or bottom and mounted on the other side of the cabinet

3	450	1	250	36	ED91SA	2CPX037816R9999
		2	500	72	ED92SA	2CPX037817R9999

Internal expansion system - Combination sets

Mounting plates, terminal blocks and Tmax circuit

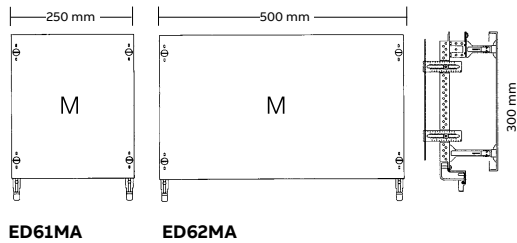

- Mounting plates that are variably adjustable in depth via the deep angle piece ED33
- Combination sets are plugged into the distribution panel at the top or bottom and mounted on the other side of the cabinet
- The maximum installation depth between mounting plate and cover is 178 mm

Height		Width			PLE	From cabinet depth	Type	Order code
RE	mm	FB	mm					
2	300	1	250	24	200	ED61MA	2CPX037820R9999	
		2	500	48				

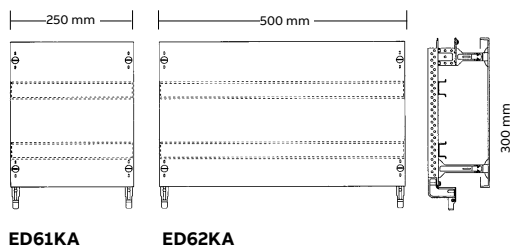

- With horizontally-arranged DIN rails 35 x 15 mm
- DIN rails can be set up to be protection-insulated with the insulator piece ZK90P2 if necessary
- Row spacing 150 mm (can be moved when it is needed)
- Combination sets are plugged into the distribution panels at the top and bottom and attached on the other side of the cabinet

2	300	1	250	24	200	ED61KA	2CPX037822R9999
		2	500	48			
3	450	1	250	36	200	ED91KA	2CPX037824R9999
		2	500	72			

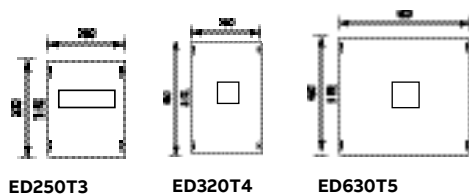

- For power switches ABB T-max
- ED250T3, Tmax XT1, 2 x 3-pole, 1 x 4-pole
Tmax XT3, 1 x 3-pole, 1 x 4-pole, in the small distributor only
1 x Tmax XT1 with rocker arm max. I_n to 100 A
- ED320T4, Tmax, T4, 3-pole
- ED630T5, Tmax, T4, 4-pole and Tmax, T5, 3- and 4-pole
Combination sets can only be used in combination with distribution panels

2	300	1	250	24	200	ED250T3	2CPX037826R9999
3	450	1	250	36	200	ED320T4	2CPX037827R9999
		2	500	72			

Interior expansion system - Distribution panels/combination sets

General accessories



ED30P2



ED31P2



ED32P2



ZK300

Article	Unit	Type	Order code
Panel connector for EDF profile For any combination of distribution panels or EDF profile rails up to a maximum of 9 grid units	2	ED30P2	2CPX062302R9999
Lowering connector for EDF profile For equalizing deep-lying mounting levels of busbars and mounting plate panels up to 9 grid units	2	ED31P2	2CPX062303R9999
Lowering bracket for EDF profile For equalizing the front to rear mounting level	2	ED32P2	2CPX062304R9999
N/PE busbar system for distribution panels Copper 12 x 5 mm, max. connection 95 mm ² , rated current (I _n) 250 A			
1-field width	1	ZK300	2CPX038551R9999
2-field width	1	ZK301	2CPX038552R9999



ZK113B



ZK113G



ZK10P10



ZK14



ZK15

Article	Number of terminals 1.5 - 4 mm ²	Number of terminals 2.5 - 25 mm ²	External dimensions H x W x D in mm	Unit	Type	Order code
N Quick plug-in terminals For Quick plug-in carrier	5	0	23 x 32 x 21	1	ZK50B	2CPX062750R9999
	5	1	32 x 32 x 31	1	ZK51B	2CPX062751R9999
	8	2	32 x 49 x 31	1	ZK82B	2CPX062752R9999
	11	3	32 x 65 x 31	1	ZK113B	2CPX062753R9999
	14	4	32 x 82 x 31	1	ZK144B	2CPX062754R9999
	17	5	32 x 98 x 31	1	ZK175B	2CPX062755R9999
PE Quick plug-in terminals For Quick plug-in carrier	20	6	32 x 115 x 31	1	ZK206B	2CPX062756R9999
	5	1	32 x 32 x 31	1	ZK51G	2CPX062757R9999
	8	2	32 x 49 x 31	1	ZK82G	2CPX062758R9999
	11	3	32 x 65 x 31	1	ZK113G	2CPX062759R9999
	14	4	32 x 82 x 31	1	ZK144G	2CPX062760R9999
Connecting bridges For Quick plug-in terminals	17	5	32 x 98 x 31	1	ZK175G	2CPX062761R9999
	20	6	32 x 115 x 31	1	ZK206G	2CPX062762R9999
				10	ZK10P10	2CPX062763R9999
				1	ZK14	2CPX064983R9999
Quick plug-in carrier For distribution panels Usable width for Quick plug-in terminals 214 mm 13 units				1	ZK14	2CPX064983R9999
Adapter for ZK50B By snapping the ZK50B N Quick plug-in terminal into the ZK15 adapter, the ZK50BT is ready for lateral mounting in the UK5 ..., A3 ... or for snapping onto the DIN rail				1	ZK15	2CPX064984R9999

Interior expansion system - Distribution panels/combination sets

General accessories



ZX66P4



ED44P10



ED45P10



ED59P10



ED42P10



ED43P10



ED47



ZA1P5



ZA122

Article	Unit	Type	Order code
Device carrier connector For connecting EDF and WR mounting frames	4	ZX66P4	2CPX062562R9999
	50	ZX66P50	2CPX068614R9999
Wire holder For wire guidance, installation depth 28.5 mm, to be inserted into the DIN rail from the rear	10	ED44P10	2CPX062335R9999
	50	ED44P50	2CPX062308R9999
	1000	ED44P1000	2CPX062703R9999
Wire holder For the wire guidance or receiving a plastic tube of \varnothing 38 mm, installation depth 55 mm, to be inserted in the DIN rail from the rear	10	ED45P10	2CPX062336R9999
	50	ED45P50	2CPX062310R9999
	1000	ED45P1000	2CPX062704R9999
DIN rails adapter For ED44 and ED45, to be snapped onto the DIN rail from the front	10	ED59P10	2CPX062339R9999
Console for the ED44 and ED45 wire holders To be inserted in the DIN rail from the rear	10	ED42P10	2CPX062333R9999
Console for the ED44 and ED45 wire holders To be snapped onto the DIN rail from the front	10	ED43P10	2CPX062334R9999
Cover As a view shutter for wire guidance in the wire holder ED44 and ED45, 1 m long	1	ED47	2CPX039309R9999
Blanking plates For 12 space units, breakable Color RAL 7035	5	ZA1P5	2CPX062384R9999
	50	ZA1P50	2CPX062378R9999
Running meter Color RAL 7035	1	ZA2	2CPX038231R9999
	20	ZA2P20	2CPX062379R9999
Cleaning agent for covers Pump spray bottle, 500 ml	1	ZA122	2CPX038293R9999

Interior expansion system - Distribution panels/combination sets

General accessories



ZA8



ZA71

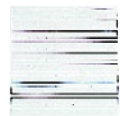

ZA27



ZA73



ZA74



ZA78



ZA79

Article	Unit	Type	Order code
Marking stripes			
20 mm, self-adhesive, 1-field width	1	ZA8	2CPX060200R9999
	5	ZA8P5	2CPX062598R9999
	40	ZA8P40	2CPX062731R9999
20 mm, self-adhesive, 2-field width	1	ZA9	2CPX060201R9999
	5	ZA9P5	2CPX062599R9999
	50	ZA9P50	2CPX062732R9999
20 mm, self-adhesive, 3-field width	1	ZA7	2CPX060004R9999
	5	ZA7P5	2CPX062597R9999
20 mm, self-adhesive, per running meter	1	ZA10	2CPX038241R9999
	10	ZA10P10	2CPX062706R9999
20 mm, self-adhesive, with additional transparent film, per running meter	1	ZA11	2CPX038230R9999
	10	ZA11P10	2CPX062707R9999
16 mm, self-adhesive, per running meter	1	ZA12	2CPX038242R9999
	10	ZA12P10	2CPX062708R9999
Labeling system for busbars L1, L2, L3, N, PE, 1 sheet = 120 different stickers	1	ZA71	2CPX038458R9999
Labeling system Self-adhesive, for labeling by hand or with a machine, consisting of: 1 sheet with 10 strips	1	ZA27	2CPX038495R9999
Labeling system For distribution panel, up to 6 RE	1	ZA73	2CPX038497R9999
Labeling system For distribution panel, up to 9 RE	1	ZA74	2CPX038498R9999
Labeling system For 8 x 12 PLE	1	ZA78	2CPX031569R9999
Legend for 72 devices PLE	1	ZA79	2CPX031570R9999

Subdistribution boards

Fire protection housing – Housing for preventive fire protection

Preventive fire protection is not just the job of the construction managers. Electrical designers and installers or switchgear manufacturers are responsible during planning and execution for making sure that their systems will not be the cause of a fire. In electrical switchgear, the following elements:

- Loose terminals
- Short circuits
- Fault arcs
- Overloads
- Insulation errors
- Lightning strikes

can cause a fire. Therefore, the system operator also needs to make the appropriate contribution by checking the electrical systems at fixed intervals, maintaining them and upgrading them as needed.

In the case of technical installations in industry or in building complexes with large concentrations of people, such as in airports, train stations, nursing homes, hospitals or hotels, it is vital that the functionality of safety-relevant electrical systems is maintained even during a fire.

ABB STRIEBEL & JOHN offers you an innovative housing system for preventive fire protection made of non-flammable material with optimal technical and economic expansion options.

A wide range of wall and standing housings are available in various cabinet sizes.

Subdistribution boards

Fire protection housing – General technical data

Technical parameters

Mounting type	UP wall mounting/AP wall mounting/AP standing mounting
Housing	Highly compressed, multi-layer fire protection panels (DIN 4102-1/DIN EN 13501-1) of building material class 'A2' non-flammable, smoke-tight
Surface	Coating light gray - similar to RAL 7035, edges in contrasting colors
Door	Door hinge right or left as standard, left also possible after conversion, opening angle approx. 180 degrees
Lock	Locking with sash lock through swivel handle with double bit half cylinder
Interior expansion	Prepared for installing distributor fields and CombiLine module system fields
Cable entries	Top and bottom
Standard ventilation	Ventilation in case of fire self-closing
Additional equipment	IP54, various decorative surfaces, reinforced back wall for free installation

Standards/regulations*

DIN EN 61439-2 (VDE 0660-600-2) (modules EDFmounting frame)	X
DIN 43880 (rail-mounted devices)	X
Protection class	IP41/IP44/IP54
Installation site/environment	Interior space
Ambient temperature, 24-hour average	+ 35°
Ambient temperature maximum value	+ 40 °
Ambient temperature minimum value	- 5°

Electrical characteristics

Rated impulse withstand voltage U_{imp}	III/6 kV
Pollution degree	3
Protection class	II
Rated surge current resistance I_{pk}	max. 17 kA
Rated short-time current I_{cw} 1.0 sec	max. 10 kA
Rated frequency	50-60 Hz
Rated insulating voltage U_i	690 V
Rated operating voltage AC U_e	400 V

Subdistribution boards

Fire protection housing – Standard features

Material
+ Decor
A2 Class

Fire
Resistance
30 Min.

Fire
Resistance
90 Min.



Material/design

- Building material with surface – A2-s1, d0
- Fire resistance F30/F90
- Protection class depending on application, IP41, IP44 or IP54
- Smoke-tight
- Cold smoke-proof
- Wall thickness reduced to 72 mm



Locking using the swivel handle

The doors have swivel levers in stainless steel look, which are located centrally and can be locked with double bit half cylinders

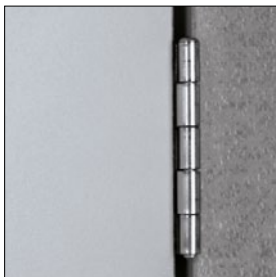

Changeable door hinge

The door hinge is easy to change - to convert, unscrew the hinge from the door joint and screw it into the opposite joint. The door is fastened using the pre-drilled fixing holes in the door and the cabinet body. The door hinge is on the right as standard.

Stainless steel hinges

High-quality stainless steel hinges with a push-out axle pin allow for easy removal of the door. If necessary, significant weight reduction can thus be achieved for transport.



Mounting tabs

The flush-mounted wall housings are screwed from the outside with two mounting tabs attached to the head part, each with a dowel on the wall behind it. Therefore, the equipped housing can be easily and quickly mounted.



Integrated ventilation system

Consisting of fan and smoke detector, ready for connection (230 V AC), this reduces the area that can be fitted by one grid unit (RE).

Subdistribution boards

Fire protection housing – Standard features



Cable sheath

Cable sheaths for bundle or individual cable entry are located at the top and bottom of the housing.

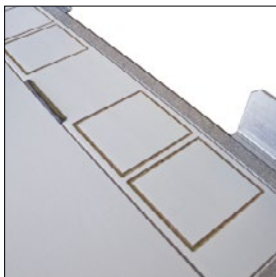

Cable sheath (delivery condition)

The cable sheaths are standard in all wall and standing housings. This ensures quick and easy cable entry for every application.

Silicone seal

To increase the protection class to IP54, a full-perimeter silicone seal is needed for the cable entry points (see page 18/338).



- Empty housing, prepared for installing distributor fields and CombiLine module system fields each minus one raster unit per housing
- Doors are easy to remove - axle pin can be pushed out (reduced transport weight)
- Door opening angle 180 degrees
- Locking with rod lock, 2-point locking
- Color light gray - similar to RAL7035, with colored edges
- High chemical resistance (surface characteristics based on DIN EN 438-2)
- High mechanical strength and stability, Brinell hardness 50 N/mm²
- High material density 1,450 kg/m³
- Integrated ventilation system (area that can be fitted is reduced by one grid unit)

Subdistribution boards

Fire protection housing – Overview



Flush-mounted wall housing UF, IP41

Housing depth 205 mm

Housing for flush mount

Material
+ Decor
A2 Class

Fire
Resistance
30 Min.

Fire
Resistance
90 Min.



Surface-mount wall housing AF, IP44

Housing depth 349 mm (internal depth 240 mm)

Housing for surface wall mounting

Material
+ Decor
A2 Class

Fire
Resistance
30 Min.

Fire
Resistance
90 Min.



Standing housing SF, IP44

Housing depth 349 mm (internal depth 240 mm)

Housing for standing installation

Material
+ Decor
A2 Class

Fire
Resistance
30 Min.

Fire
Resistance
90 Min.

Subdistribution boards

Fire protection housing – Overview



Sheath housing MF, IP41

Housing for mounting using available distributors



Electric operating compartment in compact design KEB, IP54

Housing depth 586 mm

Housing to place individually equipped distributors

External ventilation system with functional integrity required

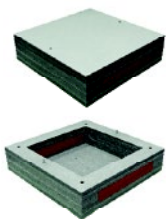

Terminal boxes without terminal block KF, IP41

Housing for wall or ceiling mounting

Mounting material for ceiling mounting available on request



Facing doors VF, IP54

Doors which are installed in front of existing flush-mounted distributors



Subdistribution boards

Fire protection housing – Additional equipment

Wall housing/standing housing when mounting or installing as freestanding unit

If installing as a free-standing unit, or in case of an extremely uneven wall, a BRW18 - BRW38 fire protection plate (42 mm thick) must be additionally screwed onto the back wall of the housing.

> The fire protection plate must be ordered separately, see page 18/328

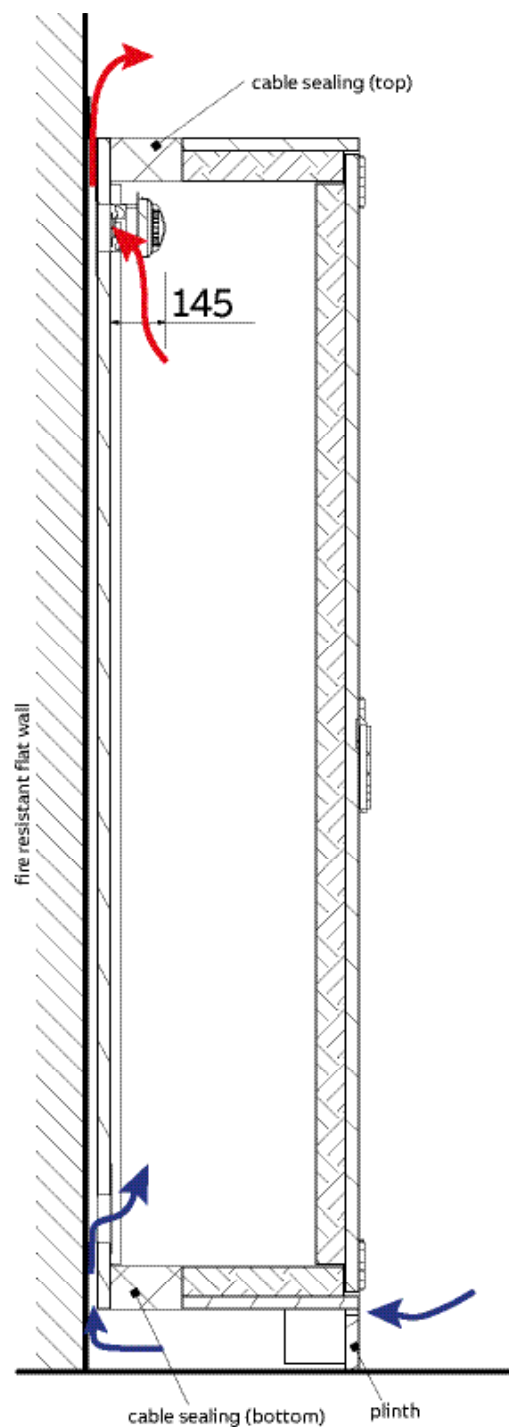

Schematic representation of ventilation in a standing housing

Subdistribution boards

Fire protection housing – Configuration example/mounting instructions

Configuration example: Surface-mount wall housing AF

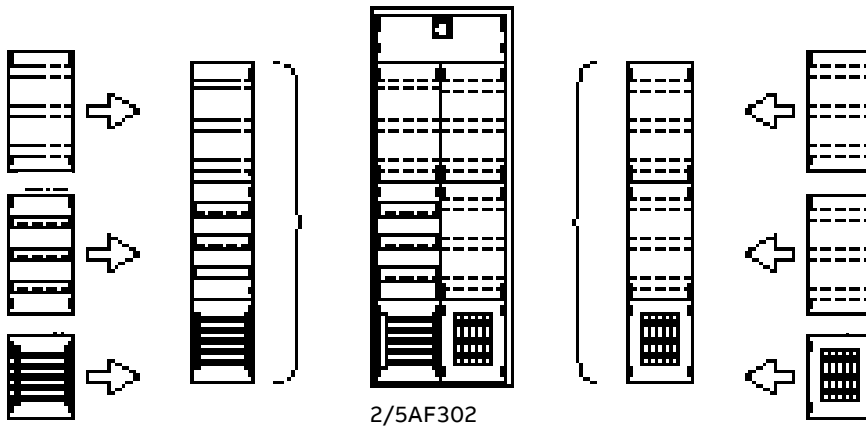

Configuration example: Standing housing SF

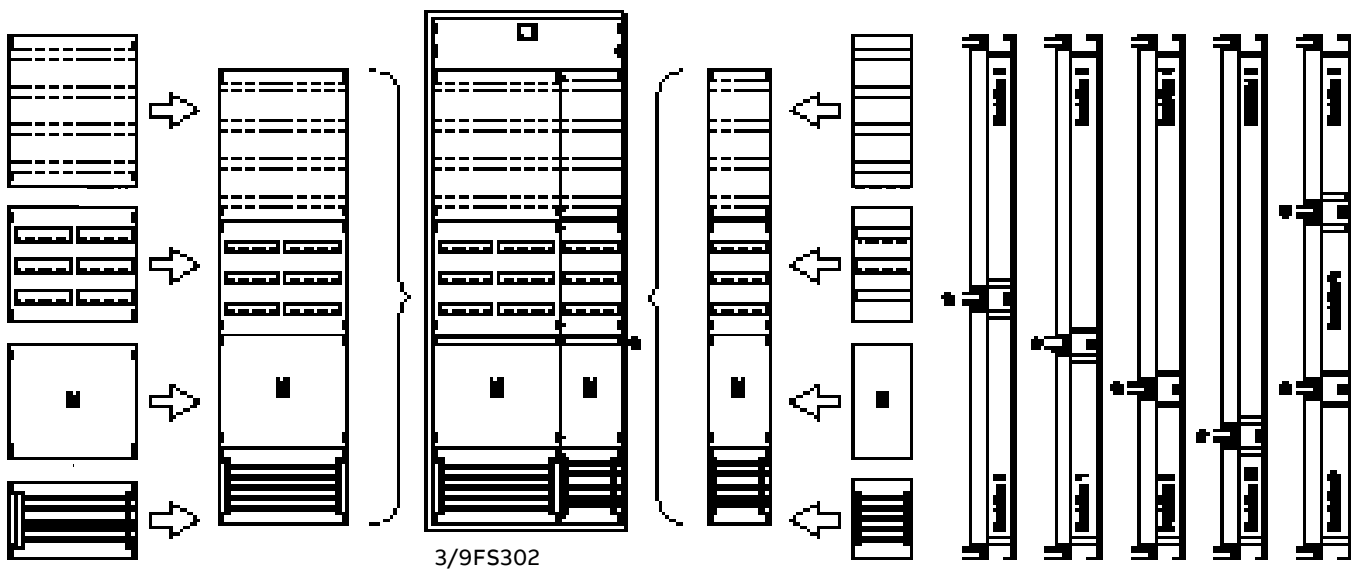

*Middle support rail adjustable up and down

Important notes

For flush-mounted, surface-mounted and standing housings, the mounting frames needed to hold the CombiLine modules or distributor panels are prefitted (for CombiLine modules and distributor fields/combination sets see chapter 8)

There is a fan in the upper part of the housing which occupies the space of one grid unit (1 RE). This space has a closed cover and is not available for the installation of CombiLine modules or distributor fields/combination sets.

When planning modular system fields for standing housings, the middle support rail, which extends over the entire width of the housing, must be taken into account (see configuration example Standing housing SF).

Subdistribution boards

Fire protection housing – Flush-mounted wall housing



Flush-mounted wall housing UF, IP41

Housing depth 205 mm

Housing for flush mount



Main features

- Material with A2 surface coating - non-combustible, tested in accordance with DIN 4102-1
- Fire resistance F30/F90, tested in accordance with DIN 4102-2
- Protection type in accordance with IP41  protection class II
- Smoke-tight, cold smoke-tight

Structure

- Flush mount (solid wall F30/F90)
- Prepared for installation of distributor fields
- Prepared for expansion with CombiLine modules on EDFmounting frame
- Changeable door hinge
- Door can be de-attached, thereby reducing weight
- Locking with sash lock using swivel handle with double bit half cylinder
- Cable entry at the bottom and top
- Door internal
- Opening angle 180 degrees

Surface

- Color light gray - similar to RAL 7035, with colored edges
- High chemical resistance
- High mechanical strength and stability

Additional equipment/options

- A variety of decorative surfaces

Subdistribution boards

Fire protection housing – Flush-mounted wall housing, IP41 , depth 205 mm

Overall height	Locking unit	Field width	Door hinge	Space units	External dimensions in mm			Weight in kg
Overall height	RE	FB		PLE	H × W × D	Type	Item number	
Flush-mounted wall housing, IP41 , depth 205 mm								
0	4	1	right	48	682 × 332 × 205	1/0UF2020	2CPX040008R9999	41
0	4	1	left	48	682 × 332 × 205	1/0UF2120	2CPX040009R9999	41
0	4	2	right	96	682 × 582 × 205	2/0UF2020	2CPX040020R9999	58
0	4	2	left	96	682 × 582 × 205	2/0UF2120	2CPX040021R9999	58
2	6	1	left	72	982 × 332 × 205	1/2UF2120	2CPX040029R9999	55
2	6	2	right	144	982 × 582 × 205	2/2UF2020	2CPX040040R9999	80
2	6	2	left	144	982 × 582 × 205	2/2UF2120	2CPX040041R9999	80



Flush-mounted wall housing, IP41 , depth 205 mm								
0	4	1	right	48	682 × 332 × 205	1/0UF2021	2CPX040052R9999	49
0	4	1	left	48	682 × 332 × 205	1/0UF2121	2CPX040053R9999	49
0	4	2	right	96	682 × 582 × 205	2/0UF2021	2CPX040064R9999	70
0	4	2	left	96	682 × 582 × 205	2/0UF2121	2CPX040065R9999	70
2	6	1	right	72	982 × 332 × 205	1/2UF2021	2CPX040076R9999	67
2	6	1	left	72	982 × 332 × 205	1/2UF2121	2CPX040077R9999	67
2	6	2	right	144	982 × 582 × 205	2/2UF2021	2CPX040088R9999	99
2	6	2	left	144	982 × 582 × 205	2/2UF2121	2CPX040089R9999	99



> For dimensions and weights, see page [For dimensions and weights, see page 18/338](#)

> For CombiLine modules and distributor panels see chapter on interior expansion systems

Subdistribution boards

Fire protection housing – Surface-mount wall housing



Surface-mount wall housing AF, IP44

Housing depth 349 mm

Housing for surface wall mounting



Main features

- Material with A2 surface coating - non-combustible, tested in accordance with DIN 4102-1/ EN 135 01-1
- Fire resistance F30/F90, tested in accordance with DIN 4102-2
- Protection type in accordance with IP44  protection class II
- Smoke-tight, cold smoke-tight
- Ventilation system in the rear wall

Structure

- Wall mounting (solid wall F30/F90)
- Prepared for installation of distributor fields
- Prepared for expansion with CombiLine modules on EDFmounting frame
- Changeable door hinge on site, standard right
- Door can be de-attached, thereby reducing weight
- Locking with rod lock using swivel handle with double bit half cylinder
- Cable entry at the bottom and top
- Mounting tabs placed externally
- Door internal
- Opening angle 180 degrees

Surface

- Color light gray - similar to RAL 7035, with colored edges
- High chemical resistance
- High mechanical strength and stability

Subdistribution boards

Fire protection housing – Surface-mount housing, IP44 □, depth 349 mm

Overall height	Locking unit	Field width	Space units	External dimensions in mm			Weight in kg
Overall height	RE	FB	PLE	H × W × D	Type	Item number	
Surface-mount housing, IP44 □, depth 349 mm							
00	3	1	36	598 × 398 × 349	1/00AF302	2CPX043265R9999	51
00	3	2	72	598 × 648 × 349	2/00AF302	2CPX043266R9999	71
0	4	1	48	748 × 398 × 349	1/0AF302	2CPX043267R9999	62
0	4	2	96	748 × 648 × 349	2/0AF302	2CPX043268R9999	85
1	5	1	60	898 × 398 × 349	1/1AF302	2CPX043269R9999	73
1	5	2	120	898 × 648 × 349	2/1AF302	2CPX043270R9999	99
2	6	1	72	1048 × 398 × 349	1/2AF302	2CPX043271R9999	83
2	6	2	144	1048 × 648 × 349	2/2AF302	2CPX043272R9999	114
3	7	1	84	1198 × 398 × 349	1/3AF302	2CPX043274R9999	94
3	7	2	168	1198 × 648 × 349	2/3AF302	2CPX043275R9999	128
3	7	3	252	1198 × 898 × 349	3/3AF302	2CPX043276R9999	163
4	8	2	192	1348 × 648 × 349	2/4AF302	2CPX043278R9999	143
5	9	2	216	1498 × 648 × 349	2/5AF302	2CPX043281R9999	157



Surface-mount housing, IP44 □, depth 349 mm							
0	3	1	36	598 × 398 × 349	1/00AF303	2CPX043380R9999	53
0	4	1	48	748 × 398 × 349	1/0AF303	2CPX043381R9999	64
0	4	2	96	748 × 648 × 349	2/0AF303	2CPX043382R9999	87
1	5	1	60	898 × 398 × 349	1/1AF303	2CPX043383R9999	75
1	5	2	120	898 × 648 × 349	2/1AF303	2CPX043384R9999	101
2	6	1	72	1048 × 398 × 349	1/2AF303	2CPX043385R9999	85
2	6	2	144	1048 × 648 × 349	2/2AF303	2CPX043386R9999	114
2	6	3	216	1048 × 898 × 349	3/2AF303	2CPX043387R9999	119
3	7	1	84	1198 × 398 × 349	1/3AF303	2CPX043388R9999	96
3	7	2	168	1198 × 648 × 349	2/3AF303	2CPX043389R9999	130
3	7	3	252	1198 × 898 × 349	3/3AF303	2CPX043390R9999	165



Important note

A cooling shutter is included for F90 fire resistance.

> For surface-mount wall housing dimensions and weights, see page 18/338

> For CombiLine modules and distributor panels see chapter on interior expansion systems

Subdistribution boards

Fire protection housing – Standing housing



Standing housing SF, IP44

Housing depth 349 mm

Housing for standing installation



Main features

- Material with A2 surface coating - non-combustible, tested in accordance with DIN 4102-1/ EN 135 01-1
- Fire resistance F30/F90, tested in accordance with DIN 4102-2
- Protection type in accordance with IP44  protection class II
- Smoke-tight, cold smoke-tight
- Ventilation system in the rear wall

Structure

- Freestanding installation
- Prepared for installation of distributor fields
- Prepared for expansion with CombiLine modules on EDF mounting frame
- Changeable door hinge, option of right or left
- Door can be de-attached, thereby reducing weight
- Locking with rod lock using swivel handle with double bit half cylinder
- Cable sheath for bundle entry or single entry
- Cable entry point, top and bottom
- Door internal
- Opening angle 180 degrees
- Base with removable front for pallet truck
- Ventilation system through the back wall of the housing

Surface

- Color light gray - similar to RAL 7035, with colored edges
- High chemical resistance
- High mechanical strength and stability

Important note

If installing as a free-standing unit, or in case of an extremely uneven wall, a fire protection plate (42 mm thick) must be additionally screwed onto the back wall of the housing (see page 18/338)

Subdistribution boards

Fire protection housing – Standing housing, IP44 ☐, depth 349 mm

Overall height	Locking unit	Field width	Door hinge	Space units	External dimensions in mm			Weight in kg
Overall height	RE	FB	(Standard)	PLE	H × W × D	Type	Item number	
Standing housing IP44 ☐, depth 349 mm								
8	12	1	right	144	2048 × 398 × 349	1/8SF302	2CPX043290R9999	152
8	12	2	right	288	2048 × 648 × 349	2/8SF302	2CPX043292R9999	206
8	12	3	right	432	2048 × 898 × 349	3/8SF302	2CPX043294R9999	259
9	13	1	right	156	2198 × 398 × 349	1/9SF302	2CPX043304R9999	163
9	13	2	right	312	2198 × 648 × 349	2/9SF302	2CPX043306R9999	220
9	13	3	right	468	2198 × 898 × 349	3/9SF302	2CPX043308R9999	278



Standing housing IP44 ☐, depth 349 mm								
8	12	1	right	144	2048 × 398 × 349	1/8SF303	2CPX043391R9999	154
8	12	2	right	288	2048 × 648 × 349	2/8SF303	2CPX043392R9999	208
8	12	3	right	432	2048 × 898 × 349	3/8SF303	2CPX043393R9999	261
9	13	1	right	156	2198 × 398 × 349	1/9SF303	2CPX043394R9999	165
9	13	2	right	312	2198 × 648 × 349	2/9SF303	2CPX043395R9999	222
9	13	3	right	468	2198 × 898 × 349	3/9SF303	2CPX043396R9999	280

Important note

A cooling shutter is included for F90 fire resistance.



> For standing housing dimensions and weights, [see page For standing housing dimensions and weights, see page 18/338](#)

> For CombiLine modules and distributor panels see chapter on interior expansion systems

Subdistribution boards

Fire protection housing – Sheath housing



Sheath housing MF, IP41

Housing depth 396 mm

Housing for mounting using available distributors

**Main features**

- Material with A2 surface coating - non-combustible, tested in accordance with DIN 4102-1
- Fire resistance F30, tested in accordance with DIN 4102-2
- Protection class in accordance with IP41
- Smoke-tight

Structure

- Wall mounting
- Changeable door hinge
- Door can be de-attached, thereby reducing weight
- Locking with rod lock using swivel handle with double bit half cylinder
- Cable sheath for bundle entry
- Door internal
- Opening angle 180 degrees

Surface

- Color light gray - similar to RAL 7035, with colored edges
- High chemical resistance
- High mechanical strength and stability

Important note

The sheath housings are not suitable for fan mounting.
Sheath housings may only be mounted on fire-resistant walls.

Subdistribution boards

Fire protection housing – Sheath housing, IP41, depth 396 mm

Internal dimensions in mm		External dimensions in mm		Weight in kg	
H × W × D	H × W × D	Type	Item number		
Sheath housing, IP41, depth 396 mm					
665 × 354 × 240	829 × 518 × 340	1/0MF300	2CPX042420R9999		85
815 × 354 × 240	979 × 518 × 340	1/1MF300	2CPX042421R9999		97
815 × 604 × 240	979 × 768 × 340	2/1MF300	2CPX042422R9999		124
1115 × 354 × 240	1279 × 518 × 340	1/3MF300	2CPX042423R9999		121



Subdistribution boards

Fire protection housing – Electric functional unit in compact design/
fire resistance 90 minutes

Fire-resistant functional unit made of non-combustible A2 building material for enclosing electrical safety systems as prescribed by building regulations. Complete distributor housings, e.g. TwinLine, with at least IP54 protection are installed in the fire-resistant functional units.

Housing of individually equipped low-voltage switchgear assemblies without separate building law proof for functional integrity (MLAR/MEltBauVO).

In this design, switchgear assemblies are suited for higher power dissipation than fire protection housings.

Important!

The functional units are prepared for connection to on-site ventilation systems. The ventilation system must be designed so that ventilation is guaranteed for the intended time even in case of fire.



For a more clear illustration, there are no doors in the figures presented

Subdistribution boards

Fire protection housing – Electric functional unit in compact design/
fire resistance 90 minutes

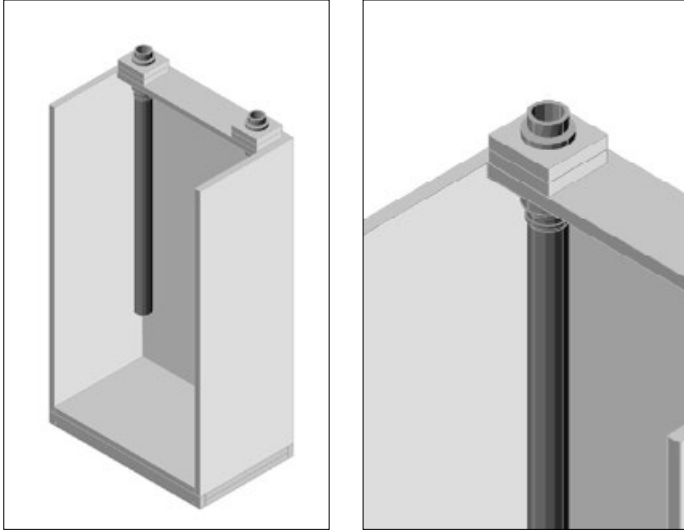

Ventilation

The functional units are prepared for connection to on-site ventilation systems. The ventilation system must be designed so that ventilation is guaranteed for the intended time even in case of fire.

Supply air DN 100

two cable entry points \varnothing 135 mm

Exhaust air DN 100

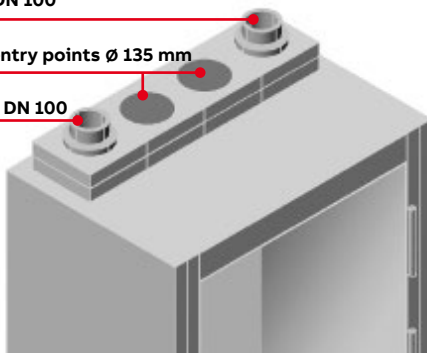

Cable entry

Cable entry from the top through two fire-resistant cable ducts.

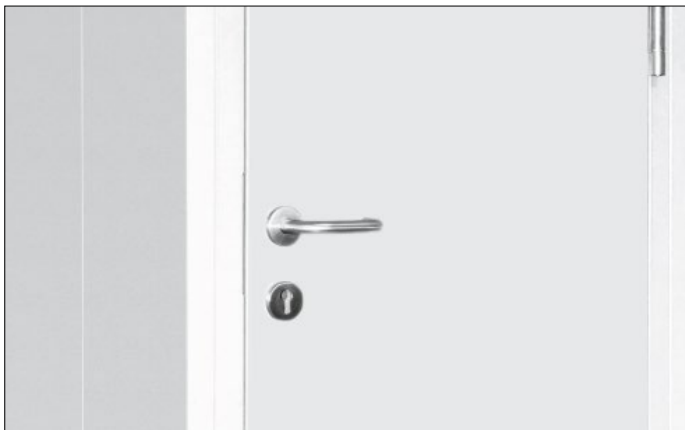

Door

- With door handle, smoke-tight, self-closing
- Prepared for profile half cylinder
- Optionally with fire-proof window

Types of delivery

- Completely assembled
- As a kit for self-assembly

Subdistribution boards

Fire protection housing – Electric functional unit in compact design/
fire resistance 90 minutes



Electric functional unit in compact design KEB, IP54

Depth 586 mm

Housing in compact design



Main features

- Fire resistance 90 minutes, fire resistant
- F 90 classification walls/ceiling
- T 90-RS classification of the door
- Smoke-tight door, tested for permanent function, self-closing
- IP54 protection class



Structure

- Functional unit with high mechanical and chemical resistance in two standard sizes
- Fire protection through the creation of a separate fire compartment
- Free-standing construction
- Door opening angle 180 degrees, self-closing
- De-attachable door, handle set in aluminum silver
- Locking via 3-latch lock for profile half cylinder
- Door with all-round smoke and fire protection seals, self-foaming in case of fire
- Fire-resistant, smoke-tight supply/exhaust air system per NW 100 mm for connection to on-site ventilation system
- Fire resistant cable sheaths 135 mm diameter
- Base mounted, included in scope of delivery

Material

- Material with surface coating, classified A2 - s1, d0: non-flammable
- Standard surface HPL is chemically highly resistant and insensitive to moisture
- Standard color light gray, similar to RAL 7035, edges and chamfers are darkened

Additional equipment/options

- Fire-proof viewing window in the door
- Additional cable entry point

Subdistribution boards

Fire protection housing – Functional units/base



KEB28R



KEB38R

Field width	External dimensions in mm			Type	Item number	Weight in kg
	H × W × D	Door hinge				
FB						
Completely mounted						
2-field width	2501 × 894 × 586	right		KEB28R	2CPX042930R9999	662
	2501 × 894 × 586	left		KEB28L	2CPX042931R9999	662
As a kit						
2-field width	2501 × 894 × 586	right		KEB28RB	2CPX042932R9999	662
	2501 × 894 × 586	left		KEB28LB	2CPX042933R9999	662

Completely mounted						
3-field width	2501 × 1144 × 586	right		KEB38R	2CPX042934R9999	692
	2501 × 1144 × 586	left		KEB38L	2CPX042935R9999	692
As a kit						
3-field width	2501 × 1144 × 586	right		KEB38RB	2CPX042936R9999	692
	2501 × 1144 × 586	left		KEB38LB	2CPX042937R9999	692



BSR2



BSR3

Article	Dimensions in mm H × W × D	Type	Item number	Weight in kg
Base* Width 810 mm 2-field width	84 × 894 × 586	BSR2	2CPX042938R9999	50
Base* Width 1060 mm 3-field width	84 × 1144 × 586	BSR3	2CPX042939R9999	65

* Bases are included in the scope of delivery of the functional units.

>For dimensions, see page 18/360

Subdistribution boards

Fire protection housing – Terminal boxes without terminal block

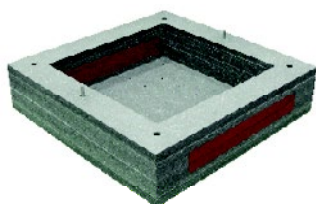
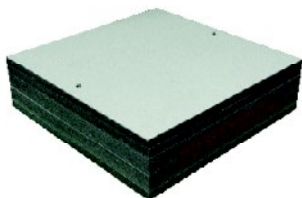

Terminal boxes without terminal block KF, IP41

Housing for wall or ceiling mounting

Mounting material for ceiling mounting available on request



Main features

- Material with A2 surface coating - non-combustible, tested in accordance with DIN 4102-1
- Fire resistance F30, tested in accordance with DIN 4102-2
- Protection class in accordance with IP41 
- Smoke-tight

Structure

- Mounting via 4 holes in the frame corners using the enclosed mounting material
- Mounting to wall or ceiling possible
- Cover screwed with two self-locking nuts
- Cover provided with a handle groove
- Cable entry points from 2 sides
- In case of fire, the cable sheath automatically foams up
- Easy mounting of the fixtures using pre-drilled holes
- Easy insertion and clamping of the cables thanks to a detachable frame plate system (layer structure)

Surface

- Color light gray - similar to RAL 7035, with colored edges
- High chemical resistance
- High mechanical strength and stability

Subdistribution boards

Fire protection housing – Terminal boxes without terminal block, IP41 

Internal dimensions in mm	External dimensions in mm	Cable entry point			Item number	Weight in kg
		W × H	Number	Type		
H × W × D	H × W × D					
Terminal boxes without terminal block, IP41 						
200 × 200 × 84	350 × 350 × 128	50 × 170	2	KF35140	2CPX041092R9999	17
300 × 300 × 84	450 × 450 × 128	50 × 270	2	KF45140	2CPX041093R9999	25
400 × 400 × 84	550 × 550 × 128	50 × 370	2	KF55140	2CPX041094R9999	34



Subdistribution boards

Fire protection housing – Facing doors

Facing doors VF IP54

- Fire-resistant and smoke-tight seals
- Panel material with surface coating - non-flammable
- Fire resistance 30 and 90 minutes
- Mounting on different wall constructions



Fire protection facing doors are intended for the separation of existing flush-mounted wall distributions from escape and rescue paths.



Subdistribution boards

Fire protection housing – Facing doors

In the standard version, the distributor may protrude 20 mm out of the wall at the most. Old doors should be de-attached and removed.

The facing door must be at least 115 mm above the existing distributor, i.e. this covering dimension plus the door thickness, due to the opening angle, must be maintained around the existing distributor.

If the current distributor protrudes more than 20 mm from the wall, an additional extension frame can be ordered for the facing door.

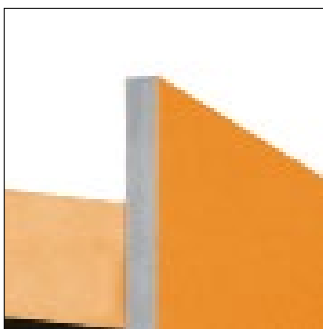

Tested material with surface coating
DIN 4102 Part 1; material class A2



Integrated frame with mounting points



Removable stainless steel hinges

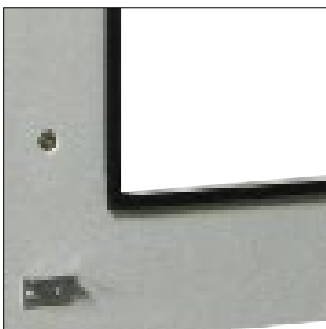

Fire and smoke protection seal all around

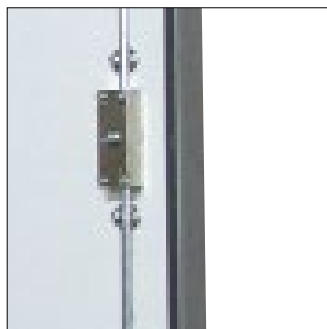

2-point locking using rod lock



Swivel handle in stainless steel look
with double bit half-cylinder

Subdistribution boards

Fire protection housing – Facing doors



Facing doors VF, IP54

Door depth for 30 minutes 51 mm

Door depth for 90 minutes 71 mm

Door mounted in front of existing flush-mounted distributors



Function

- Material with A2 surface coating - non-combustible, tested in accordance with DIN 4102-1
- Fire resistance F30/F90, tested in accordance with DIN 4102-2
- Smoke-tight
- Protection class in accordance with IP54

Structure

- 1-wing door
- Door opening angle approx. 180 degrees with F30 version, approx. 150 degrees with F90 version
- Door hinge on right
- Surrounding wall compensating frame (W x D: 115 x 28 mm) with mounting holes
- Doors opening onto the frame
- Locking with swivel handle in metal look with DIN half cylinder
- 2-point locking with rod lock
- Stainless steel hinges with push-out axle pin for de-attaching the door wings
- Mounting material: Frame dowels, screws included in scope of delivery

Surface

- Color light gray - similar to RAL7035, with colored edges
- High chemical resistance
- High mechanical strength and stability, Brinell hardness 50 N/mm²
- High material density 1,450 kg/m³
- Surface characteristics based on DIN EN 438-2

Additional equipment/options

- Additional compensating frame for larger covers
- A variety of decorative surfaces
- Door hinge on left

Subdistribution boards

Fire protection housing – Facing doors, IP54, door depth 51 mm and 71 mm

Overall height	Field width	Door hinge	Internal dimensions in mm	External dimensions in mm			Weight in kg
Overall height	FB		H × W × D	H × W × D	Type	Item number	
Facing doors, IP54, door depth 51 mm							
0	1	right	665 × 345 × 0	895 × 575 × 51	1/0VF10	2CPX041048R9999	30
0	2	right	665 × 565 × 0	895 × 795 × 51	2/0VF10	2CPX041049R9999	37
1	2	right	815 × 565 × 0	1045 × 795 × 51	2/1VF10	2CPX041050R9999	42
1	3	right	815 × 815 × 0	1045 × 1045 × 51	3/1VF10	2CPX041051R9999	53
2	2	right	965 × 565 × 0	1195 × 795 × 51	2/2VF10	2CPX041052R9999	47
2	3	right	965 × 815 × 0	1195 × 1045 × 51	3/2VF10	2CPX041053R9999	60
2	4	Double door	965 × 1065 × 0	1195 × 1295 × 51	4/2VF20	2CPX041057R9999	72
3	2	right	1115 × 565 × 0	1345 × 795 × 51	2/3VF10	2CPX043397R9999	58
3	3	right	1115 × 815 × 0	1345 × 1045 × 51	3/3VF10	2CPX043398R9999	71
3	4	Double door	1115 × 1065 × 0	1345 × 1295 × 51	4/3VF20	2CPX041058R9999	80
4	2	right	1265 × 565 × 0	1495 × 795 × 51	2/4VF10	2CPX041054R9999	58
4	3	right	1265 × 815 × 0	1495 × 1045 × 51	3/4VF10	2CPX041055R9999	73
4	4	Double door	1265 × 1065 × 0	1495 × 1295 × 51	4/4VF20	2CPX041059R9999	88
5	2	right	1415 × 565 × 0	1645 × 795 × 51	2/5VF10	2CPX043399R9999	70
5	3	right	1415 × 815 × 0	1645 × 1045 × 51	3/5VF10	2CPX043400R9999	86
5	4	Double door	1415 × 1065 × 0	1645 × 1295 × 51	4/5VF20	2CPX043401R9999	107
8	2	right	1865 × 565 × 0	2095 × 795 × 51	2/8VF10	2CPX041056R9999	79
8	4	Double door	1865 × 1065 × 0	2095 × 1295 × 51	4/8VF20	2CPX041060R9999	119



Facing doors, IP54, door depth 71 mm							
0	1	right	665 × 345 × 22	895 × 575 × 71	1/0VF11	2CPX041061R9999	42
0	2	right	665 × 565 × 22	895 × 795 × 71	2/0VF11	2CPX041062R9999	58
1	2	right	815 × 565 × 22	1045 × 795 × 71	2/1VF11	2CPX041063R9999	67
1	3	right	815 × 815 × 22	1045 × 1045 × 71	3/1VF11	2CPX041064R9999	86
2	2	right	965 × 565 × 22	1195 × 795 × 71	2/2VF11	2CPX041065R9999	76
2	3	right	965 × 815 × 22	1195 × 1045 × 71	3/2VF11	2CPX041066R9999	97
2	4	Double door	965 × 1065 × 22	1195 × 1295 × 71	4/2VF21	2CPX041070R9999	118
3	1	right	1115 × 345 × 22	1345 × 575 × 71	1/3VF11	2CPX043402R9999	70
3	2	right	1115 × 565 × 22	1345 × 795 × 71	2/3VF11	2CPX043403R9999	90
3	3	right	1115 × 815 × 22	1345 × 1045 × 71	3/3VF11	2CPX043404R9999	113
3	4	Double door	1115 × 1065 × 22	1345 × 1295 × 71	4/3VF21	2CPX041071R9999	132
4	2	right	1265 × 565 × 22	1495 × 795 × 71	2/4VF11	2CPX041067R9999	94
4	3	right	1265 × 815 × 22	1495 × 1045 × 71	3/4VF11	2CPX041068R9999	120
4	4	Double door	1265 × 1065 × 22	1495 × 1295 × 71	4/4VF21	2CPX041072R9999	146
8	2	right	1865 × 565 × 22	2095 × 795 × 71	2/8VF11	2CPX041069R9999	129
8	4	Double door	1865 × 1065 × 22	2095 × 1295 × 71	4/8VF21	2CPX041073R9999	201



Important notes

Minimum internal dimension of facing doors = niche dimension of the flush-mounted wall box without flush-mounted frame

Facing door swings over the frame on the hinge side => leave at least 40 mm (see page 18/358)

Subdistribution boards

Fire protection housing – Extension frame for facing doors

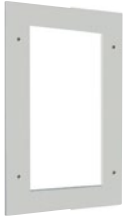

2/2EF11



4/2EF21

Overall height	Field width	Internal dimensions in mm	External dimensions in mm			Weight in kg
Overall height	FB	H × W × D	H × W × D	Type	Item number	
Extension frame for 1-wing doors						
0	1	665 × 345 × 22	895 × 575 × 22	1/0EF11	2CPX041074R9999	10
0	2	665 × 565 × 22	895 × 795 × 22	2/0EF11	2CPX041075R9999	12
1	2	815 × 565 × 22	1045 × 795 × 22	2/1EF11	2CPX041076R9999	13
1	3	815 × 815 × 22	1045 × 1045 × 22	3/1EF11	2CPX041077R9999	15
2	2	965 × 565 × 22	1195 × 795 × 22	2/2EF11	2CPX041078R9999	14
2	3	965 × 815 × 22	1195 × 1045 × 22	3/2EF11	2CPX041079R9999	16
4	2	1265 × 565 × 22	1495 × 795 × 22	2/4EF11	2CPX041080R9999	17
4	3	1265 × 815 × 22	1495 × 1045 × 22	3/4EF11	2CPX041081R9999	19
8	2	1865 × 565 × 22	2095 × 795 × 22	2/8EVF1	2CPX041082R9999	22
Extension frame for 2-wing doors						
2	4	965 × 1065 × 22	1195 × 1295 × 22	4/2EF21	2CPX041083R9999	18
3	4	1115 × 1065 × 22	1345 × 1295 × 22	4/3EF21	2CPX041084R9999	20
4	4	1265 × 1065 × 22	1495 × 1295 × 22	4/4EF21	2CPX041085R9999	21
8	4	1865 × 1065 × 22	2095 × 1295 × 22	4/8EF21	2CPX041086R9999	26



Subdistribution boards

Flush-mounted wall housing – Dimensions, weights, power loss

Front view

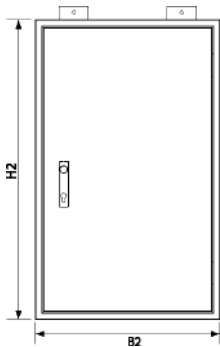

Internal view

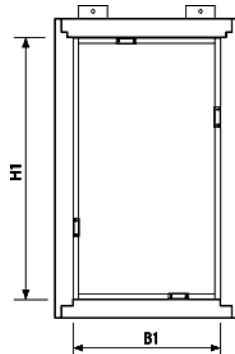

Top view

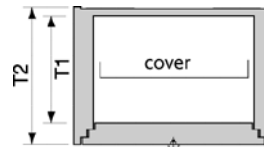

Type	Internal dimensions in mm	External dimensions in mm	Weight in kg	Permissible power dissipation (W) at 25 °C ambient temperature
	H1 × W1 × D1	H2 × W2 × D2		W
1/0UF2020	600 × 250 × 138	682 × 332 × 205	41	11
1/0UF2120	600 × 250 × 138	682 × 332 × 205	41	11
2/0UF2020	600 × 500 × 138	682 × 582 × 205	58	22
2/0UF2120	600 × 500 × 138	682 × 582 × 205	58	22
1/2UF2020	900 × 250 × 138	982 × 332 × 205	55	16
1/2UF2120	900 × 250 × 138	982 × 332 × 205	55	16
2/2UF2020	900 × 500 × 138	982 × 582 × 205	80	32
2/2UF2120	900 × 500 × 138	982 × 582 × 205	80	32



1/0UF2021	600 × 250 × 118	682 × 332 × 205	49	9
1/0UF2121	600 × 250 × 118	682 × 332 × 205	49	9
2/0UF2021	600 × 500 × 118	682 × 582 × 205	70	19
2/0UF2121	600 × 500 × 118	682 × 582 × 205	70	19
1/2UF2021	900 × 250 × 118	982 × 332 × 205	67	14
1/2UF2121	900 × 250 × 118	982 × 332 × 205	67	14
2/2UF2021	900 × 500 × 118	982 × 582 × 205	99	28
2/2UF2121	900 × 500 × 118	982 × 582 × 205	99	28



Subdistribution boards

Sheath housing/cooling shutters – Dimensions, weights, power loss

Front view

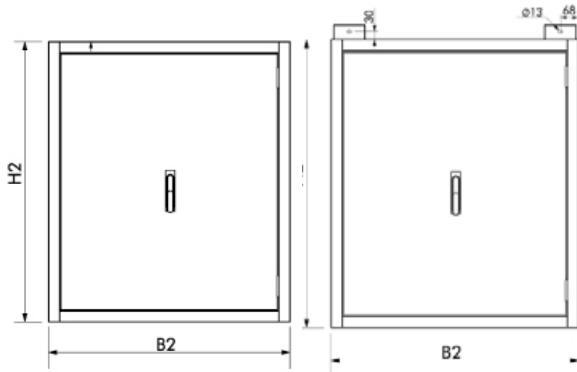

Internal view

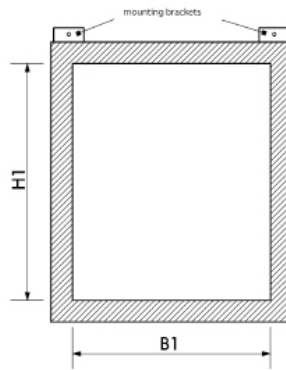

Side view



Top view

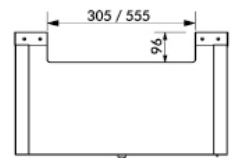

Type	Internal dimensions in mm	External dimensions in mm	Weight in kg	Permissible power dissipation (W) at 25 °C ambient temperature
	H1 × W1 × D1	H2 × W2 × D2		
1/0MF300	665 × 354 × 240	829 × 518 × 340	85	16
1/1MF300	815 × 354 × 240	979 × 518 × 340	97	18
2/1MF300	815 × 604 × 240	979 × 768 × 340	124	24
1/3MF300	1115 × 354 × 240	1279 × 518 × 340	121	23



Subdistribution boards

Surface-mount wall housing – Dimensions, weights, power loss

Front view

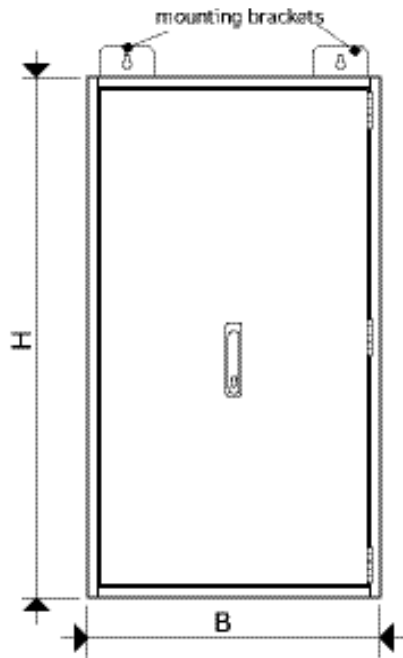

Internal view

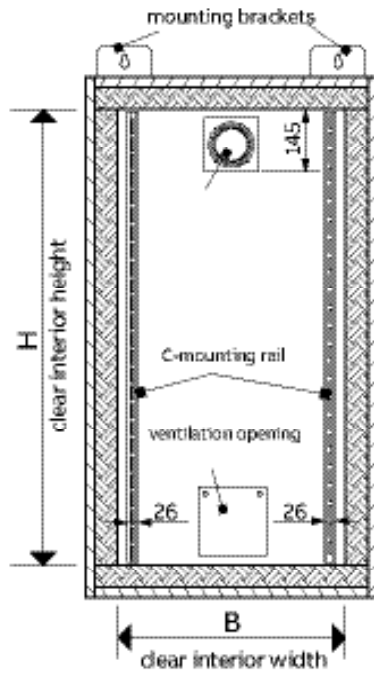

Side view

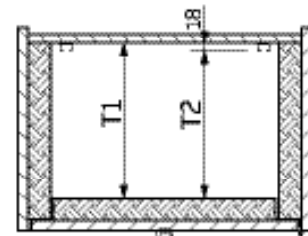
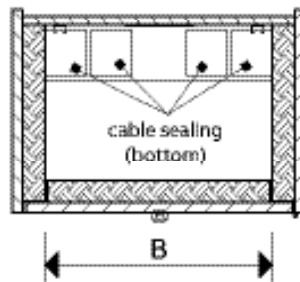
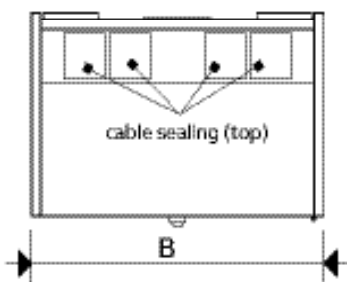
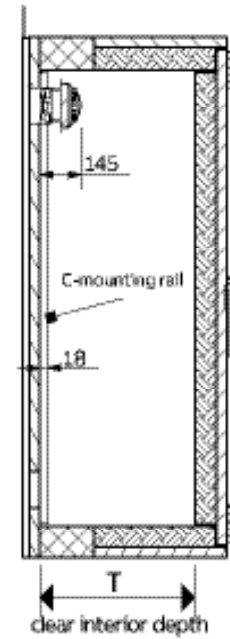

External depth of housing 349 mm

Internal depth of housing T1 240 mm

Usable internal depth T2 222 mm

> Dimensions in mm

Subdistribution boards

Surface-mount wall housing – Dimensions, weights, power loss

Article	Dimensions in mm		Weight in kg	Power dissipation
	External dimensions in mm	Internal dimensions in mm		Pv max. (W)
	H1 × W1 × D1	H2 × W2 × D2		
1/00AF302	598 × 398 × 349	454 × 254 × 240	51	237
2/00AF302	598 × 648 × 349	454 × 504 × 240	71	223
1/0AF302	748 × 398 × 349	604 × 254 × 240	62	214
2/0AF302	748 × 648 × 349	604 × 504 × 240	85	232
1/1AF302	898 × 398 × 349	754 × 254 × 240	73	220
2/1AF302	898 × 648 × 349	754 × 504 × 240	99	242
1/2AF302	1048 × 398 × 349	904 × 254 × 240	83	226
2/2AF302	1048 × 648 × 349	904 × 504 × 240	114	251
1/3AF302	1198 × 398 × 349	1054 × 254 × 240	94	232
2/3AF302	1198 × 648 × 349	1054 × 504 × 240	128	261
3/3AF302	1198 × 898 × 349	1054 × 754 × 240	163	290
2/4AF302	1348 × 648 × 349	1204 × 504 × 240	143	271
2/5AF302	1498 × 648 × 349	1354 × 504 × 240	157	280

Subdistribution boards

Standing housing – Dimensions, weights, power loss

Front view

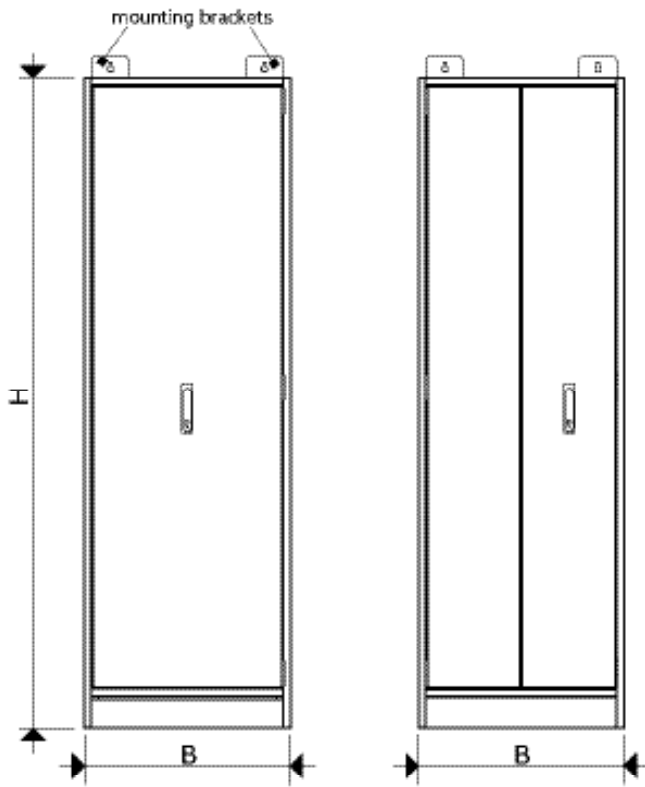

Internal view

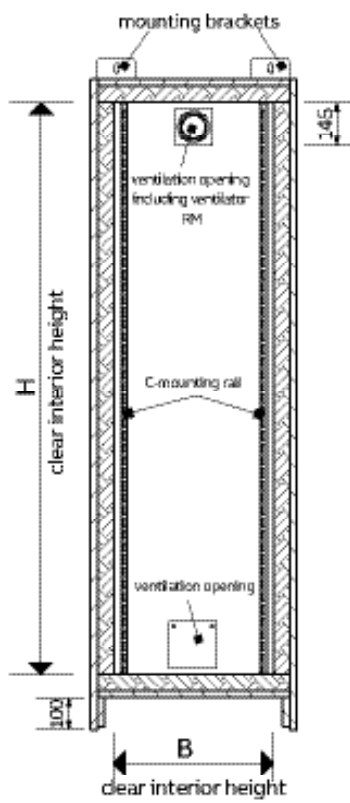

Side view

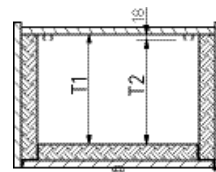
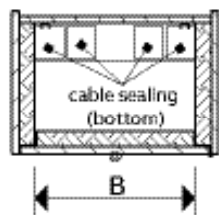
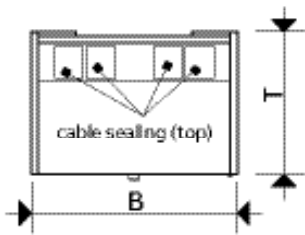
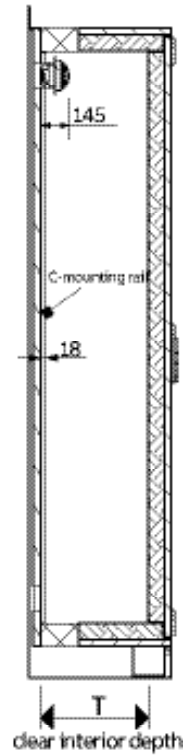

External depth of housing 349 mm

Internal depth of housing T1 240 mm

Usable internal depth T2 222 mm

Subdistribution boards

Standing housing – Dimensions, weights, power loss

Type	External dimensions in mm	Internal dimensions in mm	Weight in kg	Power dissipation
	H1 × W1 × D1	H2 × W2 × D2		Pv max. (W)
1/8SF302	2048 × 398 × 349	1804 × 254 × 240	152	261
2/8SF302	2048 × 648 × 349	1804 × 504 × 240	206	309
3/8SF302	2048 × 898 × 349	1804 × 754 × 240	259	357
1/9SF302	2198 × 398 × 349	1954 × 254 × 240	163	267
2/9SF302	2198 × 648 × 349	1954 × 504 × 240	220	318
3/9SF302	2198 × 898 × 349	1954 × 754 × 240	278	370

Subdistribution boards

Facing doors – Dimensions

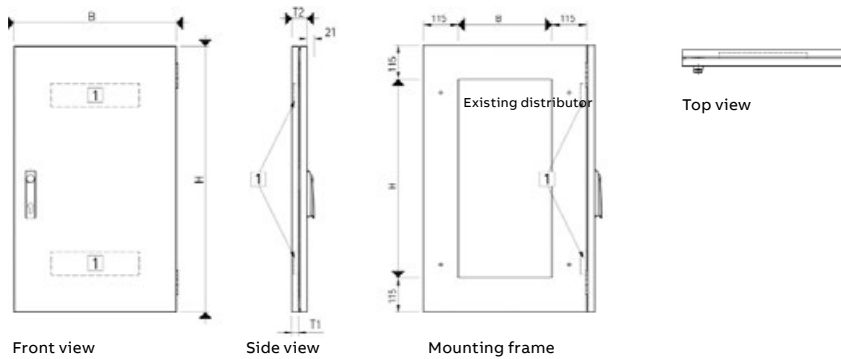

Front view

Side view

Mounting frame

Top view

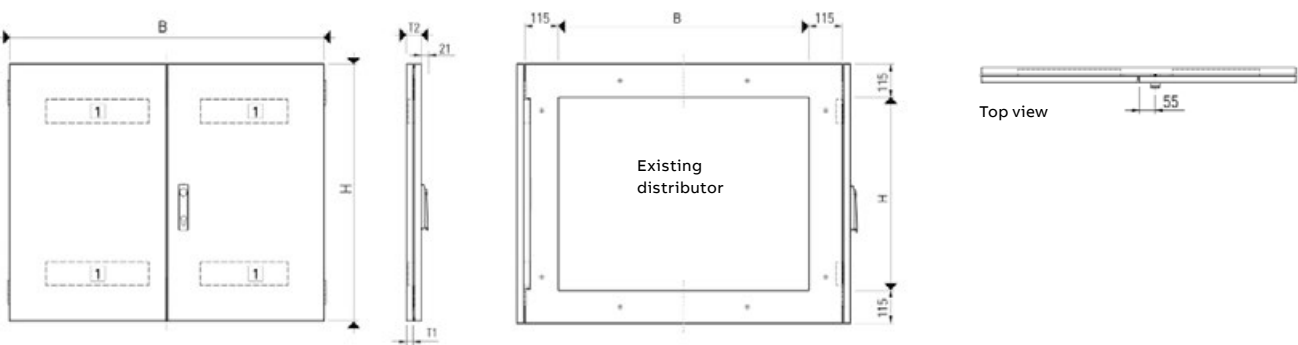

Front view

Side view

Mounting frame

Top view

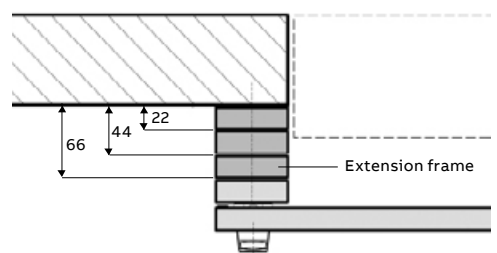

max. 3 additional extension frames (66 mm)

with 1-wing or 2-wing door

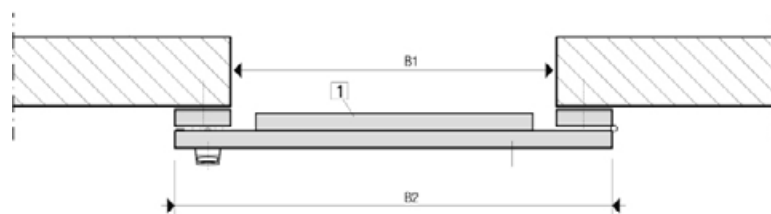

Facing door with mounting frame
Door swivels over the frame on the hinge side.
Leave at least 41/51 mm distance from the wall.

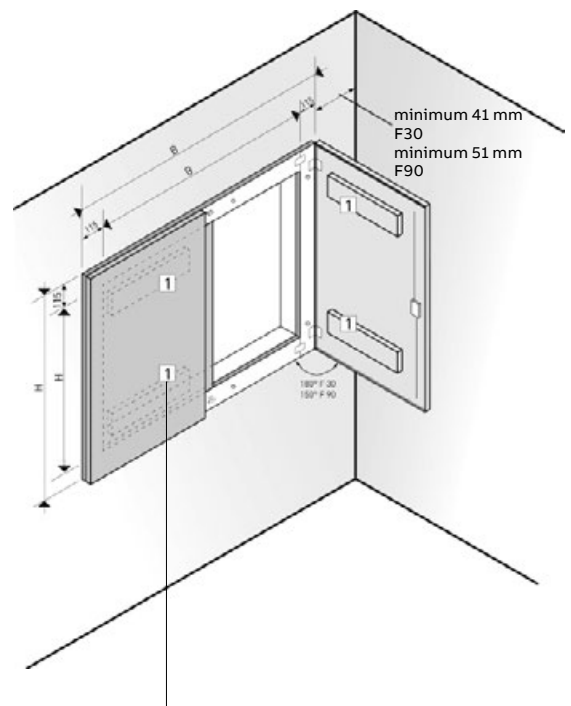

1 Bar above and below on the inside of the door, only for 30-minute design.

Subdistribution boards

Facing doors – Dimensions

Type	Internal dimensions in mm			External dimensions in mm		
	H1	B1	D1	H2	W2	D2
1/0VF10	665	345	0	895	575	51
2/0VF10	665	565	0	895	795	51
2/1VF10	815	565	0	1045	795	51
3/1VF10	815	815	0	1045	1045	51
2/2VF10	965	565	0	1195	795	51
3/2VF10	965	815	0	1195	1045	51
2/3VF10	1115	565	0	1345	795	51
3/3VF10	1115	815	0	1345	1045	51
2/4VF10	1265	565	0	1495	795	51
3/4VF10	1265	815	0	1495	1045	51
2/5VF10	1415	565	0	1645	795	51
3/5VF10	1415	815	0	1645	1045	51
2/8VF10	1865	565	0	2095	795	51
1/0VF11	665	345	22	895	545	71
2/0VF11	665	565	22	895	795	71
2/1VF11	815	565	22	1045	795	71
3/1VF11	815	815	22	1045	1045	71
2/2VF11	965	565	22	1195	795	71
3/2VF11	965	815	22	1195	1045	71
1/3VF11	1115	345	22	1345	575	71
2/3VF11	1115	565	22	1345	795	71
3/3VF11	1115	815	22	1345	1045	71
2/4VF11	1265	565	22	1495	795	71
3/4VF11	1265	815	22	1495	1045	71
2/8VF11	1865	565	22	2095	795	71
4/2VF20	965	1065	0	1195	1295	51
4/3VF20	1115	1065	0	1345	1295	51
4/4VF20	1265	1065	0	1495	1295	51
4/5VF20	1415	1065	0	1645	1295	51
4/8VF20	1865	1065	0	2095	1295	51
4/2VF21	965	1065	22	1195	1295	71
4/3VF21	1115	1065	22	1345	1295	71
4/4VF21	1265	1065	22	1495	1295	71
4/8VF21	1865	1065	22	2095	1295	71

Subdistribution boards

Electric functional unit in compact design – Dimensions for 2-field width

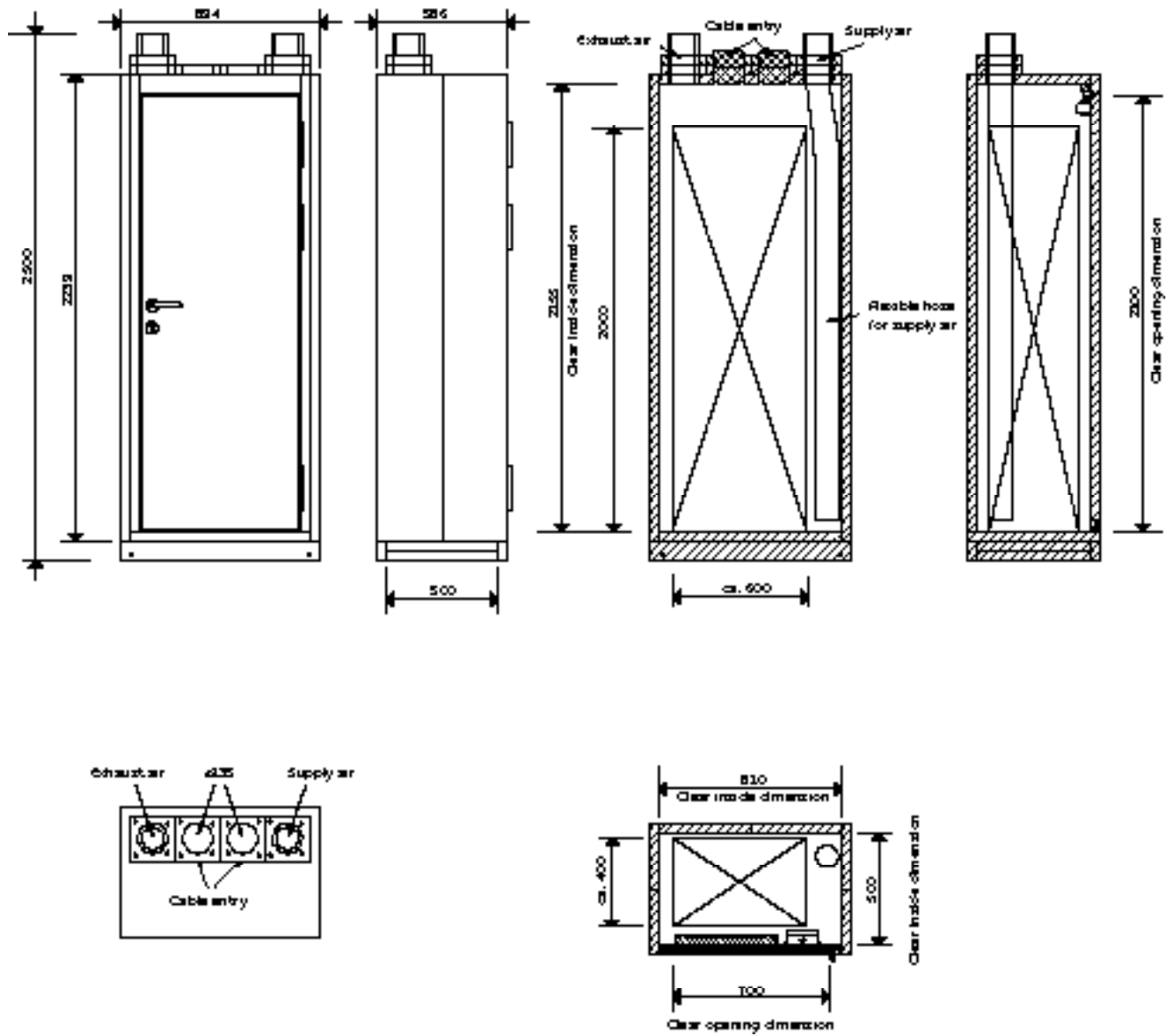

Subdistribution boards

Electric functional unit in compact design – Dimensions for 3-field width

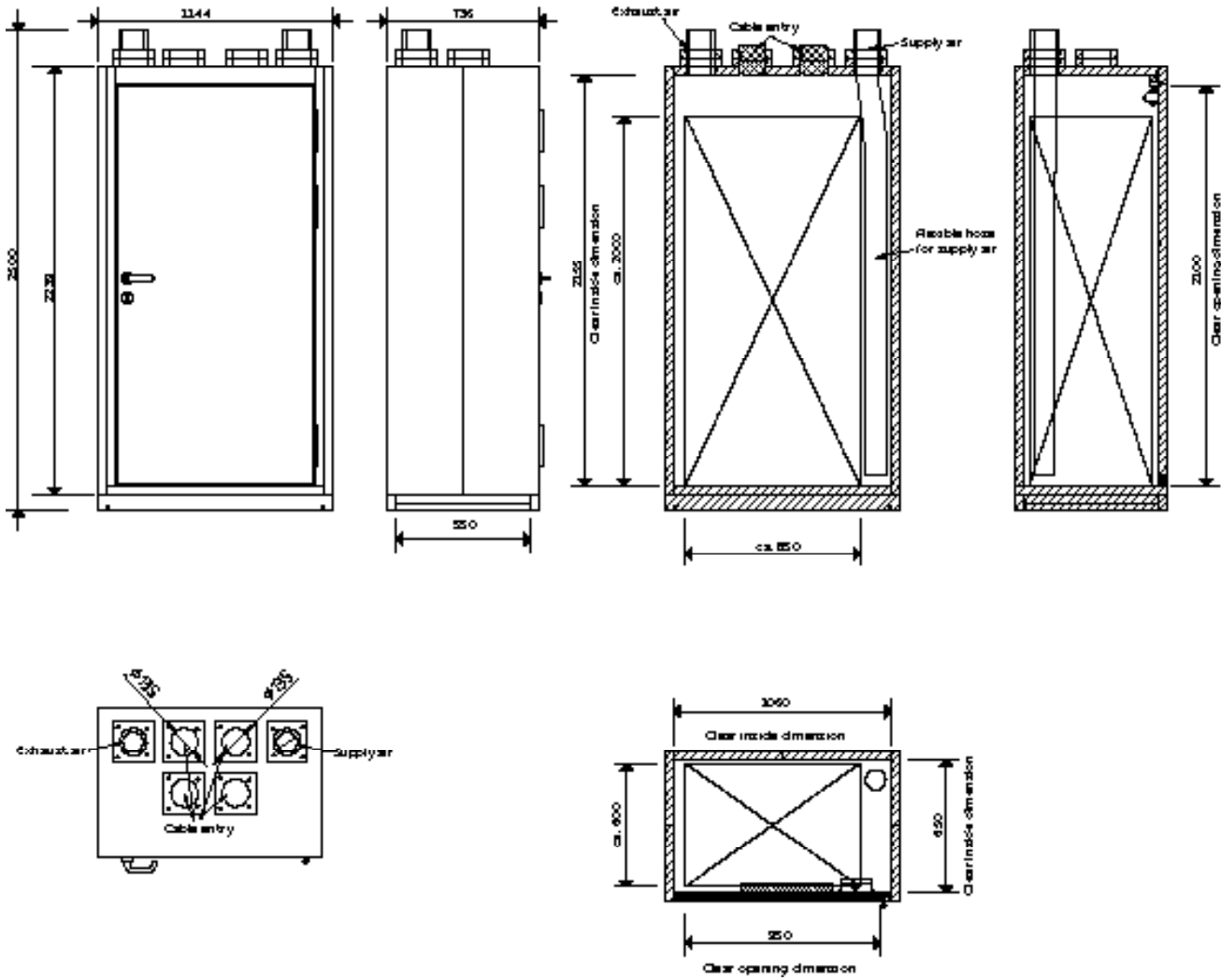

Subdistribution boards

The new flatpack and monobloc solution for wall-mounting and floor-standing cabinets

With the new TwinLine S system, ABB offers a tailored and proven concept of flatpack and monobloc wall-mounting and floor-standing cabinets.



—

This comprehensive product range includes two cabinet types TwinLine-G (depth of 225 mm) and TwinLine-L (depth of 275 mm) and provides a solution for every application. All cabinets are designed according to IEC 61439. The modular system is simple in planning, quick in assembly and safe in application.

A wide range of flange types provides the right solution for every application. All flanges are suited for all flange openings and knockouts of the complete TwinLine series. The flanges can be attached without the need of tools thanks to the handy push and lock technology.

All TwinLine cabinets can be connected side-by-side with connection set. All side walls are easily removable. Connection box can be stacked on top of floor standing cabinets. The plinth concept provides a safe transport in the workshop and on-site. The standard heights of 50 mm and 100 mm can be stacked and combined in order to fulfil installation needs. TwinLine offers unrestricted access during operation, expansion, maintenance and functional monitoring. With its 180-degree door opening and the door locking system, with the possibility to switch the door hinges from right to left it guarantees excellent flexibility.

The removable frame as standard gives the possibility to remove all covers in one handling and provides a quick assembly. With its wide range of the new modular distribution panel system, called CombiLine S, ABB offers the right solution for every application. The internal configuration system fits in all TwinLine S 55 cabinets. CombiLine S provides a time-saving installation due to hook-in technology and a simple closure system for covers with the ¼ turn quick-lock. With its new mounting concept for the CombiLine S system, TwinLine provides more flexibility and access for installation and wiring. There is also the option to have mounting plates in full cabinet size that can be adjusted in depth.

Product benefits

- Innovative flange technology
- Significantly more usable area for cable entry
- All flanges are compatible with all flange openings and knockouts within the entire TwinLine system
- Side walls can be easily removed
- Flexible internal configuration with CombiLine S modules
- Optimal accessibility and ease of installation thanks to 180 degree door opening angle
- Time-saving plinth assembly and safe transport
- Simplified accessories concept for reduced inventory levels
- Speedy and concise planning as well as calculations with the PDC software

Subdistribution boards

TwinLine S 43

The complete cabinet system in all sizes

Simple in planning, Quick in assembly, Safe in application

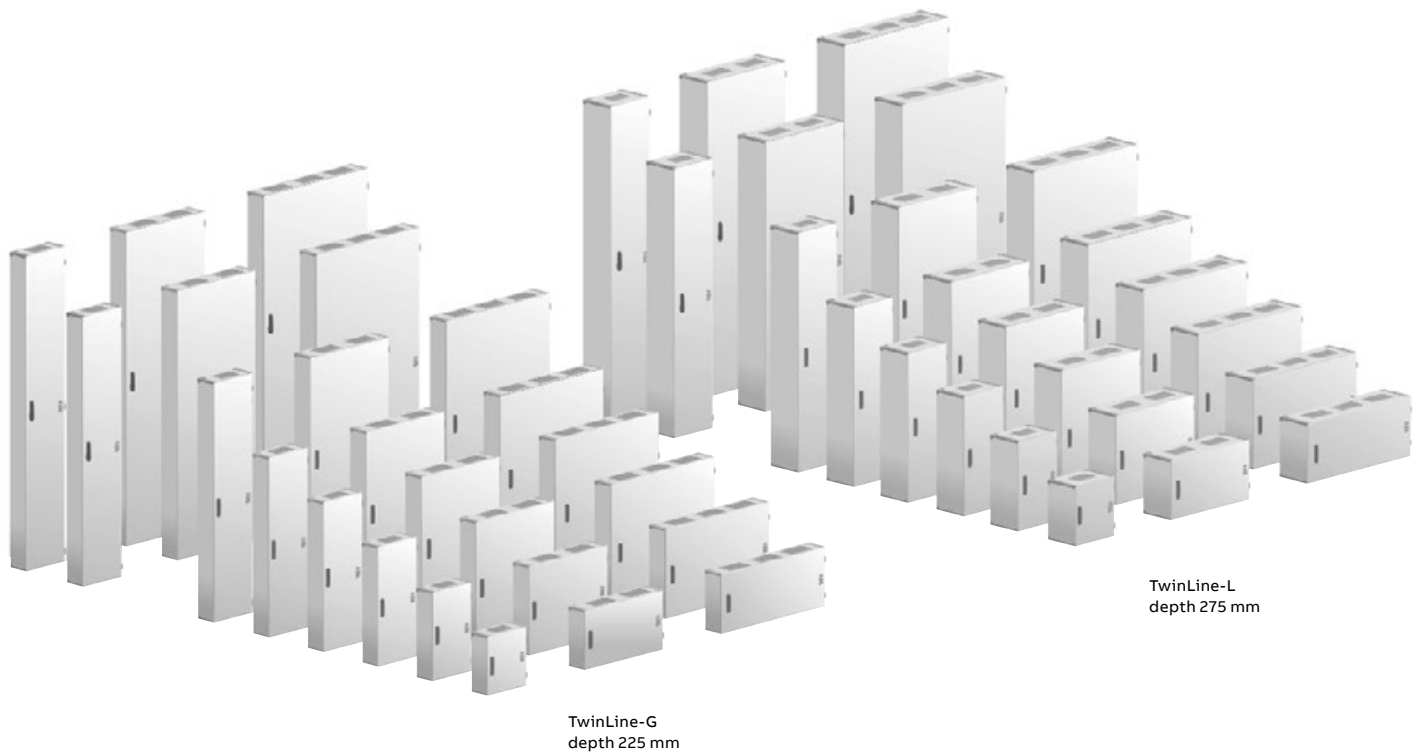

Cabinet type	TwinLine-G			TwinLine-L		
Degree of protection	up to IP43			up to IP43		
Protection class	.			.		
Depth	225			275		
Width	300	600	800	300	600	800
Height	400	■	■	■	■	■
	600	■	■	■	■	■
	800	■	■	■	■	■
	1000	■	■	■	■	■
	1200	■	■	■	■	■
	1400	■	■	■	■	■
	1600	■	■	■	■	■
	1800	■	■	■	■	■
	2000	■	■	■	■	■

> Dimensions in mm

Subdistribution boards

TwinLine S 43
System overview

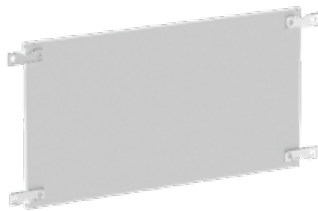
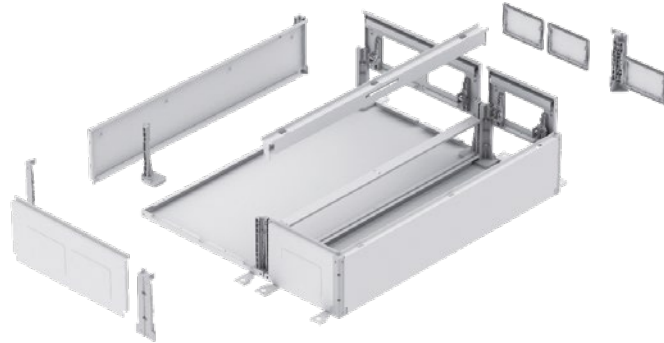

Rear wall

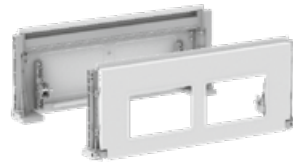

Top and bottom plate



Side walls



Installation set for removable frame



Uprights for side-by-side positioning of cabinets



Internal cable container

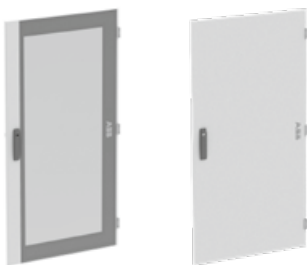

Transparent or sheet steel doors



Flanges



Plinth

Subdistribution boards

TwinLine S 43

Product benefits

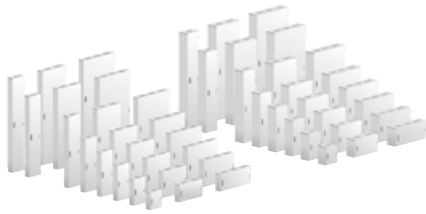

The complete cabinet system in all sizes

The fully comprehensive product range of modular wall-mounting and floor-standing cabinets includes the types TwinLine-G (depth of 225 mm) and TwinLine-L (depth of 275 mm) and provides a solution for every application. All cabinets are designed according to IEC 61439. The modular system is simple in planning, quick in assembly and safe in application.

Innovative cable entry

A wide range of flange types provides the right solution for every application. All flanges are suited for all flange openings and knockouts of the complete TwinLine cabinets. The flanges can be attached without the need of tools thanks to the handy push and lock technology.

Simple connection in series of all cabinets

All TwinLine cabinets can be connected in both, horizontally and vertically directions. Uprights for side-by-side positioning and connection sets for stacking the cabinets can be easily installed.



Time-saving plinth installation and safe transport

The new plinth concept provides a safe transport in the workshop and on-site. The plinth contains knockouts and has the possibility to install wiring ducts for cable support. The standard heights of 50 mm and 100 mm can be stacked and combined in order to fulfil installation needs.

Optimal accessibility and ease of installation

TwinLine offers unrestricted access during operation, expansion, maintenance and functional monitoring. With its 180-degree door opening and the door locking system, with the possibility to switch the door hinges from right to left it guarantees excellent flexibility.

Removable frame for CombiLine S covers

With its wide range of the new modular distribution panel system, called CombiLine S, ABB offers the right solution for every application. The removable frame as standard gives the possibility to remove all covers in one handling and provides a quick assembly.

Subdistribution boards

TwinLine S 43

Product benefits

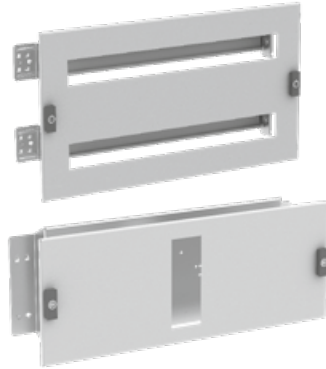

Flexibility in the assembling of internal configuration

With its new mounting concept for the CombiLine S system, TwinLine provides more flexibility and access for installation and wiring also outside of the cabinet. There is also the option to have continuous mounting plates that can be adjusted in depth.

The right internal configuration for every type of application

The wide range of the internal configuration system CombiLine S fits in all TwinLine S 43 cabinets. CombiLine S provides a time-saving installation due to hook-in technology and a simple closure system for covers with the $\frac{1}{4}$ turn quick-lock.

Subdistribution boards

TwinLine S 43

Innovative cable entry

The usable cable entry area is one of the largest cable entries available on the market. A wide range of flange types provides the right solution for every application. All flanges are suited for all flange openings and knockouts of the complete TwinLine cabinets. The flanges can be attached without the need of tools thanks to the handy push and lock technology.

- All flanges are compatible with all flange openings and knockouts within the entire TwinLine system
- Wide range of new flanges
- Tool-free flange installation thanks to push and lock technology

Membrane flange

- 2-component flange with integrated seal, material: plastic
- Tool-free installation thanks to push and lock technology
- Optimal cable entry by a combination of hard and soft components
- Additional fixing and centring

Flange for M screw fittings

- 2-component flange with integrated seal, material: plastic
- Tool-free installation thanks to push and lock technology
- With two different hole patterns

Flange with cable sleeves

- 2-component flange with integrated seal, material: plastic
- Tool-free installation thanks to push and lock technology

Closing flange

- 2-component flange with integrated seal, material: plastic
- Tool-free installation thanks to push and lock technology
- Can be used as closing flange or for customization, e.g. for cable sleeves or screw fittings

Closing flange

- With foam seal around perimeter, material: sheet steel 2 mm
- Continuous protective earth connection via flange fastener
- Can be used as closing flange or for customization, e.g. for cable sleeves or screw fittings



Subdistribution boards

TwinLine S 43

Technical specifications

Technical specifications	
Standards / regulations	IEC 61439 -1/-2/-3*
Protection class	I, earthed, in combination with CAEC6
Degree of protection	IP43 Without door IP30
Mechanical impact strength	IK 08 for the cabinet enclosure IK 07 in the area of the flange knockouts IK 07 for transparent doors IK 08 for sheet steel doors
Conditions of installation	Indoor installation Ambient air temperature max. + 40°C Ambient air temperature min. - 5°C Operating temperature max. + 55°C Storage temperature max. + 55°C Storage temperature min. - 40°C
* Powerloss determined by calculation with the method of IEC 60890 in accordance with IEC 61439-1 par. 10.10.4	
Product features	
Housing and door	Sheet steel, RAL 7035, powder-coated Door opening angle: 180 degrees Doors with espagnolette closure Doors for wall-mounting cabinets: with latch plate and 3 mm double bit pin Doors for floor-standing cabinets: with swivel handle and 3 mm double bit pin
Assembly options	Prepared to be fitted with CombiLine S modules and mounting plates
Forms of delivery	Build-up cabinets out of sets

Subdistribution boards

TwinLine S 43 Rear walls



ESBN0612

Article	Height in mm	Order details		Price	Pcs.
		Type	Order code		
Rear walls					
With external mounting brackets					
Width 300 mm	400	ESBN0304	2CPX078100R9999		1
	600	ESBN0306	2CPX078101R9999		1
	800	ESBN0308	2CPX078102R9999		1
	1000	ESBN0310	2CPX078103R9999		1
	1200	ESBN0312	2CPX078104R9999		1
	1400	ESBN0314	2CPX078105R9999		1
	1600	ESBN0316	2CPX078106R9999		1
	1800	ESBN0318	2CPX078107R9999		1
	2000	ESBN0320	2CPX078108R9999		1
	Width 600 mm	400	ESBN0604	2CPX078109R9999	
600		ESBN0606	2CPX078110R9999		1
800		ESBN0608	2CPX078111R9999		1
1000		ESBN0610	2CPX078112R9999		1
1200		ESBN0612	2CPX078113R9999		1
1400		ESBN0614	2CPX078114R9999		1
1600		ESBN0616	2CPX078115R9999		1
1800		ESBN0618	2CPX078116R9999		1
2000		ESBN0620	2CPX078117R9999		1
Width 800 mm		400	ESBN0804	2CPX078118R9999	
	600	ESBN0808	2CPX078120R9999		1
	800	ESBN0808	2CPX078120R9999		1
	1000	ESBN0810	2CPX078121R9999		1
	1200	ESBN0812	2CPX078122R9999		1
	1400	ESBN0814	2CPX078123R9999		1
	1600	ESBN0816	2CPX078124R9999		1
	1800	ESBN0818	2CPX078125R9999		1
	2000	ESBN0820	2CPX078126R9999		1

Subdistribution boards

TwinLine S 43 Top and bottom plate

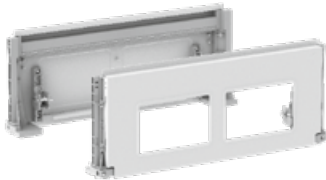

ESPL0600

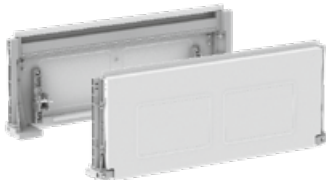

ESCL0600

Article	Width in mm	Order details		
		Type	Order code	Price
Top and bottom plates				
Type 1: One plate, all flanges open				
One plate, all flanges closed with knockouts				
Depth 225 mm	300	ESPG0300	2CPX078145R9999	2
	600	ESPG0600	2CPX078146R9999	2
	800	ESPG0800	2CPX078147R9999	2
Depth 275 mm	300	ESPL0300	2CPX078148R9999	2
	600	ESPL0600	2CPX078149R9999	2
	800	ESPL0800	2CPX078150R9999	2
Type 2: Both plates, all flanges closed with knockouts				
Depth 225 mm	600	ESCG0600	2CPX078373R9999	2
	800	ESCG0800	2CPX078374R9999	2
Depth 275 mm	600	ESCL0600	2CPX078375R9999	2
	800	ESCL0800	2CPX078376R9999	2

Subdistribution boards

TwinLine S 43 Side walls / uprights for side-by-side positioning of cabinets



ESSL0012



ESUL0012

Article	Height in mm	Order details			Price	Pcs.
		Type	Order code			
Side walls						
Depth 225 mm	400	ESSG0004	2CPX078127R9999		2	
	600	ESSG0006	2CPX078128R9999		2	
	800	ESSG0008	2CPX078129R9999		2	
	1000	ESSG0010	2CPX078130R9999		2	
	1200	ESSG0012	2CPX078131R9999		2	
	1400	ESSG0014	2CPX078132R9999		2	
	1600	ESSG0016	2CPX078133R9999		2	
	1800	ESSG0018	2CPX078134R9999		2	
	2000	ESSG0020	2CPX078135R9999		2	
	Depth 275 mm	400	ESSL0004	2CPX078136R9999		2
600		ESSL0006	2CPX078137R9999		2	
800		ESSL0008	2CPX078138R9999		2	
1000		ESSL0010	2CPX078139R9999		2	
1200		ESSL0012	2CPX078140R9999		2	
1400		ESSL0014	2CPX078141R9999		2	
1600		ESSL0016	2CPX078142R9999		2	
1800		ESSL0018	2CPX078143R9999		2	
2000		ESSL0020	2CPX078144R9999		2	
Uprights for side-by-side positioning of cabinets						
Depth 225 mm	400	ESUG0004	2CPX078223R9999		1	
	600	ESUG0006	2CPX078224R9999		1	
	800	ESUG0008	2CPX078225R9999		1	
	1000	ESUG0010	2CPX078226R9999		1	
	1200	ESUG0012	2CPX078227R9999		1	
	1400	ESUG0014	2CPX078228R9999		1	
	1600	ESUG0016	2CPX078229R9999		1	
	1800	ESUG0018	2CPX078230R9999		1	
	2000	ESUG0020	2CPX078231R9999		1	
	Depth 275 mm	400	ESUL0004	2CPX078232R9999		1
600		ESUL0006	2CPX078233R9999		1	
800		ESUL0008	2CPX078234R9999		1	
1000		ESUL0010	2CPX078235R9999		1	
1200		ESUL0012	2CPX078236R9999		1	
1400		ESUL0014	2CPX078237R9999		1	
1600		ESUL0016	2CPX078238R9999		1	
1800		ESUL0018	2CPX078239R9999		1	
2000		ESUL0020	2CPX078240R9999		1	

Subdistribution boards

TwinLine S 43 Installation set / internal cable container / mounting plates



ESIN0012



ESAI0212

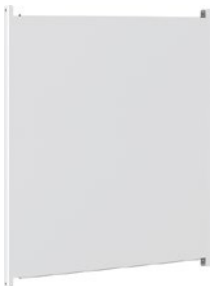

TZM304

Article	Height in mm	Width in mm	Order details		Price	Pcs.
			Type	Order code		
Installation set with removable frame						
For internal configuration in 300 mm, 600 mm, 800 mm wide cabinets	400		ESIN0004	2CPX078420R9999		1
	600		ESIN0006	2CPX078421R9999		1
	800		ESIN0008	2CPX078422R9999		1
	1000		ESIN0010	2CPX078423R9999		1
	1200		ESIN0012	2CPX078424R9999		1
	1400		ESIN0014	2CPX078425R9999		1
	1600		ESIN0016	2CPX078426R9999		1
	1800		ESIN0018	2CPX078427R9999		1
	2000		ESIN0020	2CPX078428R9999		1
	Internal cable container					
With hinged internal blind cover For 800 mm wide cabinets	600		ESAI0206	2CPX078215R9999		1
	800		ESAI0208	2CPX078216R9999		1
	1000		ESAI0210	2CPX078217R9999		1
	1200		ESAI0212	2CPX078218R9999		1
	1400		ESAI0214	2CPX078219R9999		1
	1600		ESAI0216	2CPX078220R9999		1
	1800		ESAI0218	2CPX078221R9999		1
	2000		ESAI0220	2CPX078222R9999		1
	Mounting plates					
Sheet steel 2 mm, galvanised	600	600	TZM204	2CPX010598R9999		1
		800	TZM304	2CPX010605R9999		1
	1200	600	TZM208	2CPX010602R9999		1
		800	TZM308	2CPX010609R9999		1
	1800	600	TZM2012	2CPX010941R9999		1
		800	TZM312	2CPX010942R9999		1

Subdistribution boards

TwinLine S 43 Sheet steel doors



ESAS0612



ESAS0618

Article	Height in mm	Order details		Price	Pcs.
		Type	Order code		
Doors for wall-mounting cabinets, with latch plate and double bit 3 mm					
Doors for floor-standing cabinets, with swivel handle and double bit 3 mm					
Width 300 mm	400	ESAS0304	2CPX078151R9999		1
	600	ESAS0306	2CPX078152R9999		1
	800	ESAS0308	2CPX078153R9999		1
	1000	ESAS0310	2CPX078154R9999		1
	1200	ESAS0312	2CPX078155R9999		1
	1400	ESAS0314	2CPX078156R9999		1
	1600	ESAS0316	2CPX078157R9999		1
	1800	ESAS0318	2CPX078158R9999		1
	2000	ESAS0320	2CPX078159R9999		1
Width 600 mm	400	ESAS0604	2CPX078160R9999		1
	600	ESAS0606	2CPX078161R9999		1
	800	ESAS0608	2CPX078162R9999		1
	1000	ESAS0610	2CPX078163R9999		1
	1200	ESAS0612	2CPX078164R9999		1
	1400	ESAS0614	2CPX078165R9999		1
	1600	ESAS0616	2CPX078166R9999		1
	1800	ESAS0618	2CPX078167R9999		1
	2000	ESAS0620	2CPX078168R9999		1
Width 800 mm	400	ESAS0804	2CPX078169R9999		1
	600	ESAS0806	2CPX078170R9999		1
	800	ESAS0808	2CPX078171R9999		1
	1000	ESAS0810	2CPX078172R9999		1
	1200	ESAS0810	2CPX078172R9999		1
	1400	ESAS0814	2CPX078174R9999		1
	1600	ESAS0816	2CPX078175R9999		1
	1800	ESAS0818	2CPX078176R9999		1
	2000	ESAS0820	2CPX078177R9999		1

Subdistribution boards

TwinLine S 43 Transparent doors



ESAT0612



ESAT2618

Article	Height in mm	Order details		Price	Pcs.
		Type	Order code		
Doors for wall-mounting cabinets, with latch plate and double bit 3 mm					
Doors for floor-standing cabinets, with swivel handle and double bit 3 mm					
Width 600 mm	600	ESAT0606	2CPX078178R9999		1
	800	ESAT0608	2CPX078179R9999		1
	1000	ESAT0610	2CPX078180R9999		1
	1200	ESAT0612	2CPX078181R9999		1
	1400	ESAT0614	2CPX078182R9999		1
	1600	ESAT0616	2CPX078183R9999		1
	1800	ESAT0618	2CPX078184R9999		1
	2000	ESAT0620	2CPX078185R9999		1
Width 800 mm	600	ESAT0806	2CPX078186R9999		1
	800	ESAT0808	2CPX078187R9999		1
	1000	ESAT0810	2CPX078188R9999		1
	1200	ESAT0812	2CPX078189R9999		1
	1400	ESAT0814	2CPX078190R9999		1
	1600	ESAT0816	2CPX078191R9999		1
	1800	ESAT0818	2CPX078192R9999		1
	2000	ESAT0820	2CPX078193R9999		1
Width 800 mm For 800 mm wide cabinet With internal cable container	600	ESAT2606	2CPX078194R9999		1
	800	ESAT2608	2CPX078195R9999		1
	1000	ESAT2610	2CPX078196R9999		1
	1200	ESAT2612	2CPX078197R9999		1
	1400	ESAT2614	2CPX078198R9999		1
	1600	ESAT2616	2CPX078199R9999		1
	1800	ESAT2618	2CPX078200R9999		1
	2000	ESAT2620	2CPX078201R9999		1

Subdistribution boards

TwinLine S 43 Flanges



TZ101



TZ102



TZ103



TZ110



TZ111



TZ112

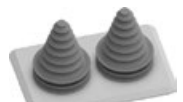

TZ104



TZ105



TZ107



TZ106

Article	Order details			
	Type	Order code	Price	Pcs.
Membrane flange				
Material: plastic				
For cable sections 2 x 6 - 32.5 mm, 2 x 6 - 25 mm, 4 x 6 - 19 mm, 10 x 6 - 15 mm, 2 x 6 - 12 mm, 31 x 6 - 11 mm, 1 x 6 - 7 mm	TZ101	2CPX010450R9999		1
	TZ101P10	2CPX010451R9999		10
	TZ101P100	2CPX010826R9999		100
Flanges for M screw fittings				
Material: plastic				
1 x M 63 / M 50, 2 x M 32 / M 20, 5 x M 25, 5 x M 20	TZ102	2CPX010452R9999		1
	TZ102P10	2CPX010453R9999		10
4 x M20 / M25, 18 x M20	TZ103	2CPX010454R9999		1
	TZ103P10	2CPX010455R9999		10
Flanges with cable sleeves				
Material: plastic				
Flanges with 8 cable sleeves For cable sections 8 x 13 - 34 mm	TZ110	2CPX010850R9999		1
Flanges with 11 cable sleeves For cable sections 1 x 14 - 54 mm, 3 x 13 - 34 mm, 3 x 13 - 26.5 mm, 4 x 5 - 21 mm	TZ111	2CPX010851R9999		1
Flange with 1 cable sleeve For cable sections 1 x 14 - 68 mm	TZ112	2CPX010852R9999		1
Flange with 2 cable sleeves For cable sections 2 x 14 - 68 mm	TZ104	2CPX010456R9999		1
Flange with 3 cable sleeves For cable sections 3 x 14 - 54 mm	TZ105	2CPX010457R9999		1
Closing flanges				
Material: plastic				
	TZ107	2CPX010460R9999		1
	TZ107P10	2CPX010461R9999		10
Material: sheet steel				
	TZ106	2CPX010458R9999		1
	TZ106P10	2CPX010459R9999		10

Subdistribution boards

TwinLine S 43 Plinth



ESAG0605



ESAL0610

Article	Width mm	Order details		Price	Pcs.
		Type	Order code		
Plinth, height 50 mm, color RAL 7012					
Depth 225 mm	300	ESAG0305	2CPX078202R9999		1
	600	ESAG0605	2CPX078204R9999		1
	800	ESAG0805	2CPX078206R9999		1
Depth 275 mm	300	ESAL0305	2CPX078208R9999		1
	600	ESAL0605	2CPX078210R9999		1
	800	ESAL0805	2CPX078212R9999		1
Plinth, height 100 mm, color RAL 7012					
Depth 225 mm Side knockouts 1 x M 32 / M 50 or 80 x 80 mm	300	ESAG0310	2CPX078203R9999		1
	600	ESAG0610	2CPX078205R9999		1
	800	ESAG0810	2CPX078207R9999		1
Depth 275 mm Side knockouts 1 x M 32 / M 50 or 80 x 80 mm	300	ESAL0310	2CPX078209R9999		1
	600	ESAL0610	2CPX078211R9999		1
	800	ESAL0810	2CPX078213R9999		1

Subdistribution boards

TwinLine S 43 Lock replacement parts



Article	Order details			
	Type	Order code	Price	Pcs.
Swivel handle and operating pins				
Swivel handle with double bit 3 mm* ¹	ESAC1001	2CPX010900R9999		1
Double bit 3 mm* ¹	ESAC1002	2CPX010901R9999		1
Double bit 5 mm	ESAC1003	2CPX010902R9999		1
Triangular 7 mm	ESAC1004	2CPX010903R9999		1
Triangular 8 mm	ESAC1005	2CPX010904R9999		1
Square 6 mm	ESAC1006	2CPX010905R9999		1
Square 7 mm	ESAC1007	2CPX010906R9999		1
Square 8 mm	ESAC1008	2CPX010907R9999		1
EK333 and key	ESAC1009	2CPX010908R9999		1
FIST type insert (FIAT)	ESAC1010	2CPX010909R9999		1
FIAT key	ESAC1013	2CPX010912R9999		1
Ronis 455 and key	ESAC1011	2CPX010910R9999		1
Ronis 405 and key	ESAC1012	2CPX010911R9999		1
Latch plates and operating pins				
For operating pin 3 mm (standard)* ² and 5 mm	TZ517	2CPX010926R9999		1
For triangular and square operating pin	TZ518	2CPX010927R9999		1
Double bit 3 mm* ²	ZH130	2CPX060490R9999		1
Double bit 5 mm	ZH131	2CPX060491R9999		1
Triangular 7 mm	ZH132	2CPX060492R9999		1
Triangular 8 mm	ZH133	2CPX060493R9999		1
Square 6 mm	ZH134	2CPX060494R9999		1
Square 7 mm	ZH135	2CPX060495R9999		1
Square 8 mm	ZH136	2CPX060496R9999		1
Daimler-Benz	ZH137	2CPX060497R9999		1

*¹ In scope of delivery of doors for floor-standing cabinets

*² In scope of delivery of doors for wall-mounting cabinets

Subdistribution boards

TwinLine S 43 Lock replacement parts



ZH91



ZH160

ZH157



ZH162

ZH165



ESAC2004



ESAC2008



TZ511



TZ501

Article	Order details			
	Type	Order code	Price	Pcs.
Universal key Double bit 3 mm/5 mm Triangular 8 mm, square 6 mm/8 mm	ZH91	2CPX066091R9999		1
Double bit 3 mm*	ZH160	2CPX060660R9999		1
Double bit 5 mm	ZH161	2CPX060661R9999		1
Triangular 7 mm	ZH157	2CPX060657R9999		1
Triangular 8 mm	ZH158	2CPX060658R9999		1
Square 6 mm	ZH162	2CPX060662R9999		1
Square 7 mm	ZH163	2CPX060663R9999		1
Square 8 mm	ZH164	2CPX060664R9999		1
Daimler-Benz	ZH165	2CPX060665R9999		1
Espagnolette closure*				
Closure for door height 400 mm	ESAC2004	2CPX010913R9999		1
Espagnolette closure height 600 mm	ESAC2006	2CPX010914R9999		1
Espagnolette closure height 800 mm	ESAC2008	2CPX010915R9999		1
Espagnolette closure height 1000 mm	ESAC2010	2CPX010916R9999		1
Espagnolette closure height 1200 mm	ESAC2012	2CPX010917R9999		1
Espagnolette closure height 1400 mm	ESAC2014	2CPX010918R9999		1
Espagnolette closure height 1600 mm	ESAC2016	2CPX010919R9999		1
Espagnolette closure height 1800 mm	ESAC2018	2CPX010920R9999		1
Espagnolette closure height 2000 mm	ESAC2020	2CPX010921R9999		1
Espagnolette guide*	TZ511	2CPX010495R9999		1
Shoe* For espagnolette closure	TZ501	2CPX010485R9999		1

*Accessory included in the scope of delivery

Subdistribution boards

TwinLine S 43 General accessories



ESAC3001P2



ESAC3003P4



ESAC3004P2



TZ637



TZ628P10



ESAC3002



TZ626



TZ601



TZ604



TZ605

Article	Order details			Pcs.
	Type	Order code	Price	
Mounting brackets 2 pcs* To mount the cabinet to the wall, to connect the plinth with the back of the cabinet or to connect cabinets in the back when using ESAC3002	ESAC3001P2	2CPX078410R9999		2
Transport lugs 4 pcs	ESAC3003P4	2CPX078412R9999		4
Lifting reinforcement for side-by-side structures 2 pcs For transporting side-by-side structures	ESAC3004P2	2CPX078413R9999		2
Door hinge: 180 degree*	TZ637	2CPX078414R9999		1
Closing plugs for hinge cutout	TZ628P10	2CPX010854R9999		1
Connection set for stacking cabinets	ESAC3002	2CPX078411R9999		1
Protective frame for stacking cabinets	TZ626	2CPX010778R9999		1
Mounting rails* For mounting frame holder	TZ601	2CPX010779R9999		1
Mounting frame holder centre* For internal and external cable container	TZ604	2CPX010782R9999		1
Mounting frame holder* left or right	TZ605	2CPX010783R9999		1

*Accessory included in the scope of delivery

Subdistribution boards

TwinLine S 43 General accessories

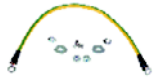

ZL8

Article	Order details		Price	Pcs.
	Type	Order code		
Door earthing set 10 mm ²	ZL8	2CPX038001R9999		1
Spray paint can Colour RAL 7035, 150 ml	ZA16	2CPX038235R9999		1
Touch-up applicator Colour RAL 7035, 12 ml	ZA116	2CPX039042R9999		1
Document holder DIN A4 Self-adhesive with transparent sleeve	ZA6	2CPX038227R9999		1
	ZA6P10	2CPX062380R9999		10
Self-adhesive with transparent sleeve and reinforced back	ZA61P10	2CPX062375R9999		10
Document holder DIN A4 Self-adhesive	ZA13	2CPX038233R9999		1
	ZA13P10	2CPX062381R9999		10
Document holder DIN A5 Self-adhesive	ZA5	2CPX038228R9999		1
	ZA5P10	2CPX062382R9999		10
Document holder support plate				
For document holder ZA13. to screw on to the door strengthening profiles	ZA123	2CPX038471R9999		1
For document holder ZA5. to screw on to the door strengthening profiles	ZA125	2CPX038472R9999		1



ZA16



ZA116



ZA6



ZA5



ZA123

System pro E combi

CombiLine S distribution panel system

Simple in planning
Quick in assembly
Safe in application

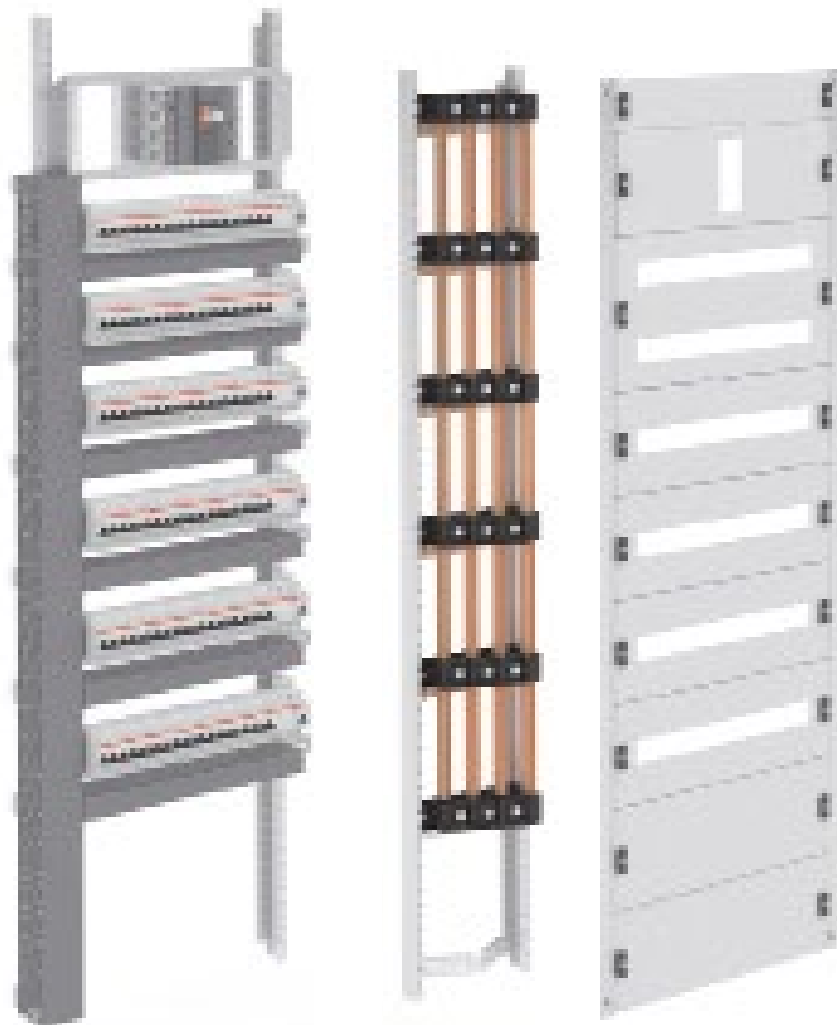

System pro E combi

CombiLine S distribution panel system

The highly sophisticated quick mounting system from ABB makes the completion of modular cabinets with distribution panels an effortless process. Simple, quick and safe – these are the three attributes of this system that speak for themselves.

TwinLine makes internal configuration fun, with a modular system of wall-mounting and floor-standing cabinets for the modular CombiLine S distribution panel system. The wide range of the CombiLine S offers the right solution for every application. One internal configuration System for all cabinets.

All of the individual parts required for assembling are packed separately and supplied in the form of a set.

The benefits: These sets allow you to take a flexible approach towards stock keeping, and avoid a time-consuming search for system parts such as brackets, screws or fastening elements. The instructions supplied with the system make assembly a child's play. Quick and clear planning and calculation become perfect with planning software.

Subdistribution boards

CombiLine S distribution panel system

Product benefits



One internal configuration system for all cabinets

All internal configuration and the busbar system for the cable containers up to 400 A fits in both cabinet depths. The internal configuration up to 800 A and the busbar system behind the device area also fits in a 275 mm cabinet depth.

Flexible in assembling

With its new mounting concept CombiLine S provides more flexibility and access for installation and wiring. Placed horizontally on two trestles, the assembly and wiring is very comfortable. An other option is to swing-out the whole internal configuration to have access from all sides.

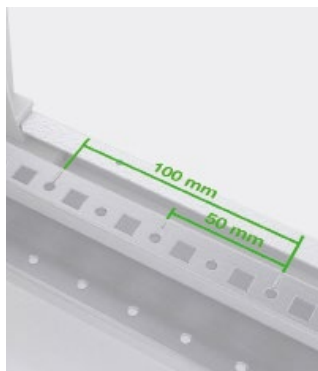

Assembly of internal configuration

CombiLine S provide a time-saving installation due the hook-in technology. This quick assembly limits the numbers of screws. Markers in 50 mm grid are on the mounting profiles for simple positioning.

Easy handling of covers

Time-saving fixation and adjustment as well as the simple closure system with 1/4 turn quick-lock provides easy handling of the covers and standard earth connection. When using devices in the covers a safe earth connection is guaranteed through 6 mm² cable with ring shoes on both sides. Optimal accessibility give the hinge set with 90 degree opening angle.

Subdistribution boards

CombiLine S distribution panel system

Product benefits



Optimal accessibility and ease of installation

The removable frame as standard gives the possibility to remove all covers in one handling and provides a quick access.

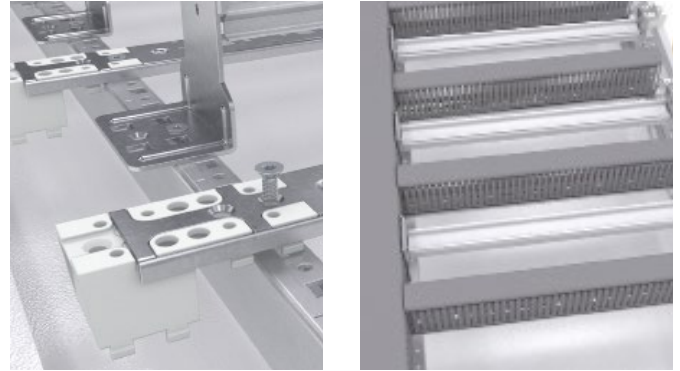

Wiring system

One support for different dimensions of wiring ducts; to have the same level for horizontal and vertical usage. An additional profile for stabilization of wiring duct and for mounting wire holders is available.

Form of internal separation up to form 2b

For the busbar system behind the device area is a horizontal transparent partition available. To separate the busbar system in external cable container it is possible to use a vertical separation.

Subdistribution boards

CombiLine S distribution panel system

The right module for every type of Application

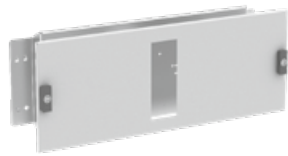

Tmax breakers

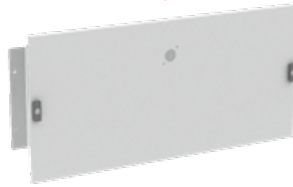

OT breakers

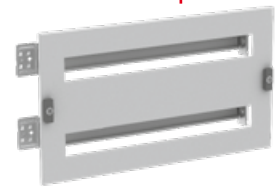

DIN rail components



Standard covers



Covers for measuring instruments



Mounting plates



Internal form of separation form 2b



Busbar systems

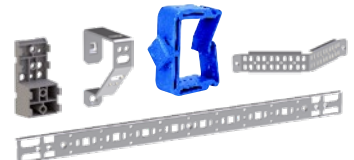

Accessories

Subdistribution boards

CombiLine S distribution panel system Technical specifications

Technical specifications	
Standards / regulations	IEC 61439 -1/-2/-3
Protection class	I, earthed
Degree of protection	IPXXC
Electrical characteristics	
Rated impulse withstand voltage (U_{imp})	6 kV
Overvoltage category	III
Pollution degree	3
Rated current (I_n)	up to 800 A
Rated peak withstand current (I_{pk})	up to 67 kA
Rated short-time withstand current (I_{cw}) 1.0 sec.	up to 32 kA
Rated frequency (f)	50 - 60 Hz
Rated insulation voltage (U_i)	1000 V
Rated operational voltage (U_o)	690 V

Subdistribution boards

CombiLine S for moulded case circuit breaker Tmax, horizontal

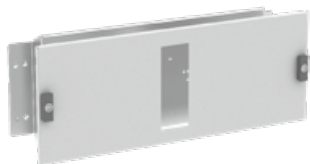

CHCC1511



CHDC1511

Tmax breaker horizontal 3-/4-pole

- Unequipped set for ABB Tmax as an incomer or outgoing breaker
- For fixed version with lever operation and front terminals
- Sheet steel cover with cut-out for 3*-/4-pole breaker
- Cover with 1/4 turn quick-lock

Width mm	Height mm	For device				Minimum cabinet depth	Order details			
		I_n max A	Type	Numbers of breakers	Numbers of poles		Type	Order code	Price	Pcs.
600	150	160	Tmax XT1	1	3/4	225	CHCA1511	2CPX078241R9999		1
	200	160	Tmax XT2	1	3/4	225	CHCB1511	2CPX078242R9999		1
	200	250	Tmax XT3	1	3/4	225	CHCC1511	2CPX078243R9999		1
	200	250	Tmax XT4	1	3/4	225	CHCD1511	2CPX078244R9999		1
	200	320	Tmax T4	1	3/4	225	CHCE1511	2CPX078245R9999		1
	300	630	Tmax T5	1	3/4	275	CHCF1511	2CPX078246R9999		1
	400	800	Tmax T6	1	3/4	275	CHCG1511	2CPX078247R9999		1
800	150	160	Tmax XT1	1	3/4	225	CHDA1511	2CPX078248R9999		1
	200	160	Tmax XT2	1	3/4	225	CHDB1511	2CPX078249R9999		1
	200	250	Tmax XT3	1	3/4	225	CHDC1511	2CPX078250R9999		1
	200	250	Tmax XT4	1	3/4	225	CHDD1511	2CPX078251R9999		1
	200	320	Tmax T4	1	3/4	225	CHDE1511	2CPX078252R9999		1
	300	630	Tmax T5	1	3/4	275	CHDF1511	2CPX078253R9999		1
	400	800	Tmax T6	1	3/4	275	CHDG1511	2CPX078254R9999		1

* For 3 poles breakers please order accessory flange codes: AD3305 XT1 3P Flange for plate-mounting - AD3306 XT2 3P Flange for plate-mounting - AD3307 XT3 3P Flange for plate-mounting - AD3308 XT4 3P Flange for plate-mounting.

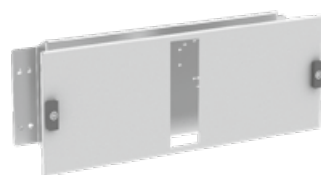

CHCC1611



CHDC1611

Tmax breaker horizontal 4-pole + RC sel.

- Unequipped set for ABB Tmax as an incomer or outgoing breaker
- For fixed version with lever operation and front terminals
 - Sheet steel cover with cut-out for 4-pole breaker and RC Sel.
 - Cover with 1/4 turn quick-lock

Width mm	Height mm	For device				Minimum cabinet depth	Order details			
		I_n max A	Type	Numbers of breakers	Numbers of poles		Type	Order code	Price	Pcs.
600	200	160	Tmax XT1	1	4 + RC sel.	225	CHCA1611	2CPX078255R9999		1
	200	160	Tmax XT2	1	4 + RC sel.	225	CHCB1611	2CPX078256R9999		1
	200	250	Tmax XT3	1	4 + RC sel.	225	CHCC1611	2CPX078257R9999		1
	200	250	Tmax XT4	1	4 + RC sel.	225	CHCD1611	2CPX078258R9999		1
	200	320	Tmax T4	1	4 + RC sel.	225	CHCE1611	2CPX078259R9999		1
	300	630	Tmax T5	1	4 + RC sel.	275	CHCF1611	2CPX078260R9999		1
	800	200	160	Tmax XT1	1	4 + RC sel.	225	CHDA1611	2CPX078261R9999	
200		160	Tmax XT2	1	4 + RC sel.	225	CHDB1611	2CPX078262R9999		1
200		250	Tmax XT3	1	4 + RC sel.	225	CHDC1611	2CPX078263R9999		1
200		250	Tmax XT4	1	4 + RC sel.	225	CHDD1611	2CPX078264R9999		1
200		320	Tmax T4	1	4 + RC sel.	225	CHDE1611	2CPX078265R9999		1
300		630	Tmax T5	1	4 + RC sel.	275	CHDF1611	2CPX078266R9999		1

Subdistribution boards

CombiLine S for moulded case circuit breaker Tmax, vertical

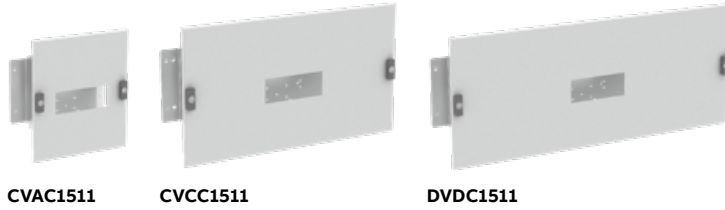

CVAC1511

CVCC1511

DVDC1511

Tmax breaker vertical 3-/4-pole

- Unequipped set for ABB Tmax as an incomer or outgoing breaker
- For fixed version with lever operation and front terminals
- Sheet steel cover with cut-out for 3*-/4-pole breaker
- Cover with 1/4 turn quick-lock

Width mm	Height mm	For device				Minimum cabinet depth	Order details			
		I_n max A	Type	Numbers of breakers	Numbers of poles		Type	Order code	Price	Pcs.
300	300	160	Tmax XT1	1	3/4	225	CVAA1511	2CPX078267R9999		1
	300	250	Tmax XT2	1	3/4	225	CVAB1511	2CPX078268R9999		1
	300	250	Tmax XT3	1	3/4	225	CVAC1511	2CPX078269R9999		1
	300	250	Tmax XT4	1	3/4	225	CVAD1511	2CPX078270R9999		1
	350	320	Tmax T4	1	3/4	225	CVAH1511	2CPX078271R9999		1
	350	630	Tmax T5	1	3/4	275	CVAH1511	2CPX078271R9999		1
600	300	160	Tmax XT1	1	3/4	225	CVCA1511	2CPX078272R9999		1
	300	160	Tmax XT2	1	3/4	225	CVCB1511	2CPX078273R9999		1
	300	250	Tmax XT3	1	3/4	225	CVCC1511	2CPX078274R9999		1
	300	250	Tmax XT4	1	3/4	225	CVCD1511	2CPX078275R9999		1
	350	320	Tmax T4	1	3/4	225	CVCH1511	2CPX078276R9999		1
	350	630	Tmax T5	1	3/4	275	CVCH1511	2CPX078276R9999		1
	450	800	Tmax T6	1	3/4	275	CVCG1511	2CPX078277R9999		1
800	300	160	Tmax XT1	1	3/4	225	CVDA1511	2CPX078278R9999		1
	300	160	Tmax XT2	1	3/4	225	CVDB1511	2CPX078279R9999		1
	300	250	Tmax XT3	1	3/4	225	CVDC1511	2CPX078280R9999		1
	300	250	Tmax XT4	1	3/4	225	CVDD1511	2CPX078281R9999		1
	350	320	Tmax T4	1	3/4	225	CVDH1511	2CPX078282R9999		1
	350	630	Tmax T5	1	3/4	275	CVDH1511	2CPX078282R9999		1
	450	800	Tmax T6	1	3/4	275	CVDG1511	2CPX078283R9999		1

* For 3 poles breakers please order accessory flange codes: AD3305 XT1 3P Flange for plate-mounting - AD3306 XT2 3P Flange for plate-mounting - AD3307 XT3 3P Flange for plate-mounting - AD3308 XT4 3P Flange for plate-mounting.

Subdistribution boards

CombiLine S for moulded case circuit breaker Tmax, vertical

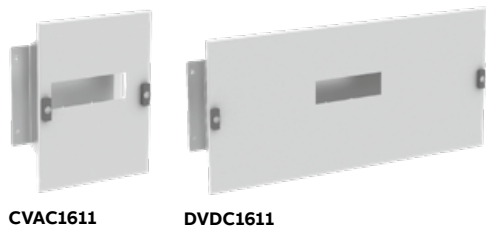

CVAC1611

DVDC1611

Tmax breaker vertical 4-pole + RC sel.

- Unequipped set for ABB Tmax as an incomer or outgoing breaker
- For fixed version with lever operation and front terminals
- Sheet steel cover with cut-out for 4-pole breaker and RC Sel.
- Cover with 1/4 turn quick-lock

Width mm	Height mm	For device					Order details			
		I_n max A	Type	Numbers of breakers	Numbers of poles	Minimum cabinet depth	Type	Order code	Price	Pcs.
300	300	160	Tmax XT1	1	4 + RC sel.	225	CVAA1611	2CPX078284R9999		1
	350	250	Tmax XT2	1	4 + RC sel.	225	CVAB1611	2CPX078285R9999		1
	350	250	Tmax XT3	1	4 + RC sel.	225	CVAC1611	2CPX078286R9999		1
	350	250	Tmax XT4	1	4 + RC sel.	225	CVAD1611	2CPX078287R9999		1
	450	320	Tmax T4	1	4 + RC sel.	225	CVAE1611	2CPX078288R9999		1
	450	630	Tmax T5	1	4 + RC sel.	275	CVAF1611	2CPX078289R9999		1
600	300	160	Tmax XT1	1	4 + RC sel.	225	CVCA1611	2CPX078290R9999		1
	350	160	Tmax XT2	1	4 + RC sel.	225	CVCB1611	2CPX078291R9999		1
	350	250	Tmax XT3	1	4 + RC sel.	225	CVCC1611	2CPX078292R9999		1
	350	250	Tmax XT4	1	4 + RC sel.	225	CVCD1611	2CPX078293R9999		1
	450	320	Tmax T4	1	4 + RC sel.	225	CVCE1611	2CPX078294R9999		1
	450	630	Tmax T5	1	4 + RC sel.	275	CVCF1611	2CPX078295R9999		1
800	300	160	Tmax XT1	1	4 + RC sel.	225	CVDA1611	2CPX078296R9999		1
	350	160	Tmax XT2	1	4 + RC sel.	225	CVDB1611	2CPX078297R9999		1
	350	250	Tmax XT3	1	4 + RC sel.	225	CVDC1611	2CPX078298R9999		1
	350	250	Tmax XT4	1	4 + RC sel.	225	CVDD1611	2CPX078299R9999		1
	450	320	Tmax T4	1	4 + RC sel.	225	CVDE1611	2CPX078300R9999		1
	450	630	Tmax T5	1	4 + RC sel.	275	CVDF1611	2CPX078301R9999		1

Subdistribution boards

CombiLine S for moulded case circuit breaker Tmax, vertical

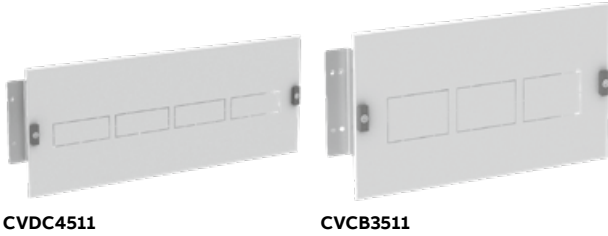

Tmax breaker vertical side-by-side

- Unequipped set for ABB Tmax as an incomer or outgoing breaker
- For fixed version with lever operation and front terminals
- Sheet steel cover with knock-out for 3*-/4-pole breaker side by side
- Cover with 1/4 turn quick-lock

Width mm	Height mm	For device				Minimum cabinet depth	Order details			
		I_n max A	Type	Numbers of breakers	Numbers of poles		Type	Order code	Price	Pcs.
600	300	250	Tmax XT1	3	3/4	225	CVCA3511	2CPX078398R9999		1
	300	250	Tmax XT2	3	3/4	225	CVCB3511	2CPX078399R9999		1
	300	250	Tmax XT3	3	3/4	225	CVCC3511	2CPX078400R9999		1
	300	250	Tmax XT4	3	3/4	225	CVCD3511	2CPX078401R9999		1
800	300	250	Tmax XT1	4	3/4	225	CVDA4511	2CPX078402R9999		1
	300	250	Tmax XT2	4	3/4	225	CVDB4511	2CPX078403R9999		1
	300	250	Tmax XT3	4	3/4	225	CVDC4511	2CPX078404R9999		1
	300	250	Tmax XT4	4	3/4	225	CVDD4511	2CPX078405R9999		1

* For 3 poles breakers please order accessory flange codes: AD3305 XT1 3P Flange for plate-mounting - AD3306 XT2 3P Flange for plate-mounting - AD3307 XT3 3P Flange for plate-mounting - AD3308 XT4 3P Flange for plate-mounting.

Subdistribution boards

CombiLine S for switch disconnecter OT, horizontal

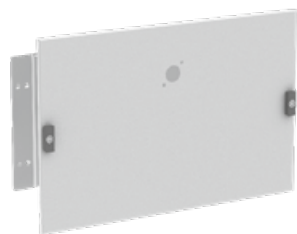

CHCQ1513



CHDQ1513

OT switch disconnecter horizontal

- Unequipped set for ABB OT...E03/04P as an incomer or outgoing switch
- Sheet steel cover with cut out for rotary handle in top of the center
- Cover fixed with one 1/4 turn quick-lock
- Important: in case of using switch disconnectors OT630 and OT800 it is not possible to use busbar system behind the mounting plate

Width mm	Height mm	For device					Order details			
		I_n max A	Type	Numbers of breakers	Numbers of poles	Minimum cabinet depth	Type	Order code	Price	Pcs.
600	350	400	OT200, OT250, OT315, OT400	1	3/4	225	CHCQ1513	2CPX078302R9999		1
	500	800	OT630, OT800	1	3/4	275	CHCR1513	2CPX078377R9999		1
800	350	400	OT200, OT250, OT315, OT400	1	3/4	225	CHDQ1513	2CPX078303R9999		1
	500	800	OT630, OT800	1	3/4	275	CHDR1513	2CPX078378R9999		1

Subdistribution boards

CombiLine S for switch disconnecter OT, vertical

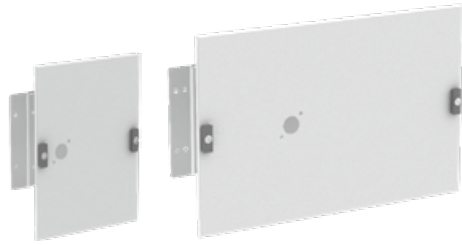

CVAP1513

CVDQ1513

OT switch disconnecter vertical left

- Unequipped set for ABB OT...E03/04P as an incomer or outgoing switch
- Sheet steel cover with cut out for rotary handle on the left side
- Cover fixed with one 1/4 turn quick-lock
- Important: in case of using switch disconnectors OT630 and OT800 it is not possible to use busbar system behind the mounting plate

Width mm	Height mm	For device					Order details			
		I_n max A	Type	Numbers of breakers	Numbers of poles	Minimum cabinet depth	Type	Order code	Price	Pcs.
300	350	250	OT200, OT250	1	3/4	225	CVAP1513	2CPX078304R9999		1
600	350	400	OT200, OT250, OT315, OT400	1	3/4	225	CVCQ1513	2CPX078305R9999		1
	500	800	OT630, OT800	1	3/4	275	CVCR1513	2CPX078379R9999		1
800	350	400	OT200, OT250, OT315, OT400	1	3/4	225	CVDQ1513	2CPX078306R9999		1
	500	800	OT630, OT800	1	3/4	275	CVDR1513	2CPX078380R9999		1

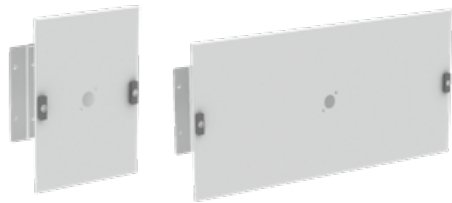

CVAP1514

CVDQ1514

OT switch disconnecter vertical center

- Unequipped set for ABB OT...E12/22P as an incomer or outgoing switch vertical
- Sheet steel cover with cut out for rotary handle in the center
- Cover fixed with 1/4 turn quick-lock
- Important: in case of using switch disconnectors OT630 and OT800 it is not possible to use busbar system behind the mounting plate

Width mm	Height mm	For device					Order details			
		I_n max A	Type	Numbers of breakers	Numbers of poles	Minimum cabinet depth	Type	Order code	Price	Pcs.
300	350	250	OT200, OT250	1	3/4	225	CVAP1514	2CPX078307R9999		1
600	350	400	OT200, OT250, OT315, OT400	1	3/4	225	CVCQ1514	2CPX078308R9999		1
	500	800	OT630, OT800	1	3/4	275	CVCR1514	2CPX078381R9999		1
800	350	400	OT200, OT250, OT315, OT400	1	3/4	225	CVDQ1514	2CPX078309R9999		1
	500	800	OT630, OT800	1	3/4	275	CVDR1514	2CPX078382R9999		1

Subdistribution boards

CombiLine S for DIN rail components

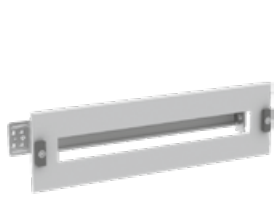

CKDB1615

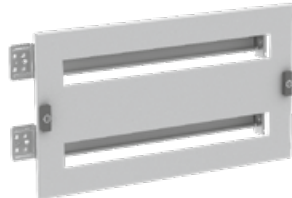

CKDB2630

DIN rail distance 150 mm for S200

- Unequipped set for DIN rail components
- Din rail distance 150 mm
- System pro M S200, switch OT160 (front level)
- DIN rail is fixed on a mounting bracket
- The material is aluminium
- On the back-side it is possible to use Unifix L
- Cover with 1/4 turn quick-lock

Width mm	Height mm	Additional information				Minimum cabinet depth	Order details			
		I_n max A	Space units (SU)	Din rail distance	Numbers of rows		Type	Order code	Price	Pcs.
600	150	160	24	150	1	225	CKDB1615	2CPX078318R9999		1
800	150	160	36	150	1	225	CKDB1815	2CPX078319R9999		1
600	300	160	48	150	2	225	CKDB2630	2CPX078406R9999		1
800	300	160	72	150	2	225	CKDB2830	2CPX078407R9999		1

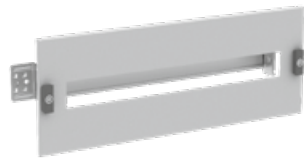

CKDB1620

DIN rail distance 200 mm for S200, Tmax

- Unequipped set for DIN rail components
- Din rail distance 200 mm
- System pro M S200, switch OT160 (front level)
- Tmax, XT1, XT3 breaker 3+4 pole version (back level)
- DIN rail is fixed on a mounting bracket
- The material is aluminium
- On the back-side it is possible to use Unifix L,
- A depth adapter enables the same depth of MCCB and DIN rail components S200
- Cover is with DIN cut-out

Width mm	Height mm	Additional information				Minimum cabinet depth	Order details			
		I_n max A	Space units (SU)	Din rail distance	Numbers of rows		Type	Order code	Price	Pcs.
300	200	250	12	200	1	225	CKDC1320	2CPX078320R9999		1
600	200	250	24	200	1	225	CKDC1620	2CPX078321R9999		1
800	200	250	36	200	1	225	CKDC1820	2CPX078322R9999		1

Subdistribution boards

CombiLine S for DIN rail components

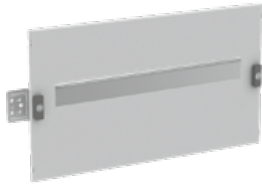

CKDR1630

DIN rail for Tmax 4 pole + RC sel.

- Unequipped set for Tmax breaker, XT1, XT3 4 pole with RC sel.
- DIN rail is fixed on a mounting bracket
- The material is aluminium
- On the back-side it is possible to use Unifix L,
- A depth adapter enables the same depth of MCCB and DIN rail components S200
- Cover is with DIN cut-out
- Cover fixed with 1/4 turn quick-lock

Width mm	Height mm	Additional information				Minimum cabinet depth	Order details			
		I_n max A	Space units (SU)	Din rail distance	Numbers of rows		Type	Order code	Price	Pcs.
600	300	250	24	300	1	225	CKDR1630	2CPX078383R9999		1
800	300	250	36	300	1	225	CKDR1830	2CPX078384R9999		1

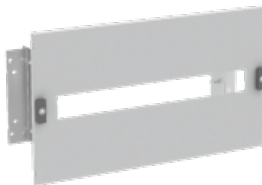

CKDU1630

DIN rail for Unifix H

- Unequipped set for System Unifix H
- The System Unifix H can be fixed on supports
- Cover is with DIN cut-out
- Cover fixed with one 1/4 turn quick-lock

Width mm	Height mm	Additional information				Minimum cabinet depth	Order details			
		I_n max A	Space units (SU)	Din rail distance	Numbers of rows		Type	Order code	Price	Pcs.
600	300	250	24	300	1	225	CKDU1630	2CPX078385R9999		1
800	300	250	36	300	1	225	CKDU1830	2CPX078386R9999		1

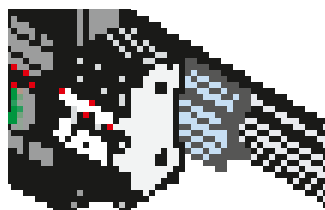

Article	Width in mm	Order details			
		Type	Order code	Price	Pcs.
Depth adapters Enables the depth of miniature circuit-breakers to be adapted to that of moulded-case circuit-breakers mounted on the same DIN rail.	600	AP6000			1
Depth adapters for Tmax XT1-XT3					

Subdistribution boards

CombiLine S covers closed



CACP3030



CACP6030



CACP8030



CACP6060



CACP8060

Article	Height in mm	Order details		Price	Pcs.
		Type	Order code		
Cover closed					
Material sheet steel. With one 1/4 turn quick-lock per side					
Width 300 mm	50	CACP3005	2CPX078340R9999		1
	100	CACP3010	2CPX078341R9999		1
	150	CACP3015	2CPX078342R9999		1
	200	CACP3020	2CPX078343R9999		1
	250	CACP3025	2CPX078344R9999		1
	300	CACP3030	2CPX078345R9999		1
	400	CACP3040	2CPX078346R9999		1
Width 600 mm	50	CACP6005	2CPX078350R9999		1
	100	CACP6010	2CPX078351R9999		1
	150	CACP6015	2CPX078352R9999		1
	200	CACP6020	2CPX078353R9999		1
	250	CACP6025	2CPX078354R9999		1
	300	CACP6030	2CPX078355R9999		1
	400	CACP6040	2CPX078356R9999		1
Width 800 mm	50	CACP8005	2CPX078360R9999		1
	100	CACP8010	2CPX078361R9999		1
	150	CACP8015	2CPX078362R9999		1
	200	CACP8020	2CPX078363R9999		1
	250	CACP8025	2CPX078364R9999		1
	300	CACP8030	2CPX078365R9999		1
	400	CACP8040	2CPX078366R9999		1
Cover closed					
Material sheet steel. With two 1/4 turn quick-lock per side					
Width 300 mm	500	CACP3050	2CPX078347R9999		1
	600	CACP3060	2CPX078348R9999		1
	800	CACP3080	2CPX078349R9999		1
Width 600 mm	500	CACP6050	2CPX078357R9999		1
	600	CACP6060	2CPX078358R9999		1
	800	CACP6080	2CPX078359R9999		1
Width 800 mm	500	CACP8050	2CPX078367R9999		1
	600	CACP8060	2CPX078368R9999		1
	800	CACP8080	2CPX078369R9999		1

Subdistribution boards

CombiLine S covers for measuring instruments



CKUA6020



CKUB6020

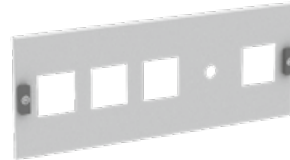

CKUC6020

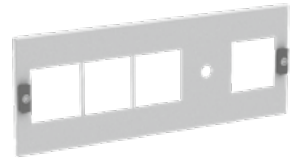

CKUD6020

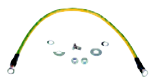

CAE06



CAHCP10

Article	Width in mm	Order details		Price	Pcs.
		Type	Order code		
Covers for universal measuring instruments					
For 2 measuring instrument 72 x 72 mm Cover fixed with one 1/4 turn screws on every side Material sheet steel Height 200 mm	600	CKUA6020	2CPX078310R9999		1
	800	CKUA8020	2CPX078311R9999		1
For 2 measuring instrument 96 x 96 mm Cover fixed with one 1/4 turn screws on every side Material sheet steel Height 200 mm	600	CKUB6020	2CPX078312R9999		1
	800	CKUB8020	2CPX078313R9999		1
For 4 universal measuring instruments 72 x 72 mm Cover fixed with one 1/4 turn screws on every side Material sheet steel Height 200 mm	600	CKUC6020	2CPX078314R9999		1
	800	CKUC8020	2CPX078315R9999		1
For 4 universal measuring instruments 96 x 96 mm Cover fixed with one 1/4 turn screws on every side Material sheet steel Height 200 mm	600	CKUD6020	2CPX078316R9999		1
	800	CKUD8020	2CPX078317R9999		1
Cover earthing set Connection between cover and structure, when using devices in the cover Cable diameter 6 mm ²		CAEC6	2CPX078462R9999		1
Hinge set for covers Opening angle 90° Per cover are 2 pcs. required		CAHCP10	2CPX078485R9999		1

Subdistribution boards

CombiLine S mounting plates

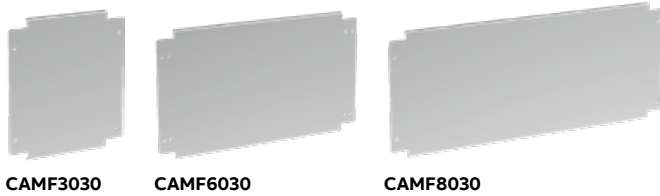

- Mounting plate is for fixed mounted on profile
- Distance between mounting plate and cover is 110 mm
- Material sheet steel

Width mm	Height mm	Usable space		Minimum cabinet depth	Order details		
		Height mm	Width mm		Type	Order code	Price
300	300	295	216	225	CAMF3030	2CPX078323R9999	1
600	150	145	432	225	CAMF6015	2CPX078324R9999	1
	200	195	432	225	CAMF6020	2CPX078325R9999	1
	250	245	432	225	CAMF6025	2CPX078326R9999	1
	300	295	432	225	CAMF6030	2CPX078327R9999	1
	400	395	432	225	CAMF6040	2CPX078328R9999	1
	500	495	432	225	CAMF6050	2CPX078329R9999	1
	600	595	432	225	CAMF6060	2CPX078330R9999	1
	800	795	432	225	CAMF6080	2CPX078331R9999	1
800	150	145	648	225	CAMF8015	2CPX078332R9999	1
	200	195	648	225	CAMF8020	2CPX078333R9999	1
	250	245	648	225	CAMF8025	2CPX078334R9999	1
	300	295	648	225	CAMF8030	2CPX078335R9999	1
	400	395	648	225	CAMF8040	2CPX078336R9999	1
	500	495	648	225	CAMF8050	2CPX078337R9999	1
	600	595	648	225	CAMF8060	2CPX078338R9999	1
	800	795	648	225	CAMF8080	2CPX078339R9999	1

Subdistribution boards

Form 2 B TwinLine S 55



CKFV8060W

Article	Depth mm	Height mm	Order details		Price	Pcs.
			Type	Order code		
Set to separate the busbars in external cable container to the device area Mounting position vertical Material transparent plastic	225	600	CKFV8060W	2CPX078636R9999		1
		800	CKFV8080W	2CPX078637R9999		1
		1000	CKFV8100W	2CPX078638R9999		1
		1200	CKFV8120W	2CPX078639R9999		1
		1400	CKFV8140W	2CPX078640R9999		1
		275	1200	CKFV9120W	2CPX078647R9999	
		1400	CKFV9140W	2CPX078648R9999		1
		1600	CKFV9160W	2CPX078649R9999		1
		1800	CKFV9180W	2CPX078650R9999		1
		2000	CKFV9200W	2CPX078651R9999		1

Subdistribution boards

CombiLine S internal form of separation Form 2b

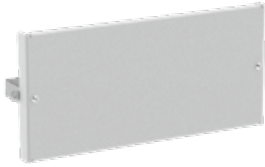

CKFH1620

- Set to separate the busbar behind device area
- Touch protection in front of the busbar system
- Mounting position horizontal
- Material is transparent plastic

Width mm	Height mm	Order details			
		Type	Order code	Price	Pcs.
600	200	CKFH1620	2CPX078463R9999		1
800	200	CKFH1820	2CPX078464R9999		1



CKFH2620

- Set to separate the busbar behind device area
- Touch protection in front of the busbar system and in addition top or bottom
- Mounting position horizontal
- Material is transparent plastic

Width mm	Height mm	Order details			
		Type	Order code	Price	Pcs.
600	200	CKFH2620	2CPX078465R9999		1
800	200	CKFH2820	2CPX078466R9999		1



CKFH3620

- Set to separate the busbar behind device area
- Touch protection behind the busbar system
- Mounting position horizontal
- Material is transparent plastic

Width mm	Height mm	Order details			
		Type	Order code	Price	Pcs.
600	200	CKFH3620	2CPX078467R9999		1
800	200	CKFH3820	2CPX078468R9999		1

Subdistribution boards

Form 2b for TwinLine S 43



CKFV8060

Article	Depth mm	Height mm	Order details		Price	Pcs.
			Type	Order code		
Set to separate the busbars in external cable container to the device area Mounting position vertical Material transparent plastic	225	600	CKFV8060	2CPX078469R9999		1
		800	CKFV8080	2CPX078470R9999		1
		1000	CKFV8100	2CPX078471R9999		1
		1200	CKFV8120	2CPX078472R9999		1
		1400	CKFV8140	2CPX078473R9999		1
		1600	CKFV8160	2CPX078474R9999		1
		1800	CKFV8180	2CPX078475R9999		1
		2000	CKFV8200	2CPX078476R9999		1
			275	600	CKFV9060	2CPX078477R9999
800	CKFV9080			2CPX078478R9999		1
1000	CKFV9100			2CPX078479R9999		1
1200	CKFV9120			2CPX078480R9999		1
1400	CKFV9140			2CPX078481R9999		1
1600	CKFV9160			2CPX078482R9999		1
1800	CKFV9180			2CPX078483R9999		1
2000	CKFV9200			2CPX078484R9999		1

Subdistribution boards

CombiLine S busbar system



CKBS1161



CKBS1231



CKBS2161



CKBS2231

Article	Width in mm	Min. cabinet depth mm	Order details		
			Type	Order code	Price Pcs.
Busbar support linear for flat busbars Behind the device area Rated (In) max. 630 A Rated peak withstand current (Ipk) up to 68 kA Rated short-time withstand current (Icw) 1.0 sec. up to 32 kA To find the right numbers of supports to achive the short-circuit see the table below, numbers of support 1	600	275	CKBS1161	2CPX078447R9999	1
	800	275	CKBS1181	2CPX078448R9999	1
Busbar support scaled for flat busbars For external cable container Rated current (In) max. 630 A Rated peak withstand current (Ipk) up to 48 kA Rated short-time withstand current (Icw) 1.0 sec. up to 23 kA To find the right numbers of supports to achive the short-circuit see the table below, numbers of support 1	300	225	CKBS1231	2CPX078449R9999	1
Busbar support linear for shaped busbars Behind the device area Rated current (In) max. 800 A Rated peak withstand current (Ipk) up to 74 kA Rated short-time withstand current (Icw) 1.0 sec. up to 35 kA To find the right numbers of supports to achive the short-circuit see the table below, numbers of support 1	600	275	CKBS2161	2CPX078370R9999	1
	800	275	CKBS2181	2CPX078371R9999	1
Busbar support scaled for shaped busbars For internal or external cable container Rated current (In) max. 800 A Rated peak withstand current (Ipk) up to 74 kA Rated short-time withstand current (Icw) 1.0 sec. up to 35 kA To find the right numbers of supports to achive the short-circuit see the table below, numbers of support 1	200/300	225	CKBS2231	2CPX078372R9999	1

Table for rated peak withstand current I_{pk} / rated short-time withstand current I_{cw} (1 sec.)

Busbar Type	Busbar I_n in A	Busbar support	No. of busbars per phase	No. support H = 1750 mm	Max. X (mm) H = 1750 mm	No. support Max. X (mm) H = 1750 mm	Max. X (mm) H = 1750 mm	No. support Max. X (mm) H = 1750 mm	Max. X (mm)
Busbar support linear for flat busbar				17kA / 10kA	40kA / 20kA	48kA / 23kA	67kA / 32kA		
BR0250	250	CKBS1161	1	4	500	-	-	-	-
BR0400	400	CKBS1181	1	4	500	6	350	6	350
BR0630	630		1	4	600	4	600	4	600
Busbar support scaled for flat busbars									
BR0250	250	CKBS1231	1	8	275	-	-	-	-
BR0400	400		1	8	275	15	125	18	100
BR0630	630		1	8	275	15	125	18	100
Busbar Type	Busbar I_n in A	Busbar support	No. of busbars per phase	No. support	Max. X (mm)	No. support	Max. X (mm)	No. support	Max. X (mm)
Busbar support linear for shaped busbars				17kA / 10kA	40kA / 20kA	48kA / 23kA	63kA / 30kA		
BA0400	400	CKBS2161	1	5	425	5	425	5	425
BA0800	800	CKBS2181	1	4	550	4	550	4	550
Busbar support scaled for shaped busbars									
BA0400	400	CKBS2231	1	5	425	5	425	5	425
BA0800	800		1	5	425	5	425	5	425

Max X = maximum distance not to be exceeded between two consecutive busbar holders

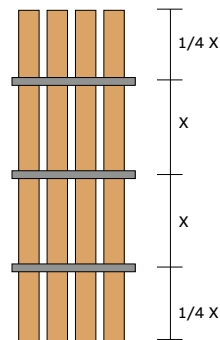

The distance between the first busbar holder and the end of the busbar must not exceed 1/4 of "X".

Subdistribution boards

CombiLine S busbar system

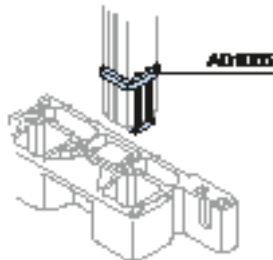
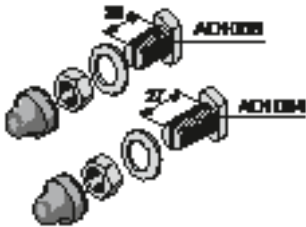
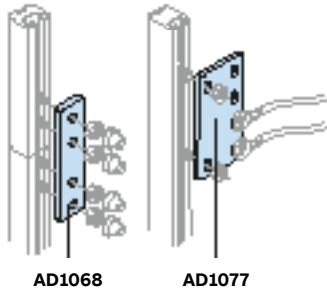

Article	Order details			
	Type	Order code	Price	Pcs.
Joints for busbars with shaped section				
No. 4 copper 400 A branch joints		AD1077		4
No. 4 joints for joining busbars with shaped section 400 / 800 A		AD1068		4
Hammer seal screws for busbars with shaped section				
No. 12 M8 screws L = 20 mm for flexible busbars and cable shoes complete with screw-covering cap		AD1056		12
No. 12 M8 screws L = 27 mm for flat busbars 10 mm complete with screw-covering cap		AD1064		12
Resting bases for busbars with shaped section				
No. 4 resting bases for 400 / 800 A busbars		AD1065		4
Busbars holders end cover				
No. 2 terminal covers for linear busbar holders CKBS1161, CKBS1181		BP0632		1

Subdistribution boards

CombiLine S busbar system

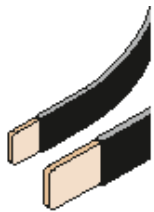

BF1602

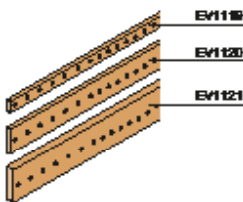
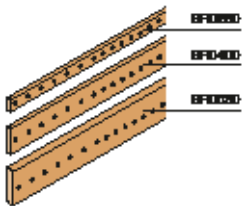
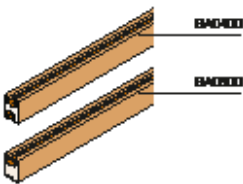











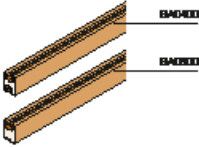

Article	Dimensions		Order details			
	Length mm	I_n A	Type	Order code	Price	Pcs.
Flexible Busbars						
Flexible busbars insulated with self-extinguishing material						
No. 2 flexible busbars, section 20 x 3	2000	250	BF1602			2
No. 2 flexible busbars, section 20 x 5	2000	400	BF2502			2
No. 2 flexible busbars, section 24 x 6	2000	500	BF4002			2
No. 2 flexible busbars, section 32 x 5	2000	630	BF4012			2
Distribution busbars with shaped section						
Busbar $I_n = 400$ A	1730	400	BA0400			1
Busbar $I_n = 800$ A	1730	800	BA0800			1
Flat busbar						
Copper busbars drilled and threaded for rapid connection of the conductors Can be used with both linear CKBS1161, CKBS1181 and scaled CKBS1231 busbar holder						
No. 2 copper busbar 15 x 5	1750	250	BR0250			2
No. 2 copper busbar 25 x 5	1750	400	BR0400			2
No. 2 copper busbar 30 x 10	1750	630	BR0630			2
Earthing busbars*						
Busbar can be mounted directly on the mounting profile or busbar 20 x 5 mm on the support for horizontal installation; Copper busbars drilled and threaded for rapid connection of the conductors						
No. 2 earthing busbars 20 x 5 threaded M6	2000		EV1119			2
No. 2 earthing busbars 25 x 5 threaded M6	2000		EV1120			2
No. 2 earthing busbars 50 x 5 threaded M6	2000		EV1121			2
Support universal, for horizontal installation For a Din rail or cable fastening rail or earth busbar max. 20 x 5 mm For fix mounting Material is metal			CASHP2	2CPX078450R9999		2
			CASHP50	2CPX078451R9999		50

* Busbar dimensions can be selected according to IEC 61439-1 table 5

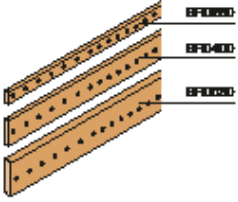
Subdistribution boards

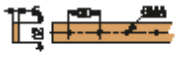
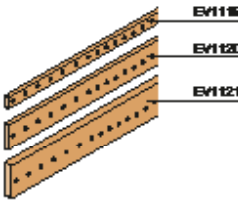
CombiLine S busbar system

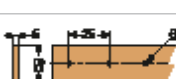
Cross section	Code	I_n in A	No. busbar/phase	Dimensions			Weight kg	
				Cu busbar im mm	Section dimensions mm ²	Length mm		
Flexible busbars up to 630 A								
		BF1602	250	1	20 x 3	60	2000	1.42
		BF2502	400	1	20 x 5	100	2000	2.15
		BF4002	500	1	24 x 6	144	2000	3
		BF4012	630	1	32 x 5	160	2000	3.36
Busbars with shaped section for applications up to 800 A								
		BA0400	400	1	20 x 20	200	1730	4
		BA0800	800	1	20 x 20	280	1730	4,4
Flat busbars for distribution up to 630 A								
Cross section	Code	I_n in A	No. busbar/phase	Cu busbar im mm	Section dimensions mm ²	Length mm	Weight kg	
Flat busbars for distribution up to 630 A								
		BR0250	250	1	15 x 5	75	1750	1.35
		BR0400	400	1	25 x 5	125	1750	1.8
		BR0630	630	1	30 x 10	300	1750	4.4
Flat drilled and threaded busbars for earthing connections*								
Cross section	Code	Threading	pitch	Cu busbar im mm	Section dimensions mm ²	Length mm	Weight kg	
		EV1119	6 MA	20	20 x 5	100	2000	
		EV1120	6 MA	20	25 x 5	125	2000	
		EV1121	6 MA	25	50 x 5	250	2000	

* Busbar dimensions can be selected according to IEC 61439-1 table 5

Subdistribution boards

CombiLine S accessories, mounting support



CASHP2



CASVP2

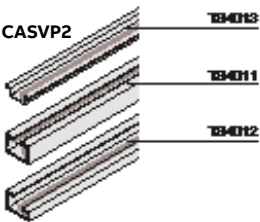

CAHB16

Article	Width mm	Order details			
		Type	Order code	Price	Pcs.
Support universal, for horizontal installation For a Din rail or cable fastening rail or earth busbar max. 20 x 5 mm Material is metal		CASHP2	2CPX078450R9999		2
		CASHP50	2CPX078451R9999		50
Support universal, for vertical installation For a Din rail or cable fastening Material is metal		CASVP2	2CPX078452R9999		2
		CASVP50	2CPX078453R9999		50
Section for accessories Length 2000 mm					
No. 2 sections EN50024 C30		TS4011			2
No. 2 sections EN50035 G32		TS4012			2
No. 2 DIN sections EN50022		TS4013			2
Horizontal mounting profile for busbar support and cable fixing Mounted on the back level of the vertical mounting profile Material metal	300	CAHB3	2CPX078456R9999		1
	600	CAHB6	2CPX078457R9999		1
	800	CAHB8	2CPX078458R9999		1

Subdistribution boards

CombiLine S accessories, wiring system



CASWP2



CAHW6



ED44P10



ED45P10

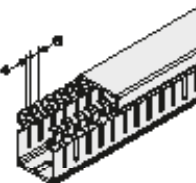
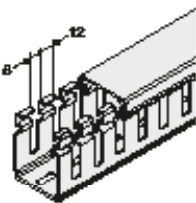

Article	Width mm	Order details			
		Type	Order code	Price	Pcs.
Support for wiring duct For wiring ducts with 60 mm and 80 mm height Material is Polyamid (PA)		CASWP2	2CPX078454R9999		2
		CASWP50	2CPX078455R9999		50
Horizontal mounting profile for Wiring system Mounted on support for wiring duct Material metal	600	CAHW6	2CPX078459R9999		1
	800	CAHW8	2CPX078461R9999		1
Wire holder For horizontal mounting profile					
Depth 28.5 mm		ED44P10	2CPX062335R9999		10
		ED44P50	2CPX062308R9999		50
		ED44P1000	2CPX062703R9999		1000
Depth 55 mm		ED45P10	2CPX062336R9999		10
		ED45P50	2CPX062310R9999		50
		ED45P1000	2CPX062704R9999		1000
Wiring ducts For horizontal and vertical installation RAL 7035, lenght 2000 mm					
Slot 8 - 12 mm Base x Height in mm					
	60 x 60		05 067		1
	60 x 80		05 087		1
	80 x 60		05 069		1
	80 x 80		05 089		1
Slot 4 - 6 mm Base x Height in mm					
	60 x 60		05 167		1
	60 x 80		05 187		1
	80 x 60		05 169		1
	80 x 80		05 189		

Subdistribution boards

CombiLine S distribution system Unifix, overview

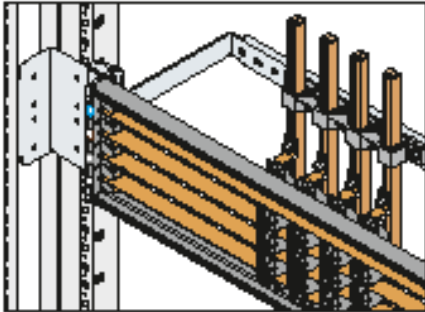

Direct connection with the 400/800 A system of busbars with shaped section.

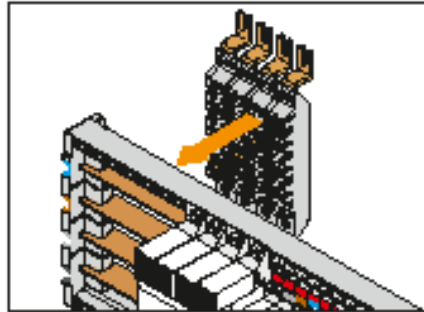

Feeder module for 400 A frame (L1-L2-L3-N).

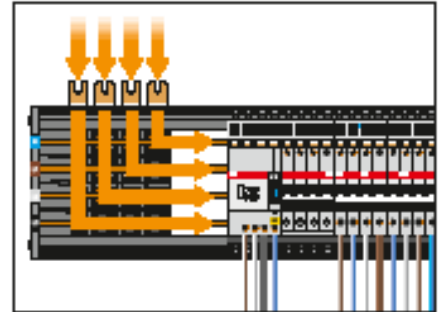

Direct power supply of the bases by means of feeder module ED2209.

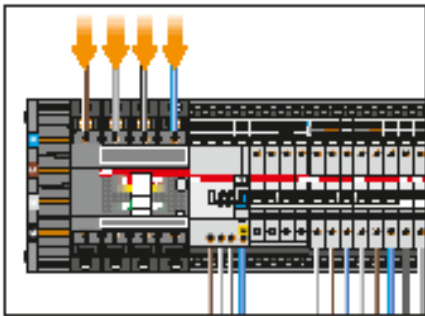

Power supply by means of general row circuit-breaker.

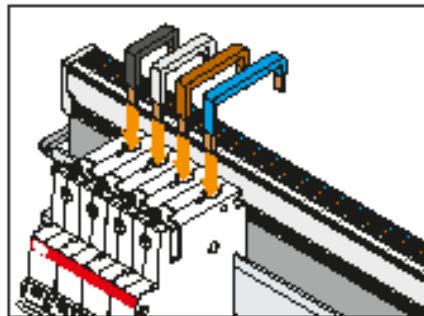

Connections (L1-L2-L3-N) for System pro M modular apparatus.

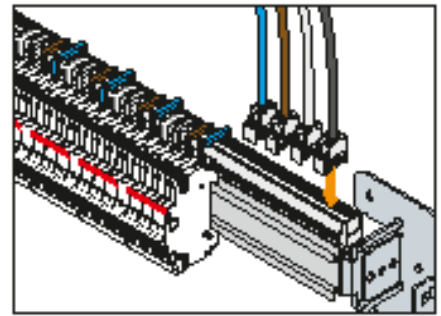

Power supply of the busbar with 100 A feeder module without cable. Terminal capacity 35mm².

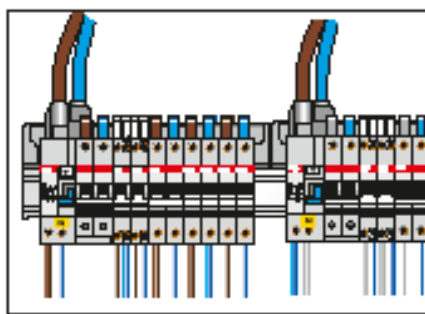

Direct power supply of the busbars by means of feeder module.

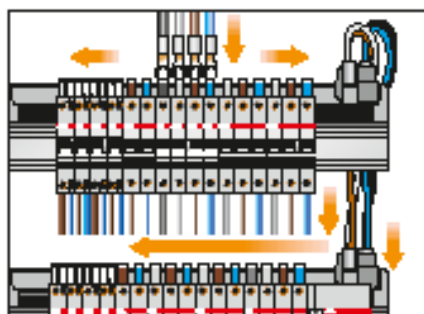

Power supply by means of modules and cables in parallel.

Subdistribution boards

CombiLine S distribution system Unifix L

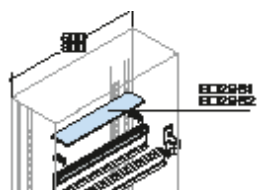
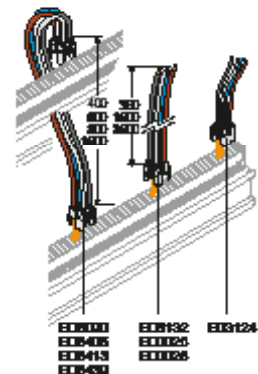
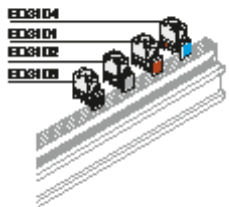
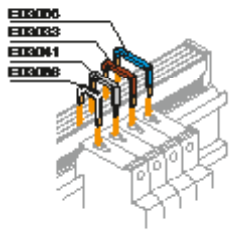
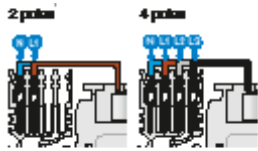

Article	Order details			
	Type	Order code	Price	Pcs.
2-pole busbars				
100 A 2P 8 module busbar, width 200 mm		ED2985		6
100 A 2P 12 module busbar, width 400 mm		ED2993		6
100 A 2P 18 module busbar, width 450 mm		ED3009		6
100 A 2P 24 module busbar, width 600 mm		ED3017		6
100 A 2P 36 module busbar, width 800 mm		ED3025		6
4-pole busbars				
100 A 4P 12 module busbar, width 400 mm		ED2944		6
100 A 4P 18 module busbar, width 450 mm		ED2951		6
100 A 4P 24 module busbar, width 600 mm		ED2969		6
100 A 4P 36 module busbar, width 800 mm		ED2977		6
Connections for various apparatus				
Connection with 2 conductors L/N 16 A		ED3108		6
Connection with 3 conductors L1/L2/L3 16 A		ED3116		6
Connection with 4 conductors L1/L2/L3/N 16 A single phase		ED3124		6
Connection with 2 conductors L1/N 40 A		ED3355		6
Connection with 3 conductors L1/L2/L3 40 A		ED3363		6
Connection with 4 conductors L1/L2/L3/N 40 A		ED3371		6
Connections for apparatus				
No. 10 connections L1-N 40 A		ED3272		10
No. 10 connections L2-N 40 A		ED3280		10
No. 10 connections L3-N 40 A		ED3298		10
No. 10 connections L 1 100 A		ED3033		10
No. 10 connections L 2 100 A		ED3041		10
No. 10 connections L 3 100 A		ED3058		10
No. 10 connections N 100 A		ED3066		10
Feeder with 4P 100 A cable, width 350 mm		ED3132		10
Feeder with 4P 100 A cable, width 1500 mm		ED0026		10
Feeder with 4P 100 A cable, width 1500 mm		ED0025		10
Power supply modules with cable				
Parallel module 2P 100 A with cable, width 600 mm		ED3082		6
Parallel module 4P 100 A with cable, width 400 mm		ED3405		6
Parallel module 4P 100 A with cable, width 600 mm		ED3090		6
Parallel module 4P 100 A with cable, width 800 mm		ED3413		6
Parallel module 4P 100 A with cable, width 1500 mm		ED3439		6
Power supply modules without cable In 100 A				
No. 10 single-pole power supply terminals L1		ED3101		10
No. 10 single-pole power supply terminals L2		ED3102		10
No. 10 single-pole power supply terminals L3		ED3103		10
No. 10 single-pole power supply terminals N		ED3104		10
Accessories				
N°10 busbar covers, width 600 mm		ED2961		10
N°2 busbar covers, width 800 mm		ED2962		2

Subdistribution boards

CombiLine S distribution system Unifix H

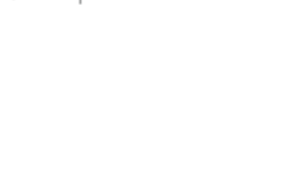
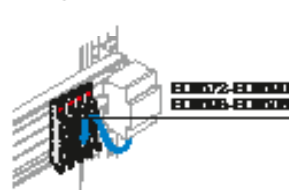
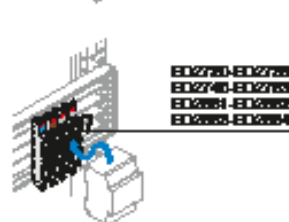
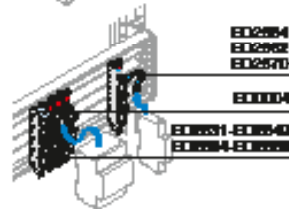
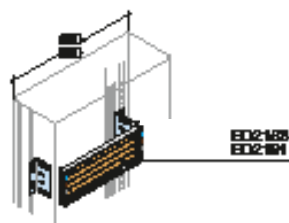

Article	Order details			
	Type	Order code	Price	Pcs.
Frames for Tmax				
Frame with 24 DIN module busbar		ED2183		1
Frame with 36 DIN module busbar		ED2191		1
Feeder modules				
4P 400 A feeder module (for ED2183-ED2191)		ED2209		1
Basic modules In 16 A				
Basic module for DIN L1-N top 16 A		ED2894		1
Basic module for DIN L1-L2 top 16 A		ED2902		1
Basic module for DIN L1-N bottom 16 A		ED2910		1
Basic module for DIN L1-L2 bottom 16 A		ED2928		1
Basic modules In 40 A				
Basic module L1/Neutral top 40 A		ED2654		1
Basic module L2/Neutral top 40 A		ED2662		1
Basic module L3/Neutral top 40 A		ED2670		1
Basic modules In 63 A				
Basic module L1 top 63 A		ED2531		1
Basic module L2 top 63 A		ED2549		1
Basic module L3 top 63 A		ED2556		1
Basic module Neutral top 63 A		ED2564		1
Basic module L1 bottom 63 A		ED2572		1
Basic module L2 bottom 63 A		ED2590		1
Basic module L3 bottom 63 A		ED2598		1
Basic module Neutral bottom 63 A		ED2606		1
Basic modules In 100 A				
Basic module with cable L1 top 100 A		ED2720		10
Basic module with cable L2 top 100 A		ED2738		2
Basic module with cable L3 top 100 A		ED2746		1
Basic module with cable Neutral top 100 A		ED2753		1
Basic modules ≤ In 40 A S800				
Basic module L1 top ≤ 40 A		ED2557		1
Basic module L2 top ≤ 40 A		ED2558		1
Basic module L3 top ≤ 40 A		ED2559		1
Basic module Neutral top ≤ 40 A		ED2560		1
Basic modules ≤ In 125 A S800				
Basic module L1 top 125 A		ED2551		1
Basic module L2 top 125 A		ED2552		1
Basic module L3 top 125 A		ED2553		1
Basic module Neutral bottom 125 A		ED2554		1
Basic module false pole, width 27 mm		ED2557		1

Subdistribution boards

CombiLine S distribution system Unifix H

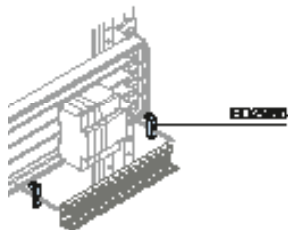
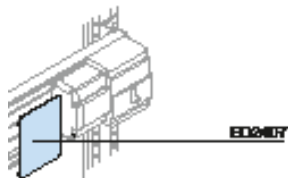
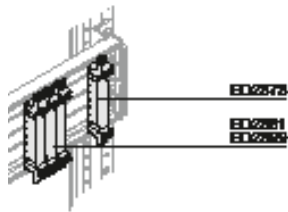
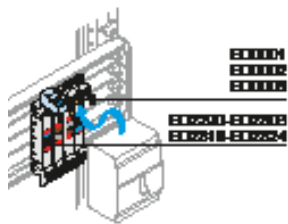
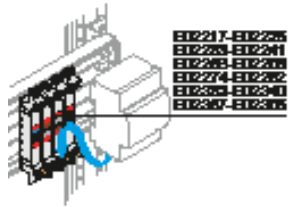

Article	Order details			
	Type	Order code	Price	Pcs.
Basic modules ≤ In 160 A, Tmax XT1				
Basic module L1 top L2 bottom		ED2217		1
Basic module L2 top L1 bottom		ED2225		1
Basic module L3 top Neutral bottom		ED2233		1
Basic module Neutral top L3 bottom		ED2241		1
Basic module false pole for residual current release RC221		ED2373		1
Basic module false pole for solenoid operator		ED2381		1
Basic modules ≤ In 250 A, Tmax XT3				
Basic module L1 top		ED2290		1
Basic module L2 top		ED2308		1
Basic module L3 top		ED2316		1
Basic module N top		ED2324		1
Basic module L1 bottom		ED2332		1
Basic module L2 bottom		ED2340		1
Basic module L3 bottom		ED2357		1
Basic module N bottom		ED2365		1
Basic module false pole for residual current release RC221		ED2373		1
Accessories				
Basic module false pole for DDA		ED2845		1
Basic module false pole for modular MDRC		ED2852		1
No. 2 IP20 covers (for ED2183-ED2191), width 173 mm (10 DIN modules)		ED2407		2
No. 6 duct supports 40 x 60 mm (only for modular apparatus)		ED2936		6
Spare parts				
No. 10 terminal covers for Tmax XT1		ED0001		10
No. 10 terminal covers for Tmax XT3		ED0003		10
No. 10 terminal covers for S200/F200		ED0004		10

Subdistribution boards

CombiLine S distribution system Unifix, technical data

Technical characteristics	Unifix H	Unifix L
Unifix systems		
Rated service voltage (U_e)	690 V AC	400 V AC
Rated insulation voltage (U_i)	1000 V AC	500 V AC
Rated impulse withstand voltage (U_{imp})	8 kV	6 kV
Rated frequency	50/60 Hz	50/60 Hz
Rated current (I_n) central power supply lateral power supply	400 A 320 A	100 A 80 A
Rated short-time withstand current (I_{cw})	25 kA	-
Maximum peak current (I_{pk})	52,5 kA - 400 V	-
Maximum installable circuit-breaker size	250 A	100 A
Conditioned short-circuit current (I_{cc}) Tmax XT1 Tmax XT3	50 kA - 400 V 50 kA - 400 V	- -
With circuit-breaker		
S200	-	6 kA - 400 V
S200M	-	10 kA - 400 V
S200P	-	25 kA - 400 V
Degree of protection	IP20 with accessory	IP20
Characteristics of the insulating material	Self-extinguishing thermoplastic V1 (UL94)	Self-extinguishing thermoplastic V1 (UL94)
Characteristics of the conductor material	Electrolytic copper	Electrolytic copper
Width (No. modules/mm)	24/600 36/800	12/400 24/600 36/800
Installation of Unifix system		
Frame for Tmax XT series 300 x 600 mm (H x L) 300 x 800 mm (H x L)	ED2183 ED2191	- -
Fixing brackets Height 300 mm	AD1097	-
Crosspiece for direct connection to the rear busbars with shaped section with PB0803 Width 600 mm Width 800 mm	TL1000 TL1100	- -
Busbar 4P 12 mod. 18 mod. 24 mod. 36 mod.	- - - -	ED2993 ED3009 ED3017 ED3025
Busbar 4P 12 mod. 18 mod. 24 mod. 36 mod.	- - - - -	ED2944 ED2951 ED2969 ED2977
Fixing support 24 mod. 36 mod.	- - -	GD1520 GD1530

⁽¹⁾ Select circuit-breakers in version with front terminals for copper cables.

Subdistribution boards

CombiLine S distribution system Unifix, selecting table

Series of circuit-breakers	Unifix H		Unifix L
Unifix systems			
Table for selecting connections according to the circuit-breaker			
SN201	(top power supply)		
DS941	ED2654 L1/N 40 A	-	ED3272 L1/N 40 A
	ED2662 L2/N 40 A	-	ED3280 L2/N 40 A
	ED2670 L3/N 40 A	-	ED3298 L3/N 40 A
S200 - DS200	(top power supply)		(bottom power supply)
F200 up to 63A (Unifix L)	ED2531 L1 63A	ED2572 L1 63A	ED3033 L1 100A
	ED2549 L2 63A	ED2590 L2 63A	ED3041 L2 100A
	ED2556 L3 63A	ED2598 L3 63A	ED3058 L3 100A
	ED2564 N 63A	ED2606 N 63A	ED3066 N 100A
	ED2845 False pole module	-	-
S800	(top power supply)		
	ED2557 L1 ≤32A	-	-
	ED2558 L2 ≤32A	-	-
	ED2559 L3 ≤32A	-	-
	ED2560 N ≤32A	-	-
	ED2551 L1 125A	-	-
	ED2552 L2 125A	-	-
	ED2553 L3 125A	-	-
	ED2554 N 125A	-	-
	ED2550 False pole module	-	-
S280 (80-100A)	(top power supply)		
E200 up to 100A - RS370 - F200 80/100A (Unifix H)	ED2720 L1 100A	-	ED3132 pow. supply L1/L2/L3/N - 350mm
	ED2738 L2 100A	-	ED0026 pow. supply L1/L2/L3/N - 1500mm
	ED2746 L3 100A	-	ED0025 pow. supply L1/L2/L3/N - 2500mm
	ED2753 N 100A	-	-
MDRC - Various apparatus	(top power supply)	(bottom power supply)	
	ED2894 L1/N 16A	ED2910 L1/N 16A	ED3108 pow. supply 2 cables L1/N 16A
	ED2902 L1/L2 16A	ED2928 L1/L2 16A	ED3116 pow. supply 3 cables L1/L2/L3 16A
	-	-	ED3124 pow. supply 4 cables L1/L2/L3/N 16A
	-	-	ED3355 pow. supply 2 cables L1/N 40A
	-	-	ED3363 pow. supply 3 cables L1/L2/L3 40A
	-	-	ED3371 pow. supply 4 cables L1/L2/L3/N 71A
Circuit-breaker Tmax XT1	(top/bottom power supply)		-
	ED2217 L1 Top/L2 Bottom	-	-
	ED2225 L2 Top/L1 Bottom	-	-
Residual current Selenoid operator	ED2233 L3 Top/N Bottom	-	-
	ED2241 N Top/L3 Bottom	-	-
	ED2373 False pole module	-	-
	ED2381 False pole module	-	-
Circuit-breaker Tmax XT3	(top power supply)	(bottom power supply)	
	ED2290 L1	ED2332 L1	-
	ED2308 L2	ED2340 L2	-
Residual current	ED2316 L3	ED2357 L3	-
	ED2324 N	ED2365 N	-
	ED2373 False pole module	-	-

⁽¹⁾ Select circuit-breakers in version with front terminals for copper cables.

Subdistribution boards

Examples of configurations

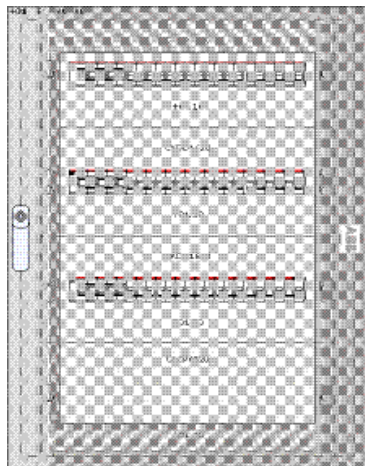

TwinLine S 43 (800 x 600 x 225 mm) IP43 and internal configuration CombiLine S

Type	Ord.no.	Description	Pcs.
ESBN0608	2CPX078111R9999	Rear wall, W 600 mm, H 800 mm	1
ESPG0600	2CPX078146R9999	Top/bottom plate (open/closed), D 225 mm, W 600 mm	1
ESSG0008	2CPX078129R9999	Side walls 2 pcs, D 225mm, H 800 mm	1
ESIN0008	2CPX078422R9999	Installation set for internal configuration, H 800 mm	1
TZ101	2CPX010450R9999	Flange for 52 entries	2
ESAT0608	2CPX078179R9999	Transparent door, W 600 mm, H 800 mm	1
CKDC1620	2CPX078321R9999	CombiLine S, DIN Components, Row distance 200 mm, 1 row, W 600 mm, H 200 mm	3
CACP6020	2CPX078353R9999	CombiLine S, Cover, plain, W 600 mm, H 200 mm	1

Subdistribution boards

Examples of configurations

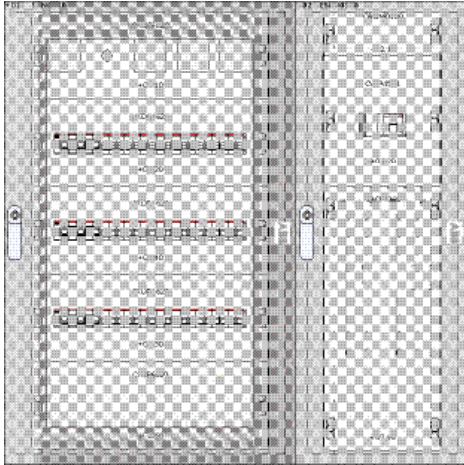

TwinLine S 43 (1000 x 600 x 225 mm + 1000 x 300 x 225 mm) IP43

Internal configuration CombiLine S, with busbars 250 A, 10 kA in external cable container

Type	Ord.no.	Description	Pcs.
ESBN0610	2CPX078112R9999	Rear wall, W 600 mm , H 1000 mm	1
ESPG0600	2CPX078146R9999	Top/bottom plate (open/closed), D 225 mm , W 600 mm	1
ESSG0010	2CPX078130R9999	Side walls 2 pcs, D 225 mm , H 1000 mm	1
ESAT0610	2CPX078180R9999	Transparent door, W 600 mm , H 1000 mm	1
ESBN0310	2CPX078103R9999	Rear wall, W 300 mm , H 1000 mm	1
ESPG0300	2CPX078145R9999	Top/bottom plate (open/closed), D 225 mm , W 300 mm	1
ESIN0010	2CPX078423R9999	Installation set for internal configuration, H 1000 mm	2
ESUG0010	2CPX078226R9999	Upright cabinet connection, D 225 mm , H 1000 mm	1
ESAS0310	2CPX078154R9999	Sheet steel door, W 300 mm , H 1000 mm	1
TZ101	2CPX010450R9999	Flange for 52 entries	3
CKDC1620	2CPX078321R9999	CombiLine S, DIN Components, Row distance 200 mm , 1 row, W 600 mm , H 200 mm	3
CACP6020	2CPX078353R9999	CombiLine S, Cover, plain, W 600 mm , H 200 mm	1
CKUC6020	2CPX078314R9999	CombiLine S, Measuring instruments, 4 pcs. 72x72 mm , W 600 mm , H 200 mm ,	1
CVAC1511	2CPX078269R9999	CombiLine S, Device vertical, W 300 mm , Tmax XT3, 1 device, 3/4 pole, fixed, lever operation	1
CACP3060	2CPX078348R9999	CombiLine S, Cover, plain, W 300 mm , H 600 mm	1
CACP3010	2CPX078341R9999	CombiLine S, Cover, plain, W 300 mm , H 100 mm	1
CASWP2	2CPX078454R9999	CombiLine S, Support, wiring duct, 2 pcs	3
CAHW6	2CPX078459R9999	CombiLine S, Mounting profile, for wiring system, W 600 mm	3
CKBS1231	2CPX078449R9999	CombiLine S, Busbar, support, flat busbars, holder scaled, W 300 mm , 1 support	3
BR0250		No. 2 flat busbars 250 A	1

Subdistribution boards

Examples of configurations

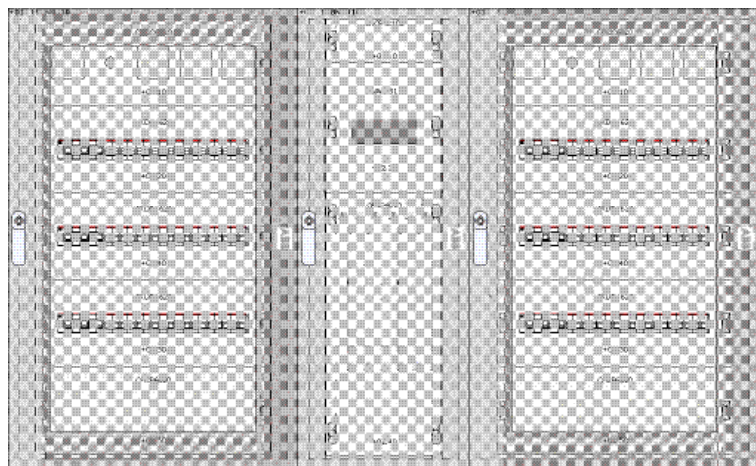

TwinLine S 43 (1000 x 600 x 225 mm + 1000 x 300 x 225 mm + 1000 x 600 x 225 mm) IP43, Internal configuration CombiLine S, with busbars 250 A, 10 kA in external cable container

Type	Ord.no.	Description	Pcs.
ESBN0610	2CPX078112R9999	Rear wall, W 600 mm, H 1000 mm	2
ESPG0600	2CPX078146R9999	Top/bottom plate (open/closed), D 225 mm, W 600 mm	2
ESSG0010	2CPX078130R9999	Side walls 2 pcs, D 225 mm, H 1000 mm	1
ESIN0010	2CPX078423R9999	Installation set for internal configuration, H 1000 mm	3
ESAT0610	2CPX078180R9999	Transparent door, W 600 mm, H 1000 mm	2
ESBN0310	2CPX078103R9999	Rear wall, W 300 mm, H 1000 mm	1
ESPG0300	2CPX078145R9999	Top/bottom plate (open/closed), D 225 mm, W 300 mm	1
ESUG0010	2CPX078226R9999	Upright cabinet connection, D 225 mm, H 1000 mm	2
ESAS0310	2CPX078154R9999	Sheet steel door, W 300 mm, H 1000 mm	1
TZ101	2CPX010450R9999	Flange for 52 entries	5
CKDC1620	2CPX078321R9999	CombiLine S, DIN Components, Row distance 200 mm, 1 row, W 600 mm, H 200 mm	6
CKUC6020	2CPX078314R9999	CombiLine S, Measuring instruments, 4 pcs. 72x72 mm, W 600 mm, H 200 mm	2
CACP6020	2CPX078353R9999	CombiLine S, Cover, plain, W 600 mm, H 200 mm	2
CACP3060	2CPX078348R9999	CombiLine S, Cover, plain, W 300 mm, H 600 mm	1
CACP3010	2CPX078341R9999	CombiLine S, Cover, plain, W 300 mm, H 100 mm	1
CVAC1511	2CPX078269R9999	CombiLine S, Device vertical, W 300 mm, Tmax XT3, 1 device, 3/4 pole, fixed, lever operation	1
CASWP2	2CPX078454R9999	CombiLine S, Support, wiring duct, 2 pcs	6
CAHW6	2CPX078459R9999	CombiLine S, Mounting profile, for wiring system, W 600 mm	6
CKBS1231	2CPX078449R9999	CombiLine S, Busbar, support, flat busbars, holder scaled, W 300 mm, 1 support	3
BR0250		No. 2 flat busbars 250A	1

Subdistribution boards

Examples of configurations

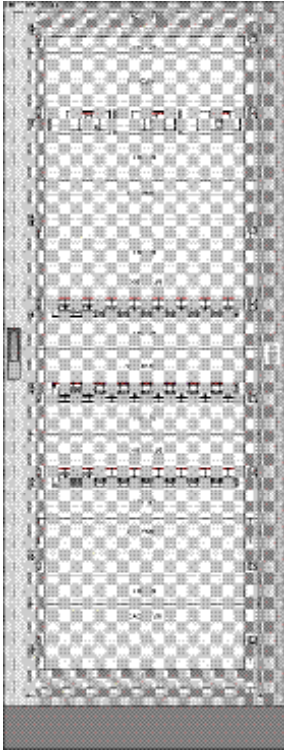

TwinLine S 43 (1600 x 600 x 275 mm) IP43

Internal configuration CombiLine S

Type	Ord.no.	Description	Pcs.
ESBN0616	2CPX078115R9999	Rear wall, W 600 mm, H 1600 mm	1
ESPL0600	2CPX078149R9999	Top/bottom plate (open/closed), D 275 mm, W 600 mm	1
ESSL0016	2CPX078142R9999	Side walls 2 pcs, D 275 mm, H 1600 mm	1
ESIN0016	2CPX078426R9999	Installation set for internal configuration, H 1600 mm	1
ESAL0610	2CPX078211R9999	Plinth, D 275 mm, W 600 mm, H 100 mm	1
ESAT0616	2CPX078183R9999	Transparent door, W 600 mm, H 1600 mm	1
TZ101	2CPX010450R9999	Flange for 52 entries	2
CKDC1620	2CPX078321R9999	CombiLine S, DIN Components, Row distance 200 mm, 1 row, W 600 mm, H 200 mm	3
CACP6010	2CPX078351R9999	CombiLine S, Cover, plain, W 600 mm, H 100 mm	1
CVCC3511	2CPX078400R9999	CombiLine S, Device vertical, W 600 mm, Tmax XT3, 3 device, 3/4 pole, fixed, lever operation	1
CACP6020	2CPX078353R9999	CombiLine S, Cover, plain, W 600 mm, H 200 mm	3
CASWP2	2CPX078454R9999	CombiLine S, Support, wiring duct, 2 pcs	3
CAHW6	2CPX078459R9999	CombiLine S, Mounting profile, for wiring system, W 600 mm	3

Subdistribution boards

Examples of configurations

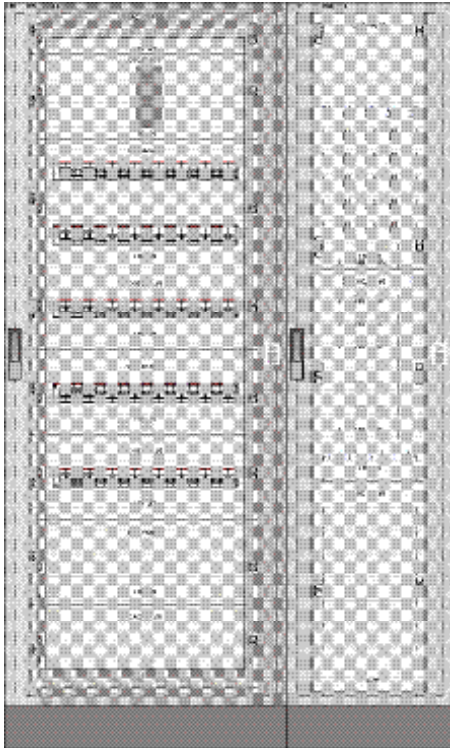

TwinLine S 43 (1600 x 600x 225 mm + 1600 x 300 x 225 mm) IP43

Internal configuration CombiLine S, with busbars 400 A, 23 kA in external cable container

Type	Ord.no.	Description	Pcs.
ESBN0616	2CPX078115R9999	Rear wall, W 600 mm, H 1600 mm	1
ESPG0600	2CPX078146R9999	Top/bottom plate (open/closed), D 225 mm, W 600 mm	1
ESSG0016	2CPX078133R9999	Side walls 2 pcs, D 225 mm, H 1600 mm	1
ESIN0016	2CPX078426R9999	Installation set for internal configuration, H 1600 mm	2
ESAG0610	2CPX078205R9999	Plinth, D 225 mm, W 600 mm, H 100 mm	1
ESAT0616	2CPX078183R9999	Transparent door, W 600 mm, H 1600 mm	1
ESBN0316	2CPX078106R9999	Rear wall, W 300 mm, H 1600 mm	1
ESPG0300	2CPX078145R9999	Top/bottom plate (open/closed), D 225 mm, W 300 mm	1
ESUG0016	2CPX078229R9999	Upright cabinet connection, D 225 mm, H 1600 mm	1
ESAG0310	2CPX078203R9999	Plinth, D 225 mm, W 300 mm, H 100 mm	1
ESAS0316	2CPX078157R9999	Sheet steel door, W 300 mm, H 1600 mm	1
TZ101	2CPX010450R9999	Flange for 52 entries	3
CKDC1620	2CPX078321R9999	CombiLine S, DIN Components, Row distance 200 mm, 1 row, W 600 mm, H 200 mm	3
CACP6010	2CPX078351R9999	CombiLine S, Cover, plain, W 600 mm, H 100 mm	1
CHCC1511	2CPX078243R9999	CombiLine S, Device horizontal, W 600 mm, Tmax XT3, 1 device, 3/4 pole, fixed, lever operation	1
CACP6020	2CPX078353R9999	CombiLine S, Cover, plain, W 600 mm, H 200 mm	2
CKDB2630	2CPX078406R9999	CombiLine S, DIN Components, Row distance 150 mm, 2 row, W 600 mm, H 300 mm	1
CACP3060	2CPX078348R9999	CombiLine S, Cover, plain, W 300 mm, H 600 mm	1
CACP3050	2CPX078347R9999	CombiLine S, Cover, plain, W 300 mm, H 500 mm	2
CASWP2	2CPX078454R9999	CombiLine S, Support, wiring duct, 2 pcs	5
CAHW6	2CPX078459R9999	CombiLine S, Mounting profile, for wiring system, W 600 mm	5
CASVP2	2CPX078452R9999	CombiLine S, Support, vertical universal, 2 pcs	2
CKBS2231	2CPX078372R9999	CombiLine S, Busbar, support, shaped busbars, holder scaled, W 300 mm, 1 support	4
BA0400		Busbar In = 400A	2

Subdistribution boards

Examples of configurations

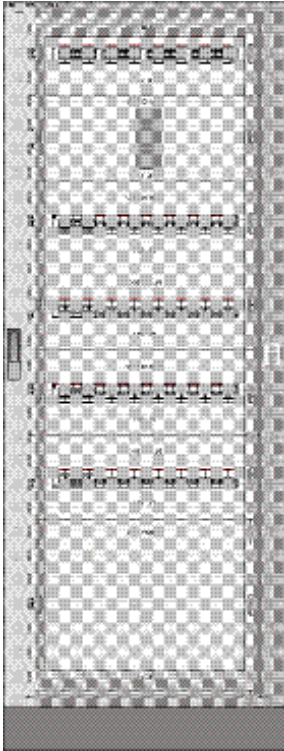

TwinLine S 43 (1600 x 600 x 225 mm) IP43

Internal configuration CombiLine S

Type	Ord.no.	Description	Pcs.
ESBN0618	2CPX078116R9999	Rear wall, W 600 mm, H 1800 mm	1
ESPG0600	2CPX078146R9999	Top/bottom plate (open/closed), D 225 mm, W 600 mm	1
ESSG0018	2CPX078134R9999	Side walls 2 pcs, D 225 mm, H 1800 mm	1
ESIN0018	2CPX078427R9999	Installation set for internal configuration, H 1800 mm	1
ESAG0610	2CPX078205R9999	Plinth, D 225 mm, W 600 mm, H 100 mm	1
ESAT0618	2CPX078184R9999	Transparent door, W 600 mm, H 1800 mm	1
TZ101	2CPX010450R9999	Flange for 52 entries	2
CKDC1620	2CPX078321R9999	CombiLine S, DIN Components, Row distance 200 mm, 1 row, W 600 mm, H 200 mm	5
CHCC1511	2CPX078243R9999	CombiLine S, Device horizontal, W 600 mm, Tmax XT3, 1 device, 3/4 pole, fixed, lever operation	1
CACP6040	2CPX078356R9999	CombiLine S, Cover, plain, W 600 mm, H 400 mm	1
CASWP2	2CPX078454R9999	CombiLine S, Support, wiring duct, 2 pcs	6
CAHW6	2CPX078459R9999	CombiLine S, Mounting profile, for wiring system, W 600 mm	6

Subdistribution boards

Examples of configurations

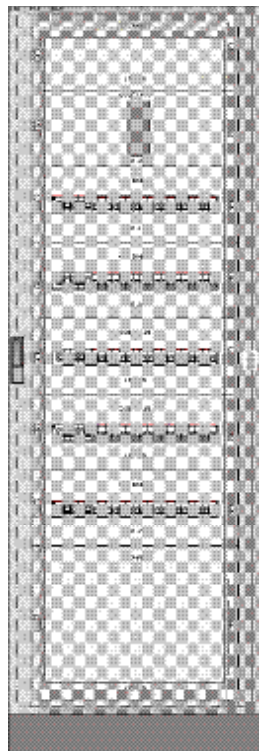

TwinLine S 43 (1800 x 600x 275 mm + Busbar 250 A, 25 kA) IP43

Internal configuration CombiLine S, with busbars 250 A, 16 kA

Type	Ord.no.	Description	Pcs.
ESBN0618	2CPX078116R9999	Rear wall, W 600 mm, H 1800 mm	1
ESPL0600	2CPX078149R9999	Top/bottom plate (open/closed), D 275 mm, W 600 mm	1
ESSL0018	2CPX078143R9999	Side walls 2 pcs, D 275 mm, H 1800 mm	1
ESIN0018	2CPX078427R9999	Installation set for internal configuration, H 1800 mm	1
ESAL0610	2CPX078211R9999	Plinth, D 275 mm, W 600 mm, H 100 mm	1
ESAT0618	2CPX078184R9999	Transparent door, W 600 mm, H 1800 mm	1
TZ101	2CPX010450R9999	Flange for 52 entries	2
CKDC1620	2CPX078321R9999	CombiLine S, DIN Components, Row distance 200 mm, 1 row, W 600 mm, H 200 mm	5
CHCC1511	2CPX078243R9999	CombiLine S, Device horizontal, W 600 mm, Tma x xT3, 1 device, 3/4 pole, fixed, lever operation	1
CACP6040	2CPX078356R9999	CombiLine S, Cover, plain, W 600 mm, H 400 mm	1
CACP6020	2CPX078353R9999	CombiLine S, Cover, plain, W 600 mm, H 200 mm	1
CASWP2	2CPX078454R9999	CombiLine S, Support, wiring duct, 2 pcs	5
CAHW6	2CPX078459R9999	CombiLine S, Mounting profile, for wiring system, W 600 mm	5
CKBS1161	2CPX078447R9999	CombiLine S, Busbar, support, flat busbars, holder linear, W 600 mm, 1 support	4
BR0250		No. 2 flat busbars 250 A	4

Subdistribution boards

Examples of configurations

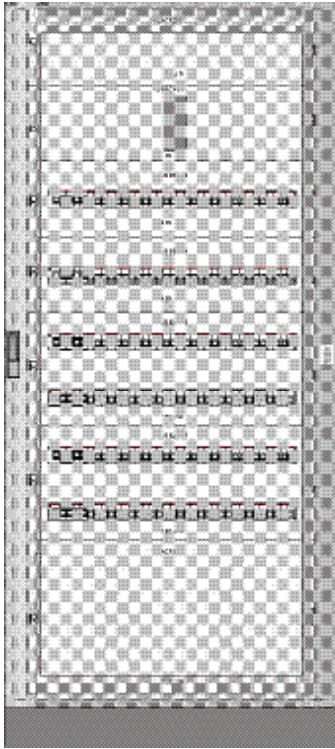

TwinLine S 43 (1800 x 800 x 275 mm) IP43

Internal configuration CombiLine S

Type	Ord.no.	Description	Pcs.
ESBN0818	2CPX078125R9999	Rear wall, W 800 mm, H 1800 mm	1
ESPL0800	2CPX078150R9999	Top/bottom plate (open/closed), D 275 mm, W 800 mm	1
ESSL0018	2CPX078143R9999	Side walls 2 pcs, D 275 mm, H 1800 mm	1
ESIN0018	2CPX078427R9999	Installation set for internal configuration, H 1800 mm	1
TZ101	2CPX010450R9999	Flange for 52 entries	3
ESAL0810	2CPX078213R9999	Plinth, D 275 mm, W 800 mm, H 100 mm	1
ESAT0818	2CPX078192R9999	Transparent door, W 800 mm, H 1800 mm	1
CKDC1820	2CPX078322R9999	CombiLine S, DIN Components, Row distance 200 mm, 1 row, W 800 mm, H 200 mm	2
CKDB2830	2CPX078407R9999	CombiLine S, DIN Components, Row distance 150 mm, 2 row, W 800 mm, H 300 mm	2
CHDC1511	2CPX078250R9999	CombiLine S, Device horizontal, W 800 mm, Tmax XT3, 1 device, 3/4 pole, fixed, lever operation	1
CACP8020	2CPX078363R9999	CombiLine S, Cover, plain, W 800 mm, H 200 mm	1
CACP8040	2CPX078366R9999	CombiLine S, Cover, plain, W 800 mm, H 400 mm	1
CASWP2	2CPX078454R9999	CombiLine S, Support, wiring duct, 2 pcs	6
CAHW8	2CPX078461R9999	CombiLine S, Mounting profile, for wiring system, W 800 mm	6

Subdistribution boards

Examples of configurations

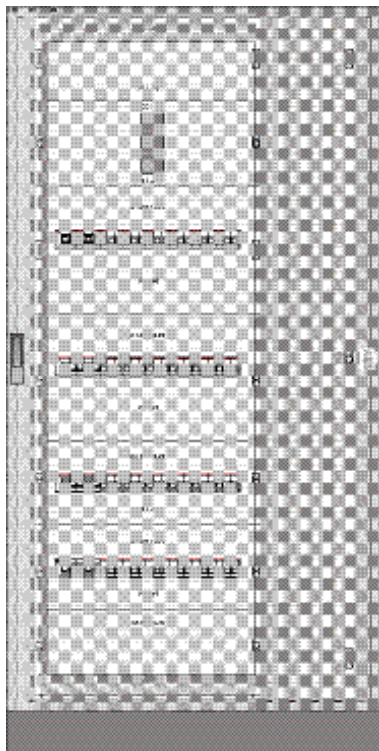

TwinLine S 43 (1600 x 800 x 225 mm) IP43 and internal cable container

Internal configuration CombiLine S

Type	Ord.no.	Description	Pcs.
ESBN0816	2CPX078124R9999	Rear wall, W 800 mm, H 1600 mm	1
ESPG0800	2CPX078147R9999	Top/bottom plate (open/closed), D 225 mm, W 800 mm	1
ESSG0016	2CPX078133R9999	Side walls 2 pcs, D 225 mm, H 1600 mm	1
ESIN0016	2CPX078426R9999	Installation set for internal configuration, H 1600 mm	1
ESAI0216	2CPX078220R9999	Internal cable container, H 1600 mm	1
ESAG0810	2CPX078207R9999	Plinth, D 225 mm, W 800 mm, H 100 mm	1
ESAT2616	2CPX078199R9999	Transparent door, for internal cable container, W 800 mm, H 1600 mm	1
TZ101	2CPX010450R9999	Flange for 52 entries	3
CKDC1620	2CPX078321R9999	CombiLine S, DIN Components, Row distance 200 mm, 1 row, W 600 mm, H 200 mm	2
CHCC1511	2CPX078243R9999	CombiLine S, Device horizontal, W 600 mm, Tmax XT3, 1 device, 3/4 pole, fixed, lever operation	1
CACP6020	2CPX078353R9999	CombiLine S, Cover, plain, W 600 mm, H 200 mm	2
CKDR1630	2CPX078383R9999	CombiLine S, DIN Components, Tmax breaker + RC mod, 1 row, W 600 mm, H 300 mm	2
CASWP2	2CPX078454R9999	CombiLine S, Support, wiring duct, 2 pcs	4
CAHW6	2CPX078459R9999	CombiLine S, Mounting profile, for wiring system, W 600 mm	4

Subdistribution boards

Examples of configurations

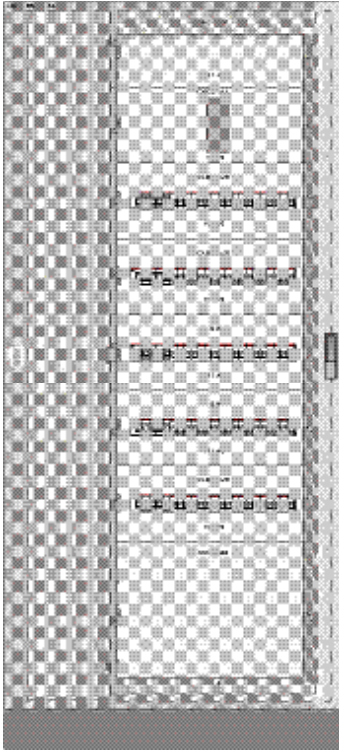

TwinLine S 43 (1800 x 800 x 275 mm) IP43 and internal cable container

Internal configuration CombiLine S

Type	Ord.no.	Description	Pcs.
ESBN0818	2CPX078125R9999	Rear wall, W 800 mm, H 1800 mm	1
ESPL0800	2CPX078150R9999	Top/bottom plate (open/closed), D 275 mm, W 800 mm	1
ESSL0018	2CPX078143R9999	Side walls 2 pcs, D 275 mm, H 1800 mm	1
ESIN0018	2CPX078427R9999	Installation set for internal configuration, H 1800 mm	1
ESAI0218	2CPX078221R9999	Internal cable container, H 1800 mm	1
ESAL0810	2CPX078213R9999	Plinth, D 275 mm, W 800 mm, H 100 mm	1
ESAT2618	2CPX078200R9999	Transparent door, for internal cable container, W 800 mm, H 1800 mm	1
TZ101	2CPX010450R9999	Flange for 52 entries	3
CKDC1620	2CPX078321R9999	CombiLine S, DIN Components, Row distance 200 mm, 1 row, W 600 mm, H 200 mm	5
CHCC1511	2CPX078243R9999	CombiLine S, Device horizontal, W 600 mm, Tmax XT3, 1 device, 3/4 pole, fixed, lever operation	1
CACP6020	2CPX078353R9999	CombiLine S, Cover, plain, W 600 mm, H 200 mm	1
CACP6040	2CPX078356R9999	CombiLine S, Cover, plain, W 600 mm, H 400 mm	1
CASWP2	2CPX078454R9999	CombiLine S, Support, wiring duct, 2 pcs	5
CAHW6	2CPX078459R9999	CombiLine S, Mounting profile, for wiring system, W 600 mm	5

Subdistribution boards

Examples of configurations

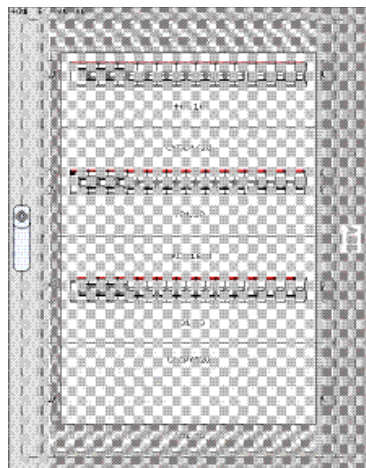

TwinLine S 55 (800 x 600 x 225 mm) IP55 and internal configuration CombiLine S

Type	Ord.no.	Description	Pcs.
ESWG0608	2CPX078568R9999	Structure TLS55, W 600 mm, H 800 mm , D 225 mm	1
ESFG0008	2CPX078598R9999	Side walls 2 pcs, D 225 mm, H 800 mm	1
ESIN0008	2CPX078422R9999	Installation set for internal configuration, H 800 mm	1
TZ101	2CPX010450R9999	Flange for 52 entries	2
ESAT0608	2CPX078179R9999	Transparent door, W 600 mm, H 800 mm	1
CKDC1620	2CPX078321R9999	CombiLine S, DIN Components, Row distance 200 mm, 1 row, W 600 mm, H 200 mm	3
CACP6020	2CPX078353R9999	CombiLine S, Cover, plain, W 600 mm, H 200 mm	1

Subdistribution boards

Examples of configurations

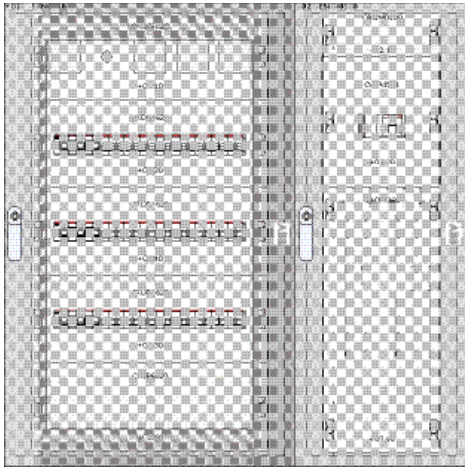

TwinLine S 55 (1000 x 600 x 225 mm + 1000 x 300 x 225 mm) IP55

Internal configuration CombiLine S, with busbars 250 A, 10 kA in external cable container

Type	Ord.no.	Description	Pcs.
ESWG0610	2CPX078569R9999	Structure TLS55, W 600 mm, H 1000 mm, D 225 mm	1
ESFG0010	2CPX078599R9999	Side walls 2 pcs, D 225 mm, H 1000 mm	1
ESWG0310	2CPX078563R9999	Structure TLS55, W 300 mm, H 1000 mm, D 225 mm	1
ESAT0610	2CPX078180R9999	Transparent door, W 600 mm , H 1000 mm	1
ESAC3005	2CPX078415R9999	Connection set for side-by-side structuring of cabinets	1
TZ626	2CPX010778R9999	Protective frame for connecting cabinets	1
ESIN0010	2CPX078423R9999	Installation set for internal configuration, H 1000 mm	2
ESAS0310	2CPX078154R9999	Sheet steel door, W 300 mm , H 1000 mm	1
TZ101	2CPX010450R9999	Flange for 52 entries	3
CKDC1620	2CPX078321R9999	CombiLine S, DIN Components, Row distance 200 mm , 1 row, W 600 mm , H 200 mm	3
CACP6020	2CPX078353R9999	CombiLine S, Cover, plain, W 600 mm , H 200 mm	1
CKUC6020	2CPX078314R9999	CombiLine S, Measuring instruments, 4 pcs. 72x72 mm , W 600 mm , H 200 mm ,	1
CVAC1511	2CPX078269R9999	CombiLine S, Device vertical, W 300 mm , Tmax XT3, 1 device, 3/4 pole, fixed, lever operation	1
CACP3060	2CPX078348R9999	CombiLine S, Cover, plain, W 300 mm , H 600 mm	1
CACP3010	2CPX078341R9999	CombiLine S, Cover, plain, W 300 mm , H 100 mm	1
CASWP2	2CPX078454R9999	CombiLine S, Support, wiring duct, 2 pcs	3
CAHW6	2CPX078459R9999	CombiLine S, Mounting profile, for wiring system, W 600 mm	3
CKBS1231	2CPX078449R9999	CombiLine S, Busbar, support, flat busbars, holder scaled, W 300 mm , 1 support	3
BR0250		No. 2 flat busbars 250 A	1

Subdistribution boards

Examples of configurations

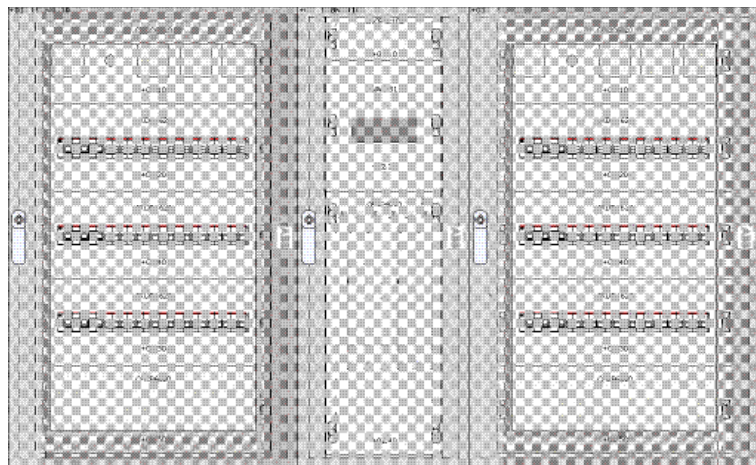

TwinLine S 55 (1000 x 600 x 225 mm + 1000 x 300 x 225 mm + 1000 x 600 x 225 mm) IP55, Internal configuration CombiLine S, with busbars 250 A, 10 kA in external cable container

Type	Ord.no.	Description	Pcs.
ESWG0610	2CPX078569R9999	Structure TLS55, W 600 mm, H 1000 mm, D225 mm	2
ESFG0010	2CPX078599R9999	Side walls 2 pcs, D 225 mm, H 1000 mm	1
ESWG0310	2CPX078563R9999	Structure TLS55, W 300 mm, H 1000 mm, D 225 mm	1
ESIN0010	2CPX078423R9999	Installation set for internal configuration, H 1000 mm	3
ESAT0610	2CPX078180R9999	Transparent door, W 600 mm, H 1000 mm	2
ESAC3005	2CPX078415R9999	Connection set for side-by-side structuring of cabinets	2
TZ626	2CPX010778R9999	Protective frame for connecting cabinets	2
ESAS0310	2CPX078154R9999	Sheet steel door, W 300 mm, H 1000 mm	1
TZ101	2CPX010450R9999	Flange for 52 entries	5
CKDC1620	2CPX078321R9999	CombiLine S, DIN Components, Row distance 200 mm, 1 row, W 600 mm, H 200 mm	6
CKUC6020	2CPX078314R9999	CombiLine S, Measuring instruments, 4 pcs. 72x72 mm, W 600 mm, H 200 mm	2
CACP6020	2CPX078353R9999	CombiLine S, Cover, plain, W 600 mm, H 200 mm	2
CACP3060	2CPX078348R9999	CombiLine S, Cover, plain, W 300 mm, H 600 mm	1
CACP3010	2CPX078341R9999	CombiLine S, Cover, plain, W 300 mm, H 100 mm	1
CVAC1511	2CPX078269R9999	CombiLine S, Device vertical, W 300 mm, Tmax XT3, 1 device, 3/4 pole, fixed, lever operation	1
CASWP2	2CPX078454R9999	CombiLine S, Support, wiring duct, 2 pcs	6
CAHW6	2CPX078459R9999	CombiLine S, Mounting profile, for wiring system, W 600 mm	6
CKBS1231	2CPX078449R9999	CombiLine S, Busbar, support, flat busbars, holder scaled, W 300 mm, 1 support	3
BR0250		No. 2 flat busbars 250A	1

Subdistribution boards

Examples of configurations

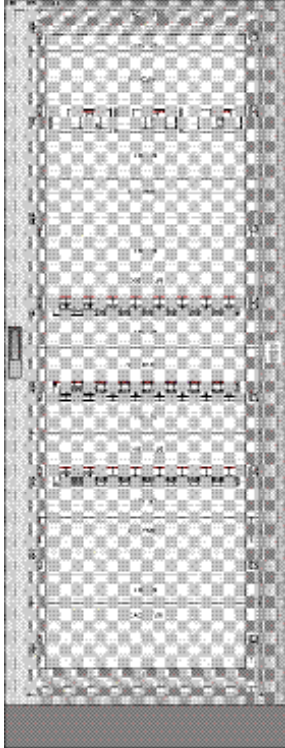

TwinLine S 55 (1600 x 600 x 275 mm) IP55

Internal configuration CombiLine S

Type	Ord.no.	Description	Pcs.
ESWL0616	2CPX078587R9999	Structure TLS55, W 600 mm, H 1600 mm, D 275 mm	1
ESFL0016	2CPX078606R9999	Side walls 2 pcs, D 275 mm, H 1600 mm	1
ESIN0016	2CPX078426R9999	Installation set for internal configuration, H 1600 mm	1
ESAL0610	2CPX078211R9999	Plinth, D 275 mm, W 600 mm, H 100 mm	1
ESAT0616	2CPX078183R9999	Transparent door, W 600 mm, H 1600 mm	1
TZ101	2CPX010450R9999	Flange for 52 entries	2
CKDC1620	2CPX078321R9999	CombiLine S, DIN Components, Row distance 200 mm, 1 row, W 600 mm, H 200 mm	3
CACP6010	2CPX078351R9999	CombiLine S, Cover, plain, W 600 mm, H 100 mm	1
CVCC3511	2CPX078400R9999	CombiLine S, Device vertical, W 600 mm, Tmax XT3, 3 device, 3/4 pole, fixed, lever operation	1
CACP6020	2CPX078353R9999	CombiLine S, Cover, plain, W 600 mm, H 200 mm	3
CASWP2	2CPX078454R9999	CombiLine S, Support, wiring duct, 2 pcs	3
CAHW6	2CPX078459R9999	CombiLine S, Mounting profile, for wiring system, W 600 mm	3

Subdistribution boards

Examples of configurations

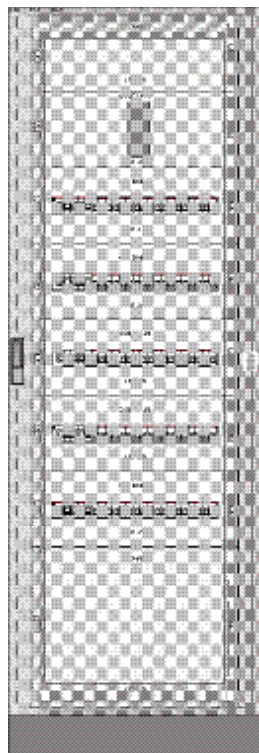

TwinLine S 55 (1800 x 600x 275 mm + Busbar 250 A, 25 kA) IP55

Internal configuration CombiLine S, with busbars 250 A, 16 kA

Type	Ord.no.	Description	Pcs.
ESWLO618	2CPX078588R9999	Structure TLS55, W 600 mm, H 1800 mm, D 275 mm	1
ESFL0018	2CPX078607R9999	Side walls 2 pcs, D 225 mm, H 1800 mm	1
ESIN0018	2CPX078427R9999	Installation set for internal configuration, H 1800 mm	1
ESAL0610	2CPX078211R9999	Plinth, D 275 mm, W 600 mm, H 100 mm	1
ESAT0618	2CPX078184R9999	Transparent door, W 600 mm, H 1800 mm	1
TZ101	2CPX010450R9999	Flange for 52 entries	2
CKDC1620	2CPX078321R9999	CombiLine S, DIN Components, Row distance 200 mm, 1 row, W 600 mm, H 200 mm	5
CHCC1511	2CPX078243R9999	CombiLine S, Device horizontal, W 600 mm, Tma x xT3, 1 device, 3/4 pole, fixed, lever operation	1
CACP6040	2CPX078356R9999	CombiLine S, Cover, plain, W 600 mm, H 400 mm	1
CACP6020	2CPX078353R9999	CombiLine S, Cover, plain, W 600 mm, H 200 mm	1
CASWP2	2CPX078454R9999	CombiLine S, Support, wiring duct, 2 pcs	5
CAHW6	2CPX078459R9999	CombiLine S, Mounting profile, for wiring system, W 600 mm	5
CKBS1161	2CPX078447R9999	CombiLine S, Busbar, support, flat busbars, holder linear, W 600 mm, 1 support	4
BR0250		No. 2 flat busbars 250 A	4

Subdistribution boards

Examples of configurations

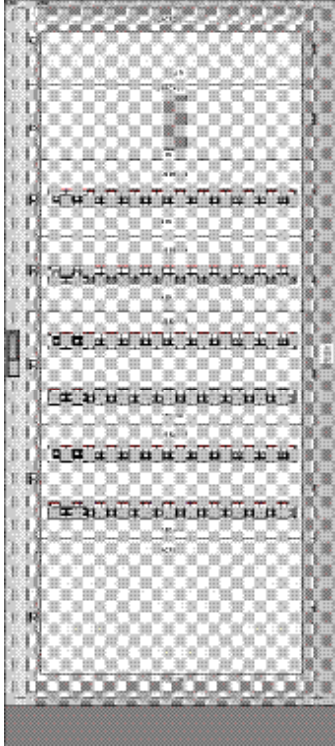

TwinLine S 55 (1800 x 800 x 275 mm) IP55

Internal configuration CombiLine S

Type	Ord.no.	Description	Pcs.
ESWL0818	2CPX078594R9999	Structure TLS55, W 800 mm, H 1800 mm, D 275 mm	1
ESFL0018	2CPX078607R9999	Side walls 2 pcs, D 225 mm, H 1800 mm	1
ESIN0018	2CPX078427R9999	Installation set for internal configuration, H 1800 mm	1
TZ101	2CPX010450R9999	Flange for 52 entries	3
ESAL0810	2CPX078213R9999	Plinth, D 275 mm, W 800 mm, H 100 mm	1
ESAT0818	2CPX078192R9999	Transparent door, W 800 mm, H 1800 mm	1
CKDC1820	2CPX078322R9999	CombiLine S, DIN Components, Row distance 200 mm, 1 row, W 800 mm, H 200 mm	2
CKDB2830	2CPX078407R9999	CombiLine S, DIN Components, Row distance 150 mm, 2 row, W 800 mm, H 300 mm	2
CHDC1511	2CPX078250R9999	CombiLine S, Device horizontal, W 800 mm, Tmax XT3, 1 device, 3/4 pole, fixed, lever operation	1
CACP8020	2CPX078363R9999	CombiLine S, Cover, plain, W 800 mm, H 200 mm	1
CACP8040	2CPX078366R9999	CombiLine S, Cover, plain, W 800 mm, H 400 mm	1
CASWP2	2CPX078454R9999	CombiLine S, Support, wiring duct, 2 pcs	6
CAHW8	2CPX078461R9999	CombiLine S, Mounting profile, for wiring system, W 800 mm	6

