

## Lenovo Flex System X6 Compute Nodes (7196) Product Guide (withdrawn product)

The Lenovo Flex System X6 Compute Node, machine type 7196, is a high-performance scalable compute node that is designed to take on the most demanding workloads. The performance, flexibility, and resiliency features enable the X6 to run mission-critical workloads, such as key business applications, database, analytics, and large virtual machine deployments.

The X6 Compute Node family is composed of the x880 X6 and x480 X6. Each compute node contains two Intel Xeon E7 processors. The x880 X6 uses E7-8800 v3 processors and supports joining two or four x880 compute nodes to form a single 8-socket server with 192 DIMM slots. The x480 uses E7-4800 v3 processors and supports joining two x480 compute nodes to form a single 4-socket server with 96 DIMM slots.

**Withdrawn:** The Flex System X6 Compute Nodes are now withdrawn from marketing.

**Suggested use:** Mission-critical scalable databases, business analytics, virtualization, enterprise applications, and cloud applications.

Figure 1 shows the Flex System X6 Compute Node.



Figure 1. The Flex System X6 Compute Node

### Did you know?

If you are using an application that requires significant computing power and you value the integration of components that Flex System offers, the X6 Compute Node family is an excellent choice. It offers the performance and reliability of the Intel Xeon E7 processor family and significant memory and I/O capacity. By using the X6 Compute Nodes, you can easily scale from two sockets to eight sockets by adding compute nodes and using the appropriate scalability connector on the front of the server.

## Key features

The increasing demand for cloud-computing and analytics workloads by enterprises to meet social, mobile, and big data requirements drives innovation to find new ways to build informational systems. Clients are looking for cost-optimized and fit-for-purpose IT solutions that manage large amounts of data, easily scale performance, and provide enterprise class reliability.

Built on decades of innovation, Lenovo introduces its sixth generation of Enterprise X-Architecture® technology into the Flex System environment with the announcement of the Flex System X6 family of compute nodes. As with their rack-mount counterparts, the System x3850 X6 and x3950 X6, Flex System X6 Compute Nodes include the following benefits:

- Fast application performance means immediate access to information.
- Agile system design helps reduce acquisition costs and provides the ability to upgrade processor and memory technology at each refresh within the same chassis.
- Resilient platforms maximize application uptime and promote easy integration in virtual environments.

X6 servers continue to lead the way as the shift toward mission-critical scalable databases, business analytics, virtualization, enterprise applications, and cloud-computing applications accelerates.

### Fast application performance

Each compute node offers the following features to boost performance:

- Based on the Intel Xeon processor E7 v3 product families, which improves productivity by offering superior system performance:
  - Two processors in each compute node, which are scalable up to eight processors in four compute nodes, depending on the processors that are used.
  - Each processor has up to 18 cores and 45 MB of L3 cache, depending on the processor that is selected.
  - Processors operate at up to 3.2 GHz.
  - Memory bus speeds up to 1600 MHz.
  - QPI links between processors up to 9.6 GTps.
- Supports up to 48 DIMM sockets, with 24 DIMMs per processor.
- Intelligent and adaptive system performance with Intel Turbo Boost Technology 2.0 allows processor cores to run at maximum speeds during peak workloads by temporarily going beyond processor thermal design power (TDP).
- Intel Hyper-Threading Technology boosts performance for multi-threaded applications by enabling simultaneous multi-threading within each processor core, up to two threads per core.
- Intel Virtualization Technology integrates hardware-level virtualization hooks with which operating system vendors can better use the hardware for virtualization workloads.
- Intel Advanced Vector Extensions (AVX) improve floating-point performance for compute-intensive technical and scientific applications.
- The usage of solid-state drives (SSDs) instead of traditional hard disk drives (HDDs) can improve I/O performance. An SSD can support up to 100 times more I/O operations per second (IOPS) than a typical HDD.
- PCI Express 3.0 I/O adapter slots that improve the theoretical maximum bandwidth by almost 100% (8 GTps per link that uses 128b/130b encoding) compared to the previous generation of PCI Express 2.0 (5 GTps per link that uses 8b/10b encoding).
- With Intel Integrated I/O Technology, the PCI Express 3.0 controller is integrated into the Intel Xeon processor E7 v3 and v2 product families. This integration helps reduce I/O latency and increase overall system performance.

### Agile system design

The X6 Compute Nodes provides the following scalability and flexibility features:

- Innovative front-access scalable design where a customer can start with one x880 X6 Compute Node with two sockets and add processing power by inserting compute nodes into the chassis (up to a total of four, depending on the processor selection) and mounting a scalability connector to the front of all the compute nodes.
- The use of front-access scalability connectors means that you can easily scale the X6 system by adding compute nodes without removing compute nodes from the chassis.
- With the usage of E7-8800 v3 processors, upgrading from a 2-socket (one compute node) to 4-socket (two compute nodes) to 8-socket (four compute nodes) complex is as simple as inserting the extra compute nodes and attaching the appropriate scalability connector to the front of all the compute nodes. No tools are required. The use of E7-4800 v3 processors facilitates an upgrade from a 2-socket (one compute node) to 4-socket (two compute nodes) complex in the same way.
- By using compute nodes as modular building blocks, clients also can create the configuration that fits their application and environment needs, which reduces acquisition costs and gives them the flexibility to grow and modify their configuration later.
- By using 32 GB LRDIMMs, each compute node supports up to 1.5 TB of memory and up to 6 TB in a scaled complex.
- Up to 8x 1.8-inch SSD bays per compute node, and up to 24 bays in an 8-socket scaled complex, provides a flexible and scalable all-in-one platform to meet your increasing demands.
- Offers 4 PCIe 3.0 I/O slots per compute node, and up to 16 slots in an 8-socket scaled complex.

### **Resilient platform**

The server provides many features to simplify serviceability and increase system uptime:

- Advanced Processor Recovery allows the system to automatically switch access and control of networking, management, and storage if there is a processor 1 failure, which provides higher availability and productivity.
- Advanced Page Retire proactively protects applications from corrupted pages in memory, which is crucial for scaling memory to terabytes.
- Redundant bit steering, memory mirroring, and memory rank sparing for redundancy if there is a non-correctable memory failure.
- The Intel Execute Disable Bit function can help prevent certain classes of malicious buffer overflow attacks when it is combined with a supported operating system.
- Intel Trusted Execution Technology provides enhanced security through hardware-based resistance to malicious software attacks, which allows an application to run in its own isolated space that is protected from all other software running on a system.
- Redundant Intel Platform Controller Hub (PCH) connections to the processors allow the platform to maintain access to networking, storage, and server management during a processor failure.
- Hot-swap drives support RAID redundancy for data protection and greater system uptime.
- Flex System Enterprise Chassis-based hot-swap power supplies and hot-swap dual-motor redundant fans provide availability for mission-critical applications.
- A light path diagnostics panel and individual light path LEDs quickly lead the technician to failed (or failing) components. This panel simplifies servicing, speeds up problem resolution, and helps improve system availability.
- Predictive Failure Analysis (PFA) detects when system components (processors, memory, HDDs, SSDs, fans, and power supplies) operate outside of standard thresholds and generates proactive alerts in advance of a possible failure, which increases uptime.
- Built-in Integrated Management Module Version II (IMM2) continuously monitors system parameters, triggers alerts, and performs recovery actions if there are failures to minimize downtime.

- Integrated industry-standard Unified Extensible Firmware Interface (UEFI) enables improved setup, configuration, and updates, and simplifies error handling.
- Integrated Trusted Platform Module (TPM) 1.2 support enables advanced cryptographic functions, such as digital signatures and remote attestation.
- Industry-standard Advanced Encryption Standard (AES) NI support for faster and stronger encryption.
- IBM Flex System Manager provides proactive systems management. It offers comprehensive systems management tools that help increase uptime, reduce costs, and improve productivity through advanced server management capabilities.
- SSDs offer better reliability than traditional mechanical HDDs for greater uptime.
- Built-in diagnostic tests that use Dynamic Systems Analysis (DSA) Preboot speed up troubleshooting tasks to reduce service time.
- Three-year customer-replaceable unit and onsite limited warranty, 9x5 next business day. Optional service upgrades are available.

## Locations of key components and connectors

Figure 2 shows the front of the server and Figure 3 shows the inside of the server.

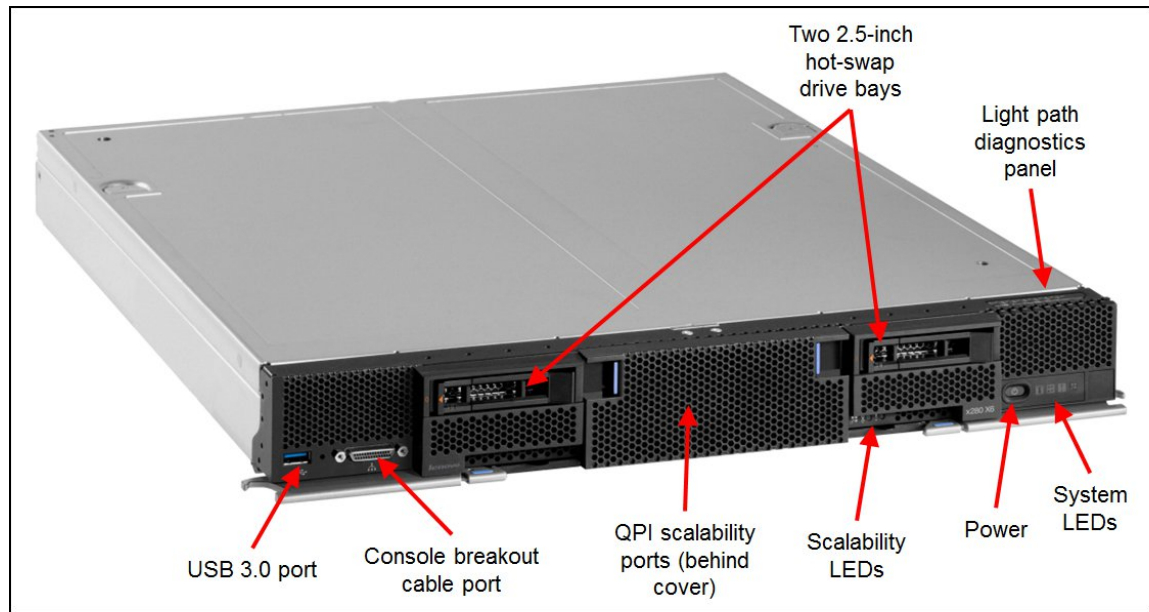

Figure 2. Front view of the Flex System X6 Compute Node

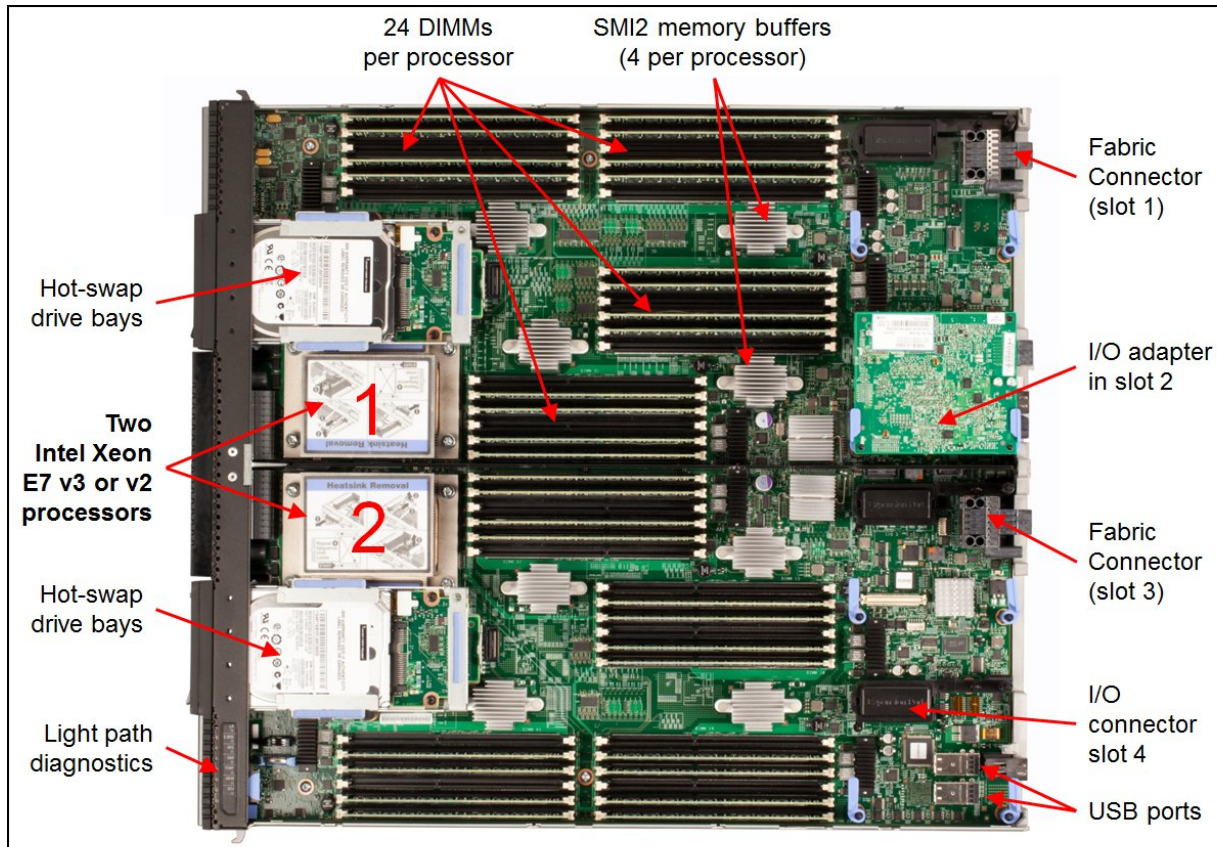

Figure 3. Inside view of the Flex System X6 Compute Node

The following figure shows how four x880 Compute Nodes can be connected to form a single 8-socket complex. This configuration is for illustrative purposes only; in a production environment, you first install the compute nodes in the chassis and then attach the scalability connector to all four nodes.



Figure 4. Four x880 X6 Compute Nodes in an 8-socket complex

## Standard specifications

The following table lists the standard specifications.

Table 1. Standard specifications

Components	Specification (per node except where noted)
Machine type	7196
Firmware	Lenovo-signed firmware
Form factor	Double-wide compute node.
Chassis support	Flex System Enterprise Chassis.
Scalability	x880 X6: <ul style="list-style-type: none"> <li>• Scales up to 4-socket by adding one x880 Compute Node + 4S scalability kit</li> <li>• Scales up to 8-socket by adding three x880 Compute Nodes + 8S scalability kit</li> </ul> x480 X6: <ul style="list-style-type: none"> <li>• Scales up to 4-socket by adding one x480 Compute Node + 4S scalability kit</li> </ul>

Components	Specification (per node except where noted)
Processor	<p>Processor selection determines whether the compute node is an x880 X6 or x480 X6:</p> <ul style="list-style-type: none"> <li>• x880 X6: Two Intel Xeon E7-8800 v3 processors, each with 18 cores (up to 2.5 GHz), 16 cores (up to 2.5 GHz), 10 cores (2.8 GHz), or 4 cores (3.2 GHz).</li> <li>• x480 X6: Two Intel Xeon E7-4800 v3 processors, each with 14 cores (2.2 GHz), 12 cores (2.1 GHz), 10 cores (1.9 GHz), or 8 cores (2.1 GHz). Three QPI links.</li> </ul> <p>All processors: QPI link up to 8.0 GTps for E7 v2 processors and QPI link up to 9.6 GTps for E7 v3 processors. Up to 1600 MHz memory speed. Up to 45 MB L3 cache per processor.</p> <p><b>Note:</b> x280 X6 with E7-2800 v2 processors is now withdrawn from marketing.</p>
Chipset	Intel C602J.
Memory	Up to 48 DIMM sockets (24 DIMMs per processor) using Low Profile (LP) DDR3 DIMMs. RDIMMs and LRDIMMs are supported. 1.5 V and low-voltage 1.35 V DIMMs are supported. Support for up to 1600 MHz memory speed, depending on the processor. Four SMI2 channels to memory buffer per processor. Two memory channels per memory buffer. Supports three DIMMs per channel.
Memory maximums	With LRDIMMs: Up to 1.5 TB with 48x 32 GB LRDIMMs and two processors. With RDIMMs: Up to 768 GB with 48x 16 GB RDIMMs and two processors.
Memory protection	ECC, Chipkill (for x4-based memory DIMMs), memory mirroring, and memory rank sparing.
Disk drive bays	Standard: Two 2.5-inch hot-swap SAS/SATA drive bays that support SAS, SATA, and SSD drives. Optional M1200 Flash Kit replaces 2.5-inch bays with four 1.8-inch front accessible bays. Optional M5100 Flash Kit with ServeRAID M5115 adapter offers eight bays by replacing 2.5-inch bays with four 1.8-inch front accessible bays plus adding four internal 1.8-inch bays.
Maximum internal storage	With two 2.5-inch hot-swap drives: Up to 3.6 TB with 1.8 TB 2.5-inch SAS HDDs, or up to 3.2 TB with 1.6 TB 2.5-inch SSDs, or up to 2 TB with 1 TB NL SATA drives. Intermix of SAS and SATA HDDs and SSDs is supported. With 1.8-inch SSDs and ServeRAID M5115 RAID adapter: Up to 3.2 TB with eight 400 GB 1.8-inch SSDs.
RAID support	RAID 0, 1, 1E, and 10 with integrated ServeRAID M1200e (based on LSI SAS3004), upgradeable to RAID 5 and 50. Two adjacent compute nodes each with two drives can form a 4-drive RAID 10 array. Optional ServeRAID M5115 (included in M5100 Flash Kit for x880) supports RAID 0, 1, 10, 5, and 50 and 1 GB cache with flash backup. M5115 supports optional RAID 6/60 and SSD performance enabler.
Network interfaces	x5x models: Four 10 Gb Ethernet ports with one four-port Embedded 10Gb Virtual Fabric Ethernet LAN-on-motherboard (LOM) controller; Emulex XE104 based. Upgradeable to FCoE and iSCSI by using Features on Demand (FoD). x3x models: None standard; optional Ethernet adapters.
PCI Expansion slots	Up to four I/O connectors for adapters. Two connectors have PCI Express 3.0 x24 (x16 + x8) interface with support for dual-ASIC adapters (slots 1 and 2), two other connectors have PCI Express 3.0 x8 interface (slots 3 and 4). Models with Embedded 10Gb LOM have only two I/O slots available (slot 2 & 4).
Ports	External: One USB 3.0. Console breakout cable port that provides local KVM and serial ports (cable comes standard with Flex System chassis; additional cables are optional). Internal: Two internal USB 2.0 for embedded hypervisor.
Systems management	UEFI, Integrated Management Module 2 (IMM2) with Renesas SH7757 controller, Predictive Failure Analysis, light path diagnostics panel, automatic server restart, and remote presence. Support for Lenovo XClarity Administrator, IBM Flex System Manager™, IBM Systems Director, and ServerGuide.
Security features	Power-on password, administrator's password, and Trusted Platform Module V1.2.

Components	Specification (per node except where noted)
Video	Matrox G200eR2 video core with 16 MB video memory that is integrated into the IMM2. Maximum resolution is 1600x1200 at 75 Hz with 16 M colors.
Limited warranty	Three-year customer-replaceable unit and onsite limited warranty with 9x5/NBD.
Operating systems supported	Microsoft Windows Server, Red Hat Enterprise Linux, SUSE Linux Enterprise Server, VMware ESXi. See the <a href="#">Operating system support</a> section for specifics.
Service and support	Optional service upgrades are available through Lenovo Services offerings: Four-hour or 2-hour response time, 24-hour or 8-hour fix time, 1-year or 2-year warranty extension, and remote technical support for Lenovo hardware and selected Lenovo and OEM software.
Dimensions	<ul style="list-style-type: none"> <li>• Width: 435 mm (17.14 in.)</li> <li>• Height 55 mm (2.19 in.)</li> <li>• Depth 500 mm (19.7 in.)</li> </ul>
Weight	Maximum weight: 12.25 kg (27 lbs).

The X6 Compute Nodes are shipped with the following items:

- Statement of Limited Warranty
- Important Notices
- Documentation flyer that contains the *Installation and Service Guide*



## Standard models

The following table lists the standard models.

**Note:** x280 X6 is now withdrawn from marketing.

Table 2. Standard models

Model	Intel Processor** (2 maximum)	Memory	RAID	Disk bays (used/max)*	10GbE Embedded	I/O slots (used/max)
x480 X6 (2-socket, can scale up to 4-socket)						
7196-15x	2x E7-4809 v3 8C 2.1 GHz 20 MB 1333 MHz 115 W	2 x 16GB (1333 MHz)‡	LSI 3004	2.5" HS (0 / 2) Open bay	4x 10 GbE	2 / 4†
7196-25x	2x E7-4820 v3 10C 1.9 GHz 25 MB 1333 MHz 115 W	2 x 16GB (1333 MHz)‡	LSI 3004	2.5" HS (0 / 2) Open bay	4x 10 GbE	2 / 4†
7196-33x	2x E7-4830 v3 12C 2.1 GHz 30 MB 1600 MHz 115 W	2 x 16GB 1600 MHz	LSI 3004	2.5" HS (0 / 2) Open bay	No	0 / 4
7196-35x	2x E7-4830 v3 12C 2.1 GHz 30 MB 1600 MHz 115 W	2 x 16GB 1600 MHz	LSI 3004	2.5" HS (0 / 2) Open bay	4x 10 GbE	2 / 4†
7196-45x	2x E7-4850 v3 14C 2.2 GHz 35 MB 1600 MHz 115 W	2 x 16GB 1600 MHz	LSI 3004	2.5" HS (0 / 2) Open bay	4x 10 GbE	2 / 4†
x880 X66 (2-socket, can scale up to 4-socket or 8-socket)						
7196-53x	2x E7-8860 v3 16C 2.2 GHz 40 MB 1600 MHz 140 W	2 x 16 GB 1600 MHz	LSI 3004	2.5" HS (0 / 2) Open bay	No	0 / 4
7196-55x	2x E7-8860 v3 16C 2.2 GHz 40 MB 1600 MHz 140 W	2 x 16 GB 1600 MHz	LSI 3004	2.5" HS (0 / 2) Open bay	4x 10 GbE	2 / 4†
7196-65x	2x E7-8870 v3 18C 2.1 GHz 45 MB 1600 MHz 140 W	2 x 16 GB 1600 MHz	LSI 3004	2.5" HS (0 / 2) Open bay	4x 10 GbE	2 / 4†
7196-75x	2x E7-8880 v3 18C 2.3 GHz 45 MB 1600 MHz 150 W	2 x 16 GB 1600 MHz	LSI 3004	2.5" HS (0 / 2) Open bay	4x 10 GbE	2 / 4†
7196-85x	2x E7-8890 v3 18C 2.5 GHz 45 MB 1600 MHz 165 W	2 x 16 GB 1600 MHz	LSI 3004	2.5" HS (0 / 2) Open bay	4x 10 GbE	2 / 4†

\*\* Processor detail: Processor quantity and model, cores, core speed, L3 cache, memory speed, and power consumption.

\* The 2.5-inch drive bays can be replaced and expanded with more internal bays to support up to eight 1.8-inch SSDs.

† These models include one 4-port Embedded 10Gb Virtual Fabric Ethernet controller. Connections are routed by using Fabric Connectors. The Fabric Connectors preclude the use of an I/O adapter in I/O connectors 1 and 3, except the ServeRAID M5115 controller, which can be installed in slot 3.

‡ For these models, the standard DIMM is rated at 1600 MHz, but operates at 1333 MHz to match the processor memory speed.

## Chassis support

The X6 Compute Nodes are supported in the Flex System Enterprise Chassis as listed in the following table.

Table 3. Chassis support

Compute node	Enterprise Chassis with CMM 68Y7030	Enterprise Chassis with CMM2 00FJ669	Carrier-Grade Chassis
x480 X6 (7196)	Yes	Yes	No
x880 X6 (7196)	Yes	Yes	No

Up to seven X6 compute nodes can be installed in the chassis in 10U of rack space. The following number of scaled systems can be installed:

- Two-socket systems: Up to seven systems in an Enterprise Chassis
- Four-socket systems: Up to three systems in an Enterprise Chassis
- Eight-socket systems: One system in an Enterprise Chassis

It might also be possible to populate the remaining bays within the chassis with other standard or double-wide nodes. The actual number of servers that can be installed in a chassis also depends on the following factors:

- The TDP power rating for the processors that are installed in the server
- The number of power supplies that are installed
- The capacity of the power supplies that are installed (2100 W or 2500 W)
- The power redundancy policy that is used (N+1 or N+N)

The following table provides guidelines about what number of X6 Compute Nodes can be installed. For more information, use the Power Configurator that is available at this website:

<http://ibm.com/systems/bladecenter/resources/powerconfig.html>

Consider the following points regarding the table:

- Green = No restriction to the number of X6 Compute Nodes that are installable.
- Yellow = Some bays must be left empty in the chassis.

Table 4. Maximum number of X6 Compute Nodes that are installable based on the power supplies that are installed and the power redundancy policy that is used

TDP rating	2100 W power supplies installed				2500 W power supplies installed			
	N+1, N=5 6 power supplies	N+1, N=4 5 power supplies	N+1, N=3 4 power supplies	N+N, N=3 6 power supplies	N+1, N=5 6 power supplies	N+1, N=4 5 power supplies	N+1, N=3 4 power supplies	N+N, N=3 6 power supplies
x480 or x880 X6 with 2 sockets								
105 W	7	7	6	6	7	7	7	7
130 W	7	7	5	6	7	7	7	7
155 W	7	7	5	5	7	7	7	7
x480 or x880 X6 with 4 sockets								
105 W	3	3	3	3	3	3	3	3
130 W	3	3	3	3	3	3	3	3
155 W	3	3	2	3	3	3	3	3
x880 X6 with 8 sockets								
105 W	1	1	1	1	1	1	1	1
130 W	1	1	1	1	1	1	1	1
155 W	1	1	1	1	1	1	1	1

## Scalability

The X6 compute nodes can scale to a 4-socket or 8-socket complex, depending on the processor that is installed into the node. Consider the following points:

- An x880 X6 node with Intel Xeon E7-8800 v3 family processors can scale up to an 8-socket configuration, and supports 2-socket, 4-socket, and 8-socket configurations. All the processors in these 2-socket, 4-socket, and 8-socket configurations must be identical.
- An x480 X6 node with Intel Xeon E7-4800 v3 family processors can scale up to a 4-socket configuration, and supports 2-socket and 4-socket configurations. All the processors in these 2-socket and 4-socket configurations must be identical.

The scaled X6 compute nodes are connected through a front interconnect system. The interconnection has a QPI bus and the sideband signals that are needed for correct operation.

There are three scalability connector assemblies for X6 nodes, as shown in the following table.

Table 5. Scalability options for X6 compute nodes

Part number	Feature code	Description
00Y3874	A4D9	Flex System x880 X6 8-Socket Scalability Connector (used to connect four x880 Compute Nodes)
00Y3871	A4D8	Flex System x880 X6 4-Socket Scalability Connector (used to connect two x480 or x880 Compute Nodes)
00Y3868	A4D7	Flex System X6 2-Socket Performance Accelerator (used in single-node configurations only)

The following figure shows the Flex System x880 X6 4-Socket Scalability Connector and how it is used to connect two X6 servers (x880 or x480).

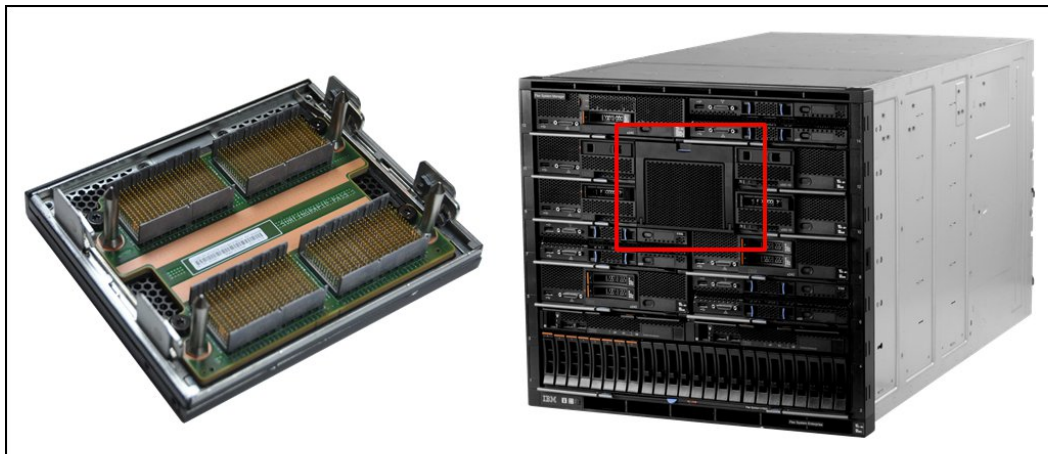

Figure 5. Flex System x880 X6 4-Socket Scalability Connector

The Flex System X6 2-Socket Performance Accelerator (00Y3868) takes the QPI links and other sideband signals that are used for multi-node X6 scaling complex and routes them back to the processors on a single X6 compute node. This configuration improves the performance of processor-to-processor communications.

## Processor options

The X6 compute nodes support the processor options that are listed in the following table. The server supports two Intel E7-4800 v3 or E7-8800 v3 processors depending on model. The table also shows which server models include each processor standard. If no corresponding model for a particular processor is listed, the processor is available only through the configure-to-order (CTO) process.

**No part numbers:** All Flex System X6 Compute Nodes have two processors as a standard. There is no option part number for processors, only feature codes.

Table 6. Processor options

Feature code*	Intel Xeon processor description	Memory bus speed (RAS / Performance)†	Models where used
Flex System x480 X6 Compute Node			
ASNX / ASP1	Xeon E7-4809 v3 8C 2.1GHz 20MB 1333MHz 115W	1333 / 1066 MHz	-
ASNY / ASP2	Xeon E7-4820 v3 10C 1.9GHz 25MB 1333MHz 115W	1333 / 1066 MHz	-
ASNZ / ASP3	Xeon E7-4830 v3 12C 2.1GHz 30MB 1600MHz 115W	1600 / 1066 MHz	33x, 35x
ASP0 / ASP4	Xeon E7-4850 v3 14C 2.2GHz 35MB 1600MHz 115W	1600 / 1066 MHz	45x
Flex System x880 X6 Compute Node			
ASP6 / ASPE	Xeon E7-8860 v3 16C 2.2GHz 40MB 1600MHz 140W	1600 / 1333 MHz	53x, 55x
ASP7 / ASPF	Xeon E7-8870 v3 18C 2.1GHz 45MB 1600MHz 140W	1600 / 1333 MHz	65x
ASP9 / ASPH	Xeon E7-8880 v3 18C 2.3GHz 45MB 1600MHz 150W	1600 / 1333 MHz	75x
ASPA / ASPJ	Xeon E7-8890 v3 18C 2.5GHz 45MB 1600MHz 165W	1600 / 1333 MHz	85x
ASPC / ASPL	Xeon E7-8893 v3 4C 3.2GHz 45MB 1600MHz 140W	1600 / 1333 MHz	-
ASPB / ASPK	Xeon E7-8891 v3 10C 2.8GHz 45MB 1600MHz 165W	1600 / 1333 MHz	-
ASP5 / ASPD	Xeon E7-8667 v3 16C 2.5GHz 45MB 1600MHz 165W	1600 / 1333 MHz	-
ASP8 / ASPG	Xeon E7-8880L v3 18C 2.0GHz 45MB 1600MHz 115W	1600 / 1333 MHz	-

\* The first feature code is for CPU 1 and the second feature code is for CPU 2.

† The processors support two memory modes: RAS mode (also known as lockstep mode) and Performance mode (also known as independent mode). In Performance mode, the SMI2 link operates at twice the memory bus speed that is shown.

## Memory options

Lenovo DDR3 memory is compatibility tested and tuned for optimal performance and throughput. Lenovo memory specifications are integrated into the light path diagnostic tests for immediate system performance feedback and optimum system uptime. From a service and support standpoint, Lenovo memory automatically assumes the system warranty.

The X6 Compute Nodes support DDR3 memory operating at speeds up to 1600 MHz with 24 DIMMs per processor, as shown in the following examples:

- A 2-socket configuration supports up to 48 DIMMs.
- A 4-socket scaled configuration supports up to 96 DIMMs.
- An 8-socket configuration supports up to 192 DIMMs.

The following table lists the memory options that are available for X6 Compute Nodes.

**Note:** The 64GB LRDIMM, part number 46W0741, is now withdrawn from marketing.

Table 7. Memory options

Part number	Feature code	Description	Maximum supported	Models where used
<b>RDIMMs</b>				
00D5024†	A3QE	4GB (1x4GB, 1Rx4, 1.35V) PC3L-12800 CL11 ECC DDR3 1600MHz LP RDIMM	48 (24 per CPU)	-
00D5036	A3QH	8GB (1x8GB, 1Rx4, 1.35V) PC3L-12800 CL11 ECC DDR3 1600MHz LP RDIMM	48 (24 per CPU)	-
46W0672	A3QM	16GB (1x16GB, 2Rx4, 1.35V) PC3L-12800 CL11 ECC DDR3 1600MHz LP RDIMM	48 (24 per CPU)	All models
<b>LRDIMMs</b>				
46W0676†	A3SR	32GB (1x32GB, 4Rx4, 1.35V) PC3L-12800 CL11 ECC DDR3 1600MHz LP LRDIMM	48 (24 per CPU)	-

† Not allowed if any eXFlash DIMMs (now withdrawn) are installed

Each processor has four memory channels to memory buffers that are implemented by using Scalable Memory Interface generation 2 (SMI2) chips. Each memory buffer has two memory channels and implements three DIMMs per channel.

The following rules apply when the memory configuration is selected:

- The X6 node supports RDIMMs and LRDIMMs.
- LRDIMMs and RDIMMs cannot be mixed within a single compute node or a scaled complex.
- 4 GB RDIMMs and LRDRIMMs cannot be used with eXFlash DIMMs (now withdrawn)
- Mixing 1.5 V and 1.35 V DIMMs in the same server is supported. In such a case, all DIMMs operate at 1.5 V.
- The processors support two memory modes: Performance mode and RAS (or lockstep) mode. In RAS (lockstep) mode, DIMMs must be installed in a pair, and the SMI link operates at the speed of the memory bus.
- When RDIMMs are installed, the maximum number of ranks that are supported per channel is eight. With LRDIMMs, the rank count per channel can be 32 (LRDIMM ranks are only 25% of the electrical load of an RDIMM rank).

- All DIMMs in all processor memory channels operate at the same speed, which is determined as the lowest value of the following components:
  - The memory mode used: Performance (independent) mode or RAS (lockstep) mode.
  - Memory speed that is supported by a specific processor.
  - Lowest of maximum operating speeds for selected memory configuration, depending on the rated speed, operating voltage, and quantity of DIMMs per channel, as listed in the “Maximum operating speed” section in the following table.

The following table shows the characteristics of the supported DIMMs. Tables cells that are highlighted in a gray indicate that the server supports higher memory frequencies or larger memory capacity (or both) than the Intel processor specification defines.

**Memory speed:** In performance mode, memory channels operate independently, and the SMI2 link operates at twice the DDR3 speed. In RAS mode, two channels operate synchronously, and the SMI2 link operates at the DDR3 speed.

Table 8. Maximum memory speeds

DIMM specification	RDIMM				LRDIMM	
	Single rank		Dual rank		Quad rank	
Part numbers	00D5024 (4 GB) 00D5036 (8 GB)		46W0672 (16 GB)		46W0676 (32 GB)	
Rated speed	1600 MHz		1600 MHz		1600 MHz	
Rated voltage	1.35 V		1.35 V		1.35 V	
Operating voltage	1.35 V	1.5 V	1.35 V	1.5 V	1.35 V	1.5 V
Max qty supported*	48	48	48	48	48	48
Max DIMM capacity	8 GB	8 GB	16 GB	16 GB	32 GB	32 GB
Max memory capacity	384 GB	384 GB	768 GB	768 GB	1.5 TB	1.5 TB
<b>Maximum operating speed - Performance mode (2:1 mode - SMI2 link operates at twice the DDR3 speed that is shown)</b>						
1 DIMM per channel	1333 MHz	1333 MHz	1333 MHz	1333 MHz	1333 MHz	1333 MHz
2 DIMMs per channel	1333 MHz	1333 MHz	1333 MHz	1333 MHz	1333 MHz	1333 MHz
3 DIMMs per channel	1066 MHz	1333 MHz	1066 MHz	1333 MHz	1333 MHz	1333 MHz
<b>Maximum operating speed - RAS mode (1:1 mode - SMI2 link operates at the DDR3 speed that is shown)</b>						
1 DIMM per channel	1333 MHz	1600 MHz	1333 MHz	1600 MHz	1333 MHz	1600 MHz
2 DIMMs per channel	1333 MHz	1600 MHz	1333 MHz	1600 MHz	1333 MHz	1600 MHz
3 DIMMs per channel	1066 MHz	1333 MHz	1066 MHz	1333 MHz	1333 MHz	1333 MHz

\* Maximum quantity per node when both processors are installed.

The following memory protection technologies are supported:

- ECC
- Chipkill (for x4-based memory DIMMs)
- Redundant bit steering (Double Device Data Correction)
- Memory mirroring
- Memory rank sparing

Chipkill and Redundant Bit Steering are supported in RAS mode. Chipkill is supported in Performance mode.

If memory mirroring is used, DIMMs must be installed in pairs for Performance mode (minimum of one pair per each processor) and quads for RAS mode. DIMMs in the pair/quad must be identical in type and size.

If memory rank sparing is used, a minimum of two single-rank or dual-rank DIMMs must be installed per populated channel (the DIMMs do not need to be identical). In rank sparing mode, one rank of a DIMM in each populated channel is reserved as spare memory. The size of a rank varies depending on the DIMMs that are installed.

## Internal storage

The X6 compute node has two 2.5-inch front-accessible hot-swap drive bays that are accessible from the front of the server. These bays are connected to the integrated ServeRAID M1210e controller.

The ServeRAID M1210e controller includes the following features:

- Based on the LSI SAS 3004 12 Gbps SAS/SATA RAID-on-Chip (ROC) controller
- Four-port controller with 12 Gbps throughput per port
- PCIe x4 Gen 2 host interface
- Supports RAID levels 0, 1, 10, and 1E; optionally supports RAID 5 and RAID 50.

The two 2.5-inch front-accessible drive bays can be replaced with four 1.8-inch drive bays, two 1.8-inch bays replacing each 2.5-inch bay, by using the ServeRAID M1200 Series Flex System Flash Kit for x880 X6. The part number for this upgrade is listed in the following table.

RAID 5 and RAID 50 are supported through a Features on Demand (FoD) upgrade, as listed in the following table. For 4-socket and 8-socket complexes, one FoD upgrade is required for each SAS controller on which you want to enable RAID 5.

Table 9. ServeRAID M1210e upgrades

Part number	Feature code	Name and description	Maximum supported
00AE930	A5H5	ServeRAID M1200 Zero Cache/RAID 5 Upgrade (FoD)	1
44T1316	A4R3	ServeRAID M1200 Series Flex System Flash Kit for X6	1

The X6 compute node also supports up to eight 1.8-inch drives with the addition of the ServeRAID M5115 controller and SSD tray hardware. These components are described in the next section.

Supported drives are listed in the [Internal drive options](#) section.

## ServeRAID M5115 SAS/SATA adapter

An alternative to the M1210e integrated controller, the X6 compute nodes also support up to eight 1.8-inch SSDs combined with a ServeRAID M5115 SAS/SATA controller. ServeRAID M5100 Series Flex System Flash Kit for x880 X6 (44T1178) enables support for up to four internal 1.8-inch SSDs and for up to four 1.8-inch SSDs instead of two 2.5-inch HDDs. The ServeRAID M5115 adapter is included in this kit.

The eight SSDs are installed in the following locations:

- Four in the front of the system in place of the two 2.5-inch drive bays
- Four on trays above the memory banks

**Tip:** The front-accessible 1.8-inch drive trays in the ServeRAID M5100 Series Flex System Flash Kit are the same as the trays in the ServeRAID M1200 Series Flex System Flash Kit.



The M5115 adapter is installed in I/O bay 3 and can be installed even if the Compute Node Fabric Connector is installed (used to route the Embedded 10Gb Virtual Fabric Adapter to bays 1 and 2, as described in the "I/O expansion options" section). The ServeRAID M5115 cannot be installed if an adapter is installed in I/O adapter slot 3.

The kit ordering information is listed in the following table with supported FoD upgrades. For 4-socket and 8-socket complexes, one FoD upgrade is required for each compute node.

Table 10. ServeRAID M5115 and options

Part number	Feature code	Description	Maximum supported
44T1178	A4DC	ServeRAID M5100 Series Flex System Flash Kit for x880 X6 (includes ServeRAID M5115 adapter)	1
90Y4410	A2Y1	ServeRAID M5100 Series RAID 6 Upgrade for Flex System (Features on Demand upgrade, adds RAID 6 and RAID 60 support)	1
90Y4412	A2Y2	ServeRAID M5100 Series Performance Upgrade for Flex System (MegaRAID FastPath) (Features on Demand upgrade)	1

The ServeRAID M5115 controller has the following specifications:

- Eight internal 6 Gbps SAS/SATA ports.
- PCI Express 3.0 x8 host interface.
- 6 Gbps throughput per port.
- 800 MHz dual-core IBM PowerPC® processor with LSI SAS2208 6 Gbps RAID on Chip (ROC) controller.
- Support for RAID levels 0, 1, 10, 5, and 50 standard. Support for RAID 6 and 60 with optional upgrade using 90Y4411.
- Onboard 1 GB data cache (DDR3 that is running at 1333 MHz) with optional flash backup (MegaRAID CacheVault technology) as part of the Enablement Kit 46C9030.
- Support for SAS and SATA HDDs and SSDs.
- Support for intermixing SAS and SATA HDDs and SSDs. Mixing different types of drives in the same array (drive group) is not recommended.
- Support for self-encrypting drives (SEDs) with MegaRAID SafeStore.
- Optional support for SSD performance acceleration with MegaRAID FastPath (90Y4412)
- Support for up to 64 virtual drives, up to 128 drive groups, up to 16 virtual drives per one drive group, and up to 32 physical drives per one drive group.
- Support for logical unit number (LUN) sizes up to 64 TB.
- Configurable stripe size up to 1 MB.
- Compliant with Disk Data Format (DDF) configuration on disk (COD).
- S.M.A.R.T. support.
- MegaRAID Storage Manager management software.

The following optional FoD license upgrades are available for the ServeRAID M5115:

- RAID 6 Upgrade (90Y4410)  
Adds support for RAID 6 and RAID 60.
- Performance Upgrade (90Y4412)

The Performance Upgrade for Flex System (implemented by using the LSI MegaRAID FastPath software) provides high-performance I/O acceleration for SSD-based virtual drives by using a lowlatency I/O path to increase the maximum I/O per second (IOPS) capability of the controller. This feature boosts the performance of applications with a highly random data storage access pattern, such as transactional databases.

**Note:** The SSD Caching Enabler (MegaRAID CacheCade Pro 2.0) is not supported because a combination of 1.8-inch SSDs and 2.5-inch HDDs is not supported.

## Internal drive options

The 2.5-inch drive bays support SAS or SATA HDDs or SATA SSDs. The following tables list the supported 2.5-inch drive options:

- Table 12: [2.5-inch hot-swap 12 Gb SAS/SATA HDDs](#)
- Table 13: [2.5-inch hot-swap 6 Gb SAS/SATA HDDs](#)
- Table 14: [2.5-inch hot-swap 6 Gb SAS/SATA SSDs](#)

Table 11. 2.5-inch hot-swap 12 Gb SAS/SATA HDDs

Part number	Feature	Description	Maximum supported
2.5-inch hot-swap HDDs - 12 Gb SAS 10K			
00WG685	AT89	300GB 10K 12Gbps SAS 2.5" G3HS HDD	2
00WG690	AT8A	600GB 10K 12Gbps SAS 2.5" G3HS HDD	2
00WG695	AT8B	900GB 10K 12Gbps SAS 2.5" G3HS HDD	2
00WG700	AT8C	1.2TB 10K 12Gbps SAS 2.5" G3HS HDD	2
00NA271	ASBM	1.8TB 10K 12Gbps SAS 2.5" G3HS 512e HDD	2
2.5-inch hot-swap HDDs - 12 Gb SAS 15K			
00WG660	AT84	300GB 15K 12Gbps SAS 2.5" G3HS HDD	2
00WG665	AT85	600GB 15K 12Gbps SAS 2.5" G3HS HDD	2
2.5-inch hot-swap HDDs - 12 Gb NL SAS			
00NA491	AT7Z	1TB 7.2K 12Gbps NL SAS 2.5" G3HS HDD	2
00NA496	AT80	2TB 7.2K 12Gbps NL SAS 2.5" G3HS 512e HDD	2
2.5-inch hot-swap SED HDDs - 12 Gb SAS 10K			
00WG705	AT8D	300GB 10K 12Gbps SAS 2.5" G3HS SED	2
00WG710	AT8E	600GB 10K 12Gbps SAS 2.5" G3HS SED	2
00WG715	AT8F	900GB 10K 12Gbps SAS 2.5" G3HS SED	2
00WG720	AT8G	1.2TB 10K 12Gbps SAS 2.5" G3HS SED	2

Table 12. 2.5-inch hot-swap 6 Gb SAS/SATA HDDs

Part number	Feature	Description	Maximum supported
2.5-inch hot-swap HDDs - 6 Gb NL SATA			
00AJ141	A4TX	1TB 7.2K 6Gbps NL SATA 2.5" G3HS HDD	2
00NA526	AT81	2TB 7.2K 6Gbps NL SATA 2.5" G3HS 512e HDD	2

Table 13. 2.5-inch hot-swap 6 Gb SAS/SATA SSDs

Part number	Feature	Description	Maximum supported
2.5-inch hot-swap SSDs - 6 Gb SAS - Enterprise Performance (10+ DWPD)			
00AJ207	A4UA	200GB SAS 2.5" MLC G3HS Enterprise SSD	2
2.5-inch hot-swap SSDs - 6 Gb SATA - Enterprise Performance (10+ DWPD)			
00YC330	AT9E	Intel S3710 800GB Enterprise Performance SATA G3HS 2.5" SSD	2
2.5-inch hot-swap SSDs - 6 Gb SATA - Enterprise Mainstream (3-5 DWPD)			
00YK212	AU3C	Intel S3610 480GB Enterprise Mainstream SATA G3HS 2.5" SSD	2
00YK217	AU3D	Intel S3610 800GB Enterprise Mainstream SATA G3HS 2.5" SSD	2
00YK222	AU3E	Intel S3610 1.2TB Enterprise Mainstream SATA G3HS 2.5" SSD	2
00YK227	AU3F	Intel S3610 1.6TB Enterprise Mainstream SATA G3HS 2.5" SSD	2
00AJ395	A577	120GB SATA 2.5" MLC G3HS Enterprise Value SSD	2
00AJ400	A578	240GB SATA 2.5" MLC G3HS Enterprise Value SSD	2
00AJ405	A579	480GB SATA 2.5" MLC G3HS Enterprise Value SSD	2
00AJ410	A57A	800GB SATA 2.5" MLC G3HS Enterprise Value SSD	2
2.5-inch hot-swap SSDs - 6 Gb SATA - Enterprise Entry (<3 DWPD)			
01GR726	AUEM	Intel S3520 240GB Enterprise Entry SATA G3HS 2.5" SSD	2
01GR731	AUEP	Intel S3520 480GB Enterprise Entry SATA G3HS 2.5" SSD	2
01GR736	AUER	Intel S3520 960GB Enterprise Entry SATA G3HS 2.5" SSD	2
01GR711	AUE7	1.92TB Enterprise Entry SATA G3HS 2.5" SSD (PM863a)	2
00WG630	AT95	Intel S3510 480GB Enterprise Entry SATA G3HS 2.5" SSD	2
00YC385	AT8R	120GB Enterprise Entry SATA G3HS 2.5" SSD	2
00YC390	AT8S	240GB Enterprise Entry SATA G3HS 2.5" SSD	2
00YC395	AT8T	480GB Enterprise Entry SATA G3HS 2.5" SSD	2
00YC400	AT8U	960GB Enterprise Entry SATA G3HS 2.5" SSD	2

The supported 1.8-inch SSDs are listed in the following table. The use of 1.8-inch requires one of the following (but not both) items:

- ServeRAID M5100 Series Flex System Flash Kit for X6
- ServeRAID M1200 Series Flex System Flash Kit for X6

Table 14. Supported 1.8-inch SSDs

Part number	Feature code	Description	Maximum supported
Enterprise SSDs			
41Y8366	A4FS	S3700 200 GB SATA 1.8-inch MLC Enterprise SSD	8
41Y8371	A4FT	S3700 400 GB SATA 1.8-inch MLC Enterprise SSD	8
Enterprise Value SSDs			
00AJ040	A4KV	S3500 80 GB SATA 1.8-inch MLC Enterprise Value SSD	8
00AJ050	A4KX	S3500 400 GB SATA 1.8-inch MLC Enterprise Value SSD	8
00AJ455	A58U	S3500 800 GB SATA 1.8-inch MLC Enterprise Value SSD	8

## Internal tape drives

The server does not support an internal tape drive. However, it can be attached to external tape drives by using Fibre Channel connectivity.

## Optical drives

The server does not support an internal optical drive option; however, you can connect an external USB optical drive. For information about available external optical drives from Lenovo, see this website: <http://support.lenovo.com/en/documents/pd011281>

Alternatively, use the remote media feature of the IMMv2 and the Chassis Management Module.

**Note:** The USB port on the compute node supplies up to 0.5 A at 5 V. For devices that require more power, an extra power source is required.

## Embedded 10Gb Virtual Fabric

Some models of the X6 compute nodes include one Embedded 4-port 10Gb Virtual Fabric controller (VFA), which is also known as LAN on Motherboard or LOM. This controller is built into the system board. Table 2 lists the models that include the Embedded 10Gb Virtual Fabric controllers. Each X6 compute node that includes the Embedded 10 Gb Virtual Fabric controllers also has a Compute Node Fabric Connector that is installed in each of I/O connectors 1 and 3 (and physically screwed onto the system board) to provide connectivity to the Enterprise Chassis midplane.

The Fabric Connector enables port 1 and 3 of embedded 10 Gb controller to be routed to I/O module bay 1, and port 2 and 4 of controller to be routed to I/O module bay 2. A compatible I/O module must be installed in those I/O module bays.

The Embedded 10Gb Virtual Fabric controller includes the following features:

- Based on a single Emulex XE104 ASIC
- Four 10 Gb Ethernet ports
- PCIe 3.0 x8 host bus interface
- Supports multiple virtual NIC (vNIC) functions
- TCP/IP Offload Engine (TOE enabled)
- SRIOV capable
- RDMA over TCP/IP capable
- RoCE capable
- iSCSI and FCoE upgrade offering through FoD

The following table lists the ordering information for the FoD upgrade, which enables the iSCSI and FCoE support on the Embedded 10Gb Virtual Fabric controller. Only one upgrade is needed per compute node.

Table 15. FoD upgrade for FCoE and iSCSI support

Part number	Feature code	Description	Maximum supported
00FM258	A5TM	Flex System X6 Embedded 10Gb Virtual Fabric Upgrade	1

## I/O expansion options

The X6 compute node has four I/O expansion connectors for attaching I/O adapters, as shown in the following figure. Installing I/O adapters allows the server to connect to switch modules in the Flex System Enterprise Chassis. The following figure also shows the location of the four I/O expansion slots.

**Note:** Slots 3 and 4 support only a subset of the adapters that are supported in slots 1 and 2. Slots 3 and 4 do not support dual-ASIC adapters because of the PCIe lanes that are routed to slots 3 and 4. For more information, see the [Network adapters](#) section.

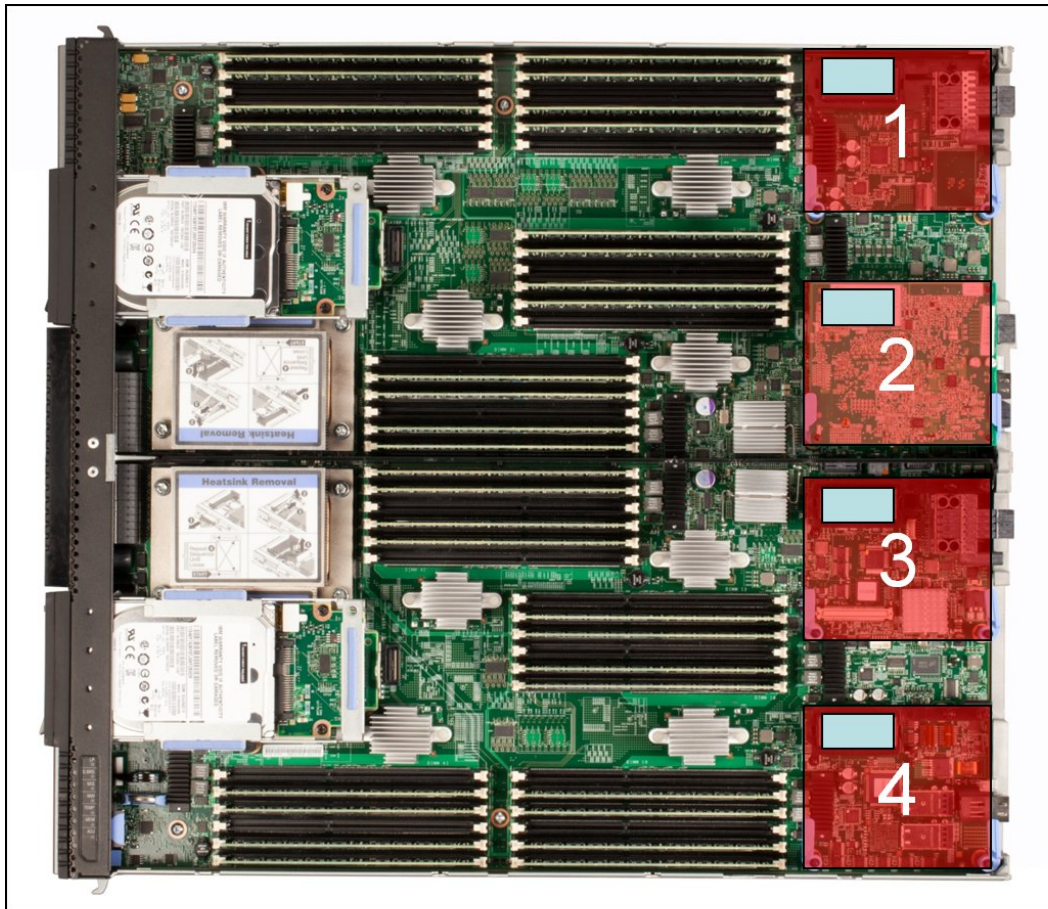

Figure 6. Location of the I/O adapter slots in the X6 Compute Node

A compatible switch or pass-through module must be installed in the corresponding I/O bays in the chassis, as listed in the following table. Installing two switches means that all of the ports of the adapter are enabled, which improves performance and network availability.

Table 16. Adapter to I/O bay correspondence

I/O adapter slot in the server	Port on the adapter	Corresponding I/O module bay in the chassis
Slot 1	Port 1	Module bay 1
	Port 2	Module bay 2
	Port 3 (for 4 & 8-port cards)	Module bay 1
	Port 4 (for 4 & 8-port cards)	Module bay 2
	Port 5 (for 8-port cards)	Module bay 1
	Port 6 (for 8-port cards)	Module bay 2
	Port 7 (for 8-port cards)	Module bay 1
	Port 8 (for 8-port cards)	Module bay 2
Slot 2	Port 1	Module bay 3
	Port 2	Module bay 4
	Port 3 (for 4 & 8-port cards)	Module bay 3
	Port 4 (for 4 & 8-port cards)	Module bay 4
	Port 5 (for 8-port cards)	Module bay 3
	Port 6 (for 8-port cards)	Module bay 4
	Port 7 (for 8-port cards)	Module bay 3
	Port 8 (for 8-port cards)	Module bay 4
Slot 3 (Dual-ASIC adapters are not supported.)	Port 1	Module bay 1
	Port 2	Module bay 2
Slot 4 (Dual-ASIC adapters are not supported.)	Port 1	Module bay 3
	Port 2	Module bay 4

For more information about supported switches, see the Flex System Interoperability Guide, which is available at: <http://lenovopress.com/fsig>

The following figure shows the location of the switch bays in the Flex System Enterprise Chassis.

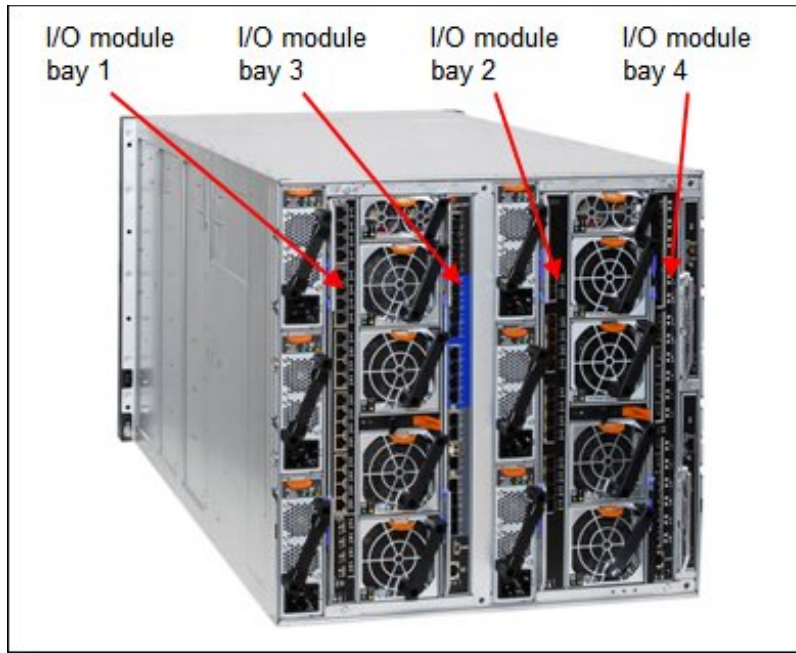

Figure 7. Location of the switch bays in the Flex System Enterprise Chassis

The following figure shows how 2-port adapters are connected to switches that are installed in the chassis.

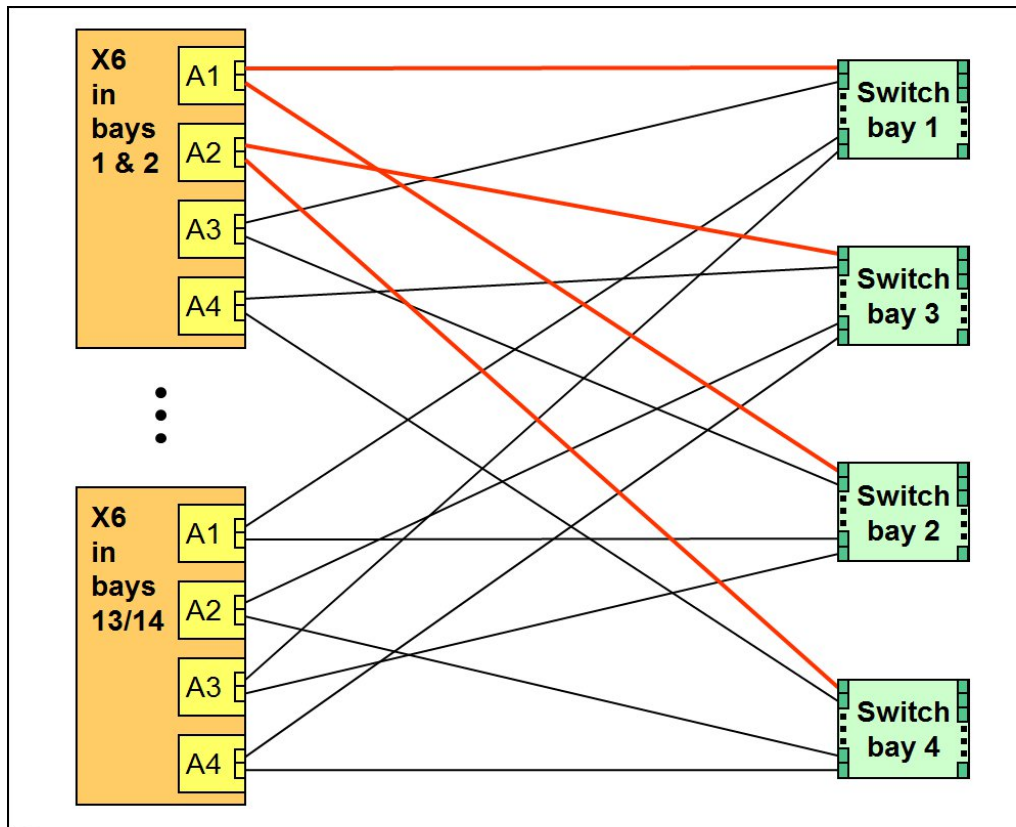

Figure 8. Logical layout of the interconnects between I/O adapters and I/O modules

## Network adapters

As described in the [Embedded 10Gb Virtual Fabric](#) section, certain models (those with a model number of the form x5x) have a 10 Gb Ethernet controller on the system board. Its ports are routed to the midplane and switches that are installed in the chassis through two Compute Node Fabric Connectors that take the place of adapters in I/O slots 1 and 3.

Models without the Embedded 10Gb Virtual Fabric controller (those with a model number of the form x2x) do not include any other Ethernet connections to the Enterprise Chassis midplane as standard. Therefore, for those models, an I/O adapter must be installed to provide network connectivity between the server and the chassis midplane and ultimately to the network switches.

The following table lists the supported network adapters and upgrades and the slots in which they are each supported. Compatible switches must be installed in the corresponding bays of the chassis.

**Note:** The following adapters with two ASICs are not supported in slots 3 and 4:

- Flex System CN4058S 8-port 10Gb Virtual Fabric Adapter
- Flex System CN4054R 10Gb Virtual Fabric Adapter (withdrawn from marketing)
- Flex System EN2024 4-port 1Gb Ethernet Adapter

Table 17. Network adapters

Part number	Feature code	Flex System adapter	Number of ports	Maximum supported†	Slots supported
40 Gb Ethernet					
90Y3482	A3HK	EN6132 2-port 40Gb Ethernet Adapter	2	4	1, 2, 3, 4
10 Gb Ethernet					
88Y5920	A4K3	CN4022 2-port 10Gb Converged Adapter	2	4	1, 2, 3, 4
01CV780	AU7X	Flex System CN4052S 2-port 10Gb Virtual Fabric Adapter Advanced (with FCoE and iSCSI)	2	4	1, 2, 3, 4
00AG540	ATBT	Flex System CN4052S 2-port 10Gb Virtual Fabric Adapter	2	4	1, 2, 3, 4
00JY804	A5RV	Flex System CN4052 Virtual Fabric Adapter SW Upgrade (FoD) (License to enable FCoE and iSCSI on 00AG540 or 00JY800)	License	4	Not applicable
01CV790	AU7Y	Flex System CN4054S 4-port 10Gb Virtual Fabric Adapter Advanced (with FCoE and iSCSI)	4	4	1, 2, 3, 4
00AG590	ATBS	Flex System CN4054S 4-port 10Gb Virtual Fabric Adapter	4	4	1, 2, 3, 4
00AG594	ATBU	Flex System CN4054S 4-port 10Gb Virtual Fabric Adapter SW Upgrade (License to enable FCoE and iSCSI on 00AG590)	License	4	Not applicable
90Y3558	A1R0	Flex System CN4054 Virtual Fabric Adapter (SW Upgrade) (License to enable FCoE and iSCSI on CN4054R, 00Y3306)	License	4	Not applicable
94Y5160	A4R6	CN4058S 8-port 10Gb Virtual Fabric Adapter	8	2	1, 2**
94Y5164	A4R9	CN4058S Virtual Fabric Adapter SW Upgrade (FoD) (FCoE/iSCSI upgrade for 94Y5160; 1 per adapter)	License	2	Not applicable
90Y3466	A1QY	EN4132 2-port 10Gb Ethernet Adapter	2	4	1, 2, 3, 4
00AG530	A5RN	EN4172 2-port 10Gb Ethernet Adapter	2	4	1, 2, 3, 4
1 Gb Ethernet					



49Y7900	A10Y	EN2024 4-port 1Gb Ethernet Adapter	4	2	1, 2**
InfiniBand					
90Y3454	A1QZ	IB6132 2-port FDR InfiniBand Adapter	2	2	2, 4

† For X6 models with Embedded 10Gb Virtual Fabric controller standard, the Compute Node Fabric Connectors occupy the same space as the I/O adapters in I/O slots 1 and 3; adapters are not supported in those slots.

\*\* Adapters with two ASICs are not supported in slots 3 and 4 because of the available PCIe lanes in those slots

For more information about adapter-to-switch compatibility, see the Flex System Interoperability Guide: <http://lenovopress.com/fsig>

For more information, see the list of Lenovo Press Product Guides in the Adapter cards category: <http://lenovopress.com/flexsystem/adapters>

## Storage host bus adapters

The following table lists the storage host bus adapters (HBAs) that are supported by the compute node.

**Note:** The Flex System FC5054 4-port 16Gb FC adapter with two ASICs is not supported in slots 3 and 4.

Table 18. Storage adapters

Part number	Feature code	Description	Number of ports
Fibre Channel			
88Y6370	A1BP	Flex System FC5022 2-port 16Gb FC Adapter	2
69Y1938	A1BM	Flex System FC3172 2-port 8Gb FC Adapter	2
95Y2375	A2N5	Flex System FC3052 2-port 8Gb FC Adapter	2
95Y2386	A45R	Flex System FC5052 2-port 16Gb FC Adapter	2
95Y2391	A45S	Flex System FC5054 4-port 16Gb FC Adapter	4
69Y1942	A1BQ	Flex System FC5172 2-port 16Gb FC Adapter	2

## Power supplies

Server power is derived from the power supplies that are installed in the chassis. There are no server options regarding power supplies.

## Integrated virtualization

The X6 compute node supports the ESXi hypervisor on a USB memory key through two internal USB ports (as shown in [Figure 3](#)). The supported USB memory keys are listed in the following table.

Table 19. Virtualization options

Part number	Feature code	Description	Maximum supported
00WH140	ATRM	Blank USB Memory Key 4G SLC for VMware ESXi Downloads	2
41Y8298	A2G0	Blank USB Memory Key for VMware ESXi Downloads	2
00WH138	ATRL	USB Memory Key 4G for VMware ESXi 6.0 Update 1A	2
00WH150	ATZG	USB Memory Key for VMware ESXi 5.5 Update 3B	2
00WH151	ATZH	USB Memory Key for VMware ESXi 6.0 Update 2	2
CTO only	AVNW	USB Memory Key for VMware ESXi 6.5	2

## Light path diagnostics panel

For quick problem determination when you are physically at the server, the compute node offers the following 3-step guided path:

1. The Fault LED on the front panel.
2. The light path diagnostics panel.
3. LEDs next to key components on the system board.

The light path diagnostics panel is visible when you remove the server from the chassis. The panel is at the upper right side of the compute node, as shown in the following figure.

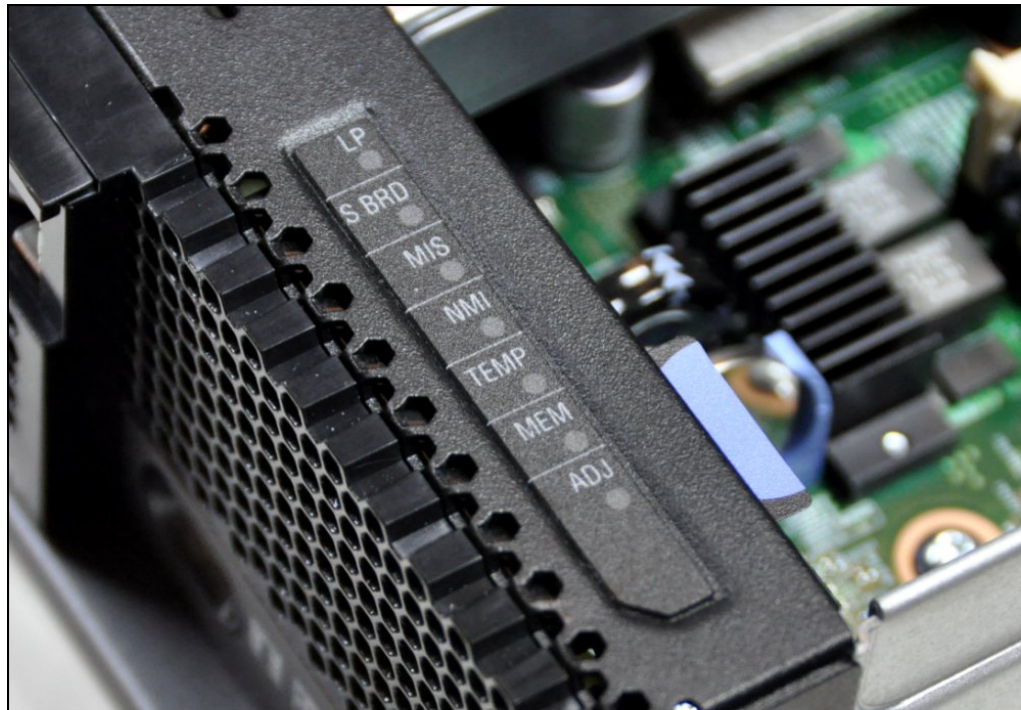

Figure 9. Location of X6 light path diagnostics panel

To illuminate the light path diagnostics LEDs, power off the compute node, slide it out of the chassis, and press the power button. The power button also serves as the light path diagnostics remind button when the server is removed from the chassis. The meanings of the LEDs are listed in the following table.

Table 20. Light path diagnostic panel LEDs

LED	Description
LP	The light path diagnostics panel is operational.
S BRD	A system board error is detected.
MIS	A mismatch occurred between the processors, DIMMs, or HDDs.
NMI	A non-maskable interrupt (NMI) occurred.
TEMP	An over-temperature condition occurred that was critical enough to shut down the server.
MEM	A memory fault occurred. The corresponding DIMM error LEDs on the system board are also lit.
ADJ	A fault is detected in the adjacent expansion unit (if installed).

## Remote management

The server contains an Integrated Management Module II (IMM2), which interfaces with the advanced management module in the chassis. The combination of these two components provides advanced service-processor control, monitoring, and an alerting function. If an environmental condition exceeds a threshold or if a system component fails, LEDs on the system board are lit to help you diagnose the problem, the error is recorded in the event log, and you are alerted to the problem. A virtual presence capability comes standard for remote server management.

Remote server management is provided through the following industry-standard interfaces:

- Intelligent Platform Management Interface (IPMI) Version 2.0
- Simple Network Management Protocol (SNMP) Version 3
- Common Information Model (CIM)
- Web browser

The server also supports virtual media and remote control features, which provide the following functions:

- Remotely viewing video with graphics resolutions up to 1600x1200 at 75 Hz with up to 23 bits per pixel, regardless of the system state
- Remotely accessing the server by using the keyboard and mouse from a remote client
- Mapping the CD or DVD drive, diskette drive, and USB flash drive on a remote client, and mapping ISO and diskette image files as virtual drives that are available for use by the server
- Uploading a diskette image to the IMM2 memory and mapping it to the server as a virtual drive
- Capturing blue-screen errors

## Operating system support

The server supports the following operating systems:

- Microsoft Windows Server 2012
- Microsoft Windows Server 2012 R2
- Microsoft Windows Server 2016
- Microsoft Windows Server, version 1709
- Red Hat Enterprise Linux 6.10 x64
- Red Hat Enterprise Linux 6.5 32-bit
- Red Hat Enterprise Linux 6.5 x64
- Red Hat Enterprise Linux 6.6 32-bit

- Red Hat Enterprise Linux 6.6 x64
- Red Hat Enterprise Linux 6.7 32-bit
- Red Hat Enterprise Linux 6.7 x64
- Red Hat Enterprise Linux 6.8 32-bit
- Red Hat Enterprise Linux 6.8 x64
- Red Hat Enterprise Linux 7.1
- Red Hat Enterprise Linux 7.2
- Red Hat Enterprise Linux 7.3
- Red Hat Enterprise Linux 7.4
- Red Hat Enterprise Linux 7.5
- Red Hat Enterprise Linux 7.6
- Red Hat Enterprise Linux 7.7
- Red Hat Enterprise Linux 7.8
- Red Hat Enterprise Linux 7.9
- SUSE Linux Enterprise Server 11 Xen x64 SP3
- SUSE Linux Enterprise Server 11 Xen x64 SP4
- SUSE Linux Enterprise Server 11 x64 SP3
- SUSE Linux Enterprise Server 11 x64 SP4
- SUSE Linux Enterprise Server 11 x86 SP3
- SUSE Linux Enterprise Server 11 x86 SP4
- SUSE Linux Enterprise Server 12
- SUSE Linux Enterprise Server 12 SP1
- SUSE Linux Enterprise Server 12 SP2
- SUSE Linux Enterprise Server 12 SP3
- SUSE Linux Enterprise Server 12 SP4
- SUSE Linux Enterprise Server 12 SP5
- SUSE Linux Enterprise Server 12 Xen
- SUSE Linux Enterprise Server 12 Xen SP1
- SUSE Linux Enterprise Server 12 Xen SP2
- SUSE Linux Enterprise Server 12 Xen SP3
- SUSE Linux Enterprise Server 12 Xen SP4
- SUSE Linux Enterprise Server 12 Xen SP5
- SUSE Linux Enterprise Server 15
- SUSE Linux Enterprise Server 15 SP1
- SUSE Linux Enterprise Server 15 SP2
- SUSE Linux Enterprise Server 15 SP3
- SUSE Linux Enterprise Server 15 SP4
- SUSE Linux Enterprise Server 15 Xen
- SUSE Linux Enterprise Server 15 Xen SP1
- SUSE Linux Enterprise Server 15 Xen SP2
- SUSE Linux Enterprise Server 15 Xen SP3
- SUSE Linux Enterprise Server 15 Xen SP4
- VMware ESXi 5.5
- VMware ESXi 5.5 U1
- VMware ESXi 5.5 U2
- VMware ESXi 5.5 U3
- VMware ESXi 6.0
- VMware ESXi 6.0 U1
- VMware ESXi 6.0 U2
- VMware ESXi 6.0 U3
- VMware ESXi 6.5
- VMware ESXi 6.5 U1
- VMware ESXi 6.5 U2
- VMware ESXi 6.5 U3

For a complete list of supported, certified and tested operating systems, plus additional details and links to relevant web sites, see the Operating System Interoperability Guide:  
<https://lenovopress.com/osig#servers=x880-x6-x480-x6-x280-x6-7196>

## Physical specifications

The X6 Compute Node features the following dimensions and weight (approximate) :

- Width: 435 mm (17.1 in.)
- Height 56 mm (2.1 in.)
- Depth 500 mm (19.7 in.)
- Maximum weight: 12.25 kg (27 lbs)

## Supported environment

The Flex System X6 Compute Node complies with ASHRAE Class A3 specifications and features the following supported operating environment:

- Power on:
  - Temperature: 5°C - 40 °C (41°F - 104 °F)
  - Humidity, non-condensing: -12 °C dew point (10.4 °F) and 8 - 85% relative humidity
  - Maximum dew point: 24 °C (75 °F)
  - Maximum altitude: 3048 m (10,000 ft.)
  - Maximum rate of temperature change: 5 °C/hr (41 °F/hr)
- Power off:
  - Temperature: 5°C - 45 °C (41°F - 113 °F)
  - Relative humidity: 8% - 85%
  - Maximum dew point: 27 °C (80.6 °F)
- Storage (non-operating):
  - Temperature: 1°C - 60 °C (33.8°F - 140 °F)
  - Altitude: 3050 m (10,006 ft.)
  - Relative humidity: 5% - 80%
  - Maximum dew point: 29 °C (84.2 °F)
- Shipment (non-operating):
  - Temperature: -40°C - 60 °C (-40 °F to 140 °F)
  - Altitude: 10,700 m (35,105 ft)
  - Relative humidity: 5% - 100%
  - Maximum dew point: 29 °C (84.2 °F)

## Warranty options

The system has a three-year warranty with 24x7 standard call center support and 9x5 Next Business Day onsite coverage. Also available are Lenovo Services warranty maintenance upgrades and post-warranty maintenance agreements, with a well-defined scope of services, including service hours, response time, term of service, and service agreement terms and conditions.

Lenovo warranty service upgrade offerings are region-specific. Not all warranty service upgrades are available in every region. For more information about Lenovo warranty service upgrade offerings that are available in your region, go to the Data Center Advisor and Configurator website <http://dcsc.lenovo.com>, then do the following:

1. In the Customize a Model box in the middle of the page, select the **Services** option in the Customization Option dropdown menu
2. Enter in the machine type & model of the system
3. From the search results, you can click either **Deployment Services** or **Support Services** to view the offerings

The following table explains warranty service definitions in more detail.

Table 21. Warranty service definitions

Term	Description
On-site service	A service technician will arrive at the client's location for equipment service.
24x7x2 hour	A service technician is scheduled to arrive at the client's location within two hours after remote problem determination is completed. Lenovo provides service around the clock, every day, including Lenovo holidays.
24x7x4 hour	A service technician is scheduled to arrive at the client's location within four hours after remote problem determination is completed. Lenovo provides service around the clock, every day, including Lenovo holidays.
9x5x4 hour	A service technician is scheduled to arrive at the client's location within four business hours after remote problem determination is completed. Lenovo provides service 8:00 am - 5:00 pm in the client's local time zone, Monday-Friday, excluding Lenovo holidays. For example, if a customer reports an incident at 3:00 pm on Friday, the technician will arrive by 10:00 am the following Monday.
9x5 next business day	A service technician is scheduled to arrive at the client's location on the business day after remote problem determination is completed. Lenovo provides service 8:00 am - 5:00 pm in the client's local time zone, Monday - Friday, excluding Lenovo holidays. Calls received after 4:00 pm local time require an extra business day for service dispatch. Next business day service is not guaranteed.
Committed Repair	Problems receive priority handling so that repairs are completed within the committed time of 6, 8, or 24 hours. Lenovo provides service 24 hours/day, every day, including Lenovo holidays.

The following Lenovo warranty service upgrades are available:

- Warranty and maintenance service upgrades:
  - Three, four, or five years of 9x5 or 24x7 service coverage
  - Onsite response from next business day to 2 or 4 hours
  - Committed repair service
  - Warranty extension of up to 5 years
  - Post warranty extensions
- Committed Repair Service
 

Committed Repair Services enhances the level of Warranty Service Upgrade or Post Warranty/Maintenance Service offering associated with the selected systems. Offerings vary and are available in select countries.

  - Priority handling to meet defined time frames to restore the failing machine to good working condition
  - Committed repair service levels are measured within the following coverage hours:
    - 24x7x6: Service performed 24 hours per day, 7 days per week, within 6 hours
    - 24x7x8: Service performed 24 hours per day, 7 days per week, within 8 hours
    - 24x7x24: Service performed 24 hours per day, 7 days per week, within 24 hours

- **Hard Disk Drive Retention**  
Lenovo's Hard Disk Drive Retention (HDDR) service is a multi-drive hard drive retention offering that ensures your data is always under your control, regardless of the number of hard drives that are installed in your Lenovo server. In the unlikely event of a hard drive failure, you retain possession of your hard drive while Lenovo replaces the failed drive part. Your data stays safely on your premises, in your hands. The Hard Drive Retention service can be purchased in convenient bundles with our warranty upgrades and extensions.
- **Microcode Support**  
Keeping microcode current helps prevent hardware failures and security exposure. There are two levels of service: analysis of the installed base and analysis and update where required. Offerings vary by region and can be bundled with other warranty upgrades and extensions.
- **Remote Technical Support Services (RTS)**  
RTS provides comprehensive technical call center support for covered servers, storage, operating systems, and applications. Providing a single source for support of hardware and software issues, RTS can reduce problem resolution time, decreasing the cost to address technical problems and increasing uptime. Offerings are available for Windows, Linux, IBM Systems Director, VMware, Microsoft business applications, and Lenovo System x storage devices, and IBM OEM storage devices.

## Regulatory compliance

The server conforms to the following standards:

- ASHRAE Class A3
- Energy Star 2.1
- FCC - Verified to comply with Part 15 of the FCC Rules Class A
- Canada ICES-004, issue 3 Class A
- UL/IEC 60950-1
- CSA C22.2 No. 60950-1
- NOM-019
- Argentina IEC 60950-1
- Japan VCCI, Class A
- IEC 60950-1 (CB Certificate and CB Test Report)
- China CCC (GB4943); (GB9254, Class A); (GB17625.1)
- Taiwan BSMI CNS13438, Class A; CNS14336
- Australia/New Zealand AS/NZS CISPR 22, Class A
- Korea KN22, Class A, KN24
- Russia/GOST ME01, IEC 60950-1, GOST R 51318.22, GOST R 51318.249, GOST R 51317.3.2, and GOST R 51317.3.3
- IEC 60950-1 (CB Certificate and CB Test Report)
- CE Mark (EN55022 Class A, EN60950-1, EN55024, EN61000-3-2, and EN61000-3-3)
- CISPR 22, Class A
- TUV-GS (EN60950-1/IEC 60950-1 and EK1-ITB2000)

## Lenovo Financial Services

Lenovo Financial Services reinforces Lenovo's commitment to deliver pioneering products and services that are recognized for their quality, excellence, and trustworthiness. Lenovo Financial Services offers financing solutions and services that complement your technology solution anywhere in the world.

We are dedicated to delivering a positive finance experience for customers like you who want to maximize your purchase power by obtaining the technology you need today, protect against technology obsolescence, and preserve your capital for other uses.

We work with businesses, non-profit organizations, governments and educational institutions to finance their entire technology solution. We focus on making it easy to do business with us. Our highly experienced team of finance professionals operates in a work culture that emphasizes the importance of providing outstanding customer service. Our systems, processes and flexible policies support our goal of providing customers with a positive experience.

We finance your entire solution. Unlike others, we allow you to bundle everything you need from hardware and software to service contracts, installation costs, training fees, and sales tax. If you decide weeks or months later to add to your solution, we can consolidate everything into a single invoice.

Our Premier Client services provide large accounts with special handling services to ensure these complex transactions are serviced properly. As a premier client, you have a dedicated finance specialist who manages your account through its life, from first invoice through asset return or purchase. This specialist develops an in-depth understanding of your invoice and payment requirements. For you, this dedication provides a high-quality, easy, and positive financing experience.

For your region-specific offers, please ask your Lenovo sales representative or your technology provider about the use of Lenovo Financial Services. For more information, see the following Lenovo website:

<https://www.lenovo.com/us/en/landingpage/lenovo-financial-services/>



## Related publications and links

For more information, see the following resources:

- US Product Announcement:  
<http://ibm.com/common/ssi/cgi-bin/ssialias?infotype=dd&subtype=ca&&htmlfid=897/ENUS115-082>
- Flex System x480 X6 website:  
<http://shop.lenovo.com/us/en/systems/servers/mission-critical/x480/>
- Flex System x880 X6 product page:  
<http://shop.lenovo.com/us/en/systems/servers/mission-critical/x880/>
- Flex System Information Center:  
<http://flexsystem.lenovofiles.com/help/index.jsp>
- *Flex System X6 Compute Node Installation and Service Guide* :  
[http://flexsystem.lenovofiles.com/help/index.jsp?topic=/com.lenovo.acc.7196.doc%2Fproduct\\_page.html](http://flexsystem.lenovofiles.com/help/index.jsp?topic=/com.lenovo.acc.7196.doc%2Fproduct_page.html)
- ServerProven for Flex System:  
<http://www.lenovo.com/us/en/serverproven/flexsystem.shtml>
- Operating System Interoperability Guide (OSIG):  
<https://lenovopress.com/osig#servers=x880-x6-x480-x6-x280-x6-7196>
- *Flex System Interoperability Guide* :  
<http://lenovopress.com/fsig>
- xREF - System x Reference:  
<http://lenovopress.com/xref>
- Support Portal:  
<http://datacentersupport.lenovo.com/products/servers/flex/x880-x6-compute-node/7196>

## Related product families

Product families related to this document are the following:

- [Blade Servers](#)

## Notices

Lenovo may not offer the products, services, or features discussed in this document in all countries. Consult your local Lenovo representative for information on the products and services currently available in your area. Any reference to a Lenovo product, program, or service is not intended to state or imply that only that Lenovo product, program, or service may be used. Any functionally equivalent product, program, or service that does not infringe any Lenovo intellectual property right may be used instead. However, it is the user's responsibility to evaluate and verify the operation of any other product, program, or service. Lenovo may have patents or pending patent applications covering subject matter described in this document. The furnishing of this document does not give you any license to these patents. You can send license inquiries, in writing, to:

Lenovo (United States), Inc.  
8001 Development Drive  
Morrisville, NC 27560  
U.S.A.  
Attention: Lenovo Director of Licensing

LENOVO PROVIDES THIS PUBLICATION "AS IS" WITHOUT WARRANTY OF ANY KIND, EITHER EXPRESS OR IMPLIED, INCLUDING, BUT NOT LIMITED TO, THE IMPLIED WARRANTIES OF NON-INFRINGEMENT, MERCHANTABILITY OR FITNESS FOR A PARTICULAR PURPOSE. Some jurisdictions do not allow disclaimer of express or implied warranties in certain transactions, therefore, this statement may not apply to you.

This information could include technical inaccuracies or typographical errors. Changes are periodically made to the information herein; these changes will be incorporated in new editions of the publication. Lenovo may make improvements and/or changes in the product(s) and/or the program(s) described in this publication at any time without notice.

The products described in this document are not intended for use in implantation or other life support applications where malfunction may result in injury or death to persons. The information contained in this document does not affect or change Lenovo product specifications or warranties. Nothing in this document shall operate as an express or implied license or indemnity under the intellectual property rights of Lenovo or third parties. All information contained in this document was obtained in specific environments and is presented as an illustration. The result obtained in other operating environments may vary. Lenovo may use or distribute any of the information you supply in any way it believes appropriate without incurring any obligation to you.

Any references in this publication to non-Lenovo Web sites are provided for convenience only and do not in any manner serve as an endorsement of those Web sites. The materials at those Web sites are not part of the materials for this Lenovo product, and use of those Web sites is at your own risk. Any performance data contained herein was determined in a controlled environment. Therefore, the result obtained in other operating environments may vary significantly. Some measurements may have been made on development-level systems and there is no guarantee that these measurements will be the same on generally available systems. Furthermore, some measurements may have been estimated through extrapolation. Actual results may vary. Users of this document should verify the applicable data for their specific environment.

© Copyright Lenovo 2024. All rights reserved.

This document, TIPS1286, was created or updated on February 3, 2018.

Send us your comments in one of the following ways:

- Use the online Contact us review form found at:  
<https://lenovopress.lenovo.com/TIPS1286>
- Send your comments in an e-mail to:  
[comments@lenovopress.com](mailto:comments@lenovopress.com)

This document is available online at <https://lenovopress.lenovo.com/TIPS1286>.

## Trademarks

Lenovo and the Lenovo logo are trademarks or registered trademarks of Lenovo in the United States, other countries, or both. A current list of Lenovo trademarks is available on the Web at <https://www.lenovo.com/us/en/legal/copytrade/>.

The following terms are trademarks of Lenovo in the United States, other countries, or both:

Lenovo®  
Flex System  
Lenovo Services  
ServeRAID  
ServerGuide  
ServerProven®  
System x®  
ThinkSystem®  
XClarity®  
eXFlash

The following terms are trademarks of other companies:

Intel® and Xeon® are trademarks of Intel Corporation or its subsidiaries.

Linux® is the trademark of Linus Torvalds in the U.S. and other countries.

Microsoft®, Windows Server®, and Windows® are trademarks of Microsoft Corporation in the United States, other countries, or both.

Other company, product, or service names may be trademarks or service marks of others.