

Lenovo ThinkSystem SR650 Server (Xeon SP Gen 1 / Gen 2)

Product Guide

Lenovo ThinkSystem SR650 is an ideal 2-socket 2U rack server for small businesses up to large enterprises that need industry-leading reliability, management, and security, as well as maximizing performance and flexibility for future growth. The SR650 server is designed to handle a wide range of workloads, such as databases, virtualization and cloud computing, virtual desktop infrastructure (VDI), enterprise applications, collaboration/email, and business analytics and big data.

Featuring the second generation of Intel Xeon Processor Scalable Family (Xeon SP Gen 2), the SR650 server offers scalable performance, storage capacity, and I/O expansion. The SR650 server supports up to two processors and up to 3 TB of memory, up to 24x 2.5-inch or 14x 3.5-inch drive bays with an extensive choice of drive technologies, and flexible I/O expansion options with a LOM slot, a dedicated storage controller slot, and up to 6x rear PCIe expansion slots.

The following figure shows the ThinkSystem SR650 with 2.5-inch hot-swap drives.



Figure 1. Lenovo ThinkSystem SR650 with 2.5-inch drive bays

Did you know?

The SR650 server offers onboard NVMe PCIe ports that allow direct connections to the U.2 NVMe PCIe SSDs, which frees up I/O slots and helps lower NVMe solution acquisition costs.

The SR650 server is designed to meet ASHRAE A4 standards (up to 45 °C, 113 °F) in select configurations, which enable customers to lower energy costs, while still maintaining world-class reliability.

The SR650 server delivers outstanding memory performance with Performance+ 2933 MHz DIMMs, which is achieved by supporting two-DIMMs-per-channel configurations at speeds up to 10% faster than the Intel specification defines, while still maintaining world-class reliability.

Key features

Combining performance and flexibility, the SR650 server is a great choice for small and medium businesses up to the large enterprise. It can provide outstanding uptime to keep business-critical applications and cloud deployments running safely. Ease of use and comprehensive systems management tools help make deployment easier. Outstanding reliability, availability, and serviceability (RAS) and high-efficiency design improve your business environment and help save operational costs.

Scalability and performance

The SR650 server offers numerous features to boost performance, improve scalability, and reduce costs:

- Improves productivity by offering superior system performance with the second generation of the Intel Xeon Processor Scalable Family with up to 28-core processors, up to 38.5 MB of last level cache (LLC), up to 2933 MHz memory speeds, and up to 10.4 GT/s Ultra Path Interconnect (UPI) links.
 - Support for up to two processors, 56 cores, and 112 threads allows to maximize the concurrent execution of multithreaded applications.
 - Intelligent and adaptive system performance with energy efficient Intel Turbo Boost 2.0 Technology allows CPU cores to run at maximum speeds during peak workloads by temporarily going beyond processor thermal design power (TDP).
 - Intel Hyper-Threading Technology boosts performance for multithreaded applications by enabling simultaneous multithreading within each processor core, up to two threads per core.
 - Intel Virtualization Technology integrates hardware-level virtualization hooks that allow operating system vendors to better utilize the hardware for virtualization workloads.
 - Intel Speed Select Technology provides improvements in server utilization and guaranteed per-core performance service levels with more granular control over processor performance.
 - Intel Deep Learning Boost (Vector Neural Network Instruction set [VNNI]) is designed to deliver significant, more efficient Deep Learning (Inference) acceleration for high-performance Artificial Intelligence (AI) workloads.
 - Intel Advanced Vector Extensions 512 (AVX-512) enable acceleration of enterprise-class and high performance computing (HPC) workloads.
- Helps maximize system performance for data intensive applications with up to 2933 MHz memory speeds and up to 3 TB of memory capacity with 3DS RDIMMs.
- Boosts the performance of data-intensive applications and delivers consistent service levels at scale for virtualized and cloud environments by using the innovative persistent memory technology that provides a unique combination of affordable large memory capacity and non-volatility for up to 7.5 TB of total server memory capacity, including 3DS RDIMMs and DCPMMs (DC persistent memory modules).
- Offers flexible and scalable internal storage in a 2U rack form factor with up to 24x 2.5-inch and 2x 3.5-inch drives for performance-optimized configurations or up to 14x 3.5-inch drives for capacity-optimized configurations, providing a wide selection of SAS/SATA HDD/SSD and PCIe NVMe SSD types and capacities.
- Provides flexibility to use SAS, SATA, or NVMe PCIe drives in the same drive bays with an AnyBay design.
- Provides I/O scalability with a LOM slot, PCIe 3.0 slot for an internal storage controller, and up to six PCI Express (PCIe) 3.0 I/O expansion slots in a 2U rack form factor.
- Reduces I/O latency and increases overall system performance with Intel Integrated I/O Technology that embeds the PCI Express 3.0 controller into the Intel Xeon Processor Scalable Family.

Availability and serviceability

The SR650 server provides many features to simplify serviceability and increase system uptime:

- Designed to run 24 hours a day, 7 days a week

- Offers protection in the event of a non-correctable memory failure with Single Device Data Correction (SDDC, also known as Chipkill, requires x4-based DIMMs), Adaptive Double Device Data Correction (ADDDC, also known as Redundant Bit Steering [RBS], requires x4-based DIMMs and Intel Xeon Gold or Platinum processors), memory mirroring, and memory rank sparing.
- Provides easy access to upgrades and serviceable parts (such as processors, memory DIMMs, and adapter cards) with tool-less cover removal.
- Offers data protection and greater system uptime with hot-swap drives supporting basic or advanced RAID redundancy.
- Provides availability for business-critical applications with redundant hot-swap power supplies and redundant hot-swap system fans.
- Simplifies servicing, speeds up problem resolution, and helps improve system availability with light path diagnostics.
- Allows preventive actions in advance of possible failure, thereby increasing server uptime and application availability with Proactive Platform Alerts (including PFA and SMART alerts) for processors, voltage regulators, memory, internal storage (SAS/SATA HDDs and SSDs, NVMe SSDs, M.2 storage, flash storage adapters), fans, power supplies, RAID controllers, and server ambient and sub-component temperatures.
- Continuously monitors system parameters, triggers alerts, and performs recovery actions in case of failure to minimize downtime with Built-in XClarity Controller (XCC).
- Provides quick access to system status, firmware, network, health, and alerts information via Virtual Operator Panel from the XClarity Mobile App running on the Android or iOS mobile device that is connected to the front USB port with XClarity Controller access.
- Speeds up troubleshooting tasks to reduce service time with diagnostics built into the XClarity Provisioning Manager.

Manageability and security

Powerful systems management features simplify local and remote management of the SR650 server and deliver enterprise-class data protection:

- Provides advanced service processor control, monitoring, and alerting functions with XClarity Controller, a next generation service processor.
- Improves Unified Extensible Firmware Interface (UEFI) system setup, configuration, updates, simplified error handling, and operating system deployment with the embedded XClarity Provisioning Manager.
- Offers XClarity Essentials software tools that can help you set up, use, and maintain the server.
- Increases uptime, reduces costs, and improves productivity through advanced server management capabilities with Lenovo XClarity Administrator that provides comprehensive hardware management.
- Provides on-the-go monitoring and management of devices in XClarity Administrator from anywhere with the Lenovo XClarity mobile app, which can help improve efficiency and reduce downtime risks.
- Centralizes infrastructure resource management with Lenovo XClarity Integrators for VMware vCenter and Microsoft System Center, extending XClarity Administrator features to virtualization management software tools and enabling users to deploy and manage infrastructure end-to-end.
- Offers advanced cryptographic functionality (such as digital signatures and remote attestation) with an integrated Trusted Platform Module (TPM) or optional Trusted Cryptographic Module (TCM) or Nationz TPM (available only in PRC).
- Keeps user data safe with Lenovo Business Vantage, a security software tool suite designed to work with the Trusted Cryptographic Module (available only in PRC).
- Offers enterprise-class data protection with advanced RAID and optional self-encrypting drives.
- Provides faster, stronger encryption with industry-standard AES NI support.
- Helps prevent certain classes of malicious buffer overflow attacks with Intel Execute Disable Bit

functionality, when combined with a supporting operating system.

- Enhances security through hardware-based resistance to malicious software attacks with Intel Trusted Execution Technology, allowing an application to run in its own isolated space, protected from all other software running on a system.

Energy efficiency

The SR650 server offers the following energy-efficiency features to save energy, reduce operational costs, increase energy availability, and contribute to the green environment:

- Delivers impressive compute power per watt, featuring 80 PLUS Titanium and Platinum redundant power supplies.
- Enables customers to lower energy costs with design to meet ASHRAE A4 standards in select configurations.
- Reduces power drawn with Intel Intelligent Power Capability that powers individual processor elements on and off as needed.
- Helps reduce power consumption with variable speed fans.
- Helps achieve lower heat output and reduced cooling needs with Lenovo XClarity Energy Manager that provides advanced data center power notification, analysis, and policy-based management.

Components and connectors

The following figure shows the front of the SR650 server with up to 16x 2.5-inch drive bays.

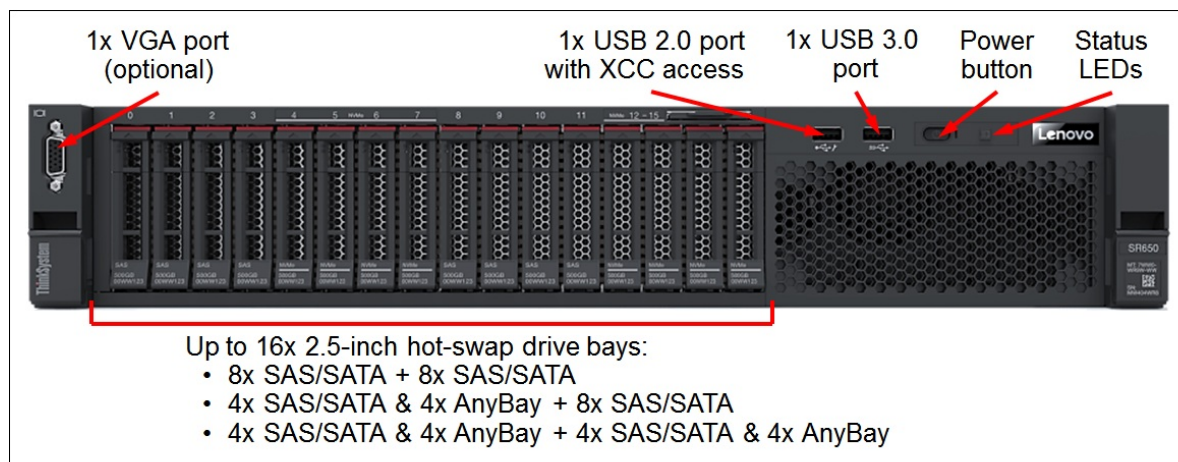

Figure 2. Front view of the SR650: Up to 16x 2.5-inch drive bays

The following figure shows the front of the SR650 server with up to 24x 2.5-inch drive bays.

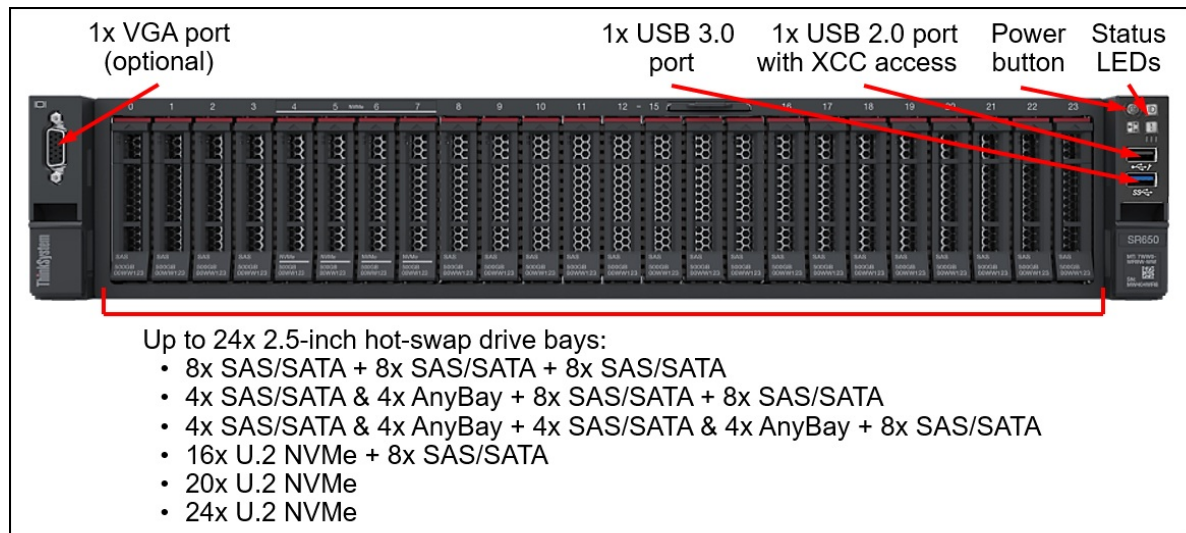

Figure 3. Front view of the SR650: Up to 24x 2.5-inch drive bays

The following figure shows the front of the SR650 server with 8x 3.5-inch drive bays.

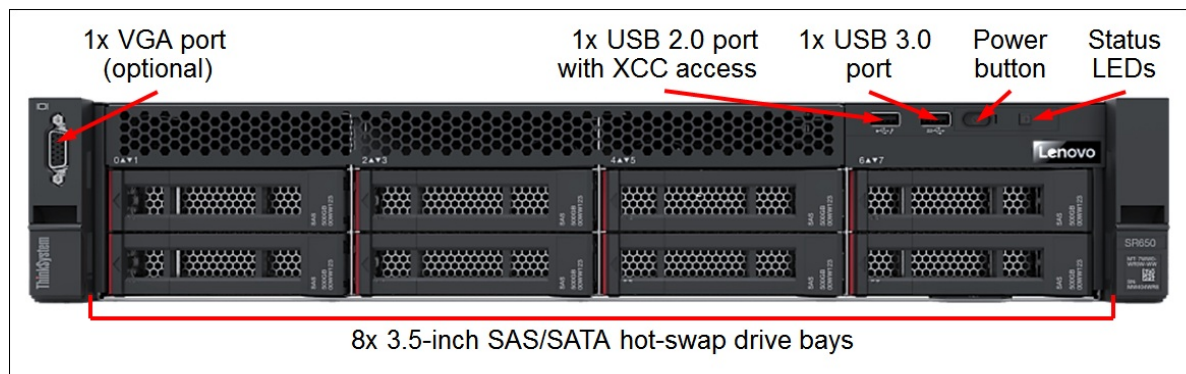

Figure 4. Front view of the SR650: 8x 3.5-inch drive bays

The following figure shows the front of the SR650 server with 12x 3.5-inch drive bays.

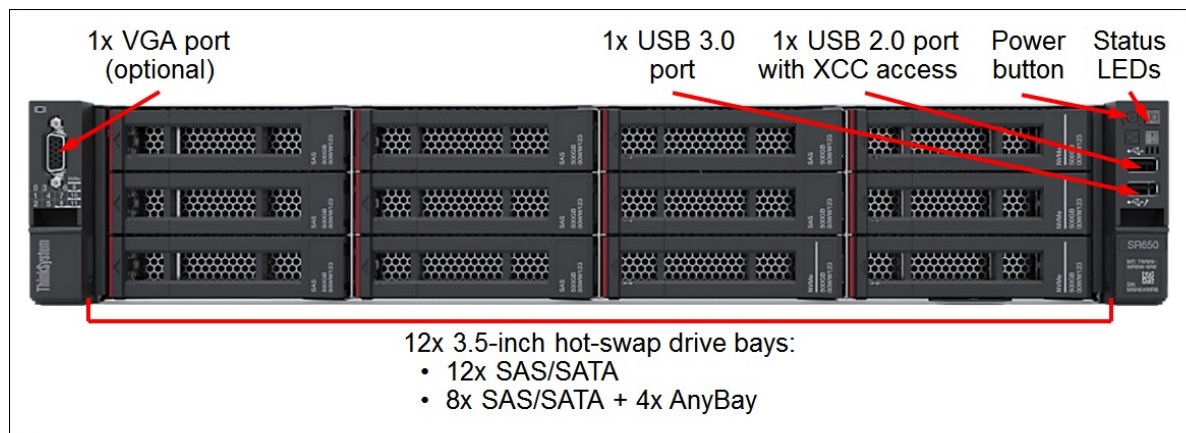

Figure 5. Front view of the SR650: 12x 3.5-inch drive bays

The front of the SR650 server includes the following components:

- Up to 16x 2.5-inch, or 24x 2.5-inch, or 8x 3.5-inch, or 12x 3.5-inch hot-swap drive bays.
- One VGA port (optional).
- One USB 3.0 port.
- One USB 2.0 port with XClarity Controller access.
- Power button.
- Status LEDs.

The following figure shows the rear of the SR650 server.

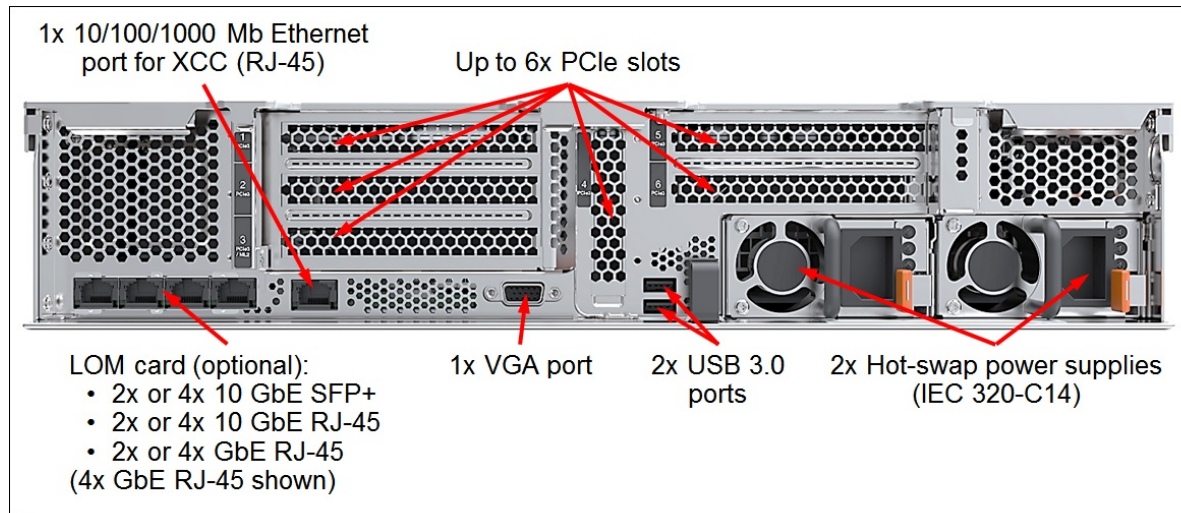

Figure 6. Rear view of the SR650

The rear of the SR650 server includes the following components:

- Up to six PCIe expansion slots (depending on the riser cards selected).
- One LOM card slot.
- One 1 GbE port for XClarity Controller.
- One VGA port.
- Two USB 3.0 ports.
- Up to two hot-swap power supplies.

The following figure shows the locations of key components inside the SR650 server.

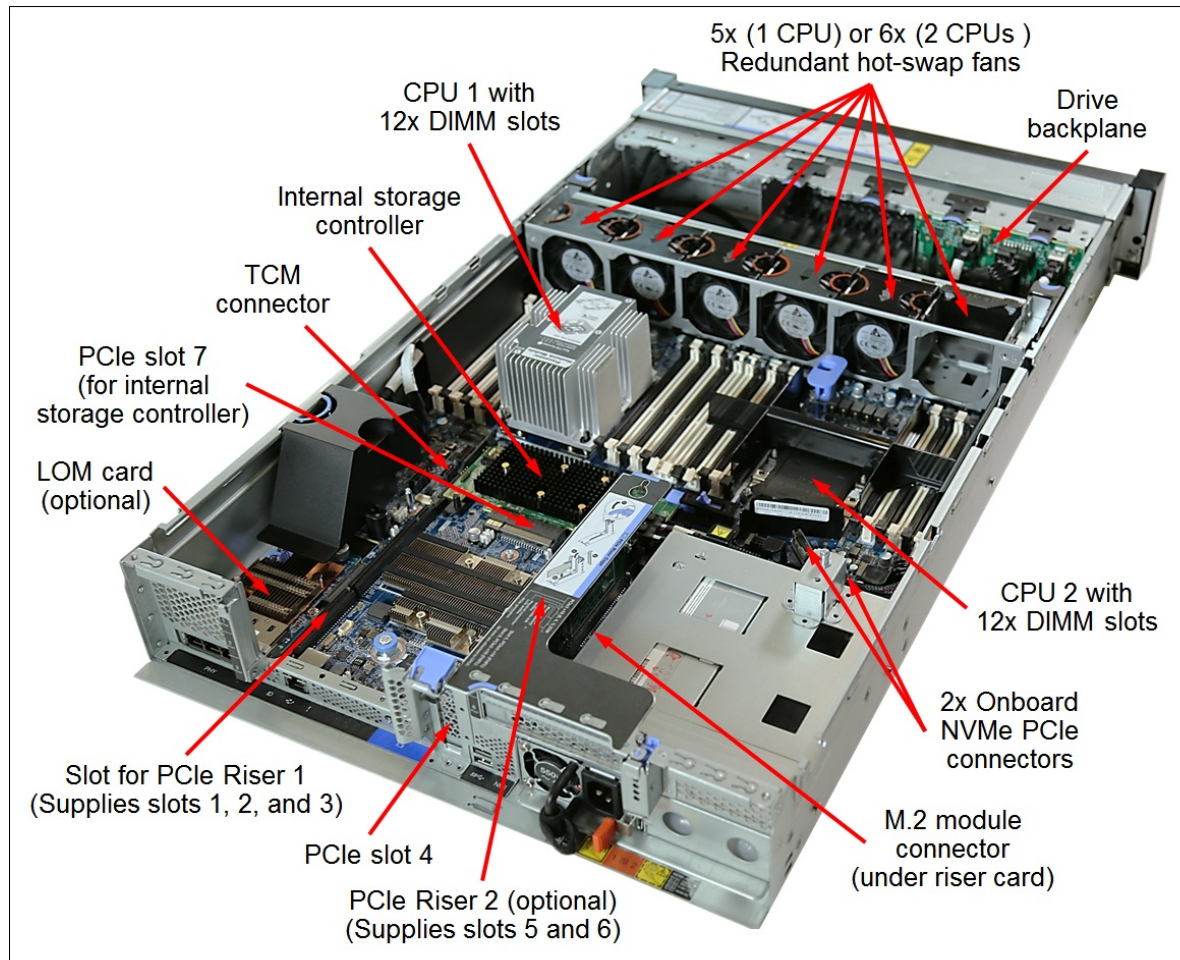

Figure 7. Internal view of the SR650

The following key components are located inside the SR650 server:

- Up to two processors.
- 24 DIMM slots (12 DIMM slots per processor).
- Drive backplanes.
- Two onboard NVMe PCIe connectors.
- One M.2 module connector.
- One LOM card connector.
- Two onboard PCIe slots 4 and 7.
- Two slots for PCIe riser cards.
- One TCM connector.
- Five (one processor) or six (two processors) hot-swap system fans.

Standard specifications

The following table lists the system specifications for the SR650 server.

Table 1. SR650 system specifications

Attribute	Specification
-----------	---------------

Attribute	Specification
Machine types	7X05 - 1 year warranty 7X06 - 3 year warranty
Form factor	2U rack-mount.
Processor	Up to two 2nd Gen Intel Xeon Bronze, Silver, Gold, or Platinum processors: <ul style="list-style-type: none"> • Up to 28 cores (2.7 GHz core speeds). • Up to 3.9 GHz core speeds (8 cores). • UPI links up to 10.4 GT/s (2 UPI links used). • Up to 38.5 MB cache. • Up to 2933 MHz memory speed. 1st Gen Intel Xeon processors are also supported.
Chipset	Intel C624.
Memory	Up to 24 DIMM sockets (12 DIMMs per processor; six memory channels per processor with two DIMMs per channel). Support for RDIMMs, LRDIMMs (1st Gen processors only), or 3DS RDIMMs. Memory speed up to 2933 MHz depending on the processor selected. Memory types cannot be intermixed.
Persistent memory	Up to 12x TruDDR4 2666 MHz DCPMMs in the DIMM slots. Not supported with 1st Gen Intel Xeon SP processors.
Memory protection	<ul style="list-style-type: none"> • Processor's integrated memory controllers: Error correction code (ECC), SDDC (for x4-based memory DIMMs), ADDDC (for x4-based memory DIMMs, requires Intel Xeon Gold or Platinum processors), memory mirroring, memory rank sparing, patrol scrubbing, and demand scrubbing. • DCPMM's onboard memory controllers: ECC, SDDC, DDDC, patrol scrubbing, and demand scrubbing. <p>Note: In the configurations with DCPMMs, memory mirroring is supported only in the App Direct mode (other DCPMM modes do not support memory mirroring) and applies only to the RDIMMs or 3DS RDIMMs (DCPMMs are not mirrored). Memory sparing is not supported in the configurations with DCPMMs.</p>
Memory capacity	<ul style="list-style-type: none"> • Memory DIMMs only: Up to 3 TB with up to 24x 128 GB 3DS RDIMMs (Up to 1.5 TB per processor). • Memory DIMMs and persistent memory modules: <ul style="list-style-type: none"> ◦ App Direct Mode: Up to 7.5 TB with up to 12x 128 GB 3DS RDIMMs and up to 12x 512 GB DCPMMs (Up to 3.75 TB per processor). ◦ Memory Mode: Up to 6 TB with up to 12x 512 GB DCPMMs (Up to 3 TB per processor). <p>Note: Server configurations with more than 1 TB of memory capacity per socket (including DCPMMs and RDIMMs or 3DS RDIMMs) require processors that support up to 4.5 TB (L-suffix) per socket.</p>

Attribute	Specification
Drive bays	<ul style="list-style-type: none"> ● Up to 16 SFF (front) and 2 LFF (rear) hot-swap drive bays: <ul style="list-style-type: none"> ○ 8x 2.5" SAS/SATA + 8x 2.5" SAS/SATA + 2x 3.5" SAS/SATA ○ 4x 2.5" SAS/SATA & 4x 2.5" AnyBay + 8x 2.5" SAS/SATA + 2x 3.5" SAS/SATA ○ 4x 2.5" SAS/SATA & 4x 2.5" AnyBay + 4x 2.5" SAS/SATA & 4x 2.5" AnyBay + 2x 3.5" SAS/SATA ● Up to 24 SFF (front) and 2 LFF (rear) hot-swap drive bays: <ul style="list-style-type: none"> ○ 8x 2.5" SAS/SATA + 8x 2.5" SAS/SATA + 8x 2.5" SAS/SATA + 2x 3.5" SAS/SATA ○ 4x 2.5" SAS/SATA & 4x 2.5" AnyBay + 8x 2.5" SAS/SATA + 8x 2.5" SAS/SATA + 2x 3.5" SAS/SATA ○ 4x 2.5" SAS/SATA & 4x 2.5" AnyBay + 4x 2.5" SAS/SATA & 4x 2.5" AnyBay + 8x 2.5" SAS/SATA + 2x 3.5" SAS/SATA ○ 4x 2.5" SAS/SATA & 4x 2.5" AnyBay + 4x 2.5" SAS/SATA & 4x 2.5" AnyBay + 4x 2.5" SAS/SATA & 4x 2.5" AnyBay ○ 16x 2.5" U.2 NVMe PCIe + 8x 2.5" SAS/SATA (factory-installed only) ○ 20x 2.5" U.2 NVMe PCIe ○ 24x 2.5" U.2 NVMe PCIe ● Up to 10 LFF SAS/SATA hot-swap drive bays: 8x 3.5" (front) + 2x 3.5" (rear) ● Up to 14 LFF hot-swap drive bays: <ul style="list-style-type: none"> ○ 12x 3.5" SAS/SATA (front) + 2x 3.5" SAS/SATA (rear) ○ 8x 3.5" SAS/SATA & 4x 3.5" AnyBay (front) + 2x 3.5" SAS/SATA (rear)
Internal storage capacity	<ul style="list-style-type: none"> ● 2.5-inch drives: <ul style="list-style-type: none"> ○ 737.28TB using 24x 30.72TB 2.5-inch SAS/SATA SSDs ○ 368.64TB using 24x 15.36TB 2.5-inch NVMe SSDs ○ 57.6TB using 24x 2.4TB 2.5-inch HDDs ● 3.5-inch drives: <ul style="list-style-type: none"> ○ 280TB using 14x 20TB 3.5-inch HDDs ○ 215.04TB using 14x 15.36TB 3.5-inch SAS/SATA SSDs ○ 30.72TB using 4x 7.68TB 3.5-inch NVMe SSDs
Storage controller	<ul style="list-style-type: none"> ● 12 Gb SAS/SATA RAID adapters with up to 8GB flash-backed cache ● 12 Gb SAS/SATA HBA (non-RAID) ● Onboard PCIe NVMe (with Intel VROC NVMe RAID support for Intel SSDs and optionally non-Intel SSDs) ● NVMe Switch Adapters (with Intel VROC NVMe RAID support for Intel SSDs and optionally non-Intel SSDs)
Optical drive bays	None. Support for an external USB DVD RW Optical Disk Drive (See Optical drives).
Network interfaces	<ul style="list-style-type: none"> ● Onboard LOM slot for up to 4x 1/10 Gb Ethernet ports: <ul style="list-style-type: none"> ○ 2x or 4x 1 GbE RJ-45 ports (no 10/100 Mb support) ○ 2x or 4x 10 GbE RJ-45 ports (no 10/100 Mb support) ○ 2x or 4x 10 GbE SFP+ ports (no 10/100 Mb support) ● Optional Mezzanine LOM (ML2) slot for dual-port 10 GbE cards with SFP+ or RJ-45 connectors or single- or dual-port 25 GbE cards with SFP28 connectors. ● 1x RJ-45 10/100/1000 Mb Ethernet systems management port.

Attribute	Specification
I/O expansion slots	<p>Up to seven slots. Slots 4 and 7 are the fixed slots on the system planar, and the remaining slots depend on the riser cards installed. The slots are as follows:</p> <ul style="list-style-type: none"> • Slot 1: PCIe 3.0 x16 or PCIe 3.0 x8; full-height, half-length (PCIe x16 slot can be single- or double-wide) • Slot 2: PCIe 3.0 x8; full-height, half-length (not present if Slot 1 is PCIe x16 double-wide or Slot 3 is ML2 x16) • Slot 3: PCIe 3.0 x8, or PCIe 3.0 x16, or ML2 x8, or ML2 x16; full-height, half-length • Slot 4: PCIe 3.0 x8; low profile (vertical slot on system planar) • Slot 5: PCIe 3.0 x16; full-height, half-length • Slot 6: PCIe 3.0 x16; full-height, half-length • Slot 7: PCIe 3.0 x8 (for an internal storage controller) <p>Slots 5 and 6 require the second processor to be installed. Single-wide PCIe x16 Slot 1 requires the second processor to be installed.</p>
Ports	<ul style="list-style-type: none"> • Front: 1x USB 2.0 port with XClarity Controller access and 1x USB 3.0 port; optional 1x VGA port. • Rear: 2x USB 3.0 ports and 1x VGA port; optional 1x DB-9 serial port.
Cooling	Five (one processor) or six (two processors) hot-swap single-rotor system fans with N+1 redundancy.
Power supply	Up to two redundant hot-swap 550 W, 750 W, or 1100 W (100 - 240 V), or 1600 W (200 - 240 V) High Efficiency Platinum AC power supplies, or 750 W (200 - 240 V) High Efficiency Titanium AC power supplies. HVDC support (PRC only).
Video	Matrox G200e with 16 MB memory integrated into the XClarity Controller. Maximum resolution is 1920x1200 at 60 Hz with 32 bits per pixel.
Hot-swap parts	Drives, power supplies, and fans.
Systems management	XClarity Controller (XCC) Standard, Advanced, or Enterprise (Pilot 4 chip), proactive platform alerts, light path diagnostics, XClarity Provisioning Manager, XClarity Essentials, XClarity Administrator, XClarity Integrators for VMware vCenter and Microsoft System Center, XClarity Energy Manager, Capacity Planner.
Security features	Power-on password, administrator's password, secure firmware updates, Trusted Platform Module (TPM) 1.2 or 2.0 (configurable UEFI setting). Optional lockable front bezel. Optional Trusted Cryptographic Module (TCM) or Nationz TPM (available only in PRC). Optional Lenovo Business Vantage security software (available only in PRC).
Operating systems	Microsoft Windows Server, Red Hat Enterprise Linux, SUSE Linux Enterprise Server, VMware ESXi. See the Operating systems section for specifics.
Warranty	One-year (Machine Type 7X05) or three-year (Machine Type 7X06) customer-replaceable unit (CRU) and onsite limited warranty with 9x5 Next Business Day Parts Delivered.
Service and support	Optional Lenovo Services upgrades: 2-hour or 4-hour response time, 6-hour or 24-hour committed service repair, warranty extension up to 5 years, 1-year or 2-year post-warranty extensions, YourDrive YourData, Enterprise Software Support, and Basic Hardware Installation Services.
Dimensions	Width: 445 mm (17.5 in.), height: 87 mm (3.4 in.), depth: 764 mm (30.1 in.). See Physical specifications for details.
Weight	Minimum configuration: 19 kg (41.9 lb), maximum: 32 kg (70.5 lb)

Models

ThinkSystem SR650 models can be configured by using the [Lenovo Data Center Solution Configurator \(DCSC\)](#).

Configure-to-order (CTO) models are used to create models with factory-integrated server customizations. For CTO models, two types of base CTO models are available for the SR650 as listed in the columns in the following table:

- General purpose base CTO models are for general business (non-HPC) and is selectable by choosing **General Purpose** mode in DCSC.
- AI and HPC base models are intended for Artificial Intelligence (AI) and High Performance Computing (HPC) configurations and solutions are enabled using the **AI & HPC Hardware - ThinkSystem Hardware** mode in DCSC. These configurations, along with Lenovo EveryScale Solutions, can also be built using [System x and Cluster Solutions Configurator \(x-config\)](#). **Tip:** Some HPC and AI models are not listed in DCSC and can only be configured in x-config.

Preconfigured server models may also be available for the SR650, however these are region-specific; that is, each region may define their own server models, and not all server models are available in every region.

The following table lists the base CTO models of the ThinkSystem SR650 server.

Table 2. Base CTO models

Machine Type/Model General purpose	Machine Type/Model for AI and HPC	Description
7X06CTO1WW	7X06CTOLWW	ThinkSystem SR650 – 3-year warranty
7X05CTO1WW	7X05CTOLWW	ThinkSystem SR650 - 1yr Warranty

For CTO orders, the following table lists the base chassis feature codes for the server.

Table 3. Base chassis for CTO models

Feature code	Description
BMN6	ThinkSystem SR650 2.5" Chassis with 8, 16 or 24 Bays v2
AUVV	ThinkSystem SR650 2.5" Chassis with 8, 16 or 24 Bays
AUVW	ThinkSystem SR650 3.5" Chassis with 8 or 12 Bays
BMNE	ThinkSystem SR650 2.5" Chassis with 8 or 16 Bays v2
AUVX	ThinkSystem SR650 2.5" Chassis with 8 or 16 Bays

Processors

The SR650 server supports one or two Intel Xeon Bronze, Silver, Gold, or Platinum processors. The following table lists the specifications of the processors for the SR650 server.

Topics in this section:

- [Processor specifications](#)
- [Processor ordering information](#)
- [Continued support for 1st Gen Intel Xeon Scalable processors](#)
- [UEFI operating modes](#)

Processor specifications

Processor support: Both 1st Gen and 2nd Gen Intel Xeon SP processors are supported. For supported 1st Gen processors, see the [Continued support for 1st Gen Intel Xeon Scalable processors](#) section.

Abbreviations used in the table:

- UPI: Ultra Path Interconnect
- TDP: Thermal Design Power
- HT: Hyper-Threading
- TB: Turbo Boost 2.0
- VT-x: Virtualization Technology
- VT-d: Virtualization Technology for Directed I/O
- SST-PP: Speed Select Technology - Performance Profile
- FMA: Fused-Multiply Add (AVX-512)
- DCPMM: DC Persistent Memory Module
- RAS: Reliability, Availability, and Serviceability
 - Std: Standard RAS
 - Adv: Advanced RAS

Table 4. Processor specifications

CPU model	Cores / threads	Core speed (Base / TB Max)	Cache	Max DDR4 speed	Max memory capacity per socket	UPI speed	TDP	HT	TB	VT-x	VT-d	SST-PP	FMA units	DCPMM	RAS
Intel Xeon Bronze processors															
3204	6 / 6	1.9 / 1.9 GHz	8.25 MB	2133 MHz	1 TB	9.6 GT/s	85 W	N	N	Y	Y	N	1	N	Std
3206R	8 / 8	1.9 / 1.9 GHz	11 MB	2133 MHz	1 TB	9.6 GT/s	85 W	N	N	Y	Y	N	1	N	Std
Intel Xeon Silver processors															
4208	8 / 16	2.1 / 3.2 GHz	11 MB	2400 MHz	1 TB	9.6 GT/s	85 W	Y	Y	Y	Y	N	1	N	Std
4209T	8 / 16	2.2 / 3.2 GHz	11 MB	2400 MHz	1 TB	9.6 GT/s	70 W	Y	Y	Y	Y	N	1	N	Std
4210	10 / 20	2.2 / 3.2 GHz	13.75 MB	2400 MHz	1 TB	9.6 GT/s	85 W	Y	Y	Y	Y	N	1	N	Std
4210R	10 / 20	2.4 / 3.2 GHz	13.75 MB	2400 MHz	1 TB	9.6 GT/s	100 W	Y	Y	Y	Y	N	1	N	Std
4210T	10 / 20	2.3 / 3.2 GHz	13.75 MB	2400 MHz	1 TB	9.6 GT/s	95 W	Y	Y	Y	Y	N	1	N	Std
4214	12 / 24	2.2 / 3.2 GHz	16.5 MB	2400 MHz	1 TB	9.6 GT/s	85 W	Y	Y	Y	Y	N	1	N	Std
4214R	12 / 24	2.4 / 3.5 GHz	16.5 MB	2400 MHz	1 TB	9.6 GT/s	100 W	Y	Y	Y	Y	N	1	N	Std
4214Y	12 / 24	2.2 / 3.2 GHz	16.5 MB	2400 MHz	1 TB	9.6 GT/s	85 W	Y	Y	Y	Y	Y	1	N	Std
	10 / 20	2.3 / 3.2 GHz													

CPU model	Cores / threads	Core speed (Base / TB Max)	Cache	Max DDR4 speed	Max memory capacity per socket	UPI speed	TDP	HT	TB	VT-x	VT-d	SST-PP	FMA units	DCPMM	RAS
	8 / 16	2.4 / 3.2 GHz													
4215	8 / 16	2.5 / 3.5 GHz	11 MB	2400 MHz	1 TB	9.6 GT/s	85 W	Y	Y	Y	Y	N	1	Y	Std
4215R	8 / 16	3.2 / 4.0 GHz	11 MB	2400 MHz	1 TB	9.6 GT/s	130 W	Y	Y	Y	Y	N	1	Y	Std
4216	16 / 32	2.1 / 3.2 GHz	22 MB	2400 MHz	1 TB	9.6 GT/s	100 W	Y	Y	Y	Y	N	1	N	Std
Intel Xeon Gold processors															
5215	10 / 20	2.5 / 3.4 GHz	13.75 MB	2666 MHz	1 TB	10.4 GT/s	85 W	Y	Y	Y	Y	N	1	Y	Adv
5215L	10 / 20	2.5 / 3.4 GHz	13.75 MB	2666 MHz	4.5 TB	10.4 GT/s	85 W	Y	Y	Y	Y	N	1	Y	Adv
5217	8 / 16	3.0 / 3.7 GHz	11 MB	2666 MHz	1 TB	10.4 GT/s	115 W	Y	Y	Y	Y	N	1	Y	Adv
5218	16 / 32	2.3 / 3.9 GHz	22 MB	2666 MHz	1 TB	10.4 GT/s	125 W	Y	Y	Y	Y	N	1	Y	Adv
5218B	16 / 32	2.3 / 3.9 GHz	22 MB	2666 MHz	1 TB	10.4 GT/s	125 W	Y	Y	Y	Y	N	1	Y	Adv
5218R	20 / 40	2.1 / 4.0 GHz	27.5 MB	2666 MHz	1 TB	10.4 GT/s	125 W	Y	Y	Y	Y	N	1	Y	Adv
5218N	16 / 32	2.3 / 3.7 GHz	22 MB	2666 MHz	1 TB	10.4 GT/s	110 W	Y	Y	Y	Y	N	1	Y	Adv
5218T	16 / 32	2.1 / 3.8 GHz	22 MB	2666 MHz	1 TB	10.4 GT/s	105 W	Y	Y	Y	Y	N	1	Y	Adv
5220	18 / 36	2.2 / 3.9 GHz	24.75 MB	2666 MHz	1 TB	10.4 GT/s	125 W	Y	Y	Y	Y	N	1	Y	Adv
5220R	24 / 48	2.2 / 4.0 GHz	35.75 MB	2666 MHz	1 TB	10.4 GT/s	150 W	Y	Y	Y	Y	N	1	Y	Adv
5220S	18 / 36	2.7 / 3.9 GHz	24.75 MB	2666 MHz	1 TB	10.4 GT/s	125 W	Y	Y	Y	Y	N	1	Y	Adv
5220T	18 / 36	1.9 / 3.9 GHz	24.75 MB	2666 MHz	1 TB	10.4 GT/s	105 W	Y	Y	Y	Y	N	1	Y	Adv
5222	4 / 8	3.8 / 3.9 GHz	16.5 MB	2933 MHz	1 TB	10.4 GT/s	105 W	Y	Y	Y	Y	N	2	Y	Adv
6208U	16 / 32	2.9 / 3.9 GHz	22 MB	2933 MHz	1 TB	No UPI	150 W	Y	Y	Y	Y	N	2	Y	Adv
6222V	20 / 40	1.8 / 3.6 GHz	27.5 MB	2400 MHz	1 TB	10.4 GT/s	115 W	Y	Y	Y	Y	N	2	Y	Adv
6226	12 / 24	2.7 / 3.7 GHz	19.25 MB	2933 MHz	1 TB	10.4 GT/s	125 W	Y	Y	Y	Y	N	2	Y	Adv
6226R	16 / 32	2.9 / 3.9 GHz	22 MB	2933 MHz	1 TB	10.4 GT/s	150 W	Y	Y	Y	Y	N	2	Y	Adv
6230	20 / 40	2.1 / 3.9 GHz	27.5 MB	2933 MHz	1 TB	10.4 GT/s	125 W	Y	Y	Y	Y	N	2	Y	Adv
6230N	20 / 40	2.3 / 3.9 GHz	27.5 MB	2933 MHz	1 TB	10.4 GT/s	125 W	Y	Y	Y	Y	N	2	Y	Adv
6230R	26 / 52	2.1 / 4.0 GHz	35.75 MB	2933 MHz	1 TB	10.4 GT/s	150 W	Y	Y	Y	Y	N	2	Y	Adv
6230T	20 / 40	2.1 / 3.9 GHz	27.5 MB	2933 MHz	1 TB	10.4 GT/s	125 W	Y	Y	Y	Y	N	2	Y	Adv

CPU model	Cores / threads	Core speed (Base / TB Max)	Cache	Max DDR4 speed	Max memory capacity per socket	UPI speed	TDP	HT	TB	VT-x	VT-d	SST-PP	FMA units	DCPMM	RAS
6234	8 / 16	3.3 / 4.0 GHz	24.75 MB	2933 MHz	1 TB	10.4 GT/s	130 W	Y	Y	Y	Y	N	2	Y	Adv
6238	22 / 44	2.1 / 3.7 GHz	30.25 MB	2933 MHz	1 TB	10.4 GT/s	140 W	Y	Y	Y	Y	N	2	Y	Adv
6238L	22 / 44	2.1 / 3.7 GHz	30.25 MB	2933 MHz	4.5 TB	10.4 GT/s	140 W	Y	Y	Y	Y	N	2	Y	Adv
6238R	28 / 56	2.2 / 4.0 GHz	38.5 MB	2933 MHz	1 TB	10.4 GT/s	165 W	Y	Y	Y	Y	N	2	Y	Adv
6238T	22 / 44	1.9 / 3.7 GHz	30.25 MB	2933 MHz	1 TB	10.4 GT/s	125 W	Y	Y	Y	Y	N	2	Y	Adv
6240	18 / 36	2.6 / 3.9 GHz	24.75 MB	2933 MHz	1 TB	10.4 GT/s	150 W	Y	Y	Y	Y	N	2	Y	Adv
6240L	18 / 36	2.6 / 3.9 GHz	24.75 MB	2933 MHz	4.5 TB	10.4 GT/s	150 W	Y	Y	Y	Y	N	2	Y	Adv
6240R	24 / 48	2.4 / 4.0 GHz	35.75 MB	2933 MHz	1 TB	10.4 GT/s	165 W	Y	Y	Y	Y	N	2	Y	Adv
6240Y	18 / 36	2.6 / 3.9 GHz	24.75 MB	2933 MHz	1 TB	10.4 GT/s	150 W	Y	Y	Y	Y	Y	2	Y	Adv
	14 / 28	2.8 / 3.9 GHz													
	8 / 16	3.1 / 3.9 GHz													
6242	16 / 32	2.8 / 3.9 GHz	22 MB	2933 MHz	1 TB	10.4 GT/s	150 W	Y	Y	Y	Y	N	2	Y	Adv
6242R	20 / 40	3.1 / 4.1 GHz	35.75 MB	2933 MHz	1 TB	10.4 GT/s	205 W	Y	Y	Y	Y	N	2	Y	Adv
6244	8 / 16	3.6 / 4.4 GHz	24.75 MB	2933 MHz	1 TB	10.4 GT/s	150 W	Y	Y	Y	Y	N	2	Y	Adv
6246	12 / 24	3.3 / 4.2 GHz	24.75 MB	2933 MHz	1 TB	10.4 GT/s	165 W	Y	Y	Y	Y	N	2	Y	Adv
6246R	16 / 32	3.4 / 4.1 GHz	35.75 MB	2933 MHz	1 TB	10.4 GT/s	205 W	Y	Y	Y	Y	N	2	Y	Adv
6248	20 / 40	2.5 / 3.9 GHz	27.5 MB	2933 MHz	1 TB	10.4 GT/s	150 W	Y	Y	Y	Y	N	2	Y	Adv
6248R	24 / 48	3.0 / 4.0 GHz	35.75 MB	2933 MHz	1 TB	10.4 GT/s	205 W	Y	Y	Y	Y	N	2	Y	Adv
6250	8 / 16	3.9 / 4.5 GHz	35.75 MB	2933 MHz	1 TB	10.4 GT/s	185 W	Y	Y	Y	Y	N	2	Y	Adv
6252	24 / 48	2.1 / 3.7 GHz	35.75 MB	2933 MHz	1 TB	10.4 GT/s	150 W	Y	Y	Y	Y	N	2	Y	Adv
6252N	24 / 48	2.3 / 3.6 GHz	35.75 MB	2933 MHz	1 TB	10.4 GT/s	150 W	Y	Y	Y	Y	N	2	Y	Adv
6254	18 / 36	3.1 / 4.0 GHz	24.75 MB	2933 MHz	1 TB	10.4 GT/s	200 W	Y	Y	Y	Y	N	2	Y	Adv
6256	12 / 24	3.6 / 4.5 GHz	33 MB	2933 MHz	1 TB	10.4 GT/s	205 W	Y	Y	Y	Y	N	2	Y	Adv
6258R	28 / 56	2.7 / 4.0 GHz	38.5 MB	2933 MHz	1 TB	10.4 GT/s	205 W	Y	Y	Y	Y	N	2	Y	Adv
6262V	24 / 48	1.9 / 3.6 GHz	33 MB	2400 MHz	1 TB	10.4 GT/s	135 W	Y	Y	Y	Y	N	2	Y	Adv
6271C*	24 / 48	2.6 / 3.9 GHz	33 MB	2666 MHz	1 TB	10.4 GT/s	165W	Y	Y	Y	Y	N	2	Y	Adv
Intel Xeon Platinum processors															

CPU model	Cores / threads	Core speed (Base / TB Max)	Cache	Max DDR4 speed	Max memory capacity per socket	UPI speed	TDP	HT	TB	VT-x	VT-d	SST-PP	FMA units	DCPMM	RAS
8253	16 / 32	2.2 / 3.0 GHz	22 MB	2933 MHz	1 TB	10.4 GT/s	125 W	Y	Y	Y	Y	N	2	Y	Adv
8256	4 / 8	3.8 / 3.9 GHz	16.5 MB	2933 MHz	1 TB	10.4 GT/s	105 W	Y	Y	Y	Y	N	2	Y	Adv
8260	24 / 48	2.4 / 3.9 GHz	35.75 MB	2933 MHz	1 TB	10.4 GT/s	165 W	Y	Y	Y	Y	N	2	Y	Adv
8260L	24 / 48	2.4 / 3.9 GHz	35.75 MB	2933 MHz	4.5 TB	10.4 GT/s	165 W	Y	Y	Y	Y	N	2	Y	Adv
8260Y	24 / 48	2.4 / 3.9 GHz	35.75 MB	2933 MHz	1 TB	10.4 GT/s	165 W	Y	Y	Y	Y	Y	2	Y	Adv
	20 / 40	2.5 / 3.9 GHz													
	16 / 32	2.7 / 3.9 GHz													
8268	24 / 48	2.9 / 3.9 GHz	35.75 MB	2933 MHz	1 TB	10.4 GT/s	205 W	Y	Y	Y	Y	N	2	Y	Adv
8270	26 / 52	2.7 / 4.0 GHz	35.75 MB	2933 MHz	1 TB	10.4 GT/s	205 W	Y	Y	Y	Y	N	2	Y	Adv
8276	28 / 56	2.2 / 4.0 GHz	38.5 MB	2933 MHz	1 TB	10.4 GT/s	165 W	Y	Y	Y	Y	N	2	Y	Adv
8276L	28 / 56	2.2 / 4.0 GHz	38.5 MB	2933 MHz	4.5 TB	10.4 GT/s	165 W	Y	Y	Y	Y	N	2	Y	Adv
8280	28 / 56	2.7 / 4.0 GHz	38.5 MB	2933 MHz	1 TB	10.4 GT/s	205 W	Y	Y	Y	Y	N	2	Y	Adv
8280L	28 / 56	2.7 / 4.0 GHz	38.5 MB	2933 MHz	4.5 TB	10.4 GT/s	205 W	Y	Y	Y	Y	N	2	Y	Adv

* Intel processor 6271C is only available in China

Configuration notes:

- The Intel Xeon Gold 5218 and 5218B processors have similar specifications; however, they use different silicon designs and cannot be mixed in the same system.
- Processors with a U suffix are only supported in single-processor configurations. This limits the PCIe slots that can be used.
- The processors that support SST-PP offer three distinct operating points that are defined by a core count with a base speed associated with that core count. The operating point is static, it is selected during the boot process and cannot be changed at runtime.

Processor ordering information

For the SR650 server models that come standard with one processor, the second processor can be ordered, if required (see the following table for ordering information). The second processor must be of the same model as the first processor. The second processor option includes a processor and a heatsink; an additional system fan is not included and needs to be purchased with the second processor (see [Cooling](#) for details).

Table 5. Processor options

Part number	Feature*	Description
Intel Xeon Bronze processors		
4XG7A37938	B4HU	SR550/SR590/SR650 Intel Xeon Bronze 3204 6C 85W 1.9GHz Processor w/o FAN
4XG7A37983	B7N3	SR550/SR590/SR650 Intel Xeon Bronze 3206R 8C 85W 1.9GHz Processor w/o FAN

Part number	Feature*	Description
Intel Xeon Silver processors		
4XG7A37935	B4HT	SR550/SR590/SR650 Intel Xeon Silver 4208 8C 85W 2.1GHz Processor w/o FAN
4XG7A37944	B4P4	SR550/SR590/SR650 Intel Xeon Silver 4209T 8C 70W 2.2GHz Processor w/o FAN
4XG7A37932	B4HS	SR550/SR590/SR650 Intel Xeon Silver 4210 10C 85W 2.2GHz Processor w/o FAN
4XG7A37981	B7N5	SR550/SR590/SR650 Intel Xeon Silver 4210R 10C 100W 2.4GHz Processor w/o FAN
4XG7A63276	BAZT	SR650 Intel Xeon Silver 4210T 10C 95W 2.3GHz Processor w/o FAN
4XG7A37929	B4HR	SR550/SR590/SR650 Intel Xeon Silver 4214 12C 85W 2.2GHz Processor w/o FAN
4XG7A37980	B7N6	SR550/SR590/SR650 Intel Xeon Silver 4214R 12C 100W 2.4GHz Processor w/o FAN
4XG7A37941	B4NW	SR550/SR590/SR650 Intel Xeon Silver 4214Y 12/10/8C 85W 2.2GHz Processor w/o FAN
4XG7A37926	B4HQ	SR550/SR590/SR650 Intel Xeon Silver 4215 8C 85W 2.5GHz Processor w/o FAN
4XG7A63274	BAZU	SR590/SR650 Intel Xeon Silver 4215R 8C 130W 3.2GHz Processor w/o FAN
4XG7A37923	B4HP	SR550/SR590/SR650 Intel Xeon Silver 4216 16C 100W 2.1GHz Processor w/o FAN
Intel Xeon Gold processors		
4XG7A37916	B4HN	SR550/SR590/SR650 Intel Xeon Gold 5215 10C 85W 2.5GHz Processor w/o FAN
4XG7A37910	B4P9	SR550/SR590/SR650 Intel Xeon Gold 5215L 10C 85W 2.5GHz Processor w/o FAN
4XG7A37919	B4HM	SR550/SR590/SR650 Intel Xeon Gold 5217 8C 115W 3.0GHz Processor w/o FAN
4XG7A37895	B4HL	SR550/SR590/SR650 Intel Xeon Gold 5218 16C 125W 2.3GHz Processor w/o FAN
4XG7A37958	B6BS	SR550/SR590/SR650 Intel Xeon Gold 5218B 16C 125W 2.3GHz Processor w/o FAN
4XG7A63272	BAZS	SR550/SR590/SR650 Intel Xeon Gold 5218R 20C 125W 2.1GHz Processor w/o FAN
4XG7A37955	B5S0	SR650 Intel Xeon Gold 5218N 16C 110W 2.3GHz Processor Option Kit w/o FAN
4XG7A38016	B4P3	SR550/SR590/SR650 Intel Xeon Gold 5218T 16C 105W 2.1GHz Processor w/o FAN
4XG7A37892	B4HK	SR550/SR590/SR650 Intel Xeon Gold 5220 18C 125W 2.2GHz Processor w/o FAN
4XG7A37974	B7N9	SR590/SR650 Intel Xeon Gold 5220R 24C 150W 2.2GHz Processor w/o FAN
4XG7A38019	B6CW	SR550/SR590/SR650 Intel Xeon Gold 5220S 18C 125W 2.7GHz Processor w/o FAN
4XG7A38005	B6CQ	SR550/SR590/SR650 Intel Xeon Gold 5220T 18C 105W 1.9GHz Processor w/o FAN
4XG7A37951	B5S1	SR550/SR590/SR650 Intel Xeon Gold 5222 4C 105W 3.8GHz Processor w/o FAN
None**	BAZV	Intel Xeon Gold 6208U 16C 150W 2.9GHz Processor
4XG7A38023	B6CV	SR550/SR590/SR650 Intel Xeon Gold 6222V 20C 115W 1.8GHz Processor w/o FAN
4XG7A38021	B6CL	SR550/SR590/SR650 Intel Xeon Gold 6226 12C 125W 2.7GHz Processor w/o FAN
4XG7A38082	BAZW	SR590/SR650 Intel Xeon Gold 6226R 16C 150W 2.9GHz Processor w/o FAN
4XG7A37889	B4HJ	SR550/SR590/SR650 Intel Xeon Gold 6230 20C 125W 2.1GHz Processor w/o FAN
4XG7A38028	B5RY	SR550/SR590/SR650 Intel Xeon Gold 6230N 20C 125W 2.3GHz Processor w/o FAN
4XG7A38081	BAZX	SR590/SR650 Intel Xeon Gold 6230R 26C 150W 2.1GHz Processor w/o FAN
4XG7A38006	B6CP	SR550/SR590/SR650 Intel Xeon Gold 6230T 20C 125W 2.1GHz Processor w/o FAN
4XG7A38001	B6CK	SR590/SR650 Intel Xeon Gold 6234 8C 130W 3.3GHz Processor w/o FAN
4XG7A38008	B6CJ	SR590/SR650 Intel Xeon Gold 6238 22C 140W 2.1GHz Processor w/o FAN
4XG7A38003	B6CR	SR590/SR650 Intel Xeon Gold 6238L 22C 140W 2.1GHz Processor w/o FAN
4XG7A38080	BAZL	SR650 Intel Xeon Gold 6238R 28C 165W 2.2GHz Processor w/o FAN
4XG7A37906	B4P2	SR550/SR590/SR650 Intel Xeon Gold 6238T 22C 125W 1.9GHz Processor w/o FAN
4XG7A15895	B4HH	SR650 Intel Xeon Gold 6240 18C 150W 2.6GHz Processor w/o FAN
4XG7A38015	B6CS	SR590/SR650 Intel Xeon Gold 6240L 18C 150W 2.6GHz Processor w/o FAN

Part number	Feature*	Description
4XG7A38079	BAZM	SR650 Intel Xeon Gold 6240R 24C 165W 2.4GHz Processor w/o FAN
4XG7A37903	B4NV	SR590/SR650 Intel Xeon Gold 6240Y 18/14/8C 150W 2.6GHz Processor w/o FAN
4XG7A37886	B4HG	SR590/SR650 Intel Xeon Gold 6242 16C 150W 2.8GHz Processor w/o FAN
4XG7A38078	BAZN	SR650 Intel Xeon Gold 6242R 20C 205W 3.1GHz Processor w/o FAN
4XG7A15874	B4HF	SR590/SR650 Intel Xeon Gold 6244 8C 150W 3.6GHz Processor w/o FAN
4XG7A37963	B6PD	SR650 Intel Xeon Gold 6246 12C 165W 3.3GHz Processor Option Kit w/o FAN
4XG7A38077	BAZP	SR650 Intel Xeon Gold 6246R 16C 205W 3.4GHz Processor w/o FAN
4XG7A15892	B4HE	SR650 Intel Xeon Gold 6248 20C 150W 2.5GHz Processor w/o FAN
4XG7A38076	BAZQ	SR650 Intel Xeon Gold 6248R 24C 205W 3.0GHz Processor w/o FAN
4XG7A38075	B96C	SR650 Intel Xeon Gold 6250 8C 185W 3.9GHz Processor w/o FAN
4XG7A15889	B4HC	SR650 Intel Xeon Gold 6252 24C 150W 2.1GHz Processor w/o FAN
4XG7A38011	B6CT	SR590/SR650 Intel Xeon Gold 6252N 24C 150W 2.3GHz Processor w/o FAN
4XG7A15872	B4HD	SR650 Intel Xeon Gold 6254 18C 200W 3.1GHz Processor w/o FAN
4XG7A38074	B96D	SR650 Intel Xeon Gold 6256 12C 205W 3.6GHz Processor w/o FAN
4XG7A38073	BAZR	SR650 Intel Xeon Gold 6258R 28C 205W 2.7GHz Processor w/o FAN
4XG7A38010	B6CU	SR590/SR650 Intel Xeon Gold 6262V 24C 135W 1.9GHz Processor w/o FAN
4XG7A86156	B4Q7	SR650 Intel Xeon Gold 6271C 24C 165W 2.6GHz Processor Option Kit w/o Fan (PRC only)
Intel Xeon Platinum processors		
4XG7A37898	B5RZ	SR550/SR590/SR650 Intel Xeon Platinum 8253 16C 125W 2.2GHz Processor w/o FAN
4XG7A37947	B5S2	SR550/SR590/SR650 Intel Xeon Platinum 8256 4C 105W 3.8GHz Processor w/o FAN
4XG7A15887	B4HB	SR650 Intel Xeon Platinum 8260 24C 165W 2.4GHz Processor w/o FAN
4XG7A15883	B4P7	SR650 Intel Xeon Platinum 8260L 24C 165W 2.4GHz Processor w/o FAN
4XG7A37901	B4NU	SR650 Intel Xeon Platinum 8260Y 24/20/16C 165W 2.4GHz Processor w/o FAN
4XG7A15870	B4HA	SR650 Intel Xeon Platinum 8268 24C 205W 2.9GHz Processor w/o FAN
4XG7A15868	B4H9	SR650 Intel Xeon Platinum 8270 26C 205W 2.7GHz Processor w/o FAN
4XG7A15881	B4H8	SR650 Intel Xeon Platinum 8276 28C 165W 2.2GHz Processor w/o FAN
4XG7A15877	B4P6	SR650 Intel Xeon Platinum 8276L 28C 165W 2.2GHz Processor w/o FAN
4XG7A15866	B4H7	SR650 Intel Xeon Platinum 8280 28C 205W 2.7GHz Processor w/o FAN
4XG7A15862	B4P5	SR650 Intel Xeon Platinum 8280L 28C 205W 2.7GHz Processor w/o FAN

* For CTO configurations, the feature code represents a processor, and fans and heatsinks are derived by the configuration tool.

** Factory-installed only; no field upgrade. Supported in the single-processor configurations only.

Configuration notes:

- Processors with 200 W or 205 W TDP, or Gold 6230N, 6240Y, 6244, or 6250 processors are supported in the following hardware configurations and ambient temperature requirements:
 - 24x 2.5" chassis.
 - Ambient temperature and drive bay configurations:
 - Up to 35 °C (95 °F): 8x 2.5" SAS/SATA drive bays (drive backplane in the middle).
 - Up to 30 °C (86 °F):
 - 4x 2.5" SAS/SATA and 4x 2.5" AnyBay (up to 4 NVMe SSDs).
 - 8x 2.5" SAS/SATA and 8x 2.5" AnyBay (up to 8 NVMe SSDs).

Note: Gold 6242R, 6246R, 6248R, 6250, 6256, and 6258R processors are supported only at the ambient temperature of up to 30 °C (86 °F) and only with 8x 2.5" SAS/SATA drive bays (drive backplane in the middle).

 - No rear HDD kit installed.
 - No PCIe flash adapters installed.
 - No GPU adapters installed, or up to four T4 GPU adapters installed.
 - The server performance might be impacted in case of a system fan failure.
- Gold 6230T, 6246, or 6252N processors are supported in the following hardware configurations:
 - 8x 3.5" SAS/SATA drive bays.
 - 8x 2.5" SAS/SATA drive bays.
 - 4x 2.5" SAS/SATA and 4x 2.5" AnyBay drive bays.

Continued support for 1st Gen Intel Xeon Scalable processors

The SR650 also continues to support the 1st Gen Intel Xeon Scalable processors (formerly codenamed "Skylake") listed in the following table.

Table 6. Long-life 1st Gen Intel Xeon Scalable processors

Part number	Feature code	Description
7XG7A05574	No CTO*	ThinkSystem SR650 Intel Xeon Silver 4109T 8C 70W 2.0GHz Processor Option Kit
7XG7A05579	No CTO*	ThinkSystem SR650 Intel Xeon Silver 4114T 10C 85W 2.2GHz Processor Option Kit
7XG7A05589	AWE5	ThinkSystem SR650 Intel Xeon Gold 6126T 12C 125W 2.6GHz Processor Option Kit

* Only available as a field upgrade for existing customers. Not available in CTO (configure to order) configurations.

For specifications of these processors, see the Intel Xeon Scalable Processor Reference for Lenovo ThinkSystem Servers:

<https://lenovopress.com/lp1262-intel-xeon-sp-processor-reference#term=SKL>

Configuration note for 1st Gen processors: If processors with 200 W or 205 W TDP are used, or if Gold 6126T, 6144, or 6146, or Platinum 8160T processors are used, the following conditions must be met:

- 24x 2.5" chassis only.
- Ambient temperature and drive bay configurations:
 - Up to 35 °C (95 °F):
 - Except Gold 6137: 8x 2.5" SAS/SATA drive bays (drive backplane in the middle).
 - Up to 30 °C (86 °F):
 - Gold 6137 only: 8x 2.5" SAS/SATA drive bays (drive backplane in the middle).
 - Except Gold 6137:
 - 4x 2.5" SAS/SATA and 4x 2.5" AnyBay (up to 4 NVMe SSDs).
 - 8x 2.5" SAS/SATA and 8x 2.5" AnyBay (up to 8 NVMe SSDs).
- No rear HDD kit installed.
- No PCIe flash adapters installed.
- No GPUs installed.
- The server performance might be impacted in case of a fan failure.

UEFI operating modes

The SR650 offers preset operating modes that affect energy consumption and performance. These modes are a collection of predefined low-level UEFI settings that simplify the task of tuning the server to suit your business and workload requirements.

The following table lists the feature codes that allow you to specify the mode you wish to preset in the factory for CTO orders.

Table 7. UEFI operating mode presets in DCSC

Feature code	Description
BFYB	Operating mode selection for: "Maximum Performance Mode"
BFYC	Operating mode selection for: "Minimal Power Mode"
BFYD	Operating mode selection for: "Efficiency Favoring Power Savings Mode"
BFYE	Operating mode selection for: "Efficiency - Favoring Performance Mode"

The preset modes for the SR650 are as follows:

- **Maximum Performance Mode** (feature BFYB): Achieves maximum performance but with higher power consumption and lower energy efficiency.
- **Minimal Power Mode** (feature BFYC): Minimize the absolute power consumption of the system.
- **Efficiency Favoring Power Savings Mode** (feature BFYD): Maximize the performance/watt efficiency with a bias towards power savings. This is the favored mode for SPECpower benchmark testing, for example.
- **Efficiency Favoring Performance Mode** (feature BFYE): Maximize the performance/watt efficiency with a bias towards performance. This is the favored mode for Energy Star certification, for example.

For details about these preset modes, and all other performance and power efficiency UEFI settings offered in the SR650, see the paper "Tuning UEFI Settings for Performance and Energy Efficiency on Intel Xeon Scalable Processor-Based ThinkSystem Servers", available from <https://lenovopress.lenovo.com/lp1477>.

Memory

The SR650 server supports up to 12 TruDDR4 memory when one processor is installed and up to 24 DIMMs when two processors are installed. Each processor has six memory channels (two integrated memory controllers with three memory channels per memory controller), and there are two DIMMs per channel.

With 2nd Gen Xeon SP processors, the server supports memory up to 2933 MHz. With 1st Gen Xeon SP processors, the server supports memory up to 2666 MHz.

Lenovo TruDDR4 memory uses the highest-quality components sourced from Tier 1 DRAM suppliers and only memory that meets strict requirements is selected. It is compatibility tested and tuned on every ThinkSystem server to maximize performance and reliability. TruDDR4 memory has a unique signature programmed into the DIMM, which enables Lenovo servers to verify whether the memory installed is qualified and supported. Lenovo qualified and supported TruDDR4 memory is covered by Lenovo warranty, and service and support provided worldwide.

The following maximum memory capacities are supported by the server with 2nd Gen Xeon SP processors (up to 2933 MHz):

- RDIMMs: 1.5 TB (768 GB per processor)
- 3DS RDIMMs: 3 TB (1.5 TB per processor)

The following maximum memory capacities supported by the server with 1st Gen Xeon SP processors (up to 2666 MHz):

- RDIMMs: 768 GB (384 GB per processor)
- LRDIMMs: 1.5 TB (768 GB per processor)
- 3DS RDIMMs: 3 TB (1.5 GB per processor)

The following memory protection technologies are supported by the processor's integrated memory controllers:

- ECC
- SDDC (for x4-based memory DIMMs)
- ADDDC (for x4-based memory DIMMs; Gold and Platinum processors only)
- Memory mirroring
- Memory rank sparing
- Patrol scrubbing
- Demand scrubbing

The following table lists memory options are supported by the server. The table also indicates which processor generation is supported for each memory option.

Table 8. Memory options

Part number	Feature code	Description	Maximum quantity**	Gen 1 CPU	Gen 2 CPU
RDIMMs - 2933 MHz Performance+					
4X77A12184	B5N6	ThinkSystem 16GB TruDDR4 Performance+ 2933MHz (2Rx8 1.2V) RDIMM	12 / 24	No	Yes
4X77A12185	B5N7	ThinkSystem 32GB TruDDR4 Performance+ 2933MHz (2Rx4 1.2V) RDIMM	12 / 24	No	Yes
4X77A12186	B5N8	ThinkSystem 64GB TruDDR4 Performance+ 2933MHz (2Rx4 1.2V) RDIMM	12 / 24	No	Yes
RDIMMs - 2933 MHz					
4ZC7A08706	B4H1	ThinkSystem 8GB TruDDR4 2933MHz (1Rx8 1.2V) RDIMM	12 / 24	No	Yes
4ZC7A08707	B4LY	ThinkSystem 16GB TruDDR4 2933MHz (1Rx4 1.2V) RDIMM	12 / 24	No	Yes
4ZC7A08708	B4H2	ThinkSystem 16GB TruDDR4 2933MHz (2Rx8 1.2V) RDIMM	12 / 24	No	Yes
4ZC7A08709	B4H3	ThinkSystem 32GB TruDDR4 2933MHz (2Rx4 1.2V) RDIMM	12 / 24	No	Yes
4ZC7A08710	B4H4	ThinkSystem 64GB TruDDR4 2933MHz (2Rx4 1.2V) RDIMM	12 / 24	No	Yes
3DS RDIMMs - 2933 MHz Performance+					
4X77A12187	B5N9	ThinkSystem 128GB TruDDR4 Performance+ 2933MHz (4Rx4 1.2V) 3DS RDIMM	12 / 24	No	Yes
3DS RDIMMs - 2933 MHz					
4ZC7A15113	B587	ThinkSystem 128GB TruDDR4 2933MHz (4Rx4 1.2V) 3DS RDIMM	12 / 24	No	Yes

** The maximum quantity shown is with one processor / two processors.

Configuration notes:

- All DIMMs in the server operate at the same speed, which is determined as the lowest value of:
 - DIMM rated speed (2666 MHz or 2933 MHz).
 - Memory speed supported by the specific processor (2133 MHz, 2400 MHz, 2666 MHz, or 2933 MHz).
 - Memory speed for the selected quantity of DIMMs per channel:
 - One DIMM per channel (1 DPC): 2933 MHz.
 - Two DIMMs per channel (2 DPC)
 - Performance+ DIMMs: 2933 MHz.
 - Other supported DIMMs: 2666 MHz.

Note: Maximum memory speed can be achieved when Max performance mode is enabled in UEFI.

- Mixing different types of memory (RDIMMs, LRDIMMs, 3DS RDIMMs) is not supported.
- All Performance+ DIMMs in the server must be of the same type, rank, and capacity (the same part number or feature code) to operate at 2933 MHz in the configurations with two DIMMs per channel. Performance+ DIMMs cannot be mixed with other DIMMs.
- Mixing RDIMMs of different ranks (single- or dual-rank), DRAM chip types (x4 or x8), speeds (2666 MHz or 2933 MHz), and capacities (8 GB, 16 GB, 32 GB, or 64 GB) is supported in the independent channel mode (the default operational mode) (excluding Performance+ RDIMMs).
- Mixing 3DS RDIMMs of different speeds (2666 MHz or 2933 MHz) and capacities (64 GB or 128 GB) is supported in the independent channel mode (excluding Performance+ 3DS RDIMMs).
- The 128 GB Performance+ 2933 MHz 3DS RDIMMs (feature code B5N9) running at 2933 MHz with two DIMMs per channel are supported at the ambient temperature of up to 30 °C (86 °F).
- The maximum quantity of DIMMs supported is reduced by the quantity of DC Persistent Memory Modules used in the configuration.
- Server configurations with more than 1 TB of memory capacity per socket (including DCPMMs and RDIMMs or 3DS RDIMMs) require processors that support up to 4.5 TB (L-suffix) per socket.
- For server configurations with memory protection, the following rules apply:
 - Single Device Data Correction (SDDC) works only in the independent channel mode and supports only x4-based memory DIMMs.
 - Adaptive Double Device Data Correction (ADDDC) works with x4-based memory DIMMs and requires two DIMM ranks per channel, Intel Xeon Gold or Platinum processors, and the Closed Page memory access mode.
 - If memory mirroring is used, then DIMMs must be installed in quantities of 2, 4, or 8 per processor for mirroring across two memory channels, or in quantities of 3, 6, 9, or 12 per processor for mirroring across three memory channels. Mixing two- and three-channel mirroring in the server is allowed (one processor uses two-channel mirroring, and another processor uses three-channel mirroring). All DIMMs in the server must be identical in type and size.
 - If memory rank sparing is used, then a minimum of two ranks must be installed per populated channel (a least one dual-rank or quad-rank DIMM, or two single-rank DIMMs). In rank sparing mode, one rank in each populated channel is reserved as spare memory for other ranks on the same channel. All DIMMs in the server must be identical in type and size.
 - SDDC, memory mirroring, and memory rank sparing modes are mutually exclusive. Only one operational memory mode can be enabled on the server.
 - In the configurations with DCPMMs, memory mirroring is supported only in the App Direct mode (other DCPMM modes do not support memory mirroring) and applies only to the RDIMMs or 3DS RDIMMs (DCPMMs are not mirrored). Memory sparing is not supported in the configurations with DCPMMs.

Persistent memory

Intel Optane DC persistent memory is an innovative technology that delivers a unique combination of affordable large memory capacity and persistence (non-volatility). The persistent memory technology can help boost the performance of data-intensive applications, such as in-memory analytics, databases, content delivery networks, and high performance computing (HPC), as well as deliver consistent service levels at scale with higher virtual machine and container density.

The SR650 server supports up to six TruDDR4 DC Persistent Memory Modules (DCPMMs) when one processor is installed and up to 12 DCPMMs when two processors are installed (up to one DCPMM per processor's memory channel) for a total of up to 6 TB of persistent memory capacity. The DCPMMs are installed in the same memory DIMM slots on the system board that are used for installing RDIMMs or 3DS RDIMMs.

2nd Gen processors only: Persistent Memory is only supported with 2nd Generation Intel Xeon SP processors. Not supported with 1st Generation processors.

The DCPMMs support the following modes of operation:

- **Memory Mode**
Memory Mode seamlessly brings large memory capacity at affordable cost points to legacy applications. In this mode, DCPMMs provide volatile memory that behaves much like traditional RDIMMs or 3DS RDIMMs (the data will not be saved in case of a power loss) and is transparent to the operating system and applications. DCPMMs provide memory capacity and RDIMMs or 3DS RDIMMs provide cache memory that is managed by the processor's memory controller. The total memory capacity that is seen by the operating system is the capacity of the DCPMMs; the capacity of the RDIMMs or 3DS RDIMMs is hidden and does not appear as a memory resource in the operating system. This mode is considered particularly suited for virtualized database deployments and big-data analytics applications.
- **App Direct Mode**
App Direct Mode brings persistency to the data and structures (the data will be saved in case of a power loss). This mode requires operating system and application awareness of two types of system memory: Persistent (DCPMMs) and DRAM (RDIMMs or 3DS RDIMMs). The total memory capacity that is seen by the operating system includes the capacity of the DCPMMs and RDIMMs or 3DS RDIMMs. This mode is considered particularly suited for in-memory databases, in-memory analytics frameworks, and ultrafast storage applications.
- **Mixed Memory Mode**
Mixed Memory Mode is a combination of Memory Mode and App Direct Mode, where a portion of the capacity of the DCPMMs is used for the Memory Mode operations, and the remaining capacity of the DCPMMs is used for the App Direct Mode operations.

The following memory protection technologies are supported by the DCPMM's onboard memory controllers:

- ECC
- SDDC
- DDDC
- Patrol scrubbing
- Demand scrubbing

The following table lists DCPMM options available for the SR650 server.

Table 9. DCPMM options

Description	Part number	Feature code	Maximum quantity*
-------------	-------------	--------------	-------------------

* The maximum quantity shown is with one processor / two processors.

The following table lists supported combinations of the DCPMMs and memory DIMMs available for the SR650 server.

Table 10. Supported DCPMM and memory DIMM combinations

DCPMM mode	DCPMM quantity*	Supported DCPMM sizes	Memory DIMM quantity*	Supported memory DIMM sizes
App Direct Mode	- / 1	128 GB, 256 GB, 512 GB	- / 12	16 GB, 32 GB, 64 GB, 128 GB
	1 / 2	128 GB, 256 GB, 512 GB	6 / 12	16 GB, 32 GB, 64 GB, 128 GB
	2 / 4	128 GB, 256 GB, 512 GB	4 / 8	16 GB, 32 GB, 64 GB, 128 GB
	2 / 4	128 GB, 256 GB, 512 GB	6 / 12	16 GB, 32 GB, 64 GB, 128 GB
	2 / 4	128 GB, 256 GB, 512 GB	8 / 16	16 GB, 32 GB, 64 GB, 128 GB
	4 / 8	128 GB, 256 GB, 512 GB	6 / 12	16 GB, 32 GB, 64 GB, 128 GB
	6 / 12	128 GB, 256 GB, 512 GB	6 / 12	16 GB, 32 GB, 64 GB, 128 GB
Memory Mode	2 / 4	128 GB	4 / 8	16 GB
	2 / 4	256 GB	4 / 8	32 GB
	2 / 4	512 GB	4 / 8	32 GB, 64 GB
	2 / 4	256 GB	6 / 12	16 GB
	2 / 4	512 GB	6 / 12	16 GB, 32 GB
	4 / 8	128 GB	6 / 12	16 GB
	4 / 8	256 GB	6 / 12	32 GB
	4 / 8	512 GB	6 / 12	32 GB, 64 GB
	6 / 12	128 GB	6 / 12	16 GB, 32 GB
	6 / 12	256 GB	6 / 12	32 GB, 64 GB
	6 / 12	512 GB	6 / 12	32 GB, 64 GB, 128 GB
Mixed Memory Mode	2 / 4	256 GB	6 / 12	16 GB
	2 / 4	512 GB	6 / 12	16 GB, 32 GB
	2 / 4	256 GB	4 / 8	16 GB
	2 / 4	512 GB	4 / 8	16 GB, 32 GB
	4 / 8	128 GB	6 / 12	16 GB
	4 / 8	256 GB	6 / 12	16 GB, 32 GB
	4 / 8	512 GB	6 / 12	16 GB, 32 GB, 64 GB
	6 / 12	128 GB	6 / 12	16 GB
	6 / 12	256 GB	6 / 12	16 GB, 32 GB
6 / 12	512 GB	6 / 12	16 GB, 32 GB, 64 GB	

* The supported exact quantity shown is with one processor / two processors.

Configuration notes:

- DCPMMs are supported only in the configurations with 8x 2.5-inch, 16x 2.5-inch, or 8x 3.5-inch drive bays.
- All DCPMMs in the server must be of the same capacity (the same part number or feature code).
- The RDIMMs or 3DS RDIMMs are required in the configurations with DCPMMs, and all RDIMMs or 3DS RDIMMs must be of the same type, rank, and capacity (the same part number or feature code).
- The DCPMMs cannot be mixed with the 8GB TruDDR4 2933 MHz RDIMM (4ZC7A08706).
- For Mixed Memory Mode, the volatile (Memory) portion of the total capacity of DCPMMs is configured in increments of 32 GB multiplied by the number of DCPMMs in the server, and the remaining capacity is allocated to the persistent (App Direct) portion. The ratio of the total capacity of RDIMMs or 3DS RDIMMs to the total capacity of the volatile portion of DCPMMs should be between 1 to 4 and 1 to 16.
- Server configurations with more than 1 TB of memory capacity per socket (including DCPMMs and RDIMMs or 3DS RDIMMs) require processors that support up to 4.5 TB (L-suffix) per socket.
- In the configurations with the processors of 200 W or 205 W TDP, or with Gold 6230N, 6240Y, 6244, or 6250 processors, the DCPMMs require two power supplies.
- Persistent memory is not supported in configurations with GPU adapters
- Persistent memory is not supported in configurations with flash storage adapters

For more information, refer to the Intel Optane DC Persistent Memory (DCPMM) Product Guide:

<http://lenovopress.com/LP1066>

Internal storage

Topics in this section:

- [Configurations](#)
- [Backplanes](#)
- [Supported drive bay combinations](#)
- [Field upgrades](#)
- [M.2 drives](#)
- [SED encryption key management with SKLM](#)

Configurations

The SR650 server supports the following internal drive bay configurations:

1. Up to 16 SFF (front) and 2 LFF (rear) hot-swap drive bays:
 - a. 8x 2.5" SAS/SATA + 8x 2.5" SAS/SATA + 2x 3.5" SAS/SATA
 - b. 4x 2.5" SAS/SATA & 4x 2.5" AnyBay + 8x 2.5" SAS/SATA + 2x 3.5" SAS/SATA
 - c. 4x 2.5" SAS/SATA & 4x 2.5" AnyBay + 4x 2.5" SAS/SATA & 4x 2.5" AnyBay + 2x 3.5" SAS/SATA
2. Up to 24 SFF (front) and 2 LFF (rear) hot-swap drive bays:
 - a. 8x 2.5" SAS/SATA + 8x 2.5" SAS/SATA + 8x 2.5" SAS/SATA + 2x 3.5" SAS/SATA
 - b. 4x 2.5" SAS/SATA & 4x 2.5" AnyBay + 8x 2.5" SAS/SATA + 8x 2.5" SAS/SATA + 2x 3.5" SAS/SATA
 - c. 4x 2.5" SAS/SATA & 4x 2.5" AnyBay + 4x 2.5" SAS/SATA & 4x 2.5" AnyBay + 8x 2.5" SAS/SATA + 2x 3.5" SAS/SATA
 - d. 4x 2.5" SAS/SATA & 4x 2.5" AnyBay + 4x 2.5" SAS/SATA & 4x 2.5" AnyBay + 4x 2.5" SAS/SATA & 4x 2.5" AnyBay
 - e. 16x 2.5" U.2 NVMe PCIe + 8x 2.5" SAS/SATA (factory-installed only)

- f. 20x 2.5" U.2 NVMe PCIe
- g. 24x 2.5" U.2 NVMe PCIe
- 3. Up to 10 LFF SAS/SATA hot-swap drive bays: 8x 3.5" SAS/SATA (front) + 2x 3.5" SAS/SATA (rear)
- 4. Up to 14 LFF hot-swap drive bays:
 - a. 12x 3.5" SAS/SATA (front) + 2x 3.5" SAS/SATA (rear)
 - b. 8x 3.5" SAS/SATA & 4x 3.5" AnyBay (front) + 2x 3.5" SAS/SATA (rear)

In addition, the SR650 server models can be configured with one or two internal M.2 SATA SSDs. The server also supports configurations without drive bays.

The following figures show the internal drive bay configurations.

1. Up to 16 SFF and 2 LFF hot-swap drive bays

- a) 8x 2.5" SAS/SATA +
8x 2.5" SAS/SATA (front)
- b) 4x 2.5" SAS/SATA & 4x 2.5" AnyBay +
8x 2.5" SAS/SATA (front)
- c) 4x 2.5" SAS/SATA & 4x 2.5" AnyBay +
4x 2.5" SAS/SATA & 4x 2.5" AnyBay (front)

+ 2x 3.5-inch SAS/SATA (rear)

Figure 8. Drive bay configurations: 16x 2.5-inch chassis

2. Up to 24 SFF and 2 LFF hot-swap drive bays







	a) 8x 2.5" SAS/SATA + 8x 2.5" SAS/SATA + 8x 2.5" SAS/SATA (front)
	b) 4x 2.5" SAS/SATA & 4x 2.5" AnyBay + 8x 2.5" SAS/SATA + 8x 2.5" SAS/SATA (front)
	c) 4x 2.5" SAS/SATA & 4x 2.5" AnyBay + 4x 2.5" SAS/SATA & 4x 2.5" AnyBay + 8x 2.5" SAS/SATA (front)
	d) 4x 2.5" SAS/SATA & 4x 2.5" AnyBay + 4x 2.5" SAS/SATA & 4x 2.5" AnyBay + 4x 2.5" SAS/SATA & 4x 2.5" AnyBay (front)
	e) 16x 2.5" U.2 NVMe + 8x 2.5" SAS/SATA (front)
	f) 20x 2.5" U.2 NVMe (front)
	g) 24x 2.5" U.2 NVMe (front)
	+ 2x 3.5-inch SAS/SATA (rear) (except Configurations 2d, 2e, 2f, 2g)

Figure 9. Drive bay configurations: 24x 2.5-inch chassis

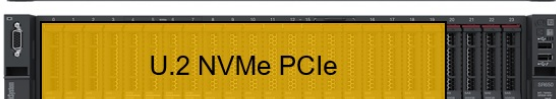
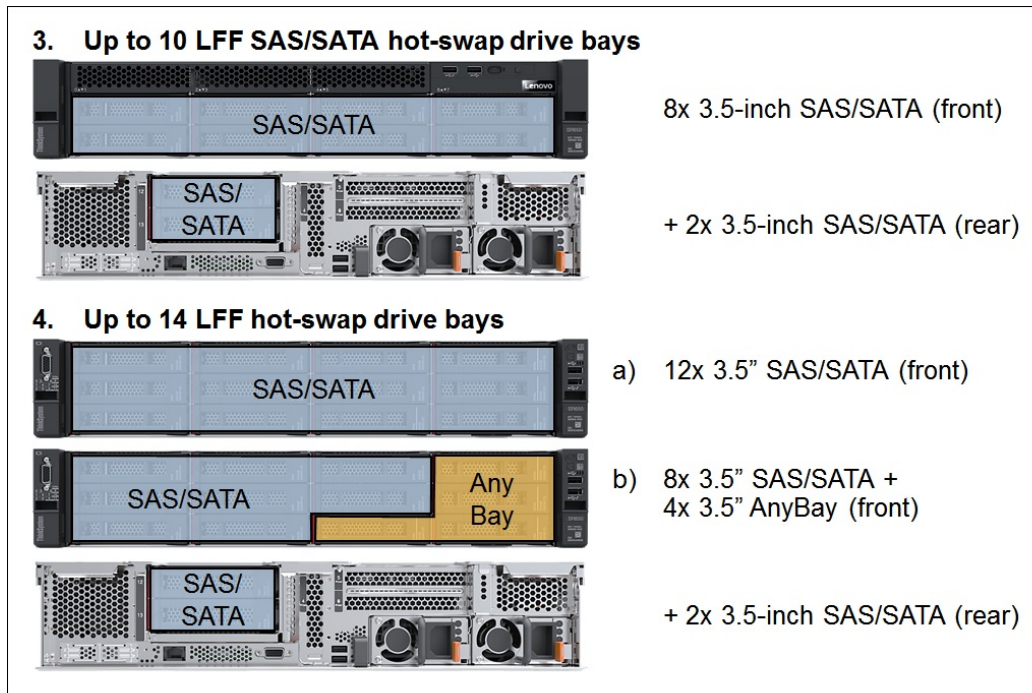

Figure 10. Drive bay configurations: 12x 3.5-inch chassis

Backplanes

The following table lists the internal storage options for the server. For field upgrades, see the [Field upgrades](#) section.

Table 11. Backplanes for CTO orders

Feature code	Description	Maximum quantity
2.5-inch front drive backplanes		
AURA	ThinkSystem 2U/Twr 2.5" SATA/SAS 8-Bay Backplane	3
AUR5	ThinkSystem 2U/Twr 2.5" AnyBay 8-Bay Backplane	3
B4PC	ThinkSystem 2U 2.5" NVMe 8-Bay Backplane	3
3.5-inch front drive backplanes		
AUR6	ThinkSystem 2U 3.5" SATA/SAS 8-Bay Backplane	1
AUR9	ThinkSystem 2U 3.5" SATA/SAS 12-Bay Backplane	1
AUR8	ThinkSystem 2U 3.5" AnyBay 12-Bay Backplane	1
2x3.5-inch rear drive backplane kits (include two fans integrated into the drive bay assembly)		
BMUW	ThinkSystem SR590/SR650 Rear HDD/SSD Kit v2 (for X30 and X350 adapters, with either 2.5" or 3.5" chassis)	1
AURZ	ThinkSystem SR590/SR650 Rear HDD/SSD Kit (for X30 and X350 adapters, with either 2.5" or 3.5" chassis)	1
BM7Q	ThinkSystem BRCM SR650 Rear 3.5" HDD Kit (for X40 adapters, 2.5" chassis only)	1
BMAQ	2U Rear 3.5 HDD kit12X3.5 (for X40 adapters, 3.5" chassis only)	1
2x3.5-inch rear drive backplane kits (do not include integrated fans; available in the PRC market only)		

Feature code	Description	Maximum quantity
BMXJ	ThinkSystem SR590/SR650 Rear HDD Kit Without Fan v2 (for X30 and X350 adapters, with either 2.5" or 3.5" chassis)	1
BF6V	ThinkSystem SR590/SR650 Rear HDD Kit Without Fan (for X30 and X350 adapters, with either 2.5" or 3.5" chassis)	1
BM7R	ThinkSystem BRCM SR650 Rear 3.5" HDD Kit without Fan (for X40 adapters, 2.5" chassis only)	1
BMAP	Rear HDD kit wo fan 12X3.5 (for X40 adapters, 3.5" chassis only)	1

Configuration notes:

- 24x 2.5-inch front drives are supported only on storage dense models that use the 24x 2.5" chassis (feature code AUVV).
- Processor TDP requirements:
 - Up to 3x 2.5" AnyBay 8-Bay Backplanes are supported in the server with the processors of up to 165 W TDP.
 - Up to 2x 2.5" AnyBay 8-Bay Backplane Kits are supported in the server with the processors of more than 165 W TDP.
- If 3x 2.5" AnyBay 8-Bay Backplane Kits are installed in the server, the Rear HDD kit cannot be installed.
- For models with 16/20/24x 2.5" U.2 NVMe PCIe drive bays (either factory-installed or upgraded in the field), the following conditions must be met:
 - Two processors with up to 165 W TDP installed.
 - No GPU adapters installed.
 - No PCIe flash adapters installed.
 - No PCIe adapters with more than 25 W TDP installed.
 - 1100 W or 1600 W power supplies installed.
 - Ambient temperature of up to 30 °C (86 °F).
 - The server performance might be impacted in case of a system fan failure.

For additional configuration details, refer to the [Controllers for internal storage](#) and [I/O expansion](#) sections.

- The feature code for the 3.5" rear drive kit varies depending on which family of storage adapters (X30 or X40) is installed and which base chassis (2.5-inch or 3.5-inch) is selected.
- The 3.5" rear drive bay feature codes (BMUW, AURZ, BM7Q, BMAQ) include two additional fans integrated into the drive bay assembly. For customers in China only, additional feature codes are also selectable and these do not include the fans (BMXJ, BF6V, BM7R, BMAP). The "without fans" feature codes can be used under the following conditions:
 - Processor TDP cannot exceed 125 W
 - Ambient temperature up to 30 °C (86 °F)
 - The acoustic noise may increase
- The 3.5" rear drive kit is connected to a separate port on the internal storage controller.
- The 3.5" rear drive kit is installed in place of the PCIe Riser Card 1; PCIe slots 1, 2, and 3 are not present.
- Lenovo AnyBay allows a choice of drive interface types in the same drive bay: SAS drives, SATA drives, or NVMe PCIe drives.
- U.2 NVMe PCIe SSDs in the 8/16/24-drive bay configurations that contain four AnyBay drive bays require either the second processor (enables the onboard NVMe controller) or the 1610-4P NVMe Switch Adapter to be installed. The 1610-4P NVMe Switch Adapter is supported only in the configurations with one processor.

- Models with 12x 3.5-inch drive bays (8x SAS/SATA + 4x AnyBay) and an 8-port SAS RAID controller or HBA support only NVMe drives in the AnyBay drive bays.

Supported drive bay combinations

The following tables list supported internal storage configurations with the SAS/SATA and AnyBay backplanes.

Internal storage configurations tables convention: The numbers in brackets (x or x+y or x+y+z) in the Storage controller column specify the quantity of drive bays connected to each of the controllers.

Table 12. Internal storage configurations: Up to 16 SFF front drive bays without rear drive bays

Hot-swap drive bay configuration	Backplane kit type and quantity			Storage controller type and quantity (OB=onboard)
	8x2.5" SATA/SAS	8x2.5" Any Bay	2x3.5" Rear HDD	
16x 2.5" chassis (Feature code AUVX) or 24x 2.5" chassis (Feature code AUVV)				
8x 2.5" SAS/SATA (front)	1	0	0	1x RAID 8i or HBA 8i (8)
				1x RAID 16i/24i or HBA 16i (8)
4x 2.5" SAS/SATA (front) + 4x 2.5" AnyBay (front)	0	1	0	1x RAID 8i or HBA 8i (8) + 1x OB or 1610-4P NVMe (4)
				1x RAID 16i/24i or HBA 16i (8) + 1x OB or 1610-4P NVMe (4)
16x 2.5" SAS/SATA (front)	2	0	0	1x RAID 16i/24i or HBA 16i (16)
				1x RAID 8i (8) + 1x HBA 8i (8)
				2x RAID 8i or 2x HBA 8i (8+8)
12x 2.5" SAS/SATA (front) + 4x 2.5" AnyBay (front)	1	1	0	1x RAID 16i/24i or HBA 16i (16) + 1x OB or 1610-4P NVMe (4)
8x 2.5" SAS/SATA (front) + 8x 2.5" AnyBay (front)	0	2	0	1x RAID 16i/24i or HBA 16i (16) + 1x OB NVMe (4) + 1x 1610-4P NVMe (4)
				2x RAID 8i or HBA 8i (8+8) + 1x OB NVMe (4) + 1x 1610-4P NVMe (4)
				1x RAID 16i (16) + 1x 1611-8P (8)

Table 13. Internal storage configurations: Up to 16 SFF front and 2 LFF rear drive bays

Hot-swap drive bay configuration	Backplane kit type and quantity			Storage controller type and quantity (OB=onboard)
	8x2.5" SATA/SAS	8x2.5" Any Bay	2x3.5" Rear HDD	
16x 2.5" chassis (Feature code AUVX) or 24x 2.5" chassis (Feature code AUVV)				
8x 2.5" SAS/SATA (front) + 2x 3.5" SAS/SATA (rear)	1	0	1	1x RAID 16i/24i or HBA 16i (10)
				1x RAID 8i (8) + 1x RAID 8i or HBA 8i (2)
				1x 430-8i HBA (8) + 1x RAID 530-8i (2)
				2x RAID 8i or HBA 8i (8+2)
4x 2.5" SAS/SATA (front) + 4x 2.5" AnyBay (front) + 2x 3.5" SAS/SATA (rear)	0	1	1	1x RAID 8i or HBA 8i (8) + 1x OB/1610-4P NVMe (4) + 1x RAID 8i or HBA 8i (2)
				1x RAID 16i/24i or HBA 16i (10) + 1x OB/1610-4P NVMe (4)
16x 2.5" SAS/SATA (front) + 2x 3.5" SAS/SATA (rear)	2	0	1	1x RAID 16i or HBA 16i (16) + 1x RAID 8i or HBA 8i (2)
				1x RAID 930-24i (18)
				3x RAID 8i or HBA 16i (8+8+2)
12x 2.5" SAS/SATA (front) + 4x 2.5" AnyBay (front) + 2x 3.5" SAS/SATA (rear)	1	1	1	1x RAID 16i or HBA 16i (16) + 1x OB/1610-4P NVMe (4) + 1x RAID 8i or HBA 8i (2)
				1x RAID 24i (18) + 1x OB/1610-4P NVMe (4)
8x 2.5" SAS/SATA (front) + 8x 2.5" AnyBay (front) + 2x 3.5" SAS/SATA (rear)	0	2	1	1x RAID 16i or HBA 16i (16) + 1x OB NVMe (4) + 1x 1610-4P NVMe (4) + 1x RAID 8i or HBA 8i (2)
				1x RAID 24i (18) + 1x OB NVMe (4) + 1x 1610-4P NVMe (4)
				2x RAID 8i or HBA 8i (8+8) + 1x Onboard NVMe (4) + 1x 1610-4P NVMe (4) + 1x RAID 8i or HBA 8i (2)

Table 14. Internal storage configurations: Up to 24 SFF front drive bays without rear drive bays

Hot-swap drive bay configuration	Backplane kit type and quantity				Storage controller type and quantity (OB=onboard)
	8x2.5" SATA/SAS	8x2.5" Any Bay	8x2.5" NVMe	2x3.5" Rear HDD	
24x 2.5" chassis (Feature code AUVV)					
24x 2.5" SAS/SATA (front)	3	0	0	0	1x RAID 24i (24)
					1x RAID 8i (8) + 1x RAID 16i (16)
					3x RAID 8i or 3x HBA 8i (8+8+8)
20x 2.5" SAS/SATA (front) + 4x 2.5" AnyBay (front)	2	1	0	0	1x RAID 24i (24) + 1x OB/1610-4P NVMe (4)
					1x RAID 8i (8) + 1x RAID 16i (16) + 1x OB/1610-4P NVMe (4)
					3x RAID 8i or HBA 8i (8+8+8) + 1x Onboard/1610-4P NVMe (4)
16x 2.5" SAS/SATA (front) + 8x 2.5" AnyBay (front)	1	2	0	0	1x RAID 24i (24) + 1x OB NVMe (4) + 1x 1610-4P NVMe (4)
					3x RAID 8i (8+8+8) + 1x OB NVMe (4) + 1x 1610-4P NVMe (4)
					1x HBA 8i (8) + 1x HBA 16i (16) + 1x OB NVMe (4) + 1x 1610-4P NVMe (4)
					1x RAID 32i (24) + 1x 1611-8P (8)
					1x RAID 16i (16) + 1x RAID 8i (8) + 1x 1611-8P (8)
12x 2.5" SAS/SATA (front) + 12x 2.5" AnyBay (front)	0	3	0	0	1x RAID 24i (24) + 1x OB NVMe (4) + 2x 1610-4P NVMe (4+4)
					3x RAID 8i or HBA 8i (8+8+8) + 1x OB NVMe (4) + 2x 1610-4P NVMe (4+4)
					1x HBA 8i (8) + 1x HBA 16i (16) + 1x OB NVMe (4) + 2x 1610-4P NVMe (4+4)
					1x RAID 32i (24) + 1x OB NVMe (4) + 1x 1611-8P (8)
					1x RAID 16i (16) + 1x RAID 8i (8) + 1x OB NVMe (4) + 1x 1611-8P (8)
16x 2.5" U.2 NVMe (front)	0	0	2	0	2x 810-4P NVMe (4+4) + 2x 1610-4P NVMe (4+4)
					2x 1611-8P (8+8)
16x 2.5" U.2 NVMe (front) + 8x 2.5" SAS/SATA (front)	1	0	2	0	1x RAID/HBA 8i (8) + 2x 810-4P NVMe (4+4) + 2x 1610-4P NVMe (4+4)
					1x RAID 8i (8) + 2x 1611-8P (8+8)
20x 2.5" U.2 NVMe (front)	0	0	3	0	1x Onboard NVMe (4) + 2x 810-4P NVMe (4+4) + 3x 1610-4P NVMe (4+4+4)
24x 2.5" U.2 NVMe (front)	0	0	3	0	4x 810-4P NVMe (4+4+4+4) + 1x 1610-8P NVMe (8)
					3x 1611-8P (8+8+8)

Table 15. Internal storage configurations: Up to 24 SFF front and 2 LFF rear drive bays

Hot-swap drive bay configuration	Backplane kit type and quantity			Storage controller type and quantity (OB=onboard)
	8x2.5" SATA/SAS	8x2.5" Any Bay	2x3.5" Rear HDD	
24x 2.5" chassis (Feature code AUVV)				
24x 2.5" SAS/SATA (front) + 2x 3.5" SAS/SATA (rear)	3	0	1	1x RAID 24i (24) + 1x RAID 8i or HBA 8i (2)
				1x RAID 8i or HBA 8i (8) + 1x RAID 16i or HBA 16i (16) + 1x RAID 8i or HBA 8i (2)
				2x RAID 16i or HBA 16i (16+10)
				2x HBA 16i (8+2) + 1x HBA 16i (16)
				3x RAID 8i or HBA 8i (8+8+8) + 1x RAID 8i or HBA 8i(2)
20x 2.5" SAS/SATA (front) + 4x 2.5" AnyBay (front) + 2x 3.5" SAS/SATA (rear)	2	1	1	1x RAID 24i (24) + 1x OB/1610-4P NVMe (4) + 1x RAID 8i or HBA 8i (2)
				1x RAID 8i (8) + 1x RAID 16i (16) + 1x OB/1610-4P NVMe (4) + 1x RAID 8i or HBA 8i (2)
				2x RAID 16i or HBA 16i (16+10) + 1x OB/1610-4P NVMe (4)
				3x RAID 8i or HBA 8i (8+8+8) + 1x OB/1610-4P NVMe (4) + 1x RAID 8i or HBA 8i (2)
16x 2.5" SAS/SATA (front) + 8x 2.5" AnyBay (front) + 2x 3.5" SAS/SATA (rear)	1	2	1	1x RAID 24i (24) + 1x OB NVMe (4) + 1x 1610-4P NVMe (4) + 1x RAID 8i (2)
				1x HBA 8i (8) + 1x HBA 16i (16) + 1x OB NVMe (4) + 1x 1610-4P NVMe (4) + 1x RAID 8i (2)
				2x RAID 16i (16+10) + 1x OB NVMe (4) + 1x 1610-4P NVMe (4)
				2x HBA 8i (8+2) + 1x HBA 16i (16) + 1x OB NVMe (4) + 1x 1610-4P NVMe (4)
				2x 16i HBA (16+10) + 1x OB NVMe (4) + 1x 1610-4P NVMe (4)

Table 16. Internal storage configurations: Up to 12 LFF front and 2 LFF rear drive bays

Hot-swap drive bay configuration	Backplane kit type and quantity				Storage controller type and quantity
	8x3.5" SATA/SAS	12x3.5" SATA/SAS	12x3.5" Any Bay	2x3.5" Rear HDD	
12x 3.5" chassis (Feature code AUVW)					
8x 3.5" SAS/SATA (front)	1	0	0	0	1x RAID 16i (8) 1x RAID 8i or HBA 8i (8)
8x 3.5" SAS/SATA (front) + 2x 3.5" SAS/SATA (rear)	1	0	0	1	1x RAID 16i or HBA 16i (10) 1x RAID 8i or HBA 8i (8) + 1x RAID 8i or HBA 8i (2) 1x RAID 16i (8) + 1x RAID 8i (2) 2x RAID 8i or HBA 8i (8+2)
12x 3.5" SAS/SATA (front)	0	1	0	0	1x RAID 16i or HBA 16i (12)
8x 3.5" SAS/SATA (front) + 4x 3.5" AnyBay (front)	0	0	1	0	1x RAID 16i or HBA 16i (12) + 1x OB/1610-4P NVMe (4)
8x 3.5" SAS/SATA (front) + 4x 3.5" AnyBay (NVMe only) (front)*	0	0	1	0	1x RAID 8i or HBA 8i (8) + 1x OB/1610-4P NVMe (4)
12x 3.5" SAS/SATA (front) + 2x 3.5" SAS/SATA (rear)	0	1	0	1	1x RAID 16i or HBA 16i (14) 1x RAID 16i or HBA 16i (12) + 1x RAID 8i (2)
8x 3.5" SAS/SATA (front) + 4x 3.5" AnyBay (front) + 2x 3.5" SAS/SATA (rear)	0	0	1	1	1x RAID 16i or HBA 16i (14) + 1x OB/1610-4P NVMe (4)

* Four NVMe SSDs are required in the 3.5" AnyBay configuration with an 8-port storage controller.

12-drive AnyBay 3.5-inch configuration with expander (PRC only)

In addition to the configurations described above, the SR650 server also supports internal storage configurations with the 3.5" AnyBay 12-Bay Backplane w/Expander to enable support for up to 12 SAS or SATA drives with the 8-port RAID 530/730/930-8i controllers.

China customers only: Internal storage configurations with the 3.5" AnyBay 12-Bay Backplane w/Expander and 8-port RAID 530/730/930-8i controllers are available in PRC only.

The following table lists the 3.5" AnyBay 12-Bay Backplane w/Expander for the SR650 server.

Table 17. 3.5" AnyBay 12-Bay Backplane w/Expander

Part number	Feature code	Description	Maximum quantity
None*	BD3Q	ThinkSystem SR650 3.5" AnyBay 12-Bay Backplane w/Expander	1

* The backplane kit can be factory-installed in standard or custom (CTO or Special Bid) models, and it does not have an option part number assigned.

Configuration notes:

- The 3.5" AnyBay 12-Bay Backplane w/Expander provides 8x 3.5" SAS/SATA (front) + 4x 3.5" AnyBay (front) drive bays.
- The following 8-port RAID adapters are supported in the configurations with the 3.5" AnyBay 12-Bay Backplane w/Expander:
 - RAID 530-8i
 - RAID 730-8i 1GB
 - RAID 730-8i 2GB
 - RAID 930-8i 2GB
- The onboard NVMe interface provides 4x PCIe 3.0 x4 ports for JBOD (non-RAID) connectivity to NVMe PCIe SSDs in the AnyBay drive bays.

Field upgrades

The following table lists the backplane options that can be installed as field upgrades.

Use with X40 adapters: These backplane kits in the table below include SAS/SATA cables for use with the onboard SATA controller or with RAID 930, 730, 530 adapters and 430 HBAs (collectively called X30 adapters). If you are adding or upgrading to RAID 940 adapters or 440 HBAs (collectively called X40 adapters), you will need to *also* order an X40 cable kit. See the [Cable kits for 440 HBAs and RAID 940 adapters](#) section for details.

Use with the 1611-8P adapter: AnyBay and NVMe backplane kits in the table below include NVMe cables for use with 1610-4P or 810-4P NVMe adapters. If you are adding or upgrading to the 1611-8P NVMe adapter, you will need to *also* order 1611-8P Cable Kit. See the [Cable kit for the 1611-8P adapter](#) section for details.

Table 18. Drive bay field upgrades

Part number	Description	Maximum quantity
2.5-inch front drive bays		
7XH7A06254	ThinkSystem SR550/SR650 2.5" SATA/SAS 8-Bay Backplane Kit	3
7XH7A06251	ThinkSystem SR650 2.5" AnyBay 8-Bay Backplane Kit	3
4XH7A09819	ThinkSystem SR650 U.2 20-Bays Upgrade Kit	1
4XH7A08810	ThinkSystem SR650 U.2 24-Bays Upgrade Kit	1
3.5-inch front drive bays		
4XH7A08770	ThinkSystem SR550/SR590/SR650 3.5" SATA/SAS 8-Bay Backplane Upgrade Kit	1
4XH7A08771	ThinkSystem SR550/SR590/SR650 3.5" SATA/SAS 12-Bay Backplane Upgrade Kit	1
4XH7A08785	ThinkSystem SR590/SR650 3.5" AnyBay 12-Bay Backplane Upgrade Kit	1
2x3.5-inch rear drive bays		
4XH7A80453	ThinkSystem SR590/SR650 Rear HDD/SSD Kit v2	1
7XH7A06253	ThinkSystem SR590/SR650 Rear HDD/SSD Kit	1
4XB7A64318	ThinkSystem SR590/SR650 Rear HDD Kit Without Fan (PRC only)	1

Configuration notes:

- The SAS/SATA and AnyBay backplane upgrade kits include drive backplanes and required SAS cables, NVMe cables, power cables, and drive bay fillers; storage controllers are not included.

- The 2.5" SATA/SAS 8-Bay Backplane Kit (7XH7A06254) adds 8x 2.5" SAS/SATA hot-swap drive bays to the previously configured models that are based on the 16x 2.5" chassis (feature code AUVX) or 24x 2.5" chassis (feature code AUVV) and support drive bay expansion capabilities (including models without drive bays).
- The 2.5" AnyBay 8-Bay Backplane Kit (7XH7A06251) adds 4x 2.5" SAS/SATA & 4x 2.5" AnyBay hot-swap drive bays to the previously configured models that are based on the 16x 2.5" chassis (feature code AUVX) or 24x 2.5" chassis (feature code AUVV) and support drive bay expansion capabilities (including models without drive bays).
- Processor TDP requirements:
 - Up to 3x 2.5" AnyBay 8-Bay Backplanes are supported in the server with the processors of up to 165 W TDP.
 - Up to 2x 2.5" AnyBay 8-Bay Backplane Kits are supported in the server with the processors of more than 165 W TDP.
- If 3x 2.5" AnyBay 8-Bay Backplane Kits are installed in the server, the Rear HDD kit cannot be installed.
- Models without any drive bays that are based on the 12x 3.5" chassis (feature code AUVW) include the Right EIA Latch with FIO (USB ports, status LEDs, and a power button). These models support adding drive bays by using the 3.5" 8-bay backplane kit (4XH7A08770), 3.5" 12-bay backplane kit (4XH7A08771), or 3.5" AnyBay 12-bay backplane kit (4XH7A08785).
- Previously configured models that are based on the 24x 2.5" chassis (feature code AUVV) can be upgraded to 20 or 24 U.2 NVMe PCIe drive bays by using the U.2 NVMe 20-Bay Backplane Upgrade Kit (4XH7A09819) or U.2 NVMe 24-Bay Backplane Upgrade Kit (4XH7A08810), respectively. Both kits include drive backplanes and required NVMe cables, power cables, drive bay fillers, and NVMe switch adapters. The U.2 NVMe 24-Bay Backplane Upgrade Kit also includes the x16/x8/x16 Riser Card 1 (4XH7A09902).
- For models with 16/20/24x 2.5" U.2 NVMe PCIe drive bays (either factory-installed or upgraded in the field), the following conditions must be met:
 - Two processors with up to 165 W TDP installed.
 - No GPU adapters installed.
 - No PCIe flash adapters installed.
 - No PCIe adapters with more than 25 W TDP installed.
 - 1100 W or 1600 W power supplies installed.
 - Ambient temperature of up to 30 °C (86 °F).
 - The server performance might be impacted in case of a system fan failure.
- **Note:** For additional configuration details, refer to the [Controllers for internal storage](#) and [I/O expansion](#) sections.
- The Rear drive bay kits (4XH7A80453 and 7XH7A06253) include two additional fans integrated into the drive bay assembly. For customers in China, the ThinkSystem SR590/SR650 Rear HDD Kit Without Fan (4XB7A64318) is also available and does not include the fans. The Rear HDD Kit Without Fan can be used under the following conditions:
 - Processor TDP cannot exceed 125 W
 - Ambient temperature up to 30 °C (86 °F)
 - The acoustic noise may increase
- The 3.5" Rear HDD/SSD Kit is connected to a separate port on the internal storage controller.
- The 3.5" Rear HDD/SSD Kit is installed in place of the PCIe Riser Card 1; PCIe slots 1, 2, and 3 are not present.
- U.2 NVMe PCIe SSDs in the 8/16/24-drive bay configurations that contain four AnyBay drive bays require either the second processor (enables the onboard NVMe controller) or the 1610-4P NVMe Switch Adapter to be installed. The 1610-4P NVMe Switch Adapter is supported only in the configurations with one processor.
- Models with 12x 3.5-inch drive bays (8x SAS/SATA + 4x AnyBay) and an 8-port SAS RAID controller or HBA support only NVMe drives in the AnyBay drive bays.

Cable kits for 440 HBAs and RAID 940 adapters

The backplane kits listed in the [Drive bay field upgrades table](#) include cables for use with the onboard SATA controller or with RAID 930, 730, 530 adapters and 430 HBAs (collectively called X30 adapters). If you wish to use the backplane kits with RAID 940 adapters or 440 HBAs (collectively called X40 adapters), then you will also need to order an additional X40 cable kit to use instead of the cables in the backplane kit.

Tip: When adding an X40 adapter, you will order both the backplane kit and the relevant X40 cable kit, however the SAS/SATA data cable(s) in the backplane kit will not be used.

Table 19. Cable kits for 440 HBAs and RAID 940 adapters

Backplane kits with X30 cables		X40 cable kits also needed (1 per backplane)	
7XH7A06254	ThinkSystem SR550/SR650 2.5" SATA/SAS 8-Bay Backplane Kit	4XH7A61097	ThinkSystem SR550/SR590/SR650 2.5" SAS/SATA/AnyBay 8-Bay X40 RAID Cable Kit
7XH7A06251	ThinkSystem SR650 2.5" AnyBay 8-Bay Backplane Kit	4XH7A61097	ThinkSystem SR550/SR590/SR650 2.5" SAS/SATA/AnyBay 8-Bay X40 RAID Cable Kit
4XH7A08770	ThinkSystem SR550/SR590/SR650 3.5" SATA/SAS 8-Bay Backplane Upgrade Kit	4XH7A61098	ThinkSystem SR550/SR590/SR650 3.5" SAS/SATA 8-Bay X40 RAID Cable Kit
4XH7A08771	ThinkSystem SR550/SR590/SR650 3.5" SATA/SAS 12-Bay Backplane Upgrade Kit	4XH7A61105	ThinkSystem SR590/SR650 3.5" SAS/SATA/AnyBay 12-Bay X40 RAID Cable Kit
4XH7A08785	ThinkSystem SR590/SR650 3.5" AnyBay 12-Bay Backplane Upgrade Kit	4XH7A61105	ThinkSystem SR590/SR650 3.5" SAS/SATA/AnyBay 12-Bay X40 RAID Cable Kit
4XH7A09819	ThinkSystem SR650 U.2 20-Bays Upgrade Kit	None	Not needed - NVMe only
4XH7A08810	ThinkSystem SR650 U.2 24-Bays Upgrade Kit	None	Not needed - NVMe only
7XH7A06253	ThinkSystem SR590/SR650 Rear HDD/SSD Kit	4XH7A61110	ThinkSystem SR590/SR630/SR650 SAS/SATA 2-Bay Rear BP X40 RAID Cable Kit
4XB7A64318	ThinkSystem SR590/SR650 Rear HDD Kit Without Fan (PRC only)	4XH7A61110	ThinkSystem SR590/SR630/SR650 SAS/SATA 2-Bay Rear BP X40 RAID Cable Kit

Cable kit for the 1611-8P adapter

The backplane kit part numbers listed in the [Drive bay field upgrades table](#) that include NVMe connections (that is, NVMe backplanes and AnyBay backplanes) only include cables for use with 1610-4P or 810-4P NVMe adapters. If you wish to use these backplane kits with the 1611-8P NVMe adapter, then you will *also* need to order an additional cable kit to use instead of the cables in the backplane kit.

Tip: When adding an 1611-8P adapter, you will order both the backplane kit and the 1611-8P cable kit, however the NVMe data cables in the backplane kit will not be used.

Table 20. Cable kit for 1611-8P adapter

Part number	Description
4X97A83642	ThinkSystem SR650 1611-8P NVMe Switch Adapter Cable Kit

M.2 drives

The server supports one or two M.2 form-factor SATA drives for use as an operating system boot solution. With two M.2 drives configured, the drives are configured by default as a RAID-1 mirrored pair for redundancy.

The M.2 drives install into an M.2 adapter which in turn is installed in a dedicated slot on the system board. See the internal view of the server in the [Components and connectors](#) section for the location of the M.2 slot.

There are two M.2 adapters supported, as listed in the following table.

Table 21. M.2 components

Part number	Feature code	Description	Maximum supported
7Y37A01092	AUMU	ThinkSystem M.2 Enablement Kit (contains the Single M.2 Boot Adapter; supports 1 drive)	1
7Y37A01093	AUMV	ThinkSystem M.2 with Mirroring Enablement Kit (contains the Dual M.2 Boot Adapter, supports 1 or 2 drives)	1

Supported drives are listed in the [Internal drive options](#) section.

For details about M.2 components, see the *ThinkSystem M.2 Drives and M.2 Adapters* product guide: <https://lenovopress.com/lp0769-thinksystem-m2-drives-adapters>

SED encryption key management with SKLM

The server supports self-encrypting drives (SEDs) as listed in the [Internal drive options](#) section. To effectively manage a large deployment of these drives in Lenovo servers, IBM Security Key Lifecycle Manager (SKLM) offers a centralized key management solution. A Lenovo Feature on Demand (FoD) upgrade is used to enable this SKLM support in the management processor of the server.

The following table lists the part numbers and feature codes for the upgrades.

Table 22. FoD upgrades for SKLM support

Part number	Feature code	Description
Security Key Lifecycle Manager - FoD (United States, Canada, Asia Pacific, and Japan)		
00D9998	A5U1	SKLM for System x/ThinkSystem w/SEDs - FoD per Install with 1 year S&S
00D9999	AS6C	SKLM for System x/ThinkSystem w/SEDs - FoD per Install with 3 year S&S
Security Key Lifecycle Manager - FoD (Latin America, Europe, Middle East, and Africa)		
00FP648	A5U1	SKLM for System x/ThinkSystem w/SEDs - FoD per Install with 1 year S&S
00FP649	AS6C	SKLM for System x/ThinkSystem w/SEDs - FoD per Install with 3 year S&S

The IBM Security Key Lifecycle Manager software is available from Lenovo using the ordering information listed in the following table.

Table 23. IBM Security Key Lifecycle Manager licenses

Part number	Description
7S0A007FWW	IBM Security Key Lifecycle Manager Basic Edition Install License + SW Subscription & Support 12 Months
7S0A007HWW	IBM Security Key Lifecycle Manager For Raw Decimal Terabyte Storage Resource Value Unit License + SW Subscription & Support 12 Months
7S0A007KWW	IBM Security Key Lifecycle Manager For Raw Decimal Petabyte Storage Resource Value Unit License + SW Subscription & Support 12 Months
7S0A007MWW	IBM Security Key Lifecycle Manager For Usable Decimal Terabyte Storage Resource Value Unit License + SW Subscription & Support 12 Months
7S0A007PWW	IBM Security Key Lifecycle Manager For Usable Decimal Petabyte Storage Resource Value Unit License + SW Subscription & Support 12 Months

Controllers for internal storage

The following table lists the storage controllers and options for internal storage of the SR650 server.

Onboard SATA: The SR650 does not offer onboard SATA

Table 24. RAID controllers and HBAs for internal storage

Part number	Feature code	Description	Maximum quantity	Slots supported
12 Gb SAS/SATA RAID controllers - 8-port adapters				
7Y37A01082	AUNG	ThinkSystem RAID 530-8i PCIe 12Gb Adapter	2	7,4,2,3,1,5,6
4Y37A78834	BMFT	ThinkSystem RAID 540-8i PCIe Gen4 12Gb Adapter	2	4,2,3,1,5,6
4Y37A72482	BJHK	ThinkSystem RAID 5350-8i PCIe 12Gb Adapter	3	4,2,3,1,5,6
7Y37A01083	AUNH	ThinkSystem RAID 730-8i 1GB Cache PCIe 12Gb Adapter	3	7,4,2,3,1,5,6
4Y37A09722	B4RQ	ThinkSystem RAID 730-8i 2GB Flash PCIe 12Gb Adapter	3	7,4,2,3,1,5,6
7Y37A01084	AUNJ	ThinkSystem RAID 930-8i 2GB Flash PCIe 12Gb Adapter	3	7,4,2,3,1,5,6
4Y37A72483	BJHL	ThinkSystem RAID 9350-8i 2GB Flash PCIe 12Gb Adapter	3	4,2,3,1,5,6
4Y37A09728	B8NY	ThinkSystem RAID 940-8i 4GB Flash PCIe Gen4 12Gb Adapter	3	4,2,3,1,5,6
12 Gb SAS/SATA RAID controllers - 16-port adapters				
4Y37A09727	B6CE	ThinkSystem RAID 530-16i PCIe 12Gb Adapter	2	7,4,2,3,1,5,6
4Y37A78835	BNAX	ThinkSystem RAID 540-16i PCIe Gen4 12Gb Adapter	2	4,2,3,1,5,6
7Y37A01085	AUNK	ThinkSystem RAID 930-16i 4GB Flash PCIe 12Gb Adapter	2	7,4,2,3,1,5,6
4Y37A72485	BJHN	ThinkSystem RAID 9350-16i 4GB Flash PCIe 12Gb Adapter	2	4,2,3,1,5,6
4Y37A09721	B31E	ThinkSystem RAID 930-16i 8GB Flash PCIe 12Gb Adapter	2	7,4,2,3,1,5,6
4Y37A78600	BM35	ThinkSystem RAID 940-16i 4GB Flash PCIe Gen4 12Gb Adapter	2	4,2,3,1,5,6
4Y37A09730	B8NZ	ThinkSystem RAID 940-16i 8GB Flash PCIe Gen4 12Gb Adapter	2	4,2,3,1,5,6
12 Gb SAS/SATA RAID controllers - 24 and 32-port adapters				
7Y37A01086	AUV1	ThinkSystem RAID 930-24i 4GB Flash PCIe 12Gb Adapter	1	1,2,3,5,6

Part number	Feature code	Description	Maximum quantity	Slots supported
4Y37A09733	B8P8	ThinkSystem RAID 940-32i 8GB Flash PCIe Gen4 12Gb Adapter	1	1,2,3,5,6
12 Gb SAS/SATA non-RAID HBAs				
7Y37A01088	AUNL	ThinkSystem 430-8i SAS/SATA 12Gb HBA	4	7,4,2,3,1,5,6
4Y37A72480	BJHH	ThinkSystem 4350-8i SAS/SATA 12Gb HBA	4	4,2,3,1,5,6
4Y37A78601	BM51	ThinkSystem 440-8i SAS/SATA PCIe Gen4 12Gb HBA	4	4,2,3,1,5,6
7Y37A01089	AUNM	ThinkSystem 430-16i SAS/SATA 12Gb HBA	2	7,4,2,3,1,5,6
4Y37A72481	BJHJ	ThinkSystem 4350-16i SAS/SATA 12Gb HBA	2	4,2,3,1,5,6
4Y37A78602	BM50	ThinkSystem 440-16i SAS/SATA PCIe Gen4 12Gb HBA	2	4,2,3,1,5,6
NVMe PCIe interfaces				
None	B9X7	Intel VROC (VMD NVMe RAID) Intel SSD Only (Standard)	1	Not applicable
4L47A39164	B96G	Intel VROC (VMD NVMe RAID) Premium (license upgrade - to enable RAID support for non-Intel NVMe SSDs)	1	Not applicable
4Y37A09737	B8P5	ThinkSystem 1611-8P PCIe Gen4 Switch Adapter	3	1, 5, 6
None*	B22D	ThinkSystem 810-4P NVMe Switch Adapter	4	2, 4, 7, 6
7Y37A01081	AUV2	ThinkSystem 1610-4P NVMe Switch Adapter	3	1, 5, 6
None^	B4PA	ThinkSystem 1610-8P NVMe Switch Adapter	1	1

* The 810-4P NVMe adapter can be factory-installed, or it is included in the 20-drive and 24-drive U.2 NVMe upgrade kits for field upgrades.

^ The 1610-8P NVMe adapter can be factory-installed, or it is included in the 24-drive NVMe upgrade kit for field upgrades.

For a comparison of the functions of the supported storage adapters, see the ThinkSystem RAID Adapter and HBA Reference:

<https://lenovopress.com/lp1288-thinksystem-raid-adapter-and-hba-reference#sr650-support=SR650>

For more information about the server configurations with 16/20/24x 2.5-inch U.2 NVMe PCIe drive bays, refer to the *NVMe-Rich Configurations of the ThinkSystem SR650* article, <http://lenovopress.com/LP0904>

Configuration notes:

- Low profile SAS RAID controllers and HBAs for internal storage are supported in the PCIe x8 slots on the system board and full-high PCIe x8 and x16 slots supplied by the riser card 1. Full-height SAS RAID controllers for internal storage (RAID 930-24i) are supported in the full-height PCIe x8 and x16 slots supplied by the riser card 1.
- If the RAID 930-24i controller is used in the configurations with 24 front drives and 2 rear drives, the RAID 930-24i controller that connects the front drive bays must be installed in the PCIe slot 5, and the RAID 530-8i controller or 430-8i HBA that connects the rear drive bays must be installed in the onboard PCIe slot 7.
- Either RAID 530-8i or RAID 730-8i 1GB controllers can be used in the server, but not both types.
- The RAID 730-8i 2GB controller cannot be used in the server configurations with the RAID 930-8i or RAID 730-8i 1GB controllers.
- The RAID 730-8i 1GB controller does not support the 3.5" Rear HDD Kit.
- Configurations using onboard NVMe and NVMe switch adapters support RAID using Intel VROC NVMe RAID as described in the [Intel VROC onboard RAID](#) section.
- In the configurations with 2.5-inch AnyBay drive bays, the 1610-4P NVMe Switch Adapter is

- supported in the full-height PCIe x16 slots supplied by the riser cards 1 and 2.
- In the configurations with one processor, the 1610-4P NVMe Switch Adapter provides 4x PCIe 3.0 x4 ports for connectivity to U.2 NVMe PCIe SSDs in four AnyBay drive bays, and it is supported in the PCIe x16 slot 1 supplied by the x16/x8 Riser Card 1 (the 1610-4P NVMe Switch Adapter has a PCIe 3.0 x16 host interface).
 - In the configurations with two processors, the onboard NVMe interface and up to two 1610-4P NVMe Switch Adapters provide 4x PCIe 3.0 x4 ports each for connectivity to U.2 NVMe PCIe SSDs in the AnyBay drive bays. Two 1610-4P NVMe Switch Adapters are supported in the PCIe x16 slots 1 and 5 or 1 and 6 only.
- Configurations with 16x 2.5-inch U.2 NVMe PCIe drive bays use the following interfaces and adapters for balanced connectivity to up to 16x U.2 NVMe PCIe SSDs (up to eight SSDs per processor) without oversubscription:
 - The onboard NVMe interface (Processor 2) that provides four PCIe 3.0 x4 ports for connections to four SSDs without oversubscription.
 - Two 810-4P NVMe Switch adapters installed in the PCIe x8 Slots 4 and 7 (Processor 1) that provide two PCIe 3.0 x4 ports each for connections to four SSDs (two SSDs per 810-4P) without oversubscription.
 - Two 1610-4P NVMe Switch adapters installed in the PCIe x16 Slot 1 (Processor 1) and PCIe x16 Slot 6 (Processor 2) that provide four PCIe 3.0 x4 ports each for connections to eight SSDs (four SSDs per 1610-4P) without oversubscription.
 - If the additional 8-bay SAS/SATA backplane is installed, it is connected to a supported internal storage controller installed in the PCIe x8 slot 3.
 - Configurations with 20x 2.5-inch U.2 NVMe PCIe drive bays use the following interfaces and adapters for connectivity to up to 20x U.2 NVMe PCIe SSDs (up to eight SSDs per Processor 1, and up to 12 SSDs per Processor 2) without oversubscription:
 - The onboard NVMe interface (Processor 2) that provides four PCIe 3.0 x4 ports for connections to four SSDs without oversubscription.
 - Two 810-4P NVMe Switch adapters installed in the PCIe x8 Slots 4 and 7 (Processor 1) that provide two PCIe 3.0 x4 ports each for connections to four SSDs (two SSDs per 810-4P) without oversubscription.
 - Three 1610-4P NVMe Switch adapters installed in the PCIe x16 Slot 1 (Processor 1) and PCIe x16 Slots 5 and 6 (Processor 2) that provide four PCIe 3.0 x4 ports each for connections to twelve SSDs (four SSDs per 1610-4P) without oversubscription.
 - Configurations with 24x 2.5-inch U.2 NVMe PCIe drive bays use the following interfaces and adapters for balanced connectivity to up to 24x U.2 NVMe PCIe SSDs (up to 12 SSDs per processor) with 2:1 oversubscription:
 - One 1610-8P NVMe Switch Adapter installed in the PCIe x16 Slot 1 (Processor 2) that provides eight PCIe 3.0 x4 ports for connections to eight SSDs with 2:1 oversubscription.
 - Four 810-4P NVMe Switch adapters installed in the PCIe x8 Slots 2, 4, and 7 (Processor 1) and PCIe x16 Slot 6 (Processor 2) that provide four PCIe 3.0 x4 ports each for connections to 16 SSDs (four SSDs per 810-4P) with 2:1 oversubscription.
 - In the configurations without GPU installed, the total quantity of the RAID 730, RAID 930, RAID 9350 and RAID 940 controllers with supercaps must not exceed 4 (up to 4 supercapacitors can be mounted in the server).
 - In the configurations with GPU installed, the total quantity of the RAID 730, RAID 930, RAID 9350 and RAID 940 controllers with supercaps must not exceed 3 (up to 3 supercapacitors can be mounted in the server).
 - **E810 Ethernet and X350 RAID/HBAs:** The use of both an Intel E810 network adapter and an X350 HBA/RAID adapter (9350, 5350 and 4350) is currently not supported in ThinkSystem servers. For details see [Support Tip HT513226](#). Planned support for this combination of adapters is 2Q/2024.

Intel VROC onboard RAID

Intel VROC (Virtual RAID on CPU) is a feature of the Intel processor that enables RAID support.

On the SR650, Intel VROC provides RAID functions for the onboard NVMe controller (Intel VROC NVMe RAID).

VROC NVMe RAID offers RAID support for any NVMe drives directly connected to the ports on the server's system board or via adapters such as NVMe retimers or NVMe switch adapters. On the SR650, RAID levels implemented are based on the VROC feature selected as indicated in the following table. RAID 1 is limited to 2 drives per array, and RAID 10 is limited to 4 drives per array. Hot-spare functionality is also supported.

Performance tip: For best performance with VROC NVMe RAID, the drives in an array should all be connected to the same processor. Spanning processors is possible however performance will be unpredictable and should be evaluated based on your workload.

The SR650 supports the VROC NVMe RAID offerings listed in the following table. The VROC Intel SSD Only offering only supports RAID on Intel branded NVMe SSDs; non-Intel branded NVMe SSDs cannot be configured in a RAID array.

Table 25. Intel VROC NVMe RAID ordering information and feature support

Part number	Feature code	Description	Intel NVMe SSDs	Non-Intel NVMe SSDs	RAID 0	RAID 1	RAID 10	RAID 5
CTO only	B9X7	Intel VROC (VMD NVMe RAID) Intel SSD Only	Yes	No	Yes	Yes	Yes	Yes
4L47A39164	B96G	Intel VROC (VMD NVMe RAID) Premium	Yes	Yes	Yes	Yes	Yes	Yes

Configuration notes:

- If a feature code is ordered in a CTO build, the VROC functionality is enabled in the factory. For field upgrades, order a part number and it will be fulfilled as a Feature on Demand (FoD) license which can then be activated via the XCC management processor user interface.

Virtualization support: Virtualization support for Intel VROC is as follows:

- **VROC (VMD) NVMe RAID :** VROC (VMD) NVMe RAID is supported by ESXi, KVM, Xen, and Hyper-V. ESXi support is limited to RAID 1 only; other RAID levels are not supported. Windows and Linux OSes support VROC RAID NVMe, both for host boot functions and for guest OS function, and RAID-0, 1, 5, and 10 are supported. On ESXi, VROC is supported with both boot and data drives.

Internal drive options

The following tables list the drive options for internal storage of the server.

2.5-inch hot-swap drives:

- [2.5-inch hot-swap 12 Gb SAS HDDs](#)
- [2.5-inch hot-swap 6 Gb SATA HDDs](#)
- [2.5-inch hot-swap 24 Gb SAS SSDs](#)
- [2.5-inch hot-swap 12 Gb SAS SSDs](#)
- [2.5-inch hot-swap 6 Gb SATA SSDs](#)
- [2.5-inch hot-swap PCIe 4.0 NVMe SSDs](#)
- [2.5-inch hot-swap PCIe 3.0 NVMe SSDs](#)

3.5-inch hot-swap drives:

- [3.5-inch hot-swap 12 Gb SAS HDDs](#)
- [3.5-inch hot-swap 6 Gb SATA HDDs](#)
- [3.5-inch hot-swap 24 Gb SAS SSDs](#)
- [3.5-inch hot-swap 12 Gb SAS SSDs](#)
- [3.5-inch hot-swap 6 Gb SATA SSDs](#)
- [3.5-inch hot-swap PCIe 4.0 NVMe SSDs](#)
- [3.5-inch hot-swap PCIe 3.0 NVMe SSDs](#)

M.2 drives:

- [M.2 SATA drives](#)

M.2 drive support: The use of M.2 drives requires an additional adapter as described in the [M.2 drives](#) subsection.

SED support: The tables include a column to indicate which drives support SED encryption. The encryption functionality can be disabled if needed. Note: Not all SED-enabled drives have "SED" in the description.

PCIe 4.0 NVMe drive support: When installed in this server, PCIe 4.0 NVMe drives will operate at PCIe 3.0 speeds.

Table 26. 2.5-inch hot-swap 12 Gb SAS HDDs

Part number	Feature code	Description	SED support	Max Qty
2.5-inch hot-swap HDDs - 12 Gb SAS 15K				
7XB7A00021	AULV	ThinkSystem 2.5" 300GB 15K SAS 12Gb Hot Swap 512n HDD	No	24
7XB7A00022	AULW	ThinkSystem 2.5" 600GB 15K SAS 12Gb Hot Swap 512n HDD	No	24
7XB7A00023	AULX	ThinkSystem 2.5" 900GB 15K SAS 12Gb Hot Swap 512e HDD	No	24
2.5-inch hot-swap HDDs - 12 Gb SAS 10K				
7XB7A00024	AULY	ThinkSystem 2.5" 300GB 10K SAS 12Gb Hot Swap 512n HDD	No	24
7XB7A00025	AULZ	ThinkSystem 2.5" 600GB 10K SAS 12Gb Hot Swap 512n HDD	No	24
7XB7A00026	AUM0	ThinkSystem 2.5" 900GB 10K SAS 12Gb Hot Swap 512n HDD	No	24
7XB7A00027	AUM1	ThinkSystem 2.5" 1.2TB 10K SAS 12Gb Hot Swap 512n HDD	No	24
7XB7A00028	AUM2	ThinkSystem 2.5" 1.8TB 10K SAS 12Gb Hot Swap 512e HDD	No	24
7XB7A00069	B0YS	ThinkSystem 2.5" 2.4TB 10K SAS 12Gb Hot Swap 512e HDD	No	24
2.5-inch hot-swap HDDs - 12 Gb NL SAS				
7XB7A00034	AUM6	ThinkSystem 2.5" 1TB 7.2K SAS 12Gb Hot Swap 512n HDD	No	24
7XB7A00035	AUM7	ThinkSystem 2.5" 2TB 7.2K SAS 12Gb Hot Swap 512n HDD	No	24
2.5-inch hot-swap SED HDDs - 12 Gb SAS 10K				
7XB7A00031	AUM5	ThinkSystem 2.5" 600GB 10K SAS 12Gb Hot Swap 512n HDD SED	Support	24
7XB7A00033	B0YX	ThinkSystem 2.5" 1.2TB 10K SAS 12Gb Hot Swap 512n HDD SED	Support	24
7XB7A00070	B0YV	ThinkSystem 2.5" 2.4TB 10K SAS 12Gb Hot Swap 512e HDD FIPS	Support	24
2.5-inch hot-swap SED HDDs - 12 Gb NL SAS				
7XB7A00064	B0YM	ThinkSystem 2.5" 2TB 7.2K SAS 12Gb Hot Swap 512e HDD FIPS	Support	24

Table 27. 2.5-inch hot-swap 6 Gb SATA HDDs

Part number	Feature code	Description	SED support	Max Qty
2.5-inch hot-swap HDDs - 6 Gb NL SATA				
7XB7A00036	AUUE	ThinkSystem 2.5" 1TB 7.2K SATA 6Gb Hot Swap 512n HDD	No	24

Table 28. 2.5-inch hot-swap 24 Gb SAS SSDs

Part number	Feature code	Description	SED support	Max Qty
2.5-inch hot-swap SSDs - 24 Gb SAS - Mixed Use/Mainstream (3-5 DWPD)				
4XB7A80340	BNW8	ThinkSystem 2.5" PM1655 800GB Mixed Use SAS 24Gb HS SSD	Support	24
4XB7A80341	BNW9	ThinkSystem 2.5" PM1655 1.6TB Mixed Use SAS 24Gb HS SSD	Support	24
4XB7A80342	BNW6	ThinkSystem 2.5" PM1655 3.2TB Mixed Use SAS 24Gb HS SSD	Support	24
4XB7A80343	BP3K	ThinkSystem 2.5" PM1655 6.4TB Mixed Use SAS 24Gb HS SSD	Support	24
2.5-inch hot-swap SSDs - 24 Gb SAS - Read Intensive/Entry/Capacity (<3 DWPD)				
4XB7A80318	BNWC	ThinkSystem 2.5" PM1653 960GB Read Intensive SAS 24Gb HS SSD	Support	24
4XB7A80319	BNWE	ThinkSystem 2.5" PM1653 1.92TB Read Intensive SAS 24Gb HS SSD	Support	24
4XB7A80320	BNWF	ThinkSystem 2.5" PM1653 3.84TB Read Intensive SAS 24Gb HS SSD	Support	24
4XB7A80321	BP3E	ThinkSystem 2.5" PM1653 7.68TB Read Intensive SAS 24Gb HS SSD	Support	24
4XB7A80322	BP3J	ThinkSystem 2.5" PM1653 15.36TB Read Intensive SAS 24Gb HS SSD	Support	24
4XB7A80323	BP3D	ThinkSystem 2.5" PM1653 30.72TB Read Intensive SAS 24Gb HS SSD	Support	24

Table 29. 2.5-inch hot-swap 12 Gb SAS SSDs

Part number	Feature code	Description	SED support	Max Qty
2.5-inch hot-swap SSDs - 12 Gb SAS - Write Intensive/Performance (10+ DWPD)				
4XB7A83214	BR10	ThinkSystem 2.5" Nytro 3750 400GB Write Intensive SAS 12Gb HS SSD	Support	24
4XB7A83215	BR0Z	ThinkSystem 2.5" Nytro 3750 800GB Write Intensive SAS 12Gb HS SSD	Support	24
4XB7A83216	BR0Y	ThinkSystem 2.5" Nytro 3750 1.6TB Write Intensive SAS 12Gb HS SSD	Support	24
4XB7A83217	BR0X	ThinkSystem 2.5" Nytro 3750 3.2TB Write Intensive SAS 12Gb HS SSD	Support	24
2.5-inch hot-swap SSDs - 12 Gb SAS - Mixed Use/Mainstream (3-5 DWPD)				
4XB7A17064	B8JD	ThinkSystem 2.5" PM1645a 3.2TB Mainstream SAS 12Gb Hot Swap SSD	No	24
2.5-inch hot-swap SSDs - 12 Gb SAS - Read Intensive/Entry/Capacity (<3 DWPD)				

Table 30. 2.5-inch hot-swap 6 Gb SATA SSDs

Part number	Feature code	Description	SED support	Max Qty
2.5-inch hot-swap SSDs - 6 Gb SATA - Mixed Use/Mainstream (3-5 DWPD)				
4XB7A82289	BQ21	ThinkSystem 2.5" 5400 MAX 480GB Mixed Use SATA 6Gb HS SSD	Support	24
4XB7A82290	BQ24	ThinkSystem 2.5" 5400 MAX 960GB Mixed Use SATA 6Gb HS SSD	Support	24
4XB7A82291	BQ22	ThinkSystem 2.5" 5400 MAX 1.92TB Mixed Use SATA 6Gb HS SSD	Support	24
4XB7A82292	BQ23	ThinkSystem 2.5" 5400 MAX 3.84TB Mixed Use SATA 6Gb HS SSD	Support	24
4XB7A17125	BA7Q	ThinkSystem 2.5" S4620 480GB Mixed Use SATA 6Gb HS SSD	No	24
4XB7A17126	BA4T	ThinkSystem 2.5" S4620 960GB Mixed Use SATA 6Gb HS SSD	No	24
4XB7A17127	BA4U	ThinkSystem 2.5" S4620 1.92TB Mixed Use SATA 6Gb HS SSD	No	24

Part number	Feature code	Description	SED support	Max Qty
4XB7A17128	BK7L	ThinkSystem 2.5" S4620 3.84TB Mixed Use SATA 6Gb HS SSD	No	24
4XB7A17088	B8HY	ThinkSystem 2.5" 5300 480GB Mainstream SATA 6Gb Hot Swap SSD	No	24
2.5-inch hot-swap SSDs - 6 Gb SATA - Read Intensive/Entry (<3 DWPD)				
4XB7A82258	BQ1Q	ThinkSystem 2.5" 5400 PRO 240GB Read Intensive SATA 6Gb HS SSD	Support	24
4XB7A82259	BQ1P	ThinkSystem 2.5" 5400 PRO 480GB Read Intensive SATA 6Gb HS SSD	Support	24
4XB7A82260	BQ1R	ThinkSystem 2.5" 5400 PRO 960GB Read Intensive SATA 6Gb HS SSD	Support	24
4XB7A82261	BQ1X	ThinkSystem 2.5" 5400 PRO 1.92TB Read Intensive SATA 6Gb HS SSD	Support	24
4XB7A82262	BQ1S	ThinkSystem 2.5" 5400 PRO 3.84TB Read Intensive SATA 6Gb HS SSD	Support	24
4XB7A82263	BQ1T	ThinkSystem 2.5" 5400 PRO 7.68TB Read Intensive SATA 6Gb HS SSD	Support	24
4XB7A72441	BM88	ThinkSystem 2.5" PM893 3.84TB Read Intensive SATA 6Gb HS SSD	No	24
4XB7A17072	B99D	ThinkSystem 2.5" S4520 240GB Read Intensive SATA 6Gb HS SSD	No	24
4XB7A17101	BA7G	ThinkSystem 2.5" S4520 480GB Read Intensive SATA 6Gb HS SSD	No	24
4XB7A17102	BA7H	ThinkSystem 2.5" S4520 960GB Read Intensive SATA 6Gb HS SSD	No	24
4XB7A17103	BA7J	ThinkSystem 2.5" S4520 1.92TB Read Intensive SATA 6Gb HS SSD	No	24
4XB7A17104	BK77	ThinkSystem 2.5" S4520 3.84TB Read Intensive SATA 6Gb HS SSD	No	24
4XB7A17105	BK78	ThinkSystem 2.5" S4520 7.68TB Read Intensive SATA 6Gb HS SSD	No	24
4XB7A38272	BCTD	ThinkSystem 2.5" Multi Vendor 480GB Entry SATA 6Gb Hot Swap SSD	No	24
4XB7A38273	BCTE	ThinkSystem 2.5" Multi Vendor 960GB Entry SATA 6Gb Hot Swap SSD	No	24
4XB7A38274	BCTF	ThinkSystem 2.5" Multi Vendor 1.92TB Entry SATA 6Gb Hot Swap SSD	No	24
4XB7A38275	BCTG	ThinkSystem 2.5" Multi Vendor 3.84TB Entry SATA 6Gb Hot Swap SSD	No	24
4XB7A17076	B8JM	ThinkSystem 2.5" 5300 480GB Entry SATA 6Gb Hot Swap SSD	No	24
4XB7A17079	B8JP	ThinkSystem 2.5" 5300 3.84TB Entry SATA 6Gb Hot Swap SSD	No	24
4XB7A38191	B93L	ThinkSystem 2.5" 5300 3.84TB Entry SATA 6Gb Hot Swap SSD SED	Support	24
4XB7A38144	B7EW	ThinkSystem 2.5" 5210 1.92TB Entry SATA 6Gb Hot Swap QLC SSD	No	24
4XB7A38145	B7EX	ThinkSystem 2.5" 5210 3.84TB Entry SATA 6Gb Hot Swap QLC SSD	No	24
4XB7A38146	B7EY	ThinkSystem 2.5" 5210 7.68TB Entry SATA 6Gb Hot Swap QLC SSD	No	24

Table 31. 2.5-inch hot-swap PCIe 4.0 NVMe SSDs

Part number	Feature code	Description	SED support	Max Qty
2.5-inch SSDs - U.2 PCIe 4.0 NVMe - Mixed Use/Mainstream (3-5 DWPD)				
4XB7A17129	BNEG	ThinkSystem 2.5" U.2 P5620 1.6TB Mixed Use NVMe PCIe 4.0 x4 HS SSD	Support	24
4XB7A17130	BNEH	ThinkSystem 2.5" U.2 P5620 3.2TB Mixed Use NVMe PCIe 4.0 x4 HS SSD	Support	24
4XB7A17133	BNEZ	ThinkSystem 2.5" U.2 P5620 6.4TB Mixed Use NVMe PCIe 4.0 x4 HS SSD	Support	24

Part number	Feature code	Description	SED support	Max Qty
2.5-inch SSDs - U.3 PCIe 4.0 NVMe - Mixed Use/Mainstream (3-5 DWPD)				
4XB7A79639	BNF1	ThinkSystem 2.5" U.3 7450 MAX 800GB Mixed Use NVMe PCIe 4.0 x4 HS SSD	Support	24
4XB7A13967	BNEJ	ThinkSystem 2.5" U.3 7450 MAX 1.6TB Mixed Use NVMe PCIe 4.0 x4 HS SSD	Support	24
4XB7A13970	BNEY	ThinkSystem 2.5" U.3 7450 MAX 3.2TB Mixed Use NVMe PCIe 4.0 x4 HS SSD	Support	24
4XB7A13971	BNEL	ThinkSystem 2.5" U.3 7450 MAX 6.4TB Mixed Use NVMe PCIe 4.0 x4 HS SSD	Support	24
4XB7A17112	B96Z	ThinkSystem U.3 Kioxia CM6-V 1.6TB Mainstream NVMe PCIe4.0 x4 Hot Swap SSD	No	24
2.5-inch SSDs - U.2 PCIe 4.0 NVMe - Read Intensive/Entry (<3 DWPD)				
4XB7A13941	BMGD	ThinkSystem 2.5" U.2 P5520 1.92TB Read Intensive NVMe PCIe 4.0 x4 HS SSD	Support	24
4XB7A13942	BMGE	ThinkSystem 2.5" U.2 P5520 3.84TB Read Intensive NVMe PCIe 4.0 x4 HS SSD	Support	24
4XB7A13943	BNEF	ThinkSystem 2.5" U.2 P5520 7.68TB Read Intensive NVMe PCIe 4.0 x4 HS SSD	Support	24
4XB7A13631	BNEQ	ThinkSystem 2.5" U.2 P5520 15.36TB Read Intensive NVMe PCIe 4.0 x4 HS SSD	Support	24
4XB7A17145	BCFT	ThinkSystem 2.5" U.2 P5500 1.92TB Read Intensive NVMe PCIe 4.0 x4 HS SSD	No	24
2.5-inch SSDs - U.3 PCIe 4.0 NVMe - Read Intensive/Entry (<3 DWPD)				
4XB7A81951	BPKX	ThinkSystem 2.5" U.3 PM1733a 1.92TB Read Intensive NVMe PCIe 4.0 x4 HS SSD	Support	24
4XB7A81952	BPKY	ThinkSystem 2.5" U.3 PM1733a 3.84TB Read Intensive NVMe PCIe 4.0 x4 HS SSD	Support	24
4XB7A81953	BPKZ	ThinkSystem 2.5" U.3 PM1733a 7.68TB Read Intensive NVMe PCIe 4.0 x4 HS SSD	Support	24
4XB7A81954	BPL0	ThinkSystem 2.5" U.3 PM1733a 15.36TB Read Intensive NVMe PCIe 4.0 x4 HS SSD	Support	24
4XB7A79646	BNF3	ThinkSystem 2.5" U.3 7450 PRO 960GB Read Intensive NVMe PCIe 4.0 x4 HS SSD	Support	24
4XB7A79647	BNF2	ThinkSystem 2.5" U.3 7450 PRO 1.92TB Read Intensive NVMe PCIe 4.0 x4 HS SSD	Support	24
4XB7A79648	BNF5	ThinkSystem 2.5" U.3 7450 PRO 3.84TB Read Intensive NVMe PCIe 4.0 x4 HS SSD	Support	24
4XB7A79649	BNF4	ThinkSystem 2.5" U.3 7450 PRO 7.68TB Read Intensive NVMe PCIe 4.0 x4 HS SSD	Support	24
4XB7A83097	BQAV	ThinkSystem 2.5" U.3 7450 PRO 15.36TB Read Intensive NVMe PCIe 4.0 x4 HS SSD	Support	24

Note: NVMe PCIe SSDs support surprise hot removal and hot insertion, provided the operating system supports PCIe SSD hot-swap.

Table 32. 2.5-inch hot-swap PCIe 3.0 NVMe SSDs

Part number	Feature code	Description	SED support	Max Qty
2.5-inch SSDs - U.2 PCIe 3.0 NVMe - Read Intensive/Entry (<3 DWPD)				

Note: NVMe PCIe SSDs support surprise hot removal and hot insertion, provided the operating system supports PCIe SSD hot-swap.

Table 33. 3.5-inch hot-swap 12 Gb SAS HDDs

Part number	Feature code	Description	SED support	Max Qty
3.5-inch hot-swap HDDs - 12 Gb SAS 10K				
7XB7A00063	B1JJ	ThinkSystem 3.5" 300GB 10K SAS 12Gb Hot Swap 512n HDD	No	14
4XB7A77004	BK12	ThinkSystem 3.5" 1.2TB 10K SAS 12Gb Hot Swap 512n HDD	No	14
3.5-inch hot-swap HDDs - 12 Gb SAS 15K				
7XB7A00038	AUU2	ThinkSystem 3.5" 300GB 15K SAS 12Gb Hot Swap 512n HDD	No	14
7XB7A00039	AUU3	ThinkSystem 3.5" 600GB 15K SAS 12Gb Hot Swap 512n HDD	No	14
7XB7A00040	AUUC	ThinkSystem 3.5" 900GB 15K SAS 12Gb Hot Swap 512e HDD	No	14
3.5-inch hot-swap HDDs - 12 Gb NL SAS				
7XB7A00042	AUU5	ThinkSystem 3.5" 2TB 7.2K SAS 12Gb Hot Swap 512n HDD	No	14
7XB7A00043	AUU6	ThinkSystem 3.5" 4TB 7.2K SAS 12Gb Hot Swap 512n HDD	No	14
7XB7A00044	AUU7	ThinkSystem 3.5" 6TB 7.2K SAS 12Gb Hot Swap 512e HDD	No	14
7XB7A00045	B0YR	ThinkSystem 3.5" 8TB 7.2K SAS 12Gb Hot Swap 512e HDD	No	14
7XB7A00046	AUUG	ThinkSystem 3.5" 10TB 7.2K SAS 12Gb Hot Swap 512e HDD	No	14
7XB7A00067	B117	ThinkSystem 3.5" 12TB 7.2K SAS 12Gb Hot Swap 512e HDD	No	14
4XB7A13906	B496	ThinkSystem 3.5" 14TB 7.2K SAS 12Gb Hot Swap 512e HDD	No	14
4XB7A13911	B7EZ	ThinkSystem 3.5" 16TB 7.2K SAS 12Gb Hot Swap 512e HDD	No	14
4XB7A38266	BCFP	ThinkSystem 3.5" 18TB 7.2K SAS 12Gb Hot Swap 512e HDD	No	14
4XB7A80353	BPKU	ThinkSystem 3.5" 20TB 7.2K SAS 12Gb Hot Swap 512e HDD	No	14
3.5-inch hot-swap SED HDDs - 12 Gb NL SAS				
7XB7A00065	B0YN	ThinkSystem 3.5" 2TB 7.2K SAS 12Gb Hot Swap 512e HDD FIPS	Support	14
7XB7A00047	AUUH	ThinkSystem 3.5" 4TB 7.2K SAS 12Gb Hot Swap 512n HDD FIPS	Support	14
7XB7A00048	B0YP	ThinkSystem 3.5" 6TB 7.2K SAS 12Gb Hot Swap 512e HDD FIPS	Support	14
7XB7A00066	B0YQ	ThinkSystem 3.5" 8TB 7.2K SAS 12Gb Hot Swap 512e HDD FIPS	Support	14

Table 34. 3.5-inch hot-swap 6 Gb SATA HDDs

Part number	Feature code	Description	SED support	Max Qty
3.5-inch hot-swap HDDs - 6 Gb NL SATA				
7XB7A00049	AUUF	ThinkSystem 3.5" 1TB 7.2K SATA 6Gb Hot Swap 512n HDD	No	14
7XB7A00050	AUUD	ThinkSystem 3.5" 2TB 7.2K SATA 6Gb Hot Swap 512n HDD	No	14
7XB7A00051	AUU8	ThinkSystem 3.5" 4TB 7.2K SATA 6Gb Hot Swap 512n HDD	No	14
7XB7A00052	AUUA	ThinkSystem 3.5" 6TB 7.2K SATA 6Gb Hot Swap 512e HDD	No	14
7XB7A00053	AUU9	ThinkSystem 3.5" 8TB 7.2K SATA 6Gb Hot Swap 512e HDD	No	14
7XB7A00054	AUUB	ThinkSystem 3.5" 10TB 7.2K SATA 6Gb Hot Swap 512e HDD	No	14
7XB7A00068	B118	ThinkSystem 3.5" 12TB 7.2K SATA 6Gb Hot Swap 512e HDD	No	14
4XB7A13907	B497	ThinkSystem 3.5" 14TB 7.2K SATA 6Gb Hot Swap 512e HDD	No	14
4XB7A13914	B7F0	ThinkSystem 3.5" 16TB 7.2K SATA 6Gb Hot Swap 512e HDD	No	14
4XB7A38130	BCFH	ThinkSystem 3.5" 18TB 7.2K SATA 6Gb Hot Swap 512e HDD	No	14
4XB7A80354	BPKV	ThinkSystem 3.5" 20TB 7.2K SATA 6Gb Hot Swap 512e HDD	No	14

Table 35. 3.5-inch hot-swap 24 Gb SAS SSDs

Part number	Feature code	Description	SED support	Max Qty
3.5-inch hot-swap SSDs - 24 Gb SAS - Mixed Use/Mainstream (3-5 DWPD)				
4XB7A80344	BNW7	ThinkSystem 3.5" PM1655 800GB Mixed Use SAS 24Gb HS SSD	Support	14
4XB7A80345	BNWA	ThinkSystem 3.5" PM1655 1.6TB Mixed Use SAS 24Gb HS SSD	Support	14
4XB7A80346	BNWB	ThinkSystem 3.5" PM1655 3.2TB Mixed Use SAS 24Gb HS SSD	Support	14
4XB7A80347	BP3G	ThinkSystem 3.5" PM1655 6.4TB Mixed Use SAS 24Gb HS SSD	Support	14
3.5-inch hot-swap SSDs - 24 Gb SAS - Read Intensive/Entry/Capacity (<3 DWPD)				
4XB7A80324	BNWD	ThinkSystem 3.5" PM1653 960GB Read Intensive SAS 24Gb HS SSD	Support	14
4XB7A80325	BNWG	ThinkSystem 3.5" PM1653 1.92TB Read Intensive SAS 24Gb HS SSD	Support	14
4XB7A80326	BNWH	ThinkSystem 3.5" PM1653 3.84TB Read Intensive SAS 24Gb HS SSD	Support	14
4XB7A80327	BP3F	ThinkSystem 3.5" PM1653 7.68TB Read Intensive SAS 24Gb HS SSD	Support	14
4XB7A80328	BP3H	ThinkSystem 3.5" PM1653 15.36TB Read Intensive SAS 24Gb HS SSD	Support	14

Table 36. 3.5-inch hot-swap 12 Gb SAS SSDs

Part number	Feature code	Description	SED support	Max Qty
3.5-inch hot-swap SSDs - 12 Gb SAS - Write Intensive/Performance (10+ DWPD)				
4XB7A83219	BR0V	ThinkSystem 3.5" Nytro 3750 800GB Write Intensive SAS 12Gb HS SSD	Support	14
4XB7A83220	BR0U	ThinkSystem 3.5" Nytro 3750 1.6TB Write Intensive SAS 12Gb HS SSD	Support	14
4XB7A83221	BR0T	ThinkSystem 3.5" Nytro 3750 3.2TB Write Intensive SAS 12Gb HS SSD	Support	14

Table 37. 3.5-inch hot-swap 6 Gb SATA SSDs

Part number	Feature code	Description	SED support	Max Qty
3.5-inch hot-swap SSDs - 6 Gb SATA - Mixed Use/Mainstream (3-5 DWPD)				
4XB7A17137	BA4W	ThinkSystem 3.5" S4620 480GB Mixed Use SATA 6Gb HS SSD	No	14
4XB7A17138	BA4X	ThinkSystem 3.5" S4620 960GB Mixed Use SATA 6Gb HS SSD	No	14
4XB7A17139	BA4Y	ThinkSystem 3.5" S4620 1.92TB Mixed Use SATA 6Gb HS SSD	No	14
4XB7A17140	BK7P	ThinkSystem 3.5" S4620 3.84TB Mixed Use SATA 6Gb HS SSD	No	14
4XB7A17097	B8JF	ThinkSystem 3.5" 5300 480GB Mainstream SATA 6Gb Hot Swap SSD	No	14
3.5-inch hot-swap SSDs - 6 Gb SATA - Read Intensive/Entry (<3 DWPD)				
4XB7A88456	BW3S	ThinkSystem 3.5" 5400 PRO 480GB Read Intensive SATA 6Gb HS SSD	Support	14
4XB7A17118	BA7K	ThinkSystem 3.5" S4520 240GB Read Intensive SATA 6Gb HS SSD	No	14
4XB7A17119	BA7L	ThinkSystem 3.5" S4520 480GB Read Intensive SATA 6Gb HS SSD	No	14
4XB7A17120	BA7M	ThinkSystem 3.5" S4520 960GB Read Intensive SATA 6Gb HS SSD	No	14
4XB7A17121	BA7N	ThinkSystem 3.5" S4520 1.92TB Read Intensive SATA 6Gb HS SSD	No	14
4XB7A17122	BK7F	ThinkSystem 3.5" S4520 3.84TB Read Intensive SATA 6Gb HS SSD	No	14
4XB7A17123	BK7G	ThinkSystem 3.5" S4520 7.68TB Read Intensive SATA 6Gb HS SSD	No	14
4XB7A38277	BCTJ	ThinkSystem 3.5" Multi Vendor 480GB Entry SATA 6Gb Hot Swap SSD	No	14
4XB7A38278	BCTK	ThinkSystem 3.5" Multi Vendor 960GB Entry SATA 6Gb Hot Swap SSD	No	14
4XB7A38279	BCTL	ThinkSystem 3.5" Multi Vendor 1.92TB Entry SATA 6Gb Hot Swap SSD	No	14
4XB7A38281	BCTM	ThinkSystem 3.5" Multi Vendor 3.84TB Entry SATA 6Gb Hot Swap SSD	No	14
4XB7A17082	B8J9	ThinkSystem 3.5" 5300 480GB Entry SATA 6Gb Hot Swap SSD	No	14
4XB7A17085	B8HQ	ThinkSystem 3.5" 5300 3.84TB Entry SATA 6Gb Hot Swap SSD	No	14

Table 38. 3.5-inch hot-swap PCIe 4.0 NVMe SSDs

Part number	Feature code	Description	SED support	Max Qty
3.5-inch SSDs - U.2 PCIe 4.0 NVMe - Mixed Use/Mainstream (3-5 DWPD)				
4XB7A17141	BNEK	ThinkSystem 3.5" U.2 P5620 1.6TB Mixed Use NVMe PCIe 4.0 x4 HS SSD	Support	4
4XB7A17143	BNEM	ThinkSystem 3.5" U.2 P5620 3.2TB Mixed Use NVMe PCIe 4.0 x4 HS SSD	Support	4
4XB7A17144	BNEN	ThinkSystem 3.5" U.2 P5620 6.4TB Mixed Use NVMe PCIe 4.0 x4 HS SSD	Support	4
3.5-inch SSDs - U.3 PCIe 4.0 NVMe - Mixed Use/Mainstream (3-5 DWPD)				
4XB7A17115	B96V	ThinkSystem 3.5" Kioxia CM6-V 1.6TB Mainstream NVMe PCIe4.0 x4 Hot Swap SSD	No	4

Note: NVMe PCIe SSDs support surprise hot removal and hot insertion, provided the operating system supports PCIe SSD hot-swap.

Table 39. 3.5-inch hot-swap PCIe 3.0 NVMe SSDs

Part number	Feature code	Description	SED support	Max Qty
3.5-inch SSDs - U.2 PCIe 3.0 NVMe - Read Intensive/Entry (<3 DWPD)				

Note: NVMe PCIe SSDs support surprise hot removal and hot insertion, provided the operating system supports PCIe SSD hot-swap.

Table 40. M.2 SATA drives

Part number	Feature code	Description	SED support	Max Qty
M.2 SSDs - 6 Gb SATA - Read Intensive/Entry (<3 DWPD)				
4XB7A90105	BXMK	ThinkSystem M.2 ER2 240GB Read Intensive SATA 6Gb NHS SSD (China only)	Support	2*
4XB7A90106	BXMJ	ThinkSystem M.2 ER2 480GB Read Intensive SATA 6Gb NHS SSD (China only)	Support	2*
4XB7A82286	BQ1Z	ThinkSystem M.2 5400 PRO 240GB Read Intensive SATA 6Gb NHS SSD	Support	2*
4XB7A82287	BQ1Y	ThinkSystem M.2 5400 PRO 480GB Read Intensive SATA 6Gb NHS SSD	Support	2*
7N47A00129	AUUL	ThinkSystem M.2 32GB SATA 6Gbps Non-Hot Swap SSD	No	2
7N47A00130	AUUV	ThinkSystem M.2 128GB SATA 6Gbps Non-Hot Swap SSD	No	2
4XB7A17073	B919	ThinkSystem M.2 5300 480GB SATA 6Gbps Non-Hot Swap SSD	No	2*

* The 5400 M.2 or ER2 drives may require the SSD Thermal Kit, 4XH7A08791. See the [Cooling](#) section for details.

USB memory key

For general portable storage needs, the server also supports the USB memory key option that is listed in the following table.

Table 41. USB memory key

Part number	Feature	Description
4X77A08621	B8NV	ThinkSystem 32GB USB Flash Drive

Optical drives

The server supports the external USB optical drive listed in the following table.

Table 42. External optical drive

Part number	Feature code	Description
7XA7A05926	AVV8	ThinkSystem External USB DVD RW Optical Disk Drive

The drive is based on the Lenovo Slim DVD Burner DB65 drive and supports the following formats: DVD-RAM, DVD-RW, DVD+RW, DVD+R, DVD-R, DVD-ROM, DVD-R DL, CD-RW, CD-R, CD-ROM.

I/O expansion

The SR650 server supports one LOM card slot and up to seven PCIe slots: one slot on the system planar that is dedicated to an internal storage controller, one regular PCIe slot on the system planar, and up to five PCIe slots with different riser cards installed into two riser sockets on the system planar (one riser socket supports installation of one riser card).

The slot form factors are as follows:

- LOM card slot
- Slot 1: PCIe 3.0 x16 or PCIe 3.0 x8; full-height, half-length (PCIe x16 slot can be single- or double-wide)
- Slot 2: PCIe 3.0 x8; full-height, half-length (not present if Slot 1 is PCIe x16 double-wide or Slot 3 is ML2 x16)
- Slot 3: PCIe 3.0 x8, or PCIe 3.0 x16, or ML2 x8, or ML2 x16; full-height, half-length
- Slot 4: PCIe 3.0 x8; low profile (vertical slot on system planar)
- Slot 5: PCIe 3.0 x16; full-height, half-length
- Slot 6: PCIe 3.0 x16; full-height, half-length
- Slot 7: PCIe 3.0 x8 (for an internal storage controller)

Configuration notes:

- Slots 5 and 6 require the second processor to be installed.
- Single-wide PCIe 3.0 x16 Slot 1 requires the second processor to be installed.
- The following configurations require the single-wide PCIe 3.0 x16 Slot 1:
 - 24 NVMe PCIe drive bays.
 - Two double-wide GPUs and one PCIe x16 adapter.
- Slots 1 - 3 are not present if the Rear HDD Kit is installed.
- Slots 1, 5, and 6 can be enabled for full-length PCIe adapters (such as GPU adapters):
 - Factory-installed GPUs: When a GPU adapter is selected, all required parts are derived.
 - Factory-enabled full-length support (no adapters included): Select the feature code B3RY, and all required parts will be derived based on the number of processors and PCIe riser cards selected.
 - Field upgrades: Refer to [Cooling](#) for upgrade kit requirements.

The locations of the PCIe slots are shown in the following figure.

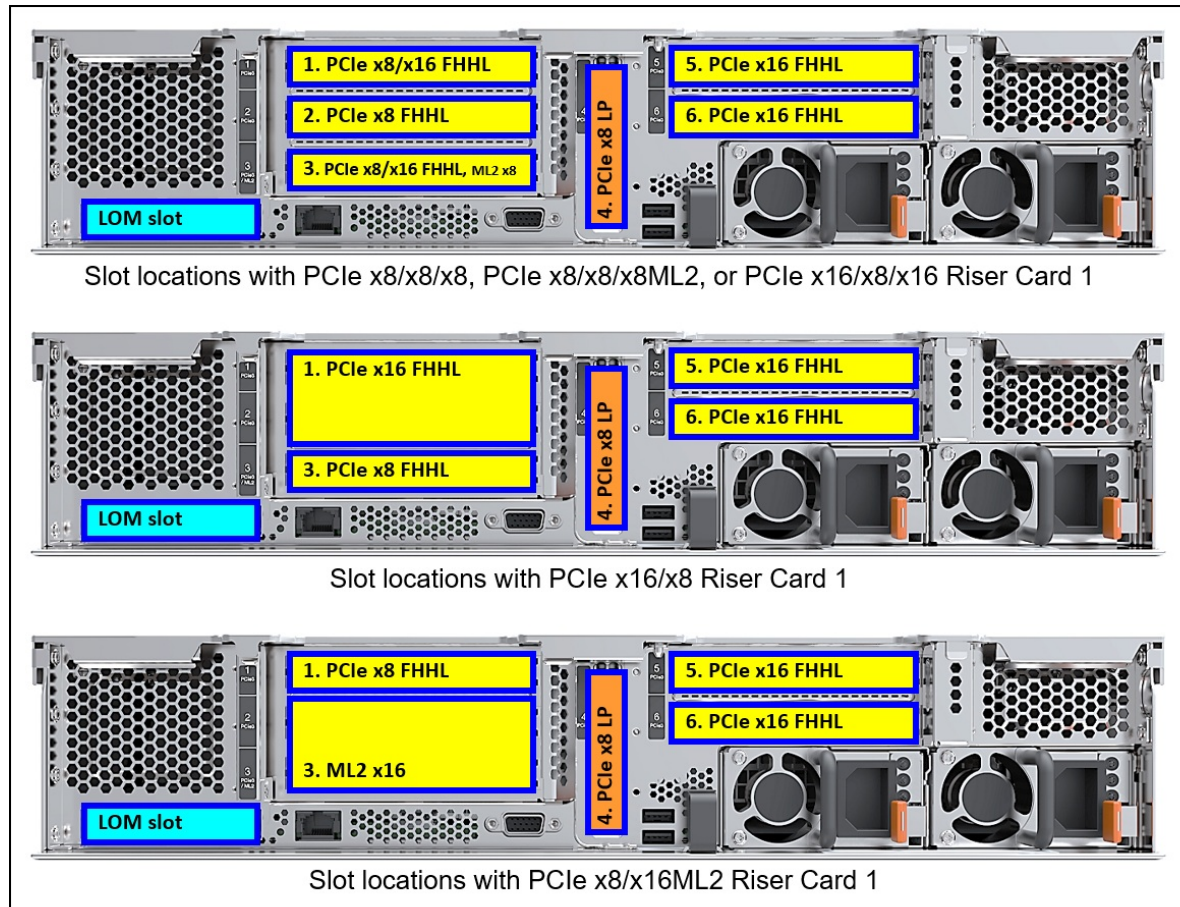

Figure 11. Slot locations

Riser 1 supplies slots 1, 2, and 3, and Riser 2 supplies slots 5 and 6. The slots that are available for use depend on the number of riser cards that are installed and whether the second processor is installed, as shown in the following table.

Table 43. Slots available for use

Riser Card 1	Riser Card 2	Slots available for use	
		Processor 1	Processor 2
None	None	LOM, 4, 7	-
None	PCIe x16/x16	LOM, 4, 7	5, 6
PCIe x8/x8/x8 or PCIe x8/x8/x8ML2	None	LOM, 1, 2, 3, 4, 7	-
PCIe x16/x8 or PCIe x8/x16ML2	None	LOM, 1, 3, 4, 7	-
PCIe x8/x8/x8 or PCIe x8/x8/x8ML2	PCIe x16/x16	LOM, 1, 2, 3, 4, 7	5, 6
PCIe x16/x8 or PCIe x8/x16ML2	PCIe x16/x16	LOM, 1, 3, 4, 7	5, 6
PCIe x16/x8/x16	PCIe x16/x16	LOM, 2, 3, 4, 7	1, 5, 6

The following table lists available PCIe riser card options.

Table 44. PCIe riser cards and miscellaneous options

Part number	Feature code	Description	Maximum quantity
x8 Riser Card 1 options (Riser card 1 supplies slots 1, 2, and 3)			
7XH7A02677	AUR4	ThinkSystem 2U x8/x8/x8 PCIe FH Riser 1	1
7XH7A02680	AUR7	ThinkSystem 2U x8/x8/x8ML2 PCIe FH Riser 1	1
4XH7A09902	B4PB	ThinkSystem SR650 x16/x8/x16 PCIe FH Riser 1	1
x16 Riser Card 1 options (Riser card 1 supplies slots 1 and 3)			
7XH7A02678	AUR3	ThinkSystem 2U x16/x8 PCIe FH Riser 1	1
7XH7A02681	AURB	ThinkSystem SR650 x8/x16ML2 PCIe FH Riser 1 Kit	1
Riser Card 2 option (Riser card 2 supplies slots 5 and 6)			
4TA7A70026	None	ThinkSystem SR650 x16/x8(or x16) PCIe FH Riser 2 Kit V2	1
7XH7A02679	AURC	ThinkSystem SR550/SR650 (x16/x8)/(x16/x16) PCIe FH Riser 2 Kit	1
Serial port upgrade kit			
4Z17A80446	BMNJ	ThinkSystem COM Port Upgrade Kit v2	1
7Z17A02577	AUSL	ThinkSystem COM Port Upgrade Kit	1

Configuration notes:

- If the PCIe x16/x8/x16 Riser Card (4XH7A09902) is installed, the onboard NVMe interface cannot be used for connections to U.2 NVMe or AnyBay drive bays.
- In the configurations with 16x 2.5-inch U.2 NVMe PCIe drive bays, the PCIe 3.0 x8 Slot 3 and PCIe 3.0 x16 Slot 5 are available, and the remaining slots are occupied by the NVMe switch adapters.
Note: If the additional 8-bay SAS/SATA backplane is installed, only the PCIe 3.0 x16 Slot 5 is available (the PCIe 3.0 x8 Slot 3 is occupied by an internal storage controller).
- In the configurations with 20x 2.5-inch U.2 NVMe PCIe drive bays, the PCIe 3.0 x8 Slot 3 is available, and the remaining slots are occupied by the NVMe switch adapters.
- In the configurations with 24x 2.5-inch U.2 NVMe PCIe drive bays, the PCIe 3.0 x16 Slots 3 and 5 are available, and the remaining slots are occupied by the NVMe switch adapters.
- For field upgrades to add an NVIDIA A-Series GPU (A100, A6000, A30, A16, A10, A2), the use of Riser 2 V2 riser kit (4TA7A70026) is required when the GPU is to be installed in slot 5. The older Riser 2 kit (7XH7A02679, now withdrawn) is not supported with the A100. For CTO orders, feature code BF9Y will be used for the correct Riser 2 bracket.
- The COM Port Upgrade Kit, part number 7Z17A02577, is used for mounting the external serial port on the rear of the SR650 server, and it includes the bracket and the cable. The COM Port option is mounted in place of one of the PCIe slots 1 - 6, and that PCIe slot cannot be used.

Network adapters

The SR650 server supports up to four onboard network ports with optional LOM cards that use the Intel Ethernet Connection X722 1/10 GbE technology integrated into the Intel C624 Platform Controller Hub (PCH). The server also supports ML2 adapters that are installed in the custom ML2 slot provided by an ML2 riser card. The LOM cards and ML2 network adapters support direct connectivity to the XClarity Controller via the Network Controller Sideband Interface (NSCI) for out-of-band systems management.

The integrated Intel Ethernet Connection X722 has the following features:

- Four 1/10 Gb Ethernet capable ports (no 10/100 Mb Ethernet support)
- NIC Teaming (load balancing and failover)
- Data Center Bridging
- iWARP (RDMA over IP)
- VMDq and SR-IOV virtualization (10 Gb speeds only, 4 PFs, 128 VFs per device)
- IEEE 802.1q Virtual Local Area Networks (VLANs)
- NVGRE, VXLAN, IPinGRE, and MACinUDP network virtualization
- IEEE 802.1Qbg Edge Virtual Bridging
- TCP, IP, and UDP checksum offload
- Large Send Offload (LSO) and Generic Send Offload (GSO)
- Receive Side Scaling (RSS) for TCP and UDP traffic
- Jumbo frames up to 9.5 Kbytes

The following table lists the network adapters that are supported with the SR650 server.

Table 45. Network adapters

Part number	Feature code	Description	Max qty#	I/O slots supported
LOM cards - 1 Gb Ethernet				
7ZT7A00545	AUKH	ThinkSystem 1Gb 4-port RJ45 LOM	1	LOM slot
LOM cards - 10 Gb Ethernet				
7ZT7A00548	AUKL	ThinkSystem 10Gb 2-port Base-T LOM	1	LOM slot
7ZT7A00546	AUKJ	ThinkSystem 10Gb 2-port SFP+ LOM	1*	LOM slot
7ZT7A00549	AUKM	ThinkSystem 10Gb 4-port Base-T LOM	1	LOM slot
7ZT7A00547	AUKK	ThinkSystem 10Gb 4-port SFP+ LOM	1*	LOM slot
ML2 adapters - 10 Gb Ethernet				
ML2 adapters - 25 Gb Ethernet				
7ZT7A00507	AUKU	Mellanox ConnectX-4 Lx 10/25GbE SFP28 2-port ML2 Ethernet Adapter	1*	3 (ML2)
PCIe Low Profile adapters - 1 Gb Ethernet				
7ZT7A00482	AUZX	Broadcom 5720 1GbE RJ45 2-Port PCIe Ethernet Adapter	4 / 6	4, 2, 6, 3, 5, 1
7ZT7A00484	AUZV	Broadcom 5719 1GbE RJ45 4-Port PCIe Ethernet Adapter	4 / 6	4, 2, 6, 3, 5, 1
7ZT7A00535	AUZW	ThinkSystem I350-T4 PCIe 1Gb 4-Port RJ45 Ethernet Adapter	4 / 6	4, 2, 6, 3, 5, 1
4XC7A62589§	BE8A§	SiNEAD I350-C4 PCIe 1Gb 4-Port RJ45 Ethernet Adapter	4 / 6	4, 2, 6, 3, 5, 1
PCIe Low Profile adapters - 10 Gb Ethernet				
7ZT7A00496	AUKP	Broadcom 57416 10GBASE-T 2-Port PCIe Ethernet Adapter	4 / 6	4, 2, 6, 3, 5, 1
00AG570	AT7S	Emulex VFA5.2 2x10 GbE SFP+ PCIe Adapter	4 / 6*	4, 2, 6, 3, 5, 1
00MM860	ATPX	Intel X550-T2 Dual Port 10GBase-T Adapter	4 / 6	4, 2, 6, 3, 5, 1
7ZT7A00537	AUKX	Intel X710-DA2 PCIe 10Gb 2-Port SFP+ Ethernet Adapter	4 / 6*	4, 2, 6, 3, 5, 1

Part number	Feature code	Description	Max qty#	I/O slots supported
4XC7A79699	BMXB	ThinkSystem Intel X710-T4L 10GBase-T 4-Port PCIe Ethernet Adapter	4 / 6	4, 2, 6, 3, 5, 1
PCIe Full Height adapters - 10 Gb Ethernet				
7ZT7A00493	AUKN	Emulex OCe14104B-NX PCIe 10Gb 4-Port SFP+ Ethernet Adapter	3 / 5*	2, 6, 3, 5, 1
PCIe Low Profile adapters - 25 Gb Ethernet				
4XC7A08238	B5T0	Broadcom 57414 10/25GbE SFP28 2-port PCIe Ethernet Adapter	4 / 6*	4, 2, 6, 3, 5, 1
4XC7A08316	BD49	Broadcom 57454 10/25GbE SFP28 4-port PCIe Ethernet Adapter V2	1 / 3*	1, 6, 5, 3
4XC7A08295	BCD6	Intel E810-DA2 10/25GbE SFP28 2-Port PCIe Ethernet Adapter	4 / 6*	4, 2, 6, 3, 5, 1
7XC7A05523	B0WY	Intel XXV710-DA2 10/25GbE SFP28 2-Port PCIe Ethernet Adapter	4 / 6*	4, 2, 6, 3, 5, 1
01GR250	AUAJ	Mellanox ConnectX-4 Lx 10/25GbE SFP28 2-Port PCIe Ethernet Adapter	4 / 6*	4, 2, 6, 3, 5, 1
4XC7A62574	BEAP	Mellanox ConnectX-5 EN 10/25GbE SFP28 2-port PCIe Ethernet Adapter	4 / 6*	4, 2, 6, 3, 5, 1
4XC7A62580	BE4U	Mellanox ConnectX-6 Lx 10/25GbE SFP28 2-Port PCIe Ethernet Adapter	4 / 6*	4, 2, 6, 3, 5, 1
4XC7A62581	BHE2	Solarflare X2522-Plus 10/25GbE SFP28 2-Port PCIe Ethernet Adapter	4 / 6*	4, 2, 6, 3, 5, 1
PCIe Low Profile adapters - 40 Gb Ethernet				
4XC7A08229	B31C	Mellanox ConnectX-5 Ex 25/40GbE 2-port Low-Latency Adapter	1 / 3*^	1, 5, 6†
PCIe Low Profile adapters - FDR InfiniBand				
PCIe x16 Low Profile adapters - 100 Gb Ethernet				
4XC7A08248	B8PP	Mellanox ConnectX-6 Dx 100GbE QSFP56 2-port PCIe Ethernet Adapter	1 / 3*	1, 5, 6†
4XC7A76757	BLC2	ThinkSystem Xilinx Alveo U50 Data Center Accelerator Adapter	1 / 2*	1, 5 [□]
PCIe x16 Low Profile adapters - 100 Gb Ethernet / HDR100 InfiniBand				
4C57A14177	B4R9	ThinkSystem Mellanox ConnectX-6 HDR100/100GbE QSFP56 1-port PCIe VPI Adapter	1 / 2*	1, 6, 5, 3†
4C57A14178	B4RA	ThinkSystem Mellanox ConnectX-6 HDR100/100GbE QSFP56 2-port PCIe VPI Adapter	1 / 2*	1, 6, 5, 3†
PCIe x16 Low Profile adapters - 200 Gb Ethernet / HDR InfiniBand				
4C57A15326	B4RC	ThinkSystem Mellanox ConnectX-6 HDR/200GbE QSFP56 1-port PCIe 4 VPI Adapter	1 / 1*	1†‡
4C57A14179	B4RB	Mellanox HDR/200GbE 2x PCIe Aux Kit	1 / 1*	5, 6†‡
PCIe Low Profile adapters - Omni-Path				
00WE023	AU0A	Intel OPA 100 Series Single-port PCIe 3.0 x8 HFA	4 / 6*	4, 2, 6, 3, 5, 1
00WE027	AU0B	Intel OPA 100 Series Single-port PCIe 3.0 x16 HFA	1 / 3*	1, 5, 6†

The maximum quantity shown is with one processor / two processors (this does not apply to LOM cards and ML2 adapters).

* The adapter comes without transceivers or cables; for ordering transceivers or cables, see the product guide for the adapter.

† The adapter is supported in the PCIe x16 slots supplied by the riser cards 1 and 2.

^ The 25 GbE connectivity requires the optional Mellanox QSA 100G to 25G Cable Adapter (4G17A10853) (one per port); the supported cables include 25 GbE passive DAC and active optical cables (25 GbE transceivers not supported)

‡ The ConnectX-6 HDR adapter is supported only in the configurations with two processors, and it requires the HDR/200GbE 2x PCIe Aux Kit.

§ The SiNEAD I350-C4 adapter is only available for customers in Mainland China (PRC). Not supported installed with Intel I350 adapters.

▣ When the Xilinx Alveo U50 is installed in slot 5, slot 6 should be left empty; When the Xilinx Alveo U50 is installed in slot 1, slot 2 should be left empty and slot 3 can only be occupied by adapters of less than 25W power consumption.

For more information, see the list of Product Guides in the Ethernet Adapters category:

<http://lenovopress.com/servers/options/ethernet#rt=product-guide>

Configuration notes:

- ML2 network adapters are supported in the ML2 x8 slot 3 supplied by the x8/x8/x8ML2 Riser Card 1 (7XH7A02680).
- PCIe full-height network adapters are supported in the full-height PCIe x8 and x16 slots supplied by the riser cards 1 and 2.
- PCIe x16 Low Profile network adapters are supported in the full-height PCIe x16 slots supplied by the riser cards 1 and 2.
- PCIe x8 or x4 Low Profile network adapters are supported in the low profile PCIe x8 slot 4 on the system board and full-height PCIe x8 and x16 slots supplied by the riser cards 1 and 2.
- The Mellanox HDR and HDR100 InfiniBand QSFP56 adapters are supported only in the configurations with up to 16x 2.5-inch or 8x 3.5-inch drive bays and only with an ambient temperature of up to 35 °C (95 °F). Not supported in 12x 3.5-inch or 24x 2.5-inch configurations.
- In the configurations with two double-wide GPU adapters and a PCIe x16 adapter, the following adapters are supported in the PCIe 3.0 x16 slot 3 supplied by the PCIe x16/x8/x16 Riser Card (4XH7A09902):
 - Mellanox ConnectX-4 1x100GbE/EDR IB QSFP28 VPI Adapter (00KH924)
 - Mellanox ConnectX-4 2x100GbE/EDR IB QSFP28 VPI Adapter (00MM960)
 - Mellanox ConnectX-5 Ex 25/40GbE 2-port Low-Latency Adapter (4XC7A08229)
 - Intel OPA 100 Series Single-port PCIe 3.0 x16 HFA (00WE027)
- Supported transceivers or DAC cables should be purchased for the SFP+, SFP28, QSFP+, and QSFP28 adapters, and UTP Category 6 or Category 5e cables should be purchased for the 10 GbE (Cat6) or 1 GbE (Cat5e or Cat6) RJ-45 adapters. The maximum number of transceivers or cables that are supported per adapter equals the quantity of the adapter ports, and all adapter ports must have the same type of the transceiver or cable selected. See the product guide for the adapter for the list of supported transceivers and cables.
- **E810 Ethernet and X350 RAID/HBAs:** The use of both an Intel E810 network adapter and an X350 HBA/RAID adapter (9350, 5350 and 4350) is currently not supported in ThinkSystem servers. For details see [Support Tip HT513226](#). Planned support for this combination of adapters is 2Q/2024.

SAS adapters for external storage

The following table lists SAS RAID controllers and HBAs for external storage attachments that are supported by the SR650 server.

Table 46. SAS RAID adapters and HBAs for external storage

Part number	Feature code	Description	Maximum quantity*	I/O slots supported
12 Gbps SAS RAID adapters				
4Y37A78836	BNWJ	ThinkSystem RAID 940-8e 4GB Flash PCIe Gen4 12Gb Adapter	4 / 4	4, 2, 3, 1, 5
12 Gbps SAS HBAs				
7Y37A01091	AUNN	ThinkSystem 430-16e SAS/SATA 12Gb HBA	4 / 5	4, 2, 3, 1, 5
4Y37A78837	BNWK	ThinkSystem 440-8e SAS/SATA PCIe Gen4 12Gb HBA	4 / 5	4, 2, 3, 1, 5
4Y37A09724	B8P7	ThinkSystem 440-16e SAS/SATA PCIe Gen4 12Gb HBA	4 / 5	4, 2, 3, 1, 5

* The maximum quantity shown is with one processor / two processors.

For a comparison of the functions of the supported storage adapters, see the ThinkSystem RAID Adapter and HBA Reference:

<https://lenovopress.com/lp1288#sr650-support=SR650&internal-or-external-ports=External>

Configuration notes:

- Low profile SAS RAID controllers and HBAs for external storage are supported in the low profile PCIe x8 slot 4 on the system board and full-high PCIe x8 and x16 slots supplied by the riser cards 1 and 2 (except slot 6).
- In the configurations without GPU installed, the total quantity of the RAID 730-8i 2GB, RAID 930-8i, RAID 930-16i, RAID 930-24i, and RAID 940-8e, and RAID 930-8e controllers in a supported combination in the server must not exceed 4 (up to 4 supercapacitors can be mounted in the server).
- In the configurations with GPU installed, the total quantity of the RAID 730-8i 2GB, RAID 930-8i, RAID 930-16i, RAID 930-24i, RAID 940-8e, and RAID 930-8e controllers in a supported combination in the server must not exceed 3 (up to 3 supercapacitors can be mounted in the server).

Mixing storage adapter families: The following HBA/RAID adapter combinations are supported:

- X30 external adapters with other X30 adapters (internal or external)
- X40 external adapters with other X40 adapters (internal or external)
- X40 external adapters with X350 internal adapters

The following HBA/RAID adapter combinations are *not* supported:

- X30 adapters (internal or external) with X40 adapters (internal or external)
- X30 adapters (internal or external) with X350 internal adapters

For more information, see the list of Product Guides in the following categories:

- RAID adapters
<http://lenovopress.com/servers/options/raid#rt=product-guide>
- Host bus adapters
<http://lenovopress.com/servers/options/hba#rt=product-guide>

Fibre Channel host bus adapters

The following table lists Fibre Channel HBAs supported by the SR650 server.

Table 47. Fibre Channel HBAs

Part number	Feature code	Description	Maximum quantity*	I/O slots supported
64 Gb Fibre Channel - PCIe				
4XC7A77485	BLC1	ThinkSystem Emulex LPe36002 64Gb 2-port PCIe Fibre Channel Adapter	4 / 6	4, 2, 6, 3, 5, 1
32 Gb Fibre Channel - PCIe				
4XC7A76525	BJ3H	ThinkSystem Emulex LPe35002 32Gb 2-port PCIe Fibre Channel Adapter V2	4 / 6	4, 2, 6, 3, 5, 1
4XC7A76498	BJ3G	ThinkSystem Emulex LPe35000 32Gb 1-port PCIe Fibre Channel Adapter v2	4 / 6	4, 2, 6, 3, 5, 1
4XC7A08250	B5SX	Emulex LPe35000 32Gb 1-port PCIe Fibre Channel Adapter	4 / 6	4, 2, 6, 3, 5, 1
4XC7A08251	B5SY	Emulex LPe35002 32Gb 2-port PCIe Fibre Channel Adapter	4 / 6	4, 2, 6, 3, 5, 1
7ZT7A00516	AUNS	QLogic QLE2740 PCIe 32Gb 1-Port SFP+ FC HBA	4 / 6	4, 2, 6, 3, 5, 1
7ZT7A00518	AUNU	QLogic QLE2742 PCIe 32Gb 2-Port SFP+ FC HBA	4 / 6	4, 2, 6, 3, 5, 1
16 Gb Fibre Channel - PCIe				
01CV830	ATZU	Emulex 16Gb Gen6 FC Single-port HBA	4 / 6	4, 2, 6, 3, 5, 1
01CV840	ATZV	Emulex 16Gb Gen6 FC Dual-port HBA	4 / 6	4, 2, 6, 3, 5, 1
01CV750	ATZB	QLogic 16Gb Enhanced Gen5 FC Single-port HBA	4 / 6	4, 2, 6, 3, 5, 1
01CV760	ATZC	QLogic 16Gb Enhanced Gen5 FC Dual-port HBA	4 / 6	4, 2, 6, 3, 5, 1
8 Gb Fibre Channel - PCIe (available only in PRC and AP)				

* The maximum quantity shown is with one processor / two processors.

Configuration note: FC HBAs are supported in the low profile PCIe x8 slot 4 on the system board and full-high PCIe x8 and x16 slots supplied by the riser cards 1 and 2.

For more information, see the list of Product Guides in the Host bus adapters category:

<http://lenovopress.com/servers/options/hba#rt=product-guide>

Flash storage adapters

The SR650 server supports the flash storage adapters listed in the following table.

Table 48. Flash storage adapters

Part number	Feature code	Description	Maximum quantity*	I/O slots supported
Mainstream Flash Adapters - PM1735				

* The maximum quantity shown is with one processor / two processors.

Configuration notes:

- Flash storage adapters are supported in the low profile PCIe x8 slot on the system board and full-high PCIe x8 and x16 slots supplied by the riser cards 1 and 2.
- Flash storage adapters are supported only in the environments with an ambient temperature of up to 35 °C (95 °F).
- Flash storage adapters are supported only with processors of up to 165 W TDP.
- Flash storage adapters are not supported with persistent memory

For more information, see the list of Product Guides in the Flash storage adapters category:
<http://lenovopress.com/servers/options/ssdadapter#rt=product-guide>

GPU adapters

The SR650 server supports graphics processing units (GPUs) listed in the following table.

Table 49. GPU adapters

Part number	Feature code	Description	Maximum quantity*	I/O slots supported
Single-wide PCIe x16 GPU adapters				
4X67A71311	BFTZ	ThinkSystem NVIDIA A10 24GB PCIe Gen4 Passive GPU	1 / 4	1, 5, 6, 2
CTO only	BQZS	ThinkSystem NVIDIA A10 24GB PCIe Gen4 Passive GPU w/o CEC	1 / 4	1, 5, 6, 2
4X67A81547	BP05	ThinkSystem NVIDIA A2 16GB PCIe Gen4 Passive GPU	3 / 5	1, 2, 3, 5, 6
CTO only	BQZT	ThinkSystem NVIDIA A2 16GB PCIe Gen4 Passive GPU w/o CEC	3 / 5	1, 2, 3, 5, 6
4X67A14926	B4YB	ThinkSystem NVIDIA Tesla T4 16GB PCIe Passive GPU	3 / 5§	1, 2, 3, 5, 6
Double-wide PCIe x16 GPU adapters				
4X67A76715	BLK1	ThinkSystem NVIDIA A100 80GB PCIe Gen4 Passive GPU	1 / 2	1, 5
CTO only	BQZP	ThinkSystem NVIDIA A100 80GB PCIe Gen4 Passive GPU w/o CEC	1 / 2	1, 5
4X67A86324	BUGD	ThinkSystem NVIDIA A800 80GB PCIe Gen4 Passive GPU	1 / 2	1, 5
4X67A76581	BJHG	ThinkSystem NVIDIA A30 24GB PCIe Gen4 Passive GPU	1 / 2	1, 5
CTO only	BQZR	ThinkSystem NVIDIA A30 24GB PCIe Gen4 Passive GPU w/o CEC	1 / 2	1, 5
4X67A76727	BNFE	ThinkSystem NVIDIA A16 64GB Gen4 PCIe Passive GPU	1 / 2	1, 5
CTO only	BQZU	ThinkSystem NVIDIA A16 64GB Gen4 PCIe Passive GPU w/o CEC	1 / 2	1, 5
4X67A71310	BFT0	ThinkSystem NVIDIA Quadro RTX A6000 48GB PCIe Active GPU	1 / 2	1, 5

* The maximum quantity shown is with one processor / two processors.

† The NVIDIA A100 requires UEFI firmware 2.80 or later, and XClarity Controller firmware 5.40 or higher.

‡ The RTX 6000 and RTX 8000 GPUs are only available via Special Bid.

§ SR650 with 1st Gen Xeon processors supports up to 4x NVIDIA T4 GPUs

Configuration notes:

- Some NVIDIA A Series GPUs are available as two feature codes, one with a CEC chip and one without a CEC chip (ones without the CEC chip have "w/o CEC" in the name). The CEC is a secondary Hardware Root of Trust (RoT) module that provides an additional layer of security, which can be used by customers who have high regulatory requirements or high security standards. NVIDIA uses a multi-layered security model and hence the protection offered by the primary Root of Trust embedded in the GPU is expected to be sufficient for most customers. The CEC defeatured products still offer Secure Boot, Secure Firmware Update, Firmware Rollback Protection, and In-Band Firmware Update Disable. Specifically, without the CEC chip, the GPU does not support Key Revocation or Firmware Attestation. CEC and non-CEC GPUs of the same type of GPU can be mixed in field upgrades.
- All GPU adapters in the server must be of the same model; mixing different GPU adapter models is not supported.
- NVIDIA A2 and T4 are PCIe x16 adapters, however in the SR650, the GPUs are also supported in PCIe riser x8 slots with x16 physical connectors. Note, however, that a x8 host connection may result in a performance decrease of approximately 5%.
- For field upgrades to add an NVIDIA A-Series GPU (A100, A6000, A30, A16, A10, A2), the use of

Riser 2 V2 riser kit (4TA7A70026) is required when the GPU is to be installed in slot 5. The older Riser 2 kit (7XH7A02679, now withdrawn) is not supported with the A100. For CTO orders, feature code BF9Y will be used for the correct Riser 2 bracket.

- The T4 GPU adapters are supported only in the specific I/O slots, as follows:
 - 1x T4 GPU adapter (one or two processors):
 - PCIe 3.0 x16 Slot 1 on the x16/x8 Riser Card 1 (7XH7A02678); or
 - PCIe 3.0 x8 Slot 1 on the x8/x8/x8 Riser Card 1 (7XH7A02677).
 - 2x T4 GPU adapters:
 - One processor: PCIe 3.0 x8 Slots 1 and 2 on the x8/x8/x8 Riser Card 1 (7XH7A02677).
 - Two processors:
 - PCIe 3.0 x16 or x8 Slot 1 on one of the following riser cards:
 - PCIe 3.0 x16 Slot 1 on the x16/x8 Riser Card 1 (7XH7A02678); or
 - PCIe 3.0 x8 Slot 1 on the x8/x8/x8 Riser Card 1 (7XH7A02677).
 - PCIe 3.0 x16 Slot 5 on the x16/x16 Riser Card 2 (4TA7A70026).
 - **Note:** Slot 6 must remain unoccupied in the configurations with two T4 GPU adapters.
 - 3x T4 GPU adapters:
 - One processor: PCIe 3.0 x8 Slots 1, 2, and 3 on the x8/x8/x8 Riser Card 1 (7XH7A02677).
 - Two processors:
 - PCIe 3.0 x16 or x8 Slot 1 on one of the following riser cards:
 - PCIe 3.0 x16 Slot 1 on the x16/x8 Riser Card 1 (7XH7A02678); or
 - PCIe 3.0 x8 Slot 1 on the x8/x8/x8 Riser Card 1 (7XH7A02677).
 - PCIe 3.0 x16 Slots 5 and 6 on the x16/x16 Riser Card 2 (4TA7A70026).
 - 4x T4 GPU adapters (require two processors):
 - PCIe 3.0 x8 or x16 Slot 1 and PCIe 3.0 x8 Slot 2 on one of the following riser cards:
 - x8/x8/x8 Riser Card 1 (7XH7A02677); or
 - x16/x8/x16 Riser Card 1 (4XH7A09902).
 - PCIe 3.0 x16 Slots 5 and 6 on the x16/x16 Riser Card 2 (4TA7A70026).
 - 5x T4 GPU adapters (require two processors) (2nd Gen Xeon processors only):
 - PCIe 3.0 x8 or x16 Slots 1 and 3, and PCIe 3.0 x8 Slot 2 on one of the following riser cards:
 - x8/x8/x8 Riser Card 1 (7XH7A02677); or
 - x16/x8/x16 Riser Card 1 (4XH7A09902).
 - PCIe 3.0 x16 Slots 5 and 6 on the x16/x16 Riser Card 2 (4TA7A70026).
- The GPU adapters are supported with the following drive bay configurations:
 - Processors of up to 150 W TDP:
 - 8x or 16x 2.5-inch SAS/SATA & AnyBay drive bays (support for up to 4x or 8x NVMe SSDs).
 - 8x 3.5-inch SAS/SATA drive bays.
 - Processors of more than 150 W and up to 205 W TDP with up to four T4 GPU adapters, or processors of more than 150 W and up to 165 W TDP:
 - 8x 2.5-inch SAS/SATA drive bays (no support for NVMe SSDs) in the environments with the ambient temperature of up to 30 °C (86 °F).
 - **Note:** The P620, P4000, P6000, V100 FHHL, and V340 GPU adapters are supported only with the processors of up to 150 W TDP.
- If a double-wide GPU adapter is installed in the PCIe slot 5, the PCIe slot 6 cannot be used.
- The P620 GPU adapters do not require any thermal kits. The GPU adapters other than P620 may require one of the optional GPU Thermal Kits (see [Cooling](#) for details).
- GPU adapters are supported with the 1100 W or 1600 W power supplies. Some configurations also support a GPU adapter with 750 W power supplies installed.
- GPU adapters (except V100 FHHL and T4 GPU adapters) are supported only in the ASHRAE A2 environments (up to 35 °C [95 °F]); the V100 FHHL and T4 GPU adapters are supported only in the environments with the ambient temperature of up to 30 °C (86 °F).

- Configurations with two double-wide GPU adapters and a PCIe x16 adapter are supported only in the environments with the ambient temperature of up to 30 °C (86 °F), and with SAS/SATA drive bays only (no AnyBay or U.2 NVMe support).
- If the GPU adapters are installed, the server performance might be impacted in case of a system fan failure.
- The GPU adapters are not supported with the T-suffix processors.
- The GPU adapters are not supported with the persistent memory modules.
- The GPU adapters are not supported with the PCIe flash storage adapters.
- The GPU adapters are not supported with the Rear HDD Kit.
- The maximum server memory that can be installed with the NVIDIA Tesla M10 GPU is 1 TB.

Auxiliary power cables

For CTO orders, the necessary GPU auxiliary power cable is derived by the configurator.

For field upgrades, some Lenovo GPU adapter options come with the necessary power cables for internal cabling. For all others, you will need to order the cable separately using the SR650 GPU cable kit. Details in the following table.

Table 50. SR650 GPU cable kit option

Part number	Description
4XH7A08794	ThinkSystem SR650 GPU Cable Kit <ul style="list-style-type: none"> • SBB7A00293 - 300mm PCIe 6pin (2x3) + PCIe 8pin (2x4) <ul style="list-style-type: none"> ◦ For use with NVIDIA M10, RTX 5000, P6000 and AMD MI25 ◦ Also included in Lenovo GPU option part numbers • SBB7A00299 - 300mm 8pin (2x4) cable <ul style="list-style-type: none"> ◦ For use with NVIDIA V100S, V100, P40, RTX 8000, A100, RTX 6000, RTX A6000 ◦ Also included in Lenovo GPU option part numbers for V100S, V100, P40, and RTX 8000 • SBB7A05971 - 300mm 2x 8pin (2x4) cable <ul style="list-style-type: none"> ◦ For use with NVIDIA V100 FHHL, RTX 4000, A10 • SBB7A05946 - 300mm 2x PCIe 6pin (2x3) <ul style="list-style-type: none"> ◦ For use with NVIDIA P4000

Cooling

The SR650 server supports up to six hot-swap single-rotor system fans that provide N+1 cooling redundancy: Models with one processor ship with five system fans, and models with two processors ship with six system fans.

In the case of a system fan failure, performance might be impacted with any of the following server configurations:

- Gen 2 processors with 200 W or 205 W TDP, or Gold 6230N, 6240Y, 6244, or 6250 are installed.
- Gen 1 processors Intel Xeon 6137, 6144, 6146, 6154, 8168, 8180, and 8180M are installed.
- Persistent memory modules are installed.
- GPU adapters are installed.
- 16/20/24x 2.5" U.2 NVMe PCIe drive bays at the ambient temperature of more than 30 °C (86 °F).

The following table shows additional cooling options.

Table 51. Cooling options

Part number	Feature code	Description	Maximum quantity
4F17A12349	AUSG	ThinkSystem SR650 Fan Option Kit (for 2nd Gen processors only; 1st Gen processor options include a fan)	1
4XH7A08791	B31F	ThinkSystem SR650/SR550/SR590 M.2 Thermal Kit	1
7XH7A05897	None	ThinkSystem SR650 GPU Thermal Kit	1
7XH7A05899	AURU	ThinkSystem SR650 2nd GPU Upgrade Kit	1
7XH7A05898	None	ThinkSystem SR650 GPU 1U Heatsink Option Kit	1
4XH7A08792	B37F	ThinkSystem SR650 V100 FHHL Air Duct Companion Kit	2

Configuration notes:

- The installation of a 2nd processor requires an extra cooling fan be installed. For CTO orders, fans are derived by the configurator. For field upgrades, 1st Gen processor option part numbers include this fan however 2nd Gen processor options do not included the fan and it must be ordered separately using SR650 Fan Option Kit (4F17A12349).
- The ThinkSystem SR650/SR550/SR590 M.2 Thermal Kit (4XH7A08791) is required when at least one M.2 5100, 5300, or 5400 SSD is installed in the server; however, the SSD Thermal Kit is not required in the server configurations with the GPU Thermal Kit (7XH7A05897) (factory-installed or field upgrade). If required, the M.2 SSD Thermal Kit is derived by the configurator for initial server configurations, or it should be purchased for M.2 5400 SSDs for field upgrades.
- The P620 GPU adapters do not require any thermal kits.
- The full-length PCIe adapters and GPU adapters other than P620 require one of the following thermal kits depending on the configuration:
 - The GPU Thermal Kit (7XH7A05897) is required when adding GPUs or full-length PCIe adapters to the SR650 server models without factory-installed GPUs or factory-enabled full-length support. The kit provides support for up to three GPUs or full-length adapters in the PCIe x16 slots 1, 5, and 6, and it contains an air duct, two low-profile heatsinks, and two full-length card holders.
 - The 2nd GPU Upgrade Kit (7XH7A05899) is required when adding more GPUs or full-length adapters to the SR650 server models with one riser card and the factory-enabled full-length support or factory-installed GPUs. The kit provides support for the additional GPUs or full-length adapters, and it contains a full-length card holder (the second riser card is not included in the kit).
 - The GPU 1U Heatsink Option Kit (7XH7A05898) is required when adding the second processor to the SR650 server models with one processor and the factory-enabled full-length support or factory-installed GPUs. The kit contains a low-profile heatsink for the second processor option.
- The V100 FHHL GPU adapters require the following quantities of the V100 FHHL Air Duct Companion Kit (4XH7A08792) in addition to one of the thermal kits described above:
 - 1x V100 FHHL GPU adapter: 1x Air Duct Companion Kit.
 - 2x or 3x V100 FHHL GPU adapters: 2x Air Duct Companion Kits.

Power supplies

The SR650 server supports up to two redundant power supplies and is capable of N+N redundancy depending on the configuration. A second power supply can be added to the models that come with one power supply.

The following table lists the power supply options.

Table 52. Power supplies

Part number	Feature code	Description	Maximum quantity
7N67A00882	AVWC	ThinkSystem 550W (230V/115V) Platinum Hot-Swap Power Supply	2
7N67A00883	AVWD	ThinkSystem 750W (230/115V) Platinum Hot-Swap Power Supply	2
7N67A00884	AVWE	ThinkSystem 750W (230V) Titanium Hot-Swap Power Supply	2
4P57A82020	BR1Y	ThinkSystem V1 750W (230Vac) Titanium Hot Swap Power Supply	2
7N67A00885	AVWF	ThinkSystem 1100W (230V/115V) Platinum Hot-Swap Power Supply	2
7N67A00886	AVWG	ThinkSystem 1600W (230V) Platinum Hot-Swap Power Supply	2

Power supply options do not include a line cord. For server configurations, the inclusion of a power cord is model dependent. Configure-to-order models can be configured without power cords if desired.

Configuration notes:

- Minimum of 1 and maximum of 2 power supplies per system.
- If 2 are installed, power supplies must be identical.
- AC power supplies support AC (Worldwide) and HVDC (PRC only) power sources
- AC power supplies have a C14 connector. The -48V DC power supply has a Positronic PLB3W3M1000/AA connector.

Important: The Standalone Solution Configuration Tool (SSCT) and Lenovo Data Center Solution Configurator (DCSC) power supply selection rules allow a subset of possible configurations due to power restrictions. Configurations that cannot be built in SSCT or DCSC due to power restrictions may still be supported. To verify support and ensure that the right power supply is chosen for optimal performance, you should always validate your server configuration using the latest version of the Lenovo Capacity Planner:

<http://datacentersupport.lenovo.com/us/en/solutions/Invo-lcp>

Power cords

Line cords and rack power cables with C13 connectors can be ordered as listed in the following table.

110V customers: If you plan to use the 1100W power supply with a 110V power source, select a power cable that is rated above 10A. Power cables that are rated at 10A or below are not supported with 110V power.

Table 53. Power cords

Part number	Feature code	Description
Rack cables - C13 to C14		
SL67B08593	BPHZ	0.5m, 10A/100-250V, C13 to C14 Jumper Cord
00Y3043	A4VP	1.0m, 10A/100-250V, C13 to IEC 320-C14 Rack Power Cable
4L67A08367	B0N5	1.0m, 13A/100-250V, C13 to C14 Jumper Cord
39Y7937	6201	1.5m, 10A/100-250V, C13 to IEC 320-C14 Rack Power Cable
4L67A08368	B0N6	1.5m, 13A/100-250V, C13 to C14 Jumper Cord
4L67A08365	B0N4	2.0m, 10A/100-250V, C13 to IEC 320-C14 Rack Power Cable
4L67A08369	6570	2.0m, 13A/100-250V, C13 to C14 Jumper Cord
4L67A08366	6311	2.8m, 10A/100-250V, C13 to IEC 320-C14 Rack Power Cable

Part number	Feature code	Description
4L67A08370	6400	2.8m, 13A/100-250V, C13 to C14 Jumper Cord
39Y7932	6263	4.3m, 10A/100-250V, C13 to IEC 320-C14 Rack Power Cable
4L67A08371	6583	4.3m, 13A/100-250V, C13 to C14 Rack Power Cable
Rack cables - C13 to C14 (Y-cable)		
00Y3046	A4VQ	1.345m, 2X C13 to C14 Jumper Cord, Rack Power Cable
00Y3047	A4VR	2.054m, 2X C13 to C14 Jumper Cord, Rack Power Cable
Rack cables - C13 to C20		
39Y7938	6204	2.8m, 10A/100-250V, C13 to IEC 320-C20 Rack Power Cable
Rack cables - C13 to C20 (Y-cable)		
47C2491	A3SW	1.2m, 16A/100-250V, 2 Short C13s to Short C20 Rack Power Cable
47C2492	A3SX	2.5m, 16A/100-250V, 2 Long C13s to Short C20 Rack Power Cable
47C2493	A3SY	2.8m, 16A/100-250V, 2 Short C13s to Long C20 Rack Power Cable
47C2494	A3SZ	4.1m, 16A/100-250V, 2 Long C13s to Long C20 Rack Power Cable
Line cords		
39Y7930	6222	2.8m, 10A/250V, C13 to IRAM 2073 (Argentina) Line Cord
81Y2384	6492	4.3m 10A/220V, C13 to IRAM 2073 (Argentina) Line Cord
39Y7924	6211	2.8m, 10A/250V, C13 to AS/NZ 3112 (Australia/NZ) Line Cord
81Y2383	6574	4.3m, 10A/230V, C13 to AS/NZS 3112 (Aus/NZ) Line Cord
69Y1988	6532	2.8m, 10A/250V, C13 to NBR 14136 (Brazil) Line Cord
81Y2387	6404	4.3m, 10A/250V, C13 - 2P+Gnd (Brazil) Line Cord
39Y7928	6210	2.8m, 220-240V, C13 to GB 2099.1 (China) Line Cord
81Y2378	6580	4.3m, 10A/220V, C13 to GB 2099.1 (China) Line Cord
39Y7918	6213	2.8m, 10A/250V, C13 to DK2-5a (Denmark) Line Cord
81Y2382	6575	4.3m, 10A/230V, C13 to DK2-5a (Denmark) Line Cord
39Y7917	6212	2.8m, 10A/230V, C13 to CEE7-VII (Europe) Line Cord
81Y2376	6572	4.3m, 10A/230V, C13 to CEE7-VII (Europe) Line Cord
39Y7927	6269	2.8m, 10A/250V, C13(2P+Gnd) (India) Line Cord
81Y2386	6567	4.3m, 10A/240V, C13 to IS 6538 (India) Line Cord
39Y7920	6218	2.8m, 10A/250V, C13 to SI 32 (Israel) Line Cord
81Y2381	6579	4.3m, 10A/230V, C13 to SI 32 (Israel) Line Cord
39Y7921	6217	2.8m, 220-240V, C13 to CEI 23-16 (Italy/Chile) Line Cord
81Y2380	6493	4.3m, 10A/230V, C13 to CEI 23-16 (Italy/Chile) Line Cord
46M2593	A1RE	2.8m, 12A/125V, C13 to JIS C-8303 (Japan) Line Cord
4L67A08362	6495	4.3m, 12A/200V, C13 to JIS C-8303 (Japan) Line Cord
39Y7926	6335	4.3m, 12A/100V, C13 to JIS C-8303 (Japan) Line Cord
39Y7922	6214	2.8m, 10A/250V, C13 to SABS 164 (S Africa) Line Cord
81Y2379	6576	4.3m, 10A/230V, C13 to SABS 164 (South Africa) Line Cord
39Y7925	6219	2.8m, 220-240V, C13 to KETI (S Korea) Line Cord
81Y2385	6494	4.3m, 12A/220V, C13 to KSC 8305 (S. Korea) Line Cord
39Y7919	6216	2.8m, 10A/250V, C13 to SEV 1011-S24507 (Swiss) Line Cord
81Y2390	6578	4.3m, 10A/230V, C13 to SEV 1011-S24507 (Sws) Line Cord

Part number	Feature code	Description
23R7158	6386	2.8m, 10A/125V, C13 to CNS 10917-3 (Taiwan) Line Cord
81Y2375	6317	2.8m, 10A/240V, C13 to CNS 10917-3 (Taiwan) Line Cord
81Y2374	6402	2.8m, 13A/125V, C13 to CNS 60799 (Taiwan) Line Cord
4L67A08363	AX8B	4.3m, 10A 125V, C13 to CNS 10917 (Taiwan) Line Cord
81Y2389	6531	4.3m, 10A/250V, C13 to 76 CNS 10917-3 (Taiwan) Line Cord
81Y2388	6530	4.3m, 13A/125V, C13 to CNS 10917 (Taiwan) Line Cord
39Y7923	6215	2.8m, 10A/250V, C13 to BS 1363/A (UK) Line Cord
81Y2377	6577	4.3m, 10A/230V, C13 to BS 1363/A (UK) Line Cord
90Y3016	6313	2.8m, 10A/120V, C13 to NEMA 5-15P (US) Line Cord
46M2592	A1RF	2.8m, 10A/250V, C13 to NEMA 6-15P Line Cord
00WH545	6401	2.8m, 13A/120V, C13 to NEMA 5-15P (US) Line Cord
4L67A08359	6370	4.3m, 10A/125V, C13 to NEMA 5-15P (US) Line Cord
4L67A08361	6373	4.3m, 10A/250V, C13 to NEMA 6-15P (US) Line Cord
4L67A08360	AX8A	4.3m, 13A/120V, C13 to NEMA 5-15P (US) Line Cord

Systems management

The SR650 supports the following systems management tools:

- [Lenovo XClarity Controller](#)
- [Light path diagnostics](#)
- [Lenovo XClarity Provisioning Manager](#)
- [Lenovo XClarity Essentials](#)
- [Lenovo XClarity Administrator](#)
- [Lenovo XClarity Integrators](#)
- [Lenovo XClarity Energy Manager](#)
- [Lenovo Capacity Planner](#)

Lenovo XClarity Controller

The SR650 server contains Lenovo XClarity Controller (XCC), which provides advanced service-processor control, monitoring, and alerting functions. XClarity Controller offers three functional levels: Standard, Advanced, and Enterprise.

By default, the SR650 server includes XClarity Controller Standard features, and it can be upgraded to Advanced or Enterprise functionality by using the Features on Demand (FoD) upgrades.

XClarity Controller Standard offers the following capabilities:

- Gathering and viewing system information and inventory
- Monitoring system status and health
- Alerting and notifications
- Event logging
- Configuring network connectivity
- Configuring security
- Updating system firmware
- Configuring server settings and devices
- Real-time power usage monitoring
- Remotely controlling server power (Power on, Power off, Restart)
- Managing FoD activation keys
- Redirecting serial console via IPMI
- Capturing the video display contents when an operating system hang condition is detected

XClarity Controller Advanced Upgrade adds the following functionality to the Standard features:

- Remotely viewing video with the following graphics resolutions:
 - Up to 1600x1200 with up to 23 bits per pixel; or
 - Up to 1920x1200 with up to 15 bits per pixel
- Remotely accessing the server using the keyboard and mouse from a remote client
- Remotely deploying an operating system
- Syslog alerting
- Redirecting serial console via SSH
- Displaying graphics for real-time and historical power usage data and temperature

XClarity Controller Enterprise Upgrade adds the following functionality to the Advanced features:

- Capping power usage
- Mapping the ISO and image files located on the local client as virtual drives for use by the server
- Mounting the remote ISO and image files via HTTPS, SFTP, CIFS, and NFS
- Collaborating across up to six users of the virtual console
- Controlling quality and bandwidth usage

The XClarity Controller provides remote server management through industry-standard interfaces:

- Intelligent Platform Management Interface (IPMI) Version 2.0
- Simple Network Management Protocol (SNMP) Version 3
- Common Information Model (CIM)
- Data Center Manageability Interface (DCMI) Version 1.5
- Redfish REpresentational State Transfer (REST) API
- Web browser with HTML5 support
- Command-line interface
- Virtual Operator Panel with XClarity Mobile App via the front USB port with XClarity Controller access

Virtual Operator Panel provides quick access to system status, firmware, network, health, and alerts information. With proper authentication, it also allows to configure systems management and network settings and to control system power (Power on, Power off, Restart). The Virtual Operator Panel can be accessed from the XClarity Mobile App running on the Android or iOS mobile device that is connected to the front USB port with XClarity Controller access (See [Components and connectors](#)).

Note: Depending on the system settings, the front USB port can be assigned to XClarity Controller for management functions, or to the system as a regular USB 2.0 port, or switched between two functions by using the system ID button.

The following table lists the XClarity Controller FoD upgrades.

Table 54. XClarity Controller FoD upgrades

Description	Part number	Feature code	Maximum quantity
ThinkSystem XClarity Controller Standard to Advanced Upgrade	4L47A09132	AVUT	1
ThinkSystem XClarity Controller Standard to Enterprise Upgrade	None*	AUPW	1
ThinkSystem XClarity Controller Advanced to Enterprise Upgrade	4L47A09133	None**	1

* Factory-installed only.

** Field upgrade only.

Configuration notes:

- For factory-installed upgrades, either Standard to Advanced Upgrade (feature AVUT) or Standard to Enterprise Upgrade (feature AUPW) can be selected, but not both.
- For field upgrades, the Advanced to Enterprise Upgrade (4L47A09133) requires the Standard to Advanced Upgrade to be activated on the server previously with either the factory-installed feature AVUT or field upgrade 4L47A09132.

Light path diagnostics

All SR650 server models include basic light path diagnostics, which provides the system LEDs on the front of the server (see [Components and connectors](#)) and the LEDs near the monitored components (for example, the DIMM error LEDs on the system board).

Lenovo XClarity Provisioning Manager

Lenovo XClarity Provisioning Manager (LXPM) is a UEFI-based application embedded in ThinkSystem servers and accessible via the F1 key during system boot.

LXPM provides the following functions:

- Graphical UEFI Setup
- System inventory information and VPD update
- System firmware updates (UEFI and XCC)
- RAID setup wizard
- OS installation wizard (including unattended OS installation)
- Diagnostics functions

Lenovo XClarity Essentials

Lenovo offers the following XClarity Essentials software tools that can help you set up, use, and maintain the server at no additional cost:

- **Lenovo Essentials OneCLI**
OneCLI is a collection of server management tools that uses a command line interface program to manage firmware, hardware, and operating systems. It provides functions to collect full system health information (including health status), configure system settings, and update system firmware and drivers.
- **Lenovo Essentials UpdateXpress**
The UpdateXpress tool is a standalone GUI application for firmware and device driver updates that enables you to maintain your server firmware and device drivers up-to-date and help you avoid unnecessary server outages. The tool acquires and deploys individual updates and UpdateXpress System Packs (UXSPs) which are integration-tested bundles.
- **Lenovo Essentials Bootable Media Creator**
The Bootable Media Creator (BOMC) tool is used to create bootable media for offline firmware update.

For more information and downloads, visit the Lenovo XClarity Essentials web page:

<http://support.lenovo.com/us/en/documents/LNVO-center>

Lenovo XClarity Administrator

Lenovo XClarity Administrator is a centralized resource management solution designed to reduce complexity, speed response, and enhance the availability of Lenovo systems and solutions. It provides agent-free hardware management for ThinkSystem servers, in addition to ThinkServer, System x, and Flex System servers. The administration dashboard is based on HTML 5 and allows fast location of resources so tasks can be run quickly.

Because Lenovo XClarity Administrator does not require any agent software to be installed on the managed endpoints, there are no CPU cycles spent on agent execution, and no memory is used, which means that up to 1GB of RAM and 1 - 2% CPU usage is saved, compared to a typical managed system where an agent is required.

Lenovo XClarity Administrator is an optional software component for the SR650. The software can be downloaded and used at no charge to discover and monitor the SR650 and to manage firmware upgrades.

If software support is required for Lenovo XClarity Administrator, or premium features such as configuration management and operating system deployment are required, Lenovo XClarity Pro software subscription should be ordered. Lenovo XClarity Pro is licensed on a per managed system basis, that is, each managed Lenovo system requires a license.

The following table lists the Lenovo XClarity software license options.

Table 55. Lenovo XClarity Pro ordering information

Part number	Feature code	Description
00MT201	1339	Lenovo XClarity Pro, per Managed Endpoint w/1 Yr SW S&S
00MT202	1340	Lenovo XClarity Pro, per Managed Endpoint w/3 Yr SW S&S
00MT203	1341	Lenovo XClarity Pro, per Managed Endpoint w/5 Yr SW S&S
7S0X000HWW	SAYV	Lenovo XClarity Pro, per Managed Endpoint w/6 Yr SW S&S
7S0X000JWW	SAYW	Lenovo XClarity Pro, per Managed Endpoint w/7 Yr SW S&S

Lenovo XClarity Administrator offers the following standard features that are available at no charge:

- Auto-discovery and monitoring of Lenovo systems
- Firmware updates and compliance enforcement
- External alerts and notifications via SNMP traps, syslog remote logging, and e-mail
- Secure connections to managed endpoints
- NIST 800-131A or FIPS 140-2 compliant cryptographic standards between the management solution and managed endpoints
- Integration into existing higher-level management systems such as cloud automation and orchestration tools through REST APIs, providing extensive external visibility and control over hardware resources
- An intuitive, easy-to-use GUI
- Scripting with Windows PowerShell, providing command-line visibility and control over hardware resources

Lenovo XClarity Administrator offers the following premium features that require an optional Pro license:

- Pattern-based configuration management that allows to define configurations once and apply repeatedly without errors when deploying new servers or redeploying existing servers without disrupting the fabric
- Bare-metal deployment of operating systems and hypervisors to streamline infrastructure provisioning

For more information, refer to the Lenovo XClarity Administrator Product Guide:

<http://lenovopress.com/tips1200>

Lenovo XClarity Integrators

Lenovo also offers software plug-in modules, Lenovo XClarity Integrators, to manage physical infrastructure from leading external virtualization management software tools including those from Microsoft and VMware.

These integrators are offered at no charge, however if software support is required, a Lenovo XClarity Pro software subscription license should be ordered.

Lenovo XClarity Integrators offer the following additional features:

- Ability to discover, manage, and monitor Lenovo server hardware from VMware vCenter or Microsoft System Center
- Deployment of firmware updates and configuration patterns to Lenovo x86 rack servers and Flex System from the virtualization management tool
- Non-disruptive server maintenance in clustered environments that reduces workload downtime by dynamically migrating workloads from affected hosts during rolling server updates or reboots
- Greater service level uptime and assurance in clustered environments during unplanned hardware events by dynamically triggering workload migration from impacted hosts when impending hardware failures are predicted

For more information about all the available Lenovo XClarity Integrators, see the Lenovo XClarity Administrator Product Guide: <https://lenovopress.com/tips1200-lenovo-xclarity-administrator>

Lenovo XClarity Energy Manager

Lenovo XClarity Energy Manager (LXEM) is a power and temperature management solution for data centers. It is an agent-free, web-based console that enables you to monitor and manage power consumption and temperature in your data center through the management console. It enables server density and data center capacity to be increased through the use of power capping.

LXEM is a licensed product. A single-node LXEM license is included with the XClarity Controller Enterprise upgrade as described in the [Remote Management](#) section. If your server does not have the XCC Enterprise upgrade, Energy Manager licenses can be ordered as shown in the following table.

Table 56. Lenovo XClarity Energy Manager

Part number	Description
4L40E51621	Lenovo XClarity Energy Manager Node License (1 license needed per server)

For more information about XClarity Energy Manager, see the following resources:

- Lenovo Support page:
<https://datacentersupport.lenovo.com/us/en/solutions/Invo-lxem>
- User Guide for XClarity Energy Manager:
<https://pubs.lenovo.com/lxem/>

Lenovo Capacity Planner

Lenovo Capacity Planner is a power consumption evaluation tool that enhances data center planning by enabling IT administrators and pre-sales professionals to understand various power characteristics of racks, servers, and other devices. Capacity Planner can dynamically calculate the power consumption, current, British Thermal Unit (BTU), and volt-ampere (VA) rating at the rack level, improving the planning efficiency for large scale deployments.

For more information, refer to the Capacity Planner web page:
<http://datacentersupport.lenovo.com/us/en/solutions/Invo-lcp>

Security

The ThinkSystem SR650 server offers the following security features:

- Power-on password
- Administrator's password
- Secure firmware updates

- Onboard Trusted Platform Module (TPM) version 1.2 or 2.0 (configurable UEFI system setting)
- Trusted Cryptographic Module (TCM) (optional; PRC only)
- Nationz Trusted Platform Module v2.0 (optional; PRC only)
- Lockable front bezel (optional)
- Self-encrypting drives (SEDs) with support for enterprise key managers - see the [SED encryption key management](#) section
- Lenovo Business Vantage security software (optional; PRC only)

The server is NIST SP 800-147B compliant.

The following table lists the security options that are available for the ThinkSystem SR650 server.

Table 57. Security options

Part number	Feature code	Description	Maximum quantity
Lockable front bezel			
7Z17A02580	AURX	ThinkSystem 2U Security Bezel	1
Trusted Cryptographic Module (PRC only)			
None*	AVKE	ThinkSystem Trusted Cryptographic Module	1
Trusted Platform Module (PRC only)			
None*	B22N	ThinkSystem Nationz Trusted Platform Module v2.0	1

* Factory-installed only; no field upgrade.

Lenovo Business Vantage is a security software tool suite (available only in PRC) designed to work with the TCM for enhanced security, to keep user data safe, and to erase confidential data completely from a drive.

Lenovo Business Vantage provides the following features:

- Encrypts files to ensure data safety by using the TCM.
- Erases confidential data from a drive.
- Prohibits unauthorized access to the USB port of devices.
- Encrypts files to ensure data security on a USB storage device.

Intel Transparent Supply Chain

Add a layer of protection in your data center and have peace of mind that the server hardware you bring into it is safe authentic and with documented, testable, and provable origin.

Lenovo has one of the world's best supply chains, as ranked by Gartner Group, backed by extensive and mature supply chain security programs that exceed industry norms and US Government standards. Now we are the first Tier 1 manufacturer to offer Intel® Transparent Supply Chain in partnership with Intel, offering you an unprecedented degree of supply chain transparency and assurance.

To enable Intel Transparent Supply Chain for the Intel-based servers in your order, add the following feature code in the [DCSC configurator](#), under the Security tab.

Table 58. Intel Transparent Supply Chain ordering information

Feature code	Description
BB0P	Intel Transparent Supply Chain

For more information on this offering, see the paper *Introduction to Intel Transparent Supply Chain on Lenovo ThinkSystem Servers*, available from <https://lenovopress.com/lp1434-introduction-to-intel-transparent-supply-chain-on-thinksystem-servers>.

Rack installation

The following table lists the rack installation options that are available for the ThinkSystem SR650 server.

Table 59. Rack installation options

Part number	Feature code	Description	Maximum quantity
4-post rail kits			
7M27A05702	AXCA	ThinkSystem Tool-less Slide Rail	1
7M27A05700	AXCH	ThinkSystem Tool-less Slide Rail Kit with 2U CMA	1
4M17A07274	AXFN	ThinkSystem Screw-in Slide Rail	1
4M17A07280	B0TD	ThinkSystem Screw-in Slide Rail Kit with 2U CMA	1
4M17A07273	BK7W	ThinkSystem Toolless Friction Rail v2	1
Cable management arm (CMA) upgrade			
7M27A05698	None^	ThinkSystem 2U CMA Upgrade Kit for Tool-less Slide Rail	1*
4M17A07275	AXFU	ThinkSystem 2U CMA Upgrade Kit for Screw-in Slide Rail	1**
Front VGA port			
4XH7A83033	BMNL	ThinkSystem SR550/SR590/SR650 EIA Latch w/ VGA Upgrade Kit v2	1
7Z17A02578	AUS8	ThinkSystem 2U EIA Latch w/ VGA Upgrade Kit	1

^ Field upgrade only.

* The CMA Upgrade Kit for Tool-less Slide Rail is supported with the Tool-less Slide Rail (7M27A05702) only.

** The CMA Upgrade Kit for Screw-in Slide Rail is supported with the Screw-in Slide Rail (4M17A07274) only.

The following table summarizes the rail kit features and specifications.

Table 60. Rail kit features and specifications summary

Feature	Tool-less Slide Rail		Screw-in Slide Rail		Tool-less Friction Rail
	Without CMA	With CMA	Without CMA	With CMA	
Part number	7M27A05702	7M27A05700	4M17A07274	4M17A07280	4M17A07273
CMA	7M27A05698	Included	4M17A07275	Included	No support
Rail length	730 mm (28.74 in.)	807 mm (31.8 in.)	836.8 mm (32.9 in.)	836.8 mm (32.9 in.)	728.1 mm (28.7 in.)
Rail type	Full-out slide (ball bearing)		Full-out slide (ball bearing)		Half-out slide (friction)
Tool-less installation	Yes		No		Yes
In-rack server maintenance	Yes		Yes		No
1U PDU support	Yes		Yes		Yes
0U PDU support	Limited*		Limited*		Limited**
Rack type	IBM and Lenovo 4-post, IEC standard-compliant		IBM and Lenovo 4-post, IEC standard-compliant		IBM and Lenovo 4-post, IEC standard-compliant
Mounting holes	Square or round		Square, round, or threaded		Square or round
Mounting flange thickness	2 mm (0.08 in.) – 3.3 mm (0.13 in.)		2 mm (0.08 in.) – 3.3 mm (0.13 in.)		2 mm (0.08 in.) – 3.3 mm (0.13 in.)
Distance between front and rear mounting flanges^	609.6 mm (24 in.) – 863.6 mm (34 in.)		609.6 mm (24 in.) – 812.8 mm (32 in.)		609.6 mm (24 in.) – 863.6 mm (34 in.)

* If a 0U PDU is used, the rack cabinet must be at least 1100 mm (43.31 in.) deep if no CMA is used, or at least 1200 mm (47.24 in.) deep if a CMA is used.

** If a 0U PDU used, the rack must be at least 1000 mm (39.37 in.) deep.

^ Measured when mounted on the rack, from the front surface of the front mounting flange to the rear most point of the rail.

Operating system support

The SR650 server with 2nd Gen Intel Xeon SP processors supports the following operating systems:

- Microsoft Windows Server 2016
- Microsoft Windows Server 2019
- Microsoft Windows Server 2022
- Red Hat Enterprise Linux 7.6
- Red Hat Enterprise Linux 7.7
- Red Hat Enterprise Linux 7.8
- Red Hat Enterprise Linux 7.9
- Red Hat Enterprise Linux 8.0
- Red Hat Enterprise Linux 8.1
- Red Hat Enterprise Linux 8.2
- Red Hat Enterprise Linux 8.3
- Red Hat Enterprise Linux 8.4
- Red Hat Enterprise Linux 8.5
- Red Hat Enterprise Linux 8.6
- Red Hat Enterprise Linux 8.7
- Red Hat Enterprise Linux 8.8
- Red Hat Enterprise Linux 8.9
- Red Hat Enterprise Linux 9.0
- Red Hat Enterprise Linux 9.1
- Red Hat Enterprise Linux 9.2
- Red Hat Enterprise Linux 9.3
- SUSE Linux Enterprise Server 12 SP4
- SUSE Linux Enterprise Server 12 SP5
- SUSE Linux Enterprise Server 12 Xen SP4
- SUSE Linux Enterprise Server 12 Xen SP5
- SUSE Linux Enterprise Server 15
- SUSE Linux Enterprise Server 15 SP1
- SUSE Linux Enterprise Server 15 SP2
- SUSE Linux Enterprise Server 15 SP3
- SUSE Linux Enterprise Server 15 SP4
- SUSE Linux Enterprise Server 15 SP5
- SUSE Linux Enterprise Server 15 Xen
- SUSE Linux Enterprise Server 15 Xen SP1
- SUSE Linux Enterprise Server 15 Xen SP2
- SUSE Linux Enterprise Server 15 Xen SP3
- SUSE Linux Enterprise Server 15 Xen SP4
- SUSE Linux Enterprise Server 15 Xen SP5
- Ubuntu 22.04 LTS 64-bit
- VMware ESXi 6.5 U2
- VMware ESXi 6.5 U3
- VMware ESXi 6.7 U1
- VMware ESXi 6.7 U2
- VMware ESXi 6.7 U3
- VMware ESXi 7.0
- VMware ESXi 7.0 U1
- VMware ESXi 7.0 U2
- VMware ESXi 7.0 U3
- VMware ESXi 8.0

- VMware ESXi 8.0 U1
- VMware ESXi 8.0 U2

The SR650 server with 1st Gen Intel Xeon SP processors supports the following operating systems:

- Microsoft Windows Server 2012 R2
- Microsoft Windows Server 2016
- Microsoft Windows Server 2019
- Microsoft Windows Server 2022
- Microsoft Windows Server, version 1709
- Microsoft Windows Server, version 1803
- Red Hat Enterprise Linux 6.10 x64
- Red Hat Enterprise Linux 6.9 x64
- Red Hat Enterprise Linux 7.3
- Red Hat Enterprise Linux 7.4
- Red Hat Enterprise Linux 7.5
- Red Hat Enterprise Linux 7.6
- Red Hat Enterprise Linux 7.7
- Red Hat Enterprise Linux 7.8
- Red Hat Enterprise Linux 7.9
- Red Hat Enterprise Linux 8.0
- Red Hat Enterprise Linux 8.1
- Red Hat Enterprise Linux 8.2
- Red Hat Enterprise Linux 8.3
- Red Hat Enterprise Linux 8.4
- Red Hat Enterprise Linux 8.5
- Red Hat Enterprise Linux 8.6
- Red Hat Enterprise Linux 8.7
- Red Hat Enterprise Linux 8.8
- Red Hat Enterprise Linux 9.0
- Red Hat Enterprise Linux 9.1
- Red Hat Enterprise Linux 9.2
- SUSE Linux Enterprise Server 11 Xen x64 SP4
- SUSE Linux Enterprise Server 11 x64 SP4
- SUSE Linux Enterprise Server 12 SP2
- SUSE Linux Enterprise Server 12 SP3
- SUSE Linux Enterprise Server 12 SP4
- SUSE Linux Enterprise Server 12 SP5
- SUSE Linux Enterprise Server 12 Xen SP2
- SUSE Linux Enterprise Server 12 Xen SP3
- SUSE Linux Enterprise Server 12 Xen SP4
- SUSE Linux Enterprise Server 12 Xen SP5
- SUSE Linux Enterprise Server 15
- SUSE Linux Enterprise Server 15 SP1
- SUSE Linux Enterprise Server 15 SP2
- SUSE Linux Enterprise Server 15 SP3
- SUSE Linux Enterprise Server 15 SP4
- SUSE Linux Enterprise Server 15 SP5
- SUSE Linux Enterprise Server 15 Xen
- SUSE Linux Enterprise Server 15 Xen SP1
- SUSE Linux Enterprise Server 15 Xen SP2
- SUSE Linux Enterprise Server 15 Xen SP3
- SUSE Linux Enterprise Server 15 Xen SP4
- SUSE Linux Enterprise Server 15 Xen SP5
- Ubuntu 22.04 LTS 64-bit
- VMware ESXi 6.0 U3
- VMware ESXi 6.5

- VMware ESXi 6.5 U1
- VMware ESXi 6.5 U2
- VMware ESXi 6.5 U3
- VMware ESXi 6.7
- VMware ESXi 6.7 U1
- VMware ESXi 6.7 U2
- VMware ESXi 6.7 U3
- VMware ESXi 7.0
- VMware ESXi 7.0 U1
- VMware ESXi 7.0 U2
- VMware ESXi 7.0 U3
- VMware ESXi 8.0
- VMware ESXi 8.0 U1
- VMware ESXi 8.0 U2

For a complete list of supported, certified and tested operating systems, plus additional details and links to relevant web sites, see the Operating System Interoperability Guide:
<https://lenovopress.com/osig#servers=sr650-7x05-7x06-sp-gen-2>

For configure-to-order configurations, the server can be preloaded with VMware ESXi installed on M.2 cards. Ordering information is listed in the following table.

Table 61. VMware ESXi preload

Part number	Feature code	Description
CTO only	B3VW	VMware ESXi 6.5 U2 (Factory Installed)
CTO only	B6U0	VMware ESXi 6.5 U3 (factory installed)
CTO only	B3VX	VMware ESXi 6.7 (Factory Installed)
CTO only	B4XA	VMware ESXi 6.7 U1 (Factory Installed)
CTO only	B6U1	VMware ESXi 6.7 U2 (factory installed)
CTO only	B88T	VMware ESXi 6.7 U3 (factory installed)
CTO only	BBZG	VMware ESXi 7.0 (Factory Installed)
CTO only	BE5E	VMware ESXi 7.0 U1 (Factory Installed)
CTO only	BHSR	VMware ESXi 7.0 U2 (Factory Installed)
CTO only	BMEY	VMware ESXi 7.0 U3 (Factory Installed)
CTO only	BMT5	VMware ESXi 8.0 (Factory Installed)
CTO only	BQ8S	VMware ESXi 8.0 U1 (Factory Installed)
CTO only	BYC7	VMware ESXi 8.0 U2 (Factory Installed)

Physical and electrical specifications

The SR650 has the following overall physical dimensions, excluding components that extend outside the standard chassis, such as EIA flanges, front security bezel (if any), and power supply handles:

- Width: 445 mm (17.5 inches)
- Height: 87 mm (3.4 inches)
- Depth: 764 mm (30.1 inches)

The following table lists the detailed dimensions. See the figure below for the definition of each dimension.

Table 62. Detailed dimensions

Dimension	Description
482 mm	X_a = Width, to the outsides of the front EIA flanges
435 mm	X_b = Width, to the rack rail mating surfaces
445 mm	X_c = Width, to the outer most chassis body feature
87 mm	Y_a = Height, from the bottom of chassis to the top of the chassis
698 mm	Z_a = Depth, from the rack flange mating surface to the rearmost I/O port surface
730 mm	Z_b = Depth, from the rack flange mating surface to the rearmost feature of the chassis body
727 mm	Z_c = Depth, from the rack flange mating surface to the rearmost feature such as power supply handle
34 mm	Z_d = Depth, from the forwardmost feature on front of EIA flange to the rack flange mating surface
47 mm	Z_e = Depth, from the front of security bezel (if applicable) or forwardmost feature to the rack flange mating surface

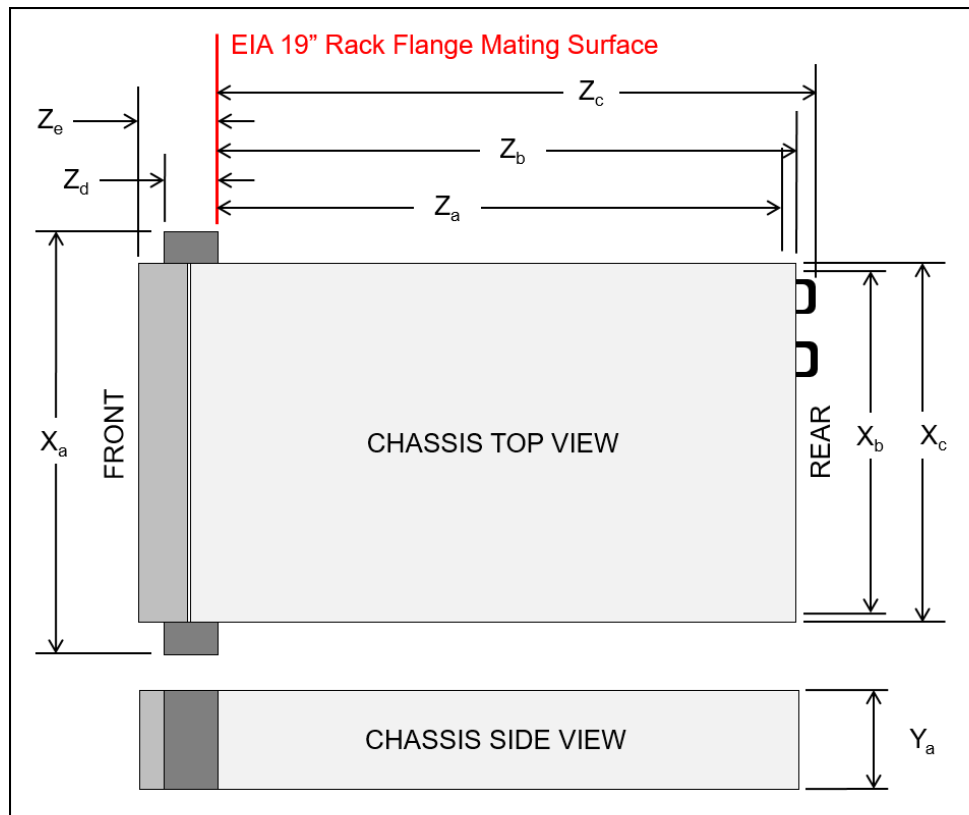

Figure 12. Server dimensions

The shipping dimensions (cardboard packaging) of the SR650 are as follows:

- Width: 592 mm (23.3 inches)
- Height: 282 mm (11.1 inches)
- Depth: 992 mm (39.1 inches)

The server has the following weight:

- Minimum configuration: 19 kg (41.9 lb)
- Maximum configuration: 32 kg (70.5 lb)

Electrical specifications for AC power supplies:

- 100 - 127 (nominal) V AC; 50 Hz / 60 Hz
- 200 - 240 (nominal) V AC; 50 Hz / 60 Hz
- 180 - 300 V DC (HVDC; supported in PRC only)

Power load and inlet current

The following table lists the maximum system power load, rated inlet current, and system heat output based on the power supply and source voltage.

Table 63. Rated system power, inlet current, and system heat output

Power supply	Source voltage	Maximum power load per system (two power supplies)	Rated current per inlet	System heat output
550 W Platinum	100 - 127 V AC	722 W	6.2 A	2463 BTU/hour
	200 - 240 V AC	704 W	3 A	2402 BTU/hour
	180 - 300 V DC	702 W	2.5 A	2395 BTU/hour
750 W Platinum	100 - 127 V AC	984 W	8.4 A	3357 BTU/hour
	200 - 240 V AC	958 W	4.1 A	3269 BTU/hour
	180 - 300 V DC	958 W	3.5 A	3269 BTU/hour
750 W Titanium	200 - 240 V AC	949 W	4.1 A	3238 BTU/hour
	180 - 300 V DC	948 W	3.5 A	3235 BTU/hour
1100 W Platinum	100 - 127 V AC	1382 W	12 A	4715 BTU/hour
	200 - 240 V AC	1408 W	6 A	4804 BTU/hour
	180 - 300 V DC	1408 W	5.1 A	4804 BTU/hour
1600 W Platinum	200 - 240 V AC	2068 W	8.7 A	7056 BTU/hour
	180 - 300 V DC	2024 W	7.3 A	6906 BTU/hour

Operating environment

The SR650 server complies with ASHRAE class A2 specifications. The server performance might be impacted when the operating temperature is outside the ASHRAE A2 specifications. Depending on the hardware configuration, some server models comply with ASHRAE class A3 and class A4 specifications.

To comply with ASHRAE class A3 and class A4 specifications, the server models must meet the following hardware configuration requirements at the same time:

- Two power supplies installed
- NVMe drives not installed
- M.2 5100 or 5300 SSDs not installed
- QLogic QL41134 PCIe 10Gb 4-Port Base-T Ethernet Adapter not installed
- Mellanox ConnectX-6 and Innova-2 FPGA adapters not installed
- PCIe flash adapters not installed
- Persistent memory modules not installed
- Graphic processing units (GPUs) not installed
- Processors with TDP more than or equal to 150 W, or Gold 6230N processors not installed

Temperature and humidity

The SR650 server is supported in the following environment:

- Air temperature:
 - Operating:
 - ASHRAE Class A4: 5 °C - 45 °C (41 °F - 113 °F); for altitudes above 900 m (2,953 ft), decrease the maximum ambient temperature by 1 °C for every 125-m (410-ft) increase in altitude
 - ASHRAE Class A3: 5 °C - 40 °C (41 °F - 104 °F); for altitudes above 900 m (2,953 ft), decrease the maximum ambient temperature by 1 °C for every 175-m (574-ft) increase in altitude
 - ASHRAE Class A2: 10 °C - 35 °C (50 °F - 95 °F); for altitudes above 900 m (2,953 ft), decrease the maximum ambient temperature by 1 °C for every 300-m (984-ft) increase in altitude
 - Non-operating: 5 °C - 45 °C (41 °F - 113 °F)
 - Storage: -40 °C - +60 °C (-40 °F - 140 °F)
- Maximum altitude: 3,050 m (10,000 ft)
- Humidity:
 - Operating:
 - ASHRAE Class A4: 8% - 90% (non-condensing); maximum dew point: 24 °C (75 °F)
 - ASHRAE Class A3: 8% - 85% (non-condensing); maximum dew point: 24 °C (75 °F)
 - ASHRAE Class A2: 8% - 80% (non-condensing); maximum dew point: 21 °C (70 °F)
 - Storage: 8% - 90% (non-condensing)

Acoustical noise emissions

The server has the following acoustic noise emissions declaration:

- Minimum configuration:
 - Operating: 5.1 bels
 - Idle: 4.9 bels
- Maximum configuration:
 - Operating: 6.2 bels
 - Idle: 6.1 bels

Notes:

- These sound levels were measured in controlled acoustical environments according to procedures specified by ISO7779 and are reported in accordance with ISO 9296.
- The declared acoustic sound levels are based on the configurations, which may change slightly depending on configuration/conditions, for example high-power processors and GPUs, and high-power network adapters.
 - Min config: 1x 85W CPU, 2x 16GB RDIMM, 1x SAS HDD, PHY 4x1G RJ45, 1x 550W PSU
 - Max config: 2x 145W CPU, 24x 64GB RDIMM, 24x SAS HDD, PHY 4x10G SFP+, 24i Raid, 2x 1100W PSU
- Government regulations (such as those prescribed by OSHA or European Community Directives) may govern noise level exposure in the workplace and may apply to you and your server installation. The actual sound pressure levels in your installation depend upon a variety of factors, including the number of racks in the installation; the size, materials, and configuration of the room; the noise levels from other equipment; the room ambient temperature, and employee's location in relation to the equipment. Further, compliance with such government regulations depends on a variety of additional factors, including the duration of employees' exposure and whether employees wear hearing protection. Lenovo recommends that you consult with qualified experts in this field to determine whether you are in compliance with the applicable regulations.

Shock and vibration

The server has the following vibration and shock limits:

- Vibration:

- Operating: 0.21 G rms at 5 Hz to 500 Hz for 15 minutes across 3 axes
- Non-operating: 1.04 G rms at 2 Hz to 200 Hz for 15 minutes across 6 surfaces
- Shock:
 - Operating: 15 G for 3 milliseconds in each direction (positive and negative X, Y, and Z axes)
 - Non-operating:
 - 12 kg - 22 kg: 50 G for 152 in./sec velocity change across 6 surfaces
 - 23 kg - 31 kg: 35 G for 152 in./sec velocity change across 6 surfaces

Particulate contamination

Airborne particulates (including metal flakes or particles) and reactive gases acting alone or in combination with other environmental factors such as humidity or temperature might damage the system that might cause the system to malfunction or stop working altogether.

The following specifications indicate the limits of particulates that the system can tolerate:

- Reactive gases:
 - The copper reactivity level shall be less than 200 Angstroms per month (Å/month)
 - The silver reactivity level shall be less than 200 Å/month
- Airborne particulates:
 - The room air should be continuously filtered with MERV 8 filters.
 - Air entering a data center should be filtered with MERV 11 or preferably MERV 13 filters.
 - The deliquescent relative humidity of the particulate contamination should be more than 60% RH
 - Environment must be free of zinc whiskers

For additional information, see the Specifications section of the documentation for the server, available from the Lenovo Documents site, <https://pubs.lenovo.com/>

Warranty and support

The SR650 server has a one-year (7X05) or three-year (Machine Type 7X06) warranty.

The standard warranty terms are customer-replaceable unit (CRU) and onsite (for field-replaceable units FRUs only) with standard call center support during normal business hours and 9x5 Next Business Day Parts Delivered.

Lenovo's additional support services provide a sophisticated, unified support structure for your data center, with an experience consistently ranked number one in customer satisfaction worldwide. Available offerings include:

- **Premier Support**

Premier Support provides a Lenovo-owned customer experience and delivers direct access to technicians skilled in hardware, software, and advanced troubleshooting, in addition to the following:

- Direct technician-to-technician access through a dedicated phone line
- 24x7x365 remote support
- Single point of contact service
- End to end case management
- Third-party collaborative software support
- Online case tools and live chat support
- On-demand remote system analysis

- **Warranty Upgrade (Preconfigured Support)**

Services are available to meet the on-site response time targets that match the criticality of your systems.

- 3, 4, or 5 years of service coverage
- 1-year or 2-year post-warranty extensions
- **Foundation Service:** 9x5 service coverage with next business day onsite response. YourDrive YourData is an optional extra (see below).
- **Essential Service:** 24x7 service coverage with 4-hour onsite response or 24-hour committed repair (available only in select markets). Bundled with YourDrive YourData.
- **Advanced Service:** 24x7 service coverage with 2-hour onsite response or 6-hour committed repair (available only in select markets). Bundled with YourDrive YourData.

- **Managed Services**

Lenovo Managed Services provides continuous 24x7 remote monitoring (plus 24x7 call center availability) and proactive management of your data center using state-of-the-art tools, systems, and practices by a team of highly skilled and experienced Lenovo services professionals.

Quarterly reviews check error logs, verify firmware & OS device driver levels, and software as needed. We'll also maintain records of latest patches, critical updates, and firmware levels, to ensure you systems are providing business value through optimized performance.

- **Technical Account Management (TAM)**

A Lenovo Technical Account Manager helps you optimize the operation of your data center based on a deep understanding of your business. You gain direct access to your Lenovo TAM, who serves as your single point of contact to expedite service requests, provide status updates, and furnish reports to track incidents over time. In addition, your TAM will help proactively make service recommendations and manage your service relationship with Lenovo to make certain your needs are met.

- **Enterprise Server Software Support**

Enterprise Software Support is an additional support service providing customers with software support on Microsoft, Red Hat, SUSE, and VMware applications and systems. Around the clock availability for critical problems plus unlimited calls and incidents helps customers address challenges fast, without incremental costs. Support staff can answer troubleshooting and diagnostic questions, address product comparability and interoperability issues, isolate causes of problems, report defects to software vendors, and more.

- **YourDrive YourData**

Lenovo's YourDrive YourData is a multi-drive retention offering that ensures your data is always under your control, regardless of the number of drives that are installed in your Lenovo server. In the unlikely event of a drive failure, you retain possession of your drive while Lenovo replaces the failed drive part. Your data stays safely on your premises, in your hands. The YourDrive YourData service can be purchased in convenient bundles and is optional with Foundation Service. It is bundled with Essential Service and Advanced Service.

- **Health Check**

Having a trusted partner who can perform regular and detailed health checks is central to maintaining efficiency and ensuring that your systems and business are always running at their best. Health Check supports Lenovo-branded server, storage, and networking devices, as well as select Lenovo-supported products from other vendors that are sold by Lenovo or a Lenovo-Authorized Reseller.

Examples of region-specific warranty terms are second or longer business day parts delivery or parts-only base warranty.

If warranty terms and conditions include onsite labor for repair or replacement of parts, Lenovo will dispatch a service technician to the customer site to perform the replacement. Onsite labor under base warranty is limited to labor for replacement of parts that have been determined to be field-replaceable units (FRUs). Parts that are determined to be customer-replaceable units (CRUs) do not include onsite labor under base warranty.

If warranty terms include parts-only base warranty, Lenovo is responsible for delivering only replacement parts that are under base warranty (including FRUs) that will be sent to a requested location for self-service. Parts-only service does not include a service technician being dispatched onsite. Parts must be changed at customer's own cost and labor and defective parts must be returned following the instructions supplied with the spare parts.

Lenovo Service offerings are region-specific. Not all preconfigured support and upgrade options are available in every region. For information about Lenovo service upgrade offerings that are available in your region, refer to the following resources:

- Service part numbers in Lenovo Data Center Solution Configurator (DCSC):
<http://dcsc.lenovo.com/#/services>
- Lenovo Services Availability Locator
<http://lenovolocator.com/>

For service definitions, region-specific details, and service limitations, please refer to the following documents:

- Lenovo Statement of Limited Warranty for Infrastructure Solutions Group (ISG) Servers and System Storage
<http://pcsupport.lenovo.com/us/en/solutions/ht503310>
- Lenovo Data Center Services Agreement
<http://support.lenovo.com/us/en/solutions/ht116628>

Services

Lenovo Services is a dedicated partner to your success. Our goal is to reduce your capital outlays, mitigate your IT risks, and accelerate your time to productivity.

Note: Some service options may not be available in all markets or regions. For more information, go to <https://www.lenovo.com/services>. For information about Lenovo service upgrade offerings that are available in your region, contact your local Lenovo sales representative or business partner.

Here's a more in-depth look at what we can do for you:

- **Asset Recovery Services**

Asset Recovery Services (ARS) helps customers recover the maximum value from their end-of-life equipment in a cost-effective and secure way. On top of simplifying the transition from old to new equipment, ARS mitigates environmental and data security risks associated with data center equipment disposal. Lenovo ARS is a cash-back solution for equipment based on its remaining market value, yielding maximum value from aging assets and lowering total cost of ownership for your customers. For more information, see the ARS page, <https://lenovopress.com/lp1266-reduce-e-waste-and-grow-your-bottom-line-with-lenovo-ars>.

- **Assessment Services**

An Assessment helps solve your IT challenges through an onsite, multi-day session with a Lenovo technology expert. We perform a tools-based assessment which provides a comprehensive and thorough review of a company's environment and technology systems. In addition to the technology based functional requirements, the consultant also discusses and records the non-functional business requirements, challenges, and constraints. Assessments help organizations like yours, no matter how large or small, get a better return on your IT investment and overcome challenges in the ever-changing technology landscape.

- **Design Services**

Professional Services consultants perform infrastructure design and implementation planning to support your strategy. The high-level architectures provided by the assessment service are turned into low level designs and wiring diagrams, which are reviewed and approved prior to implementation. The implementation plan will demonstrate an outcome-based proposal to provide business capabilities through infrastructure with a risk-mitigated project plan.

- **Basic Hardware Installation**

Lenovo experts can seamlessly manage the physical installation of your server, storage, or networking hardware. Working at a time convenient for you (business hours or off shift), the technician will unpack and inspect the systems on your site, install options, mount in a rack cabinet, connect to power and network, check and update firmware to the latest levels, verify operation, and dispose of the packaging, allowing your team to focus on other priorities.

- **Deployment Services**

When investing in new IT infrastructures, you need to ensure your business will see quick time to value with little to no disruption. Lenovo deployments are designed by development and engineering teams who know our Products & Solutions better than anyone else, and our technicians own the process from delivery to completion. Lenovo will conduct remote preparation and planning, configure & integrate systems, validate systems, verify and update appliance firmware, train on administrative tasks, and provide post-deployment documentation. Customer's IT teams leverage our skills to enable IT staff to transform with higher level roles and tasks.

- **Integration, Migration, and Expansion Services**

Move existing physical & virtual workloads easily, or determine technical requirements to support increased workloads while maximizing performance. Includes tuning, validation, and documenting ongoing run processes. Leverage migration assessment planning documents to perform necessary migrations.

Regulatory compliance

The ThinkSystem SR650 server conforms to the following regulations:

- United States: FCC Part 15, Class A; UL 60950-1
- Canada: ICES-003/NMB-03, Class A; CAN/CSA-C22.2 60950-1
- Mexico: NOM-19
- Argentina: IEC60950-1
- European Union: CE Mark (EN55022 Class A, IEC/EN60950-1, EN55024, EN61000-3-2, EN61000-3-3)
- Germany: TUV-GS (IEC/EN 60950-1, EK1-ITB2000)
- Russia, Kazakhstan, Belarus: EAC (TR CU 004/2011, TR CU 020/2011)
- China: CCC GB4943.1, GB9254 Class A, GB17625.1
- India: BIS
- Japan: VCCI, Class A
- Taiwan: BSMI CNS13438, Class A; CNS14336-1
- Korea: KN22, Class A; KN24
- Australia/New Zealand: AS/NZS CISPR 22 Class A
- Reduction of Hazardous Substances (ROHS)
- Energy Star 3.0 (excluding configurations with Bronze 3204, Gold 5222, or Platinum 8256 processors)

Note: For more information on the Energy Star 3.0 certification, refer to the *Energy Star 3.0 Certifications for ThinkSystem Servers* publication:

<http://lenovopress.com/lp1230>

External drive enclosures

The server supports attachment to external drive enclosures using a RAID controller with external ports or a SAS host bus adapter. Adapters supported by the server are listed in the [SAS adapters for external storage](#) section.

Note: Information provided in this section is for ordering reference purposes only. For the operating system and adapter support details, refer to the interoperability matrix for a particular storage enclosure that can be found on the Lenovo Data Center Support web site:

<http://datacentersupport.lenovo.com>

Table 64. External drive enclosures

Model	Description
4587HC1	Lenovo Storage D1212 Disk Expansion Enclosure (2U enclosure with 12x LFF drive bays)
4587HC2	Lenovo Storage D1224 Disk Expansion Enclosure (2U enclosure with 24x SFF drive bays)
6413HC1	Lenovo Storage D3284 High Density Expansion Enclosure (5U enclosure with 84x LFF drive bays)
7DAHCTO1WW	Lenovo ThinkSystem D4390 Direct Attached Storage (4U enclosure with 90x LFF drive bays)

For details about supported drives, adapters, and cables, see the following Lenovo Press Product Guides:

- Lenovo Storage D1212 and D1224
<http://lenovopress.lenovo.com/lp0512>
- Lenovo Storage D3284
<http://lenovopress.lenovo.com/lp0513>
- Lenovo ThinkSystem D4390
<https://lenovopress.lenovo.com/lp1681>

External storage systems

Lenovo offers the ThinkSystem DE Series and ThinkSystem DM Series external storage systems for high-performance storage. See the DE Series and DM Series product guides for specific controller models, expansion enclosures and configuration options:

- ThinkSystem DE Series Storage
<https://lenovopress.com/storage/thinksystem/de-series#rt=product-guide>
- ThinkSystem DM Series Storage
<https://lenovopress.com/storage/thinksystem/dm-series#rt=product-guide>
- ThinkSystem DG Series Storage
<https://lenovopress.com/storage/thinksystem/dg-series#rt=product-guide>

External backup units

The following table lists the external backup options that are offered by Lenovo.

Table 65. External backup options

Part number	Description
External RDX USB drives	
4T27A10725	ThinkSystem RDX External USB 3.0 Dock
External SAS tape backup drives	
6160S7E	IBM TS2270 Tape Drive Model H7S
6160S8E	IBM TS2280 Tape Drive Model H8S
6160S9E	IBM TS2290 Tape Drive Model H9S
External SAS tape backup autoloaders	
6171S7R	IBM TS2900 Tape Autoloader w/LTO7 HH SAS
6171S8R	IBM TS2900 Tape Autoloader w/LTO8 HH SAS
6171S9R	IBM TS2900 Tape Autoloader w/LTO9 HH SAS
External tape backup libraries	
6741A1F	IBM TS4300 3U Tape Library-Base Unit
6741A3F	IBM TS4300 3U Tape Library-Expansion Unit
Full High 8 Gb Fibre Channel for TS4300	
01KP938	LTO 7 FH Fibre Channel Drive
01KP954	LTO 8 FH Fibre Channel Drive
02JH837	LTO 9 FH Fibre Channel Drive
Half High 8 Gb Fibre Channel for TS4300	
01KP936	LTO 7 HH Fibre Channel Drive
01KP952	LTO 8 HH Fibre Channel Drive
02JH835	LTO 9 HH Fibre Channel Drive
Half High 6 Gb SAS for TS4300	
01KP937	LTO 7 HH SAS Drive
01KP953	LTO 8 HH SAS Drive
02JH836	LTO 9 HH SAS Drive

For more information, see the list of Product Guides in the Backup units category:
<https://lenovopress.com/servers/options/backup>

Fibre Channel SAN switches

Lenovo offers the ThinkSystem DB Series of Fibre Channel SAN switches for high-performance storage expansion. See the DB Series product guides for models and configuration options:

- ThinkSystem DB Series SAN Switches:
<https://lenovopress.com/storage/switches/rack#rt=product-guide>

Rack cabinets

The following table lists the supported rack cabinets.

Table 66. Rack cabinets

Part number	Description
7D2B0001WW / 7D2N0001WW	12U 1200mm Deep Micro Datacenter Rack
7D2C0001WW / 7D2P0001WW	18U 1200mm Deep Micro Datacenter Rack
93072RX	25U Standard Rack (1000mm)
93072PX	25U Static S2 Standard Rack (1000mm)
7D6DA007WW	ThinkSystem 42U Onyx Primary Heavy Duty Rack Cabinet (1200mm)
7D6DA008WW	ThinkSystem 42U Pearl Primary Heavy Duty Rack Cabinet (1200mm)
1410-O42	Lenovo EveryScale 42U Onyx Heavy Duty Rack Cabinet
1410-P42	Lenovo EveryScale 42U Pearl Heavy Duty Rack Cabinet
93604PX	42U 1200mm Deep Dynamic Rack
93614PX	42U 1200mm Deep Static Rack
93634PX	42U 1100mm Dynamic Rack
93634EX	42U 1100mm Dynamic Expansion Rack
93074RX	42U Standard Rack (1000mm)
7D6EA009WW	ThinkSystem 48U Onyx Primary Heavy Duty Rack Cabinet (1200mm)
7D6EA00AWW	ThinkSystem 48U Pearl Primary Heavy Duty Rack Cabinet (1200mm)
1410-O48	Lenovo EveryScale 48U Onyx Heavy Duty Rack Cabinet
1410-P48	Lenovo EveryScale 48U Pearl Heavy Duty Rack Cabinet

For specifications about these racks, see the Lenovo Rack Cabinet Reference, available from:
<https://lenovopress.com/lp1287-lenovo-rack-cabinet-reference>

For more information, see the list of Product Guides in the Rack cabinets category:
<https://lenovopress.com/servers/options/racks>

KVM switches and consoles

The following table lists the supported KVM consoles.

Table 67. KVM console

Part number	Description
4XF7A84188	ThinkSystem 18.5" LCD Console (with US English keyboard)

The following table lists the available KVM switches and the options that are supported with them.

Table 69. KVM switches and options

Part number	Description
KVM Console switches	
1754D2X	Global 4x2x32 Console Manager (GCM32)
1754D1X	Global 2x2x16 Console Manager (GCM16)
1754A2X	Local 2x16 Console Manager (LCM16)
1754A1X	Local 1x8 Console Manager (LCM8)
Cables for GCM and LCM Console switches	
46M5383	Virtual Media Conversion Option Gen2 (VCO2)
46M5382	Serial Conversion Option (SCO)

For more information, see the list of Product Guides in the KVM Switches and Consoles category:
<http://lenovopress.com/servers/options/kvm>

Power distribution units

The following table lists the power distribution units (PDUs) that are offered by Lenovo.

Table 70. Power distribution units

Part number	Feature code	Description	ANZ	ASEAN	Brazil	EET	MEA	RUCIS	WE	HTK	INDIA	JAPAN	LA	NA	PRC
0U Basic PDUs															
00YJ776	ATZY	0U 36 C13/6 C19 24A 1 Phase PDU	N	Y	Y	N	N	N	N	N	N	Y	Y	Y	N
0U Switched and Monitored PDUs															
00YJ783	AU04	0U 12 C13/12 C19 Switched and Monitored 48A 3 Phase PDU	N	N	Y	N	N	N	Y	N	N	Y	Y	Y	N
00YJ781	AU03	0U 20 C13/4 C19 Switched and Monitored 24A 1 Phase PDU	N	N	Y	N	Y	N	Y	N	N	Y	Y	Y	N
1U Switched and Monitored PDUs															
4PU7A81117	BNDV	1U 18 C19/C13 switched and monitored 48A 3P WYE PDU - ETL	N	N	N	N	N	N	N	N	N	N	N	Y	N
4PU7A77467	BLC4	1U 18 C19/C13 Switched and Monitored 80A 3P Delta PDU	N	N	N	N	N	N	N	N	N	Y	N	Y	N
4PU7A77469	BLC6	1U 12 C19/C13 switched and monitored 60A 3P Delta PDU	N	N	N	N	N	N	N	N	N	N	N	Y	N
4PU7A77468	BLC5	1U 12 C19/C13 switched and monitored 32A 3P WYE PDU	Y	Y	Y	Y	Y	Y	Y	Y	Y	N	Y	Y	Y
4PU7A81118	BNDW	1U 18 C19/C13 switched and monitored 48A 3P WYE PDU - CE	Y	Y	Y	Y	Y	Y	Y	Y	Y	N	Y	N	Y
1U Ultra Density Enterprise PDUs (9x IEC 320 C13 + 3x IEC 320 C19 outlets)															
71763NU	6051	Ultra Density Enterprise C19/C13 PDU 60A/208V/3PH	N	N	Y	N	N	N	N	N	N	Y	Y	Y	N

Part number	Feature code	Description	ANZ	ASEAN	Brazil	EET	MEA	RUCIS	WE	HTK	INDIA	JAPAN	LA	NA	PRC
71762NX	6091	Ultra Density Enterprise C19/C13 PDU Module	Y	Y	Y	Y	Y	Y	Y	Y	Y	Y	Y	Y	Y
1U C13 Enterprise PDUs (12x IEC 320 C13 outlets)															
39Y8941	6010	DPI C13 Enterprise PDU Module (WW)	Y	Y	Y	Y	Y	Y	Y	Y	Y	Y	Y	Y	Y
1U Front-end PDUs (3x IEC 320 C19 outlets)															
39Y8938	6002	DPI Single-phase 30A/120V Front-end PDU (US)	Y	Y	Y	Y	Y	Y	Y	Y	Y	Y	Y	Y	Y
39Y8939	6003	DPI Single-phase 30A/208V Front-end PDU (US)	Y	Y	Y	Y	Y	Y	Y	Y	Y	Y	Y	Y	Y
39Y8934	6005	DPI Single-phase 32A/230V Front-end PDU (International)	Y	Y	Y	Y	Y	Y	Y	Y	Y	Y	Y	Y	Y
39Y8940	6004	DPI Single-phase 60A/208V Front-end PDU (US)	Y	N	Y	Y	Y	Y	Y	N	N	Y	Y	Y	N
39Y8935	6006	DPI Single-phase 63A/230V Front-end PDU (International)	Y	Y	Y	Y	Y	Y	Y	Y	Y	Y	Y	Y	Y
1U NEMA PDUs (6x NEMA 5-15R outlets)															
39Y8905	5900	DPI 100-127V NEMA PDU	Y	Y	Y	Y	Y	Y	Y	Y	Y	Y	Y	Y	Y
Line cords for 1U PDUs that ship without a line cord															
40K9611	6504	4.3m, 32A/380-415V, EPDU/IEC 309 3P+N+G 3ph wye (non-US) Line Cord	Y	Y	Y	Y	Y	Y	Y	Y	Y	Y	Y	Y	Y
40K9612	6502	4.3m, 32A/230V, EPDU to IEC 309 P+N+G (non-US) Line Cord	Y	Y	Y	Y	Y	Y	Y	Y	Y	Y	Y	Y	Y
40K9613	6503	4.3m, 63A/230V, EPDU to IEC 309 P+N+G (non-US) Line Cord	Y	Y	Y	Y	Y	Y	Y	Y	Y	Y	Y	Y	Y
40K9614	6500	4.3m, 30A/208V, EPDU to NEMA L6-30P (US) Line Cord	Y	Y	Y	Y	Y	Y	Y	Y	Y	Y	Y	Y	Y
40K9615	6501	4.3m, 60A/208V, EPDU to IEC 309 2P+G (US) Line Cord	N	N	Y	N	N	N	Y	N	N	Y	Y	Y	N
40K9617	6505	4.3m, 32A/230V, Souriau UTG Female to AS/NZ 3112 (Aus/NZ) Line Cord	Y	Y	Y	Y	Y	Y	Y	Y	Y	Y	Y	Y	Y
40K9618	6506	4.3m, 32A/250V, Souriau UTG Female to KSC 8305 (S. Korea) Line Cord	Y	Y	Y	Y	Y	Y	Y	Y	Y	Y	Y	Y	Y

For more information, see the Lenovo Press documents in the PDU category:
<https://lenovopress.com/servers/options/pdu>

Uninterruptible power supply units

The following table lists the uninterruptible power supply (UPS) units that are offered by Lenovo.

Table 71. Uninterruptible power supply units

Part number	Description
55941AX	RT1.5kVA 2U Rack or Tower UPS (100-125VAC)
55941KX	RT1.5kVA 2U Rack or Tower UPS (200-240VAC)
55942AX	RT2.2kVA 2U Rack or Tower UPS (100-125VAC)
55942KX	RT2.2kVA 2U Rack or Tower UPS (200-240VAC)
55943AX	RT3kVA 2U Rack or Tower UPS (100-125VAC)
55943KX	RT3kVA 2U Rack or Tower UPS (200-240VAC)
55945KX	RT5kVA 3U Rack or Tower UPS (200-240VAC)
55946KX	RT6kVA 3U Rack or Tower UPS (200-240VAC)
55948KX	RT8kVA 6U Rack or Tower UPS (200-240VAC)
55949KX	RT11kVA 6U Rack or Tower UPS (200-240VAC)
55948PX	RT8kVA 6U 3:1 Phase Rack or Tower UPS (380-415VAC)
55949PX	RT11kVA 6U 3:1 Phase Rack or Tower UPS (380-415VAC)
55943KT†	ThinkSystem RT3kVA 2U Standard UPS (200-230VAC) (2x C13 10A, 2x GB 10A, 1x C19 16A outlets)
55943LT†	ThinkSystem RT3kVA 2U Long Backup UPS (200-230VAC) (2x C13 10A, 2x GB 10A, 1x C19 16A outlets)
55946KT†	ThinkSystem RT6kVA 5U UPS (200-230VAC) (2x C13 10A outlets, 1x Terminal Block output)
5594XKT†	ThinkSystem RT10kVA 5U UPS (200-230VAC) (2x C13 10A outlets, 1x Terminal Block output)

† Only available in China and the Asia Pacific market.

For more information, see the list of Product Guides in the UPS category:

<https://lenovopress.com/servers/options/ups>

Lenovo Financial Services

Lenovo Financial Services reinforces Lenovo's commitment to deliver pioneering products and services that are recognized for their quality, excellence, and trustworthiness. Lenovo Financial Services offers financing solutions and services that complement your technology solution anywhere in the world.

We are dedicated to delivering a positive finance experience for customers like you who want to maximize your purchase power by obtaining the technology you need today, protect against technology obsolescence, and preserve your capital for other uses.

We work with businesses, non-profit organizations, governments and educational institutions to finance their entire technology solution. We focus on making it easy to do business with us. Our highly experienced team of finance professionals operates in a work culture that emphasizes the importance of providing outstanding customer service. Our systems, processes and flexible policies support our goal of providing customers with a positive experience.

We finance your entire solution. Unlike others, we allow you to bundle everything you need from hardware and software to service contracts, installation costs, training fees, and sales tax. If you decide weeks or months later to add to your solution, we can consolidate everything into a single invoice.

Our Premier Client services provide large accounts with special handling services to ensure these complex transactions are serviced properly. As a premier client, you have a dedicated finance specialist who manages your account through its life, from first invoice through asset return or purchase. This specialist develops an in-depth understanding of your invoice and payment requirements. For you, this dedication provides a high-quality, easy, and positive financing experience.

For your region-specific offers, please ask your Lenovo sales representative or your technology provider about the use of Lenovo Financial Services. For more information, see the following Lenovo website:

<https://www.lenovo.com/us/en/landingpage/lenovo-financial-services/>

Seller training courses

The following sales training courses are offered for employees and partners (login required). Courses are listed in date order.

1. **Partner Technical Webinar - ISG Portfolio Update**

2024-04-15 | 60 minutes | Employees and Partners

In this 60-minute replay, Mark Bica, NA ISG Server Product Manager reviewed the Lenovo ISG portfolio. He covered new editions such as the SR680a \ SR685a, dense servers, and options that are strategic for any workload.

Published: 2024-04-15

Length: 60 minutes

Employee link: Grow@Lenovo

Partner link: [Lenovo Partner Learning](#)

Course code: 041224

2. **Partner Technical Webinar – StorMagic**

2024-03-19 | 60 minutes | Employees and Partners

March 08, 2024 – In this 60-minute replay, Stuart Campbell and Wes Ganeko of StorMagic joined us and provided an overview of StorMagic on Lenovo. They also demonstrated the interface while sharing some interesting use cases.

Published: 2024-03-19

Length: 60 minutes

Employee link: [Grow@Lenovo](#)

Partner link: [Lenovo Partner Learning](#)

Course code: 030824

3. **Intel Transparent Supply Chain on Lenovo Servers**

2024-01-29 | 12 minutes | Employees and Partners

This course introduces the Intel Transparent Supply Chain (TSC) program, explains how the program works, and discusses the benefits of the Intel TSC program to customers. Adding the Intel TSC feature to an order is explained.

Course objectives:

- Describe the Intel® Transparent Supply Chain program
- Explain how the Intel® Transparent Supply Chain program works
- Discuss the benefits of the Intel® Transparent Supply Chain program to Lenovo customers
- Explain how to add Intel® Transparent Supply Chain program feature to an order

Published: 2024-01-29

Length: 12 minutes

Employee link: [Grow@Lenovo](#)

Partner link: [Lenovo Partner Learning](#)

Course code: SXXW1230

4. **Family Portfolio: Storage Controller Options**

2024-01-23 | 25 minutes | Employees and Partners

This course covers the storage controller options available for use in Lenovo servers. The classes of storage controller are discussed, along with a discussion of where they are used, and which to choose.

After completing this course, you will be able to:

- Describe the classes of storage controllers
- Discuss where each controller class is used
- Describe the available options in each controller class

Published: 2024-01-23

Length: 25 minutes

Employee link: [Grow@Lenovo](#)

Partner link: [Lenovo Partner Learning](#)

Course code: SXXW1111

5. **Lenovo-Intel Sustainable Solutions QH**
2024-01-22 | 10 minutes | Employees and Partners

This Quick Hit explains how Lenovo and Intel are committed to sustainability, and introduces the Lenovo-Intel joint sustainability campaign. You will learn how to use this campaign to show customers what that level of commitment entails, how to use the campaign's unsolicited proposal approach, and how to use the campaign as a conversation starter which may lead to increased sales.

Published: 2024-01-22
Length: 10 minutes
Employee link: [Grow@Lenovo](#)
Partner link: [Lenovo Partner Learning](#)
Course code: SXXW2524a

6. **Family Introduction: Rack and Tower**
2024-01-19 | 11 minutes | Employees and Partners

This course is designed to give Lenovo sales and partner representatives a foundation on the characteristics of the rack and tower server family. As an introduction to the family, this course also includes positioning, when to use a product, and keywords a client may use when discussing a rack product.

Course Objectives:

- Family Characteristics
- Priority Positioning
- Product Usage
- Keywords and Phrases

Published: 2024-01-19
Length: 11 minutes
Employee link: [Grow@Lenovo](#)
Partner link: [Lenovo Partner Learning](#)
Course code: SXXW1100r3

7. **FY24Q3 Intel Servers Update**
2023-12-11 | 15 minutes | Employees and Partners

This update is designed to help you discuss the features and customer benefits of Lenovo servers that use the 5th Gen Intel® Xeon® processors. Lenovo has also introduced a new server, the ThinkSystem SD650-N V3, which expands the supercomputer server family. Reasons to call your customer and talk about refreshing their infrastructure are also included as a guideline.

Published: 2023-12-11
Length: 15 minutes
Employee link: [Grow@Lenovo](#)
Partner link: [Lenovo Partner Learning](#)
Course code: SXXW2522a

8. Family Portfolio: Intel Rack and Tower Servers
2023-12-11 | 15 minutes | Employees and Partners

This course is designed to give Lenovo sales and partner representatives a foundation of the ThinkSystem Intel Rack and Tower server family. After completing this course, you will be able to identify products and features within the ThinkSystem Intel rack and tower server family, describe unique innovations that this product family uses and recognize when a specific product should be selected.

Published: 2023-12-11
Length: 15 minutes
Employee link: [Grow@Lenovo](#)
Partner link: [Lenovo Partner Learning](#)
Course code: SXXW1204r11

9. Partner Technical Webinar - Cloudian - Ransomware
2023-10-12 | 60 minutes | Employees and Partners

In this 60-minute replay, Tim O'Neal, Eric Craig, and Charlii Collins of Cloudian discuss how Cloudian protects from Ransomware paired with VEEAM, Commvault, or Rubrik.

Published: 2023-10-12
Length: 60 minutes
Employee link: [Grow@Lenovo](#)
Partner link: [Lenovo Partner Learning](#)
Course code: 100623

10. Lenovo Data Center Product Portfolio
2023-07-21 | 15 minutes | Employees and Partners

This course introduces the Lenovo data center portfolio, and covers servers, storage, storage networking, and software-defined infrastructure products. After completing this course about Lenovo data center products, you will be able to identify product types within each data center family, describe Lenovo innovations that this product family or category uses, and recognize when a specific product should be selected.

Published: 2023-07-21
Length: 15 minutes
Employee link: [Grow@Lenovo](#)
Partner link: [Lenovo Partner Learning](#)
Course code: SXXW1110r6

11. Partner Technical Webinar - Data Center Limits and ISG TAA Compliance
2023-05-16 | 60 minutes | Employees and Partners

In this 60-minute replay, we had two topics. First Vinod Kamath, Lenovo Distinguished Engineer for Data Center Cooling presented on the Systems Configuration and Data Center Ambient Limits. Second, Shama Patari, Lenovo Trade Council, and Glenn Johnson, Lenovo Principal Engineer for Supply Chain presented on ISG TAA Compliance.

Published: 2023-05-16
Length: 60 minutes
Employee link: [Grow@Lenovo](#)
Partner link: [Lenovo Partner Learning](#)
Course code: 051223

12. **Family Portfolio: Edge Solutions**

2022-12-06 | 10 minutes | Employees and Partners

This course describes the Lenovo edge solutions. Edge servers, such as the Lenovo ThinkSystem SE350 and ThinkEdge SE450, are used at the edge of an IoT environment, and may be part of an edge solution. Solutions such as those using software from Scale Computing typically use more traditional Lenovo servers.

After completing this course, you will be able to list the edge solutions in the Lenovo portfolio, describe the features of each solution and determine which solution is best suited to a specific environment.

Published: 2022-12-06

Length: 10 minutes

Employee link: [Grow@Lenovo](#)

Partner link: [Lenovo Partner Learning](#)

Course code: SXXW1108r4

13. **Lenovo Sustainable Computing**

2022-09-16 | 4 minutes | Employees and Partners

This Quick Hit describes the Lenovo sustainable computing program, and the many ways in which Lenovo strives to respect and protect the environment.

Published: 2022-09-16

Length: 4 minutes

Employee link: [Grow@Lenovo](#)

Partner link: [Lenovo Partner Learning](#)

Course code: SXXW2504a

Related publications and links

For more information, see these resources:

- ThinkSystem SR650 product page
<https://www.lenovo.com/us/en/data-center/servers/racks/ThinkSystem-SR650/p/77XX7SR65>
- Datasheet for the ThinkSystem SR650:
<https://lenovopress.com/ds0032-lenovo-thinksystem-sr650>
- 3D Interactive Tour of the ThinkSystem SR650:
<https://lenovopress.com/lp0673-3d-tour-thinksystem-sr650>
- Walkthrough Video for the ThinkSystem SR650:
<https://lenovopress.com/lp0700-thinksystem-sr650-server-video-walkthrough>
- User Manuals for the ThinkSystem SR650:
https://thinksystem.lenovofiles.com/help/topic/7X05/introduction.html?cp=4_9
 - Quick Start Guide
 - Setup Guide
 - Rack Installation Guides
 - Maintenance Manual
 - Messages and Codes Reference
 - UEFI Manual
- Lenovo Data Center Support Downloads - ThinkSystem SR650:
<http://datacentersupport.lenovo.com/products/servers/thinksystem/sr650/7x05/downloads>
<http://datacentersupport.lenovo.com/products/servers/thinksystem/sr650/7x06/downloads>
- Lenovo Hardware Installation & Removal Videos on the ThinkSystem SR650:
 - YouTube: https://www.youtube.com/playlist?list=PLYV5R7hVcs-A25P7vBoGa_wn7D7XTgDS_
 - Youku: https://list.youku.com/albumlist/show/id_50483444
- Lenovo Data Center Solution Configurator (DCSC):
<http://dcsc.lenovo.com>

Related product families

Product families related to this document are the following:

- [2-Socket Rack Servers](#)
- [ThinkSystem SR650 Server](#)

Notices

Lenovo may not offer the products, services, or features discussed in this document in all countries. Consult your local Lenovo representative for information on the products and services currently available in your area. Any reference to a Lenovo product, program, or service is not intended to state or imply that only that Lenovo product, program, or service may be used. Any functionally equivalent product, program, or service that does not infringe any Lenovo intellectual property right may be used instead. However, it is the user's responsibility to evaluate and verify the operation of any other product, program, or service. Lenovo may have patents or pending patent applications covering subject matter described in this document. The furnishing of this document does not give you any license to these patents. You can send license inquiries, in writing, to:

Lenovo (United States), Inc.
8001 Development Drive
Morrisville, NC 27560
U.S.A.
Attention: Lenovo Director of Licensing

LENOVO PROVIDES THIS PUBLICATION "AS IS" WITHOUT WARRANTY OF ANY KIND, EITHER EXPRESS OR IMPLIED, INCLUDING, BUT NOT LIMITED TO, THE IMPLIED WARRANTIES OF NON-INFRINGEMENT, MERCHANTABILITY OR FITNESS FOR A PARTICULAR PURPOSE. Some jurisdictions do not allow disclaimer of express or implied warranties in certain transactions, therefore, this statement may not apply to you.

This information could include technical inaccuracies or typographical errors. Changes are periodically made to the information herein; these changes will be incorporated in new editions of the publication. Lenovo may make improvements and/or changes in the product(s) and/or the program(s) described in this publication at any time without notice.

The products described in this document are not intended for use in implantation or other life support applications where malfunction may result in injury or death to persons. The information contained in this document does not affect or change Lenovo product specifications or warranties. Nothing in this document shall operate as an express or implied license or indemnity under the intellectual property rights of Lenovo or third parties. All information contained in this document was obtained in specific environments and is presented as an illustration. The result obtained in other operating environments may vary. Lenovo may use or distribute any of the information you supply in any way it believes appropriate without incurring any obligation to you.

Any references in this publication to non-Lenovo Web sites are provided for convenience only and do not in any manner serve as an endorsement of those Web sites. The materials at those Web sites are not part of the materials for this Lenovo product, and use of those Web sites is at your own risk. Any performance data contained herein was determined in a controlled environment. Therefore, the result obtained in other operating environments may vary significantly. Some measurements may have been made on development-level systems and there is no guarantee that these measurements will be the same on generally available systems. Furthermore, some measurements may have been estimated through extrapolation. Actual results may vary. Users of this document should verify the applicable data for their specific environment.

© Copyright Lenovo 2024. All rights reserved.

This document, LP1050, was created or updated on March 6, 2024.

Send us your comments in one of the following ways:

- Use the online Contact us review form found at:
<https://lenovopress.lenovo.com/LP1050>
- Send your comments in an e-mail to:
comments@lenovopress.com

This document is available online at <https://lenovopress.lenovo.com/LP1050>.

Trademarks

Lenovo and the Lenovo logo are trademarks or registered trademarks of Lenovo in the United States, other countries, or both. A current list of Lenovo trademarks is available on the Web at <https://www.lenovo.com/us/en/legal/copytrade/>.

The following terms are trademarks of Lenovo in the United States, other countries, or both:

Lenovo®
AnyBay®
Bootable Media Creator
Flex System
Lenovo Services
System x®
ThinkServer®
ThinkSystem®
TopSeller
TruDDR4
UpdateXpress System Packs
XClarity®

The following terms are trademarks of other companies:

Intel®, Intel Optane™, and Xeon® are trademarks of Intel Corporation or its subsidiaries.

Linux® is the trademark of Linus Torvalds in the U.S. and other countries.

Microsoft®, Hyper-V®, PowerShell, Windows PowerShell®, Windows Server®, and Windows® are trademarks of Microsoft Corporation in the United States, other countries, or both.

SPECpower® is a trademark of the Standard Performance Evaluation Corporation (SPEC).

Other company, product, or service names may be trademarks or service marks of others.