

SAMSUNG

Service Manual

Service Manual

Service Manual



DIGITAL LASER MFP

SCX-5835NX_5935NX Series

The keynote of Product

- 33 ppm(A4) Network-ready MFP
- Toner cartridge
: Initial : 4K / Sales : 4K,10K
- Paper handling
: 500 sheets Standard cassette
: 500 sheets Optional cassette
: 50 sheets DADF
- 160GB HDD
- High Performance CCDM
- Easy to install (CRU & Option)
- Color Graphic Touch-Screen LCD (7")
- Low Cost per Page
- Direct USB



ELECTRONICS

Service Manual

Service Manual

GSPN (Global Service Partner Network)

North America : service.samsungportal.com

Latin America : latin.samsungportal.com

CIS : cis.samsungportal.com

Europe : europe.samsungportal.com

China : china.samsungportal.com

Asia : asia.samsungportal.com

Mideast & Africa : mea.samsungportal.com

© Samsung Electronics Co.,Ltd. June. 2010
Printed in Korea.

VERSION NO. : 1.00 CODE : 5835-N0000E

chapter 1 *Precautions*

| | |
|--|-----|
| 1.1 Safety Warning | 1-1 |
| 1.2 Caution for safety | 1-2 |
| 1.3 ESD Precautions | 1-5 |
| 1.4 Super Capacitor or Lithium Battery Precautions | 1-5 |

chapter 2 *Product Overview*

| | |
|------------------------------------|------|
| 2.1 Product Overview | 2-1 |
| 2.1.1 Product Summary | 5-1 |
| 2.1.2 Specifications..... | 2-2 |
| 2.1.3 Model Comparison | 2-11 |
| 2.2 System Overview | 2-14 |
| 2.2.1 System Configuration | 2-15 |
| 2.2.2 Hardware Configuration | 2-15 |
| 2.2.3 Mechanic Configuration | 2-22 |

chapter 3 *Disassembly and Reassembly*

| | |
|---|------|
| 3.1 Disassembly and Reassembly on Disassembly | 3-1 |
| 3.2 Maintenance Parts | 3-2 |
| 3.3 General Disassembly | 3-3 |
| 3.3.1 Fuser Unit | 3-3 |
| 3.3.2 DADF Pick up unit and rubber pad | 3-3 |
| 3.3.3 Pick up roller | 3-4 |
| 3.3.4 Transfer roller | 3-4 |
| 3.3.5 Cover | 3-5 |
| 3.3.6 DADF Board | 3-7 |
| 3.3.7 Scan Assy | 3-8 |
| 3.3.8 Middle Cover | 3-10 |

| | |
|--------------------------------------|------|
| 3.3.9 HDD/ Main PBA/ Fax board | 3-11 |
| 3.3.10 SMPS board | 3-12 |
| 3.3.11 Main Drive unit..... | 3-12 |
| 3.3.12 HVPS board..... | 3-13 |
| 3.3.13 LSU Unit | 3-13 |

chapter 4 *Alignment and Troubleshooting*

| | |
|---|------|
| 4.1 Alignment and Adjustments..... | 4-1 |
| 4.1.1 Paper path | 4-1 |
| 4.1.2 Clearing Paper Jams | 4-2 |
| 4.1.3 Abnormal Image Printing and Defective Roller..... | 4-13 |
| 4.1.4 Control Panel overview | 4-15 |
| 4.1.5 Understanding The Status LED | 4-18 |
| 4.1.6 Menu overview | 4-19 |
| 4.1.7 Firmware Upgrade | 4-31 |
| 4.1.8 Diagnostics..... | 4-35 |
| 4.2 Troubleshooting..... | 4-59 |
| 4.2.1 Procedure of Checking the Symptoms | 4-59 |
| 4.2.2 Error Message | 4-60 |
| 4.2.3 Solution | 4-64 |

chapter 5 *System Diagram*

| | |
|-----------------------------|-----|
| 5.1 Block Diagram | 5-1 |
| 5.2 Connection Diagram..... | 5-3 |

chapter 6 *Reference Information*

| | |
|--------------------------------------|-----|
| 6.1 Tool for Troubleshooting | 6-1 |
| 6.2 Acronyms and Abbreviations | 6-2 |

Contents

| | |
|--|-----|
| 6.2.1 Acronyms | 6-2 |
| 6.2.2 Service Parts | 6-4 |
| 6.3 The Sample Pattern for the Test..... | 6-8 |
| 6.4 Selecting a location | 6-9 |

attached *Exploded Views & Parts List*

1. Precautions

In order to prevent accidents and damages to the equipment please read the precautions listed below carefully before servicing the product and follow them closely.

1.1 Safety warning

(1) Only to be serviced by a factory trained service technician.

High voltages and lasers inside this product are dangerous. This product should only be serviced by a factory trained service technician.

(2) Use only Samsung replacement parts.

There are no user serviceable parts inside the product. Do not make any unauthorized changes or additions to the product as these could cause the product to malfunctions and create an electric shocks or fire hazards.

(3) Laser Safety Statement

The product is certified in the U.S. to conform to the requirements of DHHS 21 CFR, chapter 1 Subchapter J for Class 1(1) laser products, and elsewhere, it is certified as a Class I laser product conforming to the requirements of IEC 825. Class I laser products are not considered to be hazardous. The laser system and product are designed so there is never any human access to laser radiation above a Class I level during normal operation, user maintenance, or prescribed service condition.

Warning >> Never operate or service the product with the protective cover removed from Laser/Scanner assembly. The reflected beam, although invisible, can damage your eyes. When using this product, these basic safety pre-cautions should always be followed to reduce risk of fire, electric shock, and personal injury.



CAUTION - INVISIBLE LASER RADIATION
WHEN THIS COVER OPEN.
DO NOT OPEN THIS COVER.

VORSICHT - UNSICHTBARE LASERSTRAHLUNG,
WENN ABDECKUNG GE...FFNET.
NICHT DEM STRAHL AUSSETZEN.

ATTENTION - RAYONNEMENT LASER INVISIBLE EN CAS
D'OUVERTURE. EXPOSITION DANGEREUSE
AU FAISCEAU.

ATTENZIONE - RADIAZIONE LASER INVISIBLE IN CASO DI
APERTURA. EVITARE L'ESPOSIZIONE AL
FASCIO.

PRECAUCION - RADIACION LASER IVISIBLE CUANDO SE ABRE.
EVITAR EXPONERSE AL RAYO.

ADVARSEL - USYNLIG LASERSTRLNING VED BNING, NR
SIKKERHEDSBRYDERE ER UDE AF FUNKTION.
UNNG UDSAETTEELSE FOR STRLNING.

ADVARSEL - USYNLIG LASERSTRLNING NR DEKSEL
PNES. STIRR IKKE INN I STRLEN.
UNNG EKSPONERING FOR STRLEN.

VARNING - OSYNLIG LASERSTRLNING NR DENNA DEL
R...PPNAD OCH SPRREN R URKOPPLAD.
BETRAKTA EJ STRLEN. STRLEN R FARLIG.

VARO! - AVATTAESSA JA SUOJALUKITUS OHITETTAESSA
OLET ALTIINA NKYMTT...MLLE LASER-
STEILYLLE L KATSO STEESEEN.

注 意 - 严禁揭开此盖, 以免激光泄露灼伤

주 의 - 이 덮개를 열면 레이저광에 노출될 수 있으므로
주의하십시오.

1.2 Caution for safety

1.2.1 Toxic material

This product contains toxic materials that could cause illness if ingested.

- (1) If the LCD control panel is damaged, it is possible for the liquid inside to leak. This liquid is toxic. Contact with the skin should be avoided. Wash any splashes from eyes or skin immediately and contact your doctor. If the liquid gets into the mouth or is swallowed, see a doctor immediately.
- (2) Please keep imaging unit and toner cartridge away from children. The toner powder contained in the imaging unit and toner cartridge may be harmful, and if swallowed, you should contact a doctor.

1.2.2 Electric shock and fire safety precautions

Failure to follow the following instructions could cause electric shock or potentially cause a fire.

- (1) Use only the correct voltage, failure to do so could damage the product and potentially cause a fire or electric shock.
- (2) Use only the power cable supplied with the product. Use of an incorrectly specified cable could cause the cable to overheat and potentially cause a fire.
- (3) Do not overload the power socket, this could lead to overheating of the cables inside the wall and could lead to a fire, and/or cause your ceiling or lamp lights to flicker.
- (4) Do not allow water or other liquids to spill into the product, this can cause electric shock. Do not allow paper clips, pins or other foreign objects to fall into the product, these could cause a short circuit leading to an electric shock or fire hazard.
- (5) Never touch the plugs on either end of the power cable with wet hands, this can cause electric shock. When servicing the product, remove the power plug from the wall socket.
- (6) Use caution when inserting or removing the power connector. When removing the power connector, grip it firmly and pull. The power connector must be inserted completely, otherwise a poor contact could cause overheating possibly leading to a fire.
- (7) Take care of the power cable. Do not allow it to become twisted, bent sharply around corners or wise damaged. Do not place objects on top of the power cable. If the power cable is damaged it could overheat and cause a fire. Exposed cables could cause an electric shock. Replace the damaged power cable immediately, do not reuse or repair the damaged cable. Some chemicals can attack the coating on the power cable, weakening the cover or exposing cables causing fire and shock risks.
- (8) Ensure that the power sockets and plugs are not cracked or broken in any way. Any such defects should be repaired immediately. Take care not to cut or damage the power cable or plugs when moving the machine.
- (9) Use caution during thunder or lightning storms. Samsung recommends that this machine be disconnected from the power source when such weather conditions are expected. Do not touch the machine or the power cord if it is still connected to the wall socket in these weather conditions.
- (10) Avoid damp or dusty areas, install the product in a clean well ventilated location. Do not position the machine near a humidifier or in front of an air conditioner. Moisture and dust built up inside the machine can lead to overheating and cause a fire or cause parts to rust.
- (11) Do not position the product in direct sunlight. This will cause the temperature inside the product to rise possibly leading to the product failing to work properly and in extreme conditions could lead to a fire.
- (12) Do not insert any metal objects into the machine through the ventilator fan or other part of the casing, it could make contact with a high voltage conductor inside the machine and cause an electric shock.

1.2.3 Handling precautions

The following instructions are for your own personal safety to avoid injury and so as not to damage the product.

- (1) Ensure the product is installed on a level surface, capable of supporting its weight. Failure to do so could cause copy quality problems, and/or the product to tip or fall.
- (2) The product contains many rollers, gears and fans. Take great care to ensure that you do not catch your fingers, hair or clothing in any of these rotating devices.
- (3) Do not place any small metal objects, containers of water, chemicals or other liquids close to the product which if spilled could get into the machine and cause damage or a shock or fire hazard.
- (4) Do not install the machine in areas with high dust or moisture levels, beside an open window or close to a humidifier or heater. Damage could be caused to the product in such areas.
- (5) Do not place candles, burning cigarettes, etc on the product, These could cause a fire.

1.2.4 Assembly / Disassembly precautions

Replace parts carefully and always use Samsung parts. Take care to note the exact location of parts and also cable routing before dismantling any part of the machine. Ensure all parts and cables are replaced correctly. Please carry out the following procedures before dismantling the product or replacing any parts.

- (1) Check the contents of the machine memory and make a note of any user settings. These will be erased if the main board or network card is replaced.
- (2) Ensure that power is disconnected before servicing or replacing any electrical parts.
- (3) Disconnect interface cables and power cables.
- (4) Only use approved spare parts. Ensure that part number, product name, any voltage, current or temperature rating are correct.
- (5) When removing or re-fitting any parts do not use excessive force, especially when fitting screws into plastic.
- (6) Take care not to drop any small parts into the machine.
- (7) Handling of the OPC Drum
 - The OPC Drum can be irreparably damaged if it exposed to light. Take care not to expose the OPC Drum either to direct sunlight or to fluorescent or incandescent room lighting. Exposure for as little as 5 minutes can damage the surface of the photoconductive properties and will result in print quality degradation. Take extra care when servicing the product. Remove the OPC Drum and store it in a black bag or other lightproof container. Take care when working with the Covers (especially the top cover) open as light is admitted to the OPC area and can damage the OPC Drum.
 - Take care not to scratch the green surface of OPC Drum Unit. If the green surface of the Drum Cartridge is scratched or touched the print quality will be compromised.

1.2.5 Disregarding this warning may cause bodily injury

- (1) Be careful with the high temperature part.
The fuser unit works at a high temperature. Use caution when working on the printer. Wait for the fuser to cool down before disassembly.
- (2) Do not put finger or hair into the rotating parts.
When operating a printer, do not put hand or hair into the rotating parts (Paper feeding entrance, motor, fan, etc.). If do, you can get harm.
- (3) When you move the printer
 - When transporting/installing the equipment be sure to hold the positions as shown in the reference chapter.
The equipment is quite heavy and weighs approximately 23.1Kg (including consumables), therefore pay full attention when handling it.
 - Be sure not to hold the movable parts or units (e.g. the control panel, DADF) when transporting the equipment.
 - Be sure to use a dedicated outlet with 110V/220V power input.
 - The equipment must be grounded for safety.
 - Select a suitable place for installation. Avoid excessive heat, high humidity, dust, vibration and direct sunlight.
 - Provide proper ventilation since the equipment emits a slight amount of ozone.
 - To insure adequate working space for the copying operation, keep a minimum clearance of 10cm (3.9" on the left, 10 cm (3.9") on the right and 10 cm (3.9") on the rear.
 - The equipment shall be installed near the socket outlet and shall be accessible.
 - Be sure to fix and plug in the power cable securely after the installation so that no one trips over it.

1.3 ESD precautions

Certain semiconductor devices can be easily damaged by static electricity. Such components are commonly called “Electrostatically Sensitive (ES) Devices” or ESDs. Examples of typical ESDs are: integrated circuits, some field effect transistors, and semiconductor “chip” components.

The techniques outlined below should be followed to help reduce the incidence of component damage caused by static electricity.

Caution >>Be sure no power is applied to the chassis or circuit, and observe all other safety precautions.

1. Immediately before handling a semiconductor component or semiconductor-equipped assembly, drain off any electrostatic charge on your body by touching a known earth ground. Alternatively, employ a commercially available wrist strap device, which should be removed for your personal safety reasons prior to applying power to the unit under test.
2. After removing an electrical assembly equipped with ESDs, place the assembly on a conductive surface, such as aluminum or copper foil, or conductive foam, to prevent electrostatic charge buildup in the vicinity of the assembly.
3. Use only a grounded tip soldering iron to solder or desolder ESDs.
4. Use only an “anti-static” solder removal device. Some solder removal devices not classified as “anti-static” can generate electrical charges sufficient to damage ESDs.
5. Do not use Freon-propelled chemicals. When sprayed, these can generate electrical charges sufficient to damage ESDs.
6. Do not remove a replacement ESD from its protective packaging until immediately before installing it. Most replacement ESDs are packaged with all leads shorted together by conductive foam, aluminum foil, or a comparable conductive material.
7. Immediately before removing the protective shorting material from the leads of a replacement ESD, touch the protective material to the chassis or circuit assembly into which the device will be installed.
8. Maintain continuous electrical contact between the ESD and the assembly into which it will be installed, until completely plugged or soldered into the circuit.
9. Minimize bodily motions when handling unpackaged replacement ESDs. Normal motions, such as the brushing together of clothing fabric and lifting one’s foot from a carpeted floor, can generate static electricity sufficient to damage an ESD.

1.4 Super Capacitor or Lithium Battery Precautions

1. Exercise caution when replacing a super capacitor or Lithium battery. There could be a danger of explosion and subsequent operator injury and/or equipment damage if incorrectly installed.
2. Be sure to replace the battery with the same or equivalent type recommended by the manufacturer.
3. Super capacitor or Lithium batteries contain toxic substances and should not be opened, crushed, or burned for disposal.
4. Dispose of used batteries according to the manufacture? instructions.

2. Product spec and feature

2.1 Product Overview

2.1.1 Product Summary

Premium LMFP with High Reliability and Quality
Target user : 10 Persons N/W Small Workgroup



- 33 ppm(A4) Network-ready MFP
- Toner cartridge
 - : Initial : 4K / Sales : 4K,10K
- Paper handling
 - : 500 sheets Standard cassette
 - : 500 sheets Optional cassette
 - : 50 sheets DADF
- 160GB HDD
- High Performance CCDM
- Easy to install (CRU & Option)
- Color Graphic Touch-Screen LCD (7")
- Low Cost per Page
- Direct USB

2.1.2 Specifications

- Product Specifications are subject to change without notice. See below for product specifications.

2.1.2.1 General Print Engine

| Item | | Description |
|--------------------|-----------------|---|
| Engine Speed | Simplex | Up to 33 ppm in A4 (35 ppm in Letter) |
| | Duplex | Up to 17 ipm in A4 (18 ipm in Letter) |
| FPOT | From Ready | Less than 8.5 sec |
| | From Power Save | Less than 25 sec |
| Resolution | Optical | 600 x 600 dpi |
| | Enhanced | Addressible 1200 dpi |
| Printer Languages | | PCL6, PostScript3, PDF 1.4, TIFF, EPSON/IBM Pro (Israel only) |
| Fonts | | PCL:93 scalable, 1 bitmap, PS:136, OCR Font(OCR-A, OCR-B), barcode, 2-D barcode |
| Downloadable Fonts | | Yes (PCL & PS3 S/W Font) |

2.1.2.2 Controller & S/W

| Item | | Description |
|------------------|---------------|--|
| Processor | | Chorus3 360Mhz |
| DRAM | Std. | 256 MB |
| | Max. | 512 MB |
| Memory Expansion | | 1 DDR1 SODIMM Slots(Option Memory: 256MB DDR1) |
| Storage(Std.) | | 80GB HDD |
| Printer driver | Supporting OS | [Windows] - Windows 2000/XP(32/64bit)/2003(32/64bit)/Vista(32/64bit)/2008(32/64bit) |
| | | [Linux] - RedHat 8.0 ~ 9.0 - Fedora Core 1~4 - Madrake 9.2 ~ 10.1 - SuSE 8.2 ~ 9.2 |
| | | [Mac] - Mac OS X 10.3~10.5 |
| Default Driver | | PCL6 (For Windows), PS (for Mac, Linux) |

| Item | | Description |
|--------------------------------|---|--|
| Printer driver (Continue..) | Driver feature | [Windows] - Watermark, Overlay, N-up printing, Poster printing - Duplex, Quality, Color mode (Color, Gray scale) - Support Color spec., Device color, color management [Mac/Linux] - N-up printing, Duplex, Quality - Color mode (Color, Gray scale) |
| | WHQL | Windows 2000/XP(include 64bit)/2003/Vista |
| | Language Localization | English, French, German, Italian, Spanish, Korean, Russian, Brazilian Portuguese |
| Scan driver | TWAIN | Yes (N/W and USB) |
| | WIA | Yes (USB Only) |
| | Supporting OS | [Windows] - Windows 2000/XP(32/64bit)/2003/Vista(32/64bit) [Linux] - RedHat 8 ~ 9 - Fedora Core 1~4 - Madrake 9.2 ~ 10.1 - SuSE 8.2 ~ 9.2 [Mac] - Mac OS 10.3~10.5 |
| Application | PC-FAX | Yes |
| | NW-FAX | Yes (Supported through SmarThru Office) |
| | OCR | ReadIRIS |
| | Smart Panel | Yes (Install default: Windows, Linux, Mac) |
| | Network Management | Set IP, SWAS 4.0 & SWS SWAS Plug-In - Job Accounting, Storage management, Cloning, Remote Install * Supported Web Browser: - IE 5.5 or higher - FireFox 1.5 or higher - Safari 1.3 or higher |
| | HDD File Management S/W | N/A |
| SmarThru | Smarthru Office v2.0, SmarThru WorkFlow v2.0 (Optional) | |

| Item | | Description |
|-------------------|--------------------------------|---|
| Interface | Parallel (IEEE 1284) | No |
| | USB | Hi-Speed USB 2.0 Host (2 channel) * Use: • Front - Scan to USB - USB direct printing - F/W down load for system upgrade • Rear - Card Reader w/ Jscribe |
| | | Hi-Speed USB 2.0 Peripheral (1Channel) |
| | Wired LAN | Ethernet 10/100/1000 Base TX |
| | Foreign Device Interface (FDI) | Optional |
| Network Interface | Network OS | [Windows] - Microsoft Windows 2000/XP(32/64bits)/2003(32/64bits)/Vista(32/64bits) [Mac] - Mac OS 10.3~10.5 [Linux] - RedHat 8 ~ 9 - Fedora Core 1~4 - Madrake 9.2 ~ 10.1 - SuSE 8.2 ~ 9.2 [Novell] - Netware 5.x, 6.x(TCP/IP Only) [Others] - Unix(HP-UX,Solaris,SunOS, SCO) |
| | Protocol | * TCP/IP : TCP/IPv4, HTTP, SNMPv1/v2c/V3, LDAP, SMTP, SSL/TLS, IPSec |
| | IP Addressing | Static IP, Auto IP, BOOTP, DHCP |
| | SNMP/MIB Access | Host Resource MIB(RFC 2790), Printer MIB(RFC 3805) Finisher MIB(RFC(3806), Samsung private MIB, SNMP Trap |
| User Interface | LCD | 800 x 480 7 WVGA Color graphic LCD with Touch-Screen, 16bit color |

2.1.2.3 Scan

| Item | | Description |
|-------------------|----------------------|---|
| Scan method | | Color CCDM |
| Compatibility | | TWAIN(USB & N/W), WIA(Only for USB) |
| Color Mode | | Mono / Gray / Color |
| Scan Speed | Color/Mono. Gray | 0.73msec/line @600*600dpi |
| | Mono Binary | 0.365msec/line @300*300dpi |
| Resolution | Optical | 600 x 600ppi |
| | Enhanced | 4,800 x 4,800ppi |
| Gray Scale | | 256 levels |
| Scan Size | Max. Document Width | Max.216mm(8.5) |
| | Effective Scan Width | Max 208mm(8.2inch) |
| | Max. Document Length | Max.356mm (Legal) |
| Scan Depth | Color | Internal : 36 bits External : 24 bits |
| | Mono | - 1bit for Linearity & Halftone - 8Bits for Gray scale |
| Image Compression | | PDF,JPEG,BMP,TIFF |

2.1.2.4 Copy

| Item | | Description |
|----------------------|--|--|
| Copy Speed (DADF) | SDMC (Single Document Multiple Copy) | Simplex: up to 33 cpm in A4 (35 cpm in Letter) Duplex : up to 17 cpm in A4 (18 cpm in Letter) |
| | MDSC (Multiple Document Single Copy) | Simplex: up to 29 cpm in A4 (30 cpm in Letter) Duplex : up to 12 cpm in A4 (13 cpm in Letter) |
| FCOT | From Ready | Platen : Less than 9.5 sec DADF : Less than 11.5 sec |
| Zoom Range | | 25% ~ 400% in 1% increments (Platen) 25% ~ 200% in 1% increments (DADF) |
| Multi Copy | | 1~999 |
| Original Type | Text | Platen: Scan 600x600dpi , Printing 600x600dpi DADF: Scan 300x300dpi, Printing 600x600dpi |
| | Text/Photo | Platen: Scan 600x600dpi, Printing 600x600dpi DADF: Scan 300x300dpi, Printing 600x600dpi |
| | Photo | Platen: Scan 600x600dpi, Printing 1200x1200dpi DADF: Scan 300x300dpi, Printing 600x600dpi |
| Reduce & Enlarge | | * Zoom Range : 25% to 400% in Platen, 25% to 200% in ADF * Preset [Original(100%)] [Auto Fit] [A4 → A5(71%)] [LGL→LTR(78%)] [LGL→A4(83%)] [A4→LTR(94%)] [EXE→LTR(104%)] [A5 → A4(141%)] 25%, 50%, 150%, 200%, 400% [Custom:25-400%] |
| Duplex Copy | | Using Platen - 1 → 1Sided - 1 → 2Sided Using DADF - 1 → 1Sided - 1 → 2Sided Short, - 1 → 2Sided Long, - 2 → 1Sided - 2 → 1Sided, Rotate Side2 - 2 → 2Sided Short - 2 → 2Sided Long |

2.1.2.5 Fax

| Item | | Description |
|-----------------------|----------------------------------|---|
| Compatibility | | ITU-T G3 |
| Communication System | | PSTN/PABX |
| Modem Speed | | 33.6Kbps |
| TX Speed | | 3sec (Mono/Standard/ECM-MMR, ITU-T G3 No.1 Chart) |
| Compression | | MH/MR/MMR/JBIG/JPEG |
| Color Fax | | Yes (TX only) |
| ECM | | Yes |
| Resolution (Mono) | Std | 203*98dpi |
| | Fine | 203*196dpi |
| | S.Fine | 300*300dpi |
| Resolution (Color) | Std | 200*200dpi (TX Only) |
| | Fine | 200*200dpi (TX Only) |
| | S.Fine | 200*200dpi (TX Only) |
| Scan speed | Platen | 0.365msec/line at 300*300dpi |
| | DADF | 0.365msec/line at 300*300dpi |
| Telephone Features | Speed Dial | 200 Locations |
| | One touch dial | NONE |
| | Chain Dial | NONE |
| | Manual Dial | Yes |
| | Last Number Redial | Yes |
| | Automatic Redial Transmission | Yes |
| | Pause | Yes |
| | Flash | No |
| | Handset & Cradle | NONE |
| | Ringer Volume | OFF, LOW, MEDIUM, HIGH |
| | Tone/Pulse Select | Selectable in Tech Mode |
| VoIP Support | | Yes. (The communication in VoIP network is supported, but the fax quality may be fallen. Beacause the purpose of VoIP network is not fax but Internet network for voice.) |

2.1.2.6 Paper Handling

| Item | | Description |
|--|---------------------------|--|
| Bypass Tray | Capacity | Plain paper : 50 sheets Transparency : 5 sheets Envelopes : 5 sheets |
| | Media sizes | 76.2x127 mm(3x5) ~ 215.9x355.6mm (8.5x14.0) Banner Size Printing : 216mm x 900mm |
| | Media type | Printer Default, Plain Paper, Thick Paper, Thin Paper, Bond Paper, Color Paper, CardStock, Labels, Transparency, Envelope, Preprinted, Cotton, Recycled Paper, Archive |
| | Media weight | 16~43lb (60 to 163g/m ²) |
| Standard Cassette Tray | Capacity | 500 sheets @ 20lb (80g/m ²) |
| | Media sizes | Letter, Legal, Oficio, Folio, A4, JIS B5, ISO B5, Executive, A5 |
| | Media types | Plain Paper, Thin Paper, Pre-Printed, Recycled, Thick, Archive |
| | Media weight | Plain Paper : 75~90 g/m ² Thin Paper : 60~70 g/m ² Thick Paper : 90~105 g/m ² Pre-Printed : 75~90 g/m ² Recycled : 60~90 g/m ² Duplex : 75~90 g/m ² |
| Optional Cassette Tray(SCF) | Capacity | 500 sheets @ 20lb (80g/m ²), drawer type |
| | Media sizes | Letter, Legal, Oficio, Folio, A4, JIS B5, ISO B5, Executive, A5 |
| | Media types | Plain Paper, Thin Paper, Pre-Printed, Recycled, Thick, Archive |
| Optional Cassette Tray(SCF) (Continue..) | Media weight | Plain Paper : 75~90 g/m ² Thin Paper : 60~70 g/m ² Thick Paper : 90~105 g/m ² Pre-Printed : 75~90 g/m ² Recycled : 60~90 g/m ² Duplex : 75~90 g/m ² |
| Output Stacking | | 250 sheets @ 20lb (80g/m ²) |
| DADF | Capacity | 50 sheets (20lb, 80g/m ²) |
| | 2-sided Document Scanning | Yes (Reversing) |
| | Document Size | Width: 145 ~ 216mm (5.7~8.5) Length : 145 ~ 356mm (5.7 ~ 14.0) for Single page scan 145 ~ 400mm (5.7 ~ 15.7) for Multi pages scan Bank Check Scan : 69.6mm x 152.4mm |
| | Document Weight | 12.5~28lb |

2.1.2.7 Consumables (CRU)

| Item | | Description |
|-----------------|-----------|---|
| Toner Cartridge | MLT-D206S | Average Continuous Black Cartridge Yield: 4,000* standard pages * Declared yield value in accordance with ISO/IEC 19752 |
| | MLT-D206L | Average Continuous Black Cartridge Yield: 10,000* standard pages * Declared yield value in accordance with ISO/IEC 19752 |

2.1.2.8 Consumables (FRU)

| Item | Item | Description |
|-----------------------|--|----------------|
| DADF Rubber Pad | JC97-03069A | 50,000 feeds |
| DADF Pick-up Assembly | JC97-03070A | 100,000 feeds |
| Pick up roller | JC97-02441C | 150,000 feeds |
| Transfer Roller | JC66-01181A | 100,000 images |
| Fuser Unit | JC96-05064A(220V) JC96-05063A(110V) | 100,000 images |

2.1.2.9 Service & Environment

| Item | | Description |
|-----------------------------------|------------------------------|---|
| AMPV | | 2500 pages/month (A4 size, IDC 5% coverage) |
| Max Monthly Duty | | 75,000 pages/month (A4 size, IDC 5% coverage) |
| MPBF (Mean Page Between Failure) | | 50,000 pages |
| MTTR (mean time to repair) | | 30 minutes |
| Temperature | Operating | 10°C ~ 32°C |
| | Storage | 20°C ~ 40°C |
| Humidity | Operating | 20~80% RH |
| | Storage | 10~90% RH |
| Input Voltage | | AC 110-127V or AC 220-240V |
| Noise | Printing Simplex / Duplex | 52 dB |
| | Copying Simplex / Duplex | 54 dB |
| | Standby | 39 dB |
| Power Consumption | Ready | Less than 100W |
| | AVG. | Less than 750W |
| | Power save | Less than 25W |
| | Power off | 0W |
| Dimensions (WxDxH) | | 500x465x547 mm |
| Weight (with consumables) | | 23.1Kg |

| Item | | Description |
|---------------------|------------|-----------------------------|
| Optional Tray (SCF) | SCX-S5835A | 500 sheets feeder |
| Memory | CLP-MEM202 | 256 MB |
| Jscribe | SCX-KIT10J | JScript Related S/W Enabler |

2.1.3 Model Comparison

| | | SAMSUNG SCX-5835NX SCX-5935NX | HP LJ M3035 | Lexmark X642e | Lexmark New 4dte |
|----------------|------------------|---|---|--|---|
| Image | |  |  |  |  |
| Printer | Speed (A4/Ltr.) | 33ppm/35ppm | 33ppm/35ppm | 43ppm/45ppm | 38ppm/40ppm |
| | Copy size | A4 | A4 | Legal | Legal |
| | Resolution | 1,200 x 1,200 dpi | 1,200 x 1,200 dpi | 1,200 x 1,200 dpi | 1,200 x 1,200 dpi |
| | Emulation | PCL5e, PCL6, PS, PDF1.5 | PCL5, PCL6, PS, PDF1.5 | PCL5, PCL6, PS, PDF1.5 | PCL5, PCL6, PS, PDF1.5 |
| | Duplex Print | Standard | Standard | Option | Standard |
| Copy | Speed | 35cpm | 35cpm | 35cpm | 35cpm (Estimated) |
| | Resolution | 600dpi | 600 dpi | 600 dpi | 600 dpi (Estimated) |
| | Zoom | 25 – 400% | 25 – 400% | 25 – 400% | 25 – 400% (Estimated) |
| Scan | Resolution | 600dpi | 600dpi | 600dpi | 600dpi (Estimated) |
| Fax | Modem Speed | 33.6 Kbps | LJ-M3035xs Only | 33.6 Kbps | 33.6 Kbps |
| | Memory | HDD Backup | HDD Backup (LJ-M3035xs Only) | - | HDD Backup |
| Paper Handling | DADF | 50sh. | 50 sh | 50sh. | 50sh. |
| | Input Tray(Std.) | 500 sh. Tray 50 sh. MP | 500 sh. Tray 100 sh. MP | 500 sh. Tray 100 sh. MP | 2 x 250 sh. Tray 50 sh. MP |
| General | Memory Std.(Max) | 256MB(512MB) | 128MB(640MB) | 256MB(?) | |
| | Toner | 4K, 10K | Q7551x (13,000 sh.) | 10K, 21K | 9K, 15K |

2.2 System Overview

■ Front View

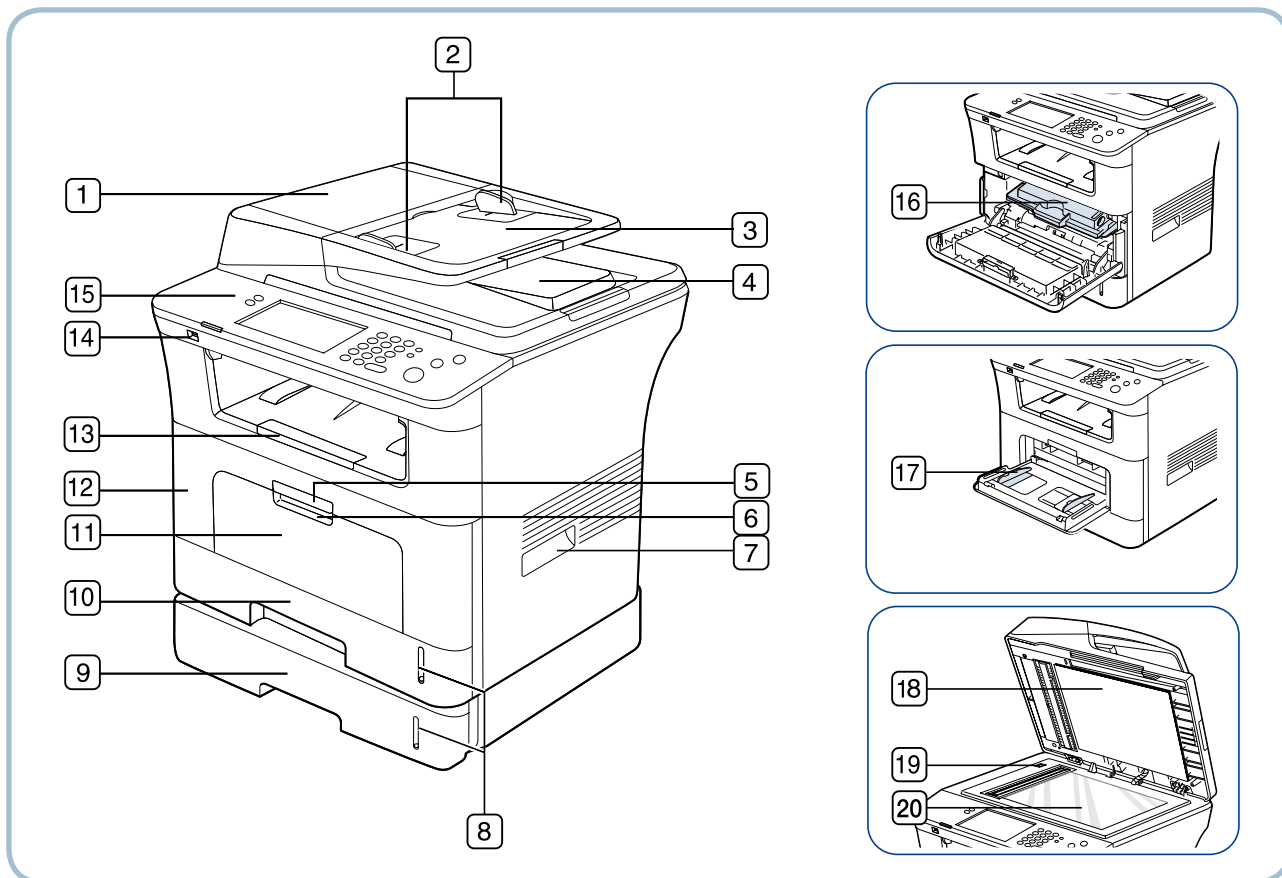

| | | | |
|----|--------------------------------|----|---------------------------------------|
| 1 | Document feeder cover | 11 | Multi-purpose tray |
| 2 | Document feeder width guides | 12 | Front cover |
| 3 | Document feeder input tray | 13 | Document output tray |
| 4 | Document feeder output tray | 14 | USB memory port |
| 5 | Front cover handle | 15 | Control panel |
| 6 | Multi-purpose tray handle | 16 | Toner cartridge |
| 7 | Handle | 17 | Multi-purpose tray paper width guides |
| 8 | Paper level indicator | 18 | Scanner lid |
| 9 | Optional tray 2 ^[a] | 19 | Scanner lock switch |
| 10 | Tray 1 | 20 | Scanner glass |

[a] Optional device.

■ Rear View

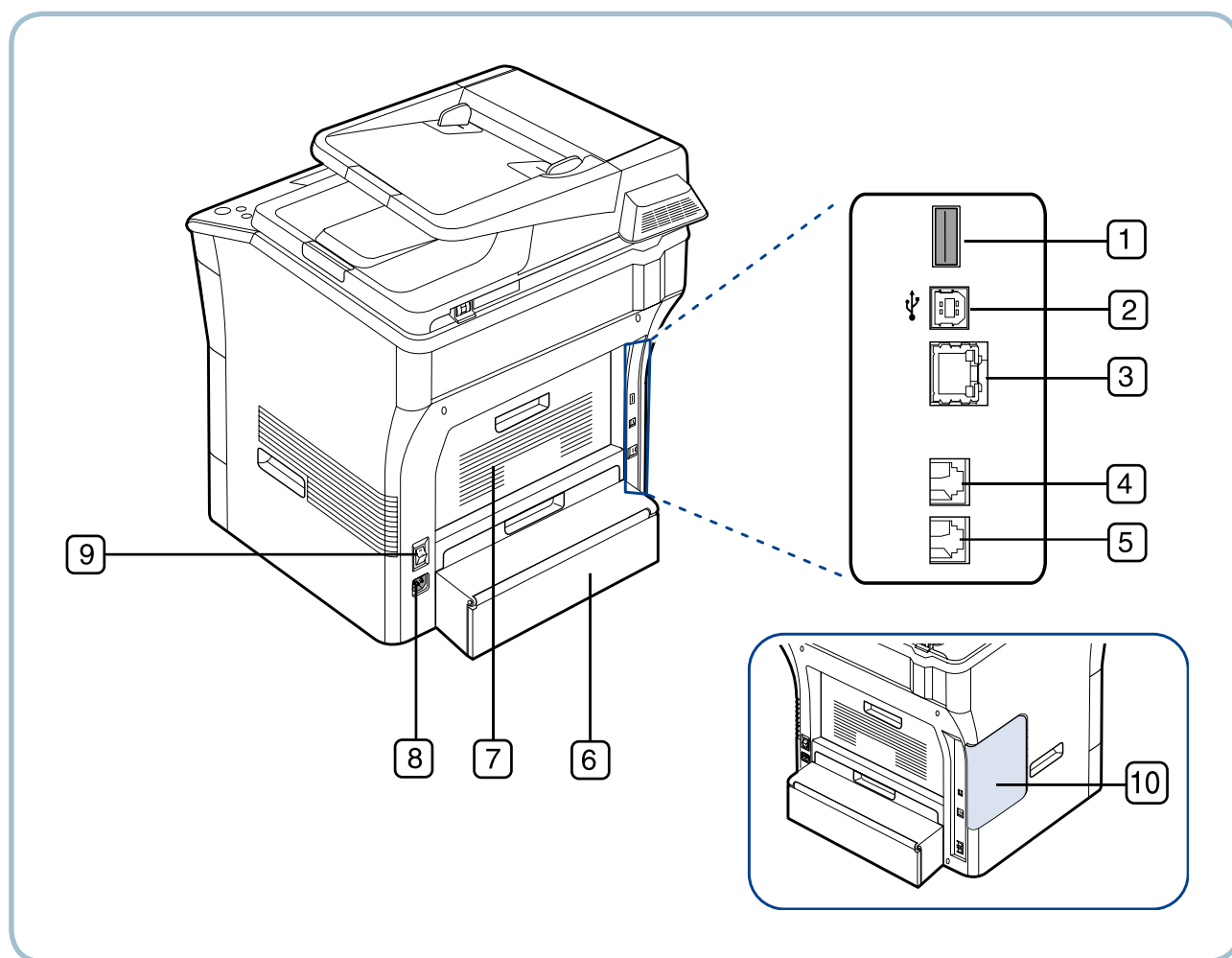

| | | | |
|---|----------------------------------|----|---------------------|
| 1 | USB host port | 6 | Duplex unit |
| 2 | USB port | 7 | Rear cover |
| 3 | Network port | 8 | Power receptacle |
| 4 | Telephone line socket | 9 | Power-switch |
| 5 | Extension telephone socket (EXT) | 10 | Control board cover |

■ System Layout

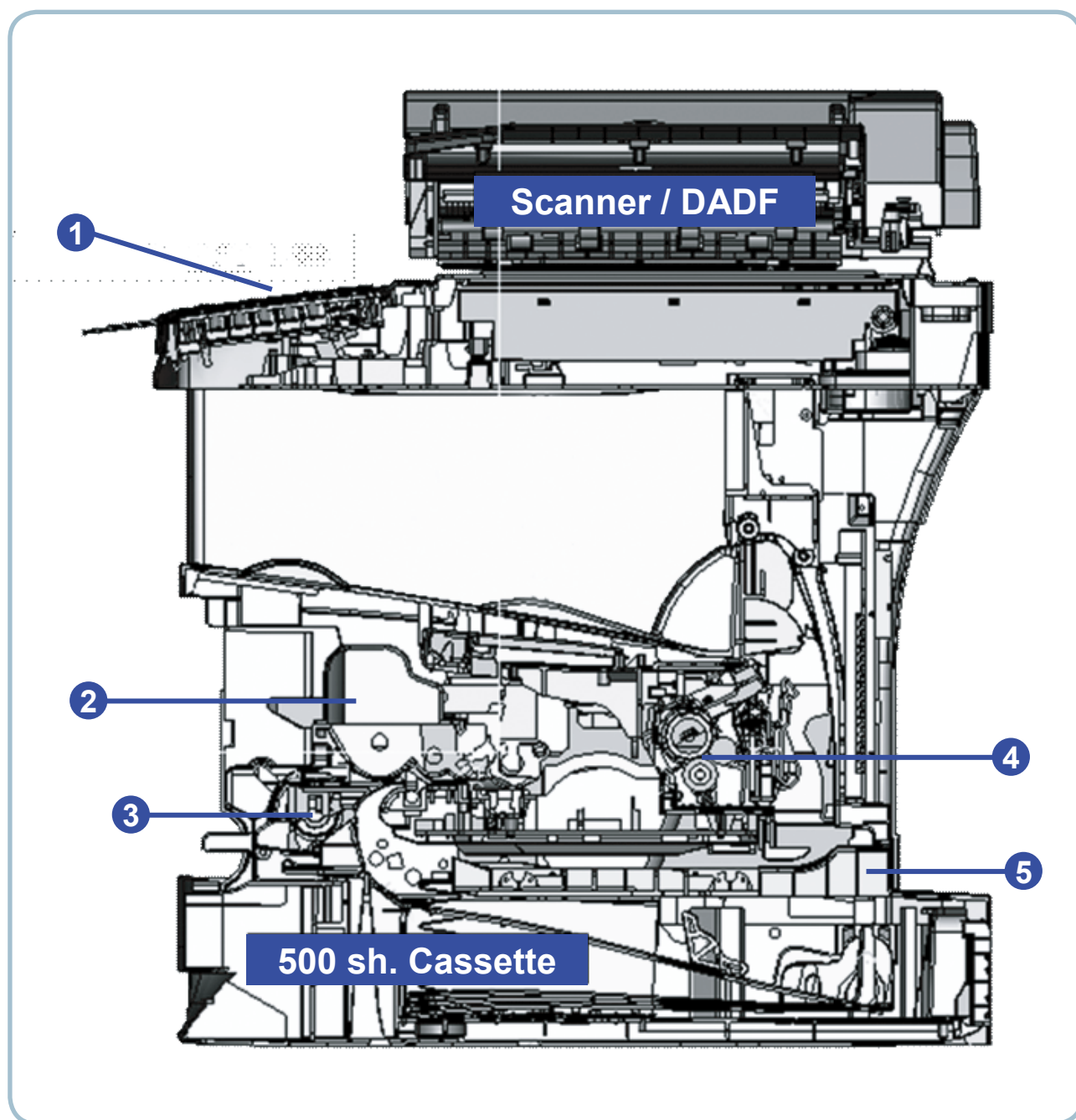

| | |
|---|---------------------------------|
| 1 | OP Panel / 7 " LCD Touch Screen |
| 2 | Toner Cartridge |
| 3 | MP Roller |
| 4 | Fuser Unit |
| 5 | Duplex Unit |

2.2.1 System Configuration

SCX-5835NX_5935NX Series consist of Main Control Part, Operation Panel Part, Scanner Part, Line Interface Part ,Power Part and Optional DIMM(Dual-In-Memory Module) for Scan-To-Email.

Main Controller is commonly applied in all products, SCX-5835NX_5935NX Series, and in case of necessary a part of components or Module is selectively adopted in accordance with required feature of each model.

2.2.2 Hardware Configuration

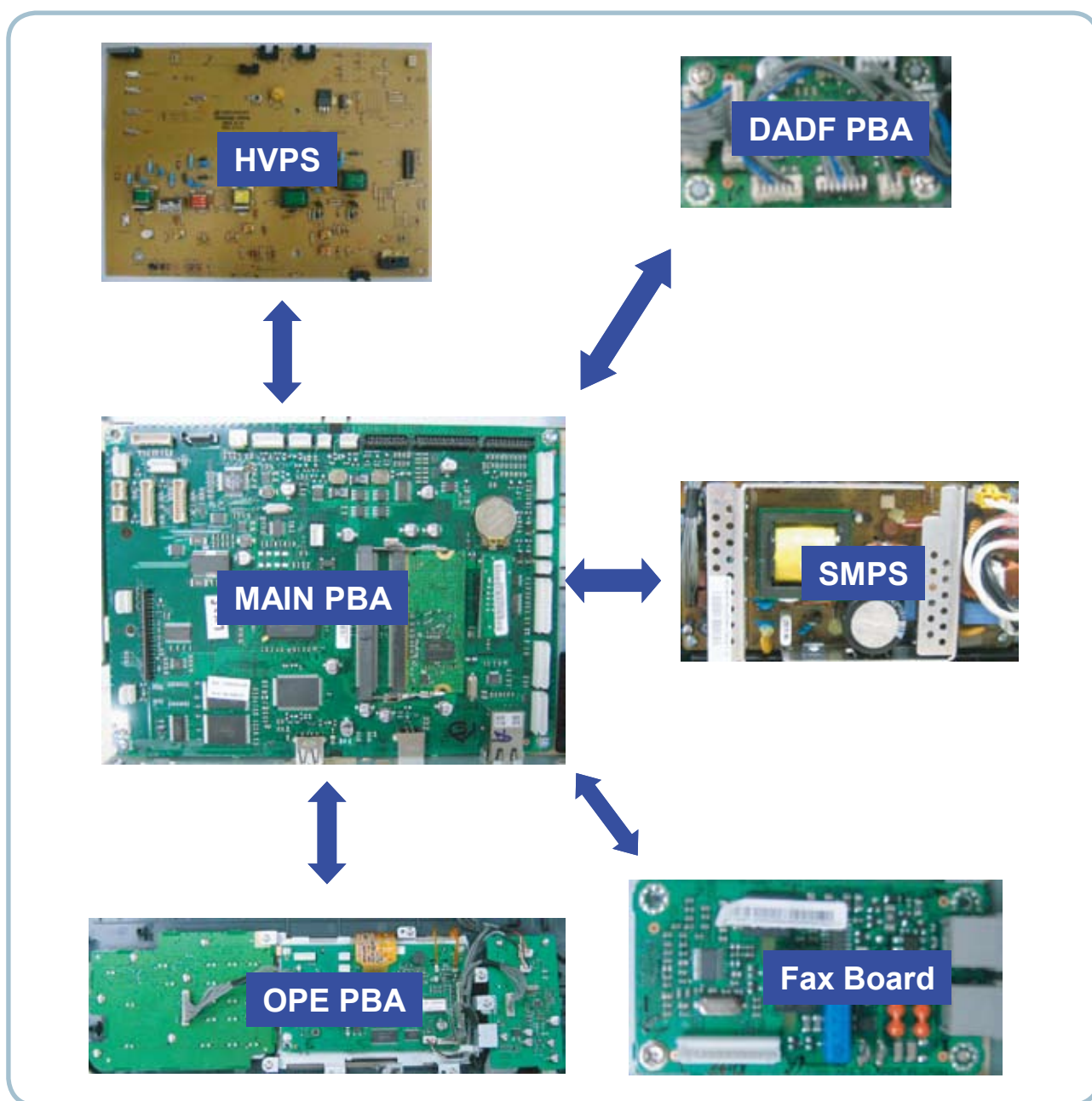

2.2.2.1 Main Controller

The Main Control Part comprises 1 CPU and 1 B'D by adopting the dedicated Controller for Fax & LBP. The Scanner Part comprises DADF& CCD and connected with Main board through Harness.

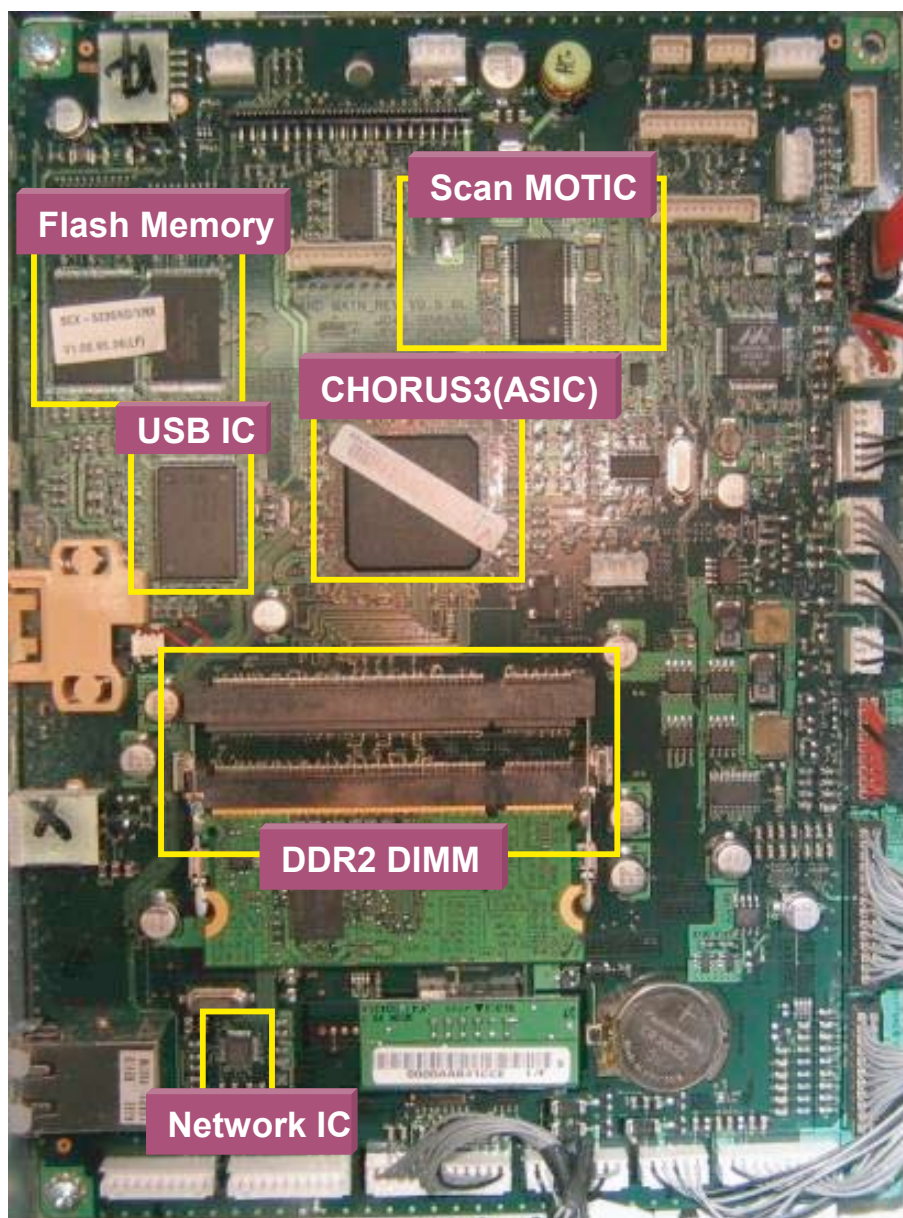

CPU (CHORUS3)

It uses the ARM 926EJS, 32Bit RISC Processor, which is dedicated Controller for Printer & Fax function and drives the each internal Operation Block by system program of Flash Memory and thereby controlling the whole System.

- Main Function Block.: Completely Integrated System for Embedded Applications,

- ▶ 32 Bit RISC Architecture, Efficient and Powerful ARM 926EJS Core.
- ▶ LSU Interface Module for Interfacing PVC or HPVC with LSU
- ▶ Dual Memory Bus Architecture
 - Operation Frequency : AHB Bus: 133MHz, Internal System Bus: 120MHz
 - Operation Power : 3.3V / 1.0V(core)

Flash Memory

It stores system program, Fonts data(PCL, PS/3), and can download the system program through PC Interface or Network.

- Capacity: 32M Byte
- Access Time : 80 nsec

System Memory (DDR2)

It is used as Swatch Buffer for Printing, Scan Buffer for Scanning and System Working Memory Area.

- System memory: 256MB Capacity
- Max Frequency: 120 MHz

System Data Memory (EEPROM + Flash Memory)

This memory, which is for storing the operation variable & the setting parameter of Elbert2, keeps the information.

Optional Memory (DIMM)

SCX-5835NX_5935NX Series provide one (1) Extension Slot for extending Memory. The RAM Extension Slot can be used for:

General Memory Extension

256 MB Optional Memory is available.

2.2.2.2 SMPS board

SMPS(Switching Mode Power Supply) Board supplies electric power to a Main Board and other boards through a Main Controller by +5V,+24V from 110V/220V power input. It has safety protection modes for over current and load.

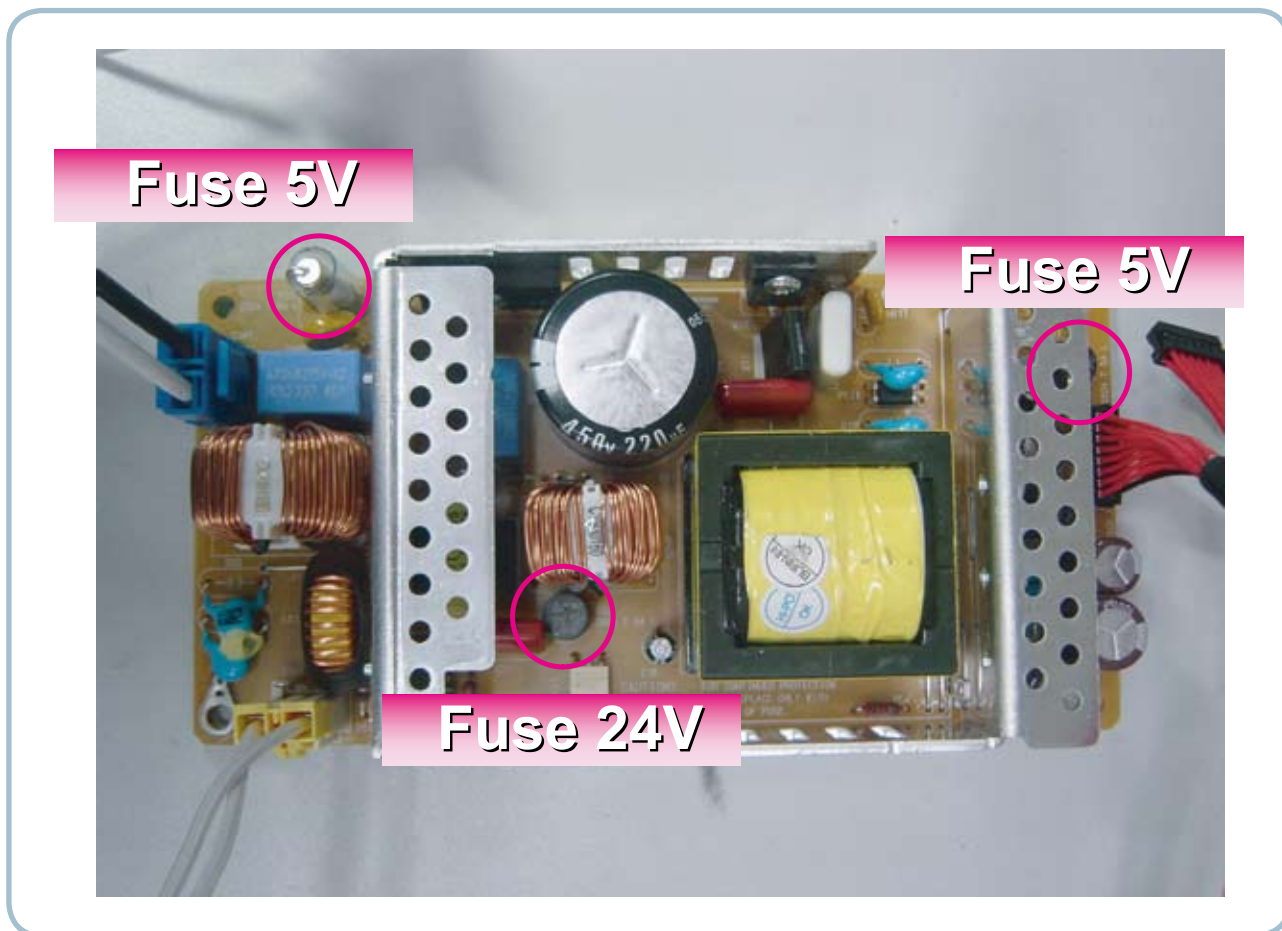

| DC Output Connector(CON3) | | | | | |
|-----------------------------|----------|------------|----|----------|-----------------------------|
| Description | PIN NO | PIN ASSIGN | | PIN NO | Description |
| Fuser ON (Active High) | Fuser_On | 1 | 2 | 24VS | Power (Photo Triac Bias) |
| Power | +24V | 3 | 4 | GND | +24V Ground |
| Power | +24V | 5 | 6 | GND | +24V Ground |
| Power | +24V | 7 | 8 | GND | +24V Ground |
| Power | +24V | 9 | 10 | GND | +24V Ground |
| Power | +5V | 11 | 12 | GND | +5V Ground |
| Power | +5V | 13 | 14 | GND | +5V Ground |
| Relay On | Relay_On | 15 | 16 | OFF/SINK | +24V On/OFF |

| AC Input Connector(CON1) | | |
|----------------------------|--------|-------------|
| PIN ASSIGN | PIN NO | Description |
| 1 | AC_L | AC Input |
| 2 | AC_N | |

| SMPS → Heater Controller(CON2) | | |
|----------------------------------|--------|-------------------------|
| PIN ASSIGN | PIN NO | Description |
| 1 | AC_L | AC Output for Heater |
| 2 | AC_N | |

2.2.2.3 HVPS board

HVPS(High Voltage Power Supply)

HVPS Part outputs the generated high voltage for THV/MHV/BIAS/DETACH/FUSER BIAS by inputting 24V, and the output high voltage is provided into OPC Cartridge and Transfer Roller.

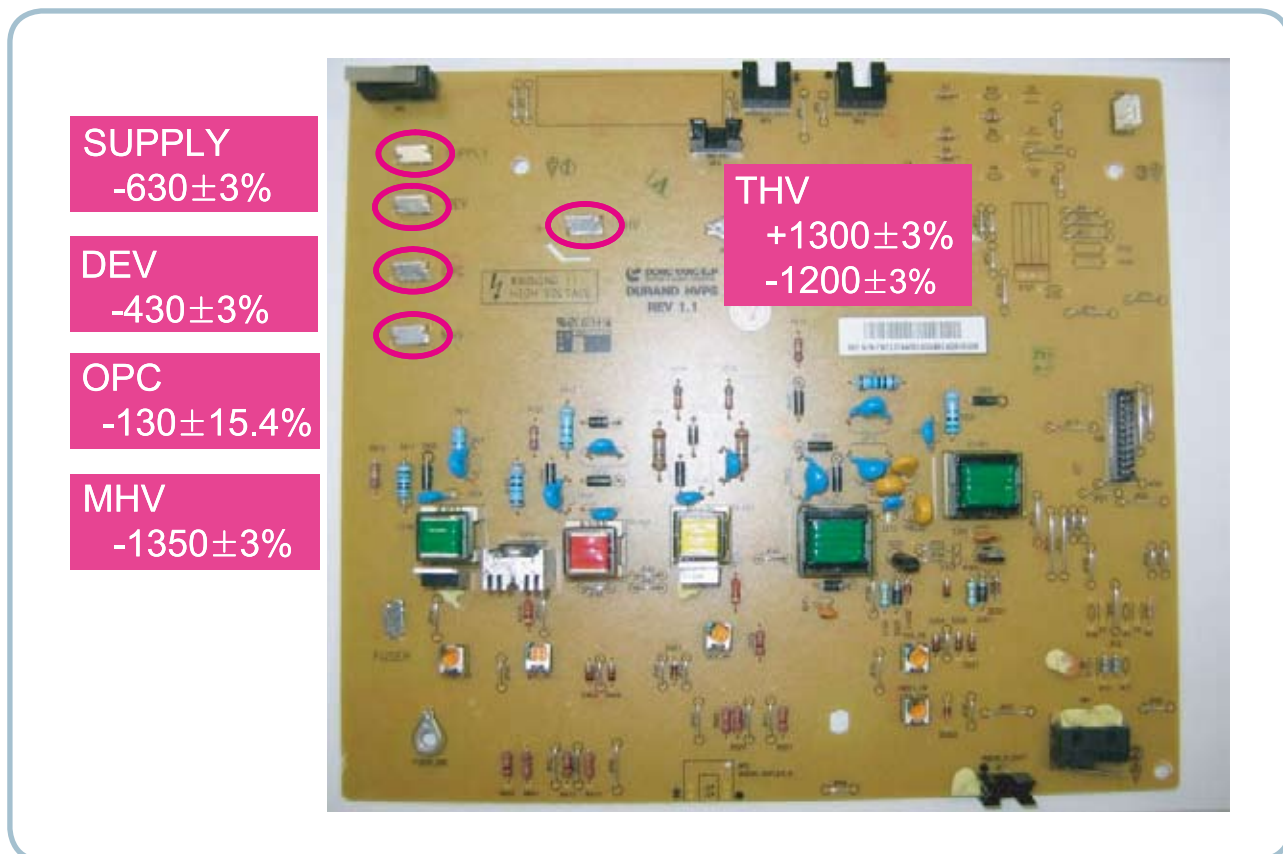

2.2.2.4 FAX Board

Specifications

- LINE CONNECTION: PSTN or PABX (RJ-11)
- Compatibility: ITU-T G3, Super G3
- Communication System: PSTN/PABX
- Modem Speed: 33.6Kbps
- TX Speed: 3 sec
 - * Standard Resolution, MMR, 33,6Kbps
 - * Phase "C" by ITU-T No.1 Chart in Memory transmission with ECM
- Scan Speed
 - Platen -> 2 sec / A4
 - ADF -> 5.5 sec / A4
 - * Scan time: 2 sec/A4 @ 203x98dpi * Scan setup time : 3.5 sec
- Receive Mode: Fax, TEL, ANS/FAX
- Compression: MH/MR/MMR/JBIG/JPEG
- ECM: Yes
- Resolution Std: 203*98dpi
 - Fine: 203*196dpi
 - S.Fine: 300*300dpi
- Contrast: Adsustable 5 levels
- Fax Memory: 32MB (in HDD)



2.2.3 Mechanic Configuration

2.2.3.1 Feeding Section

1) Cassette

It stores and automatically feeds print paper.

Pick-up Roller picks up paper, controls drive, feeds paper, removes static electricity, and so on.

> Spec.

- * Feeding Method : Cassette Type
- * Feeding Standard : Center Loading
- * Feeding Capacity : Cassette 500 Sheets
(80g/ , 20lb Paper Standard)
- * Paper Detecting Sensor : Photo Sensor
(Empty, Registration, Exit)
- * Paper Size Sensor : None

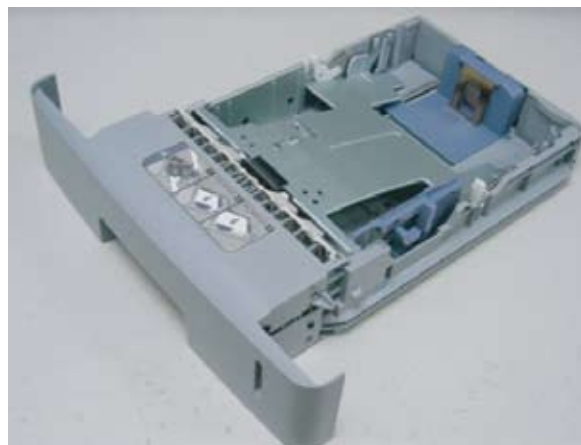

2) MPF

> Spec.

- * Capacity : Plain paper : 50 sheets
Transparency : 5 sheets
Envelopes : 5 sheets
- * Media sizes : 76.2x127mm(3"x5")
~215.9x355.6mm(8.5"x14.0")
- * Media weight : 16~43lb(60 to 163 g/m²)



2.2.3.2 Drive Unit

Drive Unit is used for image process.

Main Drive Unit is for Paper path(Pick up, Feeding, Registration).

Fuser Drive unit is for Fuser Driving, Exit roller

Duplex Drive unit is for Duplex feeding.



[Main Drive Unit]

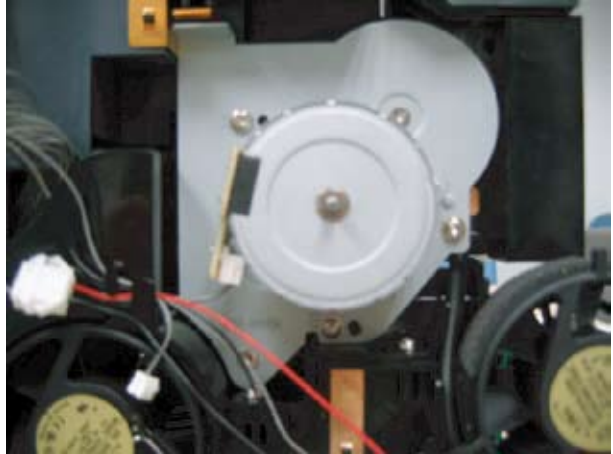

[Fuser]



[Duplex Drive Unit]

2.2.3.3 LSU (Laser scanning unit)

LSU consists of LD(Laser Diode) and polygon motor control. For realizing Color Image, it is controlled by 4 LD. When the controller generate the printing signal, LD will turn on and Polygon motor starts. If the receiving part in LSU detect the beam , Hsync is generated. When the rotation of polygon motor is steady, it is time of LSU ready status for printing. If either of two condition is not satisfied, LSU error is expected.

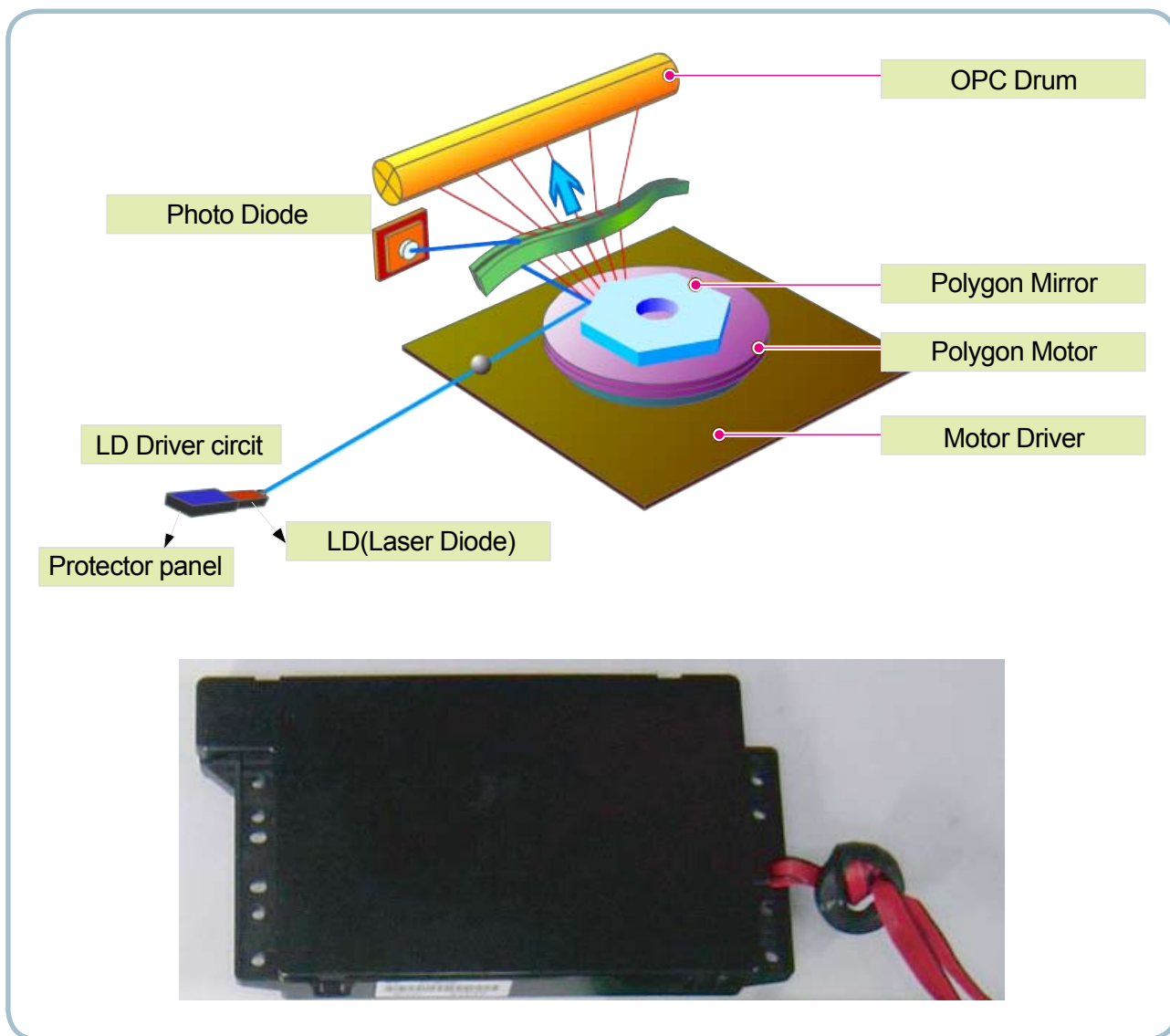

2.2.3.4 Fuser Unit

This unit consists of IH-HEAT ROLLER, Thermostats and a Thermistor. It melts and fuses the toner, transferred by the transfer roller onto the paper, by applying pressure and high temperature to complete printing job.

- Fusing type : Thermal fixing with a couple of one heat roller and two pressure rollers
- Heat roller : $\varnothing 28.3$, Anodized, single halogen lamp, thick brown color coating
- Pressure roller 1 : $\varnothing 16.0$: PFA tube, Electrically conductive
- Pressure roller 2 : $\varnothing 20.0$: LSR+PFA, Electrically conductive
- Single thermistor and a pair of thermostat
- A ball bearing at each end of heat roller (total amount; two)
- Jam removal lever / Fuser door open for jam removal
- Life span : 80,000 pages

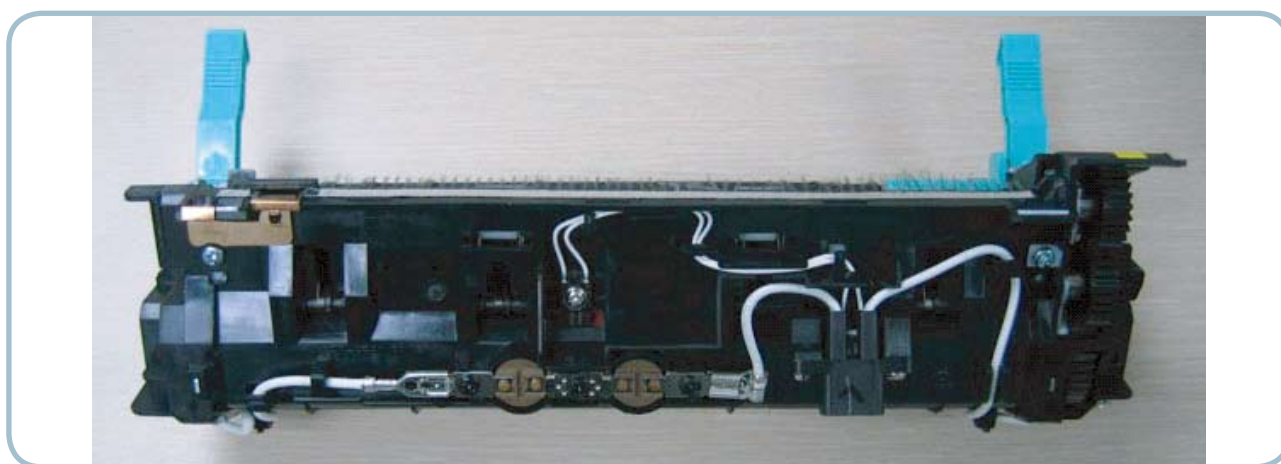

① **Thermostat**

When a heat lamp is overheated, a Thermostat cuts off the main power to prevent over-heating.
 - Non-Contact type Thermostat

② **Heat roller**

The heat roller transfers the heat from the lamp to apply a heat on the paper. The surface of a heat roller is coated with Teflon, so toner does not stick to the surface.

③ **Pressure roller**

A pressure roller mounted under a heat roller is made of a silicon resin, and the surface also is coated with Teflon. When a paper passes between a heat roller and a pressure roller, toner adheres to the surface of a paper permanently.

| Trouble | Temperature Control concept |
|---------------------------------------|--|
| Open Heat Error | 85°C below for 20 sec after power on |
| Over Heat Error (Fuser High Error) | - 220°C over for 20sec - 230°C over for 3sec |
| Low Heat Error (Fuser Low Error) | 10°C below than target Temp. for 10 sec. At Warm up 20°C below than target Temp. for 10 sec. At Printing 20°C below than target Temp. for 10 scc. At stand-by 16°C below than target Temp. for 10 scc. At pick up |

2.2.3.5 Scanner Section

- 1) Optical System: Lens Reduction type All-In-One (Scanning Lamp + Lens + CCD Image sensor).
- 2) Light Source: White LED(Light Emitting Diode)
- 3) Scanning method:
 - Platen: Optical Moving
 - DADF: Document Moving

* Scanning Area

Maximum Document Width: 216mm
Effective Scanning Width: 208mm

* Source Document Specification (DADF)

- 1) DADF capacity : 50 sheets of 20lbs /80gsm paper
- 2) Specification

| Item | Specification | Item | Specification |
|--------|---------------|-----------|---|
| Length | 145~356mm | Weight | 12.5lb ~ 28lb |
| Width | 142~216mm | Thickness | 0.075mm ~ 0.13mm |
| Curl | Below 5mm | - | This machine must be able to feed the documents in Normal Environment / Standard Paper (20lb/80gsm) |

3. Disassembly and Reassembly

3.1 General Precautions on Disassembly

When you disassemble and reassemble components, you must use extreme caution. The close proximity of cables to moving parts makes proper routing a must.

If components are removed, any cables disturbed by the procedure must be restored as close as possible to their original positions. Before removing any component from the machine, note the cable routing that will be affected.

Whenever servicing the machine, you must perform as follows:

1. Check to verify that documents are not stored in memory.
2. Be sure to remove the toner cartridge before you disassemble parts.
3. Unplug the power cord.
4. Use a flat and clean surface.
5. Replace only with authorized components.
6. Do not force plastic-material components.
7. Make sure all components are in their proper position.

Releasing Plastic Latches

Many of the parts are held in place with plastic latches. The latches break easily; release them carefully.

To remove such parts, press the hook end of the latch away from the part to which it is latched.

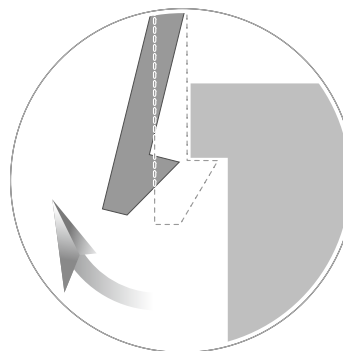

3.2 Maintenance Parts

| Sec_Code | Description | Life | Image |
|-------------------|--|------|---|
| JC97-02441C | MEA-ROLLER PICK UP | 150K |  |
| JC66-01181A | ROLLER-TRANSFER | 100K |  |
| JC96-05064A(220V) | ELA UNIT-FUSER | 100K |  |
| JC97-03070A | MEA UNIT-PICK UP DADF | 100K |  |
| JC97-03069A | MEA UNIT-DADF RUBBER | 50K |  |
| JC97-03249A | MEA UNIT-HOLDER PAD (Cassette friction pad) | 100K |  |

3.3 General Disassembly

3.3.1 Fuser Unit

1. Open the Rear Cover.

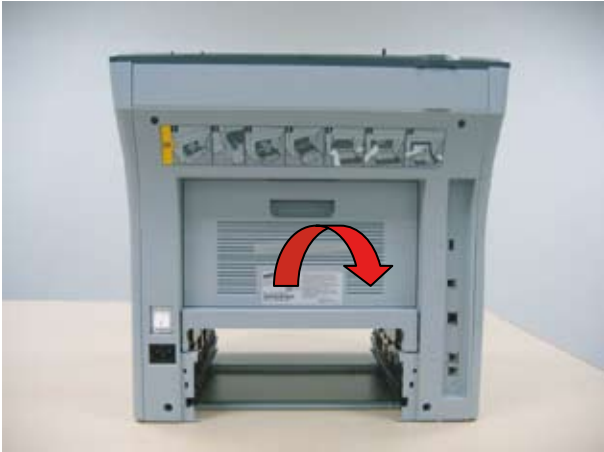

2. Remove the Fuser unit after remove the 4 screws.

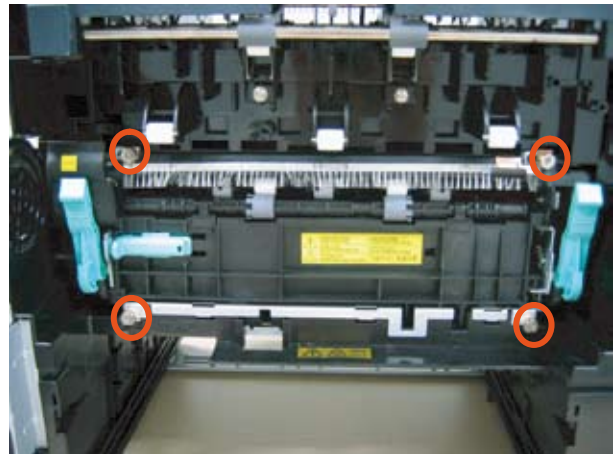

3.3.2 DADF Pick up unit and rubber pad

1. Open the DADF Cover. Remove the DADF rubber pad by removing both side hook.

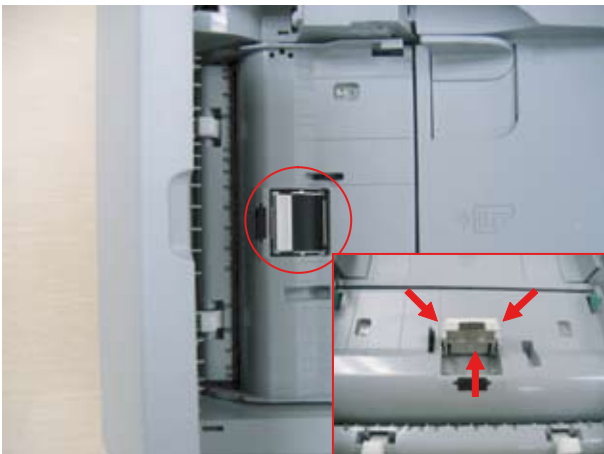

2. Remove the DADF pick up unit by removing the spring.

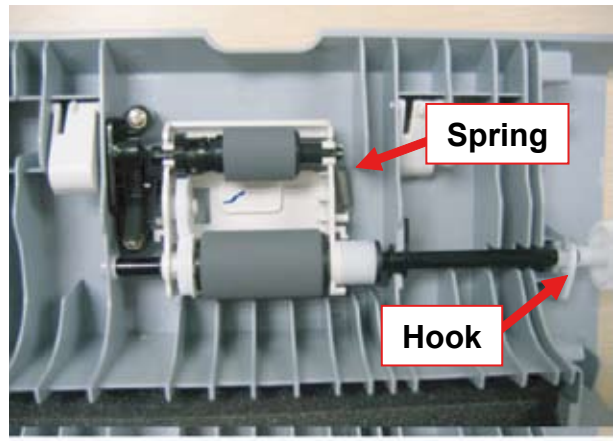

3.3.3 Pick up roller

1. Remove the Cassette.



2. Pull the Pick up roller to the direction of arrow from the bottom of SET.

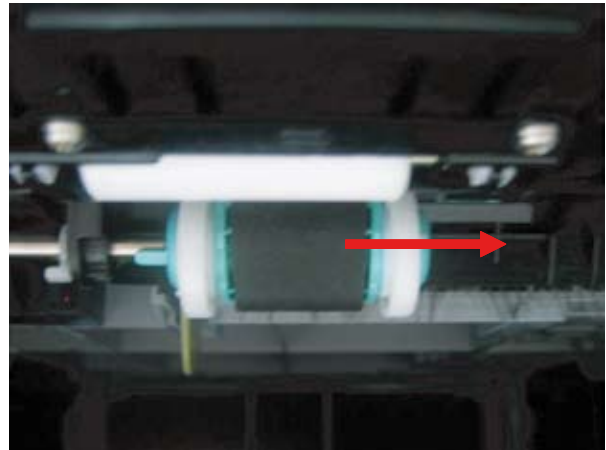

3.3.4 Transfer roller

1. Open the front cover and remove the toner cartridge. To remove the Transfer roller, Push the lever to the direction of arrow.



3.3.5 Cover

1. Remove the Cassette.



2. Remove the Duplex Unit from the rear.

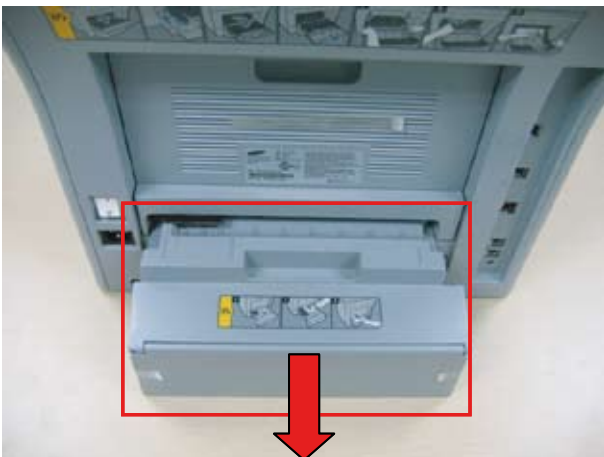

3. Open the DADF back. And Lift it up after remove the connector.

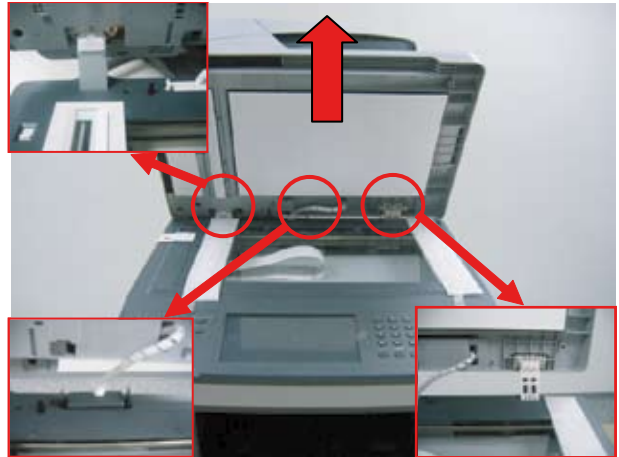

4. Remove the 4 screws from the rear.



5. Open the Front cover. And remove the 4 screws.

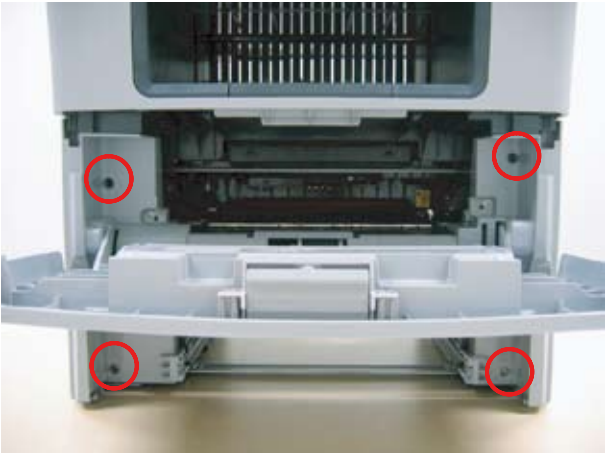

7. Remove the Right Side Cover.



6. Remove the Left Side Cover.



3.3.6 DADF Board

1. Open the DADF back. And Lift it up after remove the connector.

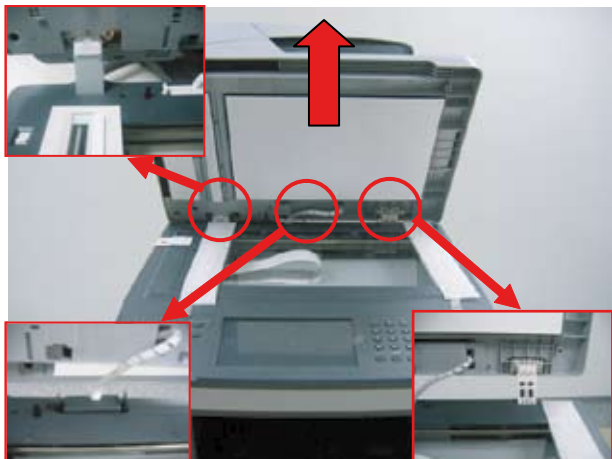

4. Remove the 3 screws from the bottom of DADF. And remove the COVER-DADF-FRONT/REAR.



2. Remove the 5 screws from the bottom of DADF.

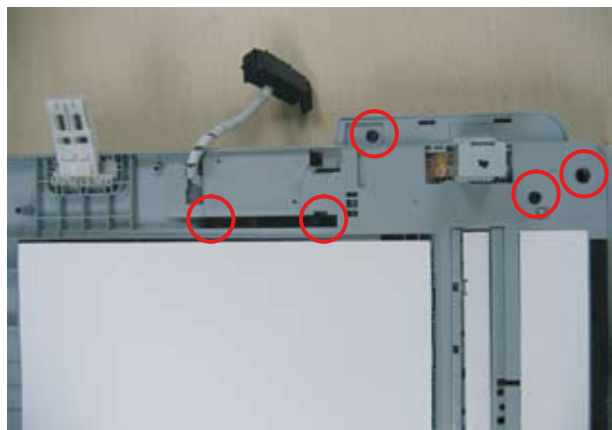

5. Disassemble the Stacker.

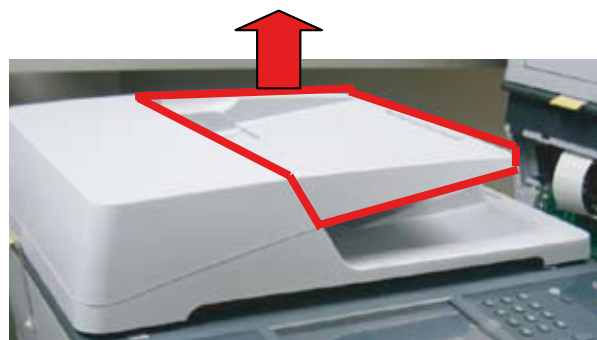

3. Remove the Sponge.



6. Remove all harness and 2 screws.



3.3.7 Scan Assy

1. Remove the COVER-DECO UPPER.



2. Remove the 1 screw.



3. Turn up the OPE unit. And remove the 8 screws.

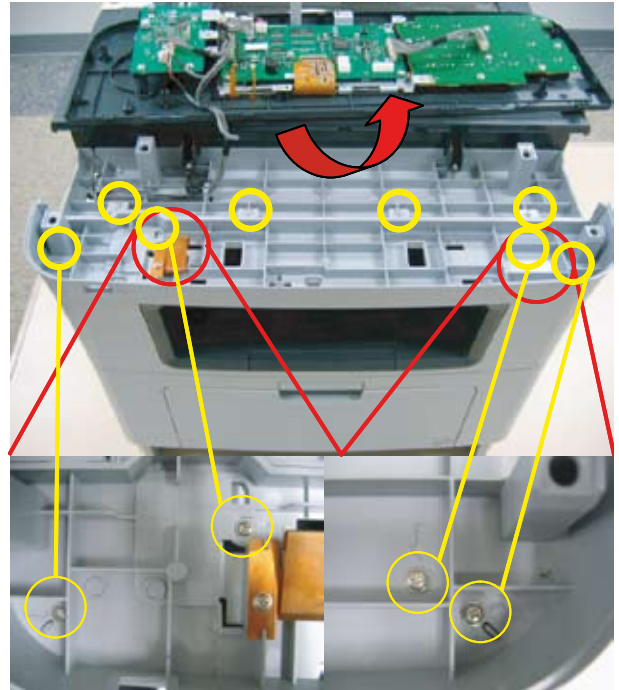

4. Remove the 2 screws from the rear.

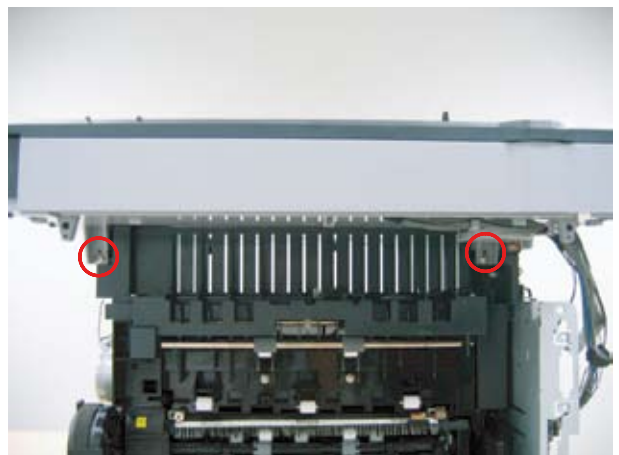

5. Remove the 1 screw.



8. Remove the Scan Upper from the Scan Lower.



6. Remove all harness connecting the Scan Assy.



9. Remove the flat cable.

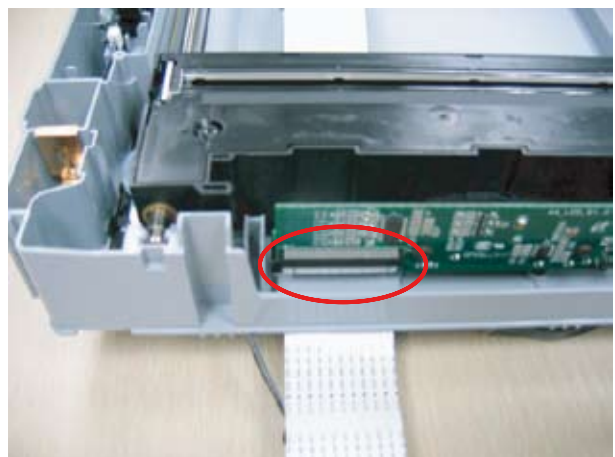

7. Lift the Scan Assy up.

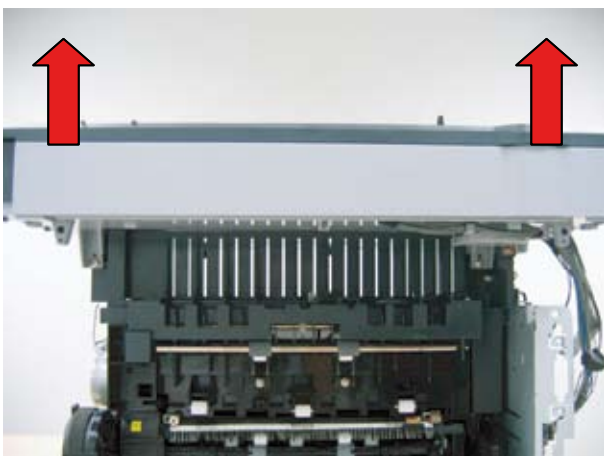

10. Remove the CCDM module after remove the belt unit.



3.3.8 Middle Cover

1. Remove the 2 screws.

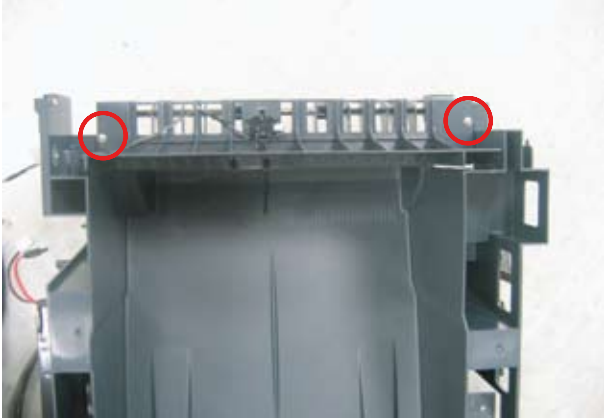

3. Remove the 5 screws and all harness.

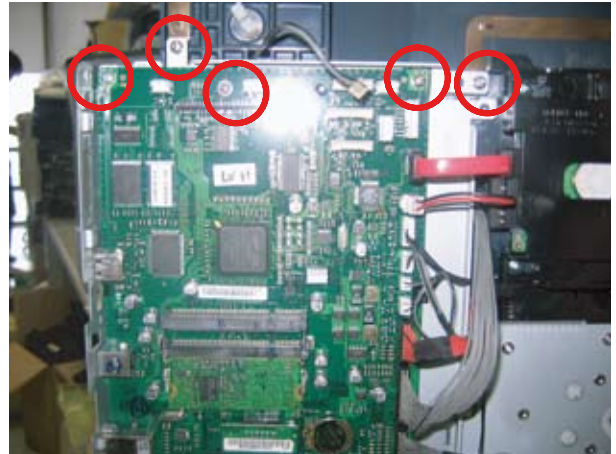

2. Remove all harness.



4. Remove the 1 screw.

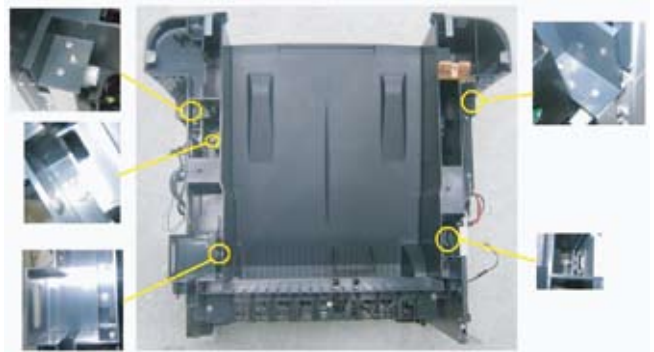

3.3.9 HDD/ Main PBA/ Fax board

1. Remove the 4 screws and harness. Remove the HDD Assy.

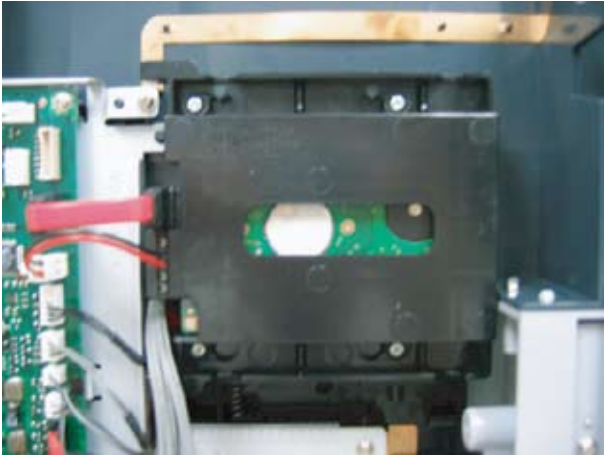

3. Remove the fax board cover after remove the 2 screws.



2. Remove all harness and 5 screws.

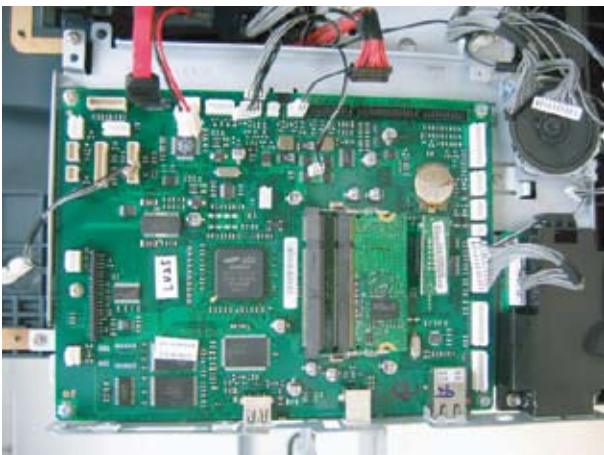

4. Remove the 1 screw.

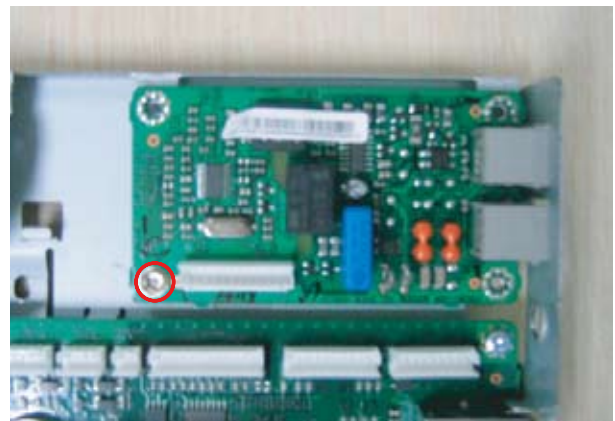

3.3.10 SMPS board

1. Remove the Cover-SMPS.



2. Remove the SMPS Shield after remove the 2 screws.

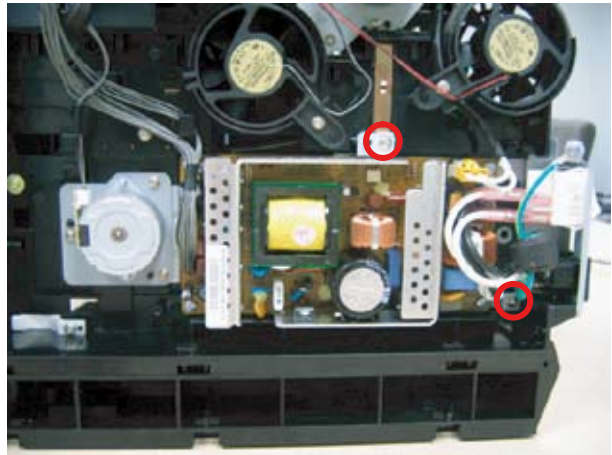

3.3.11 Main Drive unit

1. Remove the Drive unit after remove the 6 screws.

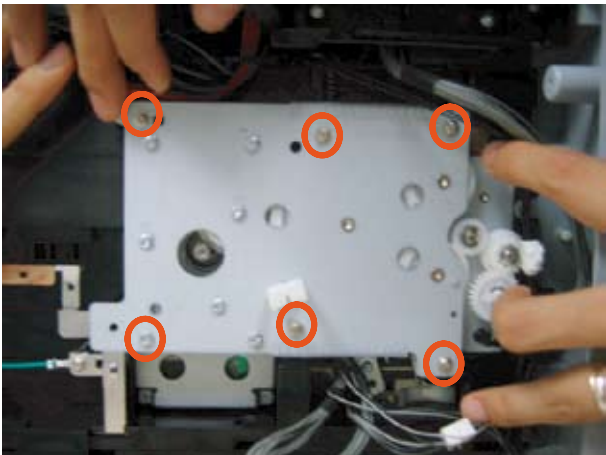

3.3.12 HVPS board

1. Separate the HVPS Shield after remove the 8 screws.

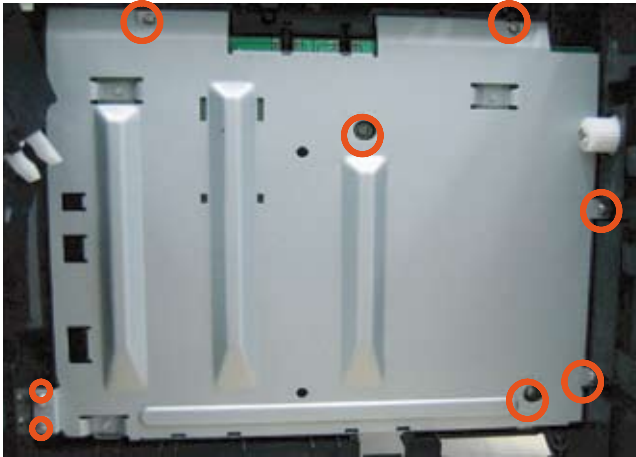

Caution

When disassembling and assembling the HVPS Shield, be careful the harness of the Cassette Sensor.

3.3.13 LSU Unit

1. Remove the LSU unit after the 2 harness and 4 screws.

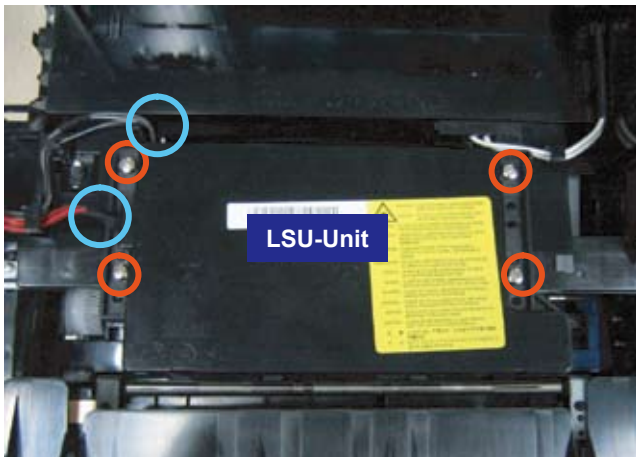

3.3.14 USB port

1. Remove the COVER-DECO UPPER



3. Turn up the OPE unit

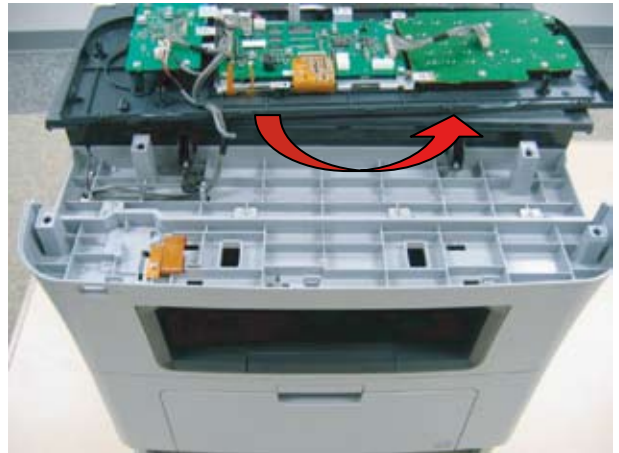

2. Remove the 1 SCREW.



4. Remove the 5 screw, 3 harness.

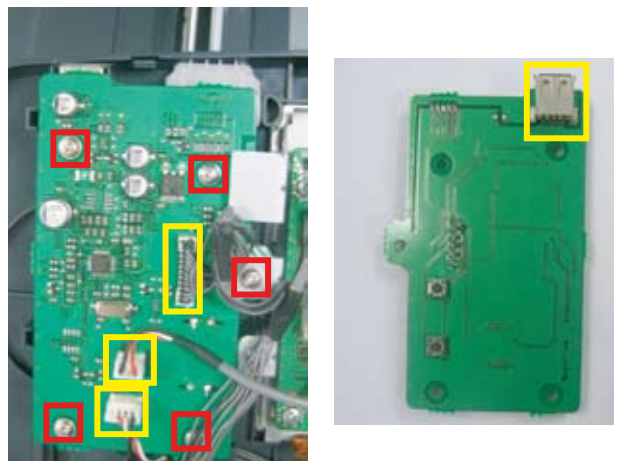

4. Alignment & Troubleshooting

This chapter describes some of the main service procedures including;

- Clearing paper jams
- Using the Diagnostic mode
- How to firmware upgrade
- Troubleshooting. etc.

4.1 Alignment and Adjustments

4.1.1 Paper path

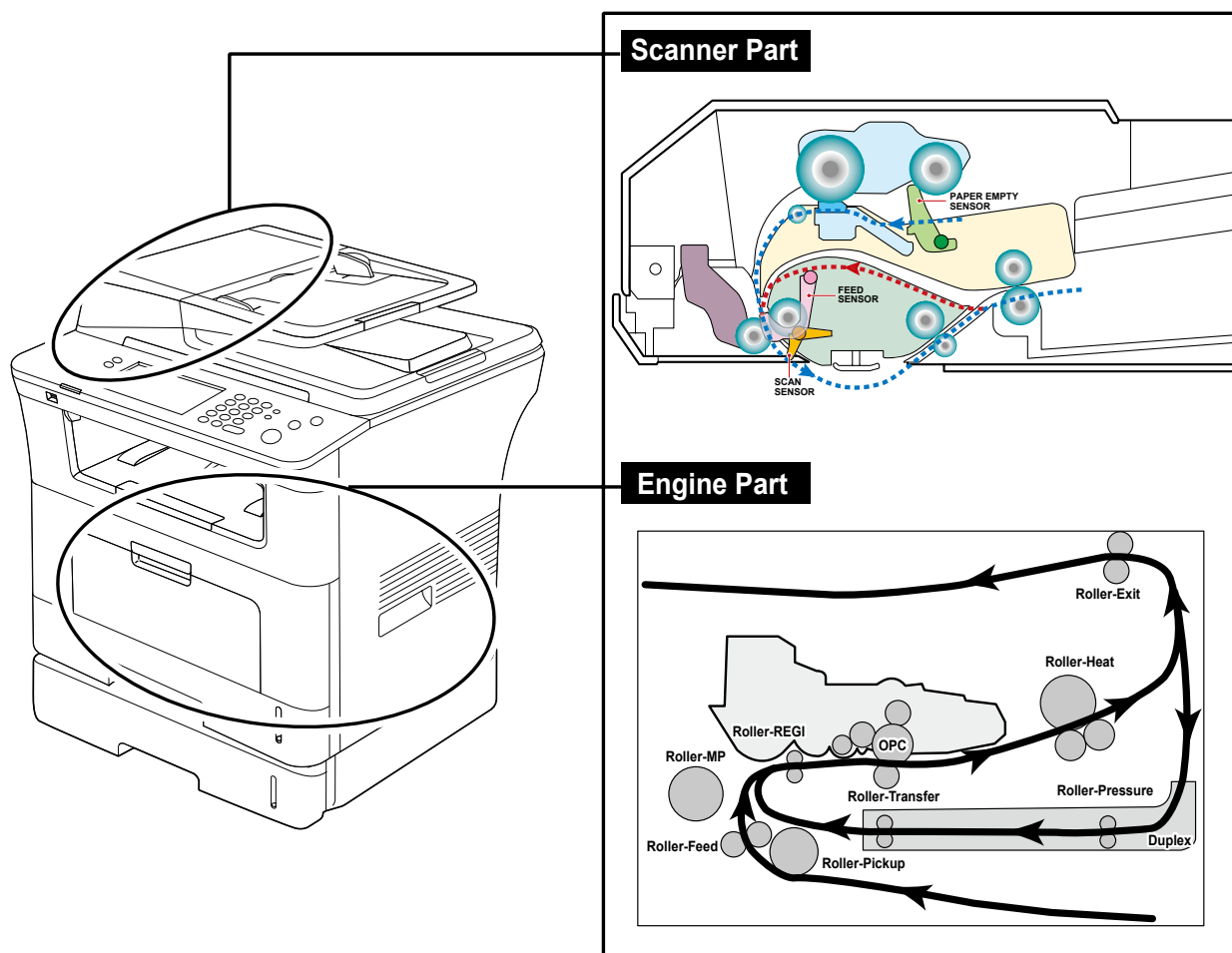

4.1.2 Clearing Paper Jams

Occasionally, paper can be jammed during a print job. Some of the causes include:

- The tray is loaded improperly or overfilled.
- The tray has been pulled out during a print job.
- The front cover has been opened during a print job.
- Paper was used that does not meet paper specifications.
- Paper that is outside of the supported size range was used.

If a paper jam occurs, LCD window will show it's speeds. Find and remove the jammed paper. If you don't see the paper, open the covers.



Do not use a pinset or a sharp metal tool when removing a jam.

The covering of a metal part can be removed which can cause an electric leakage.

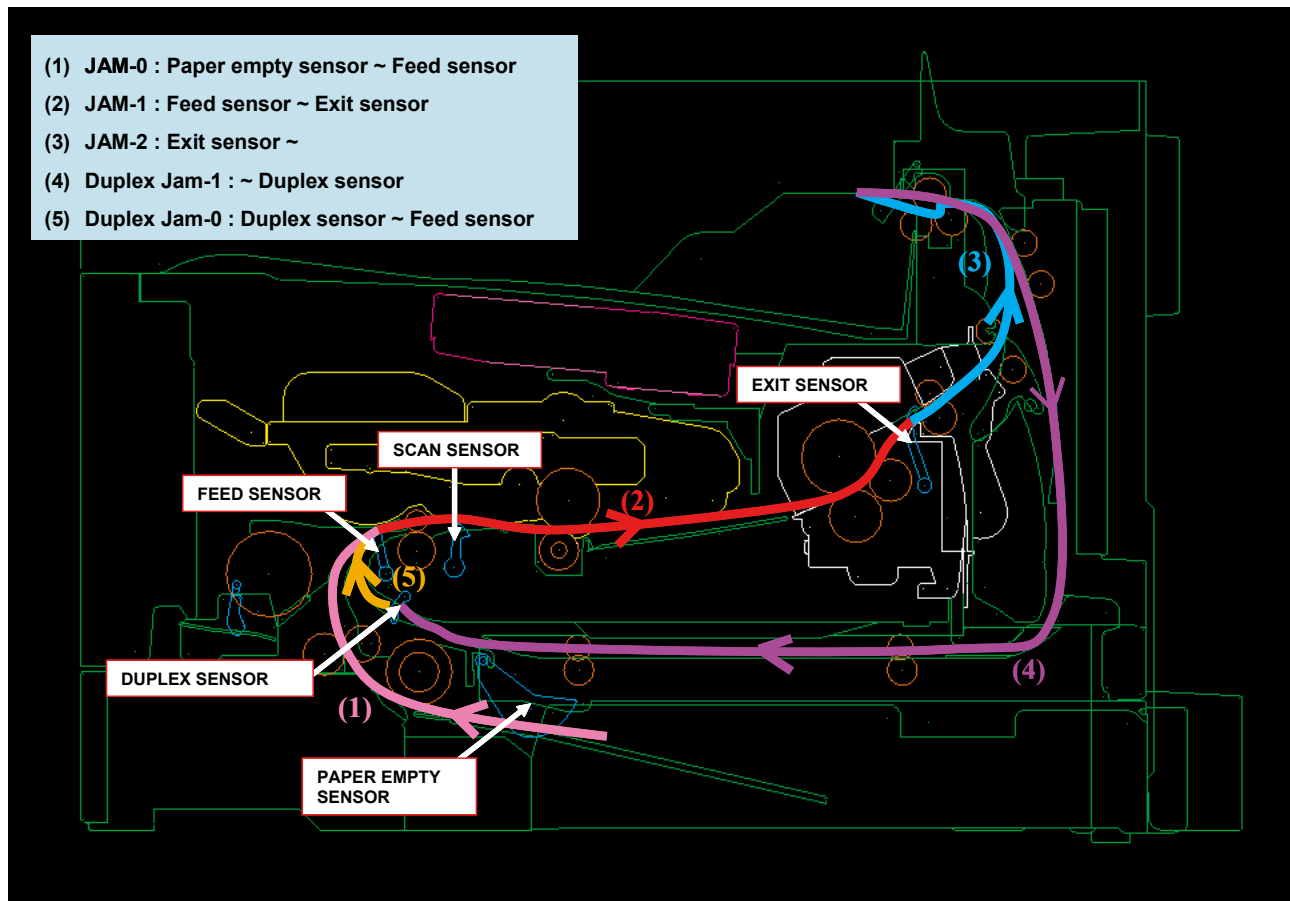

■ Description of ENGINE JAM type (Layout)



■ Description of ENGINE JAM type (Simplex)

| Type | Case | Jam Removal | Jam Layout |
|-------|--|--|--|
| Jam 0 | Leading edge of media does not arrive at registration within a certain time after pick-up (If fails at a time, it tries pick-up again) | <ol style="list-style-type: none"> 1. Pull out cassette 2. Remove jammed paper |  |
| Jam 1 | Leading edge of media does not arrive at Exit Sensor within a certain time after registration | <ol style="list-style-type: none"> 1. Open front cover 2. Pull out toner cartridge 3. Remove jammed paper |  |
| Jam 2 | Trailing edge of media does not leave Exit Sensor within a certain time after touching registration | <ol style="list-style-type: none"> 1. Open rear cover 2. Pull down jam lever on fuser unit and open fuser cover) 3. Remove jammed paper from exit |  |

■ Description of ENGINE JAM type (Duplex)

| Type | Case | Jam Removal | Jam Layout |
|--------------|--|---|---|
| Duplex Jam 1 | Trailing edge of media leaves Exit Sensor, and does not arrive at Duplex Sensor | <ol style="list-style-type: none"> 1. Open rear cover 2. Remove jammed paper <p>OR</p> <ol style="list-style-type: none"> 1. Pull out duplex unit 2. Remove jammed paper from duplex unit |  |
| Duplex Jam 0 | Leading edge of media does not arrive at registration within a certain time after touching Duplex Sensor | <ol style="list-style-type: none"> 1. Open rear cover 2. Remove jammed paper <p>OR</p> <ol style="list-style-type: none"> 1. Pull out duplex unit 2. Remove jammed paper from duplex unit |  |

■ Description of DADF JAM type

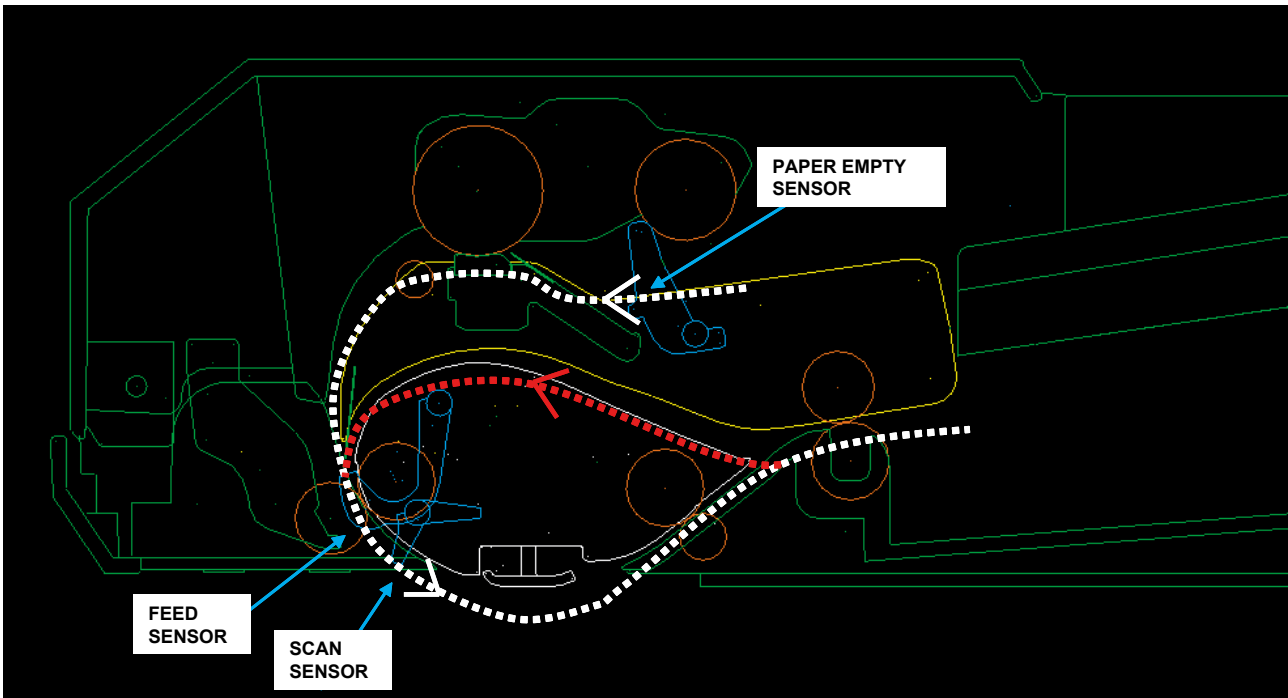

| Type | Case | Jam Removal |
|--------------|----------------------|--|
| Document Jam | All case of DADF Jam | 1. Open DADF open cover 2. Remove jammed paper OR 1. Open DADF open cover and Lift up DADF middle cover 2. Remove jammed paper |

4.1.2.1 Tips for avoiding paper jams

By selecting the correct media types, most paper jams can be avoided. When a paper jam occurs, follow the steps outlined on page 98.

- Ensure that the adjustable guides are positioned correctly.
Do not overload the tray. Ensure that the paper level is below the paper capacity mark on the inside of the tray.
- Do not remove paper from the tray while your machine is printing.
- Flex, fan, and straighten paper before loading.
- Do not use creased, damp, or highly curled paper.
- Do not mix paper types in a tray.
- Use only recommended print media.
- Ensure that the recommended side of the print media is facing down in the tray, or facing down in the multi-purpose tray.
- If paper jams occur frequently when you print on A5/B5-sized paper: Load the paper into the tray with the long edge facing the front of the tray. If load the paper this way, printing both sides of the paper (Duplex) is not supported.

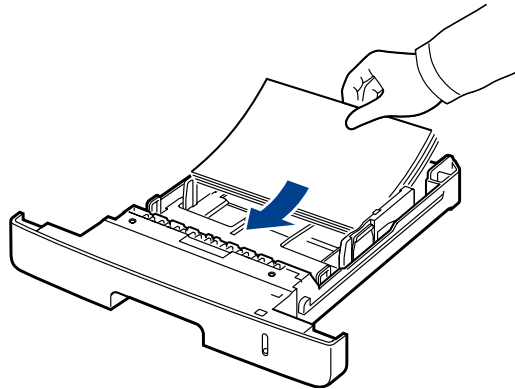

In the Printer Preferences window, set the page orientation to be rotated 90 degrees.

4.1.2.2 Clearing Original Document Jams

When an original jams while passing through the document feeder, a warning message appears on the display screen.

1. Remove any remaining pages from the document feeder.
2. Seize the misfeed paper, and remove the paper from the document output tray by carefully pulling it to the right using both hands.
4. Gently remove the jammed paper from the document feeder.

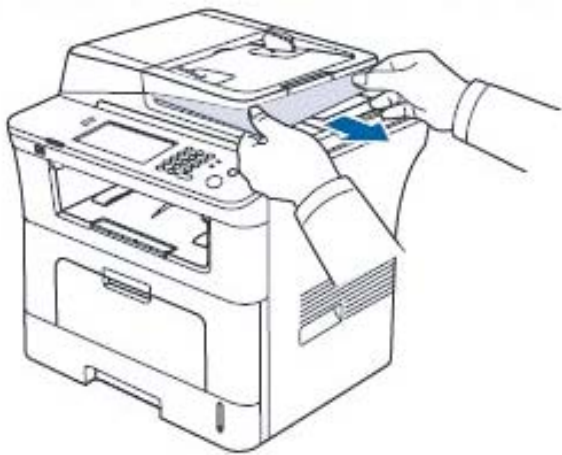

If you see no paper in this area, go to the next step.

3. Open the document feeder cover.

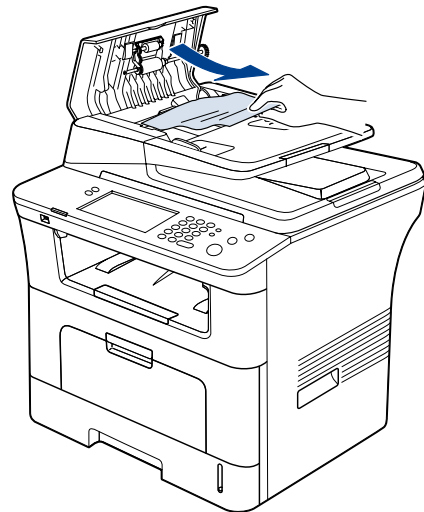
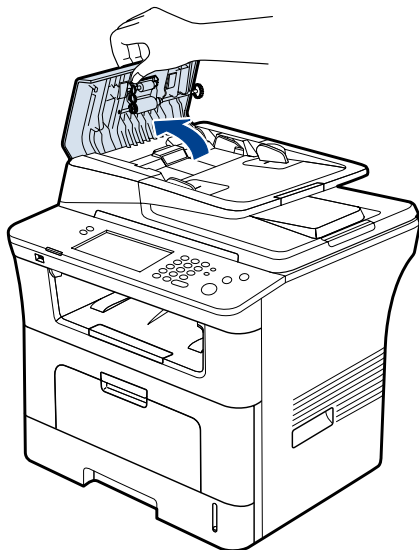

If you see no paper in this area, go to the next step.

5. Open the document feeder cover. Gently remove the jammed paper.



6. Close the document feeder cover. Reload the pages you removed, if any, in the document feeder.
7. Open the scanner lid.
8. Grasp the misfeed paper and, using both hands, remove the paper from the feed area by carefully pulling it to the right.

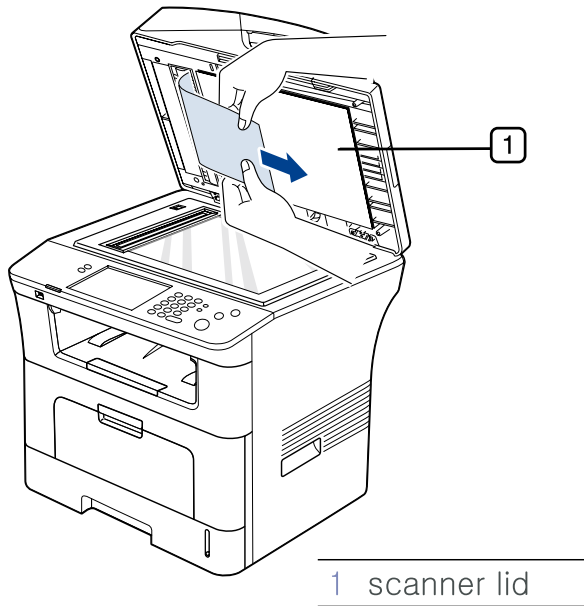

9. Close the scanner lid. Load the removed pages back into the document feeder.

4.1.2.3 Clearing paper jams

When a paper jam occurs, a warning message appears on the display screen. Refer to the table below to locate and clear the paper jam.

In tray 1

1. Open and close the front cover. The jammed paper is automatically ejected from the machine. If the paper does not exit, go to the next step.
2. Pull out tray 1.

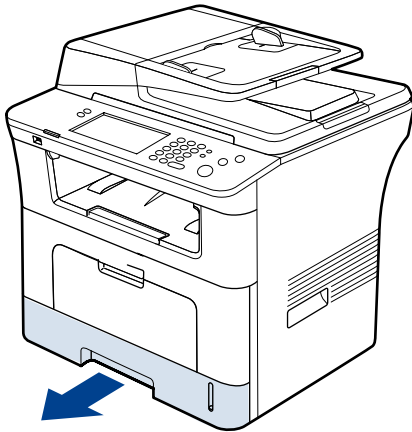

3. Remove the jammed paper by gently pulling it straight out.

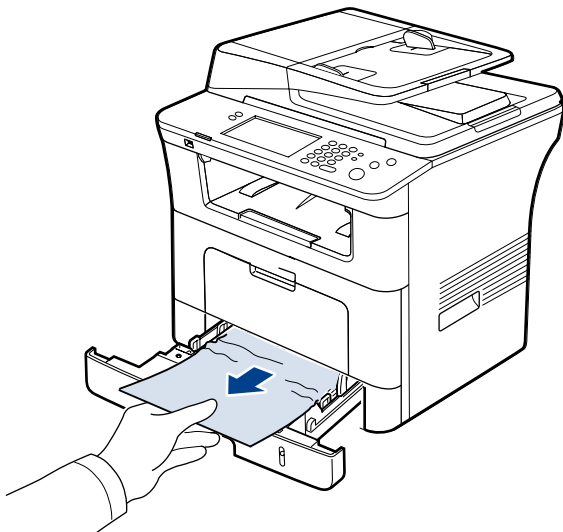

If the paper does not move when you pull, or if you do not see the paper in this area, check the fuser area around the toner cartridge.

4. Insert tray 1 back into the machine until it snaps into place. Printing automatically resumes.

In optional tray 2

1. Pull out optional tray 2 open.
2. Remove the jammed paper from the machine.

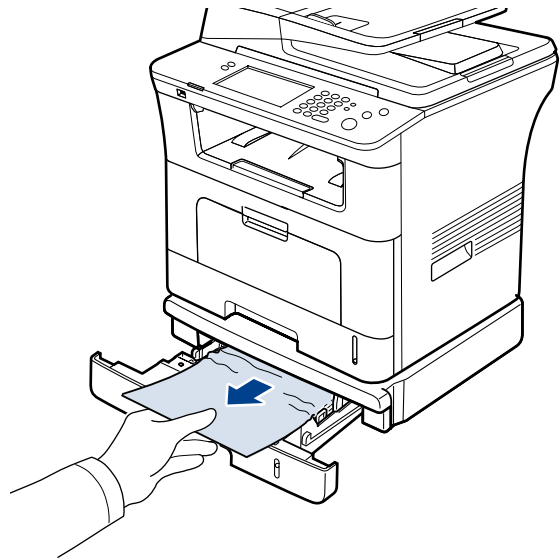

If the paper does not move when you pull or if you do not see the paper in this area, stop and go to step

3. Pull tray 1 half-way out.
4. Pull the paper straight up and out.

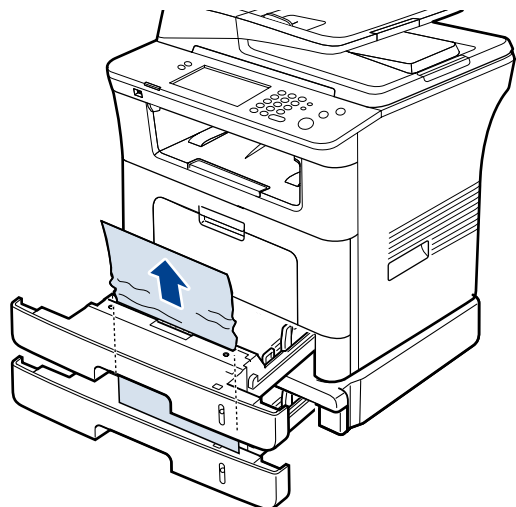

5. Insert the trays back into the machine. Printing automatically resumes.

In the multi-purpose tray

1. If the paper is not feeding properly, pull the paper out of the machine.

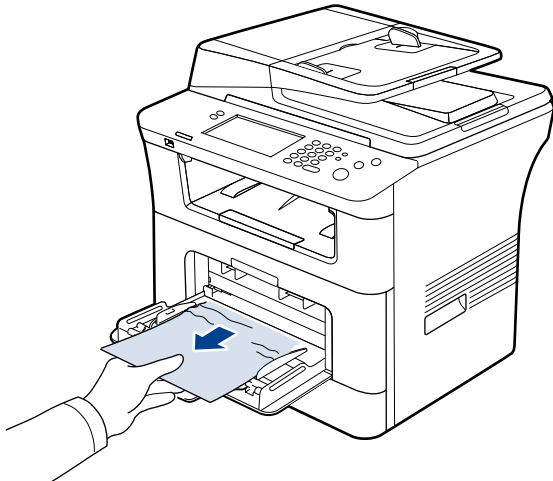

2. Open and close the front cover to resume printing.

Inside the machine

1. Open the front cover and pull the toner cartridge out, lightly pushing it down.

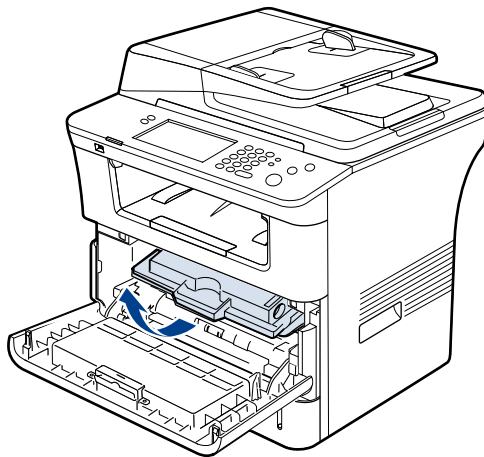

2. Remove the jammed paper by gently pulling it straight out.

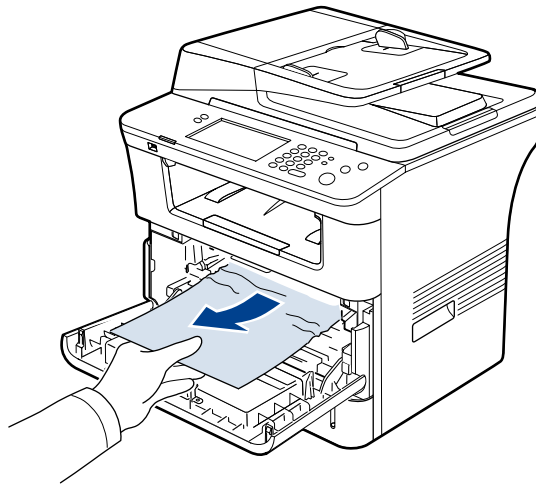

3. Replace the toner cartridge and close the front cover. Printing automatically resumes.

In exit area

1. Open and close the front cover. The jammed paper is automatically ejected from the machine.
2. Gently pull the paper out of the output tray.

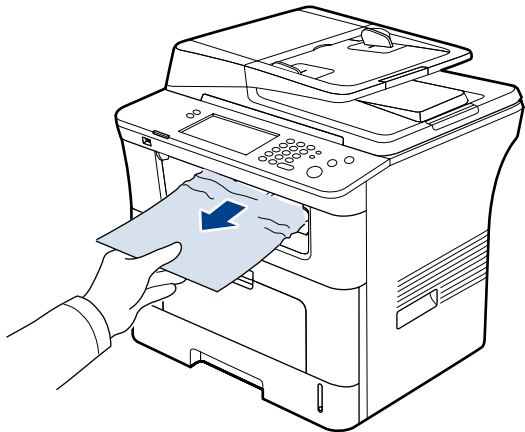

If you do not see the jammed paper or if there is any resistance when you pull, stop and go to the next step.

3. Open the rear cover.
4. If you see the jammed paper, push the pressure lever on each side up and remove the paper. Skip to step 9.

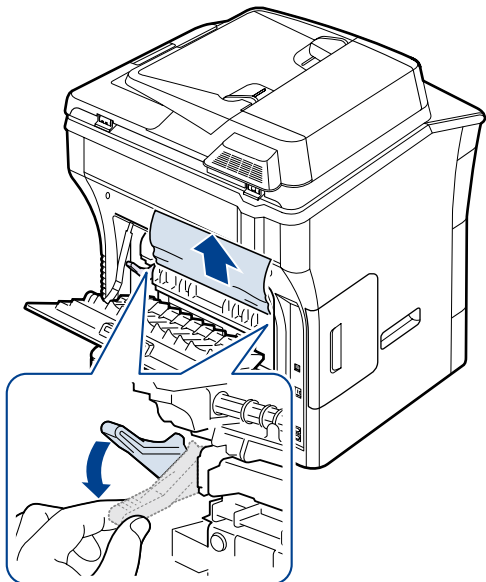

If you still do not see the paper, go to the next step.

5. Release the white strip, the rear cover stopper, and fully open the rear cover, as shown.

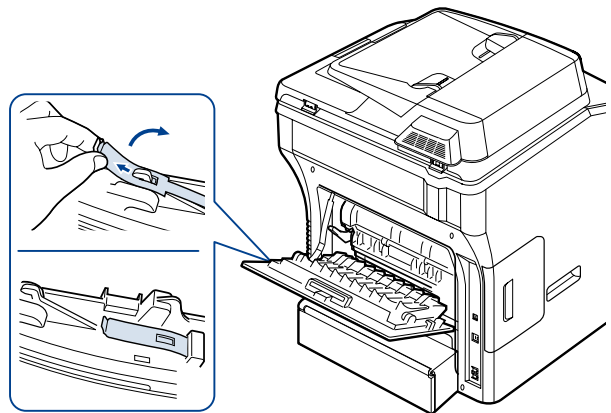

6. Unfold the duplex guide fully.

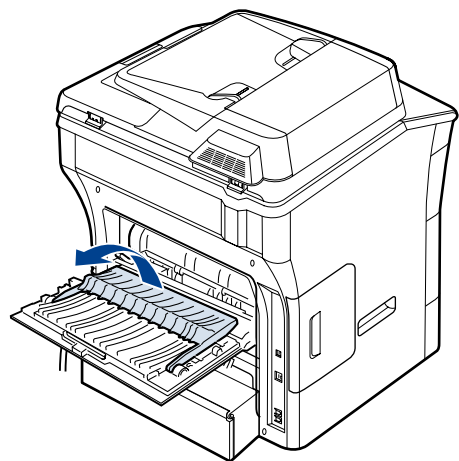

7. While pushing the fuser lever to the right, open the fuser door.

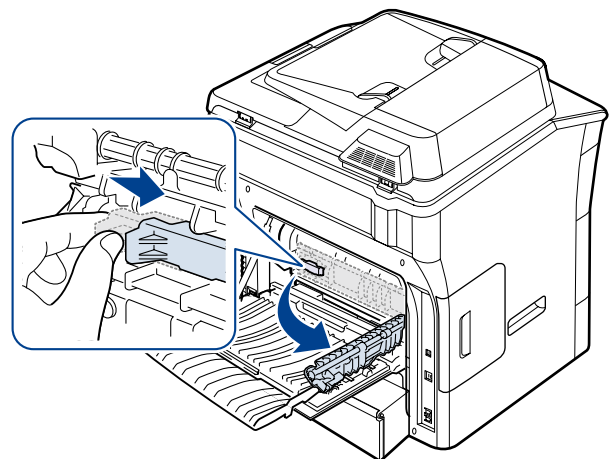

- Pull the jammed paper out. If the jammed paper does not move when you pull, push the pressure lever on each side up to loosen the paper, and then remove it.

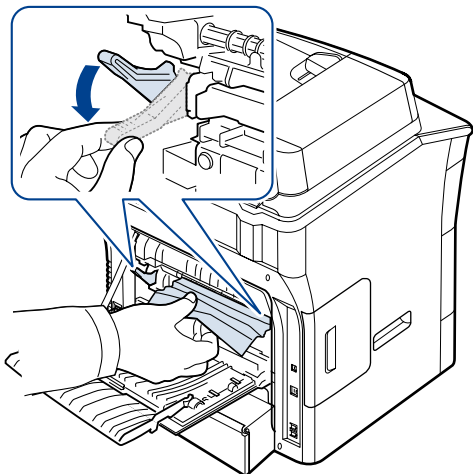

- Return the lever, door, stopper, and guide to their original position.
- Close the rear cover. Printing automatically resumes.

In the duplex unit area

If the duplex unit is not inserted correctly, a paper jam may occur. Make sure that the duplex unit is inserted correctly.

- Pull the duplex unit out of the machine.

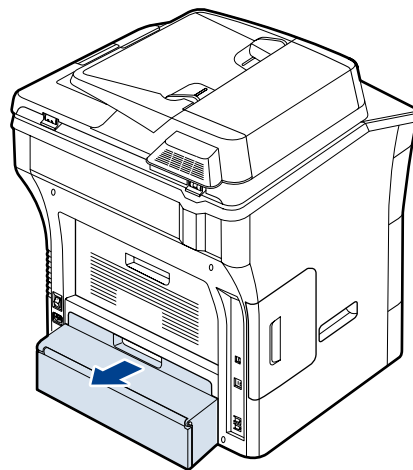

- Remove the jammed paper from the duplex unit.

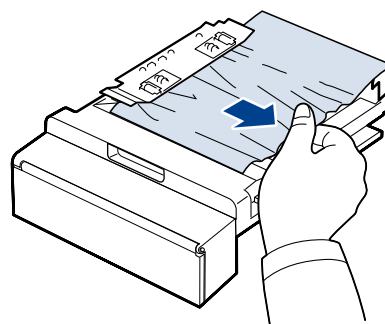

If the paper does not come out with the duplex unit, remove the paper from the bottom of the machine.

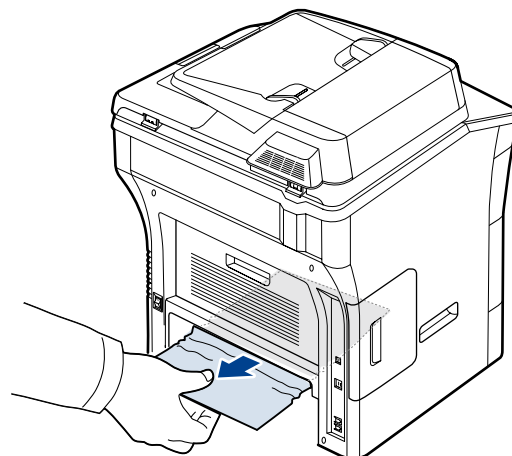

If you still do not see the paper, go to the next step.

3. Open the rear cover.

4. Unfold the duplex guide fully.

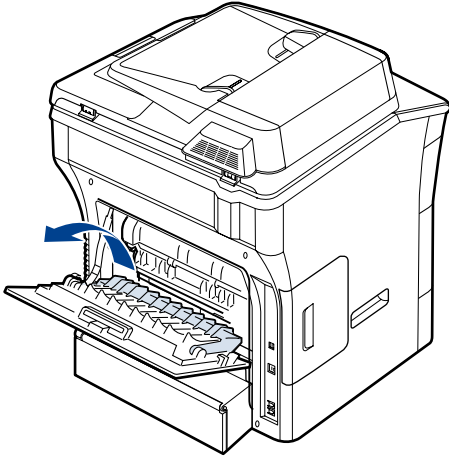

5. Pull the jammed paper out.

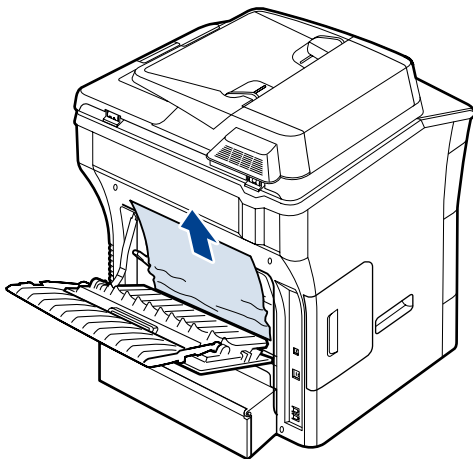

4.1.3 Abnormal Image Printing and Defective Roller

If abnormal image prints periodically, check the parts shown below.

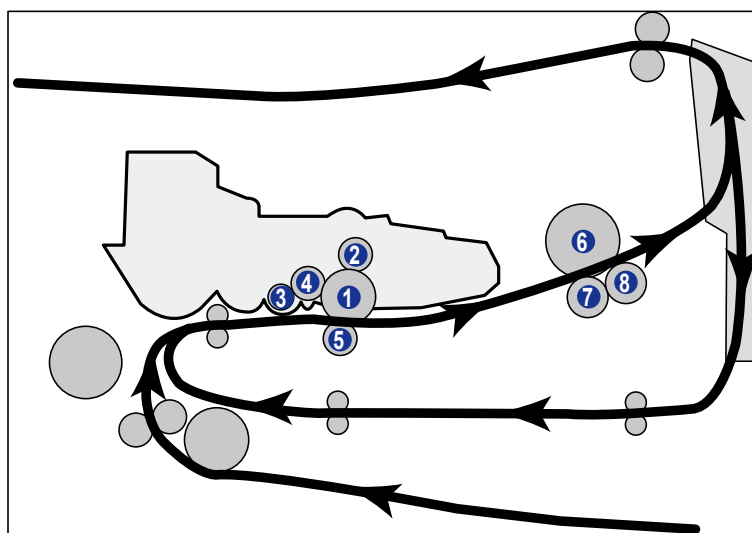

- ① OPC Drum
- ② Charge Roller
- ③ Supply Roller
- ④ Developing Roller
- ⑤ Transfer Roller
- ⑥ Heat Roller
- ⑦ Pressure Roller1
- ⑧ Pressure Roller2

| No | Roller | Abnormal image period | Kind of abnormal image |
|----|------------------|-----------------------|---|
| 1 | OPC Drum | 75.5mm | White spot, Block spot |
| 2 | Charge Roller | 37.7mm | Black spot |
| 3 | Supply Roller | 44.9mm | Horizontal density band |
| 4 | Develop Roller | 35.2mm | Horizontal density band |
| 5 | Transfer Roller | 47.1mm | Black side contamination/transfer fault |
| 6 | Heat Roller | 77.8mm | Black spot and fuser ghost |
| 7 | Pressure Roller1 | 62.8mm | Black side contamination |
| 8 | Pressure Roller2 | 50.2mm | Black side contamination |

■ Repetitive defect Image check page

Print this page. Align the this page and the printed defect image and find the defective roller.

Start line _____

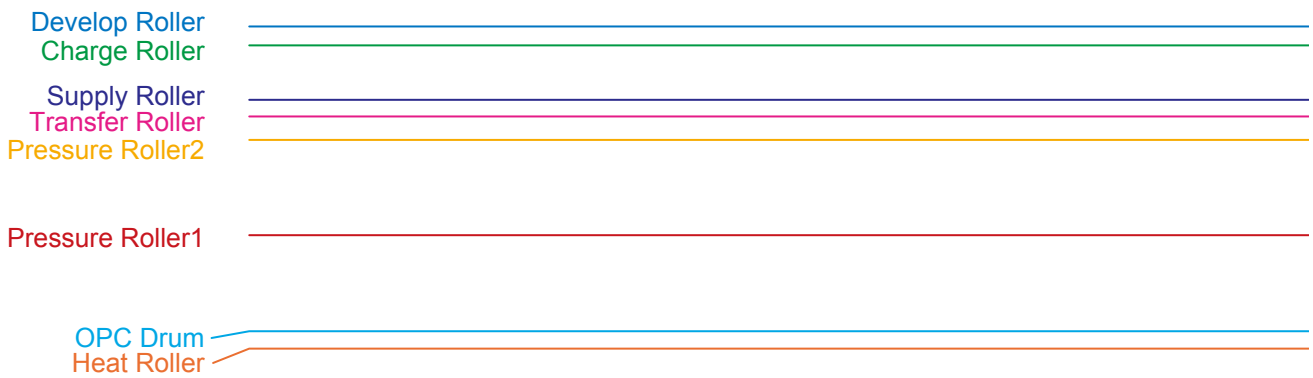

4.1.4 Control Panel overview





| | | |
|----|-----------------------|---|
| 1 | Machine Setup | Guides you to the machine setup and advanced settings. |
| 2 | Job Status | Shows jobs currently running, queued jobs and completed. |
| 3 | Status | Shows the status of your machine. |
| 4 | Display screen | Displays machine's current status and prompts during an operation. Set menus easily using the touch screen. |
| 5 | Numeric keypad | Dials fax number, and enters the number value for document copies or other options. |
| 6 | Clear: | Deletes characters in the edit area. |
| 7 | Redial/Pause | In standby mode, redials the last number; or in edit mode, inserts a pause into a fax number. |
| 8 | On Hook Dial | Engages the telephone line. |
| 9 | Interrupt | Stops a job in process to do an urgent copy job. |
| 10 | Clear All | Reverts the current settings to default values. |
| 11 | Power Saver | Sends the machine into power saver mode. You can also turn the power on and off with this button. |
| 12 | Stop | Stops an operation at any time. The pop-up window appears on the screen showing the current job that the user can stop or resume. |
| 13 | Start | Starts a job. |

4.1.4.1 Introducing the touch screen and useful buttons

Touch screen

The touch screen allows for user-friendly operation of the machine. Once you press the home icon () on the screen, it shows the Main screen.



-  : Shows Help. You can find the explanation by feature contents.
- Copy: Enters the Copy menu.
- Fax: Enters the Fax menu. (Optional)
- Scan: Enters Scan to Email, NetScan, Scan to Server menu.
- Stored Documents: Enters the Stored Documents menu.
- USB: When USB memory is inserted into the USB memory port on your machine, USB icon shows on the display screen.
- SmarThru Workflow: Enters the SmarThru Workflow menu. (Optional)
- Toner Info.: Shows amount of toner used.
- LCD Brightness: Adjusts the brightness of the touch screen.
-  : You can change the display language.
-  : Guides you to remove the USB memory devices from the machine. Follow the instruction on the LCD. This icon appears only when you connect an USB memory module.
- Logout: Logs out from the currently logged in account.

Machine Setup button

When you press Machine Setup button, you can browse current machine settings or change machine values.



-  This button allows you to move to Copy, Fax, Scan, Stored Documents menu directly.
- Machine Status: Shows the current status of the machine.
- Admin Setting: Allows an administrator to set up the machine.
- Usage Page Report: You can print the report on the amount of printouts depending on the paper size and type.

Job Status button

When you press Job Status button, the screen shows the lists of currently running jobs, queued jobs and completed jobs.



- Current Job tab: Shows the list of jobs in progress and pending.
- Completed Job tab: Provides the list of completed jobs.
- Active Notice tab: Displays any error codes that have occurred.
- No.: Gives the order of jobs.
- Job Name: Shows job information like name and type.
- Status: Gives the current status of each job.
- User: Provides user name, mainly computer name.
- Job Type: Displays details of the active job, such as job type, recipient phone number and other information.
- Detail: Shows the detailed information of the selected option on the Current Job, Completed Job and Active Notice list.
- Delete: Removes the selected job from the list.
- Delete All: Removes all the jobs from the list.
- Close: Closes the job status window and switches to previous view.

Power Saver button

When the machine is not in use, save electricity with the provided power save mode. Pressing this button puts the machine into power save mode. If you press Power Saver button for more than two seconds, a window appears, requesting that you turn the power off. If you choose Yes, the power is turned off.

This button can also be used to turn the button on.

| Status | | Description |
|--------|-------|--|
| Off | | <ul style="list-style-type: none"> • The machine is not in the power save mode. • The machine is in the low power save mode. |
| Blue | On | machine is in the power save mode. |
| | Blink | The machine is in the ready power save mode. |

Interrupt button

When you press Interrupt button, the machine goes into interrupt mode which means it stops a printing job for urgent copy job. When the urgent copy job completes, the previous printing job continues.

| Status | | Description |
|--------|----|--|
| Off | | The machine is not in interrupt printing mode. |
| Blue | On | The machine is in interrupt printing mode. |

4.1.5 Understanding The Status LED

The color of the Status LED indicates the machine's current status.

| Status | | Description |
|--------|----------|---|
| Off | | <ul style="list-style-type: none"> The machine is powered off-line. The machine is in power save mode. When data is received, or any button is pressed, it switches to on-line automatically. |
| Green | Blinking | <ul style="list-style-type: none"> When the backlight slowly blinks, the machine is receiving data from the computer. When the backlight blinks rapidly, the machine is printing data. |
| | On | <ul style="list-style-type: none"> The machine is powered on and can be used. |
| Red | Blinking | <ul style="list-style-type: none"> A minor error has occurred and the machine is waiting for the error to be cleared. Check the display message. When the problem is cleared, the machine resumes. The toner cartridge is near the end of its life. Order a new toner cartridge. You can temporarily improve print quality by redistributing the toner. |
| | On | <ul style="list-style-type: none"> The toner cartridge is totally empty. Remove the old toner cartridge and install a new one. A paper jam has occurred. The cover is opened. Close the cover. There is no paper in the tray. Load paper in the tray. The machine has stopped due to a major error. Check the display message. |

4.1.6 Menu overview

4.1.6.1 Menu Map

The control panel provides access to various menus to set up the machine or use the machine's functions. These menus can be accessed by pressing Machine Setup, Job Status, or touching menus on the display screen. Refer to the following table.

NOTE - Some menus may not appear in the display depending on options or models. If so, it is not applicable to your machine.

Main screen

The main screen is shown on the display screen on the control panel. Some menus are grayed out depending on your model.

Copy Menu Map

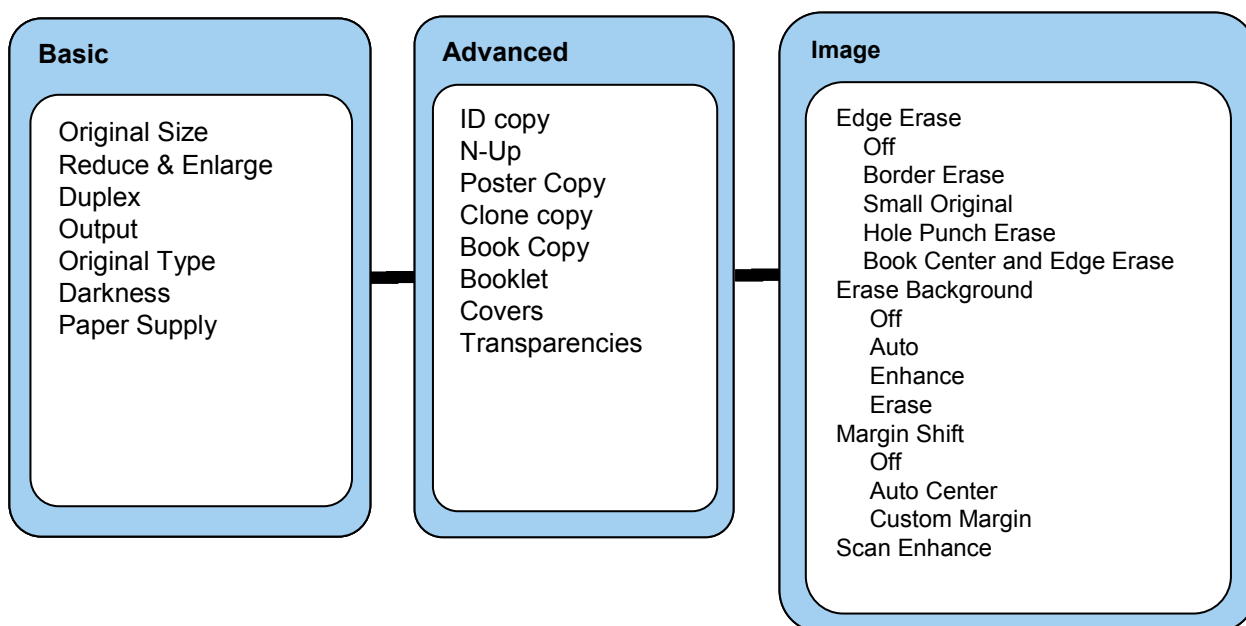

Fax Menu Map

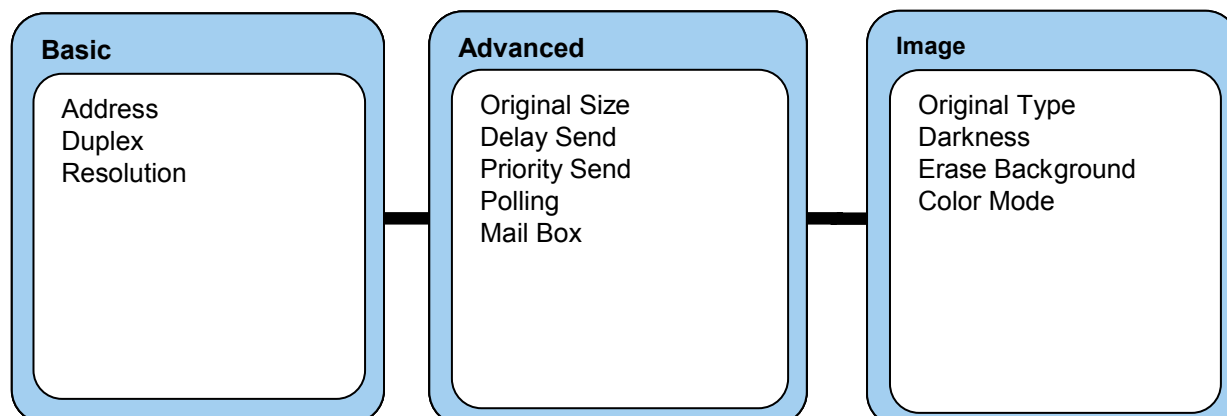

Scan Menu Map

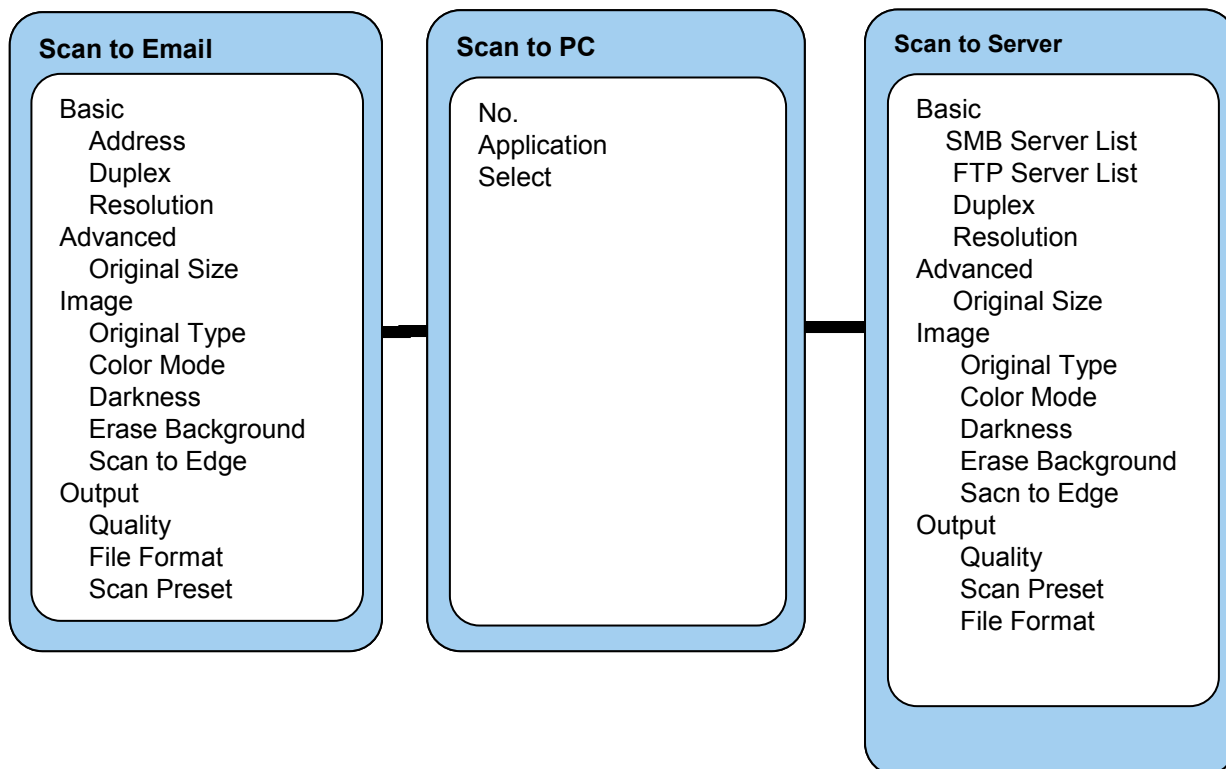

Stored Documents Menu Map

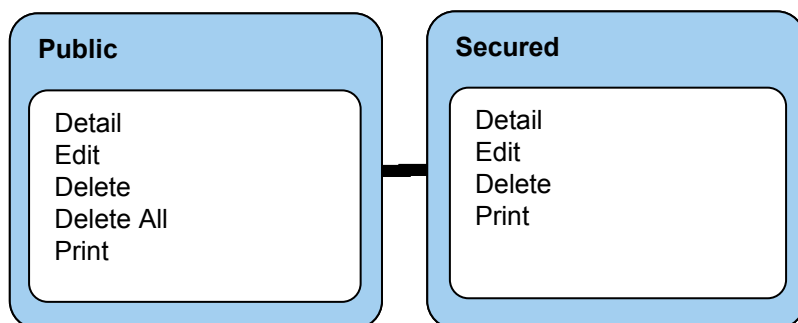

USB Menu Map

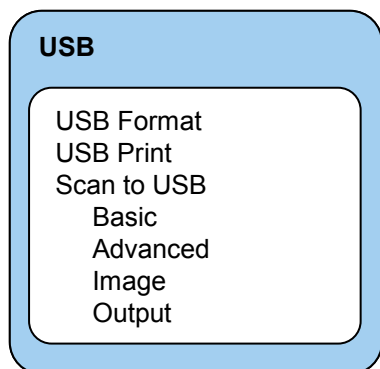

Machine Setup button

When you press the Machine Setup button on the control panel, the screen displays two menus. Machine Status shows the supplies life, billing, counters and reports. Admin Setting lets you set the advanced setup to use your machine in depth and conveniently. Usage Page Report prints a report on the number of printouts based on the paper size and type.

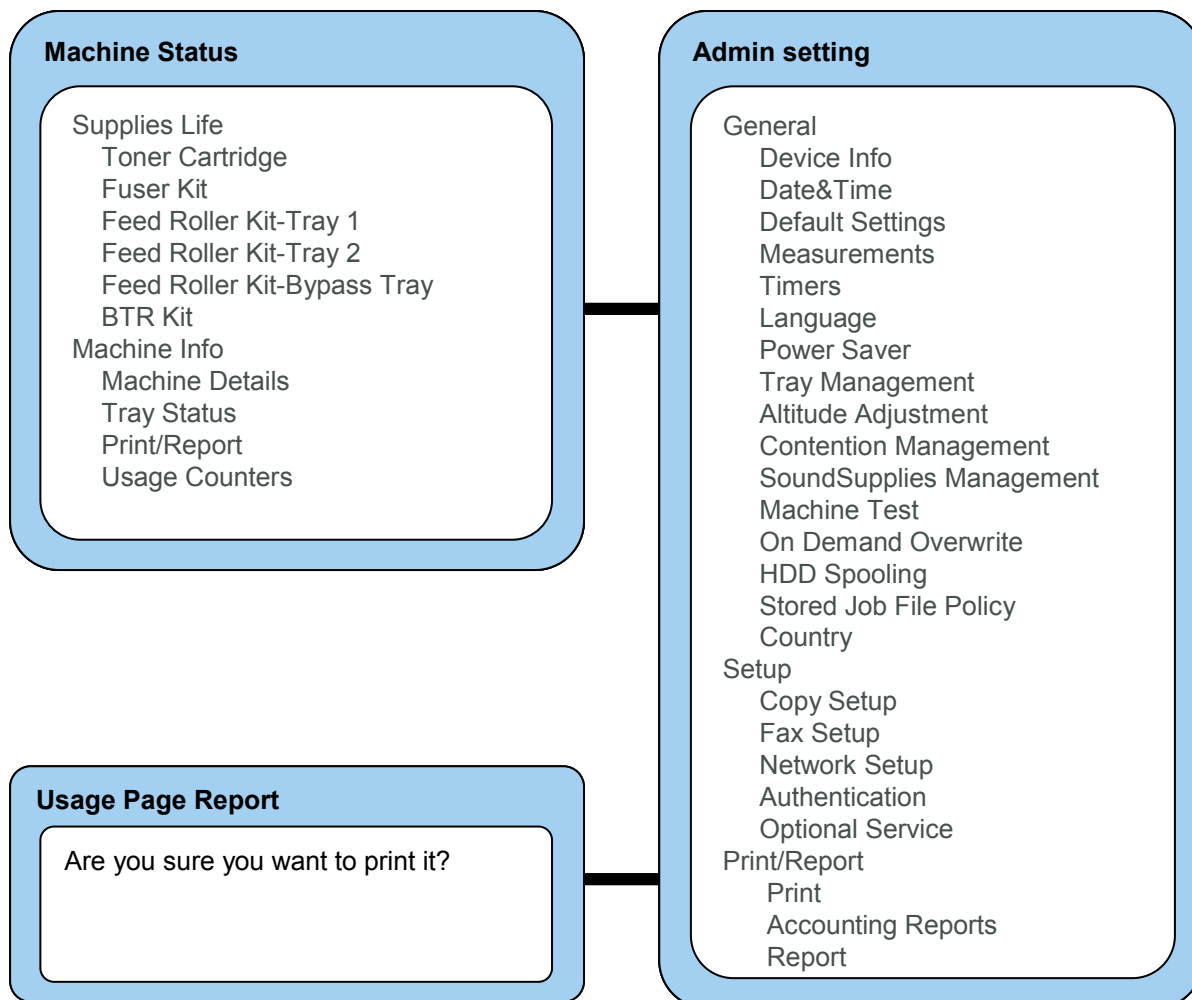

Job Status button

This menu shows the job in process, jobs waiting and, in completed, and error messages.

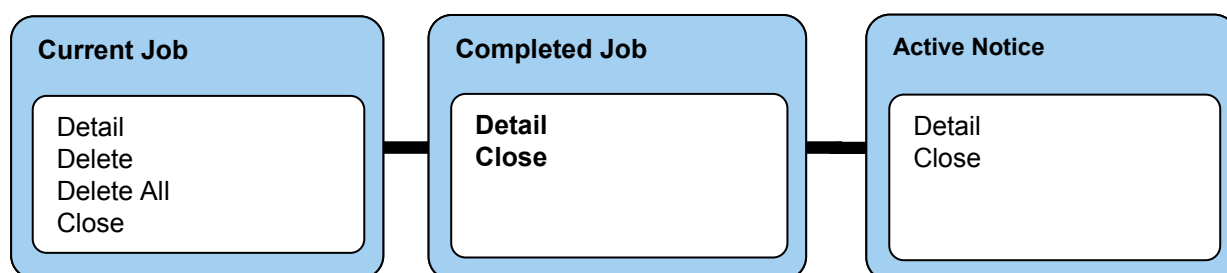

4.1.6.2 Understanding the Copy screen

When you press Copy on the Main screen, the Copy screen appears which has several tabs and lots of copying options. All the options are grouped by features so that you can configure your selections easily. If the screen displays another menu, press Home button to go to the Main screen. If you want to know more information for copy screen, please consult the user manual.

Basic Tab



- Original Size : Selects the size of the originals.
- Reduce/Enlarge : Reduces or enlarges the size of a copied image.
- Duplex : Sets the machine to print copies on both sides of the paper.
- Output : Selects Collated or Uncollated copy options.
- Original Type : Improves the copy quality by selecting the document type for the current copy job.
- Light, Dark : Adjusts the brightness level to make a copy that is easier to read, when the original contains faint markings and dark images.
- Paper Supply : Selects the paper supply tray.
- Erase Edge : Allows you to erase punch holes, staple marks, and fold creases along any of the four documents edges.

Advanced Tab



- ID Copy: Prints 2-sided originals on one sheet of paper. This feature is helpful for copying a small-sized item, such as a business card.
- N-Up: Prints 2 or 4 original images, reduced to fit onto one sheet of paper.
- Poster Copy: Prints a large image into divided 9 pages.
- Clone Copy: Prints multiple image copies from the original document on a single page.
- Book Copy: Allows you to copy an entire book.
- Booklet: Creates booklets from a sequential set of either 1-sided or 2-sided originals.
- Covers: Automatically adds covers to your copied set using stock taken from a different tray.
- Transparencies: Adds a blank or printed divider between transparencies within a set.

Image Tab



- Erase Edge: Allows you to erase punch holes, staple marks, and fold creases along any of the four documents edges.
- Erase Background: Prints an image with no background.
- Margin Shift: Creates a binding edge for the document.

4.1.6.3 Understanding the FAX screen

When you press Fax on the Main screen, the Fax screen appears which has several tabs and lots of fax options. All the options are grouped by features so that you can configure your selections easily. If the screen displays an other menu, press Home button to go to the Main screen. If you want to know more information for Fax screen, please consult the user manual.



Basic Tab

- Fax number input area : Shows the recipient's fax number using the number keypad on the control panel. If you configured the phone book, press Individual or Group.
- Add No : Lets you add more destinations.
- ← : Deletes the last digit entered.
- C : Removes all digits of the selected entry.
- Remove : Removes the selected fax number entry.
- Remove All : Removes all the fax numbers in the input area.
- Address : Picks up the frequently used fax numbers directly from your machine or from SyncThru Web Service.
- Duplex : Selects whether the machine send faxes one side of the original, both sides of the original.
- Resolution : Adjusts the resolution options.

Advanced Tab

- Original Size: Selects the size of the original document. Press OK to update current setting.
- Delay Send: Sets the machine to send a fax at a later time without your intervention.
- Priority Send: Sends an urgent fax before reserved operations.
- Polling: Used when the receiver requests the document to be faxed remotely at sender's absence or vice versa. In order to use the polling function, the originals must be previously stored in the machine.
- Mailbox: Used to store a received fax or originals in the machine memory which are ready to be polled. You can use a mailbox on the same machine you are using, or the one on a remote machine. Each mailbox has a corresponding mailbox number, name and password.
- Back: Returns to the Basic tab.

Image Tab

- Original Type: Enhances the fax quality based on the type of the original document being scanned.
- Darkness: Adjusts the level of lightness or darkness of the fax.
- Erase Background: Reduces dark backgrounds or paper patterns as in newspaper originals.
- Color Mode: Selects whether the user sends the fax in mono or color.
- Back: Returns to the Basic tab.

4.1.6.4 Understanding the SCAN screen

To use the scanning feature, press Scan on the Main screen. If the screen displays an other menu, press home button to go to the Main screen.

If the message asking Auth. ID and Password, it means the network administrator has set the authentication in SyncThru Web Service.



Press Scan to Email, Scan to PC Scan to Server.



- Scan to Email: Scans and sends the scanned output to the destination by email.
- Scan to PC : Scans and sends the scanned output to your PC.
- Scan to Server: Scans and sends the scanned output to the destination with SMB and FTP.

Basic tab

This section explains the Basic tab of Scan to Email and Scan to Server, and NetScan's basic screen.

- Scan to Email



- From: Sender's email address.
- To/Cc/Bcc: Recipients' addresses. Cc is for copies to an additional recipient and Bcc is for the same as Cc but without their name be displayed.
- Subject/Message: Subject and message of the email.
- Remove All: Erases everything in the input area.
- Address: Inputs the recipient's address just by pressing stored addresses. You can store frequently used email addresses from your computer using the SyncThru Web Service.
- Duplex: Selects whether the machine scans on one side of the paper (1 Sided), both sides of the paper (2 Sided), or both sides of paper but back is rotated 180 degrees (2 Sided, Rotate Side 2).
- Resolution: Selects the scanning resolution value.
- Back: Returns to the previous screen. If the network authentication is enabled, the log off confirmation message popes up and closes Scan to Email.

- Scan to PC

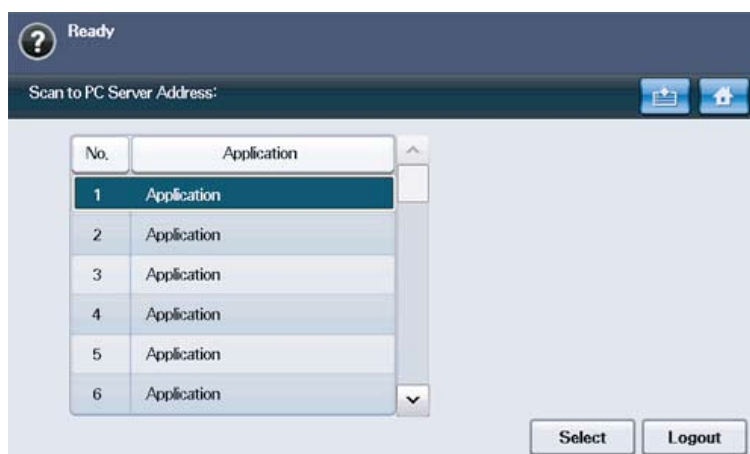

If the authentication for network appears, you have to enter user name and password to enter the Scan to PC screen.

- No.: Lists the number in order for application programs.
- Application: Shows the available application programs from your computer.
- Select: Moves to the application program you have selected.

- Scan to Server



- SMB: Sends the scanned file to SMB. Press SMB for that option.
- FTP: Sends the scanned file to FTP. Press FTP for that option.
- No.: Index number which you entered in SyncThru Web Service.
- Server: Alias name which you entered in SyncThru Web Service.
- Duplex: Selects whether the machine scans on one side of the paper (1 Sided), both sides of the paper (2 Sided), or both sides of paper but back is rotated 180 degrees (2 Sided, Rotate Side 2).
- Resolution: Selects the scanning resolution value.
- Back: Returns to the previous screen.
- Quality: Adjusts the display quality of the scan output.
- File Format: Selects the file format of the scan output.
- Scan Preset: Automatically changes some scan options such as file format, resolution, and more. You can adjust options to fit each specific purpose.
- Back: Returns to the previous screen.

Advanced tab



- Original Size: Sets the originals to a specific fixed size.
- Back: Returns to the previous screen.

Image tab



- Original Type: Selects whether the original is text or photo.
- Color Mode: Adjusts the color options of the scan output. If the original is color and you want to scan in color, press Color Mode.
- Darkness: Adjusts the degree of darkness of the scan output. Use left/right arrow to adjust the values.
- Erase Background: Erases backgrounds like paper patterns.
- Scan to Edge: Scans originals from edge-to-edge.
- Back: Returns to the previous screen.

Output tab



- Quality: Adjusts the display quality of the scan output.
- File Format: Selects the file format of the scan output.
- Scan Preset: Automatically changes some scan options such as file format, resolution, and more. You can adjust options to fit each specific purpose.
- Back: Returns to the previous screen.

4.1.6.5 Understanding the Stored Documents screen



| User Name | File Name | Date | Page |
|------------|-------------|----------|------|
| Value 1111 | FirstRoww | 2001/2/3 | 1 |
| Value 1111 | FirstRoww | 2001/2/3 | 3 |
| Value 1111 | FirstRoww | 2001/2/3 | 5 |
| Value 1111 | FirstRoww | 2001/2/3 | 7 |
| Value 1111 | FirstRoww | 2001/2/3 | 9 |
| Value 2222 | Second Roww | 2011/2/3 | 2 |

1/2 Page Total: 1 **Detail** **Edit** **Delete** **Delete All** **Print**

- Public tab : Shows the job list of delay print and store print job.
- Secured tab : Shows the job list of secure print, secure receive, and secure store print job.
- User Name : Shows the user name who registered the job.
- File Name : Shows the job name which is registered as the job information. For the computer printing, the file name shows.
- Date : Shows the date of the job registered.
- Page : Shows the total page number of the job.
- Detail : Pops the separate message showing the basic job information with the file size, the paper size and the paper type, as well.
- Edit : Lets you to modify the file name.
- Delete : Deletes the selected list.
- Delete All : Deletes all the list.
- Print : Prints the selected list.

4.1.6.6 Understanding the USB screen

When USB memory is inserted into the USB memory port on your machine, USB icon shows on the display



- **USB Format:** You can delete image files stored on an USB memory device one by one or all at once by reformatting the device.
- **USB Print:** You can directly print files stored on an USB memory device. You can print TIFF, BMP, JPEG, PDF, and PRN files.
- **Scan to USB:** You can specify image size, file format, or color mode for each scanning to USB job.

4.1.7 F/W upgrade using SWAS (SyncThru Web Admin Service)

- Start the SWAS program.
 (Windows Start menu > Programs > Samsung Network Printer Utilities > SyncThru Web Admin Service)

① Firmware Upgrade → Upgrade (check device using IP address)

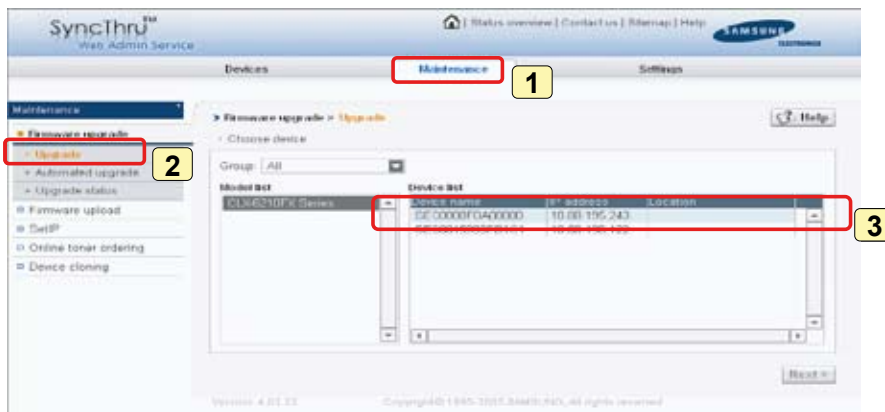

② Maintenance → Firmware upload (register firmware)



③ Maintenance → Firmware Upload (upload firmware)

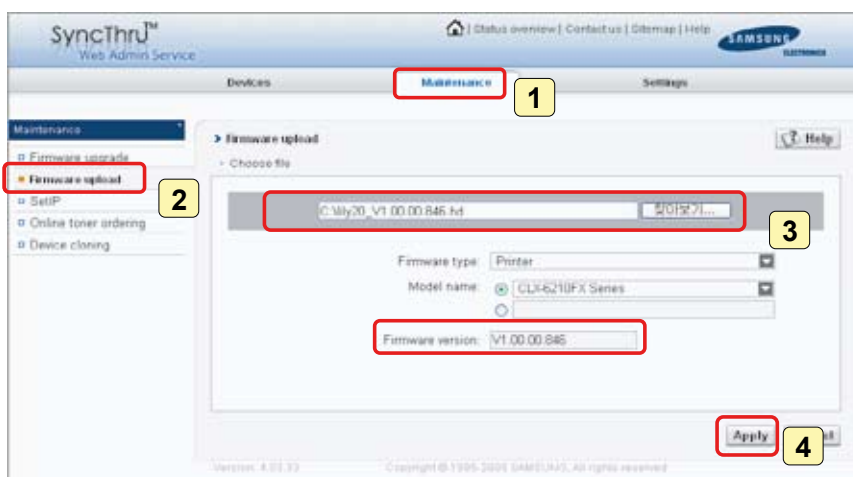

④ Maintenance → Firmware Upload (confirm uploaded firmware)

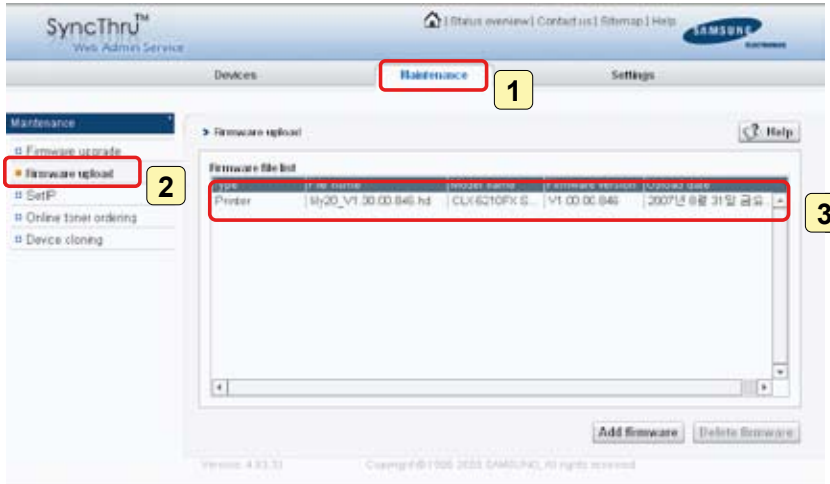

⑤ Maintenance → Firmware Upgrade → Upgrade (choose firmware)

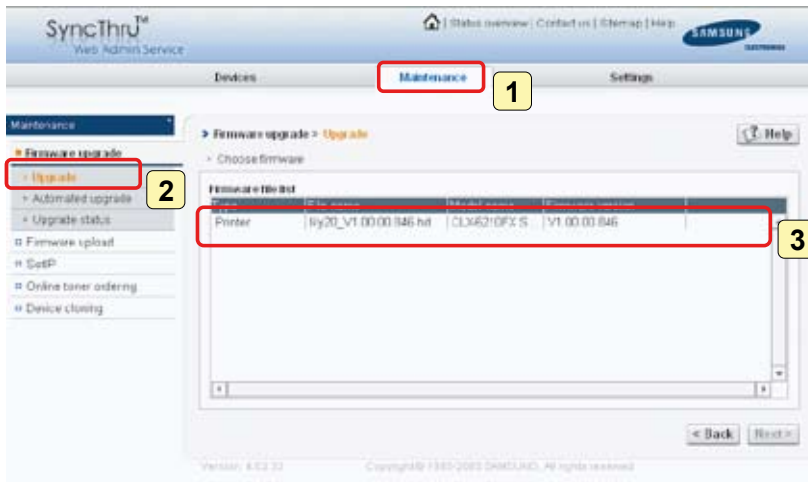

⑥ Maintenance → Firmware Upgrade → Upgrade (choose firmware)

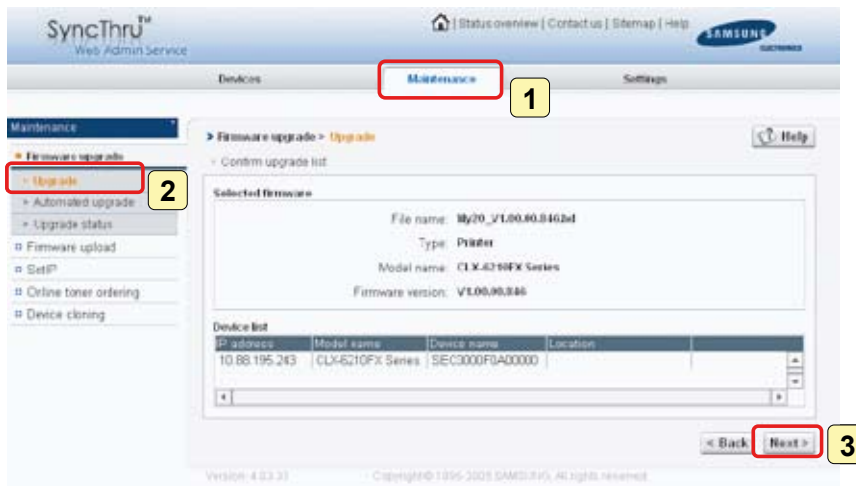

⑦ Maintenance → Firmware Upgrade → Upgrade



⑧ Maintenance → Firmware Upgrade → Upgrade (Done)

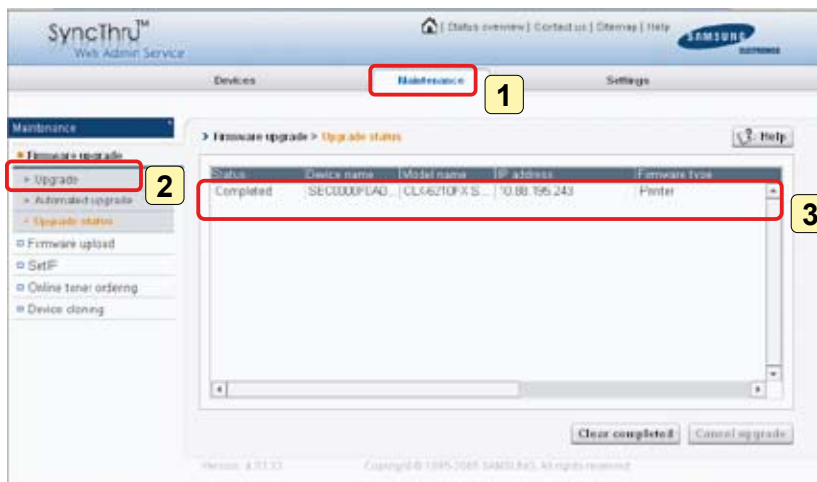

4.1.7.1 Using SyncThru Web Service (SWS)

SWS is an embedded web server in the machine. This web server informs you of machine configuration, version, status and allows you to customize the machine's settings. You can connect this server via wired and wireless network using your web browser in the remote place.

Connecting preparations

- Wired or Wireless Network connection is established.
- Web Browser (Ex> Internet Explorer) Program on your PC network connected

SWS overview

SyncThru Web Service (SWS)

- accepts HTTP request via port 80 as normal web servers.
- provides interface to users information of networked printers and allow to configure the setting of printers
- is able to provide more complicated options than Local UI for printer configuration

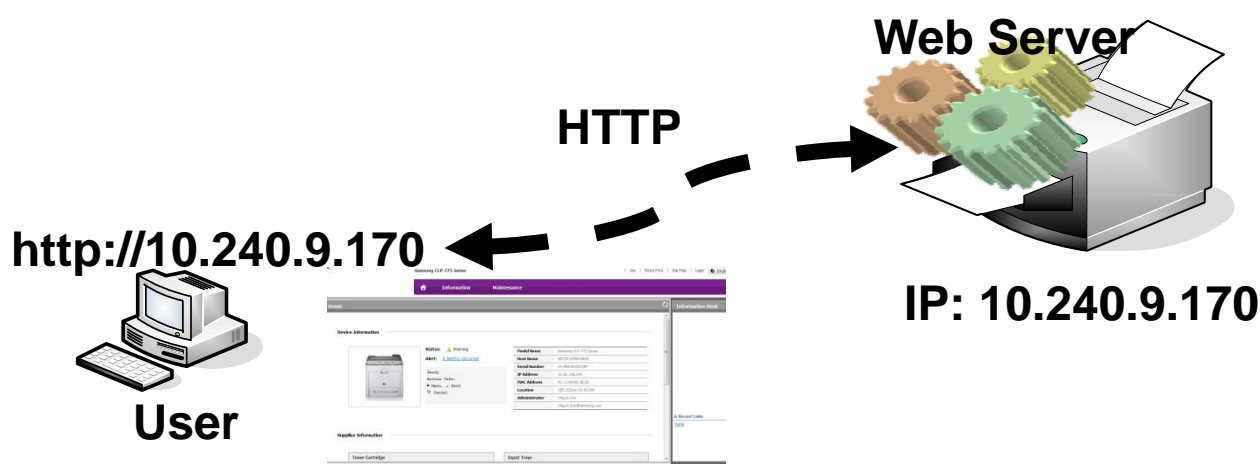

Connection Procedure

- 1) Open the Web-browser and input IP address of machine. Click "Login".
- 2) Log-in Admin Mode. (ID: admin, PW: sec00000)
- 3) Select pages to check the configuration and customize the settings

Caution

Please, change SWS Default ID and Password for system security in case of your first connection.

Note:

If the machine supports 'Direct Print', you can enable this function using the SWS menu. The default configuration is 'Disabled' for your security.

Firstly, you have to login to SWS.

- 1) Click 'Direct Print Configuration' in the pop up windows when clicking 'Direct Print'
- 2) In the 'Services' Menu, check 'Direct Print'.

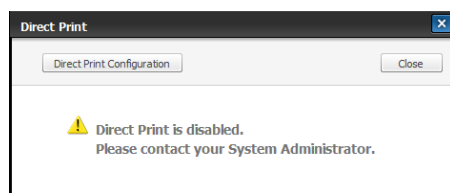

Or,

- 1) Click 'System Security' in the 'Security' menu.
- 2) Select 'Feature Management' in the left frame.
- 3) In the 'Services' Menu, check 'Direct Print'.

4.1.8 Diagnostics

4.1.8.1 Introduction

This document will capture the behavior specifications for the GUI Windows for Diagnostics. Each section of this document describes one feature with a step window image and script. However, used window image is not fixed image from the specification point of view. Acquire detail information from script. Window image is just example image will be implemented.

4.1.8.2 How to enter diagnostics mode

1. Press (1,2,3) key on dial pad simultaneously.
2. Enter password(1934).
3. Press 'OK' button.



4.1.8.3 How to exit diagnostics mode

By pressing the Home button, exit Diagnostics mode.
When exit Diagnostics mode, a popup window shall display.
By default, Reset Counters is No, Reboot Copier is Yes.

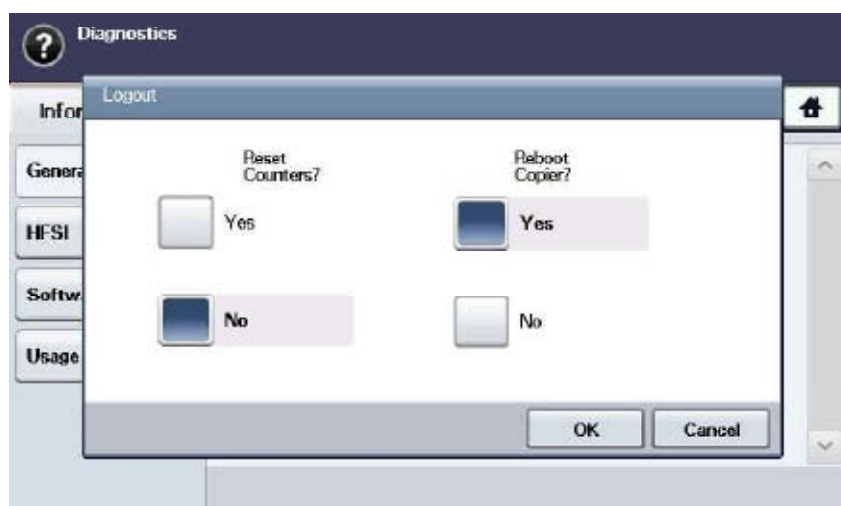

4.1.8.4 Diagnostics Menu Map

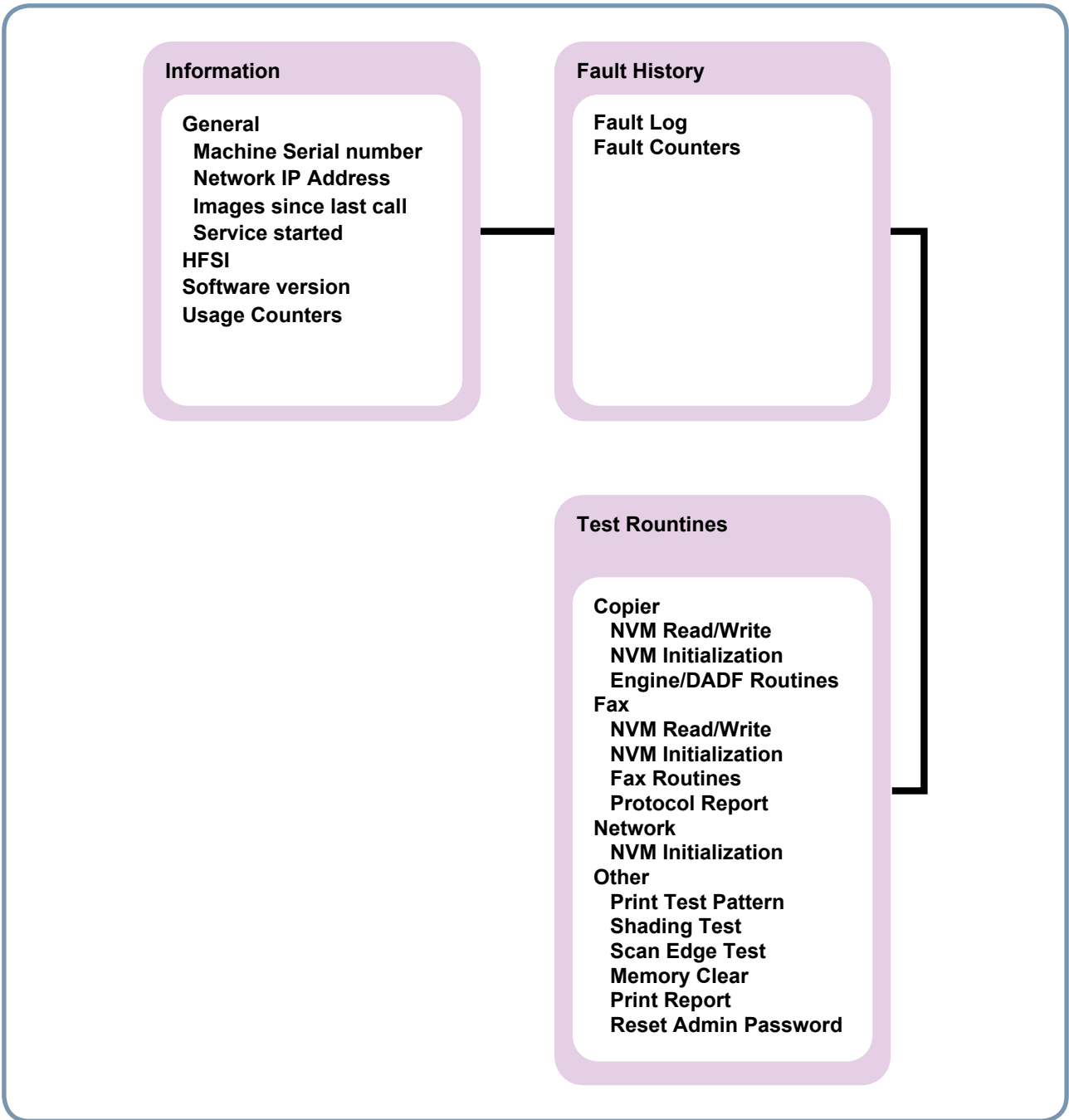

4.1.8.5 Information Tab

Information tab provides detail information of the machine.

General

- Diagnostics>Information>General
- When user selects General, OP displays Machine Serial Number, Network IP Address and Images since last call.



HFSI (High Frequency Service Items)

- Diagnostics>Information>HFSI
- When user selects General, OP displays the list of HFSI(High Frequency Service Items) read from the MCB. In the list, there are “ Item”, “Status”, “Actual”, and “Max Life”.

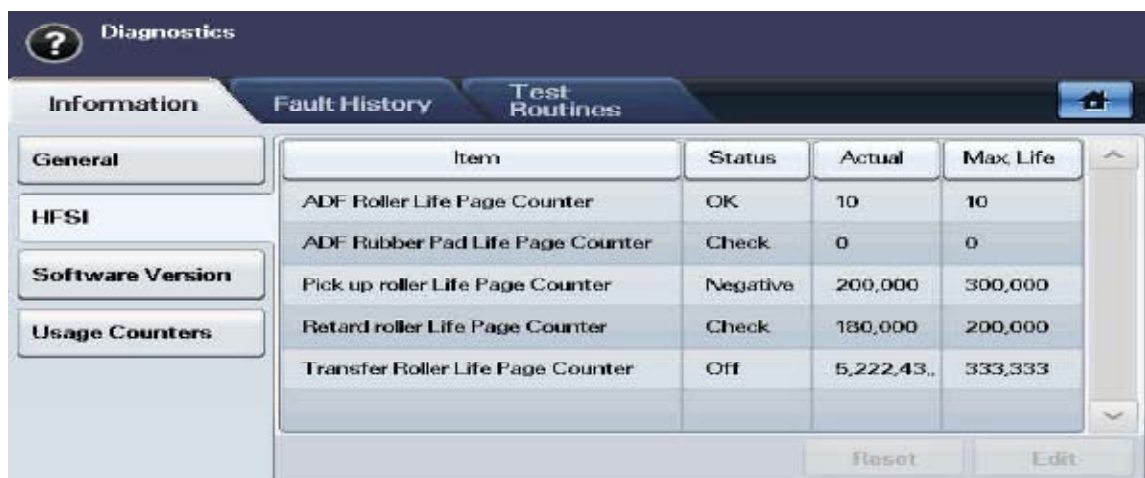

- User Behavior
 - User can select one item in the list to reset the counter using “Reset” button or to edit the Max.Life and threshold value using “Edit” button.
- Items in this column are:
 - DADF Roller / Rubber Pad Life Page
 - T1/T2/T3 P-up Roller Life Page
 - Retard Roller Life Page
 - Bypass Rubber Pad Life page
 - Transfer Roller Life Page
 - Fuser Roller / Fuser Unit Life Page
 - Heat Roller Life Page
 - Pressure Roller Life Page
- Status
 - The possible values in this column are ‘OK’, ‘Check’, ‘Negative’ and ‘Off’.
 - OK : Actual counter is smaller than the threshold value
 - Check : Actual counter is bigger than threshold value but smaller than Max.Life
 - Off : Actual counter exceeds Max.Life
 - Negative : There is no counter to display. In this case, it shall display ‘-’ in the Status and Max Life column.
- Actual
 - Values in this column are actual counts for HFSI usage
- Max. Life

Values in this column are maximum life limits set for HFSI.
- Reset

This button is used to reset the actual counter after replacing the HFSI unit.
 This button is disabled before user select one item in the list and enabled once user select any of the items in the list.
 Once user presses, a confirmation window shall display to user confirm again. The window is displayed as below.
 If user confirms reset, it will reset the counter to 0.
 If the counter of selected item is 0, ‘Reset’ button shall be disabled.

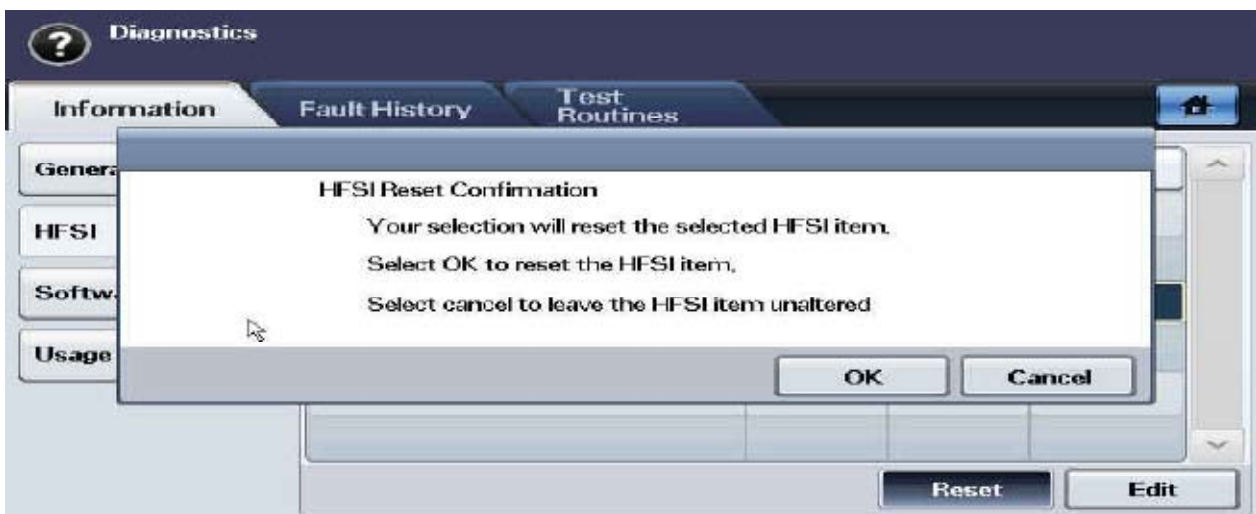

- Edit
 “Edit” button is disabled until user select one item in the list.
 Selecting “Edit” button causes edit window to be displayed.
 There are two input filed for ‘Maximum Life’ and for ‘Threshold’.



Each data field shall display default value or the last-saved value entered by the service engineer. The data field shall support the numeric characters of 0 to 9.
 The hard keypad characters of '#', 'phone' and '*' are not supported and shall generate an invalid entry message if selected.
 The hard keypad characters of 'c' shall delete all characters displayed within the selected data field. By selecting 'Cancel', window moves back to HFSI window without saving user's setting. By selecting 'OK' button, window moves back to HFSI window saving user's setting. Threshold value shall not be greater than Maximum Life.

Software Version

- Diagnostics>Information>Software Version
- When user selects Software version, OP displays the version of the Main Controller, Image Output Terminal, User Interface, Network Controller, Document Feeder, Tray 2 Firmware, Tray 3 Firmware

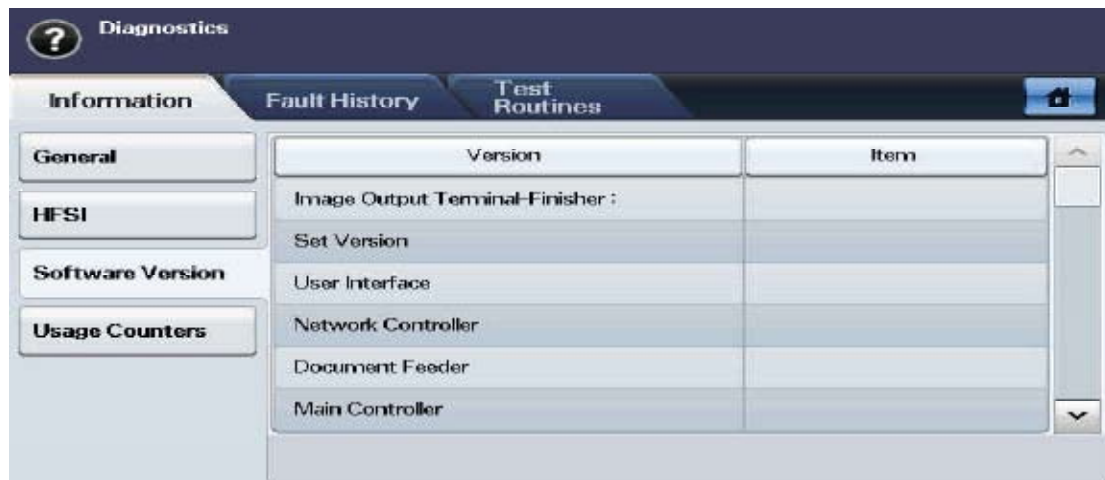

Usage Counter

- Diagnostics>Information>Usage Counter
- When user selects Usage Counter, OP displays the amount of the Items shown below.

| Item | Amount |
|---------------------------|--------|
| Total Impressions | 0 |
| Black Impressions | 0 |
| Black Copied Impressions | 0 |
| Black Printed Impressions | 0 |
| Sheets | 0 |
| Copied Sheets | 0 |

- Total Impressions
- Black Impressions
- Black Copied Impressions
- Black Printed Impressions
- Sheets
- Copied Sheets
- Black Copied Sheets
- Printed Sheets
- Black Printed Sheets
- 2 Sided Sheets
- Copied 2 Sided Sheets
- Black Copied 2 Sided Sheets
- Printed 2 Sided Sheets
- Black Printed 2 Sided Sheets
- Fax Images Received
- Images Sent
- Server Fax Images Sent
- Network Scanning Images Sent
- Email Images Sent
- Maintenance Impressions
- Black Maintenance Impressions
- Known Jams in the IOT
- Known Jams in Finishing Device(s)
- Attempted Sheet Feeds from Internal trays
- Actual sheet feeds from Internal trays
- Normal Level Power On Hours
- Power Save Hours
- Attempted Original Sheet Feeds in the DADF

4.1.8.6 Fault History Tab

Fault History provides an error information occurred.

Fault Log

- Diagnostics>Fault History>Fault Log
- Fault log window shall display errors occurred while the product was operating.

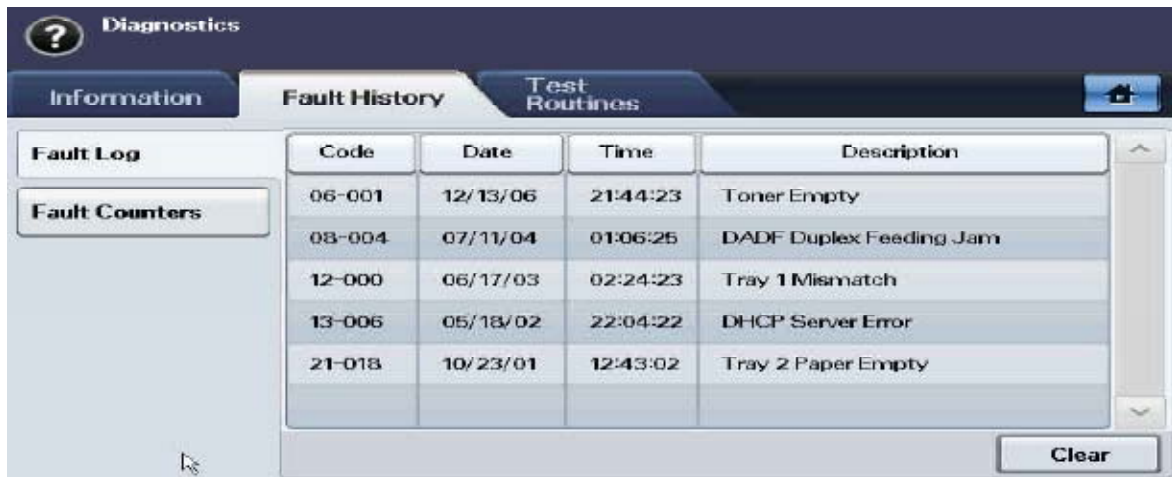

- Diagnostics>Fault History>Fault Log>Clear
- When selecting "Clear" button, Pop-up will be displayed. If you want to delete the Fault history, touch the "OK" button.



Fault Counters

- Diagnostics>Fault History>Fault Counters
- Fault counters window displays Fault group with number and name. They are

- 01 Feeder
- 02 Fuser
- 03 Motor Fan
- 04 LSU
- 05 Option Interface
- 06 CRU
- 07 Finisher
- 08 DADF



User shall select one item in the list at a time and multiple selection shall not supported. User can select 'Non Zero' or 'All'. By default, 'Non Zero' shall be selected. When press 'OK', Fault Counters Detail Window shall be displayed.

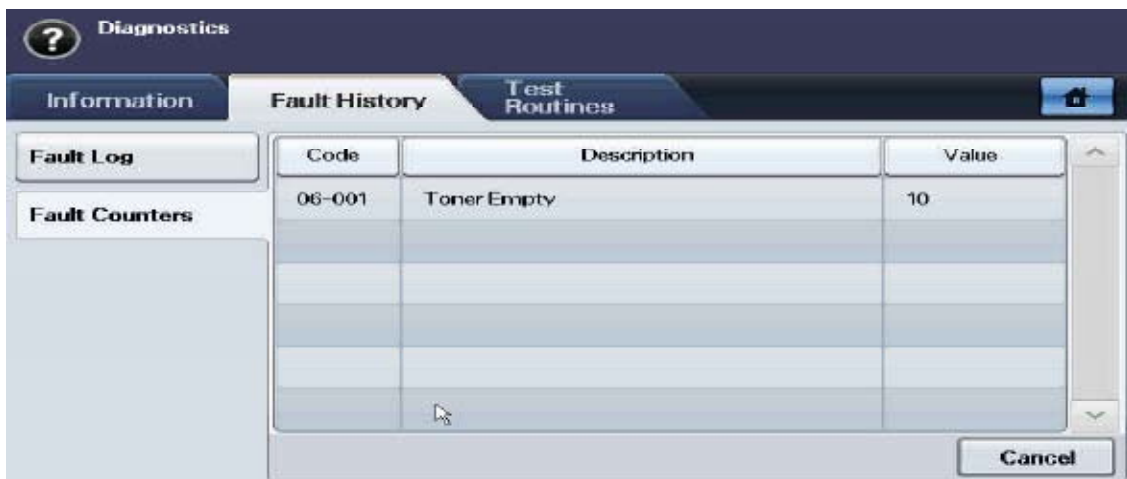

Fault Counters Detail window shall display Fault code, description and value (counter) among the selected Fault Group. Items of displayed Fault codes are different based on the selection of 'Non Zero' or 'All'. When selected 'Non Zero', Fault codes in the selected Fault Group having non zero counter shall be displayed. When selected 'All', all Fault codes in the selected Fault Group shall be displayed. Display order of Fault code is upward.

4.1.8.7 Test Routines Tab

4.1.8.7(a) Copier

NVM Read/Write

- Diagnostics>Test Routines>Copier>NVM Read/Write

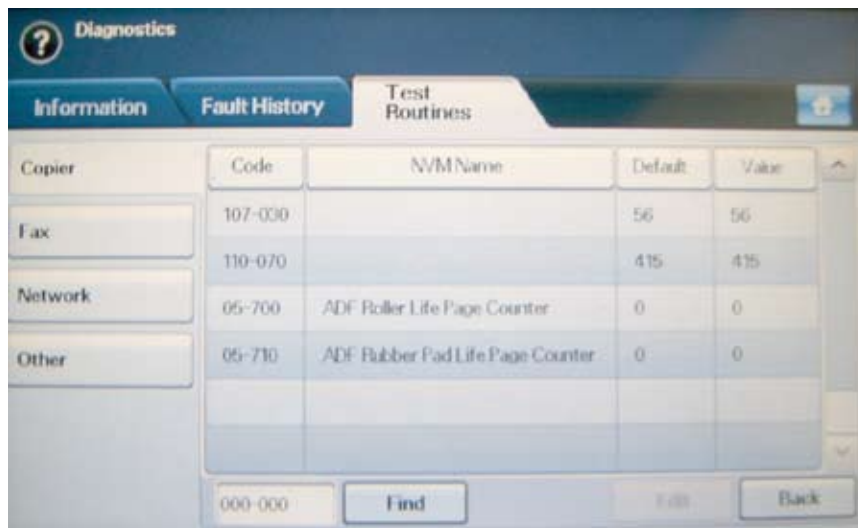

“Edit” button shall be disabled until any NVM item is selected.

“Edit” button shall be disabled when read only NVM is selected. Search edit box has 00-000 as a default. User shall input the whole number to find a specific NVM by pressing Find button. (Refer to NVM Read/Write table) If matching NVM is found, the page including the specified NVM shall be displayed and the NVM is shown as selected. If matching NVM is not found, error message such as “Invalid NVM number” shall be displayed on the status area and search edit box displays default number.

- Diagnostics>Test Routines>Copier>NVM Read/Write>Edit

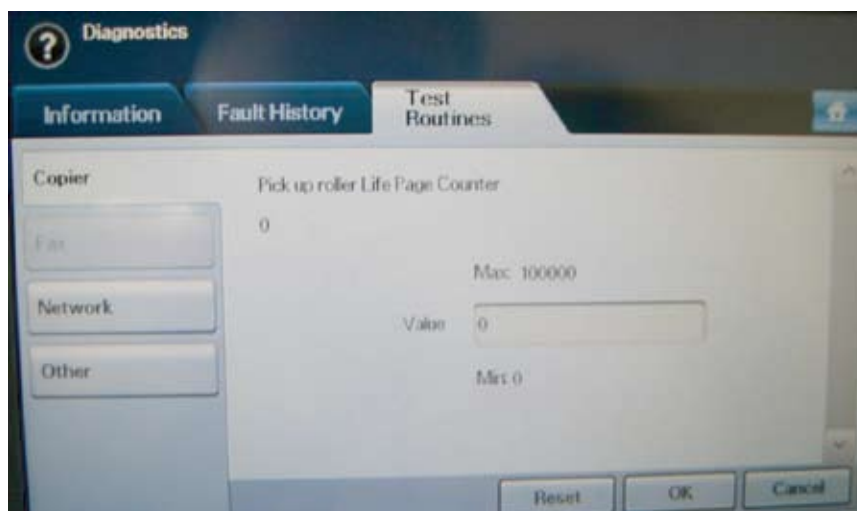

NVM Initialization

- Diagnostics>Test Routines>Copier>NVM Initialization
- By default, none of items is selected and Initialize button shall be disabled. There shall be Back button.



- Diagnostics>Test Routines>Copier>NVM Initialization>Initialize

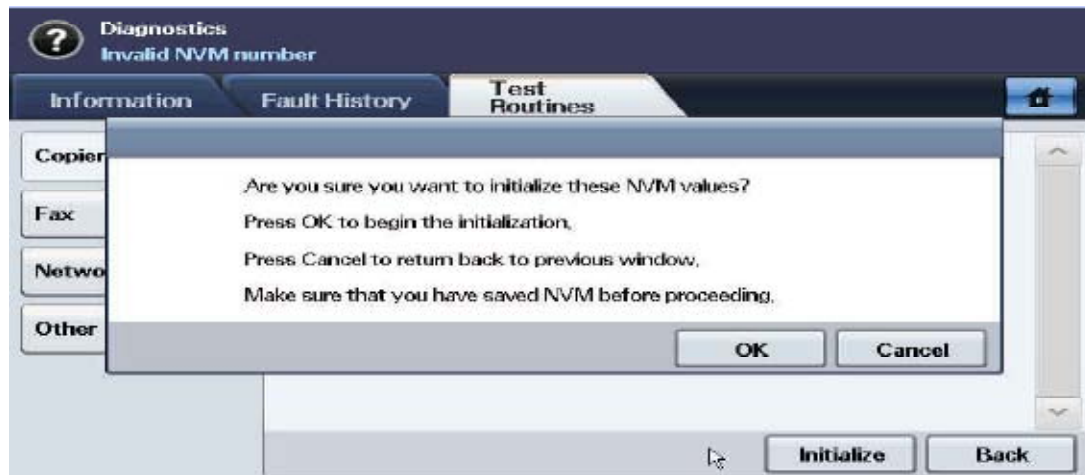

- If you want to initialize the NVM values, press OK button.
 When press OK button, SR shall show the initialization progress status and result.
 When the result is get, pop up window shall be disappeared.
 -> When the result is finished, the pop up window will disappear.

Engine/DADF Test Routines

- Diagnostics>Test Routines>Copier>Engine/DADF Test Routines.



When exit this window, OP shall send exit command. (CMD_COPY_COMP_EXITMODE)

By default, all Test routines will be displayed.

By default, search edit box has 00 .

OK/Reset button shall be disabled until any test routine is selected.

Maximum number of selection is 3.

Reset will deselect all selected test routines.

User select test routine by touching the row and deselect touching it again.

User input chain number in search edit box and only all test routines in the chain shall be displayed.



By default, Start/Stop/Stop All shall be disabled.

Start button shall be enabled when selected item is not running.

Multiple selection shall not be supported.

Stop shall be enabled only when the selected item is running.

Stop All shall be enabled when there is any running test item.

Back button shall be disabled when there is any running test item.

4.1.8.7(b) Fax

NVM Read/Write

- Diagnostics>Test Routines>Fax>NVM Read/Write



For the behavior, refer to Copier-NVM Read/Write.

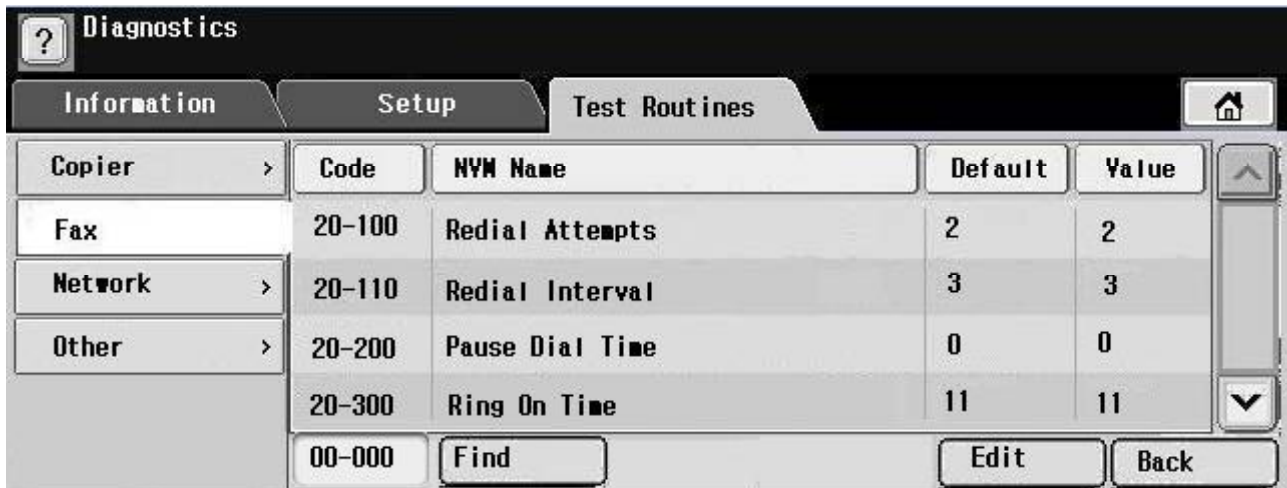

For the behavior, refer to Copier-NVM Read/Write-Edit.

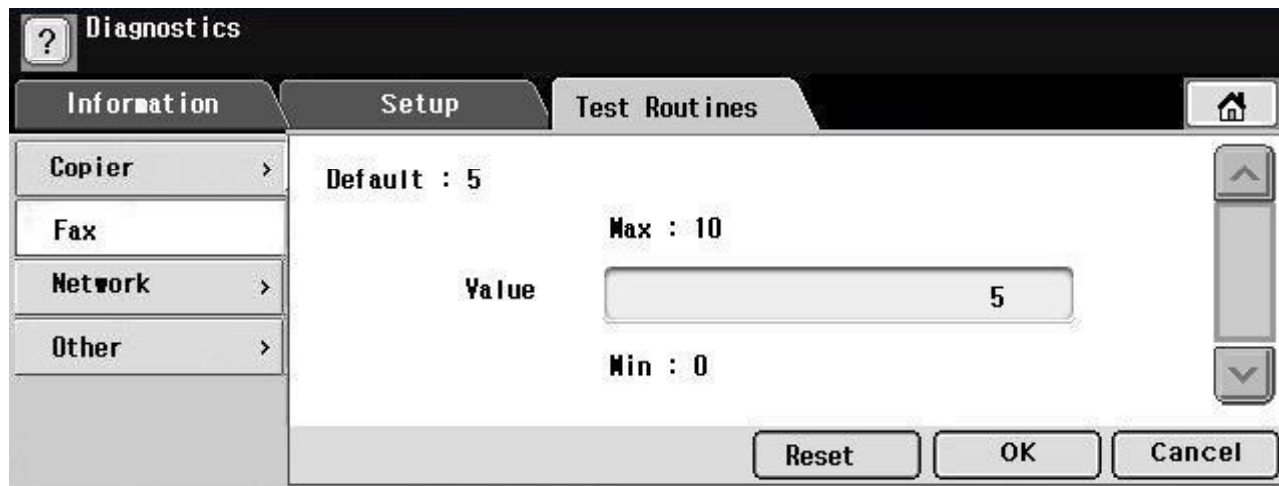

NVM Initialization

- Diagnostics>Test Routines>Fax>NVM Initialization
- By default, none of items is selected and Initialize button shall be disabled. There shall be Back button.



- Diagnostics>Test Routines>Fax>NVM Initialization>Initialize

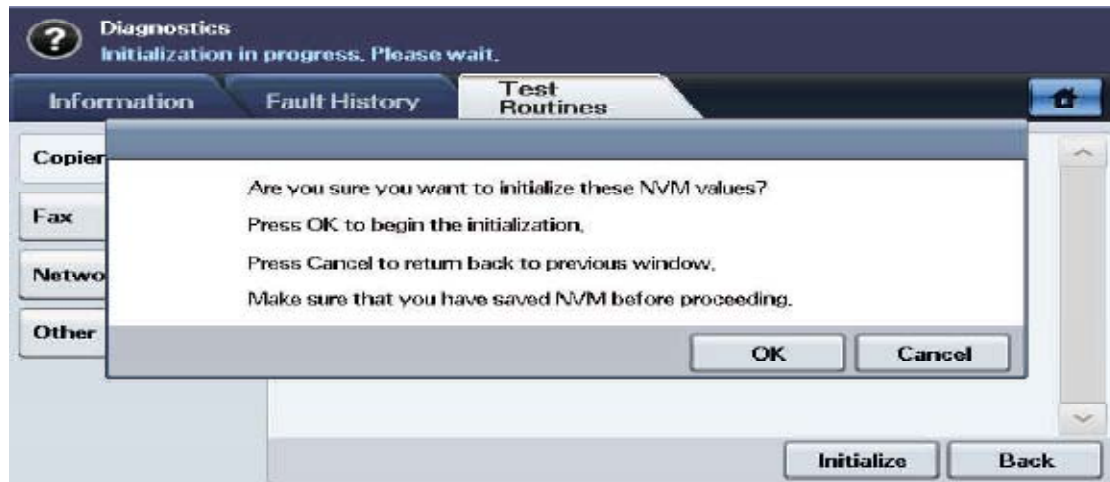

If you want to initialize the NVM values, press OK button.
 When press OK button, SR shall show the initialization progress status and result.
 When the result is get, pop up window shall be disappeared.

Protocol Report

- Diagnostics>Test Routines>Fax>Protocol Report
- When selecting Protocol Report, the sub-item will be displayed. By pressing the print, you can print the protocol report.



Fax Routines

- Diagnostics>Test Routines>Fax> Fax Routines
- For the behavior, refer to Engine/DADF Test Routines



4.1.8.7(c) Network

NVM Initialization

- Diagnostics>Test Routines>Network>NVM Initialization



- Diagnostics>Test Routines>Network>NVM Initialization>Initialize

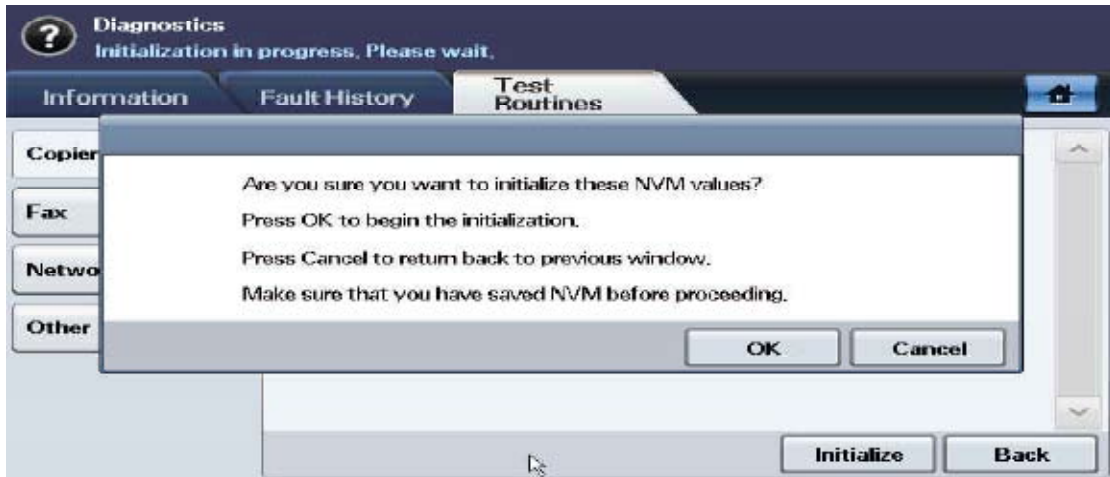

If you want to initialize the NVM values, press OK button.
When press OK button, SR shall show the initialization progress status and result.
When the result is get, pop up window shall be disappeared.

4.1.8.7(d) Other

- Diagnostics>Test Routines>Other



- Diagnostics>Test Routines>Other>Print Test Pattern



You can print the test pattern by pressing the start test button.

By default, Test Pattern number shall be 1.

You can select paper source by selecting tray of the image.

You can select simplex/duplex printing option by selecting 1 sided /2 sided button.

- Diagnostics>Test Routines>Other>Shading Test



The function is used to set the optimum scan quality determined by the specific characteristics of the CCD (Charge Coupled Device). If copy image quality is poor perform this function to check the condition of the CCD unit.

- Diagnostics>Test Routines>Other>Scan Edge Test



- Diagnostics>Test Routines>Other>Memory Clear



The function resets the system to factory default settings. This function is used to reset the system to the initial value. All the values are returned to the default values, and all the information which was set by the user will be erased. When select memory clear, user can select the country.

- Diagnostics>Test Routines>Other>Print Report



- Diagnostics>Test Routines>Other>Reset Admin. password



4.2 Troubleshooting

4.2.1 Procedure of Checking the Symptoms

Before attempting to repair the printer first obtain a detailed description of the problem from the customer.

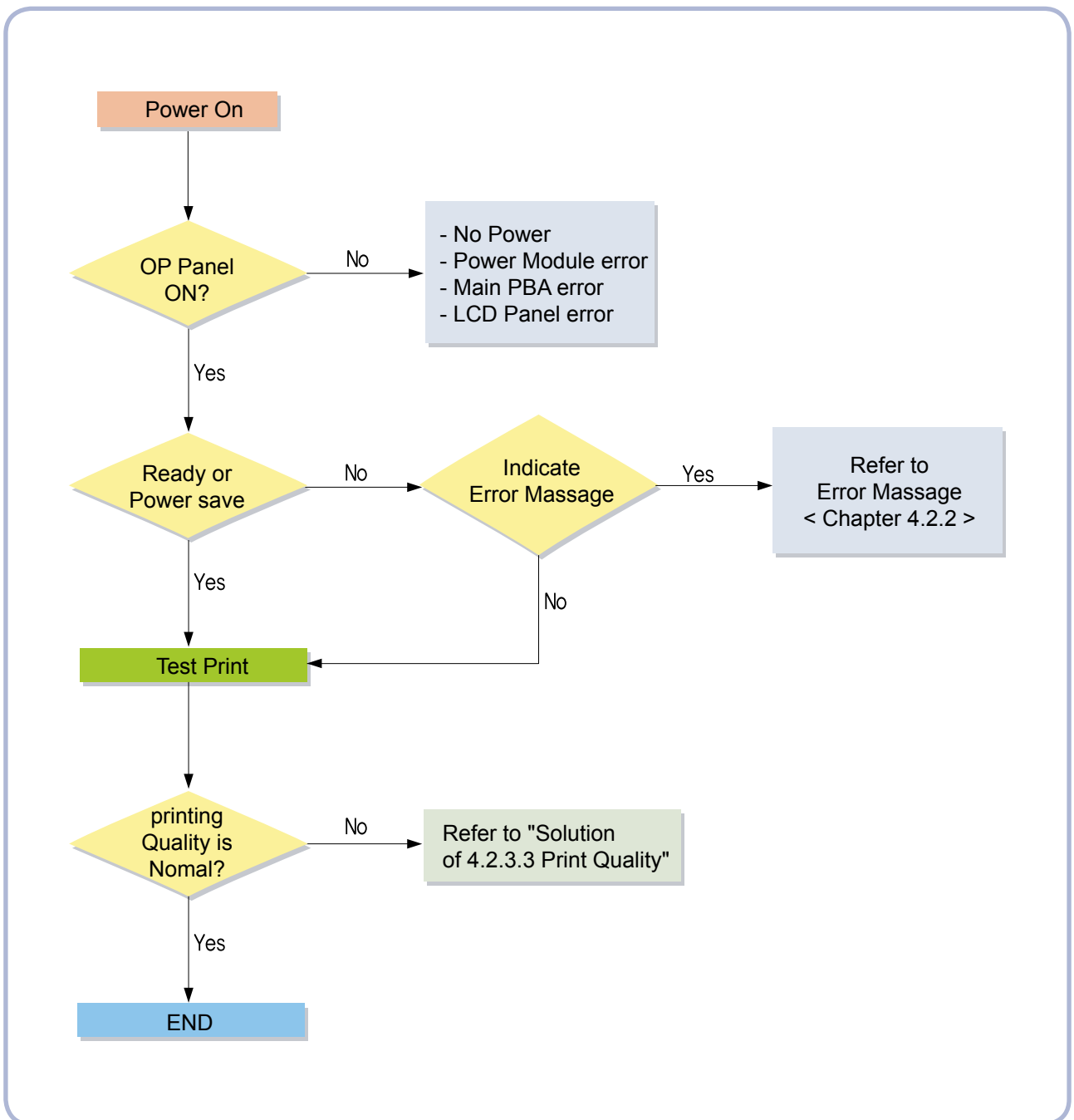

4.2.2 USING THE SMART PANEL PROGRAM



Smart Panel is a program that monitors and informs you of the machine status, and allows you to customize the machine's settings. Smart Panel is installed automatically when you install the machine software.

To use this program, you need the following:

- Windows. Check for windows operating system(s) compatible with your machine.
- Mac OS X 10.3 or higher
- Linux. Check for Linux systems that are compatible with your machine.
- Internet Explorer version 5.0 or higher for flash animation in HTML Help.

Understanding Smart Panel

If an error occurs while printing, Smart Panel appears automatically, showing the error. You can also launch Smart Panel manually. Double-click the Smart Panel icon on the Windows task bar (in Windows), or Notification Area (in Linux). You can also click it on the status bar (in Mac OS X).

| | | |
|------------------|--|------------------------------------|
| Windows |  | Double-click this icon in Windows. |
| Macintosh |  | Click this icon in Mac OS X. |
| Linux |  | Click this icon in Linux. |

If you are a Windows user, from the Start menu, select **Programs or All Programs > your printer driver name > Smart Panel**.

- If you have already installed more than one Samsung machine, first select the correct machine model you want in order to access the corresponding Smart Panel.
- Right-click (in Windows or Linux) or click (in Mac OS X) the Smart Panel icon and select your machine.
- The Smart Panel window and its contents shown in this user's guide may differ depending on the machine or operating system in use.

The Smart Panel program displays the current status of the machine, the level of toner remaining in the toner cartridge(s), and various other types of information. You can also change settings.

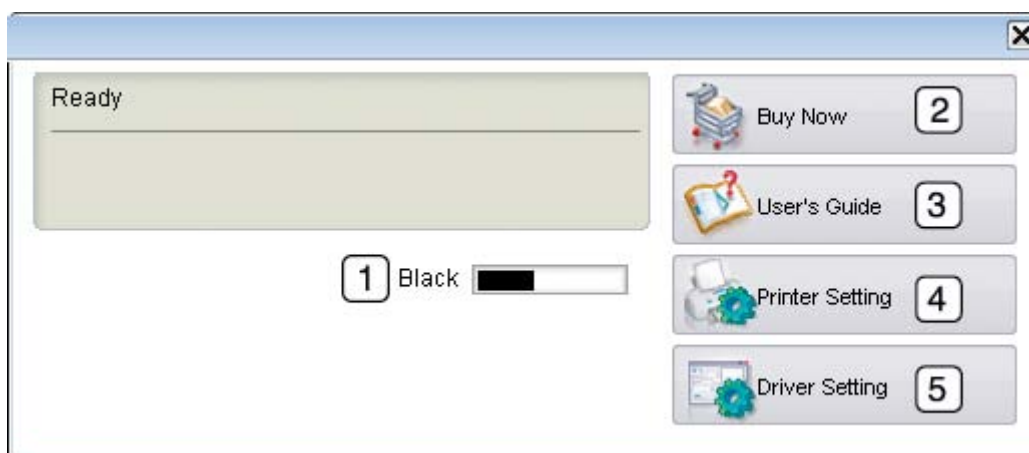

| | | |
|---|-----------------|--|
| 1 | Toner Level | View the level of toner remaining in the toner cartridge(s). The machine and the number of toner cartridge(s) shown in the above window may differ depending on the machine in use. Some machines do not have this feature. |
| 2 | Buy Now | Order replacement toner cartridge(s) online. |
| 3 | User's Guide | This button changes to Troubleshooting Guide when error occurs. You can directly open troubleshooting section in the user's guide. |
| 4 | Printer setting | Configure various machine settings in the Printer Settings Utility window. Some machines do not have this feature. If you connect your machine to a network, the SyncThru™ Web Service window appears instead of the Printer Settings Utility window. |
| 5 | Driver Setting | Set all of the machine options you need in the Printer Preferences window. This feature is available only for Windows |

Opening the Troubleshooting Guide

Find solutions for error status problems by using the troubleshooting guide. Right-click (in Windows or Linux) or click (in Mac OS X) the Smart Panel icon and select Troubleshooting Guide.

Using Printer Settings Utility

Using the Printer Settings Utility, you can configure and check print settings.

1. Right-click (in Windows or Linux) or click (in Mac OS X) the Smart Panel icon and select Printer Setting.
2. Change the settings.
3. To send the changes to the machine, click the Apply.

If your machine is connected to a network, the SyncThru™ Web Service window appears instead of the Printer Settings Utility window.

Using On screen Help File

For more information about Printer Settings Utility, click

4.2.2 Error Message

Messages appear on the control panel display to indicate the machine's status or errors. Refer to the tables below to understand the messages' and their meaning, and correct the problem, if necessary. Messages and their meanings are listed in alphabetical order.

[zzz] indicates the error code. When you contact the service center, this error code help to handle the problem.

| Message | Description | Suggested solutions |
|--|--|---|
| Fax memory is almost full. Print or remove received fax Job./ Fax memory is full. Print or remove received fax Job. | There is no more available fax memory. No more fax data can be received. | Delete the received fax data in the memory to secure memory. |
| Fuser error: [zzz]. Please turn off then on | <ol style="list-style-type: none"> 1. At warm up, the temperature keep up the lower temperature for regular time. 2. In case that the temperature has not reached warm up temperature after warm-up time. 3. At ready, Less than target temperature and for more than 10 sec. 4. At printing, Less than printing Ref. temp and for more than 10 sec. | <ol style="list-style-type: none"> 1. Check the Thermostat. If it is defective, replace it. 2. Check the Lamp. If it is defective , replace it. 3. Check the fuser connector. Reconnect it. 4. In case of printer input voltage lower than standard voltage. 5. Check the Thermistor. 6. If the Heat On signal is not occurred from Power supply, replace it. |
| Fuser unit is not installed correctly. Install it. | The fuser unit is not installed or correctly | Disassemble and reassemble the fuser unit. |
| LSU error: [zzz]. Please turn off then on | <ol style="list-style-type: none"> 1. LSU motor does not operate. 2. After LD on, the Laser beam detect signal is not occurred or irregular. 3. LSU motor does not operate or the drive signal is abnormal. | <p>* Case 1,3 : After checking the LSU motor rotation noise, check the motor signal.</p> <p>* Case 2 :</p> <ol style="list-style-type: none"> 1. Check the Beam Detecht signal. If there is a BD signal, replace the Main board. If or not, check the LD contol signal. 2. Check the LD Power is normal. 3. If it is normal, check the light receiving part. |
| Original paper jam in front of scanner duplex path | Paper has jammed during duplex printing in the DADF. | Remove the jammed paper in DADF |
| Original paper jam in front of scanner | The originals are jammed in DADF | Remove the jammed paper in DADF |

| Message | Description | Suggested solutions |
|--|---|--|
| Original paper jam inside of scanner duplex path | <ol style="list-style-type: none"> 1. The lead edge of the document failed to actuate the reverse stack sensor within the correct time after actuating the gate sensor. 2. The edge of the document failed to actuate the reverse stack sensor. | Open the DADF cover and remove the jammed paper |
| Original paper jam inside of scanner | <p>The lead edge of the document failed to actuate the gate sensor within the correct time after actuating the scan sensor.</p> <p>When the machine is on, jammed paper is detected in the DADF.</p> | Remove the jammed paper in DADF |
| Original paper jam while reversing paper in scanner | The lead edge of the document failed to actuate the duplex sensor within the correct time when the document was fed the wrong way. | Remove the jammed paper in DADF |
| Paper Jam at the bottom of duplex path | Paper has jammed during duplex printing. | <ol style="list-style-type: none"> 1. Open the side door and remove the jammed paper. 2. If there is not jammed paper but the error message is occurred, check the duplex sensor. (Component Test) |
| Paper Jam at the top of duplex path | Paper has jammed during duplex printing. | <ol style="list-style-type: none"> 1. Open the side door and remove the jammed paper. 2. If there is not jammed paper but the error message is occurred, check the duplex sensor. (Component Test) |
| Paper Jam in exit area | Paper has jammed in the fuser area. | <ol style="list-style-type: none"> 1. Open the Side door and remove the jammed paper. 2. If there is not jammed paper but the error message is occurred, check the Exit sensor. (Component Test ->Sensor Read -> Ex value) |
| Paper Jam in MP tray | Paper misfed from multi-purpose tray. | <ol style="list-style-type: none"> 1. If pick up roller does not rotate , check the pick up clutch. 2. If Pickup roller is rotating but the paper is not feeding, replace the pick up rubber. 3. Check the feed sensor. If it is defective, replace it. |

| Message | Description | Suggested solutions |
|--|---|--|
| Paper Jam in tray1 | Paper has jammed in the feeding area of the tray. | <ol style="list-style-type: none"> 1. If pick up roller does not rotate , check the pick up clutch. 2. If Pickup roller is rotating but the paper is not feeding, replace the pick up rubber. 3. Check the feed sensor. If it is defective, replace it. |
| Paper Jam in tray2 | Paper has jammed in the feeding area of the tray. | <ol style="list-style-type: none"> 1. Open the side door and Tray2 door and remove the jammed paper. 2. If there is not jammed paper but the error message is occurred, check the Feed sensor or Hardware. 3. If the paper is feeding by rotating the pick up roller, check the clutch and clutch signal. |
| Paper Jam inside of duplex path | Paper has jammed during duplex printing. | <ol style="list-style-type: none"> 1. Open the side door and remove the jammed paper. 2. If there is not jammed paper but the error message is occurred, check the duplex sensor. (Component Test) |
| Paper Jam inside of machine | Paper has jammed in the registration area | <ol style="list-style-type: none"> 1. Open the Side door and remove the jammed paper. 2. If there is not jammed paper but the error is occurred, Check the Registration Sensor (Component Test -> Sensor Read -> RG value) 3. If the paper stopped after actuating the Exit sensor, Check the Exit sensor (Component Test -> Sensor Read -> EX value) |
| Scanner locking switch is locked or another problem occurred. | The CCD lock has been locked. | <ol style="list-style-type: none"> 1. Unlock the CCD Lock 2. Check the CCDM. Is it moving when scanning. Check the FFC cable. If there is defective, change it. 3. If the problem persists after removing the FFC cable, replace the DADF board. 4. Check the Scan-motor. If there is defective, change it. |
| Sensor Failure [zzz]. Call for service | There is a problem in the sensor signal | Find the defective sensor. And replace the new one. |

| Message | Description | Suggested solutions |
|--|--|---|
| Shake toner cartridge. | The toner supply is low. | Thoroughly roll the new cartridge five or six times to distribute the toner evenly inside the cartridge. |
| System error: #02-000. Please turn off then on | <ol style="list-style-type: none"> 1. At warm up, the temperature is less than reference temperature for 20 sec. 2. Abnormal ADC has occurred. 3. ZeroCross Signal detect error has occurred. | <ol style="list-style-type: none"> 1. In case of meaning 1, replace the Fuser unit. 2. In case of meaning 3, replace the Engine control board or Fuser control board or SMPS. |
| System error: #02-003. Please turn off then on | The communication error of the MEGA88 Micom | <ol style="list-style-type: none"> 1. Open the side cover and close it. 2. Check the envelope pressing device. |
| System error: #10-004. Please turn off then on | UI error | <ol style="list-style-type: none"> 1. check the UI connector. 2. If the problem persists, replace the OPE board. 3. If the problem persists, replace the main board. |
| This IP address conflicts with an IP address already in use. Check it | The IP address is used in other place elsewhere. | Check the IP address or obtain a new IP address. |
| Toner cartridge is not compatible. Check user's guide | The toner cartridge you have installed is not for your machine. | Replace the toner cartridge. |
| Toner cartridge is not installed. Install it. | The toner cartridge is not installed or the CRUM in the cartridge is not properly connected. | Check the connection between the CRUM connector of the toner cartridge and Set. |
| Toner cartridge is worn. Replace with new one | The color toner cartridge has run out. The machine stops printing. | Replace the toner cartridge. |
| Toner is empty. Replace toner cartridge | The lifespan of the color toner cartridge which the arrow indicates is reached. | Replace the toner cartridge. |
| Toner is low. Order new toner cartridge | Toner Cartridge is almost empty. | Replace the toner cartridge. |
| Too much paper in output bin tray. Remove printed paper | The printed papers are full on the output tray. | <ol style="list-style-type: none"> 1. Remove the paper on outbin tray. 2. Check the Outbin Full Sensor (Component Test -> Sensor Read -> OB value) |

4.2.3 Solution

4.2.3.1 Scanner

4.2.3.1(a) COPY

| PROBLEM | ITEMS TO BE CHECKED | HOW TO SOLVE |
|-------------------------|---|---|
| White copy | • Check the Scan-Cover open. | • Room light can transit a thin original. |
| | • Check shading profile. | • Remake shading profile in the tech mode. |
| Black copy | • Check the CCD problem in Main PBA. | • Check the CCD harness contact. |
| | • Check shading profile. | • Remake shading profile in the tech mode. |
| Defective image quality | • Check shading profile. | • Remake shading profile in the tech mode. |
| | • Check the gap between original and scanner. | • The gap above 0.5mm can cause a blurred image. |
| Abnormal noise | • Check printing quality. | • See "Print" troubleshooting. |
| | • Check the Scanner Motor and any mechanical disturbance. | • Check the right position of the Scanner Motor, and check the any mechanical disturbance in the CCD carrying part. |
| | • Check the Motor Driver in Driver PBA. | • If any driver is defective, replace it. |

4.2.3.1(b) PC-Scan





| PROBLEM | ITEMS TO BE CHECKED | HOW TO SOLVE |
|-------------------------|---|---|
| Scanning Error | • Check the printer cable installed. | • Check correct installation, and use standard USB cable. |
| | • Check how TWAIN driver is installed. | • Remove any other scanner driver. • Reboot after reinstallation of the TWAIN driver. |
| | • Check the USB signal level. | • If USB signal level is defective, replace Main PBA. |
| Defective image Quality | • Check shading profile. • Check the gap between original and scanner glass. | • Remake shading profile in the tech mode. • The gap above 0.5mm can cause a blurred image. |
| | • Check printing quality. | • See "Print" troubleshooting. |
| Abnormal noise | • Check the Scanner Motor and any mechanical disturbance. | • Check the right position of the Scanner Motor, and check the any mechanical disturbance in the CCD carrying part. |
| | • Check the Motor Driver in Driver PBA. | • If any driver is defective, replace it. |

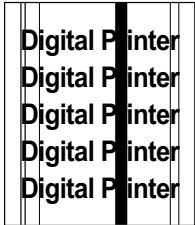

4.2.3.2 FAX

4.2.3.2(a) FAX/TELEPHONE Precautions

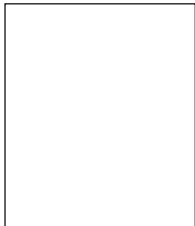
| PROBLEM | ITEMS TO BE CHECKED | HOW TO SOLVE |
|---|--|---|
| TEL LINE CANNOT BE ENGAGED (NO DIAL TONE) | <ul style="list-style-type: none"> When you press "OHD" key: a) Check line cord connection. b) Check MAIN LIU harness, and CN2 of the LIU PBA. | <ul style="list-style-type: none"> a) insert it correctly into the connection jack called "line". b) Replace defective parts. |
| Cannot MF dial | <ul style="list-style-type: none"> Check MAIN-LIU harness. | <ul style="list-style-type: none"> Replace defective parts. |
| MF dial is possible but not DP dial. | <ul style="list-style-type: none"> Check the LIU PBA. | <ul style="list-style-type: none"> Replace LIU PBA. |
| Defective fax transmission | <ul style="list-style-type: none"> Check MAIN LIU harness. Check 'hook off' : Refer to 'TEL LINE CANNOT BE ENGAGED' above. Check transmission path and reception path of the LIU PBA. | <ul style="list-style-type: none"> Replace defective parts. Refer to 'TEL LINE CANNOT BE ENGAGED' above. Replace main PBA, if abnormal. Replace LIU PBA. Replace main PBA. |
| Defective automatic fax reception | <ul style="list-style-type: none"> Is the ring checked? Refer to 'Defective Transmission.' | <ul style="list-style-type: none"> Replace LIU PBA if it cannot be checked. Refer to 'Defective Transmission'. |

4.2.3.3 Print Quality

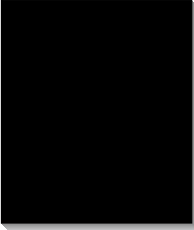
| Error Status | Check | Solution |
|--|---|--|
| <p>Vertical black line and band</p>  | <ol style="list-style-type: none"> 1. Bad blade of Toner cartridge 2. LSU 3. Bad cleaning blade of drum cartridge. | <ol style="list-style-type: none"> 1. Change Toner cartridge 2. Replace LSU 3. Replace drum cartridge. |
| <p>Vertical white line</p>  | <ol style="list-style-type: none"> 1. LSU window contamination 2. Toner cartridge | <ol style="list-style-type: none"> 1. Clean LSU window 2. If not LSU, change Toner cartridge. |
| <p>No image</p>  | <ol style="list-style-type: none"> 1. GND OPC is well grounded? 2. LSU running well? 3. Bias voltage is normal? 4. Lower toner? 5. Is there video data from Main PBA | <ol style="list-style-type: none"> 1. Measure the resistance between frame ground and the ground spring attached frame. Confirm stable ground. Unless bad ground, detach cabinet, check where is bad point 2. Adjust LSU or replace it 3. Normal Dev bias = -450V 4. Shake toner cartridge and print. If a like good, toner is empty 5. Test engine test pattern , replace Main PBA |
| <p>Light image</p>  | <ol style="list-style-type: none"> 1. LSU light power normal? 2. Enough toner? 3. High charger voltage? 4. Lower bias voltage 5. Contamination of high voltage contact. 6. Transfer volatge and roller. | <ol style="list-style-type: none"> 1. LSU light power check is difficult. Compare with new one and check. 2. Check toner and the toner cartridge counter 3~4. Measure all high voltage output. 5. Leakage toner cause bad contact and increase contact resistance. Clean contaminated area. |

| Error Status | Check | Solution |
|--|---|--|
| <p>Dark image</p>  | <ol style="list-style-type: none"> 1. LSU light power normal? 2. Bias voltage output is high? 3. Video data is always supplied? 4. Bad high charge voltage contact. | <ol style="list-style-type: none"> 1. Check the rated level and replace. 2. Set to power rating. 3. Replace defected board. 4. Check the charge voltage or change the drum cartridge. |
| <p>Background</p>  | <ol style="list-style-type: none"> 1. High voltage output is normal? 2. C/R of drum cartridge is contaminated? | <ol style="list-style-type: none"> 1. Adjust to the rated status. 2. Replace drum cartridge. |
| <p>Ghost</p>  | <ol style="list-style-type: none"> 1. High voltage output. 2. Pre-Transfer Lamp. 3. Bad high voltage contact. | <ol style="list-style-type: none"> 1. Check every high voltage. 2. Check the turn-on PTL, LED crash. 3. Clean the inside machine or replace drum cartridge. |
| <p>Stains on back of paper</p> | <ol style="list-style-type: none"> 1. Contamination of transfer roller. 2. Stains of paper path. 3. Pressure roller's contamination. | <ol style="list-style-type: none"> 1. Clean the transfer roller with vacuum cleaner. 2. Clean the area of paper path with cloth or air cleaner. 3. Remove fuser and replace it. |
| <p>Poor Fusing</p> | <ol style="list-style-type: none"> 1. Use recommended paper? 2. Check fusing temperature. 3. The machine was under the low temperature for a long time? | <ol style="list-style-type: none"> 1. Should use recommended paper. 2. Check engine controller board. If you have not thermometer, measure the thermistor voltage to CPU, If $2.3V \pm 5\%$ in printing CPU works well. Then, disassemble fuser and check the thermistor contact and thermistor. 3. Re-check after putting the machine in the warm place for certain period. |
| <p>Partial blank image (not periodic)</p> | <ol style="list-style-type: none"> 1. Toner is low? 2. The toner cartridge is out of position? | <ol style="list-style-type: none"> 1. Replace Toner cartridge. 2. Check and adjust. |

| Error Status | Check | Solution |
|--|--|---|
| Partial blank image (periodic) | <ol style="list-style-type: none"> Develop roller scar or particle. Scar or particle. (94.3 mm) Transfer roller scar or particle. (56.6 mm) | <ol style="list-style-type: none"> Replace toner cartridge. Replace drum cartridge. Replace transfer roller. |
| Different image density (left and right) <div style="border: 1px solid black; padding: 2px; width: fit-content;"> Digital Printer Digital Printer Digital Printer Digital Printer Digital Printer </div> | <ol style="list-style-type: none"> Charge roller's pressure force unbalance Dev. roller and OPC or Dev. roller and blade's pressure force unbalance Transfer roller's pressure force unbalance of each side | <ol style="list-style-type: none"> Replace drum cartridge. Replace toner cartridge and drum cartridge. Check left and right spring of transfer roller and the spring pressing the toner cartridge inside the machine |
| Horizontal band <div style="border: 1px solid black; padding: 2px; width: fit-content;"> Digital Printer Digital Printer Digital Printer Digital Printer Digital Printer </div> | <ol style="list-style-type: none"> Unstable high voltage contact Charge roller's contamination Contamination of heat roller Malfunction of LSU | <ol style="list-style-type: none"> Clean each contact and check good contact Clean charge roller Replace fuser unit Check Main PBA. |

Abnormal Image Printing and Defective Roller

| No | Roller | Abnormal image period | Kind of abnormal image |
|----|-----------------|-----------------------|---|
| 1 | OPC Drum | 75.5mm | White spot, Block spot |
| 2 | Charge Roller | 37.7mm | Black spot |
| 3 | Supply Roller | 44.9mm | Horizontal density band |
| 4 | Develop Roller | 35.2mm | Horizontal density band |
| 5 | Transfer Roller | 47.1mm | Black side contamination/transfer fault |
| 6 | Heat Roller | 77.8mm | Black spot and fuser ghost |
| 7 | Pressure Roller | 75.4mm | Black side contamination |

No Image

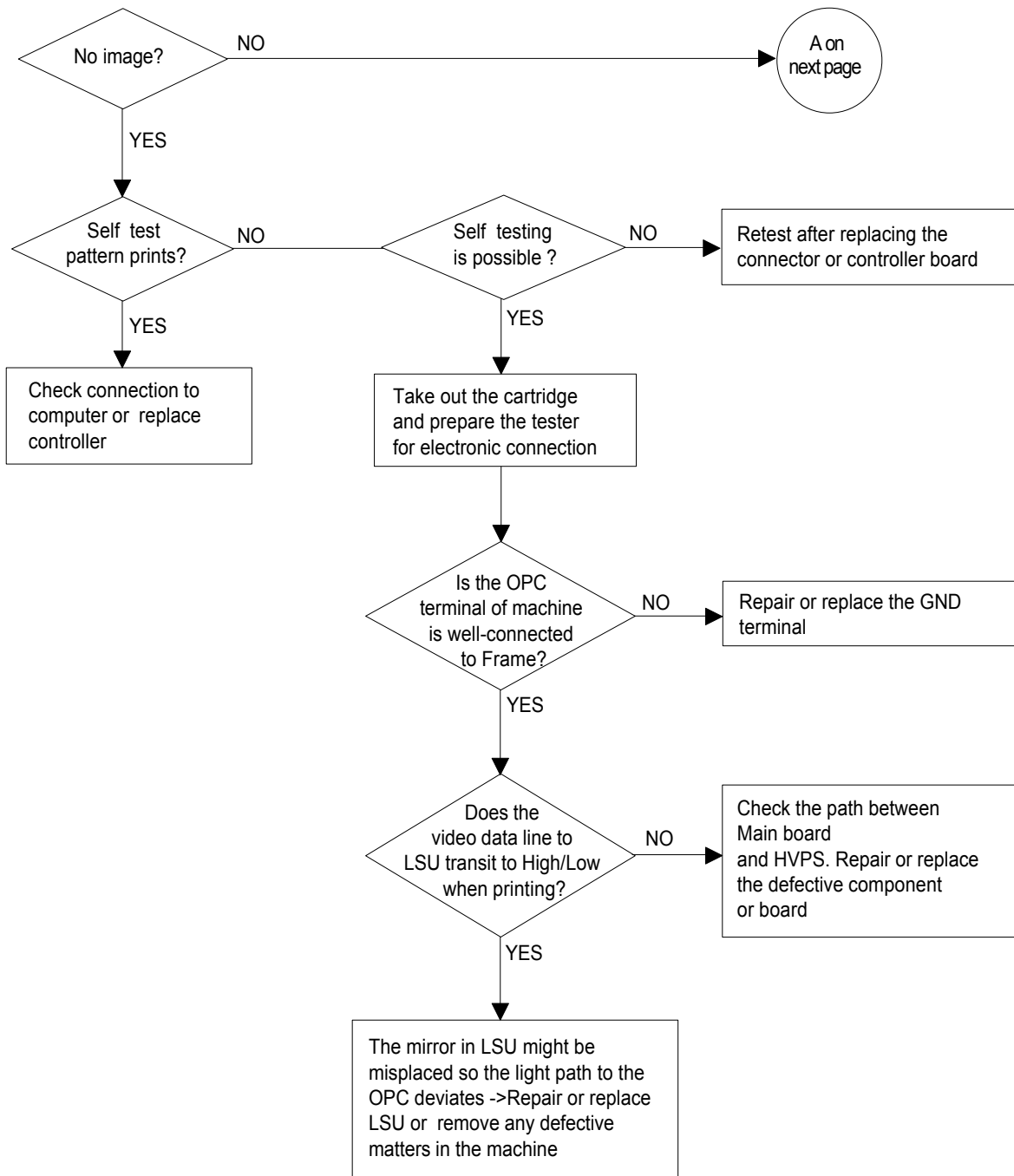
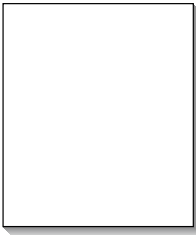

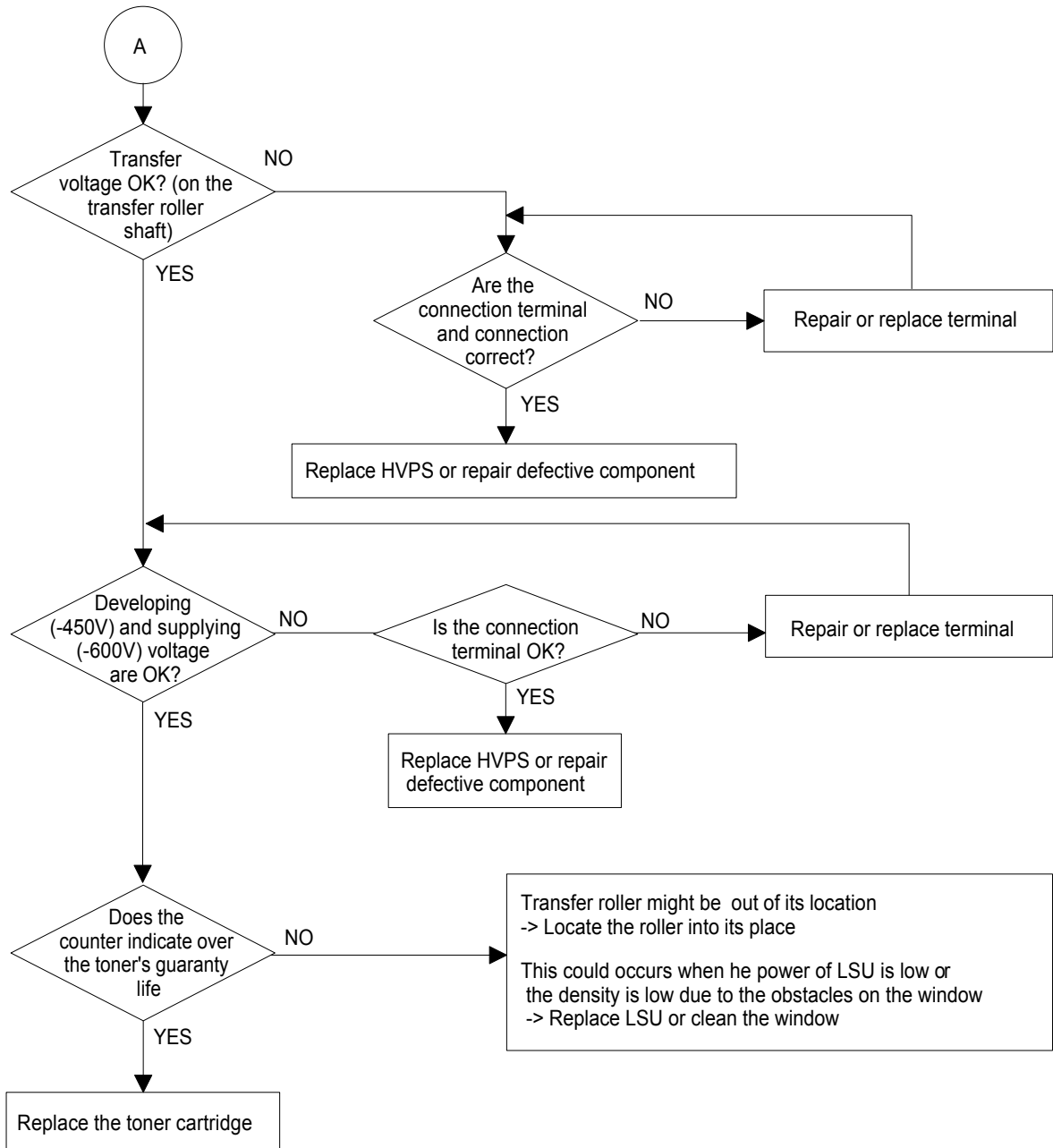

All Black

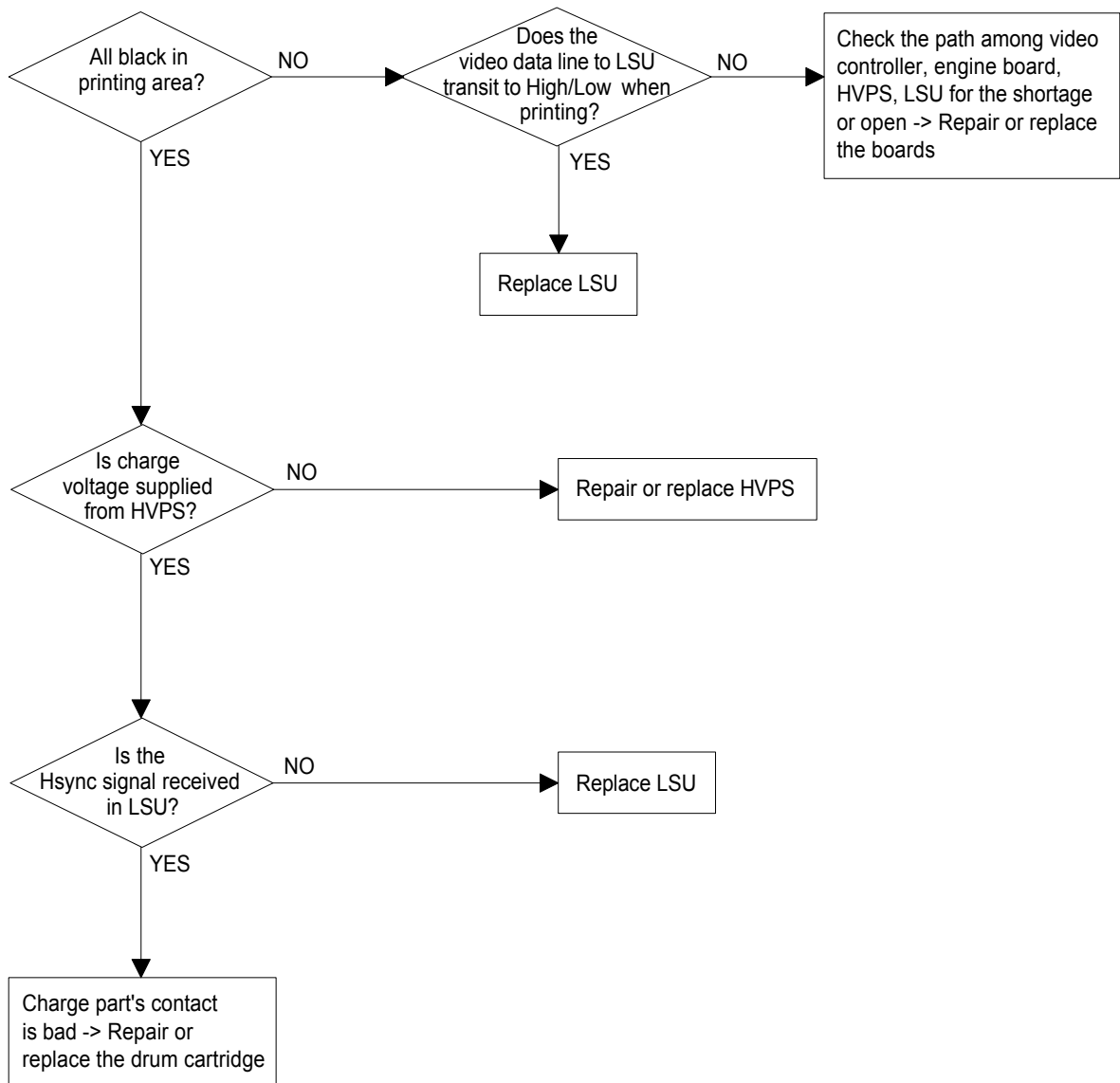
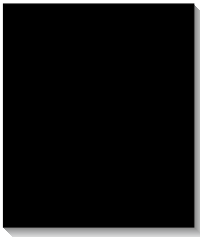

Vertical White Line (Band)

Digital Printer
 Digital Printer
 Digital Printer
 Digital Printer
 Digital Printer

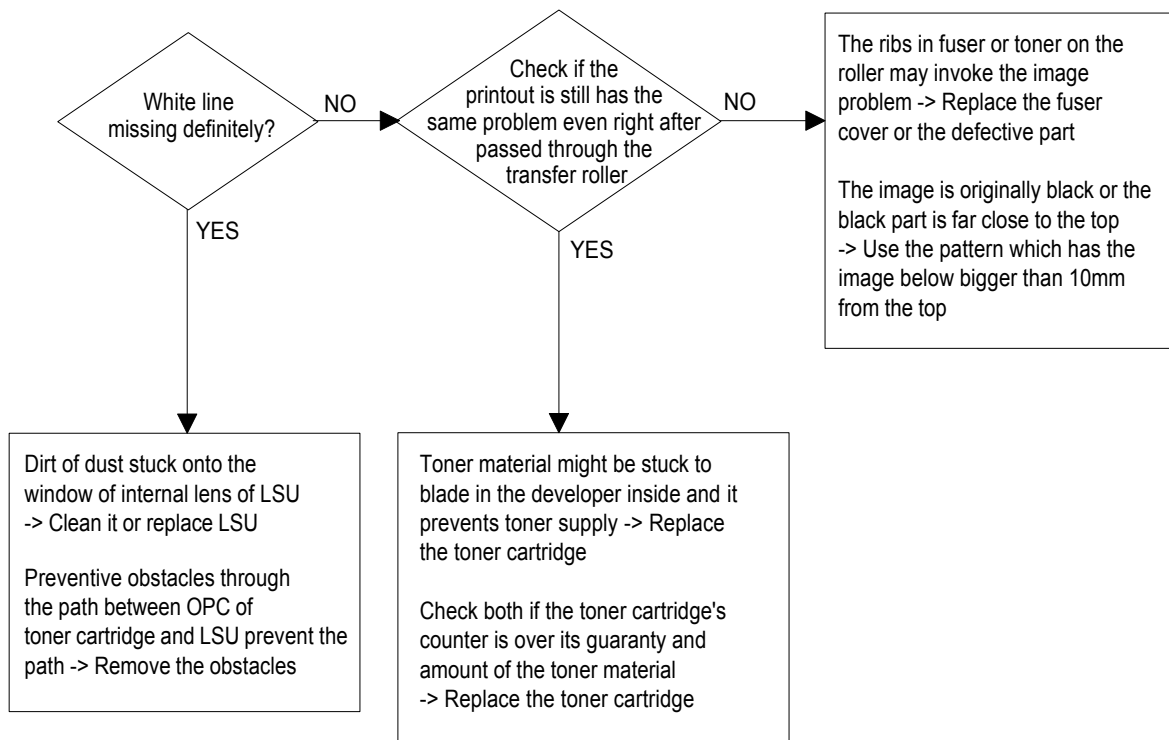

Dark Image

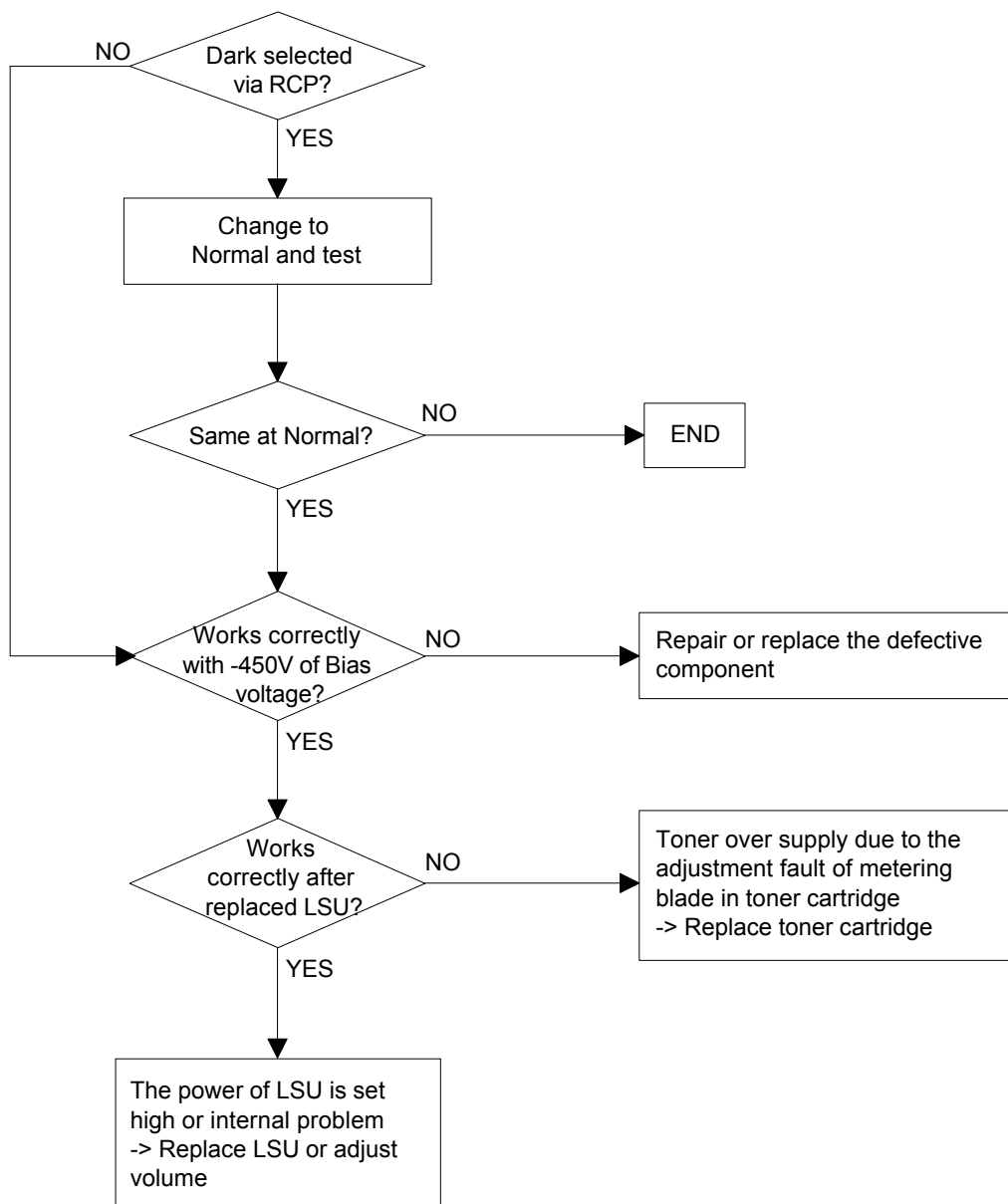

Background

Digital Printer
 Digital Printer
 Digital Printer
 Digital Printer
 Digital Printer

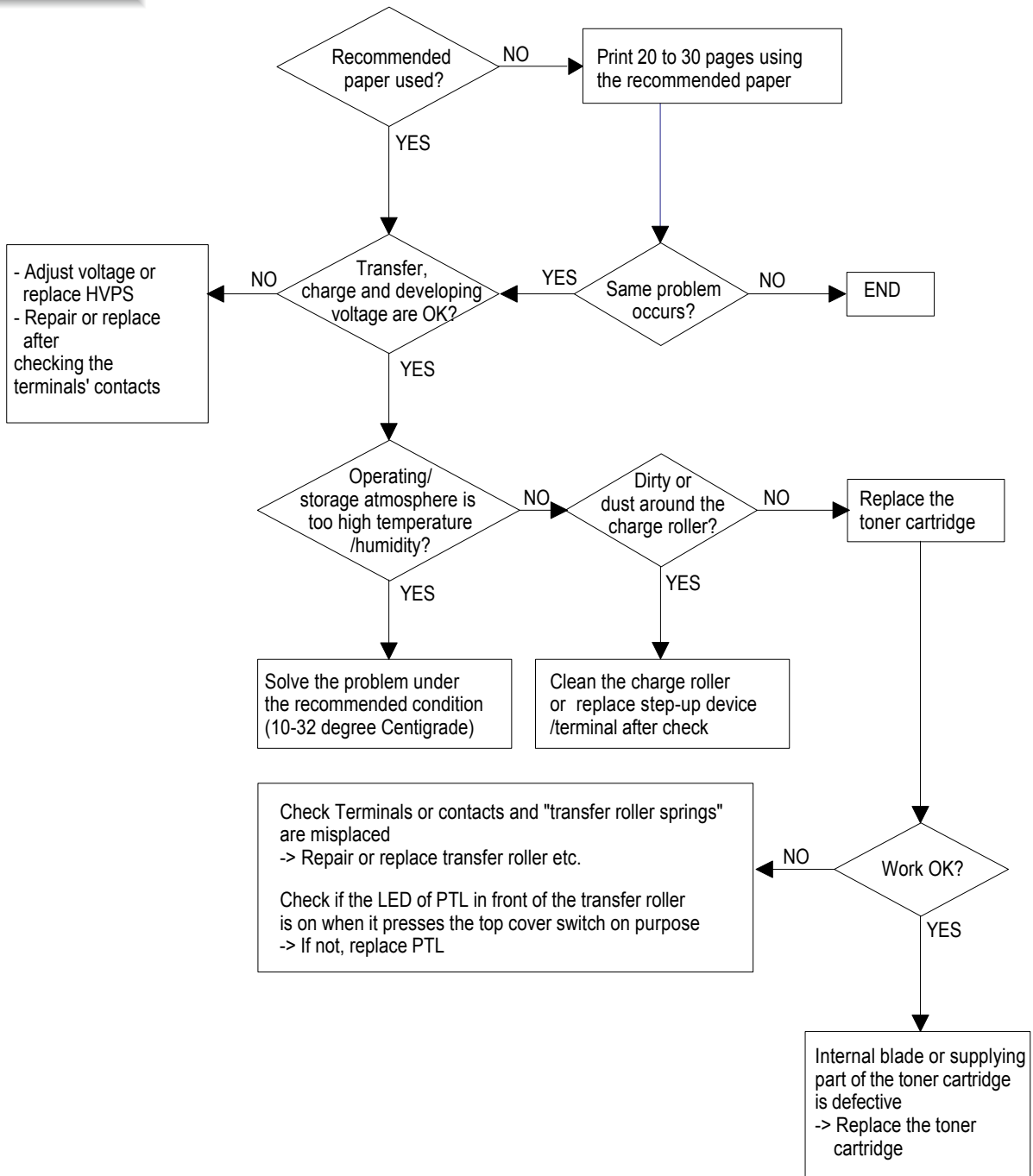

Ghost

Digital Printer
 Digital Printer
 Digital Printer
 Digital Printer
 Digital Printer

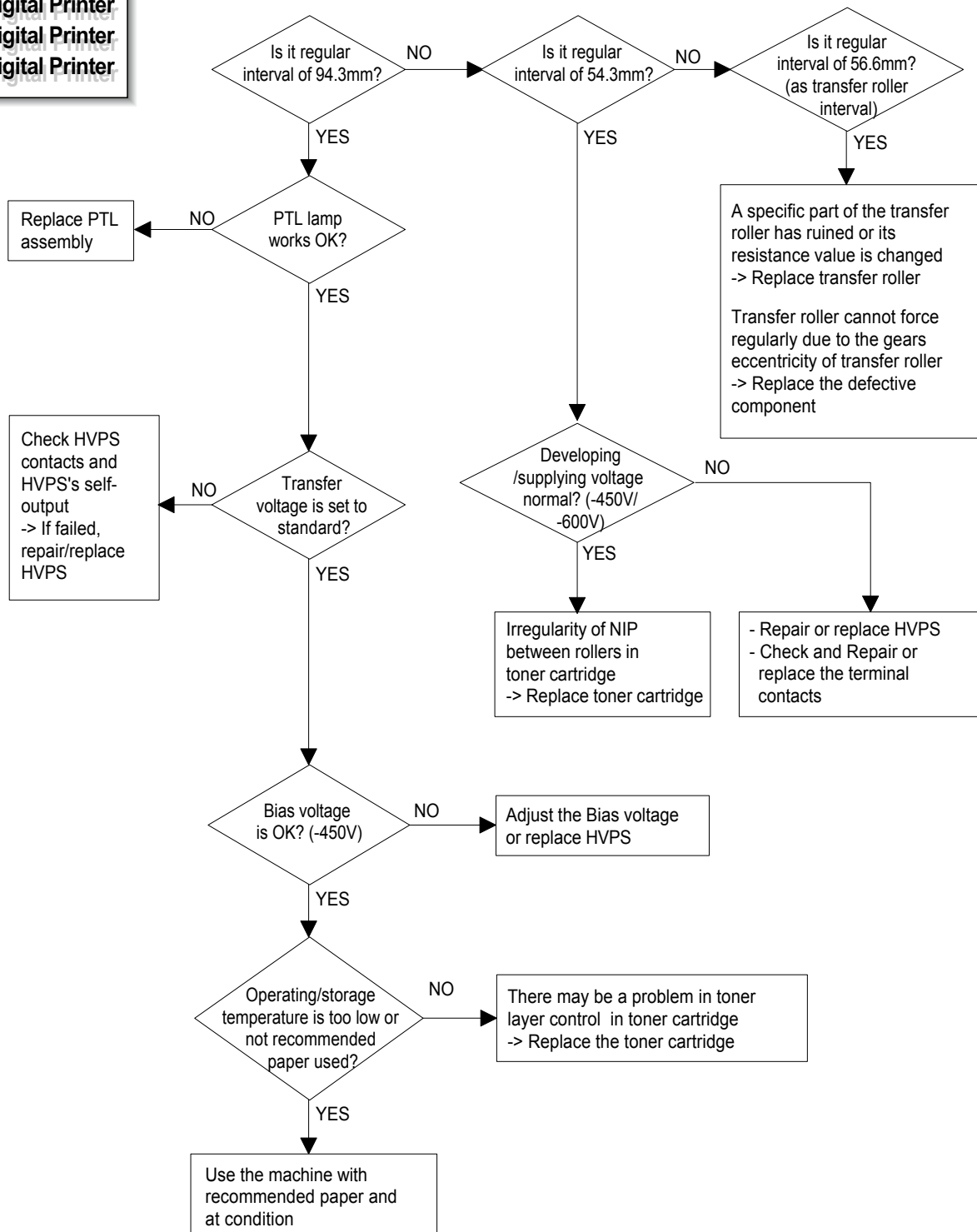

Black Spot

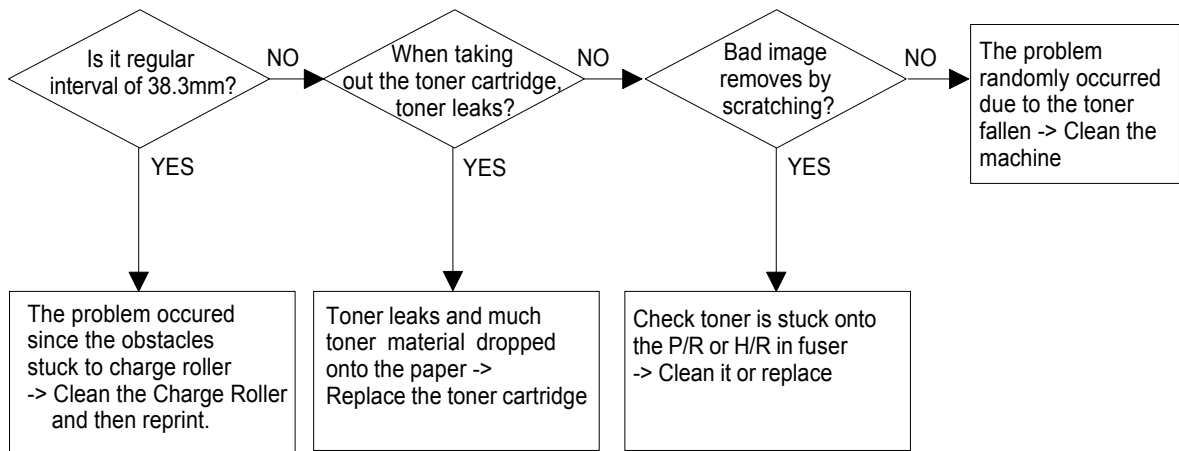

Horizontal Band

~~Digital Printer~~
 Digital Printer
 Digital Printer
 Digital Printer
 Digital Printer

Digital Printer
 Digital Printer
 Digital Printer
 Digital Printer

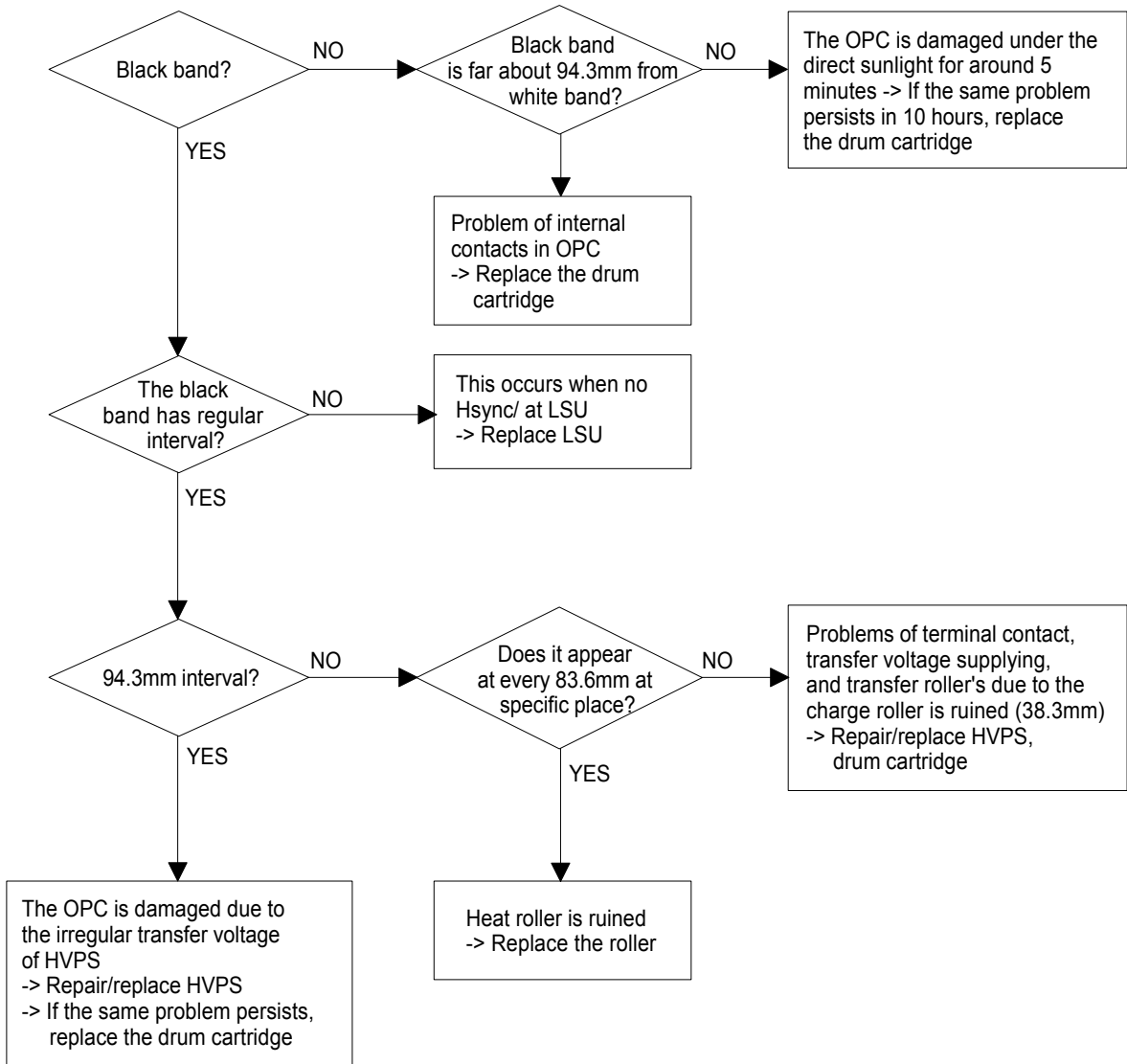

Irregular Density

Digital Printer
 Digital Printer
 Digital Printer
 Digital Printer
 Digital Printer

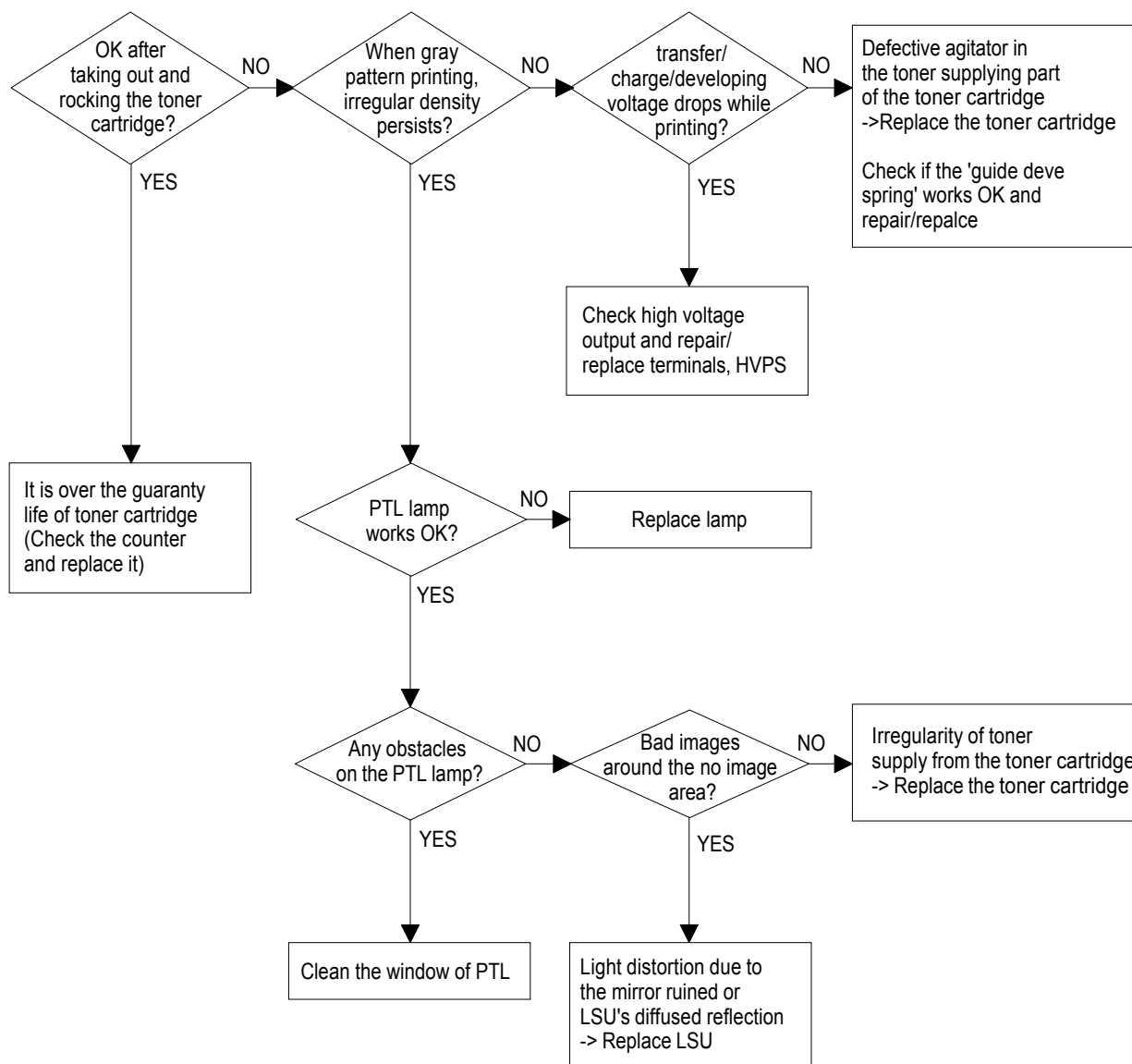

White Spot

Digital Printer
Digital Printer
Digital Printer
Digital Printer
Digital Printer

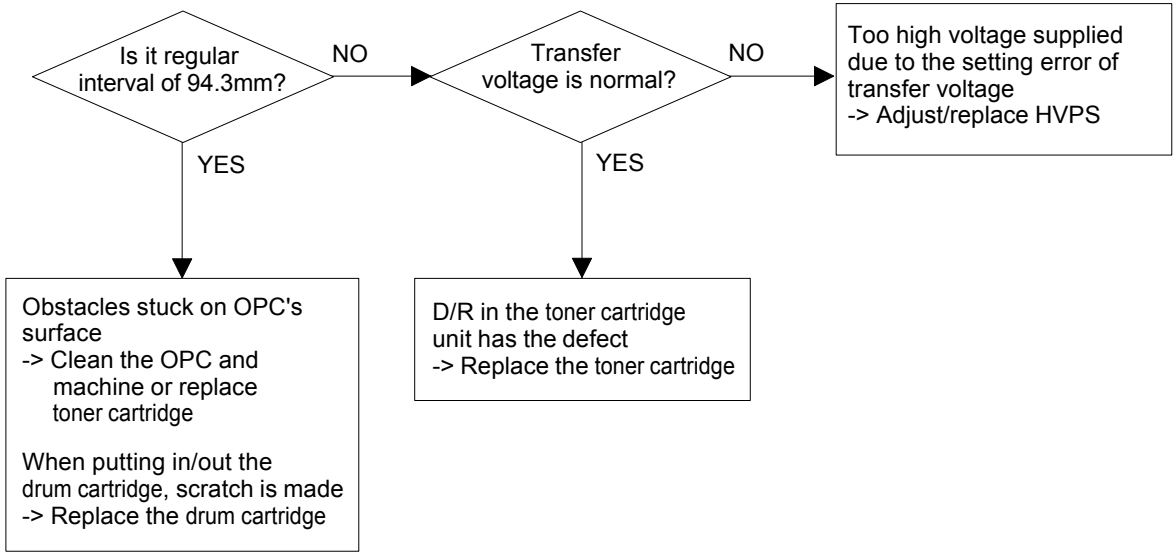

Trembling at the End When OHP Printing

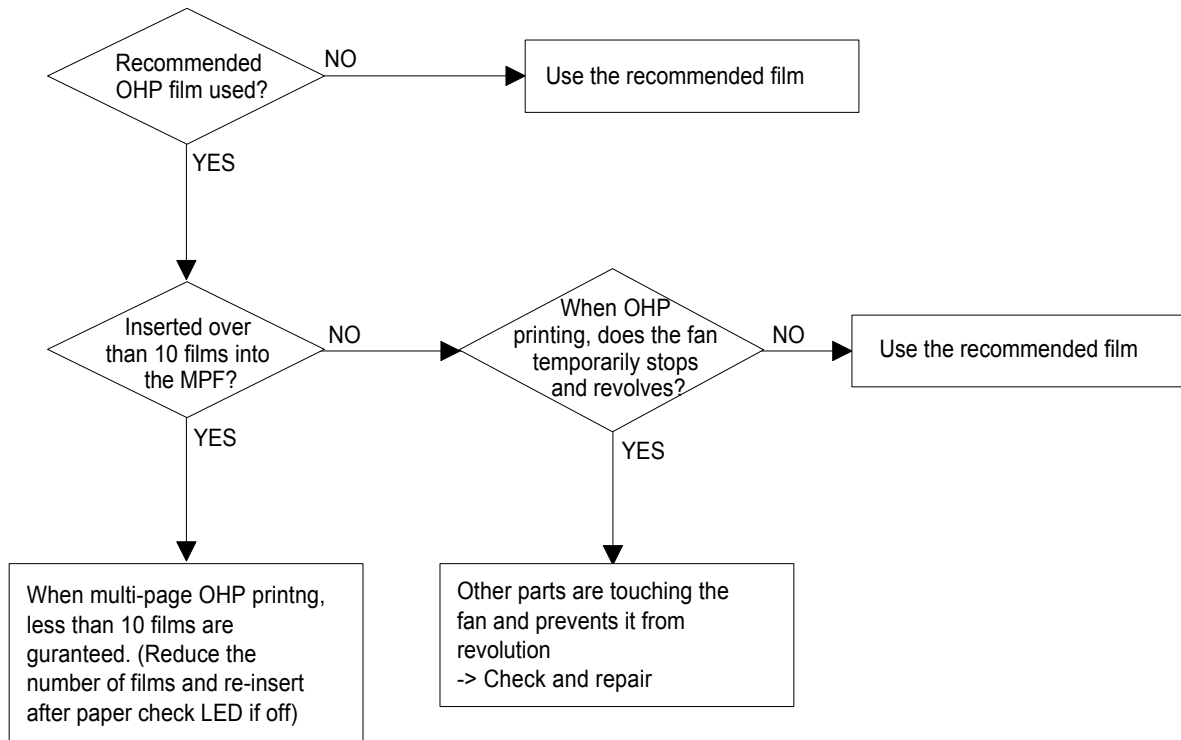

Poor Fusing Grade

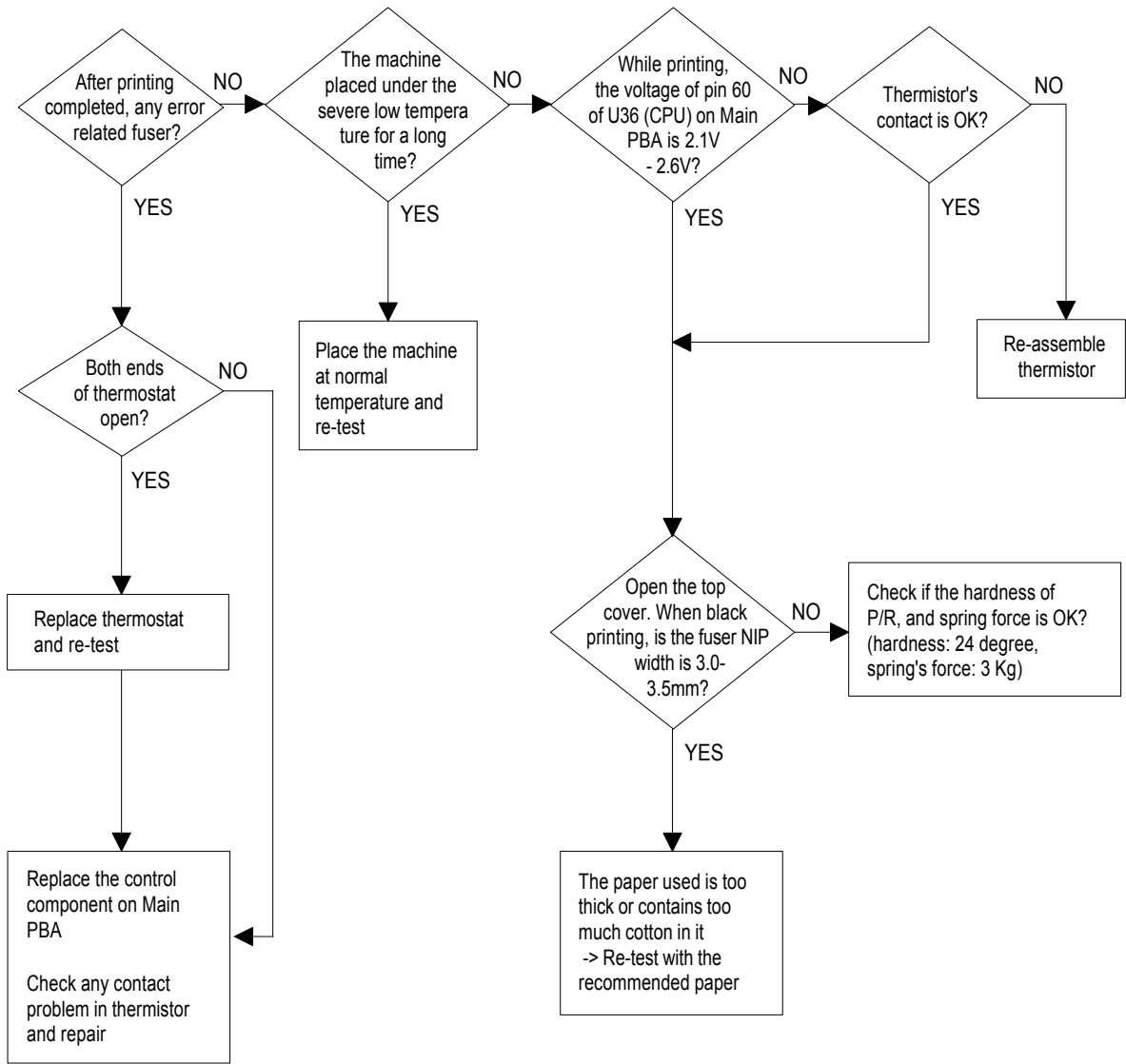

4.2.3.4 Malfunction

| Error Status | Check | Solution |
|--------------|--|--|
| No power | <ol style="list-style-type: none"> 1. Check power is supplying 2. Check fuse F1 open | <ol style="list-style-type: none"> 1. If supplying power differs from machine's power rating, replace the machine. 2. Replace it. |
| Fuser Error | <ol style="list-style-type: none"> 1. Thermostat open 2. AC wire open 3. Thermistor wire open 4. Main PBA | <ol style="list-style-type: none"> 1. Detach AC connector and measure the resistance between pin 1 and 2. If it is megohm, thermostat is open, Replace it. 2. Check bad connector contact or wire is cut. 3. Check thermistor wire and its connection. 4. Replace Main PBA |
| Cover open | <ol style="list-style-type: none"> 1. When close Side cover, check the lever is pressed 2. Micro switch's contact 3. CPU and related circuit | <ol style="list-style-type: none"> 1. Open Side cover and press the lever with pen. If Controller detects cover close, there is some mechanical trouble in Side cover and lever's assembly. If not so there is electrical problem. |
| Jam 0 | <p>Check where Jam 0 happens</p> <ol style="list-style-type: none"> 1. Paper is not picked up 2. Paper is located in feed sensor 3. Happened when inserting specific papers such as envelope into the MPF (Multipurpose Paper Feeder)? 4. Happened when inserting specific papers such as envelope into the Manual Feeder? 5. Is the Stacker Extender is folded out? 6. Does not the Guide Adjust distort the papers | <ol style="list-style-type: none"> 1. Check whether solenoid is working or not by using Engine test mode 2. Check feed sensor malfunction. 3. Re-try inserting a fewer papers. <ul style="list-style-type: none"> • fan the papers and align • take out the loaded papers and insert them reverse direction 4. Take out the loaded papers and insert them reverse direction <ul style="list-style-type: none"> • inserted papers as recommended for Manual Feeding? • When loading, tap the papers until paper detect sensor senses loading 5. When using long papers, use the Stacker Extender 6. Adjust Guide to fit the paper width |
| Jam 1 | <p>Paper is stopped in just after of fuser unit.</p> | <ol style="list-style-type: none"> 1. It is mostly resulted from double feeding. Check paper is well stocked in feeder. 2. Check feed actuator position and actuator's operating. There may be stiff moving or double reflection. If not so, check the operation of feed sensor by Engine test mode. 3. Check exit lever operation. Remove jam and check actuator moving by hand. If actuator is too stiff, paper is wrapped around the heat roller. Remove obstacles or replace. |

| Error Status | Check | Solution |
|-------------------------|--|---|
| Jam 2 | Check where Jam 2 happens 1. Paper is curled and cannot exit. 2. Paper is curled in the exit cover? | 1. Remove paper using pinset or some tool and watch if separate claws have any trouble. Clean around fuser. 2. Check locking works wells. Watch whether the ribs of exit cover have any burr or resistive edge. If they do, remove obstacles or replace. |
| Jam 2 at face-down tray | 1. Then paper is not drawn in because of the stack of papers in the Out tray. 2. Does it curl while coming out? | 1. Load recommended quantity of papers 2. Open the Cover Front and check whether roller or spring, which are related to paper out, is not out of position. If so, re-locate or replace. |
| Clutch error | 1. Check the spring of solenoid 2. Check the armature assembly/ cushion 3. Electrical check | 1. Check whether the spring is expanded or not. 2. Check armature is well installed. It may be unstable assemble. 3. Remove the Main PBA. |
| High voltage error | 1. Check the terminal output voltage 2. Check HVPS | 1. Remove the Toner cartridge and open the cover and press cover open switch lever and measure the voltage with high voltage probe and sending printing data. If the voltage is normal, change the toner cartridge. 2. Disassemble the left side cover, and check HV of the solder side of HVPS and change it. |
| Feeding obstacles | Does the Plate-knockup prevent the paper loading? | MPF : Turn the power off and on. Open and close the Side cover to return to the original state. Cassette : Adjust Guide to fit the paper width. |
| Skew | Is the Guide adjust set to the paper width? | Fit the paper width using the Guide adjust. |
| Stacking | 1. Took out the Stacker extender to support long papers? 2. Stacked too many papers more than Stacker can hold? | 1. Use extender as per the paper length. 2. The Face-up stacker normally can hold 100 pages when using 75g/m2, however, stacking capacity can be lowered depending on the type of papers. |
| Engine Error | Check CBF Harness_CN7.(Main PBA to LSU) | Refer to troubleshooting "ENGINE ERROR". |
| Document Jam | Document is not picked up(in ADF). | 1. Check document is well stocked in ADF. 2. Check whether document was been fastened together by staple or clip. 3. Load recommended quantity of papers. |
| | Document is stopped after it has fed into the ADF. | 1. Check whether the Reg. sensor is working or not. 2. Check whether the Feed Roller is working or not. |
| | Does it curl while coming out? | 1. Check the Open Cover whether there are bosses. 2. Check the ADF ass'y is well assemble. |

No Power (LCD NO display LED Off)

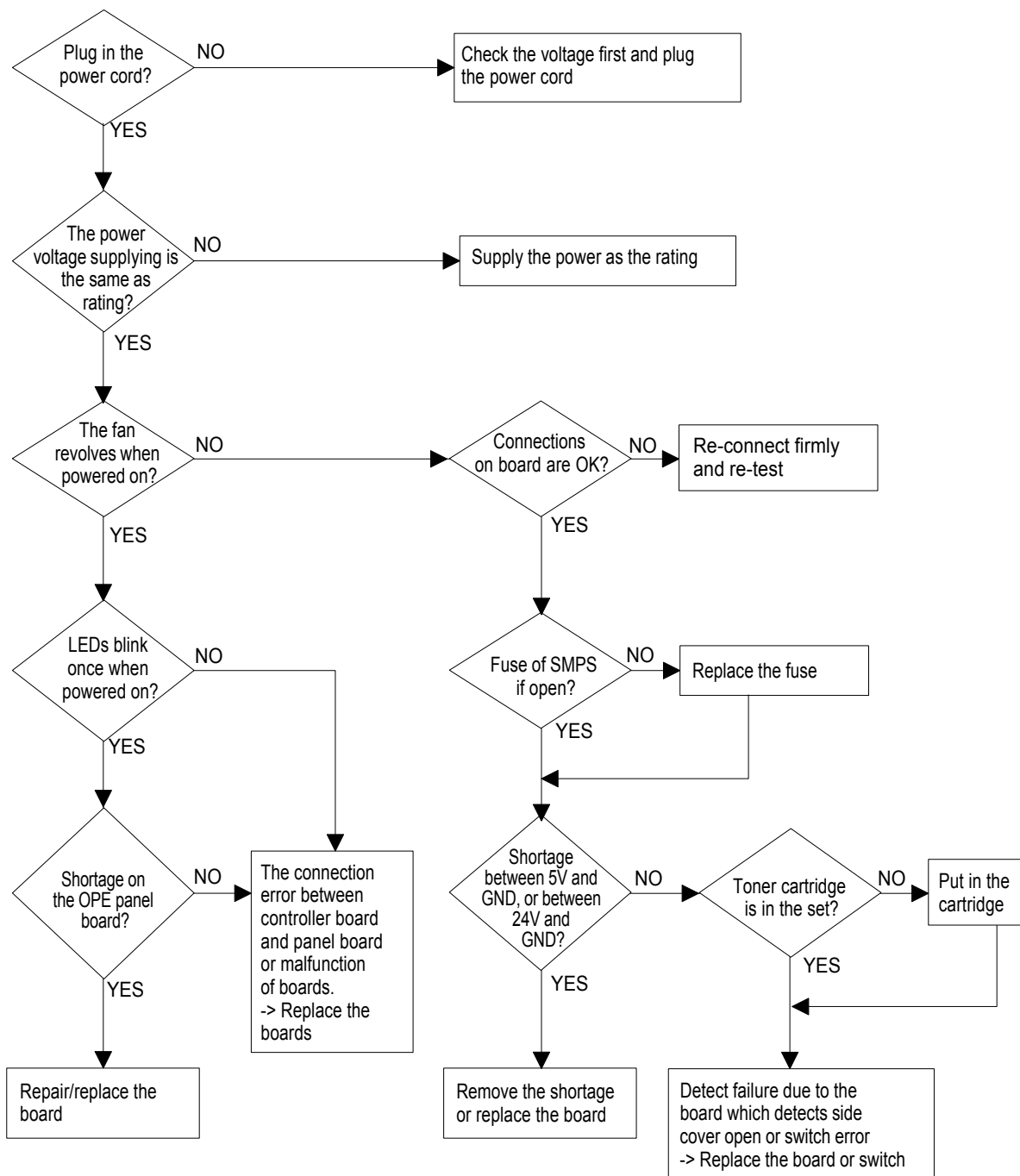

Fuser Error

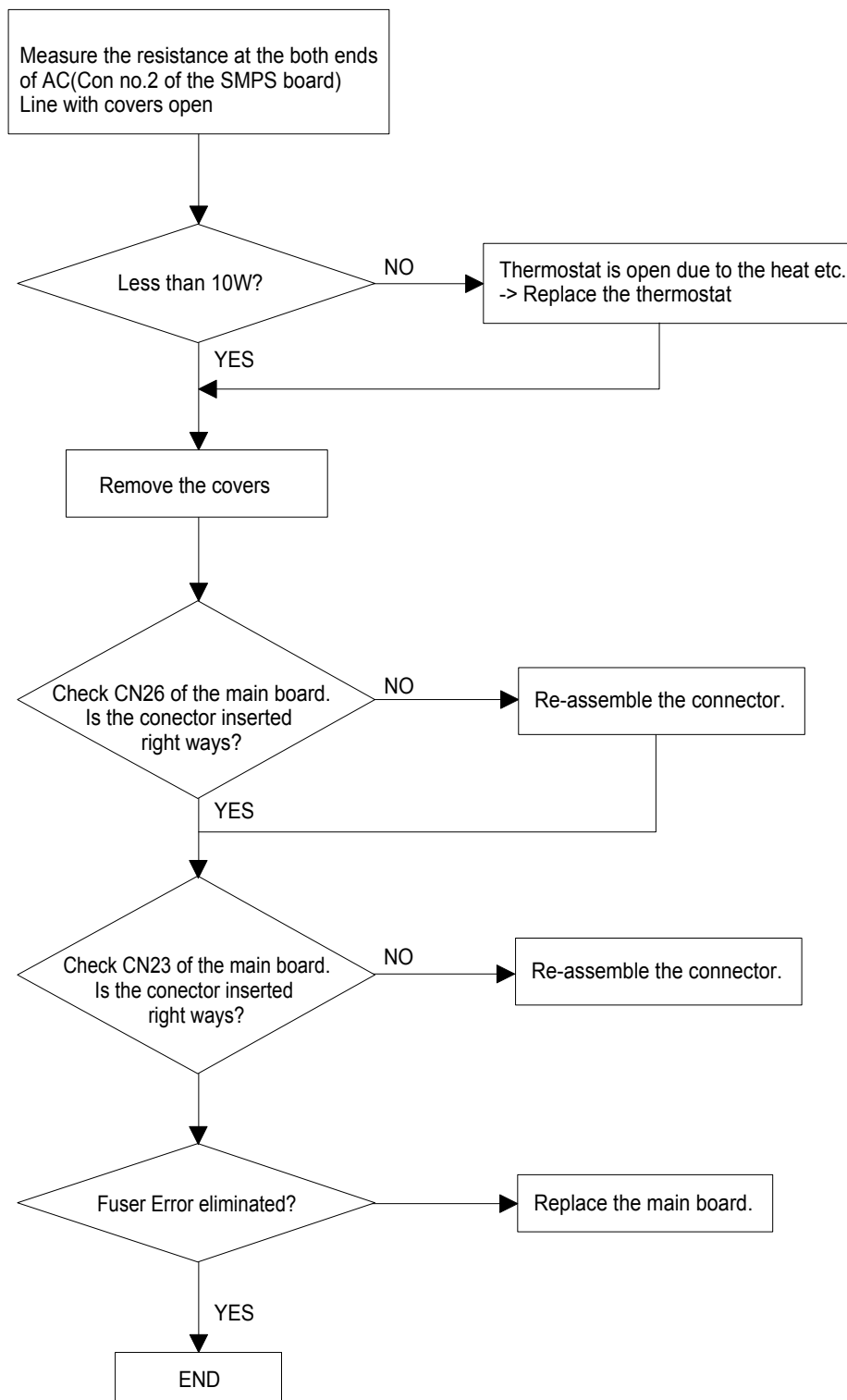

Paper Jam (Mis-Feeding)

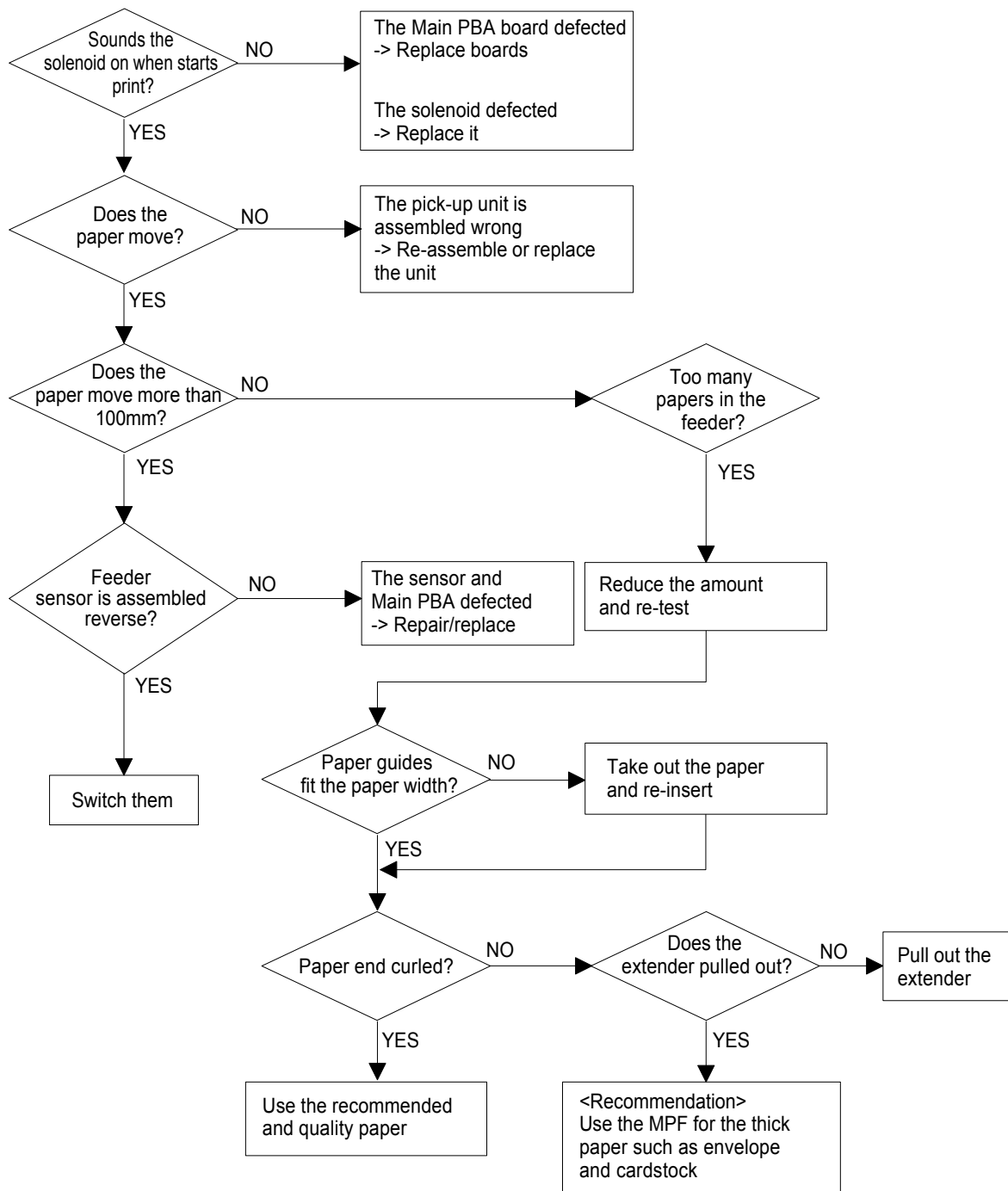

Paper Jam (Jam 1)

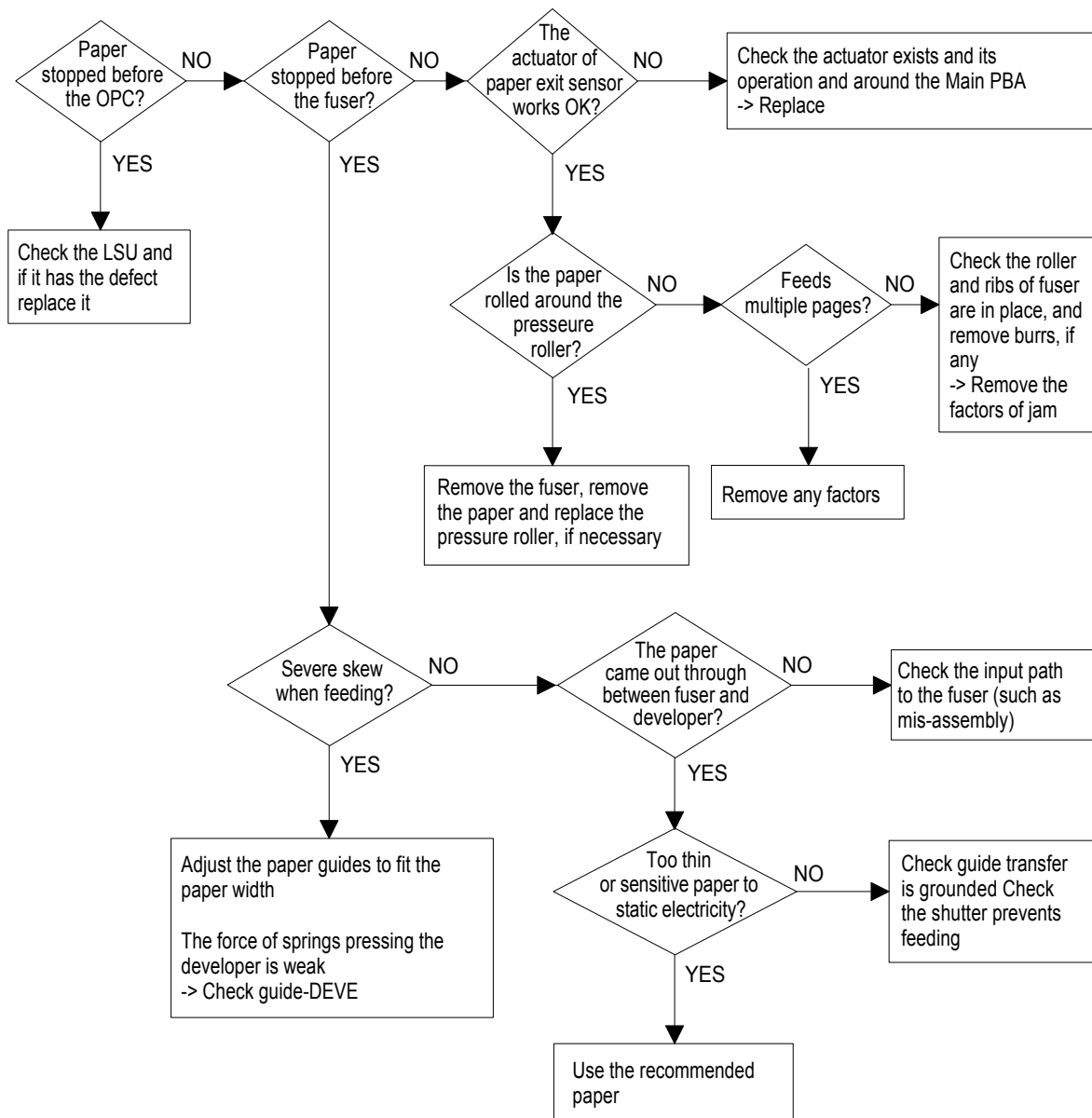

4.2.3.5 The cause and solutions of bad environment of the software

NOTE - Always try to an internal page and a copy to be sure that the machines is working and the problem is related to SW.

4.2.3.5(a) The printer is not working (1)

Description : While Power turned on, the printer is not working in the printing mode.

| Check and Cause | Solution |
|--|--|
| <ol style="list-style-type: none"> 1. Check if the PC and the printer is properly connected and the toner cartridge installed. 2. Printing is nor working in the Windows. 3. Check if the printer cable is directly connected to peripheral devices | <ol style="list-style-type: none"> 1. Replace the printer cable. If the problems not solved even after the cable replaced, check the amount of the remaining tone. 2. Check if the connection between PC and printer port is proper. If you use windows, check if the printer driver in the controller is set up. If the printer driver is properly set up, check in which program the printing is not working. The best way to find out is to open the memo pad to check the function of printing. If it is not working in a certain program, adjust the setup the program requires. Sometimes, the printout is normal within the Windows basic programs, but it's not working in a particular program. In such case, install the new driver again. If not working in the Windows basic program, Check the setup of the port of CMOS is on ECP. And check the address of IRQ 7 and 378 3. If the scanner needs to be connected to the printer, first the remove the scanner from the PC to see if the printer is properly working alone. |

4.2.3.5(b) The printer is not working (2)

Description : After receiving the printing order, no response at all or the low speed of printing occurs due to wrong setup of the environment rather than malfunction of the printer itself.

| Check and Cause | Solution |
|---|---|
| <ol style="list-style-type: none"> 1. Secure more space of the hard disk. 2. Printing error occurs even if there is enough space in the hard disk. 3. Check the parallel-port-related items in the CMOS Setup. 4. Reboot the system to print. | <ol style="list-style-type: none"> 1. Not working with the message 'insufficient printer memory' means hard disk space problem rather than the RAM problem. In this case, provide more space for the hard disk. Secure more space using the disk utilities program. 2. The connection of the cable and printer port is not proper. Check if the connection is properly done and if the parallel port in CMOS is rightly set up. 3. As a printer port, Select ECP or SPP among SPP(Normal), ECP, and EPP modes(increase printing speed) SPP normal mode support 8-bit data transfer, while ECP Mode transfer the 12-bit data. 4. If the regular font is not printing, the cable or the printer driver may be defective. Turn the PC and printer off, and reboot the system to print again. If not solved, double-click the printer in my computer If the regular fonts are not printed this time again. the cable must be defective so replace the cable with new one. |

4.2.3.5(c) Abnormal Printing

Description : The printing is not working properly even when the cable has no problem. (even after the cable is replaced) If the printer won't work at all or the strange fonts are repeated, the printer driver may be defective or wrong setup in the CMOS Setup.

| Check and Cause | Solution |
|--|---|
| <ol style="list-style-type: none"> 1. Set up the parallel port in the CMOS SETUP. 2. Printer Driver Error. 3. Error message from insufficient memory. (The printing job sometimes stops or due to insufficient virtual memory, but it actually comes from the insufficient space of the hard disk.) | <ol style="list-style-type: none"> 1. Select SPP(Normal) or ECP LPT Port the among ECP, EPP or SPP in the CMOS Setup. 2. Check the printer in My Computer.(to see if the printer driver is compatible to the present driver or delete the old driver, if defective and reinstall the new driver) 3. Delete the unnecessary files to secure enough space of the hard disk and start printing job again. |

4.2.3.5(d) SPOOL Error

Description : To spool which stands for “simultaneous peripheral operations online” a computer document or task list (or “job”) is to read it in and store it, usually on a hard disk or larger storage medium so that it can be printed or otherwise processed at a more convenient time (for example, when a printer is finished printing its current document).

| Check and Cause | Solution |
|---|---|
| <ol style="list-style-type: none"> 1. Insufficient space of the hard disk in the directory assigned for the basic spool. 2. If the previous printing error not solved. 3. When expected to collide with other program. 4. When an application program or the printer driver is damaged. 5. When some files related to OS are damaged or virus infected. 6. Memory is less than suggested one. | <ol style="list-style-type: none"> 1. Delete the unnecessary files to provide more space to start printing job. 2. If there are some files with the extension name of ****.jnl, Delete them and Reboot the Windows to restart printing job. 3. Shut down all other programs except the current one, if possible. 4. Delete the printer driver completely and reinstall it. 5. After rebooting the computer, check for viruses, restore the damaged files and reinstall the program to do the printing job. 6. Add up enough memory to the PC. |

How to delete the data in the spool manager.

In the spool manager, the installed drivers and the list of the documents waiting to be printed are shown. Select the document to be deleted and check the delete menu.

If you intend to delete the current document being printed, the data being transferred to the printer will be put out and then the document is removed. Before choosing the document, the menu is still inactive.

Or put the document out of the list and repeat the routine as in the above or finish the spool manager.

5. System Diagram

5.1 Block Diagram

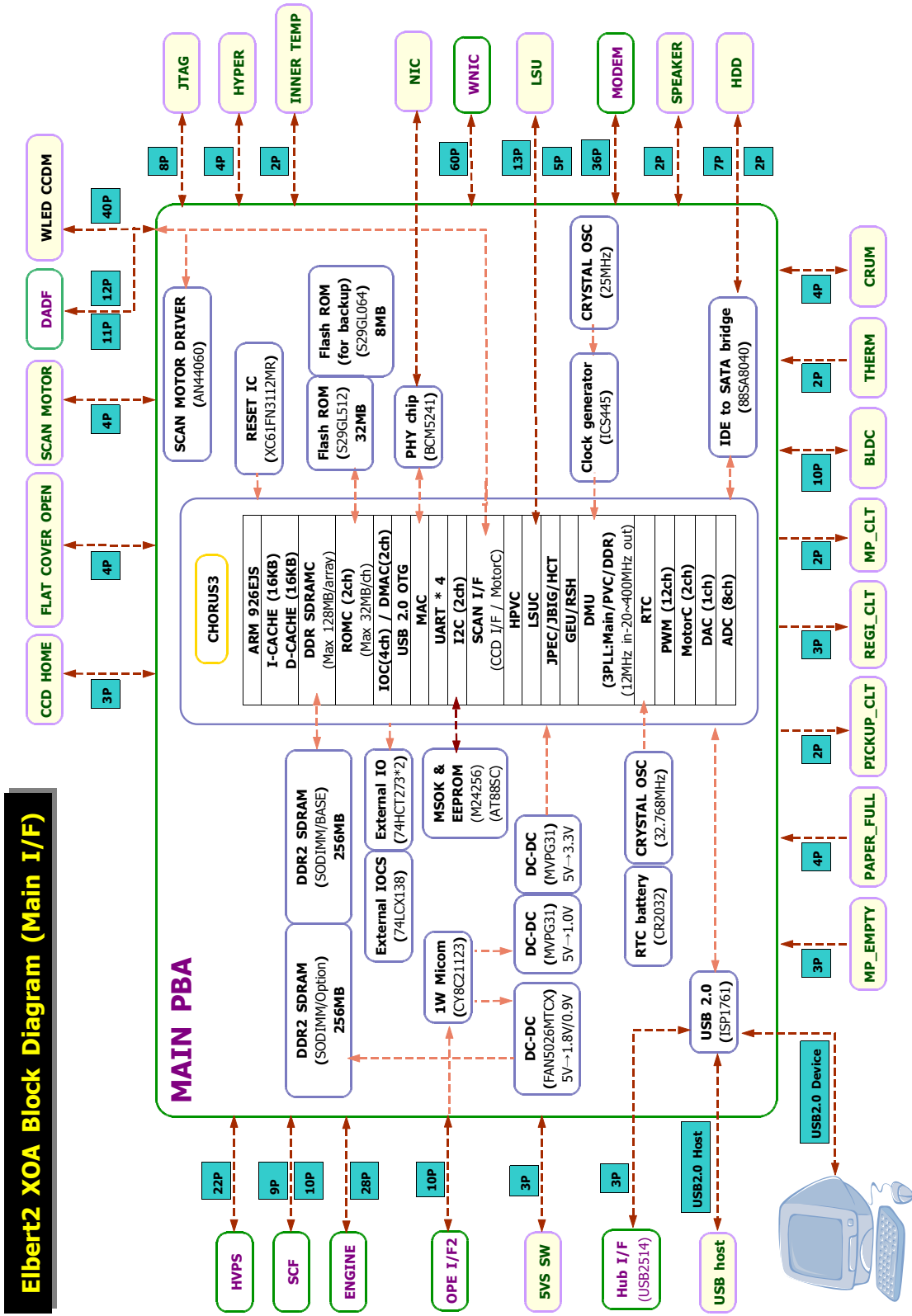

Elbert2 XOA Block Diagram (SUB B'd)

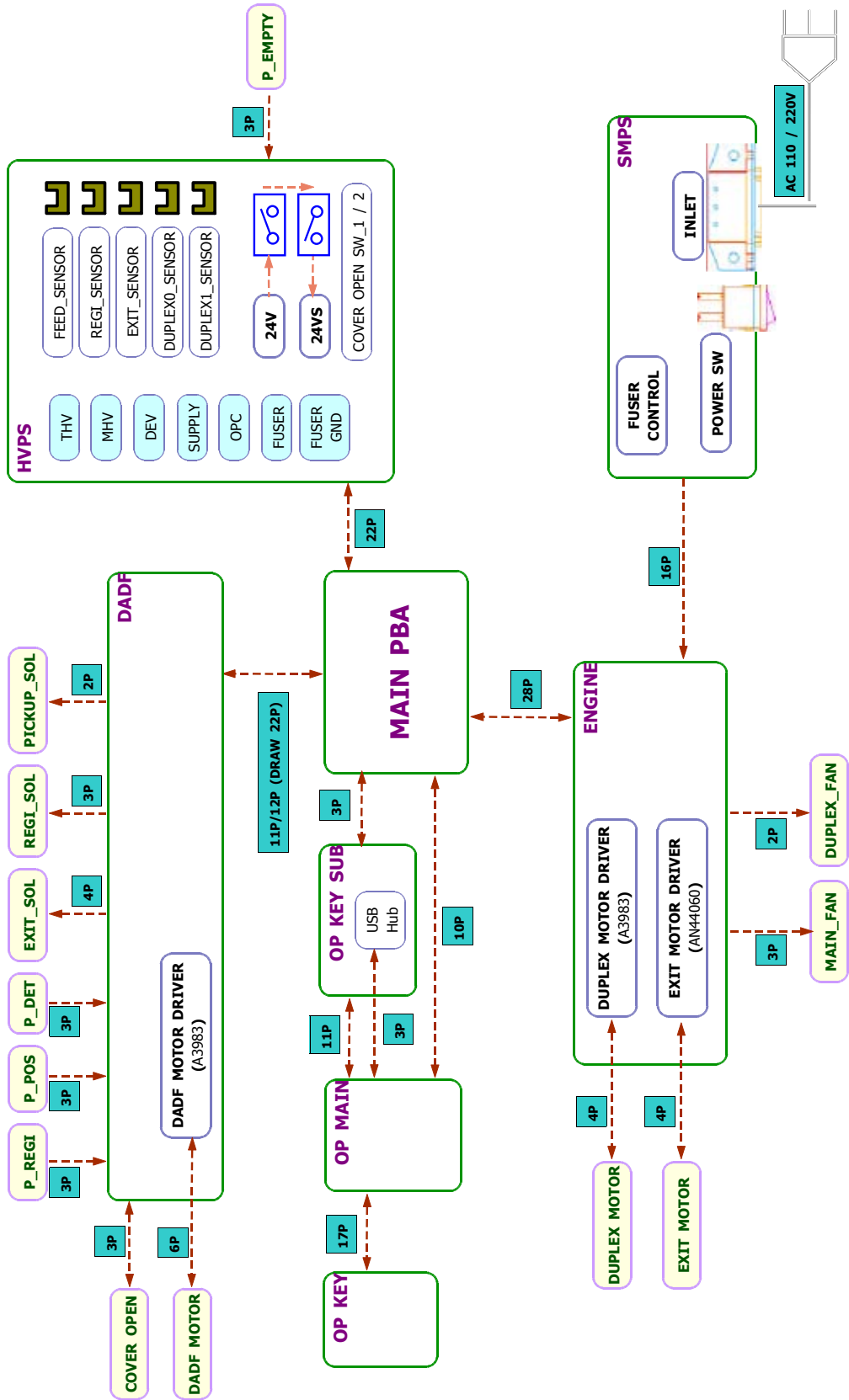

5.2 Connection Diagram

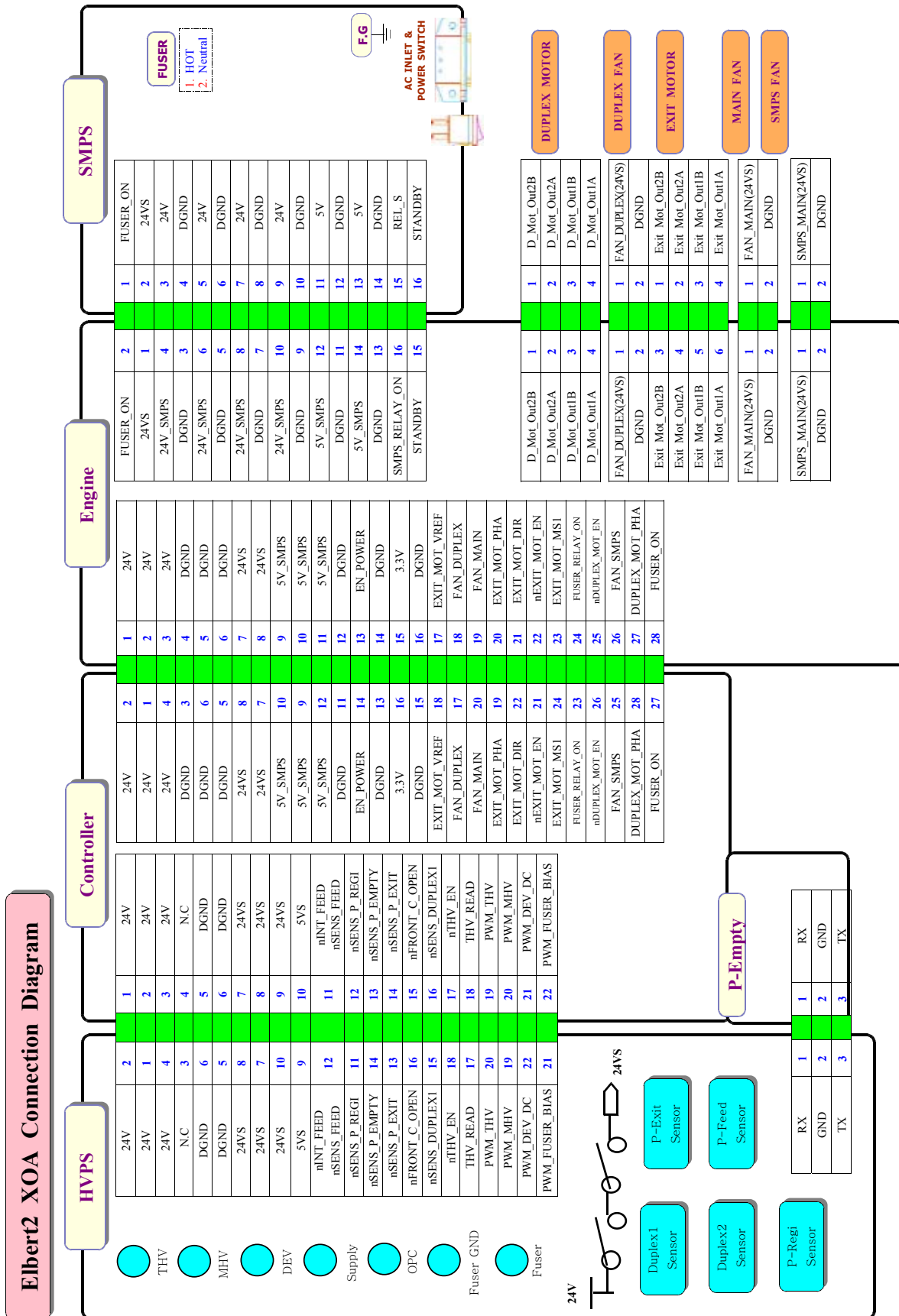

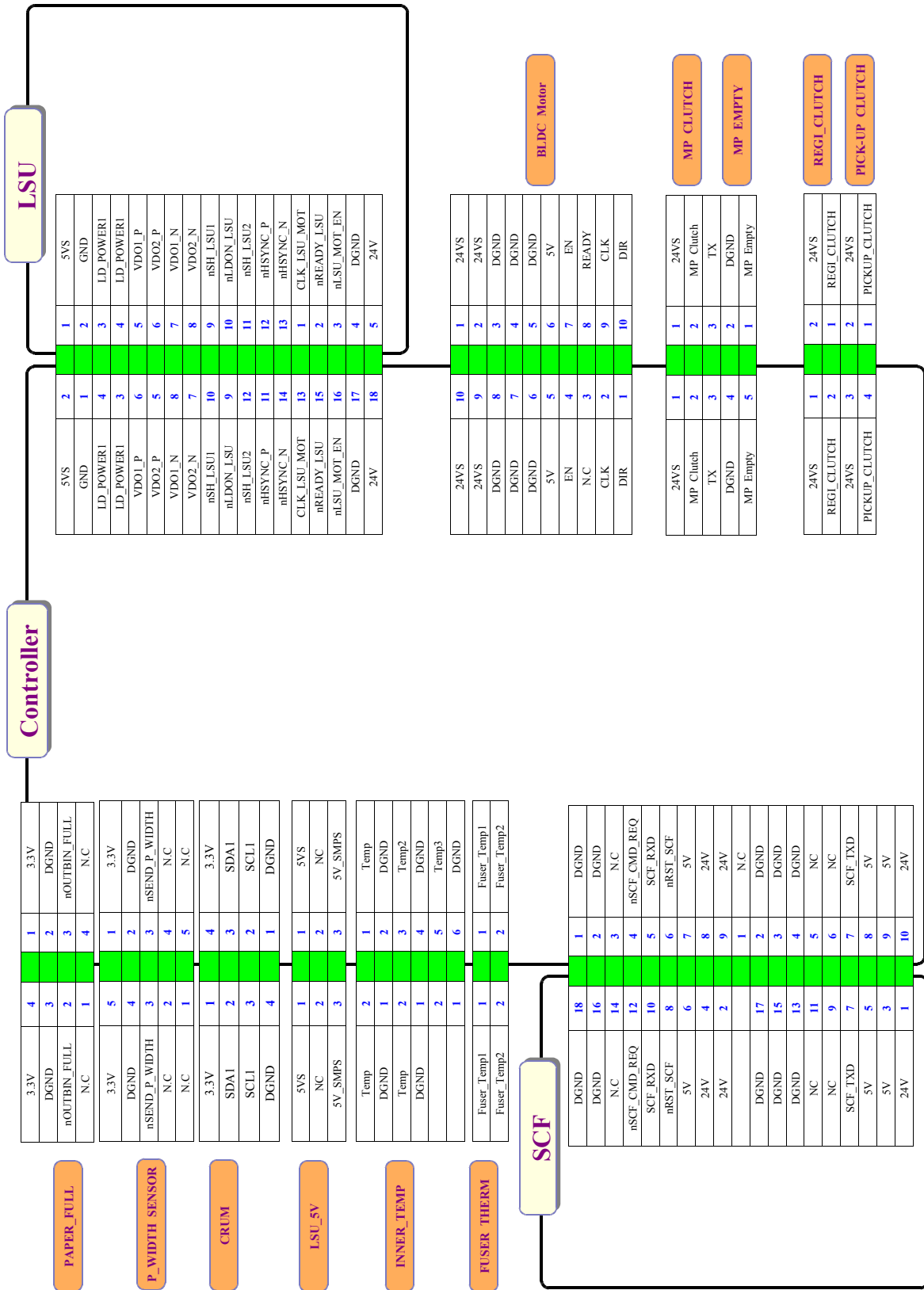

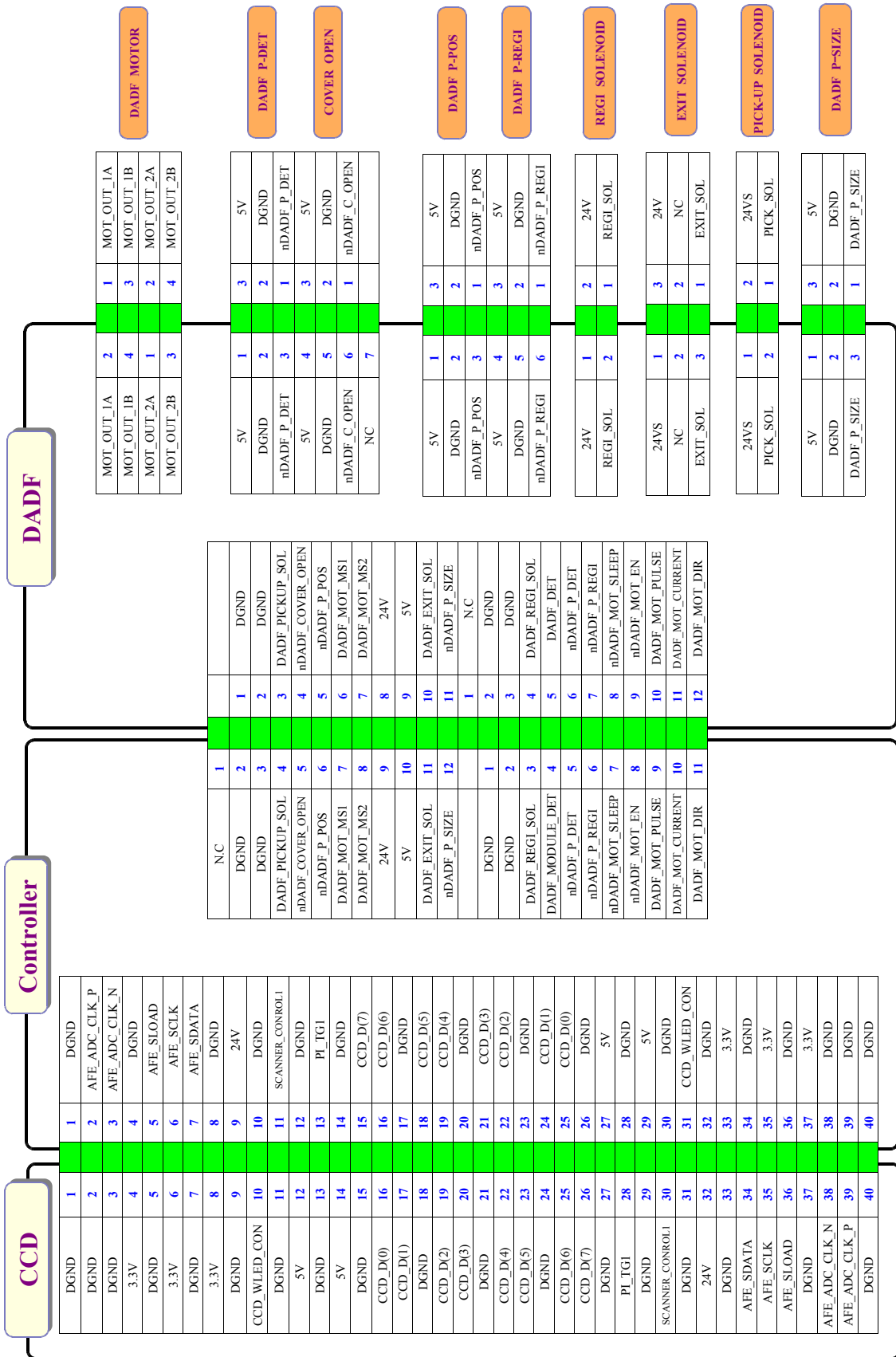

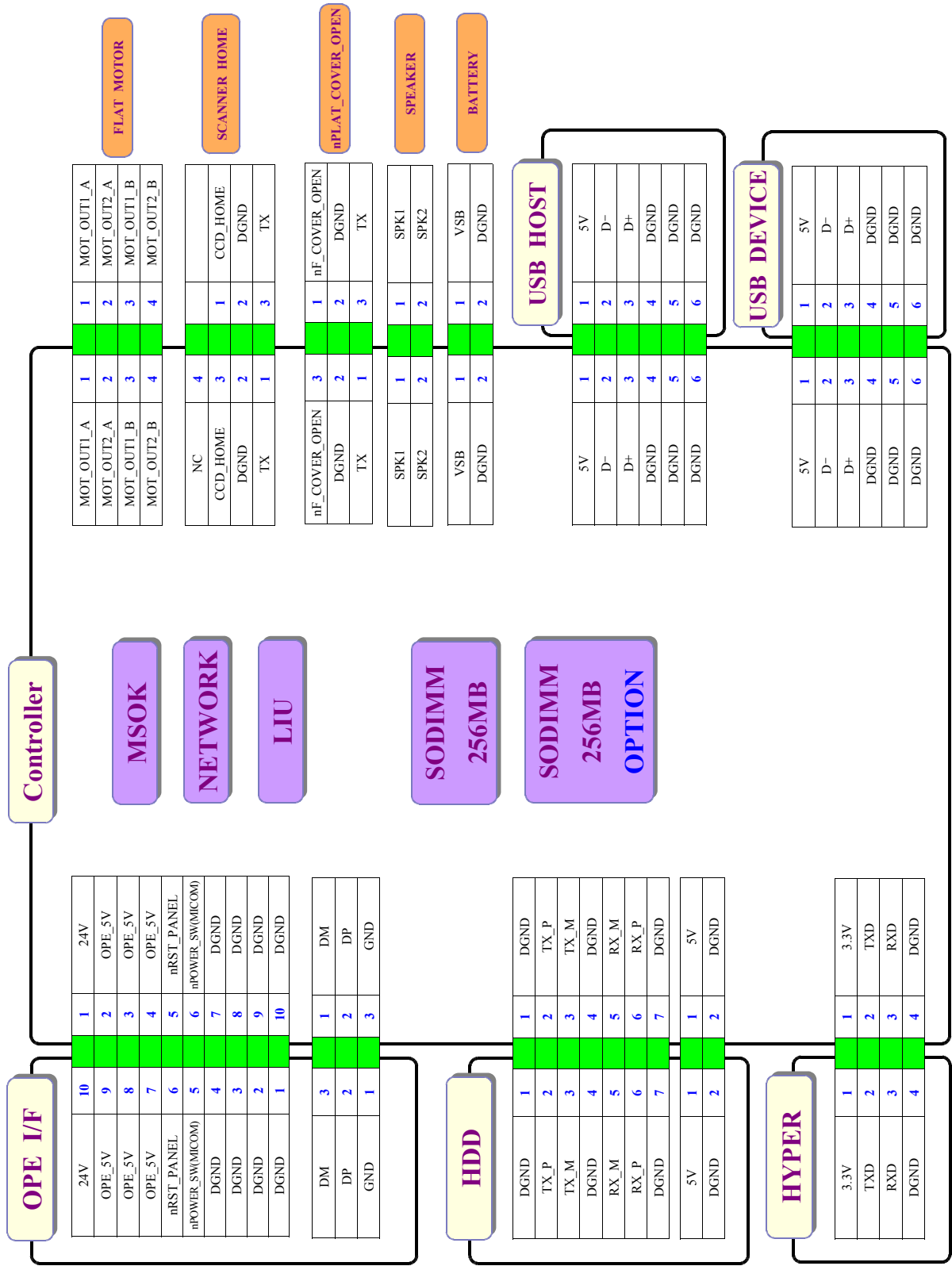

6. Reference Information

This chapter contains the tools list, list of abbreviations used in this manual, and a guide to the location space required when installing the printer. A definition of test pages and Wireless Network information definition is also included.

6.1 Tool for Troubleshooting

The following tools are recommended safe and easy troubleshooting as described in this service manual.

- **DVM (Digital Volt Meter)**

Standard : Indicates more than 3 digits.

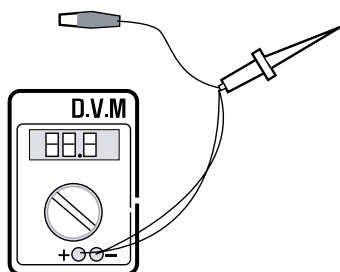

- **Driver**

Standard : “-” type, “+” type (M3 long, M3 short, M2 long, M2 short).

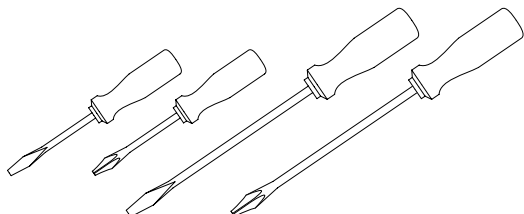

- **Tweezers**

Standard : For general home use, small type.



- **Cotton Swab**

Standard : For general home use, for medical service.



- **Cleaning Equipments**

Standard : An IPA (Isopropyl Alcohol) dry wipe tissue or a gentle neutral detergent and lint-free cloth.

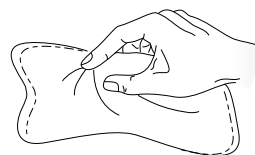

- **Vacuum Cleaner**

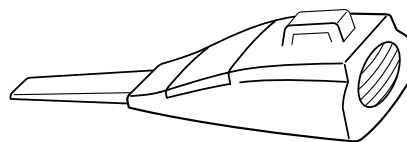

- **Spring Hook**

Standard : For general use



- **Software (Driver) installation CD ROM**

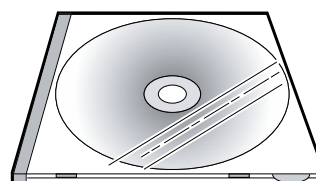

6.2 Acronyms and Abbreviations

The table below explains abbreviations used in this service manual.
The contents of this service manual are declared with abbreviations in many parts. Please refer to the table.

6.2.1 Acronyms

| | | | |
|--------|---|---------|---|
| ABS | Automatic Background Suppression(a kind of copy feature) | FDI | Foreign Device Interface |
| APF | Automatic Paper Feeder(Tray) | FIA | Foreign Interface Attachment |
| BOOTP | BOOTSTRAP PROTOCOL | FRU | Field Replaceable Unit |
| CCD | Charged Coupled Device | FPOT | First Print Out Time |
| CIS | Contact Image Sensor | GW | GateWay |
| CPM | Copies Per Minute | HH | High Temperature, High Humidity (Testing Chamber conditions) |
| CP | Control Panel(= OPE) | HPVC | Halftone Printing Video Controller in the SPGPm (Graphic Processor for Copy) |
| CQ | Copy Quality | IDC | International Data Corp. |
| CRU | Customer Replaceable Unit | IMAP | Internet Message Access Protocol |
| CRUM | CRU Memory | IPP | Internet Printing Protocols |
| CW | Center Ware | IPM | Images Per Minutes |
| CWDP | Center Ware Device Discovery Software(Samsung equivalent of Samsung's SyncThru) | IPX | Internetwork Packet Exchange |
| CWIS | Center Ware Internet Services | IQ | Image Quality |
| DADF | Duplex Auto Document Feeder (= DADH) | ITU | International Telecommunication Union |
| DC | Direct Connect | JBIG | Joint Binary Image Group (a kind of image data coding method) |
| DDNS | Dynamic Domain Name System | JPEG | Joint Photographic Expert Group (a kind of image data coding method) |
| DHCP | Dynamic Host Configuration Protocol | LCD | Liquid Crystal Display |
| DLC | Data Link Control | LEF | Long Edge Feeding |
| DNS | Domain Name System | LL | Low Temperature, Low Humidity (Testing Chamber conditions) |
| ECM | Error Correction Mode | LPR/LPD | Line Printer Daemon Protocols (LPR is a TCP-based protocol) |
| ECP | Enhanced Capability Port | LSU | Laser Scanning Unit |
| e-Coil | Extended Coil technology for Rapid(Fast) Fusing. | LUI | Local User Interface |
| EH&S | Samsung Environment, Health, & Safty | MCBF | Mean Copy Between Failure |
| ESMTP | Extended Simple Mail Transfer Protocol | MDSP | Multiple Document Single Printout |
| EP | Electro Photography | MFP | Multi-Functional Product |
| EPC | Electric Pre-Collation | MH | Modified Huffman (a kind of image data coding method) |
| FCOT | First Copy Out Time | | |

| | | | |
|--------|--|-------------|--|
| MIB | Management Information Base | RT-OS | Real Time Operating System |
| MIME | Multipurpose Internet Mail Extensions | RX | Receive |
| MR | Modified Read (a kind of image data coding method) | S2E | Scan-To-Email |
| MMR | Modified and Modified Read (a kind of image data coding method) | SAD | Solid Area Density |
| MN std | Multi-National Standard | SC | Service Call |
| MSOK | Master SOK(System Operation Key) | SCF | Second Cassette Feeder |
| MSO | Mixed Size Original | SDSP | Single Document Single Printout |
| MP | Multi Purpose | SDMP | Single Document Multiple Printout |
| MPBF | Mean Print Between Failure | SDR | Shut Down Rate |
| MSI | Multi Sheet Input | SEF | Short Edge Feeding |
| MTBF | Mean Time Between Failure | SIR | Sacrificed(or Standard) Image Reference |
| MTTR | Mean Time To Repair | SOK | System Operation Key |
| NCP | Network Control Protocol | sRGB | Standard RGB (Color Coordinate System) |
| NIC | Network Interface Card | SNMP | Simple Network Management Protocol |
| NOS | Network Operating System | TCP/IP | Transmission Control Protocol/Internet Protocol |
| NN | Normal Temperature, Normal Humidity (Testing Chamber conditions) | TBC(or tbc) | To Be Confirmed |
| NSDR | Non-Shut Down Rate(=USDR) | TBD(or tbd) | To Be Determined |
| NW | Network | TIFF | (Adobe & Aldus) Tagged Image File Format |
| OD | Optical Density | TRIM | Technical Retrofit Interim Maintenance |
| OHD | On Hook Dial | TTM | Time to Market |
| OSOK | Optional SOK(System Operation Key) | TX | Transmit |
| OP | Operational Procedure | UI | User Interface |
| PCL | Printer Control Language | UMC | Unit Manufacturing Cost |
| PDF | (Adobe) Portable Document Format | UMR | Unscheduled Maintenance Ratio |
| PPM | Pages Per Minutes | UPnP | Universal Plug and Play |
| PQ | Print Quality | USB | Universal Serial Bus |
| PS/3 | PostScript Level-3 | USDR | Un-Shut Down Rate(=NSDR) |
| PVC | Printing Video Controller in the SPGPm(Graphic Processor for Printer) | XCMI | Samsung's Management Information Base |
| QCD | Quality, Cost, and Delivery | WA | Warranty Action |
| RCP | Remote Control Panel | W x D x H | Width x Depth x Height |

6.2.2 Service Parts

| ACRONYM | EXPLANATION |
|------------------------------|--|
| ELA HOU-SCANNER ASS'Y | ELA=Electrical Assembly, HOU =Housing |
| MEA UNIT-COVER PA EXIT ASS'Y | MEA= Mechanical Assembly, PA=Paper |
| PMO-TRAY EXTENTION MP NE | PMO= Processing Mold MP=Multi-Purpose(Bypass) tray NE=for NEC (common as Samsung Halk printer) |
| MEC-CASSETTE ASS'Y(LETTER) | MEC = Mechanic Combined unit |
| COVER-M-FRONT | M=Mold |
| MPR-NAME/PLATE | MPR= Machinery Press, |
| UNIT-LSU | LSU =Laser Scanning Unit |
| SMPS-SMPS(V1)+HVPS | SMPS =Switching Mode Power Supply HVPS =High Voltage Power Supply |
| ELA-OPC UNIT SET | OPC=Organic Photo-Conductive |
| ELA HOU-MP ASS'Y | MP =Multi-Purpose (Bypass) tray |
| PBA MAIN-MAIN | PBA =Printed circuit Board Assembly |
| PMO-CONNECT PAPER MFP | MFP =Multi-Functional Peripheral |
| FAN-DC | DC =Direct Current |
| CBF POWER STITCH GRAY | CBF= Cable Form |
| MEA UNIT GUIDE CST PA ASS'Y | CST=Cassette(Paper tray), PA=Paper |
| PBA LIU | PBA =Printed circuit Board Assembly LIU =Line Interface Unit for FAX |
| SHIELD-P_MAIN LOWER | P=Press |
| CBF HARNESS-LIU GND | LIU =Line Interface Unit for FAX GND= Ground |
| PMO-COVER FEED AY | AY=Assembly |
| PMO-COVER BRKT MOTER | BRKT=Bracket |
| CBF HARNESS-LSU | LSU =Laser Scanning Unit |
| IPR-SHIELD SMPS UPPERI | IPR=Iron Press |
| PMO-BUSHING P/U.MP | P/U=Pickup MP=Multi-Purpose (Bypass) Tray |
| PMO-HOLDER GEAR TRr | TR= Transfer Roller |
| SPRING ETC-TR_L | TR_L=Transfer Roller - Left |
| PMO-CAM JAM REMOVE | PMO-CAM= Processing Mold-CAM |
| PMO-LOCKER DEVE | DEVE=Developer |

| ACRONYM | EXPLANATION |
|-------------------------------|--|
| SPECIAL SCREW(PANNEL MFP) | MFP =Multi-Functional Peripheral |
| A/S MATERAL-DUMMY UPPER ASS'Y | A/S=After-Service |
| MCT-GLASS ADF | MCT= Machinery Cutting ADF=Automatic Document Feeder |
| PPR-REGISTRATION EDGE(F) | PPR= Processing Press |
| IPR-HOLDER GLASSI | PR=Iron Press |
| MCT-GLASS SCANNER(LLEGAL) | MCT= Machinery Cutting |
| CBF HARNESS-OPE | OPE=Operation Panel(Control Panel) |
| PBA SUB-D_SUB | PBA SUB-D_SUB =>Sub Printed circuit Board Assembly for the D-SUB type electrical connector (D-Sub) a kind of the connector type(shape 'D') |
| COVER-M-CCD CABLE | M=Mold CCD=Charge Coupled Device |
| COVER-SCAN LOWER(UMAX) | UMAX=> Supplier's name for CCD module |
| ICT-INSERT SHAFTI | ICT= Iron Cutting |
| IPR-BRK SCAN BD | IPR=Iron Press BRK=Bracket BD= Board |
| CBF SIGNAL-CCD FFC | CCD = Charge Coupled Device FFC =Flexible Flat Cable |
| COVER-M-OPE | M=Mold OPE=Operation Panel(Control Panel) |
| KEY-M-COPY | M=Mold |
| PLATE-M-ALPHA KEY | M=Molde ALPHA=Alphabet |
| PMO-GUIDE DP SIDE | DP=Duplex |
| RING-CS | CS= Compress |
| GEAR-MP/DUP DRV | MP =Multi-Purpose (Bypass) tray DUP DRV = Duplex Driver |
| IPR-BRKT G DUPI | PR=Iron Press BRKT=BRACKET G= Ground UP=Duplex |
| PMO-BUSHING TX(B4) | TX=Transmit |
| PMO-TRAY CASE, MP | MP=Multi-Purpose tray(Bypass tray) |

| ACRONYM | EXPLANATION |
|----------------------------------|--|
| SPRING CS RE | CS=Compress RE=Rear |
| SPRING CS FR | CS=Compress FR=Front |
| PMO-BUSHING FINGER, F | F=Front |
| ICT-SHAFT-EXIT LOWER ID | ID=Idler |
| SPRING-EXIT ROLL FD | FD=Face Down |
| PMO-BUSHING_P/U,MP | P/U=Pickup MP =Multi-Purpose (Bypass) tray |
| PMO-HOLDER CAM MPF | MPF=Multi-Purpose Feeder(=MP) |
| PMO-GEAR P/U MPF | P/U=Pickup |
| MFP =Multi-Functional Peripheral | |
| RPR-RUBBER PICK UP,MP | RPR=Rubber Press |
| PBA SUB-MP SEN | PBA SUB-MP-SEN =>Sub Printed circuit Board Assembly for the MP-SEN(= Multi-Purpose (Bypass) tray-Sensor) |
| A/S MATERIAL-PICKUP,MP | |
| FOOT-ML80 | |
| HOLDER CATCH CST MC2 | MC2=>McKinley2 (Samsung Project code name) |
| IPR-GROUND PLATE A(OPC) | OPC=Organic Photo-Conductive |
| ELA M/M-AUD SPEAKER | ELA M/M => Electrical Assembly M/M AUD=Audio |
| CBF HARNESS-OPC GND | OPC GNG=Organic Photo-Conductive-Ground |
| IPR-GROUND PLATE SCF | SCF=Second Cassette Feeder(Tray2) |
| PBA SUB-PTL | PBA SUB-PTL=>Sub Printed circuit Board Assembly for the PTL(= Pre Transfer Lamp) |
| PBA SUB-FEED+P.EMP SEN. | PBA SUB-FEED=>Sub Printed circuit Board Assembly for the feeder EMP SEN=Empty Sensor |
| MOTOR STEP-MCK2(MAIN) | |
| GEAR-EXIT/U | EXIT/U=EXIT/Upper |
| GEAR-RDCN FEED INNER | RDCN=Reduction |
| CBF-HARNESS-MAIN-THV WIRE | THV =Transfer High Voltage |
| CBF-HARNESS-MAIN-MHV WIRE | MHV= High Voltage(Charge Voltage) |

| ACRONYM | EXPLANATION |
|----------------------|--|
| GEAR-EXIT/U, ID | U=Upper ID=Idler |
| IPR-TERMINAL FU | FU=Fuser |
| PMO-BEARING H/R-F | H/R-F=Heat Roller - Front |
| BEARING-H/R L | H/R-L=Heat Roller -Left |
| PEX-ROLLER EXIT F_UP | PEX= Processing Extrude F_UP=Face Up |
| SPRING ETC-P/R | P/R=Pressure Roller |
| SPRING(R)-CAU-HOT-FU | CAU-HOT-FU = Caution Hot -Fuser |
| PMO-ARM ACTUATOR | PMO-ARM= Processing Mold Arm |
| LABEL(R)-HV FUSER | HV=High Voltage (220V) |
| LABEL(R)-LV FUSER | LV=Low Voltage (110V) |
| PPR-SPONG SHEET | PPR=Plastic Press |
| IPR-P_PINCH(SCAN)I | PR-P = Iron Press |
| ROLLER-REGI | REGI=Registration |
| PBA SUB-REGI | PBA SUB-REGI => Sub Printed circuit Board Assembly for the Registration |
| GROUND-P_SCAN ROLLER | GROUND-P =Ground-Press |
| IPR-GUARD C/O S/W | C/O = Cover Open S/W= Switch |
| MEA UNIT-TX STACKER | TX =Transmit |
| IPR-WASHER SPRING CU | CU=Curve |

6.3 The Sample Pattern for the Test

The sample pattern shown in below is the standard pattern used in the factory.
 The life of the toner cartridge and the printing speed are measured using the pattern shown below.
 (The image is 70% of the actual A4 size).

6.3.1 A4 ISO 19752 Standard Pattern

This test page is reproduced at 70% of the normal A4 size

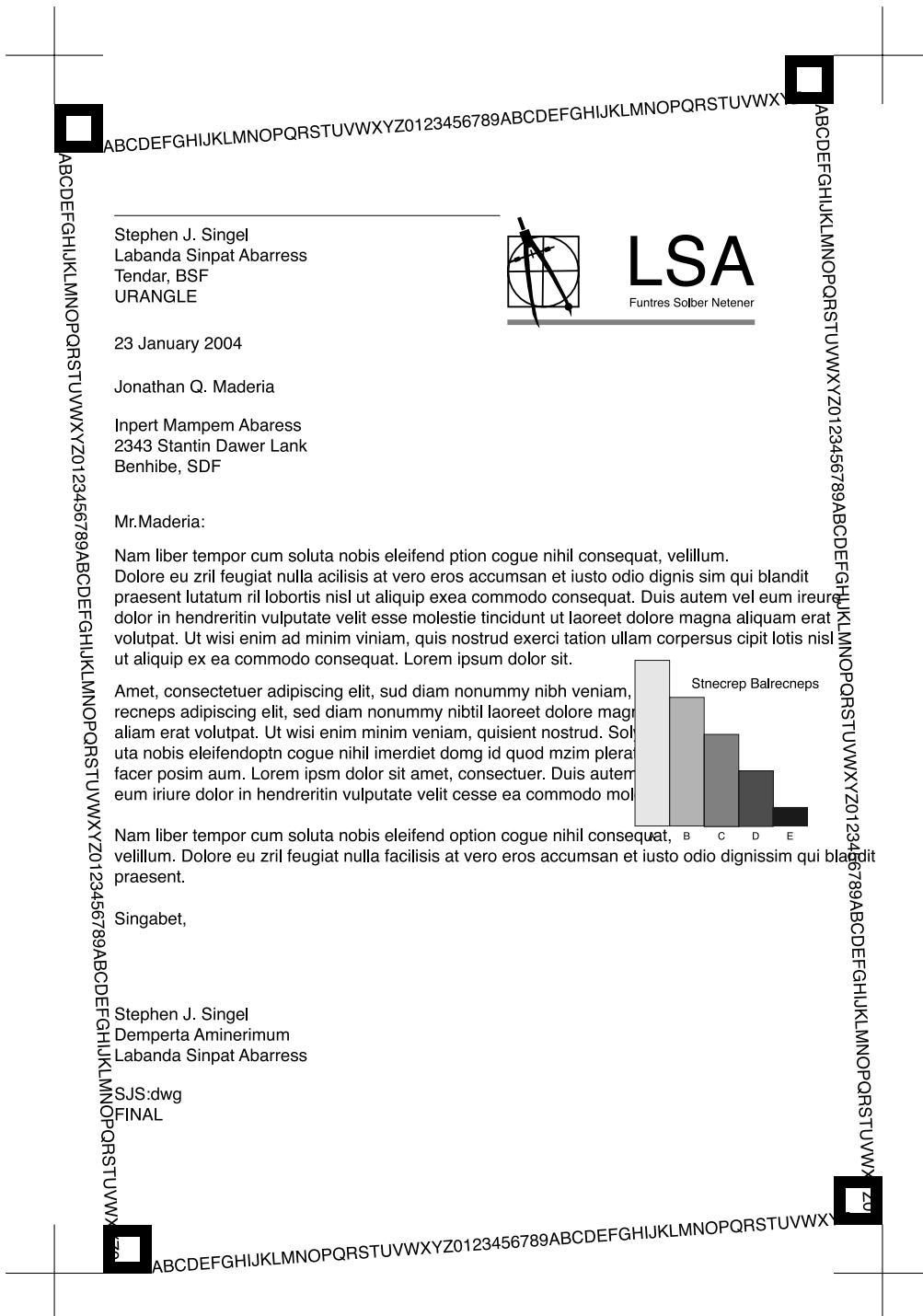

6.4 Selecting a location

Select a level, stable place with adequate space for air circulation. Allow extra space for opening covers and trays.

The area should be well-ventilated and away from direct sunlight or sources of heat, cold, and humidity. Do not set the machine close to the edge of your desk or table.

Clearance space

- Front: 482.6 mm (enough space so that the paper tray can be removed)
- Back: 180 mm (enough space for ventilation)
- Right: 100 mm (enough space for ventilation)
- Left: 100 mm (enough space for ventilation)

