



DIGITAL MIXING CONSOLE

CL5

CL3

CL1

Reference Manual

How to Use This Reference Manual

The CL5/CL3/CL1 Reference Manual (this document) allows you to search for terms and take advantage of links in the text.

Searching for terms

To search for a term, use the search function of the software you're using to view this document.

If you're using Adobe Reader, enter the term in the search box and press the <Enter> key of your computer keyboard to search for occurrences of that term.

Displaying the next/previous view

If you're using Adobe Reader, you can jump to the previous/next view in your viewing history. This is a convenient way to jump back to the previous page after you've used a link to jump to a different page.

Using the Function Tree

A function tree for the CL5/CL3/CL1 is provided on [page 4](#) and following. You can use this function tree to find the page that explains an on-screen display or function.

Contents

- How to Use This Reference Manual 1
- Function Tree 4**
- SELECTED CHANNEL section 6**
 - About the SELECTED CHANNEL section 6
 - Operations in the SELECTED CHANNEL section 6
 - SELECTED CHANNEL VIEW screen 7
- Centralogic section 11**
 - About the Centralogic section 11
 - Operations in the Centralogic section 11
 - OVERVIEW screen 12
- Input and output patching 15**
 - CL console internal patching and Dante audio network patching 15
 - Changing the output patch settings 16
 - Changing the input patch settings 19
 - Inserting an external device into a channel 21
 - Directly outputting an INPUT channel 23
 - Recording or playing back using DAW on a computer 25
- Input channels 27**
 - Signal flow for input channels 27
 - Specifying the channel name, icon and channel color 28
 - Making HA (Head Amp) settings 30
 - Sending a signal from an input channel to the STEREO/MONO buses 35
 - Sending a signal from an input channel to a MIX/MATRIX bus 39
 - Correcting delay between channels (Input Delay) 44
 - Channel library operations 45
- Output channels 46**
 - Signal flow for output channels 46
 - Specifying the channel name, icon and channel color 47
 - Sending signals from MIX channels to the STEREO/MONO bus 48
 - Sending signals from MIX channels and STEREO/MONO channels to
MATRIX buses 51
 - Correcting delay between channels (Output Delay) 55
 - Channel library operations 55

- EQ and Dynamics 56**
 - About EQ and dynamics 56
 - Using EQ 56
 - Using dynamics 59
 - Using the EQ or Dynamics libraries 63
- Grouping and linking 64**
 - About DCA groups and Mute groups 64
 - Using DCA groups 64
 - Using mute groups 66
 - Channel Link function 70
 - Copying, moving, or initializing a channel 73
- Scene memory 77**
 - About scene memories 77
 - Using scene memories 77
 - Editing scene memories 82
 - Using the Global Paste function 85
 - Using the Focus function 87
 - Using the Recall Safe function 88
 - Using the Fade function 91
 - Outputting a control signal to an external device in tandem with scene recall
(GPI OUT) 93
 - Playing back an audio file that links to a scene recall 94
 - Using Preview mode 96
- Monitor and Cue functions 97**
 - About the Monitor and Cue functions 97
 - Using the Monitor function 98
 - Using the Cue function 101
 - Operating the Cue function 102
- Talkback and Oscillator 106**
 - About the Talkback and Oscillator functions 106
 - Using Talkback 106
 - Using the Oscillator function 108
- Meters 111**
 - Operations in the METER screen 111
 - Using an MBCL meter bridge (optional) on the CL3 or CL1 console 113

Graphic EQ, effects, and Premium Rack 114
 About the virtual rack 114
 Virtual rack operations 115
 Graphic EQ operations..... 118
 About the internal effects..... 122
 Using the Premium Rack..... 130
 Using the graphic EQ, effect, and Premium Rack libraries..... 137

I/O device and external head amp 138
 Using an I/O device 138
 I/O device patching 138
 Remotely controlling an Rio unit..... 140
 Remotely controlling an amp..... 143
 Using an external head amp 144

MIDI..... 149
 MIDI functionality on the CL series console..... 149
 Basic MIDI settings 149
 Using Program Changes to recall scenes and library items 152
 Using Control Changes to control parameters 155
 Using Parameter Changes to control parameters 157

User settings (Security) 158
 User Level settings 158
 Preferences 168
 USER DEFINED keys 169
 USER DEFINED knobs..... 171
 Assignable encoders 172
 Custom fader bank 173
 Master fader 174
 Console Lock 175
 Saving and loading setup data to and from a USB flash drive..... 177
 Formatting a USB flash drive 180

Recorder..... 181
 About the USB memory recorder 181
 Assigning channels to the input and output of the recorder..... 181
 Recording audio to a USB flash drive..... 183
 Playing back audio files from a USB flash drive..... 185
 Editing the title list..... 187
 Using the CL console with Nuendo Live..... 188

Help function 193
 Loading a Help file from a USB flash drive..... 193

Loading a text file from a USB flash drive..... 193
 Viewing Help..... 194
 Using USER DEFINED keys to recall Help directly..... 194

Other functions 196
 About the SETUP screen 196
 Word clock and slot settings 198
 Using cascade connections 200
 Basic settings for MIX buses and MATRIX buses..... 202
 Switching the entire phantom power supply on/off..... 203
 Specifying the brightness of the touch screen, LEDs, channel name displays,
 and lamps 204
 Setting the date and time of the internal clock 204
 Setting the network address 205
 Initializing the unit to factory default settings 206
 Adjusting the detection point of the touch screen (Calibration function) 207
 Adjusting the faders (Calibration function) 208
 Fine-tuning the input and output gain (Calibration function) 209
 Adjusting the channel color (Calibration function)..... 211
 Adjusting the brightness of the channel name display 212
 Adjusting the contrast of the channel name display 213
 Dante audio network settings 213
 Using GPI (General Purpose Interface) 221

Appendices 227
 EQ Library List 227
 DYNAMICS Library List 228
 Dynamics Parameters 230
 Effect Type List 232
 Effects Parameters..... 233
 Premium Rack Processor Parameters 245
 Effects and tempo synchronization 247
 Parameters that can be assigned to control changes..... 248
 NRPN parameter assignments 250
 Mixing parameter operation applicability 254
 Functions that can be assigned to USER DEFINED keys 259
 Functions that can be assigned to USER DEFINED knobs..... 262
 Functions that can be assigned to the assignable encoders 263
 MIDI Data Format 264
 Warning/Error Messages..... 271
 Electrical characteristics 273
 Mixer Basic Parameters..... 274
 MIDI Implementation Chart 275
 Index..... 276

Function Tree

Page numbers in parentheses () are the page numbers of the Owner's Manual (booklet).

Main	
SELECTED CHANNEL	6
OVERVIEW	12
FUNCTION ACCESS AREA	(20)

CHANNEL PARAMETER	
PATCH/NAME	16, 29, 48
GAIN/PATCH	31
1ch	31
8ch	32
CH1-48	32
CH49-72/ST IN	32
OUTPUT	Indication only
INPUT DELAY	44
8ch	44
CH1-48	45
CH49-72/ST IN	45
DELAY SCALE	44
INSERT/DIRECT OUT	21
1ch	21, 23
8ch	22, 24
HPF/EQ	56
1ch	56
8ch	57
CH1-48	58
CH49-72/ST IN	58
OUTPUT	58
DYNAMICS	59
1ch	59
KEY IN SOURCE SELECT	62
8ch	61
CH1-48	62
CH49-72/ST IN	62
OUTPUT	62

SEND TO/SEND FROM	41, 52
TO STEREO/MONO	49
8ch	49
CH1-48	50
CH49-72/ST IN	50
OUTPUT	50

LIBRARY	
CHANNEL LIBRARY	45
EQ LIBRARY	63
DYNAMICS LIBRARY	63
GEQ LIBRARY	137
EFFECT LIBRARY	137
Portico5033/Portico5043/U76/Opt-2A/ EQ-1A/DynamicEQ LIBRARY	137
DANTE INPUT PATCH LIBRARY	139

RACK	
VIRTUAL RACK	115
RACK MOUNTER	116
GEQ EDIT	118
GEQ LINK	119
EFFECT RACK	122
EFFECT EDIT	125
EFFECT TYPE	126
PREMIUM RACK	130
PREMIUM RACK MOUNTER	131
PREMIUM RACK EDIT	132

I/O DEVICE	
DANTE PATCH	138
DANTE SETUP	138
DANTE INPUT PATCH	138
DANTE OUTPUT PATCH	140
Rio	140
REMOTE HA EDIT	141
DANTE OUTPUT PATCH	142
AMP	143
DANTE OUTPUT PATCH	143
EXTERNAL HA	146
EXTERNAL HA EDIT	147
EXTERNAL HA PORT SELECT	147

MONITOR	
MONITOR	98
CUE	103
MONITOR	99
OSCILLATOR	109
TALKBACK	107

METER	
INPUT METER	111
OUTPUT METER	111

SETUP	
USER SETUP	196
PREFERENCE	168
USER DEFINED KEYS SETUP	169
USER DEFINED KEY SETUP (List)	170
USER DEFINED KNOBS SETUP	171
USER DEFINED KNOB SETUP (List)	171
ASSIGNABLE ENCODER SETUP	172
CUSTOM FADER BANK/MASTER FADER	173
FADER ASSIGN SELECT	174

SETUP	
USER LEVEL/CREATE USER KEY	158
CREATE KEY	160
SAVE KEY	165
LOGIN	161
SAVE/LOAD	177
WORD CLOCK/SLOT	198
CASCADE IN/OUT PATCH	200, 202
OUTPUT PORT	18
MIDI/GPI	149, 221
MIDI SETUP	150
PROGRAM CHANGE	152
CONTROL CHANGE	155
GPI	222
FADER START	225
BUS SETUP	202
CONSOLE LOCK	175
DATE/TIME	204
NETWORK	205
DANTE SETUP	213

SCENE	
SCENE LIST	79
GLOBAL PASTE	85
FADE TIME	91
SONG SELECT	95
FOCUS RECALL	87
PREVIEW	96

RECORDER	
USB	181
NUENDO LIVE	188

CH JOB	
CH LINK MODE	71
DCA GROUP ASSIGN	64
MUTE GROUP ASSIGN	66
RECALL SAFE MODE	88
CH COPY MODE	73
CH MOVE MODE	74
CH DEFAULT MODE	76

PATCH	
PORT SELECT	22, 24, 100, 104, 139, 201
CH SELECT	19, 117, 174, 175, 182

Others	
CONFIRMATION	168
SOFT KEYBOARD	(21)
LOGIN	161

Startup Menu	
MODE SELECT	206
INITIALIZE ALL MEMORIES	206
INITIALIZE CURRENT MEMORIES	206
TOUCH SCREEN CALIBRATION	207
INPUT PORT TRIM	210
OUTPUT PORT TRIM	210
SLOT OUTPUT TRIM	210
FADER CALIBRATION	208
CHANNEL COLOR CALIBRATION	211

NOTE

- The explanations in this reference manual will use the CL5.
- In the case of the CL3/CL1, some screens will not show channels and faders that do not exist on those models.

SELECTED CHANNEL section

This chapter explains how to use the SELECTED CHANNEL section and the SELECTED CHANNEL VIEW screen to control the selected channel.

About the SELECTED CHANNEL section

The SELECTED CHANNEL section located to the left of the display corresponds to the mixer module on a conventional analog mixer, and enables you to manually adjust all the major parameters of the currently-selected channel.

Operations in this section will affect the channel that was most recently selected by its [SEL] key. If you have assigned an ST IN channel or STEREO channel to a single channel strip, either the L or the R channel will be selected, and the major parameters for L and R channels will be linked. You can use the knobs on the panel to control mix parameters such as head amp gain, HPF/EQ settings, the threshold setting of the dynamics processors, pan/balance settings, and send levels to the MIX/MATRIX buses.

Operations in the SELECTED CHANNEL section

Follow the steps below to perform operations in the SELECTED CHANNEL section.

1. Use a [SEL] key to select the channel you want to control.

To select a channel, press a [SEL] key in the top panel channel strip section, the Centralogic section, or the master section.

Press the appropriate bank select key so that the channels you want to control are assigned to the top panel.

The number and name of the currently-selected channel is shown in the channel select field located in the Function Access Area of the touch screen.

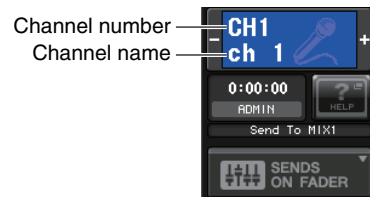

NOTE

- If an ST IN channel or STEREO channel has been assigned to a single channel strip, you can switch between L and R by repeatedly pressing the same [SEL] key.
- You can also switch channels by pressing the channel select field located in the Function Access Area. Press the left side of the field to select the preceding channel. Press the right side of the field to select the next channel.

2. Press one of the knobs in the SELECTED CHANNEL section.

Press a knob in the SELECTED CHANNEL section to display the SELECTED CHANNEL VIEW screen for the currently-selected channel. If you leave this screen displayed, you will always be able to view the settings in the screen while operating the knobs in the SELECTED CHANNEL section.

NOTE

If you have turned on the option “POPUP APPEARS WHEN KNOB(S) PRESSED” on the PREFERENCE tab (accessed by pressing the SETUP button, then the USER SETUP button), pressing a knob repeatedly will open or close the popup window (1ch).

Even if a different screen is selected, the knobs in the SELECTED CHANNEL section will always affect the currently-selected channel. In this case, a window indicating the value of that parameter will appear on screen when you operate a knob.

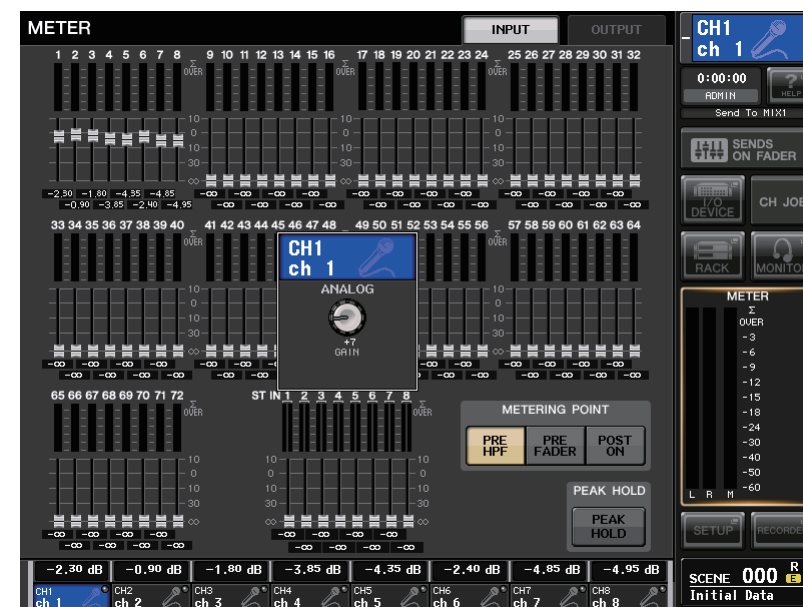

3. Use the knobs in the SELECTED CHANNEL section and the buttons on the SELECTED CHANNEL VIEW screen to edit the parameters of the selected channel.

SELECTED CHANNEL VIEW screen



SEND field

In this field, you can view the send level from the channel to each MIX/MATRIX bus, switch the on/off status of the send signals, and switch between pre and post.

1 Tabs

Enable you to select a group of 16 output bus channels to be displayed in the SEND field.

- **MIX1-16 tab**..... displays MIX buses 1-16.
- **MIX17-24/MATRIX tab**..... displays MIX buses 17-24 and MATRIX buses 1-8.

The view and the function of the knobs and buttons in the SEND field vary depending on whether a pair of bus channels (odd-numbered and even-numbered) are comprised of two mono channels or a stereo channel.



If the destination bus channels are two mono channels:

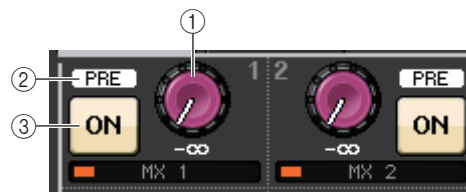

- 1 **SEND knob**
Sets the send level to the corresponding bus.
- 2 **PRE indicator**
Indicates the send point of the corresponding bus. If the PRE button on the MIX SEND 8ch screen is turned ON, this PRE indicator will be turned on.
- 3 **ON button**
Switches the send signal to the corresponding bus on or off.

If the destination bus is a stereo channel:

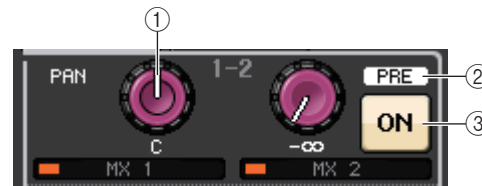

- 1 **SEND/PAN knob**
The right-hand knob adjusts the level of the signal sent to a pair of bus channels (even-numbered and odd-numbered). The left-hand knob adjusts the pan and balance of the same signal.
- 2 **PRE indicator**
Indicates the send point of the corresponding bus. If the PRE button on the MIX SEND 8ch screen is turned ON, this PRE indicator will be turned on.
- 3 **ON button**
Press the right-hand button to switch on or off the signal sent to two bus channels.

NOTE

- If the indices of a SEND/PAN knob are white, the send point is assigned as PRE; if the indices are black, it is assigned as POST.
- If the send point is PRE, you can specify the PRE point as either VARI [PRE EQ] or VARI [PRE FADER] in the BUS SETUP popup that appears when you press the SETUP button → BUS SETUP button.
- If the type of the destination bus is set to FIXED, controllers ①-② mentioned above will not be displayed. The send level will be fixed at nominal level, and the send point will be fixed at POST FADER. For details, see “Basic settings for MIX buses and MATRIX buses” on page 202.
- Press the SEND LEVEL knob or PAN knob on screen to open the SEND 8ch popup window.

■ GAIN/PATCH field

This field enables you to make HA (head amp) analog gain settings, and view the operational status of the head amp.

① GAIN knob

Sets the analog gain of the head amp.

For a channel to which the head amp has not been patched, a gray circle appears, instead of the knob. Press the knob to open the GAIN/PATCH 1ch popup window. If the Gain Compensation function is turned on, an indicator appears, showing the level of the signal output to the audio network.

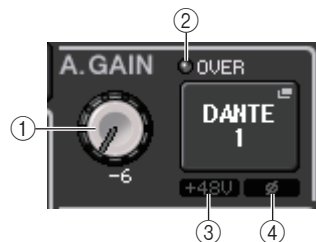

② OVER indicator

Warns you when the signal is clipping.

③ +48V indicator

Indicates the phantom power on or off status for the head amp.

④ Ø (Phase) indicator

Indicates the input phase setting for the head amp.

NOTE

- For an input channel that is patched to an input that has no head amp, ① will be a gray circle and ③ will not be shown. For an output channel, ① will be a gray circle, and ②–④ will not be shown.
- If GAIN KNOB FUNCTION is set to DIGITAL GAIN in the USER SETUP → PREFERENCE screen, the digital gain knob will appear for ①, and ③ will not be displayed. For details, refer to “Making HA (Head Amp) settings” on page 30.

■ PAN/BALANCE field

This field enables you to switch the on/off status of the signal sent from the selected channel to the STEREO/MONO bus, and adjust the pan and balance.

The view and the function of the controllers in this field vary depending on the type of the selected channel.

When an input channel or MIX channel is selected:

① TO STEREO PAN knob

Sets the pan position of a signal routed to the STEREO bus.

Press the knob to open the STEREO/MONO 8ch popup window. If the ST IN channel is selected, you can specify whether to view the PAN knob or the BALANCE knob in this popup window. For a MIX channel, the PAN knob will appear if the signal is mono, and the BALANCE knob will appear if the signal is stereo.



② ST/MONO button

Switches the on/off status of a signal sent from the channel to the STEREO/MONO bus.

If an INPUT/MIX channel is set to LCR mode, the LCR button appears in location ②.

The LCR button is an overall on/off switch for the signals sent from the channel to the STEREO/MONO bus.



When a MATRIX, STEREO, or MONO channel is selected:

① BALANCE knob

If the signal on the selected channel is stereo, the BALANCE knob will appear, enabling you to adjust the volume balance for the left and right channels. If the channel signal is monaural, a gray circle will appear in this location.

Press the knob to open the TO STEREO 8ch popup window.

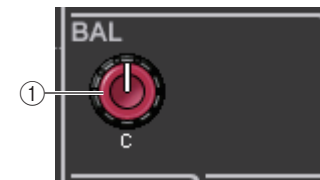

■ INPUT DELAY field

This field enables you to view the delay settings.

① ON indicator

Indicates the on/off status of the delay. If the delay is off, the indicator will not be displayed.

② Delay time

The delay value is displayed by milliseconds (ms) and also by currently-selected scale. If the scale uses units of ms, the value in the bottom row will not be displayed. Only the ms value appears in the middle row.

Press this field to open the INPUT DELAY 8ch popup window.

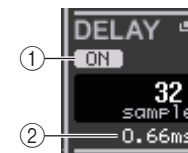

■ HPF field (input channels only)

This field enables you to set the HPF.

① HPF knob

Sets the HPF cutoff frequency.

② ON button

Switches the HPF on or off.

If an output channel is selected, a gray circle will appear in location ①, and button ② will be hidden.



■ EQ parameter field

This field displays the 4-band EQ parameter settings.

① Q knob

Specifies the Q for each band.

If the HIGH band filter type is set to LPF or H. SHELF (high-shelving), or the LOW band filter type is set to L. SHELF (low-shelving), the Q knob will not be displayed. Only the filter type name will be displayed.



NOTE

- Fully rotating the HIGH band Q knob on the panel counter-clockwise while pressing and holding it down will set the filter type to LPF. Fully rotating the Q knob clockwise while pressing and holding it down will set the filter type to high-shelving.
- Fully rotating the LOW band Q knob on the panel clockwise while pressing and holding it down will set the filter type to low-shelving.
- If an output channel has been selected, fully rotating the LOW band Q knob on the panel counter-clockwise while pressing and holding it down will set the filter type to HPF.
- You can also switch the filter type on the HPF/EQ 1ch popup window.

② FREQUENCY knob

Sets the center frequency (or cutoff frequency) for each band.

③ GAIN knob

Sets the amount of cut/boost for each band.

NOTE

- If the HIGH band filter type is set to LPF, you can switch LPF on or off using the HIGH band GAIN knob on the panel.
- If the LOW band filter type is set to HPF, you can switch HPF on or off using the LOW band GAIN knob on the panel.
- Press each knob to open the HPF/EQ 1ch popup window.

■ EQ graph field

This field graphically indicates the approximate response of the EQ. Press this field to open the HPF/EQ 1ch popup window, in which you can set the attenuator, HPF and EQ.

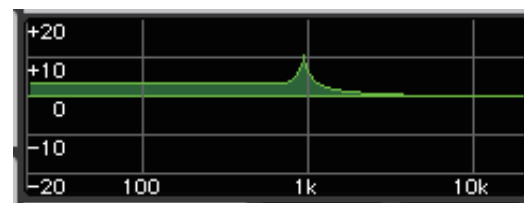

■ DYNAMICS 1/DYNAMICS 2 field

This field enables you to view and set the Dynamics 1/2 parameters.

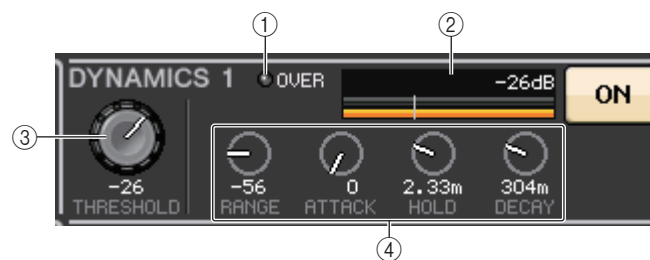

① OVER indicator

Warns you when the signal is clipping.

② Level meter

Displays the output signal level (green) and the amount of gain reduction (orange) when the Dynamics is on. The current threshold setting is shown as a white vertical line.

③ Threshold

Specifies the threshold.

④ Parameters

Indicate the values of parameters that vary depending on the currently-selected dynamics type. Press this field to open the DYNAMICS 1/DYNAMICS 2 1ch popup window, in which you can make detailed parameter settings.

■ INSERT field

This field enables you to make insert settings.

① **Popup button**

Press this button to open the INSERT/DIRECT OUT 1ch popup window.

② **ON button**

Switches the insert on or off.

③ **RACK EDIT popup button**

Appears if an effect or Premium Rack is inserted. Press this button to display the edit screen for the inserted rack.

④ **IN indicator**

Appears if a port has been assigned to the insert-in patch. It lights when the signal is sent to the insert-in.

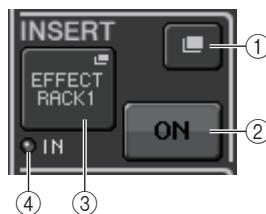

■ DIRECT OUT field

This field enables you to make insert settings.

① **Popup button**

Press this button to open the INSERT/DIRECT OUT 1ch popup window. The Direct Out level value will appear below the button.

② **ON button**

Switches the Direct Out on or off.

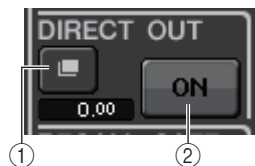

■ RECALL SAFE field

This field enables you to make Recall Safe settings.

① **Popup button**

Press this button to open the RECALL SAFE popup window.

② **ON button**

Switches the Recall Safe status on or off.

③ **PARTIAL indicator**

This will light if recall safe applies only to some of the parameters, not to all channel settings.

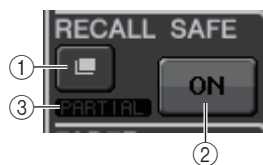

■ FADER field

This field enables you to view and make settings for the channel on/off status and the level.

① **Fader**

Displays the current level.

Use the faders on the top panel to set the levels.

② **Level indicator**

Displays the current level setting by numerical value. If the signal is clipping at any point in the channel, the ΣCLIP indicator will light.

③ **ON button**

Switches the channel status on or off. The button is linked with the corresponding [ON] key on the top panel.

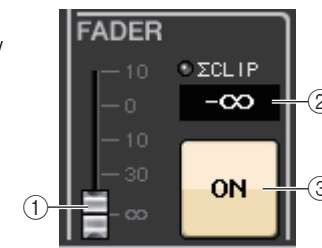

■ DCA/MUTE field

This field enables you to view and select the DCA or mute group to which the channel is assigned.

① **Tabs**

Select DCA or mute as a group to set. Press the selected tab once again to open the DCA/MUTE GROUP ASSIGN MODE popup window.

When the DCA group tab is selected:

② **DCA group select buttons**

Select the DCA group to which the channel is assigned.

③ **Mute group indicators**

Indicate the mute group to which the channel is assigned.

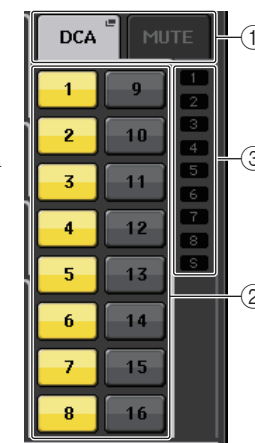

When the mute group tab is selected:

④ **Mute group select buttons**

Select the mute group to which the channel is assigned.

NOTE

If the dimmer level is set to the mute group, this button lights orange.

⑤ **MUTE SAFE button**

Temporarily removes the channel from the mute group.

⑥ **DCA group indicators**

Indicate the DCA group to which the channel is assigned.

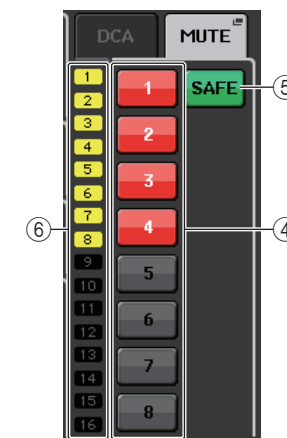

Centralogic section

This chapter explains how to use the Centralogic section and the OVERVIEW screen to simultaneously control up to eight channels.

About the Centralogic section

The Centralogic section is located below the touch screen, and lets you recall and simultaneously control a set of up to eight input channels, output channels, or DCA groups. Use the Bank Select keys in the Centralogic section to select the channels that you want to control.

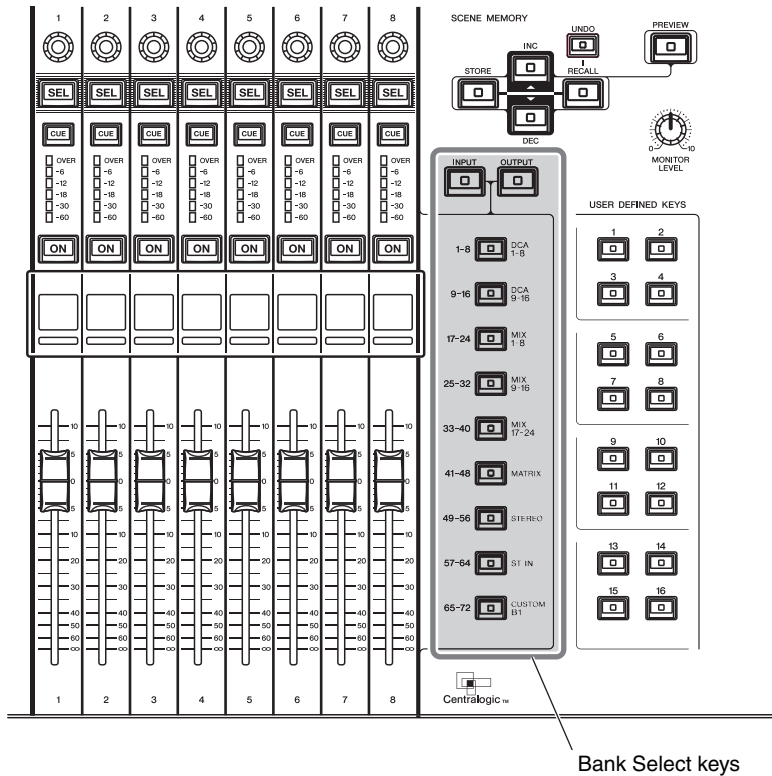

If you press one of the Bank Select keys, the channels or DCA groups corresponding to that key will be assigned to the Centralogic section, and can be controlled using the faders, [ON] keys, and [CUE] keys in the Centralogic section.

Operations in the Centralogic section

Follow the steps below to perform operations in the Centralogic section.

1. Use the Bank Select keys in the Centralogic section to select the channels or DCA groups that you want to control.

When you press a Bank Select key, the LED of that key will light. The touch screen will display the OVERVIEW screen, and the parameters of the eight channels you selected will appear.

NOTE

When the SELECTED CHANNEL VIEW screen is displayed, you can switch to the OVERVIEW screen by pressing any of the multifunction knobs 1–8. This is convenient if you want to quickly switch to the OVERVIEW screen while leaving the same channels or DCA groups selected for control.

2. Use the faders and [ON] keys in the Centralogic section to adjust the level of the group of up to eight selected channels and switch them on or off.

NOTE

- The bottom line of the OVERVIEW screen shows the channels or DCA groups that can be controlled by the faders, [ON] keys and [CUE] keys in the Centralogic section.
- The top line of the OVERVIEW screen shows the channels that can be controlled by multifunction knobs 1–8 in the Centralogic section.

3. Use the fields on the OVERVIEW screen and the multifunction knobs to adjust the parameters for the group of up to eight channels.

OVERVIEW screen

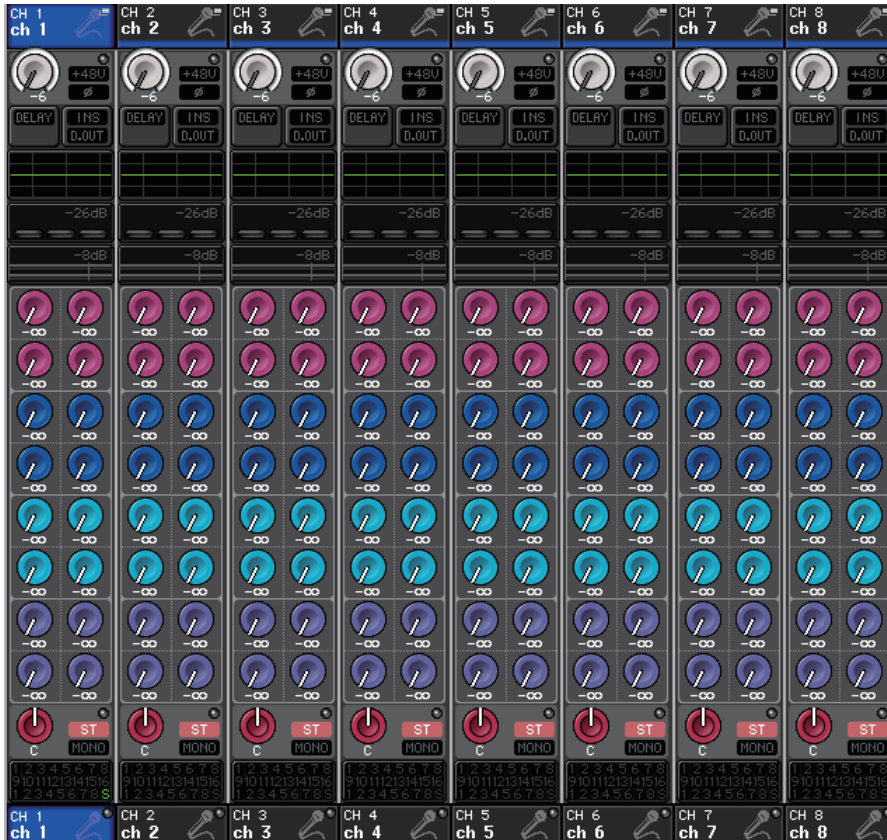

CHANNEL NAME field

This field appears at the top and bottom of the screen and displays the channel number, name, and icon for the currently-selected eight channels. The name of the currently-selected channel is highlighted.

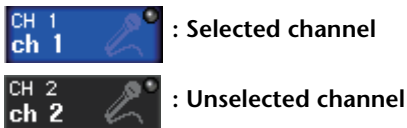

NOTE

If you have retained the channels assigned to the faders in the Centralogic section by pressing and holding down a Bank Select key, the channel names shown at the top and bottom of the OVERVIEW screen may differ.

GAIN/PATCH field

This field enables you to make HA (head amp) analog or digital gain settings and view the operational status of the head amp.

The view and the function of the controllers in this field vary depending on the type of the selected channel.

If the head amp is patched:



① GAIN knob

Sets the analog gain of the head amp.

- Press this field to assign the GAIN knob to the corresponding knob in the Centralogic section, which enables you to adjust the gain. If the Gain Compensation function is turned on, an indicator appears, showing the level of the signal output to the audio network.
- If the GAIN knob has been assigned to a knob in the Centralogic section, press the knob to open the GAIN/PATCH 8ch popup window.

② OVER indicator

Lights when the signal at the input port or from the rack output exceeds the full scale level. This indicator is available only if an input channel is selected.

③ +48V indicator

Indicates the phantom power (+48V) on or off status for the head amp. This indicator is not displayed unless the head amp is patched to the channel.

④ Ø (Phase) indicator

Indicates the input phase setting for the head amp. This indicator is available only if an input channel is selected.

NOTE

- If the slot is not connected to the head amp, the patch and the type of the MY card will be displayed.
- If GAIN KNOB FUNCTION is set to DIGITAL GAIN in the PREFERENCE screen, the digital GAIN knob will appear instead of knob ①, and indicator ③ will not be displayed. If the Gain Compensation function is turned on, an indicator appears, showing the level of the signal output to the audio network.

If the slot is patched:

The slot name will appear.



If the rack is connected:

The patch and module name will appear.



If the output is connected:

Only the patch will appear.



■ **INPUT DELAY field**

This field displays the delay status for the input channel. If an output channel has been selected, this field will be blank. Press this field to open the INPUT DELAY 8ch popup window.



① **DELAY ON/OFF indicator**

Indicates the on/off status of the delay.

■ **INSERT/DIRECT OUT field**

This field enables you to make insert and Direct Out settings. Press this field to open the INSERT/DIRECT OUT 8ch popup window.



① **INSERT ON/OFF indicator**

Indicates the insert on/off status.

② **DIRECT OUT ON/OFF indicator (input channels only)**

Indicates the Direct Out on/off status.

■ **EQ field**

This field graphically indicates the approximate response of the EQ. Press this field to open the HPF/EQ 1ch popup window, in which you can set the HPF and EQ.

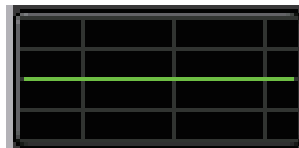

NOTE

If DCA or monitor has been selected, this field will be blank.

■ **DYNAMICS 1/2 field**

This field displays the threshold value and meter for Dynamics 1/2. Press this field to open the DYNAMICS 1/2 1ch popup window.



NOTE

If DCA or monitor has been selected, this field will be blank.

■ **SEND field**

This field displays the send level, send on/off status, and pre/post settings for 16 buses.

To select the 16 destination buses, use the [MIX 1–16] or [MIX 17–24/MATRIX] key in the SELECTED CHANNEL section on the panel.

Use the Centralogic multifunction knobs to adjust the send level for each bus. Touch the knob of the bus you want to operate; it will be assigned to the Centralogic multifunction knobs. If it is assigned to the multifunction knobs, touching that knob once again will display the SEND 8ch popup screen.

This field varies depending on the type of the destination bus.

If the destination bus is VARI (mono):

The knob color and scale color indicate the send on/off and pre/post status. If the send is off, the knob color turns gray. With the post setting, the knob scale color turns black.



If the destination bus is VARI (stereo):

If a pair of buses (odd-numbered and even-numbered) are in stereo, the left-hand knob will function as the PAN knob, and the right-hand knob will function as the SEND knob.

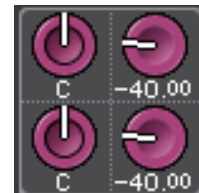

If the destination bus is set to FIXED:

The SEND ON/OFF button will appear instead of each knob.



■ **TO STEREO/MONO field**

This field displays the on/off status and pan/balance setting of the signal sent to the STEREO/MONO bus.

If you press this field, the knob will be assigned to the corresponding knob in the Centralogic section. If you press the field once again, the TO STEREO/MONO 8ch popup window will appear.

This field varies depending on the type of the selected channel.

When an input channel or MIX channel is selected:



① **TO STEREO PAN knob**

Sets the pan position of a signal routed to the STEREO bus.

Press the knob to open the STEREO/MONO 8ch popup window. If the ST IN channel is selected, you can specify whether to view the PAN knob or the BALANCE knob in this window. For a MIX channel, the PAN knob will appear if the signal is mono, and the BALANCE knob will appear if the signal is stereo.

② **ST/MONO indicator**

Indicates the status of a signal sent to the STEREO/MONO bus.

If an input or MIX channel is set to LCR mode, the LCR indicator will be displayed in location ②.



When a MATRIX channel (monaural) or MONO channel is selected:

The ΣCLIP indicator appears, indicating that the signal is clipping at some point in the channel.



For a stereo MATRIX channel or STEREO channel, the BALANCE knob appears, indicating the balance of the left/right channels.



■ **DCA group field**

A DCA group (1–16) to which the channel is assigned is displayed on the first or second row in this field.

Press this field to open the DCA/MUTE GROUP ASSIGN MODE popup window.



■ **Mute group field**

A mute group (1–8) to which the channel is assigned is displayed on the third row in this field. If the channel has been temporarily removed from the mute group, “S” (Safe) will appear on the third row. If the dimmer level has been set for a mute group, the color of the characters changes from red to orange.

Press this field to open the DCA/MUTE GROUP ASSIGN MODE popup window.

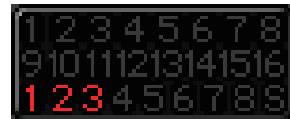

Input and output patching

This chapter explains how to edit the input patching and output patching, how to connect inserts, and how to use direct outputs.

CL console internal patching and Dante audio network patching

The following diagram shows the signal flow through the CL series console, I/O devices, and Dante audio network.

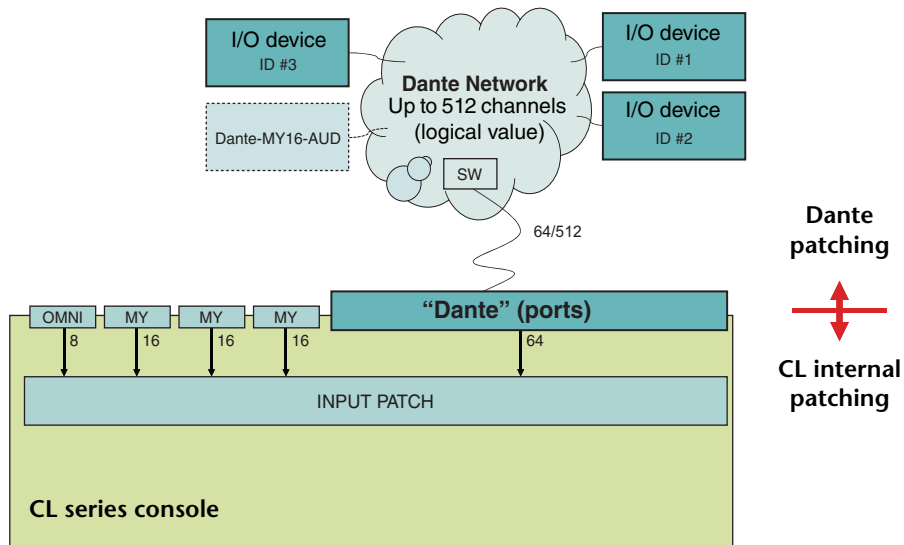

Input patching

CL series consoles and I/O devices feature two types of patching: Dante audio network patching and CL console internal patching.

For Dante audio network patching, you will use the DANTE INPUT PATCH popup window. In this window, you can patch CL console and I/O device inputs. Sixty-four (64) channels can be input from a Dante audio network to a CL series console. You can choose up to 64 channels from maximum of 512 channels (logical value) of Dante audio network signals. Select the I/O devices (within 64 channels) that you want to control from the CL series console.

Then, route the input signals (that were patched in the DANTE INPUT PATCH popup window) to channels on the CL series console. To do this, choose input ports from DANTE 1–64 in the GAIN/PATCH popup window.

NOTE

By default, DANTE 1–64 are assigned to input channels 1–64.

Output patching

Use the OUTPUT PORT popup window to patch CL console's output channels and Dante audio network. In this window, assign output channel signals to DANTE 1–64 ports.

NOTE

By default, MIX 1–24 are assigned to DANTE 1–24, MATRIX 1–8 are assigned to DANTE 25–32, STEREO L/R are assigned to DANTE 33/34, and MONO is assigned to DANTE 35.

Next, patch the output signals from DANTE 1–64 (assigned in the OUTPUT PORT popup window) to I/O device outputs. Use the OUTPUT PATCH popup window of the I/O device to make these assignments.

Changing the output patch settings

To change the patching, you can either select the output port that will be the output destination of each output channel, or you can select the output channel that will be the output source for each output port.

Selecting the output port for each output channel

1. Use the Bank Select keys in the Centralogic section to access the OVERVIEW screen containing the output channel for which you want to assign the output port.

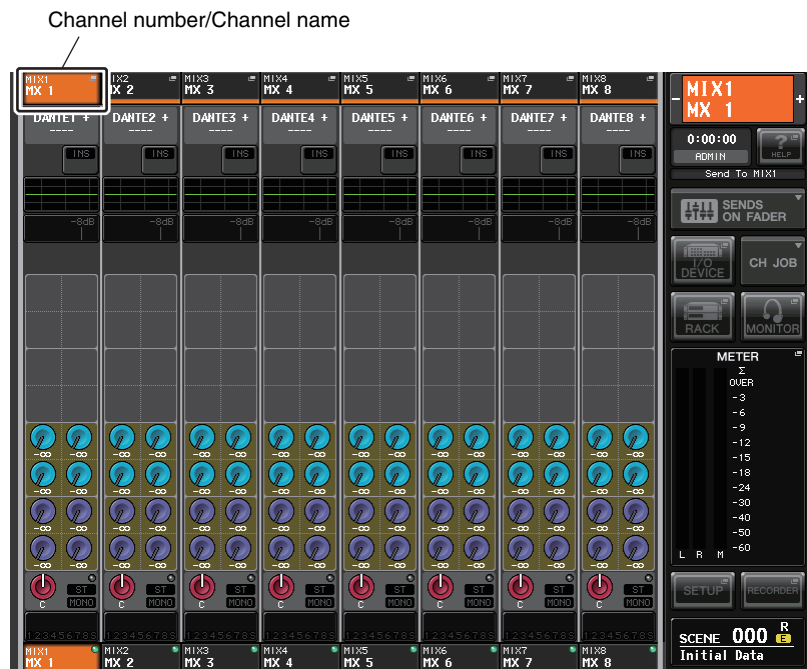

2. In the top part of the screen, press the channel number/channel name field to access the PATCH/NAME popup window.

In the PATCH/NAME popup window you can change the channel name, icon, and output port assigned to each output channel. The window includes the following items.



1. **PATCH button**
Indicates the port that is patched to the input or output channel. Press this button to enable the PATCH tab at the bottom of the screen. The PORT SELECT popup window will appear, enabling you to select the network and port.

2. **Channel select button**
Selects the channel to set.

NOTE

Switching channels on this screen will not affect the channel selection on the console.

3. **Channel icon button**
Indicates the icon and color that are currently selected for the corresponding channel. Press this button to enable the ICON tab at the bottom of the screen. The CH COLOR/ICON popup window will appear, enabling you to select the color, icon, and channel name.
4. **Channel number display box**
Indicates the channel number. This item cannot be changed.

⑤ **Channel name edit box**

Indicates the currently-specified channel. Press the inside of this box to enable the NAME tab at the bottom of the screen. The SOFT KEYBOARD popup window will appear, enabling you to edit the channel name.

⑥ **Category select list**

Selects the type of the port you want to display on the screen.

⑦ **Port select buttons**

Enable you to select a port in the current category. To cancel the selection, press the same button once again.

3. Use the output port select tabs and the output port select buttons to specify the output port that will be assigned to that channel.

If the output port select buttons are not shown at the bottom of the window, press the PATCH tab.

4. Use the Bank Select keys and the [SEL] keys to switch the output channels being controlled, and specify their output ports in the same way.

5. When you have finished making settings, press the “x” symbol located in the upper right to close the window.

You will return to the OVERVIEW screen.

Selecting the output channel for each output port

1. In the Function Access Area, press the SETUP button to access the SETUP screen.



2. In the SYSTEM SETUP field located in the center of the screen, press the OUTPUT PORT button to open the OUTPUT PORT popup window.

In the OUTPUT PORT popup window, you can assign the source channel for each output port. This popup window includes the following items.



① **Slot number/Card type**

If an output channel of slot 1–3 is selected for operations, this area indicates the slot number and the type of I/O card installed in that slot.

② **DELAY SCALE button**

Press this button to open the DELAY SCALE popup window, in which you can select the unit for the delay time.

③ **Output port**

This is the type and number of the output port to which the channel is assigned.

④ **Channel select popup button**

Enables you to select the channel that you want to assign to the output port. The name of the currently-selected channel is displayed.

⑤ **Delay time knob**

Sets the delay time of the output port. Press this knob to select it, and then use multifunction knobs 1–8 to adjust the settings. The millisecond delay time value is indicated above the knob, and the delay time value in the units selected in the DELAY SCALE popup window is indicated below the knob.

NOTE

If you have selected ms (millisecond) as the scale, the delay time value will not appear above the knob.

⑥ **DELAY button**

Switches the output port delay on or off.

⑦ **Ø (Phase) button**

Switches the phase of the signal assigned to the output port between normal phase and reverse phase.

⑧ **GAIN knob**

Adjusts the output gain of the output port. To adjust this value, press the knob on screen to select it, and then operate multifunction knobs 1–8. Rotate the knob to set the value in the range of –96 to +24 dB in 1.0 dB steps. Rotate the knob while pressing and holding it down to set the value in 0.1 dB steps. The current value appears immediately below the knob.

⑨ **Level meter**

Indicates the level of the signal assigned to the output port.

⑩ **Output port select tabs**

Switch the output ports controlled in the popup window in groups of up to eight ports. Tabs are categorized into three groups: DANTE, SLOT, and PATCH VIEW. To display tabs in the desired group, press the group name button located at the right or left end of the bottom row.

3. Use the output port select tabs at the bottom of the popup window to select the output port you want to control.

The tabs correspond to the following output ports.

- **DANTE 1–8, 9–16, 17–24, 25–32, 33–40, 41–48, 49–56, 57–64**
These tabs control the output channels of the Dante connectors.

- **SLOT1 1–8, 9–16**
- **SLOT2 1–8, 9–16**
- **SLOT3 1–8, 9–16**

These tabs enable you to control output channels 1–8 and 9–16 of slots 1–3 respectively.

- **OMNI 1–8**
This tab enables you to control OMNI jacks 1–8.

- **DIGITAL OUT**
This tab enables you to control the L/R channels of the DIGITAL OUT connector.

- **PATCH VIEW1**
- **PATCH VIEW2**
These tabs display lists of patches.

4. To assign a channel to an output port, press the channel select popup window for that port.

The CH SELECT popup window will appear. This popup window includes the following items.



① **Category select list**

Selects the category of channel shown in the popup window. The categories correspond to the following channels. They vary depending on the output port type.

- **MIX/MATRIX**..... MIX 1–MIX 24, MATRIX 1–MATRIX 8
- **ST/MONO/MONI/CUE**..... STEREO L, STEREO R, MONO(C), MONI L, MONI R, MONI C, CUE L, CUE R
- **DIRECT OUT 1–32**..... CH1–CH32 Direct Outs
- **DIRRECT OUT 33–64**..... CH33–CH64 Direct Outs
- **DIRECT OUT 65–72** CH65–CH72 Direct Outs
- **INSERT OUT 1–32**..... CH1–CH32 Insert-outs
- **INSERT OUT 33–64** CH33–CH64 Insert-outs
- **INSERT OUT 65–72** CH65–CH72 Insert-outs
- **INSERT OUT MIX/MATRIX** Insert-outs for MIX1-MIX24, MATRIX 1-MATRIX8
- **INSERT OUT ST/MONO** Insert-outs for STEREO L, STEREO R, and MONO (C)
- **CASCADE MIX/MATRIX**..... MIX1–MIX24, MATRIX1–MATRIX8
- **CASCADE ST/MONO/CUE**..... STEREO L, STEREO R, MONO(C), CUE L, CUE R

NOTE

In the case of the CL3/CL1, channels that do not exist on those models will not be shown.

② **Channel select buttons**

Select the channel to be assigned to the output port you selected in step 3.

5. Use the channel select tabs and the channel select buttons to select the source channel, and press the **CLOSE** button.

You will return to the **OUTPUT PORT** popup window.

NOTE

If **PATCH CONFIRMATION** is ON, a confirmation dialog box will appear when you attempt to change the patch settings. If **STEAL PATCH CONFIRMATION** is ON, a confirmation dialog box will appear when you attempt to change a location that is already patched elsewhere.

6. Make settings for delay, phase, and output gain as necessary.
7. Repeat steps 3–6 to assign channels to other output ports.
8. When you have finished making settings, click the “x” symbol in the upper right of the window to return to the previous screen.

Changing the input patch settings

This section explains how to change the patching of each input channel.

1. Use the Bank Select keys in the Centralogic section to access the **OVERVIEW** screen for the input channel to which you want to assign the input source.



2. In the top part of the screen, press the channel number/channel name field to access the **PATCH/NAME** popup window.

In the PATCH/NAME popup window you can view and change the channel name, icon, channel color, and input port assigned to each input channel.

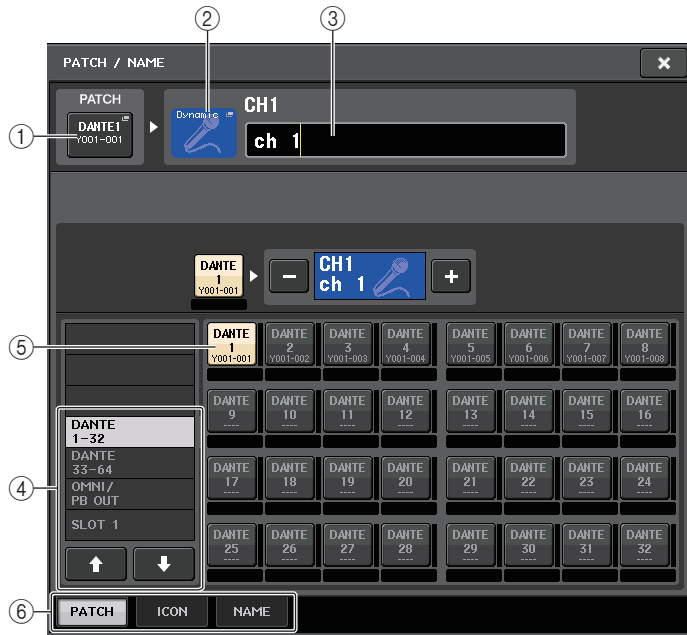

① **PATCH button**

Indicates the currently-selected input port. If you press this button when selecting an icon or changing the channel name, you will return to the input port select screen.

② **Channel icon button**

Indicates the icon that is selected for the corresponding channel. When you press this button, a screen will appear in which you can select an icon or sample name.

③ **Channel name input box**

Indicates the name that is assigned to the corresponding channel. When you press this field, a keyboard window allowing you to assign a name will appear.

④ **Category select list**

Selects the category of input port shown in the popup window. The categories correspond to the following input ports. They vary depending on the channel type.

- DANTE1–32 DANTE1–DANTE32
- DANTE33–64 DANTE33–DANTE64
- OMNI/PB OUT OMNI1–OMNI8, PB OUT(L), PB OUT(R)
- SLOT1 SLOT1(1)–SLOT1(16)
- SLOT2 SLOT2(1)–SLOT2(16)
- SLOT3 SLOT3(1)–SLOT3(16)

- EFFECT RACK..... FX1L(A)–FX8R(B)
- PREMIUM RACK.... PR1L(A)–PR2R(B)

⑤ **Input port select buttons**

Assign an input port to the currently-selected input channel.

⑥ **Tabs**

Enable you to switch between items.

3. Access the input port selection screen of the PATCH/NAME popup window, and then use the input port select tabs and input port select buttons to select an input port.

NOTE

If PATCH CONFIRMATION is ON, a confirmation dialog box will appear when you attempt to change the patch settings. If STEAL PATCH CONFIRMATION is ON, a confirmation dialog box will appear when you attempt to change a location that is already patched elsewhere.

4. When you have finished making settings, press the “x” symbol located in the upper right to close the window.

You will return to the OVERVIEW screen.

NOTE

You can also select input ports from the GAIN/PATCH popup window.

5. Repeat step 2–4 to assign input ports for other channels.

Inserting an external device into a channel

If desired, you can insert an effect processor or other external device into the signal path of an INPUT, MIX, MATRIX, STEREO, or MONO channel. When doing so, the type of input/output port used for the insertion and the location of the insert-out/in points can be specified individually for each channel.

1. As desired, connect your external equipment to an OMNI IN/OUT jack or to an I/O card installed in slots 1–3.

NOTE

If you install a digital I/O card in a slot and digitally connect an external device, you must synchronize the word clock of the CL console and the external device (see [page 198](#)).

2. Use the Bank Select keys in the Centralogic section to access the OVERVIEW screen for the channel to which you want to assign the input source.

3. Press the INSERT/DIRECT OUT field to access the INSERT/DIRECT OUT popup window.

In the INSERT/DIRECT OUT popup window, you can view or change the type of input/output port used for insertion and the location at which insertion will occur. There are two variations of this popup window; one-channel and eight-channel.

Each window view includes the following items.

INSERT/DIRECT OUT popup window (1ch)

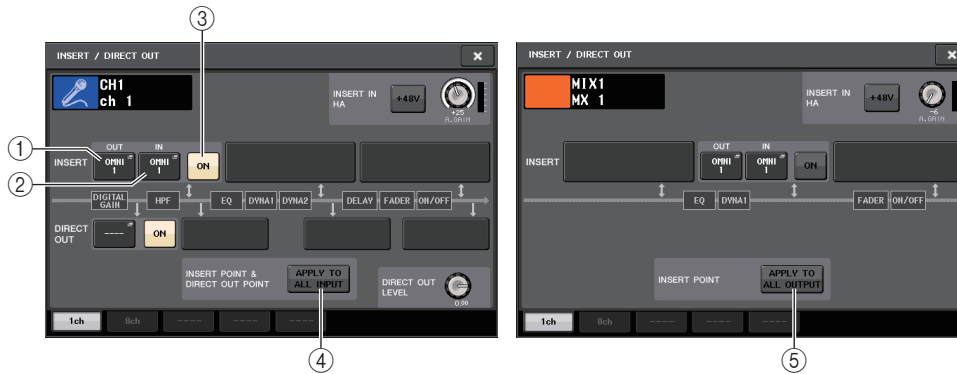

- 1 **INSERT OUT button**

Press this button to open the PORT SELECT popup window, in which you can select an output port. The name of the currently-selected port appears on the button.

- 2 **INSERT IN button**

Press this button to open the PORT SELECT popup window, in which you can select an input port. The name of the currently-selected port appears on the button.

- 3 **INSERT ON/OFF button**

Switches the insert on or off.

To change the currently-selected insert point, press one of the three blocks that does not contain any buttons.



NOTE

You can set the I/O ports to function as an insert for each block.

- 4 **APPLY TO ALL INPUT button (input channels only)**
Specifies whether the insert position/Direct Out position will be applied to all input channels.
- 5 **APPLY TO ALL OUTPUT button (output channels only)**
Specifies whether the insert position settings will be applied to all output channels.

■ INSERT IN HA field

This field will appear if you have selected an input port (that features a head amp) as the insert-in.

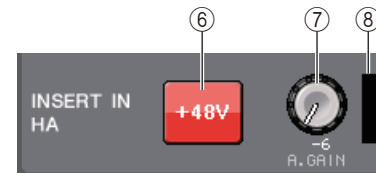

- 6 **+48V button**
Switches head amp phantom power (+48V) on or off.
- 7 **A.GAIN knob**
Indicates the analog gain setting for the head amp. Press this knob so that you will be able to use the multifunction knob to adjust the gain.
- 8 **HA meter**
Displays the level of the HA input signal.

INSERT/DIRECT OUT popup window (8ch)



① **Channel select button**

Selects the channel to set. The channel icon, color, and number appear on the button.

② **INSERT OUT button**

Press this button to open the PORT SELECT popup window, in which you can select an output port. The name of the currently-selected port appears on the button.

③ **INSERT ON/OFF button**

Switches the insert on or off. The currently-specified insert point setting appears above the button.

④ **INSERT IN button**

Press this button to open the PORT SELECT popup window, in which you can select an input port. The name of the currently-selected port appears on the button. You can also view the insert-in level by checking the indicator located to the right of the port button (that is displayed as an option).

4. Access either the one-channel or the eight-channel INSERT/DIRECT OUT popup window, and then press the INSERT OUT button.

The PORT SELECT popup window will appear, allowing you to select the output port used for insert-out. The window includes the following items.

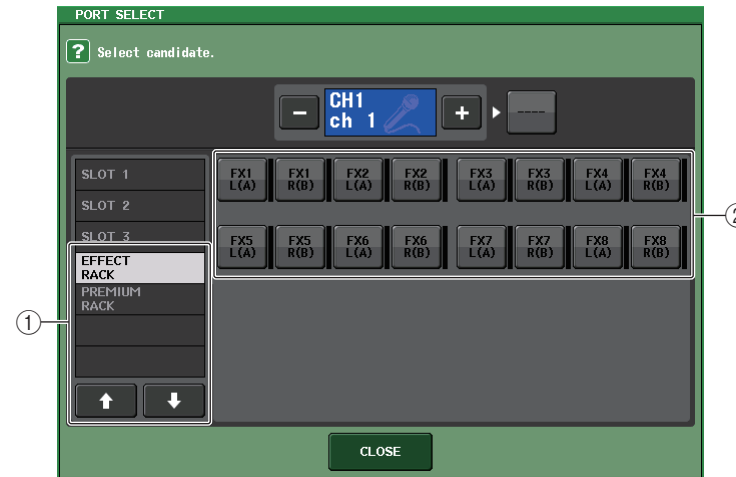

① **Category select list**

Selects the category of output port shown in the popup window. The categories correspond to the following output ports. They vary depending on the channel type.

- **OMNI** OMNI1–OMNI8
- **SLOT1** SLOT1(1)–SLOT1(16)
- **SLOT2** SLOT2(1)–SLOT2(16)
- **SLOT3** SLOT3(1)–SLOT3(16)
- **GEQ RACK** GEQ1L(A)–GEQ16R(B) (MIX, MATRIX, STEREO, and MONO channels only)
- **EFFECT RACK**..... FX1L(A)–FX8R(B)
- **PREMIUM RACK**..... PR1L(A)–PR8R(B)

② **Output port select buttons**

These buttons assign the output port that will be used as insert-out for the currently-selected channel.

NOTE

If a rack in which a GEQ or Premium Rack is mounted is specified as the insert-out or insert-in, the other patch point will automatically be assigned to the same rack. Also, insert mode will automatically be switched on. Additionally, if you defeat the insert-out or insert-in of a rack in which a GEQ or Premium Rack is mounted, the other patch point will automatically be defeated and at the same time insert mode will automatically be switched off.

- 5.** Use the category and the output port select buttons to specify the output port that will be used as insert-out, and press the **CLOSE** button.

You will return to the INSERT/DIRECT OUT popup window.

- 6.** Press the **INSERT IN** button.

The PORT SELECT popup window will appear, allowing you to select the input port used for insert-in. The categories correspond to the following input ports.

- **OMNI**..... OMNI1–OMNI8
- **SLOT1** SLOT1(1)–SLOT1(16)
- **SLOT2** SLOT2(1)–SLOT2(16)
- **SLOT3** SLOT3(1)–SLOT3(16)
- **GEQ RACK** GEQ1L(A)–GEQ16R(B) (Output channels only)
- **EFFECT RACK** FX1L(A)–FX8R(B)
- **PREMIUM RACK** PR1L(A)–PR2R(B)

- 7.** Specify the input port you will use for insert-in, and press the **CLOSE** button.

- 8.** Press the **INSERT ON/OFF** button to turn it **ON**.

In this state, insert-out/in is enabled. Adjust the input/output levels of your external device if necessary.

NOTE

- If you have selected the OMNI IN jack on the CL console as the input port for insert-in, make the HA settings in the INSERT IN HA field.
- Even if the INSERT ON/OFF button is OFF, the signal selected for insert-out will continue to be sent.



- 9.** If you want to change the insert-out/in position, access the one-channel **INSERT/DIRECT OUT** popup button, and press one of the three **INSERT** fields.

The INSERT field you pressed will be enabled.

- 10.** When you have finished making all settings, press the “x” symbol located in the upper right to close the window.

You will return to the OVERVIEW screen.

- 11.** As desired, make insert settings for other channels as well.

Directly outputting an INPUT channel

The signal of an INPUT channel can be output directly from an OUTPUT jack on the I/O device, from the desired OMNI OUT jack, or from the output channel of a desired slot.

- 1.** Connect your external device to an OMNI OUT jack, OUTPUT jack, or to an I/O card installed in slot 1–3.

NOTE

If you install a digital I/O card in a slot and digitally connect an external device, you must synchronize the word clock of the CL console and the external device (see [page 198](#)).

- 2.** Use the Bank Select keys in the Centralogic section to access the OVERVIEW screen that includes the input channel that you want to output directly.

- 3.** Press the **INSERT/DIRECT OUT** field to access the **INSERT/DIRECT OUT** popup window.

There are two variations of this popup window; one-channel and eight channel. Each window view includes the following items.

INSERT/DIRECT OUT popup window (1ch)

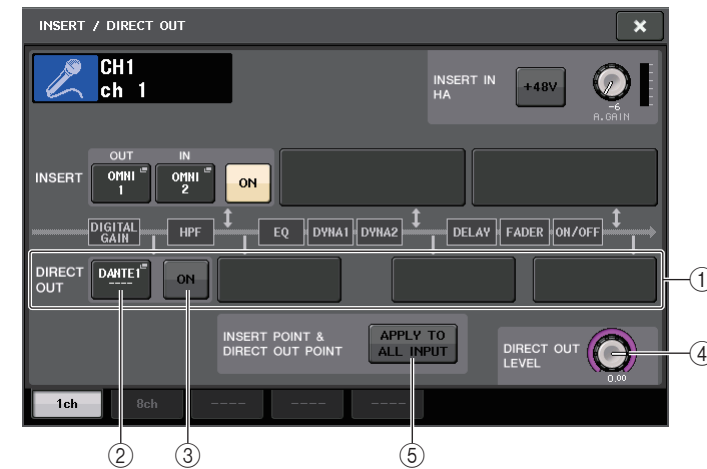

- ① **DIRECT OUT** field

Enables you to make settings for direct output. Press one of four fields to choose PRE HPF (immediately before the HPF), PRE EQ (immediately before the EQ) or PRE FADER (immediately before the fader), or POST ON (immediately after the [ON] key) as the direct output position.

- ② **DIRECT OUT PATCH button**
Press this button to open the PORT SELECT popup window, in which you can select a Direct Out output port. The name of the currently-selected port appears on the button.
- ③ **DIRECT OUT ON button**
Switches the Direct Out on or off.
- ④ **DIRECT OUT LEVEL knob**
Indicates the output level of the Direct Out. Press this knob to control the level using the multifunction knob.
- ⑤ **APPLY TO ALL INPUT button (input channels only)**
Specifies whether the insert point/Direct Out point settings will be applied to all input channels.

INSERT/DIRECT OUT popup window (8ch)



- ① **DIRECT OUT ON button**
Switches the Direct Out on or off. The currently-selected Direct Output point is indicated above the button.
- ② **DIRECT OUT PATCH button**
Press this button to open the PORT SELECT popup window, in which you can select a Direct Out output port. The name of the currently-selected port will appear on the button.
- ③ **DIRECT OUT LEVEL knob**
Indicates the output level of the Direct Out. Press this knob to control the level using the multifunction knob.

- 4. **Access either the one-channel or the eight-channel INSERT/DIRECT OUT popup window, and press the DIRECT OUT popup button.**
The PORT SELECT popup window will appear, allowing you to select the output port used for direct output. The window includes the following items.

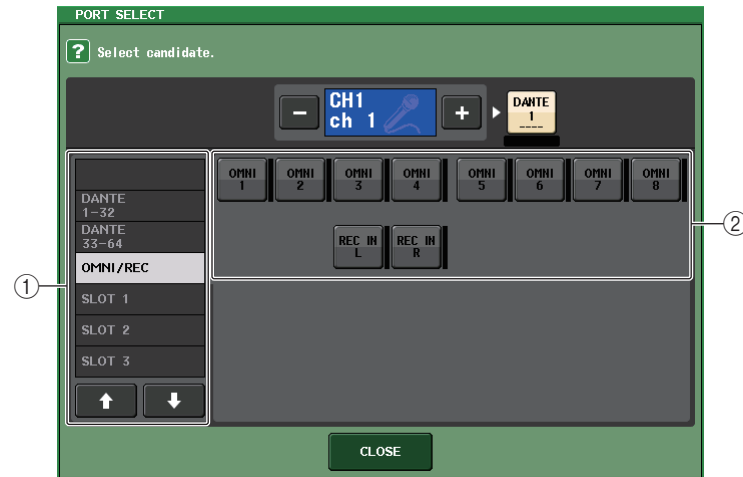

- ① **Category select list**
Selects the category of output port shown in the popup window. The categories correspond to the following output ports. They vary depending on the channel type.
 - OMNI/REC OMNI1-OMNI8, REC IN(L), REC IN(R)
 - SLOT1 SLOT1(1)-SLOT1(16)
 - SLOT2 SLOT2(1)-SLOT2(16)
 - SLOT3 SLOT3(1)-SLOT3(16)
 - DANTE1-32..... DANTE1-DANTE32
 - DANTE33-64..... DANTE33-DANTE64
- ② **Output port select buttons**
These buttons assign the output port used for direct output of the currently-selected INPUT channel.
- 5. **Use the output port select tabs and the output port select buttons to specify the output port that will be used for direct output, and press the CLOSE button.**
You will return to the INSERT/DIRECT OUT popup window.

6. Press the DIRECT OUT ON/OFF button to turn it ON.

In this state, direct output is enabled. Adjust the input level of your external device as necessary.

NOTE

With the factory settings, all are turned off.

7. If you want to change the position of the direct output, access the one-channel INSERT/DIRECT OUT popup button, and press one of the DIRECT OUT fields.

The DIRECT OUT field you pressed will be enabled.

8. If you want to adjust the level of the direct output, access either the one-channel or the eight-channel INSERT/DIRECT OUT popup window, and operate the DIRECT OUT LEVEL knob.**9. When you have finished making all settings, click the “x” symbol located in the upper right to close the window.**

You will return to the OVERVIEW screen.

10. As desired, make direct output settings for other channels as well.

Recording or playing back using DAW on a computer

If you plan to add DAW software, such as Steinberg Nuendo, to an audio network that includes a CL console and I/O devices, you must use Dante Virtual Soundcard (DVS) driver software. DVS works as an audio interface, making it possible to transmit signals between a DAW and an audio network (that includes a CL series console and I/O devices). In this way, you will be able to make multi-track recordings of live performances or use live recordings that were made a day earlier for a virtual sound check.

This section explains how to perform the setup to add DAW software to an audio network.

Required devices and software

- CL series console; I/O device
- A computer (Windows or Mac) equipped with an Ethernet port that supports a Giga-bit Ethernet (GbE) network; DAW software
- A GbE-compatible network switch
- CAT5e cable
- Dante Virtual Soundcard driver software
- Dante Controller control software

NOTE

You must have a license ID to use Dante Virtual Soundcard. The license ID is included in the CL unit package.

The latest information about the Dante Virtual Soundcard and the Dante Controller is available at the following website:

<http://www.yamahaproaudio.com/>

Using Nuendo Live

Steinberg’s Nuendo Live DAW software can be used with the CL series console, taking advantage of functionality that makes them work well together. For details, refer to “[Using the CL console with Nuendo Live](#)” on [page 188](#).

Word clock settings

In a Dante network, the master device supplies accurate word clock to other devices on the network. If the master device is removed from the network or breaks down, another device will automatically take over as the clock master.

To make this setting, in the Function Access Area, press the SETUP button, then WORD CLOCK/SLOT button to access the WORD CLOCK/SLOT popup window.

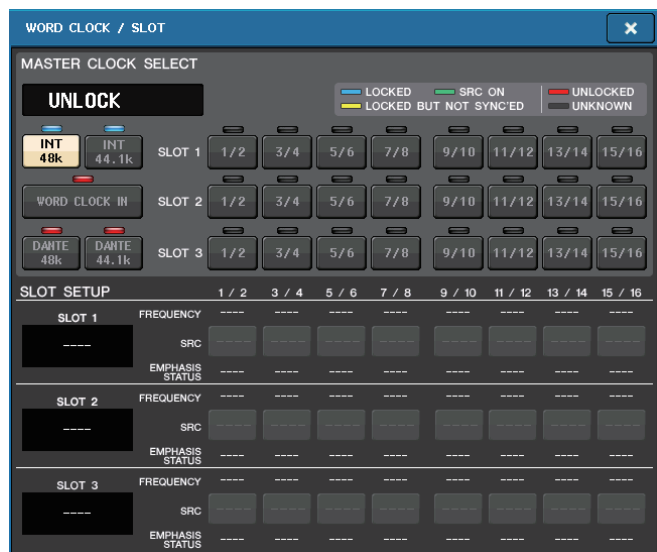

Setting up Dante Virtual Soundcard

Install a Dante Virtual Soundcard (DVS) and the Dante Controller in a computer that you want to use for audio recording.

Then, connect the GbE-compatible network port on the computer to a GbE-compatible network switch. Configure the computer to obtain an IP address automatically (this is the default setting).

Before you start DVS, select the desired audio format (e.g., 48kHz, 24-bit) and Dante latency. (Select a higher latency value to maintain network stability during the use of many channels.) For Advanced settings, select the number of channels to be used for recording and playback (the default is 8 x 8). Please refer to the Dante Virtual Soundcard User's Guide for more information on the ASIO setting (Windows).

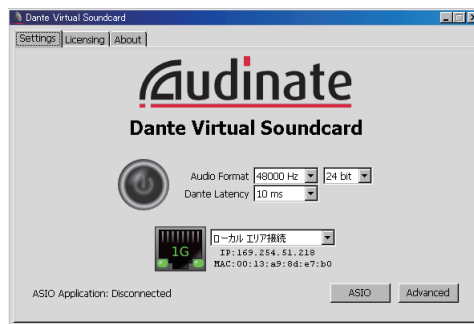

Setting up Dante Controller

Connect the network port on the computer to a GbE-compatible network switch. Configure the computer to obtain an IP address automatically (this is the default setting).

The following settings can be made via Dante Controller.

- For multi-track recording: Patch audio signals from the I/O device to DVS for multi-track recording.
- For virtual sound check: Patch audio signals in such a way that they will be output from the computer to the Dante audio network, then routed to the channels on the CL console.

Please refer to the Dante Controller manual for more information about operations and settings of the Dante Controller.

Setting up DAW software

You must make driver settings in your DAW software. In the device setting window, select “Dante Virtual Soundcard-ASIO” (for Windows PC) or “Dante” (for Mac).

Some DAW software may require internal patching with the driver. For more information, refer to the DAW software manual.

If you're using Nuendo Live DAW software, see also [“Using the CL console with Nuendo Live”](#) on page 188.

Audio recording and playback

After you have made the driver settings in your DAW software, you can record and play back audio.

For multi-track recording, set the input ports for tracks in DAW software to the ports that receive audio signals from the I/O device.

For a virtual sound check, you must route recorded audio signals to the input channels on the CL console. To do so, to patch the signals so that the signals will be output from the DAW software to DANTE 1–64 on the CL console. It may be convenient for you later if you store two sets of the DANTE INPUT PATCH settings in the library: one set for routing audio signals from the I/O device, and another set for routing audio signals from DAW software. In this way, you will be able to switch between patch settings without starting Dante Controller. In addition, you will be able to patch a specific channel (such as a vocal) to the I/O device to monitor during a virtual sound check.

Input channels

This chapter explains various operations for input channels.

Signal flow for input channels

The input channels comprise the section that processes signals received from the I/O devices, rear panel input jacks, or slots 1–3, and sends them to the STEREO bus, MONO bus, MIX buses, or MATRIX buses. There are two types of input channels, as follows.

MONO channel

These channels are used to process monaural signals. When the CL series console is in the default state, the input signal from the Dante connector is assigned.

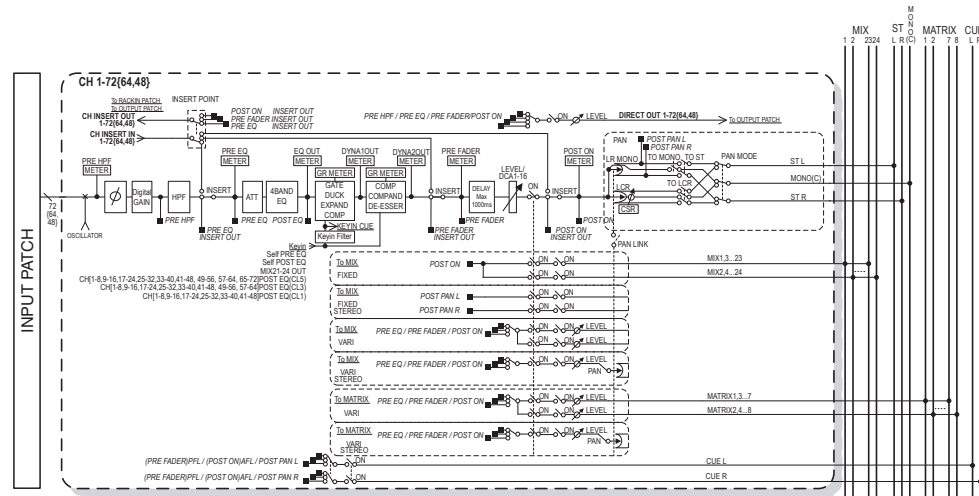

STEREO channel

These channels are used to process stereo signals. When the CL series console is in the default state, the input signal from the EFFECT RACK 1–8 is assigned.

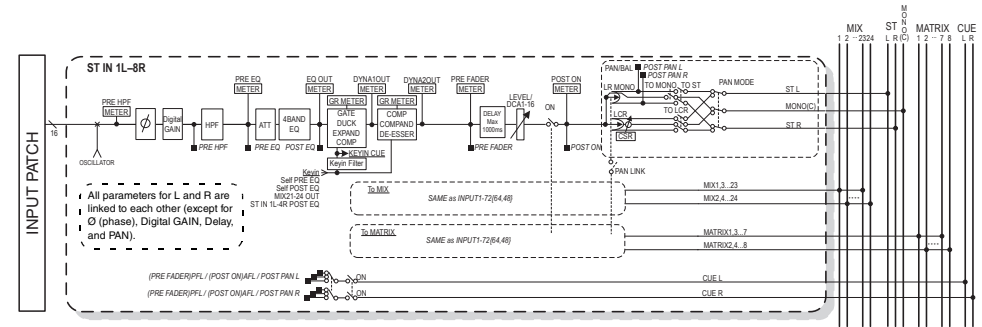

- INPUT PATCH**
 Assigns input signals to the input channels.
- Ø (phase)**
 Switches the phase of the input signal.
- DIGITAL GAIN**
 Attenuates/boosts the level of the input signal.
- HPF (High Pass Filter)**
 This is a high pass filter that cuts the region below the specified frequency.
- 4 BAND EQ (4 band equalizer)**
 A parametric EQ with four bands: HIGH, HIGH MID, LOW MID, and LOW.
- DYNAMICS 1**
 This is a dynamics processor that can be used for gating, ducking, expander, or compressor.
- DYNAMICS 2**
 This is a dynamics processor that can be used as a compressor, compander, or de-esser.
- INPUT DELAY**
 Corrects input signal delay. You can specify up to 1000ms.
- LEVEL/DCA 1–16**
 Adjusts the input level of the channel.
- ON (on/off)**
 Turns the input channel on or off. If this is off, the corresponding channel will be muted.
- PAN**
 Adjusts the panning of signals sent from the input channel to the STEREO bus. For the STEREO channel, you can switch between PAN and BALANCE. The BALANCE parameter adjusts the volume balance of the left/right signals sent from the STEREO channel to the STEREO bus. You can turn on PAN LINK in the BUS SETUP popup window so that the setting of the PAN parameter will also be applied to signals sent to two MIX or MATRIX buses that are set to stereo.

- **LCR (Left/Center/Right)**
Sends the input channel signal to the STEREO bus/MONO bus as a three-channel signal that consists of the L/R channel plus the center channel.
- **MIX ON/OFF (MIX send on/off)**
This is an on/off switch for signals sent from the input channel to MIX buses 1–24.
- **MATRIX LEVEL 1–24 (MATRIX send levels 1–24)**
Adjusts the send level of signals sent from the input channel to VARI type MIX buses 1–24. As the position from which the signal is sent to the MIX bus, you can choose from the following: immediately before EQ, pre-fader, or post-fader.
- **MATRIX ON/OFF (MATRIX send on/off)**
This is an on/off switch for signals sent from the input channel to MATRIX buses 1–8.
- **MATRIX LEVEL 1–8 (MATRIX send levels 1–8)**
Adjusts the send level of the signal sent from the input channel to MATRIX buses 1–8. As the position from which the signal is sent to the MATRIX bus, you can choose from the following: immediately before the EQ, pre-fader, or post-fader.
- **INSERT (MONO channels only)**
You can patch the desired output/input ports to insert an external device such as an effect processor. For the position of the insert-out/insert-in point, you can choose immediately before the EQ, immediately before the fader, or immediately after the [ON] key.
- **DIRECT OUT (MONO channels only)**
You can patch this to any output port to send out the input signal directly from the corresponding output port. For the position of the direct output, you can choose immediately before the HPF, immediately before the EQ, immediately before the fader, or immediately after the [ON] key.
- **METER**
Meters the input channel level. You can switch the position at which the level is detected (see [page 112](#)).

Specifying the channel name, icon and channel color

On the CL series unit, you can specify the on-screen name and icon for each input channel. This section explains how to specify the channel name, icon and channel color.

1. Access the **OVERVIEW** screen that includes the input channel for which you want to specify the channel name, icon and channel color.

Channel number/Channel name field



2. Access the **PATCH/NAME** popup window by pressing the channel number/channel name field of the channel to which you want to assign the channel name, icon and channel color.

This popup window contains the following items:

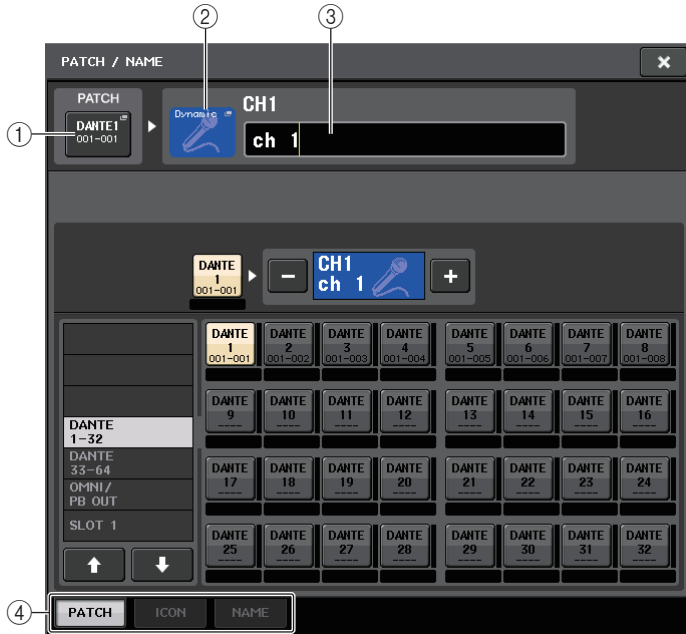

① **PATCH button**

Indicates the currently-patched port. Press this button to enable the PATCH tab at the bottom of the screen. The PORT SELECT popup window will appear, enabling you to select the network and port.

② **Channel icon button**

Indicates the icon and color that are currently selected for the corresponding channel. Press this button to enable the ICON tab at the bottom of the screen. The CH COLOR/ICON popup window will appear, enabling you to select the color, icon, and channel name.

③ **Channel name edit box**

Indicates the currently-specified channel. Press the inside of this box to enable the NAME tab at the bottom of the screen. The SOFT KEYBOARD popup window will appear, enabling you to edit the channel name.

④ **Tabs**

Use these tabs to switch between items.

3. Press the desired channel icon button.

The lower part of the popup window will change as follows.



① **Channel color select buttons**

Select a channel color. Pressing the button will immediately apply the change.

② **Icon select buttons**

Select a channel icon. Pressing the button will immediately apply the change.

③ **Sample name setup buttons**

Select a preset sample name. You can edit the name on the NAME tab later.

4. Use the icon select buttons to select the icon you want to use for the channel. You can use the channel color select buttons to select the color of the channel.

The selected icon or color will appear on the icon button in the upper part of the window.

5. To edit the channel name based on a sample name, use the sample name setup buttons to select a sample name.

The sample name you selected will be entered in the channel name field in the upper part of the window.

To enter the channel name directly, proceed to Step 6.

NOTE

You can also add or edit characters in the channel name field after you have entered the sample name. If you want to quickly assign channel names that consist of a common name plus a consecutive number, such as "Vocal 1" or "Vocal 2," enter a sample name first, and then add a number.

- 6.** If you want to enter a channel name directly (or edit a sample name that has been entered), press the channel name field in the upper part of the window.

The keyboard window will appear in the lower part of the screen, allowing you to enter or edit the characters.



- 7.** Use the [SEL] keys to switch input channels, and specify the icon or channel name for other channels in the same way.

When the PATCH/NAME popup window is displayed, you can use the [SEL] keys to switch the channel to be controlled.

- 8.** When you finish your data input, press the × symbol in the upper right of the window.

NOTE

Press the TAB button to switch to the next channel. You can also press the ENTER button to close the popup window in the same way as using the “x” symbol.

Making HA (Head Amp) settings

This section explains how to make HA (Head Amp) related settings (phantom power on/off, gain, phase) for each input channel.

Setting the analog gain

- To adjust only the HA analog gain, use the GAIN knob in the SELECTED CHANNEL section.
- To edit detailed parameter settings such as phantom power on/off or phase, use the Bank Select keys in the Centralogic section to access the OVERVIEW screen that includes the input channel for which you want to adjust the head amp.



- Press the GAIN/PATCH field of the channel for which you want to adjust the head amp. The GAIN/PATCH popup window will appear.

This popup window features four types of view. Use the tabs near the bottom of the window to select one of these four views. Each window view includes the following items.

GAIN/PATCH popup window (1ch)



① Channel icon/Channel number/Channel name indicator

Displays the channel icon, channel number, and channel name.

② HA section

Appears if the head amp is patched to the input channel. This section enables you to operate the following HA-related controllers:

- **+48V button**

Switches head amp phantom power (+48V) on or off.

- **A.GAIN (analog gain) knob**

Indicates the analog gain of the head amp. Use the multifunction knob to adjust the level. If the Gain Compensation function is turned on, an indicator will appear, showing the position of the analog gain when the function is turned on.

- **HA meter**

Displays the level of the HA input signal.

NOTE

- If a slot is patched to the channel, this section ② will display the type of the slot/MY card and slot meter instead.
- If a rack is patched to the channel, this section ② will display the rack type and the effect type.
- If nothing is patched, section ② will be blank.

- **GC (Gain Compensation) ON/OFF button**

Turns the Gain Compensation (gain correction function) on or off. If the Gain Compensation function is turned on, the level of the signal output from the I/O device to the audio network will be stabilized. For example, if the FOH console and the monitoring console are sharing the input signal from the I/O device, and if the analog gain is adjusted on the FOH console, this function will prevent the level of the signal received on the monitoring console from fluctuating. If the Gain Compensation function is turned off, the analog gain and digital gain will return to the level that was obtained when you turned on the function. Therefore, the level on the digital network will remain the same.

- **Gain compensation meter**

Indicates the level of the signal output to the audio network after gain compensation.

③ INPUT PORT button

Indicates the port that is assigned to the channel. Press the button to display the PATCH popup window, in which you can select a port to patch.

④ Icon/Channel name button

Indicates the channel number, icon, and name. Press this button to access the PATCH/NAME popup window, in which you can patch the input port and specify the channel name.

⑤ ∅ (Phase) button

Switches between normal and reverse phase settings of signals input.

⑥ D. GAIN (digital gain) knob

Indicates the digital gain value. Use the multifunction knob to adjust the level.

⑦ Digital gain meter

Indicates the level after digital gain.

⑧ GC ALL ON button/GC ALL OFF button

Switch Gain Compensation on or off for all input channels simultaneously.

GAIN/PATCH popup window (8ch)



1 Channel select button

Indicates the channel icon, number, and name. When you press this button, the corresponding channel will become a target for operations in the SELECTED CHANNEL section, and the corresponding [SEL] key will light.

2 PATCH button

Press this button to display the PORT SELECT popup window to patch the input port to the input channel.

3 +48V button

This button will appear for the input channel to which the head amp has been patched. Press the button to switch phantom power (+48V) on or off.

NOTE

If the slot (for which the connection to the head amp is not recognized) is patched, the type of the mini-YGDAI card will be displayed.

4 A.GAIN (analog gain) knob

Indicates the analog gain of the head amp. Press this knob so that you will be able to use the multifunction knob to adjust the gain.

If the Gain Compensation function is turned on, an indicator will appear, showing the position of the analog gain when the function is turned on.



5 Level meter

Indicates the input signal level.

6 GC (Gain Compensation) button

Switches the Gain Compensation function on or off for that channel.

7 Ø (Phase) button

Switches the phase of the input signal.

8 D. GAIN (digital gain) knob

Indicates the digital gain value. Press this knob so that you will be able to use the multifunction knob to adjust the gain.

9 Digital gain meter

Indicates the level after digital gain.

GAIN/PATCH popup window (1-48, 49-72/ST IN(CL5), 49-64/ST IN(CL3), ST IN(CL1))

This window displays the head amp settings of the corresponding input channels. Here you can also adjust the head amp gain in groups of the selected eight channels by using the multifunction knobs in the Centralogic section.



1 Parameter select buttons

Select one of the following parameters to view in the window.

- ANALOG GAIN Analog gain
- DIGITAL GAIN Digital gain
- PATCH Patch selection

2 GC ALL ON/GC ALL OFF buttons

Switch Gain Compensation on or off for all input channels simultaneously.

3 Channel select button

Selects the channel. You can select multiple channels simultaneously.

■ If you press the **ANALOG GAIN** parameter select button:



① **GAIN knob**

Indicates the analog gain setting for each channel. Press this knob to control the gain value using the multifunction knob. If the Gain Compensation function is turned on, an indicator will appear, showing the position of the analog gain when the function is turned on.

② **OVER indicator**

Lights when a signal at the input port or from the rack output exceeds the full scale level. This indicator is available only if an input channel is selected.

③ **+48V indicator**

Indicates the +48V on/off status for each channel.

④ **∅ (Phase) indicator**

Indicates the phase setting for each channel.

NOTE

If the input channel is patched to a slot for which the connection to the head amp is not recognized, the knob ① will be replaced with the slot/port number of the patch destination. In addition, the indicator ③ will not be displayed.

If the input channel is patched to the VIRTUAL RACK, the knob ① will be replaced with the port ID of the rack.

If nothing is patched to the input channel, the knob ① will be replaced with a dotted line "----".

■ If you press the **DIGITAL GAIN** parameter select button:



① **GAIN knob**

Indicates the digital gain setting for each channel. Press this knob to control the gain value using the multifunction knob.

② **OVER indicator**

Lights when a signal at the input port or from the rack output exceeds the full scale level. This indicator is available only if an input channel is selected.

③ **∅ (Phase) indicator**

Indicates the phase setting for each channel.

■ If you press the **PATCH** parameter select button:



① **PATCH button**

Press this button to open the PORT SELECT popup window, in which you can select an input port to patch to the channel.

4. Access either the 1ch or 8ch GAIN/PATCH popup window.

5. Use the on-screen buttons or the multifunction knobs to edit the head amp gain, phase, and phantom power on/off settings.

NOTE

- The PAD will be switched on or off internally when the HA gain is adjusted between +17 dB and +18 dB.
- Keep in mind that noise may be generated when using phantom power if there is a difference between the Hot and Cold output impedance of an external device connected to the INPUT jack.
- The GAIN knob and +48V button are valid only on channels for which the assigned input port is an INPUT jack on the I/O device, the OMNI IN on the CL unit, or a slot that is connected to an external head amp device (e.g., Yamaha AD8HR or SB168-ES).

6. Perform the same operations for other input channels as desired.

If you are viewing the 1ch GAIN/PATCH popup window, you can also use the [SEL] keys to switch the channel for editing.

If you are viewing the 8ch GAIN/PATCH popup window, you can use the Bank Select keys in the Centralogic section to switch the channels being controlled in groups of eight.

7. When you finish editing, press the × symbol in the upper right of the window.

Setting the Gain Compensation function

If you are using an I/O device (such as an Rio3224-D) on a Dante network, you can maintain the constant level of signal output to the audio network by using the Gain Compensation function. If the FOH console and the monitoring console are sharing an I/O device, or if you are performing digital recording via Dante connections, using this function will maintain the signal output at a constant level from the I/O device to the network even if the analog gain value on the I/O device is changed.

To do so, follow the steps below:

1. Sets the analog gain as described previously.
2. Press one of the knobs in the SELECTED CHANNEL section.
The SELECTED CHANNEL VIEW screen for the selected channel will appear.
3. Press the GAIN field in the SELECTED CHANNEL VIEW screen.
The GAIN/PATCH popup window will appear.
4. Press the GC button located to the right of the A. GAIN knob.

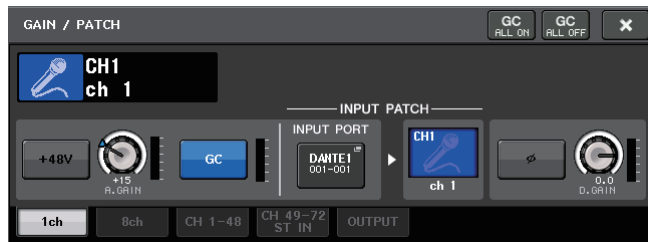

When the function is turned on, the button will light. Press the button once again to turn it off. If you adjust the analog gain value while the Gain Compensation function is turned on, the head amp level will change accordingly. However, the level of the signal output to the audio network will automatically be corrected to the level obtained when you turned Gain Compensation on. If you turn Gain Compensation off while in this state, the analog gain and the compensated gain within the I/O device will return to the settings that were in effect when you turned Gain Compensation on. Therefore, the signal level on the audio network will remain the same.

NOTE

Since the compensated gain is the gain used to automatically compensate the gain within the I/O device, it is not shown as a parameter. The position at the moment this was turned on will be displayed.

Adjusting the digital gain

If the Gain Compensation function is turned on, digital gain will be used to adjust the level of the signal input to the CL's input channels.

Follow the steps below:

1. Press the [SEL] key for the input channel that you want to control.
2. Press one of the knobs in the SELECTED CHANNEL section.
The SELECTED CHANNEL VIEW screen for the selected channel will appear.
3. Press the GAIN field.
The GAIN/PATCH popup window will appear.



4. Use multifunction knob 8 to adjust the D. GAIN parameter.

NOTE

- Press the SETUP button, then the USER SETUP button, select the PREFERENCE tab, and then set the GAIN KNOB FUNCTION to DIGITAL GAIN. You will be able to adjust the digital gain value by using the GAIN knob on the corresponding channel strip or the GAIN knob in the SELECTED CHANNEL section.
- You can also operate the digital gain by assigning INPUT GAIN → DIGITAL GAIN to a USER DEFINED knob, or by assigning an ALTERNATE function to a USER DEFINED key.

Relationship between analog and digital gain while Gain Compensation is on

If Gain Compensation is on, adjusting the analog gain by a specific amount will cause the I/O device to output to the audio network a signal that is attenuated by the same amount. Therefore, the signals on the audio network will maintain a constant corrected level in the digital domain.

For example, assume that the analog gain value has been set to +30 dB and Gain Compensation is now turned on. Under this condition, if you raise the analog gain value to +45 dB, the level of the signal sent to the audio network will stay at +30 dB (that is, attenuated by -15 dB).

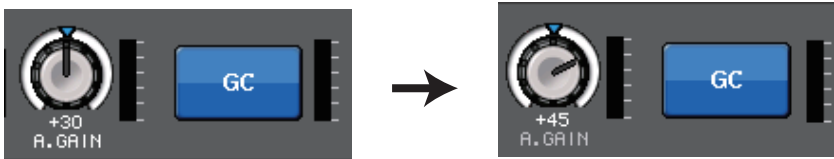

At this time, the gain of each signal input to the CL series unit will be adjusted by the digital gain parameter of the CL series console. If the FOH console and the monitoring console are sharing one I/O device, adjusting the analog gain on the FOH console will not affect the input level on the monitoring console, because the level of the signal on the audio network is maintained at a constant level.

However, please note that if the signal is distorted due to a high level of analog gain, you must first turn the Gain Compensation function off, set the gain to an appropriate input level, and then turn the function back on. If you try to lower the analog gain level while the Gain Compensation function is on, the signal on the audio network will be amplified by the same amount due to the Gain Compensation function, and the signal will remain distorted.

NOTE

You can perform this operation rapidly if you've assigned Gain Compensation on/off for the SET BY SEL function to one of the USER DEFINED keys.

Sending a signal from an input channel to the STEREO/MONO buses

This section explains how to send a signal from an input channel to the STEREO bus or MONO bus. The STEREO bus and MONO bus are used mainly to send signals to the main speakers. There are two ways to send signals to the STEREO bus or MONO bus: ST/MONO mode and LCR mode. You can select the mode individually for each channel. These two modes differ as follows.

■ ST/MONO mode

This mode sends signals from the input channel to the STEREO bus and to the MONO bus independently.

- Signals sent from an input channel to the STEREO bus and to the MONO bus can be switched on or off individually.
- The panning of a signal sent from an input channel to the STEREO bus L/R is controlled by the TO ST PAN knob. (Signals sent to the MONO bus are not affected by this knob.)
- The left/right volume balance of a signal sent from an ST IN channel to the STEREO bus is controlled by this knob. (Signals sent to the MONO bus are not affected by this knob.)

If PAN/BALANCE mode is set to PAN, you will be able to adjust the pan position of signals sent to the STEREO bus L/R individually (see [page 37](#)).

■ LCR mode

This mode sends input channel signals to three buses (STEREO (L/R) and MONO (C)) simultaneously.

- Signals sent from an input channel to the STEREO bus and MONO bus will be switched on or off collectively.
- The CSR (Center Side Ratio) knob specifies the level ratio between signals sent from an input channel to the STEREO (L/R) bus and to the MONO (C) bus.
- The TO ST PAN knob/BALANCE knob specifies the level of signals sent from an input channel to the STEREO (L/R) bus and MONO (C) bus.

NOTE

If you want to monitor the signal of the STEREO bus or MONO bus through headphones or similar devices, press the MONITOR button in the Function Access Area to select "LCR" as the monitor source before you continue with the following procedure.

1. Make sure that an input source is connected to the input channel you are adjusting. Set the phantom power, gain, and phase of the head amp to obtain the optimum input signal.
2. Use the Bank Select keys in the Centralogic section to access the OVERVIEW screen that includes the input channel from which you want to send the signal to the STEREO/MONO bus.



STEREO/MONO field

3. In the STEREO/MONO field, press a knob to select the channel you want to adjust, and then press the knob once again to access the TO STEREO/MONO popup window.

In the TO STEREO/MONO popup window you can control signals that is sent from an input channel to the STEREO/MONO bus. This popup window features four views. Use the tabs near the bottom of the window to select one of the four views. Each window view includes the following items.

TO STEREO/MONO popup window (8ch)

Here you can control the on/off and pan/balance settings of signals sent from input channels to the STEREO (L/R) bus and MONO (C) bus, in groups of eight channels.



- 1 **Channel select button**
Selects the channel. You can select multiple channels simultaneously.
- 2 **Mode LEDs**
- 3 **MODE (ST/MONO/LCR mode select) button**
Press this button repeatedly to toggle between ST/MONO and LCR. The LED of the currently-selected mode will light.
- 4 **ST/MONO buttons**
These buttons are individual on/off switches for signals sent from each channel to the STEREO bus/MONO bus when the MONO button is set to ST/MONO mode.
- 5 **Σ clipping indicator**
Lights to indicate a signal is clipping at some point in the channel.
- 6 **TO ST PAN/TO ST BALANCE knob**
For MONO channels, this acts as a PAN knob that adjusts the left/right panning of signals sent to the STEREO bus. For STEREO channels, this acts as a PAN knob, and also as a BALANCE knob that adjusts the volume of the left and right signals sent to the STEREO bus. To adjust the value, press the knob to select it, and then operate the corresponding multifunction knob.

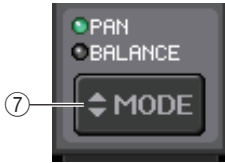

⑦ PAN/BALANCE MODE button

Switches the knob function of the TO ST PAN/TO ST BALANCE knob on the STEREO channel.

If the ST/MONO/LCR mode select button is set to LCR mode, the following button and knob are displayed instead of the ST/MONO button ④.

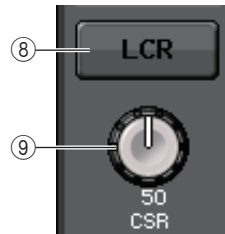

⑧ LCR button

This button is an overall on/off button for signals sent from a channel to the STEREO bus and MONO bus. If this button is off, no signal will be sent from the corresponding input channel to the STEREO bus or MONO bus.

⑨ CSR knob

Adjusts the relative level of signals sent from the channel to the STEREO (L/R) bus and to the MONO (C) bus, in the range of 0–100%. To adjust the value, press the knob to select it, and then operate the corresponding multifunction knob. (see [page 38](#))

TO STEREO/MONO popup window (CH1-48, CH49-72/ST IN(CL5), CH49-64/ST IN(CL3), ST IN(CL1))

Adjusts the status of a signal sent from the corresponding input channel to the STEREO/MONO bus. You can also adjust the pan or balance setting in groups of eight selected channels.

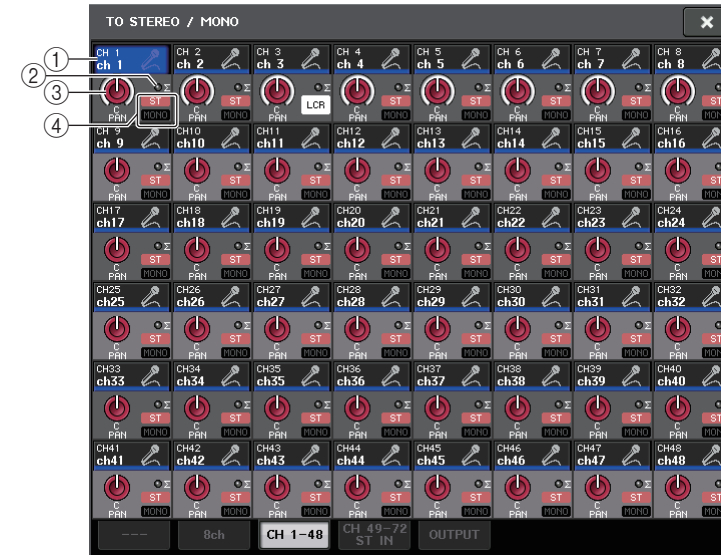

① Channel select button

Selects the channel. You can select multiple channels simultaneously.

② Σ clipping indicator

Lights to indicate a signal is clipping at some point in the channel.

③ TO ST PAN/TO ST BALANCE knob

Adjusts the panning or balance.

To adjust the value, press the knob to select it, and then operate the corresponding multifunction knob.

If the signal reaches the overload point at any meter detection point in that channel, the indicator to the right of the knob will light.

④ ST/MONO indicators

If a channel is set to ST/MONO mode, these indicators will individually indicate the on/off status of signals sent from the channel to the STEREO bus/MONO bus.

If a channel is set to LCR mode, the LCR indicator will be displayed in this location. The LCR indicator indicates the on/off status of all signals sent from that channel to the STEREO bus/MONO bus.

4. Access the eight-channel TO STEREO/MONO popup window.

5. Use the MODE button to select either ST/MONO mode or LCR mode for each channel.
6. In the MASTER section on the top panel, make sure that the [ON] key for the STEREO channel/MONO channel is turned on, and then raise the fader to an appropriate level.
7. In the INPUT section on the top panel, make sure that the [ON] key is turned on for the input channel you want to control, and then raise the fader to an appropriate position.

The subsequent steps will differ depending on whether ST/MONO mode or LCR mode was selected for the channel in step 5.

■ Channels for which ST/MONO mode is selected

8. In the TO STEREO/MONO popup window, use the STEREO/MONO button to individually turn on/off the signal sent from the input channel to the STEREO bus/MONO bus.

For a channel that is set to ST/MONO mode, signals sent to the STEREO bus and to the MONO bus can be switched on or off individually.

9. In the TO STEREO/MONO popup window, use the TO ST PAN knob to set the panning of a signal sent from the input channel to the STEREO bus.

■ Channels for which LCR mode is selected

8. In the TO STEREO/MONO popup window, use the LCR button to turn signals sent from the input channel to the STEREO bus/MONO bus on or off collectively.

For a channel that is set to LCR mode, signals sent to the STEREO bus and to the MONO bus are switched on or off collectively.

9. In the TO STEREO/MONO popup window, use the CSR knob to adjust the level difference between signals sent from that channel to the STEREO (L/R) bus and to the MONO (C) bus.

10. In the TO STEREO/MONO popup window, use the TO ST PAN knob to set the panning of signals sent from the input channel to the STEREO bus and MONO (C) bus.

If the CSR knob is set to 0%, operating the TO ST PAN knob of an INPUT channel will change the level of signals sent to the STEREO (L/R) bus and MONO (C) bus, as shown in the following diagram. In this case, the TO ST PAN knob operates as a conventional PAN knob, and no signal is sent to the MONO (C) bus.

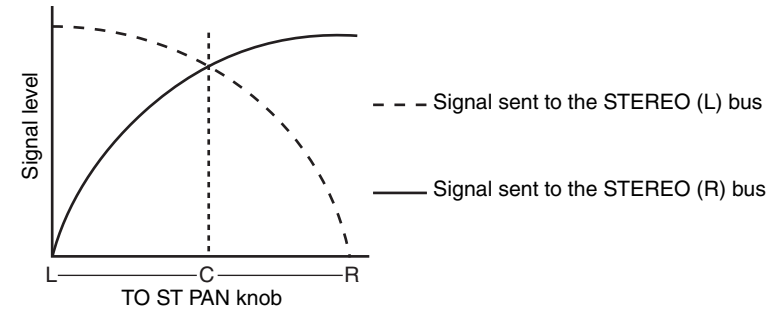

Operating the TO ST BALANCE knob of a STEREO channel will change the level of signals sent from the STEREO L/R channels to the STEREO (L/R) bus and MONO (C) bus, as shown in the following diagram. In this case, the TO ST PAN knob operates as a conventional BALANCE knob, and no signal is sent to the MONO (C) bus.

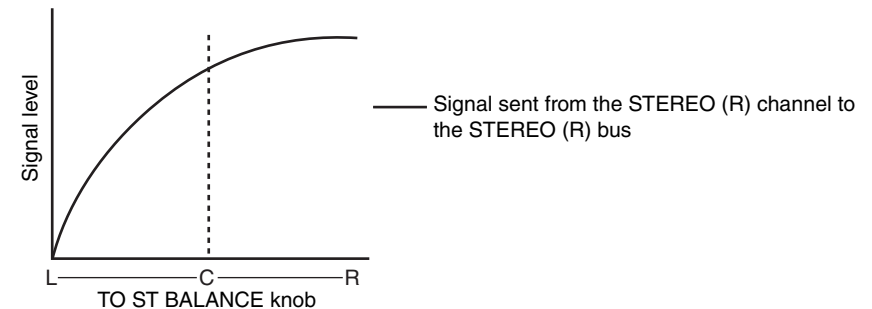
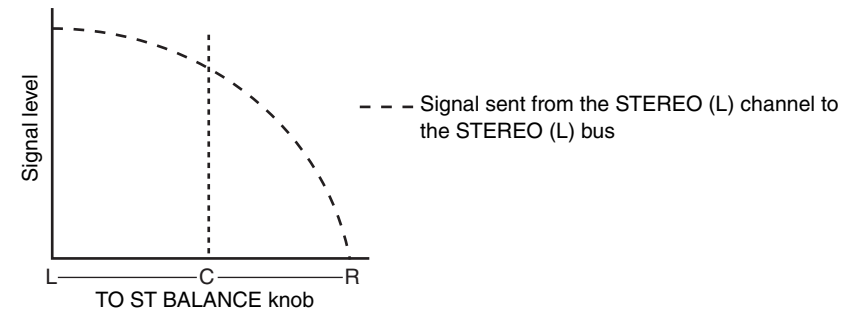

If the CSR knob is set to 100%, operating the INPUT TO ST PAN knob will change the level of signals sent to the STEREO (L/R) bus and MONO (C) bus, as shown in the following diagram.

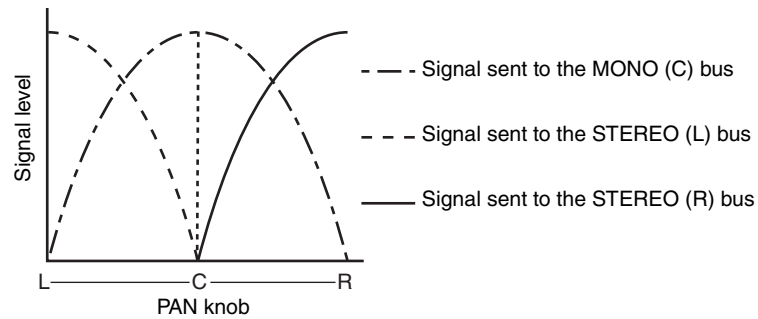

Operating the TO ST BALANCE knob of an ST IN channel will change the level of signals sent from the STEREO L/R channels to the STEREO (L/R) bus and MONO (C) bus, as shown in the following diagram.

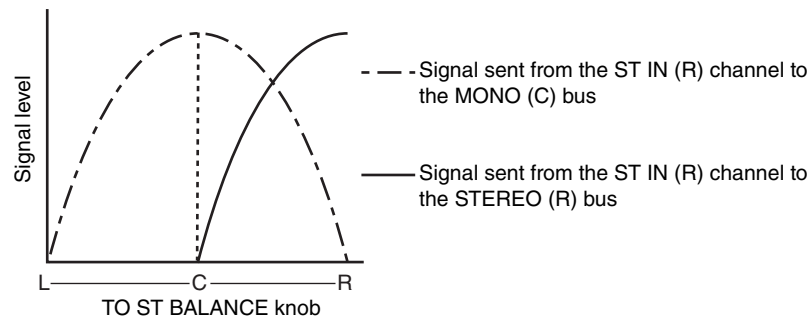
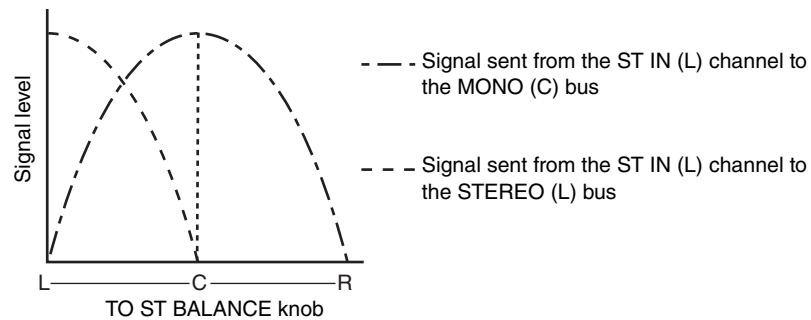

Sending a signal from an input channel to a MIX/MATRIX bus

This section explains how to send a signal from an input channel to MIX buses 1–24 and MATRIX buses 1–8.

The MIX buses are used mainly for the purpose of sending signals to foldback speakers on stage, or to effect processors. The MATRIX buses are used to produce a mix that is independent of the STEREO bus or MIX buses, and is typically sent to a master recorder or to a backstage monitoring system.

You can send a signal from an input channel to a MIX/MATRIX bus in the following three ways.

■ Using the SELECTED CHANNEL section

With this method, you use the knobs in the SELECTED CHANNEL section to adjust the send levels to the MIX/MATRIX buses. When using this method, signals sent from a specific input channel to all MIX/MATRIX buses can be adjusted collectively.

■ Using the Centralogic section

With this method, you use the multifunction knobs in the Centralogic section to adjust the level of signals sent to the MIX/MATRIX buses. When using this method, the signals sent from eight consecutive input channels to a specific MIX/MATRIX bus can be adjusted simultaneously.

■ Using the faders (SENDS ON FADER mode)

With this method, you switch the CL series unit to SENDS ON FADER mode, and use the faders on the top panel to adjust the level of signals sent to the MIX/MATRIX buses. When using this method, signals sent from all input channels to a specific MIX/MATRIX bus can be adjusted simultaneously.

Using the SELECTED CHANNEL section

This section explains how to use the knobs in the SELECTED CHANNEL section to adjust the send levels of signals sent from a specific input channel to all MIX/MATRIX buses.

- 1. Make sure that an output port is assigned to each MIX/MATRIX bus to which you want to send signals, and that your monitor system, external effect processor, or other device is connected to the corresponding output port.**
- 2. Use the [SEL] keys on the top panel to select the input channels that will send signals to the MIX/MATRIX buses.**

- 3. Press a knob in the SELECTED CHANNEL section to access the SELECTED CHANNEL VIEW screen.**



- 4. In the TO MIX/MATRIX field on screen, make sure that the MIX1-16 button or MIX17-24/MATRIX button is turned on.**

The TO MIX/TO MATRIX field displays the corresponding knobs and buttons. If this button is off, press the button to turn it on.

MIX buses can be either a FIXED type that features a fixed send level, or a VARI type that features a variable send level. The MATRIX buses are all VARI type. You can switch between FIXED and VARI types for each two adjacent odd/even-numbered MIX buses. To do so, press the SETUP button, the USER SETUP button, and then the BUS SETUP button to open the BUS SETUP popup window.

If the send-destination MIX bus is a FIXED type, a circle (○) is displayed instead of the TO MIX SEND LEVEL knob. In this case, you cannot adjust the send level.



If the send-destination MIX bus is a VARI type, or if the send-destination is a MATRIX bus, the TO MIX SEND LEVEL knob will be displayed in the same color as the corresponding knob in the SELECTED CHANNEL section. In this case, you can use the corresponding knob in the SELECTED CHANNEL section to adjust the send level.



If necessary, you can specify two adjacent odd/even-numbered MIX/MATRIX buses as a stereo bus and link the main parameters.

If the send-destination MIX/MATRIX bus is assigned as stereo, the left knob of the two adjacent TO MIX/MATRIX SEND LEVEL knobs will operate as the TO MIX/MATRIX PAN knob. (If BALANCE mode is selected in the TO STEREO/MONO popup window, it will operate as a BALANCE knob).



For a MONO channel, the right knob will adjust the common send level to the two MIX/MATRIX buses, and the left knob will adjust the panning between the two MIX/MATRIX buses. Rotating the left TO MIX/MATRIX SEND PAN knob counter-clockwise will increase the amount of signal sent to the odd-numbered MIX/MATRIX bus, and rotating it clockwise will increase the amount sent to the even-numbered MIX/MATRIX bus.

For a STEREO channel, if BALANCE mode has been selected on the TO STEREO/MONO popup window (8ch), the right knob adjusts the common send level for the two MIX/MATRIX buses, and the left knob adjusts the volume balance of the left and right signals sent to the two MIX/MATRIX buses. Rotating the left TO MIX/MATRIX SEND BAL knob counter-clockwise will increase the amount of signal sent from the L-channel to the odd-numbered MIX/MATRIX bus, and rotating it clockwise will increase the amount sent from the R-channel to the even-numbered MIX/MATRIX bus. If PAN mode has been selected in the TO STEREO/MONO popup window (8ch), the left knob will function as the PAN knob. The right knob will function as send level, just as in BALANCE mode.

- 5. Make sure that the TO MIX/MATRIX SEND ON/OFF button is turned on for the send-destination MIX bus.**

If this button is off, press the button on screen to turn it on.

- 6. In the SELECTED CHANNEL section, use the MIX/MATRIX SEND LEVEL knobs to adjust the send levels to the MIX/MATRIX buses.**

NOTE

If you want to monitor the signal being sent to a specific MIX/MATRIX bus, use the Bank Select keys in the Centralogic section to access the corresponding MIX/MATRIX channel, and then press the appropriate [CUE] key in the Centralogic section.

- 7. You can use the [SEL] keys on the top panel to switch input channels and control the send level to all MIX/MATRIX buses in the same way.**

Using the Centralogic section

You can use the multifunction knobs in the Centralogic section to adjust the send level of signals sent from eight consecutive input channels to a specific MIX/MATRIX bus.

1. Make sure that an output port is assigned to each MIX/MATRIX bus to which you want to send signals, and that your monitor system, external effect, or other device is connected to the corresponding output port.
2. Use the Bank Select keys in the Centralogic section to access the OVERVIEW screen that includes the input channel that you want to control.

In the OVERVIEW screen, you can use the TO MIX/TO MATRIX field to adjust the send levels to the MIX/MATRIX bus.



3. Press the TO MIX/MATRIX SEND LEVEL knob for the desired send-destination MIX/MATRIX bus.

A bold frame will appear around all TO MIX/MATRIX SEND LEVEL knobs for that MIX/MATRIX bus.



4. Use multifunction knobs 1–8 to adjust the send level of signals sent from the (up to) eight input channels to the selected MIX/MATRIX bus.

If necessary, you can use the Bank Select keys to switch the input channels that you want to assign to the Centralogic section, and adjust the send levels from other input channels to the selected MIX/MATRIX bus.

NOTE

If you want to monitor a signal being sent to a specific MIX/MATRIX bus, use the Bank Select keys to assign the corresponding MIX channel to the Centralogic section, and then press the [CUE] key for that MIX/MATRIX channel.

5. If you want to make detailed settings for MIX/MATRIX sends, press the TO MIX/MATRIX SEND LEVEL knob inside the bold frame once again.

When you press the currently-selected TO MIX/MATRIX SEND LEVEL knob a second time, the MIX SEND popup window or the MATRIX SEND popup window will appear. This window includes the following items.

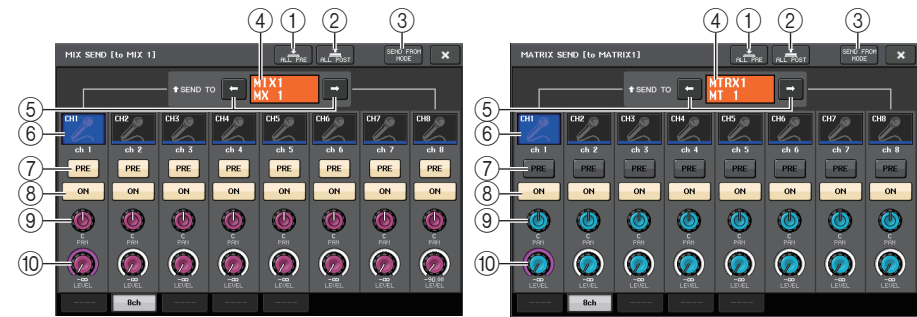

1. **ALL PRE button**

Sets the send point to “PRE.” (The send point is the point at which signals are sent from all send-source channels — including the input and output channels — to the selected send destination.) At this time, the PRE/POST button will light.

2. **ALL POST button**

Sets the send point to “POST.” (The send point is the point at which signals are sent from all send-source channels — including the input and output channels — to the selected send destination.) At this time, the PRE/POST button will turn off.

3. **SEND FROM MODE button**

Press this button to switch to the “SEND from 8ch” popup window.

4. **Send destination indicator**

Indicates the currently-selected send destination.

5. **Send destination select buttons**

Select MIX/MATRIX buses as the send destination.

⑥ Channel select button

Selects the send-source channel that you wish to control. The current channel icon, number, and color appear on the button, and the channel name appears immediately below the button.

⑦ PRE/POST button

Switches the send point of each send-source channel between PRE and POST. If the button is on, the send point is set to PRE.

⑧ SEND ON/OFF button

Switches the send of each send-source channel on or off.

⑨ SEND PAN/BALANCE knob

Sets the panning or balance of signals sent to the stereo send destination. If the send destination is set to monaural or FIXED, this knob will not appear.

If the send source is monaural, this knob functions as a PAN knob.



If the send source is stereo, you can use the PAN/BALANCE mode setting in the TO STEREO/MONO popup window to select whether PAN/BALANCE will function as a PAN or BALANCE knob.



The knob for the mode selected here will appear.



⑩ SEND LEVEL knob

Indicates the level of signals sent to the selected send destination. Press this knob to control the level using the multifunction knobs.

If the send destination is set to FIXED, only a gray circle will appear.

- Use the TO MIX/MATRIX SEND ON/OFF buttons to switch signals sent from the input channels to the currently-selected MIX/MATRIX bus on or off.
- If necessary, use the PRE buttons to select the send point of a signal that is sent from each input channel to a VARI type MIX/MATRIX bus.

NOTE

- If the PRE button is on, you can also select PRE EQ (immediately before the EQ) or PRE FADER (immediately before the fader) for each MIX/MATRIX bus. This setting is made in the BUS SETUP popup window (see [page 202](#)).
- The PRE button is not displayed for FIXED type MIX buses.

Using the faders (SENDS ON FADER mode)

You can use the faders on the top panel to adjust signals that are sent from all input channels to a specific MIX/MATRIX bus.

1. Make sure that an output port is assigned to each MIX/MATRIX bus to which you want to send signals, and that your monitor system, external effect, or other device is connected to the corresponding output port.

2. In the Function Access Area, press the SENDS ON FADER button.

The CL series unit will switch to SENDS ON FADER mode. The faders in the Channel Strip section and Master section will move to the send levels of the signals that are routed from each channel to the currently-selected MIX/MATRIX bus. The [ON] keys will also change to the SEND ON status.

If you've used the bank select keys to assign input channels to the Centralogic section, the corresponding channels will change to indicating the send levels and ON settings for the signals sent from those channels to the currently selected MIX/MATRIX bus. If the Centralogic section has been assigned to output channels, and the send-destination bus is MIX, each channel will still show the fader value and ON setting. If the send-destination bus is MATRIX, the Centralogic section will change to show the send level and ON setting for the signals sent from the MIX/STEREO/MONO channels to the currently selected MATRIX bus. MATRIX channels will continue showing the channel fader values and ON setting.

In SENDS ON FADER mode, the Function Access Area in the display will show the buttons that enable you to switch between MIX1-16 ON FADER mode and MIX17-24/MATRIX ON FADER mode, and the buttons that enable you to select the destination MIX/MATRIX buses.



3. Press the MIX1-16, MIX17-24/MATRIX switch button repeatedly to select MIX1-16 or MIX17-24/MATRIX.

In this way, you can use the MIX/MATRIX bus select buttons to specify the destination MIX/MATRIX buses.

4. Use the MIX/MATRIX bus selection buttons in the Function Access Area to select the send-destination MIX/MATRIX bus.

NOTE

- Alternatively, press a SEND LEVEL knob in the SELECTED CHANNEL section to display a popup window from which you can select a MIX/MATRIX bus.
- You can also select a MIX/MATRIX bus by using the Bank Select keys and the [SEL] keys in the Centralogic section. If you select the buses by pressing the [SEL] keys, the setting of the MIX1-16, MIX17-24/MATRIX switch button will be changed automatically.
- If you press the currently-selected MIX/MATRIX bus select button again, cue monitoring will be turned on for the related MIX/MATRIX channel. This method is convenient if you want to monitor a signal that is being sent to the selected MIX/MATRIX bus.

5. Use the faders in the Channel Strip section on the top panel to adjust the send level of signals routed from the input channels to the selected MIX/MATRIX bus.

NOTE

You can assign the SENDS ON FADER function to a USER DEFINED key. This lets you quickly switch to SENDS ON FADER mode for a specific MIX/MATRIX bus, and quickly switch back again.

6. Repeat steps 4–5 to adjust the send level for other MIX/MATRIX buses in the same way.

7. When you have finished adjusting the MIX/MATRIX send levels, press the “x” symbol in the Function Access Area.

The Function Access Area display will return to its prior state, and the CL console will exit SENDS ON FADER mode and return to normal mode.

Correcting delay between channels (Input Delay)

This section explains how to correct delay between input channels by using Input Delay function.

This function is useful when you want to correct the phase variance, caused by microphone locations on the stage, to add depth to the sound by using phase variance, or to correct a delay (a gap) that may exist between video and audio that are sent from a site for broadcast on TV.

1. Use the [SEL] keys on the top panel to select the input channel that will send signals to the MIX/MATRIX bus.
2. Press a knob in the SELECTED CHANNEL section to access the SELECTED CHANNEL VIEW screen.

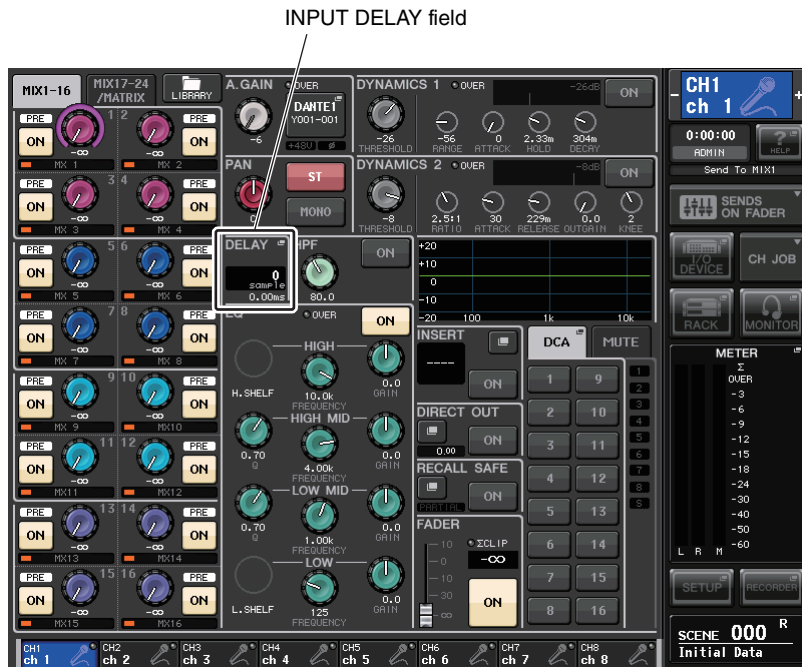

3. Press the INPUT DELAY field to access the INPUT DELAY popup window.

In the INPUT DELAY popup window you can set the on/off status and the value of the input channel delay. This popup window features three types of view. Use the tabs near the bottom of the window to select one of four views. Each window view includes the following items.

INPUT DELAY (8ch)



- 1 DELAY SCALE button

Press the button to display the DELAY SCALE popup window, in which you can select the unit for the delay time.

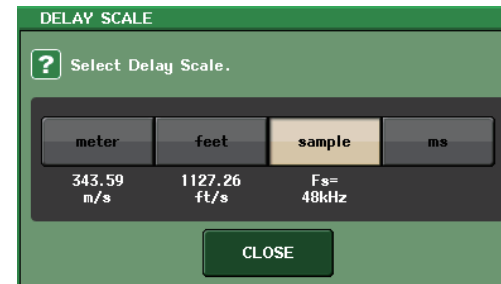

You can select one of the four delay scales: meter (meter/sec), feet (feet/sec), sample (number of samples), and ms (millisecond).

- 2 Channel select button

Lights to indicate the currently-selected input channel. Press the button to select the channel.

- 3 Delay setting knob (input channels only)

Indicates the channel delay value. You can use the multifunction knob to adjust it. You can view the current value immediately above the knob (in unit of ms) and below the knob (in the currently-selected scale). If ms (millisecond) has been selected for the DELAY SCALE, nothing will appear above the knob.

INPUT DELAY (CH1-48, CH49-72/ST IN(CL5), CH49-64/ST IN(CL3), ST IN(CL1))

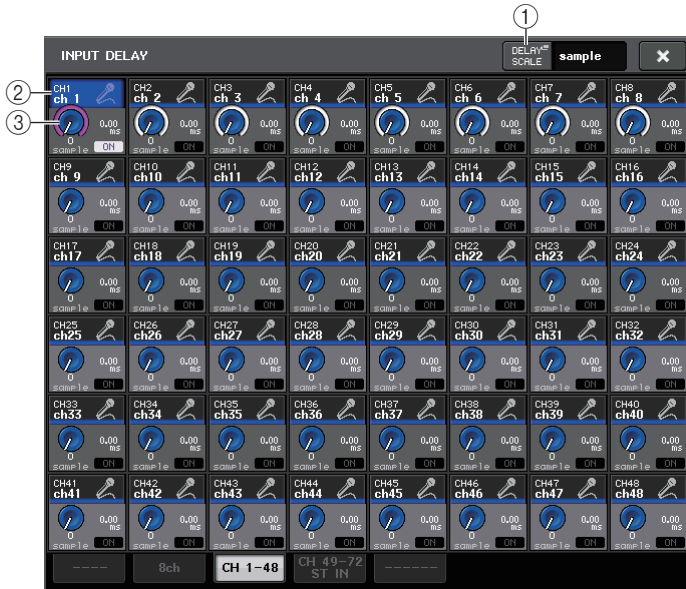

① DELAY SCALE button

Press the button to display the DELAY SCALE popup window, in which you can select the unit for the delay time.

② Channel select button

Lights indicate the currently-selected input channel. Press the button to select the channel.

③ Delay setting knob (input channels only)

Indicates the channel delay value. Press this knob to adjust the value using the multifunction knob. You can view the current value immediately above the knob (in unit of ms) and below the knob (in the currently-selected scale).

NOTE

If ms (millisecond) has been selected for the DELAY SCALE, nothing will appear to the right of the knob.

4. Access the INPUT DELAY (8ch) popup window.

5. Use the on-screen buttons and the multifunction knobs to set the delay.

6. Perform the same operations for other input channels as desired.

If you are viewing the 8ch INPUT DELAY popup window, you can use the Bank Select keys in the Centralogic section to switch the channels being controlled in groups of eight.

7. When you finish editing, press the × symbol in the upper right of the window.

Channel library operations

Channel libraries include “INPUT CHANNEL LIBRARY,” which enables you to store and recall various parameters (including the head amp settings) for input channels.

To recall a library, press the corresponding LIBRARY button in the SELECTED CHANNEL VIEW screen.



For details on using the library, refer to the “Using the library” section in the separate Owner’s Manual.

Output channels

This chapter explains output channels (MIX channels, MATRIX channels, STEREO channels, MONO channels).

Signal flow for output channels

The output channel section takes the signals sent from the input channels to the various buses, processes them with EQ and dynamics, and sends them to output ports or other buses. The following types of output channels are provided.

MIX channels

These channels process signals sent from input channels to MIX buses, and output them to the corresponding output port, MATRIX bus, STEREO bus, or MONO (C) bus.

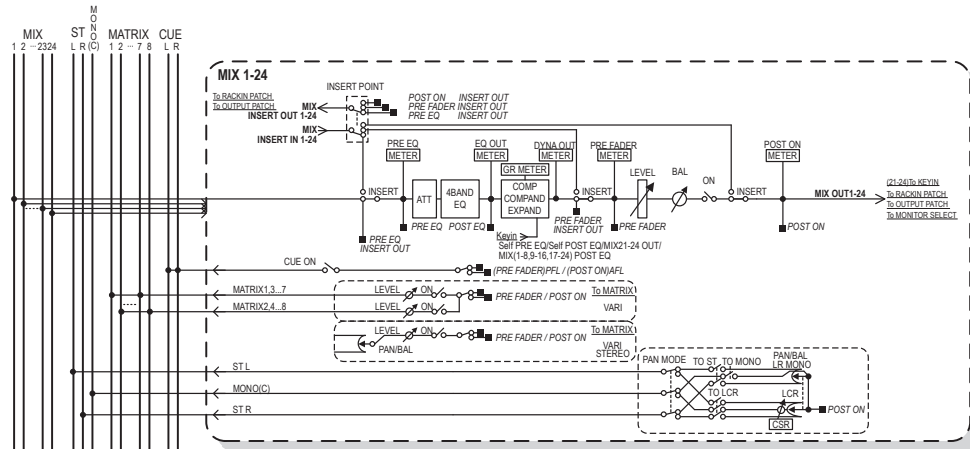

STEREO channel/MONO (C) channel

Each of these channels processes the signal sent from the input channels to the STEREO bus or MONO (C) bus, and send it to the corresponding output port or MATRIX bus. If input channels are in LCR mode, the STEREO (L/R) channels and the MONO (C) channel can be used together as a set of three output channels.

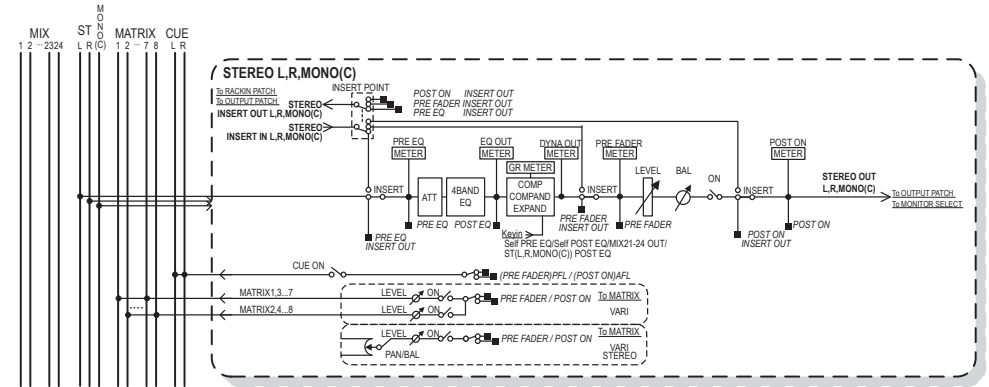

MATRIX channel

These channels process the signals sent from input channels, MIX channels, and STEREO/MONO channels to MATRIX buses, and send them to the corresponding output ports.

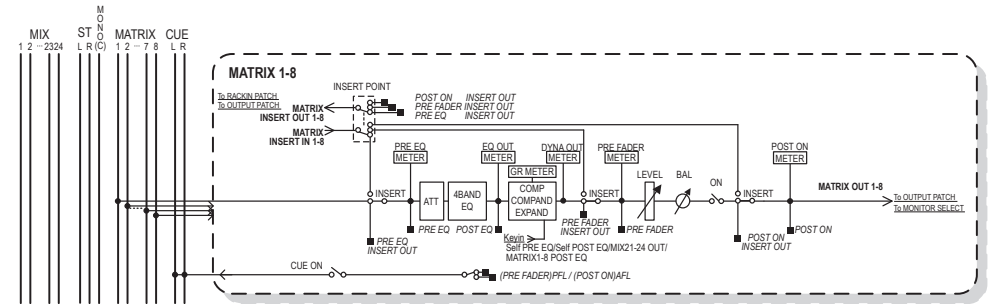

- 4 BAND EQ (4 band equalizer)**
 A parametric EQ with four bands: HIGH, HIGH MID, LOW MID, and LOW.
- DYNAMICS 1**
 This is a dynamics processor that can be used as a compressor, expander, or compander.
- LEVEL**
 Adjusts the output level of the channel.
- ON (on/off)**
 Turns the output channel on or off. If this is off, the corresponding channel will be muted.

- **MATRIX ON/OFF (MATRIX send on/off)**

This is an on/off switch for signals sent from the MIX channels, STEREO (L/R) channel, or MONO (C) channel to each MATRIX bus.

- **MATRIX (MATRIX send level)**

Adjusts the send level of signals sent from the MIX channels, STEREO (L/R) channel, or MONO (C) channel to each MATRIX bus 1–8. For the position from which the signal will be sent to the MATRIX bus, you can choose either immediately before the fader, or immediately after the [ON] key.

If the send-destination MATRIX bus is set to stereo, you can use the PAN knob to adjust the panning between the two MATRIX buses. If the send-source is a stereo MIX channel or the STEREO channel, use the BALANCE knob to adjust the volume balance of the left and right channels sent to the two MATRIX buses.

- **INSERT**

You can patch the desired output/input ports to insert an external device such as an effect processor. You can switch the insert-out and insert-in locations.

- **METER**

Indicates the level of the output channel.

You can switch the position at which the level is detected.

- **KEY IN (MIX channels 21–24 only)**

You can send the output signals of MIX channels 21–24 to dynamics processors and use them as key-in signals to control the dynamics.

- **RACK IN PATCH**

Patches the output signal of an output channel to an input of the rack.

- **OUTPUT PATCH**

Assigns an output port to an output channel.

- **MONITOR SELECT**

Selects the output signal of an output channel as a monitor source.

Specifying the channel name, icon and channel color

This section explains how to specify the channel name, icon and channel color for each output channel.

1. Use the Bank Select keys in the Centralogic section to access the OVERVIEW screen that includes the output channel for which you want to specify the channel name, icon and channel color.

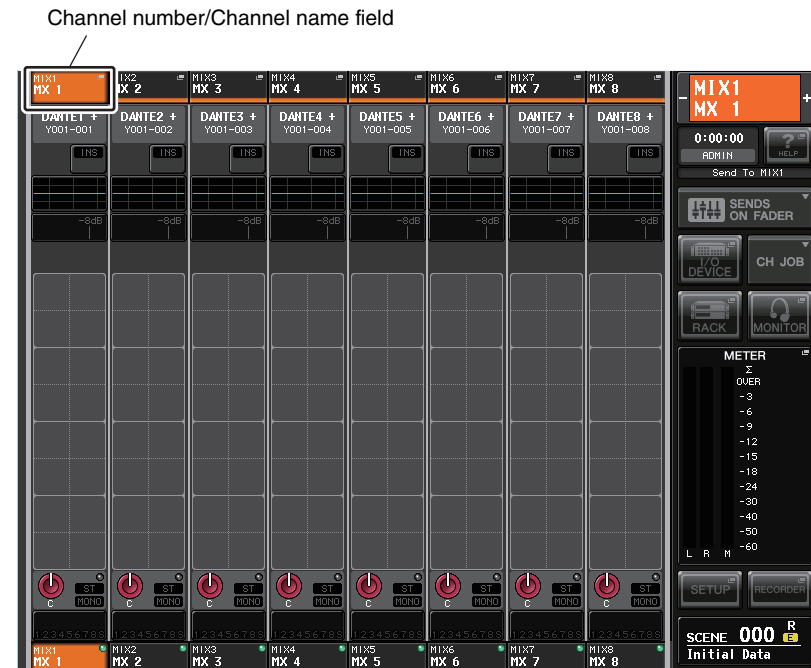

2. Access the PATCH/NAME popup window by pressing the channel number/channel name field of the channel to which you want to assign the channel name, icon and channel color.

Sending signals from MIX channels to the STEREO/MONO bus

This section explains how to send a signal from a MIX channel to the STEREO bus or MONO bus. There are two ways to send signals to the STEREO bus or MONO bus: ST/MONO mode and LCR mode. You can select the mode individually for each channel. Features of each mode are the same as for input channels.

1. Use the Bank Select keys in the Centralogic section to access the OVERVIEW screen that includes the MIX channel from which you want to send the signal to the STEREO/MONO bus.



STEREO/MONO field

2. In the STEREO/MONO field, press a knob to select the channel you want to adjust, and then press the knob once again to access the TO STEREO/MONO popup window.

In the TO STEREO/MONO popup window, you can control a signal that is sent from the MIX channel to the STEREO/MONO bus. This popup window features four types of view. Use the tabs near the bottom of the window to select one of the four views. These windows include the following items.



Follow the steps for the input channels (see [page 29](#)).

TO STEREO/MONO popup window (8ch)

You can control the on/off and pan/balance settings of the signal sent from MIX channels to the STEREO (L/R) bus and MONO (C) bus, in groups of eight channels.



① Channel select button

Selects the channel. You can select multiple channels simultaneously.

② Mode LEDs

③ MODE (ST/MONO/LCR mode select) button

Press this button repeatedly to toggle between ST/MONO and LCR. The LED of the currently-selected mode will light.

④ ST/MONO buttons

These buttons are individual on/off switches for signals that are sent from each channel to the STEREO bus/MONO bus when the MONO button is set to ST/MONO mode.

⑤ Σ clipping indicator

Lights to indicate a signal is clipping at some point in the channel.

⑥ TO ST PAN/TO ST BALANCE knob

If the type of the MIX channel signal is MONO, this knob will function as a PAN knob that adjusts the left and right pan position of the signal sent to the STEREO bus. If the type of MIX channel signal is STEREO, this knob will function as a BALANCE knob that adjusts the volume level balance of left and right signals sent to the STEREO bus. To adjust the value, press the knob to select it, and then operate the corresponding multifunction knob.

If the ST/MONO/LCR mode select button is set to LCR mode, the following button and knob are displayed instead of the ST/MONO button (④).

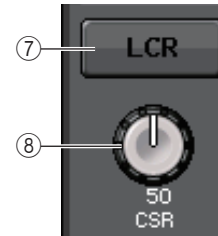

⑦ LCR button

This button is an overall on/off button for signals sent from a channel to the STEREO bus and MONO bus. If this button is off, no signals will be sent from the corresponding input channel to the STEREO bus or MONO bus.

⑧ CSR knob

Adjusts the relative level of signals sent from the channel to the STEREO (L/R) bus and to the MONO (C) bus, in the range of 0–100%. To adjust the value, press the knob to select it, and then operate the corresponding multifunction knob.

TO STEREO/MONO popup window (CH1-48, CH49-72/ST IN(CL5), CH49-64/ST IN(CL3), ST IN(CL1), OUTPUT)

This window displays the status of signals sent from the corresponding channel to the STEREO bus/MONO bus. You can also adjust the pan or balance setting in groups of eight selected channels.

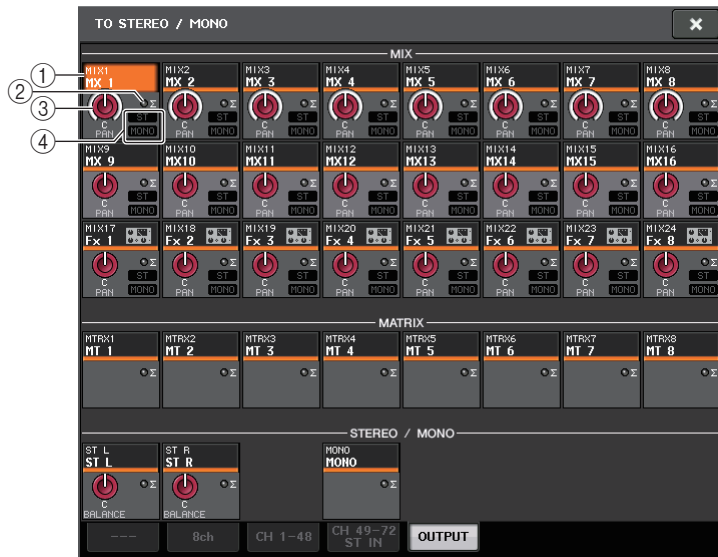

① Channel select button

Selects the channel. You can select multiple channels simultaneously.

② Σ clipping indicator

Lights to indicate a signal is clipping at some point in the channel.

③ TO ST PAN/TO ST BALANCE knob

Adjusts the panning and balance.

To adjust the value, press the knob to select it, and then operate the corresponding multifunction knob.

If the signal level reaches the overload point at any meter detection point in that channel, the Σ clipping indicator to the right of the knob will light.

④ ST/MONO indicator

If a channel is set to ST/MONO mode, these indicators will individually indicate the on/off status of signals sent from the channel to the STEREO bus/MONO bus.

If a channel is set to LCR mode, the LCR indicator is displayed in this location. The LCR indicator indicates the on/off status of all signals sent from that channel to the STEREO bus/MONO bus.

3. Access the eight-channel TO STEREO/MONO popup window.
4. Use the MODE button to select either ST/MONO mode or LCR mode for each channel.
5. In the MASTER section on the top panel, make sure that the [ON] key for the STEREO channel/MONO channel is turned on, and then raise the fader to an appropriate level.
6. Press one of the Output Bank Select Keys in the Centralogic section so that the MIX channels you want to control are recalled to the Centralogic section.
7. Make sure that the [ON] keys for those channels are on, and use the fader in the Centralogic section to raise the master level of the MIX channel to an appropriate position.

The subsequent steps will differ depending on whether ST/MONO mode or LCR mode was selected for the channel in step 4.

■ Channels for which ST/MONO mode is selected

8. In the TO STEREO/MONO popup window, use the STEREO/MONO button to turn a signal sent from the MIX channel to the STEREO bus/MONO bus on or off.
For a channel that is set to ST/MONO mode, signals sent to the STEREO bus and to the MONO bus can be switched on/off individually.
9. In the TO STEREO/MONO popup window, use the TO ST PAN knob to set the panning of a signal sent from the MIX channel to the STEREO bus.

■ Channels for which LCR mode is selected

8. Make sure that the LCR button is turned on in the TO STEREO/MONO popup window.
Channels for which the LCR button is off will not send a signal to the STEREO bus or MONO bus.
9. In the TO STEREO/MONO popup window, press the CSR knob to select it, and use multifunction knobs 1–8 to adjust the level difference between signals sent from that channel to the STEREO (L/R) bus and to the MONO (C) bus.
The CSR knob settings are the same as for input channels.
10. In the TO STEREO/MONO popup window, press the TO ST PAN knob to select it, and use multifunction knobs 1–8 to adjust the panning of signals sent from the MIX channel to the STEREO (L/R) bus and MONO (C) bus, and the level balance of signals sent to the MONO (C) bus and STEREO (L/R) bus.
Refer to [page 38](#) for details on how the signal level sent from an LCR mode MIX channel to each bus will change according to the operation of the TO ST PAN knob.

Sending signals from MIX channels and STEREO/MONO channels to MATRIX buses

This section explains how to send a signal from a MIX or STEREO/MONO channel to MATRIX buses 1–8. You can do this in either of the following three ways.

■ Using the SELECTED CHANNEL section

With this method, you use the knobs in the SELECTED CHANNEL section to adjust the send levels to the MATRIX buses. This method allows you to simultaneously control signals sent from a specific MIX, STEREO (L/R), or MONO (C) channel to all MATRIX buses.

■ Using the Centralogic section

With this method, you use the multifunction knobs in the Centralogic section to adjust the send levels to the MATRIX buses. This method allows you to simultaneously control signals sent from up to eight MIX, STEREO (L/R), or MONO (C) channels to a specific MATRIX bus.

■ Using the faders (SENDS ON FADER mode)

With this method, you switch the CL series unit to SENDS ON FADER mode, and use the faders on the top panel to adjust the level of signals sent to the MATRIX buses. When using this method, signals sent from MIX and STEREO/MONO channels to a specific MIX/MATRIX bus can be adjusted simultaneously.

Using the SELECTED CHANNEL section

Use the knobs in the SELECTED CHANNEL section to adjust the send level of signals sent from the desired MIX, STEREO (L/R) or MONO (C) channel to all MATRIX buses.

1. Make sure that an output port is assigned to the MATRIX bus to which you want to send signals, and that an external device is connected.
2. Using the Bank Select keys of the Centralogic section, assign MIX channels or STEREO/MONO channels to the Centralogic section.
3. Use the [SEL] keys in the Centralogic section to select the channels that will send signals to the MATRIX buses.

You can also use the [SEL] key in the MASTER section to directly select the STEREO/MONO channels.

4. Press a knob in the SELECTED CHANNEL section to access the SELECTED CHANNEL VIEW screen.



5. Make sure that the TO MATRIX SEND ON/OFF button is turned on for the send-destination MATRIX bus.
If this button is off, press the button on screen to turn it on.
6. In the SELECTED CHANNEL section, use the MIX/MATRIX SEND LEVEL knobs to adjust the send levels to the MATRIX buses.

NOTE

If you want to monitor the signal being sent to a specific MATRIX bus, use the Bank Select keys in the Centralogic section to access the corresponding MIX/MATRIX channel, and then press the appropriate [CUE] key in the Centralogic section.

7. Use the Bank Select keys and the [SEL] keys in the Centralogic section to switch channels, and adjust the send level from other channels to the MATRIX buses in the same way.

Using the Centralogic section

This method lets you use the multifunction knobs (in the Centralogic section) to simultaneously adjust the send levels from the eight channels selected in the Centralogic section to the desired MATRIX bus.

1. Make sure that an output port is assigned to the MATRIX bus to which you want to send signals, and that your external device is connected to the corresponding output port.
2. Use the Bank Select keys in the Centralogic section to access the OVERVIEW screen that includes the channels (MIX channels or STEREO/MONO channels) that you want to control.

In the OVERVIEW screen, you can use the TO MATRIX field to adjust the send levels to the MATRIX bus.



3. Press the TO MATRIX SEND LEVEL knob for the desired send-destination MATRIX bus.

A bold frame will appear around all TO MATRIX SEND LEVEL knobs for that MATRIX bus.



4. Use multifunction knobs 1–8 to adjust the send level of the signals sent from up to eight MIX channels or the STEREO/MONO channels to the selected MATRIX bus.

If necessary, you can use the Bank Select keys and the [SEL] keys in the Centralogic section to switch the send-source channel.

NOTE

- If you want to monitor signals being sent to a specific MATRIX bus, use the Bank Select keys to access the corresponding MATRIX channel in the Centralogic section, and then press the [CUE] key for that MATRIX channel.
- If you again press the currently-selected MATRIX bus select button, cue monitoring will be turned on for the related MATRIX channel. This method is convenient if you want to monitor a signal that is being sent to the selected MATRIX bus.

5. If you want to make detailed settings for MATRIX sends, press the TO MATRIX SEND LEVEL knob inside the bold frame once again.

When you press the currently-selected TO MATRIX SEND LEVEL knob a second time, the MATRIX SEND popup window will appear. The window includes the following items.



1. **ALL PRE button**

Sets the send point to “PRE.” (The send point is the point at which signals are sent from all send-source channels — including the input and output channels — to the selected send destination.)

2. **ALL POST button**

Sets the send point to “POST.” (The send point is the point at which signals are sent from all send-source channels — including the input and output channels — to the selected send destination.)

3. **SEND FROM MODE button**

Press this button to switch to the “SEND from 8ch” popup window.

4. **Send destination indicator**

Indicates the currently-selected send destination.

⑤ **Send destination select buttons**

Select MIX/MATRIX buses as the send destination.

⑥ **Channel select button**

Selects the send-source channel that you wish to control. The current channel icon, number, and color appear on the button, and the channel name appears immediately below the button.

⑦ **PRE/POST button**

Switches the send point of each send-source channel between PRE and POST. If the button is on, the send point is set to PRE.

⑧ **SEND ON/OFF button**

Switches the send of each send-source channel on or off.

⑨ **SEND PAN/BALANCE knob**

Sets the panning or balance of signals sent to the stereo send destination. If the send destination is set to monaural or FIXED, this knob will not appear.

If the send source is monaural, this knob functions as a PAN knob.



If the send source is stereo, you can use the PAN/BALANCE mode setting in the TO STEREO/MONO popup window to select whether PAN/BALANCE will function as a PAN or BALANCE knob.



The knob for the mode selected here will appear.



⑩ **SEND LEVEL knob**

Indicates the level of signals sent to the selected send destination. Press this knob to control the level using the multifunction knobs.

6. Use the TO MATRIX SEND ON/OFF buttons to switch signals sent from the MIX and STEREO/MONO channels to the currently-selected MATRIX bus on or off.
7. If necessary, you can use the PRE buttons to select the point from which the signal is sent from the MIX or STEREO/MONO channel to the MATRIX bus.
8. Repeat steps 3–6 to adjust the send level for other MATRIX buses in the same way.

Using the faders (SENDS ON FADER mode)

You can use the faders on the top panel to adjust signals that are sent from the MIX and STEREO/MONO channels to a specific MATRIX bus.

1. Make sure that an output port is assigned to the MATRIX bus to which you want to send signals, and that your monitor system etc. is connected to the corresponding output port.

2. In the function access area, press the SENDS ON FADER button.

The CL series unit will switch to SENDS ON FADER mode. The faders in the Channel Strip section and Master section will move to the send levels of the signals that are routed from each channel to the currently-selected MIX/MATRIX bus. The [ON] keys will also change to the SEND ON status.

In SENDS ON FADER mode, the Function Access Area in the display will show the buttons that enable you to switch between MIX 1-16 ON FADER mode and MIX 17-24/MATRIX ON FADER mode, and the buttons that enable you to select the destination MIX/MATRIX buses.

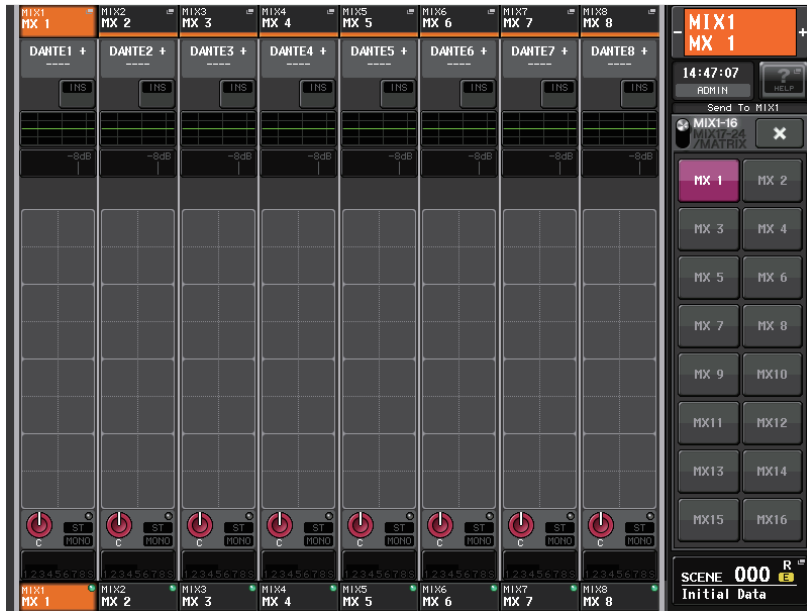

3. Use the MIX 1-16 and MIX 17-24/MATRIX select buttons to switch between MIX 1-16 and MIX 17-24/MATRIX.

Now you can use the MIX/MATRIX bus select buttons to specify the destination MIX/MATRIX buses.

4. Use the MIX/MATRIX bus selection buttons in the function access area to select the send-destination MATRIX bus.

NOTE

- Alternatively, press a SEND LEVEL knob in the SELECTED CHANNEL section to display a popup window, from which you can select a MIX/MATRIX bus.
- You can also select a MIX/MATRIX bus by using the Bank Select keys and the [SEL] keys in the Centralogic section. If you switch buses by pressing the [SEL] keys, the setting of the MIX 1-16 and MIX 17-24/MATRIX ON FADER switch buttons will also be change automatically.
- If you press the currently-selected MIX/MATRIX bus select button again, cue monitoring will be turned on for the corresponding MIX/MATRIX channel. This method is convenient if you want to monitor the signal that is being sent to the selected MIX/MATRIX bus.

5. Use the faders in the top panel Centralogic section to adjust the send level from the MIX and STEREO/MONO channels to the selected MATRIX bus.

NOTE

You can assign the SENDS ON FADER function to a USER DEFINED key. This lets you quickly switch to SENDS ON FADER mode for a specific MIX/MATRIX bus, and quickly switch back again.

6. Repeat steps 4–5 to adjust the send level for other MATRIX buses in the same way.

7. When you're finished adjusting the MATRIX send levels, press the X symbol in the function access area.

The Function Access Area display will return to its prior state, and the CL console will exit SENDS ON FADER mode and return to normal mode.

Correcting delay between channels (Output Delay)

This section explains how to correct delay between output channels by using the Output Delay function.

This Output Delay function is useful when you want to correct the timing of output signals sent to speakers that are located at a distance from each other.

Output delay settings are made in the OUTPUT PORT popup window, which will appear when you press the OUTPUT PORT button from the SETUP screen.

For details on operations in the OUTPUT PORT screen, refer to “[Selecting the output channel for each output port](#)” on [page 17](#).

Channel library operations

Channel libraries include “OUTPUT CHANNEL LIBRARY,” which enables you to store and recall various parameters (including the head amp settings) for output channels.

To recall the library, while an output channel is selected, press the LIBRARY button on the SELECTED CHANNEL VIEW screen.

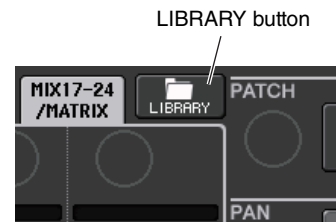

For details on using the library, refer to the “Using libraries” section in the separate Owner’s Manual.

EQ and Dynamics

This chapter explains the EQ (equalizer) and dynamics that are provided on each channel of the CL series console.

About EQ and dynamics

Each input channel and output channel on a CL series console provides a four-band EQ and dynamics. EQ can be used on all input channels and all output channels. An attenuator is provided immediately before the EQ, allowing you to attenuate the level of the input signal so that the GAIN setting for EQ will not cause the signal to clip. Input channels also provide a high-pass filter that is independent of the EQ.

Input channels provide two dynamics processors: Dynamics 1 can be used as a gate, ducking device, compressor, or expander, while Dynamics 2 can be used as a compressor, hard compander, soft compander, or de-esser. Output channels provide one dynamics processor, which can be used as a compressor, expander, hard compander, or soft compander.

Using EQ

This section explains the four-band EQ that is provided on input channels and output channels.

1. Use the Bank Select keys in the Centralogic section to access the OVERVIEW screen that includes the channel for which you want to control the EQ.

The EQ field shows the response of the EQ. In this OVERVIEW screen, you can edit the parameter by using the EQ knobs in the SELECTED CHANNEL section.



2. If you want to edit while watching the ATT/HPF/EQ parameter values, press the EQ field in the OVERVIEW screen to access the HPF/EQ popup window.

In the HPF/EQ popup window, you can edit the EQ and high-pass filter parameters and switch them on/off.

This popup window features five types of views. Each window view includes the following items.

HPF/EQ popup window (1ch)

This lets you view and edit all EQ parameters of the currently-selected channel. This is convenient if you want to make detailed EQ settings for a specific channel.

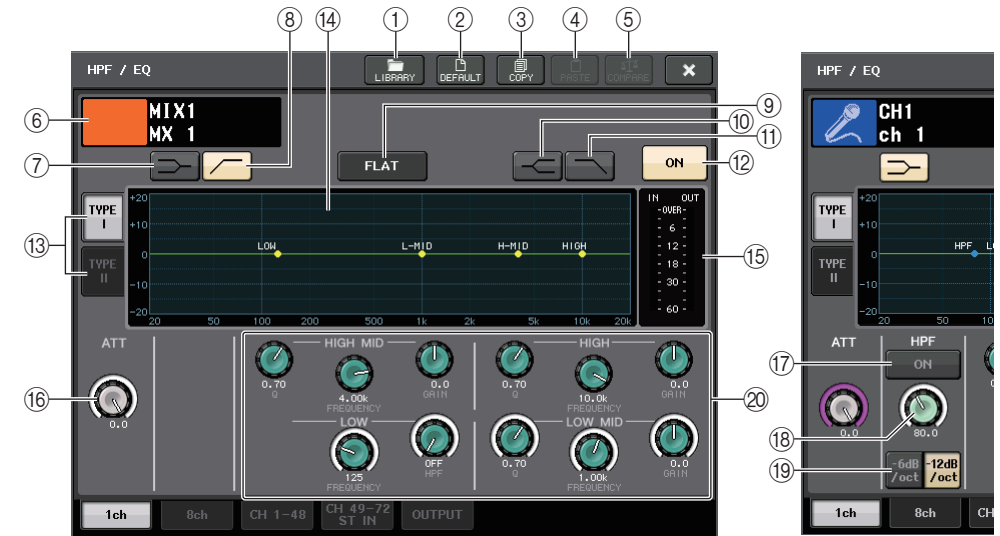

- 1 **LIBRARY button**
Press this button to open the EQ Library popup window.
- 2 **DEFAULT button**
Press this button to reset all EQ/filter parameters to the initial values.
- 3 **COPY button**
All EQ parameter settings will be stored in buffer memory.
- 4 **PASTE button**
Press this button to paste the setting in buffer memory to the current EQ. If no valid data has been stored in the buffer memory, nothing will happen.
- 5 **COMPARE button**
Press this button to swap between the current EQ settings and the data stored in buffer memory. If no valid data has been stored in the buffer memory, nothing will happen.
- 6 **Channel icon/Channel number/Channel name**
This area indicates the icon, number and name of the currently-selected channel.
- 7 **LOW SHELVEING ON/OFF button**
Turn on this button to select the shelving-type filter for the LOW band.
- 8 **HPF ON/OFF button (input channels only)**
Turn on this button to select the high pass filter for the LOW band.

⑨ **EQ FLAT button**

Press this button to reset the GAIN parameters of all EQ band to 0 dB.

⑩ **HIGH SHELIVING ON/OFF button**

Turn on this button to select the shelving type filter for the HIGH band.

⑪ **LPF ON/OFF button**

Turn on this button to select the low pass filter for the HIGH band.

⑫ **EQ ON/OFF button**

Switches the EQ on or off.

⑬ **EQ type select button**

Switches between TYPE I (an algorithm used in previous Yamaha digital mixers) and TYPE II (an algorithm that reduces interference between bands).

⑭ **EQ graph**

This graph displays real-time parameter values for the EQ and filter.

⑮ **EQ IN/OUT level meters**

Indicate the peak level of signals before and after the EQ. For a stereo channel, these meters indicate the level of both the L and R channels.

⑯ **ATT knob**

Indicates an attenuation amount before the signal enters the EQ. You can use the multifunction knobs to adjust this.

⑰ **HPF ON/OFF button (input channels only)**

Switches the HPF on or off.

⑱ **HPF FREQUENCY knob (input channels only)**

Indicates the cutoff frequency of the HPF. You can use the multifunction knobs to adjust this.

⑲ **HPF type select button**

Switches the HPF attenuation per octave between -12 dB/oct and -6 dB/oct.

⑳ **EQ parameter setting knobs**

Indicate the Q, FREQUENCY, and GAIN parameters for the LOW, LOW MID, HIGH MID, and HIGH bands. Press these knobs to control the parameter values using the multifunction knobs.

NOTE

- If shelving type has been selected for the LOW band, or if HPF is selected for the output channels, the LOW band Q parameter will not appear.
- If shelving type has been selected for the HIGH band, or if LPF is selected, the HIGH band Q parameter will not appear.

HPF/EQ popup window (8ch)

This window displays the input channel or output channel EQ settings in groups of eight channels simultaneously.

Use the knobs in the SELECTED CHANNEL section to edit the EQ settings. You can adjust the HPF settings of all eight channels displayed.



① **Channel select button**

Selects the channel that you want to control. The current channel icon and number appear on the button, and the channel name appears immediately below the button.

② **EQ graph**

This graph displays the parameter values for the EQ and filter. The currently-selected EQ type appears below the graph.

③ **EQ ON/OFF button**

Switches the EQ on or off. The OVER indicator (located to the right above the button) lights if the post-EQ signal is clipping.

④ **HPF FREQUENCY knob**

Indicates the cutoff frequency of the HPF. You can use the multifunction knobs to adjust this.

⑤ **HPF ON/OFF button**

Switches the HPF on or off.

HPF/EQ popup window (CH1-48, CH49-72/ST IN(CL5), CH49-64/ST IN(CL3), ST IN(CL1), OUTPUT)

This window displays the corresponding input channels (or output channels) simultaneously. This page is only for display, and does not allow the parameters to be edited. It is useful when you need to quickly check multiple EQ settings, or when you want to copy and paste EQ settings between distant channels.



① Channel select button

Selects the channel that you want to control in the SELECTED CHANNEL section. The current channel icon, number, and color appear on the button.

② EQ graph

Indicates the total frequency response of the EQ or filter.

③ Tabs

Use these tabs to select a channel that you want to view on the screen.

3. Access the HPF/EQ popup window (1ch), and then press the EQ ON button to enable the EQ.

If the HPF/EQ popup window (1ch) is displayed, you will be able to edit all of the EQ parameters.

4. If you want to use the high-pass filter on an input channel, operate the HPF knob or HPF ON/OFF button in the HPF/EQ popup window.

Input channels provide a high-pass filter that is independent of the four-band EQ. The HPF ON/OFF button switches the high-pass filter on or off, and the HPF knob adjusts the cutoff frequency.

NOTE

- Output channels do not feature a high-pass filter that is independent of the EQ. However, you can turn on the high-pass filter button on the popup window to use the LOW band EQ as a high-pass filter.
- For both input channels and output channels, you can turn on the low-pass filter button to use the HIGH band EQ as a low-pass filter.

5. If you want to copy EQ settings to another channel, or initialize the EQ settings, use the tool buttons in the HPF/EQ popup window.

For details on how to use these buttons, refer to “Using the tool buttons” in the separate Owner’s Manual.

NOTE

- EQ settings can be saved and recalled at any time using the dedicated library. You can also take advantage of a wide variety of presets suitable for various instruments or situations.
- You can also access the SELECTED CHANNEL VIEW screen, and use the knobs in the SELECTED CHANNEL section to edit the EQ and high-pass filter (see page 8).
- Even when the HPF/EQ popup window is displayed, you can use the knobs in the SELECTED CHANNEL section to control the EQ.

Using dynamics

Input channels feature two dynamics processors; output channels feature one dynamics processor.

1. Use the Bank Select keys to access the OVERVIEW screen that includes the channel for which you want to control the dynamics.

The DYNAMICS 1/2 field displays the dynamics on/off status and the amount of gain reduction.

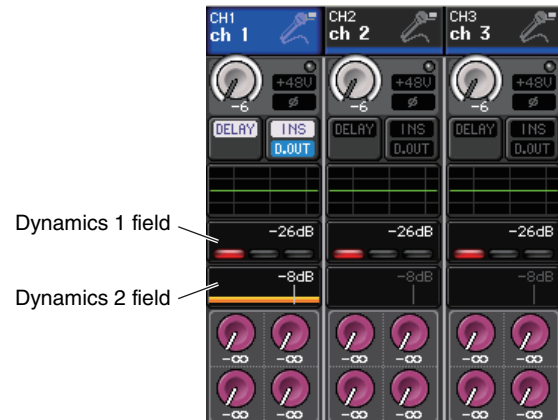

2. In the OVERVIEW screen, press the DYNAMICS 1/2 field to access the DYNAMICS 1/2 popup window.

In the DYNAMICS 1/2 popup window, you can edit the dynamics settings and turn the processor on or off.

This popup window features five types of views. Each window view includes the following items.

DYNAMICS 1/2 popup window (1ch)

This window displays only the currently-selected channel. All dynamics parameters can be viewed and edited. This is convenient if you want to make detailed dynamics settings for a specific channel.

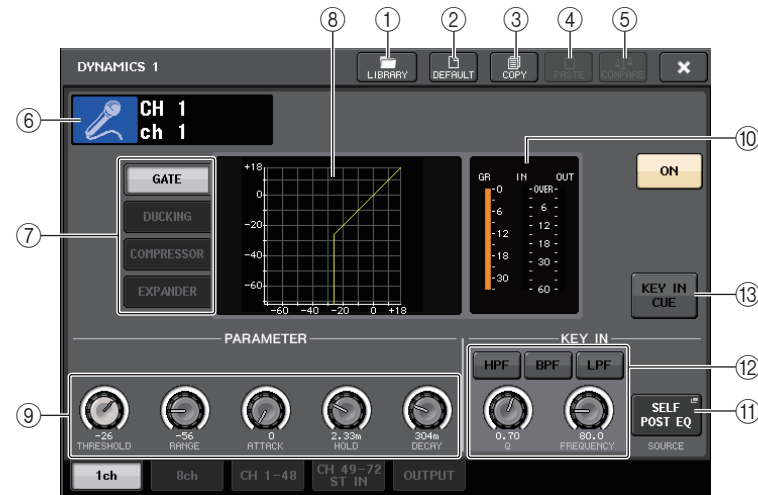

1. **LIBRARY button**
Press this button to open the DYNAMICS Library popup window.
2. **DEFAULT button**
Press this button to reset all dynamics parameters to the initial values.
3. **COPY button**
All dynamics parameter settings will be stored in buffer memory.
4. **PASTE button**
Press this button to apply the settings in buffer memory to the current dynamics. If no valid data has been stored in the buffer memory, nothing will happen.
5. **COMPARE button**
Press this button to swap between the current dynamics settings and the data stored in buffer memory. If no valid data has been stored in the buffer memory, nothing will happen.
6. **Channel icon/Channel number/Channel name**
This area indicates the icon, number, and name of the currently-selected channel.

⑦ Dynamics type buttons

Enable you to select the dynamics type. You can choose from the following dynamics types.

• Dynamics 1 for an input channel

GATE, DUCKING, COMPRESSOR, EXPANDER



• Dynamics 2 for an input channel

COMPRESSOR, COMPANDER-H, COMPANDER-S, DE-ESSER



• Dynamics 1 for an output channel

COMPRESSOR, EXPANDER, COMPANDER-H, COMPANDER-S



⑧ Dynamics graph

This graph displays the input/output response of the dynamics processors.

⑨ Dynamics parameter setting knobs

Indicate the dynamics parameter values. You can adjust the values by using the multifunction knobs.

The type of parameters will vary depending on the currently-selected dynamics type.

• GATE or DUCKING:



• COMPRESSOR or EXPANDER:



• COMPANDER-H or COMPANDER-S:



• DE-ESSER:



⑩ Dynamics IN/OUT level meters, GR meter

These meters indicate the peak level of the signals before and after the dynamics processing, and the amount of gain reduction. For a stereo channel, these meters indicate the level of both the L and R channels.

⑪ KEY IN SOURCE select button

Press this button to display the KEY IN SOURCE popup window, in which you can select a key-in signal that will trigger the dynamics.

⑫ KEY IN FILTER parameter area (Displayed only for GATE or DUCKING)

Enables you to make various settings for a filter that lets the key-in signal pass.

- **Filter select buttons** Select the type of filter from HPF, BPF, or LPF. To disable the filter, press the button that is turned on.
- **Q knob**..... Indicates the filter Q. You can adjust the value by using the multifunction knob.
- **FREQUENCY knob** Indicates the filter cutoff frequency. You can adjust the value by using the multifunction knob.

⑬ KEY IN CUE button

Enables you to cue-monitor the signal that has been selected as the KEY IN SOURCE signal. Cue will be canceled if you have selected a dynamics type that does not feature this button, or if you move to a different screen.

DYNAMICS 1/2 popup window (8ch)

This window displays the settings for eight channels, including the currently-selected channel. You can switch between eight-channel groups such as 1–8 and 9–16. Compared to the one-channel display, fewer parameters can be controlled. This window is convenient if you want to adjust the threshold or certain other parameters while watching the adjacent channels to the left and the right.



- ① **LIBRARY button**
- ② **DEFAULT button**
- ③ **COPY button**
- ④ **PASTE button**
- ⑤ **COMPARE button**

These buttons are the same as those on the DYNAMICS 1ch popup window.

- ⑥ **Channel select button**

Selects the channel that you want to control. The current channel icon and number appear on the button, and the channel name appears immediately below the button.

- ⑦ **DYNAMICS OUTPUT meters, GR meter**

These meters indicate the output levels of signals after dynamics processing, and the amount of gain reduction. If GATE is selected as the dynamics type, a three-step indicator appears, indicating the open/close status of the gate.



Type = Any type other than GATE



Type = GATE

If GATE is selected as the dynamics type, the indicator status means the following:

Gate status				
Gate status	Red	Yellow	Green	Off (dark)
On/Off status	On	On	On	Off
Open/Close status	Close	Open	Open	—
Amount of gain reduction	30 dB or more	less than 30 dB	0 dB	—

- ⑧ **Dynamics graph**

This graph displays the dynamics parameter values. The currently-selected dynamics type appears below the graph. Press the graph to access the DYNAMICS 1ch popup window for that channel.

- ⑨ **THRESHOLD knob**

Indicates the threshold value for the dynamics. You can use the corresponding multifunction knobs to adjust the value.

- ⑩ **DYNAMICS ON/OFF button**

Switches dynamics on or off.

DYNAMICS 1/2 popup window (CH1-48, CH49-72/ST IN(CL5), CH49-64/ST IN(CL3), ST IN(CL1), OUTPUT)

This window enables you to make settings of the global dynamics parameters for the corresponding channel.



- ① **LIBRARY button**
- ② **DEFAULT button**
- ③ **COPY button**
- ④ **PASTE button**
- ⑤ **COMPARE button**

These buttons are the same as those in the DYNAMICS 1ch popup window.

- ⑥ **Channel select button**

Selects the channel that you want to control. The current channel icon, number, threshold, and color appear on the button.

- ⑦ **Dynamics parameter area**

This area displays the dynamics type and various meters. Press the area to access the DYNAMICS 1ch popup window of that channel.

If DUCKING, EXPANDER, COMPANDER (-H/-S), or DE-ESSER has been selected as the dynamics type, the type appears near the top of this area.

The lower part of this area displays meters that indicate the levels of signals after dynamics processing, the GR meter, and the threshold (a numeric value). If the dynamics processor is any type other than GATE, the threshold setting is indicated as a vertical line.

- ⑧ **Tags**

Use these tabs to select a channel that you want to view on the screen.

3. Access the DYNAMICS 1/2 popup window (1ch), and press the DYNAMICS ON button to enable the dynamics processor.

4. To select a key-in signal, proceed as follows.

4-1. In the DYNAMICS 1/2 popup window (1ch), press the KEY IN SOURCE button to access the KEY IN SOURCE SELECT popup window.

KEY IN SOURCE SELECT popup window

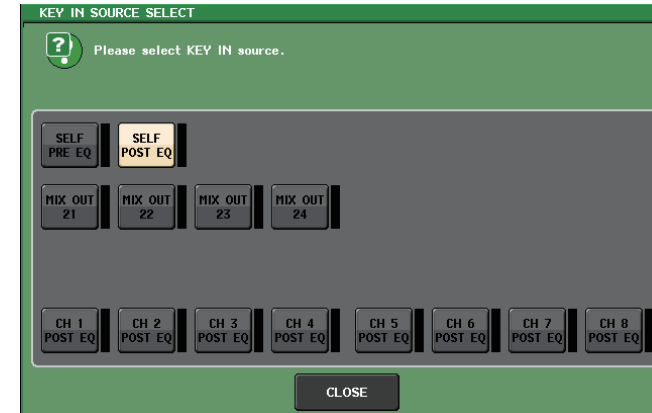

4-2. Select the key-in signal. You can choose one of the following signals.

- **SELF PRE EQ** The pre-EQ signal of the same channel
 - **SELF POST EQ** The post-EQ signal of the same channel
 - **MIX OUT 21-24** Output signals of MIX channels 21-24
 - **CH1-72 POST EQ, ST IN1L-8R POST EQ, MIX1-24 POST EQ, MTRX1-8 POST EQ, ST L/R, MONO POST EQ** The post-EQ signal of the corresponding channel *1
- *1. The selectable signals are limited to the corresponding eight-channel group.

NOTE

In the case of the CL3/CL1, channels that do not exist on those models will not be shown.

4-3. Press the CLOSE button to close the popup window.

5. If you want to copy dynamics settings to another channel, or initialize the dynamics settings, use the tool buttons in the popup window.

NOTE

- Dynamics settings can be saved and recalled at any time using the dedicated library. You can also take advantage of a wide variety of presets suitable for various instruments or situations.
- You can also access the SELECTED CHANNEL VIEW screen, and use the knobs in the SELECTED CHANNEL section to edit the dynamics settings (see page 9).
- Even when the DYNAMICS 1/2 popup window is displayed, you can use the knobs in the SELECTED CHANNEL section to control the dynamics.

Using the EQ or Dynamics libraries

You can use dedicated libraries to store and recall EQ and dynamics settings.

EQ library

There is an “INPUT EQ LIBRARY” that lets you store and recall EQ settings for input channels, and an “OUTPUT EQ LIBRARY” that lets you store and recall EQ settings for output channels.

To recall settings from a library, press the LIBRARY tool button in the HPF/EQ popup window.

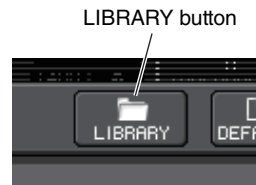

NOTE

- You can recall 199 different settings from both the input EQ library and output EQ library. Forty (40) of the input library items are read-only presets, and three (3) of the output library items are read-only presets.
- For details on how to access the HPF/EQ popup window, refer to “Using EQ” on page 56.

Dynamics library

Use the “Dynamics Library” to store or recall dynamics settings. All of the dynamics processors on CL series units use this dynamics library. (However, the available types will differ between an input channel’s Dynamics 1 and Dynamics 2, and an output channel’s Dynamics 1. You cannot recall a type that cannot be selected.)

To recall an item from the dynamics library, press the LIBRARY tool button in the DYNAMICS 1/2 popup window.

NOTE

- You can recall 199 different settings from the library. Forty-one (41) of these are read-only presets.
- For details on how to access the DYNAMICS 1/2 popup window, refer to “Using dynamics” on page 59.

For details on using the EQ and dynamics libraries, refer to the “Using the library” section in the separate Owner’s Manual.

Grouping and linking

This chapter explains the DCA Group and Mute Group functions that enable you to control the level or muting of multiple channels together, the Channel Link function that links the parameters of multiple channels, and the operations that enable you to copy or move parameters between channels.

About DCA groups and Mute groups

CL series consoles feature sixteen DCA groups and eight mute groups that enable you to control the level of multiple channels simultaneously.

DCA groups enable you to assign input channels to sixteen groups, so that the Centralogic section faders 1–8 can be used to control the level of all channels in each group. A single DCA fader will control the level of all input channels belonging to the same DCA group while maintaining the level difference between the channels. This provides a convenient way in which drum mics, for example, can be grouped.

Mute groups enable you to use USER DEFINED keys [1]–[16] to mute or unmute multiple channels in a single operation. You can use this to cut out multiple channels simultaneously. Mute groups 1–8 can be used with both input channels and output channels. Both types of channels can exist in the same group.

Using DCA groups

This section explains how to assign input channels to the sixteen DCA groups and use the faders in the Centralogic section to control them.

Assigning channels to a DCA group

There are two ways to assign a channel to a DCA group.

- You can select a specific DCA group first and then specify the channels to be assigned to the group, or
- You can select a specific channel and then specify the DCA group to which it should be assigned.

NOTE

- DCA groups can be used only with input channels.
- DCA group settings are saved as part of the scene.

■ Selecting channels to belong to a specific DCA group

1. In the Function Access Area, press the CH JOB button.

The CH JOB button lets you perform grouping, linking, and copying operations between channels. When you press this button, the Function Access Area will change as follows.

DCA GROUP button

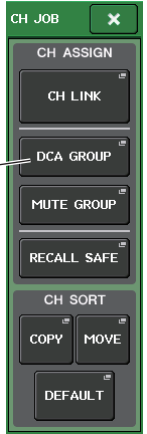

2. Press the DCA GROUP button to access the DCA/MUTE GROUP ASSIGN MODE popup window.

In the DCA/MUTE GROUP ASSIGN MODE popup window, if the DCA GROUP ASSIGN button has been selected, select the channels to be assigned to the DCA group. This popup window includes the following items.

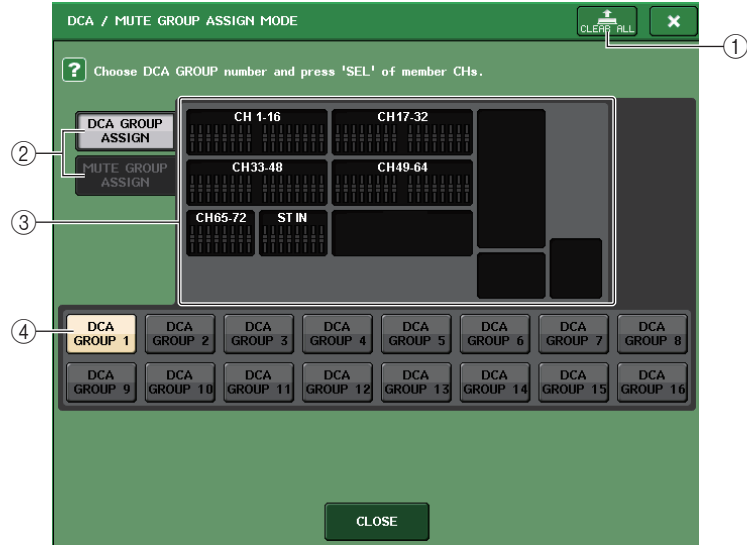

① **CLEAR ALL button**

Clears all channels that are assigned to the currently-selected DCA group.

② **DCA GROUP ASSIGN/MUTE GROUP ASSIGN buttons**

Toggle between the DCA GROUP ASSIGN popup window and the MUTE GROUP ASSIGN popup window.

③ **DCA group assign field**

This area displays the channels assigned to the currently-selected DCA group.

While this window is displayed, press the [SEL] key for the channel that you want to assign to the DCA group. The on-screen fader for that channel will turn yellow and the channel will be assigned to the DCA group. Press the same [SEL] key once again if you want to remove the channel from the group.

④ **DCA group select button**

Selects the DCA group that you want to assign.

NOTE

- In the case of the CL3/CL1, faders that do not exist on those models will not be shown.
- If the [DCA 1–8] key or [DCA 9–16] key has been selected in the Centralogic section, you can access the DCA/MUTE GROUP ASSIGN MODE popup window by pressing the [SEL] key twice in rapid succession.

In this case, the DCA/MUTE GROUP ASSIGN MODE popup window will appear with the corresponding DCA GROUP 1–16 button selected for that DCA group.

3. Use the DCA GROUP 1–16 buttons to select the DCA group to which you want to assign channels.

4. Use the [SEL] keys of the input channels to select the input channels that you want to assign to the group (multiple selections are allowed).

The [SEL] keys of the assigned channels will light, and the corresponding channels will be highlighted in yellow in the DCA group assign field of the window.

To cancel an assignment, press a lit [SEL] key once again to make it go dark.

5. Assign channels to other DCA groups in the same way.

NOTE

You can assign a single channel to more than one DCA group. In this case, the value will be the sum of the levels of all assigned DCA group faders.

6. When you finish making assignments, press the CLOSE button to close the popup window, and press the × symbol in the Function Access Area (CH JOB display).

You will return to the previous screen. The DCA/MUTE GROUP field of the OVERVIEW screen indicates the DCA group(s) to which each channel is assigned. Numbers that are lit yellow in the upper and middle rows of this field indicate the DCA groups to which that channel belongs.



NOTE

You can also access the DCA/MUTE GROUP ASSIGN MODE popup window by pressing the DCA/MUTE GROUP field in the OVERVIEW screen.

■ **Selecting the DCA groups to which a specific channel will belong**

1. Press a [SEL] key to select the input channel for which you want to make assignments.

2. Press a knob in the SELECTED CHANNEL section to access the SELECTED CHANNEL VIEW screen.

On this screen you can view all mix parameters for the currently-selected channel.

3. Use the DCA group select buttons to select the DCA group(s) to which the currently-selected channel will be assigned (multiple selections are allowed).



4. Select the DCA group(s) for other channels in the same way.

Controlling DCA groups

Use the faders in the Centralogic section to control DCA groups.

1. Assign input channels to DCA groups.
2. Using the faders in the Channel Strip section or Master section on the top panel, adjust the relative balance between the input channels that belong to the DCA group you want to use.
3. In the Centralogic section, press the [DCA 1–8] or [DCA 9–16] Bank Select key to make it light so that you will be able to control the desired DCA groups in the Centralogic section.

4. Operate the Centralogic section fader corresponding to the DCA group that you want to use.

The level of the channels assigned to that DCA group will change while preserving the level differences you established in step 2.

NOTE

Operating a DCA fader will not cause the input faders to move in tandem.

5. To switch a DCA group on/mute, press the [ON] key for that DCA group in the Centralogic section.
When you press an [ON] key in the Centralogic section to make the key indicator go dark, the channels assigned to that DCA group will be muted (the same state as when the faders are lowered to the $-\infty$ dB position).
6. To cue-monitor a DCA group, press the [CUE] key for that DCA group in the Centralogic section.

When you press the [CUE] key in the Centralogic section to make the key indicator light, the [CUE] keys for the channels assigned to that DCA group will blink, and cue monitoring will be enabled. For more information about cue, refer to [“Using the Cue function”](#) on page 101.

NOTE

You can also press the [DCA], [DCA 1–8], or [DCA 9–16] key in the Channel Strip section to select the DCA group that you want to control.

Using mute groups

This section explains how to assign channels to mute groups and use the USER DEFINED keys to control them.

Assigning channels to mute groups

As with the DCA group, there are the following two ways to assign channels to mute groups.

- You can select a specific mute group first and then specify the channels to be assigned to the group, or
- You can select a specific channel and then specify the mute group to which it should be assigned.

■ Selecting the channels that will belong to a specific mute group

1. In the Function Access Area, press the CH JOB button.

The Function Access Area will change as follows.

2. Press the MUTE GROUP button to access the DCA/MUTE GROUP ASSIGN MODE popup window.

MUTE GROUP button

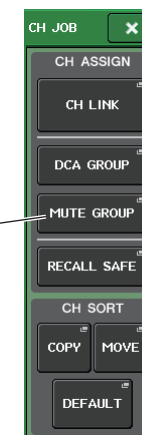

In this popup window you can select the channels that will be assigned to each mute group. The popup window includes the following items.

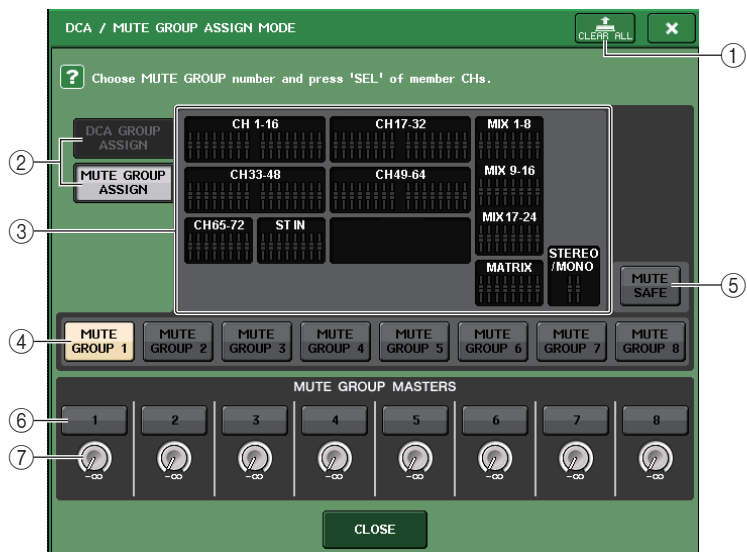

① **CLEAR ALL button**

Clears all channels that are assigned to the currently-selected mute group.

② **DCA GROUP ASSIGN/MUTE GROUP ASSIGN buttons**

Toggle between the DCA GROUP ASSIGN popup window and the MUTE GROUP ASSIGN popup window.

③ **Mute group assign field**

This area displays the channels assigned to the currently-selected mute group.

While this window is displayed, press the [SEL] key for the channel that you want to assign to the mute group. The on-screen fader for that channel will turn red and the channel will be assigned to the mute group. Press the same [SEL] key once again if you want to remove the channel from the group.

If the MUTE SAFE button is on, this field displays the channels that are targets for mute safe (that is, excluded from the mute groups). The operation procedure to apply or cancel mute safe to the channels is the same as that for assigning or removing channels to or from a mute group. The on-screen faders of the assigned channels will turn green.

④ **Mute group select button**

Selects the mute group that you want to assign.

⑤ **MUTE SAFE button**

Use this button if you want to exclude a specific channel from all mute groups, regardless of its assignment settings. The mute group assign displays the channels that are excluded from the mute groups. For more information on mute safe, “Using the Mute Safe function” on page 70.

⑥ **MUTE GROUP MASTER button**

Switches the corresponding mute group on or off.

⑦ **DIMMER LEVEL knob**

Sets the dimmer level for the corresponding mute group when the dimmer function is enabled.

NOTE

- In the case of the CL3/CL1, faders that do not exist on those models will not be shown.
- If the dimmer level is set to any level other than $-\infty$ dB, and the corresponding MUTE GROUP MASTER button is turned on, this button will light orange.

3. Use the MUTE GROUP 1–8 buttons to select the mute group to which you want to assign channels.

4. Press the [SEL] key for the input channels/output channels that you want to assign (multiple selections are allowed).

The [SEL] keys for the assigned channels will light, and the corresponding channels will be highlighted in red in the mute group assign field of the window. To cancel an assignment, press a lit [SEL] key once again to make it go dark.

5. Assign channels to other mute groups in the same way.

NOTE

You may assign a single channel to more than one mute group.

6. When you finish making assignments, press the CLOSE button to close the popup window, and press the × symbol in the Function Access Area (CH JOB display).

You will return to the previous screen. The DCA/MUTE GROUP field of the OVERVIEW screen indicates the mute group(s) to which each channel is assigned. Numbers that are lit red in the lower row of this field indicate the mute groups to which that channel belongs.



NOTE

If the dimmer level is set to any level other than $-\infty$ dB, and the corresponding MUTE GROUP MASTER button is turned on, these numbers will light orange. For a channel for which the Mute Safe function (see page 70) has been turned on, an “S” indicator will light up green at the right end of the bottom row.

■ Selecting the mute groups to which a specific channel will belong

1. Press the [SEL] key for the input channel/output channel that you want to assign.
2. Press a knob in the SELECTED CHANNEL section to access the SELECTED CHANNEL VIEW screen.
In this screen you can view the mix parameters for the currently-selected channel.
3. Use the mute group select buttons to select the mute group(s) to which the currently-selected channel will be assigned (multiple selections are allowed).



4. Select the mute group(s) for other channels in the same way.

Using mute groups

To control mute groups, you can use the MUTE GROUP MASTER buttons in the MUTE GROUP ASSIGN popup window. In addition, it may prove convenient if you assign the Mute On/Off function for a mute group 1–8 to a USER DEFINED key.

1. In the Function Access Area, press the SETUP button to access the SETUP screen.



2. In the upper left of the screen, press the USER SETUP button to access the USER SETUP popup window.

This popup window enables you to limit available functionality by user, and also to make system-wide settings. This window includes several pages, which you can switch between using the tabs located at the bottom of the window.

3. Press the USER DEFINED KEYS tab to select the USER DEFINED KEYS page.

The USER DEFINED KEYS page enables you to assign functions to USER DEFINED keys [1]–[16].

USER DEFINED key popup button

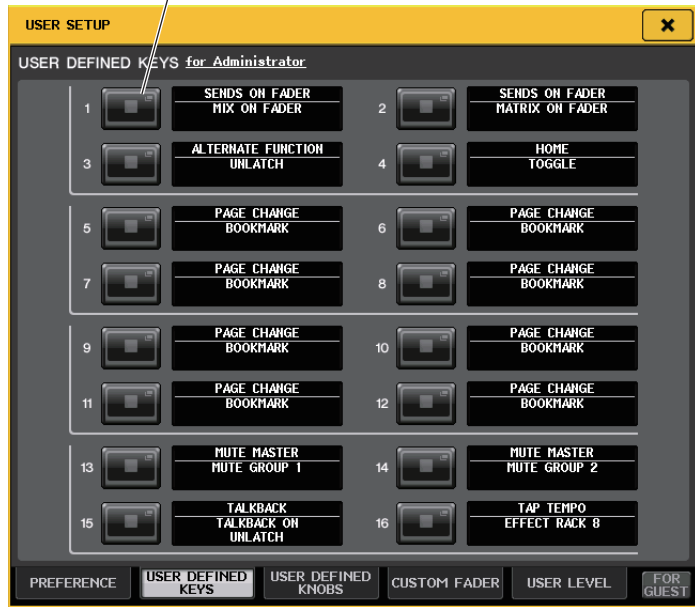

4. Press the popup button for the USER DEFINED key to which you want to assign the Mute On/Off function.

The USER DEFINED KEY SETUP popup window will appear.

5. Choose “MUTE MASTER” in the FUNCTION column, and choose “MUTE GROUP x” (where “x” is the mute group number) in the PARAMETER 1 column. Then, press the OK button.

To select an item in each column, use ↑/↓ buttons or the multifunction knobs. When you press the OK button, the Mute On/Off function for the specified mute group will be assigned to the USER DEFINED key that you selected in step 4, and you will return to the USER DEFINED KEYS page.

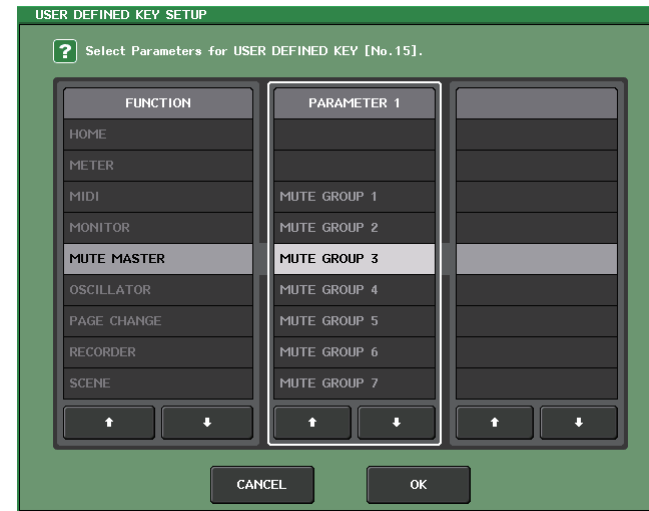

6. In the same way, assign the Mute On/Off function for another mute group to a different USER DEFINED key.

7. When you finish assigning functions to USER DEFINED keys, press the × symbol to close the USER DEFINED KEYS page.

8. In the Function Access Area, press the SETUP button to close the SETUP screen.

9. To mute a mute group, press the USER DEFINED key [1]–[16] that has been assigned to the desired mute group.

The LED of the USER DEFINED key will light, and all channels that belong to the selected mute group will be muted. At this time, the [ON] keys for the muted channels will blink. You can turn on multiple USER DEFINED keys to mute multiple mute groups.

10. To defeat muting for a mute group, press the USER DEFINED key that you lit in step 9.

NOTE

Even if a channel is assigned to a mute group, it will not be affected by operations of the USER DEFINED key if the [ON] key for that channel is already turned off to begin with.

Using the Mute Safe function

Specific channels that belong to a mute group can be temporarily excluded from mute group operations (Mute Safe).

1. In the Function Access Area, press the CH JOB button.
2. Press the MUTE GROUP button to access the DCA/MUTE GROUP ASSIGN MODE popup window.
3. Press the MUTE SAFE button.



4. Press a [SEL] key to select the channel(s) that you want to exclude from mute groups (multiple selections are allowed).

The [SEL] key will light, and the corresponding channel in the mute group assign field of the window will be highlighted in green. You can cancel the Mute Safe status by pressing a lit [SEL] key once again to make it go dark.

Channels that are set to Mute Safe will not be affected when you mute a mute group to which that channel belongs.

Channel Link function

Channel Link is a function that links the operation of parameters such as fader and EQ between input channels.

The parameters to be linked can be selected from the following choices.

- Head amp settings
- Digital gain settings
- HPF settings
- EQ settings
- Dynamics 1 settings
- Dynamics 2 settings
- Insert on and insert point settings
- Direct Out on, Direct Out level, and Direct Out point settings
- Send levels and PRE/POST settings of signals sent to MIX buses
- On/off status of signals sent to MIX buses
- Send levels and PRE/POST settings of signals sent to MATRIX buses
- On/off status of signals sent to MATRIX buses
- Fader operations
- [ON] key operations
- TO STEREO/MONO setting
- DELAY setting
- DCA GROUP ASSIGN setting
- MUTE GROUP ASSIGN and MUTE SAFE settings

Two or more input channels that are linked are called a “link group.” There is no limit on the number of link groups you can create, or on the number or combination of input channels that can be included in these link groups. You can select the types of parameters to be linked for each link group.

Linking the desired input channels

This section explains how to link specific parameters of input channels.

NOTE

Channel link settings are saved as part of the scene.

1. In the Function Access Area, press the CH JOB button.

2. Press the CH LINK button to open the CH LINK MODE popup window.

In this popup window you can view the channels that are linked and specify the parameters that will be linked. The window includes the following items.

NOTE

You can also access this window by simultaneously pressing and then releasing the [SEL] keys of two or more channels that will be linked.

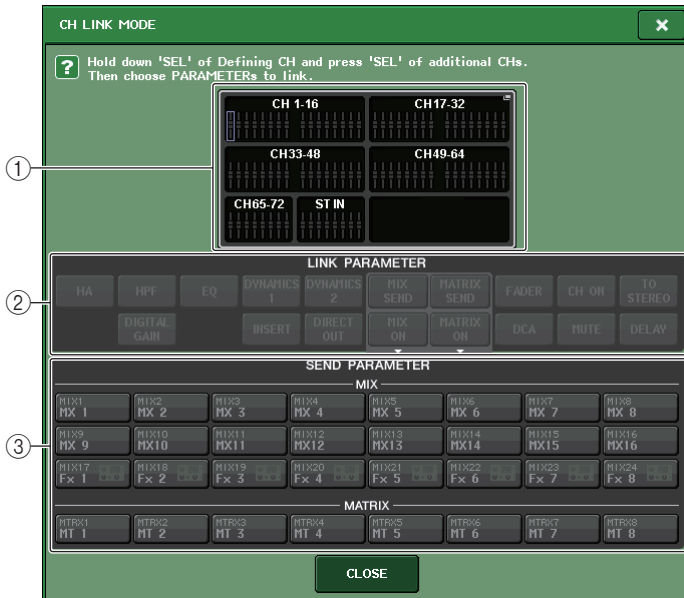
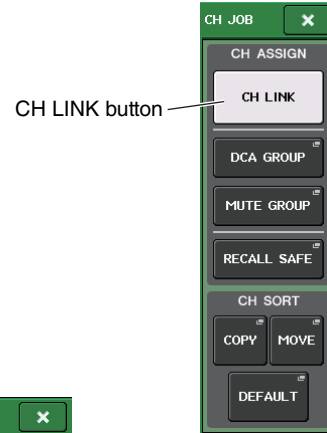

① Channel display field

When you create a link group, the corresponding channels will be highlighted. If there are two or more link groups, each group is shown in a different color.

NOTE

Left and right of the ST IN channel are always linked.

② LINK PARAMETER field

Use the buttons in this field to select the parameters that you want to link. You can do this independently for each link group.

③ SEND PARAMETER field

If you have turned on the MIX ON, MIX SEND, MATRIX ON, or MATRIX send buttons in the LINK PARAMETER field, use the buttons in this field to specify the send-destination bus(es).

NOTE

In the case of the CL3/CL1, faders that do not exist on those models will not be shown.

3. Use the buttons in the LINK PARAMETER field to select the parameter(s) that will be linked (multiple selections are allowed).

The table below lists the parameters you can select in the LINK PARAMETER field.

HA	Head amp settings
HPF	HPF settings
DIGITAL GAIN	Digital gain settings
EQ	EQ settings
DYNAMICS 1, 2	Dynamics 1 and 2 settings
INSERT	Insert settings
DIRECT OUT	Direct Out settings
MIX SEND	Send levels of signals sent to MIX buses
MIX ON	On/off status of signals sent to MIX buses
MATRIX SEND	Send levels of signals sent to MATRIX buses
MATRIX ON	On/off status of signals sent to MATRIX buses
FADER	Fader operations
DCA	DCA group assignment
CH ON	Channel on/off
MUTE	Mute group assignment
TO STEREO	On/off status of signals sent to STEREO/MONO buses
DELAY	Channel delay settings

NOTE

- If you link Dynamics 1 or 2 for two or more input channels, the parameter values will be linked, but the key-in signals are not linked. For details about dynamics, see “EQ and Dynamics” on page 56.
- If you turn on the EQ button or DYNAMICS 1/2 button, library recall operations will also be linked.
- The HA analog gain setting and the fader operation will be linked and will maintain the same relative level difference between the channels.

- If you turned on the MIX ON, MIX SEND, MATRIX ON, or MATRIX SEND buttons in step 3, use the buttons in the SEND PARAMETER field to specify the bus(es) for which you want operations to be linked (multiple selections are allowed).

The table below lists the buttons you can select in the SEND PARAMETER field.

MIX 1–24	MIX buses 1–24
MATRIX 1–8	MATRIX buses 1–8

NOTE

If nothing is selected in the SEND PARAMETER field, the send on/off and send level parameters will not be linked.

- To link channels, hold down the [SEL] key for the link-source input channel and press the [SEL] key for the link-destination channel.

At this time, the values of the parameters you selected in steps 3 and 4 will be copied from the link-source to the link-destination channel. Subsequent operations of the parameters you selected in steps 3 and 4 will be linked between channels that belong to the same link group.

The current link status is displayed in the channel display field of the window.

NOTE

- If you want to link three or more channels, hold down the link-source [SEL] key and successively press the [SEL] key for each channel you want to add to the link group.
- When you press the [SEL] key for a channel (that belongs to a link group) to make it light, the [SEL] keys of all channels that belong to the same link group will blink.
- If you link an input channel to a ST IN channel, parameters that do not exist for a ST IN channel will be ignored.

- If you want to add a new channel to an existing link group, hold down any [SEL] key within the group and press the [SEL] key for the channel that you want to add to the group.

NOTE

If the link-destination channel is already assigned to another link group, the channel will be removed from the previous group and added to the newly assigned group.

- To remove a channel from a link group, hold down any [SEL] key in the same link group, and press the [SEL] key for the channel that you want to remove.

NOTE

You can also remove all linked channels from the same link group temporarily. This can be helpful if you want to edit parameters that are linked to each other while maintaining the same relative level differences. For example, this may be the case for parameters such as the HA analog gain and fader, or if you want to change the level balance between channels that belong to the same link group. While pressing and holding down the [SEL] key for the desired linked channel, adjust the parameter value.

While you are holding down the [SEL] key, the HA analog gain and fader values will not be linked. (However, you cannot temporarily cancel this link during the “fading” phase of a recalled scene.)

You can also perform the operations from step 5 on screen.

- To link channels, press the channel display field.

The CH LINK SET popup window will appear.

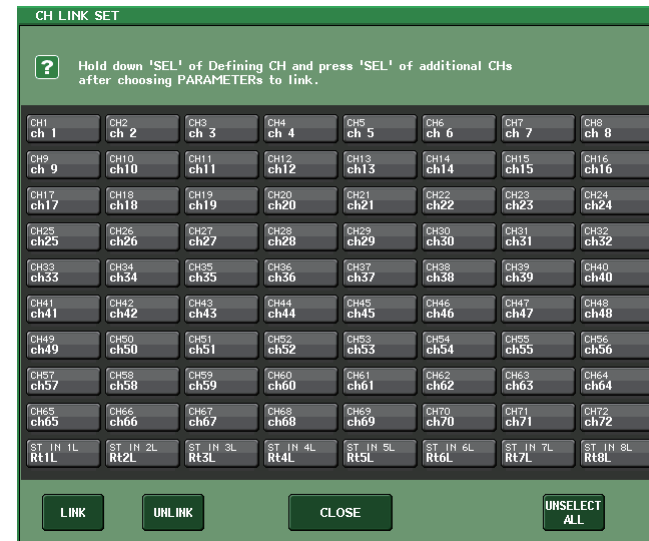

- Select a channel that you want to link.

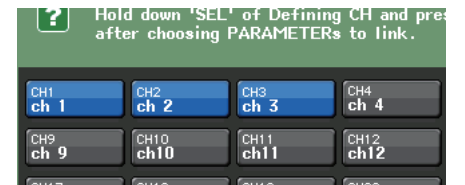

- To confirm the link, press the LINK button in the lower left of the screen.

An alphabetical character that indicates the link group will appear on the selected channel button.

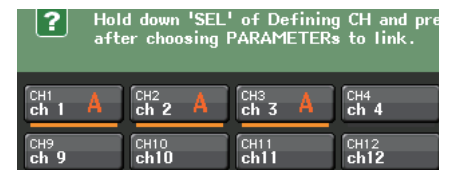

NOTE

If you use CL5 settings data on the CL3/CL1, or CL3 settings data on the CL1, buttons will be shown crossed-out if they are assigned to a channel that does not exist on that model.

- In the same way, link other channels as you wish.
- When you have finished linking channels, press the CLOSE button.

Copying, moving, or initializing a channel

You can copy or move mix parameters between channels, or restore the parameters of a specific channel to their default settings.

Copying the parameters of a channel

You can copy the mix parameter settings of a channel to another channel. When you execute the copy operation, the settings will overwrite the parameters of the copy-destination.

You can copy between the following combinations of channels.

- Between input channels
- Between the STEREO L/R channel and MONO channel
- Between MIX channels
- Between MATRIX channels

- 1. In the Function Access Area, press the CH JOB button to access the CH JOB menu.**
- 2. Press the COPY button to access the CH COPY MODE popup window.**

This popup window enables you to copy channel settings. The window contains the following items.

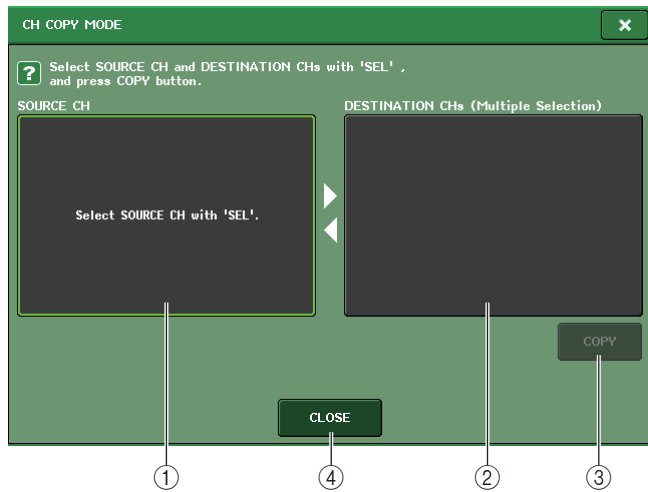
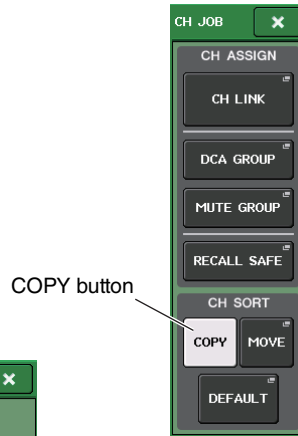

① SOURCE CH field

This field displays the copy-source channel. While this window is displayed, press a [SEL] key on the top panel to select a channel. The field will indicate the selected channel.

Before selection

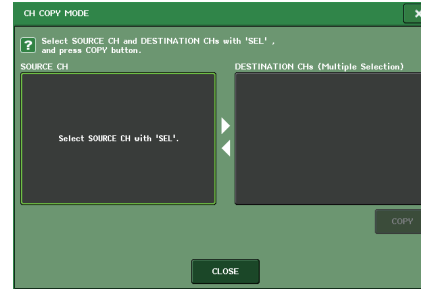

After selection

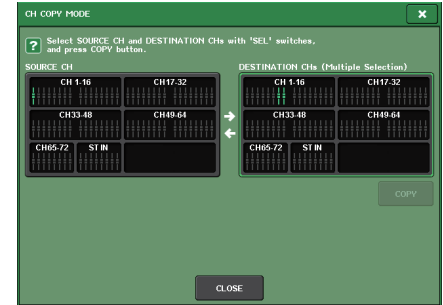

If the copy source is a MIX/MATRIX channel, buttons will appear so you will be able to select parameters to copy.

COPY TARGET field

- **MODULE PARAMETERS button**
Selected channel module parameters
- **WITH MIX SEND/WITH MATRIX SEND button**
SEND parameters of signals sent to the selected channel

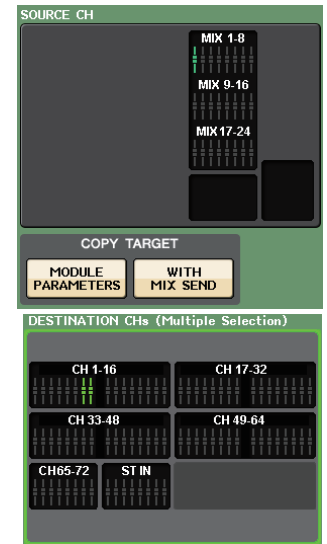

② DESTINATION CHs field

This field displays the copy-destination channel. After you select the copy source, if you select a copy-destination channel by pressing its [SEL] key (multiple selections are allowed), this field will display the selected channel.

NOTE

In the case of the CL3/CL1, faders that do not exist on those models will not be shown.

③ COPY button

Executes the copy operation. After selecting the copy-source channel and copy-destination channel(s), press this button to execute the copy operation.

④ CLOSE button

Press this button to close the popup window and return to the previous screen.

3. To select the copy-source channel, press the corresponding [SEL] key to make it light.

The corresponding channel is highlighted in the SOURCE CH field of the window.

When you choose the copy-source channel, the DESTINATION CHs field is automatically bolded, allowing you to select the copy-destination.

If you want to re-select the copy-source channel, press the SOURCE CH field.

NOTE

Copy settings can be made only in the order of “copy-source” → “copy-destination.”

4. To select the copy-destination channel(s), press the corresponding [SEL] key(s) to make it light (multiple selections are allowed).

The corresponding channel(s) are highlighted in the DESTINATION CHs field of the window.

The channels that can be selected will depend on the channel you selected in step 3.

If you want to defeat all of the selected copy-destination channels, press the DESTINATION CHs field.

5. If you have selected a MIX/MATRIX channel as the copy-source, use the buttons in the COPY TARGET field to select the parameters you want to copy.

6. To execute the copy, press the COPY button.

The copy will be executed, and the settings will overwrite the parameters of the copy-destination channel(s). After the copy has been executed, the SOURCE CH field and DESTINATION CHs field will be empty.

7. To close the CH COPY MODE popup window, press the CLOSE button.

Moving the parameters of a channel

The settings of a specific input channel can be moved to a different input channel. When you execute a Move operation, the numbering of the channels between the move-source and move-destination will move forward or backward by one.

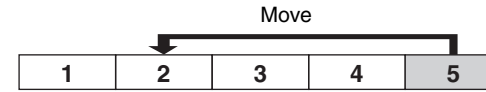

You can move settings between the following combinations of channels.

- Between input channels
- Between ST IN channels

1. In the Function Access Area, press the CH JOB button to access the CH JOB menu.

2. Press the MOVE button to access the CH MOVE MODE popup window.

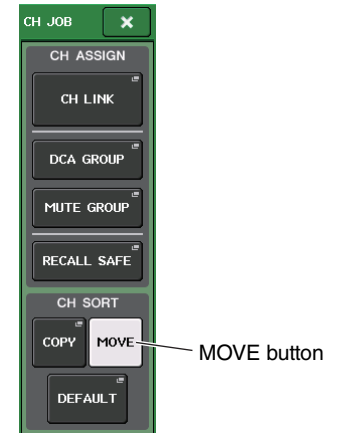

This popup window lets you move channel settings.

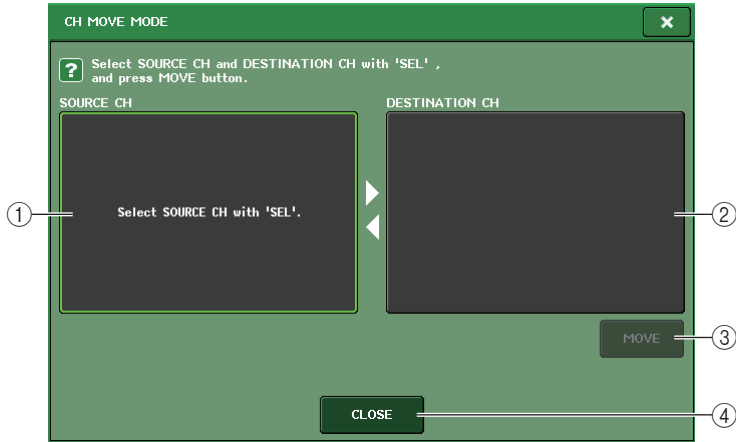

① **SOURCE CH field**

This field indicates the move-source channel. While this window is displayed, press a [SEL] key on the top panel to select an input channel. This field will indicate the selected channel. You can move settings between monaural input channels, or between ST IN channels.

② **DESTINATION CH field**

This field indicates the move-destination channel. After you select the move source, if you select a move-destination input channel by pressing its [SEL] key, this field will display the selected channel.

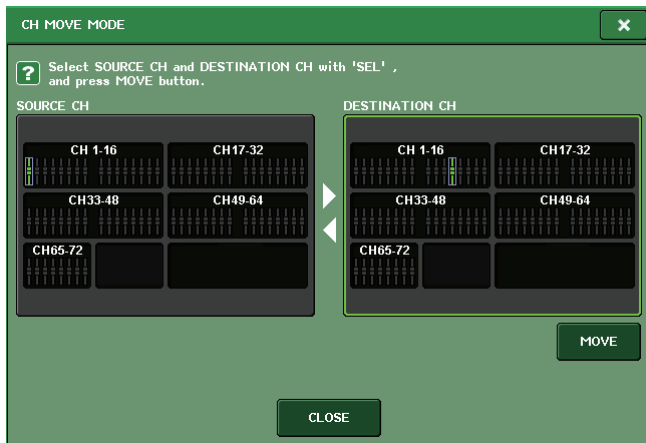

NOTE

In the case of the CL3/CL1, faders that do not exist on those models will not be shown.

③ **MOVE button**

Executes a move operation. After selecting the move-source channel and move-destination channel, press this button to execute the move.

④ **CLOSE button**

Press this button to close the popup window and return to the previous screen.

3. To select the move-source channel, press the corresponding [SEL] key to make it light.

The corresponding channel is highlighted in the SOURCE CH field of the window.

When you select the move-source channel, the DESTINATION CH field will automatically be bolded, allowing you to select the move-destination.

If you want to re-select the move-source channel, press the SOURCE CH field.

NOTE

Settings for the Move operation can be made only in the order of “move-source” → “move-destination.”

4. To select the move-destination channel, press the corresponding [SEL] key to make it light.

The corresponding channel is highlighted in the DESTINATION CH field of the window. The channels that can be selected will depend on the channel you selected in step 3.

If you want to defeat the selected move-destination channel, press the DESTINATION CH field.

5. To execute the move, press the MOVE button.

The settings of all channels between the move-source and move-destination will shift toward the move-source by one channel, and the channel settings will move from the move-source to the move-destination. When the Move has been executed, the SOURCE CH field and DESTINATION CH field will be empty.

6. To close the CH MOVE MODE popup window, press the CLOSE button.

Initializing the parameters of a channel

You can restore the parameters of a channel to an initialized state. This operation can be performed on any channel(s).

1. In the Function Access Area, press the CH JOB button to access the CH JOB menu.
2. Press the DEFAULT button to access the CH DEFAULT MODE popup window.

This popup window enables you to initialize parameters.



DEFAULT button

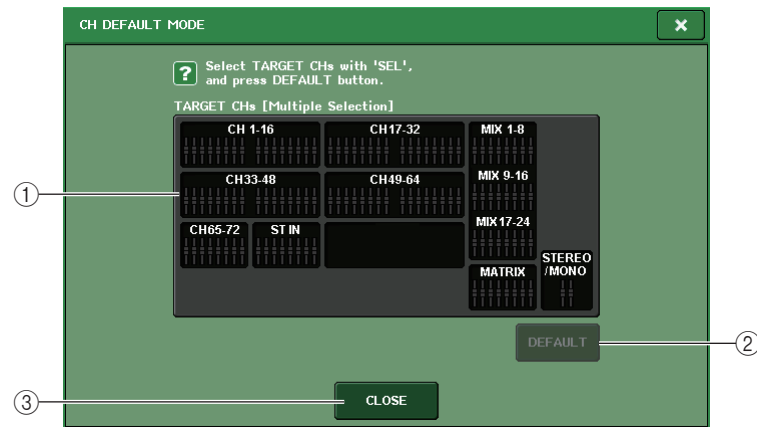

1 TARGET CHs field

This field indicates the channel selected for initialization. While this window is displayed, press a [SEL] key on the top panel to select an input channel (multiple selection is allowed). The field will indicate the selected channel(s). Press the same [SEL] key once again to de-select the channel(s).

NOTE

In the case of the CL3/CL1, faders that do not exist on those models will not be shown.

2 DEFAULT button

After selecting the channel, press this button to execute the initialization operation.

3 CLOSE button

Press this button to close the popup window and return to the previous screen.

3. To select the channel(s) to be initialized, press the corresponding [SEL] key to make it light (multiple selections are allowed).

The corresponding channel(s) are highlighted in the TARGET CHs field of the window.

If you want to de-select all of the selected channels, press the TARGET CHs field.

4. To execute the initialization, press the DEFAULT button.

The parameters of the selected channel(s) will be initialized.

After initialization, the TARGET CHs field will be empty (nothing is selected).

5. To close the CH DEFAULT MODE popup window, press the CLOSE button.

Scene memory

This chapter explains how to perform scene memory operations.

About scene memories

On CL series consoles, you can assign a name to a set of mix parameter and input/output port patch settings, and store the mix settings in memory (and later recall them from memory) as a “scene.”

Each scene is assigned a number in the range of 000–300. Scene 000 is a read-only scene used to initialize the mix parameters. Scenes 001–300 are writable scenes.

Each scene contains the position of the top panel faders and [ON] key status, as well as the following parameters.

- Input/output port patching
- Channel name and color
- Bus settings
- Head amp settings
- Digital gain settings
- EQ settings
- Dynamics 1 and 2 settings
- Input delay settings
- Rack (GEQ/effect/Premium Rack) settings
- Pan/balance settings
- Insert/Direct Out settings
- On/off status and send level of signals sent to MIX buses
- On/off status and send level of signals sent to MATRIX buses
- Settings for signals sent to the STEREO/MONO bus
- DCA group settings
- Mute group settings
- Channel link settings
- Panel assignment status (PANEL SNAPSHOT)

Using scene memories

Storing and recalling scenes

To store the current mix settings as a scene in memory and recall it later, you can use the keys in the SCENE MEMORY/MONITOR section on the top panel, or you can use the SCENE LIST window.

■ Using the keys in the SCENE MEMORY/MONITOR section

1. Use the controllers on the top panel or the buttons on the touch screen to set the mix parameters as desired.
2. Use the SCENE MEMORY [INC]/[DEC] keys to select the store-destination scene number.

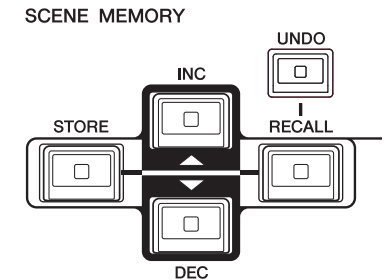

The number of the currently-selected scene appears in the SCENE field in the Function Access Area. When you select a new scene number, the number will blink. This blinking indicates that the displayed scene number is different from the currently-loaded scene number.

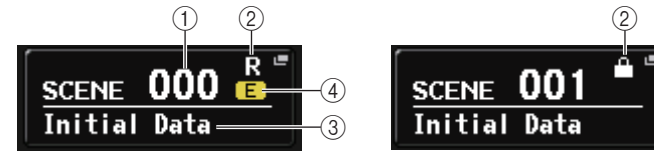

This field always displays general information about the scene. You can press this field to access the SCENE LIST window, in which you can view and edit additional settings for the scene.

- ① **Scene number**
Indicates the number of the currently-selected scene.
- ② **R symbol (READ ONLY)/Protect symbol**
Read-only scenes are indicated by an R symbol (READ ONLY) displayed here. Write-protected scenes are indicated by a Protect symbol.
- ③ **Scene title**
Indicates the title of the currently-selected scene.
- ④ **E symbol (EDIT symbol)**
This symbol appears when you edit the mix parameters for the currently-loaded scene. This symbol indicates that you must execute the Store operation if you want to keep the changes you made.

NOTE

- If you press and hold down either of the SCENE MEMORY [INC]/[DEC] keys, the scene number will count up or down continuously.
- If you press the SCENE MEMORY [INC] and [DEC] keys simultaneously, the SCENE field indication will return to the number of the currently-loaded scene.
- You cannot store data to a scene number for which the Protect symbol or R symbol is displayed.

3. Press the SCENE MEMORY [STORE] key.

The SCENE STORE popup window will appear, allowing you to assign a title or comment to the scene.

**① SCENE TITLE field**

Press this field to select it, and then enter a title for the scene (maximum 16 characters).

② COMMENT field

Press this field to select it, and then enter a comment for the scene. You can use this as a memorandum for each scene (maximum 32 characters).

4. Assign a title or comment to the scene as desired.

For details on entering text, refer to “Entering names” in the separate Owner’s Manual.

5. Press the SCENE MEMORY [STORE] key or the STORE button located in the lower part of the SCENE STORE popup window.

The SCENE STORE popup window will close, and a dialog box will ask you to confirm the Store operation.

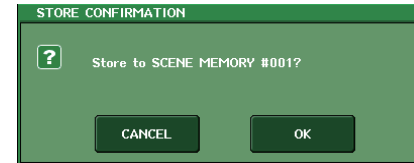
**6. To execute the Store operation, press the OK button.**

The current mix settings will be stored to the scene number you selected in step 2. When the Store operation is complete, the scene number in the Function Access Area will stop blinking. If you want to cancel the Store operation, press the CANCEL button instead of the OK button.

NOTE

You can make settings such that the Store Confirmation dialog box will not appear (see [page 168](#)). In this case, pressing the SCENE MEMORY [STORE] key once will display the SCENE STORE popup window as usual, and pressing it once again will execute the Store operation. Alternatively, you can rapidly press the SCENE MEMORY [STORE] key twice to store without seeing the SCENE STORE popup window.

7. To recall a stored scene, use the SCENE MEMORY [INC]/[DEC] keys to select the scene number that you want to recall.

The number of the currently-selected scene appears in the SCENE field of the Function Access Area.

8. Press the SCENE MEMORY [RECALL] key.

A dialog box will ask you to confirm the Recall operation.

9. To execute the Recall operation, press the OK button.

The scene you selected in step 7 will be recalled. If you want to cancel the Recall operation, press the CANCEL button instead of the OK button.

■ Using the SCENE LIST window

1. Use the controllers on the top panel or the buttons on the touch screen to set the mix parameters as desired.

2. Press the SCENE field in the Function Access Area.

The SCENE LIST window will appear, in which you can perform various scene-related operations. The window includes the following items.



① Scene list

This area lists various data about the scenes stored in memory.

② NO./TITLE buttons

Press these buttons to sort the listed scenes by number or title. Press the same button repeatedly to toggle between ascending order and descending order.

③ Scene number

Indicates the current scene number.

④ Scene title

Indicates the scene title. Press this title to display the SCENE TITLE EDIT popup window, in which you can edit the title.

⑤ Write-protect

Indicates the Write Protect on/off status. Press this button to write-protect the scene. A lock icon will appear. Press it again to cancel write protection.

⑥ Current scene

The currently-selected scene (that is, the current scene) is highlighted in blue in the list. If you press another scene number in the list, the list will scroll and that scene will become the current scene.

⑦ SCENE SELECT knob

Use the multifunction knobs to select a scene. You can view the currently-selected scene number immediately below the SCENE SELECT knob.

⑧ MULTI SELECT button

You can select consecutive multiple scenes by turning on this button and rotating the multifunction knob. If this button is off, you can still select consecutive multiple scenes by rotating the multifunction knob while pressing and holding it down.

⑨ LAST SCENE button

Press this button to select the scene that was recalled most recently.

⑩ SCENE STORE popup button

This button stores the current mix settings. Press this button to display the SCENE STORE popup window, which will enable you to assign a name to a scene and store it.

⑪ STORE UNDO button

Undoes the Store operation. This button is valid only immediately after you perform an Overwrite-store operation.

⑫ RECALL SCENE button

Recalls the currently-selected scene.

⑬ RECALL UNDO button

Undoes the Recall operation. This button is valid only immediately after you perform a Recall operation.

⑭ Page switching tabs

Switch views on the right side of the scene list.

⑮ PREVIEW button

Press this to select PREVIEW mode, which allows you to view and edit the scene settings in the display and the panel without affecting the signal processing of the current scene.

3. To store a scene, rotate one of the multifunction knobs to select the store-destination scene number.

NOTE

- You can select multiple scene numbers as the store-destination. To do so, press the MULTI SELECT button to turn it on, and then rotate a multifunction knob. Alternatively, rotate the multifunction knob while pressing and holding it down.
- If you selected multiple scenes as the store-destination, the same contents will be stored in all selected scene numbers. This is convenient if you want to create several variations based on the same mix settings.
- You can also use the SCENE MEMORY [INC]/[DEC] keys to select scene numbers.

4. Press the STORE button.

The SCENE STORE popup window will appear, allowing you to assign a title or comment to the scene.

5. Assign a title or comment to the scene as desired.

6. Press the STORE button located at the bottom of the SCENE STORE popup window.

The SCENE STORE popup window will close, and a dialog box will ask you to confirm the Store operation.

7. To execute the Store operation, press the OK button.

The current mix settings will be stored to the scene number you selected in step 3. If you want to cancel the Store operation, press the CANCEL button instead of the OK button.

8. If you want to cancel the overwrite-store operation that you just performed, press the STORE UNDO button.

Immediately after overwrite-storing a scene, you can use the STORE UNDO button to undo (cancel) the scene store operation that was executed most recently. When you press the STORE UNDO button, a dialog box will ask you to confirm the Undo operation. Press the OK button if you want to execute the Undo operation. After executing the Undo operation, you can press the STORE UNDO button once again to Redo (re-execute) the Store operation.

NOTE

- The STORE UNDO button is available only immediately after overwrite-storing.
- You can also assign the function of the STORE UNDO button to a USER DEFINED key (see [page 169](#)).

9. To recall a scene, rotate one of the multifunction knobs to select the store-source scene number.

10. Press the RECALL button.

A dialog box will ask you to confirm the Recall operation.

11. To execute the Recall operation, press the OK button.

The scene you selected in step 9 will be recalled. If you want to cancel the Recall operation, press the CANCEL button instead of the OK button.

12. If you want to cancel the Recall operation that you just performed, press the RECALL UNDO button.

A dialog box will ask you to confirm the Undo operation. Press the OK button if you want to execute the operation. After undoing the recall, you can press the RECALL UNDO button once again to Redo (re-execute).

NOTE

- You can also assign the function of the RECALL UNDO button to a USER DEFINED key (see [page 169](#)).
- You can also use MIDI messages (Program Changes) to recall scenes (see [page 152](#)).

Using USER DEFINED keys to recall

You can use the USER DEFINED keys to recall a selected scene with a single keystroke, or to step through the scenes. To do this, you must first assign a scene recall operation to a USER DEFINED key. The following recall operations can be assigned to a USER DEFINED key.

- **INC RECALL**
Immediately recalls the scene for the number that follows the currently-loaded scene.
- **DEC RECALL**
Immediately recalls the scene for the number that precedes the currently-loaded scene.
- **NOTE**
If no scene is stored in the number that precedes or follows the currently-loaded scene, the closest scene number in which a scene is stored will be recalled.
- **DIRECT RECALL**
Directly recalls the scene number that you assigned to the USER DEFINED key. When you press a USER DEFINED key to which this function is assigned, the assigned scene will be recalled immediately.

To assign one of these functions to a USER DEFINED key so that a scene can be recalled in a single keystroke, proceed as follows.

1. In the Function Access Area, press the SETUP button to access the SETUP screen.
2. In the upper left of the screen, press the USER SETUP button to access the USER SETUP popup window.

This window includes several pages, which you can switch between using the tabs located at the bottom of the window.

3. Press the USER DEFINED KEYS tab to select the USER DEFINED KEYS page.

The USER DEFINED KEYS page enables you to assign functions to USER DEFINED keys [1]–[16].

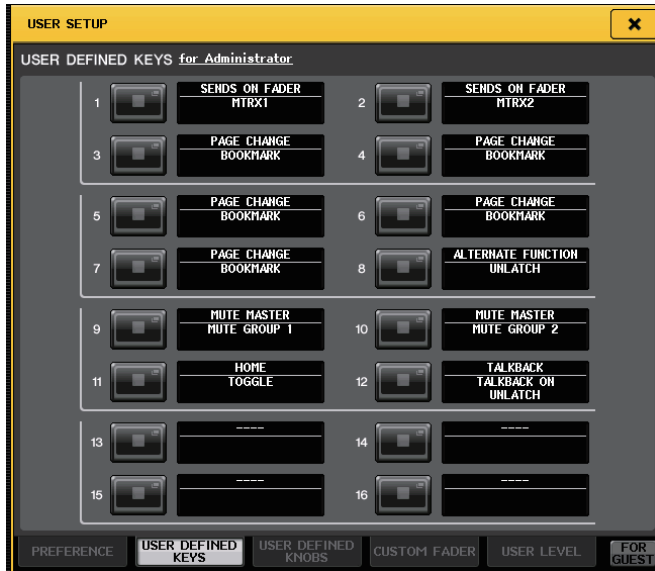

4. Press the popup button for the USER DEFINED key to which you want to assign a function.

The USER DEFINED KEY SETUP popup window will appear.

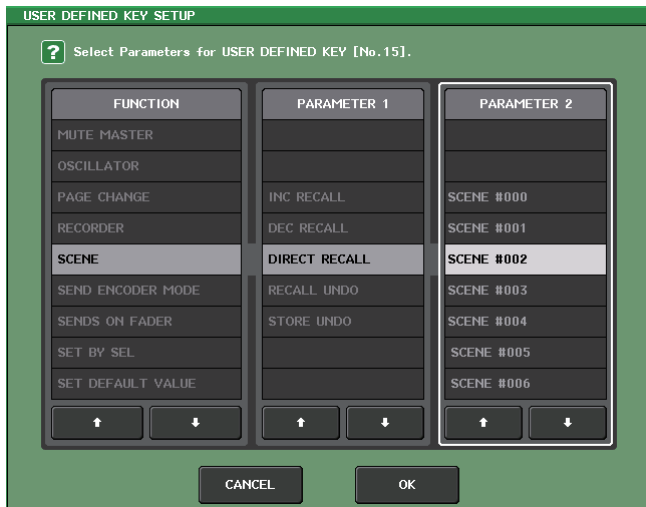

5. In the FUNCTION column, select “SCENE.”

Proceed as follows, depending on the function you want to assign.

- To assign INC RECALL or DEC RECALL**

Choose “INC RECALL” or “DEC RECALL” in the PARAMETER 1 column.

- To assign DIRECT RECALL**

Choose “DIRECT RECALL” in the PARAMETER 1 column, and choose “SCENE #xxx” (xxx is the scene number) in the PARAMETER 2 column.

6. When you have finished making settings, press the OK button to close the popup window.

If desired, assign scene-recall functions to other USER DEFINED keys in the same way.

7. Press the USER DEFINED key to which you want to assign a recall function.

The corresponding scene will be recalled.

Editing scene memories

This section explains how to sort the scenes stored in scene memory, edit their titles, and copy and paste them.

Sorting scene memories

1. Press the SCENE field in the Function Access Area.

The SCENE LIST window will appear, in which you can perform various operations related to scene memory. You can use tabs to switch the view of the right half of the SCENE LIST window between five different fields (COMMENT/FOCUS/FADE TIME/GPI OUT/PLAYBACK LINK).

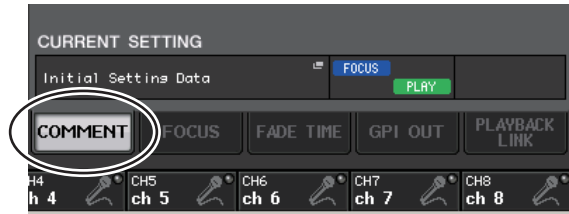

2. Press the COMMENT tab at the bottom of the SCENE LIST window.

The COMMENT field will appear in the right half of the SCENE LIST window.



① COMMENT sort button

Sorts scenes in alphabetical order of the comments in the COMMENT field. Each time you press this button, the list will alternate between ascending and descending order.

② COMMENT field

Press this field to open the SCENE COMMENT EDIT popup window, in which you can enter comments for the scene.

③ STATUS field

Indicators in this field indicate the setting status of the FOCUS, FADE TIME, PLAYBACK (playback link), and GPI (General Purpose Interface) functions. (The Playback Link function plays a desired song in a specified time duration after a scene is recalled.)

④ TIME STAMP sort button

Sorts scenes in chronological order based on the date and time in the TIME STAMP field. Each time you press this button, the list will alternate between ascending and descending order.

⑤ TIME STAMP field

Indicates the date and time the scene was stored.

For details on the TIME STAMP display format, refer to “Setting the date and time of the internal clock” on page 204.

⑥ CURRENT SETTING field

Specifies the content that will be saved by the next scene store operation. Changes made here are immediately reflected on the CL series console.

3. To select a scene number, rotate one of the multifunction knobs on the top panel.

The line highlighted in blue in the scene list indicates the scene currently selected for operations.

4. To sort the list, press one of the column headers “NO.,” “TITLE,” “COMMENT,” or “TIME STAMP” at the top of the scene list and COMMENT field.

The list will be sorted as follows, according to the column title you press.



① NO.

Sorts the list in order of scene number.

② TITLE

Sorts the list in numerical/alphabetical order of title.

③ COMMENT

Sorts the list in numerical/alphabetical order of comments.

④ TIME STAMP

Sorts the list in order of date of creation.

NOTE

By pressing the same location again, you can change the sorting order (ascending or descending).

- 5.** If you want to edit the title or comment of a scene, press the **TITLE** field or **COMMENT** field of the scene to access the **SCENE TITLE EDIT** or **SCENE COMMENT EDIT** popup window.

NOTE

You cannot edit the title or comment of a read-only scene or a write-protected scene.

- 6.** To enable/disable the protect setting, press the protect symbol.

A protect symbol is displayed for write-protected scenes. These scenes cannot be overwritten.

NOTE

The R symbol for scene number 000 cannot be disabled.

- 7.** Use the tool buttons to edit the scene memory.

For details, refer to the section “Scene memory editing” that follows.

Scene memory editing

The scenes stored in scene memory can be copied and pasted to other scene numbers, or cleared (erased).

- 1.** Press the **SCENE** field in the Function Access Area.

The SCENE LIST window will appear, in which you can perform various operations for scene memory. You can edit scene memories using the buttons located in the upper part of the SCENE LIST window.

The function of each button is described below.

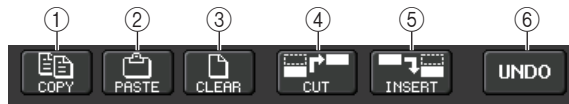
**① COPY button**

Press this button to copy the scene to buffer memory.

② PASTE button

Press this button to overwrite the selected scene with the scene in buffer memory.

③ CLEAR button

Press this button to erase the selected scene.

④ CUT button

Press this button to delete the selected scene and copy it to buffer memory. The numbers of the subsequent scenes will be decremented by one.

⑤ INSERT button

Press this button to insert the scene copied to buffer memory into the selected scene number. The numbers of the subsequent scenes will be incremented by one.

⑥ UNDO button

Cancels the most recent scene memory paste, clear, cut, or insert operation and restores the previous state.

- 2.** Perform the desired editing operation.

For more information about the procedure, refer to the corresponding explanations that follow.

Copying and pasting a scene

You can copy a scene into buffer memory, and then paste it to a different scene number.

NOTE

The Global Paste function enables you to copy any channel or any parameter settings for the current scene, then paste the data into any single or multiple scenes in memory (see [page 85](#)).

- 1.** Press the **SCENE** field in the Function Access Area.

The SCENE LIST window will appear.

- 2.** Rotate one of the multifunction knobs to select the copy-source scene number, and then press the **COPY** button.

A dialog box will ask you to confirm the Copy operation.

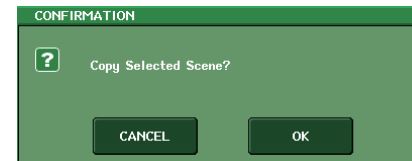

- 3.** To execute the copy, press the **OK** button.

The scene you selected in step 2 will be saved in buffer memory.

NOTE

- Be aware that if you copy or cut another scene before you paste, the newly copied or cut scene will overwrite the scene in the buffer memory.
- You cannot select multiple scenes as the copy-source.

4. Rotate one of the multifunction knobs to select the paste-destination scene number, and then press the PASTE button.

A dialog box will ask you to confirm the Paste operation.

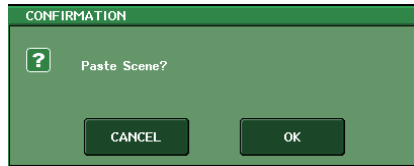

NOTE

- You can select multiple paste-destination scenes. To do so, press the MULTI SELECT button to turn it on, and then rotate a multifunction knob. Alternatively, rotate the multifunction knob while pressing and holding it down. In this case, the same content will be pasted to all selected scenes.
- A copied scene can also be inserted (see [page 85](#)).
- If nothing has been stored in the buffer memory, the PASTE button will be unavailable.

5. To execute the paste operation, press the OK button.

The scene stored in the buffer memory will be pasted to the scene number you selected in step 4. If you want to cancel the Paste operation, press the CANCEL button instead of the OK button.

Clearing a scene

1. Press the SCENE field in the Function Access Area.

The SCENE LIST window will appear.

2. Rotate one of the multifunction knobs to select the scene number that you want to clear, and then press the CLEAR button.

A dialog box will ask you to confirm the Clear operation.

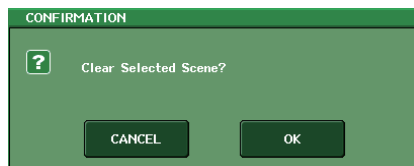

NOTE

You may select multiple scenes to be cleared. To do so, press the MULTI SELECT button to turn it on, and then rotate a multifunction knob. Alternatively, rotate the multifunction knob while pressing and holding it down.

3. To execute the Clear operation, press the OK button.

The scene number(s) you selected in step 2 will be cleared. If you want to cancel the Clear operation, press the CANCEL button instead of the OK button.

NOTE

Read-only scenes or write-protected scenes cannot be cleared.

Cutting a scene

This section explains how to cut a scene.

When you cut a scene, the numbers of the subsequent scenes will be decremented accordingly. You can paste or insert a cut scene at the desired location.

1. Press the SCENE field in the Function Access Area.

The SCENE LIST window will appear.

2. Rotate one of the multifunction knobs to select the scene number that you want to cut, and then press the CUT button.

A dialog box will ask you to confirm the Cut operation.

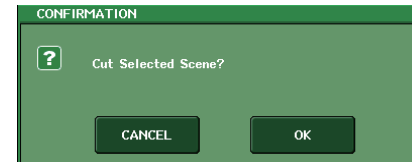

NOTE

If the scene list has been sorted in any other way than by number (in the "NO." column), the CUT button will be unavailable.

3. To execute the Cut operation, press the OK button.

The scene(s) you selected in step 2 will be cut, and the numbers of the subsequent scenes will be decremented accordingly. At this time, the scene that was cut will be stored in buffer memory.

NOTE

Read-only scenes or write-protected scenes cannot be cut.

4. If desired, you can paste (see [page 83](#)) or insert the cut scene (that was held in the buffer memory).

NOTE

Be aware that if you copy or cut another scene before you paste or insert, the newly copied or cut scene will overwrite the scene in the buffer memory.

Inserting a scene

You can insert a scene held in buffer memory at a desired scene number location.

1. Press the SCENE field in the Function Access Area.

The SCENE LIST window will appear.

2. Perform the Copy operation (see page 83) or Cut operation so that the scene you want to insert is placed in buffer memory.

NOTE

You cannot copy or cut multiple scenes as the source.

3. Rotate one of the multifunction knobs to select the insert-destination scene number, and then press the INSERT button.

A dialog box will ask you to confirm the Insert operation.

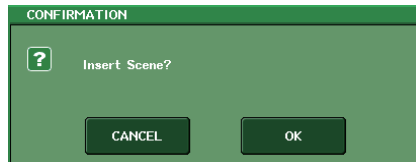

NOTE

- If you select multiple scenes as the insert-destination, the same scene will be inserted the selected number of times.
- If the scene list has been sorted in any way other than by number (in the “NO.” column), the INSERT button will be unavailable.
- If nothing has been stored in the buffer memory, the INSERT button will be unavailable.
- The INSERT button will be unavailable if there is already a scene stored at scene number 300, or if the Insert operation would cause an already-stored scene to exceed number 300.

4. To execute the Insert operation, press the OK button.

The scene stored in buffer memory will be inserted at the scene number you selected in step 3. If you selected multiple scenes as the insert-destination, the same scene will be inserted multiple times starting at the scene number you selected.

Scenes that were stored in subsequent numbers following that location will be updated and increase by the number of scenes that were inserted.

Using the Global Paste function

“Global Paste” is a function that lets you copy and paste settings for the desired channel or parameter from the current scene to scene data in memory (multiple selections are allowed). This can be convenient if you want to apply changes (that you made to the current scene) to multiple scenes that have already been stored.

NOTE

The Global Paste function will be available for a user if the SCENE LIST STORE/SORT parameter is turned on in his or her user level settings.

1. In the Function Access Area, press the SCENE field to access the SCENE LIST window.

2. Press the GLOBAL PASTE button located in the upper part of the SCENE LIST window to open the GLOBAL PASTE window.

This window enables you to select the copy-source channels/parameters and specify the paste-destination scene number.

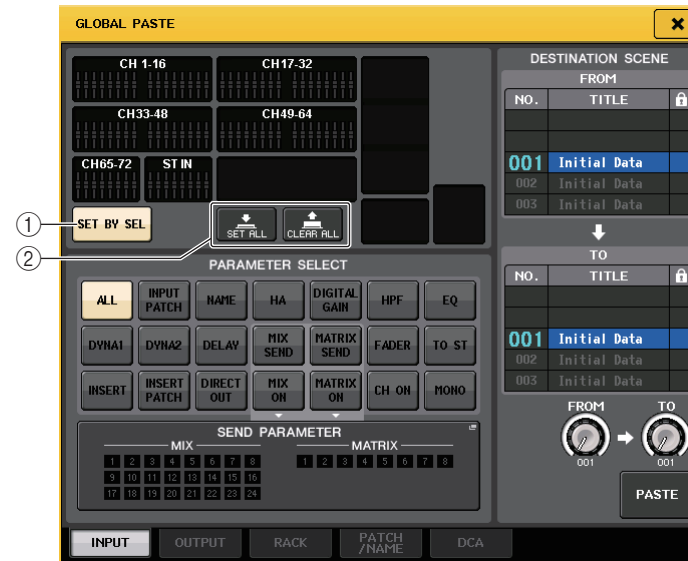

① SET BY SEL button

Turn on this button to add a channel by using the corresponding [SEL] key.

② CLEAR ALL button/SET ALL button

The CLEAR ALL button clears all of the selected channels. The SET ALL button selects all channels simultaneously.

NOTE

In the case of the CL3/CL1, faders that do not exist on those models will not be shown.

3. Use the tabs to select one of the following as the type of item you want to copy.

INPUT	Input channel and its parameters
OUTPUT	Output channel and its parameters
RACK	GEQ/effect/Premium rack
PATCH/NAME	Input/output patch, channel name
DCA	DCA group

4. Select the copy-source channel or parameter.

The view will vary depending on the tab you select.

You cannot select different parameters from different channels.

To select a channel, press the corresponding [SEL] key on the top panel.

• INPUT tab

Select an input channel in the upper left area, and select its parameter in the lower left area.

You can select the following parameters.

ALL	All input channel parameters
INPUT PATCH	Input patch settings
NAME	Channel name, icon, and channel color
HA	Settings for the head amp assigned to the corresponding input channel, and phase
DELAY	Input delay settings
HPF	HPF settings
DIGITAL GAIN	Digital gain settings for the corresponding input channel
EQ	EQ settings
DYNA 1	Dynamics 1 settings (including KEY IN SOURCE and KEY IN FILTER)
DYNA 2	Dynamics 2 settings (including KEY IN SOURCE)
MIX SEND	Send level, pan, and PRE/POST of the signal sent to a MIX bus
MATRIX SEND	Send level, pan, and PRE/POST of the signal sent to a MATRIX bus
FADER	Fader level
CH ON	On/off status of [ON] keys
INSERT	Insert on/off status and insert point
INSERT PATCH	Insert in/out patch settings, head amp settings for insert-in
DIRECT OUT	Direct Out on/off, Direct Out level, Direct Out point and patch settings
MIX ON	Send on/off to a MIX bus
MATRIX ON	Send on/off to a MATRIX bus
TO ST	TO ST on/off status, pan/balance settings
MONO	TO MONO on/off status

• OUTPUT tab

Select an output channel in the upper left area, and select its parameter in the lower left area.

You can select the following parameters.

ALL	All output channel parameters
OUTPUT PATCH	Output patch settings
NAME	Channel name, icon, and channel color
EQ	EQ settings

DYNA 1	Dynamics 1 settings (including KEY IN SOURCE)
INSERT	Insert on/off status and insert point
INSERT PATCH	Insert in/out patch settings, head amp settings for insert-in
FADER	Fader level
CH ON	On/off status of [ON] keys
TO ST/BAL	TO ST on/off status, pan/balance settings
MONO	TO MONO on/off status (MIX 1-24 only)
MATRIX SEND	Send level, pan, and PRE/POST of the signal sent to a MATRIX bus
MATRIX ON	Send on/off to a MATRIX bus
WITH SEND FROM SOURCE CHs	SEND parameters of the send-source signal that will be sent to a channel

• RACK tab

Enables you to choose from GEQ RACK, EFFECT RACK, or PREMIUM RACK. You can individually select an GEQ for a Flex15GEQ or an effect used in dual mode.

• PATCH/NAME tab

You can select the following parameters.

INPUT PATCH	All input channel patches, insert in/out patches, Direct Out patches
OUTPUT PATCH	All output channel patches, insert in/out patches
INPUT NAME	Channel names, icons, and colors for all input channels
OUTPUT NAME	Channel names, icons, and colors for all output channels
HA	Analog gain, phantom power on/off status, Gain Compensation, phase settings
CH LINK	Channel link settings

• DCA tab

You can select either ALL or LEVEL/ON. If ALL is selected, all parameters will be copied. If LEVEL/ON is selected, the master level and DCA channel on/off status will be copied. You can select copy-source items for each DCA group 1–16 individually.

5. In the DESTINATION SCENE area, select the range of paste-destination scenes.

Scenes specified between FROM and TO (inclusive) become the paste destination. Use multifunction knob 7 to specify the FROM value, and multifunction knob 8 to specify the TO value.

6. Press the PASTE button.

The selected items of the current scene will be pasted to the scene(s) in memory.

A progress bar will be displayed as the data is being pasted.

During the paste operation, the STOP button will appear. Press the STOP button if you want to abort the operation. In that case, part of data will be pasted and you will be unable to undo the operation.

Using the Focus function

“Focus” is a function that lets you specify the scene parameters that will be recalled (loaded) when you recall a scene. You can specify these settings for each scene. This function is useful if you want to recall only the input channel settings of a specific scene.

NOTE

In contrast to Focus, the CL series console features a “Recall Safe” function that enables you to exclude specific channels and parameters from recall operations. However while the Focus function is specified for each scene, Recall Safe settings are applied to all scenes.

1. Press the SCENE field in the Function Access Area.

The SCENE LIST window will appear, in which you can perform various operations for scene memory.

2. Press the FOCUS tab at the bottom of the SCENE LIST window.

The FOCUS field will appear in the right half of the SCENE LIST window.



① FOCUS button

Enables or disables the Focus function for each scene.

② SET popup button

Press this button to access the FOCUS RECALL popup screen, which allows you to select the parameters that will be subject to recall.

③ FOCUS PARAMETER indicators

These indicators show the focus recall settings that are specified for each scene.

④ CURRENT SETTING field

Here you can specify the content that will be saved by the next scene store operation.

3. Press the SET button for the scene you want to set.

The FOCUS RECALL popup window will appear. The window contains the following items.

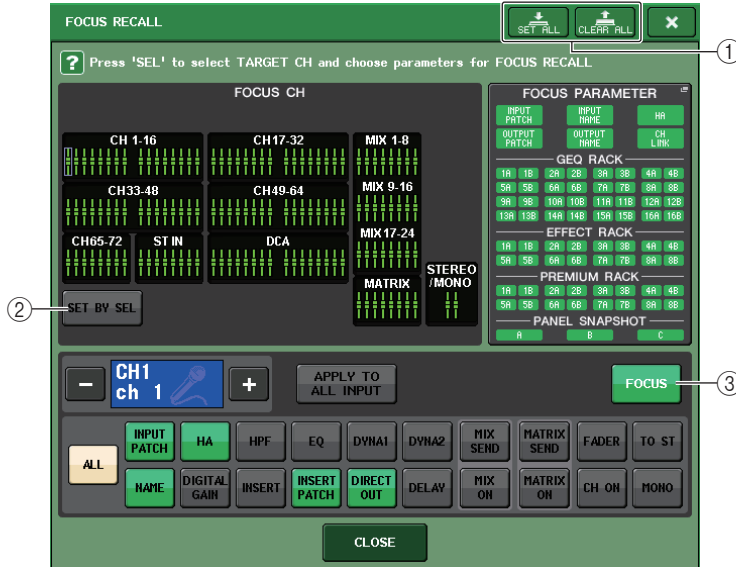

① CLEAR ALL button/SET ALL button

Turns off (or on) all focus channel selections and global focus parameter settings.

■ Focus channel display field

Indicates the target channel for a Recall operation. The view of this field is the same as that in the RECALL SAFE popup window.

To add channels as the target, turn the SET BY SEL button ② on, and then press the corresponding [SEL] keys for the desired channels.

② SET BY SEL button

Turn on this button to add a channel by using the corresponding [SEL] key. When you press the [SEL] key of a channel, the on-screen fader of the corresponding channel will turn green (all parameters will be recalled) or blue (only some parameters will be recalled). Press the same [SEL] key once again to de-select the channel.

NOTE

In the case of the CL3/CL1, channels that do not exist on those models will not be shown.

Channel focus parameter display field

Enables you to select parameters for each channel that will be affected by Recall operations. You can use the same procedure as that in the RECALL SAFE popup window.

③ **FOCUS button**

Switches the Focus Recall function on or off.

GLOBAL FOCUS PARAMETER field

Indicates the parameters and racks that will be affected by Recall operations for any scene. Procedures and contents are the same as those in the RECALL SAFE MODE popup window.

4. Follow the procedure starting with step 2 in the “Using the Recall Safe function” section to make settings.

5. If you want only specific parameters to be recalled for the selected channel or DCA group, use the buttons other than ALL in the channel focus parameter display field to select the parameters that will be recalled (multiple selections are allowed). If you want all parameters to be recalled, turn on the ALL button (this is the default setting).

If the ALL button is on, all other buttons for that scene will be turned off. Turning on any other button will turn off the ALL button.

6. Recall a scene for which you have made Focus settings.

Only the channels (DCA groups) / parameters selected in the FOCUS RECALL popup window will be recalled. Bus settings will always reproduce the state of the recalled scene, regardless of the Focus Recall settings.

NOTE

- Scenes for which Focus settings are made are marked by a “FOCUS” indicator in the STATUS field of the SCENE LIST window (COMMENT tab).
- You can use the Focus function in conjunction with the Recall Safe function. Channels or parameters that are excluded from Recall operations by either Focus or Recall Safe will not be recalled.

Using the Recall Safe function

“Recall Safe” is a function that excludes only specific parameters/channels (DCA groups) from Recall operations. Unlike the Focus settings (see page 87), which you can apply to individual scenes, the Recall Safe settings are globally applied to all scenes.

1. In the Function Access Area, press the CH JOB button to access the CH JOB popup window.

2. Press the RECALL SAFE button to access the RECALL SAFE MODE popup window.



In this popup window, you can make settings for the Recall Safe function. The window contains the following items.

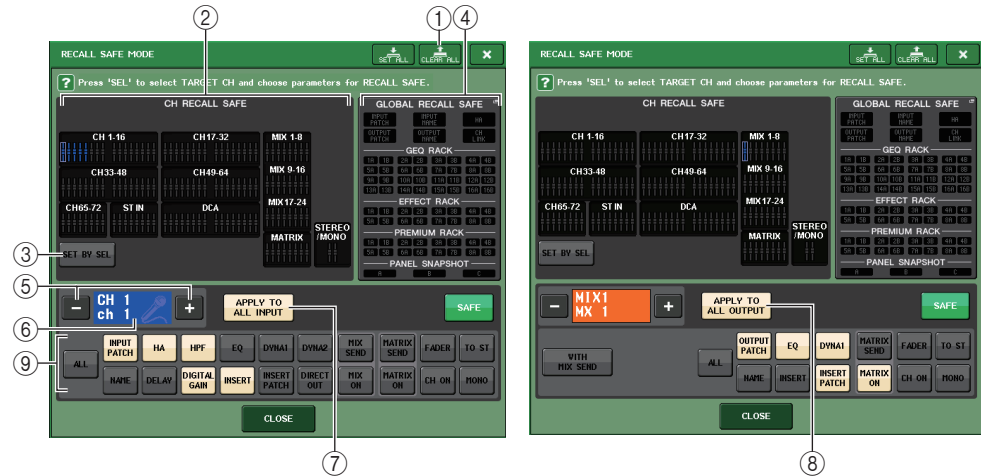

① **CLEAR ALL button/SET ALL button**

The CLEAR ALL button turns off (disables) the Recall Safe function (that is currently set for individual channels) and the Global Recall Safe function simultaneously. The SET ALL button turns on (enables) these functions simultaneously.

NOTE

The selection of parameters that would be affected by the Recall Safe function will not change.

② **CH RECALL SAFE field**

Indicates the channels currently specified for the Recall Safe function.

③ **SET BY SEL button**

Enables you to use the [SEL] keys on the panel to select channels that will be affected by the Recall Safe function. Turn this button on, and then press the [SEL] key for the channel to which you want to apply Recall Safe. The on-screen fader of the corresponding channel will turn green (all parameters for the channel will be affected by the Recall Safe function), or turn blue (some parameters for the channel will be affected by the Recall Safe function). Press the same [SEL] key once again to de-select the channel.



All parameters are affected by Recall Safe on these channels.



Some parameters are affected by Recall Safe on these channels.



Recall Safe has been canceled on these channels.

④ **GLOBAL RECALL SAFE field**

Indicates the state of Recall Safe settings that are not made in units of channels, and the Recall Safe settings for racks. Press this field to open the GLOBAL RECALL SAFE popup window.

⑤ **Channel select button**

Selects the channel for which you want to set the Recall Safe function.

NOTE

Switching channels using this button will not affect the channel selection on the top panel.

⑥ **Selected channel display**

This area indicates the icon, number, color, and name of the currently-selected channel.

⑦ **APPLY TO ALL INPUT button (input channels only)**

Turn on this button to apply the Recall Safe parameter selection for one input channel to all other input channels.

This can be convenient if you want to apply Recall Safe to the same parameters for all input channels.

⑧ **APPLY TO ALL OUTPUT button (output channels only)**

Turn on this button to apply Recall Safe parameter selection for one output channel to all other output channels.

This can be convenient if you want to apply Recall Safe to the same parameters for all output channels.

⑨ **SAFE PARAMETER SELECT field (excluding DCA groups)**

Selects Recall Safe parameters for the selected channel.

The button indication varies depending on the channel type, as follows:

• **Input channel**



NOTE

ST IN channels do not feature INSERT, INSERT PATCH, or DIRECT OUT button.

• **MIX channel**



• **MATRIX channel**



• **STEREO channel**



• **MONO channel**



If Recall Safe is turned on for global parameters, the safe parameter select buttons of the selected channel will light green, as follows.



In this illustration, the items that are lit green indicate that the INPUT PATCH, INSERT PATCH, and DIRECT OUT parameters have been set to Safe by the INPUT PATCH Global parameter settings.

In the same way, turning on the Global parameters INPUT NAME, OUTPUT PATCH, OUTPUT NAME, and HA will cause the corresponding safe parameters of each channel to light green.

On-screen buttons and corresponding parameters apply to the following channels:

Button name	Corresponding parameter	Input channel	MIX channel	MATRIX channel	STEREO/MONO channel
WITH MIX SEND	Send level to the MIX bus		○		
WITH MATRIX SEND	Send level to MATRIX bus			○	
ALL	All parameters	○	○	○	○
HA	HA-related settings	○			
HPF	HPF settings	○			
EQ	EQ settings	○	○	○	○
DYNA 1	Dynamics 1 settings	○	○	○	○
DYNA 2	Dynamics 2 settings	○			
MIX SEND	Send level to MIX bus	○			
MATRIX SEND	Send level to MATRIX bus	○	○		○
FADER	Fader settings	○	○	○	○
CH ON	[ON] key settings	○	○	○	○
TO ST	On/off setting for STEREO bus assignment, PAN, etc.	○	○		
MONO	On/off setting for MONO bus assignment	○	○		
INPUT PATCH	Input Patching	○			
DIGITAL GAIN	Digital gain settings	○			
INSERT	Insert on/off	○*1	○	○	○
INSERT PATCH	Insert patch settings	○*1	○	○	○
DIRECT OUT	Direct Out settings	○*1			
MIX ON	MIX Send On/Off	○			
MATRIX ON	MATRIX Send On/Off	○	○		○
DELAY	Delay settings	○			
NAME	Channel name	○	○	○	○
OUTPUT PATCH	Output Patching		○	○	○
BAL	BLANCE parameter settings			○	○ (stereo only)

*1. ST IN channels do not feature these buttons.

⑩ **SAFE PARAMETER SELECT field (DCA)**

Enables you to select parameters for a DCA group that will be affected by Recall Safe operations. If the ALL button is on, all DCA master parameters will be subject to Recall Safe. If LEVEL/ON is on, the DCA master level and on/off status will be subject to Recall Safe.



3. To select the channel or DCA group that will be affected by Recall Safe operations, press the corresponding [SEL] key.

The corresponding channel or DCA group will be enclosed by a white frame in the CH RECALL SAFE field. (However, this white frame does not mean that the Recall Safe setting is now enabled.) The selected channel or DCA groups 1–8 or 9–16 will be recalled to the SAFE PARAMETER SELECT field.

NOTE

If the CH RECALL SAFE field's SET BY SEL button is on, Recall Safe will be enabled when you press the [SEL] key, and the corresponding channel or DCA group will be highlighted in the CH RECALL SAFE field. You can select parameters as described in step 4 even after turning Recall Safe on.

4. If you want to enable Recall Safe for specific parameters of the selected channel or DCA group, make the following settings in the SAFE PARAMETER SELECT field.

NOTE

- Simply selecting a parameter in step 4 does not enable Recall Safe. To turn Recall Safe on or off, you must also perform the operation described in step 5 (see page 91).
- While the APPLY TO ALL INPUT button (or the APPLY TO ALL OUTPUT button) is on, operations in the SAFE PARAMETER SELECT field will apply to all input channels (or output channels).
- **If an input channel is selected:**
Use the buttons in the lower part of the SAFE PARAMETER SELECT field (except for the “ALL” button) to select the parameters that will be subject to Recall Safe (multiple selections are allowed). If you want all parameters to be subject to Recall Safe, turn on the ALL button (this is the default setting).
- **If a ST IN channel is selected:**
Use the same steps as those for an input channel. (Different buttons will be displayed.)
- **If a MIX channel is selected:**
Use the buttons in the lower part of the SAFE PARAMETER SELECT field (except for the “ALL” button) to select the parameters that will be subject to Recall Safe (multiple selections are allowed). In addition, you can use the WITH MIX SEND button displayed in the lower left of the field to enable Recall Safe for the on/off status and send level of signals sent from input channels to MIX buses. If you want all parameters shown in the lower part of the field to be subject to Recall Safe, turn on the ALL button (this is the default setting).
- **If a MATRIX channel is selected:**
Use the same steps as those for a MIX channel. (Different types of buttons will be displayed.)
- **If a DCA group is selected:**
If you press a [SEL] key for a DCA group, all parameters for the DCA groups (selected from DCA groups 1–8 and DCA groups 9–16) will be displayed simultaneously. For the parameters that will be subject to Recall Safe, you can select either “ALL” or “LEVEL/ON” (fader position and on/off status of the [ON] key). Recall Safe will be enabled when you make this selection. If you want all parameters of the DCA group to be subject to Recall Safe, turn on the ALL button. Unlike when a channel is selected, Recall Safe will be enabled for that DCA group the moment you turn on either the LEVEL/ON button or the ALL button.

- To enable Recall Safe for the selected channel, turn on the SAFE button in the SAFE PARAMETER SELECT field. (If you have selected a DCA group, turn on either the LEVEL/ON button or the ALL button.)

Channels or DCA groups for which Recall Safe is enabled will be highlighted in the CH RECALL SAFE field.

- To turn on Recall Safe for global parameters, press the GLOBAL RECALL SAFE field to access the GLOBAL RECALL SAFE popup window, and turn on the appropriate buttons.

These buttons correspond to the following parameters.

INPUT PATCH	All input channel patching (including INSERT IN/OUT and DIRECT OUT patching)
INPUT NAME	All input channel names, icons, and channel colors
OUTPUT PATCH	All output channel patching (including INSERT IN/OUT patching)
OUTPUT NAME	All output channel names, icons, and channel colors
HA	All I/O devices, and HA-related parameters for external head amps
CH LINK	All channel link group settings
GEQ RACK EFFECT RACK PREMIUM RACK	Apply Recall Safe to GEQ racks 1–16, Effect racks 1–8, Premium Racks 1–8 individually.
PANEL SNAPSHOT	Fader bank selections, GAIN/PAN/ASSIGN knob selection status (set in units of blocks)

NOTE

If a dual-type GEQ rack or Premium Rack has been selected, you can apply Recall Safe to rack A and B individually. For other racks, the Recall Safe setting for racks A and B will be linked.

- When you have finished making settings, press the CLOSE button to close the popup window. Then perform a Recall operation.

Only the selected DCA group channels and parameters will be excluded from Recall operations. Bus settings are not subject to Recall Safe. They will always be reproduced in the recalled scene.

This means that if Recall Safe is enabled for one of several channels included in a link group or one of two channels set to stereo, the parameter settings of that channel may differ from those of the other channel(s). In such cases, the applicable parameter will be automatically re-linked the next time it is operated.

You can globally apply Recall Safe to channel links by using the global parameter.

NOTE

- You can use the Recall Safe function along with the Focus function (see page 87). Channels or parameters that are excluded from Recall operations by either Focus or Recall Safe will not be recalled.
- If you hold down the [SEL] key while performing a recall operation, all parameters of that channel will be treated as Recall Safe regardless of the state of the SAFE PARAMETER SELECT selections.

Using the Fade function

“Fade” is a function that smoothly changes the faders of specified channels and DCA groups to their new values over a specified duration when you recall a scene. The settings of the Fade function are made independently for each scene.

- Press the SCENE field in the Function Access Area.

The SCENE LIST window will appear, in which you can perform various operations for scene memory.



- Press the FADE TIME tab at the bottom of the SCENE LIST window.

The FADE TIME field is shown in the right half of the SCENE LIST window.



- SET popup button**

Press this button to open the FADE TIME popup window, in which you can select a channel for which you want to use the Fade function, and specify the fade time (the duration of time over which the fader will reach its new value).

- FADER button**

Enables or disables the Fade function for each scene.

③ FADE TIME display

This area indicates the fade time specified for each scene.

④ CURRENT SETTING field

Specifies the content that will be saved by the next scene store operation.

3. Press the SET button to access the FADE TIME popup window.

In this popup window you can select the channels to which Fade will be applied, and adjust the fade time.

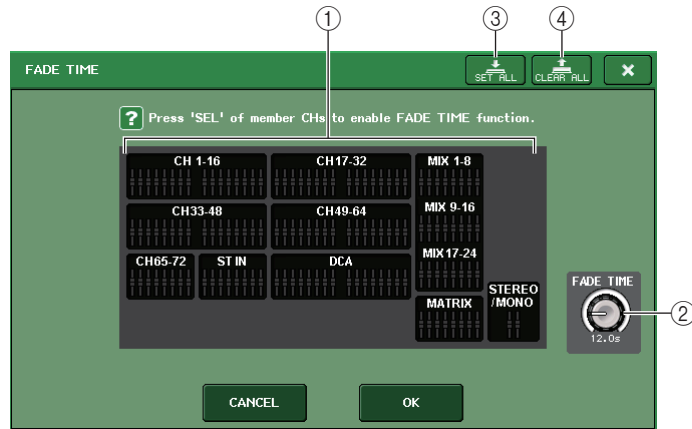

① Channel display field

The channels or DCA groups to which Fade is applied are highlighted.

② FADE TIME knob

Sets the fade time. You can adjust the fade time using the corresponding multifunction knob.

③ SET ALL button

Press this button to apply the Fade effect to all faders of that scene.

④ CLEAR ALL button

Press this button to cancel the Fade effect for all faders of that scene.

NOTE

In the case of the CL3/CL1, faders that do not exist on those models will not be shown.

4. Press the [SEL] keys for the desired channels or DCA groups to select the channels or DCA groups to which the Fade effect will be applied (multiple selections are allowed).

The [SEL] keys for the selected channels or DCA groups will light, and those channels or DCA groups will be highlighted green in the channel display field of the popup window. You can cancel the selection by pressing the lit [SEL] key once again to turn it off.

5. Use the multifunction knob that corresponds to the FADE TIME knob to adjust the fade time.

The range is 0.0 sec – 60.0 sec.

When you have finished setting the fade time, press the OK button to close the FADE TIME popup window.

NOTE

The fade time you specify here is used for all channels and DCA groups selected in step 4.

6. To enable the Fade function, press the FADE button.

You can turn the Fade function on or off individually for each scene.

NOTE

Scenes for which Fade settings are made are marked by a “FADE” indicator in the STATUS field of the SCENE LIST window (COMMENT tab).

7. Recall a scene for which the Fade function is turned on.

The faders will begin to move immediately after Recall occurs, and will reach the values of the recalled scene over the course of the specified fade time.

NOTE

- The Fade function settings can be applied individually even if faders are linked by Channel Link.
- You can stop a fade effect by holding down a [SEL] key while you stop the corresponding moving fader.
- If you recall the same scene while faders are moving, the faders of all channels or DCA groups will move immediately to their target positions.

Outputting a control signal to an external device in tandem with scene recall (GPI OUT)

A control signal can be output to an external device connected to the GPI connector of the CL series console when you recall a specific scene. Proceed as follows.

NOTE

For more information on the GPI OUT settings, refer to “Using GPI OUT” on page 223.

1. Press the SCENE field in the Function Access Area.

The SCENE LIST window will appear, in which you can perform various operations for scene memory.

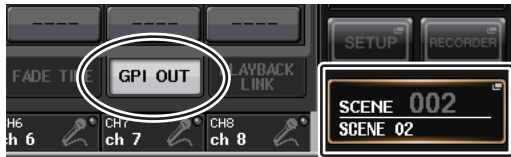

2. Press the GPI OUT tab at the bottom of the SCENE LIST window.

The GPI OUT field will appear.



① GPI OUT CONTROL buttons

These specify the control signal will be output from each GPI OUT. Pressing a button repeatedly will switch between the following functions.

- ---- (OFF) Nothing will be output.
- TRIGGER A trigger will be output when the scene is recalled.
- TALLY A tally will be output when the scene is recalled.

② CURRENT SETTING field

Specifies the content that will be saved by the next scene store operation.

3. For each scene, specify the control signal that you want to output to each GPI OUT port.

4. Recall the scene for which you want to output GPI OUT signals.

When you recall the scene, the control signals will be output to the external device connected to the GPI OUT connector.

Playing back an audio file that links to a scene recall

You can also specify an audio file that you want to play back from a USB flash drive when a specific scene is recalled. This can be convenient if you want an effect sound or BGM to be played automatically in a specific scene.

Follow the steps below to link a scene recall with audio file playback.

NOTE

- Save audio files for playback in the SONGS folder within the YPE folder. If you save them in the root directory or in other folders, you will be unable to specify them for playback. When an audio file is played, the path in the TITLE LIST screen will indicate \YPE\SONGS\.
- You cannot play audio files during recording or in recording standby mode.
- A specified audio file will be played back only once, regardless of the playback mode settings.
- Audio file names must be eight characters plus three extension characters. If you change the file name after specifying the file for playback, or if you delete or copy the file repeatedly, the specified file may become unrecognizable in rare cases.

1. Connect a USB flash drive containing the audio files to the USB connector.

2. Press the SCENE field in the Function Access Area.

The SCENE LIST window will appear, in which you can perform various operations related to scene memory.



3. Press the PLAYBACK LINK tab at the bottom of the SCENE LIST window.

The PLAYBACK LINK field is shown in the right half of the SCENE LIST window.



① PLAY button

Sets the Playback Link function's on/off status for each scene.

② Song select popup button

Press this button to open the SONG SELECT popup window, in which you can select a song and set the offset time (time duration from scene recall until the start of playback). Also, the title of the selected song will appear on the button.

③ Offset time display

Indicates the time duration from scene recall until the start of playback of the specified audio file. Set the offset time in the SONG SELECT popup window.

④ CURRENT SETTING field

Specifies the content that will be saved by the next scene store operation.

4. Press the song select popup button for a scene to which you want to link the audio file. The SONG SELECT popup window will appear.

In this popup window, you can select an audio file you want to link with the scene, and set the offset time.

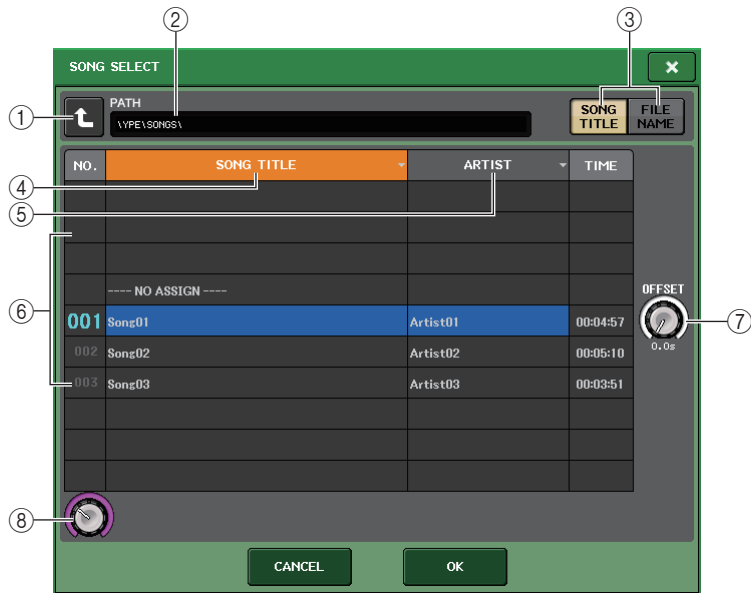

① Change directory button

Press this button to move to the next higher level.

NOTE

You cannot move to levels higher than \YPE\SONGS\.

② PATH indicator

This area indicates the current directory path.

③ SONG TITLE/FILE NAME switch buttons

Switch between the song title list and the file name list.

④ SONG TITLE list button

⑤ ARTIST list button

Press these buttons to sort the audio file list (at the current directory level) by song title and artist name respectively.

⑥ Song list

Displays the title, artist name, and audio file time duration of the audio files in the \YPE\SONGS\ folder. You can select an audio file by pressing the audio file name.

⑦ OFFSET knob

You can use the multifunction knob to set the time duration from scene recall until the start of audio file playback.

⑧ Scroll knob

Use the multifunction to scroll the list.

5. Press the screen or use the multifunction knobs to select a file that you want to link to a scene.

6. If desired, use the corresponding multifunction knobs to set the offset (the time duration until the start of audio file playback).

The offset value can be adjusted in the range of 0.0–99.0 in 0.5 sec steps.

7. Press the OK button.

The title of the selected song will appear in the center of the song list.

If you select the CANCEL button instead of the OK button, your settings will be discarded and the unit will return to the SCENE LIST popup window.

8. Press the PLAY button to turn on the link to the audio file.

The PLAY button will light in the LINK field. The PLAY indicator will appear in the STATUS field on the COMMENT tab.

9. Repeat steps 4–8 to link audio files to other scenes.

10. Recall a scene to which an audio file has been linked.

After the offset time duration has elapsed, the specified audio file will play one time.

NOTE

- After a scene has been recalled and until the offset time has elapsed, a countdown will appear in the Function Access Area.
- If another song is playing during a scene recall, the song playback will stop when the scene is recalled, regardless of the offset time setting.

Using Preview mode

Preview mode lets you view or edit the settings of a scene stored in memory without affecting the signal processing of the current scene. When you recall a scene in this mode, the settings of the newly recalled scene will appear on the panel of the CL series console, but the signal processing of the current scene will remain as it was prior to the recall. Even if you modify the settings and save them as a new scene or by overwriting, the signal processing of the current scene will remain as it was prior to the recall. During an actual performance, it can be convenient to use this to check the content of the scene you intend to recall next, or to make minor changes to a scene and then store it.

1. Press the PREVIEW button on the panel or the PREVIEW button in the SCENE LIST window.

The PREVIEW button will light, and the console will be in Preview mode.

In this state, operating controllers such as the knobs and faders will not affect the signal processing of the current scene.

2. Use the SCENE MEMORY [INC]/[DEC] keys to select the scene number that you want to recall.

3. Press the SCENE MEMORY [RECALL] key. To execute the Recall operation, press the OK button.

The scene will be recalled. However, the internal signal processing of the current scene will remain unchanged as it was prior to the Recall operation.

If desired, you can access a specific channel in the SELECTED CHANNEL section, or access a specific screen in the display to examine the values in detail.

4. If desired, use the panel controls to edit the settings.

Operating a panel control in Preview mode will edit the settings of the scene you recalled in step 3, but will not affect the signal processing of the current scene.

5. If you want to store the changes you made in step 4, select the scene number in which you want to store the scene, and press the SCENE MEMORY [STORE] key.

The settings you edited in step 4 will be stored into memory.

6. When you have finished viewing or editing the settings of the scene, press the PREVIEW button of the panel or the PREVIEW button in the SCENE LIST window.

The PREVIEW button will go dark; the CL series console will exit Preview mode and return to the normal state.

NOTE

PREVIEW mode applies to all parameters included in scene memory, all parameters included in the INPUT PATCH and OUTPUT PATCH functions, and HA parameters.

Functions in Preview mode

The current scene will be modified by the following software and external operations.

- CL Editor
- Stage Mix
- MIDI Rx
- GPI IN

Similarly, edits for the current scene will be conveyed to the following software and external devices.

- CL Editor
- Stage Mix
- MIDI Tx
- GPI OUT

The meters will indicate the state of signal processing for the current scene.

Playback Link will operate for recalling the current scene.

If cascade-connected, both master and slave units will operate independently. Link will not occur while in Preview mode.

The following functions will not operate in Preview mode.

- Synchronization with CL Editor
- Switching users
- Changing the User Level
- Load/Save functions
- Cue changes
- USER DEFINED KEYS operations
- USER DEFINED KNOB operations
- Monitor (MONITOR, CUE, OSCILLATOR, TALKBACK) changes or display
- Changing or viewing Nuendo Live settings
- Changing or viewing the recorder
- Changing DANTE SETUP or DANTE PATCH settings
- FADE TIME
- EFFECT FREEZE playback or recording
- MIDI clock and tap tempo for effects
- Internal metering for Premium Effects (GR for DynamicEQ and Portico 5043; VU for Opt-2A and U76)

In addition, you cannot enter Preview mode while performing the following operations.

- While pasting scene or EQ settings.
- While executing Global Paste
- While synchronizing with CL Editor
- While saving/loading a file

Monitor and Cue functions

This chapter explains the Monitor and Cue functions of CL series consoles.

About the Monitor and Cue functions

The Monitor function lets you audition various outputs through your nearfield monitors or headphones. On the front panel of the CL series console is a PHONES Out jack for monitoring, which enables you to monitor the monitoring source signal at any time. By assigning the MONITOR OUT L/R/C channels to the desired output jacks, you can also monitor the same signal through external speakers.

You can select the following signals as the monitor source.

- STEREO channel output signal
- MONO channel output signal
- STEREO + MONO channel output signal
- OMNI IN 1-2, 3-4, 5-6, 7-8 channel input signal (for monitoring a two channel pair)
- RECORDER PLAYBACK output signal
- A combination of up to eight MIX, MATRIX, STEREO, or MONO channel output signals, RECORDER PLAYBACK output signals, and OMNI IN 1-2, 3-4, 5-6, 7-8 input signals

The Cue function enables you to check an individual channel or DCA group by temporarily monitoring it via MONITOR OUT, CUE OUT, or PHONES. When you press the [CUE] key on the top panel, the cue signal of the corresponding channel or DCA group is sent as the monitor output or cue output from the selected output port.

NOTE

Be aware that if you turn CUE INTERRUPTION off in the MONITOR popup window, the cue signal will not be sent to the connected monitor speakers. However, the cue signal will always be sent to the PHONES Out jack.

The following diagram shows the cue/monitor signal flow.

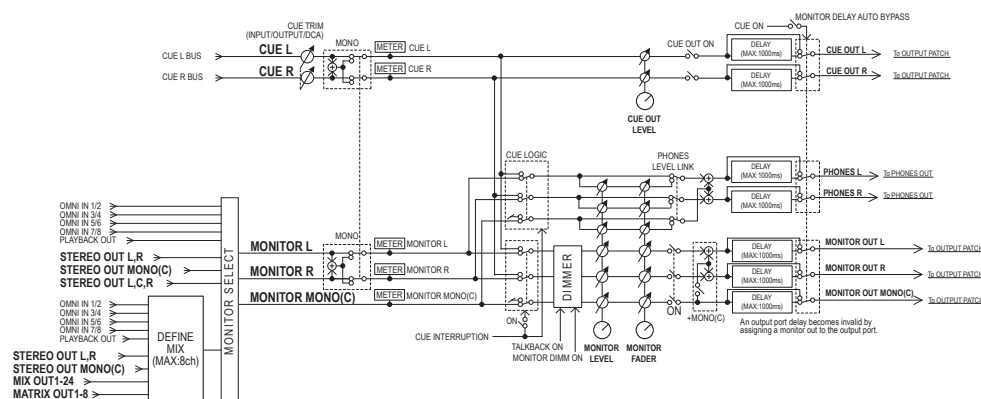

- **MONITOR SELECT**
Selects the monitor source.
- **METER**
Detects and indicates the level of the monitor signal or cue signal.
- **DIMMER**
Attenuates the monitor/cue signal by a fixed amount.
- **MONITOR LEVEL**
Adjusts the output level of the MONITOR OUT L/R/C channels. If PHONES LEVEL LINK is ON, this setting will also affect the level at the PHONES Out jack.
- **MONITOR FADER**
Use the STEREO MASTER fader or MONO MASTER fader to adjust the output level of the MONITOR OUT L/R/C channels. MONITOR FADER is positioned in series with MONITOR LEVEL. If PHONES LEVEL LINK is ON, this setting will also affect the level at the PHONES Out jack.
- **ON (on/off)**
Switches the Monitor function on or off.
- **DELAY (Monitor delay)**
Delays monitor signals. The Delay function is disabled if cue signals are being output.
- **PHONES LEVEL (Headphone level)**
Adjusts the output level at the PHONES Out jack.
- **PHONES LEVEL LINK (Headphone Level Link function)**
If this function is turned on, the MONITOR LEVEL knob will adjust the level of signals sent to the PHONES Out jack.
- **CUE INTERRUPTION (Cue Interruption function)**
If this function is turned on, pressing the [CUE] key on the top panel will cause the cue signal of the corresponding channel or DCA group to be sent as the monitor output from the selected output port. With the factory default settings, this function is turned on.
Turn it off if you do not want to output cue signals to the monitoring speakers or headphones.

Using the Monitor function

This section explains how to select the desired monitor source, and monitor it from the PHONES Out jack or external monitor speakers.

1. Connect your monitor system to the OMNI OUT jacks or ZTR OUT DIGITAL jack on the rear panel.

Monitor signals can be sent to any desired output jack or output channel. To monitor through headphones, make sure that your headphones are connected to the PHONES Out jack on the front pad.

2. In the Function Access Area, press the MONITOR button to access the MONITOR screen.

In the MONITOR screen, the MONITOR field lets you check the current monitor settings, and turn monitoring on or off.

The MONITOR screen contains the following items.

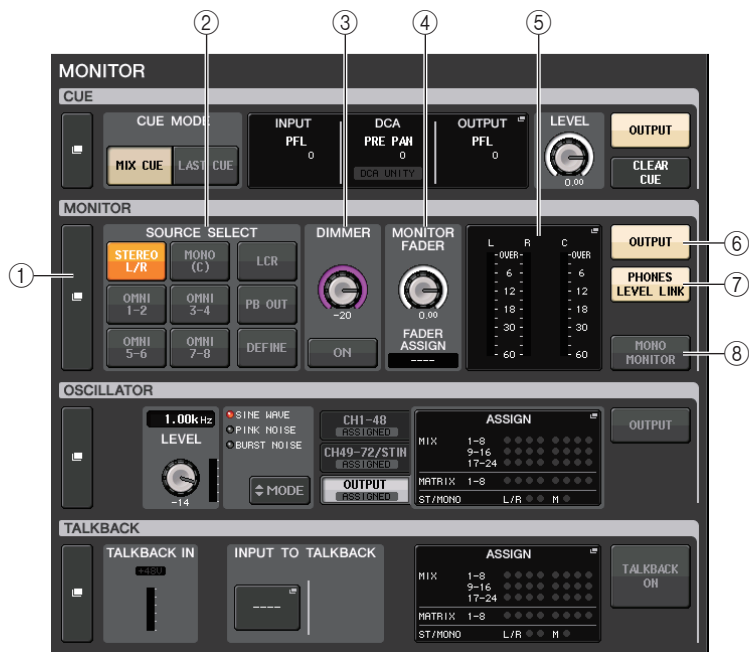

① MONITOR popup display button

Enables you to access the MONITOR popup window, in which you can make detailed monitor settings.

② SOURCE SELECT field

Selects the monitor source. If DEFINE has been selected in this field, access the MONITOR popup window to specify the source channel.

③ DIMMER field

Enables you to make settings for the Dimmer function, which temporarily attenuates monitor signals.

• DIMMER LEVEL knob

Adjusts the amount by which the monitor signals will be attenuated when the dimmer is on.

• DIMMER ON button

Turn on this button to enable the dimmer and attenuate the monitor signal.

④ MONITOR FADER field

Enables you to set and view the monitor fader that adjusts the monitor level.

• MONITOR FADER LEVEL knob

Adjusts the monitor fader level. Pressing this knob will enable you to use the multifunction knob in the Centralogic section to adjust the level.

• FADER ASSIGN display

This area displays the type of faders that are currently assigned to the monitor fader. Indicator assignments are as follows:

- ----- No assignment
- MASTER A Master A only
- MASTER A+ Master A, Master B, Custom Fader bank
- MASTER B Master B only
- MASTER B+ Master B, Custom fader bank
- CUSTOM A single fader in the Custom fader bank
- CUSTOMs Multiple faders in the Custom fader bank

⑤ Meter field

Indicates the output level of Monitor Out channels L, R, and C. Press this field to open the MONITOR popup window.

⑥ MONITOR OUTPUT button

Switches Monitor Out on or off.

⑦ PHONES LEVEL LINK button

If this is on, the MONITOR FADER LEVEL knob or MONITOR FADER will adjust the level of signals sent to the PHONES Out jack.

⑧ MONO MONITOR button

Turn on this button to switch monitor signals to mono.

3. Press the popup button or the meter field to open the MONITOR popup window.

In the MONITOR popup window you can make detailed settings for monitoring. The popup window includes the following items.

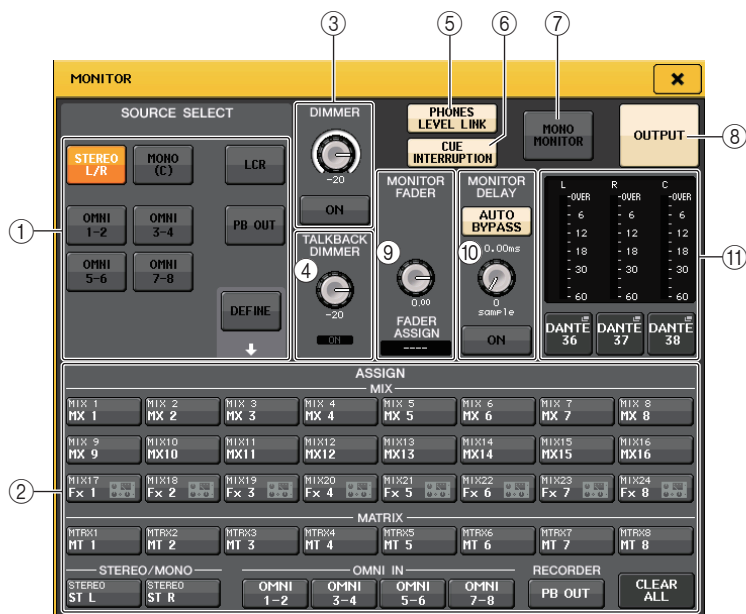

① SOURCE SELECT field

Select one of the following as the signal source that will be output to the MONITOR bus.

STEREO L/R	STEREO L/R channel signals
MONO (C)	MONO channel signal
LCR	STEREO L/R + MONO channel signals
OMNI 1-2 – 7-8	OMNI IN jacks 1-8 signals (per two channels)
PB OUT	Recorder's PLAYBACK OUT signals
DEFINE	The signal(s) selected in the ASSIGN field

② ASSIGN field

If you selected DEFINE in the SOURCE SELECT field, use this field to specify the monitor source. You can select up to eight monitor sources simultaneously. Pressing the CLEAR ALL button will clear all selections.

③ DIMMER field

Enables you to make settings for the Dimmer function, which temporarily attenuates monitor signals.

• DIMMER LEVEL knob

Adjusts the amount by which the monitor signals will be attenuated when the dimmer is on.

• DIMMER ON button

Switches the Dimmer function on or off. The monitor signal will be attenuated if this button is on.

④ TALKBACK DIMMER field

Enables you to make settings for the Dimmer function, which temporarily attenuates monitor signals when TALKBACK is on.

• TALKBACK DIMMER LEVEL knob

Adjusts the amount by which monitor signals will be attenuated when talkback is on.

• TALKBACK DIMMER ON indicator

Indicates the on/off status of the dimmer function for talkback.

⑤ PHONES LEVEL LINK button

Enables you to link the signal level at the PHONES Out jack to the monitor signal level. If this button is on, the MONITOR LEVEL knob and monitor fader knob will adjust the level of the signal sent to the PHONES OUT jack.

⑥ CUE INTERRUPTION button

Press this button to interrupt the cue signal with the monitor signal. If this button is on and the cue is enabled, the cue signal will be sent to the monitor output. With the factory default settings, this function is turned on. If you do not wish to send the cue signal to the monitor output, switch this button off.

⑦ MONO MONITOR button

Turn on this button to switch the monitor output signal to mono.

⑧ MONITOR OUTPUT button

Switches the monitor output on or off.

⑨ MONITOR FADER field

Enables you to set and view the monitor fader that adjusts the monitor level.

• MONITOR FADER LEVEL knob

Adjusts the monitor fader level. Pressing this knob will enable you to use the multifunction knobs in the Centralogic section to adjust the level.

• FADER ASSIGN indicator

This area displays the faders that are currently assigned as MONITOR FADER. Indicator assignments are as follows:

----	No assignment
MASTER A	MASTER A fader only
MASTER A+	MASTER A, as well as MASTER B fader and Custom fader bank
MASTER B	MASTER B fader only
MASTER B+	MASTER B, as well as Custom fader bank
CUSTOM	One of the Custom fader bank faders
CUSTOMs	Multiple Custom fader bank faders

⑩ MONITOR DELAY field

This field enables you to specify the monitor delay setting by which the monitor out signal is delayed.

- **AUTO BYPASS button**

Turn this on to automatically bypass monitor delay when the cue is on.

- **MONITOR DELAY knob**

Adjusts the delay time for the monitor signal. The delay time is shown above the knob in ms units, and below the knob in units of the currently selected scale. However if the scale is set to ms, the delay time value is not shown above the knob.

Press this knob and you will be able to use the multifunction knob to adjust the value.

- **MONITOR DELAY ON button**

If this button is on, the monitor signal will be delayed according to the setting of the MONITOR DELAY knob.

⑪ Meter field

- **Meters**

Indicates the output level of the monitor L/R/C channels.

- **MONITOR OUT PATCH button**

Press this button to open the PORT SELECT popup window, in which you can select an output port to patch to the monitor out L/R/C channels.

4. Use the buttons of the SOURCE SELECT field to select a monitor source.

In the SOURCE SELECT field you can select only one monitor source. However, if you have selected DEFINE, you can use the ASSIGN field to specify multiple monitor sources.

The following table shows the monitor sources that you can select in the ASSIGN field.

MIX 1–24	Output signals of MIX channels 1–24
MTRX 1–8	MATRIX buses 1–8 output signals
STEREO	STEREO L/R channel output signals
MONO (C)	MONO channel output signal
OMNI 1–2 – OMNI 7–8	OMNI IN jacks 1–8 input signals (per two channels)
PB OUT	Recorder's PLAYBACK OUT signals

NOTE

You can select a maximum of eight monitor sources in the ASSIGN field. If you select eight monitor sources, no further selections will be possible. Please turn off the buttons for unneeded sources.

5. To specify a port as the output destination for monitor signals L, C, and R, press one of the MONITOR OUT PATCH buttons (L/R/C) in the meter field to open the PORT SELECT popup window. In this window, choose from the following monitor signal output destinations (multiple selections are allowed).



DANTE 1–64	Output channels 1–64 to audio network
OMNI1–8	OMNI OUT jacks 1–8
DIGI OUT L/R	DIGITAL OUT jack on the CL unit
SLOT1–1 – SLOT3–16	Output channels 1–16 of an I/O card installed in slots 1–3

When you have selected an output port, press the CLOSE button to close the popup window.

In the same way, specify the output ports for MONITOR OUT L, R, and C.

NOTE

- If desired, you can specify output ports only for MONITOR OUT L and R to monitor through two speakers.
- If you have not specified an output port for MONITOR OUT C, selecting the MONO (C) button or LCR button as the monitor source will automatically cause the MONO channel signal to be distributed to MONITOR OUT L/R.

6. To enable monitoring, press the OUTPUT button to turn it on.

The monitor source you selected in step 4 will be sent to the output destination you specified in step 5.

NOTE

The PHONES Out jack will always output the monitor signal, regardless of whether the OUTPUT button is on or off.

7. To control the monitor fader, press the Bank Select [STEREO] key in the Centralogic section, and then operate the monitor fader.

- 8.** To adjust the monitor level, use the **MONITOR LEVEL** knob located in the **SCENE MEMORY/MONITOR** section of the top panel.

If **PHONES LEVEL LINK** is ON, use the **MONITOR LEVEL** knob and the monitor fader, as well as the **PHONES LEVEL** knob to adjust the monitor level when monitoring through headphones.

- 9.** Make settings for **Dimmer, Delay, Monaural, and CUE INTERRUPTION** as desired.

NOTE

Monitor on/off operations, selection of the monitor source, and dimmer on/off operations can also be assigned to **USER DEFINED** keys (see [page 169](#)).

Using the Cue function

About CUE groups

Cue signals on the CL series console can be categorized into the following four groups.

① **INPUT CUE group**

The cue signals of input channels make up this group. To enable Cue for this group, press the [CUE] key for any input channel to turn Cue on.

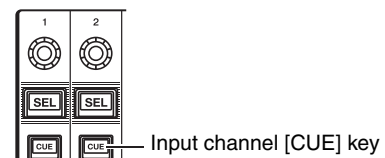

NOTE

If input channels or ST IN channels are assigned to the Centralogic section, you can also use the [CUE] keys in the Centralogic section to enable Cue for this group.

② **DCA CUE group**

The cue signals of DCA groups make up this group. To enable Cue for this group, press the [CUE] key of one of the DCA groups to turn Cue on.

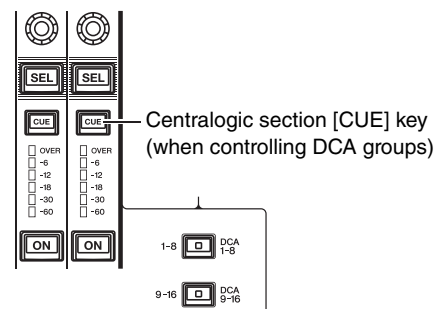

③ **OUTPUT CUE group**

The cue signals of output channels make up this group. To enable Cue for this group, press the [CUE] key of one of the output channels.

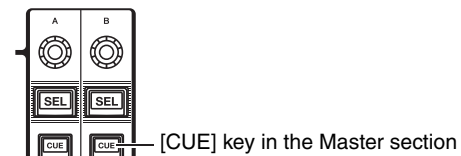

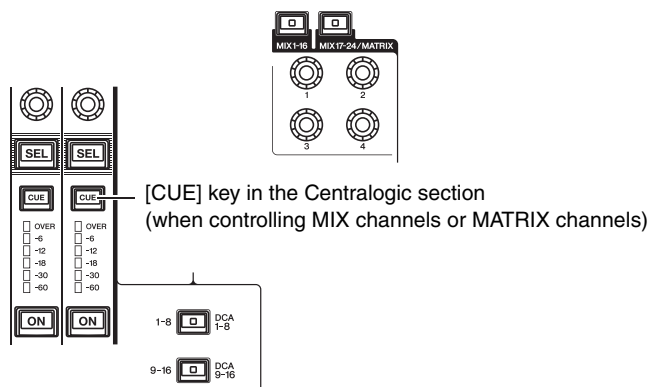

④ Other CUE group

These cue signals are operated via buttons displayed on the touch screen. This group is enabled if you turn on the CUE button in the EFFECT popup window or the PREMIUM popup window, or if you turn on the KEY IN CUE button in the DYNAMICS 1 popup window. This group will automatically be disabled when you exit the corresponding popup window.



On-screen CUE button

You cannot turn on cue monitoring between different groups simultaneously. Normally, the group to which the most recently-pressed [CUE] key (or on-screen CUE/KEY IN CUE button) belongs will take priority, and the [CUE] keys for the previously-selected group will be defeated. However, if you have switched the cue signal group in a specific order when the CUE MODE setting is MIX CUE, the state of the [CUE] keys for the previously-selected group will be restored when the current cue signal is defeated.

The following illustration shows the priority of the [CUE] keys. After you have switched groups from lower to upper levels, if you then defeat cue for the upper group, the previous [CUE] key status of the group immediately below will be restored.

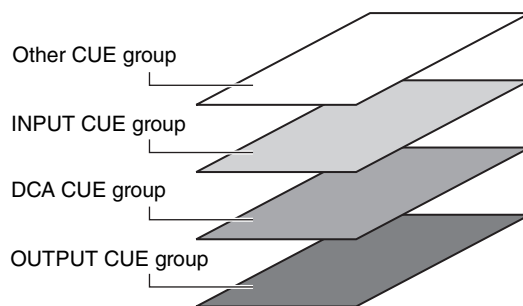

For example, if you switch groups in the order of OUTPUT CUE group → DCA CUE group → INPUT CUE group → Other CUE group, you can then successively defeat the [CUE] keys (CUE/KEY IN CUE buttons) to successively restore the [CUE] key status of the previously-selected group.

Operating the Cue function

This section explains how to use the [CUE] key for a channel or DCA group to monitor cue signals.

NOTE

Be aware that if you turn CUE INTERRUPTION off in the MONITOR popup window, the cue signal will not be sent to the connected monitor speakers. However, the front panel PHONES jack will always output the cue signal regardless of the Monitor on/off setting. See “Using the Monitor function” on page 98 for details about the Monitor function.

1. In the Function Access Area, press the MONITOR button to access the MONITOR screen.

The CUE field on the MONITOR screen enables you to check the current cue settings, and turn Cue on or off.

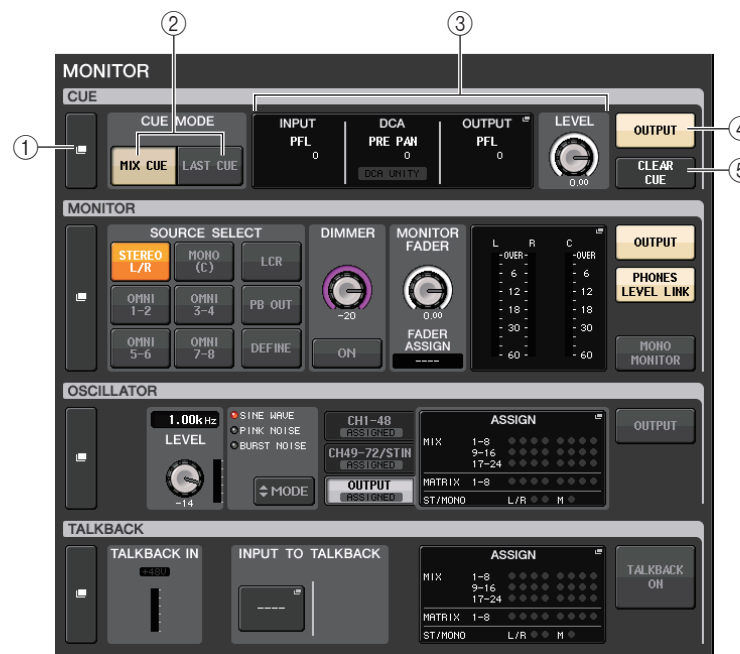

① CUE popup display button

Enables you to access the CUE popup window, in which you can make detailed cue settings.

② CUE MODE buttons

Select the cue mode. You can select MIX CUE mode (all selected channels will be cued), or LAST CUE mode (only the channel selected most recently will be cued).

③ INPUT/DCA/OUTPUT CUE field

Indicates the settings for input cue, DCA cue, and output cue. Press this field to open the CUE popup window.

④ CUE OUTPUT button

Switches the cue out on or off.

⑤ CLEAR CUE button

Cancels all cue selections simultaneously. If the CUE MODE setting is MIX CUE, all of the selected channels will be cleared.

2. Press the CUE popup display button or the INPUT/DCA/OUTPUT CUE field to open the CUE popup window.

The popup window includes the following items.

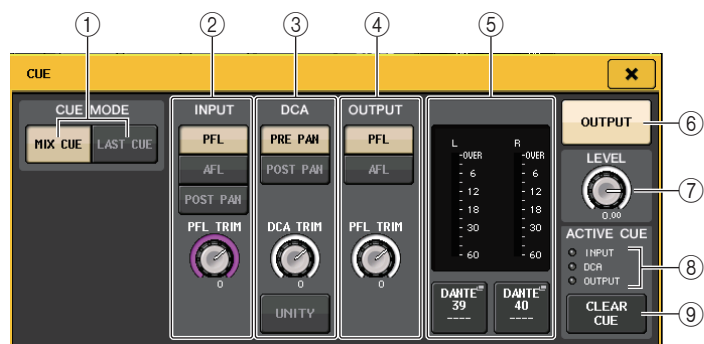

① CUE MODE buttons

Select one of the following two cue modes:

- **MIX CUE**

All selected channels will be mixed and auditioned.

- **LAST CUE**

Only the most recently selected channel will be auditioned.

② INPUT CUE field

This field enables you to make settings related to the input channel cue.

- **Cue point select button**

Sets the cue point to PFL (before fader (immediately before INPUT DELAY)), AFL (immediately after fader), or POST PAN (immediately after PAN).

NOTE

Be aware that if you turn on the POST PAN button, you will be unable to monitor signals sent to the MONO bus from an input channel in LCR mode.

- **PFL TRIM knob**

Indicates the monitor levels when PFL is selected. Use the multifunction knob to adjust the level.

③ DCA CUE field

This section enables you to make settings related to DCA cue.

- **Cue point select button**

Sets the cue point for the DCA group to PRE PAN (immediately before PAN) or POST PAN (immediately after PAN).

- **DCA TRIM knob**

Indicates the monitor level of cue signals from a DCA group. Use the multifunction knob to adjust the level.

- **UNITY button**

Turn on this button to monitor signals at the same volume level that was obtained when the master level for each DCA group was set to 0 dB (unity gain).

④ OUTPUT CUE field

This section enables you to make settings related to output channel cue.

- **Cue point select button**

Sets the cue point for the output channel to PFL (immediately before fader) or AFL (immediately after fader).

- **PFL TRIM knob**

Indicates the monitor levels when PFL is selected. Press this knob so that you will be able to use the multifunction knob to adjust the level.

⑤ Meter field

- **Meter**

This field indicates the output level of the cue L/R channels.

- **CUE OUT PATCH button**

Press this button to open the PORT SELECT popup window, in which you can select an output port to patch to the cue out L/R channels.

⑥ CUE OUTPUT button

Switches cue out on or off.

⑦ CUE LEVEL knob

Indicates the output level of the cue out. Use the multifunction knob to adjust the level.

⑧ ACTIVE CUE indicator

Lights to indicate the type of cue currently being monitored (input: blue, DCA: yellow, output: orange).

⑨ CLEAR CUE button

Press this button to clear all cue selections simultaneously.

- 3.** Use the CUE MODE button to select either the mode in which channels are mixed for auditioning, or the mode in which only the last-selected channel is auditioned.

Select the MIX CUE button or LAST CUE button.

NOTE

In MIX CUE mode, it's not possible to simultaneously turn on Cue for different Cue groups. The Cue group to which the last-cued signal belongs will be turned on, allowing only the signals of that Cue group to be monitored.

- 4.** Use the buttons and knobs of the INPUT CUE field, DCA CUE field, and OUTPUT CUE field to specify the output position and output level for each CUE group.

Refer to the explanation for each item in step 2, and make the desired settings.

- 5.** To specify a port as the output destination for cue signals L and R, press one of the CUE OUTPUT buttons (L/R) in the meter field to open the PORT SELECT popup window, and choose from the following cue signal output destinations (multiple selections are allowed).

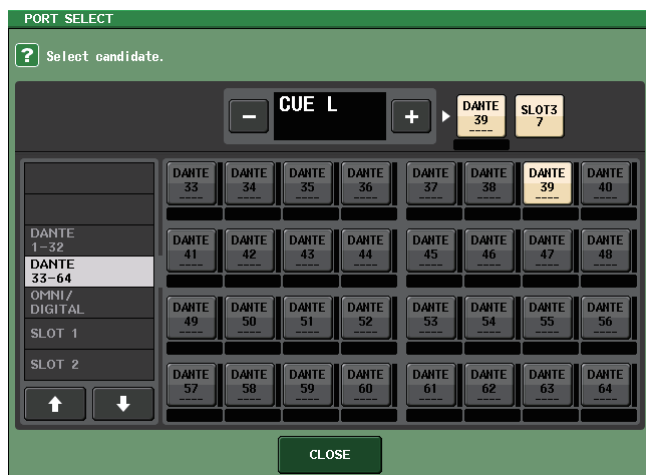

DANTE 1-64	Output channels 1–64 to audio network
OMNI1-8	OMNI OUT jacks 1–8
DIGI OUT L/R	DIGITAL OUT jack on the CL unit
SLOT1-1 – SLOT3-16	Output channels 1–16 of an I/O card installed in slots 1–3

When you have selected an output port, press the CLOSE button to close the popup window.

- 6.** To enable Cue out for the port you specified in step 5, press the CUE OUTPUT button to turn it on.

NOTE

The cue signal is sent to the monitor output and PHONES output jacks regardless of whether the CUE OUTPUT button is on or off.

However, be aware that the cue signal will no longer be sent to monitor output if CUE INTERRUPTION is turned off. The cue signal is always sent to the PHONES output jack, regardless of the CUE INTERRUPTION setting.

- 7.** Press the [CUE] key for a desired channel or DCA group to turn it on.

The cue signal of the corresponding channel will be sent to the output destination specified in step 5 and to monitor output.

A cue meter is shown in the meter field of the function access area, indicating the cue output level.

The upper part of the cue meter shows an abbreviation indicating the currently-enabled cue group or cue type. The abbreviations displayed for the cue meters have the following meaning.

IN	INPUT CUE group
DCA	DCA CUE group
OUT	OUTPUT CUE group
EFFECT	CUE in the EFFECT and PREMIUM RACK (Other CUE groups)
KEY IN	KEY IN CUE in the DYNAMICS 1 popup window (Other CUE groups)
REC/PB	CUE in the RECORDER INPUT/PLAYBACK OUT (Other CUE groups)

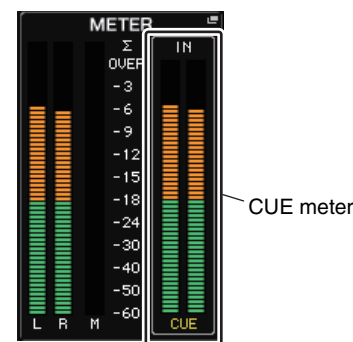

NOTE

- When using the MIX/MATRIX bus select buttons in the SENDS ON FADER popup window, you can press the selected button once again to turn on Cue for the corresponding MIX/MATRIX channel (see [page 43](#)).
- If you want cue operations and channel select operations to be linked, open the USER SETUP popup window, choose the PREFERENCE tab, and then turn on "[CUE] → [SEL] LINK" (see [page 168](#)).

- 8.** If you're auditioning the CUE signal in the monitor, adjust the Cue signal level by using the MONITOR LEVEL knob located in the SCENE MEMORY/MONITOR section of the top panel. Also adjust the MONITOR FADER LEVEL in conjunction with this.

If PHONES LEVEL LINK is ON, the cue signal level when monitoring through headphones can be adjusted in three ways: the CUE LEVEL knob, the MONITOR FADER, and the PHONES LEVEL knob.

NOTE

To adjust the level to the cue out port you specified in step 5, adjust the gain of the output port that is patched to it.

- 9.** To defeat cue, press the currently-on [CUE] key once again.

You can press the CLEAR CUE button in the Meter field of the CUE popup window to clear all cue selections.

NOTE

- If you press the CUE meter in the Function Access Area, all cue selections will be cleared.
- All cue selections will be cleared if you switch between MIX CUE mode and LAST CUE mode in the CUE MODE section.
- You can also assign the function of the CLEAR CUE button to a USER DEFINED key (see [page 169](#)).

Talkback and Oscillator

About the Talkback and Oscillator functions

Talkback is a function that sends the signal of a mic connected to the TALKBACK jack to the desired bus. This is used mainly to convey instructions from the operator or sound engineer to the performers and staff. If necessary, you can also use a mic connected to an INPUT jack on the I/O device or the OMNI IN jack on the CL unit for talkback.

CL series consoles also feature an oscillator that can output a sine wave or pink noise to the desired bus, so that you will be able to check external equipment or to test the acoustical response of the room or hall.

The diagram below shows the signal flow of the talkback and oscillator signals.

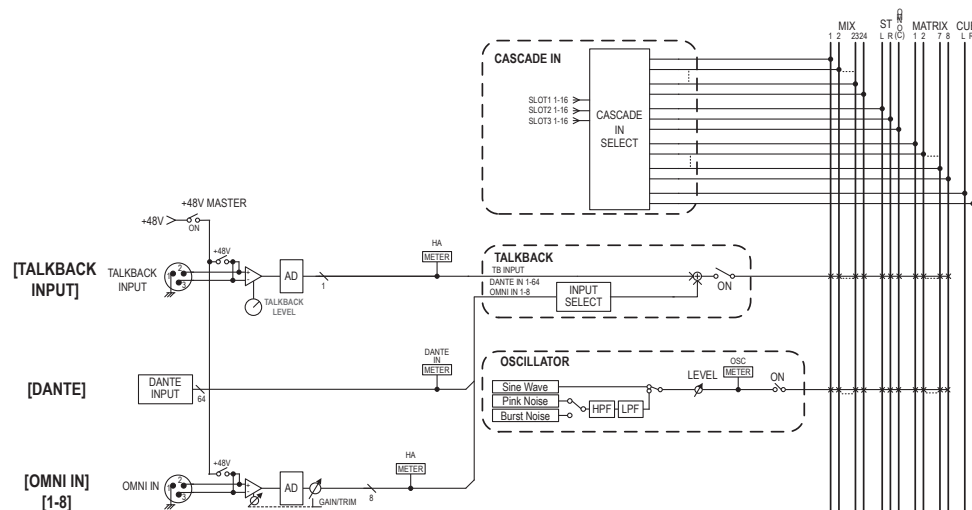

Using Talkback

The Talkback function sends the signal (that is input at the input jacks) to the desired bus.

1. In the Function Access Area, press the MONITOR button to access the MONITOR screen.

In the MONITOR screen, the TALKBACK field enables you to check the current talkback settings, and turn talkback on or off.

If you want to view or edit the talkback settings in greater detail, use the TALKBACK popup window described in step 2 and subsequent steps.

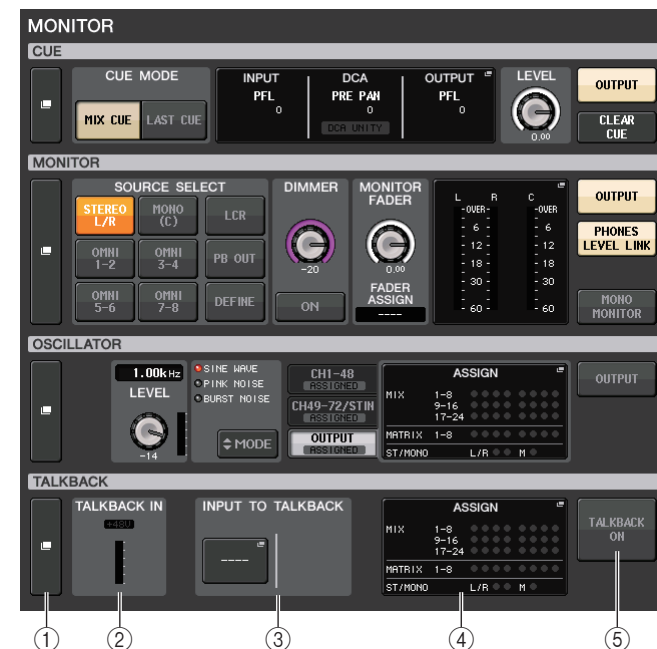

1. **TALKBACK popup display button**

Enables you to access the TALKBACK popup window, in which you can make detailed talkback settings.

2. **TALKBACK IN field**

- **+48V indicator** Indicates the on/off status of the +48V phantom power supplied to the TALKBACK jack.
- **TALKBACK IN level meter** Meters the level of signals after the input gain at the TALKBACK jack.

③ INPUT TO TALKBACK field

- **INPUT TO TALKBACK patch button**

..... Press the button to open the PORT SELECT popup window, in which you can patch a desired input port to an input port to patch to talkback. The selected port name will appear on the button.

- **+48V indicator** Indicates the on/off status of the +48V phantom power supplied to the selected port.
- **ANALOG GAIN knob** Sets the analog gain of the selected port. You can adjust the gain by using the multifunction knobs.
- **HA meter** Displays the level of the HA input signal.

④ TALKBACK ASSIGN field

An indicator lights to indicate the currently-selected output destination of the talkback signal.

⑤ TALKBACK ON button

Switches talkback on or off.

2. Press the TALKBACK popup display button or the ASSIGN field to open the TALKBACK popup window.

In this popup window you can make detailed settings for talkback.

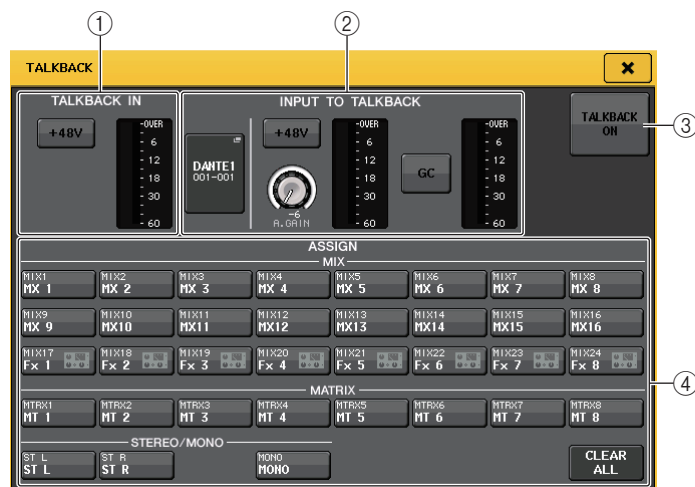

① TALKBACK IN field

- **+48V button**
Switches on or off the phantom power (+48V) supplied to the TALKBACK jack.
- **TALKBACK level meter**
Indicates the input level of the mic connected to the TALKBACK jack.

② INPUT TO TALKBACK field

This field allows a mic connected to a conventional input port to be used as a talkback input.

- **INPUT TO TALKBACK patch button**

Press the button to open the PORT SELECT popup window, in which you can patch a desired input port to talkback. The selected port name will appear on the button.

- **+48V button**

This is an on/off switch for the phantom power (+48V) supplied to the selected input port.

- **ANALOG GAIN knob**

Adjusts the analog gain setting for the selected input port. Press this knob so that you will be able to use the multifunction knob to adjust the gain.

- **HA meter**

Indicates the input level of a mic connected to the selected input port.

- **GC ON button**

Turns the Gain Compensation (gain correction function) on or off. The button will appear if the input jack of the I/O device is patched.

- **Gain Compensation meter**

Indicates the level after Gain Compensation. It will appear if the input jack of the I/O device is patched.

NOTE

These parameters and meters will not appear if no input port is selected.

③ TALKBACK ON button

Switches talkback on or off.

④ ASSIGN field

- **Channel select buttons**
Enable you to select a channel (bus) on which the talkback signal is sent.
- **CLEAR ALL button**
Press this button to clear all selections.

3. Connect a mic to the TALKBACK jack on the front panel, and then rotate the TALKBACK GAIN knob to adjust the input sensitivity of the mic signal.

The meter in the TALKBACK IN field indicates the input level of the mic connected to the TALKBACK jack. If you want phantom power (+48V) to be supplied to the TALKBACK jack, turn on the +48V button located in the TALKBACK IN field.

4. If you want to use an input jack other than the TALKBACK jack as supplementary input for talkback, follow the steps below.

- 4-1. Press the INPUT TO TALKBACK patch button in the INPUT TO TALKBACK field to open the PORT SELECT popup window.
- 4-2. Press the button for the input that you want to use for talkback to turn the button indicator on.
You can select only one input at a time.
- 4-3. Press the CLOSE button to close the popup window.
Use the INPUT TO TALKBACK field GAIN knob and level meter to adjust the input level of the connected mic.

NOTE

The PAD will be switched on or off internally when the HA gain is adjusted between +17 dB and +18 dB.
Keep in mind that noise may be generated when using phantom power if there is a difference between the Hot and Cold output impedance of an external device connected to the INPUT jack.

5. Press a button in the ASSIGN field to specify the bus(es) to which the talkback signal will be sent (multiple selections are allowed).

NOTE

You can press the CLEAR ALL button to defeat all selections.

6. To enable talkback, press the TALKBACK ON button to turn it on.

The TALKBACK ON button will alternately turn on or off each time you press the button (Latch operation).

While talkback is on, signals from the TALKBACK jack and the selected INPUT jack will be output to the destination buses.

NOTE

- You can also assign talkback on/off or an ASSIGN change to a USER DEFINED key. In this case, you can select either a Latch operation or an Unlatch operation (the function will be enabled only while you continue holding down the key) (see [page 169](#)).
- When talkback is on, you can use the talkback dimmer to lower the monitor levels other than the talkback signal (see [page 99](#)).

Using the Oscillator function

You can send a sine wave or pink noise from the internal oscillator to the desired bus.

1. In the Function Access Area, press the MONITOR button to access the MONITOR screen.

In the MONITOR screen, the OSCILLATOR field lets you check the current oscillator settings, and turn the oscillator on or off.

If you want to view or edit the oscillator settings in greater detail, use the OSCILLATOR popup window described in step 2 and subsequent steps.



① OSCILLATOR popup display button

Enables you to access the OSCILLATOR popup window, in which you can make detailed oscillator settings.

② OSCILLATOR LEVEL field

This adjusts the level of the oscillator. A meter beside the LEVEL knob indicates the output level of the oscillator. If OSCILLATOR MODE is set to SINE WAVE, the frequency of the oscillator is shown.

Press the LEVEL knob to adjust the oscillator level using the multifunction knob.

③ OSCILLATOR MODE field

Indicates the currently-selected oscillator mode. Pressing the MODE button repeatedly will switch modes.

④ **OSCILLATOR ASSIGN field**

An indicator lights to indicate the currently-selected oscillator output destination (input channels or buses). Use the tabs on the left to select channels or buses to display.

NOTE

In the case of the CL3/CL1, channels that do not exist on those models will not be shown.

⑤ **OSCILLATOR OUTPUT button**

Turns the oscillator output on or off.

2. Press the popup button or the ASSIGN field to open the OSCILLATOR popup window.

In this popup window, you can make detailed settings for the oscillator.

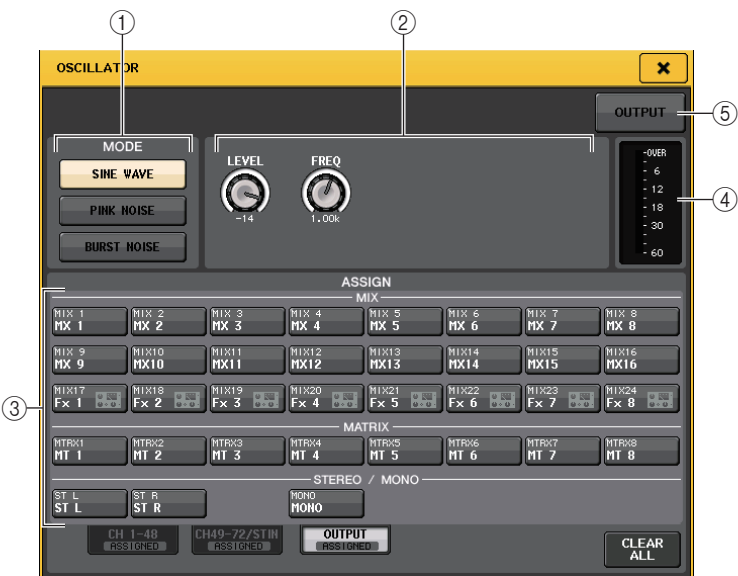

① **OSCILLATOR MODE buttons**

Select one of the following three oscillator operating modes:

SINE WAVE	When the oscillator is turned on, a sine wave will be output continuously.
PINK NOISE	When the oscillator is turned on, pink noise will be output continuously.
BURST NOISE	When the oscillator is turned on, pink noise will be output intermittently.

② **Parameter field**

Enables you to set the oscillator parameters. The controllers and their functions in this field vary depending on the selected mode. You can adjust the values by using the multifunction knobs.

Mode = SINE WAVE

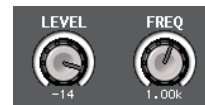

- **LEVEL knob**..... Indicates the output level of the sine wave.
- **FREQ knob**..... Indicates the frequency of the sine wave.

Mode = PINK NOISE



- **LEVEL knob**..... Indicates the output level of the pink noise.
- **HPF knob**..... Indicates the cutoff frequency of the HPF that processes pink noise. Use the button below the knob to switch the HPF on or off.
- **LPF knob**..... Indicates the cutoff frequency of the LPF that processes pink noise. Use the button below the knob to switch the LPF on or off.

Mode = BURST NOISE



- **LEVEL knob, HPF knob, and LPF knob**..... Same as in PINK NOISE mode.
- **WIDTH**..... Indicates the length of noise being output intermittently.
- **INTERVAL**..... Indicates the length of silence between noise bursts.

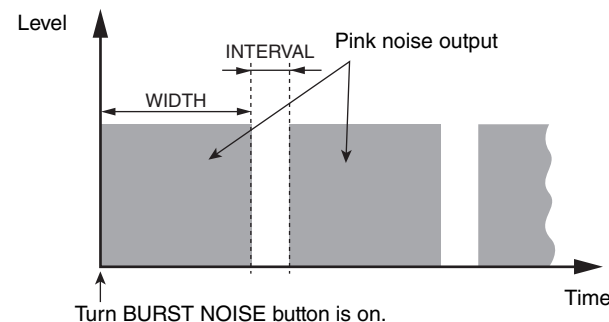

③ ASSIGN section

Enables you to select a channel to which the oscillator signal will be sent. Press one of the three tabs located at the bottom of the screen, then press the button(s) for the channel(s) in this section (multiple selections are allowed). The “ASSIGNED” indicator is lit green for a tab that contains a selection.

You can press the CLEAR ALL button to defeat all selections.

NOTE

In the case of the CL3/CL1, channels that do not exist on those models will not be shown.

④ Meter section

Indicates the oscillator output level.

⑤ OSCILLATOR OUTPUT button

Turns the oscillator on or off.

3. Press a button in the MODE field to select the type of signal you want to output.**4. Use the knobs and buttons in the parameter field to adjust the oscillator parameters.**

The displayed parameters will differ depending on the oscillator selected in the MODE field. The knobs shown in the parameter field can be operated using the corresponding multifunction knobs.

5. Press a button in the ASSIGN field to specify the input channel(s) or bus(es) to which the oscillator signal will be sent (multiple selections are allowed).**6. To enable the oscillator, press the OUTPUT button to turn it on.**

The oscillator signal will be sent to the input channel or bus you selected in step 5. When you press the button again, the oscillator will turn off.

Meters

This chapter explains the METER screen that shows the input and output level meters for all channels, and operations related to the optional MBCL meter bridge.

Operations in the METER screen

By accessing the METER screen, you can view the input and output levels of all channels on the screen, and switch the level meter's metering points (the points in the signal route at which the level is detected).

1. In the Function Access Area, press the METER field to access the METER screen.

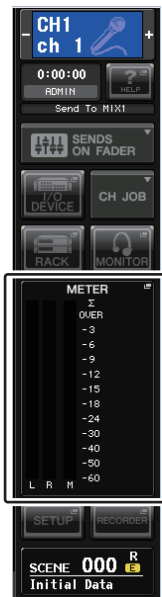

INPUT METER screen

This screen shows the meters and faders for all input channels.



NOTE

In the case of the CL3/CL1, channels that do not exist on those models will not be shown.

OUTPUT METER screen

This screen shows the meters and faders for all output channels.

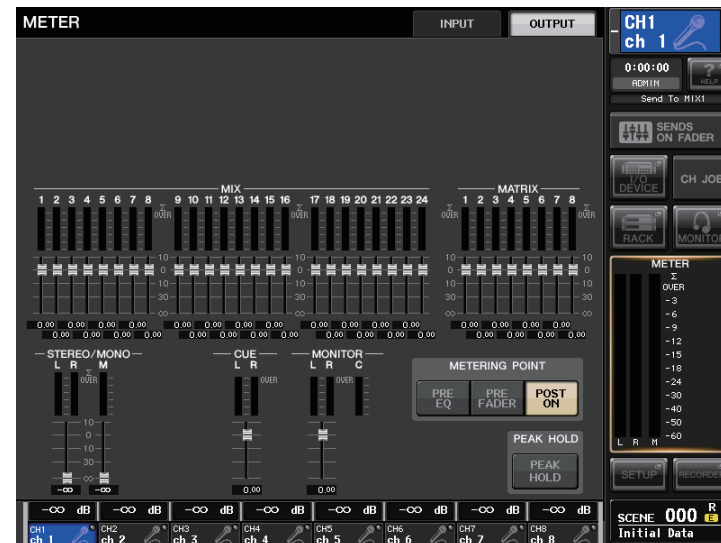

INPUT/OUTPUT tabs

Use these tabs to switch between the INPUT METER screen and OUTPUT METER screen.



Fader level and meter display

This area displays the meter, fader, and level value for each channel.

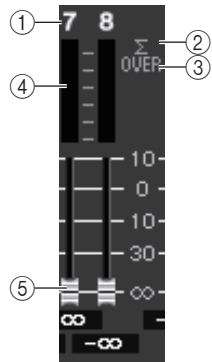

① Channel number

Indicates the channel number.

② Σ clipping indicator

Lights to indicate that a signal is clipping at some point in the channel.

③ OVER indicator

This indicator will light if the signal clips at the METERING POINT.

④ Meter

This meter indicates the input or output level of the channel.

⑤ Fader

The channel level is indicated by the fader position and by a numeric value (in dB) that appears immediately below the fader.

NOTE

Press any part of the meter area to assign the corresponding fader bank to the Centralogic section.

Centralogic fader display

This area displays the level of the faders currently set in the Centralogic section.



METERING POINT field

Select one of the following as the metering point at which the level will be detected.

■ For INPUT METER

- PRE HPF Immediately before the HPF
- PRE FADER Pre-fader (immediately before INPUT DELAY)
- POST ON Immediately after the [ON] key



■ For OUTPUT METER

- PRE EQ Immediately before the EQ
- PRE FADER Immediately before the fader
- POST ON Immediately after the [ON] key

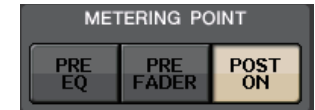

NOTE

On the CL3 or CL1 console, the metering point for output channels will also affect the optional meter bridge (MBCL).

PEAK HOLD button

Turn on this button to hold the peak level indication on each meter. Turn off this button to clear the peak hold indication.



2. If necessary, press a button in the METERING POINT field to switch the metering point.

The metering point for the level meters can be set independently for input channels and output channels.

3. If you want the peak levels of the level meter to be held, press the PEAK HOLD button to turn it on.

PEAK HOLD button on/off operations will affect both input channels and output channels as well as the MBCL meter bridge. When you turn this button off, the peak level indications that had been held will be cleared.

NOTE

You can also assign the PEAK HOLD button on/off function to a USER DEFINED key (see [page 169](#)).

Using an MBCL meter bridge (optional) on the CL3 or CL1 console

If the optional meter bridge (MBCL) is installed on the CL3 or CL1 console, you will always be able to view the output levels of MIX, MATRIX, STEREO, MONO, and CUE channels.

The MBCL meters indicate the output levels in 12-segment steps (OVER, -3 dB, -6 dB, -9 dB, -12 dB, -15 dB, -18 dB, -24 dB, -30 dB, -40 dB, -50 dB, -60 dB).

You can select the metering point (the point at which the level is detected) from the following choices. For information on how to change the metering point, refer to the section “[Operations in the METER screen](#)” on [page 111](#).

- **PRE EQ**Immediately before the EQ
- **PRE FADER**Immediately before the fader
- **POST ON**Immediately after the [ON] key

Graphic EQ, effects, and Premium Rack

This chapter explains how to use the built-in graphic EQ, effects, and Premium Rack.

About the virtual rack

CL series consoles enable you to use the built-in graphic EQ (subsequently abbreviated as “GEQ”) and effects/processors to modify signals. You can use two types of GEQ: 31BandGEQ which enables you to freely adjust thirty-one bands (frequency regions), and Flex15GEQ which enables you to adjust any fifteen of thirty-one bands. You can also use 54 different effect types. The CL series consoles feature Premium Rack, which employs VCM technology. This technology models analog circuitry on a component level to faithfully reproduce amazing analog sounds. The Premium Rack offers six types of processors.

In order to use a GEQ, effect, or Premium Rack, you must mount the GEQ, effect, or Premium Rack in each virtual rack, and patch the input and output of that rack to the desired signal route. In other words, the operation is just as though you had installed a signal processor or effect device in an actual rack, and used patch cords to connect it. You can mount a GEQ instance in each of the sixteen racks 1–16, an effect rack instance in each of the eight racks 1–8, and a Premium Rack instance in each of the eight racks 1–8.

Up to two channels of input and output can be used for each rack. (However if the “31BandGEQ” is mounted in a rack, there will be only one channel for input and output.)

The figure below shows the signal flow for the virtual racks.

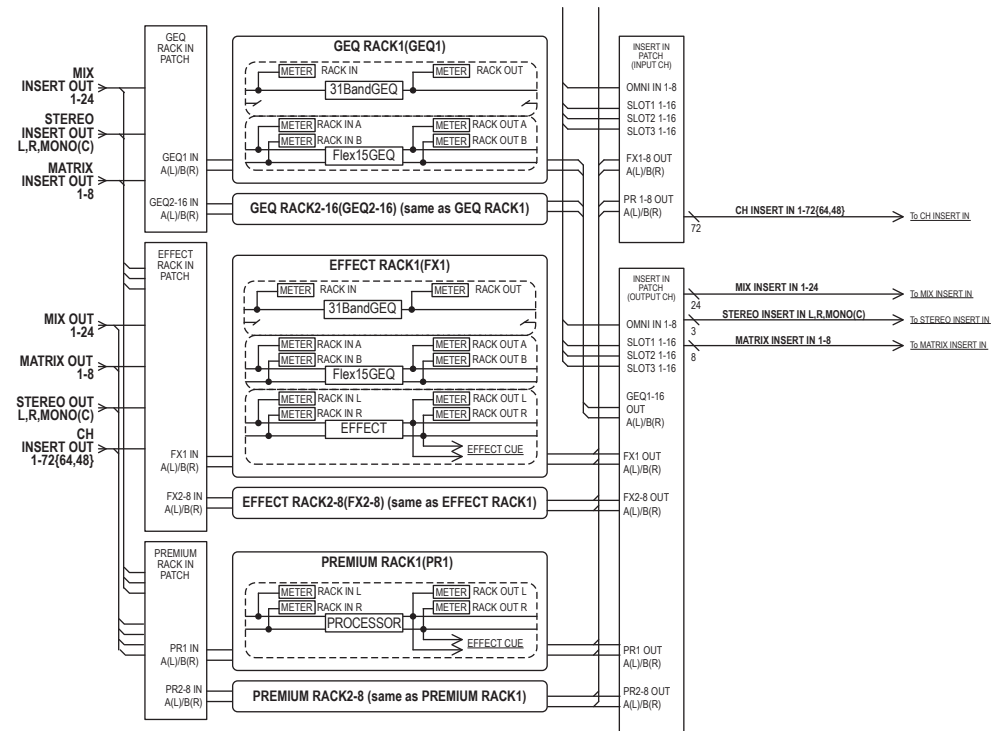

NOTE

The CL console provides a rack for mounting an I/O device (such as an Rio series), external head amps (Yamaha AD8HR, SB168-ES, etc.) as well as the virtual rack for GEQ, effects and Premium Rack. For details, see “I/O device and external head amp” on page 138.

Virtual rack operations

This section explains how to mount a GEQ or effect in the virtual rack, and patch the input and output of the rack as an example.

1. In the Function Access Area, press the RACK button to access the VIRTUAL RACK window.



2. In the upper part of the VIRTUAL RACK window, press the GEQ 1-8, GEQ 9-16, or EFFECT tab to access the GEQ or EFFECT field.

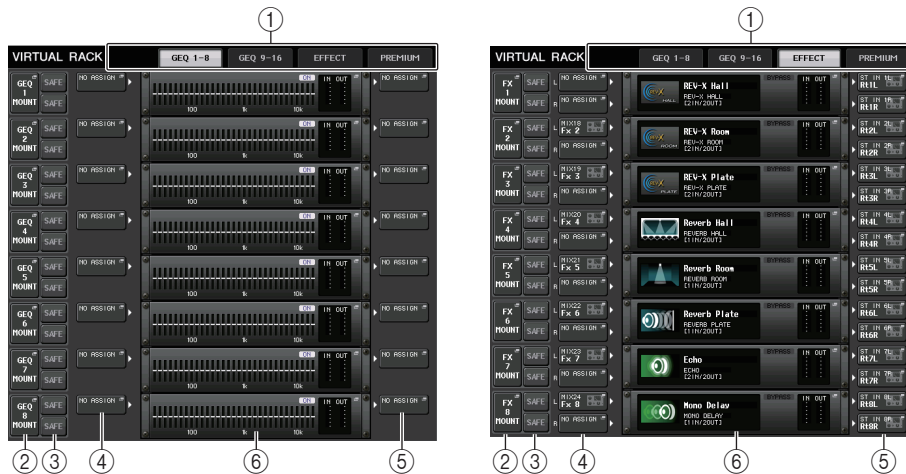

① Rack tabs

Selects the type of rack you want to display on the screen. Choose from GEQ 1-8 and GEQ 9-16 (GEQ rack), EFFECT (effect rack), and PREMIUM (Premium Rack).

② Rack mount popup button

Press this button to open the RACK MOUNTER popup window, in which you can select the type of the rack you want to mount.



③ SAFE toggle button

Switches Recall Safe on or off for the rack. Racks with Recall Safe on will be excluded from Recall operations.

④ INPUT PATCH button

Press this button to open the CH SELECT popup window, in which you can select the path of the signal patched to the rack input. The selected path will appear on the button.

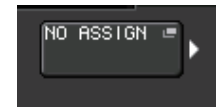

If the type is EFFECT, two buttons (L/R) will appear. If the type is Flex15GEQ, two buttons (A/B) will appear. If the type is 31BandGEQ, one button will appear.

⑤ OUTPUT PATCH button

Press this button to open the CH SELECT popup window, in which you can select the path of the signal patched to the rack output. The selected path will appear on the button.

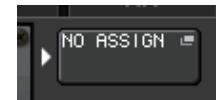

If the type is EFFECT, two buttons (L/R) will appear. If the type is Flex15GEQ, two buttons (A/B) will appear. If the type is 31BandGEQ, one button will appear.

NOTE

For the CL3/CL1, the INPUT PATCH/OUTPUT PATCH fields will be shown crossed-out if a channel that does not exist on that model has been specified.

⑥ Rack container

Indicates the contents of the rack. This container varies depending on the rack type you selected in the RACK MOUNTER popup window.

- If nothing is mounted:



Press this area to open the RACK MOUNTER popup window, in which you can select the GEQ or effect that will be mounted in the rack.

- If 31BandGEQ is mounted:

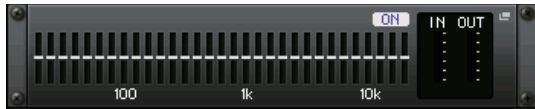

This area indicates the settings for each band, GEQ on/off status, and input/output level. Press this area to open the GEQ EDIT popup window, in which you can modify the GEQ settings.

- If Flex15GEQ is mounted:

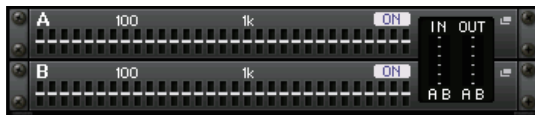

This area indicates the settings for each band, the GEQ on/off status, and the input and output levels for A and B respectively. Press this area to open the GEQ EDIT popup window, in which you can modify the GEQ settings for A and B.

- If an effect is mounted (EFFECT rack only):

This area indicates the effect type, number of inputs and outputs, bypass on/off status, and the input/output level. Press this area to open the EFFECT EDIT popup window, in which you can modify the effect settings.

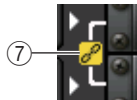

- ⑦ **Link indicator**

Indicates that an odd-numbered rack and even-numbered rack of the 31BandGEQ, or A and B of the Flex15GEQ are linked each other.

- 3. To mount a GEQ or effect in the rack, press the rack mount button for that rack.

The RACK MOUNTER popup window will appear.

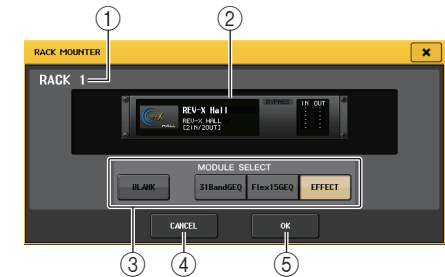
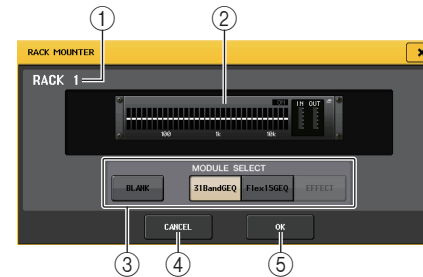

- ① **Rack number**

This indicates the number of the selected rack.

- ② **Virtual rack**

This area indicates the GEQ or effect selected via the MODULE SELECT buttons.

- ③ **MODULE SELECT**

Use these buttons to select the GEQ or effect that will be mounted in the rack. Each button has the following function.

- **BLANK button** Removes the GEQ or effect currently mounted in the rack; the rack will be empty.
- **31BandGEQ button** Mounts a 31BandGEQ in the rack.
- **Flex15GEQ button** Mounts a Flex15GEQ in the rack.
- **EFFECT button** Mounts an effect in the rack.

NOTE

Input/output patching will be defeated if you change the item mounted in a rack.

- ④ **CANCEL button**

Cancels the changes you made in the RACK MOUNTER popup window, and closes the window.

- ⑤ **OK button**

Applies the changes you made in the RACK MOUNTER popup window, and closes the window.

NOTE

- Be aware that if you remove a GEQ or effect that was mounted in a rack and close the window, all edits to the parameter settings for that GEQ or effect will be discarded. If you have not yet closed the window, you can recover the parameter settings by mounting the same GEQ or effect once again.
- You can also display the RACK MOUNTER popup window by pressing a vacant rack in the GEQ/EFFECT field.

4. Use the **MODULE SELECT** buttons to select the item you want to mount, and press the **OK** button.

5. To select the input source for a rack, press the **INPUT PATCH** button for that rack. The **CH SELECT** popup window will appear, allowing you to select the input source for the rack. Switch the list as necessary, and select the input source channel that you want to patch.

When you select an input source in the **CH SELECT** popup window, a dialog box will ask you for confirmation. To confirm the operation, press the **OK** button.

NOTE

- You have the option of making settings so that the confirmation dialog box will not appear (see page 169).
- Normally you can specify two channels of input for each rack. However if you have selected 31BandGEQ, only one channel can be used.



1 Category select list

Selects the category of channel shown in the popup window.

- **MIX/MATRIX**..... MIX 1–24, MATRIX 1–8 ^{*1, *2}
- **ST/MONO**..... STEREO L/R, MONO ^{*1, *2}
- **INSERT OUT 1–32**..... CH 1–32 ^{*1}
- **INSERT OUT 33–64** CH 33–64 ^{*1}
- **INSERT OUT 65–72** CH 65–72 ^{*1}
- **INSERT OUT MIX/MATRIX** MIX 1–24, MATRIX 1–8
- **INSERT OUT ST/MONO** STEREO L/R, MONO

*1. Not displayed for GEQ 1–16 RACK.

*2. Not displayed for PREMIUM 3–8 RACK. Displayed only for PREMIUM 1–2 RACK.

NOTE

In the case of the CL3/CL1, channels that do not exist on those models will not be shown.

2 Channel select buttons

Use these buttons to select the input source channel.

3 CLOSE button

Closes the popup window.

NOTE

In the case of the GEQ, patching it to either an insert-out or insert-in will automatically assign the other patch point to the same rack. Also, insert mode will automatically be switched on. Additionally, if you defeat the insert-out or insert-in of a GEQ, the other patch point will automatically be defeated and at the same time insert mode will automatically be switched off. For more information on insert-in/out, see “Inserting an external device into a channel” on page 21.

6. To select the output source for a rack, press the **OUTPUT PATCH** button for that rack.

The **CH SELECT** popup window will appear, allowing you to select the output destination for the rack. Switch the list items as necessary, and select the output destination that you want to use.

When you select an output destination in the **CH SELECT** popup window, a dialog box will ask you to confirm the change. To confirm the change, press the **OK** button.

NOTE

- You can make settings such that the confirmation dialog box will not appear (see page 169).
- Normally you will be able to specify two channels of output for a rack, but if the 31BandGEQ is selected only one channel can be used.

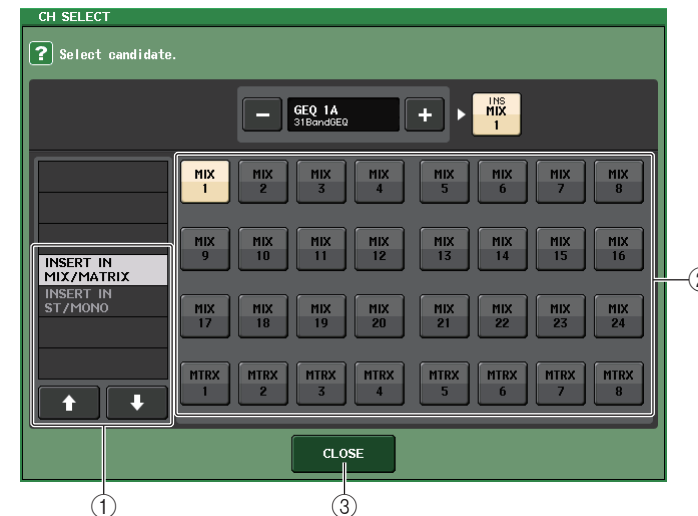

1 Category select list

Selects the category of channel shown in the popup window.

- **CH 1–32**..... CH 1–32 ^{*1, *2}
- **CH 33–64**..... CH 33–64 ^{*1, *2}

- CH 65–72..... CH 65–72 ^{*1, *2}
- INSERT IN 1–32 CH 1–32 ^{*1}
- INSERT IN 33–64 CH 33–64 ^{*1}
- INSERT IN 65–72 CH 65–72 ^{*1}
- INSERT IN MIX/MATRIX..... MIX 1–24, MATRIX 1–8
- INSERT IN ST/MONO STEREO L/R, MONO

*1. Not displayed for GEQ 1-16 RACK.

*2. Not displayed for PREMIUM 3–8 RACK. Displayed only for PREMIUM 1–2 RACK.

NOTE

- In the case of the CL3/CL1, channels that do not exist on those models will not be shown.
- If you use CL5 settings data on the CL3/CL1, or CL3 settings data on the CL1, buttons will be shown crossed-out if they are assigned to a channel that does not exist on that model.

② Channel select buttons

Use these buttons to select the output destination.

③ CLOSE button

Closes the popup window.

7. To switch Recall Safe on/off for each rack, press the SAFE button for that rack.

If Recall Safe is turned on for a rack, the contents and parameters of that rack will not change when a scene is recalled. For more information on Recall Safe, “Using the Recall Safe function” on page 88.

Be aware that the Recall Safe settings of each rack will not preserve the input/output patching to that rack. Recall Safe settings for patching must be made on the input-source or output-destination channel.

NOTE

The type of GEQ, effect, or premium rack mounted in each rack, its parameter settings, and the input-source and output-destination patch settings are saved as part of the scene.

Graphic EQ operations

About the graphic EQ

The CL series console enables you to mount a GEQ in GEQ racks 1–16 and patch it to the insert-out and insert-in of a MIX/MATRIX channel or STEREO/MONO channel. You can also mount it in EFFECT racks 1–8 (FX 1–8) and patch it to the insert-out/in of an input channel, MIX/MATRIX channel or STEREO/MONO channel. The gain of each band can be adjusted using the faders and [ON] keys in the Centralogic section.

The following two types of GEQ are provided.

■ 31BandGEQ

This is a monaural 31-band GEQ. Each band is 1/3 octave wide, the adjustable gain range is ± 15 dB, and the gain of all thirty-one bands can be adjusted.

If a 31BandGEQ is mounted in a rack, one channel of input and output can be used for that rack.

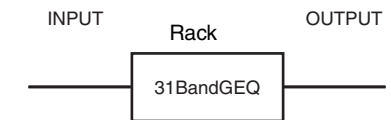

■ Flex15GEQ

This is a monaural 15-band GEQ. Each band is 1/3 octave wide, and the adjustable gain range is ± 15 dB. The Flex15GEQ enables you to adjust the gain for any fifteen of the same bands as the thirty-one bands of the 31bandGEQ. (Once you have used up fifteen bands of adjustment, you will not be able to adjust the gain of another band until you reset a previously-adjusted band to the flat setting.)

A rack for which the Flex15GEQ is selected will have two Flex15GEQ units (shown as “A” and “B” respectively) mounted in that rack, and will allow two channels of input and output. If you mount a Flex15GEQ in each rack, you will be able to use up to 48 GEQ units simultaneously.

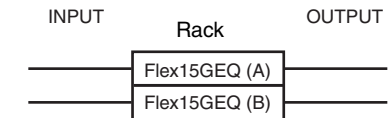

Inserting a GEQ in a channel

This section explains how to insert a GEQ into the selected channel for use.

1. Refer to steps 1–6 in the “Virtual rack operations” on page 115 section to mount a GEQ in a rack and set its input source and output destination.

The rack shown in the GEQ field indicates the approximate GEQ settings and the input and output levels. A rack in which a Flex15GEQ is mounted will show information for two GEQ units (A and B).

NOTE

If you are using a stereo source, you can mount a Flex15GEQ, or mount two 31BandGEQ units in adjacent odd-numbered/even-numbered racks. This will let you link the two GEQ units in a later step.

2. In the GEQ field or the EFFECT field, press the rack in which you mounted the GEQ.

The GEQ popup window will appear, allowing you to edit the GEQ parameters.

NOTE

The popup windows for the 31BandGEQ and the Flex15GEQ are nearly identical. However, the Flex15GEQ individually displays two GEQ units (A and B) mounted in a single rack.

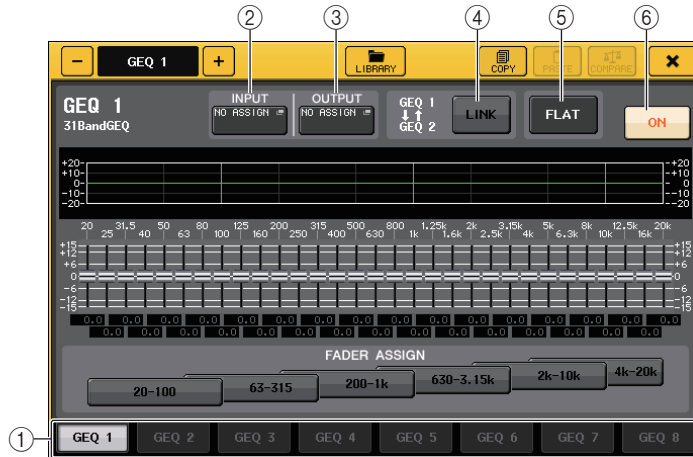

1 Rack select tabs

Switch among GEQ 1–8, among GEQ 9–16 or among EFFECT1–8. For a rack in which a Flex 15 GEQ is mounted, the tabs will be split as xA and xB (x is the rack number).

2 INPUT PATCH button

Opens the CH SELECT popup window, in which you can select the input source of the rack. The operating procedure is the same as for the INPUT PATCH button in the GEQ field.

3 OUTPUT PATCH button

Opens the CH SELECT popup window, enabling you to select the output destination of the rack. The operating procedure is the same as for the OUTPUT PATCH button in the GEQ field.

4 GEQ LINK button

Links adjacent GEQ units.

In the case of a 31bandGEQ, the GEQ units in adjacent odd-numbered/even-numbered racks will be linked. In the case of a Flex15GEQ, the GEQ(A) and GEQ(B) within the same rack will be linked.

NOTE

The GEQ LINK button is shown only if linking is possible.

5 FLAT button

Returns all bands of the currently selected GEQ to 0 dB.

6 GEQ ON/OFF button

Switches the currently-selected GEQ on or off.

3. If you are using a stereo source, link the two GEQ units.

You will be able to use the GEQ LINK button if you have selected a 31BandGEQ or Flex15GEQ for adjacent odd-numbered/even-numbered racks. When you turn this button on, the following popup window will appear. To enable linking, press any button other than CANCEL. The popup window contains the following items.

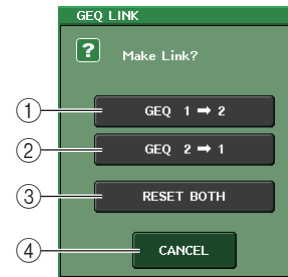

1 GEQ x→y button (“x” and “y” are the rack number, or the rack number and alphabetical character A or B)

The parameters of “x” will be copied to “y,” and then linked.

2 GEQ y→x button

The parameters of “y” will be copied to “x,” and then linked.

3 RESET BOTH button

The parameters of both will be initialized, and then linked.

4 CANCEL button

Cancels the link and closes the popup window.

When you link GEQ units, a symbol will appear in the GEQ field to indicate the linked status.



4. Press the GEQ ON/OFF button to turn the GEQ on.

After you have turned the GEQ on, adjust the bands of the GEQ.

For details on GEQ operations, refer to the following section “[Using the 31BandGEQ](#)” on [page 120](#), or “[Using the Flex15GEQ](#)” on [page 121](#).

NOTE

You can view the input and output levels of the GEQ in the rack in the GEQ field.

Using the 31BandGEQ

You will use the Centrallogic section's faders 1–8 and [ON] keys to control the 31BandGEQ.

1. Refer to steps 1–6 in the “Virtual rack operations” section on page 115 to mount a 31BandGEQ in a rack and set its input source and output destination.

The rack in which the 31BandGEQ is mounted will show the approximate settings and input and output levels.

2. In the GEQ field or the EFFECT field, press the rack in which you mounted the 31BandGEQ.

The GEQ popup window will appear. In the GEQ popup window you can use the tabs to switch among the racks.

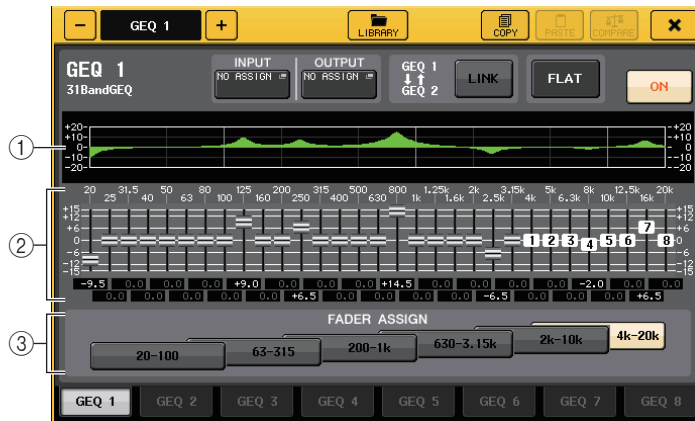

- 1 EQ graph

Indicates the approximate response of the current 31BandGEQ.

- 2 Faders

Indicate the amount of boost and cut for each band of the 31BandGEQ. The actual values are shown in the numerical boxes below.

- 3 FADER ASSIGN field

In this field you can select the group of bands that will be controlled by the Centrallogic section's faders.

3. Press the GEQ ON/OFF button to turn the 31BandGEQ on.
4. Press one of the buttons in the FADER ASSIGN field to select the group of bands you will control using the Centrallogic section's faders.

The buttons in the FADER ASSIGN field correspond to the following groups of bands.

20–100	Eight bands 20.0 Hz–100 Hz
63–315	Eight bands 63.0 Hz–315 Hz
200–1k	Eight bands 200 Hz–1.00 kHz
630–3.15k	Eight bands 630 Hz–3.15 kHz
2k–10k	Eight bands 2.00 kHz–10.0 kHz
4k–20k	Eight bands 4.00 kHz–20.0 kHz

When you press one of these buttons, the faders for the bands selected on screen will turn white, and the numbers of the corresponding faders in the Centrallogic section will be displayed. Now you can use the faders in the Centrallogic section to control the band.

NOTE

The above operation is possible even if the Centrallogic section is locked. When you turn off the button in the FADER ASSIGN field, it will return to the locked state.

5. Operate the faders in the Centrallogic section.

The corresponding frequency region will be boosted or cut.

NOTE

When a fader in the Centrallogic section is set to the center (flat) position, the corresponding [ON] key indicator will turn off. This indicates that the corresponding band is not being modified. If you raise or lower the fader even the slightest amount, the [ON] key will light, indicating that this band has been modified. If you press a lit [ON] key to make it go dark, the corresponding band will immediately return to the flat state.

6. Repeat steps 4 and 5 to adjust each band.

NOTE

If you switch the display to a different screen or rack, the fader assignments in the Centrallogic section will forcibly be defeated. However, if you once again display the same rack, the group of bands you had previously been controlling will automatically be assigned to the faders.

7. When you have finished making settings, turn off the buttons in the FADER ASSIGN field.

The faders and [ON] keys in the Centrallogic section will return to their previous function.

NOTE

When you close the GEQ popup window, the buttons in the FADER ASSIGN field automatically turn off.

8. If you want to copy the currently-displayed 31BandGEQ settings to the GEQ of another rack, or to initialize the settings, you can do so using the tool buttons at the top of the popup window.

For details on how to use these buttons, refer to “Using the tool buttons” in the separate Owner's Manual.

NOTE

- Only 31BandGEQ settings that use fifteen bands or less can be copied to a Flex15GEQ.
- GEQ settings can be saved and recalled at any time using the dedicated library.

Using the Flex15GEQ

You will use the Centrallogic section's faders 1–8 and [ON] keys to control the Flex15GEQ.

1. Refer to steps 1–6 in the “Virtual rack operations” section on page 115 to mount a Flex15GEQ in a rack and set its input source and output destination.

A rack in which a Flex15GEQ is mounted will show information for two GEQ units (A and B).

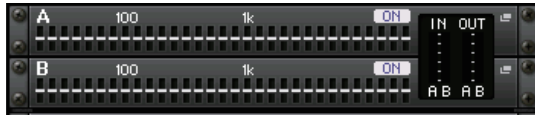

NOTE

If you mount a Flex15GEQ, two monaural 31BandGEQ units will be placed in a single rack. However, only up to fifteen bands can be adjusted for each unit.

2. Press the rack in which you mounted the Flex15GEQ.

The GEQ popup window for GEQ(A) or GEQ(B) will appear.



This window is the same as that for the 31BandGEQ, except that the AVAILABLE BANDS parameter box indicates the real-time number of additional bands (maximum 15) that can be controlled in the current GEQ.

For a rack in which a Flex15GEQ is mounted, the rack switch tabs will be split as xA and xB (x is the rack number).

3. Press the GEQ ON/OFF button to turn the Flex15GEQ on.
4. Press one of the buttons in the FADER ASSIGN field to select the group of bands you will control using the Centrallogic section's faders.
For details on the bands corresponding to each button in the FADER ASSIGN field, refer to step 4 of “Using the 31BandGEQ” on page 120.

When you press one of these buttons, the faders for the bands selected on the touch screen will turn white, and the numbers of the corresponding faders in the Centrallogic section will be displayed. Now you can use the faders in the Centrallogic section to control the band.

NOTE

The above operation is possible even if the Centrallogic section is locked. When you turn off the button in the FADER ASSIGN field, the faders will return to the locked state.

5. Operate the faders in the Centrallogic section.

For each of a Flex15GEQ's two GEQ units (A and B), a maximum of fifteen bands can be controlled. The AVAILABLE BANDS parameter box in the FADER ASSIGN field indicates the real-time number of additional bands that can be controlled in the current GEQ. If you have used all fifteen bands, you will have to return one of these bands to the flat position before you can operate any other band.



NOTE

- The [ON] key will light if you raise or lower a fader even the slightest amount. This indicates that the corresponding band has been modified.
- To quickly return a boosted or cut band to the flat position, press the corresponding [ON] key in the Centrallogic section to make it go dark.

6. Repeat steps 4 and 5 to adjust up to fifteen bands.

NOTE

If you switch the display to a different screen, the fader assignments in the Centrallogic section will forcibly be defeated. However if you once again display the same rack, the group of bands you had previously been controlling will automatically be assigned to the faders.

7. When you have finished making settings, turn off the buttons in the FADER ASSIGN field.

The faders and [ON] keys in the Centrallogic section will return to their previous function.

NOTE

When you close the GEQ popup window, the buttons in the FADER ASSIGN field automatically turn off.

8. If you want to copy the currently-displayed Flex15GEQ settings to the GEQ of another rack, or to initialize the settings, you can do so using the tool buttons at the top of the popup window.

For details on how to use these buttons, refer to “Using the tool buttons” in the separate Owner's Manual.

NOTE

GEQ settings can be saved and recalled using the dedicated library.

About the internal effects

The internal effects of the CL series console can be mounted in EFFECT racks 1–8, and patched to an output channel's output or input channel's input, or inserted into a channel. For each effect mounted in a rack, you can choose one of 54 types of effect.

With the default settings, the signals from MIX channels 17–24 are input to racks 1–8, and from the racks are then output to ST IN 1–8 (L/R).

NOTE

Some effect types can be mounted only in racks 1, 3, 5 or 7.

To use an internal effect via send and return, assign the output of a MIX channel to the input of the effect, and assign the output of the effect to an input channel. In this case, the corresponding output channel is used as a master channel for the effect send, and the input channel is used as an effect return channel.

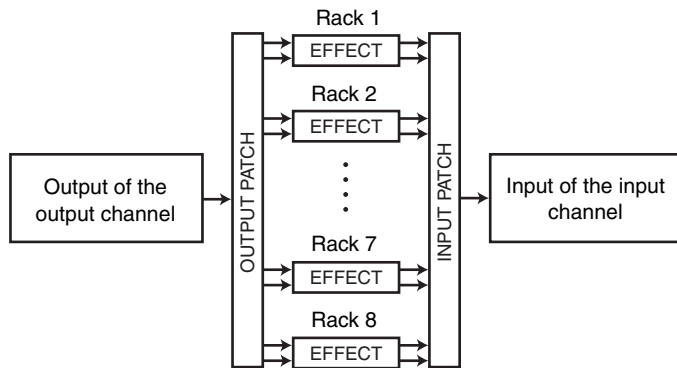

Alternatively, you can assign the input and output of the internal effect to the insert-out/in of a desired channel (except for a ST IN channel), so that the effect is inserted into that channel.



* Excluding a ST IN channel

The internal effects are categorized into two groups: “STEREO type” (2-in/2-out) effects that process the L/R channel input signals independently, and “MIX type” (1-in/2-out) effects that mix the two channels before processing them.

If signals are assigned to both the L and R inputs of an effect, the way in which the L/R channels are processed will depend on whether a Stereo effect type or a Mix effect type is selected, as follows.

■ STEREO type effects

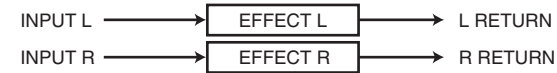

■ MIX type effects



If a signal is assigned to only one input of a two-input effect, it will be processed as mono-in/stereo-out regardless of whether a Stereo effect type or Mix effect type is selected. However, please note that this will not apply to COMP276, COMP276S, COMP260, COMP260S, EQUALIZER601, and OPENDECK.



Using an internal effect via send and return

This section explains how to use a MIX bus as an effect send bus and a ST IN channel as an effect return channel, so that the effect can be used in a send and return configuration.

NOTE

- If you want to use a MIX bus as an effect send bus, select “VARI” as the bus type. This will allow you to adjust the send level separately for each input channel.
- If you want to use the input to an effect in stereo, it can be convenient to assign the send destination MIX bus to stereo. (For details on bus assignments, see “Basic settings for MIX buses and MATRIX buses” on page 202.)

1. Follow steps 1–3 described in “Virtual rack operations” on page 115, to mount an effect in a rack.

The rack in which an effect is mounted will indicate the effect type used by that effect, the number of inputs and outputs, and the levels before and following the effect.



2. Press the INPUT PATCH L button to open the CH SELECT popup window, and select a MIX channel as the input source for the rack.

For details on the CH SELECT popup window, refer to step 5 of “Virtual rack operations” on page 115. The output of the MIX channel you are using as the effect send is now assigned to the L input of the effect.

If you are using a stereo source, assign the L/R signals of the stereo MIX channel to the L/R inputs of the rack.

3. Press the OUTPUT PATCH L button to open the CH SELECT popup window, and select the L input of the desired ST IN channel as the output-destination for the rack.

For details on the CH SELECT popup window, refer to step 6 of “Virtual rack operations” on page 115. The L input of the ST IN channel used as the effect return channel is now assigned to the L output of the effect.

If you are using the output of the effect in stereo, assign the R input of the same ST IN channel to the R output of the rack in the same way.

NOTE

You can select more than one output destination for the effect.

4. Press the rack in which you mounted the effect.

The EFFECT popup window will appear, allowing you to edit the effect parameters.

② OUTPUT PATCH buttons

Press these buttons to open the CH SELECT popup window. The operating procedure is the same as for the OUTPUT button in the GEQ field.

③ Input/output meters

Indicate the level of the signals before and after the effect.

④ MIX BAL. knob

This knob adjusts the balance between the original sound and the effect sound included in the output signal from the effect. If you press this knob to select it, you will be able to adjust it using the corresponding multifunction knob.

5. As necessary, use the multifunction knob to adjust the MIX BAL. knob.

Adjusts the balance between the original sound and the effect sound included in the output signal from the effect. This parameter is provided for all effect types.

If you are using the effect via send and return, set this to 100% (effect sound only).

NOTE

For more information on setting the effect parameters, see “Editing the internal effect parameters” on page 125.

6. To adjust the effect send level of an input channel, use the Bank Select keys in the Centralogic section to access the OVERVIEW screen that includes the input channel you want to control.



① INPUT PATCH buttons

Press these buttons to open the CH SELECT popup window. The operating procedure is the same as for the INPUT button in the GEQ field.



- Use the MIX1-16, MIX17-24 and MATRIX keys of the SELECTED CHANNEL section (top panel) so that the SEND field shows the MIX bus that is patched as the effect send.

You can also use the MIX1-16, MIX17-24 and MATRIX buttons in the SELECTED CHANNEL VIEW screen to switch the displayed bus.

- Press the TO MIX SEND LEVEL knob that corresponds to the desired MIX bus, and turn the multifunction knob to adjust the send level of the signal sent from each channel to the MIX bus.

In this state you can adjust the send level of the signal sent from the input channel to the internal effect. Adjust the send level of other input channels in the same way.

If you press the selected knob once again, the MIX SEND popup window (8ch) for the send-destination MIX bus will appear. This popup window contains on/off switches for the signals sent from each channel to the corresponding bus, and lets you select the send point (PRE or POST) (see [page 41](#)).

NOTE

At this time, you make sure that the send level from the ST IN channel you selected in step 3 to the corresponding MIX bus is set to $-\infty$ dB. If you raise this send level, the output of the effect will be returned to the input of the same effect, possibly causing oscillation.

- To adjust the master level of the effect send, call up the MIX channel you specified as the input-source of the rack in step 2 to the Centralogic section, and adjust the corresponding fader.

Set the level as high as possible without allowing the post-effect signal to reach the overload point.

NOTE

The input and output levels of the effect are shown by the input/output meters in the upper right of the EFFECT popup window.

- To adjust the effect return level, operate the ST IN channel that you selected as the output-destination for the rack in step 3.

Inserting an internal effect into a channel

This section explains how to insert an effect into a channel by assigning the input/output of the internal effect to the input/output of the desired channel (except for a ST IN channel).

- Follow steps 1–3 described in “[Virtual rack operations](#)” on [page 115](#), to mount an effect in a rack.

The rack in which an effect is mounted will indicate the effect type used by that effect, the number of inputs and outputs, and the levels before and after the effect.

- Press the L side of the INPUT PATCH button to open the CH SELECT popup window, and select the insert-out of a channel as the input-source.

For details on the CH SELECT popup window, refer to step 5 of “[Virtual rack operations](#)” on [page 115](#). Insert-out is now assigned to the L input of the effect.

- Press the L side of the OUTPUT PATCH button to open the CH SELECT popup window, and select the insert-in of the same channel as the output-destination.

For details on the CH SELECT popup window, refer to step 6 of “[Virtual rack operations](#)” on [page 115](#). Insert-in is now assigned to the L output of the effect.

If you are inserting an effect into a channel that handles a stereo source, assign the R channel insert-out/insert-in to the R input and output.

- Use the Bank Select keys in the Centralogic section to access the OVERVIEW screen for the channel into which you inserted the effect.

- Press the INSERT/DIRECT OUT field to access the INSERT/DIRECT OUT popup window.

Make sure that the rack you inserted into the input and output ports is selected. For more information on insert-out/in, see “[Inserting an external device into a channel](#)” on [page 21](#).

- Turn on the INSERT ON/OFF button for the channel into which you inserted the effect.

If it is off, press the button to turn it on. In this state, effect insertion is enabled for the corresponding channel.

- In the Function Access Area, press the RACK button to access the VIRTUAL RACK window, and use the EFFECT tab to display the EFFECT field.

- Press the effect rack that you inserted into the channel. The EFFECT popup window will appear.

In this popup window you can edit the effect parameters.

- Select the effect type and edit the effect parameters.

For details on editing the effect parameters, refer to “[Editing the internal effect parameters](#).”

NOTE

- The levels before and after the effect are shown by the input and output meters in the upper right of the EFFECT popup window.
- Adjust the effect send master level and the effect parameters so that the signal does not reach the overload point at the input or output stage of the effect.

- Using the fader of the channel you selected as the rack’s output destination in step 3, adjust the level as appropriate.

Editing the internal effect parameters

This section explains how to change the effect type and edit the parameters.

1. Follow steps 1–3 described in “Virtual rack operations” on page 115, to mount an effect in a rack.

A rack in which an effect is mounted will show the following information.



1 Effect title/type

This area indicates the effect title, the name of the type that is used, and a graphic. The number of input/output channels (1 IN/2 OUT or 2 IN/2 OUT) of this effect is also shown.

2 Input/output meters

Indicate the level of the signals before and after the effect.

2. Press the rack in which the effect you want to edit is mounted.

The EFFECT popup window will appear, allowing you to edit the effect parameters. In the EFFECT popup window you can use the tabs to switch among the eight racks (EFFECT 1 – EFFECT 8).



1 INPUT PATCH buttons

Press these buttons to open the CH SELECT popup window.

2 OUTPUT PATCH buttons

Press these buttons to open the CH SELECT popup window.

3 Effect type field

Displays the effect title, the name of the type that is used, and a graphic. The number of input and output channels (1 IN/2 OUT or 2 IN/2 OUT) of this effect is also shown. Press this field to open the EFFECT TYPE popup window, in which you can select the effect type.

4 EFFECT CUE button

Enables you to cue-monitor the output of the currently-displayed effect. This Cue function is valid only while this screen is displayed. The cue will be canceled automatically when you switch to a different screen.

5 Special parameter field

Indicates special parameters that are specific to some effect types.

6 BYPASS button

Temporarily bypasses the effect.

7 Input/output meters

Indicate the level of the signals before and after the effect.

8 Effect parameter field

This area indicates parameters for the currently-selected effect type. When you press a knob in this field, you will be able to use the multifunction knobs to control the corresponding horizontal row of knobs.

You can also make fine adjustments by rotating a knob while pressing and holding it down.

9 Rack select tabs

Use these tabs to switch among EFFECT 1–8.

3. To change the effect type, press the effect type field to open the EFFECT TYPE popup window.

Press a new effect type to select it.

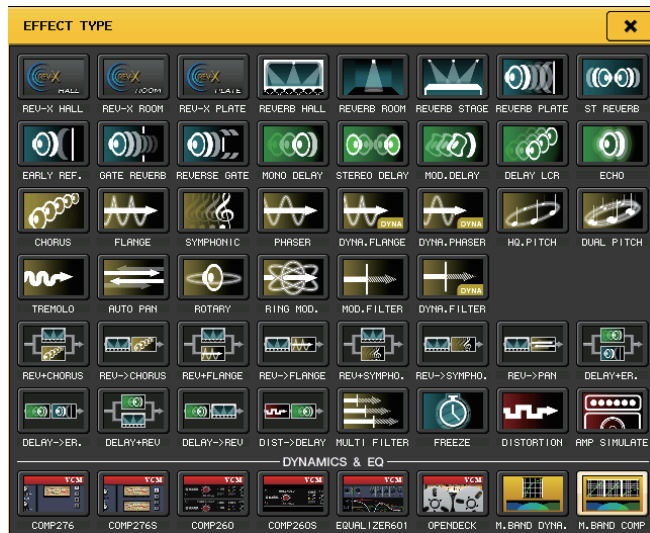

NOTE

- You can also change the effect type by recalling a library setting.
- Effect types “HQ.PITCH” and “FREEZE” can be used only in rack 1, 3, 5, or 7. Also, even if you copy these two effect types, you will not be able to paste them to rack 2, 4, 6, or 8.

4. To edit the effect parameters, press a knob in the effect parameter field to select it, and turn the corresponding multifunction knob.

NOTE

For details on the parameters of each effect type, refer to the Appendices (see [page 233](#)).

5. Edit the settings in the special parameter field as necessary.

For some effect types, parameters such as the following will appear in the special parameter field.

■ TEMPO

This field appears if a tempo-type or modulation-type effect is selected.

① **MIDI CLK button**

If you turn this button on, the BPM parameter of that effect will be set to match the tempo of the MIDI timing clock being input from the MIDI port.

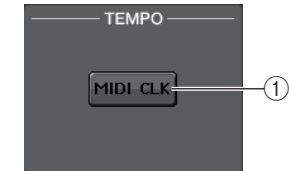

■ PLAY/REC

This field appears if FREEZE is selected as the effect type.

① **PLAY button/REC button**

Enable you to record (sample) and play back when using the freeze effect. For detailed operations, see “Using the Freeze effect” on [page 129](#).



■ SOLO

This field appears if M.BAND DYNA. or M.BAND COMP. is selected as the effect type.

① **HIGH/MID/LOW buttons**

Allow only the selected frequency band to pass (multiple selections are allowed).

② **Gain reduction meters**

Indicate the amount of gain reduction for each band.



■ Gain reduction meter

This field appears if Comp276/276S or Comp260/260S is selected as the effect type.

① **Gain reduction meters**

Indicate the amount of gain reduction applied by the compressor.

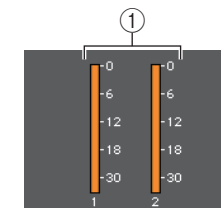

■ Type

This field is displayed when Equalizer601 is selected as the effect type.

① DRIVE button/CLEAN button

Select one of two equalizer types that feature different effects.

DRIVE emulates changes in frequency response of analog circuits, creating a driven sound that enhances analog characteristics by adding some distortion.

CLEAN emulates changes in frequency response that are typical of analog circuits, creating a clear non-distorted sound that is inherently digital.

② FLAT button

This button resets the gain of all bands to 0dB.

6. If you want to monitor the output signal of the currently-displayed effect, press the EFFECT CUE button to turn it on.

NOTE

If the Cue mode is set to MIX CUE, all channels for which the CUE key is turned on will be monitored. However, only the output signal of the effect will be monitored if you turn on the EFFECT CUE button. (The [CUE] keys that had been turned on until then will be temporarily defeated.)

7. If you want to bypass the currently-displayed effect, press the BYPASS button to turn it on.

8. If you want to copy the currently-displayed effect settings to the effect of another rack, or to initialize the settings, you can do so using the tool buttons at the top of the popup window.

For details on how to use these buttons, refer to “Using the tool buttons” in the separate Owner’s Manual.

NOTE

Effect settings can be stored and recalled using the effect library.

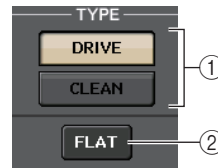

Using the Tap Tempo function

“Tap tempo” is a function that lets you specify the delay time of a delay effect or the modulation speed of a modulation effect by striking a key at the desired interval.

To use the Tap function, you must first assign Tap Tempo to a USER DEFINED key, and then operate that USER DEFINED key.

1. In the Function Access Area, press the SETUP button to access the SETUP screen.



2. In the upper left of the screen, press the USER SETUP button to access the USER SETUP popup window.

This window includes several pages, which you can switch between using the tabs located at the bottom of the window.

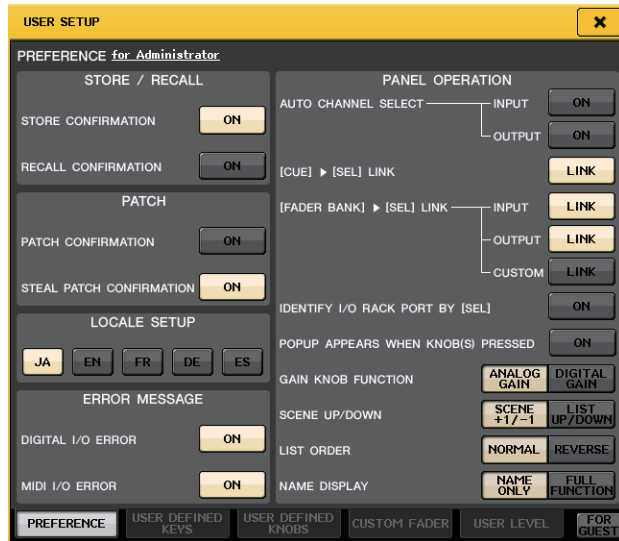

3. Press the USER DEFINED KEYS tab to select the USER DEFINED KEYS page.

The USER DEFINED KEYS page enables you to assign functions to USER DEFINED keys [1]-[16].

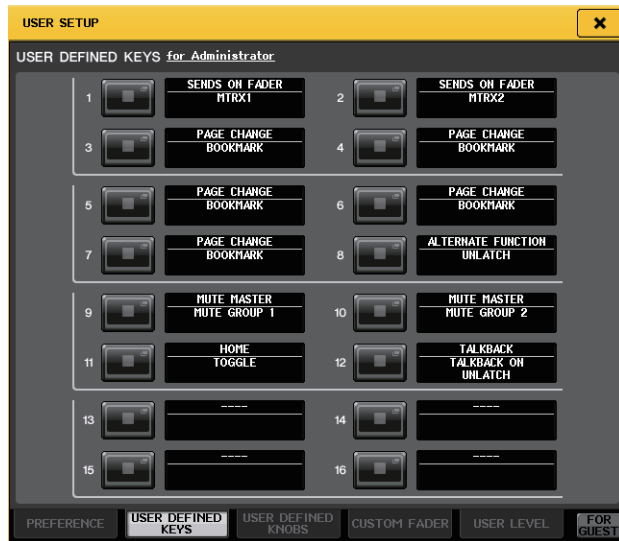

4. Press the popup button for the USER DEFINED key to which you want to assign the Tap Tempo function.

The USER DEFINED KEY SETUP popup window will appear.

5. Select "TAP TEMPO" in the FUNCTION column, select "CURRENT PAGE" in the PARAMETER 1 column, and press the OK button.

Use the ↑/↓ buttons or multifunction knobs to select an item in each column. Press the OK button. The Tap Tempo function will be assigned to the USER DEFINED key that you selected in step 4.

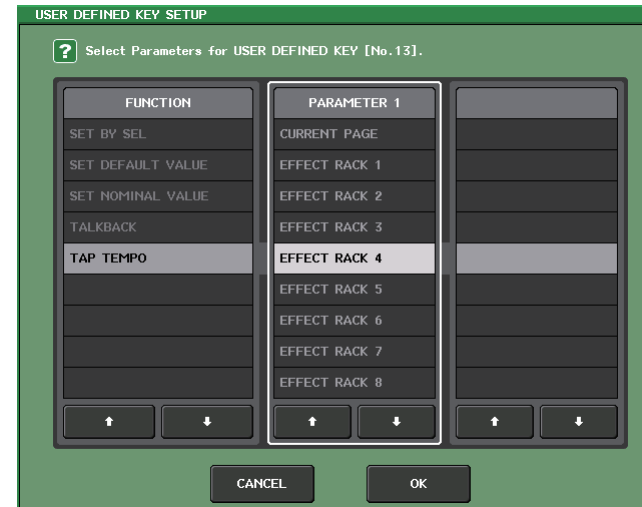

NOTE

- If you specify "CURRENT PAGE" in the PARAMETER 1 column, the Tap Tempo function can be used for the currently-displayed effect (rack).
- If you specify "RACK x" (x=1-8) in the PARAMETER 1 column, you will be able to use the Tap Tempo function only for a specific effect (rack).
- For more information on USER DEFINED keys, see "USER DEFINED keys" on page 169.

6. In the Function Access Area, press the RACK button to access the VIRTUAL RACK window, and then use the EFFECT tab to display the EFFECT field.

7. Press the rack in which the effect you want to control is mounted.

The EFFECT popup window will appear.

- 8.** Press the effect type field to open the EFFECT TYPE popup window, and select an effect type that includes the BPM parameter.

The BPM parameter is included in delay-type and modulation-type effects, and can be used to specify the delay time or modulation speed.

NOTE

For details on the parameters of each effect type, refer to the Appendices (see [page 233](#)).

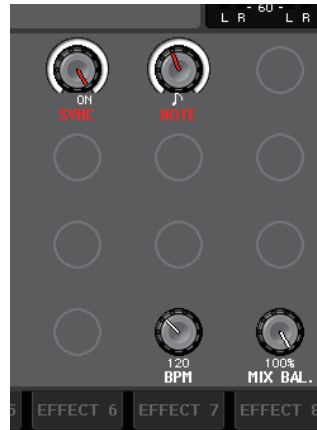

- 9.** Set the SYNC parameter to ON.

- 10.** At the desired tempo, repeatedly press the USER DEFINED key to which you assigned the Tap Tempo function.

The average interval (BPM) at which you press the key will be calculated, and that value will be applied to the BPM parameter.

The average interval will be input to the parameter.
(the average of a, b, and c)

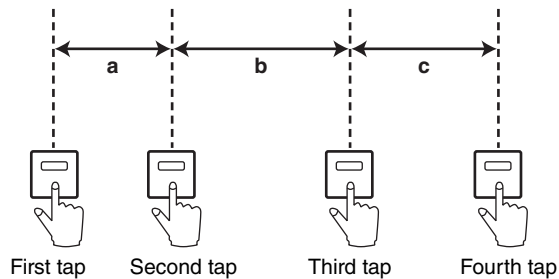

NOTE

- If the average value is outside the range of 20–300 BPM, it will be ignored.
- If you turn on the MIDI CLK button in the special parameter field, the BPM parameter value will change in relation to the tempo of the MIDI timing clock received from the MIDI port.

Using the Freeze effect

This section explains how to use the “FREEZE” effect type, which provides the functionality of a simple sampler. When this effect type is selected, you can perform operations on screen to record (sample) and play back a sound.

- 1.** In the Function Access Area, press the RACK button to access the VIRTUAL RACK window, and then use the EFFECT tab to display the EFFECT field.

- 2.** Mount an effect in rack 1, 3, 5, or 7.

NOTE

Effect types “FREEZE” and “HQ.PITCH” can be used only in rack 1, 3, 5, or 7.

- 3.** Press the rack in which the effect you want to control is mounted.

The EFFECT popup window will appear.

- 4.** Press the effect type field to open the EFFECT TYPE popup window, and select “FREEZE.”

If the “FREEZE” effect type is selected, a PLAY button, REC button, and progress bar will appear in the special parameter field.



- ① PLAY button

- ② REC button

- ③ Progress bar

NOTE

As an alternative to switching the effect type, you can also recall the “FREEZE” effect type from the effect library.

- 5. To begin recording (sampling), press the REC button and then press the PLAY button.**

The signal being input to the effect will be recorded. The bar reflects the current recording progress. When a fixed time has elapsed, the buttons will automatically turn off.

NOTE

You can adjust the parameters in the window to make detailed settings for recording time, the way in which recording will begin, and the way in which the sample will play back. For details on the parameters, refer to the Appendices (see [page 242](#)).

- 6. To play back the recorded sample, press the PLAY button.**

NOTE

The sampled content will be erased if you record another sample, change the effect, or turn off the power to the CL unit.

Using the Premium Rack

About the Premium Rack

The CL series console features processors that faithfully emulate meticulously-selected vintage analog processors, and a newly-developed Premium Rack, as well as graphic EQs and built-in effects. The Premium Rack employs VCM technology, which models analog circuitry on a component level to faithfully reproduce and fine-tune amazing analog sounds.

The Premium Rack offers six types of processors.

Name	Outline
Portico 5033	Models RND's analog 5-band EQ.
Portico 5043	Models RND's analog compressor/limiter.
U76	Models a typical vintage compressor/limiter.
Opt-2A	Models a classic vacuum tube (optical type) compressor.
EQ-1A	Models a classic vacuum tube passive-type vintage EQ.
Dynamic EQ	Newly-developed EQ that features a dynamically changing gain and enables you to control the cut/boost amount in relation to the input level.

Using the Premium Rack

The procedure to set up the I/O patches for the rack are the same as those for the effect rack. (see [page 122](#))

For the premium rack, only racks 1–2 can be used via send/return. Racks 3–8 are only for patching as inserts. (Refer to steps 5 and 6 of “[Virtual rack operations](#)” on [page 115](#).)

- 1. In the Function Access Area, press the RACK button to access the VIRTUAL RACK window.**
- 2. In the upper part of the VIRTUAL RACK window, press the PREMIUM tab to display the PREMIUM RACK field.**

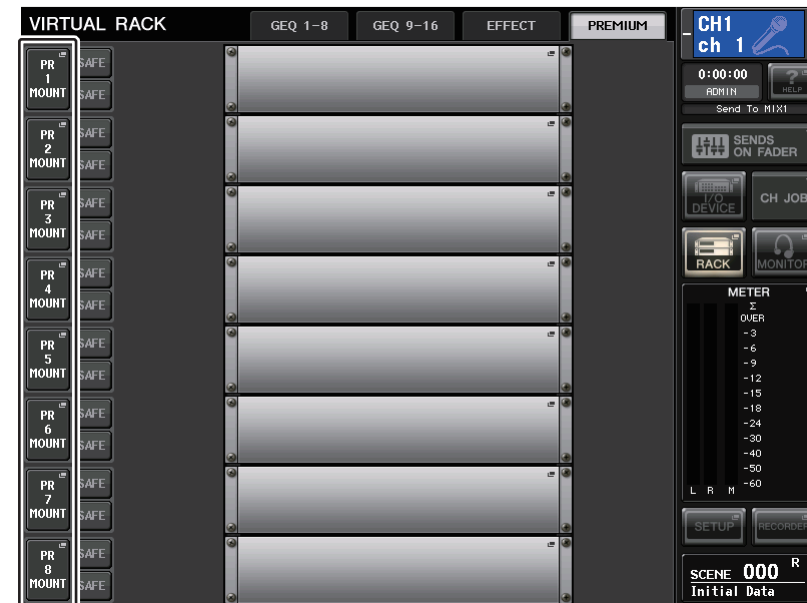

- To mount a Premium Rack in the rack, press the RACK MOUNT button for that rack. The PREMIUM RACK MOUNTER popup window will appear.



- Use the MODULE SELECT buttons to select the type you want to mount, and press the OK button.

There are two ways to mount each processor:

- DUAL** The processor is used on two mono channels.
- STEREO**..... The processor is used on one stereo channel.

The DUAL button and STEREO button indicate how many rack space units are occupied by the Premium Rack processor.



The U76 occupies two rack spaces. Other processors occupy one rack space. If you mount a two-space Premium Rack processor in the rack, you will be unable to mount any more processors below those rack spaces. Also, you cannot mount a two-space processor in an even-numbered rack.

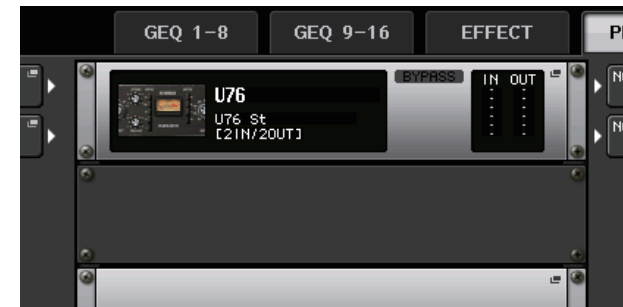

- Press the L side or the A side of the INPUT PATCH button to open the CH SELECT popup window, and select the insert-out of a channel as the input-source. For details on the CH SELECT popup window, refer to step 5 of “Virtual rack operations” on page 115. Insert-out is now assigned to the L input of the processor.
- Press the L side or the A side of the OUTPUT PATCH button to open the CH SELECT popup window, and select the insert-in of the same channel as the output-destination. For details on the CH SELECT popup window, refer to step 6 of “Virtual rack operations” on page 115. Insert-in is now assigned to the L output of the processor. If you are inserting a processor into a channel that handles a stereo source, assign the R channel insert-out and insert-in to the R input and output of the processor.
- Use the Bank Select keys in the Centralogic section to access the OVERVIEW screen for the channel into which you want to insert the processor.
- Press the INSERT/DIRECT OUT field to access the INSERT/DIRECT OUT popup window. Make sure that the rack you inserted in the input and output ports is selected. For details on Insert Out/In, refer to “Inserting an external device into a channel” on page 21.
- Turn on the INSERT ON/OFF button for the channel into which you inserted the processor. If it is off, press the button to turn it on. In this state, processor insertion is enabled for the corresponding channel.
- In the Function Access Area, press the RACK button to access the VIRTUAL RACK window, and use the PREMIUM tab to display the PREMIUM RACK field.
- Press the processor rack that you inserted into the channel to open the Premium Rack popup window. In this popup window you can edit the processor parameters.

12. Adjust the parameters.

For details on editing the parameters, refer to the next section “Editing the Premium Rack parameters.”

NOTE

Adjust the digital gain and the processor parameters so that the signal does not reach the overload point at the input or output stage of the processor.

13. Using the fader of the channel you selected as the rack’s output destination in step 6, adjust the level as appropriate.

Editing the Premium Rack parameters

Each Premium Rack window includes the following items:



1 ASSIST button

Press this button to open a window in which you can assign the parameters to the multifunction knobs for control.

2 LIBRARY button

Press the button to open the Library popup window for Premium Rack. (For each module type)

3 DEFAULT button

Restores the default parameter setting.

4 Multifunction knob access field

Indicates the name and value of the parameters that are assigned to the multifunction knobs. To switch the parameter to control, press the knob in the window.

NOTE

- If the ASSIST button is on, you will be able to easily identify the parameters that are currently available for editing, and the parameters that will be available for editing after you select them.
- You can adjust the parameter in finer steps by turning a multifunction knob while pressing and holding it down.

■ Portico 5033

Portico 5033 is a processor that emulates a 5-band analog EQ developed by Rupert Neve Designs (RND). 5033EQ features a unique tone control response. It inherited the history of the “1073,” which was praised as one of the greatest devices developed by Mr. Rupert Neve. Yamaha’s VCM technology has modeled the EQ to the last detail, including the input/output transformer that was designed by Mr. Rupert Neve himself. As a result, this processor model produces musically high-quality sound even when bypassed. Its response features unique effects. For example, if the Lo setting is cut, the low range becomes tight, and if the Hi setting is raised, the desired range will be boosted without hurting your ears.

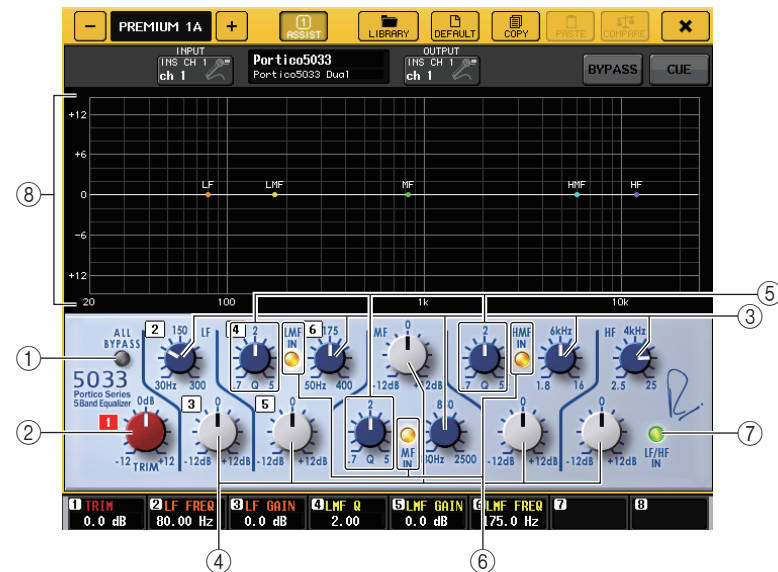

1 ALL BYPASS button

Switches EQ bypass on or off. Even when EQ bypass is on, the signal will pass through the input/output transformer and amp circuits.

2 TRIM knob

Adjusts the input gain of the effect.

3 LF/LMF/MF/HMF/HF Frequency knobs

Adjust the frequency for each band.

4 LF/LMF/MF/HMF/HF Gain knobs

Adjust the amount of boost or cut for each band.

5 LMF/MF/HMF Q knobs

Adjust the Q (steepness) of each band. The higher the Q value, the narrower the range in which you can control the gain for the band.

- ⑥ **LMF/MF/HMF IN button**
Turn LMF/MF/HMF EQ on or off respectively.
- ⑦ **LF/HF IN button**
Turn LF and HF EQ on or off simultaneously.
- ⑧ **Graph**
Indicates the graphical EQ response.

■ Portico 5043

Portico 5043, like Portico 5033, is a processor that emulates RND's analog compressor. The actual 5043 Compressor is equipped with the same input/output transformer as that of the 5033 EQ, delivering a natural, analog-like tonality and effect. It enables you to obtain a range of results from hard compression to natural sound, and is suitable for a broad range of audio sources ranging from drums to vocals. The most notable feature of this model is that you can switch the gain reduction type. You can choose either an FF (Feed-Forward) circuit type (which is the current mainstream), or an FB (Feed-Back) circuit which was typically used in vintage compressors. This allows you to create sounds with various characteristics as appropriate for your applications.

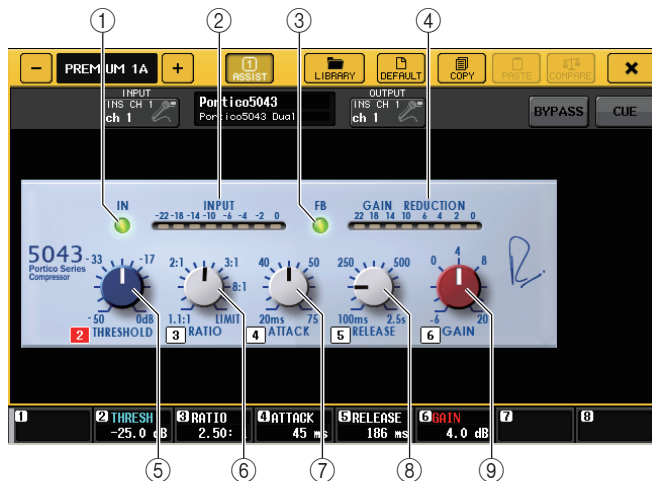

- ① **IN button**
Turns the compressor's bypass on or off. When the compressor is bypassed, the button indicator will turn off. However, even if the compressor is bypassed, the signal will pass through the input/output transformer and amp circuits.
- ② **INPUT meter**
Indicates the input signal level.
One meter appears in DUAL mode, and two meters appear in STEREO mode.

- ③ **FB button**
Switches the gain reduction method between FF (Feed-Forward) circuit and FB (Feed-Back) circuit. The button will light when FB circuit is selected.
The FF circuit is used in most contemporary compressors. This type is useful when you want to apply compression thoroughly while maintaining a consistent tonal color.
The FB circuit is used in vintage compressors. This type is suitable when you want to apply a smooth compression while adding a tonal color that is characteristic to the device.
- ④ **GAIN REDUCTION meter**
Indicates the amount of gain reduction.
- ⑤ **THRESHOLD knob**
Adjusts the threshold at which compression starts to be applied.
- ⑥ **RATIO knob**
Adjusts the compression ratio. Fully rotate the knob clockwise to switch to the limiter.
- ⑦ **ATTACK knob**
Adjusts the compressor's attack time.
- ⑧ **RELEASE knob**
Adjusts the compressor's release time.
- ⑨ **GAIN knob**
Adjusts the output gain.

■ U76

U76 is a processor that emulates a popular vintage compressor used in a wide range of situations. This processor does not provide the threshold parameter that is found on conventional compressors. Instead, the intensity of compression is determined by the balance between the input gain and the output gain. The “All mode” setting for the RATIO parameter allows you to create a heavily-compressed sound that is typical of this model. It produces an aggressive tonal character with a rich addition of overtones.

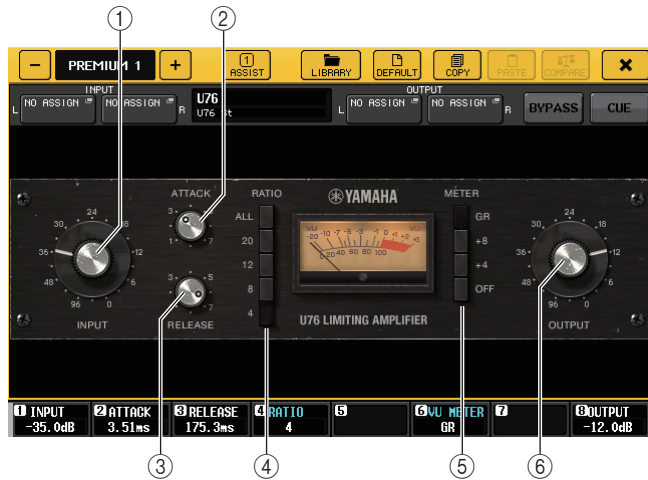

① INPUT knob

Adjusts the input level. As the input level gets higher, more compression is applied.

② ATTACK knob

Adjusts the compressor's attack time. Fully rotate the knob clockwise to set the fastest attack time.

③ RELEASE knob

Adjusts the compressor's release time. Fully rotate the knob clockwise to set the fastest release time.

④ RATIO switch buttons

Use these five buttons to set the compression ratio.

A button with the higher number will raise the compression ratio more. Pressing the ALL button selects All mode, in which the RATIO will become high, and sharp compression with a faster release time will be applied, creating substantially-distorted aggressive sound.

⑤ METER switch buttons

Switch the meter display.

- **GR**.....Indicates the amount of gain reduction applied by the compressor.
- **+4/+8**.....Each meter uses -18 dB as the reference level of the output signal, and indicates “0VU” for the value of the reference level added by +4 dB or +8 dB.
- **OFF**.....Turns off the meter display.

⑥ OUTPUT knob

Adjusts the output level.

If you have adjusted the amount of gain reduction by changing the INPUT level, the level of audible volume will also change. In this case, use the OUTPUT knob to adjust the volume level.

■ Opt-2A

Opt-2A is a processor that emulates a popular vintage model of tube opto compressors. It features smooth compression produced using optical components such as a photocell and a light source to control the level. It also features beautiful high-range overtones created by the warm distortion typical of tube circuits, resulting in elegant and sophisticated sounds.



① GAIN knob

Adjusts the output level.

② PEAK REDUCTION knob

Adjusts the compression amount of the signal.

③ RATIO knob

Adjusts the compression ratio.

④ METER SELECT knob

Switches the meter display.

GAIN REDUCTION indicates the amount of gain reduction when the compressor is operating. With -18 dB as the reference level of the output signal, the OUTPUT +10 and OUTPUT +4 settings respectively will cause the value +10 dB or +4 dB from this reference level to be shown as “0VU” on the meter.

■ EQ-1A

EQ-1A is a processor that emulates a famous passive-type vintage EQ. It features a unique style of operation, allowing you to individually boost and attenuate (cut) each of two frequency ranges (high and low). The frequency response is utterly unlike that of a conventional EQ, and is a uniquely distinctive characteristic of this model. The input/output circuits and vacuum tubes produce a tonal character that is highly musical and well-balanced.



① IN switch

Turns the processor on or off.

When the switch is off, the signal will bypass the filter section, but pass through the input/output transformer and amp circuits.

② LOW FREQUENCY knob

Sets the frequency of the low range filter.

③ (LOW) BOOST knob

Sets the amount of boost applied to the frequency band specified by the LOW FREQUENCY knob.

④ (LOW) ATTEN knob

Sets the amount of attenuation applied to the frequency band specified by the LOW FREQUENCY knob.

⑤ BAND WIDTH knob

Sets the width of the frequency band controlled by the high range filter.

As you rotate the knob toward the right (Broad), the band will become wider and the peak level will decrease. This affects only the response of the boost.

⑥ HIGH FREQUENCY knob

Sets the frequency of the high range filter. This affects only the response of the boost.

⑦ (HIGH) BOOST knob

Sets the amount of boost applied to the frequency band specified by the HIGH FREQUENCY knob.

⑧ (HIGH) ATTEN knob

Sets the amount of attenuation applied to the frequency band specified by the ATTEN SEL knob.

⑨ (HIGH) ATTEN SEL knob

Switches the frequency region attenuated by the ATTEN knob.

■ Dynamic EQ

Dynamic EQ is a newly-developed equalizer that does not emulate any specific model of equalizer. The sidechain has a filter that extracts the same frequency band as the EQ. This allows you to apply EQ in the same way as you might apply a compressor or expander to a specific frequency region, causing the EQ gain to vary dynamically only when a specific frequency region of the input signal becomes too high or too low. For example you could use this on a vocal sound as a de-esser, so that EQ is applied to a specific frequency band only when sibilance or high-frequency consonants reach an unpleasant level, thus preserving a natural sound that does not impair the original tonal character. Two full-band Dynamic EQs are provided, enabling you to process a wide range of audio sources.



① BAND ON/OFF button

Turns each band on or off.

② **SIDECCHAIN CUE button**



Press this button on to monitor the sidechain signal sent to the CUE bus. At this time, the graph indicates the filter response for the sidechain.

③ **SIDECCHAIN LISTEN button**

Turn this button on to output the sidechain signal (linked to the dynamics) to the bus (such as a STEREO bus or MIX/MATRIX bus) to which the insert channel signal is sent. At this time, the graph indicates the response of the sidechain filters.

④ **FILTER TYPE buttons**

Switch the type of the main bus equalizers and sidechain filters. Main bus EQ and sidechain filter will link as follows:

FILTER TYPE	 (Low Shelf)	 (Bell)	 (Hi Shelf)
Main EQ	Low Shelf	Bell	Hi Shelf
Sidechain filter	LPF	BPF	HPF

⑤ **FREQUENCY knob**

Sets the frequency band that will be controlled by the equalizer and sidechain filter.

⑥ **Q knob**

Sets the Q value (steepness) of the equalizer and sidechain filter.

As you rotate this knob clockwise, the frequency range to which the equalizer or sidechain filter is applied will become wider.

⑦ **THRESHOLD knob**

Specifies the threshold at which the processor will begin taking an effect.

⑧ **RATIO knob**

Sets the boost/cut ratio relative to the input signal.

Rotating the knob clockwise will set the ratio for boost, and counter-clockwise for cut. Fully rotating the knob in either direction will create the maximum effect.

⑨ **ATTACK/RELEASE buttons**

Enable you to select one of the three settings as the attack/release time for compression or boost.

Select FAST for a faster attack and faster release. Select SLOW for a faster attack and slower release. Select AUTO to automatically adjust the attack/release time depending on the frequency ranges.

⑩ **MODE buttons**

Specify whether the processor is triggered when the sidechain signal level exceeds the threshold value (ABOVE), or when the level does not reach the threshold value (BELOW).

⑪ **EQ GAIN meter**

Indicates the dynamically-changing EQ gain.

⑫ **THRESHOLD meter**

Indicates the sidechain signal level in relation to the threshold level.

⑬ **Graph area**

Displays the equalizer response.

In most cases, this area displays the reference EQ graph that indicates the frequency and intensity, and the dynamic EQ graph that indicates the dynamically-changing EQ responses.

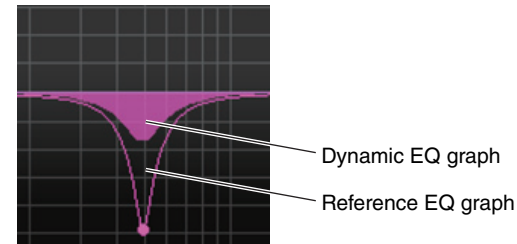

If SIDECCHAIN CUE or SIDECCHAIN LISTEN is on, this area displays the sidechain filter response.

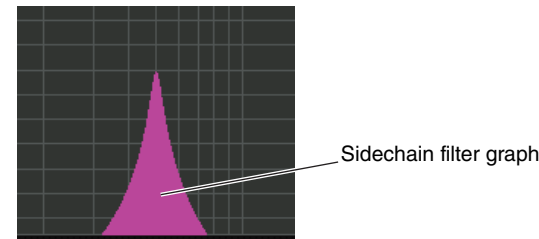

Using the graphic EQ, effect, and Premium Rack libraries

■ GEQ library

Use the “GEQ library” to store and recall GEQ settings. All GEQ units used in the CL series console can reference this GEQ library. Although there are two types, 31BandGEQ and Flex15GEQ, you are free to recall items between differing types. However, only 31BandGEQ settings that use less than fifteen bands can be recalled to a Flex15GEQ.

200 items can be recalled from the library. Number 000 is read-only data for initialization, and the remaining library numbers can be freely read or written.

To recall an item from the GEQ library, press the LIBRARY button located at the top of the GEQ popup window.



NOTE

- Store and recall operations are performed on individual GEQ units. For one rack, you can store and recall two Flex15GEQ units independently as A and B.
- To access the GEQ popup window, press the rack in the GEQ field.

■ Effect library

Use the “Effect library” to store and recall effect settings. 199 items can be recalled from the effect library. Numbers 001–027 are read-only presets, and the remaining library numbers can be freely read or written.

To recall an item from the effect library, press the LIBRARY button located at the top of the EFFECT popup window.



NOTE

If you recall an effect whose effect type is COMP276, COMP276S, COMP260, COMP260S, EQUALIZER610, OPENDECK, M.BAND DYNA., or M.BAND COMP, the other effects may be momentarily muted in some cases.

■ Premium Rack library

For the premium rack, there are six library items for each module type. You'll use the library of each module type to store and recall Premium Rack settings. The libraries are numbered 000–100, and 000 is read-only data for initialization. All library items other than #000 can be freely read and written.

To recall an item from the Premium Rack library, press the LIBRARY button located at the top of the popup window for the corresponding Premium Rack.



I/O device and external head amp

This chapter explains how to use an I/O device or an external head amp that is connected to the CL series console.

Before you proceed, use DANTE SETUP to specify the I/O devices that will be mounted. For details, refer to “Mounting an I/O device on the Dante audio network” on page 217.

Using an I/O device

CL series consoles enable you to remotely control channel parameters of an I/O device (such as an Rio series product) connected to the Dante connector.

For details on connecting the CL series console to an I/O device, refer to the “Connecting to I/O devices” section in the separate Owner’s Manual.

I/O device patching

Here’s how an I/O device connected to the Dante connector can be patched to the Dante audio network.

1. Connect the CL series console to an I/O device.

For details, refer to the “Connecting to I/O devices” and “Quick Guide” sections in the separate Owner’s Manual.

2. In the function access area, press the I/O DEVICE button to access the I/O DEVICE screen.



3. In the upper part of the I/O DEVICE screen, press the DANTE PATCH tab to access the DANTE PATCH field.

The DANTE PATCH field includes the following items.

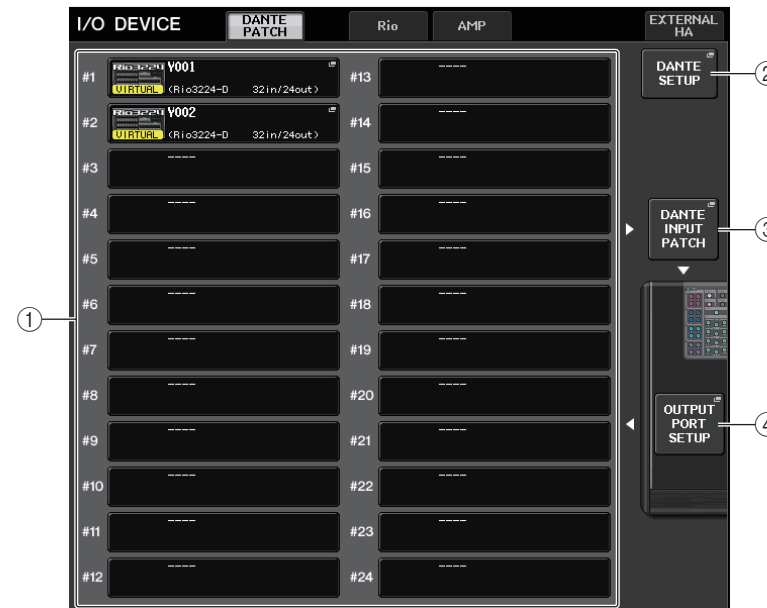

① I/O device list

This shows the ID number and model name of the I/O devices.

Press here to access the OUTPUT PATCH popup window, where you can specify patching from the console’s output ports to the I/O devices.

② DANTE SETUP button

Press this button to open the DANTE SETUP popup window, in which you can make settings for the audio network.

③ DANTE INPUT PATCH button

Press this button to open the DANTE INPUT PATCH popup window, in which you can select any of 64 channels that will be input from the I/O devices to the console.

④ OUTPUT PORT SETUP button

Press this button to access the PATCH VIEW 1 tab of the OUTPUT PORT popup window, where you can choose the 64 channels that will be output from the console’s output ports to I/O devices.

4. To specify the 64 channels that will be input from the I/O devices to the console, press the DANTE INPUT PATCH button.

The DANTE INPUT PATCH popup window will appear. This popup window includes the following items.

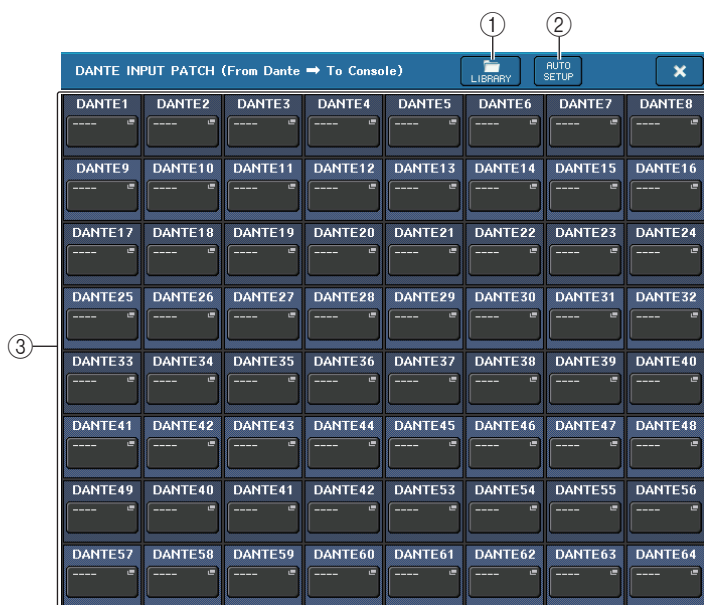

① LIBRARY button

Enables you to store or recall the DANTE INPUT PATCH settings to or from the library. You can store ten sets of settings in the library.

NOTE

- If you recall data whose I/O device registration state differs from the current state, patching to devices not registered in the I/O device list will be kept in its current state, and will not be recalled.
- Similarly, if the UNIT ID is different than when the data was stored, the settings will not be recalled; the current state will be maintained.

② AUTO SETUP button

The current I/O device connection status will be ascertained, and input patching to the console will be performed automatically according to the order in which they are registered in the I/O device list.

When you press this button, a confirmation popup dialog will appear, asking you to confirm the execution of auto patching. Press the OK button to execute auto patching. Otherwise, press CANCEL to return to the previous screen.

③ Port select buttons



Press one of the buttons to open the PORT SELECT popup window.

The Dante Device ID number (hexadecimal) and channel number (decimal) are shown in the upper row on the button.

The first eight characters of the channel label (Dante Audio Channel Label) for each port are shown in the lower row on the button.

If no patch has been assigned, the upper row will indicate "---" and the lower row will indicate nothing.

NOTE

- If you've connected a device other than an I/O device supported by the CL series, the upper line of the button will show the first four letters of the Device Label, a dash "-", and the channel number (decimal).
- If no Dante Audio Channel Label has been specified, the lower row will indicate nothing.
- You can set the Dante Audio Channel Label using Audinate's "Dante Controller" software. For the latest information, refer to the Yamaha pro audio website. <http://www.yamahaproaudio.com/>

5. Press the AUTO SETUP button.

A confirmation popup dialog will appear, asking you to confirm the input patching from the I/O devices to the console; press OK, and the patching will be performed automatically.

6. If you want to edit the patching individually, press the port select button.

The PORT SELECT popup window will appear.

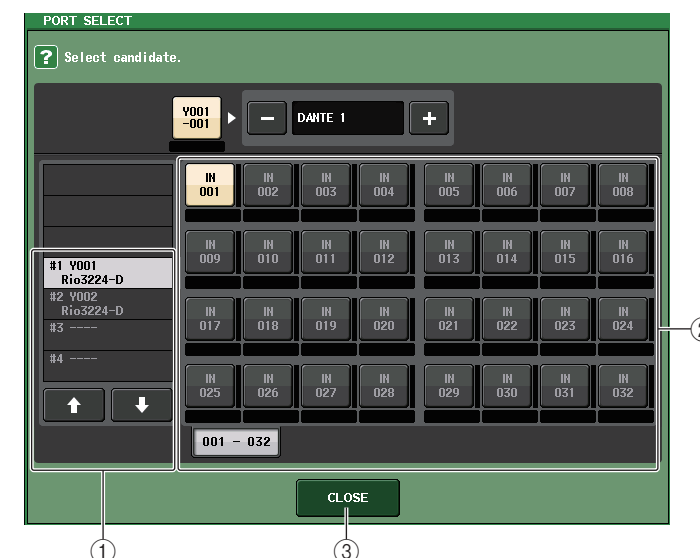

① Category select list

Enables you to select the I/O device containing the input port that you want to assign.

② Port select buttons

Select the input port.

③ CLOSE button

Completes the settings and closes the popup window.

- 7.** To assign the output ports of the I/O device, select and press the I/O device in the DANTE PATCH field of the I/O device screen to access the OUTPUT PATCH popup window.

The OUTPUT PATCH popup window will appear.

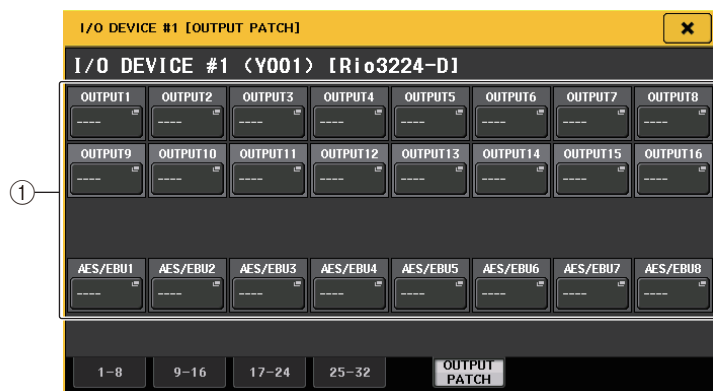

① Port select buttons

Press one of the buttons to open the PORT SELECT popup window.

- 8.** If you want to change the patching, press the port select button.

The PORT SELECT popup window will appear.

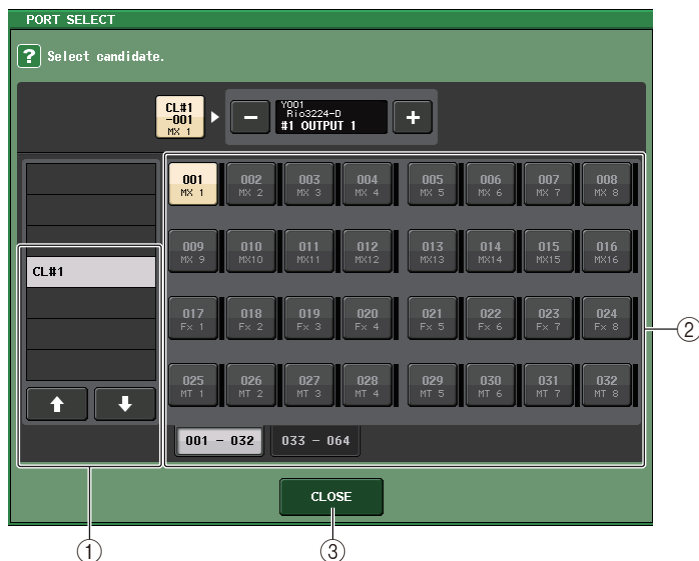

① Category select list

Select the Dante port to which the signal you want to output is assigned.

② Port select buttons

Select the Dante port (DANTE 1–64) to which the signal you want to output is assigned.

③ CLOSE button

Completes the settings and closes the popup window.

- 9.** In the same way, specify the channels that you want to output to other OUTPUT ports.

Remotely controlling an Rio unit

Here's how to remotely control an Rio unit that's connected to the Dante connector.

- 1.** In the upper part of the I/O DEVICE screen, press the Rio tab to access the Rio field.

The Rio field includes the following items.

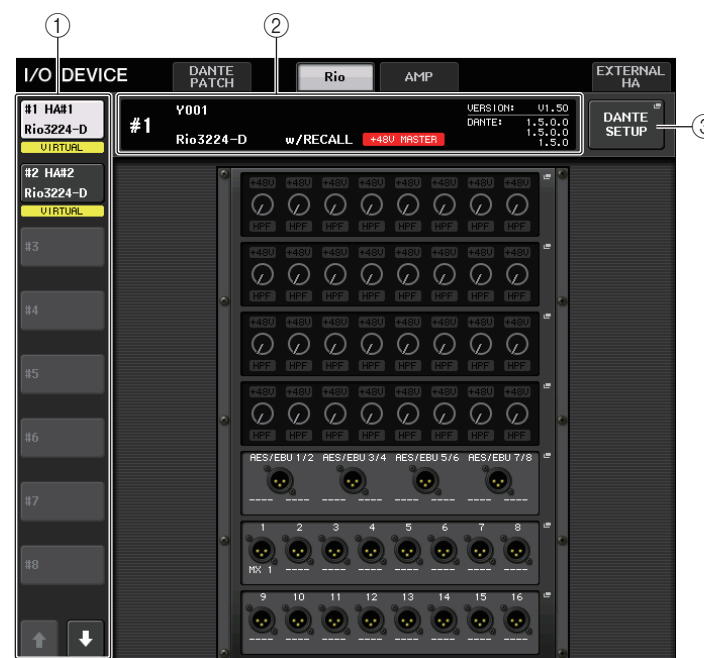

① Display switch buttons

Press one of these buttons to view the corresponding I/O device. If you press and hold down the button, all LEDs of the corresponding I/O device will blink.

② ID/model name indication

This shows the ID number, model name, and version of the I/O device.

③ DANTE SETUP button

Press this button to open the DANTE SETUP popup window, in which you can make settings for the audio network.

■ HA display

This shows the HA settings of the I/O device. Press this area to open the I/O DEVICE HA popup window, in which you can make detailed head amp settings.



④ Analog gain knob

Indicates the analog gain setting. This item is only for display, and cannot be edited.

⑤ +48V indicator

Indicates the phantom power (+48V) on/off status for each port.

⑥ OVER indicator

Warns you when the input signal is clipping.

⑦ HPF indicator

Indicates the high pass filter on or off status for each port.

■ INPUT display

This shows the input settings of the I/O device.



If you press the [SEL] key of an input channel, the corresponding port will light.

■ OUTPUT display

This shows the output settings of the I/O device. Press here to access the OUTPUT PATCH popup window, where you can make output port settings for the I/O device.



If you press the [SEL] key of an output channel, the corresponding port will light.

2. To remotely control the head amp of an I/O device, press the I/O device in the HA display.

The I/O DEVICE HA popup window will appear. In this window, you can remotely control the head amp on the I/O device from the CL series console by using the on-screen knobs and buttons or the multifunction knobs on the top panel.



① +48V MASTER

Indicates the on/off status of the I/O device's master phantom power. (Switching this on or off is performed on the I/O device itself.)

② +48V button

Switch phantom power on or off for each channel.

③ GAIN knob

Indicates the gain of the head amp on the I/O device. To adjust the value, press the knob to select it, and use multifunction knobs 1–8. The level meter located immediately to the right of the knob shows the input level of the corresponding port.

④ GC button

Switches on or off the Gain Compensation function that maintains a consistent signal level on the audio network.

⑤ FREQUENCY knob/HPF button

These controllers switch on or off the high-pass filter built into the head amp of the I/O unit, and adjust its cutoff frequency. If you press the FREQUENCY knob to select it, you will be able to adjust it using the corresponding multifunction knob.

⑥ Displayed port switch tabs

These tabs switch the port that is displayed in the I/O DEVICE HA popup window.

⑦ GC ALL ON button/GC ALL OFF button

Switch Gain Compensation on or off for all input channels simultaneously.

3. To remotely control the I/O device's head amp from an input channel of the CL series console, use the bank select keys in the Centralogic section to access the OVERVIEW screen that includes the channel for which you want to control the head amp.

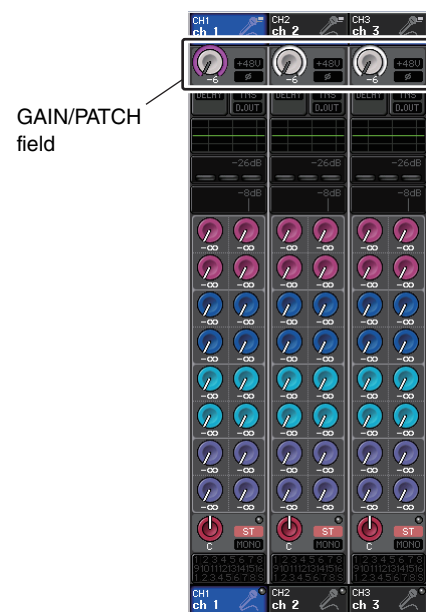

4. Press the GAIN/PATCH field of the channel for which you want to adjust the I/O device's head amp. The GAIN/PATCH popup window will appear.



5. When you have finished making settings, press the "x" symbol to close the popup window.

6. If you press a rack in which an output I/O device is mounted, the OUTPUT PATCH popup window will appear.



If you need to make output port settings, make these settings as described in step 7 and following of the I/O device patching procedure (see page 140).

Remotely controlling an amp

Here's how to remotely control an amp that's connected to the Dante connector.

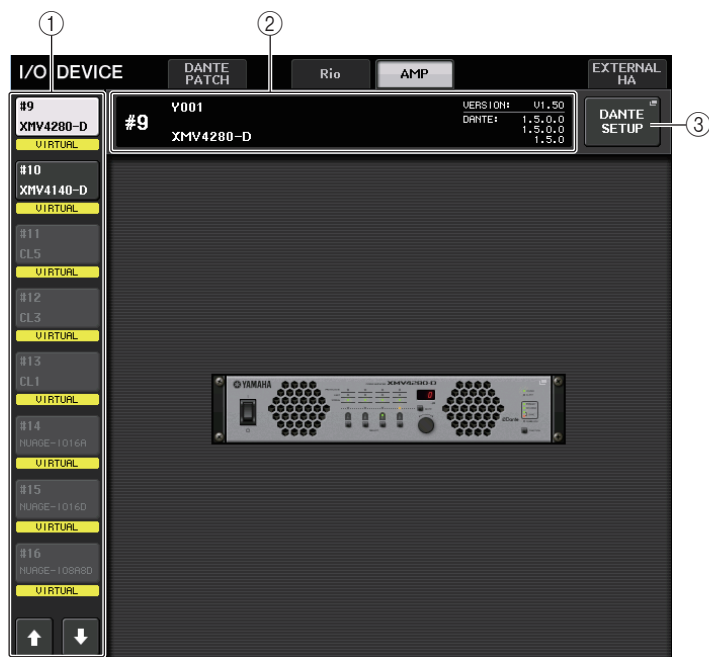

1. In the upper part of the I/O DEVICE screen, press the AMP tab to access the AMP field.

The AMP field includes the following items.

- 1 **Display switch buttons**
Press one of these buttons to view the corresponding I/O device.
- 2 **ID/model name indication**
This shows the ID number, model name, and version of the I/O device.
- 3 **DANTE SETUP button**
Press this button to open the DANTE SETUP popup window, in which you can make settings for the audio network.

2. Press a displayed I/O device to open the OUTPUT PATCH popup window.

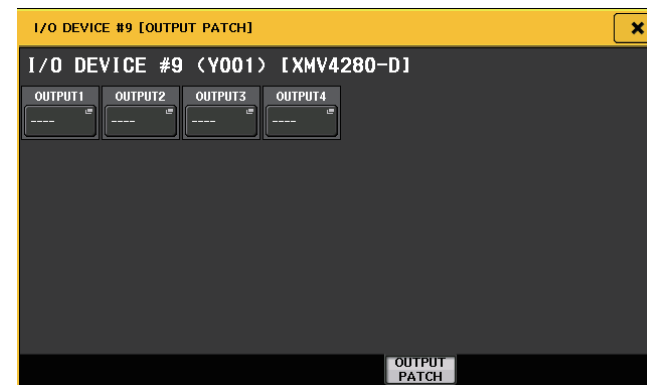

If you need to make output port settings, make these settings as described in step 7 and following of the I/O device patching procedure (see [page 140](#)).

Using an external head amp

If an I/O card (such as an MY16-ES64 card) supports the remote protocol of an external head amp in the CL's slot, you will be able to remotely control from the CL console some parameters of the external head amp (Yamaha SB168-ES or AD8HR), such as phantom power (+48V) on/off status, gain, and HPE. For details on the I/O card settings, refer to the owner's manual for the I/O card.

Connecting the CL series console to an AD8HR

To remotely control the AD8HR from the CL series console, install an MY16-ES64 EtherSound card in Slot 1 on the CL unit, then use an Ethernet cable to connect the CL unit to the NAI48-ES. Then, connect the HA REMOTE connector on the NAI48-ES to the HA REMOTE 1 connector on the AD8HR using an RS422 D-sub 9-pin cable. This connection enables you to remotely control the AD8HR from the CL series console.

To transmit audio signals (input to the AD8HR) to the CL series console, connect the DIGITAL OUT A (or B) connector on the AD8HR to the AES/EBU connector on the NAI48-ES using a D-sub 25-pin AES/EBU cable. Signals will be sent or received between the NAI48-ES and the CL series console via the MY16-ES64 card.

Alternatively, you can use a "daisy chain" connection to remotely control multiple AD8HR units simultaneously. To do this, connect the AD8HR's HA REMOTE 2 connector to the second AD8HR's HA REMOTE 1 connector. If you use the NAI48-ES, you can connect up to six AD8HR units. In this case, to input AD8HR's audio signals into the CL series console, install two MY16-EX cards on the CL unit since each slot on the CL unit accepts up to 16 channel signals. Then, use an Ethernet cable to make connections to the MY16-ES64.

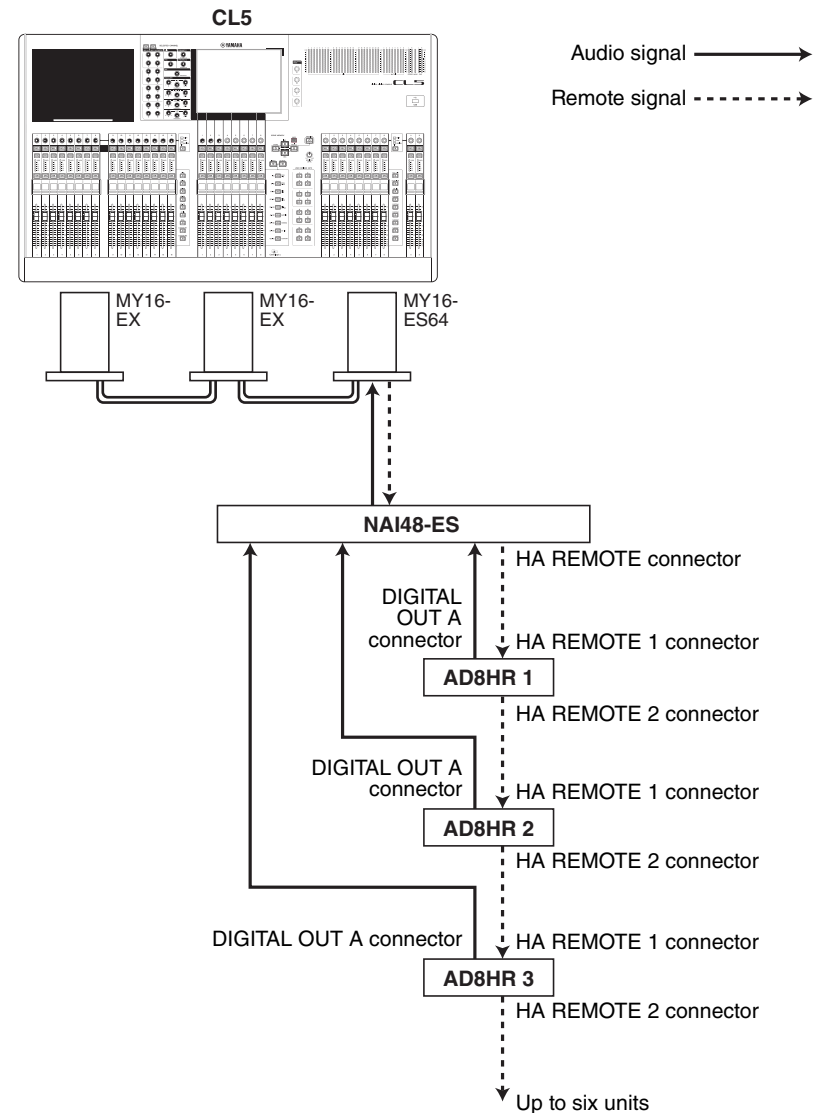

Connecting the CL series console to an SB168-ES

To remotely control the SB168-ES from the CL series console, install an MY16-ES64 EtherSound card in Slot 1 on the CL, then use an Ethernet cable to connect the CL to the SB168-ES. This connection enables you to remotely control the SB168-ES from the CL series console.

Alternatively, you can use a daisy chain or ring connection and install two MY16-EX expansion cards in the slots on the CL unit to remotely control up to three SB168-ES units simultaneously.

NOTE

Remote control data will be received and transmitted only at Slot 1 on the CL series console.

■ Daisy chain connection

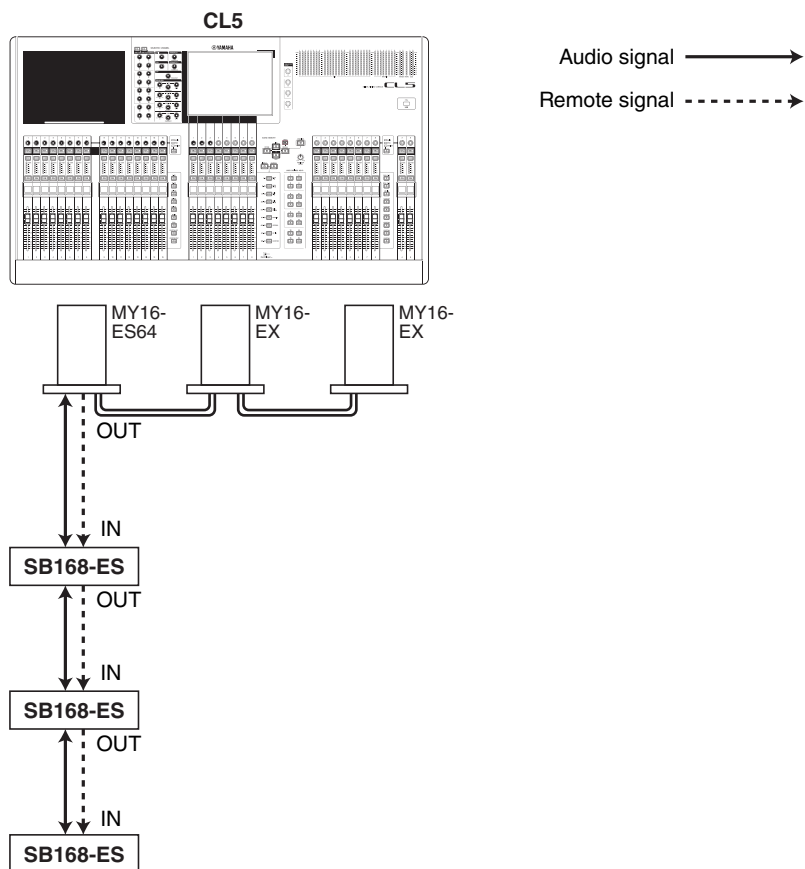

■ Ring connection

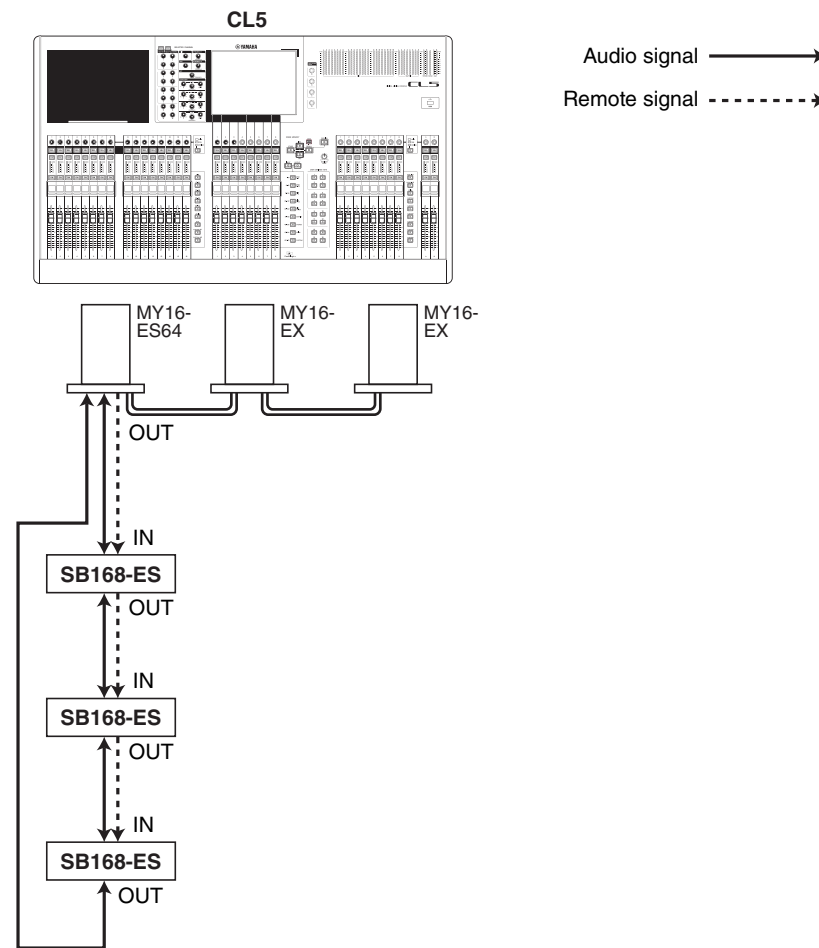

NOTE

Please refer to the SB168-ES Owner's Manual for information on setting up the MY16-ES64/ MY16-EX cards and EtherSound network.

Remotely controlling an external head amp

You can remotely control from the CL series console an external head amp (“external HA”) connected via MY16-ES64 or NAI48-ES.

1. Connect the CL series console to an external HA.

For details, refer to the “Using an external head amp” on page 144 section and the owner’s manual of your external HA.

2. In the Function Access Area, press the I/O DEVICE button to access the I/O DEVICE window.



3. In the upper part of the I/O DEVICE window, press the EXTERNAL HA tab to display the EXTERNAL HA field.

The EXTERNAL HA field includes the following items.

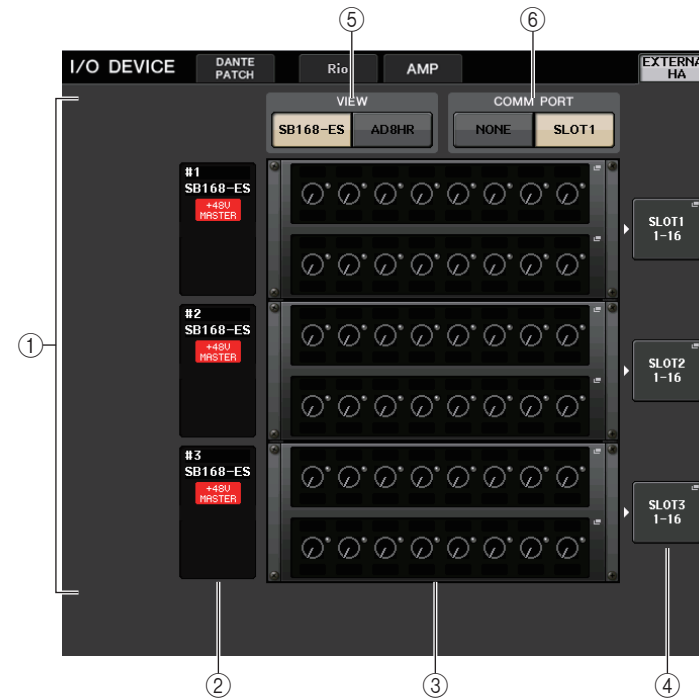

① EXTERNAL HA field

Indicates the state of the connected external HA.

② ID/Model name/+48V master

Displays information for the external HA mounted in the rack. The ID number is automatically assigned in order of the connected devices from 1 to six. This field also enables you to view the on/off status of the master phantom power.

③ Virtual racks

This section accommodates up to six racks in which remotely-controllable external HA units can be mounted. If an external HA is mounted, this field will indicate the HA settings (GAIN setting, and on/off status of the phantom power and HPF). Press a rack to open the EXTERNAL HA popup window.

④ EXTERNAL HA PORT SELECT popup button

Press this button to open the EXTERNAL HA PORT SELECT popup window, in which you can specify the input ports to which the external HA mounted in the rack will be connected.

⑤ VIEW switch buttons

Switch the virtual rack display between SB168-ES and AD8HR. Select the view according to the connected device.

⑥ COMM PORT switch buttons

Specifies whether the external HA connected to the slot will be controlled remotely. Select “SLOT1” if you want to remotely control the external HA.

4. Press the “SLOT1” COMM PORT switch button.

The external HA units that can be controlled will appear in the virtual rack.

5. To specify the input ports for an external HA, press the EXTERNAL HA PORT SELECT popup button for that rack.

The EXTERNAL HA PORT SELECT popup window will appear. The popup window includes the following items.

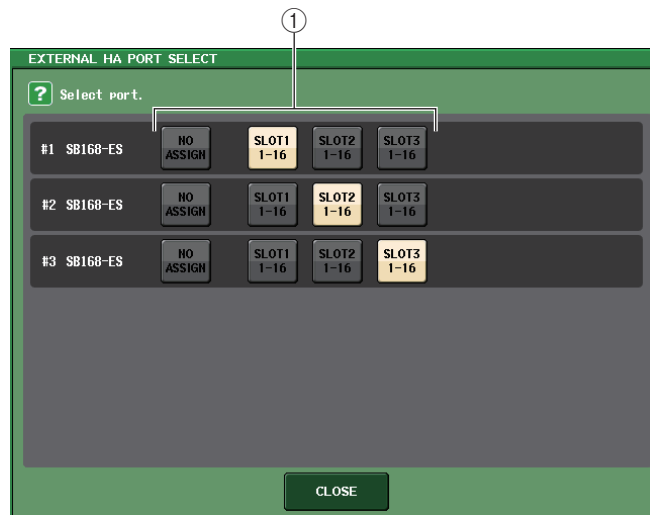

① PORT SELECT buttons

Specify the input ports to which the external HA is connected.

6. Use the PORT SELECT buttons to specify the input ports to which the audio output of the external HA is connected.

When you have finished making settings, press the CLOSE button to close the popup window.

NOTE

If an external HA is connected to one of the slots on the CL series console, you must specify an appropriate input port manually. If this is set incorrectly, the external HA will not be detected correctly when you patch input ports to input channels.

7. To remotely control an external HA, press the rack in which the external HA you want to control is mounted.

The EXTERNAL HA popup window will appear. Here you can remotely control the external HA by using the on-screen knobs and buttons on the CL series console or the knobs on the top panel.



① +48V MASTER

If an external HA is connected, the on/off status of the master phantom power is shown here. (Switching this on or off is performed on the external HA itself.)

② +48V button

Switches phantom power on or off for each channel.

③ GAIN knob

Indicates the gain level of the external HA. To adjust the value, press the knob to select it, and use multifunction knobs 1–8. The level meter located immediately to the right of the knob shows the input level of the corresponding port.

④ FREQUENCY knob/HPF button

These controllers switch on or off the high-pass filter built into the external HA, and adjust its cutoff frequency. If you press the FREQUENCY knob to select it, you will be able to adjust it using the corresponding multifunction knob.

⑤ Rack select tabs

Enable you to select the rack displayed in the EXTERNAL HA popup window.

NOTE

- If you connect an additional AD8HR, the setting for this AD8HR will be used. These knobs and buttons are displayed in the EXTERNAL HA popup window even if an AD8HR is not connected, allowing you to create and store a scene even while the AD8HR is not connected.
- Error messages related to the SB168-ES will not be displayed. In addition, you will be unable to set the EtherSound parameters. Use the AVS-ESMonitor software application for these functions.

8. To remotely control the external HA from an input channel of the CL series console, use the Bank Select keys to access the OVERVIEW screen that includes the channel on which you want to control the HA.

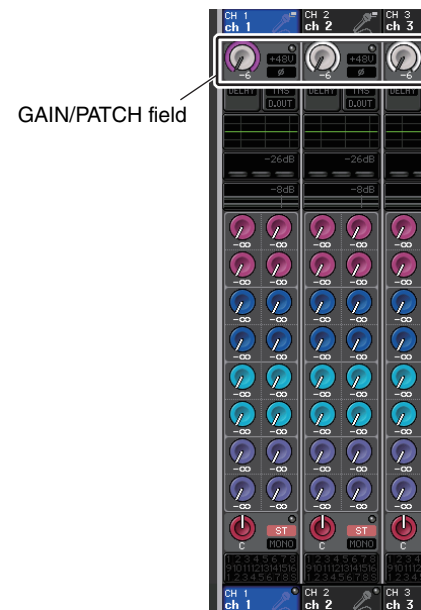

9. Press the GAIN/PATCH field of the channel on which you want to control the external HA. The GAIN/PATCH popup window will appear.



10. Press the PATCH button, and select the input port assigned to the external HA. With these settings, you will be able to use the external HA in the same way as the head amp on the I/O device or the CL unit. For details about the GAIN/PATCH popup window, refer to “Making HA (Head Amp) settings” on page 30.

MIDI

This chapter explains how to transmit MIDI messages from an external device to the CL series console to control the CL console's parameters, and how to send out MIDI messages from the CL console as you operate the unit.

MIDI functionality on the CL series console

The CL series console can use MIDI to perform the following operations:

■ Program Change transmission and reception

When you execute a specific event (scene/effect library recall) on the CL series console, a Program Change message (a number that is assigned to the event) can be transmitted to an external device. Conversely, the corresponding event can be executed when a Program Change message is received from an external device.

■ Control Change transmission and reception

When you execute a specific event (fader, knob, or key operation) on the CL series console, the corresponding Control Change message can be transmitted to an external device. Conversely, events can be executed when Control Change messages are received from an external device. This allows you to record fader and key operations on a MIDI sequencer or other external device, and play them back later.

■ Parameter Change (SysEx) transmission and reception

When specific events (fader, knob, or key operations, changes in system settings or user settings) are executed, "Parameter Change" SysEx (system exclusive) messages can be transmitted to an external device. Conversely, events can be executed when Parameter Changes are received from an external device.

Using this capability, CL operations can be recorded and played back on a MIDI sequencer or other external device. In addition, changes in system and user settings can be received and executed by another CL console.

NOTE

You can select the port used for transmission and reception of MIDI messages from the rear panel MIDI IN/OUT connectors or an I/O card installed in a slot 1. All of the functionality described in this section will be available on the port you select.

Basic MIDI settings

You can select the type of MIDI messages the CL series console will transmit and receive, the MIDI port that will be used, and the MIDI channel.

1. In the Function Access Area, press the **SETUP** button to access the **SETUP** screen.



2. In the center of the screen, press the **MIDI/GPI** button to access the **MIDI/GPI** popup window.

This window includes several pages, which you can switch among using the tabs located at the bottom of the window.

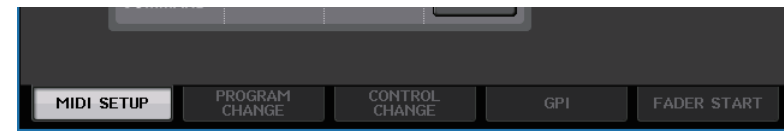

3. Press the MIDI SETUP tab to access the MIDI SETUP page.

In the MIDI SETUP page you can select the type of MIDI messages that will be transmitted and received, and choose the port that will be used. This page includes the following items.

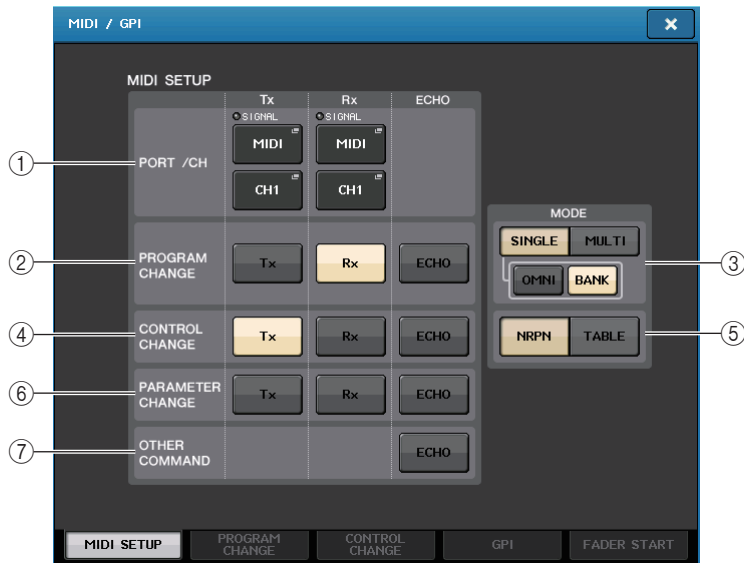

① PORT/CH field

Enables you to select the port and MIDI channel that will be used to transmit and receive MIDI messages.

- **Tx PORT/Tx CH**.....Press these buttons to open popup windows in which you can respectively select a port and MIDI channel to transmit MIDI messages.
- **Rx PORT/Rx CH**.....Press these button to open popup windows in which you can respectively select a port and MIDI channel to receive MIDI messages.

② PROGRAM CHANGE field

Enables you to switch MIDI Program Change message transmission and reception on or off.

- **Tx**.....Switches Program Change transmission on or off.
- **Rx**.....Switches Program Change reception on or off.
- **ECHO**.....Switches on or off echo output of Program Change messages (If this function is on, Program Change messages received from an external device will be retransmitted without modification.)

③ PROGRAM CHANGE MODE field

Enables you to select the Program Change transmit/receive mode.

- **SINGLE**.....If this button is on, Program Changes will be transmitted and received on a single MIDI channel (Single mode).
- **MULTI**If this button is on, Program Changes will be transmitted and received on multiple MIDI channels (Multi mode).

- **OMNI** If this button is on, Program Changes on all MIDI channels will be transmitted and received in Single mode. Multi mode transmission/reception and Single mode transmission are disabled.
- **BANK** If this button is on, Bank Select messages can be transmitted and received in Single mode. (Bank Select messages switch the group of Program Change messages to be used.)

④ CONTROL CHANGE field

Enables you to switch MIDI Control Change message transmission and reception on or off.

- **Tx** Switches Control Change transmission on or off.
- **Rx** Switches Control Change reception on or off.
- **ECHO** Switches on or off echo output of Control Change messages (If this function is on, Control Change messages received from an external device will be retransmitted without modification.)

⑤ CONTROL CHANGE MODE field

Enables you to select the Control Change transmission/reception mode.

- **NRPN** If this button is on, the CL mix parameters will be transmitted/received as NRPN messages on one MIDI channel (NRPN mode).
- **TABLE button**..... If this button is on, the CL mix parameters will be transmitted/received as Control Change messages on one MIDI channel (TABLE mode).

⑥ PARAMETER CHANGE field

Enables you to turn SysEx (system exclusive) messages on or off. (These special messages are used to change the CL parameters.)

- **Tx** Switches Parameter Change transmission on or off.
- **Rx** Switches Parameter Change reception on or off.
- **ECHO** Switches on or off echo output of Parameter Change messages (If this function is on, Parameter Change messages received from an external device will be retransmitted without modification.)

⑦ OTHER COMMAND field

Switches on or off echo output of other messages (If this function is on, other messages received from an external device will be retransmitted without modification.)

4. To specify the port that will be used to transmit or receive each type of MIDI message, press the transmit (Tx) or receive (Rx) port select popup button.

The MIDI SETUP popup window for selecting the port will appear. Operations in this window are the same for both transmission (Tx) and reception (Rx). This window includes the following items.

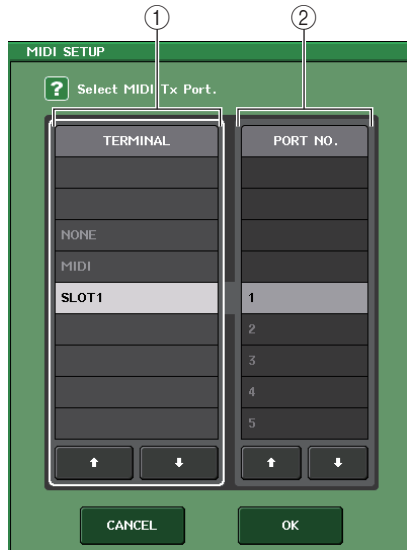

① **TERMINAL field**

Enables you to select the port that will transmit or receive MIDI messages.

You can choose from the following items.

NONE	No port will be used.
MIDI	MIDI IN (Rx) and OUT (Tx) connectors on the rear panel
SLOT1	A card that supports serial transmission and is installed in Slot 1 on the rear panel

② **PORT NO. field**

If you select SLOT 1 in the TERMINAL field, choose port number 1–8 in this field. (The number of available ports will vary depending on the card that is installed.) The currently-available card is valid only for port 1.

5. Specify the type of port and the port number.

Use the \uparrow/\downarrow buttons to select an item. Press the OK button to confirm the selected port and close the MIDI SETUP popup window.

NOTE

Alternatively, you can select a port by pressing the desired port name in the field, or by pressing the field to highlight it and then rotating one of the multifunction knobs to select the port.

6. To specify the channel on which MIDI messages will be transmitted or received, press the channel select popup button.

The MIDI SETUP popup window for selecting the channel will appear. Operations in this window are the same for both transmission (Tx) and reception (Rx). This window includes the following items.

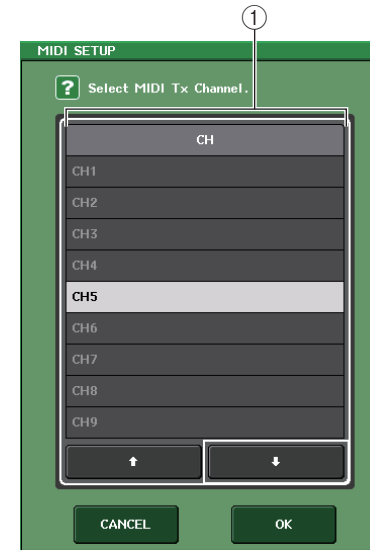

① **CH field**

Enables you to select CH1–CH16 as the channel that will transmit or receive MIDI messages.

7. Select the channel.

Use the \uparrow/\downarrow buttons to select an item. Press the OK button to confirm the selected channel and close the MIDI SETUP popup window.

NOTE

- Alternatively, you can select the channel by pressing the desired channel in the field or by rotating one of the multifunction knobs.
- When transmitting or receiving Parameter Changes, the channel number you specify here is used as the device number (a number that identifies the transmitting or receiving unit).

8. Turn transmission/reception on or off for each MIDI message.

NOTE

- For details on using Program Change messages, refer to “Using Program Changes to recall scenes and library items,” below.
- For details on using Control Change messages, refer to “Using Control Changes to control parameters” on page 155.

Using Program Changes to recall scenes and library items

The CL series console lets you assign a specific event (scene recall or effect library recall) to each Program Change number, so that when this event is executed on the CL console, a Program Change message of the corresponding number will be transmitted to an external device. Conversely, the corresponding event can be executed when a Program Change message is received from an external device.

1. Connect the CL series console to an external device.

The following illustration shows an example of using the MIDI IN/OUT connectors to transmit and receive MIDI messages.

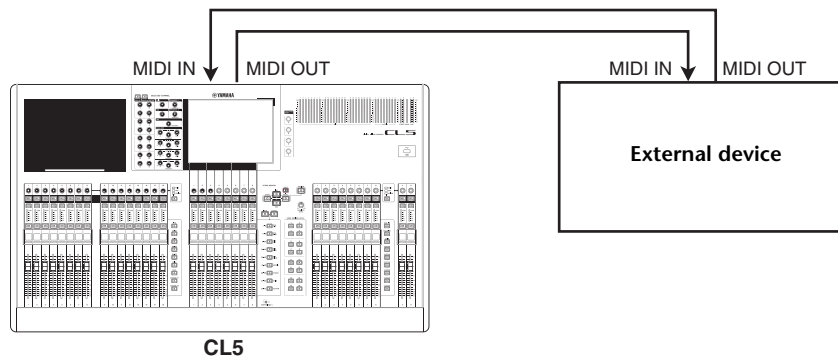

2. In the Function Access Area, press the SETUP button to access the SETUP screen.

3. In the center of the screen, press the MIDI/GPI button to access the MIDI/GPI popup window.

4. Press the MIDI SETUP tab to access the MIDI SETUP page, then select the port and MIDI channel on which Program Changes will be transmitted and received, as described in “Basic MIDI settings” on page 149.

5. Press the PROGRAM CHANGE tab to access the PROGRAM CHANGE page.

On the PROGRAM CHANGE page, you can specify how Program Changes will be transmitted and received, and choose the event (scene recall or effect library recall) that will be assigned to each program number.

This page includes the following items.



① PROGRAM CHANGE

Switches Program Change transmission and reception on or off. This setting is linked with the PROGRAM CHANGE section on the MIDI SETUP page.

- **Tx** Turn this button on to transmit corresponding Program Change messages when events on the list are executed.
- **Rx** Turn this button on to execute corresponding events when Program Change messages are received.
- **ECHO** Turn this button on to transmit Program Change messages that are received from an external device.

② PROGRAM CHANGE MODE field

Enables you to select the Program Change transmit/receive mode. This setting is linked with the PROGRAM CHANGE MODE section on the MIDI SETUP page.

③ List

Shows the event (scene recall or library recall) assigned to each MIDI channel and MIDI Program Change number. The list shows the following items.

- **CH/BANK** If “CH” appears as the column heading instead of “BANK,” the column indicates the MIDI channel (1–16) on which Program Changes are transmitted/received. If Program Change transmission and reception is in Single mode and the BANK button is on, this will be labeled “BANK,” and the numerical value in this column will correspond to the bank number.
- **NO** Indicates the program number 1–128.

- **PROGRAM CHANGE EVENT**

.....Indicates the type/number/title of the event assigned to each channel (bank number) or program number. Press an individual event display area to access the MIDI PROGRAM CHANGE popup window, in which you can select the event that you want to assign.

④ **Scroll knob**

Press this knob to scroll the list using the multifunction knob.

⑤ **CLEAR ALL button**

Press this button to erase all events from the list.

⑥ **INITIALIZE ALL button**

Press this button to restore all event assignments on the list to their default state.

6. Use the buttons in the PROGRAM CHANGE MODE field to select the Program Change transmission/reception mode.

You can select one of the following two Program Change transmission/reception modes.

- **Multi mode (when the MULTI button is on):**

Program changes of all MIDI channels will be transmitted and received. (The transmit/receive channel specified in the MIDI SETUP page will be ignored.)

When a Program Change is received, the event assigned to the corresponding MIDI channel and program number in the list will be executed.

When you execute the specified event on the CL series console, the Program Change of the corresponding MIDI channel and program number in the list will be transmitted.

- **Single mode (when the SINGLE button is on):**

Only Program Changes of the transmit (Tx) and receive (Rx) channels specified in the MIDI SETUP page will be transmitted and received.

When a Program Change on the Rx channel is received, the event assigned to that program number of the corresponding channel in the list will be executed.

When you execute the specified event on the CL series console, the Program Change of the corresponding program number will be transmitted on the Tx channel shown in the list. (If an event is assigned to more than one program number on the same channel, the lowest-numbered program number will be transmitted.)

If you turn on the OMNI button/BANK button in Single mode, operation will change as follows.

- **When the OMNI button is on:**

Program changes of all MIDI channels will be received. However, regardless of the MIDI channel that is received, the event assigned to the corresponding program number of the Rx channel will be executed. Turning on the OMNI button will not change the operation for Program Change transmission.

- **When the BANK button is on:**

The CH indication in the list will change to BANK (bank number), and Bank Select (Control Change #0, #32) and Program Change messages can be transmitted and received. This can be convenient if you want to control more than 128 events on a single MIDI channel.

When Bank Select and then Program Change messages (in that order) are received on the Rx channel, the event assigned to that bank number and program number in the list will be executed.

When you execute a specific event on the CL series console, Bank Select and Program Change messages for the bank number and program number assigned to that event will be transmitted on the Tx channel. (If the same event is assigned more than once in the list, the lowest-numbered bank number and program number will be transmitted.)

NOTE

- The settings of the OMNI and BANK buttons are ignored in Multi mode.
- If the BANK button is on and only a Program Change on an applicable MIDI channel is received, the last-selected bank number will be used.
- If the BANK button is on, the OMNI button can also be turned on at the same time. In this case, Bank Select and Program Change messages of all MIDI channels will be received.

7. Use the buttons in the PROGRAM CHANGE field to turn transmission and reception on or off, and make settings for echo output.

This field includes the following items.

- **Tx button** Switches Program Change transmission on or off.
- **Rx button** Switches Program Change reception on or off.
- **ECHO button** Selects whether incoming Program Changes are echoed-out from the MIDI transmission port.

8. To change the event assignment for each program number, press the desired event in the list.

The MIDI PROGRAM CHANGE popup window will appear. In this window, you can specify the event assigned to each program number. This popup window includes the following items.

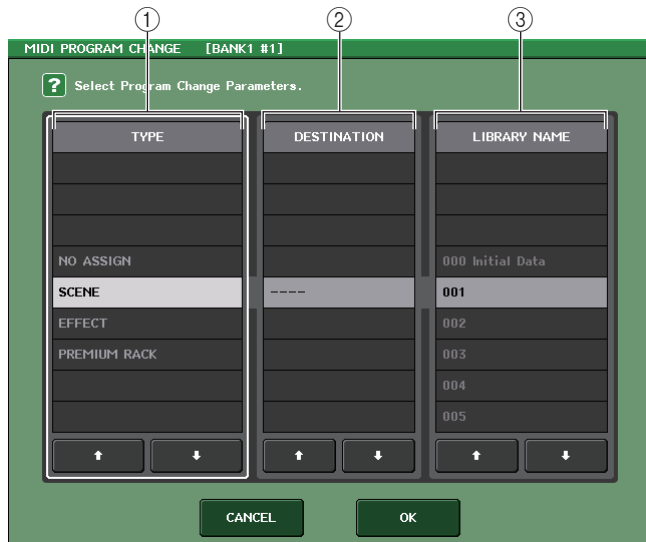

① TYPE field

Enables you to select the type of event.

The following table lists the events you can select.

NO ASSIGN	No assignment
SCENE	Scene memory recall operations
EFFECT	Effect library recall operations
PREMIUM RACK	Premium Rack library recall operations

② DESTINATION field

Enables you to select the rack for which you want to recall a library item. If EFFECT or PREMIUM RACK is selected in the TYPE field, the rack number will be shown. If SCENE is selected, this will indicate “- -”, and no choice is available for this field.

③ LIBRARY NUMBER/LIBRARY NAME field

Enables you to select the scene or library item to recall.

If you selected SCENE or EFFECT in the TYPE field, the LIBRARY NUMBER and LIBRARY NAME field will appear. If you selected PREMIUM RACK in the TYPE field, the LIBRARY NUMBER field will appear.

9. Use the TYPE field to select the type of event to assign. If the type is other than SCENE, use the DESTINATION field to select the rack number into which you want to recall the item. Use the LIBRARY NUMBER/LIBRARY NAME field to select the scene or library number that will be recalled.

Use the \uparrow / \downarrow buttons to select an item. Press the OK button to confirm the change and close the MIDI PROGRAM CHANGE popup window.

NOTE

- You can also select the desired event, scene, or library in this field by pressing it.
- If you press an item in the field to highlight it, you will be able to rotate any of the multifunction knobs to select the event, scene, or library.

10. Assign events to other program numbers in the same way.

With these settings, executing the specified event on the CL series console will cause the corresponding Program Change (or Bank Select and Program Change) messages to be transmitted to an external device.

When an external device transmits Program Change (or Bank Select and Program Change) messages on the appropriate channel, the event assigned to that program number of the corresponding MIDI channel (or bank number) will be executed.

NOTE

- You can use the CLEAR ALL button to erase all assignments to program numbers. The INITIALIZE ALL button will return all program number assignments to their default state.
- Assignments to program numbers are maintained as settings for the entire system, rather than for individual scenes.
- In Single mode, if the same event is assigned to more than one program number on a Tx channel, only the lowest program number will be transmitted. (If the BANK button is on, only the program number of the lowest bank number will be transmitted.)
- In Multi mode, if the same event is assigned to more than one MIDI channel and more than one program number, only the lowest program number on each MIDI channel will be transmitted.

Using Control Changes to control parameters

You can use MIDI Control Change messages to control specified events (fader/knob operations, [ON] key on/off operations etc.) on the CL series console. This capability can be used to record fader and key operations on a MIDI sequencer or other external device, and play back this data later.

You can use Control Changes to control events in either of the following two ways.

■ Using Control Changes

This method uses typical Control Changes (control numbers 1–31, 33–95, 102–119). You can freely assign an event to each control number.

■ Using NRPN (Non Registered Parameter Number)

This method uses a special type of Control Change messages called NRPN.

NRPN uses Control Change numbers 99 and 98 to specify the MSB (Most Significant Byte) and LSB (Least Significant Byte) of the parameter number, and subsequently-transmitted Control Change messages of Control Change number 6 (or 6 and 38) to specify the value of that parameter.

The event assigned to each combination of MSB and LSB is pre-defined, and cannot be changed.

NOTE

For details on the events assigned to NRPN messages, refer to the Appendices (see [page 250](#)).

1. Connect the CL series console to an external device.
2. In the Function Access Area, press the SETUP button to access the SETUP screen.
3. In the center of the screen, press the MIDI/GPI button to access the MIDI/GPI popup window.
4. Press the MIDI SETUP tab to access the MIDI SETUP page, then select the port and MIDI channel on which Control Changes will be transmitted and received, as described in “Basic MIDI settings” on [page 149](#).
5. Press the CONTROL CHANGE tab to access the CONTROL CHANGE page.

On the CONTROL CHANGE page, you can specify how Control Changes will be transmitted and received, and specify the event (fader/knob operation, [ON] key on/off operation, etc.) assigned to each control number. This page includes the following items.



- 1 **CONTROL CHANGE field**
Enables you to switch Control Change transmission/reception on or off, and specify whether Control Changes will be echoed out. This setting is linked with the CONTROL CHANGE field on the MIDI SETUP page.
- 2 **CONTROL CHANGE MODE field**
Enables you to select the Control Change transmission/reception mode. This setting is linked with the CONTROL CHANGE MODE field on the MIDI SETUP page.
- 3 **List**
Shows the event (fader/knob pattern, [ON] key on/off operation, etc.) assigned to each control number.
 - **NO.** Indicates the Control number. You can use Control numbers 1–31, 33–95, and 102–119.
 - **CONTROL CHANGE EVENT**
..... Indicates and enables you to select the type of event assigned to each control number. When you press an event, the MIDI CONTROL CHANGE popup window will appear, allowing you to change the control number assignment.
- 4 **CLEAR ALL button**
Press this button to clear all event assignments on the list.
- 5 **INITIALIZE ALL button**
Press this button to restore all event assignments on the list to their default state.
- 6 **Scroll knob**
Scrolls the contents of the list. You can use a multifunction knob to operate this.

6. Use the buttons in the CONTROL CHANGE MODE field to select the Control Change transmission/reception mode.

You can choose one of the following two modes for Control Change transmission/reception.

• NRPN mode (when the NRPN button is on):

Various mix parameters on the CL series console will be transmitted and received on a single MIDI channel as NRPN messages. If you select this mode, the assignments on the list will be ignored.

• TABLE mode (when the TABLE button is on):

Various mix parameters on the CL series console will be transmitted and received on a single MIDI channel as Control Change messages.

NOTE

The channel on which Control Changes are transmitted and received is specified by the PORT/CH field on the MIDI SETUP page (see [page 150](#)).

7. Use the buttons in the CONTROL CHANGE field to turn transmission and reception on or off, and make settings for echo output.

Each button has the following function.

- **Tx button**.....Switches Control Change transmission on or off.
- **Rx button**.....Switches Control Change reception on or off.
- **ECHO button**Selects whether incoming Control Changes will be echoed out from the MIDI transmit port.

8. To change the event assignment for each control number, press the corresponding event.

The MIDI CONTROL CHANGE popup window will appear. In this window you can specify the event assigned to each control number. The window contains the following items.

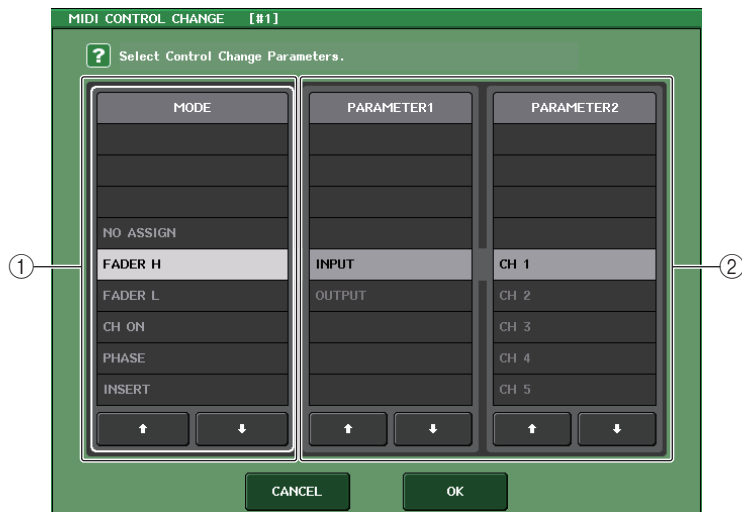

① MODE field

Enables you to select the type of event.

② PARAMETER 1/2 field

In conjunction with the MODE field, this field specifies the type of event.

NOTE

- The list shown is the same for all models of the CL series.
For the CL3/CL1, the display will indicate “Cannot Assign!” if you specify a parameter that does not exist on that model.
- If NRPN mode is selected as the Control Change transmission/reception mode, the settings in this window are ignored.
- For details on the events that can be assigned to Control Changes, refer to the Appendices (see [page 248](#)).

9. In the order of the MODE field → PARAMETER1 field → PARAMETER2 field, specify the type of event you want to assign.

Use the **↑/↓** buttons to select an item. Press the OK button to confirm the change and close the MIDI CONTROL CHANGE popup window.

NOTE

- You can also press the desired event in the field to select it.
- If you press an item in the field to highlight it, you will be able to rotate one of the multifunction knobs to select an event.

10. Assign events to other control numbers in the same way.

When you operate the parameters you assigned on the CL series console, Control Change messages will be transmitted to external devices. Similarly, if the corresponding Control Change messages are received from an external device on the appropriate channel, the parameters assigned to those control numbers will change.

NOTE

- You can use the CLEAR ALL button to erase all assignments to control numbers. The INITIALIZE ALL button will return all control number assignments to their default state.
- Assignments to control numbers are maintained as settings for the entire system, rather than for individual scenes.

Using Parameter Changes to control parameters

On the CL series console, you can use a type of system exclusive messages called “Parameter Changes” to control specific events (fader/knob operations, [ON] key on/off operations, system and user settings, etc.) as an alternative to using Control Changes or NRPN messages.

For details on the Parameter Changes that can be transmitted and received, refer to “MIDI data format” in the Appendices.

- 1.** Connect the CL series console to an external device.
- 2.** In the Function Access Area, press the SETUP button to access the SETUP screen.
- 3.** In the center of the screen, press the MIDI/GPI button to access the MIDI/GPI popup window.
- 4.** Press the MIDI SETUP tab to access the MIDI SETUP page, and select the port and MIDI channel on which Parameter Changes will be transmitted and received, as described in “[Basic MIDI settings](#)” on [page 149](#).

NOTE

- Parameter changes include a “device number” that specifies the transmitting or receiving device. The transmit (Tx) channel and receive (Rx) channel specified on the MIDI SETUP page are used as the device number.
- Please be aware that if the device number included in the transmitted Parameter Change does not match the device number of the receiving CL console, the message will be ignored.
- Do not turn Parameter Change and Control Change transmission/reception on at the same time. Otherwise, a large amount of data will flood the MIDI port and may cause overflows or other problems.

- 5.** Use the Tx button and Rx button in the PARAMETER CHANGE field to turn on Parameter Change transmission/reception.

In this state when you operate specific parameters on the CL console, the corresponding Parameter Change messages will be transmitted. If valid Parameter Change messages are received from an external device, the parameters assigned to those Parameter Changes will be controlled.

User settings (Security)

This chapter explains the following settings and operations: the User Level settings that restrict access to the parameters by certain users, the Console Lock function that temporarily denies access to the console, the Preference settings that customize the operating environment, and Save/Load operations using a USB flash drive.

User Level settings

User Level settings allow you to restrict the parameters that can be operated by each user, or to change the settings of USER DEFINED keys and preference settings for each user. Settings for each user can be stored as a “user authentication key” inside the console or together on a USB flash drive, allowing users to be switched easily. This can be convenient in the following situations.

- Unintended or mistaken operation can be prevented.
- The range of functionality operable by an outside engineer (guest engineer) can be limited.
- In situations in which multiple operators alternate with each other, output settings etc. can be locked to prevent unintended operations.
- Preferences of each operator can easily be switched.

User types and user authentication keys

There are three types of user, as follows. To operate the CL series console, you must log-in as a user.

- **Administrator** The administrator of the CL console can use all of its functionality. Only one set of Administrator settings is internally maintained in the console. The Administrator can create user authentication keys for other users. Even if the console was locked by another user, the administrator can use the administrator password to unlock it.
- **Guest** A Guest can use only the range of functionality permitted by the Administrator. Only one set of Guest settings is maintained inside the console.
- **User**..... A User can use only the range of functionality permitted by the Administrator. User settings are saved internally or on a USB flash drive as user authentication keys. Multiple sets of user settings (up to ten in internal memory) can be saved, each with the desired user name. A User who has Power User privileges can create or edit user authentication keys with a specified user level.

When a user logs in, the user settings for that user are applied. User settings include the following information.

- Password (except for Guest)
- User Level settings (except for Administrator)
- Preferences
- USER DEFINED keys
- Assignable encoders
- Custom fader bank
- MASTER fader

Privileges for each user are as follows.

Logged-in user	Editing user setup data, such as USER DEFINED keys and Preferences	Editing User Level settings	Password setting	Editing comments	User authentication key	
					Create new	Overwrite-save
Administrator	Available (Can edit the settings for Administrator and for Guest.)	Available (Cannot edit the user level, since the administrator can always perform all operations. Can edit the settings for Guest.)	Available	—	Available	—
User	Power user	Available	Available	Available	Available	Available
	Normal user (User without Power User privileges)	Available	N/A (Viewing only)	Available	Available	—
Guest	Available	N/A (Viewing only)	—	Available	—	—

Setting the Administrator password

With the factory settings, the Administrator password is not set, meaning that anyone can log in with Administrator privileges and perform all operations. If you want to restrict the operations of other users, you must specify an Administrator password.

1. In the Function Access Area, press the **SETUP** button to access the **SETUP** screen.



2. Press the PASSWORD CHANGE button.

A keyboard window will appear, allowing you to enter a password.



3. Enter the password in the NEW PASSWORD field, then enter the same password in the RE-ENTER PASSWORD field for verification, and finally press the OK button.

The password can be up to eight characters. If the two passwords that were entered match, the Administrator password will be set.

For details on entering a password, refer to “Entering names” in the separate Owner’s Manual.

Creating a user authentication key

You can create a user authentication key and save it on a USB flash drive or in the console’s internal memory. A user authentication key can be created only by an Administrator or Power User. The user level is specified when the authentication key is created, but USER SETUP settings other than the user level (such as preferences and the USER DEFINED keys) will be carried over from the user who is currently logged-in.

1. To create a user authentication key on a USB flash drive, connect a USB flash drive to the USB connector.

If you want to save the user authentication key in internal memory, simply proceed to step 2.

2. In the Function Access Area, press the SETUP button to access the SETUP screen.



3. Press the CREATE USER KEY button.

The CREATE USER KEY popup window will appear.

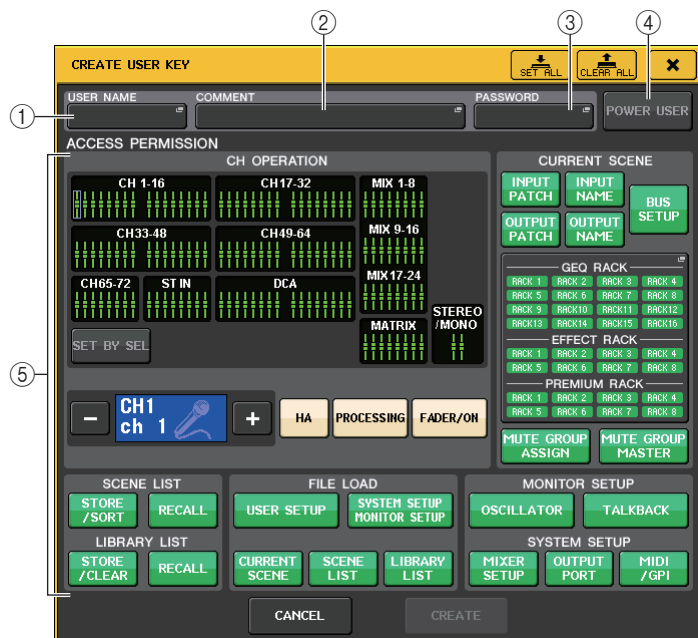

① USER NAME

Indicates the user name of up to eight characters. Press this area to access a keyboard window, in which you can enter the user name.

② COMMENT

Enables you to specify and view a comment of up to 32 characters about the user. Press this area to access a keyboard window, in which you can enter the comment.

③ PASSWORD

Enables you to specify a password of up to eight characters. Press this area to access a keyboard window, in which you can enter the password.

④ POWER USER

Specifies whether Power User privileges will be granted to this user.

⑤ ACCESS PERMISSION

These settings specify the range of operations that the user can perform. For details on each item, refer to [page 166](#).

NOTE

In the case of the CL3/CL1, faders that do not exist on those models will not be shown.

4. When you have specified the user name, comment, password, power user privileges on/off, and user rights, press the CREATE button.

The CREATE KEY popup window will appear.

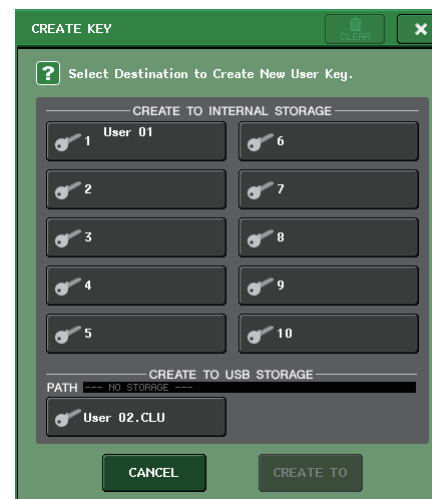

5. If you want to create a user authentication key in the console's internal memory, press a button in the CREATE TO INTERNAL STORAGE field.

You can store ten keys in the console's internal memory.

6. If you want to create a user authentication key on your USB flash drive, press the button in the CREATE TO USB STORAGE field.

NOTE

The file name of the user authentication key will be the current user name, and it will be created and saved in the root directory.

7. Press the CREATE TO button.

The user authentication key will be created in the location specified in step 5 or step 6.

Logging-in

To operate the CL series console, you must log in as the Administrator, Guest, or a User.

User settings for the Administrator and Guest are saved in the console itself. However, to log in as a User you must either select a key that is saved in the console itself, or connect the USB flash drive in which a user authentication key has been saved. If you use a user authentication key on a USB flash drive, you will continue as the logged-in user even if you remove the USB flash drive after logging-in.

NOTE

If the power is turned off and then on again, the console will generally start up in the log-in state in which the power was turned off. If a user password has been assigned, you will need to enter the password. However if you cancel the input, you will be forcibly logged-in as Guest.

■ Logging-in as Administrator

1. In the Function Access Area, press the **SETUP** button to access the **SETUP** screen.



2. Press the log-in button to open the LOGIN popup window.



3. Press the **ADMINISTRATOR** button, and then press the **LOGIN** button.

If no Administrator password has been set, you will simply be logged-in. If a password has been set, a keyboard window will appear, allowing you to enter the password.



4. Enter the password and press the **OK** button.

If the password was incorrect, a message of "Wrong Password!" will appear near the bottom of the screen.

■ Logging-in as Guest

1. In the Function Access Area, press the SETUP button to access the SETUP screen.
2. Press the log-in button to open the LOGIN window.



3. Press the GUEST button, and then press the LOGIN button.

■ Logging-in as a User

To log-in as a User, you will use a user authentication key saved in the console or on a USB flash drive. If using a USB flash drive, you may also log-in using a user authentication key created on a different CL series console.

With a user authentication key stored in the console

1. In the Function Access Area, press the SETUP button to access the SETUP screen.
2. Press the log-in button to open the LOGIN window.



3. In the LOAD FROM INTERNAL STORAGE field, choose the user authentication key with which you want to log in, and press the LOAD button.

If no password has been set, you will simply be logged-in. If a password has been set, a keyboard window will appear, allowing you to enter the password.

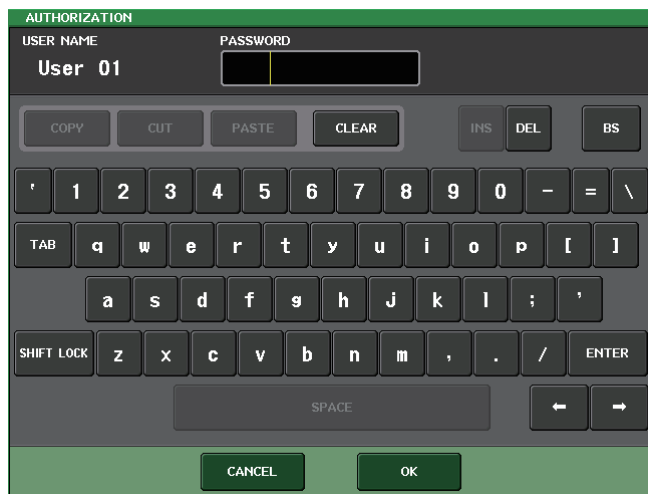

4. Enter the password and press the OK button.

If the password was incorrect, a message of “Wrong Password!” will appear near the bottom of the screen.

With a user authentication key stored in a USB flash drive

1. Connect the USB flash drive to the USB connector.
2. In the Function Access Area, press the SETUP button to access the SETUP screen.

3. Press the log-in button to open the LOGIN window.

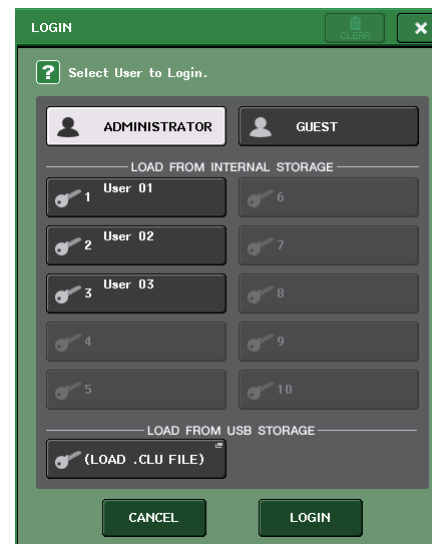

4. In the LOAD FROM USB STORAGE field, click the (LOAD .CLU FILE) popup button.

The SAVE/LOAD popup window will appear, and the files and directories saved on the USB flash drive will be displayed. The user authentication key file has a “.CLU” file name extension.



5. Rotate the multifunction knob to select the user authentication key for the user as whom you want to log in.

For details about loading files from the USB flash drive, refer to “[Loading a file from the USB flash drive](#)” on [page 178](#).

6. Press the LOAD button.

If no password has been set, you will simply be logged-in. If a password has been set, a keyboard window will appear, allowing you to enter the password.

NOTE

- If you have selected a user authentication key that was created on a different CL series console, a keyboard window will appear, allowing you to enter the Administrator password of the CL series console that you will be using. (If the Administrator passwords are identical, this window will not appear.) When you enter the correct Administrator password, another keyboard window will appear, allowing you to enter the password for the selected user.
- If you re-save the user authentication key, you will not be asked for the Administrator password the next time.
For details on re-saving the user authentication key, refer to “[Editing a user authentication key](#)” on [page 165](#).



7. Enter the password and press the OK button.

If the password was incorrect, a message of “Wrong Password!” will appear near the bottom of the screen.

Changing the password

Follow the steps below to change the password of the logged-in user. A change in the Administrator password is updated immediately. A change in a User password is also updated immediately, but will be discarded if the user simply logs out after changing it. The change must be saved by overwriting the old authentication key before the user logs-out. The Guest account does not have a password.

- 1. In the Function Access Area, press the SETUP button to access the SETUP screen.**
- 2. Press the PASSWORD CHANGE button.**

A keyboard window will appear, allowing you to enter a password.



3. Enter the current password and press the OK button.

When you enter the correct password, a keyboard window will appear, allowing you to enter the new password.

4. Enter the new password in the NEW PASSWORD field, then enter the same password in the RE-ENTER PASSWORD field for verification, and finally press the OK button.

If the two passwords that were entered match, the new password will be set.

Editing a user authentication key

If you are logged-in as a user, you can edit your preference settings, USER DEFINED keys, USER DEFINED knobs, assignable encoders, custom fader banks, master fader, comments, and password, and save (overwrite) them onto your user authentication key. If you are logged-in as a Power User, you can also change the user level.

1. Log-in as a user, and edit the Preference settings (page 168), USER DEFINED keys (page 169), USER DEFINED knobs (page 171), assignable encoders (page 172), custom fader bank (page 173), and master fader (page 174) settings.

If you are logged-in as a Power User, you can also change the user level.

2. In the Function Access Area, press the SETUP button to access the SETUP screen.



3. Press the SAVE KEY button.

The SAVE KEY popup window will appear.



4. Press the save-destination button, and then press the SAVE TO button.
5. A dialog box will ask you to confirm that you want to overwrite that user authentication key; press OK button.

Changing the user level

You can view or change the user level.

- **Administrator** The Administrator does not have a user level setting, but can change the user level setting of the Guest account.
- **Guest** The Guest can view the user level setting of the Guest account, but cannot change it.
- **Normal user** A normal user can view the user level setting of his or her User account, but cannot change it.
- **Power User** A power user can view and change his or her User account.

1. In the Function Access Area, press the SETUP button to access the SETUP screen.



2. Press the USER SETUP button to access the USER SETUP popup window.

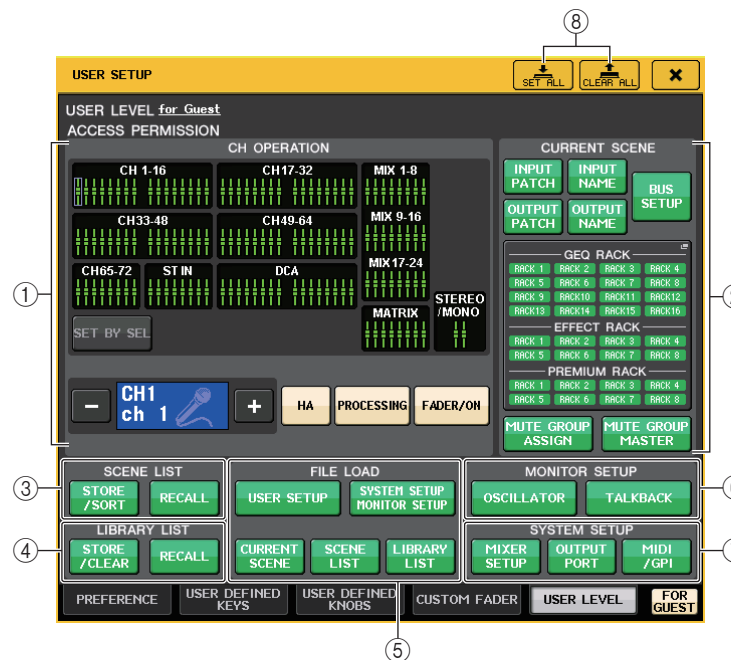

3. Press the USER LEVEL tab to access the USER LEVEL page.

If you are logged-in as the Administrator, you can switch to the USER LEVEL for GUEST page, and view or change the user level of the Guest account.

This page includes the following items.

1 CH OPERATION

Here you can specify (for each channel) the operations that will be permitted for input channels, output channels, and DCA groups. The settings will apply to the currently selected channel. Settings for currently-selected channels will be displayed below the CH OPERATION section. Use the panel [SEL] keys or the Selected Channel field in the Function Access Area to select the channel for which you want to make settings.

The type of buttons shown will depend on the selected channel or group.

INPUT channel..... [HA], [PROCESSING], [FADER/ON]

MIX/MATRIX channel..... [WITH SEND], [PROCESSING], [FADER/ON]

STEREO/MONO channel..... [PROCESSING], [FADER/ON]

DCA group [DCA MASTER], [DCA GROUP ASSIGN]

- **HA**..... Restricts operation of the HA (Head Amp) patched to that channel.
- **PROCESSING** Restricts operation of all signal processing parameters for that channel (excluding the fader, channel on/off, and send level).
- **FADER/ON** Restricts operation of that channel's fader, channel on/off, and send level.
- **WITH SEND** Restricts operation of that channel's send parameters. (From MIX, From MATRIX)
- **DCA MASTER** Restricts operation of that channel's DCA group fader, ON/OFF, and ICON/COLOR/NAME.
- **DCA GROUP ASSIGN** Restricts changes of assignment to that DCA group.
- **SET BY SEL**..... If this button is on, you can press the panel [SEL] key of a channel to enable or disable the operating restrictions for that channel.

② CURRENT SCENE

Specifies the operations that can be performed on the current scene memory.

- **INPUT PATCH/INPUT NAME**..... Restricts operations for input channel patching and names.
- **OUTPUT PATCH/OUTPUT NAME**..... Restricts operations for output channel patching and names.
- **BUS SETUP**..... Restricts operations for bus setup.
- **GEQ RACK/EFFECT RACK/PREMIUM RACK**
..... Restricts operations for the racks. Press this area to open the RACK USER LEVEL popup window, in which you can set this restriction. However, there will be no restriction on operating the MIDI CLK button displayed for delay-type and modulation-type effects, or the PLAY/REC button displayed for the FREEZE effect.
- **MUTE GROUP ASSIGN/MUTE GROUP MASTER**
..... Restricts operations for mute group assignment and mute group master.

NOTE

In the case of the CL3/CL1, faders that do not exist on those models will not be shown.

③ SCENE LIST

Specifies the operations that can be performed on scene memories.

- **STORE/SORT operations**
- **RECALL operations**

④ LIBRARY LIST

Specifies the operations that can be performed on libraries.

- **STORE/CLEAR operations**
- **RECALL operations**

⑤ FILE LOAD

Specifies the settings that will be applied when a file is loaded from a USB flash drive. The user authentication key contains settings such as the user level, preferences, and the USER DEFINED key settings (USER SETUP settings). Other data is saved in an "ALL" file. The "ALL" file also includes the USER SETUP settings of the Administrator and the Guest.

- **USER SETUP (Preference and USER DEFINED keys settings)**
- **SYSTEM SETUP/MONITOR SETUP**
- **CURRENT SCENE**
- **SCENE LIST**
- **LIBRARY LIST**

⑥ MONITOR SETUP

Specifies the monitor setup operations that can be performed.

- **OSCILLATOR**
- **TALKBACK**

⑦ SYSTEM SETUP

Specifies the system setup operations that can be performed.

- **MIXER SETUP**
- **OUTPUT PORT**
- **MIDI/GPI**

⑧ SET ALL/CLEAR ALL button

Permits/clears all items.

4. Specify the user level by pressing the button for each item that will be permitted.
5. When you have finished making settings, close the popup window and press the **SETUP** button in the Function Access Area.

Preferences

Follow the steps below to make various settings for the CL console operating environment, such as how popup windows appear, and whether [SEL] key operations will be linked. These settings are changed for the user who is logged-in, but if you are logged-in as the Administrator, you will also be able to change the Guest settings.

1. In the Function Access Area, press the **SETUP** button to access the **SETUP** screen.
2. Press the **SETUP** button to open the **USER SETUP** popup window.

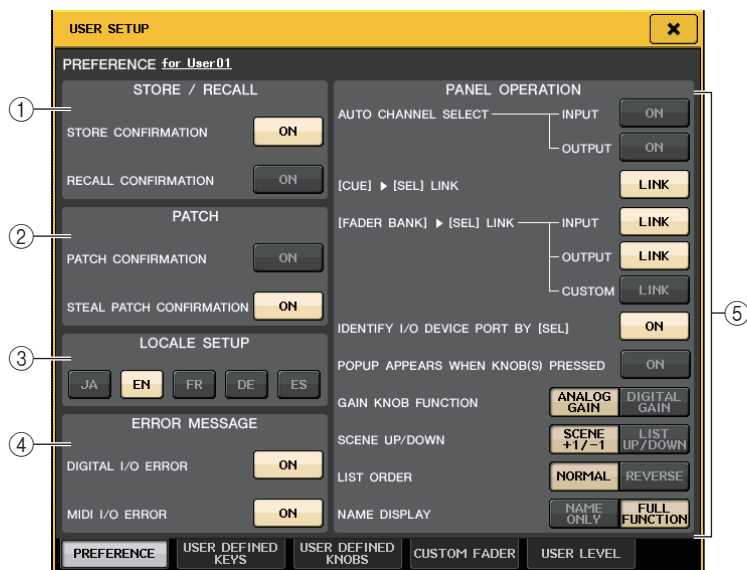

3. Press the **PREFERENCE** tab to access the **PREFERENCE** page.

If you are logged-in as the Administrator, you can also turn on the **FOR GUEST** button in the lower right of the screen to access the **PREFERENCE** for Guest page and make preference settings for the Guest account.

This page includes the following items.

① STORE/RECALL field

Enables you to turn on or off options related to scene store/recall operations.

- **STORE CONFIRMATION**
- **RECALL CONFIRMATION**

If these ON buttons are lit, a confirmation message will appear when you perform a Store or Recall operation respectively.

② PATCH field

Enables you to turn on or off options related to patch operations.

- **PATCH CONFIRMATION**

If this ON button is lit, a confirmation message will appear when you edit an input patch or output patch.

- **STEAL PATCH CONFIRMATION**

If this ON button is lit, a confirmation message will appear when you edit an input or output patch item that is already patched to a port.

③ LOCALE SETUP field

In the **SAVE/LOAD** screen or **RECORDER** screen, select **JA** if you want Japanese to be displayed. (This does not select the Help language.)

④ ERROR MESSAGE field

Specifies whether error messages will be displayed.

- **DIGITAL I/O ERROR**

If this ON button is lit, an error message will appear when a digital I/O error occurs.

- **MIDI I/O ERROR**

If this is on, an error message will appear when a MIDI transmit/receive error occurs.

⑤ PANEL OPERATION field

Enables you to make settings for options related to panel operation.

- **AUTO CHANNEL SELECT**

Specifies whether the corresponding channel will be selected when you operate the [ON] key or fader for the channel. You can set this parameter separately for **INPUT** (input channels) and **OUTPUT** (output channels).

- **[CUE] > [SEL] LINK**

Specifies whether channel selection will be linked with cue operations. If the **LINK** button is on, channels for which cue operations were performed will be selected.

- **[FADER BANK] > [SEL] LINK**

Specifies whether channel selection will be linked with fader bank selection. You can set this parameter separately for **INPUT** (input channels), **OUTPUT** (output channels), and **CUSTOM** (Custom fader bank).

If the **LINK** button is on, and you select the corresponding fader bank, the channel in that bank that was selected most recently will be selected, and its [SEL] key will light.

- **IDENTIFY I/O DEVICE PORT BY [SEL]**

Specifies whether to enable a function that allows you to identify the I/O device port connected to a channel by pressing the [SEL] key for that channel.

If this ON button is lit, pressing a [SEL] key on the panel will cause the signal indicator to flash for the port of the I/O device that is assigned to the corresponding channel by the **INPUT PATCH/OUTPUT PATCH** settings.

- **POPUP APPEARS WHEN KNOB(S) PRESSED**

Specifies whether pressing a knob in the SELECTED CHANNEL section while the SELECTED CHANNEL VIEW screen is displayed will cause a popup window (1ch) to appear. If the ON button is lit, a popup window (1ch) will open (or close) whenever you press a knob.

- **NOTE**

If you press the SEND or PAN knob, a popup window (8ch) will open.

- **GAIN KNOB FUNCTION**

Specifies what will happen when you operate the GAIN knob in the SELECTED CHANNEL section on the panel. When the ANALOG GAIN button is lit, you can adjust analog gain on the head amp. When the DIGITAL GAIN button is lit, you can adjust digital gain on the console.

- **SCENE UP/DOWN**

Specifies what the SCENE MEMORY [INC]/[DEC] keys will do when pressed in the SCENE popup windows.

When the SCENE +1/-1 button is lit, pressing the [INC] or [DEC] key will increment or decrement the scene number.

When the LIST UP/DOWN button is lit, pressing the [INC] or [DEC] key will scroll the list upward or downward.

- **LIST ORDER**

Specifies the order in which scene memories and library items will appear on the list.

When the NORMAL button is lit, the list appears in ascending numerical order. When the REVERSE button is lit, the list appears in descending numerical order.

- **NAME DISPLAY**

Specifies the content of the channel name display on the top panel.

When the NAME ONLY button is lit, only the channel name appears. When the FULL FUNCTION button is lit, the channel name display also indicates knob assignment information and fader level.

4. Use the buttons on screen to make Preference settings.

5. When you have finished making settings, close the popup window and press the SETUP button in the Function Access Area.

USER DEFINED keys

This section explains how to assign the desired functions to the USER DEFINED keys in the USER DEFINED KEYS section on the top panel, and press these keys to execute the defined function.

This assignment procedure will define the USER DEFINED keys for the user who is currently logged-in, but if you are logged-in as the Administrator, you can also make USER DEFINED key settings for the Guest account.

1. In the Function Access Area, press the SETUP button to access the SETUP screen.

2. Press the USER SETUP button to access the USER SETUP popup window.

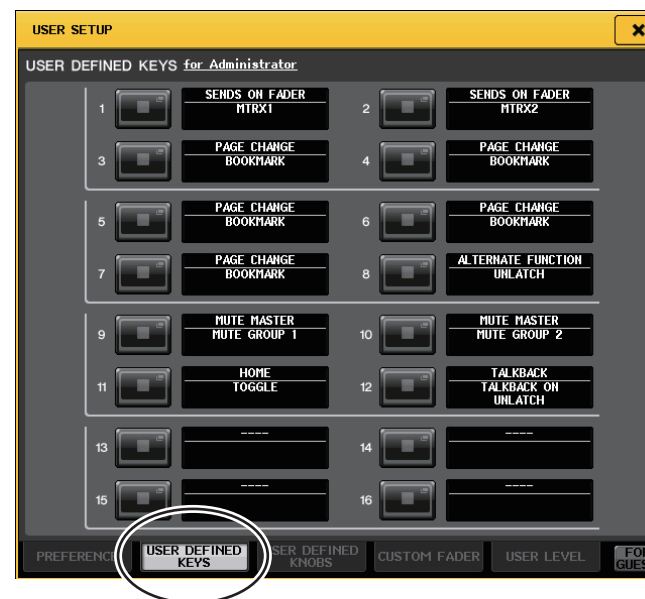

3. Press the USER DEFINED KEYS tab to select the USER DEFINED KEYS page.

If you are logged-in as the Administrator, you can also turn on the FOR GUEST button in the lower right of the screen to access the USER DEFINED KEYS for Guest page and make USER DEFINED key settings for the Guest account.

The sixteen buttons on screen corresponds to USER DEFINED keys [1]–[16] on the top panel. The name of function or parameter assigned to each key appears to the right of the corresponding on-screen button. If nothing is assigned to the key, an indication of “---” will appear next to the button.

4. Press the button corresponding to the USER DEFINED key to which you want to assign a function.

The USER DEFINED KEY SETUP window will appear. In this window, you can select a function to assign to the USER DEFINED key, and select the parameters.

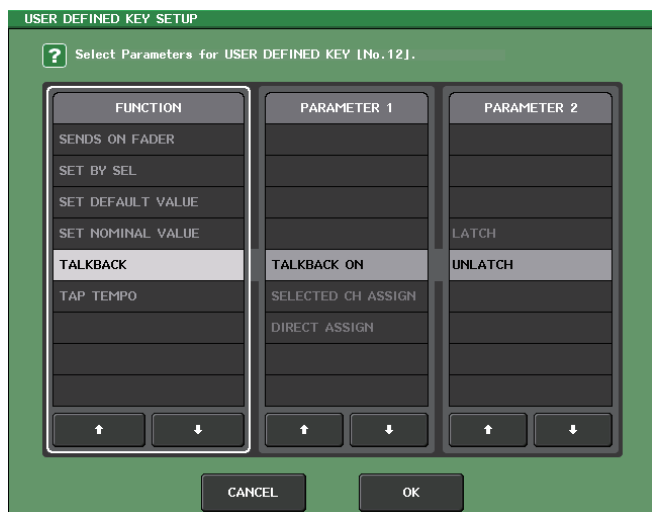

NOTE

The list shown is the same for all models of the CL series.
For the CL3/CL1, the display will indicate “Cannot Assign!” if you specify a parameter that does not exist on that model.

5. Make sure that the FUNCTION field is enclosed by a frame, then use the ↑/↓ buttons in the lower part of the field or the multifunction knobs on the top panel to select the function you want to assign.
For details on the assignable functions and their parameters, refer to “[Functions that can be assigned to USER DEFINED keys](#)” on [page 259](#).
6. If the selected function has parameters, press the PARAMETER 1 or 2 field to move the frame, and select parameters 1 and 2 in the same way.
7. Press the OK button to close the USER DEFINED KEY SETUP window.
8. Assign the desired functions to other USER DEFINED keys in the same way.
9. To execute an assigned function, press the corresponding USER DEFINED [1]–[16] key on the panel.

Using the Alternate function

If you assign the Alternate function (ALTERNATE FUNCTION) to a USER DEFINED key, you will be able to switch parameters on or off by operating the knobs in the SELECTED CHANNEL section while pressing and holding down the USER DEFINED key.

The console enters Alternate mode when you press and hold down the USER DEFINED key to which the Alternate function has been assigned (the key will light).

The Alternate function features two options: LATCH and UNLATCH.

If you select UNLATCH, Alternate mode is turned on only while you are pressing and holding down the USER DEFINED key. If you select LATCH, you will be able to turn Alternate mode on or off by the key presses. You do not need to hold down the key.

NOTE

- The console exits Alternate mode when you switch the display between the OVERVIEW screen and the SELECTED CHANNEL VIEW screen, or when you open a popup window.
- In Alternate mode, “ALT” will be displayed in the user name field of the Function Access Area.

In Alternate mode, the following knobs change their behavior.

- **[GAIN] knob**
Rotate the knob to adjust the digital gain value. If DIGITAL GAIN has been selected for HA KNOB FUNCTION on the PREFERENCE page in the USER SETUP popup window, rotate this knob to adjust the analog gain value of the head amp.
- **[MIX/MATRIX] knob**
Rotate this knob to switch between PRE and POST for the corresponding send signal.
Press this knob to switch the corresponding send signal on or off.
- **[HPF] knob**
Press this knob to switch the high pass filter on or off.
- **[DYNAMICS 1] knob**
Press this knob to switch DYNAMICS 1 on or off.
- **[DYNAMICS 2] knob**
Press this knob to switch DYNAMICS 2 on or off.

NOTE

In Alternate mode, all knobs in the SELECTED CHANNEL section other than those knobs mentioned above will be disabled.

USER DEFINED knobs

This section explains how to assign the desired functions to the USER DEFINED knobs in the USER DEFINED KNOBS section on the top panel, and press these knobs to execute the defined function.

This assignment procedure will define the USER DEFINED knobs for the user who is currently logged-in, but if you are logged-in as the Administrator, you can also make USER DEFINED knob settings for the Guest account.

1. In the Function Access Area, press the **SETUP** button to access the **SETUP** screen.
2. Press the **USER SETUP** button to access the **USER SETUP** popup window.

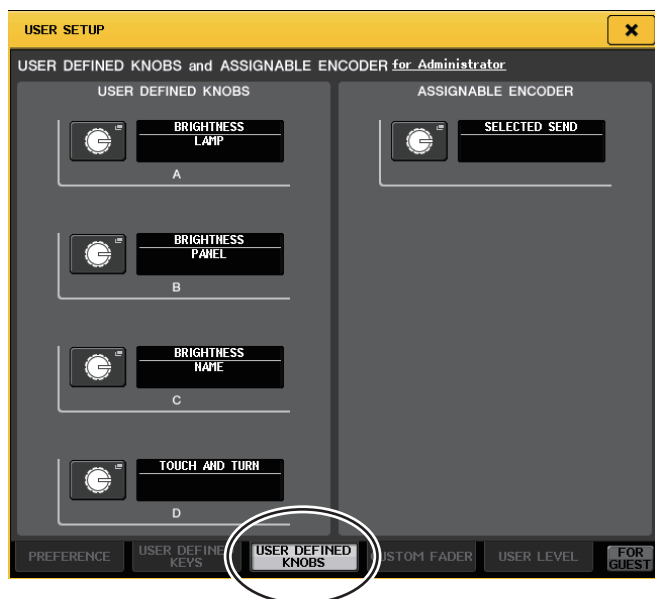

3. Press the **USER DEFINED KNOBS** tab to select the **USER DEFINED KNOBS** page.
If you are logged-in as the Administrator, you can also turn on the **FOR GUEST** button in the lower right of the screen to access the **USER DEFINED KNOBS** for Guest page and make **USER DEFINED** knob settings for the Guest account.
The four on-screen buttons correspond to **USER DEFINED** knobs [1]–[4] on the top panel. The name of function or parameter assigned to each key appears to the right of the corresponding on-screen button. If nothing is assigned to the knob, an indication of “---” will appear next to the button.
4. Press the button corresponding to the **USER DEFINED** knob to which you want to assign a function.
The **USER DEFINED KNOB SETUP** window will appear. In this window you can select a function to assign to the **USER DEFINED** knob, and select the parameters.

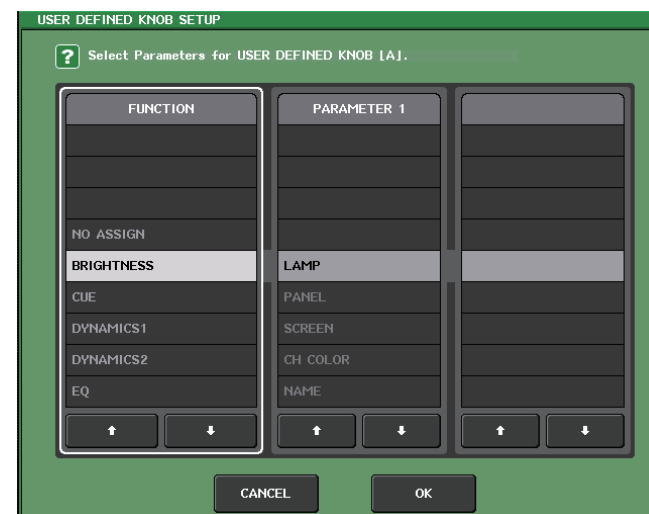

NOTE

The list shown is the same for all models of the CL series.
For the CL3/CL1, the display will indicate “Cannot Assign!” if you specify a parameter that does not exist on that model.

5. Make sure that the **FUNCTION** field is enclosed by a frame, then use the **↑/↓** buttons in the lower part of the field or the multifunction knobs on the top panel to select the function you want to assign.
For details on the assignable functions and their parameters, refer to “[Functions that can be assigned to USER DEFINED knobs](#)” on page 262.
6. If the selected function has parameters, press the **PARAMETER 1** or **2** field to move the frame, then select parameters 1 and 2 in the same way.
7. Press the **OK** button to close the **USER DEFINED KNOB SETUP** window.
8. Assign the desired functions to other **USER DEFINED** knobs in the same way.
9. To execute an assigned function, press the corresponding **USER DEFINED [1]–[4]** knob on the panel.

About TOUCH AND TURN

The **TOUCH AND TURN** function is assigned to the **USER DEFINED [4]** knob by default. If this function is assigned to one of the **USER DEFINED** knobs, you can press a desired knob on the touch screen and then use the **USER DEFINED** knob to immediately operate that on-screen knob.

At this time, a pink frame is shown around the knob in the touch screen, indicating that you can operate that knob.



Assignable encoders

You can assign the desired function to the GAIN/PAN/ASSIGN knob on the fader strip of each channel, and control the function using the knob.

1. In the Function Access Area, press the **SETUP** button to access the **SETUP** screen.
2. Press the **USER SETUP** button to access the **USER SETUP** popup window.

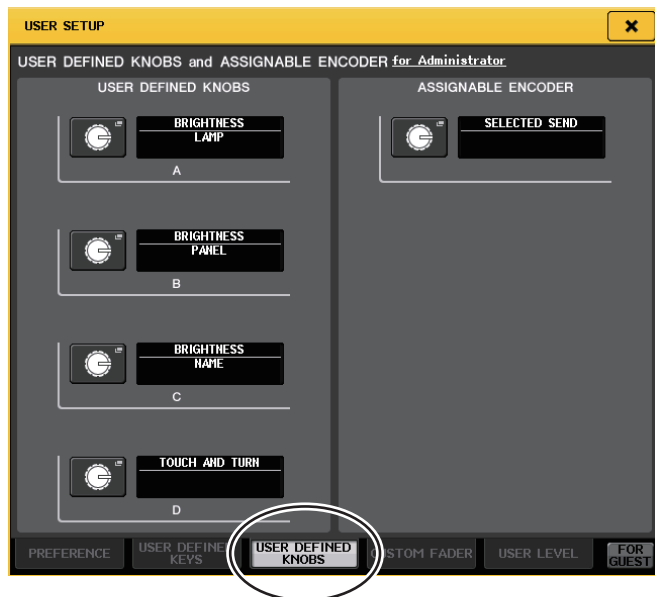

3. Press the **USER DEFINED KNOBS** tab to select the **USER DEFINED KNOBS** page.
If you are logged-in as the Administrator, you can also turn on the **FOR GUEST** button in the lower right of the screen to access the **USER DEFINED KNOBS** and **ASSIGNABLE ENCODER** for Guest setup, and make assignable knob settings for the Guest account.

4. Press the button in the **ASSIGNABLE ENCODER** field.
The **ASSIGNABLE ENCODER SETUP** popup window will appear.

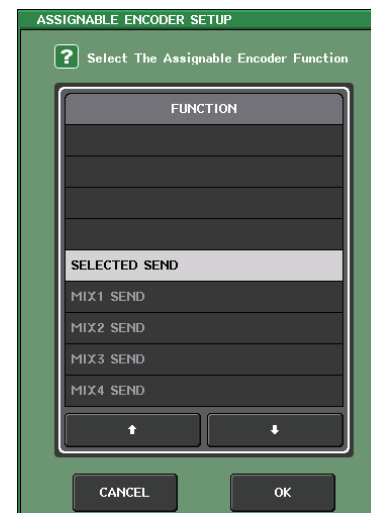

5. Use the **↑/↓** buttons in the lower part of the field or the multifunction knobs on the top panel to select the function you want to assign.
For details on the assignable functions and their parameters, refer to [“Functions that can be assigned to the assignable encoders”](#) on page 263.

NOTE

SELECTED SEND is the default setting. It functions as the send to the MIX/MATRIX channel that is selected for SENDS ON FADER in the Function Access Area.

6. Press the **OK** button to close the **ASSIGNABLE ENCODER SETUP** window.
7. Press the **[GAIN/PAN/ASSIGN]** key on the top panel repeatedly to select **ASSIGN**.

The CL3 and CL1 feature one **[GAIN/PAN/ASSIGN]** key. Therefore, the function of all **GAIN/PAN/ASSIGN** knobs will change simultaneously. On the CL5, you can switch the knob function in block A (left side) and block C/Master fader section (right side) independently by using the corresponding **[GAIN/PAN/ASSIGN]** keys.

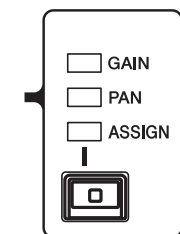

NOTE

This assignment does not apply to the multifunction knobs in the Centralogic section, since these knobs are used to control on-screen parameters.

8. Operate the **GAIN/PAN/ASSIGN** knob on each fader strip.

Custom fader bank

Groups that organize channels routed to the top-panel faders are called “fader banks.”

There are input and output channel banks, as well as custom fader banks. Custom fader banks enable you to select various combinations of channels, regardless of channel types. This section explains how to set up a custom fader bank.

1. In the Function Access Area, press the **SETUP** button to access the **SETUP** screen.

2. Press the **USER SETUP** button to access the **USER SETUP** popup window.



3. Press the **CUSTOM FADER** tab to access the **CUSTOM FADER BANK/MASTER FADER** page.

If you are logged-in as the Administrator, you can also turn on the **FOR GUEST** button in the lower right of the screen to access the **CUSTOM FADER BANK/MASTER FADER** for Guest page, and make custom fader bank settings for the Guest account.

This page includes the following items.

① CUSTOM FADER BANK field

• Bank select buttons

Enable you to select a custom fader bank to which you want to assign a group of channels.

The number and name of the custom fader banks vary depending on the console model.

CL5: A1, A2, B1, C1, C2, C3, C4, C5, C6

CL3: A1, A2, A3, B1, B2

CL1: A1, B1, B2, B3, B4

② MASTER FADER field

• MASTER button

Press this button to set channels that will be controlled by the faders in the Master fader section.

③ Block indicators

Display the graphics of the block and faders that are the current target for editing.

The graphics vary depending on the console model.

CL5: A (16 faders), B, C, MASTER

CL3: A (16 faders), B, MASTER

CL1: A (8 faders), B, MASTER

④ Fader select button

Selects the target fader. Press this button to select it, then press the [SEL] keys on the top panel to add the corresponding channels to the selected fader bank.

⑤ Channel select popup button

Opens the channel select popup window, in which you can change the channel specified for CHANNEL ASSIGN.

⑥ CLEAR ALL button

Clears the current fader bank assignment. Pressing this button will open a confirmation dialog box. Press OK to clear the assignment. Otherwise, press CANCEL to return to the previous screen without changing the setting.

4. Use the **Bank Select** keys to recall the fader settings to the top panel for the channels you want to add to the custom fader bank.

5. Press the bank select button for the custom fader bank you want to set up.



6. In the **CHANNEL ASSIGN** field, press the number button for the fader you want to set up.



7. On the top panel, press the [SEL] key of the channel that you want to assign to that fader number.



The name of the selected channel will appear on the channel select popup button.

8. To assign channels to other faders, repeat steps 4 through 7.
9. If necessary, select channels by pressing the channel select popup buttons.



Use the list in the left column to select the desired channel group, then use the buttons in the right column to select channels.

When you have finished selecting the channels, press the CLOSE button.

Master fader

You can set channels that will be controlled by the two faders in the Master fader section.

1. In the Function Access Area, press the SETUP button to access the SETUP screen.
2. Press the USER SETUP button to access the USER SETUP popup window.



3. Press the CUSTOM FADER tab to access the CUSTOM FADER BANK/MASTER FADER page.

If you are logged-in as the Administrator, you can also turn on the FOR GUEST button in the lower right of the screen to access the CUSTOM FADER BANK/MASTER FADER for Guest page, and make master fader settings for the Guest account.

4. Press the MASTER button.

The CHANNEL ASSIGN field shows the channel assignments of the master section.



5. Press the channel select popup button of the fader (A or B) that you want to edit, and choose the channel.



Use the list in the left column to select the desired channel group, then use the buttons in the right column to select channels. When you have finished selecting the channels, press the CLOSE button.

Console Lock

You can temporarily prohibit console operations in order to prevent unwanted operation. This setting completely disables operations of the panel and touch screen, so that controllers cannot be operated by an accidental touch or by an unauthorized third party while the operator is taking a break.

If a password is set for the currently logged-in user, that password will be used for the Console Lock function.

NOTE

- If you have forgotten the password, refer to “Initializing the unit to the factory default settings” in the separate Owner’s Manual.
- The Guest cannot set a password.
- Even while the console is locked, you can operate the console from an external device via MIDI or CL Editor as usual.

Locking the console

1. In the Function Access Area, press the SETUP button to access the SETUP screen.



2. Press the CONSOLE LOCK button.

If you are logged-in as a user for whom a password is set, a keyboard window will appear, allowing you to enter the password.



3. Enter the password for the logged-in user, and press the OK button.

The CONSOLE LOCK screen will appear, the Console Lock function will be enabled, and all controllers (excluding the MONITOR LEVEL knob) will become inoperable.

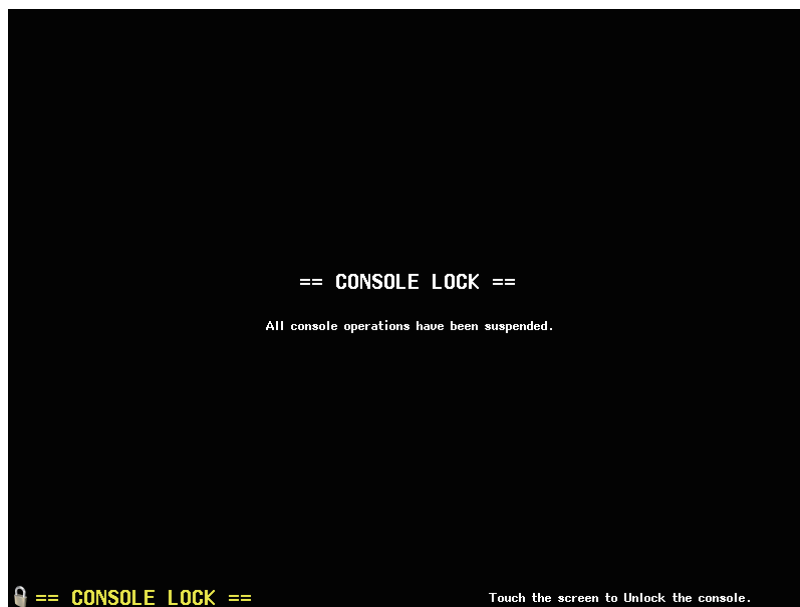

Unlocking the console

1. Press the CONSOLE LOCK screen.

If you are logged-in as a user for whom no password is set, the console will be unlocked.

If you are logged-in as a user for whom a password is set, a keyboard window will appear, allowing you to enter the password.

2. Enter the password for the logged-in user or for the Administrator, and press the OK button.

The console will be unlocked, you will return to the SETUP screen, and the controllers will be operable once again.

Specifying the CONSOLE LOCK screen image

If an image file has been saved on the USB flash drive, you can view that image on the CONSOLE LOCK screen.

In the SAVE/LOAD popup window, specify the image file that you want to display, and then load it from the USB flash drive. For details about loading files from the USB flash drive, refer to “[Loading a file from the USB flash drive](#)” on page 178.

NOTE

Supported image file format is BMP in 800 x 600 pixels and 16/24/32-bit, but they will be converted into 16-bit for display.

Saving and loading setup data to and from a USB flash drive

This section explains how to connect a commercially-available USB flash drive to the USB connector located to the right of the display, and save the internal settings and user authentication keys of the CL series console to the USB flash drive or load them from the USB flash drive.

NOTE

- Operation is guaranteed only for USB flash drives.
- The operation of USB flash drives with capacities of up to 32GB has been verified. (However, this does not necessarily guarantee the operation of all USB flash drives.) The FAT16 and FAT32 formats are supported. A USB flash drive with a capacity of 4GB or larger will be formatted in FAT32, and a USB flash drive with a capacity of 2GB or smaller will be formatted in FAT16.

NOTICE

An ACCESS indicator appears in the Function Access Area while data is being accessed (saved, loaded, or deleted). During this time, do not disconnect the USB plug or power-off the CL unit. Doing so may damage the data in the flash drive.

Saving the CL console's internal data on a USB flash drive

All of the CL series console's internal data can be saved on a USB flash drive as a setting file. The saved file will have an extension of ".CLF".

1. In the Function Access Area, press the **SETUP** button to access the **SETUP** screen.



2. Press the **SAVE/LOAD** button to access the **SAVE/LOAD** popup window.



3. If necessary, press the directory icon and change the directory.

To move to the next higher level, press the arrow button in the PATH field.

4. Press the **SAVE** button.

A keyboard window will appear, allowing you to enter a file name and comment.

5. Enter a file name or comment, and press the **SAVE** button.

When the file has been saved, the **PROCESSING** popup window that shows the progress of the writing operation will close.

NOTE

- If you are going to overwrite a file or save a file with the same name in the same folder, a dialog will ask you to confirm the overwrite.
- You can enter a comment of up to 32 characters.
- You may enter a file name of more than eight characters. However, the drive name, path name, and file name are limited to a total of 256 characters. If you exceed this limit, you will be unable to save the file. If an error message appears at the bottom of the screen, shorten the file name and try saving the file again.

Loading a file from the USB flash drive

Follow the steps below to load CL settings file (extension .CLF) from the USB flash drive into the CL series console.

You can use the same procedure to load the following files as well as setting files.

Extension	Type	Contents of file
.CLF	ALL	CL console internal setting file
.CLU	KEY	CL console user authentication key
.XML	XML	XML file for displaying Help
.TXT	TEXT	Text file for displaying Help
.BMP	BMP	Image file for display in the CONSOLE LOCK screen (256 or more colors, uncompressed bitmap format)

NOTICE

Some data may contain settings that will cause the console to output signals immediately after the data is loaded. Therefore, before loading data, turn off the power to the equipment connected to the CL series console and/or lower the volume of such equipment so that there will not be a problem even if a signal is output from the CL console.

1. In the Function Access Area, press the **SETUP** button to access the **SETUP** screen.
2. Press the **SAVE/LOAD** button to access the **SAVE/LOAD** popup window.



3. To select the file that you want to load, press the name of the desired file in the file list, or rotate the corresponding multifunction knob on the panel. The highlighted line in the file list indicates the file that is selected for operations.
4. If you want the DANTE SETUP and I/O device-related settings saved in the CL settings file (file name extension .CLF) to be applied to the CL console, press the **WITH DANTE SETUP AND I/O DEVICE** button to turn it on.
5. Press the **LOAD** button. A confirmation dialog box will appear.

6. Press the **OK** button to begin loading the file.

When the file has finished loading, the **PROCESSING** popup window that shows the progress of the loading operation will close. If you cancel this procedure while it is in progress, data up to the cancellation point will still be loaded.

Some setting data may not be loaded, depending on the **USER LEVEL** setting during the load operation.

Editing the files saved on the USB flash drive

This section explains how to perform editing operations such as sorting the files and directories on the USB flash drive, editing the file names or comments, copying, and pasting.

File editing

1. In the Function Access Area, press the **SETUP** button to access the **SETUP** screen.
2. Press the **SAVE/LOAD** button to access the **SAVE/LOAD** popup window. The list will show the files and sub-directories that have been saved.



- 1 **COPY** button
Copies a file into buffer memory (a temporary holding area).
- 2 **PASTE** button
Pastes the file from buffer memory.
- 3 **DELETE** button
Deletes the selected file or directory.

NOTE

A directory cannot be deleted unless it is empty. The message "Directory Not Empty!" will appear.

④ MAKE DIR button

Creates a new directory.

⑤ PATH

Indicates the name of the current directory. Press the arrow button to move to the next higher level. If the current directory is the top level, the arrow button is dimmed.

⑥ VOLUME NAME/FREE SIZE

Indicates the volume name and the amount of free space on the USB flash drive.

If the USB flash drive is write-protected, a protect symbol will appear in the VOLUME NAME field.

⑦ File list

This area lists the files that are saved on the USB flash drive.

The highlighted line indicates the file selected for operations.

The file list contains the following items. When you press the item name at the top of each column, it will turn orange, and the list will be sorted by that item. Each time you press the item name, the sorting order will alternate between ascending and descending order.

- **FILE NAME** Indicates the file name or directory name, and shows an icon indicating its type.
- **COMMENT** The comment added to the CL console setting file is displayed here.
- **READ ONLY** A lock symbol in this column indicates that the corresponding file is protected. You can press this area to enable or disable the protect setting.
- **TYPE** ALL indicates a file containing CL internal settings, KEY indicates a user authentication key, XML indicates a Help file, BMP indicates a bitmap image file, MP3 indicates an MP3 file, and [DIR] indicates a directory.
- **TIME STAMP** Indicates the date and time at which the file was modified most recently.

⑧ File selection knob

Selects a file on the file list. You can operate this knob using the multifunction knob.

⑨ SAVE button

Saves all of the CL console internal settings together (see [page 177](#)).

⑩ LOAD button

Loads the selected CL setting file (see [page 178](#)).

⑪ CREATE USER KEY button

Creates a user authentication key (see [page 158](#)).

⑫ FORMAT button

Initializes the USB flash drive (see [page 180](#)).

⑬ WITH DANTE SETUP AND I/O DEVICE button

If this is off, the DANTE SETUP and I/O device settings will be omitted when a settings file is loaded.

NOTE

The DANTE SETUP settings SECONDARY PORT and CONSOLE ID will not be changed even if the WITH DANTE SETUP AND I/O DEVICE button is on.

3. Perform the desired editing operation.

For details on the procedure, refer to the explanations that follow.

■ Sorting files and editing file names/comments**1. To sort the files, press one of the headings "FILE NAME," "COMMENT," "READ ONLY," "TYPE," or "TIME STAMP" at the top of each column on the file list.**

The list will be sorted as follows, according to the column heading you press.

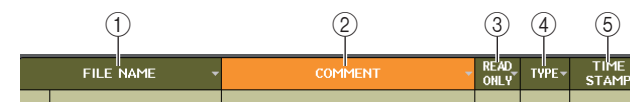
**① FILE NAME**

Sort the list in numerical/alphabetical order of the file names.

② COMMENT

Sort the list in numerical/alphabetical order of the comment.

③ READ ONLY

Sort the list by Write Protect on/off status.

④ TYPE

Sort the list by file type.

⑤ TIME STAMP

Sort the list by date and time of update.

NOTE

By pressing the same location again, you can change the direction (ascending order or descending order) in which the list is sorted.

2. If you want to edit the file name or comment, press the FILE NAME field or COMMENT field of each file to access the keyboard window.**3. Enter a file name or comment, and press the RENAME button or SET button.****4. To turn the protect setting on or off, press the READ ONLY field for the file.**

A protect symbol is displayed for write-protected files. These files cannot be overwritten.

NOTE

You cannot edit the file name or comment of a write-protected file.

■ Copying and pasting a file

Follow the steps below to copy a desired file into buffer memory, and then paste it with a different file name.

1. Turn the multifunction knob to select the copy-source file, and press the COPY button.

The highlighted line in the file list indicates the file that is selected for operations.

2. If necessary, press the directory icon and change the directory.
To move to the next higher level, press the arrow button in the PATH field.

3. Press the PASTE button.

A keyboard window will appear, allowing you to enter the file name.

4. Enter the file name, and press the PASTE button.

NOTE

You cannot use a file name that already exists when you paste a file.

■ Deleting a file

1. Rotate the multifunction knob to select a file to delete, then press the DELETE button.

A dialog box will ask you to confirm the Delete operation.

2. To execute the Delete operation, press the OK button.

NOTE

You cannot delete a protected file.

■ Creating a directory

1. If necessary, press the directory icon and change the directory.
To move to the next higher level, press the arrow button in the PATH field.

2. Press the MAKE DIR button.

A keyboard window will appear, allowing you to enter a directory name.

3. Enter the name of the directory you want to create, then press the MAKE button.

NOTE

You cannot create a directory using a directory name that already exists.

Formatting a USB flash drive

Follow the steps below to format a USB flash drive.

A USB flash drive with a capacity of 4GB or larger will be formatted in FAT32, and a USB flash drive with a capacity of 2GB or smaller will be formatted in FAT16.

1. In the Function Access Area, press the SETUP button to access the SETUP screen.
2. Press the SAVE/LOAD button to access the SAVE/LOAD popup window.



3. Press the FORMAT button.

A keyboard window will appear, allowing you to enter the volume name that will be applied after formatting.

4. Enter a volume name, and press the FORMAT button.

A dialog box will ask you to confirm the Format operation.

5. To execute the Format operation, press the OK button.

Recorder

This chapter explains the functionality and operation of the recorder.

About the USB memory recorder

The CL series console features a USB memory recorder function that lets you easily record internal signals to a USB flash drive, or play back audio files recorded on a USB flash drive.

As the file format for recording, the CL series console supports MP3 (MPEG-1 Audio Layer-3). For playback, it supports MP3 as well as WMA (Windows Media Audio) and AAC (MPEG-4 AAC) files. However, DRM (Digital Rights Management) is not supported.

By using the USB memory recorder, the output from the STEREO bus or a MIX bus can be recorded to a USB flash drive, or background music or sound effects saved on a USB flash drive can be played back via an assigned input channel.

■ Signal flow for the USB memory recorder

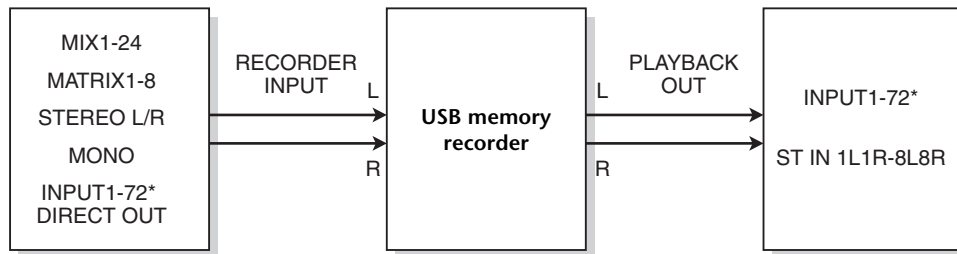

* CL3: INPUT1-64, CL1: INPUT1-48

NOTE

- Recording and playback cannot be done simultaneously.
- The signal being recorded cannot be input to an INPUT channel.

Assigning channels to the input and output of the recorder

Follow the steps below to patch the desired channels to the input and output of the USB memory recorder. You can patch any desired output channel or the direct output of an INPUT channel to the recorder input, and you can patch the recorder output to any desired input channel.

1. In the Function Access Area, press the **RECORDER** button to access the **RECORDER** screen.
2. Press the **USB** tab in the upper right of the screen.

On this screen you can assign signals to the input and output of the USB memory recorder, and perform recording and playback operations.



- ① **RECORDER INPUT popup buttons (L/R)**
Press these buttons to open the CH SELECT popup window, in which you can select the signals patched to the recorder's L/R input channels.
- ② **RECORDER INPUT GAIN knob**
Sets the level of the signal input to the recorder.
- ③ **RECORDER INPUT CUE button**
Press this button to audition the signal input to the recorder.

NOTE

You cannot turn on this button and the **PLAYBACK OUTPUT CUE** button simultaneously.

④ RECORDER INPUT meters

Indicate the level of the signals input to the recorder.

⑤ PLAYBACK OUT popup buttons (L/R)

Press these buttons to open the CH SELECT popup window, in which you can select the signals patched to the recorder's L/R output channels for playback.

⑥ PLAYBACK OUT GAIN knob

Sets the level of the recorder playback output signal.

⑦ PLAYBACK OUT CUE button

Press this button to audition the signal output from the recorder.

NOTE

You cannot turn on this button and the RECORDER INPUT CUE button simultaneously.

⑧ PLAYBACK OUT meters

Indicates the level of the recorder playback output signal.

3. To assign channels to the recorder inputs, press the RECORDER INPUT popup button L or R.

The CH SELECT popup window will appear.



① Category list

Enables you to select the type of channels.

② Channel select buttons

Select the channels that will be patched to the USB memory recorder's inputs.

- MIX 1–24.....MIX channels 1–24
- MTRX 1–8.....MATRIX channels 1–8
- ST L/RSTEREO channel L/R

- ST L+C STEREO channel L mixed with the MONO (C) channel
- ST R+C..... STEREO channel R mixed with the MONO (C) channel
- MONO..... MONO channel
- CH1–72 Direct output of an INPUT channel 1–72

NOTE

In the case of the CL3/CL1, channels that do not exist on those models will not be shown.

4. Use the category list and the channel select buttons to select the channel that you want to patch to the USB memory recorder output.

If you select a channel to which a channel is already patched, a dialog box will ask you to confirm the patch change. Press the OK button in the dialog box.

5. When you have finished assigning the channel, press the CLOSE button.

You will return to the RECORDER screen.

6. Assign a channel to the other input in the same way.

NOTE

The USB memory recorder always records and plays back in stereo. If you want to record in monaural, with the same signal for left and right, you must assign both of the recorder inputs to the same channel.

7. To assign channels to the recorder playback outputs, press the PLAYBACK OUT popup button L or R.

The CH SELECT popup window will appear.



① Category List

Enables you to select the type of channels.

② Channel select buttons

Select the channels that will be patched to the USB memory recorder's playback outputs, from the following choices.

- **CHI-72**..... INPUT channels 1-72
- **STIN 1L/1R-STIN 8L/8R**..... ST IN channels 1-8 L/R

NOTE

In the case of the CL3/CL1, channels that do not exist on those models will not be shown.

8. Use the category list and the channel select buttons to select the channel that you want to patch to the USB memory recorder output.

If you select a channel to which another signal is already patched, a dialog box will ask you to confirm the patch change. Press the OK button in the dialog box.

NOTE

The recorder playback output can be patched to multiple channels.

9. When you have finished assigning the channel, press the CLOSE button.

You will return to the RECORDER screen.

10. Assign a channel to the other output in the same way.

Recording audio to a USB flash drive

You can record the signal of the desired output channels as an audio file (MP3) onto the USB flash drive inserted in the USB connector located to the right of the display.

1. In the Function Access Area, press the **RECORDER** button to access the **RECORDER** screen.
2. Press the **USB** tab in the upper right of the screen.



■ TRANSPORT field

This field enables you to control recording and playback of a song.

① Current song

Indicates the currently-selected song's track number, title and artist name. The following indicators will appear during playback or recording.

Playing



Recording



② Elapsed time display

Indicates the elapsed playback time of the current song during playback, and the elapsed recording time during recording.

③ Remaining time display

Indicates the remaining playback time of the current song during playback.

④ Current song format

Indicates the file format and bit rate of the current song (the file being played back).

⑤ REC RATE button

Switches the recording rate.

⑥ Display switch button

Switches between displaying and hiding the RECORDER INPUT and PLAYBACK OUT fields at the bottom of the song list.

⑦ REW button

Moves the playback point to the beginning of the current song. If the playback point has already been located at the beginning, the point will move to the beginning of the preceding song that has been checked for playback.

When the playback point is not at the beginning of the current song, holding down this button for two seconds or longer will rewind the playback point.

If you operate this button during playback, playback will resume from the point at which the button was released.

⑧ STOP button

The recorder will change from play/record/recording-standby mode to stop mode.

⑨ PLAY/PAUSE button

Changes the recorder mode as follows:

Stop mode → Playback mode, then starts playback from the beginning of the current song

Playback mode → Playback pause mode

Playback pause mode → Playback mode, then starts playback from the paused point.

Recording standby mode → Recording mode

Recording mode → Recording-pause mode

Recording pause mode → Recording mode, then starts recording from the paused point.

⑩ FF button

Moves the playback point to the beginning of the next song that is marked with a PLAY check symbol.

If you hold down this button for two seconds or longer, fast-forward will occur.

If you operate this button during playback, playback will resume from the point at which the button was released.

⑪ REC button

Places the recorder in recording standby mode.

The pause indicator of the PLAY/PAUSE (▶ ||) button will light.

NOTE

You can also assign the function of each button to a USER DEFINED key (see [page 169](#)).

■ PLAY MODE field

This field enables you to specify how the recorder will behave when playback of the current song is complete.

⑫ SINGLE button

If this button is on, only the current song will play.

If this button is off, when the current song finishes playing, the recorder will play the next song in the list that is marked with a PLAY check symbol.

⑬ REPEAT button

If this button is on, playback will repeat. If the SINGLE button is on, only the current song will play repeatedly. If the SINGLE button is off, all songs in the list that are marked with a PLAY check symbol will repeatedly play in the order of the list.

If this is off, the song will play only once. If the SINGLE button is on, the current song will play only once, and then stop. If the SINGLE button is off, all songs in the list that are marked with a PLAY check symbol will play once in the order of the list, and then playback will stop.

3. Connect a USB flash drive with sufficient free capacity to the USB connector.

The FREE SIZE field indicates the amount of free capacity. When you connect a USB flash drive to the USB connector, a YPE folder and a SONGS folder within that YPE folder will be created automatically in the root directory of the USB flash drive.

The files created by recording operations will be saved in the above SONGS folder, or in the currently-selected folder below that level.

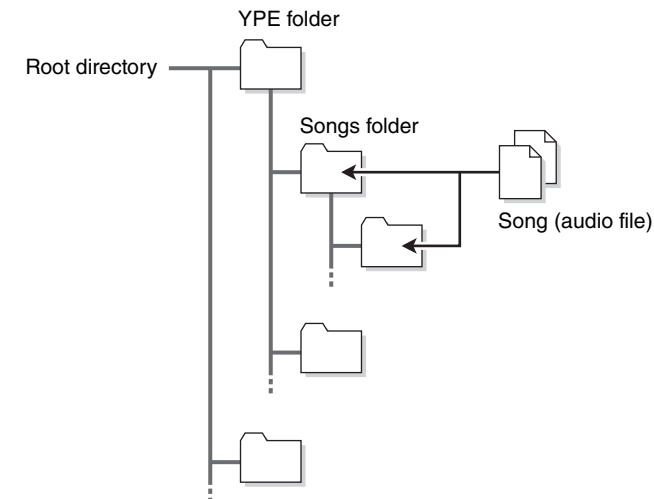
■ Directory structure of a USB flash drive**4. Assign the desired channels to the input and output of the USB memory recorder (see [page 181](#)).**

- 5. To monitor the signal being recorded, raise the fader for the channel(s) that are patched to the input of the recorder.**

The level of the input signal to the recorder is shown by the RECORDER INPUT field's level meter in the RECORDER screen. If necessary, use the GAIN knob in the RECORDER INPUT field to adjust the input level to the recorder.

NOTE

- The signal being recorded will not be output from the recorder output jacks (PLAYBACK OUT).
- Operating the GAIN knob will not affect the level of the signal being output to other ports from the corresponding output channel.

- 6. Press the REC RATE field in the lower right of the screen, then select the bit rate for the audio file that will be recorded.**

You can choose 96 kbps, 128 kbps, or 192 kbps. Higher bit rates will improve the audio quality, but will increase the size of the data.

NOTE

The word clock rate at which the CL series console is currently operating will automatically be selected as the sampling rate for the audio file.

- 7. Press the REC (●) button.**

The REC (●) button and the PAUSE (||) indicator of the PLAY/PAUSE (▶||) button will light. The current song indicator area will show “---RECORDING---”

- 8. To start recording, press the PLAY/PAUSE (▶||) button.**

During recording, the REC (●) button and the PLAY (▶) indicator of the PLAY/PAUSE (▶||) button will light. You can also see the elapsed recording time.

- 9. To stop recording, press the STOP (■) button.**

The audio file will be saved to the USB flash drive.

NOTE

- In the default state, the recorded audio file will be saved in the SONGS folder within the YPE folder. You may also specify a folder of a level below the SONGS folder.
- The recorded file will be given a default title and file name. You can change this later.

- 10. To audition the recorded content, proceed as follows.**

- 10-1. Select a recorded audio file, and press the PLAY/PAUSE (▶||) button.

The recorded content will be played back via the input channel you specified in step 4.

You can also turn on the CUE button in the PLAYBACK OUT field to audition it.

- 10-2. To stop playback, press the STOP (■) button.

Playing back audio files from a USB flash drive

You can play back audio files that have been saved on your USB flash drive. In addition to files that were recorded on the CL series console, you can also play files that were copied from your computer to the USB flash drive.

The three types of file format that can be played are MP3 (MPEG-1 Audio Layer-3), WMA (Windows Media Audio), and AAC (MPEG-4 AAC). The playable sampling rates are 44.1 kHz and 48 kHz. The supported bit rate ranges from 64 kbps to 320 kbps.

- 1. Connect a USB flash drive that contains the audio files to the USB connector.**

NOTE

If you want to play back an audio file, you must save it in the SONGS folder within the YPE folder, or in a folder you have created below the SONGS folder. Files located in other folders and files of unsupported formats will not be recognized.

- 2. In the Function Access Area, press the RECORDER button to access the RECORDER screen.**



- 1 Title list**

This list shows the playable audio files and the folders that are saved in the selected folder of USB flash drive. The row with the blue background in the center of the list indicates the song file/folder that is selected for operations.

② Status indicator

A symbol indicating whether the file is playing or paused is shown at the left edge of the title list.

▶: Playing, ||: Paused

③ Track number

Indicates the file number on the list.

④ Sub-directory

If there is a folder at a lower level, a folder icon is shown at the track number position. You can move to the lower level by pressing the folder icon.

⑤ PLAY check symbol

Enables you to select multiple files that will be played back consecutively.

⑥ SELECT knob

Use the multifunction knob to switch the current song. (The title list will scroll up or down.)

⑦ NOW PLAYING button

If you turn this button on, the currently-playing song will always be selected in the list (it will have a blue background).

⑧ MOVE UP/MOVE DOWN buttons

Sort the current song list in descending or ascending order.

⑨ Display switch buttons

Switch between the SONG TITLE display and the FILE NAME display on the list.

⑩ SAVE LIST button

Saves the order of the current title list and PLAY check symbol setting as a playlist.

⑪ RELOAD button

Loads the playlist that was saved most recently. Use this button to revert the current playlist you are editing back to the previous setting.

3. You can use the change directory button on screen and the folder icon in the NO. column to view a content list of the folder that includes the desired file.

If the directory on the USB flash drive is displayed:

- **Upper level**.....Press this button to move up to the directory that is one level higher than the current one.

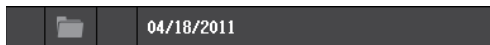

- **Subdirectory**.....Press this button to move to the corresponding sub-directory.

**NOTE**

- If you select a folder in this way, that folder will automatically be selected as the recording destination.

- The folders that can be selected are restricted to the SONGS folder inside the YPE folder, and folders located below the SONGS folder.
- The CL series console can recognize a file name that is a maximum of 64 single-byte characters. If the file name is longer than this, the desired file may not play correctly.
- A maximum of 300 songs can be managed in a single directory. A maximum of 64 subdirectories can be managed.

4. Use the multifunction knob or press the on-screen file name to select the desired file.**5. Press a button in the PLAY MODE to select the playback mode.**

You can choose from the following four playback modes.

SINGLE button	REPEAT button	Mode
On	On	The currently-selected song will play repeatedly until you stop playback.
On	Off	The currently-selected song will play once and then stop.
Off	On	Starting with the currently-selected song on the title list, songs will play back consecutively until the last song. Then, playback will return to the first song and will continue until you stop playback.
Off	Off	Starting with the currently-selected song in the title list, songs will play back consecutively, and playback will stop at the last song on the list.

6. If you have selected a consecutive playback mode in step 5, press the PLAY check symbol column for each song you want to play.

When performing consecutive playback, the files marked with a check symbol will be played.

7. Press the PLAY/PAUSE (▶ ||) button.

The song you selected in step 4 will begin playing.

NOTE

- The USB memory recorder can play back audio files that feature a sampling rate of 44.1 kHz or 48 kHz.
- Even if the sampling rate at which the CL series console is operating differs from the sampling rate of the audio file being played, the SRC (Sampling Rate Converter) function will automatically convert the rate so that the file will be played back correctly.
- If the REPEAT button is on, playback will continue until you stop playback.

8. To stop playback, press the STOP (■) button.

Editing the title list

You can change the order of the audio files shown in the title list, and edit the titles or artist names.

1. Connect a USB flash drive containing audio files to the USB connector.
2. In the Function Access Area, press the RECORDER button to access the RECORDER screen (USB tab).



1. **SONG TITLE/FILE NAME EDIT button**
Enables you to edit the title of the song selected in the list. The file name cannot be edited here.
2. **ARTIST EDIT button**
Enables you to edit the artist name of the song selected in the list.
3. **SONG TITLE/FILE NAME SORT button**
Sorts the list in numerical/alphabetical order of the title or file name.
4. **ARTIST SORT button**
Sorts the list in numerical/alphabetical order of the artist name.
5. **SAVE LIST button**
Saves the order of the current title list and PLAY check symbol settings to a USB flash drive as a playlist.

6. **SONG TITLE/FILE NAME button**
Enables you to select either song title or file name to be displayed in the SONG TITLE/FILE NAME field.
 3. In the screen, you can use the folder icon in the NO. column and the change directory button to view the contents of the folder that includes the desired file.
 4. If you want to edit a title in the title list, press the SONG TITLE/FILE NAME EDIT button. If you want to edit the artist name, press the ARTIST EDIT button.
A popup window will appear, allowing you to edit the text.
- NOTE**
- If the title or artist name contains characters that cannot be displayed, these characters will be converted into □ for display.
 - The title and the artist name can be edited only for MP3 format audio files.
5. **Edit the title or artist name.**
A maximum of 128 single-byte characters (64 double-byte characters) can be input for both the title and for the artist name. If the text cannot be shown completely in the input field, the text will scroll horizontally.
 6. **Press the OK button to close the popup window.**
 7. If necessary, use the SONG TITLE/FILE NAME SORT button, ARTIST SORT button, and MOVE UP/MOVE DOWN buttons on screen to change the order of the title list.
Use the following buttons to change the order of the title list.

- **SONG TITLE/FILE NAME SORT button**
Press this button to sort the title list in numerical → alphabetical order by title/file name. Pressing the button repeatedly will alternate between ascending and descending order.
- **ARTIST SORT button**
Press this button to sort the title list in numerical → alphabetical order by artist name. Pressing the button repeatedly will alternate between ascending and descending order.
- **MOVE UP/MOVE DOWN buttons**
Press these buttons to move the track number of the file currently-selected in the title list upward or downward by one.
- **SAVE LIST button**
Press this button to store the title list order and playback selections (the PLAY check symbol) to a USB flash drive as a play list. You should perform this operation if you want the state of the title list to be preserved even after you disconnect the USB flash drive or turn off the power to the console.
Since these settings are stored for each folder, a confirmation dialog box will ask you whether you want to save them when you attempt to change folders.

Using the CL console with Nuendo Live

The CL series consoles can operate in an integrated manner with Steinberg's Nuendo Live DAW software.

In addition to the equipment and software mentioned in “Recording or playing back using DAW on a computer” on page 25, the “CL Extension” software which integrates the CL series and Nuendo Live can be installed in your computer, allowing you to operate Nuendo Live from the CL series console to easily perform multi-track recording operations.

Here we explain how to operate Nuendo Live from the CL series console.

Preparing the project

Make the following settings as described in “Recording or playing back using DAW on a computer” on page 25.

1. Setting up Dante Virtual Soundcard or Dante Accelerator

Specify the audio format, network settings, and ASIO driver settings so that Dante Virtual Soundcard (DVS) or Dante Accelerator (DANTE-ACCEL) can be used.

2. Setting up Dante Controller

Use Dante Controller to patch between the I/O device and DVS, and between DVS and the CL series console. Assign the signals from the I/O device to the various input ports of DVS. Patching can also be specified from the CL series console.

NOTE

Separately, route the signals from I/O devices to the channels on the CL series console. (see page 138)

The following example shows Dante Controller settings for patching I/O device channels 1–16 to DVS.

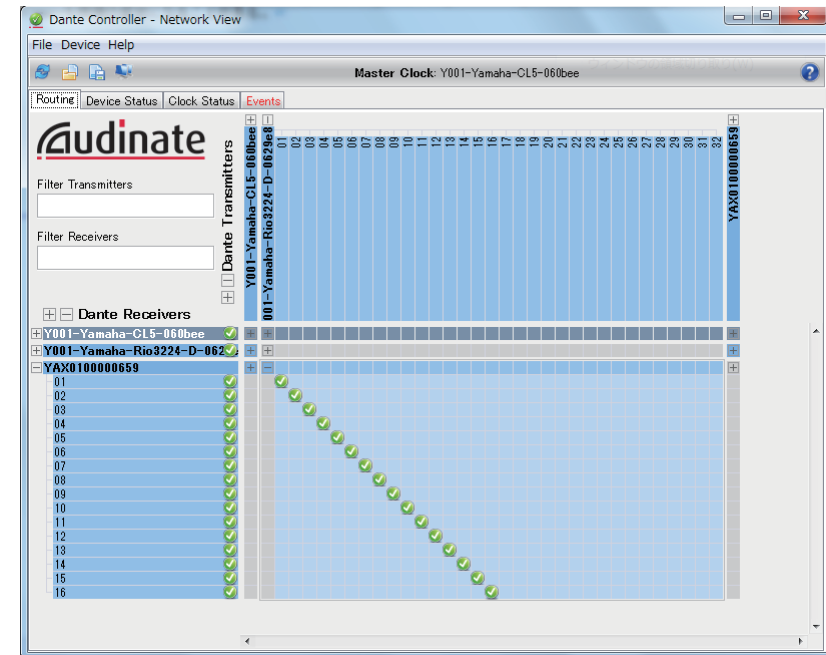

In this case, the DANTE INPUT PATCH settings of the CL series console must be switched when changing between multi-track recording and multi-track playback. Switching will be easy if you've stored the respective settings in the DANTE INPUT PATCH LIBRARY (see page 139).

3. Setting up Nuendo Live

When you start Nuendo Live and create a new project, a track for each channel specified for DVS will be created automatically. In addition, the tracks will automatically use the channel names and color information as specified on the CL series console.

Make the following settings in Nuendo Live.

- In Setup button → Audio System, select DVS or DANTE-ACCEL as the driver.

NOTE

For details on the settings of each software program, refer to the manual for that software.

Recording into a project

1. In the Function Access Area, press the **RECORDER** button to access the **RECORDER** screen.
2. Press the Nuendo Live tab in the upper right of the screen.
The Nuendo Live screen will appear.



The screen shows the following items.

- 1 **Nuendo meter display field**
This shows the channel levels of Nuendo Live.
- 2 **PEAK CLEAR button**
Clears the peak levels indicated by the peak hold function.
- 3 **Marker list field**
Lists the marker information recorded in the current Nuendo Live project.
The markers can be selected by pressing the on-screen list or by using the multifunction knobs.
- 4 **Nuendo Live SETUP button**
Specify the device that the console will use for communication when working with Nuendo Live.
(see [page 190](#))
- 5 **DANTE INPUT PATCH button**
Press this to access the DANTE INPUT PATCH screen (see [page 138](#)).

- 6 **Location information display**
This displays information for the current location of the Nuendo Live project. You can press the button at the right to switch the time display format.
 - 7 **GO TO PROJECT START button**
Returns the location to the start of the project.
 - 8 **GO TO PREVIOUS MARKER button**
Returns the location to the previous marker.
 - 9 **GO TO NEXT MARKER button**
Advances the location to the next marker.
 - 10 **GO TO PROJECT END button**
Advances the location to the end of the project.
 - 11 **CYCLE button**
Turns repeat on/off for the project.
 - 12 **STOP button**
Stops playback/recording of the project.
 - 13 **PLAY button**
Starts playback of the project.
 - 14 **RECORD button**
Starts/stops recording of the project.
 - 15 **EASY RECORDING button**
Immediately starts recording all tracks.
Pressing this button will reset the current location to the end point of the latest recording, place all tracks in recording mode, start recording, and then display and lock the recording panel.
Recording will start retroactively by the specified time duration (default: 10 seconds).
 - 16 **Record lock button**
Turns recording status lock on/off.
This prevents recording from being accidentally stopped during recording.
 - 17 **DVS information display**
Shows the device label of the selected DVS.
 - 18 **ADD MARKER button**
Adds a marker to the project at the current location.
 - 19 **RECALL LINK button**
Specifies whether a marker will be created when you recall a scene. If this function is turned on, the button will be lit.
- NOTE**
Transport functions can also be controlled from USER DEFINED keys. (see [page 169](#))

3. Press the EASY RECORDING button to start recording.
4. When you have finished recording, press the record lock button and then the STOP button.

Specifying DVS or DANTE-ACCEL

1. In the Nuendo Live screen, press the NUENDO Live SETUP button.

The NUENDO LIVE SETUP popup window will appear.

NOTE

- Even if the CL's CONSOLE ID is set to something other than #1, you can still specify DVS or DANTE-ACCEL in the NUENDO Live SETUP screen.
- However, you must not select the same DVS or DANTE-ACCEL from more than one CL console.

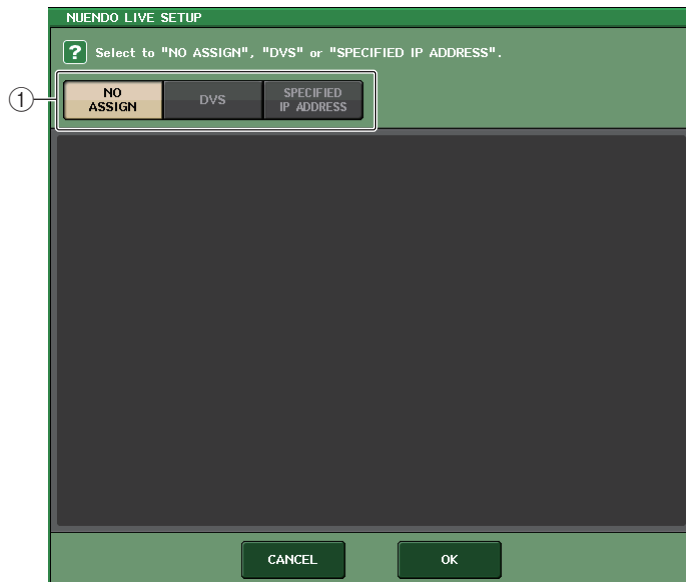

① Setup method selection buttons

Use these buttons to select one of the following methods to specify DVS or DANTE-ACCEL.

- **NO ASSIGN** Not assigned
- **DVS** Select a DVS from the device list
- **SPECIFIED IP ADDRESS** When using DANTE-ACCEL, specify the IP address of the PC

■ When setup method selection button = DVS

To choose from a list of the I/O devices on the Dante audio network, press the DVS button to display the DEVICE LIST field.

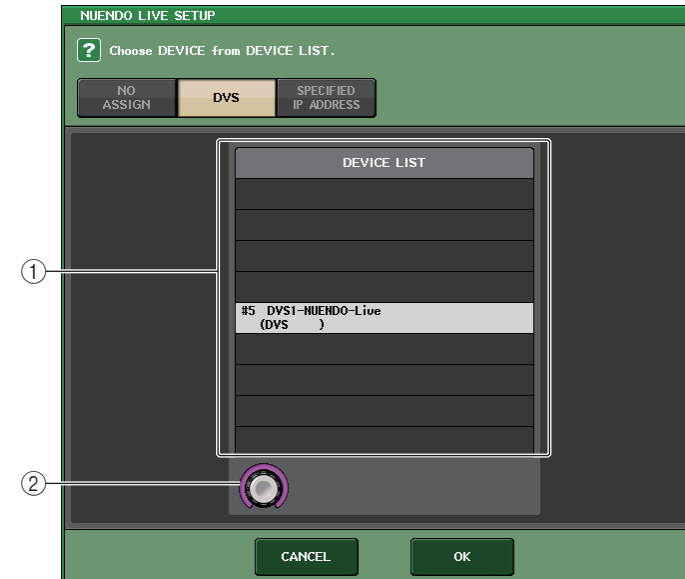

This screen contains the following items.

① DEVICE LIST

Shows a list of the I/O devices on the Dante audio network.

From the list, choose the DVS that you want to use with Nuendo Live.

② DEVICE LIST select knob

Operate the multi-function knob to choose the DVS that you want to select.

■ When setup method selection button = SPECIFIED IP ADDRESS

If you're using DANTE-ACCEL, use the SPECIFIED IP ADDRESS field to specify the IP address of the PC. Since the IP address of DANTE-ACCEL will differ from the IP address used by CL Extension, you must specify the IP address manually.



This screen contains the following items.

① IP ADDRESS knobs

Use the multifunction knobs to specify the IP address.

NOTE

- As the IP address, specify the IP address of the PC that is running Nuendo Live.
- Set the address of that PC in the range of 169.254.0.0 – 169.254.255.255, and set the subnet mask as 255.255.0.0.
- For the PC in which DANTE-ACCEL is installed, the Dante port of DANTE-ACCEL as well as the Ethernet port of the PC must both be connected to the same network.

Refer to the illustration below.

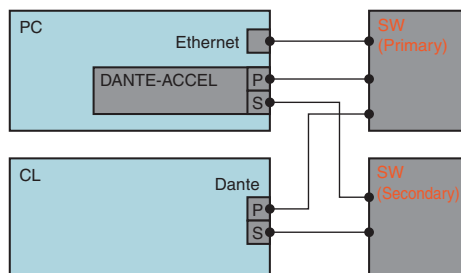

NOTE

Depending on the firmware version, DANTE-ACCEL might not support redundant networking. Refer to the following website to check whether your version of the DANTE-ACCEL (Dante Accelerator) firmware supports redundant networking.
<http://www.yamahaproaudio.com/>

2. When you have finished making settings, press the OK button to close the NUENDO LIVE SET UP popup window.

Playing a multi-track project

1. In the Nuendo Live screen, press the DANTE INPUT PATCH button.
2. Assign the signals from Nuendo Live to the desired DANTE1–DANTE64 ports. For example, press the PORT SELECT button for DANTE1.

The PORT SELECT popup window will appear.

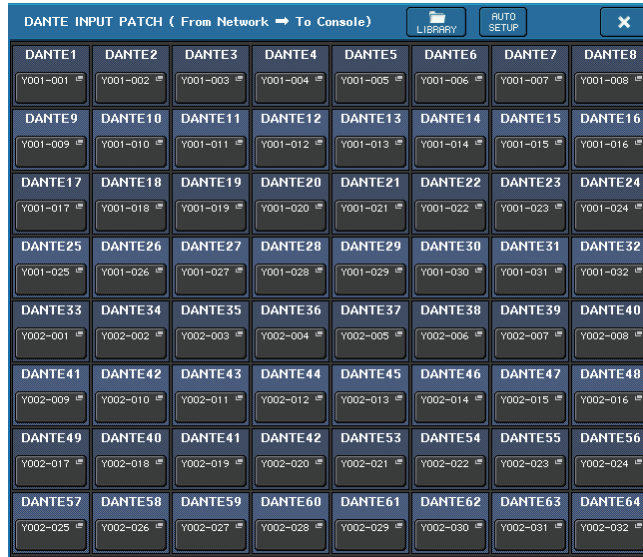

3. In the list at the left, select the DVS you're using with Nuendo Live, and select the port that you want to assign to DANTE1.
4. Press the + button located in the upper part of the screen to switch to DANTE2, and assign a DVS port to it in the same way.
5. When you have finished making settings, press the CLOSE button to exit the screen.
6. Press the "X" symbol in the upper right of the DANTE INPUT PATCH window to close it.

NOTE

If you've saved the DANTE INPUT PATCH settings in the library, it will be easy to switch the settings on the CL series console (see [page 139](#)).

7. In the Nuendo Live screen, press the START button.
8. Operate the channels so that sound is output.
9. To stop playback, press the STOP button.

Help function

You can view Help files provided by Yamaha, or display any user-created text file.

We accept no responsibility for any damage that may occur as a result of using Help files created by a third party other than Yamaha.

Loading a Help file from a USB flash drive

NOTE

A help file for only one language is stored in the console's internal memory. Once you load the help file, it will be preserved in internal memory even if the power is turned off.

The first time you press the HELP button to view the help file after turning the power on, it will take a while for the help file to be loaded from internal memory. It is not possible to read from internal memory while the USB flash drive is being accessed, including while the recorder is recording or playing back, and therefore Help cannot be displayed during this time.

Once the data has finished loading, subsequently pressing the HELP button will display the help file instantly.

1. Before you proceed, save the Help file (file extension: .xml) provided by Yamaha on your USB flash drive. For the latest information on help files, refer to the Yamaha Pro Audio website.

<http://www.yamahaproaudio.com/>

2. In the Function Access Area, press the SETUP button to access the SETUP screen.
3. Press the SAVE/LOAD button to access the SAVE/LOAD popup window.



4. To select the Help file (file extension: .xml) that you want to load, press one of the Help files in the file list, or turn the multifunction knob on the panel.
5. Press the LOAD button. A confirmation dialog box will appear.
6. Press the OK button to load the file.

Loading a text file from a USB flash drive

1. Using a commercially available text editor or the "Notepad" included with Microsoft Windows, create a text file (file extension: .txt) and save it on your USB flash drive.

By default, the character code set of the text file will be detected as UTF-8. However, by adding a line consisting of [ISO-8859-1] or [Shift_JIS] at the beginning of the file, you can force recognition of the file using that character code set. You can specify the desired character code set when using your text editor to save the text file.

The Help function is able to display the following text files (character code sets/languages).

- Text files written in the ISO-8859-1 character code set (English, German, French, Spanish, etc.)
- Text files written in the Shift_JIS character code set (Japanese)
- Text files of the above languages written in the UTF-8 character code set.





The maximum size of the text file is 1024 Kbytes.

2. In the Function Access Area, press the SETUP button to access the SETUP screen.
3. Press the SAVE/LOAD button to access the SAVE/LOAD popup window.
4. To select the text file you want to load, press one of the text files in the file list or turn the multifunction knob on the panel.
5. Press the LOAD button. A confirmation dialog box will appear.
6. Press the OK button to load the file.

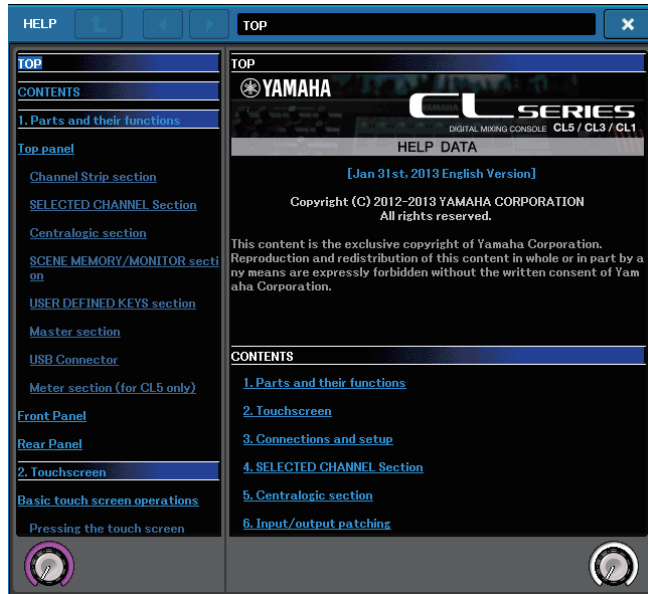
Viewing Help

1. Before you proceed, load the Help file or text file from your USB flash drive.
2. In the Function Access Area, press the  (Help) button to access the HELP popup window.



3. By turning multifunction knobs 1–2 you can scroll the index area at the left. By turning multifunction knobs 3–8 you can scroll the main area at the right.
4. By pressing a link (underlined text) in the text, you can scroll to the linked destination.
By pressing a window link (a location with an → symbol and underlined text), you can close the HELP popup window and open the corresponding window.
5. You can also scroll by using the buttons in the tool bar as needed.
 -  button.....Scrolls to the chapter that precedes the currently-displayed location.
 -  button.....Returns to the preceding item in the history of links you pressed.
 -  button.....Proceeds to the subsequent item in the history of links you pressed.
6. To close the window, press the  (Help) button of the Function Access Area or the “x” symbol of the HELP popup window.

Using USER DEFINED keys to recall Help directly

1. Before you proceed, load the Help file from your USB flash drive.
2. In the Function Access Area, press the SETUP button to access the SETUP screen.



3. In the upper left of the screen, press the USER SETUP button to access the USER SETUP popup window.

- Press the USER DEFINED KEYS tab to select the USER DEFINED KEYS page.

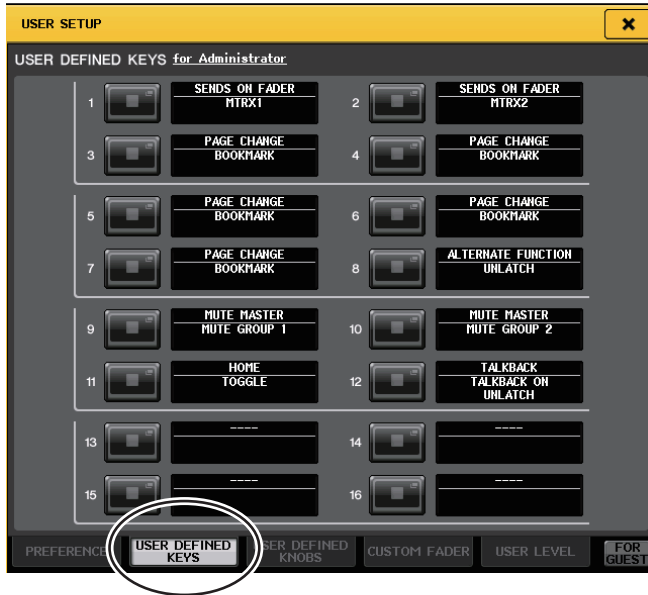

- Press the button corresponding to the USER DEFINED key to which you want to assign the Help function.
- In the FUNCTION column, choose "HELP" and press the OK button.
- When you have finished assigning functions to USER DEFINED keys, press the × symbol to close the USER DEFINED KEYS page.
- In the Function Access Area, press the SETUP button to close the SETUP screen.

■ Recalling the HELP popup window using only a USER DEFINED key

- Press the USER DEFINED key to which the Help function is assigned. The HELP popup window will appear.
- To close the window, once again press the USER DEFINED key to which the Help function is assigned.

■ Directly recalling the Help for a specific panel controller

- While holding down the USER DEFINED key to which you have assigned the Help function, press (or rotate) the panel controller for which you want to recall Help.
Panel controllers (other than the faders) will not function as long as you continue holding down the USER DEFINED key to which the Help function is assigned.
- If the corresponding controller has an explanation associated with it, the HELP popup window will appear, and you will automatically scroll to the corresponding item.
If there are multiple explanations for the same controller, you can repeat step 9 to successively display these explanations.
- To close the window, once again press the USER DEFINED key to which the Help function is assigned.

■ Directly recalling the Help for a specific controller in the LCD screen

- While holding down the USER DEFINED key to which you have assigned the Help function, press the on-screen controller for which you want to recall Help.
The on-screen buttons and tabs will not function as long as you continue holding down the USER DEFINED key to which the Help function is assigned.
- If there is a corresponding Help item, the HELP popup window will appear and you will automatically scroll to the corresponding item.
If there are multiple explanations for the same controller, close the HELP popup window and then repeat step 9 to successively view these explanations.
- To close the window, once again press the USER DEFINED key to which the Help function is assigned.

Other functions

This chapter explains various functions of CL series consoles that are not covered in other chapters.

About the SETUP screen

The SETUP screen enables you to set various parameters that apply to the entire CL console. To access the SETUP screen, press the SETUP button in the Function Access Area. The screen contains the following items.



■ CURRENT USER field

This field enables you to make various user-related settings.

① USER SETUP popup button

Press this button to open the USER SETUP popup window, in which you can make various settings for each user.

② CURRENT USER popup button

Press this button to open the LOG IN popup window, in which you can switch log-in users.

③ COMMENT EDIT popup button

Press this button to open the USER COMMENT EDIT popup window, in which you can enter comments.

④ PASSWORD CHANGE popup button

Press this button to open the PASSWORD CHANGE popup window, in which you can change the password.

⑤ SAVE KEY popup button

Enables you to save the user authentication key. Press this button to open the SAVE KEY popup window. (see [page 165](#))

■ STORAGE field

This field enables you to create, save, or load a user authentication key.

⑥ CREATE USER KEY popup button

Press this button to open the CREATE USER KEY popup window, in which you can create a new user authentication key.

⑦ SAVE/LOAD popup button

Press this button to open the SAVE/LOAD popup window, in which you can save or load user authentication keys and console files.

■ SYSTEM SETUP field

This field enables you to make various settings that globally apply to the CL console.

⑧ +48V MASTER button

Switches the console's master +48V master phantom power on or off. If this button is off, phantom power will not be supplied even if the +48V button of an OMNI jack input channel or TALKBACK IN is on.

NOTE

This +48V MASTER setting does not affect the inputs of external racks such as DANTE inputs (I/O devices). Each rack has a +48V MASTER switch, and will operate according to its setting.

⑨ WORD CLOCK/SLOT popup button

Press this button to open the WORD CLOCK/SLOT popup window, in which you can make word clock settings and various settings for each slot.

⑩ CASCADE popup button

Press this button to open the CASCADE popup window, in which you can make patch settings for cascade connections.

⑪ OUTPUT PORT popup button

Press this button to open the OUTPUT PORT popup window, in which you can make output port settings.

⑫ MIDI/GPI popup button

Press this button to open the MIDI/GPI popup window, in which you can make MIDI and GPI-related settings.

⑬ DANTE SETUP button

Press this button to open the DANTE SETUP popup window. This window enables you to make various audio network settings (console ID setting; SECONDARY PORT functionality setting; audio bit rate; latency setting; selections for devices controlled via the I/O DEVICE screen).

■ BUS SETUP field

This field enables you to make bus-related settings.

⑭ BUS SETUP popup button

Press this button to open the BUS SETUP popup window, in which you can make MIX bus/MATRIX bus-related settings.

■ DATE/TIME popup button

Press this button to open the DATE/TIME popup window, in which you can set the date and time.

■ NETWORK popup button

Press this button to open the NETWORK popup window, in which you can set the network address.

■ Indicator field

This field displays various information about the console's status.

⑮ BATTERY indicator

Indicates the status of the internal battery.

NOTE

The LOW or NO indication will appear if the battery runs down. In this case, immediately contact your Yamaha dealer or a Yamaha service center listed at the end of the operating manual (separate document) to have the backup battery replaced.

⑯ POWER SUPPLY indicator

Indicates the currently-running power supply: INT (internal) or EXT (PW800).

⑰ Version indicator

Indicates the version number of the main CPU, sub CPU, and DANTE module.

■ CONSOLE LOCK button

This button executes the Console Lock function. If the console password has been set, pressing this button will open the AUTHORIZATION popup window. Enter the correct password to execute Console Lock.

If the console password has not been set, pressing this button will execute the Console Lock immediately.

■ CONTRAST/BRIGHTNESS field

This field enables you to set the LCD brightness and contrast.

⑱ BANK A/BANK B buttons

Select a bank to which you want to save the brightness and contrast settings. You can save two different settings in bank A and B, and switch between them if desired.

⑲ CONTRAST NAME knob

Adjusts the contrast of the channel name display.

⑳ BRIGHTNESS NAME knob

Adjusts the brightness of the channel name display.

BRIGHTNESS CH COLOR knob

Adjusts the brightness balance of the channel color and the channel name display.

BRIGHTNESS SCREEN knob

Adjusts the brightness of the display.

BRIGHTNESS PANEL knob

Adjusts the brightness of the panel LEDs.

BRIGHTNESS LAMP knob

Adjusts the brightness of the lamp connected to the LAMP connector.

Word clock and slot settings

“Word clock” refers to the clock that provides the basis of timing for digital audio signal processing. To send and receive digital audio signals between devices, those devices must be synchronized to the same word clock. If digital audio signals are transferred in an unsynchronized state, the data may not be transmitted or received correctly, and noise may be present in the signal, even if the sampling rates are the same.

Specifically, you must first decide which device will transmit the reference word clock for the entire system (the word clock master), and then set the remaining devices (the word clock slaves) so that they synchronize to the word clock master.

If you wish to use the CL series console as a word clock slave that is synchronized to the word clock supplied from an external device, you must specify the appropriate clock source (the port through which the word clock is obtained).

This section explains how to select the clock source that the CL series console will use.

1. In the Function Access Area, press the **SETUP** button to access the **SETUP** screen.



2. In the **SYSTEM SETUP** field at the center of the screen, press the **WORD CLOCK/SLOT SETUP** button to open the **WORD CLOCK/SLOT SETUP** popup window. This popup window contains the following items.

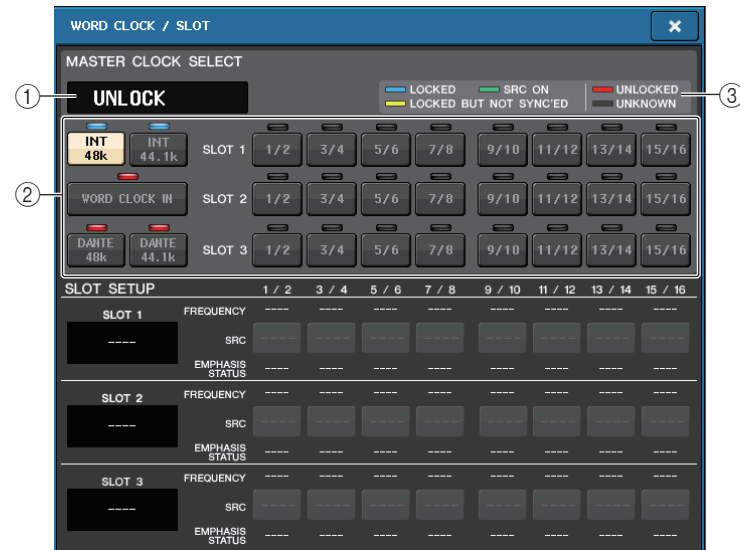

■ MASTER CLOCK SELECT field

1. **Master clock frequency display**

Indicates the frequency (44.1 kHz or 48 kHz) of the currently-selected master clock. If the unit is not synchronizing to the master clock, “UNLOCK” will appear.

NOTE

If sample rate pull-up/down has been specified in the Dante Controller application, this area indicates the change in the sample rate as a percentage, such as -4.0% , -0.1% , $+4.0\%$, 4.1667% , etc.



2. **Master clock select buttons**

Use the buttons to select the clock source that you want to use as the word clock master from the following options:

- **INT 48 k**
- **INT 44.1 k**
The CL console internal clock (sampling rate 48 kHz or 44.1 kHz) will be the clock source.
- **WORD CLOCK IN**
The word clock supplied from the WORD CLOCK IN jack on the rear panel of the console will be used as the clock source.

- DANTE 48 k
- DANTE 44.1 k

The word clock supplied from the Dante jack on the rear panel of the console will be used as the clock source.

- **SLOT 1–3**

The word clock supplied via a digital I/O card installed in a console slot will be used as the clock source. Word clock can be selected in pairs for each slot.

③ Clock status display

Indicates the status of synchronization with the master clock for each clock source. Each indicator is explained below:

- **LOCK (light blue)**

Indicates that a clock synchronized with the selected clock source is being input. If an external device is connected to the corresponding connector or slot, input/output is occurring properly between that device and the CL series console. If the sampling frequency is close, this status may be displayed even if not synchronized.

- **LOCK, BUT NOT SYNC'ED (yellow)**

A valid clock is being input, but is not synchronized with the selected clock source. If an external device is connected to the corresponding connector, input/output cannot occur correctly between that device and the CL series console.

- **SRC ON (green)**

This is a special status applied only to SLOT 1–3, indicating that the corresponding channel's SRC (Sampling Rate Converter) is enabled. This means that even if the signal is not synchronized, normal input/output with the CL series console is occurring.

- **UNLOCK (red)**

A valid clock is being input, but the CL series console is not synchronized to the selected clock. If an external device is connected to the corresponding connector, it will be unable to communicate properly with the CL console.

- **UNKNOWN (black)**

This indicates that the clock status cannot be detected because no external device is connected or because there is no valid clock input. You will be able to select this connector/slot, but successful synchronization cannot occur until a valid connection is established.

If the indicator for the port selected as the clock source has turned light blue, and the clock frequency appears in the upper left of the MASTER CLOCK SELECT field, this indicates that the CL series console is operating correctly with the new clock.

NOTE

- If the indicator for the selected clock does not turn light blue, make sure that the external device is correctly connected, and that the external device is set to transmit clock data.
- Noise may occur at the output jacks when the word clock setting is changed. To protect your speaker system, be sure to turn down the power amp volume before changing the word clock setting.
- If you attempt to select a channel (for which SRC is on) as the word clock source, a message will appear, warning you that the sampling rate converter will be disabled.

■ SLOT SETUP field

This field enables you to make various settings related to the MY slots on the rear panel of the console.



① Card name

Indicates the type of card installed in the slot. If nothing is installed, “----” will appear.

② SRC buttons

The SRC (Sampling Rate Converter) function can be switched on or off for a slot in which an MY card (MY8-AE96S) that features the SRC function is installed. If another type of card is installed, or if no card is installed, no SRC button will appear.

③ FREQUENCY display

Indicates the sampling frequency of input signals if the installed card can detect the substatus of input signals, such as an AES/EBU card. If another type of card is installed, or if no card is installed, “----” will appear.

④ EMPHASIS STATUS display

Indicates the emphasis information of input signals if the installed card can detect the substatus of input signals, such as an AES/EBU card. If another type of card is installed, or if no card is installed, “----” will appear.

3. In the MASTER CLOCK SELECT field, select a clock source.

4. To close the WORD CLOCK/SLOT popup window, press the “x” symbol located in the upper right.

You will return to the SETUP screen.

5. To close the SETUP screen, press the SETUP button in the Function Access Area.

Using cascade connections

Using multiple CL series consoles, or a CL console and an external mixing console (such as a Yamaha PM5D) in a cascade connection enable buses to be shared among the devices. This can be convenient if you want to use an external mixer to increase the number of inputs.

This section explains cascade connections and operation, using an example in which two CL units are connected in a cascade configuration.

About cascade connections

To cascade two CL series consoles, you must first install digital I/O cards in the appropriate slots, and connect the output ports of the sending unit (the cascade slave) to the input ports of the receiving unit (the cascade master).

The following illustration shows an example in which three eight-channel digital I/O cards for each unit are installed in the cascade slave CL unit and in the cascade master CL unit. The DIGITAL OUT jacks of the sending unit are connected to the DIGITAL IN jacks of the receiving unit.

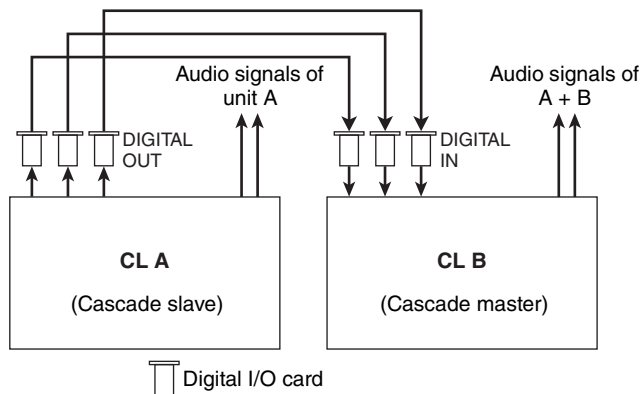

In this example, up to twenty four buses chosen from MIX bus 1–24, MATRIX bus 1–8, STEREO bus (L/R), MONO (C) bus, and CUE bus (L/R) can be shared, and the mixed signals transmitted from the cascade master CL unit. (If you use three 16-ch digital I/O cards, all buses can be shared among the devices.)

You must specify bus assignments for each or channel on each CL unit. Separate procedures are outlined below for the cascade slave and the cascade master.

NOTE

- If you are making a cascade connection between the CL unit and the PM5D, you can use the CL unit as the cascade slave by setting the PM5D's CASCADE IN PORT SELECT to a slot. However, only the audio signals will be cascaded, and the control signals cannot be linked.
- You can also use an AD/DA card to make cascade connections with an analog mixer.
- There is no limit to the number of units that can be cascade-connected, but the signal delay at the cascade slave will increase in accordance with the number of units from the cascade master.

Operations on a cascade slave CL unit

1. In the Function Access Area, press the **SETUP** button to access the **SETUP** screen.

2. In the **SYSTEM SETUP** field located in the center of the **SETUP** screen, press the **CASCADE** button to open the **CASCADE** popup window.

This window enables you to select an I/O port used for cascade connections. The window consists of two pages: The **CASCADE IN PATCH** page and the **CASCADE OUT PATCH** page. To switch pages, press the corresponding tab at the bottom of the window.

3. Press the **CASCADE OUT PATCH** tab to access the **CASCADE OUT PATCH** page.

In this screen you can select the slot and output port that will output each bus.



① Port select popup buttons (CASCADE OUT PATCH section)

Enable you to select the output port for cascade connections for each of MIX 1–24, MATRIX 1–8, STEREO L/R, MONO, and CUE L/R buses. Press the button to open the PORT SELECT popup window, in which you can select a port.

② CASCADE LINK MODE buttons

Specify whether only cue operations will be linked, or all linkable operations including scene store/recall operations will also be linked when CL series consoles are cascade-connected.

③ CASCADE COMM PORT buttons

Specify the communication port used for transmitting and receiving link information when operations such as cue and scene store/recall are linked between cascade-connected CL series consoles.

4. Press the port select popup button for the bus for which you want to assign the port.

The PORT SELECT popup window will appear.

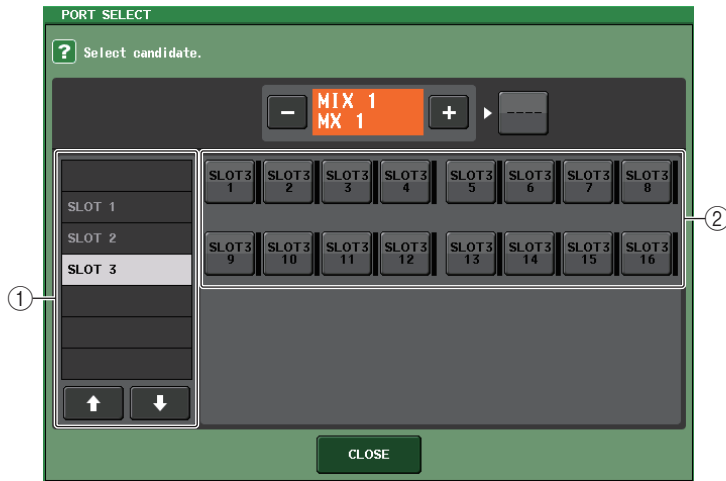

This popup window contains the following items.

① Category select list

Selects the port (slot 1–3) that will be shown on the screen.

② Port select buttons

Within the specified slot, these buttons select the ports that will be patched.

5. Use the category select list and port select buttons to select the desired slot and output ports, and then press the CLOSE button.

The port will be assigned to the selected bus.

6. Repeat steps 4 and 5 to assign ports to other buses.

NOTE

You cannot assign two or more buses to the same output port. If you select a port to which a signal route has already been assigned, the previous assignment will be canceled.

7. If you want to use the Cascade Link function to link parameters and events between two CL consoles, proceed as follows.

7–1. Use the CASCADE COMM PORT field to select the port that will transmit and receive control signals for cascade link.

You can choose from the following items.

- **NONE**..... No link operation
- **MIDI**..... Use MIDI port
- **SLOT1** Use SLOT1

NOTE

Control signals for cascade link and MIDI messages cannot share the same port. If you select a port that is already specified for transmission/reception of MIDI messages, a dialog box will ask whether it is OK to cancel the existing settings.

7–2. Use the CASCADE LINK MODE buttons to select the item that you want to link.

You can choose from the following items.

• **OFF**

No link operation

• **CUE**

The following cue-related parameters and events will be linked.

- Cue enable/disable
- Cue mode (MIX CUE or LAST CUE)
- Cue point settings for input channels and output channels

• **ALL**

All linkable parameters and events (including cue-related parameters) will be linked.

- Cue-related parameters and events (see above)
- Scene recall operations
- Scene store operations
- DIMMER (MONITOR screen) operations
- Panel LED and display brightness (SETUP screen) operations
- Master mute group operations

8. To close the CASCADE popup window, press the CLOSE button.

Operations on the cascade master CL unit

1. In the Function Access Area, press the **SETUP** button to access the **SETUP** screen.
2. In the **SYSTEM SETUP** field located in the center of the **SETUP** screen, press the **CASCADE** button to open the **CASCADE** popup window.
3. Press the **CASCADE IN PATCH** tab to access the **CASCADE IN PATCH** page.
4. Press the **port select popup** button for the bus to which you want to assign a port.
The **PORT SELECT** popup window will appear.
5. Use the **category select list** and **port select buttons** to select the desired slot and input ports, and then press the **CLOSE** button.
The port will be assigned to the selected bus.
6. Repeat steps 4 and 5 to assign ports to other buses.
If desired, you can assign two or more buses to the same input port.
7. If you want to link specific parameters or events between two CL series consoles, proceed as follows.
 - 7-1. Use the **CASCADE COMM PORT** field to select the port that will transmit and receive control signals for cascade link.
The items you can select are the same as in the **CASCADE OUT PATCH** popup window (see page 200).

NOTE
Control signals for the cascade link and MIDI messages cannot share the same port. If you select a port that is already specified for transmission/reception of MIDI messages, a dialog box will ask whether it is OK to cancel the existing settings.

 - 7-2. Use the **CASCADE LINK MODE** buttons to select the item that you want to link.
The items you can select are the same as in the **CASCADE OUT PATCH** popup window (see page 200).
8. To close the **CASCADE** popup window, press the **CLOSE** button.
In this state, the bus signals of the cascade slave will be sent via the slot to the buses of the cascade master, and the combined signals of both buses will be output from the cascade master. If the Cascade Link function is enabled, the specified operations or parameter changes performed on either CL series console will be followed by the other CL console.

Basic settings for MIX buses and MATRIX buses

This section explains how to change the basic settings for MIX buses and MATRIX buses, such as switching between stereo and monaural, and selecting the send point from which the signal of an input channel will be sent.

The settings you make in the following procedure will be saved as part of the scene.

1. In the Function Access Area, press the **SETUP** button to access the **SETUP** screen.
2. In the center right of the **SETUP** screen, press the **BUS SETUP** button to open the **BUS SETUP** popup window.
In the **BUS SETUP** popup window you can make various settings for MIX buses and MATRIX buses.



MIX 1–16 page

MIX BUS 17–24/MATRIX BUS page

① SIGNAL TYPE switch buttons

Select how signals are processed for every adjacent pair of buses. Select either **STEREO** (stereo signal) or **MONOx2** (monaural signal x 2).

② Bus type/send point select buttons (MIX bus only)

For every adjacent pair of buses, you can select the bus type and (for vari-type) the send point. These buttons correspond to the following parameters.

Button	Bus type	Pre-fader send point
VARI [PRE EQ]	VARI	Immediately before the EQ
VARI [PRE FADER]	VARI	Immediately before the fader
FIXED	FIXED	---

③ Send point select buttons (MATRIX bus only)

Select the pre-fader send point from the input channel. These buttons correspond to the following parameters.

Button	Pre-fader send point
PRE EQ	Immediately before the EQ
PRE FADER	Immediately before the fader

④ PAN LINK button

This button appears only if two adjacent buses are paired in stereo and the bus type is set to VARI. If the button is on, the pan setting of signals sent from input channels to the corresponding two buses will link with the STEREO bus pan setting.

3. Use the MIX1-16 tab and MIX17-24/MATRIX tab to access the buses whose settings you want to edit.

4. Use the buttons in the SIGNAL TYPE field to specify whether each bus will function as STEREO (main parameters will be linked for two adjacent odd-numbered/even-numbered buses) or MONOx2 (use as two monaural channels).

5. Use the buttons of the PRE FADER SEND POINT/BUS TYPE field to select the position from which the signal of the input channel will be sent.

In the case of a MIX bus, you can use this field to switch the type of bus (VARI or FIXED).

6. As desired, turn the buttons in the PAN LINK field on or off.

In the PAN LINK field, you can specify whether the panning of the signal routed from an input channel to the stereo bus will be linked with operation of the INPUT TO ST PAN knob (if the input channel's SIGNAL TYPE is set to STEREO and BUS TYPE is set to VARI).

- If the PAN LINK button is on:

If the send-destination bus is stereo, the PAN knob that appears in the location of the SEND LEVEL knob on the screens for input channels will be linked with the INPUT TO ST PAN knob.

- If the PAN LINK button is off:

The PAN knob that appears in the location of the SEND LEVEL knob of input channels in various screens is not linked with INPUT TO ST PAN; it can be operated independently.

Switching the entire phantom power supply on/off

1. In the function access area, press the SETUP button to access the SETUP screen.



2. In the center of the SETUP screen, press the +48V MASTER field's ON button or OFF button.

If this button is off, phantom power will not be supplied even if the +48V button of an OMNI jack input channel or TALKBACK IN is on.

NOTE

This +48V MASTER setting does not affect the inputs of external racks such as DANTE inputs (I/O devices). Each rack has a +48V MASTER switch, and will operate according to its setting.

Specifying the brightness of the touch screen, LEDs, channel name displays, and lamps

Follow the steps below to specify the brightness of the touch screen, top panel LEDs, channel name displays, and lamps connected to the rear panel LAMP connectors.

1. In the Function Access Area, press the **SETUP** button to access the **SETUP** screen.
2. In the field located in the right of the bottom row of the **SETUP** screen, press the **BANK A** or **BANK B** button.

You can save two different brightness settings in bank A and B, and switch between them rapidly if desired.



3. Use the multifunction knobs to set the following parameters.

CONTRAST field

- **NAME** Adjusts the contrast of the characters in the channel name displays on the top panel.

BRIGHTNESS field

- **NAME** Adjusts the brightness of the channel name displays on the top panel. This will also change the CH COLOR brightness. If you want to adjust the CH COLOR brightness after setting the name display brightness, use the CH COLOR knob.
- **CH COLOR**..... Adjusts the brightness of the channel colors on the top panel. This lets you apply a relative adjustment to only the channel color brightness without changing the channel name display brightness.
- **SCREEN**..... Adjusts the brightness of the touch screen. If the brightness is set to lower than level 2, the CL will start up next time with a brightness setting of 2 so that you will be able to see the screen.
- **PANEL** Adjusts the brightness of the top panel LEDs. If the optional MBCL meter bridge is installed on the CL3/CL1, this knob setting will also affect the LEDs on the meter bridge.

NOTE

If the AD8HR is connected, the brightness of the AD8HR's LEDs will also change.

- **LAMP** Adjusts the brightness of the lamps connected to the rear panel LAMP jacks.
4. If desired, switch between banks A and B and make settings for the other bank in the same way.

Now you can switch between the BANK A and BANK B buttons to change the brightness of the touch screen, LCD, channel name displays, and lamps in a single operation. You can also assign this parameter to a USER DEFINED key, and press that key to switch between banks A and B.

Setting the date and time of the internal clock

This section explains how to set the date and time of the CL console's internal clock, and how to select the date and time display format.

The date and time you specify here will affect the time stamp used when saving a scene.

1. In the Function Access Area, press the **SETUP** button to access the **SETUP** screen.
2. In the center of the **SETUP** screen, press the **DATE/TIME** button to access the **DATE/TIME** popup window.



This popup window includes the following items.

1) DATE

Specifies the date of the internal clock.

2) TIME

Specifies the time of the internal clock.

3) FORMAT

Specifies the format in which the time of the internal clock is displayed.

3. In the **FORMAT** field, press the **MODE** buttons several times to select the desired format for date and time display.

You can select from the following display formats.

- **Date**
MM/DD/YYYY (Month/Day/Year)
DD/MM/YYYY (Day/Month/Year)
YYYY/MM/DD (Year/Month/Day)
- **Time**
24-Hour (hours shown in the range of 0–23)
12-Hour (hours shown from 0am–11am, and 0pm– 11pm)

4. Use multifunction knobs 1–6 on the top panel to specify the current date and time.
5. When you have finished making settings, press the **OK** button.

The date, time, and display format you specified will be finalized, and the popup window will close. If you press the **CANCEL** button or the “x” symbol instead of the **OK** button, your changes will be discarded and the popup window will close.

Setting the network address

This section explains how to set the network address that will be required when you use the NETWORK connector on the CL series console to connect it to a computer.

NOTE

Only the Administrator can change network settings.

1. In the Function Access Area, press the **SETUP** button to access the **SETUP** screen.
2. In the center of the **SETUP** screen, press the **NETWORK** button to access the **NETWORK** popup window.



① IP ADDRESS

Specifies an address that identifies an individual device on the Internet or LAN network.

② GATEWAY ADDRESS

Specifies an address that identifies a device (gateway) that converts data between different media or protocols to allow communication within the network.

③ SUBNET MASK

Within the IP address used in the network, this defines the bits that are used for the network address that distinguishes the network.

④ MAC ADDRESS

Indicates the MAC (Machine Access Control) address, which identifies a host in a network. This address is for display only, and cannot be edited.

NOTE

The NETWORK connector on the CL series console transmits data via either 100BASE-TX (transmission speed: maximum 100 Mbps) or 10BASE-T (transmission speed: max 10 Mbps).

3. Press the on-screen knob or the multifunction knobs on the top panel to specify the address.

If you plan to connect the CL series console to your computer in a one-to-one connection, we recommend that you use the following default values. Make sure that the IP address and Gateway address do not match the addresses of any other device on the network.

IP address: 192.168.0.128 or similar

Gateway address: 192.168.0.1 or similar

Subnet mask: 255.255.255.0 or similar

For details on settings related to connecting to a LAN, refer to the CL Editor Installation Guide.

4. When you have finished making settings, press the **OK** button.

If you changed the setting, a confirmation dialog box will appear.

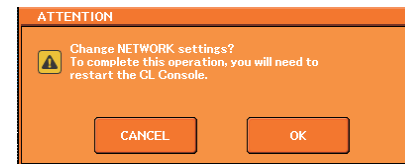

5. To make the setting, press the **OK** button.

The changes will be finalized, and the popup screen will close. If you decide to cancel the change, press the **CANCEL** button instead of the **OK** button.

NOTE

In order for the change to take effect, you must power-off the CL series console and then turn it on again.

6. Restart the CL series console.

Initializing the unit to factory default settings

If an error occurs in the CL console internal memory, or if you forget the password and cannot operate the unit, you can use the following procedure to initialize the internal memory.

NOTICE

The entire memory will be deleted if you initialize the internal memory!

Proceed with the following operation only if you are very sure you want to delete the entire memory.

1. While holding down the SCENE MEMORY [STORE] key on the panel, turn on the power to the CL unit.

After the opening screen, the following startup menu screen will appear.

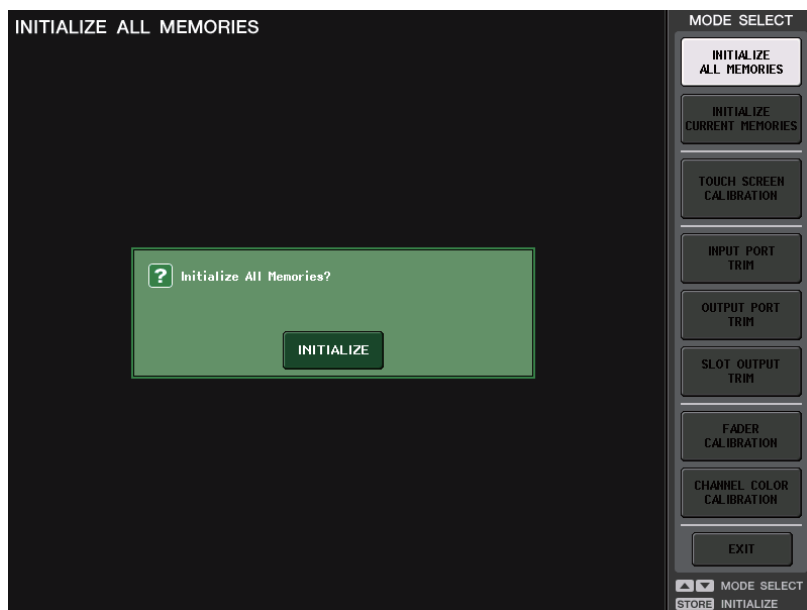

2. Press one of the following buttons, depending on the type of initialization you want to perform.
 - **INITIALIZE ALL MEMORIES**
The entire memory, including scene memories and libraries, will be returned to factory default settings.
 - **INITIALIZE CURRENT MEMORIES**
The contents of memory — except for scene memories and libraries — will be returned to its factory default settings.

3. A dialog box will ask you to confirm the initialization. Press the INITIALIZE button.
A dialog box will ask you to reconfirm the operation.

4. Press the OK button in the confirmation dialog box.

The Initialization operation starts.

NOTE

Do not press any buttons until initialization is complete.

5. A message indicates that the initialization process is complete. Press the EXIT button.

The CL unit will start up in normal operating mode.

NOTE

Alternatively, you can continue operation by selecting a different menu instead of pressing the EXIT button.

Adjusting the detection point of the touch screen (Calibration function)

Follow the steps below to correctly align the positions of the LCD display and the touch screen.

1. While holding down the SCENE MEMORY [STORE] key on the panel, turn on the power to the CL unit.

After the opening screen, the following startup menu screen will appear.

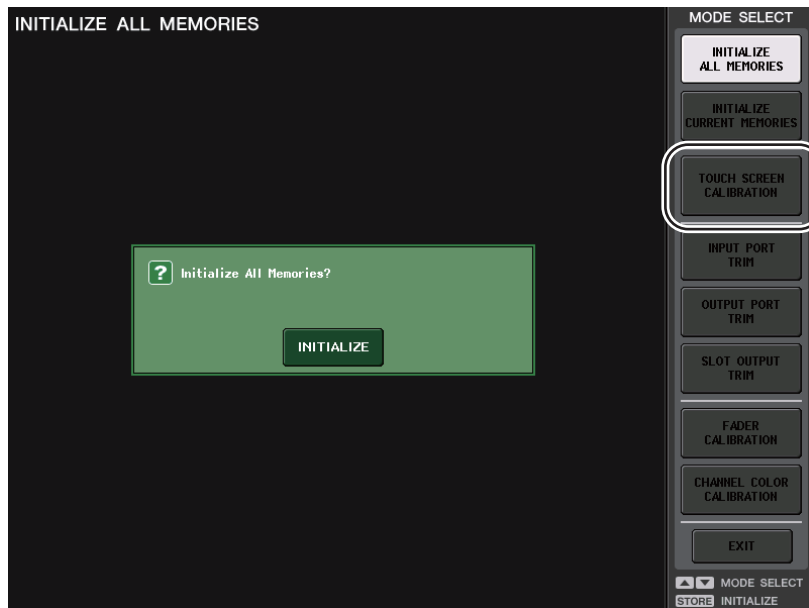

2. Press the TOUCH SCREEN CALIBRATION button.

The TOUCH SCREEN CALIBRATION MODE screen will appear, allowing you to calibrate the touch screen.

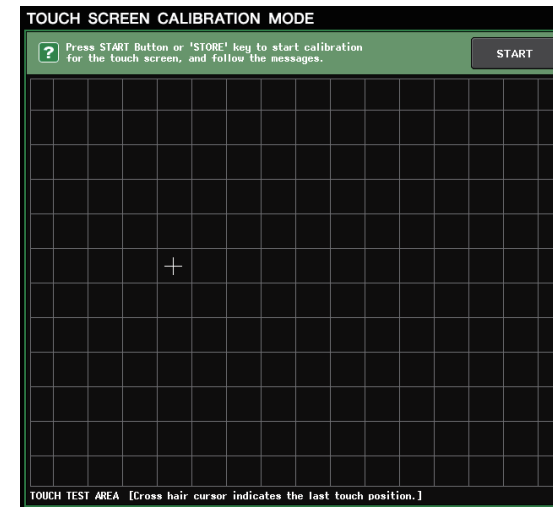

NOTE

If you are unable to access the calibration screen by pressing the TOUCH SCREEN CALIBRATION button, you can use the SCENE MEMORY [INC]/[DEC] keys to select TOUCH SCREEN CALIBRATION, and then press the [STORE] key to start.

3. Press the START button.
A confirmation dialog box will appear.
4. Press the OK button in the dialog box.
5. A cross-shaped cursor will appear in the screen a total of three times. Press each location at which it appears.

NOTE

To set the detection points accurately, press the cross-shaped cursor from the position and posture in which you normally operate the unit.

6. Press the EXIT button.

The CL unit will start up in normal operating mode.

NOTE

Alternatively, you can continue operation by selecting a different menu instead of pressing the EXIT button.

Adjusting the faders (Calibration function)

Depending on the environment in which you use the CL series console, discrepancies may occur in the motion of the motor faders. You can use the Calibration function to correct these discrepancies.

NOTE

For information about adjusting the input gain or the detection point of the touch screen, refer to the appropriate sections in this chapter.

1. While holding down the SCENE MEMORY [STORE] key on the panel, turn on the power to the CL unit.

After the opening screen, the following startup menu screen will appear.

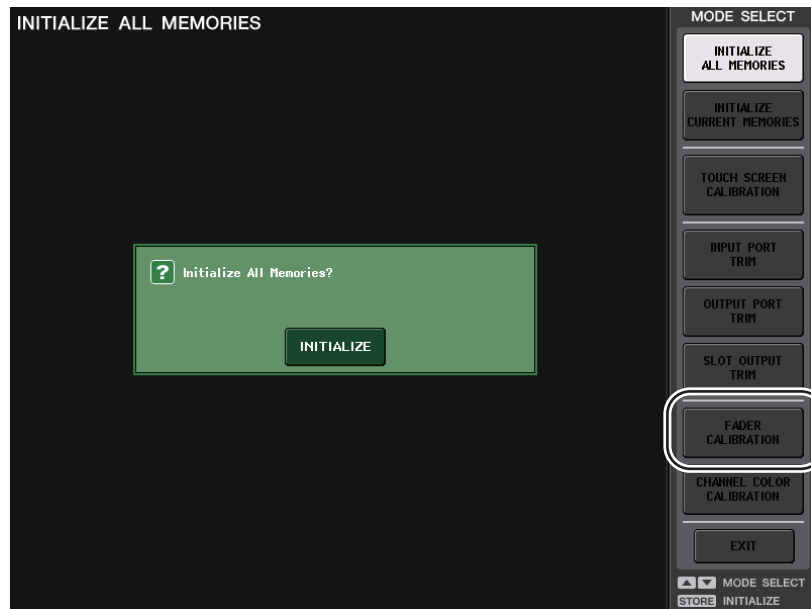

2. Press the FADER CALIBRATION button.

The FADER CALIBRATION MODE screen will appear, enabling you to adjust the faders. The specified faders in the channel strip section, Centralogic section, and Master section will be semi-automatically calibrated. This window will also appear if a problem is detected in the fader settings while the CL is starting up.



3. Press a [SEL] key to specify the faders that you want to calibrate. Faders for which a problem was detected at start-up will already be selected.
4. Press the START button. A confirmation dialog box will appear.
5. Press the OK button in the dialog box.
6. Each of the specified faders will move to the target positions in the following sequence. Manually adjust the faders to the correct positions.
 - ① $-\infty$ dB (all the way down)
 - ② -20 dB
 - ③ 0 dB
 - ④ $+10$ dB (all the way up)
7. After you adjust the fader position, press the [NEXT] button. The process will proceed to the next fader position.

- 8.** Repeat steps 6–7 to adjust the faders for positions ① through ④.

After the positions are corrected, automatic motorized calibration will start.

- 9.** When calibration is complete and if the **RESTART** button has not appeared, press the **APPLY** button.

The calibration settings will be saved in internal memory. If the **RESTART** button appears, calibration has failed. Press the **RESTART** button to execute calibration once again.

- 10.** Press the **EXIT** button.

The CL unit will start up in normal operating mode.

NOTE

Alternatively, you can continue operation by selecting a different menu instead of pressing the **EXIT** button.

Fine-tuning the input and output gain (Calibration function)

If necessary, you can make fine adjustments to the input and output gain.

- 1.** While holding down the **SCENE MEMORY [STORE]** key on the panel, turn on the power to the CL unit.

After the opening screen, the following startup menu screen will appear.

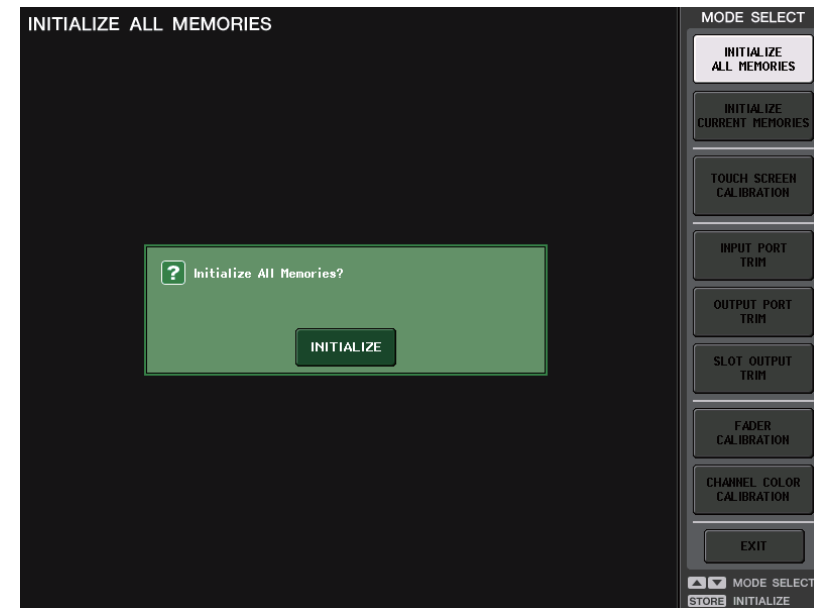

- 2.** In the **MODE SELECT** field, select the item you want to adjust, and then press the button.

The corresponding setting screen will appear.

You can make the following three gain adjustments for analog input and output.

- **INPUT PORT TRIM (Fine adjustment of the analog input gain)**

Access the INPUT PORT TRIM window, and make fine adjustments to the gain of the specified analog input port in 0.1 dB steps.



- **OUTPUT PORT TRIM (Fine adjustment of the output port gain)**

Access the OUTPUT PORT TRIM window, and make fine adjustments to the gain of the specified analog output port in 0.01 dB steps.

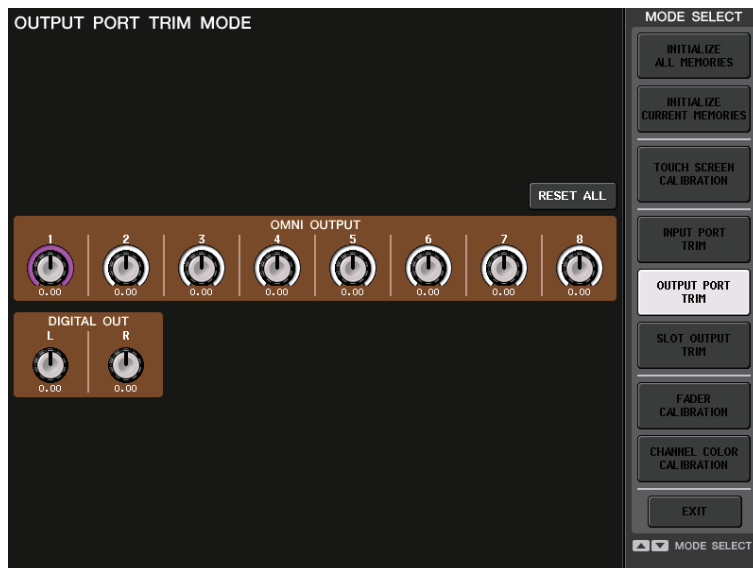

- **SLOT OUTPUT TRIM (Fine adjustment of the slot output port gain)**

Access the SLOT OUTPUT TRIM window, and make fine adjustments to the gain of the output ports of the specified slot in 0.01 dB steps.

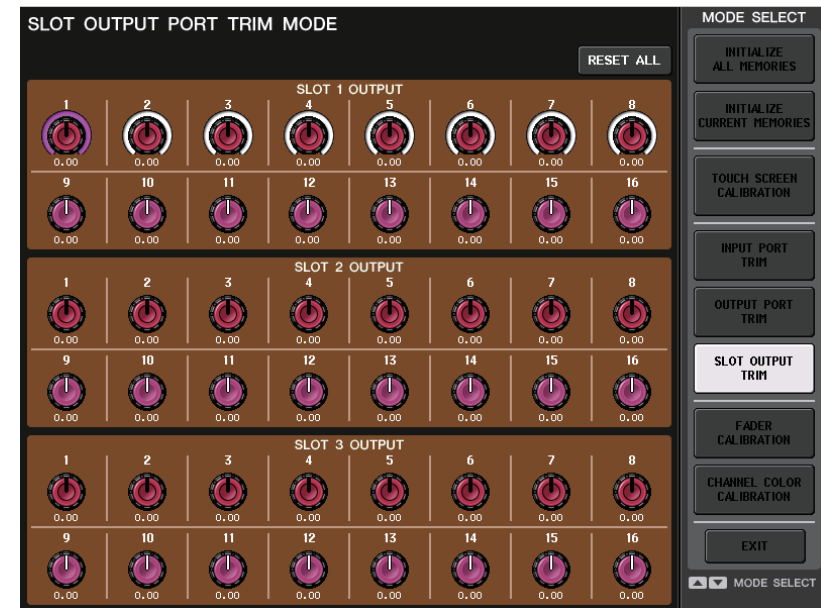

3. Press an on-screen knob to select it, and then use the corresponding multifunction knob to adjust the value.

If you press the RESET ALL button provided in each screen, all settings in the screen will be reset to 0 dB.

The factory settings are also 0 dB.

4. Press the EXIT button.

The CL unit will start up in normal operating mode.

NOTE

Alternatively, you can continue operation by selecting a different menu instead of pressing the EXIT button.

Adjusting the channel color (Calibration function)

If necessary, you can adjust the channel color.

1. While holding down the SCENE MEMORY [STORE] key on the panel, turn on the power to the CL unit.

After the welcome screen, the following startup menu screen will appear.

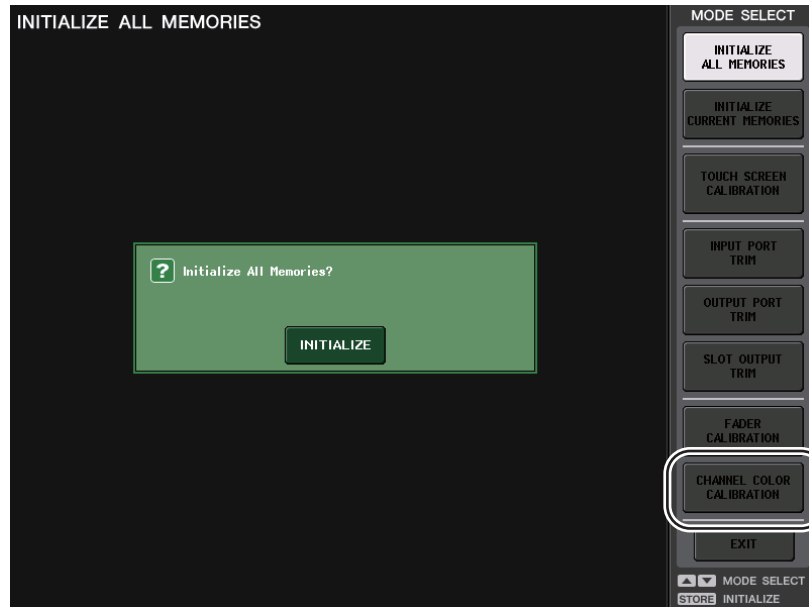

2. Press the CHANNEL COLOR CALIBRATION button.

The CHANNEL COLOR CALIBRATION MODE screen will appear, allowing you to adjust the channel color.

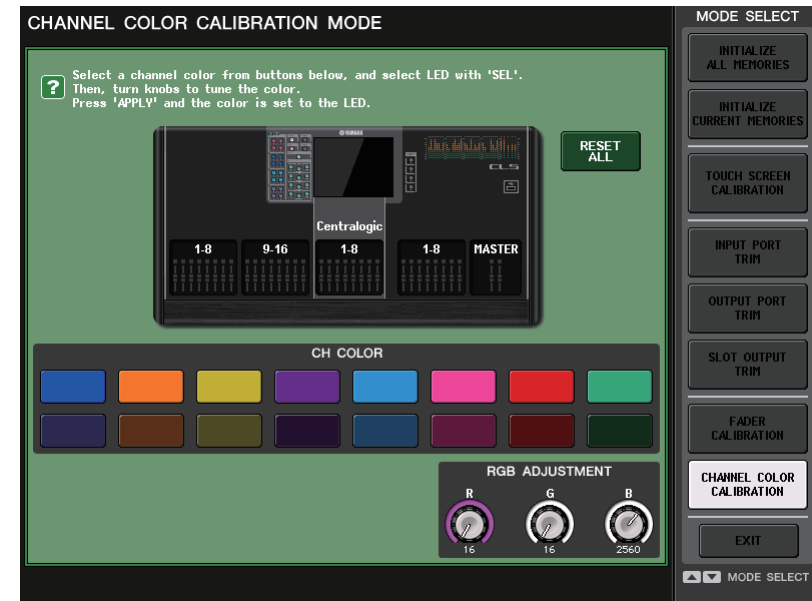

NOTE

In the case of the CL3/CL1, channels that do not exist on those models will not be shown.

3. Press a [SEL] key on the top panel to select the indicator for which you want to adjust the color.

NOTE

Only one can be selected. Multiple selections are not possible.

4. Press one of the color buttons on screen to select the desired color.

All channel color indicators turn the selected color. The currently-selected color button on screen will be surrounded by a white frame.

5. While comparing the color of the selected channel's indicator with the color of the other channel indicators (for which the [SEL] keys are turned off), use the three right-most multifunction knobs to adjust the color.

The RGB values in the RGB ADJUSTMENT field change accordingly.

- 6.** When you have finished adjusting the color, press the **APPLY** button located on the right of the window to confirm the change.

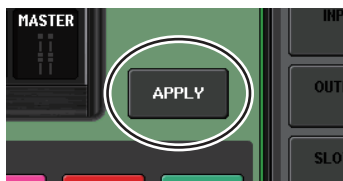

NOTE

The **APPLY** button appears only if you change the RGB values.

- 7.** To reset all channel color indicators to the factory default setting, press the **RESET ALL** button.



- 8.** Press the **EXIT** button.

The CL unit will start up in normal operating mode.

NOTE

Alternatively, you can continue operation by selecting a different menu instead of pressing the **EXIT** button.

Adjusting the brightness of the channel name display

If necessary, you can adjust the brightness of the channel name display.

- 1.** While holding down the **SCENE MEMORY [STORE]** key of the panel, turn on the power.

After the welcome screen, the following startup menu screen will appear.

- 2.** Press the **CHANNEL COLOR CALIBRATION** button.

The **CHANNEL COLOR CALIBRATION MODE** screen will appear, allowing you to adjust the channel color.

- 3.** Press the **[CUE]** key or **[ON]** key of the channel whose brightness you want to adjust.

Pressing the **[CUE]** key will increase the brightness, and pressing the **[ON]** key will decrease the brightness.

- 4.** When you have finished adjusting the brightness, press the **APPLY** button located in the right of the screen to confirm the change.



- 5.** Press the **EXIT** button.

The CL will start up in normal operating mode.

NOTE

Alternatively, you can continue operation by selecting a different menu instead of pressing the **EXIT** button.

Adjusting the contrast of the channel name display

If necessary, you can adjust the contrast of the channel name display.

1. While holding down the SCENE MEMORY [STORE] key of the panel, turn on the power.

After the welcome screen, the following startup menu screen will appear.

2. Press the CHANNEL COLOR CALIBRATION button.

The CHANNEL COLOR CALIBRATION MODE screen will appear, allowing you to adjust the channel color.

3. Hold down a [SEL] key on the panel, and turn multi-function knob 1 in the Centralogic section.

Turning the knob toward the left will lighten the contrast of all channels; turning it toward the right will darken the contrast of all channels.

4. If you want to adjust a channel whose contrast differs from that of the other channels, hold down the [SEL] key of the desired channel and press its [CUE] key or [ON] key.

Pressing the [CUE] key will darken the contrast, and pressing the [ON] key will lighten the contrast.

5. When you have finished adjusting the contrast, press the APPLY button located in the right of the screen to confirm the change.



NOTE

The APPLY button appears only if you change the setting.

6. Press the EXIT button.

The CL will start up in normal operating mode.

NOTE

Alternatively, you can continue operation by selecting a different menu instead of pressing the EXIT button.

Dante audio network settings

You will use the CL series console to make Dante audio network settings for the console itself and the I/O devices connected to the Dante connector of the CL series console. This section explains how to make Dante audio network settings.

Setting up a Dante audio network

1. In the function access area, press the SETUP button to access the SETUP screen.



2. In the DANTE field at the center of the screen, press the DANTE SETUP button to open the DANTE SETUP popup window.

3. In the upper part of the DANTE SETUP popup screen, press the SETUP tab to access the SETUP field.



This screen contains the following items.

① **CONSOLE ID select buttons**

Set the IDs for the CL series consoles.

If five or more CL units are connected to a network, and you plan not to assign IDs to some of the units, press the OFF button of each of those units to turn off the ID.

② **SECONDARY PORT select buttons**

Specify how the Dante audio network is configured.

③ **CANCEL button**

When editing the CONSOLE ID or SECONDARY PORT settings, you can press this button to cancel the changes you made.

④ **APPLY button**

After changing the CONSOLE ID or SECONDARY PORT settings, press this button to apply the changes you made.

⑤ **BIT select buttons**

Enable you to set the audio bit depth to 24-bit or 32-bit.

NOTE

24bit: Use this when transmitting and receiving data to or from an Rio unit. When using a CL series system, you will normally use this setting.

32bit: This is effective when transmitting and receiving 25-bit or larger data (when using cascade or gain compensation), but the amount of data being transmitted will increase 20–30% compared to 24-bit.

⑥ **LATENCY select buttons**

Enable you to set the Dante audio network latency to 0.25 ms, 0.5 ms, 1.0 ms, or 5.0 ms.

The latency setting varies depending on the network connection method and size. For details, refer to “[Setting the Dante audio network latency](#)” on [page 215](#).

⑦ **DANTE PATCH BY select buttons**

Use these select buttons when using Dante Controller to make Dante patch settings.

If the THIS CONSOLE button is selected, the DANTE INPUT PATCH and DANTE OUTPUT PATCH settings can be edited from the CL series console.

If the DANTE CONTROLLER button is selected, it will not be possible to edit the Dante patch settings.

You can operate these buttons regardless of the state of the DANTE PATCH BY select buttons on other CL series consoles on the network.

NOTE

- Settings that are shared with the I/O device (BIT/LATENCY/W.CLOCK) will reflect the settings of the CL series console whose CONSOLE ID is set to #1.
- If the DANTE CONTROLLER button is selected in the DANTE PATCH BY section, and you attempt to edit the Dante patching or related settings, the message “This Operation is Not Allowed” will appear at the bottom of the screen.

Switching the CONSOLE ID and SECONDARY PORT

1. In the SETUP field, select the CONSOLE ID and the SECONDARY PORT.

The button you switched is shown in red.



2. Press the APPLY button.

A popup window will appear, asking you to confirm the change to the CONSOLE ID and SECONDARY PORT.

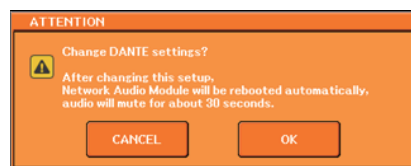

3. To execute the change, press the OK button.

The network audio module will be rebooted in order to change the settings.

When the Dante audio network settings have been applied, the button you selected will return to its original appearance.

NOTE

- If you change the SECONDARY PORT, you must also change the method of connection between the CL series console and the I/O devices. For example if the connections used for the REDUNDANT setting are left as they are when you change the setting to DAISY CHAIN, it will become impossible to send and receive audio. Be sure to disconnect the cables before you change the setting.
- The CONSOLE ID and SECONDARY PORT settings will not be changed even if you initialize the CL series console.

Setting the Dante audio network latency

An appropriate latency setting for signals sent and received via a Dante audio network varies depending on the network connection method and size. This section explains how to set an appropriate latency setting depending on the connection method of Dante-enabled devices that are connected to the CL series console.

■ Relationship between the switches and the number of hops

An appropriate latency setting on a Dante audio network varies depending on the number of hops in the network.

One hop is the step from one router (switch) to the next. You count the number of hops starting from the master device to the most distant device (assuming that all devices are connected in series).

Switches mean network switches and routers, as well as the switches that are built into CL series consoles and I/O devices.

Set the latency value based on the number of hops. The following table shows typical latency settings based on the number of hops.

Number of hops	Latency (ms)
Up to 3	0.25
Up to 5	0.5
Up to 10	1.0
11 or more (or if a problem occurs)	5.0

NOTE

- Depending on network conditions, you may need to raise the latency value even if the number of hops is small.
- If a problem occurs, select 5.0 ms so that you will be able to identify whether the latency setting is the cause of the problem.

■ Connection examples and latency settings

Daisy chain connections

Simple 64-in/48-out

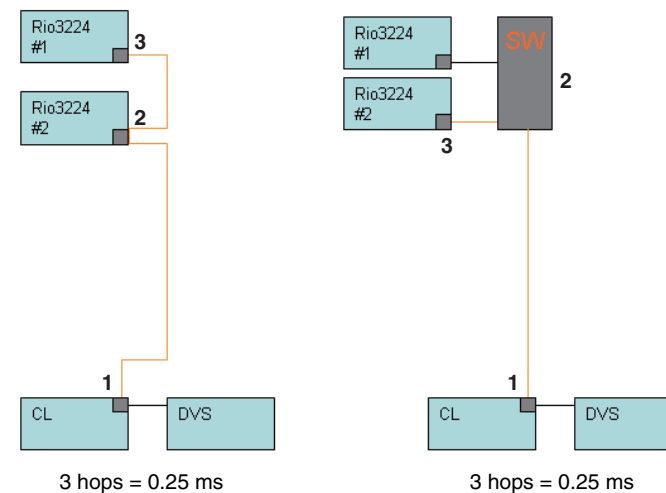

Daisy chain connections

FOH and monitor consoles are sharing 64-in/48-out.

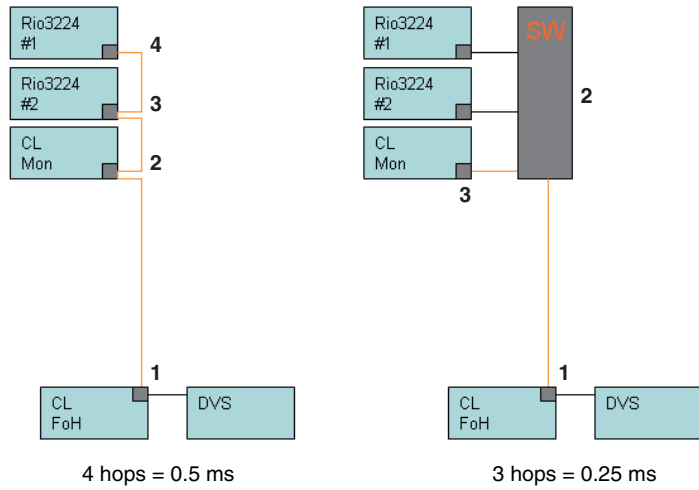

Redundant connections

Simple 64-in/48-out

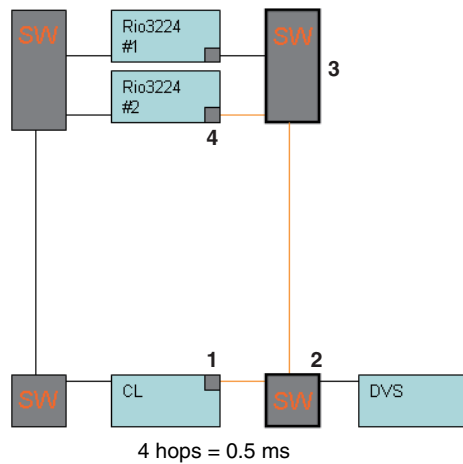

Redundant connections

FOH and monitor consoles are sharing 64-in/48-out.

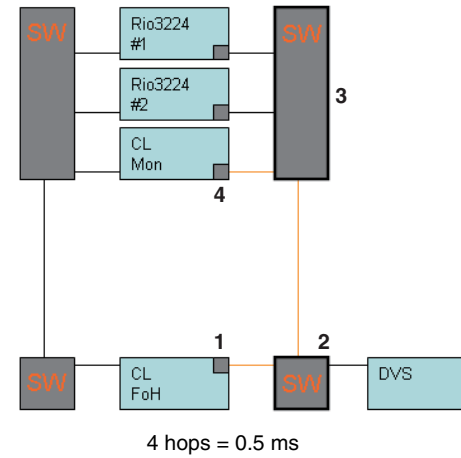

Daisy chain connections

256-ch HA remote (maximum size)

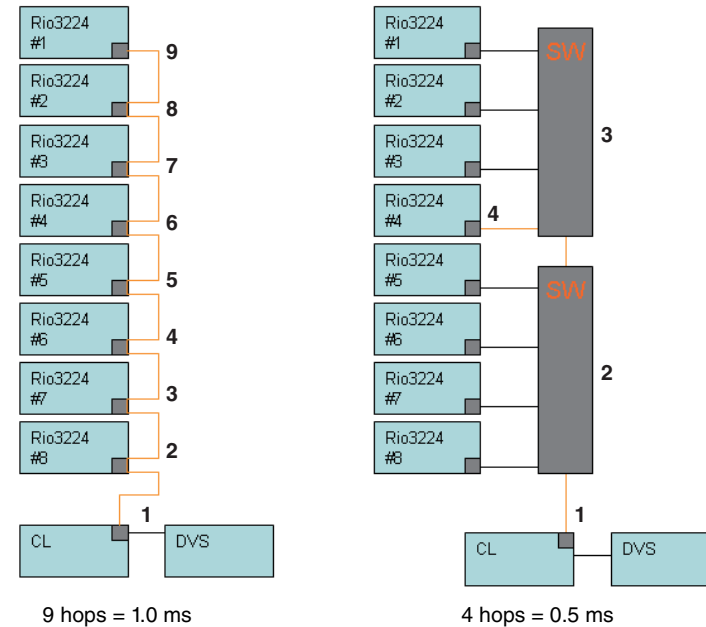

Redundant connections

Two consoles are sharing 256-ch HA remote (maximum size)

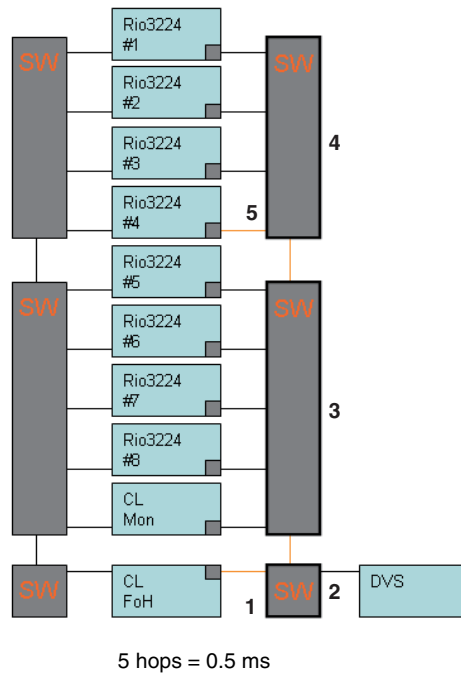

Mounting an I/O device on the Dante audio network

Here's how to select which of the multiple I/O devices on the Dante audio network will be mounted so that they can be used. Up to 24 units can be mounted for one CL series console.

1. In the lower part of the DANTE SETUP popup screen, press the **DEVICE MOUNT** tab to access the **DEVICE MOUNT** field.



This screen contains the following items.

- ① **CLEAR ALL button**
Clears all I/O devices in the list to an unmounted state.
- ② **REFRESH button**
Updates the displayed list of I/O devices on the Dante audio network.
- ③ **I/O device select buttons**
Press one of the buttons to open the **DEVICE SELECT** popup window.
The upper line of the button shows the device label.
The lower line of the button shows the model name and the number of inputs and outputs.
If no device has been mounted, the upper row will indicate “---” and the lower row will show nothing.

2. Press an I/O device select button to access the DEVICE SELECT popup window.

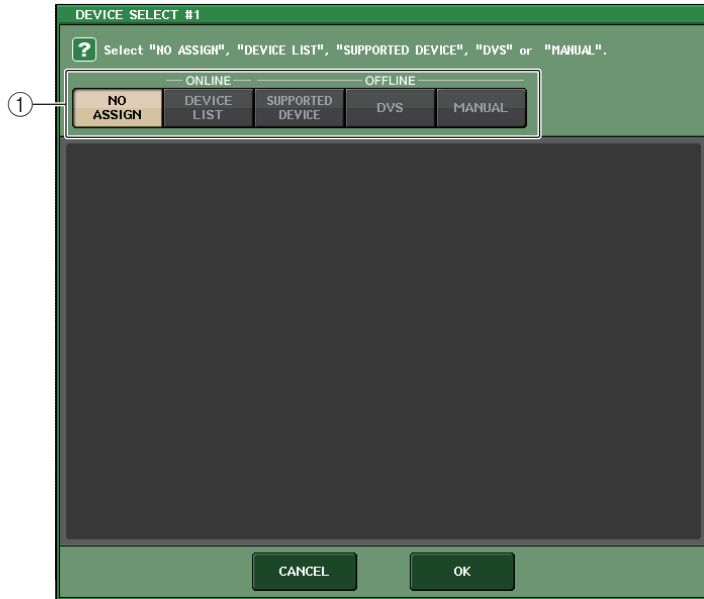

① **Setup method selection buttons**

Choose one of the following methods for mounting the I/O device.

- **NO ASSIGN**..... Not mounted
- **DEVICE LIST**..... Select and mount from the device list
- **SUPPORTED DEVICE**..... Select and mount a supported device
- **DVS** Enter a device label and mount (only for DVS)
- **MANUAL** Enter a device label and mount

■ When the setup method select button is DEVICE LIST

To mount by choosing from a list of the I/O devices on the Dante audio network, press the DEVICE LIST button to display the DEVICE LIST field.

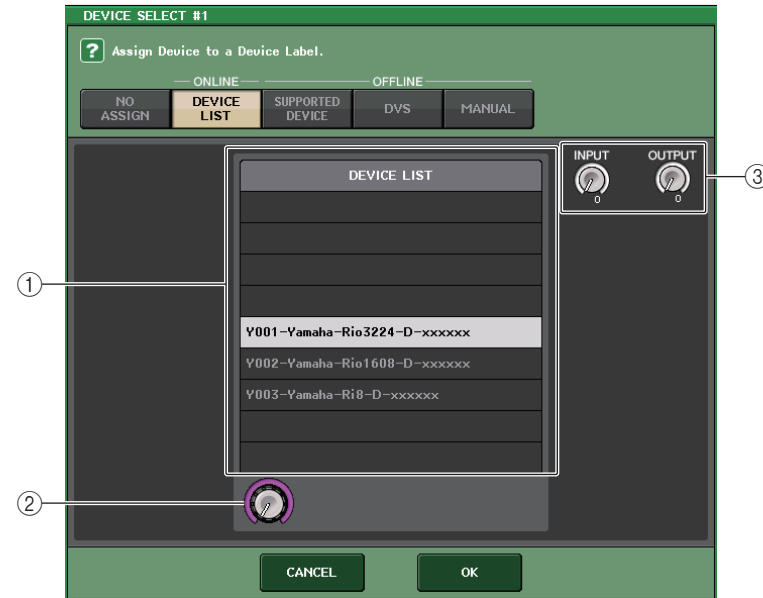

This screen contains the following items.

- ① **DEVICE LIST**
Shows a list of the I/O devices on the Dante audio network.
From the list, choose the I/O device that you want to mount.
- ② **DEVICE LIST select knob**
Use the multi-function knob to select the I/O device that you want to mount.
- ③ **INPUT/OUTPUT knobs**
Use the multi-function knobs to specify the number of inputs and outputs on the Dante audio network. If the selected I/O device is supported by the CL series, the number of inputs and outputs will be entered automatically.

■ When the setup method select button is SUPPORTED DEVICE

If you want to select and mount an I/O device that is supported by the CL series, press the SUPPORTED DEVICE button to see the SUPPORTED DEVICE field. These settings can be made even when not connected to a Dante audio network.

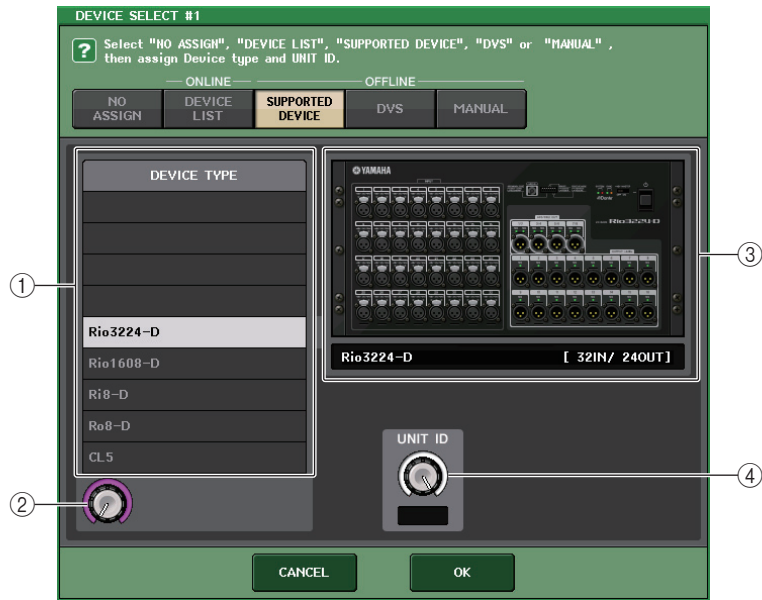

This screen contains the following items.

① DEVICE TYPE

This area shows a list of the I/O device types that are supported by the CL series. From the list, choose the type of I/O device that you want to mount.

② DEVICE TYPE select knob

Use the multi-function knob to select the type of I/O device that you want to mount.

③ I/O device indication

This area shows the selected I/O device.

The upper line shows the front panel of the I/O device.

The lower line shows the model name and the number of inputs and outputs.

④ UNIT ID knob

Use the multifunction knobs to specify the UNIT ID.

The indicator shows the UNIT ID.

NOTE

- If there is one I/O device, set the I/O device's UNIT ID to "1".
- If multiple devices are connected, assign the ID numbers so that there is no conflict between devices.
- For devices other than the Rio series, it is possible for devices of differing models to be assigned to the same ID as an Rio series unit or the same ID as a different model of device. However since the I/O device input/output port screen shows the UNIT ID, this will make it difficult to distinguish between the units, so we recommend that whenever possible, you avoid allowing the ID numbers to overlap.
- If you have a device whose UNIT ID or device label cannot be changed from its panel or its edit screen etc. (such as the Dante-MY16-AUD card or DANTE-ACCEL), and you want to use that device as a SUPPORTED DEVICE, you must change its device label via Dante Controller.
- The Dante-MY16-AUD and DANTE-ACCEL will be recognized as a SUPPORTED DEVICE if you assign the device label as follows.

Dante-MY16-AUD: Y###-Audinate-DANTE-MY16*****

DANTE-ACCEL: Y###-Yamaha-DANTE-ACCEL*****

is a three-digit hexadecimal number containing the digits 0–9 and uppercase A–F (000–FFF)

* indicates any desired character (alphabetical uppercase or lowercase, numerals, or - (hyphen) may be used)

- If you are controlling the CL console from an Rio series unit, we recommend that you set the Rio unit's START UP MODE to "REFRESH." Operation will be safer with the "REFRESH" setting, since mute will be cleared after synchronization has been completed with CL units whose system setting for REMOTE HA ASSIGN is set to "WITH RECALL." With the "RESUME" setting, mute will be cleared and the unit will start operating with the settings that were backed up by the Rio series unit itself, which could allow unexpected audio to be output.
- A single CL console can control the HA of up to eight Rio series units. If nine or more Rio series units are connected, you can either divide the HA control between multiple CL consoles, or you can omit specifying REMOTE HA ASSIGN for the Rio series units whose HA does not need to be controlled, and use them with START UP MODE set to "RESUME."

■ When setup method selection button = DVS

■ When setup method selection button = MANUAL

If you want to enter the device label of an I/O device and mount it, press the DVS or MANUAL button to access the DVS/MANUAL field.



This screen contains the following items.

① DEVICE LABEL

Displays the device label of the I/O device which you entered from the keyboard.

② INPUT/OUTPUT knobs

Use the multi-function knobs to specify the number of inputs and outputs on the Dante audio network.

③ Device label entry keyboard

Use this keyboard to enter the device label of the I/O device.

NOTE

- If the I/O device is a DVS, mount it by pressing the DVS button.
- If the device label you entered is detected automatically, the INPUT/OUTPUT knob settings will be ignored, and the rated number of inputs and outputs will be specified.

3. After you've selected the I/O device to mount, press the OK button to close the DEVICE SELECT popup window.

REMOTE HA settings

Here's how to select which of the multiple HA devices on the Dante audio network will be mounted so that they can be used. Up to 8 units can be mounted for one CL series console.

1. In the lower part of the DANTE SETUP popup screen, press the REMOTE HA tab to access the REMOTE HA field.

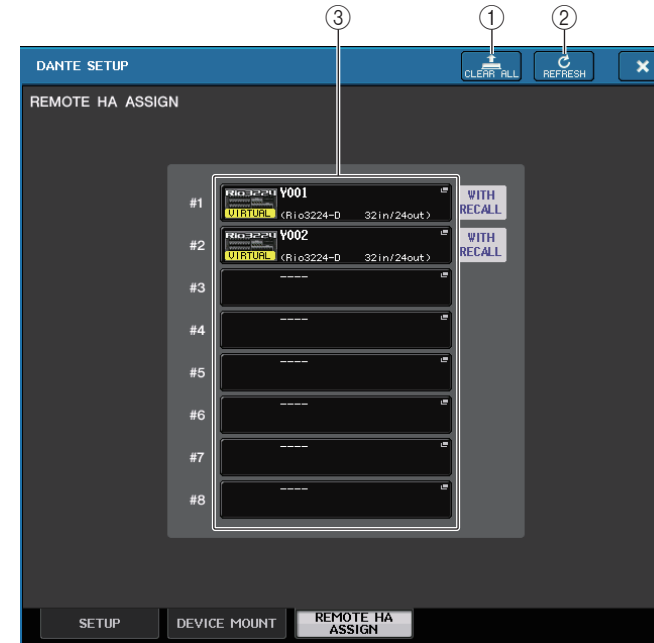

This screen contains the following items.

① CLEAR ALL button

Clears all HA devices in the list to an unmounted state.

② REFRESH button

Updates the displayed list of HA devices on the Dante audio network.

③ HA device select buttons

Press one of these buttons to open the REMOTE HA SELECT popup window.

The upper line of the button shows the device label.

The lower line of the button shows the product name and the number of inputs and outputs.

If no device has been mounted, the upper row will indicate “---” and the lower row will show nothing.

2. Press a HA device select button to access the REMOTE HA SELECT popup window.

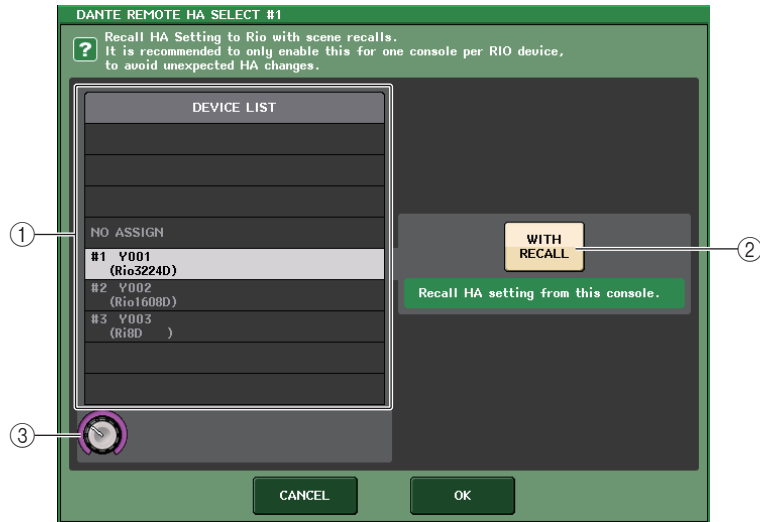

This screen contains the following items.

① DEVICE LIST

Shows a list of the HA devices on the Dante audio network.

② with RECALL button

If this button is on, the settings saved in the CL series console will be applied to the HA device when the CL series console starts up and when a scene is recalled.

③ DEVICE LIST select knob

Use the multi-function knob to select the HA device that you want to mount.

NOTE

- Do not specify “with RECALL” if an HA device is shared by multiple CL series consoles and settings have already been made on a different CL series console.
- The HA device can also be operated from a CL series console that is not set to “with RECALL.”

3. After you’ve selected the HA device to mount, press the OK button to close the REMOTE HA SELECT popup window.

If you’ve changed the setting by pressing the “with RECALL” button, a confirmation dialog box will appear.

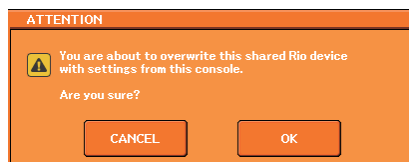

To make the setting, press the OK button.

Using GPI (General Purpose Interface)

The rear panel GPI (General Purpose Interface) connector can be used as an input/output connector. This connector provides five GPI IN ports and five GPI OUT ports. For example you can use an external switch to control internal parameters of the CL series console or to switch scenes. Conversely, operations or scene changes performed on the CL series console can send control signals to an external device.

For details on how to send control signals to an external device when you switch scenes, refer to “Outputting a control signal to an external device in tandem with scene recall (GPI OUT)” on page 93.

Using GPI IN

You can use the GPI IN ports of the GPI connector to control the parameters of the CL series console from an external device. For example, you could use an external switch to turn the CL series console’s Talkback on/off, operate the Tap Tempo function, or switch scenes.

1. Connect an external device to the CL series console’s GPI connector.
2. In the function access area, press the SETUP button to access the SETUP screen.



3. Press the MIDI/GPI button.

The MIDI SETUP screen will appear.

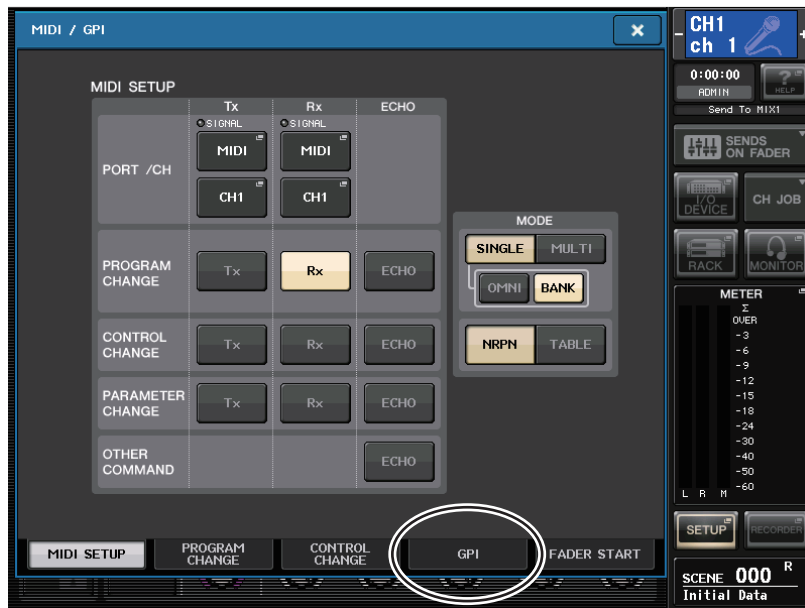

4. Press the GPI tab.

The GPI page will appear.

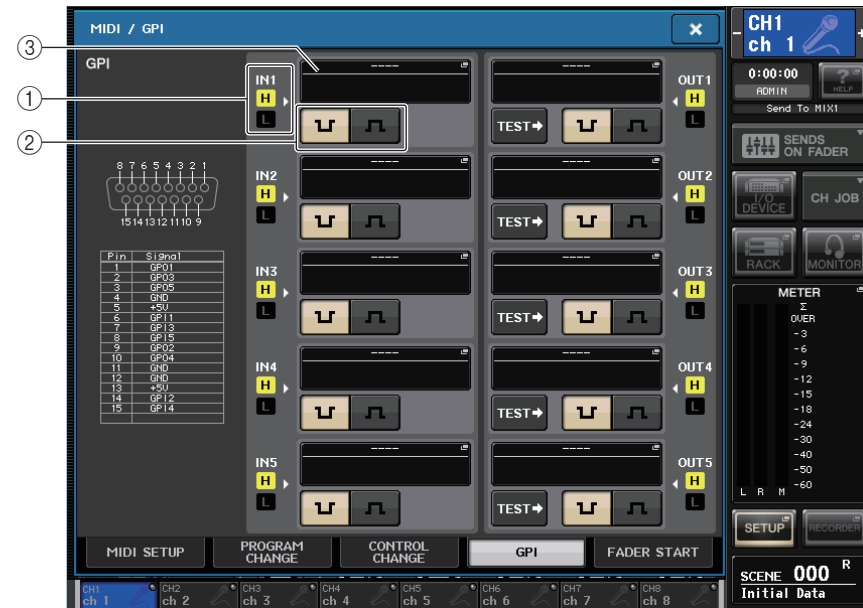



① GPI IN status indicator

This indicates the status of the voltage being input to the GPI IN port.

② POLARITY MODE select button

This button selects the polarity of the GPI IN port.

 (Low active) When operating an on/off-type parameter, it will become active when the switch is grounded.

 (High active) When operating an on/off-type parameter, it will become active when the switch is opened or when a high-level voltage is input.

③ GPI IN SETUP popup button

Press this button to open the GPI IN SETUP popup window.

The button shows the name of the currently selected function or parameter.

5. Specify the POLARITY MODE for each port.

For each port, select either low-active or high-active as appropriate for the specifications of the external device you're using.

- To assign the function or parameter that you want to control, press the GPI IN SETUP popup button.

The GPI IN SETUP popup window will appear.

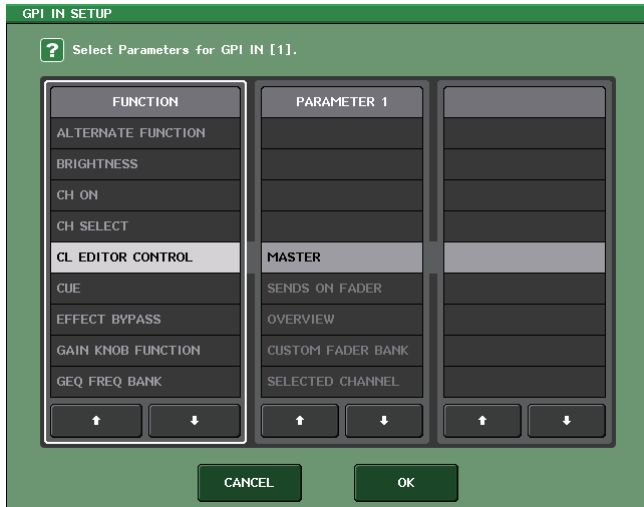

NOTE

The items that can be selected are the same as for the USER DEFINED keys.

- In each field, select the desired function or parameter.

NOTE

- With latched operation, the function will switch between active and inactive each time a trigger is input from the external switch. In this case, we recommend that you use a non-locking type of external switch.
- With unlatched operation, the function will be active only while the signal from the external switch is at the high level or low level. In this case, you may use either a non-locking or a locking type of external switch as appropriate for your needs.

- When you have finished making settings, press the OK button.

You will return to the GPI screen.

- Repeat steps 5 through 8 to specify functions and parameters for other ports.

NOTE

Settings in the GPI screen are common to all scenes. They can be saved as SETUP data.

Using GPI OUT

The GPI OUT ports of the GPI OUT connector allow you to control an external device by performing operations on the CL series console.

- Connect an external device to the CL series console's GPI connector.
- In the function access area, press the SETUP button to access the SETUP screen.
- Press the MIDI/GPI button. The MIDI/GPI screen will appear.
- Press the GPI tab. The GPI page will appear.

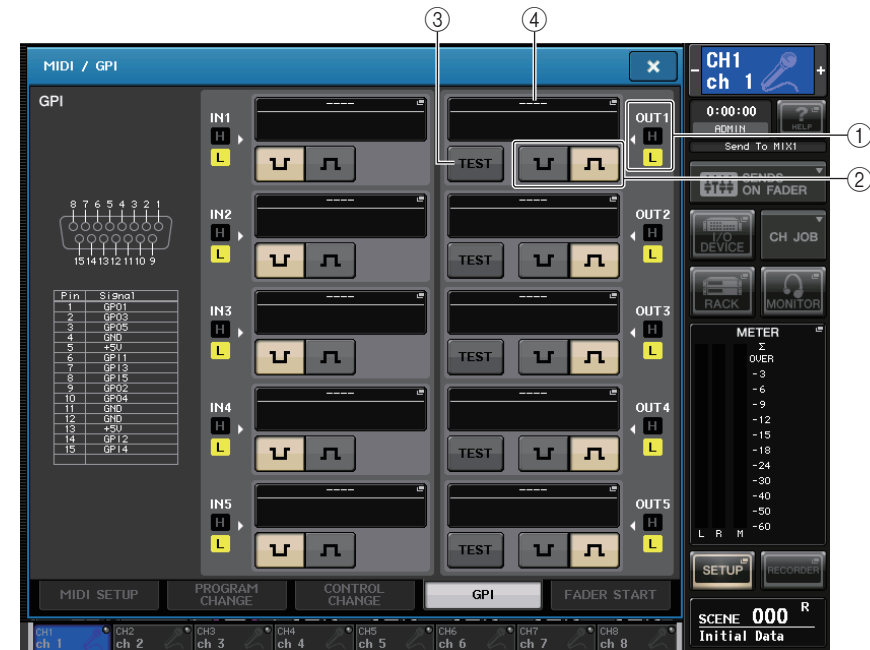



- GPI OUT status indicator**

This indicates the status of the voltage that is being output from each GPI OUT port.

- POLARITY MODE select button**

This button selects the polarity of the GPI OUT port.

 (Low active) Grounded when the GPI OUT port is active.

 (Low active) Open when the GPI OUT port is active.

③ GPI OUT SETUP popup button

Press this button to open the GPI OUT SETUP popup window.

The button shows the name of the currently selected function or parameter.

④ TEST button

While this is on, the corresponding GPI OUT port will be active and will output a control signal.

5. Specify the POLARITY MODE for each port.

For each port, select either low-active or high-active as appropriate for the specifications of the external device you're using.

6. To assign a function or parameter, press the GPI OUT SETUP popup button.

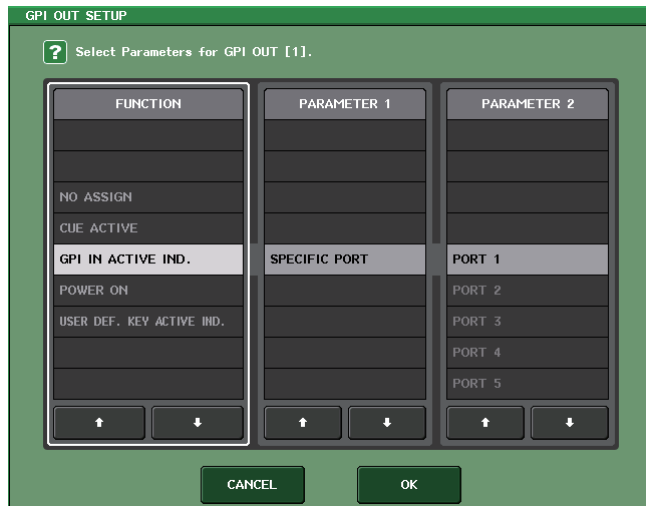

You can assign the following functions.

Function	Parameter	CL console operation
NO ASSIGN	---	No assignment
CUE ACTIVE	CUE ON	Turn on the [CUE] key of the selected channel
	DCA ONLY	Turn on the DCA [CUE] key
	INPUT ONLY	Turn on the [CUE] key of an input channel
	OUTPUT ONLY	Turn on the [CUE] key of an output channel
GPI IN ACTIVE IND.	PORT 1–PORT 5	The function assigned to GPI IN port 1–5 becomes active
POWER ON	---	The power of the CL series console is turned on
USER DEF. KEY ACTIVE IND.	USER DEFINED KEY 1–USER DEFINED KEY 16	The function assigned to the USER DEFINED key becomes active

7. In each field, select the desired function or parameter.

8. When you have finished making settings, press the OK button.

9. Repeat steps 5 through 8 to specify functions and parameters for other ports.

Using FADER START

Make FADER START settings if you want a device connected to a GPI OUT port to operate in tandem with fader operations.

1. Connect an external device to the CL series console's GPI connector.

2. In the function access area, press the SETUP button to access the SETUP screen.

3. Press the MIDI/GPI button.

The MIDI/GPI screen will appear.

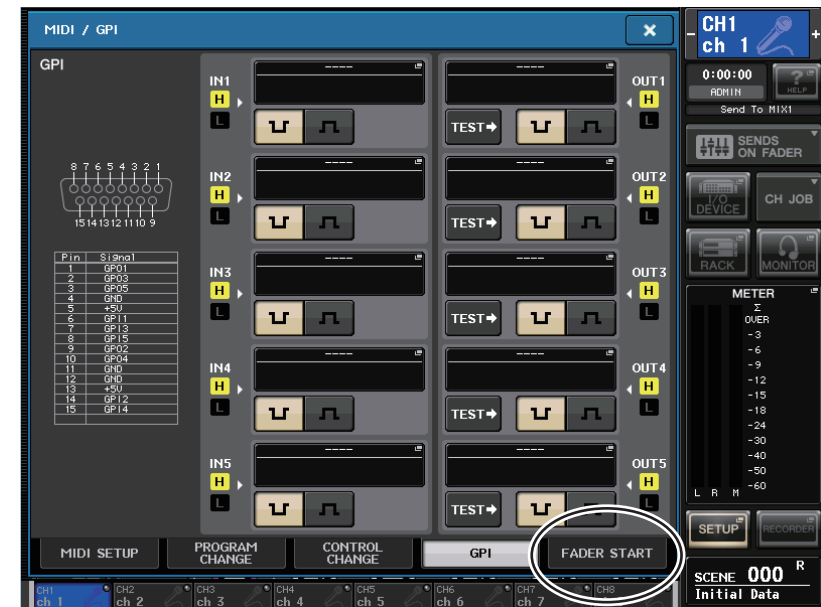

4. Press the FADER START tab to access the FADER START page.

The following items are displayed.

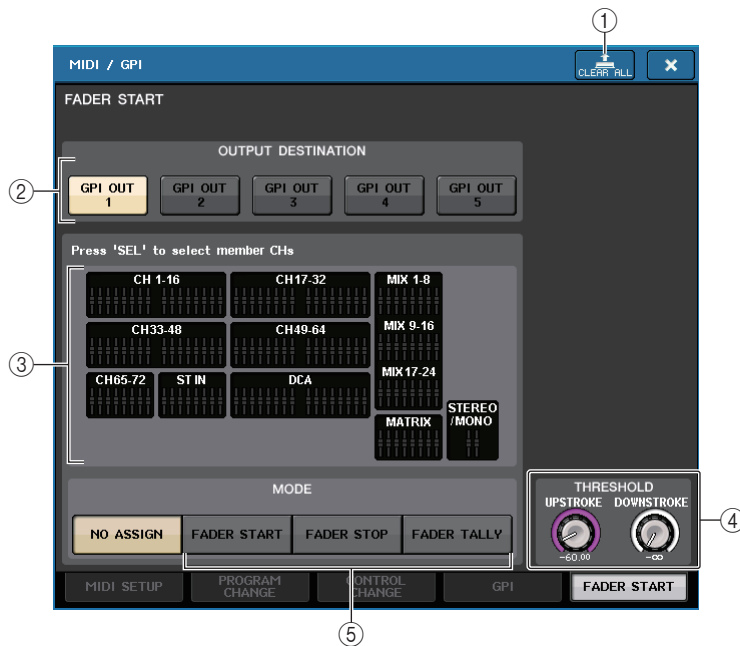

① CLEAR ALL button

Press this button to clear all selections.

② OUTPUT DESTINATION field

- **GPI OUT1–GPI OUT5 buttons**

Select the GPI OUT port for which you want to make settings.

③ Fader indicator

This indicates the selected fader. Use the [SEL] keys of the console panel to select a fader.

NOTE

In the case of the CL3/CL1, channels that do not exist on those models will not be shown.

④ THRESHOLD field

- **UPSTROKE/DOWNSTROKE knobs**

These specify the level that will be the threshold for outputting a trigger signal. A trigger signal will be output when the fader exceeds the UPSTROKE level, or when the fader falls below the DOWNSTROKE level. If FADER TALLY is selected as the fader mode, UPSTROKE and DOWNSTROKE specify the level range for which a trigger signal will be output. You can use the multifunction knobs to operate these parameters.

NOTE

- The THRESHOLD values specified by the UPSTROKE/DOWNSTROKE knobs are common to all GPI OUT ports. However, you can individually choose the channel (fader) for each GPI OUT port.
- Only the UPSTROKE value will be valid if MODE is set to FADER START, and only the DOWNSTROKE value will be valid if MODE is set to FADER STOP. If MODE is set to FADER TALLY, both the UPSTROKE and DOWNSTROKE values will be valid.

⑤ MODE field

Here you can select the mode of fader operation that will be the trigger for signal output from the GPI OUT port.

You can choose from the following fader modes.

- **NO ASSIGN**

Operating the fader of the selected channel will not cause a signal to be output.

- **FADER START**



A trigger signal 250 msec long will be output when the fader of the selected channel moves upward through the specified UPSTROKE level (–138.0 dB to 10.0 dB) from a point below it.

- **FADER STOP**

A trigger signal 250 msec long will be output when the fader of the selected channel reaches the specified DOWNSTROKE level (–∞ dB to 9.95 dB).

- **FADER TALLY**

A trigger signal will be output when the fader of the selected channel moves upward through the specified UPSTROKE level (–138.0 dB to 10.0 dB) from a point below it. This signal will be held until the fader reaches the specified DOWNSTROKE level (–∞ dB to 9.95 dB) or until that GPI OUT port receives a different trigger.

The following illustration shows how the signal that is output from the GPI OUT port will change in each fader mode when a fader is operated. In this example, UPSTROKE in the THRESHOLD field is set to -60.00 , and DOWNSTROKE is set to $-\infty$. (This illustration shows the case in which  is selected as the polarity of the GPI OUT port. If the polarity is , the polarity of the output signal will be reversed.)

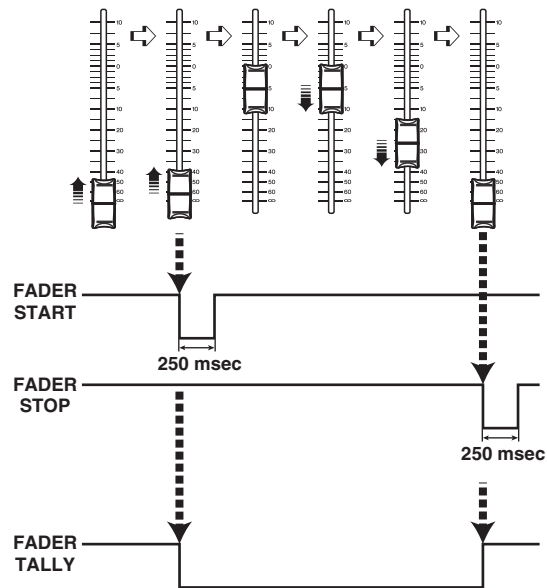

NOTE

At the high level, the output signal of the port will be open. If the receiving device requires high level, take it from the +5V power supply pin. However in this case, the amount of current is limited; for details, refer to the "Input/output characteristics" section in the separate Owner's Manual.

5. For each GPI OUT port, specify the channel that will cause the external device to operate, and the type of operation.
6. When you have finished making settings, click the "x" symbol located in the upper right to close the FADER MODE screen.

Appendices

EQ Library List

#	Title	Parameter				
		LOW	L-MID	H-MID	HIGH	
01	Bass Drum 1		PEAKING	PEAKING	PEAKING	H.SHELF
		G	+3.5 dB	-3.5 dB	0.0 dB	+4.0 dB
		F	100 Hz	265 Hz	1.06 kHz	5.30 kHz
		Q	1.25	10.0	0.90	—
02	Bass Drum 2		PEAKING	PEAKING	PEAKING	LPF
		G	+8.0 dB	-7.0 dB	+6.0 dB	ON
		F	80.0 Hz	400 Hz	2.50 kHz	12.5 kHz
		Q	1.4	4.5	2.2	—
03	Snare Drum 1		PEAKING	PEAKING	PEAKING	H.SHELF
		G	-0.5 dB	0.0 dB	+3.0 dB	+4.5 dB
		F	132 Hz	1.00 kHz	3.15 kHz	5.00 kHz
		Q	1.25	4.5	0.11	—
04	Snare Drum 2		L.SHELF	PEAKING	PEAKING	PEAKING
		G	+1.5 dB	-8.5 dB	+2.5 dB	+4.0 dB
		F	180 Hz	335 Hz	2.36 kHz	4.00 kHz
		Q	—	10.0	0.70	0.10
05	Tom-tom 1		PEAKING	PEAKING	PEAKING	PEAKING
		G	+2.0 dB	-7.5 dB	+2.0 dB	+1.0 dB
		F	212 Hz	670 Hz	4.50 kHz	6.30 kHz
		Q	1.4	10.0	1.25	0.28
06	Cymbal		L.SHELF	PEAKING	PEAKING	H.SHELF
		G	-2.0 dB	0.0 dB	0.0 dB	+3.0 dB
		F	106 Hz	425 Hz	1.06 kHz	13.2 kHz
		Q	—	8.0	0.90	—
07	High Hat		L.SHELF	PEAKING	PEAKING	H.SHELF
		G	-4.0 dB	-2.5 dB	+1.0 dB	+0.5 dB
		F	95.0 Hz	425 Hz	2.80 kHz	7.50 kHz
		Q	—	0.50	1.0	—
08	Percussion		L.SHELF	PEAKING	PEAKING	H.SHELF
		G	-4.5 dB	0.0 dB	+2.0 dB	0.0 dB
		F	100 Hz	400 Hz	2.80 kHz	17.0 kHz
		Q	—	4.5	0.56	—
09	E. Bass 1		L.SHELF	PEAKING	PEAKING	H.SHELF
		G	-7.5 dB	+4.5 dB	+2.5 dB	0.0 dB
		F	35.5 Hz	112 Hz	2.00 kHz	4.00 kHz
		Q	—	5.0	4.5	—

#	Title	Parameter				
		LOW	L-MID	H-MID	HIGH	
10	E. Bass 2		PEAKING	PEAKING	PEAKING	H.SHELF
		G	+3.0 dB	0.0 dB	+2.5 dB	+0.5 dB
		F	112 Hz	112 Hz	2.24 kHz	4.00 kHz
		Q	0.10	5.0	6.3	—
11	Syn. Bass 1		PEAKING	PEAKING	PEAKING	H.SHELF
		G	+3.5 dB	+8.5 dB	0.0 dB	0.0 dB
		F	85.0 Hz	950 Hz	4.00 kHz	12.5 kHz
		Q	0.10	8.0	4.5	—
12	Syn. Bass 2		PEAKING	PEAKING	PEAKING	H.SHELF
		G	+2.5 dB	0.0 dB	+1.5 dB	0.0 dB
		F	125 Hz	180 Hz	1.12 kHz	12.5 kHz
		Q	1.6	8.0	2.2	—
13	Piano 1		L.SHELF	PEAKING	PEAKING	H.SHELF
		G	-6.0 dB	0.0 dB	+2.0 dB	+4.0 dB
		F	95.0 Hz	950 Hz	3.15 kHz	7.50 kHz
		Q	—	8.0	0.90	—
14	Piano 2		PEAKING	PEAKING	PEAKING	H.SHELF
		G	+3.5 dB	-8.5 dB	+1.5 dB	+3.0 dB
		F	224 Hz	600 Hz	3.15 kHz	5.30 kHz
		Q	5.6	10.0	0.70	—
15	E. G. Clean		PEAKING	PEAKING	PEAKING	H.SHELF
		G	+2.0 dB	-5.5 dB	+0.5 dB	+2.5 dB
		F	265 Hz	400 Hz	1.32 kHz	4.50 kHz
		Q	0.18	10.0	6.3	—
16	E. G. Crunch 1		PEAKING	PEAKING	PEAKING	PEAKING
		G	+4.5 dB	0.0 dB	+4.0 dB	+2.0 dB
		F	140 Hz	1.00 kHz	1.90 kHz	5.60 kHz
		Q	8.0	4.5	0.63	9.0
17	E. G. Crunch 2		PEAKING	PEAKING	PEAKING	H.SHELF
		G	+2.5 dB	+1.5 dB	+2.5 dB	0.0 dB
		F	125 Hz	450 Hz	3.35 kHz	19.0 kHz
		Q	8.0	0.40	0.16	—
18	E. G. Dist. 1		L.SHELF	PEAKING	PEAKING	H.SHELF
		G	+5.0 dB	0.0 dB	+3.5 dB	0.0 dB
		F	355 Hz	950 Hz	3.35 kHz	12.5 kHz
		Q	—	9.0	10.0	—
19	E. G. Dist. 2		L.SHELF	PEAKING	PEAKING	H.SHELF
		G	+6.0 dB	-8.5 dB	+4.5 dB	+4.0 dB
		F	315 Hz	1.06 kHz	4.25 kHz	12.5 kHz
		Q	—	10.0	4.0	—
20	A. G. Stroke 1		PEAKING	PEAKING	PEAKING	H.SHELF
		G	-2.0 dB	0.0 dB	+1.0 dB	+4.0 dB
		F	106 Hz	1.00 kHz	1.90 kHz	5.30 kHz
		Q	0.90	4.5	3.5	—

#	Title	Parameter				
		LOW	L-MID	H-MID	HIGH	
21	A. G. Stroke 2		L.SHELF	PEAKING	PEAKING	H.SHELF
		G	-3.5 dB	-2.0 dB	0.0 dB	+2.0 dB
		F	300 Hz	750 Hz	2.00 kHz	3.55 kHz
		Q	—	9.0	4.5	—
22	A. G. Arpeg. 1		L.SHELF	PEAKING	PEAKING	PEAKING
		G	-0.5 dB	0.0 dB	0.0 dB	+2.0 dB
		F	224 Hz	1.00 kHz	4.00 kHz	6.70 kHz
		Q	—	4.5	4.5	0.125
23	A. G. Arpeg. 2		L.SHELF	PEAKING	PEAKING	H.SHELF
		G	0.0 dB	-5.5 dB	0.0 dB	+4.0 dB
		F	180 Hz	355 Hz	4.00 kHz	4.25 kHz
		Q	—	7.0	4.5	—
24	Brass Sec.		PEAKING	PEAKING	PEAKING	PEAKING
		G	-2.0 dB	-1.0 dB	+1.5 dB	+3.0 dB
		F	90.0 Hz	850 Hz	2.12 kHz	4.50 kHz
		Q	2.8	2.0	0.70	7.0
25	Male Vocal 1		PEAKING	PEAKING	PEAKING	PEAKING
		G	-0.5 dB	0.0 dB	+2.0 dB	+3.5 dB
		F	190 Hz	1.00 kHz	2.00 kHz	6.70 kHz
		Q	0.11	4.5	0.56	0.11
26	Male Vocal 2		PEAKING	PEAKING	PEAKING	H.SHELF
		G	+2.0 dB	-5.0 dB	-2.5 dB	+4.0 dB
		F	170 Hz	236 Hz	2.65 kHz	6.70 kHz
		Q	0.11	10.0	5.6	—
27	Female Vo. 1		PEAKING	PEAKING	PEAKING	PEAKING
		G	-1.0 dB	+1.0 dB	+1.5 dB	+2.0 dB
		F	118 Hz	400 Hz	2.65 kHz	6.00 kHz
		Q	0.18	0.45	0.56	0.14
28	Female Vo. 2		L.SHELF	PEAKING	PEAKING	H.SHELF
		G	-7.0 dB	+1.5 dB	+1.5 dB	+2.5 dB
		F	112 Hz	335 Hz	2.00 kHz	6.70 kHz
		Q	—	0.16	0.20	—
29	Chorus & Harmo		PEAKING	PEAKING	PEAKING	PEAKING
		G	-2.0 dB	-1.0 dB	+1.5 dB	+3.0 dB
		F	90.0 Hz	850 Hz	2.12 kHz	4.50 kHz
		Q	2.8	2.0	0.70	7.0
30	Total EQ 1		PEAKING	PEAKING	PEAKING	H.SHELF
		G	-0.5 dB	0.0 dB	+3.0 dB	+6.5 dB
		F	95.0 Hz	950 Hz	2.12 kHz	16.0 kHz
		Q	7.0	2.2	5.6	—
31	Total EQ 2		PEAKING	PEAKING	PEAKING	H.SHELF
		G	+4.0 dB	+1.5 dB	+2.0 dB	+6.0 dB
		F	95.0 Hz	750 Hz	1.80 kHz	18.0 kHz
		Q	7.0	2.8	5.6	—

#	Title	Parameter				
		LOW	L-MID	H-MID	HIGH	
32	Total EQ 3	L.SHELF	PEAKING	PEAKING	H.SHELF	
		G	+1.5 dB	+0.5 dB	+2.0 dB	+4.0 dB
		F	67.0 Hz	850 Hz	1.90 kHz	15.0 kHz
		Q	—	0.28	0.70	—
33	Bass Drum 3	PEAKING	PEAKING	PEAKING	PEAKING	
		G	+3.5 dB	-10.0 dB	+3.5 dB	0.0 dB
		F	118 Hz	315 Hz	4.25 kHz	20.0 kHz
		Q	2.0	10.0	0.40	0.40
34	Snare Drum 3	L.SHELF	PEAKING	PEAKING	PEAKING	
		G	0.0 dB	+2.0 dB	+3.5 dB	0.0 dB
		F	224 Hz	560 Hz	4.25 kHz	4.00 kHz
		Q	—	4.5	2.8	0.10
35	Tom-tom 2	L.SHELF	PEAKING	PEAKING	H.SHELF	
		G	-9.0 dB	+1.5 dB	+2.0 dB	0.0 dB
		F	90.0 Hz	212 Hz	5.30 kHz	17.0 kHz
		Q	—	4.5	1.25	—
36	Piano 3	PEAKING	PEAKING	PEAKING	H.SHELF	
		G	+4.5 dB	-13.0 dB	+4.5 dB	+2.5 dB
		F	100 Hz	475 Hz	2.36 kHz	10.0 kHz
		Q	8.0	10.0	9.0	—
37	Piano Low	PEAKING	PEAKING	PEAKING	H.SHELF	
		G	-5.5 dB	+1.5 dB	+6.0 dB	0.0 dB
		F	190 Hz	400 Hz	6.70 kHz	12.5 kHz
		Q	10.0	6.3	2.2	—
38	Piano High	PEAKING	PEAKING	PEAKING	PEAKING	
		G	-5.5 dB	+1.5 dB	+5.0 dB	+3.0 dB
		F	190 Hz	400 Hz	6.70 kHz	5.60 kHz
		Q	10.0	6.3	2.2	0.10
39	Fine-EQ Cass	L.SHELF	PEAKING	PEAKING	H.SHELF	
		G	-1.5 dB	0.0 dB	+1.0 dB	+3.0 dB
		F	75.0 Hz	1.00 kHz	4.00 kHz	12.5 kHz
		Q	—	4.5	1.8	—
40	Narrator	PEAKING	PEAKING	PEAKING	H.SHELF	
		G	-4.0 dB	-1.0 dB	+2.0 dB	0.0 dB
		F	106 Hz	710 Hz	2.50 kHz	10.0 kHz
		Q	4.0	7.0	0.63	—

DYNAMICS Library List

#	Title	Type	Parameter	Value			
1	Gate	GATE	Threshold (dB)	-26			
			Range (dB)	-56			
			Attack (ms)	0			
			Hold (ms)	2.56			
			Decay (ms)	331			
2	Ducking	DUCKING	Threshold (dB)	-19			
			Range (dB)	-22			
			Attack (ms)	93			
			Hold (ms)	1.20 S			
			Decay (ms)	6.32 S			
3	A. Dr. BD	GATE	Threshold (dB)	-11			
			Range (dB)	-53			
			Attack (ms)	0			
			Hold (ms)	1.93			
			Decay (ms)	400			
4	A. Dr. SN	GATE	Threshold (dB)	-8			
			Range (dB)	-23			
			Attack (ms)	1			
			Hold (ms)	0.63			
5	De-Esser	DE-ESSER	Threshold (dB)	-8			
			Frequency (kHz)	2.00			
			Type	HPF			
			Q	1.6			
			6	Comp	COMPRESSOR	Threshold (dB)	-8
						Ratio (:1)	2.5
Attack (ms)	30						
Out gain (dB)	0.0						
Knee	2						
Release (ms)	250						
7	Expand	EXPANDER	Threshold (dB)	-23			
			Ratio (:1)	1.7			
			Attack (ms)	1			
			Out gain (dB)	3.5			
			Knee	2			
			Release (ms)	70			
8	Compander (H)	COMPANDER-H	Threshold (dB)	-10			
			Ratio (:1)	3.5			
			Attack (ms)	1			
			Out gain (dB)	0.0			
			Width (dB)	6			
			Release (ms)	250			
9	Compander (S)	COMPANDER-S	Threshold (dB)	-8			
			Ratio (:1)	4			
			Attack (ms)	25			
			Out gain (dB)	0.0			
			Width (dB)	24			
			Release (ms)	180			

#	Title	Type	Parameter	Value			
10	A. Dr. BD	COMPRESSOR	Threshold (dB)	-24			
			Ratio (:1)	3			
			Attack (ms)	9			
			Out gain (dB)	5.5			
			Knee	2			
			Release (ms)	58			
11	A. Dr. BD	COMPANDER-H	Threshold (dB)	-11			
			Ratio (:1)	3.5			
			Attack (ms)	1			
			Out gain (dB)	-1.5			
			Width (dB)	7			
			Release (ms)	192			
			12	A. Dr. SN	COMPRESSOR	Threshold (dB)	-17
						Ratio (:1)	2.5
						Attack (ms)	8
Out gain (dB)	3.5						
Knee	2						
Release (ms)	12						
13	A. Dr. SN	EXPANDER	Threshold (dB)	-23			
			Ratio (:1)	2			
			Attack (ms)	0			
			Out gain (dB)	0.5			
			Knee	2			
			Release (ms)	151			
			14	A. Dr. SN	COMPANDER-S	Threshold (dB)	-8
Ratio (:1)	1.7						
Attack (ms)	11						
Out gain (dB)	0.0						
Width (dB)	10						
Release (ms)	128						
15	A. Dr. Tom	EXPANDER	Threshold (dB)	-20			
			Ratio (:1)	2			
			Attack (ms)	2			
			Out gain (dB)	5.0			
			Knee	2			
			Release (ms)	749			
			16	A. Dr. OverTop	COMPANDER-S	Threshold (dB)	-24
Ratio (:1)	2						
Attack (ms)	38						
Out gain (dB)	-3.5						
Width (dB)	54						
Release (ms)	842						
17	E. B. Finger	COMPRESSOR	Threshold (dB)	-12			
			Ratio (:1)	2			
			Attack (ms)	15			
			Out gain (dB)	4.5			
			Knee	2			
Release (ms)	470						

#	Title	Type	Parameter	Value
18	E. B. Slap	COMPRESSOR	Threshold (dB)	-12
			Ratio (:1)	1.7
			Attack (ms)	6
			Out gain (dB)	4.0
			Knee	hard
			Release (ms)	133
19	Syn. Bass	COMPRESSOR	Threshold (dB)	-10
			Ratio (:1)	3.5
			Attack (ms)	9
			Out gain (dB)	3.0
			Knee	hard
			Release (ms)	250
20	Piano1	COMPRESSOR	Threshold (dB)	-9
			Ratio (:1)	2.5
			Attack (ms)	17
			Out gain (dB)	1.0
			Knee	hard
			Release (ms)	238
21	Piano2	COMPRESSOR	Threshold (dB)	-18
			Ratio (:1)	3.5
			Attack (ms)	7
			Out gain (dB)	6.0
			Knee	2
			Release (ms)	174
22	E. Guitar	COMPRESSOR	Threshold (dB)	-8
			Ratio (:1)	3.5
			Attack (ms)	7
			Out gain (dB)	2.5
			Knee	4
			Release (ms)	261
23	A. Guitar	COMPRESSOR	Threshold (dB)	-10
			Ratio (:1)	2.5
			Attack (ms)	5
			Out gain (dB)	1.5
			Knee	2
			Release (ms)	238
24	Strings1	COMPRESSOR	Threshold (dB)	-11
			Ratio (:1)	2
			Attack (ms)	33
			Out gain (dB)	1.5
			Knee	2
			Release (ms)	749
25	Strings2	COMPRESSOR	Threshold (dB)	-12
			Ratio (:1)	1.5
			Attack (ms)	93
			Out gain (dB)	1.5
			Knee	4
			Release (ms)	1.35 S

#	Title	Type	Parameter	Value
26	Strings3	COMPRESSOR	Threshold (dB)	-17
			Ratio (:1)	1.5
			Attack (ms)	76
			Out gain (dB)	2.5
			Knee	2
			Release (ms)	186
27	BrassSection	COMPRESSOR	Threshold (dB)	-18
			Ratio (:1)	1.7
			Attack (ms)	18
			Out gain (dB)	4.0
			Knee	1
			Release (ms)	226
28	Syn. Pad	COMPRESSOR	Threshold (dB)	-13
			Ratio (:1)	2
			Attack (ms)	58
			Out gain (dB)	2.0
			Knee	1
			Release (ms)	238
29	SamplingPerc	COMPANDER-S	Threshold (dB)	-18
			Ratio (:1)	1.7
			Attack (ms)	8
			Out gain (dB)	-2.5
			Width (dB)	18
			Release (ms)	238
30	Sampling BD	COMPRESSOR	Threshold (dB)	-14
			Ratio (:1)	2
			Attack (ms)	2
			Out gain (dB)	3.5
			Knee	4
			Release (ms)	35
31	Sampling SN	COMPRESSOR	Threshold (dB)	-18
			Ratio (:1)	4
			Attack (ms)	8
			Out gain (dB)	8.0
			Knee	hard
			Release (ms)	354
32	Hip Comp	COMPANDER-S	Threshold (dB)	-23
			Ratio (:1)	20
			Attack (ms)	15
			Out gain (dB)	0.0
			Width (dB)	15
			Release (ms)	163
33	Solo Vocal1	COMPRESSOR	Threshold (dB)	-20
			Ratio (:1)	2.5
			Attack (ms)	31
			Out gain (dB)	2.0
			Knee	1
			Release (ms)	342

#	Title	Type	Parameter	Value
34	Solo Vocal2	COMPRESSOR	Threshold (dB)	-8
			Ratio (:1)	2.5
			Attack (ms)	26
			Out gain (dB)	1.5
			Knee	3
			Release (ms)	331
35	Chorus	COMPRESSOR	Threshold (dB)	-9
			Ratio (:1)	1.7
			Attack (ms)	39
			Out gain (dB)	2.5
			Knee	2
			Release (ms)	226
36	Click Erase	EXPANDER	Threshold (dB)	-33
			Ratio (:1)	2
			Attack (ms)	1
			Out gain (dB)	2.0
			Knee	2
			Release (ms)	284
37	Announcer	COMPANDER-H	Threshold (dB)	-14
			Ratio (:1)	2.5
			Attack (ms)	1
			Out gain (dB)	-2.5
			Width (dB)	18
			Release (ms)	180
38	Limiter1	COMPANDER-S	Threshold (dB)	-9
			Ratio (:1)	3
			Attack (ms)	20
			Out gain (dB)	-3.0
			Width (dB)	90
			Release (ms)	3.90 s
39	Limiter2	COMPRESSOR	Threshold (dB)	0
			Ratio (:1)	∞
			Attack (ms)	0
			Out gain (dB)	0.0
			Knee	hard
			Release (ms)	319
40	Total Comp1	COMPRESSOR	Threshold (dB)	-18
			Ratio (:1)	3.5
			Attack (ms)	94
			Out gain (dB)	2.5
			Knee	hard
			Release (ms)	447
41	Total Comp2	COMPRESSOR	Threshold (dB)	-16
			Ratio (:1)	6
			Attack (ms)	11
			Out gain (dB)	6.0
			Knee	1
			Release (ms)	180

* At fs=44.1 kHz

Dynamics Parameters

Input channels provide DYNAMICS section 1 and DYNAMICS section 2. Output channels provide DYNAMICS section 1.

An input channel's DYNAMICS section 1 provides the following four types:

GATE, DUCKING, COMPRESSOR, and EXPANDER.

An input channel's DYNAMICS section 2 provides the following four types:

COMPRESSOR, COMPANDER-H (Compander Hard), COMPANDER-S (Compander Soft), and DE-ESSER.

An output channel's DYNAMICS section 1 provides the following four types:

COMPRESSOR, EXPANDER, COMPANDER-H (Compander Hard), and COMPANDER-S (Compander Soft).

■ GATE

A gate attenuates signals below a set THRESHOLD level by a specified amount (RANGE).

Parameter	Range	Description
THRESHOLD (dB)	-72 to 0 (73 points)	This determines the level at which the gate effect is applied.
RANGE (dB)	-∞, -69 to 0 (71 points)	This determines the amount of attenuation when the gate closes.
ATTACK (ms)	0-120 (121 points)	This determines how fast the gate opens when the signal exceeds the threshold level.
HOLD (ms)	44.1kHz: 0.02 ms – 2.13 sec 48kHz: 0.02 ms – 1.96 sec (160 points)	This determines how long the gate stays open once the trigger signal has fallen below the threshold.
DECAY (ms)	44.1kHz: 6 ms – 46.0 sec 48kHz: 5 ms – 42.3 sec (160 points)	This determines how fast the gate closes once the hold time has expired. The value is expressed as the duration required for the level to change by 6 dB.

• I/O Characteristics

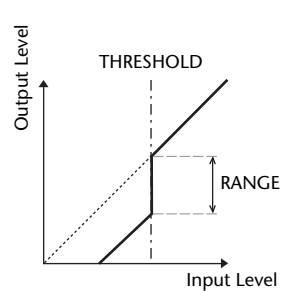

• Time Series Analysis

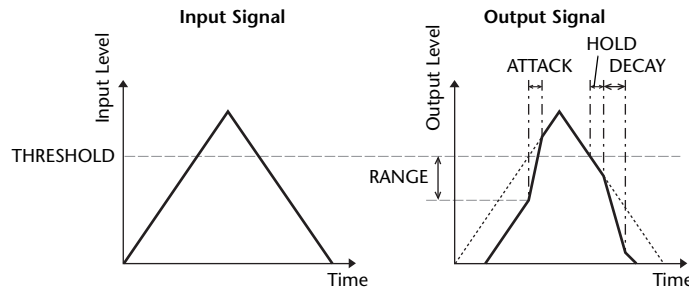

■ DUCKING

Ducking is commonly used for voice-over applications in which the background music level is reduced automatically when an announcer speaks. When the KEY IN source signal level exceeds the specified THRESHOLD, the output level is attenuated by a specified amount (RANGE).

Parameter	Range	Description
THRESHOLD (dB)	-54 to 0 (55 points)	This determines the level of trigger signal (KEY IN) required to activate ducking.
RANGE (dB)	-70 to 0 (71 points)	This determines the amount of attenuation when ducking is activated.
ATTACK (ms)	0-120 (121 points)	This determines how soon the signal is ducked once the ducker has been triggered.
HOLD (ms)	44.1kHz: 0.02 ms – 2.13 sec 48kHz: 0.02 ms – 1.96 sec (160 points)	This determines how long ducking remains active once the trigger signal has fallen below the THRESHOLD level.
DECAY (ms)	44.1kHz: 6 ms – 46.0 sec 48kHz: 5 ms – 42.3 sec (160 points)	This determines how soon the ducker returns to its normal gain once the trigger signal level drops below the threshold. The value is expressed as the duration required for the level to change by 6 dB.

• I/O Characteristics

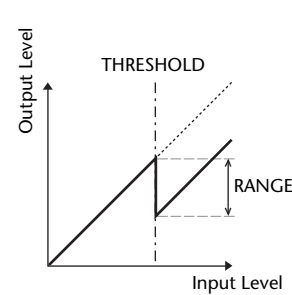

• Time Series Analysis

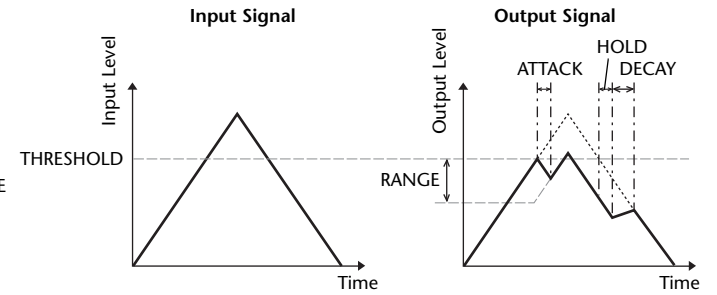

■ COMPRESSOR

The COMP processor attenuates signals above a specified THRESHOLD by a specified RATIO. The COMP processor can also be used as a limiter, which, with a RATIO of ∞:1, reduces the level to the threshold. This means that the limiter's output level never actually exceeds the threshold.

Parameter	Range	Description
THRESHOLD (dB)	-54 to 0 (55 points)	This determines the level of input signal required to trigger the compressor.
RATIO	1.0:1, 1.1:1, 1.3:1, 1.5:1, 1.7:1, 2.0:1, 2.5:1, 3.0:1, 3.5:1, 4.0:1, 5.0:1, 6.0:1, 8.0:1, 10:1, 20:1, ∞:1 (16 points)	This determines the amount of compression, that is, the change in output signal level relative to change in input signal level.
ATTACK (ms)	0-120 (121 points)	This determines how soon the signal will be compressed once the compressor has been triggered.
RELEASE (ms)	44.1kHz: 6 ms - 46.0 sec 48kHz: 5 ms - 42.3 sec (160 points)	This determines how soon the compressor returns to its normal gain once the trigger signal level drops below the threshold. The value is expressed as the duration required for the level to change by 6 dB.
OUT GAIN (dB)	0.0 to +18.0 (181 points)	This sets the compressor's output signal level.
KNEE	Hard, 1-5 (6 points)	This determines how compression is applied at the threshold. For higher knee settings, compression is applied gradually as the signal exceeds the specified threshold, creating a more natural sound.

- I/O Characteristics (KNEE= hard, OUT GAIN=0.0dB)

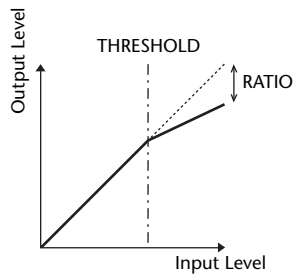

- Time Series Analysis (RATIO= ∞:1)

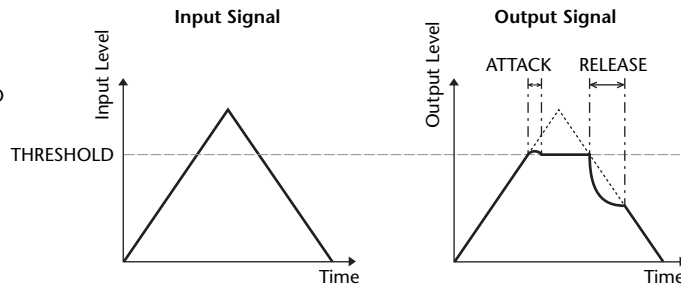

■ EXPANDER

An expander attenuates signals below a specified THRESHOLD by a specified RATIO.

Parameter	Range	Description
THRESHOLD (dB)	-54 to 0 (55 points)	This determines the level of input signal required to trigger the expander.
RATIO	1.0:1, 1.1:1, 1.3:1, 1.5:1, 1.7:1, 2.0:1, 2.5:1, 3.0:1, 3.5:1, 4.0:1, 5.0:1, 6.0:1, 8.0:1, 10:1, 20:1, ∞:1 (16 points)	This determines the amount of expansion.
ATTACK (ms)	0-120 (121 points)	This determines how soon the expander returns to its normal gain once the trigger signal level exceeds the threshold.
RELEASE (ms)	44.1kHz: 6 ms - 46.0 sec 48kHz: 5 ms - 42.3 sec (160 points)	This determines how soon the signal is expanded once the signal level drops below the threshold. The value is expressed as the duration required for the level to change by 6 dB.
OUT GAIN (dB)	0.0 to +18.0 (181 points)	This sets the expander's output signal level.
KNEE	Hard, 1-5 (6 points)	This determines how expansion is applied at the threshold. For higher knee settings, expansion is applied gradually as the signal falls below the specified threshold, creating a more natural sound.

- I/O Characteristics (KNEE= hard, OUT GAIN= 0.0dB)

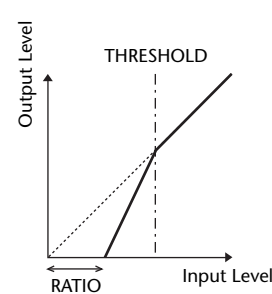

- Time Series Analysis (RATIO= ∞:1)

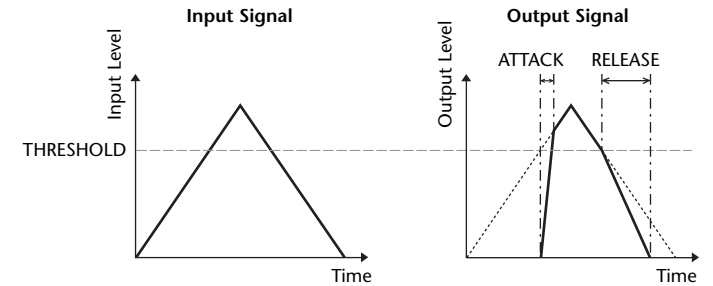

■ COMPANDER HARD (COMPANDER-H), COMPANDER SOFT (COMPANDER-S)

The hard and soft companders combine the effects of the compressor, expander and limiter.

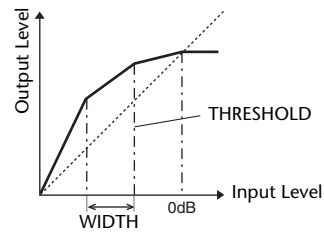

The companders function differently at the following levels:

- ① **0 dB and higher** Functions as a limiter.
- ② **Exceeding the threshold** Functions as a compressor.
- ③ **Below the threshold and width** Functions as an expander.

The hard compander has an expansion ratio of 5:1, while the soft compander has an expansion ratio of 1.5:1. The expander is essentially turned off when the width is set to maximum. The compressor has a fixed knee setting of 2.

- * The gain is automatically adjusted according to the ratio and threshold values, and can be increased by up to 18 dB.
- * The OUT GAIN parameter enables you to compensate for the overall level change caused by the compression and expansion processes.

Parameter	Range	Description
THRESHOLD (dB)	-54 to 0 (55 points)	This determines the level at which compression is applied.
RATIO	1.0:1, 1.1:1, 1.3:1, 1.5:1, 1.7:1, 2.0:1, 2.5:1, 3.0:1, 3.5:1, 4.0:1, 5.0:1, 6.0:1, 8.0:1, 10:1, 20:1 (15 points)	This determines the amount of compression.
ATTACK (ms)	0-120 (121 points)	This determines how soon the signal is compressed or expanded once the compander has been triggered.
RELEASE (ms)	44.1kHz: 6 ms - 46.0 sec 48kHz: 5 ms - 42.3 sec (160 points)	This determines how soon the compressor or expander returns to the normal gain once the trigger signal level drops below or exceeds the threshold respectively. The value is expressed as the duration required for the level to change by 6 dB.
OUT GAIN (dB)	-18.0 to 0.0 (181 points)	This sets the compander's output signal level.
WIDTH (dB)	1-90 (90 points)	This determines how far below the threshold expansion will be applied. The expander is activated when the level drops below the threshold and width.

■ DE-ESSER

This detects and compresses only the sibilants and other high-frequency consonants of the vocal.

Parameter	Range	Description
THRESHOLD	-54 to 0 (55 points)	Threshold level at which the de-esser effect applies.
FREQUENCY	1kHz-12.5kHz (45 points)	Cutoff frequency of the filter used to detect the high frequencies.
TYPE	HPF, BPF	Type of filter used to detect the frequency band.
Q	10.0-0.10 (41 points)	Q (steepness) of the filter when TYPE is BPF.

Effect Type List

Title	Type	Description
REV-X Hall	REV-X HALL	New reverb algorithm that delivers dense and rich reverberation, smooth decay, and provides a spaciousness and depth that enhances the original sound. Choose from three types depending on your location and needs; REV-X HALL, REV-X ROOM, and REV-X PLATE.
REV-X Room	REV-X ROOM	
REV-X Plate	REV-X PLATE	
Reverb Hall	REVERB HALL	Concert hall reverberation simulation with gate
Reverb Room	REVERB ROOM	Room reverberation simulation with gate
Reverb Stage	REVERB STAGE	Reverb designed for vocals, with gate
Reverb Plate	REVERB PLATE	Plate reverb simulation with gate
Stereo Reverb	ST REVERB	Stereo reverb
Early Ref.	EARLY REF.	Early reflections without the subsequent reverb
Gate Reverb	GATE REVERB	Gated early reflections
Reverse Gate	REVERSE GATE	Gated reverse early reflections
Mono Delay	MONO DELAY	Simple mono delay
Stereo Delay	STEREO DELAY	Simple stereo delay
Mod.Delay	MOD.DELAY	Simple repeat delay with modulation
Delay LCR	DELAY LCR	3-tap (left, center, right) delay
Echo	ECHO	Stereo delay with crossed left/right feedback
Chorus	CHORUS	Chorus
Flange	FLANGE	Flanger
Symphonic	SYMPHONIC	Proprietary Yamaha effect that produces a richer and more complex modulation than normal chorus
Phaser	PHASER	16-stage stereo phase shifter
Dyna.Flange	DYNA.FLANGE	Dynamically controlled flanger
Dyna.Phaser	DYNA.PHASER	Dynamically controlled phase shifter
HQ. Pitch	HQ.PITCH	Mono pitch shifter, producing stable results
Dual Pitch	DUAL PITCH	Stereo pitch shifter
Tremolo	TREMOLO	Tremolo
Auto Pan	AUTO PAN	Auto-panner
Rotary	ROTARY	Rotary speaker simulation
Ring Mod.	RING MOD.	Ring modulator
Mod.Filter	MOD.FILTER	Modulated filter
Dyna.Filter	DYNA.FILTER	Dynamically controlled filter
Rev+Chorus	REV+CHORUS	Reverb and chorus in parallel
Rev→Chorus	REV→CHORUS	Reverb and chorus in series
Rev+Flange	REV+FLANGE	Reverb and flanger in parallel
Rev→Flange	REV→FLANGE	Reverb and flanger in series
Rev+Sympho.	REV+SYMPHO.	Reverb and symphonic in parallel
Rev→Sympho.	REV→SYMPHO.	Reverb and symphonic in series
Rev→Pan	REV→PAN	Reverb and auto-pan in series
Delay+Er.	DELAY+ER.	Delay and early reflections in parallel
Delay→Er.	DELAY→ER.	Delay and early reflections in series

Title	Type	Description
Delay+Rev	DELAY+REV	Delay and reverb in parallel
Delay→Rev	DELAY→REV	Delay and reverb in series
Dist→Delay	DIST→DELAY	Distortion and delay in series
Multi Filter	MULTI FILTER	3-band parallel filter (24 dB/octave)
Freeze	FREEZE	Simple sampler
Distortion	DISTORTION	Distortion
Amp Simulate	AMP SIMULATE	Guitar amp simulation
Comp276	COMP276	This compressor emulates the characteristics of an analog compressor that has become a sought-after classic in recording studios.
Comp276S	COMP276S	This is a stereo model of COMP276.
Comp260	COMP260	This compressor emulates the characteristics of a compressor/limiter of the latter 1970s that has become a sought-after classic for live SR.
Comp260S	COMP260S	This is a stereo model of the COMP260.
Equalizer601	EQUALIZER601	This equalizer emulates the characteristics of an analog equalizer of the 1970s. It can be used to obtain a sense of drive.
OpenDeck	OPENDECK	This is a tape saturation effect that emulates the tape compression produced by two open-reel tape recorders: a recording deck and a reproduction deck.
M.Band Dyna.	M.BAND DYNA.	Multi-band dynamics processor
M.Band Comp	M.BAND COMP	Multi-band compressor

Effects Parameters

■ REV-X HALL, REV-X ROOM, REV-X PLATE

Newly-developed two input, two output reverb algorithm. Delivers dense and rich reverberation, smooth decay, and provides a spaciousness and depth that enhances the original sound. Choose from three types depending on your location and needs; REV-X HALL, REV-X ROOM, and REV-X PLATE.

Parameter	Range	Description
REV TIME	0.28–27.94 s *1	Reverb time
INI. DLY	0.0–120.0 ms	Initial delay before reverb begins
HI. RATIO	0.1–1.0	High-frequency reverb time ratio
LO. RATIO	0.1–1.4	Low-frequency reverb time ratio
LO.FREQ	22.0 Hz–18.0 kHz	Frequency point for LO.RATIO setting
DIFF.	0–10	Reverb diffusion (left–right reverb spread)
ROOM SIZE	0–28	Size of room
DECAY	0–53	Gate closing speed
HPF	THRU, 22.0 Hz–8.00 kHz	High-pass filter cutoff frequency
LPF	1.00 kHz–18.0 kHz, THRU	Low-pass filter cutoff frequency

*1. These values are for when the effect type is REV-X HALL and the ROOM SIZE=28. The range will differ depending on the effect type and ROOM SIZE setting.

■ REVERB HALL, REVERB ROOM, REVERB STAGE, REVERB PLATE

One input, two output hall, room, stage, and plate reverb simulations, all with gates.

Parameter	Range	Description
REV TIME	0.3–99.0 s	Reverb time
INI. DLY	0.0–500.0 ms	Initial delay before reverb begins
HI. RATIO	0.1–1.0	High-frequency reverb time ratio
LO. RATIO	0.1–2.4	Low-frequency reverb time ratio
DIFF.	0–10	Reverb diffusion (left–right reverb spread)
DENSITY	0–100%	Reverb density
E/R DLY	0.0–100.0 ms	Delay between early reflections and reverb
E/R BAL.	0–100%	Balance of early reflections and reverb (0% = all reverb, 100% = all early reflections)
HPF	THRU, 21.2 Hz–8.00 kHz	High-pass filter cutoff frequency
LPF	50.0 Hz–16.0 kHz, THRU	Low-pass filter cutoff frequency
GATE LVL	OFF, –60 to 0 dB	Level at which gate kicks in
ATTACK	0–120 ms	Gate opening speed
HOLD	*1	Gate open time
DECAY	*2	Gate closing speed

*1. 0.02 ms–2.13 s (fs=44.1 kHz), 0.02 ms–1.96 s (fs=48 kHz)

*2. 6.0 ms–46.0 s (fs=44.1 kHz), 5.0 ms–42.3 s (fs=48 kHz)

■ **STEREO REVERB**

Two input, two output stereo reverb.

Parameter	Range	Description
REV TIME	0.3–99.0 s	Reverb time
REV TYPE	Hall, Room, Stage, Plate	Reverb type
INI. DLY	0.0–100.0 ms	Initial delay before reverb begins
HI. RATIO	0.1–1.0	High-frequency reverb time ratio
LO. RATIO	0.1–2.4	Low-frequency reverb time ratio
DIFF.	0–10	Reverb diffusion (left–right reverb spread)
DENSITY	0–100%	Reverb density
E/R BAL.	0–100%	Balance of early reflections and reverb (0% = all reverb, 100% = all early reflections)
HPF	THRU, 21.2 Hz–8.00 kHz	High-pass filter cutoff frequency
LPF	50.0 Hz–16.0 kHz, THRU	Low-pass filter cutoff frequency

■ **EARLY REF.**

One input, two output early reflections.

Parameter	Range	Description
TYPE	S-Hall, L-Hall, Random, Revers, Plate, Spring	Type of early reflection simulation
ROOMSIZE	0.1–20.0	Reflection spacing
LIVENESS	0–10	Early reflections decay characteristics (0 = dead, 10 = live)
INI. DLY	0.0–500.0 ms	Initial delay before reverb begins
DIFF.	0–10	Reflection diffusion (left–right reflection spread)
DENSITY	0–100%	Reflection density
ER NUM.	1–19	Number of early reflections
FB GAIN	–99 to +99%	Feedback gain
HI. RATIO	0.1–1.0	High-frequency feedback ratio
HPF	THRU, 21.2 Hz–8.00 kHz	High-pass filter cutoff frequency
LPF	50.0 Hz–16.0 kHz, THRU	Low-pass filter cutoff frequency

■ **GATE REVERB, REVERSE GATE**

One input, two output early reflections with gate, and early reflections with reverse gate.

Parameter	Range	Description
TYPE	Type-A, Type-B	Type of early reflection simulation
ROOMSIZE	0.1–20.0	Reflection spacing
LIVENESS	0–10	Early reflections decay characteristics (0 = dead, 10 = live)
INI. DLY	0.0–500.0 ms	Initial delay before reverb begins
DIFF.	0–10	Reflection diffusion (left–right reflection spread)
DENSITY	0–100%	Reflection density
HI. RATIO	0.1–1.0	High-frequency feedback ratio
ER NUM.	1–19	Number of early reflections
FB GAIN	–99 to +99%	Feedback gain
HPF	THRU, 21.2 Hz–8.00 kHz	High-pass filter cutoff frequency
LPF	50.0 Hz–16.0 kHz, THRU	Low-pass filter cutoff frequency

■ **MONO DELAY**

One input, one output basic repeat delay.

Parameter	Range	Description
DELAY	0.0–2730.0 ms	Delay time
FB. GAIN	–99 to +99%	Feedback gain (plus values for normal-phase feedback, minus values for reverse-phase feedback)
HI. RATIO	0.1–1.0	High-frequency feedback ratio
HPF	THRU, 21.2 Hz–8.00 kHz	High-pass filter cutoff frequency
LPF	50.0 Hz–16.0 kHz, THRU	Low-pass filter cutoff frequency
SYNC	OFF/ON	Tempo parameter sync on/off
NOTE	*1	Used in conjunction with TEMPO to determine DELAY

*1.  (Max. value depends on tempo setting)

■ **STEREO DELAY**

Two input, two output basic stereo delay.

Parameter	Range	Description
DELAY L	0.0–1350.0 ms	Left channel delay time
DELAY R	0.0–1350.0 ms	Right channel delay time
FB. G L	–99 to +99%	Left channel feedback (plus values for normal-phase feedback, minus values for reverse-phase feedback)
FB. G R	–99 to +99%	Right channel feedback (plus values for normal-phase feedback, minus values for reverse-phase feedback)
HI. RATIO	0.1–1.0	High-frequency feedback ratio
HPF	THRU, 21.2 Hz–8.00 kHz	High-pass filter cutoff frequency
LPF	50.0 Hz–16.0 kHz, THRU	Low-pass filter cutoff frequency
SYNC	OFF/ON	Tempo parameter sync on/off
NOTE L	*1	Used in conjunction with TEMPO to determine left channel DELAY
NOTE R	*1	Used in conjunction with TEMPO to determine right channel DELAY

*1.  (Maximum value depends on the tempo setting)

MOD.DELAY

One input, two output basic repeat delay with modulation.

Parameter	Range	Description
DELAY	0.0–2725.0 ms	Delay time
FB. GAIN	–99 to +99%	Feedback gain (plus values for normal-phase feedback, minus values for reverse-phase feedback)
HI. RATIO	0.1–1.0	High-frequency feedback ratio
FREQ.	0.05–40.00 Hz	Modulation speed
DEPTH	0–100%	Modulation depth
WAVE	Sine/Tri	Modulation waveform
HPF	THRU, 21.2 Hz–8.00 kHz	High-pass filter cutoff frequency
LPF	50.0 Hz–16.0 kHz, THRU	Low-pass filter cutoff frequency
SYNC	OFF/ON	Tempo parameter sync on/off
DLY.NOTE	*1	Used in conjunction with TEMPO to determine DELAY
MOD.NOTE	*2	Used in conjunction with TEMPO to determine FREQ

*1. (Maximum value depends on the tempo setting)

*2.

DELAY LCR

One input, two output 3-tap delay (left, center, right).

Parameter	Range	Description
DELAY L	0.0–2730.0 ms	Left channel delay time
DELAY C	0.0–2730.0 ms	Center channel delay time
DELAY R	0.0–2730.0 ms	Right channel delay time
FB. DLY	0.0–2730.0 ms	Feedback delay time
LEVEL L	–100 to +100%	Left channel delay level
LEVEL C	–100 to +100%	Center channel delay level
LEVEL R	–100 to +100%	Right channel delay level
FB. GAIN	–99 to +99%	Feedback gain (plus values for normal-phase feedback, minus values for reverse-phase feedback)
HI. RATIO	0.1–1.0	High-frequency feedback ratio
HPF	THRU, 21.2 Hz–8.00 kHz	High-pass filter cutoff frequency
LPF	50.0 Hz–16.0 kHz, THRU	Low-pass filter cutoff frequency
SYNC	OFF/ON	Tempo parameter sync on/off
NOTE L	*1	Used in conjunction with TEMPO to determine DELAY L
NOTE C	*1	Used in conjunction with TEMPO to determine DELAY C
NOTE R	*1	Used in conjunction with TEMPO to determine DELAY R
NOTE FB	*1	Used in conjunction with TEMPO to determine FB. DLY

*1. (Maximum value depends on the tempo setting)

ECHO

Two input, two output stereo delay with crossed feedback loop.

Parameter	Range	Description
DELAY L	0.0–1350.0 ms	Left channel delay time
DELAY R	0.0–1350.0 ms	Right channel delay time
FB. DLY L	0.0–1350.0 ms	Left channel feedback delay time
FB. DLY R	0.0–1350.0 ms	Right channel feedback delay time
FB. G L	–99 to +99%	Left channel feedback gain (plus values for normal-phase feedback, minus values for reverse-phase feedback)
FB. G R	–99 to +99%	Right channel feedback gain (plus values for normal-phase feedback, minus values for reverse-phase feedback)
L→R FBG	–99 to +99%	Left to right channel feedback gain (plus values for normal-phase feedback, minus values for reverse-phase feedback)
R→L FBG	–99 to +99%	Right to left channel feedback gain (plus values for normal-phase feedback, minus values for reverse-phase feedback)
HI. RATIO	0.1–1.0	High-frequency feedback ratio
HPF	THRU, 21.2 Hz–8.00 kHz	High-pass filter cutoff frequency
LPF	50.0 Hz–16.0 kHz, THRU	Low-pass filter cutoff frequency
SYNC	OFF/ON	Tempo parameter sync on/off
NOTE L	*1	Used in conjunction with TEMPO to determine DELAY L
NOTE R	*1	Used in conjunction with TEMPO to determine DELAY R
NOTE FBL	*1	Used in conjunction with TEMPO to determine FB. D L
NOTE FBR	*1	Used in conjunction with TEMPO to determine FB. D R

*1. (Maximum value depends on the tempo setting)

CHORUS

Two input, two output chorus effect.

Parameter	Range	Description
FREQ.	0.05–40.00 Hz	Modulation speed
AM DEPTH	0–100%	Amplitude modulation depth
PM DEPTH	0–100%	Pitch modulation depth
MOD. DLY	0.0–500.0 ms	Modulation delay time
WAVE	Sine, Tri	Modulation waveform
SYNC	OFF/ON	Tempo parameter sync on/off
NOTE	*1	Used in conjunction with TEMPO to determine FREQ.
LSH F	21.2 Hz–8.00 kHz	Low shelving filter frequency
LSH G	–12.0 to +12.0 dB	Low shelving filter gain
EQ F	100 Hz–8.00 kHz	EQ (peaking type) frequency
EQ G	–12.0 to +12.0 dB	EQ (peaking type) gain
EQ Q	10.0–0.10	EQ (peaking type) bandwidth
HSH F	50.0 Hz–16.0 kHz	High shelving filter frequency
HSH G	–12.0 to +12.0 dB	High shelving filter gain

*1.

■ **FLANGE**

Two input, two output flange effect.

Parameter	Range	Description
FREQ.	0.05–40.00 Hz	Modulation speed
DEPTH	0–100%	Modulation depth
MOD. DLY	0.0–500.0 ms	Modulation delay time
FB. GAIN	–99 to +99%	Feedback gain (plus values for normal-phase feedback, minus values for reverse-phase feedback)
WAVE	Sine, Tri	Modulation waveform
SYNC	OFF/ON	Tempo parameter sync on/off
NOTE	*1	Used in conjunction with TEMPO to determine FREQ.
LSH F	21.2 Hz–8.00 kHz	Low shelving filter frequency
LSH G	–12.0 to +12.0 dB	Low shelving filter gain
EQ F	100 Hz–8.00 kHz	EQ (peaking type) frequency
EQ G	–12.0 to +12.0 dB	EQ (peaking type) gain
EQ Q	10.0–0.10	EQ (peaking type) bandwidth
HSH F	50.0 Hz–16.0 kHz	High shelving filter frequency
HSH G	–12.0 to +12.0 dB	High shelving filter gain

*1.

■ **SYMPHONIC**

Two input, two output symphonic effect.

Parameter	Range	Description
FREQ.	0.05–40.00 Hz	Modulation speed
DEPTH	0–100%	Modulation depth
MOD. DLY	0.0–500.0 ms	Modulation delay time
WAVE	Sine, Tri	Modulation waveform
SYNC	OFF/ON	Tempo parameter sync on/off
NOTE	*1	Used in conjunction with TEMPO to determine FREQ.
LSH F	21.2 Hz–8.00 kHz	Low shelving filter frequency
LSH G	–12.0 to +12.0 dB	Low shelving filter gain
EQ F	100 Hz–8.00 kHz	EQ (peaking type) frequency
EQ G	–12.0 to +12.0 dB	EQ (peaking type) gain
EQ Q	10.0–0.10	EQ (peaking type) bandwidth
HSH F	50.0 Hz–16.0 kHz	High shelving filter frequency
HSH G	–12.0 to +12.0 dB	High shelving filter gain

*1.

■ **PHASER**

Two input, two output 16-stage phaser.

Parameter	Range	Description
FREQ.	0.05–40.00 Hz	Modulation speed
DEPTH	0–100%	Modulation depth
FB. GAIN	–99 to +99%	Feedback gain (plus values for normal-phase feedback, minus values for reverse-phase feedback)
OFFSET	0–100	Lowest phase-shifted frequency offset
PHASE	0.00–354.38 degrees	Left and right modulation phase balance
STAGE	2, 4, 6, 8, 10, 12, 14, 16	Number of phase shift stages
SYNC	OFF/ON	Tempo parameter sync on/off
NOTE	*1	Used in conjunction with TEMPO to determine FREQ.
LSH F	21.2 Hz–8.00 kHz	Low shelving filter frequency
LSH G	–12.0 to +12.0 dB	Low shelving filter gain
HSH F	50.0 Hz–16.0 kHz	High shelving filter frequency
HSH G	–12.0 to +12.0 dB	High shelving filter gain

*1.

■ **DYNA.FLANGE**

Two input, two output dynamically controlled flanger.

Parameter	Range	Description
SOURCE	INPUT, MIDI	Control source: input signal or MIDI Note On velocity
SENSE	0–100	Sensitivity
DIR.	UP, DOWN	Upward or downward frequency change
DECAY	*1	Decay speed
OFFSET	0–100	Delay time offset
FB.GAIN	–99 to +99%	Feedback gain (plus values for normal-phase feedback, minus values for reverse-phase feedback)
LSH F	21.2 Hz–8.00 kHz	Low shelving filter frequency
LSH G	–12.0 to +12.0 dB	Low shelving filter gain
EQ F	100 Hz–8.00 kHz	EQ (peaking type) frequency
EQ G	–12.0 to +12.0 dB	EQ (peaking type) gain
EQ Q	10.0–0.10	EQ (peaking type) bandwidth
HSH F	50.0 Hz–16.0 kHz	High shelving filter frequency
HSH G	–12.0 to +12.0 dB	High shelving filter gain

*1. 6.0 ms–46.0 s (fs=44.1 kHz), 5.0 ms–42.3 s (fs=48 kHz)

■ **DYNA.PHASER**

Two input, two output dynamically controlled phaser.

Parameter	Range	Description
SOURCE	INPUT, MIDI	Control source: input signal or MIDI Note On velocity
SENSE	0–100	Sensitivity
DIR.	UP, DOWN	Upward or downward frequency change
DECAY	*1	Decay speed
OFFSET	0–100	Lowest phase-shifted frequency offset
FB.GAIN	–99 to +99%	Feedback gain (plus values for normal-phase feedback, minus values for reverse-phase feedback)
STAGE	2, 4, 6, 8, 10, 12, 14, 16	Number of phase shift stages
LSH F	21.2 Hz–8.00 kHz	Low shelving filter frequency
LSH G	–12.0 to +12.0 dB	Low shelving filter gain
HSH F	50.0 Hz–16.0 kHz	High shelving filter frequency
HSH G	–12.0 to +12.0 dB	High shelving filter gain

*1. 6.0 ms–46.0 s (fs=44.1 kHz), 5.0 ms–42.3 s (fs=48 kHz)

■ **HQ. PITCH**

One input, two output high-quality pitch shifter.

Parameter	Range	Description
PITCH	–12 to +12 semitones	Pitch shift
FINE	–50 to +50 cents	Pitch shift fine
DELAY	0.0–1000.0 ms	Delay time
FB. GAIN	–99 to +99%	Feedback gain (plus values for normal-phase feedback, minus values for reverse-phase feedback)
MODE	1–10	Pitch shift precision
SYNC	OFF/ON	Tempo parameter sync on/off
NOTE	*1	Used in conjunction with TEMPO to determine DELAY

*1.  (Maximum value depends on the tempo setting)

■ **DUAL PITCH**

Two input, two output pitch shifter.

Parameter	Range	Description
PITCH 1	–24 to +24 semitones	Channel #1 pitch shift
FINE 1	–50 to +50 cents	Channel #1 pitch shift fine
LEVEL 1	–100 to +100%	Channel #1 level (plus values for normal phase, minus values for reverse phase)
PAN 1	L63 to R63	Channel #1 pan
DELAY 1	0.0–1000.0 ms	Channel #1 delay time
FB. G 1	–99 to +99%	Channel #1 feedback gain (plus values for normal-phase feedback, minus values for reverse-phase feedback)
MODE	1–10	Pitch shift precision
PITCH 2	–24 to +24 semitones	Channel #2 pitch shift
FINE 2	–50 to +50 cents	Channel #2 pitch shift fine
LEVEL 2	–100 to +100%	Channel #2 level (plus values for normal phase, minus values for reverse phase)
PAN 2	L63 to R63	Channel #2 pan
DELAY 2	0.0–1000.0 ms	Channel #2 delay time
FB. G 2	–99 to +99%	Channel #2 feedback gain (plus values for normal-phase feedback, minus values for reverse-phase feedback)
SYNC	OFF/ON	Tempo parameter sync on/off
NOTE 1	*1	Used in conjunction with TEMPO to determine Channel #1 delay
NOTE 2	*1	Used in conjunction with TEMPO to determine Channel #2 delay

*1.  (Maximum value depends on the tempo setting)

■ **TREMOLO**

Two input, two output tremolo effect.

Parameter	Range	Description
FREQ.	0.05–40.00 Hz	Modulation speed
DEPTH	0–100%	Modulation depth
WAVE	Sine, Tri, Square	Modulation waveform
SYNC	OFF/ON	Tempo parameter sync on/off
NOTE	*1	Used in conjunction with TEMPO to determine FREQ.
LSH F	21.2 Hz–8.00 kHz	Low shelving filter frequency
LSH G	–12.0 to +12.0 dB	Low shelving filter gain
EQ F	100 Hz–8.00 kHz	EQ (peaking type) frequency
EQ G	–12.0 to +12.0 dB	EQ (peaking type) gain
EQ Q	10.0–0.10	EQ (peaking type) bandwidth
HSH F	50.0 Hz–16.0 kHz	High shelving filter frequency
HSH G	–12.0 to +12.0 dB	High shelving filter gain

*1. 

■ AUTOPAN

Two input, two output autopanner.

Parameter	Range	Description
FREQ.	0.05–40.00 Hz	Modulation speed
DEPTH	0–100%	Modulation depth
DIR.	*1	Panning direction
WAVE	Sine, Tri, Square	Modulation waveform
SYNC	OFF/ON	Tempo parameter sync on/off
NOTE	*2	Used in conjunction with TEMPO to determine FREQ.
LSH F	21.2 Hz–8.00 kHz	Low shelving filter frequency
LSH G	–12.0 to +12.0 dB	Low shelving filter gain
EQ F	100 Hz–8.00 kHz	EQ (peaking type) frequency
EQ G	–12.0 to +12.0 dB	EQ (peaking type) gain
EQ Q	10.0–0.10	EQ (peaking type) bandwidth
HSH F	50.0 Hz–16.0 kHz	High shelving filter frequency
HSH G	–12.0 to +12.0 dB	High shelving filter gain

*1. L↔R, L→R, L←R, Turn L, Turn R

*2. 

■ ROTARY

One input, two output rotary speaker simulator.

Parameter	Range	Description
ROTATE	STOP, START	Rotation stop, start
SPEED	SLOW, FAST	Rotation speed (see SLOW and FAST parameters)
SLOW	0.05–10.00 Hz	SLOW rotation speed
FAST	0.05–10.00 Hz	FAST rotation speed
DRIVE	0–100	Overdrive level
ACCEL	0–10	Acceleration at speed changes
LOW	0–100	Low-frequency filter
HIGH	0–100	High-frequency filter

■ RING MOD.

Two input, two output ring modulator.

Parameter	Range	Description
SOURCE	OSC, SELF	Modulation source: oscillator or input signal
OSC FREQ	0.0–5000.0 Hz	Oscillator frequency
FM FREQ.	0.05–40.00 Hz	Oscillator frequency modulation speed
FM DEPTH	0–100%	Oscillator frequency modulation depth
SYNC	OFF/ON	Tempo parameter sync on/off
FM NOTE	*1	Used in conjunction with TEMPO to determine FM FREQ

*1. 

■ MOD.FILTER

Two input, two output modulation filter.

Parameter	Range	Description
FREQ.	0.05–40.00 Hz	Modulation speed
DEPTH	0–100%	Modulation depth
PHASE	0.00–354.38 degrees	Left-channel modulation and right-channel modulation phase difference
TYPE	LPF, HPF, BPF	Filter type: low pass, high pass, band pass
OFFSET	0–100	Filter frequency offset
RESO.	0–20	Filter resonance
LEVEL	0–100	Output level
SYNC	OFF/ON	Tempo parameter sync on/off
NOTE	*1	Used in conjunction with TEMPO to determine FREQ

*1. 

■ DYNA.FILTER

Two input, two output dynamically controlled filter.

Parameter	Range	Description
SOURCE	INPUT, MIDI	Control source: input signal or MIDI Note On velocity
SENSE	0–100	Sensitivity
DIR.	UP, DOWN	Upward or downward frequency change
DECAY	*1	Filter frequency change decay speed
TYPE	LPF, HPF, BPF	Filter type
OFFSET	0–100	Filter frequency offset
RESO.	0–20	Filter resonance
LEVEL	0–100	Output Level

*1. 6.0 ms–46.0 s (fs=44.1 kHz), 5.0 ms–42.3 s (fs=48 kHz)

■ **REV+CHORUS**

One input, two output reverb and chorus effects in parallel.

Parameter	Range	Description
REV TIME	0.3–99.0 s	Reverb time
INI. DLY	0.0–500.0 ms	Initial delay before reverb begins
HI. RATIO	0.1–1.0	High-frequency reverb time ratio
DIFF.	0–10	Spread
DENSITY	0–100%	Reverb density
REV/CHO	0–100%	Reverb and chorus balance (0% = all reverb, 100% = all chorus)
HPF	THRU, 21.2 Hz–8.00 kHz	High-pass filter cutoff frequency
LPF	50.0 Hz–16.0 kHz, THRU	Low-pass filter cutoff frequency
FREQ.	0.05–40.00 Hz	Modulation speed
AM DEPTH	0–100%	Amplitude modulation depth
PM DEPTH	0–100%	Pitch modulation depth
MOD. DLY	0.0–500.0 ms	Modulation delay time
WAVE	Sine, Tri	Modulation waveform
SYNC	OFF/ON	Tempo parameter sync on/off
NOTE	*1	Used in conjunction with TEMPO to determine FREQ.

*1. 

■ **REV→CHORUS**

One input, two output reverb and chorus effects in series.

Parameter	Range	Description
REV TIME	0.3–99.0 s	Reverb time
INI. DLY	0.0–500.0 ms	Initial delay before reverb begins
HI. RATIO	0.1–1.0	High-frequency reverb time ratio
DIFF.	0–10	Spread
DENSITY	0–100%	Reverb density
REV.BAL	0–100%	Reverb and chorused reverb balance (0% = all chorused reverb, 100% = all reverb)
HPF	THRU, 21.2 Hz–8.00 kHz	High-pass filter cutoff frequency
LPF	50.0 Hz–16.0 kHz, THRU	Low-pass filter cutoff frequency
FREQ.	0.05–40.00 Hz	Modulation speed
AM DEPTH	0–100%	Amplitude modulation depth
PM DEPTH	0–100%	Pitch modulation depth
MOD. DLY	0.0–500.0 ms	Modulation delay time
WAVE	Sine, Tri	Modulation waveform
SYNC	OFF/ON	Tempo parameter sync on/off
NOTE	*1	Used in conjunction with TEMPO to determine FREQ.

*1. 

■ **REV+FLANGE**

One input, two output reverb and flanger effects in parallel.

Parameter	Range	Description
REV TIME	0.3–99.0 s	Reverb time
INI. DLY	0.0–500.0 ms	Initial delay before reverb begins
HI. RATIO	0.1–1.0	High-frequency reverb time ratio
DIFF.	0–10	Spread
DENSITY	0–100%	Reverb density
REV/FLG	0–100%	Reverb and flange balance (0% = all reverb, 100% = all flange)
HPF	THRU, 21.2 Hz–8.00 kHz	High-pass filter cutoff frequency
LPF	50.0 Hz–16.0 kHz, THRU	Low-pass filter cutoff frequency
FREQ.	0.05–40.00 Hz	Modulation speed
DEPTH	0–100%	Modulation depth
MOD. DLY	0.0–500.0 ms	Modulation delay time
FB. GAIN	–99 to +99%	Feedback gain (plus values for normal-phase feedback, minus values for reverse-phase feedback)
WAVE	Sine, Tri	Modulation waveform
SYNC	OFF/ON	Tempo parameter sync on/off
NOTE	*1	Used in conjunction with TEMPO to determine FREQ.

*1. 

■ **REV→FLANGE**

One input, two output reverb and flanger effects in series.

Parameter	Range	Description
REV TIME	0.3–99.0 s	Reverb time
INI. DLY	0.0–500.0 ms	Initial delay before reverb begins
HI. RATIO	0.1–1.0	High-frequency reverb time ratio
DIFF.	0–10	Spread
DENSITY	0–100%	Reverb density
REV.BAL	0–100%	Reverb and flanged reverb balance (0% = all flanged reverb, 100% = all reverb)
HPF	THRU, 21.2 Hz–8.00 kHz	High-pass filter cutoff frequency
LPF	50.0 Hz–16.0 kHz, THRU	Low-pass filter cutoff frequency
FREQ.	0.05–40.00 Hz	Modulation speed
DEPTH	0–100%	Modulation depth
MOD. DLY	0.0–500.0 ms	Modulation delay time
FB. GAIN	–99 to +99%	Feedback gain (plus values for normal-phase feedback, minus values for reverse-phase feedback)
WAVE	Sine, Tri	Modulation waveform
SYNC	OFF/ON	Tempo parameter sync on/off
NOTE	*1	Used in conjunction with TEMPO to determine FREQ.

*1. 

■ **REV+SYMPHO.**

One input, two output reverb and symphonic effects in parallel.

Parameter	Range	Description
REV TIME	0.3–99.0 s	Reverb time
INI. DLY	0.0–500.0 ms	Initial delay before reverb begins
HI. RATIO	0.1–1.0	High-frequency reverb time ratio
DIFF.	0–10	Spread
DENSITY	0–100%	Reverb density
REV/SYM	0–100%	Reverb and symphonic balance (0% = all reverb, 100% = all symphonic)
HPF	THRU, 21.2 Hz–8.00 kHz	High-pass filter cutoff frequency
LPF	50.0 Hz–16.0 kHz, THRU	Low-pass filter cutoff frequency
FREQ.	0.05–40.00 Hz	Modulation speed
DEPTH	0–100%	Modulation depth
MOD. DLY	0.0–500.0 ms	Modulation delay time
WAVE	Sine, Tri	Modulation waveform
SYNC	OFF/ON	Tempo parameter sync on/off
NOTE	*1	Used in conjunction with TEMPO to determine FREQ.

*1.

■ **REV→SYMPHO.**

One input, two output reverb and symphonic effects in series.

Parameter	Range	Description
REV TIME	0.3–99.0 s	Reverb time
INI. DLY	0.0–500.0 ms	Initial delay before reverb begins
HI. RATIO	0.1–1.0	High-frequency reverb time ratio
DIFF.	0–10	Spread
DENSITY	0–100%	Reverb density
REV.BAL	0–100%	Reverb and symphonic reverb balance (0% = all symphonic reverb, 100% = all reverb)
HPF	THRU, 21.2 Hz–8.00 kHz	High-pass filter cutoff frequency
LPF	50.0 Hz–16.0 kHz, THRU	Low-pass filter cutoff frequency
FREQ.	0.05–40.00 Hz	Modulation speed
DEPTH	0–100%	Modulation depth
MOD. DLY	0.0–500.0 ms	Modulation delay time
WAVE	Sine, Tri	Modulation waveform
SYNC	OFF/ON	Tempo parameter sync on/off
NOTE	*1	Used in conjunction with TEMPO to determine FREQ.

*1.

■ **REV→PAN**

This is a 1-in/2-out series-connected reverb and auto-pan effect.

Parameter	Range	Description
REV TIME	0.3–99.0 s	Reverb time
INI. DLY	0.0–500.0 ms	Initial delay before reverb begins
HI. RATIO	0.1–1.0	High-frequency reverb time ratio
DIFF.	0–10	Spread
DENSITY	0–100%	Reverb density
REV.BAL	0–100%	Reverb and panned reverb balance (0% = all panned reverb, 100% = all reverb)
HPF	THRU, 21.2 Hz–8.00 kHz	High-pass filter cutoff frequency
LPF	50.0 Hz–16.0 kHz, THRU	Low-pass filter cutoff frequency
FREQ.	0.05–40.00 Hz	Modulation speed
DEPTH	0–100%	Modulation depth
DIR.	*1	Panning direction
WAVE	Sine, Tri, Square	Modulation waveform
SYNC	OFF/ON	Tempo parameter sync on/off
NOTE	*2	Used in conjunction with TEMPO to determine FREQ.

*1. L↔R, L→R, L←R, Turn L, Turn R

*2.

■ **DELAY+ER.**

One input, two output delay and early reflections effects in parallel.

Parameter	Range	Description
DELAY L	0.0–1000.0 ms	Left channel delay time
DELAY R	0.0–1000.0 ms	Right channel delay time
FB. DLY	0.0–1000.0 ms	Feedback delay time
FB. GAIN	–99 to +99%	Feedback gain (plus values for normal-phase feedback, minus values for reverse-phase feedback)
HI. RATIO	0.1–1.0	High-frequency feedback ratio
DLY/ER	0–100%	Delay and early reflections balance (0% = all delay, 100% = all early reflections)
HPF	THRU, 21.2 Hz–8.00 kHz	High-pass filter cutoff frequency
LPF	50.0 Hz–16.0 kHz, THRU	Low-pass filter cutoff frequency
TYPE	S-Hall, L-Hall, Random, Revers, Plate, Spring	Type of early reflection simulation
ROOMSIZE	0.1–20.0	Reflection spacing
LIVENESS	0–10	Early reflections decay characteristics (0 = dead, 10 = live)
INI. DLY	0.0–500.0 ms	Initial delay before reverb begins
DIFF.	0–10	Spread
DENSITY	0–100%	Reverb density
ER NUM.	1–19	Number of early reflections
SYNC	OFF/ON	Tempo parameter sync on/off
NOTE L	*1	Used in conjunction with TEMPO to determine left channel DELAY L
NOTE R	*1	Used in conjunction with TEMPO to determine right channel DELAY R
NOTE FB	*1	Used in conjunction with TEMPO to determine FB. DLY

*1. (Maximum value depends on the tempo setting)

■ **DELAY→ER.**

One input, two output delay and early reflections effects in series.

Parameter	Range	Description
DELAY L	0.0–1000.0 ms	Left channel delay time
DELAY R	0.0–1000.0 ms	Right channel delay time
FB. DLY	0.0–1000.0 ms	Feedback delay time
FB. GAIN	–99 to +99%	Feedback gain (plus values for normal-phase feedback, minus values for reverse-phase feedback)
HI. RATIO	0.1–1.0	High-frequency feedback ratio
DLY.BAL	0–100%	Delay and early reflected delay balance (0% = all early reflected delay, 100% = all delay)
HPF	THRU, 21.2 Hz–8.00 kHz	High-pass filter cutoff frequency
LPF	50.0 Hz–16.0 kHz, THRU	Low-pass filter cutoff frequency
TYPE	S-Hall, L-Hall, Random, Revers, Plate, Spring	Type of early reflection simulation
ROOMSIZE	0.1–20.0	Reflection spacing
LIVENESS	0–10	Early reflections decay characteristics (0 = dead, 10 = live)
INI. DLY	0.0–500.0 ms	Initial delay before reverb begins
DIFF.	0–10	Spread
DENSITY	0–100%	Reverb density
ER NUM.	1–19	Number of early reflections
SYNC	OFF/ON	Tempo parameter sync on/off
NOTE L	*1	Used in conjunction with TEMPO to determine left channel DELAY L
NOTE R	*1	Used in conjunction with TEMPO to determine right channel DELAY R
NOTE FB	*1	Used in conjunction with TEMPO to determine FB. DLY

*1.  (Maximum value depends on the tempo setting)

■ **DELAY+REV**

One input, two output delay and reverb effects in parallel.

Parameter	Range	Description
DELAY L	0.0–1000.0 ms	Left channel delay time
DELAY R	0.0–1000.0 ms	Right channel delay time
FB. DLY	0.0–1000.0 ms	Feedback delay time
FB. GAIN	–99 to +99%	Feedback gain (plus values for normal-phase feedback, minus values for reverse-phase feedback)
DELAY HI	0.1–1.0	Delay high-frequency feedback ratio
DLY/REV	0–100%	Delay and reverb balance (0% = all delay, 100% = all reverb)
HPF	THRU, 21.2 Hz–8.00 kHz	High-pass filter cutoff frequency
LPF	50.0 Hz–16.0 kHz, THRU	Low-pass filter cutoff frequency
REV TIME	0.3–99.0 s	Reverb time
INI. DLY	0.0–500.0 ms	Initial delay before reverb begins
REV HI	0.1–1.0	High-frequency reverb time ratio
DIFF.	0–10	Spread
DENSITY	0–100%	Reverb density
SYNC	OFF/ON	Tempo parameter sync on/off
NOTE L	*1	Used in conjunction with TEMPO to determine left channel DELAY L
NOTE R	*1	Used in conjunction with TEMPO to determine right channel DELAY R
NOTE FB	*1	Used in conjunction with TEMPO to determine FB. DLY

*1.  (Maximum value depends on the tempo setting)

■ **DELAY→REV**

One input, two output delay and reverb effects in series.

Parameter	Range	Description
DELAY L	0.0–1000.0 ms	Left channel delay time
DELAY R	0.0–1000.0 ms	Right channel delay time
FB. DLY	0.0–1000.0 ms	Feedback delay time
FB. GAIN	–99 to +99%	Feedback gain (plus values for normal-phase feedback, minus values for reverse-phase feedback)
DELAY HI	0.1–1.0	Delay high-frequency feedback ratio
DLY.BAL	0–100%	Delay and delayed reverb balance (0% = all delayed reverb, 100% = all delay)
HPF	THRU, 21.2 Hz–8.00 kHz	High-pass filter cutoff frequency
LPF	50.0 Hz–16.0 kHz, THRU	Low-pass filter cutoff frequency
REV TIME	0.3–99.0 s	Reverb time
INI. DLY	0.0–500.0 ms	Initial delay before reverb begins
REV HI	0.1–1.0	High-frequency reverb time ratio
DIFF.	0–10	Spread
DENSITY	0–100%	Reverb density
SYNC	OFF/ON	Tempo parameter sync on/off
NOTE L	*1	Used in conjunction with TEMPO to determine left channel DELAY L
NOTE R	*1	Used in conjunction with TEMPO to determine right channel DELAY R
NOTE FB	*1	Used in conjunction with TEMPO to determine FB. DLY

*1.  (Maximum value depends on the tempo setting)

■ **DIST→DELAY**

One input, two output distortion and delay effects in series.

Parameter	Range	Description
DST TYPE	DST1, DST2, OVD1, OVD2, CRUNCH	Distortion type (DST = distortion, OVD = overdrive)
DRIVE	0–100	Distortion drive
MASTER	0–100	Master volume
TONE	–10 to +10	Tone control
N. GATE	0–20	Noise reduction
SYNC	OFF/ON	Tempo parameter sync on/off
DLY.NOTE	*1	Used in conjunction with TEMPO to determine DELAY
MOD.NOTE	*2	Used in conjunction with TEMPO to determine FREQ.
DELAY	0.0–2725.0 ms	Delay time
FB. GAIN	–99 to +99%	Feedback gain (plus values for normal-phase feedback, minus values for reverse-phase feedback)
HI. RATIO	0.1–1.0	High-frequency feedback ratio
FREQ.	0.05–40.00 Hz	Modulation speed
DEPTH	0–100%	Modulation depth
DLY.BAL	0–100%	Distortion and delay balance (0% = all distortion, 100% = all delayed distortion)

*1.  (Maximum value depends on the tempo setting)

*2. 

■ **MULTI FILTER**

Two input, two output 3-band multi-filter (24 dB/octave).

Parameter	Range	Description
TYPE 1	LPF, HPF, BPF	Filter 1 type: high pass, low pass, band pass
FREQ. 1	28.0 Hz–16.0 kHz	Filter 1 frequency
LEVEL 1	0–100	Filter 1 level
RESO. 1	0–20	Filter 1 resonance
TYPE 2	LPF, HPF, BPF	Filter 2 type: high pass, low pass, band pass
FREQ. 2	28.0 Hz–16.0 kHz	Filter 2 frequency
LEVEL 2	0–100	Filter 2 level
RESO. 2	0–20	Filter 2 resonance
TYPE 3	LPF, HPF, BPF	Filter 3 type: high pass, low pass, band pass
FREQ. 3	28.0 Hz–16.0 kHz	Filter 3 frequency
LEVEL 3	0–100	Filter 3 level
RESO. 3	0–20	Filter 3 resonance

■ **FREEZE**

One input, two output basic sampler.

Parameter	Range	Description
REC MODE	MANUAL, INPUT	In MANUAL mode, recording is started by pressing the REC and PLAY buttons. In INPUT mode, Record-Ready mode is engaged by pressing the REC button, and actual recording is triggered by the input signal.
REC DLY	–1000 to +1000 ms	Recording delay. For plus values, recording starts after the trigger is received. For minus values, recording starts before the trigger is received.
PLY MODE	MOMENT, CONTI., INPUT	In MOMENT mode, the sample plays only while the that the PLAY button is pressed. In CONT mode, playback continues once the PLAY button has been pressed. The number of times the sample plays is set using the LOOP NUM parameter. In INPUT mode, playback is triggered by the input signal.
TRG LVL	–60 to 0 dB	Input trigger level (i.e., the signal level required to trigger recording or playback)
TRG MASK	0–1000 ms	Once playback has been triggered, subsequent triggers are ignored for the duration of the TRG MASK time.
START	*1	Playback start point in milliseconds
END	*1	Playback end point in milliseconds
LOOP	*1	Loop start point in milliseconds
LOOP NUM	0–100	Number of times the sample plays
PITCH	–12 to +12 semitones	Playback pitch shift
FINE	–50 to +50 cents	Playback pitch shift fine
MIDI TRG	OFF, C1–C6, ALL	PLAY button can be triggered by using MIDI Note on/off messages.
START [SAMPLE]	0–131000	Playback start point in samples
END [SAMPLE]	0–131000	Playback end point in samples
LOOP [SAMPLE]	0–131000	Loop start point in samples

*1. 0.0–5941.0 ms (fs=44.1 kHz), 0.0 ms–5458.3 ms (fs=48 kHz)

■ **DISTORTION**

One input, two output distortion effect.

Parameter	Range	Description
DST TYPE	DST1, DST2, OVD1, OVD2, CRUNCH	Distortion type (DST = distortion, OVD = overdrive)
DRIVE	0–100	Distortion drive
MASTER	0–100	Master volume
TONE	–10 to +10	Tone
N. GATE	0–20	Noise reduction

■ AMP SIMULATE

One input, two output guitar amp simulator.

Parameter	Range	Description
AMP TYPE	*1	Guitar amp simulation type
DST TYPE	DST1, DST2, OVD1, OVD2, CRUNCH	Distortion type (DST = distortion, OVD = overdrive)
DRIVE	0-100	Distortion drive
MASTER	0-100	Master volume
BASS	0-100	Bass tone control
MIDDLE	0-100	Middle tone control
TREBLE	0-100	High tone control
N. GATE	0-20	Noise reduction
CAB DEP	0-100%	Speaker cabinet simulation depth
EQ F	100 Hz-8.00 kHz	EQ (peaking type) frequency
EQ G	-12.0 to +12.0 dB	EQ (peaking type) gain
EQ Q	10.0-0.10	EQ (peaking type) bandwidth

*1. STK-M1, STK-M2, THRASH, MIDBST, CMB-PG, CMB-VR, CMB-DX, CMB-TW, MINI, FLAT

■ COMP276

This effect emulates the characteristics of analog compressors that are widely used in recording studios. It will produce a thick, strong frame sound suitable for drums and bass. You can control two monaural channels independently.

Parameter	Range	Description
INPUT 1	-180 to 0 dB	Adjusts the CH1 input level
OUTPUT 1	-180 to 0 dB	Adjusts the CH1 output gain
RATIO 1	2:1, 4:1, 8:1, 12:1, 20:1	Ratio for CH1 compressor
ATTACK 1	0.022-50.4 ms	Attack time for CH1 compressor
RELEASE 1	10.88-544.22 ms	Release time for CH1 compressor
MAKE UP1	OFF, ON	Automatically corrects output gain reduction when CH1 compressor is applied
SIDEHPF1	OFF, ON	When the HPF in the side chain of the CH1 compressor is turned on, the compression applied to the low range will be weakened, thus emphasizing the low range.
INPUT 2	-180 to 0 dB	Adjusts the CH2 input level
OUTPUT 2	-180 to 0 dB	Adjusts the CH2 output gain
RATIO 2	2:1, 4:1, 8:1, 12:1, 20:1	Ratio of CH2 compressor
ATTACK 2	0.022-50.4 ms	Attack time of CH2 compressor
RELEASE 2	10.88-544.22 ms	Release time of CH2 compressor
MAKE UP2	OFF, ON	Automatically corrects output gain reduction when the CH2 compressor is applied
SIDEHPF2	OFF, ON	When the HPF in the side chain of the CH2 compressor is turned on, the compression applied to the low range will be weakened, thus emphasizing the low range.

■ COMP276S

This effect emulates the characteristics of analog compressors that are widely used in recording studios. It produces a thick, strong frame sound suitable for drums and bass. You can link and control the L and R channel parameters.

Parameter	Range	Description
INPUT	-180 to 0 dB	Adjusts the input level
OUTPUT	-180 to 0 dB	Adjusts the output gain
RATIO	1:2, 4:1, 8:1, 12:1, 20:1	Ratio of the compressor
ATTACK	0.022-50.4 ms	Attack time of the compressor
RELEASE	10.88-544.22 ms	Release time of the compressor
MAKE UP	OFF, ON	Automatically corrects output gain reduction when the compressor is applied
SIDE HPF	OFF, ON	When the HPF in the side chain of the compressor is turned on, the compression applied to the low range will be weakened, thus emphasizing the low range.

■ COMP260

This effect emulates the characteristics of mid 70's compressors/limiters that are the standard for live SR. You can control two monaural channels independently. You can also link several parameters via stereo links.

Parameter	Range	Description
THRE.1	-60 to 0.0 dB	Threshold of CH compressor
KNEE1	SOFT, MEDIUM, HARD	Knee of CH1 compressor
ATTACK1	0.01-80.0 ms	Attack time of CH1 compressor
RELEASE1	6.2-999 ms	Release time of CH1 compressor
RATIO1	1.0-500, ∞	Ratio of CH1 compressor
OUTPUT1	-20 to 40 dB	Adjusts the CH1 output gain
THRE.2	-60 to 0.0 dB	Threshold of CH2 compressor
KNEE2	SOFT, MEDIUM, HARD	Knee of CH2 compressor
ATTACK2	0.01-80.0 ms	Attack time of CH2 compressor
RELEASE2	6.2-999 ms	Release time of CH2 compressor
RATIO2	1.0-500, ∞	Ratio of CH2 compressor
OUTPUT2	-20 to 40 dB	Adjusts the CH2 output gain
ST LINK	OFF, ON	Links CH1 and CH2 as a stereo pair. THRE., KNEE, ATTACK, RELEASE, and RATIO parameters are linked; OUTPUT parameter is not linked

■ COMP260S

This effect emulates the characteristics of mid 70's compressors/limiters that are the standard for live SR. You can link and control the L and R channel parameters.

Parameter	Range	Description
THRE.	-60 to 0.0 dB	Threshold of the compressor
KNEE	SOFT, MEDIUM, HARD	Knee of the compressor
ATTACK	0.01-80.0 ms	Attack time of the compressor
RELEASE	6.2-999 ms	Release time of the compressor
RATIO	1.0-500, ∞	Ratio of the compressor
OUTPUT	-20 to 40 dB	Adjusts the output gain

■ **EQUALIZER601**

This effect emulates the characteristics of 70's analog equalizers. Re-creating the distortion of typical analog circuits will add drive to the sound.

Parameter	Range	Description
LO TYPE	HPF-2/1, LSH-1/2	Type of EQ1
LO F	16.0 Hz to 20.0 kHz	Cut-off frequency of EQ1
LO G	-18.0 to +18.0 dB	Gain of EQ1
MID1 Q	0.50-16.0	Q of EQ2
MID1 F	16.0 Hz to 20.0 kHz	Center frequency of EQ2
MID1 G	-18.0 to +18.0 dB	Gain of EQ2
MID2 Q	0.50-16.0	Q of EQ3
MID2 F	16.0 Hz to 20.0 kHz	Center frequency of EQ3
MID2 G	-18.0 to +18.0 dB	Gain of EQ3
INPUT	-18.0 to +18.0 dB	Input gain
OUTPUT	-18.0 to +18.0 dB	Output gain
MID3 Q	0.50-16.0	Q of EQ4
MID3 F	16.0 Hz to 20.0 kHz	Center frequency of EQ4
MID3 G	-18.0 to +18.0 dB	Gain of EQ4
MID4 Q	0.50-16.0	Q of EQ5
MID4 F	16.0 Hz to 20.0 kHz	Center frequency of EQ5
MID4 G	-18.0 to +18.0 dB	Gain of EQ5
HI TYPE	LPF-2/1, HSH-1/2	Type of EQ6
HI F	16.0 Hz to 20.0 kHz *1	Cut-off frequency of EQ6
HI G	-18.0 to +18.0 dB	Gain of EQ6
LO SW	OFF, ON	Switches EQ1 on/off
MID1 SW	OFF, ON	Switches EQ2 on/off
MID2 SW	OFF, ON	Switches EQ3 on/off
MID3 SW	OFF, ON	Switches EQ4 on/off
MID4 SW	OFF, ON	Switches EQ5 on/off
HI SW	OFF, ON	Switches EQ6 on/off
TYPE	CLEAN, DRIVE	Selects the equalizer type. The CLEAN equalizer provides non-distorted, clear, typical digital sound, emulating variations in frequency response in the analog circuits. The DRIVE equalizer provides distorted, driven sound that enhances analog flavor, emulating changes in frequency response in the analog circuits.

*1. 16.0 Hz to 20.0 kHz (LPF-1, LPF-2), 1.0 kHz to 20.0 kHz (HSH-1, HSH-2)

■ **OPENDECK**

It emulates the tape compression created by two open reel tape recorders (a recording deck and a playback deck.) You can change the sound quality by adjusting various elements, such as the deck type, tape quality, playback speed, etc.

Parameter	Range	Description
REC DEC	Swss70, Swss78, Swss85, Amer70	Selects the recording deck type
REC LVL	-96.0 to +18.0 dB	Adjusts the input level of the recording deck. As you raise the level, tape compression is generated, which narrows the dynamic range and distorts the sound
REC HI	-6.0 to +6.0 dB	Adjusts the high range gain of the recording deck
REC BIAS	-1.00 to +1.00	Adjusts the bias of the recording deck
REPR DEC	Swss70, Swss78, Swss85, Amer70	Selects the playback deck type
REPR LVL	-96.0 to +18.0 dB	Adjusts the output level of the playback deck
REPR HI	-6.0 to +6.0 dB	Adjusts the high range gain of the playback deck
REPR LO	-6.0 to +6.0 dB	Adjusts the low range gain of the playback deck
MAKE UP	Off, On	When you adjust the REC LVL, the REPR LVL reflects the change, maintaining the relative output level. You can change the amount of distortion without changing the output level.
TP SPEED	15ips, 30ips	Selects the tape speed
TP KIND	Old, New	Selects the tape type

■ **M.BAND DYNA.**

Two input, two output 3-band dynamics processor, with individual solo and gain reduction metering for each band.

Parameter	Range	Description
L-M XOVER	21.2 Hz-8.00 kHz	Crossover frequency between the low and mid bands
M-H XOVER	21.2 Hz-8.00 kHz	Crossover frequency between the mid and high bands
SLOPE	-6 dB, -12 dB	Filter slope
LOW GAIN	-12.0 dB to +12.0 dB	Low band gain
MID GAIN	-12.0 dB to +12.0 dB	Mid band gain
HI. GAIN	-12.0 dB to +12.0 dB	High band gain
TOTAL	-72.0 dB to +12.0 dB	Overall gain
CEILING	-6.0 dB to 0.0 dB, OFF	Restricts the output so that it will not exceed the specified level
CMP.THRE	-24.0 dB to 0.0 dB	Threshold of the compressor
CMP.RAT	1:1 to 20:1	Ratio of the compressor
CMP.ATK	0-120 ms	Attack time of the compressor
CMP.REL	*1	Release time of the compressor
CMP.KNEE	0-5	Knee of the compressor
CMP.BYP	OFF/ON	Bypasses the compressor
EXP.THRE	-54.0 dB to -24.0 dB	Threshold of the expander
EXP.RAT	1:1 to 5:1	Ratio of the expander
EXP.REL	*1	Release time of the expander
EXP.BYP	OFF/ON	Bypasses the expander
LIM.THRE	-12.0 dB to 0.0 dB	Threshold of the limiter
LIM.ATK	0-120 ms	Attack time of the limiter

Parameter	Range	Description
LIM.REL	*1	Release time of the limiter
LIM.KNEE	0–5	Knee of the limiter
LIM.BYP	OFF/ON	Bypasses the limiter
PRESENCE	–10 to +10	Positive (+) values lower the threshold of the high band and raise the threshold of the low band. Negative (–) values do the opposite. If this is set to 0, the high, mid, and low bands will be affected in the same way.
LOOKUP	0.0–100.0 ms	Lookup delay
MAKE UP	OFF/ON	Automatically adjusts the output level

*1. 6.0 ms–46.0 s (fs=44.1 kHz), 5.0 ms–42.3 s (fs=48 kHz)

■ M.BAND COMP

Two input, two output 3-band compressor, with individual solo and gain reduction metering for each band.

Parameter	Range	Description
L-M XOVER	21.2 Hz–8.00 kHz	Crossover frequency between the low and mid bands
M-H XOVER	21.2 Hz–8.00 kHz	Crossover frequency between the mid and high bands
SLOPE	–6 dB, –12 dB	Filter slope
LOW GAIN	–12.0 dB to +12.0 dB	Low band gain
MID GAIN	–12.0 dB to +12.0 dB	Mid band gain
HI. GAIN	–12.0 dB to +12.0 dB	High band gain
TOTAL	–72.0 dB to +12.0 dB	Overall gain
CEILING	–6.0 dB to 0.0dB, OFF	Restricts the output so that it will not exceed the specified level
LOW THRE	–54.0 dB to 0.0 dB	Threshold of the low band compressor
LOW RAT	1:1 to 20:1	Ratio of the low band compressor
LOW ATK	0–120 ms	Attack time of the low band compressor
LOW REL	*1	Release time of the low band compressor
LOW KNEE	0–5	Knee of the low band compressor
LOW BYP	OFF/ON	Bypasses the low band compressor
MID THRE	–54.0 dB to 0.0 dB	Threshold of the mid band compressor
MID RAT	1:1 to 20:1	Ratio of the mid band compressor
MID ATK	0–120 ms	Attack time of the mid band compressor
MID REL	*1	Release time of the mid band compressor
MID KNEE	0–5	Knee of the mid band compressor
MID BYP	OFF/ON	Bypasses the mid band compressor
HI. THRE	–54.0 dB to 0.0 dB	Threshold of the high band compressor
HI. RAT	1:1 to 20:1	Ratio of the high band compressor
HI. ATK	0–120 ms	Attack time of the high band compressor
HI. REL	*1	Release time of the high band compressor
HI. KNEE	0–5	Knee of the high band compressor
HI. BYP	OFF/ON	Bypasses the high band compressor
LOOKUP	0.0–100.0 ms	Lookup delay
MAKE UP	OFF/ON	Automatically adjusts the output level

*1. 6.0 ms–46.0 s (fs=44.1 kHz), 5.0 ms–42.3 s (fs=48 kHz)

Premium Rack Processor Parameters

■ Portico5033

This models an analog 5-band EQ made by the RND company.

Parameter	Range	Description
ALL BYPASS	OFF, ON	Turns bypass on/off for the EQ. Even in the bypassed state, the signal will pass through the input/output transformers and the amp circuit.
TRIM	–12.0 to 12.0 dB	Input gain
LF FREQ	30.00 to 300.0 Hz	Center frequency of the LF band
LF GAIN	–12.0 to 12.0 dB	Gain of the LF band
LMF IN	OFF, ON	Switches the LMF band on/off
LMF Q	0.70 to 5.00	Q of the LMF band
LMF FREQ	50.00 to 400.0 Hz	Center frequency of the LMF band
LMF GAIN	–12.0 to 12.0 dB	Gain of the LMF band
MF IN	OFF, ON	Switches the MF band on/off
MF Q	0.70 to 5.00	Q of the MF band
MF FREQ	330.0 to 2500 Hz	Center frequency of the MF band
MF GAIN	–12.0 to 12.0 dB	Gain of the MF band
HMF IN	OFF, ON	Switches the HMF band on/off
HMF Q	0.70 to 5.00	Q of the HMF band
HMF FREQ	1.80k to 16.0k Hz	Center frequency of the HMF band
HMF GAIN	–12.0 to 12.0 dB	Gain of the HMF band
LF/HF IN	OFF, ON	Switches the LF/HF bands on/off
HF FREQ	2.50k to 25.0k Hz	Center frequency of the HF band
HF GAIN	–12.0 to 12.0 dB	Gain of the HF band

■ Portico5043

This models an analog compressor/limiter made by the RND company.

Parameter	Range	Description
IN	OFF, ON	Turns bypass on/off for the compressor. When bypassed, the button will be unlit. However even in the bypassed state, the signal will pass through the input/output transformers and the amp circuit.
FB	OFF, ON	Switches between feed-forward type and feed-back type.
THRESHOLD	–50.0 to 0.0 dB	Threshold level
RATIO	1.10 : 1 to 28.9 : 1, LIMIT	Compression ratio
ATTACK	20 to 75 ms	Attack time
RELEASE	100 ms to 2.50 sec	Release time
GAIN	–6.0 to 20.0 dB	Output level

■ **U76**

This models a well-known vintage compressor/limiter used in a wide range of situations.

Parameter	Range	Description
INPUT	-96.0 to 0.0 dB	Input level
OUTPUT	-96.0 to 0.0 dB	Output level
ATTACK	5.50 to 0.10 ms	Attack time of the compressor. Turning this all the way to the right produces the fastest attack.
RELEASE	1100.0 to 56.4 ms	Release time of the compressor. Turning this all the way to the right produces the fastest release.
RATIO	ALL, 4, 8, 12, 20	Switches the compression ratio. Pressing ALL produces the strongest effect.
METER	OFF, +4, +8, GR	Switches the meter display

■ **Opt-2A**

This processor emulates a well-known vintage model of vacuum tube opto compressor.

Parameter	Range	Description
GAIN	-56.0 dB to 40.0 dB	Output level
PEAK REDUCTION	-48.0 dB to 48.0 dB	Amount of gain reduction
RATIO	2.00 to 10.00	Compression ratio
METER SELECT	OUTPUT+10, GAIN REDUCTION, OUTPUT+4	Switches the meter display

■ **EQ-1A**

This processor emulates a vintage EQ that's considered a classic example of a passive EQ.

Parameter	Range	Description
LOW FREQUENCY	20, 30, 60, 100 Hz	Frequency range of the low range filter
(LOW) BOOST	0.0 to 10.0	Boost amount of the low range filter
(LOW) ATTEN	0.0 to 10.0	Attenuation amount of the low range filter
HIGH FREQUENCY	3k, 4k, 5k, 8k, 10k, 12k, 16k Hz	Frequency range of the high range filter
(HIGH) BOOST	0.0 to 10.0	Boost amount of the high range filter
(HIGH) BAND WIDTH	0.0 to 10.0	Band width of the high range filter
(HIGH) ATTEN SEL	5k, 10k, 20k Hz	Frequency range attenuated by the high range filter
(HIGH) ATTEN	0.0 to 10.0	Attenuation amount of the high range filter
IN	OFF, ON	Turns the processor on/off. If this is off, the filter section will be bypassed, but the signal will pass through the input/output transformers and the amp circuit.

■ **Dynamic EQ**

This is a newly developed equalizer that dynamically changes the EQ gain in response to the input signal, controlling the amount of EQ cut or boost in a way similar to a compressor or expander.

Parameter	Range	Description
BAND ON/OFF	OFF, ON	Turns the corresponding band on/off
SIDECHAIN CUE	OFF, ON	If this is on, the sidechain signal that controls the dynamics will be sent to the CUE bus for monitoring.
SIDECHAIN LISTEN	OFF, ON	If this is on, the sidechain signal that is linked to the dynamics will be output to the bus (such as the STEREO bus or a MIX/MATRIX bus) to which the inserted channel is being sent.
FILTER TYPE	Low Shelf, Bell, Hi Shelf	Switches the type of equalizer and sidechain filter
FREQUENCY	20.0 to 20.0k Hz	Frequency controlled by the equalizer and sidechain filter
Q	15.0 to 0.50	Q of the equalizer and sidechain filter
THRESHOLD	-80.0 to 10.0 dB	Threshold value at which processing begins to apply
RATIO	∞ : 1 to 1 : 1.50	Sets the boost/cut ratio relative to the input signal.
MODE	BELOW, ABOVE	Specifies whether the processor will operate when the sidechain signal exceeds the threshold setting (ABOVE) or when it falls below the threshold setting (BELOW)
ATTACK/RELEASE	FAST, SLOW, AUTO	Attack time/release time for when compression or boost is applied

Effects and tempo synchronization

Some effects of the CL series can be synchronized with the tempo. There are two such types of effect: delay-type effects and modulation-type effects. For delay-type effects, the delay time will change according to the tempo. For modulation-type effects, the frequency of the modulation signal will change according to the tempo.

Parameters related to tempo synchronization

The following five parameters are related to tempo synchronization.

- 1) SYNC 2) NOTE 3) TEMPO 4) DELAY 5) FREQ.

SYNC:This is the on/off switch for tempo synchronization.

NOTE and TEMPO:These are the basic parameters for tempo synchronization.

DELAY and FREQ.:DELAY is the delay time, and FREQ. is the frequency of the modulation signal. These directly affect the way in which the effect sound will change. DELAY is relevant only for delay-type effects, and FREQ. is relevant only for modulation-type effects.

How the parameters are related

Tempo synchronization calculates the DELAY (or FREQ.) value^{*a} from the TEMPO and NOTE.

Turn SYNC ON

Change NOTE → DELAY (or FREQ.) will be set

In this case, the DELAY (or FREQ.) value is calculated as follows.

$$\text{DELAY (or FREQ.)} = \text{NOTE} \times 4 \times (60/\text{TEMPO})$$

Change TEMPO → DELAY (or FREQ.) will be set

In this case, the DELAY (or FREQ.) value is calculated as follows.

$$\text{DELAY} = \text{NOTE} \times 4 \times (60/\text{TEMPO}) \text{ sec}$$

$$\text{FREQ.} = (\text{TEMPO}/60) / (\text{NOTE} \times 4) \text{ Hz}$$

Example 1:

When SYNC=ON, DELAY=250 ms, TEMPO=120, you change NOTE from 8th note to quarter note

$$\begin{aligned} \text{DELAY} &= \text{new NOTE} \times 4 \times (60/\text{TEMPO}) \\ &= (1/4) \times 4 \times (60/120) \\ &= 0.5 \text{ (sec)} \\ &= 500 \text{ ms} \end{aligned}$$

Thus, the DELAY will change from 250 ms to 500 ms.

Example 2:

When SYNC=ON, DELAY=250 ms, NOTE=8th note, you change TEMPO from 120 to 121

$$\begin{aligned} \text{DELAY} &= \text{NOTE} \times 4 \times (60 / \text{new TEMPO}) \\ &= (1/8) \times 4 \times (60/121) \\ &= 0.2479 \text{ (sec)} \\ &= 247.9 \text{ (ms)} \end{aligned}$$

Thus, the TEMPO will change from 250 ms to 247.9 ms.

^{*a} Rounded values are used for the calculation results.

Ranges of the NOTE and TEMPO values

The ranges of the NOTE and TEMPO values are limited by the ranges of the DELAY or FREQ. values. You cannot set NOTE or TEMPO values that would cause DELAY or FREQ. to exceed their maximum possible values when synchronized to tempo. This limitation also applies even when SYNC is OFF.

Special characteristics of the TEMPO parameter

The TEMPO parameter has the following characteristics that are unlike other parameters.

- It is a common value shared by all effects
- You cannot store it to or recall it from the Effects Library. (You can store it to and recall it from a Scene.)

This means that the TEMPO value may not necessarily be the same when an effect is recalled as when that effect was stored. Here is an example.

Store the effect: TEMPO=120 → Change TEMPO to 60 → Recall the effect: TEMPO=60

Normally when you change the TEMPO, the DELAY (or FREQ.) will be re-set accordingly. However if the DELAY (or FREQ.) were changed, the effect would sound differently when recalled than when it was stored. To prevent the effect from changing in this way between store and recall, the CL series does not update the DELAY (or FREQ.) value when an effect is recalled, even if the TEMPO is no longer the same as when that effect was stored.

* The NOTE parameter is calculated based on the following values.

$$\begin{array}{cccccccc} \text{♩} = 1/4 & \text{♪} = 1/8 & \text{♫} = 1/16 & \text{♬} = 1/32 & \text{♭} = 1/2 & \text{♮} = 1 & \text{♯} = 2 & \text{♭♭} = 4 \\ \text{♩} = 1/4 & \text{♪} = 1/8 & \text{♫} = 1/16 & \text{♬} = 1/32 & \text{♭} = 1/2 & \text{♮} = 1 & \text{♯} = 2 & \text{♭♭} = 4 \end{array}$$

Parameters that can be assigned to control changes

Mode	Parameter 1	Parameter 2
NO ASSIGN	—	0
FADER H	INPUT	CH 1–CH 72*1 STIN1L–STIN8R
	OUTPUT	MIX 1–MIX 24 MATRIX 1–MATRIX 8 STEREO L–MONO(C)
FADER L	INPUT	CH 1–CH 72*1 STIN1L–STIN8R
	OUTPUT	MIX 1–MIX 24 MATRIX 1–MATRIX 8 STEREO L–MONO(C)
CH ON	INPUT	CH 1–CH 72*1 STIN1L–STIN8R
	OUTPUT	MIX 1–MIX 24 MATRIX 1–MATRIX 8 STEREO L–MONO(C)
PHASE	INPUT	CH 1–CH 72*1 STIN1L–STIN8R
INSERT	INPUT	CH 1–CH 72*1
	OUTPUT	MIX 1–MIX 24 MATRIX 1–MATRIX 8 STEREO L–MONO(C)
DIRECT OUT	ON	CH 1–CH 72*1
PAN/BALANCE	INPUT	CH 1–CH 72*1 STIN1L–STIN8R
BALANCE	OUTPUT	MIX 1–MIX 24 MATRIX 1–MATRIX 8 STEREO L–STEREO R
TO STEREO	ON	CH 1–CH 72*1 STIN1L–STIN8R
TO MONO	ON	CH 1–CH 72*1 STIN1L–STIN8R
LCR	ON	CH 1–CH 72*1 STIN1L–STIN8R
	CSR	MIX 1–MIX 24
MIX/MATRIX SEND	MIX 1 ON – MIX24 ON	CH 1–CH 72*1 STIN1L–STIN8R
	MATRIX 1 ON – MATRIX 8 ON	
	MIX 1 POINT – MIX 24 POINT	
	MATRIX 1 POINT – MATRIX 8 POINT	
	MIX 1 LEVEL H – MIX 24 LEVEL H	
	MIX 1 LEVEL L – MIX 24 LEVEL L	
	MATRIX 1 LEVEL H – MATRIX 8 LEVEL H	
	MATRIX 1 LEVEL L – MATRIX 8 LEVEL L	
	MIX 1/2 PAN – MIX 23/24 PAN	
	MATRIX1/2 PAN – MATRIX7/8 PAN	
MIX TO STEREO	TO STEREO ON	MIX 1–MIX 24
	TO MONO ON	
	PAN	

Mode	Parameter 1	Parameter 2
MIX TO MATRIX	MATRIX 1 POINT – MATRIX 8 POINT	MIX 1–MIX 24
	MATRIX 1 ON – MATRIX 8 ON	
	MATRIX 1 LEVEL H – MATRIX 8 LEVEL H	
	MATRIX 1 LEVEL L – MATRIX 8 LEVEL L	
	MATRIX 1/2 PAN – MATRIX 7/8 PAN	
STEREO TO MATRIX	MATRIX 1 POINT – MATRIX 8 POINT	STEREO L–MONO(C)
	MATRIX 1 ON – MATRIX 8 ON	
	MATRIX 1 LEVEL H – MATRIX 8 LEVEL H	
	MATRIX 1 LEVEL L – MATRIX 8 LEVEL L	
	MATRIX 1/2 PAN – MATRIX 7/8 PAN	
INPUT EQ	ON	CH 1–CH 72*1 STIN1L–STIN8R
	LOW Q	
	LOW FREQ	
	LOW GAIN	
	LOW MID Q	
	LOW MID FREQ	
	LOW MID GAIN	
	HIGH MID Q	
	HIGH MID FREQ	
	HIGH MID GAIN	
	HIGH Q	
	HIGH FREQ	
	HIGH GAIN	
	LPF ON	
	LOW TYPE	
HIGH TYPE		
INPUT ATT	INPUT	CH 1–CH 72*1 STIN1L–STIN8R
INPUT HPF	ON	CH 1–CH 72*1 STIN1L–STIN8R
	FREQ	
OUTPUT EQ	ON	MIX 1–MIX 24 MATRIX 1–MATRIX 8 STEREO L–MONO(C)
	LOW Q	
	LOW FREQ	
	LOW GAIN	
	LOW MID Q	
	LOW MID FREQ	
	LOW MID GAIN	
	HIGH MID Q	
	HIGH MID FREQ	
	HIGH MID GAIN	
	HIGH Q	
	HIGH FREQ	
	HIGH GAIN	
	LOW TYPE	
	HIGH TYPE	
LOW HPF ON		
HIGH LPF ON		

Mode	Parameter 1	Parameter 2
OUTPUT ATT	OUTPUT	MIX1-MIX24 MATRIX1-MATRIX8 STEREO L-MONO(C)
INPUT DYNAMICS1	ON	CH 1-CH 72*1 STIN1L-STIN8R
	ATTACK	
	THRESHOLD	
	RANGE	
	HOLD H	
	HOLD L	
	DECAY/RELEASE H	
	DECAY/RELEASE L	
	RATIO	
	KNEE/WIDTH	
	GAIN H	
GAIN L		
INPUT DYNAMICS2	ON	CH 1-CH 72*1 STIN1L-STIN8R
	ATTACK	
	THRESHOLD	
	RELEASE H	
	RELEASE L	
	RATIO	
	GAIN H	
	GAIN L	
	KNEE/WIDTH	
	FILTER FREQ	
OUTPUT DYNAMICS1	ON	MIX 1-MIX 24 MATRIX 1-MATRIX 8 STEREO L-MONO(C)
	ATTACK	
	THRESHOLD	
	RELEASE H	
	RELEASE L	
	RATIO	
	GAIN H	
GAIN L		
EFFECT	BYPASS	Rack1-8
	MIX BALANCE	
	PARAM 1 H - PARAM 32 L	

Mode	Parameter 1	Parameter 2
GEQ	ON A	Rack1-16
	ON B	
	GAIN A 1 - GAIN A 31	
	GAIN B 1 - GAIN B 31	
PREMIUM RACK A	BYPASS	Rack1-8
	PARAM 1 H - PARAM 64 L	
PREMIUM RACK B	BYPASS	Rack1-8
	PARAM 1 H - PARAM 64 L	
DCA	ON	DCA 1-DCA 16
	FADER H	
	FADER L	
MUTE MASTER	ON	MASTER 1-MASTER 8
RECALL SAFE	ON	CH 1-CH 72*1 STIN1L-STIN8R MIX 1-MIX 24 MATRIX 1-MATRIX 8 STEREO L-MONO(C) GEQ RACK 1A-16B EFFECT RACK 1A-8B PREMIUM RACK 1A-8B DCA 1-DCA16

*1. CL3: CH1-CH64, CL1: CH1-CH48

NRPN parameter assignments

Parameter	From (HEX)	To (HEX)	
FADER	INPUT	0000	0057
	MIX1-20, MATRIX, STEREO LR	0060	007D
INPUT to MIX9-16 LEVEL	MIX9 SEND	007E	00D5
	MIX10 SEND	00DE	0135
	MIX11 SEND	013E	0195
	MIX12 SEND	019E	01F5
	MIX13 SEND	01FE	0255
	MIX14 SEND	025E	02B5
	MIX15 SEND	02BE	0315
INPUT to MATRIX1-4 LEVEL	MIX16 SEND	031E	0375
	MATRIX1 SEND	037E	03D5
	MATRIX2 SEND	03DE	0435
	MATRIX3 SEND	043E	0495
MIX1-20, STEREO LR to MATRIX LEVEL	MATRIX4 SEND	049E	04F5
	MATRIX1 SEND	04FE	0513
	MATRIX2 SEND	0514	0529
	MATRIX3 SEND	052A	053F
	MATRIX4 SEND	0540	0555
	MATRIX5 SEND	0556	056B
	MATRIX6 SEND	056C	0581
	MATRIX7 SEND	0582	0597
ON	MATRIX8 SEND	0598	05AD
	INPUT	05B6	060D
INPUT to MIX9-16 ON	MIX1-20, MATRIX, STEREO LR	0616	0633
	MIX9 SEND	0634	068B
	MIX10 SEND	0694	06EB
	MIX11 SEND	06F4	074B
	MIX12 SEND	0754	07AB
	MIX13 SEND	07B4	080B
	MIX14 SEND	0814	086B
	MIX15 SEND	0874	08CB
INPUT to MATRIX1-4 ON	MIX16 SEND	08D4	092B
	MATRIX1 SEND	0934	098B
	MATRIX2 SEND	0994	09EB
	MATRIX3 SEND	09F4	0A4B
MIX1-20, STEREO LR to MATRIX ON	MATRIX4 SEND	0A54	0AAB
	MATRIX1 SEND	0AB4	0AC9
	MATRIX2 SEND	0ACA	0ADF
	MATRIX3 SEND	0AE0	0AF5
	MATRIX4 SEND	0AF6	0B0B
	MATRIX5 SEND	0B0C	0B21
	MATRIX6 SEND	0B22	0B37
	MATRIX7 SEND	0B38	0B4D
MIX1-8 to STEREO ON	MATRIX8 SEND	0B4E	0B63
PHASE	MIX TO ST	0B64	0B6B
	INPUT	0B6C	0BC3

Parameter	From (HEX)	To (HEX)	
INSERT ON	INPUT	0BCC	0C13
	MIX1-20, MATRIX, STEREO LR	0C2C	0C49
INPUT to MIX9-16 PRE/POST	MIX9 SEND	0C4A	0CA1
	MIX10 SEND	0CAA	0D01
	MIX11 SEND	0D0A	0D61
	MIX12 SEND	0D6A	0DC1
	MIX13 SEND	0DCA	0E21
	MIX14 SEND	0E2A	0E81
	MIX15 SEND	0E8A	0EE1
INPUT to MATRIX1-4 PRE/POST	MIX16 SEND	0EEA	0F41
	MATRIX1 SEND	0F4A	0FA1
	MATRIX2 SEND	0FAA	1001
INPUT57-64 to MIX1-8 LEVEL	MATRIX3 SEND	100A	1061
	MATRIX4 SEND	106A	10C1
	MIX1 SEND	10CA	10D1
	MIX2 SEND	10D2	10D9
	MIX3 SEND	10DA	10E1
	MIX4 SEND	10E2	10E9
	MIX5 SEND	10EA	10F1
	MIX6 SEND	10F2	10F9
INPUT57-64 to MATRIX5-8 LEVEL	MIX7 SEND	10FA	1101
	MIX8 SEND	1102	1109
	MATRIX5 SEND	110A	1111
	MATRIX6 SEND	1112	1119
INPUT57-64 to MIX1-8 ON	MATRIX7 SEND	111A	1121
	MATRIX8 SEND	1122	1129
	MIX1 SEND	112A	1131
	MIX2 SEND	1132	1139
	MIX3 SEND	113A	1141
	MIX4 SEND	1142	1149
	MIX5 SEND	114A	1151
	MIX6 SEND	1152	1159
INPUT57-64 to MATRIX5-8 ON	MIX7 SEND	115A	1161
	MIX8 SEND	1162	1169
	MATRIX5 SEND	116A	1171
	MATRIX6 SEND	1172	1179
INPUT57-64 to MIX1-8 PRE/POST	MATRIX7 SEND	117A	1181
	MATRIX8 SEND	1182	1189
	MIX1 SEND	118A	1191
	MIX2 SEND	1192	1199
	MIX3 SEND	119A	11A1
	MIX4 SEND	11A2	11A9
	MIX5 SEND	11AA	11B1
	MIX6 SEND	11B2	11B9
INPUT57-64 to MATRIX5-8 PRE/POST	MIX7 SEND	11BA	11C1
	MIX8 SEND	11C2	11C9
	MATRIX5 SEND	11CA	11D1
	MATRIX6 SEND	11D2	11D9
	MATRIX7 SEND	11DA	11E1
	MATRIX8 SEND	11E2	11E9

Parameter	From (HEX)	To (HEX)	
INPUT57-64 EQ	LOW TYPE	11EA	11F1
	HIGH TYPE	11F2	11F9
INPUT57-64 HPF	FREQ	11FA	1201
INPUT57-64 to MIX1/2-7/8 PAN	MIX1/2	1202	1209
	MIX3/4	120A	1211
	MIX5/6	1212	1219
INPUT57-64 to MATRIX5/6, 7/8 PAN	MIX7/8	121A	1221
	MATRIX5/6	1222	1229
INPUT57-64 to STEREO	MATRIX7/8	122A	1231
INPUT57-64 RECALL SAFE	ON	1232	1239
INPUT57-64 to MONO	ON	123A	1241
INPUT49-64 DYNAMICS1	RATIO	1242	1249
	KNEE/WIDTH	124A	1259
	GAIN	125A	1269
INPUT49-64 DYNAMICS2	reserved	126A	1279
	FILTER FREQ	127A	1289
INPUT65-72, STIN5-8 RECALL SAFE	ON	128A	1299
EQ INPUT, MIX1-20, MATRIX, STEREO LR	ON	129A	12A9
	LOW Q	1304	1381
	LOW FREQ	1382	13FF
	LOW GAIN	1400	147D
	LOW MID Q	147E	14FB
	LOW MID FREQ	14FC	1579
	LOW MID GAIN	157A	15F7
	HIGH MID Q	15F8	1675
	HIGH MID FREQ	1676	16F3
	HIGH MID GAIN	16F4	1771
	HIGH Q	1772	17EF
	HIGH FREQ	17F0	186D
	HIGH GAIN	186E	18EB
	ATT	18EC	1969
	HPF ON	196A	19C1
	LPF ON	19E8	1A65
INPUT DYNAMICS1	1AE3	1AE4	1B3B
	ON	1AE4	1B3B
	ATTACK	1B44	1B9B
	THRESHOLD	1B44	1BF8
	RANGE	1C04	1C5B
INPUT DYNAMICS2	HOLD	1C64	1CBB
	DECAY/RELEASE	1CC4	1D1B
MIX1-20, MATRIX, STEREO LR DYNAMICS1	ON	1D24	1DA1
	ATTACK	1DA2	1E1F
	THRESHOLD	1E20	1E9D
	RELEASE	1E9E	1F1B
	RATIO	1F1C	1F99
PAN/BALANCE	GAIN	1F9A	2017
	KNEE/WIDTH	2018	2095
	INPUT	2096	20ED

Parameter	From (HEX)	To (HEX)
INPUT to MIX9/10-15/16 PAN	MIX9/10	20F6 214D
	MIX11/12	2156 21AD
	MIX13/14	21B6 220D
	MIX15/16	2216 226D
INPUT to MATRIX1/2, 3/4 PAN	MATRIX1/2	2276 22CD
	MATRIX3/4	22D6 232D
MIX1-20, STEREO LR to MATRIX PAN	MATRIX1/2	2336 234B
	MATRIX3/4	234C 2361
	MATRIX5/6	2362 2377
	MATRIX7/8	2378 238D
MIX1-8 to STEREO PAN	MIX TO ST	238E 2395
BALANCE	MIX1-20, MATRIX, STEREO LR	2396 23B3
MIX, STEREO LR, MONO to MATRIX PRE/POST	MATRIX1 SEND	23B4 23CE
	MATRIX2 SEND	23D0 23EA
	MATRIX3 SEND	23EC 2406
	MATRIX4 SEND	2408 2422
	MATRIX5 SEND	2424 243E
	MATRIX6 SEND	2440 245A
	MATRIX7 SEND	245C 2476
	MATRIX8 SEND	2478 2492
MIX21-24, MONO to MATRIX ON	MATRIX1 SEND	2494 2498
	MATRIX2 SEND	249A 249E
	MATRIX3 SEND	24A0 24A4
	MATRIX4 SEND	24A6 24AA
	MATRIX5 SEND	24AC 24B0
	MATRIX6 SEND	24B2 24B6
	MATRIX7 SEND	24B8 24BC
	MATRIX8 SEND	24BE 24C2
INPUT65-72, STIN5-8 to MIX1-8 LEVEL	MIX1 SEND	24C4 24D3
	MIX2 SEND	24D4 24E3
	MIX3 SEND	24E4 24F3
	MIX4 SEND	24F4 2503
	MIX5 SEND	2504 2513
	MIX6 SEND	2514 2523
	MIX7 SEND	2524 2533
	MIX8 SEND	2534 2543
INPUT65-72, STIN5-8 to MIX1-8 ON	MIX1 SEND	2544 2553
	MIX2 SEND	2554 2563
	MIX3 SEND	2564 2573
	MIX4 SEND	2574 2583
	MIX5 SEND	2584 2593
	MIX6 SEND	2594 25A3
	MIX7 SEND	25A4 25B3
	MIX8 SEND	25B4 25C3

Parameter	From (HEX)	To (HEX)
INPUT65-72, STIN5-8 to MIX1-8 PRE/POST	MIX1 SEND	25C4 25D3
	MIX2 SEND	25D4 25E3
	MIX3 SEND	25E4 25F3
	MIX4 SEND	25F4 2603
	MIX5 SEND	2604 2613
	MIX6 SEND	2614 2623
	MIX7 SEND	2624 2633
	MIX8 SEND	2634 2643
INPUT65-72, STIN5-8 to MIX1/2-7/8 PAN	MIX1/2	2644 2653
	MIX3/4	2654 2663
	MIX5/6	2664 2673
	MIX7/8	2674 2683
EFFECT RACK1-8	BYPASS	2684 26BB
	MIX BALANCE	26BC 26C3
	PARAM1	26C4 26CB
	PARAM2	26CC 26D3
	PARAM3	26D4 26DB
	PARAM4	26DC 26E3
	PARAM5	26E4 26EB
	PARAM6	26EC 26F3
	PARAM7	26F4 26FB
	PARAM8	26FC 2703
	PARAM9	2704 270B
	PARAM10	270C 2713
	PARAM11	2714 271B
	PARAM12	271C 2723
	PARAM13	2724 272B
	PARAM14	272C 2733
	PARAM15	2734 273B
	PARAM16	273C 2743
	PARAM17	2744 274B
	PARAM18	274C 2753
	PARAM19	2754 275B
	PARAM20	275C 2763
	PARAM21	2764 276B
	PARAM22	276C 2773
	PARAM23	2774 277B
	PARAM24	277C 2783
	PARAM25	2784 278B
	PARAM26	278C 2793
	PARAM27	2794 279B
	PARAM28	279C 27A3
	PARAM29	27A4 27AB
	PARAM30	27AC 27B3
PARAM31	27B4 27BB	
PARAM32	27BC 27C3	

Parameter	From (HEX)	To (HEX)
GEQ RACK1A-3B	ON	27C4 27C9
	GAIN1	27CA 27CF
	GAIN2	27D0 27D5
	GAIN3	27D6 27DB
	GAIN4	27DC 27E1
	GAIN5	27E2 27E7
	GAIN6	27E8 27ED
	GAIN7	27EE 27F3
	GAIN8	27F4 27F9
	GAIN9	27FA 27FF
	GAIN10	2800 2805
	GAIN11	2806 280B
	GAIN12	280C 2811
	GAIN13	2812 2817
	GAIN14	2818 281D
	GAIN15	281E 2823
	GAIN16	2824 2829
	GAIN17	282A 282F
	GAIN18	2830 2835
	GAIN19	2836 283B
	GAIN20	283C 2841
	GAIN21	2842 2847
	GAIN22	2848 284D
	GAIN23	284E 2853
	GAIN24	2854 2859
	GAIN25	285A 285F
	GAIN26	2860 2865
	GAIN27	2866 286B
	GAIN28	286C 2871
	GAIN29	2872 2877
	GAIN30	2878 287D
GAIN31	287E 2883	
FADER	MIX21-24, MONO	28E4 28E8
INPUT1-56, STIN1-4 to MIX1-8 LEVEL	MIX1 SEND	28EA 2929
	MIX2 SEND	292A 2969
	MIX3 SEND	296A 29A9
	MIX4 SEND	29AA 29E9
	MIX5 SEND	29EA 2A29
	MIX6 SEND	2A2A 2A69
	MIX7 SEND	2A6A 2AA9
	MIX8 SEND	2AAA 2AE9
INPUT1-56, STIN1-4 to MATRIX5-8 LEVEL	MATRIX5 SEND	2AEA 2B29
	MATRIX6 SEND	2B2A 2B69
	MATRIX7 SEND	2B6A 2BA9
	MATRIX8 SEND	2BAA 2BE9

Parameter	From (HEX)	To (HEX)	
MIX21-24, MONO to MATRIX LEVEL	MATRIX1 SEND	2BEA	2BEE
	MATRIX2 SEND	2BF0	2BF4
	MATRIX3 SEND	2BF6	2BFA
	MATRIX4 SEND	2BFC	2C00
	MATRIX5 SEND	2C02	2C06
	MATRIX6 SEND	2C08	2C0C
	MATRIX7 SEND	2C0E	2C12
	MATRIX8 SEND	2C14	2C18
ON	MIX21-24, MONO	2C2A	2C2E
INPUT1-56, STIN1-4 to MIX1-8 ON	MIX1 SEND	2C30	2C6F
	MIX2 SEND	2C70	2CAF
	MIX3 SEND	2CB0	2CEF
	MIX4 SEND	2CF0	2D2F
	MIX5 SEND	2D30	2D6F
	MIX6 SEND	2D70	2DAF
	MIX7 SEND	2DB0	2DEF
	MIX8 SEND	2DF0	2E2F
INPUT1-56, STIN1-4 to MATRIX5-8 ON	MATRIX5 SEND	2E30	2E6F
	MATRIX6 SEND	2E70	2EAF
	MATRIX7 SEND	2EB0	2EEF
	MATRIX8 SEND	2EF0	2F2F
MIX9-24 to STEREO ON	MIX TO ST	2F36	2F45
INSERT	MIX21-24, MONO	2F46	2F4A
INPUT1-56, STIN1-4 to MIX1-8 PRE/POST	MIX1 SEND	2F4C	2F8B
	MIX2 SEND	2F8C	2FCB
	MIX3 SEND	2FCC	300B
	MIX4 SEND	300C	304B
	MIX5 SEND	304C	308B
	MIX6 SEND	308C	30CB
	MIX7 SEND	30CC	310B
	MIX8 SEND	310C	314B
INPUT1-56, STIN1-4 to MATRIX5-8 PRE/POST	MATRIX5 SEND	314C	318B
	MATRIX6 SEND	318C	31CB
	MATRIX7 SEND	31CC	320B
	MATRIX8 SEND	320C	324B
DCA13-16	ON	324C	324F
	FADER	3252	3255
BALANCE	MIX21-24 (MONO)	3258	325C

Parameter	From (HEX)	To (HEX)	
MIX21-24, MONO EQ	ON	325E	3262
	LOW Q	3264	3268
	LOW FREQ	326A	326E
	LOW GAIN	3270	3274
	LOW MID Q	3276	327A
	LOW MID FREQ	327C	3280
	LOW MID GAIN	3282	3286
	HIGH MID Q	3288	328C
	HIGH MID FREQ	328E	3292
	HIGH MID GAIN	3294	3298
	HIGH Q	329A	329E
	HIGH FREQ	32A0	32A4
	HIGH GAIN	32A6	32AA
	HPF ON	32AC	32B0
	LPF ON	32B2	32B6
	INPUT1-56, STIN1-4 EQ	LOW TYPE	3440
HIGH TYPE		3480	34BF
MIX, MATRIX, STEREO LR, MONO EQ	LOW TYPE	34C0	34E2
	HIGH TYPE	34E4	3506
INPUT65-72, STIN5-8 EQ	LOW TYPE	3508	3517
	HIGH TYPE	3518	3527
INPUT65-72, STIN5-8 HPF	FREQ	3528	3537
DIRECT OUT INPUT65-72	ON	3538	353F
INPUT65-72, STIN5-8 to MATRIX5-8 LEVEL	MATRIX5 SEND	3540	354F
	MATRIX6 SEND	3550	355F
	MATRIX7 SEND	3560	356F
	MATRIX8 SEND	3570	357F
INPUT65-72, STIN5-8 to MATRIX5-8 ON	MATRIX5 SEND	3580	358F
	MATRIX6 SEND	3590	359F
	MATRIX7 SEND	35A0	35AF
INPUT65-72, STIN5-8 to MATRIX5-8 PRE/POST	MATRIX8 SEND	35B0	35BF
	MATRIX5 SEND	35C0	35CF
	MATRIX6 SEND	35D0	35DF
INPUT65-72, STIN5-8 to MATRIX5-8 PRE/POST	MATRIX7 SEND	35E0	35EF
	MATRIX8 SEND	35F0	35FF
	MATRIX5/6	3600	360F
INPUT65-72, STIN5-8 to MATRIX5/6, 7/8 PAN	MATRIX7/8	3610	361F
MIX21-24, MONO DYNAMICS1	FREQ	3640	367F
	ON	3680	3684
	ATTACK	3686	368A
	THRESHOLD	368C	3690
	RELEASE	3692	3696
	RATIO	3698	369C
	GAIN	369E	36A2
	KNEE/WIDTH	36A4	36A8
INPUT1-56, STIN1-4 to MIX1/2-7/8 PAN	MIX1/2	36AA	36E9
	MIX3/4	36EA	3729
	MIX5/6	372A	3769
	MIX7/8	376A	37A9

Parameter	From (HEX)	To (HEX)	
INPUT1-56, STIN1-4 to MATRIX5/6, 7/8 PAN	MATRIX5/6	37AA	37E9
	MATRIX7/8	37EA	3829
MIX21-24, MONO to MATRIX1/2-7/8 PAN	MATRIX1/2	382A	382E
	MATRIX3/4	3830	3834
	MATRIX5/6	3836	383A
MIX9-24 to STEREO PAN	MATRIX7/8	383C	3840
	MIX TO ST	3842	3851
GEQ RACK4A-6B	ON	3852	3857
	GAIN1	3858	385D
	GAIN2	385E	3863
	GAIN3	3864	3869
	GAIN4	386A	386F
	GAIN5	3870	3875
	GAIN6	3876	387B
	GAIN7	387C	3881
	GAIN8	3882	3887
	GAIN9	3888	388D
	GAIN10	388E	3893
	GAIN11	3894	3899
	GAIN12	389A	389F
	GAIN13	38A0	38A5
	GAIN14	38A6	38AB
	GAIN15	38AC	38B1
	GAIN16	38B2	38B7
	GAIN17	38B8	38BD
	GAIN18	38BE	38C3
	GAIN19	38C4	38C9
	GAIN20	38CA	38CF
	GAIN21	38D0	38D5
	GAIN22	38D6	38DB
	GAIN23	38DC	38E1
	GAIN24	38E2	38E7
	GAIN25	38E8	38ED
	GAIN26	38EE	38F3
	GAIN27	38F4	38F9
	GAIN28	38FA	38FF
	GAIN29	3900	3905
	GAIN30	3906	390B
GAIN31	390C	3911	
LCR INPUT1-64, STIN1-4, MIX1-16	ON	3912	3969
	CSR	396A	39C1
DIRECT OUT INPUT1-64	ON	39C2	3A01
INPUT1-56, STIN1-4 TO STEREO	ON	3A02	3A41
DCA1-12	ON	3A42	3A4D
	FADER	3A4E	3A59
MUTE MASTER	ON	3A5A	3A61
RECALL SAFE	ON	3A66	3B05

Parameter	From (HEX)	To (HEX)	
EXTERNAL GAIN1	3B06	3B0B	
INPUT GAIN 1	3B0F	3B15	
EXTERNAL GAIN2	3B16	3B1B	
INPUT GAIN 2	3B1F	3B25	
EXTERNAL GAIN3	3B26	3B2B	
INPUT GAIN 3	3B2F	3B35	
EXTERNAL GAIN4	3B36	3B3B	
INPUT GAIN 4	3B3F	3B45	
EXTERNAL GAIN5	3B46	3B4B	
INPUT GAIN 5	3B4F	3B55	
EXTERNAL GAIN6	3B56	3B5B	
INPUT GAIN 6	3B5F	3B65	
EXTERNAL GAIN7	3B66	3B6B	
INPUT GAIN 7	3B6F	3B75	
EXTERNAL GAIN8	3B76	3B7B	
INPUT GAIN 8	3B7F	3B85	
EXTERNAL +48V 1	3B86	3B8B	
INPUT +48V 1	3B8F	3B95	
EXTERNAL +48V 2	3B96	3B9B	
INPUT +48V 2	3B9F	3BA5	
EXTERNAL +48V 3	3BA6	3BAB	
INPUT +48V 3	3BAF	3BB5	
EXTERNAL +48V 4	3BB6	3BBB	
INPUT +48V 4	3BBF	3BC5	
EXTERNAL +48V 5	3BC6	3BCB	
INPUT +48V 5	3BCF	3BD5	
EXTERNAL +48V 6	3BD6	3BDB	
INPUT +48V 6	3BDF	3BE5	
EXTERNAL +48V 7	3BE6	3BEB	
INPUT +48V 7	3BEF	3BF5	
EXTERNAL +48V 8	3BF6	3BFB	
INPUT +48V 8	3BFF	3C05	
EXTERNAL HPF1	3C06	3C0B	
INPUT HPF1	3C0F	3C15	
EXTERNAL HPF2	3C16	3C1B	
INPUT HPF2	3C1F	3C25	
EXTERNAL HPF3	3C26	3C2B	
INPUT HPF3	3C2F	3C35	
EXTERNAL HPF4	3C36	3C3B	
INPUT HPF4	3C3F	3C45	
EXTERNAL HPF5	3C46	3C4B	
INPUT HPF5	3C4F	3C55	
EXTERNAL HPF6	3C56	3C5B	
INPUT HPF6	3C5F	3C65	
EXTERNAL HPF7	3C66	3C6B	
INPUT HPF7	3C6F	3C75	
EXTERNAL HPF8	3C76	3C7B	
INPUT HPF8	3C7F	3C85	
INPUT1-56, STIN1-4 TO MONO	ON	3C86	3CC5
MIX1-16 TO MONO	ON	3CC6	3CD5

HA

Parameter	From (HEX)	To (HEX)	
SLOT OUT DELAY	ON	3CD6	3D05
	TIME HIGH	3D06	3D35
	TIME LOW	3D36	3D65
OMNI OUT DELAY	ON	3D66	3D6D
	TIME HIGH	3D76	3D7D
	TIME LOW	3D86	3D8D
DIGITAL OUT DELAY	ON	3D96	3D97
	TIME HIGH	3D98	3D99
	TIME LOW	3D9A	3D9B
INPUT1-48, STIN1-4 DYNAMICS1	RATIO	3D9C	3DD3
	KNEE/WIDTH	3DD4	3E0B
	GAIN	3E0C	3E43
INPUT1-48, STIN1-4 DYNAMICS2	reserved	3E44	3E7B
	FILTER FREQ	3E7C	3EB3
	ON	3EB4	3EB7
	GAIN1	3EB8	3EBB
	GAIN2	3EBC	3EBF
	GAIN3	3EC0	3EC3
	GAIN4	3EC4	3EC7
	GAIN5	3EC8	3ECB
	GAIN6	3ECC	3ECF
	GAIN7	3ED0	3ED3
	GAIN8	3ED4	3ED7
	GAIN9	3ED8	3EDB
	GAIN10	3EDC	3EDF
	GAIN11	3EE0	3EE3
	GAIN12	3EE4	3EE7
	GAIN13	3EE8	3EEB
	GAIN14	3EEC	3EEF
	GAIN15	3EF0	3EF3
	GAIN16	3EF4	3EF7
	GAIN17	3EF8	3EFB
	GAIN18	3EFC	3EFF
	GAIN19	3F00	3F03
	GAIN20	3F04	3F07
	GAIN21	3F08	3F0B
	GAIN22	3F0C	3F0F
	GAIN23	3F10	3F13
	GAIN24	3F14	3F17
	GAIN25	3F18	3F1B
	GAIN26	3F1C	3F1F
	GAIN27	3F20	3F23
	GAIN28	3F24	3F27
	GAIN29	3F28	3F2B
	GAIN30	3F2C	3F2F
	GAIN31	3F30	3F33

GEQ RACK7A-8B

Parameter	From (HEX)	To (HEX)	
MIX, MATRIX, STEREO LR, MONO EQ	ATT	3F34	3F56
INPUT65-72, STIN5-8 TO STEREO	ON	3F58	3F67
INPUT65-72, STIN5-8, MIX17-24 TO MONO	ON	3F68	3F7F
LCR IN65-72, STIN5-8, MIX17-24	ON	3F80	3F97
	CSR	3F98	3FAF
INPUT65-72, STIN5-8 DYNAMICS1	RATIO	3FB0	3FBF
	KNEE/WIDTH	3FC0	3FCF
	GAIN	3FD0	3FDF
INPUT65-72, STIN5-8 DYNAMICS2	reserved	3FE0	3FEF
	FILTER FREQ	3FF0	3FFF

Mixing parameter operation applicability

This table indicates which settings affect the behavior of each input channel and output channel parameter.

It also indicates whether or not they can be linked as stereo, and whether or not they are relevant to the RECALL SAFE, GLOBAL PASTE, and USER LEVEL settings, and a channel library.

■ Input channels

Parameter		Stereo ^{*1}	CHANNEL LINK	RECALL SAFE, FOCUS RECALL, GLOBAL PASTE ^{*8}		USER LEVEL	Channel Library
				ALL	Parameter Select button		
HA	Gain	O ^{*10}	HA ^{*10}	O	HA, GLOBAL HA	HA	O
	Gain Compensation	O	HA	O	HA, GLOBAL HA	HA	O
	+48V			O	HA, GLOBAL HA	HA	O
	Phase			O	HA, GLOBAL HA	HA	O
Digital Gain		O ^{*10}	DIGITAL GAIN ^{*10}	O	DIGITAL GAIN	HA	O
Name, Icon, Color				O	INPUT NAME, GLOBAL INPUT NAME	INPUT NAME	O
Input Patch				O	INPUT PATCH, GLOBAL INPUT PATCH	INPUT PATCH	
Insert	Out Patch			O	INPUT INSERT PATCH, GLOBAL INPUT PATCH	INPUT PATCH	
	In Patch			O	INPUT INSERT PATCH, GLOBAL INPUT PATCH	INPUT PATCH	
	+48V, Gain, Gain Compensation				INPUT INSERT PATCH, GLOBAL HA	HA	
	On		INPUT INSERT	O	INPUT INSERT	INPUT PROCESSING	O
	Point		INPUT INSERT	O	INPUT INSERT	INPUT PROCESSING	O
Direct Out	Out Patch			O	INPUT DIRECT OUT, GLOBAL INPUT PATCH	INPUT PATCH	
	On, Level		DIRECT OUT	O	INPUT DIRECT OUT	INPUT PROCESSING	O
	Point		DIRECT OUT	O	INPUT DIRECT OUT	INPUT PROCESSING	O
HPF		O	INPUT HPF	O	INPUT HPF	INPUT PROCESSING	O
Att		O	INPUT EQ	O	INPUT EQ	INPUT PROCESSING	O
EQ		O	INPUT EQ	O	INPUT EQ	INPUT PROCESSING	O
Dynamics1	Key-In Source			O	INPUT DYNA1	INPUT PROCESSING	
	Key-In Filter	O	INPUT DYNAMICS1	O	INPUT DYNA1	INPUT PROCESSING	O
	Others	O	INPUT DYNAMICS1	O	INPUT DYNA1	INPUT PROCESSING	O
Dynamics2	Key-In Source			O	INPUT DYNA2	INPUT PROCESSING	
	Others	O	INPUT DYNAMICS2	O	INPUT DYNA2	INPUT PROCESSING	O
To Mix	On	O	INPUT MIX ON ^{*2}	O	INPUT MIX ON ^{*7}	INPUT FADER/ON ^{*4}	O
	Level	O	INPUT MIX SEND ^{*2}	O	INPUT MIX SEND ^{*7}	INPUT FADER/ON ^{*4}	O
	Pan/Balance	O ^{*11}		O	INPUT MIX SEND ^{*7}	INPUT FADER/ON ^{*4}	O
	Pre/Post	O	INPUT MIX SEND ^{*2}	O	INPUT MIX SEND ^{*7}	INPUT PROCESSING ^{*4}	O
To Matrix	On	O	INPUT MATRIX ON ^{*3}	O	INPUT MATRIX ON ^{*7}	INPUT FADER/ON ^{*4}	O
	Level	O	INPUT MATRIX SEND ^{*3}	O	INPUT MATRIX SEND ^{*7}	INPUT FADER/ON ^{*4}	O
	Pan/Balance	O ^{*11}		O	INPUT MATRIX SEND ^{*7}	INPUT FADER/ON ^{*4}	O
	Pre/Post	O	INPUT MATRIX SEND ^{*3}	O	INPUT MATRIX SEND ^{*7}	INPUT PROCESSING ^{*4}	O
DELAY	ms	O ^{*10}	INPUT DELAY ^{*10}	O	INPUT DELAY	INPUT PROCESSING	O
	ON	O	INPUT DELAY	O	INPUT DELAY	INPUT PROCESSING	O
To Stereo		O	TO STEREO	O	INPUT TO ST	INPUT PROCESSING	O
To Mono		O	TO STEREO	O	INPUT TO MONO	INPUT PROCESSING	O

Parameter	Stereo ^{*1}	CHANNEL LINK	RECALL SAFE, FOCUS RECALL, GLOBAL PASTE ^{*8}		USER LEVEL	Channel Library
			ALL	Parameter Select button		
Pan/balance	O ^{*11}		O	INPUT TO ST	INPUT FADER/ON	O
Pan Mode	O		O	*5	INPUT PROCESSING	O
LCR	On	TO STEREO	O	*5	INPUT PROCESSING	O
	CSR	TO STEREO	O	*5	INPUT PROCESSING	O
	Mode	TO STEREO	O	*5	INPUT PROCESSING	O
On	O	INPUT CH ON	O	INPUT CH ON	INPUT FADER/ON	O
Fader	O ^{*10}	INPUT FADER ^{*10}	O	INPUT FADER	INPUT FADER/ON	O
Mute Assign	O	INPUT MUTE	O	*5	MUTE GROUP ASSIGN	O
DCA Assign	O	INPUT DCA	O	*5	DCA GROUP ASSIGN	O
Fade Time, On	O ^{*6}		O	*9	STORE	O ^{*6}
Channel Link	O			GLOBAL CH LINK		
Cue	O					
Key In Cue						
Mute Safe	O					
Recall Safe, Focus Recall, Global Paste	O					

*1 These parameters can be linked between L and R of ST IN channels 1–8.

*2 Applies to parameters for which the MIX channel 1–24 individual Send Parameter setting and the item in the table are both enabled.

*3 Applies to parameters for which the MATRIX channel 1–8 individual Send Parameter setting and the item in the table are both enabled.

*4 These parameters are available if “FADER/ON” or “PROCESSING” for the Send source channel is set to ON. At that time, “WITH SEND” for the Send destination channel must also be set to ON.

*5 Applicable to parameters that function only when ALL is selected.

*6 Applicable only to On/Off.

*7 Valid when assigned to either a Send source channel or a Send destination channel.

*8 Settings marked GLOBAL in this table apply to all channels; these settings are GLOBAL RECALL SAFE, FOCUS PARAMETER, and GLOBAL PASTE for PATCH/NAME.

*9 Applies to ALL only when using GLOBAL PASTE, and only to ON/OFF.

*10 Operates differentially

*11 Balance only

■ MIX Channels

Parameter	Linked for a stereo pair	RECALL SAFE, FOCUS RECALL, GLOBAL PASTE *8, *12		USER LEVEL	Channel Library	
		ALL	Parameter Select button			
Name, Icon, Color		<input type="radio"/>	MIX NAME, GLOBAL OUTPUT NAME	OUTPUT NAME	<input type="radio"/>	
Output Patch		<input type="radio"/>	MIX OUTPUT PATCH, GLOBAL OUTPUT PATCH	OUTPUT PATCH		
Insert	Out Patch		MIX INSERT PATCH, GLOBAL OUTPUT PATCH	OUTPUT PATCH		
	In Patch		MIX INSERT PATCH, GLOBAL OUTPUT PATCH	OUTPUT PATCH		
	+48V, Gain, Gain Compensation		MIX INSERT PATCH, GLOBAL HA	MIX PROCESSING		
	On	<input type="radio"/>	<input type="radio"/>	MIX INSERT	MIX PROCESSING	<input type="radio"/>
	Point	<input type="radio"/>	<input type="radio"/>	MIX INSERT	MIX PROCESSING	<input type="radio"/>
Att	<input type="radio"/>	<input type="radio"/>	MIX EQ	MIX PROCESSING	<input type="radio"/>	
EQ	<input type="radio"/>	<input type="radio"/>	MIX EQ	MIX PROCESSING	<input type="radio"/>	
Dynamics1	Key-In Source		<input type="radio"/>	MIX DYNA1	MIX PROCESSING	
	Others	<input type="radio"/>	<input type="radio"/>	MIX DYNA1	MIX PROCESSING	<input type="radio"/>
To Matrix	On	<input type="radio"/>	<input type="radio"/>	MIX MATRIX ON*7	MIX FADER/ON*4	<input type="radio"/>
	Level	<input type="radio"/> *13	<input type="radio"/>	MIX MATRIX SEND*7	MIX FADER/ON*4	<input type="radio"/>
	Pan/Balance	<input type="radio"/>	<input type="radio"/>	MIX MATRIX SEND*7	MIX FADER/ON*4	<input type="radio"/>
	Pre/Post	<input type="radio"/>	<input type="radio"/>	MIX MATRIX SEND*7	MIX PROCESSING*4	<input type="radio"/>
To Stereo	<input type="radio"/>	<input type="radio"/>	MIX TO ST	MIX PROCESSING	<input type="radio"/>	
To Mono	<input type="radio"/>	<input type="radio"/>	MIX MONO	MIX PROCESSING	<input type="radio"/>	
Pan/Balance	<input type="radio"/> *11	<input type="radio"/>	MIX TO ST, TO ST/BAL (GLOBAL PASTE ONLY)	MIX FADER/ON	<input type="radio"/>	
LCR	On	<input type="radio"/>	<input type="radio"/>	*5	MIX PROCESSING	<input type="radio"/>
	CSR	<input type="radio"/>	<input type="radio"/>	*5	MIX PROCESSING	<input type="radio"/>
	Mode	<input type="radio"/>	<input type="radio"/>	*5	MIX PROCESSING	<input type="radio"/>
On	<input type="radio"/>	<input type="radio"/>	MIX CH ON	MIX FADER/ON	<input type="radio"/>	
Fader	<input type="radio"/>	<input type="radio"/>	MIX FADER	MIX FADER/ON	<input type="radio"/>	
From Input	On	<input type="radio"/>		WITH MIX SEND, WITH SEND FROM SOURCE CHs	WITH MIX SEND*4	
	Level	<input type="radio"/>		WITH MIX SEND, WITH SEND FROM SOURCE CHs	WITH MIX SEND*4	
	Pan/Balance	<input type="radio"/> *11		WITH MIX SEND, WITH SEND FROM SOURCE CHs	WITH MIX SEND*4	
	Pre/Post	<input type="radio"/>		WITH MIX SEND, WITH SEND FROM SOURCE CHs	WITH MIX SEND*4	
Mute Assign	<input type="radio"/>	<input type="radio"/>	*5	MUTE GROUP ASSIGN	<input type="radio"/>	
Fade Time, On	<input type="radio"/> *6	<input type="radio"/>	*9	STORE	<input type="radio"/> *6	
Cue	<input type="radio"/>					
Mute Safe	<input type="radio"/>					
Recall Safe, Focus Recall, Global Paste	<input type="radio"/>					

*4 These parameters are available if "FADER/ON" or "PROCESSING" for the Send source channel is set to ON. At that time, "WITH SEND" for the Send destination channel must also be set to ON.

*5 Applicable to parameters that function only when ALL is selected.

*6 Applicable only to On/Off.

*7 Valid when they are set for either the Send source channel or Send destination channel.

*8 Settings marked GLOBAL in this table apply to all channels; these settings are GLOBAL RECALL SAFE, FOCUS PARAMETER, and GLOBAL PASTE for PATCH/NAME.

*9 Applies to ALL only when using GLOBAL PASTE, and only to ON/OFF.

*11 Balance only

*12 For GLOBAL PASTE, the MIX, MATRIX, STEREO, and MONO settings of each channel will be set in common as the OUTPUT.

*13 Linked only for stereo MATRIX

■ **MATRIX Channels**

Parameter	Linked for a stereo pair	RECALL SAFE, FOCUS RECALL, GLOBAL PASTE *8, *12		USER LEVEL	Channel Library	
		ALL	Parameter Select button			
Name, Icon, Color		<input type="radio"/>	MATRIX NAME, GLOBAL OUTPUT NAME	OUTPUT NAME	<input type="radio"/>	
Output Patch		<input type="radio"/>	MATRIX OUTPUT PATCH, GLOBAL OUTPUT PATCH	OUTPUT PATCH		
Insert	Out Patch		<input type="radio"/>	MATRIX INSERT PATCH, GLOBAL OUTPUT PATCH	OUTPUT PATCH	
	In Patch		<input type="radio"/>	MATRIX INSERT PATCH, GLOBAL OUTPUT PATCH	OUTPUT PATCH	
	+48V, Gain, Gain Compensation		<input type="radio"/>	MATRIX INSERT PATCH, GLOBAL HA	MATRIX PROCESSING	
	On	<input type="radio"/>	<input type="radio"/>	MATRIX INSERT	MATRIX PROCESSING	<input type="radio"/>
	Point	<input type="radio"/>	<input type="radio"/>	MATRIX INSERT	MATRIX PROCESSING	<input type="radio"/>
Att	<input type="radio"/>	<input type="radio"/>	MATRIX EQ	MATRIX PROCESSING	<input type="radio"/>	
EQ	<input type="radio"/>	<input type="radio"/>	MATRIX EQ	MATRIX PROCESSING	<input type="radio"/>	
Dynamics1	Key-In Source		<input type="radio"/>	MATRIX DYNA1	MATRIX PROCESSING	
	Others	<input type="radio"/>	<input type="radio"/>	MATRIX DYNA1	MATRIX PROCESSING	<input type="radio"/>
Balance	<input type="radio"/>	<input type="radio"/>	MATRIX BAL, TO ST/BAL (GLOBAL PASTE ONLY)	MATRIX FADER/ON	<input type="radio"/>	
On	<input type="radio"/>	<input type="radio"/>	MATRIX CH ON	MATRIX FADER/ON	<input type="radio"/>	
Fader	<input type="radio"/>	<input type="radio"/>	MATRIX FADER	MATRIX FADER/ON	<input type="radio"/>	
From Input From Mix From Stereo/Mono	On	<input type="radio"/>		WITH MATRIX SEND, WITH SEND FROM SOURCE CHs	WITH MATRIX SEND*4	
	Level	<input type="radio"/>		WITH MATRIX SEND, WITH SEND FROM SOURCE CHs	WITH MATRIX SEND*4	
	Pan/Balance	<input type="radio"/> *11		WITH MATRIX SEND, WITH SEND FROM SOURCE CHs	WITH MATRIX SEND*4	
	Pre/Post	<input type="radio"/>		WITH MATRIX SEND, WITH SEND FROM SOURCE CHs	WITH MATRIX SEND*4	
Mute Assign	<input type="radio"/>	<input type="radio"/>	*5	MUTE GROUP ASSIGN	<input type="radio"/>	
Fade Time, On	<input type="radio"/> *6	<input type="radio"/>	*9	STORE	<input type="radio"/> *6	
Cue	<input type="radio"/>					
Mute Safe	<input type="radio"/>					
Recall Safe, Focus Recall, Global Paste	<input type="radio"/>					

*4 These parameters are available if "FADER/ON" or "PROCESSING" for the Send source channel is set to ON. At that time, "WITH SEND" for the Send destination channel must also be set to ON.

*5 Applicable to parameters that function only when ALL is selected.

*6 Applicable only to On/Off

*7 Valid when they are set for either the Send source channel or Send destination channel.

*8 Settings marked GLOBAL in this table apply to all channels; these settings are GLOBAL RECALL SAFE, FOCUS PARAMETER, and GLOBAL PASTE for PATCH/NAME.

*9 Applies to ALL only when using GLOBAL PASTE, and only to ON/OFF.

*11 Balance only

*12 For GLOBAL PASTE, the MIX, MATRIX, STEREO, and MONO settings of each channel will be set in common as the OUTPUT.

■ **STEREO, MONO Channels**

Parameter	Linked for a stereo pair	RECALL SAFE, FOCUS RECALL, GLOBAL PASTE *8, *12		USER LEVEL	Channel Library	
		ALL	Parameter Select button			
Name, Icon, Color		O	STEREO, MONO NAME, GLOBAL OUTPUT NAME	OUTPUT NAME	O	
Output Patch		O	STEREO, MONO OUTPUT PATCH, GLOBAL OUTPUT PATCH	OUTPUT PATCH		
Insert	Out Patch		STEREO, MONO INSERT PATCH, GLOBAL OUTPUT PATCH	OUTPUT PATCH		
	In Patch		STEREO, MONO INSERT PATCH, GLOBAL OUTPUT PATCH	OUTPUT PATCH		
	+48V, Gain, Gain Compensation		STEREO, MONO INSERT PATCH, GLOBAL HA	STEREO, MONO PROCESSING		
	On	O	O	STEREO, MONO INSERT	STEREO, MONO PROCESSING	O
	Point	O	O	STEREO, MONO INSERT	STEREO, MONO PROCESSING	O
Att	O	O	STEREO, MONO EQ	STEREO, MONO PROCESSING	O	
EQ	O	O	STEREO, MONO EQ	STEREO, MONO PROCESSING	O	
Dynamics1	Key-In Source		O	STEREO, MONO DYNA1	STEREO, MONO PROCESSING	
	Others	O	O	STEREO, MONO DYNA1	STEREO, MONO PROCESSING	O
To Matrix	On	O	O	STEREO, MONO MATRIX ON*7	STEREO, MONO FADER/ON*4	O
	Level	O*13	O	STEREO, MONO MATRIX SEND*7	STEREO, MONO FADER/ON*4	O
	Pan/Balance	O	O	STEREO, MONO MATRIX SEND*7	STEREO, MONO FADER/ON*4	O
	Pre/Post	O	O	STEREO, MONO MATRIX SEND*7	STEREO, MONO PROCESSING*4	O
Balance	O	O	STEREO, MONO BAL, TO ST/BAL (GLOBAL PASTE ONLY)	STEREO, MONO FADER/ON	O	
On	O	O	STEREO, MONO CH ON	STEREO, MONO FADER/ON	O	
Fader	O	O	STEREO, MONO FADER	STEREO, MONO FADER/ON	O	
Mute Assign	O	O	*5	MUTE GROUP ASSIGN	O	
Fade Time, On	O*6	O	*9	STORE	O*6	
Cue	O					
Mute Safe	O					
Recall Safe, Focus Recall, Global Paste	O					

*4 These parameters are available if "FADER/ON" or "PROCESSING" for the Send source channel is set to ON. At that time, "WITH SEND" for the Send destination channel must also be set to ON.

*5 Applicable to parameters that function only when ALL is selected.

*6 Applicable only to On/Off.

*7 Valid when they are set for either the Send source channel or Send destination channel.

*8 Settings marked GLOBAL in this table apply to all channels; these settings are GLOBAL RECALL SAFE, FOCUS PARAMETER, and GLOBAL PASTE for PATCH/NAME.

*9 Applies to ALL only when using GLOBAL PASTE, and only to ON/OFF.

*12 For GLOBAL PASTE, the MIX, MATRIX, STEREO, and MONO settings of each channel will be set in common as the OUTPUT.

■ **DCA**

Parameter	RECALL SAFE, FOCUS RECALL, GLOBAL PASTE		USER LEVEL
	ALL	Parameter Select button	
Name, Icon, Color	O	*5	DCA MASTER
On	O	DCA LEVEL/ON	DCA MASTER
Fader	O	DCA LEVEL/ON	DCA MASTER
Fade Time, On	O	*9	STORE
Input	DCA Assign		DCA GROUP ASSIGN

*5 Applicable to parameters that function only when ALL is selected.

*9 Applies to ALL only when using GLOBAL PASTE, and only to ON/OFF.

Functions that can be assigned to USER DEFINED keys

FUNCTION	PARAMETER 1	PARAMETER 2	Explanation		
NO ASSIGN	—	—	No assignment.		
ALTERNATE FUNCTION	LATCH	—	Toggle ALTERNATE FUNCTION each time it is pressed.		
	UNLATCH	—	Switch to ALTERNATE FUNCTION only while pressed.		
BRIGHTNESS	BANK CHANGE	—	Toggle between the brightness settings stored in A and B.		
CH ON	SPECIFIC CH	*4)	Switch the CH ON/OFF.		
CH SELECT	INC	—	Increment or decrement the selected channel number.		
	DEC	—			
	SPECIFIC CH	*1)	Select a channel from list 1).		
CL EDITOR CONTROL	MASTER	—	Access the corresponding screen of CL Editor.		
	SENDS ON FADER	—			
	OVERVIEW	CH 1-16 {CL5/CL3/CL1}			
		CH17-32 {CL5/CL3/CL1}			
		CH33-48 {CL5/CL3/CL1}			
		CH49-64 {CL5/CL3}			
		CH65-72 {CL5}			
		ST IN			
		MIX1-16			
		MIX17-24			
		MATRIX			
		STEREO/MONO			
		DCA			
		CUSTOM FADER BANK		A1 {CL5/CL3/CL1}	
				A2 {CL5/CL3}	
				A3 {CL3}	
	B1 {CL5/CL3/CL1}				
	B2 {CL3/CL1}				
	B3 {CL1}				
	B4 {CL1}				
	C1 {CL5}				
	C2 {CL5}				
	C3 {CL5}				
	C4 {CL5}				
	C5 {CL5}				
	C6 {CL5}				
	SELECTED CHANNEL	—			

FUNCTION	PARAMETER 1	PARAMETER 2	Explanation
CL EDITOR CONTROL	LIBRARY	DYNAMICS LIBRARY	Access the corresponding screen of CL Editor.
		INPUT EQ LIBRARY	
		OUTPUT EQ LIBRARY	
		EFFECT LIBRARY	
		GEQ LIBRARY	
		INPUT CH LIBRARY	
	OUTPUT EQ LIBRARY		
	PREMIUM RACK LIBRARY	Portico5033 LIBRARY	
		Portico5043 LIBRARY	
		U76 LIBRARY	
		Opt-2A LIBRARY	
		EQ-1A LIBRARY	
	DynamicEQ LIBRARY		
	PATCH EDITOR	INPUT PATCH	
		OUTPUT PATCH	
		INPUT INSERT PATCH	
		OUTPUT INSERT PATCH	
		DIRECT OUT PATCH	
		PATCH LIST	
	RACK EDITOR	RACK	
		GEQ 1-16	
		EFFECT 1-8	
		PREMIUM 1A	
		PREMIUM 1B	
		:	
		PREMIUM 8A	
		PREMIUM 8B	
	METER	INPUT METER	
		OUTPUT METER	
	GROUP/LINK	DCA GROUP	
MUTE GROUP			
SCENE	CHANNEL LINK		
	SCENE MEMORY		
	RECALL SAFE		
	FADE TIME		
FOCUS RECALL			
CUE	OUTPUT	—	Switch CUE on/off
	CLEAR CUE		
	SPECIFIC CH	*2)	CUE the channel selected from list 2).

FUNCTION	PARAMETER 1	PARAMETER 2	Explanation
EFFECT BYPASS	EFFECT RACK1-8		
	PREMIUM RACK1A		
	PREMIUM RACK1B		
	:		
	PREMIUM RACK8A		
GAIN KNOB FUNCTION	LATCH	—	Toggle the function of the GAIN knob (ANALOG GAIN/DIGITAL GAIN). Lit when DIGITAL GAIN is selected.
	UNLATCH	—	Assign the function of the GAIN knob (ANALOG GAIN/DIGITAL) to DIGITAL GAIN only while held down. * However if the GAIN KNOB FUNCTION is switched to DIGITAL GAIN in the PREFERENCE screen etc., this will remain lit until the next time it is pressed.
GEQ FREQ BANK	INC	—	Adds or removes a frequency bank in the GEQ EDIT screen.
	DEC		
GPI OUT	LATCH	PORT1-PORT5	Toggle the GPI OUT function. Lit when active.
	UNLATCH		Make GPI OUT active only while pressed.
HELP	—	—	Opens and closes the HELP pop-up window. Operating the controllers on the panel (excluding faders), or controllers on the screen, while holding down this key will display the related information.
HOME	SELECTED CH VIEW	—	Displays the SELECTED CHANNEL VIEW screen.
	OVERVIEW	—	Displays the OVERVIEW screen.
	TOGGLE	—	Each press of the key will alternately display the SELECTED CHANNEL VIEW screen and the OVERVIEW screen.
METER	PEAK HOLD ON	—	Turns the meter's peak hold function on/off. Lit when on.
MIDI	PROGRAM CHANGE	PGM 0-128	Transmit the corresponding MIDI message.
	CONTROL CHANGE	CC 1-31, 33-95, 102-119	
	NOTE ON	NOTE ON C-2 (0)	
		:	
		NOTE ON G 8 (127)	

FUNCTION	PARAMETER 1	PARAMETER 2	Explanation	
MONITOR	OUTPUT	—	Switch MONITOR on/off.	
	SELECTED CH ASSIGN	—	While holding down this key, press the SEL key of a MIX or MATRIX channel to switch the assignment on/off. During this time, the [SEL] LED will be lit if assign is ON, or dark if OFF. The assignment setting made while holding down this key will be stored. Pressing the key again will recall the stored setting. Settings can be stored in multiple keys to facilitate rapid assignment switching.	
		SOURCE SELECT	STEREO L/R	Recall the selected signal to the monitor.
			MONO(C)	
			LCR	
			PB OUT	
			OMNI1-2	
			OMNI3-4	
	OMNI5-6			
	MUTE MASTER	MUTE GROUP 1	—	Switch MUTE GROUP MASTER on/off.
:				
MUTE GROUP 8				
ALL MUTE		—	Turns all MUTE GROUP MASTER settings on/off together.	
NUENDO LIVE	TRANSPORT	GO TO PROJECT START	Operate the transport functions of Nuendo Live.	
		GO TO PREV MARKER		
		REWIND		
		FAST FORWARD		
		GO TO NEXT MARKER		
		GO TO PROJECT END		
		CYCLE		
		STOP		
		START		
		REC		
	EASY RECORDING			
PEAK CLEAR	—	Clear the peak indicators of the Nuendo Live screen.		
OSCILLATOR	OSCILLATOR ON	—	Switch the OSC on/off.	
	SELECTED CH ASSIGN	—	While holding down this key, press a SEL key of a channel to switch the assignment on/off. During this time, the [SEL] LED will be lit if assign is ON, or dark if OFF.	
	DIRECT ASSIGN	*1)	Assign the oscillator to the channel selected from list 1).	

FUNCTION	PARAMETER 1	PARAMETER 2	Explanation
PAGE CHANGE	BOOKMARK		Memorize the currently selected screen (hold down the key for two seconds or longer), or display the last-memorized screen (press and release the key within two seconds). Popup screens can also be memorized. In the case of a rack, the number of that rack is also memorized.
	BOOKMARK with "SEL"	—	Memorize the above BOOKMARK with the addition of the SEL status.
	PREVIOUS PAGE	—	Display the previous/next page.
	NEXT PAGE		
	CLOSE POPUP	—	Close the displayed popup window.
RECORDER	TRANSPORT	PLAY/PAUSE, STOP, FF/NEXT, REW/PREVIOUS, REC	Display the previous/next page.
		AUTO REC	Shortcut function for STOP → REC → PLAY. Recording will be initiated in a single action. If this is executed during recording, the file being recorded will first be closed, and then recording will continue with a new file.
		REC & START	Start recording immediately without entering record-ready mode.
	DIRECT PLAY	NO ASSIGN	The specified audio file will be played once from the beginning. Audio files to be played should be saved in the SONGS folder inside the YPE folder. Please note that a file cannot be specified if it is saved in the root directory or in any other folder. When you execute playback, the path in the TITLE LIST screen will move to \YPE\SONGS\.
		(TITLE 1)	
		:	
SCENE	INC RECALL	—	Recall the scene of the next existing number.
	REC RECALL	—	Recall the scene of the previous existing number.
	DIRECT RECALL	SCENE #000–#300	Directly recall the scene of the specified number.
	RECALL UNDO	—	Execute RECALL UNDO.
	STORE UNDO	—	Execute STORE UNDO.
SEND ENCODER MODE	MIX1-16/MIX17-24, MATRIX	—	If INPUT or ST IN is selected, switch the function of the Selected Channel section's send encoders from TO MIX1-16/TO MIX17-24, MATRIX.
SENDS ON FADER	MIX1–MIX24	—	Switches the MIX ON FADER function for the selected MIX on and off.
	MTRX1–MTRX8		Switches the MATRIX ON FADER function for the selected MATRIX on and off.
	MIX ON FADER		Switches the MIX ON FADER function on and off.
	MATRIX ON FADER		Switches the MATRIX ON FADER function on and off.
	SENDS ON FADER		Switches the SENDS ON FADER function on and off.

FUNCTION	PARAMETER 1	PARAMETER 2	Explanation
SET BY SEL	SET [+48V]	—	Hold down this key and press SEL to switch it on/off. During this time, the [SEL] LED will be lit if on or dark if off. If SET [PRE SEND] is selected, "SEND ON FADER" mode is engaged while you are holding down the [SEL] key.
	SET [Ø]		
	SET [INSERT ON]		
	SET [DIRECT OUT ON]		
	SET [PRE SEND]		
	SET [TO STEREO]		
	SET [TO MONO]		
SET DEFAULT VALUE	—	—	While holding down this key, press a knob in the Selected Channel or Centralogic section to reset it to the default value.
	—	—	While holding down this key, press a [SEL] key to set the fader of that channel to nominal level.
TALKBACK	TALKBACK ON	LATCH	Switch TALKBACK on/off.
		UNLATCH	Turn TALKBACK on while pressed.
	SELECTED CH ASSIGN	—	While holding down this key, press a SEL key of an OUTPUT channel to switch the assignment on/off. During this time, the [SEL] LED will be lit if assign is ON, or dark if OFF. The assignment setting made while holding down this key will be stored. Pressing the key again will recall the stored setting. Settings can be stored in multiple keys to facilitate rapid assignment switching.
		DIRECT ASSIGN	*3)
TAP TEMPO	CURRENT PAGE	—	Use the tap tempo function in the displayed screen.
	EFFECT RACK1–8	—	Use the tap tempo function for the specified effect.

- *1) CL5: CH1–CH72, CL3: CH1–CH64, CL1: CH1–CH48, ST IN 1L–ST IN 8R, MIX1–MIX24, MTRX1–MTRX8, ST L, ST R, MONO(C)
- *2) CL5: CH1–CH72, CL3: CH1–CH64, CL1: CH1–CH48, ST IN 1–ST IN 8, MIX1–MIX24, MTRX1–MTRX8, STEREO, MONO(C)
- *3) MIX1–MIX24, MTRX1–MTRX8, ST L, ST R, MONO(C)
- *4) CL5: CH1–CH72, CL3: CH1–CH64, CL1: CH1–CH48, ST IN 1–ST IN 8, MIX1–MIX24, MTRX1–MTRX8, STEREO, MONO(C), DCA1–DCA16

Functions that can be assigned to USER DEFINED knobs

FUNCTION	PARAMETER 1	PARAMETER 2
NO ASSIGN		
BRIGHTNESS	LAMP	
	PANEL	
	SCREEN	
	CH COLOR	
	NAME	
CUE	INPUT PFL TRIM	
	DCA TRIM	
	OUTPUT PFL TRIM	
	CUE LEVEL	
DYNAMICS1	THRESHOLD	*2)
	RANGE	
	RATIO	
	ATTACK	
	HOLD	
	DECAY	
	RELEASE	
	OUTGAIN	
	KNEE	
	WIDTH	
DYNAMICS2	THRESHOLD	*4)
	RATIO	
	FREQUENCY	
	ATTACK	
	RELEASE	
	OUTGAIN	
	KNEE	
	WIDTH	
EQ	ATT	*2)
	LOW Q	
	LOW FREQUENCY	
	LOW GAIN	
	LOW MID Q	
	LOW MID FREQUENCY	
	LOW MID GAIN	
	HIGH MID Q	
	HIGH MID FREQUENCY	
	HIGH MID GAIN	
	HIGH Q	
	HIGH FREQUENCY	
	HIGH GAIN	

FUNCTION	PARAMETER 1	PARAMETER 2
EXTERNAL HA	GAIN1–GAIN8	*10)
HPF	FREQUENCY	*4)
I/O DEVICE	GAIN1–GAIN32	*11)
INPUT DELAY	DELAY TIME	*3)
INPUT GAIN	ANALOG GAIN	*4)
	DIGITAL GAIN	
MIDI CONTROL CHANGE	CTRL 1–CTRL 31	
	CTRL 33–CTRL 95	
	CTRL 102–CTRL 119	
MONITOR	DIMMER LEVEL	
	TALKBACK DIMMER LEVEL	
	MONITOR DELAY	
	MONITOR FADER	
OSCILLATOR	LEVEL	
	SINE WAVE FREQUENCY	
	HPF	
	LPF	
	WIDTH	
	INTERVAL	
OUTPUT PORT	DELAY TIME	*12)
	GAIN	
TO MIX LEVEL	MIX1–MIX24	*3)
TO MATRIX LEVEL	MATRIX1–MATRIX8	*7)
TO MIX PAN	MIX1/2–MIX23/24	*3)
TO MATRIX PAN	MATRIX1/2–MATRIX7/8	*7)
TO ST/MONO	PAN/BAL	*5)
	CSR	
TOUCH AND TURN		

- *2) SELECTED CH, CL5: CH1–CH72, CL3: CH1–CH64, CL1: CH1–CH48, ST IN 1–ST IN 8, MIX1–MIX24, MTRX1–MTRX8, STEREO, MONO (C)
- *3) SELECTED CH, CL5: CH1–CH72, CL3: CH1–CH64, CL1: CH1–CH48, ST IN 1L–ST IN 8R
- *4) SELECTED CH, CL5: CH1–CH72, CL3: CH1–CH64, CL1: CH1–CH48, ST IN 1–ST IN 8
- *5) SELECTED CH, CL5: CH1–CH72, CL3: CH1–CH64, CL1: CH1–CH48, ST IN 1L–ST IN 8R, MIX1–MIX24
- *7) SELECTED CH, CL5: CH1–CH72, CL3: CH1–CH64, CL1: CH1–CH48, ST IN 1L–ST IN 8R, MIX1–MIX24, ST L, ST R, MONO (C)
- *10) # 1–# 6
- *11) REMOTE HA # 1–# 8
- *12) DANTE 1–DANTE64, OMNI 1–OMNI 8, SLOT1 1–SLOT1 16, SLOT2 1–SLOT2 16, SLOT3 1–SLOT3 16, DIGITAL OUT L, DIGITAL OUT R
- *13) SELECTED CH, MIX1–MIX24, MTRX1–MTRX8, STEREO, MONO (C)

Functions that can be assigned to the assignable encoders

PAN	GAIN	ASSIGN	FUNCTION	PARAMETER 1	PARAMETER 2
O			PAN/BALANCE	PAN	
				BAL	
	O		ANALOG GAIN	A.GAIN	*1
	O		DIGITAL GAIN	D.GAIN	*1
		O	SELECTED SEND	MIX1-MTRX8 Depends on status	*2
		O	MIX1 SEND	MIX1	*3
		O	MIX2 SEND	MIX2	*3
		O	MIX3 SEND	MIX3	*3
		O	MIX4 SEND	MIX4	*3
		O	MIX5 SEND	MIX5	*3
		O	MIX6 SEND	MIX6	*3
		O	MIX7 SEND	MIX7	*3
		O	MIX8 SEND	MIX8	*3
		O	MIX9 SEND	MIX9	*3
		O	MIX10 SEND	MIX10	*3
		O	MIX11 SEND	MIX11	*3
		O	MIX12 SEND	MIX12	*3
		O	MIX13 SEND	MIX13	*3
		O	MIX14 SEND	MIX14	*3
		O	MIX15 SEND	MIX15	*3
		O	MIX16 SEND	MIX16	*3
		O	MIX17 SEND	MIX17	*3
		O	MIX18 SEND	MIX18	*3
		O	MIX19 SEND	MIX19	*3
		O	MIX20 SEND	MIX20	*3
		O	MIX21 SEND	MIX21	*3
		O	MIX22 SEND	MIX22	*3
		O	MIX23 SEND	MIX23	*3
		O	MIX24 SEND	MIX24	*3
		O	MATRIX1 SEND	MTRX1	*3
		O	MATRIX2 SEND	MTRX2	*3
		O	MATRIX3 SEND	MTRX3	*3
		O	MATRIX4 SEND	MTRX4	*3
		O	MATRIX5 SEND	MTRX5	*3
		O	MATRIX6 SEND	MTRX6	*3
		O	MATRIX7 SEND	MTRX7	*3
		O	MATRIX8 SEND	MTRX8	*3
		O	HPF FREQUENCY	HPF	*4
		O	DYNAMICS1 THRESHOLD	THRE1	*5
		O	DYNAMICS2 THRESHOLD	THRE2	*6

- *1 Preference setting and the state of the ALTERNATE function will determine whether this will be analog gain or digital gain.
- *2 The send destination that is the target of Sends On Fader will be selected.
- *3 Preference setting and the state of the ALTERNATE function will determine whether turning the encoder will switch the PRE/POST setting of the corresponding send or will switch the corresponding send on/off when pressed.
- *4 Preference setting and the state of the ALT function will determine whether pressing the encoder will switch the high-pass filter on/off.
- *5 Preference setting and the state of the ALT function will determine whether pressing the encoder will switch DYNAMICS 1 on/off.
- *6 Preference setting and the state of the ALT function will determine whether pressing the encoder will switch DYNAMICS 2 on/off.

MIDI Data Format

This section explains the format of the data that the CL series is able to understand, send, and receive.

1 CHANNEL MESSAGE

1.1 NOTE OFF (8n)

Reception

These messages are echoed to MIDI OUT if [OTHER COMMAND ECHO] is ON. They are received if [Rx CH] matches, and used to control effects.

STATUS	1000nnnn	8n	Note off message
DATA	0nnnnnnn	nn	Note number
	0vvvvvvv	vv	Velocity (ignored)

1.2 NOTE ON (9n)

Reception

These messages are echoed to MIDI OUT if [OTHER COMMAND ECHO] is ON. They are received if [Rx CH] matches, and used to control effects.

STATUS	1001nnnn	9n	Note on message
DATA	0nnnnnnn	nn	Note number
	0vvvvvvv	vv	Velocity (1-127:on, 0:off)

1.3 CONTROL CHANGE (Bn)

Two types of CONTROL CHANGE can be transmitted and received; [NRPN] (Non-Registered Parameter Numbers) and freely-assigned [TABLE] (1CH x 110) messages. Select either [TABLE] or [NRPN].

Reception

These messages are echoed to MIDI OUT if [CONTROL CHANGE ECHO] is ON. If [TABLE] is selected, these messages are received when [CONTROL CHANGE Rx] is ON and [Rx CH] matches, and will control parameters according to the settings of the [CONTROL CHANGE EVENT LIST]. For the parameters that can be assigned, refer to “Parameters that can be assigned to control changes” on page 248.

If [NRPN] is selected, these messages are received when [CONTROL CHANGE Rx] is ON and the [Rx CH] matches; the four messages NRPN control number (62h, 63h) and DATA ENTRY control number (06h, 26h) are used to control the specified parameter.

Transmission

If [TABLE] is selected, and if [CONTROL CHANGE Tx] is ON when you operate a parameter that is assigned in the [CONTROL CHANGE EVENT LIST], these messages will be transmitted on the [Tx CH] channel. For the parameters that can be assigned, refer to “Parameters that can be assigned to control changes” on page 248. If [NRPN] is selected, and if [CONTROL CHANGE Tx] is ON when you operate a specified parameter, the four messages NRPN control number (62h, 63h) and DATA ENTRY control number (06h, 26h) are transmitted on the [Tx CH] channel. For the parameters that can be assigned, refer to “Parameters that can be assigned to control changes” on page 248.

CONTROL CHANGE messages are not used for transmission to CL Editor because there is no guarantee that the contents of the assignment tables will match. (PARAMETER CHANGE messages are always used.)

CONTROL CHANGE numbers 0 and 32 are for selecting banks.

STATUS	1011nnnn	Bn	Control change
DATA		00	Control number (00)

	0vvvvvvv	vv	Control Value (0-127)
STATUS	1011nnnn	Bn	Control change
DATA		20	Control number (32)
	0vvvvvvv	vv	Control Value (0-127)

If [TABLE] is selected

STATUS	1011nnnn	Bn	Control change
DATA	0nnnnnnn	nn	Control number (1-5, 7-31, 33-37, 38-95, 102-119) *
	0vvvvvvv	vv	Control Value (0-127)

- * Numbers 0, 32, and 96–101 cannot be used.
- * Control number 6, 38 can be used.

Equation for converting a Control Value to parameter data

paramSteps = paramMax – paramMin + 1;
 add = paramWidth / paramSteps;
 mod = paramWidth – add * paramSteps;
 curValue = paramSteps * add + mod / 2;

(1) If the assigned parameter has fewer than 128 steps

paramWidth = 128; rxValue = Control value;

(2) If the assigned parameter has 128 or more but less than 16,384 steps

paramWidth = 16384;

(2-1) When High and Low data is received
 rxValue = Control value(High) * 128 + Control value(Low);

(2-2) When only Low data is received
 rxValue = (curValue & 16256) + Control value(Low);

(2-3) When only High data is received
 rxValue = Control value(High) * 128 + (curValue & 127);

(3) If the assigned parameter has 16,384 or more but less than 2,097,152 steps

paramWidth = 2097152;

(3-1) When High, Middle, and Low data is received
 rxValue = Control value(High) * 16384 + Control value(Middle) * 128 + Control value(Low);

(3-2) When only Low data is received
 rxValue = (curValue & 2097024) + Control value(Low);

(3-3) When only Middle data is received
 rxValue = (curValue & 2080895) + Control value(Middle) * 128;

(3-4) When only High data is received
 rxValue = (curValue & 16383) + Control value(High) * 16384;

(3-5) When only Middle and Low data is received
 rxValue = (curValue & 2080768) + Control value(Middle) * 128 + Control value(Low);

(3-6) When only High and Low data is received
 rxValue = (curValue & 16256) + Control value(High) * 16384 + Control value(Low);

(3-7) When only High and Middle data is received
 rxValue = (curValue & 127) + Control value(High) * 16384 + Control value(Middle) * 128;

if (rxValue > paramWidth)
 rxValue = paramWidth;
 param = (rxValue – mod / 2) / add;

If [NRPN] is selected

STATUS	1011nnnn	Bn	Control change
DATA	01100010	62	NRPN LSB
	0vvvvvvv	vv	Parameter number LSB
STATUS	1011nnnn	Bn	Control change *
DATA	01100011	63	NRPN MSB
	0vvvvvvv	vv	Parameter number MSB
STATUS	1011nnnn	Bn	Control change *
DATA	00000110	06	Data entry MSB
	0vvvvvvv	vv	Parameter data MSB
STATUS	1011nnnn	Bn	Control change *
DATA	00100110	26	Data entry LSB
	0vvvvvvv	vv	Parameter data LSB

- * The STATUS byte of the second and subsequent messages need not be added during transmission. Reception must occur correctly whether or not the status byte is omitted.

1.4 PROGRAM CHANGE (Cn)

Reception

If [PROGRAM CHANGE ECHO] is ON, bank select messages will also be echoed from MIDI OUT.

If SINGLE CH is selected, these messages are received if [PROGRAM CHANGE Rx] is ON and the [Rx CH] matches. However if [OMNI] is ON, these messages are received regardless of the channel. When these messages are received, scene memory, effect library and premium rack library are recalled according to the settings of the [PROGRAM CHANGE EVENT LIST].

Transmission

If [PROGRAM CHANGE Tx] is ON, these messages are transmitted according to the [PROGRAM CHANGE Table] settings when scene memory, effect library and premium rack library are recalled.

If SINGLE CH is selected, these messages are transmitted on the [Tx CH] channel. If the recalled scene memory, effect library and premium rack library has been assigned to more than one PROGRAM NUMBER, the lowest-numbered PROGRAM NUMBER for each MIDI channel will be transmitted.

PROGRAM CHANGE messages are not used for transmission to CL Editor because there is no guarantee that the contents of the assignment tables will match. (PARAMETER CHANGE messages are always used.)

You can choose either MULTI MIDI CH or SINGLE CH.

If SINGLE is selected

You can choose the Rx CH, OMNI CH, and Tx CH. You can choose whether a bank select message will be added. A bank of up to 16 can be specified.

If MULTI is selected

The Rx and Tx channels will be the same. The assignment table will use the settings for each MIDI channel. Bank select messages will not be added.

You can make settings for up to sixteen MIDI channels.

STATUS	1100nnnn	Cn	Program change
DATA	0nnnnnnn	nn	Program number (0-127)

2 SYSTEM REALTIME MESSAGE

2.1 SONG SELECT (F3)

Reception

Select the track number shown in the TITLE LIST screen of the USB memory recorder.

```
STATUS      11110011 F3 Song select
Song number 0sssssss ss Song number (0-127)
```

2.2 TIMING CLOCK (F8)

Reception

This message is used to control effects. This message is transmitted twenty-four times per quarter note.

Echoing of this message depends on the OTHER item in the ECHO settings.

```
STATUS      11111000 F8 Timing clock
```

2.3 ACTIVE SENSING (FE)

Reception

Once this message has been received, MIDI communication will be initialized (e.g., Running Status will be cleared) if no message is received for an interval of 400 ms. This message is not subject to echoing.

```
STATUS      11111110 FE Active sensing
```

2.4 SYSTEM RESET (FF)

Reception

When this message is received, MIDI communication will be initialized (e.g., Running Status will be cleared).

This message is not subject to echoing.

```
STATUS      11111111 FF System reset
```

3 SYSTEM EXCLUSIVE MESSAGE

3.1 MMC

< MMC STOP >

Reception

If the [DEVICE NO.] matches or is 7F, receives this message and stops.

```
STATUS      11110000 F0 System exclusive message
ID No.      01111111 7F Real time System exclusive
Device ID   0ddddd dd Destination (00-7E, 7F:all call)
COMMAND     00000110 06 Machine Control Command(MCC) sub-id
            00000001 01 Stop(MCS)
EOX         11110111 F7 End of exclusive
```

< MMC PLAY >

Reception

If the [DEVICE NO.] matches or is 7F, receives this message and starts playback.

```
STATUS      11110000 F0 System exclusive message
ID No.      01111111 7F Real time System exclusive
Device ID   0ddddd dd Destination (00-7E, 7F:all call)
COMMAND     00000110 06 Machine Control Command(MCC) sub-id
            00000010 02 Play(MCS)
EOX         11110111 F7 End of exclusive
```

< MMC DEFERED PLAY >

Reception

If the [DEVICE NO.] matches or is 7F, receives this message and starts playback.

```
STATUS      11110000 F0 System exclusive message
ID No.      01111111 7F Real time System exclusive
Device ID   0ddddd dd Destination (00-7E, 7F:all call)
COMMAND     00000110 06 Machine Control Command(MCC) sub-id
            00000011 03 Deferred Play(MCS)
EOX         11110111 F7 End of exclusive
```

< MMC RECORD STROBE >

Reception

If the [DEVICE NO.] matches or is 7F, receives this message, and if stopped, starts recording.

```
STATUS      11110000 F0 System exclusive message
ID No.      01111111 7F Real time System exclusive
Device ID   0ddddd dd Destination (00-7E, 7F:all call)
COMMAND     00000110 06 Machine Control Command(MCC) sub-id
            00000110 06 Record strobe
EOX         11110111 F7 End of exclusive
```

< MMC PAUSE >

Reception

If the [DEVICE NO.] matches or is 7F, receives this message, and if playing, pauses.

```
STATUS      11110000 F0 System exclusive message
ID No.      01111111 7F Real time System exclusive
Device ID   0ddddd dd Destination (00-7E, 7F:all call)
COMMAND     00000110 06 Machine Control Command(MCC) sub-id
            00001001 09 Pause(MCS)
EOX         11110111 F7 End of exclusive
```

3.2 BULK DUMP

This message is used to send or receive the contents of various memories stored within the unit.

The basic format is as follows.

Command	rx/tx	Function
F0 43 0n 3E cc cc 19 mm ... mm dd dd ... ee F7	rx/tx	BULK DUMP DATA
F0 43 2n 3E 19 mm ... mm dd dd F7	rx	BULK DUMP REQUEST

The CL series uses the following data types for a bulk dump.

Module Name(mm)	Data Number(dd)
SCENE LIB	"SCENE_" *1) *14) *15) *16)
INPUT EQ LIB	"INEQ_" *2) *7) *8)
OUTPUT EQ LIB	"OUTEQ_" *3) *9) *10) *11)
Dynamics LIB	"DYNA_" *4) *7) *8) *9) *10) *11) *21) *22)
INPUT CH LIB	"INCHNNL_" *17) *7) *8)
OUTPUT CH LIB	"OUTCHNNL_" *18) *9) *10) *11)
GEQ LIB	"GEQ_" *5) *12)
EFFECT LIB	"EFFECT_" *6) *13)
Premium Effect	"PEFFECT_" *19)
Portico5033 LIB	"P5033_" *20)
Portico5043 LIB	"P5043_" *20)
U76 LIB	"U76_" *20)
Opt-2A LIB	"OPT-2A_" *20)

Module Name(mm)	Data Number(dd)
EQP-1A LIB	"EQ-1A_" *20)
DynamicEQ LIB	"DYNAEQ_" *20)
Dante Input Patch LIB	"DANTEIN_" *23)
Mixer Setup	"MIXERSET_" Fix (512)
Outport Setup	"OUT_PORT_" Fix (512)
Monitor Setup	"MONITOR_" Fix (512)
MIDI Setup	"MIDI_SET_" Fix (512)
Lib Number	"LIB_NUM_" Fix (512)
Program Change Table	"PRGMCHG_" Fix (512)
Control Change Table	"CTRLCHG_" Fix (512)
Preference (Current)	"PREF_CUR_" Fix (512)
Preference (Admin)	"PREF_ADM_" Fix (512)
Preference (Guest)	"PREF_GST_" Fix (512)
User Defined Keys (Current)	"UDEF_CUR_" Fix (512) include Knob, Encoder
User Defined Keys (Admin)	"UDEF_ADM_" Fix (512) include Knob, Encoder
User Defined Keys (Guest)	"UDEF_GST_" Fix (512) include Knob, Encoder
Custom Fader Bank (Current)	"CFAD_CUR_" Fix (512)
Custom Fader Bank (Admin)	"CFAD_ADM_" Fix (512)
Custom Fader Bank (Guest)	"CFAD_GST_" Fix (512)
User Level (Current)	"UKEY_CUR_" Fix (512)
User Level (Guest)	"UKEY_GST_" Fix (512)

- *1) 0-300 Scene Number (0 Request Only),
- *2) 1-199 Input EQ Library Number (1-40 Request Only)
- *3) 1-199 Output EQ Library Number (1-3 Request Only)
- *4) 1-199 Dynamics Library Number (1-41 Request Only)
- *5) 0-199 GEQ Library Number (0 Request Only)
- *6) 1-199 Effect Library Number (1-27 Request Only)
- *7) 512-583 Input 1-72,
- *8) 584-599 STIN 1L-8R,
- *9) 768-791 MIX 1-24,
- *10) 1024-1031 MATRIX 1-8,
- *11) 1280-1282 STEREO L-C,
- *12) 512-530 GEQ 1-19, 531-538 EFFECT GEQ 1-8,
- *13) 512-519 EFFECT 1-8,
- *14) 512 Current Data,
- *15) 768 Current Data with Recall Safe,
- *16) 8192 Store Undo Data, 8193 Recall Undo Data, 8194 Clear Undo Data,
- *17) 0-199 Input CH Library Number (0 Request Only),
- *18) 0-199 Output CH Library Number (0 Request Only),
- *19) 512-527 Premium Rack 1A, 1B, 2A, ... 8A, 8B
- *20) 0-100 Each Premium Effect Library Number (0 Request Only)
- *21) 1536-1607 Input 1-72 (for Dynamics2),
- *22) 1608-1623 STIN 1L-8R (for Dynamics2),
- *23) 0-10 Dante Input Patch Library Number (0 Request Only)

Data is lost when you write to the preset library.

The unique header (Model ID) identifies whether the device is a CL series.

To calculate the check sum, add the bytes starting with the byte after BYTE COUNT (LOW) and ending with the byte before CHECK SUM, take the binary complement, and set bit 7 to 0.

CHECK SUM = (-sum)&0x7F

Bulk Dumps can be received at any time, and can be transmitted at any time when a Bulk Dump Request is received.

A Bulk Dump is transmitted on the [Rx CH] channel in response to a Bulk Dump Request.

In the data portion, seven words of 8-bit data are converted into eight words of 7-bit data.

[Conversion from actual data to bulk data]

```
d[0-6]: actual data
b[0-7]: bulk data
b[0] = 0;
for( I=0; I<7; I++){
    if( d[I]&0x80){
        b[0] |= 1<<(6-I);
    }
    b[I+1] = d[I]&0x7F;
}
}
```

[Recovery from bulk data to actual data]

```
d[0-6]: actual data
b[0-7]: bulk data
for( I=0; I<7; I++){
    b[0] <<= 1;
    d[I] = b[I+1]+(0x80&b[0]);
}
}
```

3.3 PARAMETER CHANGE

Reception

This message is echoed if [PARAMETER CHANGE ECHO] is ON.
 This message is received if [PARAMETER CHANGE Rx] is ON and [Rx CH] matches the Device number included in the SUB STATUS. When a PARAMETER CHANGE is received, the specified parameter will be controlled. When a PARAMETER REQUEST is received, the current value of the specified parameter will be transmitted as a PARAMETER CHANGE with its Device Number as the [Rx CH].

Transmission

If [PARAMETER CHANGE Tx] is ON, and you edit a parameter for which CONTROL CHANGE transmission has not been enabled, a PARAMETER CHANGE will be transmitted with the [Tx CH] as its device number.
 In response to a PARAMETER REQUEST, a PARAMETER CHANGE will be transmitted with [Rx CH] as its device number.

Command	rx/tx	Function
F0 43 1n 3E 19 .. F7 PARAMETER CHANGE	rx/tx	CL series native parameter change
F0 43 3n 3E 19 .. F7 PARAMETER REQUEST	rx/tx	CL series native parameter request

4 PARAMETER CHANGE details

4.1 CURRENT SCENE, SETUP, BACKUP, USER SETUP

4.1.1 Format (PARAMETER CHANGE)

Receive

Data will be received when [PARAMETER CHANGE Rx] is on and the Device number of both [Rx CH] and SUB STATUS are matched. The data will be echoed when [PARAMETER CHANGE ECHO] is on. The corresponding parameter will be changed immediately the data is received.

Transmission

Data will be transmitted with the [Device Number] in [Tx CH] when [PARAMETER CHANGE Tx] is on and the parameter is not registered on the [CONTROL CHANGE EVENT LIST].

STATUS	11110000	F0	System exclusive message
ID No.	01000011	43	Manufacture's ID number (YAMAHA)
SUB STATUS	0001nnnn	1n	n=0-15 (Device number=MIDI Channel)
GROUP ID	00111110	3E	Digital mixer
MODEL ID	00010010	19	CL Series
DATA Category	0ccccccc	cc	
DATA	0eeeeeee	eh	Element no High.
	0eeeeeee	e1	Element no Low.
	0iiiiiii	ih	Index no High.
	0iiiiiii	il	Index no Low.
	0ccccccc	ch	Channel no High.
	0ccccccc	c1	Channel no Low.
	0ddddddd	dd	Data
	:	:	
EOX	11110111	F7	End of exclusive

4.1.2 Format (PARAMETER REQUEST)

Receive

Data will be received when [PARAMETER CHANGE Rx] is on and the Device number of both [Rx CH] and SUB STATUS are matched. The data will be echoed when [PARAMETER CHANGE ECHO] is on. The corresponding parameter will be changed via PARAMETER CHANGE immediately the data is received.

STATUS	11110000	F0	System exclusive message
ID No.	01000011	43	Manufacture's ID number (YAMAHA)
SUB STATUS	0001nnnn	3n	n=0-15 (Device number=MIDI Channel)
GROUP ID	00111110	3E	Digital mixer
MODEL ID	00010010	19	CL Series
DATA Category	0ccccccc	cc	
DATA	0eeeeeee	eh	Element no High.
	0eeeeeee	e1	Element no Low.
	0iiiiiii	ih	Index no High.
	0iiiiiii	il	Index no Low.
	0ccccccc	ch	Channel no High.
	0ccccccc	c1	Channel no Low.
EOX	11110111	F7	End of exclusive

4.1.3 Data category

Data Category		Name
0x01	00000001	Current Scene /Setup/Backup/ User Setup Data

4.2 FUNCTION CALL – LIBRARY STORE, RECALL –

4.2.1 Format (PARAMETER CHANGE)

Receive

Data will be received when [PARAMETER CHANGE Rx] is on and the Device number of both [Rx CH] and SUB STATUS are matched. The data will be echoed when [PARAMETER CHANGE ECHO] is on. The corresponding parameter will be changed immediately the data is received.

Transmission

Data will be transmitted with the [Device Number] (MIDI CH) in [Tx CH] when [PARAMETER CHANGE Tx] is on.

STATUS	11110000	F0	System exclusive message
ID No.	01000011	43	Manufacture's ID number (YAMAHA)
SUB STATUS	0001nnnn	1n	n=0-15 (Device number=MIDI Channel)
GROUP ID	00111110	3E	Digital mixer
MODEL ID	00010010	19	CL Series
DATA CATEGORY	00000000	00	OTHER DATA
FUNCTION NAME	01001100	"L"	(ASCII CODE)
	01101001	"i"	(ASCII CODE)
	01100010	"b"	(ASCII CODE)
	0ffffff	ff	(ASCII CODE)
	0ffffff	ff	(ASCII CODE)
	0ffffff	ff	(ASCII CODE)
	0ffffff	ff	(ASCII CODE)
	0ffffff	ff	(ASCII CODE)
	0ffffff	ff	(ASCII CODE)
MODULE NAME	0mmmmmmm	mm	(ASCII CODE)
	0mmmmmmm	mm	(ASCII CODE)
	0mmmmmmm	mm	(ASCII CODE)
	0mmmmmmm	mm	(ASCII CODE)
	0mmmmmmm	mm	(ASCII CODE)
	0mmmmmmm	mm	(ASCII CODE)
	0mmmmmmm	mm	(ASCII CODE)
	0mmmmmmm	mm	(ASCII CODE)
DATA	0nnnnnnn	nh	Number High
	0nnnnnnn	n1	Number Low
	0ccccccc	ch	Channel High
	0ccccccc	c1	Channel Low
EOX	11110111	F7	End of exclusive

4.2.2 Function Name

Function Name	
Store	"LibStr_"
Recall	"LibRcl_"
Unknown Factor Store	"LibUnStr"
Unknown Factor Recall	"LibUnRcl"
Store Undo (only Score)	"LibStrUd"
Recall Undo (only Scene)	"LibRclUd"

4.2.3 Module Name

Module Name	
Scene	"SCENE__"
Input EQ	"INEQ__"
Output EQ	"OUTEQ__"
Dynamics	"DYNA__"
Input CH	"INCHNNL_"
Output CH	"OUTCHNNL_"
GEQ	"GEQ__"
Effect	"EFFECT__"
Portico5033	"P5033__"
Portico5043	"P5043__"
U76	"U76__"
Opt-2A	"OPT-2A__"
EQP-1A	"EQ-1A__"
DynamicEQ	"DYNAEQ__"
Dante Input Patch	"DANTEIN_"

Function		Number	Channel*1)	tx/rx
"LibStr__"	SCENE	1-300	*5)	tx/rx
	INPUT EQ LIB	41-199	*1)	tx/rx
	OUTPUT EQ LIB	4-199	*2) *3) *4)	tx/rx
	Dynamics LIB	42-199	*1) *2) *3) *4) *8)	tx/rx
	INPUT CH LIB	1-199	*1)	tx/rx
	OUTPUT CH LIB	1-199	*2) *3) *4)	tx/rx
	GEQ LIB	1-199	*6)	tx/rx
	EFFECT LIB	28-199	*7)	tx/rx
	Premium Effect LIB	1-100	*9)	tx/rx
	Dante Input Patch LIB	1-10	*5)	tx/rx
"LibUnStr"	SCENE	1-300	0	tx
	INPUT EQ LIB	41-199	0	tx
	OUTPUT EQ LIB	4-199	0	tx
	Dynamics LIB	42-199	0	tx
	INPUT CH LIB	1-199	0	tx
	OUTPUT CH LIB	1-199	0	tx
	GEQ LIB	1-199	0	tx
	EFFECT LIB	28-199	0	tx
	Premium Effect LIB	1-100	0	tx
	Dante Input Patch LIB	1-10	0	tx
"LibRcl__"	SCENE	0-300	*5)	tx/rx
	INPUT EQ LIB	1-199	*1)	tx/rx
	OUTPUT EQ LIB	1-199	*2) *3) *4)	tx/rx
	Dynamics LIB	1-199	*1) *2) *3) *4) *8)	tx/rx
	INPUT CH LIB	0-199	*1)	tx/rx
	OUTPUT CH LIB	0-199	*2) *3) *4)	tx/rx
	GEQ LIB	0-199	*6)	tx/rx
	EFFECT LIB	1-199	*7)	tx/rx
	Premium Effect LIB	0-100	*9)	tx/rx
	Dante Input Patch LIB	0-10	*5)	tx/rx
"LibUnRcl"	SCENE	0	*5)	tx
	INPUT EQ LIB	0	*1)	tx
	OUTPUT EQ LIB	0	*2) *3) *4)	tx

Function		Number	Channel*1)	tx/rx
	Dynamics LIB	0	*1) *2) *3) *4) *8)	tx
	INPUT CH LIB	0	*1)	tx
	OUTPUT CH LIB	0	*2) *3) *4)	tx
	GEQ LIB	0	*6)	tx
	EFFECT LIB	0	*7)	tx
	Premium Effect LIB	0	*9)	tx
	Dante Input Patch LIB	0	*5)	tx
"LibStrUd"	SCENE	0	0	
"LibRclUd"	SCENE	0	0	

- *1) 0:CH1 - 71:CH72
72:ST IN 1L - 87:ST IN 8R
- *2) 256:MIX 1 - 279:MIX 24
- *3) 512:MATRIX 1 - 519: MATRIX 8
- *4) 1024:STEREO L - 1026:STEREO C
- *5) 512:will be used if the recalling or storing data is only one.
- *6) 0: GEQ1A, 1: GEQ1B, 2: GEQ2A, ... 36: GEQ19A, 37:GEQ19B
38: EFFECT GEQ1A, 39: EFFECT GEQ1B,
40: EFFECT GEQ2A, ... 52: EFFECT GEQ8A, 53: EFFECT GEQ8B
- *7) 0:Effect1- 7:Effect8
- *8) 1280:CH1 - 1351:CH72
1352:ST IN 1L - 1367:ST IN 8R
- *9) 0: Premium Rack 1A, 1: Premium Rack 1B,
2: Premium Rack 2A, ... 14: Premium Rack 8A, 15: Premium Rack 8B

4.3 FUNCTION CALL – LIBRARY EDIT –

4.3.1 Format (PARAMETER CHANGE)

Receive

Data will be received when [PARAMETER CHANGE Rx] is on and the Device number of both [Rx CH] and SUB STATUS are matched. The data will be echoed when [PARAMETER CHANGE ECHO] is on. The corresponding memory/library will be changed immediately the data is received.

Transmission

PARAMETER CHANGE will be sent in reply to Request. If [PARAMETER CHANGE ECHO] is on, the message will be sent as it is.

STATUS	11110000	F0	System exclusive message
ID No.	01000011	43	Manufacturer's ID number (YAMAHA)
SUB STATUS	0001nnnn	1n	n=0-15 (Device number=MIDI Channel)
GROUP ID	00111110	3E	Digital mixer
MODEL ID	00010010	19	CL Series
DATA CATEGORY	00000000	00	OTHER DATA
FUNCTION NAME	01001100	"L"	(ASCII CODE)
	01101001	"i"	(ASCII CODE)
	01100010	"b"	(ASCII CODE)
	0fffffff	ff	(ASCII CODE)
	0fffffffff	ff	(ASCII CODE)
	0fffffff	ff	(ASCII CODE)
	0ffffff	ff	(ASCII CODE)
	0ffff	ff	(ASCII CODE)
	0fff	ff	(ASCII CODE)
	0ff	ff	(ASCII CODE)
MODULE NAME	0mmmmmm	mm	(ASCII CODE).
	0mmmmmm	mm	(ASCII CODE)
	0mmmmmm	mm	(ASCII CODE)
	0mmmmmm	mm	(ASCII CODE)

	0mmmmmm	mm	(ASCII CODE)
	0mmmmmm	mm	(ASCII CODE)
	0mmmmmm	mm	(ASCII CODE)
	0mmmmmm	mm	(ASCII CODE)
DATA	0sssssss	sh	number -source start High
	0sssssss	sl	number -source start Low
	0eeeeeee	eh	number -source end High
	0eeeeeee	el	number -source end Low
	0ddddddd	dh	number -destination start High
	0ddddddd	dl	number -destination to start Low
EOX	11110111	F7	End of exclusive

4.3.2 Function Name

Function Name	
Copy	"LibCpy__"
Paste	"LibPst__"
Clear	"LibClr__"
Cut	"LibCut__"
Insert	"LibIns__"
Edit Undo	"LibEdtUd"

4.3.3 Module Name

Module Name		Function
SCENE LIB	"SCENE__"	Copy, Paste, Clear, Cut, Insert, EditUndo
INPUT EQ LIB	"INEQ__"	Clear Only
OUTPUT EQ LIB	"OUTEQ__"	Clear Only
Dynamics LIB	"DYNA__"	Clear Only
INPUT CH LIB	"INCHNNL_"	Clear Only
OUTPUT CH LIB	"OUTCHNNL_"	Clear Only
GEQ LIB	"GEQ__"	Clear Only
EFFECT LIB	"EFFECT__"	Clear Only
Portico5033 LIB	"P5033__"	Clear Only
Portico5043 LIB	"P5043__"	Clear Only
U76 LIB	"U76__"	Clear Only
Opt-2A LIB	"OPT-2A__"	Clear Only
EQP-1A LIB	"EQ-1A__"	Clear Only
DynamicEQ LIB	"DYNAEQ__"	Clear Only
Dante Input Patch LIB	"DANTEIN_"	Clear Only

4.5.2 Format (PARAMETER REQUEST)

Receive

The PARAMETER CHANGE will be sent with Device number [Rx CH] immediately the data is received.

```

STATUS      11110000 F0 System exclusive message
ID No.      01000011 43 Manufacturer's ID number (YAMAHA)
SUB STATUS  0011nnnn 3n n=0-15 (Device number=MIDI Channel)
GROUP ID    00111110 3E Digital mixer
MODEL ID    00010010 19 CL Series
DATA CATEGORY 00000000 00 OTHER DATA
FUNCTION NAME 01001100 "L" (ASCII CODE)
01101001 "i" (ASCII CODE)
01100010 "b" (ASCII CODE)
01000101 "E" (ASCII CODE)
01111000 "x" (ASCII CODE)
01101001 "i" (ASCII CODE)
01110011 "s" (ASCII CODE)
01110100 "t" (ASCII CODE)
MODULE NAME 0mmmmmmmm mm (ASCII CODE)
0mmmmmmmm mm (ASCII CODE)
0mmmmmmmm mm (ASCII CODE)
0mmmmmmmm mm (ASCII CODE)
0mmmmmmmm mm (ASCII CODE)
0mmmmmmmm mm (ASCII CODE)
0mmmmmmmm mm (ASCII CODE)
0mmmmmmmm mm (ASCII CODE)
0mmmmmmmm mm (ASCII CODE)
0mmmmmmmm mm (ASCII CODE)
0mmmmmmmm mm (ASCII CODE)
0mmmmmmmm mm (ASCII CODE)
0mmmmmmmm mm (ASCII CODE)
0mmmmmmmm mm (ASCII CODE)
0mmmmmmmm mm (ASCII CODE)
0mmmmmmmm mm (ASCII CODE)
DATA 0nnnnnnnn nh Request Number High
0nnnnnnnn nl Request Number Low
EOX 11110111 F7 End of exclusive
    
```

4.5.3 Module Name

Module Name	Number
SCENE LIB	"SCENE_" 1-300
INPUT EQ LIB	"INEQ_" 41-200
OUTPUT EQ LIB	"OUTEQ_" 4-200
Dynamics LIB	"DYNA_" 42-200
INPUT CH LIB	"INCHNNL_" 1-200
OUTPUT CH LIB	"OUTCHNL_" 1-200
GEQ LIB	"GEQ_" 1-200
EFFECT LIB	"EFFECT_" 55-200
Portico5033 LIB	"P5033_" 1-100
Portico5043 LIB	"P5043_" 1-100
U76 LIB	"U76_" 1-100
Opt-2A LIB	"OPT-2A_" 1-100
EQP-1A LIB	"EQ-1A_" 1-100
DynamicEQ LIB	"DYNAEQ_" 1-100
Dante Input Patch LIB	"DANTEIN_" 1-10

4.6 FUNCTION CALL – COLLECTION STORE –

4.6.1 Format (PARAMETER CHANGE)

Transmission

Data will be transmitted with the [Device Number] in [Tx CH] when [PARAMETER CHANGE Tx] is on.

```

STATUS      11110000 F0 System exclusive message
ID No.      01000011 43 Manufacturer's ID number (YAMAHA)
SUB STATUS  0001nnnn 1n n=0-15 (Device number=MIDI Channel)
GROUP ID    00111110 3E Digital mixer
MODEL ID    00010010 19 CL Series
DATA CATEGORY 00000000 00 OTHER DATA
FUNCTION NAME 01001100 "C" (ASCII CODE)
01101001 "o" (ASCII CODE)
01100010 "l" (ASCII CODE)
01010101 "U" (ASCII CODE)
01101110 "n" (ASCII CODE)
01010011 "S" (ASCII CODE)
01110100 "t" (ASCII CODE)
01110010 "r" (ASCII CODE)
MODULE NAME 0mmmmmmmm mm (ASCII CODE)
0mmmmmmmm mm (ASCII CODE)
0mmmmmmmm mm (ASCII CODE)
0mmmmmmmm mm (ASCII CODE)
0mmmmmmmm mm (ASCII CODE)
0mmmmmmmm mm (ASCII CODE)
0mmmmmmmm mm (ASCII CODE)
0mmmmmmmm mm (ASCII CODE)
0mmmmmmmm mm (ASCII CODE)
0mmmmmmmm mm (ASCII CODE)
0mmmmmmmm mm (ASCII CODE)
0mmmmmmmm mm (ASCII CODE)
0mmmmmmmm mm (ASCII CODE)
0mmmmmmmm mm (ASCII CODE)
0mmmmmmmm mm (ASCII CODE)
0mmmmmmmm mm (ASCII CODE)
0mmmmmmmm mm (ASCII CODE)
0mmmmmmmm mm (ASCII CODE)
DATA 0nnnnnnnn nh Number High
0nnnnnnnn nl Number Low
0ccccccc ch Channel High
0ccccccc cl Channel Low
EOX 11110111 F7 End of exclusive
    
```

4.6.2 Function Name

Function	Number	tx/rx
"ColUnStr" Setup	0	tx
User Defined Key	0	tx
Program Change	0	tx
Control Change	0	tx

4.6.3 Module Name

Module Name	
Mixer Setting	"MIXERSET"
Outport Setting	"OUT_PORT"
Monitor Setting	"MONITOR_"
MIDI Setting	"MIDI_SET"
Lib Number	"LIB_NUM_"
Program Change Table	"PRGMCHG_"
Control Change Table	"CTRLCHG_"
Preference (Current)	"PREF_CUR"
Preference (Admin)	"PREF_ADM"
Preference (Guest)	"PREF_GST"
User Defined Keys (Current)	"UDEF_CUR"

Module Name	
User Defined Keys (Admin)	"UDEF_ADM"
User Defined Keys (Guest)	"UDEF_GST"
Custom Fader Bank (Current)	"CFAD_CUR"
Custom Fader Bank (Admin)	"CFAD_ADM"
Custom Fader Bank (Guest)	"CFAD_GST"
User Level (Current)	"UKEY_CUR"
User Level (Guest)	"UKEY_GST"

4.7 FUNCTION CALL – MODULE –

4.7.1 Format (PARAMETER CHANGE)

Receive

Data will be received when [PARAMETER CHANGE Rx] is on and the Device number of both [Rx CH] and SUB STATUS are matched. The data will be echoed when [PARAMETER CHANGE ECHO] is on. The corresponding effect will function immediately the data is received (depending on the effect type).

```

STATUS      11110000 F0 System exclusive message
ID No.      01000011 43 Manufacturer's ID number (YAMAHA)
SUB STATUS  0001nnnn 1n n=0-15 (Device number=MIDI Channel)
GROUP ID    00111110 3E Digital mixer
MODEL ID    00010010 19 CL Series
DATA CATEGORY 00000000 00 OTHER DATA
FUNCTION NAME 01001101 "M"
01101111 "o"
01100100 "d"
01000110 "F"
01111000 "x"
01010100 "T"
01110010 "r"
01100111 "g"
MODULE NAME 0mmmmmmmm mm (ASCII CODE)
0mmmmmmmm mm (ASCII CODE)
0mmmmmmmm mm (ASCII CODE)
0mmmmmmmm mm (ASCII CODE)
0mmmmmmmm mm (ASCII CODE)
0mmmmmmmm mm (ASCII CODE)
0mmmmmmmm mm (ASCII CODE)
0mmmmmmmm mm (ASCII CODE)
0mmmmmmmm mm (ASCII CODE)
0mmmmmmmm mm (ASCII CODE)
0mmmmmmmm mm (ASCII CODE)
0mmmmmmmm mm (ASCII CODE)
0mmmmmmmm mm (ASCII CODE)
DATA 0eeeeeee ee Effect number (0:RACK1 - 7:RACK8)
0pppppppp pp Release:0, Press:1
EOX 11110111 F7 End of exclusive
    
```

4.7.2 Module Name

Module Name		Number
Freeze Play button	"FRZPLAY_"	0:RACK1, 2:RACK3, 4:RACK5, 6:RACK7
Freeze Record button	"FRZREC_"	0:RACK1, 2:RACK3, 4:RACK5, 6:RACK7

This will not work when the Effect Type is different.

4.8 FUNCTION CALL – CHANNEL –

4.8.1 Pair ON/OFF Trigger Format (PARAMETER CHANGE)

Receive

Data will be received when [PARAMETER CHANGE Rx] is on and the Device number of both [Rx CH] and SUB STATUS are matched. The data will be echoed when [PARAMETER CHANGE ECHO] is on.

```

STATUS      11110000 F0 System exclusive message
ID No.      01000011 43 Manufacture's ID number (YAMAHA)
SUB STATUS  0001nnnn 1n n=0-15 (Device number=MIDI Channel)
GROUP ID    00111110 3E Digital mixer
MODEL ID    00010010 19 CL Series
DATA CATEGORY 00000000 00 OTHER DATA
FUNCTION NAME 01000011 "C"
              01101000 "h"
              01101100 "l"
              01010000 "P"
              01101001 "i"
              01110010 "r"
              01000011 "C"
              01110000 "p"
MODULE NAME 0mmmmmmm mm (ASCII CODE)
              0mmmmmmm mm (ASCII CODE)
              0mmmmmmm mm (ASCII CODE)
              0mmmmmmm mm (ASCII CODE)
              0mmmmmmm mm (ASCII CODE)
              0mmmmmmm mm (ASCII CODE)
              0mmmmmmm mm (ASCII CODE)
              0mmmmmmm mm (ASCII CODE)
              0mmmmmmm mm (ASCII CODE)
              0mmmmmmm mm (ASCII CODE)
DATA        0sssssss sh Source Channel Number H *1)
              0sssssss sl Source Channel Number L *1)
              0ddddddd dh Destination Channel Number H *1)
              0ddddddd dl Destination Channel Number L *1)
EOX         11110111 F7 End of exclusive
    
```

4.8.2 Module Name

Module Name	
Pair On (with Copy)	"PAIRONCP"
Pair On (with Reset Both)	"PAIRONRS"
Pair Off	"PAIROFF_"

*1) 0 :CH1 - 71:CH72
 256 :MIX 1 - 279:MIX 24
 512 :MATRIX 1 - 519: MATRIX 8

4.9 LEVEL METER DATA

4.9.1 Format (PARAMETER CHANGE)

When transmission is enabled by receiving Request for Level Meter, the corresponding metering data will be sent in every 50 millisecond for 10 seconds. If metering information is expected to be continuously sent, Request is needed to be sent in at least every 10 seconds.

Receive

The data will be echoed when [PARAMETER CHANGE ECHO] is ON.

Transmission

When transmission is enabled by receiving Request, the corresponding metering data will be sent in constant interval for a given period of time (The interval and time will vary depending on devices). When rebooted or port setting is changed, the transmission will be disabled.

When [PARAMETER CHANGE ECHO] is on, the message will be sent as it is.

```

STATUS      11110000 F0 System exclusive message
ID No.      01000011 43 Manufacture's ID number (YAMAHA)
SUB STATUS  0001nnnn 1n n=0-15 (Device number=MIDI Channel)
GROUP ID    00111110 3E Digital mixer
MODEL ID    00010010 19 CL Series
DATA CATEGORY 00100001 21 REMOTE LEVEL METER
DATA        0mmmmmmm mm ADDRESS UL
              0mmmmmmm mm ADDRESS LU
              0mmmmmmm mm ADDRESS LL
              0ddddddd dd Data1
              :           :
EOX         11110111 F7 End of exclusive
    
```

4.9.2 Format (PARAMETER REQUEST)

Receive

Data will be received when [PARAMETER CHANGE Rx] is on and the Device number of both [Rx CH] and SUB STATUS are matched. The data will be echoed when [PARAMETER CHANGE ECHO] is on. the corresponding metering data will be sent via [Rx CH] in constant interval for a given period of time (The interval and time will vary depending on devices).

When Address UL = 0x7F is received, all metering data transmission will be immediately stopped [disabled].

Transmission

When [PARAMETER CHANGE ECHO] is on, the message will be sent as it is.

```

STATUS      11110000 F0 System exclusive message
ID No.      01000011 43 Manufacture's ID number (YAMAHA)
SUB STATUS  0011nnnn 3n n=0-15 (Device number=MIDI Channel)
GROUP ID    00111110 3E Digital mixer
MODEL ID    00010010 19 CL Series
DATA CATEGORY 00100001 21 REMOTE LEVEL METER
DATA        0mmmmmmm mm ADDRESS UL
              0mmmmmmm mm ADDRESS LU
              0mmmmmmm mm ADDRESS LL
              0ccccccc ch Count H
              0ccccccc cl Count L
EOX         11110111 F7 End of exclusive
    
```

Warning/Error Messages

Message	Meaning
xxx Parameters Copied.	Parameter xxx was copied to the copy buffer.
xxx Parameters Initialized.	Parameter xxx was initialized.
xxx Parameters Pasted.	Parameter xxx was pasted from the copy buffer.
xxx Parameters Swapped with Copy Buffer.	Parameter xxx was exchanged with the contents of the copy buffer.
ALTERNATE FUNCTION: Turned off!	ALTERNATE FUNCTION was turned off.
Assignment is Restricted to Max. 8 Sources!	The Monitor Define function allows a maximum of eight sources to be selected, but you attempted to assign more than eight.
Cannot Assign!	In the USER DEFINED KEYS popup of the CL3/CL1, you attempted to edit an item that cannot be edited for that model.
Cannot Bookmark This Popup.	This popup window cannot be bookmarked.
Cannot Mount This Type of Device in This Position.	You attempted to mount a specific device at a position where it cannot be mounted.
Cannot Paste!	Cannot paste the character string.
Cannot Recall!	Failed to recall a scene memory or library.
Cannot Select This Channel.	You attempted to select a channel that cannot be operated due to your user level or some other reason.
Cannot Store!	Failed to store a scene memory or library.
Cannot Undo!	You pressed the [UNDO] button when Undo was not available.
Channel Copied.	Channel settings have been copied.
Channel Moved.	Channel settings have been moved.
Channel Returned to Default Settings.	Channel settings have been returned to the default settings.
Couldn't Access File.	File on the USB flash drive could not be accessed for some reason.
Couldn't Write File.	File could not be saved to the USB flash drive.
Current User Changed. [xxx]	Current user was changed to [xxx].
Directory Not Empty!	You attempted to delete a directory, but failed because there were files remaining in the directory.
EDITOR: Data Framing Error! EDITOR: Data Overrun!	Invalid signals are being exchanged with CL Editor.
EDITOR: Rx Buffer Full!	Too much data is being received at the CL Editor input port.
EDITOR: Tx Buffer Full!	Too much data is being transmitted from the CL Editor output port.
EFFECT CUE: Turned Off.	CUE was defeated because you switched from the EFFECT popup window or the premium rack popup window to a different screen.
External HA Connection Conflict!	External HA data could not be recalled, because the state of connections to the external HA has changed since the scene was stored.
External Power Supply is Cut Off!	The PW800 (EXT) power supply connected to the CL series console has stopped operating.
File Access is Busy!	The following operation has not been performed yet because the USB flash drive is being accessed.

Message	Meaning
File Already Exists!	The USB flash drive already contains a file/directory with the same name as the one you are attempting to save, rename, or create.
File Error [xx]!	Internal file access error
File Protected!	Overwriting was not possible because the file on the USB flash drive is write-protected.
Flash Memory Initializing Finished.	Memory initialization has been completed.
Help File Not Found!	The help file has not been loaded.
Illegal Address!	The IP address or Gateway address setting is invalid.
Illegal MAC Address! Cannot Use Network.	Communication via the Network connector is not possible because the MAC address setting has been damaged for some reason. Please contact your Yamaha service center listed at the end of the Owner's Manual (separate document).
Illegal Storage Format!	The USB flash drive could not be accessed because its format is invalid or unsupported.
Internal Power Supply is Cut Off!	The internal (INT) power supply has stopped operating. Alternatively, some other problem has occurred. Contact a Yamaha service center listed at the end of the owner's manual (separate document).
Internal Power Supply is Turned On.	The internal (INT) power supply has started up normally.
KEY IN CUE: Turned Off.	KEY IN CUE was defeated because you switched from the DYNAMICS 1 popup window of an input channel to a different screen.
Loading Aborted.	Loading from USB flash drive was aborted.
Loading Finished.	Finished loading from USB flash drive.
Low Battery!	The backup battery voltage is low.
Maximum Number of Audio Files Exceeded!	The number of songs that can be managed by the USB memory recorder has been exceeded.
Memory Error! All Memories were Initialized.	All data has been initialized because the data in internal backup memory has been lost, due to failure of the backup battery or some other reason. Please contact your Yamaha service center listed at the end of the operating manual (separate document).
MIDI: Data Framing Error! MIDI: Data Overrun!	An inappropriate signal is being input to the MIDI input port.
MIDI: Rx Buffer Full!	Too much data is being received at the MIDI input port.
MIDI: Tx Buffer Full!	Too much data is being transmitted from the MIDI output port.
No Access From Recorder!	In the RECORDER screen, it is not possible to move to a level higher than \YPE\SONGS\.
No channel selected.	A copy-source channel was not selected in the GLOBAL PASTE screen.
No Copy Item Selected.	In the Global Paste screen, you attempted to paste without having selected an item to paste.
No Corresponding Help Items.	The corresponding section was not found in the Hlep file.
No ID3 Tag exists. You can not edit.	The music file cannot be edited because it has no ID3 tag.
No Response from External HA.	No response from an external AD8HR.
No Response from I/O DEVICE.	The I/O devices not responding.

Message	Meaning
Page Bookmarked.	The current screen or popup has been bookmarked.
Password Changed.	The password has been changed.
PLAYBACK OUT CUE: Turned Off.	CUE was cancelled for PLAYBACK OUT because you switched from the RECORDER screen to another screen.
PlayBack Failed: Recorder is Busy!	Audio file link playback is not possible because recording is in progress.
Please wait, Dante patch is proceeding now.	You attempted to edit in the DANTE PATCH screen at a time when patching was not possible.
Power Supply Fan has Malfunctioned!	The cooling fan of the internal power supply has stopped. If a malfunction has occurred, please contact your Yamaha service center listed at the end of the operating manual (separate document).
Processing Aborted.	Processing was interrupted.
PREVIEW Mode : Cannot Use This Function.	The operation was ignored because this function cannot be used during Preview.
PREVIEW Mode : Disabled	Preview was disabled.
PREVIEW Mode : Enabled	Preview was enabled.
Re-Enter Password!	When specifying the user password, the password was not entered a second time.
RECORDER: CODEC Error [0x%08X] !	A codec error occurred in the RECORDER screen.
Recorder Busy: Operation Aborted!	Operation of the button was cancelled because time is required for recorder processing.
RECORDER IN CUE: Turned Off.	CUE was cancelled for RECORDER IN because you switched from the RECORDER screen to another screen.
Removed from the Channel Link group.	The channel was removed from the link group.
Saving Aborted.	Saving to the USB flash drive has been interrupted.
Saving Finished.	Finished saving to USB flash drive.
SCENE #xxx is Empty!	No data has been stored in the scene you attempted to recall, or the data has been damaged so that it cannot be recalled.
SCENE #xxx is Protected!	You attempted to overwrite (store) a protected scene.
SCENE #xxx is Read Only!	You attempted to overwrite (store) a read-only scene.
Scene Playback Link Canceled!	The audio playback link for the scene was cancelled.
SLOT x: Data Framing Error! SLOT x: Data Overrun!	Invalid signals are being input from the SLOT x input port.
SLOT x: Rx Buffer Full!	Too much data is being received at the SLOT x input port.
SLOT x: Tx Buffer Full!	Too much data is being sent from the SLOT x output port.
Some Song Files Are Unidentified.	Some songs were not identified. Songs that have not been specified might be used for DIRECT PLAY or PLAY BACK LINK.
Song File Not Found!	The file specified for SCENE LINK or DIRECT PLAY assigned to a USER DEFINED key does not exist.
STAGEMIX: Data Framing Error! STAGEMIX: Data Overrun!	Invalid signals are being exchanged with StageMix.
STAGEMIX: Rx Buffer Full!	Too much data is being received at the StageMix input port.

Message	Meaning
STAGEMIX: Tx Buffer Full!	Too much data is being transmitted from the StageMix output port.
Storage Full!	The file could not be saved because there is insufficient space on the USB flash drive.
Storage Not Found!	The USB flash drive could not be recognized.
Storage Not Ready!	Access is not possible because the USB flash drive is not ready.
Sync Error! [xxx]	The CL series console is not synchronized to the [xxx] signal.
Tap Operation Ignored.	Tap operation was ignored because the TAP TEMPO button is not displayed in the screen.
This Operation is Not Allowed.	This operation has been ignored because the current user does not have permission.
Too Large Files! Loading Failed.	Loading is not possible because the bitmap file is too large. The maximum supported file size is 307,256 Bytes.
Too Many Bands Used! Cannot Compare.	Copying 31BandGEQ and comparing it to Flex15GEQ has failed because more than 15 bands are included in the copy source.
Too Many Bands Used! Cannot Paste to Flex15GEQ.	Copying and pasting 31BandGEQ to Flex15GEQ has failed because more than 15 bands are included in the copy source.
Total Slot Power Capability Exceeded!	Power consumption of the I/O cards installed in the slots has exceeded the rated value.
Unassigned Encoder.	Your operation has been ignored because there is no parameter that corresponds to the knob you operated.
Unsupported File Format!	The file you attempted to load from the USB flash drive is of an unsupported format.
USB Currently Active for Recorder function!	Save or Load operations are unavailable because the USB memory recorder is recording or playing.
USB Currently Active for SAVE or LOAD!	The recorder cannot operate, since mixer scene memory or library data is being saved to or loaded from the USB flash drive.
USB Memory Busy: Recorder Stopped!	Recording/playback stopped because time is required for USB flash drive processing.
USB Memory Full !	Can't save the RECORDER playlist because there is insufficient free space on the USB flash drive.
USB Memory Full! Recorder Stopped.	Recorder processing was halted because the USB flash drive capacity ran out while the USB memory recorder was operating.
USB Memory is Protected!	The USB flash drive's Protect setting is turned on.
USB Memory Unmounted! Recorder Stopped.	Recorder processing was halted because the USB flash drive was disconnected while the USB memory recorder was operating.
USB over current Error! Disconnect USB device.	The USB device was disconnected because of excessive USB current.
Word Clock Error! Recorder Stopped!	Recorder was halted because synchronization to the word clock was lost.
Wrong Audio File Format!	The format of the audio file is invalid.
Wrong Password!	The password you input was incorrect.
Wrong Word Clock!	The CL series console cannot synchronize because the source selected by MASTER CLOCK SELECT in the WORD CLOCK screen is not appropriate.
You Cannot Create User Key.	The current user does not have permission to create a user key.

Electrical characteristics

All faders are nominal when measured. Output impedance of signal generator:150ohms

■ Frequency Response.

Fs= 44.1 kHz or 48 kHz @20 Hz–20 kHz, referenced to the nominal output level @1 kHz

Input	Output	RL	Conditions	Min.	Typ.	Max.	Unit
OMNI IN 1-8	OMNI OUT 1-8	600 Ω	GAIN: +66dB	-1.5	0.0	0.5	dB
	PHONES	8 Ω		-3.0	0.0	0.5	

■ Gain Error.

Fs= 44.1 kHz or 48 kHz @1 kHz

Input	Output	RL	Conditions	Min.	Typ.	Max.	Unit
OMNI IN 1-8	OMNI OUT 1-8	600 Ω	Input level : -62 dBu , GAIN : +66 dB → Output level +4.0 dBu (Typ.)	-2.0	0	2.0	dB
			Input level : +10 dBu , GAIN : -6 dB → Output level +4.0 dBu (Typ.)				
Internal OSC	OMNI OUT 1-8	600 Ω	Full scale output, Output level : +24.0 dBu (Typ.)	-0.5	0	0.5	
	PHONES	8 Ω	-30 dBFs, phones level control : max. → Output level 0 dBu (Typ.)	-0.5	0	0.5	

■ Total Harmonic Distortion.

Fs= 44.1 kHz or 48 kHz

Input	Output	RL	Conditions	Min.	Typ.	Max.	Unit
OMNI IN 1-8	OMNI OUT 1-8	600 Ω	+4 dBu @20 Hz–20 kHz, GAIN: +66dB			0.1	%
			+4 dBu @20 Hz–20 kHz, GAIN: -6dB			0.05	
Internal OSC	OMNI OUT 1-8	600 Ω	Full Scale Output @1 kHz			0.02	
	PHONES	8 Ω	Full Scale Output @1 kHz, PHONES Level Control: Max.			0.2	

* Total Harmonic Distortion is measured with a 18 dB/octave filter @80 kHz

■ Hum & Noise.

Fs= 44.1 kHz or 48 kHz, EIN= Equivalent Input Noise

Input	Output	RL	Conditions	Min.	Typ.	Max.	Unit
OMNI IN 1-8	OMNI OUT 1-8	600 Ω	Rs= 150 Ω, GAIN: +66dB Master fader at nominal level and one Ch fader at nominal level.		-128 EIN		dBu
			Rs= 150 Ω, GAIN: -6dB Master fader at nominal level and one Ch fader at nominal level.		-84	-79	
All INPUTs	OMNI OUT 1-8	600 Ω	Rs= 150 Ω, GAIN: -6dB Master fader at nominal level and all OMNI IN 1-8 in faders at nominal level.			-70	
—	OMNI OUT 1-8	600 Ω	Residual Output Noise, ST Master Off			-88	
—	PHONES	8 Ω	Residual Output Noise, PHONES Level Control Min.			-88	

* Hum & Noise are measured with A-weight filter.

■ Dynamic Range.

Fs= 44.1 kHz or 48 kHz

Input	Output	RL	Conditions	Min.	Typ.	Max.	Unit
OMNI IN 1-8	OMNI OUT 1-8	600 Ω	AD + DA, GAIN: -6dB		108		dB
—	OMNI OUT 1-8	600 Ω	DA Converter		112		dB

* Dynamic Range are measured with A-weight filter.

■ Sampling Frequency

Parameter	Conditions	Min.	Typ.	Max.	Unit	
External Clock	Frequency Range Fs= 44.1 kHz Fs= 45.9375 kHz (44.1 kHz +4.1667%) Fs= 44.1441 kHz (44.1 kHz +0.1%) Fs= 44.0559 kHz (44.1 kHz -0.1%) Fs= 42.336 kHz (44.1 kHz -4.0%) Fs= 48 kHz Fs= 50 kHz (48 kHz +4.1667%) Fs= 48.048 kHz (48 kHz +0.1%) Fs= 47.952 kHz (48 kHz -0.1%) Fs= 46.080 kHz (48 kHz -4.0%)	-200		+200	ppm	
	Jitter of PLL	DIGITAL IN Fs= 44.1 kHz DIGITAL IN Fs= 48 kHz			10 ns	
Internal Clock	Frequency		44.1		kHz	
	Accuracy	Word Clock : Int 44.1 kHz Word Clock : Int 48 kHz	-50	+50	ppm	
	Jitter	Word Clock : Int 44.1 kHz			4.429	ns
		Word Clock : Int 48 kHz			4.069	

Mixer Basic Parameters

Libraries

Name	Number	Total
Scene Memory	Preset 1 + User 300	301
Input CH Library	Preset 1 + User 199	200
Output CH Library	Preset 1 + User 199	200
Input EQ Library	Preset 40 + User 159	199
Output EQ Library	Preset 3 + User 196	199
Dynamics Library	Preset 41 + User 158	199
Effect Library	Preset 27 + User 172	199
GEQ Library	Preset 1 + User 199	200
Premium Rack Library		
Portico5033		
Portico5043		
U76	Preset 1 + User 199	200
Opt-2A		
EQ-1A		
DynamicEQ		
Dante Input Patch Library	Preset 1 + User 10	11

Input Function

Function	Parameter
Phase	Normal/Reverse
Digital Gain	-96 dB to +24 dB
HPF	Slope= 12 dB/Oct Frequency= 20 Hz to 600 Hz
Attenuator	-96 dB to 0 dB
4 Band Equalizer	Frequency= 20 Hz to 20 kHz
	Gain= -18 dB to +18 dB
	Q= 0.10 to 10.0
	Low Shelving (Low Band) High Shelving, LPF (High Band) Type I/Type II
Insert	Insert Point: Pre EQ/Pre Fader/Post On
Direct Out	Direct Out Point: Pre HPF/Pre EQ/Pre Fader/Post On

Function	Parameter
Dynamics 1	Type: Gate/Ducking/Comp/Expander
	Threshold= Gate: -72 dB to 0 dB Others: -54 dB to 0 dB
	Ratio= 1:1 to ∞:1
	Attack= 0 msec to 120 msec
	Hold= 48 kHz: 0.02 msec to 1.96 sec 44.1 kHz: 0.02 msec to 2.13 sec
	Decay= 48 kHz: 5 msec to 42.3 sec 44.1 kHz: 6 msec to 46.1 sec
	Release= 48 kHz: 5msec to 42.3 sec 44.1 kHz: 6 msec to 46.1 sec
	Range= Gate: -∞ dB to 0 dB Ducking: -70 dB to 0 dB
	Gain= 0.0 dB to +8dB
	Knee= Hard to 5 (soft)
Dynamics 2	Type: Comp/De-Esser/Compander H/Compander S
	Threshold= -54 dB to 0 dB
	Ratio= 1:1 to ∞:1 Compander: 1:1 to 20:1
	Attack= 0 msec to 120 msec
	Release= 48 kHz: 5 msec to 42.3 sec 44.1 kHz: 6 msec to 46.1 sec
	Gain= -18 dB to 0 dB, 0 dB to +18 dB
	Knee= Hard to 5 (soft)
	Key In: Self Pre EQ/Self Post EQ/Mix Out21-24 Ch1-STIN8R (8ch block)
	Width= 1 dB to 90 dB
	Frequency= 1.0 KHz to 12.5KHz
Fader	Type: HPF, BPF
	Q= 0.10 to 10.0
	Level: 1024 steps, ∞, -138 dB to +10 dB
	On/Off
	Position L63 to R63 Pan Mode: Pan/Balance
	16 Groups
	8 Groups
	24 sends
	Fix/Variable can be set each two mixes
	Mix Send Point: Pre EQ/Pre Fader/Post On
Mix Send	Level: 1024 steps, ∞, -138 dB to +10 dB
	8 Sends
Matrix Send	Matrix Send Point: Pre EQ/Pre Fader/Post On
	Level: 1024 steps, ∞, -138 dB to +10 dB
LCR Pan	CSR= 0% to 100%
DELAY	0 ms to 1000 msec

Output Function

Function	Parameter
Attenuator	-96 dB to 0 dB
4Band Equalizer	Frequency= 20 Hz to 20 kHz
	Gain= -18 dB to +18 dB
	Q= 0.10 to 10.0
	Low Shelving (Low Band) High Shelving, LPF (High Band) Type I/Type II
Insert	Insert Point: Pre EQ/Pre Fader/Post On
Dynamics 1	Type: Comp/Expander/Compander H/Compander S
	Threshold= -54 dB to 0 dB
	Ratio= 1:1 to ∞:1 Compander: 1:1 to 20:1
	Attack= 0 msec to 120 msec
	Release= 48 kHz: 5 msec to 42.3 sec 44.1 kHz: 6msec to 46.1 sec
	Gain= -18 dB to 0 dB, 0 dB to +18 dB
	Knee= Hard to 5 (soft)
Fader	Key In: Self Pre EQ/Self Post EQ/Mix Out21-24 MIX24/ MTRX1-8/STIN LR/MONO(C) (8ch block)
	Width= 1 dB to 90 dB
Level: 1024 steps, ∞, -138 dB to +10 dB	
On/Off	
Pan/Balance	Position L63 to R63
Mute Group	8 Groups
Mix to Matrix	Matrix Send Point: Pre Fader/Post On
Stereo to Matrix	Level: 1024 steps, ∞, -138 dB to +10 dB
Oscillator	Level= 0 to -96dB (1 dB step) On/Off= Software control

Output Port

Function	Parameter
Out Port Delay	0 msec to 1000 msec
Out Port Phase	Normal/Reverse
Gain	-96 to +24 dB

Processor

Function	Parameter
GEQ	31 bands x 16(24) or 15 bands x 32(48) systems
Effects	Stereo In/Stereo Out multi effector x 8 systems
Premium Rack Parameter	Stereo(Dual) In/Stereo(Dual) Out Premium Rack x 8 systems

Model: CL5/CL3/CL1 MIDI Implementation Chart Version: 1.0

Function...	Transmitted	Recognized	Remarks
Basic Channel Default Changed	1-16 1-16	1-16 1-16	Memorized
Mode Default Messages Altered	X X *****	1, 3 X X	Memorized
Note Number True Voice	0-127 X	0-127 X	
Velocity Note On Note Off	0 9nH, v=0,127 X	0 9nH, v=1-127 O	Effect Control
After Touch Key's Ch's	X X	X X	
Pitch Bend	X	X	
Control Change 0,32 6,38 98,99 1-31,33-95, 102-119	O O O O	O O O O	Bank Select Data Entry NRPN LSB,MSB Assignable Cntrl
Prog Change :True#	O 0-127 *****	O 0-127 0-300	Assignable
System Exclusive	O *1	O *1,*2	
Common :Song Pos. :Song Sel. :Tune	X X X	X O X	Recorder Control
System Real Time :Clock :Commands	X X	O X	Effect Control
Aux Messages :All Sound Off :Reset All Cntrls :Local ON/OFF :All Notes OFF :Active Sense :Reset	X X X X X X	X X X X O O	
Notes	*1 Bulk Dump/Request and Parameter Change/Request. *2 MMC		

Mode 1: OMNI ON, POLY
Mode 3: OMNI OFF, POLYMode 2: OMNI ON, MONO
Mode 4: OMNI OFF, MONOO: Yes
X: No

Index

A

Assignable encoders 172
 Functions that can be assigned 263
 Audio file (links to a scene recall) 94

C

Calibration function 207, 208, 209, 211
 Cascade connections 200
 Centralogic section 11
 Channel
 Copying, moving, initializing 73
 Channel color 29, 204, 211
 Channel library 45, 55
 Channel Link 70
 Channel name displays 204
 Console Lock 175
 Control Changes
 Control parameters 155
 Cue function 97, 101
 Operating 102
 Custom fader bank 173

D

Dante audio network 15, 213
 DAW 25
 DCA groups 64
 Directly outputting 23
 Dynamics 56, 59
 Libraries 63
 DYNAMICS Library List 228
 Dynamics Parameters 230

E

Effect 114
 Libraries 137
 Effect Type List 232
 Effects and tempo synchronization 247
 Effects Parameters 233
 Electrical characteristics 273
 EQ 56
 Libraries 63
 EQ Library List 227
 External device 21
 External head amp 138, 144

F

Factory set 206
 Fade function 91
 Focus function 87
 Function Tree 4

G

Gain 30
 Analog gain 30
 Digital gain 34
 Gain Compensation 34, 35
 Global Paste function 85
 GPI 221
 Graphic EQ 114
 Libraries 137
 Operations 118
 Grouping 64

H

HA (Head Amp) 30
 Help function 193
 Recalling 194
 Viewing 194

I

I/O device 138
 Initialize 206
 Input channels 27
 Channel library 45
 Channel name and icon 28
 Sending to MIX/MATRIX bus 39
 Sending to STEREO/MONO buses 35
 Input Delay 44
 Input patch 19
 Inserting 21
 Internal clock 204
 Internal effects 122

L

Lamps 204
 LEDs 204
 Linking 64

M

Master fader 174
 MATRIX buses 39, 51, 202
 MBCL meter bridge (optional) 113
 METER screen 111
 Meters 111
 MIDI 149
 MIDI Data Format 264
 MIDI Implementation Chart 275
 MIX buses 39, 202
 MIX channels
 Sending to MATRIX buses 51
 Sending to STEREO/MONO bus 48
 Mixer Basic Parameters 274
 Mixing parameter operation applicability .. 254
 Monitor function 97, 98
 Mute groups 64, 66

N

Network address 205
 NRPN parameter assignments 250
 Nuendo Live 188

O

Oscillator 106, 108
 Output channels 46
 Channel library 55
 Channel name and icon 47
 Output Delay 55
 Output patch 16
 OVERVIEW screen 12

P

Parameter Changes 157
 Parameters that can be assigned to
 control changes 248
 Patching 15
 Pink frame (TOUCH AND TURN) 171
 Preferences 168
 Premium Rack 130
 Libraries 137
 Premium Rack Processor Parameters 245
 Preview mode 96
 Program Changes 152

R

Recall Safe function 88
 Recall scenes 80, 152

S

Scene memory 77
 Editing 82
 Security 158
 SELECTED CHANNEL section 6
 SELECTED CHANNEL VIEW screen 7
 SETUP screen 196
 Slot 198
 STEREO/MONO buses 35, 48
 STEREO/MONO channels
 Sending to MATRIX buses 51

T

Talkback 106
 Title list 187
 TOUCH AND TURN 171
 Touch screen 204

U

USB flash drive
 Formatting 180
 Loading a file 178
 Loading a Help file 193
 Loading a text file 193
 Playing back audio files 185
 Recording audio 183
 Saving and loading setup data 177
 USB memory recorder 181
 USER DEFINED keys 169
 Functions that can be assigned 259
 Recalling Help 194
 USER DEFINED knobs 171
 Functions that can be assigned 262
 User Level settings 158

V

Virtual rack 114
 Operations 115

W

Warning/Error Messages 271
 Word clock 198



Yamaha Pro Audio Global Web Site
<http://www.yamahaproaudio.com/>
Yamaha Manual Library
<http://www.yamaha.co.jp/manual/>

C.S.G., Pro Audio Division
© 2012-2013 Yamaha Corporation

301IP-C0