

 Allied Telesis™

# Product Catalog

Issue 15 | 2015

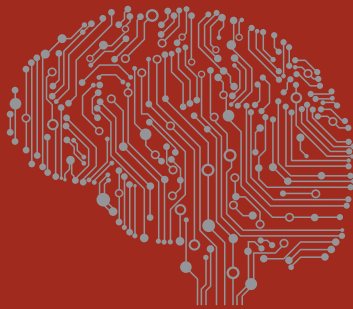



**NETWORK SMARTER™**

# Table of Contents

<b>SMARTER SOLUTIONS FOR A SMARTER WORLD .....</b>	<b>2</b>	<b>INTEGRATED MULTISERVICE ACCESS PLATFORM (iMAP) .....</b>	<b>37</b>
<b>SWITCHES .....</b>	<b>3</b>	Chassis .....	38
Allied Telesis Management Framework .....	4	Controller Cards .....	39
SwitchBlade x8100 Series .....	6	Channel Units .....	40
SwitchBlade x908 .....	8	<b>INTELLIGENT MULTISERVICE GATEWAYS (iMG) .....</b>	<b>41</b>
SwitchBlade x3100 Series .....	10	<b>MEDIA CONVERTERS .....</b>	<b>45</b>
Aggregation and Distribution .....	12	Standalone .....	46
Intelligent Edge .....	14	Industrial .....	48
CentreCOM Gigabit Edge .....	16	Mounting Hardware .....	48
CentreCOM Fast Ethernet Fiber Edge .....	17	Converteam .....	49
CentreCOM Fast Ethernet Copper Edge .....	18	Chassis-Based .....	50
WebSmart .....	20	<b>OPTICS .....</b>	<b>51</b>
Unmanaged .....	22	Pluggable Optics .....	52
Industrial Switches .....	24	Network Service Provider Optics .....	54
<b>SECURITY APPLIANCES .....</b>	<b>25</b>	<b>NICS .....</b>	<b>55</b>
Next-Generation Firewalls .....	26	Laptop NICs .....	56
Secure VPN Routers .....	28	Desktop/Workstation NICs .....	58
<b>WIRELESS .....</b>	<b>29</b>	Server NICs .....	60
Extricom Series WLAN Products .....	30	<b>NETWORK MANAGEMENT SOFTWARE .....</b>	<b>61</b>
CloudBlanket NMS .....	30	AlliedView NMS Enterprise Edition .....	62
Enterprise WLAN Switches .....	30	AlliedView NMS Service Provider Edition .....	63
UltraThin Access Points .....	31	<b>INDEX .....</b>	<b>65</b>
TQ and WR Series Access Points .....	32	<b>ENVIRONMENTAL POLICY .....</b>	<b>72</b>
UWC Controllers .....	33		
Wireless Accessories .....	34		
Antennas .....	36		

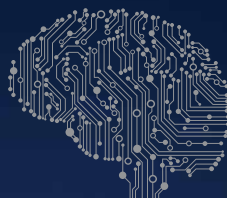

**NETWORK SMARTER**



# Smarter Solutions for a Smarter World

Our world is increasing in complexity. Organizations are changing at an ever-increasing rate. Businesses face an uphill battle to adapt to change, and to stay ahead of the competition. At the same time, our cities are increasingly becoming more populated; and with this growth, issues such as demand on resources and public safety become a key focus for government and civic leaders.

Not only do people expect instant access to an always-on network, but there is a rapidly increasing number of “things” that are being connected—devices that deliver information to enable smarter decisions to be made, improving the efficiency of organizations and cities, alike. Like people, these devices require instant access to an always-on network. Unlike people, these devices are a critical component of various services and infrastructure that must always be available.

Delivering reliable connectivity for everything from enterprise organizations to complex, critical infrastructure projects is not a trivial task. Ensuring new services can be deployed quickly, that changes can be made simply, and that the network “just works” requires intelligent technology from the edge to the core. Technology that delivers value and reduces operational expenditure, allowing more to be done with less. That superior technology has made Allied Telesis the default standard for many organizations around the world today.

Allied Telesis has engineered advanced networking products and technologies for more than a quarter of a century. Our solutions-based philosophy of producing products that deliver value to our customers, together with extensive service and support, has resulted in Allied Telesis solutions being deployed globally—in organizations of all types and sizes. With a portfolio of products and technologies providing end-to-end networking solutions for enterprise, government, service provider, and critical infrastructure customers, Allied Telesis is the smarter choice.

As a major networking industry manufacturer, Allied Telesis is committed to providing our customers with solutions designed and built to the highest standards and quality. Our manufacturing conforms to ISO 9001 standards and all of our facilities adhere to the strict ISO 14001 standard to ensure a healthier planet.

As a leading provider of networking solutions, Allied Telesis enables reliable and efficient delivery of a broad variety of services over a single, unified network, meeting the demands of today’s organizations, both now and into the future. We are committed to innovating the way in which services and applications are delivered and managed, resulting in smarter solutions, delivering increased value and lower operating costs.

## NETWORK SMARTER



# Switches

[alliedtelesis.com/switches](http://alliedtelesis.com/switches)

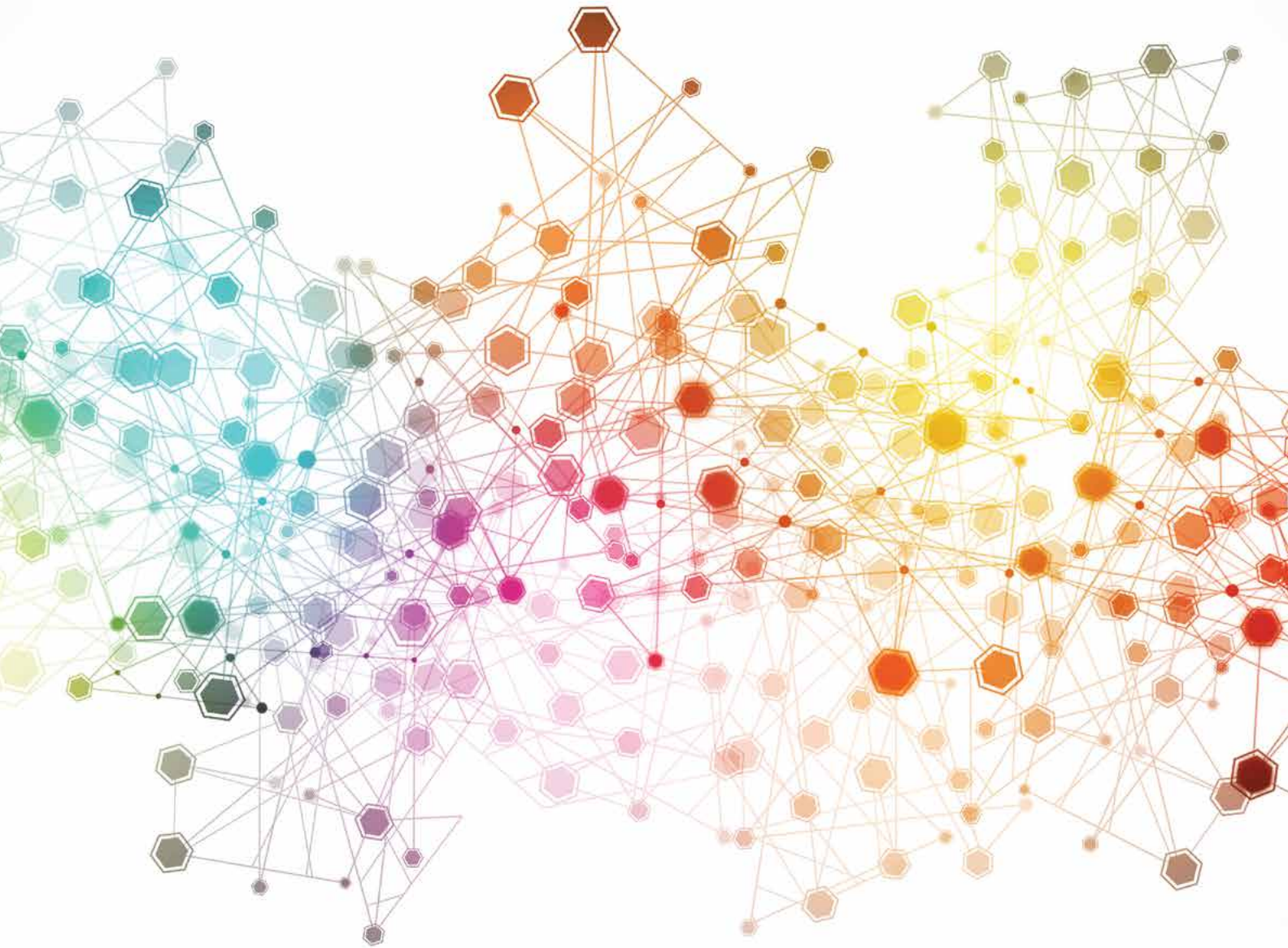

Allied Telesis engineers high-performance, high-quality, future-proof products to meet requirements for Enterprise, campus, branch, and private cloud networks of various sizes. Allied Telesis SwitchBlade® and xSeries switches, with the AlliedWare Plus™ operating system, provide scalable and versatile switching solutions for today's enterprise and service provider networks from edge to core. These switches, featuring Allied Telesis Management Framework™ (AMF), decrease network operating expenses by automating and simplifying many day-to-day tasks. Allied Telesis also produces top-of-rack switches for the enterprise data center market, extended temperature products for industry, and unmanaged and WebSmart switches for small and medium business.

## ALLIED TELESIS MANAGEMENT FRAMEWORK

# A Simple, Powerful, Cost-Effective Solution

AMF uses innovative and unique technology to deliver all the benefits of SDN centralized management, but without the complexity and cost. Reducing network running costs by automating and simplifying many day-to-day tasks, AMF allows skilled staff to be better utilized.

## Save time and reduce costs by up to 60% with AMF

**CENTRALIZED MANAGEMENT** Manage the entire network as a single virtual device.

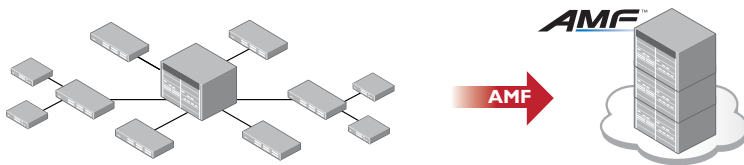

**AUTO-BACKUP** Automatically backup the entire network daily for peace-of-mind networking.

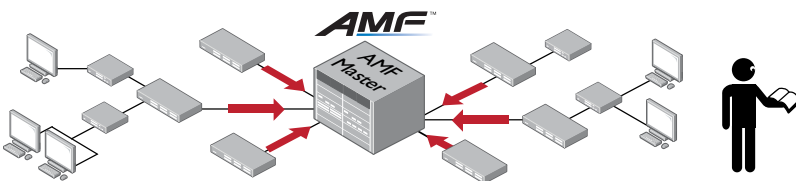

**AUTO-UPGRADE** Upgrade the network with a single command.

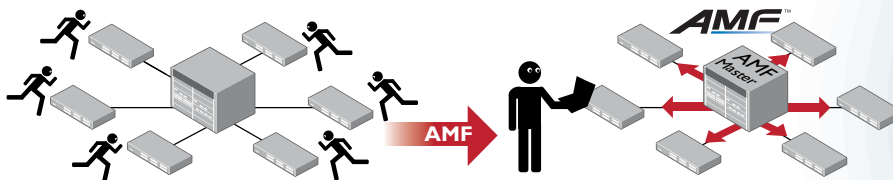

**AUTO-PROVISIONING AND AUTO-RECOVERY** Plug-and-Play additions or replacements.

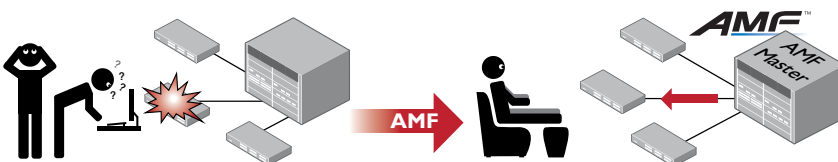

### Save Time. Save Money.

A significant amount of time, and therefore cost, is spent by highly skilled network engineers, performing mundane or repetitive tasks on a daily basis. These tasks include installing new or replacement network devices, upgrading configurations or firmware, and making configuration changes across multiple devices. With AMF, configured devices can be added directly into the network and device configuration can be managed automatically without requiring significant time from skilled engineers.

### Eliminate the Chore of Configuration Management

Research consistently shows that network configuration management is arduous and error-prone. Significant time and effort is expended on ensuring that the latest configuration changes are stored safely. AMF reduces effort and the risk of errors by managing the configurations for all devices in the network automatically.

### AMF Benefits

Enabling AMF in a network unlocks the following benefits:

- Plug-and-Play addition of new switches to a network
- Plug-and-Play replacement of failed switches
- Simultaneous configuration of multiple switches
- Automated roll out of software upgrades across a network
- Automated backup of configuration and operating system images from all nodes in a network
- AMF provides powerful network management automation, and is built right in to the AlliedWare Plus Operating System

## Efficiency

If there are multiple sites in a company, especially sites a long distance from the center site such as in nationwide or worldwide companies, skilled IT engineers must be placed at each local site. This requires network operations to develop multiple networking policies and complex network designs, which result in expensive networking costs. To address these issues, AMF achieves consistent network policy and design and then reduces networking costs. As a result, IT resources are effectively allocated to optimize your IT strategy.

## AMF for Large Networks

AMF is a proven solution for saving time and reducing costs by automating many everyday network management tasks. The new AMF Controller allows the benefits of AMF to be applied to much larger networks, multiplying the time and cost savings.

### Products Featuring AMF

- AMF Master or Member**
  - ▶ **SwitchBlade x8100 Series**  
Core Chassis Switches
  - ▶ **SwitchBlade x908**  
8-slot Core Chassis Switch
  - ▶ **x930 Series** COMING SOON  
Advanced Core Switches
- AMF Member**
  - ▶ **x900 Series**  
Advanced Layer 3 Switches
  - ▶ **x610 Series**  
Advanced Layer 3 switches
  - ▶ **AT-DC2552XS/L3** NEW  
High-Performance Aggregation Switch
  - ▶ **x510 Series**  
Intelligent Stackable Edge Switches
- ▶ **x310 Series**  
Fast Ethernet Intelligent Stackable Access Switches
- ▶ **x230 Series**  
Gigabit Intelligent PoE Access Switches
- ▶ **x210 Series**  
Gigabit Intelligent Access Switches
- ▶ **GS900MX Series** COMING SOON  
Stackable Gigabit Edge Switches
- ▶ **AT-AR4050S** COMING SOON  
High-Performance Next-Generation Firewall
- ▶ **AT-AR3050S** COMING SOON  
Next-Generation Firewall
- ▶ **AT-TQ4600** COMING SOON  
Enterprise-Class Wireless Access Point

A single AMF Master can support up to 120 devices, which is ideal for small- to medium-sized Enterprise networks. For larger networks, the AMF Controller

extends the benefits of AMF to more than 7,000 devices, even across different locations in different time zones.

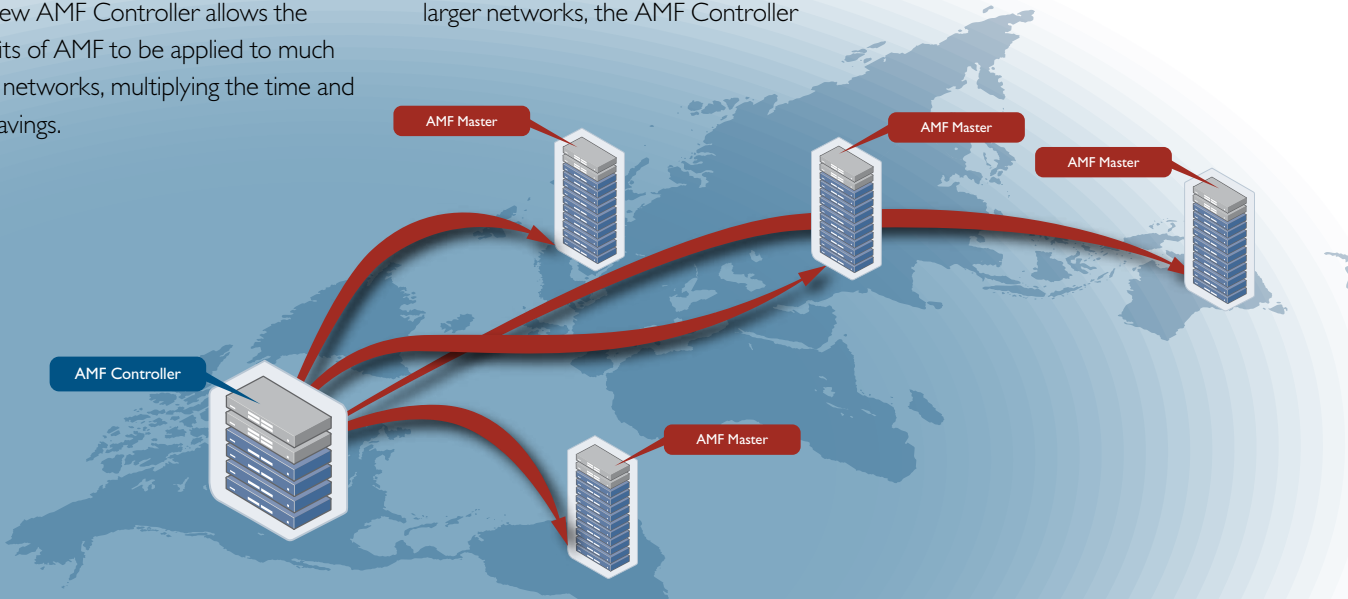

## Unified Network Management

It takes only two steps to unify the management of an entire network:

### Step 1

Install an AMF Master license to unify management of the LAN and WAN devices



### Step 2

Install a Wireless Manager license to unify the management of wireless access points with wired network devices

Now management of the entire wired and wireless network is unified under a single AMF Master for increased efficiency and cost reduction.

# SwitchBlade® x8100 Series

[alliedtelesis.com/switches/sbx8100](http://alliedtelesis.com/switches/sbx8100)

## CORE CHASSIS SWITCHES



SwitchBlade x8100 Series core chassis switches are primarily engineered for medium to large enterprise networks — but are equally at home in the enterprise data center. They are designed to deliver high availability, maximum performance, future scalability, and high port count in compact, eco-friendly packages.

### Advanced Operating System

The SwitchBlade x8100 Series features the AlliedWare Plus operating system, providing users with advanced Layer 3 functionality and an industry-standard Command Line Interface (CLI).

**AlliedWare Plus™**  
OPERATING SYSTEM

### High Availability Architecture

The SwitchBlade x8100 Series is designed to deliver high availability for mission-critical applications found in data centers, hospitality, government, and financial institutions. Dual redundant control/fabric modules inter-connecting through redundant paths to all the line cards ensure continuous operation even in the event of a fabric failure or a firmware upgrade. Dual redundant power supplies ensure maximum system up-time, while two PoE power supplies ensure continuous power to the endpoints.

### Small Physical Size

The SwitchBlade x8112 packs up to 400 Gigabit or up to 120 10G Ethernet ports into a single, compact 7RU-high chassis.

The 6-slot SwitchBlade x8106 chassis is the ultimate choice in compact flexibility. It is designed to provide high-density Gigabit or 10 Gigabit connectivity in 4RU and has the same high availability architecture as the SwitchBlade x8112.

### Scalable Architecture

The SwitchBlade x8100 Series guarantees performance for medium and large network core solutions.

With CFC960 control cards, two chassis can be stacked together into a single virtual unit using VCStack Plus.™ This creates a powerful and completely resilient network core, which can even be distributed over long distance.

### In-Service Software Upgrade (ISSU)

In-Service Software Upgrade (ISSU) increases network uptime by enabling a customer to upgrade the software running on their chassis without disrupting network traffic. This means that upgrades and maintenance tasks can be completed without having to schedule an outage. ISSU can be used on any SwitchBlade x8100 system with two AT-SBx81CFC960 controller cards installed, and is compatible with VCStack Plus so that software upgrades can be performed hitlessly across two chassis to further reduce downtime.

### Wireless Manager

An intelligent, unified wireless network control system is essential for reducing operational expenditure because it provides the ability to manage infrastructure, security, mobility, and

services from one central location — with many of these being updated automatically in real time.

The Allied Telesis Wireless Manager has been designed specifically to meet the requirements of enterprise organizations and addresses key concerns about mobility, security, and TCO. The Wireless Manager is embedded within the operating system of the switch so no separate server is required. It is able to control a number of Allied Telesis TQ Series wireless access points and can centralize the provisioning, operation, administration, and maintenance for the entire enterprise wireless infrastructure, thereby reducing TCO and improving the user experience.



## SwitchBlade x8100 Series Components

- ▶ **AT-SBx8106**  
Rackmount 6-slot chassis including fan tray
- ▶ **AT-SBx8112**  
Rackmount 12-slot chassis including fan tray
- ▶ **AT-SBx81CFC400**  
Control/fabric module with 400Gbps of switching performance
- ▶ **AT-SBx81CFC960**  
Control/fabric module with 960Gbps of switching performance and 4-port 10GbE SFP+
- ▶ **AT-SBx81XS6**  
6-port 10GbE SFP+ Ethernet line card
- ▶ **AT-SBx81XS16**  
16-port 10GbE SFP+ Ethernet line card
- ▶ **AT-SBx81GT24**  
24-port 10/100/1000T Ethernet line card
- ▶ **AT-SBx81GT40**  
40-port 10/100/1000T RJ point five Ethernet line card
- ▶ **AT-SBx81GP24** **PoE+**  
24-port 10/100/1000T PoE+ Ethernet line card
- ▶ **AT-SBx81GS24a**  
24-port SFP Ethernet line card
- ▶ **AT-SBxPWRSYS1**  
1200W AC system power supply
- ▶ **AT-SBxPWRSYS1-80**  
1200W DC system power supply
- ▶ **AT-SBxPWRPOE1** **PoE**  
1200W AC PoE power supply
- ▶ **AT-FL-CFC400-01**  
Premium feature license for CFC400
- ▶ **AT-FL-CFC960-01**  
Premium feature license for CFC960
- ▶ **AT-FL-CF9-VCSPLUS**  
VCStack Plus license for CFC960
- ▶ **AT-FL-CF4-AM40**  
AMF Master License up to 40 nodes
- ▶ **AT-FL-CF4-AM80**  
AMF Master License up to 80 nodes
- ▶ **AT-FL-CF9-AM40**  
AMF Master License up to 40 nodes
- ▶ **AT-FL-CF9-AM80**  
AMF Master License up to 80 nodes
- ▶ **AT-FL-CF9-AM120**  
AMF Master License up to 120 nodes

### Unified Management for Large Networks

Managing wired and wireless networks has traditionally required separate management tools running on separate platforms. In addition, management of large distributed networks increases complexity and can lead to differences in policy as local administrators make decisions in isolation. The Allied Telesis SwitchBlade x8100 has the capability to manage large-scale wired and wireless networks on a single platform to reduce complexity and increase administrative consistency.

The Allied Telesis Management Framework (AMF) is the key to unifying network management. It saves time and reduces costs by automating many everyday network management tasks. A single AMF Master can support a network of up to 120 devices; however this number of devices can be dramatically increased by installing the AMF Controller, which enables multiple AMF Masters to be managed from a single point. With the AMF Controller, a network of over 7,000 devices can be managed, allowing all the time saving, cost reducing benefits of AMF to be multiplied and efficiencies to be increased.



To add even more benefits, AMF can be combined with the Wireless Manager to reduce the burden of managing, upgrading, and troubleshooting both wired and wireless networks, which further reduces costs and improves service levels across the entire network.

#### Licenses available for SwitchBlade x8100 controller cards

CONTROLLER CARD	AMF MASTER	AMF CONTROLLER	WIRELESS MANAGER
<b>AT-SBx81CFC400</b>	AT-FL-CF4-AM40 AT-FL-CF4-AM80	n/a	n/a
<b>AT-SBx81CFC960</b>	AT-FL-CF9-AM40 AT-FL-CF9-AM80 AT-FL-CF9-AM120	AT-FL-CF9-AC10 AT-FL-CF9-AC30 AT-FL-CF9-AC60	AT-FL-CF9-WM40 AT-FL-CF9-WM80 AT-FL-CF9-WM120

FEATURES	AT-SBx8112	AT-SBx8106	
<b>FORM FACTOR</b>	Rackmount		
<b>SWITCH FUNCTIONALITY</b>	Advanced Layer 3		
<b>CONTROLLER CARD</b>	AT-SBx81CFC400 AT-SBx81CFC960		
<b>CHASSIS MODULE SLOTS</b>	12	6	
<b>LINE CARD SLOTS</b>	10	4 (5 with one CFC)	
<b>CARDS/MODULES</b>	10/100/1000T ports	24 × RJ-45 (AT-SBx81GT24) 24 × PoE+ (AT-SBx81GP24) 40 × RJ point five (AT-SBx81GT40)	
	100/1000X SFP ports	24 × SFP (AT-SBx81GS24a)	
	10G ports	6 × 10G SFP+ (AT-SBx81XS6) 16 × 10G SFP+ (AT-SBx81XS16)	
	PSU type	Dual system hot-swappable internal Dual PoE+ hot-swappable internal	
<b>POWER SUPPLY</b>	-48VDC PSU option	■	
	Additional PSU	AT-SBxPWRSYS1 / AT-SBxPWRPOE1	
<b>POWER OVER ETHERNET</b>	IEEE 802.3at (PoE+)	■	
	PoE+ enabled ports	240	120
	Max PoE+ power	2400W	
	Max full power ports (boost power)	80	
<b>ENVIRONMENTAL</b>	Cooling	Hot-swappable fan tray	
	Temperature range	0°C to 40°C	
<b>MANAGEMENT</b>	Web GUI	■	
	CLI / Telnet / SNMP	■	
	IPv6 management	■	
	DHCPv4 / v6 server	■	
	AMF Master	■	
	AMF Controller	■ (AT-SBx81CFC960 only)	
	Wireless Manager	■ (AT-SBx81CFC960 only)	
<b>NETWORK RESILIENCE</b>	Spanning Tree	■	
	Link Aggregation (LACP)	■	
	EPSRing	■	
	VCStack Plus	■ (AT-SBx81CFC960 only)	
	ISSU	■ (AT-SBx81CFC960 only)	
<b>QoS</b>	VRRPv3	■	
	IEEE 802.1p priority queues	8	
<b>SECURITY</b>	IEEE 802.1Q VLANs	4096	
	RADIUS / TACACS+	■	
	SSH / SSL	■	
	IEEE 802.1x	■	
	DoS protection	■	
	DHCP snooping	■	
	Static routes v4 / v6	■	
	RIP / RIPng	■	
<b>ROUTING</b>	OSPFv2 / v3	■	
	VRF Lite	■ (AT-SBx81CFC960 only)	
	BGP4 / BGP4+	■	
	IGMPv1 / v2 / v3	■	
<b>MULTICASTING</b>	MLDv1 / v2	■	
	PIMv4 / PIMv6	■	
	PIM-SSM	■	

# SwitchBlade® x908

alliedtelesis.com/switches/sbx908

## ADVANCED LAYER 3 MODULAR COMPACT SWITCH

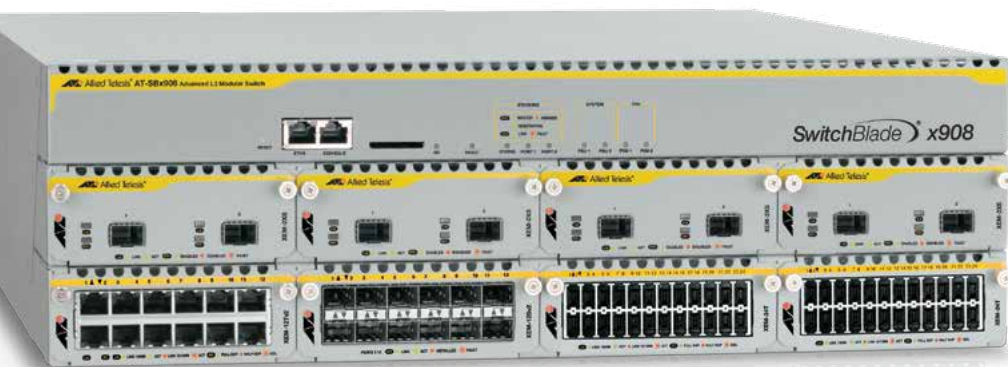

### Advanced Operating System

The SwitchBlade x908 features the AlliedWare Plus operating system, which combines superior networking functionality and strong management



capabilities with the exceptional performance that today's networks demand. As a standards-based implementation, it also assures full interoperability with other major network equipment, and features enhanced usability for a superior customer experience.

### Virtual Chassis Stacking (VCStack)

VCStack™ provides excellent resiliency by creating a single “virtual chassis” from two SwitchBlade x908 physical devices, using dedicated high-speed stacking links. VCStack provides a highly available system where network resources are spread out across stacked units, reducing the impact should one of the stacked units fail. Switch ports may be aggregated on different units, for high availability. VCStack delivers a resilient solution at a fraction of the cost of a full chassis-based system, and the stack may be managed as a single network node, greatly simplifying management tasks.



### Active-Active Architecture

The Active-Active architecture allows two SwitchBlade x908 chassis to be inter-connected via a passive 160Gbps rear panel connector, allowing the two switches to communicate. This architecture ensures that edge devices, which are connected to both switches, can continue to operate even in the event of a single SwitchBlade x908 failure. This architecture, unlike some competitive Active-Redundant architectures, ensures users achieve the full 100% utilization of their purchased network components for the maximum time, thus decreasing Total Cost of Ownership (TCO).

### Ethernet Protection Switched Rings (EPSRing)

The use of the SwitchBlade x908, in conjunction with other EPSRing-enabled devices, provides a 10Gbps high-bandwidth resilient ring backbone capable of providing sub 50ms failover. This architecture is perfect for the backbone core of any enterprise or service provider network, as it allows nearly hit-free networking to be accomplished, and is suitable for the delivery of voice, video, and data.



The SwitchBlade x908 8-slot industry-leading modular compact switch is the ideal solution for the small to medium modern enterprise network core where reliability, resiliency, and high performance are the key requirements.

### Allied Telesis Management Framework (AMF)

AMF is a sophisticated suite of management tools that simplifies network management. The SwitchBlade x908 can act as an AMF Master (license required), to control a network of AMF nodes and provide a central point for network management and configuration backups.



### High Availability

The SwitchBlade x908 was designed with reliability in mind. With dual power supplies, fan modules, and a comprehensive range of expansion modules (XEMs) — all hot-swappable — the network can be maintained and reconfigured when necessary without affecting uptime.

### Scalable

The SwitchBlade x908 supports up to eight XEM expansion modules, allowing the user to change the configuration of his network as needed. Each SwitchBlade x908 can support up to 192 Gigabit ports or up to 16 × 10GbE ports, while stacking two chassis, to build a resilient core that doubles the number of ports.



## SwitchBlade x908 Components

- ▶ **AT-SBx908**  
Rackmount 8-Slot Chassis Including Fan Module
- ▶ **AT-XEM-2XS**  
2-Port 10GbE SFP+ Expansion Module
- ▶ **AT-XEM-2XP**  
2-Port 10GbE XFP Expansion Module
- ▶ **AT-XEM-2XT**  
2-Port 10GbE Expansion Module
- ▶ **AT-XEM-12S** and **AT-XEM-12Sv2**  
12-Port SFP Expansion Module
- ▶ **AT-XEM-12T** and **AT-XEM-12Tv2**  
12-Port 10/100/1000T Expansion Module
- ▶ **AT-XEM-24T**  
24-Port 10/100/1000T RJ point five Expansion Module
- ▶ **AT-PWR05**  
AC Load Sharing System Power Supply
- ▶ **AT-PWR05-80**  
DC Load Sharing System Power Supply
- ▶ **AT-HS-STK-CBL**  
650 mm High Speed Stacking Cable
- ▶ **AT-FAN03**  
Spare Fan Module
- ▶ **AT-FL-SBx9-01**  
Advanced Layer 3 Feature License
- ▶ **AT-FL-SBx9-02**  
IPv6 Feature License
- ▶ **AT-FL-SBx9-AM40**  
AMF Master License for up to 40 Nodes
- ▶ **AT-FL-SBx9-WM20**  
Wireless Manager for up to 20 APs
- ▶ **AT-UTP/RJ.5-100-A-008**  
RJ point five to RJ-45 1 m Ethernet cables (pack of 8)
- ▶ **AT-UTP/RJ.5-300-A-008**  
RJ point five to RJ-45 3 m Ethernet cables (pack of 8)



Allied Telesis delivers increased port density with the addition of the latest Ethernet connectivity technology, RJ point five. These half-size copper Gigabit port connectors allow twice the port density of the current RJ-45 standard connectors, ideal for the aggregation of large numbers of Gigabit links.

### Enterprise Applications

The SwitchBlade x908 is the ideal Enterprise switch for small- to medium-sized network installations, but is also at home in larger distributed campus-type networks, when individual switches are connected using EPSRing technology.

### MEF Certified

The SwitchBlade x908 has been certified by the Metro Ethernet Forum (MEF) certification program, which tests products for conformance to the strict requirements of carrier Ethernet. Compliance with this certification makes the deployment of this chassis a much easier option for Network Service Providers (NSPs).



### Small Physical Size

The SwitchBlade x908 packs a remarkable amount of networking performance into a small, 3RU-high box. Taking up no more rack space than three simple “pizza box” switches, the SwitchBlade x908 provides users with unrivaled reliability and flexibility.

FEATURES		AT-SBx908
<b>FORM FACTOR</b>		Rackmount / stack
<b>SWITCH FUNCTIONALITY</b>		Advanced Layer 3
<b>CHASSIS MODULE SLOTS</b>		8
<b>CARDS/MODULES</b>	10/100/1000T ports	12 × RJ-45 (AT-XEM-12T) 12 × RJ-45 (AT-XEM-12Tv2) 24 × RJ point five (AT-XEM-24T)
	100/1000X SFP ports	12 × 100/1000X SFP (AT-XEM-12S) 12 × 1000X SFP (AT-XEM-12Sv2)
	10G ports	2 × 10G XFP (AT-XEM-2XP) 2 × 10G SFP+ (AT-XEM-2XS) 2 × 10G RJ-45 (AT-XEM-2XT)
<b>POWER SUPPLY</b>	PSU type	Dual hot-swappable internal
	-48VDC PSU option Additional PSU	■ AT-PWR05
<b>SCALABILITY</b>	MAC address table size	16K / 64K
	Stacking (VCStack)	■ (2)
	Stacking bandwidth	160G
<b>ENVIRONMENTAL</b>	Cooling	Hot-swappable fan modules
	Temperature range	0°C to 40°C
<b>MANAGEMENT</b>	Web GUI	■
	CLI / Telnet / SNMP	■
	IPv6 management	■
	DHCPv4 / v6 server	■
	Allied Telesis Management Framework (AMF)	■
	Wireless Manager	■
<b>NETWORK RESILIENCE</b>	Spanning Tree	■
	Link aggregation (LACP)	■
	EPSRing	■
<b>QoS</b>	VRRPv3	■
	IEEE 802.1p priority queues	8
<b>SECURITY</b>	IEEE 802.1Q VLANs	4096
	RADIUS / TACACS+	■
	SSH / SSL	■
	IEEE 802.1x	■
	DoS protection	■
	DHCP snooping	■
	Static routes v4 / v6	■
<b>ROUTING</b>	RIP / RIPng	■
	OSPFv2 / v3	■
	BGP4 / BGP4+	■
	Policy-based routing	■
	VRF Lite	■
<b>MULTICASTING</b>	IGMPv1 / v2 / v3	■
	MLDv1 / v2	■
	PIMv4 / PIMv6	■
	PIM-SSM	■

# SwitchBlade® x3100 Series

alliedtelesis.com/switches/sbx3100

## ACCESS EDGE CHASSIS SWITCHES

The SwitchBlade x3100 Series access edge chassis switch is available in either a 12- or 6-slot version and primarily targeted for service provider fiber access networks. Equally at home in the enterprise network edge or in the data center, the switch is designed to deliver high availability and maximum performance with a wirespeed non-blocking backplane and high port count.

### FTTx Service Provider Applications

The SwitchBlade x3100 is a versatile, carrier-class FTTx platform for delivering Gigabit services to residential, Multi-Dwelling Unit (MDU) and business customers in the last mile. It features redundant power supplies, controllers, and WAN ports to ensure reliability standards in carrier networks are met, along with powerful sub-50 millisecond failover protection using EPSRing for link level protection. The Series is available with AC or DC power options.

As a FTTx platform, the SwitchBlade x3100 can support a maximum of 400 ports (12-slot chassis) or 160 ports (6-slot

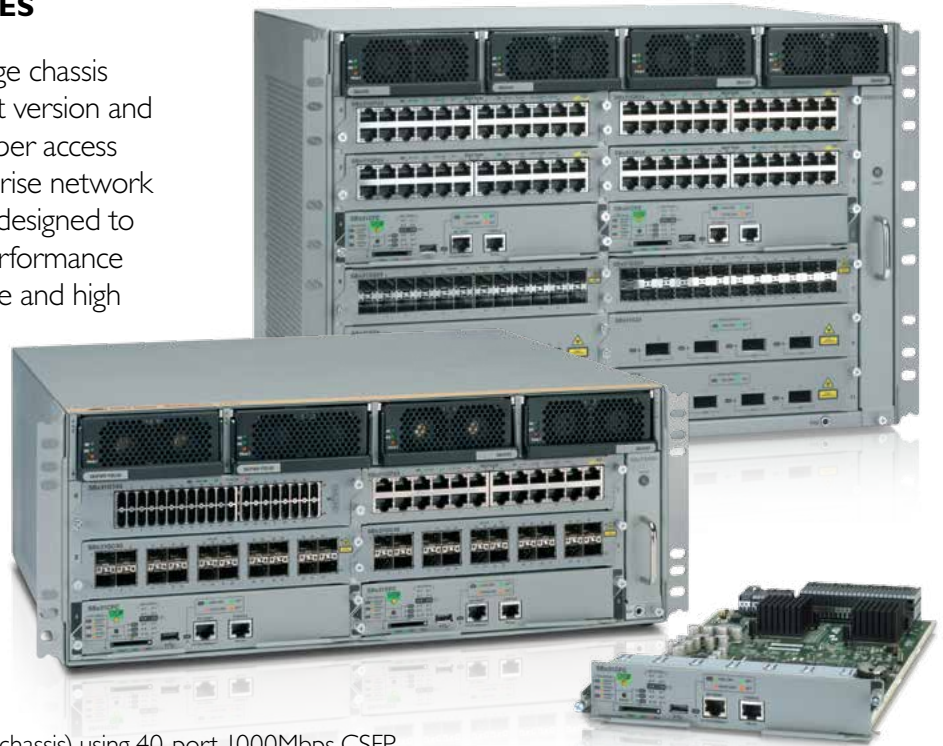

chassis) using 40-port 1000Mbps CSFP-based line cards (AT-SBx31GC40). It can also support redundant 10G uplinks using 4 ports on the CFC960 or 6-port SFP+-based line cards (AT-SBx31XS6). Both the CFC and the line card support LAG and EPSR on uplinks when used as transport. The SwitchBlade x3100 can act as an aggregation hub for last-mile

FTTx applications using 10G line cards. It features 80 Gigabit non-blocking throughput to each slot, thus providing a maximum level of performance for FTTx services, both 1G and 10G. Coupled with ultra-fast 960G central fabric controllers (AT-SBx31CFC960), FTTx services can operate at wirespeed connectivity.

FEATURES	AT-SBx3112 AT-SBx3106	AT-SBx3112-96POE+	AT-SBx3112-8XR	AT-SBx3112-12XS	AT-SBx3112-6XS	AT-SBx3112-B01-80
<b>PRODUCT</b>	Chassis with fan tray	Chassis bundle	Chassis bundle	Chassis bundle	Chassis bundle	Chassis bundle
<b>SWITCH FUNCTIONALITY</b>	Layer 2+	Layer 2+	Layer 2+	Layer 2+	Layer 2+	Layer 2+
<b>ACCESSORIES</b>	Controller Fabric Card (CFC) 24 × 10/100/1000T PoE+ 4 × XFP (10GbE) 6 × SFP+ (10GbE) System power supply PoE power supply Fan tray	1 × AT-SBx31CFC960 or 400 4 × AT-SBx31GP24	2 × AT-SBx31CFC960 or 400 2 × AT-SBx31XZ4	2 × AT-SBx31CFC960 or 400 2 × AT-SBx31XS6	1 × AT-SBx31CFC960 or 400 1 × AT-SBx31XS6	2 × AT-SBx31CFC960 2 × AT-SBxPWRSYS1 1 × AT-SBxPWRPOE1 1 × AT-SBx31FAN
<b>POWER SUPPLY</b>	PSU type -48VDC PSU option	Dual internal hot-swap ■	Dual internal hot-swap ■	Dual internal hot-swap ■	Dual internal hot-swap ■	Dual internal hot-swap ■ 2 × AT-SBxPWRSYS1-80
<b>POWER OVER ETHERNET</b>	IEEE 802.3at Class 4 and 802.3af Class 3 Max PoE-enabled ports (per chassis) Max IEEE 802.3at ports (per chassis) Max IEEE 802.3af ports (per chassis) Mode	■ 96 80 200 A	■ 96 80 200 A	■ 96 80 200 A	■ 96 80 200 A	■ 96 80 200 A
<b>ENVIRONMENTAL</b>	Cooling Temperature range	Hot-swappable fan tray 0°C to 40°C	Hot-swappable fan tray 0°C to 40°C	Hot-swappable fan tray 0°C to 40°C	Hot-swappable fan tray 0°C to 40°C	Hot-swappable fan tray 0°C to 40°C
<b>MANAGEMENT</b>	CLI / Telnet / SNMP / NMS	■	■	■	■	■
<b>NETWORK RESILIENCE</b>	Spanning Tree Link aggregation (LACP) EPSRing	■ ■ ■	■ ■ ■	■ ■ ■	■ ■ ■	■ ■ ■
<b>QoS</b>	IEEE 802.1p priority queues	8	8	8	8	8
<b>SECURITY</b>	IEEE 802.1Q VLANs VLAN double tagging (Q-in-Q) RADIUS / TACACS+ / SSH	4K ■ ■	4K ■ ■	4K ■ ■	4K ■ ■	4K ■ ■



SwitchBlade x3112 Channel Units

FEATURES		AT-SBx31GP24	AT-SBx31GT24	AT-SBx31GT40	AT-SBx31GS24	AT-SBx31GC40
<b>COPPER</b>	10/100/1000T or 10/100/1000T plus PoE+ 10/100/1000T	24	24	40		
<b>FIBER</b>	100MB / 1 Gigabit SFP 1 Gigabit CSFP / SFP				24	40/20

FEATURES		AT-SBx3106	AT-SBx3112
<b>POWER SUPPLY</b>	AC		AT-SBxPWRSYS1-10
	DC		AT-SBxPWRSYS1-80
	PoE		AT-SBxPWRPOE1-10
<b>CENTRAL FABRIC CONTROL</b>	Primary		AT-SBx31CFC960
	Secondary		AT-SBx31CFC960
<b>UPLINK AND TRANSPORT</b>	Slots	4	8
	Number of ports	32 – SFP+	4 – SFP+
	Port speed	10Gbps	
<b>CHANNEL UNIT SLOTS</b>	FTTx	4	8
	Ethernet	160	320
<b>TEMPERATURE RANGE</b>		0°C to 40°C	

An evolution of the Allied Telesis tried and tested iMAP carrier-grade platform, the SwitchBlade x3100 delivers true IP Triple Play services such as IPTV, VoIP, Tiered High Speed Internet Access (HSIA), and other cloud-based services such as Over-the-Top video, remote storage and backup, and cloud computing.

Raw performance combined with high availability also allows it to be deployed as both end-of-row and aggregation in data center applications, and in campus applications as the ultimate in network edge connectivity.

### High-Availability Architecture

The SwitchBlade x3100 is designed to deliver 99.999% reliability, while offering high availability with sub-millisecond hitless failover for mission-critical applications where uptime is essential such as data centers, hospitality, government, financial institutions, and medical institutions.

Dual redundant management/fabric modules inter-connecting through

redundant paths to the line cards over a passive backplane, and dual redundant power options, ensure maximum system up-time. Power is delivered via up to two system power supplies and two Power over Ethernet supplies to ensure continual operation.

### Power over Ethernet Plus (PoE+)

The SwitchBlade x3100 supports IEEE 802.3at PoE+ (30W) to enable customers to future-proof their networks. PoE+ provides greater power for applications such as IP surveillance cameras supporting Pan, Tilt, and Zoom, IP video phones, RFID readers, Point-of-Sale, or wireless access points.



### Secure Management

Only authorized administrators can access the management interface of the SwitchBlade x3100. Protocols such as SSH provide an encrypted interface for both local and remote connections, with out-of-band management achieved through a dedicated Gigabit port if required.

### Securing the Network Edge

To ensure the protection of the data, it is important to control access to the network. Protocols such as IEEE 802.1x authentication guarantee that only known users are connected to the network. Unknown users who physically connect can be isolated to a predetermined part of the network, offering guests such benefits as Internet access while ensuring the integrity of private network data.

### Secure Differentiation

QoS schemes for SwitchBlade x3100 access solutions are designed to ensure that application performance and availability are not impacted with network growth. Features such as IEEE 802.1p/Q enable tiered data services for residential, business, and enterprise users to prioritize real-time applications such as IP phones and IP cameras.

### Environmentally Friendly

In keeping with the Allied Telesis commitment to environmentally friendly processes and products, the SwitchBlade x3100 is designed to reduce power consumption and minimize hazardous waste. Features include the use of high-efficiency power supplies and low-power chip sets. The switches also include an eco-friendly button on the front panel, allowing conservation of additional power by turning off all diagnostic LED indicators when they are not required.



# Aggregation and Distribution

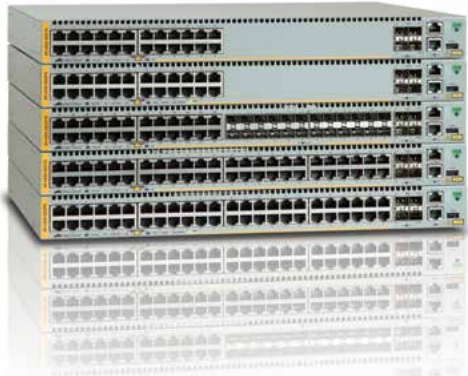

## x930 Series

Allied Telesis x930 Series switches are a high-performing and feature-rich choice for today's networks. With a range of 24- and 48-port models with 10 Gigabit uplink ports, the option of PoE+, and the power of Allied Telesis Virtual Chassis Stacking (VCStack), the x930 Series has the flexibility and performance for demanding aggregation and distribution applications.



FEATURES	AT-DC2552XS/L3	AT-x930-28GTX AT-x930-28GPX	AT-x930-28GTX	AT-x930-52GTX AT-x930-52GPX	AT-x900-12XT/S	
<b>FORM FACTOR</b>	Desktop / rackmount / stack	Desktop / rackmount / stack	Desktop / rackmount / stack	Desktop / rackmount / stack	Desktop / rackmount / stack	
<b>SWITCH FUNCTIONALITY</b>	Advanced Layer 3	Advanced Layer 3	Advanced Layer 3	Advanced Layer 3	Advanced Layer 3	
<b>PORTS AND MEDIA SUPPORT</b>	10/100/1000T ports	24	24 combo	48	12 combo	
	100/1000X SFP ports		24 combo		12 combo	
	1G/10G SFP+ ports	48	4	4	4	2 (AT-XEM-2XS 10G only)
	10G RJ-45 copper ports					2 (AT-XEM-2XT)
	40G QSFP+ ports	4 (future software release)	2 (AT-StackQS) (future software release)	2 (AT-StackQS) (future software release)	2 (AT-StackQS) (future software release)	
Expansion module bays		1	1	1	1	
<b>POWER SUPPLY</b>	PSU type	Dual internal hotswap	Dual internal hotswap	Dual internal hotswap	Fixed internal	
	-48VDC PSU option		■ (AT-PWR250-80)	■ (AT-PWR250-80)	■ (AT-PWR250-80)	
	Redundant power supply	N/A	N/A	N/A	N/A	
Additional PSU	AT-PWR06	AT-PWR150 AT-PWR250 AT-PWR800 AT-PWR1200	AT-PWR250 AT-PWR800 AT-PWR1200	AT-PWR250 AT-PWR800 AT-PWR1200		
<b>POWER OVER ETHERNET</b>	IEEE 802.3af (PoE)		■ (GPX model only)	■ (GPX model only)		
	IEEE 802.3at (PoE+)		■ (GPX model only)	■ (GPX model only)		
	PoE-enabled ports		24 (GPX model only)		48 (GPX model only)	
	Max PoE power		1560W (GPX model only)		1560W (GPX model only)	
Max full power ports		24 (GPX model only)		48 (GPX model only)		
<b>SCALABILITY</b>	MAC address table size	128K	64K	64K	64K	16K
	Stacking (VCStack)	■ 2	■ 8	■ 8	■ 8	■ AT-XEM-STK (2)
	Long-distance VCStack		■ 8	■ 8	■ 8	
	Stacking bandwidth	160G (QSFP+)	40G (SFP+) 160G (AT-StackQS)	40G (SFP+) 160G (AT-StackQS)	40G (SFP+) 160G (AT-StackQS)	60G (AT-XEM-STK)
<b>ENVIRONMENTAL</b>	Cooling	Fan	Fan	Fan	Fan	
	Temperature range	0°C to 40°C	0°C to 40°C	0°C to 40°C	0°C to 40°C	0°C to 50°C
<b>MANAGEMENT</b>	Web GUI		■	■	■	
	CLI / Telnet / SNMP	■	■	■	■	
	IPv6 management	■	■	■	■	
	DHCPv4 / v6 server	■	■	■	■	
	AMF Master	■	■	■	■	
<b>NETWORK RESILIENCE</b>	Spanning Tree	■	■	■	■	
	Link aggregation (LACP)	■	■	■	■	
	EPSRing	■	■	■	■	
VRRPv3	■	■	■	■	■	
<b>QOS</b>	IEEE 802.1p priority queues	8	8	8	8	
<b>SECURITY</b>	IEEE 802.1Q VLANs	4096	4096	4096	4096	
	RADIUS / TACACS+	■	■	■	■	
	SSH / SSL	■	■	■	■	
	IEEE 802.1x	■	■	■	■	
	DoS protection	■	■	■	■	
DHCP snooping	■	■	■	■	■	
<b>ROUTING</b>	Static routes v4 / v6	■	■	■	■	
	RIP / RiPng	■	■	■	■	
	OSPFv2 / v3	■	■	■	■	
	Policy-based routing	■	■	■	■	
VRF Lite	■	■	■	■	■	
<b>MULTICASTING</b>	IGMPv1 / v2 / v3	■	■	■	■	
	MLDv1 / v2	■	■	■	■	
	PIMv4 / PIMv6	■	■	■	■	
	PIM-SSM / PIM-SSMv6	■	■	■	■	



# Intelligent Edge



## x510 Series

The Allied Telesis x510 Series of stackable Gigabit switches includes a full range of security and resiliency features. With a choice of 24- and 48-port models with 10 Gigabit uplinks, PoE+, and fiber, combined with the power of VCStack, they offer a versatile solution for applications at the network edge.

### EPSRing

Putting a ring of Ethernet switches at the core of a network is a simple way to increase the network's resiliency. Such



a network is no longer susceptible to a single point of failure. Traditionally, spanning tree-based technologies are used to protect rings, but they are relatively slow



FEATURES	AT-SBx3112	AT-x510-28GTX AT-x510-28GPX AT-x510DP-28GTX	AT-x510-28GSX	AT-x510-52GTX AT-x510-52GPX AT-x510DP-52GTX	AT-x510L-28GT AT-x510L-28GP	AT-x510L-52GT AT-x510L-52GP*
<b>FORM FACTOR</b>	Rackmount	Desktop / rackmount / stack	Desktop / rackmount / stack	Desktop / rackmount / stack	Desktop / rackmount / stack	Desktop / rackmount / stack
<b>SWITCH FUNCTIONALITY</b>	Layer 2+	Basic Layer 3 upgradeable to advanced Layer 3	Basic Layer 3 upgradeable to advanced Layer 3	Basic Layer 3 upgradeable to advanced Layer 3	Basic Layer 3 upgradeable to advanced Layer 3	Basic Layer 3 upgradeable to advanced Layer 3
<b>PORTS AND MEDIA SUPPORT</b>	10/100/1000T 100/1000X SFP ports 1G/10G SFP+ ports	192/320 192/320 48 (10G only)	24 24	48 4 (2 if stacked)	24 4 (2 if stacked) 10G license required	48 4 (2 if stacked) 10G license required
<b>POWER SUPPLY</b>	PSU type -48vDC PSU option Additional PSU	Dual system hot-swappable internal, dual PoE+ hot-swappable internal AT-SBxPWRSYS1 / AT-SBxPWRPOE1	Dual fixed internal (dual hotswap AT-x510DP only)	Dual fixed internal (dual hotswap AT-x510DP only)	Single fixed internal	Single fixed internal
<b>POWER OVER ETHERNET</b>	IEEE 802.3at PoE+ enabled ports Max PoE+ power Max full power ports (30W)	■ (PoE+) 240 2400W 80	■ (GPX only) 24 (GPX only) 370W (GPX only) 12 (GPX only)	■ (GPX only) 48 (GPX only) 370W (GPX only) 12 (GPX only)	■ (GP only) 24 (GP only) 185W (GP only) 6 (GP only)	■ (GP only) 48 (GP only) 185W (GP only) 6 (GP only)
<b>SCALABILITY</b>	MAC address table size Stacking (VCStack) Long-distance VCStack Stacking bandwidth	32K ■ (4) ■ (4) 40G (2 × SFP+)	16K ■ (4) ■ (4) 40G (2 × SFP+)	16K ■ (4) ■ (4) 40G (2 × SFP+)	16K ■ (4) ■ (4) 40G (2 × SFP+)	16K ■ (4) ■ (4) 40G (2 × SFP+)
<b>ENVIRONMENTAL</b>	Cooling Temperature range	Hot-swappable fan tray 0°C to 40°C	Fan 0°C to 45°C	Fan 0°C to 45°C	Fan 0°C to 45°C	Fan 0°C to 45°C
<b>MANAGEMENT</b>	Web GUI CLI / Telnet / SNMP IPv6 management DHCPv4 / v6 server AMF Member	■ ■ ■ ■ ■	■ ■ ■ ■ ■	■ ■ ■ ■ ■	■ ■ ■ ■ ■	■ ■ ■ ■ ■
<b>NETWORK RESILIENCE</b>	Spanning Tree Link aggregation (LACP) EPSRing VRRPv3	■ ■ ■ ■	■ ■ ■ ■	■ ■ ■ ■	■ ■ ■ ■	■ ■ ■ ■
<b>QoS</b>	IEEE 802.1p priority queues	8	8	8	8	8
<b>SECURITY</b>	IEEE 802.1Q VLANs RADIUS / TACACS+ SSH / SSL IEEE 802.1x DoS protection DHCP snooping	4096 ■ ■ ■ ■ ■	4096 ■ ■ ■ ■ ■	4096 ■ ■ ■ ■ ■	4096 ■ ■ ■ ■ ■	4096 ■ ■ ■ ■ ■
<b>ROUTING</b>	Static routes v4 / v6 RIP / RIPv6 OSPFv2 / v3 Policy-based routing	■ ■ ■ ■	■ ■ ■ ■	■ ■ ■ ■	■ ■ ■ ■	■ ■ ■ ■
<b>MULTICASTING</b>	IGMPv1 / v2 / v3 MLDv1 / v2 PIMv4 / PIMv6 PIM-SSM	■ ■ ■ ■	■ ■ ■ ■	■ ■ ■ ■	■ ■ ■ ■	■ ■ ■ ■

\* Not available in North America



x510-52GP

to recover from link failure. This can create problems for applications that have strict loss requirements, such as voice and video traffic, where the speed of recovery is highly significant. Allied Telesis Ethernet Protection Switched Ring (EPSRing) provides high-speed (~50ms) reconfigurations in the event of a failure, ensuring no noticeable loss of service.



## x230 Series

Allied Telesis x230 Series switches provide optimal performance for connecting and remotely powering wireless access points, IP video surveillance cameras, and IP phones. The AT-x230-10GP and AT-x230-18GP provide 8 or 16 PoE+-capable Gigabit ports, and 2 SFP uplinks, for secure powered connectivity at the network edge.



AT-IX5-28GPX	AT-x310-26FT AT-x310-26FP	AT-x310-50FT AT-x310-50FP	AT-x230-10GP	AT-x230-18GP	AT-x210-9GT	AT-x210-16GT	AT-x210-24GT
Desktop / rackmount / stack	Desktop / rackmount	Desktop / rackmount	Desktop / rackmount	Desktop / rackmount	Desktop / rackmount	Desktop / rackmount	Desktop / rackmount
Basic Layer 3	Basic Layer 3 upgradeable to advanced Layer 3	Basic Layer 3 upgradeable to advanced Layer 3	Layer 2+	Layer 2+	Layer 2+	Layer 2+	Layer 2+
24	24	48	8	16	8	14 + 2 combo	20 + 4 combo
4 (2 if stacked)	2	2	2	2	1	2 combo	4 combo
Dual hotswap internal	Fixed internal	Fixed internal	Fixed internal	Fixed internal	Fixed internal	Fixed internal	Fixed internal
AT-PWR800							
■	■ (FP only)	■ (FP only)	■	■			
24	24 (FP only)	48 (FP only)	8	16			
720W	370W (FP only)	370W (FP only)	120W	240W			
24	12 (FP only)	12 (FP only)	4	8			
16K	16K	16K	16K	16K	8K	8K	8K
■ (4)	■ (4)	■ (4)					
■ (4)							
40G (2 × SFP+)	4G (2 × SFP DAC)	4G (2 × SFP DAC)					
Fan	Fanless (FT only)	Fan	Fan	Fan	Fanless	Fanless	Fanless
0°C to 45°C	0°C to 40°C (FT) / 50°C (FP)	0°C to 50°C	0°C to 50°C	0°C to 50°C	0°C to 50°C	0°C to 40°C	0°C to 40°C
■	■	■	■	■	■	■	■
■	■	■	■	■	■	■	■
■	■ (client only)	■ (client only)	■ (client only)	■ (client only)	■ (client only)	■ (client only)	■ (client only)
■	■	■	■	■	■	■	■
■	■	■	■	■	■	■	■
■	■	■	■	■	■	■	■
■	■	■	■	■	■	■	■
■	■	■	■	■	■	■	■
8	8	8	8	8	4	4	4
4096	4096	4096	4096	4096	256	256	256
■	■	■	■	■	■	■	■
■	■	■	■	■	■	■	■
■	■	■	■	■	■	■	■
■	■	■	■	■	■	■	■
■	■	■	■	■	■	■	■
■	■	■	■	■	■	■	■
■	■	■	■ (snooping)	■ (snooping)	■ (snooping)	■ (snooping)	■ (snooping)
■	■	■	■ (snooping)	■ (snooping)	■ (snooping)	■ (snooping)	■ (snooping)
■	■	■	■	■	■	■	■
■	■	■	■	■	■	■	■
■	■	■	■	■	■	■	■
■	■	■	■	■	■	■	■
■	■	■	■	■	■	■	■
■	■	■	■	■	■	■	■
■	■	■	■	■	■	■	■
■	■	■	■	■	■	■	■
■	■	■	■	■	■	■	■
■	■	■	■	■	■	■	■

# CentreCOM Gigabit Edge

CentreCOM™ is the Allied Telesis global brand of cost-effective switches for customers who need to manage their network communications with a minimal investment. CentreCOM Gigabit Ethernet switches provide advanced management and security features to the edge while cost-effectively enhancing delivery of converged data.



FEATURES	AT-9000/12POE	AT-9000/28	AT-9000/28POE	AT-9000/28SP	AT-9000/52	AT-8000GS/24	AT-8000GS/24POE	AT-8000GS/48
<b>SWITCH FUNCTIONALITY</b>	Layer 2	Layer 2	Layer 2	Layer 2	Layer 2	Layer 2	Layer 2	Layer 2
<b>PORTS AND MEDIA SUPPORT</b>	10/100/1000T 8 4 (100 or 1000Mbps) SFP+ SFP+	28 4 combo (100 or 1000Mbps)	28 4 combo (100 or 1000Mbps)	4 combo (100 or 1000Mbps)	48 4 combo (100 or 1000Mbps)	24 4 combo (100 or 1000Mbps)	24 4 combo (100 or 1000Mbps)	48 4 combo (100 or 1000Mbps)
<b>POWER OVER ETHERNET</b>	Power over Ethernet (PoE) PoE ports IEEE 802.3af Class 3 (15.4W) IEEE 802.3at Class 4 (30W) PoE budget	8 8 8 123.2W	24 24 12 370W				24 9 140W	
<b>SCALABILITY</b>	MAC address table size Stacking	8K ■*	8K ■*	8K ■*	8K ■*	8K ■(6)	8K ■(6)	8K ■(6)
<b>ENVIRONMENTAL</b>	Cooling Eco-friendly Temperature range	Low noise fan ■ 0°C to 40°C	Low noise fan ■ 0°C to 40°C	Low noise fan ■ 0°C to 40°C	Fan ■ 0°C to 40°C	Fan ■ 0°C to 40°C	Fan ■ 0°C to 40°C	Fan ■ 0°C to 40°C
<b>MANAGEMENT</b>	Web CLI / Telnet / SNMP IPv6	■ ■ ■	■ ■ ■	■ ■ ■	■ ■ ■	■ ■ ■	■ ■ ■	■ ■ ■
<b>NETWORK RESILIENCE</b>	Spanning Tree Link aggregation (LACP) EPRing	■ ■ ■	■ ■ ■	■ ■ ■	■ ■ ■	■ ■ ■	■ ■ ■	■ ■ ■
<b>QoS</b>	IEEE 802.1p priority queues IEEE 802.1Q VLANs IEEE 802.1x	8 4094 ■	8 4094 ■	8 4094 ■	8 4094 ■	4 256 ■	4 256 ■	4 256 ■
<b>SECURITY</b>	MAC-based authentication Web-based authentication RADIUS / IEEE 802.1x TACACS SSH / SSL	■ ■ ■ ■ ■	■ ■ ■ ■ ■	■ ■ ■ ■ ■	■ ■ ■ ■ ■	■ ■ ■ ■ ■	■ ■ ■ ■ ■	■ ■ ■ ■ ■
<b>AMF</b>								

\* Enhanced stacking up to 24 units



FEATURES	AT-GS908M	AT-GS916M	AT-GS924M	AT-GS924MX	AT-GS924MPX	AT-GS948MX	AT-GS948MPX
<b>SWITCH FUNCTIONALITY</b>	Layer 2	Layer 2	Layer 2	Layer 2	Layer 2	Layer 2	Layer 2
<b>PORTS AND MEDIA SUPPORT</b>	10/100/1000T 8 1 SFP+ SFP+	16 2 combo (100 or 1000Mbps)	24 4 combo (100 or 1000Mbps)	24 2 combo (100 or 1000Mbps)	24 2 combo (100 or 1000Mbps)	48 2 combo (100 or 1000Mbps)	48 2 combo (100 or 1000Mbps)
<b>POWER OVER ETHERNET</b>	Power over Ethernet (PoE) PoE ports IEEE 802.3af Class 3 (15.4W) IEEE 802.3at Class 4 (30W) PoE budget				2 370W	24 24 12 12 370W	48 24 12 12 370W
<b>SCALABILITY</b>	MAC address table size Stacking	8K ■	8K ■	8K ■	16K ■(4)	16K ■(4)	16K ■(4)
<b>ENVIRONMENTAL</b>	Cooling Eco-friendly Temperature range	Fanless ■ 0°C to 50°C	Fan ■ 0°C to 50°C	Fan ■ 0°C to 50°C	Fan ■ 0°C to 50°C	Fan ■ 0°C to 50°C	Fan ■ 0°C to 45°C
<b>MANAGEMENT</b>	Web CLI / Telnet / SNMP IPv6	■ ■ ■	■ ■ ■	■ ■ ■	■ ■ ■	■ ■ ■	■ ■ ■
<b>NETWORK RESILIENCE</b>	Spanning Tree Link aggregation (LACP) EPRing	■ ■ ■	■ ■ ■	■ ■ ■	■ ■ ■	■ ■ ■	■ ■ ■
<b>QoS</b>	IEEE 802.1p priority queues IEEE 802.1Q VLANs IEEE 802.1x	4 256 ■	4 256 ■	4 256 ■	8 4094 ■	8 4094 ■	8 4094 ■
<b>SECURITY</b>	MAC-based authentication Web-based authentication RADIUS / IEEE 802.1x TACACS SSH / SSL	■ ■ ■ ■ Open SSL	■ ■ ■ ■ Open SSL	■ ■ ■ ■ Open SSL	■ ■ ■ ■ AMF-Edge	■ ■ ■ ■ AMF-Edge	■ ■ ■ ■ AMF-Edge
<b>AMF</b>							

# CentreCOM Fast Ethernet Fiber Edge

Allied Telesis Fast Ethernet fiber switches provide both additional security and network size compared with copper-based networks. The switches target the enterprise edge market, and are traditionally used in defense, government, campus, and security applications.

## Security of Data

Allied Telesis guarantees protection and secure management of networks by providing administrators strong security standards and authentication mechanisms for access at the edge of a network. Allied Telesis edge switches allow network controllers to restrict external devices from gaining unauthenticated access to the network.

## Effective Traffic Monitoring

In order to fully understand the performance of the network and ensure the ongoing smooth delivery of critical data, users must be able to measure and analyze the traffic in real time. Allied Telesis edge switches facilitate effective traffic monitoring with sFlow and RMON, which together provide better visibility of the performance and use of the network, helping management to make appropriate decisions crucial for an organization to function efficiently.

## Securing the Network Edge

Protocols such as IEEE 802.1x port-based authentication guarantee that only known users are connected to the network, ensuring data protection. Unknown users who physically connect can be isolated to a predetermined part of the network, offering guest benefits such as Internet access, while ensuring the integrity of private network data. Security protocols such as SSL, SSH, and SNMPv3 facilitate this protection of the network for both local or remote connections.

## Access Control Lists (ACLs)

Access Control Lists enable inspection of incoming frames and classify them based on various criteria. Specific actions can then be applied to these frames to more effectively manage the network traffic. Typically, ACLs are used as a security mechanism, either permitting or denying entry for frames in a group; but they can also be applied to QoS.

## Ideal and Reliable Connectivity

Powerful line rate performance makes these switches ideal for branch offices or the wiring closet of larger offices. The state-of-the-art QoS capability of these products ensures reliable delivery of advanced network services, such as voice and video, while effectively controlling the continually increasing traffic needs of today's networks.

### SFP/SFP+ Optics

Learn more about Allied Telesis pluggable optics on page 51.



FEATURES		AT-FS970M/16F8-LC	AT-FS970M16F8-SC	AT-FS970M/24F
<b>SWITCH FUNCTIONALITY</b>		Layer 2-4	Layer 2-4	Layer 2-4
<b>PORTS AND MEDIA SUPPORT</b>	100FX	16 (LC) MMF	16 (SC) MMF	24 (LC) MMF
	10/100TX	8	8	
	10/100/1000T	2	2	2
	SFP	2 combo (100 or 1000Mbps)	2 combo (100 or 1000Mbps)	2 combo (100 or 1000Mbps)
<b>POWER SUPPLY</b>		2 fixed internal	2 fixed internal	2 fixed internal
<b>SCALABILITY</b>		16K	16K	16K
<b>ENVIRONMENTAL</b>	MAC address table size	16K	16K	16K
	Cooling	Fan	Fan	Fan
	Variable speed fan	■	■	■
	Eco-friendly	■	■	■
<b>MANAGEMENT</b>	Temperature range	0°C to 40°C	0°C to 40°C	0°C to 40°C
	Web	■	■	■
	CLI	■	■	■
	Telnet	■	■	■
<b>NETWORK RESILIENCE</b>	SNMP	■	■	■
	Spanning Tree	■	■	■
	Link aggregation (LACP)	■	■	■
<b>QoS</b>	IEEE 802.1p priority queues	8	8	8
	IEEE 802.1Q VLANs	4096	4096	4096
	RADIUS	■	■	■
	TACACS	■	■	■
	SSH/SSL	■	■	■
<b>SECURITY</b>	IEEE 802.1x	■	■	■
	ROUTING	Basic	Basic	Basic

# CentreCOM Fast Ethernet Copper Edge

Allied Telesis CentreCOM Fast Ethernet copper switches provide performance and flexibility at an affordable price. These switches are ideal for the enterprise edge market, with Power over Ethernet models providing connectivity for IP cameras, IP phones, and wireless access points.

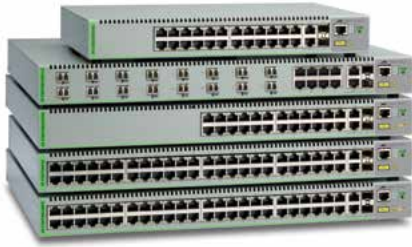

## CentreCOM FS970M Series

The Allied Telesis FS970M Series of high performance Fast Ethernet switches provides advanced enterprise features at an affordable investment level to improve the delivery of converged data. The FS970M Series is ideal for branch offices or the wiring closet of larger offices. The state-of-the-art QoS capability of this product ensures reliable delivery of advanced network services, such as voice, while effectively controlling the continually increasing traffic needs of today's networks.



FEATURES		AT-FS970M/8	AT-FS970M/8PS	AT-FS970M/8PS-E	AT-FS970M/24C	AT-FS970M/24PS	AT-FS970M/24LPS	AT-FS970M/48	AT-FS970M/48PS
<b>SWITCH FUNCTIONALITY</b>		Layer 2-4	Layer 2-4	Layer 2-4	Layer 2-4	Layer 2-4	Layer 2-4	Layer 2-4	Layer 2-4
<b>PORTS AND MEDIA SUPPORT</b>	10/100TX	8	8	8	24	24	24	48	48
	10/100/1000T	2	2	2	2	2	2	2	2
	SFP	2 combo 100 or 1000Mbps	2 combo 100 or 1000Mbps	2 combo 100 or 1000Mbps	2 combo 100 or 1000Mbps	2 combo 100 or 1000Mbps	2 combo 100 or 1000Mbps	2 combo 100 or 1000Mbps	2 combo 100 or 1000Mbps
	Modular uplinks				2				
<b>POWER SUPPLY</b>	PSU type	Fixed internal	Fixed internal	Fixed internal	Fixed internal	2 Fixed internal	Fixed internal	Fixed internal	2 fixed internal
	Redundant PSU option					■	■	■	■
<b>POWER OVER ETHERNET</b>	Power over Ethernet (PoE)		■	■		■	■		■
	PoE ports		8	8		24	24		48
	IEEE 802.3af Class 3 (15.4W)		8	8		24	12		24
	IEEE 802.3at Class 4 (30W)		6	6		12	6		12
	PoE budget		185W	185W		370W	185W		370W
<b>SCALABILITY</b>	MAC address table size	16K	16K	16K	16K	16K	16K	16K	16K
	Stacking								
<b>ENVIRONMENTAL</b>	Cooling	Fanless	Fan	Fan	Fanless	Fan	Fan	Fanless	Fan
	Variable-speed fan		■	■		■	■		■
	Eco-friendly		■	■	■	■	■	■	■
	Temperature range	0°C to 40°C	0°C to 40°C	0°C to 50°C	0°C to 40°C	0°C to 40°C	0°C to 40°C	0°C to 40°C	0°C to 40°C
<b>MANAGEMENT</b>	Web	■	■	■	■	■	■	■	■
	CLI	■	■	■	■	■	■	■	■
	Telnet	■	■	■	■	■	■	■	■
	SNMP	■	■	■	■	■	■	■	■
<b>NETWORK RESILIENCE</b>	Spanning Tree	■	■	■	■	■	■	■	■
	Link aggregation (LACP)	■	■	■	■	■	■	■	■
<b>QoS</b>	IEEE 802.1p priority queues	8	8	8	8	8	8	8	8
<b>SECURITY</b>	IEEE 802.1Q VLANs	4096	4096	4096	4096	4096	4096	4096	4096
	RADIUS	■	■	■	■	■	■	■	■
	TACACS	■	■	■	■	■	■	■	■
	SSH/SSL	■	■	■	■	■	■	■	■
	IEEE 802.1x	■	■	■	■	■	■	■	■
	Multiple Dynamic VLANs		■	■	■	■	■	■	■
<b>ROUTING</b>		Basic	Basic	Basic	Basic	Basic	Basic	Basic	Basic

AT-FS970M



## CentreCOM FS900M Series

CentreCOM FS900M Series switches feature quiet operation with a compact, fanless model. All models feature an extended temperature range from 0–50°C. FS900M models can be connected in an EPSRing as transit nodes. In the event of a network failure, fault detection, and route change are performed promptly, minimizing downtime.



	AT-FS909M	AT-FS917M	AT-FS926M	AT-8000/8POE	AT-8000S/16	AT-8000S/24	AT-8000S/24POE	AT-8000S/48	AT-8000S/48POE
	Layer 2	Layer 2	Layer 2	Layer 2	Layer 2	Layer 2	Layer 2	Layer 2	Layer 2
	8	16	24	8	16	24	24	48	48
	1	1	2	1	1	2	2	2	2
	1 combo 1000Mbps	1 combo 1000Mbps	2 combo 1000Mbps	1 combo 1000Mbps	1 combo 100 or 1000Mbps	2 combo 100 or 1000Mbps	2 combo 100 or 1000Mbps	2 combo 100 or 1000Mbps	2 combo 100 or 1000Mbps
	Fixed internal	Fixed internal	Fixed internal	Fixed internal	Fixed internal	Fixed internal	Fixed internal	Fixed internal	Fixed internal
				■			■		■
				8			24		48
				6			12		24
				95W			185W		375W
	8K	8K	8K	8K	8K	8K	8K	8K	8K
						■	■	■	■
	Fanless	Fanless	Fanless	Fan	Fanless	Fanless	Fan	Fan	Fan
	■	■	■						
	0°C to 50°C	0°C to 50°C	0°C to 50°C	0°C to 40°C	0°C to 40°C	0°C to 40°C	0°C to 40°C	0°C to 40°C	0°C to 40°C
	■	■	■		■	■	■	■	■
	■	■	■	■	■	■	■	■	■
	■	■	■	■	■	■	■	■	■
	■	■	■	■	■	■	■	■	■
	■	■	■	■	■	■	■	■	■
	4	4	4		4	4	4	4	4
	256	256	256	255	256	256	256	256	256
	■	■	■	■	■	■	■	■	■
					■	■	■	■	■
					■	■	■	■	■
					■	■	■	■	■
					■	■	■	■	■



Allied Telesis WebSmart switches perform a dual role in providing connectivity for a variety of computer networks. For small office networks, they provide security and data priority, allowing the deployment of Voice over IP and similar applications. In larger networks, WebSmart switches provide security, authentication, and data priority — but at a lower cost point than a fully-managed device.

### Simple Configuration

Allied Telesis WebSmart switches may be used directly from the box, with no additional configuration. Additional features can be enabled using a simple Graphical User Interface (GUI) management system, allowing less technical users to configure the devices.

### Affordable Solutions

Allied Telesis WebSmart switches offer a solution with key “managed switch” features — without the price tag associated with managed switches.

These switches are perfect for budget-sensitive companies looking for advanced features such as Quality of Service (QoS), port mirroring, Virtual LAN (VLAN), and Power over Ethernet (PoE). In addition, WebSmart switches may be used on the edge of a large managed network while still providing high levels of security.



#### FAST ETHERNET

FEATURES		AT-FS750/16	AT-FS750/24	AT-FS750/28POE	AT-FS750/52
<b>PORTS AND MEDIA SUPPORT</b>	10/100TX	16	24	24	48
	10/100/1000T	2	2	4	4
	SFP	2 combo	2 combo	2 combo	2 combo
	100FX SFP support	■	■	■	■
<b>POWER SUPPLY</b>	Internal	Internal	Internal	Internal	
<b>POWER OVER ETHERNET</b>	Power over Ethernet (PoE)			■	
	PoE ports			24	
	IEEE 802.3af Class 3 (15.4W)			12	
	IEEE 802.3at Class 4 PoE+ (30W)			6	
PoE budget			185W		
<b>SCALABILITY</b>	MAC address table size	8K	8K	8K	8K
<b>ENVIRONMENTAL</b>	Cooling	Fanless	Fanless	Fan	Fan
	Eco-friendly			■	■
<b>MANAGEMENT</b>	Web	■	■	■	■
	SNMPv1 / v2	■	■	■	■
<b>NETWORK RESILIENCE</b>	Spanning Tree	■	■	■	■
	Rapid Spanning Tree	■	■	■	■
	Link aggregation (LACP)	■	■	■	■
	IGMP snooping (v1 / v2)	■	■	■	■
Port setting (speed, availability, flow control)	■	■	■	■	
<b>QoS</b>	IEEE 802.1p priority queues	4	4	4	4
	IEEE 802.1Q VLANs	256	256	256	256
<b>SECURITY</b>	IEEE 802.1x	■	■	■	■
	RADIUS / DHCP client	■	■	■	■
<b>OTHER</b>	Jumbo frames (9K)	■			
	Port mirroring	■	■	■	■
	MAC filtering / ingress / egress rate limiting / broadcast storm control	■	■	■	■
<b>IDEAL ENVIRONMENT</b>	Home office / SMB / security at the edge	Home office / SMB / security at the edge	Home office / SMB / security at the edge	Home office / SMB / security at the edge	
<b>CUSTOMER'S NEEDS</b>	Management at the edge / basic, entry-level security / Web-based management / copper Ethernet at the edge of the fiber network	Management at the edge / basic, entry-level security / Web-based management / copper Ethernet at the edge of the fiber network	Low-cost Power over Ethernet / management at the edge / basic, entry-level security / Web-based management / copper Ethernet at the edge of the fiber network	Management at the edge / basic, entry-level security / Web-based management / copper Ethernet at the edge of the fiber network	



## GS950 Series

Allied Telesis redesigned the popular GS950 Series of Gigabit WebSmart switches with PoE, delivering up to 30 Watts per port to support video surveillance and security cameras, wireless access points, IP phones, and other PoE-powered devices. The GS950 Series also features IPv6 management and TACACS+ to add an extra layer of security.



### GIGABIT ETHERNET

	AT-GS950/8	AT-GS950/8POE	AT-GS950/10PS	AT-GS950/16	AT-GS950/16PS	AT-GS950/24	AT-GS950/48PS	AT-GS950/48
	8	8	10	16	16	24	48	48
	2 combo	2 combo	2 combo	2 combo	2 combo	4 combo	4 combo	4 combo
	■	■	■	■	■	■	■	■
	Internal	Internal	Internal	Internal	Internal	Internal	Internal	Internal
		4	8		16		24	
		4	4		12		24	
			2		6		12	
		60W	75W		185W		370W	
	8K	8K	8K	8K	8K	8K	8K	8K
	Fanless	Fanless	Fanless	Fanless	Fan	Fanless	Fan	Fan
	■	■	■	■	■	■	■	■
	■ v3	■	■	■ v3	■	■ v3	■	■
	■	■	■	■	■	■	■	■
	■	■	■	■	■	■	■	■
	■	■	■	■	■	■	■	■
	■	■	■	■	■	■	■	■
	4	4	4	4	4	4	4	4
	256	256	256	256	256	256	256	256
	■	■	■	■	■	■	■	■
	■	■	■	■	■	■	■	■
	■	■	■	■	■	■	■	■
	■	■	■	■	■	■	■	■
	■	■	■	■	■	■	■	■
	Home office / SMB / security at the edge	Home office / SMB / security at the edge	POS and retail / home office / SMB / security cameras / security at the edge	Home office / SMB / security at the edge	POS and retail / home office / SMB / security cameras / security at the edge	Home office / SMB / security at the edge	POS and retail / home office / SMB / security cameras / security at the edge	Home office / SMB / security at the edge
	Management at the edge / basic, entry-level security / Web-based management / copper Ethernet at the edge of the fiber network	Low-cost Power over Ethernet / management at the edge / basic, entry-level security / Web-based management / copper Ethernet at the edge of the fiber network	Security and video surveillance / management at the edge / basic, entry-level security / Web-based management / copper Ethernet at the edge of the fiber network	Management at the edge / basic, entry-level security / Web-based management / copper Ethernet at the edge of the fiber network	Security and video surveillance / management at the edge / basic, entry-level security / Web-based management / copper Ethernet at the edge of the fiber network	Management at the edge / basic, entry-level security / Web-based management / copper Ethernet at the edge of the fiber network	Security and video surveillance / management at the edge / basic, entry-level security / Web-based management / copper Ethernet at the edge of the fiber network	Management at the edge / basic, entry-level security / Web-based management / copper Ethernet at the edge of the fiber network

# Unmanaged

Unmanaged switches are simple to deploy, requiring no user setup — making them the ideal solution for Small Office / Home Office (SOHO) applications. Their silent, eco-friendly, low-power operation ensures both minimal running costs and no intrusive noise.

## Auto-Negotiation and Auto MDI/MDI-X

Allied Telesis unmanaged copper switch ports support auto-negotiation and auto MDI/MDI-X, enabling them to interface with legacy Ethernet and Fast Ethernet products without the need for special cables or user configuration.

## Fanless Design

All Allied Telesis unmanaged switches feature a fanless design. This quiet operation makes them perfectly suited for use in home and small-office installations.

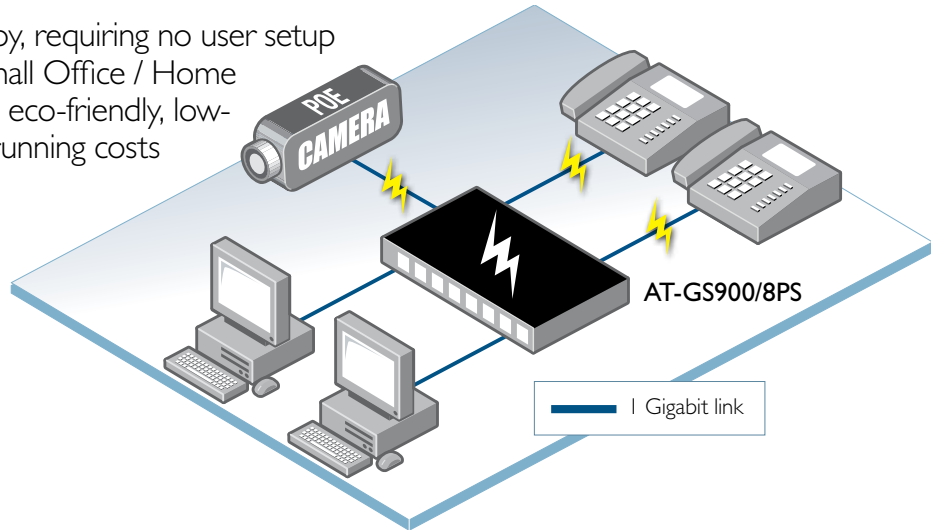

### FAST ETHERNET

FEATURES		AT-FS705LE	AT-FS705L	AT-FS705EFC/SC	AT-FS708LE
PORTS AND MEDIA SUPPORT	10/100TX	5	5	4	8
	100FX			1 x SC, MMF	
	SFP (1000Mbps)				
POWER SUPPLY		External (high efficiency)	Internal	External (high efficiency)	External (high efficiency)
POWER OVER ETHERNET	Power over Ethernet (PoE)				
	PoE ports				
	IEEE 802.3af Class 3 (15.4W)				
	PoE budget				
SCALABILITY	MAC address table size	2K	2K	4K	4K
ENVIRONMENTAL	Cooling	Fanless	Fanless	Fanless	Fanless
	Eco-friendly	■	■	■	■
IDEAL ENVIRONMENT		SOHO / network edge	SOHO / network edge	Edge switch on fiber-based network	SOHO / network edge
CUSTOMER'S NEEDS		Plug and Play / cost-effective / simple to install	Plug and Play / cost-effective / simple to install	Interface to fiber / Backbone network / longer than 100 m cable runs / cost-effective / simple to install	Plug and Play / cost-effective / simple to install





### GIGABIT ETHERNET

FEATURES		AT-GS900/5E	AT-GS900/8E	AT-GS900/8	AT-GS900/8PS	AT-GS900/16	AT-GS900/24
<b>PORTS AND MEDIA</b>	10/100/1000T SFP	5	8	8	8 1	16	24
<b>POWER SUPPLY</b>		External (high efficiency)	External (high efficiency)	Internal	Internal	Internal	Internal
<b>POWER OVER ETHERNET</b>	Power over Ethernet (PoE)				■		
	PoE ports				4		
	IEEE 802.3af Class 3 (15.4W)				4		
	IEEE 802.3at Class 4 PoE+ (30W)				2		
	PoE budget				75W		
<b>SCALABILITY</b>	MAC address table size	4K	4K	8K	8K	8K	16K
<b>ENVIRONMENTAL</b>	Cooling	Fanless	Fanless	Fanless	Fanless	Fanless	Fanless
	Eco-friendly	■	■	■	■	■	■
<b>IDEAL ENVIRONMENT</b>		SOHO / network edge	SOHO / network edge	SOHO / network edge	SOHO / network edge	SOHO / network edge	SOHO / network edge
<b>CUSTOMER'S NEEDS</b>		High performance / Plug and Play / low maintenance / cost-effective / simple to install	High performance / Plug and Play / low maintenance / cost-effective / simple to install	High performance / Plug and Play / low maintenance / cost-effective / simple to install	High performance / Plug and Play / low maintenance / cost-effective / simple to install / centralized power	High performance / Plug and Play / low maintenance / cost-effective / simple to install	High performance / Plug and Play / low maintenance / cost-effective / simple to install



### FAST ETHERNET

	AT-FS708	AT-FS708/POE	AT-FS708LE/POE	AT-FS716L	AT-FS717FC/SC	AT-FS724L
	8	8	8	16	16	24
		1			1 x SC, MMF	
	Internal	Internal	External	Internal	Internal	Internal
		■	■			
		8	4			
		4	2			
		65W	31W			
	1K	8K	1K	8K	4K	8K
	Fanless	Fanless	Fanless	Fanless	Fanless	Fanless
	■	■	■	■		■
	SOHO / network edge	Small office network with wireless, IP cameras	Small office network with wireless, IP cameras	Small office network	Edge switch on fiber-based network	Small office network
	Plug and Play / cost-effective / simple to install	Ability to power wireless access points, cameras, etc. / interface to fiber backbone network / longer than 100 m cable runs / cost-effective / simple to install	Ability to power wireless access points, cameras, etc. / cost-effective / simple to install	Plug and Play / cost-effective / simple to install	Interface to fiber backbone network / longer than 100 m cable runs / cost-effective / simple to install	Plug and Play / cost-effective / simple to install

Allied Telesis industrial and extended temperature products provide the capability to extend networks outside of an office environment. Extended temperature switches enable highly-effective solutions to be built without the need to employ higher-cost industrial temperature devices.

Designed for Programmable Logic Controllers (PLCs), robots, industrial pumps, industrial control units, and various outdoor applications such as video surveillance, control level (and higher) in factory automation, roadside control signs, high-speed mobility, and building automation, Allied Telesis industrial and extended temperature switches are flexible and can adapt to unique environments.



## IE200 Series

Allied Telesis IE200 Series switches provide a powerful, intelligent platform for a broad range of industrial applications. Uptime and resilience are maximized using innovative technologies such as EPSRing, while deployment and management is simplified—and total cost of ownership reduced—using Allied Telesis Management Framework (AMF). These switches can provide managed L2 connectivity, based on the AlliedWare Plus management platform. Available in Gigabit and Fast Ethernet, PoE+ and non-PoE models, the IE200 Series is designed for standalone or DIN rail mounting and can be powered by one or two external DC power supplies (not included).

- › Operating temperature: -40°C to 70°C
- › 4 × 10/100 or 10/100/1000T plus 2 × 100/1000X SFP ports
- › Redundant power input: 12-48vDC (non-PoE) or 24-48vDC (PoE)
- › 802.3at PoE (6GP and 6FP models)
- › DIN rail mounted
- › IP30 rated, IP31 add-on (sold separately)
- › Advanced Ethernet Protection Switched Ring (EPSRing)
- › AlliedWare Plus advanced operating system

- ▶ **AT-IE200-6GT** INDUSTRIAL  
4 × 10/100/1000T ports and 2 × 100/1000X SFP ports Gigabit industrial Ethernet switch
- ▶ **AT-IE200-6GP** INDUSTRIAL PoE+  
4 × 10/100/1000T PoE+ ports and 2 × 100/1000X SFP ports Gigabit industrial Ethernet PoE+ switch
- ▶ **AT-IE200-6FT** INDUSTRIAL  
4 × 10/100T ports and 2 × 100/1000X SFP ports industrial Fast Ethernet switch
- ▶ **AT-IE200-6FP** INDUSTRIAL PoE+  
4 × 10/100T PoE+ ports and 2 × 100/1000X SFP ports industrial Fast Ethernet PoE+ switch



**NEW**

## IE510 Series

The Allied Telesis IE510 Series meets the high reliability requirements demanded by industrial and network service provider applications. The IE510 can be easily managed through NMS, Web GUI, SNMP, Telnet, or SSH while the fiber ports extend the connection distance, increasing the network elasticity and performance. With the wide operating temperature range of between -40° and 75°C, IE510 Series switches can be deployed in any of the harshest industrial environments.

- › Operating temperature: -40°C to 75°C
- › 24 × 10/100/1000 SFP ports plus 4 × 1/10G SFP+ ports
- › AlliedWare Plus advanced operating system
- › Redundant power inputs for higher system reliability
- › Advanced Ethernet Protection Switched Ring (EPSRing)
- › Superior security mechanisms including SSL, SSH, IEEE 802.1x, MAC, IP filtering, RADIUS, TACACS+, and VLAN for access protection

- ▶ **AT-IE510-28GSX** INDUSTRIAL PoE+ ECCO  
Layer 3 managed Gigabit industrial switch



## IFS802SP Series

The Allied Telesis IFS802SP Series features high performance industrial managed Layer 2 connectivity that meets the high reliability requirements of industrial network operations. The IFS802SP Series is designed for standalone or DIN rail mounting, and is powered by either one or two external DC power supplies.

- › Operating temperature: -10°C to 60°C (non-PoE)  
-40°C to 75°C (PoE)
- › 8 × 10/100TX ports
- › 2 × 10/100/1000T / SFP (100/1000Mbps) ports
- › 12-48vDC redundant power supply (48vDC for PoE)
- › DIN rail mounted
- › IP30 metal case
- › Managed Layer 2 functionality
- › Provides standards-based IEEE 802.3af PoE up to 8 ports of Class 3 powered devices at 15.4 Watts (PoE)

- ▶ **AT-IFS802SP-80** INDUSTRIAL  
8-port 10/100T industrial managed switch with 2 SFP combo ports
- ▶ **AT-IFS802SP/POE (W)-80** INDUSTRIAL PoE+  
8-port 10/100T industrial managed PoE switch with 2 SFP combo ports

# Security Appliances

[alliedtelesis.com/securityapps](http://alliedtelesis.com/securityapps)

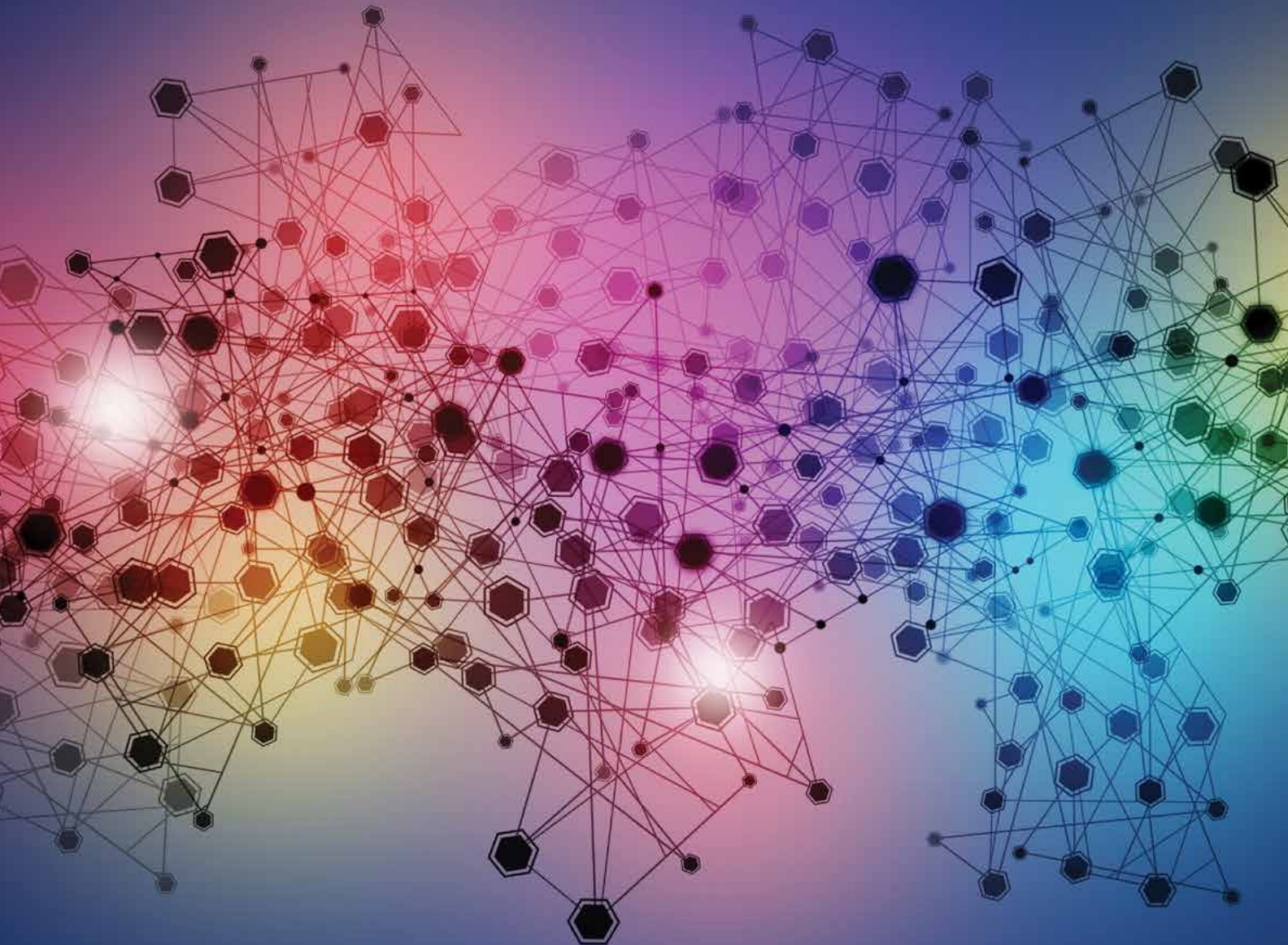

The comprehensive, high-performance Allied Telesis AR Series features Next-Generation Firewalls and conventional secure VPN routers. Both product types offer functions such as advanced routing, QoS, IPv6, and advanced security, which includes firewall and VPN services. AR Series products are able to deliver the breadth of functionality that small- and medium-sized businesses require at a price point they can afford, and with a proven reliability that makes Allied Telesis a trusted networking partner.

Allied Telesis Next-Generation Firewalls are an ideal integrated security platform for today's networks. Next-Generation Firewall and threat protection is combined with routing and switching, to provide an innovative high-performance solution.



## Deep Packet Inspection (DPI) Firewall

The Allied Telesis Firewall is a next-generation, Deep Packet Inspection (DPI) engine that provides real-time, Layer 7 classification of network traffic. Rather than being limited to filtering packets based on protocols and ports, the firewall can determine the application associated with the packet. This allows Enterprises to differentiate business-critical from non-critical applications, and enforce security and acceptable use policies in ways that make sense for the business.

## Best-of-Breed Security

Allied Telesis integrated security platforms utilize Best-of-Breed security providers for the ultimate in up-to-the-minute protection from all known threats. Flexible licensing options make it easy to choose the right combination of security features to best meet business needs.

## Sophisticated Application Control

The Internet has evolved exponentially. Whereas once it simply provided pages to be browsed, it now offers applications that enable people to interact, with services such as collaborative document creation, social networking, video conferencing, cloud-based storage, banking, and much more.

Organizations must be able to control the applications that their people use, and how they use them. Allied Telesis Next-Generation Firewalls provide the visibility and control that are necessary to safely navigate the increase in online applications used for effective business today.

## Intrusion Detection and Prevention Systems (IDS/IPS)

IDS/IPS is an intrusion detection and prevention system that can protect networks from malicious traffic. IDS/IPS monitors inbound and outbound traffic, and identifies threats which may not be detected by the firewall alone.

## IP Reputation

IP Reputation is becoming increasingly popular as a method of improving the success of Intrusion Prevention by reducing false positives. IP Reputation provides an extra variable to the prevention decision, which allows drop rules to be actioned only if the reputation of the web site exceeds a chosen threshold.

## Easy to Manage

Allied Telesis Next-Generation Firewalls run the advanced AlliedWare Plus fully featured operating system. The comprehensive Graphical User Interface (GUI) provides a single-pane-of-glass interface, with the dashboard providing at-a-glance status of threat detection and protection. The GUI centralizes management of the integrated components, to control and protect online business resources and applications.

Full support for Allied Telesis Management Framework (AMF) allows Allied Telesis firewalls to integrate with Allied Telesis switching products to form a network able to be managed as a single virtual device. A full suite of automated tools ensures that the firewall configuration is backed up, and able to be recovered with no user intervention, maximizing availability of online services.

## High Performance

High performance is guaranteed by harnessing the power of multi-core processors and application acceleration engines. This dramatically increases throughput and enables simultaneous packet inspection.



NEW



NEW

FEATURES		AT-AR3050S	AT-AR4050S
<b>FORM FACTOR</b>		Desktop / rack mount	Desktop / rack mount
<b>WAN PORTS</b>	10/100/1000T	2 combo	2 combo
	100/100X (SFP)	2 combo	2 combo
	WAN bypass	2	2
<b>LAN PORTS</b>	10/100/1000T	8	8
<b>MEDIA SUPPORT</b>	USB port	1	1
	SDHC slot	1	1
<b>POWER SUPPLY</b>		Fixed internal	Fixed internal
<b>ENVIRONMENTAL</b>	Temperature range	0°C to 45°C	0°C to 45°C
	Cooling	Speed-controlled fan	Speed-controlled fan
<b>PERFORMANCE</b>	CPU	Dual-core 800MHz	Quad-core 1.5GHz
	RAM	1 GB	2 GB
	Throughput	See datasheet	See datasheet
<b>MANAGEMENT</b>	Console port	RJ-45	RJ-45
	Web-based GUI	■	■
	CLI	■	■
	SNMP	■	■
	Telnet / SSH	■	■
<b>NETWORK RESILIENCE</b>	AMF	■	■
	VRRP and VRRPv3	■	■
<b>THREAT PROTECTION</b>	Spanning Tree	■	■
	Anti-virus	■	■
	Anti-malware	■	■
	IDS / IPS	■	■
	IP reputation	■	■
<b>SECURITY</b>	Automatic threat updates	■	■
	IEEE 802.1Q VLANs	■	■
	RADIUS / TACACS+	■	■
<b>FIREWALL</b>	Command authorization	■	■
	DPI firewall	■	■
	Application control	■	■
	URL filtering	■	■
	Web content control	■	■
	Traffic shaping	■	■
	DMZ	■	■
	Port forwarding	■	■
Dynamic NAT	■	■	
<b>TUNNELLING</b>	IPsec VPN tunnels	256	256
	SSL / TLS VPN users	100	100
	L2TPv3	■	■
	GRE	■	■
<b>ROUTING</b>	Static routing	■	■
	RIP / RIPng	■	■
	OSPFv2 / OSPFv3	■	■
	BGP4 / BGP4+	■	■
	IGMP	■	■
	PIMv4 / PIMv6	■	■
	Bridging (LAN / WAN)	■	■
	PPPoE	■	■
DHCPv4/v6 client, server, relay		■	■

# Secure VPN Routers

Allied Telesis WAN and Internet multiservice access VPN routers include solutions for T1/E1, ISDN, xDSL, and leased-line connections.



		SECURE MODULAR VPN ROUTERS		SECURE GIGABIT MODULAR VPN ROUTER	SECURE xDSL ROUTER
FEATURES		AT-AR415S	AT-AR750S	AT-AR770S	AT-AR440S
<b>FORM FACTOR</b>		Desktop / rack mount	Desktop / rack mount	Desktop / rack mount	Desktop / wallmount / rack mount
<b>PORTS AND MEDIA SUPPORT</b>		10/100TX 10/100/1000T SFP xDSL (WAN)	10/100TX 10/100/1000T SFP xDSL (WAN)	10/100TX 10/100/1000T SFP xDSL (WAN)	10/100TX 10/100/1000T SFP xDSL (WAN)
		1 (WAN) + 4 (LAN)	2 (WAN) + 5 (LAN)	2 (WAN) + 4 (LAN)	5 (LAN)
				2 (combo) 100 or 1000Mbps	
					ADSL2/2+ (Annex A)
		1	1	1	1
		1	2	2	1
<b>OPTIONAL PIC CARDS</b>					
T1/E1 WAN		AT-AR020	AT-AR020	AT-AR020	AT-AR020
BRI - ISDN (S/T)		AT-AR021S	AT-AR021S	AT-AR021S	AT-AR021S
2Mbps sync port		AT-AR023	AT-AR023	AT-AR023	AT-AR023
4 x async		AT-AR024	AT-AR024	AT-AR024	AT-AR024
2 x FXS VoIP		AT-AR027	AT-AR027	AT-AR027	AT-AR027
<b>POWER SUPPLY</b>		Fixed internal	Fixed internal	Fixed internal	Fixed internal
<b>ENVIRONMENTAL</b>					
Indoor / outdoor usage		Indoor	Indoor	Indoor	Indoor
Temperature range		0°C to 40°C	0°C to 40°C	0°C to 40°C	0°C to 50°C
<b>MANAGEMENT</b>					
Web		■	■	■	■
CLI access		Async, Telnet	Async, Telnet	Async, Telnet	Async, Telnet
SNMP		v2 and v3	v2 and v3	v2 and v3	v2 and v3
<b>NETWORK RESILIENCE</b>					
VRRP		■	■	■	■
<b>QoS</b>					
IEEE 802.1p priority queues		■	■	■	■
Queueing mechanisms		■	■	■	■
Priority mechanisms		■	■	■	■
<b>SECURITY</b>					
IEEE 802.1Q VLANs		64	64	64	64
RADIUS		■	■	■	■
SSL		■	■	■	■
IEEE 802.1x		■	■	■	■
DoS protection		■	■	■	■
Firewall		4000 sessions (AT-FL18B) 8000 sessions (AT-FL18C)	■	■	■
<b>OTHER</b>					
DMZ		■	■	■	■
MAC filter		■	■	■	■
IP / TCP / UDP filter		■	■	■	■
URL filter		■	■	■	■
Peer-to-peer protocols detection		■	■	■	■
Encryption (DES, 3DES, AES)		■	■	■	■
UPnP		■	■	■	■
VPN concurrent tunnels		1 - standard 5 - AT-FL19B, 10 - AT-FL19C 25 - AT-FL19D, 50 - AT-FL19E	250	1000	100
<b>ROUTING</b>					
RIPv1 and v2		■	■	■	■
IPv4		■	■	■	■
IPv6		AT-AR400-ADVL3UPGRD	AT-AR700-ADVL3UPGRD	AT-AR700-ADVL3UPGRD	AT-AR400-ADVL3UPGRD
OSPF		■	■	■	■
NAT / NAPT		■	■	■	■
NAT VPN pass-through (sessions)		■	■	■	■
PPPoE / PPTP / L2TP		■	■	■	■
DHCP client / server / relay		■	■	■	■
WAN load balancing		AT-FL15 (option)	Included	Included	AT-FL15 (option)
Server load balancing		AT-AR400-ADVL3UPGRD	AT-AR700-ADVL3UPGRD	AT-AR700-ADVL3UPGRD	AT-AR400-ADVL3UPGRD
BGP-4		AT-AR400-ADVL3UPGRD	AT-AR700-ADVL3UPGRD	AT-AR700-ADVL3UPGRD	AT-AR400-ADVL3UPGRD
<b>IDEAL ENVIRONMENT</b>		Medium business	Medium business	Large business	Branch office
<b>CUSTOMER'S NEEDS</b>		Remote access	Remote access	Remote access	Head office connectivity

# Wireless

[alliedtelesis.com/wireless](http://alliedtelesis.com/wireless)



The broad portfolio of Allied Telesis wireless products provides customers with high performance and low operating costs. Optimized for deployment across most environments, Allied Telesis wireless solutions are ideal for every application — from offices to classrooms, from distributed retail stores to large hospitals and campuses, and from warehouses to convention centers and sports arenas/stadiums. Advanced software features and a broad range of accessories meet the demands of SOHO to Enterprise-class networks.

# Extricom Series WLAN Products

The Allied Telesis Extricom™ Series WLAN system incorporates multiple breakthrough innovations that raise the bar for WLAN performance, flexibility, and ease of ownership. Based on Channel Blanket™, a groundbreaking architectural design, it delivers a solution that is fully IEEE 802.11a/b/g/n/ac-compliant, but changes all of the paradigms about the Wi-Fi experience.

## CloudBlanket™ NMS

### EXTRICOM SERIES WLAN MANAGEMENT

CloudBlanket NMS is a comprehensive cloud-based system enabling the efficient management of Extricom Series WLAN deployments from a single browser screen. Implementing the FCAPS (Fault, Configuration, Accounting, Performance, and Security) model, CloudBlanket NMS connects with Allied Telesis Extricom Series WLAN switches and access points to provide easy, standard-based administration, configuration, and monitoring.

CloudBlanket NMS supports any deployment size — from small systems with a few WLAN switches, up to large-scale deployments with thousands of switches.

CloudBlanket NMS applies to any WLAN vertical including education, hospitality, hospitals, logistics, data centers, and high-density large venues.

The Extricom Series WLAN system is based on UltraThin™ WLAN access points that are directly connected and fed from a central switch, the “brains” of the system. The WLAN switches orchestrate the user’s network access and authentication, AP association, traffic and traffic load balancing, band steering, as well as all QoS and security. Each such WLAN access point and switch network provides several Channel Blankets, making it possible among other things, to maximize the data bandwidth available per user.

Key advantages of the system include:

- **Very high throughput**, by providing better coverage, eliminating co-channel interference, and patented TrueReuse™ of channel bandwidth.
- **Stable, reliable performance** with industry-leading noise immunity and multiple uplinks, even in environments that render classic WLAN architectures ineffective.
- **Easy to deploy and maintain**, without the complexities of WLAN cell RF planning.
- **Seamless mobility** via blankets of WLAN coverage that is unmatched in the industry.
- **Built for Enterprise IP Triple Play** (voice, video, data), without performance trade-offs.

# Enterprise WLAN Switches



FEATURES		AT-EXLV-2000	AT-EXLS-3000	AT-EXMS-1000	AT-EXMS-500
<b>DESCRIPTION</b>		Large venue WLAN switch platform with 16 GbE ports for APs, up to 2 Channel Blankets, standalone and cascade options	Large-scale WLAN switch platform connecting up to 8 MS-1000 edge switches, up to 4 Channel Blankets, standalone only	Large-size Enterprise WLAN switch platform with 16 GbE ports for APs, up to 4 Channel Blankets, standalone and cascade options	Medium-size Enterprise WLAN switch platform with 8 GbE ports for APs, up to 4 Channel Blankets, standalone only
<b>FORM FACTOR</b>	Standalone	1RU desktop / 19 in rackmount	1RU desktop / 19 in rackmount	1RU desktop / 19 in rackmount	1RU desktop / 19 in rackmount
	Cascade	■		■	
<b>PORTS AND MEDIA SUPPORT</b>	Wired LAN uplink	2 × GbE combo ports (copper/SFP)	2 × GbE combo ports (copper/SFP)	2 × GbE combo ports (copper/SFP)	2 × GbE combo ports (copper/SFP)
	Connection to APs	16 × GbE copper	8 × GbE copper (for connecting MS-1000 only)	16 × GbE copper	8 × GbE copper
<b>MANAGEMENT</b>	Web GUI / CloudBlanket NMS	■	■	■	■
<b>WLAN STANDARDS</b>		IEEE 802.11a/b/g/n/ac IEEE 802.11e/WMM	IEEE 802.11a/b/g/n/ac IEEE 802.11e/WMM	IEEE 802.11a/b/g/n/ac IEEE 802.11e/WMM	IEEE 802.11a/b/g/n/ac IEEE 802.11e/WMM
<b>SECURITY</b>	Multi-layered security including standards-based RSN and rogue detection	■	■	■	■
	Encryption	IEEE 802.11i hardware-based encryption for: WEP-64 and WEP-128, WPA-TKIP / AES (CCMP), WPA2-TKIP / AES (CCMP)	IEEE 802.11i hardware-based encryption for: WEP-64 and WEP-128, WPA-TKIP / AES (CCMP), WPA2-TKIP / AES (CCMP)	IEEE 802.11i hardware-based encryption for: WEP-64 and WEP-128, WPA-TKIP / AES (CCMP), WPA2-TKIP / AES (CCMP)	IEEE 802.11i hardware-based encryption for: WEP-64 and WEP-128, WPA-TKIP / AES (CCMP), WPA2-TKIP / AES (CCMP)
<b>SPECTRUM</b>	Maximum simultaneous Channel Blankets	2	4	4	4
	Operating frequencies (dependent on APs)	2.412 – 2.484 5.180 – 5.825	2.412 – 2.484 5.180 – 5.825	2.412 – 2.484 5.180 – 5.825	2.412 – 2.484 5.180 – 5.825
<b>POWER SUPPLY</b>	Feed	100-240 VAC, 5 A max	100-240 VAC, 5 A max	100-240 VAC, 5 A max	100-240 VAC, 5 A max
	IEEE 802.3af (PoE) injectors to APs	■		■	■
<b>ENVIRONMENTAL</b>	Indoor / outdoor usage	Indoor	Indoor	Indoor	Indoor
	Temperature range	0°C to 45°C	0°C to 45°C	0°C to 45°C	0°C to 45°C
<b>IDEAL ENVIRONMENT</b>		Large public venue	Large Enterprise	Enterprise	SME, Campus
<b>CUSTOMER'S NEEDS</b>		High performance WLAN, difficult RF environments, high user density	High performance WLAN, difficult RF environments, high user density	High performance WLAN, difficult RF environments, high user density	High performance WLAN, difficult RF environments, high user density



**NEW**

# UltraThin Access Points



FEATURES		AT-EXRP-23ac	AT-EXRP-32n	AT-EXRP-32E0n	AT-EXRP-22n	AT-EXRP-22En
<b>DESCRIPTION</b>		UltraThin dual-radio access point, includes 1 x IEEE 802.11 a/b/g/n radio, 1 x IEEE 802.11 a/b/g/n/ac radio, internal antennas	UltraThin triple-radio access point, includes 3 x IEEE 802.11 a/b/g/n radios and internal antennas	UltraThin triple-radio access point, includes 3 x IEEE 802.11 a/b/g/n radios, outdoor enclosure and connectors for external antennas	UltraThin dual-radio access point, includes 2 x IEEE 802.11 a/b/g/n radios and internal antennas	UltraThin dual-radio access point, includes 2 x IEEE 802.11 a/b/g/n radios and connectors for external antennas
<b>FORM FACTOR</b>		Desktop / wallmount / ceiling mount	Desktop / wallmount / ceiling mount	Wallmount / ceiling mount / pole mount	Desktop / wallmount / ceiling mount	Wallmount / ceiling mount
<b>PORTS AND MEDIA SUPPORT</b>	Ethernet	1 x 100/1000T	1 x 100/1000T	1 x 100/1000T	1 x 100/1000T	1 x 100/1000T
	Wireless radio	1 x IEEE 802.11a/b/g/n/ac (3x3 MIMO) 1 x IEEE 802.11a/b/g/n (2x2 MIMO)	3 x IEEE 802.11a/b/g/n (2x2 MIMO)	3 x IEEE 802.11a/b/g/n (2x2 MIMO)	3 x IEEE 802.11a/b/g/n (2x2 MIMO)	3 x IEEE 802.11a/b/g/n (2x2 MIMO)
<b>MANAGEMENT</b>		Web GUI / CloudBlanket NMS				
<b>WLAN STANDARDS</b>		IEEE 802.11ac, 5GHz IEEE 802.11a/b/g/n, 2.4GHz and 5GHz	IEEE 802.11a/b/g/n, 2.4GHz and 5GHz	IEEE 802.11a/b/g/n, 2.4GHz and 5GHz	IEEE 802.11a/b/g/n, 2.4GHz and 5GHz	IEEE 802.11a/b/g/n, 2.4GHz and 5GHz
<b>SECURITY</b>		Multi-layered security including standards-based RSN and rogue detection				
<b>SPECTRUM</b>		Simultaneous Channel Blankets: 2 Operating frequencies (GHz): 2.412 – 2.484, 5.180 – 5.825	Simultaneous Channel Blankets: 3 Operating frequencies (GHz): 2.412 – 2.484, 5.180 – 5.825	Simultaneous Channel Blankets: 3 Operating frequencies (GHz): 2.412 – 2.484, 5.180 – 5.825	Simultaneous Channel Blankets: 2 Operating frequencies (GHz): 2.412 – 2.484, 5.180 – 5.825	Simultaneous Channel Blankets: 2 Operating frequencies (GHz): 2.412 – 2.484, 5.180 – 5.825
<b>SUPPORTED RATES</b>		IEEE 802.11ac: 433.3 Mbps IEEE 802.11n: 300 Mbps	IEEE 802.11n: 300 Mbps	IEEE 802.11n: 300 Mbps	IEEE 802.11n: 300 Mbps	IEEE 802.11n: 300 Mbps
<b>TRANSMITTED POWER (MAX)</b>		IEEE 802.11ac: 18 dBm IEEE 802.11n: 19 dBm IEEE 802.11b/g: 20 dBm IEEE 802.11a: 19 dBm	IEEE 802.11n: 19 dBm	IEEE 802.11n: 19 dBm	IEEE 802.11n: 19 dBm	IEEE 802.11n: 19 dBm
<b>ANTENNA</b>		Internal, omni-directional	Internal, omni-directional	External detachable, directional or omni-directional	Internal, omni-directional	External detachable, directional or omni-directional
<b>POWER SUPPLY</b>		PoE (IEEE 802.3af) or external	PoE (IEEE 802.3af) or external	PoE (IEEE 802.3af) or external	PoE (IEEE 802.3af) or external	PoE (IEEE 802.3af) or external
<b>ENVIRONMENTAL</b>		Indoor / outdoor usage Temperature range: -5°C to 45°C	Indoor Temperature range: -5°C to 45°C	Indoor Temperature range: -10°C to 40°C	Outdoor Temperature range: -5°C to 45°C	Indoor Temperature range: -5°C to 45°C / 23°F to 113°F
<b>IDEAL ENVIRONMENT</b>		Enterprise, large public venue	Enterprise, large public venue	Enterprise, large public venue, campus	Enterprise, large public venue	Enterprise, large public venue, campus
<b>CUSTOMER'S NEEDS</b>		High performance WLAN, difficult RF environments, high user density	High performance WLAN, difficult RF environments, high user density	High performance WLAN, difficult RF environments, high user density	High performance WLAN, difficult RF environments, high user density	High performance WLAN, difficult RF environments, high user density

## Enterprise WLAN Switch Hardware Licenses

- ▶ **AT-EXLC-400G**  
4-port standalone mode, AT-EXMS-500
- ▶ **AT-EXLC-800G-8**  
8-port standalone mode, AT-EXMS-500
- ▶ **AT-EXLC-800G-16**  
8-port standalone mode, AT-EXMS-1000
- ▶ **AT-EXLC-1200G**  
12-port standalone mode, AT-EXMS-1000
- ▶ **AT-EXLC-1600**  
16-port standalone mode, AT-EXMS-1000
- ▶ **AT-EXLC-3200**  
32-port cascade, dual AT-EXMS-1000 platform
- ▶ **AT-EXLC-LV**  
AT-EXLV-2000 with 16 UltraThin APs
- ▶ **AT-EXLC-LV-3200**  
32-port cascade, dual AT-EXLV-2000
- ▶ **AT-EXLC-LS-EDGE**  
16-port AT-EXMS-1000 edge switch
- ▶ **AT-EXLC-LS**  
8 AT-EXMS-1000 edge switches on AT-EXLS-3000 platform
- ▶ **AT-EXLC-LS-Redundancy**  
Large scale redundancy between AT-EXLS-3000 switches (requires AT-EXLC-LS license)
- ▶ **AT-EXSU 400GU-8**  
Upgrade AT-EXLC-400G to AT-EXLC-800G-8 on AT-EXMS-500 platform
- ▶ **AT-EXSU 800GU-12**  
Upgrade AT-EXLC-800G-16 to AT-EXLC-1200G on AT-EXMS-1000 platform
- ▶ **AT-EXSU 800GU-16**  
Upgrade AT-EXLC-800G-16 to AT-EXLC-1600 on AT-EXMS-1000 platform
- ▶ **AT-EXSU 1200GU-16**  
Upgrade AT-EXLC-1200G to AT-EXLC-1600 on AT-EXMS-1000 platform
- ▶ **AT-EXLC-3200R**  
32-port resiliency for redundancy between cascade switches (requires AT-EXLC-3200)
- ▶ **AT-EXLC-TR**  
TrueReuse on standalone AT-EXMS-500/1000
- ▶ **AT-EXLC-UP**  
Upgrade existing firmware for non-support customers

## Accessories



FEATURES		AT-EXRE-1000	AT-EXMC-1000
<b>DESCRIPTION</b>		<b>PoE Range Extender</b> Access points / WLAN switch wired network range extension to 200 m over copper	<b>Media Converter</b> Access points / WLAN switch wired network range extension to 400 m over fiber
<b>FORM FACTOR</b>		Desktop / wallmount / rackmount	Desktop / wallmount / rackmount
<b>PORTS AND MEDIA SUPPORT</b>		2 x Ethernet IEEE 802.3x, full/half-duplex 100/1000T	Switch side: 1 x Ethernet IEEE 802.3x, full/half-duplex 100/1000T with PoE 1 x SFP port for 1000X AP side: 1 x Ethernet IEEE 802.3x, full/half-duplex 100/1000T with PoE 1 x SFP port for 1000X
<b>POWER SUPPLY</b>		PoE (IEEE 802.3af)	Switch side: PoE (IEEE 802.3af) AP side: External 48 VDC
<b>ENVIRONMENTAL</b>		Indoor / outdoor Temperature range: 0°C to 45°C	Indoor Temperature range: 0°C to 45°C
<b>IDEAL ENVIRONMENT</b>		Enterprise, Large Public Venue, Campus	Enterprise, Large Public Venue, Campus

# TQ and WR Series

## WIRELESS ACCESS POINTS

Allied Telesis TQ Series wireless access points support the latest IEEE 802.11ac standards, doubling the raw wireless capacity available with an IEEE 802.11n access point. With flexible deployment modes: standalone, AP-cluster, or controlled by the UWC WLAN controller, TQ Series access points are suitable for a wide variety of environments — from small offices to large campuses.

Allied Telesis WR Series access points are suitable for residential managed WLAN deployments.



		ACCESS POINTS AND ROUTERS	
FEATURES		AT-WR2304N	AT-TQ4600
FORM FACTOR		Desktop / wallmount	Desktop / wallmount / ceiling mount
	Ethernet	1 x 10/100TX (WAN); 4 x 10/100TX (LAN)	1 x 10/100/1000T
PORTS AND MEDIA SUPPORT	Wireless radio	1 x IEEE 802.11b/g/n (2x2 MIMO) : 300Mbps	1 x IEEE 802.11a/n/ac (3x3 MIMO 1300Mbps) 1 x IEEE 802.11b/g/n (3x3 MIMO) : 450Mbps
	POWER SUPPLY	External	External or IEEE 802.3af PoE (PD)
ENVIRONMENTAL	Indoor / outdoor usage	Indoor	Indoor
	Temperature range	0°C to 45°C	Powered via PoE: 0°C to 40°C Powered via PSU: 0°C to 40°C
SCALABILITY	Clustering		Up to 16 members
MANAGEMENT	Operations management	Standalone	Standalone / controlled mode
	Web GUI	HTTP, HTTPS	HTTP, HTTPS
	CLI access		
	SNMP	v1, v2c	v1, v2c
	UPnP	■	
SECURITY	RADIUS / IEEE 802.1x / SSL	■	■
	Encryption	AES	AES
	DoS protection	■	■
	Firewall	■	
	DMZ	■	
	NAT / NAPT	■	
	ALG	■	
	VPN pass-through	Multiple sessions	
	Filtering	■	■
	MAC address	■	■
	IP	■	
BRIDGING	TCP / UDP port	■	
	URL	■	
	MAC cloning	■	
	PPPoE / PPTP / L2TP	■	
	VLAN		■
ROUTING	VLAN bridging		
	IPv4	■	
WIRELESS	Supported protocols	Static routing	
	IEEE 802.11e (QoS)	WMM	WMM
	IEEE 802.11i (security)	■	■
	Mode: infrastructure	Access point, station	Access point
	Wireless Distribution System (WDS)	■	■
	Wireless Protected Setup (WPS)	■	
	Captive portal		Controlled mode only
	Dynamic channel planning	■	■
	Multiple SSID	4	32
	VLAN to SSID mapping		■
	Regulatory domain compliance		■
	Rogue AP detection		■
	Antenna	2 x 2.4GHz (2dBi) omni, detachable	3 x 2.4GHz (3dBi) / 3 x 5GHz (4dBi), omni embedded
	Antenna diversity mode		■
Wi-Fi certified	■	■	
IDEAL ENVIRONMENT	Small business (SMB)	Enterprise	
CUSTOMER'S NEEDS	User access / indoor wireless bridge	User access (BYOD) / indoor wireless bridge / hotspot	

## CONTROLLER FOR TQ SERIES ACCESS POINTS

Allied Telesis WLAN controllers are the single point of management for the operation, administration, and maintenance of all access points in an Enterprise. The WLAN controller is available as either a hardware appliance or hosted software for cloud-based applications.

Key features include:

- Simplified Plug-and-Play access ports
- RF management and control
- Wireless Intrusion Prevention System
- Security safeguards
- Resilience
- Seamless mobility
- Client location tracking
- Graphic visualization



FEATURES		SOFTWARE APPLIANCE	HARDWARE APPLIANCE	
		AT-UWC-Install + AT-UWC-BaseST	AT-UWC-60-APL	
<b>FORM FACTOR</b>		Virtual machine software	Desktop, 1RU	
<b>DEPLOYMENT MODE</b>	Data forwarding		Distributed, centralized	
	Grouping / clustering		RF group, mobility group	
	Wireless network topology		Access point, WDS	
<b>SCALABILITY</b>	Clients per AP		200	
	Clients per controller		8000	
	APs per controller	10, upgradable up to 200		10, upgradable up to 60
	Groups		255	
	Controllers per group		64	
	APs per group		2000	
	WLANs		64	
	VLANs		4096	
	AP profiles		16	
	Network profile		64	
<b>PORTS AND MEDIA SUPPORT</b>	Ethernet	1 × vNIC	6 × 1000T	
	Serial		1	
	USB		2	
<b>POWER SUPPLY</b>			AC/DC adapter	
<b>ENVIRONMENTAL</b>	Temperature range		5°C to 40°C	
	Cooling		Fan	
<b>MANAGEMENT</b>	RF coverage hole arrangement		■	
	Self-recovery of AP fault		■	
	RF interference mitigation		■	
	Dynamic Tx power adjustment		■	
	Dynamic channel selection		■	
	Client load balancing		■	
	Plug and Play / discovery mechanism		Layer 2 and Layer 3	
Client location service		■		
<b>HIGH AVAILABILITY</b>	Adaptive AP operations mode		■	
	Controller redundancy		N:N	
<b>ROUTING</b>	Bridging		■	
	Routing		■	
	Mobility		Layer 2 and Layer 3, Fast BSS transition	
<b>NETWORKING</b>	Client load balancing		■	
	Wireless Multimedia Media (WMM)		■	
	Optimized video streaming		■	
	Rate limiting		■	
	MAC layer QoS		■	
<b>SECURITY</b>	Access Control List (ACL)		■	
	Guest access		Captive portal, Web authentication	
	Intrusion detection / prevention system		Wireless IDS (wIDS), rogue AP detection, rogue client	
<b>IDEAL ENVIRONMENT</b>		Small to mid-sized enterprise		
<b>CUSTOMER'S NEEDS</b>		Cloud-based application	Dedicated server model	
		User access (BYOD) / Hotspot / centralized WLAN management		

Allied Telesis offers a variety of wireless network accessories, including antennas, power supplies, service modules, splitters, mounting hardware, and cabling.

## PoE



		PSE PoE		PD PoE
FEATURES		AT-6101G	AT-6101GP	AT-6102G
<b>FORM FACTOR</b>		Desktop	Desktop	Desktop / wallmount
<b>PORTS AND MEDIA</b>	10/100/1000T	1	1	1
<b>POWER SUPPLY</b>	PSU type	Fixed internal	Fixed internal	PoE
<b>POWER OVER ETHERNET</b>	IEEE 802.3af	■	■	■
	IEEE 802.3at		■	
	PoE-enabled ports	1	1	1
	Max number of full power ports	1	1	1
	Mode	B	B	A or B
	PoE power	15.4W	30W	10W
	DC out (vDC)			5 / 7.5 / 9 / 12
<b>ENVIRONMENTAL</b>	Cooling	Fanless	Fanless	Fanless
<b>MANAGEMENT</b>		Unmanaged	Unmanaged	Unmanaged
<b>CUSTOMER'S NEEDS</b>		Feeding protected PoE to any Fast and Gigabit Ethernet equipment without having to replace non-PoE switches	Feeding protected PoE to any Fast and Gigabit Ethernet equipment without having to replace non-PoE switches	Makes any non-PoE equipment capable of PoE up to Gigabit Ethernet speed / extract power from a PoE line and supply 5 / 7.5 / 9 or 12VDC to any equipment

### PoE MODE

- A: Feeding and receiving power on data pairs
- B: Feeding and receiving power on spare pairs

### PSE

Power Sourcing Equipment feeding power to a Powered Device.

### PD

Powered Device receives power from Power Sourcing Equipment.

### WMM

Wireless Multimedia is a Wi-Fi Alliance interoperability certification that provides basic Quality of Service (QoS) to applications running over Wi-Fi.

### WISP

Wireless Internet Service Provider.

## Accessories



		WALLMOUNT	COAX CABLES			
FEATURES		AT-WR4501	AT-TQ0001	AT-TQ0003	AT-TQ0041	AT-TQ0045
<b>ENVIRONMENTAL</b>	Indoor / outdoor usage	Outdoor	Outdoor	Outdoor	Outdoor	Outdoor
<b>ANTENNA / CABLE TYPE</b>			HDF200	HDF200	HDF400	HDF400
<b>ANTENNA GAIN (dBi)</b>	@ 2.4GHz					
	@ 5GHz					
<b>INSERTION LOSS (dB)</b>	@ 2.4GHz		-0.5	-1.7	-0.3	-1.2
	@ 5GHz		-0.7	-2.7	-0.5	-2.1
<b>CONNECTOR</b>			1 x N plug 1 x RP-SMA plug	1 x N plug 1 x RP-SMA plug	2 x N plug	2 x N plug
<b>COMPATIBLE EQUIPMENT</b>	AT-WR2304N	■	■	■	■	■
	AT-TQ2450		■	■		
	AT-WR4662n	■				■
<b>IDEAL ENVIRONMENT</b>		WISP / Enterprise	WISP / Enterprise	WISP / Enterprise	WISP / Enterprise	WISP / Enterprise
<b>CUSTOMER'S NEEDS</b>		Wallmount	Higher gain or directional antenna	Higher gain or directional antenna	External antenna	External antenna

# NICs



## CLIENT (STA) MODE

The equipment's wireless interface can be configured to operate as a wireless client connecting to any other access points.

## IEEE 802.11f (IAPP)

Inter Access Point Protocol simplifies and speeds roaming between two access points.

## WLL

Wireless Local Loop defines the wireless access of customer's premises to the Telco operator network.

## FULL HOTSPOT

The equipment is able to implement a full-featured hotspot system including wireless access, Web page management, multiple virtual hotspots on a single radio interface, RADIUS server, and customer's profile management application.

FEATURES		WIRELESS NICS
		AT-WNP300N
<b>BUS TYPE</b>		PCI 2.2 (full and low-profile bracket)
<b>PORTS AND MEDIA SUPPORT</b>	Wireless radio	IEEE 802.11b/g/n (2x2 MIMO : 150Mbps)
<b>ENVIRONMENTAL</b>	Temperature range	0°C to 45°C
<b>WIRELESS AND SECURITY</b>	IEEE 802.11e (QoS)	WMM
	IEEE 802.11i (security)	■
	IEEE 802.1x supplicant	■
	WEP (bits)	64 / 128
	WPA-EAP, WPA-PSK	■
	WPA2-EAP, WPA2-PSK	■
	Wireless Protected Setup (WPS)	■
	Dynamic data rate scaling	■
<b>DIAGNOSTIC LEDS</b>		■
<b>DRIVER SUPPORT</b>	Windows 2000	■
	Windows XP	■
	Windows Vista	■
	Windows 7	Via NDIS wrapper
<b>CERTIFICATIONS</b>	WHQL	■
	Wi-Fi Alliance	■



CAT5 CABLES		ANTENNA	RF SPLITTERS		SURGE PROTECTOR
AT-TQ0051	AT-TQ0053	AT-TQ0500	AT-TQ0292	AT-TQ0592	AT-TQ0591
Outdoor CAT5 UTP	Outdoor CAT5 UTP	Outdoor Omni	Outdoor	Outdoor	Outdoor
		2 5			
			-0.6	-0.5 -0.5	-1.5 -1.5
1 × RJ-45 plug 1 × waterproof RJ-45 plug	1 × RJ-45 plug 1 × waterproof RJ-45 plug	1 × N plug	3 × N socket	3 × N socket	1 × N plug 1 × N socket
■	■	■	■	■	■
WISP / Enterprise	WISP / Enterprise	WISP / Enterprise	WISP / Enterprise	WISP / Enterprise	WISP / Enterprise
Achieve IP67 protection level for outdoor equipment		Hotspot / AP	Two antennas on one radio I/F	Two antennas on one radio I/F	Equipment lightning protection

# Antennas

ANTENNA TYPE	GAIN (dBi)	ALLIED TELESIS TenQ ANTENNA MODEL		LOBE WIDTH (°)		POLARIZATION
		2.4GHz	5GHz	Horizontal	Vertical	
OMNI	2	AT-TQ0500		360	45	Vertical
	5		AT-TQ0500	360	30	Vertical
	8	AT-TQ0201E	AT-TQ0501E	360	17	Vertical
	12	AT-TQ0202E	AT-TQ0502E	360	5	Vertical
PANEL	8	AT-TQ0221E	AT-TQ0521E	75	50	Vertical / horizontal
	15	AT-TQ0222E	AT-TQ0522E	30	30	Vertical / horizontal
	20	AT-TQ0223E	AT-TQ0523E	15	15	Vertical / horizontal
SECTOR	12	AT-TQ0241E	AT-TQ0541E	120	15	Vertical
	14	AT-TQ0242E	AT-TQ0542E	60	15	Vertical
	18	AT-TQ0243E		30	15	Vertical
PARABOLIC	19	AT-TQ0261E		15	15	Vertical
	23		AT-TQ0561E	7.5	7.5	Vertical
	24	AT-TQ0262E		8	8	Vertical
	27.5		AT-TQ0562E	5.2	5.2	Vertical

## Antenna Types

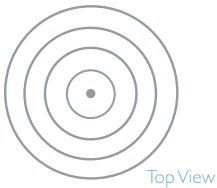

**Omni**  
Omnidirectional antennas radiate power uniformly in every direction on the horizontal plane. Most access points and client devices have omnidirectional antennas.



**Panel**  
A flat antenna with a radiation lobe similar to a cone. It is directional and is normally used for point-to-point links or at the end-points of a point-to-multipoint network.



**Sector**  
A flat antenna with a radiation lobe similar to a cone with an elliptical footprint. It is directional and is normally used in the central site of a point-to-multipoint network.

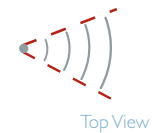

**Parabolic**  
A dish-shaped, directional antenna with a radiation lobe similar to that of a panel antenna. It is usually larger than a panel and has a higher gain. Parabolic antennas are suitable for long-distance, point-to-point links.

## Gain

Gain expresses how much an antenna enhances its transmitted and received signals relative to a simple dipole. Gain is expressed in dB and is logarithmic.

## Polarization

Polarization defines the position in space of electrical and magnetic fields. The best signal transfer happens when both transmitting and receiving antennas have the same polarization. A 90° difference between transmitting and receiving antennas may produce up to -30dB of signal attenuation.

## Loss

Loss is the attenuation or reduction in power of a system, expressed in dB. All cables and connector devices have a loss variable and must be considered when designing a wireless system, especially when directional antennas are used.

### LOW GAIN

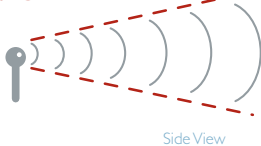

An omnidirectional antenna concentrates the signal in a 360° belt around it. The higher the gain, the thinner the belt, resulting in a better signal far from the antenna — but a narrower communication area.

produce a focused beam, and are typically deployed in medium- to long-distance point-to-point links.

### HIGH GAIN

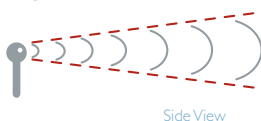

Panel and parabolic antennas have a nearly circular footprint. Low gain panels can be used for both short distance point-to-point and point-to-multipoint links, such as wireless coverage for user access. High-gain panel and parabolic antennas

A sector antenna footprint is a horizontal ellipse with a width of 30°, 60°, 90°, or 120°. High gain sector antennas have a vertically thinner footprint while keeping the same horizontal width, suited for the central site of a point-to-multipoint link or coverage of a certain “sector” in mobile networks.

# iMAP

[alliedtelesis.com/imap](http://alliedtelesis.com/imap)

IP is driving new, innovative services and applications. Converged services and real-time communications are changing lifestyles, along with the type of network required to deliver them. Service providers face the challenge of re-architecting the access network to meet today's IP-driven broadband service, such as IP Triple Play, and at the same time try to anticipate the requirements for the "next new service." Selecting the best platform and technology becomes critical to protecting investments and responding competitively to new service needs.

The Allied Telesis integrated Multiservice Access Platform (iMAP™) is the benchmark of true next-generation IP access solutions, fulfilling all of today's critical broadband service needs — and designed to evolve with new service demands.

# integrated Multiservice Access Platform

As the world's communications systems move to an all IP and Ethernet access network with IP/MPLS core, the Allied Telesis iMAP represents the first and only true IP access platform designed for this purpose. Its unique carrier-grade IP/Ethernet capabilities are suitable for any provider building an IP access network. Industry-leading capabilities position the iMAP as the access network for alternative and emerging carriers, Independent Operating Companies (IOCs), PTTs, ILECs, ISPs, public utilities, and private organizations such as hospitals, hotels, and Multi-Tenant Units/Multi-Dwelling Units (MTU/MDU).

## Chassis



FEATURES		MicroMAP 9001	iMAP 9100	iMAP 9700			iMAP 9810		
PART NUMBER		AT-TN-254-80	AT-TN-9101 / 2 / 3	AT-TN-250G-B			AT-TN-253G		
PHYSICAL HEIGHT			1RU	9RU			3RU		
POWER SUPPLY	Single AC		AT-TN-9102	Requires additional AT-TN-R113			Requires additional AT-TN-R113		
	Dual AC (option)	Future	AT-TN-9103	Requires additional AT-TN-R113 and AT-TN-R114			Requires additional AT-TN-R113 and AT-TN-R114		
	Dual DC	Standard	AT-TN-9101	Standard			Standard		
CONTROLLER CARDS	Primary fabric controller	Not required	CFC12 (AT-TN-408)	CFC56 (AT-TN-407)	CFC56 (AT-TN-407)	CFC56 (AT-TN-407)	CFC100 (AT-TN-409)	CFC100 (AT-TN-409)	CFC100 (AT-TN-409)
	Optional redundant controller	Not required		CFC56 (AT-TN-407)	CFC56 (AT-TN-407)	CFC56 (AT-TN-407)	CFC100 (AT-TN-409)	CFC100 (AT-TN-409)	CFC100 (AT-TN-409)
NETWORK TRANSPORT	Slots	None integrated into chassis	None – transport on CFC12 fabric	2	2	2	2	2	2
	Model	None	CFC12 fabric (AT-TN-408)	GE3 (AT-TN-301)	XE1S (AT-TN-310)	XE6 (AT-TN-309)	GE3 (AT-TN-301)	XE1S (AT-TN-310)	XE6 (AT-TN-309)
	Uplink ports	4 × SFP 1/2.5G	4 × SFP + 2 × 10/100/1000T	3 × SFP	1 × SFP+	6 × SFP+	3 × SFP	1 × SFP+	6 × SFP+
	Uplink speed		Gigabit	Gigabit	10GbE	10GbE	Gigabit	10GbE	10GbE
CHANNEL UNIT SLOTS		1	3	17 (16 with dual-fabric cards)		15 (when dual XE6 installed, 14 with dual-fabric cards)	8		6 (when dual XE6 installed)
MAX PORTS	xDSL		72	408		360	192		144
	POTS		72	408		360	192		144
	T1/E1		24	136		120	64		48
	Dual fiber (100Mbps)		30	170		150	80		60
	BiDi fiber (100Mbps)		60	340		300	192		120
	BiDi fiber (1000Mbps)		72	408		360	192		144
	10/100TX (copper)		30	170		150	80		60
	Gigabit SFP		24	136		120	64		48
	GEPON		192	1088		960	512		384
UDSL24	24	N/A	N/A		192				
TEMPERATURE RANGE		-40°C to 65°C	-40°C to 65°C (AT-TN-9102/3 AC version: 0°C to 55°C)	-40°C to 65°C			-40°C to 65°C		



# Controller Cards



FEATURES		CFC12	CFC56	CFC100
<b>PART NUMBER</b>		AT-TN-408	AT-TN-407	AT-TN-409
<b>CHASSIS COMPATIBLE</b>	iMAP 9100	■		
	iMAP 9700		■	
	iMAP 9810			■
<b>PERFORMANCE</b>	Switching fabric	12Gbps	56Gbps	100Gbps
	EPSR	■	■	■
	VLANs per port	4095	4095	4095
	Per VLAN rate limiting	■	■	■
<b>UPLINKS</b>	SFP (1000Mbps)	4		
	10/100/1000T	2		
<b>SECURITY</b>	Upstream forwarding only	■	■	■
	ACL support	■	■	■
<b>QoS</b>	Priority queues	8	8	8
	Priority scheduling	■	■	■

## One Access Platform, Any Service

The iMAP product family is designed to support IP Triple Play services using Ethernet technology. With redundant Gigabit Ethernet connections, or 10 Gigabits on the iMAP 9810 to each line card from the control modules, there is ample bandwidth and throughput for all current and future services and access technologies. The central fabric control cards enable multiple 10 Gigabit uplink and transport capability, ensuring future capacity and performance needs are addressed without requiring a major hardware upgrade.

## Multiple Services, Diversified and Increased Revenues

In addition to traditional and enhanced ADSL/ADSL2+ and VDSL2, the iMAP provides the capability to offer revenue-generating residential and business services such as FTTx, T1/E1, G.SHDSL, and POTS — all from the same platform. With features like Ethernet Protection Switched Rings, iMAPs can be networked together with full redundancy and sub-50ms switchover times, ensuring carrier-grade 99.999% availability and maximum uptime.

# Channel Units



FEATURES		POTS24C	ADSL24AE	PAC24C	ADSL24B	VDSL24A	VDSL24B	UDSL24
<b>PART NUMBER</b>		AT-TN-143	AT-TN-140	AT-TN-145	AT-TN-124	AT-TN-130	AT-TN-128	AT-TN-146-A
<b>COPPER</b>	POTS	24		24				
	ADSL (Annex A)		24	24				24
	ADSL (Annex B)				24			
	VDSL2 (Annex A)					24		24
	VDSL2 (Annex B)						24	
	T1/E1 (circuit emulation)							
<b>FIBER</b>	100Mbps BiDi, SMF							
	100/1000Mbps BiDi, SMF							
	SFP (1000Mbps)							
	GEAPON							
<b>PHYSICAL</b>	Single / double width channel unit	Single	Single	Double	Single	Single	Single	Single
<b>SALES REGION</b>		All	All	US only	EU only	All	All	All



FEATURES		CES8	FX20BX	FX20BX40	GE24BX	GE8	GEAPON
<b>PART NUMBER</b>		AT-TN-119	AT-TN-139	AT-TN-142	AT-TN-144	AT-TN-117	AT-TN-118
<b>COPPER</b>	POTS						
	ADSL (Annex A)						
	ADSL (Annex B)						
	VDSL2 (Annex A)						
	VDSL2 (Annex B)						
	T1/E1 (circuit emulation)	8					
<b>FIBER</b>	100Mbps BiDi, SMF		20 (10 km)	20 (40 km)			
	100/1000Mbps BiDi, SMF				24 (20 km)		
	SFP (1000Mbps)					8	
	GEAPON						2
<b>PHYSICAL</b>	Single / double width channel unit	Single	Single	Single	Single	Single	Single
<b>SALES REGION</b>		All	All	All	All	All	All

A complex network diagram with numerous nodes and connecting lines, rendered in shades of blue and black, serving as a background for the text.

The rapid changes from broadcast to on-demand video and from surfing the Web to content sharing have not only increased demands for bandwidth, but created greater needs to manage converged IP services. If a service provider is to capitalize on the revenue opportunities derived from multimedia services and satisfied consumer needs, an intelligent home gateway approach becomes essential.

Moving from a “dumb pipe” to a service-oriented connection requires having both management and functionality at both the access side and the terminal side. Whether a single-family home or MDU, with the home gateway located outdoors or within the residence, service providers need management, control, and provisioning capabilities. Allied Telesis iMG products for DSL and fiber applications are designed as extensions of the Allied Telesis access platform, with unified management functionality and features.

# intelligent Multiservice Gateways

Fiber-based iMGs offer Gigabit or 100 Megabit-to-the-home service and include such features as GR909 testing, TDR wire analysis, and HPNA endpoint analysis. In addition, the iMGs support Layer 3 capabilities, whole home service, and Microsoft Mediaroom.

Allied Telesis iMG ONT products provide a smarter, feature-rich, flexible approach to delivering subscriber services, and are critical to a service provider wanting to deliver reliable, high-quality, high-revenue services. The iMG family of full-featured indoor and outdoor gateways support xDSL and fiber (FTTH) options,

## AlliedView™ NMS

Allied Telesis Network Management Software tools can help visualize and plan for network growth while maintaining the health and performance of the network. See page 61.



FEATURES		iMG634 Series	iMG634W Series	AT-iMG1405	AT-iMG1405W	AT-iMG1425	AT-iMG1425W	AT-iMG1425RF	AT-iMG1505
<b>ENVIRONMENTAL</b>	Indoor usage	■	■	■	■	■	■	■	■
	Outdoor usage								
<b>UPLINK</b>	ADSL2+ Annex A	AT-iMG634A-R2	AT-iMG634WA-R2						
	ADSL2+ Annex B	AT-iMG634B-R2	AT-iMG634WB-R2						
	Ethernet 100Mbps copper	■	■						
	Ethernet 100Mbps fiber (SMF)								
	Ethernet 100Mbps fiber (BIDI)								■
	Ethernet 100Mbps fiber SFP module								
	Ethernet 1000Mbps fiber (BIDI)			■ SFP	■ SFP	■ SFP	■ SFP	■ SFP	■ (20 km)
<b>LAN INTERFACE</b>	10/100TX	4	4	3	3	3	3	3	
	10/100/100T			2	2	2	2	2	5
	T1/E1								
	Wireless IEEE 802.11b/g		■						
	Wireless IEEE 802.11b/g/n				■		■		
	HPNAv3.1								
<b>WAN PORT</b>	Copper / fiber	Copper	Copper	Fiber	Fiber	Fiber	Fiber	Fiber	Fiber
<b>CATV RF OVERLAY</b>	High output power							■	
	FXS	2	2			2	2	2	
<b>PHONE INTERFACES</b>	PSTN lifeline	■	■			■	■	■	
	VoIP PROTOCOLS	SIP / MGCP	■	■		■	■	■	
<b>CONSOLE INTERFACE</b>	RS232 RJ-45 connector	■	■						
	USB			■	■	■	■	■	■
<b>QoS</b>	IEEE 802.1p priority queues	■	■	■	■	■	■	■	■
	IEEE 802.1Q VLANs mgmt	■	■	■	■	■	■	■	■
<b>MANAGEMENT</b>	AlliedView NMS	■	■	■	■	■	■	■	■
	TR-069			■	■	■	■	■	■
	SNMPv1, v2 and v3	■	■	■	■	■	■	■	■
	Telnet, Web, GUI, CLI	■	■	■	■	■	■	■	■
	Remote software upgrade	■	■	■	■	■	■	■	■
<b>ACCESSORY AVAILABLE</b>	Fiber outlet kit AT-iMG001								■
	Battery backup AT-iMG008	■	■	■	■	■	■	■	■
	Outdoor case AT-EN-SFR-ONT								

all designed with the features, management, and IP functionality needed to deliver the “connected home.” As the name implies, intelligent Multiservice Gateway products are fully featured for delivering multimedia services such as broadcast and streaming IP video, Internet data, analog voice, and VoIP from a single subscriber line to multiple devices in the home.

Features and functionality between the iMAP access family, or the SwitchBlade x3112 and iMG home gateway family, are intelligently integrated with Allied Telesis AlliedView NMS for end-to-end management and diagnostics. This ensures every service is manageable all the way to the subscriber, eliminating the “holes” often caused by using “dumb” devices that merely terminate subscriber lines. Consequently, less time is spent on provisioning, and unnecessary truck rolls are reduced — leading to lower OPEX and greater customer satisfaction.



	AT-IMG1525	AT-IMG1525RF	AT-IMG2426F	AT-IMG2504	AT-IMG2522	AT-IMG2524	AT-IMG2524F	AT-IMG2524H	AT-IMG746MOD
	■	■	■	■	■	■	■	■	■
			■	■	■	■	■	■	■
							■	■	■
	■	■	■ SFP						■
	■ (20 km)	■ (20 km)	■ SFP	■ (20 km)	■ (20 km)	■ (20 km)	■ (20 km)	■ (20 km)	■
									6
	5	5	6	4	4	4	4	4	1
									■
								■	
	Fiber	Fiber	Fiber	Fiber	Fiber	Fiber	Fiber	Fiber	Fiber
		■					■		
	2	2	2		2	2	2	2	4
	■	■			■	■	■	■	■
	■	■	■		■	■	■	■	■
	■	■	■	■	■	■	■	■	■
	■	■	■	■	■	■	■	■	■
	■	■	■	■	■	■	■	■	■
	■	■	■	■	■	■	■	■	■
	■	■	■	■	■	■	■	■	■
	■	■	■	■	■	■	■	■	■
	■	■	■	■	■	■	■	■	■
	■	■	■	■	■	■	■	■	■
	■	■	■	■	■	■	■	■	■
	■	■	■	■	■	■	■	■	■
	■	■	■	■	■	■	■	■	■
	■	■	■	■	■	■	■	■	■

# iMG Feature Matrix

MODEL	DEPLOYMENT		WAN							POTS	LAN ETHERNET			LAN — OTHER				
	Outdoor	Indoor	xDSL	100M	100M/1000	GE	AFTTX	EPON	GPON	FXO	10/1000	10/100/1000	T1/E1	VDSL	G.Fast	RF	HPNA	Wireless
AT-IMG746MOD	■	■		■		■		■		4	6	1	2				■	
AT-IMG1405		■				■ (SFP)					2	3						
AT-IMG1405W		■				■ (SFP)					2	3						IEEE 802.11
AT-IMG1425		■				■ (SFP)				2	2	3						
AT-IMG1425W		■				■ (SFP)				2	2	3						IEEE 802.11
AT-IMG1425RF		■				■ (SFP)				2	2	3				■		
AT-IMG1525		■			■					2		5						
AT-IMG1505		■			■							5						
AT-IMG1525RF		■			■					2		5				■		
AT-IMG2426F	■	■		■		■				2		6						
AT-IMG2504	■	■			■							4						
AT-IMG2522	■	■				■				2		2						
AT-IMG2524	■	■				■				2		4						
AT-IMG2524F	■	■			■							4						
AT-IMG2524H	■	■			■					2		4						■



# Media Converters

[alliedtelesis.com/mediaconverters](http://alliedtelesis.com/mediaconverters)

Allied Telesis media converters extend network distances by adding fiber and VDSL (via coax and telephone-grade twisted pair) only where it is needed. This enables customers to keep pace with changing technology and to integrate high-bandwidth devices into the network without changing the entire network infrastructure. From standalone units to chassis-based blades, Allied Telesis media converters are highly configurable to meet every need.

# Standalone



ETHERNET AND FAST ETHERNET STANDALONE MEDIA CONVERTERS

FEATURES		AT-MC13	AT-MC101XL	AT-MC102XL	AT-MC103XL	AT-MC103LH	AT-MC104XL	AT-MC115XL	AT-MC116XL	AT-MC605
PORTS	Port 1	10T	100TX	100TX	100TX	100TX	100FX MMF (SC)	10T or 100TX	10T or 100TX	100TX
	Port 2	10FL (ST)	100FX (ST)	100FX (SC)	100FX (SC)	100FX (SC)	100FX (SC)	10FL (ST) or 100SX (ST)	10FL (SC) or 100SX (SC)	RJ-11
	Type	MMF	MMF	MMF	SMF	SMF	SMF	MMF	MMF	VDSL
IEEE STANDARD		10FL	100FX	100FX	100FX	100FX	100FX	100SX	100SX	
Tx WAVELENGTH		850 nm	1310 nm	1310 nm	1310 nm	1310 nm	1310 nm	850 nm	850 nm	
Rx WAVELENGTH		850 nm	1310 nm	1310 nm	1310 nm	1310 nm	1310 nm	850 nm	850 nm	
MAX DISTANCE		2 km	2 km	2 km	15 km	40 km	15 km	2 km	2 km	3 km
FUNCTIONALITY	Rate and speed									
	MissingLink support		■	■	■	■	■	■	■	
	Smart MissingLink support									
	Max frame size	9KB	9KB	9KB	9KB	9KB	9KB	9KB	9KB	
	Diagnostic LEDs	6	7	7	7	7	7	8	8	6
POWER OVER ETHERNET	IEEE 802.3af Class 3									
	PoE-enabled ports									
	Max full power ports									
	Mode									
	PoE power									
POWER SUPPLY	PSU type	External	External	External	External	External	External	External	External	External
	Multi-region	■				■	■	■	■	■
	Compatible with AT-MCR12 12-slot chassis	■	■	■	■	■	■	■	■	■
	Compatible with AT-MCR1 1-slot chassis	■	■	■	■	■	■	■	■	■

Allied Telesis media converters enable the connection of disparate cabling types in networks where many cabling types exist. Network segments may also operate at different speeds, and media converters can be used to convert between speeds. Typically, media converters are used to connect copper and fiber-optic cabling that coexist in a network. Converters exist in a variety of standalone, multi-port, and modular forms. These different physical forms address the need for different applications and conversion densities.

## EXTENDED TEMPERATURE

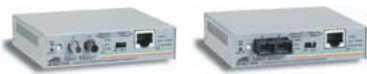

### AT-MC115XL / AT-MC116XL

These media converters provide connectivity at both 10 and 100Mbps, providing conversion from copper 10T to fiber 10FL and copper 100TX to fiber 100SX. Operating at 850 nm wavelength over multi-mode fiber, the media converters can operate at up to 2 km at 10Mbps and 300 m at 100Mbps. The AT-MC115XL supports a fiber ST connector, and the AT-MC116XL supports fiber SC.

- » Operating temperature: 0°C to 50°C
- » 10T to 10FL
- » 100TX to 100SX
- » Multi-mode fiber with ST and SC connector
- » Standalone, rack, or DIN rail mounted

### MissingLink

The Allied Telesis MissingLink™ feature enables media converters to pass the link status of their connections and thereby trigger corrective action when a problem on a link is detected.

For example, if the twisted-pair cable to the 10/100TX port on an Allied Telesis media converter were to fail, the unit would respond by dropping the link on the 100FX fiber-optic port.

Most managed devices, such as switches and routers, can be configured to take a specific recovery action in the event of the loss of connection on a port. In some cases, the unit can be configured to seek a redundant path to a disconnected end-node or send out a trap to a network management station, and so alert the network administrator of the problem.

### Smart MissingLink

The Allied Telesis Smart MissingLink™ feature has identical operation to MissingLink, with an added link failure alert system. If any of the media converter ports fail, the link LED will begin to flash. This aids with diagnostics, allowing network administrators to more quickly locate and rectify the fault.

### Redundancy

In many cases, Allied Telesis media converters are critical components in a network, carrying data between sites over long distances. It is imperative that all efforts are taken to ensure reliability of the network, and thus a network design with redundancy is mandatory. The components most likely to fail are the power supplies. The majority of Allied Telesis media converters can be deployed with hot-swappable, hot-removable power supplies to ensure maximum uptime.





### ETHERNET AND FAST ETHERNET STANDALONE MEDIA CONVERTERS

### PCI-BASED MEDIA CONVERTERS

	AT-MC606	AT-FS201	AT-FS202	AT-PC232/POE	AT-FS232	AT-FS232/1	AT-FS232/2	AT-FS238A/1	AT-FS238B/1	AT-MC102XL-PCI	AT-MC102XL-PCIe
100TX	10/100TX	10/100TX	10/100TX	10/100TX	10/100TX	10/100TX	10/100TX	10/100TX	10/100TX	100TX	100TX
BNC	100FX (ST)	100FX (SC)	100FX (SC)	100FX (SC)	100FX (SC)	100FX (SC)	100FX (SC)	100FX (SC)	100FX (SC)	100FX (SC)	100FX (SC)
VDSL	MMF	MMF	MMF	MMF	MMF	SMF	SMF	BiDi - SMF	BiDi - SMF	MMF	MMF
	100FX	100FX	100FX	100FX	100FX	100FX	100FX	100FX	100FX	100FX	100FX
	1310 nm	1310 nm	1310 nm	1310 nm	1310 nm	1310 nm	1310 nm	1310 nm	1550 nm	1310 nm	1310 nm
	1310 nm	1310 nm	1310 nm	1310 nm	1310 nm	1310 nm	1310 nm	1550 nm	1310 nm	1310 nm	1310 nm
2 km	2 km	2 km	2 km	2 km	2 km	15 km	40 km	15 km	15 km	2 km	2 km
	■	■	■	■	■	■	■	■	■	■	■
	■	■	■	■	■	■	■	■	■	■	■
	■	■	■	■	■	■	■	■	■	■	■
	1532 bytes	1532 bytes	1916 bytes	1532 bytes	1532 bytes	1532 bytes	1532 bytes	1532 bytes	1532 bytes	9KB	9KB
6	7	7	13	9	9	9	9	9	9	2	2
			■								
			1								
			1								
			A								
			15.4W								
	External	External	External	Internal	External	External	External	External	External	PCI	PCIe
	■	■	■	■	■	■	■	■	■	■	■
	■	■	■	■	■	■	■	■	■	■	■
	■	■	■	■	■	■	■	■	■	■	■



### Universal Power Supply

For customers already using Allied Telesis media converters, replacement power adapters are available.

► **AT-MCPWR**  
Universal, high-efficiency external power adapter



### GIGABIT STANDALONE MEDIA CONVERTERS

FEATURES		AT-MC1004	AT-MC1008/SP	AT-GS2002/SP	AT-PC2002POE
PORTS	Port 1	1000T	1000T	10/100/1000T	10/100/1000T
	Port 2	1000SX (SC)	SFP	SFP 100 or 1000Mbps	SFP 100 or 1000Mbps
	Fiber type	MMF	LC*	LC*	LC*
IEEE STANDARD		1000SX	1000SX and LX	1000SX and LX	100FX and 1000X
Tx WAVELENGTH		850 nm	Depends on SFP	Depends on SFP	Depends on SFP
Rx WAVELENGTH		850 nm	Depends on SFP	Depends on SFP	Depends on SFP
MAX FIBER DISTANCE		550 m	Depends on SFP	Depends on SFP	Depends on SFP
FUNCTIONALITY	Rate and speed			■	■
	MissingLink support	■	■	■	■
	Smart MissingLink support	■	■	■	■
	Max frame size	9KB	9KB	1536 bytes	1536 bytes
	Diagnostic LEDs	8	8	11	15
POWER OVER ETHERNET	IEEE 802.3af Class 3				■
	PoE-enabled ports				1
	Max no. of full power ports				1
	Mode				Mode A
PoE power				15.4W	
POWER SUPPLY	PSU type	External	External	External	Internal
	Multi-region		■	■	
	Compatible with AT-MCR12 12-slot chassis	■	■	■	
	Compatible with AT-MCR1 1-slot chassis	■	■	■	

\* Dependent on GBIC or SFP

Allied Telesis Industrial Ethernet Media Converters offer an operating range from -40° to 75°C. The temperature-hardened IMC Series features Plug-and-Play and Auto-Negotiation.



		INDUSTRIAL MEDIA CONVERTERS			
FEATURES		AT-IMC1000TP/SFP	AT-IMC1000T/SFP	AT-IMC100T/SCMM	AT-IMC100T/SCSM
<b>PORTS</b>	Port 1	10/100/1000T	10/100/1000T	10/100TX	10/100TX
	Port 2	1000Mbps SFP	100 or 1000Mbps SFP	100FX (SC)	100FX (SC)
	Fiber type	Depends on SFP	Depends on SFP	MMF	SMF
<b>IEEE STANDARD</b>		100FX and 1000X	1000X	100FX	100FX
<b>Tx WAVELENGTH</b>		Depends on SFP	Depends on SFP	1310 nm	1310 nm
<b>Rx WAVELENGTH</b>		Depends on SFP	Depends on SFP	1310 nm	1310 nm
<b>MAX FIBER DISTANCE</b>		Depends on SFP	Depends on SFP	2 km	30 km
<b>FUNCTIONALITY</b>	Rate and speed	■	■	■	■
	Max frame size	9K	9K	9K	9K
	Diagnostic LEDs	4	6	7	7
	IEEE 802.3at Class 4	■			
<b>POWER OVER ETHERNET</b>	PoE+ enabled ports	1			
	Max no. of full power ports	1			
	Mode	Mode A			
	PoE power	30W			
<b>POWER SUPPLY</b>	PSU type	External	External	External	External

## Mounting Hardware

The majority of unmanaged Allied Telesis AT-MC, AT-GS, and AT-FS Series media converters can be mounted in a number of ways.

### Desktop

All Allied Telesis media converters have the option to be fitted with rubber feet. These allow the product to be positioned on the desktop.

### Wall

A standalone media converter or switch can be easily mounted on a wall or under a table using this wallmount fixture.

- ▶ **AT-WLMT**  
Wallmount fixture (supplied in packages of 10)



### DIN Rail

This universal bracket allows a wide range of Allied Telesis media converters and media/rate converters to be mounted onto an industry-standard 35 mm DIN rail.

- ▶ **AT-DINRAIL1-010**  
Mounting kit (supplied in packages of 10)



### Rack

Larger multi-channel and modular media converters ship with 19" rackmount kits. Smaller media converters may also be rack-mounted in a number of ways:



- ▶ **AT-MCR1 chassis**  
This small chassis can be rack-mounted, and allows a single standalone media converter or 2-port switch to be powered by an internal power supply. It is available with either AC or -48VDC power supply.



- ▶ **AT-MCR12 chassis**  
This chassis allows mounting of up to 12 standalone media converters or switches. The chassis supports optional redundant power supplies and can be AC or DC powered.

- ▶ **AT-TRAY1 and AT-TRAY4**  
These simple trays allow one to four standalone media converters to be mounted into a rack.





The Converteon™ family provides the next generation of managed media conversion. Expandable from a single unit to a modular 18-slot chassis, Converteon primarily provides Fast Ethernet and Gigabit-rate media conversion. Support for IEEE 802.3ah Ethernet in the First Mile (EFM) makes Converteon ideal for both service providers and the enterprise.



► **AT-CV1000**  
1-slot chassis

- » External power adapter
- » Silent, fanless design
- » Standalone or wallmount



► **AT-CV1203**  
2-slots chassis

- » External power adapters (one as standard)
- » Resilient power adapters (AT-CV1200PSU)
- » Supports dying gasp
- » Standalone or wallmount



► **AT-CV5001**  
18-slot rackmount chassis

- » Optional redundant power supply
- » Optional Telnet and SNMP management (AT-CV5M02)
- » Optional redundant management with the addition of a second management module (AT-CV5M02)
- » Hot-swappable blades
- » Field-serviceable power supplies and fans
- » Hot-swappable power supply modules (AT-CV5001AC-60 and AT-CV5001DC-80)
- » Resilient power supply modules (maximum of two)

**SFP and SFP+ Optics**

Learn more about Allied Telesis pluggable optics on page 51.



FEATURES		CONVERTEON MODULES			
		AT-CM301	AT-CM302	AT-CM3K0S	AT-CV1KSS
PORTS	Port 1	10/100TX	10/100TX	10/100/1000T	SFP
	Port 2	100FX (ST)	100FX (SC)	100 or 1000Mbps SFP	SFP
	Fiber type	MMF	MMF	Depends on SFP	Depends on SFP
IEEE STANDARD		100FX	100FX	1000X	1000X
Tx WAVELENGTH		1310 nm	1310 nm		1310 nm
Rx WAVELENGTH		1310 nm	1310 nm		1310 nm
MAX FIBER DISTANCE		2 km	2 km	Depends on SFP	Depends on SFP
FUNCTIONALITY	Media type	■	■	■	■
	Rate and speed	■	■	■	
	MissingLink support	■	■	■	■
	Smart MissingLink support	■	■	■	■
	Max frame size	10KB	10KB	10KB	9KB
	Diagnostic LEDs	9	9	9	5
	Rate limiting	■	■	■	■
OAM	Dying gasp support	■	■	■	
	Management	■	■	■	
ECO-FRIENDLY		■	■	■	

# Chassis-Based



► **AT-MCF2000**  
Multi-channel manageable media converter

The AT-MCF2000 provides ultra high-density, modular, multi-channel media conversion, with high availability and is ideal for fiber deployments. The units can be used unmanaged, or SNMP managed with the installation of the optional management module.

- » Small, 1RU chassis
- » High-density conversion, with up to 24 Fast Ethernet channels
- » Hot-swappable media blades (maximum of two)
- » Hot-swappable management module (AT-MCF2000M)
- » Stack multiple chassis using stacking modules (AT-MCF2000S)
- » Hot-swappable power supply modules (AT-MCF2000AC)
- » Resilient power supply modules
- » Hot swappable fan module for use when only 1 power module is installed (AT-MCF2KFAN)
- » Operates in unmanaged and managed modes



► **AT-MCF2300**  
4-slot chassis

The AT-MCF2300 is an end-to-end managed media conversion system. Holding one to four multi-channel blades, the 3RU chassis provides a maximum of 48 independent channels. An optional management module provides control of the chassis, while dual hot-swappable power modules ensure maximum system uptime.

- » 3RU chassis
- » High-density conversion, with up to 48 Fast Ethernet channels
- » Hot-swappable media blades (maximum of four)
- » Hot-swappable management module (AT-MCF2000M)
- » Stack multiple chassis using stacking modules (AT-MCF2000S)
- » Hot-swappable power supply modules (AT-MCF2300AC)
- » Resilient power supply modules
- » Hot-swappable fan module (AT-MCF2300FAN)
- » Operates in unmanaged and managed modes

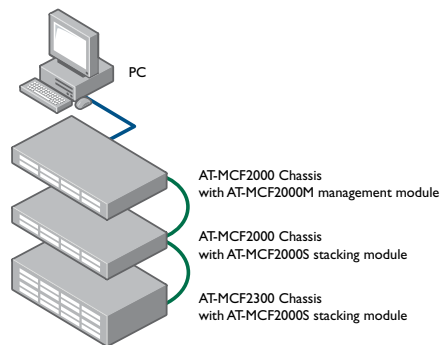

## Stacking AT-MCF2x00 Chassis

The AT-MCF2000 and AT-MCF2300 can be stacked together to provide a single management entity for the complete stack of up to eight chassis or a maximum of 16 media blades. One chassis has a SNMP management module installed, and this interconnects with the other chassis that are fitted with a stacking module.



FEATURES		MODULES FOR AT-MCF2x00 CHASSIS		
		AT-MCF2012LC	AT-MCF2012LC/1	AT-MCF2032SP
PORTS	Port 1	12 × 10/100TX	12 × 10/100TX	12 × 10/100/1000T
	Port 2	12 × 100FX (LC)	12 × 100FX (LC)	12 × SFP
	Fiber type	MMF	SMF	Depends on SFP
IEEE STANDARD		100FX	100FX	100 or 1000X
Tx WAVELENGTH		1310 nm	1310 nm	Depends on SFP
Rx WAVELENGTH		1310 nm	1310 nm	Depends on SFP
MAX FIBER DISTANCE		2 km	15 km	Depends on SFP
FUNCTIONALITY	Media type	■	■	■
	Rate and speed	■	■	■
	MissingLink support	■	■	■
	Smart MissingLink support	■	■	■
	Max frame size	1632 bytes	1632 bytes	10KB
	Diagnostic LEDs	■	■	■

# Optics

[alliedtelesis.com/optics](http://alliedtelesis.com/optics)



Allied Telesis optics provide fiber and copper connectivity for the full range of Allied Telesis product lines. Pluggable optics allow one product the flexibility to expand by media type (copper or fiber), speed (Fast Ethernet and 1, 10, or 40 Gigabit), and/or distance (220 m to 80 km).

Allied Telesis offers SFP, CSFP, XFP, SFP+, and QSFP+ pluggable optics, which comply with industry networking regulations. This compliance allows Allied Telesis pluggable optics to be used on any industry-standard networking equipment.

## SFP Series (SP)

The SP Series delivers flexible, full-duplex Ethernet connectivity. These hot-swappable fiber interfaces simply plug into an SFP slot on Allied Telesis products that are SFP compatible. Configurations can be optimized to meet a variety of distance and service requirements.

## XFP Series (XP)

The XP Series offers 10 Gigabit Ethernet connectivity in a flexible, small form factor. These hot-swappable optical interfaces simply plug into an XFP slot in any compatible Allied Telesis product for simple migration to 10 Gigabit data rates.

## cSFP Series

The cSFP Series offers two channel Bi-Directional SFP designed expressly for high-speed communication applications. This hot-pluggable transceiver simply plugs into a cSFP slot on an Allied Telesis product for convenient transmission capacity upgrade.



GIGABIT FIBER OPTICS

FEATURES	AT-SPSX	AT-SPSX/I	AT-SPEX	AT-SPLX10	AT-SPLX10/I
FORM FACTOR	SFP	SFP	SFP	SFP	SFP
FIBER TYPE	MMF	MMF	MMF	SMF	SMF
NUMBER OF FIBERS	2 (Rx, Tx)	2 (Rx, Tx)	2 (Rx, Tx)	2 (Rx, Tx)	2 (Rx, Tx)
SPEED	1000Mbps	1000Mbps	1000Mbps	1000Mbps	1000Mbps
DIGITAL DIAGNOSTICS MONITORING (DDM)		■			■
Rx WAVELENGTH	850 nm	850 nm	1310 nm	1310 nm	1310 nm
Tx WAVELENGTH	850 nm	850 nm	1310 nm	1310 nm	1310 nm
MAX DISTANCE	220 / 550 m	220 / 550 m	2 km	10 km	10 km
CONNECTOR TYPE	LC	LC	LC	LC	LC
TEMPERATURE	0°C to 70°C	-40°C to 85°C	0°C to 70°C	0°C to 70°C	-40°C to 85°C



FAST ETHERNET FIBER OPTICS

FEATURES	AT-SPFX/2	AT-SPFXBD-LC-13	AT-SPFXBD-LC-15	AT-SPFX/15
FORM FACTOR	SFP	SFP	SFP	SFP
FIBER TYPE	MMF	SMF	SMF	SMF
NUMBER OF FIBERS	2 (Rx, Tx)	1 (BiDi)	1 (BiDi)	2 (Rx, Tx)
SPEED	100Mbps	100Mbps	100Mbps	100Mbps
Rx WAVELENGTH	1310 nm	1550 nm	1310 nm	1310 nm
Tx WAVELENGTH	1310 nm	1310 nm	1550 nm	1310 nm
MAX DISTANCE	2 km	15 km	15 km	15 km
CONNECTOR TYPE	LC	LC - BiDi	LC - BiDi	LC
TEMPERATURE	0°C to 70°C	0°C to 70°C	0°C to 70°C	0°C to 70°C

COPPER OPTICS

FEATURES	AT-SPTX
FORM FACTOR	SFP
SPEED	10/100/1000T
MAX DISTANCE	100 m
CONNECTOR TYPE	RJ-45
TEMPERATURE	0°C to 70°C

## EXTENDED TEMPERATURE

Allied Telesis supports a wide range of industrial temperature optical accessories for use in all its extended and industrial temperature products. All optical accessories support operating temperatures of -40°C to 85°C.

- ▶ **AT-SPSX/I**  
1000SX SFP for multi-mode fiber
- ▶ **AT-SPLX10/I**  
1000LX SFP for single-mode fiber (10 km)
- ▶ **AT-SPLX40/I** NEW  
1000LX SFP for single-mode fiber (40 km)
- ▶ **AT-SPLX80/I** NEW  
1000LX SFP for single-mode fiber (80 km)
- ▶ **AT-SP10SR/I**  
10G SFP+ for multi-mode fiber (300 m)
- ▶ **AT-SP10LR/I**  
10G SFP+ for single-mode fiber (10 km)
- ▶ **AT-SP10LR20/I**  
10G SFP+ for single-mode fiber (20 km)
- ▶ **AT-SP10ER40/I**  
10G SFP+ for single-mode fiber (40 km)
- ▶ **AT-SP10ZR80/I**  
10G SFP+ for single-mode fiber (80 km)



10 GIGABIT FIBER OPTICS (XFP)

FEATURES	AT-XPER40	AT-XPER80
FORM FACTOR	XFP	XFP
FIBER TYPE	SMF	SMF
COPPER TYPE		
NUMBER OF FIBERS	2 (Rx, Tx)	2 (Rx, Tx)
SPEED	10G	10G
DIGITAL DIAGNOSTICS MONITORING (DDM)	■	■
Rx WAVELENGTH	1550 nm	1550 nm
Tx WAVELENGTH	1550 nm	1550 nm
MAX DISTANCE	40 km	80 km
CONNECTOR TYPE	LC	LC
TEMPERATURE	-5°C to 70°C	-5°C to 70°C



### SFP10 Series (SFP+)

The SFP10 Series offers customers a wide variety of 10 Gigabit Ethernet connectivity options for data center, enterprise, and service provider transport applications. These hot-swappable devices plug into an Ethernet SFP+ port and have the smallest 10G form factor in the industry. Configurations can be optimized to meet a variety of distance and service requirements.

### QSFP Series (QSFP+)

The QSFP Series offers the latest industry-standard 40 Gigabit Ethernet connectivity in a flexible, small form factor. It is ideal for Datacom/Telecom switch and router connections, as well as data aggregation, backplane, proprietary protocol, and high-density applications. This hot-swappable transceiver simply plugs into an QSFP slot on any compatible Allied Telesis product.

IEEE 802.3 Ethernet specification for networks over multi-mode fiber

Standard	Speed	Max Distance (MMF)
100X	100Mbps	2 km
1000X	1000Mbps	220 m



GIGABIT FIBER OPTICS						COMPACT GIGABIT FIBER OPTICS (CSFP)	
AT-SPBD10-13	AT-SPBD10-14	AT-SPLX40	AT-SPLX40/I	AT-SPZX80	AT-SPZX80/I	AT-SPBD20DUAL-14	AT-SPBD40DUAL-14
SFP	SFP	SFP	SFP	SFP	SFP	CSFP	CSFP
SMF	SMF	SMF	SMF	SMF	SMF	SMF	SMF
1 (BiDi)	1 (BiDi)	2 (Rx, Tx)	2 (Rx, Tx)	2 (Rx, Tx)	2 (Rx, Tx)	2 (BiDi)	2 (BiDi)
1000Mbps	1000Mbps	1000Mbps	1000Mbps	1000Mbps	1000Mbps	1000Mbps	1000Mbps
		■	■	■	■	■	■
1490 nm	1310 nm	1310 nm	1310 nm	1550 nm	1550 nm	1310 nm	1310 nm
1310 nm	1490 nm	1310 nm	1310 nm	1550 nm	1550 nm	1490 nm	1490 nm
10 km	10 km	40 km	40 km	80 km	80 km	20 km	40 km
LC - BiDi	LC - BiDi	LC	LC	LC	LC	2 × LC	2 × LC
0°C to 70°C	0°C to 70°C	0°C to 70°C	-40°C to 85°C	-5°C to 70°C	-40°C to 85°C	-40°C to 85°C	-40°C to 85°C



40 GIGABIT FIBER OPTICS (QSFP+)	
FEATURES	AT-QSFP3R
FORM FACTOR	QSFP+
FIBER TYPE	MMF
NUMBER OF FIBERS	2 (Rx, Tx)
SPEED	40G
DIGITAL DIAGNOSTICS MONITORING (DDM)	■
Rx WAVELENGTH	850 nm
Tx WAVELENGTH	850 nm
MAX DISTANCE	Up to 150 m
TEMPERATURE	0°C to 70°C



**QSFP+ Cables**

- ▶ **AT-QSFP1CU**  
QSFP+ 1 m cable
- ▶ **AT-QSFP3CU**  
QSFP+ 3 m cable



**Breakout Cables**

- ▶ **AT-QSFP-4SFP10G-3CU**  
QSFP+ port to 4 × 10G ports, 3 m
- ▶ **AT-QSFP-4SFP10G-5CU**  
QSFP+ port to 4 × 10G ports, 5 m



**Optical Cables**

- ▶ **AT-MTP12-1**  
MTP cable for AT-QSFP3R, 1 m
- ▶ **AT-MTP12-5**  
MTP cable for AT-QSFP3R, 5 m



10 GIGABIT FIBER OPTICS (SFP+)											
AT-SP10SR	AT-SP10SR/I	AT-SP10LR	AT-SP10LR/I	AT-SP10LRM	AT-SP10LR20/I	AT-SP10ER40/I	AT-SP10ZR80/I	AT-SP10TW1	AT-SP10TW3	AT-SP10TW7	
SFP+	SFP+	SFP+	SFP+	SFP+	SFP+	SFP+	SFP+	SFP+	SFP+	SFP+	
MMF	MMF	SMF	SMF	MMF	SMF	SMF	SMF				
								Twinax	Twinax	Twinax	
2 (Rx, Tx)	2 (Rx, Tx)	2 (Rx, Tx)	2 (Rx, Tx)	2 (Rx, Tx)	2 (Rx, Tx)	2 (Rx, Tx)	2 (Rx, Tx)				
10G	10G	10G	10G	10G	10G	10G	10G	10G	10G	10G	
■	■	■	■	■	■	■	■				
850 nm	850 nm	1310 nm	1310 nm	1310 nm	1310 nm	1550 nm	1550 nm				
850 nm	850 nm	1310 nm	1310 nm	1310 nm	1310 nm	1550 nm	1550 nm				
300 m	300 m	10 km	10 km	Up to 220 m	20 km	40 km	80 km	1 m	3 m	7 m	
LC	LC	LC	LC	LC	LC	LC	LC				
0°C to 70°C	-40°C to 85°C	0°C to 70°C	-40°C to 85°C	0°C to 70°C	-40°C to 85°C	-40°C to 85°C	-40°C to 85°C	0°C to 70°C	0°C to 70°C	0°C to 70°C	

# Network Service Provider Optics

## EtherWAVE Optics

The AT-SPBD40 offers the latest industry standard in flexible, small form factor full-duplex Gigabit Ethernet connectivity. These hot-swappable, fiber interfaces simply plug into a SFP slot on Allied Telesis SFP-compatible products. Configurations can be optimized to meet varied distance and service requirements.



- ▶ **AT-SPBD40-xxxxs-c/I**  
40 km 1000X SFP, LC SMF  
xxxx: CWDM Channel 1470, 1490, 1510, 1530, 1550, 1570, 1590, 1610 nm  
s: side pairing H or L  
c: connector type A (APC), U (UPC)
  

▶ <b>AT-SPBD40-1270H-A/I</b>	▶ <b>AT-SPBD40-1390H-A/I</b>	▶ <b>AT-SPBD40-1510H-A/I</b>
▶ <b>AT-SPBD40-1270L-A/I</b>	▶ <b>AT-SPBD40-1390L-A/I</b>	▶ <b>AT-SPBD40-1510L-A/I</b>
▶ <b>AT-SPBD40-1290H-A/I</b>	▶ <b>AT-SPBD40-1410H-A/I</b>	▶ <b>AT-SPBD40-1530H-A/I</b>
▶ <b>AT-SPBD40-1290L-A/I</b>	▶ <b>AT-SPBD40-1410L-A/I</b>	▶ <b>AT-SPBD40-1530L-A/I</b>
▶ <b>AT-SPBD40-1310H-A/I</b>	▶ <b>AT-SPBD40-1430H-A/I</b>	▶ <b>AT-SPBD40-1550H-A/I</b>
▶ <b>AT-SPBD40-1310L-A/I</b>	▶ <b>AT-SPBD40-1430L-A/I</b>	▶ <b>AT-SPBD40-1550L-A/I</b>
▶ <b>AT-SPBD40-1330H-A/I</b>	▶ <b>AT-SPBD40-1450H-A/I</b>	▶ <b>AT-SPBD40-1570H-A/I</b>
▶ <b>AT-SPBD40-1330L-A/I</b>	▶ <b>AT-SPBD40-1450L-A/I</b>	▶ <b>AT-SPBD40-1570L-A/I</b>
▶ <b>AT-SPBD40-1350H-A/I</b>	▶ <b>AT-SPBD40-1470H-A/I</b>	▶ <b>AT-SPBD40-1590H-A/I</b>
▶ <b>AT-SPBD40-1350L-A/I</b>	▶ <b>AT-SPBD40-1470L-A/I</b>	▶ <b>AT-SPBD40-1590L-A/I</b>
▶ <b>AT-SPBD40-1370H-A/I</b>	▶ <b>AT-SPBD40-1490H-A/I</b>	▶ <b>AT-SPBD40-1610H-A/I</b>
▶ <b>AT-SPBD40-1370L-A/I</b>	▶ <b>AT-SPBD40-1490L-A/I</b>	▶ <b>AT-SPBD40-1610L-A/I</b>

## iMG Optics

- ▶ **AT-TN-P015-A**  
SC, Gigabit/100M, 20 km SFP, TX 1310, RX 1480 - 1560, use with iMG1400 Series
- ▶ **AT-SPBD20EAPON-13/I**  
20 km, Bidirectional, 1 Gigabit GEAPON SFP for AT-IMG2426F





# NICs

[alliedtelesis.com/nics](http://alliedtelesis.com/nics)



From 100Mbps to 10 Gigabit, Allied Telesis seamlessly connects desktops, laptops, servers, and thin clients with a continually expanding portfolio of high-quality, reliable, and cost-effective Network Interface Cards (NICs).

With the addition of the 2911 Series multi-port Gigabit and 10 Gigabit server Network Interface Cards, Allied Telesis has optimized NICs for virtualization. Using multi-port cards in virtualized environments is critical to applications in order to provide redundancy and data connectivity for these workloads. The priority queuing offered by Allied Telesis server NICs can help set up networks based on specific needs. The comprehensive diagnostics and configuration software suite (Broadcom Advanced Control Suite) provides system administrators and engineers with a powerful tool to analyze interface cards and review specific data.

As the worldwide leader in fiber Network Interface Cards, Allied Telesis continues to offer the highest-quality cards at competitive prices. All Allied Telesis server NICs are Citrix, VMware, and Microsoft Hyper-V qualified.



FEATURES		FAST ETHERNET FIBER	GIGABIT FIBER
		AT-2814FX	AT-2874SX
<b>BUS TYPE</b>		ExpressCard/34 (54 compatible)	ExpressCard/34 (54 compatible)
<b>PORTS AND MEDIA SUPPORT</b>		SC	SC
<b>QoS</b>		IEEE 802.1p priority queues	■
<b>PERFORMANCE</b>		TCP/IP checksum CPU offload	■
<b>MANAGEMENT</b>		Managed boot agent (PXE remote boot ROM)	2.1
		VLAN support	■
		Advanced power management (ACPI)	■
<b>DRIVER SUPPORT</b>		Windows 7	■
		Windows 7 (64-bit)	■
		Windows Vista	■
		Windows Vista (64-bit)	■
		Windows XP	■
		Windows 8	■
		Windows 8 (64-bit)	■
		Linux 2.6	■
<b>IPv6 SUPPORT</b>		■	■
<b>DIAGNOSTICS</b>		LEDs	■
<b>IDEAL ENVIRONMENT</b>		Laptop computers in secure areas	Laptop computers with fiber connectivity
<b>CUSTOMER'S NEEDS</b>		100Mbps fiber connectivity / laptop connectivity	1000Mbps fiber connectivity / laptop connectivity

## Preboot Execution Environment (PXE) Support

PXE allows network administrators to perform preboot procedures on a system, such as installing an operating system, running a virus checker, or downloading a predefined system configuration. PXE support included in Allied Telesis NICs allows a workstation or computer to boot from a remote server connected to the network prior to booting from the local hard drive.

# Desktop/Workstation NICs



FEATURES		GIGABIT COPPER			COPPER AND FIBER			
		AT-2912T	AT-2911T/2	AT-2701FTXa	AT-2716POE/FX	AT-2911GP/SX	AT-2911GP/LX	AT-2911GP/SFP
<b>BUS TYPE</b>		PCIe (x1)	PCIe (x1)	PCI (32-bit)	PCIe (x1)	PCIe (x1)	PCIe (x1)	PCIe (x1)
<b>PORTS AND MEDIA SUPPORT</b>	100TX			■				
	10/100/1000T Class 3 PoE				■	■	■	■
	10/100/1000T	■	■ (2 ports)					
	100FX			SC, ST	SC, ST			
	1000X					SC, LC	SC, LC	1000Mbps SFP
<b>FIBER TYPE</b>				MMF	MMF	MMF	SMF	Depends on SFP
<b>MAX FIBER DISTANCE</b>				2 km	2 km	220 m / 500 m	10 km	Depends on SFP
<b>QoS</b>		IEEE 802.1p priority queues	■	■	■	■	■	■
<b>PERFORMANCE</b>	TCP/IP checksum CPU offload	■	■		■	■	■	■
	Jumbo frames		■		■	■	■	■
	Link aggregation support		■		■	■	■	■
	Link aggregation failover		■		■	■	■	■
	Wake-on-LAN	■	Copper port	■	■	Copper port	Copper port	Copper port
<b>MANAGEMENT</b>	Managed boot agent (PXE remote boot ROM)	2.1	2.1	2.1	2.1	2.1	2.1	2.1
	DASH (TruManage)	■						
	VLAN support	■	■	■	■	■	■	■
	Advanced power management (ACPI)	■	■	■	■	■	■	■
	SNMP	■	■		■	■	■	■
<b>SECURITY</b>		IPSec offload	■					
<b>DRIVER SUPPORT</b>	Windows 7 (32 and 64-bit)	■	■	■	■	■	■	■
	Windows 2008	■	■		■	■	■	■
	Windows Vista (32 and 64-bit)	■	■	■	■	■	■	■
	Windows XP (64-bit)	■	■	■	■	■	■	■
	Windows 8	■	■	■	■	■	■	■
	Windows 8 (64-bit)	■	■	■	■	■	■	■
	Windows Server 2008 R2	■	■	■	■	■	■	■
	Windows Server 2012	■	■	■	■	■	■	■
	NDIS2	■	■	■	■	■	■	■
Linux 2.6	■	■	■	■	■	■	■	
<b>IPv6 SUPPORT</b>		■	■	■	■	■	■	■
<b>DIAGNOSTICS</b>	LEDs	■	■	■	■	■	■	■
	Virtual cable tester	■	■					
<b>PHYSICAL</b>		Low profile bracket and full height provided	■	■	■	■	■	■
<b>IDEAL ENVIRONMENT</b>		Desktop computers in ultra secure areas	Desktop computers in secure areas, virtualization servers	Desktop computers in secure areas	Desktop computers with fiber interfaces that want to power a PoE phone (or other device) from the secondary port	Desktop computers with fiber interfaces that want to power a PoE phone (or other device) from the secondary port	Desktop computers with fiber interfaces that want to power a PoE phone (or other device) from the secondary port	Desktop computers with fiber interfaces that want to power a PoE phone (or other device) from the secondary port
<b>CUSTOMER'S NEEDS</b>		Data encryption	High performance, load balancing, virtualization	100Mbps fiber connectivity / choice of fiber or copper interfaces	PoE / VoIP connectivity	PoE+	PoE+	PoE+, Choice of SFP

# Desktop/Workstation NICs

## Jumbo Frames Support

Normal Ethernet packets are limited to a maximum size of 1548 bytes. Received packets larger than this are normally rejected by the interface card as errors. Jumbo frames support is beneficial for sending large packets, especially when the data contained in these packets either has a time-critical element, or is so large that the time taken to send multiple smaller packets is too great. Jumbo frame packets are normally up to 9000 bytes long.

## Long-Distance Fiber

With the introduction of single-mode fiber NICs, Allied Telesis has extended the size of a fiber network from up to two kilometers over multi-mode fiber; to up to 20 km for Fast Ethernet, and 10 km for Gigabit Ethernet.

## Advanced Power Management (ACPI)

ACPI is part of the environmental control initiative for computers. Allied Telesis NICs support ACPI, which places the system in a low power state when it is not receiving or transmitting data.



FEATURES		GIGABIT COPPER AND FIBER			GIGABIT FIBER		
		AT-2911STX	AT-2911LTX	AT-2916SX	AT-2916LX10	AT-2931SX	AT-2911SX
<b>BUS TYPE</b>		PCIe (x1)	PCIe (x1)	PCI (32-bit)	PCI (32-bit)	PCI-x (32/64-bit)	PCIe (x1)
	10/100/1000T	■	■				
	100FX						
	1000X						
<b>FIBER TYPE</b>		SC, LC	SC, LC	SC, LC	LC	SC, LC	SC, LC
<b>MAX FIBER DISTANCE</b>		MMF	SMF	MMF	SMF	MMF	MMF
		220 m / 500 m	10 km	220 m / 500 m	10 km	220 m / 500 m	220 m / 500 m
<b>QoS</b>	IEEE 802.1p priority queues	■	■	■	■	■	■
<b>PERFORMANCE</b>	TCP/IP checksum CPU offload	■	■	■	■	■	■
	Jumbo frames	■	■	■	■	■	■
	Link aggregation support	■	■	■	■	■	■
	Link aggregation failover	■	■	■	■	■	■
	Teaming	■	■	■	■	■	■
<b>MANAGEMENT</b>	Wake-on-LAN	Copper port	Copper port				
	Managed boot agent (PXE remote boot ROM)	2.1	2.1	2.1	2.1	2.1	2.1
	DASH (TruManage)						
	VLAN support	■	■	■	■	■	■
	Advanced power management (ACPI)	■	■	■	■	■	■
<b>SECURITY</b>	SNMP	■	■	■	■	■	■
<b>DRIVER SUPPORT</b>	IPSec offload						
	Windows 7 (32 and 64-bit)	■	■	■	■	■	■
	Windows 2008 (32 and 64-bit)	■	■	■	■	■	■
	Windows Vista (32 and 64-bit)	■	■	■	■	■	■
	Windows XP (32 and 64-bit)	■	■	■	■	■	■
	Windows 8	■	■	■	■	■	■
	Windows 8 (64-bit)	■	■	■	■	■	■
	Windows Server 2008 R2	■	■	■	■	■	■
	Windows Server 2012	■	■	■	■	■	■
	NDIS2	■	■	■	■	■	■
Linux 2.6	■	■	■	■	■	■	
<b>IPV6 SUPPORT</b>							
<b>DIAGNOSTICS</b>	LEDs	■	■	■	■	■	■
<b>PHYSICAL</b>	Low profile bracket and full height provided	■	■	■	■	■	■
<b>IDEAL ENVIRONMENT</b>		Desktop computers in secure areas	Desktop computers in secure areas	Desktop computers in secure areas	Desktop computers in secure areas	Service requiring Gigabit connectivity	Service requiring Gigabit connectivity
<b>CUSTOMER'S NEEDS</b>		1000Mbps fiber connectivity / choice of fiber or copper interfaces	1000Mbps fiber connectivity / choice of fiber or copper interfaces	Performance	Performance / long-distance networking	High performance / load balancing / redundant links	High performance / load balancing / virtualization

## Wake-on-LAN (WoL)

WoL is a feature of interface cards that allows a computer fitted with a card to be remotely powered-on. The computer receives a special data packet via the network port that will cause the computer to boot. This, coupled with PXE support, allows network administrators to gain complete access to all computers on their networks.



GIGABIT FIBER					FAST ETHERNET FIBER			
AT-2911LX	AT-2911SFP	AT-2911SX/2LC	AT-2911LX/2LC	AT-2911SFP/2	AT-2701FXa	AT-2711FX	AT-2711LX	AT-2712FX
PCIe (x1)	PCIe (x1)	PCIe (x1)	PCIe (x1)	PCIe (x1)	PCI (32-bit)	PCIe (x1)	PCIe (x1)	PCIe (x1)
SC, LC	1000Mbps SFP	LC (2 ports)	LC (2 ports)	SFP (2 ports)	SC, ST	MT, SC, ST, LC	SC, LC	SC
SMF	Depends on SFP	MMF	SMF	Depends on SFP	MMF	MMF	SMF	MMF
10 km	Depends on SFP	220 m / 500 m	10 km	Depends on SFP	2 km	2 km	10 km	2 km
■	■	■	■	■	■	■	■	■
■	■	■	■	■	■	■	■	■
■	■	■	■	■	■	■	■	■
■	■	■	■	■	■	■	■	■
■	■	■	■	■	■	■	■	■
2.1	2.1	2.1	2.1	2.1	2.1	2.1	2.1	2.1
■	■	■	■	■	■	■	■	■
■	■	■	■	■	■	■	■	■
■	■	■	■	■	■	■	■	■
■	■	■	■	■	■	■	■	■
■	■	■	■	■	■	■	■	■
■	■	■	■	■	■	■	■	■
■	■	■	■	■	■	■	■	■
■	■	■	■	■	■	■	■	■
■	■	■	■	■	■	■	■	■
■	■	■	■	■	■	■	■	■
■	■	■	■	■	■	■	■	■
■	■	■	■	■	■	■	■	■
Service requiring Gigabit connectivity	Service requiring Gigabit connectivity	Desktop computers in secure areas, virtualization servers	Desktop computers in secure areas, virtualization servers	Desktop computers in secure areas, virtualization servers	Desktop computers in secure areas	Desktop computers in secure areas	Desktop computers in secure areas	Desktop computers in secure areas
High performance / load balancing / long-distance networking / virtualization	High performance / load balancing / long-distance networking	High performance, load balancing, virtualization	High performance, load balancing, virtualization	High performance, load balancing, virtualization	100Mbps fiber connectivity / modern PCIe computer	100Mbps fiber connectivity / choice of fiber or copper interfaces	100Mbps fiber connectivity / long-distance networking	Highly secure environment

## Network Virtualization

Allied Telesis Server NICs are specifically designed for use in a virtualized environment. The cards interact directly with the virtualization hypervisor software, offloading many of the interface tasks from the main CPU, thus increasing the overall performance of the virtual machine.

The VNCI0S Series 10 Gigabit interface card improves performance with next-generation technology — VMware, Data Center Bridging, Direct Path, NetQueue — that includes features such as loopback (inter-VM communication), priority-weighted bandwidth management, and doubling the number of data queues per port from four to eight. Also supported are multicast and broadcast data on a virtualized server.

## Superior Functionality

The VNCI0S Series includes dedicated hardware and processors to process frames at the highest levels for both transmit and receive paths in the operating system — advantageous for virtualization applications.

The VNCI0S Series enables convergence of all networked communications possible in a server, such as data (LAN), storage networks (iSCSI), and clustering.

### SFP/SFP+ Optics

Learn more about Allied Telesis pluggable optics on page 51.



		GIGABIT COPPER		SFP+ 10 GIGABIT	
FEATURES		AT-2973SX	AT-2973T	AT-ANC10S/2	AT-ANC10S/4
<b>BUS TYPE</b>		PCIe (x4)	PCIe (x4)	PCIe (x8)	PCIe (x8)
<b>PORTS AND MEDIA SUPPORT</b>	10/100/1000T				
	1000X	LC (2 ports)			
	SFP+		■ (2 ports)	■ (2 ports)	■ (4 ports)
	Fiber type	MMF		MMF, SMF	MMF, SMF
	Max fiber distance	220 m / 500 m		Depends on SFP+	Depends on SFP+
<b>QoS</b>	IEEE 802.1p priority queues	■	■	■	■
<b>PERFORMANCE</b>	TCP/IP checksum CPU offload	■	■	■	■
	Jumbo frames	■	■	■	■
	Link aggregation support	■	■	■	■
	Link aggregation failover	■	■	■	■
	TOE	■	■	■	■
	iSCSI	■	■	■	■
<b>MANAGEMENT</b>	Wake-on-LAN		■		
	Managed boot agent (PXE remote boot ROM)	2.1	2.1	2.1	2.1
	VLAN support	■	■	■	■
	Advanced power management (ACPI)	■	■	■	■
	SNMP	■	■	■	■
<b>DRIVER SUPPORT</b>	Windows 7 (32 and 64-bit)	■	■		
	Windows 2008 (32 and 64-bit)	■	■	■	■
	Windows Vista (32 and 64-bit)	■	■		
	Windows 8	■	■	■	■
	Windows 8 (64-bit)	■	■	■	■
	Windows Server 2008 R2	■	■	■	■
	Windows Server 2012	■	■	■	■
	Linux 2.6	■	■	■	■
<b>IPv6 SUPPORT</b>		■	■	■	■
<b>DIAGNOSTICS</b>	LEDs	■	■	■	■
	Virtual cable tester		■		
<b>PHYSICAL</b>	Low profile bracket and full height provided	■	■	■	■
<b>IDEAL ENVIRONMENT</b>		Virtualization servers	Virtualization servers	Virtualization servers	Virtualization servers
<b>CUSTOMER'S NEEDS</b>		High performance with low CPU utilization	High performance with low CPU utilization	High performance with low CPU utilization	High performance with low CPU utilization

# Network Management Software

[alliedtelesis.com/software/nms](http://alliedtelesis.com/software/nms)

It's a complex job to administer a network. Rapid trouble resolution and the ability to monitor network performance is critical for every business. One size does not fit all when it comes to network management — everything depends on the network and user needs.

Allied Telesis software tools can help visualize and plan for network growth while maintaining the health and performance of the network.

# AlliedView NMS

## ENTERPRISE EDITION

AlliedView™ NMS Enterprise Edition is a comprehensive management platform designed to offer enterprise customers powerful tools for the management of their Allied Telesis products as well as third-party switches. AlliedView NMS maximizes operational efficiency by providing proactive management and diagnostics, reducing operational expense and shortening tasks involved with network administration.

### Features

- Intuitive graphical interface
- Network-wide management
- Network backup/restore
- Network software management
- MIB browser
- GUI snapshot utility
- RMON 4 group support
- NMS alarms with e-mail notifications
- SNMP v1, v2c, and v3
- Secure SSH management
- Network VLAN management
- QoS management
- Windows OS server support
- Remote Java and Web clients
- Manages Allied Telesis and third-party elements



### Low-Cost Deployment

AlliedView NMS Enterprise Edition is designed to operate on a Windows-based machine running XP, 7, or Server 2003/8/10. With a tiered approach to licensing, users can deploy AlliedView NMS on even the smallest sized networks in a cost-effective manner, and scale to thousands of network elements.

### Network Inventory

AlliedView NMS Enterprise Edition provides automatic topology and device discovery of networks. The platform

allows for multiple network and device views where the user can observe the entire network or focus in on an individual network device. In addition, AlliedView NMS contains an inventory of different device types and enables views of VLANs, network interfaces, ports, and physical links.

### Flexible Configuration

The extensive management capabilities of AlliedView NMS Enterprise Edition allows the user to manage thousands of Allied Telesis network elements, all configured

from a central location. Products can be easily configured for both Layer 2 and Layer 3 functionality, VLANs, and resilient EPSR and LACP trunks.

### Network Upgrades

AlliedView NMS performs scheduled or on-demand network-wide firmware and software upgrades to Allied Telesis and third-party network elements. AlliedView NMS maintains control of software releases to ensure all elements in the network maintain the latest available update.



# AlliedView NMS

## SERVICE PROVIDER EDITION

AlliedView NMS provides a unified management platform for network, element, and service management for every type of service provider and enterprise network. AlliedView NMS supports more than 200 different Allied Telesis products, including switches, routers, multiservice access, and fiber- or copper-based gateways.

AlliedView NMS incorporates user interfaces that are efficient as well as operator friendly to take the complexity out of performing routine tasks. The Command Line Interface (CLI) used for provisioning and element management is based on a format widely used and recognized in the industry. It is combined with an intuitive GUI for diagnostics, network mapping, and alarm reporting, among other features, which offer the operator an easy-to-understand means of displaying and reviewing information.

The scalability of AlliedView NMS offers a wide range of use from medium-sized networks all the way to large service provider networks with thousands of devices and multiple services. This includes support and administrative security for centralized or distributed client-side operations based on its software architecture. The enhanced tools incorporated into AlliedView NMS address the critical need to reduce time and labor to manage the network, and at the same time offer higher levels of customer service through rapid responsiveness.

### Scalable Architecture

AlliedView NMS is a Java-based application suite that supports both Java and HTML clients. The core services include a relational database and may be deployed on a dedicated Windows server, or in a virtual server environment. The server supports core functions such as discovery of managed

### Features

- Intuitive graphical interface
- Drill-down functionality
- MIB browser
- MIB compiler
- GUI snapshot utility
- RMON 4 group support
- Supports NMS alarms
- Supports SNMP v1, v2c and v3
- VLAN management
- QoS management
- Multi-platform
- HP OpenView, Tivoli NetView, Ipswitch
- WhatsUp and SNMPc interoperability
- Supports Allied Telesis managed devices

objects, receiving and processing alarm information and notifications, data collection, report generation, status polling, and northbound interfaces.

All updates relative to the database are processed through the server:

The server software also supports distributed user clients, and provides scalability in terms of the number of clients that can be concurrently supported. The distributed clients act as the user interfaces between the

end-users or administrators and the AlliedView NMS server. Client support is comprised of the following functions:

- Interfaces with the clients and channels all of their transactions to the server applications
- Generates the user view of the network through database operations
- Generates alarms and autonomous messaging from the server database to the clients



### **Auto-Discovery Features**

AlliedView NMS performs active auto-discovery of every network element whenever a new element or device is added to the network. Auto-discovery features go beyond merely capturing hardware inventory populated in the network, to providing detailed network topology and configuration information.

If a new network element, iMG, or port is added to the network, auto-discovery provides the operator automated information and updates for inventory and configuration management. This allows the network to be maintained at a “current state,” while eliminating any need to manually enter information when changes occur.

### **Network Mapping**

AlliedView NMS provides the ability to create and maintain a logical network map, including sites and locations where each piece of equipment resides, and to actually create an overlay of the network on a geographic network map.

### **Network Topology**

Auto-discovery allows the operator to create and view the actual topology of the network, including Layer 2 and 3 networks, VLANs, EPSRings (domains), physical nodes, physical cards (network interfaces and ports), terminal devices (iMGs), and physical links.

### **Zero Touch Service Provisioning**

Allied Telesis has streamlined the provisioning process through its “one-touch provisioning” feature in AlliedView NMS. Each type of service, as well as port or link, can be assigned its own profile using configuration data that matches the requirement. Once done, the profile can be applied to each subscriber line, port, or link in a single keystroke rather than having to re-enter the same data over and over again. In a large service network with large numbers of subscribers, the time savings are tremendous, as is the reduction in configuration errors that sometimes occurs.

An additional key benefit in a service network, where revenue generation is critical, is in rapid service deployment and turn up. New subscribers can be added and activated quickly, thereby increasing revenues as well as providing a higher level of customer service.

In addition to auto- or bulk-provisioning the service VLANs using a defined service profile, the same procedure could be applied to the uplink or port for applying configuration and QoS parameters. Auto-configuring enables new nodes to be added and turned up quickly, and likewise new line cards or modules added to existing nodes. At the same time, it ensures conformity

in the provisioning of the network configuration — eliminating the problems that sometimes occur when a new piece of equipment is added to the network and configured incorrectly.

### **Network Upgrades**

AlliedView NMS allows software and firmware upgrades to be made network-wide on either a scheduled or unscheduled basis, as the network operator requires. Since AlliedView NMS maintains an up-to-date inventory of all the equipment in the network, as well as release level of the software and firmware, it becomes the tool to manage periodic upgrades.

### **Northbound Interface**

AlliedView NMS can be integrated with existing Operation Support Systems (OSS) and Business Support Systems (BSS) through a Web services-based northbound interface. This enables the automation of service activations, changes, and deactivations to be done on the higher level OSS/BSS systems and flow through to the Allied Telesis network elements.

Allied Telesis Management Framework (AMF) .....	4	AT-6102G .....	34
AlliedView NMS Enterprise Edition .....	62	AT-8000/8POE .....	19
AlliedView NMS Service Provider Edition .....	63	AT-8000GS/24 .....	16
AT-2701FTXa .....	57	AT-8000GS/24POE .....	16
AT-2701FXa .....	59	AT-8000GS/48 .....	16
AT-2711FX .....	59	AT-8000S/16 .....	19
AT-2711LX .....	59	AT-8000S/24 .....	19
AT-2712FX .....	59	AT-8000S/24POE .....	19
AT-2716POE/FX .....	57	AT-8000S/48 .....	19
AT-2814FX .....	56	AT-8000S/48POE .....	19
AT-2874SX .....	56	AT-9000/12POE .....	16
AT-2911GP/LX .....	57	AT-9000/28 .....	16
AT-2911GP/SFP .....	57	AT-9000/28POE .....	16
AT-2911GP/SX .....	57	AT-9000/28SP .....	16
AT-2911LTX .....	58	AT-9000/52 .....	16
AT-2911LX .....	59	AT-ANC10S/2 .....	60
AT-2911LX/2LC .....	59	AT-ANC10S/4 .....	60
AT-2911SFP .....	59	AT-AR020 .....	28
AT-2911SFP/2 .....	59	AT-AR021S .....	28
AT-2911STX .....	58	AT-AR023 .....	28
AT-2911SX .....	58	AT-AR024 .....	28
AT-2911SX/2LC .....	59	AT-AR027 .....	28
AT-2911T/2 .....	57	AT-AR3050S .....	27
AT-2912T .....	57	AT-AR400-ADVL3UPGRD .....	28
AT-2916LX10 .....	58	AT-AR4050S .....	27
AT-2916SX .....	58	AT-AR415S .....	28
AT-2931SX .....	58	AT-AR440S .....	28
AT-2973SX .....	60	AT-AR700-ADVL3UPGRD .....	28
AT-2973T .....	60	AT-AR750S .....	28
AT-6101G .....	34	AT-AR770S .....	28
AT-6101GP .....	34	AT-CM301 .....	49

AT-CM302.....	49	AT-EXRP-32E0n.....	31
AT-CM3K0S.....	49	AT-EXRP-32n.....	31
AT-CV5M02.....	49	AT-EXSU 1200GU-16.....	31
AT-CV1000.....	49	AT-EXSU 400GU-8.....	31
AT-CV1200PSU.....	49	AT-EXSU 800GU-12.....	31
AT-CV1203.....	49	AT-EXSU 800GU-16.....	31
AT-CV1KSS.....	49	AT-FAN03.....	9
AT-CV5001.....	49	AT-FL18B.....	28
AT-CV5001AC-60.....	49	AT-FL18C.....	28
AT-CV5001DC-80.....	49	AT-FL19B.....	28
AT-DC2552XS/L3.....	13	AT-FL19C.....	28
AT-DINRAIL1-010.....	48	AT-FL19D.....	28
AT-EXLC-1200G.....	31	AT-FL19E.....	28
AT-EXLC-1600.....	31	AT-FL-CF4-AM40.....	7
AT-EXLC-3200.....	31	AT-FL-CF4-AM80.....	7
AT-EXLC-3200R.....	31	AT-FL-CF9-AC10.....	7
AT-EXLC-400G.....	31	AT-FL-CF9-AC30.....	7
AT-EXLC-800G-8.....	31	AT-FL-CF9-AC60.....	7
AT-EXLC-800G-16.....	31	AT-FL-CF9-AM40.....	7
AT-EXLC-LS.....	31	AT-FL-CF9-AM80.....	7
AT-EXLC-LS-EDGE.....	31	AT-FL-CF9-AM120.....	7
AT-EXLC-LS-Redundancy.....	31	AT-FL-CF9-VCSPLUS.....	7
AT-EXLC-LV.....	31	AT-FL-CF9-WM120.....	7
AT-EXLC-LV-3200.....	31	AT-FL-CF9-WM40.....	7
AT-EXLC-TR.....	31	AT-FL-CF9-WM80.....	7
AT-EXLC-UP.....	31	AT-FL-CFC400-01.....	7
AT-EXLS-3000.....	30	AT-FL-CFC960-01.....	7
AT-EXLV-2000.....	30	AT-FL-SBx9-01.....	9
AT-EXMC-1000.....	31	AT-FL-SBx9-02.....	9
AT-EXMS-1000.....	30	AT-FL-SBx9-AM40.....	9
AT-EXMS-500.....	30	AT-FL-SBx9-WM20.....	9
AT-EXRE-1000.....	31	AT-FS201.....	47
AT-EXRP-22En.....	31	AT-FS202.....	47
AT-EXRP-22n.....	31	AT-FS232.....	47
AT-EXRP-23ac.....	31	AT-FS232/1.....	47

AT-FS232/2.....	47	AT-GS900/16 .....	23
AT-FS238A/1 .....	47	AT-GS900/24 .....	23
AT-FS238B/1 .....	47	AT-GS908M .....	16
AT-FS705EFC/SC .....	22	AT-GS916M.....	16
AT-FS705L .....	22	AT-GS924M.....	16
AT-FS705LE .....	22	AT-GS924MPX.....	16
AT-FS708 .....	23	AT-GS924MX.....	16
AT-FS708LE .....	22	AT-GS948MPX .....	16
AT-FS708LE/POE .....	23	AT-GS948MX .....	16
AT-FS708/POE .....	23	AT-GS950/10PS.....	21
AT-FS716L.....	23	AT-GS950/16 .....	21
AT-FS717FC/SC.....	23	AT-GS950/16PS.....	21
AT-FS724L .....	23	AT-GS950/24 .....	21
AT-FS750/16.....	20	AT-GS950/48 .....	21
AT-FS750/24.....	20	AT-GS950/48PS.....	21
AT-FS750/28POE .....	20	AT-GS950/8 .....	21
AT-FS750/52.....	20	AT-GS950/8POE.....	21
AT-FS909M.....	19	AT-GS2002/SP .....	47
AT-FS917M .....	19	AT-HS-STK-CBL .....	9
AT-FS926M.....	19	AT-IE200-6FP .....	24
AT-FS970M/16F8-LC .....	17	AT-IE200-6FT.....	24
AT-FS970M16F8-SC .....	17	AT-IE200-6GP .....	24
AT-FS970M/24C.....	19	AT-IE200-6GT .....	24
AT-FS970M/24F.....	17	AT-IE510-28GSX.....	24
AT-FS970M/24LPS.....	19	AT-IFS802SP-80 .....	24
AT-FS970M/24PS.....	19	AT-IFS802SP/POE (W)-80 .....	24
AT-FS970M/48.....	19	AT-IMC100T/SCMM.....	48
AT-FS970M/48PS .....	19	AT-IMC100T/SCSM.....	48
AT-FS970M/8.....	19	AT-IMC1000TP/SFP.....	48
AT-FS970M/8PS .....	19	AT-IMC1000T/SFP .....	48
AT-FS970M/8PS-E.....	19	AT-IMG634A-R2.....	43
AT-GS900/5E .....	23	AT-IMG634B-R2.....	43
AT-GS900/8 .....	23	AT-IMG634WA-R2.....	43
AT-GS900/8E.....	23	AT-IMG634WB-R2.....	43
AT-GS900/8PS.....	23	AT-IMG746MOD.....	43, 44

AT-IMG1405 .....	43, 44	AT-MCF2012LC/1 .....	50
AT-IMG1405W .....	43, 44	AT-MCF2032SP .....	50
AT-IMG1425 .....	43, 44	AT-MCF2300 .....	50
AT-IMG1425RF .....	43, 44	AT-MCF2300AC .....	50
AT-IMG1425W .....	43, 44	AT-MCF2300FAN .....	50
AT-IMG1505 .....	43, 44	AT-MCPWR .....	47
AT-IMG1525 .....	43, 44	AT-MCR1 .....	48
AT-IMG1525RF .....	43, 44	AT-MCR12 .....	48
AT-IMG2426F .....	43, 44	AT-MTP12-1 .....	53
AT-IMG2504 .....	43, 44	AT-MTP12-5 .....	53
AT-IMG2522 .....	43, 44	AT-PC2002POE .....	47
AT-IMG2524 .....	43, 44	AT-PC232/POE .....	47
AT-IMG2524F .....	43, 44	AT-PWR01 .....	13
AT-IMG2524H .....	43, 44	AT-PWR05 .....	9
AT-IX5-28GPX .....	15	AT-PWR05-80 .....	9
AT-MC1004 .....	47	AT-PWR06 .....	13
AT-MC1008/SP .....	47	AT-PWR150 .....	13
AT-MC101XL .....	47	AT-PWR250 .....	13
AT-MC102XL .....	47	AT-PWR800 .....	13
AT-MC102XL-PCI .....	47	AT-PWR1200 .....	13
AT-MC102XL-PCIe .....	47	AT-QSFP1CU .....	53
AT-MC103LH .....	47	AT-QSFP3CU .....	53
AT-MC103XL .....	47	AT-QSFP-4SFP10G-3CU .....	53
AT-MC104XL .....	47	AT-QSFP-4SFP10G-5CU .....	53
AT-MC115XL .....	46, 47	AT-QSFPSR .....	53
AT-MC116XL .....	46, 47	AT-RPS3000 .....	13
AT-MC13 .....	47	AT-SBx31CFC960 .....	10, 11
AT-MC605 .....	47	AT-SBx31FAN .....	10
AT-MC606 .....	47	AT-SBx31GC40 .....	10, 11
AT-MCF2KFAN .....	50	AT-SBx31GP24 .....	10, 11
AT-MCF2000 .....	50	AT-SBx31GS24 .....	11
AT-MCF2000AC .....	50	AT-SBx31GT24 .....	11
AT-MCF2000M .....	50	AT-SBx31GT40 .....	11
AT-MCF2000S .....	50	AT-SBx31XS6 .....	10
AT-MCF2012LC .....	50	AT-SBx31XZ4 .....	10

AT-SBx81CFC400.....	7	AT-SPBD10-14.....	53
AT-SBx81CFC960.....	7	AT-SPBD20DUAL-14.....	53
AT-SBx81GP24.....	7	AT-SPBD20EPON-13/I.....	54
AT-SBx81GS24a.....	7	AT-SPBD40DUAL-14.....	53
AT-SBx81GT24.....	7	AT-SPBD40-XXXXS-C/I.....	54
AT-SBx81GT40.....	7	AT-SPEX.....	53
AT-SBx81XS16.....	7	AT-SPFX/2.....	52
AT-SBx81XS6.....	7	AT-SPFX/15.....	52
AT-SBx3106.....	10	AT-SPFXBD-LC-13.....	52
AT-SBx3112.....	10, 15	AT-SPFXBD-LC-15.....	52
AT-SBx8106.....	7	AT-SPLX10.....	53
AT-SBx8112.....	7	AT-SPLX10/I.....	52, 53
AT-SBx908.....	9	AT-SPLX40.....	53
AT-SBx3112-6XS.....	10	AT-SPLX40/I.....	52, 53
AT-SBx3112-8XR.....	10	AT-SPLX80/I.....	52
AT-SBx3112-12XS.....	10	AT-SPSX.....	53
AT-SBx3112-96POE+.....	10	AT-SPSX/I.....	52, 53
AT-SBx3112-B01-80.....	10	AT-SPTX.....	52
AT-SBxPWRPOE1.....	7, 10	AT-SPZX80.....	53
AT-SBxPWRPOE1-10.....	11	AT-SPZX80/I.....	53
AT-SBxPWRSYS1.....	7, 10	AT-StackQS.....	13
AT-SBxPWRSYS1-10.....	11	AT-TN-117.....	40
AT-SBxPWRSYS1-80.....	7, 10, 11	AT-TN-118.....	40
AT-SP10ER40/I.....	52, 53	AT-TN-119.....	40
AT-SP10LR.....	53	AT-TN-124.....	40
AT-SP10LR20/I.....	52, 53	AT-TN-128.....	40
AT-SP10LR/I.....	52, 53	AT-TN-130.....	40
AT-SP10LRM.....	53	AT-TN-139.....	40
AT-SP10SR.....	53	AT-TN-140.....	40
AT-SP10SR/I.....	52, 53	AT-TN-142.....	40
AT-SP10TW1.....	53	AT-TN-143.....	40
AT-SP10TW3.....	53	AT-TN-144.....	40
AT-SP10TW7.....	53	AT-TN-145.....	40
AT-SP10ZR80/I.....	52, 53	AT-TN-146-A.....	40
AT-SPBD10-13.....	53	AT-TN-250G-B.....	38

AT-TN-253G .....	38	AT-TQ0522E .....	36
AT-TN-254-80 .....	38	AT-TQ0523E .....	36
AT-TN-301 .....	38	AT-TQ0541E .....	36
AT-TN-309 .....	38	AT-TQ0542E .....	36
AT-TN-310 .....	38	AT-TQ0561E .....	36
AT-TN-407 .....	38, 39	AT-TQ0562E .....	36
AT-TN-408 .....	38, 39	AT-TQ0591 .....	35
AT-TN-409 .....	38, 39	AT-TQ0592 .....	35
AT-TN-9101 .....	38	AT-TQ4600 .....	32
AT-TN-9102 .....	38	AT-TRAY1 .....	48
AT-TN-9103 .....	38	AT-TRAY4 .....	48
AT-TN-PO15-A .....	54	AT-UTP/RJ.5-100-A-008 .....	9
AT-TN-R113 .....	38	AT-UTP/RJ.5-300-A-008 .....	9
AT-TN-R114 .....	38	AT-UWC-60-APL .....	33
AT-TQ0001 .....	35	AT-UWC-Install + AT-UWC-BaseST .....	33
AT-TQ0003 .....	35	AT-WLMT .....	48
AT-TQ0041 .....	35	AT-WNP300N .....	35
AT-TQ0045 .....	35	AT-WR2304N .....	32
AT-TQ0051 .....	35	AT-WR4501 .....	35
AT-TQ0053 .....	35	AT-x6EM/Xs2 .....	13
AT-TQ0201E .....	36	AT-x210-16GT .....	15
AT-TQ0202E .....	36	AT-x210-24GT .....	15
AT-TQ0221E .....	36	AT-x210-9GT .....	15
AT-TQ0222E .....	36	AT-x230-10GP .....	15
AT-TQ0223E .....	36	AT-x230-18GP .....	15
AT-TQ0241E .....	36	AT-x310-26FP .....	15
AT-TQ0242E .....	36	AT-x310-26FT .....	15
AT-TQ0243E .....	36	AT-x310-50FP .....	15
AT-TQ0261E .....	36	AT-x310-50FT .....	15
AT-TQ0262E .....	36	AT-x510-28GPX .....	15
AT-TQ0292 .....	35	AT-x510-28GSX .....	15
AT-TQ0500 .....	35, 36	AT-x510-28GTX .....	15
AT-TQ0501E .....	36	AT-x510-52GPX .....	15
AT-TQ0502E .....	36	AT-x510-52GTX .....	15
AT-TQ0521E .....	36	AT-x510DP-28GTX .....	15



AT-x510DP-52GTX .....	15	iMAP 9100 .....	38
AT-x510L-28GP .....	15	iMAP 9700 .....	38
AT-x510L-28GT .....	15	iMAP 9810 .....	38
AT-x510L-52GP .....	15	iMAP ADSL24AE .....	40
AT-x510L-52GT .....	15	iMAP ADSL24B .....	40
AT-x610-24SPs/X.....	13	iMAP CES8.....	40
AT-x610-24Ts .....	13	iMAP CFC100.....	38, 39
AT-x610-24Ts-POE+ .....	13	iMAP CFC12 .....	38, 39
AT-x610-24Ts/X.....	13	iMAP CFC56.....	38, 39
AT-x610-24Ts/X-POE+ .....	13	iMAP FX20BX.....	40
AT-x610-48Ts.....	13	iMAP FX20BX40.....	40
AT-x610-48Ts-POE+ .....	13	iMAP GE24BX.....	40
AT-x610-48Ts/X .....	13	iMAP GE3 .....	38
AT-x610-48Ts/X-POE+ .....	13	iMAP GE8 .....	40
AT-x900-12XT/S .....	13	iMAP GEAPON .....	40
AT-x900-24XS .....	13	iMAP PAC24C.....	40
AT-x900-24XT .....	13	iMAP POTS24C .....	40
AT-x930-28GPX.....	13	iMAP UDSL24.....	40
AT-x930-28GSTX .....	13	iMAP VDSL24A.....	40
AT-x930-28GTX.....	13	iMAP VDSL24B.....	40
AT-x930-52GPX .....	13	iMAP XE1S .....	38
AT-x930-52GTX .....	13	iMAP XE6 .....	38
AT-XEM-2XS.....	13	MicroMAP 9001 .....	38
AT-XEM-12S .....	9	StackXG.....	13
AT-XEM-12Sv2 .....	9	SwitchBlade x3100 Series.....	10
AT-XEM-12T .....	9	SwitchBlade x8100 Series.....	6
AT-XEM-12Tv2.....	9	SwitchBlade x908.....	8
AT-XEM-2XP.....	9		
AT-XEM-2XS.....	9		
AT-XEM-2XT .....	9		
AT-XEM-24T .....	9		
AT-XEM-STK.....	13		
AT-XPER40.....	53		
AT-XPER80 .....	53		
CloudBlanket NMS .....	30		

Allied Telesis continuously enhances its products. As a result, this catalog may not correctly represent all products currently available. Products may also vary by geographic region. Product specifications can change without notice, and while Allied Telesis makes every effort to ensure the accuracy of information presented in this catalog, the Company does not accept liability for errors or changes in the stated specifications.

For current product availability by region, full and complete product specifications and warranty information, please contact your regional sales manager or visit [alliedtelesis.com](http://alliedtelesis.com).

As a major industry developer and manufacturer of networking equipment, Allied Telesis is committed to providing our customers with products designed and built to the highest quality, while minimizing the impact to the environment during both manufacturing and product operation.

## Our Philosophy

Allied Telesis recognizes the importance of protecting the global environment and promoting conservation of biodiversity. We creatively utilize technology for sustainable social progress and for protecting the environment. Allied Telesis is committed to passing down a healthy global environment to the next generation.

## Our Policy

Allied Telesis takes a proactive approach to:

- continual improvement of the local and global environment,
- prevention of pollution, and
- environmental management to fulfill corporate social responsibilities.

To achieve these objectives:

- Allied Telesis executive management has established and provides the resources for an Environmental Management System (EMS).
- We offer products designed to conserve energy; manufactured to save resources.
- We seek to reduce the risks to human health and the health of the environment from the use of hazardous chemical substances.
- We strive to reduce our impact on the environment through reduction, reuse, and recycling of waste materials (we practice 3R).
- We comply with all applicable environmental regulatory requirements, industry-specific self-regulation and stakeholder's requirements.

## Reduced Operational Power Consumption

Using the latest technology and a range of power saving techniques, Allied Telesis has reduced power consumption by up to 50% over a wide range of its network devices. Reducing power consumption has a direct benefit for the environment. Additionally, further energy savings can also be made where products are installed in controlled temperature environments such as server rooms. Such environments allow the equipment to run cooler, requiring less effort and power from the device, resulting in a decrease in power utility costs and an increase in equipment reliability.

Eco-friendly is the brand name used by Allied Telesis to signify our low power range of networking products. Eco-friendly products will eventually encompass our entire product portfolio, as we continue to introduce new, lower power technology to meet customer demand.

**Reducing Power on Network Ports:** The latest switching silicon can detect the length of cables connected to a port. Using "measure and minimize" technology, Allied Telesis can ensure that maximum power is only injected into cables with the longest lengths, reducing the power injected into short

cable lengths. Advanced products can ensure that selected ports are disabled overnight or on weekends, further reducing power.

**Reducing Indicator Activity:** All networking devices feature a varying array of power-consuming indicator devices (typically LEDs) to aid in installation and diagnostics. On the latest Allied Telesis products, these LEDs can be disabled when not required, saving up to a further 2% of operating power.

**Power Supply Efficiency:** The overall power consumption of a network device is ultimately dictated by the efficiency of the power supply. A power supply delivering only 50% efficiency draws twice the actual required power, with half the power wasted in the form of heat. Allied Telesis uses ultra-efficient power supplies, delivering conversion efficiencies of more than 80%, which produce less heat and reduce power consumption by up to 30%. Allied Telesis is now rating power supplies, informing the user of their efficiency.

## Manufacturing

Allied Telesis prides itself on using state-of-the-art manufacturing equipment. While quality and efficiency are key parameters, Allied Telesis is also focused on reducing the potential damage to the environment caused during the manufacturing process.

**ISO 9001 Standard:** All Allied Telesis manufacturing facilities conform to ISO 9001 standards. Efficient production techniques, coupled with stringent design parameters ensure that Allied Telesis maintains its position as one of the highest quality networking producers in the industry.

**ISO 14001 Standard:** Allied Telesis has long been a responsible manufacturer, ensuring the minimum damage to the world's environment. All of our facilities adhere to the strict ISO 14001 standard for environment management of our production processes.

Allied Telesis manufacturing facilities also ensure minimal impact on the environment by use of the latest technology and processes. All water used in our manufacturing process is recycled.

## Logistics

The majority of Allied Telesis network products are manufactured in Asia. Transporting these products across the world to the consumer markets can therefore have significant impact on the environment. Whenever possible, Allied Telesis attempts to use bulk sea transportation, as this has significantly less environmental impact when compared to air freight.

## Restrictions on Hazardous Substances (RoHS) Compliance

Allied Telesis declares that the homogeneous content of the materials and components used in products bearing the CE Mark conform to the requirements established by the European Union RoHS (Restriction of the use of certain Hazardous Substances in electrical and electronic equipment) Directive, 2011/65/EU. Maximum Concentration Values of lead (Pb), mercury (Hg), hexavalent chromium (Cr+6), polybrominated biphenyls (PBB), and polybrominated diphenyl ethers (PBDE) shall be no more than 1000 ppm and cadmium (Cd) shall be no more than 100 ppm. Allied Telesis ensures RoHS conformance by requiring Declarations of Conformity and Full Materials Disclosure from all suppliers; by monitoring incoming materials and by maintaining strict manufacturing process controls.

## REACH Policy

As a manufacturer of Articles that do not release chemical substances into the environment, Allied Telesis is committed to ensuring that there are no SVHCs (Substances of Very High Concern) above allowable threshold (1000 ppm) used in our products. We have procedures and processes in place to ensure continued conformity with REACH regulations.

## WEEE Policy

Allied Telesis distributors and channel partners share a common commitment to recycle waste electronic equipment and safely dispose of what cannot be recycled, in accordance with the WEEE directive.

## Conflict Minerals Policy

Allied Telesis is committed to social and environmental responsibility and we expect the same commitment from our supply chain. This includes compliance with Section 1502 of the Dodd-Frank Wall Street Reform and Consumer Protection Act, which requires U.S. publicly traded companies to trace the origins of tin, tantalum, tungsten, and gold (3TG) used in their products. The intended purpose of which is to prevent the use of (3TG) mined in the Democratic Republic of Congo (DRC) and adjoining countries in order to eliminate these "conflict minerals" as a source of funding for the ongoing conflict. We have a dedicated team of people working with our suppliers to reasonably assure that the 3TG in our products are "conflict free."

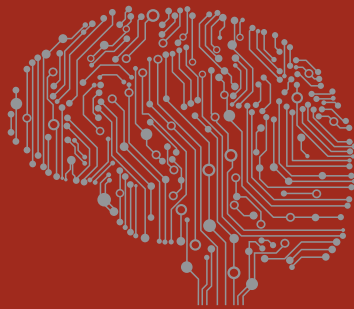

**NETWORK SMARTER™**

Company Details



IQ Trading - официальный дистрибьютор в Украине  
Украина, 04080, Киев, ул. Межигорская, 87-А  
тел.: +380(44) 351 1437, факс: +380(44) 351 1438  
e-mail: [disti@iqtrading.com.ua](mailto:disti@iqtrading.com.ua), [www.iqtrading.com.ua](http://www.iqtrading.com.ua)