

air-air and  
water-air units

CONTROL BROCHURE

NA 14.33 E 12 - 2019

**Electronic control**

**CIATrTc**

# CONTENTS

<b>1 - GENERAL DESCRIPTION</b> .....	<b>3</b>
1.1. pGD1 graphic terminal .....	3
1.2. TCO user terminal (optional).....	3
1.3. Sensors .....	3
1.4. pCOe expansion cards (optional).....	4
1.5. SMALL board (optional).....	4
1.6. BMS communication .....	5
1.7. Communication in a pLAN network.....	5
<b>2 - USER INTERFACES</b> .....	<b>6</b>
2.1. pGD1 graphic terminal (standard).....	6
2.2. TCO user terminal (optional).....	7
<b>3 - CONNECTIONS</b> .....	<b>8</b>
3.1. Main board .....	8
3.2. Serial connection of RS485 probes to the Field-bus of the control board (optional) .....	9
3.3. Connection of terminals to the control board.....	10
3.4. pCOe expansion card with address 7 (optional) .....	11
3.5. pCOe expansion card with address 8 (optional) .....	12
3.6. pCOe expansion card with address 9 (optional) .....	13
3.7. Connection of the SMALL board with address (optional) .	14
<b>4 - UNIT OVERVIEW IN THE PGD1 TERMINAL</b> .....	<b>15</b>
<b>5 - MENU STRUCTURE IN THE PGD1 TERMINAL</b> .....	<b>16</b>
<b>6 - STARTING / STOPPING THE UNIT</b> .....	<b>17</b>
<b>7 - SETPOINTS SELECTION</b> .....	<b>18</b>
<b>8 - SELECTION OF THE OPERATING MODE</b> .....	<b>19</b>
8.1. COOLING operating mode (summer) .....	20
8.2. HEATING operating mode (winter).....	20
<b>9 - SCHEDULE PROGRAMMING</b> .....	<b>21</b>
9.1. Schedule programming: pGD1 terminal.....	21
9.2. Schedule programming: TCO terminal.....	23
<b>10 - DISPLAY OF THE INPUTS / OUTPUTS STATUS</b> .....	<b>25</b>
<b>11 - COMPONENTS MANAGEMENT</b> .....	<b>26</b>
11.1. Compressors .....	26
11.2. Cycle reversing valve (CRV).....	26
11.3. Outdoor circuit fans .....	26
11.4. Outdoor circuit 3-way valve .....	27
11.5. Indoor circuit supply fans.....	27
11.6. Indoor circuit return fans (optional).....	27
11.7. Auxiliary water coil (optional).....	28
11.8. Electrical heater (optional).....	28
11.9. Gas burner (optional).....	28
11.10. Outdoor air damper .....	29
11.11. Supply and return dampers for zoning into 2 zones ...	31
11.12. Cooling recovery circuit (optional) .....	31
11.13. Rotary heat exchanger (optional) .....	31
11.14. Humidification (optional).....	31
11.15. Meter of power energy (optional).....	31
<b>12 - OPTIONAL FUNCTIONS OF CONTROL</b> .....	<b>32</b>
12.1. Control of the supply air temperature .....	32
12.2. Zoning of the air flow .....	33
12.3. Dehumidification.....	34
12.4. Outdoor temperature compensation.....	34
<b>13 - SAFETY FUNCTIONS</b> .....	<b>35</b>
13.1. Defrosting function (air-air units) .....	35
13.2. Anti-freeze safety (water-air units).....	35
13.3. Low outdoor temperature safety (water-air units).....	35
13.4. Protections against low outdoor temp.(optional) .....	35
13.5. High supply temperature safety.....	35
13.6. High or low indoor temperature safety .....	36
13.7. Anti-fire safety.....	36
13.8. Compressor lock .....	36
13.9. Additional low-pressure safety.....	36
13.10. High temp. safety in tandem compressors (optional) .	36
13.11. Clogged filter detector (optional) .....	36
13.12. Refrigerant leak detector (optional).....	36
13.13. High-speed safety on plug-fans (optional).....	36
<b>14 - ALARMS</b> .....	<b>37</b>
14.1. Alarm display .....	37
14.2. Signalling of remote alarms (optional).....	37
14.3. Alarm list.....	38
<b>15 - LIST OF PARAMETERS OF "UNIT STATUS"</b> .....	<b>40</b>
<b>16 - LIST OF PARAMETERS OF "MAIN MENU"</b> .....	<b>41</b>
<b>17 - LIST OF PARAMETERS OF "TECHNICAL MENU"</b> .....	<b>51</b>
17.1. Parameters of the USER screens .....	51
17.2. Parameters of the MANUFACTURER screens .....	55
17.3. Parameters of the MAINTENANCE screens .....	67
<b>18 - CONNECTING THE UNIT TO A BMS SUPERVISION NETWORK</b> .....	<b>76</b>
18.1. Enabling supervision .....	76
18.2. Configuration of the supervision network .....	76
18.3. Failure of BMS communication .....	76
18.4. Carel and Modbus supervision variables .....	77
18.5. LonWorks® supervisory variables.....	98
<b>19 - CONFIGURATION OF THE PLAN NETWORK</b> .....	<b>99</b>
19.1. Addressing of the boards.....	99
19.2. Configuration of the shared terminal .....	99
19.3. Address assignment to private terminals.....	100
19.4. Configuration of the shared sensors (optional) .....	100
<b>20 - TECHNICAL AND ELECTRICAL CHARACTERISTICS</b> .....	<b>101</b>
20.1. Ambient probe .....	104
20.2. Air quality probe 4.. 20 mA .....	105
<b>21 - TROUBLESHOOTING</b> .....	<b>106</b>

ORIGINAL TEXT: SPANISH VERSION

# 1 - GENERAL DESCRIPTION

The **CIATrtc** control is an electronic module designed for the control and supervision of air-air and water-air units (especially rooftop models) by microprocessors.

This control is basically comprised of a  $\mu$ PC MEDIUM control board, a pGD1 graphic terminal, a TCO user terminal (optional) and sensors.

It has a field-bus RS485 that allows the management of components such as: pCOe expansion modules, plug-fans, probes of temperature or relative humidity of the ambient air, leak detectors, energy meters, variable frequency drives, etc.

The **CIATrtc** control allows the connection to a centralised technical management system by using a specific BMS card (optional) for the following communication protocols: Carel, Modbus, LonWorks®, BACnet™ MSTP, Konnex, Modbus TCP/IP, BACnet™ Ethernet, TCP/IP, SNMP V1-2-3, FTP and HTTP.

It also manages a local connection between units through a pLAN network ( $\mu$ PC MEDIUM Local Area Network), thus allowing communication of data and information for a maximum of 15 units. This enables the reduction of the number of pGD1 terminals, since a single shared terminal can monitor all  $\mu$ PC MEDIUM boards.

## Main functions:

- Selection of the operating mode: HEATING, COOLING, AUTOMATIC or VENTILATION.
- Selection of the setpoint.
- Permanent control of the operating parameters.
- View of the values measured by the probes.
- Timing of the compressors
- Defrosting management (in air-air heat pump units).
- Refrigerant anti-freeze safety (in water-air heat pump units).
- Operation of all the seasons via the condensation and evaporation pressure control.
- Control of the outlet temperature.
- Compensation of the setpoint based on the outdoor temperature.
- Time (possibility of 3 setpoints) and weekly schedule.
- Anti-fire safety device.
- Failure diagnosis and main alarm.

## Optional functions:

This control allows controlling optional elements such as:

- Electronic outdoor fans.
- Cooling recovery circuit for renewing the air.
- Rotary recovery with on/off control or with variable speed.
- Outdoor air damper for renewing air, depending on the temperature of the mixing air or depending on the air quality probe.
- Mixing box for thermal, enthalpic or thermoenthalpic free-cooling.
- Control of the overpressure.
- Zoning up to 4 zones with variation of air flow.
- Supply and return plug-fans.
- Supply and return centrifugal fans with variable frequency drive (VFD).
- Auxiliary electrical heaters: one or two stages with on/off control or a stage with proportional control.
- Hot water coil with 3-way valve, with proportional or on/off control.
- Gas burner with one or two stages of proportional control.
- Humidifier with proportional or on/off control.
- Air flow controller.

- Clogged filter detector.
- Smoke detection station.
- Refrigerant leak detector.
- Ambient temperature or humidity RS485 probe(s).
- Air quality probe(s) for measuring CO<sub>2</sub>
- Energy meter and calculation of the cooling and heating capacities.

## 1.1. pGD1 graphic terminal

This pGD1 terminal is used to:

- Carry out initial programming of the unit.
- Modify operating parameters.
- Switch the unit ON / OFF.
- Select the operating mode.
- Adjust the setpoints.
- Display the variables controlled and sensor values measured.
- Display the current alarms and their historical record.



## 1.2. TCO user terminal (optional)

This terminal is used to:

- Switch the unit ON / OFF.
- Select the operating mode.
- Adjust the setpoints.
- Display the installation's temperatures and humidity, outdoor temperature, supply air temperature, CO<sub>2</sub> sensor and opening of the outdoor damper.
- Display alarms codes.



## 1.3. Sensors

Standard sensors included in the control:

- Temperature of the return air and temperature of the outlet air.
- Pressure or temperature in the outdoor coils (air-air units) or refrigerant anti-freeze safety (water-air units).
- Outdoor air temperature.
- Mixing air temperature.
- NTC ambient air temperature.

*Note: If the unit is integrated in a pLAN network it can read the probes value of the master unit for: ambient temperature and outdoor temperature.*

# 1 - GENERAL DESCRIPTION

## Optional probes connected on the $\mu$ PC MEDIUM board:

- Relative humidity of the return air: this probe is used with the options of enthalpic or thermoenthalpic free-cooling or humidifier.
- Outdoor air relative humidity: this probe is used instead of the outdoor temperature probe and is necessary with the option of enthalpic or thermoenthalpic free-cooling.

When the unit needs the outdoor humidity probe), this one is connected on the board in place of the NTC ambient temperature probe. In this case, it's necessary to use a RS485 ambient temperature probe connected on the Field-bus.

- Air quality probe to enable measuring  $\text{CO}_2$ . This probe can be installed in the environment or duct-mounted.

A second probe can be connected on the pCO<sub>e</sub> expansion card with address 9 to improve the air quality control.

*Note: If the unit is integrated in a pLAN network, it can read the probes value of the master unit for: outdoor humidity, indoor humidity and air quality.*

## Optional probes connected, in series, on the Field-bus:

- RS485 ambient T probe (1 to 4 probes connected in series):
  - When the unit needs the outdoor humidity probe (with enthalpic or thermoenthalpic free-cooling), this one is connected on the board in place of the NTC ambient temperature probe. In this case, a RS485 ambient temperature probe is used.
  - An ambient temperature probe with RS485 communication is required for installation at distances up to 30 meters.
- RS485 ambient T + RH probe (1 to 4 probes connected in series):
  - This probe is necessary with enthalpic or thermoenthalpic free-cooling. In this case, the outdoor humidity probe is also added.
- RS485 enthalpy probes on the mixing air and the supply air for calculation of the cooling and heating capacities.

*Note: If the unit is integrated in a pLAN network, it can read the probes value of the master unit for: ambient T or T + RH.*

## Location of the sensors on the machine

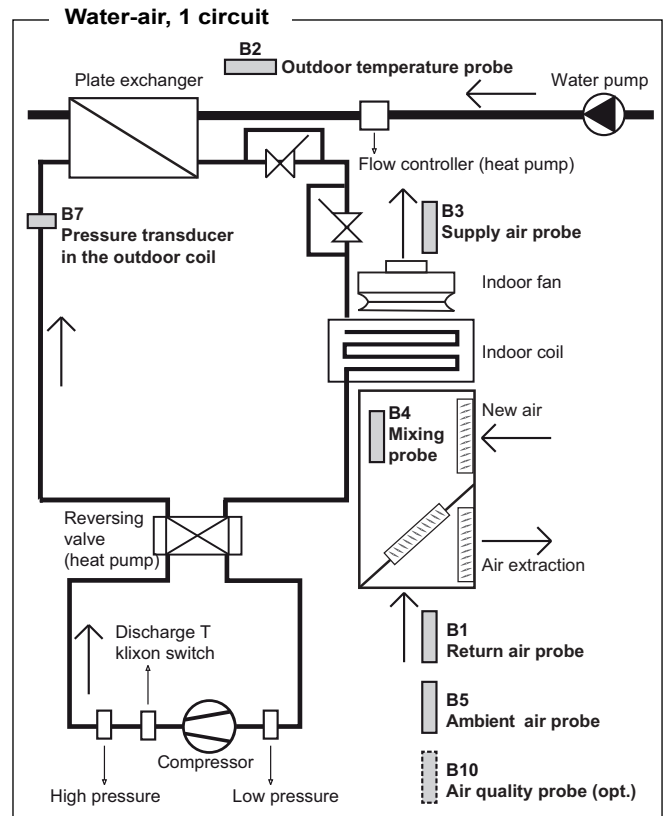
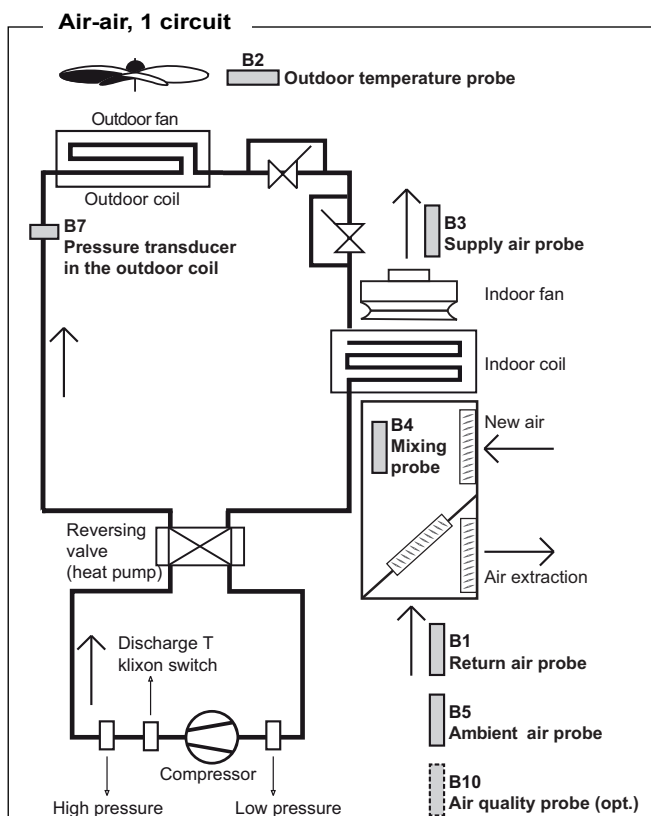

## 1.4. pCO<sub>e</sub> expansion cards (optional)

For the management of some optional elements, the control needs additional inputs and outputs. This problem is solved by the use of pCO<sub>e</sub> expansion card connected in series on the Field-Bus

### Card with address 7:

This module is needed to manage the options:

- Control of units with 4 compressors and 4 circuits.
- Proportional humidifier.
- Overpressure control with extraction damper.

### Card with address 8:

This module is needed to manage the options:

- Control of the condensation and evaporation pressures of the indoor unit.
- Low outdoor temperature (GREAT COLD).
- Mechanical disconnection of stages.

### Card with address 9:

This module is needed to manage the options:

- Second air quality probe ( $\text{CO}_2$ ) for installation in the environment or outdoor. The outdoor probe allows the measurement of the difference between indoor and outdoor  $\text{CO}_2$  concentration, in ppm (level of ADI).
- Rotary heat exchanger with variable speed.
- Zoning into 2 zones with dampers.
- Control of supply and return dampers (external to the unit).

## 1.5. SMALL board (optional)

A  $\mu$ PC SMALL board with address 11 connected in series on the Field-Bus allows the management of the zoning of the air flow up to 4 different zones through dampers.

# 1 - GENERAL DESCRIPTION

## 1.6. BMS communication

This control allows the connection to a centralised technical management system by using a specific BMS card (optional) for the following communication protocols:

### Carel and Modbus

One RS485 serial card is connected for the supervisory network with both Carel and Modbus protocol.

### Ethernet pCO Web

The Ethernet pCO Web card allows the network communication with the protocols Modbus TCP/IP, TCP/IP, SNMP V1-2-3, FTP and HTTP.

### BACnet™

To establish communication with a network with the BACnet™ MSTP protocol is needed a BACnet™ RS485 serial card (*configuration by the integrator*).

This open standard, developed by ASHRAE, enables air conditioning and heating systems for homes and buildings to be connected for the sole purpose of performing intelligent energy management.

### BACnet™ Ethernet

The Ethernet pCO Web card allows the network communication with the protocol BACnet™ Ethernet (*configuration by the integrator*).

### LonWorks®

To establish communication with a network with the LonWorks® protocol, is needed a FTT RS485 serial card.

The supervisory program is stored in flash memory and can be programmed directly from the LonWorks® network by using tools such as LonMaker®.

### Konnex (KNX)

A network with the Konnex protocol needs a Konnex serial card (*configuration by the integrator*).

This open standard enables the connection and integration of devices in building automation applications both at the commercial and at the residential level.

## Supervision solutions

Different solutions of supervision are available bases on the dimensions of the installation for unit fitted with Ethernet pCO Web and RS485 Carel / Modbus cards:

### pCO Web

It is the solution for the management and supervision of a single unit if this incorporates the Ethernet pCO Web card.

### PlantWatchPRO3

This is a solution designed for the monitoring of small and medium-size installations, capable of manage up to 30 units. Suitable for technical environments, no parts are in movement. It's available in two versions: panel and wall.

Includes: 7 " touch display, buzzer for notifications, 1 USB port and 1 SD card slot for downloading reports, charge devices models and applying service packs.

For this option, each unit needs one RS485 Carel / Modbus board.

### BOSS

This is the solution for the management and supervision of air-conditioning installations with up to 300 units. Integrated Hotspot Wi-Fi.

It offers advanced monitoring and maintenance functions and allows zones and groups to be created to simplify the management of the installation. It also allows energy meters to be integrated to monitor the installation electricity consumption.

BOSS is available in two versions:

- CPU device.
- CPU device, monitor, keyboard and screen.

For this option, each unit needs one RS485 Carel / Modbus board.

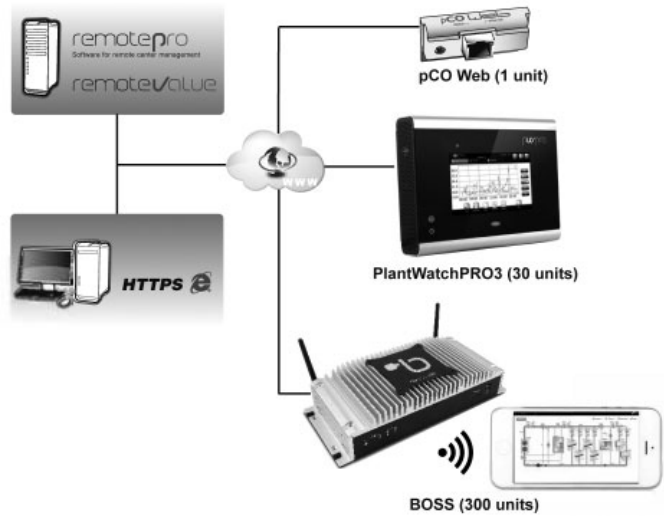

These systems are used to manage the installation remotely. All the information on the system can be accessed via a simple Internet connection. The online interface, the same one used by the local user, enables monitoring and complete configuration of the installation: from the office or anywhere else the user happens to be.

To control multiple sites remotely, there are special tools dedicated to centralized management, such as **RemotePRO** and **RemoteValue**.

## 1.7. Communication in a pLAN network

A pLAN network (µPC MEDIUM Local Area Network) allows data and information to be exchanged between units, for a maximum of 15 units. This enables the reduction of the number of pGD1 terminals, since a single shared terminal can monitor all boards in the network. Characterisc of the network: communications standard: RS485; transmission speed: 65,2 Kbit/s; maximum network length: 500 m.

The pLAN network must be composed, at least, by the following components:

- A **control board** for each unit integrated into the network. The maximum number of units in the aforementioned network is 15. One of the units is configured as the master unit in the network and the other units are configured as slaves.
- A **pGD1 terminal** which is configured as shared terminal. All boards integrated into the network can be monitored from this terminal.

Additional components:

- **Private pGD1 terminals:** it is possible to add the same number of terminals that the number of existing units in the network.
- **Shared sensors:** in a pLAN network with the appropriate facility's conditions, the value measured by some sensors installed on the master unit can be shared with the slave units.

These sensors are: outdoor temperature, ambient temperature, outdoor humidity, ambient humidity and CO<sub>2</sub> air quality.

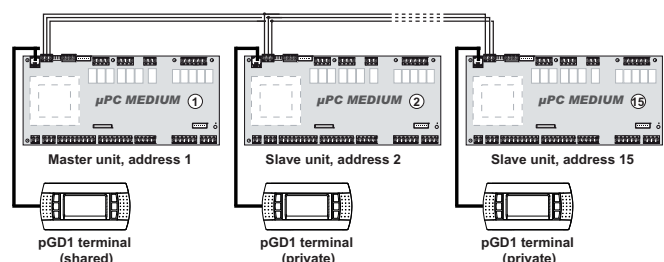

## 2 - USER INTERFACES

### 2.1. pGD1 graphic terminal (standard)

#### Features

- LCD FSTN display (132 x 64 pixel), backlit in blue.
- The screen provides detailed explanations of control in easy to understand English. No decoding is required.
- Only 6, large, easy-to-use buttons are required to maneuver through the entire menus.

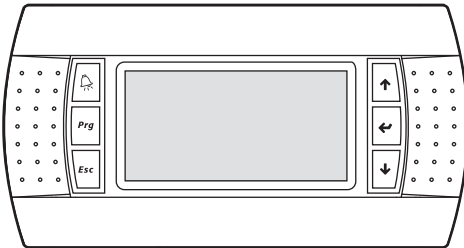

Dimensions:  
Length: 156 mm  
Width: 82 mm  
Depth: 31 mm

#### First run of the software

On the first run of the software installed on the control, the following screen appears on the terminal, informing about the installation of the values by default:

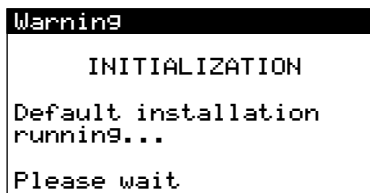

The screen that appears later indicates that it is necessary to reset the terminal to confirm installation:



When you switch on the power again, the terminal loads the initial screen, showing:

- The unit number in the pLAN network (U01 indicates that the unit is the master in the pLAN network or a stand-alone unit).
- The measured indoor temperature (Ind.T).
- The measured outdoor temperature (Out.T).
- The default installation language. The available languages are: Spanish (ES), French (FR), English (EN), Italian (IT), Turkish (TR), and German (AL).
- The time and date.

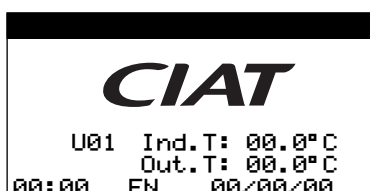

#### Keys and combinations (quick guide)

Key	Function
	<b>Alarm</b> There is/are active alarm(s) if the key is illuminated red. By pressing the key once, the description of the first alarm will be shown. By using the up/down keys, the other alarms stored in the memory can be consulted. By pressing this key for a second time, the alarm(s) will be reset. If no alarm is active, the message "No alarm active" appears.
	<b>Prg</b> This allows the MAIN MENU screen to be accessed to select the operating mode, setpoints, off/on, inputs/outputs and schedule programming (no password required). The key will light up in orange.
	<b>Esc</b> To exit any screen, pressing this key returns the user to the start screen of the previous menu. From the main screen, if keeping this key pressed for a few seconds, access is given to a group of help screens with information on the key or key combination that enable performing the most important control functions.
	<b>Esc + Down</b> By pressing both keys simultaneously for a few seconds, it's possible to change of unit in the pLAN network.
	<b>Up / Down</b> These keys enable consulting the information displayed on-screen by going forward or back. They can also modify values. By pressing both keys at the same time, direct access is gained to the group of input/output screens (belonging to the MAIN MENU).
	<b>Enter</b> This enables confirming the modified values. By pressing the key once, the cursor is placed on the first screen parameter. Pressing the key again confirms the adjusted parameter value and it then proceeds to the next parameter.
	<b>Prg + Esc</b> By pressing both keys simultaneously for a few seconds from any screen, access is given to the TECHNICAL MENU for the parametrisation and maintenance screens of the unit, to which only the fitter and/or engineer should have access (password required).
	<b>Prg + Enter</b> The unit is switched off/on by pressing both these keys at the same time for a few seconds. This action is equivalent to off/on from the MAIN MENU screen.
	<b>Prg + Up</b> HEATING mode (winter) is selected by pressing both these keys at the same time for a few seconds.
	<b>Prg + Down</b> COOLING mode (summer) is selected by pressing both these keys at the same time for a few seconds.
	<b>Alarm + Prg</b> The screen contrast (LCD with a resolution of 133 x 64 pixels) can be set by pressing these keys at the same time + up or down.
	<b>Alarm + Down</b> The language of the screens is selected by pressing both these keys at the same time for a few seconds.
	<b>Alarm + Enter</b> By pressing both keys simultaneously it is possible to access to information about the firmware and software of the board.

## 2 - USER INTERFACES

### 2.2. TCO user terminal (optional)

#### Features

- LCD display, backlit in blue.
- Built-in temperature sensor.
- Clock and schedule programming.

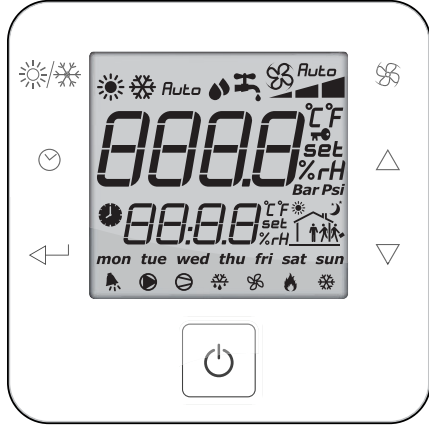

Dimensions:  
Length: 86 mm  
Width: 86 mm  
Depth: 51 mm

#### Screen

The TCO terminal has an LCD display to show the information of the unit and to interact with the user.

Symbol	Meaning
	Selection of HEATING mode (winter)
	Selection of COOLING mode (summer)
<i>Auto</i>	Selection of AUTOMATIC mode
	Indoor fan in operation (3 possible speeds in plug-fan)
	Main indicator of: - Temperature (°C or °F) - Activated block key (key) - Setpoint (set) - Relative humidity (%RH)
	Secondary indicator of: - Temperature (°C or °F) - Setpoint (set) - Hour and minute - Relative humidity (%RH)
	Alarm indicator
	Pump of the hot water coil in operation
	Compressor in operation
	Defrosting indicator
	Outdoor fan in operation
	Active backup in HEATING mode
	Operation in cooling mode (in AUTO mode it makes known whether the unit is operating in COOLING or HEATING)
	Selection of the type of schedule: 6 possible phases.
	Activation of the indicator of the schedule programming
<i>mon tue wed thu fri sat sun</i>	Indicators of the days of the week (Monday to Sunday)

#### Keys and combinations (quick guide)

Key	Function
	<b>Operating mode</b> Allows the operating mode to be selected: HEATING, COOLING, AUTO or VENTILATION (only if selection by panel is activated)
	<b>Fan</b> Allows to select 3 different flows in plug-fans: V1: minimum flow V2: nominal flow V3: maximum flow
	<b>Schedule programming</b> Short press: allows to activate the schedule programming stored in the TCO terminal Long press (3 secs): allows the time and the schedule programming to be modified.
	<b>Up / Down</b> These keys allow the user to go forward and backward to consult the information found on the screen. They can also modify values
	<b>Enter</b> This enables confirming the modified values. It also allows the set of values to be seen on the screen (temperature measured, temperature setpoint, humidity measured, humidity setpoint, outdoor temperature, discharge T, alarm code, CO <sub>2</sub> mesure, outdoor damper opening)
	<b>On / Off</b> Allows the unit to be turned OFF/ON

#### View in succession of the values measured

In addition to view in the ambient (or return) air temperature on the main screen, it is possible to view other values through the set that is activated by pressing the key.

The following values will be shown with each press:

1) Ambient or return T 	2) Setpoint temp. 	3) Ambient RH (opt) 
4) Setpoint RH (opt) 	5) Outdoor temperature 	6) Supply temperature 
7) Active alarms 	8) CO <sub>2</sub> measure (opt.) 	9) Outd. damper (opt) 

# 3 - CONNECTIONS

## 3.1. Main board

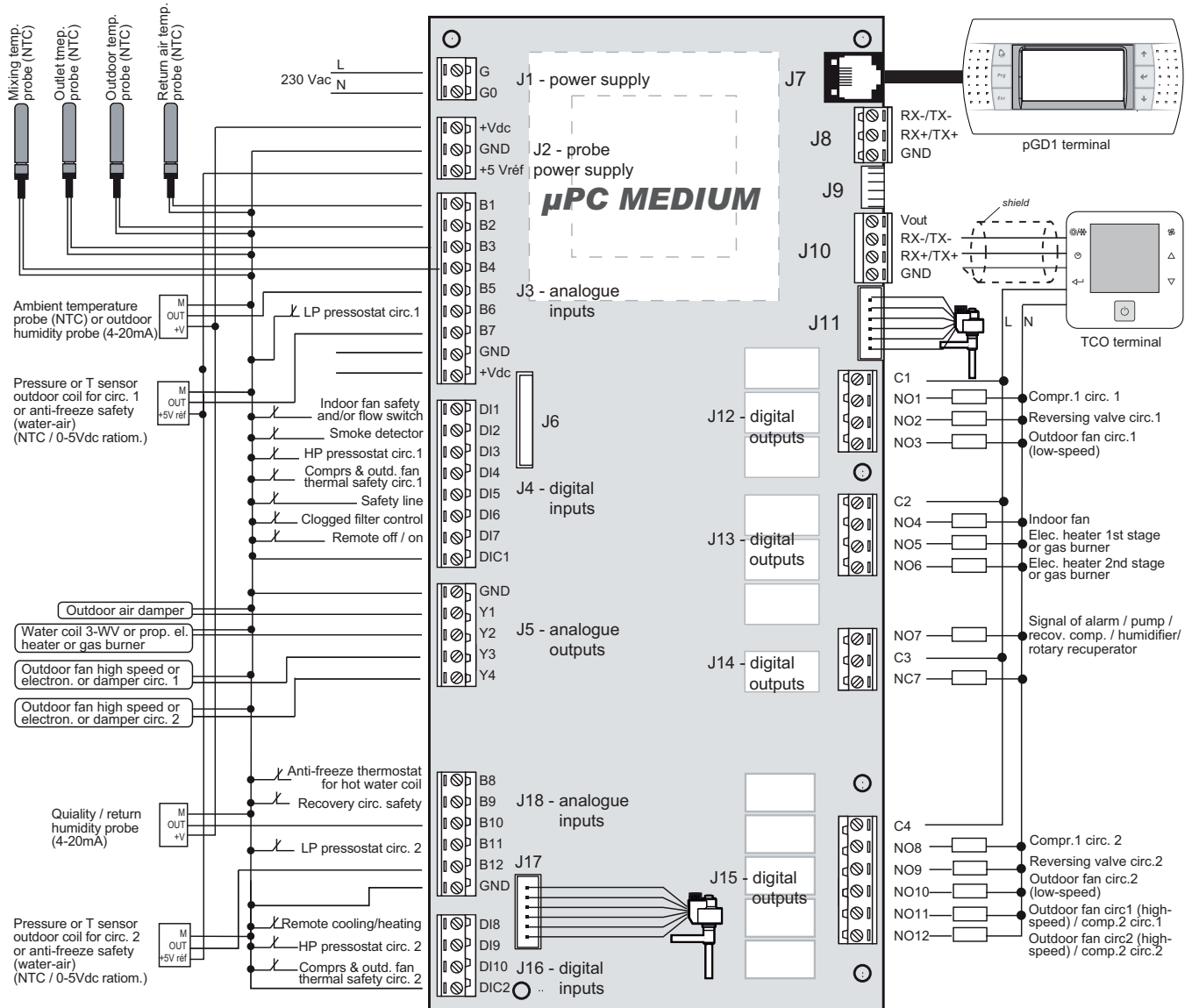

### Air-air unit: description of inputs and outputs

#### Analogue outputs

Proportional control of optional elements:

- Y1: Control of the opening of the outdoor air damper.
- Y2: Control of the three-way valve on the auxiliary coil for hot water or on the proportional electrical heater or on the gas burner
- Y3: Electronic outdoor fan circuit 1 (units with 1 or 2 circuits) / electronic outdoor fans circuits 1 and 2 (units with 4 circuits)  
High-speed outdoor fan circuit 1 (units with 1 or 2 circuits with 2-speed fan) (units with 4 compressors and 2 circuits with 2-speed fan)  
Damper for condensation pressure control on centrifugal outdoor fan circuit 1
- Y4: Electronic outdoor fan circuit 2 (units with 2 circuits) / electronic outdoor fans circuits 3 and 4 (units with 4 circuits)  
High-speed outdoor fan circuit 2 (units with 2 circuits with 2-speed fan) (units with 4 compressors and 2 circuits with 2-speed fan)  
Damper for condensation pressure control on centrifugal outdoor fan circuit 2

#### Analogue inputs

Temperature, pressure and humidity reading sensors:

- B1: Return air temperature probe
- B2: Outdoor air temperature probe
- B3: Outlet air temperature probe
- B4: Mixing air temperature probe
- B5: NTC ambient air temperature probe (by default) or outdoor air relative humidity probe (optional)
- B7: Pressure / temperature sensor for the outdoor coil 1
- B10: Air quality probe or return air relative humidity probe (optionals)
- B12: Pressure / temperature sensor for the outdoor coil 2

### Water-air unit: description of inputs and outputs

#### Analogue outputs

Proportional control of optional elements:

- Y1: Control of the opening of the outdoor air damper.
- Y2: Control of the three-way valve on the auxiliary coil for hot water or on the proportional electrical heater or on the gas burner
- Y3: Control of plates exchanger 3-way valve of circuit 1 (units with 1 or 2 circuits) / plates exchangers 3-way valve of circuits 1 and 2 (units with 4 circuits)
- Y4: Control of plates exchanger 3-way valve of circuit 2 (units with 2 circuits) / plates exchangers 3-way valve of circuits 3 and 4 (units with 4 circuits)

#### Analogue inputs

Temperature, pressure and humidity reading sensors:

- B1: Return air temperature probe
- B2: Outdoor air temperature probe
- B3: Outlet air temperature probe
- B4: Mixing air temperature probe
- B5: NTC ambient air temperature probe (by default) or outdoor air relative humidity probe (optional)
- B7: Refrigerant anti-freeze safety circuit 1
- B10: Air quality probe or return air relative humidity probe (optionals)
- B12: Refrigerant anti-freeze safety circuit 2



### 3 - CONNECTIONS

#### Air-air unit: description of inputs and outputs

##### Digital inputs

Safety devices and failure indication:

- B6: Low pressure pressostat circuit 1
- B8: Anti-freeze safety for the hot water coil
- B9: Recovery circuit safety device (optional)
- B11: Low pressure pressostat circuit 2
- DI1: Indoor fan protection and air flow control (optional)
- DI2: Smoke detector (optional)
- DI3: High pressure pressostat circuit 1
- DI4: Compressor and outdoor fan protection device circuit 1
- DI5: Safety thermistor for the electrical heater or gas burner alarm signal (opt.)
- DI6: Clogged filter control (optional)
- DI7: Remote off / on
- DI8: Remote cooling / heating
- DI9: High pressure pressostat circuit 2
- DI10: Compressor and outdoor fan protection device circuit 2

##### Digital outputs

On/off control of the unit components and optional elements:

- NO1: Compressor 1 of circuit 1
- NO2: Cycle reversing valve circuit 1
- NO3: Outdoor fan circuit 1 (units with 1 or 2 circuits)  
Low-speed outdoor fan circuit 1 (units 1 or 2 circuits with 2-speed fan)  
Outdoor fans circuits 1 and 2 (units with 4 circuits)  
Low-speed outdoor fans circuits 1 & 2 (units 4 circuits with 2-speed fan)
- NO4: Indoor fan
- NO5: 1st electrical heater stage or gas burner (optionals)
- NO6: 2nd electrical heater stage or gas burner (optionals)
- NO7: Alarm signal or pump in the water auxiliary circuit or compressor in the recovery circuit or on-off humidifier or rotary recovery (optionals)
- NO8: Compressor 1 of circuit 2 (units with 2 circuits) or compressor 3 (units with 4 circuits)
- NO9: Cycle reversing valve circuit 2
- NO10: Outdoor fan circuit 2 (units with 2 circuits)  
Low-speed outdoor fan circuit 2 (units with 2 circuits with 2-speed fan)  
High-speed outdoor fans circuits 1 & 2 (units 4 circ. with 2-speed fan)
- NO11: Compressor 2 of circuit 1 (units with 2 circuits) or compressor 2 (units with 4 circuits) or high-speed outdoor fan circuit 1 (units with 1 circuit or 2 compressors and 2 circuits, with 2-speed fan) (units with 4 compressors and 2 circuits with 2-speed fan)
- NO12: Compressor 2 of circuit 2 (units with 2 circuits) or compressor 4 (units with 4 circuits) or high-speed outdoor fan circuit 2 (units with 2 compressors and 2 circuits, with 2-speed fan) (units with 4 compressors and 2 circuits with 2-speed fan)

#### Water-air unit: description of inputs and outputs

##### Digital inputs

Safety devices and failure indication:

- B6: Low pressure pressostat circuit 1
- B8: Anti-freeze safety for the hot water coil
- B9: Recovery circuit safety device (optional)
- B11: Low pressure pressostat circuit 2
- DI1: Indoor fan protection and air flow control (optional)
- DI2: Smoke detector (optional)
- DI3: High pressure pressostat circuit 1
- DI4: Compressor and outdoor fan protection device circuit 1
- DI5: Water flow switch
- DI6: Clogged filter control (optional)
- DI7: Remote off / on
- DI8: Remote cooling / heating
- DI9: High pressure pressostat circuit 2
- DI10: Compressor and outdoor fan protection device circuit 2

##### Digital outputs

On/off control of the unit components and optional elements:

- NO1: Compressor 1 of circuit 1
- NO2: Cycle reversing valve circuit 1
- NO3: On-off signal (not used)
- NO4: Indoor fan
- NO5: 1st electrical heater stage or gas burner (optionals)
- NO6: 2nd electrical heater stage or gas burner (optionals)
- NO7: Alarm signal or pump in the water auxiliary circuit or compressor in the recovery circuit or on-off humidifier or rotary recovery (optionals)
- NO8: Compressor 1 of circuit 2 (units with 2 circuits) or compressor 3 (units with 4 circuits)
- NO9: Cycle reversing valve circuit 2
- NO10: On-off signal (not used)
- NO11: Compressor 2 of circuit 1 (units with 2 circuits) or compressor 2 (units with 4 circuits)
- NO12: Compressor 2 of circuit 2 (units with 2 circuits) or compressor 4 (units with 4 circuits)

### 3.2. Serial connection of RS485 probes to the Field-bus of the control board (optional)

The following serial probes can be connected on the RS485 Field-bus (connector J10), configured with different addresses:

- 1 to 4 probes of ambient temperature or temperature + humidity.
- Enthalpy probes on the mixing air and the supply air for calculation of the cooling and heating capacities.

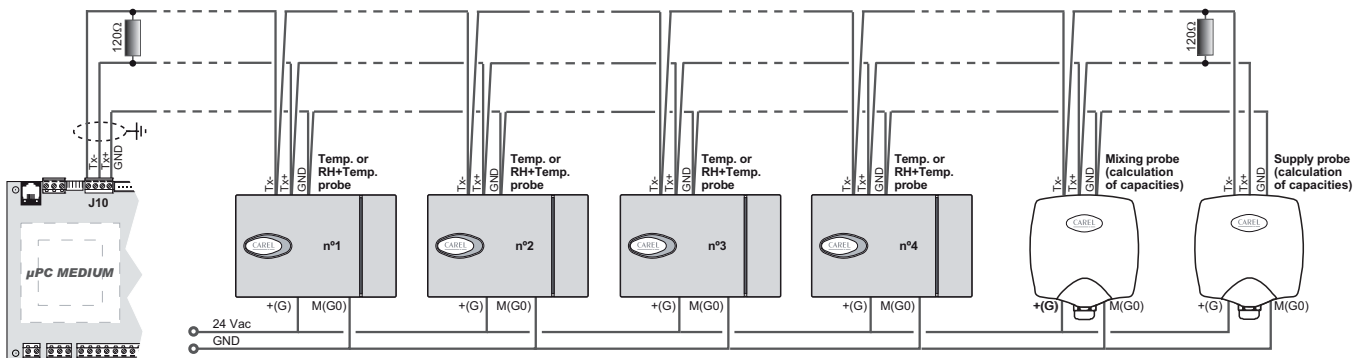

#### RS485 probes configuration:

**Ambient probe No.1:**  
Address: 128  
Modbus 1, 8, N, 2  
9600 bps



**Ambient probe No.2:**  
Address: 129  
Modbus 1, 8, N, 2  
9600 bps



**Ambient probe No.3:**  
Address: 130  
Modbus 1, 8, N, 2  
9600 bps

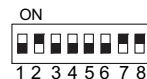

**Ambient probe No.4:**  
Address: 131  
Modbus 1, 8, N, 2  
9600 bps



**Mixing enthalpic probe:**  
Address: 132  
Modbus 1, 8, N, 2  
9600 bps



**Supply enthalpic probe:**  
Address: 133  
Modbus 1, 8, N, 2  
9600 bps



Important: It is recommended to insert an electrical resistance of 120Ω, between connectors TX+ and TX- of the μPC MEDIUM output (connector J10) and on the final component of the RS485 network, to avoid potential problems of communication.

# 3 - CONNECTIONS

## 3.3. Connection of terminals to the control board

### Connection of the pGD1 terminal (standard)

The terminal can be installed at a maximum distance of 500 metres from the microPC control board.

- Up to 50 metres, it can be connected directly with telephone wire.
- From 50 to 200 metres, it is necessary to use the TCONN bypass cards and AWG 20/22 shielded cable with 2 twisted pairs.

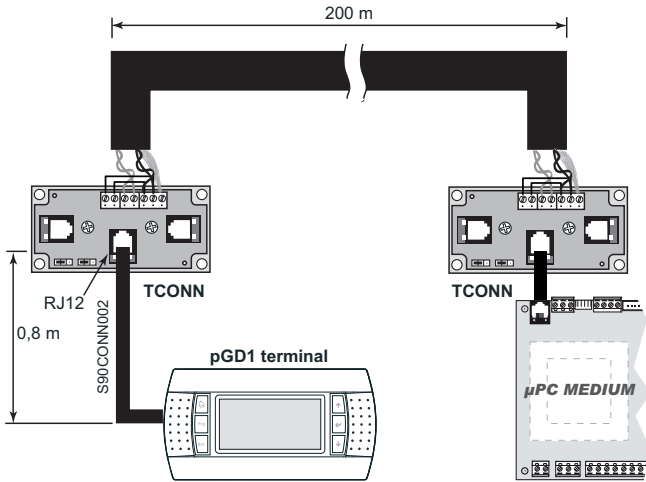

- From 200 to 500 metres, it is necessary to use the TCONN bypass cards, AWG 20/22 shielded cable with 1 twisted pair and external 20...30Vdc (150 mA) power supply.

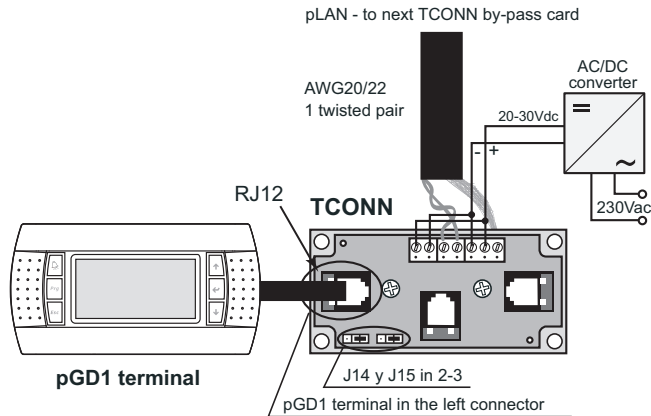

#### Configuration:

To ensure communication between the pGD1 terminal and the control board, the terminal must be configured with address 16.

In the event of a terminal supplied separately, this is not sent addressed and the following procedure must be carried out:

- 1) Simultaneously press the + + keys.
- 2) On the screen accessed, set address 16 in:  
`Display address setting.`

Note: If the terminal is going to be integrated into the pLAN, refer to the chapter 19, which explains the configuration of the terminals in the network.

### Connection of the TCO terminal (optional)

The terminal can be installed on the RS485 Filed-bus at a maximum distance of 100 metres from the control board.

The connection requires the following:

- Power supply (the same as the control board) at 230Vac 50/60Hz (L&N): 2 wires (section 0.5 at 1.5 mm<sup>2</sup>).
- Communication with the board (RX+/TX+ & RX-/TX-): shielded cable type AWG20 or AWG22 with 1 braided pair + drainwire + shielding (e.g., model BELDEN 7703NH).

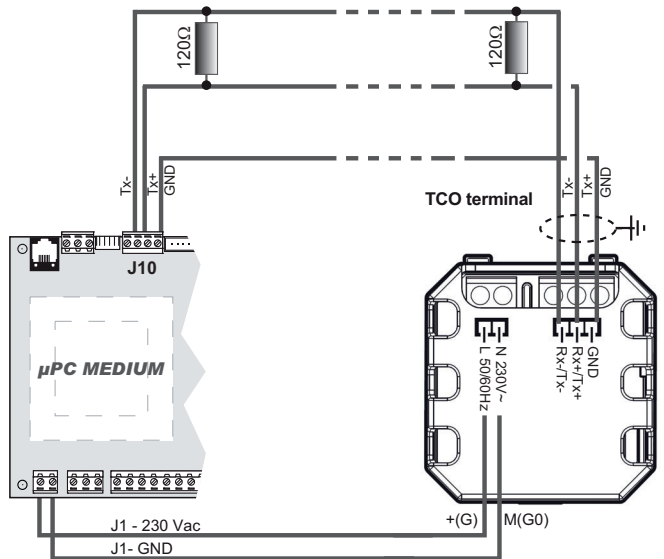
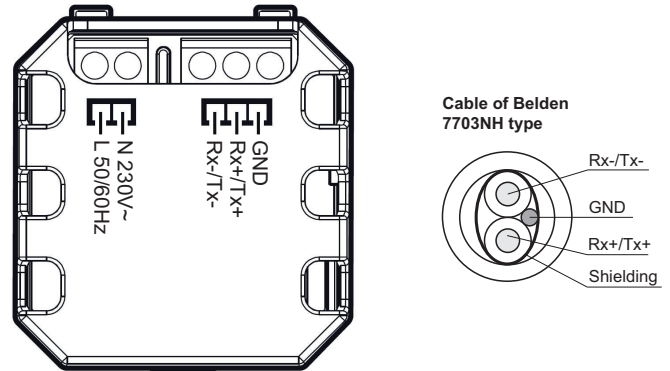

**Important:** It is recommended to insert an electrical resistance of 120Ω, between connectors TX+ and TX- of the board output (connector J10) and on the final component of the RS485 network, to avoid potential problems of communication.

#### Configuration:

To ensure communication between the TCO terminal and the control board, the terminal must be configured with address 10 and speed 9600 bps.

The terminal is sent addressed, and on the power up, the screen should display the firmware version "1.1" on the power up and, then, the "init." symbol. The terminal will be fully operational after a few seconds.

In the unlikely event of a communications failure the screen will display "Cr". Please make sure to check connections and the firmware version.

## 3 - CONNECTIONS

### 3.4. pCOe expansion card with address 7 (optional)

This module is needed to manage the options:

- Control of units with 4 compressors and 4 circuits.
- Proportional humidifier.
- Overpressure control with extraction damper.

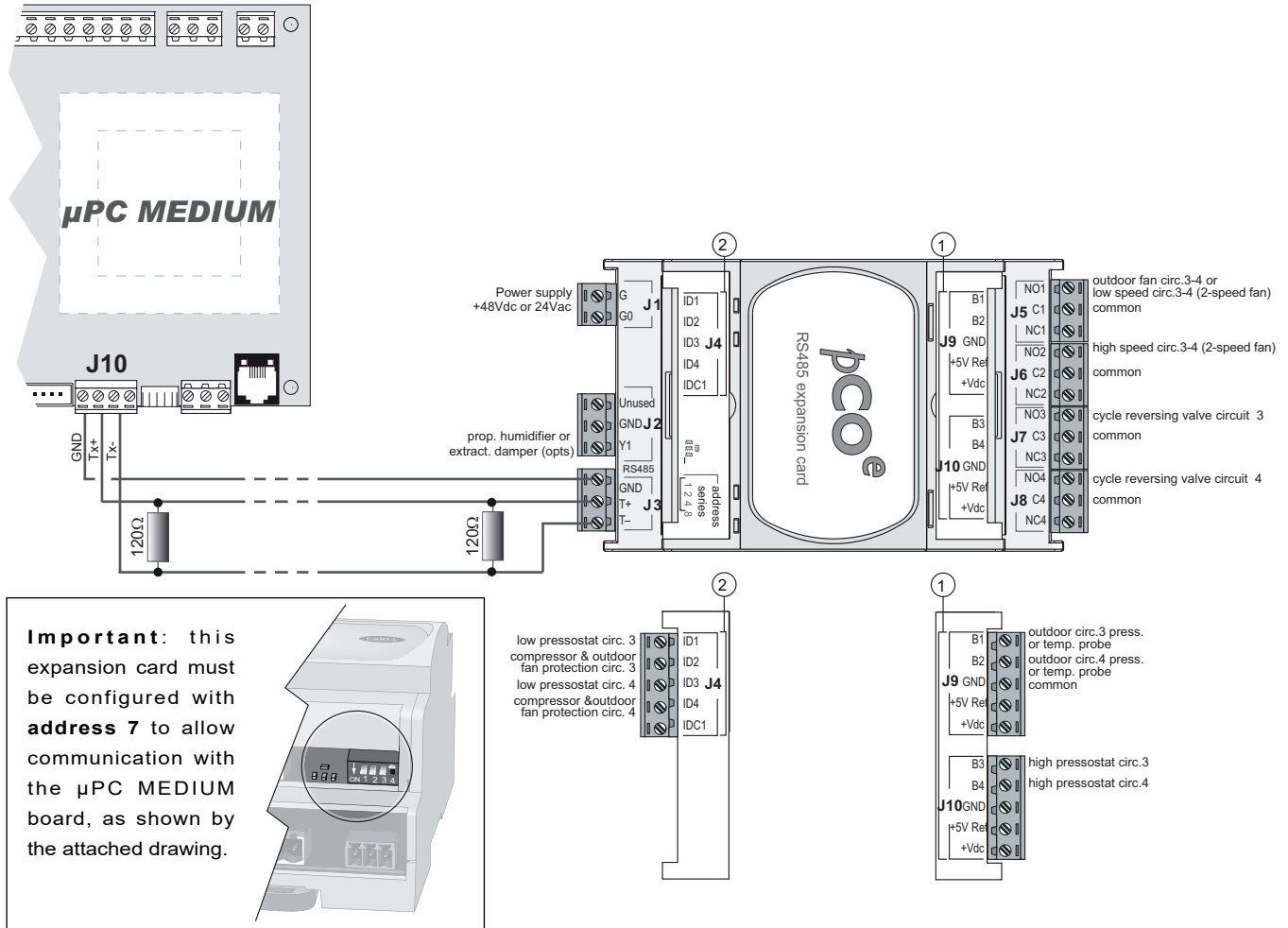

#### Air-air units: description of inputs and outputs

##### Analogue inputs

- B1: pressure / temperature sensor for the outdoor coil 3
- B2: pressure / temperature sensor for the outdoor coil 4
- B3: high pressure pressostat circuit 3
- B4: high pressure pressostat circuit 4

##### Digital inputs

- ID1: low pressure pressostat circuit 3
- ID2: compressor and outdoor fan protection device circuit 3
- ID3: low pressure pressostat circuit 4
- ID4: compressor and outdoor fan protection device circuit 4

##### Digital outputs

- NO1: outdoor fans circuits 3 and 4  
low-speed outdoor fans circuits 3 and 4 (units with 2-speed fan)
- NO2: high-speed outdoor fans circuits 3 and 4 (units with 2-speed fan)
- NO3: cycle reversing valve circuit 3
- NO4: cycle reversing valve circuit 4

##### Analogue output

- Y1: proportional humidifier or extraction damper (optionals)

#### Water-air units: description of inputs and outputs

##### Analogue inputs

- B1: refrigerant anti-freeze safety circuit 3
- B2: refrigerant anti-freeze safety circuit 4
- B3: high pressure pressostat circuit 3
- B4: high pressure pressostat circuit 4

##### Digital inputs

- ID1: low pressure pressostat circuit 3
- ID2: compressor protection device circuit 3
- ID3: low pressure pressostat circuit 4
- ID4: compressor protection device circuit 4

##### Digital outputs

- NO1: on-off signal (not used)
- NO2: on-off signal (not used)
- NO3: cycle reversing valve circuit 3
- NO4: cycle reversing valve circuit 4

##### Analogue output

- Y1: proportional humidifier or extraction damper (optionals)

## 3 - CONNECTIONS

### 3.5. pCOe expansion card with address 8 (optional)

This module is needed to manage the options:

- Control of the condensation and evaporation pressures of the indoor unit.
- Low outdoor temperature (GREAT COLD).
- Mechanical disconnection of stages.

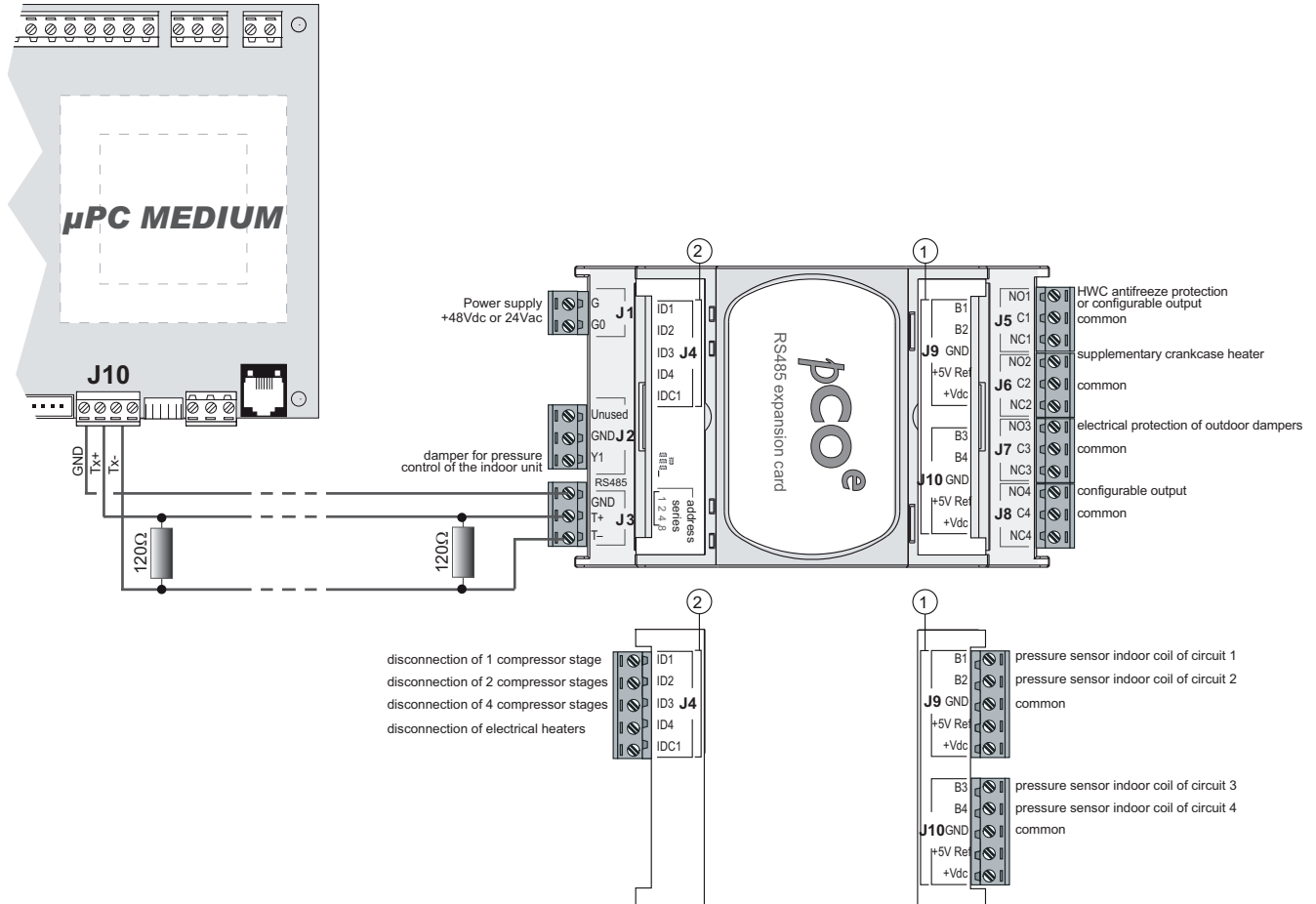

### Air-air and water-air units: inputs and outputs

#### Analogue inputs

- B1: pressure sensor for the indoor coil of circuit 1
- B2: pressure sensor for the indoor coil of circuit 2
- B3: pressure sensor for the indoor coil of circuit 3 or temperature probe for the inlet of the hot water coil with GREAT COLD option
- B4: pressure sensor for the indoor coil of circuit 4 or temperature probe for the outlet of the hot water coil with GREAT COLD option

#### Digital inputs

- ID1: disconnection of 1 compressor stage
- ID2: disconnection of 2 compressor stages
- ID3: disconnection of 4 compressor stages
- ID4: disconnection of electrical heaters

#### Digital outputs

- NO1: circuit of the hot water coil with antifreeze protection or configurable output (humidificator, HWC pump, general alarm,...)
- NO2: compressor with supplementary crankcase heater
- NO3: electrical heater for protection of outdoor dampers
- NO4: configurable output (humidificator, HWC pump, general alarm,...)

#### Analogue output

- Y1: damper for pressure control of the the indoor unit

**Important:** this expansion card must be configured with **address 8** to allow communication with the  $\mu$ PC MEDIUM board, as shown by the attached drawing.

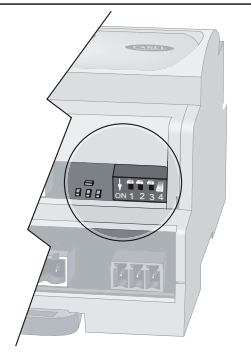

## 3 - CONNECTIONS

### 3.6. pCOe expansion card with address 9 (optional)

This module is needed to manage the options:

- Second air quality probe (CO<sub>2</sub>) for installation in the environment or outdoor.
- Rotary heat exchanger with variable speed.
- Zoning into 2 zones with dampers.
- Control of supply and return dampers (external to the unit).

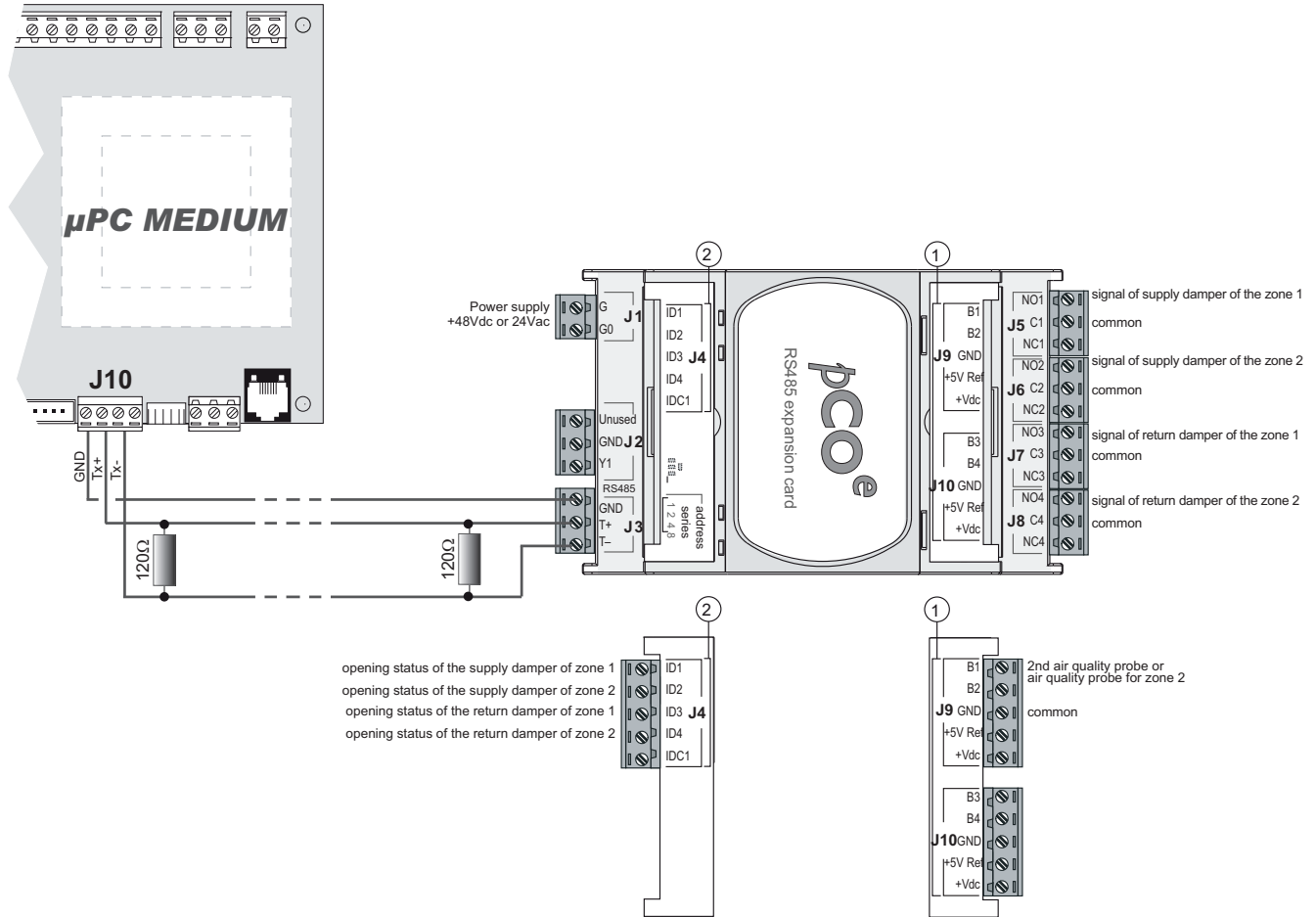

### Air-air and water-air units: inputs and outputs

#### Analogue inputs

- B1: second air quality probe for installation in the environment or outdoor (4-20mA / 0...5000 ppm) or air quality probe for the zone 2 (4-20mA)
- B2: unused
- B3: exhaust T probe (prop. rotary heat exchanger)
- B4: recovery T probe (prop. rotary heat exchanger)

#### Digital inputs

- DI1: opening status of the supply damper of zone 1 or the supply damper external to the unit
- DI2: opening status of the supply damper of zone 2
- DI3: opening status of the return damper of zone 1 or return damper external to the unit
- DI4: opening status of the return damper of zone 2

#### Digital outputs

- NO1: opening signal of supply damper of the zone 1 or supply damper (external to the unit)
- NO2: opening signal of supply damper of the zone 2
- NO3: opening signal of return damper of the zone 1 or return damper (external to the unit)
- NO4: opening signal of return damper of the zone 2

#### Analog output

- Y1: 0...10Vdc output for wheel control (proportional rotary heat exchanger)

**Important:** this expansion card must be configured with **address 9** to allow communication with the **μPC MEDIUM** board, as shown by the attached drawing.

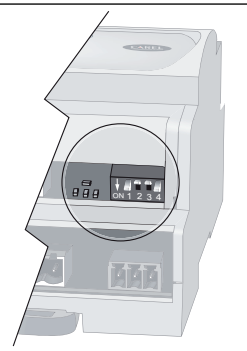

## 3 - CONNECTIONS

### 3.7. Connection of the SMALL board with address 11 (optional)

A  $\mu$ PC SMALL board is needed to manage the option:

- Zoning up to 4 zones with variation of air flow through dampers.

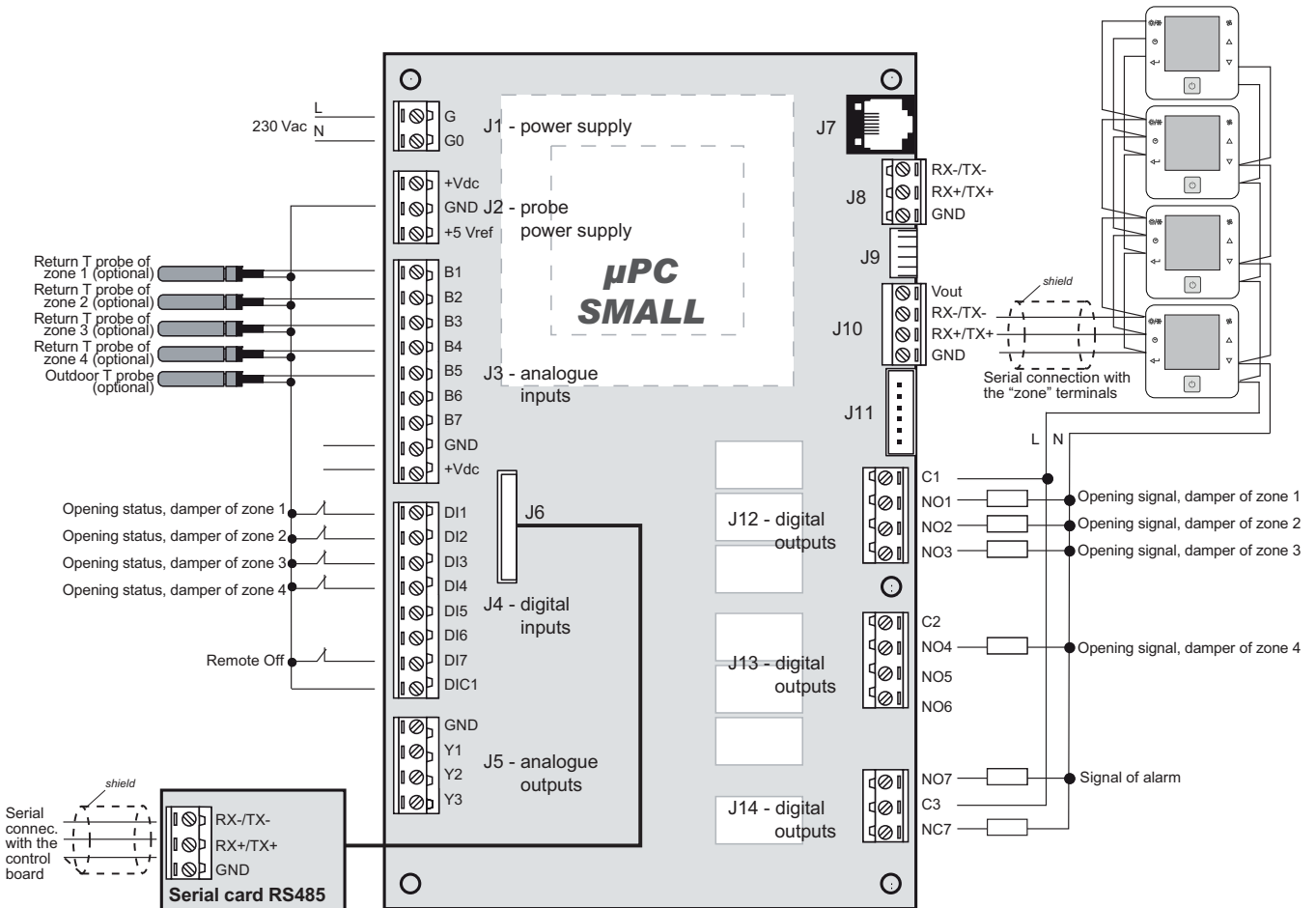

#### Air-air and water-air units: inputs and outputs

##### Connector J1

Unit power supply

##### Connector J2

Sensors power supply

##### Connector J3 (Analog inputs)

Temperature reading sensors:

- B1: return temperature probe of the zone 1 (optional) (1)
- B2: return temperature probe of the zone 2 (optional) (1)
- B3: return temperature probe of the zone 3 (optional) (1)
- B4: return temperature probe of the zone 4 (optional) (1)
- B5: outdoor temperature probe (optional) (2)

##### Connector J4 (Digital inputs)

Status:

- DI1: opening status of the supply damper of the zone 1
- DI2: opening status of the supply damper of the zone 2
- DI3: opening status of the supply damper of the zone 3
- DI4: opening status of the supply damper of the zone 4
- DI7: remote off

##### Connector J6

RS485 Fieldbus serial connection with the  $\mu$ PC MEDIUM control board.  
Board address = 11

##### Connector J10

RS485 Fieldbus serial connection with the "Zone" terminals (up to 4 terminals).

##### Connector J12 (Digital outputs)

On/off control of dampers:

- NO1: opening signal of the supply damper of the zone 1
- NO2: opening signal of the supply damper of the zone 2
- NO3: opening signal of the supply damper of the zone 3

##### Connector J13 (Digital outputs)

On/off control of dampers:

- NO4: opening signal of the supply damper of the zone 4

##### Connector J14 (Digital outputs)

On/off control of the unit components:

- NO7: signal of alarm

(1) By default, the probes of ambient temperature built-in the zone terminals are used by the control

(2) By default, the probe of outdoor temperature connected on the main control board is used by the control (connector J3 - B2)

## 4 - UNIT OVERVIEW IN THE PGD1 TERMINAL

### INITIAL screen

When the pGD1 terminal is switched on, the screen below shows this information:

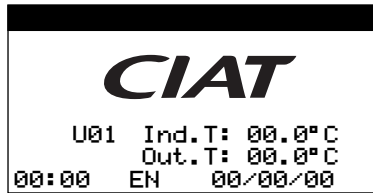

**U01:** This indicates the number of the unit in which the terminal is connected.

**Ind.T:** This indicates the ambient (by default) or return (optional) air temperature.

**Out.T:** Outdoor air temperature. In units with humidity probe, this indicates the relative humidity of the indoor air.

**00:00:** Time

**00/00/00:** Date

**EN:** Language of the terminal screens. The available languages are: Spanish (ES), French (FR), English (EN), German (DE), Italian (IT), and Turkish (TR).

The language of the screens can be selected by pressing the keys





at the same time for a few seconds.

### UNIT STATUS screens

The main parameters of the regulation are displayed in this group of screens.

They can be accessed by pressing the  key from the initial screen.

To move from one screen to another use the keys  .

The first screen of this group collects the following information:

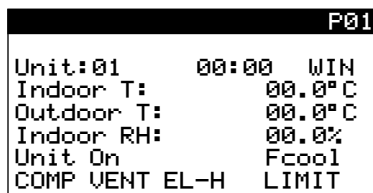

**Unit:** This represents the unit number (by default: 01). If the unit is included in a local pLAN, this number can vary between 1 and 15.

**00:00:** Indicates the time.

**WIN / SUM / AL:** This indicates the operating status: WINTER or SUMMER. In the event of alarm, the indication "AL" will appear alternately.

**Indoor T:** This indicates the ambient (by default) or return (optional) air temperature.

**Outdoor T:** This indicates the outdoor air temperature.

**Indoor RH:** This indicates the relative humidity of the indoor air (in units with return or ambient humidity probe, optional).

**Unit:** This indicates the OFF/ON status:

**On:** Turned on.

**Off:** Turned off.

**Remote Off:** If enabled for a remote shutdown.

**Off by phase:** If the unit is shut down by schedule programming.

**Machine status:** Available options status:

**Fcool:** Active free-cooling.

**COMP:** Active compressors in summer in addition to free-cooling.

**Deum:** Dehumidification.

**Gas:** Gas burner operating above the minimum.

**COMP VENT EL-H:** The meaning of these texts on the display is: compressor (COMP), supply fan (VENT) and electrical heaters (RES) in operation.

**LIMIT:** This text appears intermittently when the control of the supply temperature is activated, limiting the capacity of the unit.

On the second screen of the group is shown:



**00:00** and **00/00/0000:** This indicates the time and date.

**WIN / SUM / AL:** Operating mode.

**Active temp.:** Setpoint temperature.

**Unit:** This indicates the OFF/ON status.

**Machine status:** Available options status (e.g. Fcool).

**LIMIT:** This text appears intermittently when the control of the supply temperature is activated

The last screen of the group only appears when the unit is integrated in a pLAN or supervision network for centralised technical management system:

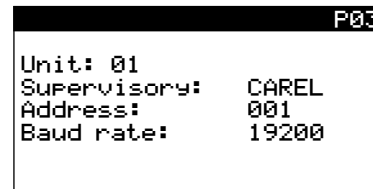

**Unit:** Unit No. in the pLAN network.

**Supervisory:** Type of protocol: Carel, Lonworks, Modbus and Modbus extended.

Note: "commissioning" can also be selected to display the variables using the PCO MANAGER software.

**Address:** in the supervision network. This could be different from the board address.

**Baud rate:** Bit rate (19200, 9600, 4800, 2400, 1200).

## 5 - MENU STRUCTURE IN THE PGD1 TERMINAL

### MAIN MENU screens

From any screen, by pressing the  key, the home screen of the MAIN MENU is accessed.



The MAIN MENU includes the screens to select the operating mode and setpoints, unit off/on, to display all system-controlled variables (inputs/outputs) and schedule programming.

No password is required to access this menu.

```

Main menu
1.SETPOINT      : →
2.Inputs/outputs :
3.Off/On       :
4.Winter/summer :
5.Timer Prog.  :
6.Gas Burner   :
    
```

### TECHNICAL MENU screens

From any screen, by pressing the   keys at the same time for a few seconds, it is possible to access the home screen of the Technical menu.

The TECHNICAL MENU includes the screens for parameterization and maintenance of the unit, which must only be accessed by the installer and/or maintenance staff .

```

Technical Menu
USER      : →
Maintenance :
Manufacturer :
    
```

These 3 screen groups are protected by access password. If any of these passwords must be known: please consult.

```

PU00
Enter User
Password:      ****
    
```

Once the password for one of these groups is entered, rest of the screens in the group can be accessed by pressing .

### USER screens

In this group of displays it is possible to display and modify all the control parameters for the different functions and processes managed by the program: setpoint limits, control differential, control dead zone, free-cooling parameters, compensation etc.

Only the parameters that have been enabled under the MANUFACTURER level.

```

USER MENU
CONTROL      : →
Communication :
Other        :
    
```

### MAINTENANCE screens

This group of displays is reserved for the Technical Support Service (TSS). It is intended for the management of counters of compressor and other components of the unit, for the calibration of the connected sensors and to force the output of the relays.

```

Maintenance Menu
IMPUTS/OUTPUTS: →
Counters:
Alarm record:
    
```

### MANUFACTURER screens



The unit is configured on these screens with the selection and activation of the devices that have to be controlled. This configuration is factory-set and must not be modified unless there is a change in components.

```

MANUFACTURER MENU
Unit Configuration
Defrosting Config.
Compressor Config.
Control Config.
Safety Config.
Alarm Config.
Unit Initializ.
    
```

### HELP screens

From the INITIAL screen, by pressing the  keys for a few seconds, access is given to a group of help screens with information on the terminal key or key combination that enables carrying out the most important control functions.

To move from one display to another, use the keys  .

```

A01
Help display 1/4
Prg ---> Main menu
Alr ---> Act. alarms
Esc ---> Exit / back
    
```

```

A02
Help display 2/4
Prg+Ent+time-->
ON-OFF by keyboard
    
```

```

A03
Help display 3/4
Down+Prg--->SUMMER
Up+Prg --->WINTER
Up+Down --->I/O Menu
    
```

```

A04
Help display 4/4
Esc+Down->Change eLAN
Prg+Esc-->Technical M.
Alr+Ent-->Syst. Info.
    
```



## 6 - STARTING / STOPPING THE UNIT

There are different procedures for starting / stopping the unit (On/Off):

### • By keyboard (from the terminal):

This procedure is always valid. If the unit is stopped from the terminal, it cannot be started using any of the other procedures.

If the unit has stopped, all the functions and the different variables are disabled.

The ON / OFF function can be carried out:

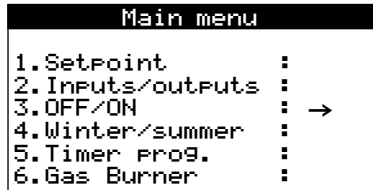

#### \* On the pGD1 terminal:

From the MAIN MENU, in the group **3. OFF/ON**.

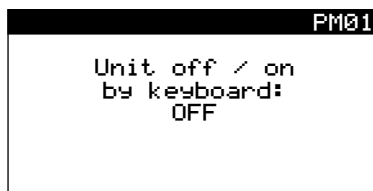

Press the  key, the following screen is reached:



It can also be done from the keyboard of the terminal, by simultaneously pressing the   keys for a few seconds.

#### \* On the TCO terminal (optional):

By pressing the .

When the unit is stopped, the display will only show the date, time and the OFF symbol.



### • By time phase (with schedule programming):

From the MAIN MENU, in the group of screens **5. TIMER PROG.** the unit can be stopped outside of the schedule.

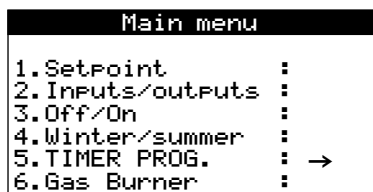

Note: See the different types of schedules in the chapter of "SCHEDULE PROGRAMMING".

The "On/Off by time phase" can only be done if the option "On" is selected on the screen PM01.

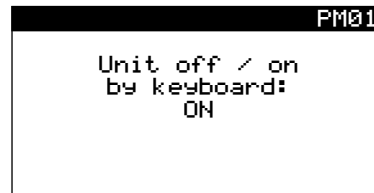

Important: If the procedures of "On/Off by time phase" and "remote On/Off" are simultaneously active, the unit will start only if both agree.

### • By digital input (remote On/Off):

The "remote On/Off" is carried out by means of the digital input DI7 of connector J4:

- open contact: unit OFF
- closed contact: unit ON

Note: To activate the remote off/on the bridge made in this input must be eliminated (see wiring diagram)

This procedure must be enabled on the group of screens **USER** → **OTHER** of the TECHNICAL MENU (password protected).

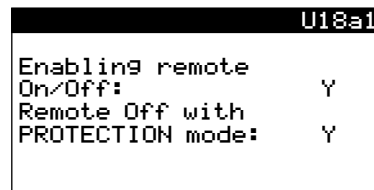

When the unit is stopped by "remote On/Off", it is also possible to enable the automatic unit start when a temperature setpoint for PROTECTION of the building is reached.

The "remote On/Off" can only be done if the option "On" is selected on the screen PM01.

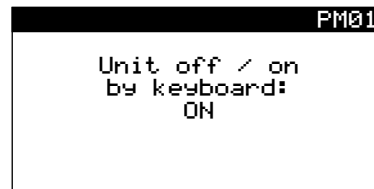

Note: The "On/Off by keyboard" always has priority over the "remote On/Off".

Important: If the procedures of "remote On/Off" and "On/Off by time phase" are simultaneously active, the unit will start only if both agree.

Important: The "remote On/Off" must be disabled for maintenance tasks.

## 7 - SETPOINTS SELECTION

The control of the ambient temperature is carried out by starting up the unit: compressors and/or backup component (electrical heater, water coil, etc.).

To do so, the control compares the temperature reading of the ambient air probe (or the return probe) with the setpoint value.

The control has two different set points: one for operation in COOLING mode (summer) and another for operation in HEATING mode (winter).

The selection of the setpoint can be carried out:

- **On the pGD1 terminal:**

From the MAIN MENU, in the group **1. SETPOINT**.

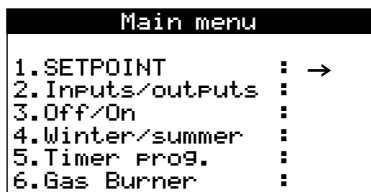

On the first screen of this group, the setpoints of temperature can be selected.

Note: if the indication "by schedule" appears on the screen, this means that the setpoints have been set in the schedule programming.

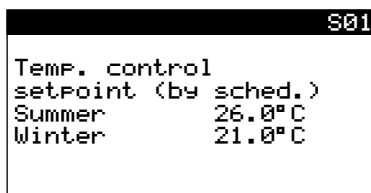

On the next screen it is possible to modify the humidity setpoint when its management is enabled (optional).

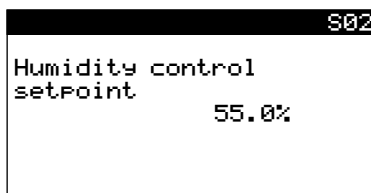

The third screen enables the display of the following calculations of setpoints:

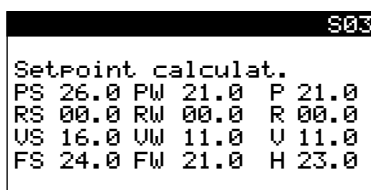

In which:

- PS In COOLING mode (summer): Setpoint + Dead Zone / 2
- PW In HEATING mode (winter): Setpoint + Dead Zone / 2
- P Current selection of the setpoint
- RS Setpoint of the electrical heaters in COOLING mode
- RW Setpoint of the electrical heaters in HEATING mode
- R Current selection of the setpoint for the electrical heaters

- US Setpoint of the auxiliary hot water coil in COOLING mode
- UW Setpoint of the auxiliary hot water coil in HEATING mode
- U Current selection of the setpoint for the auxiliary coil
- FU Setpoint of free-cooling in COOLING mode
- FI Setpoint of free-cooling in HEATING mode
- F Current selection of the setpoint for the free-cooling

On the last screen of this group, it is possible to display the limits of setpoint for the supply (outlet) temperature in COOLING mode (summer) and HEATING mode (winter):

- In COOLING mode (summer): to prevent excessively significant drops in the ambient temperature.
- In HEATING mode (winter): to avoid the stratification of the hot air masses.

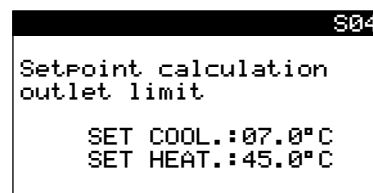

When the unit includes the option of zoning up to 4 zones with variation of air flow, the first screens displayed will allow the selection of the setpoints for each zone:

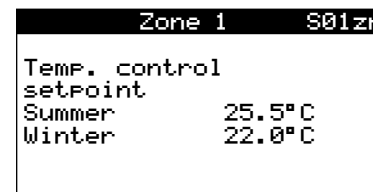

With the air zoning, the control use the minimum setpoint in COOLING mode and the maximum setpoint in HEATING mode, among all the setpoints in the 4 zones. The S01 screen displays these setpoints and their value cannot be changed.

Note: the optional air zoning can be selected on a screen of the group **MANUFACTURER → UNIT CONFIGURATION** of the TECHNICAL MENU (password protected).

- **On the TCO terminal (optional):**

To modify the setpoint, it is necessary to press only the  $\triangle$  or  $\nabla$  keys.

At that time, the display will light up and the current setpoint value from active mode (COOLING or HEATING) will appear next to the text **set**.



Note: The temperature control can be performed with the ambient probe installed on the TCO terminal (optional).

The selection of this probe can only be done from a screen of the group **MANUFACTURER → UNIT CONFIGURATION** of the TECHNICAL MENU (password protected).

## 8 - SELECTION OF THE OPERATING MODE

There are different procedures for the selection of the operating mode:

- **On the pGD1 terminal:**

From the MAIN MENU, in the group **4. SUMMER/WINTER**.

```

Main menu
1.Setpoint      :
2.Inputs/outputs :
3.Off/On       :
4.WINTER/SUMMER : →
5.Timer prog.  :
6.Gas Burner   :
    
```

Press the  key, the following screen is reached:

```

FC01
Winter/summer select.
'by keyboard'

      WINTER

Enable lock:  N
    
```

This screen allows to select 3 options:

- **By keyboard:** on this screen, it is possible to switch between summer mode (COOLING) and winter mode (HEATING).

```

FC01
Winter/summer select.
'by keyboard'

      SUMMER

Enable lock:  N
    
```

Note: When the parameter «Enable lock» is activated (Y), this screen is for information purposes only, so that the final user cannot change it. In this case, it has been blocked from a screen of the Group **MAINTENANCE → INPUTS/OUTPUTS** of the **TECHNICAL MENU** (password protected).

Nevertheless, these operations can also be carried out using the following key combinations:

  : HEATING mode

  : COOLING mode

- **Only ventilation:** on this screen, it is possible to select the VENTILATION mode. It allows operation for only indoor fans and free-cooling/free-heating.

```

FC01
Winter/summer select.
'only ventilation'

Enable lock:  N
    
```

- **Automatic:** on this screen, it is possible to select two options for automatic mode:

- \* *By outdoor temperature (by default):* The unit changes from operation in COOLING mode to HEATING mode or vice versa depending on the temperature measured by the outdoor air probe.

In this case, the setpoints of outdoor temperature can be modified in COOLING mode or HEATING mode.

```

FC01
Winter/summer select.
'automatic' +
      by out.T.
      WINTER
SUM. if out.T > 22.0°C
WIN. if out.T < 20.0°C
Enable lock:  N
    
```

- \* *By indoor temperature:* The unit changes from operation in COOLING mode to HEATING mode or vice versa depending on the temperature measured by the ambient (or return) air probe and the active COOLING and HEATING setpoints



```

FC01
Winter/summer select.
'automatic' +
      by ind.T.
      WINTER

Enable lock:  N
    
```

- **On the TCO terminal (optional):**

By pressing the  key, the operating mode of the unit can be selected. With each press, the icon corresponding to the operating mode selected will be lit up.

The available modes are: HEATING  - COOLING  - AUTO *Auto* y VENTILATION (without icon).



- **By digital input:**

The selection of the operating mode is performed via a switch connected on digital input DI8 of connector J16:

- open contact: COOLING mode
- closed contact: HEATING mode

Note: The selection of the type of switching “by digital input” is carried out on a screen of the group **MANUFACTURER → UNIT CONFIGURATION** of the **TECHNICAL MENU** (password protected).

## 8 - SELECTION OF THE OPERATING MODE

### 8.1. COOLING operating mode (summer) ❄️

The control will compare the temperature reading of the ambient (or return) air probe with the value set by the COOLING setpoint and with the value of the control band.

The unit will stop when the ambient (or return) temperature drops below the setpoint + one-half of the dead zone value.

The input command of the various stages is the one featured on the chart.

- 2 compressors (1 circuit)

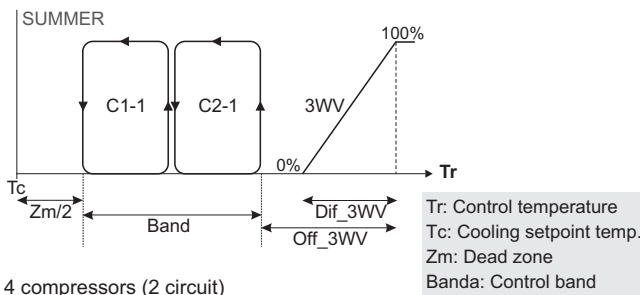

- 4 compressors (2 circuit)

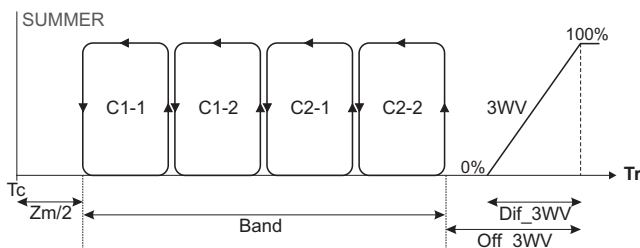

As backup cooling, these units can incorporate a cold water coil (V3V). For the regulation of the coil, the control has a proportional or on/off output Y2 which controls the three-way valve.

For the input of the compressor stages, the control will use the control band value, whilst for the water coil (optional), it will take the differential into account.

The input command for the previous chart can be modified using parameters in order to give priority to the hot water coil.

Note: In units with tandem compressors, when the outdoor coil pressure of a circuit overcomes a limit value (41,5 bar by default), one of the two compressors will be stopped, thereby avoiding the stop of both compressors due to the high pressure. This compressor will start working again if the pressure drops below 36,5 bar.

#### Illustrative example:

- Summer setpoint = 26.0°C
- Differential band = 3.0°C and Dead zone = 0°C
- Unit without cold water coil.

- *Units 2 compressors:*

With the temperature below 26.0°C, the compressors stop. If the temperature starts to rise and exceeds 27.5°C, compressor C1-1 starts. If it continues to rise and exceeds 29.0°C, compressor C2-1 is also activated.

If the temperature drops below 27.5°C compressor C2-1 stops. If it continues to drop until reaching a value below 26.0°C, compressor C1-1 stops (the off and on command for the compressors will depend on whether the rotation is activated or not).

- *Units 4 compressors:*

The control band is divided between 4 compressors.

### 8.2. HEATING operating mode (winter) ☀️

The control will compare the temperature reading of the ambient (or return) air probe with the value set by the HEATING setpoint and with the value of the control band.

As backup heating, these units can incorporate any of the following components:

- a hot water coil (V3V).
- two stages of electrical heaters (R)
- a gas burner.

An example of input command of the various stages is the one featured on the chart.

- 2 compressors (1 circuit) + electrical heaters

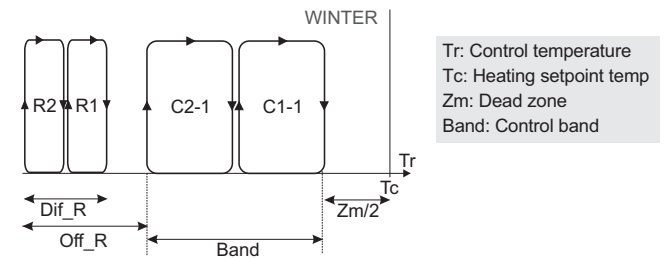

- 4 compressors (2 circuits) + hot water coil

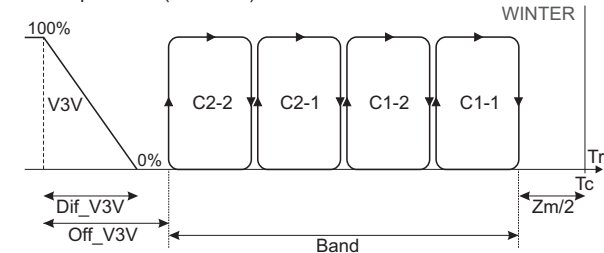

For the regulation of the hot water coil, the control has a proportional or on/off output Y2 which controls the three-way valve, and for the regulation of the electrical heaters, there are two on/off outputs NO6- NO7.

The previous configuration is typical for the options however the control can also administer a proportional electrical heater stage in the output Y2 and an on/off water coil in output NO6

For the input of the compressor stages, the control will use the control band value, whilst for the input of heaters and of the water coil (optionals), it will take the respective differentials into account.

The input command for the previous chart can be modified using parameters in order to:

- Give priority to the hot water coil (by default).
- Activate the electrical heater stages without activating the compressor(s) for cases of compressor breakdown or blocking due to a low outdoor temperature.

Important: if this blocking is enabled, half of the compressors will be disconnected at an outdoor temperature of -11.5°C, and all other compressors with a temperature of -14.5°C. The recovery compressor (optional) is authorized to operate.

#### Forced disconnection of stages

It is possible to disconnect compressor or electrical heater stages, by using parameters or mechanically through the digital inputs of the expansion card pCOe with address 8.

This is useful for reducing electric consumption in time bands when the electric price rate is high or in those cases where the electricity consumption or the section of the electrical outlet are limited.

## 9 - SCHEDULE PROGRAMMING

### 9.1. Schedule programming: pGD1 terminal

The pGD1 terminal incorporates a time scheduler with possibility of 3 different programs. It allows to choose for each day of the week one of these 3 programs.

The schedule programming is accessed from the MAIN MENU. This is the group of screens **5. TIMER PROG.**

```

Main menu
1.Setpoint      :
2.Inputs/outputs :
3.Off/On       :
4.Winter/summer :
5.TIMER PROG.  : →
6.Gas Burner   :
    
```

#### Date and time

On the first screen, it is possible to change the time and date of the control. The day of the week will be automatically updated.

```

PH01
Clock setting
Time: 13:45
Date: 22/06/2017
Day: Thursday
    
```

On the next screen, the automatic change of schedule can be activated (by default).

```

PH02
DST:          ENABLE
Transition time:060min
Start: LAST SUNDAY
in MARZO     at 02.00
End: LAST SUNDAY
in OCTOBER   at 02.00
    
```

In this way, , from LAST SUNDAY IN MARCH at 2.00 hours until LAST SUNDAY IN OCTOBER a at 3.00 hours, to the normal schedule (winter schedule) it is necessary to add 60 minutes, thus obtaining the summer schedule.

These values are adjustable to be adapted to different hourly changes out of the European Union.

#### Start type

The start type and the condition of the unit outside of the schedule program will be selected on the screen PH03:

- **ON/OFF schedule:** within the program the unit will operate with the setpoint established on COOLING mode (summer) and HEATING mode (winter), whilst outside the schedule it will be stopped.

```

PH03
Start type
'ON-OFF schedule'
    
```

- **Schedule only setpoint change:** two control setpoint temperatures will be set on the screen PH07 (summer) and on the screen PH08 (winter): one, during the program slots (Indoor set.) and another outside the program (Outdoor set.).

```

PH03
Start type
'schedule only
setpoint change'
    
```

```

PH07
Schedule with setpoint
change (summer)
Indoor set. 26.0°C
Outdoor set. 28.0°C
    
```

```

PH08
Schedule with setpoint
change (winter)
Indoor set. 21.0°C
Outdoor set. 19.0°C
    
```

- **ON/OFF schedule with limit SET of ON:** outside the schedule program the unit is off, however a start safety device is established when the temperature goes above or below the limit setpoints introduced in PH09, PH10 and PH11.

With this type of start-up two new parameters are displayed on the screen:

- \* **Disab.comp.COOL:** when the unit is working with the safety limit setpoint in COOLING mode, the compressors can be disabled in order that if the conditions of the outdoor air are favourable, the unit carries out free-cooling.
- \* **Dis. air refresh.:** when the unit is working with the safety limit setpoint is disabled the air renewal.

```

PH03
Start type
'ON-OFF schedule with
limit SET of ON'
- ON for LIMIT SET -
Disab. comp. COOL: N
Dis. air refresh.: N
    
```

The regulation setpoint and safety limit setpoint are established on the screen PH09 (summer) and on the screen PH10 (winter):

- \* **Indoor set.:** setpoint for the time slots.
- \* **Limit set.:** safety limit setpoint outside the schedule.

```

PH09
Schedule with ON
by limit SP (summ.)
Indoor set. 26.0°C
Limit set. 34.0°C
    
```

# 9 - SCHEDULE PROGRAMMING

```

PH10
Schedule with ON
by limit SP (winter)
Indoor set.    21.0°C
Limit set.     13.0°C
    
```

On the screen PH11 the differentials are established for the limit set:

```

PH11
Schedule with ON
by limit SP
Win.Lim. Diff. 01.0°C
Sum.Lim. Diff. 02.0°C
    
```

- **3 setpoints schedule + OFF of unit:** outside the schedule program the unit is switched off, inside the schedule 3 setpoints can be established: COMFORT: standard setpoint; ECONOMY: setpoint more removed from the comfort point, used at times with low occupancy of the building; and PROTECTION: setpoint of building protection, usually used at night, when the building is empty. This schedule is introduced on PH13, PH14 and PH15.

With this type of start-up two new parameters are displayed on the screen:

- \* **Disab.comp.COOL:** when the unit is working with the safety limit setpoint in COOLING mode, the compressors can be disabled in order that if the conditions of the outdoor air are favourable, the unit carries out free-cooling.
- \* **Dis. air refresh.:** when the unit is working with the safety limit setpoint is disabled the air renewal.

```

PH03
Start type
3 setpoints schedule
+ OFF of unit
- ON for SET LIMITE -
Disab. comp. COOL: N
Dis. air refresh.: N
    
```

On the screen PH13 there will be assigned, for every day of the week, every 30 minutes, which will be the select setpoint.

The symbol that represents each setpoint is: **—** OFF, **■** PROTECTION, **▣** ECONOMY, **▢** COMFORT.

In the top left zone of the display it is indicated the day of the week to which there is assigned the schedule (in the example: on Monday).

When it is created it is possible to copy in any other day of the week.

For example: it copies to Tuesday: YES (the Tuesday schedule will be the same that on Monday).

```

PH13
MON copy to TUE: YES
      23:00 to 23:30
00-08:-----
08-16:-----
16-24:-----
    
```

Three regulation setpoints will be established on screen PH14 (summer) and screen PH15 (winter):

- \* **Set.COMFORT:** standard setpoint of the unit.
- \* **Set.ECONOMY:** setpoint more removed from the comfort point, used at times with low occupancy.
- \* **Set.PROTECTION:** setpoint of building protection, usually used at night, when the building is empty.
- \* **Dif.lim.PROT:** differential for the PROTECTION setpoint.

```

PH14
Schedule with setpoint
change (Summer)
CONFORT Set    26.0°C
ECONOMY Set    28.0°C
PROTECTION Set 34.0°C
PROT.Lim.Dif   02.0°C
    
```

```

PH15
Schedule with setpoint
change (Winter)
CONFORT Set    21.0°C
ECONOMY Set    19.0°C
PROTECTION Set 13.0°C
PROT.Lim.Dif   01.0°C
    
```

- **Manual:** by selecting this type of start the unit will be on or off without taking into account the schedule programming.

In this case, the unit can be switched off/on from this display.

```

PH03
Start type
'Manual'
ON
    
```

```

PH03
Start type
'Manual'
OFF
    
```

- **Forced:** this permits an occasional start-up or shutdown of the unit without modifying the set schedule program. When this period ends, the unit goes back to the start type that was programmed.

To activate it press the key  for a few seconds. Access is gained to a screen on which the forced running time is established.

Note: This forced start-up only can be done from the PH03 screen.

```

PH03
Start type
-FORCED-
ON time: 002 h
    
```

## 9 - SCHEDULE PROGRAMMING

### Daily schedule

Three different daily schedules can be created on the PH04, PH05 and PH06 screens, each of them with a maximum of three time slots in which the unit will be switched on.

Outside of the slots, the unit will work with a different setpoint from the previous one or it will switch off, according to the start type selected on the screen PH03.

For example:

- Program 1: Slot 1: morning from 06:30h to 11:00h  
 Slot 2: morning from 11:30h to 13:30h  
 Slot 3: evening from 17:00h to 19:00h
- Program 2: Slot 1: morning from 08:00h to 14:00h  
 Slot 2: evening from 17:00h to 20:00h
- Program 3: Slot 1: morning from 07:00h to 15:00h

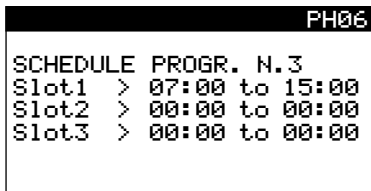
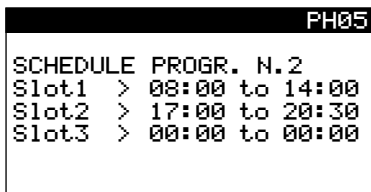
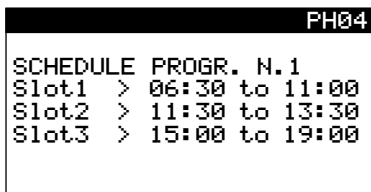

Note: the start type "3 setpoints schedule + OFF of unit" has its own schedule program defined on the screen PH13 (see the previous section).

### Weekly schedule

On this display, it is possible to assign a schedule program for each day of the week.

The available options are:

- 1: schedule program No.1
- 2: schedule program No.2
- 3: schedule program No.3
- 0: no programming

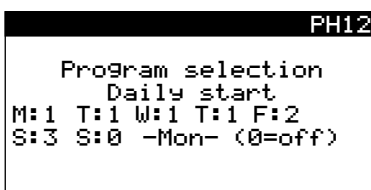

### 9.2. SCHEDULE PROGRAMMING: TCO terminal

With the TCO terminal enabled (optional), the schedule programming of this terminal can be done.

Note: the activation of both, the TCO terminal and its scheduler, is carried out from the group of screens **MANUFACTURER** → **UNIT CONFIGURATION** of the TECHNICAL MENU (password protected).

The TCO terminal has a scheduler that allows 6 time slots to be chosen for each day of the week, indicated by the following icons on the screen:



A change in the setpoint temperature or the disconnection of the unit can be scheduled in these time slots.

### Clock setting of the terminal

By pressing the key for a long time, the terminal changes to the initial clock display (CLOC).



From there, by pressing the key, the time update display is accessed.

The current time appears intermittently and can be modified with the help of the keys. The new time can be validated with the key.



The minutes appear below intermittently. Its value can also be modified with the keys and validated with the key.

There are two ways of returning to the main display: by repeatedly pressing the key or not acting on the terminal for some seconds.

### Creation of a schedule program

By pressing the key for a long time, the terminal changes to the initial clock display (CLOC).



Next, by pressing the key, the terminal changes to the initial schedule program screen (TIME BAND).

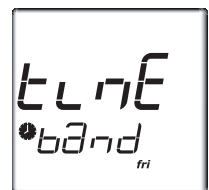



If it desired to abandon the programming, by pressing the key again, the terminal changes to the exit display (ESC), which is exited by pressing .





## 9 - SCHEDULE PROGRAMMING

If it is desired to continue with the scheduled programme,  must be pressed with the terminal on the initial programming display (TIME BAND).

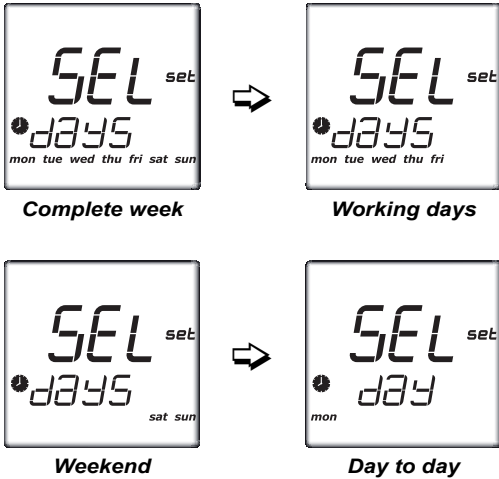
The text SEL DAYS will then appear on the display to select the days of the week to which the schedule will apply. With the   keys, the following groups can be selected:



If it's desired to leave the programming, by pressing the  key again, the terminal changes to the exit display (ESC), which is exited by pressing .





If it is desired to continue with the schedule programming, the  key must be pressed on the screen of the days to which it applies in order to access the first time slot. The sequence of these slots is as follows:

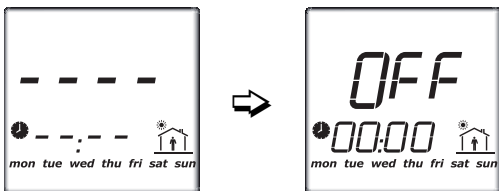

The first time slot will flicker on this display. If it is desired to schedule this slot, the  key will be pressed and automatically stop flickering, going on to appear as follows:





Next, with the  key, the activation time of the program for the selected slot will be set, and then, whether the unit will remain stopped (OFF) or at the setpoint value.

Finally, the schedule slot will cease flickering. By pressing the  key, the scheduling created will be saved and the terminal will go on to display the next slot.

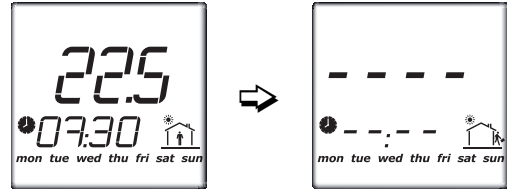
It will be necessary to define a minimum of two slots for each day, since only the initial time is established for each slot, and not the ending time.



To delete the schedule from a time slot, it is necessary to select it with the  key, and then, by pressing the   keys, the time will be modified until the display returns to show the following:

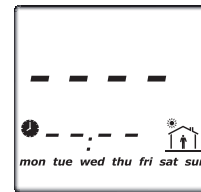



Note: Before making a new schedule, it must be checked whether there is already one defined. If any schedule is made that may affect another that is already stored, the latter will not be saved.

### Activation of the schedule programming

By pressing the  key for a short time, the stored schedule programming corresponding to the activation time is activated.



The symbol  and the active scheduling slot will always appear on the main display, both on stopped units and units in operation.

With the unit in operation, by pressing the keys  or  the setpoint for the time slot will be shown.



Note: The text **set** will appear next to the setpoint value.

To deactivate the schedule programming, it is necessary only to press the  key for a short while.



The screen PH17 of the pGD1 terminal (group 5. TIMER PROG.) shows if the scheduler of the TCO terminal is active, the current timeband and the temperature setpoint.

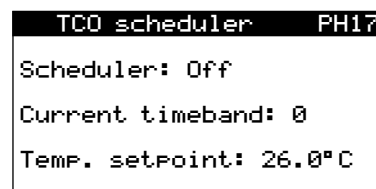



## 10 - DISPLAY OF THE INPUTS / OUTPUTS STATUS

All variables which are controlled by the system are displayed in this group of screens, including the status of the digital inputs, the digital outputs and the analogue outputs, both the main board and the installed expansion cards. This group of screens is accessed from the MAIN MENU, in **2. INPUTS/OUTPUTS**.

- Values measured by the sensors: screens I01, I01a, I01b, I02, I02a, I03, I03a, I03b, I03c, I04a, I04b, I05a, I05b, I05, I06.

```

I01
Return temperature
Probe      16.0°C
Outdoor temperature
Probe      20.0°C
    
```

- Cumulated operating hours by the unit and each compressor: screens I07, I07a.

```

I07
Operating hours
Unit:      00000
Compress. 1-C1: 00000
Compress. 2-C1: 00000
    
```

- Digital inputs status: screen I08 (main board), I08a (expansion card addr.7), I08b (card addr.8), I08c (card addr.9).

```

I08
Digital input
status (1...14):
CCCCCCCCCCCCCCCC
    
```

C: Closed contact  
O: Open contact

- Digital outputs status: screens I09, I09a, I09b, I10, I11 (main board), screen I10b (expansion card addr.9).

```

I09
Compressor 1 - C1  OFF
Compressor 2 - C1  OFF
Compressor 1 - C2  OFF
Compressor 2 - C2  OFF
    
```

- Status of the indoor fan and the optional element connected on the output NO7 of the connector J14: screen I11.

```

I11
Indoor fan      OFF
Recovery comp. OFF
    
```

- Opening status of the analog outputs: screens I12, I12a (main board), I12b (expansion card addr.8), I12c (expansion card addr.9).

```

I12
Outdoor damper: 025%
Heat valve:     000%
    
```

- Display of the connected boards and terminals in the pLAN network (optional): screens I14, I15.

```

I13
PLAN ROOF-TOP N:XX
I/O 1.8 ██████████
I/O 9.16 ██████████
    
```

- Measurements performed by the energy meter (optional): screens I15, I16, I17, I18.

```

GAVAZZI I15
L1-L2:      00000
L2-L3:      00000
L3-L1:      00000
Neutral 1:   00000
Neutral 2:   00000
Neutral 3:   00000
    
```

- Readings of the refrigerant leak detector (optional) screen I18a.

```

I18a
Gas detector n°001
Concentration
020%      00200PPM
LED      Red: O Green: ●
RELAYS   Off
    
```

- Calculation of the cooling and heating capacities (optional): screens I18b, I18c, I18d, I18e.

```

Cooling power: I18b
Input enthalpy
value:     00.0 kcal/kg
Input humidity
value:     50.0 %
Input temperature
value:     000.0 °C
    
```

- Información sobre la configuración de la unidad: screen I19.

```

UNIT CONFIG. I19
AIR-AIR rev. heat PUMP
4 Comp./2 Circ.
Double vol.
Elec.heaters
Refrigerant: R410A
WO No.: 13042422
    
```

- Information about the version of the installed software: screen I20.

```

SOFTWARE I20
CIATrtc CONTROL
ROOFTOP_UPC_11_4A_LEN
Ver.: 11.4      12/12/19
Bios: 6.50     11/03/19
Boot: 5.00     18/07/12
    
```

- Information about main features of the hardware: screen I21.

```

HARDWARE I21
Board type:   uPC
Board size:   medium
Total flash:  2048kB
RAM:          1024kB
Built-In type:
Main cycle:   50.5 cycle/s 0019ms
    
```

## 11 - COMPONENTS MANAGEMENT

**Important:** All screens for the configuration of the unit and all its components are included on the TECHNICAL MENU and they are password protected. To modify these parameters it is necessary to request the required password.

Note: The chapter 17 “List of TECHNICAL MENU parameters” includes all these parameters together with an explanation and the screen of the pGD1 terminal in which they are located.

### 11.1. Compressors

#### Rotation of the compressors

The control allows the rotation of the compressors to equal their number of operating hours. With this function, activated by default, the compressor which starts up first is the one which has the least number of accumulated operating hours.

From this moment, the type of rotation of the circuits will be:

- Grouped: First there connect all the compressors of the same circuit.
- Equalized (by default) : First there connects an alone compressor of every circuit. Once connected all the circuits there connects the second compressor of every circuit.

Note: for units with an active recovery circuit, the operation of the compressor will depend on the position of the outdoor air damper and it will not enter into rotation with the other compressors.

#### Compressor timing

All of the compressors, including the one for the active recovery circuit (optional), shall respect the following timings:

- **Delay of the start-up of the outdoor fan with regard to the indoor fan ( $t_0=30s$ )**

This determines the minimum time that should elapse between the start-up of the indoor fan and the start-up of the outdoor fan in order to guarantee a stable airflow.

- **Delay of the start-up of the compressor with regard to the outdoor fan ( $t_1=10s$ )**

This determines the minimum time that should elapse between the start-up of the outdoor fan and the start-up of the first compressor to limit the simultaneous start-up.

Therefore for the start-up of the first compressor it must pass:  $t_0 + t_1$

- **Minimum operation time ( $t_2=120s$ )**

This keeps the compressor in operation during the period selected. It is not allowed to be shut down unless there is a failure in the circuit.

The minimum time of operation of the compressors must be 120 seconds (do not change).

- **Minimum shut-down time ( $t_3=180s$ )**

This determines the time that must elapse from the last shutdown of the compressor before it can start up again.

- **Time between start-ups of the same compressor ( $t_4=300s$ )**

This sets the maximum number of compressor start-ups in one hour.

- **Time between start-ups of several compressors ( $t_5=60s$ )**

This determines the minimum time that should elapse between the start-up of a compressor and the start-up of the following one. It limits the simultaneous start-up and the peaks of starting current of an unit.

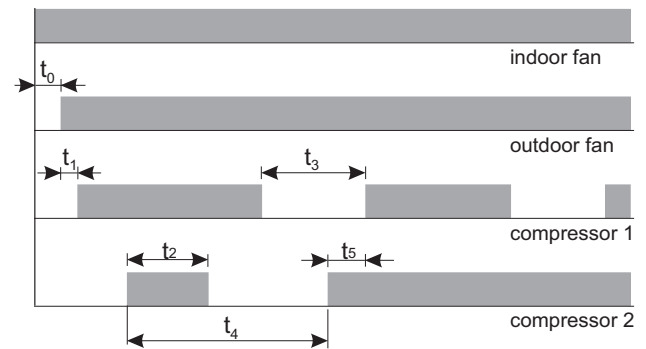

### 11.2. Cycle reversing valve (CRV)

In the heat pump units, there is a four-way cycle reversing valve per circuit which allows the HEATING / COOLING operation mode of the unit to be selected.

- Valve with voltage (N.O.): for operating in COOLING mode and during defrosting (by default).
- Valve without voltage (N.C.): for operating in HEATING mode.

### 11.3. Outdoor circuit fans

#### Types of fans

In air-air units, the control enables managing various types of outdoor fans provided that the unit is fitted with pressure transducers in the outdoor coils (by default):

- 2-speed axial. In this case, it's possible to select, by means of parameters, the pressures for the change in speed as well as the fan disconnection time to implement this change. The fan start is always carried out at high speed.
- 1-speed axial / radial.
- Electronic. In this case, it's possible to select, using three parameters, the maximum speed in COOLING and HEATING mode (by default 100%), as well as the minimal speed (0%).
- Centrifugal.

#### Operating mode

The outdoor fans will be in operation with the manufacturer's settings whenever the compressors are in operation, except in these cases:

- Disconnection is timed to the stopping of the compressor in 60 seconds both in COOLING mode (to reduce the condensation pressure) and HEATING mode (to remove ice from the coil).
- Disconnection during defrosting, except when the defrosting is started by low pressure, which will operate if the pressure rises over the ON value and will disconnect if the pressure drops below the OFF value.
- In HEATING mode, with the unit started but compressors stopped by low outdoor temperature, the fan will be activated for 60 seconds every 30 minutes.
- With the unit running in AUTO mode and the outdoor fan stopped, it will also be activated for 60 seconds every 30 minutes.

#### Condensation and evaporation control

The control can manage the condensation pressure (in COOLING mode) and the evaporation pressure (in HEATING mode), with AUTO setpoint, according to the outdoor temperature and the circuit capacity (half or full).

## 11.4. Outdoor circuit 3-way valve

For water-air units, the outdoor circuit uses a 3-way valve that controls the water circulate by the plates exchanger. Its operation is simultaneous to the operation of the compressor, except in the following cases:

- Connection 40 seconds before the compressor.
- Timed disconnection at 300 seconds. With this, heat can be dissipated in COOLING mode and problems with freezing can be avoided in HEATING mode.

## Condensation and evaporation control

The control can manages the condensation pressure (in COOLING mode) and the evaporation pressure (in HEATING mode) acting on the proportional 3-way valve.

It will be regulated depending on the pressure measured by the refrigerant anti-freeze sensor by the signal 0..10Vdc of the analogue outputs Y3 and Y4 (J5 connector).

## 11.5. Indoor circuit supply fans

### Types of fans

The indoor circuit includes one or more fans that drive the air-conditioned to the premises through the network of ducts.

The control can managed diferent types of supply indoor fans:

- Centrifugal.
- Centrifugal with variable frequency drive (VFD). These fans adapted its rotational speed to the needs of the installation.

It is possible to select the type of speed control for centrifugal fans + VDF:

- \* Constant flow control (by default): in this case it is possible to fix the setpoint of flow.
- \* PWM control (0...100%): in this case it is possible to fix the percentage of speed modulation in COOLING, HEATING and VENTILATION mode.

- Radial.
- Electronic plug-fan. These variable speed fans adapted its rotational speed to the needs of the installation.

It is possible to select the type of speed control for EC plug-fans:

- \* Constant flow control (by default): in this case it is possible to fix the setpoint of flow in COOLING, HEATING and VENTILATION mode.
- \* PWM control (0...100%): in this case it is possible to fix the percentage of speed modulation in COOLING, HEATING and VENTILATION mode.

In units with supply plug-fans and tandem compressors it is also possible to reduce the supply air flow rate up to 50% (under certain conditions of power demand).

Note: The plug-fans and the centrifugal fans with VFD will be connected on the Field-bus of the  $\mu$ PC MEDIUM board by means of one card RS485, with address 1 (9600 bps, 8 bits of data, 2 stop bits without parity).

## Operating mode

The time delay for the start of the indoor fan in the start up of the unit is 30 seconds.

In the case of an unit with 100% outdoor air, the default value will be 90 seconds to allow the complete opening of the outdoor air damper.

In units with TCO terminal, the default value will be 60 seconds to ensure that the communication has been established.

With the factory settings, the supply fan is always working when the unit is connected. It can only be stopped:

- Upon stopping the compressor, an ON - OFF time can be defined for the fan in order to avoid the stratification of warm air masses.
- In units with CO2 air quality probe, when demand of air renewal does not exist, neither of temperature nor of humidity.

Upon stopping the unit, depending on the season of the year, a time can be set during which the fan will stay in operation in order to prevent the appearance of humidity in the coil or to dissipate heat from the electrical heaters. This delay is established by default in 60 seconds in both HEATING and COOLING modes.

During maintenance operations, the indoor fan can be started up if no alarm prevents this.

## Fabric ducts

For units with centrifugal fan + variable frequency drive (VFD) or plug-fans it is possible to enable an special control of the start-up for facilities with fabric ducts that it prolongs the set time. By default, the supply flow will remain 35% for 20 seconds.

Note: For units without centrifugal fan + VFD or plug-fan it will be necessary to use a softstarter, external to the CIATrtc control.

## Condensation and evaporation control

The control can manages the condensation pressure (in HEATING mode) and the evaporation pressure (in mode COOLING) acting on the plug-fans or the centrifugal fans with a damper.

To do this, the unit must incorporate pressure or temperature sensors fitted to the indoor coils (expansion card pCOe addr.8)

## 11.6. Indoor circuit return fans (optional)

Units equipped with a mixing box, with motorized damper for controlling the exhaust air and the fresh air, can incorporate return fan(s) of any of the following types:

- Centrifugal.
- Centrifugal with variable frequency drive (VFD).
- Radial.
- Electronic plug-fan.

With return plug-fans or the centrifugal fans with VFD it is possible to select the type of speed control, in the same way as for the supply fans.

Note: The plug-fans and the centrifugal fans with VFD will be connected on the Field-bus of the  $\mu$ PC MEDIUM board by means of one card RS485, with address 2 (9600 bps, 8 bits of data, 2 stop bits without parity).

## 11 - COMPONENTS MANAGEMENT

### 11.7. Auxiliary water coil (optional)

The control has a proportional or off/on output (Y2 - connector J5) where a three-way valve can be connected (3-WV) to control a water coil.

This output can also be used to control a proportional electrical heater or gas burner which means that these support elements are not compatible.

#### Hot water coil

The hot water coil could be activated under the following circumstances:

- As a backup in HEATING mode, following the input of all the available compressors (by default) or as first control stage.
- As a backup in HEATING mode, in accordance with the supply temperature, when this one drops below the control setpoint (ambient or return).
- During the defrosting operation if selected as backup.
- As a backup in COOLING mode, to raise the supply temperature. The difference between the supply temperature and the ambient temperature is limited to improve the thermal comfort.
- As a backup in COOLING mode, to raise the indoor temperature, when this one drops below an offset configured (by default -5°C).
- With the unit running or shut down if an anti-freeze alarm is triggered (AL09).
- With the unit stopped when the outdoor temperature drops below a safety value (by default 4°C). In this case, the pump is activated and the 3-way valve is opened to maintain, in the water coil, a water outlet temperature of 10°C in ON operating mode and 15°C in OFF operating mode.

Important: The pump of the water circuit has to be activated whenever the 3-way valve is switched on. To do this, it's necessary to configure like "pump", the output NO7 (connector J14), or the outputs NO1 or NO4 of the expansion card pCOe with address 8. This configuration is performed on a screen of the group **MANUFACTURER → UNIT CONFIGURATION** of the TECHNICAL MENU (password protected).

It's the installer's responsibility to connect the pump to the electronic control, except with the factory-installed GREAT COLD option.

#### GREAT COLD

This optional allows the antifreeze protection depending on the water temperature. If the water temperature in the coil drops below 4°C, the control activates the pump and the 3-way valve opens to 100%. The pump stops when 7°C are reached.

The GREAT COLD option includes:

- A circulation pump factory-installed.
- Probes in the input and the output of the coil, connected to the analogic inputs B3 and B4 of the pCOe expansion card with address 8.
- An electrical heating for the piping layout connected to the digital output NO1 of the pCOe expansion card with address 8.

#### Cold water coil

The cold water coil can be activated as a backup in COOLING mode, following the input of all the available compressors (by default) or as first control stage.

### 11.8. Electrical heater (optional)

The control has two on/off outputs (NO5 and NO6) for controlling 2 stages of electrical heaters.

A stage can also be connected in the proportional output 0/10V (Y2 - J5 connector). This output can be used for the control of a hot water coil or a gas burner which means that these support elements are not compatible.

The electrical heater will be activated under the following circumstances:

- As backup in HEATING mode, following the input of all the available compressors.
- As backup in HEATING mode, in accordance with the supply temperature, when this one drops below the control setpoint (ambient or return).
- In HEATING mode, instead of compressors, if they are disabled or signalling an alarm. This option is interesting when the electrical consumption or the section of the electrical power supply is limited.
- During the defrosting operation if selected as backup.
- As backup in COOLING mode, in accordance with the return temperature when the latter drops below an offset configured (by default -7°C).
- As backup in COOLING mode, to raise the supply temperature. The difference between the supply temperature and the ambient temperature is limited to improve the thermal comfort.

### 11.9. Gas burner (optional)

The control has a proportional output 0/10V (Y2 - connector J5) where a gas burner with proportional actuator can be connected.

The burner connection is managed by the control, in HEATING mode, through an ON/OFF signal of the digital output NO5. In the case of a 2nd burner stage, it's connected on the digital output NO6.

- In cooling-only units, the burner is activated in the same way as an electrical heater with one or two stages.
- In heat pump units it is possible to choose three different methods for controlling the burner. This can be done on the screen **6. GAS BURNER** of the MAIN MENU:
  - Operation after compressors as one or two electrical heater stages (both option not compatible).
  - Operation instead of compressors.
  - Operation instead of compressors if the outdoor temperature is lower than the value set (5°C by default).

When the return temperature drops below the value setpoint, the burner will start to operate. The power control is carried out in accordance with the temperatures of the supply air and return air. The control compares both temperatures. If the supply temperature is excessively high, the control limits the power supplied by the burner despite the demand. This comparison avoids the stratification of the hot air masses and keeps the supply temperature below the safety value (55°C by default), which stops the burner.

Moreover, the control compares the supply temperature and the ambient temperature to improve the feeling of thermal comfort.

The gas burner integrates its own operating control, as well as its own safety devices. The CIATrct control receives a safety signal from the burner in the event of failure (digital input DI5). This signal only indicates the failure.

# 11 - COMPONENTS MANAGEMENT

## 11.10. Outdoor air damper

For control of the outdoor air damper (optional), the control has a proportional output 0/10V (Y1).

This will be activated for the following circumstances:

### Free-cooling

The operation of the free-cooling, in units with mixing box, allows the outdoor air conditions to be taken advantage of when these are more favourable than those of the return air.

Note: the free-cooling function is not compatible with the activation of the rotary heat exchanger or the recovery circuit.

After free-cooling, the first compressor of the main circuit will enter into operation, if necessary.

To check whether or not the conditions of the outdoor air are more favourable than those for the return air, three procedures can be used:

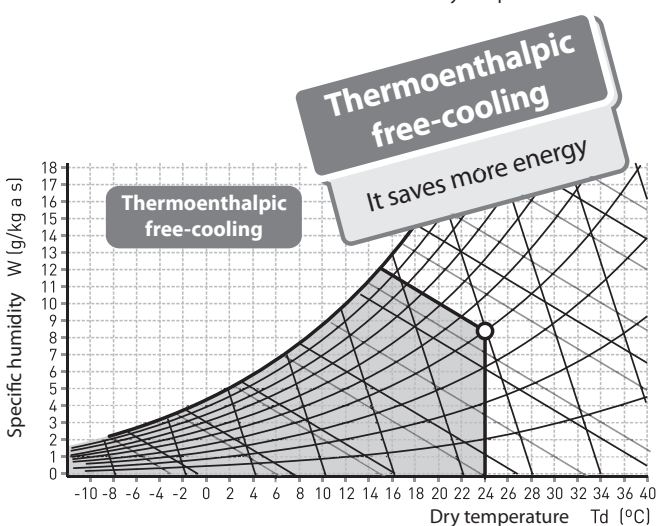
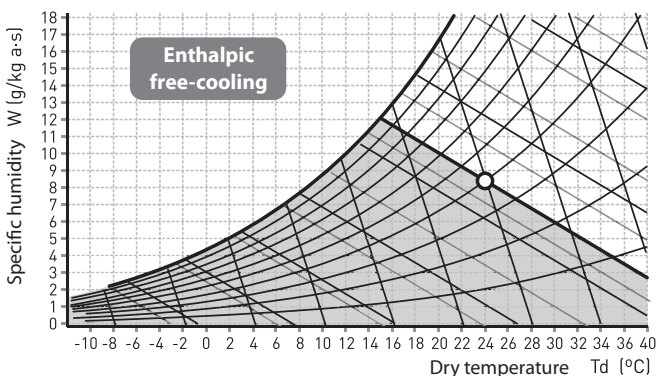
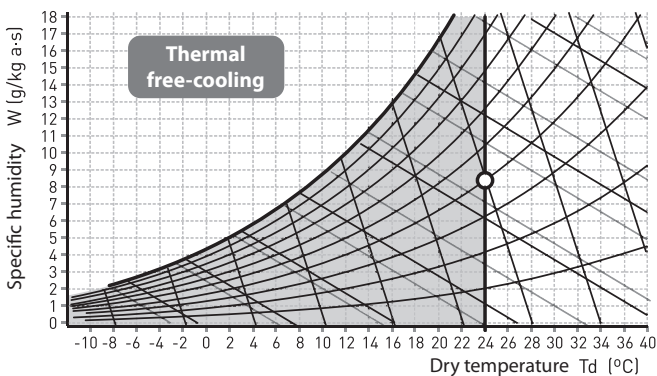

- For **thermal free-cooling**, the opening of the outdoor air damper is ordered when the temperature of the outdoor air is lower than that of the return air plus a differential. In this case, the control uses the outdoor and return air temperature probes.
- For **enthalpic free-cooling**, the control calculates the enthalpy of the return air and of the outdoor air based on the temperature and relative humidity readings of the return and outdoor air. After calculating the enthalpies, carry out the following comparison:
  - \* Damper closed and  $(T_{out} - T_{ret}) > \text{enthalpy diff.}$ , damper opens.
  - \* Damper open and  $(T_{out} - T_{ret}) \leq \text{enthalpy diff.}$ , damper closes.
- For **thermoenthalpic free-cooling**, the opening of the outdoor air damper is performed when the enthalpy of the outdoor air is lower than that of the return air plus a differential and it also meets the condition that the outdoor temperature is lower than that of the return air by 1°C, which allows the outdoor conditions to be taken advantage of in a better manner.

### Free-cooling in summer (COOLING mode)

The free-cooling will be active when the following conditions are met:

- The unit is operating in COOLING or AUTO mode.
- Free-cooling function summer authorised.
- The outdoor temperature is less than the return temperature minus the free-cooling differential.

Free-cooling function depends on two parameters:

- **Offset:** this defines the difference between the setpoint and the air return temperature at which the outdoor air damper begins the opening.
- **Differential:** the opening of the outdoor air damper is carried out in accordance with the return air temperature.

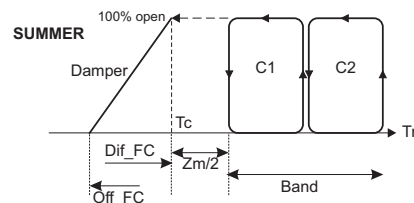

It's possible to disable the compressors if it is considered that the difference between the return temperature and the outdoor temperature is sufficient with free-cooling.

### Free-cooling in winter (HEATING mode)

Free-cooling in winter is useful, for example, in shopping centres, discos etc. where, during operation in winter, due to overheating, the temperature is always greater at the setpoint and cooling has to be initiated instead of heating.

This function will be active provided that these conditions are met:

- The unit is operating in HEATING mode.
- Free-cooling function winter authorised.
- The outdoor temperature is less than the return temperature minus the free-cooling differential.
- The outlet temperature is above 10°C.

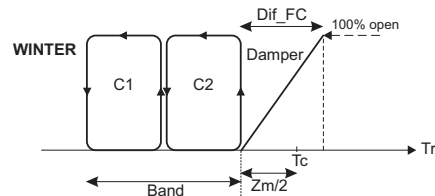

# 11 - COMPONENTS MANAGEMENT

## Air renewal

### Units with mixing air probe

When the outdoor conditions do not permit free-cooling, but air renewal is required, control of the outdoor air damper can be carried out according to 3 parameters:

#### 1. Desired renewal percentage:

This value is set at 20% by default.

In units with recovery circuit this value is set at 60%.

#### 2. Supply - return air temperature:

If the outlet and/or return air temperature conditions are very unfavourable, the command is given to close the outdoor damper, ignoring air renewal, until optimum conditions are reached.

- In HEATING mode, minimum supply temperature 30°C and/or minimum return temperature 15°C.
- In COOLING mode, minimum supply temperature 20°C and/or minimum return temperature 31°C.

The following chart shows the logic applied by the control with the value obtained for these temperatures:

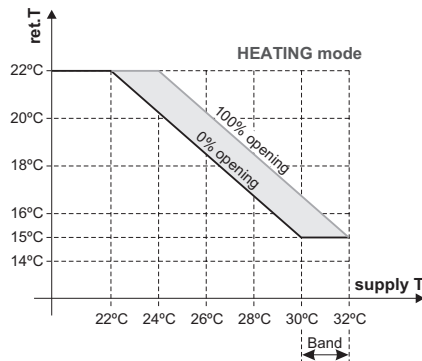

where:

- Minimum outlet air temperature = 30°C
- Minimum return air temperature = 15°C
- Return air setpoint temperature = 22°C
- Damper control band = 2°C

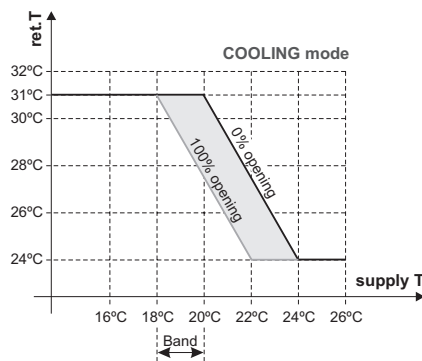

where:

- Minimum supply temperature = 20°C
- Minimum return temperature = 31°C
- Return setpoint temperature = 24°C
- Damper control band = 2°C

#### 3. Minimum mixing temperature:

By default: 12°C in HEATING mode and 35°C in COOLING mode.

In units with recovery circuit this value is set at 5°C in HEATING mode and 42°C in COOLING mode.

The control will calculate the renewal percentage in accordance with the outdoor, return and minimum mixing air temperatures:

$$\% \text{ renewal} = \frac{\text{Return air } T - \text{mixing air } T (12^\circ\text{C})}{\text{Return } T - \text{outdoor } T} \times 100$$

The control will compare the 3 opening percentages obtained and, with the lowest of these 3 values, will establish the instantaneous opening of the outdoor air damper.

Next, depending on the renewal air calculated with the following formula, the opening or the closing of the damper will be ordered:

$$\% \text{ renewal} = \frac{\text{Return air } T - \text{mixing air } T}{\text{Return } T - \text{outdoor } T} \times 100$$

For the opening or closing of the damper, a maximum variation is set at 3% over a period of 60 seconds.

Note: the maximum opening value of the damper can also be blocked by parameter and will take priority over the one previously obtained.

If the outdoor conditions change and the unit starts to request free-cooling, the starting position of the damper will be the one that it had for air renewal at this time.

Note: during defrosting and, with the unit shut down, the outdoor damper will remain closed.

### Units with mixing air probe + CO2 air quality probe

If the unit has an air quality probe (in the B10 input of the board or in the pLAN network) in addition to the mixing temperature probe.

The control of the damper will be carried out in accordance with the CO<sub>2</sub> particles measured and the mixing temperature.

The instantaneous opening percentage will be calculated depending on:

- Supply - return temperatures.
- Measurement of the quality probe (ppm).
- Minimum mixing air temperature.

Using these two probes together improves the management of the air renewal with low outdoor temperatures.

Note: on units with CO<sub>2</sub> air quality probe for outdoor installation, external CO<sub>2</sub> level can be limited to permit air renewal (by default 2000 ppm). The outdoor damper will close from that value.

### Overpressure control

In installations with different air flow in supply and return (to prevent the outdoor air intake or to eliminate odours from inside) the outdoor damper and the exhaust damper will be managed independently.

For the exhaust damper regulation, the control has a proportional output 0/10V (Y2) on the pCO<sub>e</sub> expansion module with address 7.

• The percentage of opening of the exhaust damper shall be obtained from the following formula:

$$\% \text{ extrac. damper} = \% \text{ outd. damper} - \left[ \left( \frac{\text{return flow}}{\text{supply flow}} - 1 \right) \times 100 \times K \right]$$

where:

K = overpressure constant (this constant allows to adjust the opening of the exhaust damper in the site).

• The value calculated for the exhaust flow will be:

$$\text{exhaust flow} = \text{renewal flow} - (\text{supply flow} - \text{return flow})$$

Important: this type of control of the dampers penalizes the exhaust of air and thereby, the cooling recovery.

# 11 - COMPONENTS MANAGEMENT

## 11.11. Supply and return dampers for zoning into 2 zones

This control allows the zoning into 2 zones via a pCOe expansion card with address 9.

- With this type of zoning, the ducts of supply and return are splitted into two branches. In each branch is placed a damper with an on/off servomotor and end of stroke stop. The startup of the unit will not be allowed if the opening of the dampers of supply and return of a same zone is not detected. In the case of opening of the two zones will be allowed the operation with 100 % of flow.
- Two ambient temperature probes (T) will be installed (one on each zone) to control both the unit and the dampers of supply and return, depending on the temperature setpoint and the operating mode.
- Two air quality probes (CO<sub>2</sub>) will be installed to control the outdoor air requirement. The renewal of air and the dampers of supply and return will be managed depending on the air quality setpoint. The percentage of opening of the outdoor damper will take place according to the renewal of air required depending on the air quality setpoint and the maximum value of the two probes of CO<sub>2</sub>.

## 11.12. Cooling recovery circuit (optional)

For unit with a cooling recovery circuit (active recovery), the compressor will function whenever:

- There is demand for COOLING or for HEATING.
- The temperature conditions for supply, return and mixing air allow the opening of the outdoor air damper at 10% for a period of time greater than 90 seconds (values set by default).

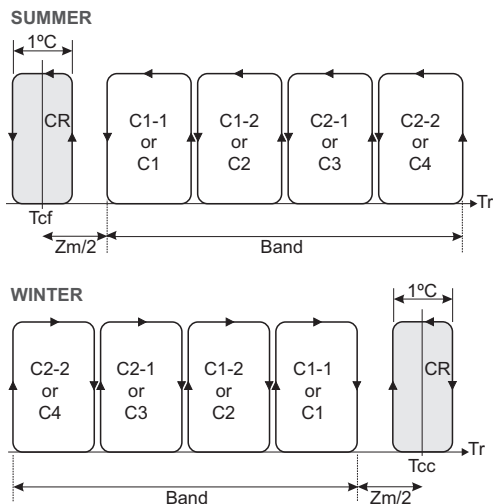

Key:  
 CR: Recovery compressor  
 C1-1 to C2-2 (C1 to C4): Main compressors  
 Tr: Regulation temperature  
 Tcf: Cooling temperature setpoint (COOLING mode)  
 Tcc: Heating temperature setpoint (HEATING mode)  
 Zm: Dead zone  
 Band: control band

The recovery compressor can function even though there is no demand, depending on the temperature measured by the supply air probe. Please, refer to the paragraph "Regulation of the supply temperature" in chapter 12.

Note: in cooling only unit with recovery circuit, it's possible to select the operating of this compressor like heat pump.

## 11.13. Rotary heat exchanger (optional)

The control can manage a rotary heat exchanger (passive recovery) connected on the output NO7 (connector J14), or on the outputs NO1 or NO4 of the pCOe expansion card with address 8.

This configuration is performed on a screen of the group **MANUFACTURER → UNIT CONFIGURATION** of the TECHNICAL MENU (password protected).

The management may be:

- **On-off:** this will function whenever there is demand for COOLING or for HEATING and when the temperature conditions for outlet, return and mixing air allow for an opening of the outdoor air damper of 5% for a period of time greater than 10 seconds (default values).
- **Variable:** the variable wheel speed will depend on the minimum value of the exhaust temperature and the recovery temperature on the wheel.

If this value is lower to 6°C, the speed of the wheel decreases until reaching a minimum value fixed of 10% when the temperature is lower to 1°C (by default).

## 11.14. Humidification (optional)

The control can manage an on/off humidifier connected on the output NO7 (connector J14), or on the outputs NO1 or NO4 of the pCOe expansion card with address 8. This configuration is performed on a screen of the group **MANUFACTURER → UNIT CONFIGURATION** of the TECHNICAL MENU (password protected).

A humidifier with proportional control can be connected on the 0/10V output (Y1) of the pCOe expansion card with address 7.

The control of the safety devices and alarms is carried out by the humidifier.

The humidifier operating signal is produced when the relative humidity of the return air is lower than the humidity setpoint established (55%) minus the differential (5%).

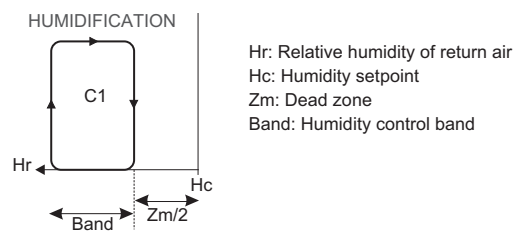

## 11.15. Meter of power energy (optional)

The control can manage a energy meter. The readings that it realizes are visualized on the pGD1 terminal.

The energy meter will be connected on the Field-bus of the μPC MEDIUM board by means of one RS485 card, with address 5 (9600 bps, 8 bits of data, 2 stop bits without parity).

### Calculation of the cooling/heating capacities

To perform this calculation, it's necessary to connect two RS485 enthalpic probes: one for the mixing air (placed before the indoor coil) and other for the supply air (placed after the indoor coil).

These probes will be connected on the Field-bus of the control board via two RS485 cards, with address 132 for the mixing probe and address 133 for the supply probe.

## 12 - OPTIONAL FUNCTIONS OF CONTROL

### 12.1. Control of the supply air temperature

The control of supply is activated when two circumstances are fulfilled:

- The supply temperature is included between the maximum and minimum values of supply setpoints.
- The difference between the supply temperature and the ambient temperature is lower than the offset set. The ambient probe improves the supply temperature control, limiting the difference between both temperatures. It increases the thermal comfort level of the installation.

#### Control in summer (COOLING mode)

The control of the **minimum temperature limit** in the supply air prevents excessively significant drops in the ambient temperature.

This setting is important for units with automatic switching between COOLING and HEATING mode, with low outdoor temperatures and hot water coil, to avoid the risk of freezing of the coil if the unit starts to operate in COOLING mode.

In COOLING mode, the control is activated when the supply temperature is included between the maximum and minimum setpoint, and the difference with the ambient temperature is lower than the offset set:

- Minimum setpoint in COOLING mode: 10°C
- Maximum setpoint in COOLING mode: 22°C
- Offset with regard to the ambient temperature measured: 15°C
- Control band (differential): 5°C

For example:

Ambient T: 30,5°C - Offset: 15°C = 15,5°C -> control On

Ambient T: 24,0°C - Offset: 15°C = 9,0°C -> control Off

The compressors will gradually disconnect to avoid an excessively low supply temperature.

The following components could be used as "backup" to increase it: hot water coil (V3V), compressors in HEATING mode (C) and electrical heaters (R).

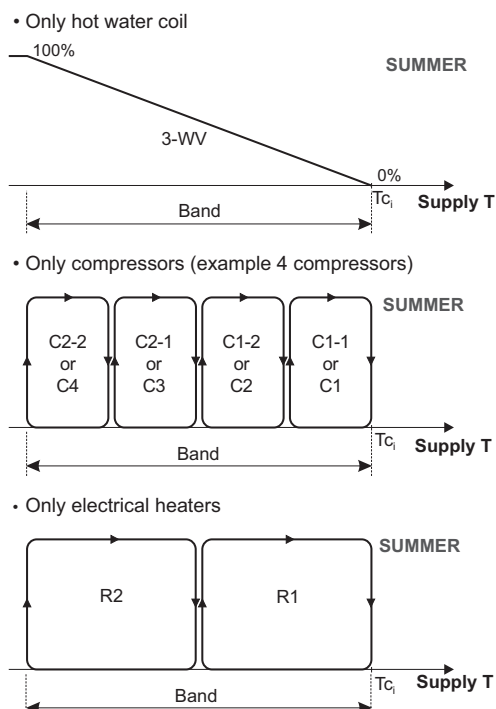

- Compressors (ex. 4 compressors) + hot water coil

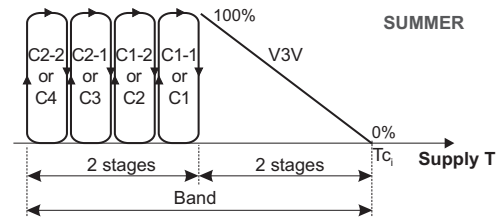

- Compressors (ex. 4 compressors) + electrical heaters

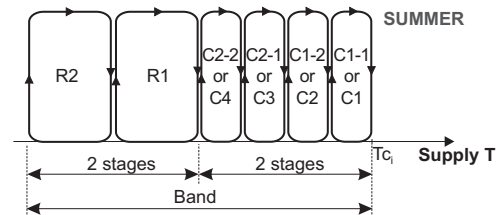

Where:

**SupplyT**: supply temperature

**T<sub>c1</sub>**: supply temperature setpoint

#### Control in winter (HEATING mode)

The control of the **maximum temperature limit** in the supply air avoids the stratification of the hot air masses.

In HEATING mode, the control is activated when the supply temperature is included between the maximum and minimum setpoint and the difference with the ambient temperature is higher than the offset set:

- Minimum setpoint in HEATING mode: 30°C
- Maximum setpoint in HEATING mode: 45°C
- Offset with regard to the ambient temperature measured: 22°C
- Control band (differential): 5°C

For example:

Ambient T: 17,5°C + Offset: 22°C = 39,5°C -> control On

Ambient T: 24,0°C + Offset: 22°C = 46,0°C -> control Off

The backup stages and the compressors will be disconnected (always starting with the electric heaters) within the control band (by default 5°C).

The control of the **minimum temperature limit** in the supply air activates compressors in HEATING mode, hot water auxiliary coil or electrical heater (in the order of entry established for HEATING mode), to prevent a drop of supply temperature below the ambient temperature setpoint in HEATING mode (by default 21°C).

This control avoids the risk of freezing of the coil, for units with low outdoor temperatures and hot water coil.

If the unit is working in HEATING mode, when there is demand of free-cooling in winter, the control of minimum supply temperature changes and it is carried out as a function of the setpoint of minimum supply temperature in COOLING mode (10°C by default).

Note: when the control of supply is activated, on the screens P01 and P02 of the Group **Unit status** the text "LIMIT" appears intermittently.

These screens can be accessed by pressing the key from the Initial screen.



## 12 - OPTIONAL FUNCTIONS OF CONTROL

### 12.2. Zoning of the air flow

The zoning of the air flow up to 4 different zones is done by using a board assembled in a separate box from the unit. This SMALL board is connected in series on the Field-Bus with address 11.

This function allows to adapt the indoor air flow to the requirements of the installation. A different flow rate can be set for each zone. The sum of these flows must be found within a range:

- Maximum total flow: by default 100%.
- Minimum total flow: by default 35%. A minimum air flow below 35% can never be set to ensure the proper functioning of the unit. Although the flow demanded by the active zones is less than 35%, the unit will operate with this flow.

The electronic control will manage the air flow and the capacity depending on:

- The number of active zones.
- The sensors of the cooling circuits.
- The probes of ambient temperature built-in the zone terminals (the location of the terminal is important for the measured value).
- The setpoints of temperature in COOLING mode and HEATING mode set by the user for each zone. In this case the control will use the minimum setpoint in COOLING mode and the maximum setpoint in HEATING mode.

According to the obtained values, the control will order the opening or closing of the supply dampers of each zone independently.

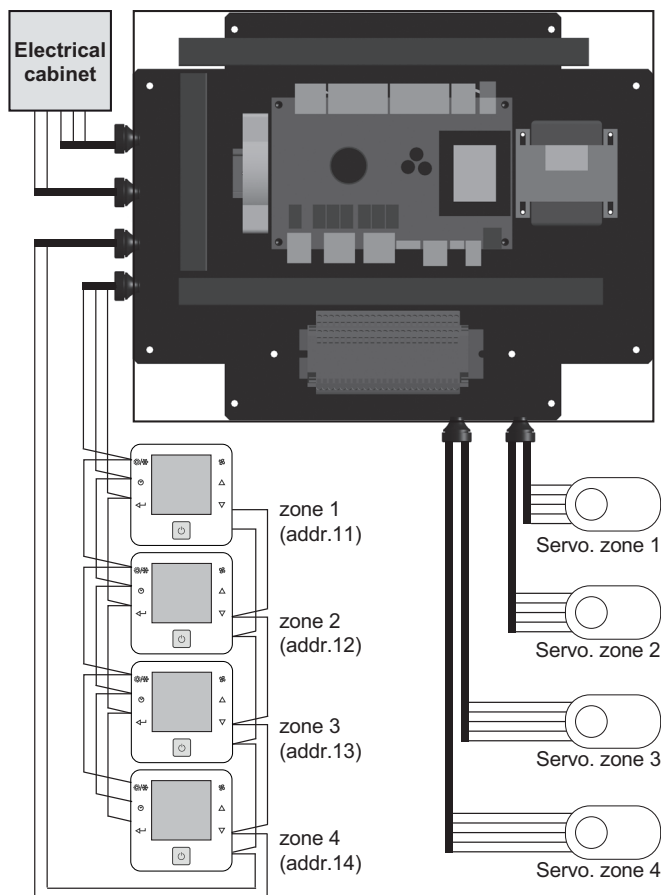

#### Keys and combinations in the zone terminals

These terminals are the same as the user's terminal (optional). Refer to Chapter 2 "User interfaces" for more information on its operation.

#### Screens displayed on each terminal zone

In addition to view the main screen, it is possible to display other screens through the set that is activated by pressing the key.

The following values will be shown with each press:



The main screen shows the ambient temperature, current operating mode of the unit, time and day of the week.

The following screen shows the temperature setpoint for this zone.



The temperature setpoint for this zone can be modified with the keys. The setpoint corresponds to the current operating mode.

Note: The operating mode of the unit is modified in the pGD1 terminal.

It is also possible to modify the setpoints of the zone terminals in the pGD1 terminal. This function is performed on some screens of the Group 1. SETPOINT of the MAIN MENU (see Chapter 7).



This screen shows the zone that corresponds to the terminal.

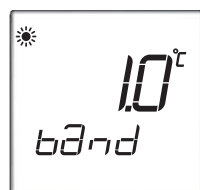

This screen shows the regulation band associated with the temperature setpoint.

The regulation band for this zone can be modified with the keys.

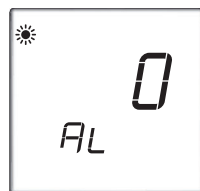

This screen shows if there is an active alarm by means of a code.

Refer to the codes in the "alarms list" of chapter 14.

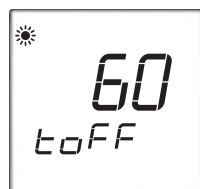

This display shows the delay set for the opening/closing of the damper.

This delay can be modified with the keys.

These terminals allow for schedule programming. See Chapter 9 for more information.

#### Zoning box connections

The installer must carry out the following connections:

- **Connection of the zone terminals:**
  - Power supply (the same as the control board) at 230Vac 50/60Hz (L&N): 2 wires (section 0.5 at 1.5 mm<sup>2</sup>).
  - Communication (RX+/TX+ & RX-/TX-): shielded cable type AWG20 or AWG22 with 1 braided pair + drainwire + shielding (e.g., model BELDEN 7703NH).

## 12 - OPTIONAL FUNCTIONS OF CONTROL

Zone terminals can be installed at a maximum distance of 100 metres from the zoning box.

These terminals are configured with their corresponding address in the factory. In the unlikely event of a communications failure the screen will display "Cr". Please make sure to check connections and the firmware version.

- **Connection de the servomotores for the supply dampers:**

- 5 wires (section 0.5 at 1.5 mm<sup>2</sup>), supply 24Vac.

- **Connection to the electrical cabinet of the unit:**

- Power supply: 230Vac ((L&N): 2 wires (section 0.5 at 1.5 mm<sup>2</sup>).
- Communication (RX+/TX+ & RX-/TX-): shielded cable type AWG20 or AWG22 with 1 braided pair + drainwire + shielding (e.g., model BELDEN 7703NH).

Note: Please refer to the wiring diagram provided with the unit to get more detailed information about the wiring.

### 12.3. Dehumidification

This function is carried out by starting up the compressors in COOLING mode when the relative humidity of the return (or ambient) air is greater than the humidity setpoint established plus the differential.

The compressors are stopped when they enter into the dead zone.

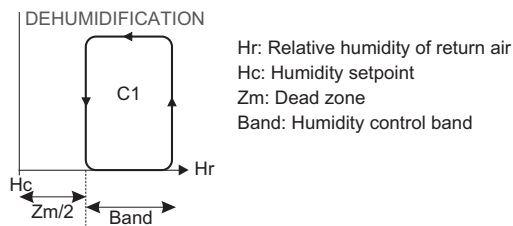

Note: In the event that several compressors have been selected in dehumidification, these will start or stop through the same dehumidification stage.

To ensure that the compressors can control humidity, the return air must have a temperature ranging between the setpoint  $\pm 15\%$  of the temperature differential and the setpoint  $\pm 85\%$  of the temperature differential, as indicated in the following chart.

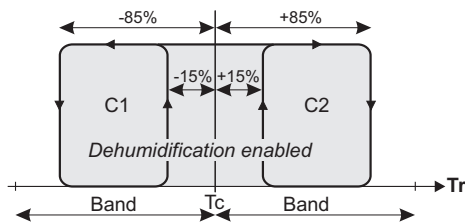

Tr: return temperature  
Tc: setpoint temperature  
Band: temperature control band

#### COOLING mode

Tc = 26.0°C, Band = 2°C  
85% = 1.7°C, 15% = 0.3°C

#### OFF dehumidification < 24.3°C

ON dehumidification > 25.7°C  
ON dehumidification < 26.3°C  
OFF dehumidification > 27.7°C

#### HEATING mode

Tc = 21.0°C, Band = 2°C  
85% = 1.7°C, 15% = 0.3°C

#### OFF dehumidification < 19.3°C

ON dehumidification > 20.7°C  
ON dehumidification < 21.3°C  
OFF dehumidification > 22.7°C

If the value "% return temperature ON dehumidification" is equal to the value "% return temperature OFF dehumidification", this graphic is not taken into account for the dehumidification, and the dehumidification by temperature is not limited.

### 12.4. Outdoor temperature compensation

This function allows the setpoint temperature to vary in accordance with the temperature measured by the outdoor air probe.

The outdoor temperature compensation rules are different for HEATING and COOLING mode operation.

The compensation of the setpoint enables thermal "shock" between the inside and outside of the premises to be prevented whilst at the same time providing significant energy savings when the outdoor temperature values are particularly significant for ambient temperature control.

#### COOLING mode (Summer)

The compensation function increases the setpoint temperature when the outdoor temperature increases.

- Minimum outdoor temperature to start compensation = 30°C
- Compensation differential that determines the variation band of outdoor temperature = 5°C
- Maximum increase in the temperature setpoint allowed = 5°C

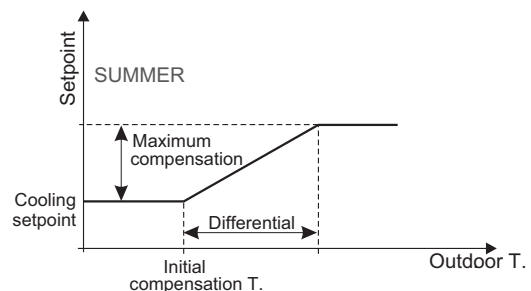

#### HEATING mode (Winter)

The compensation function decreases the setpoint temperature when the outdoor temperature decreases.

- Maximum outdoor temperature to start compensation = 0°C
- Compensation differential that determines the variation band of outdoor temperature = 5°C
- Maximum decrease in the temperature setpoint allowed = 5°C

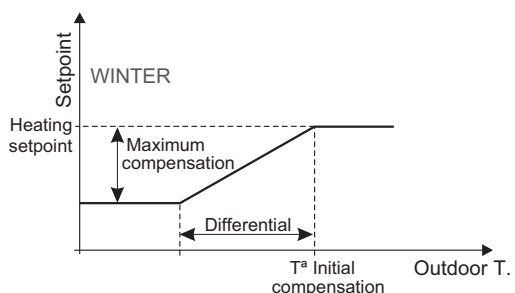

## 13 - SAFETY FUNCTIONS

### 13.1. Defrosting function (air-air units)

When the unit is working in HEATING mode, the defrosting of the outdoor coils is performed by cycle inversion in order to remove any ice which has accumulated on them.

In units with two or four circuits, the defrosting procedure will be independent, i.e., the one will not start until the first one finishes.

Defrosting is carried out in the following cases:

#### • Defrosting by minimum pressure

When the pressure measured by the low pressure transducer drops below 2,5 bar (by default).

Note: If the unit tries to perform a 4th defrosting operation in less than an hour, this could be due to a lack of refrigerant caused by a small leak or failure in the expansion valve, which means that the control will trigger a low pressure alarm. This safety device is reset manually.

#### • Defrosting by difference with the outdoor temperature

The defrosting function is activated if the difference between the outdoor temperature and the evaporation temperature exceeds 16°C (by default).

In addition to this condition, always it is necessary that:

- The outdoor temperature is lower than 10°C.
- The pressure measured by the low pressure transducer is lower than the initial value for defrosting, 5.6 bar.
- The time that must elapse from the last defrosting of the affected circuit has been exceeded, 20 minutes.
- The time that must elapse from the last defrosting of another circuit (units with 2 circuits) has been exceeded, 90 seconds.

### Defrosting operation

#### • Starting defrosting

If one of the last cases is met, once the delay has elapsed at the start of defrosting, 120 seconds, the shut-down of the compressors will be triggered.

The regimen will be changed 30 seconds after the compressors are stopped, giving power to the 4-way valve. The compressors will be started up after 15 seconds, so that they can perform the defrosting procedure.

During the defrosting operation, the behaviour of the other unit components will be as follows:

- The indoor fan will continue to operate.
- the outdoor fans will be connected when a set pressure of 35 bar is exceeded, if the outdoor temperature is greater than -5°C. They will be disconnected if the pressure drops below 33 bar, the outdoor temperature drops below -6°C or a maximum connection time elapses.
- This action enables prolonging the duration of defrosting and, as such, the ice accumulated on the coil is completely removed.
- The optional backup device incorporate by the unit can be enabled: electrical heaters, hot water coil, gas burner or boiler.
- The outdoor air damper (optional) will remain closed.
- The rotary heat exchanger (optional) will operate. In this case, the outdoor damper will remain open.

#### • Ending defrosting

The following conditions must be met in order to end:

- By maximum time, after 10 minutes from the start.
- By pressure, when this exceeds 33 bar.
- By opening the high pressure pressostat. This alarm will not be indicated.

When the defrosting operation ends, the compressors stops, the four-way valve is reversed again and, after this, it will be possible to restart the compressors by the normal pressure control.

### 13.2. Anti-freeze safety (water-air units)

This is done through the analogue inputs on the  $\mu$ PC MEDIUM board: B7 (circuit 1) - B12 (circuit 2) and the pCOe expansion card with address 7: B1 (circuit 3) - B2 (circuit 4), through the conversion to the measurement temperature taken by the pressure transducer located between the plate exchanger and the cycle reversing valve.

This safety device is started if, after 120 seconds of operation by the compressor working in HEATING mode, the refrigerant temperature is lower than -2°C (early alarm). If this temperature does not exceed -1°C after 90 seconds the compressor stops. Once the minimum OFF time of the compressor has elapsed, if the refrigerant temperature is greater than 6°C (-2°C + 8°C differential), the compressor can once again be started. Otherwise, the refrigerant anti-freeze alarm is considered and it will be manually reset.

If the refrigerant temperature is less than -5°C after the compressor has been operating for 120 seconds, the compressor is stopped and directly, and without delay, the refrigerant anti-freeze alarm is considered.

If 10 early anti-freeze alarms ( $T^a < -2^\circ\text{C}$ ) are triggered in less than 120 seconds these will also be considered as a refrigerant anti-freeze alarm.

Note: If 10 alarms are triggered in less than 24 hours the water-air unit is blocked by the anti-freeze alarm. In this case, Technical Support Service (TSS) must be contacted.

### 13.3 Low outdoor temperature safety (water-air units)

When the outdoor temperature drops below 4°C, the heat valve is activated and the circulation pump is connected, to prevent freezing of the plate exchanger.

### 13.4. Protections against low outdoor temperature (optional)

The control can manage the following protections by means of the pCOe expansion card with address 8:

- Compressor with an additional crankcase heater
- Electrical heater for antifreeze protection of external dampers.
- Electrical heater for protecting the electric panel (1 or 2 stages).
- Hot water coil circuit with the GREAT COLD option. This protection includes an electrical heating for the piping layout.

### 13.5. High supply temperature safety

In units with optional electrical heaters or gas burner, when the supply temperature exceeds 55°C, this optional will be shut down and will not be reconnected until this temperature drops below 53°C.

## 13 - SAFETY FUNCTIONS

### 13.6. High or low indoor temperature safety

The control indicates an alarm event when the indoor temperature (return or ambient) drops below 15°C or exceeds 40°C. This alarm is timed at 30 minutes.

### 13.7. Anti-fire safety

When the return air temperature exceeds a safety value the anti-fire safety device will be activated (60°C by default) and the unit will stop. It will not return to operation until the temperature has dropped to below 40°C.

In units with outdoor air damper it is possible to select the damper position in the event of an anti-fire alarm or when the unit incorporates a smoke station (optional) connected to the digital input DI2 (connector J4).

The following functioning logic must be selected to comply with the French regulations on Fire safety (ERP).

- In case of failure of the thermal protection of the indoor fan, this fan and all components are stopped, the outdoor air damper is open to 100% (return air damper closed). Manual reset.
- In case of failure of the thermal protection of the electrical heaters, all components are stopped and the indoor fan after 120 seconds, the outdoor air damper is open to 100% (return air damper closed). Manual reset.

```
CS01a
Anti-fire safety
french ERP: N

Damper status during
failure: OPEN
Delay shutdown ind.fan
with resist.:120 se9
```

### 13.8. Compressor lock

In the event of a power cut-off for a period longer than 2 hours, the compressors will be locked. The unit must remain 8 hours consecutively with voltage to unlock the compressors.

The notification screen on the pGD1 also shows the remaining time until the end of the locking.

```
Warning AV01
Compressor lock
for heating of the
cranckcase heater (8h)
7h 59m 35s

Active warning: 00
```

From a screen of the Group **MAINTENANCE → COUNTERS** of the TECHNICAL MENU (password protected) it is allowed to reset this lock of compressors, but this shall be recorded in the data register of the control.

```
A01c1
Power ON
Time : 00:00
Date : 00/00/2000

Power OFF
Time : 00:00
Date : 00/00/2000
```

### 13.9. Additional low-pressure safety

Additional safety to the low pressure presostat with the pressure sensor on the outdoor coil and the unit running in HEATING mode. When the pressure drops below 2 bar the affected circuit stops and will not reconnect until the pressure does not exceed 4 bar.

### 13.10. High temperature safety in tandem compressors (optional)

In units with tandem compressors, working in COOLING mode, when the outdoor coil pressure of a circuit overcomes a limit value (41,5 bar by default), one of the two compressors will be stopped, thereby avoiding the stop of both compressors due to the high pressure.

This compressor will start working again if the pressure drops below 36,5 bar.

### 13.11. Clogged filter detector (optional)

A clogged filter presostat can be connected on the digital input DI6 (connector J4).

This safety can be configured as indication only (default) or unit shutdown.

### 13.12. Refrigerant leak detector (optional)

A refrigerant leak detector can be connected on the Field-bus of the control board by means of one serial card RS485, with address 6 (9600 bps, 8 bits, without parity and 2 stop bits).

When a concentration of gas established by parameter is exceeded, the alarm is activated and the unit is stopped.

The counter of the number of operating hours and days for the refrigerant gas detector is accessed in the group of screens **MAINTENANCE → COUNTERS** of the TECHNICAL MENU (password protected).

```
A12h
Gas detector No.001

Running hours 00000h
00000d
```

This information is very important to realize the maintenance works on the leakage detector:

- Annual test: To comply with the requirements of the EN378 and F GAS is necessary to perform a test of the detector every year.
- Every 3 years: a calibration is recommended.
- Every 5 / 6 years: change the detector element of the sensor and perform a calibration is recommended.

### 13.13. High-speed safety on plug-fans (optional)

The pGD1 terminal can display a warning message when a plug-fan exceed the maximum permissible speed for a period of time longer than 30 minutes (by default).

This safety can be configured as indication only (default) or unit shutdown.



# 14 - ALARMS

## 14.1. Alarm display

### On the pGD1 terminal:

There is/are active alarm(s) if the key  is illuminated red.

By pressing the key once, the description of the first alarm will be shown.

By using the   keys, the other alarms stored in the memory can be consulted. For example:

For example:

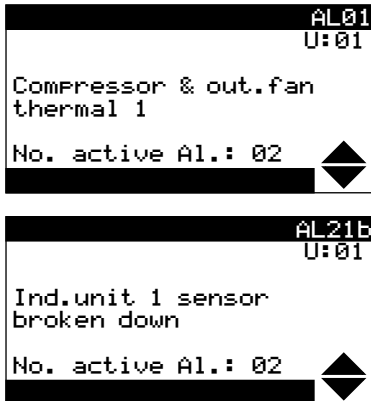

By pressing this key  for a second time, the alarm(s) will be reset.

If no alarm is active, the message "No alarm active" appears.



Note: active warnings will also be displayed.

### Alarms record

In the group **MAINTENANCE → ALARMS RECORD** of the TECHNICAL MENU (password protected), the alarm and failure log screens are accessed.

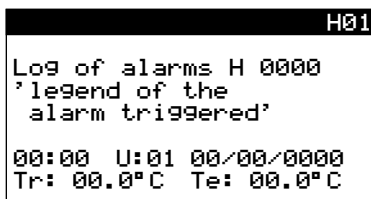
Each screen shows the description of the alarm, together with its date and time, the unit in which the pGD1 terminal is connected (U:01), as well as the ambient (or return) temperature (Tr) and the outdoor temperature (Te) existing at the time of the alarm.



By using the   keys, the last 100 alarms stored can be consulted.

The failures of electrical power supply also will remain registered.

From a screen of the group **MANUFACTURER → UNIT INITIALIZ.** of the TECHNICAL MENU (password protected) is possible to erase the "Alarms record".

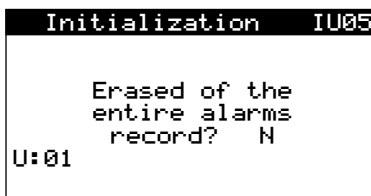



### On the TCO terminal (optional):

If the icon  appears on the TCO terminal display, there is/are active alarm(s).

In addition to view in the ambient (or return) air temperature on the main display, it is possible to view other values through the set that is activated by pressing the  key. One of those values may be an alarm code. If there is more than one alarm is indicated the code of the most important alarm, And below the symbol AL.



With the  key, it is possible to write on the display the value "0" in the place of the alarm. Pressing the  key will reset inactive alarms and will return to the main display.



The icon  will disappear from the display if there is no active alarm.

## 14.2. Signalling of remote alarms (optional)

The digital output NO7 (connector J14) can be used to connect an relay for alarm signalling. The alarms that could activate the relay are selected on the group **MANUFACTURER → ALARM CONFIG** of the TECHNICAL MENU (password protected).

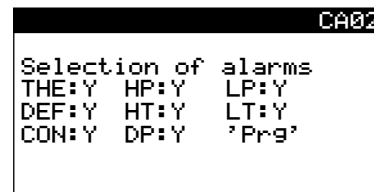

- THE: Thermal
- HP: High pressure
- LP: Low pressure
- DEF: Defrost
- HT: High temperature
- LT: Low temperature
- CON: Counters
- DP: Disconnected probes

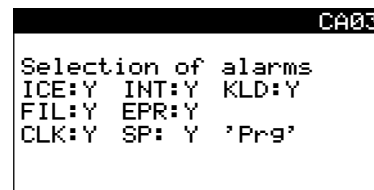

- ICE: Anti-freeze HWC
- INT: Indoor fan safety / flow switch / plug-fan without communication / anti-free
- KLD: Compressor discharge
- FIL: Clogged filter
- EPR: Eprom not OK
- CLK: Clock
- SP: Setpoint W / S

From these selection screens, by pressing the  key, access is given to additional information screens, indicating which alarm the acronym stands for.

## 14 - ALARMS

### 14.3. Alarm list

Controlled alarms	Unit shutdown	Affected circ. shutdown	Type of reset	Timing	Actuation	pGD1	TCO	Addr.
Thermal protection of compressor(s) and outdoor fan(s) circuit 1	No	Yes	Auto (*)	No	Shutdown of circuit 1	AL01	AL1	27
Thermal protection of compressor(s) and outdoor fan(s) circuit 2	No	Yes	Auto (*)	No	Shutdown of circuit 2	AL02	AL2	28
Thermal protection of compressor(s) and outdoor fan(s) circuit 3	No	Yes	Auto (*)	No	Shutdown of circuit 3	AL01a	AL101	151
Thermal protection of compressor(s) and outdoor fan(s) circuit 4	No	Yes	Auto (*)	No	Shutdown of circuit 4	AL02a	AL201	152
High pressure circuit 1	No	Yes	Auto (*)	No	Shutdown of circuit 1	AL05	AL5	29
High pressure circuit 2	No	Yes	Auto (*)	No	Shutdown of circuit 2	AL06	AL6	30
High pressure circuit 3	No	Yes	Auto (*)	No	Shutdown of circuit 3	AL05a	AL501	153
High pressure circuit 4	No	Yes	Auto (*)	No	Shutdown of circuit 4	AL06a	AL601	154
High and low pressure recovery circuit	No	No	Auto (*)	No	Shutdown of the recovery compressor	AL07	AL7	118
Maintenance of the recovery compressor	No	No	Manual	No	Indication only	AL08	AL8	119
Anti-freeze alarm of hot water coil	Yes (in COOLING mode)	Yes (in COOLING mode)	Manual	Yes 2 s	HEATING: this closes outdoor air damper and opens hot water coil valve COOLING: this stops compressors and closes outdoor damper	AL09	AL9	31
High return temperature	No	No	Manual	Yes (prog.)	Indication only	AL10	AL10	34
Low return temperature	No	No	Manual	Yes (prog.)	Indication only	AL11	AL11	35
Low pressure circuit 1 (possible gas leak in the circuit)	No	Yes	Auto (*)	No	Shutdown of circuit 1	AL12	AL12	38
Low pressure circuit 2 (possible gas leak in the circuit)	No	Yes	Auto (*)	No	Shutdown of circuit 2	AL13	AL13	39
Low pressure circuit 3 (possible gas leak in the circuit)	No	Yes	Auto (*)	No	Shutdown of circuit 3	AL12a	AL1201	155
Low pressure circuit 4 (possible gas leak in the circuit)	No	Yes	Auto (*)	No	Shutdown of circuit 4	AL13a	AL1301	156
Low pressure due to continuous defrosting by min. pressure or T of circ.1 (possible gas leak in the circuit)	No	Yes	Auto (*)	No	Shutdown of circuit 1	AL12b	AL1202	225
Low pressure due to continuous defrosting by min. pressure or T of circ.2 (possible gas leak in the circuit)	No	Yes	Auto (*)	No	Shutdown of circuit 2	AL12c	AL1203	226
Low pressure due to continuous defrosting by min. pressure or T of circ.3 (possible gas leak in the circuit)	No	Yes	Auto (*)	No	Shutdown of circuit 3	AL13b	AL1302	227
Low pressure due to continuous defrosting by min. pressure or T of circ.4 (possible gas leak in the circuit)	No	Yes	Auto (*)	No	Shutdown of circuit 4	AL13c	AL1303	228
Compressor 1 - circuit 1 maintenance	No	No	Manual	No	Indication only	AL16	AL16	36
Compressor 1 - circuit 2 maintenance	No	No	Manual	No	Indication only	AL17	AL17	37
Compressor 2 - circuit 1 maintenance or compressor 1 - circuit 3 (unit 4 circ.)	No	No	Manual	No	Indication only	AL18	AL18	122
Compressor 2 - circuit 2 maintenance or compressor 1 - circuit 4 (unit 4 circ.)	No	No	Manual	No	Indication only	AL19	AL19	123
Thermal indoor fan and/or air flow switch	Yes	Yes	Manual	0 s (thermal relay) 30 s (flow switch)	Serious alarm, unit shutdown	AL20	AL20	40
Outdoor circuit coil probe 1 (air-air unit)	No	Yes	Manual	No	Shutdown of circuit 1	AL21	AL21	41
Outdoor circuit coil probe 2 (air-air unit)	No	Yes	Manual	No	Shutdown of circuit 2	AL22	AL22	42
Outdoor circuit coil probe 3 (air-air unit)	No	Yes	Manual	No	Shutdown of circuit 3	AL21a	AL2101	157
Outdoor circuit coil probe 4 (air-air unit)	No	Yes	Manual	No	Shutdown of circuit 4	AL22a	AL2201	158
Indoor circuit coil probe 1	No	Yes	Auto	No	Shutdown of circuit 1	AL21b	AL2102	212
Indoor circuit coil probe 2	No	Yes	Auto	No	Shutdown of circuit 2	AL21c	AL2103	213
Indoor circuit coil probe 3	No	Yes	Auto	No	Shutdown of circuit 3	AL22b	AL2202	214
Indoor circuit coil probe 4	No	Yes	Auto	No	Shutdown of circuit 4	AL22c	AL2203	215
Clogged filters	No	No	Manual	Yes (5 s)	Indication only or unit shutdown (configurable on CS08b)	AL23	AL23	43
Thermal electrical heaters stages 1 & 2	No	No	Auto (*)	No	Shutdown of electrical heater	AL24	AL24	48
Gas Burner	No	No	Manual	No	Indication only (safety in the burner)	AL24	AL24	48
Failure Eprom memory	No	No	Manual	No	Serious alarm, but indication only	AL26	AL26	32
Clock	No	No	Manual	No	Indication only	AL27	AL27	33
Unit maintenance	No	No	Manual	No	Indication only	AL28	AL28	108
Return temperature probe	Yes	Yes	Manual	No	Serious alarm, unit shutdown	AL29	AL29	109
RS485 probe No.1 without communication	No	No	Auto	No	Indication only	AL30b	AL3002	163
Ambient temperature probe No.1	No	No	Manual	No	Indication only	AL30c	AL3003	164
Ambient humidity probe No.1	No	No	Manual	No	Indication only	AL30a	AL3001	165
RS485 probe No.2 without communication	No	No	Auto	No	Indication only	AL30e	AL3005	175
Ambient temperature probe No.2	No	No	Manual	No	Indication only	AL30f	AL3006	176
Ambient humidity probe No.2	No	No	Manual	No	Indication only	AL30d	AL3004	177
RS485 probe No.3 without communication	No	No	Auto	No	Indication only	AL30h	AL3008	257
Ambient temperature probe No.3	No	No	Manual	No	Indication only	AL30i	AL3009	258

(\*) If a certain number of alarms take place over a period of time, this reset can be changed to "Manual" (configurable on CA04, CA05, CA06 & CA07).

## 14 - ALARMS

Controlled alarms	Unit shutdown	Affected circ. shutdown	Type of reset	Timing	Actuation	pGD1	TCO	Addr.
Ambient humidity probe No.3	No	No	Manual	No	Indication only	AL30g	AL3007	259
RS485 probe No.4 without communication	No	No	Auto	No	Indication only	AL30k	AL3011	260
Ambient temperature probe No.4	No	No	Manual	No	Indication only	AL30l	AL3012	261
Ambient humidity probe No.4	No	No	Manual	No	Indication only	AL30j	AL3010	262
pLAN network probe: T, RH or CO <sub>2</sub> without commun.	No	No	Manual	No	Indication only	AL31	AL31	110
Outdoor temperature probe	No	No	Manual	No	Indication only	AL32	AL32	111
Indoor humidity probe	No	No	Manual	No	Indication only	AL33	AL33	112
Outdoor humidity probe	No	No	Manual	No	Indication only	AL34	AL34	113
Supply temperature probe	No	No	Manual	No	Indication only	AL35	AL35	114
Mixing temperature or air quality probe	No	No	Manual	No	Indication only	AL35a	AL3501	130
COOLING setpoint < HEATING setpoint	Yes	Yes	Manual	No	Serious alarm, unit shutdown	AL36	AL36	115
Compressor(s) discharge T circuit 1	No	Yes	Auto	No	Shutdown of circuit 1	AL37	AL37	126
Compressor(s) discharge T circuit 2	No	Yes	Auto	No	Shutdown of circuit 2	AL38	AL38	127
Compressor discharge T circuit 3	No	Yes	Auto	No	Shutdown of circuit 3	AL37a	AL3701	159
Compressor discharge T circuit 4	No	Yes	Auto	No	Shutdown of circuit 4	AL38a	AL3801	160
Anti-fire safety device / smoke detection	Yes	Yes	Manual	No	Serious alarm, shut-down of the unit and outdoor damper open / closed (configurable by parameter on CS01)	AL39	AL39	136
Supply temperature limit exceeded	No	No	Manual	No	Shutdown of electrical heaters or burner	AL40	AL40	166
Refrigerant anti-freeze safety circuit 1 (water-air)	No	Yes	Auto (**)	Yes (120 s)	HEATING mode: Shutdown of circuit 1	AL41	AL41	193
Refrigerant anti-freeze safety circuit 2 (water-air)	No	Yes	Auto (**)	Yes (120 s)	HEATING mode: Shutdown of circuit 2	AL42	AL42	194
Refrigerant anti-freeze safety circuit 3 (water-air)	No	Yes	Auto (**)	Yes (120 s)	HEATING mode: Shutdown of circuit 3	AL41a	AL4101	195
Refrigerant anti-freeze safety circuit 4 (water-air)	No	Yes	Auto (**)	Yes (120 s)	HEATING mode: Shutdown of circuit 4	AL42a	AL4201	196
Unit blocking due to anti-freeze alarm (water-air)	Si	Si	Manual	No	HEATING mode: unit shutdown	AL43	AL43	197
Water flow switch alarm (water-air)	Si	Si	Auto	Yes (30 s)	HEATING mode: unit shutdown	AL44	AL44	199
pCOe card address 7 without communication	No	Yes	Auto	No	Shutdown of circuits 3 - 4	AL45a	AL4501	162
pCOe card address 7 fault alarm	No	No	Auto	No	Shutdown of circuits 3 - 4	AL45f	AL4506	161
pCOe card address 8 without communication	No	Yes	Auto	No	Shutdown of evaporation / condensation pressures control	AL45b	AL4502	211
pCOe card address 8 fault alarm	No	No	Auto	No	Shutdown of evaporation / condensation pressures control	AL45g	AL4507	210
pCOe card address 9 without communication	No	Yes	Auto	No	Unit shutdown and dampers on the previous position to the alarm	AL45c	AL4503	---
pCOe card address 9 fault alarm	No	No	Auto	No	Unit shutdown and dampers on the previous position to the alarm	AL45h	AL4508	---
Energy meter without communication	No	No	Auto	No	Indication only	AL46	AL46	192
Supply plug-fan without communication	No	No	Auto	No	Indication only	AL47	AL47	201
Pressure sensor for air flow control (supply plug-fan)	No	No	Auto	No	Indication only	AL48	AL48	202
Return plug-fan without communication	No	No	Auto	No	Indication only	AL49	AL49	205
Pressure sensor for air flow control (return plug-fan)	No	No	Auto	No	Indication only	AL50	AL50	206
Leak detector sensor	Yes	Yes	Manual	Yes (60 s)	Unit shutdown	AL51a	AL5101	83
Gas leak detected	Yes	Yes	Manual	Yes (60 s)	Unit shutdown	AL51b	AL5102	82
Leak detector without communication	Yes	Yes	Manual	Yes (30 s)	Unit shutdown	AL51c	AL5103	81
Variable frequency drive (VFD) of supply fan without communication	Yes	Yes	Manual	No	Unit shutdown	AL61	AL61	51
Variable frequency drive (VFD) of return fan without communication	Yes	Yes	Manual	No	Unit shutdown	AL62	AL62	97
TCO terminal without communication	No	No	Auto	No	Indication only	---	AL6301	---
TCO with failure in the internal temperature sensor	No	No	Auto	No	Indication only	---	AL6302	---
Water inlet T probe on the hot water coil (expansion card I/O pCOe addr.8)	No	No	Auto	No	Indication only	AL64	AL64	221
Anti-freeze alarm on the hot water coil (expansion card I/O pCOe addr.8)	Yes (in COOLING mode)	Yes (in COOLING mode)	Auto	No	The pump is activated and the hot water coil valve open to 100%	AL65	AL65	222
Water outlet T probe on the hot water coil (expansion card I/O pCOe addr.8)	Yes (in COOLING mode)	Yes (in COOLING mode)	Manual	No	Serious alarm, the pump is activated and the hot water coil valve open to 100%	AL66	AL66	223
Failure of the ambient air temperature probe (NTC)	No	No	Auto	No	Indication only	AL67	AL67	224
Failure of the recovery temp. probe on the wheel	No	No	Auto	No	Shutdown of the rotary heat exchanger	AL69	AL69	
Failure in the supply damper (pCOe card address 9)	Si	Si	Auto	Yes (150 s)	Unit shutdown	AL70	AL70	
Failure in the return damper (pCOe card address 9)	Si	Si	Auto	Yes (150 s)	Unit shutdown	AL71	AL71	
Power cut-off for a period longer than 2 hours	Si	Si	Auto	Yes (2 hours)	Blocking of compressors for 8 hours to ensure heating of the crankcase heater	AV01		
Warning whenever the supply fan speed limit (rpm) is exceeded	No	No	Auto	Yes (30 min)	Only indication Note: Unit shutdown by parameter	AV02		
Warning whenever the return fan speed limit (rpm) is exceeded	No	No	Auto	Yes (30 min)	Only indication Note: Unit shutdown by parameter	AV02		

(\*\*) If 10 alarms are triggered in less than 24 hours the water-air unit is blocked by the anti-freeze alarm (manual reset).

## 15 - LIST OF PARAMETERS OF "UNIT STATUS"

Screen	Parameter	Description of the parameter	Value	Min.	Max.	UOM	Type	R/W	Add. BMS
P01	PLAN_ADDRESS	Address of the unit in the pLAN network	0	0	0	---	Integer	R	
P01	HORA	Clock: hour	0	0	0	h	Integer	R	48
P01	MINUTO	Clock: minute	0	0	0	min	Integer	R	47
P01	MODO_VENT	VENTILATION operating mode	0	0	1	---	Digital	R	236
P01	MODO_FRIO	COOLING operating mode	0	0	1	---	Digital	R	
P01	GLOBAL_ALARM	Signal of active alarms	0			---	Digital	R	26
P01	TEMP_INT	Indoor temperature for regulation of the unit	0.0	-99.9	0.0	°C	Analog	R	291
P01	TEMP_EXT	Temperature of the outdoor air	0.0	-99.9	0.0	°C	Analog	R	2
P01	HUM_INT	Indoor relative humidity for regulation of the unit	0.0	0.0	0.0	%rH	Analog	R	5
P01	ESTADO_EQUIPO	Unit status (ON, OFF, remote OFF, OFF by phase)	0	0	0	---	Integer	R	
P01	ON_FASCE	Indication of unit switch-on by schedule programming	0			---	Digital	R	
P01	DESHUMIDIFICA	Indication of active dehumidifier	0			---	Digital	R	
P01	HUMIDIFICA	Indication of active humidifier	0	0	1	---	Digital	R	22
P01	ON_COMPENSACION	Indication of active compensation	0			---	Digital	R	
P01	ON_DESESCARCHE	Indication of active defrosting	0			---	Digital	R	183
P01	ON_FREECOOL	Indication of active free-cooling	0			---	Digital	R	184
P01	ON_FREEHEAT	Indication of active free-heating	0			---	Digital	R	185
P01	LAMP_COMPRESOR	Indication of compressors in operation	0	0	1	---	Digital	R	
P01	LAMP_VINT	Indication of indoor fans in operation	0	0	1	---	Digital	R	
P01	LAMP_RESISTENCIA	Indication of electrical heaters in operation	0	0	1	---	Digital	R	
P01	ON_LIMITE_TEMP_IMPULSION	Indication of unit in operation with limit of supply temperature	0	0	1	---	Digital	R	238
P02	HORA	Clock: hour	0	0	0	h	Integer	R	48
P02	MINUTO	Clock: minute	0	0	0	min	Integer	R	47
P02	DIA	Clock: day	0	0	0	day	Integer	R	49
P02	MES	Clock: month	0	0	0	month	Integer	R	50
P02	ANO	Clock: year	0	0	0	year	Integer	R	51
P02	MODO_FRIO	VENTILATION operating mode	0	0	1	---	Digital	R	
P02	MODO_VENT	COOLING operating mode	0	0	1	---	Digital	R	236
P02	GLOBAL_ALARM	Signal of active alarms	0			---	Digital	R	26
P02	SET_TEMP_DISPLAY	Active setpoint temperature	0.0	0.0	0.0	°C	Analog	R	
P02	ESTADO_EQUIPO	ON/OFF unit status	0	0	0	---	Integer	R	
P02	ON_FASCE	Indication of unit switch-on by schedule programming	0			---	Digital	R	
P02	DESHUMIDIFICA	Indication of active dehumidifier	0			---	Digital	R	
P02	HUMIDIFICA	Indication of active humidifier	0	0	1	---	Digital	R	22
P02	ON_COMPENSACION	Indication of active compensation	0			---	Digital	R	
P02	ON_DESESCARCHE	Indication of active defrosting	0			---	Digital	R	183
P02	ON_FREECOOL	Indication of active free-cooling	0			---	Digital	R	184
P02	ON_FREEHEAT	Indication of active free-heating	0			---	Digital	R	185
P02	LAMP_COMPRESOR	Indication of compressors in operation	0	0	1	---	Digital	R	
P02	LAMP_VINT	Indication of indoor fans in operation	0	0	1	---	Digital	R	
P02	LAMP_RESISTENCIA	Indication of electrical heaters in operation	0	0	1	---	Digital	R	
P02	ON_LIMITE_TEMP_IMPULSION	Indication of unit in operation with limit of supply temperature	0	0	1	---	Digital	R	238
P03	PLAN_ADDRESS	Address of the unit in the pLAN network	0	0	0	---	Integer	R	
P03	HAB_SUPERVISION	Enabling the supervision serial card (optional)	1	0	1	---	Digital	R	50
P03	TIPO_PROT_COM	Supervision protocol (Carel, Modbus or Lonworks)	1	0	0	---	Integer	R	
P03	BMS_ADDRESS	Address of the unit in the supervision network	1	0	0	---	Integer	R	
P03	BAUD_RATE	Bits rate: 0=1200 1=2400 2=4800 3=9600 4=19200	4	0	4	---	Integer	R	
P03	PROT_MODBUS_EXTENDIDO	Modbus extended	1	0	1	---	Digital	R	
P03	Stop_bits_Number_MB	Bit stop number: 0=1 1=2	0	0	1	---	Digital	R	
P03	Parity_Type_MB	Type of parity: 0=no parity 1=odd 2=even	0	0	2	---	Integer	R	



## 16 - LIST OF PARAMETERS OF THE “MAIN MENU”

### Parameters of “SETPOINTS”

Screen	Parameter	Description of the parameter	Value	Min.	Max.	UOM	Type	R/W	Add. BMS
S01zn	MOD_MB_UPC_ZONIFICA_CIAT_1.SET_POINT_TEMP_FRIO_T11	Temperature setpoint in COOLING mode (summer) in the terminal of zone 1 (zoning of the air flow)	26.0	0.0	50.0	°C	Analog.	R/W	283
S01zn	MOD_MB_UPC_ZONIFICA_CIAT_1.SET_POINT_TEMP_CALOR_T11	Temperature setpoint in HEATING mode (winter) in the terminal of zone 1 (zoning of the air flow)	21.0	0.0	50.0	°C	Analog.	R/W	284
S02zn	MOD_MB_UPC_ZONIFICA_CIAT_1.SET_POINT_TEMP_FRIO_T12	Temperature setpoint in COOLING mode (summer) in the terminal of zone 2 (zoning of the air flow)	26.0	0.0	50.0	°C	Analog.	R/W	285
S02zn	MOD_MB_UPC_ZONIFICA_CIAT_1.SET_POINT_TEMP_CALOR_T12	Temperature setpoint in HEATING mode (winter) in the terminal of zone 2 (zoning of the air flow)	21.0	0.0	50.0	°C	Analog.	R/W	286
S03zn	MOD_MB_UPC_ZONIFICA_CIAT_1.SET_POINT_TEMP_FRIO_T13	Temperature setpoint in COOLING mode (summer) in the terminal of zone 3 (zoning of the air flow)	26.0	0.0	50.0	°C	Analog.	R/W	287
S03zn	MOD_MB_UPC_ZONIFICA_CIAT_1.SET_POINT_TEMP_CALOR_T13	Temperature setpoint in HEATING mode (winter) in the terminal of zone 3 (zoning of the air flow)	21.0	0.0	50.0	°C	Analog.	R/W	288
S04zn	MOD_MB_UPC_ZONIFICA_CIAT_1.SET_POINT_TEMP_FRIO_T14	Temperature setpoint in COOLING mode (summer) in the terminal of zone 4 (zoning of the air flow)	26.0	0.0	50.0	°C	Analog.	R/W	289
S04zn	MOD_MB_UPC_ZONIFICA_CIAT_1.SET_POINT_TEMP_CALOR_T14	Temperature setpoint in HEATING mode (winter) in the terminal of zone 4 (zoning of the air flow)	21.0	0.0	50.0	°C	Analog.	R/W	290
S01	SET_POINT_TEMP_FRIO	Temperature setpoint in COOLING mode (summer)	26,0	LIM_INF_TEMP	LIM_SUP_TEMP	°C	Analog.	R/W	15
S01	SET_POINT_TEMP_CALOR	Temperature setpoint in HEATING mode (winter)	21,0	LIM_INF_TEMP	LIM_SUP_TEMP	°C	Analog.	R/W	16
S02	SET_POINT_HUM	Indoor humidity setpoint	55,0	LIM_INF_HUM	LIM_SUP_HUM	%rH	Analog.	R/W	18
S02	HAB_SONDA_HUM_INT_VIRTUAL	Enabling the pLAN indoor humidity probe	0			---	Digital	R	
S03	SET_COMPRESOR_EN_FRIO	Calculation of setpoints: Setpoint in COOLING mode (summer) + Dead Zone / 2	0,0	0,0	0,0	°C	Analog.	R	
S03	SET_COMPRESOR_EN_CALOR	Calculation of setpoints: Setpoint in HEATING mode (winter) + Dead Zone / 2	0,0	0,0	0,0	°C	Analog.	R	
S03	SET_TEMP_COMPRESOR	Current selection of the setpoint	0,0	0,0	0,0	°C	Analog.	R	
S03	SET_RES_EN_FRIO	Calculation of setpoints: Setpoint of the electrical heaters in COOLING mode	0,0	0,0	0,0	°C	Analog.	R	
S03	SET_RES_EN_CALOR	Calculation of setpoints: Setpoint of the electrical heaters in HEATING mode	0,0	0,0	0,0	°C	Analog.	R	
S03	SET_TEMP_RES	Current selection of setpoint for electrical heaters	0,0	0,0	0,0	°C	Analog.	R	
S03	SET_VLV_CALOR_EN_FRIO	Calculation of setpoints: Setpoint of the hot water coil in COOLING mode	0,0	0,0	0,0	°C	Analog.	R/W	
S03	SET_VLV_CALOR_EN_CALOR	Calculation of setpoints: Setpoint of the hot water coil in HEATING mode	0,0	0,0	0,0	°C	Analog.	R/W	
S03	SET_VLV_CALOR	Current selection of setpoint for the hot water coil	0,0	0,0	0,0	°C	Analog.	R/W	
S03	SET_FCOOL_VER	Calculation of setpoints: free-cooling in summer	00,0	-99,9	99,9	---	Integer	R	
S03	SET_FCOOL_INV	Calculation of setpoints: free-cooling in winter	00,0	-99,9	99,9	---	Integer	R	
S03	SET_FHEAT	Calculation of setpoints: free-heating	00,0	-99,9	99,9	---	Integer	R	
S04	SET_IMPULSION_FRIO_CAL	Supply setpoint calculated in COOLING mode	7,0	0,0	30,0	°C	Analog.	R	122
S04	SET_IMPULSION_CALOR_CAL	Supply setpoint calculated in HEATING mode	45,0	0,0	55,0	°C	Analog.	R	121

### Parameters of “INPUTS/OUTPUTS”

Screen	Parameter	Description of the parameter	Value	Min.	Max.	UOM	Type	R/W	Add. BMS
I01	TEMP_RET	Display of the return air temperature	0,0	-99,9	99,9	°C	Analog.	R	1
I01	TEMP_EXT	Display of the outdoor air temperature	0,0	-99,9	99,9	°C	Analog.	R	2
I01a	TEMP_SONDA_AMB	Display of the ambient air temperature (NTC or RS485)	0,0	-99,9	99,9	°C	Analog.	R	
I01a	SONDA_AMB_1_TEMP	Display of the ambient temperature probe No.1 - RS485	0,0	-99,9	99,9	°C	Analog.	R	193
I01a	SONDA_AMB_2_TEMP	Display of the ambient temperature probe No.2 - RS485	0,0	-99,9	99,9	°C	Analog.	R	196
I01a	SONDA_AMB_3_TEMP	Display of the ambient temperature probe No.3 - RS485	0,0	-99,9	99,9	°C	Analog.	R	241
I01a	SONDA_AMB_4_TEMP	Display of the ambient temperature probe No.4 - RS485	0,0	-99,9	99,9	°C	Analog.	R	244
I01a	SEL_TEMP_SONDAS_AMB_CALOR	Selection of the value of ambient temperature with RS485 probes in HEATING mode 0=average, 1=minimum, 2=maximum	0	0	2	---	Integer	R/W	200
I01a	SEL_TEMP_SONDAS_AMB_FRIO	Selection of the value of ambient temperature with RS485 probes in COOLING mode 0=average, 1=minimum, 2=maximum	0	0	2	---	Integer	R/W	199

## 16 - LIST OF PARAMETERS OF THE “MAIN MENU”

### Parameters of “INPUTS/OUTPUTS” (...continuation)

Screen	Parameter	Description of the parameter	Value	Min.	Max.	UOM	Type	R/W	Add. BMS
I01b	TEMP_TCO	Selection of the value of ambient temperature with TCO terminal	0.0	-99.9	99.9	°C	Analog.	R	14
I02	HUM_INT	Display of the ambient humidity RS485 probe (average value)	0.0	0.0	0.0	%rH	Analog.	R	5
I02	SONDA_AMB_1_HUM	Display of the ambient humidity probe No.1 - RS485	0.0	-99.9	99.9	%rH	Analog.	R	194
I02	SONDA_AMB_2_HUM	Display of the ambient humidity probe No.2 - RS485	0.0	-99.9	99.9	%rH	Analog.	R	197
I02	SONDA_AMB_3_HUM	Display of the ambient humidity probe No.3 - RS485	0.0	-99.9	99.9	%rH	Analog.	R	242
I02	SONDA_AMB_4_HUM	Display of the ambient humidity probe No.4 - RS485	0.0	-99.9	99.9	%rH	Analog.	R	245
I02a	HUM_EXT	Display of the outdoor air humidity	0.0	0.0	0.0	%rH	Analog.	R	6
I03	TEMP_IMP	Display of the supply air temperature	0.0	0.0	0.0	°C	Analog.	R	7
I03	TEMP_MEZCLA	Display of the mixing air temperature	0.0	0.0	0.0	°C	Analog.	R	8
I03a	CO2	Display of the CO2 probe or the difference between indoor probe and outdoor probe (in units with outdoor CO2 probe)	0	0	0	ppm	Integer	R	3
I03a	CO2_FISICA_zona1	Reading of the CO2 probe of zone 1 (zoning into 2 zones)	0	0	32767	ppm	Integer	R	256
I03a	CO2_FISICA_zona2	Reading of the CO2 probe of zone 2 (zoning into 2 zones) or second CO2 probe (outdoor or indoor probe)	0	0	32767	ppm	Integer	R	220
I03b	TEMP_ENTRADA_BAC	Display of the water inlet temperature of the hot water coil	0.0	0.0	0.0	°C	Analog.	R	25
I03b	TEMP_SALIDA_BAC	Display of the water outlet temperature of the hot water coil	0.0	0.0	0.0	°C	Analog.	R	26
I03c	TEMP_EXTRACCION_RUEDA	Display of the exhaust air temperature on the wheel	0.0	0.0	0.0	°C	Analog.	R	247
I03c	TEMP_RECUPERACION_RUEDA	Display of the recovery air temperature on the wheel	0.0	0.0	0.0	°C	Analog.	R	249
I04a	T_P_BEXT_C1	Display of the pressure (or temp.) in the outdoor coil of circuit 1 (in water-air units indicates the value of the refrigerant anti-freeze safety)	0.0	-99.9	99.9	Bar	Analog.	R	3
I04a	TEMP_CAL_BEXT_C1	Calculated temperature in the outdoor coil of circuit 1	0.0	-99.9	99.9	°C	Analog.	R	123
I04a	T_P_BEXT_C1_2	Display of the pressure (or temp.) in the outdoor coil of circuit 3 (4 circuit units) (in water-air units indicates the value of the refrigerant anti-freeze safety)	0.0	-99.9	99.9	Bar	Analog.	R	106
I04a	TEMP_CAL_BEXT_C1_2	Calculated temperature in the outdoor coil of circuit 3 (4 circuit units)	0.0	-99.9	99.9	°C	Analog.	R	125
I04b	T_P_BEXT_C2	Display of the pressure (or temp.) in the outdoor coil of circuit 2 (in water-air units indicates the value of the refrigerant anti-freeze safety)	0.0	-99.9	99.9	Bar	Analog.	R	4
I04b	TEMP_CAL_BEXT_C2	Calculated temperature in the outdoor coil of circuit 2	0.0	-99.9	99.9	°C	Analog.	R	124
I04b	T_P_BEXT_C2_2	Display of the pressure (or temp.) in the outdoor coil of circuit 4 (4 circuit units) (in water-air units indicates the value of the refrigerant anti-freeze safety)	0.0	-99.9	99.9	Bar	Analog.	R	107
I04b	TEMP_CAL_BEXT_C2_2	Calculated temperature in the outdoor coil of circuit 4 (4 circuit units)	0.0	-99.9	99.9	°C	Analog.	R	126
I05a	T_P_BINT_C1	Display of the pressure in the indoor coil of circuit 1 Note: in case of a sensor connected in the pCOe card addr. 8	0.0	-99.9	99.9	Bar	Analog.	R	204
I05a	TEMP_CAL_BINT_C1	Calculated temperature in the indoor coil of circuit 1	0.0	-99.9	99.9	°C	Analog.	R	208
I05a	T_P_BINT_C1_2	Display of the pressure in the indoor coil of circuit 3 (4 circuit units) Note: in case of a sensor connected in the pCOe card addr. 8	0.0	-99.9	99.9	Bar	Analog.	R	205
I05a	TEMP_CAL_BINT_C1_2	Calculated temperature in the outdoor coil of circuit 3 (4 circuit units)	0.0	-99.9	99.9	°C	Analog.	R	209
I05b	T_P_BINT_C2	Display of the pressure in the indoor coil of circuit 2 Note: in case of a sensor connected in the pCOe card addr. 8	0.0	-99.9	99.9	Bar	Analog.	R	206
I05b	TEMP_CAL_BINT_C2	Calculated temperature in the outdoor coil of circuit 2	0.0	-99.9	99.9	°C	Analog.	R	210
I05b	T_P_BINT_C2_2	Display of the pressure in the indoor coil of circuit 4 (4 circuit units) Note: in case of a sensor connected in the pCOe card addr. 8	0.0	-99.9	99.9	Bar	Analog.	R	207
I05b	TEMP_CAL_BINT_C2_2	Calculated temperature in the outdoor coil of circuit 4 (4 circuit units)	0.0	-99.9	99.9	°C	Analog.	R	211
I05	PR_ENT_EXTERIOR	Display of the integer part of the outdoor enthalpy (in units with enthalpic free-cooling)	0	0	0	Kcal/Kg	Integer	R	14
I05	SEC_ENT_EXTERIOR	Display of the decimal part of the outdoor enthalpy (in units with enthalpic free-cooling)	0	0	0	Kcal/Kg	Integer	R	15
I05	HUM_EXT	Display of the outdoor air humidity	0.0	0.0	0.0	%rH	Analog.	R	6
I06	PR_ENT_INTERIOR	Display of the integer part of the indoor enthalpy (in units with enthalpic free-cooling)	0	0	0	Kcal/Kg	Integer	R	16
I06	SEC_ENT_INTERIOR	Display of the decimal part of the indoor enthalpy (in units with enthalpic free-cooling)	0	0	0	Kcal/Kg	Integer	R	17
I06	HUM_INT	Display of the indoor air humidity	0.0	0.0	0.0	%rH	Analog.	R	5
I07	N_HOR_ON_EQUIPO	Display of operating hours of unit	0	0	0	h	Integer	R	62
I07	N_HOR_COMP1	Display of operating hours of compressor 1 of circuit 1	0	0	0	h	Integer	R	10
I07	N_HOR_COMP2	Display of operating hours of compressor 2 of circuit 1 (1 circ. units) or compressor 1 of circuit 2 (2 circ. units) or compressor of circuit 3 (4 circ. units)	0	0	0	h	Integer	R	11
I07	N_HOR_COMP1_2	Display of operating hours of compressor 2 of circuit 1 (2 circuit units) or compressor of circuit 2 (4 circuit units)	0	0	0	h	Integer	R	53
I07a	N_HOR_COMP2_2	Display of operating hours of compressor 2 of circuit 2 (2 circuit units) or compressor of circuit 4 (4 circuit units)	0	0	0	h	Integer	R	69
I07a	N_HOR_CR	Display of operating hours of the recovery compressor (with active recovery)	0	0	0	h	Integer	R	12

## 16 - LIST OF PARAMETERS OF THE “MAIN MENU”

### Parameters of “INPUTS/OUTPUTS” (...continuation)

Screen	Parameter	Description of the parameter	Value	Min.	Max.	UOM	Type	R/W	Add. BMS
I08	DIN01_RTVI_VIRT	Status of digital input 1: indoor fan thermal protection and control of the air flow	0	0	1	---	Digital	R	
I08	DIN02_INC_VIRT	Status of digital input 2: gas detector (optional)	0	0	1	---	Digital	R	
I08	DIN03_AP1_VIRT	Status of digital input 3: high pressure pressostat of circuit 1	0	0	1	---	Digital	R	
I08	DIN04_TC1_VIRT	Status of digital input 4: thermal protection of compressors and outdoor fans of circuit 1	0	0	1	---	Digital	R	
I08	DIN05_TS_VIRT	Status of digital input 5: safety thermistor of electrical heaters / alarm signal of the gas burner (air-air units) or water floor switch (air-water units)	0	0	1	---	Digital	R	
I08	DIN06_FS_VIRT	Status of digital input 6: clogged filters detector (optional)	0	0	1	---	Digital	R	
I08	DIN07_ON_OFF_VIRT	Status of digital input 7: remote ON/OFF	0	0	1	---	Digital	R	
I08	DIN08_C_F_VIRT	Status of digital input 8: remote COOLING/HEATING	0	0	1	---	Digital	R	
I08	DIN09_AP2_VIRT	Status of digital input 9: high pressure pressostat of circuit 2	0	0	1	---	Digital	R	
I08	DIN10_TC2_VIRT	Status of digital input 10: thermal protection of compressors and outdoor fans of circuit 2	0	0	1	---	Digital	R	
I08	DIN11_BP1_VIRT	Status of digital input 11: low pressure pressostat of circuit 1	0	0	1	---	Digital	R	
I08	DIN12_BP2_VIRT	Status of digital input 12: low pressure pressostat of circuit 2	0	0	1	---	Digital	R	
I08	DIN13_AH_BAC_VIRT	Status of digital input 13: HWC antifreeze safety	0	0	1	---	Digital	R	
I08	DIN14_CR_VIRT	Status of digital input 14: safety of the recovery circuit (optional)	0	0	1	---	Digital	R	
I08a	DIN15_BP1_2_VIRT	Status of digital input 1 (pCOe card addr.7): low pressure pressostat of circuit 3	0	0	1	---	Digital	R	
I08a	DIN16_TC1_2_VIRT	Status of digital input 2 (pCOe card addr.7): thermal protection of compressors and outdoor fans of circuit 3	0	0	1	---	Digital	R	
I08a	DIN17_BP2_2_VIRT	Status of digital input 3 (pCOe card addr.7): low pressure pressostat of circuit 4	0	0	1	---	Digital	R	
I08a	DIN18_TC2_2_VIRT	Status of digital input 4 (pCOe card addr.7): thermal protection of compressors and outdoor fans of circuit 4	0	0	1	---	Digital	R	
I08a	DIN19_AP1_2_VIRT	Status of digital input 5 (pCOe card addr.7): high pressure pressostat of circuit 3	0	0	1	---	Digital	R	
I08a	DIN20_AP2_2_VIRT	Status of digital input 6 (pCOe card addr.7): high pressure pressostat of circuit 4	0	0	1	---	Digital	R	
I08b	DIN21_OFF_1ET_VIRT	Status of digital input 1 (pCOe card addr.8): mechanical disconnection of 1 stage of compressor	0	0	1	---	Digital	R	
I08b	DIN22_OFF_2ET_VIRT	Status of digital input 2 (pCOe card addr.8): mechanical disconnection of 2 stages of compressor	0	0	1	---	Digital	R	
I08b	DIN23_OFF_4ET_VIRT	Status of digital input 3 (pCOe card addr.8): mechanical disconnection of 4 stages of compressor	0	0	1	---	Digital	R	
I08b	DIN24_OFF_RES_VIRT	Status of digital input 4 (pCOe card addr.8): mechanical disconnection of electrical heaters	0	0	1	---	Digital	R	
I08c	DIN25_VIRT	Status of digital input 1 (pCOe card addr.9): supply damper of zone 1 (zoning in 2 zones with dampers)	0	0	1	---	Digital	R	
I08c	DIN26_VIRT	Status of digital input 2 (pCOe card addr.9): supply damper of zone 2 (zoning in 2 zones with dampers)	0	0	1	---	Digital	R	
I08c	DIN27_VIRT	Status of digital input 3 (pCOe card addr.9): return damper of zone 1 (zoning in 2 zones with dampers)	0	0	1	---	Digital	R	
I08c	DIN28_VIRT	Status of digital input 4 (pCOe card addr.9): return damper of zone 2 (zoning in 2 zones with dampers)	0	0	1	---	Digital	R	
I09	COMPRESOR_1	Status of contactor of compressor 1	0			---	Digital	R	16
I09	COMPRESOR_1_2	Status of contactor of compressor 2 of circuit 1 (2 circuit units) or compressor of circuit 2 (4 circuit units)	0			---	Digital	R	
I09	COMPRESOR_2	Status of contactor of compressor 2 of circuit 1 (1 circ. units) or compressor 1 of circuit 2 (2 circ. units) or compressor of circuit 3 (4 circ. units)	0			---	Digital	R	17
I09	COMPRESOR_2_2	Status of contactor of compressor 2 of circuit 2 (2 circuit units) or compressor of circuit 4 (4 circuit units)	0			---	Digital	R	
I09a	RES_ELECTRICA_1_O_VALV	Status of contactor of 1st stage of electrical heaters or gas burner or hot water coil valve	0			---	Digital	R	20
I09a	RES_ELECTRICA_2	Status of contactor of 2nd stage of electrical heaters	0			---	Digital	R	21
I10	OUT_VIC1	Status of cycle reversing valve of circuit 1	0	0	1	---	Digital	R	18
I10	OUT_VIC1_2	Status of cycle reversing valve of circuit 3 (4 circuit units)	0	0	1	---	Digital	R	147
I10	VENTILADOR_EXT_1	Status of outdoor fan(s) of circuit 1	0	0	1	---	Digital	R	23
I10	VENTILADOR_EXT_1_2	Status of outdoor fan(s) of circuit 2	0	0	1	---	Digital	R	149
I10a	OUT_VIC2	Status of cycle reversing valve of circuit 2	0	0	1	---	Digital	R	19
I10a	OUT_VIC2_2	Status of cycle reversing valve of circuit 4 (4 circuit units)	0	0	1	---	Digital	R	148
I10a	VENTILADOR_EXT_2	Status of outdoor fan(s) of circuit 3	0	0	1	---	Digital	R	24
I10a	VENTILADOR_EXT_2_2	Status of outdoor fan(s) of circuit 4	0	0	1	---	Digital	R	150
I10b	DOUT22_VIRT	Status of digital output 1 (pCOe card addr.9): opening signal of the supply damper of zone 1 (zoning in 2 zones with dampers)	0	0	1	---	Digital	R	

## 16 - LIST OF PARAMETERS OF THE “MAIN MENU”

### Parameters of “INPUTS/OUTPUTS” (...continuation)

Screen	Parameter	Description of the parameter	Value	Min.	Max.	UOM	Type	R/W	Add. BMS
I10b	DOUT23_VIRT	Status of digital output 2 (pCOe card addr.9): opening signal of the supply damper of zone 2 (zoning in 2 zones with dampers)	0	0	1	---	Digital	R	
I10b	DOUT24_VIRT	Status of digital output 3 (pCOe card addr.9): opening signal of the return damper of zone 1 (zoning in 2 zones with dampers)	0	0	1	---	Digital	R	
I10b	DOUT25_VIRT	Status of digital output 4 (pCOe card addr.9): opening signal of the return damper of zone 2 (zoning in 2 zones with dampers)	0	0	1	---	Digital	R	
I11	ON_VENTILADOR_INT	Status of indoor unit supply fan	0	0	1	---	Digital	R	15
I11	OUT_07	Status of output NO7 in which one of the following options can be connected: on-off humidifier, compressor of recovery circuit or circulation pump of the hot water coil	0			---	Digital	R	
I12	VIS_Y1_AOUT_COMPUERTA	Display of opening % of outdoor air damper (optional). Range vary between 0% (0V) and 100% (10V)	0	0	999	---	Integer	R	
I12	VIS_Y2	Display of opening % of output Y2 (0-10V), in which one of the following options can be connected: hot water coil, proportional electrical heater or gas burner	0	0	0	---	Integer	R	
I12a	VIS_Y3	Display of operating % of electronic outdoor fan(s) of circuit 1 (2 circuit units) or circuits 1 - 2 (4 circuit units) (connected on the analogue output Y3 of connector J5)	0	0	0	---	Integer	R	
I12a	VIS_Y4	Display of operating % of electronic outdoor fan(s) of circuit 2 (2 circuit units) or circuits 3 - 4 (4 circuit units) (connected on the analogue output Y4 of connector J5)	0	0	0	---	Integer	R	
I12b	VIS_Y5	Display of opening % of the damper for condensation / evaporation pressure control of the indoor unit (connected on the analogue output Y1 of the pCOe card addr.8)	0	0	999	---	Integer	R	
I12c	VIS_Y7	Display of operating % of the wheel (variable rotary heat exchanger)	0	0	100	---	Integer	R	
I13	PLAN_ADDRESS	Address of the unit on the pLAN network	0	0	32	---	Integer	R/W	
I13	UNIT_NET1 a UNIT_NET16	Display of the µPC MEDIUM boards connected on the pLAN network, as well as their position on the pLAN network. Number 16 is reserved for the shared terminal	0	0	32	---	Integer	R	
I14	PLAN_ADDRESS	Address of the unit on the pLAN network	0	0	32	---	Integer	R/W	
I13	UNIT_NET17 a UNIT_NET32	Display of the private pGD1 terminals connected on the pLAN network, as well as their position. The address of each terminal must coincide with the board to which it is associated +16.	0	0	32	---	Integer	R	
I15	MOD_MB_ENERGY_METERS_ CIAT_1.Energy_Address_Msk	Reading of the energy meter: address	0	0	254	---	Integer	R/W	
I15	MOD_MB_ENERGY_METERS_ CIAT_1.Voltage_L1_L2_L_SPV	Reading of the energy meter: voltage between phases L1-L2	0	0	99990	V	Integer	R	167
I15	MOD_MB_ENERGY_METERS_ CIAT_1.Voltage_L2_L3_L_SPV	Reading of the energy meter: voltage between phases L2-L3	0	0	99990	V	Integer	R	168
I15	MOD_MB_ENERGY_METERS_ CIAT_1.Voltage_L3_L1_L_SPV	Reading of the energy meter: voltage between phases L3-L1	0	0	99990	V	Integer	R	169
I15	MOD_MB_ENERGY_METERS_ CIAT_1.Voltage_1_L_SPV	Reading of the energy meter: voltage between phase and neutral L1	0	0	99990	V	Integer	R	170
I15	MOD_MB_ENERGY_METERS_ CIAT_1.Voltage_2_L_SPV	Reading of the energy meter: voltage between phase and neutral 2	0	0	99990	V	Integer	R	171
I15	MOD_MB_ENERGY_METERS_ CIAT_1.Voltage_3_L_SPV	Reading of the energy meter: voltage between phase and neutral 3	0	0	99990	V	Integer	R	172
I16	MOD_MB_ENERGY_METERS_ CIAT_1.Energy_Address_Msk	Reading of the energy meter: address	0	0	254	---	Integer	R/W	
I16	MOD_MB_ENERGY_METERS_ CIAT_1.Current_1_L_SPV	Reading of the energy meter: phase current L1	0.0	0.0	999.9	A	Analog.	R	131
I16	MOD_MB_ENERGY_METERS_ CIAT_1.Current_2_L_SPV	Reading of the energy meter: phase current L2	0.0	0.0	999.9	A	Analog.	R	132
I16	MOD_MB_ENERGY_METERS_ CIAT_1.Current_3_L_SPV	Reading of the energy meter: phase current L3	0.0	0.0	999.9	A	Analog.	R	133
I16	MOD_MB_ENERGY_METERS_ CIAT_1.Power_Factor_L_MSK	Reading of the energy meter: power factor	0	0	9	---	Integer	R	
I16	MOD_MB_ENERGY_METERS_ CIAT_1.Frequency	Reading of the energy meter: frequency	0.0	0.0	99.9	Hz	Analog.	R	142
I17	MOD_MB_ENERGY_METERS_ CIAT_1.Energy_Address_Msk	Reading of the energy meter: address	0	0	254	---	Integer	R/W	
I17	MOD_MB_ENERGY_METERS_ CIAT_1.Apparent_Power_1_L_SPV	Reading of the energy meter: reactive power phase L1	0.0	0.0	999.9	kVAr	Analog.	R	134
I17	MOD_MB_ENERGY_METERS_ CIAT_1.Apparent_Power_2_L_SPV	Reading of the energy meter: reactive power phase L2	0.0	0.0	999.9	kVAr	Analog.	R	135
I17	MOD_MB_ENERGY_METERS_ CIAT_1.Apparent_Power_3_L_SPV	Reading of the energy meter: reactive power phase L3	0.0	0.0	999.9	kVAr	Analog.	R	136
I17	MOD_MB_ENERGY_METERS_ CIAT_1.Apparent_Power_L_SPV	Reading of the energy meter: total reactive power	0000.0	0000.0	0999.9	---	Integer	R	
I17	MOD_MB_ENERGY_METERS_ CIAT_1.Apparent_Energy_M_MSK	Reading of the energy meter: equivalent reactive energy	0	0	999	---	Integer	R/W	
I18	MOD_MB_ENERGY_METERS_ CIAT_1.Energy_Address_Msk	Reading of the energy meter: address	0	0	254	---	Integer	R/W	

## 16 - LIST OF PARAMETERS OF THE "MAIN MENU"

### Parameters of "INPUTS/OUTPUTS" (...continuation)

Screen	Parameter	Description of the parameter	Value	Min.	Max.	UOM	Type	R/W	Add. BMS
I18	MOD_MB_ENERGY_METERS_CIAAT_1.Power_1_L_SPV	Reading of the energy meter: phase power L1	0.0	0.0	999.9	kW	Analog	R	137
I18	MOD_MB_ENERGY_METERS_CIAAT_1.Power_2_L_SPV	Reading of the energy meter: phase power L2	0.0	0.0	999.9	kW	Analog	R	138
I18	MOD_MB_ENERGY_METERS_CIAAT_1.Power_3_L_SPV	Reading of the energy meter: phase power L3	0.0	0.0	999.9	kW	Analog	R	139
I18	MOD_MB_ENERGY_METERS_CIAAT_1.Power_L_SPV	Reading of the energy meter: total power	0.0	0.0	999.9	kW	Analog	R	140
I18	MOD_MB_ENERGY_METERS_CIAAT_1.Energy_M_MSK	Reading of the energy meter: energy	0	0	999	---	Integer	R	
I18	MOD_MB_ENERGY_METERS_CIAAT_1.MWh	Reading of the energy meter: MWh	0	0	1	---	Digital	R	
I18	MOD_MB_ENERGY_METERS_CIAAT_1.Hourmeter_M_MSK	Reading of the energy meter: time (hours)	0	0	999	---	Integer	R	
I18a	MOD_MB_GAS_LEAKAGE_CIAAT_1.Detect_Device_Number_Tmp	Refrigerant gas detector number	1	1	247	---	Integer	R/W	
I18a	MOD_MB_GAS_LEAKAGE_CIAAT_1.Concentration_Percent	Reading of the gas leak detector: concentration (%)	0	0	100	%	Integer	R	
I18a	MOD_MB_GAS_LEAKAGE_CIAAT_1.Concentration_ppm	Reading of the gas leak detector: concentration (ppm)	0	0	32767	ppm	Integer	R	
I18a	MOD_MB_GAS_LEAKAGE_CIAAT_1.Red_Led	Reading of the gas leak detector: red led (1: Active; 0: Off)	0	0	1	---	Digital	R	
I18a	MOD_MB_GAS_LEAKAGE_CIAAT_1.Green_Led	Reading of the gas leak detector: green led (1: Active; 0: Off)	0	0	1	---	Digital	R	
I18a	MOD_MB_GAS_LEAKAGE_CIAAT_1.Relay_Status	Reading of the gas leak detector: relay (1: Active; 0: Off)	0	0	1	---	Digital	R	
I18b	ENTALPIA_MEZCLA_KCAL	Calculation of cooling and heating capacities: display of input enthalpy	0.0	0.0	99.9	Kcal/Kg	Analog	R	237
I18b	SONDA_MEZCLA_HUM	Calculation of cooling and heating capacities: supply probe - display of input humidity	50.0	0.0	99.9	%rH	Analog	R/W	232
I18b	SONDA_MEZCLA_TEMP	Calculation of cooling and heating capacities: mixing probe RS485 - display of input temperature	0.0	-999.9	999.9	°C	Analog	R	231
I18c	ENTALPIA_IMPULSION_KCAL	Calculation of cooling and heating capacities: display of output enthalpy	0.0	0.0	99.9	Kcal/Kg	Analog	R	238
I18c	SONDA_IMPULSION_HUM	Calculation of cooling and heating capacities: supply probe - display of output humidity	0.0	0.0	99.9	%rH	Analog	R	235
I18c	SONDA_IMPULSION_TEMP	Calculation of cooling and heating capacities: mixing probe RS485 - display of output temperature	0.0	-999.9	999.9	°C	Analog	R	234
I18c	MODO_FRIO	Calculation of cooling and heating capacities: operating mode	0	0	1	---	Digital	R	
I18d	SET_CAUDAL_VINT_CALOR	Calculation of cooling and heating capacities: display of supply flow	1200	0	9999	x10 m3/h	Integer	R/W	201
I18d	DIF_ENTALPIA_POT_TERMICA_KCAL	Calculation of cooling and heating capacities: display of the input-output enthalpy difference	0.0	0.0	99.9	KJ/Kg	Analog	R	
I18d	Densidad_aire_impulsion	Calculation of cooling and heating capacities: display of air density	0	0	9999	x10 g/m3	Integer	R	
I18d	Pot_termica	Calculation of cooling and heating capacities: display of total capacity	0.0	0.0	3276.7	KW	Analog	R	239
I18d	MOD_MB_ENERGY_METERS_CIAAT_1.Power_L_SPV	Calculation of cooling and heating capacities: display of electric power	0.0	0.0	999.9	kW	Analog	R	140
I18e	MODO_FRIO	Calculation of cooling and heating capacities: operating mode	0	0	1	---	Digital	R	
I18e	EER_COP	Calculation of cooling and heating capacities: display of EER / COP calculation	0.0	0.0	99.9	---	Analog	R	240
I18e	ON_COMPRESOR	Calculation of cooling and heating capacities: display of started compressors	0	0	1	---	Digital	R	186
I18e	PORC_COMPRESORES	Calculation of cooling and heating capacities: display of compressor stages (%)	0	0	999	%	Integer	R	
I18e	COMPRESOR_REC	Calculation of cooling and heating capacities: display of recovery compressor	0	0	1	---	Digital	R/W	117
I18e	RENOVACION_CAL	Calculation of cooling and heating capacities: display of air renewal calculated depending on the mixing probe or the CO2 probe	0	0	99	%	Integer	R	124
I18e	TEMP_INT	Calculation of cooling and heating capacities: display of indoor temperature used in the unit control	0.0	-99.9	99.9	°C	Analog	R/W	291
I18e	TEMP_EXT	Calculation of cooling and heating capacities: display of outdoor temperature	0.0	-99.9	99.9	°C	Analog	R/W	2
I19	INFO_EQUIPO_1	Unit information: air-air, water-air, cooling only, reversible heat pump	1	0	9	---	Integer	R	191
I19	INFO_EQUIPO_2	Information of compressors-circuits (0,1c,2c-1c,2c-2c,2c+p,2c en 3et,4c tandem, 4c-4c ) + recovery compressor	1	0	99	---	Integer	R	192
I19	UNICO_VOL_AIRE_EXT_CIRC_2	Enabling a single volume of outdoor air in units with 2 or 4 circuit	0	0	1	---	Digital	R	
I19	INFO_EQUIPO_3	Unit information: electrical heaters - gas burner - hot water coil	1	0	9	---	Integer	R	193
I19	TIPO_REFRIGERANTE	Refrigerant type (0=R22; 1=R134a; 2=R404A; 3=R407C; 4=R410A)	4	0	4	---	Integer	W	43

## 16 - LIST OF PARAMETERS OF THE "MAIN MENU"

### Parameters of "INPUTS/OUTPUTS" (...continuation)

Screen	Parameter	Description of the parameter	Value	Min.	Max.	UOM	Type	R/W	Add. BMS
I19	NUM_WO_DIG_1	Work order number of the unit (digit 1)	0	0	9	---	I	W	185
I19	NUM_WO_DIG_2	Work order number of the unit (digit 2)	0	0	9	---	I	W	186
I19	NUM_WO_DIG_3	Work order number of the unit (digit 3)	0	0	9	---	I	W	187
I19	NUM_WO_DIG_4	Work order number of the unit (digit 4)	0	0	9	---	I	W	188
I19	NUM_WO_DIG_5	Work order number of the unit (digit 5)	0	0	9	---	I	W	189
I19	NUM_WO_DIG_6	Work order number of the unit (digit 6)	0	0	9	---	I	W	190
I19	NUM_WO_DIG_7	Work order number of the unit (digit 7)	0	0	9	---	I	W	191
I19	NUM_WO_DIG_8	Work order number of the unit (digit 8)	0	0	9	---	I	W	192
I02zn	MOD_MB_UPC_ZONIFICA_CIAT_1.TEMP_TCO11	Visualization of the temperature measured by the terminal in zone 1 (zoning of the air flow)	0.0	-99.9	99.9	°C/°F	Analog	W	
I02zn	MOD_MB_UPC_ZONIFICA_CIAT_1.TEMP_TCO12	Visualization of the temperature measured by the terminal in zone 2 (zoning of the air flow)	0.0	-99.9	99.9	°C/°F	Analog	W	
I02zn	MOD_MB_UPC_ZONIFICA_CIAT_1.TEMP_TCO13	Visualization of the temperature measured by the terminal in zone 3 (zoning of the air flow)	0.0	-99.9	99.9	°C/°F	Analog	W	
I02zn	MOD_MB_UPC_ZONIFICA_CIAT_1.TEMP_TCO14	Visualization of the temperature measured by the terminal in zone 4 (zoning of the air flow)	0.0	-99.9	99.9	°C/°F	Analog	W	
I08zn	MOD_MB_UPC_ZONIFICA_CIAT_1.COMPUERTA_IMP_ZONA1_ABIERTA	Status of digital input 01 of SMALL board (addr.11): zoning of the air flow	0	0	1	---	Digital	W	
I08zn	MOD_MB_UPC_ZONIFICA_CIAT_1.COMPUERTA_IMP_ZONA2_ABIERTA	Status of digital input 02 of SMALL board (addr.11): zoning of the air flow	0	0	1	---	Digital	W	
I08zn	MOD_MB_UPC_ZONIFICA_CIAT_1.COMPUERTA_IMP_ZONA3_ABIERTA	Status of digital input 03 of SMALL board (addr.11): zoning of the air flow	0	0	1	---	Digital	W	
I08zn	MOD_MB_UPC_ZONIFICA_CIAT_1.COMPUERTA_IMP_ZONA4_ABIERTA	Status of digital input 04 of SMALL board (addr.11): zoning of the air flow	0	0	1	---	Digital	W	
I08zn	MOD_MB_UPC_ZONIFICA_CIAT_1.IN_DIG05_INC	Status of digital input 05 of SMALL board (addr.11): zoning of the air flow	0	0	1	---	Digital	W	
I08zn	MOD_MB_UPC_ZONIFICA_CIAT_1.IN_DIG06_RTVI	Status of digital input 06 of SMALL board (addr.11): zoning of the air flow	0	0	1	---	Digital	W	
I08zn	MOD_MB_UPC_ZONIFICA_CIAT_1.IN_DIG07_ON_OFF	Status of digital input 07 of SMALL board (addr.11): zoning of the air flow	0	0	1	---	Digital	W	
I09zn	MOD_MB_UPC_ZONIFICA_CIAT_1.APERTURA_COMPUERTA_IMP_ZONA1	Status of the supply damper in zone 1 (zoning)	0	0	1	---	Digital	W	
I09zn	MOD_MB_UPC_ZONIFICA_CIAT_1.APERTURA_COMPUERTA_IMP_ZONA2	Status of the supply damper in zone 2 (zoning)	0	0	1	---	Digital	W	
I09zn	MOD_MB_UPC_ZONIFICA_CIAT_1.APERTURA_COMPUERTA_IMP_ZONA3	Status of the supply damper in zone 3 (zoning)	0	0	1	---	Digital	W	
I09zn	MOD_MB_UPC_ZONIFICA_CIAT_1.APERTURA_COMPUERTA_IMP_ZONA4	Status of the supply damper in zone 4 (zoning)	0	0	1	---	Digital	W	
I09zn	MOD_MB_UPC_ZONIFICA_CIAT_1.DOUT5	Status of output No.5 of SMALL board (addr.11)	0	0	1	---	Digital	W	
I09zn	MOD_MB_UPC_ZONIFICA_CIAT_1.DOUT6	Status of output No.6 of SMALL board (addr.11)	0	0	1	---	Digital	W	
I09zn	MOD_MB_UPC_ZONIFICA_CIAT_1.DOUT7	Status of alarm relay of SMALL board (addr.11)	0	0	1	---	Digital	W	
I20	logo_bool	Type of logo	0	0	1	---	Digital	R/W	
I20	MOD_HWSW_CHK_CIAT_2_1.SwVerX_msk	Release version (high part)	9	1	99	---	Integer	R	
I20	MOD_HWSW_CHK_CIAT_2_1.SwVerY_msk	Release version (low part)	9	0	9	---	Integer	R	
I20	MOD_HWSW_CHK_CIAT_2_1.SwVerZ_msk	Sequential number	0	0	999	---	Integer	R	
I20	MOD_HWSW_CHK_CIAT_2_1.SwBetaOfficial_msk	If the software is a BETA version (0=Beta; 1=Official)	0	0	1	---	Digital	R	
I20	MOD_HWSW_CHK_CIAT_2_1.SwVerD_msk	Demo version	0	0	99	---	Integer	R	
I20	MOD_HWSW_CHK_CIAT_2_1.Sw_Day	Software: day	0	0	99	---	Integer	R	
I20	MOD_HWSW_CHK_CIAT_2_1.Sw_Month	Software: month	0	0	99	---	Integer	R	
I20	MOD_HWSW_CHK_CIAT_2_1.Sw_Year	Software: year	0	0	99	---	Integer	R	
I20	MOD_HWSW_CHK_CIAT_2_1.H_Bios_Release	Version number of the BIOS (high part)	0	0	9	---	Integer	R	
I20	MOD_HWSW_CHK_CIAT_2_1.L_Bios_Release	Version number of the BIOS (low part)	0	0	99	---	Integer	R	
I20	MOD_HWSW_CHK_CIAT_2_1.Bios_Day	BIOS: day	0	0	99	---	Integer	R	
I20	MOD_HWSW_CHK_CIAT_2_1.Bios_Month	BIOS: month	0	0	99	---	Integer	R	
I20	MOD_HWSW_CHK_CIAT_2_1.Bios_Year	BIOS: year	0	0	99	---	Integer	R	
I20	MOD_HWSW_CHK_CIAT_2_1.H_Boot_Release	Version number of the BOOT (high part)	0	0	9	---	Integer	R	
I20	MOD_HWSW_CHK_CIAT_2_1.L_Boot_Release	Version number of the BOOT (low part)	0	0	99	---	Integer	R	
I20	MOD_HWSW_CHK_CIAT_2_1.Boot_Day	BOOT: day	0	0	99	---	Integer	R	
I20	MOD_HWSW_CHK_CIAT_2_1.Boot_Month	BOOT: month	0	0	99	---	Integer	R	
I20	MOD_HWSW_CHK_CIAT_2_1.Boot_Year	BOOT: year	0	0	99	---	Integer	R	
I21	PCO_TYPE	Type of board	0	1	12	---	Integer	R/W	

## 16 - LIST OF PARAMETERS OF THE “MAIN MENU”

### Parameters of “INPUTS/OUTPUTS” (...continuation)

Screen	Parameter	Description of the parameter	Value	Min.	Max.	UOM	Type	R/W	Add. BMS
I21	BOARD_TYPE	Board size	0	0	99	---	Integer	R/W	
I21	MOD_HWSW_CHK_CIAT_2_1.pCO_Compact_Type_A	pCO Compact Type A	0	0	1	---	Digital	R	
I21	MEMORY_SIZE0	Flash memory	0	0	9999	---	Integer	R/W	
I21	MEMORY_SIZE1	RAM memory	0	0	9999	---	Integer	R/W	
I21	MOD_HWSW_CHK_CIAT_2_1.Builtin_DSP	Built-in type	0	0	9	---	Integer	R	
I21	MOD_HWSW_CHK_CIAT_2_1.Cycle_X_Sec	Program cycle	0.0	0.0	99.9	---	Analog.	R	
I21	MOD_HWSW_CHK_CIAT_2_1.Cycle_Time	Cycle/s	0	0	9999	---	Integer	R	

### Parameters of “UNIT ON/OFF”

Screen	Parameter	Description of the parameter	Value	Min.	Max.	UOM	Type	R/W	Add. BMS
PM01	SYS_ON	Selection of the unit ON/OFF by keyboard or remote: 0: Switch-off (Off) 1: Switch-on (On)	0	0	1	---	Digital	R/W	65

### Parameters of “WINTER/SUMMER”

Screen	Parameter	Description of the parameter	Value	Min.	Max.	UOM	Type	R/W	Add. BMS
FC01	SEL_FRIO_CALOR	Procedures for the selection of the COOLING/HEATING mode: 0: by keyboard 1: remote (digital input) 2: auto 3: only ventilation	0	0	3	---	Integer	R/W	59
FC01	MODO_FRIO_CALOR_AUTO	COOLING/HEATING selection in AUTO: 0: by indoor temperature 1: by outdoor temperature	1	0	1	---	Digital	R/W	232
FC01	CALOR_FRIO_PANEL	COOLING/HEATING selection by keyboard: 0: HEATING (winter) 1: COOLING (summer)	1			---	Digital	R/W	66
FC01	SET_TEMP_EXT_CAMBIO_FRIO	Outdoor temperature setpoint for change to COOLING mode (in AUTO mode)	22.0	99.9	99.9	°C	Analog.	R/W	223
FC01	SET_TEMP_EXT_CAMBIO_CALOR	Outdoor temperature setpoint for change to HEATING mode (in AUTO mode)	20.0	99.9	99.9	°C	Analog.	R/W	222
FC01	PGD1_bloqueado_SEL_FRIO_CALOR	Enabling of the blocking of summer / winter selection in the pGD1 (so that the final user cannot change it)	0	0	1	---	Digital	R/W	240

### Parameters of “SCHEDULE PROGRAMMING”

Screen	Parameter	Description of the parameter	Value	Min.	Max.	UOM	Type	R/W	Add. BMS
PH01	TIPO_RELOJ	Type of clock (No, Actual, pLAN)	1	0	0	---	Integer	R/W	57
PH01	HORA	Setting the clock: hour	0	0	0	h	Integer	R/W	48
PH01	NEW_HOUR	Setting the clock: new hour	0	0	23	h	Integer	R/W	
PH01	NEW_MINUTE	Setting the clock: new minute	0	0	59	---	Integer	R/W	
PH01	MINUTO	Setting the clock: minute	0	0	0	min	Integer	R/W	47
PH01	NEW_DAY	Setting the clock: new day	0	0	31	---	Integer	R/W	
PH01	DIA	Setting the clock: day	0	0	0	day	Integer	R/W	49
PH01	NEW_MONTH	Setting the clock: new month	0	0	12	---	Integer	R/W	
PH01	MES	Setting the clock: month	0	0	0	month	Integer	R/W	50
PH01	ANO	Setting the clock: year	0	0	0	year	Integer	R/W	51
PH01	NEW_YEAR	Setting the clock: new year	0	0	99	---	Integer	R/W	
PH01	DIA_SEMANA	Day of the week	0	0	0	day	Integer	R/W	52
PH02	MOD_DST_CIAT_1.En_DST	Activation of the schedule programming	1	0	1	---	Digital	R/W	
PH02	MOD_DST_CIAT_1.DST_Minute	Transition time: it is necessary to add 60 minutes, thus obtaining the summer schedule (hourly changes in the European Union)	0	0	240	---	Integer	R/W	
PH02	MOD_DST_CIAT_1.Srt_DST_MonthW	Starting date for the implementation of change: day of the month	0	0	4	---	Integer	R/W	

## 16 - LIST OF PARAMETERS OF THE “MAIN MENU”

### Parameters of “SCHEDULE PROGRAMMING” (...continuation)

Screen	Parameter	Description of the parameter	Value	Min.	Max.	UOM	Type	R/W	Add. BMS
PH02	MOD_DST_CIAT_1.Srt_DST_Week	Starting date for the implementation of change: week	0	0	7	---	Integer	R/W	
PH02	MOD_DST_CIAT_1.Srt_DST_Month	Starting date for the implementation of change: month	0	0	12	---	Integer	R/W	
PH02	MOD_DST_CIAT_1.Srt_DST_Hour	Starting date for the implementation of change: hour	0	0	23	---	Integer	R/W	
PH02	MOD_DST_CIAT_1.End_DST_MonthW	Completion date for the implementation of change: day of the month	0	0	4	---	Integer	R/W	
PH02	MOD_DST_CIAT_1.End_DST_Week	Completion date for the implementation of change: week	0	1	7	---	Integer	R/W	
PH02	MOD_DST_CIAT_1.End_DST_Month	Completion date for the implementation of change: month	0	1	12	---	Integer	R/W	
PH02	MOD_DST_CIAT_1.End_DST_Hour	Completion date for the implementation of change: hour	0	0	23	---	Integer	R/W	
PH03	TIPO_PROG_HORARIA	Type of start-up: 0 = ON/OFF schedule 1 = Schedule only setpoint change 2 = ON/OFF schedule with limit SET of ON 3 = Forced 4 = 3 setpoints schedule + OFF of unit	3	0	4	---	Integer	R/W	71
PH03	ARR_FORZADO	Forced start-up	0			---	Digital	R/W	120
PH03	TIME_ARR_FORZADO	On time with forced start-up	2	1	999	h	Integer	R/W	73
PH03	HAB_BLOQ_COMP_ON_FASE_LIM_FRIO	Disable the compressors in summer with “ON/OFF schedule with limit SET of ON” (nocturnal freecooling)	0	0	1	---	Digital	R/W	72
PH03	HAB_BLOQ_RENOVACION_ON_FASE_LIM	Disable the outdoor air renewal with “ON/OFF schedule with limit SET of ON” (nocturnal operation)	0	0	1	---	Digital	R/W	73
PH04	H_ARR_1A	Start-up hour of slot 1- program 1	6	0	23	h	Integer	R/W	74
PH04	M_ARR_1A	Start-up minute of slot 1-program 1	30	0	59	min	Integer	R/W	75
PH04	H_PAR_1A	Stop hour of slot 1 - program 1	11	0	23	h	Integer	R/W	76
PH04	M_PAR_1A	Stop minute of slot 1 - program 1	0	0	59	min	Integer	R/W	77
PH04	H_ARR_1B	Start-up hour of slot 2 - program 1	11	0	23	h	Integer	R/W	78
PH04	M_ARR_1B	Start-up minute of slot 2 - program 1	30	0	59	min	Integer	R/W	79
PH04	H_PAR_1B	Stop hour of slot 2 - program 1	13	0	23	h	Integer	R/W	80
PH04	M_PAR_1B	Stop minute of slot 2 - program 1	30	0	59	min	Integer	R/W	81
PH04	H_ARR_1C	Start-up hour of slot 3 - program 1	15	0	23	h	Integer	R/W	82
PH04	M_ARR_1C	Start-up minute of slot 3 - program 1	0	0	59	min	Integer	R/W	83
PH04	H_PAR_1C	Stop hour of slot 3 - program 1	19	0	23	h	Integer	R/W	84
PH04	M_PAR_1C	Stop minute of slot 3 - program 1	0	0	59	min	Integer	R/W	85
PH05	H_ARR_2A	Start-up hour of slot1 - program 2	8	0	23	h	Integer	R/W	86
PH05	M_ARR_2A	Start-up minute of slot 1 - program 2	0	0	59	min	Integer	R/W	87
PH05	H_PAR_2A	Stop hour of slot 1 - program 2	14	0	23	h	Integer	R/W	88
PH05	M_PAR_2A	Stop minute of slot 1 - program 2	0	0	59	min	Integer	R/W	89
PH05	H_ARR_2B	Start-up hour of slot 2 - program 2	17	0	23	h	Integer	R/W	90
PH05	M_ARR_2B	Start-up minute of slot 2 - program 2	0	0	59	min	Integer	R/W	91
PH05	H_PAR_2B	Stop hour of slot 2 - program 2	20	0	23	h	Integer	R/W	92
PH05	M_PAR_2B	Stop minute of slot 2 - program 2	30	0	59	min	Integer	R/W	93
PH05	H_ARR_2C	Start-up hour of slot 3 - program 2	0	0	23	h	Integer	R/W	94
PH05	M_ARR_2C	Start-up minute of slot 3 - program 2	0	0	59	min	Integer	R/W	95
PH05	H_PAR_2C	Stop hour of slot 3 - program 2	0	0	23	h	Integer	R/W	96
PH05	M_PAR_2C	Stop minute of slot 3 - program 2	0	0	59	min	Integer	R/W	97
PH06	H_ARR_3A	Start-up hour of slot 1 - program 3	7	0	23	h	Integer	R/W	98
PH06	M_ARR_3A	Start-up minute of slot 1 - program 3	0	0	59	min	Integer	R/W	99
PH06	H_PAR_3A	Stop hour of slot 1 - program 3	15	0	23	h	Integer	R/W	100
PH06	M_PAR_3A	Stop minute of slot 1 - program 3	0	0	59	min	Integer	R/W	101
PH06	H_ARR_3B	Start-up hour of slot 2 - program 3	0	0	23	h	Integer	R/W	102
PH06	M_ARR_3B	Start-up minute of slot 2 - program 3	0	0	59	min	Integer	R/W	103
PH06	H_PAR_3B	Stop hour of slot 2 - program 3	0	0	23	h	Integer	R/W	104
PH06	M_PAR_3B	Stop minute of slot 2 - program 3	0	0	59	min	Integer	R/W	105
PH06	H_ARR_3C	Start-up hour of slot 3 - program 3	0	0	23	h	Integer	R/W	106
PH06	M_ARR_3C	Start-up minute of slot 3 - program 3	0	0	59	min	Integer	R/W	107
PH06	H_PAR_3C	Stop hour of slot 3 - program 3	0	0	23	h	Integer	R/W	108
PH06	M_PAR_3C	Stop minute of slot 3 - program 3	0	0	59	min	Integer	R/W	109
PH07	SET_INT_FRIO	Schedule only setpoint change: internal Set in summer	26.0	-99.9	99.9	°C	Analog.	R/W	61
PH07	SET_EXT_FRIO	Schedule only setpoint change: external Set in summer	28.0	-99.9	99.9	°C	Analog.	R/W	59



# 16 - LIST OF PARAMETERS OF THE “MAIN MENU”

## Parameters of “SCHEDULE PROGRAMMING” (...continuation)

Screen	Parameter	Description of the parameter	Value	Min.	Max.	UOM	Type	R/W	Add. BMS
PH08	SET_INT_CALOR	Schedule only setpoint change: internal Set in winter	21.0	-99.9	99.9	°C	Analog	R/W	60
PH08	SET_EXT_CALOR	Schedule only setpoint change: external Set in winter	19.0	-99.9	99.9	°C	Analog	R/W	58
PH09	SET_INT_LIM_FRIO	ON/OFF schedule with limit SET of ON (summer): internal Set	26.0	-99.9	99.9	°C	Analog	R/W	79
PH09	SET_EXT_LIM_FRIO	ON/OFF schedule with limit SET of ON (summer): limit Set	34.0	-99.9	99.9	°C	Analog	R/W	77
PH10	SET_INT_LIM_CALOR	ON/OFF schedule with limit SET of ON (winter): internal Set	21.0	-99.9	99.9	°C	Analog	R/W	78
PH10	SET_EXT_LIM_CALOR	ON/OFF schedule with limit SET of ON (winter): limit Set	13.0	-99.9	99.9	°C	Analog	R/W	76
PH11	DIF_LIM_CALOR	ON/OFF schedule with limit SET of ON (winter): differential	1.0	0.0	99.9	°C	Analog	R/W	81
PH11	DIF_LIM_FRIO	ON/OFF schedule with limit SET of ON (summer): differential	2.0	0.0	99.9	°C	Analog	R/W	80
PH12	LUN_A	Monday schedule (0 = off; 1 = prog. 1; 2 = prog. 2; 3 = prog. 3)	1	0	3	---	Integer	R/W	110
PH12	MAR_A	Tuesday schedule (0 = off; 1 = prog. 1; 2 = prog. 2; 3 = prog. 3)	1	0	3	---	Integer	R/W	111
PH12	MIE_A	Wednesday schedule (0 = off; 1 = prog. 1; 2 = prog. 2; 3 = prog. 3)	1	0	3	---	Integer	R/W	112
PH12	JUE_A	Thursday schedule (0 = off; 1 = prog. 1; 2 = prog. 2; 3 = prog. 3)	1	0	3	---	Integer	R/W	113
PH12	VIE_A	Friday schedule (0 = off; 1 = prog. 1; 2 = prog. 2; 3 = prog. 3)	3	0	3	---	Integer	R/W	114
PH12	SAB_A	Saturday schedule (0 = off; 1 = prog. 1; 2 = prog. 2; 3 = prog. 3)	0	0	3	---	Integer	R/W	115
PH12	DOM_A	Sunday schedule (0 = off; 1 = prog. 1; 2 = prog. 2; 3 = prog. 3)	0	0	3	---	Integer	R/W	116
PH12	DIA_SEMANA	Weekday	0	0	0	day	Integer	R/W	52
PH13	MOD_SCHED_GRAPH_CIAT_1.FH1_Day_Prg	Schedule day FH1 -- 0=don - 6=sab	0	0	6	---	Integer	R/W	
PH13	MOD_SCHED_GRAPH_CIAT_1.FH1_Day_Copy	Day of copy FH1 -- 0=dom - 6=sab	0	0	6	---	Integer	R/W	
PH13	MOD_SCHED_GRAPH_CIAT_1.FH1_Copy	Enabling copy of the daily program	0	0	1	---	Digital	R/W	
PH13	MOD_SCHED_GRAPH_CIAT_1.Hour_Start_Pointer	Current start hour in programming	0	0	23	---	Integer	R	
PH13	MOD_SCHED_GRAPH_CIAT_1.En_Pointer	Enabling graphic programming	0	0	1	---	Digital	R	
PH13	MOD_SCHED_GRAPH_CIAT_1.Minute_Start_Pointer	Current start minute in programming	0	0	23	---	Integer	R	
PH13	MOD_SCHED_GRAPH_CIAT_1.Hour_End_Pointer	Current end hour in programming	0	0	23	---	Integer	R	
PH13	MOD_SCHED_GRAPH_CIAT_1.Minute_End_Pointer	Current end minute in programming	0	0	23	---	Integer	R	
PH13	MOD_SCHED_GRAPH_CIAT_1.Loaded	Load of FH data	0	0	1	---	Digital	R	
PH13	MOD_SCHED_GRAPH_CIAT_1.Fh_00_00	Schedule 00:00	0	0	Set_Limit	---	Integer	R/W	
PH13	MOD_SCHED_GRAPH_CIAT_1.Fh_00_30	Schedule 00:30	0	0	Set_Limit	---	Integer	R/W	
PH13	MOD_SCHED_GRAPH_CIAT_1.Fh_01_00	Schedule 01:00	0	0	Set_Limit	---	Integer	R/W	
PH13	MOD_SCHED_GRAPH_CIAT_1.Fh_01_30	Schedule 01:30	0	0	Set_Limit	---	Integer	R/W	
PH13	MOD_SCHED_GRAPH_CIAT_1.Fh_02_00	Schedule 02:00	0	0	Set_Limit	---	Integer	R/W	
PH13	MOD_SCHED_GRAPH_CIAT_1.Fh_02_30	Schedule 02:30	0	0	Set_Limit	---	Integer	R/W	
PH13	MOD_SCHED_GRAPH_CIAT_1.Fh_03_00	Schedule 03:00	0	0	Set_Limit	---	Integer	R/W	
PH13	MOD_SCHED_GRAPH_CIAT_1.Fh_03_30	Schedule 03:30	0	0	Set_Limit	---	Integer	R/W	
PH13	MOD_SCHED_GRAPH_CIAT_1.Fh_04_00	Schedule 04:00	0	0	Set_Limit	---	Integer	R/W	
PH13	MOD_SCHED_GRAPH_CIAT_1.Fh_04_30	Schedule 04:30	0	0	Set_Limit	---	Integer	R/W	
PH13	MOD_SCHED_GRAPH_CIAT_1.Fh_05_00	Schedule 05:00	0	0	Set_Limit	---	Integer	R/W	
PH13	MOD_SCHED_GRAPH_CIAT_1.Fh_05_30	Schedule 05:30	0	0	Set_Limit	---	Integer	R/W	
PH13	MOD_SCHED_GRAPH_CIAT_1.Fh_06_00	Schedule 06:00	0	0	Set_Limit	---	Integer	R/W	
PH13	MOD_SCHED_GRAPH_CIAT_1.Fh_06_30	Schedule 06:30	0	0	Set_Limit	---	Integer	R/W	
PH13	MOD_SCHED_GRAPH_CIAT_1.Fh_07_00	Schedule 07:00	0	0	Set_Limit	---	Integer	R/W	
PH13	MOD_SCHED_GRAPH_CIAT_1.Fh_07_30	Schedule 07:30	0	0	Set_Limit	---	Integer	R/W	
PH13	MOD_SCHED_GRAPH_CIAT_1.Loaded	Load of FH data	0	0	1	---	Digital	R	
PH13	MOD_SCHED_GRAPH_CIAT_1.Fh_08_00	Schedule 08:00	0	0	Set_Limit	---	Integer	R/W	
PH13	MOD_SCHED_GRAPH_CIAT_1.Fh_08_30	Schedule 08:30	0	0	Set_Limit	---	Integer	R/W	
PH13	MOD_SCHED_GRAPH_CIAT_1.Fh_09_00	Schedule 09:00	0	0	Set_Limit	---	Integer	R/W	
PH13	MOD_SCHED_GRAPH_CIAT_1.Fh_09_30	Schedule 09:30	0	0	Set_Limit	---	Integer	R/W	
PH13	MOD_SCHED_GRAPH_CIAT_1.Fh_10_00	Schedule 10:00	0	0	Set_Limit	---	Integer	R/W	
PH13	MOD_SCHED_GRAPH_CIAT_1.Fh_10_30	Schedule 10:30	0	0	Set_Limit	---	Integer	R/W	

## 16 - LIST OF PARAMETERS OF THE “MAIN MENU”

### Parameters of “SCHEDULE PROGRAMMING” (...continuation)

Screen	Parameter	Description of the parameter	Value	Min.	Max.	UOM	Type	R/W	Add. BMS
PH13	MOD_SCHED_GRAPH_CIAT_1.Fh_11_00	Schedule 11:00	0	0	Set_Limit	---	Integer	R/W	
PH13	MOD_SCHED_GRAPH_CIAT_1.Fh_11_30	Schedule 11:30	0	0	Set_Limit	---	Integer	R/W	
PH13	MOD_SCHED_GRAPH_CIAT_1.Fh_12_00	Schedule 12:00	0	0	Set_Limit	---	Integer	R/W	
PH13	MOD_SCHED_GRAPH_CIAT_1.Fh_12_30	Schedule 12:30	0	0	Set_Limit	---	Integer	R/W	
PH13	MOD_SCHED_GRAPH_CIAT_1.Fh_13_00	Schedule 13:00	0	0	Set_Limit	---	Integer	R/W	
PH13	MOD_SCHED_GRAPH_CIAT_1.Fh_13_30	Schedule 13:30	0	0	Set_Limit	---	Integer	R/W	
PH13	MOD_SCHED_GRAPH_CIAT_1.Fh_14_00	Schedule 14:00	0	0	Set_Limit	---	Integer	R/W	
PH13	MOD_SCHED_GRAPH_CIAT_1.Fh_14_30	Schedule 14:30	0	0	Set_Limit	---	Integer	R/W	
PH13	MOD_SCHED_GRAPH_CIAT_1.Fh_15_00	Schedule 15:00	0	0	Set_Limit	---	Integer	R/W	
PH13	MOD_SCHED_GRAPH_CIAT_1.Fh_15_30	Schedule 15:30	0	0	Set_Limit	---	Integer	R/W	
PH13	MOD_SCHED_GRAPH_CIAT_1.Loaded	Load of FH data	0	0	1	---	Digital	R	
PH13	MOD_SCHED_GRAPH_CIAT_1.Fh_16_00	Schedule 16:00	0	0	Set_Limit	---	Integer	R/W	
PH13	MOD_SCHED_GRAPH_CIAT_1.Fh_16_30	Schedule 16:30	0	0	Set_Limit	---	Integer	R/W	
PH13	MOD_SCHED_GRAPH_CIAT_1.Fh_17_00	Schedule 17:00	0	0	Set_Limit	---	Integer	R/W	
PH13	MOD_SCHED_GRAPH_CIAT_1.Fh_17_30	Schedule 17:30	0	0	Set_Limit	---	Integer	R/W	
PH13	MOD_SCHED_GRAPH_CIAT_1.Fh_18_00	Schedule 18:00	0	0	Set_Limit	---	Integer	R/W	
PH13	MOD_SCHED_GRAPH_CIAT_1.Fh_18_30	Schedule 18:30	0	0	Set_Limit	---	Integer	R/W	
PH13	MOD_SCHED_GRAPH_CIAT_1.Fh_19_00	Schedule 19:00	0	0	Set_Limit	---	Integer	R/W	
PH13	MOD_SCHED_GRAPH_CIAT_1.Fh_19_30	Schedule 19:30	0	0	Set_Limit	---	Integer	R/W	
PH13	MOD_SCHED_GRAPH_CIAT_1.Fh_20_00	Schedule 20:00	0	0	Set_Limit	---	Integer	R/W	
PH13	MOD_SCHED_GRAPH_CIAT_1.Fh_20_30	Schedule 20:30	0	0	Set_Limit	---	Integer	R/W	
PH13	MOD_SCHED_GRAPH_CIAT_1.Fh_21_00	Schedule 21:00	0	0	Set_Limit	---	Integer	R/W	
PH13	MOD_SCHED_GRAPH_CIAT_1.Fh_21_30	Schedule 21:30	0	0	Set_Limit	---	Integer	R/W	
PH13	MOD_SCHED_GRAPH_CIAT_1.Fh_22_00	Schedule 22:00	0	0	Set_Limit	---	Integer	R/W	
PH13	MOD_SCHED_GRAPH_CIAT_1.Fh_22_30	Schedule 22:30	0	0	Set_Limit	---	Integer	R/W	
PH13	MOD_SCHED_GRAPH_CIAT_1.Fh_23_00	Schedule 23:00	0	0	Set_Limit	---	Integer	R/W	
PH13	MOD_SCHED_GRAPH_CIAT_1.Fh_23_30	Schedule 23:30	0	0	Set_Limit	---	Integer	R/W	
PH14	SET_INT_FRIO	Setpoint for COMFORT time slots in summer	26.0	-99.9	99.9	°C	Analog.	R/W	61
PH14	SET_EXT_FRIO	Setpoint for ECONOMY time slots in summer	28.0	-99.9	99.9	°C	Analog.	R/W	59
PH14	SET_EXT_LIM_FRIO	Setpoint for BUILDING PROTECTION time slots in summer	34.0	-99.9	99.9	°C	Analog.	R/W	77
PH14	DIF_LIM_FRIO	Differential for setpoint of BUILDING PROTECTION in summer	2.0	0.0	99.9	°C	Analog.	R/W	80
PH15	SET_INT_CALOR	Setpoint for COMFORT time slots in winter	21.0	-99.9	99.9	°C	Analog.	R/W	60
PH15	SET_EXT_CALOR	Setpoint for ECONOMY time slots in winter	19.0	-99.9	99.9	°C	Analog.	R/W	58
PH15	SET_EXT_LIM_CALOR	Setpoint for BUILDING PROTECTION time slots in winter	13.0	-99.9	99.9	°C	Analog.	R/W	76
PH15	DIF_LIM_CALOR	Differential for setpoint of BUILDING PROTECTION in winter	1.0	0.0	99.9	°C	Analog.	R/W	81
PH16	ThTune_clock_hours	Display of data from the TCO terminal: hour	0	0	99	---	Integer	R	
PH16	ThTune_clock_minutes	Display of data from the TCO terminal: minutes	0	0	99	---	Integer	R	
PH16	NEW_DAY	Display of data from the TCO terminal: day	0	0	31	---	Integer	R/W	
PH16	NEW_MONTH	Display of data from the TCO terminal: month	0	0	12	---	Integer	R/W	
PH16	NEW_YEAR	Display of data from the TCO terminal: year	0	0	99	---	Integer	R/W	
PH16	ThTune_clock_weekday	Display of data from the TCO terminal: weekday	0	1	7	---	Integer	R	
PH17	HAB_PROG_HORARIA_CLOCK_KEY	Display of data from the TCO terminal: ON/OFF schedule prog.	0	0	1	---	Digital	R	
PH17	ThTune_Temperature_setpoint	Display of data from the TCO terminal: temperature setpoint	0.0	0.0	99.9	---	Analog.	R/W	
PH17	Current_Timeband_Icon	Display of data from the TCO terminal: current band of schedule prog.	0	0	6	---	Integer	R/W	

### Parameters of “GAS BURNER”

Screen	Parameter	Description of the parameter	Value	Min.	Max.	UOM	Type	R/W	Add. BMS
G01	CONTROL_QUEMADOR_GAS	Control of the gas burner or gas boiler: 0 = burner/boiler as 2nd stage; 1 = only burner/boiler 2 = only burner/boiler with low outdoor temperature	0	0	2	---	Integer	R/W	2
G01	SET_QUEMADOR_BAJA_TEXT	Setpoint of outdoor temperature below which the burner/boiler is activated instead of compressors	5.0	-10.0	10.0	°C	Analog.	R/W	120

# 17 - LIST OF PARAMETERS OF THE "TECHNICAL MENU"

## 17.1. Parameters of the USER screens

The USER screen group is protected by an access key. If this password has to be known: please consult.

### USER screens → CONTROL

Screen	Parameter	Description of the parameter	Value	Min.	Max.	UOM	Type	R/W	Add. BMS
L01	LANGUAGE	Selection of the language of the software installed: 0=Spanish; 1=French; 2=English; 3=Italian; 4=Turc; 5=German	0	0	5	---	Integer	R/W	63
U01	LIM_SUP_TEMP_FRIO	Upper limit of temperature setpoint in COOLING mode (summer)	30,0	20	50	°C	Analog.	R/W	19
U01	LIM_INF_TEMP_FRIO	Lower limit of temperature setpoint in COOLING mode (summer)	15,0	0	30	°C	Analog.	R/W	20
U01a	LIM_SUP_TEMP_CALOR	Upper limit of temperature setpoint in HEATING mode (winter)	30,0	20	50	°C	Analog.	R/W	148
U01a	LIM_INF_TEMP_CALOR	Lower limit of temperature setpoint in HEATING mode (winter)	15,0	0	30	°C	Analog.	R/W	149
U02	BANDA_TEMP_FRIO	Control band of temperature in COOLING mode (summer)	2°C	0	15	°C	Analog.	R/W	21
U02	BANDA_TEMP_CALOR	Control band of temperature in HEATING mode (winter)	2°C	0	15	°C	Analog.	R/W	22
U03	ZONA_MUERTA_TEMP	Dead zone of temperature control	0,0	0	3	°C	Analog.	R/W	39
U04	LIM_INF_HUM	Lower limit of humidity setpoint	25,0	0	LIM_SUP_HUM	%rH	Analog.	R/W	24
U04	LIM_SUP_HUM	Upper limit of humidity setpoint	80,0	LIM_INF_HUM	99,9	%rH	Analog.	R/W	23
U05	BANDA_HUMEDAD	Humidity control band	5,0	0	99,9	%rH	Analog.	R/W	17
U05	ZONA_MUERTA_HUM	Dead zone of humidity control	4,0	0	50	%rH	Analog.	R/W	40
U07	DELTA_FREE_COOL	Differential between outdoor temperature and return temperature to enable free-cooling function	3,0	0	15	°C	Analog.	R/W	27
U07	MAX_APERTURA_COMPUERTA_FREE	Maximum opening of the outdoor air damper with freecooling or freeheating	100 (*)	0	100	%	Integer	R/W	208
U08	PR_ENT_DIF	Delta of enthalpy to enable freecooling (whole part)	1	0	30	kc/kg	Integer	R/W	20
U08	SEC_ENT_DIF	Delta of enthalpy to enable freecooling (decimal part)	0	0	999	kc/kg	Integer	R/W	21
U08	MAX_APERTURA_COMPUERTA_FREE	Maximum opening of outdoor air damper with freecooling or freeheating	100 (*)	0	100	%	Integer	R/W	208
U09	OFFSET_FCOOL	Offset of the free-cooling damper with regard to the setpoint in COOLING mode (summer)	-2,0	-5	5	°C	Analog.	R/W	28
U09	DIF_FCOOL	Differential of the free-cooling damper with regard to the setpoint in COOLING mode (summer)	2,0	0	5	°C	Analog.	R/W	29
U10	OFFSET_FHEAT	Offset of the free-cooling damper with regard to the setpoint in HEATING mode (winter)	-2,0	-5	5	°C	Analog.	R/W	30
U10	DIF_FHEAT	Differential of the free-cooling damper with regard to the setpoint in HEATING mode (winter): Differential	2,0	0	5	°C	Analog.	R/W	31
U11	SET_RENOVACION	% Outdoor air for renewal	20% 60% (recov.)	0	99	%	Integer	R/W	36
U11b	POS_COMPUERTA_CALOR_AL_INICIO	Outdoor damper in the start-up in HEATING mode (winter)	1:	0: Normal 1: Closed		---	Digital	R/W	54
U11b	POS_COMPUERTA_FRIO_AL_INICIO	Outdoor damper in the start-up in COOLING mode (summer)	0	0: Normal 1: Closed		---	Digital	R/W	243
U11b	MIN_APERTURA_COMPUERTA	Minimum opening of the outdoor air damper	0	0	100	%	Integer	R/W	165
U11b	MAX_APERTURA_COMPUERTA	Maximum opening of the outdoor air damper	100 (*)	0	100	%	Integer	R/W	131
U11c	TIME APERTURA_COMPUERTA	Opening time of the outdoor air damper	90	0	999	s	Integer		
U11c	SET_POINT_FRIO_ON_EQUIPO	Temperature setpoint in COOLING mode for unit ON with 100% outdoor air	30,0	-99,9	99,9	°C	Analog.		
U11c	SET_POINT_CALOR_ON_EQUIPO	Temperature setpoint in HEATING mode for unit ON with 100% outdoor air	17,0	-99,9	99,9	°C	Analog.		
U11d	TIME_RET_ON_VINT	Delay in opening of supply and return dampers with regard to the indoor fan connection	150	0	999	s	Integer	R/W	216
U12b	OFFSET_CAL_IMP_FRIO	Compensation between ambient temperature and supply temperature for the supply temperature control in COOLING mode (summer)	17,0	0	30	°C	Analog.	R/W	114
U12b	SET_IMPULSION_FRIO_MIN	Minimum setpoint for the supply temperature control in COOLING mode (summer)	10,0	0	SET_IMPULSION_FRIO_MAX	°C	Analog.	R/W	32
U12b	SET_IMPULSION_FRIO_MAX	Maximum setpoint for the supply temperature control in COOLING mode (summer)	22,0	SET_IMPULSION_FRIO_MIN	30	°C	Analog.	R/W	115
U12b	BANDA_IMP_FRIO	Differential for the supply temperature control in COOLING mode (summer)	5,0	0	20	°C	Analog.	R/W	33
U12c	OFFSET_CAL_IMP_CALOR	Compensation between ambient temperature and supply temperature for the supply temperature control in HEATING mode (winter)	25,0	0	30	°C	Analog.	R/W	112
U12c	SET_IMPULSION_CALOR_MIN	Minimum setpoint for the supply temperature control in HEATING mode (winter)	30,0	25	SET_IMPULSION_CALOR_MAX	°C	Analog.	R/W	113
U12a	SET_IMPULSION_CALOR_MAX	Maximum setpoint for the supply temperature control in HEATING mode (winter)	45,0	SET_IMPULSION_CALOR_MIN	55	°C	Analog.	R/W	83

(\*) Maximum opening of the outdoor damper of 75% in Space PF 650 to 1200

# 17 - LIST OF PARAMETERS OF THE "TECHNICAL MENU"

## USER screens → CONTROL (...continuation)

Screen	Parameter	Description of the parameter	Value	Min.	Max.	UOM	Type	R/W	Add. BMS
U12a U12c	BANDA_IMP_CALOR	Differential for the supply temperature control in HEATING mode (winter)	20,0	0	20	°C	Analog	R/W	84
U12d	SP_CO2	Setpoint of the outdoor probe for CO2 air quality control (ppm).	1000	-32767	32767	ppm	Integer	R/W	4
U12d	DIF_CO2	Differential of the outdoor probe for CO2 quality control (ppm)	500	-32767	32767	ppm	Integer	R/W	5
U12d	LIM_MIN_SET_RENOVACION_CON_CO2	Minimum opening of the outdoor air damper for AIR RENEWAL with CO2 probe	0	0	100	%	Integer	R/W	257
U12d	TIME_SET_RENOVACION_CON_CO2	Time with minimum opening of the outdoor air damper for AIR RENEWAL with CO2 probe	60	0	999	s	Integer	R/W	258
U12d	LIM_MAX_SET_RENOVACION_CON_CO2	Maximum opening of the outdoor air damper for AIR RENEWAL with CO2 probe	100	0	100	%	Integer	R/W	233
U12e	SP_LIM_CO2_EXTERIOR	Setpoint of minimum outdoor temperature to start the compensation control in COOLING mode (summer). From this value the outdoor damper is closed.	2000	0	5000	ppm	Integer	R/W	248
U12e	DIF_LIM_CO2_EXTERIOR	Differential for compensation in COOLING mode (summer)	200	0	1000	ppm	Integer	R/W	249
U13	SET_COMP_EXT_FRIO	Maximum compensation in COOLING mode (summer)	30,0	-99,9	99,9	°C	Analog	R/W	34
U13	VAL_DIF_COMP_EXT_FRIO	Setpoint of minimum outdoor temperature to start the compensation control in HEATING mode (winter)	5,0	-99,9	99,9	°C	Analog	R/W	35
U13	MAX_COMP_EXT_FRIO	Differential for compensation in HEATING mode (winter)	5,0	0	99,9	°C	Analog	R/W	36
U14	SET_COMP_EXT_CALOR	Maximum compensation in HEATING mode (winter)	0,0	-99,9	99,9	°C	Analog	R/W	64
U14	VAL_DIF_COMP_EXT_CALOR	Differential for compensation in HEATING mode (winter)	5,0	-99,9	99,9	°C	Analog	R/W	65
U14	MAX_COMP_EXT_CALOR	Maximum compensation in HEATING mode (winter)	5,0	0	99,9	°C	Analog	R/W	66
U19	NUM_COMP_DESHUM	Number of compressors in dehumidification	0	0	NUM COMPRESORES	---	Integer	R/W	22
U20	BANDA_RES	Differential for control of electrical heaters or gas burner/boiler in HEATING mode (winter)	2,0	0	5	°C	Analog	R/W	53
U20	OFFSET_RES	Offset for control of electrical heaters or gas burner/boiler in HEATING mode (winter)	-2,0	-5	5	°C	Analog	R/W	52
U20	SET_HAB_RES_TEMP_EXT	Setpoint for enabling the electrical heaters or the gas burner/boiler by the outdoor temperature	20,0	-20	40	°C	Analog	R/W	129
U28	OFFSET_VALV_CALOR	Offset for control of the hot water coil in HEATING mode (winter)	-2,0	-10	0	°C	Analog	R/W	62
U28	BANDA_VALV_CALOR	Differential for control of the hot water coil in HEATING mode (winter)	2,0	0	5	°C	Analog	R/W	63
U28	HAB_PRIORIDAD_BAC_CALOR	Enable the priority of the hot water coil or the heat recovery coil with regard to the compressors in HEATING mode (winter)	1: yes	0: no 1: yes		---	Digital	R/W	132
U28b	OFFSET_VALV_FRIO	Offset for control of the cold water coil with regard to the compressors in COOLING mode (summer)	2,0	0	10	°C	Analog	R/W	220
U28b	BANDA_VALV_FRIO	Differential for control of the cold water coil with regard to the compressors in COOLING mode (summer)	2,0	0	5	°C	Analog	R/W	221
U28b	HAB_PRIORIDAD_VALV_FRIO	Enable the priority of the cold water coil with regard to the compressors in COOLING mode (summer)	0: no	0: no 1: yes		---	Digital	R/W	209
U20b	HAB_RES_EN_FRIO	Enabling of electrical heaters as backup in COOLING mode (summer) to raise the return temperature	1	0: no	1: yes	---	Digital	R/W	92
U20b	OFFSET_RES_EN_FRIO	Offset of electrical heaters as backup in COOLING mode (summer) to raise the return temperature	-7,0	-99,9	0,0	°C	Analog	R/W	73
U20b	HAB_VALV_CALOR_EN_FRIO	Enabling of hot water coil as backup in COOLING mode (summer) to raise the return temperature	1	0: no	1: yes	---	Digital	R/W	93
U20b	OFFSET_VALV_CALOR_EN_FRIO	Offset of hot water coil as backup in COOLING mode (summer) to raise the return temperature	-5,0	-99,9	0,0	°C	Analog	R/W	74
U35a1	HAB_ZONIFICACION_1_ZONA_POR_VAR	Enable the air flow reduction in units with power zoning by dampers	0	0: no	1: yes	---	Digital	R/W	68
U35a1	PORC_CAUDAL_50_PORC_COMP_TANDEM	% of air flow with the selection of flow automatic reduction with power zoning	50,0	50,0	75,0	%	Analog	R/W	150
U35a1	RED_CAUDAL_POR_ZONIFICACION	Enable the flow reduction of 50% power with power zoning	0	0: no	1: yes	---	Digital	R	69
U35a2	HAB_ZONA1_PARA_ZONIF_COMPUERTAS	In units with power zoning: enable the power zoning by dampers in the zone 1	1	0: no	1: yes	---	Digital	R/W	248
U35a2	HAB_ZONA2_PARA_ZONIF_COMPUERTAS	In units with power zoning: enable the power zoning by dampers in the zone 2	1	0: no	1: yes	---	Digital	R/W	249
U35a2	HAB_ZONIFICACION_1_ZONA_POR_COMP	In units with power zoning: display of zone 1 enabled	0	0: no	1: yes	---	Digital	R	
U35a2	HAB_ZONIFICACION_2_ZONA_POR_COMP	In units with power zoning: display of zone 2 enabled	0	0: no	1: yes	---	Digital	R	
U35a2	PORC_CAUDAL_50_PORC_COMP_TANDEM	In units with power zoning: % of flow with which the unit will work with regard to the setpoint flow	50,0	50,0	75,0	%	Analog	R/W	150
U35b	HAB_RED_CAUDAL_CON_COMP_TANDEM	Enable the flow reduction of 50% power without zoning (in units with tandem compressors and plug-fan)	0	0: no	1: yes	---	Digital	R/W	207
U35b	PORC_CAUDAL_50_PORC_COMP_TANDEM	% of air flow with selection of flow automatic reduction without zoning (units with tandem compres. and plug-fan)	50,0	50,0	75,0	%	Analog	R/W	150
U35b	RED_CAUDAL_AUTOMATICO	Enable the automatic flow reduction without zoning (in units with tandem compressors and plug-fan)	0	0: no	1: yes	---	Digital	R	70

## 17 - LIST OF PARAMETERS OF THE "TECHNICAL MENU"

### USER screens → CONTROL (...continuation)

Screen	Parameter	Description of the parameter	Value	Min.	Max.	UOM	Type	R/W	Add. BMS
U35a3	ON_COMPUERTA_Z1	Display of zone 1 activated (zoning of the air flow)	0	0: no	1: yes	---	Digital	W	311
U35a3	ON_COMPUERTA_Z2	Display of zone 2 activated (zoning of the air flow)	0	0: no	1: yes	---	Digital	W	312
U35a3	ON_COMPUERTA_Z3	Display of zone 3 activated (zoning of the air flow)	0	0: no	1: yes	---	Digital	W	313
U35a3	ON_COMPUERTA_Z4	Display of zone 4 activated (zoning of the air flow)	0	0: no	1: yes	---	Digital	W	314
U35a3	PORC_CAUDAL_ZONIFICA_ZONA1	% of flow in the zone 1 (zoning of the air flow)	25.0	0.0	100.0	%	Analog.	R/W	
U35a3	PORC_CAUDAL_ZONIFICA_ZONA3	% of flow in the zone 2 (zoning of the air flow)	25.0	0.0	100.0	%	Analog.	R/W	
U35a3	PORC_CAUDAL_ZONIFICA_ZONA2	% of flow in the zone 3 (zoning of the air flow)	25.0	0.0	100.0	%	Analog.	R/W	
U35a3	PORC_CAUDAL_ZONIFICA_ZONA4	% of flow in the zone 4 (zoning of the air flow)	25.0	0.0	100.0	%	Analog.	R/W	
U35a3	PORC_CAUDAL_ZONIFICA_MAX	Limit of maximum flow % (zoning of the air flow)	100.0	PORC_CAUDAL_ZONIFICA_MIN	100.0	%	Analog.	R/W	
U35a3	PORC_CAUDAL_ZONIFICA_MIN	Limit of minimum flow % (zoning of the air flow)	35.0	25.0	PORC_CAUDAL_ZONIFICA_MAX	%	Analog.	R/W	
U35a3	HAB_ON_EQUIPO_POR_4ZONAS	Activation of the reduction of flow with zoning	0	0: no	1: yes	---	Digital	W	315
U35a3	PORC_CAUDAL_ZONIFICA	Display of the current reduction of flow with zoning	25.0	PORC_CAUDAL_ZONIFICA_MIN	PORC_CAUDAL_ZONIFICA_MAX	%	Analog.	W	
U35b1	HAB_RED_CAUDAL_CON_COMP_TANDEM	Enable the flow reduction of 50% power without zoning (in units with tandem compressors and plug-fan)	0	0: no	1: yes	---	Digital	R/W	207
U35b1	PORC_CAUDAL_50_PORC_COMP_TANDEM	% of air flow with selection of flow automatic reduction without zoning (units with tandem compres. and plug-fan)	50.0	50.0	75.0	%	Analog.	R/W	150
U35b1	RED_CAUDAL_AUTOMATICO	Enable the automatic flow reduction without zoning (in units with tandem compressors and plug-fan)	0	0: no	1: yes	---	Digital	R	70
U36	DESCONEXION_NUM_COMPRESORES	Enable the forced stages disconnection: Number of compressor stages to disconnect	0	0	NUM_ETAPAS_COMPRESOR	---	Integer	R/W	128
U36	DESCONEXION_NUM_RESISTENCIAS	Enable the forced stages disconnection: Number of elec. heaters stages to disconnect	0	0	NUM_RES	---	Integer	R/W	129
U36	HAB_OFF_ETAPAS_POR_DIN	Enable the forced stages disconnection of compressor and/or electrical heater by digital input	0	0: no	1: yes	---	Digital	R/W	
U37	NEW_PASS_UT	New password of USER	****	0	9999	---	Integer	R/W	28

### USER screens → COMMUNICATION

Screen	Parameter	Description of the parameter	Value	Min.	Max.	UOM	Type	R/W	Add. BMS
U36a	TIPO_PROT_COM	Type of protocol in supervision network (0=Carel; 1=LonWorks; 2=Modbus; 3=Commissioning; 4=Modbus extended)	0: Carel	0	4	---	Integer		
U36b	BMS_ADDRESS	Unit address in the supervision network	1	0	207	---	Integer		
U36b	BAUD_RATE	Baud rate for the supervisory connection (0=1200; 1=2400; 2=4800; 3=9600; 4=19200)	4	0	4	---	Integer		
U36b	Stop_bits_Number_MB	Number of stop bits for the MODBUS protocol	0	0: 2 bits	1: 1 bit	---	Digital		
U36b	Parity_Type_MB	Type of parity for the MODBUS protocol (0=no; 1=couple; 2=odd)	0: no	0	2	---	Integer		
U36c	HAB_DETECCION_FALLO_COM_BMS	Enabling BMS communication failure detection, allowing the load of parameters by default	0: no	0: no	1: yes	---	Digital	R/W	173
U36c	TIME_PERDIDA_COMUNICACION_BMS	Period of time for checking the loss of BMS communication before the load of parameters by default	15	0	99	min	Integer		
U36c	VAR_DETECCION_FALLO_BMS	Variable to change by the BMS for checking the loss of BMS communication for more than 15 minutes (1-->0)	0: no	0: no	1: yes	---	Digital	R/W	174
U36c	PERDIDA_COMUNICACION_BMS	Variable of the signalling on-screen of the BMS communication loss	0: no	0: no	1: yes	---	Digital		
U40a	SET_POINT_TEMP_FRIO_BMS	Value by default with the loss of BMS communication: temperature setpoint in COOLING mode (summer)	26,0	LIM_INF_TEMP_FRIO	LIM_SUP_TEMP_FRIO	°C	Analog.		
U40a	SET_POINT_TEMP_CALOR_BMS	Value by default with the loss of BMS communication: temperature setpoint in HEATING mode (winter)	21,0	LIM_INF_TEMP_CALOR	LIM_SUP_TEMP_CALOR	°C	Analog.		
U40b	SYS_ON_BMS	Value by default with the loss of BMS communication: Unit ON/OFF by keyboard or remote	1	0: OFF 1: ON		---	Digital		
U40c	SEL_FRIO_CALOR_BMS	Value by default with the loss of BMS communication: COOLING/HEATING selection	2	0: by keyboard 1: remote (digital input) 2: auto		---	Integer		
U40c	MODO_FRIO_CALOR_AUTO_BMS	Value by default with the loss of BMS communication: COOLING/HEATING selection in AUTO mode	0	0: by indoor temp. 1: by outdoor temp.		---	Digital		
U40c	CALOR_FRIO_PANEL_BMS	Value by default with the loss of BMS communication: COOLING/HEATING selection by keyboard	1	0: HEATING 1: COOLING		---	Digital		

## 17 - LIST OF PARAMETERS OF THE "TECHNICAL MENU"

### USER screens → COMMUNICATION (...continuation)

Screen	Parameter	Description of the parameter	Value	Min.	Max.	UOM	Type	R/W	Add. BMS
U40d	DESCONEXION_NUM_Compresores_BMS	Value by default with the loss of BMS communication: Number of compressor stages to disconnect	0	0	NUM_ETAPAS_COMPRESOR	---	Integer		
U40d	DESCONEXION_NUM_RESISTENCIAS_BMS	Value by default with the loss of BMS communication: Number of electrical heaters stages to disconnect	0	0	NUM_RES	---	Integer		
U40e	TIPO_PROG_HORARIA_BMS	Value by default with the loss of BMS communication: Type of start-up with schedule programming: 0 = ON/OFF schedule; 1 = Schedule only setpoint change; 2 = ON/OFF schedule with limit SET of ON; 3 = Forced; 4 = 3 setpoints schedule + OFF of unit	0	0	4	---	Integer		
U40f	H_ARR_1A_BMS	Value by default with the loss of BMS communication: Start-up hour of slot 1- program 1	9	0	23	h	Integer		
U40f	M_ARR_1A_BMS	Value by default with the loss of BMS communication: Start-up minute of slot 1-program 1	0	0	59	min	Integer		
U40f	H_PAR_1A_BMS	Value by default with the loss of BMS communication: Stop hour of slot 1 - program 1	21	0	23	h	Integer		
U40f	M_PAR_1A_BMS	Value by default with the loss of BMS communication: Stop minute of slot 1 - program 1	0	0	59	min	Integer		
U40f	H_ARR_1B_BMS	Value by default with the loss of BMS communication: Start-up hour of slot 2 - program 1	0	0	23	h	Integer		
U40f	M_ARR_1B_BMS	Value by default with the loss of BMS communication: Start-up minute of slot 2 - program 1	0	0	59	min	Integer		
U40f	H_PAR_1B_BMS	Value by default with the loss of BMS communication: Stop hour of slot 2 - program 1	0	0	23	h	Integer		
U40f	M_PAR_1B_BMS	Value by default with the loss of BMS communication: Stop minute of slot 2 - program 1	0	0	59	min	Integer		
U40f	H_ARR_1C_BMS	Value by default with the loss of BMS communication: Start-up hour of slot 3 - program 1	0	0	23	h	Integer		
U40f	M_ARR_1C_BMS	Value by default with the loss of BMS communication: Start-up minute of slot 3 - program 1	0	0	59	min	Integer		
U40f	H_PAR_1C_BMS	Value by default with the loss of BMS communication: Stop hour of slot 3 - program 1	0	0	23	h	Integer		
U40f	M_PAR_1C_BMS	Value by default with the loss of BMS communication: Stop minute of slot 3 - program 1	0	0	59	min	Integer		
U40g	LUN_A_BMS	Value by default with the loss of BMS communication: Monday schedule (0=off; 1=program 1; 2=program 2; 3=program 3)	1	0	3	---	Integer		
U40g	MAR_A_BMS	Value by default with the loss of BMS communication: Tuesday schedule (0=off; 1=program 1; 2=program 2; 3=program 3)	1	0	3	---	Integer		
U40g	MIE_A_BMS	Value by default with the loss of BMS communication: Wednesday schedule (0=off; 1=program 1; 2=program 2; 3=program 3)	1	0	3	---	Integer		
U40g	JUE_A_BMS	Value by default with the loss of BMS communication: Thursday schedule (0=off; 1=program 1; 2=program 2; 3=program 3)	1	0	3	---	Integer		
U40g	VIE_A_BMS	Value by default with the loss of BMS communication: Friday schedule (0=off; 1=program 1; 2=program 2; 3=program 3)	1	0	3	---	Integer		
U40g	SAB_A_BMS	Value by default with the loss of BMS communication: Saturday schedule (0=off; 1=program 1; 2=program 2; 3=program 3)	1	0	3	---	Integer		
U40g	DOM_A_BMS	Value by default with the loss of BMS communication: Sunday schedule (0=off; 1=program 1; 2=program 2; 3=program 3)	1	0	3	---	Integer		
U40g	DIA_SEMANA	Weekday	0	0	0	day	Integer	R/W	52

### USER screens → OTHER

Screen	Parameter	Description of the parameter	Value	Min.	Max.	UOM	Type	R/W	Add. BMS
U18a	AUTOSTART	Enabling of automatic start-up after blocking	1: yes	0: no	1: yes	---	Digital	R/W	58
U18a	TIME_ON_AUTOSTART	Timing for the automatic start-up after a power failure (for phasing the start-up of different units in the same installation)	5	5	999	s	Integer	R/W	166
U18a1	HAB_ONOFF_REMOTO	Enabling of remote ON/OFF	1: yes	0: no	1: yes	---	Digital	R/W	59
U18a1	HAB_OFF_REMOTO_CON_PROTECCION	Enabling of the BUILDING PROTECTION mode when the remote ON/OFF connected on digital input is OFF	0: no	0: no	1: yes	---	Digital		
U18a1	HAB_BLOQ_COMP_ON_FASE_LIM_FRIO	Disable compressors in COOLING mode (summer) with "ON/OFF schedule with limit SET of ON" (nocturnal freecooling)	0: no	0: no	1: yes	---	Digital	R/W	72
U18a1	HAB_BLOQ_RENOVACION_ON_FASE_LIM	Disable outdoor air renewal in COOLING mode (summer) with "ON/OFF schedule with limit SET of ON" (nocturnal freecooling)	0: no	0: no	1: yes	---	Digital	R/W	73
U18a2	SET_EXT_LIM_FRIO	Setpoint for BUILDING PROTECTION time slots in COOLING mode (summer)	34	-99,9	99,9	°C	Analog	R/W	77
U18a2	DIF_LIM_FRIO	Differential for setpoint of BUILDING PROTECTION in COOLING mode (summer)	2	0	99,9	°C	Analog	R/W	80
U18a2	SET_EXT_LIM_CALOR	Setpoint for BUILDING PROTECTION time slots in HEATING mode (winter)	13	-99,9	99,9	°C	Analog	R/W	76
U18a2	DIF_LIM_CALOR	Differential for setpoint of BUILDING PROTECTION in HEATING mode (winter)	1	0	99,9	°C	Analog	R/W	81
U18b	TIME_PANT	Back-lighting time of the pGD1 terminal display	30	0	999	s	Integer		
U18c	HAB_G_PRINC	Enabling of automatic return to the MAIN screen	0: no	0: no	1: yes	---	Digital		
U18c	TIME_RETURN_MENU	Time for the automatic return to the MAIN screen	120	0	999	s	Integer		

# 17 - LIST OF PARAMETERS OF THE “TECHNICAL MENU”

## 17.2. Parameters of the MANUFACTURER screens

The MANUFACTURER screen group is protected by an access key. If this password has to be known: please consult.

### MANUFACTURER screens → UNIT CONFIGURATION

Screen	Parameter	Description of the parameter	Value	Min.	Max.	UOM	Type	R/W	Add. BMS
CU01	MODELO_EQUIPO	Unit model (only PF series)	0	0...44 (only PF series)		---	Integer	R/W	58
CU01	TIPO_EQUIPO	Unit type	0	0: air-air 1: water-air		---	Integer	R/W	182
CU01	HAB_BOMBA_CALOR	Enabling of the heat pump operation	1	0: cooling only 1: rev. heat pump		---	Digital	R/W	45
CU01	NUM_WO_DIG_1	Work order number of the unit -WO (digit 1)	0	0	9	---	Analog	R/W	185
CU01	NUM_WO_DIG_2	Work order number of the unit -WO (digit 2)	0	0	9	---	Analog	R/W	186
CU01	NUM_WO_DIG_3	Work order number of the unit -WO (digit 3)	0	0	9	---	Analog	R/W	187
CU01	NUM_WO_DIG_4	Work order number of the unit -WO (digit 4)	0	0	9	---	Analog	R/W	188
CU01	NUM_WO_DIG_5	Work order number of the unit -WO (digit 5)	0	0	9	---	Analog	R/W	189
CU01	NUM_WO_DIG_6	Work order number of the unit -WO (digit 6)	0	0	9	---	Analog	R/W	190
CU01	NUM_WO_DIG_7	Work order number of the unit -WO (digit 7)	0	0	9	---	Analog	R/W	191
CU01	NUM_WO_DIG_8	Work order number of the unit -WO (digit 8)	0	0	9	---	Analog	R/W	192
CU02	NUM_COMP_CIRC	Number of compressor	1	0: Without compressor 1: 1 compr./ 1 circuit 2: 2 compr./ 1 circuit 3: 2 compr./ 2 circuits 4: 2 compr. + 1 part 5: 2 compr. (3 stages) 6: 4 compr./ 2 circuits 7: 4 compr./ 4 circuits		---	Integer	R/W	60
CU02	HAB_UNICO_VOL_AIRE_EXT	Enable the single volume of outdoor air	no	0: no	1: yes	---	Digital	R/W	57
CU03	CONF_OUT07	Element connected on the digital output OUT07	3	0: Humidifier 1: Pump in HWC circuit 2: Recovery compr. 3: Alarm 4: Inactive 5: Rotary heat exch.		---	Integer	R/W	117
CU03	HAB_OUT07_BOMBA_BAC	Enable the pump and the heat valve of the HWC with low outdoor temperature	0	0	1	---	Digital	R/W	
CU03	SET_ON_VALV_CALOR_POR_BAJA_TEXT	Setpoint to start-up the pump and the HWC valve depending on the low outdoor temperature	4,0	-10	10	°C	Analog	R/W	82
CU03	MIN_APERTURA_VALV_CALOR	Minimum opening of the HWC valve with low outdoor temp. and unit ON	10	0	100	%	Integer	R/W	211
CU03	TIME_RET_OFF_BOMBA_BAC	Delay time to stop of the HWC pump	60	0	999	s	Integer	R/W	210
CU03	HAB_BOMBA_CALOR_COMP_REC	Recovery compressor as heat pump	1	0: rec. comp cooling only 1: rec. comp heat pump		---	Digital	R/W	203
CU03	MIN_APERTURA_ON_REC	% of minimum opening of outdoor damper to allow the start of the recovery compressor or the rotary heat exchanger	10	0	99	%	Integer	R/W	68
CU03	TIME_MIN_APERTURA_ON_REC	Time with minimum opening of outdoor damper to allow the start of the recovery compressor or the rotary heat exchanger	90	0	999	seg	Integer	R/W	9
CU03	HAB_REC_ROTATIVO_VARIABLE	Enable the rotary heat exchanger with variable wheel	0	0: no	1: yes	---	Digital	R/W	247
CU03	HAB_COMPUERTA_CON_DESESCARCHE	Enable the opening of the outdoor damper during defrosting with rotary heat exchanger	0	0: no	1: yes	---	Digital		
CU03a	CONF_OUT01_MOD_N8	Configuration salida digital OUT01 del modulo de expansión PCOE addr.8	6	0: Humidifier 1: Pump in HWC circuit 2: Recovery compr. 3: Alarm 4: Inactive 5: Rotary heat exch. 6: -----		---	Integer	R/W	218
CU03a	HAB_OUT01_N8_BOMBA_BAC	Enable the pump and the heat valve of the HWC with low outdoor temperature	0	0	1	---	Digital	R/W	
CU03a	SET_ON_VALV_CALOR_POR_BAJA_TEXT	Setpoint to start-up the pump and the HWC valve depending on the low outdoor temperature	4,0	-10	10	°C	Analog	R/W	82
CU03a	MIN_APERTURA_VALV_CALOR	Minimum opening of the HWC valve with low outdoor temp. and unit ON	10	0	100	%	Integer	R/W	211
CU03a	TIME_RET_OFF_BOMBA_BAC	Delay time to stop of the HWC pump	60	0	999	s	Integer	R/W	210
CU03a	HAB_BOMBA_CALOR_COMP_REC	Recovery compressor as heat pump	1	0: rec. comp cooling only 1: rec. comp heat pump		---	Digital	R/W	203
CU03a	MIN_APERTURA_ON_REC	% of minimum opening of outdoor damper to allow the start of the recovery compressor or the rotary heat exchanger	10	0	99	%	Integer	R/W	68
CU03a	TIME_MIN_APERTURA_ON_REC	Time with minimum opening of outdoor damper to allow the start of the recovery compressor or the rotary heat exchanger	90	0	999	seg	Integer	R/W	9
CU03a	HAB_REC_ROTATIVO_VARIABLE	Enable the rotary heat exchanger with variable wheel	0	0: no	1: yes	---	Digital	R/W	247

## 17 - LIST OF PARAMETERS OF THE "TECHNICAL MENU"

### MANUFACTURER screens → UNIT CONFIGURATION (...continuation)

Screen	Parameter	Description of the parameter	Value	Min.	Max.	UOM	Type	R/W	Add. BMS
CU03a	HAB_COMPUERTA_CON_DESESCARCHE	Enable the opening of the outdoor damper during defrosting with rotary heat exchanger	0: no	0: no	1: yes	---	Digital		
CU03b	CONF_OUT04_MOD_N8	Configuration salida digital OUT04 del modulo de expansión PCOE addr.8	6: ----	0: Humidifier 1: Pump in HWC circuit 2: Recovery compr. 3: Alarm 4: Inactive 5: Rotary heat exch. 6: ----		---	Integer	R/W	219
CU03b	HAB_OUT04_N8_BOMBA_BAC	Enable the pump and the heat valve of the HWC with low outdoor temperature	0	0	1	---	Digital	R/W	
CU03b	SET_ON_VALV_CALOR_POR_BAJA_TEXT	Setpoint to start-up the pump and the HWC valve depending on the low outdoor temperature	4,0	-10	10	°C	Analog.	R/W	82
CU03b	MIN_APERTURA_VALV_CALOR	Minimum opening of the HWC valve with low outdoor temp. and unit ON	10	0	100	%	Integer	R/W	211
CU03b	TIME_RET_OFF_BOMBA_BAC	Delay time to stop of the circulation pump of the HWC	60	0	999	s	Integer	R/W	210
CU03b	HAB_BOMBA_CALOR_COMP_REC	Recovery compressor as heat pump	1	0: rec. comp cooling only 1: rec. comp heat pump		---	Digital	R/W	203
CU03b	MIN_APERTURA_ON_REC	% of minimum opening of outdoor damper to allow the start of the recovery compressor or the rotary heat exchanger	10	0	99	%	Integer	R/W	68
CU03b	TIME_MIN_APERTURA_ON_REC	Time with minimum opening of outdoor damper to allow the start of the recovery compressor or the rotary heat exchanger	90	0	999	seg	Integer	R/W	9
CU03b	HAB_REC_ROTATIVO_VARIABLE	Enable the rotary heat exchanger with variable wheel	0: no	0: no	1: yes	---	Digital	R/W	247
CU03b	HAB_COMPUERTA_CON_DESESCARCHE	Enable the opening of the outdoor damper during defrosting with rotary heat exchanger	0: no	0: no	1: yes	---	Digital		
CU03c	SET_TEMP_MAX_AOUT_REC_ROT_VAR	Setpoint of maximum outlet temperature of the variable rotary heat exchanger	6,0	0,0	20,0	°C	Integer	R/W	
CU03c	SET_TEMP_MIN_AOUT_REC_ROT_VAR	Setpoint of minimum outlet temperature of the variable rotary heat exchanger	1,0	0,0	20,0	°C	Integer	R/W	
CU03c	MAX_AOUT_REC_ROT_VARIABLE	Maximum speed of the variable rotary heat exchanger	100	30	100	%	Integer	R/W	
CU03c	MIN_AOUT_REC_ROT_VARIABLE	Minimum speed of the variable rotary heat exchanger	10	0	100	%	Integer	R/W	
CU04	TIPO_VENT_INT	Type of indoor fan (supply fan)	1	1: centrifugal 2: radial 3: EC plug-fan 4: centrifugal+VFD		---	Integer	R/W	196
CU04	NUM_VINT_PLUG_FAN	Number of supply plug-fans	2	0	9	---	Integer		
CU04	CTE_CALCULO_CAUDAL_VINT	Constant of calculation for the indoor plug-fan	260	0	999	---	Integer		
CU04	CAUDAL_VINT_NOMINAL	Nominal flow of the supply plug-fan	1200	0	9999	x10 m3/h	Integer		
CU04	PORC_CAUDAL_VINT_MIN	Percentage for minimum flow rate of the supply plug-fan	-20	-99	0	%	Integer		
CU04	PORC_CAUDAL_VINT_MAX	Percentage for maximum flow rate of the supply plug-fan	20	0	99	%	Integer		
CU04	Polea_MOTOR_INT	Diameter in mm of the pulley installed on the supply motor	170	0	999	---	Integer		
CU04	Polea_VENT_INT	Diameter in mm of the pulley installed on the supply fan	260	0	999	---	Integer		
CU04	Pda_VENT_INT_min	Minimum point of differential pressure of the supply fan	125	0	9999	Pa	Integer		
CU04	Rpm_VENT_INT_min	Minimum point of speed (rpm) of the supply fan	592	0	9999	rpm	Integer		
CU04	Pda_VENT_INT_max	Maximum point of differential pressure of the supply fan	600	0	9999	Pa	Integer		
CU04	Rpm_VENT_INT_max	Maximum point of speed (rpm) of the supply fan	962	0	9999	rpm	Integer		
CU04a	MOD_MB_VFD_CIAT_1.Sel_Scale_Current	Frequency inverter type for indoor motor	0	0	1	---	Digital		
CU04a	MOD_MB_VFD_CIAT_1.Nominal_Volt	Nominal voltage of indoor motor	400	180	690	V	Integer		
CU04a	MOD_MB_VFD_CIAT_1.Motor_Cosfi	Cos phi of indoor motor	85	30	99	---	Integer		
CU04a	MOD_MB_VFD_CIAT_1.Nominal_Frequency	Nominal frequency of indoor motor	50.0	30.0	320.0	Hz	Analog.		
CU04a	MOD_MB_VFD_CIAT_1.Nominal_Speed	Nominal speed of indoor motor	1440	300	20000	rpm	Integer		
CU04a	MOD_MB_VFD_CIAT_1.Nominal_Current	Nominal current of indoor motor	0	0	999.9	A	Analog.		
CU04a	MOD_MB_VFD_CIAT_1.Current_Limit	Current limit of indoor motor	0	0	999.9	A	Analog.		
CU04c	HAB_COMP_REG_PRES_U_INT	Enabling of the damper for control of the indoor unit pressure	0: no	0: no	1: yes	---	Digital		
CU04c	MAX_AOUT_VENT_INT_FRIO	Max. analogue output for the supply fan in COOLING mode	100	30	100	%	Integer		
CU04c	MAX_AOUT_VENT_INT_CALOR	Max. analogue output for the supply fan in HEATING mode	100	30	100	%	Integer		
CU04c	MIN_AOUT_VENT_INT	Min. analogue output for the supply fan	0	0	100	%	Integer		



## 17 - LIST OF PARAMETERS OF THE "TECHNICAL MENU"

### MANUFACTURER screens → UNIT CONFIGURATION (...continuation)

Screen	Parameter	Description of the parameter	Value	Min.	Max.	UOM	Type	R/W	Add. BMS
CU041	TIPO_VENT_RET	Type of return fan	0		0: none 1: centrifugal 2: radial 3: EC plug-fan 4: centrifugal + VFD	---	Integer	R/W	202
CU041	HAB_CONTROL_SOBREPRESIÓN	Enable the overpressure control - exhaust damper control	0: no	0: no	1: yes	---	Digital	R/W	71
CU041	NUM_VRET_PLUG_FAN	Number of return plug-fans	2	0	9	---	Integer		
CU041	CTE_CALCULO_CAUDAL_VRET	Constant of calculation for the return plug-fan	260	0	999	---	Integer		
CU041	CAUDAL_VRET_NOMINAL	Nominal flow of the return plug-fan	1200	0	9999	x10 m3/h	Integer		
CU041	PORC_CAUDAL_VRET_MIN	Percentage for minimum flow rate of the return plug-fan	-30	-99	0	%	Integer		
CU041	PORC_CAUDAL_VRET_MAX	Percentage for maximum flow rate of the return plug-fan	00	0	99	%	Integer		
CU041	Polea_MOTOR_RET	Diameter in mm of the pulley installed on the return motor	170	0	999	---	Integer		
CU041	Polea_VENT_RET	Diameter in mm of the pulley installed on the return fan	260	0	999	---	Integer		
CU041	Pda_VENT_RET_min	Minimum point of differential pressure of the return fan	125	0	9999	Pa	Integer		
CU041	Rpm_VENT_RET_min	Minimum point of speed (rpm) of the return fan	592	0	9999	rpm	Integer		
CU041	Pda_VENT_RET_max	Maximum point of differential pressure of the return fan	600	0	9999	Pa	Integer		
CU041	Rpm_VENT_RET_max	Maximum point of speed (rpm) of the return fan	962	0	9999	rpm	Integer		
CU04b	MOD_MB_VFD_CIAI_2_Sel_Scale_Current	Frequency inverter type for return motor	0	0	1	---	Digital		
CU04b	MOD_MB_VFD_CIAI_2_Nominal_Volt	Nominal voltage of return motor	400	180	690	V	Integer		
CU04b	MOD_MB_VFD_CIAI_2_Motor_Cosphi	Cos phi of return motor	85	30	99	---	Integer		
CU04b	MOD_MB_VFD_CIAI_2_Nominal_Frequency	Nominal frequency of return motor	50.0	30.0	320.0	Hz	Analog.		
CU04b	MOD_MB_VFD_CIAI_2_Nominal_Speed	Nominal speed of return motor	1440	300	20000	rpm	Integer		
CU04b	MOD_MB_VFD_CIAI_2_Nominal_Current	Nominal current of return motor	0	0	999.9	A	Analog.		
CU04b	MOD_MB_VFD_CIAI_2_Current_Limit	Current limit of return motor	0	0	999.9	A	Analog.		
CU05	TIPO_VENT_EXT	Type of outdoor fan (air-air unit)	3		1: centrifugal 2: axial / radial 3: 2-speed axial 4: electronic	---	Integer	R/W	1
CU05	MAX_AOUT_VENT_EXT_FRIO	Maximum analogue output for the outdoor fan in COOLING mode (or prop. 3-WV in water-air unit)	100	30	100	%	Integer		
CU05	MAX_AOUT_VENT_EXT_CALOR	Maximum analogue output for the outdoor fan in HEATING mode (or prop. 3-WV in water-air unit)	100	30	100	%	Integer		
CU05	MIN_AOUT_VENT_EXT	Minimum analogue output for the outdoor fan (or prop. 3-WV in water-air unit)	10% (air-air) 0% (water-air)	0	100	%	Integer	R/W	184
CU05	SET_ON_AGUA_AIRE_POR_BAJA_TEXT	In water-air units, enable the actication of the heat valve and the connection of the circulation pump, to prevent freezing of the plate exchanger, when the outdoor temperature drops below this temperature	4.0	-10.0	10.0	°C	Analog.	R	
CU051	MAX_AOUT_VENT_EXT_FRIO_EN_ON	Maximum analogue output for the connection of the outdoor fan in COOLING mode	100	30	MAX_AOUT_VENT_EXT_FRIO	%	Integer	R/W	252
CU051	MAX_AOUT_VENT_EXT_CALOR_EN_ON	Maximum analogue output for the connection of the outdoor fan in HEATING mode	100	30	MAX_AOUT_VENT_EXT_CALOR	%	Integer	R/W	253
CU051	MAX_AOUT_VENT_EXT_FRIO_EN_OFF	Maximum analogue output for the disconnection of the outdoor fan in COOLING mode	50	30	MAX_AOUT_VENT_EXT_FRIO	%	Integer	R/W	254
CU051	MAX_AOUT_VENT_EXT_CALOR_EN_OFF	Maximum analogue output for the disconnection of the outdoor fan in HEATING mode	50	30	MAX_AOUT_VENT_EXT_CALOR	%	Integer	R/W	255
CU05a	VAL_INI_VEXT_ALTA_VEL_COND	Final value of the outdoor fan at high speed in condensation	R410A - 34.0 bar R407C - 22.5 bar	0	60	bar	Analog.	R/W	68
CU05a	VAL_FIN_VEXT_ALTA_VEL_COND	Initial value of the outdoor fan at high speed in condensation	R410A - 27.0 bar R407C - 17.0 bar	0	60	bar	Analog.	R/W	70
CU05a	VAL_FIN_VEXT_ALTA_VEL_EVAP	Final value of the outdoor fan at high speed in evaporation	R410A - 10.0 bar R407C - 5,7 bar	0	60	bar	Analog.	R/W	101
CU05a	VAL_INI_VEXT_ALTA_VEL_EVAP	Initial value of the outdoor fan at high speed in evaporation	R410A - 8.0 bar R407C - 4.6 bar	0	60	bar	Analog.	R/W	103
CU05a	TIME_CAMBIO_VEL_VEXT	Timing for changing the speed of the outdoor fan	2	1	10	s	Integer		
CU05b	HAB_COMP_REG_PRES_U_EXT	Enable damper for controlling the pressure of the outdoor unit	0: no	0: no	1: yes	---	Digital	R/W	169
CU06	HAB_QUEMADOR_GAS	Gas burner activation	0: no	0: no	1: yes	---	Digital	R/W	86
CU07	NUM_RES	Number of elec. heaters	0: -----		0: ----- 1: 1 electrical heater 2: 2 electrical heaters 3: 2 el. heaters (3 st.) 4: proportional	---	Integer	R/W	41

## 17 - LIST OF PARAMETERS OF THE “TECHNICAL MENU”

### MANUFACTURER screens → UNIT CONFIGURATION (...continuation)

Screen	Parameter	Description of the parameter	Value	Min.	Max.	UOM	Type	R/W	Add. BMS
CU07	HAB_RES_DESESCARCHE	Enable electrical heaters or gas burner in defrostings	0: no	0: no	1: yes	---	Digital	R/W	99
CU07	NUM_RES_DES	Number of electrical heaters during defrosting	0	0	NUM_RES	---	Integer	R/W	61
CU07	VAL_BAC_DESESCARCHE	% proportional electrical heater in defrostings	100	0	100	%	Integer	R/W	
CU07	HAB_RESISTENCIA_PROP	Enable the proportional electrical heater	0	0: no	1: yes	---	Digital	R	
CU07	HAB_RES_SIN_COMPRESOR	Enable the electrical heater for replacing the compressor	0	0: no	1: yes	---	Digital	R/W	181
CU08	HAB_VALVULA_CALOR	Enable the valve of the hot water coil	0: no	0: no	1: yes	---	Digital	R/W	103
CU08	HAB_VALVULA_FRIO	Enable the valve of the cold water coil	0: no	0: no	1: yes	---	Digital	R/W	
CU08	HAB_VALVULA_ON_OFF	Enable the on/off valve of the water coil	0	0: proportional 1: on-off		---	Digital	R/W	
CU08	HAB_BAC_DESESCARCHE	Enable the hot water coil in defrostings	0: no	0: no	1: yes	---	Digital	R/W	129
CU08	VAL_BAC_DESESCARCHE	% of proportional hot water coil in defrostings	100	0	100	%	Integer		
CU08	NUM_RES_DES	Number of electrical heaters during defrosting	0	0	3	---	Integer	R/W	61
CU08	HAB_PROT_ANTIHIELO_BAC_GF	Enabling the antifreeze protection for low outdoor temperature with the hot water coil	0: no	0: no	1: yes	---	Digital	R/W	128
CU08a	SET_ANTIHIELO_AGUA_BAC	Antifreeze protection setpoint of the hot water coil with low outdoor temperatures	4,0	-20,0	10,0	°C	Analog	R/W	229
CU08a	DIF_ANTIHIELO_AGUA_BAC	Differential for reset of the antifreeze protection of hot water coil	3,0	0,0	10,0	°C	Analog	R/W	230
CU08b	SET_TEMP_AGUA_BAC	Water temperature setpoint of the hot water coil	10,0	0,0	20,0	°C	Analog	R/W	56
CU08b	OFFSET_TEMP_AGUA_BAC	Water temperature offset of the hot water coil with OFF unit	5,0	0,0	10,0	°C	Analog	R/W	51
CU08b	BANDA_TEMP_AGUA_BAC	Band of the water temperature setpoint of the hot water coil	2,0	0,0	5,0	°C	Analog	R/W	57
CU09	HAB_MB_SOND_AMB	Enable the ambient probe	1: yes	0: no	1: yes	---	Digital	R/W	167
CU09	CONTROL_SOND_AMB	Enable control with ambient probe	1	0: Return temp. 1: Ambient temp.		---	Digital	R/W	189
CU09	TIPO_SONDA_AMB	Type of ambient probe: 1: 1 probe RS485 2: 2 probes RS485 3: probe in pLAN network 4: 1 probe NTC 5: 3 probes RS485 6: 4 probed RS485 7: 1 probe 4-20mA	4	0	7	---	Integer	R/W	46
CU09	SEL_TEMP_2_SOND_AMB_FRIO	Selection of temperature value with ambient probes in COOLING model (0=average, 1=minimum; 2=maximum)	0	0	2	---	Integer		
CU09	SEL_TEMP_2_SOND_AMB_CALOR	Selection of temperature value with ambient probes in HEATING mode (0=average, 1=minimum; 2=maximum)	0	0	2	---	Integer		
CU10	HAB_SONDA_TEMP_IMP	Enable the supply air temperature probe	1: yes	0: no	1: yes	---	Digital	R/W	48
CU10	TIPO_TEMP_EXT	Type of outdoor temperature probe (0=No, 1=Actual, 2=pLAN)	1	0	2	---	Integer	R/W	54
CU10	TIPO_SONDA_HUM_INT	Type of indoor humidity probe (0=No, 1=Actual, 2=pLAN, 3=Virtual, 4=RS485) Note: This probe is necessary with entálpic free-cooling and/or for humidity regulation	0: no	0	4	---	Integer	R/W	56
CU10	TIPO_SONDA_HUM_EXT	Type of outdoor temperature probe (0=No, 1=Actual, 2=pLAN) Note: This probe is necessary with entálpic free-cooling	0: no	0	2	---	Integer	R/W	55
CU10	HAB_SONDA_BAT_EXT	Enabling the outdoor coil sensor. Condensation and evaporation control by outdoor coil sensors (air-air) or by refrigerant anti-freeze sensors (water-air)	1: yes	0: no	1: yes	---	Digital	W	78
CU10	HAB_SONDA_BAT_INT	Enabling the indoor coil sensor. Only available with the pCOe expansion card addr.8	0: no	0: no	1: yes	---	Digital		
CU10a	HAB_CONTROL_HUM_DESHUM	Humidity management	0: no	0: no	1: yes	---	Digital	R/W	47
CU10a	HAB_HUMIDIFICA	Enabling humidification function: 0: no 1: on-off (digital output NO7 of the connector J14) 2: proporcional (analogue output Y1 of the pCOe expansion card addr. dir.7)	0	0	2	---	Integer	R/W	190
CU10a	NUM_COMP_DESHUM	Number of compressors in dehumidification	0	0	NUM_CompressorES	---	Integer	R/W	22
CU10a	PORCEN_TEMP_ON_DESH	% Indoor temperature for compressors ON in dehumidification	15	0	100	%	Integer	R/W	189
CU10a	PORCEN_TEMP_OFF_DESH	% Indoor temperature for compressors OFF in dehumidification	85	0	100	%	Integer	R/W	188
CU10a	SET_HUM_OFF_COMPUERTA	Setpoint for closing the outdoor damper with high indoor humidity	100	0	100	%rH	Analog	R/W	130
CU10b	HAB_VALV_CALOR_POR_IMP_MIN_FRIO	Control of minimum supply temperature with hot water coil in COOLING mode	1: yes	0: no	1: yes	---	Digital	R/W	100
CU10b	HAB_COMP_CALOR_POR_IMP_MIN_FRIO	Control of minimum supply temperature with compressor in COOLING mode	1: yes	0: no	1: yes	---	Digital	R/W	101
CU10b	HAB_RES_POR_IMP_MIN_FRIO	Control of minimum supply temperature with electrical heaters in COOLING mode	1: yes	0: no	1: yes	---	Digital	R/W	102

## 17 - LIST OF PARAMETERS OF THE "TECHNICAL MENU"

### MANUFACTURER screens → UNIT CONFIGURATION (...continuation)

Screen	Parameter	Description of the parameter	Value	Min.	Max.	UOM	Type	R/W	Add. BMS
CU10c	HAB_VALV_CALOR_POR_IMP_MIN_CALOR	Control of minimum supply temperature with hot water coil in HEATING mode	1: yes	0: no	1: yes	---	Digital	R/W	218
CU10c	HAB_COMP_CALOR_POR_IMP_MIN_CALOR	Control of minimum supply temperature with compressor in HEATING mode	1: yes	0: no	1: yes	---	Digital	R/W	219
CU10c	HAB_RES_POR_IMP_MIN_CALOR	Control of minimum supply temperature with electrical heaters in HEATING mode	1: yes	0: no	1: yes	---	Digital	R/W	220
CU11	TIPO_SONDA_RENOVACION	Type of probe for air renewal: 0: None 1: Mixed air temperature 2: Actual air quality probe 3: pLAN air quality probe 4: Actual air quality probe (2 probes) 5: Environment air quality probe + Outdoor air quality probe	1	0	5	---	Integer	R/W	127
CU11	HAB_LIM_CO2	Activate the air quality control	1: yes	0: no	1: yes	---	Digital	R/W	84
CU11	TIPO_CO2	Type of CO2 control: 0=%; 1=ppm	1=ppm	0	1	---	Digital		
CU11	HAB_SONDA_MEZCLA_CON_CO2	Enable the mixing probe with CO2 probe (B4 input)	1: yes	0: no	1: yes	---	Digital	R/W	85
CU11	HAB_SET_TEMP_CO2	Enable the control of the outdoor air damper depending on the mixing temperature with CO2 probe	0: no	0: no	1: yes	---	Digital	R	
CU11	SET_TEMP_CO2_CALOR	Setpoint of mixing temperature to close the outdoor air damper in HEATING mode (winter) with CO2 probe	17,0	10,0	20,0	°C	Analog	R/W	99
CU11	SET_TEMP_CO2_FRIO	Setpoint of mixing temperature to close the outdoor air damper in COOLING mode (summer) with CO2 probe	30,0	20,0	50,0	°C	Analog	R/W	225
CU11b	SEL_CO2_SONDAS_CO2	Selection of CO2 value with two CO2 probes (0=average, 1=minimum; 2=maximum)	0	0	2	---	Integer	R/W	234
CU11a	SET_TEMP_MEZCLA_CALOR	Setpoint of mixing temperature to close the outdoor air damper in HEATING mode (winter)	12,0°C 5,0°C (recovery comp.& refr.motor)	0,0	20,0	°C	Analog	R/W	91
CU11a	SET_TEMP_MEZCLA_FRIO	Setpoint of mixing temperature to close the outdoor air damper in COOLING mode (summer)	35,0°C 42,0°C (recovery comp. & refr.motor)	20,0	50,0	°C	Analog	R/W	224
CU12	TIPO_RELOJ	Clock card	1: yes	0: no	1: yes	---	Integer	R/W	57
CU12	HAB_PRES_BEXT	Type of sensor on the outdoor coil: 0: temperature 1: pressure	1: pressure	0	1	---	Digital	R/W	134
CU12	HAB_PRES_BINT	Type of sensor on the indoor coil (available with the oCOe expansion card addr.8) 0: temperature 1: pressure	1: pressure	0	1	---	Digital		
CU12	TIPO_REFRIGERANTE	Type of refrigerant: 0: R22 1: R134A 2: R404A 3: R407C 4: R410A	4: R410A	0	4	---	Integer		
CU12	HAB_MB_GAS_LEAKEAGE_DETECTOR	Enable the gas leak detector	0: no	0: no	1: yes	---	Digital	R/W	80
CU12a	SEL_FRIO_CALOR	Procedures for the selection of the COOLING/HEATING mode: 0: by keyboard 1: remote (by digital input) 2: auto 3: only ventilation	2: AUTO	0	3	---	Integer	R/W	59
CU12a	MODO_FRIO_CALOR_AUTO	COOLING/HEATING selection in AUTO: 0: by indoor temperature 1: by outdoor temperature	1: by outdoor T	0	1		Digital	R/W	232
CU12a	HAB_COMPENSACION	Enable the setpoint compensation depending on the outdoor temperature	0: no	0: no	1: yes	---	Digital	R/W	55
CU12a	HAB_PROT_BAJA_TEMP_EXTERIOR	Enable the protection for low outdoor temperature by digital outputs of the pCOe expansion module	0: no	0: no	1: yes	---	Digital		
CU12a	HAB_MB_TERMOSTATO_TCO	Enabling of the TCO terminal by MODBUS	1: yes	0: no	1: yes	---	Digital	R/W	229
CU12b	CONTROL_TCO_SONDA	Selection of the control probe with TCO terminal: 0=TCO 1=ambient 2=return	0: TCO	0	2	---	Integer	R/W	217
CU12b	CONTROL_SONDA_AMB	Enable the control with ambient probe	1: ambient temp.	0	1	---	Digital	R/W	189
CU12b	ThTune_bloqueado	Keypad lock of the TCO terminal	0: no	0	1	---	Digital	R/W	230
CU12b	Clock_Source_ThTune_or_Pco	Selection of clock source in TCO terminal or control board	1: mPC	0: TCO 1: mPC		---	Digital		
CU12b	pCO_ThTune_Scheduler	Selection of scheduler in TCO terminal or control board	0: mPC	0: mPC 1: TCO		---	Digital		
CU12b	HAB_CAMBIO_CAUDAL_POR_TCO	Enable the flow change by TCO terminal (supply plug-fan)	0: no	0: no	1: yes	---	Digital		

## 17 - LIST OF PARAMETERS OF THE "TECHNICAL MENU"

### MANUFACTURER screens → UNIT CONFIGURATION (...continuation)

Screen	Parameter	Description of the parameter	Value	Min.	Max.	UOM	Type	R/W	Add. BMS
CU12c	HAB_CONTROL_COMPUERTA_IMP_RET	Enable the control of supply and return damper (external to the unit)	0	0: no	1: yes	---	Digital	R/W	250
CU12e	HAB_4COMP_4CIRC_CAUDAL_VARIABLE	Selection of the operation with a single volume of outdoor air	0	0	1	---	Digital	R	
CU12d	HAB_ZONIFICACION_POR_VARIABLE	Enabling of the zoning of power and indoor air flow (units with tandem compressors and supply plug fan)	0	0: no	1: yes	---	Digital	R/W	67
CU12d	HAB_ZONIFICACION_POR_COMPUERTAS	Enabling of the air zoning in 2 zones with external dampers (pCOe expansion card addr.9) (units with tandem compressors and supply plug fan)	0	0: no	1: yes	---	Digital	R/W	239
CU12d	HAB_ZONIFICACION_4_ZONAS	Enabling of the zoning of the air flow up to 4 zones by motorised dampers (SMALL board addr.11)	0	0	1	---	Digital	R/W	239
CU01zn	MOD_MB_UPC_ZONIFICA_CIAT_1. HAB_MB_TERMOSTATO_TCO_11	Enable the terminal of zone 1 (zoning of the air flow)	1	0	1	---	Digital	R/W	307
CU01zn	MOD_MB_UPC_ZONIFICA_CIAT_1. HAB_MB_TERMOSTATO_TCO_12	Enable the terminal of zone 2 (zoning of the air flow)	1	0	1	---	Digital	R/W	308
CU01zn	MOD_MB_UPC_ZONIFICA_CIAT_1. HAB_MB_TERMOSTATO_TCO_13	Enable the terminal of zone 3 (zoning of the air flow)	1	0	1	---	Digital	R/W	309
CU01zn	MOD_MB_UPC_ZONIFICA_CIAT_1. HAB_MB_TERMOSTATO_TCO_14	Enable the terminal of zone 4 (zoning of the air flow)	1	0	1	---	Digital	R/W	310
CU13	HAB_MB_ENERGY_METER	Enabling of the electric energy meter	0	0: no	1: yes	---	Digital	R/W	190
CU13	HAB_MB_THERMAL_ENERGY_METER	Enabling of the meter of COOLING/HEATING capacities	0	0: no	1: yes	---	Digital	R/W	237
CU13a	MOD_MB_ENERGY_METERS_CIAT_1.Type_EM_Msk	Number of energy meters	0	0	9	---	Integer	R	
CU13a	MOD_MB_ENERGY_METERS_CIAT_1.Energy_Address_Msk	Address of the energy meter	0	0	254	---	Integer	R/W	
CU13a	MOD_MB_ENERGY_METERS_CIAT_1.Gavazzi_New_Address	New address of the energy meter	1	1	255	---	Integer	R/W	
CU13a	MOD_MB_ENERGY_METERS_CIAT_1.System_Type	Energy meter: type of electrical system	0	0	4	---	Integer	R/W	179
CU13a	MOD_MB_ENERGY_METERS_CIAT_1.CT_H_MSK	Energy meter: current transformer ratio, upper part (primary CT)	0	0	999	---	Integer	R	
CU13a	MOD_MB_ENERGY_METERS_CIAT_1.CT_L_MSK	Energy meter: current transformer ratio, low part (primary CT)	0	0	999	---	Integer	R	
CU13a	MOD_MB_ENERGY_METERS_CIAT_1.Sec_CT	Energy meter: current transformer ratio (secondary CT)	0	0	5	---	Integer	R/W	
CU13a	MOD_MB_ENERGY_METERS_CIAT_1.VT_H_MSK	Energy meter: voltage transformer ratio, upper part (primary VT)	0	0	999	---	Integer	R	
CU13a	MOD_MB_ENERGY_METERS_CIAT_1.VT_L_MSK	Energy meter: voltage transformer ratio, low part (primary VT)	0	0	999	---	Integer	R	
CU13a	MOD_MB_ENERGY_METERS_CIAT_1.Sec_VT	Energy meter: voltage transformer ratio, low part (secondary VT)	0	0	999	---	Integer	R/W	
CU13a	MOD_MB_ENERGY_METERS_CIAT_1.Reset_TMP	Reset of the records stored in the meter	0	0	1	---	Integer	R/W	
CU14	HAB_SUPERVISION	Enabling of the serial card for BMS communication	1	0: no	1: yes	---	Digital	R	50
CU14	HAB_FREECOOL_VER	Enabling of the free-cooling in COOLING mode (summer)	1	0: no	1: yes	---	Digital	R/W	52
CU14	HAB_FREEHEAT	Enabling of the free-heating in HEATING mode (winter)	0	0: no	1: yes	---	Digital	R/W	53
CU14	HAB_FREECOOL_INV	Enabling of the free-cooling in HEATING mode (winter)	1	0: no	1: yes	---	Digital	R/W	62
CU14	HAB_RENOVACION_AIRE	Enabling of the renewal with outdoor air	1	0: no	1: yes	---	Digital	R/W	233
CU14	HAB_EQUIPO_100_AIRE_EXTERIOR	Enabling of the unit operation with 100% outdoor air	0	0: no	1: yes	---	Digital	R/W	231
CU14a	TIPO_FREECOOLING	Type of free-cooling: 0=thermal 1=enthalpic 2= thermoenthalpic	0	0	2	---	Integer	R/W	118
CU15a	SET_IMPULSION_CALOR_FC	Value of the supply temperature to close the outdoor damper in HEATING mode (winter)	30,0	0,0	50,0	°C	Analog.	R/W	85
CU15a	SET_TEMP_OFF_FC_CALOR	Value of the return temperature to close the outdoor damper in HEATING mode (winter)	15,0	0,0	50,0	°C	Analog.	R/W	86
CU15a	BANDA_TEMP_OFF_FC_CALOR	Regulation band to close the outdoor damper in HEATING mode (winter)	2,0	0,0	5,0	°C	Analog.	R/W	87
CU15b	SET_IMPULSION_FRIO_FC	Value of the supply temperature to close the outdoor damper in COOLING mode (summer)	20,0	0,0	50,0	°C	Analog.	R/W	88
CU15b	SET_TEMP_OFF_FC_FRIO	Value of the return temperature to close the outdoor damper in COOLING mode (summer)	31,0	0,0	50,0	°C	Analog.	R/W	89
CU15b	BANDA_TEMP_OFF_FC_FRIO	Regulation band to close the outdoor damper in COOLING mode (summer)	2,0	0,0	5,0	°C	Analog.	R/W	90
CU16	MAN_VIC_C1	4-way valve of circuit 1	0	0: N.Open 1: N.Closed	---	---	Digital		
CU16	MAN_VIC_C2	4-way valve of circuit 2	0	0: N.Open 1: N.Closed	---	---	Digital		

## 17 - LIST OF PARAMETERS OF THE “TECHNICAL MENU”

### MANUFACTURER screens → UNIT CONFIGURATION (...continuation)

Screen	Parameter	Description of the parameter	Value	Min.	Max.	UOM	Type	R/W	Add. BMS
CU16	MAN_VIC_C1_2	4-way valve of circuit 3 (4 circuit units)	0	0: N.Open 1: N.Closed	---		Digital		
CU16	MAN_VIC_C2_2	4-way valve of circuit 4 (4 circuit units)	0	0: N.Open 1: N.Closed	---		Digital		
CU17a	MOD_MB_PROTOCOL_MNG_C1AT_1.Baudrate	Parameter for the MODBUS MASTER communication of the Field-bus card No.1: Baud rate (0=1200, 1=2400, 2=4800, 3=9600, 4=19200)	4	0	4	---	Integer	R/W	
CU17a	MOD_MB_PROTOCOL_MNG_C1AT_1.Stop_bits	Parameter for the MODBUS MASTER communication of the Field-bus card No.1: stop bits (0=1 or 1=2)	1	0	1	---	Integer	R/W	
CU17a	MOD_MB_PROTOCOL_MNG_C1AT_1.Parity_mode	Parameter for the MODBUS MASTER communication of the Field-bus card No.1: parity mode (0=no parity, 1=odd or 2=even)	0	0	2	---	Integer	R/W	
CU17a	MOD_MB_PROTOCOL_MNG_C1AT_1.Timeout	Parameter for the MODBUS MASTER communication of the Field-bus card No.1: Timeout	300	100	5000	ms	Integer	R/W	
CU17b	MOD_MB_PROTOCOL_MNG_C1AT_1.Baudrate_2ndMaster	Parameter for the MODBUS MASTER communication of the Field-bus card No.2: Baud rate (0=1200, 1=2400, 2=4800, 3=9600, 4=19200)	4	0	4	---	Integer	R/W	
CU17b	MOD_MB_PROTOCOL_MNG_C1AT_1.Stop_bits_2ndMaster	Parameter for the MODBUS MASTER communication of the Field-bus card No.2: stop bits (0=1 or 1=2)	1	0	1	---	Integer	R/W	
CU17b	MOD_MB_PROTOCOL_MNG_C1AT_1.Parity_mode_2ndMaster	Parameter for the MODBUS MASTER communication of the Field-bus card No.2: parity mode (0=no parity, 1=odd or 2=even)	0	0	2	---	Integer	R/W	
CU17b	MOD_MB_PROTOCOL_MNG_C1AT_1.Timeout_2ndMaster	Parameter for the MODBUS MASTER communication of the Field-bus card No.2: Timeout	300	100	5000	ms	Integer	R/W	

### MANUFACTURER screens → DEFROSTING CONFIGURATION

Screen	Parameter	Description of the parameter	Value	Min.	Max.	UOM	Type	R/W	Add. BMS
CD04	VAL_DES_MIN	Setpoint for start of defrosting by minimal pressure	-21°C (T) 2.5 bar (R410A) 1,0 bar (R407C)	-25	10	bar	Analog.	R/W	104
CD04	TIME_MAX_DUR_DES_MIN	Outdoor fans connection during the defrosting procedure by minimal pressure	240	0	600	s	Integer		
CD05	VAL_DES_DIF	Difference between the outdoor temperature and the evaporation temperature measured to start the defrosting procedure	16	5	20	°C	Analog.	R/W	105
CD05	SET_TEMP_EXT_DES	Outdoor temperature setpoint to allow the defrosting by difference	10	0	50	°C	Analog.	R/W	226
CD05	TIME_MAX_DUR_DES_DIF	Time of connection of the outdoor fan during the defrosting procedure by difference between the outdoor temperature and the evaporation temperature	120	0	600	s	Integer		
CD06	TIME_DES_C1_2	Time between defrosting of different circuits	90	0	999	s	Integer		
CD06	TIME_ENTRE_DES_DIF	Minimum time between defrosting of the same circuit by difference between the outdoor temperature and the evaporation temperature	20	0	99	min	Integer		
CD07	VAL_ON_VEXT_DES_OBL	Value of pressure to switch-on the outdoor fan during the defrosting	35.0 bar (R410A) 22.0 bar (R407C)	10	45	bar	Analog.	R/W	95
CD07	VAL_OFF_VEXT_DES_OBL	Value of pressure to switch-off the outdoor fan during the defrosting	33.0 bar (R410A) 20.0 bar (R407C)	10	45	bar	Analog.	R/W	96
CD07	SET_TEMP_VEXT_OFF_DES	Outdoor temperature setpoint below which there is not allowed to operate the outdoor fan during the defrosting	-6,0	-9,9	0	°C	Analog.	R/W	111
CD08	HAB_ON_VEXT_INI_DES	Enable the connection of the outdoor fan at the start of the defrosting	1: yes	0: no	1: yes	---	Digital	R/W	200
CD08	TIME_ON_VEXT_INI_DES	Running time of the outdoor fan at the start of the defrosting	45	0	120	s	Integer	R/W	185
CD09	VAL_INI_DES	Setpoint to start the defrosting	-5°C (T) 5.6 bar (R410A) 2,7 bar (R407C)	-10	10	bar	Analog.	R/W	37
CD09	VAL_FIN_DES	Setpoint to end the defrosting	9°C (T) 33.0 bar (R410A) 21,0 bar (R407C)	0	50	bar	Analog.	R/W	38
CD10	TIME_RET_INICIO_DES	Time delay to start the defrosting	120	0	999	s	Integer	R/W	34
CD10	TIME_MIN_DUR_DES	Minimum period of duration of the defrosting	1	0	999	min	Integer	R/W	64
CD10	TIME_MAX_DUR_DES	Maximum period of duration of the defrosting	10	0	999	min	Integer	R/W	35

## 17 - LIST OF PARAMETERS OF THE "TECHNICAL MENU"

### MANUFACTURER screens → COMPRESSOR CONFIGURATION

Screen	Parameter	Description of the parameter	Value	Min.	Max.	UOM	Type	R/W	Add. BMS
CC01	TIME_MIN_OFF_COMP	Minimum time of shutdown of a compressor	180	0	9999	s	Integer	R/W	27
CC01	TIME_MIN_ON_COMP	Minimum time of connection of a compressor	120	0	9999	s	Integer	R/W	33
CC02	TIME_MIN_ON_ON_COMP	Time between start-ups of the same compressor	300	0	9999	s	Integer	R/W	31
CC02	TIME_MIN_ON_ON_COMP_DIST	Time between start-ups of different compressors	60	0	9999	s	Integer	R/W	32
CC03	TIME_RET_AL_BP	Low pressure alarm delay	15	0	9999	s	Integer	R/W	19
CC03	HAB_ROT_COMP	Enabling of the compressors rotation	1	0: no	1: yes	---	Digital	W	64
CC03	EQUALIZED_CIRC_POWER	Type of circuit rotation: 0 = grouped; 1 = equalized; 2 = grouped on increasing - equalized on decreasing	1	0	2	---	Digital		
CC04	DESHAB_AL_BP_CALOR	Cancel LP pressostats in winter	0: no	0: no	1: yes	---	Digital	R/W	87
CC04	DESHAB_AL_BP_DES	Cancel LP pressostats in defrosting	0: no	0: no	1: yes	---	Digital	R/W	88
CC04a	HAB_OFF_COMP_DES	Enable the compressors shutdown before the defrosting	1: yes	0: no	1: yes	---	Digital	R/W	90
CC04a	TIME_OFF_COMP_DES	Time of compressors shutdown during the defrosting	45	0	9999	s	Integer		
CC04b	TIME_CAMBIO_V4V	4-way valve: time before the change and after the compressors shutdown	30	0	9999	s	Integer		
CC04c	HAB_OFF_COMP_CAMBIO_F_C	Compressors shutdown before the change COOLING/HEATING	1: yes	0: no	1: yes	---	Digital	R/W	91
CC04c	TIME_OFF_COMP_CAMBIO_F_C	Time of compressors shutdown due to the change of COOLING/HEATING mode	180	0	9999	s	Integer		
CC05	TIPO_BLOQ_COMP_FRIO_FC	Disable the compressors with free-cooling, in COOLING mode: 0: no; 1: by Delta ambient T - outdoor T 2: Outdoor T setpoint	2	0	2	---	Integer	R/W	72
CC05	SET_TEMP_BLOQ_COMP_FRIO_FC	Blocking setpoint to disconnect the compressors with free-cooling, in COOLING mode, due to the low outdoor temperature	10,0	-99,9	99,9	°C	Analog	R/W	92
CC05	VAL_DIF_BLOQ_COMP_FRIO_FC	Blocking setpoint to disconnect the compressors with free-cooling, by delta of ambient temperature - outdoor temperature	14,0	-99,9	99,9	°C	Analog	R/W	93
CC05	SET_HUM_BLOQ_COMP_FRIO_FC	Blocking humidity setpoint to disconnect the compressors with free-cooling, in COOLING mode	80,0	0,0	100,0	%HR	Analog	R/W	154
CC06	TIPO_BLOQ_COMP_CALOR	Disable the compressors in HEATING mode depending on the outdoor T	0	0: no	1: yes	---	Digital	R/W	131
CC06	SET_TEMP_BLOQ_COMP_CALOR_50_PORC	Blocking setpoint to disconnect half of the compressors in HEATING mode due to the low outdoor temperature	-11.5	-99,9	99,9	°C	Analog	R/W	298
CC06	SET_TEMP_BLOQ_COMP_CALOR	Blocking setpoint to disconnect all of the compressors in HEATING mode due to the low outdoor temperature (the optional recovery compressor is authorized to operate). In this case the fan will be activated for 60 sec every 30 min	-14.5	-99,9	99,9	°C	Analog	R/W	94

### MANUFACTURER screens → CONTROL CONFIGURATION

Screen	Parameter	Description of the parameter	Value	Min.	Max.	UOM	Type	R/W	Add. BMS
CR01	CONTROL_P_PI	Type of temperature control: 0:Proportional (P) # 1:Proportional+Integral (PI)	1	0	1	---	Digital	R/W	63
CR01	BANDA_TEMP_FRIO	Band for temperature control in summer (COOLING mode)	2.0	0.0	15.0	°C	Analog	R/W	
CR01	BANDA_TEMP_CALOR	Band for temperature control in winter (HEATING mode)	2.0	0.0	15.0	°C	Analog	R/W	
CR01	TIME_INTEGRACION	Integration time with PI temperature control	120	0	999	s	Integer	R/W	42
CR01a	CONTROL_P_PI_IMP	Type of supply temperature control: 0: Proportional (P) # 1: Proportional+Integral (PI)	1	0	1	---	Digital		
CR01a	BANDA_IMP_FRIO	Band for supply temperature control in summer (COOLING mode)	5.0	0.0	15.0	°C	Analog	R/W	
CR01a	BANDA_IMP_CALOR	Band for supply temperature control in winter (HEATING mode)	20.0	0.0	15.0	°C	Analog	R/W	
CR01a	TIME_INTEGRACION_IMP	Integration time with PI supply temperature control	120	0	999	s	Integer		
CR02	HAB_RES_EN_FRIO	Enable the electrical heaters as backup in COOLING mode (summer) to increase the outdoor temperature	1	0: no	1: yes	---	Digital	R/W	92
CR02	HAB_VALV_CALOR_EN_FRIO	Enable the hot water coil as backup in COOLING mode (summer) to increase the outdoor temperature	1	0: no	1: yes	---	Digital	R/W	93
CR03	HAB_OFF_VINT_FRIO	Indoor fan stoppage when the setpoint in COOLING mode is reached	0	0: no	1: yes	---	Digital	R/W	94
CR03	HAB_OFF_VINT_CALOR	Indoor fan stoppage when the setpoint in HEATING mode is reached	0	0: no	1: yes	---	Digital	R/W	95
CR03	HAB_OFF_VINT_POR_CO2	Indoor fan stoppage when the compressors are stopped, without demand of air renewal and with CO2 probe	0	0: no	1: yes	---	Digital	R/W	204
CR03a	TIME_VINT_ON_ANTIESTRATIF	Running time of the indoor fan without demand of compressor operation, to prevent the stratification of the hot air masses	0	0	999	min	Integer	R/W	186
CR03a	TIME_VINT_OFF_ANTIESTRATIF	Stopping time of the indoor fan without demand of compressor operation, to prevent the stratification of the hot air masses	0	0	999	min	Integer	R/W	187
CR04	TIME_RET_OFF_VINT_FRIO	Delay of the indoor fan stoppage with regard to the compressors stoppage in COOLING mode	60	0	999	s	Integer	R/W	23
CR04	TIME_RET_OFF_VINT_CALOR	Delay of the indoor fan stoppage with regard to the compressors stoppage in HEATING mode	60	0	999	s	Integer	R/W	24

## 17 - LIST OF PARAMETERS OF THE “TECHNICAL MENU”

### MANUFACTURER screens → CONTROL CONFIGURATION (...continuation)

Screen	Parameter	Description of the parameter	Value	Min.	Max.	UOM	Type	R/W	Add. BMS
CR04a	TIME_RET_OFF_VEXT_FRIO	Delay of the outdoor fan stoppage with regard to the compressors stoppage in COOLING mode	30	0	999	s	Integer	R/W	
CR04a	TIME_RET_OFF_VEXT_CALOR	Delay of the outdoor fan stoppage with regard to the compressors stoppage in HEATING mode	30	0	999	s	Integer	R/W	
CR05	TIME_RET_ON_COMP_ON_VINT	Delay of the start-up of the first compressor with regard to the indoor fan (to guarantee a sufficiently stable flow)	30	0	999	s	Integer	R/W	25
CR05	TIME_RET_ON_COMP_ON_VEXT	Delay of the start-up of the first compressor with regard to the outdoor fan	10	10	120	s	Integer		
CR05a	TIME_RET_ON_VINT	Delay of the indoor fan start-up (to allow the complete opening of the outdoor air damper)	30 60 (plug-fan + TCO)	0	999	s	Integer	RW	216
CR05a	TIME_RET_ON_VINT_CALOR	Delay of the indoor fan start-up in HEATING mode	0	0	999	s	Integer		
CR06	HAB_C_COND_VENT_EXT	Enable the condensation control of the outdoor unit (COOLING mode)	1	0	1	---	Digital	R/W	171
CR06	HAB_C_COND_VENT_EXT_AUTO	Enable the automatic condensation control of the outdoor unit	1	0	1	---	Digital	R/W	
CR06	TIME_VEXT_OFF_MAX_COND	Running time of compressor before to start the condensation control (delay of the fan connection with regard to the compressors)	0	0	999	s	Integer	R/W	
CR06	TIME_VEXT_ON_MAX_COND	Delay of the outdoor fan working at the maximum speed before to start the condensation control	120 s 30 s (electronic or damper)	0	999	s	Integer	R/W	
CR06	CONTROL_P_PI_C_COND_VEXT	Type of condensation control of the outdoor unit: 0: Proportional (P) 1: Proportional+Integral+Derivative (PID)	1	0	1	---	Digital	R/W	179
CR06	BANDA_C_COND_VEXT	Differential on the condensation control of the outdoor unit	5.0	0.0	30.0	Bar	Analog	R/W	69
CR06	TIME_INT_C_COND_VEXT	Integration time with PID condensation control of the outdoor unit	120	0	999	s	Integer	R/W	133
CR06	Td_PID_COND_VEXT	Derivative with PID condensation control of the outdoor unit	0.2	0.0	99.9	---	Analog	R/W	
CR06a	OFFSET_CAL_C_COND_VEXT_HALF_CAP	Offset for calculation the condensation control of the outdoor unit with half load circuit	10.5	0.0	30.0	°C	Analog	R/W	
CR06a	OFFSET_CAL_C_COND_VEXT_HIGH_CAP	Offset for calculation the condensation control of the outdoor unit with half full circuit	15.5	0.0	30.0	°C	Analog	R/W	
CR06a	SET_C_COND_VEXT_MIN	Minimum value of setpoint for condensation control	25.0	-10.0	30.0	°C	Analog	R/W	
CR06a	SET_C_COND_VEXT_MAX	Maximum value of setpoint for condensation control	60.0	0.0	60.0	°C	Analog	R/W	
CR06a	SET_TEMP_C_COND_VEXT1	Temperaure setpoint calculated for condensation control of circuit 1	0.0	-99.9	99.9	°C	Analog	R	
CR06a	SET_C_COND_VEXT_CAL_AOUT3	Pressure setpoint calculated for condensation control of circuit 1	0.0	0.0	30.0	Bar	Analog	R	
CR06a	SET_TEMP_C_COND_VEXT2	Temperaure setpoint calculated for condensation control of circuit 2	0.0	-99.9	99.9	°C	Analog	R	
CR06a	SET_C_COND_VEXT_CAL_AOUT4	Pressure setpoint calculated for condensation control of circuit 2	0.0	0.0	30.0	Bar	Analog	R	
CR06b	SET_C_COND_VEXT	Setpoint on the condensation control of the outdoor unit	27.0	0.0	60.0	Bar	Analog	R/W	67
CR07	HAB_C_EVAP_VENT_EXT	Enable the evaporation control of the outdoor unit (HEATING mode)	1	0	1	---	Digital	R/W	172
CR07	HAB_C_EVAP_VENT_EXT_AUTO	Enable the automatic evaporation control of the outdoor unit	1	0	1	---	Digital	R/W	
CR07	TIME_VEXT_ON_MAX_EVAP	Delay of the outdoor fan working at the maximum speed before to start the evaporation control	120 s 30 s (electronic or damper)	0	999	s	Integer	R/W	
CR07	CONTROL_P_PI_C_EVAP_VEXT	Type of evaporation control of the outdoor unit: 0: Proportional (P) 1: Proportional+Integral+Derivative (PID)	1	0	1	---	Digital	R/W	178
CR07	BANDA_C_EVAP_VEXT	Differential on the evaporation control of the outdoor unit	5.0	0.0	30.0	Bar	Analog	R/W	102
CR07	TIME_INT_C_EVAP_VEXT	Integration time with PID evaporation control of the outdoor unit	120	0	999	s	Integer	R/W	132
CR07	Td_PID_EVAP_VEXT	Derivative with PID evaporation control of the outdoor unit	0.1	0.0	99.9	---	Analog	R/W	
CR07a	OFFSET_CAL_C_EVAP_VEXT_HALF_CAP	Offset for calculation the evaporation control of the outdoor unit with half load circuit	7.0	0.0	30.0	°C	Analog	R/W	
CR07a	OFFSET_CAL_C_EVAP_VEXT_HIGH_CAP	Offset for calculation the evaporation control of the outdoor unit with half full circuit	8.0	0.0	30.0	°C	Analog	R/W	
CR07a	SET_C_EVAP_VEXT_MIN	Minimum value of setpoint for condensation control	-5.0	-10.0	30.0	°C	Analog	R/W	
CR07a	SET_C_EVAP_VEXT_MAX	Maximum value of setpoint for condensation control	10.0	0.0	30.0	°C	Analog	R/W	
CR07a	SET_TEMP_C_EVAP_VEXT1	Temperaure setpoint calculated for condensation control of circuit 1	0.0	-99.9	99.9	°C	Analog	R	
CR07a	SET_C_EVAP_VEXT_CAL_AOUT3	Pressure setpoint calculated for condensation control of circuit 1	0.0	0.0	30.0	Bar	Analog	R	
CR07a	SET_TEMP_C_EVAP_VEXT2	Temperaure setpoint calculated for condensation control of circuit 2	0.0	-99.9	99.9	°C	Analog	R	

## 17 - LIST OF PARAMETERS OF THE "TECHNICAL MENU"

### MANUFACTURER screens → CONTROL CONFIGURATION (...continuation)

Screen	Parameter	Description of the parameter	Value	Min.	Max.	UOM	Type	R/W	Add. BMS
CR07a	SET_C_EVAP_VEXT_CAL_AOUT4	Pressure setpoint calculated for condensation control of circuit 2	0.0	0.0	30.0	Bar	Analog.	R	
CR07b	SET_C_EVAP_VEXT	Setpoint on the condensation control of the outdoor unit	10.0	0.0	60.0	Bar	Analog.	R/W	100
CR08	HAB_C_COND_VENT_INT	Enable the condensation control of the indoor unit (HEATING mode) Note: in units with pressure or temperature sensors in the indoor coils (pCOe expansion card addr.8)	0	0: no	1: yes	---	Digital	R/W	217
CR08	TIME_VINT_ON_MAX_COND	Delay of the indoor fan working at the maximum speed before to start the condensation control	120	0	999	s	Integer	R/W	
CR08a	SET_C_COND_VINT	Setpoint on the condensation control of the indoor unit	27.0	0.0	60.0	Bar	Analog.	R/W	216
CR08a	BANDA_C_COND_VINT	Differential on the condensation control of the indoor unit	8.0	0.0	30.0	Bar	Analog.	R/W	217
CR08a	CONTROL_P_PI_C_COND_VINT	Type of condensation control of the indoor unit: 0: Proportional (P) # 1: Proportional+Integral (PI)	0	0	1	---	Digital	R/W	
CR08a	TIME_INT_C_COND_VINT	Integration time with PI condensation control of the indoor unit	120	0	999	s	Integer	W	
CR09	HAB_C_EVAP_VENT_INT	Enable the evaporation control of the indoor unit (COOLING mode) Note: in units with pressure or temperature sensors in the indoor coils (pCOe expansion card addr.8)	0	0: no	1: yes	---	Digital	R/W	216
CR09	TIME_VINT_ON_MAX_EVAP	Delay of the indoor fan working at the maximum speed before to start the evaporation control	120	0	999	s	Integer	W	
CR09a	SET_C_EVAP_VINT	Setpoint for evaporation control of the indoor unit	10.0	0.0	60.0	bar	Analog.	R/W	218
CR09a	BANDA_C_EVAP_VINT	Differential on the evaporation control of the indoor unit	2.0	0.0	30.0	bar	Analog.	R/W	219
CR09a	CONTROL_P_PI_C_EVAP_VINT	Type of evaporation control of the indoor unit: 0: Proportional (P) # 1: Proportional+Integral (PI)	0	0	1	---	Digital	R/W	
CR09a	TIME_INT_C_EVAP_VINT	Integration time with PI evaporation control of the indoor unit	120	0	999	s	Integer	W	
CR10	HAB_VENT_EXT_AUTO_MODAL_FRIO	Enabling AUTO operation of the outdoor fan in COOLING mode	1	0	1	---	Digital	W	
CR10	HAB_VENT_EXT_AUTO_MODAL_CALOR	Enabling AUTO operation of the outdoor fan in HEATING mode	1	0	1	---	Digital	W	
CR10	TIME_VEXT_ON_MODAL_AUTO	With the unit ON and the compressors stopped: connection time for the outdoor fan (for safety)	1	0	999	min	Integer	R/W	
CR10	TIME_VEXT_OFF_MODAL_AUTO	With the unit ON and the compressors stopped: disconnection time for the outdoor fan (for safety)	30	0	999	min	Integer	R/W	

### MANUFACTURER screens → SAFETY CONFIGURATION

Screen	Parameter	Description of the parameter	Value	Min.	Max.	UOM	Type	R/W	Add. BMS
CS01	SET_AL_INCENDIO	Return temperature setpoint to activate the anti-fire alarm	60.0	40.0	80.0	°C	Analog.	R/W	116
CS01	DIF_AL_INCENDIO	Return temperature differential to activate the anti-fire alarm	20.0	10.0	50.0	°C	Analog.	R/W	117
CS01	COMP_OFF_AL_INCENDIO	Status of the outdoor damper with anti-fire alarm: 0 = open 1 = closed	0	0	1	---	Digital	R/W	170
CS01a	REG_ANTI_INCENDIO_FRA_ERP	French regulations on Fire safety (ERP): 0 = disabled 1 = enabled	0	0	1	---	Digital	R/W	234
CS01a	TIME_RET_OFF_VINT_REG_INC_ERP	Delay of the indoor fan stoppage in units with electrical heaters, with French regulations on Fire safety (ERP)	120	0	999	s	Integer	R/W	
CS02	VAL_INI_AL_ANTIHILO	Initial value of the anti-freeze alarm for water-air units	-2,0	VAL_INI_FORCE_AL_ANTIHILO	50	°C	Analog.	R/W	143
CS02	VAL_DIF_AL_ANTIHILO	Differential value of the anti-freeze alarm for water-air units	8,0	0	50	°C	Analog.	R/W	144
CS03	SET_IMPULSION_CALOR_MAX	Setpoint to control the maximum supply temperature in HEATING mode (winter)	45.0	30.0	55.0	°C	Analog.	R/W	83
CS03	OFFSET_AL_IMPULSION_ALTA	Offset of the supply temperature setpoint to activate the high supply temperature alarm	10.0	0.0	20.0	°C	Analog.	R/W	118
CS03	DIF_AL_IMPULSION_ALTA	Differential of the supply temperature setpoint to activate the high supply temperature alarm	2.0	1.0	10.0	°C	Analog.	R/W	119
CS04	SET_ALTA_TEMP_FRIO	Setpoint of high indoor temperature in COOLING mode (summer) for alarm signal	50.0	0.0	60.0	°C	Analog.	R/W	41
CS04	SET_BAJA_TEMP_FRIO	Setpoint of low indoor temperature in COOLING mode (summer) for alarm signal	10.0	0.0	60.0	°C	Analog.	R/W	42
CS05	SET_ALTA_TEMP_CALOR	Setpoint of high indoor temperature in HEATING mode (winter) for alarm signal	50.0	0.0	60.0	°C	Analog.	R/W	43
CS05	SET_BAJA_TEMP_CALOR	Setpoint of low indoor temperature in HEATING mode (winter) for alarm signal	10.0	0.0	60.0	°C	Analog.	R/W	44
CS06	TIME_RET_AL_TEMP	Delay on the high / low indoor temperature for alarm signal	30	0	999	min	Integer	R/W	18



## 17 - LIST OF PARAMETERS OF THE “TECHNICAL MENU”

### MANUFACTURER screens → SAFETY CONFIGURATION (...continuation)

Screen	Parameter	Description of the parameter	Value	Min.	Max.	UOM	Type	R/W	Add. BMS
CS07	TIME_AL_VIRT	Delay of the alarm of the pLAN probe disconnection (due to data transmission)	30	0	9999	s	Integer	R/W	65
CS08	TIME_RET_AL_TERM_VENT_INT	Delay of the alarm of the indoor fan thermal protection (to avoid the alarm during the start-up)	0 s 30 s (air flow switch)	0	999	s	Integer	R/W	26
CS08	TIME_RET_AL_CAUDAL_AGUA	Delay of the alarm of the water flow switch (water-air unit)	30	0	120	s	Integer	R/W	183
CS08	HAB_AL_CAUDAL_AGUA_FRIO_CALOR	Selecting water flow switch safety (water-air unit): 0: Heating 1: Cooling-Heating	0: Heating	0	1	---	Digital	W	
CS08a	HAB_AVISO_ALTA_RPM_PLUG_FAN	Enable the warning message when a plug-fan exceed the maximum speed	1: Sí	0: no 1: yes		---	Digital	R/W	
CS08a	TIME_RET_ALTA_RPM_PLUG_FAN	Delay of the warning message when a plug-fan exceed the maximum speed	30	0	999	min	Integer	R/W	
CS08a	HAB_OFF_POR_AVISO_ALTA_RPM	Enable the unit shutdown when a plug-fan exceed the maximum speed: 0: Indication only 1: Unit shutdown	0	0	1	---	Digital	R/W	
CS08a	Máximal_Speed_Fan1	Maximum speed of the indoor fan 1	0	0	9999	rpm	Integer	R/W	
CS08a	Máximal_Speed_Fan2	Maximum speed of the indoor fan 2	0	0	9999	rpm	Integer	R/W	
CS08b	HAB_OFF_POR_AL_FILTRO_SUCIO	Configuration of the clogged filters alarm: 0: Indication only 1: Unit shutdown	0	0	1	---	Digital	R/W	
CS09	MOD_MB_GAS_LEAKAGE_CIA1_1.Detect_Device_Number_Tmp	Identification number of the gas leak detector	1	1	247	---	Integer	R/W	
CS09	MOD_MB_GAS_LEAKAGE_CIA1_1.Alarm_Setp_ppm	Limit value in ppm to activate the alarm of the gas leak detector	0	0	32767	ppm	Integer	R/W	
CS09	MOD_MB_GAS_LEAKAGE_CIA1_1.Alarm_Setp_Percent	Limit value in % to activate the alarm of the gas leak detector	0	0	100	%	Integer	R	
CS09	MOD_MB_GAS_LEAKAGE_CIA1_1.AI_Gas_Leakage_Dly	Delay of the alarm of the gas leak detector	0	0	59	min	Integer	R/W	
CS10	MOD_MB_GAS_LEAKAGE_CIA1_1.Buzzer_Delay	Disable the acoustic alarm of the gas leak detector after a certain activation time	0	0	59	min	Integer	R	
CS10	MOD_MB_GAS_LEAKAGE_CIA1_1.Del_AI_Offline	Delay of the sensor failures with Modbus communication (to prevent false alarms)	30	0	300	---	Integer	R/W	
CS11	SET_RES_CALEFACTORA_TUBERIA_BAC	Setpoint to activate the electrical heater around the piping of the hot water coil	4.0	-10.0	10.0	°C	Analog	R/W	
CS11	SET_RES_CARTER_DOBLE_COMPRESOR	Setpoint to activate the supplementary crankcase heater and the 1st stage of electrical heater for protection of the electric panel	-8.0	-20.0	0.0	°C	Analog	R/W	
CS11	SET_RES_CALEFACTORA_COMPUERTA	Setpoint to activate the electrical heater for protection of the outdoor dampers	-12.0	-20.0	0.0	°C	Analog	R/W	
CS11	SET_RES_CALEFACTORA_CUADRO_2	Setpoint to activate the 2nd stage of electrical heater for protection of the electric panel	-16.0	-20.0	0.0	°C	Analog	R/W	
CS12	VAL_INI_AL_BP	Start value of the alarm of low pressure safety	2.0	0.0	9.9	Bar	Analog	R/W	
CS12	VAL_FIN_AL_BP	Final value of the alarm of low pressure safety	4.0	0.0	9.9	Bar	Analog	R/W	
CS13	HAB_LIM_POT_COMP_TANDEM_POR_AP	Enable the power limitation due to the high pressure, in units with tandem compressors (one of the two compressors is stopped)	1	0	1	---	Digital	R/W	241
CS13	VAL_INI_AL_AP	Start value of the alarm of high pressure safety	41.5	0.0	45.0	Bar	Analog	R/W	
CS13	VAL_FIN_AL_AP	Final value of the alarm of high pressure safety	36.5	0.0	45.0	Bar	Analog	R/W	
CS13	TIME_LIM_POT_COMP_AP_ARRANQUE	Delay of the alarm of high pressure safety	60	0	99	s	Integer	R	

### MANUFACTURER screens → ALARMS CONFIGURATION

Screen	Parameter	Description of the parameter	Value	Min.	Max.	UOM	Type	R/W	Add. BMS
CA01	TIME_RS_SIR	Alarm management: acoustic alarm reset	2	0	9999	s	Integer	R/W	
CA01	RL_AL	Alarm relay (0=normal, 1=buzzer)	0	0	1	---	Digital	R/W	
CA01	SEL_ALARMA_POR_MASK	Relay activation with active alarm selected in the screen	1	0	1	---	Digital	R/W	180
CA02	HAB_TER	For remote output, selection of alarm of thermal protection	1	0	1	---	Digital	R/W	
CA02	HAB_HP	For remote output, selection of alarm of high pressure	1	0	1	---	Digital	R/W	
CA02	HAB_LP	For remote output, selection of alarm of low pressure	1	0	1	---	Digital	R/W	
CA02	HAB_DES	For remote output, selection of alarm of defrosting	1	0	1	---	Digital	R/W	
CA02	HAB_HT	For remote output, selection of alarm of high temperature	1	0	1	---	Digital	R/W	

## 17 - LIST OF PARAMETERS OF THE "TECHNICAL MENU"

### MANUFACTURER screens → ALARMS CONFIGURATION (...continuation)

Screen	Parameter	Description of the parameter	Value	Min.	Max.	UOM	Type	R/W	Add. BMS
CA02	HAB_LT	For remote output, selection of alarm of low temperature	1	0	1	---	Digital	R/W	
CA02	HAB_CON	For remote output, selection of alarm of counters	1	0	1	---	Digital	R/W	
CA02	HAB_SD	For remote output, selection of alarm of disconnected probes	1	0	1	---	Digital	R/W	
CA03	HAB_HIE	For remote output, selection of alarm of HWC antifreeze protection	1	0	1	---	Digital	R/W	
CA03	HAB_INT	For remote output, selection of alarm of indoor fan thermal protection	1	0	1	---	Digital	R/W	
CA03	HAB_KLD	For remote output, selection of alarm of compressor discharge	1	0	1	---	Digital	R/W	
CA03	HAB_FIL	For remote output, selection of alarm of clogged filter	1	0	1	---	Digital	R/W	
CA03	HAB_EPR	For remote output, selection of alarm of EPROM failure	1	0	1	---	Digital	R/W	
CA03	HAB_REL	For remote output, selection of alarm of clock	1	0	1	---	Digital	R/W	
CA03	HAB_SP	For remote output, selection of alarm of COOLING/HEATING setpoint	1	0	1	---	Digital	R/W	
CA04	HAB_BQ_AL_AP	Enable the change to manual reset of the high pressure safety after a certain number of alarms	1	0	1	---	Digital	R/W	
CA04	NUM_VECES_BQ_AL_AP	Number of alarms to change to manual reset of the high pressure safety	4	0	20	---	Integer	R/W	
CA04	TIME_BQ_AL_AP	Time in minutes to count the number of alarms for blocking due to high pressure	30	0	1440	min	Integer	R/W	
CA05	HAB_BQ_AL_BP	Enable the change to manual reset of the low pressure safety after a certain number of alarms	1	0	1	---	Digital	R/W	
CA05	NUM_VECES_BQ_AL_BP	Number of alarms to change to manual reset of the low pressure safety	4	0	20	---	Integer	R/W	
CA05	TIME_BQ_AL_BP	Time in minutes to count the number of alarms for blocking due to low pressure	30	0	1440	min	Integer	R/W	
CA06	HAB_BQ_AL_TERM	Enable the change to manual reset of the thermal protection of compressors and outdoor fans after a certain number of alarms	1	0	1	---	Digital	R/W	
CA06	NUM_VECES_BQ_AL_TERM	Number of alarms to change to manual reset of the thermal protection of compressors and outdoor fans	4	0	20	---	Integer	R/W	
CA06	TIME_BQ_AL_TERM	Time in minutes to count the number of alarms for blocking due to the thermal protection of compressors and outdoor fans	30	0	1440	min	Integer	R/W	
CA07	HAB_BQ_AL_TERM_RES	Enable the change to manual reset of the thermal protection of electrical heaters after a certain number of alarms	1	0	1	---	Digital	R/W	
CA07	NUM_VECES_BQ_AL_TERM_RES	Number of alarms to change to manual reset of the thermal protection of electrical heaters	4	0	20	---	Integer	R/W	
CA07	TIME_BQ_AL_TERM_RES	Time in minutes to count the number of alarms for blocking due to the thermal protection of electrical heaters	30	0	1440	min	Integer	R/W	

### MANUFACTURER screens → UNIT INITIALIZATION

Screen	Parameter	Description of the parameter	Value	Min.	Max.	UOM	Type	R/W	Add. BMS
L01	LANGUAGE	Selection of the language of the software installed: 0=Spanish; 1=French; 2=English; 3=Italian; 4=Turc; 5=German	0	0	5	---	Integer	R/W	63
IU02	logo_bool	Type of logo	0	0: CIAT 1: CARRIER	---	---	Digital		
IU03	MOD_HWSW_CHK_CIAT_1.Msk_Default_Init	Installation of the default values for the setting parameters	0	0: no	1: yes	---	Integer		
IU04	VIRT_VAL_ENSAYO	Installation of the values of compressor and defrosting timings for testing the unit - Minimum compressor OFF timer: 180 sec → 18 sec - Minimum time between 2 compressor start-ups: 300 sec → 30 sec - Minimum compressor ON time: 120 sec → 12 sec - Minimum time between 2 start-ups of different compr.: 60 sec → 6 sec - Maximum time between defrosting operations: 40 min → 5 min - Minimum time between defrosting operations: 20 min → 5 min - Time between defrosting by diff. between outd.T & evap. T: 10 min → 5 min. - Time between defrosting operations in different circuits: 90 sec → 10 sec - Delay in the defrosting start: 120 sec → 10 sec - Time min. outdoor damper opening to ON of recovery compr.: 90 s → 10 s - Min. outdoor damper opening to ON of recovery compr.: 10% → 0% - Time outd. fan at max. speed when ON compr. with cond. control : 120 s → 30 s - Time outd. fan at max. speed when ON compr. with evap. control : 120 s → 30 s - Setpoint to enable the electrical heaters due to outdoor T: 20°C → 40°C.	0	0: no	1: yes	---	Digital		
IU04	VIRT_VAL_NORMAL	The normal timing of the unit are restored.	0	0: no	1: yes	---	Digital		
IU05	RESET_EVENTOS	Reset the alarms log	0	0: no	1: yes	---	Digital		
IU06	NEW_PASS_UT	New USER password	*****	0	9999	---	Integer	R/W	28
IU06	NEW_PASS_ASS	New MAINTENANCE password	*****	0	9999	---	Integer	R/W	29
IU06	NEW_PASS_COS	New MANUFACTURER password	*****	0	9999	---	Integer	R/W	30

# 17 - LIST OF PARAMETERS OF THE “TECHNICAL MENU”

## 17.3. Parameters of the MAINTENANCE screens

The MAINTENANCE screen group is protected by an access key. If this password has to be known: please consult.

### MAINTENANCE screens → INPUTS / OUTPUTS

Screen	Parameter	Description of the parameter	Value	Min.	Max.	UOM	Type	R/W	Add. BMS
A0	SEL_FRIO_CALOR	Procedures for the selection of the COOLING/HEATING mode: 0: by keyboard 1: remote (digital input) 2: auto 3: only ventilation	0	0	3	---	Integer	R/W	59
A0	MODO_FRIO_CALOR_AUTO	COOLING/HEATING selection in AUTO: 0: by indoor temperature 1: by outdoor temperature	1	0	1	---	Digital	R/W	232
A0	CALOR_FRIO_PANEL	COOLING/HEATING selection by keyboard: 0: HEATING (winter) 1: COOLING (summer)	1	0	1	---	Digital	R/W	66
A0	SET_TEMP_EXT_CAMBIO_FRIO	Outdoor temperature setpoint for change to COOLING mode (in AUTO mode)	22.0	99.9	99.9	°C	Analog	R/W	223
A0	SET_TEMP_EXT_CAMBIO_CALOR	Outdoor temperature setpoint for change to HEATING mode (in AUTO mode)	20.0	99.9	99.9	°C	Analog	R/W	222
A0	PGD1_bloqueado_SEL_FRIO_CALOR	Enabling of the blocking of summer / winter selection in the pGD1 (so that the final user cannot change it)	0	0	1	---	Digital	R/W	240
A00	Comm_Address_Fan1	Address of the supply plug-fan	1	1	247	---	Integer	R/W	
A00	Control_mode_SET1_Fan1	Type of flow control with supply plug-fan 1: closed loop sensor ctr 2: open loop pwm ctr	1	0	2	---	Integer	R/W	
A00	VEL_VENT_TCO	Plug-fan speed with TCO terminal	2	1	3	---	Integer	R/W	
A00	SET_CAUDAL_VINT_FRIO	Setpoint of flow in COOLING mode with supply plug-fan	1200	CAUDAL_VINT_NOMINAL_MIN	CAUDAL_VINT_NOMINAL_MAX	x10 m3/h	Integer	R/W	200
A00	Speed_Input_perc_FRIO_Fan1	Percentage of speed modulation in COOLING mode with supply plug-fan	50	0	100	%	Integer	R/W	160
A00	SET_CAUDAL_VINT_CALOR	Setpoint of flow in HEATING mode with supply plug-fan	1200	CAUDAL_VINT_NOMINAL_MIN	CAUDAL_VINT_NOMINAL_MAX	x10 m3/h	Integer	R/W	201
A00	Speed_Input_perc_CALOR_Fan1	Percentage of speed modulation in HEATING mode with supply plug-fan	50	0	100	%	Integer	R/W	161
A00	SET_CAUDAL_VINT_VENTILACION	Setpoint of flow in VENTILATION mode with supply plug-fan	1200	CAUDAL_VINT_NOMINAL_MIN	CAUDAL_VINT_NOMINAL_MAX	x10 m3/h	Integer	R/W	197
A00	Speed_Input_perc_VENTIL_Fan1	Percentage of speed modulation in VENTILATION mode with supply plug-fan	50	0	100	%	Integer	R/W	159
A00a	SET_CAUDAL_VINT	Setpoint of flow selected with supply plug-fan (it can be the COOLING, HEATING or VENTILATION setpoint)	1200	0	9999	x10 m3/h	Integer		
A00a	Speed_Input_perc	% of speed modulation selected with supply plug-fan (it can be COOLING, HEATING or VENTILATION setpoint)	50	0	100	%	Integer		
A00a	CAUDAL_VINT_MEDIDO_AJUSTE	Current flow with supply plug-fan		0	9999	x10 m3/h	Integer	R	198
A00a	CurrModLev_msk_Fan1	Current % of speed modulation with supply plug-fan		0	9999	%	Integer		
A00a	actual_speed_msk_Fan1	Current speed with supply plug-fan	0	0	9999	rpm	Integer	R	199
A00f	Máximal_Speed_Fan1	Maximum speed allowed with supply plug-fan	0	0	9999	rpm	Integer		
A00f	Ramp_up_TIME_Fan1	Ramp-up time with supply plug-fan	5	0	625	s	Integer		
A00f	Ramp_dwn_TIME_Fan1	Ramp down time with supply plug-fan	5	0	625	s	Integer		
A00e	VALUE_Al_sensor_pda_Fan1	Voltage minimum value of the air pressure differential sensor to signal its alarm.	0.1	0.0	10.0	V	Integer		
A00e	TIME_RET_Al_sensor_pda_Fan1	Delay time to start the fan for alarm signaling of the air pressure differential sensor	30	10	120	s	Integer		
A00g	AIN2_Min_Value_Ebm_Fan1	Minimum limit of the air pressure differential sensor with supply plug-fan	0	0	5000	Pa	Integer		
A00g	AIN2_Max_Value_Ebm_Fan1	Maximum limit of the air pressure differential sensor with supply plug-fan	1000	0	5000	Pa	Integer		
A00h	Output_function_caracteristic_F1	Setting the analog output of master indoor plug-fan	1	0: PWM	1: speed	---	Integer		
A00h	Output_caracteristic_X1_Fan1	X1 value of the analog output of master indoor plug-fan	3	0	100	%	Integer		
A00h	Output_caracteristic_Y1_Fan1	Y1 value of the analog output of master indoor plug-fan	0,0	0,0	10,0	V	Analog		
A00h	Output_caracteristic_X2_Fan1	X2 value of the analog output of master indoor plug-fan	100	0	100	%	Integer		
A00h	Output_caracteristic_Y2_Fan1	Y2 value of the analog output of master indoor plug-fan	9,5	0,0	10,0	V	Analog		
A20	MOD_MB_VFD_CIAT_1.Type_Require_IO	Control type of frequency inverter of indoor motor: 1: closed loop sensor ctr 2: panel control 3: open loop pwm ctr	1	1	3	---	Integer		

# 17 - LIST OF PARAMETERS OF THE “TECHNICAL MENU”

## MAINTENANCE screens → INPUTS / OUTPUTS (...continuation)

Screen	Parameter	Description of the parameter	Value	Min.	Max.	UOM	Type	R/W	Add. BMS
A20	Pda_VENT_INT_min	Minimum point of differential pressure of the supply fan	125	0	9999	Pa	Integer	R/W	155
A20	Rpm_VENT_INT_min	Minimum point of speed (rpm) of the supply fan	592	0	9999	rpm	Integer	R/W	156
A20	Pda_VENT_INT_max	Maximum point of differential pressure of the supply fan	600	0	9999	Pa	Integer	R/W	157
A20	Rpm_VENT_INT_max	Maximum point of speed (rpm) of the supply fan	962	0	9999	rpm	Integer	R/W	158
A20	Speed_Input_perc_VENTILACION_Fan1	Percentage of speed modulation in VENTILATION mode with indoor fan	50	0	100	%	Integer	R/W	159
A20	Speed_Input_perc_FRIO_Fan1	Percentage of speed modulation in COOLING mode with indoor fan	50	0	100	%	Integer	R/W	160
A20	Speed_Input_perc_CALOR_Fan1	Percentage of speed modulation in HEATING mode with indoor fan	50	0	100	%	Integer	R/W	161
A20a	Speed_Input_perc_Fan1	Percentage of speed modulation with indoor fan	50	0	100	%	Integer		
A20a	Speed_Hz_VFD_INT	Frequency read on the indoor motor	---	0	99.9	Hz	Analog.	R	162
A20a	Analog_IN1_Ebm_Fan1	Pressure differential read on the indoor fan	---	0	32767	Pa	Integer	R	163
A20a	Speed_rpm_VFD_INT	Speed read on the indoor motor	---	0	9999	rpm	Integer	R	164
A20a	Rpm_VENT_INT_calculado	Speed calculated on the indoor fan	---	0	32767	rpm	Integer	R	165
A20f	MOD_MB_VFD_CIA1_1.Min_Setting_A1	Minimum value of the analog input A1 of indoor motor VFD	0	0	1000.0	%	Analog.	R	166
A20f	MOD_MB_VFD_CIA1_1.Max_Setting_A1	Maximum value of the analog input A1 of indoor motor VFD	1000.0	0	1000.0	%	Analog.	R	167
A20f	MOD_MB_VFD_CIA1_1.Min_Frequency	Minimum frequency value of indoor motor VFD	25.0	0	320.0	Hz	Analog.	R	168
A20f	MOD_MB_VFD_CIA1_1.Max_Frequency	Maximum frequency value of indoor motor VFD	50.0	0	320.0	Hz	Analog.	R	169
A20f	MOD_MB_VFD_CIA1_1.Acceler_Time	Ramp-up time with frequency inverter of indoor motor	5	0	3000	s	Analog.		
A20f	MOD_MB_VFD_CIA1_1.Deceler_Time	Ramp down time with frequency inverter of indoor motor	5	0	3000	s	Analog.		
A20e	VALUE_AI_sensor_pda_Fan1	Voltage minimum value of the air pressure differential sensor to signal its alarm.	0.1	0.0	10.0	V	Integer		
A20e	TIME_RET_AI_sensor_pda_Fan1	Delay time to start the fan for alarm signaling of the air pressure differential sensor	30	10	120	s	Integer		
A20g	AIN2_Min_Value_Ebm_Fan1	Minimum limit of the air pressure differential sensor with indoor fan	0	0	5000	Pa	Integer		
A20g	AIN2_Max_Value_Ebm_Fan1	Maximum limit of the air pressure differential sensor with indoor fan	1000	0	5000	Pa	Integer		
A001	Control_mode_SET1_Fan2	Type of flow control with return plug-fan: 1: constant flow control 2: PWM control	1	1	2	---	Integer		
A001	SET_CAUDAL_VRET_VENTILACION	Setpoint of flow in VENTILATION mode with return plug-fan	1200	CAUDAL_VRET_NOMINAL_MIN	CAUDAL_VRET_NOMINAL_MIN	x10 m3/h	Integer	R/W	203
A001	SET_CAUDAL_VRET_FRIO	Setpoint of flow in COOLING mode with return plug-fan	1200	CAUDAL_VRET_NOMINAL_MIN	CAUDAL_VRET_NOMINAL_MIN	x10 m3/h	Integer	R/W	206
A001	SET_CAUDAL_VRET_CALOR	Setpoint of flow in HEATING mode with return plug-fan	1200	CAUDAL_VRET_NOMINAL_MIN	CAUDAL_VRET_NOMINAL_MIN	x10 m3/h	Integer	R/W	207
A001	Speed_Input_perc_VENTILACION_Fan2	Percentage of speed modulation in VENTILATION mode with return plug-fan	50	0	100	%	Integer		
A001	Speed_Input_perc_FRIO_Fan2	Percentage of speed modulation in COOLING mode with return plug-fan	50	0	100	%	Integer		
A001	Speed_Input_perc_CALOR_Fan2	Percentage of speed modulation in HEATING mode with return plug-fan	50	0	100	%	Integer		
A001a	SET_CAUDAL_VRET	Setpoint of flow selected with return plug-fan (it can be the COOLING, HEATING or VENTILATION setpoint)	1200	0	9999	x10 m3/h	Integer		
A001a	Speed_Input_perc_Fan2	Percentage of speed modulation selected with return plug-fan (it can be the COOLING, HEATING or VENTILATION setpoint)	50	0	100	%	Integer		
A001a	CAUDAL_VRET_MEDIDO_AJUSTE	Current flow with return plug-fan		0	9999	x10 m3/h	Integer		204
A001a	CurrModLev_msk_Fan2	Current percentage of speed modulation with return plug-fan		0	9999	%	Integer		
A001a	actual_speed_msk_Fan2	Current speed with return plug-fan	0	0	9999	rpm	Integer	R	205
A001f	Máximal_Speed_Fan2	Maximum speed allowed with return plug-fan	0	0	9999	rpm	Integer		
A001f	Ramp_up_TIME_Fan2	Ramp-up time with return plug-fan	5	0	625	s	Integer		
A001f	Ramp_dwn_TIME_Fan2	Ramp down time with return plug-fan	5	0	625	s	Integer		
A001e	VALUE_AI_sensor_pda_Fan2	Voltage minimum value of the air pressure differential sensor to signal its alarm.	0.1	0.0	10.0	V	Integer		
A001e	TIME_RET_AI_sensor_pda_Fan2	Delay time to start the fan for alarm signaling of the air pressure differential sensor	30	10	120	s	Integer		

# 17 - LIST OF PARAMETERS OF THE “TECHNICAL MENU”

## MAINTENANCE screens → INPUTS / OUTPUTS (...continuation)

Screen	Parameter	Description of the parameter	Value	Min.	Max.	UOM	Type	R/W	Add. BMS
A001g	AIN2_Min_Value_Ebm_Fan2	Minimum limit of the air pressure differential sensor with return plug-fan	0	0	5000	Pa	Integer		
A001g	AIN2_Max_Value_Ebm_Fan2	Maximum limit of the air pressure differential sensor with return plug-fan	1000	0	5000	Pa	Integer		
A001h	Output_function_characteristic_F2	Setting the analog output of master return plug-fan 0: PWM; 1: speed	1	0	1	---	Integer		
A001h	Output_characteristic_X1_Fan2	X1 value of the analog output of master return plug-fan	3	0	100	%	Integer		
A001h	Output_characteristic_Y1_Fan2	Y1 value of the analog output of master return plug-fan	0,0	0,0	10,0	V	Analog.		
A001h	Output_characteristic_X2_Fan2	X2 value of the analog output of master return plug-fan	100	0	100	%	Integer		
A001h	Output_characteristic_Y2_Fan2	Y2 value of the analog output of master return plug-fan	9,5	0,0	10,0	V	Analog.		
A201	MOD_MB_VFD_CIAT_2.Type_Require_IO	Control type of frequency inverter of return motor: 1: closed loop ctr 2: panel control 3: open loop pwm ctr	1	1	3	---	Integer		
A201	Pda_VENT_RET_min	Minimum point of differential pressure of the return fan	125	0	9999	Pa	Integer	R/W	170
A201	Rpm_VENT_RET_min	Minimum point of speed (rpm) of the return fan	592	0	9999	rpm	Integer	R/W	171
A201	Pda_VENT_RET_max	Maximum point of differential pressure of the return fan	600	0	9999	Pa	Integer	R/W	172
A201	Rpm_VENT_RET_max	Maximum point of speed (rpm) of the return fan	962	0	9999	rpm	Integer	R/W	173
A201	Speed_Input_perc_VENTILACION_Fan2	% of speed modulation in VENTILATION mode with return fan	50	0	100	%	Integer	R/W	174
A201	Speed_Input_perc_FRIO_Fan2	% of speed modulation in COOLING mode with return fan	50	0	100	%	Integer	R/W	175
A201	Speed_Input_perc_CALOR_Fan2	% of speed modulation in HEATING mode with return fan	50	0	100	%	Integer	R/W	176
A201a	Speed_Input_perc_Fan2	Percentage of speed modulation with return fan	50	0	100	%	Integer		
A201a	Speed_Hz_VFD_RET	Frequency read on the return motor	---	0	99.9	Hz	Analog.	R	177
A201a	Analog_IN1_Ebm_Fan2	Pressure differential read on the return fan	---	0	32767	Pa	Integer	R	178
A201a	Speed_rpm_VFD_RET	Speed read on the return motor	---	0	9999	rpm	Integer	R	179
A201a	Rpm_VENT_RET_calculado	Speed calculated on the return fan	---	0	32767	rpm	Integer	R	180
A201f	MOD_MB_VFD_CIAT_2.Min_Setting_A1	Minimum value of the analog input A1 of return motor VFD	0	0	1000.0	%	Analog.	R	181
A201f	MOD_MB_VFD_CIAT_2.Max_Setting_A1	Maximum value of the analog input A1 of return motor VFD	1000.0	0	1000.0	%	Analog.	R	182
A201f	MOD_MB_VFD_CIAT_2.Min_Frequency	Minimum frequency value of return motor VFD	25.0	0	320.0	Hz	Analog.	R	183
A201f	MOD_MB_VFD_CIAT_2.Max_Frequency	Maximum frequency value of return motor VFD	50.0	0	320.0	Hz	Analog.	R	184
A201f	MOD_MB_VFD_CIAT_2.Acceler_Time	Ramp-up time with frequency inverter of return motor	5	0	3000	s	Analog.		
A201f	MOD_MB_VFD_CIAT_2.Deceler_Time	Ramp down time with frequency inverter of return motor	5	0	3000	s	Analog.		
A201e	VALUE_AI_sensor_pda_Fan2	Voltage minimum value of the air pressure differential sensor to signal its alarm	0.1	0.0	10.0	V	Integer		
A201e	TIME_RET_AI_sensor_pda_Fan2	Delay time to start the fan for alarm signaling of the air pressure differential sensor	30	10	120	s	Integer		
A201g	AIN2_Min_Value_Ebm_Fan2	Minimum limit of the air pressure diff. sensor with return fan	0	0	5000	Pa	Integer		
A201g	AIN2_Max_Value_Ebm_Fan2	Maximum limit of the air pressure diff. sensor with return fan	1000	0	5000	Pa	Integer		
A002b	HAB_RED_CAUDAL_CONDUCTO_TEXTIL	Enable flow reduction to fan start with fabric duct	1	0: no	1: yes	---	Digital	R/W	
A002b	PORC_CAUDAL_CONDUCTO_TEXTIL	Percentage of flow to fan start with fabric duct	35.0	20.0	75.0	%	Analog.	R/W	
A002b	TIME_RED_CAUDAL_CONDUCTO_TEXTIL	Reduced flow timing to fan start with fabric duct	20	0	999	s	Integer	R/W	
A002	SET_CAUDAL_VINT_CALOR	Supply flow (measured value or value set by parameter)	1200	0	9999	x10 m3/h	Integer	R/W	201
A002	SET_CAUDAL_VRET_CALOR	Return flow (measured value or value set by parameter)	1200	0	9999	x10 m3/h	Integer	R/W	207
A002	Sobrepresión	Calculation of the OVERPRESSURE	0.0	0.0	99.9	%	Analog.	R	151
A002	SET_AJUSTE_SOBREPresión	Constant of adjustment of the calculation of the overpressure	1.0	0.0	10.0	---	Analog.	R/W	152
A002	AOUT_COMPUERTA	Output outdoor air damper	000.0	000.0	999.9	%	Integer	R	10
A002	AOUT_COMPUERTA_EXTRACCION	Output exhaust air damper	000.0	000.0	999.9	%	Integer	R	153
A002a	CAUDAL_IMPULSION_MSK	Supply flow (measured value or value set by parameter)	0	0	9999	x10 m3/h	Integer	R	

## 17 - LIST OF PARAMETERS OF THE "TECHNICAL MENU"

### MAINTENANCE screens → INPUTS / OUTPUTS (...continuation)

Screen	Parameter	Description of the parameter	Value	Min.	Max.	UOM	Type	R/W	Add. BMS
A002a	CAUDAL_RETORNO_MSK	Return flow (measured value or value set by parameter)	0	0	9999	x10 m3/h	Integer	R	
A002a	RENOVACION_CAL	Calculation of the air renewal with mixing probe or CO2 probe	0	0	99	%	Integer	R	124
A002a	CAUDAL_RENOVACION_MSK	Renewal flow	0	0	9999	x10 m3/h	Integer	R	201
A002a	CAUDAL_EXTRACCION_MSK	Extraction flow	0	0	9999	x10 m3/h	Integer	R	
A002d	TIPO_SONDA_HUM_INT	Type of indoor humidity probe: 0=No, 1=Actual, 2=pLAN, 3=Virtual, 4=RS485	0	0	4	---	Integer	R/W	56
A002d	TIPO_SONDA_HUM_EXT	Type of indoor humidity probe: 0=No, 1=Actual, 2=pLAN	0	0	2	---	Integer	R/W	55
A002e	TIPO_FREECOOLING	Type of freecooling: 0: Thermal 1: Enthalpic 2: Thermoenthalpic	0	0	2	---	Integer	R/W	118
A002e	SET_POINT_HUM	Humidity setpoint	50.0	LIM_INF_HUM	LIM_SUP_HUM	%rH	Analog.	R/W	18
A002f	HAB_SONDA_AMB	Enable the ambient probe	1	0	1	---	Digital	R/W	167
A002f	CONTROL_SONDA_AMB	Enable control with ambient probe	1	0	1	---	Digital	R/W	189
A002f	TIPO_SONDA_AMB	Type of ambient probe: 1: 1 probe RS485 2: 2 probes RS485 3: probe in pLAN network 4: 1 probe NTC 5: 3 probes RS485 6: 4 probed RS485 7: 1 probe 4-20mA	4	1	7	---	Integer	R/W	46
A002f	SEL_TEMP_SONDAS_AMB_FRIO	Selection of temperature value with ambient probes in COOLING mode: 0=average 1=minimum 2=maximum	0	0	2	---	Integer	R/W	199
A002f	SEL_TEMP_SONDAS_AMB_CALOR	Selection of temperature value with ambient probes in HEATING mode: 0=average 1=minimum 2=maximum	0	0	2	---	Integer	R/W	200
A04	TAR_TEMP_RET	Calibration of the return air temperature probe	0,0	-9,9	9,9	°C	Analog.	R/W	45
A04	TAR_TEMP_EXT	Calibration of the outdoor air temperature probe	0,0	-9,9	9,9	°C	Analog.	R/W	46
A04a	TAR_TEMP_AMB	Calibration of the ambient air temperature probe	0,0	-9,9	9,9	°C	Analog.	R/W	108
A04b	TAR_TEMP_TCO	Calibration of the TCO ambient temperature probe	0,0	-9,9	9,9	°C	Analog.	R	
A05	TAR_TEMP_IMP	Calibration of the supply air temperature probe	0,0	-9,9	9,9	°C	Analog.	R/W	47
A05	TAR_TEMP_MEZCLA	Calibration of the mixing air temperature probe	0,0	-9,9	9,9	°C	Analog.	R/W	50
A05a	TAR_CO2	Calibration of the CO2 air quality probe	0,0	-999	999	ppm	Integer	R/W	215
A05a	TAR_CO2_zona2	Calibration of the second CO2 air quality probe (installation in the environment or outdoor) or zone 2 probe (zoning into 2 zones)	0,0	-999	999	ppm	Integer	R/W	221
A5b	TAR_TEMP_ENTRADA_BAC	Calibration of the HWC inlet water temperature probe	0,0	-9,9	9,9	°C	Analog.	R/W	227
A5b	TAR_TEMP_SALIDA_BAC	Calibration of the HWC outlet water temperature probe	0,0	-9,9	9,9	°C	Analog.	R/W	228
A5c	TAR_TEMP_EXTRACCION_RUEDA	Calibration of the exhaust temperature probe on the wheel (recovery heat exchanger)	0,0	-9,9	9,9	°C	Analog.	R/W	248
A5c	TAR_TEMP_RECUPERACION_RUEDA	Calibration of the recovery temperature probe on the wheel (recovery heat exchanger)	0,0	-9,9	9,9	°C	Analog.	R/W	250
A06	TAR_T_P_BEXT_C1	Calibration of the outdoor unit sensor of circuit 1	0,0	-9,9	9,9	bar	Analog.	R/W	48
A06	TAR_T_P_BEXT_C1_2	Calibration of the outdoor unit sensor of circuit 3 (4 circuit units)	0,0	-9,9	9,9	bar	Analog.	R/W	109
A06a	TAR_T_P_BEXT_C2	Calibration of the outdoor unit sensor of circuit 2	0,0	-9,9	9,9	bar	Analog.	R/W	49
A06a	TAR_T_P_BEXT_C2_2	Calibration of the outdoor unit sensor of circuit 4 (4 circuit units)	0,0	-9,9	9,9	bar	Analog.	R/W	110
A06b	TAR_T_P_BINT_C1	Calibration of the indoor unit sensor of circuit 1	0,0	-9,9	9,9	bar	Analog.	R/W	212
A06b	TAR_T_P_BINT_C1_2	Calibration of the indoor unit sensor of circuit 3 (4 circuit units)	0,0	-9,9	9,9	bar	Analog.	R/W	213
A06c	TAR_T_P_BINT_C2	Calibration of the indoor unit sensor of circuit 2	0,0	-9,9	9,9	bar	Analog.	R/W	214
A06c	TAR_T_P_BINT_C2_2	Calibration of the indoor unit sensor of circuit 4 (4 circuit units)	0,0	-9,9	9,9	bar	Analog.	R/W	215
A06d	MOD_MB_SERIAL_PROBE_C1AT2_1.Offset_Temp	Ambient air temperature probe RS485 No.1: offset	0.0	Min_Diff_Temp_AAA	Max_Diff_Temp_AAA	---	Analog.	R/W	

# 17 - LIST OF PARAMETERS OF THE “TECHNICAL MENU”

## MAINTENANCE screens → INPUTS / OUTPUTS (...continuation)

Screen	Parameter	Description of the parameter	Value	Min.	Max.	UOM	Type	R/W	Add. BMS
A06d	MOD_MB_SERIAL_PROBE_C IAT2_1.Temperature	Reading of the ambient air temperature probe RS485 No. 1	0.0	-30.0	158.0	---	Analog.	R	
A06d	MOD_MB_SERIAL_PROBE_C IAT2_1.Offset_Humi	Ambient air humidity probe RS485 No.1: offset	0.0	-10.0	10.0	---	Analog.	R/W	
A06d	MOD_MB_SERIAL_PROBE_C IAT2_1.Humidity	Reading of the ambient air humidity probe RS485 No. 1	0.0	0.0	99.9	---	Analog.	R	
A06e	MOD_MB_SERIAL_PROBE_C IAT2_1.Temperature	Calibration of the ambient probe RS485 No.1: temperature	0.0	-999.9	999.9	---	Analog.	R	
A06e	MOD_MB_SERIAL_PROBE_C IAT2_1.Humidity	Calibration of the ambient probe RS485 No.1: humidity	0.0	32.0	32.0	---	Analog.	R	
A06e	MOD_MB_SERIAL_PROBE_C IAT2_1.Dew_Point	Calibration of the ambient probe RS485 No.1: dew point	0.0	-999.9	999.9	---	Analog.	R	
A06f	MOD_MB_SERIAL_PROBE_C IAT2_2.Offset_Temp	Ambient air temperature probe RS485 No.2: offset	0.0	Min_Diff_Temp_AAA	Max_Diff_Temp_AAA	---	Analog.	R/W	
A06f	MOD_MB_SERIAL_PROBE_C IAT2_2.Temperature	Reading of the ambient air temperature probe RS485 No. 2	0.0	-30.0	158.0	---	Analog.	R	
A06f	MOD_MB_SERIAL_PROBE_C IAT2_2.Offset_Humi	Ambient air humidity probe RS485 No.2: offset	0.0	-10.0	10.0	---	Analog.	R/W	
A06f	MOD_MB_SERIAL_PROBE_C IAT2_2.Humidity	Reading of the ambient air humidity probe RS485 No. 2	0.0	0.0	99.9	---	Analog.	R	
A06g	MOD_MB_SERIAL_PROBE_C IAT2_2.Temperature	Calibration of the ambient probe RS485 No.2: temperature	0.0	-999.9	999.9	---	Analog.	R	
A06g	MOD_MB_SERIAL_PROBE_C IAT2_2.Humidity	Calibration of the ambient probe RS485 No.2: humidity	0.0	32.0	32.0	---	Analog.	R	
A06g	MOD_MB_SERIAL_PROBE_C IAT2_2.Dew_Point	Calibration of the ambient probe RS485 No.2: dew point	0.0	-999.9	999.9	---	Analog.	R	
A06h	MOD_MB_SERIAL_PROBE_C IAT2_3.Offset_Temp	Ambient air temperature probe RS485 No.3: offset	0.0	Min_Diff_Temp_AAA	Max_Diff_Temp_AAA	---	Analog.	R/W	
A06h	MOD_MB_SERIAL_PROBE_C IAT2_3.Temperature	Reading of the ambient air temperature probe RS485 No. 3	0.0	-30.0	158.0	---	Analog.	R	
A06h	MOD_MB_SERIAL_PROBE_C IAT2_3.Offset_Humi	Ambient air humidity probe RS485 No.3: offset	0.0	-10.0	10.0	---	Analog.	R/W	
A06h	MOD_MB_SERIAL_PROBE_C IAT2_3.Humidity	Reading of the ambient air humidity probe RS485 No. 3	0.0	0.0	99.9	---	Analog.	R	
A06i	MOD_MB_SERIAL_PROBE_C IAT2_3.Temperature	Calibration of the ambient probe RS485 No.3: temperature	0.0	-999.9	999.9	---	Analog.	R	
A06i	MOD_MB_SERIAL_PROBE_C IAT2_3.Humidity	Calibration of the ambient probe RS485 No.3: humidity	0.0	32.0	32.0	---	Analog.	R	
A06i	MOD_MB_SERIAL_PROBE_C IAT2_3.Dew_Point	Calibration of the ambient probe RS485 No.3: dew point	0.0	-999.9	999.9	---	Analog.	R	
A06j	MOD_MB_SERIAL_PROBE_C IAT2_4.Offset_Temp	Ambient air temperature probe RS485 No.4: offset	0.0	Min_Diff_Temp_AAA	Max_Diff_Temp_AAA	---	Analog.	R/W	
A06j	MOD_MB_SERIAL_PROBE_C IAT2_4.Temperature	Reading of the ambient air temperature probe RS485 No.4	0.0	-30.0	158.0	---	Analog.	R	
A06j	MOD_MB_SERIAL_PROBE_C IAT2_4.Offset_Humi	Ambient air humidity probe RS485 No.4: offset	0.0	-10.0	10.0	---	Analog.	R/W	
A06j	MOD_MB_SERIAL_PROBE_C IAT2_4.Humidity	Reading of the ambient air humidity probe RS485 No.4	0.0	0.0	99.9	---	Analog.	R	
A06k	MOD_MB_SERIAL_PROBE_C IAT2_4.Temperature	Calibration of the ambient probe RS485 No.4: temperature	0.0	-999.9	999.9	---	Analog.	R	
A06k	MOD_MB_SERIAL_PROBE_C IAT2_4.Humidity	Calibration of the ambient probe RS485 No.4: humidity	0.0	32.0	32.0	---	Analog.	R	
A06k	MOD_MB_SERIAL_PROBE_C IAT2_4.Dew_Point	Calibration of the ambient probe RS485 No.4: dew point	0.0	-999.9	999.9	---	Analog.	R	
A07	TAR_HUM_INT	Calibration of the indoor air humidity probe	0.0	-9.9	9.9	%rH	Analog.	R/W	54
A07	TAR_HUM_EXT	Calibration of the outdoor air humidity probe	0.0	-9.9	9.9	%rH	Analog.	R/W	55
A07b1	IS_SONDA_AMB	Lower threshold for the ambient probe 4-20 mA	0.0	-99.9	99.9	°C	Analog.	R/W	
A07b1	FS_SONDA_AMB	Upper threshold for the ambient probe 4-20 mA	50.0	-99.9	99.9	°C	Analog.	R/W	
A07c	IS_CO2	Lower threshold for the CO2 quality probe	0	0	10000	ppm	Integer	R/W	
A07c	FS_CO2	Upper threshold for the CO2 quality probe	2000	0	10000	ppm	Integer	R/W	
A07c1	IS_CO2_zona2	Lower threshold for the CO2 quality probe: second ambient probe or outdoor probe	0	0	10000	ppm	Integer	R/W	
A07c1	FS_CO2_zona2	Upper threshold for the CO2 quality probe: second ambient probe or outdoor probe	2000	0	10000	ppm	Integer	R/W	
A07d	IS_SONDA_HUM	Lower threshold for the humidity probes 4-20 mA	10.0	0.0	100.0	%rH	Analog.	R/W	72
A07d	FS_SONDA_HUM	Upper threshold for the humidity probes 4-20 mA	90.0	0.0	100.0	%rH	Analog.	R/W	71
A07d	LIM_MIN_HUM_ALARMA	Minimum limit of humidity to signal alarm	0.0	0.0	110.0	%rH	Analog.	R/W	146
A07d	LIM_MAX_HUM_ALARMA	Maximum limit of humidity to signal alarm	100.0	0.0	110.0	%rH	Analog.	R/W	147
A07e	IS_Presión	Lower threshold for the pressure transducer	0.0	-2.0	50.0	Bar	Analog.	R/W	97

## 17 - LIST OF PARAMETERS OF THE “TECHNICAL MENU”

### MAINTENANCE screens → INPUTS / OUTPUTS (...continuation)

Screen	Parameter	Description of the parameter	Value	Min.	Max.	UOM	Type	R/W	Add. BMS
A07e	FS_Presión	Upper threshold for the pressure transducer	45.0	0.0	50.0	Bar	Analog.	R/W	98
A07f	TIPO_REFRIGERANTE	Type of refrigerant (4=R410A)	4	0	4	---	Integer	R/W	43
A07f	T_P_BEXT_C1	Reading of the pressure transducer of outdoor circuit 1	0.0	0.0	0.0	Bar	Analog.	R	
A07f	TEMP_CAL_BEXT_C1	Conversion to temperature of the pressure transducer of outdoor circuit 1	0.0	0.0	0.0	°C	Analog.	R	
A07f	T_P_BEXT_C1_2	Reading of the pressure transducer of outdoor circuit 3 (4 circuit units)	0.0	0.0	0.0	Bar	Analog.	R	
A07f	TEMP_CAL_BEXT_C1_2	Conversion to temperature of the pressure transducer of outdoor circuit 3	0.0	0.0	0.0	°C	Analog.	R	
A07g	T_P_BEXT_C2	Reading of the pressure transducer of outdoor circuit 2	0.0	0.0	0.0	Bar	Analog.	R	
A07g	TEMP_CAL_BEXT_C2	Conversion to temperature of the pressure transducer of outdoor circuit 2	0.0	0.0	0.0	°C	Analog.	R	
A07g	T_P_BEXT_C2_2	Reading of the pressure transducer of outdoor circuit 4 (4 circuit units)	0.0	0.0	0.0	Bar	Analog.	R	
A07g	TEMP_CAL_BEXT_C2_2	Conversion to temperature of the pressure transducer of outdoor circuit 4	0.0	0.0	0.0	°C	Analog.	R	
A07f1	TIPO_REFRIGERANTE	Type of refrigerant (4=R410A)	4	0	4	---	Integer	R/W	43
A07f1	T_P_BINT_C1	Reading of the pressure transducer of indoor circuit 1	0.0	0.0	0.0	Bar	Analog.	R	
A07f1	TEMP_CAL_BINT_C1	Conversion to temperature of the pressure transducer of indoor circuit 1	0.0	0.0	0.0	°C	Analog.	R	
A07f1	T_P_BINT_C1_2	Reading of the pressure transducer of indoor circuit 3 (4 circuit units)	0.0	0.0	0.0	Bar	Analog.	R	
A07f1	TEMP_CAL_BINT_C1_2	Conversion to temperature of the pressure transducer of indoor circuit 3	0.0	0.0	0.0	°C	Analog.	R	
A07g1	T_P_BINT_C2	Reading of the pressure transducer of indoor circuit 2	0.0	0.0	0.0	Bar	Analog.	R	
A07g1	TEMP_CAL_BINT_C2	Conversion to temperature of the pressure transducer of indoor circuit 2	0.0	0.0	0.0	°C	Analog.	R	
A07g1	T_P_BINT_C2_2	Reading of the pressure transducer of indoor circuit 4 (4 circuit units)	0.0	0.0	0.0	Bar	Analog.	R	
A07g1	TEMP_CAL_BINT_C2_2	Conversion to temperature of the pressure transducer of outdoor circuit 4	0.0	0.0	0.0	°C	Analog.	R	
A07h	HAB_FILTRO1	Enabling of probe software filter to avoid reading oscillations	0			---	Digital	R/W	98
A07h	TIME_FILTRO1	Filter time	30	0	99	s	Integer	R/W	
A07h	GRADI_FILTRO1	Filter differential	10.0	0.0	99.9	---	Analog.	R/W	
A07i	HAB_FILTRO_CAL_IMP	Enabling of probe software filter with supply SET by ambient probe	1	0	1	---	Digital	R/W	168
A07i	TIME_FILTRO_CAL_IMP	Filter time with supply SET by ambient probe	60	0	99	s	Integer	R/W	
A07i	GRADI_FILTRO_CAL_IMP	Filter differential with supply SET by ambient probe	1.0	0.0	99.9	---	Analog.	R/W	
A11	SET_RENOVACION_CAL	% Outdoor air for renewal	0	0	0	%	Integer	R	126
A11	RENOVACION_CAL	% air renewal with mixing probe	0	0	0	%	Integer	R	124
A11	CAL_APER_RENOV_2	% real opening of outdoor damper	0	0	0	%	Integer	R	125
A11	TIME_CAL	Calculation time	60	0	99	s	Integer	R/W	194
A11	V_CAL	Calculation constant	3	0	99	%	Integer	R/W	195
A11	DIF_TEMP_RENOVACION_CAL	Difference between mixing and return T, and between mixing temperature and exterior for renewal calculation	3,0	0	9,9	°C	Analog.	R/W	145
A12	NEW_PASS_ASS	New MAINTENANCE password	*****	0	9999	---	Integer	R/W	29

### MAINTENANCE screens → COUNTERS

Screen	Parameter	Description of the parameter	Value	Min.	Max.	UOM	Type	R/W	Add. BMS
A01	N_HOR_ON_EQUIPO	Accumulated operating hours of the unit	0	0	32767	h	Integer	R/W	62
A01	SET_HOR_ON_EQUIPO	Operating hours of the unit for alarm indication	20000	0	32000	h	Integer	R/W	37
A01	RESET_ON_HORAS_MAQUINA	Reset the counter for number of hours of unit operation	0	0	1	---	Digital	R/W	107
A01a	N_HOR_VENT	Accumulated operating hours of the indoor fan	0	0	0	h	Integer	R	136
A01a	N_HOR_FREEC_FREEH	Accumulated operating hours of the free-cooling or free-heating	0	0	32767	h	Integer	R	213
A01a	N_HOR_REC_ROTATIVO	Accumulated operating hours of the rotary heat exchanger	0	0	32767	h	Integer	R	214
A01a	N_HOR_RES1	Accumulated operating hours of the electrical heater, stage 1	0	0	32767	h	Integer	R	137
A01a	N_HOR_RES2	Accumulated operating hours of the electrical heater, stage 2	0	0	32767	h	Integer	R	138
A01a	N_HOR_VALV_CALOR	Accumulated operating hours of the auxiliary hot water coil	0	0	32767	h	Integer	R	212
A01b	Countdown_ON_1	Remaining time to complete the “minimum time of ON” of compressor 1 circuit 1	0	0	999	s	Integer	R	
A01b	Countdown_OFF_1	Remaining time to complete the “minimum time of OFF” of compressor 1 circuit 1	0	0	999	s	Integer	R	
A01b	Countdown_ON_1_2	Remaining time to complete the “minimum time of ON” of compressor 2 circuit 1 (2 circuit units) or compressor circuit 2 (4 circuit units)	0	0	999	s	Integer	R	
A01b	Countdown_OFF_1_2	Remaining time to complete the “minimum time of OFF” of compressor 2 circuit 1 (2 circuit units) or compressor circuit 2 (4 circuit units)	0	0	999	s	Integer	R	



# 17 - LIST OF PARAMETERS OF THE "TECHNICAL MENU"

## MAINTENANCE screens → COUNTERS (...continuation)

Screen	Parameter	Description of the parameter	Value	Min.	Max.	UOM	Type	R/W	Add. BMS
A01b	Countdown_ON_2	Remaining time to complete the "minimum time of ON" of compressor 2 of circuit 1 (1 circ. units) or compressor 1 of circuit 2 (2 circ. units) or compressor of circuit 3 (4 circ. units)	0	0	999	s	Integer	R	
A01b	Countdown_OFF_2	Remaining time to complete the "minimum time of OFF" of compressor 2 of circuit 1 (1 circ. units) or compressor 1 of circuit 2 (2 circ. units) or compressor of circuit 3 (4 circ. units)	0	0	999	s	Integer	R	
A01b	Countdown_ON_2_2	Remaining time to complete the "minimum time of ON" of compressor 2 of circuit 2 (2 circuit units) or compressor of circuit 4 (4 circuit units)	0	0	999	s	Integer	R	
A01b	Countdown_OFF_2_2	Remaining time to complete the "minimum time of OFF" of compressor 2 of circuit 2 (2 circuit units) or compressor of circuit 4 (4 circuit units)	0	0	999	s	Integer	R	
A01b	Countdown_ON_R	Remaining time to complete the "minimum time of ON" of recovery compressor	0	0	999	s	Integer	R	
A01b	Countdown_OFF_R	Remaining time to complete the "minimum time of OFF" of recovery compressor	0	0	999	s	Integer	R	
A01b	RESET_TIME_COMPRESOR	Reset the timings of the compressor counters (to avoid waiting times at maintenance tasks)	0	0	1	---	Digital	R/W	182
A01c	HORAS_BLOQUEO_COMP_TENSION	Remaining time to complete the compressors lock due to a power cut-off for a period longer than 2 hours (to ensure the heating of the crankcase heater)	8	0	8	h	Integer	R/W	
A01c	RESET_BLOQUEO_COMP_TENSION	Reset the timings of the compressors lock due to a power cut-off (It is recorded in the register of control data)	0	0	1	---	Digital	R/W	
A01c1	PowerON_Hour	Last power supply to the unit: hour	0	0	99	h	Integer	R	
A01c1	PowerON_Minute	Last power supply to the unit: minute	0	0	99	min	Integer	R	
A01c1	PowerON_Day	Last power supply to the unit: day	0	0	99	min	Integer	R	
A01c1	PowerON_Month	Last power supply to the unit: month	0	0	99	---	Integer	R	
A01c1	PowerON_Year	Last power supply to the unit: year	0	0	99	---	Integer	R	
A01c1	PowerOFF_Hour	Last power cut-off of the unit: hour	0	0	99	h	Integer	R	
A01c1	PowerOFF_Minute	Last power cut-off of the unit: minute	0	0	99	min	Integer	R	
A01c1	PowerOFF_Day	Last power cut-off of the unit: day	0	0	99	min	Integer	R	
A01c1	PowerOFF_Month	Last power cut-off of the unit: month	0	0	99	---	Integer	R	
A01c1	PowerOFF_Year	Last power cut-off of the unit: year	0	0	99	---	Integer	R	
A01d	DISABLE_COMP1	Disable compressor 1 of circuit 1 (for maintenance task / failure)	0	0	1	---	Digital	R/W	
A01d	DISABLE_COMP1_2	Disable compressor 2 of circuit 1 (2 circuit units) or compressor of circuit 2 (4 circuit units) (for maintenance task / failure)	0	0	1	---	Digital	R/W	
A01d	DISABLE_COMP2	Disable compressor 2 of circuit 1 (1 circ. units) or compressor 1 of circuit 2 (2 circ. units) or compressor of circuit 3 (4 circ. units) (for maintenance task / failure)	0	0	1	---	Digital	R/W	
A01d	DISABLE_COMP2_2	Disable compressor 2 of circuit 2 (2 circuit units) or compressor of circuit 4 (4 circuit units) (for maintenance task / failure)	0	0	1	---	Digital	R/W	
A02	N_HOR_COMP1	Operating hours compressor 1 of circuit 1	0	0	0	h	Integer	R/W	10
A02	SET_HOR_COMP1	Value operating hours of compressor 1 of circuit 1 for alarm indication	10000	0	32000	h	Integer	R/W	38
A02	RESET_ON_HORAS_COMP1	Reset the counter of operating hours compressor 1 of circuit 1	0	0	1	---	Digital	R/W	105
A02a	N_HOR_COMP1_2	Operating hours compressor 2 of circuit 1 (2 circuit units) or compressor circuit 2 (4 circuit units)	0	0	0	h	Integer	R/W	53
A02a	SET_HOR_COMP1_2	Value operating hours of compressor 2 of circuit 1 (2 circuit units) or compressor circuit 2 (4 circuit units) for alarm indication	10000	0	32000	h	Integer	R/W	67
A02a	RESET_ON_HORAS_COMP1_2	Reset the counter of operating hours compressor 2 of circuit 1 (2 circuit units) or compressor circuit 2 (4 circuit units)	0	0	1	---	Digital	R/W	124
A03	N_HOR_COMP2	Operating hours compressor 1 of circuit 2 (2 circuit units) or compressor circuit 2 (4 circuit units)	0	0	0	h	Integer	R/W	11
A03	SET_HOR_COMP2	Value operating hours of compressor 2 of circuit 1 (1 circ. units) or compressor 1 of circuit 2 (2 circ. units) or compressor of circuit 3 (4 circ. units) for alarm indication	10000	0	32000	h	Integer	R/W	39
A03	RESET_ON_HORAS_COMP2	Reset the counter of operating hours compressor 2 of circuit 1 (1 circ. units) or compressor 1 of circuit 2 (2 circ. units) or compressor of circuit 3 (4 circ. units)	0	0	1	---	Digital	R/W	106
A03a	N_HOR_COMP2_2	Operating hours compressor 2 of circuit 2 (2 circuit units) or compressor of circuit 4 (4 circuit units)	0	0	0	h	Integer	R/W	69
A03a	SET_HOR_COMP2_2	Value operating hours of compressor 2 of circuit 2 (2 circuit units) or compressor of circuit 4 (4 circuit units)	10000	0	32000	h	Integer	R/W	70
A03a	RESET_ON_HORAS_COMP2_2	Reset the counter of operating hours compressor 2 of circuit 2 (2 circuit units) or compressor of circuit 4 (4 circuit units)	0	0	1	---	Digital	R/W	125
A03b	N_HOR_CR	Operating hours compressor recuperación	0	0	0	h	Integer	R/W	12
A03b	SET_HOR_CR	Value operating hours of the recovery compressor for alarm indication	10000	0	32000	h	Integer	R/W	13
A03b	RESET_ON_HORAS_CR	Reset the counter of operating hours the recovery compressor	0	0	1	---	Digital	R/W	133
A03c	N_ARR_V_INT_H	Counter of number of start-ups of indoor fan	0	0	0	---	Integer	R/W	139
A03c	N_ARR_COMP1_H	Counter of number of start-ups of compressor 1 of circuit 1	0	0	0	---	Integer	R/W	141
A03c	N_ARR_COMP2_H	Counter of number of start-ups of compressor 2 of circuit 1 (1 circ. units) or compressor 1 of circuit 2 (2 circ. units) or compressor of circuit 3 (4 circ. units)	0	0	0	---	Integer	R/W	145

## 17 - LIST OF PARAMETERS OF THE "TECHNICAL MENU"

### MAINTENANCE screens → COUNTERS (...continuation)

Screen	Parameter	Description of the parameter	Value	Min.	Max.	UOM	Type	R/W	Add. BMS
A03c	N_ARR_CR_H	Counter of number of start-ups of the recovery compressor	0	0	99	---	Integer	R/W	44
A03d	N_ARR_COMP1_2_H	Counter of number of start-ups of compressor 2 of circuit 1 (2 circuit units) or compressor circuit 2 (4 circuit units)	0	0	0	---	Integer	R/W	143
A03d	N_ARR_COMP2_2_H	Counter of number of start-ups of compressor 2 of circuit 2 (2 circuit units) or compressor of circuit 4 (4 circuit units)	0	0	0	---	Integer	R/W	147
A03d	N_ARR_RES1_H	Counter of number of 1st stage of electrical heater or gas burner	0	0	0	---	Integer	R/W	149
A03d	N_ARR_RES2_H	Counter of number of 2nd stage of electrical heater or gas burner	0	0	0	---	Integer	R/W	151
A10d	N_DES_C1_L	Counter of number of defrosting of circuit 1	0	0	0	---	Integer	R/W	154
A10d	N_DES_C1_2_L	Counter of number of defrosting of circuit 3 (4 circuit units)	0	0	9999	---	Integer	R	156
A10d	N_DES_C2_L	Counter of number of defrosting of circuit 2	0	0	0	---	Integer	R/W	158
A10d	N_DES_C2_2_L	Counter of number of defrosting of circuit 4 (4 circuit units)	0	0	9999	---	Integer	R	160
A10e	N_SEG_ULT_DES_C1	Duration of the last defrosting operation of circuit 1	0	0	0	s	Integer	R/W	161
A10e	N_SEG_ULT_DES_C1_2	Duration of the last defrosting operation of circuit 3 (4 circuit units)	0	0	999	s	Integer	R	162
A10e	N_SEG_ULT_DES_C2	Duration of the last defrosting operation of circuit 2	0	0	0	s	Integer	R/W	163
A10e	N_SEG_ULT_DES_C2_2	Duration of the last defrosting operation of circuit 4 (4 circuit units)	0	0	999	s	Integer	R	164
A10f	CONT_TED_C1	Elapsed time between the last two defrostings of circuit 1	0	0	0	---	Integer	R	
A10f	CONT_TED_C1_2	Elapsed time between the last two defrostings of circuit 3 (4 circuit units)	0	0	32767	---	Integer	R	
A10f1	CONT_TED_C2	Elapsed time between the last two defrostings of circuit 2	0	0	32767	---	Integer	R	
A10f1	CONT_TED_C2_2	Elapsed time between the last two defrostings of circuit 4 (4 circuit units)	0	0	32767	---	Integer	R	
A12a	N_AL_AP1	Number of alarms of high pressure of circuit 1	0	0	9999	---	Integer	R	
A12a	N_AL_AP1_2	Number of alarms of high pressure of compressor 2 of circuit 1 (2 circuit units) or compressor circuit 2 (4 circuit units)	0	0	9999	---	Integer	R	
A12a	N_AL_BP1	Number of alarms of low pressure of compressor 1 circuit 1	0	0	9999	---	Integer	R	
A12a	N_AL_BP1_2	Number of alarms of low pressure of compressor 2 circuit 1 (2 circuit units) or compressor circuit 2 (4 circuit units)	0	0	9999	---	Integer	R	
A12a	N_AL_KLD1	Number of alarms of discharge temperature of compressor 1 circuit 1	0	0	9999	---	Integer	R	
A12a	N_AL_KLD2	Number of alarms of discharge temperature of compressor 2 of circuit 1 (1 circ. units) or compressor 1 of circuit 2 (2 circ. units) or compressor of circuit 3 (4 circ. units)	0	0	9999	---	Integer	R	
A12b	N_AL_AP2	Number of alarms of high pressure of compressor 2 of circuit 1 (1 circ. units) or compressor 1 of circuit 2 (2 circ. units) or compressor of circuit 3 (4 circ. units)	0	0	9999	---	Integer	R	
A12b	N_AL_AP2_2	Number of alarms of high pressure of compressor 2 circuit 2 (2 circuit units) or compressor of circuit 4 (4 circuit units)	0	0	9999	---	Integer	R	
A12b	N_AL_BP2	Number of alarms of low pressure of compressor 2 of circuit 1 (1 circ. units) or compressor 1 of circuit 2 (2 circ. units) or compressor of circuit 3 (4 circ. units)	0	0	9999	---	Integer	R	
A12b	N_AL_BP2_2	Number of alarms of low pressure of compressor 2 circuit 2 (2 circuit units) or compressor of circuit 4 (4 circuit units)	0	0	9999	---	Integer	R	
A12b	N_AL_KLD2	Number of alarms of discharge temperature of compressor 2 of circuit 1 (1 circ. units) or compressor 1 of circuit 2 (2 circ. units) or compressor of circuit 3 (4 circ. units)	0	0	9999	---	Integer	R	
A12b	N_AL_KLD2_2	Number of alarms of discharge temperature of compressor 2 circuit 2 (2 circuit units) or compressor of circuit 4 (4 circuit units)	0	0	9999	---	Integer	R	
A12c	N_AL_ANTIHILO_REF_C1	Number of alarms of antifreeze safety of circuit 1 (water-air units)	0	0	9999	---	Integer	W	
A12c	N_AL_ANTIHILO_REF_C2	Number of alarms of antifreeze safety of circuit 2 (water-air units)	0	0	9999	---	Integer	W	
A12e0	N_AL_TERM_VENT_INT	Number of alarms of thermal protection of indoor fan	0	0	9999	---	Integer	R	
A12e0	N_AL_TERM_RES_ELECTRICA	Number of alarms of electrical heaters thermistor	0	0	9999	---	Integer	R	
A12e0	N_AL_AP_BP_CR	Number of alarms of high-low pressure of the recovery compressor	0	0	9999	---	Integer	R	
A12e0	N_BQ_AL_ANTIHILO	Number of alarms of antifreeze safety (water-air units)	0	0	9999	---	Integer	W	
A12e0	N_JUMP_INICIAL	Number of alarms of power supply failure	0	0	9999	---	Integer	R	
A12e1	N_AL_CAUDAL_AGUA	Number of alarms of the water flow switch (water-air units)	0	0	9999	---	Integer	W	
A12e1	N_AL_ANTIHILO_BAC	Number of alarms of the hot water coil	0	0	9999	---	Integer	R	
A12e1	N_AL_INCENDIO	Number of alarms of the anti-fire safety	0	0	9999	---	Integer	R	
A12f	N_AL_HUM_INT	Number of alarms of the indoor humidity probe	0	0	9999	---	Integer	R	
A12f	N_AL_HUM_EXT	Number of alarms of the outdoor humidity probe	0	0	9999	---	Integer	R	
A12f	N_AL_TEMP_RET	Number of alarms of the return temperature probe	0	0	9999	---	Integer	R	
A12f	N_AL_TEMP_EXT	Number of alarms of the outdoor temperature probe	0	0	9999	---	Integer	R	
A12f	N_AL_TEMP_IMP	Number of alarms of the supply temperature probe	0	0	9999	---	Integer	R	
A12f	N_AL_TEMP_MEZCLA	Number of alarms of the mixing temperature probe	0	0	9999	---	Integer	R	
A12g0	N_AL_SONDA_AMB_1	Number of alarms of the ambient temperature probe No.1	0	0	9999	---	Integer	R	
A12g0	N_AL_SONDA_AMB_2	Number of alarms of the ambient temperature probe No.2	0	0	9999	---	Integer	R	

## 17 - LIST OF PARAMETERS OF THE “TECHNICAL MENU”

### MAINTENANCE screens → COUNTERS (...continuation)

Screen	Parameter	Description of the parameter	Value	Min.	Max.	UOM	Type	R/W	Add. BMS
A12g0	N_AL_T_P_BEXT_C1	Number of alarms of the pressure transducer of the outdoor circuit 1	0	0	9999	---	Integer	R	
A12g0	N_AL_T_P_BEXT_C1_2	Number of alarms of the pressure transducer of the outdoor circuit 3 (4 circuit units)	0	0	9999	---	Integer	W	
A12g0	N_AL_T_P_BEXT_C2	Number of alarms of the pressure transducer of the outdoor circuit 2	0	0	9999	---	Integer	R	
A12g0	N_AL_T_P_BEXT_C2_2	Number of alarms of the pressure transducer of the outdoor circuit 4 (4 circuit units)	0	0	9999	---	Integer	W	
A12h	MOD_MB_GAS_LEAKAGE_C1AT_1.Detect_Device_Number_Tmp	Identification of the gas leak detector	1	1	247	---	Integer	R/W	
A12h	MOD_MB_GAS_LEAKAGE_C1AT_1.Sensor_Timer	Operating hours of the gas leak detector	0	0	32767	h	Integer	R	
A12h	MOD_MB_GAS_LEAKAGE_C1AT_1.Running_Days	Operating days of the gas leak detector	0	-32768	32767	---	Integer	R	
A12i	MOD_MB_GAS_LEAKAGE_C1AT_1.Detect_Device_Number_Tmp	Identification of the gas leak detector	1	1	247	---	Integer	R/W	
A12i	MOD_MB_GAS_LEAKAGE_C1AT_1.Reset_Hours_Counter	Reset the counter of operating hours of the gas leak detector	0	0	1	---	Integer	R/W	
A12i	MOD_MB_GAS_LEAKAGE_C1AT_1.Reset_Day	Last reset of the counter of the gas leak detector: day	0	0	99	---	Integer	R	
A12i	MOD_MB_GAS_LEAKAGE_C1AT_1.Reset_Month	Last reset of the counter of the gas leak detector: month	0	0	99	---	Integer	R	
A12i	MOD_MB_GAS_LEAKAGE_C1AT_1.Reset_Year	Last reset of the counter of the gas leak detector: year	0	0	99	---	Integer	R	
A12i	MOD_MB_GAS_LEAKAGE_C1AT_1.Reset_Hour	Last reset of the counter of the gas leak detector: hour	0	0	99	---	Integer	R	
A12i	MOD_MB_GAS_LEAKAGE_C1AT_1.Reset_Minute	Last reset of the counter of the gas leak detector: minute	0	0	99	---	Integer	R	
A13	RESET_ON_CONT	Reset the counter of number of start-ups	0	0	1	---	Digital	R/W	
A13	RESET_DES_CONT	Reset the counter of number of defrosting operations	0	0	1	---	Digital	R/W	
A13	RESET_ON_CONT_AL	Reset the counter of number of alarms	0	0	1	---	Digital	R/W	

### MAINTENANCE screens → ALARMS RECORD

Screen	Parameter	Description of the parameter	Value	Min.	Max.	UOM	Type	R/W	Add. BMS
H01	Last_Ind_Read	Last alarm input	0	0	999	---	Integer	R	
H01	MASK_CODE	Description of the alarm	0	0	99	---	Integer	R	
H01	MASK_HOUR	Hour	0	0	99	---	Integer	R	
H01	MASK_MINUTE	Minute	0	0	99	---	Integer	R	
H01	PLAN_ADDRESS	pLAN address	0	0	15	---	Integer	R/W	
H01	MASK_DAY	Day	0	1	31	day	Integer	R	
H01	MASK_MONTH	Month	0	1	99	month	Integer	R	
H01	MASK_YEAR	Year	0	0	99	year	Integer	R	
H01	MASK_TEMP_INT	Indoor air temperature at the time of the alarm	0.0	-99.9	99.9	°C	Analog.	R	
H01	MASK_TEMP_EXT	Outdoor air temperature at the time of the alarm	0.0	-99.9	99.9	°C	Analog.	R	

## 18 - CONNECTING THE UNIT TO A BMS SUPERVISION NETWORK

### 18.1. Enabling supervision

The connection of the unit to a BMS supervision network for centralised technical management is enabled on a screen of the group **MANUFACTURER → UNIT CONFIGURATION** (of the **TECHNICAL MENU** (password protected)).

CU14	
Supervision	Y
Summer fcooling	Y
Winter fheating	N
Winter fcooling	Y
Air renewal	Y
100% outdoor air	N

### 18.2. Configuration of the supervision network

The configuration of the supervision network is performed in the Group of screens **USER → COMMUNICATION** (password protected).

The type of supervision protocol is selected on the first screen. The available protocols are: Carel, Lonworks, Modbus and Modbus extended. It is also possible to select "commissioning" to display the variables through the PCO MANAGER software.

U36a	
Type of protocol for supervision network :	Carel

On the next screen it is possible to assign an address to the card within the network, and the characteristics of the network are defined:

- Baud rate: transmission speed in bps.
- Stop bit No: this variable can take value 1 or 2.
- Parity type: without parity, couple or odd.

U36b	
Unit address for supervision network :	001
Baud rate :	19200
Stop bit No :	2
Parity type :	No

Configuration depending on the installed communications card:

#### RS485 serial card

Protocol: CAREL or MODBUS

Address: 1 to 207

Baud rate: 1200, 2400, 4800, 9600, 19200 bps

#### KONNEX serial card (Configuration by the Integrator)

Protocol: MODBUS

Address: 1 (The address is configured in the card)

Baud rate: 9600 bps

#### BACNET MSTP RS485 card (Configuration by the Integrator)

Protocol: CAREL or MODBUS

Address: 1 to 207

Baud rate: 1200, 2400, 4800, 9600, 19200 bps

#### BACNET ETHERNET PCOWEB card (Configuration by the Integrator)

Protocol: CAREL

Address: 1 (The address is configured in the card)

Baud rate: 19200 bps

#### ETHERNET PCOWEB card

Protocol: CAREL

Address: 1 (The address is configured in the card)

Baud rate: 19200 bps

#### LONWORKS FTT serial card

Protocol: LON

Address: 1 (The address is configured in the card)

Baud rate: 4800 bps

### 18.3. Failure of BMS communication

The following screen enables the detection of a failure in the BMS communication. The period of time for checking the loss of communication is 15 minutes.

U36c	
Enable BMS communic. fault detection:	Y
Time for fault:	15 m
Var.digital BMS fault detection n. 174:	Y
BMS commun. fault:	Y

If the detection of a failure in the BMS communication has been enabled on the last screen, the values by default of the main parameters can be introduced on the next screens:

U40a	
VALUES WITHOUT BMS	
Temp. control setpoint	
Summer	26.0°C
Winter	21.0°C

U40b	
VALUES WITHOUT BMS	
Unit off/on	
	ON

U40c	
VALUES WITHOUT BMS	
Winter/Summer select. 'automatic' by ind.T.	
	SUMMER

U40d	
VALUES WITHOUT BMS	
DISCONNECTING	
No. compressor stages to disconnect:	0
No. el.heaters stages to disconnect:	0

U40e	
VALUES WITHOUT BMS	
Start type	'ON-OFF schedule'

U40f	
VALUES WITHOUT BMS	
SCHEDULE PROGR. N.1	
Slot 1>06:30 to 11:00	
Slot 2>11:30 to 13:30	
Slot 3>15:00 to 19:00	

U40f	
VALUES WITHOUT BMS	
Program select.	
Daily start	
M:1 T:1 W:1 T:1 F:1	
S:1 Su: -Sun-(0=off)	

# 18 - CONNECTING THE UNIT TO A BMS SUPERVISION NETWORK

## 18.4. Carel and Modbus supervision variables

### Equivalence between Carel and Modbus protocols

Carel		Modbus			TCP/IP Modbus	
Variable type	Maximum addresses	Type of variable	Maximum addresses	Conversion	Maximum addresses	Conversion
Digital	1 ... 207	Digital	1 ... 207	Modbus record = Carel address	1 ... 207	TCP/IP address = Carel address
Analogue	1 ... 207	Word record	1 ... 207	Modbus record = Carel address	1 ... 207	TCP/IP address = Carel address
Integer	1 ... 207	Word record	208 ... 415	Modbus record = Carel address + 128	5001 ... 5207	TCP/IP address = Carel address + 5000

Note: Carel peripherals do not allow the address 0.

### Digital variables

Carel Addr.	Modbus record	Modbus Extended	Read/Write	Variable	Parameter type	Min. value	Max. value	Description
1	1	1	R	IN_DIG13_AP1	Digital input	0	1	HP pressure pressostat circuit 1
2	2	2	R	IN_DIG14_AP2	Digital input	0	1	HP pressure pressostat circuit 2
3	3	3	R	IN_DIG7_BP1	Digital input	0	1	LP pressure pressostat circuit 1
4	4	4	R	IN_DIG9_BP2	Digital input	0	1	LP pressure pressostat circuit 2
5	5	5	R	IN_DIG8_TC1	Digital input	0	1	Thermal protection of compressor 1 circuit 1
6	6	6	R	IN_DIG10_TC2	Digital input	0	1	Thermal protection of compressor 1 circuit 2 (2 circ. units) o compressor 3 (4 circ. units)
7	7	7	R	IN_DIG6_TS	Digital input	0	1	Electrical heater(s) thermal protection
8	8	8	R	IN_DIG5_ON_OFF	Digital input	0	1	Remote ON/OFF selection
9	9	9	R	IN_DIG3_C_F	Digital input	0	1	Remote HEATING/COOLING mode selection
10	10	10	R	IN_DIG1_AH_BAC	Digital input	0	1	Anti-freeze thermostat signal
11	11	11	R	IN_DIG2_FS	Digital input	0	1	Clogged filter pressure switch signal
12	12	12	R	IN_DIG4_RTVI	Digital input	0	1	Indoor fan overload/general interlock signal (RTVi)
13	13	13	R	MODO_CALOR	Status	0	1	HEATING (winter) operating mode
14	14	14	R	MODO_FRIO	Status	0	1	COOLING (summer) operating mode
15	15	15	R	VENTILADOR_INT	Digital output	0	1	Indoor fan
16	16	16	R	COMPRESOR_1	Digital output	0	1	Contacteur of compressor 1 of circuit 1
17	17	17	R	COMPRESOR_2	Digital output	0	1	Contacteur of compressor 2 of circuit 1 (1 circ. units) o compressor 1 of circuit 2 (2 circ. units) o compressor of circuit 3 (4 circ. units)
18	18	18	R	OUT_VIC1	Digital output	0	1	Cycle reversing valve of circuit 1
19	19	19	R	OUT_VIC2	Digital output	0	1	Cycle reversing valve of circuit 2
20	20	20	R	RES_ELECTRICA_1_O_BAC	Digital output	0	1	Thermal protection of the 1st heater or gas burner
21	21	21	R	RES_ELECTRICA_2	Digital output	0	1	Thermal protection of the 2nd heater
22	22	22	R	HUMIDIFICA	Digital output	0	1	Output for the humidifier
23	23	23	R	VENTILADOR_EXT_1	Digital output	0	1	Low-speed outdoor fan circ. 1 (1 or 2 circ. units) / Low-speed outdoor fan circ. 1 & 2 (4 circ. units)
24	24	24	R	VENTILADOR_EXT_2	Digital output	0	1	Low-speed outdoor fan circ. 2 (2 circ. units) / High-speed outdoor fan circ. 1 & 2 (4 circ. units)
25	25	25	R/W	RESET_ALARMS	Alarm	0	1	Alarm reset
26	26	26	R	GLOBAL_ALARM	Alarm	0	1	General alarm
27	27	27	R	mAL_TERM_COMP_VEXT_1	Alarm	0	1	Thermal protection alarm of compressor(s) of circuit 1
28	28	28	R	mAL_TERM_COMP_VEXT_2	Alarm	0	1	Thermal protection alarm of compressor(s) of circuit 2
29	29	29	R	mAL_AP1	Alarm	0	1	High pressure alarm of circuit 1
30	30	30	R	mAL_AP2	Alarm	0	1	High pressure alarm of circuit 2
31	31	31	R	mAL_ANTIHIELO_BAC	Alarm	0	1	Anti-freeze alarm
32	32	32	R	mPERM_MEM_ERROR	Alarm	0	1	Damaged EPROM
33	33	33	R	mAL_RELOJ	Alarm	0	1	Timer broken or disconnected
34	34	34	R	mAL_ALT_TEMP_REG	Alarm	0	1	Overly high return air temperature
35	35	35	R	mAL_BAJ_TEMP_REG	Alarm	0	1	Overly low return air temperature
36	36	36	R	mAL_SET_HOR_COMP1	Alarm	0	1	Maintenance of compressor 1 of circuit 1
37	37	37	R	mAL_SET_HOR_COMP2	Alarm	0	1	Maintenance of compressor 2 of circuit 1 (1 circuit unit) or compressor 1 of circuit 2 (2 circ. units) or compressor of circuit 3 (4 circ. units)
38	38	38	R	mAL_BP1	Alarm	0	1	Low pressure alarm of circuit 1 (possible gas leak in the circuit)
39	39	39	R	mAL_BP2	Alarm	0	1	Low pressure alarm of circuit 2 (possible gas leak in the circuit)
40	40	40	R	mAL_TERM_VENT_INT	Alarm	0	1	General interlock alarm (RTVi)

## 18 - CONNECTING THE UNIT TO A BMS SUPERVISION NETWORK

### Digital variables (...continuation)

Carel Addr.	Modbus record	Modbus Extended	Read Write	Variable	Parameter type	Min. value	Max. value	Description
41	41	41	R	mAL_T_P_BEXT_C1	Alarm	0	1	Alarm of the outdoor coil sensor of circuit 1
42	42	42	R	mAL_T_P_BEXT_C2	Alarm	0	1	Alarm of the outdoor coil sensor of circuit 2
43	43	43	R	mAL_FILTRO_SUCIO	Alarm	0	1	Clogged filter alarm
44	44	44	R	mAL_TERM_RES_ELECTRICA	Alarm	0	1	Electrical heater(s) thermal protection alarm
45	45	45	R/W	HAB_BOMBA_CALOR	Configuration	0: cooling only 1: heat pump		Enable the operation in heat pump mode
46	46	46	R	HAB_RELOJ	Status	0: no; 1: yes		Enable the card clock
47	47	47	R/W	HAB_CONTROL_HUM_DESHUM	Configuration	0: no; 1: yes		Enable the dehumidification function
48	48	48	R/W	HAB_SONDA_TEMP_IMP	Configuration	0: no; 1: yes		Enable the supply air temperature probe
49	49	49	R	SEL_FC_FH_ENTALPICO	Status	0: no; 1: yes		Enable enthalpic free-cooling
50	50	50	R	HAB_SUPERVISION	Configuration	0: no; 1: yes		Enable the supervisory serial board
51	51	51	R	MOD_MB_VFD_C1AT_1. mAl_Offline_VFD	Alarm	0	1	Communication fault with the frequency inverter of indoor motor
52	52	52	R/W	HAB_FREECOOL	Configuration	0: no; 1: yes		Enable free-cooling in COOLING mode (summer)
53	53	53	R/W	HAB_FREEHEAT	Configuration	0: no; 1: yes		Enable free-heating in HEATING mode (winter)
54	54	54	R/W	POS_COMPUERTA_CALOR_AL_INICIO	Regulation	0: normal 1: closed		Select outdoor air damper position at start-up in HEATING mode
55	55	55	R/W	HAB_COMPENSACION	Configuration	0: no; 1: yes		Enable setpoint compensation in accordance with the outdoor temperature
56	56	56	R/W	HAB_OFF_VINT_DES	Defrosting	0: no; 1: yes		Enable indoor fan stoppage during defrosting
57	57	57	R/W	HAB_UNICO_VOL_AIRE_EXT	Configuration	0: no; 1: yes		Enable simultaneous defrosting
58	58	58	R/W	AUTOSTART	Regulation	0: no; 1: yes		Enable automatic start-up after blocking/power cut
59	59	59	R/W	HAB_ONOFF_REMOTO	Regulation	0: no; 1: yes		Enable remote ON/OFF
60	60	60	R	HAB_ON_OFF_HOR	Status	0: no; 1: yes		Enable ON-OFF Schedule prog.
61	61	61	R	HAB_CAMBIO_MODO_HOR	Status	0: no; 1: yes		Enable setpoint change Schedule prog.
62	62	62	R/W	HAB_FREECOOL_INV	Configuration	0: no; 1: yes		Enable free-cooling in HEATING mode (winter)
63	63	63	R/W	CONTROL_P_PI	Fan	0: no; 1: yes		Temperature control type: proportional (P) or proportional + integral (P+I)
64	64	64	R/W	HAB_ROT_COMP	Compressor	0: no; 1: yes		Enable rotation of compressors
65	65	65	R/W	SYS_ON	Comands	0: off 1: on		Unit ON/OFF
66	66	66	R/W	CALOR_FRIO_PANEL	Comands	0: winter 1: summer		Select HEATING/COOLING mode via the panel
67	67	67	R/W	HAB_ZONIFICACION_EQUIPO	Configuration	0: no; 1: yes		Enable power and flow reduction for the zoning of the unit
68	68	68	R/W	HAB_ZONIFICACION_1_ZONA	Comands	0: 2 zones 1: 1 zone		Selection of number of active zones (2 zones or 1 zone)
69	69	69	R	RED_CAUDAL_POR_ZONIFICACION	Status	0: disabled 1: enabled		Status of flow reduction in zoning
70	70	70	R	RED_CAUDAL_AUTOMATICO	Status	0: disabled 1: enabled		Status of flow reduction in automatic flow reduction
71	71	71	R/W	HAB_CONTROL_SOBREPresión	Configuration	0: no; 1: yes		Enable OVERPRESSURE control
72	72	72	R/W	HAB_BLOQ_COMP_ON_FASE_LIM_FRIO	RTC	0: no; 1: yes		Disable the compressors in summer with scheduling and setpoint limit in summer (freecooling night)
73	73	73	R/W	HAB_BLOQ_RENOVACION_ON_FASE_LIM	RTC	0: no; 1: yes		Disable the outdoor air exchange and scheduling limit setpoint (night)
74	74	74	R	SYS_ON1	Status	0: off 1: on		Display of unit status
75	75	75	R/W	HAB_BINATI	Fan	0: no; 1: yes		Condensation fan by maximum pressure
76	76	76	R	COMPRESOR_1_2_F	Digital output	0	1	Contacteur of compressor 2 circuit 1 (2 circ. units) or compressor 2 (4 circ. units)
77	77	77	R	COMPRESOR_2_2_F	Digital output	0	1	Contacteur of compressor 2 circuit 2 (2 circ. units) or compressor 4 (4 circ. units)
78	78	78	R/W	HAB_SONDA_BAT_EXT_1	Configuration	0: no; 1: yes		Enable outdoor coil sensor of circuit 1
79	79	79	R/W	HAB_SONDA_BAT_EXT_2	Configuration	0: no; 1: yes		Enable outdoor coil sensor of circuit 2
80	80	80	R/W	HAB_MB_GAS_LEAKEAGE_DETECTOR	Configuration	0: no; 1: yes		Enabling gas leakage detector
81	81	81	R	MOD_MOB_GAS_LEAKAGE_C1AT_1.mAl_Offline_ModBus	Alarm	0	1	Communication fault with the gas leakage detector
82	82	82	R	MOD_MOB_GAS_LEAKAGE_C1AT_1.mRelay_Status	Alarm	0	1	Alarm of gas leakage detected
83	83	83	R	MOD_MOB_GAS_LEAKAGE_C1AT_1.mSensor_Fault	Alarm	0	1	Alarm of broken or disconnected sensor of gas leakage detector
84	84	84	R/W	HAB_LIM_CO2	Configuration	0: no; 1: yes		CO2 limit enabled

# 18 - CONNECTING THE UNIT TO A BMS SUPERVISION NETWORK

## Digital variables (...continuation)

Carel Addr.	Modbus record	Modbus Extended	Read/Write	Variable	Parameter type	Min. value	Max. value	Description
85	85	85	R/W	HAB_SONDA_MEZCLA_CON_CO2	Configuration	0: no; 1: yes		Enabling mixing air probe with CO2 probe (input B6 or B8 with pLAN CO2 probe)
86	86	86	R/W	HAB_QUEMADOR_GAS	Configuration	0: no; 1: yes		Gas burner control enabled
87	87	87	R/W	DESHAB_AL_BP_CALOR	Compressor	0: no; 1: yes		Cancel LP pressure pressostat in HEATING mode (winter)
88	88	88	R/W	DESHAB_AL_BP_DES	Compressor	0: no; 1: yes		Cancel LP pressure pressostat during defrosting
89	89	89	R/W	HAB_DES_FIN_MIN_SONDA	Defrosting	0: no; 1: yes		End of defrosting with the lowest temperature/pressure sensor value
90	90	90	R/W	HAB_OFF_COMP_DES	Compressor	0: no; 1: yes		Stop compressors before defrosting
91	91	91	R/W	HAB_OFF_COMP_CAMBIO_F_C	Compressor	0: no; 1: yes		Stop compressors before HEATING/COOLING operating mode change
92	92	92	R/W	RES_VER	Fan	0: no; 1: yes		Electrical heaters as support in COOLING mode (summer)
93	93	93	R/W	VLV_VER	Fan	0: no; 1: yes		Hot water coil as support in COOLING mode (summer)
94	94	94	R/W	HAB_OFF_VINT_FRIO	Fan	0: no; 1: yes		Stop indoor fan when stopping the compressors in COOLING mode
95	95	95	R/W	HAB_OFF_VINT_CALOR	Fan	0: no; 1: yes		Stop indoor fan when stopping the compressors in HEATING mode
96	96	96	R/W	SONDA_HUM_4_20	Service	0: 0-1V 1: 4-20mA		Type of humidity sensor
97	97	97	R	MOD_MB_VFD_CIAT_2.mAl_Offline_VFD	Alarm	0	1	Communication fault with the frequency inverter of return motor
98	98	98	R/W	HAB_FILTRO1	Service	0: no; 1: yes		Enable sensor filter
99	99	99	R/W	HAB_RES_DESESCARCHE	Configuration	0: no; 1: yes		Enable electrical heaters or gas burner during defrosting
100	100	100	R/W	ACC_IMP_VLV	Configuration	0: no; 1: yes		Supply air temperature control with auxiliary hot water coil
101	101	101	R/W	ACC_IMP_BC	Configuration	0: no; 1: yes		Supply air temperature control with compressors
102	102	102	R/W	ACC_IMP_RES	Configuration	0: no; 1: yes		Supply air temperature control with electrical heaters
103	103	103	R/W	HAB_Válvula_CALOR	Configuration	0: no; 1: yes		Enable auxiliary hot water coil (3-way valve)
104	104	104	R	HAB_CO2	Status	0: no; 1: yes		CO2 sensor installed
105	105	105	R/W	RESET_ON_HORAS_COMP1	Service	0: no; 1: yes		Reset operating hours of compressor 1 of circuit 1
106	106	106	R/W	RESET_ON_HORAS_COMP2	Service	0: no; 1: yes		Reset operating hours of compressor 1 of circuit 2 (2 circ. units) or compressor 3 (4 circ. units)
107	107	107	R/W	RESET_ON_HORAS_MAQUINA	Service	0: no; 1: yes		Reset operating hours of the unit
108	108	108	R	mAL_SET_HOR_ON_EQUIPO	Alarm	0	1	Alarm due to cumulative unit operating hours
109	109	109	R	mAL_TEMP_RET	Alarm	0	1	Alarm of the return air temperature probe
110	110	110	R	mAL_S_VIRTUAL	Alarm	0	1	Alarm of the virtual pLAN probe
111	111	111	R	mAL_TEMP_EXT	Alarm	0	1	Alarm of the outdoor temperature probe
112	112	112	R	mAL_HUM_RET	Alarm	0	1	Alarm of the return humidity probe
113	113	113	R	mAL_HUM_EXT	Alarm	0	1	Alarm of the outdoor humidity probe
114	114	114	R	mAL_TEMP_IMP	Alarm	0	1	Alarm of the supply air temperature probe
115	115	115	R	mAL_SETPOINT	Alarm	0	1	Alarm setpoint HEATING mode (winter) > COOLING mode (summer)
116	116	116	R	IN_DIG11_CR	Digital input	0	1	HP and LP pressure pressostat recovery circuit (with cooling recovery)
117	117	117	R	COMPRESOR_REC	Digital output	0	1	Contact of the recovery compressor (with cooling recovery)
118	118	118	R	mAL_AP_BP_CR	Alarm	0	1	Alarm of the HP and LP pressure pressostat of the recovery circuit
119	119	119	R	mAL_SET_HOR_CR	Alarm	0	1	Recovery compressor maintenance (with cooling recovery)
120	120	120	R/W	FORZADO	RTC	0: no; 1: yes		Forced start-up
121	121	121	R/W	NEW_DATE	RTC	0: no; 1: yes		Activate time and date change
122	122	122	R	mAL_SET_HOR_COMP1_2	Alarm	0	1	Maintenance of compr. 2 circ. 1 (2 circ. units) or compr. 2 (4 circ. units)
123	123	123	R	mAL_SET_HOR_COMP2_2	Alarm	0	1	Maintenance of compr.2 circ. 2 (2 circ. units) or compr. 4 (4 circ. units)
124	124	124	R/W	RESET_ON_HORAS_COMP1_2	Service	0: no; 1: yes		Reset operating hours compr. 2 circ. 1 (2 circ. units) or compr. 2 (4 circ. units)
125	125	125	R/W	RESET_ON_HORAS_COMP2_2	Service	0: no; 1: yes		Reset operating hours compr. 2 circ. 2 (2 circ. units) or compr. 4 (4 circ. units)
126	126	126	R	mAL_KLD1	Alarm	0	1	Discharge temperature limit of compressor(s) of circ. 1 exceeded
127	127	127	R	mAL_KLD2	Alarm	0	1	Discharge temperature limit of compressor(s) of circ. 2 exceeded
128	128	128	R/W	HAB_PROT_ANTIHELO_BAC_GF	Configuration	0: no; 1: yes		Enabling of the antifreeze protection of the hot water coil with low outdoor temperatures
129	129	129	R/W	HAB_BAC_DESESCARCHE	Configuration	0: no; 1: yes		Enable auxiliary hot water coil during defrosting
130	130	130	R	mAL_TEMP_MEZCLA	Alarm	0	1	Alarm of the mixed air temperature probe
131	131	131	R/W	TIPO_BLOQ_COMP_CALOR	Compressor	0: no; 1: yes		Disable compressors in HEATING mode (winter) according to outdoor temperature
132	132	132	R/W	HAB_PRIORIDAD_BAC	Regulation	0: no; 1: yes		Enable hot water coil priority with respect to compressors
133	133	133	R/W	RESET_ON_HORAS_CR	Service	0: no; 1: yes		Reset operating hours of the recovery compressor

## 18 - CONNECTING THE UNIT TO A BMS SUPERVISION NETWORK

### Digital variables (...continuation)

Carel Addr.	Modbus record	Modbus Extended	Read/Write	Variable	Parameter type	Min. value	Max. value	Description
134	134	134	R/W	HAB_PRES_BEXT	Configuration	0: temp. 1: pressure		Enable pressure sensors in the outdoor coil
135	135	135	R	IN_DIG12_INC	Digital input	0: no; 1: yes		Digital input of the smoke detector
136	136	136	R	mAL_INCENDIO	Alarm	0	1	Smoke detector alarm
137	137	137	R/W	HAB_BINATI_EVAP	Fan	0: no; 1: yes		Evaporation fan by minimum pressure
138	138	138	R/W	HAB_DES_TIME	Defrosting	0: no; 1: yes		Enable defrosting by time
139	139	139	R/W	HAB_DES_MIN	Defrosting	0: no; 1: yes		Enable defrosting by minimum pressure/temperature
140	140	140	R/W	HAB_DES_DIF	Defrosting	0: no; 1: yes		Enable defrosting by difference between outdoor temperature and evaporation temperature
141	141	141	R	IN_DIG19_AP1_2	Digital input	0	1	High pressure pressostat of circuit 3 (4 circuit units)
142	142	142	R	IN_DIG20_AP_2_2	Digital input	0	1	High pressure pressostat of circuit 4 (4 circuit units)
143	143	143	R	IN_DIG15_BP1_2	Digital input	0	1	Low pressure pressostat of circuit 3 (4 circuit units)
144	144	144	R	IN_DIG16_TC1_2	Digital input	0	1	Thermal protection of compressor of circuit 3 (4 circuit units)
145	145	145	R	IN_DIG17_BP2_2	Digital input	0	1	Low pressure pressostat of circuit 4 (4 circuit units)
146	146	146	R	IN_DIG18_TC2_2	Digital input	0	1	Thermal protection of compressor of circuit 4 (4 circuit units)
147	147	147	R	OUT_VIC1_2	Digital output	0	1	Cycle reversing valve of circuit 3 (4 circuit units)
148	148	148	R	OUT_VIC2_2	Digital output	0	1	Cycle reversing valve of circuit 4 (4 circuit units)
149	149	149	R	VENTILADOR_EXT_1_2	Digital output	0	1	Low-speed outdoor fan of circuits 3 and 4 (4 circ. units)
150	150	150	R	VENTILADOR_EXT_2_2	Digital output	0	1	High-speed outdoor fan of circuits 3 and 4 (4 circ. units)
151	151	151	R	mAL_TERM_COMP_VEXT_1_2	Alarm	0	1	Thermal protection alarm of compressor circuit 3 (4 circuit units)
152	152	152	R	mAL_TERM_COMP_VEXT_2_2	Alarm	0	1	Thermal protection alarm of compressor circuit 4 (4 circuit units)
153	153	153	R	mAL_AP1_2	Alarm	0	1	High pressure alarm of circuit 3 (4 circuit units)
154	154	154	R	mAL_AP2_2	Alarm	0	1	High pressure alarm of circuit 4 (4 circuit units)
155	155	155	R	mAL_BP1_2	Alarm	0	1	Low pressure alarm of circuit 3 (4 circuit units) (possible gas leak in the circuit)
156	156	156	R	mAL_BP2_2	Alarm	0	1	Low pressure alarm of circuit 4 (4 circuit units) (possible gas leak in the circuit)
157	157	157	R	mAL_T_P_BEXT_C1_2	Alarm	0	1	Alarm of the outdoor coil sensor of circuit 3 (4 circuit units)
158	158	158	R	mAL_T_P_BEXT_C2_2	Alarm	0	1	Alarm of the outdoor coil sensor of circuit 4 (4 circuit units)
159	159	159	R	mAL_KLD1_2	Alarm	0	1	Exceeded limit of discharge temperature of compressor(s) of circuit 3
160	160	160	R	mAL_KLD2_2	Alarm	0	1	Exceeded limit of discharge temperature of compressor(s) of circuit 4
161	161	161	R	mAl_I_O_Mismatch	Alarm	0	1	Alarm of inputs/outputs mismatch of expansion card pCOe addr.7 (4 comp. / 4 circ.)
162	162	162	R	mAl_Offline	Alarm	0	1	Expansion card pCOe addr.7 (4 comp. / 4 circ.) without communication
163	163	163	R	mAL_OFFLINE_SOND_AMB	Alarm	0	1	Alarm due to no communication with ambient sensor RS485 No.1
164	164	164	R	mAL_SOND_TEMP_AMB	Alarm	0	1	Alarm ambient temperature sensor No.1 broken or disconnected
165	165	165	R	mAL_SOND_HUM_AMB	Alarm	0	1	Alarm ambient humidity sensor No.1 broken or disconnected
166	166	166	R	mAL_IMPULSION_ALTA	Alarm	0	1	Alarm of high supply air temperature
167	167	167	R/W	HAB_MB_SOND_AMB	Configuration	0: no; 1: yes		Enable ambient sensor
168	168	168	R/W	HAB_FILTRO_CAL_IMP	Service	0: no; 1: yes		Enable supply air STP calculation with ambient sensor
169	169	169	R/W	HAB_COMP_REG_PRES_U_EXT	Configuration	0: no; 1: yes		Outdoor damper status with fire alarm
170	170	170	R/W	COMP_OFF_ALL_INCENDIO	Alarm	0: open 1: closed		Enable condensation control of outdoor unit
171	171	171	R/W	HAB_C_COND_VENT_EXT	Fan	0: no; 1: yes		Enable evaporation control of outdoor unit
172	172	172	R/W	HAB_C_EVAP_VENT_EXT	Fan	0: no; 1: yes		Habilitación del control de evaporación de la unidad exterior
173	173	173	R/W	HAB_DETECCION_FALLO_COM_BMS	Special	0	1	Enabling detection of failure of BMS communication to load the default values
174	174	174	R/W	VAR_DETECCION_FALLO_BMS	Special	0	1	Variable to write by the BMS to avoid the detection of failure of BMS communication (1 -> 0)
175	175	175	R	mAl_Offline_SOND_AMB_2	Alarm	0	1	Alarm due to no communication with ambient sensor RS485 No.2
176	176	176	R	mAl_Broken_Temp_Probe_AMB_2	Alarm	0	1	Alarm ambient temperature sensor No.2 broken or disconnected
177	177	177	R	mAl_Broken_Humid_Probe_AMB_2	Alarm	0	1	Alarm ambient humidity sensor No.2 broken or disconnected
178	178	178	R/W	CONTROL_P_PI_C_EVAP_VEXT	Fan	0: P; 1: P+I		Type of control: P or P + I for outdoor unit evaporation control
179	179	179	R/W	CONTROL_P_PI_C_COND_VEXT	Fan	0: P; 1: P+I		Type of control: P or P + I for outdoor unit condensation control
180	180	180	R/W	SEL_ALARMA_POR_MASK	Alarm	0: no; 1: yes		Relay activation with selected active alarms on display



## 18 - CONNECTING THE UNIT TO A BMS SUPERVISION NETWORK

### Digital variables (...continuation)

Carel Addr.	Modbus record	Modbus Extended	Read/Write	Variable	Parameter type	Min. value	Max. value	Description
181	181	181	R/W	HAB_RES_SIN_COMPRESOR	Configuration	0: no; 1: yes		Enable electrical heaters for replacing the compressors
182	182	182	R/W	RESET_TIME_COMPRESOR	Service	0: no; 1: yes		Reset compressor timings
183	183	183	R	ON_DESESCARCHE	Status	0	1	Signal of unit on defrosting operation
184	184	184	R	ON_FREECOOL	Status	0	1	Display of the free-cooling operation
185	185	185	R	ON_FREEHEAT	Status	0	1	Display of the free-heating operation
186	186	186	R	ON_COMPRESOR	Status	0	1	Display of the compressors status
187	187	187	R	ON_RESISTENCIA	Status	0	1	Display of the electrical heaters operation
188	188	188	R	NOT_SYSON1	Status	0	1	Display of the unit OFF
189	189	189	R/W	CONTROL_SOND_AMB	Configuration	0: return T 1: amb. T		Temperature control by means of ambient temperature sensor
190	190	190	R/W	HAB_MB_ENERGY_METER	Configuration	0: no; 1: yes		Enable energy meter connected as Modbus slave
191	191	191	R/W	Reset_Energy	Configuration	0: no; 1: yes		Reset of energy meter counter
192	192	192	R	mAl_Offline	Alarm	0	1	Alarm due to no communication with energy meter
193	193	193	R	mAL_ANTIHIELO_REF_C1	Alarm	0	1	Anti-freeze refrigerant alarm of circuit 1
194	194	194	R	mAL_ANTIHIELO_REF_C2	Alarm	0	1	Anti-freeze refrigerant alarm of circuit 2
195	195	195	R	mAL_ANTIHIELO_REF_C1_2	Alarm	0	1	Anti-freeze refrigerant alarm of circuit 3 (4 circuit units)
196	196	196	R	mAL_ANTIHIELO_REF_C2_2	Alarm	0	1	Anti-freeze refrigerant alarm of circuit 4 (4 circuit units)
197	197	197	R	mAL_BQ_ANTIHIELO	Alarm	0	1	Unit blocking due to anti-freeze refrigerant alarm
198	198	198	R/W	RESET_AL_BQ_ANTIHIELO	Alarm	0: no; 1: yes		Reset of unit blocking due to anti-freeze refrigerant alarm
199	199	199	R	mAL_CAUDAL	Alarm	0	1	Water flow switch digital input alarm (water-air units)
200	200	200	R/W	HAB_ON_VEXT_INI_DES	Defrosting	0: no; 1: yes		Enable outdoor fan connection at start of defrosting
201	201	201	R	mAl_Offline_MB_Ebm_Fan1	Alarm	0	1	Alarm due to no communication plug-fan indoor fan
202	202	202	R	mAl_sensor_pres_dif_aire	Alarm	0	1	Differential pressure sensor alarm for flow control
203	203	203	R/W	HAB_BOMBA_CALOR_COMP_REC	Configuration	0:cooling only 1:heat pump		Recovery compressor - cooling only or heat pump
204	204	204	R/W	HAB_OFF_VINT_POR_CO2	Fan	0: no; 1: yes		Indoor fan stoppage when compressor stops if there is no demand for air renewal by CO2 sensor
205	205	205	R	mAl_Offline_MB_Ebm_Fan2	Alarm	0	1	Plug-fan return fan alarm without communication
206	206	206	R	mAl_sensor_pres_dif_aire_Fan2	Alarm	0	1	Differential pressure sensor alarm for return flow control
207	207	207	R/W	HAB_RED_CAUDAL_CON_COMP_TANDEM	Comands	0: no; 1: yes		Enable the automatic reduction of flow with 50% power in tandem compressors
--	--	208	R/W	HAB_Válvula_FRIO	Configuration	0: no; 1: yes		Enable the auxiliary cold water coil (3-way valve)
--	--	209	R/W	HAB_PRIORIDAD_VALV_FRIO	Regulation	0: no; 1: yes		Enable the cold water coil priority with respect to compressors
--	--	210	R	mAl_I_O_Mismatch	Alarm	0	1	Alarm of inputs/outputs mismatch of expansion card pCOe addr.8
--	--	211	R	mAl_Offline	Alarm	0	1	Expansion card pCOe addr.8 without communication
--	--	212	R	mAL_T_P_BINT_C1	Alarm	0	1	Alarm of the indoor coil sensor of circuit 1 (possible gas leak in the circuit)
--	--	213	R	mAL_T_P_BINT_C2	Alarm	0	1	Alarm of the indoor coil sensor of circuit 2 (possible gas leak in the circuit)
--	--	214	R	mAL_T_P_BINT_C1_2	Alarm	0	1	Alarm of the indoor coil sensor of circuit 3 (4 circuit units) (possible gas leak in the circuit)
--	--	215	R	mAL_T_P_BINT_C2_2	Alarm	0	1	Alarm of the indoor coil sensor of circuit 4 (4 circuit units) (possible gas leak in the circuit)
--	--	216	R/W	HAB_C_EVAP_VENT_INT	Fan	0: no; 1: yes		Enable evaporation control of indoor unit
--	--	217	R/W	HAB_C_COND_VENT_INT	Fan	0: no; 1: yes		Enable condensation control of indoor unit
--	--	218	R/W	HAB_VALV_CALOR_POR_IMP_MIN_CALOR	Configuration	0: no; 1: yes		Control of minimum supply temperature with hot water coil with unit in HEATING mode
--	--	219	R/W	HAB_COMP_CALOR_POR_IMP_MIN_CALOR	Configuration	0: no; 1: yes		Control of minimum supply temperature with compressors in heating with unit in HEATING mode
--	--	220	R/W	HAB_RES_POR_IMP_MIN_CALOR	Configuration	0: no; 1: yes		Control of minimum supply temperature with electrical heaters in HEATING mode
--	--	221	R	mAL_TEMP_ENTRADA_BAC	Alarm	0	1	Alarm of water inlet temperature of the hot water coil probe
--	--	222	R	mAL_TEMP_SALIDA_BAC	Alarm	0	1	Alarm of water outlet temperature of the hot water coil probe
--	--	223	R	mAL_ANTIHIELO_AGUA_BAC	Alarm	0	1	Water anti-freeze alarm of hot water coil

## 18 - CONNECTING THE UNIT TO A BMS SUPERVISION NETWORK

### Digital variables (...continuation)

Carel Addr.	Modbus record	Modbus Extended	Read Write	Variable	Parameter type	Min. value	Max. value	Description
--	--	224	R	mAL_TEMP_AMB	Alarm	0	1	Alarm of ambient air temperature sensor
--	--	225	R	mBQ_AL_BP1_DESESCARCHE	Alarm	0	1	Alarm of low pressure of circuit 1 by continuous defrosting by minimum pressure or temperature (possible gas leak in the circuit)
--	--	226	R	mBQ_AL_BP2_DESESCARCHE	Alarm	0	1	Alarm of low pressure of circuit 2 by continuous defrosting by minimum pressure or temperature (possible gas leak in the circuit)
--	--	227	R	mBQ_AL_BP1_2_DESESCARCHE	Alarm	0	1	Alarm of low pressure of circuit 3 by continuous defrosting by minimum pressure or temperature (possible gas leak in the circuit)
--	--	228	R	mBQ_AL_BP2_2_DESESCARCHE	Alarm	0	1	Alarm of low pressure of circuit 4 by continuous defrosting by minimum pressure or temperature (possible gas leak in the circuit)
--	--	229	R/W	HAB_BM_TERMOSTATO_TCO	Configuration	0: no; 1: yes		Enabling of the TCO terminal by MODBUS
--	--	230	R/W	ThTune_bloqueado	Configuration	0: no; 1: yes		Keypad lock of the TCO terminal
--	--	231	R/W	HAB_EQUIPO_100_AIRE_EXTERIOR	Configuration	0: no; 1: yes		Enabling of unit operation with 100% outdoor aire
--	--	232	R/W	MODO_FRIO_CALOR_AUTO	Configuration	0: indoor T 1: outdoor T		COOLING/HEATING switching in AUTO mode
--	--	233	R/W	HAB_RENOVACION_AIRE	Configuration	0: no; 1: yes		Enabling of fresh air renewal
--	--	234	R/W	REG_ANTI_INCENDIO_FRA_ERP	Alarm	0: no; 1: yes		Enabling ERP French fire safety
--	--	235	R	MODO_CALOR_SIN_FC_INV	Status	0: no; 1: yes		HEATING operating mode without freecooling winter
--	--	236	R	MODO_VENT	Status	0: no; 1: yes		ONLY VENTILATION operating mode
--	--	237	R/W	HAB_MB_THERMAL_ENERGY_METER	Configuration	0: no; 1: yes		Enabling COOLING / HEATING power meter
--	--	238	R	ON_LIMITE_TEMP_IMPULSION	Status	0: no; 1: yes		Signal of unit operating with supply temperature limit
--	--	239	R/W	HAB_ZONIFICACION_POR_COMPUERTAS	Configuration	0: no; 1: yes		Enabling of the zoning by dampers (expansion module I/O)
--	--	240	R/W	PGD1_bloqueado_SEL_FRIO_CALOR	Configuration	0: no; 1: yes		Enabling of the blocking of summer / winter selection in the pGD1 terminal
--	--	241	R/W	HAB_LIM_POT_COMP_TANDEM_POR_AP	Service	0: no; 1: yes		Enabling power limitation in tandem compressor by high pressure
--	--	242	R	OFF_PROG_HOR	Status	0: no; 1: yes		Signaling of the OFF by scheduling on the TCO or pGD1
--	--	243	R/W	POS_COMPUERTA_FRIO_AL_INICIO	Regulation	0: Normal 1: Cerrada		Select outdoor air damper position at start-up in COOLING mode
--	--	244	R/W	HAB_COMPENSACION_POWER_FACTOR	Configuration	0: no; 1: yes		Power factor setpoint
--	--	245	R	mAL_TEMP_EXTRACCION_RUEDA	Alarm	0	1	Sensor alarm of the extraction air temperature of the wheel
--	--	246	R	mAL_TEMP_RECUPERACION_RUEDA	Alarm	0	1	Sensor alarm of the recovery air temperature of the wheel
--	--	247	R/W	HAB_REC_ROTATIVO_VARIABLE	Configuration	0: no; 1: yes		Enabling of rotary recovery with variable wheel
--	--	248	R/W	HAB_ZONA1_PARA_ZONIF_COMPUERTAS	Regulation	0: no; 1: yes		Enabling of the zone 1 in the optional zoning by dampers
--	--	249	R/W	HAB_ZONA2_PARA_ZONIF_COMPUERTAS	Regulation	0: no; 1: yes		Enabling of the zone 2 in the optional zoning by dampers
--	--	250	R/W	HAB_CONTROL_COMPUERTA_IMP_RET	Configuration	0: no; 1: yes		Enabling of dampers control for supply and return of unit
--	--	251	R	APERTURA_COMPUERTA_IMP	Status	0	1	Signal for opening the supply damper
--	--	252	R	APERTURA_COMPUERTA_RET	Status	0	1	Signal for opening the return damper
--	--	253	R	COMPUERTA_IMP_ABIERTA	Status	0	1	Signal of supply damper open
--	--	254	R	COMPUERTA_RET_ABIERTA	Status	0	1	Signal of return damper open
--	--	255	R	AL_COMPUERTA_IMP_NO_ABIERTA	Alarm	0	1	Alarm of supply damper not open
--	--	256	R	AL_COMPUERTA_RET_NO_ABIERTA	Alarm	0	1	Alarm of return damper not open
--	--	257	R	mAI_Offline_SOND_AMB_3	Alarm	0	1	Alarm due to no communication with ambient sensor RS485 No.3
--	--	258	R	mAI_Broken_Temp_Probe_AMB_3	Alarm	0	1	Alarm ambient temperature sensor No.3 broken or disconnected
--	--	259	R	mAI_Broken_Humid_Probe_AMB_3	Alarm	0	1	Alarm ambient humidity sensor No.3 broken or disconnected
--	--	260	R	mAI_Offline_SOND_AMB_4	Alarm	0	1	Alarm due to no communication with ambient sensor RS485 No.4
--	--	261	R	mAI_Broken_Temp_Probe_AMB_4	Alarm	0	1	Alarm ambient temperature sensor No.4 broken or disconnected
--	--	262	R	mAI_Broken_Humid_Probe_AMB_4	Alarm	0	1	Alarm ambient humidity sensor No.4 broken or disconnected

## 18 - CONNECTING THE UNIT TO A BMS SUPERVISION NETWORK

### Digital variables (...continuation)

Carel Addr.	Modbus record	Modbus Extended	Read / Write	Variable	Parameter type	Min. value	Max. value	Description
--	--	280	R/W	REC_ROTATIVO	Status	0	1	Status of the rotary heat exchanger
--	--	284	R	COMPUERTA_IMP_ZONA1_CERRADA	Status	0: Open 1: Closed		Supply damper in zone 1 closed
--	--	285	R	COMPUERTA_RET_ZONA1_CERRADA	Status	0: Open 1: Closed		Return damper in zone 1 closed
--	--	286	R	AL_COMPUERTA_IMP_Z1_NO_CERRADA	Alarm	0	1	Alarm because the supply damper in zone 1 not closed
--	--	287	R	AL_COMPUERTA_RET_Z1_NO_CERRADA	Alarm	0	1	Alarm because the return damper in zone 1 not closed
--	--	288	R	Fan2_Alarm_Present	Alarm	0	1	Return plug-fan without communication
--	--	289	R/W	HAB_OFF_REMOTE_CON_PROTECTION	Configuration	0: no; 1: yes		Enabling of the remote OFF with BUILDING PROTECTION mode
--	--	290	R/W	HAB_G_PRINC	Configuration	0: no; 1: yes		Enabling of automatic return to the MAIN screen
--	--	291	R/W	HAB_OFF_ETAPAS_POR_DIN	Configuration	0: no; 1: yes		Enable the forced stages disconnection by digital input: compressor stages and/or electrical heaters
--	--	293	R	BLOQUEO_COMPRESORES_POR_TENSION	Configuration	0: no; 1: yes		Enabling of the compressors lock due to a power cut-off for a period longer than 2 hours (to ensure the heating of the crankcase heater)
--	--	294	R/W	HAB_SONDA_HUM	Configuration	0: no; 1: yes		Enabling of the humidity probe
--	--	295	R/W	HAB_ZONIFICACION_4_ZONAS	Configuration	0: no; 1: yes		Enabling of the air flow zoning up to 4 zones by motorised dampers
--	--	299	R/W	HAB_OFF_POR_SOND_AMB_CON_100_EXT	Configuration	0	1	Enable the unit OFF by ambient probe in operation with 100% fresh air
--	--	307	R/W	HAB_MB_TERMOSTATO_TCO_11_T	Configuration	0	1	Enable the terminal of zone 1 (zoning of the air flow)
--	--	308	R/W	HAB_MB_TERMOSTATO_TCO_12_T	Configuration	0	1	Enable the terminal of zone 2 (zoning of the air flow)
--	--	309	R/W	HAB_MB_TERMOSTATO_TCO_13_T	Configuration	0	1	Enable the terminal of zone 3 (zoning of the air flow)
--	--	310	R/W	HAB_MB_TERMOSTATO_TCO_14_T	Configuration	0	1	Enable the terminal of zone 4 (zoning of the air flow)
--	--	311	R	ON_COMPUERTA_Z1	Digital output	0	1	Display of zone 1 activated (zoning of the air flow)
--	--	312	R	ON_COMPUERTA_Z2	Digital output	0	1	Display of zone 2 activated (zoning of the air flow)
--	--	313	R	ON_COMPUERTA_Z3	Digital output	0	1	Display of zone 3 activated (zoning of the air flow)
--	--	314	R	ON_COMPUERTA_Z4	Digital output	0	1	Display of zone 4 activated (zoning of the air flow)
		315	R/W	HAB_ON_EQUIPO_POR_4ZONAS	Status	0	1	Activation of the reduction of supply flow with zoning

# 18 - CONNECTING THE UNIT TO A BMS SUPERVISION NETWORK

## Analogue variables

Carel Addr.	Modbus record	Modbus Extended	Read Write	Variable	Parameter type	UOM	Min. value	Max. value	Description
1	1	1	R	TEMP_RET	Analog input	°C	-99.9	99.9	Return air temperature
2	2	2	R	TEMP_EXT	Analog input	°C	-99.9	99.9	Outdoor air temperature
3	3	3	R	T_P_BEXT_C1	Analog input	Bar	-99.9	99.9	Pressure (or temp) in the outdoor coil of circuit 1
4	4	4	R	T_P_BEXT_C2	Analog input	Bar	-99.9	99.9	Pressure (or temp) in the outdoor coil of circuit 2
5	5	5	R	HUM_REG	Analog input	%rH	-999.9	999.9	Return air relative humidity
6	6	6	R	HUM_EXT	Analog input	%rH	-999.9	999.9	Outdoor air relative humidity
7	7	7	R	TEMP_IMP	Analog input	°C	-99.9	99.9	Supply air temperature
8	8	8	R	TEMP_MEZCLA	Analog input	°C	-99.9	99.9	Mixing air temperature
9	9	9	R	TEMP_AMB	Analog input	°C	-99.9	99.9	Ambient air temperature
10	10	10	R	AOUT_COMPUERTA	Analog output	---	0	32767	Opening of the damper of outdoor air
11	11	11	R	AOUT_BAC_O_RES_PROP_O_COMP_INV	Analog output	---	0	32767	Modulating output for the valve of the hot water coil
12	12	12	R	AOUT_VEN_EXT1	Analog output	---	0	32767	Modulating output for electronic outdoor fan of circuit 1 (1-2 circ. units) or circuits 1 and 2 (4 circ. units)
13	13	13	R	AOUT_VEN_EXT2	Analog output	---	0	32767	Modulating output for electronic outdoor fan of circuit 2 (2 circ. units) or circuits 3 and 4 (4 circ. units)
14	14	14	R	TEMP_TCO	Analog input	°C	-99.9	99.9	Ambient air temperature of the TCO terminal
15	15	15	R/W	SET_POINT_TEMP_FRIO	Comands	°C	LIM_INF_TEMP	LIM_SUP_TEMP	Return air temperature setpoint in COOLING mode (summer)
16	16	16	R/W	SET_POINT_TEMP_CALOR	Comands	°C	LIM_INF_TEMP	LIM_SUP_TEMP	Return air temperature setpoint in HEATING mode (winter)
17	17	17	R/W	BANDA_HUMEDAD	Regulation	%rH	0	99.9	Humidity control differential in COOLING mode (summer)
18	18	18	R/W	SET_POINT_HUM	Comands	%rH	LIM_INF_HUM	LIM_SUP_HUM	Humidity control setpoint in COOLING mode (summer)
19	19	19	R/W	LIM_SUP_TEMP_FRIO	Regulation	°C	LIM_INF_TEMP	50.0	Upper limit of temperature setpoint in COOLING mode (summer)
20	20	20	R/W	LIM_INF_TEMP_FRIO	Regulation	°C	0	LIM_SUP_TEMP	Lower limit of temperature setpoint in COOLING mode (summer)
21	21	21	R/W	BANDA_TEMP_FRIO	Regulation	°C	0	15.0	Differential for temperature regulation in COOLING mode (summer)
22	22	22	R/W	BANDA_TEMP_CALOR	Regulation	°C	0	15.0	Differential for temperature regulation in HEATING mode (winter)
23	23	23	R/W	LIM_SUP_HUM	Regulation	%rH	LIM_INF_HUM	99.9	Upper limit of humidity setpoint
24	24	24	R/W	LIM_INF_HUM	Regulation	%rH	-99.9	LIM_SUP_HUM	Lower limit of humidity setpoint
25	25	25	R	TEMP_ENTRADA_BAC	Analog input	°C	-99.9	99.9	Water inlet temperature of the hot water coil
26	26	26	R	TEMP_SALIDA_BAC	Analog input	°C	-99.9	99.9	Water outlet temperature of the hot water coil
27	27	27	R/W	DELTA_FREE_COOL	Regulation	°C	-5.0	5.0	Temperature differential for free-cooling
28	28	28	R/W	OFFSET_FCOOL	Regulation	°C	-5.0	5.0	Free-cooling ramp in COOLING mode (summer): Offset
29	29	29	R/W	DIF_FCOOL	Regulation	°C	0	5.0	Free-cooling ramp in COOLING mode (summer): Differential
30	30	30	R/W	OFFSET_FHEAT	Regulation	°C	-5.0	5.0	Free-heating ramp in HEATING mode (winter): Offset
31	31	31	R/W	DIF_FHEAT	Regulation	°C	0	5.0	Free-heating ramp in HEATING mode (winter): Differential
32	32	32	R/W	SET_IMPULSION_FRIO_MIN	Regulation	°C	0	SET_IMPULSION_FRIO_MAX	Setpoint for minimum supply air temperature control in COOLING mode (summer)
33	33	33	R/W	BANDA_IMP_FRIO	Regulation	°C	0	20.0	Minimum supply air temperature control differential in COOLING mode (summer)
34	34	34	R/W	SET_COMP_EXT_FRIO	Regulation	°C	-99.9	99.9	Outdoor temperature compensation setpoint in COOLING mode (summer)
35	35	35	R/W	VAL_DIF_COMP_EXT_FRIO	Regulation	°C	-99.9	99.9	Outdoor temperature compensation differential in COOLING mode (summer)
36	36	36	R/W	MAX_COMP_EXT_FRIO	Regulation	°C	0	99.9	Maximum compensation in COOLING mode (summer)
37	37	37	R/W	VAL_INI_DES	Regulation	Bar	-10.0	10.0	Defrosting start-up setpoint
38	38	38	R/W	VAL_FIN_DES	Regulation	Bar	0	50.0	Defrosting stop setpoint
39	39	39	R/W	ZONA_MUERTA_TEMP	Regulation	°C	0	3.0	Dead zone of temperature control
40	40	40	R/W	ZONA_MUERTA_HUM	Regulation	%rH	0	50.0	Dead zone of humidity control
41	41	41	R/W	SET_ALTA_TEMP_FRIO	Alarm	°C	0	60.0	Setpoint of high temperature on the return air in COOLING mode (summer)

# 18 - CONNECTING THE UNIT TO A BMS SUPERVISION NETWORK

## Analogue variables (...continuation)

Carel Addr.	Modbus record	Modbus Extended	Read/Write	Variable	Parameter type	UOM	Min. value	Max. value	Description
42	42	42	R/W	SET_BAJA_TEMP_FRIO	Alarm	°C	0	60.0	Setpoint of low temperature on the return air in COOLING mode (summer)
43	43	43	R/W	SET_ALTA_TEMP_CALOR	Alarm	°C	0	60.0	Setpoint of high temperature on the return air in HEATING mode (winter)
44	44	44	R/W	SET_BAJA_TEMP_CALOR	Alarm	°C	0	60.0	Setpoint of low temperature on the return air in HEATING mode (winter)
45	45	45	R/W	TAR_TEMP_RET	Service	°C	-9.9	9.9	Calibration of return air sensor
46	46	46	R/W	TAR_TEMP_EXT	Service	°C	-9.9	9.9	Calibration of outdoor air sensor
47	47	47	R/W	TAR_TEMP_IMP	Service	°C	-9.9	9.9	Calibration of supply air sensor
48	48	48	R/W	TAR_T_P_BEXT_C1	Service	Bar	-9.9	9.9	Calibration of the outdoor coil sensor of circuit 1
49	49	49	R/W	TAR_T_P_BEXT_C2	Service	Bar	-9.9	9.9	Calibration of the outdoor coil sensor of circuit 2
50	50	50	R/W	TAR_TEMP_MEZCLA	Service	°C	-9.9	9.9	Calibration of mixing air sensor
51	51	51	R/W	OFFSET_TEMP_AGUA_BAC	Configuration	°C	0	10.0	Offset of water temperature of the hot water coil with the unit stopped
52	52	52	R/W	OFFSET_RES	Regulation	°C	-5.0	5.0	Offset to control the electrical heaters or gas burner
53	53	53	R/W	DIF_RES	Regulation	°C	0	5.0	Differential to control the electrical heaters or gas burner
54	54	54	R/W	TAR_HUM_AMB	Service	%rH	-9.9	9.9	Calibration of return humidity sensor
55	55	55	R/W	TAR_HUM_EXT	Service	%rH	-9.9	9.9	Calibration of outdoor humidity sensor
56	56	56	R/W	SET_TEMP_AGUA_BAC	Configuration	°C	0	20.0	Water temperature setpoint of the hot water coil
57	57	57	R/W	BANDA_TEMP_AGUA_BAC	Configuration	°C	0	5.0	Band of the water temperature setpoint of the hot water coil
58	58	58	R/W	SET_EXT_CALOR	RTC	°C	-99.9	99.9	Schedule prog. with setpoint change: HEATING mode (winter) outdoor setpoint
59	59	59	R/W	SET_EXT_FRIO	RTC	°C	-99.9	99.9	Schedule prog. with setpoint change: COOLING mode (summer) outdoor setpoint
60	60	60	R/W	SET_INT_CALOR	RTC	°C	-99.9	99.9	Schedule prog. with setpoint change: HEATING mode (winter) indoor setpoint
61	61	61	R/W	SET_INT_FRIO	RTC	°C	-99.9	99.9	Schedule prog. with setpoint change: COOLING mode (summer) indoor setpoint
62	62	62	R/W	OFFSET_VALV	Regulation	°C	-10.0	0	Auxiliary hot water coil offset (heat valve)
63	63	63	R/W	DIF_VALV	Regulation	°C	0	5.0	Auxiliary hot water coil differential (heat valve)
64	64	64	R/W	SET_COMP_EXT_CALOR	Regulation	°C	-99.9	99.9	Outdoor temperature compensation setpoint in HEATING mode (winter)
65	65	65	R/W	VAL_DIF_COMP_EXT_CALOR	Regulation	°C	-99.9	99.9	Outdoor temperature compensation differential in HEATING mode (winter)
66	66	66	R/W	MAX_COMP_EXT_CALOR	Regulation	°C	0	99.9	Maximum compensation in HEATING mode (winter)
67	67	67	R/W	SET_C_COND_VEXT	Fan	Bar	0	60.0	Outdoor fan condensation control setpoint
68	68	68	R/W	VAL_INI_VEXT_ALTA_VEL_COND	Configuration	Bar	0	60.0	Initial value of the outdoor fan at high speed in condensation
69	69	69	R/W	BANDA_C_COND_VEXT	Fan	Bar	0	10.0	Outdoor fan condensation control differential
70	70	70	R/W	VAL_FIN_VEXT_ALTA_VEL_COND	Configuration	Bar	0	60.0	Final value of the outdoor fan at high speed in condensation
71	71	71	R/W	LIM_MAX_HUM	Service	%rH	0	100.0	Maximum humidity limit
72	72	72	R/W	LIM_MIN_HUM	Service	%rH	0	100.0	Minimum humidity limit
73	73	73	R/W	OFFRESVER	Regulation	°C	-99.9	0	Offset for backup with electrical heaters in COOLING mode (summer) due to low return temperature
74	74	74	R/W	OFFVLVVER	Regulation	°C	-99.9	0	Offset for backup with hot water coil in COOLING mode (summer) due to low return temperature
75	75	75	R	VER_SOFT	Status	---	0	99.9	Control board software version
76	76	76	R/W	SET_EXT_LIM_CALOR	RTC	°C	-99.9	99.9	Schedule prog. ON by limit setpoint in HEATING mode (winter): limit setpoint
77	77	77	R/W	SET_EXT_LIM_FRIO	RTC	°C	-99.9	99.9	Schedule prog. ON by limit setpoint in COOLING mode (summer): limit setpoint
78	78	78	R/W	SET_INT_LIM_CALOR	RTC	°C	-99.9	99.9	Schedule prog. ON by limit setpoint in HEATING mode (winter): indoor setpoint
79	79	79	R/W	SET_INT_LIM_FRIO	RTC	°C	-99.9	99.9	Schedule prog. ON by limit setpoint in COOLING mode (summer): indoor setpoint
80	80	80	R/W	DIF_LIM_FRIO	RTC	°C	0	99.9	Schedule prog. ON by limit setpoint in COOLING mode (summer): limit differential
81	81	81	R/W	DIF_LIM_CALOR	RTC	°C	0	99.9	Schedule prog. ON by limit setpoint in HEATING mode (winter): limit differential
82	82	82	R/W	SET_AL_BAJA_TEXT	Configuration	°C	-10.0	10.0	Setpoint for hot water coil ON with unit OFF due to low outdoor temperature
83	83	83	R/W	SET_IMPULSION_CALOR_MAX	Regulation	°C	SET_IMPULSION_CALOR_MIN	55.0	Setpoint for maximum supply air temperature control in HEATING mode (winter)

## 18 - CONNECTING THE UNIT TO A BMS SUPERVISION NETWORK

### Analogue variables (...continuation)

Carel Addr.	Modbus record	Modbus Extended	Read Write	Variable	Parameter type	UOM	Min. value	Max. value	Description
84	84	84	R/W	BANDA_IMP_CALOR	Regulation	°C	0	20.0	Differential for maximum supply air temperature control in HEATING mode (winter)
85	85	85	R/W	SET_IMPULSION_CALOR_FC	Config.	°C	0	50.0	Supply air temperature setpoint for turning OFF the outdoor air damper in HEATING mode (winter)
86	86	86	R/W	SET_TEMP_OFF_FC_CALOR	Config.	°C	0	50.0	Return air temperature setpoint for turning OFF the outdoor air damper in HEATING mode (winter)
87	87	87	R/W	BANDA_TEMP_OFF_FC_CALOR	Config.	°C	0	5.0	Control band for turning OFF the outdoor air damper in HEATING mode (winter)
88	88	88	R/W	SET_IMPULSION_FRIO_FC	Config.	°C	0	50.0	Supply air temperature setpoint for turning OFF the outdoor air damper in COOLING mode (summer)
89	89	89	R/W	SET_TEMP_OFF_FC_FRIO	Config.	°C	0	50.0	Return air temperature setpoint for turning OFF the outdoor air damper in COOLING mode (summer)
90	90	90	R/W	BANDA_TEMP_OFF_FC_FRIO	Config.	°C	0	5.0	Control band for turning OFF the outdoor air damper in COOLING mode (summer)
91	91	91	R/W	SET_TEMP_MEZ	Config.	°C	0	20.0	Mixed air temperature setpoint for turning OFF the outdoor air damper in HEATING mode (winter)
92	92	92	R/W	SET_BLOQ_COMP_FRIO_FC	Compressor	°C	-99.9	99.9	Setpoint for compressor blocking in COOLING mode (summer) with free-cooling by outdoor temperature
93	93	93	R/W	VAL_DIF_BLOQ_COMP_FRIO_FC	Compressor	°C	-99.9	99.9	Setpoint for compressor blocking in COOLING mode with free-cooling by delta ambient T - outdoor T
94	94	94	R/W	SET_BLOQ_COMP_CALOR	Compressor	°C	-99.9	99.9	Blocking setpoint to disconnect all of the compressors in HEATING mode due to the low outdoor temperature
95	95	95	R/W	VAL_ON_VEXT_DES_OBL	Defrosting	Bar	10.0	45.0	Setpoint for the outdoor fan connection during the defrosting procedure
96	96	96	R/W	VAL_OFF_VEXT_DES_OBL	Defrosting	Bar	10.0	45.0	Setpoint for the outdoor fan disconnection during the defrosting procedure
97	97	97	R/W	IS_Presión	Service	Bar	-2.0	50.0	lower limit of pressure on the pressure transducer
98	98	98	R/W	FS_Presión	Service	Bar	0	50.0	Upper limit of pressure on the pressure transducer
99	99	99	R/W	SET_TEMP_CO2	Config.	°C	10.0	20.0	Temperature setpoint for turning OFF the outdoor air damper in HEATING mode (winter) with CO2 sensor
100	100	100	R/W	SET_C_EVAP_VEXT	Fan	Bar	0	60.0	Setpoint for the outdoor fan evaporation control
101	101	101	R/W	VAL_FIN_VEXT_ALTA_VEL_EVAP	Config.	Bar	0	60.0	Final value for the outdoor fan working at high speed in evaporation
102	102	102	R/W	BANDA_C_EVAP_VEXT	Fan	Bar	0	10.0	Differential for the outdoor fan evaporation control
103	103	103	R/W	VAL_INI_VEXT_ALTA_VEL_EVAP	Config.	Bar	0	60.0	Initial value for the outdoor fan working at high speed in evaporation
104	104	104	R/W	VAL_DES_MIN	Defrosting	Bar	-25.0	10.0	Setpoint to start the defrosting by minimum pressure / temp.
105	105	105	R/W	VAL_DES_DIF	Defrosting	°C	5.0	20.0	Initial defrosting setpoint by difference between outdoor T and evaporation T
106	106	106	R	T_P_BEXT_C1_2	Analog input	Bar	-99.9	99.9	Pressure (or temp) in the outdoor coil of circuit 3 (4 circuit units)
107	107	107	R	T_P_BEXT_C2_2	Analog input	Bar	-99.9	99.9	Pressure (or temp) in the outdoor coil of circuit 4 (4 circuit units)
108	108	108	R/W	TAR_TEMP_AMB	Service	°C	-9.9	9.9	Calibration of ambient air temperature sensor
109	109	109	R/W	TAR_T_P_BEXT_C1_2	Service	Bar	-9.9	9.9	Calibration of outdoor coil sensor of circuit 3 (4 circuit units)
110	110	110	R/W	TAR_T_P_BEXT_C2_2	Service	Bar	-9.9	9.9	Calibration of outdoor coil sensor of circuit 4 (4 circuit units)
111	111	111	R/W	SET_TEXT_VEXT_OFF_DES	Desesc.	°C	-9.9	0	Outdoor temperature setpoint for non-activation of outdoor fans during defrosting
112	112	112	R/W	OFFSET_CAL_IMP_CALOR	Regulation	°C	0	30.0	Ambient T compensation in order to calculate supply air setpoint in HEATING mode (winter)
113	113	113	R/W	SET_IMPULSION_CALOR_MIN	Regulation	°C	25.0	SET_IMPULSION_CALOR_MAX	Setpoint for minimum supply air temperature control in HEATING mode (winter)
114	114	114	R/W	OFFSET_CAL_IMP_FRIO	Regulation	°C	0	30.0	Ambient temperature compensation to calculate supply air setpoint in COOLING mode (summer)
115	115	115	R/W	SET_IMPULSION_FRIO_MAX	Regulation	°C	SET_IMPULSION_FRIO_MIN	30.0	Setpoint for maximum supply air temperature control in COOLING mode (summer)
116	116	116	R/W	SET_AL_INCENDIO	Alarm	°C	40.0	80.0	Fire alarm setpoint (return air temperature)
117	117	117	R/W	DIF_AL_INCENDIO	Alarm	°C	10.0	50.0	Fire alarm differential (return air temperature)
118	118	118	R/W	OFFSET_AL_IMPULSION_ALTA	Alarm	°C	0	20.0	Setpoint compensation for high supply air temperature alarm
119	119	119	R/W	DIF_AL_IMPULSION_ALTA	Alarm	°C	1.0	10.0	Differential for high supply air temperature alarm
120	120	120	R/W	SET_QUEMADOR_BAJA_TEXT	Comands	°C	-10.0	10.0	Outdoor temperature setpoint to activate gas burner instead of the compressors
121	121	121	R	SET_IMPULSION_CALOR_CAL	Status	°C	0	55.0	Supply air setpoint calculated in HEATING mode (winter)

## 18 - CONNECTING THE UNIT TO A BMS SUPERVISION NETWORK

### Analogue variables (...continuation)

Carel Addr.	Modbus record	Modbus Extended	Read Write	Variable	Parameter type	UOM	Min. value	Max. value	Description
122	122	122	R	SET_IMPULSION_FRIO_CAL	Status	°C	0	30.0	Supply air setpoint calculated in COOLING mode (summer)
123	123	123	R	TEMP_CAL_BEXT_C1	Analog input	°C	-99.9	99.9	Calculated temperature in the outdoor coil of circuit 1
124	124	124	R	TEMP_CAL_BEXT_C2	Analog input	°C	-99.9	99.9	Calculated temperature in the outdoor coil of circuit 2
125	125	125	R	TEMP_CAL_BEXT_C1_2	Analog input	°C	-99.9	99.9	Calculated temperature in the outdoor coil of circuit 3
126	126	126	R	TEMP_CAL_BEXT_C2_2	Analog input	°C	-99.9	99.9	Calculated temperature in the outdoor coil of circuit 4
127	127	127	R/W	VAR_ANALOGICA_AUX_PVPRO_1	Special	---	-3276.8	3276.7	Analogue variable No.1 saved for the PVPRO
128	128	128	R/W	VAR_ANALOGICA_AUX_PVPRO_2	Special	---	-3276.8	3276.7	Analogue variable No.2 saved for the PVPRO
129	129	129	R/W	SET_HAB_RES_TEMP_EXT	Regulation	°C	-20.0	40.0	Setpoint for electrical heaters enabling due to low outdoor temperature
130	130	130	R/W	SET_HUM_OFF_COMPUERTA	Config	%rH	0	100.0	Humidity setpoint for closing the outdoor air damper
131	131	131	R	Current_1_L_SPV	Status	A	0	999.9	Current of line 1
132	132	132	R	Current_2_L_SPV	Status	A	0	999.9	Current of line 2
133	133	133	R	Current_3_L_SPV	Status	A	0	999.9	Current of line 3
134	134	134	R	Apparent_Power_1_L_SPV	Status	kVAR	0	999.9	Reactive power of line 1
135	135	135	R	Apparent_Power_2_L_SPV	Status	kVAR	0	999.9	Reactive power of line 2
136	136	136	R	Apparent_Power_3_L_SPV	Status	kVAR	0	999.9	Reactive power of line 3
137	137	137	R	Power_1_L_SPV	Status	kW	0	999.9	Effective power of line 1
138	138	138	R	Power_2_L_SPV	Status	kW	0	999.9	Effective power of line 2
139	139	139	R	Power_3_L_SPV	Status	kW	0	999.9	Effective power of line 3
140	140	140	R	Power_L_SPV	Status	kW	0	999.9	Equivalent power
141	141	141	R	VT_L_SPV	Status	---	0	9999	Multiplier of the voltage transformer
142	142	142	R	Frequency	Status	Hz	0	99.9	Frequency of power supply
143	143	143	R/W	VAL_INI_AL_ANTIHIELO	Alarm	°C	VAL_INI_FORCE_AL_ANTIHIELO	50.0	Initial value of the anti-freeze alarm (water-air units)
144	144	144	R/W	VAL_DIF_AL_ANTIHIELO	Alarm	°C	0	50.0	Differential value of the anti-freeze alarm (water-air units)
145	145	145	R/W	DIF_TEMP_RENOVACION_CAL	Service	°C	0	9.9	Temperature differential for the calculated air renewal
146	146	146	R/W	LIM_MIN_HUM_ALARMA	Service	%rH	0	100.0	Minimum humidity limit for alarm signalling
147	147	147	R/W	LIM_MAX_HUM_ALARMA	Service	%rH	0	100.0	Maximum humidity limit for alarm signalling
148	148	148	R/W	LIM_SUP_TEMP_CALOR	Regulation	°C	LIM_INF_TEMP_CALOR	50.0	Upper limit of temperature setpoint in HEATING mode (winter)
149	149	149	R/W	LIM_INF_TEMP_CALOR	Regulation	°C	0	LIM_SUP_TEMP_CALOR	Lower limit of temperature setpoint in HEATING mode (winter)
150	150	150	R/W	PORC_CAUDAL_50_PORC_COMP_TANDEM	Comands	%	50	75	% flow of fan with selection of automatic flow reduction
151	151	151	R	SOBREPresión	Status	%	0	99.9	Calculation of the overpressure
152	152	152	R/W	CTE_AJUSTE_SOBREPresión	Service	---	0	10	Constant adjustment of the calculation of the overpressure
153	153	153	R	AOUT_COMPUERTA_EXTRACCION	Analog output	---	0	999.9	Output for the extraction air damper
154	154	154	R	SET_HUM_BLOQ_COMP_FRIO_FC	Compressor	%rH	0	100	Setpoint of compressor blocking in summer with free-cooling with high outdoor humidity
155	155	155	R/W	Pda_VENT_INT_min	Service	Pa	0	9999	Minimum point of differential pressure of the indoor fan
156	156	156	R/W	Rpm_VENT_INT_min	Service	rpm	0	9999	Minimum point of speed (rpm) of the indoor fan
157	157	157	R/W	Pda_VENT_INT_max	Service	Pa	0	9999	Maximum point of differential pressure of the indoor fan
158	158	158	R/W	Rpm_VENT_INT_max	Service	rpm	0	9999	Maximum point of speed (rpm) of the indoor fan
159	159	159	R/W	Speed_Input_perc_VENTILACION_Fan1	Service	%	0	100	% of speed modulation of the indoor fan in VENTILATION mode
160	160	160	R/W	Speed_Input_perc_FRIO_Fan1	Service	%	0	100	% of speed modulation of the indoor fan in COOLING mode
161	161	161	R/W	Speed_Input_perc_CALOR_Fan1	Service	%	0	100	% of speed modulation of the indoor fan in HEATING mode
162	162	162	R	Speed_Hz_VFD_INT	Status	Hz	0	99.9	Frequency read on the indoor motor
163	163	163	R	Analog_IN1_Ebm_Fan1	Status	Pa	0	32767	Pressure differential read on the indoor fan
164	164	164	R	Speed_rpm_VFD_INT	Status	rpm	0	9999	Speed read on the indoor motor

# 18 - CONNECTING THE UNIT TO A BMS SUPERVISION NETWORK

## Analogue variables (...continuation)

Carel Addr.	Modbus record	Modbus Extended	Read Write	Variable	Parameter type	UOM	Min. value	Max. value	Description
165	165	165	R	Rpm_VENT_INT_calculado	Status	rpm	0	32767	Speed calculated on the indoor fan
166	166	166	R	MOD_MB_VFD_C1AT_1.Min_Setting_A1	Status	%	0	1000.0	Min. value of the analog input A1 of indoor motor VFD
167	167	167	R	MOD_MB_VFD_C1AT_1.Max_Setting_A1	Status	%	0	1000.0	Max. value of the analog input A1 of indoor motor VFD
168	168	168	R	MOD_MB_VFD_C1AT_1.Min_Frequency	Status	Hz	0	320.0	Minimum frequency value of indoor motor VFD
169	169	169	R	MOD_MB_VFD_C1AT_1.Max_Frequency	Status	Hz	0	320.0	Maximum frequency value of indoor motor VFD
170	170	170	R/W	Pda_VENT_RET_min	Service	Pa	0	9999	Minimum point of differential pressure of the return fan
171	171	171	R/W	Rpm_VENT_RET_min	Service	rpm	0	9999	Minimum point of speed (rpm) of the return fan
172	172	172	R/W	Pda_VENT_RET_max	Service	Pa	0	9999	Maximum point of differential pressure of the return fan
173	173	173	R/W	Rpm_VENT_RET_max	Service	rpm	0	9999	Maximum point of speed (rpm) of the return fan
174	174	174	R/W	Speed_Input_perc_VENTILACION_Fan2	Service	%	0	100	% of speed modulation in VENTILATION mode with return fan
175	175	175	R/W	Speed_Input_perc_FRIO_Fan2	Service	%	0	100	% speed modulation in COOLING mode with return fan
176	176	176	R/W	Speed_Input_perc_CALOR_Fan2	Service	%	0	100	% speed modulation in HEATING mode with return fan
177	177	177	R	Speed_Hz_VFD_RET	Status	Hz	0	99.9	Frequency read on the return motor
178	178	178	R	Analog_IN1_Ebm_Fan2	Status	Pa	0	32767	Pressure differential read on the return fan
179	179	179	R	Speed_rpm_VFD_RET	Status	rpm	0	9999	Speed read on the return motor
180	180	180	R	Rpm_VENT_RET_calculado	Status	rpm	0	32767	Speed calculated on the return fan
181	181	181	R	MOD_MB_VFD_C2AT_2.Min_Setting_A1	Status	%	0	1000.0	Min. value of the analog input A1 of return motor VFD
182	182	182	R	MOD_MB_VFD_C2AT_2.Max_Setting_A1	Status	%	0	1000.0	Max. value of the analog input A1 of return motor VFD
183	183	183	R	MOD_MB_VFD_C2AT_2.Min_Frequency	Status	Hz	0	320.0	Minimum frequency value of return motor VFD
184	184	184	R	MOD_MB_VFD_C2AT_2.Max_Frequency	Status	Hz	0	320.0	Maximum frequency value of return motor VFD
185	185	185	R/W	NUM_WO_DIG_1	Config.	---	0	9	Work Order Number of the unit - Digit 1
186	186	186	R/W	NUM_WO_DIG_2	Config.	---	0	9	Work Order Number of the unit - Digit 2
187	187	187	R/W	NUM_WO_DIG_3	Config.	---	0	9	Work Order Number of the unit - Digit 3
188	188	188	R/W	NUM_WO_DIG_4	Config.	---	0	9	Work Order Number of the unit - Digit 4
189	189	189	R/W	NUM_WO_DIG_5	Config.	---	0	9	Work Order Number of the unit - Digit 5
190	190	190	R/W	NUM_WO_DIG_6	Config.	---	0	9	Work Order Number of the unit - Digit 6
191	191	191	R/W	NUM_WO_DIG_7	Config.	---	0	9	Work Order Number of the unit - Digit 7
192	192	192	R/W	NUM_WO_DIG_8	Config.	---	0	9	Work Order Number of the unit - Digit 8
193	193	193	R/W	SOND_AMB_1_TEMP	Status	°C	-99.9	99.9	Ambient probe No. 1 - temperature value
194	194	194	R/W	SOND_AMB_1_HUM	Status	%rH	0.0	99.9	Ambient probe No. 1 - humidity value
195	195	195	R/W	SOND_AMB_1_ROCIO	Status	°C	-99.9	99.9	Ambient probe No. 1 - dew point
196	196	196	R/W	SOND_AMB_2_TEMP	Status	°C	-99.9	99.9	Ambient probe No. 2 - temperature value
197	197	197	R/W	SOND_AMB_2_HUM	Status	%rH	0.0	99.9	Ambient probe No. 2 - humidity value
198	198	198	R/W	SOND_AMB_2_ROCIO	Status	°C	-99.9	99.9	Ambient probe No. 2 - dew point
199	199	199	R/W	SEL_TEMP_2_SOND_AMB_FRIO	Config.	---	0: average 1: minimal 2: maximum		Selection of temperature value with 2 to 4 ambient probes in COOLING mode
200	200	200	R/W	SEL_TEMP_2_SOND_AMB_CALOR	Config.	---	0: average 1: minimal 2: maximum		Selection of temperature value with 2 to 4 ambient probes in HEATING mode
201	201	201	R	CAUDAL_RENOVACION_MSK	Status	x 10m³/h	0	9999	Renewal flow of the outdoor air
202	202	202	R	NUM_WO_H_SPV	Status		0	9999	Work Order Number of the unit (WO) - (high level)
203	203	203	R	NUM_WO_L_SPV	Status		0	9999	Work Order Number of the unit (WO) - (low level)
204	204	204	R	T_P_BINT_C1	Analog input	Bar	-99.9	99.9	Pressure (or temp.) in the indoor coil of circuit 1
205	205	205	R	T_P_BINT_C2	Analog input	Bar	-99.9	99.9	Pressure (or temp.) in the indoor coil of circuit 2
206	206	206	R	T_P_BINT_C1_2	Analog input	Bar	-99.9	99.9	Pressure (or temp.) in the indoor coil of circuit 3
207	207	207	R	T_P_BINT_C2_2	Analog input	Bar	-99.9	99.9	Pressure (or temp.) in the indoor coil of circuit 4
----	----	208	R	TEMP_CAL_BINT_C1	Analog input	°C	-99.9	99.9	Calculated temperature in the indoor coil of circuit 1
----	----	209	R	TEMP_CAL_BINT_C2	Analog input	°C	-99.9	99.9	Calculated temperature in the indoor coil of circuit 2



# 18 - CONNECTING THE UNIT TO A BMS SUPERVISION NETWORK

## Analogue variables (...continuation)

Carel Addr.	Modbus record	Modbus Extended	Read / Write	Variable	Parameter type	UOM	Min. value	Max. value	Description
----	----	210	R	TEMP_CAL_BINT_C1_2	Analog input	°C	-99.9	99.9	Calculated temperature in the indoor coil of circuit 3
----	----	211	R	TEMP_CAL_BINT_C2_2	Analog input	°C	-99.9	99.9	Calculated temperature in the indoor coil of circuit 4
----	----	212	R/W	TAR_T_P_BINT_C1	Service	Bar	-9.9	9.9	Calibration of indoor coil sensor of circuit 1
----	----	213	R/W	TAR_T_P_BINT_C2	Service	Bar	-9.9	9.9	Calibration of indoor coil sensor of circuit 2
----	----	214	R/W	TAR_T_P_BINT_C1_2	Service	Bar	-9.9	9.9	Calibration of indoor coil sensor of circuit 3
----	----	215	R/W	TAR_T_P_BINT_C2_2	Service	Bar	-9.9	9.9	Calibration of indoor coil sensor of circuit 4
----	----	216	R/W	SET_C_COND_VINT	Fan	Bar	0	60.0	Setpoint for the indoor fan condensation control
----	----	217	R/W	BANDA_C_COND_VINT	Fan	Bar	0	10.0	Differential for the indoor fan condensation control
----	----	218	R/W	SET_C_EVAP_VINT	Fan	Bar	0	60.0	Setpoint for the indoor fan evaporation control
----	----	219	R/W	BANDA_C_EVAP_VINT	Fan	Bar	0	10.0	Differential for the indoor fan evaporation control
----	----	220	R/W	OFFSET_VALV_FRIO	Regulation	°C	0	10.0	Offset of cold water coil (cold valve)
----	----	221	R/W	BANDA_VALV_FRIO	Regulation	°C	0	5.0	Differential of cold water coil (cold valve)
----	----	222	R/W	SET_TEMP_EXT_CAMBIO_CALOR	Comands	°C	-99.9	99.9	Outdoor temperature setpoint to change to HEATING mode
----	----	223	R/W	SET_TEMP_EXT_CAMBIO_FRIO	Comands	°C	-99.9	99.9	Outdoor temperature setpoint to change to COOLING mode
----	----	224	R/W	SET_TEMP_MEZCLA_FRIO	Config.	°C	20.0	50.0	Mixed air temperature setpoint for turning OFF the outdoor air damper in COOLING mode (summer)
----	----	225	R/W	SET_TEMP_CO2_FRIO	Config.	°C	20.0	50.0	Temperature setpoint for turning OFF the outdoor air damper in COOLING mode (summer) with CO2 sensor
----	----	226	R/W	SET_TEMP_EXT_DES	Desesc.	°C	0.0	50.0	Outdoor temperature setpoint to allow the defrosting by difference between outdoor T and evaporation T
----	----	227	R/W	TAR_TEMP_ENTRADA_BAC	Service	°C	-9.9	9.9	Adjust of the water inlet temperature of hot water coil
----	----	228	R/W	TAR_TEMP_SALIDA_BAC	Service	°C	-9.9	9.9	Adjust of the water outlet temperature of hot water coil
----	----	229	R/W	SET_ANTIHIELO_AGUA_BAC	Config.	°C	-20.0	10.0	Water antifreeze setpoint of the hot water coil
----	----	230	R/W	DIF_ANTIHIELO_AGUA_BAC	Config.	°C	0.0	10.0	Differential to reset the water antifreeze of the hot water coil
----	----	231	R/W	SONDA_MEZCLA_TEMP	Status	°C	-99.9	99.9	Mixing probe - temperature value
----	----	232	R/W	SONDA_MEZCLA_HUM	Status	%rH	0.0	99.9	Mixing probe - humidity value
----	----	233	R	SONDA_MEZCLA_ROCIO	Status	°C	-99.9	99.9	Mixing probe - dew point
----	----	234	R	SONDA_IMPULSION_TEMP	Status	°C	-99.9	99.9	Supply probe - temperature value
----	----	235	R	SONDA_IMPULSION_HUM	Status	%rH	0.0	99.9	Supply probe - humidity value
----	----	236	R	SONDA_IMPULSION_ROCIO	Status	°C	-99.9	99.9	Supply probe - dew point
----	----	237	R	ENTALPIA_MEZCLA_KCAL	Status	Kcal/Kg	0.0	99.9	Mixing enthalpy
----	----	238	R	ENTALPIA_IMPULSION_KCAL	Status	Kcal/Kg	0.0	99.9	Supply enthalpy
----	----	239	R	Pot_termica	Status	KW	0	3276,7	COOLING / HEATING power meter
----	----	240	R	EER_COP	Status		0	3276,7	EER or COP value
----	----	241	R	SONDA_AMB_3_TEMP	Status	°C	-99.9	99.9	Ambient probe No. 3 - temperature value
----	----	242	R	SONDA_AMB_3_HUM	Status	%rH	0.0	99.9	Ambient probe No. 3 - humidity value
----	----	243	R	SONDA_AMB_3_ROCIO	Status	°C	-99.9	99.9	Ambient probe No. 3 - dew point
----	----	244	R	SONDA_AMB_4_TEMP	Status	°C	-99.9	99.9	Ambient probe No. 4 - temperature value
----	----	245	R	SONDA_AMB_4_HUM	Status	%rH	0.0	99.9	Ambient probe No. 4 - humidity value
----	----	246	R	SONDA_AMB_4_ROCIO	Status	°C	-99.9	99.9	Ambient probe No. 4 - dew point
----	----	247	R	TEMP_EXTRACCION_RUEDA	Analog input	°C	-99.9	99.9	Extraction air temperature of the wheel
----	----	248	R/W	TAR_TEMP_EXTRACCION_RUEDA	Service	°C	-9.9	9.9	Sensor calibration of extraction air temperature of the wheel
----	----	249	R	TEMP_RECUPERACION_RUEDA	Analog input	°C	-99.9	99.9	Recovery air temperature of the wheel
----	----	250	R/W	TAR_TEMP_RECUPERACION_RUEDA	Service	°C	-9.9	9.9	Sensor calibration of recovery air temperature of the wheel
----	----	267	R	SET_TEMP_DISPLAY	Status	°C	-99.9	99.9	Active setpoint temperature
----	----	268	R	DIF_ENTALPIA_POT_TERMICA_KCAL	Status	KJ/Kg	-3276.8	3276.7	Calculation of cooling and heating capacities: display of the input-output enthalpy difference
----	----	269	R/W	PORC_CAUDAL_ZONIFICA_MIN	Config.	%	25.0	100.0	Limit of minimum flow % (zoning of the air flow)
----	----	270	R/W	PORC_CAUDAL_ZONIFICA_MAX	Config.	%	25.0	100.0	Limit of maximum flow % (zoning of the air flow)

## 18 - CONNECTING THE UNIT TO A BMS SUPERVISION NETWORK

### Analogue variables (...continuation)

Carel Addr.	Modbus record	Modbus Extended	Read Write	Variable	Parameter type	UOM	Min. value	Max. value	Description
----	----	271	R/W	PORC_CAUDAL_ZONIFICA_ZONA1	Config.	%	25.0	100.0	% of flow in the zone 1 (zoning of the air flow)
----	----	272	R/W	PORC_CAUDAL_ZONIFICA_ZONA2	Config.	%	25.0	100.0	% of flow in the zone 2 (zoning of the air flow)
----	----	273	R/W	PORC_CAUDAL_ZONIFICA_ZONA3	Config.	%	25.0	100.0	% of flow in the zone 3 (zoning of the air flow)
----	----	274	R/W	PORC_CAUDAL_ZONIFICA_ZONA4	Config.	%	25.0	100.0	% of flow in the zone 4 (zoning of the air flow)
----	----	283	R/W	SET_POINT_TEMP_FRIO_T11_T	Comands	°C	0	50.0	Temperature setpoint in COOLING mode (summer) in the terminal of zone 1 (zoning of the air flow)
----	----	284	R/W	SET_POINT_TEMP_CALOR_T11_T	Comands	°C	0	50.0	Temperature setpoint in HEATING mode (winter) in the terminal of zone 1 (zoning of the air flow)
----	----	285	R/W	SET_POINT_TEMP_FRIO_T12_T	Comands	°C	0	50.0	Temperature setpoint in COOLING mode (summer) in the terminal of zone 2 (zoning of the air flow)
----	----	286	R/W	SET_POINT_TEMP_CALOR_T12_T	Comands	°C	0	50.0	Temperature setpoint in HEATING mode (winter) in the terminal of zone 2 (zoning of the air flow)
----	----	287	R/W	SET_POINT_TEMP_FRIO_T13_T	Comands	°C	0	50.0	Temperature setpoint in COOLING mode (summer) in the terminal of zone 3 (zoning of the air flow)
----	----	288	R/W	SET_POINT_TEMP_CALOR_T13_T	Comands	°C	0	50.0	Temperature setpoint in HEATING mode (winter) in the terminal of zone 3 (zoning of the air flow)
----	----	289	R/W	SET_POINT_TEMP_FRIO_T14_T	Comands	°C	0	50.0	Temperature setpoint in COOLING mode (summer) in the terminal of zone 4 (zoning of the air flow)
----	----	290	R/W	SET_POINT_TEMP_CALOR_T14_T	Comands	°C	0	50.0	Temperature setpoint in HEATING mode (winter) in the terminal of zone 4 (zoning of the air flow)
----	----	291	R	TEMP_INT	Analog input	°C	-99.9	99.9	Indoor temperature for regulation of the unit
----	----	292	R	SET_TEMP_DISPLAY_FRIO	Status	°C	-99.9	99.9	Current setpoint in COOLING mode (summer) displayed
----	----	293	R	SET_TEMP_DISPLAY_CALOR	Status	°C	-99.9	99.9	Current setpoint in HEATING mode (winter) displayed
----	----	294	R	TEMP_TCO11	Analog input	°C	-99.9	99.9	Display of temperature measured by the terminal probe of zone 1 (zoning of the air flow)
----	----	295	R	TEMP_TCO12	Analog input	°C	-99.9	99.9	Display of temperature measured by the terminal probe of zone 2 (zoning of the air flow)
----	----	296	R	TEMP_TCO13	Analog input	°C	-99.9	99.9	Display of temperature measured by the terminal probe of zone 3 (zoning of the air flow)
----	----	297	R	TEMP_TCO14	Analog input	°C	-99.9	99.9	Display of temperature measured by the terminal probe of zone 4 (zoning of the air flow)
----	----	298	R/W	SET_TEMP_BLOQ_COMP_CALOR_50_PORC	Compressor	°C	-99.9	99.9	Blocking setpoint to disconnect half of the compressors in HEATING mode due to the low outdoor temperature
----	----	299	R	TEMP_RET_Z1	Analog input	°C	-99.9	99.9	Display of temperature measured by the optional NTC remote probe in the terminal of zone 1 (zoning of the air flow)
----	----	300	R	TEMP_RET_Z2	Analog input	°C	-99.9	99.9	Display of temperature measured by the optional NTC remote probe in the terminal of zone 2 (zoning of the air flow)
----	----	301	R	TEMP_RET_Z3	Analog input	°C	-99.9	99.9	Display of temperature measured by the optional NTC remote probe in the terminal of zone 3 (zoning of the air flow)
----	----	302	R	TEMP_RET_Z4	Analog input	°C	-99.9	99.9	Display of temperature measured by the optional NTC remote probe in the terminal of zone 4 (zoning of the air flow)

# 18 - CONNECTING THE UNIT TO A BMS SUPERVISION NETWORK

## Integer variables

Direc. Carel	Modbus record	Modbus Extended	Read/Write	Variable	Parameter type	UOM	Min. value	Max. value	Description
1	209	5002	R/W	TIPO_VENT_EXT	Config.	---	1: centrifugal 2: radial 3: 2 speeds 4: electronic		Outdoor fan type
2	210	5003	R/W	CONTROL_QUEMADOR_GAS	Comands	---	0 = burner 2nd stage 1 = only burner 2 = only burner with low outdoor T		Gas burner control
3	211	5004	R	CO2	Status	ppm	0	32767	Reading of the CO2 air quality sensor
4	212	5005	R/W	SP_CO2	Regulation	ppm	-32767	32767	CO2 air quality control setpoint
5	213	5006	R/W	DIF_CO2	Regulation	ppm	-32767	32767	CO2 air quality control differential
6	214	5007	R	Concentration_ppm_Gas_Leakag	Status	ppm	0	32767	Ppm concentration in the gas leakage detector
7	215	5008	R	Concentration_Percent_Gas_Leakag	Status	%	0	100	Percentage concentration in the gas leakage detector
8	216	5009	R/W	Alarm_Setp_ppm	Alarm	ppm	0	32767	Alarm limit in ppm for gas leakage detector
9	217	5010	R/W	TIME_MIN_APERTURA_ON_REC	Config.	s	0	999	Time required with minimum opening outdoor air damper for turning ON the recovery compressor
10	218	5011	R	N_HOR_COMP1	Status	h	0	32767	Operating hours of compressor 1 of circuit 1
11	219	5012	R	N_HOR_COMP2	Status	h	0	32767	Operating hours of compressor 1 of circuit 2 (2 circ. units) o compressor 3 (4 circ. units)
12	220	5013	R	N_HOR_CR	Status	h	0	32767	Operating hours of recovery compressor
13	221	5014	R/W	SET_HOR_CR	Service	h	0	32000	Operating hours limit of recovery compressor
14	222	5015	R	PR_ENT_EXTERIOR	Status	kc/kg	0	99	Integer part of outdoor enthalpy
15	223	5016	R	SEC_ENT_EXTERIOR	Status	kc/kg	0	999	Decimal part of outdoor enthalpy
16	224	5017	R	PR_ENT_INTERIOR	Status	kc/kg	0	99	Integer part of indoor enthalpy
17	225	5018	R	SEC_ENT_INTERIOR	Status	kc/kg	0	999	Decimal part of indoor enthalpy
18	226	5019	R/W	TIME_RET_AL_TEMP	Alarm	s	0	999	Delay in return air temperature alarm (high/low temp.)
19	227	5020	R/W	TIME_RET_AL_BP	Compressor	s	0	9999	Delay in low pressure alarm
20	228	5021	R/W	PR_ENT_DIF	Regulation	kc/kg	0	99	Integer part of difference between outdoor and indoor enthalpy
21	229	5022	R/W	SEC_ENT_DIF	Regulation	kc/kg	0	999	Decimal part of difference between outdoor and indoor enthalpy
22	230	5023	R/W	NUM_COMP_DESHUM	Regulation	---	0	NUM COMPRESSORES	Number of compressors during dehumidification
23	231	5024	R/W	TIME_RET_OFF_VINT_FRIO	Fan	s	0	999	Delay when stopping the indoor fan in COOLING mode (summer)
24	232	5025	R/W	TIME_RET_OFF_VINT_CALOR	Fan	s	0	999	Delay when stopping the indoor fan in HEATING mode (winter)
25	233	5026	R/W	TIME_RET_ON_COMP	Fan	s	0	999	Delay when starting the compressors after starting the indoor fan
26	234	5027	R/W	TIME_RET_AL_TERM_VENT_INT	Alarm	s	0	999	Delay for the interlock alarm (RTVI)
27	235	5028	R/W	TIME_MIN_OFF_COMP	Compressor	s	0	9999	Minimum stop time for the compressors
28	236	5029	R/W	NEW_PASS_UT	Safety	---	0	9999	New USER password
29	237	5030	R/W	NEW_PASS_ASS	Safety	---	0	9999	New MAINTENANCE password
30	238	5031	R/W	NEW_PASS_COS	Safety	---	0	9999	New MANUFACTURER password
31	239	5032	R/W	TIME_MIN_ON_ON_COMP	Compressor	s	0	9999	Minimum time between start-ups of the same compressor
32	240	5033	R/W	TIME_MIN_ON_ON_COMP_DIST	Compressor	s	0	9999	Time between start-ups of different compressors
33	241	5034	R/W	TIME_MIN_ON_COMP	Compressor	s	0	9999	Minimum start-up time of a compressor
34	242	5035	R/W	TIME_RET_INICIO_DES	Defrosting	s	0	999	Delay period before start of defrosting procedure
35	243	5036	R/W	TIME_MAX_DUR_DES	Defrosting	min	0	999	Maximum defrosting time
36	244	5037	R/W	SET_RENOVACION	Regulation	%	0	99	% of outdoor air for renewal
37	245	5038	R/W	SET_HOR_ON_EQUIPO	Service	h	0	32000	Operating hours limit of the unit
38	246	5039	R/W	SET_HOR_COMP1	Service	h	0	32000	Operating hours limit of compressor 1 of circuit 1
39	247	5040	R/W	SET_HOR_COMP2	Service	h	0	32000	Operating hours limit of compressor 1 of circuit 2 (2 circ. units) or compressor 3 (4 circ. units)
40	248	5041	R/W	TIME_ENTRE_DES_DIF	Defrosting	min	0	99	Minimum time between defrosting of the same circuit by difference with outdoor temperature
41	249	5042	R/W	NUM_RES	Config.	---	0: ----- 1: 1 elec. heater 2: 2 elec. heater 3: 2 elec. heater (3 st.) 4: proportional		Number of electrical heater stages

# 18 - CONNECTING THE UNIT TO A BMS SUPERVISION NETWORK

## Integer variables (...continuation)

Carel Addr.	Modbus record	Modbus Extended	Read Write	Variable	Parameter type	UOM	Min. value	Max. value	Description
42	250	5043	R/W	TIME_INTEGRACION	Fan	s	0	999	Integral time for proportional + integral control (P+I)
43	251	5044	R/W	TIPO REFRIGERANTE	Configuration	---	4: R410A		Type of refrigerant
44	252	5045	R	N_ARR_CR_H	Status	---	0	99	Number of starts of recovery compressor (high level)
45	253	5046	R	N_ARR_CR_L	Status	---	0	9999	Number of starts of recovery compressor (low level)
46	254	5047	R/W	TIPO_SOND_AMB	Configuration	---	1: 1 probe RS485 2: 2 probes RS485 3: probe pLAN 4: 1 probe NTC 5: 3 probes RS485 6: 4 probes RS485 7: 1 probe 4/20mA		Type of ambient probe
47	255	5048	R	MINUTO	Status	min	0	99	Clock setting: minute
48	256	5049	R	HORA	Status	h	0	99	Clock setting: hour
49	257	5050	R	DIA	Status	---	0	99	Clock setting: day
50	258	5051	R	MES	Status	---	0	99	Clock setting: month
51	259	5052	R	AGNO	Status	---	0	99	Clock setting: year
52	260	5053	R	DIA_SEMANA	Status	---	0	9	Clock setting: weekday
53	261	5054	R	N_HOR_COMP1_2	Status	---	0	32767	Operating hours of compressor 2 of circuit 1 (2 circ. units) or compressor 2 (4 circ. units)
54	262	5055	R/W	TIPO_TEMP_EXT	Configuration	---	0: no 1: actual 2: pLAN		Type of outdoor air temperature sensor
55	263	5056	R/W	TIPO_SONDA_HUM_EXT	Configuration	---	0: no 1: actual 2: pLAN		Type of outdoor air relative humidity sensor
56	264	5057	R/W	TIPO_SONDA_HUM_INT	Configuration	---	0: no 1: actual 2: virtual 3: pLAN 4: RS485		Type of indoor relative humidity sensor
57	265	5058	R/W	TIPO_RELOJ	Configuration	---	0: no 1: actual 2: pLAN		Type of clock board
58	266	5059	R/W	MODELO_EQUIPO	Configuration	---	0	44	Selection of the unit model in the series Space PF
59	267	5060	R/W	SEL_FRIO_CALOR	Configuration	---	0: panel 1: remote 2: automatic		COOLING/HEATING mode selection
60	268	5061	R/W	NUM_COMP_CIRC	Configuration	---	0: No compressor 1: 1 compr./ 1 circuit 2: 2 compr./ 1 circuit 3: 2 compr./ 2 circuits 4: 2 compr. + 1 parc 5: 2 compr. (3 stages) 6: 4 compr./ 2 circuits 7: 4 compr./ 4 circuits		Number of compressors
61	269	5062	R/W	NUM_RES_DES	Configuration	---	0	NUM_RES	Number of electrical heater stages during defrosting
62	270	5063	R	N_HOR_ON_EQUIPO	Status	---	0	32767	Operating hours of the unit
63	271	5064	R/W	LANGUAGE	Regulation	---	0: spanish 1: french 2: english 3: italian 4: turc 5: german		Selection of the language of the software installed on the control board
64	272	5065	R/W	TIME_MIN_DUR_DES	Defrosting	min	0	999	Minimum defrosting time
65	273	5066	R/W	TIME_AL_VIRT	Alarm	s	0	9999	Delay of alarm for disconnection of pLAN sensor
66	274	5067	R	NUM_AL	Status	---	0	99	Number of active alarms
67	275	5068	R/W	SET_HOR_COMP1_2	Service	h	0	32000	Operating hours limit of compressor 2 of circuit 1 (2 circ. units) or compressor 2 (4 circ. units)
68	276	5069	R/W	MIN_APERTURA_ON_REC	Configuration	%	0	99	% opening of damper to enable the start-up of the recovery compressor
69	277	5070	R	N_HOR_COMP2_2	Status	h	0	32767	Operating hours of compressor 2 of circuit 2 (2 circ. units) or compressor 4 (4 circ. units)
70	278	5071	R/W	SET_HOR_COMP2_2	Service	h	0	32000	Operating hours limit of compressor 2 of circuit 2 (2 circ. units) or compressor 4 (4 circ. units)
71	279	5072	R/W	TIPO_ARR	RTC	---	Schedule: 0: ON-OFF 1: only setpoint change 2: ON-OFF + limit setpoint 3: Manual 4: 3 setpoint + unit ON/OFF 5: Forced		Start-up type for the schedule programming

# 18 - CONNECTING THE UNIT TO A BMS SUPERVISION NETWORK

## Integer variables (...continuation)

Carel Addr.	Modbus record	Modbus Extended	Read Write	Variable	Parameter type	UOM	Min. value	Max. value	Description
72	280	5073	R/W	TIPO_BLOQ_COMP_FRIO_FC	Compressor	---	0: no 1: delta amb. T - outd. T 2: outdoor set		Disable the compressors with free-cooling in COOLING mode (summer)
73	281	5074	R/W	TIME_F_MAN	RTC	s	1	999	Minimum running time with forced start-up (h)
74	282	5075	R/W	H_ARR_1A	RTC	h	0	23	Start-up hour slot 1 programme 1
75	283	5076	R/W	M_ARR_1A	RTC	min	0	59	Start-up minute slot 1 programme 1
76	284	5077	R/W	H_PAR_1A	RTC	h	0	23	Stop hour slot 1 programme 1
77	285	5078	R/W	M_PAR_1A	RTC	min	0	59	Stop minute slot 1 programme 1
78	286	5079	R/W	H_ARR_1B	RTC	h	0	23	Start-up hour slot 2 programme 1
79	287	5080	R/W	M_ARR_1B	RTC	min	0	59	Start-up minute slot 2 programme 1
80	288	5081	R/W	H_PAR_1B	RTC	h	0	23	Stop hour slot 2 programme 1
81	289	5082	R/W	M_PAR_1B	RTC	min	0	59	Stop minute slot 2 programme 1
82	290	5083	R/W	H_ARR_1C	RTC	h	0	23	Start-up hour slot 3 programme 1
83	291	5084	R/W	M_ARR_1C	RTC	min	0	59	Start-up minute slot 3 programme 1
84	292	5085	R/W	H_PAR_1C	RTC	h	0	23	Stop hour slot 3 programme 1
85	293	5086	R/W	M_PAR_1C	RTC	min	0	59	Stop minute slot 3 programme 1
86	294	5087	R/W	H_ARR_2A	RTC	h	0	23	Start-up hour slot 1 programme 2
87	295	5088	R/W	M_ARR_2A	RTC	min	0	59	Start-up minute slot 1 programme 2
88	296	5089	R/W	H_PAR_2A	RTC	h	0	23	Stop hour slot 1 programme 2
89	297	5090	R/W	M_PAR_2A	RTC	min	0	59	Stop minute slot 1 programme 2
90	298	5091	R/W	H_ARR_2B	RTC	h	0	23	Start-up hour slot 2 programme 2
91	299	5092	R/W	M_ARR_2B	RTC	min	0	59	Start-up minute slot 2 programme 2
92	300	5093	R/W	H_PAR_2B	RTC	h	0	23	Stop hour slot 2 programme 2
93	301	5094	R/W	M_PAR_2B	RTC	min	0	59	Stop minute slot 2 programme 2
94	302	5095	R/W	H_ARR_2C	RTC	h	0	23	Start-up hour slot 3 programme 2
95	303	5096	R/W	M_ARR_2C	RTC	min	0	59	Start-up minute slot 3 programme 2
96	304	5097	R/W	H_PAR_2C	RTC	h	0	23	Stop hour slot 3 programme 2
97	305	5098	R/W	M_PAR_2C	RTC	min	0	59	Stop minute slot 3 programme 2
98	306	5099	R/W	H_ARR_3A	RTC	h	0	23	Start-up hour slot 1 programme 3
99	307	5100	R/W	M_ARR_3A	RTC	min	0	59	Start-up minute slot 1 programme 3
100	308	5101	R/W	H_PAR_3A	RTC	h	0	23	Stop hour slot 1 programme 3
101	309	5102	R/W	M_PAR_3A	RTC	min	0	59	Stop minute slot 1 programme 3
102	310	5103	R/W	H_ARR_3B	RTC	h	0	23	Start-up hour slot 2 programme 3
103	311	5104	R/W	M_ARR_3B	RTC	min	0	59	Start-up minute slot 2 programme 3
104	312	5105	R/W	H_PAR_3B	RTC	h	0	23	Stop hour slot 2 programme 3
105	313	5106	R/W	M_PAR_3B	RTC	min	0	59	Stop minute slot 2 programme 3
106	314	5107	R/W	H_ARR_3C	RTC	h	0	23	Start-up hour slot 3 programme 3
107	315	5108	R/W	M_ARR_3C	RTC	min	0	59	Start-up minute slot 3 programme 3
108	316	5109	R/W	H_PAR_3C	RTC	h	0	23	Stop hour slot 3 programme 3
109	317	5110	R/W	M_PAR_3C	RTC	min	0	59	Stop minute slot 3 programme 3
110	318	5111	R/W	LUN_A	RTC	---	0	3	Selection of the schedule programme for Monday
111	319	5112	R/W	MAR_A	RTC	---	0	3	Selection of the schedule programme for Tuesday
112	320	5113	R/W	MIE_A	RTC	---	0	3	Selection of the schedule programme for Wednesday
113	321	5114	R/W	JUE_A	RTC	---	0	3	Selection of the schedule programme for Thursday
114	322	5115	R/W	VIE_A	RTC	---	0	3	Selection of the schedule programme for Friday
115	323	5116	R/W	SAB_A	RTC	---	0	3	Selection of the schedule programme for Saturday
116	324	5117	R/W	DOM_A	RTC	---	0	3	Selection of the schedule programme for Sunday
117	325	5118	R/W	CONF_OUT07	Configuration	---	0: Humidifier 1: Pump in HWC circuit 2: Pump in boiler circuit 3: Alarm 4: Inverter compressor 5: Rotary heat exchanger		Type of element connected on the digital output OUT07
118	326	5119	R/W	TIPO_FREECOOLING	Configuration	---	0: thermal 1: enthalpic 2: thermoenthalpic		Type of free-cooling: thermal, enthalpic or thermal enthalpic
119	327	5120	R/W	_NEW_HOUR	RTC	h	0	23	Clock setting: new hour
120	328	5121	R/W	_NEW_MINUTE	RTC	min	0	59	Clock setting: new minutes

# 18 - CONNECTING THE UNIT TO A BMS SUPERVISION NETWORK

## Integer variables (...continuation)

Carel Addr.	Modbus record	Modbus Extended	Read / Write	Variable	Parameter type	UOM	Min. value	Max. value	Description
121	329	5122	R/W	_NEW_DAY	RTC	---	1	31	Clock setting: new day
122	330	5123	R/W	_NEW_MONTH	RTC	---	1	12	Clock setting: new month
123	331	5124	R/W	_NEW_YEAR	RTC	---	0	99	Clock setting: new year
124	332	5125	R	RENOVACION_CAL	Status	%	0	99	Calculation of air renewal % depending on mixing temperature
125	333	5126	R	CAL_APER_RENOV_2	Status	%	0	99	Calculation of damper opening % depending on renewal
126	334	5127	R	SET_RENOVACION_CAL	Status	%	0	99	Calculation of outdoor air % allowed for renewal
127	335	5128	R/W	TIPO_SONDA_RENOVACION	Configuration	---	0: None 1: Mixed air temperature 2: Actual air quality probe 3: pLAN air quality probe		Type of sensor installed on the analogue input B8
128	336	5129	R/W	DESCONEXION_NUM_COMPRESORES	Comands	---	0	NUM_ETAPAS_COMPRESOR	Number of stages of compressors to disconnect
129	337	5130	R/W	DESCONEXION_NUM_RESISTENCIAS	Comands	---	0	NUM_RES	Number of stages of electrical heaters to disconnect
130	338	5131	R	NUM_ETAPAS_COMPRESOR	Status	---	0	4	Number of compressor stages
131	339	5132	R/W	MAX_APERTURA_COMPUERTA	Regulation	%	0	100	Maximum opening of the outdoor air damper
132	340	5133	R/W	TIME_INT_C_EVAP_VEXT	Fan	s	0	999	Integral time for P+I control for outdoor unit evaporation control
133	341	5134	R/W	TIME_INT_C_COND_VEXT	Fan	s	0	999	Integral time for P+I control for outdoor unit condensation control
134	342	5135	R	NUM_WO_SPV	Status	---	0	9999	Number of work order of the unit (WO) (high level)
135	343	5136	R/W	NUM_WO_SPV	Status	---	0	9999	Number of work order of the unit (WO) (low level)
136	344	5137	R	N_HOR_VENT	Status	h	0	32767	Operating hours of the indoor fan
137	345	5138	R	N_HOR_RES1	Status	h	0	32767	Operating hours of electrical heater No. 1
138	346	5139	R	N_HOR_RES2	Status	h	0	32767	Operating hours of electrical heater No. 2
139	347	5140	R	N_ARR_V_INT_H	Status	---	0	99	Number of start-ups of the indoor fan (high level)
140	348	5141	R	N_ARR_V_INT_L	Status	---	0	9999	Number of start-ups of the indoor fan (low level)
141	349	5142	R	N_ARR_COMP1_H	Status	---	0	99	Number of start-ups of compressor 1 of circuit 1 (high level)
142	350	5143	R	N_ARR_COMP1_L	Status	---	0	9999	Number of start-ups of compressor 1 of circuit 1 (low level)
143	351	5144	R	N_ARR_COMP1_2_H	Status	---	0	99	Number of start-ups of compressor 2 of circuit 1 (2 circ. units) or compressor 2 (4 circ. units) (high level)
144	352	5145	R	N_ARR_COMP1_2_L	Status	---	0	9999	Number of start-ups of compresor 2 of circuit 1 (2 circ. units) or compressor 2 (4 circ. units) (low level)
145	353	5146	R	N_ARR_COMP2_H	Status	---	0	99	Number of start-ups of compressor 2 of circuit 1 (1 circ. units) or compressor 1 of circuit 2 (2 circ. units) or compressor of circuit 3 (4 circ. units) (high level)
146	354	5147	R	N_ARR_COMP2_L	Status	---	0	9999	Number of start-ups of compressor 2 of circuit 1 (1 circ. units) or compressor 1 of circuit 2 (2 circ. units) or compressor of circuit 3 (4 circ. units) (low level)
147	355	5148	R	N_ARR_COMP2_2_H	Status	---	0	99	Number of start-ups of compressor 2 of circuit 2 (2 circ. units) or compressor 4 (4 circ. units) (high level)
148	356	5149	R	N_ARR_COMP2_2_L	Status	---	0	9999	Number of start-ups of compressor 2 of circuit 2 (2 circ. units) or compressor 4 (4 circ. units) (low level)
149	357	5150	R	N_ARR_RES1_H	Status	---	0	99	Number of start-ups of 1st stage of electrical heater (high level)
150	358	5151	R	N_ARR_RES1_L	Status	---	0	9999	Number of start-ups of 1st stage of electrical heater (low level)
151	359	5152	R	N_ARR_RES2_H	Status	---	0	99	Number of start-ups of 2nd stage of electrical heater (high level)
152	360	5153	R	N_ARR_RES2_L	Status	---	0	9999	Number of start-ups of 2nd stage of electrical heater (low level)
153	361	5154	R	N_DES_C1_H	Status	---	0	99	Number of defrosting procedures of circuit 1 (high level)
154	362	5155	R	N_DES_C1_L	Status	---	0	9999	Number of defrosting procedures of circuit 1 (low level)
155	363	5156	R	N_DES_C1_2_H	Status	---	0	99	Number of defrosting procedures of circuit 3 (high level)
156	364	5157	R	N_DES_C1_2_L	Status	---	0	9999	Number of defrosting procedures of circuit 3 (low level)
157	365	5158	R	N_DES_C2_H	Status	---	0	99	Number of defrosting procedures of circuit 2 (high level)
158	366	5159	R	N_DES_C2_L	Status	---	0	9999	Number of defrosting procedures of circuit 2 (low level)

## 18 - CONNECTING THE UNIT TO A BMS SUPERVISION NETWORK

### Integer variables (...continuation)

Carel Addr.	Modbus record	Modbus Extended	Read / Write	Variable	Parameter type	UOM	Min. value	Max. value	Description
159	367	5160	R	N_DES_C2_2_H	Status	---	0	99	Number of defrosting procedures of circuit 4 (high level)
160	368	5161	R	N_DES_C2_2_L	Status	---	0	9999	Number of defrosting procedures of circuit 4 (low level)
161	369	5162	R	N_SEG_ULT_DES_C1	Status	---	0	999	Time since the last defrosting procedure of circuit 1
162	370	5163	R	N_SEG_ULT_DES_C1_2	Status	---	0	999	Time since the last defrosting procedure of circuit 3
163	371	5164	R	N_SEG_ULT_DES_C2	Status	---	0	999	Time since the last defrosting procedure of circuit 2
164	372	5165	R	N_SEG_ULT_DES_C2_2	Status	---	0	999	Time since the last defrosting procedure of circuit 4
165	373	5166	R/W	MIN_APERTURA_COMPUERTA	Regulation	%	0	100	Minimum opening of the outdoor air damper
166	374	5167	R/W	TIME_ON_AUTOSTART	Regulation	s	5	999	Automatic start-up time after blocking
167	375	5168	R	Voltage_L1_L2_L_SPV	Status	V	0	9999	Voltage between lines 1 and 2
168	376	5169	R	Voltage_L2_L3_L_SPV	Status	V	0	9999	Voltage between lines 2 and 3
169	377	5170	R	Voltage_L3_L1_L_SPV	Status	V	0	9999	Voltage between lines 3 and 1
170	378	5171	R	Voltage_1_L_SPV	Status	V	0	9999	Voltage of line 1
171	379	5172	R	Voltage_2_L_SPV	Status	V	0	9999	Voltage of line 2
172	380	5173	R	Voltage_3_L_SPV	Status	V	0	9999	Voltage of line 3
173	381	5174	R	Power_Factor_MSK_BMS_GAVAZZI	Status	---	0	32	Power factor of the energy meter
174	382	5175	R	Apparent_Energy_H_SPV	Status	kVAh	0	9999	Reactive energy (Integer part)
175	383	5176	R	Apparent_Energy_L_SPV	Status	kVAh	0	9999	Reactive energy (Decimal part)
176	384	5177	R	Energy_H_SPV	Status	KWh	0	9999	Energy (Integer part)
177	385	5178	R	Energy_L_SPV	Status	KWh	0	9999	Energy (Decimal part)
178	386	5179	R	CT_L_SPV	Status	---	0	9999	Multiplier of the current transformer
179	387	5180	R	System_Type	Status	---	0: 3p 1: 3P.n 2: 2P 3: 1P 4: 3P.A		Type of power supply
180	388	5181	R	Hourmeter_H_SPV	Status	h	0	9999	Hours of electrical energy meter (High part)
181	389	5182	R	Hourmeter_L_SPV	Status	h	0	9999	Hours of electrical energy meter (Low part)
182	390	5183	R/W	TIPO_EQUIPO	Config.	---	0: air-air 1: water-air		Selection of the type of unit
183	391	5184	R/W	TIME_RET_AL_CAUDAL	Alarm	s	0	120	Flow switch time delay
184	392	5185	R/W	MIN_AOUT_VENT_EXT	Config.	%	0	100	Minimum analogue output for outdoor fan
185	393	5186	R/W	TIME_ON_VEXT_INI_DES	Defrosting	s	0	120	Outdoor fan connection time at the start of defrosting
186	394	5187	R/W	TIME_VINT_ON_ANTIESTRATIF	Fan	min	0	999	Anti-stratification: indoor fan ON time
187	395	5188	R/W	TIME_VINT_OFF_ANTIESTRATIF	Fan	min	0	999	Anti-stratification: indoor fan OFF time
188	396	5189	R/W	PORCEN_TEMP_OFF_DESH	Config.	%	0	100	% return air temperature with regard to the setpoint for disconnection of compressor in dehumidification
189	397	5190	R/W	PORCEN_TEMP_ON_DESH	Config.	%	0	100	% return air temperature with regard to the setpoint for the connection of compressor in dehumidification
190	398	5191	R/W	HAB_HUMIDIFICA	Config.	---	0: no 1: on/off 2: proportional		Enabling humidification function
191	399	5192	R	INFO_EQUIPO_1	Status	---	0: air-air cooling only 1: air-air heat pump 2: water-air cooling only 3: water-air heat pump		Unit information
192	400	5193	R	INFO_EQUIPO_2	Status	---	0: ----- 1: 1 comp / 1 circ 2: 2 comp / 1 circ 3: 2 comp / 2 circ 4: 2 comp.+1 par. 5: 2 comp.(3et.) 6: 4 comp / 2 circ 7: 4 comp / 4 circ 10: rec. comp 11: 1 comp / 1 circ + rec. 12: 2 comp / 1 circ + rec. 13: 2 comp / 2 circ + rec. 14: 2 comp.+ 1 par.+ rec. 15: 2 comp. (3 st.) + rec. 16: 4 comp / 2 circ + rec. 17: 4 comp / 4 circ + rec.		Unit information: compressors-circuits

# 18 - CONNECTING THE UNIT TO A BMS SUPERVISION NETWORK

## Integer variables (...continuation)

Carel Addr.	Modbus record	Modbus Extended	Read Write	Variable	Parameter type	UOM	Min. value	Max. value	Description
193	401	5194	R	INFO_EQUIPO_3	Status	---	0: --- 1: electrical heaters 2: gas burner 3: el. heaters.+ gas burner 4: HWC 5: HWC + el. heaters 6: HWC + gas burner 7: HWC+ gas burner + heaters		Unit information: electrical heaters, gas burner, hot water coil (HWC)
194	402	5195	R/W	TIME_CAL	Service	s	0	99	Damper opening calculation time
195	403	5196	R/W	V_CAL	Service	%	0	99	% damper opening in calculation time
196	404	5197	R/W	TIPO_VENT_INT	Config.		1: centrifuge 2: axial / radial 3: plug-fan EC 4: centrifuge + VFD		Type of indoor (supply) fan
197	405	5198	R/W	SET_CAUDAL_VINT_VENTILACION	Service	x 10m³/h	CAUDAL_VINT_NOMINAL_MIN	CAUDAL_VINT_NOMINAL_MAX	Flow setpoint in ventilation with the indoor plug-fan
198	406	5199	R	CAUDAL_VINT_MEDIDO_AJUSTE	Status	x 10m³/h	0	9999	Flow rate measured with indoor plug-fan
199	407	5200	R	actual_speed_msk	Status	rpm	0	9999	Speed measured with indoor plug-fan
200	408	5201	R/W	SET_CAUDAL_VINT_FRIO	Service	x 10m³/h	CAUDAL_VINT_NOMINAL_MIN	CAUDAL_VINT_NOMINAL_MAX	Flow rate setpoint in cooling mode with indoor plug-fan
201	409	5202	R/W	SET_CAUDAL_VINT_CALOR	Service	x 10m³/h	CAUDAL_VINT_NOMINAL_MIN	CAUDAL_VINT_NOMINAL_MAX	Flow rate setpoint in heating mode with indoor plug-fan
202	410	5203	R/W	TIPO_VENT_RET	Configuration		0: no 1: centrifuge 2: axial / radial 3: plug-fan EC 4: centrifuge + VFD		Type of return fan
203	411	5204	R/W	SET_CAUDAL_VRET_VENTILACION	Service	x 10m³/h	CAUDAL_VRET_NOMINAL_MIN	CAUDAL_VRET_NOMINAL_MAX	Flow rate setpoint in ventilation mode with return plug-fan
204	412	5205	R	CAUDAL_VRET_MEDIDO_AJUSTE	Status	x 10m³/h	0	9999	Flow rate measured with return plug-fan
205	413	5206	R	actual_speed_msk_FAN2	Status	rpm	0	9999	Speed measured with return plug-fan
206	414	5207	R/W	SET_CAUDAL_VRET_FRIO	Service	x 10m³/h	CAUDAL_VRET_NOMINAL_MIN	CAUDAL_VRET_NOMINAL_MAX	Flow rate setpoint in cooling mode with return plug-fan
207	415	5208	R/W	SET_CAUDAL_VRET_CALOR	Service	x 10m³/h	CAUDAL_VRET_NOMINAL_MIN	CAUDAL_VRET_NOMINAL_MAX	Flow rate setpoint in heating mode with return plug-fan
----	----	5209	R/W	MAX_APERTURA_COMPUERTA_FREEE	Regulation	%	0	100	Maximum opening of the outdoor air damper with freecooling or freeheating
----	----	5210	R/W	CONF_OUT08	Configuration	---	0: Alarm 1: Pump in HWC circuit		Type of element connected in digital outlet 08
----	----	5211	R/W	TIME_RET_OFF_BOMBA_BAC	Configuration	s	0	999	Delay time to stop the pump of the hot water coil
----	----	5212	R/W	MIN_APERTURA_VALV_CALOR	Configuration	%	0	100	Minimum opening of heat valve (HWC) with low outdoor temperature and the unit working
----	----	5213	R	N_HOR_VALV_CALOR	Status	h	0	32767	Operating hours of the hot water coil
----	----	5214	R	N_HOR_FREEC_FREEH	Status	h	0	32767	Operating hours of the free-cooling or free-heating
----	----	5215	R	N_HOR_REC_ROTATIVO	Status	h	0	32767	Operating hours of the rotary heat exchanger
----	----	5216	R/W	TAR_CO2	Service	ppm	-9999	9999	Set of the air quality probe
----	----	5217	R/W	TIME_RET_ON_VINT	Fan	s	0	999	Delay time to start the indoor with unit "ON"
----	----	5218	R/W	CONTROL_TCO_SONDA	Configuration	---	0: TCO 1: Ambient 2: Return		Selection of the control probe with TCO terminal
----	----	5219	R/W	CONF_OUT01_MOD_N8	Configuration	---	0: humidifier 1: pump in HWC circuit 2: recovery compressor 3: alarm 4: --- 5: rotary heat exchanger 6: -----		Configuration of the digital output OUT01 of the pCOe expansion card with address 8
----	----	5220	R/W	CONF_OUT04_MOD_N8	Configuration	---	0: humidifier 1: pump in HWC circuit 2: recovery compressor 3: alarm 4: --- 5: rotary heat exchanger 6: -----		Configuration of the digital output OUT04 of the pCOe expansion card with address 8



## 18 - CONNECTING THE UNIT TO A BMS SUPERVISION NETWORK

### Integer variables (...continuation)

Carel Addr.	Modbus record	Modbus Extended	Read / Write	Variable	Parameter type	UOM	Min. value	Max. value	Description
----	----	5221	R	CO2_FISICA_zona2	Status	ppm	0	32767	Reading of the CO2 air quality sensor: second sensor or zone 2 sensor
----	----	5222	R/W	TAR_CO2_zona2	Service	ppm	-9999	9999	Set of the CO2 air quality sensor: second sensor or zone 2 sensor
----	----	5223	R/W	Power_factor_setpoint	Service	---	0	32	Power factor setpoint
----	----	5224	R	AOUT_REC_ROT_VARIABLE	Status	%	0	100	Analogue output for the rotary heat exchanger with variable wheel
----	----	5225	R	Analog_IN2_Ebm_Fan1	Status	---	0	32767	Current value on the differential pressure sensor with supply plug-fan
----	----	5226	R	Analog_IN2_Ebm_Fan2	Status	---	0	32767	Current value on the differential pressure sensor with return plug-fan
----	----	5227	R/W	MIN_APERTURA_ON_REC_CALOR	Configuration	%	0	99	% of minimum opening of outdoor damper to allow the start of the recovery compressor
----	----	5228	R/W	TIPO_PROT_COM	Configuration	---	0	4	Type of protocol in supervision network (0=Carel; 1=LonWorks; 2=Modbus; 3=Commissioning; 4=Modbus extended)
----	----	5229	R/W	BMS_ADDRESS	Configuration	---	1	207	Address of the unit in the supervision network
----	----	5230	R/W	BAUD_RATE	Configuration	---	0	4	Bits rate in the supervision network (0=1200, 1=2400, 2=4800, 3=9600, 4=19200)
----	----	5231	R/W	Parity_Type_MB	Configuration	---	0	2	Type of parity for the MODBUS protocol
----	----	5232	R	Densidad_aire_impulsion	Status	x10 g/m3	0	9999	Calculation of cooling and heating capacities: display of air density
----	----	5233	R	PORC_COMPRESORES	Status	%	0	999	Calculation of cooling and heating capacities: display of compressor stages (%)
----	----	5234	R/W	LIM_MAX_SET_RENOVACION_CON_CO2	Configuration	%	0	100	Maximum opening of the outdoor air damper for AIR RENEWAL with CO2 probe
----	----	5235	R/W	SEL_CO2_SONDAS_CO2	Configuration	---	0	2	Selection of CO2 value with two CO2 probes (0=average, 1=minimum; 2=maximum)
----	----	5248	R/W	TIME_INTEGRACION_HUM_DESHUM	Configuration	s	0	999	Integration time with PI humidity control
----	----	5249	R	SP_LIM_CO2_EXTERIOR	Regulation	ppm	0	5000	Setpoint of the outdoor probe for CO2 air quality control (ppm). From this value the outdoor damper is closed.
----	----	5250	R	DIF_LIM_CO2_EXTERIOR	Regulation	ppm	0	1000	Differential of the outdoor probe for CO2 quality control (ppm)
----	----	5251	R/W	MAX_AOUT_VENT_EXT_FRIO	Configuration	%	30	100	Maximum analogue output for the outdoor fan in COOLING mode (summer)
----	----	5252	R/W	MAX_AOUT_VENT_EXT_CALOR	Configuration	%	30	100	Maximum analogue output for the outdoor fan in HEATING mode (winter)
----	----	5253	R/W	MAX_AOUT_VENT_EXT_FRIO_EN_ON	Configuration	%	30	100	Maximum analogue output to connect the outdoor fan in COOLING mode (summer)
----	----	5254	R/W	MAX_AOUT_VENT_EXT_CALOR_EN_ON	Configuration	%	30	100	Maximum analogue output to connect the outdoor fan in HEATING mode (winter)
----	----	5255	R/W	MAX_AOUT_VENT_EXT_FRIO_EN_OFF	Configuration	%	30	100	Maximum analogue output to disconnect the outdoor fan in COOLING mode (summer)
----	----	5256	R/W	MAX_AOUT_VENT_EXT_CALOR_EN_OFF	Configuration	%	30	100	Maximum analogue output to disconnect the outdoor fan in HEATING mode (winter)
----	----	5257	R	CO2_FISICA_zona1	Status	ppm	0	32767	Reading of the CO2 probe (zone 1) (zoning into 2 zones)
----	----	5258	R/W	LIM_MIN_SET_RENOVACION_CON_CO2	Configuration	%	0	99	Minimum opening of the outdoor air damper for AIR RENEWAL with CO2 probe
----	----	5259	R/W	TIME_SET_RENOVACION_CON_CO2	Configuration	s	0	999	Time with minimum opening of the outdoor air damper for AIR RENEWAL with CO2 probe

## 18 - CONNECTING THE UNIT TO A BMS SUPERVISION NETWORK

### 18.5. LonWorks® supervisory variables

The LONWORKS serial card will be written to in the factory, by default, with the variables indicated in the following table. It is possible to change these variables, but a maximum of 59 variables can be written.

Type	Index	Description	Name NV	Type NV	Address
Analogue	1	Return air temperature	nvoRoomTemp	105	Output
Analogue	2	Outdoor air temperature	nvoOutsideTemp	105	Output
Analogue	3	Defrosting temperature of circuit No. 1	nvoDesTemp1	105	Output
Analogue	4	Defrosting temperature of circuit No. 2	nvoDesTemp2	105	Output
Analogue	5	Relative return humidity	nvoRoomHR	81	Output
Analogue	6	Outdoor air relative humidity	nvoOutsideHR	81	Output
Analogue	7	Outlet temperature	nvoImpTemp	105	Output
Analogue	10	Outdoor air damper outlet	nvoFcoolDamp	105	Output
Analogue	11	Heat valve output (auxiliary water coil)	nvoV3VPos	105	Output
Analogue	15	Return air temperature setpoint in summer	nviSetTempCool	105	Input
Analogue	15	Return air temperature setpoint in summer	nvoSetTempCool	105	Output
Analogue	16	Return air temperature setpoint in winter	nviSetTempHeat	105	Input
Analogue	16	Return air temperature setpoint in winter	nvoSetTempHeat	105	Output
Analogue	58	Outdoor control setpoint in winter for daily phase	nviSetPrgExtHeat	105	Input
Analogue	58	Outdoor control setpoint in winter for daily phase	nvoSetPrgExtHeat	105	Output
Analogue	59	Outdoor control setpoint in summer for daily phase	nviSetPrgExtCool	105	Input
Analogue	59	Outdoor control setpoint in summer for daily phase	nvoSetPrgExtCool	105	Output
Analogue	60	Indoor control setpoint in winter for daily phase	nviSetPrgIntHeat	105	Input
Analogue	60	Indoor control setpoint in winter for daily phase	nvoSetPrgIntHeat	105	Output
Analogue	61	Indoor control setpoint in summer for daily phase	nviSetPrgIntCool	105	Input
Analogue	61	Indoor control setpoint in summer for daily phase	nvoSetPrgIntCool	105	Output
Integer	10	Operating hours of compressor No. 1	nvoHourComp1	8	Output
Integer	11	Operating hours of compressor No. 2	nvoHourComp2	8	Output
Integer	62	Machine operating hours	nvoHourMaq	8	Output
Digital	8	Remote On/Off signal	nvoOnOffRem	95	Output
Digital	15	Indoor fan	nvoOnSupFan	95	Output
Digital	16	Compressor contact 1	nvoOnComp1	95	Output
Digital	17	Compressor contact 2	nvoOnComp2	95	Output
Digital	18	Cycle reversing valve 1	nvoOnV4v1	95	Output
Digital	19	Cycle reversing valve 2	nvoOnV4v2	95	Output
Digital	20	Heater contact 1	nvoOnRes1	95	Output
Digital	21	Heater contact 2	nvoOnRes2	95	Output
Digital	23	Outdoor fan 1	nvoOnFanExt1	95	Output
Digital	24	Outdoor fan 2	nvoOnFanExt2	95	Output
Digital	26	General alarm	nvoAlrGen	95	Output
Digital	27	Thermal 1	nvoAlrTermC1	95	Output
Digital	28	Thermal 2	nvoAlrTermC2	95	Output
Digital	29	High pressure 1	nvoAlrHPC1	95	Output
Digital	30	High pressure 2	nvoAlrHPC2	95	Output
Digital	31	Anti-freeze	nvoAlrIce	95	Output
Digital	32	Damaged EPROM	novAlrEprom	95	Output
Digital	33	Broken or disconnected clock	novAlrTime	95	Output
Digital	34	Overly high return air temperature	nvoAlrRoomHT	95	Output
Digital	35	Overly low return air temperature	nvoAlrRoomLT	95	Output
Digital	36	Maintenance of compr.1	nvoAlrMantC1	95	Output
Digital	37	Maintenance of compr. 2	nvoAlrMantC2	95	Output
Digital	38	Low pressure 1	nvoAlrLPC1	95	Output
Digital	39	Low pressure 2	nvoAlrLPC2	95	Output
Digital	40	Inter-blocking	nvoAlrTermFan	95	Output
Digital	41	Defrosting 1	nvoAlrDes1	95	Output
Digital	42	Defrosting 2	nvoAlrDes2	95	Output
Digital	43	Clogged filter	nvoAlrDirtFilt	95	Output
Digital	44	Thermal heater	nvoAlrTermRes	95	Output
Digital	61	Enable schedule phase	nviHabProg	95	Input
Digital	61	Enable schedule phase	nvoHabProg	95	Output
Digital	65	Unit off / on	nviOnOff	95	Input
Digital	66	Selection of winter/summer mode	nviHeatCool	95	Input
Digital	66	Selection of winter/summer mode	nvoHeatCool	95	Output
Digital	74	Machine state view (off/on)	nvoOnOff	95	Output

# 19 - CONFIGURATION OF THE PLAN NETWORK

A pLAN network shall be made up of a maximum of:



- 15 control boards: addresses 1 to 15. Address 1 shall be reserved for the master board.
- 1 common terminal: address 16.
- 15 private terminals: addresses 17 to 31. The address of each private terminal will coincide with the address total for the corresponding board + 16.

The steps necessary for completely configuring the pLAN are described in the following sections.

**Important:** both the units and the terminals are pre-configured in the factory.



## 19.1. Addressing of the boards

**Important:** To assign addresses to the boards, they **cannot** be connected to that network.

- The procedure is activated by simultaneously pressing the UP  + DOWN  + ENTER  keys.

- On the first screen displayed, the terminal must be configured with address 00.

The value of "Display address setting" is modified pressing the ENTER  key.

Change the address value with the UP  and DOWN  keys until 00 appears. Press the ENTER  key to confirm the value.

```

Display address
setting:      16
I/O board
address:     02
    
```



When the address has been changed, the screen shows:

```

Display address
changed
    
```

This operation is only performed once and it serves to configure all of the boards of the network.

Afterwards, proceed as follows for each of the control boards:

- Cut-off the electricity supply.
- Next, simultaneously press the ALARM  + UP  keys for a few seconds and turn the board on.

Once this operation is done, the following screen will appear:

```

#####
Selftest
Please wait
#####
    
```

```

PLAN address
UP:          increase
down:       decrease
enter:      save &exit
    
```



- When all the boards have been assigned their address they can be reconnected to the network using the J11 connector for each board to do so.

## 19.2. Configuration of the shared terminal

All of the control boards that make up the network can also be monitored from a single terminal, known as the shared terminal.

**This operation only has to be performed once, with a terminal that is connected to any unit.**

- To start the procedure, it is necessary to supply power to the unit to which the terminal has been connected.



- By simultaneously pressing the UP  + DOWN  + ENTER  keys, the following display appears:

```

Display address
setting:      00
    
```

This screen indicates that the terminal currently has the address 00. This was used to address the boards, as explained in the previous section.

To change this address, press the ENTER  key, and the cursor will be above the terminal's address.

Change the address value with the UP  and DOWN  keys until 16 appears.

The "I/O board address" (address of the board) appears at the same time with the value "--".

Press the ENTER  key to confirm the value 16.

```

Display address
setting:      16
I/O board
address:     --
    
```

If the procedure has been performed correctly "Display address setting" (address of the modified terminal) appears on the screen.

If "NO LINK" (no communication) appears instead of the previous screen, power must be cut-off and restarted. The entire procedure must be repeated.



```

NO LINK
    
```

# 19 - CONFIGURATION OF THE PLAN NETWORK

## 19.3. Address assignment to private terminals

Next, the addresses will be assigned to the private terminal and the shared terminal for each of the boards which make up the network. The private terminal must be addressed even if the board do not have one at that time. The address for the private terminal must coincide with the sum of the corresponding board number + 16.

- By simultaneously pressing the UP  + DOWN  + ENTER  keys, the following screen appears:

```

Display address
setting:      16
I/O board
address:     XX
    
```

Where "XX" represents the address of the board in which the terminal is connected (values 1 to 15).

The values for this screen are confirmed by pressing the ENTER  key 3 times.

- From this screen, pressing the ENTER  key, grants access to the display in which the addresses of the private and common terminals are assigned for the board with address XX.

```

P:XX adr Priv/shared
trm1 16          sh
trm2 YY          PR
trm3 none        OK?
    
```

Pressing the ENTER  key on this display moves the cursor from one field to another, while the cursor keys change the current value of the field.

The text "P:XX" indicates that, in this case, the I/O board with address XX has been selected.

trm1=16 (terminal 1: address 16) → shared (to switch between the different control boards).

trm2=YY (terminal 2: address YY) → private (only for displaying the board output with address XX).



As shown above: YY = XX + 16. For example:

- a private terminal with address 17 will correspond to the board with address 01, i.e., 17 = 01 + 16
- a private terminal with address 18 will correspond to the board with address 02, i.e., 18 = 02 + 16

To exit the configuration procedure and save, select the 'OK ? NO' field, place the cursor over the 'YES' text and then press ENTER .

To exit without saving, leave the terminal alone without touching any key for 30 seconds.

- With the terminal connected to the above board, the addresses of the terminals can be assigned for the rest of the boards without needing to change the unit.



To do so, simultaneously press the UP  + DOWN  + ENTER  keys, and the following screen appears:

```

Display address
setting:      16
I/O board
address:     XX
    
```

From this point, repeat the above steps to assign addresses.

- When the network is completely configured, with the shared terminal placed on any board, the other boards of the network can be supervised.

To move from one board to another, press the ESC  +DOWN  keys.

For example, the following screen is the main one for the board with address 1 (Unit: 01):

```

P01
Unit:01      00:00  WIN
Indoor T:    00.0°C
Outdoor T:   00.0°C
Indoor RH:   00.0%
Unit On
    
```

## 19.4. Configuration of the shared sensors (optional)

In a pLAN network with the appropriate facility's conditions, the value measured by some sensors installed on the master unit (address 1) can be shared: outdoor humidity, indoor humidity, ambient temperature, outdoor temperature and air quality CO<sub>2</sub>.

All of the units will read from these sensors, except those which have incorporated their own sensors.

The configuration of these sensors is performed on the Group of screens **MANUFACTURER → UNIT CONFIGURATION** (password protected):

```

CU09
Ambient Probe: Y
Control by ambient T.
Amb. Probe type: PLAN
    
```

```

CU10
Outlet Probe Y
Outd.T. probe PLAN
Ind. RH probe PLAN
Outd.RH probe PLAN
Outd.unit sens. Y
Ind.unit sens. Y
    
```

```

CU11
Probe for refresh.:
PLAN Air quality
Activate control: Y
Units:PPM'
Mixing temp. probe: Y
    
```

## 20 - TECHNICAL AND ELECTRICAL CHARACTERISTICS

Main CPU board installed in the unit's electric panel, which allows data to be input, treated by the microcontroller and the operation of the unit to be managed completely.

The program and the parameters are stored in non-volatile memory, there by ensuring their storage even in the case of a power failure (without needing an auxiliary coil). The program can be loaded through the PC or from a program key.

### microPC board

#### ELECTRICAL FEATURES

Power supply (controller with terminal connected)	230 Vac +10/-15% (by default) 24 Vac +10/-15% 50/60 Hz and 28 to 36 Vdc +10/-20% (optional)
Maximum current with the connected terminal	25 VA (Vac)
Terminal strip	with removable male/female connectors (250 Vac max.) connectors set with screws
Isolation between the power supply line and the control	double
Data memory	13 kB at 8 bits (max. limit: 400,000 writes per memory location)
Working cycle with applications of average complexity	0.2 s

#### Analogue inputs

Analogue conversion	A/D converter to 10-bit integrated in CPU
Maximum number	7 in SMALL boards and 12 in MEDIUM boards
Input type: B1, B2, B3, B4, B8 and B9	low temperature NTC: 10k $\Omega$ $\pm$ 0.1% to 25°C; -50/90°C high temperature NTC: 50k $\Omega$ to 25°C; 0/150°C input: 0/1 Vdc
Input type: B5 and B10	low temperature NTC: 10k $\Omega$ to 25°C; -50/90°C high temperature NTC: 50k $\Omega$ to 25°C; 0/150°C input: 0/1 Vdc and 4/20 mA
Input type: B6, B7, B11 and B12	low temperature NTC: 10k $\Omega$ to 25°C; -50/90°C high temperature NTC: 50k $\Omega$ to 25°C; 0/150°C input: 0/1 Vdc radiometric pressure probe
Time constant for each input	0.5 s
Input precision	$\pm$ 0.3% of the complete scale
Classification of the average circuits (IEC EN 61010-1)	Category I

#### Digital inputs

No. of inputs on SMALL boards	7
No. of inputs on MEDIUM boards	10

#### Analogue outputs

Maximum number	3 in SMALL boards and 4 in MEDIUM boards
Type	0 to 10Vdc
Precision	$\pm$ 3% of the complete scale or $\pm$ 5% of the complete scale (maximum load 5mA)
Resolution	8-bit
Maximum charge	2 k $\Omega$ (5 mA)

#### Digital outputs

Composition of groups	SMALL board: Group 1 (1 to 6); Group 2 (7) MEDIUM board: Group 1 (1 to 6); Group 2 (7); Group 3 (8 to 12)
Electrical contacts Note: relays of the same group with basic isolation must have the same power supply (24 Vdc or 230 Vac). Relays of the same group have basic isolation among themselves. The isolation between the various groups is double.	SMALL board (relays 1 to 7): EN60730-1: NO 1(1)A 250Vac cos $\varphi$ =0.4; 100,000 $\chi\psi\chi\lambda\epsilon\sigma$ UL-873: NO 1 A resistive 24 Vac, 30 Vdc; 100,000 cycles Test capacity: 24Vac; pulse 15A; continuous 1A 30,000 cycles  MEDIUM board (relays 1 to 12): EN60730-1: NO 1(1)A 250Vac cos $\varphi$ =0.4; 100,000 $\chi\psi\chi\lambda\epsilon\sigma$ UL-873: NO 1 A resistive 24 Vac, 30 Vdc; 100,000 cycles Test capacity: 24Vac; pulse 15A; continuous 1A 30,000 cycles

#### TECHNICAL CHARACTERISTICS

Storage conditions / Operating conditions	-20T70 °C; %RH 90 non-condensation / -10T60 °C; %RH 90 non-condensation
Protection index	IP00
Environmental pollution	normal
Classification according to protection against electric shocks	To be incorporated in class I and/or II appliances
PTI of the insulating materials	250V
Period of electric stress across the insulating parts	Long
Type of relay action	1C
Type of disconnection or microswitching	Micro-switch for all of the relay outlets
Category of resistance to heat and fire	Category D (UL94 - V0)
Immunity from voltage surge	Category 1
Ageing specifications (operating hours)	80.000
Number of automatic operating cycles	100,000 (EN 60730-1); 30,000 (UL 873)
Software class and structure	Class A
Category of protection against discharges (IEC EN 61000-4-5)	Category III
Dimensions: Length x Height x Depth	SMALL board: 175 x 113 x 55 mm (10 DIN modules) MEDIUM board: 228 x 113 x 55 mm (13 DIN modules)

## 20 - TECHNICAL AND ELECTRICAL CHARACTERISTICS

### pCOe expansion modules

#### GENERAL CHARACTERISTICS

Storage conditions	-40T70 °C; %RH 90 non-condensing
Operating conditions	-20T70 °C; %RH 90 non-condensing
Protection index	IP40 only on the front panel
Environmental pollution	2
Classification according to protection against electric shocks	To be incorporated in class I and/or II appliances
Period of electric stress across the insulating parts	Long
Type of relay action	1C
Type of disconnection or microswitching	Micro-switch for all of the relay outlets
Category of resistance to heat and fire	Category D
Immunity from voltage surge	Category III
Ageing specifications (operating hours)	80.000
Number of automatic operating cycles	100,000 (EN 60730-1); 30,000 (UL 873)
Software class and structure	Class A
Dimensions: Length x height x width	110 x 70 x 60 mm (4 DIN modules)

#### CONNECTION WITH $\mu$ PC MEDIUM BOARD

Type	Asynchronous half duplex, 2 dedicated wires
Connector	Removable 3-way connector
Driver	Balanced differential MCR 7V
Maximum distance to $\mu$ PC MEDIUM board	With telephone cable: - cable resistance $\leq 0.14 \Omega/m$ : 600 metros - cable resistance $\leq 0.25 \Omega/m$ : 400 metros  With shielded cable AWG24 - cable resistance $\leq 0.078 \Omega/m$ : 600 metros

#### ELECTRICAL FEATURES

Power supply	24 Vac $\pm 10/-15\%$ 50/60 Hz and 48 Vdc (36 to 72 V); P = 6 W (9 VA)
Terminal strip	with removable male/female connectors (250 Vac max.; 8 A max.)
CPU	at 8 bits and 4.91 MHz
Operation delay	0.5s
Maximum transmission speed	19200 bps

#### Analogue inputs

Analogue conversion	A/D converter to 10-bit integrated in CPU
Maximum number	4 (B1 to B4)
Type (this can be selected via software)	NTC Carel (-50/90°C; R/T $10k\Omega \pm 1\%$ to 25°C) Voltage: 0/1 Vdc, 0/5 Vdc radiometric or 0/10 Vdc current: 0/20 mA or 4/20 mA. Input resistance: 100k $\Omega$
NTC input type precision	$\pm 0.3$ complete scale

#### Digital inputs

Number	4
Type	Contact voltage-free, 5 mA, Inputs not optically isolated, internal power supply

#### Analogue outputs

Number	1 (Y1)
Type	Optically isolated 0/10 Vdc
Precision	$\pm 1\%$
Resolution	8-bit
Maximum charge	1 k $\Omega$ (10 mA)

#### Digital outputs

Number	4
Type	Relays with switched contacts (2000 VA, 250 Vac, 8 A resistive)
Characteristics (EN 60730-1)	2 A resistive, 2 A inductive, $\cos \varphi = 0.4$ , 2(2)A (100.000 cycles)

## 20 - TECHNICAL AND ELECTRICAL CHARACTERISTICS

### **pGD1 terminal**

TECHNICAL CHARACTERISTICS OF THE DISPLAY	
Type	FSTN graphic
Back-lighting	Blue LED (controlled using software)
Resolution	132 x 64 pixel
TECHNICAL CHARACTERISTICS OF THE POWER SUPPLY	
Voltage	Power supply through the telephone cable or external source 18/30 Vdc protected by an external 250 mA fuse
Maximum power input	1.2 W
CONNECTION WITH THE microPC BOARD	
Type	asynchronous half duplex, 2 dedicated wires
Connector for the terminal	6-way telephone plug
Driver	CMR 7 V (type RS485) balanced differential
GENERAL CHARACTERISTICS	
Protection index	IP65 for assembly in panel / IP40 for wall assembly
UL	type 1
Operating conditions	-20T60 °C, 90% RH non-condensing
Storage conditions	-20T70 °C, 90% RH non-condensing
Software class and structure	A
Classification according to protection against electric shocks	To be incorporated in class I or II appliances
PTI of the insulating material	250V
Dimensions: Length x Height x Depth	156 x 82 x 31 mm

### **TCO terminal**

TECHNICAL CHARACTERISTICS OF THE POWER SUPPLY	
Voltage	Power supply 230Vac(+10/-15) 50/60Hz
Maximum power	1 VA
CONNECTION WITH THE microPC BOARD	
Type	AGW20 or AGW22 with 1 braided pair + drainwire + shielding
GENERAL CHARACTERISTICS	
Protection index	IP20
Operating conditions	-10T60 °C, 10 to 90% RH non-condensing
Storage conditions	-20T70 °C, 10 to 90% RH non-condensing
Software class and structure	A
Environmental pollution	2
Category of resistance to heat and fire	Category D
Immunity from voltage surge	Category 2
Classification according to protection against electric shocks	To be incorporated in class I and/or II appliances
Electric safety	IEC EN 60730-1, IEC EN 60730-2-9
Electromagnetic compatibility	IEC EN 61000-6-1, IEC 61000-6-3, IEC EN 61000-6-2, IEC EN 61000-6-4
PTI of the insulating material	275 V
Precision of the temperature measurement	0T40 °C ± 1%
Dimensions: Length x Height x Depth	Model to fit: 86 x 86 x 51 mm Surface model: 86 x 142 x 23 mm or 142 x 86 x 23 mm

## 20 - TECHNICAL AND ELECTRICAL CHARACTERISTICS

### 20.1. Ambient probe

#### Wall version (DPW)

Case index of protection: IP30

Sensor index of protection: IP30.

#### Assembly and setting instructions

- This probe must be fixed to the panel or the wall of the room to be conditioned, at ca. 1.5 m height.
- Open the case using a flathead screwdriver in the slot, paying extra care not to damage the electronic parts.

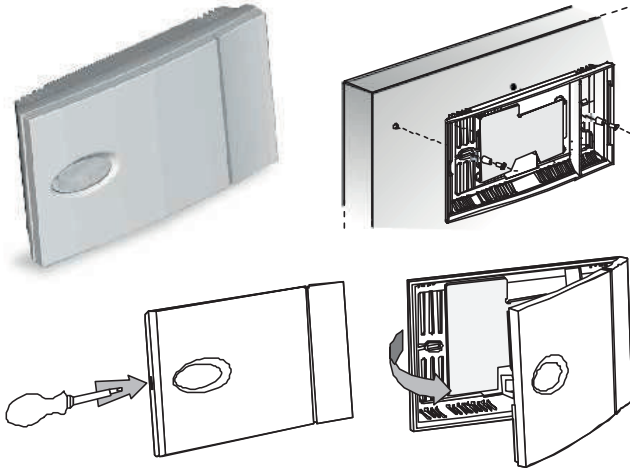

- Fasten the rear of the sensor case to the panel or the wall (for fastening the case, use the screws supplied with the fastening kit, paying attention to use the proper spacers, to not damage the sensor's electronics).
- The electrical connection must be carried out depending on the unit setting:
  - NTC probe S5a: B5 (connector J3) : with 2 x 1,5 mm<sup>2</sup> section cable, within a maximum distance of 30 metres.
  - RS485 (connector J10): with AWG20 section cable, single braided pair preferably shielded with drain wire + Power supply 24 Vac (2 wires).
  - \* Temperature: S21 to S24.
  - \* Temperature + humidity: S31 to S34.
- Note: in the case of more than one probe, connection of the probes in series, in the RS485 network.
- Close the sensor with the top cover by pressing lightly.



Inside view, bottom shell



Inside view, top shell

#### Duct version (DPD)

Case index of protection: IP55

Sensor index of protection: IP40.

#### Assembly and setting instructions

- The duct version is connected to the air duct using the special fastening bracket.
- Fasten the bracket to the air duct.

- Insert the rod on the bracket to the required depth.
- Tighten the screw on the bracket to fasten.

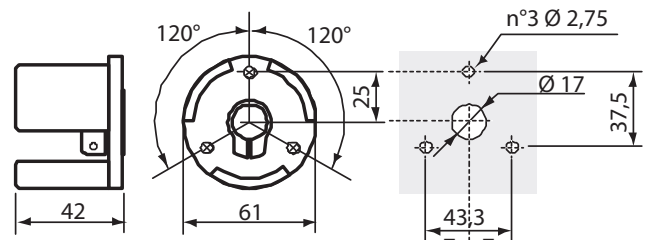
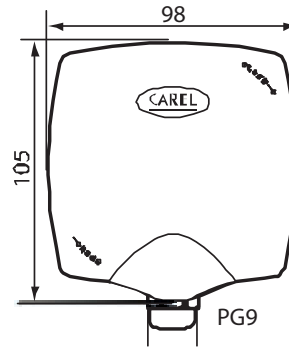

- For the electrical connections, remove the top cover of the sensor. Remove the cover by rotating it anticlockwise



View of sensor without cover



Interior view

#### Industrial environment version (DPP)

Case index of protection: IP55

Sensor index of protection: IP54.

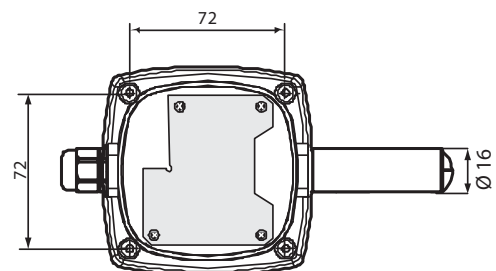

#### Assembly and setting instructions

The industrial environment version is wall or panel mounted.

- Open the case by turning the top cover anticlockwise (fig.1).
- Fasten the rear of the sensor case to the panel or the wall (use the screws supplied together with the sensor) placing the screws



## 20 - TECHNICAL AND ELECTRICAL CHARACTERISTICS

in the holes provided. (fig.2).

- Make sure that the screws that hold the board protective cover are fastened tightly (fig.3).
- Close the sensor by turning the cover clockwise (fig.4).

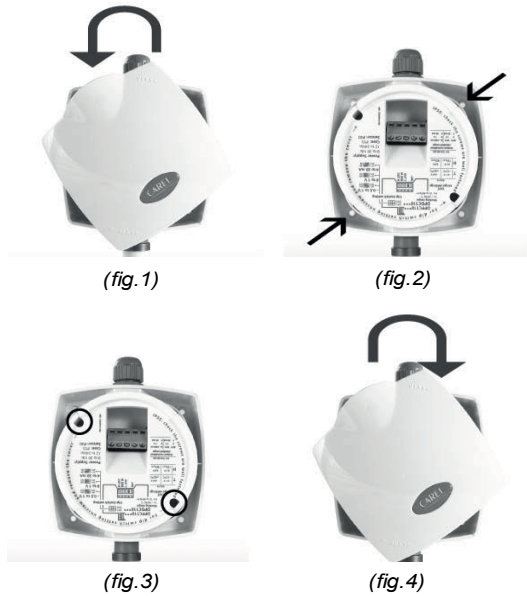

### Cleaning and maintenance

When cleaning the instrument do not use ethyl alcohol, hydrocarbons (petrol), ammonia and derivatives. Use neutral detergents and water. Periodically check the aeration slits on the sensor to make sure that air can flow freely through, without obstructions due to impurities or dust in the site of installation.

## 20.2. Air quality probe 4.. 20 mA

### Installation in the environment

- This probe must be fixed to the interior wall of the room to be conditioned, at ca. 1.5 m height in the room and at least 50 cm from the next wall.
- It should never be mounted:
  - On outside walls.
  - In niches or behind curtains.
  - Above or near heat sources or shelves.
  - On walls covering heat sources such as a chimney.
  - In the radiation range of heat sources and lighting bodies e.g. spotlights.
  - In areas exposed to direct solar radiation.

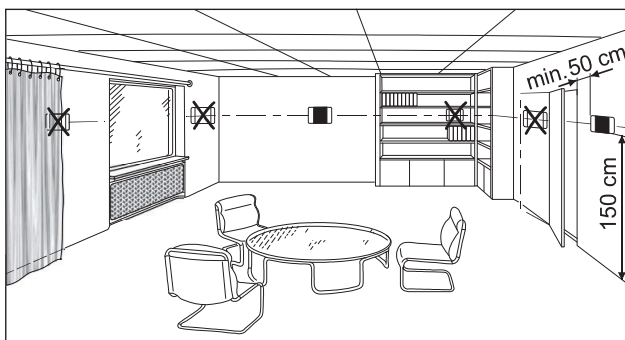
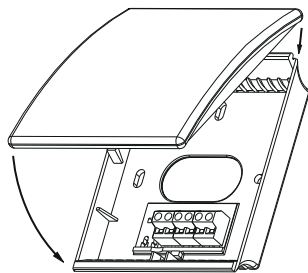

### Duct-mounted

This version can be connected to the air duct in these two ways:

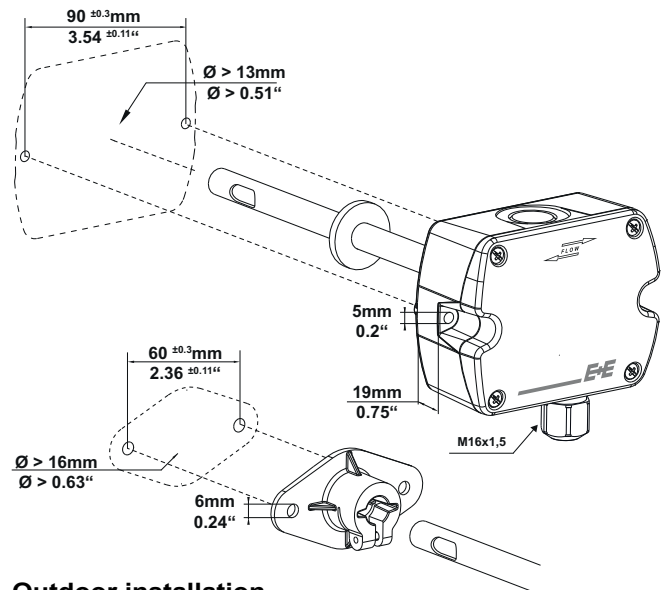

### Outdoor installation

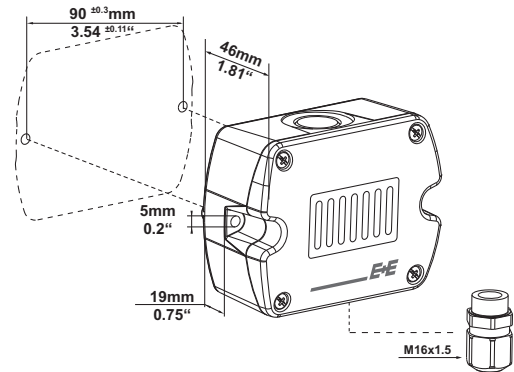

### Electrical connection

This probe (S10) is configured as analogue output 4...20 mA (0..2000 ppm), in the analogue input B10 of the control board (connector J18). Recommended cable section: 1,5 mm<sup>2</sup>.

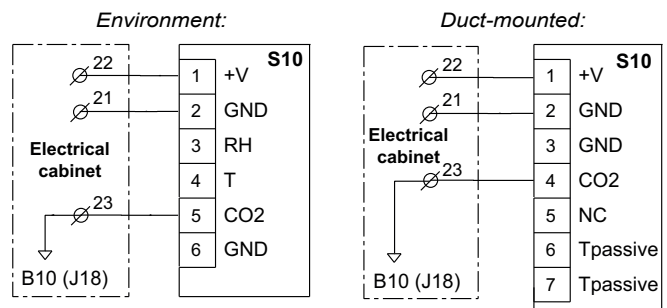

The second probe (S10-2) is configured as analogue output 4...20 mA (0..2000 ppm), in the analogue input B1 of the expansion card pCO<sub>e</sub> with address 9 (connector J9). Recommended cable section: 1,5 mm<sup>2</sup>.

### Environment or outdoor:

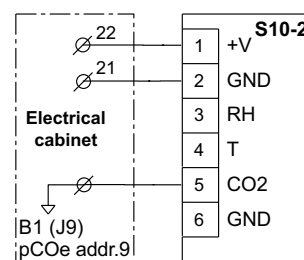

## 21 - TROUBLESHOOTING

- *The unit does not switch on (the power LED on the main board is switched off).*

Check:

1. The presence of main power;
2. That the transformer output voltage is 24 Vac/Vdc;
3. That the power supply connector at 24 Vac/Vdc is correctly inserted;
4. That the overload fuse is intact.

- *When switching on, there are general problems with the LCD (strange characters, blank display).*

Check:

1. That the software in the flash is correct;
2. The pLAN address of the pCOc and on the terminal (check that they comply with the requirements of the current application);
3. The connection between the pGD1 terminal and the μPC MEDIUM board.

- *Erroneous readings of the input signals.*

Check:

1. The correct power supply to the μPC MEDIUM board and probes;
2. The separation between the power supply of the digital inputs and that of the μPC MEDIUM board. A 24 Vac/24 Vac, 5 VA transformer can be used.
3. That the cables from the probes are connected according to the instructions;
4. That the probe cables are located far enough away from possible sources of magnetic interference (power cables, contactors, high voltage cables or cables connected to units with high current peaks);
5. That there is not a high level of heat resistance between the probe and the sensor cap (if present). If necessary, apply conductive paste or oil into the caps to ensure good temperature transfer.
6. If there is a probe error or μPC MEDIUM board conversion error, the checks to be carried out would vary depending on the type of probe:

### Active temperature/humidity probes with 0/1V signal:

Using a voltmeter, measure the probe signal between the Bn and GND terminals and check that the voltage corresponds to the temperature/humidity value: 1 mVdc corresponds to 0.1% HR. Example: reading 200 mVdc (0.2 Vdc), the probe sends a signal which corresponds to 20%RH; applying the same logic, 0 mVdc corresponds to 0°C/0% RH;

### Pressure probes:

If there are errors when reading these probes, check that:

- The analogue inputs of these sensors are set to receive 4/20 mA signals;

- Check that the probe capillary is not blocked.
- The full scale set by the software corresponds to that used by the sensors.

Using a voltmeter to measure the voltage between the Bn and GND terminals, an indication is obtained of the current probe signal, considering that the input has an impedance of 100Ω, by applying the formula  $I = V/R$ .

The pressure value "Ps" sent by the probe could be calculated as follows (FS = full scale):

$$Ps = (Vmed/100 - 0.004) \times (FSmax - FSmin) / 0.016 + FSmin$$

Example: the probe used has FSmin = -0.5 bar, FSmax = 7 bar; the voltage read is equal to Vmed = 1.0 Vdc.

The pressure Ps that the probe is measuring is thus:

$$Ps = (1.0/100 - 0.004) \times [7 - (-0.5)] / 0.016 + (-0.5) = 2.3 \text{ bar}$$

### NTC probes:

The probe signal is a resistive value which depends on the temperature.

The following table indicates some of the resistance values for different temperatures. By disconnecting the input probe and measuring the resistance with a multimeter, the table can be consulted for the corresponding temperature value.

°C	kΩ	°C	kΩ	°C	kΩ
-20	67,7	0	27,2	20	12,0
-15	53,3	5	22,0	25	10,0
-10	42,2	17	17,9	30	8,3
-5	33,8	15	14,6	35	6,9

- *To check the setting of the probe inputs.*

Switch off the μPC MEDIUM board and perform the following measurements with a tester between the Bn and AVSS probe inputs:

probe type	voltage measured
NTC	2.5 V
4/20mA	0 V
0/1V; 0/5V; 0/10V	0 V

- *Unusual alarm signal from the digital input.*

Check whether the alarm signal is present in the input, measure the voltage between the "IDC" common terminal and the digital input terminal which indicates the alarm "IDn":

- if voltage is present (24 Vac or Vdc, depending on the power supply used for the digital inputs), the contact of the connected alarm device is closed;
- if the voltage is near 10 Vac or 10 Vdc (see above) the contact is open.

Unless otherwise expressly stated, the control generates an alarm when detecting open contacts.



