



**DEPARTMENT OF THE ARMY
UNITED STATES ARMY INFORMATION
SYSTEMS ENGINEERING COMMAND
FORT HUACHUCA, ARIZONA 85613-5300**



**TECHNICAL GUIDE
FOR
INSTALLATION INFORMATION
INFRASTRUCTURE ARCHITECTURE**

BY

**IMPLEMENTATION ENGINEERING
SUBJECT MATTER EXPERT**

JULY 2008

FORT DETRICK ENGINEERING DIRECTORATE

Distribution C

Distribution authorized to U.S. Government agencies and their contractors only, for administrative or operational use, July 2008. Refer other requests for this document to Commander, U.S. Army Information Systems Engineering Command, ATTN: AMSEL-IE-DE, Fort Detrick, MD 21702.

DISCLAIMER

The use of trade names in this document does not constitute an official endorsement or approval of the use of such commercial hardware or software. Do not cite this document for advertisement.

CHANGES

Refer requests for all changes that affect this document to: USAISEC, ATTN: AMSEL-IE-DE, Fort Detrick, MD 21702-5047.

DISPOSITION INSTRUCTIONS

Destroy this document when no longer needed. Do not return it to the organization. Safeguard and destroy this document with consideration given to its classification or distribution statement requirements.

**TECHNICAL GUIDE
FOR
INSTALLATION INFORMATION
INFRASTRUCTURE ARCHITECTURE**

BY

**IMPLEMENTATION ENGINEERING
SUBJECT MATTER EXPERT**

JULY 2008

**U.S. ARMY INFORMATION SYSTEMS ENGINEERING
COMMAND
FORT DETRICK ENGINEERING DIRECTORATE**

Distribution C

Distribution authorized to U.S. Government agencies and their contractors only, for administrative or operational use, July 2008. Refer other requests for this document to Commander, U.S. Army Information Systems Engineering Command, ATTN: AMSEL-IE-DE, Fort Detrick, MD 21702.

Product Certification

Signatures on file in the S&IG indicate the Director's approval of the Technical Guide content and the CSE/CSH certification that the format meets the requirements of the Letter of Instruction for Preparation of Technical Guides, AMSEL-IE-TD, May 2002.

Approval Dates:

SSE:  16 July 2008

Director:  21 Jul 08

Signature, Technical Director:

ALBERT RIVERA

Deputy/Technical Director

TABLE OF CONTENTS

	Page
1.0 INTRODUCTION	1
1.1 Background	1
1.2 Scope	1
1.3 Supporting Appendices or Attachments	2
2.0 BUILDING TELECOMMUNICATIONS CABLING SYSTEM SPECIFICATIONS ...	2
2.1 Classified Information Infrastructure	2
2.2 Building Telecommunications Cabling System Overview	2
2.3 Workstation Outlet	3
2.4 Building Telecommunications Wiring	8
2.5 Telecommunications Spaces	15
2.6 Grounding	18
2.7 Telecommunications System Labeling	20
2.8 Building Entrance Facility	21
2.9 Testing	22
3.0 OUTSIDE PLANT TELECOMMUNICATIONS CABLING SYSTEM SPECIFICATIONS	23
3.1 Classified Information Infrastructure	23
3.2 System Overview	23
3.3 System Architecture	23
3.4 Outside Plant	25
3.5 Environmental and Historical Considerations	25
3.6 General Considerations	25
3.7 Outside Plant Cable Placement Options	29
3.8 Underground (Maintenance Holes, Cable Vaults, and Ducts)	31
3.9 Direct Buried Cable Installation	46
3.10 Crossing Obstructions	48
3.11 Aerial Cable	48
3.12 Free Space Optics	50
3.13 General Range Information Infrastructure Design	52
3.14 Pier Installation	54
3.15 General Cable Specifications	55
3.16 Main Distribution Frame	65
3.17 Building Terminations	66
3.18 Grounding	66
3.19 Final Acceptance Test	68
4.0 VOICE SWITCHING, CENTRAL OFFICE/END OFFICE, AND CONVERGENCE	74
5.0 NETWORK ARCHITECTURE	74
6.0 NETWORK AND SYSTEMS MANAGEMENT	75
6.1 Introduction	75
6.2 Purpose	75
7.0 WIRELESS LOCAL AREA NETWORK	75

TABLE OF CONTENTS (CONTINUED)

	Page
Appendices	
Appendix A. Technical Guidance Checklist for Installation Information Infrastructure Architecture	A-1
Appendix B. Building Cabling System Figures	B-1
Appendix C. North America And European Drawings	C-1
Appendix D. References	D-1
Glossary. Acronyms And Abbreviations	Glossary-1

Tables

Table 1. Outlet Types	5
Table 2. Coaxial Cable	11
Table 3. Maximum Length of Subsidiary Conduit Containing Bends	38
Table 4. Extending the Point of Entrance	39
Table 5. Multimode Dual-windowed Fiber Cable Characteristics	59
Table 6. Single-mode Dual-windowed Fiber Cable Characteristics	61
Table 7. Non-zero Dispersion-shifted Single-mode FOC Characteristics	62
Table 8. Fiber Sizing Between Building	63
Table 9. Standard Cable Reel Lengths and Diameters	69
Table 10. European Standard Cable Reel Lengths and Diameters	73
Table 11. Cable Spreadsheet Sample	73

Figures

Figure B-1. Telecommunications Room Entrance and Riser	B-1
Figure B-2. Telecommunications Room Horizontal Distribution	B-2
Figure B-3A. Telecommunications Room Standard Premise Distribution	B-3
Figure B-3B. Standard Premise Distribution	B-4
Figure B-4. Telecommunications Room Standard Supporting Structure and Riser	B-5
Figure B-5. Telecommunications Room Small Facility/Warehouse	B-6
Figure B-6. Telecommunications Outlet Types	B-7
Figure B-7. Systems Furniture Wiring	B-8
Figure B-8. Premise Distribution Supporting Structure - Renovations	B-9
Figure B-9. Typical Floor Plan	B-10
Figure C-1. OSP Infrastructure Standards – North America	C-1
Figure C-2. Drawing Symbols – North America and Europe	C-2
Figure C-3. Conduit Placement/Cut and Resurface – North America	C-3
Figure C-4. Typical Maintenance Hole – North America (1 of 2)	C-4
Figure C-5. Typical Maintenance Hole – North America (2 of 2)	C-5
Figure C-6. Pedestals and Building Entrance Details – North America (1 of 2)	C-6
Figure C-7. Pedestals and Building Entrance Details – North America (2 of 2)	C-7
Figure C-8. MDF and Cable Vault Schematic – North America	C-8
Figure C-9. OSP Infrastructure Standards – Europe	C-9
Figure C-10. Conduit Placement/Cut and Resurface – Europe	C-10

TABLE OF CONTENTS (CONTINUED)

	Page
Figure C-11. Typical Maintenance Hole – Europe (1 of 2).....	C-11
Figure C-12. Typical Maintenance Hole – Europe (2 of 2).....	C-12
Figure C-13. Pedestals and Building Entrance Details – Europe (1 of 2)	C-13
Figure C-14. Pedestals and Building Entrance Details – Europe (2 of 2)	C-14
Figure C-15. MDF and Cable Vault Schematic – Europe	C-15

TECHNICAL GUIDE FOR INSTALLATION INFORMATION INFRASTRUCTURE ARCHITECTURE

1.0 INTRODUCTION

This Technical Guide (TG) provides guidance for the planning, design, and implementation of the Installation Information Infrastructure Architecture (I3A) for Army installations worldwide. This document will establish an implementation concept that can be used to shape architectural templates and influence the design process for the I3A. It will identify proven infrastructure construction techniques, define common practices, and serve as an authoritative implementation guide.

1.1 Background

In previous engineering designs each area of communications was addressed separately, to include design standards, schedules, and funding. This approach led to confusion, design re-engineering, and duplication of effort. The I3A concept was initiated to synchronize the efforts and formulate a more efficient and effective design process. The I3A establishes an Army-wide Information Technology (IT) architectural design standard. The I3A is the source to fuel effective Army Knowledge Management (AKM) necessary to support the Army Transformation Campaign Plan. The I3A captures installation infrastructure, synchronizes the implementation of automation programs, provides for analysis of operational force and sustaining base connectivity, and identifies costs associated with IT modernization. The I3A Configuration Control Board (CCB) manages I3A issues and tracks developments in IT, information assurance, enterprise systems management (ESM), and automation information system (AIS). The Configuration Control Board (CCB), which oversees several working groups that address IT issues, meets quarterly.

1.2 Scope

This document is intended to support gathering the necessary requirements, conducting site surveys, and performing analysis, design and implementation of IT. This guide specifically assists the designer in the integration of the telecommunications and information systems. This guide is synchronized with the Unified Facilities Criteria (UFC), which are mandated under Department of Defense (DOD) policy. The UFC system is prescribed by Military Standard (MIL-STD) 3007 and provides planning, design, construction, sustainment, restoration, and modernization criteria, and applies to the military departments, the defense agencies, and the DOD field activities in accordance with (IAW) Under Secretary of Defense for Acquisition Technology and Logistics (AT&L) memorandum, 29 May 2002.

The UFC are living documents and will be periodically reviewed, updated, and made available to users as part of the Services' responsibility for providing technical criteria for military construction. Headquarters, U.S. Army Corps of Engineers (USACOE), Naval Facilities Engineering Command (NAVFAC), and Air Force Civil Engineer Support Agency (AFCEA) are responsible for administration of the UFC system. Defense agencies shall contact the preparing service for document interpretation and improvements. Technical content of UFC is the responsibility of the pertinent DOD working group. Recommended changes with supporting rationale shall be sent to the respective service proponent office by Criteria Change Request (CCR). The UFC are effective upon issuance and are distributed only in electronic media from the following sources: *Whole Building Design Guide* World Wide Web (Web)-site <http://dod.wbdg.org/>. Hard copies of UFC printed from electronic

media shall be checked against the current electronic version prior to use to ensure that they are current.

1.3 Supporting Appendices or Attachments

This TG is divided into six sections: Introduction, System Overview, Evaluation Process, Site Survey Results, Risks, and Conclusions and Recommendations. There are four appendices and a Glossary of acronyms and abbreviations is provided.

- Appendix A – Technical Guidance Checklist for I3A
- Appendix B – Building Cabling System (BCS) Figures
- Appendix C – North America and Europe Drawings
- Appendix D - References

2.0 BUILDING TELECOMMUNICATIONS CABLING SYSTEM SPECIFICATIONS

The BCS is designed to satisfy I3A policy information system (IS) requirements within a facility. The BCS shall be installed IAW the Telecommunications Industry Association (TIA) and Electronics Industry Association (EIA) Building Telecommunications Wiring Standards general guidelines with modifications and clarifications provided below. The TIA/EIA specifications can be purchased at <http://www.tiaonline.org/standards/>. Telecommunications design shall be performed and stamped by a Registered Communications Distribution Designer (RCDD). This BCS section is synchronized with UFC 3-580-1, Telecommunications Building Cabling Systems Planning and Design. The objective of this UFC is to provide planning guidance for the development of an input to the BCS telecommunications portion of the DD 1391. The UFC-3-580-1 is designed to satisfy I3A policy or UFC 3-580-10 Design: Navy and Marine Corps Intranet (NMCI) Standard Construction Practices IS requirements within a facility.

2.1 Classified Information Infrastructure

Engineers engaged in the design of classified (collateral or higher) information infrastructure shall coordinate the infrastructure design with the Certified Telecommunications Electronics Material Protected from Emanating Spurious Transmissions (TEMPEST) Technical Authority (CTTA) and Designated Accreditation Authority (DAA) responsible for that area. The designer shall also refer to the U.S. Army Information Systems Engineering Command (USAISEC) TG for the Integration of SECRET Internet Protocol (IP) Router Network (SIPRNET). The USAISEC SIPRNET TG is an IT systems security engineering guide for communicators supporting the war fighter. The TG may be used to assist Army personnel in developing access solutions for SIPRNET connectivity to support the war fighter's increased use of secure networking and methods of interfacing with secure IT in CONUS. Although the document may contain some information that may be useful in the OCONUS environment, the exact specifications and requirements in that theater may differ from the CONUS theater. The USAISEC SIPRNET guide is based upon applicable National Security Agency (NSA), DOD, Defense Information Systems Agency (DISA), and Department of the Army (DA) documents.

2.2 Building Telecommunications Cabling System Overview

Design a complete, standards based, flexible building telecommunications systems for Army buildings based upon the functional purpose of the various spaces within the facility. An

acceptable BCS encompasses, but is not limited to: copper and fiber optic (FO) entrance cable, termination equipment, copper and fiber backbone cable, copper and fiber horizontal distribution cable, workstation outlets, racks, cable management, patch panels, cable tray, cable ladder, conduit, grounding, and labeling. Figure B-1 of Appendix B provides an overview of the cable entrance and backbone distribution. Figure B-2 of Appendix B provides an overview of the horizontal distribution.

2.3 Workstation Outlet

The following specifications pertain to telecommunications outlets and connectors:

2.3.1 Outlet Box

Specify double gang electrical boxes of at least 2-1/8 inches (in) (54 millimeters (mm)) depth to provide dedicated space for current and possible future FO cable (FOC) installation. For single connector outlets, such as voice-only, cable television (community antenna television (CATV)) or closed circuit television (CCTV), use a single gang 2 in by 4 in by 2-1/4 in (51 mm x 102 mm x 57 mm), electrical box recess mounted, with the faceplate flush with the wall surface. Locate a service power outlet within 6 inches (152 millimeters (mm)) of the CATV or CCTV outlet. Designers shall specify 4-11/16-in (119 mm) square by 2-1/4 (57 mm) boxes for 1-in (27 mm) conduit installations and outlet boxes that have or may require FO cabling.

2.3.2 Outlet Faceplate

Use a full (double gang) faceplate for standard administrative outlet locations, with connectors for all copper and, if used, FOC. Standard administrative outlets may, by specific user request, use single gang outlet faceplates in conjunction with a reducing ring. For single gang outlet boxes, use a single gang outlet faceplate with appropriate connector locations and, if required, mounting lugs for wall telephones. Outlet faceplate shall include two blank positions for future applications.

2.3.3 Outlet Connectors

The following specifications pertain to copper, FO and coaxial cable outlet/connector. The category for cable, jacks, termination blocks, and patch panels shall be the same throughout each circuit and system. Specify more than one category only if providing more than one system requiring different categories. In general for horizontal cable, Category 6 (Cat 6) shall be used for all voice and data circuits.

2.3.3.1 Copper Outlet/Connector

Copper outlet/connector shall be TIA/EIA Category 6 for all projects. All connectors shall be 8-pin/8-position insulation displacement terminations wired per T568A (default configuration) or T568B (if required to maintain system configuration uniformity, security or other user-specified reasons). Category 5 (Cat 5), Category 5e (Cat 5e), and Category 3 (Cat 3) rated connectors shall not be used in new construction or rehabilitation projects. Copper outlet/connector and plugs shall be un-keyed unless the user requires keyed outlet/connector and plugs to maintain system uniformity, security, or other user specified reasons.

2.3.3.2 FO Outlet/Connector

Terminate all FO work area cables in dual 568SC connectors. Provide FO connectors IAW the paragraph entitled FO Terminations in this TG. The default choice for FO

outlet/connector shall be TIA/EIA “SC” type (568SC). Other type connectors (small-form-factor) (MT-RJ, VF-45, etc.) may be substituted as required by the user. Small form factor connectors (available from several manufacturers), offer a potential for significant installation cost reduction. Any type of fiber connector used shall meet the performance requirements specified within Annex A of TIA/EIA-568-B.3, and meet the requirements of the corresponding TIA FO Connector Intermateability Standard (FOCIS) document.

2.3.3.3 Coaxial Outlet/Connector

Coaxial outlet/connector shall normally be “F” type connectors. Use of other type connectors (i.e., Bayonet Neill Concelman (BNC), etc.) shall be considered only if specifically required by the user. The designer shall coordinate with the cable service provider where franchise agreements are in place. All passive CATV devices shall support 1 Gigahertz (GHz) bandwidth.

2.3.4 Outlet/Connector Markings

Each communications outlet shall have a unique identifying number IAW TIA/EIA 606-A. In the telecommunications room (TR), this unique identifying number shall be associated with the position on the patch panel or cross-connect to which the outlet is connected. Each horizontal cable shall be labeled both at the outlet and patch panel or cross-connect position in the communications closet. Connector voice and data dedication use may be reassigned as requirements dictate. **Note:** In the standard cabling scheme, the designations “voice” and “data” are arbitrary and do not imply that one outlet is better than the other, the outlets are identical in capability.

2.3.5 Outlet Types and Density

Table 1 shows outlet types that are commonly used in military construction projects. Sketches of these outlets are included in Figure B-7 of Appendix B. The outlet types do not cover all possible user required configurations. The designer shall certify that all user-defined outlets have a corresponding valid requirement, such as fiber for various levels of classification. Outlet configurations shall comply with this TG, TIA/EIA-568-B, and TIA/EIA-569-B. Outlet densities are provided for planning purposes, when actual outlet locations are not known and cannot be determined with available information. The designer can develop reasonably accurate total outlet count estimates based on the size and dedicated usage of the space. These factors fall within the ranges given in TIA/EIA-569-B, and are based on gross area (overall building footprint without deducting for hallways, equipment rooms, restrooms, etc.). See Figure B-9 of Appendix B for a typical building floor plan.

Table 1. Outlet Types

Facility Space Category	Outlet Configuration	Planning Area (SF(SM)) per Outlet
Administrative space, to include classrooms, and medical/clinics	Two 8-pin modular (RJ45 type) outlet/connector in a double gang outlet faceplate, one connector labeled voice use and one labeled data use.	80(7.5)
Headquarters and special users	Minimum of two 8-pin modular (RJ45 type) outlet/connector in a double gang outlet faceplate, one connector labeled voice use and one labeled data use, with additional 8-pin modular and/or fiber outlet/connectors as required.	80(7.5)
Systems furniture	Two 8-pin modular (RJ45 type) outlet/connector in a modular furniture outlet faceplate with outlet box extender, one connector labeled voice use, and one connector labeled data use.	See below
Intermediate Space	Two 8-pin modular (RJ45 type) outlet/connector in a double gang outlet faceplate, one connector labeled voice use and one labeled data use.	200(18.5)
Non-admin spaces (CDCs, chapels, Recreation centers, etc.)	Two 8-pin modular (RJ45 type) outlet/connector in a double gang outlet faceplate, one connector labeled voice use and one labeled data use.	500(46.5)
Barracks space/bachelor officer's quarters (BOQ)	See below	See below

Table 1. Outlet Types (continued)

Facility Space Category	Outlet Configuration	Planning Area (SF(SM)) per Outlet
Warehouse space, unit storage, maintenance facilities	Two 8-pin modular (RJ45 type) outlet/connector in a double gang outlet faceplate, one connector labeled voice use and one labeled data use.	5000(465)
Wall and pay telephone outlet	One 8-pin modular (RJ45 type) connector in a single gang outlet faceplate with mounting lugs, labeled voice use.	As needed
Family housing units	See below	See below
Wireless access points	One 8-pin modular (RJ45 type) connectors in a single gang outlet faceplate labeled for data.	See below

2.3.5.1 Family Housing Units

The designer shall determine the minimum outlet quantity for Army Family Housing (AFH) units based upon the number of rooms in the AFH unit. In general, provide one telephone outlet and one CATV outlet (as a minimum) in each of the following: kitchen, living room, dining room, family room/area, each bedroom, and any other logical location deemed appropriate. Copper outlet/connector shall be TIA/EIA Cat 6 for U.S. Army and U.S. Air Force projects.

2.3.5.2 Quarters

For U.S. Army barracks projects, provide one 8-pin modular (RJ45 type) connector in a single gang outlet faceplate, labeled voice use and one CATV outlet per sleeping/living area. In Unaccompanied Enlisted Personnel Housing (UEPH), BOQ, Senior Enlisted Bachelor Quarters (SEBQ)/etc., provide one single RJ-45 outlet and one CATV in each room of the suite; i.e., bedroom and living room, configured per TIA/EIA-570.

2.3.5.3 Systems Furniture Wiring

The designer shall specify a minimum of one systems furniture outlet per single occupancy cubicle. The designer shall specify a minimum of two systems furniture outlets per cubicle designated for servers, printers, copiers, or facsimile (FAX) machines. When systems furniture is installed as part of the construction contract, ensure that systems furniture specifications include EIA American National Standards Institute (ANSI)/TIA/EIA-568-B and EIA ANSI/TIA/EIA-569-B cabling and raceway standards. Multi-user telecommunication outlet assembly (MUTOA) may be used in lieu of fixed furniture outlets. However, the distribution of work area cables from the MUTOA to the desktop shall be addressed and accounted for in the telecommunications and the furniture designs.

2.3.5.4 Wireless Access Point (WAP) Cabling

Wireless access points may be required for WLANS in some situations, and are required for Wireless Intrusion Detection Systems (WIDS). If the project management for IT has approved the inclusion of wireless in the design, the recommendations here shall be followed. The designer shall specify one-Cat 6, unshielded twisted pair (UTP) cable, each to a standard 8-pin modular connector for each wireless AP outlet. The Cat 6 cable can be used in conjunction with Power over Ethernet (PoE) to provide both power and data to the AP. The TIA/EIA technical committee TR-42 is currently working on a Technical Service Bulletin (TSB-162) *Telecommunications Cabling Guidelines for Wireless Access Points*. The intent of this TSB is to provide a pre-cabled grid to support 802.11 wireless local area networks (LAN). The current guidance is to place one WAP at the center of each 55 by 55 foot (ft) square grid, for up to 20 users. For grid locations with over 20 users, provide two UTP cables. The TSB is based upon International Standards Organization (ISO)/International Engineering Consortium (IEC) TR 24704 *Information Technology Customer Premises Cabling for Wireless Access Points*. Both TIA and ISO utilize a 39-ft (12 meters (m)) diameter circle for WAP coverage. The designer shall note that a wireless survey will be required after the completion of construction to ensure proper wireless coverage. The WAP grid provides a foundation for implementing wireless, but does not eliminate final wireless design. Provide WAP outlets at a minimum of one every 25,000 square feet within each building to support the DOIM installed Wireless Intrusion Detection System.

2.3.5.5 General Range Information Infrastructure Design

The telecommunications sections of range construction projects shall follow the general provisions of this I3A TG for new construction and renovations. There are several distinct types of information networks in a range environment: administrative, range control and tactical. The administrative networks support telephone and data requirements to the occupants of the range buildings, and safety telephones. The special Range Control networks control downrange targets, sensors, and monitors and transport this information to off-site locations. The tactical networks support the unit training requirements in a field environment. In addition, there could be security and alarm networks.

2.3.6 Utility Rooms and Closets

All utility rooms and closets, such as electrical, mechanical and telecommunications, shall be wired with at least one wall mounted telecommunications outlet, with a mounting lug face plate.

2.3.7 Elevators

For buildings with elevators, a four-pair copper cable with an eight-position modular outlet adapter shall be installed for each elevator. The exact location of the outlet assembly shall be verified with the elevator installer or contractor.

2.3.8 Safety, Courtesy, and Convenience

Provide wall outlets at all logical locations to support safety, courtesy, and convenience. Examples include safety: barracks hall, laundry room; courtesy: building lobby/entrance, stairways; convenience: break rooms, rear (unmanned) entrances.

2.3.9 Building Automation Systems (BAS)

When requested by the building support systems planner, provide wall outlets at identified locations to support BAS. For example, one such outlet may be a direct digital controller (DDC) outlet for the heating, ventilation, cooling (HVAC) system. The IS/IT-designer does not have primary responsibility for identifying these circuits, and shall defer to the building support systems planner. Applying a BAS requires close coordination between the IT designer and the various utilities and automated systems designers. The TIA/EIA published *TIA/EIA-862 Building Automation Systems Cabling Standard for Commercial Buildings* in April of 2002, to specify a generic cabling system for BAS. The TIA/EIA-862 defines the TR and equipment rooms, BAS outlets, connection points, cross-connects, device terminations, and interconnection point details for the building utilities. The TIA/EIA-862 uses the same cabling technology and architecture as TIA/EIA-568-B, and Section 6 of TIA/EIA-862 provides coverage area planning for typical BAS links. The TIA/EIA-862 states that BAS controllers shall be located and cabling shall be terminated in the TRs serving that area. Additionally, Section 7.3 states “Because the scope of ANSI/TIA/EIA-569-A does not cover BAS cabling, additional pathway and space capacity may be required.” Actual building systems equipment shall be located in the respective mechanical rooms and shall be distinct from the TR.

2.4 Building Telecommunications Wiring

The following information pertains to horizontal cable and backbone cable. All horizontal and backbone wiring shall be designed in a star-configuration as defined in TIA/EIA-568-B.1. All cables shall be terminated within TRs, telecommunications equipment rooms, and work areas.

2.4.1 Horizontal Cable

The following information pertains to copper, FOC, and cable run lengths.

2.4.1.1 Copper Voice and Data

One Cat 6, for general projects, UTP cable shall be installed to each standard 8-pin modular connector provisioned at the outlet. For example, install two 4-pair UTP cables to a standard administrative outlet, or one 4-pair UTP cable to each single connector outlet. Copper cables shall not be split between multiple modular connectors. Use only cable that has passed the Underwriters Laboratory (UL) LAN certification program and is labeled with UL acceptable markings. Plenum cables shall be provided IAW National Fire Protection Association, Inc. (NFPA) 70, or when directed by the facility safety officer or local building code. Provide terminations IAW the paragraph entitled “Copper Termination” in this TG. The designer shall not use 150 ohm shielded twisted pair for new construction. The Cat 5, Cat 5e, and Cat 3 rated cable shall not be used in new construction or rehabilitation projects.

a. Copper Termination.

Terminations shall be performed using an 8-pin (RJ45 type) connector, rated for the category of the installed cable. In the standard Army cabling scheme, horizontal cables are arbitrarily designated “voice” and “data” to identify and differentiate their purpose. This designation in no way indicates a difference in capability of the cable. Copper distribution cable shall be terminated at the TR on 110-type cabinet or rack-mounted patch panels compliant with Cat 6 for general projects. Very small projects (i.e., less than ten users) may use an TIA /EIA category qualified block or backboard mounted patch panel. Cables from

the same outlet shall be terminated on the same patch panel and individually identified. All terminations shall be wired to the TIA/EIA T568A configuration. Do not use T568B wiring configurations unless specifically requested by the user and approved by the authority having jurisdiction. Copper cables shall not be split between multiple modular connectors.

b. Copper Patch Cables.

Copper patch cables shall be 4-pair, 24 American Wire Gauge (AWG) stranded UTP cable, rated for Cat 6, with 8-pin modular connectors at each end. Provide sufficient copper patch cables, of various appropriate lengths, to terminate all copper patch panel appearances.

c. Category 6 Augmented and Category 7.

The TIA/EIA is the United States trade organization and standards body that specifies structured cabling systems. The ISO/IEC is a network of the national standards institutes of 151 countries and international standards body responsible for specifying structured cabling systems. The TIA committee TR-42 has approved for publication the standard for 10GBase-T cabling, or augmented Cat 6 (Cat 6A), ANSI/TIA/EIA-568-B.2-10. ISO/IEC has ISO/IEC 11801 Addendum 1 Draft Class EA. The ISO/IEC currently has a standard for a shielded-twisted pair (STP) cabling system, designated as Class F. The TIA/EIA has not yet formed a task group to explore the standardization of ISO/IEC 11801 Class F as Category 7. Cat 6A cable is 15-20 percent larger in diameter than Cat 6 and Cat 5e cable. USAISEC, as of the publication of this TG, has not yet been able to evaluate the impact to cable tray fill and the cost increase for Cat 6A cable. Implementation of Class F cabling within the United States runs the risk of utilizing larger cable, shielding shall be grounded properly, and the termination connector may non-standard.

2.4.1.2 Fiber Optic Cable (FOC)

Provide FOC to each outlet only at the specific request of the user, the DAA, or in accordance with a specific USACE standard design. As a minimum, administrative (including hospital) outlet boxes and faceplates shall be sized and configured to allow for the future installation of two strands of FOC. When the user requires FOC, multi-mode 50/125-micron laser optimized cable shall be installed. Single-mode FOC may be substituted as required by the user. Plenum cables shall be provided IAW NFPA 70, or when directed by facility safety officer or local building code.

a. FO Termination.

All FO distribution cable shall be terminated in cabinet/rack-mounted patch panels, and at the outlet. Do not use smart terminal (ST) style adapters for new construction unless specifically required for interface with existing equipment reused on installations. Check with activity for specific requirements for ST adapters. The default choice for FO adapters and connectors shall be TIA/EIA “subscriber connector (SC)” type (568SC). TIA/EIA 604-3A “SC” type connectors are preferred in new systems as the international standard now accepted by the U.S. Government. Other type connectors (small-form-factor) (LC, MT-RJ, VF-45, etc.) may be substituted as required by the user. Provide FO adapters and connectors IAW TIA/EIA-604 FOCIS and the corresponding FOCIS for the type of connector used.

b. FO Patch Cables.

Fiber optic patch cables shall use the same FOC type and connectors as the patch panels they are interconnecting. Utilize duplex patch cables for all patch panels. Provide sufficient

FO patch cables, plus 25 percent spare, of various appropriate lengths, to terminate all FO patch panel (FOPP) appearances..

2.4.1.3 Cable Length

Copper data cable length shall be limited to 295 ft (90 m) from patch panel termination in the TR to the data outlet termination IAW TIA/EIA-568-B.1. Adjust the average cable length for planning purposes as required (i.e., average measured length). Exception: buildings with collapsed backbones that use FOCs for all data and copper UTP for voice-only, may exceed the 295 ft length.

2.4.2 Backbone Cable

The following subparagraphs pertain to copper and fiber optic backbone cable. The building backbone shall have no more than two hierarchical levels of cross-connects. Copper backbone cable shall be used only for voice circuits. Fiber optic cable shall connect the data backbone.

2.4.2.1 Copper Backbone Cable

Multi-pair voice backbone cable shall meet the requirements of Insulated Cable Engineers Association (ICEA) S-80-576 and TIA/EIA-568-B.2 for riser rated UTP cable. Conductors shall be solid un-tinned copper, 24 AWG with a nominal characteristic impedance of 100 ohm. The copper backbone cable originating in the main TR or main cross connect shall be terminated in each TR on 110 type, insulation displacement, wiring blocks mounted on the telephone backboard. Provide at least two backbone cable pairs for every outlet connected to the TR served by the backbone cable. Plenum cables shall be provided IAW NFPA 70, or when directed by the facility safety officer. The ICEA specifications are listed in the references, and can be purchased at <http://global.ihc.com>.

2.4.2.2 Copper Termination

Termination shall be performed using 110-type connectors, rated for the installed cable. All terminations shall be wired IAW TIA/EIA T568A. Twisted pair outside plant (OSP) cable is terminated on the Protected Entrance Terminal (PET), see paragraph 3. See Figures B-5 and B-6 of Appendix B for details. Cross-connects can then be placed from the PET to the first set of 110-type terminal blocks as needed. The first set of terminal blocks provides connection for all backbones and for outlets served by the main TR. For main TRs that contain a telephone distribution frame, the horizontal main distribution frame (MDF) blocks shall serve as the main cross connects. Refer to MDF description in the section on Dial Central Offices (DCO) in the *USAISEC TG for Circuit Switching*. For example, in a three-floor building, one backbone cable shall be terminated on 110-type blocks on the same backboard as the PET; one backbone cable shall be terminated on 110-type blocks in the second floor TR; and one backbone cable shall be terminated on 110-type blocks in the third floor TR. A backbone cable connects a second set of 110-type blocks in each TR to a rack mounted, 8-pin (RJ45 type) connector voice patch panel. This panel can be patched to the distribution patch panel, which in turn terminates the Cat 6 outlet wiring. Cross-connects can be done by the Director of Information Management (DOIM)/telephone personnel, and jumpers can be installed by the user/Information Mission Area (IMA) department, providing the desired connectivity between the OSP and the inside plant wiring. This design allows maximum flexibility for future moves, additions, and changes.

2.4.2.3 FO Backbone Cable

For all projects, a minimum of 12 strands of 50/125-micron laser optimized multimode FOC and 12 strands single mode FOC shall be installed between the main TR or main cross connect and each TR. If requested by the user, only 12 strands of one type of fiber may be used. Plenum cables shall be provided IAW NFPA 70, or when directed by local regulations.

Note: The U.S. Army Gigabit Ethernet (GbE) data network architecture dictates the use of single mode FOC between TRs.

FO Termination. All FO backbone cable shall be terminated in cabinet/rack-mounted patch panels, at each end. Do not use ST style adapters for new construction unless specifically required for interface with existing equipment reused on installations. Check with activity for specific requirements for ST adapters. The default choice for FO adapters and connectors shall be TIA/EIA “SC” type (568SC). TIA/EIA 604-3A “SC” type connectors are preferred in new systems as the international standard now accepted by the U.S. Government. Other type connectors (small-form-factor) (MT-RJ, VF-45, etc.) may be substituted as required by the user. Provide FO adapters and connectors IAW TIA/EIA-604 FOCIS and the corresponding FOCIS for the type of connector used.

2.4.3 CATV or CCTV Cable

When CATV or CCTV requirements are identified, either a 75-ohm broadband coaxial cable or single-mode FOC system shall be installed. Refer to the paragraphs above for FOC. When a coaxial system is installed, care shall be taken to ensure the correct cable is used. The designer shall coordinate with the cable service provider where franchised agreements are in place. Plenum cables shall be provided IAW NFPA 70 or when directed by the facility safety officer. The table below lists cable types with corresponding distance limitation. Table 2 is derived from vendor specifications (Anixter) for coaxial cable. The RG-59 shall not be used for CATV projects; however, RG-6 shall be used to outlet locations and RG-11 for feeder and trunk cables.

Table 2. Coaxial Cable

Cable	Distance (feet)	Distance (meters)
RG-6	<=250	<=76
RG-11	<=400	<=122
625 Series	>400	>122

2.4.3.1 CATV Systems

Community antenna TV systems are generally referred to as cable TV. The CATV systems shall be designed IAW (1) where required, provide a complete system to be owned and maintained by the U.S. Government including backbone consisting of backboards/cabinets and wire and conduit with outlets and jacks in all offices, and (2) other locations as required by the user. System shall be designed IAW applicable TIA/EIA, Building Industry Consulting Service International (BICSI), and NFPA 70 standards, and shall be coordinated with the local CATV service provider. System shall include head end amplifier when required by the local provider, amplifiers, splitters, combiners, line taps, cables, outlets, tilt compensators, and all other parts, components, and equipment necessary to provide a complete and usable system. System shall provide a high quality signal to all outlets with a

return path for interactive television and cable modem access. The system shall be designed to operate within the 5 to 1000 Megahertz (MHz) bandwidth using 1000 MHz passive devices and a minimum of 750 MHz active devices. Each outlet shall have a minimum signal level of 0 decibel millivolts (dBmV) (1000 microvolts) and a maximum of 15 dBmV at 55 and 750 MHz.

Distribution system shall be star topology with each outlet connected to a communications closet with a feeder cable or a drop cable and each communications closet connected to the head end equipment with a trunk cable.

Provide cable installed in conduit as follows:

- Trunk Cable, RG-11 or 625 series
- Feeder cable, RG-11
- Drop Cable, RG-6

2.4.4 Building Infrastructure

See Figures B-1 through B-8 of Appendix B for details. Figure B-9 of Appendix B provides a typical floor plan used in designing a building or office cabling system. Design a complete telecommunications pathway system that provides a flexible, re-usable, expandable pathway for premise distribution of telecommunications services throughout the facility. The preferred pathway system is cable tray from the TER and TRs throughout the serving areas. The required pathway methods for distribution from the cable tray to the telecommunications outlet are conduit (preferred) and non-continuous support to a conduit stub-up. For non-continuous pathways provide suitable supports that provide an accessible pathway for cables not supported by conduit. Non-continuous cable support shall not be used as a substitute for cable tray

2.4.4.1 Cable Tray

Solid bottom, slotted bottom, or welded wire cable tray shall be used to provide a centralized cable management/distribution system. Cable tray shall be used for horizontal distribution to the maximum extent possible (80 percent to 90 percent of the horizontal cable length). See Figure B-5 of Appendix B for details. Cable trays shall be designed to accommodate a maximum calculated fill ratio of 50 percent to a maximum inside depth of 6 inches (150 mm). For planning purposes, the maximum pathway fill shall be 25 percent. For barracks, the designer shall provide 1 square inch (650 square mm) cross-sectional area of the tray or wire way for each barracks unit, and not exceed the 50 percent fill ratio. Ladder cable tray and center spine cable tray shall not be utilized for horizontal distribution. Provide 12 inches of clearance above cable trays for future access as per TIA/EIA-569-B, paragraph 4.5.6.2. Designers shall coordinate with other disciplines to ensure clearances can be achieved. Cable ladder shall not be used in lieu of cable tray.

2.4.4.2 Enclosed Duct (Perimeter Raceway)

When a building design does not provide for installation of cable tray, enclosed square duct may be installed. Enclosed duct may also be used in place of cable tray when cable plant requires physical security. For initial design guidance follow TIA/EIA-569-B, which states "Pathway (raceway) fill is calculated by dividing the summation of the cross-sectional area of all cables by the most restrictive cross-sectional area of the raceway system." During

actual design, the designer shall plan for an optimal fill ratio of 40 percent. Under no circumstances shall a fill ratio of 60 percent be exceeded.

2.4.4.3 Conduit

Electrical metallic tubing (EMT) conduit shall be installed from the cable backbone distribution system, whether cable tray or enclosed duct, to each outlet, or installed from a receptacle box, into an accessible ceiling space directly above the receptacle box (stub-up). Conduit for standard outlets shall be a minimum of 1 inch (27 mm) EMT conduit. When cable tray or enclosed duct is not used, individual conduits shall be installed from the TR to each outlet. Conduit bend radii shall be coordinated with cable bend radius. Conduit entries at outlet and junction boxes shall be arranged so that cables passing through the box shall enter and exit at opposite sides of the box. Do not use metal flex conduit for telecommunications wiring except when installing floor-access boxes in a raised floor, where floor-access box shall be relocated within a specified service area: i.e., 15-20 ft radius typical. The designer and installer shall follow the maximum allowable fill as defined in TIA/EIA-569-B table 9. Under no circumstances shall the designer exceed a fill capacity designated in the table. **Note:** Conduit shall not be used in family housing projects unless it is a high-rise apartment building.

2.4.4.4 Pull Boxes

Pull boxes shall be placed in conduit runs where a continuous conduit length exceeds 100 feet, or where there are more than two 90-degree bends. Pull boxes shall be placed in straight runs of conduit and not be used in lieu of a bend.

2.4.4.5 Non-Continuous Cable Supports

Provide suitable supports that provide a continuous accessible pathway for cables not supported by conduit or cable tray. Non-continuous cable supports shall not be used in place of the cable tray system. Non-continuous cable supports (J-hooks, etc.) shall be specifically designed to support category rated cabling. Supports shall not exceed 20 cables or 50 percent of the fill capacity, which ever is less. Spacing shall not exceed five feet between supports.

2.4.4.6 Open Office Wiring

- a. Systems Furniture Wiring

Design systems furniture wiring connections IAW TIA/EIA-569-B.

- b. Multi-user Telecommunication Outlet Assembly (MUTOA)

The ANSI/TIA/EIA-568-B.1 allows MUTOAs in an open office environment. This option provides greater flexibility in an office that is frequently reconfigured. A multi-user telecommunications outlet assembly facilitates the termination of single or multiple horizontal cables in a common location within a furniture cluster or similar open area. The cables from MUTOAs to work stations in system furniture or open office are simply long work area cables supported by the systems furniture raceway. The MUTOAs do not include an additional connection, and are limited to terminating a maximum of 12 users. Follow the guidance of ANSI/TIA/EIA-568-B.1, Section 6.4.1 for MUTOA application and design. Multi-user telecommunication outlet assembly (MUTOA) may be used in lieu of fixed furniture outlets. However, the distribution of work area cables from the MUTOA to the

desktop shall be addressed and accounted for in the telecommunications and the furniture designs.

c. Consolidation Point (CP)

The CP is an interconnection point within the horizontal cabling using ANSI/TIA/EIA-568-B.2 or ANSI/TIA/EIA-568-B.3 compliant connecting hardware. It differs from the multi-user telecommunications outlet assembly in that it requires an additional connection for each horizontal cable run. The CP is limited to terminating a maximum of 12 users. Follow the guidance of ANSI/TIA/EIA-568-B.1, Section 6.4.2 for CP application and design.

d. Direct Connection

Figure B-8 of Appendix B shows two possible solutions for direct wiring to the systems furniture. This concept is one of a continuous home run from the TR to the furniture outlet. Continuous runs are not the recommended method, and shall only be used in open office environments that cannot be readily reconfigured. Testing of the installed cable plant is simplified by providing an end-to-end circuit, without an additional connection point. Follow the guidance of ANSI/TIA/EIA-569-B, Section 6.3.2 for direct connection application and design.

e. Under floor conduits.

Under floor conduits shall only be used if no other alternative exists for feeding systems furniture. Under floor conduits shall be designed and installed IAW TIA/EIA-569-B. Under floor outlet boxes shall contain a spare conduit for future expansion.

f. Protection and Separation.

The designer and implementer shall ensure the telecommunications cable is protected at all transition points, and that metallic separation is provided between telecommunication and power wiring in the power pole, under floor conduit, and/or systems furniture track IAW TIA/EIA-569-B and Article 800-52 of ANSI/NFPA 70.

2.4.4.7 Small Facilities and Renovations

In new construction involving small, mixed use (non administrative) facilities, or construction projects involving renovation of existing buildings, use of “J” hooks, flexible cable tray, and alternative support systems specifically certified for Cat 6 cable is permissible. All alternative telecommunications supporting structures shall be TIA/EIA-569-B compliant, and design and installed in accordance with TIA/EIA-569-B, NEMA/BICSI 568, and the manufacturers specifications. Alternative support systems shall not exceed a 50 percent fill ratio. “J” hooks shall not exceed 20 cables or 50 percent of the fill capacity, whichever is less. Surface mounted non-metallic raceway may be used in renovation projects where access to the walls for installation of conduit and outlet boxes is not possible, or where historical requirements prohibit the alteration of the building structure. See Figure B-9 of Appendix B for details.

2.4.4.8 WAPs

The WAP cabling infrastructure shall be installed in the same manner as other telecommunications outlets within this design guide. The infrastructure shall include the cable tray and conduit or J-hooks to support the Cat 6 cable connected to the WAP. The use of “J” hooks, flexible cable tray, and alternative support systems specifically certified for Cat 6, cable is permissible to support the WAPs from the cable tray. J” hooks shall not

exceed a 50 percent fill ratio. Horizontal cabling to distribution areas shall be supported in cable tray.

2.5 Telecommunications Spaces

Provide a telecommunications equipment room (TER) and/or telecommunications rooms (TR) within each building or facility as described in this document. See Figures B-4 through B-6 of Appendix B for sample closet layouts. Provide a telecommunication equipment room (TER) as the main telecommunications room for each building. TIA/EIA-568-B.1 has replaced telecommunications closet (TC) with TR. The engineer shall use the reference to TR to more accurately describe the space needed for telecommunications equipment. In new construction or renovation, take into account the heat load of all active electronic equipment to be installed in TRs and equipment rooms. The designer shall estimate these loads and coordinate HVAC requirements. Active electronics shall be placed in a conditioned space. Follow requirements of ANSI/TIA/EIA-569-B when active electronics are to be located in TCs and equipment rooms.

2.5.1 Multi-story Buildings

In multi-story buildings, a minimum of one TR shall be located on each floor. Small facilities, i.e., air traffic control towers, firing ranges, storage facility, etc., may use one TR for the entire facility. The designer shall consider the outlet density (Table 1 when determining whether additional TRs are required for non-administrative facilities. Collapsed backbone buildings, i.e., major command and control (C2) facilities, may reduce the number of TRs to a minimum in line with the collapsed wiring architecture. The TRs on successive floors shall be vertically stacked wherever possible. A minimum of four 4-in (103 mm) sleeves shall be installed between stacked closets on successive floors, IAW TIA/EIA-569-B.

2.5.2 TR Sizing

The TRs shall be sized IAW TIA/EIA-569-B for all new construction projects with primarily administrative function (small mixed-use facilities shall not require full compliance with TIA/EIA-569-B). Generally, the TR shall be sized to approximately 1.1 percent of the area it serves. For example, a 10,000 square ft (1,000 square meters) area shall be served by a minimum of one 11 ft x 10 ft (3.4 m x 3 m) TR. Facilities with requirements exceeding those of the average administrative building (i.e., C2 facilities, etc.) will require TRs sized to approximately two percent or more of the area served. Large floor areas shall be divided into “serving areas” with TRs for each serving area. Each serving area can be no larger than 10,000 square feet (1,000 square m) as stipulated in TIA/EIA-569-B. The TR sizing allowances shall be made only in cases of construction projects involving building renovation, and under most circumstances a TR shall not be smaller than 11 ft x 7 ft (3 m x 2.2 m). The designer shall avoid irregular sized TRs, such as narrow rooms or odd shapes. Provide adequate space in TRs to facilitate tenant owned telecommunications system support equipment requirements in tenant installed freestanding cabinets or racks. Total TR space (as a percentage of the building’s area) shall be scaled upward, to reflect the increased number of circuits in buildings with more than the standard number of circuits to each workspace. Smaller building TRs are covered in Annex B of TIA/EIA-569-B. The designer shall consult with the architectural designer or facilities engineer if the TR is to house Voice over Internet Protocol (VoIP), wireless, PoE, or large numbers of network switches. The architectural designer may have to compensate for the

additional rack space required to house the VoIP and PoE equipment, uninterruptible power supply (UPS), and servers supporting VoIP and wireless systems.

2.5.2.1 Range Considerations

In multi-story buildings, a minimum of one TR shall be located on each floor. Small facilities, i.e., air traffic control towers, firing range towers, etc., may use one TR for the entire facility. TRs on successive floors shall be vertically stacked wherever possible. A minimum of three 4-inch rigid conduits shall be installed between stacked closets on successive floors, IAW EIA/TIA-569-B.

2.5.2.2 Barracks Considerations

Standard I3A or TIA/EIA-569-B TRs are normally too large for barracks facilities. Within barracks facilities provide a 7ft by 10ft main TR on the first floor, and provide one 6ft by 8ft TR on subsequent floors. Provision barracks TRs IAW TIA/EIA-569B. Telecommunications enclosures are acceptable in barracks with non-linear designs. The main TR meets the basic requirements of TIA/EIA-569-B

2.5.3 Room Interior Finishes

Floors, walls, and ceilings shall be treated to eliminate dust. Finishes shall be light in color to enhance room lighting. Dropped ceilings shall not be installed in TRs.

2.5.4 Room Door

The TR doors shall be a minimum of 36 in (1 m) wide, 86 in (2 m) tall, without doorsill, hinged to open outward, and be fitted with a lock to control access to the room.

2.5.5 Room Location

The TRs shall be dedicated spaces not shared with other functions (i.e., electrical rooms, mechanical rooms, etc). The TRs shall be located centrally in the area they serve. The TRs shall be located such that maximum copper cable distance from the patch panel through the structured cabling system to the furthest outlet does not exceed 295 feet. In rehabilitation projects, rooms containing transformers, air handling units, etc., shall be avoided if at all possible. If shared facilities cannot be avoided, ensure that proper electrical/telecommunications cable separations are maintained per National Electric Safety Code (NESC) and National Electric Code (NEC).

2.5.6 Telephone Backboards

A minimum of one wall shall be covered with rigidly fixed 3/4 inch (20 mm) A-C plywood, preferably void free, 8 feet (2440 mm) high, capable of supporting attached equipment. Plywood shall be fire-rated. Fire rated backboards are TIA/EIA approved and are easier to field verify than the fire retardant paint. When renovating an existing closet that does not have adequate space, the backboard shall be sized as large as possible to accommodate the PET and 110-type blocks. See Figure B-5 and B-6 of Appendix B for sample backboard layouts.

2.5.7 Equipment Racks

Equipment racks shall be floor mounted 84 inches (2100 mm) high and 19 inches (475 mm) wide located at or near the center of the TR. Equipment racks are normally 7 feet (2.1 m) high, but may be adjusted for special conditions. If mounting requirements for oversize equipment are anticipated, 23 inches (580 mm) may be substituted. In narrow or crowded

closets, equipment racks may be floor mounted adjacent to a wall, but shall provide a minimum 36 inches (900 mm) space

both in front and behind the rack, behind any installed equipment, and a minimum side clearance of 24 inches (600 mm) on end racks. Provide 100 percent spare rack capacity based on the amount of rack capacity utilized by the patch panels provided. Spare racks shall be provided for the mounting of government purchased and installed LAN equipment. Wall mounted racks may be utilized in small buildings or for small systems.

2.5.8 Equipment Cabinets

Equipment cabinets shall be used where physical security is required, to mount secure or mission critical equipment, in circumstances where controlled access is desired, such as CATV or CCTV, distribution in barracks, or by specific user request. Equipment cabinets are normally 7 feet (2.1 m) high, but may be adjusted for special conditions. Cable may be terminated in an enclosed 19-inch (475 mm) cabinet to provide enhanced protection for terminations and patching facilities. Cabinets shall provide, at a minimum, sufficient space for current and anticipated future equipment requirements. Equipment cabinets may be floor or wall mounted and shall be logically grouped based on the purpose of the equipment they enclose. Cooling fans shall be provided in all equipment cabinets.

2.5.9 UTP Patch Panels

The UTP patch panels shall be installed in, or adjacent to, the equipment racks or cabinets, which will house LAN equipment. Patch panels shall consist of eight-position modular jacks, with rear mounted type 110 insulation displacement connectors, category rated for the UTP system being installed, and arranged in rows or columns on 19-inch (475 mm) rack mounted panels. Nineteen-inch (475 mm) wall mounted may be utilized when necessary. Jack pin/pair configuration shall be T568A per EIA ANSI/TIA/EIA-568-B. The modular jacks shall conform to the requirements of EIA ANSI/TIA/EIA-568-B, and shall be rated for use with the installed cable plant. Provide a minimum spare capacity of 10 percent in the installed patch panels.

2.5.10 FOPPs

Fiber optic patch panels shall be installed in, or adjacent to, the equipment racks or cabinets, which will house LAN equipment. Patch panel connectors and couplers shall be the same type and configuration as used elsewhere in the system. Utilize 568SC duplex connectors on 19-inch (475 mm) rack mounted panels, unless otherwise directed. Twenty-three inch (580 mm) rack mounted panels, or minimum 12x10 in (300x250 mm) wall mounted enclosures may be utilized when necessary, such as at small facilities in U.S. Army projects. A 3-ft (1-meter) slack loop of fiber shall be provided within each panel, and panels shall provide strain relief for cables. Patch panels shall properly provide termination, splice storage, routing, radius limiting, cable fastening, storage, and cross-connection. Provide a minimum spare capacity of 10 percent in the installed patch panels. Single mode and multi-mode fiber optic cables shall be terminated on separate fiber optic patch panels.

2.5.11 Ladder, Wire Cable Tray and Fiber Wire Way

Ladder type or welded wire cable tray shall be used in the TR to provide distribution between the telephone backboard, equipment racks, backbone conduits, and the distribution cable tray. All metallic cable tray sections will be bonded and the cable tray system will be grounded to the TMG or TMGB. Plastic or composite wire ways designed for fiber optic

cables are permissible for the fiber optic system. Copper cabling shall not be installed in any dedicated fiber optic support systems.

2.5.12 Room Lighting

Light fixtures shall be mounted a minimum of 9 feet (3 meters) above the finished floor and provide a minimum of 50 ft candles (500 lx) of illumination measured 3 feet (1 meter) above the finished floor.

2.5.13 Room Climate Control

Each TR shall be independently climate controlled, capable of providing year round ambient temperature control (24 hours/day, 365 days/year) to protect all installed electronic equipment. Rooms shall be provided with positive atmospheric pressure to exclude dust. The designer shall consult with the mechanical designer or facilities engineer if the TR is to house blade servers, PoE, or large numbers of network switches. These devices can generate a considerable amount of heat; therefore, the mechanical designer may have to compensate for these additional loads.

2.5.14 Room Contaminants

Information system equipment shall not be installed in spaces where moisture, liquid or gaseous spillage, or other contaminants may be present.

2.5.15 Electrical Power

Provide a minimum of two dedicated 110 volt, 20-ampere quadraplex receptacles in each TR. Each receptacle shall be on a separate 20-ampere branch circuit serving only that receptacle. Additional convenience receptacles shall be provided at 6 feet (1800 mm) intervals around the perimeter walls. For all projects, provide a dedicated 20-ampere circuit and a quadraplex receptacle for each 19 inch (480 mm) rack or cabinet. These receptacles shall be installed on the bottom or immediately adjacent to racks or cabinets to avoid equipment power cords from being placed across the TR floor. The designer shall consult with the electrical designer or facilities engineer if the TR is to house blade servers, PoE switches, PoE mid-span hubs, UPS, or large numbers of network switches. Large PoE switches may require multiple 110V or multiple 220 V circuits. The electrical designer may have to compensate for the considerable current draw amount of these devices.

Design note for renovations: The designer shall specify a disconnecting means as defined in the NEC, Article 645.10, if the existing panel is not collocated or in close proximity of the branch-circuit power panel.

2.5.16 Voice Communications

Each TR shall have one wall-outlet installed at or near the entry door for emergency or voice communications.

2.6 Grounding

All unclassified TRs shall be connected to the building earth electrode subsystem (EES) IAW MIL-STD-188-124-B for U.S. Army installations, and as clarified in the TG for USAISEC Lightning Protection, Power Quality Analysis, Grounding, Bonding, and Shielding (LPAGBS). Information on grounding of classified facilities can be found in MIL-STD-188-124-B and Military Handbook (MIL-HDBK)-419-A. **Figures 10 and 11 of Appendix C** provide detailed schematics for the signal grounding system. An acceptable grounding system encompasses: fault protection grounds, lightning protection grounds,

signal reference grounds, and direct current (DC) power grounds (when applicable). Refer to NFPA 780 and MIL-HDBK-419-A for proper lightning protection and NFPA 70 for proper fault protection grounding. The telecommunications designer shall review project drawing to ensure that the lightning and fault protection grounds are addressed by the appropriate disciplines. The telecommunications designer shall ensure that the different grounding systems are not mixed within the building.

2.6.1 Building Earth Electrode Subsystem (EES)

The building EES forms the primary electrical, life-safety grounding system. Typically, a grounding electrode conductor connects the main building-grounding electrode to the main electrical entrance panel or cabinet. NFPA 70, Article 250 Section III provides guidance on the grounding electrode system and conductor. End user buildings (EUB) and area distribution nodes (ADN) shall have a resistance-to-earth of 10 ohms or less, following MIL-STD-188-124-B. The switch manufacturers may specify the resistance-to-earth as 5 ohms or less for a telephone switch or DCO. The designer shall be conscious of the proposed utilization of the facility and plan accordingly. Sites shall provide proper supporting documentation and specifications to the designer to support resistance-to-ground requirements more stringent than that of NFPA 70 or MIL-STD-188-124-B for non-voice switch buildings. Proper documentation includes international, national or local codes, DOD and DA standards, or manufacturers' equipment specifications.

2.6.2 Cable Entrance Grounding

All metallic shields and strength members for OSP cable entering a building shall be connected to the lightning protection ground system. The designer shall ensure that the lightning protection is IAW MIL-STD-188-124-B and NFPA 780, *Standard for the Installation of Lightning Protection Systems*, latest issue.

2.6.2.1 Building Point of Entrance

The NFPA 70 defines the point of entrance as the location where “the wire or cable emerges from an external wall, from a concrete floor-slab, or from a rigid metal conduit or an intermediate metal conduit (IMC) grounded to an electrode IAW 800.400-B.” The Telecommunications Entrance Facility (TEF) is the space housing the point of entrance of the telecommunications service.

2.6.2.2 Copper Cable Entrance

The OSP copper cable shield, armor, and metallic strength member shall be bonded to the Lightning Protection Subsystem as close as possible to the building point of entrance with a No. 6 AWG or larger ground wire. The designer shall use a non-bonded splice case for the transition from OSP rated cable to interior rated cable, or shall indicate that the implementer not install the splice case carry-through bonding conductor. If the designer shall extend the OSP copper cable past 50 feet (15 m) IAW NFPA 70 Section 800.50, the metallic strength member shall be bonded to the lightning protection ground as close as possible to the conduit egress point with a No. 6 AWG or larger copper ground wire.

2.6.2.3 Fiber Cable Entrance

The OSP FOC armor and metallic strength member shall be bonded to the Lightning Protection Subsystem as close as possible to the building point of entrance with a No. 6 AWG or larger ground wire. The designer shall use a non-bonded splice case for the transition from OSP rated cable to interior rated cable, or shall indicate that the implementer

not install the splice case carry-through bonding conductor. If the designer shall extend the OSP fiber cable past 50 feet IAW NFPA 70 Section 770.50, the metallic strength member shall be bonded to the lightning protection ground as close as possible to the conduit egress point with a No. 6 AWG or larger copper ground wire. If inside/outside cable is used, a cable shield isolation gap shall be incorporated.

2.6.2.4 Copper Protector Block

All OSP copper cables shall be terminated on primary protector blocks, equipped with 5-pin solid state or gas protector modules. The protector blocks shall be bonded to the Lightning Protection Subsystem with a No. 6 AWG or larger copper ground wire. Blocks shall be UL listed. Place the protector block as close as possible to the lightning protection ground.

2.6.3 Telecommunications Room Signal Ground

All TRs shall have a high frequency signal ground designed IAW MIL-STD-188-124-B. The signal ground shall consist of a ground plane in the room, a ring around the inside perimeter of the room for TR, or a ground bus bar for telecommunications closets. The signal ground ring or bar shall be connected to the building EES by using the building steel girders or a ground cable if the girders are not accessible. The size of the grounding electrode conductor of a grounded or ungrounded alternating current (AC) system shall not be less than given in National Electrical Code (NEC) Table 250.66. The values in NEC Table 250.66 are based on the size of the service-entrance conductors, but the grounding electrode conductor is not required to exceed 3/0 AWG copper or 250-kcmil aluminum. The telecommunications designer shall ensure that the different signal grounding system does not interconnect with the fault protection and lightning protection sub-systems within the building.

2.6.4 Telecommunications Rack and Supporting Structure

All telecommunications racks and supporting structures (cable trays, ladders, conduits, and baskets) TR shall be bonded to the TR signal ground plane, ring, or bus bar as defined in and TIA/EIA-569-B. All individual sections of all metallic cable tray and ladder systems shall be bonded to each other and to the raceway which they support.

2.7 Telecommunications System Labeling

The following subparagraphs pertain to patch panel, distribution facilities, and outlet labeling.

2.7.1 Outlet/Patch Panel Labels

The telecommunications systems labeling shall be done IAW TIA/EIA-606-A. All outlets and patch panel positions shall be labeled as to their function and with a unique identifier code. All devices, outlet locations, and designations shall also appear on the system drawings. As a minimum the following shall be reflected in the outlet/patch panel labeling:

- Security Level (if applicable)
- Room Number
- Alpha or Numeric Designator
- Labeling shall be a minimum of ¼-inch (6mm) high
- Handwritten labels shall not be used for the final configuration

2.7.2 Conformance to Existing Standards

It is desirable that the labeling system conforms to any existing labeling, to the DOIM standard, or if neither exists to the method described above. All designations shall be done in standard commercial labeling. Handwritten labels shall not be used for the final configuration.

2.7.3 Telecommunications Outlet Labeling

Outlet labeling shall be done IAW TIA/EIA-606. Each outlet location shall be labeled with a unique designator and level of classification, in sequence starting with "A" or "1" and proceeding clockwise around the room. The left or top 8-pin (RJ-45 type) Cat 6 or compliant connector shall be designated for voice and be labeled "VOICE." The right or bottom 8-pin (RJ-45 type) Cat 6 compliant connector shall be designated for data and be labeled "DATA." All LAN components in the system shall also be labeled with similar designations IAW TIA/EIA 606. For FO connections, the left or top FO connection shall be labeled "A" and the right or bottom FO connection shall be labeled "B."

2.7.4 Telecommunications Patch Panel Labeling

Patch panel labeling shall be done IAW TIA/EIA 606. Each position shall be labeled with a unique designator corresponding to the outlet location. In addition to TIA/EIA-606-A requirements, the top or left 8-pin (RJ-45 type) Cat 6 compliant port for each outlet location shall be designated for voice and be labeled "VOICE." The bottom or right 8-pin (RJ-45 type) Cat 6 compliant port for each outlet location shall be designated for data and be labeled "DATA." Fiber optic port labeling shall be done IAW TIA/EIA 606. The left or top connection shall be labeled "A." The right or bottom connection shall be labeled "B." Color-coding IAW TIA/EIA-606-A may be added to the labeling.

2.7.5 Distribution System Labeling

The distribution system is described in TIA/EIA-606-A for pathways. In addition, all transitions and changes in distribution system size and type shall be labeled. Each cabinet shall be labeled at the top with a unique designation.

2.8 Building Entrance Facility

The building entrance facility (equipment room) is the demarcation point between the OSP cabling and the inside plant distribution cabling.

2.8.1 Telecommunications Entrance Facility (TEF)

The TEF is the space housing the point of entrance of the telecommunications service. The TEF is also the space where the inter- and intra-building backbone facilities join. Telecommunication-related antenna entrances and electronic equipment may also be located in the TEF.

2.8.2 PETs

2.8.2.1 Protector Modules

The PET shall be equipped to protect the inside plant wiring and equipment from power surges. See paragraph 3.17 for a description of the PET. The PET shall be grounded to the

2.8.2.2 Sheath Limitations

If the OSP sheath distance from the building entrance point to the PET or FO connector housing location is greater than 50 cable feet (15 m); the use of EMT or a splice case with transition to riser rated cable is required.

2.8.2.3 Stencils

All PETs shall be stenciled with the terminal number and cable count.

2.8.3 Fiber Termination Device

The OSP FOCs are terminated on optical patch panels. The inside plant FO backbone cables are terminated on optical patch panels in the same or adjacent equipment racks. Patch cables are connected between the patch panels to provide the desired connectivity. All patch panels shall be stenciled with the panel number and the cable count.

2.9 Testing

The designer shall specify that all telecommunications cable, installed as part of a project, be tested to the commercial standards for that cable system.

2.9.1 UTP Tests

All metallic cable pairs shall be tested for proper identification (ID) and continuity. All opens, shorts, crosses, grounds, and reversals shall be corrected. Correct color-coding and termination of each pair shall be verified in the communications closet and at the outlet. Horizontal wiring shall be tested from and including the termination device in the communications closet to, and including the modular jack in each room. Backbone wiring shall be tested end-to-end, including termination devices, from terminal block to terminal block, in the respective TCs. These tests shall be completed and all errors corrected before any other tests are started.

2.9.2 Cat 6 Circuits

All Cat 6 circuits shall be tested using a test set that meets the accuracy requirements of ANSI/TIA/EIA-568-B.1 and ANSI/TIA/EIA-568-B.2-1. All test requirements shall be completed as specified in ANSI/TIA/EIA-568-B.1 and ANSI/TIA/EIA-568-B.2-1.

2.9.3 Coaxial Cable

Cable shall be tested for continuity, shorts, and opens. Characteristic impedance shall be verified over the range of intended operation. Cable length shall be verified. Cable shall be sweep-tested for attenuation over the range of intended operation.

2.9.4 FOC

All category FO circuits shall be tested using a test set that meets the accuracy requirements of ANSI/TIA/EIA-568-B.1 and ANSI/TIA/EIA-568-B.3. All test requirements shall be completed as specified in ANSI/TIA/EIA-568-B.1 and ANSI/TIA/EIA-568-B.3.

Unless stated otherwise, tests shall be performed from both ends of each circuit. Connectors shall be visually inspected for scratches, pits, or chips and shall be re-terminated if any of these conditions exist.

3.0 OUTSIDE PLANT TELECOMMUNICATIONS CABLING SYSTEM SPECIFICATIONS

This section provides engineering and installation standards for OSP infrastructure for projects that support the core enterprise information infrastructure at Army posts, camps, bases, and stations worldwide. The OSP System is designed to satisfy I3A policy IS requirements on a facility. System design, integration, and quality assurance (QA) services are also part of this documentation. The OSP shall be installed IAW the specifications referenced within this document, with modifications and clarifications provided below. Telecommunications design shall be performed and stamped by a RCDD. This OSP section is synchronized with UFC 3-580-2, Telecommunications Systems Outside Plant Cabling System Planning and Design. The objective of this UFC is to provide planning guidance for the development of an input to the building cabling system telecommunications portion of the DD 1391. The UFC-3-580-2 is designed to satisfy U.S. Army I3A policy or UFC 3-580-10 Design: NMCI Standard Construction Practices IS requirements within a facility.

3.1 Classified Information Infrastructure

Engineers engaged in the design of classified (collateral or higher) Information Infrastructure shall coordinate the infrastructure design with the CTTA and DAA responsible for that area. This TG cannot attempt to replace the publications that were produced to support the design of Red/Black infrastructure. The engineer shall consult the following applicable documents for consideration and design guidance. If a hardened carrier distribution system (HCDS) is implemented, as detailed in the design drawings, the HCDS shall only include the HCDS, the fiber, and a lock box or cabinet. The HCDS hand holes and maintenance holes (MH) shall be considered part of the HCDS system and are expected to be fully compliant with NSTISSI 7003. Specifically, the walls of the installed HCDS hand holes and/or MHs shall meet or exceed the minimum requirements for encasing the HCDS. If a CTTA review is required, and the review determines that TEMPEST countermeasures are required, the CTTA shall consider a variety of methods that can be applied to the system/facility to achieve TEMPEST security. The RED/BLACK guidance contained in NSTISSAM TEMPEST/2-95 (For Official Use Only (FOUO)) shall be considered by the CTTA along with other measures (e.g., TEMPEST Zoning, TEMPEST suppressed equipment and shielding) to determine the most cost-effective countermeasures to achieve TEMPEST security. Only those RED/BLACK criteria specifically identified by the CTTA shall be implemented. Additional information on grounding can be found in MIL-STD-188-124-B and MIL-HDBK-419-A. Information on Protected Distribution Systems can be found in NSTISSI No.7003, 13 December 1996.

3.2 System Overview

Items included under OSP infrastructure are MH and duct, copper cable, FOC, MDF, terminations, cable vaults, multiplexing equipment, environmentally controlled housings, cross-connects, and copper and FO entrance cable.

3.3 System Architecture

The DOD currently employs a number of architecture topologies for the design of OSP. These topologies include ring, star, and mesh configurations. These topologies are based upon telephone or dial central offices CO/DCO, main communications nodes (MCN) and ADNs, and EUBs. The goal of the Army is to migrate to a fiber only cable plant, but it will occur over time as the voice network switches on the installation migrates from a copper

only capability to the ability to attach to either fiber or copper. The intent is to provide data and voice service at the least cost possible, to include total cost of ownership. Each installation and situation has to be individually analyzed to determine the best technical solution, based on the sources of investment. The DOD is spearheading the effort to converge voice and data over the same transport layer. Connectivity between nodes, and from the nodes to EUBs, provides the post transport backbone. The OSP designer shall design the OSP infrastructure to support the topology of the service that has authority over the construction project and allow future migration to a converged network.

3.3.1 Minimum New Cable Requirements

If the design requires installation of new cable, the following minimum requirements and section 3.15.4.5 apply:

3.3.1.1 MCN to MCN

For planning purposes, use a minimum of 24 strands of single-mode FOC between MCNs to provide load balancing, network reliability, and growth.

3.3.1.2 MCN to ADN/ADN to ADN

Design a minimum of 12 strands of single-mode FOC between the ADN and MCN. Design a minimum of 24 strands of single-mode FOC between each ADN and two adjacent physical ADN locations, or to one ADN and one MCN location.

3.3.1.3 ADN to EUB

Design a minimum of 12 strands of single-mode FOC to connect a EUB with less than 300 users to an ADN. Design a minimum of 24 strands of single-mode FOC to connect a EUB with between 300 and 600 users to an ADN. Design a minimum of 24 strands of single-mode FOC from a EUB with more than 600 users, to an ADN location, plus four additional strands for 100 user increments above 600 users, up to 48 strands.

3.3.2 MCN/ADN Cable Paths

The physical path of the cable from a physical ADN location to each adjacent MCN/ADN shall be directly to the connected MCN/ADN without routing through or patching through any other building, with the exception of stand-alone cable huts or vaults.

3.3.2.1 Copper

The number of OSP copper pairs is calculated by multiplying the number of users or jumpers in the building times 1.5 pairs. This factor shall add in some additional pairs for faxes, modems, and special circuits. The cable is then sized to the nearest logical standard cable size. For example, a building with 85 users would require a 200-pair cable ($85 \times 1.5 = 128 \rightarrow 200$ pair).

3.3.3 Redundant Cable Paths

The backbone networks are normally constructed with a concrete encased path so that a single cable cut cannot isolate any core node or critical node from other core nodes. The user shall present official justification to have two physically diverse cable routes from a EUB location to a node location. Justification includes DOD directives and DAA certification.

3.4 Outside Plant

This section contains the engineering, installation, and material guidance for the installation of OSP infrastructure and electronics. An overall schematic for OSP sizing of duct and cable is provided in Figure C-1 (Figure C-9 for Europe) – OSP Infrastructure Standards.

3.5 Environmental and Historical Considerations

Most military installations contain areas that may be affected by environmental or historical matters. Environmental hazards may include toxic waste, fuel spillage/leakage, asbestos, unexploded ordnance, etc. Wildlife preservation may be another area of concern at some sites. Compliance with historical restrictions shall require special engineering considerations (type of exterior facing, mounting of terminals, placement of pedestals, etc.). These types of situations shall be further defined in the design package. Disposal of waste materials shall be accomplished by the installer IAW the site's documented procedures for clean and/or environmentally hazardous material as specified in the design package.

3.5.1 Price of Conformance

Although these issues may not appear to have a high impact on the engineering solution, the price of conformance to site restrictions may add considerable cost to the project. Special conditions shall be discussed with the DOIM and agreements documented.

3.6 General Considerations

3.6.1 Digging Permits

The installer shall coordinate with the site Directorate of Public Works (DPW) to schedule all excavation and obtain the required digging permits. Permission (approved digging permits) shall be obtained from the site prior to the start of any excavation and/or construction.

3.6.2 Utility Location

The DOIM or DPW shall be responsible for the location and marking of the utilities, unless otherwise stated in the design package. The installer shall furnish a schedule of proposed excavation involving utility locations to the DOIM/DPW in sufficient time to allow marking. Since each DOIM/DPW has different operating requirements, the location lead-time shall be stated in the design package. An acceptable utility mark shall be within 24 inches (600 mm) of the edge of the utility. After the utilities are located and marked, the installer is responsible for maintaining the marks until they are no longer required. The intent is that the utilities shall be located and marked only once and not after each rainfall.

3.6.3 Pot Holing

The installer, either U.S. Government or contractor, is responsible for positively determining the exact location and depth of all marked utilities suspected to be within 24 inches (600 mm) of the proposed excavation or directional drilling by hand digging and/or pot holing to ensure the trenching or boring/drilling equipment does not damage the utilities. The installer shall create an initial hole no larger than 12 in x 12 in (300 mm x 300 mm), when pot holing in road surfaces prior to boring operations. However, the installer may increase the hole in size as needed to determine the exact size and depth of the utility being located.

3.6.4 Slot Trenching

With the approval of the U.S. Government, the installer may use vacuum excavation equipment to dig slot trenches. Slot trenches may be used for the installation of conduit or cable through congested areas having poorly marked utilities that cannot be avoided by adjusting cable routes.

3.6.5 Road Crossings

The designer shall plan the cable route to cross the road only as necessary to serve subscribers without the use of aerial inserts. Such crossings shall be constructed by cutting or sawing perpendicularly across the road, by trenching perpendicularly across the road, by directional boring under the road, or by pipe pushing under the road. Pavements shall not be cut where the traffic detection wires of traffic light control systems are embedded.

3.6.6 Cuts and Resurfaces

Cuts shall typically extend at least 6 inches beyond either side of the trench to provide a stable base for the surface material, unless otherwise directed by the design package. Roads, streets, parking lots, etc., shall only be closed for as long as is required to complete the work required to place the duct (including tamping the backfill) and allow the slurry, concrete, and/or asphalt to properly set IAW manufactures specifications.

Once the concrete or slurry has set, the surface shall be restored to original conditions within 72 hours, unless otherwise approved by the government. Certain streets or roadways may have cutting restrictions or special requirements that require traffic be resumed as soon as possible. Contractors shall be prepared to comply with these restriction and requirements. Steel plates may be used as an option to open the street to traffic while the material is curing.

3.6.6.1 Dowels

Construction joints resulting from restoration in concrete pavement in excess of 180-mm (7-inches) thick or subjected to heavy vehicle traffic shall be doweled. Dowels may be required in thickness of less than 7 inches (180-mm), as specified by the DPW or equivalent.

3.6.6.2 Right-of-Way Permits and Easements

The U.S. Government will verify and document that for any crossing requiring a right-of-way permit or easement, such permit shall be available to the installer. The installer shall be responsible for obtaining the appropriate permits and approvals in a timely manner to ensure compliance with established completion dates.

3.6.7 Materials

The following are materials that may be encountered.

3.6.7.1 Rock

Rock shall consist of boulders measuring 1/2-cubic yard (yd³) (0.382-cubic meter [cm³]) or more, or other material such as rock in ledges, bedded deposits, un-stratified masses, and conglomerate deposits, or below-ground concrete masonry structures, that cannot be moved without systematic drilling and blasting or the use of a rock saw. Pavements shall not be considered as rock. Excavate rock to a minimum of 4 inches (100-mm) below the trench depths required to place the duct bank or cable. The installer shall backfill the rock excavation and all excess trench excavation with a cushion of sand at least 4 inches (100-

mm) prior to placing the duct or cable. Refer to Unified Facilities Guide Specifications (UFGS) UFGS-02300, Earthwork, for additional excavation details.

3.6.7.2 Unstable Soil

When wet or otherwise unstable soil that is incapable of properly supporting the conduit or MH is encountered in the trench bottom, the installer shall, at no additional cost to the U.S. Government, remove such soil to the depth required; establish a sound base, and backfill the trench to trench bottom grade with coarse sand or fine gravel. The site U.S. Government representative shall determine if the soil is unstable. Refer to UFGS-02300, Earthwork, for additional details on trenching. Applicable safety procedures Occupational Safety and Health Administration (OSHA), host nation, and local shall be followed for shoring or sloping.

3.6.7.3 Select Backfill

The direct buried (DB) duct system shall be buried in layers of select backfill whenever the DB duct system is not concrete encased. The backfill shall be placed IAW commercial standards and UFGS-02300, Earthwork, whichever is more stringent. The installer shall obtain the signature of the on-site U.S. Government quality control (QC)/QA representative, signifying the acceptability of the duct placement and spacing, prior to placing any backfill over the duct.

3.6.7.4 Flowable Fill or Slurry

The preferred method for backfilling the portion of the trench above concrete-encased duct systems under roads and parking lots is with flowable fill, also known as slurry. The flowable fill shall have a compression strength rated between 50 to 100 pounds per square inch (lb/in²) (345 and 689 kilopascal [kPa]). Flowable fill shall not be used as a substitute for concrete encasement. Backfilling the portion of the trench above concrete-encased duct systems under roads and parking lots with clean backfill is acceptable with Government approval.

3.6.8 Backfilling

In accordance with UFGS-02300, Earthwork, all excavated areas around the new MHs, ducts, or cables shall be backfilled with approved excavated materials consisting of earth, loam, sandy clay, sand, gravel, and soft shale free from large clumps.

3.6.8.1 Placement

Backfill materials shall be deposited and tamped in 6-inch (150-mm) layers until the conduit has a cover of not less than 1 ft (300 mm). The remainder of the backfill materials shall be placed into the excavation and then tamped in 1-ft (300-mm) layers. The earth shall be graded to a reasonable uniformity, mounded, and left in a uniform and neat condition.

3.6.8.2 Unsatisfactory Materials

Blasted rock, large boulders, broken concrete, or pavement shall not be used as backfill materials.

3.6.8.3 Other Materials

A slurry or flowable fill type backfill can be used in lieu of a tamped backfill. The slurry or flowable fill shall have a compression strength rated between 50 to 100 lb/in² (345 and 689

kPa) once it has set up. Flowable fill shall not be used as a substitute for concrete encasement.

3.6.9 Restoration

Restoration to the same condition as found prior to construction shall be completed within 72 hours for all areas where no additional intrusion is required. Roads, streets, parking lots, etc. shall only be closed for as long as is required to complete the work and allow the slurry, concrete, and/or asphalt to properly set IAW the manufacturers' specifications. Certain streets or roadways may have cutting restrictions or special requirements that require that traffic be resumed as soon as possible. Designers shall ensure that the contractors are prepared to comply with these restrictions and requirements.

3.6.9.1 Improved Areas

Roadways, walks, paved areas, and other surfaces disturbed by the installer shall be resurfaced with same type of material and to the same thickness as the original surface. Roadways shall have a minimum thickness of 3.5 inches (90 mm) of resurfaced pavement.

3.6.9.2 Grass

All grass surfaces shall be leveled and reseeded, unless otherwise directed (such as the placement of sod) in the design package. For grassy areas where the installer shall have to bring heavy equipment back onto the construction site, the areas shall be rough graded and covered with protective matting to prevent erosion. For durations longer than two weeks between construction and final disturbance, the installer shall rough seed the area to provide cover until final grading and seeding are accomplished.

3.6.9.3 Dowels

Construction joints resulting from restoration in concrete pavement in excess of 7-inches (180-mm) thick or subjected to heavy vehicle traffic shall be doweled. Dowels may be required in thickness of less than 7 inches (180 mm) as specified by the DPW or equivalent.

3.6.9.4 Cleanup

Areas impacted by the installer's construction (roads, sidewalks, parking lots, etc.) shall be maintained free from waste, debris, washout, etc. The installer shall clean any mud tracks built up on roads, parking lots, etc., or washouts within 24 hours or as specified by the U.S. Government.

3.6.10 Detection of Buried Cables and Underground Conduits

3.6.10.1 Warning Tape

All warning tape shall be polyethylene (PE) plastic tape, a minimum width of 150 mm (6 inches), IAW APWA Uniform Color Code, and imprinted with the words "WARNING - TELECOMMUNICATION CABLE BELOW" at not more than 1.2 m (48 inch) intervals. Minimum thickness of the tape shall be 0.10 mm (0.004 in). Tape shall have a minimum strength of 12.0 Megapascal (MPa) (1750 pounds per square inch (PSI)) lengthwise and 10.3 MPa (1500 PSI). Tape shall be manufactured with integral wires, foil backing, or other means of enabling detection by a metal detector or underground cable detector typically used in the OSP industry when tape is buried up to 920 mm (3 feet) deep. The materials in the warning tape shall be chemically inert and will not degrade when exposed to acids, alkalis, and other destructive substances found in soil.

3.6.10.2 Detection Wire for Non-metallic Piping

Detection wire shall be insulated, single strand, solid copper with a minimum of 12 AWG coated with a minimum 30 mm PE jacket designed specifically for buried use.

3.6.10.3 Detectable Warning Tape Installation

Detectable warning tape shall be installed a minimum of 305 mm (12 inches) to 405 mm (18 inches) above all new non metallic conduit formations and DB cable installations and shall not exceed the manufacturer's recommended depth below grade. Tape shall be placed at a depth of no less than 310 mm (12 inches) below surface grade. Buried cables include cables placed in open trenches and cables placed by plowing.

3.6.10.4 Permanent Tracer Wire

Permanent tracer wire shall be installed in all new duct banks (The conduits may contain a toneable cable today, but it might be removed in the near future). One tracer wire shall be installed per duct bank. The tracer wire shall be placed centrally as possible in the top conduit formation. When dielectric cable is installed in existing conduit formations that do not contain toneable cables, a tracer wire shall be installed along with the dielectric cable. Splices in the tracer wire shall be connected by means of a compression type connector to ensure continuity. Wire nuts shall not be used. After installation, tracer wire shall be tested to verify continuity of the tracer wire system and a report indicating continuity shall be submitted to the permitting authority as part of the as-built construction records.

3.7 Outside Plant Cable Placement Options

3.7.1 Building Entries

The standard method for entering buildings with new cable is underground through subsidiary or lateral conduits for underground cable, and through galvanized rigid steel conduit (RSC) stub-outs from the building for direct-buried (DB) cable. Above ground entries may be used in lieu of underground entries with the Governments approval

3.7.1.1 Underground Entrance

Typical foundation types encountered include slab-on-grade, crawl space, full basement, and deep drilling on piles. Footers encountered may be continuous or non-continuous. The footer portion of the foundation shall not be cut. Entrance conduits shall pass below footers or through the building foundation wall. Galvanized RSC shall be placed where the entrance conduits pass through foundation walls. Annular spaces between the conduits and floors and walls shall be sealed to prevent water intrusion and fire stopped as required by the NEC and local codes. Conduits shall extend between four to six inches above the finished floor or below the ceiling to aid in pulling cables. Entrance conduits shall be plugged or sealed to prevent water intrusion. Where conduits cannot be placed within 75 mm (3 in) of a wall as shown in Figure C-5 (Figure C-10 for Europe) – Pedestals and Building Entrance Details the conduits shall enter a pull box within the building.

3.7.1.2 Above Ground Entrances

Entrance conduits shall not be mounted on the exteriors of buildings unless previously approved by the U.S. Government. The location of existing main telephone terminal rooms on floors above ground level is insufficient by itself to justify mounting entrance conduits on the exterior of buildings. Where approved by the U.S. Government, the amount of conduits

mounted on the external walls of buildings shall be minimized. Pull boxes shall be placed where conduits penetrate external walls.

3.7.1.3 Pull Boxes

Pull boxes shall be sized IAW the guidance in Article 314.28 of the NEC 2005 and the cable manufactures recommended cable bending radius (which ever is the greatest) to accommodate the fiber optic and copper cables sized for the building. A basic premise of Article 314 for a pull box used for an angle turn is that the distance between raceway entries enclosing the same conductor (cable) shall not be less than six times the metric designator (trade size) of the larger raceway. For a 4" conduit that distance measured on a straight line would be 24". The pull box shall be sized to accommodate the copper cable for the building even if installation of the copper cable is not part of this project. Electrical-metallic tubing (EMT) shall not be used on the exteriors of buildings. Conduits mounted on the exterior of buildings shall be hidden from view in a manner approved and as directed by the U.S. Government.

3.7.1.4 Transition

The transition from plastic to RSC for entrance conduits shall take place at the bottom of the trench prior to sweeps or bends to the building.

3.7.1.5 Demarcation Point

For the purposes of this document, the demarcation point between OSP work/functions and inside plant work (ISP)/functions shall be the building entrance terminal (BET), also referred to as a protected entrance terminal (PET), for both copper and fiber optic cables. In other words, the OSP work shall include installing a cable into a building, installing the BET and terminating the cable on this BET.

3.7.2 Underground

Underground pathways and spaces shall be dedicated for cable placement (e.g., DB cable, buried duct/conduit, MHs, hand holes, and shared space, such as a utility tunnel providing other services). An underground MH and duct system, as required due to utility congestion, high traffic, or high building density, shall be used as the preferred method for placement of outside cable plant in new construction and rehabilitation within the site cantonment areas, unless otherwise specified in the design package. For the purposes of this document, the term cantonment is defined to mean the part of the military installation where the following buildings/functions are permanently located/concentrated: administrative offices, headquarters, operations buildings, motor pools, logistic facilities, troop barracks, dining facilities, garrison support functions, theaters, post exchanges, etc. The key here is 'concentration of buildings'. There may be more than one cantonment area on an installation such as: the hangers, control tower, operations center, etc for an airfield may be considered a separate cantonment area. Family housing, rail heads, maintenance facilities may or may not be included in the cantonment area. Ranges, training areas, drop zones, impact areas, ammo storage areas, recreation areas, etc are not part of the cantonment area. The existing MH and duct system shall be leveraged to the maximum extent possible by the repair and reuse of damaged existing conduit runs and MHs (where economically feasible) and by reinforcing existing full conduit runs with new conduits. Existing MHs may be overbuilt to an adequate size with U.S. Government approval.

3.7.3 Direct Buried

The DB cable plant system is the preferred method for placement in less congested areas.

3.7.4 Aerial

Aerial cable plant systems are not a preferred solution but may be used as specified in the design package. Exceptions may include range cables or other long runs through undeveloped areas, in cases where underground systems cannot be installed, or in conformance to local mandates. The desired or required reliability (I.E. 5-9s of reliability) of some communications systems may preclude the use of aerial pathways. Aerial pathways and spaces may consist of poles, messenger wire, anchoring guy wires, splice closures, and terminals.

3.7.5 Pier and Bridge Telecommunications

Pier and bridge telecommunication systems shall be installed in ducts, with pull boxes placed at critical points. These critical points may be where the structure has a change of direction, where access for ship berths is required, or at a 90-degree bend. Duct expansion joints are required at each pier expansion joint; and where the conduit enters a distribution point approximately 5 feet (1.5 m) from the point of entrance. The designer shall use polyvinyl chloride (PVC) covered Galvanized Iron Pipe (GIP), or "Red Thread" Fiberglass Conduit, employing approved hardware hangers, for conduit systems on piers.

3.8 Underground (Maintenance Holes, Cable Vaults, and Ducts)

Supporting documentation for the design and construction of MHs, cable vaults, and duct systems is found in ANSI/TIA/EIA-758, *BICSI Customer Owned Outside Plant Telecommunications Cabling Standard*; Rural Utilities Service (RUS) Bulletin 1751F-643/RUS Form 515C; RUS Bulletin 1751F-644; and RUS Bulletin 1753F-151. See Table 1 for the complete names of these references.

3.8.1 MHs

Maintenance holes are used to facilitate placing and splicing of cables. Telecommunications MHs shall not be shared with electrical installations other than those needed for the telecommunications equipment.

Maintenance holes are reinforced concrete units provided with a removable lid that permits internal access via ladder or rungs to the housed components. They accommodate cables, splice closures, racking systems, and low voltage electronic equipment. Maintenance holes shall be equipped with corrosion-resistant pulling irons and cable racks that are grounded and a sump for drainage. The quality of the concrete pour and the construction of the maintenance hole shall be such that the rebar or visible rock shall not be seen in the surface of a MH wall. In other words the pour shall not have any voids.

Maintenance holes shall be installed on a leveled, crushed, washed, gravel base of sufficient depth, a minimum thickness of 6 inches (150 mm) under the entire MH, to allow for drainage and stability. Where MHs are installed in roadways, the structure and lid (cover) shall support heavy vehicular traffic. See Figure C-4 (Figure C-11 for Europe) – Typical Maintenance Hole for additional details.

3.8.1.1 Type

The preferred MH is a pre-cast reinforced concrete, splayed or non-splayed, multi-directional type with cast-in single or multiple plastic terminators to accept the conduits.

Thin concrete knockout sections may be provided for terminating multiple-bore conduits. The preferred MH interior size is 12 ft x 6 ft x 7 ft [3.7 m (length) x 1.8 m (width) x 2 m (height)]. Other sizes may be used only with U.S. Government approval. Splayed MHs shall be provided near DCOs and remote switching units (RSU), where future duct expansion is expected. Maintenance holes shall have a load rating of HS-20 for heavy vehicular traffic.

3.8.1.2 Basic Layout

Maintenance holes in main or lateral duct runs shall be placed as defined below. Measurements between MHs are from lid-to-lid (center-to-center) (C/C), unless otherwise indicated. Measurements from MHs to buildings, to pedestals, to riser poles, etc., are from the MH lid to the outside wall, bottom of pole, etc., (center-to-point). New MHs shall be placed to support the locations of junction points, offsets, load points, and curvature in the duct line.

The spacing of access points (maintenance holes or hand holes) in a maintenance hole and duct system is determined by: environment (containment area or range area); media to be installed (copper cables only, copper and fiber cables, or fiber cables only); proximity to cable origination points (DCO or nodes); and allowable pulling tension of the media. The following are some design guidelines:

- Maintenance hole and hand holes in duct systems in cantonment areas that have or will potentially have multiple cables (copper and fiber) shall not be spaced more than 600' apart.
- Maintenance hole and hand holes in duct systems in sparsely populated areas or at end of runs that will only have fiber cables or small copper cables (not to exceed 100 pair) in them can be spaced up to 1000' apart.
- Maintenance hole and hand holes in duct systems in sparsely populated areas or at end of runs that will only have fiber cables in them can be spaced up to 2000' apart.
- Maintenance hole and hand holes used as splice points in direct buried systems (typically in ranges) can be placed as required (typically at end of reel splices).

Caveats:

- Do not use a hand hole for copper cable splice points, or for more than one fiber splice case.
- Do not place maintenance holes or hand holes so far apart as to exceed the manufacturer's recommended pulling tension for the cables.
- Maintenance holes and hand holes may be placed closer together to accommodate distribution designs.
- The maintenance holes near a DCO or node need to be full size maintenance hole (6'x12'x7'H) due to existing, or potential for, multiple cables and multiple splice cases.
- Deviations from the guidelines require prior approval of the U.S. Government.

3.8.1.3 Accessories

Each new MH shall be equipped with a lid, sump, pulling-in irons, ground rod, bonding ribbon, cable racks, and hooks. Accessories shall be designed for use in a telecommunications MH. Cable hooks shall be placed IAW RUS Bulletin 1751F-643, RUS Bulletin 1753F-151, and the *AT&T Outside Plant Engineering Handbook*, August 1994, Practices 632-305-215 and 919-240-300 to support the weight of the cable and splice case.

a. Maintenance Hole Lids – A MH shall include a point of egress for maintenance personnel. The MH lid shall be circular and not less than 30 inches (765 mm) in diameter and shall not violate the H-20 load rating of the MH. Additional lids or oversized lids may be provided for MHs with special uses i.e., oversized MHs, MHs containing carrier or loading equipment, or MHs located outside a DCO. The lid shall fit in a steel ring or frame and be equipped with a concrete collar to be at grade level, as required. The frame and collar shall be attached to the MH IAW the manufacturer's instructions, but as a minimum, the lid shall form a watertight seal and shall resist lateral movement if accidentally bumped. Collar sections shall be precisely matched with each other when stacking to prevent snagging of personnel or equipment when entering or exiting the maintenance hole. There shall be no overhangs between collar sections

b. Locking Covers – The first MH outside a DCO or wire node, MHs at critical junctions, or MHs equipped with carrier equipment will have lockable cover. Additional MHs may be identified as requiring lockable covers in the Statement of Work (SOW)/Engineering Design Plan (EDP). The preferred lockable lid cover is one that utilizes a lever and clamp mechanism placed into a receiver that is installed into the cover. The mechanism will allow the cover to be replaced without indexing the cover to the frame. When locked, the mechanism will be flush with the frame surface minimizing the potential for the cover to be dislodged. The bolt used to secure the cover is available in many configurations and can only be turned with a socket provided by the manufacturer. The U.S. Government will select the bolt configuration. A disposable tamper evident plastic cap snaps into the lock body covering the recessed bolt head keeping dirt and debris out of the bolt area. An alternative means of securing the MH utilizes an inner, water resistant cover that can be locked by a General Services Administration (GSA)-approved, changeable combination lock. The U.S. Government will provide the locks.

c. Sump – A sump shall be cast into the floor of the MH. The floor shall slope toward the sump to provide drainage from all areas into the sump. The sump shall be approximately 13 in x 13 in (330 mm x 330 mm), or a 13-inch (330-mm) diameter circle, and shall be 4 inches (100-mm) deep covered with a removable perforated or punched plate to permit drainage. The cover shall be fastened to the housing by a chain, rope, or hinge.

d. Pulling-in Irons – Cable pulling-in irons shall be installed on the wall opposite each main conduit entrance location, 3-1/2 to 9 inches (90-230 mm) from the floor of the MH and in line with the conduit entrance. The pulling-in irons shall be placed and embedded during the construction of the MH wall.

e. Grounding in MHs – All new MHs installed shall include ground rods and bonding ribbon. The ground rod and bonding ribbon may only be omitted when the following conditions apply:

(1) A MH is designed and constructed with an integral ground system with all ironwork bonded together.

(2) The MH is identified as containing an integral ground system with a manufacturer's label.

(3) U.S. Government approval is obtained.

All existing MHs that require new splices, or where existing splices are opened, shall be bonded and grounded. If no bonding ribbon and ground rod exist, then they shall be installed and all other existing splice cases shall be bonded and grounded. New cables installed in MH and conduit systems shall be bonded and grounded a minimum of every 1,000 feet (305 m). In accordance with RUS 1751F-802 and NEC, Article 250, the resistance for OSP grounding shall be nominally 25 ohms (Ω).

f. Ground Rod – A Ground Rod of iron or steel that is galvanized or copper clad at least 5/8-inch (16-mm) in diameter and at least 9-feet (2.75 m) long shall be installed in the floor of each new MH. Four inches (100-mm) of the rod, plus or minus 1/2 inch (1.3 mm) shall extend above the finished floor level. The rod shall not enter the MH more than 3 inches (80 mm) or less than 2 inches (50 mm) from the vertical surface of the adjacent wall. All MH splices shall be bonded to the MH ground. In existing MHs, new ground rods and/or bonding ribbon shall be designed at each splice location if none presently exists. The ground rod shall be installed and bonded IAW the NEC, Article 250.

g. Bonding Ribbon – A bonding ribbon shall be installed in all new MHs. The bonding ribbon shall be attached to all rack anchors and be pre-cast into the MHs. The bonding ribbon shall be installed around the interior of the MH so that splice cases can be bonded to it.

h. Hardware – A minimum of five cable racks, each containing at least 47 hook spaces mounted vertically, shall be provided on each long wall. Two of the cable racks shall be installed flush to the wall and three with standoffs to create splice bays (Figure C-4 [Figure C-11 for Europe]). End wall MH racks shall be provided at the T-end of multi-directional MHs. Corner racks shall be provided at the in-line end of the MH. Offset-cable racks shall set out from the wall a minimum of 3 inches (80 mm). Each cable rack shall be equipped with hooks to support all existing or new cables. If there are no existing/new cables, each rack shall be equipped with two cable hooks (minimum length 7-1/2 inches (190 mm)). All racks and hooks shall be of galvanized metal. A device or method to lock the hooks to the rack (I.E. Step Locks) shall be provided for the hooks that will support splice cases. Figure C-4 (Figure C-11 for Europe) – Typical Maintenance Hole shows a typical rack installation.

i. Water Resistance – Reasonable efforts shall be taken to prevent water from entering a telecommunications MH. The manufacturer's instructions for installing a MH shall be followed. As a minimum, the following guidance shall apply as long as it does not violate a manufacturer's recommendations or warranty. Additional requirements may be identified in the design package.

(1) A water resistant gasket or seal shall be placed between the sections of pre-cast MHs.

(2) Water resistant gaskets or seals shall be placed between the lid frames, collars, and MH tops.

(3) The area around ducts penetrating the MH walls shall be sealed with a permanent water-resistant material.

(4) Vacant ducts shall be sealed with a mechanical, screw-type, reusable duct plug.

(5) Ducts containing cables shall be sealed with water-blocking foam or other recommended sealants designed for this purpose.

(6) Ducts containing innerduct or multi-cell fabric mesh innerduct shall be sealed with manufacturer's recommended materials or methods.

3.8.1.4 Duct Assignment and Cable Racking

Duct assignment and cable racking shall be engineered and installed IAW the *AT&T Outside Plant Engineering Handbook*, August 1994, Practices 632-305-215 and 919-240-300, and standard drawings, unless otherwise directed in the design package. Copper cables shall be racked to the MH sidewalls in such a manner so as to make the best use of the wall space available. When placing cables care shall be taken so as to avoid blocking ducts in the sidewalls or access to splice cases. Fiber optic cables will be engineered with enough slack so that a 6-m (20-foot) service loop can be installed in each pull through MH or a 15-m (50-foot) splice loop on each cable installed into a splice case. The service and splice slack shall be coiled and lightly secured in loops that do not violate the bending radius and placed in the MH in such a manner that the cables are out of the way and not wrapped around other cables.

Main conduits entering poured-in-place or precast MHs should be located in the lower portion of the end wall and centered between end walls. Conduits entering side walls should be located a minimum of 4 in. (102 mm) from end walls which are located farthest from the central office or serving node. Clearances of 12 in. (305 mm) should be maintained between main conduit formations and roofs or floors of MHs. Unless indicated on the construction drawings, wall recesses should be provided at conduit entrances. Subsidiary conduits entering MHs should be located to provide clearances of 4 in. (102 mm) from roofs and adjacent walls.

3.8.1.5 Stencil

All new MHs shall be stenciled with a number designated by the DOIM.

3.8.1.6 Depth of Cover

A minimum of 24 inches (600 mm) of top cover shall be provided above the top of the MH.

3.8.2 Hand Holes

Hand holes are reinforced concrete units provided with a lid that permits internal access to the housed components. Hand holes are typically used as pull points for small diameter cables for building access. A hand hole shall not be used in place of a MH or in a main conduit system. Hand holes shall not be used for splicing cables without prior U.S. Government approval. Telecommunications hand holes shall not be shared with electrical installations. The minimum hand hole size is 4 ft x 4 ft x 4 ft (1.2 m x 1.2 m x 1.2 m). Larger hand holes (i.e., 1.2 m x 1.8 m x 1.2 m) are acceptable. Hand holes installed where vehicle traffic may be present shall be load rated as H-20 and shall be equipped with round MH lids.

3.8.2.1 Accessories

Each new hand hole shall be equipped with a lid, pull irons, cable racks, and hooks designed for use in telecommunications systems. Cable hooks shall be placed to support the weight of the cable.

3.8.2.2 Stencil

All new hand holes shall be stenciled with a number designated by the DOIM.

3.8.3 Cable Vault

A schematic of an MDF and cable vault is provided in Figure C-8 (Figure C-15 for Europe) – MDF and Cable Vault Schematic.

3.8.3.1 Size

The cable vault shall be sized to provide for future projected growth. As a minimum, it shall extend the entire length of the MDF.

3.8.3.2 Layout

A center rack shall be provided for the splicing of the tip cables to the OSP cables. However, wall racking, if cited in the design package, is allowable for small to medium central offices. The vault shall be designed to allow ample space for splicing of the cables. For planning, a typical vault splice is 1 ft x 3 ft (300 m x 900 m).

3.8.4 Conduit/Duct

Underground conduit structures consist of pathways for the placements of telecommunications cable between points of access. Underground installation of ducts/conduits shall be achieved by trenching, boring, or plowing.

a. Examples of conduit types include:

- Encased Buried (EB)-20 – for encasement in concrete
- EB-35 – for encasement in concrete
- DB-100 – for direct burial or encasement in concrete
- DB-120 – for direct burial or encasement in concrete
- Rigid Nonmetallic Conduit Schedule 40 – for direct burial or encasement in concrete
- Rigid Nonmetallic Conduit Schedule 80 – for direct burial or encasement in concrete
- Multiple Plastic Duct (MPD) – for direct burial or installation in conduit
- Rigid Metallic Conduit – for direct burial or encasement in concrete
- Intermediate Metallic Conduit – for direct burial or encasement in concrete
- Fiberglass Duct – for direct burial or encasement in concrete
- Innerduct PE – for direct burial or installation in conduit
- Innerduct PVC – for direct burial or installation in conduit
- High Density Polyethylene (HDPE) – for directional drilling
- EB-20 and DB-60 conduit shall meet National Electrical Manufacturers' Association (NEMA) Standard TC-6

- EB-35 and DB-120 conduit shall meet NEMA Standard TC-8
- Schedule 40 and Schedule 80 rigid nonmetallic conduit shall meet NEMA Standard TC-2

b. Nonmetallic conduits shall be encased in concrete of minimum 3,000 lb/in² (20,700 kPa) compressive strength where vehicular traffic (i.e., automotive, railway) is above the pathway, or where a bend or sweep is placed.

c. Spacers will be used to properly support ducts that are to be concrete encased and shall be installed IAW the manufacturer's specifications. If the manufacturer's specifications are unknown, a spacer shall be installed a minimum of one spacer every 10 feet (3 m). Ducts supplied in 20-foot (6.1-m) lengths require spacers every 5 feet (1.5 m). The duct shall not be damaged, cracked, or crushed prior to or during installation. Conduit systems not encased in concrete shall be installed in layers with backfill installed around and between the ducts. Spacers may be used where conduits are not encased in concrete to provide integrity of orientation. Construction vehicles shall not be driven over DB conduits.

d. Ensure the integrity of the orientation of the duct bank between MHs. Do not allow the ducts to twist or tangle between MHs.

e. Ducts that are classified as stub-outs shall be plugged inside the maintenance hole or building and tagged, identifying them as stub-outs and capped on the far end to prevent soil and water from entering the duct. A locator ball may be placed at the stub out location to facilitate future locating of the stub out.

f. The duct system shall be concrete-encased in all main cantonment areas unless otherwise specified in the EDP/PWS. At a minimum, the duct system shall be encased where any bend/sweep exceeds 10°, in any direction, in any stream/drainage area subject to washing out, and in major construction zones. Ducts placed under paved road surfaces and certain heavy traffic non-surfaced roads shall be protected by one of the following methods: Concrete-encased duct, galvanized RSC, steel pipe casings, or directional boring of HDPE ducts (when done IAW paragraph 3.6.9).

3.8.4.1 Ducts Installed in Trenches

The type of duct for new installation shall be PVC, Schedule EB, DB, or Schedule 40. Schedule EB duct shall be used only if the duct is encased in concrete. Schedule DB or Schedule 40 duct shall be used for applications where the duct is DB or encased in concrete.

3.8.4.2 Joints and Connectors

Ducts shall be joined in such a manner as to be soil tight. Joints shall form a sufficiently smooth interior surface between joining sections so that cables shall not be damaged when pulled past the joint. Joints between dissimilar types of ducts (PVC, HDPE, galvanized steel pipe (GSP), EB, DB, etc.) shall use the appropriate connectors designed for the purpose of providing a seal between the ducts and preventing damage to cables pulled through these joints. All joint surfaces shall be prepared IAW manufactures instructions and at a minimum the mating surfaces shall be wiped clean before joining.

3.8.4.3 Bends and Sweeps

Accomplish changes in direction of runs exceeding a total of 10 degrees, either vertically or horizontally, by long sweeping bends having a minimum radius of 25 feet (7.62 m). Long sweeps may be made up of one or more curved or straight sections and/or combinations

thereof. Bends made manually shall not reduce the internal diameter of the conduit. There shall be no more than the equivalent of two 90-degree bends (180 degrees total) between pull points, including offsets and kicks with a curvature radius of less than 100 feet (30 m). Back-to-back 90-degree bends shall be avoided. The following definitions are explained:

- a. Ninety-Degree Bend – Any radius bend in a piece of pipe that changes direction of the pipe 90 degrees.
- b. Kick – A bend in a piece of pipe, usually less than 45 degrees, made to change the direction of the pipe.
- c. Offset – Two bends usually having the same degree of bend, made to avoid an obstruction blocking the run of the pipe.
- d. Ninety-Degree Sweep – A bend that exceeds the manufacturer’s standard size 90-degree bend (e.g., 24 inches (600 mm) is standard for 4-inch (100-mm) conduit).
- e. Back-to-Back 90-Degree Bend – Any two 90-degree bends placed closer together than 10 feet (3 m) in a conduit run.

Where the radius is less than 40-feet (12 m), 15-foot (4.6 m) radius-manufactured bends shall be used. If possible, the entire change in direction shall be made with a single arc of 15-foot (4.6 m) radius. Manufactured bends may be used on subsidiary/lateral conduits at the riser pole or building entrance. Manufactured bends shall have a minimum radius of 10 times the internal diameter of the conduit IAW NEC Chapter 9 and ANSI/TIA/EIA-758.

Bends and sweeps shall be concrete-encased to protect the duct from the pressures developed while pulling cables. Where a duct enters a building and sweeps up through a floor slab, galvanized RSC shall be used. For ducts transitioning from the lower duct window of a MH to the nominal trench depth, the transition shall be accomplished in no less than 30 linear feet (9.1 m) from the MH in order to reduce the radius of the bends. The duct shall be concrete-encased in the transition area.

3.8.4.4 Section Lengths

The section length of conduit shall not exceed 600 feet (183 m) between pulling points in main conduit runs without U.S. Government approval. The section length of subsidiary duct is limited mainly by the size of the cable to be pulled into it and the number of bends it shall contain. Table 3 lists the maximum section lengths.

Table 3. Maximum Length of Subsidiary Conduit Containing Bends

Cable Diameter Mm (in)	Limited Lengths of Duct*		
	One 90 Degree Bend (m) (ft)	Two 90 Degree Bends (m) (ft)	Three 90 Degree Bends (m) (ft)
25.4 (1.0)	182 (600)	107 (350)	76.2 (250)
30.5 (1.2)	152 (500)	91.4 (300)	
35.6 (1.4)	122 (400)	83.8 (275)	
40.6 (1.6)	107 (350)	76.2 (250)	
45.7 (1.8)	91.4 (300)	61 (200)	
56 (2.2)	76.2 (250)	45.7 (150)	
66 (2.6) or greater	61 (200)	45.7 (150)	

*Bends may be vertical or horizontal. Reverse curves and the use of three 90-degree bends shall be avoided.

3.8.4.5 Minimum Duct Bank Sizing

The minimum sizing for new duct banks is listed below. The total number of conduits required shall be determined, including existing conduits, conduits installed by this effort, and known future requirements, along with 50 percent of this total for spares.

a. Ducts between the cable vault and the first MH shall be based upon the size of the switch, the number of outside cable pairs served from the switch location, the FO requirements, and future growth.

b. A main duct run includes the MHs and ducts from a DCO or node and provides the pathways for large feeder cables and/or core FOCs. New main duct runs shall consist of a minimum of 6-way, 4-inch duct banks. In Europe, at least 125-mm ducts shall be used. One of the ducts shall be equipped with four integrated 30-mm (1.19-inch) (minimum) sub-ducts or four 51-mm (2-inch) conduits connected into an assembly.

c. A lateral duct run is defined as a minor branch run from the main duct run between MHs. New lateral duct runs shall be a minimum of four-way, 4-inch duct banks. In Europe, at least 125-mm ducts shall be used. One of the ducts shall be equipped with four integrated 30-mm (1.19-inch) (minimum) sub-ducts or four 51-mm (2-inch) conduits connected into an assembly.

d. Entrance ducts are defined as ducts from a MH or hand hole to an EUB. New EUB entrance ducts shall be a minimum of two-way, 4-inch duct banks. In Europe, at least 125-mm ducts shall be used. One of the ducts shall be equipped with four integrated 30-mm (1.19-inch) (minimum) sub-ducts or four 51-mm (2-inch) conduits connected into an assembly.

e. Entrance conduits in minor buildings, as listed in the design package, shall be a minimum of one-way, 4 inch (100-mm) ducts if the entrance cables are less than 1-inch (25-mm) diameter and if less than 40 percent of the duct area shall be used.

f. The lengths of ducts entering buildings or terminating at riser poles shall not be placed longer than the values specified in Table 2 without prior U.S. Government approval.

g. In accordance with the NEC, cables entering a building from the outside and not rated for inside plant use may not extend beyond 50 feet (15 m) from the cable’s point of entry into the building. The point of entry is defined as the place where the cable penetrates the exterior wall or floor. The point of entry may be extended beyond the 50-feet (15-m) limitation by using either rigid metal conduit (RMC) or IMC, both of which shall be grounded. The EMT is not an acceptable media for extending the point of entry into a building for cables that have metal in them (transmission media, shields, or strength members). The point of entry for non-metallic cables may be extended using EMT or PVC.. Reference the NEC, Sections 770.50 and 800.50.

Table 4. Extending the Point of Entrance

Cable Types		Extend Point of Entrance with:			
Non-Conductive	Indoor Listed	PVC	EMT	IMC	RMC
No	No	No	No	Yes	Yes
No	Yes	No	No	Yes	Yes
Yes	Yes	N/A	N/A	N/A	N/A
Yes	No	Yes	Yes	Yes	Yes

--	--	--	--	--	--

3.8.4.6 Duct Installation Guidelines

a. Depth of Cover – At least 24 inches (600 mm) of cover is required above the top of the duct bank. At least 18 inches (457 mm) of cover is required under roads or sidewalks (if duct is concrete-encased). For ducts installed in solid rock, the cover shall consist of at least 150 mm (6 inches) of concrete. If rock is encountered below grade, the minimum cover above the concrete-encased duct shall be 12 inches (300 mm). See Figure C-3 (Figure C-10 for Europe) – Conduit Placement/Cut and Resurface for details. The cover or fill shall be compacted IAW UFGS-02300, Earthwork.

b. Trench Width – The installer shall engineer the trench width to the minimum width required to support the size of the duct bank being installed. For installing ducts, the trench width depends on the number of ducts, size of ducts, arrangement of ducts, and space around ducts (at least 2 inches [50 mm]). Additional width may be required to work in deep trenches or with large count duct banks. Shoring of walls or sloping shall be performed as required by the OSHA and/or local requirements. The trench width for DB conduit shall be wide enough to permit tamping of dirt on the sides of the conduit formation. See Figure C-3 (Figure C-10 for Europe) – Conduit Placement/Cut and Resurface for details.

c. Concrete Encasement – The duct system shall be concrete-encased in all main cantonment areas. At a minimum, the duct system shall be encased under all traffic areas, where any bend/sweep exceeds 10 degrees, in any direction, and in any stream/drainage area subject to washing out and in major construction zones. Concrete encasement of the ducts for a “core path” shall be required when there are no alternate paths. Concrete-encased duct, galvanized RSC, or pipe casings or HDPE duct placed by Horizontal Directional Drilling (HDD) shall also be placed under all paved road surfaces and certain heavy traffic non-surfaced roads as documented in the design package. Concrete forms shall be utilized when encasing ducts into a maintenance hole to limit blockage of empty duct knock-outs or windows in the maintenance hole. The encasement/pipe shall be extended a minimum of 6-feet (1.8-m) beyond the roadbed for all road crossings. The installer shall use only one brand of Portland cement that conforms to American Society for Testing and Materials (ASTM) C 150. The concrete shall be a wet type mix and placed in such a manner as to ensure the concrete completely surrounds all ducts and that no air or voids are trapped in the mix. (A dry bag of ready mix type cement that has not been mixed with water and just dumped in the trench is not acceptable.) The installer shall obtain the signature of the on-site U.S. Government QC/QA representative, signifying the acceptability of the duct placement and spacing, prior to pouring any concrete over the duct. Concrete used to encase conduits shall be a minimum 20,700-kPa (3,000-PSI) compressive strength.

d. Duct Placement – New ducts shall be swept down and installed in the lowest available duct positions within the lowest available duct window in the MH. Additional ducts required in the future shall be placed on top of the existing ducts. Ducts placed under this project shall not prevent placement of future ducts in the upper duct positions. Conduits shall terminate in bell ends or duct terminators at the point of entrance into the MHs and buildings. Main conduits entering poured-in-place or precast MHs should be located in the lower portion of the end wall and centered between end walls. Conduits entering side walls should be located a minimum of 4 in. (102 mm) from end walls which are located farthest

from the central office or serving node. Clearances of 12 in. (305 mm) should be maintained between main conduit formations and roofs or floors of MHs. Unless indicated on the construction drawings, wall recesses should be provided at conduit entrances. Subsidiary conduits entering MHs should be located to provide clearances of 4 in. (102 mm) from roofs and adjacent walls.

e. Rerouting of Existing Ducts – Existing ducts shall be joined to new MHs (pre-cast or cast-in-place) by rerouting the designated ducts from the demolished or abandoned MH to the new MH. Rerouting shall begin far enough back from the old MH, at least 30 feet, to allow for standard bending radius and pulling tension. Continuity of operations on the affected cables shall be maintained during the duct rerouting actions.

f. Reinforcement of Existing Ducts – New ducts installed to reinforce an existing duct bank shall be placed above the existing duct bank, if the minimum top cover of 600 mm (24 inches) can be maintained. If sufficient top cover is not available, the new duct shall be placed beside the existing duct bank.

g. Pull String/Rope/Tape – Once ducts are mandrelled to verify their integrity, a pull string, pull rope, or pull tape rated at not less than 200-lb (890-newton (N)) tensile strength shall be installed in each new conduit and innerduct/sub-duct. A minimum of 5 feet (1.5 m) shall be provided at each end of the conduit. The string/rope/tape shall be coiled and secured at each end in such a manner as to prevent it from being accidentally pulled back into the duct.

h. Plugs – All ducts, sub-ducts, and, innerducts, whether main or subsidiary runs, shall be plugged using universal duct plugs in MHs, hand holes, and building entrances. Foam sealant is not acceptable in a building. Outdoor rated ducts (sub-ducts, etc) entering a building will be fire stopped IAW the NEC, local codes, and the manufacturer's instructions.

i. Duct Seals – The area between the entrance conduits and the penetrated floors and/or walls of a building or MH shall be sealed to be waterproof or fire-stopped as appropriate. Use of hydraulic cement between the duct and wall is acceptable for waterproofing the duct entry point.

j. Toneable duct – One duct in a new duct bank, containing only FOC, shall contain an imbedded toneable metallic wire, or contain an installed toneable metallic wire for duct locates.

k. Duct Tie Down – Duct systems to be concrete encased shall be tied down to minimize, if not totally eliminate, the duct system from movement during the placement of concrete. All sections of conduit systems to be concrete encased shall be tied down using an industry recognized method such as metal rods (for stakes) and metal strapping (for securing the duct system). The metal strapping shall be wrapped completely around the conduit structure and then securely attached to the metal rods. The metal rods shall be a minimum of ¼-inch thick. Rods will be driven into the ground a minimum of 12 inches depending on soil density. For example, clay would require the minimum depth; whereas, sandy soil shall be at an increased depth. The ducts shall be tied down every 10 ft or closer.

3.8.5 Galvanized RSC and Steel Casings

For road crossings not using the cut and restore method, RSC or steel pipe casings, or HDPE duct placed by HDD shall be used as specified in the design package. The RSC and steel

casings, or HDPE shall be placed under the highway in a manner that does not damage the conduit or casing.

3.8.5.1 Size and Fill

The installer shall use a steel casing, a minimum of 12-inch (300-mm) diameter with a minimum wall thickness of 3/16-inches (5-mm), for pushing under commercial railroad crossings and for multi-duct conduit runs under non-commercial railroad beds. The steel casing shall have an inner diameter, a minimum of 4-inches (100-mm) wider than the outer diameter of the conduit formation (with spacers) that is to be placed within the casing. Spacers will be used to support ducts installed within the casing. A single 4-inch (100-mm) diameter RSC can be installed under non-commercial railroad beds in single conduit applications. After the duct installation, the casing shall be filled with fine sand (blown in with air pressure) or slurry and sealed on both ends with at least a 3-inch (75-mm) thick concrete wall. Installation of the fill will be done in such a manner so as to not damage or deform the ducts. See Figure C-3 (Figure C-10 for Europe) – Conduit Placement/Cut and Restore for details on railroad crossings.

3.8.5.2 Materials

Galvanized RSC used as telecommunications conduit shall be made from soft, weldable quality steel that is suitable for bending. The hot-dipped zinc coating (galvanization) placed on the interior of the conduit shall be smooth and free from blisters, projections, and other defects. The weight of the zinc coating on the interior and exterior surfaces shall not be less than 2 ounces per square foot (ft²) (61 grams per 1,000 square centimeters [cm²]) of total coated surface. Steel pipe casings shall comply with ASTM A-139 Grade B or ASTM A-252. Pipe ramming shall be done IAW the USAISEC Technology Integration Center (TIC) Technical Report (TR) No. 2001.04.

3.8.6 Split Duct.

Pre-manufactured split ducts are designed to be placed around existing cable, such as when repairing conduit, capturing existing conduit, or for use on a long DB cable run where the cable is placed in the open duct while the duct and trench are still open. Pre-manufactured split duct shall be used for crossing roads in DB cable runs only after one-fifth of the cable reel length for cables greater than 1 inch (25 mm) in diameter, and one-third of the cable reel length for cables less than 1 inch (25 mm) in diameter, is used in each unspliced span. The pre-manufactured split duct under road crossings shall be concrete-encased. Duct glue shall be used when joining the split duct to augment the clamps and prevent concrete from seeping through the joints. Normal conduit shall be used in all other areas.

3.8.7 Rod/Mandrel/Slug/Clean Ducts or Conduits

3.8.7.1 Rod Duct

Rodding a duct entails inserting or pushing a rod into the duct to:

- Determine the length of the duct
- Locate the other end of the duct
- Determine if the duct is usable or blocked
- Insert a pull string in the duct

3.8.7.2 Mandrelling

Mandrelling a duct consists of pulling a test mandrel or slug through the duct to ensure that the duct diameter is intact and ready for the installation of cables. Mandrelling can also be used to clean any mud, sand, or dirt out of the duct. The mandrel's diameter, 1/2-inch (13-mm) less than the duct's inside diameter, depends on the type and size of the ducts. New ducts in main and subsidiary duct runs shall be mandrelled with a test mandrel (non-flexible) or slug that is approximately 12 inches (300 mm) in length and 1/2 inch (13 mm) less than the duct inside diameter. The test mandrel shall be used to verify the integrity of the duct joints, to test for out-of-round duct, and to verify that sweeps are not so severe as to preclude the placement of large diameter cables. The 12-inch (300-mm) test mandrel shall not pass through ducts with 90-degree sweeps. A 6-inch (150-mm) length test mandrel may be used to test duct runs to buildings or riser poles. Flexible mandrels, wire brushes, rubber duct swabs, leather washer duct cleaners, etc., may be used to clean the ducts.

Sample Mandrel sizes.

- DB120 = 3.75 in mandrel based on a 4.24 in ID
- DB 60 = 3.75 in mandrel based on a 4.19 in ID
- SCH40 = 3.50 in mandrel based on a 3.99 in ID

3.8.7.3 Existing Ducts

Existing vacant ducts that are to be used in new cable installations, as defined in the design package, shall be cleaned and tested with a test mandrel to detect any obstructions, collapsed ducts, or duct inconsistencies. The installer shall repair damaged ducts if approved by the U.S. Government. The duct shall not be mandrelled if existing cables are in the duct.

3.8.8 Sub-duct/Innerduct/Multi-duct/ Fabric Mesh Innerduct

Innerduct, sub-duct, multi-duct, or fabric mesh innerduct is typically a nonmetallic pathway and may be placed within or in place of a duct to subdivide the space and facilitate initial and subsequent placement of multiple cables in a single duct space. All subdivided spaces shall have a pull rope or pull tape installed. The PVC sub-ducts that do not have cables installed shall be plugged with a duct plug. A minimum of one out of every four new ducts shall be subdivided with innerduct, sub-duct, multi-duct, or fabric-mesh innerduct.

3.8.9 Sub-duct

Sub-duct shall provide the equivalent of four each 1-1/4-inch (32-mm) diameter (minimum) conduits in the space that is normally occupied by a 4-inch (100-mm) conduit. The sub-ducts shall be held in relation to each other with spacers.

3.8.9.1 Multi-duct

Multi-ducts are pre-manufactured duct systems that are equipped with four fully integrated 1.19-inch (30-mm) (minimum) sub-ducts.

3.8.9.2 Innerduct

Innerducts are smaller diameter ducts, typically 1-inch (25-mm) diameter (minimum), that are placed inside existing ducts. The innerduct shall consist of a minimum of three each, 1-inch (25-mm) PE ducts installed inside a single, 4-inch (100-mm) duct. Innerducts shall be

used in existing conduit systems, in RSCs, or in split RSCs. Rigid-type innerducts with pull strings shall be provided.

3.8.9.3 Fabric-Mesh Innerduct

Fabric-mesh innerducts are made of a stiff, fabric mesh cloth folded and sewn in such a way as to create individual cells through which a cable may be installed without tangling with cables in other cells. Fabric mesh-type innerducts may be used as approved by the U.S. Government and shall be limited to a maximum of six cells per tape, unless otherwise approved by the U.S. Government. The designer may specify up to three, three cell, tapes per conduit. Multi-cell fabric mesh shall have an uninterrupted, shared, sewn spine to prevent twisting. The multi-cell fabric mesh shall be cut off in each hole with at least 2 ft of slack in the material left and at least 5 ft of pull string that will be attached to a permanent part of the maintenance hole structure, such as tied to the pulling irons. Conduit formations shall not be undersized based on the increased modularity of the fabric-mesh innerduct. Fiber optic cables shall not be “home run” from buildings to serving nodes because of the increased modularity of fabric type innerducts. Fabric-mesh innerducts is available with tracer wire which would eliminate the need to install locator wire in conduit banks that are either empty or only contain dielectric cables.

3.8.9.4 Conduit Rehabilitation

The designer may consider rehabilitation of existing conduits as an alternative to installation of new concrete encased conduit where the cost, location, or magnitude of the construction effort is prohibitive. The conduit rehabilitation shall be one IAW standard practices of ASTM 1216, using ASTM compliant products and processes. The rehabilitated conduit shall have an inner diameter sufficient to support the intended cable installation and minimal growth. The designer shall note that the inner diameter of existing conduits will be reduced by the application of resin-impregnated tubes for rehabilitation.

3.8.9.5 Rehabilitation Survey Requirements

Conduits intended as candidates shall be inspected to ensure that rehabilitation is feasible. The ASTM 1216 states that conduits shall be cleaned and inspected prior to the installation of the resin-impregnated tube. Therefore, the survey shall verify that cleaning is sufficient to prepare the conduit for rehabilitation. The survey shall include inspection from manhole or building entrance end points, either visually or by a conduit video system of both ends of the conduit. A record of the video inspection shall be maintained after the survey. Collapsed or crushed duct shall not be used for rehabilitation.

3.8.9.6 Rehabilitation QA Inspection and Acceptance

Restored conduits shall have a friction coefficient that meets ASTM 1216. The conduit shall be inspected by a conduit video system to verify it was restored to a usable system that meets the minimum requirements outlined in the underground conduits section of this guide, with the exception of inside diameter.

3.8.10 Directional Boring/Horizontal Directional Drilling (HDD)

The HDD is a trenchless method for installing ducts for underground cable. Ducts are installed by drilling or boring a path through the soil and placing the ducts within this path. The vertical profile of the bore alignment is typically in the shape of an inverted arc.

3.8.10.1 Restrictions

Ducts installed using the HDD method under roads shall be deep enough to clear existing utilities and meet H-20 load ratings. The ducts placed by HDD shall not directly enter a MH but shall be attached to conduit stub-outs that extend a minimum of 10 feet (3 m) from the MH. The HDD may be done in areas approved by the U.S. Government or as stated in the design package. The maximum radius curvature of a bore is limited to the maximum conduit diameter times 100 feet per inch (30.5 m per 25 mm).

3.8.10.2 Methodology

The HDD is a multi-stage process consisting of drilling a pilot bore along a predetermined path and then pulling the desired product back through the drilled space. Utilize back reaming when it is necessary to enlarge the pilot bore hole. In order to minimize friction and provide a soil-stabilizing agent, a drilling fluid is introduced into the annular space created during the boring operation. The rotation of the bit in the soil wetted by the drilling fluid creates slurry. This slurry acts to stabilize the surrounding soil and prevents collapse of the borehole and loss of lubrication.

3.8.10.3 Pits

In order to confine any free flowing slurry at the ground surface during pull back or drilling, sump areas shall be created to contain any escaping slurry that might damage or be hazardous in surrounding areas. All residual slurry shall be removed from the surface and the site restored to preconstruction conditions. Excavation for entry, recovery pits, slurry sump pits, or any other excavation shall be carried out as specified in UFGS-02300 Earthwork. Sump areas are required to contain drilling fluids.

3.8.10.4 Drilling Fluids

A mixture of bentonite clay or other approved slurry and potable water shall be used as the cutting and soil stabilization fluid. The viscosity shall vary to best fit the soil conditions encountered. Water used shall be clean and fresh, with a minimum of a 6-Phosphate (pH) level. No other chemicals or polymer surfactant (surface-active substance) are to be used in the drilling fluid without the written consent of the U.S. Government and after a determination is made that the chemicals to be added are environmentally safe and not harmful or corrosive to the facility. When drilling in suspected contaminated ground, the drilling fluid shall be tested for contamination and disposed of appropriately. Any excess material shall be removed upon the completion of the bore.

3.8.10.5 Tracking

The installer shall provide a method of locating and tracking the drill head during the pilot bore and shall ensure the proposed installation is installed as intended. All facilities shall be installed in such a way that their location can be readily determined by electronic designation after installation. For non-conductive installations, this shall be accomplished by attaching a continuous conductive material externally, internally, or integrally with the product. A copper wire line or a coated conductive tape may be used for this conductive material.

3.8.10.6 Duct Installed by Directional Boring

Materials shall meet or exceed the following standards:

<u>Material Type</u>	<u>Standard</u>
----------------------	-----------------

PE	ASTM D 2447
HDPE	ASTM D 2447
	ASTM D 3350
	ASTM D 2239

A PVC conduit with mechanical connectors made for the purpose of directional drilling may be used with U.S. Government approval.

3.8.10.7 Joints

An HDD conduit shall be placed with soil tight joints. Joints between dissimilar types of ducts (PVC, HDPE, GSP, EB, DB, etc.) shall use the appropriate connectors to provide a seal between the ducts and to prevent damage to cables pulled through these joints.

3.8.10.8 Restoration

The site shall be restored after installation of the conduit is complete. The work site shall be cleaned of all excess slurry remaining on the ground. The installer performing the boring is responsible for removal and final disposition of excess slurry or spoils as the conduit is introduced. Excavated areas shall be restored IAW UFGS-02300, Earthwork. The cost of restoring damage caused by heaving, settlement, escaping drilling fluid (fracout), or the directional drilling operation to roads, parking lots, pavements, curbs, sidewalks, driveways, lawns, storm drains, landscapes, and other facilities shall be borne by the installer. Fracout is the case of environmental damage, when the bentonite clay used, instead of reaching its intended destination, seeps into the waterways or into the ground, ruining the habitat.

3.9 Direct Buried Cable Installation

The DB cable shall be engineered and installed IAW RUS Bulletins 1751F-640, 641, and 642.

3.9.1 Cable Type

Rodent-protected cable shall be used for all buried applications, unless otherwise specified in the design package.

3.9.2 Warning Tape

See paragraph 3.6.10 for the details on warning tape.

3.9.3 Warning Signs

Buried cable warning signs or route markers shall be provided no less than every 250 feet (76 m) or at each change in route direction, on both sides of street crossings, on pipelines, and on buried power cables. Color-coded warning signs or markers shall be orange in color.

3.9.4 Plowing

Plowing shall be used in range environments or other areas where there are no significant obstacles and where cable runs typically exceed 1,000 feet (305 m) between splices. The design package shall identify areas in which plowing is deemed feasible.

3.9.5 Trenching

3.9.5.1 Backhoe Trenching

Trenching with a backhoe shall be done only for short distances (i.e., MH to building). The installer shall hand dig at all existing MH locations, building entrance points, utility crossings, through tree roots, under curbs, etc.

3.9.5.2 Trencher Trenching

A maximum trench width of 12 inches (300 mm) shall be used in DB applications done by a trencher. The installer shall hand dig at all existing MH locations, building entrance points, utility crossings, through tree roots, under curbs, etc.

3.9.6 Depth of Placement

3.9.6.1 Copper Cable

The depth of placement for a DB copper cable shall provide a minimum top cover of 24 inches (600 mm) in soil, 36 inches (900 mm) at ditch crossings, and 6 inches (150 mm) in solid rock (RUS Bulletin 345-150/RUS Form 515A).

3.9.6.2 FOC

Direct buried FOC shall be placed at a depth providing a minimum top cover of 42 inches (1070 mm). In solid rock, the minimum top cover shall be 6 inches (150 mm).

3.9.6.3 Frost Considerations

In areas where frost heaving can be expected, the cable or wire shall be buried below the frost line. Movement of OSP housings due to frost heaving can cause damage to the insulated copper conductors, optical fibers, or loss of shield and/or armor continuity. In areas where movement of OSP housings by frost heaving is encountered, the OSP housings shall be installed on stub poles. The stub poles shall be set below the frost line and IAW the requirements of RUS Form 515.

3.9.6.4 Other Considerations

The DOIM/DPW may have special depth requirements for certain areas (i.e., tank tracks, ranges, etc.), which shall be provided in the design package.

3.9.7 DB Cable Splicing

Buried splices shall be engineered and installed as identified in the design package. For example, a buried splice may be used for the following conditions with U.S. Government approval:

- Electrical or explosion hazard (i.e., ammunition areas)
- Vehicular hazard (i.e., motor pool areas)
- Security hazard (i.e., within a high security compound)

Only splice cases specifically designed for a buried application shall be used. All buried splices shall be encapsulated. All other splices in a DB run shall be placed in pedestals or MHs. Encapsulation is not required in a pedestal.

3.10 Crossing Obstructions

3.10.1 Pavement Crossing

Cut and resurface is the preferred method to be used when crossing any paved area. Push/bore and/or horizontal directional drilling shall be used for special circumstances only as specified in the design package. The preferred method of cut and resurface is the “T” cut. That is, the outer edge of the cut of the road surface is to extend six inches beyond the edge of the trench on both sides. See Figure C-3 (Figure C-10 for Europe) – Conduit Placement/Cut and Resurface for placement details.

3.10.2 Range Road Crossing

For road crossings on ranges, concrete encasement shall be extended a minimum of 6 feet beyond the edges of the roadbed.

3.10.3 Railroad Crossing

Push and bore with steel casings is the preferred method for railroad crossings. When multiple conduit formations are placed, a minimum of a 12-inch (300-mm) diameter steel casing, with a minimum wall thickness of 3/16-inch (5-mm), shall be used. The casing shall extend no less than 12 feet (3.7 m) beyond the centerline of the track or the outermost track if multiple tracks are crossed. In accordance with the NESC, the casing shall be located no less than 50 in (1,270 mm) below the top of the rails. The casing shall be no less than 36 in (900 mm) below the bottom of any crossed drainage ditch.

Directional boring shall not be used to place conduits below commercial railroad beds. Directional boring is not the preferred method to place conduits below U.S. Government railroad beds. When required by the U.S. Government, as stated in the design package, directionally bored HDPE shall be placed a minimum of 15 feet (4.6 m) below the roadbed in typical soil. The conduits shall be placed at a depth so that standard E-80 live and impact loads 80,000-lb/ft (119,500-kg/m), axle loads spaced on 5-feet (1.5-m) centers) shall not produce more than five percent deflection in the proposed HDPE conduits.

3.10.4 Rocky Soil Crossing

Pushes shall not be engineered for sites with rocky soil conditions. Boring shall not be engineered for sites with rocky soil conditions without U.S. Government approval. Cut and resurface methods shall be used to the maximum extent possible.

3.11 Aerial Cable

Supporting documentation for aerial placement is available in RUS Bulletins 1751F-630 and 1751F-635. Aerial cable runs shall be used only with U.S. Government approval in extenuating circumstances or for long runs outside of the cantonment area, as specified in the design package.

3.11.1 Messenger Strand

The smallest messenger strand used for all new installations shall be 6.6 m. A 2.2-m strand shall be used only as an extension of existing 2.2-m strands. Fiber optic cable shall be installed on its own messenger. Copper and fiber cables shall not be lashed on the same messenger without U.S. Government approval. Figure 8 cable may be used; however, no additional cable shall be lashed to it.

3.11.2 Guys and Anchors

Place new guys and/or anchors for each new messenger strand at each applicable location (cable turns, wind loading, cable ends, etc.). The down guy shall be sized to the next larger strand.

3.11.3 Aerial Splices and Terminals

3.11.3.1 Fiber

Aerial fiber splices shall not be used without U.S. Government approval. Fiber optic splices shall be placed in a pedestal at the bottom of the pole. The cable alone shall not support the aerial splice case. Fiber splice locations shall include enough cable slack so that the splice case can be moved into a splice trailer or tent for maintenance or service. The cable slack shall be coiled and secured in a maintenance hole so as to not entangle with other cables of be subject to damage while entering the maintenance hole. The cable slack for aerial applications shall be secured to the existing messenger. The cable slack in direct buried applications shall be buried next the pedestal.

3.11.3.2 Copper

Support all terminals and splices by direct attachment to a fixed object (pole, building, pedestal, etc.). The cable shall not support devices. Pole-mounted and fixed-count terminals shall be used. Terminals shall be placed so that no single drop exceeds 152 m (500 feet) in length.

3.11.4 Water Protection

Weatherproof all outdoor connections by using weather boots or other approved methods. Form a rain-drip loop at all cable entrances into buildings at the point of ingress. Waterproof all building entrance points.

3.11.5 Horizontal Clearances for Poles/Aerial Cable

The following horizontal clearances, as specified in the *AT&T Outside Plant Engineering Handbook*, Practice 918-117-090, shall be adhered to, unless otherwise directed by the design package:

- Fire hydrants, signal pedestals – 4 feet (1.2 m)
- Curbs – 6 inches (150 mm)
- Railroad tracks – 15 feet (4.6 m)
- Power cables less than 750 volts (v) – 5 feet (1.5 m) or more

3.11.6 Vertical Clearances for Aerial Cable

The following vertical clearances, as specified in the *AT&T Outside Plant Engineering Handbook*, Practices 627-070-015 through 017, and Practice 918-117-090, shall be adhered to, unless otherwise directed by the design package:

- Streets or roads – 18 feet (5.5 m)
- Driveways to residences and garages – 10 feet (3 m)
- Alleyways – 5.2 m (17 feet)
- Pedestrian walkways – 8 feet (2.4 m)
- Railroad tracks (measured from top of rail) – 27 feet (8.2 m)

3.11.7 Cable Placement on Bridges and Over Waterways

The designer shall specify attachments to bridges so they will not interfere with painting of the bridge structures. The designer shall also follow these recommendations:

a. The designer shall ensure that the lowest cable point is far enough above the high water mark to avoid being entangled in flotsam when making attachments over waterways which are subject to flooding.

b. The designer shall, use a messenger strand, when placing aerial cable on bridges, and lash the cable to it to prevent abrasion to the cable sheath. The use of cable rings is not recommended due to abrasion concerns.

c. The designer shall specify that the bell end of the conduit is installed in the direction from which the cable is pulled to prevent pull line or cable snags on a non belled end, when placing conduit for cable installation on a bridge,.

d. The designer shall specify expansion joints at locations where the bridge expansion joints exist to prevent cable stretching and to facilitate all bridge members (the cable now being one) flexing at the points designated. Provision for expansion shall be made if the bridge has such provision.

e. The designer shall specify inner duct in the conduit for installation of small cable, allowing for future expansion. Inner duct either corrugated or fabric mesh does not of itself require expansion joints; however, particular attention shall be paid in letting the inner duct "relax" or contract back to its original size and length after the pull is complete.

3.12 Free Space Optics

The FSO can provide an alternative to FO connectivity, for the "last mile," to EUBs and small enclaves. Typical FSO implementations arise from one of the following factors that prohibit traditional infrastructure— rapid deployment, right of way permit issues, water, railroads, and rough terrain. The FSO is a line-of-sight (LOS), point-to-point, wireless optic technology that uses the transmission of modulated infrared beams through the atmosphere to obtain broadband communications. The FSO operates in the unlicensed near-infrared spectrum 750 nanometer (nm) to 1550 nm wavelength range. The FSO systems can function over distances of several kilometers (km), as long as there is a clear LOS between the source and the destination.

Design Note: For systems operating at 1.25 gigabits per second (Gbps) the link distance shall be kept around 1000 meters. If the FSO system is to operate in an environment of low visibility (fog) a back up system (e.g., MMW, SHDSL, 802.11a) shall be used.

There are a number of manufacturers producing FSO equipment. The designer shall utilize an FSO device that was tested, approved, and recommended by the USAISEC TIC. The FSO equipment shall be designed to prevent data loss due to temporary blockages, such as birds, smoke, dust, rain, and light fog. The FSO devices shall be FDA and IEC 60825-1 Class 1M approved to ensure safety. Operational test reports on individual equipment are available from USAISEC TIC, such as TR No. AMSEL-IE-TI 04-009 November 2003 *Free Space Optics (FSO) Comparison Report* and TR No. AMSEL-IE-TI, 05-066, June 2005 *Grafenwoehr Free Space Optics (FSO) Demonstration Report*.

3.12.1 FSO Technical Requirements

The FSO will meet or exceed the following requirements:

- a. Comply to or exceed industry standard emissions and eye safe considerations (e.g., certified eye safe as per IEC 60825 Class 1 or Class 1M)
- b. Support Simple Network Management Protocol management
- c. Support remote configuration and management
- d. Remote diagnostics capabilities
- e. Environmental controls (heater, defrosters, etc.)
- f. Automated acquisition of link capabilities
- g. Management channel
- h. Support for GbE
- i. The equipment shall be constructed so as to have sufficient protection against dust, sand, or birds. Hardened housing shall be used to provide robust, waterproof environment.
- j. The system shall maintain its guaranteed performance when operates continuously or intermittently under any combination of the following conditions without readjustment and when maintained IAW the vendor's recommendation:
 - k. Ambient temperature: 10° Celsius (C) to 40°C (indoor) 10°C to 50°C (outdoor)
 - l. Relative humidity of up to 95 percent.
- m. The system shall be fully protected against lightning and voltage surge. It shall also be protected against damages from accidental reversal of polarity.
- n. All test equipment, tools, accessories, and software necessary for the Operation and Maintenance support shall be submitted as part of the FSO System offer.

3.12.2 FSO Considerations

The designer shall consider a number of different factors when deploying FSO. These include installation stability, beam alignment, mounting locations, atmospheric effects, impairments, required throughput, signal interfaces, security requirements, power requirements, and power availability.

3.12.2.1 Installation Stability and Beam Alignment

The FSO equipment is typically mounted on the outside edge of building rooftops, on towers or inside building windows. These “solid” objects tilt, twist, vibrate, and sway due to heat, wind load, and seasonal changes. The FSO equipment used shall be able to compensate for minor movements and maintain beam alignment. There are generally two methods for keeping FSO laser transmitters and photo detection receivers aligned: active beam tracking and beam divergence. Active beam tracking allows the FSO system to adjust end-to-end alignment a small number of degrees through beam strength tracking. Beam divergence is the intentional spreading of the laser beam to allow for FSO link head movement within both receivers' field of view.

3.12.2.2 Mounting Locations, Atmospheric Effects, and Impairments

The FSO transmitters and receivers shall be mounted as close to the building edge as possible. Setting the transmitters or receivers back could cause beam interference due to heat scintillation or refraction from the building roof. When placed within a building, FSO can work through building windows with little or no attenuation. This allows the designer to avoid roof rights or premise cabling pathway issues. The designer shall consider actual

glass losses in the overall link budget for through window implementations. Additionally, the designer shall investigate to see if newer windows are manufactured with an infrared reflecting coating or if older windows have a high lead content. The Infrared (IR) coating or lead could add severe impairment to a FSO link.

The designer shall consider the occurrence of rain, dust, snow, fog, or smog when implementing FSO. These weather conditions can add impairments to the transmission path. USAISEC TIC testing has shown fog to cause severe and sometimes total signal loss. Signal penetration through prevailing weather conditions is a factor of beam strength, distance, and weather interference. The FSO device shall have gain control to accommodate distances and weather conditions. The gain control may be manual or automatic. However, beam power output is restricted by the eye safety requirements for this class of LASER. The designer shall consider a radio backup link) for severe weather conditions, such as most millimeter-wave, microwave, 802.11 Wireless LAN (WLAN), or 802.16 WiMAX. The FSO laser does not need municipal or host nation approval, but the backup radio link may require approval and frequency management. The backup wireless link may have additional security requirements as the radio frequency (RF) signal can not be controlled as well as the FSO beam.

3.12.2.3 FSO Security

DOD Directive (DODD) 8100.bb requires Federal Information Processing Standard (FIPS) 140.2 Level 1 or 2, end-to-end encryption, on all Army wireless implementations. Therefore the designer shall incorporate required encryption of data passed through the FSO required to pass FIPS 140-2 and IA certification. The designer shall ensure that any encryption hardware is capable of supporting the throughout speeds and protocols.

3.12.2.4 FSO Throughput

The FSO throughput is a factor of beam strength, distance between devices, and weather conditions. The designer shall consider the required bandwidth against the specific distance for each application. For systems operating at 1.25 Gbps the link distance shall be kept around 1000 meters.

3.12.2.5 FSO Signal Interfaces

The FSO device shall be able to interface to the local data switch through standard FO connectors such as SC type connectors. The FSO device shall be able to transparently transport the data stream.

3.13 General Range Information Infrastructure Design

The telecommunications sections of range construction projects shall follow the general provisions of the U.S. Army I3A TG for new construction and renovations. There are several distinct types of information networks in a range environment: administrative, range control (RC), and tactical. The administrative networks support telephone and data requirements to the occupants of the range buildings, and safety telephones. The special RC networks control down-range targets, sensors, and monitors and transports this information to off-site locations. The tactical networks support the unit training requirements in a field environment. In addition, there could be security and alarm networks.

These paragraphs provide guidance for the design of the administrative use networks with provisions for interfacing with the other networks. The following paragraphs provided specific design information for TRs and OSP telecommunication cables for range projects.

3.13.1 TRs

In multi-story buildings, a minimum of one TR shall be located on each floor, with one TR acting as the aggregating TR or main cross-connect (MC) for the building. Small facilities (i.e., air traffic control towers, firing range towers, etc.) may use one TR for the entire facility. The TRs on successive floors shall be vertically stacked, wherever possible. A minimum of four, 4-in trade size conduit sleeves shall be installed between stacked closets on successive floors, IAW ANSI/EIA/TIA-569-B, paragraph 8.12.

3.13.2 Backbone Cabling

The backbone cabling for range facilities shall be single mode FO IAW the I3A TG. The IT designer shall also refer to the I3A guide for supporting infrastructure for the distribution and riser cables.

3.13.3 Range Information Infrastructure Design

Utilizing the RC building as a distribution node for all range telecommunications and as an intermediary between the ranges and the main cantonment area provides the ideal range information infrastructure architecture. The DB cable plant shall be used for range telecommunications cables. If it is not feasible to use DB cable due to local mandates or rough terrain, aerial cable plant may be used. Pedestals or MHs shall be placed at end of reel splice locations, where access to cable pairs or strands is required, and at future use points. In some range scenarios, a MH or a buried splice would be preferred over a pedestal due to the free roaming abilities of heavy equipment, such as tanks and mowers. When using pedestals, efforts shall be taken to protect it from damage, such as protective stub poles, locations in tree lines, or close-to-steep banks. When using buried splices, above ground warning signs and electronic locating devices, such as radio frequency ID or magnetic devices, shall be located with the splice.

3.13.3.1 Maintenance Hole and Duct Systems

The IT designer shall normally not use the MH and duct systems architecture in the range environment. Maintenance holes and ducts would incur too high a cost to the range project. At individual range complexes, a MH and duct infrastructure could be installed from RC building to adjacent support buildings for growth and expansion. When a duct system is required, a minimum of two, 4-in PVC ducts, one with four sub-ducts or nine-way (3 each 3-way) textile mesh, shall be installed to each individual support building.

3.13.3.2 Direct Bury Depth of Placement

The minimum depth of placement for a DB copper cable to ranges shall provide cover of 36 in of soil; 48 inches at ditch crossings, and 6 inches of solid rock. To direct bury a FOC, the minimum depth shall provide a cover of 42 inches overall. In solid rock, the minimum depth is reduced to 6 inches for FOC. The DOIM may have special depth requirements for certain areas, such as tank trails, firing ranges, etc.

3.13.3.3 Concrete Encasement

The IT designer shall normally not use a concrete-encased underground MH or duct systems in the range environment. Maintenance holes and ducts would incur too high a cost to the range project. Concrete encasement or GSP shall be used in range projects under road crossings, heavy equipment (tank) crossing, or high traffic areas. The IT designer shall plan for four, 4-inch PVC ducts; one with four sub-ducts or nine way (3 each 3-way) textile

innerducts, under road crossings, heavy equipment (tank) crossings, and high traffic areas. The encasement/pipe shall be extended a minimum of 6 feet beyond the roadbed for all road crossings, heavy equipment (tank) crossings, and high traffic areas on ranges. IAW the referenced standards, PVC ducts shall also be encased in concrete at all sweeps or bends; at stream or drainage ditch crossings, or other areas subject to washout. For consistency, the contractor shall use only one brand of cement that conforms to RUS Bulletin 1751F-644 (http://www.usda.gov/rus/telecom/publications/pdf_files/1751f644-08-02.pdf).

3.13.4 OSP Cable

The IT designer shall consider DB cables as the first choice for range telecommunications cables. If it is not feasible to use DB cables due to local mandates or rough terrain, aerial cables shall be used. The IT designer shall specify a minimum of 24 strands of single mode FOC from the DCO, or closest RSU, to RC building. Alternatives to FOC between the main cantonment area and the RC building may be considered on a case-by-case basis. The IT designer shall also specify a minimum of 12 strands of single mode FOC from the RC building to the individual ranges or range buildings. The IT designer shall use single mode FOC, as needed, to extend the data backbone, monitor circuits, sensors, cameras etc., to all range buildings from the RC building. Alternatives to FOC between the RC building and the individual ranges or range buildings may be considered on a case-by-case basis. In addition to the normal administratively required strands of FOCs for voice and data networks to the ranges, the range cables shall be sized to support circuits for the ever-changing training and tactical scenarios, and RC (minimum 25-percent spare strands). Cables homed to the RC facility would add flexibility to these systems.

3.14 Pier Installation

Pier telecommunications shall be installed in a duct system, with pull boxes placed at critical points.

3.14.1 Pier Igloos

Pier Igloos are structures where cable is terminated into terminal/plugs for shipboard use. Cable is generally run to igloos via a conduit system, raised into the igloos for termination and use, and is cross-connected to cable continuing to other igloos. Igloos can provide both copper and FO termination through a commercially available combination fiber/copper cable type plug for shipboard use. This connectivity provides service to meet shipboard requirements. Inside the igloo, restricted from shipboard personnel, FO and copper cross connections may be changed to meet special requirements for special situations. See Figure C-16 of Appendix C for igloo details.

3.14.2 General Pier Installation Guidance

Expansion joints are required at each pier expansion joint and areas where the conduit enters an Igloo. The PVC covered GIP or fiberglass conduit shall be used for the conduit and shall be installed in such a manner that docking vessels cannot crush or scrape it. For that reason, the designer shall place the cable on the underside of the pier and support with approved PVC covered (NFGS Specification, Section 16722A) or stainless steel hangers. The designer shall place an inner duct into the conduit if only a small cable is to be installed. If spare ducting is to be placed, ensure that a pull line is installed and that the duct is plugged or capped at both ends of the run. If the spare duct enters or exits a pull box, plugging or capping is required inside the pull box. Expansion joints act like a slip joint, allowing the

conduit to move, (breathe), precluding separation or buckling. If the conduit is to be allowed to move, the cable and inner duct shall not be installed taut or it shall break. Leave sufficient slack to allow for the conduit movement. Slack for expansion shall also be left in pull boxes.

3.14.3 Pier Cable Types

Copper and FO cables for shipboard use shall be terminated in igloos located at the pier edge. These igloos may provide data, telephone, and video, (Cable TV, security cameras etc). All ship board connectivity is accomplished via the front faceplate of the igloo. Only station/base personnel shall have access to the igloo internal cabling and only they shall be permitted to make physical wire or cable changes. Only filled cables such as PE-39 and filled FOC shall be installed on piers.

3.15 General Cable Specifications

3.15.1 General Installation

Cables shall be placed in such a manner as to avoid kinks and other sheath deformities. Cables shall be rated IAW the NEC for the environment that they will be installed in. When considering the use of indoor/outdoor rated cable the economics of the design shall be factored into the decision. Typically indoor/outdoor rated cable shall be limited to the link from the splice in the maintenance hole to the BET.

3.15.1.1 Pulling Tension

When pulling cable into ducts, innerducts, or sub-ducts, the manufacturer's specified pulling tension shall not be exceeded. A lubricant shall be used in the amount specified by the lubricant manufacturer. The lubricant shall be a pourable, water-based, slow-drying fluid that shall not stress-crack the low-density PE and shall not damage the cable jackets.

3.15.1.2 Evaluating Existing Cable/Testing New Cable

When the installation includes work on an existing cable, the installer shall test all affected pairs before completing any throws or splices. A list of the defective pairs shall be submitted before the work proceeds. After the cable work is completed, the installer shall test all affected cable pairs. The installer shall clear trouble on any existing pairs that were not on the original list.

3.15.1.3 Bending Radius

During installation, the minimum bend radius for non-gopher resistant OSP twisted-pair cable shall be no less than 10 times the cable diameter; after installation, it shall be no less than eight times the cable diameter, or as specified by the cable manufacturer. The minimum bend radius for gopher-resistant OSP twisted-pair cable during installation shall be no less than 15 times the cable diameter; after installation, it shall be no less than 10 times the cable diameter, or as specified by the cable manufacturer (reference TIA/EIA 758, paragraph 6.1.4.4). The minimum bending radius for FOCs during installation shall be no less than 20 times the outside diameter of the FOC, or as specified by the cable manufacturer, and after installation shall be no less than 15 times the cable diameter (reference TIA/EIA 758, paragraph 6.3.6).

3.15.2 Cable ID/Cable Tags

Cable ID/Cable tags shall be installed at all termination points (terminals) and splices, including house cables. In MHs, all new and existing cables that are part of the project shall

be tagged/re-tagged between the splice and the wall and on both sides of a splice loop or maintenance loop. When a cable is re-homed to a new node, DCO, x-connect box, etc; all existing cable tags and terminal labels on the re-homed cable shall be re-tagged and re-labeled to reflect the new information. One tag is required for a copper cable pull-through, and two tags are required for a FOC pull-through. Labels in MHs and HHs shall be machined produced on a durable material suitable for the environment. Handwritten labels are not acceptable.

3.15.2.1 Cable Label Schemes

Typically, unless otherwise directed by the SOW/PWS or site requirements, the unique identifier for each cable will include an indicator of the originating location of the cable. For a copper cable it can be as simple as a local policy such as: Cables 1 through 15 originate from the node in building xxx; Cables 16 through 25 originate from building yyy. For fiber optic cable the originating building number could be included as part of the identifier. The following cables label schemes shall be used unless directed otherwise by the SOW/PWS or site requirements.

- a. To identify a copper cable, size + type **and** cable ID+ count are needed.
- b. Cable sizes shall be identified with an abbreviation. For example, a 1,200-pair cable shall be identified as P12-24PF whereas the 24 represents the AWG wire gauge. All cables with fewer than 25 pairs shall include an “X.”
 - 6-pair = P6X-24PF
 - 12-pair = P12X-24PF
 - 18-pair = P18X-24PF
 - To identify a 900-pair, 24- AWG copper cable:
 - P9-24PF = size and type
 - 03, 1-900 = cable number and count
 - (Only **existing** cable is identified with a “CA” prefix.)
 - To identify two different cables under the same sheath:
 - P18-24PF
 - 07, 1-1,500 + T1, 1-300
 - Fiber optic cables shall be identified with cable ID + count **and then** size + type.
 - F 12, 1-72 = cable number and strand count
 - 12 SM = type of cable
 - To identify a 10-pair, 0.6 mm European copper cable:
 - 10x2x0.6 = size and type
 - 01, 1-10 = cable number and count
 - To identify an 800-pair, 0.6 mm European copper cable:
 - 800x2x0.6 = size and type
 - 05, 1-800 = cable number and count

3.15.2.2 Existing Cable Labeling

When an existing cable is rehomed to a new node, then the new node identifier should apply to all of the rehomed cable to include laterals. Therefore all the existing cable tags, the labels on the building terminals, and associated cables records shall be changed to reflect the new information (new node). This requirement is not to be construed as a requirement to place labels on cables that do not have existing tags, unless the identification of the cable is easy to determine with minimal or no impact on cost or schedule. Such as when there is only one cable in the maintenance hole and the identifier and count was verified in the previous maintenance hole. Due to the potential labor required to verify the identifiers and counts on cables with no tags, this effort should be identified as a separate requirement or task in the SOW/PWS.

3.15.3 Copper Specifications

3.15.3.1 Telephone Cable Requirements

The installer shall ensure that all cable used in North America is UL listed and meets the specifications of Telcordia Document, GR-421-CORE, *Generic Requirements for Metallic Telecommunications*, December 1998. Cables specified for use in Europe may not meet UL or Telcordia specifications.

3.15.3.2 European Telephone Cable Requirements

All multi-pair copper cable installed between buildings shall be waterproof, IAW DIN VDE 0815 and 0816, *Wiring Cables for Telecommunications and Data Processing Systems*. The copper conductor size shall be 0.6-mm diameter. Commercially available industry standard cables shall be type A-02YSOF(L)2Y...x2x0.6 ST III BD (the “...” denotes the pair count).

a. The conductors in the cable shall be color-coded. A basic color-coding scheme shall be used to provide different color combinations on the insulation for each pair. The North American standard is based on a 25-pair group IAW Telcordia Documents (Tip: white, red, black, yellow, violet; Ring: blue, orange, green, brown, slate). The European standard is based on 10-pair groups as follows:

- The basic colors of wires of five starquads in the sub unit are red for the first quad, green for the second quad, grey for the third quad, yellow for the fourth quad, and white for the fifth quad
- Black rings code the individual wires
- The pilot unit bears a red helix
- All other units bear a white or transparent helix

b. Minimum Guaranteed Pairs: One hundred percent of pairs in a cable prior to installation and 99 percent of pairs after installation where it is not economical to recover the defective pair(s) shall pass performance or acceptance tests. Defective pairs shall be identified by location and type of fault. Splicing faults shall be corrected.

3.15.3.3 Splices

a. Copper and FOC splicing shall be performed IAW RUS Bulletin 1735F-401, *Standards for Splicing Copper and Fiber Optic Cable*, February 1995.

b. Cable shall be spliced into one continuous length. All copper splices shall be of the fold-back type to facilitate future work in the splice. Fiber cable shall contain splice loops in trays IAW manufacturer's recommendations.

c. Completed splices shall meet similar performance and mechanical specifications of a single cable of the same overall length.

d. Self-piercing electrical filled connectors shall be used when splicing plastic-insulated conductors. The installer shall place and install connectors using a tool specifically designed to place those connectors. In North America, a 25-pair splicing module, 3M-type MS2 or equal shall be used. The same modules shall be used throughout the project and shall be consistent with previously installed connectors to preclude a requirement for a variety of installation tools. B-wire connectors shall not be used. In Europe, a 10-pair splicing module system is used.

e. Binder group integrity shall be maintained.

f. All dead pairs in a copper cable shall be spliced through if the size of the continuing cable shall allow a clear and cap at the end. Only UL listed material shall be used when capping cable pairs.

g. All underground and buried splice cases shall use encapsulant-fillable closures and shall be filled with encapsulant upon completion of the splice IAW RUS Bulletin 345-72 (PE-74). Cable sheaths shall be bonded at all cable splices with bonding harnesses to assure sheath continuity.

h. Splice cases shall not be installed in such a manner that their weight is being supported by the cables on the cable hooks in the maintenance hole. The use of non-encapsulated, re-enterable splice cases for copper and fiber that are suitable to environmentally-sealed telephone splices in the aerial or underground non-pressurized network are acceptable for non-DB locations. The preferred method for installing splice cases is to hang them from an overhead support, such as a pipe supported by the set of cable hooks above the splice case

3.15.3.4 Cable Count Assignment

When assigning cable counts, the center of the cable shall be the last pairs assigned on a cable route. The upper or higher cable pair counts shall be used first. Therefore, the highest pair count in a cable shall be located closest to the switch location, and the lowest pair count shall be farthest away. Per the requirements of 6- and/or 12-pair terminals, pair 13 (of a binder group) rather than Pair 1 shall be spared.

3.15.3.5 Cable Gauge, Resistance Design

The cable gauge shall be 24-AWG (0.6 mm in Europe), unless otherwise specified in the design package.

3.15.3.6 Loading

a. Analog sets/circuits exceeding 18,000 feet (5.49 km) require U.S. Government approval. If approved, these sets/circuits shall be loaded.

b. When loading cables, H88 loading shall be used 3,000 feet (914 m) from the switch location/digital loop carrier for the first load (including calculations for tip cables, jumper wires, etc.) and every 6,000-sheath feet thereafter. End sections shall be greater than 3,000

feet (914 m) and less than 12,000 feet (3.66 km). End sections include all drops and station wire.

c. Build-out capacitors shall be designed on trunk circuits between switches for placement between load points for distances shorter than 6,000 feet (1.83 km) between loads or between loads and end sections.

d. Pairs for any data circuits shall not be loaded.

e. If digital or data sets are being used for the telephone system, these pairs shall not be loaded.

3.15.4 Fiber Specifications

3.15.4.1 FOC Requirements

a. All specifications for FOCs pertain to finished cable, not raw (uncabled) fiber. The FOC shall conform to the specifications contained in RUS Bulletin 1753F-601, EIA/TIA-472, and EIA 472D, ICEA S-83-596-2001, “Standard for Optical Fiber Premises Distribution Cable” or ICEA S-87-640-2006, “ICEA Standard for Optical Fiber Outside Plant Communications Cable”. See Table 1 for the complete names of these references.

b. The International Telecommunication Union-Telecommunication (ITU-T) G.652 fiber as defined below in Paragraph 3.10.4.2b is also known as standard single-mode fiber and is the most commonly deployed fiber. It is the preferred FOC for the majority of the cable to be installed by this program. The non-zero dispersion shifted fiber (NZDSF) identified in Paragraph 3.10.4.2c has been developed for optimized dispersion characteristics in high-capacity, long-distance networks. Compliant to ITU-T G.655 and G.656 recommendations, these fibers support Course Wave Division Multiplexing (CWDM), Dense Wave Division Multiplexing (DWDM), Optical Carrier (OC)-192 and 10-gigabit applications. The NZDSF is typically not required or used for applications of less than 40 km (25 miles).

3.15.4.2 Fiber Types

All new OSP fiber cable shall be single-mode. With U.S. Government approval, multimode fiber may be installed only in situations involving the extension of existing systems, as specified in the design package, or in situations that cannot be adapted to single-mode cable.

a. Multimode Fiber – Fiber strands shall have a nominal core/cladding diameter of 50/125 microns. All cabled multimode fibers shall possess the following characteristics over the entire specified temperature range as shown in Table 5.

Table 5. Multimode Dual-windowed Fiber Cable Characteristics

Function	Parameters for 50 microns	Parameters for 62.5 microns
Core/Cladding Diameter	50/125	62.5/125
Coating Diameter Microns	250	250
Core Eccentricity Maximum	6%	6%
Core Ovality	6%	6%
Refractive Index Delta	1%	2%
Core Diameter Microns	50 +/-3	62.5 +/-3
Cladding Diameter Microns	125 +/-3	125 +/-3
Numerical Aperture	0.20 +/-0.015	0.275+/-0.015
850 nm		
Maximum Attenuation dB/km	3.5	3.75

**Technical Guide for Installation Information
Infrastructure Architecture, July 2008**

Minimum Bandwidth MHz-km	*500	160
1,300 nm		
Maximum Attenuation dB/km	1.5	1.0
Minimum Bandwidth MHz-km	*600	500
Cable Tensile Load Rating	**2,670 N (600 lb)	
Cable Minimum Bending Radius	15 x cable diameter under no load. **0-800 N (0-180 lb). 20 x cable diameter under load. **800-2,700 N (181-600 lb) (Note 2).	
*Building/Breakout Cables (Tight Buffer). Minimum bandwidths do not apply to tight buffered, or breakout-type cables. The minimum bandwidths for tight-buffered cable are 400 MHz-km at both 850 nm and 1,300 nm. The index of refraction profile of multimode fiber shall be near-parabolic graded index. **Building/Breakout Cables (Tight Buffer). Tensile load rating and minimum bending radius do not apply to tight-buffered breakout-type cables.		

dB=decibel; km=kilometer; MHz=megahertz; nm=nanometer

b. Single-mode Fiber – Fiber strands shall have a nominal core diameter of 8.3 microns. The cladding diameter shall be 125 microns (+/-2 microns). All cabled single-mode fibers shall have a maximum attenuation value of 0.35 dB/km for high grade at 1,310 nm over the entire specified temperature range as shown in Table 5. The fibers described in Table 6 are glass with a protective coating and an outer buffer tube. These fibers are placed in a cable of up to 192 fibers and are further protected by various layers as described in Paragraph 3.10.4.3. Plastic fibers shall not be used.

Table 6. Single-mode Dual-windowed Fiber Cable Characteristics

Function	Parameters
Maximum Attenuation dB/km @ 1,310 nm	*0.35
Maximum Attenuation dB/km @ 1,550 nm	*0.25
Core Diameter Microns	8.3 (nominal)
Core Eccentricity	Less than or equal to 1.0 micron
Cladding Diameter Microns	125 +/-2
Coating Diameter Microns	250 +/-2
Mode Field Diameter Microns	8.8 +/-0.5
Zero Dispersion Range	1310 +/-010 nm
Maximum Dispersion Range	3.2 ps/nm - km (range 1,285 to 1330 nm) 19 ps/nm - km (range 1,550 nm)
Refractive Index	0.37%
Cable Tensile Load Rating	600 lb (Note 3)
Cable Minimum Bending Radius	**15 x cable diameter under no load. 0-800 N (0-180 lb) (Note 3). 20 x cable diameter under load. 800-2,700 N (181-600 lb).
*Building/Breakout Cables (Tight Buffer). Maximum attenuations do not apply to tight buffered, breakout-type cables. Maximum attenuation for tight buffered cable is 1.25 dB/km @ 1,310 nm and 1.0 dB/km @ 1,550 dB/km.	
**Building/Breakout Cables (Tight Buffer). Tensile load rating and minimum bending radius do not apply to tight buffered, breakout-type cables.	

ps=picosecond

c. Non-zero Dispersion-shifted Fiber (NZDSF) – Fiber optic cables installed to support dense wave division multiplexing (DWDM) as identified in the design package shall be NZDSF optic cable when the distance exceeds 25 miles. The NZDSF cables shall meet or exceed the recommendations of International Telecommunication Union (ITU)-Telecommunication Standardization Sector (ITU-T) G.655, (03/2003) “Characteristics of a non-zero dispersion shifted single-mode optical fiber cable,” (Reference: Table 1/G.655-G.655A and Table 2/G.655-G.655B). Table 7 is an extraction of the ITU-T G.655. If the use of standard fiber versus non-zero dispersion-shifted fiber for the distance is in question, than an analysis shall be performed to determine which fiber will best support channel capacity for the distance the cable is to be installed.

Table 7. Non-zero Dispersion-shifted Single-mode FOC Characteristics

Fiber Attributes		
Attribute	Detail	Value
Mode Field Diameter	Wavelength	1,550 nm
	Range of nominal values	8-11 μm
	Tolerance	$\pm 0.7 \mu\text{m}$
Cladding Diameter	Nominal	125 μm
	Tolerance	$\pm 1 \mu\text{m}$
Core Concentricity Error	Maximum	0.8 μm
Cladding Noncircularity	Maximum	2.0 %
Cable Cut-off Wavelength	Maximum	1,450 nm
Macrobend Loss	Radius	30 mm
	Number of turns	100
	Maximum at 1,550 nm	0.50 dB
Proof Stress	Minimum	0.69 GPa
Chromatic Dispersion Coefficient Wavelength Range: 1,530-1,565 nm	λ_{min} and λ_{max}	1,530 and 1,565 nm
	Minimum value of D_{min}	0.1 ps/nm·km
	Maximum value of D_{max}	6.0 ps/nm·km 10.0 ps/nm·km*
	Sign	Positive or negative
	$D_{max} - D_{min}$ *	≤ 5.0 ps/nm·km*
Uncabled Fiber PMD Coefficient	Maximum	(see note).
Attenuation Coefficient	Maximum at 1,550 nm	0.35 dB/km
PMD Coefficient	M	20 cables
	Q	0.01 %
	Maximum PMD _Q	0.5 ps/ $\sqrt{\text{km}}$
<p>Note: An optional maximum PMD coefficient on uncabled fiber may be specified by cabling to support the primary requirement on cable PMD link design value (PMD_Q), if it was demonstrated for a particular cable construction.</p>		

* Values that apply to systems with minimum channel spacing of 100 GHz or less.

λ =wavelength; μm =micrometer; D=Chromatic Dispersion Coefficient; GHz=gigahertz; GPa=gigapascal; M=cable sections; PMD=polarization mode dispersion; Q=small probability level

3.15.4.3 Temperature Range

Outdoor cables shall have an operating and storage range of -40 to +70 degrees C. Indoor cables shall have an operating and storage range of -20 to +70 degrees C. Cables shall perform to their specified attenuation over the entire temperature range specified above. The attenuation shall not vary by more than 0.2 dB/km for single-mode fibers, 0.5 dB/km for multimode fibers, and shall never exceed specified attenuation limits.

3.15.4.4 Fiber Cable Count Assignment

Fiber optic cable strand counts shall be assigned in a similar manner as copper counts. The high number counts shall be dropped first, and the strand one count shall be the farthest from the serving node. Fibers shall typically be split, handled, terminated in groups or bundles of 12 strands. Groups that are designated as spares or for future growth (also called dark fibers) shall be dropped in the maintenance holes in an area stipulated by the SOW/SOR/PWS or the DOIM to position them for future growth.

3.15.4.5 Fiber System Design Guideline

If there is not specific guidance in the project documents, then use the following as a guideline for assigning fiber optic strands to buildings. One of the guiding principals is to eliminate single points of failure that would impact critical users or large groups of users.

a. General

- Dual-Homed = two connections over two physically diverse paths or over a single concrete encased path
- Dual-Uplinked =two (or more) connections over one physical path
- Single linked = one connection over one physical path
- All core nodes shall at a minimum be Dual-Homed to each MCN (SVR FRM, NMS, TLA).
- All distribution nodes shall at a minimum be dual-homed to at least two MCN core nodes.
- All distribution nodes should be connected to two adjacent distribution nodes.
- All EUBs that support Special C2 users shall at a minimum be dual-homed to two distribution nodes (ADN).
- All EUBs that support C2 users shall at a minimum be dual uplinked to one distribution nodes (ADN).
- All EUBs that support C2 Routine users shall at a minimum be dual uplinked to one distribution nodes (ADN).
- All EUBs that support non-C2 users shall at a minimum be single linked to one distribution nodes (ADN).
- Designs for new fiber optic cables shall include at least 50% spare, unused strands, with cables designed in multiples of 12 strand groups.

b. New Cable Installation.

Table 8. Fiber Sizing Between Building

From	To	Strands	Notes
MCN	MCN	24	1.
Server Farm	MCN	24	1, 3
ADN	MCN	12	1, 3
ADN	ADN	12	1.
ADN	EUB	12	1, 2, 3, 4, 5

Note 1. The numbers listed are for the minimum required strands.

Note 2. 12 strands will support up to 300 users in an EUB. 4 additional strands are required for each group of 100 users above this threshold.

Note 3. Dual homing will require the same number of strands for both paths.

Note 4. Dual uplinks may require additional strands.

Note 5. Direct connections of multiple closets in a building to and ADN may require additional strands.

c. Existing Cable Guidelines

Use of existing fiber optic cables is acceptable if the following conditions are met. These determinations need to be accomplished during the survey and design phases of the project.

- The number of existing strands are adequate to support the required number of links (transmit and receive, multiple closet uplinks, Dual uplinks, etc).
- The strands are tested to verify that they meet the requirements/specification of the proposed transport method (1Gig, 10 Gig, DWDM, etc)

3.15.4.6 Use of Innerduct/Subduct/Fabric Mesh

For underground installation, each FOC shall be installed in innerduct, fabric mesh, or subduct. Fiber optic cable shall not be installed directly in a 4-inch (100-mm) duct.

3.15.4.7 Splices and Power Budget

a. Splicing of FOC shall be accomplished using fusion splicing to weld the two fibers together. Fusion splices shall have insertion loss values of <0.05 dB and return loss values of >55 dB. Mechanical splices shall only be used with prior Government consent. Mechanical splices shall have insertion loss values of <0.15 dB with return loss values of >35 dB..

b. IAW RUS Bulletin 1751F-642 for buried FOC plant, direct buried filled splice cases installed in maintenance holes or hand holes is the preferred method for splicing fiber optic cable plant.

c. Loop-through splicing shall be used in lieu of homeruns/dedicated cables to the serving location. In loop-through splicing, only the fiber strands breaking off from the main cable to enter a building are cut and spliced. The other fibers are not cut. The sheath is cut from the cable, exiting fibers are cut and spliced, and remaining fibers are folded back within the case (not cut) and then routed on.

3.15.4.8 Manufactured Outside Plant Cable Assemblies

A manufactured OSP cable assembly will be an FOC that is manufactured with connection points that allow for the connection of smaller FOCs to be attached without splicing in the field. The manufactured OSP assembly will be constructed in such a matter that the assembly can be installed either in a conduit, DB, or aerial system and will not be adversely affected by its environment any more than the traditional fiber cable products. Care shall be taken in the design, ordering, and installation phases so that excessive cable lengths are not disguised as maintenance loops. Maintenance loops on manufactured cable assemblies shall be IAW manufactures' recommendations. In lieu of manufactures' recommendations, a 20 foot maintenance loop is adequate.

The use of manufactured OSP cable assemblies is permitted in outside plant designs. The connection points shall be selected to meet the overall design of the cable system.

3.15.4.9 FOC Slack

a. The installed length of a FOC shall include additional amounts of cable for slack. This slack shall be distributed throughout the cable run to provide extra cable for cut repairs, path relocations, splice loops, maintenance, etc.

b. Slack in an underground system shall be secured in loops, typically with plastic cable ties and placed so as to be out of harms way and still be accessible if in a maintenance hole. Slack on aerial cables shall be neatly organized using aerial fiber optic storage loops (snowshoes). The snowshoes size shall be based on the cable bend radius.

c. The minimum amount of slack will be calculated as follows:

- Splice locations = 50 ft on each cable sheath to allow splicing to take place in a splice trailer.
- Road crossings (Aerial) = 100 ft
- Aerial per linear mile = three locations with 100 ft each
- Pull through maintenance hole = 20 ft

3.15.5 Transfers, Cuts, and Throws

Cable transfers, cuts, and throws shall be performed to maximize existing resources. All cables and terminals affected by cable count transfers shall be retagged in the field to reflect the new changes.

3.16 Main Distribution Frame

The MDF is the interface between the OSP cable and the switch cables. The iron framework of the MDF supports the horizontal blocks and vertical connectors. The MDF shall be equipped with guard rails and end rails. The engineer shall provide new vertical sections to support all newly installed cable if none are available. A minimum of 760 mm (30 inches) of clearance around the frame is required for safety.

3.16.1 Horizontal Blocks

The horizontal blocks terminate the cables between the switch and the MDF. Each connection corresponds to a telephone number on the switch. The switch engineer shall determine the number of horizontal blocks on the frame. All horizontal blocks shall be stenciled to show the termination IDs.

3.16.2 Vertical Connectors

The vertical connectors are mounted on the vertical side of the MDF. Each connector protects 100 or 200 pairs of the OSP cables. The connector is equipped with tip cables that are pre-terminated on the connector. The tip cables are routed from the MDF through the floor to the cable vault or over the MDF to the wall, where they are spliced to the OSP cable. The connectors for the tip cables shall be provided as either stub-up or stub-down as determined by the type of installation required. The vertical connectors protect the electronics in the DCO by providing lightning and surge protection. Each termination corresponds to a pair of the OSP cables. All OSP cable pairs shall be terminated on connectors. All vertical connectors shall be stenciled to show the cable number and the pair counts for all connectors on that vertical connector. All connectors shall show the count terminated. A schematic showing the vertical side of the MDF is shown in Figure C-7 (Figure C-15 for Europe) – MDF and Cable Vault Schematic. Space-saver type MDF connectors shall be used, unless otherwise directed by the U.S. Government.

3.16.3 Cross-connects

Cross-connects shall be installed between the OSP terminations on the vertical connectors and the switch terminations on the horizontal blocks. This process connects an OSP pair to

a telephone number. Approximately 8 inches (200 mm) of slack shall be left in the cross-connect wire to allow re-termination for moves, additions, or changes.

3.16.4 Special Circuits

Since special circuits (such as data circuits, T-1s, or alarms) are non-switched, they shall be treated differently than voice and modem circuits. The protector modules shall be marked IAW the existing site procedure to indicate a special circuit. Various colors of protector modules are available to help in this differentiation. The special circuits shall be cross-connected to designated blocks on the horizontal side (not to the switch blocks).

3.17 Building Terminations

3.17.1 PETs

All OSP copper cables shall be terminated on primary protector blocks, equipped with 5-pin solid state or gas protector modules.

3.17.2 Terminals and Hardware

Terminals and hardware shall be UL listed, and shall be made of a flame-retardant construction and equipped with a built-in splice chamber; 5-pin gas protector modules, locking cover, and output on 110 blocks, or RJ21 connectors. The PET for European projects will be equipped with protected, line sharing adapter (LSA+) terminal blocks. All PETs shall be connected to the lightning protection grounding system for the building.

3.17.3 Fiber Patch Panels

3.17.3.1 Fiber Termination Device

All strands of FOCs, both OSP and inside plant, will be properly terminated on FOPPs. The OSP plant FOC will be extended IAW the NEC standards into the main data closet/location of the building and terminated there. If the main data closet/location cannot be determined, the OSP FOC will be terminated on a lockable patch panel collocated with the copper PET. Inside plant FO riser cables between the main data closet/location and any satellite data closet(s)/location(s) will be terminated at both locations on the FOPPs. All FOPPs will be stenciled with the panel number and the cable count.

3.17.3.2 Fiber Terminations

All terminations shall be made using subscriber connector (SC) or straight tip connectors (ST™ compatible) or as defined in the SOR/PWS. Duplex SC is the recommended connector per ANSI for OSP cable terminations. The use of Physical Contact (PC) family of connectors may be required based on performance requirements of the network or system to be installed, interface of the terminal electronics, or planned upgrades to the system or network. The PC is also referred to as Polished Connectors. The PC family of connectors includes Ultra PC (UPC), Super PC (SPC), and Angle PC (APC). These connectors shall typically be used to support systems with 10 gigabit or higher rates.

3.18 Grounding

All unclassified TRs shall be connected to the building EES IAW MIL-STD-188-124-B. Information on grounding of classified facilities can be found in MIL-STD-188-124-B and MIL-HDBK-419-A. Figure C-17 of Appendix C provides detailed schematics for the signal grounding system. An acceptable grounding system encompasses: fault protection grounds,

lightning protection grounds, signal grounds, and DC power grounds (when applicable). Refer to NFPA 780 and MIL-HDBK-419-A for proper lightning protection and NFPA 70 for proper fault protection grounding. The telecommunications designer shall review project drawing to ensure that the lightning and fault protection grounds are addressed by the appropriate disciplines. The telecommunications designer shall ensure that the different grounding systems are not mixed within the building.

3.18.1 Building Ground

The building EES forms the primary electrical, life-safety grounding system. Typically, a grounding electrode conductor connects the main building-grounding electrode to the main electrical entrance panel or cabinet. NFPA 70, Article 250 Section III provides guidance on the grounding electrode system and conductor. The EUBs and ADNs shall have a resistance-to-earth of 10 ohms or less, following MIL-STD-188-124-B. The switch manufacturers may specify the resistance-to-earth as 5 ohms or less for a telephone switch or DCO. The designer shall be conscious of the proposed utilization of the facility and plan accordingly. Sites shall provide proper supporting documentation and specifications to the designer to support resistance-to-ground requirements more stringent than that of NFPA 70 or MIL-STD-188-124-B for non-voice switch buildings. Proper documentation includes international, national or local codes, DOD and DA standards, or manufacturers' equipment specifications.

3.18.2 Cable Entrance Grounding

All metallic shields and strength members for OSP cable entering a building shall be connected to the lightning protection ground system. The designer shall ensure that the lightning protection is IAW MIL-STD-188-124-B and NFPA 780, *Standard for the Installation of Lightning Protection Systems*, latest issue.

3.18.2.1 Building Point of Entrance

The NFPA 70 defines the point of entrance as the location where “the wire or cable emerges from an external wall, from a concrete floor-slab, or from a rigid metal conduit or an IMC grounded to an electrode IAW 800.400-B.” The Telecommunications Entrance Facility (TEF) is the space housing the point of entrance of the telecommunications service.

3.18.2.2 Copper Cable Entrance

The OSP copper cable shield, armor, and metallic strength member shall be bonded to the lightning protection ground as close as possible to the building point of entrance with a No. 6 AWG or larger ground wire. The designer shall use a non-bonded splice case for the transition from OSP rated cable to interior rated cable or shall indicate that the implementer not install the splice case carry-through bonding conductor. If the designer shall extend the OSP copper cable past 50 feet (15 m) IAW NFPA 70 Section 800.50, the metallic strength member shall be bonded to the lightning protection ground as close as possible to the conduit egress point with a No. 6 AWG or larger copper ground wire.

3.18.2.3 Fiber Cable Entrance

The OSP FOC armor and metallic strength member shall be bonded to the lightning protection ground as close as possible to the building point of entrance with a No. 6 AWG or larger ground wire. The designer shall use a non-bonded splice case for the transition from OSP rated cable to interior rated cable or shall indicate that the implementer not install the

splice case carry-through bonding conductor. If the designer shall extend the OSP fiber cable past 50 feet IAW NFPA 70 Section 770.50, the metallic strength member shall be bonded to the lightning protection ground as close as possible to the conduit egress point with a No. 6 AWG or larger copper ground wire. If inside/outside cable is used, a cable shield isolation gap shall be incorporated.

3.18.2.4 Copper Protector Block

All OSP copper cables shall be terminated on primary protector blocks, equipped with 5-pin solid state or gas protector modules. The protector blocks shall be bonded to the lightning protection ground with a No. 6 AWG or larger copper ground wire. Terminals and hardware shall be UL-listed, made of a flame-retardant construction, and equipped with a built-in splice chamber; 5-pin gas protector modules, locking cover, and output on 66 blocks, 110 blocks, or RJ21 connectors. The PET for European projects will be equipped with protected, LSA+ terminal blocks. All PETs shall be connected to the lightning protection grounding system for the building. Place the protector block as close as possible to the lightning protection ground.

3.19 Final Acceptance Test

3.19.1 Telecommunications Cable Plant

Testing will consist of, but will not be limited to, the following cable tests:

- Insulation resistance
- Shorts/crosses
- Grounds
- Opens
- Reversals
- Splits
- Transpositions
- Shield continuity
- Loop resistance
- Insertion loss (performed only when specified)
- Capacitance

3.19.2 FOC

Testing will consist of Optical Time Domain Reflectometer (OTDR) measurements for one strand in each 12-strand bundle of fiber, and Power Source/Power Meter tests on every strand in all cables. Each strand of fiber cable not terminated at each end will be tested with the OTDR. While using the OTDR, measure the length of the strand and look for any circuit discontinuities and/or splice points. Run a strip chart for each fiber strand tested and record the cable ID, strand ID, source location, meter location, and dB loss at each specified nm wavelength and fiber length, and note whether the strand passed or failed the test. The following tests will also be included as a minimum:

- Attenuation
- Bandwidth

- Power Source/Power Meter: This test will consist of bi-directional, dual-window (1,300/1,550 nm) testing of every fiber strand installed.

Table 9 shows the standard cable reel lengths and diameters.

Table 9. Standard Cable Reel Lengths and Diameters

Cable Type	Number of Pairs	AWG	Standard Length (ft)	Nominal Diameter (in)
PE-22	6 x	19	5,000	0.53
Air Core	12 x	19	5,000	0.6
Alpeth	25	19	5,000	0.81
Sheath	50	19	2,500	1.08
	6 x	22	5,000	0.43
	12 x	22	5,000	0.53
	25	22	5,000	0.7
	50	22	5,000	0.85
	100	22	5,000	1.07
	200	22	5,000	1.48
	300	22	2,000	1.75
	400	22	2,000	1.96
	600	22	1,000	2.44
	900	22	1,000	2.88
	1,200	22	750	3.29
	6 x	24	10,000	0.41
	12 x	24	10,000	0.46
	25	24	10,000	0.55
	50	24	5,000	0.66
	100	24	5,000	0.87
	200	24	5,000	1.18
	300	24	2,500	1.38
	400	24	2,500	1.53
	600	24	2,500	1.85
	900	24	1,500	2.31
	1,200	24	1,000	2.69
	1,500	24	1,000	2.92
	1,800	24	750	3.01
	2,100	24	500	3.39
	25	26	10,000	0.49
	50	26	10,000	0.57
	100	26	10,000	0.71
	200	26	5,000	0.97
	300	26	5,000	1.14
	400	26	5,000	1.30
	600	26	2,500	1.54
	900	26	2,500	1.88
	1,200	26	1,500	2.10
	1,500	26	1,500	2.32

Table 9. Standard Cable Reel Lengths and Diameters (continued)

Cable Type	Number of Pairs	AWG	Standard Length (ft)	Nominal Diameter (in)
	1,800	26	1,000	2.48
	2,100	26	1,000	2.68
	2,400	26	1,000	2.90
	2,700	26	1,000	3.03
	3,000	26	750	3.20
Figure-8	6 x	22	9,930	0.96
Filled	12 x	22	9,930	1
Alpeth	25	22	9,810	1.16
Sheath	50	22	6,540	1.34
	6 x	24	11,340	0.88
	12 x	24	11,340	0.96
	25	24	11,340	1.02
	50	24	11,340	1.18
	50	26	13,320	1.08
	100	26	8,820	1.26
PE-89	6 x	19	5,000	0.52
Filled	12 x	19	5,000	0.62
Alpeth	25	19	5,000	0.86
Sheath	50	19	5,000	1.12
	100	19	2,500	1.51
	200	19	1,500	2.04
	6 x	22	5,000	0.48
	12 x	22	5,000	0.52
	25	22	5,000	0.66
	50	22	5,000	0.86
	75	22	5,000	0.96
	100	22	5,000	1.1
	150	22	5,000	1.32
	200	22	2,500	1.49
	300	22	2,000	1.72
	400	22	2,000	1.96
	600	22	1,000	2.4
	900	22	1,000	2.9
	1,200	22	750	3.28
	6 x	24	10,000	0.44
	12 x	24	10,000	0.48
	25	24	10,000	0.58
	50	24	10,000	0.7
	75	24	5,000	0.86
	100	24	5,000	0.94
	150	24	5,000	1.06
	200	24	5,000	1.2
	300	24	2,500	1.45

Table 9. Standard Cable Reel Lengths and Diameters (continued)

Cable Type	Number of Pairs	AWG	Standard Length (ft)	Nominal Diameter (in)
	400	24	2,000	1.59
	600	24	2,000	1.92
	900	24	1,000	2.32
	1,200	24	1,000	2.68
	1,500	24	1,000	2.92
	1,800	24	750	3.2
	2,100	24	600	3.44
	25	26	10,000	0.52
	50	26	10,000	0.58
	100	26	10,000	0.78
	200	26	5,000	1.02
	300	26	5,000	1.18
	400	26	5,000	1.33
	600	26	2,500	1.59
	900	26	2,000	1.92
	1,200	26	1,500	2.1
	1,500	26	1,000	2.34
	1,800	26	1,000	2.6
	2,100	26	1,000	2.78
	2,400	26	1,000	2.92
	2,700	26	750	3.14
	3,000	26	750	3.24
	6 x	19	5,000	0.58
PE-89	12 x	19	5,000	0.66
Filled	25	19	5,000	0.9
Rodent	50	19	2,500	1.18
Protected	6 x	22	5,000	0.54
Alpeth	12 x	22	5,000	0.58
Sheath	25	22	5,000	0.7
	50	22	5,000	0.9
	100	22	5,000	1.14
	200	22	2,500	1.51
	300	22	2,000	1.76
	400	22	2,000	2
	600	22	1,000	2.46
	900	22	1,000	2.94
	1,200	22	750	3.28
	6 x	24	10,000	0.5
	12 x	24	10,000	0.54
	25	24	10,000	0.58
	50	24	10,000	0.74
	100	24	5,000	0.98
	200	24	5,000	1.26

Table 9. Standard Cable Reel Lengths and Diameters (continued)

Cable Type	Number of Pairs	AWG	Standard Length (ft)	Nominal Diameter (in)
	300	24	2,500	1.49
	400	24	2,000	1.63
	600	24	2,000	1.96
	900	24	1,000	2.36
	1,200	24	1,000	2.68
	1,500	24	1,000	2.94
	1,800	24	750	3.22
	25	26	10,000	0.58
	50	26	10,000	0.66
	100	26	10,000	0.82
	200	26	5,000	1.08
	300	26	5,000	1.22
	400	26	5,000	1.38
	600	26	2,500	1.63
	900	26	2,000	1.92
	1,200	26	1,500	2.11
	1,500	26	1,000	2.36
	1,800	26	1,000	2.62
	2,100	26	1,000	2.78
	2,400	26	1,000	2.94
	2,700	26	750	3.18
	3,000	26	750	3.26
A-2YF(L)2Y	2	0.6	Special order only	9.0 (0.35)
PE insulation	4	0.6	Special order only	11.5 (0.45)
Jelly filled cable core	6	0.6	1,000	12.0 (0.47)
Laminated sheath	10	0.6	1,000	13.5 (0.53)
DIN VDE 0816	20	0.6	1,000	16.5 (0.65)
	30	0.6	1,000	19.5 (0.77)
	50	0.6	1,000	23.5 (0.93)
	100	0.6	1,000	31.5 (1.24)
	150	0.6	1,000	37.5 (1.48)
	200	0.6	1,000	42.5 (1.67)
	300	0.6	500	52.0 (2.05)
	500	0.6	300	67.0 (2.64)
	600	0.6	300	74.0 (2.91)
	800	0.6	300	85.0 (3.35)
A-2YF(L)2Y	6	0.8	1,000	13.0 (0.51)
PE insulation	10	0.8	1,000	15.0 (0.59)
Jelly filled cable core	20	0.8	1,000	18.0 (0.71)
Laminated sheath	30	0.8	1,000	21.0 (0.83)
DIN VDE 0816	50	0.8	1,000	26.0 (1.02)

Table 10 shows the European standard cable reel lengths and diameters.

Table 10. European Standard Cable Reel Lengths and Diameters

Cable Type	Number of Pairs	Conductor Size (mm)	Standard Reel Length (m)	Nominal Outside Diameter mm (in)
	100	0.8	1,000	34.0 (1.34)
	150	0.8	500	40.0 (1.57)
	200	0.8	500	47.0 (1.85)
	300	0.8	300	61.0 (2.40)
	500	0.8	300	78.0 (3.07)

Table 11 shows a sample of a cable spreadsheet.

Table 11. Cable Spreadsheet Sample

Termination	Required Copper Pairs	Served From	Copper Cable & Count	Required Fiber Strands	Served From	Fiber Cable & Count	Priority	Remarks
MH 5	900	B 376	6, 1-900 C/C	N/A	N/A	N/A	Phase 1	
B 390	900	B 376	6, 901-1,800	192	B 376	FOC A, 1-192	Phase 1	Backbone fiber to ADN.
B 220	50	B 376	7, 1-50	12	B 376	FOC A-2, 25-36	Phase 2	
B 218	100	B 376	7, 51-150	12	B 376	FOC A-2, 37-48	Phase 2	
B 219	100	B 376	7, 151-250	12	B 376	FOC A-2, 49-60	Phase 2	
B 233	50	B 376	7, 251-300	12	B 376	FOC A-2, 61-72	Phase 2	
B 223	100	B 376	7, 301-400	12	B 376	FOC A-2, 73-84	Phase 2	
B 224	200	B 376	7, 401-600	12	B 376	FOC A-2, 85-96	Phase 2	
B 231	100	B 376	7, 601-700	12	B 376	FOC A-2, 97-108	Phase 2	
B 228	100	B 376	7, 701-800	12	B 376	FOC A-2, 109-120	Phase 2	
B 227	100	B 376	7, 801-900	12	B 376	FOC A-2, 121-132	Phase 2	
B 225	100	B 376	7, 901-1,000	12	B 376	FOC A-2, 133-144	Phase 2	
B 202	100	B 376	7, 1001-1,100	12	B 376	FOC A-1, 1-12	Phase 2	
B 203	100	B 376	7, 1101-1,200	12	B 376	FOC A-1, 13-24	Phase 2	
B 214	100	B 376	7, 1201-1,300	12	B 376	FOC A-1, 25-36	Phase 2	
B 204	100	B 376	7, 1501-1,600	12	B 376	FOC A-1, 37-48	Phase 2	
B 212	100	B 376	7, 1401-1,500	12	B 376	FOC A-1, 49-60	Phase 2	
B 206	100	B 376	7, 1301-1,400	12	B 376	FOC A-1, 61-72	Phase 2	

Table 11. Cable Spreadsheet Sample (continued)

Termination	Required Copper Pairs	Served From	Copper Cable & Count	Required Fiber Strands	Served From	Fiber Cable & Count	Priority	Remarks
B 192	100	B 376	7, 1601-1,700	12	B 376	FOC A-1, 73-84	Phase 2	
B 193	100	B 376	7, 1701-1,800	12	B 376	FOC A-1, 85-96	Phase 2	
B 399				12	B 376	FOC D1, 1-12	Phase 2	LAN C-DCO is B 376.

4.0 VOICE SWITCHING, CENTRAL OFFICE/END OFFICE, AND CONVERGENCE

Voice switching architecture and technology is addressed in *USAISEC TG for Circuit Switching*. The information previously provided in the section entitled Dial Central Office/Remote Switching Unit is also included in the *TG for Circuit Switching*. The circuit switching guide provides generic technical guidance for the design of telephone systems that support U.S. Army facilities. The document contains design guidance related to identifying system requirements, supporting engineering site surveys, performing new construction planning and systems designs, in support of procuring, engineering, installing, testing, and cutting over administrative telephone systems within the boundaries of U.S. Army installations. The document is currently under review for revisions and updates.

The convergence of voice, data, and video is addressed in the *Voice over Internet Protocol Design Guidelines*, currently in Draft. The document describes the design requirements that will be used to implement VoIP. The TG incorporates regulatory policies and guidance as well as best business practices within industry. The document applies to both converged and non-converged networks, as defined within the DISA GSCR.

5.0 NETWORK ARCHITECTURE

The network architecture topology normally follows the existing telephone topology. Geographic dispersion, number of users in the area, available space for electronics equipment, existing cable and duct system, and identified areas of future growth are also considered when selecting core node locations. The converged architecture will provide a common IP based transport for all Non-secure IP Router Network, encrypted SIPRNET, Non-authenticated Users, Synchronous Optical Network (SONET), and Sensitive Information voice, data, and video services on the post, camp or station network. The converged architecture provides a core node backbone using carrier class switching to provide a high degree of scalability and availability to all required services as described in the U.S. Army Network Enterprise Technology Command (NETCOM) Horse Blanket LandWarNet LAN/campus area network (CAN) technical profile.

Data network architecture and technology is addressed in *USAISEC TIC Installation Information Infrastructure Modernization Program (I3MP) Data Performance Guide*.

6.0 NETWORK AND SYSTEMS MANAGEMENT

6.1 Introduction

System and network management is becoming increasingly important in today's environment of distributed applications and heightened security and is addressed in *USAISEC TG for Network and Systems Management (NSM)*. Network and system administrators rely heavily on automated NSM tools for tasks such as discovering, diagnosing and correcting problems, updating software, and maintaining network/system operations. Managing networks and systems is a difficult and complicated task requiring extensive knowledge in numerous areas such as operating systems, networking devices and protocols, addressing, databases, applications, and others. NSM systems are intended to ease the burden on resources associated with these tasks.

6.1.1 NSM Objectives

The objective of an NSM is to provide effective, responsive, and proactive management of networks and systems with minimal life-cycle support costs. This includes the integration of lower level management systems and subsystems to provide an enterprise view of the network and system assets. The primary uses of NSM are:

- Provide backup and recovery services
- Monitor, identify, track, and correct information system and network communication failures
- Monitor, identify, and correct network and system security problems
- Monitor, control, and fine tune network and systems performance
- Identify communication and processing resource usage
- Manage inventory and distribute software information assurance and security

6.2 Purpose

The *USAISEC Security Engineering TG* defines the process for performing Information System Security (ISS) Engineering (ISSE) at the USAISEC. The Information Assurance Technical Framework (IATF), Version 3.0, September 2000, defines ISSE as the process for addressing a user's information protection needs and is part of the systems engineering, systems acquisition, risk management, certification and accreditation (C&A) and the life cycle support processes. The *USAISEC Security Engineering TG* presents the IATF description for ISSE, but also defines how this process is implemented by USAISEC within the U.S. Army.

7.0 WIRELESS LOCAL AREA NETWORK

The *USAISEC Wireless Local Area Network Architecture TG* provides detailed guidance on WLAN implementation for edge connectivity.

**APPENDIX A. TECHNICAL GUIDANCE CHECKLIST
 FOR INSTALLATION INFORMATION INFRASTRUCTURE ARCHITECTURE**

Item	Compliance Y N N/A Not addressed	TG Paragraph	Standard and Section	Requirement	Comments
		2.0	TIA/EIA-568-B and TIA/EIA-569-B	Does this project include structured BCSs?	Continue through this checklist and TG for detailed information on BCS implementation.
		2.1		Does this project include a secure information systems infrastructure?	Refer to the USAISEC TG for the Integration of SIPRNET (January 2006)
		2.3	TIA/EIA-568-B and TIA/EIA-569-B	Design the workstation outlet configuration, locations and densities IAW sub-paragraphs 2.3.1 through 2.3.10	
		2.4	TIA/EIA-568-B	Specify standardized cabling types IAW paragraphs 2.4.1 through 2.4.3	
		2.4.4	TIA/EIA-569-B	Design the cabling infrastructure according to paragraphs 2.4.4.1 through 2.4.4.7	

Item	Compliance Y N N/A Not addressed	TG Paragraph	Standard and Section	Requirement	Comments
		2.5	TIA/EIA-568-B and TIA/EIA-569-B	Specify and provision the TRs according to paragraphs 2.5.1 through 2.5.16	
		2.6	MIL-HNBK-419-A MIL-STD-188-124-B NFPA 70	Design the telecommunications grounding system IAW USAISEC TG and the specified standards.	The TG for USAISEC LPAGBS provides additional detail on overall grounding systems.
		2.7	TIA/EIA-606-A	Specify the labeling and identification of the telecommunications system IAW paragraphs 2.7.1 through 2.7.5	
		2.8	TIA/EIA-568-B and TIA/EIA-569-B, TIA/EIA-758	Design the cable entrance IAW paragraphs 2.8.1 through 2.8.3	
		2.9	TIA/EIA-568-B	Specify the complete testing of all installed cabling IAW paragraphs 2.9.1 through 2.9.4	

Item	Compliance Y N N/A Not addressed	TG Paragraph	Standard and Section	Requirement	Comments
		3.0		Does this project include structured OSP Cabling Systems?	Continue through this checklist and TG for detailed information on Outside Plant Cabling Systems implementation.
		3.1		Does this project include a secure information systems infrastructure?	Refer to the USAISEC TG the Integration of SIPRNET (January 2006)
		3.3		Design the OSP to support the U.S. Army architecture and meet the requirements of the user.	
		3.5		Consider and document all environmental and historical concerns.	
		3.6		Conform to all general considerations when designing and executing an OSP project, as specified in paragraphs 3.6.1 through 3.6.10	
		3.7		Select proper placement option for OSP location and application.	
		3.8		Conform to all underground construction considerations when designing and executing an underground OSP system.	The underground OSP system is the preferred method within the post, camp or station cantonment area.

Item	Compliance Y N N/A Not addressed	TG Paragraph	Standard and Section	Requirement	Comments
		3.9		Conform to all DB construction considerations when designing and executing a direct-buried OSP system.	
		3.10		Conform to paragraphs 3.10.1 through 3.10.4 when crossing or passing through OSP obstructions	
		3.11		Conform to all aerial cable construction considerations when designing and executing an aerial cable OSP system.	Aerial cable runs shall be used only with U.S. Government approval in extenuating circumstances or for long runs outside of the cantonment area, as specified in the design package.
		3.12		Design any FSO links IAW section 3.12 and paragraphs 3.12.1 through 3.12.2	FSO can provide an alternative to FO connectivity, for the “last mile,” to EUBs and small enclaves, but shall closely follow the performance and security requirements specified.
		3.13		Does this project include ranges, or is the project located on a range?	Design any range project or connectivity IAW the guidance and directions provided in paragraphs 3.13.1 through 3.13.4.

Item	Compliance Y N N/A Not addressed	TG Paragraph	Standard and Section	Requirement	Comments
		3.14		Does this project include piers, or is the project located on a pier?	Design any pier project or connectivity IAW the guidance and directions provided in paragraphs 3.14.1 through 3.14.3.
		3.15		Specify and install standardized cabling types in accordance with paragraphs 3.15.1 through 3.15.5	
		3.16		Is an MDF installation or upgrade required in this project? Specify and install the MDF IAW paragraphs 3.16.1 through 3.16.4.	
		3.17		Design and install building terminations IAW paragraphs 3.17.1 through 3.17.3.	
		3.18	MIL- HDBK- 419-A MIL-STD- 188-124-B NFPA 70	Design the telecommunications grounding system IAW USAISEC technical guidance and the specified standards.	The TG for USAISEC LPAGBS provides additional detail on overall grounding systems.
		3.19		Specify the complete testing of all installed OSP cabling IAW paragraphs 3.19.1 through 3.19.2.	

Item	Compliance Y N N/A Not addressed	TG Paragraph	Standard and Section	Requirement	Comments
		4.0		Does this project include a voice switching system?	Voice switching architecture and technology is addressed in USAISEC TG for Circuit Switching.
		5.0		Does this project encompass the data backbone, or attach to the data core?	Data network architecture and technology is addressed in USAISEC TIC Installation Information Infrastructure Modernization Program (I3MP) Data Performance Guide
		6.0		Does this project encompass the data backbone, or attach to the data core?	System and network management is addressed in USAISEC TG for NSM.

APPENDIX B. BUILDING CABLING SYSTEM FIGURES

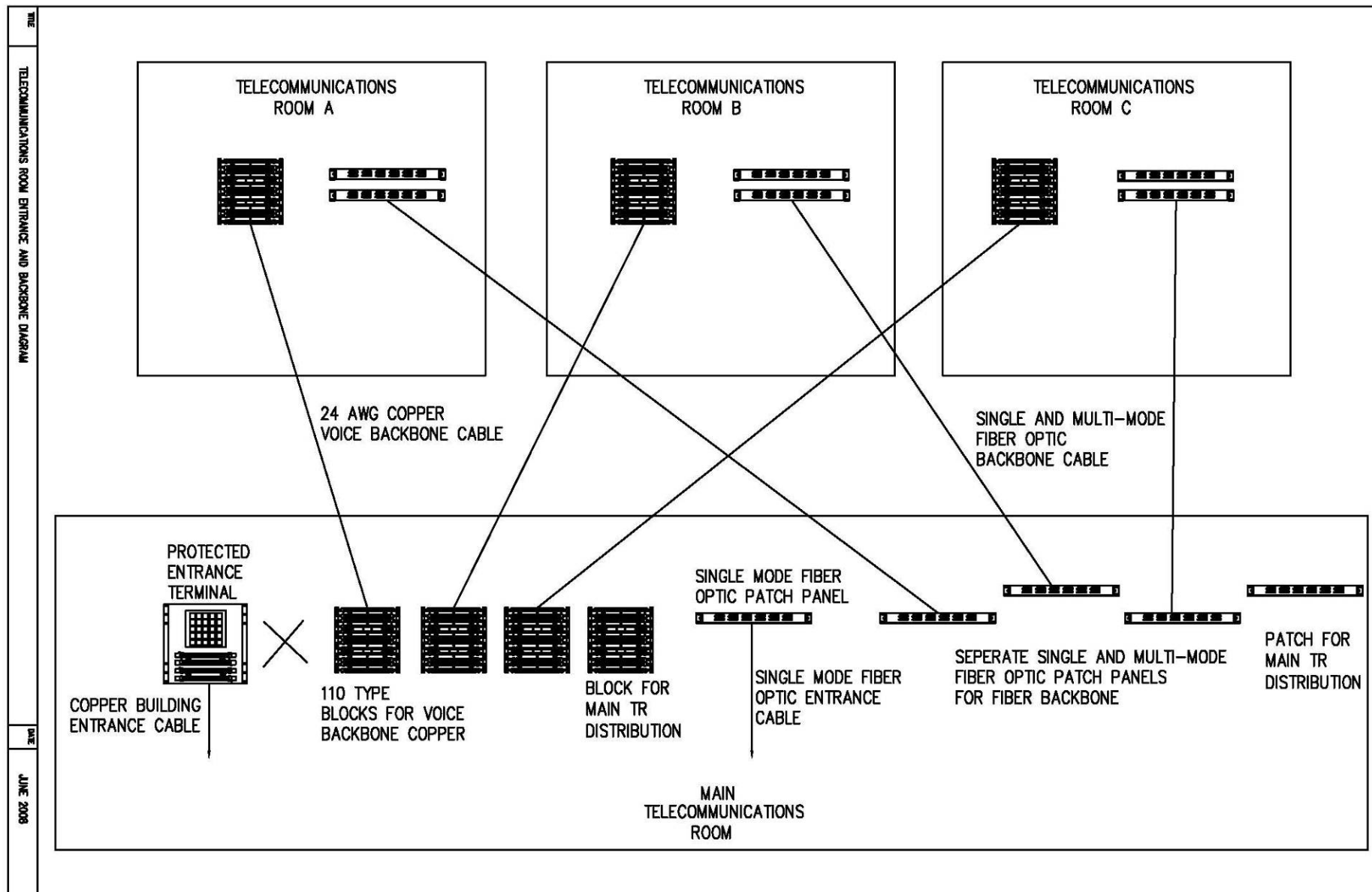

Figure B-1. Telecommunications Room Entrance and Riser

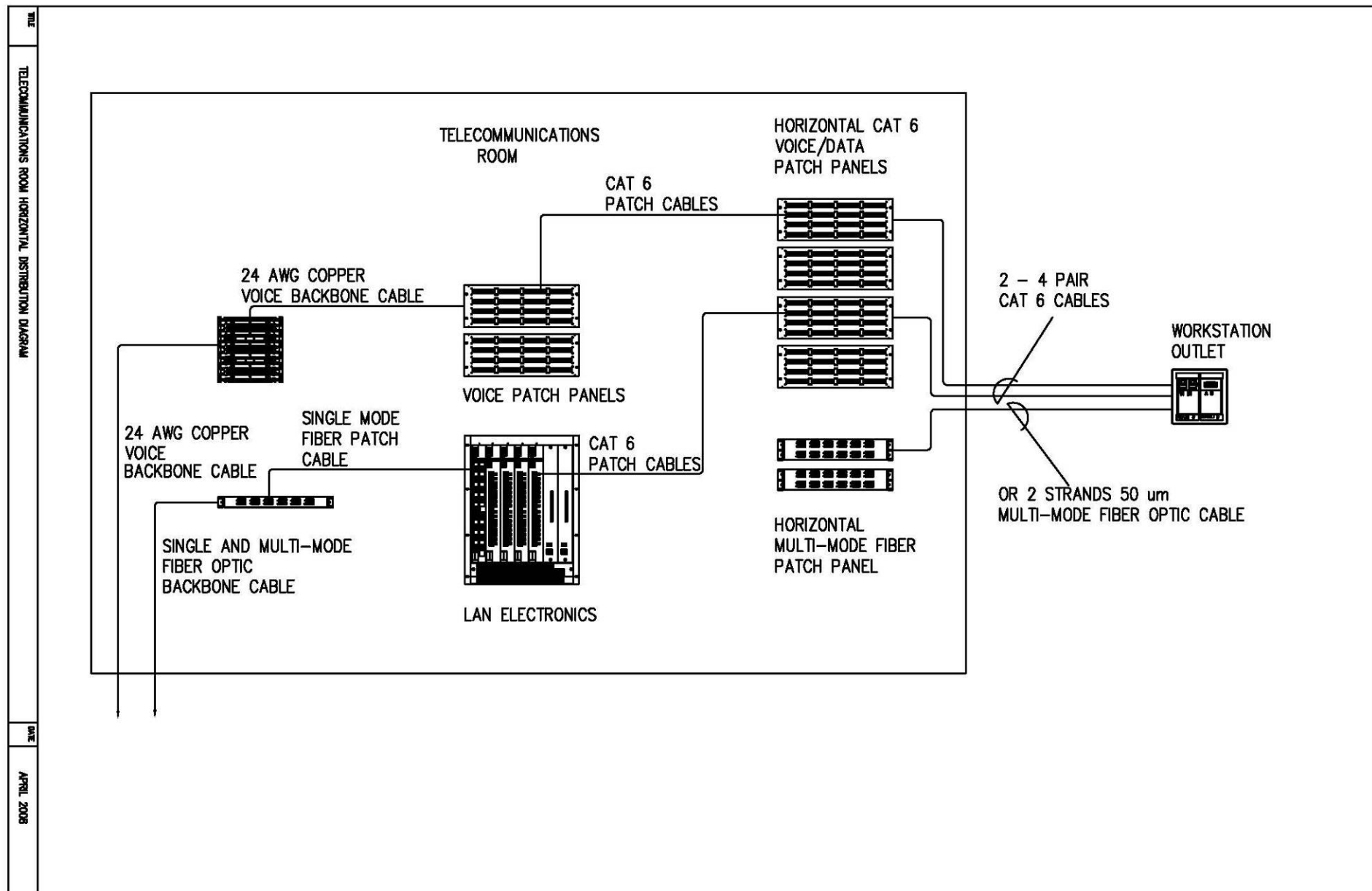

Figure B-2. Telecommunications Room Horizontal Distribution

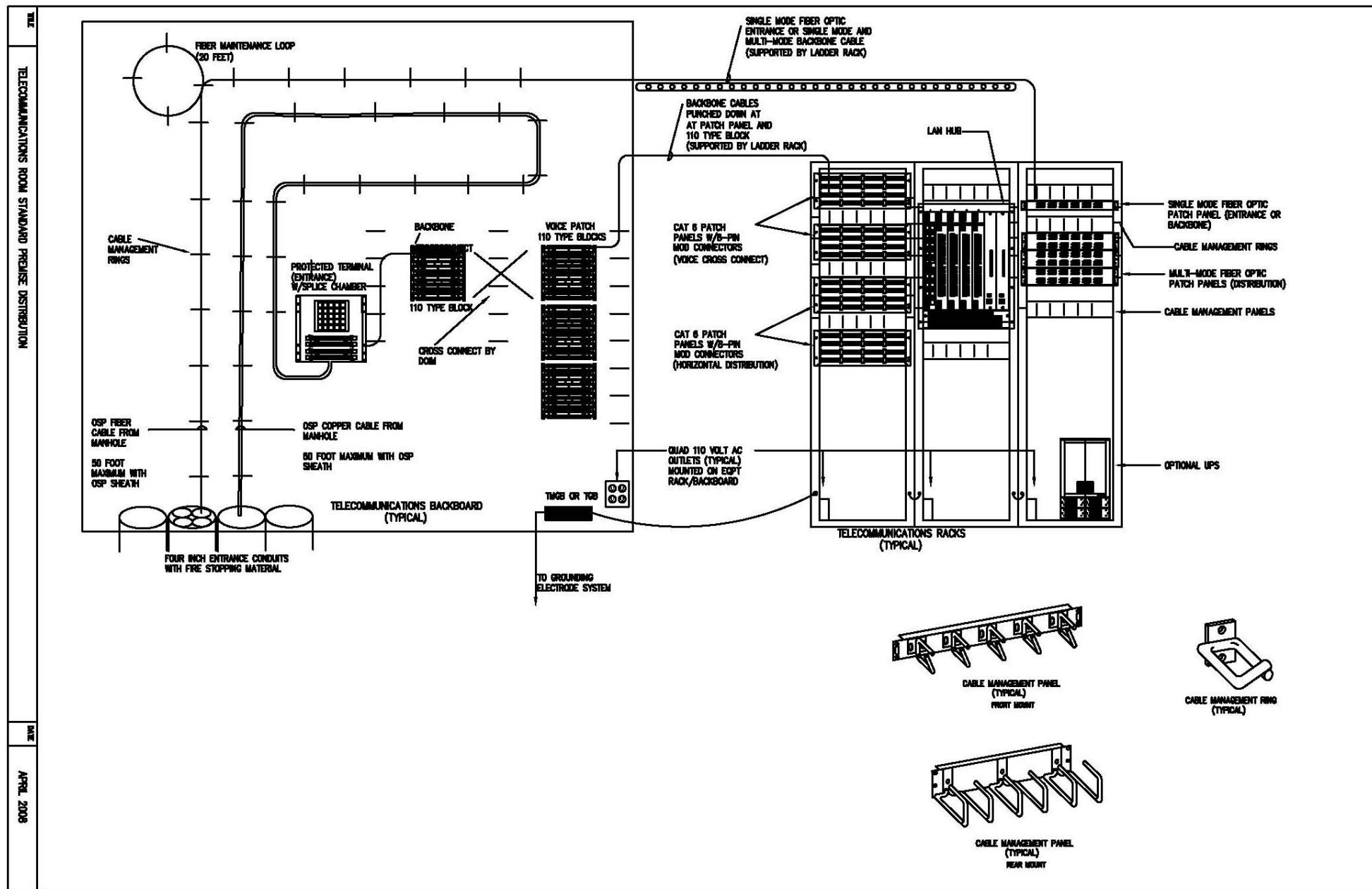

Figure B-3A. Telecommunications Room Standard Premise Distribution

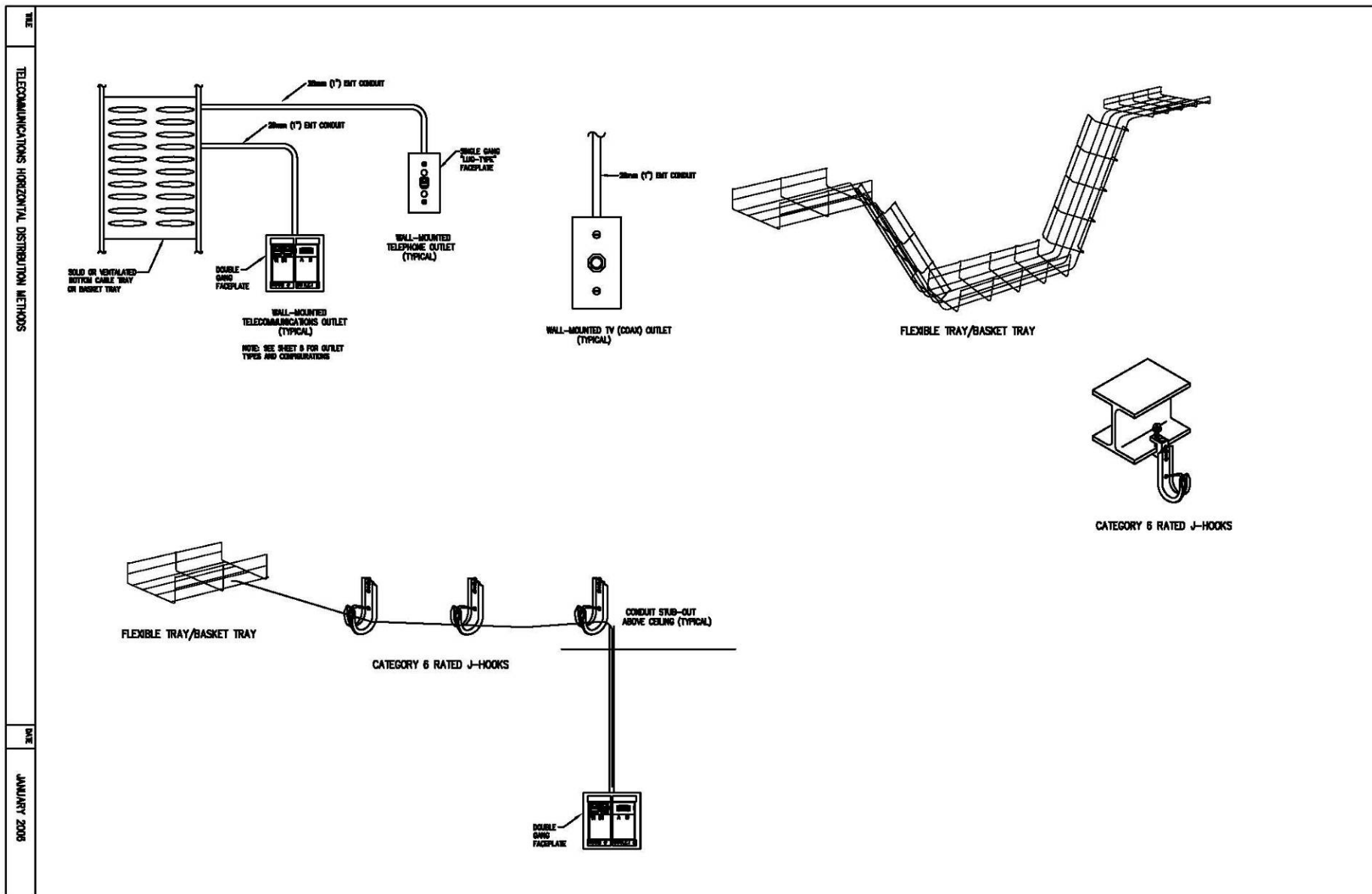

Figure B-3B. Standard Premise Distribution

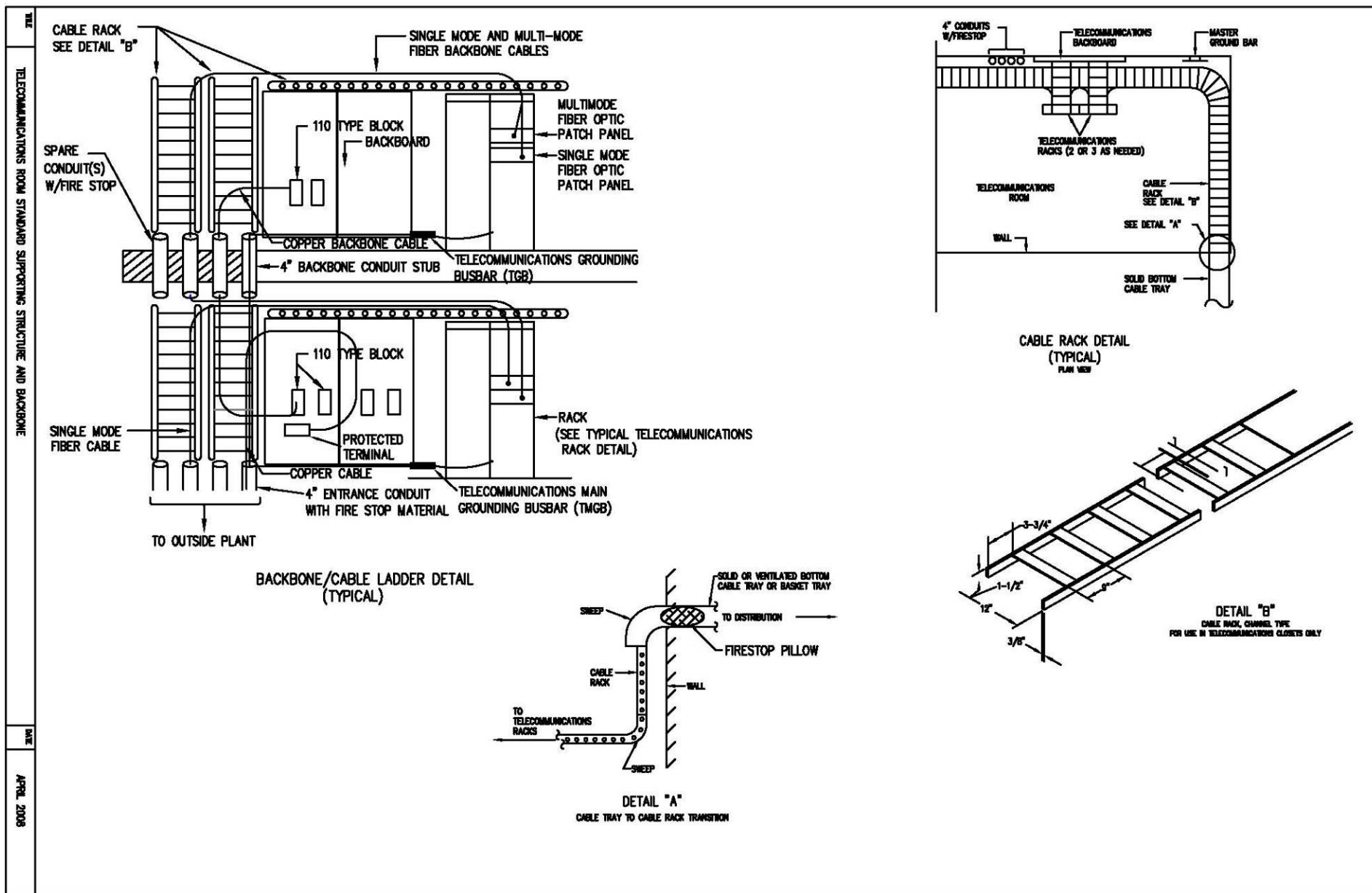

Figure B-4. Telecommunications Room Standard Supporting Structure and Riser

TELECOMMUNICATIONS ROOM SMALL FACILITY/WAREHOUSE PREMISE DISTRIBUTION
 DATE: APRIL 2008

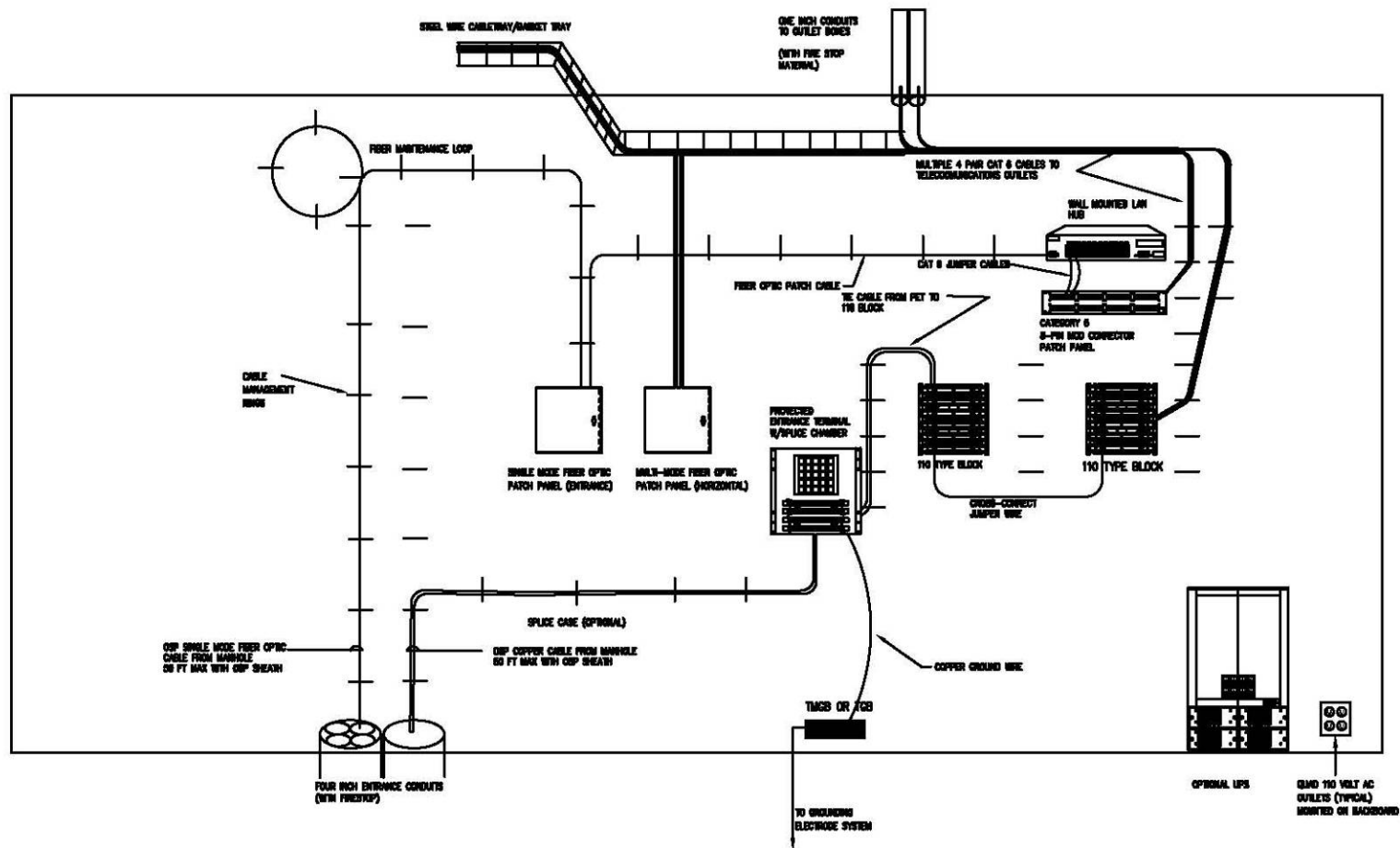

Figure B-5. Telecommunications Room Small Facility/Warehouse

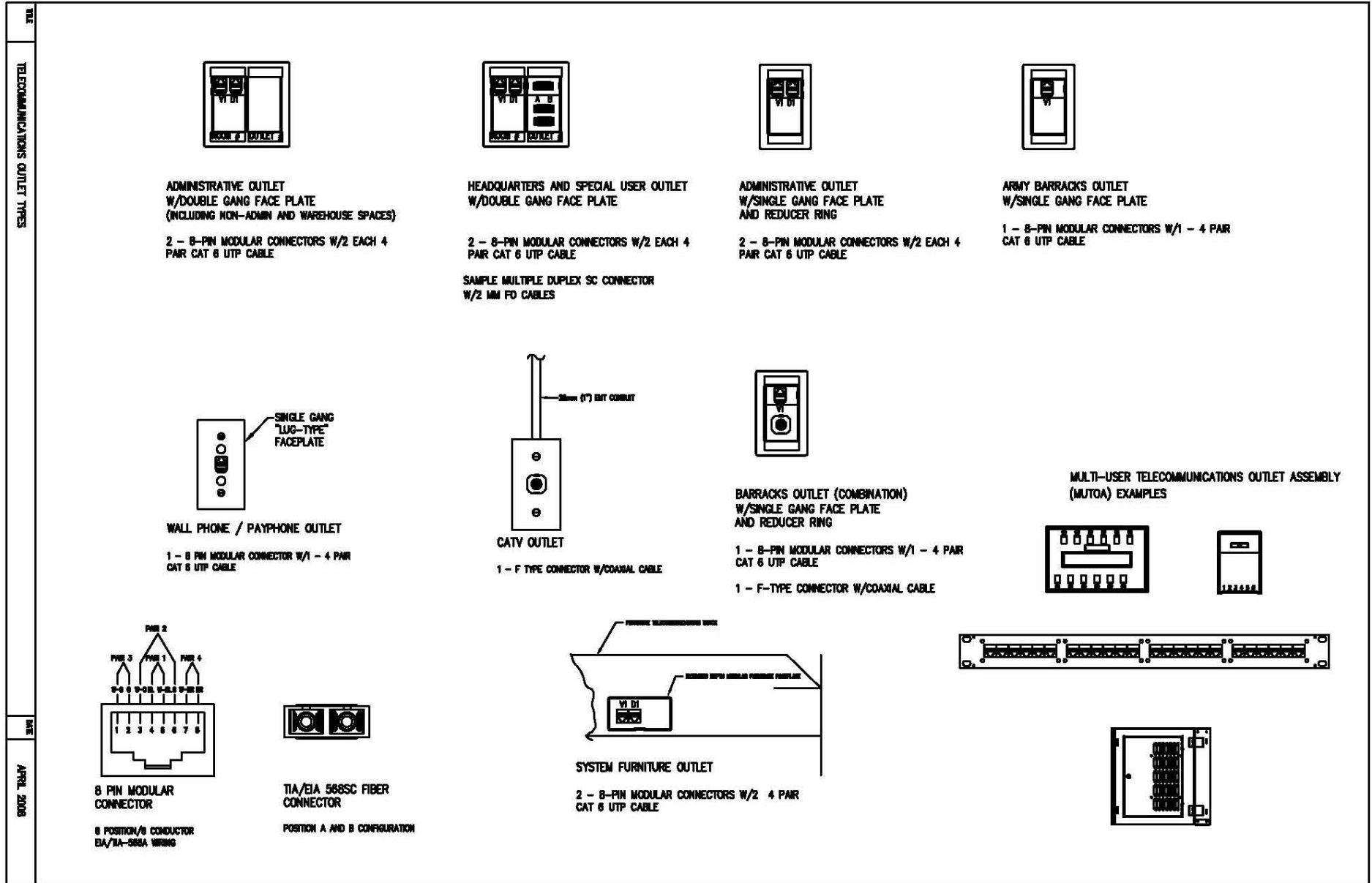

Figure B-6. Telecommunications Outlet Types

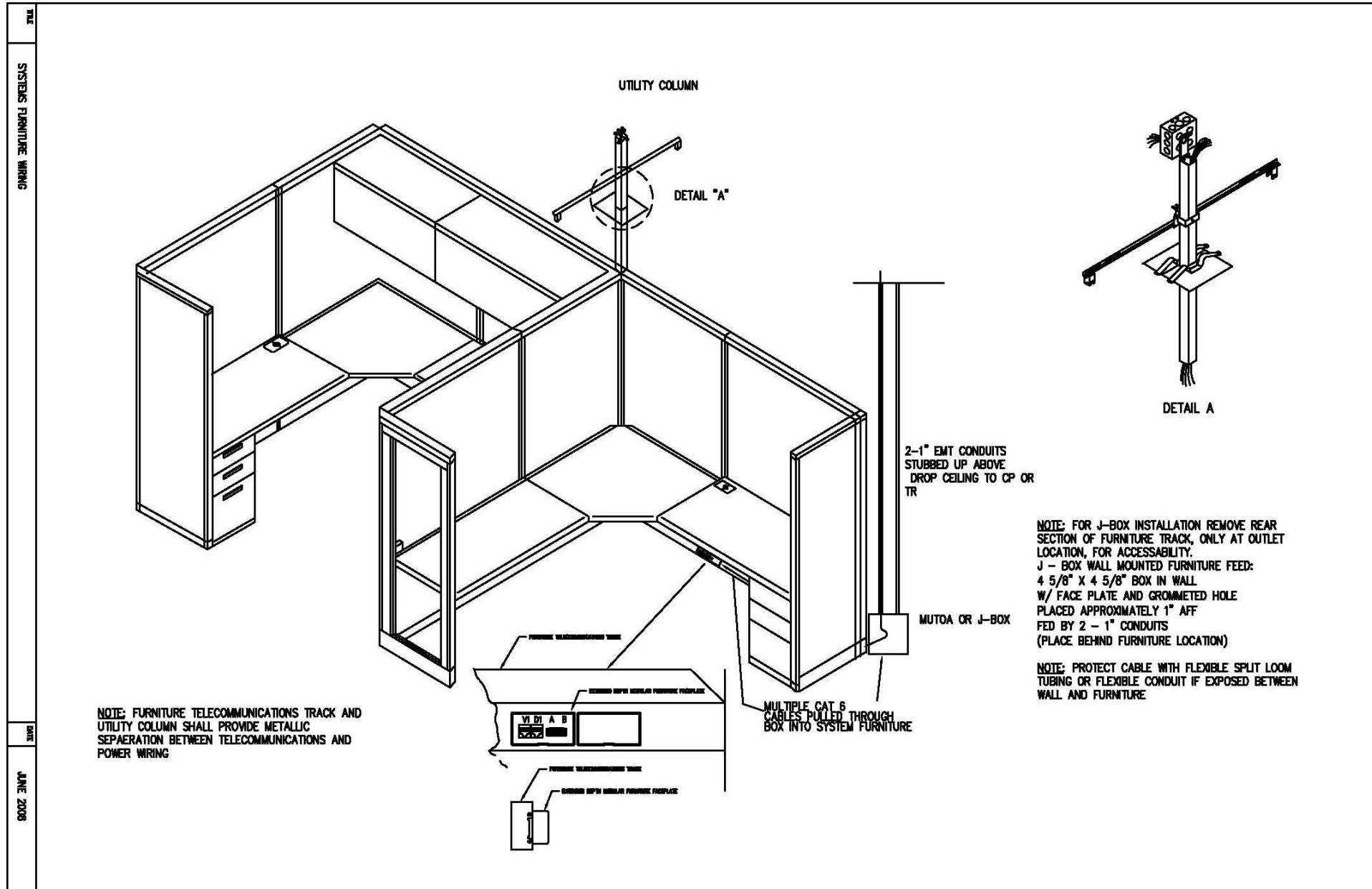

Figure B-7. Systems Furniture Wiring

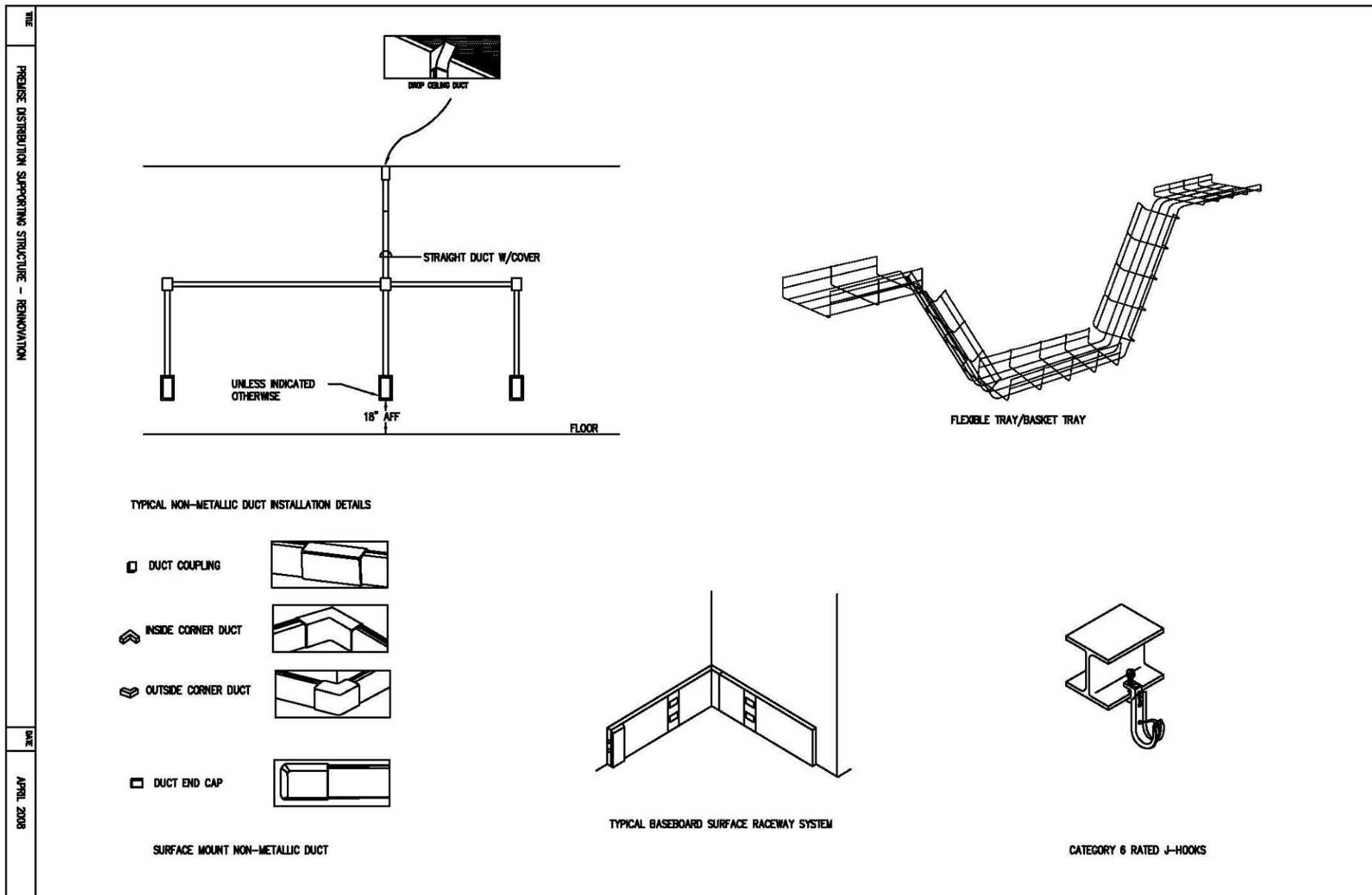

Figure B-8. Premise Distribution Supporting Structure - Renovations

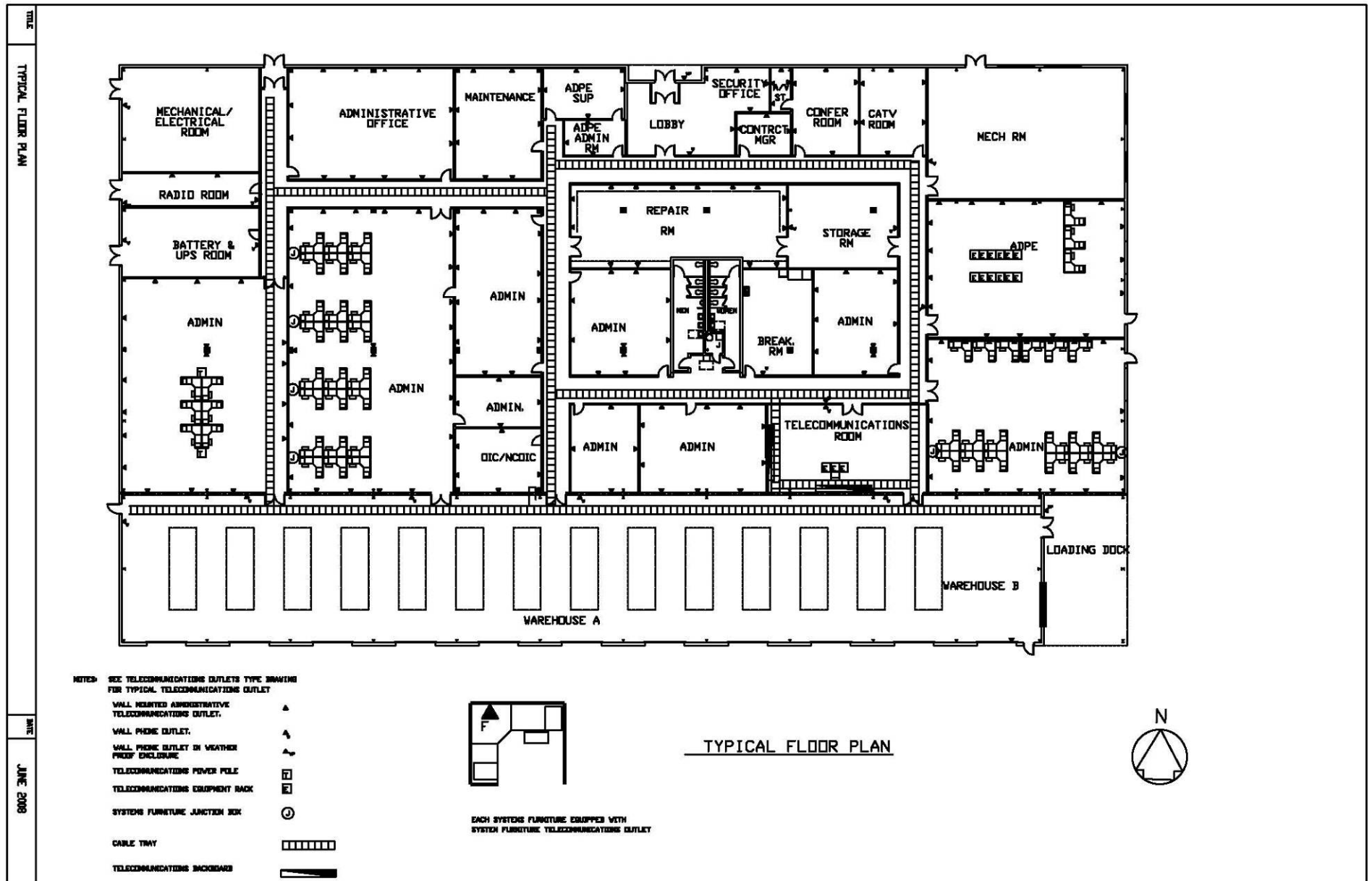

Figure B-9. Typical Floor Plan

CLOSET CONFIGURATION– Total Ground Subsystems using a Signal Ground Bar for the SRGS

N^{1,2} Lightning Protection Grounds Lightning terminals, outside climbing ladders, cable, entrance plates, transient lightning protectors, structural steel, metal outside cable shields/sheaths (M.S 5.1.1.3.5), etc.

NOTES:

- N¹: Different subsystem grounds should be connected, bonded to each other, if possible, only through the EES
- N²: M-S = MIL-STD-188-124B
- N³: Facility Entrance Plate or outside manhole ground point.
- N⁴: Engineering judgment required on selecting the lowest Z path to the EES Gnd.

N¹ Signal (HF) Grounds
Higher freq circuits, frames, steel girders, equipment, chassis, racks, etc. See also MS 5.1.1.4.2

N^{1,2} Fault Protection Grounds EGCs and DC Power Grounds)

- 1) EGCs. EGCs (Equipment Grounding Conductors "Green" Ground wire runned with AC power supply cables). Motor frames, generators, other rotating machinery (M-S 5.1.1.2.5.4).
- 2) DC Power Grounds. One leg of each dc power system shall be grounded with a single connection directly to the EES (MS 5.1.1.2.5.5)

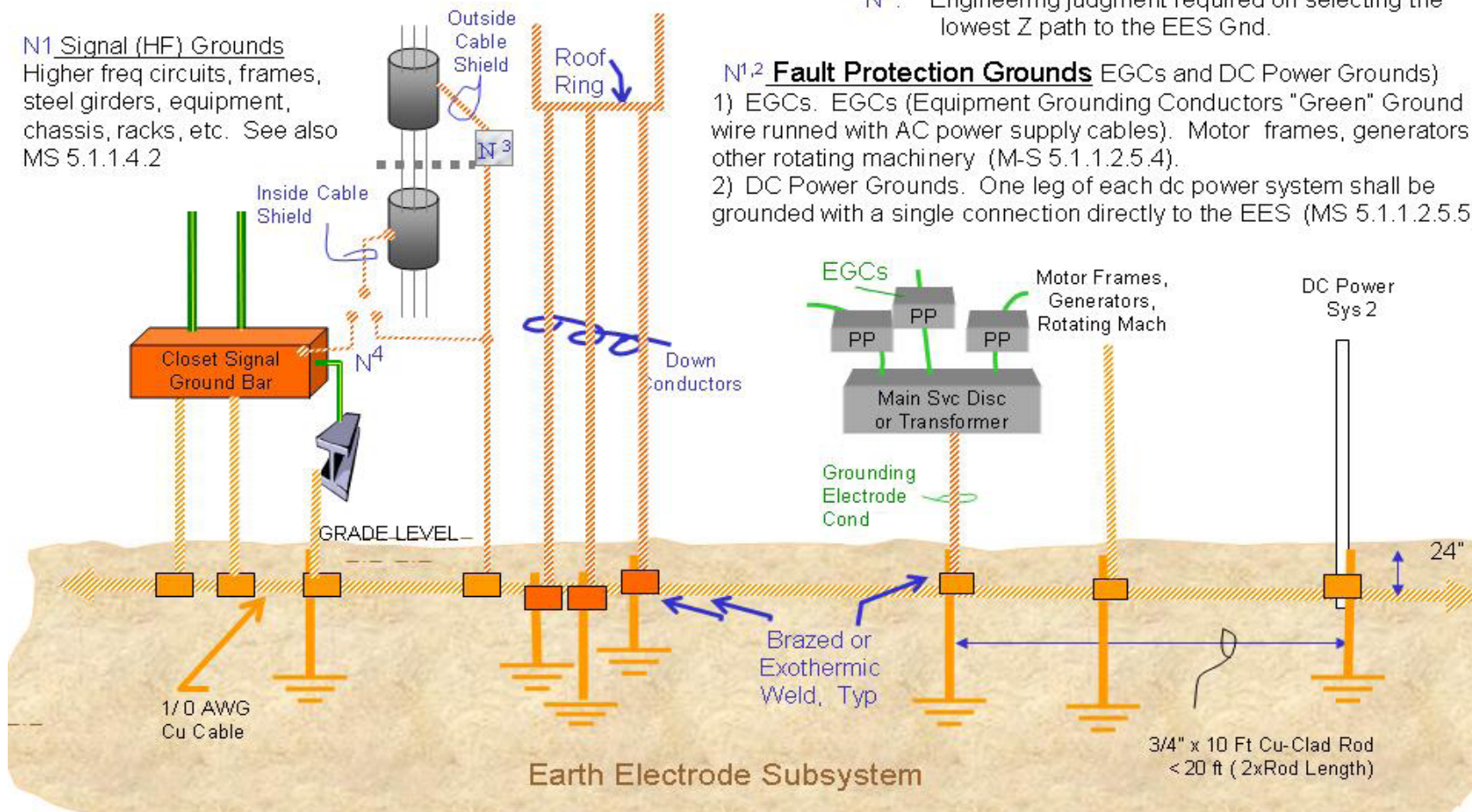

Figure B-10. Grounding System

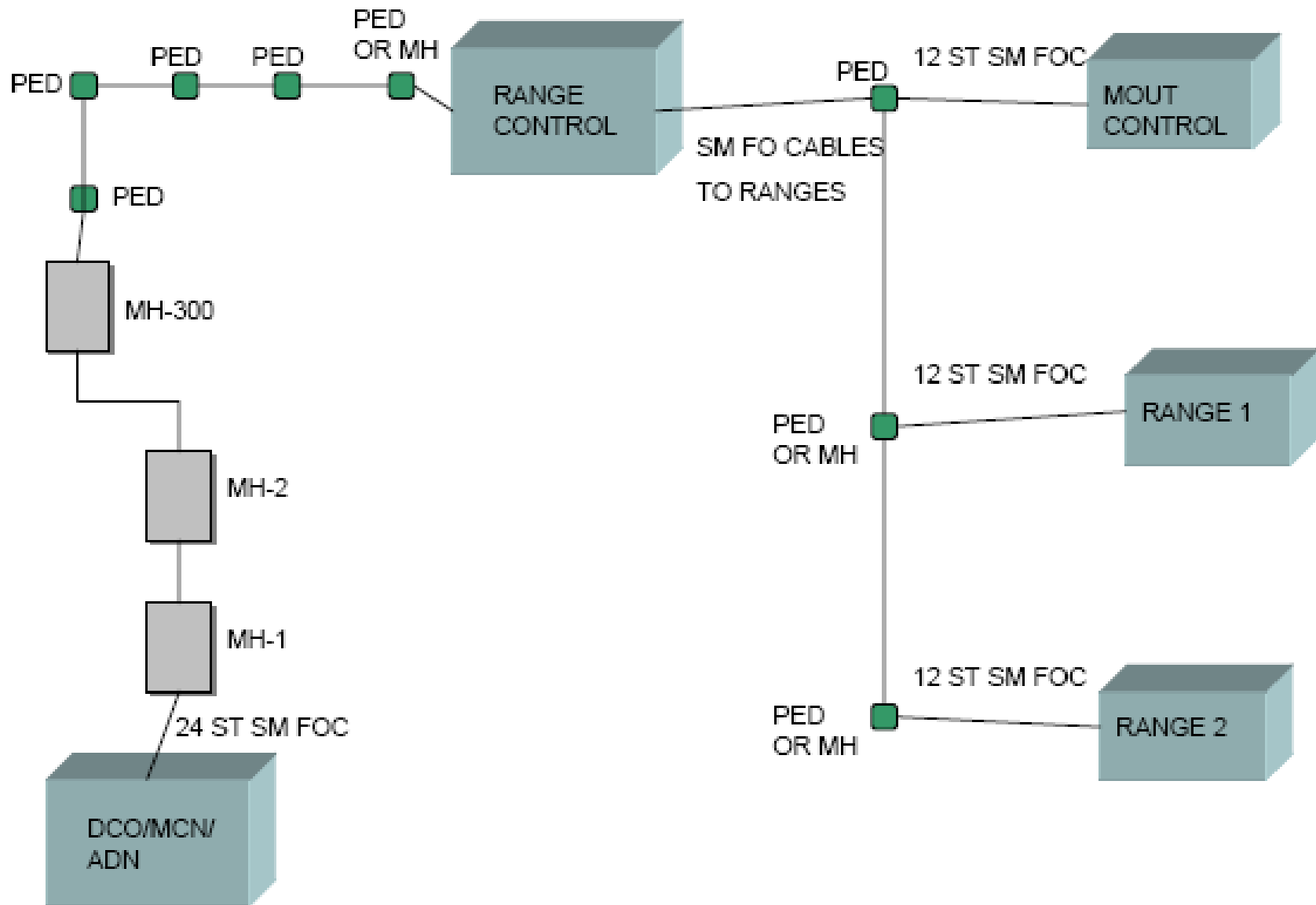

Figure B-11. Range Design

APPENDIX C. NORTH AMERICA AND EUROPEAN DRAWINGS

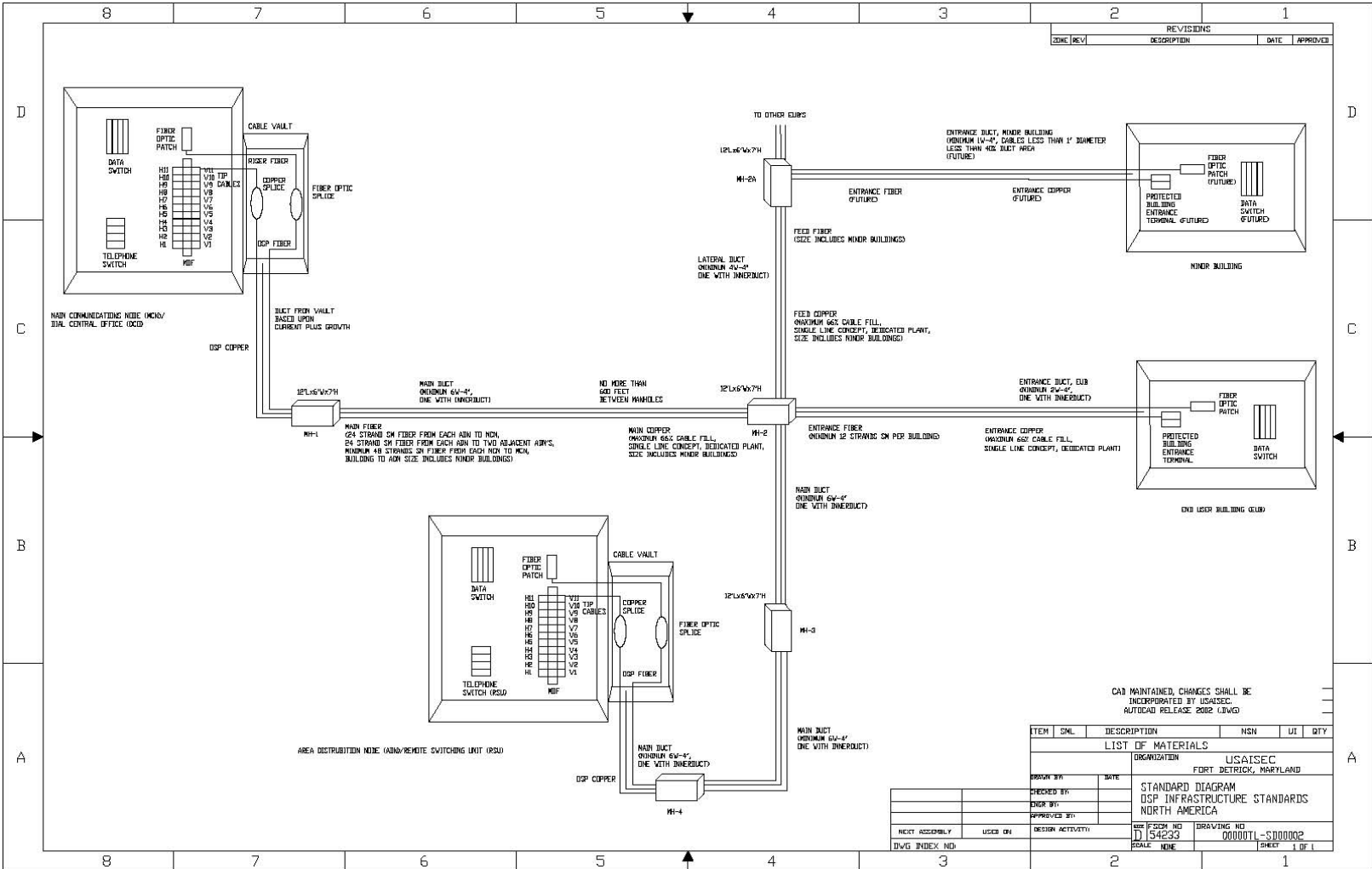

Figure C-1. OSP Infrastructure Standards – North America

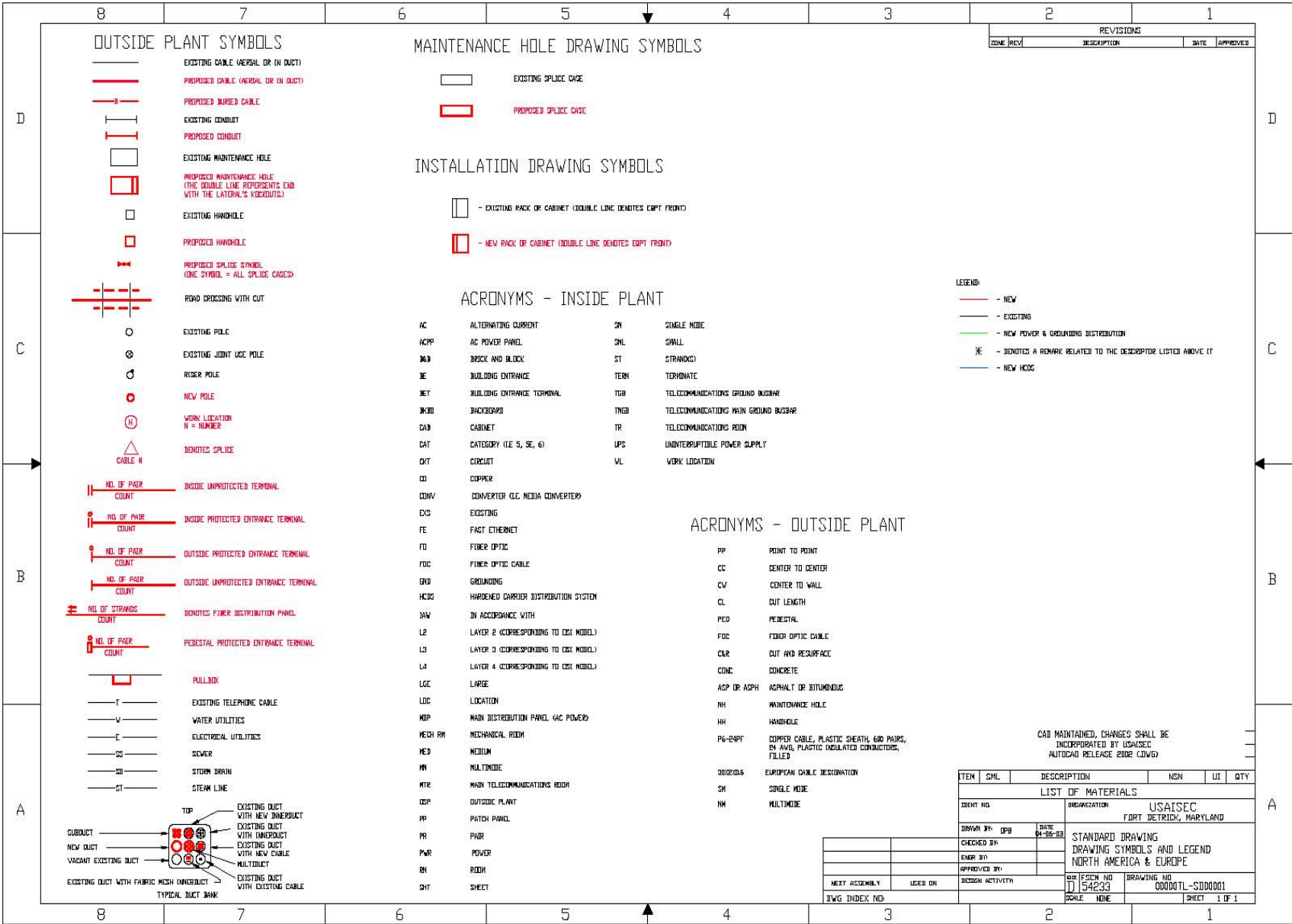

Figure C-2. Drawing Symbols – North America and Europe

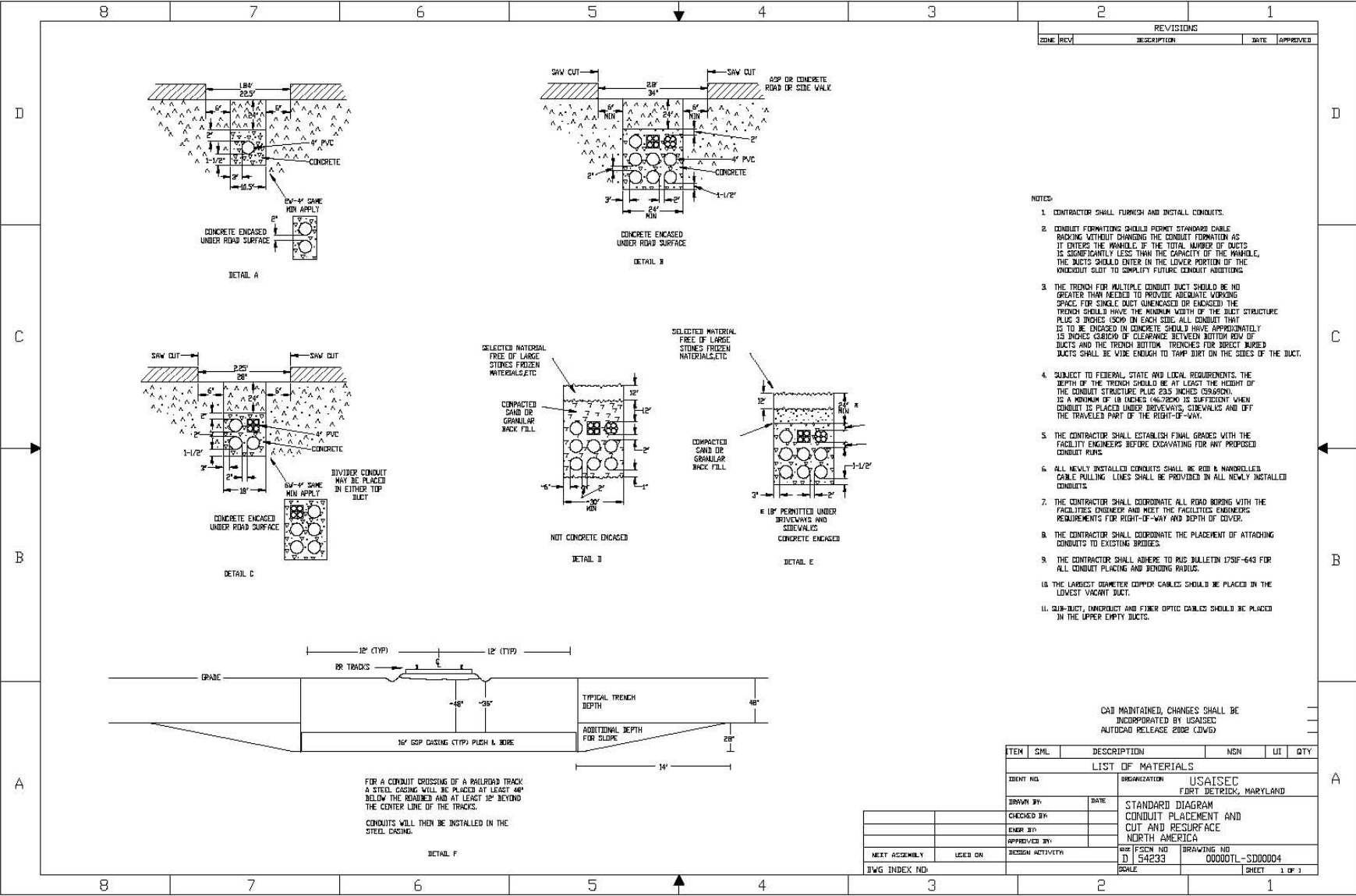

Figure C-3. Conduit Placement/Cut and Resurface – North America

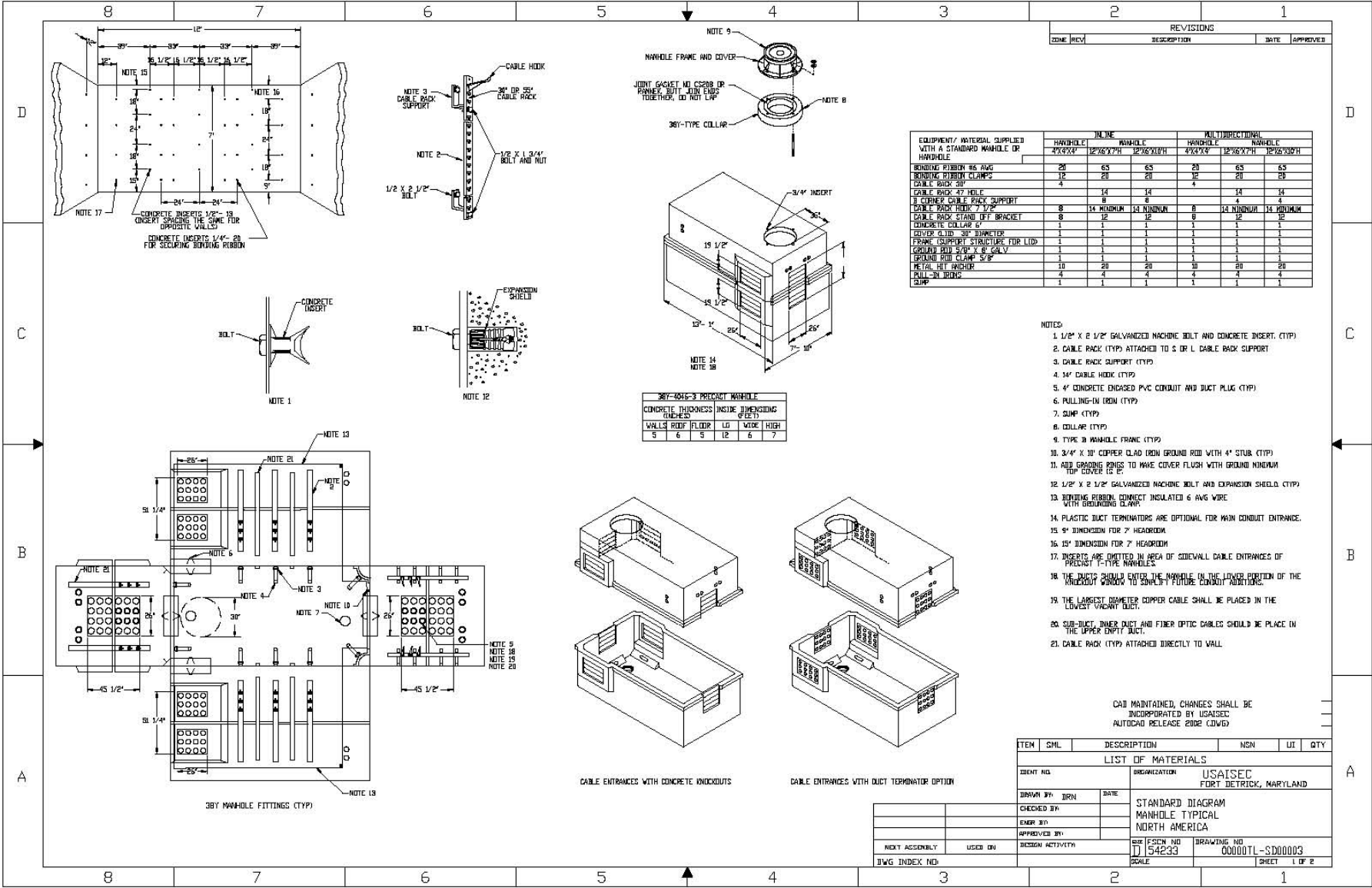

Figure C-4. Typical Maintenance Hole – North America (1 of 2)

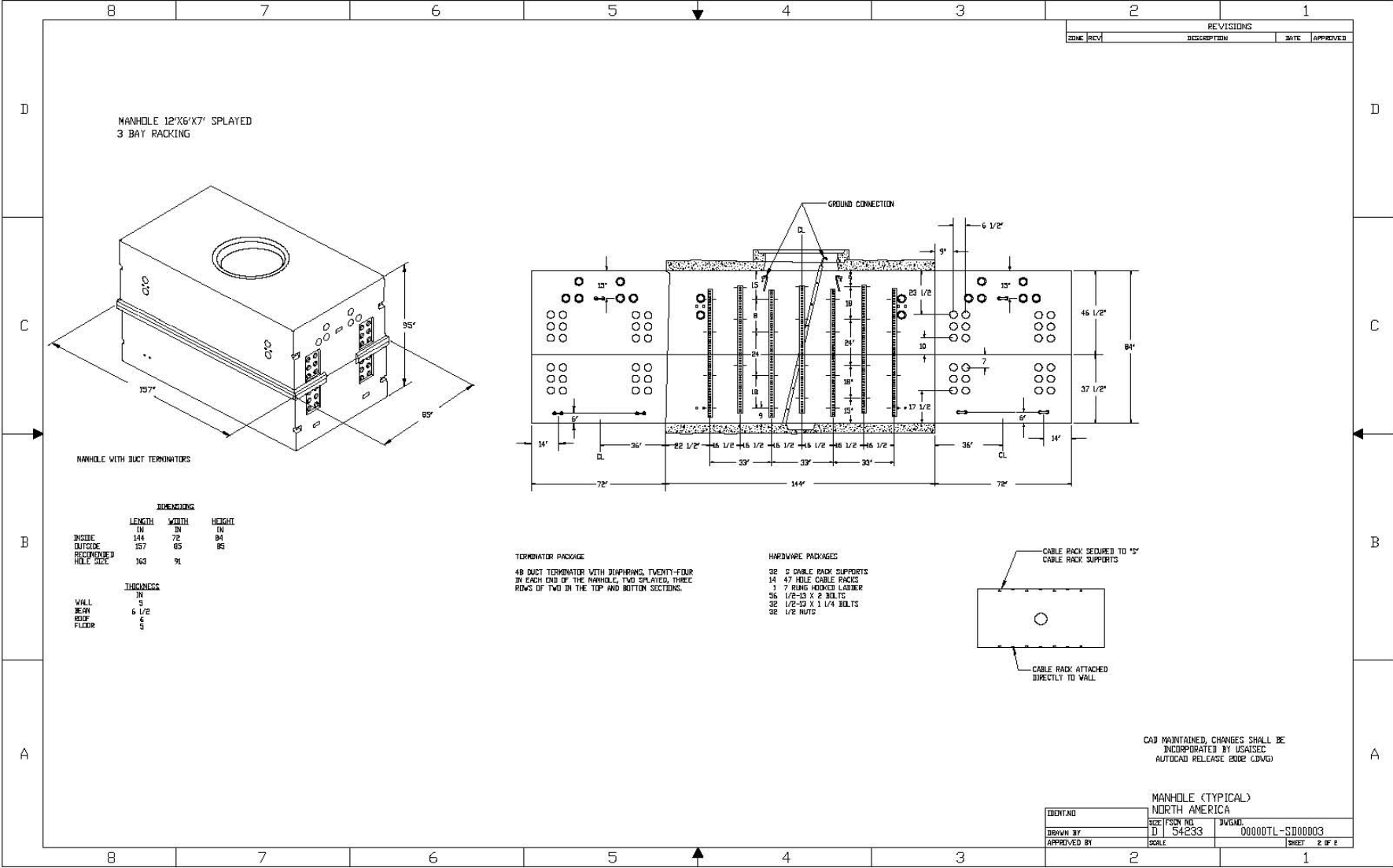

Figure C-5. Typical Maintenance Hole – North America (2 of 2)

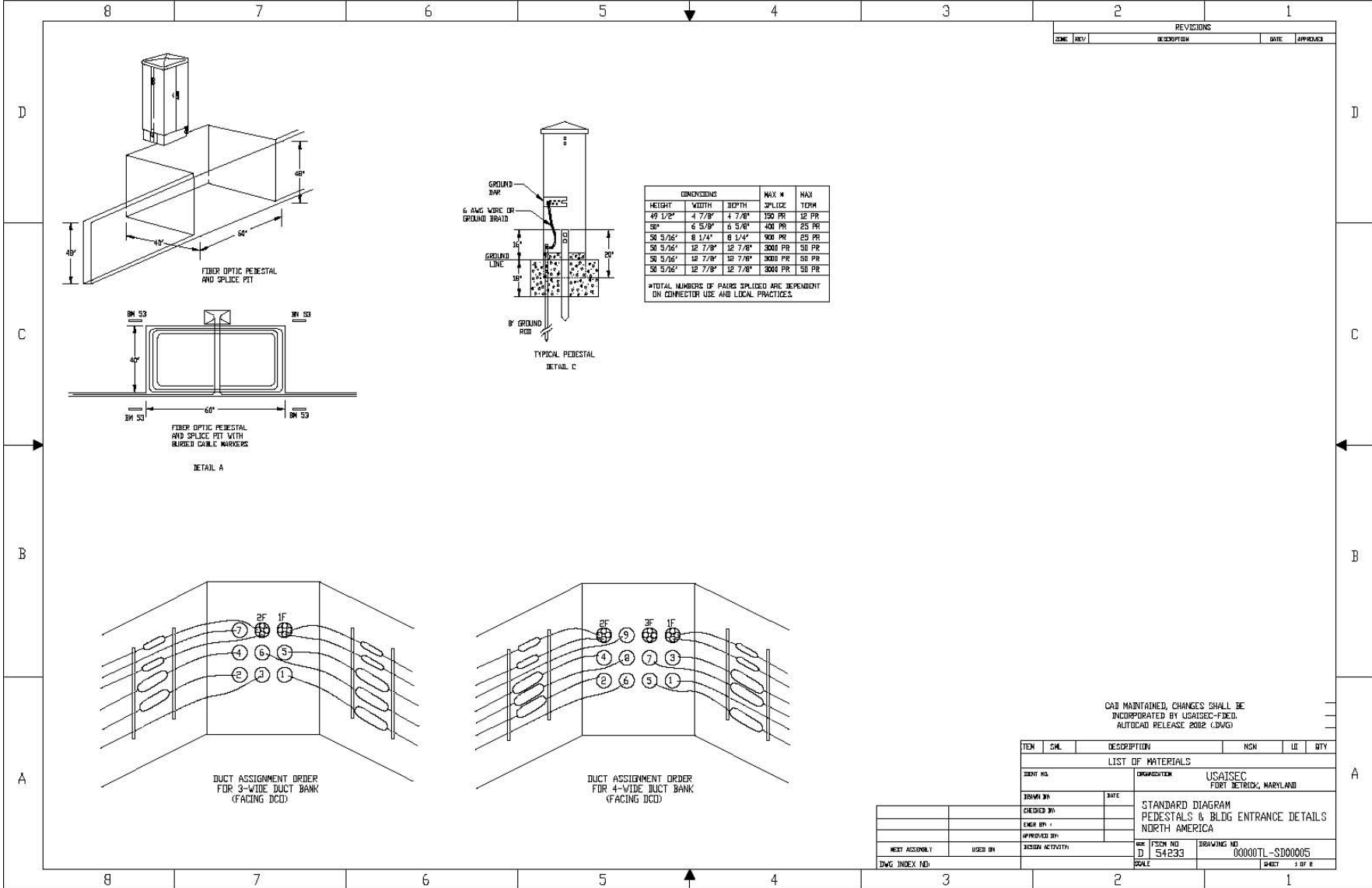

Figure C-6. Pedestals and Building Entrance Details – North America (1 of 2)

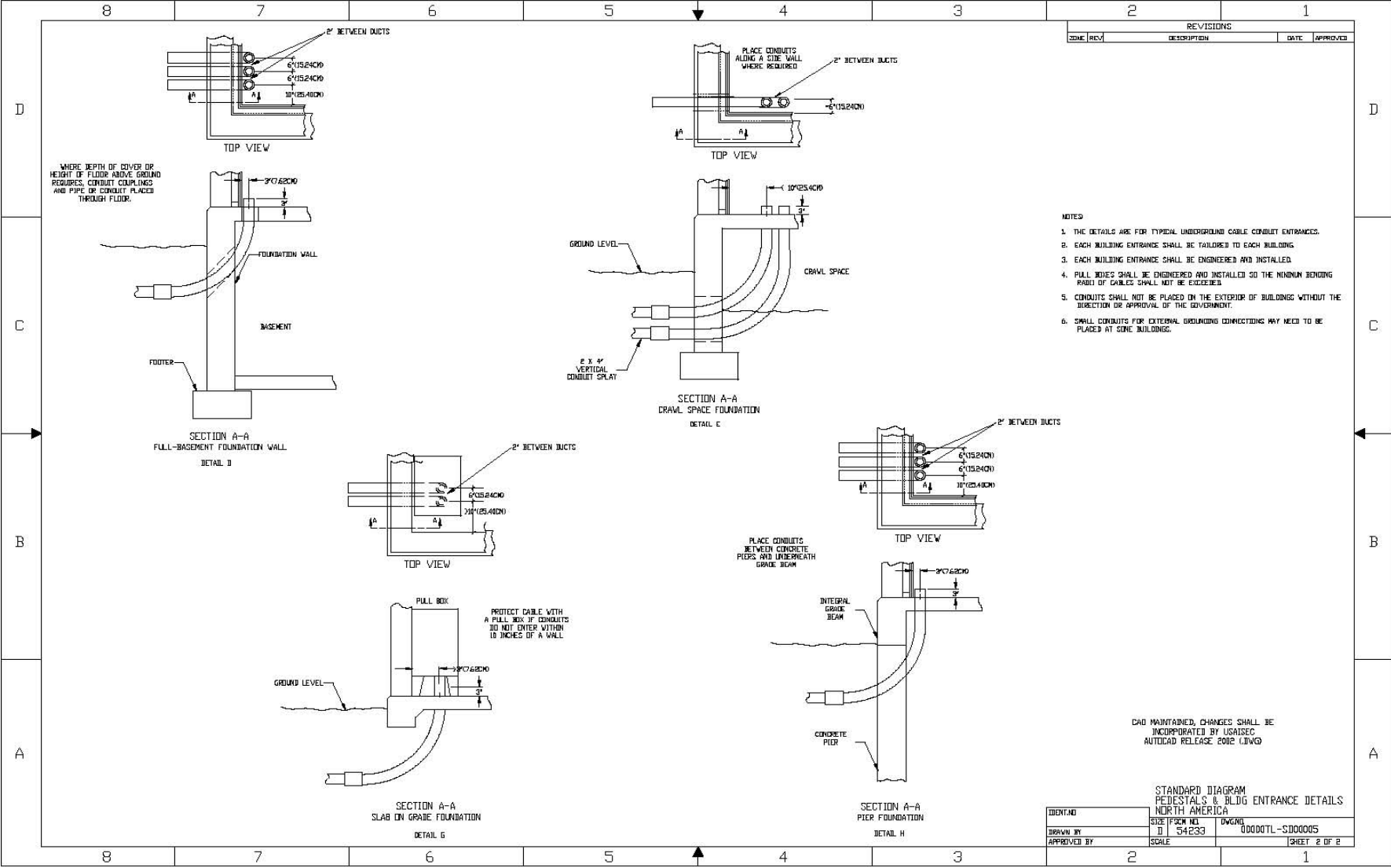

Figure C-7. Pedestals and Building Entrance Details – North America (2 of 2)

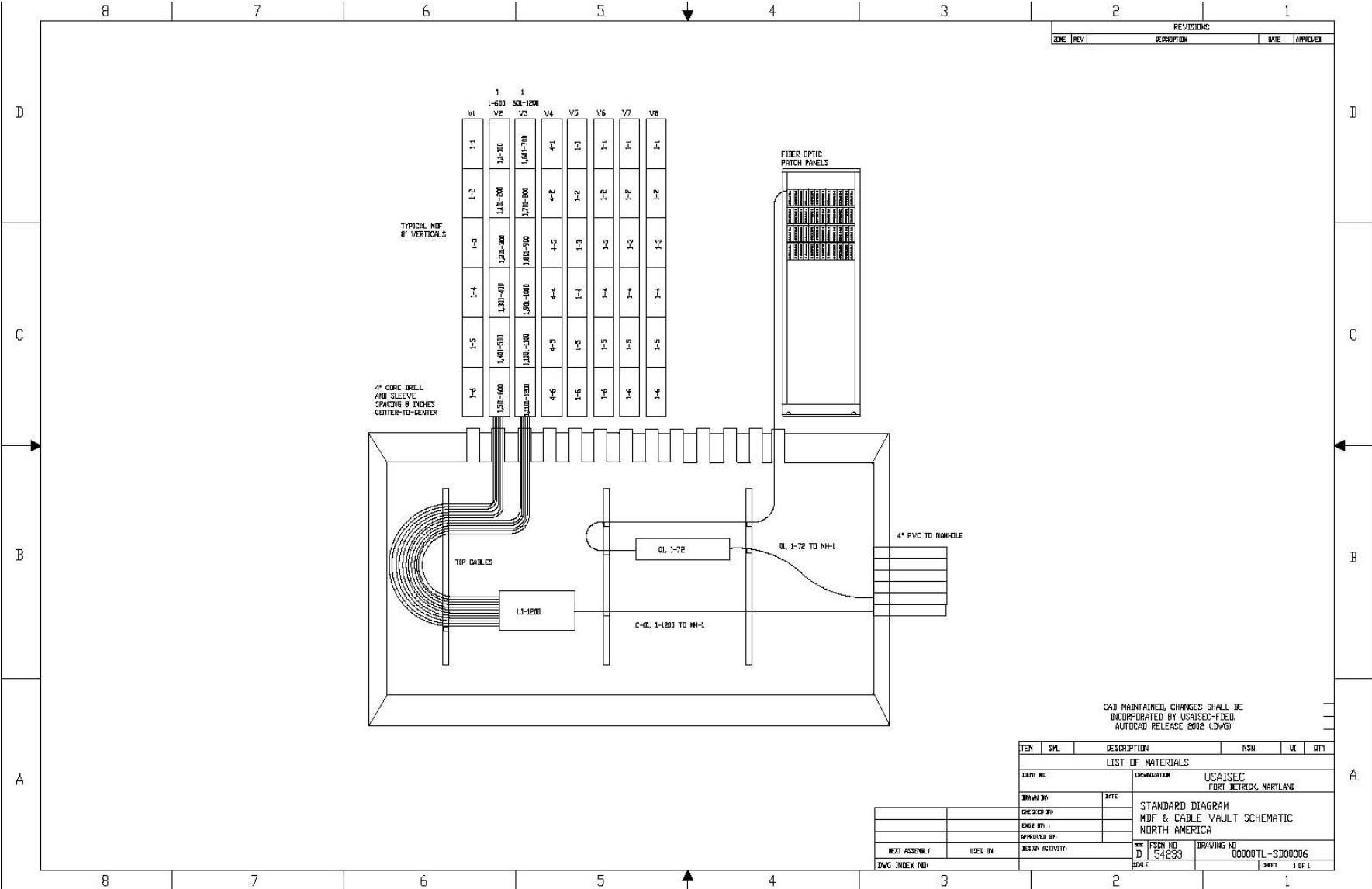

Figure C-8. MDF and Cable Vault Schematic – North America

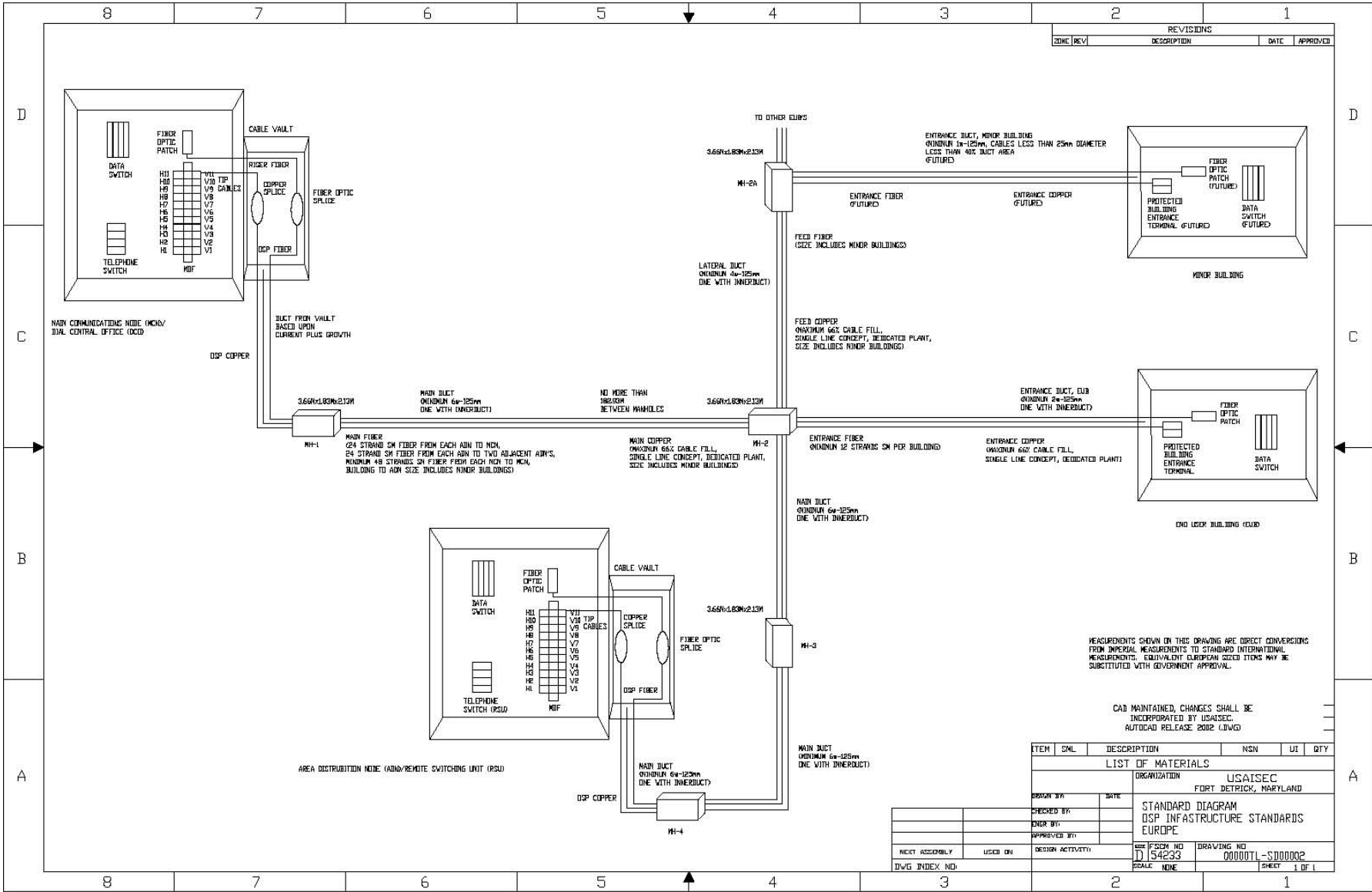

Figure C-9. OSP Infrastructure Standards – Europe

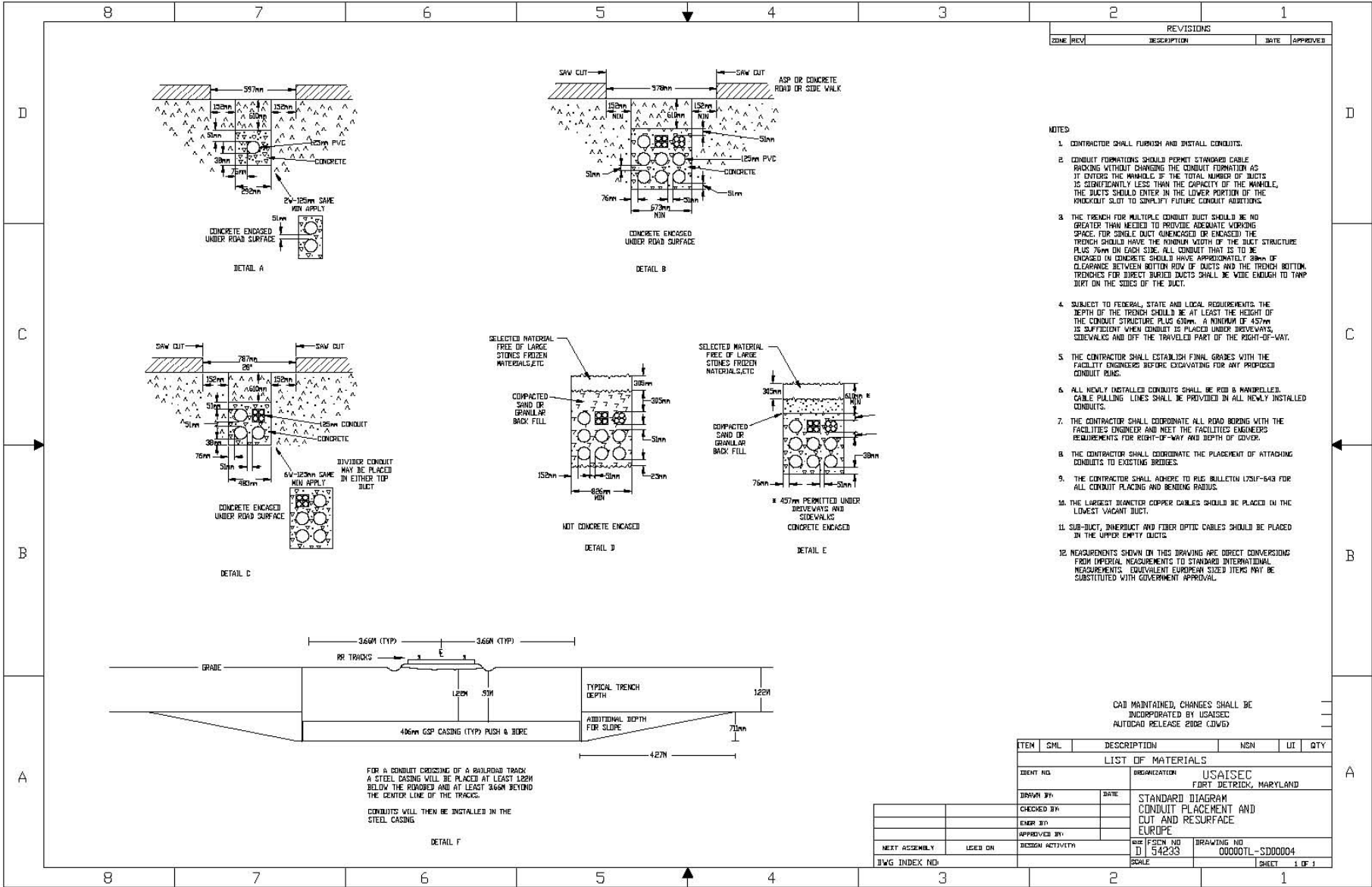

Figure C-10. Conduit Placement/Cut and Resurface – Europe

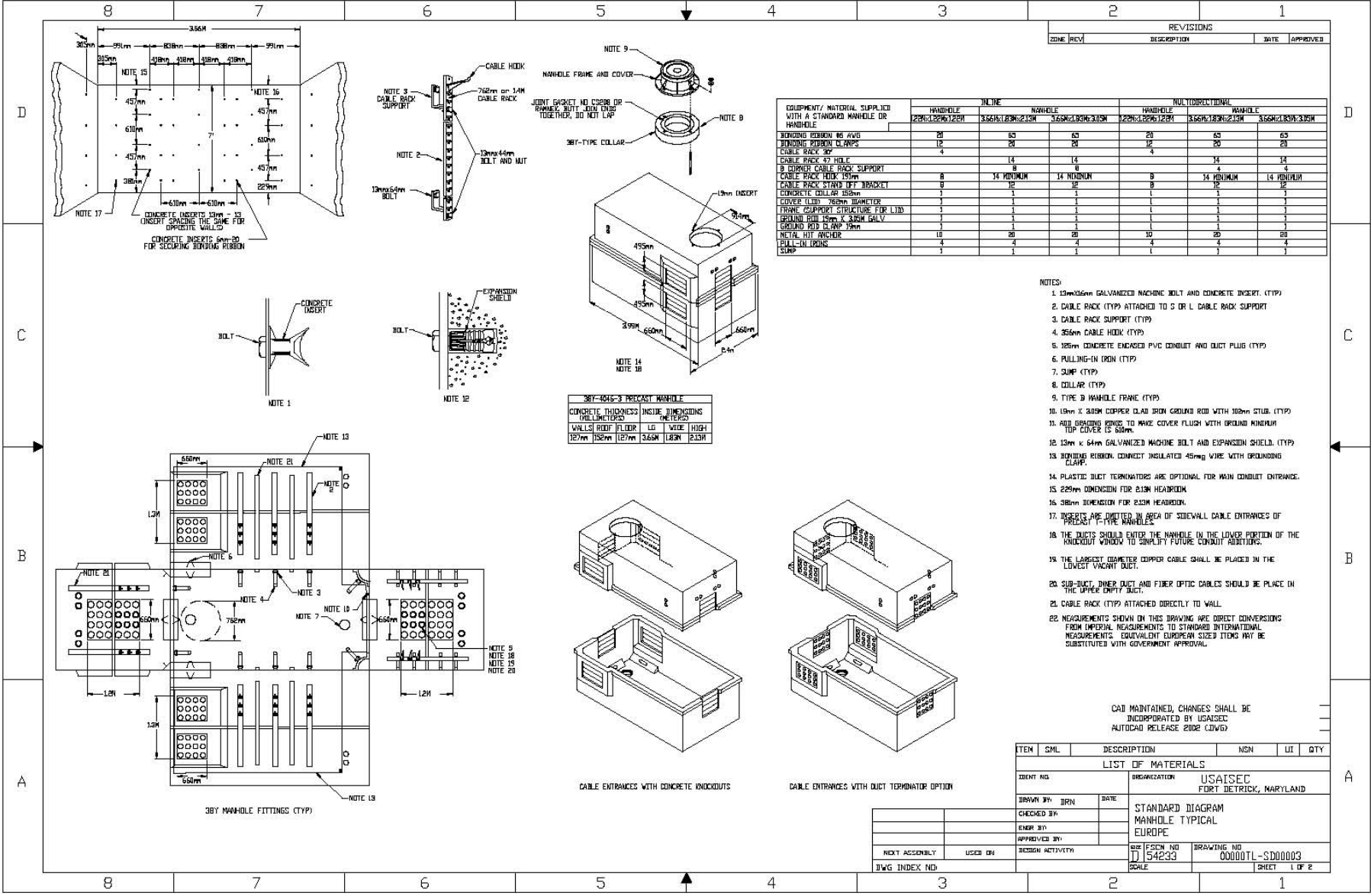

Figure C-11. Typical Maintenance Hole – Europe (1 of 2)

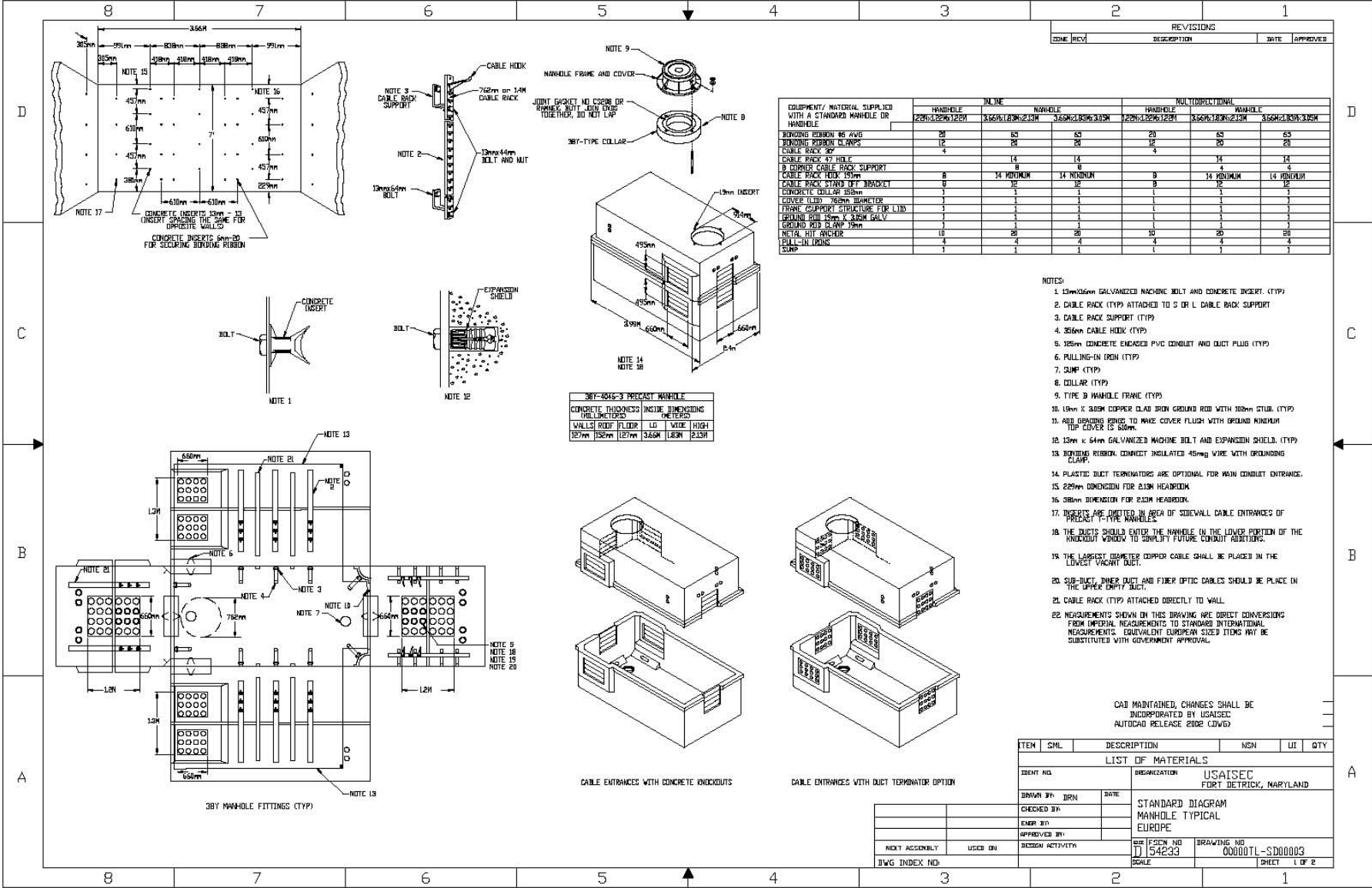

Figure C-12. Typical Maintenance Hole – Europe (2 of 2)

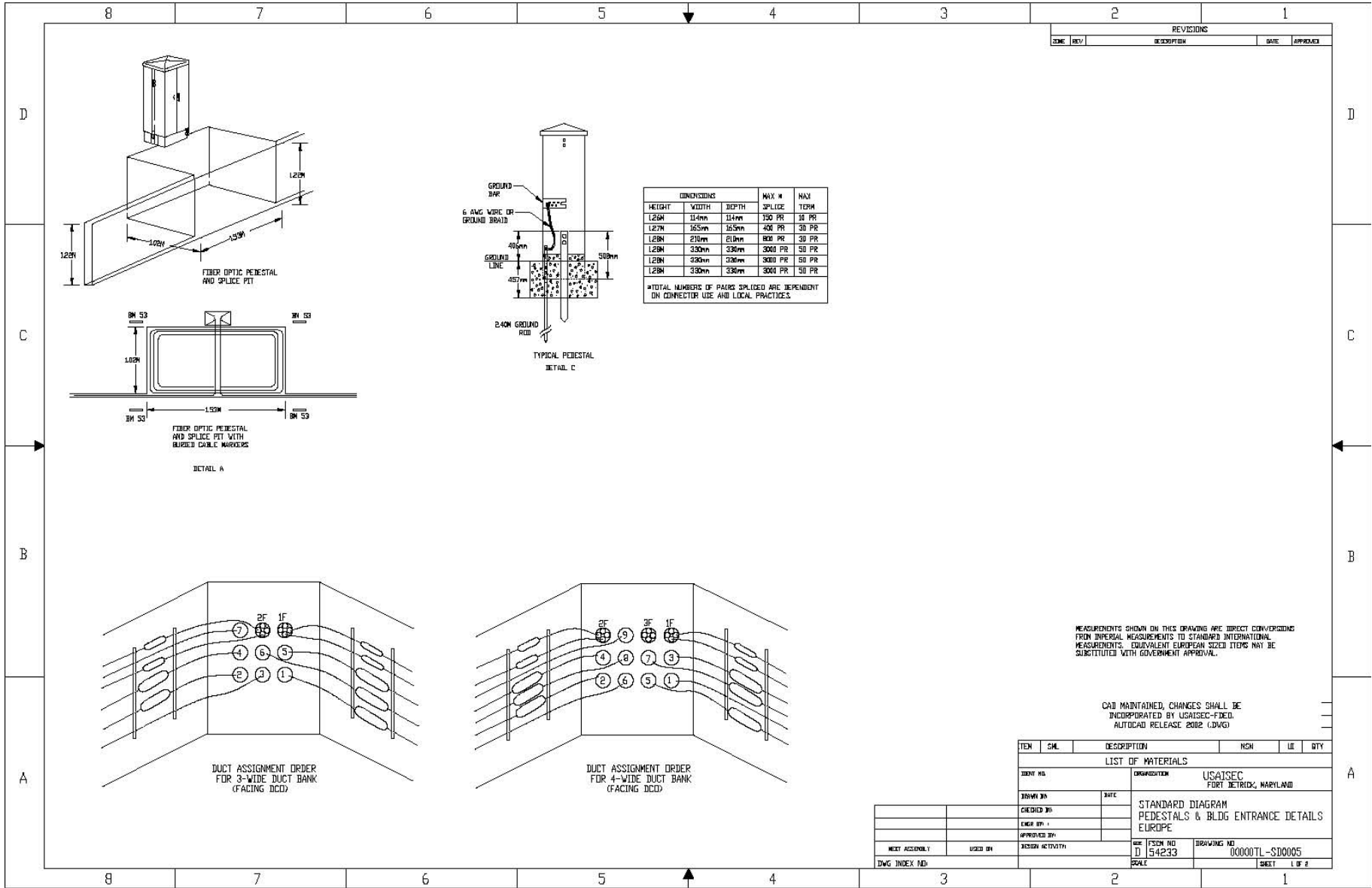

Figure C-13. Pedestals and Building Entrance Details – Europe (1 of 2)

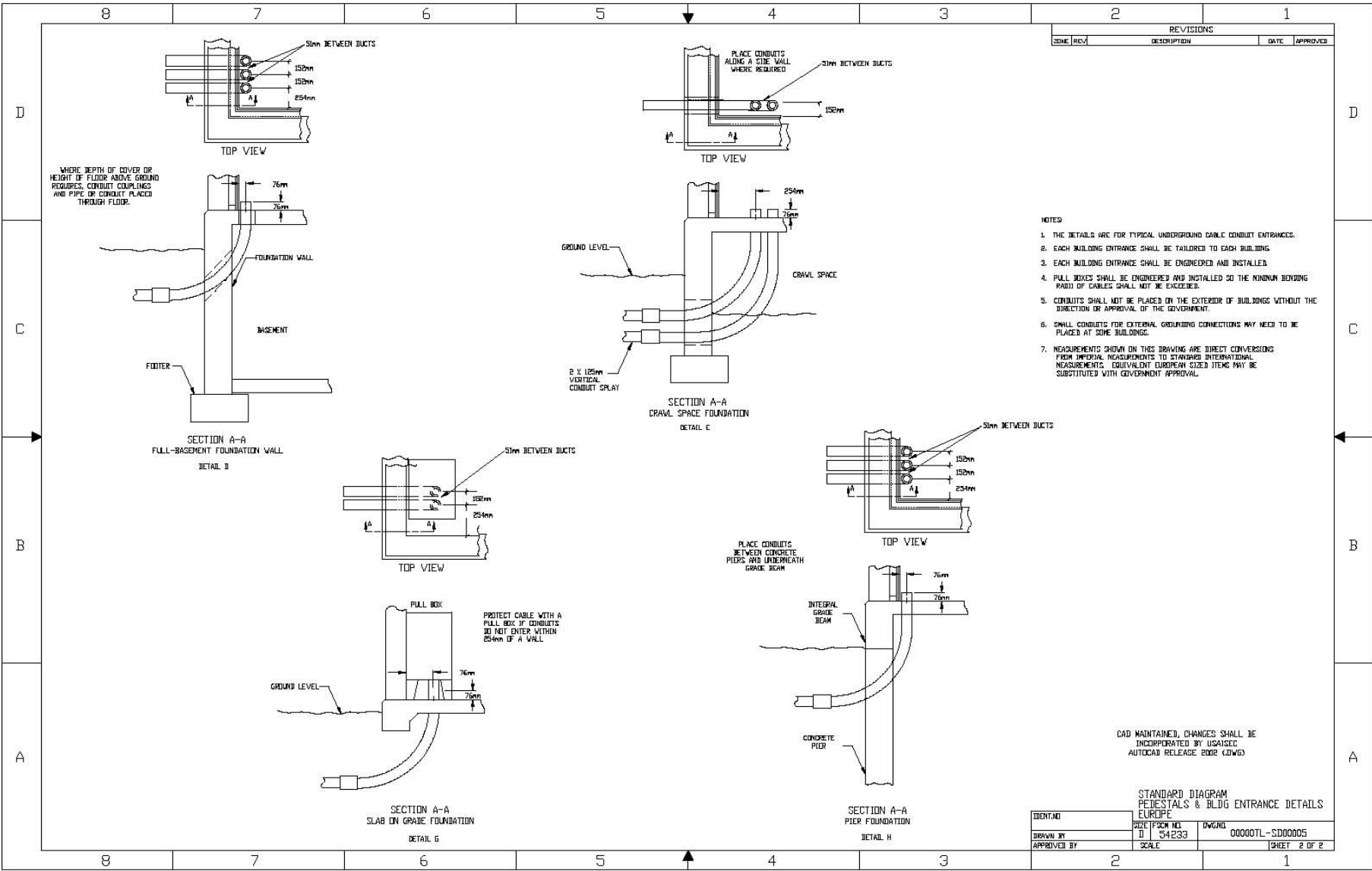

Figure C-14. Pedestals and Building Entrance Details – Europe (2 of 2)

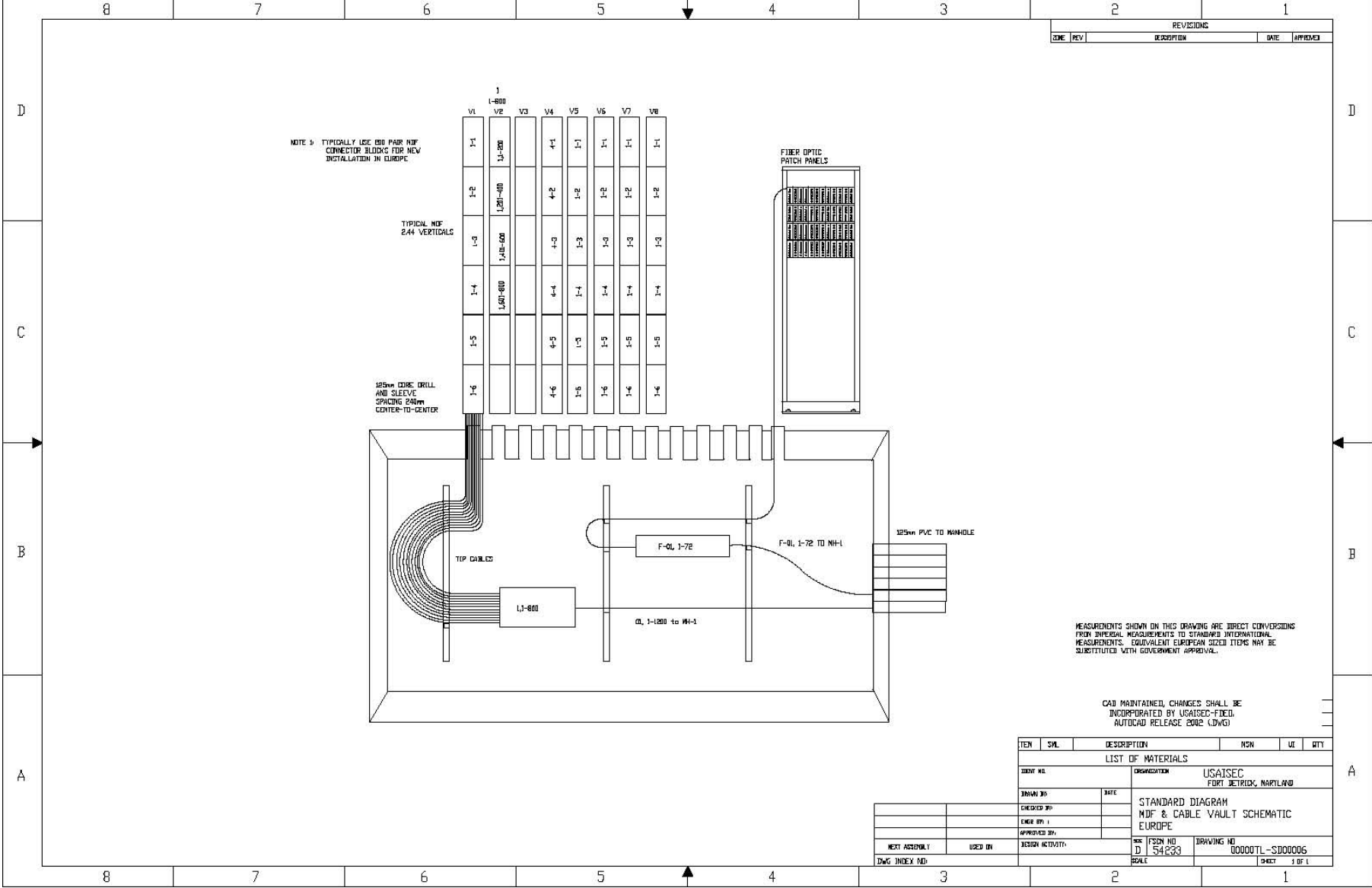

Figure C-15. MDF and Cable Vault Schematic – Europe

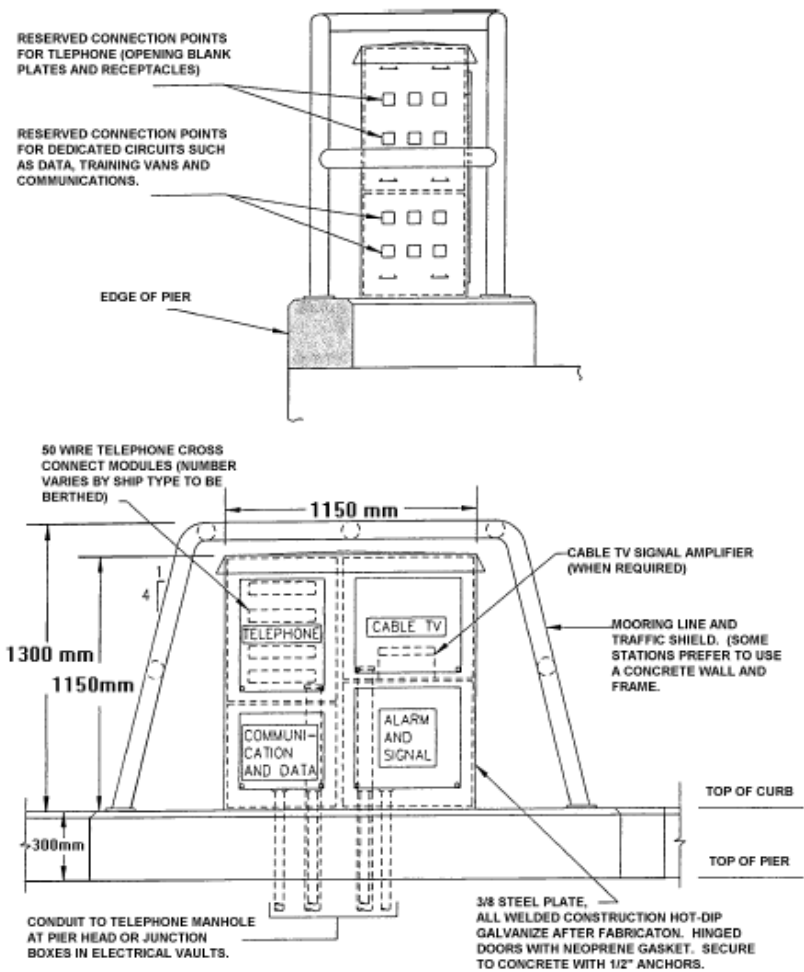

Figure C-16. Illustration of Pier Igloo Construction

CLOSET CONFIGURATION– Total Ground Subsystems using a Signal Ground Bar for the SRGS

N^{1,2} Lightning Protection Grounds Lightning terminals, outside climbing ladders, cable, entrance plates, transient lightning protectors, structural steel, metal outside cable shields/sheaths (M.S 5.1.1.3.5), etc.

NOTES:
 N¹: Different subsystem grounds should be connected, bonded to each other, if possible, only through the EES
 N²: M-S = MIL-STD-188-124B
 N³: Facility Entrance Plate or outside manhole ground point.
 N⁴: Engineering judgment required on selecting the lowest Z path to the EES Gnd.

N¹ Signal (HF) Grounds
 Higher freq circuits, frames, steel girders, equipment, chassis, racks, etc. See also MS 5.1.1.4.2

N^{1,2} Fault Protection Grounds EGCs and DC Power Grounds)
 1) EGCs. EGCs (Equipment Grounding Conductors "Green" Ground wire runned with AC power supply cables). Motor frames, generators, other rotating machinery (M-S 5.1.1.2.5.4).
 2) DC Power Grounds. One leg of each dc power system shall be grounded with a single connection directly to the EES (MS 5.1.1.2.5.5)

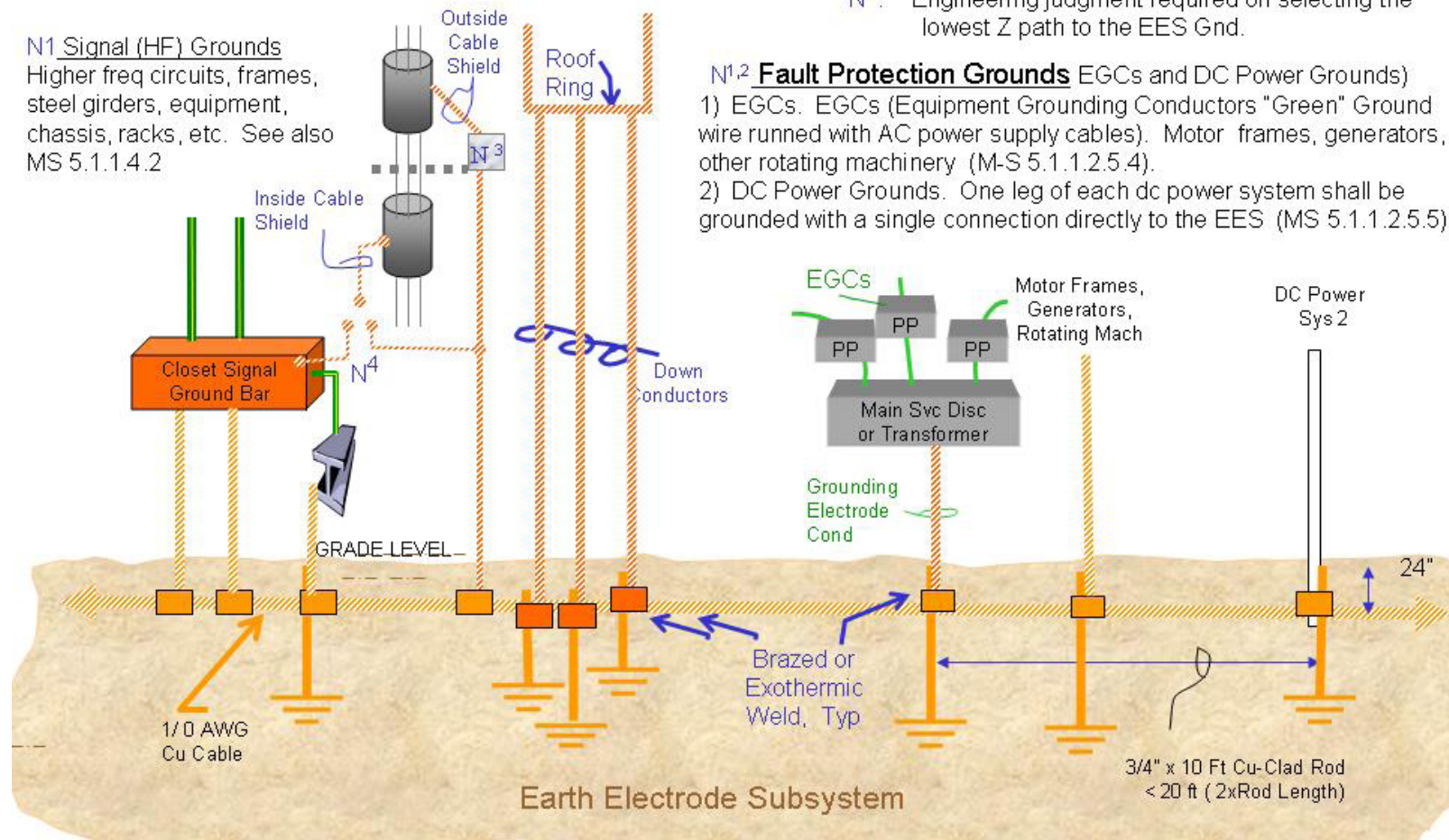

Figure C-17. Grounding System

This page intentionally left blank.

APPENDIX D. REFERENCES

1. ANSI/TIA/EIA-568-B.1 Commercial Building Telecommunications Cabling Standard, Part 1: General Requirements
2. ANSI/TIA/EIA-568-B.2 Commercial Building Telecommunications Cabling Standard, Part 2: Balanced Twisted Pair Cabling Components
3. ANSI/TIA/EIA-568-B.2 –1 Addendum 1 – Transmission Performance Specifications for 4-pair 100-ohm Category 6 Cabling
4. ANSI/TIA/EIA-568-B.2–4 Addendum 4 - Solderless Connection Reliability Requirements for Copper Connecting Hardware
5. ANSI/TIA/EIA-568-B.3 Commercial Building Telecommunications Cabling Standard, Part 3: Optical Fiber Cabling Components
6. ANSI/TIA/EIA-568-B.3-1 Addendum 1 –Additional Transmission Performance Specifications for 50/125 Optical Fiber Cables
7. ANSI/TIA/EIA-569-B Commercial Building Standard for Telecommunications Pathways and Spaces
8. ANSI/TIA/EIA-526-7 Measurement of Optical Power Loss of Installed Single-Mode Fiber Cable Plant
9. ANSI/TIA/EIA-526-14A Measurement of Optical Power Loss of Installed Multimode Fiber Cable Plant
10. ANSI/TIA/EIA-606-A Administrative Standard for the Telecommunications Infrastructure of Commercial Buildings
11. ANSI-J-STD-607-A-2002, Commercial Building Grounding (Earthing) and Bonding Requirements for Telecommunications, Telecommunications Industry Association (TIA), October 2002.
12. EN 50173:1996 Information Technology – Generic Cabling Systems
13. EN 50174-1:2001 Information Technology – Cabling Installation, Part 1: Specification and Quality Assurance
14. EN 50174-2:2001 Information Technology – Cabling Installation, Part 2: Installation Planning and Practices Inside Buildings
15. EN 50174-3:2002 DRAFT Information Technology – Cabling Installation, Part 3: Installation Planning and Practices Outside Buildings
16. ISO/IEC 11801:2002 Information Technology – Generic Cabling for Customer Premises
17. ISO/IEC 14763-1:1999 Information Technology – Implementation and Operation of Customer Premises Cabling, Part 1: Administration
18. ISO/IEC 14763-2:2000 Information Technology – Implementation and Operation of Customer Premises Cabling, Part 2: Planning and Installation
19. ISO/IEC 14763-3:2000 Information Technology – Implementation and Operation of Customer Premises Cabling, Part 3: Testing of Optical Fiber Cabling
20. NFPA 70, National Electrical Code, 2002 Edition, National Fire Protection Association, Inc., August 2001.
21. NFPA 780, Standard for the Installation of Lightning Protection Systems, latest issue

22. C2-2002, National Electrical Safety Code, 2002 Edition, Institute of Electrical and Electronics Engineers, Inc., August 2002.
23. MIL-STD-188-124B, Grounding, Bonding And Shielding for Common Long Haul/Tactical Communication Systems Including Ground Based Communications- Electronics Facilities and Equipments.
24. MIL-HDBK-419A, Grounding, Bonding, and Shielding For Electronic Equipments and Facilities.
25. UFC 1-300-01 Criteria Format Standard
26. UFC 3-580-10 Design: Navy And Marine Corps Intranet (NMCI) Standard Construction Practices Information System (IS)
27. UFGS-16710 09/2004, Structured Telecommunications Cabling and Pathway System.

Outside Plant References

Priority	Source	Identifier	Title	Source URL
1	Army	N/A	Site-specific EDP	N/A
2	Army	N/A	United States Army Information Systems Engineering Command (USAISEC) Worldwide Outside Plant Design and Performance Requirements (OSPDRM)	N/A
3	BICSI	OSPDRM	Outside Plant Design Reference Manual (OSPDRM).	http://www.bicsi.org
3	Army	N/A	Campus Area Network Design Guide	N/A
4	ASTM	ASTM A139	Standard Specification for Electric-Fusion (Arc)-Welded Steel Pipe (NPS 4 and Over)	http://www.astm.org
4	ASTM	ASTM A252	Standard Specification for Welded and Seamless Steel Pipe Piles	http://www.astm.org
4	ASTM	ASTM C150	Portland Cement	http://www.astm.org
4	ASTM	ASTM C857	Standard Practice for Minimum Structural Design Loading for Underground Precast Concrete Utility Structures	http://www.astm.org
4	ASTM	ASTM C858	Standard Specification for Underground Precast Concrete Utility Structures	http://www.astm.org
4	ASTM	ASTM C891	Standard Practice for Installation of Underground Precast Concrete Utility Structures	http://www.astm.org
4	ASTM	ASTM C1037	Standard Practice for Inspection of Underground Precast Concrete Utility Structures	http://www.astm.org
4	ASTM	ASTM D1556	Standard Test Method for Density and Unit Weight of Soil in Place by the Sand-Cone Method	http://www.astm.org
4	ASTM	ASTM D1557	Standard Test Methods for Laboratory Compaction Characteristics of Soil Using Modified Effort (56,000 ft-lbf/ft ³ (2,700 kN-m/m ³))	http://www.astm.org
4	ASTM	ASTM D2167	Standard Test Method for Density and Unit Weight of Soil in Place by the Rubber Balloon Method	http://www.astm.org
4	ASTM	ASTM D2239	Standard Specification for Polyethylene (PE) Plastic Pipe (SIDR-PR) Based On Controlled Inside Diameter	http://www.astm.org
4	ASTM	ASTM D2447	Specification for Polyethylene (PE) Plastic Pipe, Schedule 40 and Schedule 80 Based On Controlled Outside Diameter	http://www.astm.org
4	ASTM	ASTM D2487	Standard Practice for Classification of Soils for Engineering Purposes (Unified Soil Classification System)	http://www.astm.org
4	ASTM	ASTM D3350	Standard Specification for Polyethylene Plastic Pipe and Fittings Materials	http://www.astm.org
4	ASTM	ASTM F1216	Standard Practice for Rehabilitation of Existing Pipelines and Conduits by the Inversion and Curing of a Resin-Impregnated Tube	http://www.astm.org

Table D-1. References (continued)

Priority	Source	Identifier	Title	Source URL
4	ANSI	ANSI/TIA/EIA-568	Commercial Building Telecommunications Cabling Standards Set	http://global.ihs.com
4	ANSI	ANSI/TIA/EIA-569	Addendum (ADD) 1 - Surface Raceways	http://global.ihs.com
4	ANSI	J-STD-607	Commercial Building Grounding (Earthing) and Bonding Requirements for Telecommunications	http://global.ihs.com
4	ANSI	ANSI/TIA/EIA-758	Customer-Owned Outside Plant Telecommunications Cabling Standard	http://global.ihs.com
4	ANSI	NFPA-70	National Electric Code (NEC)	http://www.nfpa.org/catalog
4	ANSI	T1.105-2001	Synchronous Optical Network (SONET)-Basic Description including Multiplex Structure, Rates and Formats	http://webstore.ansi.org
4	AASHTO	AASHTO HS-20 44	HS-20 44 Load Ratings	
5	ANSI	Y32.9-1972	Graphic Symbols for Electrical Wiring and Layout Diagrams used in Architectural and Building Construction (DOD adopted)	http://webstore.ansi.org
4	TIA/EIA	TIA/EIA-422	Electrical Characteristics of Balanced Voltage Digital Interface Circuits	http://global.ihs.com
4	TIA/EIA	TIA/EIA-423	Electrical Characteristics of Unbalanced Voltage Digital Interface Circuits	http://global.ihs.com
4	TIA/EIA	TIA/EIA-472	Specifications for Fiber Optic Cables	http://global.ihs.com
5	IEEE	IEEE-315	Graphic Symbols for Electrical and Electronic Diagrams	http://webstore.ansi.org
5	TTC	Technical Report #2001.04	Guidelines for Pipe Ramming	http://www.latech.edu
5	Federal	FED-STD-1037	Telecommunications: Glossary of Telecommunication Terms	http://www.its.bldrdoc.gov
5	RUS	1751F-630	Design of Aerial Plant	www.usda.gov/rus/telecom/publications/bulletins.htm
5	RUS	1751F-640	Design of Buried Plant - Physical Considerations	www.usda.gov/rus/telecom/publications/bulletins.htm
5	RUS	1751F-641	Construction of Buried Plant	www.usda.gov/rus/telecom/publications/bulletins.htm
5	RUS	1751F-642	Construction Route Planning of Buried Plant	www.usda.gov/rus/telecom/publications/bulletins.htm
5	RUS	1751F-643	Underground Plant Design	www.usda.gov/rus/telecom/publications/bulletins.htm
5	RUS	1751F-644	Underground Plant Construction	www.usda.gov/rus/telecom/publications/bulletins.htm

Table D-1. References (continued)

Priority	Source	Identifier	Title	Source URL
5	RUS	1751F-802	Electrical Protection Grounding Fundamentals	www.usda.gov/rus/telecom/publications/bulletins.htm
5	RUS	1753F-201	RUS Standard for Acceptance Tests and Measurements of Telecommunications Plant	www.usda.gov/rus/telecom/publications/bulletins.htm
5	RUS	1753F-401	Standards for Splicing Copper and Fiber Optic Cable (PC-2)	www.usda.gov/rus/telecom/publications/bulletins.htm
5	RUS	345-72	REA Specification for Filled Splice Closures, PE-74	www.usda.gov/rus/telecom/publications/bulletins.htm
5	RUS	Form 515a	Specifications and Drawings for Construction of Buried Plant (RUS Bulletin 1753F-150)	www.usda.gov/rus/telecom/publications/bulletins.htm
5	RUS	Form 515b	Specifications and Drawings for Underground Plant (RUS Bulletin 1753F-151)	www.usda.gov/rus/telecom/publications/bulletins.htm
5	RUS	Form 515c	Specifications and Drawings for Construction of Aerial Plant (RUS Bulletin 1753F-152)	www.usda.gov/rus/telecom/publications/bulletins.htm
5	RUS	Form 515d	Specifications and Drawings for Service Entrance Installations at Customer Access Locations (RUS Bulletin 1753F-153)	www.usda.gov/rus/telecom/publications/bulletins.htm
4	Telcordia	FR-440	Transport Systems Generic Requirements	http://telecom-info.telcordia.com
4	Telcordia	FR-Fiber-1	Fiber Optic Cables and Connections	http://telecom-info.telcordia.com
4	Telcordia	FR-SONET-17	Broadband and Transport Network Generic Requirements: SONET and ATM Transport Technologies	http://telecom-info.telcordia.com
4	Telcordia	GR-111	Generic Requirements for Thermoplastic Insulated Riser Cable	http://telecom-info.telcordia.com
4	Telcordia	GR-1400	SONET Dual-Fed Unidirectional Path Switched Ring (UPSR) Equipment Generic Criteria	http://telecom-info.telcordia.com
4	Telcordia	GR-253	Synchronous Optical Network (SONET) Transport Systems: Common Generic Criteria	http://telecom-info.telcordia.com
4	Telcordia	GR-421	Generic Requirements for Metallic Telecommunications Cables	http://telecom-info.telcordia.com
4	Telcordia	GR-3151	Generic Requirements for Copper Splice Closures	http://telecom-info.telcordia.com
4	Telcordia	MDP-326-170	Pressure Tight Splice Closures	http://telecom-info.telcordia.com
6	Lucent	621-400-011	Guying Definitions	http://www.lucentdocs.com
6	Lucent	622-020-020	Conduit and Manhole Construction General	http://www.lucentdocs.com
6	Lucent	622-020-100	General Conduit and Conduit Couplings - Description	http://www.lucentdocs.com
6	Lucent	622-100-010	Conduit and Manholes Precautions	http://www.lucentdocs.com
6	Lucent	622-300-211	Main Conduit Reinforcing	http://www.lucentdocs.com
6	Lucent	622-500-011	Manholes - General	http://www.lucentdocs.com
6	Lucent	622-505-210	Concrete Maintenance Holes Cast-In-Place Construction	http://www.lucentdocs.com

Table D-1. References (continued)

Priority	Source	Identifier	Title	Source URL
6	Lucent	622-506-100	Precast Concrete Manholes, 38Y Types Description	http://www.lucentdocs.com
6	Lucent	622-506-200	Manholes, Precast Concrete 38Y-Type Installation 38Y-Type Installation	http://www.lucentdocs.com
6	Lucent	622-520-100	Conduit, Manholes And Cable Vaults Manholes Manhole, Hardware Manholes -- Equipping	http://www.lucentdocs.com
6	Lucent	622-520-100 ADD	Manholes-Equipping	http://www.lucentdocs.com
6	Lucent	626-107-006	AR-Series Riser Cables Description, Use Reel Lengths	http://www.lucentdocs.com
6	Lucent	627-610-225	Placing Metallic Riser and Building Cable	http://www.lucentdocs.com
6	Lucent	628-200-200	Underground Cable Placing, Rodding and Cleaning Ducts	http://www.lucentdocs.com
6	Lucent	628-200-206	Underground Cable, Pulling Cable Into Subsidiary Ducts	http://www.lucentdocs.com
6	Lucent	628-200-208	Underground Cable Placing	http://www.lucentdocs.com
6	Lucent	628-200-216	Fiber Optic Cable Placing in Innerduct and Direct Buried Duct	http://www.lucentdocs.com
6	Lucent	629-200-205	Guidelines for Trenching, Backfilling, and Ground Restoration of Buried Plant	http://www.lucentdocs.com
6	Lucent	629-200-206	Guidelines for Placing Buried Plant	http://www.lucentdocs.com
6	Lucent	629-200-215	Buried Plant Plowing	http://www.lucentdocs.com
6	Lucent	900-200-318	Outside Plant Engineering Handbook	http://www.lucentdocs.com
6	Lucent	901-350-300	Feeder Cable--Size	http://www.lucentdocs.com
6	Lucent	915-251-300	Outside Plant Design--Distribution Cable Design	http://www.lucentdocs.com
6	Lucent	917-152-200	Outside Plant Engineering -- Facility Design~Distribution Facilities General Information Distribution Cable Design -- Cable Sizing And Transmission	http://www.lucentdocs.com
6	Lucent	917-356-001	Outside Plant Engineering -- Facility Design~~~Distribution Facilities Engineering And Implementation Methods System For New Buried Distribution Facilities	http://www.lucentdocs.com
6	Lucent	917-356-100	Outside Plant Engineering -- Facility Design~~~Distribution Facilities Buried Urban Distribution Systems	http://www.lucentdocs.com
6	Lucent	917-356-100 ADD	Buried Urban Distribution Systems	http://www.lucentdocs.com
6	Lucent	917-356-201	Buried Non Urban Cable Systems	http://www.lucentdocs.com
6	Lucent	918-117-090	Clearances for Aerial Plant	http://www.lucentdocs.com
6	Lucent	918-117-090 ADD	Clearances for Aerial Plant	http://www.lucentdocs.com
6	Lucent	919-000-100	Design of Communication Lines Crossing Railroads	http://www.lucentdocs.com
6	Lucent	919-120-150	Pole Lines Numbering of Poles	http://www.lucentdocs.com
6	Lucent	919-120-200	Pole Lines Classification and Loading	http://www.lucentdocs.com
6	Lucent	919-120-200 ADD	Pole Lines Classification and Loading	http://www.lucentdocs.com
6	Lucent	919-120-600	Pole Lines Design Considerations	http://www.lucentdocs.com
6	Lucent	919-240-300	Underground Conduit Maintenance Holes	http://www.lucentdocs.com
6	Lucent	919-240-400	Underground Conduit Materials Types and Fields of Use	http://www.lucentdocs.com
6	Lucent	919-240-500	Underground Conduit Special Construction	http://www.lucentdocs.com
6	Lucent	919-240-520	Conduit Bridge Crossings	http://www.lucentdocs.com
6	Lucent	919-240-520 ADD	Conduit Bridge Crossings ADD	http://www.lucentdocs.com
5	IEEE	NESC 2002	National Electrical Safety Code (NESC) 2002	http://standards.ieee.org/nesc/
N/A	Army	N/A	USAISEC-FDED, Grounding and Bonding Guide	N/A
4*	ISO	BS EN 50173-1	Information Technology - Generic Cabling Systems - Part 1: General Requirements and Office Areas	http://global.ihs.com
4*	ISO	BS EN 50173-2	Information Technology - Generic Cabling Systems - Part 2: Office Premises	http://global.ihs.com

Table D-1. References (continued)

Priority	Source	Identifier	Title	Source URL
4*	ISO	BS EN 50173-3	Information Technology - Generic Cabling Systems - Part 5: Data Centres	http://global.ihs.com
4*	ISO	BS EN 50174-1	Information Technology – Cabling Installation - Part 1: Specification and Quality Assurance	http://global.ihs.com
4*	ISO	BS EN 50174-2	Information Technology – Cabling Installation - Part 2: Installation Planning and Practices Inside Buildings	http://global.ihs.com
4*	ISO	BS EN 50174-3	Information Technology – Cabling Installation - Part 2: Installation Planning and Practices Inside Buildings	http://global.ihs.com

*For projects in Europe only.

AASHTO=American Association of State Highway and Traffic Officials; ASTM=American Society for Testing and Materials; BICSI=Building Industry Consulting Service International, Inc.; CD-ROM=compact disk-read only memory; DIN=Deutsches Institut für Normung e.V.; DOD=Department of Defense; GR=Generic Requirements; N/A=not applicable; TTC=Trenchless Technology Center; URL=Universal Resource Locator; VDE=Verband der Elektrotechnik Elektronik Informationstechnik

This page intentionally left blank.

GLOSSARY. ACRONYMS AND ABBREVIATIONS

AC	alternating current
ADD	Addendum
ADN	area distribution node
AFCESA	Air Force Civil Engineer Support Agency
AFH	Army Family Housing
AIS	automation information system
AKM	Army Knowledge Management
ANSI	American National Standards Institute
ASTM	American Society for Testing and Materials
AT&L	Acquisition Technology and Logistics
AWG	American Wire Gauge
BAS	Building Automation Systems
BCS	Building Cabling System
BICSI	Building Industry Consulting Service International
BOQ	Bachelor officer's quarters
BS	British Standards
C&A	Certification and accreditation
C/C	center-to-center
C2	command and control
Cat 3	Category 3
Cat 5	Category 5
Cat 5e	Category 5e
Cat 6	Category 6
CATV	cable television
CATV	community antenna television
CCB	Configuration Control Board
CCR	Criteria Change Request
CCTV	closed circuit television
CDN	converged distribution node
CD-ROM	compact disk-read only memory
cm ³	cubic meter
CP	consolidation point
CTTA	Certified TEMPEST Technical Authority
D	Chromatic Dispersion Coefficient
DA	Department of the Army
DAA	Designated Accreditation Authority
dB	decibel
DB	direct buried
dBmV	decibel millivolts
DC	direct current
DCO	Dial Central Office
DDC	direct digital controller
DIN	Deutsche Industrie Normenasusschluss
DISA	Defense Information Systems Agency
DOD	Department of Defense

DOIM	Director of Information Management
DPW	Directorate of Public Works
DWDM	dense wave division multiplexing
EB	encased buried
EDP	Engineering Design Plan
EES	Earth Electrode Subsystem
EIA	Electronics Industry Association
EMT	Electrical metallic tubing
EN	Engineering Notice
ESM	enterprise systems management
EUB	end user building
FAX	facsimile
FDED	Fort Detrick Engineering Directorate
FO	fiber optic
FOC	fiber optic cable
FOCIS	Fiber Optic Connector Intermateability Standard
FOPP	fiber optic patch panel
FOUO	For Official Use Only
ft	foot/feet
GbE	Gigabit Ethernet
Gbps	gigabits per second
GHz	gigahertz
GIP	galvanized iron pipe
GPa	gigapascal
GR	generic requirement
GSA	General Services Administration
GSP	galvanized steel pipe
HCDS	hardened carrier distribution system
HDD	horizontal directional drilling
HDPE	High Density Polyethylene
HVAC	heating, ventilation, cooling
I3A	Installation Information Infrastructure Architecture
I3MP	Installation Information Infrastructure Modernization Program
IA.	information assurance
IATF	Information Assurance Technical Framework
IAW	in accordance with
ICEA	Insulated Cable Engineers Association
ID	identification
IEC	International Engineering Consortium
IEEE	Institute of Electrical and Electronics Engineers
IMA	information mission area
IMC	intermediate metal conduit
in	inches
IP	Internet Protocol
IS	information system

ISO	International Standards Organization
ISS	Information System Security
ISSE	Information Systems Security Engineering
IT	information technology,
ITU	International Telecommunication Union
ITU-T	International Telecommunication Union-Telecommunication Standardization Sector
km	kilometer
kPa	kilopascal
LAN	local area network
lb/in ²	pounds per square inch
LOS	line-of-sight
LPAGBS	Lightning Protection, Power Quality Analysis, Grounding, Bonding, and Sheilding
LSA	line sharing adapter
M	cable sections
m	meter
MCN	main communications node
MDF	main distribution frame
MH	maintenance hole
MHz	megahertz
MIL-HDBK	Military Handbook
MIL-STD	Military Standard
mm	millimeter
MPa	Megapascal
MPD	Multiple Plastic Duct
MUTOA	multi-user telecommunication outlet assembly
N	newton
N/A	not applicable
NAVFAC	Naval Facilities Engineering Command
NEC	National Electrical Code
NEMA	National Electrical Manufacturers Association
NESC	National Electric Safety Code
NFPA	National Fire Protection Association
nm	nanometer
NMCI	Navy and Marine Corps Intranet
NSA	National Security Agency
NZDSF	non-zero dispersion-shifted fiber
OSHA	Occupational Safety and Health Administration
OSP	outside plant
OSPDPR	Outside Plant Design and Performance Requirements
OTDR	optical time domain reflectometer
PE	polyethylene
PET	protected entrance terminal

PMD	polarization mode dispersion
PoE	Power over Ethernet
ps	picosecond
PSI	pounds per square inch
PVC	polyvinyl chloride
QA	quality assurance
QC	quality control
RCDD	registered communications distribution designer
RMC	rigid metal conduit
RSC	rigid steel conduit
RSU	remote switching units
RUS	rural utilities service
SC	subscriber connector
SIDR-PR	Standard Specification for Polyethylene Plastic Pipe
SIPRNET	SECRET Internet Protocol Router Network
SONET	synchronous optical network
SOW	Statement of Work
ST	smart terminal
TC	telecommunications closet
TEF	Telecommunications Entrance Facility
TEMPEST	Telecommunications Electronics Material Protected from Emanating Spurious Transmissions
TG	Technical Guide, viii
TIA	Telecommunications Industry Association
TIC	Technology Integration Center
TR	telecommunications room
TR	Technical Report
TSB	Technical Service Bulletin
TTC	Trenchless Technology Center
UFC	Unified Facilities Criteria
UFGS	Unified Facilities Guide Specification
UL	Underwriters Laboratory
UPS	uninterruptible power supply
UPSR	unidirectional path switched ring
URL	Universal Resource Locator
USACOE	U.S. Army Corps of Engineers
USAISEC	U.S. Army Information Systems Engineering Command
UTP	unshielded twisted pair
VDE	Verband der Elektrotechnik Elektronik Informationstechnik
VoIP	Voice over Internet Protocol
WAP	Wireless access point
WLAN	wireless local area network
WWW	World Wide Web