

3 DAY SALE

THUR 27TH - SAT 29TH MARCH 2014



FREE SAUSAGE SIZZLE

RAIN CHECKS TAKEN
until 4.00pm Saturday
29th March 2014



EVERYTHING IS ON SALE
ONLINE OR INSTORE

DRILLING MACHINES
• 16mm drill capacity • 2MT
BUY EITHER D138 OR D140 TO RECEIVE A

FREE VAZEY DRILL PRESS TABLE
Valued at \$71 (D199) RRP
ONLINE ORDERS USE:
PROMO CODE: 3DSM14
See How It Works
WATCH THE VIDEO ONLINE
www.machineryhouse.com.au/D199

SBD-20B Bench Drill
\$297
SAVE \$99
ORDER CODE: D138

SPD-20B Pedestal Drill
\$330
SAVE \$99
ORDER CODE: D140

OWN A MIG?
DISPOSABLE CYLINDERS AVAILABLE



SEE PAGE 2 FOR MORE INFORMATION
\$55 EACH
ORDER CODES: 00183, 00184, 00185

PACKAGE INCLUDES: TURBOSET 200 Map-Pro Gas & Oxygen Disposable Cylinders

SAVE \$43.80 RRP



(K075)
PACKAGE PRICE ONLY \$339
(O017 + O0181 + O0182)

T-13S 330mm HAFCO SPIRAL CUTTER HEAD

- 330mm x 152mm timber capacity
- Powered in-feed rollers



NEW RELEASE

\$584
SAVE \$65
ORDER CODE: W815

SEE PAGE 29 FOR MORE MODELS

VEHICLE POSITIONING JACKS

- 680kg per Jack
- 270mm Max. Tyre Width
- 620mm Max. Opening
- Sold in pairs



\$220 PER PAIR
ORDER CODE: A332

NEW RELEASE

CASTOR WHEELS

- 2 x fixed & 2 x swivel brake
- Capacity 70kg each



\$39
SAVE \$16
ORDER CODE: C410

SEE PAGE 2 FOR MORE SIZES

- 2 x fixed & 2 x swivel brake
- Capacity 410kg each



\$79
SAVE \$20
ORDER CODE: C411

DIGITAL CALIPER

Metric - Imperial - Fractions conversion



150mm/6"
\$25
SAVE \$6.90
ORDER CODE: M738

200mm/8"
\$35
SAVE \$14.50
ORDER CODE: M739

SEE PAGE 6 FOR FULL RANGE

TRADE SERIES TOOL CHEST & ROLLER CABINET PACKAGE

- TCH-6D (T700)
- 6 Drawer Tool Chest
- 670 x 310 x 375mm (L x W x H)
- TCH-3DE (T701)
- 3 Drawer Tool Chest Extension
- 670 x 315 x 265mm (L x W x H)
- TRC-7D (T715)
- 7 Drawer Roller Cabinet
- 685 x 470 x 1000mm (L x W x H)



(K006B)
PACKAGE PRICE ONLY \$549
(T700 + T701 + T715)

SAVE \$94.50 RRP

HEX KEYS WITH BALL END

METRIC (H801) OR IMPERIAL (H800)



\$10 EACH
ORDER CODE: H800 or H801

BECOME A MACHINERYHOUSE MATE

- GAIN ACCESS TO:**
- ✓ ONLINE PROMOS
 - ✓ EXCLUSIVE OFFERS
 - ✓ TRACK YOUR ORDERS
 - ✓ PAPERLESS WARRANTY
 - ✓ NEWSLETTERS
 - ✓ LATEST RELEASES
 - ✓ COMPETITIONS

\$70 FREE DISCOUNT VOUCHERS
\$20 MATE 20% OFF
\$50 MATE 50% OFF

SIGN UP FOR MATES RATES
MACHINERYHOUSE.COM.AU/SIGNUP

www.machineryhouse.com.au

SYDNEY
(02) 9890 9111
Unit 1/2 Windsor Rd
Northmead NSW

BRISBANE
(07) 3274 4222
625 Boundary Rd
Coopers Plains QLD

MELBOURNE
(03) 9212 4422
1 Fowler Rd
Dandenong VIC

PERTH
(08) 9373 9999
41-43 Abernethy Rd
Belmont WA

OPEN UNTIL 4:00PM
SATURDAY 29th March

Sale prices & specifications are subject to change without notification. All Prices include GST unless ex GST is specified. Rain checks & prices valid until 29/03/14. *RECORD POWER EXCLUDED FROM SALE. ABN 96 000 286 957

WELDING HELMETS - Auto Darken

TEC-1G

- Stick, MIG, TIG, plasma & grinding
- Darkens in 1/16,000 sec
- Adjustable shade: 9-13
- 2 arc sensors
- No batteries required



\$69 (W009)

TEC-II

- Stick, MIG, TIG, plasma, & grinding
- Darkens in 1/25,000 sec
- Adjustable shade: 9-13
- 2 arc sensors
- No batteries required



\$99 (W010)

TEC-3G

- Stick, MIG, TIG, plasma, OXY & grinding
- Darkens in 1/25,000 sec
- Adjustable shade from: 5-8 / 9-13
- 4 arc sensors with 1 battery



\$165 (W013)

TEC-4G

- Stick, MIG, TIG, plasma, OXY & grinding
- Darkens in 1/25,000 sec
- Adjustable shade from: 6-9 / 9-13
- 4 arc sensors with 1 battery



\$229 (W016)

WE-100 WELDING FUME EXTRACTOR

- 2 x 800W 240V motors, 2 speeds
- Captures up to 99.97% of 0.3 micron noxious fumes



\$1,485 (W270)

UNIMIG

ARC 170DC WELDER PACKAGE
DC TIG & ARC Inverter Welder
INCLUDES: (W164 + W170 + O0184 + O0171)



ONLY \$440 (K017)

AC/DC 200 WELDER PACKAGE
TIG/ARC Inverter Welder
INCLUDES: Finger tip control (W174 + W174A)



ONLY \$1,350 (K017C)

CUT40 PLASMA



ONLY \$849 (C422)

MINI MIG 180 WELDER PACKAGE
INCLUDES: (W240 + O0185 + O0171)



ONLY \$495 (K019A)

MIG 165 PACKAGE
MIG-STICK-TIG Inverter
INCLUDES: (W177 + O0185 + O0171)



ONLY \$749 (K019)

MIG 250 PACKAGE
MIG-STICK-TIG Inverter
INCLUDES: (W179 + W013)



ONLY \$1,295 (K017D)

200K PACKAGE
MIG-STICK-TIG Inverter
INCLUDES: (W181 + W181B)



ONLY \$1,450 (K017B)

250SWF PACKAGE
MIG-STICK-TIG Inverter
INCLUDES: (W186 + W013)



ONLY \$2,499 (K018A)

TURBOSET 200 Professional & Portable Mini Gas Set

- Flame temperature over 3000°C
- Metal carry stand
- Torch with 2M hose
- 2 x regulators with flashback arrestors
- Made in Italy



\$297 (O017)

DISPOSABLE CYLINDERS

Map-Pro 400g **Oxygen 930ml**



\$19 (O0181) **\$38** (O0182)

2.2L DISPOSABLE CYLINDERS

In many cases, disposable cylinders are cheaper than refilling reusable cylinders. Non-refillable cylinders often save time and do not require periodic re-certification. The 2.2 litre disposable gas cylinders have a much larger capacity and are filled to a much higher pressure than conventional disposable cylinders currently available.

Ar - Argon
• MIG welding of aluminium and all TIG welding
• Contains 100% Argon



\$55 (O0183)

Ar/O2
• MIG welding of stainless steel
• Contains 98% Argon & 2% Oxygen



\$55 (O0184)

Ar/CO2
• MIG welding of carbon steel
• Contains 90% Argon & 10% Carbon Dioxide



\$55 (O0185)

ARGON GAS REGULATOR
Suits 2.2 Litre Disposable Gas Cylinders

- Adjustable pressure dial with gauge
- 0-8 L/min



\$49.50 (O0171)

INDUSTRIAL 240V FANS

- Ø450mm blade
- 180W, 240V motor 350rpm
- 120 cub m/min
- 3-speed control
- Swivels to 90° inside frame



Floor \$69 (F026)

AXIAL FLOW FAN

- 520W, 240V motor 2800rpm
- 60 cub m/min
- Ø300mm I/D
- Ideal for fume extraction



\$129 (F050)

ELECTRIC MOTORS 240V

- TEFC



SAVE

ARBOR PRESSES

- Heavy-duty construction
- Cast iron frame • Four-position anvil
- Square ram



SHAFT MOTOR MOTOR

SHAFT DIA.	MOTOR POWER	MOTOR SPEED	PRICE
Ø5/8"	1hp	1440rpm	\$154 (E040)
Ø19mm	2hp	1440rpm	\$199 (E092)
Ø19mm	2.5hp	2800rpm	\$189 (E084)
Ø19mm	3hp	2800rpm	\$220 (E112)

ENGINEERS FILE SET

5 PIECE Second Cut - 200mm

- Cushion grip handles
- Flat, round, 1/2 round, square & triangular



\$22 (F100)

up to 30% OFF RRP

PUNCH SETS

- 3/16" Letter **\$35** (P350)
- 3/16" Number **\$15** (P351)
- 5/16" Letter **\$45** (P354)
- 5/16" Number **\$20** (P355)



CASTOR WHEELS

- 2 x fixed & 2 x swivel brake



up to 25% OFF RRP

INDUSTRIAL CASTOR WHEELS

- 2 x fixed & 2 x swivel brake



CASTOR WHEELS

- 2 x swivel brake only



SAVE

CASTOR WHEELS

Ø63mm x 25mm wide

- 4 x swivel with foot lever
- Capacity 63kg each



\$78 (W935)

AUTOMATIC CENTRE PUNCH

- Automatic centre punch is ideal for punching most metals, plastic and wood. No need to use a hammer just line up & press
- 130mm long
- Ø13mm diameter
- Knurled steel body



\$7.50 (P366)

CENTRE PUNCH SET 3 PIECE

- 150mm long
- Point sizes: 2.5, 5.5, 7.0mm
- Ø8, 9.5 & 12mm
- Knurled steel body
- Extra long length for easy use
- Hardened & tempered



\$15 (P367)

up to 20% OFF RRP

COLD CHISEL SET 3 PIECE

- Flat cold chisels
- Hi-grade chrome vanadium steel
- (Width x shaft hex x length)
- 9.9 x 8.0 x 138mm
- 12.6 x 11.0 x 150mm
- 16.2 x 12 x 165mm



\$13.50 (P363)

SAVE

PIN PUNCH SET 6 PIECE

- Hi-grade chrome vanadium steel
- (Tip Ø x shaft hex x length)
- Ø3 x 10 x 150mm
- Ø4 x 10 x 150mm
- Ø5 x 10 x 150mm
- Ø6 x 10 x 150mm
- Ø7 x 12 x 150mm
- Ø8 x 12 x 150mm



\$15 (P365)

PUNCH & CHISEL SET 14 PIECE

- Hi-grade chrome vanadium steel
- 4 x Pin Punches
- 1 x Centre Punch
- 5 x Flat Cold Chisels
- 4 x Tapered Punches



\$39 (P364)

SAVE

HEX KEY SETS 9 PIECE

- Heat treated CRV Steel
- Extra long ball end hex keys



METRIC 1.5-10mm \$10 (H801)

IMPERIAL 1/16-3/8" \$10 (H800)

ENGINE STANDS

450kg
4 Castor wheels
(2 swivel)
\$69 (A341)



TCS-450 SWIVEL TRUCK CRANE

• 450kg & 230kg positions
• 360 degree working angle



SWIVELS 360°

\$189 (A353)

HCH-1T ENGINE CRANE

• Industrial series
• Manual pump
• Tilting & swivelling lifting hook



\$429 (A357)

**EURO STYLE
1 TONNE CAP.**

Optional Engine Tilter
\$39 (A3425)

1T ENGINE CRANES

• 1 Tonne capacity
• Folds up legs for storage
• Heavy duty double action pump



\$229 (A350)

SAVE

Air over Hydraulic Model Shown
\$286 (A351)

MOTORCYCLE LIFTER

• 220-760mm height adjustment
• 454kg capacity



\$469 (A349)

Motorbike not included

AUTO PARTS WASHERS

• Automatic safety fusible link on lid (Except A369)
• 240V input



SAVE

\$59 (A370)

\$159 (A369)

\$139 (A368)

\$209 (A374)

CHAIN BLOCKS

• Safety catch on swivel hook
• High resistance G80 load chain
• Double safety brake pawls
• Ball bearing load wheel

1 Tonne x 3m
\$79 (C143)

1 Tonne x 6m
\$110 (C144)

2 Tonne x 3m
\$129 (C145)

NEW RELEASE



GIRDER TROLLEYS

• Suits I-beams & universal beams
• Ball bearing wheels



1 Tonne **\$79** (C147)

2 Tonne **\$110** (C148)

MOBILE GIRDER RAIL - 1 TONNE

• 1 Tonne lifting capacity
• 2500-3600mm height adjustable gantry via lifting arms & hooks
• Double safety locking pins - both ends
• 4 x swivel wheels with brakes
• Suits 1T girder trolleys & chain blocks



SAVE \$108 RRP

PACKAGE PRICE ONLY \$739

1 TONNE MGT-1T **\$599** (C188)

MGP-17 PULLER SET WITH SLIDE HAMMER

• 15-30mm internal diameter capacity
• 15-80mm external diameter capacity
• 3 sets of 100mm legs



\$110 (P013)

10T PANEL BEATING KIT

INCLUDES: Pump, hose & fittings, 130mm ram, 90° V-head, 80mm rubber head, spreader ram, extension tubes

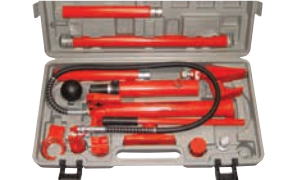

\$165 (A367)

PANEL BEATING RAM KIT

• 10 tonne
• 11 piece
• Supplied in steel case



\$249 (A364)

MECHANIC'S CREEPER & SEATS



Mechanic's Creeper
1000mm Height, 1000 x 430mm (L x W)
\$33 (A362)

Square Seat
375mm Height
\$22 (A361)



Garage Stool
Round Pneumatic
675-795mm Height Adj.
\$79 (A359)

HP-20 HYDRAULIC PRESS

• 20 tonne capacity
• Spring return ram
• Complete with bending plates



SAVE

\$259 (P144)

PP-20 HYDRAULIC PRESS

• 20 tonne capacity
• Removable ram
• Complete with, 100mm gauge & bending plates



SLIDING RAM

\$349 (P143)

HPT-30P HYDRAULIC PNEUMATIC PRESS

• 30 tonne capacity
• Pneumatic / hydraulic operation
• Sliding ram position
• Includes bending plates

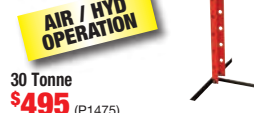

AIR / HYD OPERATION

\$495 (P1475)

HPT-40P HYDRAULIC PNEUMATIC PRESS

• 40 tonne capacity
• Spring return ram
• Pneumatic / hydraulic operation
• Complete with bending plates



AIR / HYD OPERATION

\$690 (P149)

HP-50 HYDRAULIC PRESS

• 50 tonne capacity
• Spring return ram
• 2-stage hand pump
• Winch on table to raise & lower
• Complete with V-blocks

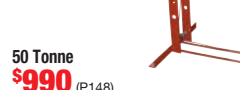

\$990 (P148)

PP-10HD HYDRAULIC PRESS - Bench Model

• 10 tonne capacity
• 180mm ram stroke
• Spring return ram
• Complete with bending plates



NEW RELEASE

\$319 (P141)

HYDRAULIC GEAR PULLER KIT

• 100, 150 & 200mm pulling legs
• 10 tonne hyd. ram
• 105mm bearing separator
• 2 & 3 jaw yoke assembly & cross beam
• Extension rods
• Centering adaptors

\$209 (P011)

BUSH DRIVER SET

• Enables you to remove and install bushings ranging from 10 - 42mm
• Handle lengths: 115, 140 & 160mm
• Manufactured from aluminium



\$35 (P030)

BEARING RACE & SEAL DRIVER SET

• Installs wheel bearing races & seals
• Discs sizes 39.5, 44.5, 50, 59, 63, 65, 72, 76, 81mm
• Manufactured from aluminium



SAVE

\$49 (P031)

HYDRAULIC CHASSIS PUNCH SET

• Dies: 22.5, 28.3, 34.6, 43.2, 49.6, & 61.5mm
• 1.6mm capacity in mild steel



\$198 (P020)

HM-10 MINI MILL DRILL

• 350W, 240V motor
• Electronic variable speed 100-2500rpm
• 2 speed gearbox
• Head tilts ±45°
• Travels:
(X) 225mm
(Y) 100mm
(Z) 190mm



\$825 (M150A)

AL-30 BENCH LATHE

• 180 x 300mm capacity
• 250W, 240V motor
• 90mm centre height
• Variable speed 0-2500rpm



TOOL SET INCLUDED

\$749 (L194)

AL-280P LATHE MILL DRILL

• 400 x 409mm cap.
• 3MT spindle & tailstock
• 0.75hp, 240V motor
• 20mm bore
• 7 lathe spindle speeds



\$1,595 (L159)

30L WET & DRY VACUUM CLEANER

• 1000W, 240V motor
• 30L stainless steel tank
• Air flow rate 53L/sec
• 2.5M x Ø40mm hose



\$179 (V503)

80L WET & DRY VACUUM CLEANER

• 2000W, 240V motor
• 80L stainless steel tank
• Two brush motors
• Air flow rate 106L/sec
• 2.5M x Ø40mm hose



\$369 (V510)

RUBBER MAT Clip Together - Type

• 910 x 910mm (10mm thick)
• Ideal for the workshop
• Clips together for desired size area needed



ONLY \$29 (M805)

RUBBER MAT Anti Fatigue

• 1505 x 905mm (8mm thick)
• Ideal for workshop or Ute
• Tapered edge



ONLY \$39 (M800)

MH-826 TAPE MEASURE

• Metric & Imperial
• 8 metre / 315"
• Smooth extraction & retraction
• Belt clip on side



NEW RELEASE

\$6.00 (M750)

FOLDING UTILITY KNIFE

• Sure-grip aluminium handle with belt clip
• Includes 5 replacement blades
• Quick change blade mechanism



\$7.50 (08048)

CRANE SCALES

• Back light display
• High resolution digital display
• 3 x AAA batteries
• 0.2kg increments (C190)
• 0.5kg increments (C191)

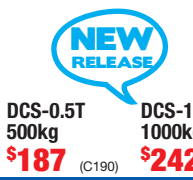

NEW RELEASE

\$187 (C190)

\$242 (C191)

HAND SHEARS

GREAT VALUE

Thick Cap.	Blade Length	
4mm	150mm	\$89 (S186)
5mm	300mm	\$149 (S188)

HAND SHEARS

- Shears plate & round bar (S195 also shears angle)

Thick Cap.	Blade Length	
5mm	160mm	\$159 (S189)
6mm	200mm	\$279 (S191)
6mm	300mm	\$379 (S193)
8mm	200mm	\$659 (S195)

HAND PUNCHES

- Spring return handles
- Material depth back stop
- Heavy duty steel fabricated

Ø DIA.	THICK THROAT	
10mm	6mm 80mm	\$239 (P108)
16mm	10mm 160mm	\$649 (P110)

SJ-22 SWAGE & JENNY

- Heavy duty cast iron
- 0.7mm mild steel capacity
- 175mm throat
- 50mm shaft to centre
- Includes 5 sets of rolls, wiring, crimping, edge beading, single bead & elbow edging

\$259 (S640)

T DOLLIES

- 3 piece set • Zinc plated

STRAIGHT
 Ø13mm x 100mm
 Ø19mm x 150mm
 Ø25mm x 200mm
\$45 (S2242)

TAPERED
 Ø25.3-10mm x 140mm
 Ø37.5-10mm x 200mm
 Ø50.0-10mm x 280mm
\$110 (S224)

PB-24 MANUAL PANBRAKE 600 x 1.0mm

- Bench Model
- Steel fabricated construction
- Clamping blade has adjustments
- Adjustable clamping pressure beam
- Multiple finger widths 26, 57, 76, 224, 254mm for bending of pans or boxes

\$349 (S249)

PB-4 MANUAL PANBRAKE 1220 x 1.2mm

- Steel fabricated construction
- Clamping blade has adjustments
- Adjustable clamping pressure beam
- Multiple finger widths for bending of pans or boxes

\$899 (S250)

PB-416H PANBRAKE 1300 x 1.6mm

- Robust steel-fabricated construction
- Finger widths to enable the bending of pans or boxes to a depth of 70mm

\$1,980 (S253)

PB-416D PANBRAKE 1260 x 1.5mm

- Robust steel-fabricated construction
- Foot clamping, allowing material to be positioned & clamped at the same time

\$2,189 (S260)

CURVING ROLLS

- Ground rolls with wiring grooves
- Top roll lifts out

CAPACITY	INC. STAND	
610 x 1mm	~	\$429 (S268)
1000 x 1.2mm	YES	\$699 (S270)
1270 x 1.2mm	YES	\$1,089 (S271)

3-in-1 SHEET METAL MACHINES

CAPACITY	INC. STAND	
300 x 1mm	~	\$299 (S648)
760 x 1mm	~	\$629 (S650)
1000 x 1mm	~	\$935 (S652)
1310 x 1mm	YES	\$1,990 (S654S)

SG-41 GUILLOTINE 1320 x 1.2mm

- Cast iron construction
- 700mm backgauge with fine adjust.

\$1,639 (S602)

UB-100 BAR BENDER COLD BENDING

- Flat: 100 x 5mm
- Square: 16 x 16mm
- Round: Ø18mm dia.

\$209 (B043)

RR-10 MANUAL SECTION & PIPE ROLLING MACHINE

- 50 x 10mm flat bar capacity
- Hardened 98mm top & 118mm bottom rolls
- 30mm heat treated drive shaft
- Cast iron housing on heavy duty stand
- Gear driven rolls
- Heavy duty steel fabricated frame
- Bottom rolls are knurled for additional grip on material
- Manual screw adjustment of top roller
- Adjustable side support guide rolls
- Standard flat & angle rolls are included
- One piece guiding mono block mounted on cross head
- *Additional dies are required to roll round bar, round pipe/tube & square tube

MANUAL OPERATION

\$990 (S681)

HYDRAULIC PIPE BENDERS 1/2 - 2"

- Includes 6 pipe formers to suit: 1/2", 3/4", 1", 1-1/4", 1-1/2", 2" water pipe
- Fitted with special long stroke 12 tonne hydraulic ram

Manual **\$165** (P066) | Pneumatic/Manual **\$242** (P065)

\$330 (P064)

TBR5-25 TUBE BENDER

- Includes 8 formers
- 3/4" & 1" square cap.
- 3/8" - 7/8" round cap.
- Suitable for 1.2mm wall thickness in mild steel

\$187 (T055)

MANUAL PIPE NOTCHERS

- Up to 3mm wall thickness
- Horizontal & vertical operation

Pipe Capacity	
1/4", 3/8", 1/2"	\$187 (P094)
3/4", 1", 1-1/4"	\$330 (P095)
1-1/2" & 2"	\$490 (P096)

N-16 SHEET METAL NOTCHER

- 1.6mm thick mild steel cap.
- Cuts 150 x 150mm at 90°
- Bottom blades have 4 cutting edges
- Cast base & body includes extreme rigidity & durability

\$539 (S247)

PN-76 PIPE & TUBE NOTCHER

- Ideal for steel, stainless, pipe & tube at 90° & angle joints
- 20-76mm outside diameter capacity
- Compound action swivel vice achieving angles between 30 - 90°
- 3kW, 415V Motor
- Includes stand & 1 x pipe/tube roller, suits 25mm NB pipe & 32mm tube
- Rollers are sold separately 20-76mm

\$2,299 (L850)

LC-2500kg

SAVE

GARRICK LIFTING EQUIPMENT

RATCHET TIE DOWN STRAPS

5m x 25mm, 750kg	\$11.00 (H280)
6m x 35mm, 1500kg	\$14.30 (H282)
9m x 50mm, 2500kg	\$19.80 (H284)

GIRDER CLAMP

1 Tonne
75-230mm beam width
\$77 (C175)

UNIVERSAL PLATE CLAMP

1 Tonne
0-20mm opening
\$132 (C177)

CHAIN BLOCK

0.5 Tonne x 3M
\$132 (C179)

GIRDER TROLLEY

1 Tonne
64-210mm beam width
\$143 (C181)

BG8-915 Bench Grinder

200mm Grinder with 36"x 2" Linisher
\$462 (G156)

240V

OPTIONAL STAND

SAVE

3 x FREE Sanding Belts (A8002)
1 x FREE Scotchbrite Linishing Belt (A36202)
 with (G156) purchase

ONLINE ORDERS USE:
PROMO CODE: 3DSM14

Linishall

L-1520 - Belt Linisher Sander (415V)

100 x 1520mm Linisher
\$1,320 (L095)

INCLUDES STAND

SAVE

INDUSTRIAL

BG8 Bench Grinder

200mm
ONLY \$1,496 (G155)

240V

DPS-450 DRILL PRESS ROLLER SUPPORT

- Suits Ø60-100mm column diameters
- 2 x 450mm wide rollers
- Adjustable width 600-900mm



Drilling machine & piece of wood not included

\$59 (W3425)

DRILLING MACHINES

- 16mm drill capacity
- 16-speed • 2MT
- Safety micro switch
- 1hp 240V motor
- 16mm drill chuck

FREE VAZEY TABLE see front page for details



SBD-20B Bench Model
\$297 (D138)

SPD-20B Pedestal Model
\$330 (D140)

DRILLING MACHINES

- 20mm drill capacity
- 16-speed • 2MT
- Safety micro switch
- 1hp 240V motor
- 16mm drill chuck
- Work light



SBD-25A Bench Model
\$349 (D144)

SPD-25A Pedestal Model
\$385 (D147)

PD-22 PEDESTAL DRILL

- 28mm drill capacity
- 16-speed • 3MT
- Safety micro switch
- 1hp 240V motor
- 16mm drill chuck
- Work light



\$495 (D148)

PD-26 PEDESTAL DRILL

- 31.5mm drill capacity
- 12-speed • 3MT
- Safety micro switch
- 1.5hp 240V motor
- 16mm drill chuck
- Work light



\$715 (D152)

BS-48 LINISHER SANDER

- Belt size 100mm x 1220mm
- High performance 2800rpm finishing machine
- 1.5kW / 2hp, 240V motor
- Large 100 x 290mm working surface
- Quick change belt system
- Tilting finishing head
- Ø100mm dust chute



INCLUDES STAND

\$449 (L1185)

LINISHER SANDERS

- 2000mm belt length
- High performance 2800rpm
- 3kW 415V (L119)
- 4kW 415V (L120)
- 75 x 465mm working surface (L119)
- 150 x 465mm working surface (L120)



BS-76 75mm Belt Width
\$679 (L119)

BS-152 150mm Belt Width
\$869 (L120)

9" DRILL PRESS LOCKING CLAMP

- 2" (50mm) maximum jaw opening
- 3" (75mm) throat depth
- Fastens to drill press slot
- Secures work pieces tightly



\$16.50 (C103)

PD-35 PEDESTAL DRILL

- 31.5mm drill capacity
- 9-speed 180-1680rpm
- 3MT spindle
- Safety micro switch on pulley guard
- 1hp 240V motor
- Includes drill chuck & arbor
- Made in Taiwan



\$1,265 (D162)

GHD-22 GEARED HEAD DRILL

- 31.5mm drill capacity
- 8-speed 105-2900rpm
- High/low with forward & reverse switch
- 3MT spindle
- Safety chuck guard
- 1.2hp 415V motor
- Includes 16mm drill chuck & arbor



\$1,749 (D170)

DIAMOND DRESSER

- 0.5CT industrial diamond
- Ø3/8" x 4"



\$17 (G189)

WHEEL DRESSER

- Complete with dressing cutters



\$17 (G189A)

BUFFING KIT Ø200mm

- Suits Ø200mm grinders
- 1 x roughing & finishing mops
- 1 x 16mm left hand taper spindle
- 1 x green compound



\$35 (G185)

GRINDER STANDS

- Suits grinders 150-200mm (G181)
- Suits grinders 150-250mm (G181S)



\$79 (G181)

\$119 (G181S)

BENCH GRINDERS

- Full cast iron base
- Dust chutes
- Adjustable tool rests & eye shields



240V 1hp Ø200mm
\$259 (G161)

415V 1hp Ø200mm
\$259 (G161A)

240V 1.3hp Ø250mm
\$459 (G162)

415V 1.3hp Ø250mm
\$479 (G162A)

BG-12 INDUSTRIAL PEDESTAL GRINDER

- Ø305mm wheels
- 3hp 415V motor
- Adjustable wheel guards
- Full cast iron body
- Includes dust extraction outlets, safety eye shields & stand



\$979 (G164)

CS-275 COLD SAW

- 90 x 50mm rectangle capacity
- 75mm round capacity
- Dual material clamp system
- Built in blade coolant pump
- Ø275mm blade
- Blade speed 42rpm
- 1.3hp 240V motor



90 x 50mm Rect. cap.
\$1,155 (S816)

OPTIONAL STAND \$198 (S820)

BS-4A BAND SAW

- 150 x 100mm rect. capacity
- 3 speed • 45° mitre vice
- Vertical cutting table
- 1/2hp 240V motor



\$330 (B002)

BS-5S BAND SAW

- 200 x 125mm rectangular capacity
- 45° swivel head
- 1/2hp 240V motor
- 3 speed
- Includes vertical cutting table



\$519 (B003)

BS-7L BAND SAW

- 305 x 178mm rect. capacity
- 1hp 240V motor • 4 speed
- Coolant system • 45° mitre vice



\$935 (B006)

BS-7DS SWIVEL HEAD BAND SAW

- 215 x 178mm capacity
- 1hp 240V motor
- 4 speed 24-41-61-82rpm
- Dual mitre to 45° via swivel head and sliding vice
- Adjustable feed rate
- Built-in coolant system
- Limit switch stops machine when cut is complete



\$1,529 (B008A)

ROLLER CONVEYOR

NOTE: Roller conveyor, length stop and conveyor stands all sold separately

• 20 Rollers with 150mm pitch
• Roller capacity of 70kg each
• Powder coated frames

ROLLER CONVEYOR			
WIDTH	LENGTH	Price	CODE
290mm	3 Metre	\$275	(L812)
450mm	3 Metre	\$319	(L818)
600mm	3 Metre	\$352	(L824)

STANDS TO SUIT			
WIDTH	HEIGHT ADJ.	Price	CODE
290mm	505-800mm	\$71.50 each	(L816)
290mm	715-1050mm	\$71.50 each	(L814)
450mm	505-800mm	\$71.50 each	(L822)
450mm	715-1050mm	\$71.50 each	(L820)
600mm	505-800mm	\$71.50 each	(L828)

3 METRE LENGTH-STOP \$396 (L800)
Designed to suit HAFCO (L812) 290mm x 3 metre roller conveyor

ROLLER STANDS

• 3 METRE LENGTH-STOP \$396 (L800)

Designed to suit HAFCO (L812) 290mm x 3 metre roller conveyor

Ø38mm 450-720mm 30kg cap.	Ø56mm 710-1125mm 100kg cap.	Ø52mm 580-970mm 800kg cap.	Ø52mm 580-970mm 800kg cap.
\$38 (W343A)	\$54 (W343)	\$89 (W343A)	\$89 (W343B)

PLATFORM TROLLEYS

- 907 x 608mm platform base
- Soft foam handle folds flat
- 2 fixed & 2 swivel wheels



300kg Ø127mm Rubber Wheels
\$69 (T670)



300kg Ø203mm Pneumatic Wheels
\$99 (T672)

PLATFORM TROLLEY

- 2 fixed & 2 swivel wheels
- Removable handle
- Ø152mm Rubber wheels



500kg 1257 x 761mm Base
\$220 (T676)

PT-2500 PALLET JACK

- 2500kg lift capacity
- 3-stage fingertip control
- 85 to 195mm lift height
- 1220mm fork length
- 685mm total fork width



\$275 (J061)

MPS-1000 MANUAL STACKER

- 1000kg lift capacity
- 1600mm lift height
- 1060mm fork length
- Adjustable width forks



\$1,529 (J070)

LIFTER TROLLEYS

- Foot operated hydraulic pump
- Lockable wheels



226kg 740mm Lift Height
\$198 (J048)



500kg 900mm Lift Height
\$479 (J055)

PLASTIC SERVICE CART

- 250kg total load rating
- 2 fixed & 2 swivel wheels
- Includes 1 plastic storage tray handle
- 3 trays (790 x 440 x 70mm)



\$139 (T748)

STEEL SERVICE CART

- Key lockable & sliding top table
- 2 drawers with ball bearing slides
- 2 fixed & 2 swivel brake wheels



\$253 (T754)

ETT-1D ENGINE TEAR DOWN TABLE

- 1220 x 710mm table top
- Key lockable drawer
- Fluid collection pan



\$259 (A385)

TOOL BOXES & CABINETS

WORKSHOP Series

Tool Chest & Roller Cabinet

- Ball bearing slides
- Lockable by key
- Powder coated quality finish

WCH-6D
6 Drawer Tool Chest
600 x 260 x 340mm
(L x W x H)

\$77 (T690)



WRC-5D
5 Drawer Roller Cabinet
616 x 330 x 762mm
(L x W x H)

\$176 (T695)



SAVE \$46 RRP

PACKAGE PRICE (K004)
T690 + T695
ONLY \$240 +GST

TRADE Series

Tool Chests & Roller Cabinet

- Heavy duty ball bearing slides
- Lockable by key
- Protective drawer liners
- Powder coated quality finish

TCH-6D
6 Drawer Tool Chest
670 x 310 x 375mm
(L x W x H)

\$165 (T700)



TCH-3DE
3 Drawer Tool Chest
670 x 315 x 265mm
(L x W x H)

\$99 (T701)



TCH-12D
12 Drawer Tool Chest
670 x 445 x 495mm
(L x W x H)

\$297 (T706)



TRC-7D
7 Drawer Roller Cabinet
685 x 470 x 1000mm
(L x W x H)

\$330 (T715)



SAVE \$53 RRP

PACKAGE PRICE (K006)
T700 + T715
ONLY \$475 +GST



SAVE \$94.50 RRP

PACKAGE PRICE (K006B)
T701 + T715
ONLY \$549 +GST



SAVE \$72 RRP

PACKAGE PRICE (K006A)
T706 + T715
ONLY \$599 +GST

INDUSTRIAL Series

Tool Chest, Roller Cabinet & Side Locker

- Industrial duty ball bearing slides
- Protective drawer liner
- Lockable by key

ICH-8D
8 Drawer Tool Chest
1051 x 445 x 552mm
(L x W x H)

\$440 (T720)



IRC-7D
7 Drawer Roller Cabinet
1067 x 458 x 1007mm
(L x W x H)

\$594 (T724)



ISC-7D
7 Drawer Side Cabinet
430 x 460 x 845mm
(L x W x H)

\$297 (T727)



ISL-2D
2 Drawer Side Locker
425 x 460 x 1390mm
(L x W x H)

\$275 (T726)



PACKAGE PRICE (K005)
T720 + T724 + T726
ONLY \$1,210 +GST

SAVE \$209 RRP

DESIGN YOUR ULTIMATE TOOL BOX COMBO



WORKSHOP SERIES

Industrial Truck Tool Boxes

- 4 x heavy duty side handles
- Dual gas struts support lid
- Ball bearing slides on drawers
- Includes rubber drawer liners

SAVE



TB-EC70/2
2 Drawer
702 x 404 x 585mm (L x W x H)
\$330 (T745)



TB-EC70F/3
3 Drawer
702 x 404 x 590mm (L x W x H)
\$359 (T7463)



TB-HD70/2
2 Drawer
700 x 600 x 750mm (L x W x H)
\$495 (T744)



TB-HD120/2
2 Drawer
1210 x 600 x 750mm (L x W x H)
\$693 (T7442)

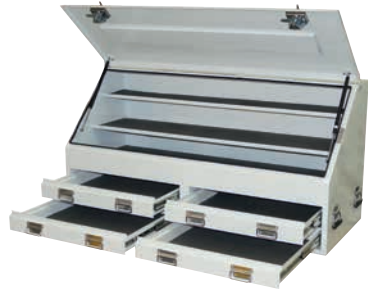

TB-HD150/4
4 Drawer
1500 x 600 x 750mm (L x W x H)
\$869 (T7445)

ITB-3036 INDUSTRIAL TOOL BOX SET

- 0.9mm thickness mild steel (30" box)
- 1.6mm thickness mild steel (36" box)
- Lifting handles on either side
- Powder coated finish
- 775 x 430 x 310mm (30" box)
- 915 x 440 x 570mm (36" box)
- Single latch on (30" box)
- Single gas strut lid for easy access (36" box)
- 2 x internal security locks & box section for forklift access (36" box)

\$209 (T736A)

2 x BOXES



ITB-48 INDUSTRIAL TOOL BOX

- 1.6mm thickness mild steel
- Lifting handles on either side
- Powder coated finish
- 1220 x 630 x 700mm (L x W x D)
- Dual gas struts supports lid
- 2 x security pad lockable latches
- Box section for forklift access

\$385 (T738)



ALL 3 BOXES ONLY \$569
(T736A + T738)

ONLINE ORDERS USE:
PROMO CODE:
3DSM14

SDH-MAG MAGNETIC SPRAY CAN & SCREWDRIVER HOLDER

- Attaches easily to a toolbox or any metal surface
- Six rubber-coated magnets won't scratch surfaces
- 2.5kg weight capacity
- Holds 5 screwdrivers & 2 spray cans
- Use for bottles spray cans, paint, lubricants, and more

\$11 (T703)



up to 30% OFF RRP



UTE-1450 INDUSTRIAL UTE TOOL BOX - Aluminium

- 1450 x 500 x 700mm (L x W x D)
- Made from 1.8mm Aluminium checker plate
- Stainless steel T handle key locks on lid
- Dual gas struts supports lid
- Built in top shelf inside

\$459 (T742)



WORK BENCHES

WORKSHOP Series

**WBS-5D Work Bench
5 Drawer**
1370 x 510 x 890mm (L x W x H)

- Ball bearing slide drawers
- Heavy duty steel construction
- 2 huge shelf compartments
- Powder coated quality finish



ONLY \$297
(A383)

SAVE

**WBS-3D Work Bench
3 Drawer**
2000 x 640 x 870mm (L x W x H)

- 3 Key lockable drawers
- Heavy duty mechanical bearing slide drawers
- Heavy duty steel construction
- Huge shelf compartment



ONLY \$352
(A380)

GREAT VALUE

WORKSHOP Series

WBT-38 WORK BENCH WITH BACKING PANEL

- 5 drawers with smooth ball bearing slides
- Heavy duty steel construction
- Quality industrial finish
- 2 huge adjustable shelves
- Solid 38mm thick timber top
- Sturdy steel pegboard backing panel
- 890mm table height
- Weight (nett) 86kg

1370 x 510 x 1570mm (L x W x H)

Fixed back hanging panel perfect for optional accessories below (For buckets see A430 etc)

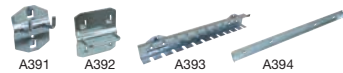

Optional Hooks - suits A384	CODE	PRICE
Double Prong Hook - 40mm wide	A391	\$2.20
Single Loop Hook - 60mm wide	A392	\$2.75
12 Slot Screw Driver Holder - 370mm long	A393	\$8.80
Bucket Rail - 440mm wide	A394	\$4.40

ONLY \$396
(A384)



NOTE: shown with optional buckets & hooks

INDUSTRIAL Series

WTC-1450 INDUSTRIAL TOOLING CABINET WORKSTATION

- 5 drawers, top with red plastic buckets, the rest with steel dividers. Key lockable
- Powder coated quality finish
- Portable on castor wheels, 2 with brake
- Fixed back hanging panel perfect for optional accessories (see below A439 etc.)
- 100kg each drawer capacity
- Table Dimensions (L x W x H)
1103 x 580 x 950mm
- Weighs 121kg

1170 x 580 x 1450mm (L x W x H)

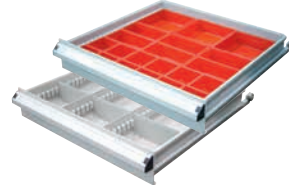

ONLY \$899
(T773)

INDUSTRIAL SERIES

LP-900 BACKING PANELS Louvre Type (2 Piece) (A410)

- 2 piece steel backing panel set
- Louvre slots to suit optional buckets (A430 - A436)
- 20mm mounting frame with 2 bends gives additional strength
- Attractive grey powder-coated finish stands up to heavy-duty service
- Includes 8 x mounting screws
- Dimensions of each panel: 900 x 456 x 20mm



2 PANELS

ONLY \$55
(A410)

up to 20% OFF RRP

SAVE

SP-900 BACKING PANELS Square Hole Type (2 Piece) (A412)

- 2 piece steel backing panel set
- Square holes to suit optional hooks & holders (A439 - A448)
- 20mm mounting frame with 2 bends gives additional strength
- Attractive grey powder-coated finish stands up to heavy-duty service
- Includes 8 x mounting screws
- Dimensions of each panel: 900 x 456 x 20mm



2 PANELS

ONLY \$55
(A412)

up to 20% OFF RRP

HOOKS & STORAGE BUCKETS

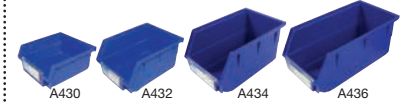

Optional Plastic Buckets (W x D x H) suits A384, A426, T790, T685 & A410	CODE	PRICE
105 x 110 x 50mm	A430	\$3.30
105 x 140 x 75mm	A432	\$4.40
140 x 220 x 125mm	A434	\$8.80
140 x 270 x 125mm	A436	\$11.00

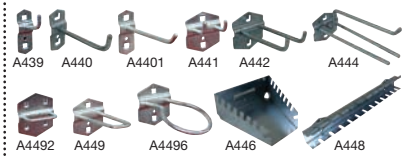

Optional Hooks - suits A426, T790, T773 & A412	CODE	PRICE
Single Hook 25mm long	A439	\$2.20
Single Hook 75mm long	A440	\$2.75
Single Hook 100mm long	A4401	\$2.75
Double Hook 25mm long	A441	\$2.75
Double Hook 75mm long	A442	\$3.30
Plier Holder - 3 Prong 150mm long	A444	\$4.40
U Shape Hook 23 x 55mm	A4492	\$2.75
U Shape Hook 70 x 25mm	A449	\$2.75
Round Hook Ø60mm	A4496	\$2.75
Spanner Holder - 135mm long	A446	\$9.90
Screwdriver Holder - 390mm long	A448	\$11.00

INDUSTRIAL SERIES

IBP-ST BACKING PANEL (A426)

- 1733 x 205 x 825mm (L x W x H)
- 2 x Back Panels - Square holes suits hooks
- 2 x Back Panels - Louvred slots suits plastic buckets
- Bottom & Top Storage Tray Shelves - For additional storage
- 3 Vertical Supports - With adjustable clamps to mount to work bench
- Suits the IWB-40 work Bench or most 1800mm in length work benches

IWB-40 WORK BENCH (A420)

- Frame - Heavy duty steel fabricated frame with powder coated finish for maximum rigidity
- Adjustable Feet - Heavy duty easy to use screw out adjustable feet with rubber pads
- Bench Top - 2mm high density laminate over 41mm thick medium density chipboard with bull-nosed hard PVC edge. All work-tops are very firm with 1000kg weight capacity and also resist alkali and oil.
- The IBP-ST Backing Panel is suitable for this work bench
- 180 x 75 x 90cm (L x W x H)

PACKAGE PRICE ONLY \$495
(K029) A426 + A420



SAVE \$110 RRP

ONLY \$187
(A426)

ONLY \$330
(A420)

HC-2 UNDER BENCH DRAWER CABINET (A422)

- 2 Drawer, Key lockable
- 100mm height drawers
- 580 x 570 x 280mm (W x D x H)
- Fits under IWB-40 Bench (A420)

ONLY \$154
(A422)



IWB-40 INDUSTRIAL WORK BENCH PACKAGE

- Work Bench..... (A420)
- Backing Panel..... (A426)
- 4 x Single Prong Hook..... (A440)
- 4 x Double Prong Hook..... (A442)
- 1 x Triple Prong Hook..... (A444)
- 1 x Spanner Holder..... (A446)
- 1 x Screw Driver Holder..... (A448)



- Plastic Buckets (W x D x H)
- 8 x (105 x 110 x 50mm) Plastic Buckets..... (A430)
- 8 x (105 x 140 x 75mm) Plastic Buckets..... (A432)
- 6 x (140 x 220 x 125mm) Plastic Buckets..... (A434)

SAVE \$216.80 RRP

PACKAGE PRICE ONLY \$595
(K030)

INDUSTRIAL TOOLING CABINETS

- ✓ Industrial Quality
- ✓ 100kg Drawer Capacity
- ✓ Key Lockable
- ✓ 97% Drawer Access
- ✓ Sliding Drawers
- ✓ Mechanical Safety Lock

SAVE



Drawer Lock Mechanism

Heavy Duty Ball Bearing Rail Design on Drawers



ONLY \$539
(T764)

Type A
Type B



ONLY \$759
(T770)

Type A
Type B



ONLY \$869
(T772)

Type E



ONLY \$649
(T766)

Type A
Type B



ONLY \$759
(T768)

Type C
Type D

Cabinets with Wheels & Handle
(2 x fixed & 2 x swivel brake Ø125mm castor wheels)

Suitable to fit under A420 work Bench

CODE	T764
Drawer No.	6
Drawer Capacity kg	100 each
Dimensions (WxDxH)mm	565x580x750
Weight (Nett) kg	90

CODE	T770
Drawer No.	7
Drawer Capacity kg	100 each
Dimensions (WxDxH)mm	565x653x1200
Weight (Nett) kg	112

CODE	T772
Drawer No.	7
Drawer Capacity kg	100 each
Dimensions (WxDxH)mm	881x653x1200
Weight (Nett) kg	135

CODE	T766
Drawer No.	6
Drawer Capacity kg	100 each
Dimensions (WxDxH)mm	565x653x954
Weight (Nett) kg	90

CODE	T768
Drawer No.	6
Drawer Capacity kg	100 each
Dimensions (WxDxH)mm	723x653x954
Weight (Nett) kg	104

Industrial Storage & Tooling Cabinet

BSC-900 Storage Cabinet 900 x 450 x 900mm (L x W x H)

- Ideal for workshops and industrial applications
- Storage cabinets made from reinforced sheet metal
- Hinged doors and a 3-point key lock design
- 2 x Shelves with 150kg load capacity - adjustable height and position
- Powder coated grey finish



TC-900 Tooling Cabinet 900 x 450 x 900mm (L x W x H)

- 75kg load capacity per drawer
- Single key lock with mechanical drawer safety lock
- Top drawer includes moveable plastic division boxes
- Remaining drawers have adjustable steel dividers
- 4 x 100mm and 2 x 200mm height drawers



BSC-900 Top Storage Cabinet(T774)

TC-900 Bottom Tooling Cabinet(T775)

SAVE \$199 RRP

PACKAGE PRICE ONLY \$945
(K033)

SC-1800 Industrial Storage Cabinet

900 x 450 x 1800mm (L x W x H)

Storage cabinets made from reinforced sheet metal, with hinged doors and a 3-point key lock design. Cabinets will store just about anything. Ideal for workshops and industrial applications

COMPLETE WITH THE FOLLOWING:

- 4 x Shelves - Adjustable height and position, 150kg load capacity
- Drawer 1 - 100mm high, ball bearing slides, 75kg load capacity
- Drawer 2 - 200mm high, ball bearing slides, 75kg load capacity

CODE	T762
Shelf Load Capacity kg	150
Drawer Load Capacity kg	75
Dimensions (LxWxH)mm	900x450x1800
Weight (Nett) kg	94



ADDITIONAL DRAWERS & SHELVES AVAILABLE

SAVE

ONLY \$649
(T762)

A PERFECT STORAGE UNIT

Optional Accessories

To suit SC-1800 Storage Cabinet (T762)

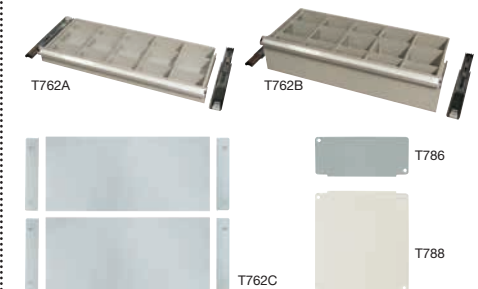

Extra Drawers - to suit (T762)	CODE	PRICE
154 x 65mm Steel Divider - suits 100mm	T786	\$2.00
154 x 165mm Steel Divider - suits 200mm	T788	\$3.00
2 x Shelf & 4 x Bracket Kit	T762C	\$55.00
100mm Deep Drawer, 75kg Capacity	T762A	\$77.00
200mm Deep Drawer, 75kg Capacity	T762B	\$99.00

STORAGE SYSTEMS

Parts Bins

- ABS drawers - oil & impact resistant
- Includes drawer dividers



MODEL	PTB-20	PTB-32	PTB-60	PTB-24C	PTB-48C	PTB-48CD	PTB-18C	PTB-15C	PTB-30CHD
ORDER CODE	T7951	T7952	T7953	T7955	T7956	T7958	T7961	T7962	T7964
Drawers Qty / Type	20 / ABS	32 / ABS	60 / ABS	24 / ABS+Clear	48 / ABS+Clear	48 / ABS+Clear	18 / ABS+Clear	15 / ABS+Clear	30 / ABS+Clear
Drawer Dividers Qty	20	32	60	24	48	48	36	30	60
Drawers (L x W x H) mm	90 x 218 x 70	90 x 218 x 70	90 x 218 x 70	120 x 218 x 69	120 x 218 x 69	120 x 218 x 69	164 x 375 x 105	164 x 375 x 105	164 x 375 x 105
Cabinet (L x W x H) mm	586 x 222 x 350	466 x 222 x 642	586 x 222 x 937	444 x 222 x 642	586 x 222 x 937	586 x 270 x 970	550 x 400 x 880	880 x 400 x 440	880 x 400 x 880
PRICE	\$159	\$205	\$336	\$189	\$329	\$469	\$375	\$308	\$489

RTS-4T Flexi-Rack Wood Shelving

- 4 shelves with 16mm thick particle board
- 455kg per shelf capacity
- Dimensions 1040 x 430 x 1830mm (L x W x H)
- Durable powder coat finish resists rust!
- Can be configured as a work bench
- Multiple configurations when you purchase more than one unit
- Vertical posts have double sided punched holes allowing to link units together

- ✓ Industrial Quality
- ✓ 455kg Shelf Capacity
- ✓ Adjustable Shelf Height



CODE	S013
Shelves No.	4
Shelf Load Capacity kg	455
Dimensions (L x W x H) mm	1040 x 430 x 1830
Weight (Nett) kg	35



RSS-4WS Industrial Steel Shelving

- Industrial strong wire mesh inserts
- 364kg per shelf capacity
- Dimensions 1955 x 610 x 1830mm (L x W x H)
- Silver corrosive resistant powder coated finish
- Adjustable grid pattern wire shelving
- Vertical posts have double sided punched holes allowing to link units together
- Come in flat pack for easy shipping

- ✓ Industrial Quality
- ✓ 364kg Shelf Capacity
- ✓ Adjustable Shelf Height

CODE	S014
Shelves No.	4
Shelf Load Capacity kg	364
Dimensions (L x W x H) mm	1955 x 610 x 1830
Weight (Nett) kg	56



Industrial Mobile Storage Bin Racks

- Heavy duty plastic bins, ideal for storing parts, washers, screws, bits, bolts, o-rings, rivets, for assembly lines, workshops & garages
- Quick & easy clip together assembly with adjustable shelves
- Zinc plated wire shelving with bin locating guides
- Steel frame with silver powder coated finish
- Ø100mm swivel castors (2 x lockable)
- Flat packed for shipping

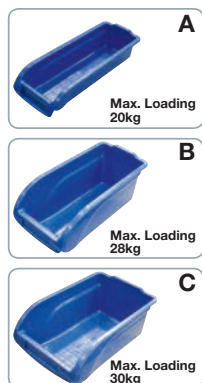

MODEL	SR-22	SR-36	SR-72
CODE	S020	S021	S022
Total Number of Bins	No. 22	36	72
Plastic Bin Quantity/Size A	No./mm 15 x (345 x 105 x 75mm)	15 x (345 x 105 x 75mm)	30 x (345 x 105 x 75mm)
Plastic Bin Quantity/Size B	No./mm 4 x (345 x 140 x 150mm)	12 x (345 x 140 x 150mm)	24 x (345 x 140 x 150mm)
Plastic Bin Quantity/Size C	No./mm 3 x (345 x 205 x 150mm)	9 x (345 x 205 x 150mm)	18 x (345 x 205 x 150mm)
Number of Castor Wheels	No. 4 (2 Lockable)	4 (2 Lockable)	6 (2 Lockable)
Assembled Dimensions (L x W x H) mm	880 x 410 x 950	880 x 410 x 1705	1740 x 410 x 1705 (Side by Side) 880 x 820 x 1705 (Back to Back)

SR-DSL Mobile Storage Shelving System

- Ideal for workshops and industrial applications
- 3 x shelves - adjustable height
- 1 x square hole type panel
- 2 x louvre type panels
- 300kg load capacity
- Handle either side for easy movability
- Large base for extra storage
- 4 x Ø100mm swivel castor wheels (2 x lockable)
- Powder coated grey finish
- 886 x 650 x 1405mm (L x W x H)
- Weighs 56kg

ONLY \$349
(T790)



Hooks & Buckets

Optional Hooks - suit T790	CODE	PRICE
Single Hook 25mm long	A439	\$2.20
Single Hook 75mm long	A440	\$2.75
Single Hook 100mm long	A4401	\$2.75
Double Hook 25mm long	A441	\$2.75
Double Hook 75mm long	A442	\$3.30
Plier Holder - 3 Prong 150mm long	A444	\$4.40
U Shape Hook 23 x 55mm	A4492	\$2.75
U Shape Hook 70 x 25mm	A449	\$2.75
Round Hook Ø60mm	A4496	\$2.75
Spanner Holder - 135mm long	A446	\$9.90
Screwdriver Holder - 390mm long	A448	\$11.00
Optional Buckets - suit T790	CODE	PRICE
105 x 110 x 50mm	A430	\$3.30
105 x 140 x 75mm	A432	\$4.40
140 x 220 x 125mm	A434	\$8.80
140 x 270 x 125mm	A436	\$11.00



PACKAGE includes:

- Mobile Storage System... (T790)
- 2 x Single Prong Hook... (A440)
- 2 x Double Prong Hook... (A442)
- 1 x Triple Prong Hook... (A444)
- 1 x Spanner Holder... (A446)
- 1 x Screw Driver Holder... (A448)
- Plastic Buckets: (W x D x H)
- 8 x (105 x 110 x 50mm) (A430)
- 8 x (105 x 140 x 75mm) (A432)
- 6 x (140 x 220 x 125mm) ... (A434)
- 6 x (140 x 270 x 125mm) ... (A436)

SAVE \$203.20 RRP
PACKAGE PRICE ONLY \$459
(K032)

DRILL CHUCKS

HEAVY DUTY

Keyed Keyless

1-10mm Keyed	JT2	\$33	(C298)
0.5-13mm Keyed	JT6	\$45	(C289)
0.5-16mm Keyed	JT3	\$64	(C290)
0.5-13mm Keyless	JT6	\$79	(C292)
3-16mm Keyless	JT3	\$92	(C294)

DRILL CHUCKS Keyed

1-13mm x JT6 **\$28** (C2982)

1-16mm x JT3 **\$37** (C2985)

DRILL CHUCK Keyless with Lock

• Superior gripping - Self tightening feature to increase gripping force

1-13mm x JT6 **\$56** (C299)

SAVE

INDUSTRIAL DRILL CHUCK ARBORS - TAPER SHANK Keyed - Ball Bearing Type

• Greater tightening force

2MT x JT2	\$11.20	(D4412)
2MT x JT6	\$13.00	(D442)
2MT x JT3	\$13.00	(D442A)
3MT x JT6	\$16.80	(D443)
3MT x JT3	\$16.80	(D443A)
3MT x JT4	\$23.00	(D455)
4MT x JT6	\$23.00	(D454)
4MT x JT3	\$23.00	(D454A)
4MT x JT4	\$23.00	(D456)

DRILL SETS - HSS

• High speed steel, Tinite coated
• 114° point
• Suitable for wood & metal

25 piece Metric 1 - 13mm
\$29 (D120)

29 piece Imperial 1/16" - 1/2"
\$29 (D121)

DRILL BIT GAUGE Metric/Imperial

• 1-13mm & 1/16 - 1/2"
• Manufactured from stainless steel

up to 25% OFF RRP

\$12 (M988)

CENTRE DRILLS - HSS Fully Ground

Size	Point Diameter	Shank	Price	Code
1	1.25mm	3.2mm	\$4.60	(D501)
2	2mm	5mm	\$5.60	(D502)
3	3.2mm	8mm	\$7.40	(D503)
4	4mm	10mm	\$9.30	(D504)
5	5mm	12.5mm	\$13.00	(D505)

SAVE

SLEEVES Hardened & ground

Note: NT40, NT30 & R8 Morse taper adapters also available

Size	Outside	Inside	Price	Code
2-1	2MT	1MT	\$9.30	(D420)
3-2	3MT	2MT	\$14.00	(D422)
4-2	4MT	2MT	\$18.70	(D423)
4-3	4MT	3MT	\$20.00	(D424)
5-4	5MT	4MT	\$44.00	(D425)
6-5	6MT	5MT	\$126.00	(D426)

DRILL EXTENSION SLEEVES Morse Taper

Size	Outside	Inside	Price	Code
2-2	2MT	2MT	\$55.00	(D400)
2-3	2MT	3MT	\$64.00	(D401)
3-3	3MT	3MT	\$92.00	(D402)
3-4	3MT	4MT	\$92.00	(D403)
4-5	4MT	5MT	\$195.00	(D404)

UNIVERSAL D BIT GRINDER

• Grinding wheel size 100 x 50 x 20mm
• 180W 240V motor
• Halogen light 12V
• Taper angles 0 - 180°
• Relief angle 0 - 45°
• Negative angle 0 - 26°
• Spindle speed 3600rpm
• Includes collets & attachments

\$1,089 (G1975)

JOBBER DRILL SET

• 170 Piece • 1-10mm • HSS

up to 25% OFF RRP

\$139 (D126)

REDUCED SHANK DRILL SETS - HSS 8 Piece

• 13, 14, 15, 16, 18, 20, 22 & 25mm
• 13mm reduced shank

\$69 (D117)

REDUCED SHANK DRILL SETS - HSS 8 Piece

• 9/16, 5/8, 11/16, 3/4, 13/16, 7/8, 15/16, 1" • 1/2" reduced shank

\$69 (D118)

2MT DRILL SET 10 Piece

• 14.5, 15, 16, 17, 18, 19, 20, 21, 22, & 23mm • 2MT shank, HSS

\$99 (D119)

EDBD-13 DRILL SHARPENER

• 3-13mm - 1/8" - 1/2" capacity
• Tough plastic construction
• Capable of split point sharpening
• Grinds two flute drills of unlimited length
• 80W, 4200 rpm, 240V motor
• Fixed drill point 118°

\$79 (D070)

PP-13C PRECISION DRILL SHARPENER

• 3-13mm - 1/8" - 1/2" capacity
• Chisel point and split point operations
• Grinds two flute drills of unlimited length
• Precision grinding results with diamond wheel
• Hand operated
• Angles from 90-135°
• Powerful 140V motor
• ER20 Collets 3 - 13mm
• Replacement CBN wheel (D1115)

\$539 (D111)

ADJUSTABLE REAMERS

METRIC SIZE	IMPERIAL SIZE	PRICE
9.5 - 10.3mm	3/8" - 13/32"	\$37 (R710)
10.3 - 11.1mm	13/32" - 7/16"	\$39 (R712)
11.1 - 11.9mm	7/16" - 15/32"	\$42 (R714)
11.9 - 13.5mm	15/32" - 17/32"	\$47 (R716)
13.5 - 15.0mm	17/32" - 19/32"	\$47 (R718)
15.0 - 16.6mm	19/32" - 21/32"	\$49 (R720)
16.6 - 18.2mm	21/32" - 23/32"	\$53 (R722)
18.2 - 19.8mm	23/32" - 25/32"	\$59 (R724)
19.8 - 21.4mm	25/32" - 27/32"	\$62 (R726)
21.4 - 23.8mm	27/32" - 15/16"	\$67 (R728)
23.8 - 26.9mm	15/16" - 1.1/16"	\$78 (R730)

ADJUSTABLE REAMER SET - 8 Piece HSS

• Metric sizes Ø11.9 - Ø26.9mm
• Imperial size Ø15/32" - Ø1.1/16"

SAVE \$52.90 RRP

\$199 (R700)

HOLE SAW SETS

• High speed steel M42 Bi-Metal
• Range: 19, 22, 25, 32, 35, 38, 44, 51, 57, 64, 76mm
• Pilot drill & spring
• Includes 3/8" & 1/2" shank arbors

11 Piece HSS \$89 (D102)

BROACH CUTTER ADAPTORS

• Coolant bottle & hose
• Suits drilling machines
• Suit 19mm shank broach cutters

8 Piece Carbide Tipped \$79 (D108)

FITTING & MACHINING & TECHNICAL BOOKS

• 639 pages of technical information
• Hard cover

SAVE

\$69 (L341)

ADJUSTABLE REAMER SET - 8 Piece HSS

• 639 pages of technical information
• Hard cover

Engineers 163p \$45 (L343)

Fastener 247p \$54 (L344)

MAGNETIC BASE DRILLS

HF-35 Manual feed

• Drills up to Ø35mm through 50mm plate
• Includes drill chuck and adaptor for use of twist drills up to 12mm diameter
• CE approved

\$759 (D950)

HF-30A Automatic feed

• Drills up to Ø30mm through 50mm plate in the automatic feed mode, and 35mm diameter through 50mm plate with manual feed
• CE approved

\$1,299 (D9505)

HF-750 Manual feed

• Drills up to Ø75mm through 50mm plate
• 3MT drill to 31.5mm
• 4 speed 1800W 240V motor
• Forward/reverse for tapping

\$1,299 (D9507)

BROACH DRILL SET - 6 Piece

• 14, 16, 18, 20, 22 & 24 (19mm shank)
• 25mm Depth of cut
• 6.35mm locating pin

\$158 (D109)

BROACH CUTTERS - HSS

• Suits HAFCO magnetic drills
• TM Broach cutters have a 19mm universal shank

FREE BROACH DRILL SET (D109) With HAFCO Magnetic Base Drills

ONLINE ORDERS USE: PROMO CODE: 3DSM14

WOW

25mm Drill Length	CODE	50mm Drill Length	CODE
12mm	\$27 (D9512)	14mm	\$37 (D9550)
13mm	\$28 (D9513)	16mm	\$37 (D9552)
14mm	\$28 (D9514)	18mm	\$37 (D9554)
16mm	\$28 (D9516)	20mm	\$42 (D9556)
17mm	\$30 (D9517)	22mm	\$42 (D9558)
18mm	\$30 (D9518)	24mm	\$46 (D9560)
20mm	\$34 (D9520)	25mm	\$51 (D9562)
22mm	\$40 (D9522)	26mm	\$51 (D9564)
23mm	\$40 (D9523)	28mm	\$56 (D9566)
24mm	\$43 (D9524)	30mm	\$58 (D9568)
25mm	\$45 (D9525)	32mm	\$65 (D9570)
26mm	\$45 (D9526)	34mm	\$70 (D9572)
28mm	\$48 (D9528)	35mm	\$70 (D9574)
30mm	\$50 (D9530)	38mm	\$74 (D9576)
32mm	\$53 (D9532)	40mm	\$74 (D9578)
34mm	\$57 (D9534)	44mm	\$88 (D9580)
35mm	\$58 (D9535)	48mm	\$112 (D9582)
		50mm	\$112 (D9584)

6.35mm PIN **\$8.40** (D9510)

6.35mm PIN **\$8.40** (D9511)

TAP SETS - HSS

- Precision ground threads
- Tolerance of H6
- 1 x Taper, 1 x Intermediate, 1 x Plug



Metric Taps - Set of 3		
SIZE (mm)	CODE	
M3 x 0.5	\$11.20 (T800)	
M4 x 0.7	\$11.20 (T801)	
M5 x 0.8	\$11.20 (T802)	
M6 x 1.0	\$13.00 (T803)	
M8 x 1.25	\$18.70 (T804)	
M10 x 1.5	\$20.00 (T805)	
M12 x 1.75	\$27.00 (T806)	
M16 x 2.0	\$35.00 (T808)	
M20 x 2.5	\$57.00 (T810)	

UNC - Set of 3		
SIZE (TPI)	CODE	
1/4" x 20	\$12.10 (T834)	
5/16" x 18	\$16.80 (T835)	
3/8" x 16	\$18.70 (T836)	
1/2" x 13	\$35.00 (T837)	
5/8" x 11	\$39.00 (T838)	
3/4" x 10	\$57.00 (T839)	

Whitworth - Set of 3		
SIZE (TPI)	CODE	
1/8" x 40	\$11.20 (T820)	
3/16" x 24	\$11.20 (T821)	
1/4" x 20	\$13.00 (T822)	
5/16" x 18	\$16.80 (T823)	
3/8" x 16	\$18.70 (T824)	
1/2" x 12	\$35.00 (T825)	
5/8" x 11	\$39.00 (T826)	
3/4" x 10	\$57.00 (T827)	

HSS - BSPT TAPS

- Sold individually



BSPT Taps - HSS		
SIZE (TPI)	CODE	
1/8" x 28	\$11.20 (T850)	
1/4" x 19	\$14.00 (T851)	
3/8" x 19	\$18.70 (T852)	
1/2" x 14	\$20.00 (T853)	

BUTTON DIES - HSS

- Precision ground threads
- High Speed Steel



SAVE

Metric - Button Dies			
SIZE (mm)	DIA.	CODE	
M3 x 0.5	1"	\$9.30 (T903)	
M4 x 0.7	1"	\$9.30 (T904)	
M5 x 0.8	1"	\$9.30 (T905)	
M6 x 1.0	1"	\$9.30 (T906)	
M8 x 1.25	1"	\$9.30 (T908)	
M10 x 1.5	1 1/2"	\$13.00 (T910)	
M12 x 1.75	1 1/2"	\$13.00 (T912)	
M16 x 2.0	1 1/2"	\$13.00 (T916)	
M20 x 2.5	1 1/2"	\$13.00 (T920)	

UNC - Button Dies			
SIZE (TPI)	DIA.	CODE	
1/4" x 20	1"	\$9.30 (T940)	
5/16" x 18	1"	\$9.30 (T941)	
3/8" x 16	1 1/2"	\$13.00 (T942)	
1/2" x 13	1 1/2"	\$13.00 (T943)	
5/8" x 11	1 1/2"	\$13.00 (T944)	
3/4" x 10	1 1/2"	\$13.00 (T945)	

Whitworth - Button Dies			
SIZE (TPI)	DIA.	CODE	
1/8" x 40	1"	\$9.30 (T930)	
3/16" x 24	1"	\$9.30 (T931)	
1/4" x 20	1"	\$9.30 (T932)	
5/16" x 18	1"	\$9.30 (T933)	
3/8" x 16	1 1/2"	\$13.00 (T934)	
1/2" x 12	1 1/2"	\$13.00 (T935)	
5/8" x 11	1 1/2"	\$13.00 (T936)	
3/4" x 10	1 1/2"	\$13.00 (T937)	

HSS TAP & DRILL SET

29 Piece - Metric Set

- M3, M4, M5, M6, M8, M10 & M12 Taps (3 taps per size)
- Includes drill to suit each size tap



HSS \$64 (T019)

TAP & DIE SET

32 Piece - Metric Set



M3-M12 (Alloy) \$45 (T012) **M3-M12 (HSS) \$101** (T013)

TAP & DIE SET ALLOY STEEL

45 Piece

Metric M6-M24 \$120 (T014)
Imperial 1/4"-1" \$120 (T015)



RE-THREADING TAP/DIE KIT

42 Piece Metric, UNC, UNF

- All taps and dies are hex shaped for use with a socket or wrench
- Contents: covering all M6-M12, 1/4"-5/8" coarse and fine thread
- Includes 2 thread files



SAVE \$84 (T020)

SCREW EXTRACTOR SET - 10 Piece

- Thread range 3/16"-5/8" (M5-M16)
- Drill size required: 1/8", 5/32", 3/16", 7/32", 1/4", 9/32", 5/16", 11/32", 3/8", 13/32"



\$22 (T870)

TAP & DIE SET - HSS

45 Piece



Metric M6-M24 \$392 (T016)

THREAD REPAIR KIT

Metric sizes: (M5x0.8mm, M6x1.0mm, M8x1.25mm, M10x1.5mm, M12x1.75mm)



\$139 (T100)

INDIVIDUAL THREAD REPAIR KITS

- 1 piece fully ground drill
- 1 piece DIN352 HSS tap
- 10 stainless steel threading inserts
- 1 insert handle

SIZE	
M6 x 1.0mm Pitch	\$23 (T107)
M8 x 1.25mm Pitch	\$27 (T109)
M10 x 1.5mm Pitch	\$32 (T110)
M12 x 1.75mm Pitch	\$32 (T113)

TAP WRENCHES

- Adjustable tap wrench
- Hardened Jaws
- Forged steel



SIZE	
M1 - M8	\$9.30 (T863)
M5 - M13	\$20.00 (T011)
M9 - M27	\$22.00 (T866)

MAGNETIC TAPPER

- Quick release tapping chuck
- Magnetic base with on/off switch
- Guide bar provides precise tapping
- M3 - M12 Capacity



\$149 (T0119)

TAP WRENCHES Ratchet Type

- Forward/reverse operation & lock
- Designed for use with taps reamers screw extractors & other tools with a square shank
- Ideal for use in confined areas

SIZE	
No.1 M3-M10	\$13.00 (T860)
No.2 M5-M12	\$16.80 (T861)

BUTTON DIE HOLDERS

- Adjustable Die holder to suit button dies



DIE SIZE	
1" OD	\$8.40 (T951)
1 1/2" OD	\$14.00 (T952)

REVERSIBLE TAPPING CHUCKS

- Suitable for all drilling and milling machines for small production runs
- Cushioned drive prevents thread distortion and cross threading

MODEL	TAPPING	TAPER	
K1-MT2	M3-M6	2MT	\$121 (T002A)
K2-MT2	M5-M10	2MT	\$121 (T002)
K3-MT3	M6-M14	3MT	\$149 (T003)

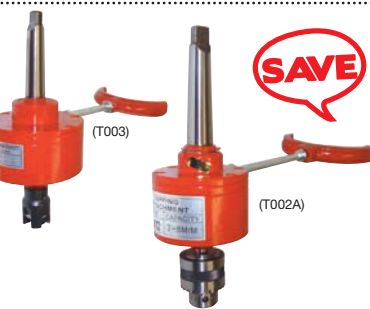

SAVE

FIXED TAPPING CHUCKS

- Positive clamping of the square section of the tap
- Adjustable spring collet to suit all sizes in the range
- Ø50mm body

SHANK	Tapping Range	
3MT	M8-M18	\$140 (T004B)
4MT	M8-M18	\$149 (T005B)

TAPPING CHUCKS ADJUSTABLE CLUTCH

- Pre-select torque drive to prevent tap breakage and allow for blind hole tapping
- Fast tap reversal. Re-entry cushioning eliminates cross threading

MOUNT	RANGE	
JT6	M5-M12	\$336 (T004)
Threaded	M8-M20	\$420 (T005)



SAVE

DEBURRING TOOL

- Style "E" with universal extendible handle
- Includes 9 blades



\$13 (D110)

DEBURRING TOOL Pocket Clip

- Includes 10 HSS blades
- Pencil clip type
- Pocket clip to keep handy in your top pocket



\$15 (D061)

DEBURRING TOOL Sheet Metal Burr

- Hand guard
- 2 x Ø11.7mm blades
- Simultaneously removes burrs from both sides of sheet metal
- Range 0-7.5mm



\$16 (D063)

DEBURRING TOOL

- Includes 10 x HSS blades
- Ergonomically designed
- Has thumb rest
- Grips well in hand
- Telescopic holder
- Blades can be stored from the back side



\$22 (D060)

KEYWAY BROACH SETS

- Supplied in wooden case
- High-speed steel broach set consisting of broaches, bushes & packing shims



SAVE \$96 RRP
Metric 4, 5, 6, 8mm \$399 (M498) **Imperial 1/8, 3/16, 1/4, 3/8" \$399** (M500)

KEYWAY BROACHES INDIVIDUAL

- HSS consisting of a broach & packing shim

Metric SIZE	STYLE	
3mm	A	\$56 (M4982)
4mm	B	\$56 (M4983)
5mm	B	\$56 (M4984)
6mm	C	\$74 (M4985)
8mm	C	\$74 (M4986)
10mm	D	\$130 (M4987)
12mm	D	\$130 (M4988)

DEBURRING TOOL SET Universal

- 4 x screw on flute countersinks for hole deburring & chamfering 6, 10, 14, 18mm
- 1 x deburring tool
- 1 x HSS blade
- 1 x pocket clip deburring tool



SAVE \$39 (D062)

DEBURRING TOOL SET Universal - 23 piece

- 2 x De-Burring tool holders
- 1 x Sheet Metal De-Burring tool
- 1 x 10 pack of HSS blades
- 1 x 20mm countersink blade
- 2 x Scraper blades
- 1 x "V" scraper
- 1 x Inverted "V" scraper
- 4 x Telescopic extensions
- Wrenches



\$89 (D065)

MACHINE MOUNTS

- Suitable for all machines to level and reduce vibration



CAPACITY	SIZE	THREAD	
100kg	Ø85mm	M10	\$22 (M001)
250kg	Ø120mm	M12	\$32 (M0015)
500kg	Ø102mm	M16	\$51 (M002)

VICE SOFT JAWS - Aluminium

- Magnetic tabs to ensure jaws remain fixed to the vice



SIZE	Plain	Prism	Rubber
100mm	\$8.30 (V053)	(V0537)	(V0534)
125mm	\$9.30 (V0531)	(V0538)	(V0535)
150mm	\$11.20 (V0532)	(V0539)	(V0536)

VICE BRAKE BENDERS

- Sheet metal bender
- Bends up to 2mm thick mild steel
- Magnetic back designed to keep bender on vice
- Segmented blade



SIZE	PRICE	Code
100mm	\$35	(V050)
125mm	\$45	(V051)
150mm	\$60	(V052)

BLACKSMITHS CAST STEEL ANVIL

- Manufactured from cast steel
- Square & round hardy hole
- 680 x 200 x 195mm size
- 20mm square & round hole

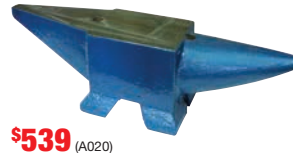

\$539 (A020)

ANGLE VICE CLAMPS 90°



60mm	\$70 (V099)
100mm	\$84 (V100)

BENCH VICE - Cast Iron

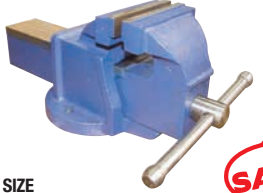

SIZE	PRICE	Code
100mm	\$49	(V088)
127mm	\$79	(V089)
152mm	\$109	(V090)

MULTI-PURPOSE VICE

- Swivel head & base
- Includes anvil & pipe jaws



125mm	\$139 (V074)
-------	--------------

OFFSET FABRICATED VICES

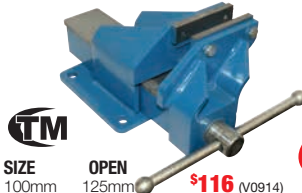

SIZE	OPEN	PRICE	Code
100mm	125mm	\$116	(V0914)
125mm	150mm	\$140	(V0915)
150mm	175mm	\$205	(V0916)
200mm	220mm	\$392	(V0918)

COMPOUND VICES

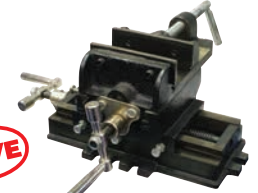

SIZE	TRAVEL	PRICE	Code
105mm	114 x 102mm	\$67	(V120)
150mm	203 x 152mm	\$107	(V122)

COMPOUND VICES Heavy Duty



SIZE	TRAVEL	PRICE	Code
105mm	100 x 100mm	\$84	(V1204)
125mm	125 x 125mm	\$130	(V1205)

DRILL PRESS VICES



SIZE	PRICE	Code
100mm	\$18	(V124)
127mm	\$23	(V125)
152mm	\$28	(V126)

DRILL PRESS VICES

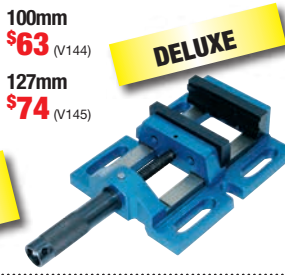

100mm	\$63 (V144)
127mm	\$74 (V145)

HEAVY DUTY DRILL VICES

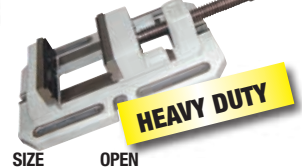

SIZE	OPEN	PRICE	Code
100mm	100mm	\$120	(V154)
140mm	140mm	\$168	(V155)
200mm	200mm	\$233	(V158)

PRECISION DRILL PRESS VICES with step jaws

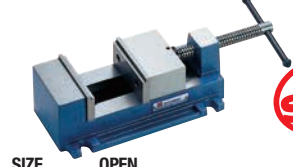

SIZE	OPEN	PRICE	Code
100mm	100mm	\$149	(V141)
130mm	110mm	\$177	(V142)
160mm	115mm	\$205	(V143)

TILTING DRILL VICE



100mm \$55 (V114)

COMPOUND TABLES

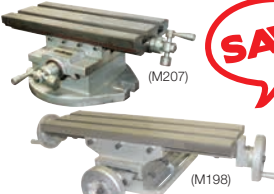

TABLE SIZE	HEIGHT	PRICE	Code
140 x 300mm	120mm	\$168	(M207)
155 x 470mm	130mm	\$177	(M198)

COMPOUND TABLE

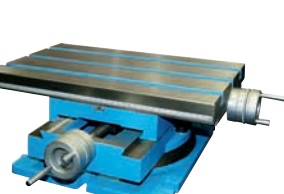

TABLE SIZE	HEIGHT	PRICE	Code
240 x 425mm	165mm	\$364	(M2061)

K-TYPE MILLING VICES



SIZE	OPEN	PRICE	Code
100mm	62mm	\$126	(V104)
127mm	80mm	\$177	(V105)
152mm	112mm	\$196	(V106)
203mm	146mm	\$345	(V108)

ANGLOCK MACHINE VICE



SIZE	OPEN	PRICE	Code
160mm	170mm	\$204	(V3061)

PRECISION ANGLOCK MACHINE VICES



SIZE	OPEN	PRICE	Code
100mm	103mm	\$233	(V304)
127mm	110mm	\$247	(V305)
152mm	142mm	\$266	(V306)
203mm	197mm	\$645	(V307)

MECHANICAL / HYDRAULIC MACHINE VICES PHV SERIES



JAW WIDTH	JAW OPENING	MAX. PRESSURE	PRICE	Code
130mm	225mm	3500kgf	\$748	(V330)
160mm	310mm	4000kgf	\$841	(V332)
200mm	310mm	6000kgf	\$1,542	(V334)
250mm	345mm	7000kgf	\$2,711	(V336)

MORE MODELS AVAILABLE ONLINE

MODULAR MACHINE VICES

- High accuracy, large clamp range
- High grade alloy steel
- Low profile



SIZE	OPEN	PRICE	Code
152mm	200mm	\$738	(V311)
152mm	300mm	\$766	(V311A)
203mm	300mm	\$1,087	(V312)
203mm	400mm	\$1,196	(V312A)

3 WAY ANGLE MILLING VICES



SIZE	OPEN	PRICE	Code
75mm	82mm	\$233	(V113)
125mm	95mm	\$327	(V115)

TILTING MACHINE VICE

- Rotates 360° in the horizontal plane
- Tilts from 0-90° in the vertical plane



SIZE	OPEN	PRICE	Code
152mm	155mm	\$458	(V111)

DIVIDING HEAD



CENTRE HEIGHT	PRICE	Code
128mm	\$458	(D0021)

DIVIDING HEADS



CENTRE HEIGHT	PRICE	Code
100mm	\$429	(D001)
128mm	\$572	(D002)

SUPER INDEXING HEAD



CHUCK SIZE	BORE	PRICE	Code
Ø152mm	40mm	\$869	(R002)
Ø203mm	63mm	\$1,089	(R004)

MAGNETIC CHUCKS

- Cam-operated On/Off handle to hold and release the work piece
- Adjustable rear keeper plate

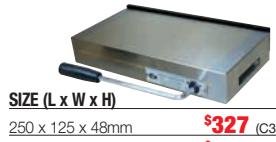

SIZE (L x W x H)	PRICE	Code
250 x 125 x 48mm	\$327	(C300)
300 x 150 x 48mm	\$420	(C302)
450 x 150 x 53mm	\$561	(C306)
450 x 200 x 53mm	\$673	(C308)

ANGLE PLATE - SWIVEL

- Horizontal 0° to vertical 90°
- Precision-ground working surfaces

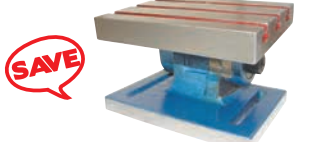

SIZE	T-SLOT	PRICE	Code
203 x 255 x 165mm	14mm	\$204	(M200)

ROTARY TABLE

- Ø75mm table
- 36:1 Ratio
- Hand wheel grad. in 10min divisions
- Hand wheel can be set to zero
- Horizontal or Vertical operation
- Height: 41.27mm



\$89 (R001)

ROTARY TABLES



SIZE	CENTRE HEIGHT	PRICE	Code
Ø110mm	80mm	\$239	(R005)
Ø152mm	80mm	\$269	(R006)
Ø203mm	105mm	\$419	(R008)
Ø254mm	115mm	\$499	(R010)

TILTING ROTARY TABLE

- Ø100mm table
- 0-90° Tilt range
- Graduations: 0-360° in 5° increments
- 36:1 Ratio



\$159 (R0014)

TILTING ROTARY TABLES

- Tilting range 0-90° horizontal to vertical
- 90-1 ratio



SIZE	PRICE	Code
Ø200mm	\$829	(R026)
Ø250mm	\$990	(R027)
Ø320mm	\$1,089	(R028)

ROTARY TABLE KIT

- Hand wheel graduated in 10min divisions
- Horizontal or vertical
- Height: 41.27mm
- 36:1 Ratio



SIZE	CENTRE HEIGHT	PRICE	Code
Ø152mm	83mm	\$399	(R0065)

CLAMP KITS - 58 PIECE

LARGER KITS AVAILABLE



Imperial		Metric	
1/2" Slot	3/8" UNC Stud	\$92 (C090)	10mm Slot M8x1.25 Stud \$121 (C095)
5/8" Slot	1/2" UNC Stud	\$92 (C091)	12mm Slot M10x1.25 Stud \$98 (C0951)
3/4" Slot	5/8" UNC Stud	\$126 (C092)	14mm Slot M12x1.75 Stud \$107 (C096)
5/8" Slot	1/2" UNC Stud	\$107 (C094)	16mm Slot M12x1.75 Stud \$107 (C096A)

MINI CLAMP KITS 10 Piece



Studs	Table Slot	Price
M6x1.0mm	8mm	\$20 (C0954)
M8x1.25mm	10mm	\$20 (C0948)

U-CLAMPS



Studs	Table Slot	Price
1/2"x13tpi	5/8"	\$56 (C083)
M12	14mm	\$56 (C0832)

T-SLOT MINI CLAMPS

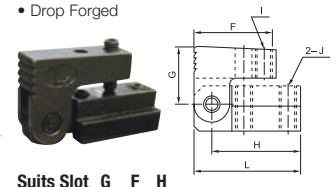

Suits Slot	G	F	H	Price
13.8mm	24	41	46	\$42 (C0861)
15.8mm	27	50	55	\$44 (C0871)
17.5mm	29	50	55	\$48 (C0881)

TEE NUTS

• Supplied in pack of 2

Table Slot	Stud Size	Price
5/8"	1/2" UNC	\$9.30 (C084)
10mm	M8	\$9.30 (C085)
12mm	M10	\$9.30 (C085A)
14mm	M12	\$10.20 (C086)
16mm	M12	\$10.20 (C087)
18mm	M16	\$11.20 (C088)

FLANGED NUTS

• Supplied in pack of 2

Thread Size	Price
1/2" UNC	\$6.50 (N084)
M10	\$7.40 (N085)
M12	\$7.40 (N086)
M16	\$8.40 (N088)

ANGLE PLATES

• Precision ground

Size (L x W x H)	Price
112 x 88 x 75mm	\$55 (M242)
150 x 125 x 112mm	\$70 (M243)
200 x 150 x 125mm	\$107 (M244)
228 x 150 x 175mm	\$126 (M245)
250 x 150 x 200mm	\$126 (M246)

VEE BLOCKS Cast Iron

• Supplied in pairs

(L x W x H)	Width of Vee	Price
75 x 50 x 50	50mm	\$38 (V003)
100 x 63 x 63	70mm	\$54 (V004)
150 x 50 x 100	100mm	\$79 (V006)

VEE BLOCK Alloy Steel

• Supplied as matching pair with one clamp

Size	Price
63 x 50 x 50mm	\$99 (V010)

PARALLEL SETS

Precision ground to 0.0003" tolerance • 150mm long

Quantity	Price
4 Matched Pairs	\$79 (M250)
9 Matched Pairs	\$158 (M252)
9 Matched Pairs (Large)	\$211 (M253)

SJ-7 SCREW JACK SET 7 Piece

• Height range 56mm - 85mm
• Screw jack base size Ø31.75mm

\$24.20 (M2087)

VSJA SCREW JACK SET

• 2 x Ø38mm 65 - 90mm
• 2 x Ø50mm 90 - 140mm
• Acme threads

\$139.70 (M208)

HSS T-SLOT CUTTERS

Note: Inserts not included Uses (L066 or L0661)

T-SLOT CUTTER Ø.	SHANK	Price
10mm	18 x 8mm	\$70 (M3280)
12mm	21 x 9mm	\$88 (M3281)
14mm	25 x 11mm	\$98 (M3282)
16mm	28 x 12mm	\$116 (M3283)
18mm	32 x 16mm	\$148 (M3284)

FACE MILL 90°

Note: Inserts not included Uses (L066 or L0661)

DIA	TIPS	BORE	Price
50mm	3	22mm	\$84 (M510)
63mm	4	27mm	\$92 (M511)
75mm	5	27mm	\$111 (M512)

UNIVERSAL MILLING KIT

• 12mm end mill
• 16mm end mill
• 50mm face mill 22mm mounting spigot
• 1 x pack of 10 Inserts APMT1035

\$233 (M530)

SLOT DRILL & END MILL SETS - HSS

12 Piece

Metric	Imperial	Price
4-12mm	3/16-1/2"	\$64 (M333)

10 Piece

Metric	Imperial	Price
6-20mm	1/4-3/4"	\$65 (M330)
		\$65 (M332)

END MILLS - Carbide Insert

Note: Inserts not included Uses (L059)

DIA	LENGTH	TIPS	Price
12mm	80	1	\$56 (M519)
16mm	90	2	\$65 (M520)
20mm	110	2	\$74 (M521)
20mm	130	3	\$140 (M523)
25mm	120	3	\$84 (M522)
25mm	140	4	\$168 (M524)

SUPER HIGH RAKE CUTTERS 45°

Note: Inserts not included Uses (L065)

DIA	TIPS	BORE	Price
50mm	4	22mm	\$121 (M515)
63mm	5	22mm	\$140 (M516)
80mm	6	27mm	\$168 (M517)
100mm	6	32mm	\$215 (M518)

FACE MILL ARBORS

• Material: SCM-21
• Hardness HRC 50°-55°

TAPER x Bore(mm)	DRAWBAR	Price
MT3 x Ø22	1/2"	\$54 (M562)
MT3 x Ø27	1/2"	\$54 (M563)
R8 x Ø22	7/16"	\$54 (M539)
R8 x Ø27	7/16"	\$54 (M536)
R8 x Ø32	7/16"	\$54 (M537)
NT30 x Ø22	12mm	\$57 (M540)
NT30 x Ø27	12mm	\$57 (M542)
NT30 x Ø32	12mm	\$57 (M544)
NT30 x Ø40	12mm	\$88 (M545)
NT40 x Ø22	16mm	\$83 (M550)
NT40 x Ø27	16mm	\$83 (M552)
NT40 x Ø32	16mm	\$83 (M554)
NT40 x Ø40	16mm	\$83 (M555)

COLLET & CHUCK SETS

SAVE

TYPE	TAPER	QTY	Price
ER32	3MT	6pce	\$210 (C922B)
ER32	NT30	6pce	\$210 (C9245)

ER COLLET CHUCKS R8, NT30, NT40, MT3

COLLET TYPE	TAPER (J)	DRAWBAR (G)	Price
ER-32	MT3	1/2" Whitworth	\$112 (C105)
ER-32	R8	7/16" x 20UNF	\$126 (C106)
ER-32	NT-30	M12 x 1.75	\$126 (C110)
ER-32	NT-40	M16 x 2.0	\$140 (C112)
ER-40	MT3	1/2" Whitworth	\$126 (C1054)
ER-40	R8	7/16" x 20UNF	\$149 (C138)
ER-40	NT-30	M12 x 1.75	\$140 (C111)
ER-40	NT-40	M16 x 2.0	\$154 (C114)

FACE MILL CUTTER with arbor

Note: Inserts not included Uses (L066)

• Integral arbor
• Suits 1/2" whitworth draw bars

DIA	TIPS No.	TAPER	Price
32mm	2	3MT	\$74 (M528)
50mm	3	3MT	\$101 (M529)

POWER FEED UNITS

• Automatic cut-out
• 110V carbon brush motor
• Rapid speed 200rpm
• Variable speed

Model	Price
Transformer 240V Input 110V Output	\$106 (M240)
(M227)	

ER COLLET & CHUCK SETS

TYPE	TAPER	Collet Qty	Price
ER32	3MT	6pce	\$233 (C922A)
ER32	R8	6pce	\$252 (C923)
ER32	NT30	6pce	\$252 (C924)
ER32	NT40	6pce	\$261 (C925)
ER32	3MT	18pce	\$369 (C926)
ER32	R8	18pce	\$392 (C927)
ER32	NT30	18pce	\$392 (C928)
ER32	NT40	18pce	\$397 (C929)
ER32	BT-40	18pce	\$341 (C929A)
ER40	R8	7pce	\$275 (C960)
ER40	NT30	7pce	\$275 (C961)
ER40	NT40	7pce	\$289 (C962)
ER40	R8	23pce	\$514 (C964)
ER40	NT30	23pce	\$556 (C965)
ER40	NT40	23pce	\$523 (C966)
ER40	BT-40	23pce	\$514 (C967)

BORING HEAD KITS

• Micro adjustment, rigid locking with two vertical and one horizontal boring bar positions
• Complete with tool holder, boring bars and storage case

SHANKS NOT SUPPLIED

Size	Price
Ø50mm	\$139.70 (M182)
Ø75mm	\$187.00 (M183)

ARBORS TO SUIT

TAPER	DRAWBAR	Price
3MT	1/2" Whitworth	\$60.50 (M192)
R8	7/16" UNF	\$60.50 (M190)
NT30	12mm	\$60.50 (M193)
NT40	16mm	\$97.90 (M194)

BORING BAR SETS Carbide Tipped

SIZE	PIECE	SUITS	Price
12mm	9	M182	\$60.50 (M180)
18mm	12	M183, M184, M183A, M185	\$79.20 (M181)
18mm	4	M183, M184, M183A, M185	\$88.00 (M181A)

BHB BORING HEAD

• Capacity of 10-240mm

\$364.10 (M184)

SHANKS TO SUIT

TAPER	THREAD	Price
3MT	1/2" Whitworth	\$111.10 (M195A)
R8	7/16" UNF	\$111.10 (M196)
NT30	12mm	\$111.10 (M197)
NT40	16mm	\$125.40 (M197A)
BT40	16mm	\$218.90 (M197B)

BORING & FACING HEAD

VBHU - Universal
Cutting range 5 - 250mm bore
\$1,168 (M185)

LIVE CENTRES



2MT **\$65** (C050)
3MT **\$74** (C052)
4MT **\$102** (C054)

LIVE CENTRES High Speed



3MT 5000rpm **\$112** (C0731)
4MT 3500rpm **\$120** (C0741)
5MT 3000rpm **\$187** (C0751)

LIVE CENTRE SETS

• Accuracy: 0.005mm

3MT 4500rpm 400kg Load Capacity **\$163** (C0631) **SAVE**

4MT 3500rpm 1300kg Load Capacity **\$233** (C0641)



PIPE CENTRES



SAVE

SIZE	CONE DIA.	PRICE
3MT	106mm	\$129 (C045)
4MT	128mm	\$163 (C046)
5MT	156mm	\$232 (C047)

DEAD CENTRES

• Precision ground
• Carbide tipped

(C040)

(C041)

2MT **\$15.90** (C040)
3MT **\$28.00** (C041)

PARTING TOOL HOLDERS

• NOTE: HSS parting blade not supplied (L0007)

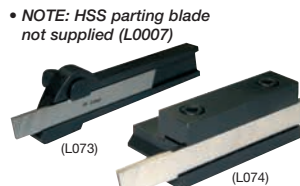

(L073) (L074)

Blade Size	Centre Height	PRICE
1/2" x 3/32"	16mm	\$31 (L073)
1/2" x 3/32"	12mm	\$45 (L074)

LATHE PARTING TOOL KIT - INSERT TYPE

Consisting of:

- Parting off block, blade, 2 x inserts, key insert remover & hex key
- 12, 16 & 20mm kits include 2 Inserts
- 25mm kit includes 10 Inserts



Centre Height	Blade Size	PRICE
12mm	26 x 2m	\$158 (L464)
16mm	26 x 2mm	\$158 (L465)
20mm	26 x 3mm	\$158 (L466)
25mm	32 x 3mm	\$252 (L467)

KNURLING TOOL HOLDERS

• Diamond pattern

SAVE



(L079) (L080) (L070)

Knurl Pitch

Medium	\$31 (L079)
Medium	\$63 (L080)
Coarse, Medium, Fine	\$73 (L070)

KNURLING TOOL KIT

- Head 1: Medium (2 Wheels)
- Head 2: Fine (2 Wheels)
- Head 3: Straight (1 Wheel)

Suits: 12 or 16mm centre height



\$82 (L076)

BORING BARS with holders

- 45° & 90° square holes
- Includes 1 bar

NOTE: HSS tool bits NOT supplied



Boring Bar Length x Dia.	Holder Length x Square	PRICE
4 1/2 x Ø3/8"	2 1/8 x 1/2"	\$16.80 (L100)
5 1/4 x Ø7/16"	2 1/2 x 5/8"	\$18.70 (L101)
6 3/4 x Ø9/16"	3 x 3/4"	\$23.00 (L102)
9 x Ø3/4"	3.3/4 x 1"	\$31.00 (L103)
11 1/2 x Ø15/16" 4 1/2 x 1 1/4"		\$36.00 (L104)

LATHE TOOL KIT - HSS

Suits 10-12mm centre height

Includes:

- 1 x R & L/H & straight tool holder
- 1 x 3/8" HSS boring bar
- 2 x 1/8" & 2 x 3/16" HSS tool bits



\$69 (L072)

TURNING TOOL HOLDERS

NOTE: HSS tool bits NOT supplied (L002B)

English Style - Drop head

American style

Hand	Shank WxH	Length	PRICE
Left	5/8 x 3/4"	7 1/2"	\$31 (L075L)
Right	5/8 x 3/4"	7 1/2"	\$31 (L075R)
Straight	5/8 x 3/4"	7 1/2"	\$31 (L075S)

Hand	Shank WxH	Length	PRICE
Left	3/8 x 7/8"	5"	\$31 (L070L)
Right	3/8 x 7/8"	5"	\$31 (L070R)
Straight	3/8 x 7/8"	5"	\$31 (L070S)

HIGH SPEED STEEL BITS

TYPE	PIECE SET	PRICE
1/8" sq. x 2 1/2" long	3-Pce	\$8.40 (L0001)
3/16" sq. x 2 1/2" long	3-Pce	\$10.20 (L0002)
1/4" sq. x 2 1/2" long	3-Pce	\$11.20 (L0003)
5/16" sq. x 2 1/2" long	3-Pce	\$13.00 (L0004)
3/8" sq. x 3" long	2-Pce	\$14.00 (L0005)
1/2" sq. x 4" long	1-Pce	\$11.20 (L0006)

PART OFF BLADES

1/2" x 3/32" x 4" long	1-Pce	\$16.80 (L0007)
5/8" x 3/32" x 5" long	1-Pce	\$24.00 (L0016)

BORING BAR SET

- Boring Bars: 8, 10, 12mm
- 3 x Inserts
- CCMT060204

SAVE



\$130 (L431)

BORING BAR SET

- Boring Bars: 8, 10, 12, 16mm
- 10 x Inserts
- CCMT060204



\$257 (L430)

LATHE TOOL SET - 10mm

- Kit includes: 4 x turning tool, 1 x boring tool & 1 x Insert per tool
- Comes in a deluxe case



\$69 (L0055)

CARBIDE TOOL SET - 12mm

- Kit includes: turning, profiling, parting, threading, roughing tools & 1 x Insert per tool



\$159 (L0099)

CARBIDE TOOL SET - 16mm

- Kit includes: turning, profiling, parting, threading, roughing tools & 1 x Insert per tool



\$159 (L0077)

CARBIDE LATHE THREADING KIT

- 1 x Right Hand External Threading Tool 12x12mm
- 10 x 11ER A60 (60°) inserts
- Torx Key



12mm **\$99** (L470)

CARBIDE TURNING KITS



12mm **\$215** (L450)
16mm **\$233** (L451)
20mm **\$303** (L452)
25mm **\$326** (L453)

Consisting of:

- 1 x R/H
- 1 x L/H tool holder
- 1 x boring bar
- 1 pack x 10 Inserts

CARBIDE THREADING KITS



12mm **\$158** (L456)
16mm **\$158** (L457)
20mm **\$168** (L458)
25mm **\$210** (L459)

Consisting of:

- 1 x Internal
- 1 x External tool holder
- 2 x 55°, 2 x 60° inserts (2 x internal & external)

VERTICAL MILL SLIDE

- Table surface 100 x 150mm, 3/8" Tee Slot
- Inc. 63mm Vice

Note: Will only suit Lathes with a centre height of 125mm



\$149 (L277)

LATHE SAFETY CHUCK GUARDS

- Comes complete with mounting bracket, micro switch, and wiring to be connected to the electrical cabinet

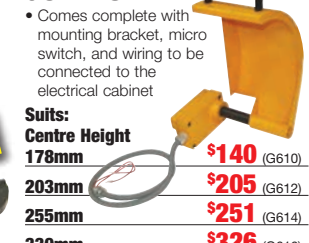

Suits:

Centre Height 178mm	\$140 (G610)
203mm	\$205 (G612)
255mm	\$251 (G614)
330mm	\$326 (G616)

3-JAW LATHE CHUCKS SELF CENTERING CHUCKS BACKPLATE MOUNT



SIZE	PRICE
Ø80mm	\$111 (C198)
Ø100mm	\$111 (C200)
Ø125mm	\$120 (C202)
Ø160mm	\$158 (C203)

4-JAW LATHE CHUCKS INDEPENDENT BACKPLATE MOUNT



SAVE

SIZE	PRICE
Ø100mm	\$88 (C230)
Ø125mm	\$98 (C232)
Ø160mm	\$140 (C250)
Ø200mm	\$210 (C251)

5C COLLET BLOCK SET

- All surfaces ground
- Collet capacity 3-26mm



\$73 (C999)

5C COLLET CHUCK SET

- Suits most lathes with 5MT headstock spindle taper & minimum 38mm bore
- Capacity 3 - 26mm x 5C collets
- Complete with 5MT-5C adaptor
- Drawer tube 430mm long
- 150mm handwheel
- Collets not included



\$186 (C980)

5C COLLET SETS to suit:



TYPE	PCE/SET	RANGE	PRICE
Metric	24	3-26mm	\$232 (C984)
Imperial	17	1/16"-1 1/16"	\$168 (C985)

QUICK CHANGE TOOLPOST

- Suits 75-115mm centre height
- 4 holders supplied
- 2 sides • Model QA-100



\$140 (L280)

QUICK CHANGE TOOLPOST

- Suits 150-170mm centre height
- 4 holders supplied
- 2 sides • Model QA-140



\$168 (L292)

QUICK CHANGE TOOLPOSTS



SAVE

CENTRE HEIGHT	HOLDERS	PRICE
150-170	4	\$420 (L295)
168	6	\$503 (L293)
202	6	\$590 (L294)
230	5	\$645 (L296)

QUICK CHANGE TOOLPOSTS - 40 position

- The system allows a repeat accuracy of 0.01mm with 40 possible angular positions of the tool holder
- Supplied with 3 square tool holders and one Vee tool holder



Lathe Swing	No. of Tool Holders	Tool Size	PRICE
150-300	4	16	\$494 (L299)
200-400	4	20	\$560 (L2992)
300-500	4	25	\$626 (L2994)
400-700	4	32	\$1,112 (L2996)

CB-2 GRAVITY FEED COOLANT SYSTEM

- Retrofit to most drilling & milling machines
- Includes 2 x 1 litre plastic bottles, flex hose nozzle, flow control valve & 2 x support brackets

\$23 (P220)

FLEXIBLE COOLANT HOSE KITS

- Hose 150mm x 6 = 900mm
- Includes connector pliers...



\$44 (H165)

- Y Fitting, BSP male & in-line valve, various nozzles & more...



\$65 (H167)

COOLANT PUMP & TANK

- Plastic tank • 1/8hp 240V
- Magnetic base nozzle
- Return hose
- On/Off switch



\$199 (P235)

COOLANT PUMP

MOTOR VOLTAGE	SUBMERGE DEPTH	PRICE
240V	1/8hp 130mm	\$99 (P232)
415V	1/8hp 130mm	\$99 (P233)
415V	1/4hp 180mm	\$209 (P230)

METAL CUTTING FLUID

Soluble
1 Litre **\$14.85** (S090A)

Semi-Synthetic
5 Litres **\$44** (S090)
20 Litres **\$165** (S091)

DIGITAL SCALES & DISPLAY UNITS

Scale and display unit for use on sheet metal, metal working and woodworking machines. These digital scale units are designed specifically for convenient display of Z-Axis, X-Axis or Y-Axis machine tool movement. Can be mounted on almost any surface, offering the user precise linear measurement capabilities. Precise depth control floating zero allows you to set "zero" anywhere within operating range with a push of a button. The scale is aluminium and can be cut to length to suit any setup. The display has a magnetic back panel and scales come with mounting brackets.

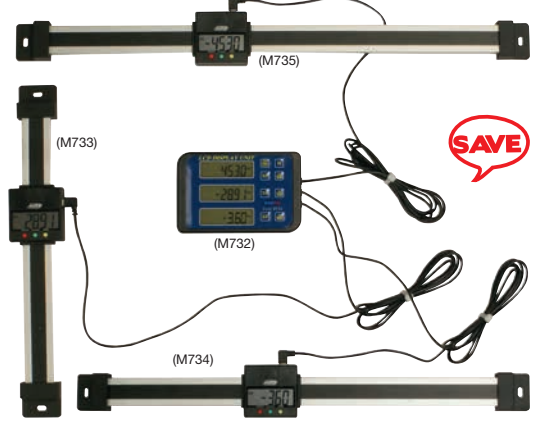

SAVE

LCD Display Units

- 2 x AAA batteries
- 2 metre cable lengths
- Magnetic back panel for mounting
- Resolution: 0.01mm/0.0005"
- Metric/Imperial switch
- Zero setting
- ON/OFF switch
- Back-light display

2-Axis DRO \$92 (M731)

3-Axis DRO \$130 (M732)



Aluminium Digital Scale Units

- 1.5V battery - can be powered by display unit
- With data output
- Zero setting
- Metric/Imperial switch
- ON/OFF switch
- Supplied with battery & mounting bracket

SCALE TYPE	LENGTH	PRICE
Vertical	200mm	\$37 (M733)
Horizontal	300mm	\$46 (M734)
Horizontal	400mm	\$56 (M735)
Horizontal	600mm	\$74 (M736)
Horizontal	1000mm	\$89 (M737)

DIGITAL READOUTS & SCALES

Easson

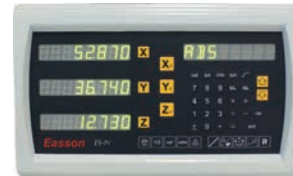

2-Axis (ES14) DIGITAL READOUT \$418 (D7142)

3-Axis (ES14) DIGITAL READOUT \$495 (D7143)



1, 2, or 3-Axis (ES12) DIGITAL READOUT - With Graphics \$539 (D705)

SIZE	SCALES	PRICE
200mm	\$185 (D720)	600mm \$219 (D728)
250mm	\$195 (D721)	700mm \$219 (D730)
300mm	\$201 (D722)	750mm \$224 (D731)
350mm	\$204 (D723)	800mm \$224 (D732)
400mm	\$210 (D724)	900mm \$243 (D734)
450mm	\$210 (D725)	1000mm \$247 (D736)
500mm	\$215 (D726)	1100mm \$383 (D736A)
550mm	\$215 (D727)	1200mm \$402 (D737)

DIGITAL HEIGHT GAUGE

- Dual imperial/metric scale
- Fine adjustment
- Carbide-tipped scribe
- 12"/300mm capacity
- Comes in a plastic case

300mm/12" \$176 (M704)

SURFACE MARKING OUT GAUGE

- Supplied with 2 spindles 225 & 300mm
- Can be used on flat or curved surfaces
- Fine adjustment

\$45 (M053)

MEASURING KIT

- 0 - 25mm Micrometer
- 150mm / 6" Rule
- 150mm / 6" Vernier
- 100 x 70mm Square



\$60.50 (M012)

MAGNETIC BASE & DIAL INDICATOR

- 0-10mm dial travel



\$55 (M055)

DIGITAL ANGLE RULES

- Absolute & incremental
- Zero button
- 360° Range
- Quick lock system

180mm	\$25 (M970)
280mm	\$35 (M972)
480mm	\$39 (M974)

DIGITAL ANGLE GAUGE

- Absolute & incremental • 228mm long
- Zero button • 360° Range



3 x LED Light Flexible Head Telescopic Magnetic Pick up Tool

- 3 x LED light
- Flexible head
- Adjustable length extends from 170mm to 545mm
- Pick up tool lifts 2.27kg
- Includes 3 x LR44 batteries

\$16.80 (T9501)

1 x LED Light Telescopic Magnetic Pick up Tool

- LED light illuminates dark areas
- Cushion handle
- Extends from 193-805mm
- Magnetic head lifts 2kg
- Includes 3 x AG13 batteries

up to 35% OFF RRP

\$10 (M0006)

2 x LED Light Telescopic Inspection Mirror

- 2 x LED light
- 50 x 80mm mirror
- Adjustable length extends from 290 - 870mm
- Includes 2 x CR2032 batteries

\$12 (M0008)

4 PIECE TELESCOPIC INSPECTION SET

- Mirror extends 240 - 920mm
- Magnetic pick up tool extends 165 - 695mm
- 3.6kg fixed & swivel head magnetic pick up tools
- 2.3kg fix head magnetic pick up tool

\$12 (M0009)

DIGITAL BEVEL BOX

- Range 180°
- Digital readout display
- 3 embedded disc magnets on base
- 0.1 degree resolution



\$49 (M977)

Z-AXIS PRESET GAUGE With Light Display

- Magnetic base for easy set-up
- Height can be micro-adjusted and audited with gauge block
- Accuracy within 0.005mm



\$233 (M691)

TOUCH POINT SENSOR With Beeper - 160mm

- When held in a collet chuck or tool holding device & touched against the work piece, the red light illuminates
- Accuracy within 0.005mm

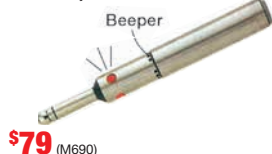

\$79 (M690)

CENTRE & EDGE FINDER

- Precision ground
- Used for locating work edges, grooves, shoulders & centre points
- Ø9.52mm (3/8") Shank
- 76mm long
- Tip Ø5mm



\$13 (M692)

NIC - PORTABLE VIDEO INSPECTION CAMERA - 3 Metre

- 72 x 54mm colour screen
- 1 metre flexible cable with camera & LED lighting
- Includes 2M extension cable & pick up tools
- Includes 1 x 9V battery

\$139 (M697)

CABLE EXTENSIONS	PRICE
2 Metre	\$25 (M6972)
3 Metre	\$45 (M6973)



MACHINE LAMPS & WORK LIGHTS (240V)

35 Watt - 240V Halogen Flexible Arm Magnetic Base (12V Transformer) \$111 (L283)

3 Watt - 240V 3 x LED's - 750 lux Flexible Arm (Built in transformer) \$121 (L2814)

55 Watt - 12V Halogen 3 x Pivot Arm 800mm long Low voltage 12V operation \$111 (L284)

55 Watt - 240V Halogen 3 x Pivot Arm 800mm long (12V Transformer) \$120 (L285)

22 Watt - 240V Fluorescent Tube with 5X Magnify 3 x Pivot Arm \$134 (L282)

36 Watt - 240V Fluorescent Tubes 3 x Pivot Arm \$149 (L2825)

12 Watt - 24V 6 x LED Aluminium work light bar IP67 water proof \$196 (L2812)



alcock

tools that stand the test of time

All prices include GST

SLOT DRILL SET

- Manufactured from HSS M35 5% Co bright finish screwed shank
- Two Flute



5 PIECE METRIC
6, 8, 10, 12, 16mm

\$63 (M3351)

END MILL SET

- Manufactured from HSS M35 5% Co bright finish screwed shank
- Four Flute



5 PIECE METRIC
6, 8, 10, 12, 16mm

\$63 (M3352)

END MILL SET - Solid carbide

- Manufactured from solid carbide
- Bright finish
- Plain shank



4 PIECE METRIC
6, 8, 10, 12mm

\$129 (M337)

SLOT DRILL & END MILL SETS

- Manufactured from HSS M2
- Plain shank
- Includes 5 end mills & 5 slot drills

10 PIECE METRIC
6, 10, 12, 16, 20mm

\$98 (M3301)

10 PIECE IMPERIAL
1/4", 3/8", 1/2", 5/8", 3/4"

\$98 (M3321)



COUNTERBORE SET

- HSS M35 bright finish
- Plain shank
- 6 piece set
- Range: M3, M4, M5, M6, M8, M10



\$92 (M3381)

RADIUS CUTTER SET

- 4 piece set
- High grade high speed steel M35 bright finish
- Radius sizes: 4, 5, 6, 8mm
- Shank sizes: 12, 16, 20mm



\$92 (M3391)

BALL NOSE CUTTER SET

- 5 piece set
- HSS M35 5% Co bright finish
- Plain shank
- 2 flute
- Sizes: 6, 8, 10, 12, 16mm
- Shank sizes: 6, 10, 10, 12, 16mm



\$79 (M3355)

INDUSTRIAL COUNTERSINK SETS

- 4 piece
- HSS M2 bright finish
- Cross hole type
- Sizes Ø: 2-5, 5-10, 10-15, 15-20mm
- Angle 45°



\$55 (D1051)

- 6 piece suitable for sheetmetal
- HSS M2 bright finish
- 3 flute type
- Sizes Ø: 1.5-6.3, 6.3-8.3, 8.3-10.4, 10.4-12.4, 12.4-16.5, 16.5-20.5mm



\$65 (D1061)

COMBINATION TAP & DRILL SET

- HSS M2 bright finish
- Hex shank
- M3, M4, M5, M6, M8, M10
- Includes Hex snap-on for hand drill



\$42 (T0191)

CENTRE DRILL SET

- Industrial quality
- HSS M2 bright finish
- No. 1, 2, 3, 4, 5



\$29 (D508)

SHEET METAL STEP DRILL SET

- HSS M2 bright finish
- Ø4-12 x 1mm, Ø6-20 x 2mm, Ø6-30 x 2mm



\$65 (D1071)

ENGINEERS FILES

- Cushion grip handle
- 250mm length files



up to **30% OFF** RRP

TYPE	GRADE	CODE
Flat	Coarse	\$9.00 (F120)
Flat	Second Cut	\$9.00 (F121)
Flat	Smooth	\$9.00 (F122)
Half Round	Coarse	\$9.00 (F124)
Half Round	Second Cut	\$9.00 (F125)
Half Round	Smooth	\$9.00 (F126)
Round	Coarse	\$9.00 (F127)
Round	Second Cut	\$9.00 (F128)
Round	Smooth	\$9.00 (F129)

HOLE SAW SET - HSS

- HSS M42 Bi-Metal set
- 11 Sizes: 19, 22, 25, 32, 35, 38, 44, 51, 57, 64, 76mm
- Includes 3/8" & 1/2" shank arbors & pilot drill



\$89 (D102)

HOLE SAW SET - Carbide

- Heat resistant carbide teeth for long life
- Suitable for stainless steel, steel, fibre glass, and glass reinforced products
- Range: 16, 20, 22, 25, 28, 30, 32, 35mm



8 Piece Carbide Tipped \$79 (D108)

2MT SHANK DRILL SET

- 100% HSS flute length
- Sizes 14.5, 15, 16, 17, 18, 19, 20, 21, 22, 23mm



\$159 (D122)

REDUCED SHANK DRILL SETS

- Industrial quality
- High speed steel M2 grade 100% flute length
- 118° point angle

8 PIECE METRIC
Range: 13 - 25mm
Shank Ø13mm
\$109 (D1171)



8 PIECE IMPERIAL
9/16" - 1" Range
Shank Ø1/2"
\$109 (D1181)

INDUSTRIAL DRILL SETS

- Precision ground flutes
- HSS M2 bright finish
- 135° split point centre

25 PIECE METRIC
1 - 13mm (x 0.5mm)
\$69 (D1272)



29 PIECE IMPERIAL
1/16" - 1/2" (x 1/64")
\$69 (D1282)

\$69 (D1282)

51 PIECE METRIC
1 - 6mm (x 0.1mm)
\$79 (D1285)

\$79 (D1285)

MORSE TAPER SHANK DRILLS

- High Speed Steel
- Made to DIN345 standard



Ø (mm)	TAPER	CODE
12.5	1MT	\$12.10 (D300)
13	1MT	\$12.10 (D301)
13.5	1MT	\$14.00 (D302)
14	1MT	\$15.90 (D303)
14.5	2MT	\$15.90 (D304)
15	2MT	\$16.80 (D305)
15.5	2MT	\$16.80 (D306)
16	2MT	\$17.70 (D307)
16.5	2MT	\$18.70 (D308)
17	2MT	\$18.70 (D309)
17.5	2MT	\$18.70 (D310)
18	2MT	\$20.00 (D311)

Ø (mm)	TAPER	CODE
18.5	2MT	\$20.00 (D312)
19	2MT	\$21.00 (D313)
19.5	2MT	\$23.00 (D314)
20	2MT	\$24.00 (D315)
20.5	2MT	\$27.00 (D316)
21	2MT	\$28.00 (D317)
21.5	2MT	\$28.00 (D318)
22	2MT	\$30.00 (D319)
22.5	2MT	\$34.00 (D320)
23	2MT	\$35.00 (D321)
23.5	2MT	\$36.00 (D322)
24	2MT	\$36.00 (D323)

Ø (mm)	TAPER	CODE
24.5	2MT	\$37.00 (D324)
25	2MT	\$37.00 (D325)
25.5	2MT	\$37.00 (D326)
26	2MT	\$43.00 (D327)
26.5	2MT	\$43.00 (D328)
27	2MT	\$44.00 (D329)
27.5	2MT	\$45.00 (D330)
28	2MT	\$46.00 (D331)
28.5	2MT	\$48.00 (D332)
29	2MT	\$54.00 (D333)
29.5	2MT	\$54.00 (D334)
30	2MT	\$62.00 (D335)

LARGER SIZES AVAILABLE

"Now there is an alternative"
Measumax 
 a new dimension in quality & value

All prices include GST

MICROMETERS



RANGE	ACCURACY	Price
0-1"	0.004"	\$28 (Q101)
1-2"	0.004"	\$35 (Q103)
2-3"	0.005"	\$37 (Q106)
3-4"	0.005"	\$56 (Q109)
0-25mm	0.004mm	\$28 (Q102)
25-50mm	0.004mm	\$35 (Q105)
50-75mm	0.005mm	\$37 (Q107)
75-100mm	0.005mm	\$56 (Q110)

MICROMETER SETS



3 Pc. 0-75mm	0.01mm	\$102 (Q111)
4 Pc. 0-100mm	0.01mm	\$132 (Q114)
4 Pc. 0-4"	0.0001"	\$129 (Q116)



6 Pc. 150-300mm	0.01mm	\$458 (Q118)
-----------------	--------	--------------



6 Pc. 0-150mm	0.01mm	\$269 (Q115)
6 Pc. 0-6"	0.0001"	\$269 (Q117)

DEPTH MICROMETERS



SAVE

RANGE	ACCURACY	Price
0-50mm	±0.004mm	\$107 (Q145)
0-2"	±0.00016"	\$107 (Q1455)

3-POINT INTERNAL MICROMETERS



12-20mm	0.004mm	\$556 (Q161)
20-50mm	0.004mm	\$1,397 (Q162)
50-100mm	0.005mm	\$1,865 (Q163)

DIGITAL HEIGHT GAUGES - Single Column



0-300mm/12"	\$369 (Q2105)
0-600mm/24"	\$462 (Q2106)

SAVE

PRECISION MACHINE LEVELS



200mm	\$158 (Q205)
250mm	\$214 (Q206)
300mm	\$232 (Q207)

PRECISION FRAME LEVEL

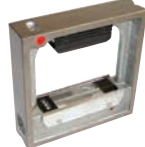

200mm	\$214 (Q208)
-------	--------------

DIGIT MICROMETERS - Easy Read



0-25mm	0.004mm	\$74 (Q100)
0-1"	0.004mm	\$74 (Q1001)

INTERNAL MICROMETERS

5-30mm	\$87 (Q134)
25-50mm	\$102 (Q135)

VERNIER CALIPER - Fine Adjustment



RANGE	GRADUATIONS	Price
0-130mm/5"	0.02mm/0.001"	\$46 (Q1945)
0-180mm/7"	0.02mm/0.001"	\$56 (Q1946)
0-280mm/11"	0.02mm/0.001"	\$92 (Q1947)

DIAL CALIPERS



0-6"	0.001" Grad.	\$74 (Q190)
0-150mm	0.02mm Grad.	\$74 (Q191)
0-200mm	0.02mm Grad.	\$102 (Q192)

DIGITAL CALIPERS



150mm/6"	\$83 (Q180)
200mm/8"	\$107 (Q181)
300mm/12"	\$158 (Q182)

COOLANT PROOF DIGITAL CALIPERS



150mm/6"	0.01mm/0.0005"	\$149 (Q1851)
200mm/8"	0.01mm/0.0005"	\$168 (Q1861)
300mm/12"	0.01mm/0.0005"	\$229 (Q1871)

VERNIER CALIPERS - Large Mono Block



SAVE

600mm/24"	0.02mm/0.001"	\$275 (Q198)
1000mm/40"	0.02mm/0.001"	\$607 (Q199)
1500mm/60"	0.02mm/0.001"	\$1,271 (Q1995)

GEAR TOOTH VERNIER CALIPER

1-26 Module	0.02mm Graduations	\$101 (Q234)
-------------	--------------------	--------------

DIAL INDICATORS Economy

0-10mm	0.01mm	\$45 (Q211)
0-1"mm	0.001"	\$45 (Q212)

DIAL TEST INDICATOR Economy

0-0.8mm	0.01mm	\$83 (Q217)
---------	--------	-------------

DIGITAL INDICATOR

0.01mm/0.0005" resolution	\$101 (Q2205)
---------------------------	---------------

DIAL BORE GAUGES

50-160mm	0.01mm	\$149 (Q226)
2-6"	0.001"	\$149 (Q2265)
10-18mm	0.01mm	\$178 (Q228)
18-35mm	0.01mm	\$154 (Q229)

CENTERING DIAL INDICATOR

0-3mm	0.01mm Graduations	\$140 (Q515)
-------	--------------------	--------------

SAVE

COMBINATION SETS

4 piece	\$82 (Q200)
300mm/12"	\$83 (Q200A)

COMBINATION SET - High Accuracy

4 Pce. 300mm/12"	\$99 (Q2005)
------------------	--------------

UNIVERSAL BEVEL PROTRACTOR

0-360°	\$92 (Q201)
--------	-------------

SCREW CUTTING GAUGE

4 thread forms	\$9.30 (Q612)
----------------	---------------

THREAD GAUGE

28 Imperial / 23 Metric	\$13 (Q610)
55 & 60°	

RADIUS GAUGES

1-7mm	\$18.70 (Q614)
7.5-15mm	\$26.00 (Q615)

FEELER GAUGE

0.03-1.0mm	\$14.90 (Q616)
------------	----------------

- High grade tool steel
- Hardened tempered & polished

POCKET PROTRACTOR

150mm / 0-180°	\$24 (Q601)
----------------	-------------

SPRING CALIPERS

DIVIDERS	\$7.50 (Q634)
INSIDE	\$7.50 (Q635)
OUTSIDE	\$7.50 (Q636)

SAVE

SCRIBERS

Double Ended Scriber 190mm	\$8.40 (Q630)
Pocket Scriber 150mm	\$17.70 (Q631)

RULERS Metric one side / Imperial on the other side

150mm/6"	\$5.00 (Q620)	600mm/24"	\$15.00 (Q622)
300mm/12"	\$10.00 (Q621)	1000mm/40"	\$22.00 (Q623)

MAGNETIC BASES

1-Lock Clamp	\$79 (Q430)
130mm Reach	
Fine Adjustment Clamp	\$56 (Q435)
300mm Reach	
Fine Adjustment Heavy Duty	\$56 (Q4351)
335mm Reach	
1-Lock Hydraulic Clamp	\$101 (Q436)
330mm Reach	

ENGINEERS SQUARES

Grade B 90° Inside/Outside	
75mm	\$25 (Q644)
100mm	\$32 (Q645)
150mm	\$36 (Q646)
255mm	\$56 (Q647)

STRAIGHT DIAL TEST INDICATOR HOLDER

01/4" Shank, 76mm Reach	\$20 (Q438)
-------------------------	-------------

DIAL TEST INDICATOR HOLDER

01/4" Shank 70mm Reach	\$20 (Q437)
------------------------	-------------

BoxTac[®] Assortment Packs

All the sizes you need in one convenient kit!

Hex Cap Screw Assortment

Metric

PIECES	CODE	PRICE
106	K72024	\$12



Hose Clamp Assortment

PIECES	CODE	PRICE
40	K72146	\$12



Machine Screw Assortment

Metric

PIECES	CODE	PRICE
363	K74358	\$20



Key Steel Assortment

Metric

PIECES	CODE	PRICE
60	K72310	\$12



Grommet Assortment

PIECES	CODE	PRICE
125	K74702	\$12



Nitrile O-Ring Assortment

Metric

PIECES	CODE	PRICE
225	K72168	\$12



Set Screw Assortment

Metric

PIECES	CODE	PRICE
150	K74444	\$12



Key Steel Assortment

Imperial (SAE)

PIECES	CODE	PRICE
60	K72312	\$12

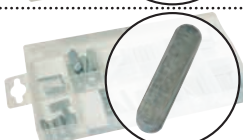

Nitrile O-Ring Assortment

Imperial (SAE)

PIECES	CODE	PRICE
225	K72169	\$12



Nut & Bolt Assortment

Stainless Steel

PIECES	CODE	PRICE
224	K72062	\$12



Woodruff Key Assortment

Metric

PIECES	CODE	PRICE
80	K72316	\$12



O-Ring Assortment

Imperial (SAE)

PIECES	CODE	PRICE
382	K74146	\$20



Nylon Lock Nut Assortment

Metric

PIECES	CODE	PRICE
150	K72450	\$12

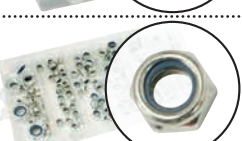

Roll Pin Assortment

Metric

PIECES	CODE	PRICE
120	K72204	\$12



O-Ring Assortment

Metric

PIECES	CODE	PRICE
397	K74150	\$20



Flat & Spring Washer Assortment

Metric

PIECES	CODE	PRICE
790	K72116	\$12

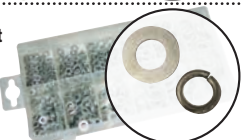

Spring & Hitch Pin Assortment

PIECES	CODE	PRICE
175	K72712	\$12



Grease Nipple Assortment

Metric

PIECES	CODE	PRICE
50	K74234	\$12



Sealing Washer Assortment

PIECES	CODE	PRICE
141	K72090	\$12



Lynch Pin Assortment

PIECES	CODE	PRICE
50	K74122	\$20



External Snap Ring Assortment

Metric

PIECES	CODE	PRICE
300	K74378	\$12



Internal Snap Ring Assortment

Metric

PIECES	CODE	PRICE
300	K74384	\$12



Finishing Belts Packs of 3



Aluminium Oxide

SIZE	GRIT	CODE
915 x 50mm (36" x 2")	40G	\$4.95 (A8000)
915 x 50mm (36" x 2")	60G	\$4.95 (A8001)
915 x 50mm (36" x 2")	80G	\$4.95 (A8002)
915 x 50mm (36" x 2")	100G	\$4.95 (A8003)
915 x 50mm (36" x 2")	120G	\$4.95 (A8004)
915 x 50mm (36" x 2")	240G	\$6.60 (A8005)
915 x 100mm (36" x 4")	40G	\$8.25 (A8016)
915 x 100mm (36" x 4")	60G	\$8.25 (A8017)
915 x 100mm (36" x 4")	80G	\$8.25 (A8018)
915 x 100mm (36" x 4")	120G	\$8.25 (A8020)
1220 x 50mm (48" x 2")	40G	\$6.60 (A8030)
1220 x 50mm (48" x 2")	60G	\$6.60 (A8031)
1220 x 50mm (48" x 2")	80G	\$6.60 (A8032)
1220 x 50mm (48" x 2")	100G	\$6.60 (A8033)
1220 x 50mm (48" x 2")	120G	\$6.60 (A8034)
1220 x 100mm (48" x 4")	40G	\$12.30 (A8044)
1220 x 100mm (48" x 4")	60G	\$12.30 (A8045)
1220 x 100mm (48" x 4")	80G	\$12.30 (A8046)
1220 x 100mm (48" x 4")	100G	\$12.30 (A8047)
1220 x 100mm (48" x 4")	120G	\$12.30 (A8048)
1220 x 150mm (48" x 6")	40G	\$14.85 (A8058)
1220 x 150mm (48" x 6")	60G	\$14.85 (A8059)
1220 x 150mm (48" x 6")	80G	\$14.85 (A8060)
1220 x 150mm (48" x 6")	100G	\$14.85 (A8061)
1220 x 150mm (48" x 6")	120G	\$14.85 (A8062)
1500 x 100mm (59" x 4")	40G	\$14.85 (A8065)
1500 x 100mm (59" x 4")	60G	\$14.85 (A8066)
1500 x 100mm (59" x 4")	80G	\$14.85 (A8067)
1500 x 100mm (59" x 4")	100G	\$14.85 (A8068)
1500 x 100mm (59" x 4")	120G	\$14.85 (A8069)

Zirconia

SIZE	GRIT	CODE
915 x 50mm (36" x 2")	40G	\$9.90 (A8009)
915 x 50mm (36" x 2")	60G	\$9.90 (A8010)
915 x 50mm (36" x 2")	80G	\$9.90 (A8011)
915 x 50mm (36" x 2")	100G	\$9.90 (A8012)
915 x 50mm (36" x 2")	120G	\$9.90 (A8013)
915 x 100mm (36" x 4")	40G	\$16.50 (A8023)
915 x 100mm (36" x 4")	60G	\$16.50 (A8024)
915 x 100mm (36" x 4")	80G	\$16.50 (A8025)
915 x 100mm (36" x 4")	100G	\$16.50 (A8026)
915 x 100mm (36" x 4")	120G	\$16.50 (A8027)
1220 x 50mm (48" x 2")	40G	\$13.20 (A8037)
1220 x 50mm (48" x 2")	60G	\$13.20 (A8038)
1220 x 50mm (48" x 2")	80G	\$13.20 (A8039)
1220 x 50mm (48" x 2")	100G	\$13.20 (A8040)
1220 x 50mm (48" x 2")	120G	\$13.20 (A8041)
1220 x 100mm (48" x 4")	40G	\$24.75 (A8051)
1220 x 100mm (48" x 4")	60G	\$24.75 (A8052)
1220 x 100mm (48" x 4")	80G	\$24.75 (A8053)
1220 x 100mm (48" x 4")	100G	\$24.75 (A8054)
1220 x 100mm (48" x 4")	120G	\$24.75 (A8055)
1500 x 100mm (59" x 4")	40G	\$28.00 (A8072)
1500 x 100mm (59" x 4")	60G	\$28.00 (A8073)
1500 x 100mm (59" x 4")	80G	\$28.00 (A8074)
1500 x 100mm (59" x 4")	100G	\$28.00 (A8075)
1500 x 100mm (59" x 4")	120G	\$28.00 (A8076)
2000 x 75mm (79" x 3")	40G	\$24.75 (A8079)
2000 x 75mm (79" x 3")	60G	\$24.75 (A8080)
2000 x 75mm (79" x 3")	80G	\$24.75 (A8081)
2000 x 75mm (79" x 3")	100G	\$24.75 (A8082)
2000 x 75mm (79" x 3")	120G	\$24.75 (A8083)
2000 x 100mm (79" x 3")	36G	\$44.55 (A8085)
2000 x 150mm (79" x 6")	40G	\$44.55 (A8090)
2000 x 150mm (79" x 6")	60G	\$44.55 (A8091)
2000 x 150mm (79" x 6")	80G	\$44.55 (A8092)
2000 x 150mm (79" x 6")	100G	\$44.55 (A8093)

Sanding Discs

Packs of 3

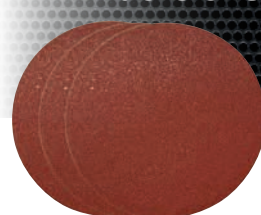

Aluminium Oxide

SIZE	GRIT	CODE
150mm (6")	60G	\$3.70 (A5312)
150mm (6")	80G	\$3.70 (A5313)
150mm (6")	100G	\$3.70 (A5314)
178mm (7")	60G	\$4.95 (A5332)
178mm (7")	80G	\$4.95 (A5333)
178mm (7")	100G	\$4.95 (A5334)
178mm (7")	120G	\$4.95 (A5335)
228mm (9")	60G	\$6.60 (A5352)
228mm (9")	80G	\$6.60 (A5353)
228mm (9")	100G	\$6.60 (A5354)
228mm (9")	120G	\$6.60 (A5355)
305mm (12")	40G	\$9.90 (A5371)
305mm (12")	60G	\$9.90 (A5372)
305mm (12")	80G	\$9.90 (A5373)
305mm (12")	100G	\$9.90 (A5374)
305mm (12")	120G	\$9.90 (A5375)
350mm (14")	40G	\$12.30 (A5391)
350mm (14")	60G	\$12.30 (A5392)
350mm (14")	80G	\$12.30 (A5393)
350mm (14")	100G	\$12.30 (A5394)
350mm (14")	120G	\$12.30 (A5395)
380mm (15")	40G	\$12.30 (A5401)
380mm (15")	60G	\$12.30 (A5402)
380mm (15")	80G	\$12.30 (A5403)
380mm (15")	100G	\$12.30 (A5404)
380mm (15")	120G	\$12.30 (A5405)

TOGGLE CLAMPS

See www.machineryhouse.com.au for specifications and sizes.

KL-102B
Vertical
100kg
\$11.20 (C1001)

KL-12130
Vertical
227kg
\$13 (C100)

KL-225D
Horizontal
250kg
\$13 (C1005)

KL-201C
Horizontal
100kg
\$16.80 (C1003)

KL-36020
Straight Line
220kg
\$17.70 (C1008)

SAVE

SANDBLASTING CABINETS

SBP-215 SANDBLAST HOPPER

- Portable hopper on wheels
- 19 litre hopper capacity
- Ø270 inside diameter
- Recommended free air delivery: 254L/min. @ 100psi
- Industrial blasting gun & 2 metres of hose
- Includes 1/16" & 1/8" air jet
- 1/16" air jet requires 6cfm
- 1/8" air jet requires 25cfm

\$159 (S334)



SB-100 SANDBLAST CABINET

- Portable but rugged steel cabinet
- Acrylic protective screen with replaceable shield
- Recommended to be used with dust collector
- Recommended to use 1 x 25kg abrasive grit
- Recommended free air delivery: 254L/min. @ 100psi
- Complete with internal low-voltage light, extra replacement shield, gloves, gun and ceramic tips

\$169 (S288)



SB-100 INSIDE CABINET SIZE
(LxWxH) 590 x 500 x 300-360mm

SB-200 SANDBLAST CABINET

- Heavy-duty steel cabinet, includes stand and hopper
- Acrylic protective screen with replaceable shield
- Stands approx. 1.49 metres high
- Recommended to be used with dust collector
- Recommended to use 2 x 25kg abrasive grit
- Recommended free air delivery: 340L/min. @ 100psi
- Complete with internal low-voltage light, tempered glass screen with replacement shields, gloves, gun & ceramic tips

\$269 (S289)

SB-200 INSIDE CABINET SIZE
(LxWxH) 835 x 510 x 360-550mm



SB-375 SANDBLAST CABINET

- Pressure valve control with gauge
- LED control panel
- 2 doors for easy access with safety interlocks
- Stands approx. 1.65 metres high
- Includes built-in 240V vacuum & filter
- Recommended to use 3 x 25kg abrasive grit
- Recommended free air delivery: 340L/min. @ 100psi
- Complete with internal low-voltage light, tempered glass screen with replacement shields, gloves, gun & ceramic tips

\$879 (S300)

SB-375 INSIDE CABINET SIZE
(LxWxH) 940 x 600 x 340-580mm



BLASTING BEADS

GARNET BEAD

Suitable for metals & alloys, wood, plastic, fine honing, de-burring, & jet cutting

• 25kg



INDA GLASS BEAD

Precise control for peening, cleaning, finishing, & de-burring processes

• 25kg



PORTABLE SAND BLAST KIT

- Includes gun and hose



CONSUMABLES

Type	CODE	PRICE	
Work SHIELD FILM suits SB-100 (Pack x 10)	SC100	\$22.00	SC100
WORK SHIELD FILM suits SB-200 & SB-375 (Pack x 5)	SC004	\$11.00	
GLOVES suits SB-100, 200, 375, 420 & 990	2SC0035	\$36.50	2SC0035
BLAST GUN suits SB-100, SB-200, SB-375	6SC0042	\$41.00	6SC0042
4.5mm NOZZLE suits SB-90, 100, 200, 375 (Pack x 2)	6SC0059	\$13.00	6SC0059
5.0mm NOZZLE suits SB-100, 375 (Pack x 2)	6SC0060	\$13.00	
6.0mm NOZZLE suits: SB-100, 200, 375 (Pack x 2)	6SC0061	\$13.00	
7.0mm NOZZLE Suits SB-100, 200, 375 (Pack x 2)	6SC0062	\$13.00	

SB-420 SANDBLAST CABINET

- Foot operated industrial blast gun
- Powder coated steel construction
- 2 side doors and front opening panel for easy access
- Stands 1675mm high
- Built in 240V motor vacuum & filter system at rear of sandblast cabinet
- Recommended to use 3 x 25kg abrasive grit
- Recommended free air delivery: 680L/min. @ 100psi
- Complete with gloves, air regulator, internal low-voltage light, air industrial duty blast gun with ceramic tips & extra replacement shield



INCLUDES DUST EXTRACTION



\$1,155 (S302)

SB-420 INSIDE CABINET SIZE
(LxWxH) 1200 x 600 x 340-570mm

SBC-990 SANDBLAST CABINET

- Foot operated industrial blast gun
- Gas struts with 2 x safety interlocks
- Stands 1770mm high
- Built in 240V motor vacuum & filter system at rear of sandblast cabinet
- Recommended to use 3 x 25kg abrasive grit
- Recommended free air delivery: 680L/min. @ 100psi
- Complete with gloves, air regulator, internal low-voltage light, air industrial duty blast gun with ceramic tips & extra replacement shield

\$1,650 (S305)

SBC-990 INSIDE CABINET SIZE
(LxWxH) 1175 x 885 x 625-845mm



INCLUDES DUST EXTRACTION



Consumables

Consumables to suit SB-420 / SBC-990	CODE	Price
FILM - For light Pack x 5 (SB-420)	3SC0005	\$12.50
FILM - Front screen Pack x 5 (SB-420)	SC004	\$11.00
FILM - For light Pack x 3 (SBC-990)	7SC0030	\$12.50
FILM - Front screen Pack x 4 (SBC-990)	7SC0024	\$14.00
NOZZLE 6mm Ceramic Pack x 2 (SB-420/SBC-990)	3SC0206	\$15.50
NOZZLE 7mm Ceramic Pack x 2 (SB-420/SBC-990)	3SC0207	\$17.00
GLOVES - Heavy Duty (SB-420/SBC-990)	2SC0035	\$36.50
GUN (SB-420/SBC-990)	3SC0300	\$60.00
AIR JET & Sleeve (SB-420/SBC-990)	7SC5155	\$20.00

RETRACTABLE AIR REEL

- ID Ø9.5mm x 15 metres of air hose
- Polyurethane mesh hose is highly durable with increased flexibility
- Ability to be mounted from the wall or ceiling
- Pivots 310°
- Working pressure 232psi / 16Bar



SAVE

\$119 (H045)

RETRACTABLE AIR REEL

- ID Ø10mm x 20 metres of air hose
- PVC hose • 300psi
- Complete with mounting brackets
- 1/4" BSP fitting



\$82.50 (H052)

RETRACTABLE AIR REEL

- ID Ø10mm x 20 metres of air hose
- PVC hose • 300psi WP
- Complete with mounting brackets
- Slow return, stop anywhere
- 4-Way roller support for hose
- 1/4" BSP fitting
- Industrial return spring



\$220 (H040)

RETRACTABLE AIR REEL

- Includes: carry handle & mounting bracket
- Automatic rewind



\$215 (H0101)
\$269 (H0102)

HIGH FLOW AIR FITTINGS

Description

- 1/4" BSP Female Coupling **\$6.50** (F920)
- 1/4" BSP Male Coupling **\$6.50** (F921)
- 3/8" Hose Tail Coupling **\$6.50** (F923)
- 1/4" Female Adaptor (pkt 2) **\$5.60** (F920B)
- 1/4" Male Adaptor (pkt 2) **\$5.60** (F921B)
- 3/8" Tail Adaptor (pkt 2) **\$5.60** (F923B)
- 3/8"-1/4" Tail/Male (pkt 2) **\$6.30** (F803)
- 3/8"-1/4" Tail/Female (pkt 2) **\$7.60** (F811)



COUPLING SET

- 5 piece 1/4" BSP Set
- 1 x female, 3 x male,
- 1-touch 1/4" BSP male coupling



\$15 (F918)

SPRAY GUN KIT - 3 Piece High Volume Low Pressure

- 1 x gravity feed spray gun 1.7mm needle
- 1 x gravity feed spray gun 1.0mm needle
- 1 x pressure regulator with gauge
- Consumption 3.5-7.1CFM
- Spray pattern adjustment dial
- Operating pressure 29-50psi

SAVE

\$79 (S344)



BURR SETS - 5 piece

- Solid carbide burr
- Double cut burrs
- 1/4" shanks



\$66 (B900)

\$77 (B905)

RE-COIL AIR HOSE

7.5M x Ø10mm

- Fitted with one-touch coupling and plug



\$15 (H019)

up to 20% OFF RRP

INDUSTRIAL PVC AIR HOSE

- Complete with one touch coupler & plug
- 300psi
- Working temp -40C to 65C
- Resistance to oils & abrasions



\$28 (H008)

\$46 (H009)

AIR DUSTER GUNS

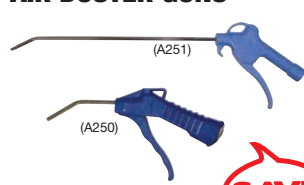

\$9.30 (A250)

\$12.10 (A251)

AIR ACCESSORY KIT

- Spray gun - gravity type
- De-greasing gun with Pot - long nozzle
- Tyre inflator with gauge
- Dusting gun with self coil hose



\$29 (S445)

AIR DRILL

- Drill with 3/8" chuck
- Reversible 1800rpm
- Air Inlet 1/4"



\$45 (A038A)

AIR NIBBLER

- 1.6mm capacity



\$64 (A082)

AIR SHEAR

- 1.6mm capacity



\$73 (A086)

AIR BELT SANDER

- 10 x 330mm Belt size



\$92 (A066)

TYRE GAUGES

- Inflater with Dial Gauge
- 1/4" Thread
- 0-160psi in 5psi graduations

\$27 (A259)

- Professional Inflater with Roller Gauge - 3 in 1 function
- 1/4" Thread
- 0-160psi

\$64 (A264)



MAXUS X-LITE AIR COMPRESSORS



- 4 Litre - 125psi**
- 0.5hp 240V induction motor
- 10 amp plug
- Recessed control panel
- Aluminium single tank

\$242 (C321)



- 9.5 Litre - 135psi**
- 1hp 240V Induction motor
- 10 amp plug
- Dual air outlets
- Regulator for precise control
- Aircraft aluminium alloy twin tanks

\$385 (C322)



AIR COMPRESSOR



ONLINE ORDERS USE:
PROMO CODE:
3DSM14

FREE
15 Metre AIR HOSE
with any
Air Compressor
purchase

Value at \$33
(H008) RRP

MODELS CODE	ROSS C327
Drive Type	DIRECT
Tank Size	Litres 36
Free Air Delivery	L/min 205
Cylinders	V-Twin
Motor	hp 2.75
Voltage	V / Amps 240 / 10
PRICE	\$352

The Ultimate Linishing Tool **PA Multitool**

SAVE

Multitool Linishing Attachment
Belt: 50 x 915mm
Disc: Ø175mm
\$198 (L085)

ONLINE ORDERS USE:
PROMO CODE:
3DSM14
FREE 3 BELTS
with any MULTITOOL linishing att.

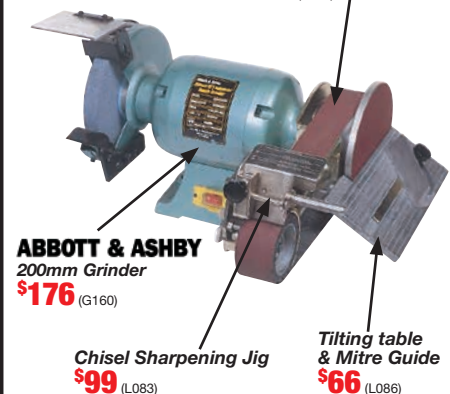
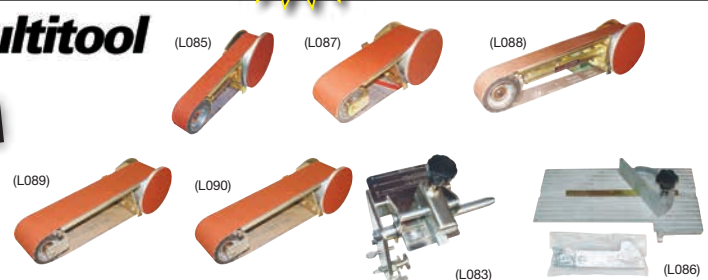

ABBOTT & ASHBY
200mm Grinder
\$176 (G160)

Chisel Sharpening Jig
\$99 (L083)

Tilting table & Mitre Guide
\$66 (L086)

ABBOTT & ASHBY
Industrial Bench Grinder (240V)
150mm Grinder
\$99 (G150)



PA Multitool Linishing Attachments

50 x 915mm	\$198 (L085)
100 x 915mm	\$286 (L087)
50 x 1220mm	\$319 (L088)
100 x 1220mm	\$352 (L089)
100 x 1220mm - to Suit 1" Shaft	\$385 (L090)
Chisel Sharpening Jig	\$99 (L083)
Tilting Table & Mitre Guide	\$66 (L086)

AIR IMPACT GUN KIT 1/2"

- 1/2" Impact gun with cushion grip
- 9, 10, 11, 13, 14, 17, 19, 22, 24, 27mm Sockets
- 1/2" x 100mm Extension
- Inline oiler



\$56 (A047)

AIR RATCHET WRENCH KIT 3/8"

- 8, 10, 12, 13, 14, 17, 19mm sockets
- 3/8 - 3/8 flex coupler & 50mm extension
- 3/8 - 1/4 x 50mm hex bit adaptor



\$50 (A049)

AIR IMPACT GUN & RATCHET WRENCH KIT 1/2"

- 1/2" impact wrench gun
- 1/2" ratchet wrench
- 9, 10, 11, 13, 14, 17, 19, 22, 24, 27mm Sockets
- 1/2" x 100mm Ext.
- Inline oiler



\$73 (A048)

AIR HAMMER CHISEL SET

- Max air pressure 90psi
- 2.3CFM
- 5 chisels 175mm long & retainer spring
- Mini oiler



\$32 (A050)

AIR DIE GRINDER KIT 14 piece

- Supplied with 10 grinding stones with 3 & 6mm collets
- Cushion grip handle

SAVE



\$36 (A051)

AIR TOOL KIT 34 piece

- 1/2" impact wrench, 9, 10, 11, 13, 14, 17, 19, 22, 24, 27mm sockets
- 3/8" ratchet wrench
- Air hammer / chisel with 4 x chisels
- 1/4" die grinder with 10 x grinding stones

SAVE



\$149 (A053)

AIR POP RIVET KIT 3/16"

- Traction power 6kg/cm
- 15mm stroke
- Rivet stem dies: 1.6, 2.0, 2.7 & 3.2mm
- Rivet Head Sizes: 2.4, 3.2, 4.0 & 4.8mm



\$116 (A046)

AIR BRUSH KIT

- Suitable for 2 pack, enamel & acrylic
- 2 x glass jars • Air pressure 10-40psi
- Spray pattern 5mm

\$33 (S346)



AIR MICRO DIE GRINDER KIT

- 58,000rpm
- 4.2CFM consumption
- 10 stones, 1/8" collet & inline oiler
- Grinder body dimensions 140mm Ø15.5mm

\$55 (A052)



AIR COMPRESSORS

- Quality, slow-running, efficient compressors suitable for home or factory use
- Long lasting Cast Iron pumps with stainless steel valves
- Belt drive compressors
- Fully automatic electric cut in/out
- Thermal overload protection on motors
- All models include filter regulator



SAVE



SUPER 12 - 60L Tank



SUPER 16 - 60L Tank

SAVE



SUPER 16 - 125L Tank

MODEL CODE		SUPER 12 C340	SUPER 16 C342	SUPER 16 C345	SS25 C330	SS30 C332	SS40 C335
Tank Size	Litres	60	60	125	150	150	250
Free Air Delivery	CFM / L/min	8.4 / 238	11.6 / 328	11.6 / 328	16.3 / 461	21.5 / 609	26 / 821
Cylinders		2	3	3	2	3	2
Pump Type		V-Twin	W-Triple	W-Triple	V-Twin	W-Triple	V-Twin
Motor Power	kW / hp	1.65 / 2.2	2.25 / 3	2.25 / 3	4.0 / 5.5	5.6 / 7.5	7.5 / 10
Voltage	V / Amps	240 / 10	240 / 15	240 / 15	415 / 15	415 / 15	415 / 20
PRICE		\$825	\$935	\$1,265	\$1,980	\$2,398	\$3,333

ONLINE ORDERS USE:
PROMO CODE:
3DSM14

FREE
15 Metre AIR HOSE
with any Air Compressor purchase

Valued at **\$33** (H008) RRP



SS30 Industrial



415V RANGE AVAILABLE
Ask for Show Specials



TM300



TM325



TM420SD

MODEL CODE		TM300 C501	TM325 C503	TM420SD C504	K25SDL C511
Tank Size	Litres	45	58	58	100
Free Air Delivery	CFM / L/min	6.53 / 185	7.2 / 204	11.9 / 339	10.2 / 289
Pump Type		Twin	Twin	Twin / 2 Stage	Twin / 2 Stage
Motor Power	kW / hp	1.65 / 2.25	1.65 / 2.25	2.2 / 3	2.25 / 3
Voltage	V / Amps	240 / 10	240 / 10	240 / 15	240 / 15
PRICE		\$792	\$836	\$1,089	\$1,496

FREE
15 Metre AIR HOSE & Regulator with any PILOT 240V Air Compressor purchase
Valued at **\$107.80** (H008) (A220) RRP

ONLINE ORDERS USE:
PROMO CODE:
3DSM14



K25SDL

RESTORATION

SHRINKER STRETCHERS

SHST-1.2H

- 1.2mm mild steel capacity
- 1.6mm aluminium capacity
- 0.9mm stainless steel capacity
- 25.4mm throat depth
- Curves to a 76mm radius
- Includes shrinker & stretcher dies

NEW RELEASE

OPTIONAL STAND \$180
(S2263)

ONLY \$250
(S2262)



SHST-1.2H0

- 1.2mm mild steel capacity
- 1 x set of shrinking dies
- 1 x set of stretching dies
- 120mm throat depth

ONLY \$450
(S2264)

NEW RELEASE



SHST-1.6HD

- 1.6mm mild steel capacity
- 1 x set of shrinking dies
- 1 x set of stretching dies
- 205mm throat depth

ONLY \$450
(S2266)



SHST-1.2

- 1.2mm mild steel capacity
- 1 x set of shrinking dies
- 1 x set of stretching dies

ONLY \$439
(S226)



PPH-51 PNEUMATIC PLANISHING HAMMER

- 500mm throat
- 1.2mm mild steel capacity
- 875-1350 blows/min
- Includes 25, 50, 76mm radius anvils
- Foot pedal operation

ONLY \$229
(S227A)



ENGLISH WHEELS

EWM-71

- 710mm throat
- 1.2mm mild steel capacity
- 1.6mm Copper & Aluminium capacity
- Includes 50, 76, 101, 152, 203, 254mm radius dies & 1 x flat die

SAVE

ONLY \$495
(S225A)



EWM-89

- 890mm throat
- 1.6mm mild steel capacity
- Ø152 x 57mm top anvil
- Includes 60, 83, 127, 216 & 305mm radius dies & 1 x flat die

ONLY \$639
(S2257)



SWIVEL ROLLER HEAD

EWM-75

- 711mm throat capacity
- 1.6mm mild steel capacity
- 2mm Copper & aluminium cap.
- Top anvil Ø203 x 50mm
- Heat treated dies
- Includes 50, 73, 101, 152, 203, 305mm radius dies & 1 x flat die

ONLY \$590
(S225)

NEW RELEASE



METAL PANEL RESTORATION DOLLIES

SDS-5 STEEL STRAIGHT T-DOLLY SET

- Ø13 x 70mm long
- Ø16 x 80mm long
- Ø20 x 95mm long
- Ø25 x 110mm long
- Ø30 x 140mm long

\$90 (S223)



NEW RELEASE

SDL-2 STEEL STRAIGHT T-DOLLY SET

- Ø40 x 170mm long
- Ø50 x 200mm long

\$90 (S2231)



TPD-3 STEEL TAPERED DOLLY SET

- Ø10 - Ø25.4 x 140mm long
- Ø10 - Ø38 x 203mm long
- Ø10 - Ø50.8 x 279.5mm long

\$110 (S2232)

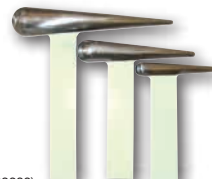

NEW RELEASE

CD-3 STEEL CURVED DOLLY SET

- Ø13 x 152mm long
- Ø19 x 152mm long
- Ø25.4 x 203mm long

\$70 (S2233)



MDS-2 STEEL MUSHROOM DOLLY SET

- Ø48mm domed head
- Ø70mm domed head

\$70 (S2234)

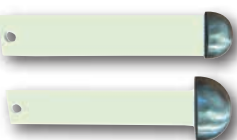

NEW RELEASE

MDL-2 STEEL MUSHROOM DOLLY SET

- Ø120mm domed head
- Ø150mm domed head

\$150 (S2235)



OVD-1 ALUMINIUM OVAL DOLLY

- 280 x 160 x 60mm

\$150 (S2236)



BDL-1 STEEL BOWL DOLLY

- Ø150mm
- Ideal for forming bowls

\$120 (S2237)



DS-880 STAND

ONLY \$150
(S2238)



RTSB-100 LEATHER STEEL SHOT BAG

- Velcro sealed
- 150 x 100mm
- Pre-filled with steel shot

\$45 (S214)



NEW RELEASE

RTSBS-2 LEATHER SAND BAGS

- Velcro sealed
- 200 x 305mm
- 305 x 460mm
- Pre-filled with fine sand

\$80 (S212)



RSBS-3 LEATHER SAND BAGS

- Velcro sealed
- Ø150, Ø254, Ø356mm
- Pre-filled with fine sand

\$80 (S210)



BTDS-128 BENCH TOP STAND

ONLY \$70
(S2239)



GEARED HEAD DRILLS

- 31.5mm drill capacity
- Thread tapping with auto reverse (D181 only)
- 12 speed (95-3200rpm) 415V model (D181)
- 6 speed (95-1600rpm) 240V model (D181A)
- 3MT spindle
- 1.1kW/1.5hp motor

DMF-42

\$1,890 ex GST

\$2,079 inc GST (D181A)

\$1,990 ex GST

\$2,189 inc GST (D181)

MILLING TABLE



- 31.5mm drill capacity
- Thread tapping with auto reverse
- Automatic feed
- Variable speed (50-2850rpm) digital display
- 3MT spindle
- 2.2kW/3hp 240V

GHD-30V

\$2,590 ex GST

\$2,849 inc GST (D176)

240V



- 40mm drill capacity
- Thread tapping with auto reverse
- Automatic feed
- 12 speed (95-3200rpm) 415V Model (D177)
- 6 speed (95-1600rpm) 240V Model (D177A)
- 4MT spindle
- 1.5kW/2hp motor
- 120mm spindle travel

GHD-32

\$2,090 ex GST

\$2,299 inc GST (D177/D177A)



- 40mm drill capacity
- Thread tapping with auto reverse
- Automatic feed
- 18 speed (50-1450rpm)
- 4MT spindle
- 1.5kW/2hp 415V
- 180mm spindle travel

ALL MODELS ON SALE

GHD-38B

\$2,890 ex GST

\$3,179 inc GST (D1325)



COLD SAWS

- Automatic retract safety blade guard
- Deadman trigger switch
- Dual material clamp
- Quick action vice
- Includes coolant pump system, blade & stand

CS-315C / CS-315D

240V 44rpm / 415V 22/44rpm

\$1,790 ex GST

\$1,969 inc GST (S827 / S828)



110 x 70mm Rect. Cap



160 x 90mm Rect. Cap

VARIABLE SPEED 24-120rpm

CS-350V

240V / 415V

\$2,990 ex GST

\$3,289 inc GST (S829 / S830)

ROLLER CONVEYOR SYSTEM

- 10 x Ø60mm Zinc plated steel rollers
- 300mm roller pitch
- 600-950mm adjustable height
- Includes 3 x stands with adjustable levelling pads

RC-450HD

540 x 3000mm (W x L)

\$590 ex GST

\$649 inc GST (L830)

RC-600HD

690 x 3000mm (W x L)

\$690 ex GST

\$759 inc GST (L835)

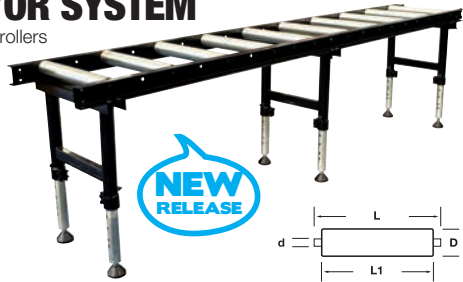

NEW RELEASE

EXTRA CONVEYOR ROLLERS
FRAME WIDTH (L) (L1) (D) (d)

540	495	450	60	M12	\$50	(L831)
690	645	600	60	M12	\$60	(L836)

RR-24 SECTION & TUBE ROLLING MACHINE

- 16 - 76mm tube capacity
- 0.5-2mm tube wall thickness
- Roving foot pedal control with emergency stop
- Includes: 9 round tube dies - 16, 19, 22, 25, 32, 38, 51, 63, 76mm
- 8 Square tube dies - 16, 19, 22, 25, 30, 38, 40, 50mm
- 1.1kW / 1.5hp 240V motor

\$1,540 ex GST

\$1,649 inc GST (S682)



240V

SAVE

TB-60 ELECTRIC PIPE & TUBE BENDER (240V)

- Ø51 x 2mm Steel Tube Capacity
- Ø1-1/4" x 1/8" Steel pipe - medium (nominal bore)
- User friendly digital control panel with microprocessor, allowing users to set the required bending angles
- Capable of storing 50 programs, 9 bends/program
- Electric brake and automatic return to stop
- 210° maximum bending angle
- Included pipe formers: 1/2", 3/4", 1", 1 1/4" NB

\$3,590 ex GST

\$3,949 inc GST (T606)

OPTIONAL FORMERS SUITS

SIZES	PRICES
TB-60 25.4, 31.8, 38mm	\$990 (T610)
TB-60 51mm	\$759 (T620)



OPTIONAL STAND \$275 (T603)



HYDRAULIC HORIZONTAL BENDERS

THE BULLDOZER HORIZONTAL BENDER

- A rigid structure utilizing the body of the machine to support a powerful ram
- The ram is made from super precision ground hard chromium shaft
- Includes standard flat V dies, 1 x 75mm, 1 x 105mm high & an adjustable ram stroke stop
- The tool post is of wear-resistant carbon steel supported midsection and bottom

BZ-H20T

80 x 10mm Flat Bar

\$5,890 ex GST

\$6,479 inc GST (P500/415V) (P502/240V)

20 TONNE

BZ-H25T

130 x 12mm Flat Bar

\$6,990 ex GST

\$7,689 inc GST (P504/415V) (P503/240V)

25 TONNE



240V or 415V AVAILABLE



made in New Zealand

LS-20 LOCKSEAMER (240V)

- 0.4 - 1mm mild steel capacity
- Hardened form rolls & gears - 58HRC
- Hardened & ground shafts fitted with precision needle bearings
- Reinforced steel plate stand provides rigidity which eliminates drumming
- 1.1kW / 1.5hp, 240V motor
- Power flanger fitted to top of machine
- Fitted with pittsburgh rolls & double seam rolls

\$3,500 ex GST

\$3,850 inc GST (S730)

SAVE



SECTION & PIPE ROLLS

- Hardened & ground drive shafts with double taper roller bearing support



Made in Turkey



PK-35F

50 x 50 x 5mm

\$4,150 ex GST

\$4,565 inc GST (S745 240V/S746 415V)

HPK-50

50 x 50 x 6mm

\$8,500 ex GST

\$9,350 inc GST (S750)

HPK-80

80 x 80 x 8mm

\$16,950 ex GST

\$18,645 inc GST (S756)

SHEET METAL NOTCHERS

- A transparent safety blade guard enables scribed lines to be quickly and accurately lined to cutting blade
- Roving foot pedal
- Adjustable material stops and guides on both sides of the cutting blade

PN-130

PNEUMATIC 120 x 120 x 3mm MS

\$2,250 ex GST

\$2,475 inc GST (S231)

HN-220

HYDRAULIC 200 x 220 x 4mm MS

\$4,750 ex GST

\$5,225 inc GST (S232)



MILL DRILLS

• 3MT Spindle taper

BELT DRIVE

HM-32
• Travels:
(X) 540mm
(Y) 190mm
(Z) 410mm



\$220
(M135A)
OPTIONAL STAND

\$1,250 ex GST
\$1,375 inc GST (M121)

GEARED HEAD

HM-36
• Travels:
(X) 475mm
(Y) 195mm
(Z) 450mm



\$220
(M135A)
OPTIONAL STAND

\$1,490 ex GST
\$1,639 inc GST (M122)

DOVETAIL COLUMN
GEARED HEAD

HM-46
• Travels:
(X) 475mm
(Y) 195mm
(Z) 450mm



\$220
(M135A)
OPTIONAL STAND

\$1,650 ex GST
\$1,815 inc GST (M123 240V/M124 415V)

DOVETAIL COLUMN
GEARED HEAD

HM-48
• Travels:
(X) 540mm
(Y) 185mm
(Z) 410mm



\$2,950 ex GST
\$3,245 inc GST (M126)

SAVE

3-Axis Digital Readout
\$3,650 ex GST
\$4,015 inc GST (M126D)

HM-50 MILLING MACHINE

- 3-Axis digital readout system
- 1.5kW, 2hp / 240V
- 1000 x 240mm worktable
- NT30 spindle
- X-Axis power feed
- Tilting head ±90° left to right
- Spindle lock for quill
- Includes halogen light, metric collet & chuck set (4-16mm), coolant system, swarf tray

Travels: (X) 600mm
(Y) 200mm
(Z) 340mm

\$4,450 ex GST
\$4,895 inc GST (M160D)



X3 MILL DRILL

- Variable speed, 3MT (100-2000rpm)
- 2 speed gearbox
- 600W 240V motor
- 50mm face mill capacity
- Dovetail vertical slide
- 550 x 160mm table size
- Travels: (X) 400mm
(Y) 150mm
(Z) 350mm



\$1,590 ex GST
\$1,749 inc GST (M153)

\$319
(M154A)
OPTIONAL STAND



SUPER X3 MILL DRILL

- Electronic variable speed, 3MT (100-1750rpm)
- Includes tapping function
- 1000W 240V motor
- 50mm face mill capacity
- Dovetail vertical slide
- Tilting head 30° L, 90° R
- Digital speed readout
- 550 x 160mm table size
- Travels: (X) 400mm
(Y) 150mm
(Z) 350mm



\$1,950 ex GST
\$2,145 inc GST (M155)

\$319
(M154A)
OPTIONAL STAND

UPGRADE TO

Horizontal Spindle Model HM-52 \$594 extra
Geared Head/Horizontal 415V HM-52G \$880 extra

TURRET MILLING MACHINES

- 2-Axis digital readout system
- 3hp motor
- NT30 Spindle
- X-Axis power feed
- Tilting head ±90° left to right

Travels:
(X) 760mm
(Y) 360mm
(Z) 430mm



BM-30A (240V)
\$7,350 ex GST
\$8,085 inc GST (M603D)

MADE IN TAIWAN

Travels:
(X) 1050mm
(Y) 420mm
(Z) 500mm



BM-70VE (415V)
\$16,600 ex GST
\$18,260 inc GST (M630D)

- 3-Axis digital readout system
- 5HP 415V motor
- NT40 Spindle
- Z-Axis powered elevating motor
- Includes: coolant system, halogen light & swarf tray

BM-52VE & BM-62VE
Travels: (X) 865mm
(Y) 420mm
(Z) 400mm



BM-52VE (415V)
\$8,990 ex GST
\$9,889 inc GST (M596D)

Travels:
(X) 1120mm
(Y) 520mm
(Z) 440mm



HORIZONTAL & VERTICAL

BM-62VE (415V)
\$10,450 ex GST
\$11,495 inc GST (M598D)

BM-90HV (415V)
\$29,500 ex GST
\$32,450 inc GST (M633D)

BENCH LATHES



\$220
(L143)
OPTIONAL STAND

AL-60 SIEG C6
250 x 500mm
\$1,290 ex GST
\$1,419 inc GST (L148)



AL-250G
250 x 500mm
\$1,490 ex GST
\$1,639 inc GST (L149)

\$220
(L150)
OPTIONAL STAND

26mm BORE



AL-320G
320 x 600mm
\$1,790 ex GST
\$1,969 inc GST (L141)

\$220
(L142)
OPTIONAL STAND

38mm BORE



AL-335
300 x 910mm
\$2,790 ex GST
\$3,069 inc GST (L183)

INCLUDES STAND

AL-336/D GEARED HEAD CENTRE LATHES

- 300 x 900mm capacity
- 150mm centre height
- 38mm spindle bore
- 2-Axis digital readout system (L682D)
- 18 spindle speeds (65-1810rpm)
- 2hp 240V motor
- Includes: 3 & 4-jaw chucks, faceplate, dead centres, work light, steadies, foot brake, splash tray & stand



AL-336
\$2,990 ex GST
\$3,289 inc GST (L682)

AL-336D Deluxe
2-Axis DRO, QCT, Leadscrew Covers
\$3,590 ex GST
\$3,949 inc GST (L682D)

SAVE

(L682D) shown

AL-340D CENTRE LATHES

- 2-Axis digital readout system
- Quick change tool-post - 4 Holders
- Concertina leadscrew cover
- 178mm centre height
- 1000mm between centres
- 39mm spindle bore
- 2hp motor
- Includes: 3 & 4-jaw chucks, faceplate, dead centres, work light, steadies, foot brake, splash tray & stand



AL-340D
240V, 8 speed (70-2000rpm)
\$4,990 ex GST
\$5,489 inc GST (L179D)

AL-340D
415V, 16 speed (35-2000rpm)
\$4,990 ex GST
\$5,489 inc GST (L179E)

BAND SAWS



BUILT IN COOLANT SYSTEM

BS-912 - 240V
305 x 178mm Cap.
\$1,490 ex GST
\$1,639 inc GST (B014)



BS-916A - 240V
350 x 228mm Cap.
\$2,180 ex GST
\$2,398 inc GST (B015)



AUTOMATIC ELECTRIC CUT OUT

BS-250 - 415V
415 x 250mm Cap.
\$2,990 ex GST
\$3,289 inc GST (B018)



SWIVEL HEAD

SOLD FOR OVER 25 YEARS

BS-10S - 415V
400 x 230mm Cap.
\$4,090 ex GST
\$4,499 inc GST (B028)

BS-10S - 415V
400 x 230mm Cap.
Semi-Automatic
\$4,790 ex GST
\$5,269 inc GST (B029)

DUAL MITRE, SWIVEL HEAD BAND SAWS

- 510 x 260mm (W x H) (B034)
- 600 x 440mm (W x H) (B035A)
- Variable blade speed 26-80 M/min
- Hydraulic clamping 2-speed vice
- Dual Swivel head to 45° left & 60° right
- Roller bearing & carbide blade guides
- Semi-automatic operation, machine returns to open height position after finishing the cutting process



SAVE

BS-320AS
\$11,400 ex GST
\$12,540 inc GST (B034)

BS-461AS
\$15,540 ex GST
\$16,995 inc GST (B035A)

HYDRAULIC CLAMPING VICE

DOUBLE COLUMN NC BAND SAWS

- NC Touch screen controller
- Hydraulic vice clamping and hitch feed system
- Includes bundle cutting clamps (nesting fixture)
- Hydraulic carbide blade guides
- Hydraulic swarf conveyor
- Automatic kerf compensation
- Hydraulic blade tensioning system
- Inverter controlled blade speed
- Dual valve pressure & feed rate



ACTUAL POWER

LARGER MODELS AVAILABLE

H-300HA-NC
300 x 300mm (W x H)
\$19,500 ex GST
\$21,450 inc GST (B118)

H-400HA-NC
420 x 400mm (W x H)
\$24,500 ex GST
\$26,950 inc GST (B120)

H-460HA-NC
480 x 460mm (W x H)
\$27,950 ex GST
\$30,745 inc GST (B122)

SWIVEL HEAD BAND SAWS



EB-260A
225 x 180mm
415V - 2 Speed
\$1,790 ex GST
\$1,969 inc GST (B061)



EB-260V
225 x 180mm
240V - Variable
\$1,790 ex GST
\$1,969 inc GST (B062V)

EB-280DS
310 x 205mm
2 Speed
\$3,290 ex GST
\$3,619 inc GST (B067)



EB-280DSV
245 x 180mm
415V - 2 Speed
\$2,690 ex GST
\$2,959 inc GST (B063)

EB-280DSV
245 x 180mm
240V - Variable
\$2,790 ex GST
\$3,069 inc GST (B063V)

EB-320DSV
255 x 200mm
Variable Speed
\$3,500 ex GST
\$3,850 inc GST (B067D)



NEW RELEASE

EB-351DSA Semi-Auto
345 x 205mm
2 Speed Hydraulic vice
\$5,590 ex GST
\$6,149 inc GST (B072)

SAVE

EB-330DSC
295 x 230mm
415V - 2 Speed
\$3,990 ex GST
\$4,389 inc GST (B075)

AL-356/V CENTRE LATHES

HEAVY DUTY CENTRE LATHES



(L656D Shown)

51mm BORE

AL-356
415V, 16 Speed
\$5,250 ex GST
\$5,775 inc GST (L656E)

AL-356V
240V Variable Speed
\$5,890 ex GST
\$6,479 inc GST (L656D)



80mm BORE

(L625D)

CL-40B
460 x 1000mm
\$11,590 ex GST
\$12,749 inc GST (L601D)

CL-60B
460 x 1500mm
\$12,590 ex GST
\$13,849 inc GST (L605D)

CL-68A
510 x 1500mm
\$13,890 ex GST
\$15,279 inc GST (L625D)

SAVE

CL-75
560 x 2000mm
\$15,990 ex GST
\$17,589 inc GST (L626D)

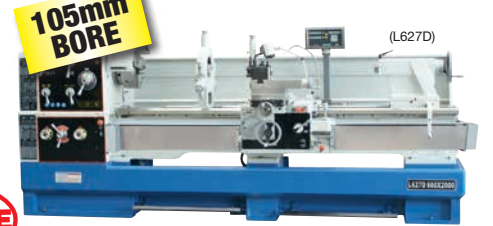

105mm BORE

(L627D)

CL-100A
660 x 2000mm
\$19,750 ex GST
\$21,725 inc GST (L627D)

CL-100A
660 x 3000mm
\$23,500 ex GST
\$25,850 inc GST (L628D)

HEAVY DUTY CENTRE LATHES

- 2-Axis digital readout system
- Taper turning attachment
- Quick change toolpost
- X & Z axis rapid traverse joystick on saddle
- 9kW / 12hp 415V motor

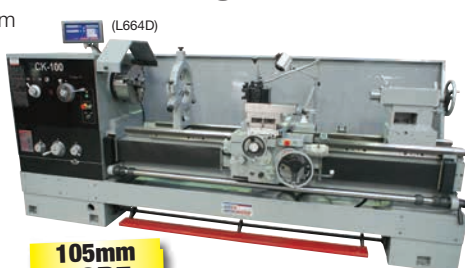

(L664D)

CK-80
500 x 2000mm
\$14,950 ex GST
\$16,445 inc GST (L662D)

CK-100
660 x 2000mm
\$17,950 ex GST
\$19,745 inc GST (L664D)

CK-100
660 x 3000mm
\$20,950 ex GST
\$23,045 inc GST (L666D)

SAVE

TOOLROOM CENTRE LATHES

- 2-Axis digital readout system
- Triple headstock bearings
- 12 speeds (40-2000rpm) 5.5kW / 7.5hp, 415V motor (L632D & L634D)
- 12 speeds (12-1200rpm) 11.25kW / 15hp, 415V motor (L639D & L642D)



TM

(L639D)

TM-1740G
430 x 1000mm
78mm Bore
\$13,950 ex GST
\$15,345 inc GST (L632D)

TM-1960G
480 x 1500mm
78mm Bore
\$15,950 ex GST
\$17,545 inc GST (L634D)

TM-2680G
660 x 2000mm
115mm Bore
\$26,500 ex GST
\$29,150 inc GST (L639D)

TM-26120G
660 x 3000mm
115mm Bore
\$30,450 ex GST
\$33,495 inc GST (L642D)

HYDRAULIC PRESSES



30 TONNE

HPM-30
30 TONNE
Pneumatic/Hydraulic
\$850 ex GST
\$935 inc GST (P130M)



50 TONNE

HPM-50
50 TONNE
Motorised/Hydraulic
\$2,700 ex GST
\$2,970 inc GST (P131M)



INCLUDES V-BLOCKS

HDP-15
15 TONNE
\$1,390 ex GST
\$1,529 inc GST (P127)



HDP-35
35 TONNE
\$2,490 ex GST
\$2,739 inc GST (P129)

SLIDING RAM AVAILABLE

HP-63T
63 TONNE
\$3,890 ex GST
\$4,279 inc GST (P400)



HP-150T
150 TONNE
\$7,850 ex GST
\$8,635 inc GST (P404)



HP-200T
200 TONNE
\$9,350 ex GST
\$10,285 inc GST (P406)

MOTORISED PLATE ROLLS

- Swing out top roller
- Safety wire interlock system
- Two rolls powered by gearbox drive system
- Precision ground rolls with wiring grooves
- Includes a conical bending guide roller
- 415V motor



PR-133
1300 x 2.5mm
\$4,750 ex GST
\$5,225 inc GST (S761)

PR-134
1300 x 4.5mm
\$5,690 ex GST
\$6,259 inc GST (S761S)

PR-136
1300 x 6.5mm
\$7,850 ex GST
\$8,635 inc GST (S762)

Initial Pinch Style Rolls

PR-132 MOTORISED PLATE ROLLS

- 1270 x 1.5mm mild steel capacity
- Initial pinch rolls with pre-bending
- Two rolls powered by gearbox drive system
- Safety wire interlock system with emergency shut-off
- Swing out end enables complete cylinder to be removed
- 1.5kW / 2hp 415V motor



PR-132
1270 x 1.5mm
\$2,090 ex GST
\$2,299 inc GST (S764)

Initial Pinch Style Rolls

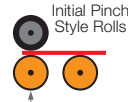

SAVE

HEAVY DUTY MOTORISED PLATE ROLLS

- Two rolls powered by gearbox system
- Mobile control panel with foot pedals
- Safety wire interlock system
- Motorised up & down top roll
- Includes section roll system with flat bar and tube dies
- 415V motor



Pyramid Style Rolls

PR-203
2000 x 3mm
\$6,850 ex GST
\$7,535 inc GST (S765)

PR-3106
3100 x 6mm
\$14,250 ex GST
\$15,675 inc GST (S771)

PR-258
2550 x 8mm
\$11,750 ex GST
\$12,925 inc GST (S767)

PR-2512
2550 x 12mm
\$18,900 ex GST
\$20,790 inc GST (S769)

MB1250 MAGNETIC PANBRAKE **METALMASTER**

- 1300 x 1.6mm mild steel capacity
- 240V electromagnetic clamping system
- No limitation to depth of boxes
- Quick and accurate setting of angle stop
- Open ended allows folding of complex shapes
- Includes: 25, 37.5, 52.5, 70, 140, 280, 585 & 1300mm clamp bars



\$2,990 ex GST
\$3,289 inc GST (S542)

NEW RELEASE

240V

HYDRAULIC PUNCH & SHEARS

- Four work stations all guarded (punching, plate, angle & bar shearing)
- Punching capacity up to 40mm standard
- Power inching for easy job set up
- Adjustable stroke for faster punching



IW-45MQ
45T 415V 5hp
\$5,950 ex GST
\$6,545 inc GST (P170)

IW-45MQ
45T 240V 3hp
\$6,650 ex GST
\$7,315 inc GST (P170A)

SAVE

- Five work stations all guarded (punching, notching, plate, angle & bar shearing)
- Adjustable stroke for faster punching



IW-45K
45T 415V 5hp
\$7,650 ex GST
\$8,415 inc GST (P171)

IW-60H
60T 415V 7.5hp
\$8,650 ex GST
\$9,515 inc GST (P173)

10 PIECE PUNCH & DIE SETS
ONLY \$330 (P165) 6-26mm
\$495 (P166) 11-40mm
When you purchase a **SUNRISE PUNCH & SHEAR**



IW-60S
60T 415V 7.5hp
\$12,150 ex GST
\$13,365 inc GST (P174)

IW-100S
100T 415V 10hp
\$17,350 ex GST
\$19,085 inc GST (P176)

IW-80S
80T 415V 10hp
\$14,250 ex GST
\$15,675 inc GST (P175)

IW-125S
125T 415V 15hp
\$21,850 ex GST
\$24,035 inc GST (P177)

MANUAL PANBRAKES

METALMASTER

- Extended fingers allows bending of pans or boxes to a depth of 230mm
- Ground segmented fingers
- Safety top beam support stop lever
- Quick action beam adjustment
- Includes rear manual back gauge & digital angle gauge



DIGITAL ANGLE GAUGE

PB-422A
1250 x 2mm
\$2,890 ex GST
\$3,179 inc GST (S262)

PB-820A
2440 x 2mm
\$4,390 ex GST
\$4,829 inc GST (S264)

MANUAL GUILLOTINES

METALMASTER

- Quality steel-fabrication construction
- Spring loaded material clamp beam
- Adjustable blade clearance for thin material
- Includes front sheet supports & backgauge



SG-416A
1300 x 1.6mm
\$2,350 ex GST
\$2,585 inc GST (S534A)

SG-812
2470 x 1.2mm
\$3,350 ex GST
\$3,685 inc GST (S536)

HYDRAULIC NC PANBRAKES

METALMASTER

- Hydraulic bending with manual material clamp
- Extended fingers allows bending of pans or boxes to a depth of 230mm
- Easy to use single angle programmable controller incorporating digital readout for angles from 0-130°
- 4kW / 5.5hp 415V motor



PB-425Y
1250 x 2.5mm
\$6,250 ex GST
\$6,875 inc GST (S581)

PB-820Y
2500 x 2mm
\$6,950 ex GST
\$7,645 inc GST (S583A)

SAVE

HYDRAULIC GUILLOTINES

METALMASTER

- Equipped with shadow line lighting-alignment device
- Photo electric rear guarding with 3 beams
- Plate support tables with transfer balls
- 9CrSi blade for stainless steel
- 5.5kW / 7.5hp 415V motor



LARGER MODELS AVAILABLE

(S927 Shown)

Motorised Backgauge
1300 x 4mm (DRO)
\$9,250 ex GST
\$10,175 inc GST (S924)

Manual Backgauge
2500 x 4mm (DRO)
\$10,500 ex GST
\$11,550 inc GST (S926)

Motorised Backgauge
2500 x 4mm (DRO)
\$11,250 ex GST
\$12,375 inc GST (S927)

HYDRAULIC NC PANBRAKES

METALMASTER

- Hydraulic bending & clamping
- Easy to use single angle programmable controller incorporating digital readout 0-130°
- Rapid radius adjustment
- 3.75kW / 5hp 415V motor



PB-440
1300 x 4mm
\$8,150 ex GST
\$8,965 inc GST (S581A)

PB-825A
2500 x 2.5mm
\$8,090 ex GST
\$8,899 inc GST (S583B)

PB-830A
2500 x 4mm
\$13,250 ex GST
\$14,575 inc GST (S584A)

Save \$3,201 OFF RRP PACKAGE
\$26,190 ex GST
(K059) \$28,809 inc GST
(S584A + S934)

HG-2504
2500 x 4mm
\$13,500 ex GST
\$14,850 inc GST (S934)

HG-2506
2500 x 6mm
\$16,750 ex GST
\$18,425 inc GST (S937)

HG-3206
3200 x 6mm
\$19,990 ex GST
\$21,989 inc GST (S940)

HYDRAULIC NC GUILLOTINES

METALMASTER

- Ezy-Set NC-89 Go-To controller via ballscrew backgauge
- Rapid blade gap adjustment
- Individual hydraulic hold downs
- 4 edge 9CrSi blade for stainless steel
- Three photo electric rear guarding
- 250mm throat depth



SEE ENTIRE RANGE ON SALE
visit machineryhouse.com.au

HG-3206 HYDRAULIC NC GUILLOTINE

- 3200mm x 6mm cutting capacity
- Ezy-Set NC-89 Go-To controller with 1000mm ballscrew backgauge
- Rapid blade gap adjustment
- Transfer balls on table with squaring arm
- Shadow line lighting
- 250mm throat capacity
- Individual hydraulic hold downs with nylon pads

SAVE



250mm THROAT

METALMASTER

PB-110B HYDRAULIC NC PRESSBRAKE

- 110T x 3200mm capacity
- Ezy-Set NC-89 Go-To controller X & Y-Axis with ballscrew backgauge
- Segmented 86° offset top punch
- Solid one piece four way multi-vee (V) die block
- Hydraulic/Mechanical ram, synchronised positive stop design
- Quick action top tool holder with wedge type adjustment
- Fitted with safety light curtains

INCLUDES SAFETY LIGHT CURTAINS



PACKAGE DEAL
\$48,000 ex GST (K057A) (S940 + S904G)
\$52,800 inc GST
SAVE \$4,620 RRP
UPGRADE TO 135Tonne Pressbrake \$1,500 ex GST extra (K058)

\$19,990 ex GST
\$21,989 inc GST (S940)

\$29,400 ex GST
\$32,340 inc GST (S904G)



German Design & Technology

WETSTONE GRINDERS

TiGer 2000S

- Ø200 x 40mm K220 aluminium oxide wheel
- Ø200 x 30mm leather honing wheel
- 120W / 240V induction type motor
- Removable leather honing wheel. After sharpening, it removes the burr to give you a smooth edge
- Includes grinding wheel, honing wheel, grinding paste, angle setting jig, jig for straight edges, plane irons, ripping chisels, knife jig & Break - proof water tank

\$198 (W859)



TiGer 2500

- Ø250 x 50mm K220 aluminium oxide wheel
- Ø200 x 30mm leather honing wheel
- 200W / 240V induction - type motor
- Speed 90 rev/min
- Includes grinding wheel, honing wheel, grinding paste, angle setting jig, jig for straight edges, plane irons, ripping chisels & break - proof water tank
- Designed for uninterrupted operation

\$287 (W868)



ACCESSORIES: Suit TiGer 2000S & 2500

HOUSE HOLD SHARPENING KIT **\$99** (W861)



Jig 40



Jig 60



Jig 120



Jig 160

WOOD TURNERS SHARPENING KIT **\$99** (W862)



Jig 25



Jig 55



Grinding Support 110



Stone Grader

WHEEL DRESSING ATTACHMENT **\$49** (W8633)

\$49 (W8633)

- Wheel dressing attachment ensuring that the grinding wheel is always perfectly round and level



OS-58 BOBBIN SANDER

- 1/2", 3/4", 1", 1-1/2", 2" & 3"
- 370 x 290mm cast iron table
- Rotating & oscillating
- 450W / 240V motor



\$217 (W843)

hf-50 ROUTER

- 610 x 360mm cast iron table
- 8000 - 24000rpm variable speed
- 0 - 40mm spindle height
- 1.5kW / 2hp, 240V motor



\$316 (W846)

HS120 TABLE SAW

- Ø315mm TCT blade
- 550 x 800 work table
- Tilt arbor 45°
- 3hp, 240V motor



\$359 (W443)

HA-1000 DUST COLLECTOR

- 109cfm HPLV system
- 5 micron filter
- 50 litre tank
- 1.5hp, 240V motor



\$158 (W885)

HD12 DUST COLLECTOR

- 680cfm LPHV system
- Large collection area
- 3/4hp, 240V motor
- Includes 4 in 1 reducer & 2M hose



\$178 (W886)

CIRCULAR PLUNGE CUT SAW

cs-55

PROFESSIONAL RESULT



\$275 (W874)
Normally **\$361.90**

SAVE \$86.90 RRP

- 160mm
- 1.2kW
- 55mm

Package Includes:

- cs-55 circular plunge cut saw (240V)
- 1 x 1400 x 200mm guide rail
- 1 x clamp & stop accessories pack
- 1 x anti fall over saw clamp



Use as a plunge saw.

Use instead of a circular saw bench for precise parallel panel sizing.

Use as a normal circular saw.

OPTIONAL ACCESSORIES

Saw Blades

160 x 24T **\$26** (W879)

160 x 48T **\$26** (W880)



Anti-Fall Over Saw Clamp

\$8.90 (W878)



Guide Rail Aluminium

\$74 (W876)



Accessory Guide Rail Clamps & Stop

\$24 (W877)



Accessory H/D Guide Rail Clamps & Stop

\$38 (W8775)



Deco Flex SCROLL SAW

- 406mm throat capacity
- Tilting table 0-45°
- 90W / 240V motor
- Variable speeds
- Includes flexible shaft with 3.2mm chuck for drilling, sanding, polishing, engraving & moulding



\$163 (W348)

SCROLL SAW ACCESSORY KIT

- Polishing, Grinding & Sanding Kit

\$24 (W348A)



bts 900x BELT & DISC LINISHER SANDER

- 100 x 915mm belt
- Ø150mm disc
- Tilting table & mitre guide
- Vertical or horizontal finishing position
- 370W 240V motor



\$178 (L105)

Slik 7.0b OSCILLATING BELT SANDER

- 16m/sec belt speed
- Tilting sanding belt 90-180°
- 2515mm x 150mm belt size
- 2.9kW 240V 15A motor



\$1,375 (L904)

Plana 3.0 PLANER & THICKNESSER COMBINATION

The Plana 3.0 is the most efficient and cost effective planer & thicknesser available for the professional user, serious home woodworkers and educational workshops.

- 250 x 210mm thickness capacity
- 260 x 1050mm cast iron table
- Ø100mm dust outlet
- Large professional planing fence
- Cast Iron thickness table adjustment to 1/10mm for super fine finishing
- 3hp 240V 15A motor



\$1,534 (W850)

Basato 3h Vario BAND SAW

- 305 x 205mm cutting capacity
- Unique variable speed drive system 370 - 750m/min
- Large 548 x 400mm cast iron table
- Twin 3-roller precision blade guides
- Precision rip fence with magnifier
- Patented table tilting from -17° to +45°
- Standard base unit with wheel kit
- 800W / 1.06hp, 240V motor
- Includes heavy duty mitre gauge & 95mm dust chute



\$683 (W855)

Basato 4 BAND SAW

- 375 x 250mm cutting capacity
- Twin 3-roller precision blade guides
- Precision rip fence with magnifier
- Patented table tilting -17° to +45°
- Large 548 x 400mm cast iron table
- Solid rip fence with eyeglass
- Quick release mechanism for quick blade change
- Two cutting speeds 800-1200 m/min
- Cabinet base with storage facility & wheels assembly standard
- 1500W / 2hp, 240V motor



\$1,039 (W856)



Woodfast

BUILT TO LAST

TH410 THICKNESSER

- Large 407 x 225mm capacity
- Heavy duty 2.25kW / 3hp 240V motor
- 3 knives cutter block system, 5300rpm
- Heavy duty cast iron table 600 x 415mm
- Great innovation variable feed speed system between 5 - 7m/min
- Sound-proofing to reduce noise
- 4mm maximum depth of cut via hand wheel with digit height counter
- Integral extraction hood with a 120mm dust extraction outlet
- In-feed/out-feed support arms with 3 material rollers
- Includes Ø100mm dust chute & digital readout height gauge



\$1,673 (W680)



TS250RS PANEL SAW

- Ø254mm saw blade with 45° tilting arbor
- 80mm @ 90°, 54mm @ 45° depth of cut
- 1.5kW / 2hp 240V motor
- 1200 x 238mm sliding table size
- Professional aluminium sliding work table with 1250mm travel
- 30mm dust extraction outlet on blade guard as well as a 100mm chute from the enclosed stand
- Includes heavy duty aluminium extrusion rip fence with fine adjustment
- 800 x 620mm work table
- 600mm ripping capacity



\$1,574 (W688)



MBS500 BAND SAW

- 465mm throat capacity
- 285mm height capacity
- 630 x 480mm cast iron table
- 2 blade speeds, 380 & 800m/min
- 1.5kW / 2hp 240V motor
- Roller blade guides
- Quick-release blade tension mechanism
- Blade tension sight indicator
- Rack & pinion adjustment on top blade guide
- Cast iron table tilts to 45°
- Twin 100mm dust chutes
- Includes mitre guide, quick lock rip fence & mobile wheel kit



\$1,574 (W691)

M910 HEAVY DUTY WOOD LATHE

- Electronic variable speed 50-3890rpm
- Heavy duty vibration absorbing cast iron construction
- 1.5kW / 2hp 240V inverter motor
- 520mm swing over bed
- 975mm distance between centres
- 4 large QUATRO design headstock bearings
- 720mm maximum bowl diameter on onboard turning
- 30mm x (3.5mm pitch) spindle
- Includes bowl turning attachment, faceplate, drive & live centres, tool rest & stand



\$3,356 (W685)



THICKNESSERS



T-13A 330mm

- 330mm x 152mm timber capacity
- Double sided HSS blades
- 4 post design
- Depth of cut indicator
- 100mm Dust Chute
- 1.8kW / 2.4hp 240V motor



ONLY \$386 (W813)

T-13S

- 330mm x 152mm timber capacity
- Patented helical head: helical head has 26 indexible HSS inserts for superior finish, longer cut time & quieter operation
- Unique "Snipe lock" design, firmly locks cutter head assembly to help minimize snipe
- Depth of cut indicator
- 100mm Dust Chute
- 1.8kW / 2.4hp 240V motor



ONLY \$584 (W815)



T-330 Deluxe

- 330 x 152mm capacity
- 2 speed feed
- Digital height readout
- 2 blade HSS cutter
- 1800W 240V motor
- Includes stand, 100mm dust chute 100-50mm reducing adaptor



\$475 (W805)



T-380A

- 380 x 150mm capacity
- 3 blade HSS cutter
- 2 speed gearbox
- Digital height gauge
- 100mm dust chute
- 2hp 240V motor



\$1,386 (W414)



T-20

- 508 x 200mm capacity
- 4 blade HSS cutter
- 2 speed feed rollers with pressure adjustment
- Digital height gauge
- 125mm dust chute
- Anti kick back fingers
- Table locking handles lock both left & right
- 3hp 240V (W415A)
- 5hp 415V (W415)



\$2,267 (W415) (W415A)



SPIRAL CUTTER HEAD



T-380S THICKNESSER

- 380 x 150mm capacity
- 4 x Spiral cutter head with 68 pre-loaded carbide inserts
- 2 speed gearbox
- Digital height gauge
- 100mm dust chute
- 3hp 240V



\$2,326 (W414S)

T-20S THICKNESSER

- 508 x 200mm capacity
- 4 x Spiral cutter head with 92 pre-loaded carbide inserts
- Digital height gauge
- 125mm dust chute
- 2 speed feed
- 5hp 415V



\$3,316 (W415S)

DCK-2 DUST ACCESSORY KIT

- 2 x 3m x Ø100mm hose
• 10 hose clamps
• 1 x 558mm wide Floor sweeper
• 1 x Table saw hood
• 1 x Universal dust hood
• 1 x 150mm Dust hood
• 1 x "Y" fitting
• 2 x Shut-off valves

\$84 (W344)

DUST HOSE

- Flexible reinforcing
• Durable polymer material

SIZE - Sold Per Metre

- Ø63mm \$12.80/metre (W3985)
• Ø100mm \$14.80/metre (W399)
• Ø125mm \$21.00/metre (W398A)

INDIVIDUAL ADAPTORS

- Constructed out of rugged rubber



Table listing various dust collection components like Reducer, Joiner, Elbow, and Steel Hose Clamps with their sizes and prices.

AP-12 AIR FILTRATION UNIT

- 3 speed settings
• 3 timer settings (1Hr, 2Hr, 4Hr)
• 1044CFM, 68dB
• Remote control ON/OFF



\$376 (W326)

DC-3 DUST COLLECTOR

- 1200CFM LPHV system
• Portable, on wheels
• 5 micron fine filter bag
• Twin inlets Ø100mm
• 2hp 240V motor



\$316 (W394)

FC-10 FILTER CARTRIDGE

- Increases filtering area by 700%
• 1 micron filtration
• Includes 10 plastic bottom bags
• Ø500mm x 600mm high
• Suits most Ø500mm dust collectors

\$198 (W328)

WDP-610 WOOD DOWEL PIN KIT

- Multi-Purpose Drill Guide with Handle
• HSS. Standard Step Drill. Dia. 9.5mm (3/8")
• Long Reach CrV Screwdriver
• 3 x Wood Brad Point Drills (6, 8, 10mm)
• 10 x 6x30mm Wood Dowel Pins
• 10 x 8x40mm Wood Dowel Pins
• 10 x 10x40mm Wood Dowel Pins
• 10 x Wood Plugs
• 20 x Wood Screws

NOTE: Dust collector NOT included with FC-10

\$42 (W648)

VV-230 WOOD WORKING VICE

- 230mm jaw width
• Quick release
• 260mm maximum opening
• Mounts under bench

\$89 (V184)

DCM-200 METAL or WOOD DUST COLLECTOR

- 1.5kW / 2hp (15A) 240V motor
• Dual inlets Ø100mm
• 1200CFM



\$683 (W322)

4-Metres Flame Retardant Hose (Suitable for Metals) \$148 (W322A) Ø100mm

DC-7 DUST COLLECTOR

- 2300CFM LPHV system
• 3hp 240V
• Portable, on wheels
• 5 micron fine filter bag
• Triple inlets Ø100mm



\$475 (W329)

DC-80 DUST COLLECTOR

- 2800CFM LPHV system
• 3hp 415V
• Portable, on wheels
• 2 micron filter bag
• Triple inlets Ø100mm



\$861 (W397)

DC-90 DUST COLLECTOR

- 2800CFM LPHV system
• 5hp 415V
• Portable, on wheels
• 2 micron filter bag
• Triple inlets Ø100mm



\$1,039 (W331)

CD-2A CYCLONE DUST COLLECTOR

- 1200CFM LPHV System
• Ultra-high efficiency cyclonic separation
• 1 micron pleated canister filter
• 113 litre steel drum with plastic bag system dust disposal
• 1.5kW / 2hp, 15A 240V motor



\$1,138 (W318)

MOBILE BASE - 227kg

- 2 wheels with lever action for raising
• Perfect for moving machines
• 227kg capacity
• Min/Max: 279x279mm/482x1295mm
• Weight 17kgs



\$78 (W930)

MOBILE BASE - 454kg

- Ø72mm wheels - 2 wheels swivel
• Perfect for moving machines
• 454kg capacity
• Min/Max: 580x580mm/750x850mm
• 2 screw stops



\$178 (W931)

SAW BLADE & ROUTER SETTING GAUGE - Digital

- Horizontal & vertical measuring
• Hole depth max. 50.8mm
• 60mm wide aperture
• Digital readings in millimetres, inches & fractions
• Magnetic base

\$20 (W644)



up to 20% OFF RRP

WHG-6 DIGITAL HEIGHT GAUGE

- Horizontal & vertical measuring
• 0-150mm measuring range
• Hardened steel scriber jaw
• Digital readings in millimetres, inches & fractions
• Magnetic base

\$22 (W643)



MD912 DIGITAL MOISTURE METRE

- Moisture content reading 2-70%
• Resolution: 0.5%
• Wood species selection function
• Hold feature freezes reading
• Includes 9V battery & spare set of probes

\$49 (W645)



PT-6 JOINTER - 150mm

- Long 1200mm cast iron table with 13mm rebating
• 3 blade cutter head
• 1hp 240V



\$495 (W619)

P-200H JOINTER - 200mm

- Long 1785mm cast iron table with 13mm rebating
• 2hp 15A 240V
• 4 blade cutter head



\$980 (W629)

PT-300 PLANER & THICKNESS COMBINATION MITRE SAW STAND

- 304 (W) x 220mm (H) thicknesser capacity
• 1510 x 400mm jointer table size
• 3hp 240V 15A motor
• 4 blades on Ø78mm cutter head



\$2,029 (W613)

MITRE SAW STAND

- Adjustable material support rollers
• Roller support width 1250 - 2050mm
• Folds down flat & compact
• Quick action hand clamp lever saw supports



\$138 (W826)

M-16 CHISEL MORTICER

- 16mm chisel capacity
• 160 x 46mm adjust. table
• 120mm head stroke
• 1400rpm spindle speed
• 125mm timber width capacity
• Cast iron construction
• 0.37kW, 240V motor



\$306 (W347)

Chisa 7.0 CHISEL MORTICER

- 145mm timber capacity
• 170 x 140mm table movement
• 750W / 1hp 240V
• 220mm stroke
• Includes 2 chisels



\$712 (W3465)

M-25 CHISEL MORTICER

- 160mm timber capacity
• 255 x 180mm table movement
• 125mm head stroke
• Cast iron construction
• 3-position job clamp & depth stop
• 0.75kW / 1hp 240V motor



\$1,376 (W345)

CMB-5 CHISEL MORTICER BIT SET - HSS

- 5 piece (1/4", 5/16", 3/8", 1/2", 5/8")
• 19mm shank diameter



\$49 (W411)

B-18V SCROLL SAW

- 450mm throat capacity
• Tilting table 0-45°
• 120W / 240V motor
• Variable speeds
• Includes light, air blower



\$247 (W352)

BP-250 BAND SAW

- 245 x 100mm cap.
• Ø60mm dust port
• Cast iron table tilts 0-45°
• 375W / 1/2hp 240V motor



245 x 100mm WxH capacity \$267 (W417)

BP305 BAND SAW

- 305 x 175mm cap.
• Safety micro's on blade guards
• 100mm dust collector port
• Cast iron table tilts 0-45°
• 750W / 1hp 240V



305 x 175mm WxH capacity \$445 (W4202)

BP-355 BAND SAW

- 345 x 245mm cap
• Safety micro's on blade guards
• Ball bearing blade guides
• Cast iron table tilts to 45°
• 100mm dust chute
• 2 x blade speeds via pulley system
• 2hp 240V motor



345 x 245mm WxH capacity \$879 (W4224)

BAND SAWS

- 2-speed 488/1010m/min
• Ball bearing blade guides
• Safety micro's on blade guards
• 2hp 240V motor

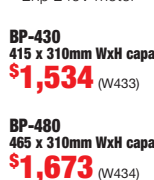

BP-430 415 x 310mm WxH capacity \$1,534 (W433)

BP-480 465 x 310mm WxH capacity \$1,673 (W434)

BAND SAWS

- 2-speed 565/670 M/min
• Foot brake with micro-switch
• 3hp motor



BP-500 - 240V 15A 510 x 335mm WxH capacity \$2,128 (W425)

BP-500 - 415V 510 x 335mm WxH capacity \$2,128 (W427)

WOOD LATHES

- Variable speed 500-2000rpm
- Swivelling headstock
- Outboard tool rest extension
- Dust proof magnetic switch
- 2 Morse tapers, 1" x 10tpi spindle thread
- 750W, 240V motor
- Includes bowl turning attachment, faceplate, drive & live centres, tool rest & stand

INCLUDES BOWL TURNING ATTACHMENT



WL-18
310mm Swing
900mm Between Centres
\$475 (W382)

WL-20
370mm Swing
1100mm Between Centres
\$564 (W384)

BONUS
Bowl Sanding System (W305)
Valued at **\$71.50**

ONLINE ORDERS USE:
PROMO CODE: **3DSM14**

WL-46A WOOD LATHE

- Electronic variable speed (100-3200rpm) with a digital screen
- Cast iron construction, bed, head and tailstock
- Headstock is free to slide along the length of the bed
- 1.5kW / 2hp 240V motor • Dust proof magnetic switch
- Heavy cast iron legs
- 462mm swing over bed • 1194mm between centres
- Includes faceplate, tool rest, tailstock, drive & live centres & stand



WL-46A
462mm Swing
1194mm Between Centres
\$1,772 (W387)

BONUS
Bowl Sanding System (W305)
Valued at **\$71.50**

ONLINE ORDERS USE:
PROMO CODE: **3DSM14**

BONUS
Bowl Turning Attachment (W387A)
Valued at **\$99**

WOOD CHISELS (HSS)



8 PIECE SET (HSS)
Up to 230mm Handle
\$108 (W301)

6 PIECE SET (HSS)
Up to 230mm Handle
\$108 (W302)

SAVE

WSC-100 SCROLL CHUCK 100mm

- Suits lathe with 20" swing of bed*
- 0.2mm tolerance
- 4-Jaw self centring
- Gripping internally & externally
- Includes T-key, 1 x wood screw & 24 Indexing plate

Scroll Chuck & 1 x Insert
30 x 3.5mm (W370A)
3/4" x 16TPI (W370B)
1" x 10TPI (W370C)

\$148 EACH

- OPTIONAL JAWS**
- W371
 - W372
 - W373
 - W374
- Bowl Jaws 200mm** **\$49** (W371)
Step Jaws 100mm **\$34** (W372)
Jaws 25mm **\$34** (W373)
Power Grip Jaws 90mm **\$34** (W374)

BSS-5075 BOWL SANDING SYSTEM

- Rotary Sander
- 2 x Ø50mm sanding heads
- 2 x Ø75mm sanding heads
- 50 Assorted Ø50mm sanding discs
- 50 Assorted Ø75mm sanding discs

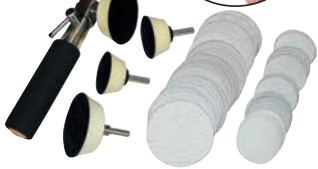

\$64 (W305)

DS-1632 DRUM SANDER

- 400mm sanding width
- 3.2 - 127mm sanding height
- 1720rpm drum speed
- Variable table feeds
- 63mm diameter dust hood outlet
- 0.75kW/1hp 240V motor



\$799 (L110)

DS-25 TWIN DRUM SANDER

- 635 (W) x 6-127mm (H) capacity
- 2 x 100mm dust outlets
- 3hp 240V 15A plug
- Variable speed conveyor feed

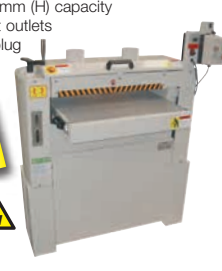

\$2,069 (L129)

OVS-JM BOBBIN SANDER

- Rotating and oscillating action
- 609 x 609mm cast iron table tilts 45°
- 1725rpm
- 1hp 240V motor
- Includes 1/4", 3/8", 1/2", 5/8", 3/4", 1", 1 1/2", 2", 3" & 4" sanding spindle & sleeves



\$1,376 (W795)

DS-15S DISC SANDERS

- Ø380mm Disc
- Tilting table up 0-15° down 0-45°
- Heavy 400 x 375mm cast iron table
- 2hp 1462rpm brake motor (240 or 415V)
- Includes: Mitre guide 1 x Sanding Disc Cabinet Stand



\$1,375 (L1352) (L1354)

L-69A BELT & DISC LINISHER SANDER

- 150 x 1220mm belt • Ø230mm disc
- Tilting table for disc or belt in vertical position
- 550W 240V
- Quick action belt release



\$319 (L107)

L-612A BELT & DISC LINISHER SANDER

- 150 x 1220mm belt
- Ø305mm disc
- Tilting table to belt & disc
- Can use linisher in vertical or horizontal position
- 1.5hp 240V



\$669 (L109)

L-612 BELT & DISC LINISHER SANDER

- 150 x 1220mm belt
- Ø305mm disc
- Cast iron tilting disc table
- Can use linisher in vertical or horizontal position
- 2hp 15A 240V



\$879 (L108)

L-80 BELT SANDER

- Belt tilts horizontal and vertical
- 755 x 250mm cast iron table
- 150mm wide belt
- 1.5hp 240V



\$879 (L112)

TS-251 TABLE SAW

- 254mm TCT blade
- 910 x 940mm alloy table
- Tilt arbor 45°
- 2hp, 240V motor



\$219 (W446)

HS120 TABLE SAW

- Ø315mm blade • Sliding Table
- 2200W, 240V motor • Portable
- 83mm depth of cut
- Tilt arbor to 45°



\$359 (W443)

SB-12 TABLE SAW

- Ø300mm TCT blade
- 510 x 686mm cast table
- Tilt arbor 45°
- 3hp, 240V motor



\$890 (W452)

SB-10H TABLE SAW

- Ø254mm TCT blade
- 1170 x 800mm cast table
- Tilt arbor 45°
- 3hp, 240V motor



\$1,138 (W453)

ST-250 TABLE SAW

- Ø254mm TCT blade
- 865 x 800mm cast table
- Tilt arbor 45° • 1250mm cross cut
- 3hp, 240V motor



\$1,375 (W450)

ST-12D TABLE SAWS

- 305mm TCT Blade • 95mm depth of cut
- Heavy duty quick action 1220mm rip fence
- Enclosed cabinet on mobile wheels
- 2200W 20A 240V (W454)
- 3750W 415V (W455)



240V or 415V
\$1,529 (W454 or W455)

Includes:
ST-12D Table Saw
Saw Guard Hood (W459)
Sliding Table (W458)

SAVE \$341 RRP

PACKAGE PRICE ONLY \$2,629
(240V K050 or 415V K052)

PS-1810 PANEL SAW

- Ø315mm saw blade / Ø90mm scribe
- 45° tilting arbor
- 1240mm ripping capacity
- Table 820 x 800mm (extensions 1260 x 800mm)
- 2.6 kW / 3.5hp (15A) 240V motor
- Includes mitre guide, push stick & overhead guard

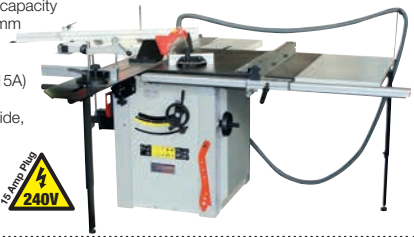

\$2,366 (W700)

RT-100 SLIDING ROUTER TABLE

- 785 x 560mm table
- Suitable for brand name routers
- Sliding aluminium table
- Table tilts 45° for easy access to mount router
- Adjustable guide & hold-down clamps
- 60mm dust collector port



\$465 (W4485)

SP-300 SPINDLE MOULDER

- 710 x 640mm table
- 30mm spindle
- Tilt arbor to 30°
- 4 speeds fwd/rev
- 3hp 240V 15A plug



\$2,029 (W640)

SPINDLE MOULDER CUTTER HEAD

- Suits 30mm spindles*
- 90mm body diameter
- 28 Blades (7 Profiles)
- 5100 - 6300rpm



\$158 (W647)

HPS-1600E PANEL SAW

- Ø254mm main saw blade • Ø120mm scoring saw blade
- 5.3hp 415V main motor • Tilt arbor to 45°
- 1270mm ripping capacity with fence
- Depth of cut: 70mm @ 90°, 48mm @ 45°
- Chromed and hardened solid rip fence rail



\$7,078 (W741)

**NEW
RELEASES**

FLOORING TILE SYSTEM

- High impact polymer • Clip together
- Tile size: 305 x 305 x 10mm



TYPE	COLOUR	QTY	PRICE	SKU
Tile	Black	22	\$65	(M806)
Tile	White	22	\$65	(M807)
Tile	Red	22	\$65	(M808)
Tile	Blue	22	\$65	(M809)
Tile	Yellow	22	\$65	(M810)
Edge/Lug	Black	10	\$18	(M813)
Edge	Black	10	\$18	(M814)
Corner	Black	4	\$9	(M815)

RR-5G RING ROLLING MACHINE

- High quality, precision machined rollers
- Heat-treated and hardened rolls
- 5 x 25mm flat bar capacity
- Ø6mm round bar capacity
- 343mm handle length



\$90
SAVE \$9.00

ORDER CODE: S680

HANDY WORKSHOP TIPS & TECHNIQUES GUIDE BOOK

- Chapter 1: Setting Up Your Workshop
- Chapter 2: Tools and Techniques
- Chapter 3: Measuring and Marking
- Chapter 4: Fasteners and Workshop Supplies
- Chapter 5: Drilling
- Chapter 6: Grinding, Polishing and Cutting
- Chapter 7: Working with Metal
- Chapter 8: Welding
- Chapter 9: Machining
- Chapter 10: Woodworking Machinery



\$35
SAVE

ORDER CODE: L345

HGC-1T BEAM CLAMP

- 1 Tonne capacity
- 75-230mm beam width
- Heavy duty construction
- Low headroom
- Quick installation by hand
- Complies to AS/NZS4991

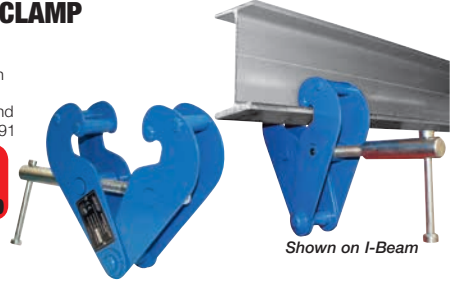

\$65
SAVE \$12.00

ORDER CODE: C146

Shown on I-Beam

SRG-12 CURVING ROLLS

- High quality carbon steel rollers
- Quick release top roller
- 305 x 1mm sheet metal capacity
- Ø32mm rollers



\$179
SAVE \$19.00

ORDER CODE: S267

600mm HEAVY DUTY MAGNETIC SWEEPER PICKUP TOOL

- For picking up metal shavings & other ferrous objects up to 15kg
- Quick release magnet
- 75 x 100 x 600mm body



\$75
SAVE \$13.00

ORDER CODE: M9991

**BEAT THE RUSH
BUY ONLINE**



NATIONWIDE
DELIVERY TO
YOUR DOOR

COMPARE
PRODUCTS
ONLINE

Online Orders Can
Be Picked Up From Your
Nearest Store!
Please call prior to collection

OVER
5,000
PRODUCTS
ONLINE

**BECOME A
MACHINERYHOUSE
MATE!**

**SIGN UP FOR
MATES RATES**

GAIN ACCESS TO:

- ✓ ONLINE PROMOS
- ✓ EXCLUSIVE OFFERS
- ✓ TRACK YOUR ORDERS

- ✓ PAPERLESS WARRANTY
- ✓ NEWSLETTERS
- ✓ LATEST RELEASES
- ✓ COMPETITIONS

MACHINERYHOUSE.COM.AU/SIGNUP

**HARE & FORBES
MACHINERYHOUSE**

**3 DAY
SALE THUR 27TH - SAT 29TH
MARCH 2014**

Rain Checks available...

Rain checks & prices valid until Sat 29th March 2014
All Prices Include GST unless ex GST is specified

machineryhouse.com.au