

GOODSON

Tools and Supplies for Engine Builders

2018



From the President's Desk

Change is inevitable. Sometimes change is good; sometimes change is not so good. Throughout Goodson's 73 year history, we've seen lots of change, but one thing has been constant — the way we treat you, our customers.

2018 marks the beginning of my tenure as company president. This is a challenge I am been looking forward to for a while. I promise, that while I may do some things a little different than my predecessors, how you, our customers, are treated will never change. We will continue to ship same-day, introduce new products annually, shape and size grinding wheels in-house, offer outstanding technical service and much more.

Thank you for your past business; we look forward to serving you with Full Service ... FAST!



*Roger Schumacher,
Goodson President*

Do You Have The Next New Product?

Here at Goodson we pride ourselves on releasing new and innovative products each and every year. How do we do it you ask? Simple... we listen to you, and by listening we learn where you have obstacles, or road blocks that slow you down or prevent you from doing a machining operation simply because the tool you need does not exist. We also look to you the professional engine builder because you see things before we do and some of our best new products have come right out the machine shop.

We have several ways to compensate you when you do have the "next new product" idea. We can have you manufacture the product it and sell that tool directly to Goodson. We can make the tool and pay you a royalty, or we will buy the idea from you and then later determine whether it has the ability to fulfill that need in the engine shop. So I am asking you right now.....do you have the next great idea? We want to know about it. Call or email Dave Monyhan because we know the next "great" new product is being developed right now in your shop.

GOODSON Ironclad Guarantee

Goodson won't risk losing your business for any reason. If you're not 100% satisfied with your purchase, we'll fix it, exchange it or credit your account for the purchase price. To send an item back, just include a note detailing the reason for the return and ship it back, freight pre-paid within 60 days. The only time we can't honor this guarantee is if a tool has been damaged through misuse or modification. All abrasives have a shelf life so we can only guarantee them for one year from the original purchase date.



Erik Shepard



Chris Jensen

Goodson Techxperts™ on staff to help you

When you have questions about product applications, tooling interchangeability, machining procedures, extending tool life, engine specs or any other technical topic, give the Goodson Tech Services Department a call.

A note from the Sales Manager

Over the last couple of years Goodson has positioned itself to be even stronger in its ability to service "you" our valued customer by acquiring various companies. It was just a couple of years ago that RADIAC became a brand and the Radiac products have greatly increased our ability to supply you with a variety of quality abrasives for all the different machines in your shop, especially for cam and crankshaft grinding. Also Goodson acquired the "seat grinding" division of Kwik-Way and now



David P. Monyhan,
National Sales Manager

produces all of the seat grinding guns, stone holders and heavy duty dresser. Most recently Goodson released the "extended nose" aircraft seat grinding guns to service the Lycoming, and Continental piston driven airplane engines. Currently Goodson is dimensionally correct to service most all engines from lawn-mowers to land-movers. Our commitment to you is unchallenged, we will continue to EARN your business, with the correctly dimensional products to full fill your machining and abrasive needs as we continue to grow. It is because of YOU that Goodson is able to do this.



Goodson Is Known By The Companies It Keeps

It's an old adage, that a person is known by the company they keep. Well that's true for companies as well. At Goodson, we strive to have the best quality products in stock for you, our valued customers. Sometimes Goodson will make mistakes and sometimes the vendors get behind with orders and don't ship on time. All companies have these issues each

and every day. At Goodson, we deal with these issues immediately and make every effort to make things right. After all, you have a choice of where to spend your shop supply dollars and we want to assure you that we are here to EARN that business.

In this year's catalog, you'll notice that Goodson now offers Kibblewhite Hard Parts for V-Twin engines. It was our

ability to serve you better that made the decision for us.

Kibblewhite hard parts are made in America and will be in stock when you need them.

American Made



RAPIDEX

A rapid-use index of product categories

Cylinder Head Rebuilding

Pilots.....	1-3
Valve Seat Work.....	4-22
Valve Refacing.....	23-25
Reamers.....	26-27
Valve Guide Resizing.....	28-30
Valve Guide Replacement.....	31-35
Valve Seal Work.....	36
Valve Spring Work.....	37-43
Cylinder Head Resurfacing.....	44-47
Crack Detection & Repair.....	48-53
Porting & Polishing.....	58-60

Cleaning, Assembly & Safety

Parts Storage & Organizers.....	61, 69
Wire Wheels & Brushes.....	62-63
Cleaning.....	62-69
Parts Baskets.....	68
Last Blast Paint & Metal Markers.....	70
Assembly Lubes.....	71
Flex-Hones®.....	72

Index Falls between pages 72 and 73

Coolants & Lubricants.....	73
----------------------------	----

Short Block Rebuilding

Cylinder Boring & Honing.....	74-81
Boring Bar Tooling & Supplies.....	74-75
Honing Stones.....	76-81
Rod Honing.....	82-83
Rod & Piston Work.....	84-89
Lifter Bore Tooling.....	91
Camshaft Work.....	92-93

Crankshaft/Flywheel Grinding

Crankshaft Grinding Wheels.....	94-95
Crankshaft Grinding & Polishing.....	96-100
Flywheel Grinding.....	102-104

Miscellaneous Tools

Diamond Dresser Tools.....	106-107
Machine Replacement Parts.....	108-109

Brake Service Tooling

Brake Tips & Holders.....	110-111
Brake Lathe Silencers.....	112
Brake Lathe Replacement Parts.....	113-115
Brake Lathe Mounting Adaptors.....	116

Measuring Tools

Dial Bore Gauges.....	118-119
Micrometers.....	120
Calipers & Dial Indicators.....	121

V-Twin & Metric Hard Parts

Seats & Seat Inserts.....	123
Valve Guides.....	124
Replacement Valves.....	125
Valve Springs.....	126-127

© Copyright 2018, Goodson Mfg. Co., Inc. All copy and illustrations are copyrighted. Absolutely no mechanical or electronic reproduction or use of any part is allowed without our prior written permission. Goodson reserves the right to correct printing errors. Prices are subject to change without notice.

ABRASIVES WARRANTY: Abrasives have a shelf life, therefore, all abrasives are warranted against manufacturing defects for 1 year from the date of original purchase.

CYLINDER HEAD REBUILDING
CLEANING, ASSEMBLY & SAFETY
SHORT BLOCK REBUILDING
CRANKSHAFT/ FLYWHEEL GRINDING
MISCELLANEOUS TOOLS & SUPPLIES
BRAKE SERVICE TOOLING
MEASURING TOOLS
V-TWIN & METRIC HARD PARTS



Aircraft Extended Nose Seat Grinding Motor

- Heavy Duty Electric Motor
- Extended drive unit allows easy access to aircraft engines including Lycoming and Continental
- Spline drive for use with Sioux-Style stone holders
- Available in 110V or 220V models
- 11,500 RPM (free speed) / 6982 RPM under load
- Weighs 12 lbs.
- 3/5 HP, 7.5 AMP motor

Description	Order No.
110V Extended Nose Unit	GL-XL110
220V Extended Nose Unit	SGL-XL220

Aviation Valve Seat Grinding Kits

Spline Drive Seat Grinding Kit includes everything listed below. Everything comes packed in a handy storage case. Kit includes:

Description	Order No.	Includes
110V Aviation Valve Seat Grinding Kit	SAV-110-KIT	▼
220V Aviation Valve Seat Grinding Kit	SAV-220-KIT	▼
110V Extended Drive Unit	SGL-XL110	x
220V Extended Drive Unit	SGL-XL220	x
Heavy Duty Valve Seat Wheel Dresser	031-1900-02	x x
Includes .375" Top Dressing Stand Pilot	031-0202-55	
Replacement Dresser Diamond	G-18	
.375" Sioux-Style Stone Holders (NEW!)	SX-375	2 2
Heavy Duty Plastic Storage Box	SG-CASE	x x
Stone Removal Tool	SX-SRT	x x
Leather Vibration Reducers (3 Pack)	SHW-3	x x
Bounce Spring Set	BSS-100	x x
.375" Bushing Set	3D-DB7	x x
.375" Top High Speed Steel Tapered Pilots		
	.343" Dia.	AP-5343
	.344" Dia.	AP-5344
	.345" Dia.	AP-5345
	.375" Dia.	AP-5375 x x
	.376" Dia.	AP-5376 x x
	.377" Dia.	AP-5377
	.406" Dia.	AP-5406
	.407" Dia.	AP-5407
	.408" Dia.	AP-5408
	.436" Dia.	AP-5436
	.437" Dia.	AP-5437 x x
	.438" Dia.	AP-5438 x x
	.439" Dia.	AP-5439 x x
	.498" Dia.	AP-5498
	.499" Dia.	AP-5499
	.500" Dia.	AP-5500 x x
	.501" Dia.	AP-5501 x x
	.502" Dia.	AP-5502 x x
General Purpose Valve Seat Stones		
	30° 1-3/4" Dia.	SX-1430-GP x x
	45° 1-3/4" Dia.	SX-1445-GP x x
	30° 2-1/2" Dia.	SX-2030-GP x x
	45° 2-1/2" Dia.	SX-2045-GP x x
Cool Blue Valve Seat Stones		
	00° 1-3/4" Dia.	SX-1400-CB x x
	00° 2-1/2" Dia.	SX-2000-CB x x
Finishing Valve Seat Stones		
	30° 1-3/4" Dia.	SX-1430-F x x
	45° 1-3/4" Dia.	SX-1445-F x x
	30° 2-1/2" Dia.	SX-2030-F x x
	45° 2-1/2" Dia.	SX-2045-F x x



.375" Top Pilot Spline Drive Valve Seat Stone Holder

- ¹¹/₁₆ x 16 thread
- Use your Sioux Style stones with your .375" Top Pilots
- Order No. SX-375

Extended Reach Valve Seat Run-Out Gauge for .375" Top Pilots

- Hardened guide bushings and contact point
- Quick thumb-screw set-up
- Jeweled bearing indicator reads to ± .050" with .001" precision
- Range: 1.00" to 2.50"
- OAL: 11³/₄"
- Order No. VSG-375-XL



CYLINDER HEAD REBUILDING
CLEANING, ASSEMBLY & SAFETY
SHORT BLOCK REBUILDING
CRANKSHAFT/ FLYWHEEL GRINDING
MISCELLANEOUS TOOLS & SUPPLIES
BRAKE SERVICE TOOLING
MEASURING TOOLS
V-TWIN & METRIC HARD PARTS

CYLINDER HEAD REBUILDING
CLEANING, ASSEMBLY & SAFETY
SHORT BLOCK REBUILDING
CRANKSHAFT/ FLYWHEEL GRINDING
MISCELLANEOUS TOOLS & SUPPLIES
BRAKE SERVICE TOOLING
MEASURING TOOLS
V-TWIN & METRIC HARD PARTS

Introducing: The GOODSON Custom Spring Bench



We've built these Spring Benches to our Customers' Specific Requirements.

Let Goodson Build One for You!

Every bench is custom made to YOUR needs for YOUR production lines. Do you work on a specific head or do a specific task over and over? Let Goodson help you do your job faster and easier.

**1 SPRING
AT A TIME**

**Contact Goodson With
Your Specs Today!
Ask for Dave,
Erik or Chris**

**16 SPRINGS
AT A TIME**

**What will
yours be?**

**8 SPRINGS
AT A TIME**

American Made



3-D Fast Cut™ System Honda Clone Kit

- Fits a 1" ball head driver • Kit includes everything you need to machine your Honda Race Kart Engines such as 6.5HP Honda GX200 or X Clone DUCAR Box Stock Motor
- More Ball Head Drivers on page 4

Description	Order No.	
Honda Cone Kit	3 D-CLONE-KIT ▼	
3D Ball Head for .236"/6mm Pilot (2.56"L)	3D-BH236	x
Cutter Tips 45°/1.0mm	FT-5043A-HD	x
45°/1.4mm	IFT-4524A-HD	x
Tip Holder .550"-.984" Range	3DH-1999M	x
Bounce Springs Short 1.050" / 26.7mm	3D-BS1	x
.340" ID Medium 1.540" / 39.2 mm	3D-BS3	x
.420" OD Long 2.550" / 64.8 mm	3D-BS2	x
Bounce Spring Bushing (1)	3D-BB1	x
Bounce Spring Spacer 22mm long	3D-BB2	x
.2170" Carbide Pilot .236" Top	PCT-2170M	x
Valve Guide Level (3" vial)	VGL-100	x
3-D Fast Cut™ Accessories		
Replacement 2.5mm Hex Key	3D-2.5	x
Replacement Screws for Ball Head	3D-BH1032	
Cutter Blade Mounting Screw	FT-SCREW	
Blade Wrench	FT-WRENCH	x
Tool Setting Fixture	3D-TSFA	x
Bridgeport & DCM Ball Head Driver	3D-3/4SS	

Solid Carbide Single Pass Boring Tool for Kwik-Way

- Greater fracture resistance than most carbide bits • Ideal for hard alloys or interrupted cuts in automotive, high performance, marine, motorcycle and diesel engines
- Replaces OE Kwik-Way
- $\frac{5}{16}$ " diameter x 1.200 OAL

Description	Order No.
Single Pass Boring Tool	KWL-1071
Diamond Lap - $3\frac{1}{4}$ " OD, $\frac{1}{2}$ " ID	LP-KW
Lapping Oil - 4 oz. (118.3mL)	LP-LO-4
Dressing Stick	LP-DS

SX-375

KW-375



.375" Top Pilot Valve Seat Stone Holders

- Ball bearing stone holders
- Use your favorite valve seat stones with your .375" Top pilots • Two styles to choose from

Drive Style	Thread	Order No.
Spline (Star)	$\frac{11}{16}$ " x 16	SX-375
Hex	$\frac{13}{16}$ x 13	KW-375



Ergonomically designed trigger and composite grip for unmatched user comfort

Available in hex drive and spline (star) drive units

1/4" air inlet

90° Angle High-Speed Air Driver

- 2 models available - spline drive or hex drive
- 11,000 RPM motor
- 5/8" - 11 spindle
- 1/4" air inlet • 6 CFM • Rear exhaust
- Weighs 2.25 lbs. • Measures 8.75" long
- Composite grip and trigger are ergonomically designed for unmatched user comfort
- Replaces the 1792AG Grinder

Description	Order No.
Sioux-Style (Spline Drive)	AG-SX90
Kwik-Way Style (Hex Drive)	AG-KW90

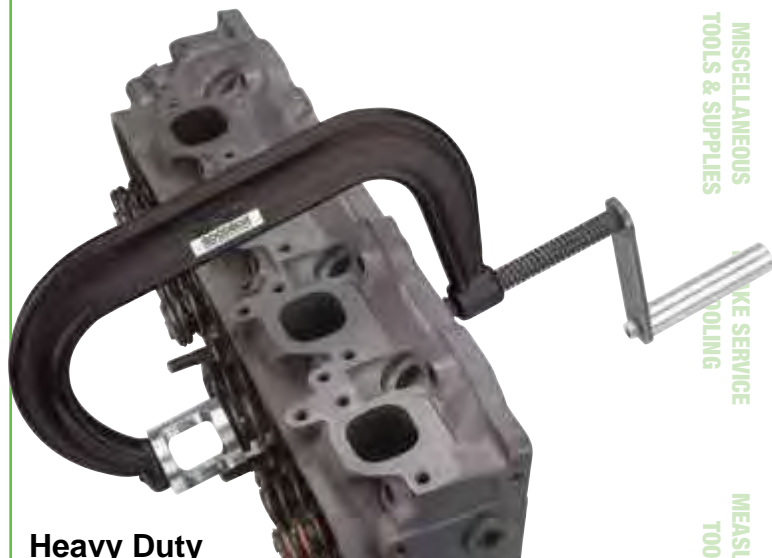

Heavy Duty Manual Valve Spring Compressor

- Drop forged steel frame
- Open receiver design allows for quick access to keepers
- Accommodates springs up to $1\frac{3}{4}$ " diameter
- 8 $\frac{1}{2}$ " throat • 6" deep
- Compresses springs up to 1000 pounds

Description	Order No.
Manual Valve Spring Compressor	CF-1300
Small Replacement Foot	CF-1300SF
Large Replacement Foot	CF-1300LF

CYLINDER HEAD REBUILDING
CLEANING, ASSEMBLY & SAFETY
SHORT BLOCK REBUILDING
FLYWHEEL GRINDING
CRANKSHAFT/ TOOLS & SUPPLIES
MISCELLANEOUS
VALVE SERVICE
MEASURING TOOLS
V-TWIN & METRIC HARD PARTS



"In addition to the wide selection of tools and supplies found in this catalog, we have access to hundreds of hard-to-find tools not shown due to their specialized nature. If you're looking for a special tool, call us and we'll help you find it."
- Wendy, Goodson Purchasing, 31 years of service



SUNNEN
Water-Based Honing Coolant Concentrate

- Contains no mineral oil, sulfur or chlorine
- Superior to conventional honing oils in reducing or eliminating workpiece temperature build-up
- Suitable as a grinding coolant or general purpose metal working fluid for both ferrous and non-ferrous parts
- Contains no dangerous nitrates, nitrites, PCBs, PTTBA, Mercurials or Phenols
- Has the ability to "self-clean" resulting in longer coolant life and consistent surface finish
- Two formulas to choose from
- SCC-205 is formulated for honing hardened steel using fine grit diamond plated tools or metal bond abrasives
- SCC-605 is formulated for honing cast iron
- 5 Gallon Pails

Description	Order No.
For Hardened Steel	SCC-205
For Cast Iron	SCC-605

SUNNEN

Valve Guide Gauge Set

- The only way to be sure clearance is correct is to GAUGE IT!
- Check all types of guides for size and roundness FAST
- Set up and measure valve guide IDs quickly and easily
- Complete set includes gauge, 3 probes (.312", .344" and .375"), hex wrench, setting fixture and metal storage case with spaces for all components • Dial calibrated in .0002" increments



Description	Order No.	Incl.			
Complete Valve Guide Gauge Set	P-310	▼			
Valve Guide Gauge	P-300	x			
Setting Fixture	P-610A	x			
Valve Guide Probes	Size	Range in.	mm		
Build Your Own	.236"	.244" to .264"	5.69 to 6.71	P-236	
Valve Guide Gauge	.250"	.238" to .278"	6.05 to 7.05	P-250	
Set! Order the	.281"	.269" to .309"	6.83 to 7.85	P-281	
Valve Guide Gauge	.312"	.300" to .340"	7.62 to 8.64	P-312	x
(P-300), Setting	.344"	.332" to .372"	8.43 to 9.45	P-344	x
Fixture (P-610A)	.375"	.363" to .403"	9.22 to 10.24	P-375	x
and the Valve	.406"	.394" to .434"	10.01 to 11.02	P-406	
Guide Probe you	.438"	.426" to .466"	10.82 to 11.84	P-438	
need.	.469"	.457" to .497"	11.61 to 12.62	P-469	
	.500"	.488" to .528"	12.40 to 13.41	P-500	



GR-3000

Small Diameter Dial Bore Gauge & Accessories

- Dial Bore Gauge assembly consists of .0001" (.002mm) reading indicator, probe retractor and probe retainer bushing in a reinforced nylon insulating shroud
- Dial Bore Gauge diameter range: 0.054" to 0.535" (1.37 to 13.6mm)

- How to Order:**
- 1 - Gauge (GR-3000)
 - 2 - Probe
 - 3 - Transfer Pin
 - 4 - Probe Extension

Description	Order No.		
1-Small Diameter Dial Bore Gauge	GR-3000		
2-Adjustable Probes	Range in	mm	
	.165" to .189"	5.69 to 6.71	G-1180
	.185" to .209"	6.05 to 7.05	G-1200
	.205" to .228"	6.83 to 7.85	G-1220
	.224" to .248"	7.62 to 8.64	G-1240
	.244" to .268"	8.43 to 9.45	G-1260
	.264" to .287"	9.22 to 10.24	G-1280
	.283" to .307"	10.01 to 11.02	G-1300
	.303" to .327"	10.82 to 11.84	G-1320
	.323" to .346"	11.61 to 12.62	G-1340
	.343" to .366"	12.40 to 13.41	G-1360
	.362" to .386"	12.40 to 13.41	G-1380
3-Transfer Pin (fits all probes above)	G-2264		
4-Probe Extension	KZIX-3500		
Setting Fixture for .054" to 2.00" Range	SCF-502		
Size Setting Adaptor	CF-540		

Looking for a
SUNNEN **item**
that's not listed in the
catalog?
Give Goodson a call.
We get weekly deliveries
from Sunnen so we can
special order whatever
you need.

CYLINDER HEAD REBUILDING
CLEANING, ASSEMBLY & SAFETY
SHORT BLOCK REBUILDING
CRANKSHAFT/ FLYWHEEL GRINDING
MISCELLANEOUS TOOLS & SUPPLIES
BRAKE SERVICE TOOLING
MEASURING TOOLS
V-TWIN & METRIC HARD PARTS

Goodson exclusive

Ergonomically designed grip made of billet aluminum

Water Pressure Button
Air Pressure Button

36" Stainless Steel wand will not corrode

Threaded to make brush changes quick and easy

Air/Water outlet holes are drilled in a spiral pattern to create a swirling vortex to enhance the wand's cleaning power.



Wand design creates a vortex action to power scrub the oil galleries clean

Connect the Water Connect the Air Select a Brush You're Set to Clean

3 Brush Sizes are standard with this kit — $\frac{5}{8}$ ", $\frac{1}{2}$ " and $\frac{3}{8}$ " diameter



High Pressure Oil Gallery Cleaning System

Aggressively clean the oil galleries in most engines — Gas to Diesel, Stock to High-Performance

- Ergonomically designed handle
- Incorporates the aggressive cleaning action of a stainless steel wire brush with the hydro action of a specially designed water manifold to be used in conjunction with your shop air to quickly and easily clean the oil gallery holes in gas and diesel engines
- Standard Kit includes a 36"L cleaning wand with pistol grip air/water manifold and 3 brushes ($\frac{3}{8}$ ", $\frac{1}{2}$ " & $\frac{5}{8}$ " dia.)

Description	Order No.	Incl.
Standard Kit	HPOG-1000	▼
$\frac{3}{8}$ " Cleaning Brush	HPOG-375	x
$\frac{1}{2}$ " Cleaning Brush	HPOG-500	x
$\frac{5}{8}$ " Cleaning Brush	HPOG-625	x
36" Cleaning Wand	HPOG-W36	x
18" Cleaning Wand (optional)	HPOG-W18	



tech tips

from the techxperts™

High Pressure Oil Gallery Cleaning System Operating Procedure

- 1 - Choose the correct size stainless steel brush. Sizes to choose from are: $\frac{3}{8}$ ", $\frac{1}{2}$ " and $\frac{5}{8}$ ". Other sizes can be special ordered.
- 2 - Attach the brush to the end of the wand using the threaded end. Hand tighten only. Do not over-tighten.
- 3 - Connect to a hot or cold water source. Be sure not to exceed 110°F (43.3°C).

- 4 - Connect to an air source. 125 PSI max.
- 5 - Lay the engine block horizontally and insert the cleaning brush into the bore you are going to clean. Move the wand back and forth to loosen the grime and build-up in the oil gallery.
- 6 - Press the trigger for the water to flush the oil gallery. The wand design creates a vortex to loosen and blast debris from the oil gallery. If using hot water, use gloves to protect yourself from burns.
- 7 - Add air pressure to finish the cleaning process and force any residual water and debris from the oil gallery.
- 8 - Repeat steps 5 to 7 for each oil gallery.

NOTE: You can use any combination of brush, water and air that suits your application.

CYLINDER HEAD REBUILDING
CLEANING, ASSEMBLY & SAFETY
SHORT BLOCK REBUILDING
FLYWHEEL GRINDING
CRANKSHAFT/ MISCELLANEOUS TOOLS & SUPPLIES
BRAKE SERVICE TOOLING
MEASURING TOOLS
V-TWIN & METRIC HARD PARTS



CYLINDER HEAD REBUILDING
CLEANING, ASSEMBLY & SAFETY
SHORT BLOCK REBUILDING
CRANKSHAFT/ FLYWHEEL GRINDING
MISCELLANEOUS TOOLS & SUPPLIES
BRAKE SERVICE TOOLING
MEASURING TOOLS
V-TWIN & METRIC HARD PARTS

Black Diamond™ Replacement Valves for Milwaukee-Eight™ Heads

- Black Nitro-neg Stems
- One-piece forged stainless steel valves impregnated by a special German process to improve wear properties and reduce friction
- Provide resistance to corrosion and wear superior to hard chromium and electrolysis nickel plating

Type	Head Diameter	Stem Dia.	Tulip Radius	Tulip Angle	Overall Length	Black Diamond™ Triple Groove
Intake	1.571" (39.90mm)	0.2347"	0.235"	10°	4.015"	20-21012
Intake	1.591" (40.40mm)	0.2347"	0.235"	10°	4.015"	20-21015
Intake	1.630" (41.40mm)	0.2347"	0.235"	10°	4.055"	20-21013
Exhaust	1.264" (32.11mm)	0.2342"	0.460"	24°	4.050"	20-21016
Exhaust	1.184" (32.11mm)	0.2342"	0.460"	24°	4.050"	20-21017

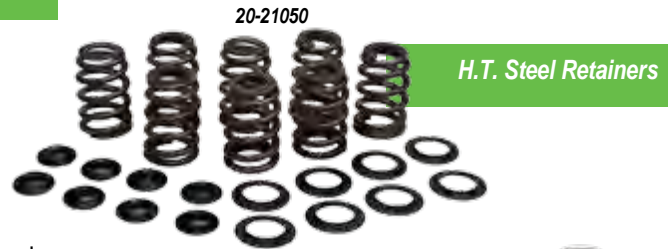
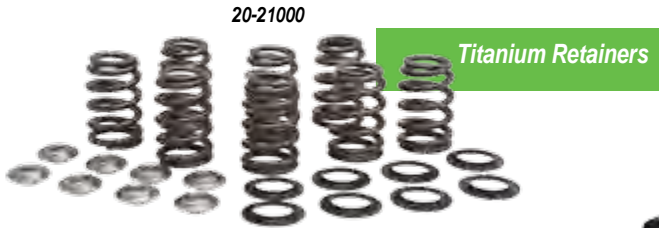
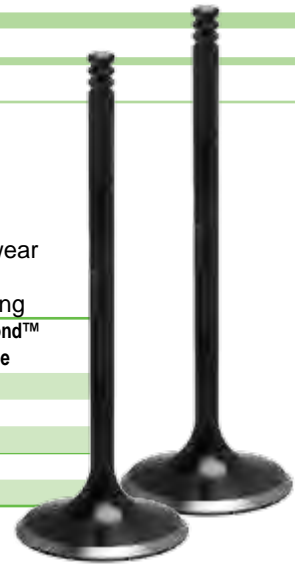

Milwaukee-Eight™ Beehive Valve Spring Kits

- Advanced spring design with special attention to cam and spring harmonics, stress, mass and operating RPM
- Premium-grade, super clean ground chrome silicon wire
- Heat-treated and shot peened for long life
- Kits include 8 Retainers, 8 Springs and 8 Basewashers
- Kit 20-21200 does NOT require Basewashers, it is compatible with OE seals or Order No. 71046 (below)

Max Lift	Installed Height	Seat Pressure	Open Pressure	@ Lift	Order No.
.465"	1.410"	80 lbs.	212 lbs.	.465"	20-21000
.465"	1.410"	80 lbs.	212 lbs.	.465"	20-21050
.550"	1.550"	104 lbs.	230 lbs.	.550"	20-21200

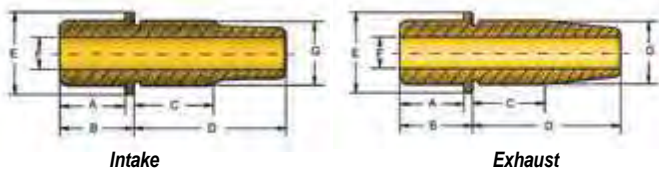

Milwaukee-Eight™ Manganese Bronze Valve Guides

- Use with 6mm seals (71046 or OE)

Intake							Manganese Bronze	Cast Iron
A	B	C	D	E	F	G		
.480"	.545"	.540"	1.110"	.600"	.2347"	.4750"	20-21020M	20-21020C
						.4760"	20-21021M	20-21021C
						.4770"	20-21022M	20-21022C
						.4850"	20-21029M	20-21029C
Exhaust							Manganese Bronze	Cast Iron
A	B	C	D	E	F	G		
.480"	.545"	.600"	1.110"	.600"	.2342"	.4750"	20-21030M	20-21030C
						.4760"	20-21031M	20-21031C
						.4770"	20-21032M	20-21032C
						.4850"	20-21039M	20-21039C

MSRP ea.



Milwaukee-Eight™ Tophat Valve Seal

- Designed to fit Milwaukee-Eight™ Valve Guides
- 6.0mm Stem Diameter
- 0.712" Overall Length • 1.170" Seal OD
- For intake and exhaust • 16 pack
- Order No. 71046



Look for additional Valve Train Hard Parts for Harley-Davidson Applications starting on page 123!

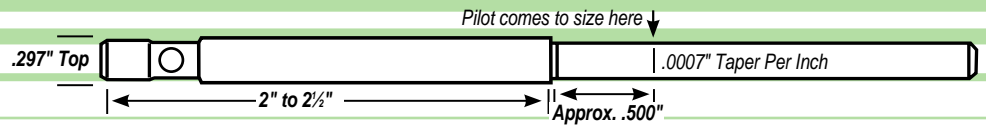

.297" Solid-Tapered High Speed Steel Pilots

Inch	mm	OAL	Order No.	Inch	mm	OAL	Order No.	Inch	mm	OAL	Order No.	Inch	mm	OAL	Order No.				
.1496"	3.80	3.375"	P-1149N	.1779"	4.52	4.50"	P-1178N	.2173"	5.52	4.50"	P-1217N	.2490"	6.32	4.50"	P-1249N	.2810"	7.14	4.50"	P-1281N
.1574"	4.00	4.50"	P-1158N	.1968"	5.00	4.50"	P-1197N	.2362"	6.00	4.50"	P-1236N	.2500"	6.35	4.50"	P-1250N	.3120"	7.92	4.50"	P-1312N
.1582"	4.02	4.50"	P-1159N	.1976"	5.02	4.50"	P-1198N	.2370"	6.02	4.50"	P-1237N	.2510"	6.37	4.50"	P-1251N	.3130"	7.95	4.50"	P-1313N
.1771"	4.50	4.50"	P-1177N	.2165"	5.50	4.50"	P-1216N	.2381"	6.05	4.50"	P-1238N	.2598"	6.60	5.25"	P-1260N	.3149"	8.00	4.50"	P-1315N
												.2755"	7.00	4.50"	P-1275N	.3427"	8.72	4.50"	P-1343N

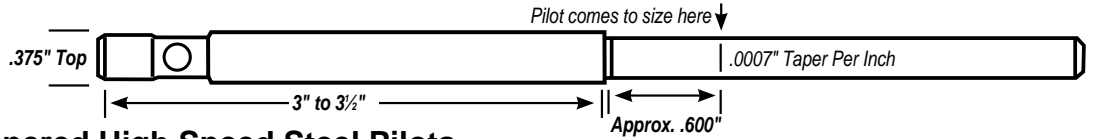

.375" Solid-Tapered High Speed Steel Pilots

Inch	mm	OAL	Order No.	Inch	mm	OAL	Order No.	Inch	mm	OAL	Order No.	Inch	mm	OAL	Order No.				
.1771"	4.50	6.00"	P-5177N	.2490"	6.32	6.00"	P-5249N	.2952"	7.50	6.00"	P-5295N	.3417"	8.67	6.50"	P-5341N	.3780"	9.60	7.00"	P-5378N
.1960"	4.98	6.00"	P-5196N	.2500"	6.35	6.00"	P-5250N	.2960"	7.52	6.00"	P-5296N	.3427"	8.70	6.50"	P-5342N	.3790"	9.62	7.00"	P-5379N
.1968"	5.00	6.00"	P-5197N	.2510"	6.37	6.00"	P-5251N	.3095"	7.86	6.00"	P-5309N	.3437"	8.72	6.50"	P-5343N	.3820"	9.70	7.00"	P-5382N
.1976"	5.02	6.00"	P-5198N	.2559"	6.50	6.00"	P-5256N	.3105"	7.88	6.00"	P-5310N	.3447"	8.75	6.50"	P-5344N	.3937"	10.00	7.00"	P-5394N
.2165"	5.50	6.00"	P-5216N	.2566"	6.52	6.00"	P-5257N	.3115"	7.91	6.00"	P-5311N	.3457"	8.78	6.50"	P-5345N	.4331"	11.00	7.75"	P-5433N
.2173"	5.52	6.00"	P-5217N	.2590"	6.58	6.00"	P-5258N	.3125"	7.93	6.00"	P-5312N	.3543"	9.00	6.50"	P-5354N	.4365	11.08	7.75"	P-5436N
.2185"	5.55	6.00"	P-5218N	.2598"	6.60	6.00"	P-5260N	.3135"	7.96	6.00"	P-5313N	.3551"	9.02	6.50"	P-5355N	.4375"	11.11	7.75"	P-5437N
.2354"	5.98	6.00"	P-5235N	.2748"	6.98	6.00"	P-5274N	.3145"	7.98	6.00"	P-5314N	.3587"	9.11	6.50"	P-5358N	.4385"	11.13	7.75"	P-5438N
.2362"	6.00	6.00"	P-5236N	.2756"	7.00	6.00"	P-5275N	.3149"	8.00	6.00"	P-5315N	.3730"	9.47	7.00"	P-5373N	.4395"	11.16	7.75"	P-5439N
.2370"	6.02	6.00"	P-5237N	.2763"	7.02	6.00"	P-5277N	.3165"	8.03	6.00"	P-5316N	.3740"	9.49	7.00"	P-5374N				
.2381"	6.05	6.00"	P-5238N	.2775"	7.05	6.00"	P-5278N	.3397"	8.62	6.50"	P-5339N	.3750"	9.52	7.00"	P-5375N	.5000"	12.70	7.75"	P-5500N
.2393"	6.08	6.00"	P-5239N	.2792"	7.09	6.00"	P-5279N	.3407"	8.65	6.50"	P-5340N	.3760"	9.55	7.00"	P-5376N	.5010"	12.72	7.75"	P-5501N
												.3770"	9.57	7.00"	P-5377N	.5020"	12.75	7.75"	P-5502N

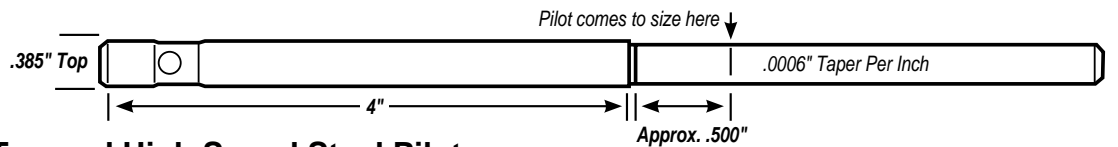

.385" Solid-Tapered High Speed Steel Pilots

Inch	mm	OAL	Order No.	Inch	mm	OAL	Order No.	Inch	mm	OAL	Order No.	Inch	mm	OAL	Order No.				
.2165"	5.50	7.50"	P-5216S	.2510"	6.38	7.50"	P-5251S	.3130"	7.95	7.50"	P-5313S	.3450"	8.76	7.50"	P-5345S	.5000"	12.70	8.75"	P-5500S
.2173"	5.52	7.50"	P-5217S	.2598"	6.60	7.50"	P-5260S	.3141"	7.98	7.50"	P-5314S	.3543"	9.00	7.50"	P-5354S	.5010"	12.73	8.75"	P-5501S
.2350"	5.97	7.50"	P-5235S	.2744"	6.97	7.50"	P-5274S	.3149"	8.00	7.50"	P-5315S	.3550"	9.02	7.50"	P-5355S	.5020"	12.75	8.75"	P-5502S
.2362"	6.00	7.50"	P-5236S	.2755"	7.00	7.50"	P-5275S	.3161"	8.03	7.50"	P-5316S	.3560"	9.04	7.50"	P-5356S				
.2370"	6.02	7.50"	P-5237S	.2763"	7.02	7.50"	P-5276S	.3170"	8.05	7.50"	P-5317S	.3580"	9.09	7.50"	P-5358S				
.2381"	6.05	7.50"	P-5238S	.2771"	7.04	7.50"	P-5277S	.3410"	8.66	7.50"	P-5341S	.3730"	9.47	7.50"	P-5373S				
.2500"	6.35	7.50"	P-5250S	.2779"	7.06	7.50"	P-5278S	.3420"	8.68	7.50"	P-5342S	.3740"	9.50	7.50"	P-5374S				
				.3100"	7.87	7.50"	P-5310S	.3430"	8.71	7.50"	P-5343S	.3750"	9.53	7.50"	P-5375S				
				.3125"	7.94	7.50"	P-5312S	.3440"	8.73	7.50"	P-5344S	.3760"	9.55	7.50"	P-5376S				

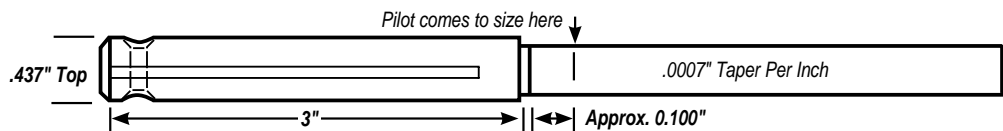

.437" Solid-Tapered High Speed Steel Pilots

Inch	mm	OAL	Order No.	Inch	mm	OAL	Order No.	Inch	mm	OAL	Order No.	Inch	mm	OAL	Order No.				
.2160"	5.50	6.75"	P-5216K	.2381"	6.05	6.75"	P-5238K	.3125"	7.94	6.75"	P-5312K	.3427"	8.70	6.75"	P-5342K	.3730"	9.47	6.75"	P-5373K
.2170"	5.52	6.75"	P-5218K	.2755"	7.00	6.75"	P-5275K	.3135"	7.96	6.75"	P-5313K	.3437"	8.73	6.75"	P-5343K	.3740"	9.50	6.75"	P-5374K
.2354"	5.98	6.75"	P-5235K	.2760"	7.02	6.75"	P-5276K	.3145"	7.98	6.75"	P-5314K	.3440"	8.74	8.00"	P-5344K	.3750"	9.52	6.75"	P-5375K
.2362"	6.00	6.75"	P-5236K	.2775"	7.05	6.75"	P-5277K	.3150"	8.00	6.75"	P-5315K	.3457"	8.78	6.75"	P-5345K				
.2370"	6.02	6.75"	P-5237K	.2787"	7.08	6.75"	P-5279K	.3157"	8.02	6.75"	P-5316K	.3543"	9.00	6.75"	P-5354K				
				.3100"	7.88	6.75"	P-5310K	.3169"	8.05	6.75"	P-5317K	.3550"	9.03	6.75"	P-5355K				
				.3115"	7.90	6.75"	P-5311K	.3417"	8.68	6.75"	P-5341K	.3587"	9.09	6.75"	P-5358K				

CYLINDER HEAD
REBUILDING
CLEANING,
ASSEMBLY & SAFETY
SHORT BLOCK
REBUILDING
FLYWHEEL, GRINDING
CRANKSHAFT/
TOOLS & SUPPLIES
MISCELLANEOUS
BRAKE SERVICE
TOOLING
MEASURING
TOOLS
V-TWIN & METRIC
HARD PARTS



.375" Top Expanding Pilots

• Expand up to .020" (.51mm) • Includes Collet & Expander

Size	mm	Range	Pilot	Collet	Expander
.216"	5.50	.213"-.233"	P-5.5MMNX	P-216-COLLET	P-1216-EXP
.236"	6.00	.233"-.253"	P-6MMNX	P-6MM-COLLET	P-1236-EXP
.250"	6.35	.247"-.267"	P-250NX	P-250-COLLET	P-1250-EXP
.256"	6.50	.253"-.273"	P-6.5MMNX	P-65MM-COLLET	P-6.5MM-EXP
.275"	7.00	.272"-.292"	P-7MMNX	P-7MM-COLLET	P-7MM-EXP
.312"	7.92	.309"-.329"	P-312NX	P-312-COLLET	P-343-EXP
.335"	8.50	.330"-.350"	P-8.5MMNX	P-343-COLLET	P-343-EXP
.343"	8.70	.340"-.360"	P-343NX	P-343-COLLET	P-343-EXP
.354"	9.00	.350"-.370"	P-9MMNX	P-375-COLLET	P-375-EXP
.375"	9.50	.372"-.392"	P-375NX	P-375-COLLET	P-375-EXP
.393"	10.00	.390"-.410"	P-10MMNX	P-10MM-COLLET	P-10MM-EXP
.437"	11.00	.430"-.450"	P-11MMNX	P-11MM-COLLET	P-11MM-EXP
.453"	11.50	.450"-.470"	P-453NX	P-11MM-COLLET	P-11MM-EXP
.472"	12.00	.469"-.489"	P-12MMNX	P-12MM-COLLET	P-12MM-EXP



.385" Top Expanding Pilots

• Expand up to .020" (.51mm) • Includes Collet & Expander

Size	mm	Range	Pilot	Collet	Expander
.236"	6.00	.233"-.253"	P-6MMSX	P-6MM-COLLET	P-1236-EXP
.250"	6.35	.247"-.267"	P-250SX	P-250-COLLET	P-1250-EXP
.256"	6.50	.253"-.273"	P-6.5MMSX	P-65MM-COLLET	P-6.5MM-EXP
.275"	7.00	.272"-.292"	P-7MMSX	P-7MM-COLLET	P-7MM-EXP
.281"	7.10	.278"-.298"	P-281SX	P-281-COLLET	P-281-EXP
.295"	7.50	.290"-.310"	P-7.5MMSX	P-281-COLLET	P-281-EXP
.312"	7.92	.309"-.329"	P-312SX	P-312-COLLET	P-343-EXP
.335"	8.50	.330"-.350"	P-8.5MMSX	P-343-COLLET	P-343-EXP
.343"	8.70	.340"-.360"	P-343SX	P-343-COLLET	P-343-EXP
.354"	9.00	.350"-.370"	P-9MMSX	P-375-COLLET	P-375-EXP
.375"	9.50	.372"-.392"	P-375SX	P-375-COLLET	P-375-EXP
.393"	10.00	.390"-.410"	P-10MMSX	P-10MM-COLLET	P-10MM-EXP
.406"	10.30	.403"-.423"	P-406SX	P-10MM-COLLET	P-10MM-EXP
.437"	11.00	.430"-.450"	P-11MMSX	P-11MM-COLLET	P-11MM-EXP
.453"	11.50	.450"-.470"	P-453SX	P-11MM-COLLET	P-11MM-EXP
.472"	12.00	.469"-.489"	P-12MMSX	P-12MM-COLLET	P-12MM-EXP
.500"	12.70	.497"-.517"	P-500SX	P-12MM-COLLET	P-12MM-EXP

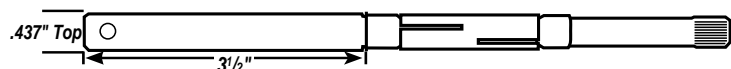

.437" Top Expanding Pilots

• Expand up to .020" (.51mm) • Includes Collet & Expander

Size	mm	Range	Pilot	Collet	Expander
.236"	6.00	.233"-.253"	P-6MMKX	P-6MM-COLLET	P-1236-EXP
.275"	7.00	.272"-.292"	P-7MMKX	P-7MM-COLLET	P-7MM-EXP
.312"	7.92	.309"-.329"	P-312KX	P-312-COLLET	P-343-EXP
.343"	8.70	.340"-.360"	P-343KX	P-343-COLLET	P-343-EXP
.375"	9.50	.372"-.392"	P-375KX	P-375-COLLET	P-375-EXP
.393"	10.00	.390"-.410"	P-10MMKX	P-10MM-COLLET	P-10MM-EXP
.437"	11.00	.430"-.450"	P-11MMKX	P-11MM-COLLET	P-11MM-EXP
.453"	11.50	.450"-.470"	P-453KX	P-11MM-COLLET	P-11MM-EXP

tech tips

from the techexperts™

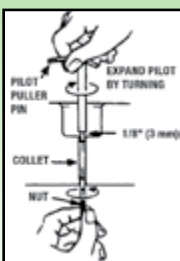

Setting your expanding pilot

- 1 Select an expanding pilot that is the same diameter as the valve guide ID
- 2 Insert the pilot into the valve guide making sure that the expanding section of the pilot (collet) is completely within the valve guide. The pilot will not center properly and may be damaged if the collet extends outside of the valve guide.
- 3 Pilot shoulder should be about 1/8" above the valve guide
- 4 Turn the pilot while holding the nut at the opposite end. This will expand the collet and secure the pilot into position

NOTE: DO NOT use Expanding Pilots with multi-angle valve seat cutting systems (ie: 3-D Fast Cut)

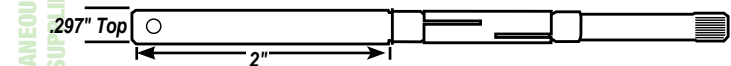

.297" Top Expanding Pilots

• Expand up to .020" (.51mm) • Comes with Collet & Expander • High Speed Steel

Size	mm	Range	Pilot	Collet	Expander
.2165"	5.50	.213"-.233"	P-1216NX	P-216-COLLET	P-1216-EXP
.2362"	6.00	.233"-.253"	P-1236NX	P-6MM-COLLET	P-1236-EXP
.2500"	6.35	.247"-.267"	P-1250NX	P-250-COLLET	P-1250-EXP
.2756"	7.00	.275"-.294"	P-1275NX	P-275-COLLET	P-275-EXP
.2810"	7.14	.278"-.298"	P-1281NX	P-281-COLLET	P-1281-EXP
.3120"	7.92	.309"-.329"	P-1312NX	P-312-COLLET	P-1312-EXP
.3149"	8.00	.312"-.332"	P-1315NX	P-312-COLLET	P-1315-EXP

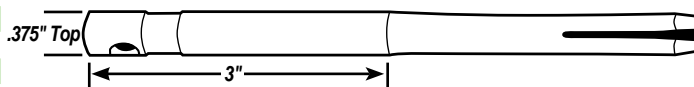

.375" Top Leveling Split Pilots

- Centers deep in the valve guide
- Includes a groove for bearing-style stone holders
- Compensates for wear up to .010"
- Replace KO Lee

Size	Range	mm	OAL	Order No.
5.0mm	.193"-.203"	4.90-5.84	5.25"	P-5MM-VNX
5.5mm	.213"-.223"	5.41-5.66	5.00"	P-5.5MM-VNX
6.0mm	.233"-.243"	5.91-6.17	5.00"	P-6MM-VNX
0.250"	.247"-.257"	6.27-6.52	5.25"	P-250-VNX
7.0mm	.273"-.283"	6.93-7.18	5.25"	P-7MM-VNX
0.312"	.299"-.319"	7.59-8.10	5.25"	P-312-VNX
8.0mm	.312"-.322"	7.92-8.17	5.25"	P-8MM-VNX
0.343"	.340"-.350"	8.63-8.88	5.25"	P-343-VNX
9.0mm	.351"-.361"	8.91-9.16	5.25"	P-9MM-VNX
0.375"	.372"-.382"	9.44-9.70	6.00"	P-375-VNX
0.437"	.434"-.444"	11.02-11.27	6.25"	P-437-VNX

.375" Extended Length Expanding Pilots

• Expand up to .020" (.51mm) • Comes with Collet & Expander • High Speed Steel

Size	mm	Range	Pilot	Collet	Expander
.3120"	7.92	.309"-.329"	P-312NXL	P-312-COL	P-343-EXP
.3430"	8.71	.340"-.360"	P-343NXL	P-343L-COL	P-343-EXP
.3750"	9.52	.372"-.392"	P-375NXL	P-375L-COL	P-375-EXP
.4060"	10.31	.403"-.423"	P-406NXL	P-406L-COL	P-10MM-EXP
.4527"	11.50	.450"-.470"	P-453NXL	P-453L-COL	P-453-EXP
.4724"	12.00	.469"-.489"	P-12MMNXL	P-12MML-COL	P-12MM-EXP
.5000"	12.70	.497"-.517"	P-500NXL	P-500L-COL	P-12MM-EXP

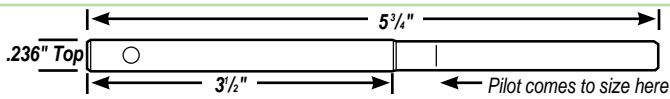

.236" Top Tapered Carbide Pilots

- Less deflection under stress • Due to the brittle nature of carbide we can only warranty carbide pilots for size

Inch	mm	Order No.	Inch	mm	Order No.	Inch	mm	Order No.
.1559"	3.96	PCT-1560M	.1968"	5.00	PCT-1970M	.2560"	6.50	PCT-2560M
.1566"	3.98	PCT-1570M	.1980"	5.03	PCT-1980M	.2570"	6.53	PCT-2570M
.1575"	4.00	PCT-1575M	.2161"	5.49	PCT-2160M	.2578"	6.55	PCT-2580M
.1578"	4.01	PCT-1580M	.2170"	5.52	PCT-2170M	.2590"	6.58	PCT-2590M
.1759"	4.47	PCT-1760M	.2181"	5.54	PCT-2180M	.2598"	6.60	PCT-2600M
.1771"	4.50	PCT-1770M	.2350"	5.97	PCT-2350M	.2756"	7.00	PCT-2756M
.1779"	4.52	PCT-1780M	.2358"	5.99	PCT-2360M	.2759"	7.01	PCT-2760M
.1960"	4.98	PCT-1960M	.2370"	6.02	PCT-2370M	.2763"	7.02	PCT-2765M
						.2771"	7.04	PCT-2770M

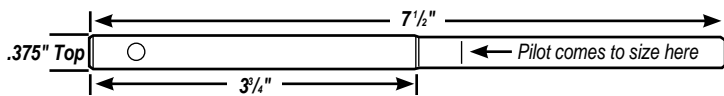

.375" Top Tapered Carbide Pilots

Inch	mm	Order No.	Inch	mm	Order No.	Inch	mm	Order No.
.1575"	4.00	PCT-1575	.2370"	6.02	PCT-2370	.3150"	8.00	PCT-3150
.1771"	4.50	PCT-1770	.2598"	6.60	PCT-2600	.3422"	8.70	PCT-3420
.1968"	5.00	PCT-1970	.2756"	7.00	PCT-2756	.3433"	8.72	PCT-3430
.2165"	5.50	PCT-2165	.2759"	7.01	PCT-2760	.3440"	8.73	PCT-3440
.2173"	5.52	PCT-2170	.2763"	7.02	PCT-2765	.3728"	9.47	PCT-3730
.2355"	5.98	PCT-2355	.2771"	7.04	PCT-2770	.3740"	9.50	PCT-3740
.2362"	6.00	PCT-2362	.3122"	7.93	PCT-3120	.3750"	9.52	PCT-3750

tech tips

from the techxperts™

When choosing a pilot, first decide if you need a "live" pilot (one which turns with the tooling) or "dead" pilot (one which remains stationary in the bore). Choose the top size, then the guide bore size.

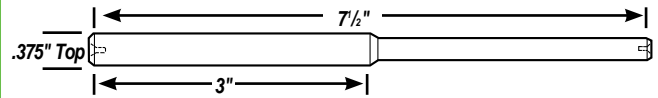

.375" Top Serdi-Style (Live) Straight Carbide Pilots

- For applications where the pilot must turn with the tooling
- Solid carbide construction
- Due to the brittle nature of carbide, Goodson can only warranty these carbide pilots for size

Inch	mm	Order No.	Inch	mm	Order No.	Inch	mm	Order No.
.1571"	3.99	PCS-399	.2600"	6.61	PCS-661	.3157"	8.02	PCS-802
.1767"	4.49	PCS-449	.2752"	6.99	PCS-699	.3425"	8.70	PCS-870
.1771"	4.50	PCS-450	.2756"	7.00	PCS-700	.3433"	8.72	PCS-872
.1960"	4.98	PCS-498	.2760"	7.01	PCS-701	.3437"	8.73	PCS-873
.1964"	4.99	PCS-499	.2764"	7.02	PCS-702	.3440"	8.74	PCS-874
.1968"	5.00	PCS-500	.2768"	7.03	PCS-703	.3720"	9.45	PCS-945
.2157"	5.48	PCS-548	.2771"	7.04	PCS-704	.3724"	9.46	PCS-946
.2161"	5.49	PCS-549	.3110"	7.90	PCS-790	.3728"	9.47	PCS-947
.2165"	5.50	PCS-550	.3114"	7.91	PCS-791	.3732"	9.48	PCS-948
.2354"	5.98	PCS-598	.3118"	7.92	PCS-792	.3736"	9.49	PCS-949
.2358"	5.99	PCS-599	.3122"	7.93	PCS-793	.3744"	9.51	PCS-951
.2362"	6.00	PCS-600	.3130"	7.95	PCS-795	.3748"	9.52	PCS-952
.2368"	6.01	PCS-601	.3146"	7.99	PCS-799			
.2559"	6.50	PCS-650	.3150"	8.00	PCS-800			
.2594"	6.59	PCS-659	.3154"	8.01	PCS-801			

tech tips

from the techxperts™

We get asked from time to time why Goodson carries so many sizes and styles of pilots.

The short answer is, "They're needed."

To expand on that ... The pilot is possibly the most important tool you can have. Without the right size pilot, you won't be able to do accurate work.

Most of us probably think of that in terms of Top and Bottom Size, but there's another dimension that's becoming more important every day. The pilot's top length.

You've probably worked on (or at least seen) heads with deeply set valves. This is especially common in diesel applications. Some of them are set so deeply that a standard pilot just won't cut it. You need a pilot that extends above the deck while still being fully seated in the guide in order to perform top quality seat work.

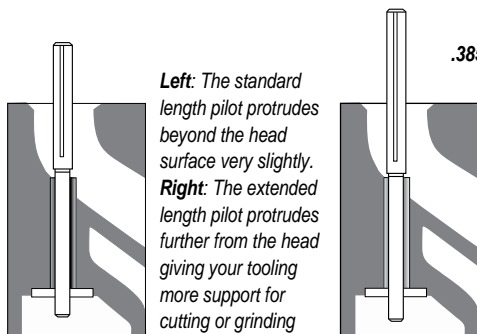

Left: The standard length pilot protrudes beyond the head surface very slightly.
Right: The extended length pilot protrudes further from the head giving your tooling more support for cutting or grinding

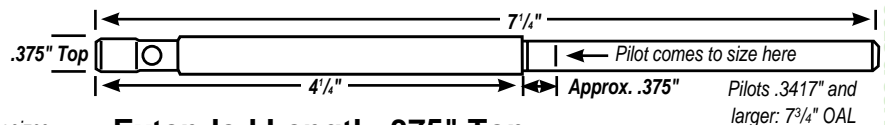

Extended Length .375" Top Solid-Tapered High Speed Steel Pilots

Inch	mm	Order No.	Inch	mm	Order No.	Inch	mm	Order No.
.2165"	5.50	P-5217NL	.3115"	7.91	P-5311NL	.3447"	8.75	P-5344NL
.2173"	5.52	P-5218NL	.3125"	7.93	P-5312NL	.3457"	8.78	P-5345NL
.2362"	6.00	P-5236NL	.3135"	7.95	P-5313NL	.3730"	9.47	P-5373NL
.2370"	6.02	P-5237NL	.3145"	7.98	P-5314NL	.3740"	9.50	P-5374NL
.2598"	6.60	P-5260NL	.3150"	8.00	P-5315NL	.3750"	9.52	P-5375NL
.2606"	6.62	P-5261NL	.3157"	8.02	P-5316NL	.3760"	9.55	P-5376NL
.2755"	7.00	P-5275NL	.3417"	8.68	P-5341NL	.3820"	9.70	P-5382NL
.2756"	7.01	P-5276NL	.3427"	8.70	P-5342NL			
.3105"	7.88	P-5310NL	.3437"	8.73	P-5343NL			

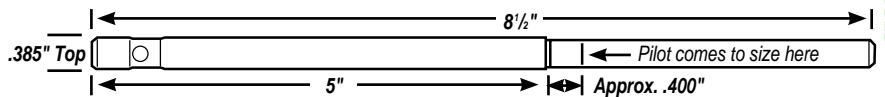

Extended Length .385" Top Solid-Tapered High Speed Steel Pilots

Inch	mm	.385" Top	Inch	mm	.385" Top	Inch	mm	.385" Top
.2756"	7.00	P-5276SL	.3125"	7.93	P-5312SL	.3460"	8.79	P-5346SL
.2795"	7.10	P-5279SL	.3447"	8.75	P-5344SL	.3720"	9.45	P-5372SL
						.3730"	9.47	P-5373SL

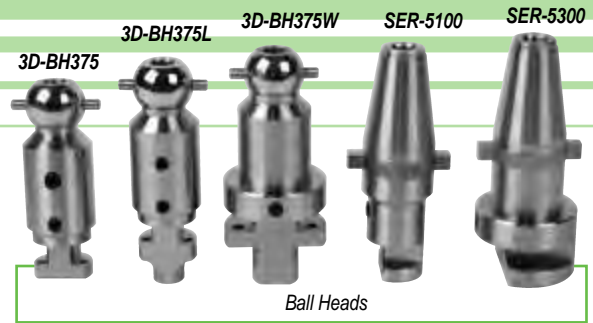

3-D Fast Cut™ Starter Kits

- Can be used with your existing pilots • Ball heads are available to fit most common seat grinder pilots • Choose from over 100 3-angle blade profiles on pages 6-9
- Fully compatible with most popular 3-angle cutting systems including Kwik-Way, Peterson, Rottler, Serdi, Sunnen, T&S, Winona Van Norman, Newen, etc.

Description	Fits Pilot	Order No.	Includes			
Complete Starter Kits	.375" / 9.53mm	3D-375-KIT				
(see page 1 for our selection of pilots)	.385" / 9.78mm	3D-385-KIT				
	.390" / 9.90mm	3D-390-KIT				
	.437" / 11.10mm	3D-437-KIT				
Ball Head Standard 3.346" long	.375" / 9.53mm	3D-BH375	x			
	.385" / 9.78mm	3D-BH385		x		
3/8" channel fits most	.390" / 9.90mm	3D-BH390			x	
3-angle systems	.437" / 11.10mm	3D-BH437				x
Ball Head Extended Length 3.80" long	.375" / 9.53mm	3D-BH375L				
Ball Head Wide Body 4.0625" long	.375" / 9.53mm	3D-BH375W				
Serdi-Style Tool Bodies 4" long	Use with Serdi-style pilots (page 3)					
	Standard .375" / 9.53mm	SER-5100				
	Large Body .375" / 9.53mm	SER-5300				
Tip Holders	.709" - 1.181" / 18-30mm Range	3D-2000	x	x	x	x
	1.02" - 1.653" / 26-42mm Range	3D-2001	x	x	x	x
	1.575" - 2.362" / 40-60mm Range	3D-2002	x	x	x	x
Tip Holders-Wide Body	1.575" - 2.362" / 40-60mm Range	3D-2003				
	2.385" - 3.150" / 58-80mm Range	3D-2004				
Cutters	45°/1.0mm	FT-45039V1	x	x	x	x
	45°/1.3mm	FT-45051V1	x	x	x	x
more on pages 6 - 9	45°/1.5mm	FT-45059V1	x	x	x	x
	45°/1.9mm	FT-45075V1	x	x	x	x
Tool Setting Fixture		3D-TSFA	x	x	x	x
Cutter Blade Mounting Screw		FT-SCREW	x	x	x	x
Blade Wrench		FT-WRENCH	x	x	x	x
Automotive Spring Set (4 Pc.)		3D-SS4	x	x	x	x
Bushing Set (1 pair)	.375"	3D-DB7				x
	.385"	3D-DB6			x	
	.437"	3D-DB5			x	
Ball Head	#3 Morse Taper Driver	3D-CM3				
Drive Adaptors	#4 Morse Taper Driver	3D-CM4				
	Bridgeport & DCM Driver	3D-3/4SS				
3-D Fast Cut™ Accessories						
Lift Clip for Enhanced Control, especially on Spring Pad Cutters (pg. 10)		3D-CLIP				
Replacement 1/8" Hex Key		3D-1/8	x	x	x	x
Replacement 2.5mm Hex Key		3D-2.5	x	x	x	x
Replacement 3/8" Hex Key		3D-3/32	x	x	x	x
Replacement Screws for NWN Ball Head Base (5) - metric		MGA-4X5MM				
Replacement Screw for 3D Ball Head Base - SAE 10x32		3D-BH1032				
Adjusting Screw for Holder #3D-2000, OAL: .395" / 10mm		3D-2000-S				
Adjusting Screw for Holder #3D-2001, OAL: .475" / 12mm		3D-2001-S				
Adjusting Screw for Holder #3D-2002, OAL: .625" / 15.9mm		3D-2002-S				

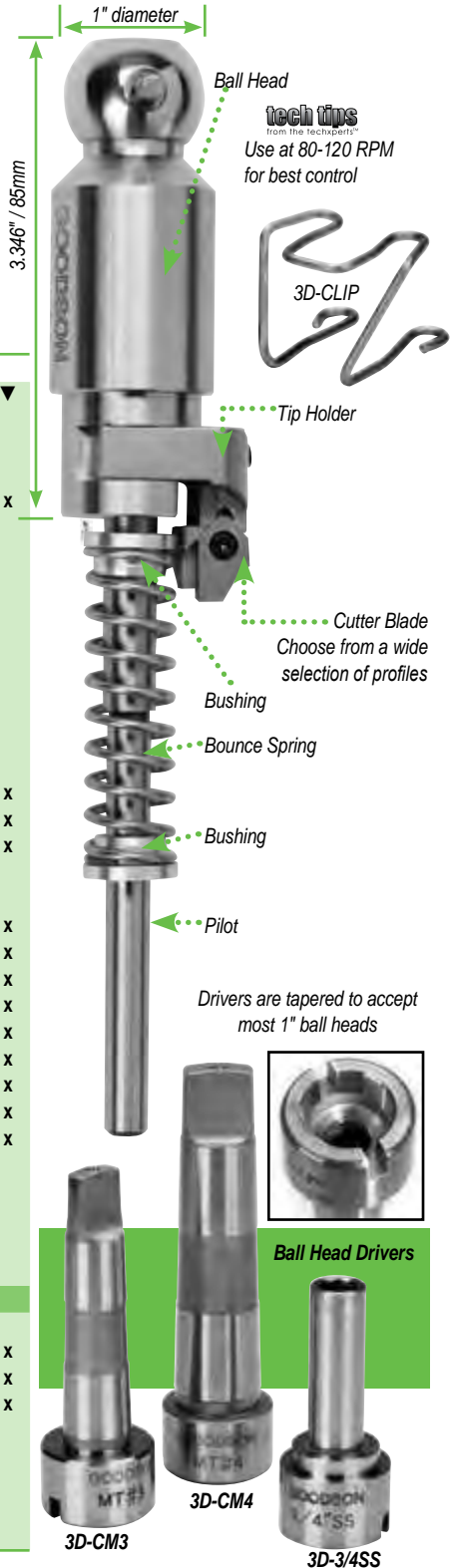

See page 5 for our Valve Seat Removal Tooling for the 3-D Fast Cut™ System

tech tips

from the techxperts™

Choosing the Ball Head

Choose the correct Ball Head for your machine by finding your pilot size in the charts on pages 4 & 5 (Example if you have .375" top pilots you will use the 3D-BH375; if your pilot size is .236", you will use 3D-BH236, etc.). Goodson 3-D tooling is available in kits, incorporating all of the necessary pieces. You can also purchase items on an individual basis. Goodson carries many accessories and optional equipment for you to choose from.

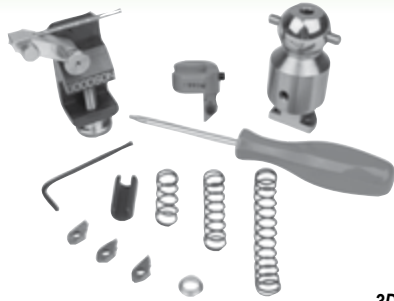

Holders have been modified to provide support to cutters without interfering with the bowl diameter.

Micro Tips FTM-190 and FTM-82R6B-HP only fit Tip Holder 3DH-1995

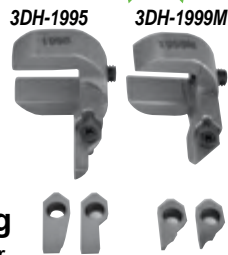

3-D Fast Cut™ System Micro Ball Head Tooling

• Fits the same 1" ball head driver

Description	Order No.	
Micro Ball Head Starter Kit	3D-236-KIT	▼
3D Ball Head for .236"/6mm Pilot (2.56"L)	3D-BH236	x
Micro Cutter Tips 45°/1.0mm	FTM-185	x
See pg. 7 45°/1.0mm	FTM-187	x
for profiles 39°/1.0mm	FTM-188	x
90° (For counterboring)	FTM-190	x
82° Radius Cutter	FTM-82R6B-HP	x
Tip Holders .550"-.984" Range	3DH-1999M	x
.551"-.850" Range	3DH-1995	x
Bounce Springs Short 1.050" / 26.7mm	3D-BS1	x
.340" ID Medium 1.540" / 39.2 mm	3D-BS3	x
.420" OD Long 2.550" / 64.8 mm	3D-BS2	x
Bounce Spring Bushing (2)	3D-BB1	x
Bounce Spring Spacer 22mm long	3D-BB2	x
3-D Fast Cut™ Accessories		
Replacement 2.5mm Hex Key	3D-2.5	x
Replacement Screws for Ball Head	3D-BH1032	x
Cutter Blade Mounting Screw	FT-SCREW	x
Blade Wrench	FT-WRENCH	x
Tool Setting Fixture	3D-TSFA	x
Setting Micrometer for Counterbore Cutting	3DM-236	x

.236" Top Carbide Pilots

Inch	mm	Order No.	Inch	mm	Order No.
.1559"	3.96	PCT-1560M	.2350"	5.97	PCT-2350M
.1566"	3.98	PCT-1570M	.2355"	5.99	PCT-2360M
.1575"	4.00	PCT-1575M	.2370"	6.02	PCT-2370M
.1578"	4.01	PCT-1580M	.2560"	6.50	PCT-2560M
.1759"	4.47	PCT-1760M	.2570"	6.53	PCT-2570M
.1771"	4.50	PCT-1770M	.2578"	6.55	PCT-2580M
.1779"	4.52	PCT-1780M	.2590"	6.58	PCT-2590M
.1960"	4.98	PCT-1960M	.2598"	6.60	PCT-2600M
.1968"	5.00	PCT-1970M	.2756"	7.00	PCT-2756M
.1980"	5.03	PCT-1980M	.2759"	7.01	PCT-2760M
.2161"	5.49	PCT-2160M	.2763"	7.02	PCT-2765M
.2170"	5.52	PCT-2170M	.2771"	7.04	PCT-2770M
.2181"	5.54	PCT-2180M			



Valve Seat Removal Tooling

- Fits most popular 3-angle cutting tools including our popular 3-D Fast Cut™ System, Kwik-Way, Peterson, Rottler, Serdi, T&S, Winona Van Norman, Newen, etc.
- Use to relieve press fit for easier seat removal
- Requires a minimum of 2 cuts
- For precise set up use **MGA-MIC**
- Tip Holders include one cutting tip and mounting screw (see chart below)
- Replacement tips and screws sold separately
- Ball Head and Drive Tools sold separately (see page 4)

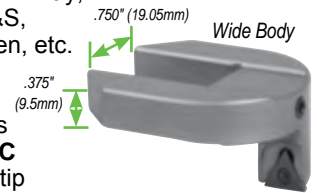
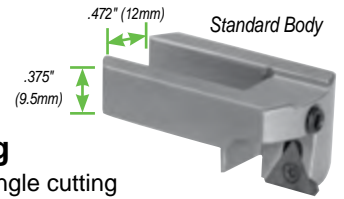

Description	Replacement Tip	Order No.
Tip Holders	3DB-1999i	3D-1999C
	3DB-250	3D-2000C
	3DB-250	3D-2001C
	3DB-250	3D-2002C
Wide Body Tip Holders	3DB-250	3D-2003C
	3DB-250	3D-2004C
Replacement Tip		3DB-1999i
		3DB-250
Replacement Screw for 3DB-1999i		3DB-1999S
for 3DB-250		3DS-SCREW
tech tips		
Cutting Range with Pilot Size		
Holder	.236" Top	.375" Top
3D-1999C	0.960"-1.225"	1.095"-1.360"
3D-2000C	1.056"-1.480"	1.194"-1.480"
3D-2001C	1.376"-2.000"	1.386"-2.000"
3D-2002C	1.524"-2.460"	1.544"-2.460"
3D-2003C	1.680"-2.400"	1.680"-2.400"
3D-2004C	2.280"-3.200"	2.280"-3.200"

3-D Fast Cut Setting Micrometers

- Accurate to .001"
- Standard micrometer uses tapered .375" Pilot to match your ball head (sold separately, page 1)
- Use to set cutting diameter of 90° carbide cutters when modifying counterbores

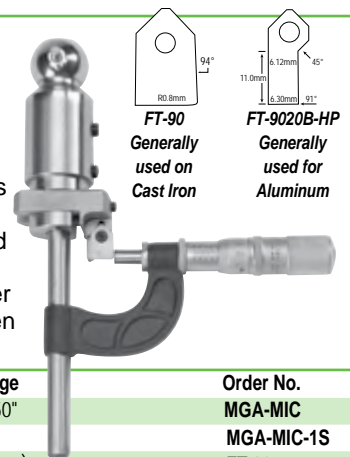

Description	Cutting Range	Order No.
Standard Micrometer	1.000" - 2.650"	MGA-MIC
Setting Standard		MGA-MIC-1S
90° Cutter (generally used for Cast Iron)		FT-90
90° Cutter (generally used for Aluminum)		FT-9020B-HP

Micro Setting Micrometer

- Use with .236" Pilot (PCT-2360M)

Description	Cutting Range	Order No.
Micro Micrometer	0.236" - 2.000"	3DM-236
90° Micro Cutter		FTM-190
Pilot		PCT-2360M

CYLINDER HEAD REBUILDING
CLEANING, ASSEMBLY & SAFETY
SHORT BLOCK REBUILDING
FLYWHEEL, GRINDING
CRANKSHAFT/ MISCELLANEOUS
TOOLS & SUPPLIES
BRAKE SERVICE TOOLING
MEASURING TOOLS
V-TWIN & METRIC HARD PARTS

Diamond Hand Files

- Choose between 360 & 600 grit
- Use for fine touch-ups on your Seat Cutter Blades

Description	Order No.
Diamond File Set -	DFS-2
1-360 grit & 1-600 grit	
600 Grit Files (2-pack)	DFS-6

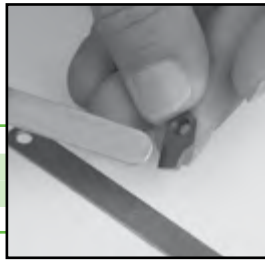

Cutter Key:

- I** Intake
- E** Exhaust
- S** Specialty

Mondello Signature Series Cutter Blades

Add 10 to 20 CFM to Cylinder Heads

Designed to increase airflow by as much as 20 CFM, these cutters are intended for certain applications. Generally you should use intake cutters on intakes and exhaust on exhausts, but as with most things, there's always an exception. Experiment to find the right combination for you and your customers.



<p>I IFT-30B-HP</p>	<p>I IFT-4560B-HP</p>	<p>I IFT-4539B-HP</p>
<p>E IFT-4524-HD</p>	<p>E IFT-4524A-HD</p>	<p>I IFT-4560-HD</p>
<p>I IFT-4560A-HD</p>	<p>E IFT-4556B-HP</p>	<p>E EFT-5060B-HP</p>
<p>E EFT-5061B-HP</p>	<p>I IFT-5065B-HP</p>	<p>E EFT-5046B-HP</p>
<p>E IFT-5025B-HP</p>	<p>E EFT-5567B-HP</p>	<p>E EFT-5557B-HP</p>
<p>E EFT-5550B-HP</p>	<p>E EFT-5565B-HP</p>	<p>S IFT-1056-HD</p>
<p>S IFT-1556-HD</p>	<p>S IFT-1043-HD</p>	<p>S IFT-1543-HD</p>
<p>S IFT-86RB-HP</p>	<p>S IFT-82R6B-HP</p>	
<p>S IFT-75R6B-HP</p>	<p>E RBP-RR4</p>	

3-Pc. Set
High Performance Cutters

- Increase flow & improve horsepower with this set
- Machine your intake seat with **IFT-4539B-HP** then use cutter **IFT-75R6B-HP** to machine below the seat and blend into the port
- On exhaust, machine with **IFT-4524-HD**
- Order No. **IFT-HP-SET**

Radius Profile Seat Cutter Blades

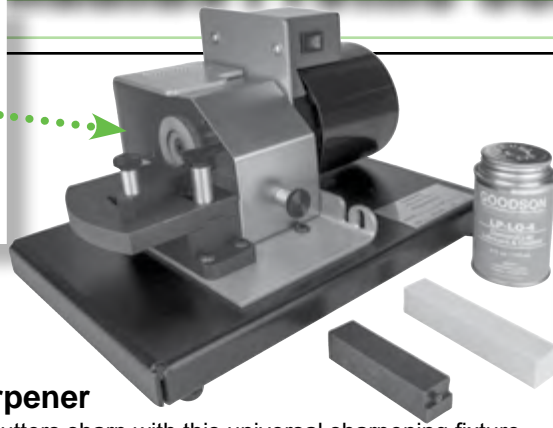
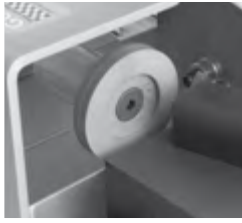

Goodson
exclusive

Universal Cutter Blade Sharpener

- Keep your multi-angle cutters sharp with this universal sharpening fixture
- Balanced ball-bearing fan-cooled electric motor
- Variable angle plus/minus 15° • 1/4" dia. Diamond Lap
- Lighted on/off rocker switch
- Safety catch tray with splash guard for lapping oil
- Available in 115V, 60 Hz and 220V 50 Hz

American Made

Description	Order No.	Incl.
Sharpener Kit 115V	3D-SHARP	▼
Sharpener Kit 220V	3D-SHARP-220	▼
3D Cutter Holder	3D-HOLDER	x x
Diamond Lap	LP-RFA	x x
Dressing Stick	LP-DS	x x
4 oz. Lapping Oil with Dauber	LP-LO-4	x x
Canvas Machine Cover	GMC-PRF	

Cutter Key:

I Intake
E Exhaust
S Specialty

Turn the Page for
More Valve Seat
Cutter Blades

Cutter Blades This Page Micro Cutter Blades

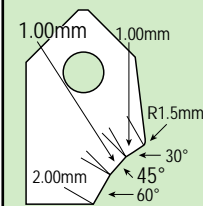

I FT-5043A-HD

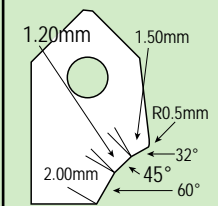

I FT-4247A-HD

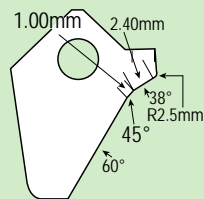

I FT-068B-HP

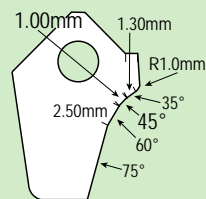

I FT-069B-HP

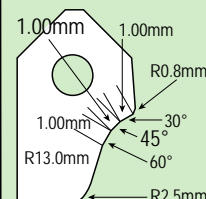

I FT-5118A-HP

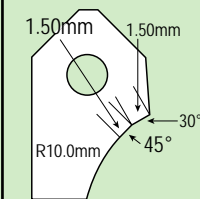

I FT-5119A-HP

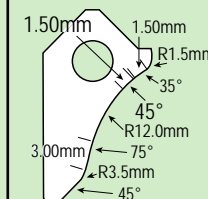

E FT-003B-HP

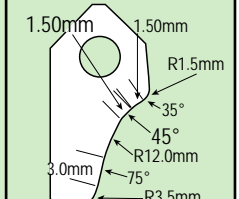

E FT-004B-HP

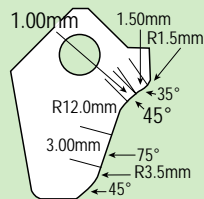

E FT-005B-HP

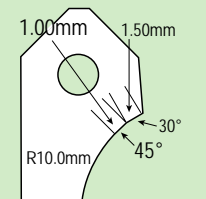

E FT-5120A-HP

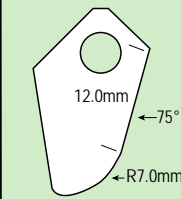

S FT-002B-HP

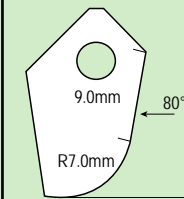

S FT-033B-HP

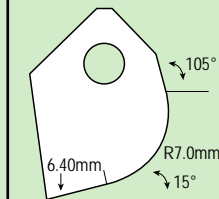

S FT-077B-HP

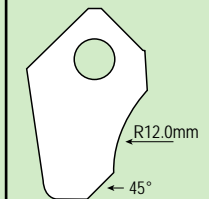

S FT-084B-HP

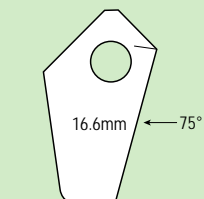

S FT-085B-HP

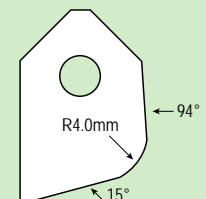

S FT-5121A-HP

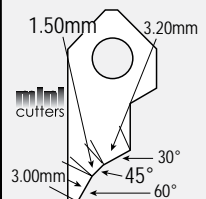

S FT-213B-HP

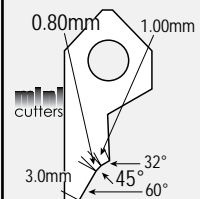

S FT-215B-HP

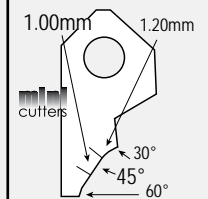

S FT-4028B-HP

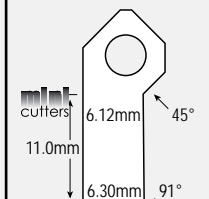

S FT-9020B-HP

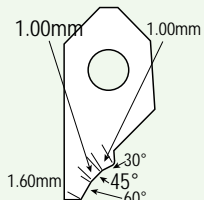

S FTM-185

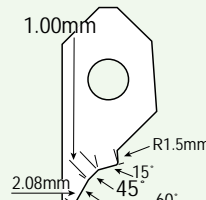

S FTM-187

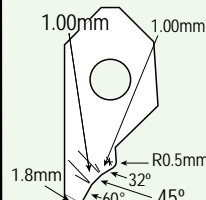

S FTM-188

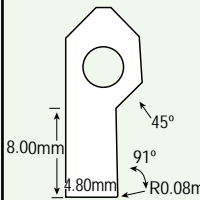

S FTM-190

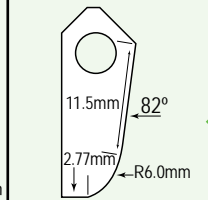

S FTM-82R6B-HP

**Micro
Blades**
Work with holders
on page 5

CYLINDER HEAD
REBUILDING

CLEANING,
ASSEMBLY & SAFETY

SHORT BLOCK
REBUILDING

CRANKSHAFT/
FLYWHEEL GRINDING

MISCELLANEOUS
TOOLS & SUPPLIES

BRAKE SERVICE
TOOLING

MEASURING
TOOLS

V-TWIN & METRIC
HARD PARTS

3-D Multi-Angle Seat Cutter Blades

Single Angle Valve Seat Cutter Blades

CYLINDER HEAD
REBUILDING

CLEANING,
ASSEMBLY & SAFETY

SHORT BLOCK
REBUILDING

CRANKSHAFT/
FLYWHEEL GRINDING

MISCELLANEOUS
TOOLS & SUPPLIES

BRAKE SERVICE
TOOLING

MEASURING
TOOLS

V-TWIN & METRIC
HARD PARTS

<p>FT-45039U1</p>	<p>FT-45039U2</p>	<p>FT-45039V1</p>	<p>FT-45039W1</p>	<p>FT-45039W2</p>	<p>FT-45039W3</p>
<p>FT-45051V2</p>	<p>FT-45051V4</p>	<p>FT-45051V1</p>	<p>FT-45051V3</p>	<p>FT-45051X1</p>	<p>FT-45055V1</p>
<p>FT-45059V1</p>	<p>FT-45059V2</p>	<p>FT-45059V3</p>	<p>FT-45059X1</p>	<p>FT-45063U1</p>	<p>FT-45063U2</p>
<p>FT-45063V1</p>	<p>FT-45063V3</p>	<p>FT-45063V2</p>	<p>FT-45063W1</p>	<p>FT-45071V1</p>	<p>FT-45075V2</p>
<p>FT-45075V1</p>	<p>FT-45079U1</p>	<p>FT-45079U2</p>	<p>FT-45079V1</p>	<p>FT-45098U1</p>	<p>FT-45098U2</p>
<p>FT-30039T1</p>	<p>FT-30051S1</p>	<p>FT-30059S1</p>	<p>FT-30059S3</p>	<p>FT-30063S1</p>	<p>FT-30071S1</p>
<p>FT-30075S1</p>	<p>FT-30079S1</p>	<p>FT-30079S2</p>	<p>FT-30098S1</p>	<p>FT-30098S2</p>	<p>resharpening available</p> <p>Have Goodson Resharp Your Valve Seat Cutter Blades</p>

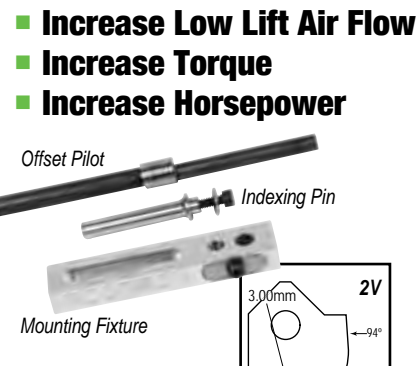

Diesel Relief Tooling

- Use with your seat and guide machine or Bridgeport Mill equipped with a multi-angle seat cutting system
- Developed for Goodson by Joe Mondello Racing Engines
- Use for 6.0L & 7.3L Ford, 12 Valve, 5.9L Cummins & 6.6L Duramax diesel engines
- For 2-Valve & 4-Valve heads
- Complete kit includes the Mounting Fixture, .375" Top Offset Pilot, Indexing Pin & Radius Cutter
- This tool is only for use with radius cutters BSS-20CC and BSS-45CC

Description	Order No.	Incl.
7mm Diesel Relief Tool Kit	DVRT-7MM-KIT	▼
8mm Diesel Relief Tool Kit	DVRT-8MM-KIT	▼
20CC Radius Cutter for 2-Valve Heads	BSS-20CC	x
45CC Radius Cutter for 4-Valve Heads	BSS-45CC	x

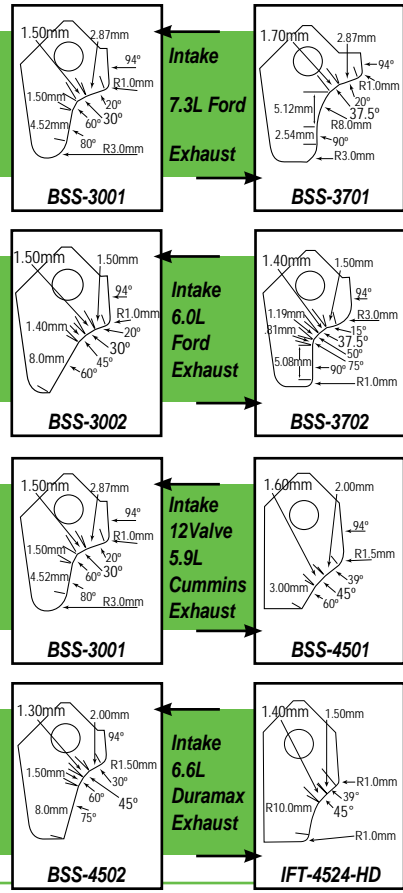

black smoke series cutters for High Performance Diesel Engines
 Developed for Goodson by Joe Mondello Racing Engines.

See How to Use the Diesel Relief Tooling on YouTube! Search for Diesel Valve Relief Tool.

... another satisfied customer

"It has been a long time since I have seen such a great vendor as these people. They are simply great. I give them an A+++ rating and hope to deal with them more."
 - Wayne Hudson, Hillboro, Oregon (via Facebook), Goodson customer since 2014

CYLINDER HEAD REBUILDING

CLEANING, ASSEMBLY & SAFETY

SHORT BLOCK REBUILDING

CRANKSHAFT/ FLYWHEEL GRINDING

MISCELLANEOUS TOOLS & SUPPLIES

BRAKE SERVICE TOOLING

MEASURING TOOLS

V-TWIN & METRIC HARD PARTS

3-D FAST CUT™ SYSTEM



3-D Fast Cut Adjustable Spring Pad Cutters

- No need to change tooling, just change the tool holder and start cutting spring pads
- Works with all popular 3-angle cutting systems
- Square blades are indexable and replaceable
- Tool holder includes one blade

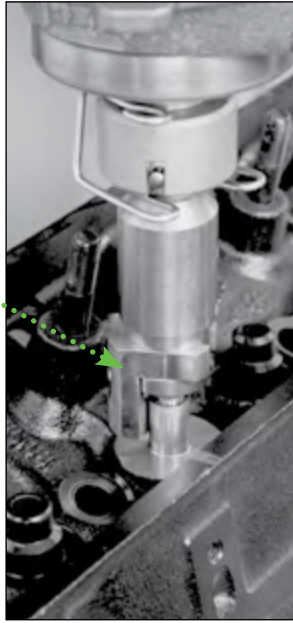

Tool Holders		
Blade Size	Application	Order No.
3/8" / 9.53mm	All except Sunnen®	SPC-375
1/2" / 12.70mm	All except Sunnen®	SPC-500
Replacement Carbide Cutters (for all holder styles above)		
3/8" / 9.53mm		SPCI-375
1/2" / 12.70mm		SPCI-500



Minnesota Fast Freeze

- Instantly chills seats & guides to -50°F (-45.5°C)
- Creates interference fit with heated aluminum heads
- Finish seat and guide work faster than ever
- Aerosol*
- Use on tight bushings, pins, shafts, etc.
- Order No. **MFF-8**

*Hazardous Goods Fees Apply When Shipped by Air

Press Fit Lubricants

- A light coat eases press fit
- Ideal for valve guides, piston pins, cylinder sleeves, etc.
- Eliminates the scoring, gouging and galling of parts during press fitting

Description	Order No.
Goodson Aerosol* 6 oz. (170 g)	PFL-200*
Sunnen® Aerosol* 7 oz. (198 g)	B-200*
Sunnen® Brush Applicator 200 mL (not shown)	B-200L

*Hazardous Goods Fees Apply When Shipped By Air



3-D Fast Cut™ Bowl Profiler

- Machine seats & bowls on a pair of V8 heads in about 40 minutes
- Remove material to recontour cylinder head bowl areas and unshroud valves in combustion chambers
- Blades can be modified using our 3D-SHARP (see page 7)
- Will not work with Sunnen® Ball Heads

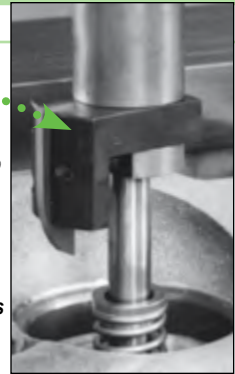

Holder Diameter Range	Order No.
1.25"-1.87" / 32-48mm	NBN-1
1.57"-2.13" / 40-54mm	NBN-2

Blades sold separately

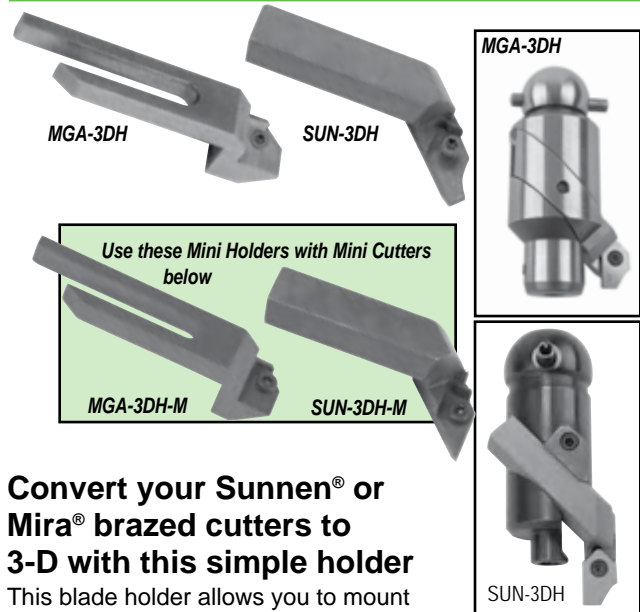
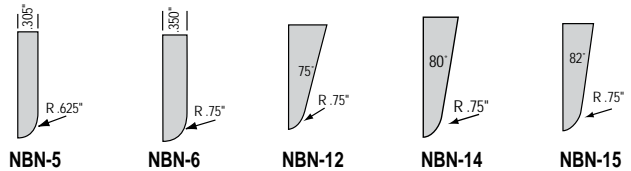

Convert your Sunnen® or Mira® brazed cutters to 3-D with this simple holder

This blade holder allows you to mount premium, replaceable carbide cutters on your existing MIRA® and Sunnen® ball-type tool holders. Choose from our wide selection of replaceable cutters, previously only available for 3-D Fast Cut™ or similar seat cutting systems.

Description	Order No.
Standard Cutter Holders	Mira® MGA-3DH Sunnen® VSC-Series SUN-3DH
Mini Cutter Holders	Mira® MGA-3DH-M Sunnen® SUN-3DH-M
Mini Cutters	30°/45°/60° FT-213B-HP 32°/45°/60° FT-215B-HP
view profiles on page 7	30°/45°/60° FT-4028B-HP 45°/90° FT-9020B-HP
Replacement Screw	FT-SCREW

Precision Valve Seat Run-Out Gauge

- Use with .375" Top Pilot
- Measure run-out to .0001" directly from the seat
- Locked to the pilot
- Dial indicator remains stationary while rotating contact pointer
- .800" - 2.500" dia. range
- Order No. **SCG-375**

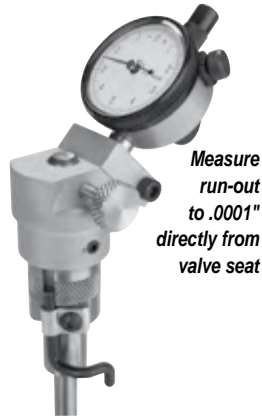

Valve Seat Run-Out Gauge

- Hardened guide bushings & contact pilot
- Quick thumb screw set-up
- Jeweled bearing indicator reads to ±.050" with .001" precision
- Range: 1.00"-2.50"



Pilot Size	Order No.
.375"	VSG-375
.385"	VSG-385

* Note: Extended length on page NP-3



Valve Seat Machining Aid

- Machine valve seats to a mirror-like finish
- Universal - works with any type of cylinder head machining center
- Use full strength
- Safe for metal surfaces
- Works with mineral-based cutting oils, not water based
- Quart (946mL)
- Order No. **PF-2020**



Valve and Seat Scribe Tool

- Fits .375" Top Pilot
- Kit includes: tool body, scribe, 1 pilot sleeve, and 6.6mm, 8.0mm, 5/16", 11/32" and 3/8" valve stem sleeves
- Sleeves fit tool body to valve stems & pilots
- Use valve to set point then scribe seat with inner & outer radii
- Grind seat top & throat to match face precisely
- Order No. **ST-30-BD**



Layout Fluids

- 2 colors to choose from (blue and red)
- Toluene-free • Dries in minutes
- Provides a thin film without cracking or chipping • Prevents glare with a uniform, deep color
- 2 oz. markers feature felt tip applicator
- 4 oz. containers includes brush in cap



Description	Color	Order No.
2 oz. Layout Fluid Markers	Blue	VBF-2
	Red	VRF-2
4 oz. Layout Fluid	Blue	VBF-4
	Red	VRF-4

Cutting & Tapping Fluid

- Cut through even the hardest metals
- Spray clings to the surface of the tool to prolong tool life
- Ideal for stainless steel, high nickel alloys, titanium and more
- Use for reaming, seat cutting and CBN cutting
- Aerosol*
- Order No. **CTF-14***



*Hazardous Goods Fees Apply When Shipped by Air

Spray Bluing Fluid

- Fast drying • Will not rub off
- Good adhesion to all metals and glass
- Non-corrosive • Resists heat
- No flaking or peeling
- Scribes clean lines for precision work
- Eliminates rags, daubers, spilled bottles
- Dries to a smooth level coating
- Aerosol*
- Order No. **SBF-16***



*Hazardous Goods Fees Apply When Shipped by Air



Prussian Blue Paste

- Aids precision fitting of machined surfaces
- Locates high spots on bearings, valves, gears and other close-tolerance components
- Non-drying, easy clean-up
- Coat parts with a uniform film of Prussian Blue; assemble in working position and turn shaft; improper fit will show up as easy-to-see bright streaks
- 0.75 fl. oz. tube
- Order No. **PB-75**

CYLINDER HEAD REBUILDING
CLEANING, ASSEMBLY & SAFETY
SHORT BLOCK REBUILDING
CRANKSHAFT/ FLYWHEEL GRINDING
MISCELLANEOUS TOOLS & SUPPLIES
BRAKE SERVICE TOOLING
MEASURING TOOLS
V-TWIN & METRIC HARD PARTS

Neway Valve Seat Cutting System

CYLINDER HEAD
REBUILDING

CLEANING,
ASSEMBLY & SAFETY

SHORT BLOCK
REBUILDING

CRANKSHAFT/
FLYWHEEL GRINDING

MISCELLANEOUS
TOOLS & SUPPLIES

BRAKE SERVICE
TOOLING

MEASURING
TOOLS

V-TWIN & METRIC
HARD PARTS

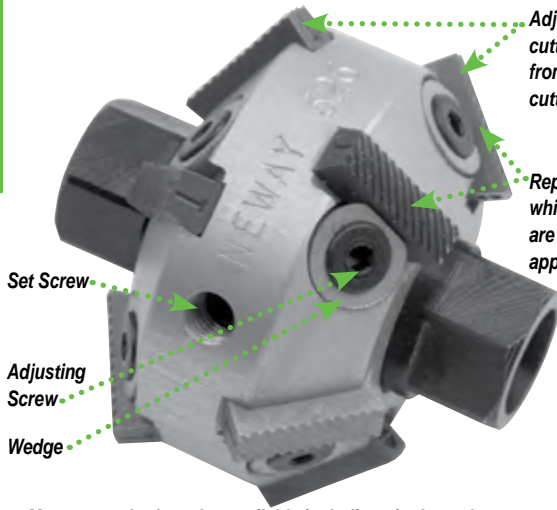

Adjustable Tungsten Carbide cutter blades. Cutters work in a range from 3/8" smaller and 1/4" larger than the cutter body size.

Replaceable cutter blades (see chart for which blades to order for your cutter) are included with body purchase (where applicable).

Cutter body is made of anodized aluminum around a steel hub

Set Screw

Adjusting Screw

Wedge

Many cutter body styles available including single angle and double angle for a variety of cutting applications

special
order

Don't see the cutter you need in the chart below? Goodson can order any Neway Cutter Body available.

Replacement Blades & Parts

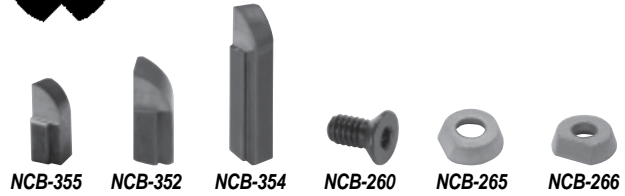
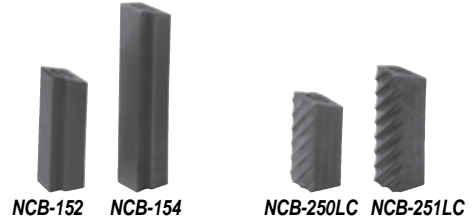
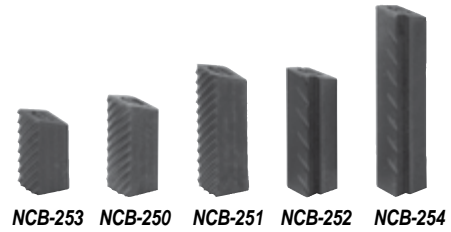

Description	Small Series Cutter Bodies (Use .297" Top Pilots - page 1)			Order No.
Cutter Body Diameter	Blade Angle	Qty.	Replacement Blade	
0.830" / 21.1mm	32°	3	non-replaceable	NCU-132
0.850" / 21.6mm	45°	3	non-replaceable	NCU-131
0.874" / 22.2mm	60°	3	non-replaceable	NCU-133
0.975" / 24.8mm	31°	3	NCB-250	NCU-115
	31°	3	NCB-253	NCU-123
	45°	3	NCB-253	NCU-122
	15°	3	NCB-253	NCU-120
1.000" / 25.4mm	30°	3	NCB-250	NCU-126
	60°	3	NCB-252	NCU-111
	75°	3	NCB-254	NCU-125
	31°/46°	3/3	NCB-253	NCU-103
1.125" / 28.6mm	31°/46°	3/3	NCB-251	NCU-102
	15°/60°	3/3	NCB-251, -254	NCU-124
Replacement Blades	Angle	Blade Lgth.		
	15-46°	5/16" / 7.9mm		NCB-253
	Sold Individually	3/8" / 9.53mm		NCB-250
		1/2" / 12.7mm		NCB-251
60-75°	1/2" / 12.7mm			NCB-252
	3/4" / 19.05mm			NCB-254
	60-75°	1/2" / 12.7mm		NCB-152
Correction Blades	3/4" / 19.05mm			NCB-154
Hard Seat Blades	15-46°	3/8" / 9.53mm		NCB-250LC
Blades		1/2" / 12.7mm		NCB-251LC
	Radius Combustion Chamber Blades	3/8" / 9.53mm		NCB-355
		1/2" / 12.7mm		NCB-352
		3/4" / 19.05mm		NCB-354
Flat Head Screw				NCB-260
Wedge for bodies over 1" / 25.4mm				NCB-265
Wedge for 1" / 25.4mm & smaller bodies				NCB-266
Tool Kit (includes brush, 2 hex keys and pilot puller)				NKA-246
Large Storage Case (holds 11 pieces)				NCA-497
EZ-Turn Wrench				NTW-EZ
1/2" T-Handle Driver				NTW-505
3/8" T-Handle Driver				NTW-513
Drive Adaptor	1/2" to 3/8" / 12.7-9.53mm			NTW-503-1

Description	Standard Series Cutter Bodies (Use .375" Top Pilots - page 1)			Order No.	
Cutter Body Diameter	Blade Angle	Qty.	Replacement Blade		
1.125" / 28.6mm	30°	3	NCB-250	NCU-278	
	45°	3	NCB-250	NCU-268	
	60°	3	NCB-252	NCU-269	
1.250" / 31.6mm	15°/75°	3/3	NCB-250, -254	NCU-212	
	30°	3	NCB-250	NCU-607	
	30°/45°	3/3	NCB-250	NCU-230	
	31°/46°	3/3	NCB-250	NCU-203	
	45°	5	NCB-250	NCU-608	
	60°	3	NCB-252	NCU-270	
1.375" / 35.0mm	15°/60°	5/5	NCB-251, -254	NCU-619	
	30°/45°	3/3	NCB-250, -251	NCU-232	
	1.500" / 38.0mm	15°/75°	3/3	NCB-251, -254	NCU-217
		30°/45°	3/3	NCB-251	NCU-234
1.750" / 44.5mm	30°/45°	5/5	NCB-251	NCU-626	
	31°/46°	5/5	NCB-251	NCU-622H	
	60°	3	NCB-254	NCU-205H	
	15°/60°	5/5	NCB-251, -254	NCU-643	
	30°/45°	5/5	NCB-251	NCU-645	
	31°/46°	5/5	NCB-251	NCU-642H	
2.000" / 50.8mm	55°	5	NCB-251	NCU-17555	
	60°	3	NCB-254	NCU-293	
	75°	3	NCB-254	NCU-272	
	31°/46°	5/5	NCB-251	NCU-652	
	15°/60°	5/5	NCB-251, -254	NCU-653	
2.25" / 57.0mm	30°/45°	5/5	NCB-251	NCU-660	
	50°	5	NCB-251	NCU-20050	
	60°	5	NCB-254	NCU-657	
	55°	5	NCB-251	NCU-22555	
2.50" / 63.5mm	15°/60°	5/5	NCB-251, -254	NCU-666	
	30°/45°	7/7	NCB-251	NCU-677	
	50°	7	NCB-251	NCU-25050	
	52°	7	NCB-251	NCU-25052	
	55°	7	NCB-251	NCU-25055	
	60°	5	NCB-251	NCU-675	
	70°	7	NCB-254	NCU-7063	



Neway T-Handle Drivers

- Two sizes to fit small series cutter bodies and standard series cutter bodies
- Adaptor available



Description	Order No.
3/8" Hex	NTW-513
1/2" Hex	NTW-505
1/2" to 3/8" Adaptor	NTW-503-1

Neway Easy Turn Wrench

- Turn cutters continuously
- Produces a smooth seat quickly and easily
- Improves material removal control • Spring loaded
- Includes drive adaptor to convert 1/2" to 3/8"

Description	Order No.
Wrench	NTW-EZ
Drive Adaptor	NTW-503-1

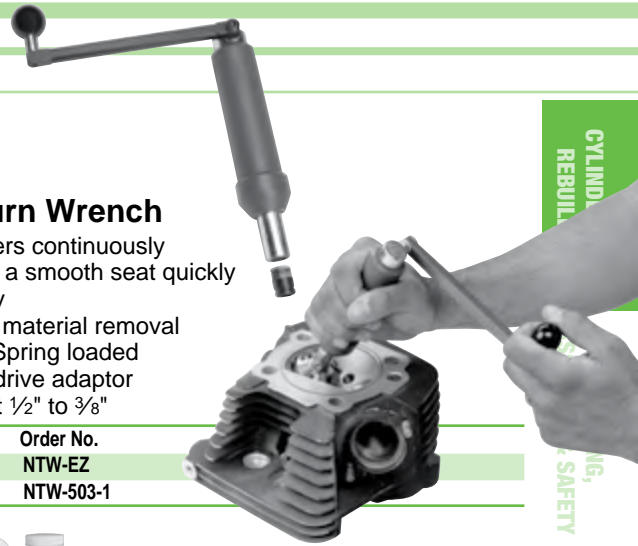

Valve Seat Cutting Fluid

- High silicone content reduces drag on cutters so they last longer
- Promotes smoother cuts
- May be diluted up to 9:1
- Non-aerosol spray



Size	Order No.
16 oz. Spray / 473 mL	SCF-2
1 Gal. / 3.79 L	SCF-10

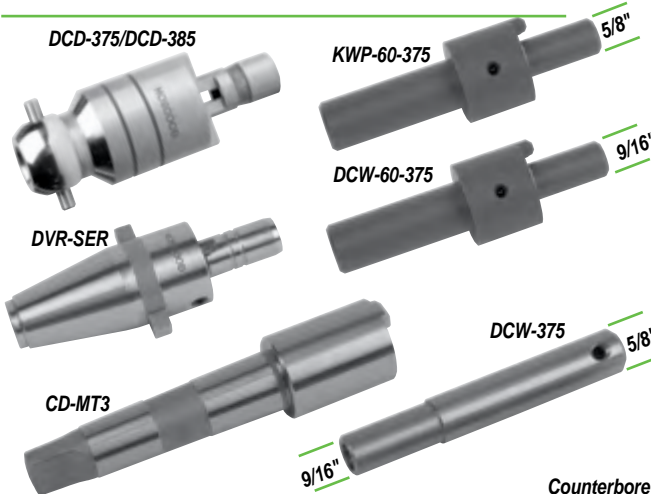

Counterbore Cutter Drive Adaptors

Counterbore cutters on page 14

Cutter Drivers	Order No.
#3 MT Driver	CD-MT3
Fits .750" Bridgeport Collet	
3/8" arbor, .375" pilot	DCW-60-375
3/8" arbor, .385" pilot	DCW-60-385
5/8" arbor, .375" pilot	KWP-60-375
5/8" arbor, .385" pilot	KWP-60-385
Ball Head Driver .375" pilot, 3/8" arbor	DCD-375
Ball Head Driver .385" pilot, 3/8" arbor	DCD-385
3/8" Driver for Serdi & Rottler SG-9A, SG-9M	DVR-SER
5/8" Driver for Serdi & Rottler SG-9A, SG-9M	DVR-SER-58

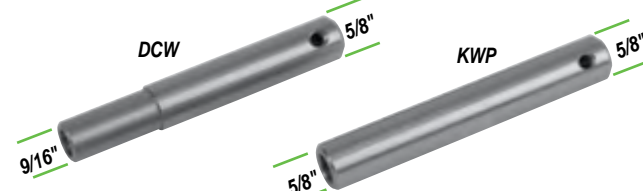

Wear Sleeves for Counter Bore Cutters

- Wear sleeves fit CD-MT3 Driver above

Wear Sleeves		Wear Sleeves	
For 3/8" (14.27mm) arbor DCW & DWI style seat cutters		For 5/8" / 15.87mm arbor KWP & KPI style seat cutters	
Pilot Top Size	Order No.	Pilot Top Size	Order No.
.375" (9.53mm)	DCW-375	.375" (9.53mm)	KWP-375
.385" (9.78mm)	DCW-385	.385" (9.78mm)	KWP-385
.437" (11.10mm)	DCW-437	.437" (11.10mm)	KWP-437

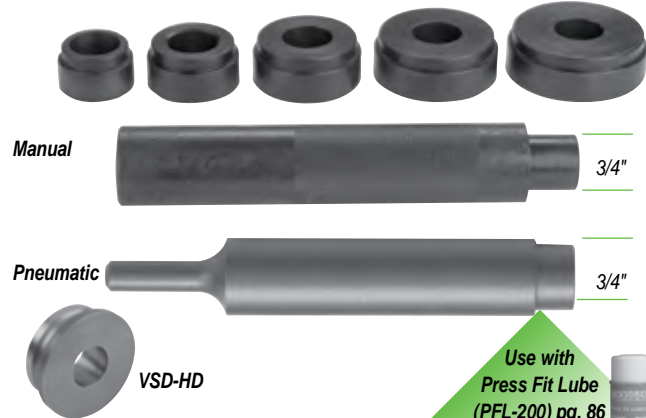

Valve Seat Drivers For Fast Seat Installation

- Pneumatic Drivers install seats faster, easier and without galling • Driver Head ID is .75" / 19.05mm

Description	Order No.
Manual Drivers	
.375" / 9.53mm and .385" / 9.78mm ID	VSD-202-G
Driver Heads	
1.000" thru 1.125" Seats / 25.4 - 28.6mm	VSD-203-G
1.250" thru 1.375" Seats / 31.8 - 34.9mm	VSD-204-G
1.500" thru 1.625" Seats / 38.1 - 41.3mm	VSD-205-G
1.750" thru 1.875" Seats / 44.5 - 47.6mm	VSD-206-G
2.000" thru 2.125" Seats / 50.8 - 54.0mm	VSD-207-G
1.750" thru 2.000" Seats / 44.5 - 50.8mm	VSD-HD
Pneumatic Drivers	
.375" / 9.53mm and .385" / 9.78mm ID	PSD-385
.437" / 11.10mm ID	PSD-437

Use with Press Fit Lube (PFL-200) pg. 86 or Fluid Weld (FW-2) pg. 52

CYLINDER REBUILDING, CRANKSHAFT/ FLYWHEEL GRINDING, MISCELLANEOUS TOOLS & SUPPLIES, BRAKE SERVICE TOOLING, MEASURING TOOLS, V-TWIN & METRIC HARD PARTS

... another satisfied customer

"We have been doing business with Goodson for over 10 years. They have outstanding customer service and a great selection of specialty tooling and parts for Harleys."

- Bob LaGuardia, Diamond Bar Choppers, Diamond Bar CA, Goodson customer since 2000

CYLINDER HEAD REBUILDING

CLEANING, ASSEMBLY & SAFETY

SHORT BLOCK REBUILDING

CRANKSHAFT/ FLYWHEEL GRINDING

MISCELLANEOUS TOOLS & SUPPLIES

TOOLING

MEASURING TOOLS

V-TWIN & METRIC HARD PARTS



Indexable Counterbore Cutters

These indexable counterbore cutters eliminate down time from having brazed cutters reset or sharpened. You can service them right in your own shop! Each cutter body includes 2 carbide cutter tips with 4 cutting edges. When one edge wears, simply rotate the tip to a new cutting edge. You'll also get insert screws and a wrench with every cutter body.



DWI-SERIES

- Fits DCM Tech, Sunnen, and Winona Van Norman
- 9/16" / 14.3mm arbor

KPI-SERIES

- Fits Kansas Instruments, Kwik-Way and Peterson
- 5/8" / 15.9mm arbor

Size	mm	DWI-Series	KPI-Series
		DCM Tech, WVN (9/16" arbor)	K.I., KW, Peterson (5/8" arbor)
1.062"	26.97	DWI-1062	-----
1.125"	28.57	DWI-1125	-----
1.187"	30.15	DWI-1187	-----
1.250"	31.75	DWI-1250	KPI-1250
1.312"	33.32	DWI-1312	KPI-1312
1.375"	34.93	DWI-1375	KPI-1375
1.437"	36.50	DWI-1437	KPI-1437
1/4" Replacement Cutting Insert for Cutters above		SCI-250-B	-----
Replacement Screw for SCI-250-B		SCS-T7	-----
Allen Wrench for SCS-T7		SCW-T7	-----

Size	mm	DWI-Series	KPI-Series
		DCM Tech, WVN (9/16" arbor)	K.I., KW, Peterson (5/8" arbor)
1.500"	38.10	DWI-1500	KPI-1500
1.562"	39.67	DWI-1562	KPI-1562
1.625"	41.28	DWI-1625	KPI-1625
1.687"	42.85	DWI-1687	KPI-1687
1.750"	42.85	DWI-1750	KPI-1750
1.812"	44.45	DWI-1812	KPI-1812
1.875"	47.63	DWI-1875	KPI-1875
1.937"	49.20	DWI-1937	KPI-1937
2.000"	50.80	DWI-2000	KPI-2000
2.062"	52.37	DWI-2062	KPI-2062
2.125"	53.98	DWI-2125	KPI-2125
3/8" Replacement Cutting Insert for Cutters above		SCI-375-B	-----
Replacement Screw for SCI-375-B		SCS-T15	-----
Torx Wrench for SCS-T15		SCW-T15	-----



Minnesota Fast Freeze

- Creates interference fit with heated aluminum heads
- Finish seat and guide work faster than ever
- Aerosol* • Use on tight bushings, pins, shafts, etc.
- Order No. **MFF-8**
- * Hazardous Goods Fees Apply When Shipped Air

Nickel-Chrome Valve Seats For a Variety Of Applications



OD	ID	Depth	Order No.	OD	ID	Depth	Order No.
1.250"	0.812"	1/4"	VS-1250	1.625"	1.375"	7/32"	VS-1625A
1.312"	1.000"	1/4"	VS-1312	1.687"	1.375"	1/4"	VS-1687
1.375"	1.062"	1/4"	VS-1375	1.750"	1.500"	1/4"	VS-1750
1.437"	1.125"	1/4"	VS-1437	1.812"	1.500"	1/4"	VS-1812
1.500"	1.187"	1/4"	VS-1500	1.875"	1.562"	1/4"	VS-1875
1.562"	1.250"	1/4"	VS-1562	1.937"	1.625"	1/4"	VS-1937
1.562"	1.312"	7/32"	VS-1562A	2.000"	1.625"	1/4"	VS-2000
1.625"	1.312"	1/4"	VS-1625				

See page 5 for valve seat removal tools that fit 3-D Fast Cut



Valve Seat Removers – A Low-Cost Way to Pull Valve Seat Inserts

- Use to pry out valve seat inserts or stubborn grease seals
- Three angles available
- **Not** recommended for use on aluminum heads
- Set includes one of each angle

Description	Order No.
3- Pc. Set	VSP-SET ▼
90°	VSP-90 x
100°	VSP-100 x
120°	VSP-120 x

Valve Seat Inserts

- For Harley-Davidson®
- Easy to machine
- Effectively dissipate heat for consistent valve sealing
- Hardness increases during engine break-in
- Radiused for easy installation

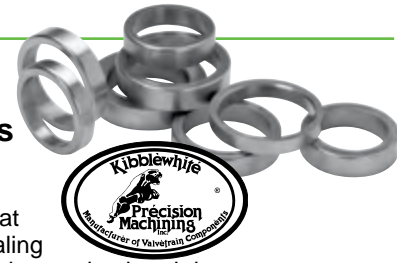

Replacement Valve Seats For Shovel Head 1200 & 1340

Application	OD	ID	Thickness	Order No.
Exhaust	1.944"	1.575"	.400"	10-HC493
Intake	2.135"	1.750"	.400"	10.12 10-HC542

Oversize Seats For Shovel, Evolution & Twin Cam – machining required

	OD	ID	Thickness	Order No.
	1.630"	1.180"	.385"	10-HC414
	1.757"	1.410"	.430"	10-HC447
	1.882"	1.530"	.410"	10-HC478
	2.008"	1.610"	.440"	10-HC510
	2.040"	1.700"	.425"	10-HC518
	2.070"	1.610"	.460"	10-HC526
	2.132"	1.800"	.460"	10-HC541
	2.163"	1.750"	.455"	10-HC549

For Iron Head Sportster

Application	OD	ID	Thickness	Order No.
Exhaust	1.757"	1.371"	.315"	10-HC446
Intake	2.068"	1.750"	.315"	10-HC525

Universal Repair Seat

	OD	ID	Thickness	Order No.
Powdered	1.339"	1.024"	.375"	10-SC340
Metal	1.693"	1.299"	.434"	10-SC430
	1.820"	1.375"	.450"	10-HC462
	1.945"	1.375"	.440"	10-HC494
	2.257"	1.550"	.500"	10-HC573

Valve Lapping Tools & Supplies

Petroleum Based Lapping Compound

- Silicon-carbide, grease-based compound
- Precise mating between valves and seats for fast cutting



Grit	Size	Order No.
400	2 oz. / 56.7g	VLC-2-400
600	2 oz. / 56.7g	VLC-2-600
800	2 oz. / 56.7g	VLC-2-800
1200	2 oz. / 56.7g	VLC-2-1200
120, 280	2 oz. / 56.7g ea.	VLC-4
120	1 lb. / 453.6g	VLC-120
180	1 lb. / 453.6g	VLC-180
280	1 lb. / 453.6g	VLC-280

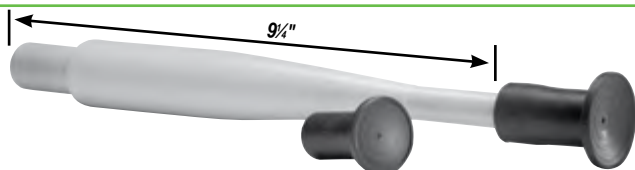

Vacuum Style Lapping Stick

- Press the spring-loaded vacuum pump for a firm hold – stays on until you release the vacuum
- Includes 3 cup sizes (also sold separately)

Description	Cup ID	Order No.
Vacuum Lapping Stick 9 1/4" Long		VLV-50
Replacement Cups	19.1mm / 0.750" dia.	VLV-3/4
	25.4mm / 1.000" dia.	VLV-1
	31.8mm / 1.250" dia.	VLV-1 1/4

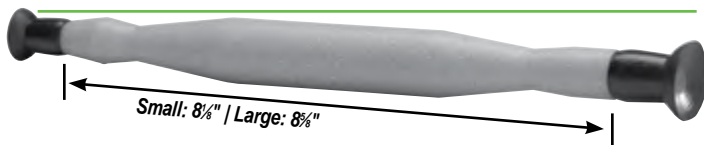

Traditional Valve Lapping Sticks

- Oil resistant polyethylene handles
- Locking tabs eliminate cup slippage

Description	Cup ID	Order No.
Small Lapping Stick 8 1/2" Long		VLS-15
Replacement Cups	15.9mm / 0.625" dia.	VLS-5/8
	20.6mm / 0.813" dia.	VLS-13/16
Large Lapping Stick 8" Long		VLS-30
Replacement Cups	28.6mm / 1.125" dia.	VLS-1 1/8
	34.9mm / 1.375" dia.	VLS-1 3/8

Conversion Calculator

We've tried to convert as many SAE measurements to Metric (and vice versa) as possible. In some cases there hasn't been enough room.

If you need to convert a measurement, here are the formulas:

Starting Measurement	Conversion Formula	Converted Measurement
Inches (in)	Inches x 25.4	Millimeters (mm)
Feet (ft)	Feet x .3048	Meters (m)
Millimeters (mm)	Millimeters ÷ 25.4	Inches (in)
Fahrenheit (F)	(5 ÷ 9) x (F - 32)	Celsius (C)
Celsius (C)	(9 ÷ 5) x (C + 32)	Fahrenheit (F)

Air Powered Valve Lapping Tool



- Operates on 90psi
- Includes air tool and 3 replacement cups • Air actuated ... no electricity needed • Cups also sold separately



Description	Cup ID	Order No.
Air Powered Valve Lapping Tool		AVLP-300
Replacement Cups	21mm / 0.827" dia.	AVLP-301
	33mm / 1.299" dia.	AVLP-302
	38mm / 1.496" dia.	AVLP-303

Mechanical Valve Lapping Tool

- Auto oscillation with a simple crank
- Includes blade drive for slotted valves

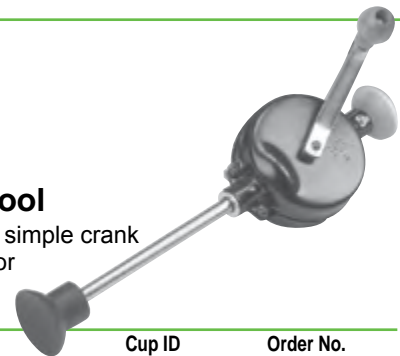

Description	Cup ID	Order No.
Mechanical Valve Lapping Tool		VL-EB
Replacement Cups	33.3mm / 1.313" dia.	VLS-15/16
	44.5mm / 1.750" dia.	VLS-1 3/4

Powered Lapping Tool

- Change rotary action into an effective oscillating motion • Drive with a power drill
- Makes lapping faster and easier
- Includes 2 cup sizes



Description	Cup ID	Order No.
Complete Tool		VLP-100
Replacement Cups	22.2mm / 0.875" dia.	VLP-10
	25.4mm / 1.000" dia.	VLP-20

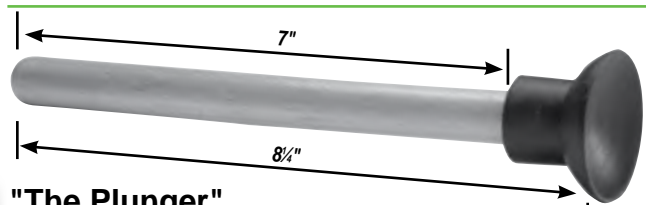

"The Plunger" Hand Valve Lapping Stick

- Large diameter for sure grip
- For 2" and larger valves

Description	Cup ID	Order No.
Hand Valve Lapping Stick 8 1/4" Long		VLS-75
Replacement Cup 44.5mm / 1.750" dia.	.313"	VLS-1 3/4

CYLINDER HEAD REBUILDING
CLEANING, ASSEMBLY & SAFETY
SHORT BLOCK REBUILDING
CRANKSHAFT/ FLYWHEEL GRINDING
MISCELLANEOUS TOOLS & SUPPLIES
BRAKE SERVICE TOOLING
MEASURING TOOLS
V-TWIN & METRIC HARD PARTS

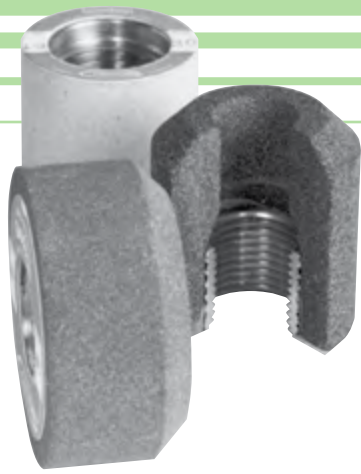

Goodson seat wheels are built to grind accurately & outlast the competition

- Brass bushings resist galling or seizing to the holder
- Heat-cured, permanent epoxy bonding prevents loose bushings
- Bushings are set deep to expose the most abrasive for long life
- Each wheel is pre-trued and checked to assure accurate, vibration-free grinding

**GP**

General Purpose
Removes material from cast-iron seats or inserts. Ideal for antiques.

CB

Cool Blue
Superior general purpose stone for high performance Beryllium seats. Cuts faster. For tractors and trucks with diesel engines.

S

Stellite
Specially formulated to grind Stellite and other types of hardened seat inserts, ie. Diesel & Industrial.

F

Finish
Gives an ideal final finish with minimal stock removal.

NC

Nickel Chrome
For aluminum heads with chrom-alloy seat inserts. Won't load up or groove. Speckled.

R

Ruby
The original Black & Decker composition, general purpose stone.

KW

Fits Kwik-Way 13/16"x13 thread

Custom angles and sizes are available in house. Call for more information.

Colors may vary due to manufacturing processes

Size	General Purpose (GP)			Cool Blue (CB)		Finishing (F)		Stellite (S)				
	Inch	mm	00°	30°	45°	00°	45°	30°	45°	00°	45°	
1/4"	32	KW-1000-GP	KW-1030-GP	KW-1045-GP	KW-1000-CB	KW-1045-CB	————	KW-1045-F	KW-1000-S	KW-1045-S		
1/16"	33	KW-1000A-GP	————	KW-1045A-GP	KW-1000A-CB	KW-1045A-CB	————	————	————	————		
1/8"	35	KW-1100-GP	KW-1130-GP	KW-1145-GP	KW-1100-CB	KW-1145-CB	KW-1130-F	KW-1145-F	KW-1100-S	KW-1145-S		
1/16"	36	KW-1100A-GP	————	KW-1145A-GP	KW-1100A-CB	KW-1145A-CB	————	KW-1145A-F	KW-1100A-S	KW-1145A-S		
1/2"	38	KW-1200-GP	KW-1230-GP	KW-1245-GP	KW-1200-CB	KW-1245-CB	KW-1230-F	KW-1245-F	KW-1200-S	KW-1245-S		
1/16"	39	KW-1200A-GP	————	KW-1245A-GP	————	KW-1245A-CB	————	KW-1245A-F	KW-1200A-S	KW-1245A-S		
1/8"	41	KW-1300-GP	KW-1330-GP	KW-1345-GP	KW-1300-CB	KW-1345-CB	KW-1330-F	KW-1345-F	KW-1300-S	KW-1345-S		
1 1/16"	43	KW-1300A-GP	————	KW-1345A-GP	KW-1300A-CB	KW-1345A-CB	————	KW-1345A-F	KW-1300A-S	KW-1345A-S		
1 3/4"	44	KW-1400-GP	KW-1430-GP	KW-1445-GP	KW-1400-CB	KW-1445-CB	KW-1430-F	KW-1445-F	KW-1400-S	KW-1445-S		
1/8"	47	KW-1500-GP	KW-1530-GP	KW-1545-GP	KW-1500-CB	KW-1545-CB	KW-1530-F	KW-1545-F	KW-1500-S	KW-1545-S		
2"	51	KW-1600-GP	KW-1630-GP	KW-1645-GP	KW-1600-CB	KW-1645-CB	KW-1630-F	KW-1645-F	KW-1600-S	KW-1645-S		
2 1/8"	54	KW-1700-GP	KW-1730-GP	KW-1745-GP	KW-1700-CB	KW-1745-CB	KW-1730-F	KW-1745-F	KW-1700-S	KW-1745-S		
2 1/4"	57	KW-1800-GP	KW-1830-GP	KW-1845-GP	KW-1800-CB	KW-1845-CB	————	KW-1845-F	KW-1800-S	KW-1845-S		
2 3/8"	60	KW-1900-GP	KW-1930-GP	KW-1945-GP	KW-1900-CB	KW-1945-CB	————	————	————	————		
Size	Nickel Chrome (NC)			Ruby (R)								
	Inch	mm	00°	45°	00°	45°						
1"	25	KW-700-NC	KW-745-NC		KW-700-R	KW-745-R						
1/16"	27	KW-800-NC	KW-845-NC		KW-800-R	KW-845-R						
1/8"	28	KW-900-NC	KW-945-NC		KW-900-R	KW-945-R						
1/4"	32	KW-1000-NC	KW-1045-NC		KW-1000-R	KW-1045-R						
1/8"	35	KW-1100-NC	KW-1145-NC		KW-1100-R	KW-1145-R						
1/16"	36	KW-1100A-NC	KW-1145A-NC		————	————						
1/2"	38	KW-1200-NC	KW-1245-NC		KW-1200-R	KW-1245-R						
1/16"	39	KW-1200A-NC	KW-1245A-NC		————	————						
1/8"	41	KW-1300-NC	KW-1345-NC		KW-1300-R	KW-1345-R						
1 1/16"	43	KW-1300A-NC	KW-1345A-NC		————	————						
1 3/4"	44	KW-1400-NC	KW-1445-NC		KW-1400-R	KW-1445-R						
1/8"	47	KW-1500-NC	KW-1545-NC		KW-1500-R	KW-1545-R						
2"	51	KW-1600-NC	KW-1645-NC		KW-1600-R	KW-1645-R						
2 1/8"	54	KW-1700-NC	KW-1745-NC		————	————						
2 1/4"	57	KW-1800-NC	KW-1845-NC		————	————						
2 3/8"	60	KW-1900-NC	KW-1945-NC		————	————						

Ordering is easy!

- 1 - Find the diameter (valve head diameter + 1/16" to 1/8").
- 2 - Find the angle you need (you can modify angles with our Valve Seat Stone Dresser, page 20).
- 3 - Select the abrasive to match your job.

tech tips

from the techxperts™



Hex Drive Seat Grinding Kit
includes everything listed below.
Everything comes packed in
a handy storage case.

Valve Seat Grinding Sets

Order the set as-is or modify a set to meet your specific needs. Set contents include:

Description	OE Number	Order No.	Includes		
45° Hex Drive Motor Seat Grinding Set (110V, 50/60 Hz)	—	SGH-110-KIT	1		
45° Hex Drive Motor Seat Grinding Set (220V, 50/60Hz)	—	SGH-220-KIT	1		
Flex Drive Motor Seat Grinding Set (110V, 50/60 Hz)	—	SGF-110-KIT	1		
Flex Drive Motor Seat Grinding Set (220V, 50/60Hz)	—	SGF-220-KIT	1		
Hex Drive Seat Grinder - 45° 110V, 50/60Hz	031-3100-20	031-3100-20	1		
Hex Drive Seat Grinder - 45° 220V, 50/60Hz	031-3100-27	031-3100-27	1		
Flex Drive Seat Grinder 110V, 50/60Hz	031-3000-15	031-3000-15	1		
Flex Drive Seat Grinder 220V, 50/60Hz	031-3000-35	031-3000-35	1		
Universal Wheel Dresser w/G-1 P Diamond	—	SWD-UNI	1		
Replacement Dressing Stand Diamond	—	G-13P	1		
Dressing Stand Pilot with .437" Top	031-0202-80	031-0202-80	1		
Dressing Stand Pilot with .437" Top	031-1102-89	031-1102-89	1		
Stone Holder - 13/16" x 13 Thread w/Plunger	031-0300-30	031-0300-30	2		
Flex-Drive Stone Holder with Stabilizer	031-0300-64	031-0300-64	2		
Heavy Duty Plastic Case (21 ⁵ / ₁₆ " x 12 ¹ / ₂ " x 13 ¹ / ₂ ")	001-1000-25	SG-CASE	1		
Seat Stone Removal Tool	—	KW-SRT	1		
Leather Washer / Vibration Reducer (3 Pc.)	031-1009-41	KHW-3	1		
.437" Top Pilots	Dia./mm				
	.2755" / 7.00mm	030-0237-30	P-5275K	1	
	.2760" / 7.01mm	—	P-5276K	1	
	.2765" / 7.05mm	030-0237-40	P-5277K	1	
	.3125" / 7.93mm	030-0239-35	P-5312K	1	
	.3135" / 7.96mm	030-0239-51	P-5313K	1	
	.3145" / 7.98mm	030-0239-78	P-5314K	1	
	.3150" / 8.00mm	030-0239-94	P-5315K	1	
	.3437" / 8.72mm	030-0242-73	P-5343K	1	
	.3440" / 8.74mm	030-0243-03	P-5344K	1	
	.3457" / 8.78mm	030-0243-11	P-5345K	1	
	.3730" / 9.47mm	030-0247-70	P-5373K	1	
	.3750" / 9.52mm	030-0247-70	P-5375K	1	
General Purpose Valve Seat Grinding Stones (3/8" x 13)	30°		45°		
1.375" / 35mm	KW-1130-GP	1	1	1	1
1.500" / 38mm	KW-1230-GP	1	1	1	1
1.615" / 41mm	KW-1330-GP	1	1	1	1
1.750" / 44mm	KW-1430-GP	1	1	1	1
1.785" / 47mm	KW-1530-GP	1	1	1	1
2.000" / 51mm	KW-1630-GP	1	1	1	1
2.125" / 54mm	KW-1730-GP	1	1	1	1
Finishing Valve Seat Grinding Stones (3/8" x 13)	30°		45°		
1.375" / 35mm	KW-1130-F	1	1	1	1
1.500" / 38mm	KW-1230-F	1	1	1	1
1.625" / 41mm	KW-1330-F	1	1	1	1
1.750" / 44mm	KW-1430-F	1	1	1	1
1.785" / 47mm	KW-1530-F	1	1	1	1
2.000" / 51mm	KW-1630-F	1	1	1	1
2.125" / 54mm	KW-1730-F	1	1	1	1

KWIK-WAY
Seat Grinding Equipment & Supplies
GOODSON
Tools and Supplies for Engine Builders

American Made

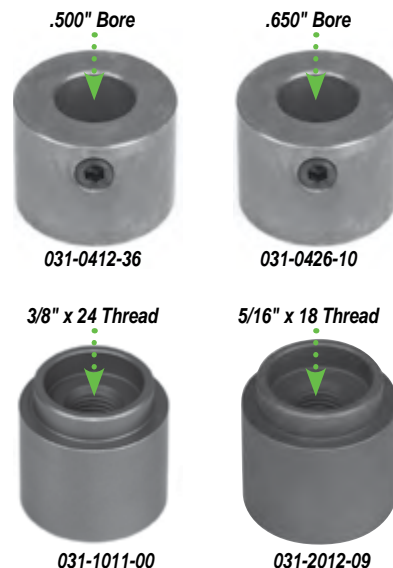

Hex Drive Replacement Assemblies

• Adapt your Seat Grinder Motor to fit various Kwik-Way Seat Grinders

Description	Order No.
.500" Bore	031-0412-36
Fit SGA Motor Units with Serial No. 0 to 2000	
.650" Bore	031-0426-10
Fit SGA Motor Units with Serial No. 4000 & up	
3/8" x 24 Thread	031-1011-00
Fit SGAI Hex Motor Units	
5/16" x 18" Thread	031-2012-09
Fit SSG Hex Motor Units	



45° Kwik-Way Hex Drive (SGH) Electric Motor Unit

- Heavy duty electric motor
- 11,500 RPM • Weighs 9 lbs.
- 3/5 HP, 7.5 Amps

Description	Order No.
110V, 50/60Hz	031-3100-20
220V, 50/60Hz	031-3100-27
Accessories	
Hex Drive Assembly	031-3112-17
Leather Washer	031-1009-41

CYLINDER HEAD REBUILDING
CLEANING, ASSEMBLY & SAFETY
SHORT BLOCK REBUILDING
CRANKSHAFT/ FLYWHEEL GRINDING
MISCELLANEOUS TOOLS & SUPPLIES
BRAKE SERVICE TOOLING
MEASURING TOOLS
V-TWIN & METRIC HARD PARTS



"If you need a custom angle or size in a Valve Seat Stone, Goodson can do it. We grind seat stones in-house to standard and custom dimensions. Give Goodson a call today."

- Tim, Goodson Production - 3 years of service

SX

Fits Sioux™, KO Lee, US, Thor, Skil, Winona 11/16"x16 thread

Colors may vary due to manufacturing processes

CYLINDER HEAD
REBUILDING

CLEANING,
ASSEMBLY & SAFETY

SHORT BLOCK
REBUILDING

CRANKSHAFT/
FLYWHEEL GRINDING

MISCELLANEOUS
TOOLS & SUPPLIES

BRAKE SERVICE
TOOLING

MEASURING
TOOLS

V-TWIN & METRIC
HARD PARTS

Size		General Purpose (GP)				Cool Blue (CB)		Ruby	
Inch	mm	00°	30°	45°	60°	00°	45°	00°	45°
7/8"	22							SX-500-R	SX-545-R
15/16"	24							SX-600-R	SX-645-R
1"	25							SX-700-R	SX-745-R
1 1/16"	27							SX-800-R	SX-845-R
1 1/8"	2	SX-900-GP	SX-930-GP	SX-945-GP				SX-900-R	SX-945-R
1 3/16"	30	SX-900A-GP		SX-945A-GP					
1 1/4"	32	SX-1000-GP	SX-1030-GP	SX-1045-GP	SX-1060-GP	SX-1000-CB	SX-1045-CB	SX-1000-R	SX-1045-R
1 5/16"	33	SX-1000A-GP		SX-1045A-GP		SX-1000A-CB	SX-1045A-CB		
1 3/8"	35	SX-1100-GP	SX-1130-GP	SX-1145-GP	SX-1160-GP	SX-1100-CB	SX-1145-CB	SX-1100-R	SX-1145-R
1 1/2"	36	SX-1100A-GP		SX-1145A-GP		SX-1100A-CB	SX-1145A-CB		
1 1/2"	38	SX-1200-GP	SX-1230-GP	SX-1245-GP	SX-1260-GP	SX-1200-CB	SX-1245-CB	SX-1200-R	SX-1245-R
1 5/8"	39	SX-1200A-GP		SX-1245A-GP		SX-1200A-CB	SX-1245A-CB		
1 5/8"	41	SX-1300-GP	SX-1330-GP	SX-1345-GP	SX-1360-GP	SX-1300-CB	SX-1345-CB	SX-1300-R	SX-1345-R
1 11/16"	43	SX-1300A-GP		SX-1345A-GP		SX-1300A-CB	SX-1345A-CB		
1 3/4"	44	SX-1400-GP	SX-1430-GP	SX-1445-GP	SX-1460-GP	SX-1400-CB	SX-1445-CB	SX-1400-R	SX-1445-R
1 7/8"	47	SX-1500-GP	SX-1530-GP	SX-1545-GP	SX-1560-GP	SX-1500-CB	SX-1545-CB	SX-1500-R	SX-1545-R
2"	51	SX-1600-GP	SX-1630-GP	SX-1645-GP	SX-1660-GP	SX-1600-CB	SX-1645-CB	SX-1600-R	SX-1645-R
2 1/8"	54	SX-1700-GP	SX-1730-GP	SX-1745-GP		SX-1700-CB	SX-1745-CB	SX-1700-R	SX-1745-R
2 1/4"	57	SX-1800-GP	SX-1830-GP	SX-1845-GP	SX-1860-GP	SX-1800-CB	SX-1845-CB	SX-1800-R	SX-1845-R
2 3/8"	60	SX-1900-GP	SX-1930-GP	SX-1945-GP	SX-1960-GP	SX-1900-CB	SX-1945-CB	SX-1900-R	SX-1945-R
2 1/2"	63	SX-2000-GP	SX-2030-GP	SX-2045-GP		SX-2000-CB	SX-2045-CB	SX-2000-R	SX-2045-R
2 5/8"	66	SX-2100-GP	SX-2130-GP	SX-2145-GP		SX-2100-CB	SX-2145-CB		

Size		Stellite (S)			Finishing (F)			Nickel Chrome		
Inch	mm	00°	30°	45°	00°	30°	45°	00°	30°	45°
1/2"	12.7							SX-200-NC		
5/16"	14.3							SX-200A-NC		
5/8"	15.9							SX-300-NC		
1 1/16"	17.4							SX-300A-NC		
3/4"	19.1							SX-400-NC		
1 3/16"	20.6							SX-400A-NC		
7/8"	22				SX-500-F		SX-545-F	SX-500-NC		SX-545-NC
1 5/16"	24				SX-600-F		SX-645-F	SX-600-NC		SX-645-NC
1"	25				SX-700-F		SX-745-F	SX-700-NC		SX-745-NC
1 1/16"	27				SX-800-F		SX-845-F	SX-800-NC		SX-845-NC
1 1/8"	28	SX-900-S	SX-930-S	SX-945-S	SX-900-F	SX-930-F	SX-945-F	SX-900-NC	SX-930-NC	SX-945-NC
1 3/16"	30	SX-900A-S		SX-945A-S	SX-900A-F		SX-945A-F	SX-900A-NC		SX-945A-NC
1 1/4"	32	SX-1000-S	SX-1030-S	SX-1045-S	SX-1000-F	SX-1030-F	SX-1045-F	SX-1000-NC	SX-1030-NC	SX-1045-NC
1 5/16"	33	SX-1000A-S		SX-1045A-S	SX-1000A-F		SX-1045A-F	SX-1000A-NC		SX-1045A-NC
1 3/8"	35	SX-1100-S	SX-1130-S	SX-1145-S	SX-1100-F	SX-1130-F	SX-1145-F	SX-1100-NC	SX-1130-NC	SX-1145-NC
1 1/2"	36	SX-1100A-S		SX-1145A-S	SX-1100A-F		SX-1145A-F	SX-1100A-NC		SX-1145A-NC
1 1/2"	38	SX-1200-S	SX-1230-S	SX-1245-S	SX-1200-F	SX-1230-F	SX-1245-F	SX-1200-NC	SX-1230-NC	SX-1245-NC
1 5/8"	39	SX-1200A-S		SX-1245A-S	SX-1200A-F		SX-1245A-F	SX-1200A-NC		SX-1245A-NC
1 5/8"	41	SX-1300-S	SX-1330-S	SX-1345-S	SX-1300-F	SX-1330-F	SX-1345-F	SX-1300-NC	SX-1330-NC	SX-1345-NC
1 11/16"	43	SX-1300A-S		SX-1345A-S	SX-1300A-F		SX-1345A-F	SX-1300A-NC		SX-1345A-NC
1 3/4"	44	SX-1400-S	SX-1430-S	SX-1445-S	SX-1400-F	SX-1430-F	SX-1445-F	SX-1400-NC	SX-1430-NC	SX-1445-NC
1 7/8"	47	SX-1500-S	SX-1530-S	SX-1545-S	SX-1500-F	SX-1530-F	SX-1545-F	SX-1500-NC	SX-1530-NC	SX-1545-NC
2"	51	SX-1600-S	SX-1630-S	SX-1645-S	SX-1600-F	SX-1630-F	SX-1645-F	SX-1600-NC	SX-1630-NC	SX-1645-NC
2 1/8"	54	SX-1700-S	SX-1730-S	SX-1745-S	SX-1700-F	SX-1730-F	SX-1745-F	SX-1700-NC	SX-1730-NC	SX-1745-NC
2 1/4"	57	SX-1800-S	SX-1830-S	SX-1845-S	SX-1800-F	SX-1830-F	SX-1845-F	SX-1800-NC	SX-1830-NC	SX-1845-NC
2 3/8"	60	SX-1900-S	SX-1930-S	SX-1945-S	SX-1900-F	SX-1930-F	SX-1945-F	SX-1900-NC	SX-1930-NC	SX-1945-NC
2 1/2"	63	SX-2000-S	SX-2030-S	SX-2045-S	SX-2000-F	SX-2030-F	SX-2045-F	SX-2000-NC	SX-2030-NC	SX-2045-NC
2 5/8"	66							SX-2100-NC	SX-2130-NC	SX-2145-NC

All Valve Seat Wheels are guaranteed against manufacturing defects for 1 year from original purchase date



Double Angle Valve Seat Wheels

- Fits Sioux-Style 7/8"x14 thread
- 30° one side, 45° on the other side

Inch mm		General Purpose	Nickel-Chrome	Cool Blue
		Order No.	Order No.	Order No.
3"	76.2	SXL-2345-GP	SXL-2345-NC	SXL-2345-CB
3 1/4"	82.5	SXL-2445-GP	SXL-2445-NC	SXL-2445-CB
3 1/2"	88.9	SXL-2545-GP	SXL-2545-NC	SXL-2545-CB
3 3/4"	92.3	SXL-2645-GP	SXL-2645-NC	SXL-2645-CB
4"	101.6	SXL-2745-GP	SXL-2745-NC	SXL-2745-CB

KWIK-WAY
 Seat Grinding Equipment & Supplies
MFG BY

GOODSON

Tools and Supplies for Engine Builders



Sioux-Style Valve Seat Grinding Kits

These kits include everything you need to get started in seat grinding. Choose between kits including 110V and 220V Spline Drive Electric Grinders. After that, everything else in the kit is identical. We started with the most common sizes of pilots and valve seat stones, but you can customize one of these kits to meet your specific needs.

Description	OE Number	Order No.	Includes	
45° Spline Drive Motor Seat Grinding Set (110V, 50/60 Hz)		SGK-110-KIT	▼	
45° Spline Drive Motor Seat Grinding Set (220V, 50/60Hz)		SGK-220-KIT	▼	
Spline Drive Seat Grinder - 45° 110V, 50/60 Hz	031-3100-21	031-3100-21	1	
Spline Drive Seat Grinder - 45° 220V, 50/60 Hz	031-3100-28	031-3100-28	1	
Universal Seat Wheel Dresser w/G-13P Diamond	-----	SWD-UNI	1 1	
Replacement Dressing Diamond	-----	G-13P		
Dressing Stand Pilot	031-0202-55	031-0202-55	1 1	
Stone Holder - 1/8" x 16 Thread	1702	SX-HOLDER	2 2	
Heavy Duty Plastic Storage Box (21 ⁵ / ₁₆ " x 12 ¹ / ₂ " x 13 ¹ / ₂ "	001-1000-25	SG-CASE	1 1	
Seat Stone Removal Tool	-----	SX-SRT	1 1	
Bounce Spring Set (3 Pc.)	-----	BSS-100	1 1	
Leather Washer / Vibration Reducer (3 Pc.)	031-1009-41	SHW-3	1 1	
.385" Top Pilots	Dia./mm			
	.2755" / 7.00mm	P-5275S	1 1	
	.2763" / 7.02mm	P-5277S	1 1	
	.2779" / 7.05mm	P-5278S	1 1	
	.3125" / 7.94mm	P-5312S	1 1	
	.3130" / 7.95mm	P-5313S	1 1	
	.3141" / 7.98mm	P-5314S	1 1	
	.3149" / 8.00mm	P-5315S	1 1	
	.3430" / 8.71mm	P-5343S	1 1	
	.3440" / 8.73mm	P-5344S	1 1	
	.3450" / 8.76mm	P-5345S	1 1	
	.3750" / 9.53mm	P-5375S	1 1	
	.3760" / 9.55mm	P-5376S	1 1	
General Purpose Seat Grinding Stones (1/16"x16)	30°		45°	
1.375" / 35mm	SX-1130-GP	1 1	SX-1145-GP	1 1
1.500" / 38mm	SX-1230-GP	1 1	SX-1245-GP	1 1
1.625" / 41mm	SX-1330-GP	1 1	SX-1345-GP	1 1
1.750" / 44mm	SX-1430-GP	1 1	SX-1445-GP	1 1
1.785" / 47mm	SX-1530-GP	1 1	SX-1545-GP	1 1
2.000" / 51mm	SX-1630-GP	1 1	SX-1645-GP	1 1
2.125" / 54mm	SX-1730-GP	1 1	SX-1745-GP	1 1
Finishing Valve Seat Grinding Stones (1/16"x16)	30°		45°	
1.375" / 35mm	SX-1130-F	1 1	SX-1145-F	1 1
1.500" / 38mm	SX-1230-F	1 1	SX-1245-F	1 1
1.625" / 41mm	SX-1330-F	1 1	SX-1345-F	1 1
1.750" / 44mm	SX-1430-F	1 1	SX-1445-F	1 1
1.785" / 47mm	SX-1530-F	1 1	SX-1545-F	1 1
2.000" / 51mm	SX-1630-F	1 1	SX-1645-F	1 1 1
2.125" / 54mm	SX-1730-F	1 1	SX-1745-F	1 1



45° Sioux-Style (SGK) Spline Drive Electric Motor Unit

- Heavy duty electric motor
- 11,500 RPM
- Weighs 9 lbs.
- 3/5 HP • 7.5 Amps

Description	Order No.
110V, 50/60Hz	031-3100-21
220V, 50/60Hz	031-3100-28



034-3112-00

Replacement Drive Assemblies

- Easy to install
- Always keep one on hand for emergencies

Description	Order No.
Spline Drive (SGH)	034-3112-00

CYLINDER HEAD REBUILDING
 CLEANING, ASSEMBLY & SAFETY
 SHORT BLOCK REBUILDING
 FLYWHEEL GRINDING
 CRANKSHAFT/ MISCELLANEOUS TOOLS & SUPPLIES
 TOOLS
 BRAKE SERVICE TOOLING
 MEASURING TOOLS
 V-TWIN & METRIC HARD PARTS

Seat Stone Holders, Adaptors & More

Valve Seat Stone Holders & Accessories

- Ball-bearing stone holders • Ideal replacements for worn holders • Save time by having several holders set up with commonly used sizes, compositions or angles of seat stones

NEW! Sioux-Style & Kwik-Way Style Stone Holders for .375" Top Pilots, page NP-5

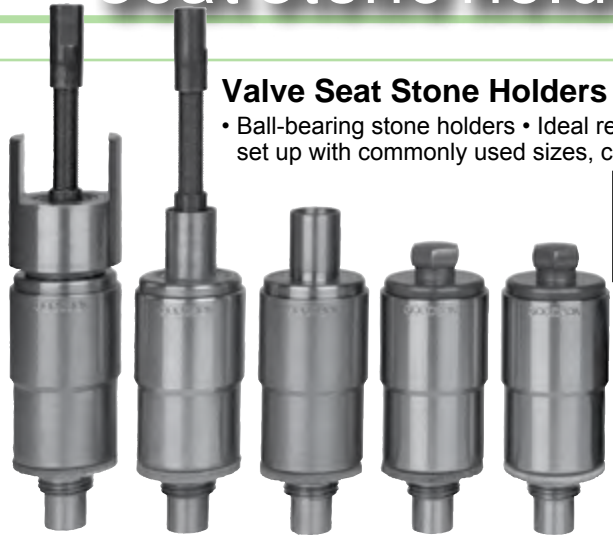

.437" Pilot, 1 1/16"x13 Thread Kwik-Way Stone Holders	
All Kwik-Way Holders are rebuildable unless noted	
Order No.	
Flex-Drive Stone Holder with Stabilizer & Coupling	031-0300-64
Flex-Drive Stone Holder with Stabilizer	031-0300-80
Flex-Drive Stone Holder only	031-0300-85
Hex-Drive Stone Holder w/o Spring Plunger	031-0300-56
Hex-Drive Stone Holder with Spring Plunger	031-0300-30



.385" Pilot, 1 1/16"x16 Thread Sioux-Style Stone Holders		
	OE #	Order No.
Short Body (Spline)	1672	SX-1672
Sioux-Style (Spline)	1702	SX-HOLDER
3/8" Hex Drive	1702BB	SX-1702BB



Accessories	Order No.
Stabilizer Assembly with Bronze Bushing	031-0126-60
Heavy-Duty Twisted Cable Steel Coupling	031-0304-10
Replacement Hex Drive Body Cap	031-0302-95
Replacement Spring Plunger Assembly	031-0313-97
Leather Vibration Reducer (3 pc.) For KW-Holders	KHW-3
Valve Seat Stone Removal Tool	KW-SRT

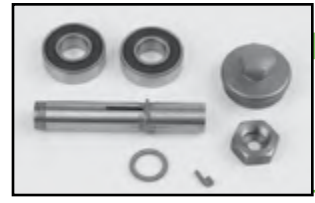

Rebuild Kits	Order No.
For Hex Drive Stone Holder without Spring Plunger Includes 2 Bearings, Bearing Sleeve, Bearing Lock Nut, Sleeve Key, Hex Cap & Garter Spring	034-0002-00

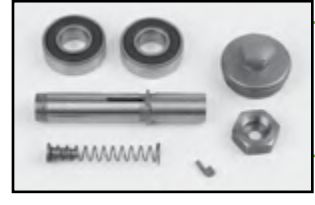

For Hex Drive Stone Holder with Spring Plunger Includes 2 Bearings, Bearing Sleeve, Bearing Lock Nut, Sleeve Key, Hex Cap & Spring Plunger	034-0002-15
---	--------------------



For Flex Drive Stone Holder Includes 2 Bearings, Bearing Sleeve, Heavy Duty Flex Coupling, Inner Sleeve Key & Set Screw	034-0003-25
Rebuild kit components are not available individually	

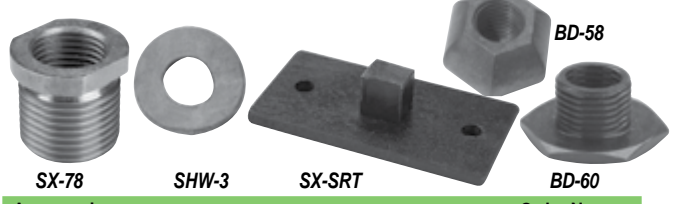

Accessories	Order No.
Sioux-Style Conversion Bushings 1 1/16"x16 to 7/8"x14	SX-78
Leather Vibration Reducer (3 pc.) For SX-Holders	SHW-3
Standard Bounce Spring Set (3pc.)	BSS-100
Valve Seat Stone Removal Tool	SX-SRT

.375" Pilot, Thread Black & Decker Stone Holders		
	OE #	Order No.
Black & Decker Style 3/16"x16	BD-HOLDER	BDS-HOLDER
Includes BD-60 adaptor to convert 3/16"x16 to 1 1/16"x16 Sioux-style stones		
Sioux-Style fits .375" Pilot 1 1/16"x16 thread		SX-375
Hex Drive fits .375" Pilot 1 3/16"x13 thread		KW-375
Accessories	Order No.	
Black & Decker 5/8" Hexball 5/8"x24 thread	BD-58	
3/16"-16 to 1 1/16"-16 Adaptor for Sioux Style	BD-60	



Grinding Wheel Adaptors	
Description	Order No.
1 3/16"-13 (KW) Threaded Stones to 1 1/16"-16 Threaded Holders (Sioux™, KO Lee)	031-0390-02
1 3/16"-13 (KW) Threaded Stones to 3/8"-16 Threaded Holders (Black & Decker)	031-0391-00
1 3/16"-13 (KW) Threaded Stones to 2 1/2"-18 Threaded Holders (Kwik-Way)	031-0393-04

Billet Aluminum Tooling Stand	
Accommodates tooling using 3/8" or larger pilots. Perfect for stone holders! Room for up to 5 tools.	
Order No. TS-5	



new

CYLINDER HEAD REBUILDING
CLEANING, ASSEMBLY & SAFETY
SHORT BLOCK REBUILDING
CRANKSHAFT/ FLYWHEEL GRINDING
MISCELLANEOUS TOOLS & SUPPLIES
BRAKE SERVICE TOOLING
MEASURING TOOLS
V-TWIN & METRIC HARD PARTS

Air & Electric Seat Grinder Motors



Flex Drive (SGF) Heavy Duty Electric Motor Unit

- Heavy duty electric motor
- Flex Drive allows for slight operator misalignment
- 11,500 RPM (free speed) • 6982 RPM (under load)
- Weighs 12 lbs. • 3/5 HP • 7.5 Amps
- Use with Flex Drive Stone Holders (page 20)

Description	Order No.
110V, 50/60Hz	031-3000-15
220V, 50/60Hz	031-3000-35
Replacement Nose Assembly	031-3005-17

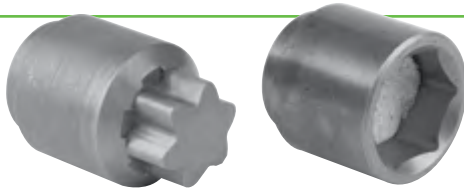

034-3112-00

031-3112-17

Replacement Drive Assemblies

- Easy to install
- Always keep one on hand for emergencies

Description	Order No.
Spline Drive (SGK)	034-3112-00
Hex Drive with Leather Washer (SGH)	031-3112-17
Replacement Leather Washer	031-1009-41



Kwik-Way 45° Hex Drive (SGH) Electric Motor Unit

- Heavy duty • 11,500 RPM (free speed)
- 6982 RPM (under load) • 9 lbs. • 3/5 HP
- 7.5 amps • Use with Hex Drive Stone Holders (page 20)

Description	Order No.
110V, 50/60Hz	031-3100-20
220V, 50/60Hz	031-3100-27
Replacement Nose Assembly	031-3105-12
Hex Drive Assembly with Leather Washer	031-3112-17



45° (SGK) Sioux-Style Spline Drive Electric Motor Unit

- Heavy duty • 11,500 RPM (free speed)
- 6982 RPM (under load) • 9 lbs. • 3/5 HP
- 7.5 amps • Use with SX Stone Holder (page 20)

Description	Order No.
110V, 50/60Hz	031-3100-21
220V, 50/60Hz	031-3100-28
Replacement Nose Assembly	034-3105-00
Replacement Spline Drive Assembly	034-3112-00

new

90° Angle High-Speed Air Driver

- 2 models available - spline or hex drive
- 11,000 RPM motor • 5/8" - 11 spindle
- 1/4" air inlet • 6 CFM • Rear exhaust
- Weighs 2.25 lbs. • Measures 8.75" long
- Composite grip and trigger are ergonomically designed for unmatched user comfort

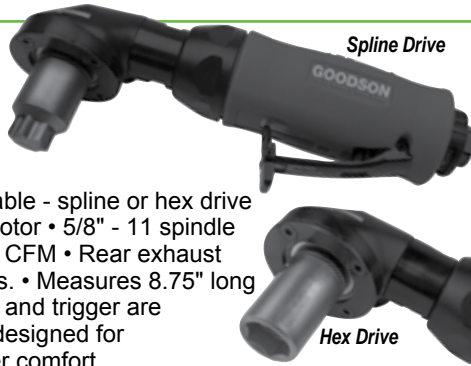

Description	Order No.
Spline Drive (SGK)	AG-SX90
Hex Drive (SGH)	AG-KW90

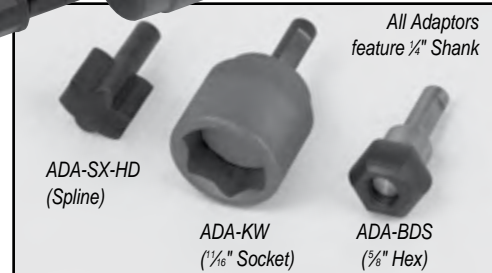

Universal 4500 RPM Air Driver & Adaptors

- Planetary gear set-up reduces speed to 4500 RPM for best finish, more control and increased torque
- Use vertically to reduce side load on stones
- Weighs just 2 lbs./0.91 kg
- Adaptors available for a variety of stone holders
- Precision clamping collet and wrenches included
- Use with bounce springs (page 22) for best results

Description	Order No.
4500 RPM Air Driver	AG-4500
Hexball Driver	ADA-BDS
Kwik-Way Drive Adaptor	ADA-KW
Sioux-Style Drive Adaptor	ADA-SX-HD

Valve Seat Angle Grinder Adaptors

- Turn your 4½" Angle Grinder with 5/8"x11 threads into a Valve Seat Grinder
- Available for Sioux and Kwik-Way
- Stone holders and pilots available separately



Description	Order No.
Spline-Drive (SGK) Adaptor	SW-SX
Hex Socket (SGH) Adaptor	SW-KW
B&D Angle Drive Adapter	SW-BD

CYLINDER HEAD GRINDING
CLEANING, ASSEMBLY & SAFETY
SHORT BLOCK
FLYWHEEL GRINDING
CRANKSHAFT/
MISCELLANEOUS TOOLS & SUPPLIES
BRAKE SERVICE TOOLING
MEASURING TOOLS
V-TWIN & METRIC HARD PARTS

Goodson
EXCLUSIVE**American Made**

Universal Valve Seat Wheel Dressing Stand

- Infinitely adjustable from 0° to 90°
- Scale marked in 1° increments
- Dress stones up to 4" diameter
- Includes Premium dresser diamond & dresser pilot
- Base has pre-drilled holes for easy mounting to your bench
- **Choose dresser pilot separately from chart below**

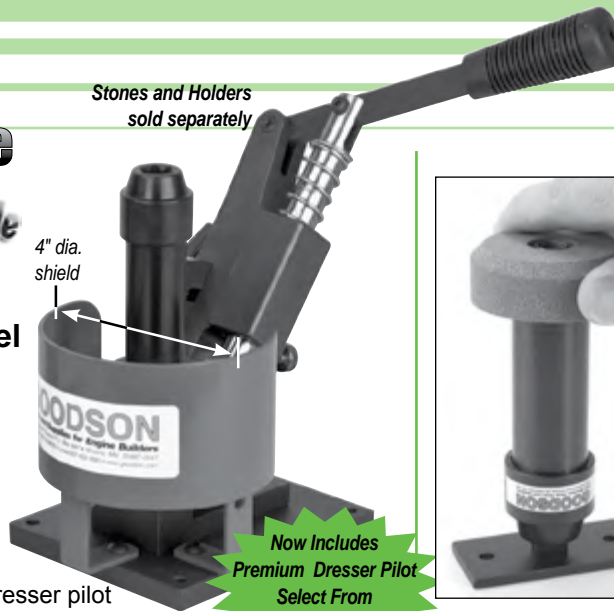

**Now Includes
Premium Dresser Pilot
Select From
Chart Below**

Description	Order No.	Incl.
Universal Dressing Stand	SWD-UNI	▼
Replacement Premium Dressing Diamond	G-13P	x
Dressing Stand Riser Bushings (.250" & .875" Tall)	SK-9-10	x
Replacement Parts		
Spring Detent	SWD-UNI-DET	
Arm Assembly with Spring & Plunger	SWD-UNI-ARM	

See pages 16-21 for valve seat stones, stone holders, air drivers, etc.

Heavy Duty Valve Seat Wheel Dresser

- Ball bearing mounted diamond carrier
- Adjustable in 1° increments from 0° to 90°
- Includes diamond
- **Order dressing pilot separately from list below**
- Designed for maximum accuracy



**Includes Premium
Dresser Pilot - Select
From Chart
Below**

Description	Order No.
Heavy Duty Dresser	031-1900-02
Replacement Torsion Spring for 031-1900-02	000-1850-78
Replacement Diamond Dresser	G-18

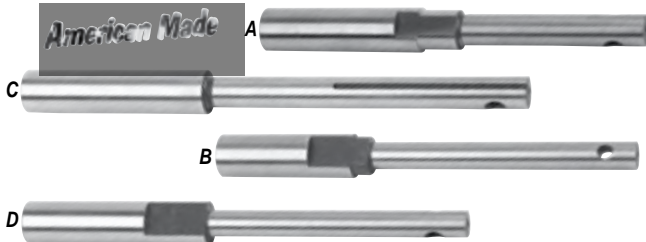

Valve Seat Wheel Dresser Pilots for Universal & Heavy Duty Wheel Dressers

Dresser Pilots (select based on stone holder type)		
Fits Stone Holder Type	OAL	Order No.
A .437" Hex Stone Holder	5 1/2"	031-1102-89
B .437" Hex or Flex Stone Holder	7 1/4"	031-0202-80
C .385" Top Stone Holder	6"	031-0202-55
D .375" Top Stone Holder	6 3/8"	031-0202-47

Stones and Holders
sold separately

Seat Stone Removal Tool

Once in a while a valve seat stone will be so tight on the stone holder that it's almost impossible to get off. That's why we came up with this tool. Simply fasten it to your bench with screws or bolts (not included) or clamp it in a vise, set the holder onto the fixture and twist the stone off easily.



Description	Order No.
Sioux-Style	SX-SRT
Kwik-Way Style	KW-SRT

Valve Seat Height Gauge

- Adjusts for all popular valve seat diameters • Gauge accurate to .001"
- Seat contact probe aligns on valve seat while gauge rides along the fire deck • Pilot aligns in valve guide
- Fully adjustable seat contact probe and gauge positions allow tool to fit popular seat diameters from .750" to 3.00"
- Includes Dial Indicator



Description	Fits Pilot	Order No.
Valve Seat Height Gauge Kit	.375"	VSHG-375
Replacement Dial Indicator		EDI-1

tech tips

Goodson recommends using Bounce Springs with your Valve Seat Stones to prevent damage to the stone and the from the techparts™ seat. This is especially important with the very small stones.

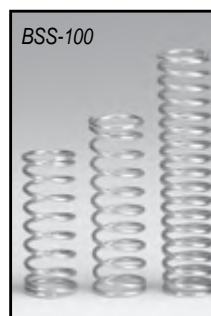

Standard Bounce Spring Set

- Includes 1 each of 3 lengths: 1" / 24.5mm, 1.50" / 38.1mm and 2" / 50.8mm
- ID = .450" / 11.4mm
- OD = .570" / 14.5mm
- Order No. **BSS-100**

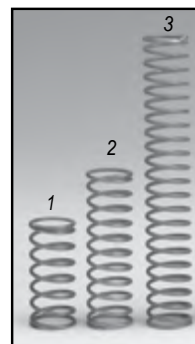

Small Diameter Bounce Springs

- ID = .406" / 10.3mm
- OD = .500" / 12.7mm

Length / mm	Order No.
1.10" / 27.9	BS-1
1.67" / 42.4	BS-2
3.00" / 76.2	BS-3

Valve Refacing

Use VG-STOP for extra long stemmed valves

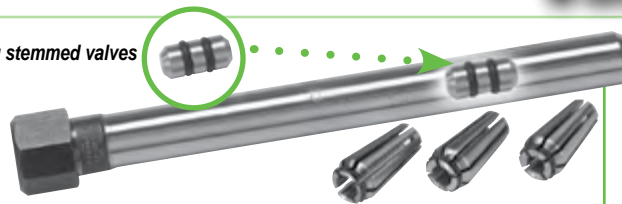

Adaptor for 1/2" Chucks

- For small diameter valves
- Hardened steel collet holder fits any machine with a 1/2" chuck • Collet seats in retainer nut for fast, easy removal
- Internal stop adjusts with a screwdriver, allowing you to reface an entire set of valves to identical specs quickly
- 3 collet sizes cover range of 4.5 - 6.5mm
- Start with the set then replace collets as needed (**collets will not work without the holder**) • Use the Adaptor Stop to machine longer valve stems

Description	Range	Order No.	Incl.
Full Set		UVRC-46	▼
Steel Collet Holder (collets MUST be used)		UVRC-46R	x
Replacement	4.5 - 5.0 mm (.177"-.196")	UVRC-5MM	x
Collets	5.0 - 5.5 mm (.196"-.216")	UVRC-5.5MM	x
	6.0 - 6.5 mm (.236"-.256")	UVRC-6.5MM	x
Adaptor Stop		VG-STOP	x

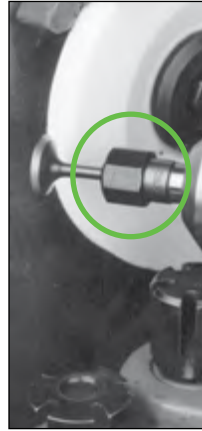

Valve Stem to Valve Face Concentricity Gauge

- Accurate to .001"
- Features a rugged, positive stop –set it once and do an entire set of valves
- Use before grinding to eliminate needless cleaning & machine time • Use after refacing to ensure stem concentricity • Also check pilots and other small parts for concentricity
- For stems as small as 4mm
- Order No. **VCG-16**

CYLINDER HEAD REBUILDING
CLEANING, ASSEMBLY & SAFETY
SHORT BLOCK REBUILDING
FLYWHEEL GRINDING
CRANKSHAFT/TOOLS & SUPPLIES
MISCELLANEOUS
BRAKE SERVICE TOOLING
MEASURING TOOLS
V-TWIN & METRIC HARD PARTS

Diamond Dresser Tools for Common Valve Refacers

• Select from Standard or Premium Grade • See the complete assortment of diamond dresser tools on pages 106 and 107.

Valve Refacers	Machine	Description	Carat	Radiac #	Standard	Premium
	B&D, Skil, Sioux™, Thor, VanDorn, WVN	3/8"x1 5/8"	1/5	2335660	G-1	G-1P
	Kwik-Way, Tobin Arp (S&D)	5/16"x2 1/2"	1/5	2335662	G-3	---
	Kwik-Way, Valve Master (1714)	1/2"x3 3/4" 20NF	1/5	---	G-4	---
	Sioux™ (1713, 1715), IDL, WVN (CG50, CG80)	3/8"x2 3/4" 24NF	1/5	2335664	G-5	G-5P
	IDL, WVN (CG-50, CG-80)	3/8"x3 3/4" 24NF	1/5	---	G-80	G-80P
	US	7/16"x2"	1/5	---	G-6	---
	Skil (Talent)	5/16"x2 1/4" 18NC	1/5	---	G-9	---
	Kwik-Way	7/16"x2 3/4" 20NF	1/5	2335670	G-17	G-17P



GMC-RIMAC

Protect Your Valuable Machines When Not In Use!



GMC-KW



GMC-VST

GMC-PRF

Sundura® Canvas Machine Covers

- Heavy-weight, breathable black Sundura® fabric won't hold in moisture
- Several sizes to fit a variety of machines • All covers will fit other machines, just match your machine's dimensions to the cover dimensions
- Covers are opaque, pictures for demonstration only

Fits Machine	Dimensions	Order No.
Goodson Ring Filer or Sharpening Fixture	13"L x 7 1/2"D x 7 1/2"H	GMC-PRF
Rimac Spring Tester	32" Dia. x 18 1/2"H, tapers to 3" sq.	GMC-RIMAC
Goodson VST-60G Spring Tester	10"L x 14"D x 18"H	GMC-VST
Sioux 2075 Valve Refacer	35"L x 27"D x 16"H	GMC-SX
Kwik-Way SVS II Valve Refacer	35"L x 15"D x 12"H, trapezoid shape	GMC-KW
Rottler VR10 Valve Refacer	45"L x 28"D x 25"H	GMC-VR10
Rottler VR12 Valve Refacer	39"L x 31"D x 25"H	GMC-VR12



"We pride ourselves on getting orders to you quickly. Goodson stocks a wide variety of products in our warehouse and we use most shipping carriers so you can receive your order in 3 days or less."

- Craig, Goodson Shipping - 3 years of service

Precision made wheels – superior performance

We stock more than 40 individual valve refacer wheels, each one designed for a specific machine. Our 4" general purpose wheel for Black & Decker is different from our 4" general purpose wheel for Sioux™. We won't compromise on performance just to simplify our inventory. Your valve refacer requires a certain type of grit, grade and bond and Goodson delivers. All Goodson Valve Refacing Wheels are designed to be used with mineral based grinding oils such as VGO-10 or VGO-SD10. Goodson guarantees all valve refacing wheels against manufacturing defects for 1 year from original purchase date.

Choose from these types: **ST** = for grinding stainless, **S** = for grinding Stellite, **T** = for grinding Titanium, **GP** = for general purpose grinding and **CB** = for general purpose grinding of harder materials. Stone color may vary due to manufacturing process.

To Fit	Use	Dia x Ht x Arb	Shape	Type	Color	Fits Models	OE No.	Order No.
Black & Decker	Valve	4" x 1" x 5/8"	Offset	GP	Gray	A, B, C, LW, M, MW, N, NW, NWB	16371	F336037*
		4" x 1" x 5/8"	Offset	CB	Blue	A, B, C, LW, M, MW, N, NW, NWB	Goodson Spec	GV-146-CB
		4" x 1" x 5/8"	Offset	S	Ruby	A, B, C, LW, M, MW, N, NW, NWB	16371	GV-144
		4" x 1" x 5/8"	Offset	T	Green	All but 680, 682, 285, 956	Goodson Spec	GV-150
		5" x 1" x 5/8"	Offset/20°	GP	Pink	P, PC, PCB, T, TD, TG	34131	GV-156
	Stem	4" x 1 1/8" x 1/2"	Cup	GP	Ruby	All models	20939	GV-145
Comec	Valve	215 x 35 x 76mm	Flared	GP	Gray	VR416, RV-516	7604	GV-925
	Stem	100 x 50 x 20mm	Cup	GP	White	VR416, RV-516	7606	GV-928
IDL Sunnen	Valve	8" x 1 1/4" x 1 1/2"	Flared	GP	White	CG-50, -80, -82, V-90, VR-7000	8230	GV-823
		8" x 1 1/4" x 1 1/2"	Flared	GP	Gray	CG-50, -80, -82, V-90, VR-7000	VR1703	GV-825
		8" x 1 1/4" x 1 1/2"	Flared	S	White	CG-50, -80, -82, V-90, VR-7000	Goodson Spec	GV-821
		8" x 1 1/4" x 1 1/2"	Flared	S	Pink	CG-50, -80, -82, V-90, VR-7000	8230-3	GV-826
		8" x 1 1/4" x 1 1/2"	Flared	T	Green	CG-50, -80, -82, V-90, VR-7000	VR1704	GV-827
	Stem	8" x 1 1/4" x 1 1/2"	Flared	GP	Ruby	CG-80, CG-82, V-90, VR-7000	VR1701	GV-824
Kwik-Way	Valve	4 1/2" x 7/8" x 7/8"	Offset	GP	Black	CV, SK, KK, VC, SV, XC	010-0450-10	GV-257
		4 1/2" x 7/8" x 7/8"	Offset	S	Gray	CV, SK, KK, VC, SV, XC	010-0457-03	GV-259
		5" x 7/8" x 7/8"	Offset	GP	White	EVS, VS	Goodson Spec	GV-251
		5" x 7/8" x 7/8"	Offset	GP	Gray	EVS, VS	010-0509-01	GV-252
		5" x 7/8" x 7/8"	Offset	T	Green	EVS, VS	010-0508-04	GV-255
		7" x 1" x 7/8"	Offset	GP	Gray	SVS, SVS-2	010-0709-00	GV-280
		7" x 1" x 7/8"	Offset	CB	Blue	SVS, SVS-2	Goodson Spec	GV-280-CB
		7" x 1" x 7/8"	Offset	S	White	SVS, SVS-2	010-0707-50	GV-281
		7" x 1" x 7/8"	Offset	T	Green	SVS, SVS-2	010-0708-05	GV-282
		7" x 1" x 7/8"	Offset	T	Green	SVS, SVS-2	Goodson Spec	GV-282A
		7" x 1 9/16" x 7/8"	Offset	GP	Orange	SVS, SVS-2		F372239*
		7" x 1 9/16" x 7/8"	Offset	GP	Ruby	SVS, SVS-2		F377419*
	Stem	3" x 1 1/4" x 5/8"	Cup	GP	Gray	All Models except VL		F336036*
	3" x 1 1/4" x 5/8"	Cup	GP	Gray	All but VL	010-0300-05	GV-237	
	3" x 1 1/4" x 5/8"	Cup	CB	Blue	All but VL	Goodson Spec	GV-237-CB	
	8" x 1 3/8" x 7/8"	Offset	GP	Gray	VL	010-0819-0	GV-260	
KO Lee	Valve	5" x 3/4" x 5/8"	Offset	GP	Gray	All models	OV5GH60	GV-658
		5" x 3/4" x 5/8"	Offset	S	White	All models	OV5GH80S	GV-659
	Stem	4" x 1" x 5/8"	Cup	GP	Gray	K500(C) & K403(C)	RV4KH60	GV-345
	4" x 1" x 5/8"	Cup	CB	Blue	All but 500 & CRW	Goodson Spec	GV-345-CB	
Rottler VR-7	Valve	7" x 1" x 7/8"	Offset	GP	Gray	VR-7	VTRW-8	GV-280
		7" x 1" x 7/8"	Offset	T	Green	VR-7	VTRW-7	GV-282
		7" x 1" x 7/8"	Offset	GP	Orange	VR-7		F372239*
		7" x 1" x 7/8"	Offset	GP	Ruby	VR-7		F377419*
		Stem	3" x 1 1/4" x 5/8"	Cup	GP	Gray	VR-7	VTRW-9
	3" x 1 1/4" x 5/8"	Cup	GP	Gray	VR-7		F336036*	
Rottler VR-8	Valve	8" x 1 1/4" x 1 1/2"	Flared	GP	Gray	VR-8	Goodson Spec	GV-525
	Stem	100 x 50 x 20mm	Cup	GP	White	VR416, VR-516	7606	GV-928
Rottler VR-9 & VR-12	Valve	9" x 1 1/4" x 1 1/2"	Offset	GP	Orange	VR-9, VR-12		GV-725
		9" x 1 1/4" x 1 1/2"	Offset	S	Pink	VR-9, VR-12		GV-726
		9" x 1 1/4" x 1 1/2"	Offset	T	Green	VR-9, VR-12		GV-727

Colors may vary due to manufacturing processes. All valve refacing wheels are guaranteed for 1 year from original purchase date.



A TYROLIT Company

Note: Look for * to find genuine Radiac valve refacing wheels.



new

CYLINDER HEAD REBUILDING
CLEANING, ASSEMBLY & SAFETY
SHORT BLOCK REBUILDING
CRANKSHAFT/ FLYWHEEL GRINDING
MISCELLANEOUS TOOLS & SUPPLIES
BRAKE SERVICE TOOLING
MEASURING TOOLS
V-TWIN & METRIC HARD PARTS

Valve Refacing Wheels

Colors may vary due to manufacturing processes. All valve refacing wheels are guaranteed for 1 year from original purchase date.

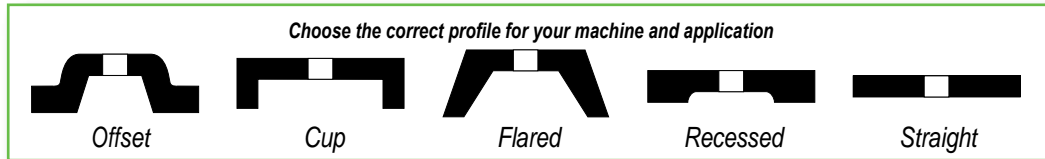

To Fit	Use	Dia x Ht x Arb	Shape	Type	Color	Fits Models	OE No.	Order No.
Skil	Valve	5" x 3/4" x 5/8"	Offset	GP	Gray	All models	7556/VW80	GV-658
Snap-On	Valve	5" x 3/4" x 5/8"	Offset	S	White	All models	VW80S	GV-659
	Stem	4" x 1" x 5/8"	Cup	GP	Gray	All but Skil 491	7557/VR2M89	GV-345
	Stem	4" x 1" x 5/8"	Cup	CB	Blue	All but 500 & CRW	Goodson Spec	GV-345-CB
Sioux™	Valve	4" x 1" x 5/8"	Offset	CB	Blue	All but 680, 682, 285, 956	Goodson Spec	GV-146-CB
	Valve	4" x 1" x 5/8"	Offset	GP	Gray	All but 680, 682, 285, 956	78SP	GV-147
	Valve	4" x 1" x 5/8"	Offset	GP	Black	All but 680, 682, 285, 956	78E	GV-148
	Valve	4" x 1" x 5/8"	Offset	S	Gray	All but 680, 682, 285, 956	78A	GV-149
	Valve	4" x 1" x 5/8"	Offset	S	Ruby	All but 680, 682, 285, 956	Goodson Spec	GV-144
	Valve	4" x 1" x 5/8"	Offset	T	Green	All but 680, 682, 285, 956	Goodson Spec	GV-150
	Valve	5" x 1" x 5/8"	Offset/20°	GP	Pink	Thor 299 & 300	Goodson Spec	GV-156
	Valve	6" x 5/8" x 3/4"	Offset	S	White	685L	186	GV-186
	Valve	7" x 1 1/16" x 1 3/4"	Str./15°	CB	Blue	680, 956, 2001 & 2075	Goodson Spec	GV-270-CB
	Valve	7" x 1 1/16" x 1 3/4"	Str./15°	S	White	680, 956, 2001 & 2075	177	GV-271
	Valve	7" x 1 1/16" x 1 3/4"	Str./15°	T	Green	680, 956, 2001 & 2075	174	GV-272
	Valve	7" x .675" x 1 3/4"	Str./15°	GP	Ruby	2001, 2075, 680 & 956		A379613*
	Valve	7" x .675" x 1 3/4"	Str./15°	ST, T	Green	2001, 2075, 680 & 956		A340229*
	Stem	4" x 1" x 5/8"	Cup	GP	Gray	All but 682 & 685	81 (73533)	GV-345
	Stem	4" x 1" x 5/8"	Cup	CB	Blue	All but 500 & CRW	Goodson Spec	GV-345-CB
Sunnen (TA) S&D	Valve	6" x 1 1/16" x 3/4"	Flared	GP	Black	VR6500, all S&D	VR602	GV-766
	Valve	6" x 1 3/8" x 3/4"	Flared	GP	Gray	VR6500		F345291*
	Stem	5" x 1 1/2" x 3/4"	Cup	GP	White	VR6500, all S&D	VR601	GV-755
Winona	Valve	5" x 3/4" x 5/8"	Off./Bev.	GP	Gray	E, Y, YW, X, XA	75399	GV-658
Van	Valve	5" x 3/4" x 5/8"	Off./Bev.	S	White	K500HM, K403CM	75400	GV-659
Norman	Stem	4" x 1" x 5/8"	Cup	GP	Gray	All but 500 & CRW	40352	GV-345
	Stem	4" x 1" x 5/8"	Cup	CB	Blue	All but 500 & CRW	Goodson Spec	GV-345-CB

Colors may vary due to manufacturing processes. All valve refacing wheels are guaranteed for 1 year from original purchase date.



Mineral Based Valve Grinding Oil

- Long-lasting • Cools while grinding
- Removes particles for a better finish
- Inhibits rust • Prevents rancidity, foaming & deposits

Quantity	Order No.
1 gallon / 3.79 L	VGO-10
5 gallons / 18.93 L	VGO-50



Valve Grinding Aid For Titanium, Stainless & Stellite Valves

- Not water soluble - add to your mineral based Valve Grinding Oil for better finish on titanium, stainless steel and stellite valves
- Mix ratio: 1:4 • Won't hinder your regular valve grinding process
- Seeks out, and bonds to hot metals
- Ideal for grinding hard metal racing valves • 32 oz. / 946 mL
- Order No. **VGA-T32**



Severe Duty Valve Refacer Oil For Titanium, Inconel®, Stainless Steel & Stellite Valves

- Mineral Based
- Includes additives to improve cutting performance under high pressure

Size	Order No.
1 gallon / 3.79 L	VGO-SD10
5 gallons / 18.93 L	VGO-SD50

CYLINDER HEAD REBUILDING
CLEANING, ASSEMBLY & SAFETY
SHORT BLOCK REBUILDING
FLYWHEEL GRINDING
CRANKSHAFT/GRINDING
MISCELLANEOUS TOOLS & SUPPLIES
BRAKE SERVICE TOOLING
MEASURING TOOLS
V-TWIN & METRIC HARD PARTS



"At Goodson, we're trained to know your business. Weekly training sessions are held for our entire staff to help us better understand your work so we can provide you with the best possible service."

- Anne, Goodson Accounting - 14 years of service

CYLINDER HEAD
REBUILD

CLEANING,
ASSEMBLY & SAFETY

SHORT BLOCK
REBUILDING

CRANKSHAFT/
FLYWHEEL GRINDING

MISCELLANEOUS
TOOLS & SUPPLIES

MAKE SERVICE
TOOLING



V-TWIN
MARTIN

High Speed Steel Core Drill/Reamers

- Save time – drill and ream in a single pass
- Top-quality, high speed steel
- Prepares the guide bore for standard OD valve guide inserts
- Several shank designs to fit most Seat & Guide machines

tech tips
from the techxperts™

For best results,
limit speed to
175 RPM

Fits	Size	mm	Order No.
Winona Van Norman .468" flat	.343" x .500"	8.7x12.7	CDR-6055G
Tobin-Arp & Sunnen	.343" x .500"	8.7x12.7	CDR-6105G
Peterson and K.I.	.343" x .500"	8.7x12.7	CDR-6196G
1/2" round shank	.375" x .500"	9.5x12.7	CDR-6197G
Kwik-Way and DCM	.343" x .500"	8.7x12.7	CDR-6211G
1/2" round shank	.375" x .500"	9.5x12.7	CDR-6212G
Serdi	.275" x .437"	7.0x11.1	CDR-7192G
3/8" with flat	.275" x .500"	7.0x12.7	CDR-7193G
	.312" x .437"	7.9x11.1	CDR-7194G
	.312" x .500"	7.9x12.7	CDR-7195G
	.343" x .500"	8.7x12.7	CDR-7196G
	.375" x .500"	9.5x12.7	CDR-7197G
Cobalt Core Drills/ Reamers	Size	mm	Order No.
1/2" round shank	.275" x .437"	7.00x11.1	CDR-274-CB
	.275" x .500"	7.00x12.7	CDR-275-CB
	.311" x .5628"	7.90x14.3	CDR-563-CB
	.312" x .500"	7.92x12.7	CDR-312-CB
	.343" x .500"	8.71x12.7	CDR-343-CB
	.373" x .625"	9.47x16.5	CDR-625-CB
	.375" x .500"	9.53x12.7	CDR-375-CB

Valve Guide Tooling For 24 Valve, 7mm Cummins

- To replace integral guides used in this diesel cylinder head
- Replacement guides are .502/.511" stepped to use with OE or replacement seals below

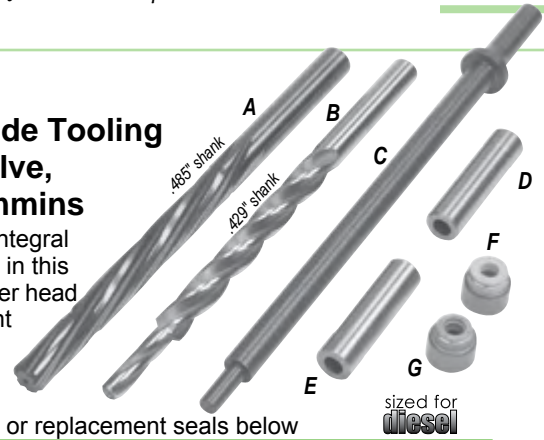

Description	Order No.	Includes
Complete Kit	CVG-KIT	▼
Tooling Kit Only	CVG-59KIT	▼
A Core Reamer (.426" pilot, .485" shank)	CCR-59	1 1
B Core Drill (7mm pilot, .429" shank)	CCD-59	1 1
C Guide Driver (7.0mm)	PHL-2235-G	1 1
D Cast Iron Valve Guide (Exhaust)	CIG-3022	12
E Cast Iron Valve Guide (Intake)	CIG-3021	12
F Exhaust Seals (12 pk.)	CVS-59E	1
G Intake Seals (12 pk.)	CVS-59i	1

Check these other tools for diesel applications

sized for
diesel

Air Powered Valve Guide Drivers	page 31
Valve Guides	page 31
Pneumatic Valve Spring Compressor.....	page 38
Heat Tabs.....	page 52

Piloted Core Drills and Reamers

- CNC-machined to .0003" T.I.R. or less • Ideal for any Bridgeport-type (collet driven) machine • Use dry at 175 to 225 RPM

Piloted Core Drills

- Center accurately in the guide • Cutting angle prevents the bit from wandering due to irregular guide wear • Flutes are designed to enlarge bores quickly • Manufactured to close tolerances of concentricity

Precision Reamers

- Pilot size is carefully matched to the OD of the related core drill • Assures accurate location of the reamer for smooth, vibration free operation • Gives proper interference fit to match manufacturer specifications

Core Drills

Core Reamers

	OD	Pilot	OE No.	Order No.	OD	OE No.	Order No.
DCM Tech,	.4687"	.312"	DP-1550	DPP-1511B	.500"	66-02147, RR-115	DRR-115
Peterson /	.4687"	.344"	66-02138, DP-1511	DPP-1511	.500"	66-02147, RR-115	DRR-115
Kansas	.4687"	.375"	66-02140, DP-1530	DPP-1530	.500"	66-02147, RR-115	DRR-115
Instruments	.5312"	.375"	DP-1730	DPP-1530A	.5625"	66-02148, RR-916	DRR-916
1/2" Round Shank	.5937"	.375"	66-02144, DP-1930	DPP-1970B	.625"	66-02149, RR-519	DRR-519
Sunnen™ /	.490"	.312"	VGS-156A	DTA-2082B	.500"	VGS-162A	DRT-2097
Tobin-Arp	.490"	.343"	VGS-152A	DTA-2082	.500"	VGS-162A	DRT-2097
1/2" with Flat	.490"	.371"	VGS-153A	DTA-2083	.500"	VGS-162A	DRT-2097
Winona	.4687"	.344"	804206	DD-1532-G	.500"	804237	DR-500-G
Van Norman	.4687"	.375"	804207	DD-1532A-G	.500"	804237	DR-500-G
IDL /	.475"	.341"	501003	DVN-2	.500"	501011	DRV-79
Van Norman	.475"	.375"	501004	DVN-3	.500"	501011	DRV-79
5/16" Sq. Drive							
Universal	.429"	7mm		CCD-59	4365"	Use for Ford 6.0L Diesel	FCR-60-1
.429" Round	.429"	7mm		CCD-59	4375"	Use for Ford 6.0L Diesel	FCR-60
Shank	.429"	7mm		CCD-59	4995"	Use for Cummins Diesel	CCR-59
					.562"	.500" pilot	CCR-562B
	.541"	8mm		CCD-550	.550"	.540" pilot	CCR-550

Note: For the best performance, Core Drills and Reamers should be used in matched pairs. If you order a drill slightly smaller or larger than the OE specification to fit your machine, please order the matching reamer listed immediately to the right of the drill in the table.

Bronze Reaming Oil

- Prevents build-up • Extends reamer life
- Improves valve guide finish

Size	Order No.
1 Pint / 473.2mL	BW-303-G
1 Quart / 946.4mL	BW-303A-G
1 Gallon / 1.893L	BW-305-G



tech tips
from the techxperts™

For best results always use Carbide Reamers with Bronze Reaming Oil (BW-303A-G)

tech tips
from the techxperts™

Once used on cast iron, do NOT use on bronze.

Small Reamers for Cast Iron or Bronze

- Premium quality reamers with tough cobalt flutes for long life in cast iron or bronze • 1/8" square drive

Inch	mm	Order No.
.1565"	3.98	MR-156
.1575"	4.00	MR-4MM
.1585"	4.03	MR-158
.1760"	4.47	MR-176
.1771"	4.50	MR-4.5MM
.1780"	4.52	MR-178
.1960"	4.98	MR-196
.1968"	5.00	MR-5.0MM
.1980"	5.03	MR-198
.2165"	5.50	MR-5.5MM
.2362"	6.00	MR-6.0MM
.2756"	7.00	MR-7.0MM

Solid Carbide Valve Guide Reamers Specifically Designed For Use Only With Bronze Guides

- Unique flute design for longer tool life
- New cutting geometry requires less torque to drive the reamer
- More rigid tool construction.
- Faster feeds than conventional design
- New 4 flute pilot design holds cutting oil in contact with workpiece at all times.
- Pilot allows easier alignment with bushing.
- Simply the best valve guide reamer we've created!

Inch	mm	Order No.	Inch	mm	Order No.
.1771"	4.50	HGR-4.5MM	.3140"	7.98	HGR-3140
.1968"	5.00	HGR-5.0MM	.3160"	8.00	HGR-8MM
.2165"	5.50	HGR-5.5MM	.3410"	8.66	HGR-3410
.2362"	6.00	HGR-6MM	.3420"	8.69	HGR-3420
.2598"	6.60	HGR-6.6MM	.3425"	8.70	HGR-3425
.2750"	6.98	HGR-2750	.3430"	8.71	HGR-3430
.2756"	7.00	HGR-7MM	.3435"	8.72	HGR-3435
.2766"	7.03	HGR-2766	.3440"	8.74	HGR-3440
.3110"	7.90	HGR-3110	.3543"	9.00	HGR-9MM
.3115"	7.91	HGR-3115	.3720"	9.45	HGR-3720
.3120"	7.92	HGR-3120			



High Speed Finish Reamers Exclusively for Cast Iron

Precision size cast iron guides. Piloted and made from the finest tempered steel. With proper care, these reamers will accurately size multiple guides without losing their efficient cutting action. **NOT for hardened or bronze guides.**

Inch	mm	Order No.
3/16" Square Drive		
.2165"	5.50	WR-5.5MM-G
.217"	5.51	WR-217-G
.218"	5.54	WR-218-G
.236"	6.00	WR-6MM-G
.250"	6.35	WR-250-G
.256"	6.50	WR-6.5MM-G
.259"	6.58	WR-259-G
.260"	6.60	WR-260-G
.261	6.63	WR-261-G
.273"	6.93	WR-273-G
.274"	6.96	WR-274-G
.275"	6.99	WR-275-G
.2755"	7.00	WR-7MM-G
.276"	7.01	WR-276-G
.277"	7.03	WR-277-G
.278"	7.06	WR-278-G
.281"	7.14	WR-281-G

Inch	mm	Order No.
1/4" Square Drive		
.310"	7.87	WR-310-G
.311"	7.90	WR-311-G
.312"	7.92	WR-312-G
.313"	7.95	WR-313-G
.314"	7.98	WR-314-G
.315"	8.00	WR-8MM-G
.316"	8.03	WR-316-G
.317"	8.05	WR-317-G
.318"	8.08	WR-318-G
.327"	8.31	WR-327-G
.328"	8.33	WR-328-G
.334"	8.48	WR-8.5MM-G
.340"	8.64	WR-340-G
.341"	8.66	WR-341-G
.342"	8.69	WR-342-G
.343"	8.71	WR-343-G
.3435"	8.72	WR-3435-G
.344"	8.74	WR-344-G
.345"	8.76	WR-345-G
.346"	8.79	WR-346-G
.353"	8.97	WR-353-G
.354"	9.00	WR-9MM-G
.355"	9.02	WR-355-G
.356"	9.04	WR-356-G
.358"	9.09	WR-358-G

Inch	mm	Order No.
1/4" Square Drive		
.372"	9.45	WR-372-G
.373"	9.47	WR-373-G
.374"	9.50	WR-374-G
.375"	9.52	WR-375-G
.376"	9.55	WR-376-G
.377"	9.58	WR-377-G
.378"	9.60	WR-378-G
.379"	9.63	WR-379-G
.380"	9.65	WR-380-G
.386"	9.80	WR-386-G
.393"	9.98	WR-393-G
.394"	10.00	WR-10MM-G
.395"	10.03	WR-395-G
.404"	10.26	WR-404-G
.405"	10.29	WR-405-G
.433"	11.00	WR-11MM-G
.435"	11.05	WR-435-G
.436"	11.07	WR-436-G
.437"	11.10	WR-437-G
.453"	11.51	WR-453-G
.472"	12.00	WR-12MM-G
.496"	12.60	WR-496-G
.499"	12.67	WR-499-G
.500"	12.70	WR-500-G

tech tips
from the techxperts™

For best results, use high speed steel finish reamers exclusively on cast iron. Ream without oil.

CYLINDER HEAD REBUILDING
CLEANING, ASSEMBLY & SAFETY
SHORT BLOCK REBUILDING
CRANKSHAFT/ FLYWHEEL GRINDING
MISCELLANEOUS TOOLS & SUPPLIES
BRAKE SERVICE TOOLING
MEASURING TOOLS
V-TWIN & METRIC HARD PARTS

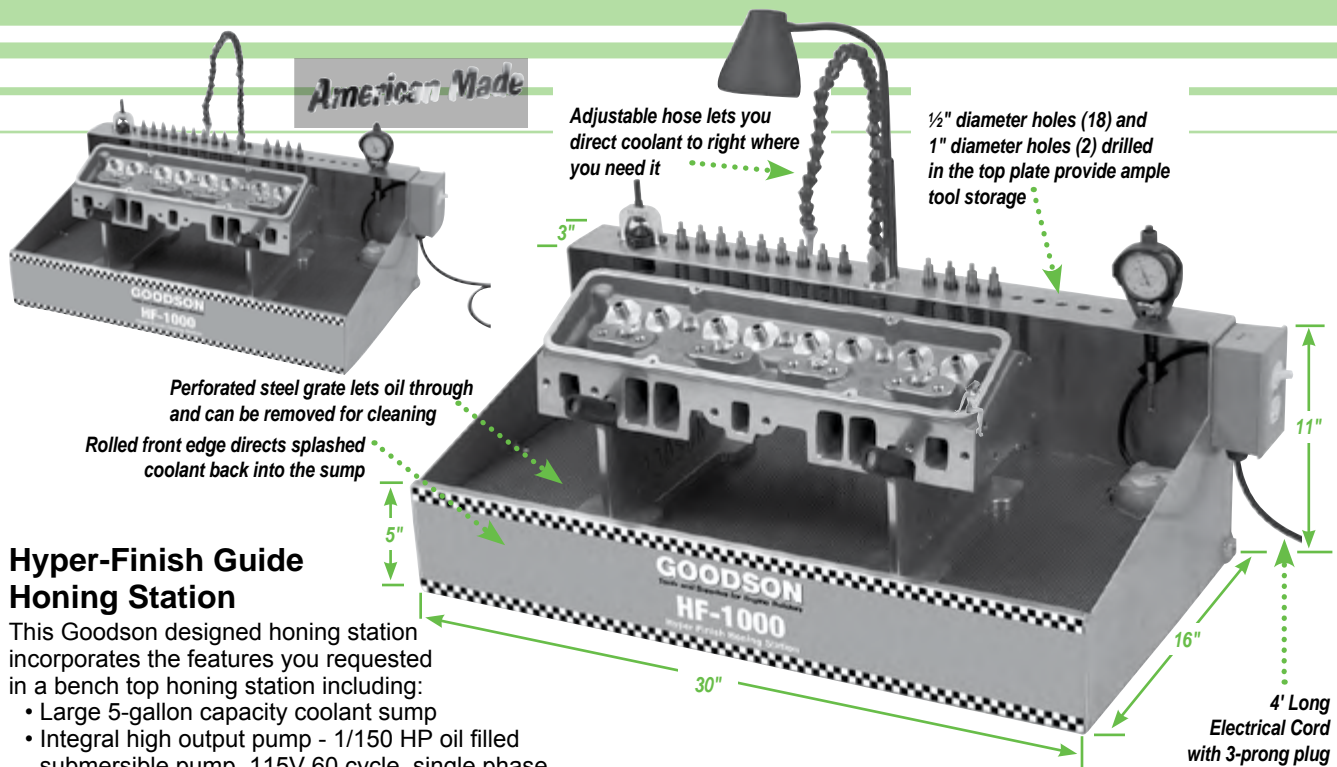

American Made

Adjustable hose lets you direct coolant to right where you need it

1/2" diameter holes (18) and 1" diameter holes (2) drilled in the top plate provide ample tool storage

Perforated steel grate lets oil through and can be removed for cleaning

Rolled front edge directs splashed coolant back into the sump

Hyper-Finish Guide Honing Station

This Goodson designed honing station incorporates the features you requested in a bench top honing station including:

- Large 5-gallon capacity coolant sump
- Integral high output pump - 1/150 HP oil filled submersible pump, 115V 60 cycle, single phase heavy-duty motor
- Aluminum construction for durability and easy cleaning
- Perforated steel grate allows used coolant through to recirculate
- Removable steel grate for easy maintenance
- Built-in, easy-to-reach storage for tools

Buy the complete kit and save!

Description	JobberOrder No.	
Complete 110V Honing Station Kit	HF-1000KIT	▼
Complete 220V Honing Station Kit (w/o light or box)	HF-1000E-KIT	▼
Honing Station Only - 110V	HF-1000	x
Honing Station Only - 220V (w/o light)	HF-1000E	x
Universal Head Holders	HH-200	x x
Replacement Pump 110V	HF-PUMP	x
Replacement Pump 220V	HF-PUMP-E	x
5 Gallons Diamond Honing Oil	DHO-50	x x

Carbide or High Speed Steel Valve Guide Top Cutters

- Matches Seat & Guide machine pilots

Description	Shank	Order No.
Cutters 1 1/4" High-Speed Steel	.500"	GFH-100
1 1/4" Carbide	.500"	GFC-200
1 1/8" High-Speed Steel	.486"	GFH-300
3/16" (.1875") Shank Pilots .312" (7.93mm)		GFP-312
.343" (8.73mm)		GFP-343
.375" (9.53mm)		GFP-375
.437" (11.11mm)		GFP-437
.500" (12.70mm)		GFP-500

3/16" dia. shank

Cutter



Valve Guide OD Chamfer Tool

- Improve oil deflection
- Universal cutter chamfers any OD from 1/4" to 5/8" (6.35-15.9mm)
- Most precise when used in a Seat and Guide Machine
- Order No. **GCT-35**



1" Diameter Carbide Top Cutter / Spot Facer

- Long-life, quick-cutting carbide blades
- Shorten or face cast-iron valve guides and stud bosses up to 1" / 25.4mm diameter
- Universal drive shank fits all types of power chucks 3/8" or larger

Description	Order No.
Cutter Body	G-1270
Pilot .312" (7.93mm)	G-1270A
.343" (8.73mm)	G-1270B
.375" (9.53mm)	G-1270C
.437" (11.11mm)	G-1270D

Pilot Installs Here

Cutter Body
3/8" Shank

Pilot

3/8" Shank



Valve Guide Top Collar

- Supports guide top during machining
- Protects against damage or breakage
- Ideal for high-performance work, and for installing Bronze-Wall® guide inserts or thin-wall liners (pages 33-35)

Size	Range	Order No.
.500"	.496" -.504"	VGC-502
.530"	.526" -.534"	VGC-530
.566"	.562" -.570"	VGC-566



CYLINDER HEAD REBUILDING

CLEANING, ASSEMBLY & SAFETY

SHORT BLOCK REBUILDING

FLYWHEEL GRINDING

CRANKSHAFT/ TOOLS & SUPPLIES

MISCELLANEOUS TOOLS & SUPPLIES

BRAKE SERVICE TOOLING

MEASURING TOOLS V-TWIN & METRIC HARD PARTS



"If any of our products aren't satisfactory, we want you to send it back...we have a no hassle return policy. Just send it back, freight pre-paid within 30 days and we'll exchange it, fix it or credit your account for the amount of the purchase."

- Nancy, Goodson Warehouse Manager, 23 years of service



Truing Sleeve



Adaptor

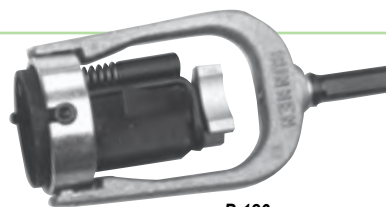
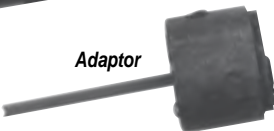

P-180
Hone Head

Honing Stone



Wedge (included with
Mandrel)



Mandrel

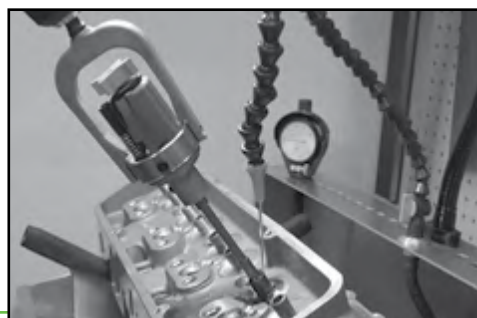

Valve Guide Hone Set

- Sets-up fast • Easy to use!
- Produces straight, round holes for top-quality work
- Ideal for high-performance applications
- Use a low RPM, 1/2" drill for driving power (200 RPM max.)
- Sunnen® tooling is NOT interchangeable with Goodson Hyper-Finish (page 28)

Description	Order No.
Sunnen Honal® Valve Guide Hone Set	P-190
Includes: Head & Driver. Mandrels & Sleeves (1 of ea. for sizes - 5/16", 1 1/32", 3/8", & 7/16")	
Adaptors: (1) PK10-A & (1) PK12-A. Stones L10-J69 & L12-J67. Case & instructions	
Sunnen Honal® Valve Guide Hone Head & Driver only	P-180

tech tips

from the techxperts™

Ordering Information: The head and driver are interchangeable with the adaptors. Only one head and driver is required. Mandrels are available to cover all popular sizes. Please select from the parts in the photo above and order per size range desired. We suggest you have an adaptor for each mandrel to save change-over time between sizes.

BL Mandrels (Order Mandrel, Sleeve, Stones, Adaptor & Stone Retainer Separately)

Size	Inch	mm	Mandrel	Sleeve	Roughing Stones	Finishing Stones	Adaptor	Stone Retainer
3/16"	.185"-.190"	4.7-4.8	BL6-185CS	S-185	L6-J47 (12)	L6-J67 (12)	PSK6-A‡	LN-3087C
	.190"-.195"	4.8-4.9	BL6-190CS	S-190	L6-J47 (12)	L6-J67 (12)	PSK6-A‡	LN-3087C
5mm	.195"-.200"	4.9-5.1	BL6-195CS	S-195	L6-J47 (12)	L6-J67 (12)	PSK6-A‡	LN-3087C
	.210"-.215"	5.3-5.5	BL6-210CS	S-210	L6-J47 (12)	L6-J67 (12)	PSK6-A‡	LN-3087C
5.5mm	.215"-.220"	5.5-5.6	BL6-215CS	S-215	L6-J47 (12)	L6-J67 (12)	PSK6-A‡	LN-3087C
	.225"-.230"	5.7-5.8	BL6-225CS	S-225	L6-J47 (12)	L6-J67 (12)	PSK6-A‡	LN-3087C
6mm	.230"-.235"	5.8-6.0	BL6-230CS	S-230	L6-J47 (12)	L6-J67 (12)	PSK6-A‡	LN-3087C
	.235"-.240"	6.0-6.1	BL6-235CS	S-235	L6-J47 (12)	L6-J67 (12)	PSK6-A‡	LN-3087C
1/4"	.245"-.250"	6.2-6.4	BL8-245AS	S-245	L8-J47 (6)	L8-J67 (6)	PK8-A	-----
	.250"-.255"	6.4-6.5	BL8-250AS	S-250	L8-J47 (6)	L8-J67 (6)	PK8-A	-----
6.6mm	.255"-.260"	6.5-6.6	BL8-255AS	S-255	L8-J47 (6)	L8-J67 (6)	PK8-A	-----
	.270"-.275"	6.8-7.0	BL8-270AS	S-270	L8-J47 (6)	L8-J67 (6)	PK8-A	-----
7mm	.275"-.280"	7.0-7.1	BL8-275AS	S-275	L8-J47 (6)	L8-J67 (6)	PK8-A	-----
	5/16" ♦	.308"-.316"	7.8-8.0	BL10-308AS	S-308	L10-J69 (6)	PK10-A	-----
1 1/32"	♦ .339"-.347"	8.6-8.8	BL10-339AS	S-339	L10-J47 (6)	L10-J69 (6)	PK10-A	-----
	23/64"	.354"-.362"	9.0-9.2	BL10-354AS	S-354	L10-J47 (6)	PK10-A	-----
3/8"	♦ .370"-.385"	9.4-9.8	BL12-370AS	S-370	L12-J47 (6)	L12-J67 (6)	PK12-A	-----
	7/16" ♦	.432"-.447"	11.0-11.4	BL12-432AS	S-432	L12-J47 (6)	L12-J67 (6)	PK12-A

♦ Included in set Order No. P-190 ‡NOTE: Remove the stone retainer included with the PSK6-A and replace with LN-3087C for valve guide honing



Minnesota Fast Freeze

- Instantly chills seats & guides to -50°F (-45.5°C) • Creates interference fit with heated aluminum heads • Finish seat and guide work faster than ever • Aerosol*
- Use on tight bushings, pins, shafts, etc.
- Order No. **MFF-8**

*Hazardous Goods Fees Apply When Shipped by Air

Press Fit Lubricants

- A light coat eases press fit
- Ideal for valve guides, piston pins, cylinder sleeves, etc.
- Eliminates the scoring, gouging and galling of parts during press fitting



Description	Order No.
Goodson Aerosol* 6 oz. (170 g)	PFL-200*
Sunnen® Aerosol* 7 oz. (198 g)	B-200*
Sunnen® Brush Applicator 200 mL (not shown)	B-200L

*Hazardous Goods Fees Apply When Shipped By Air

CYLINDER HEAD REBUILDING
CLEANING, ASSEMBLY & SAFETY
SHORT BLOCK REBUILDING
CRANKSHAFT/ FLYWHEEL GRINDING
MISCELLANEOUS TOOLS & SUPPLIES
BRAKE SERVICE TOOLING
MEASURING TOOLS
V-TWIN & METRIC HARD PARTS

Valve Guide Replacement

Valve Guide Drivers

- Corrosion-resistant finish 1° negative angle prevents guides from spreading
- Rockwell hardness of 45-50
- Pilots are slightly smaller than guide ID for easy removal

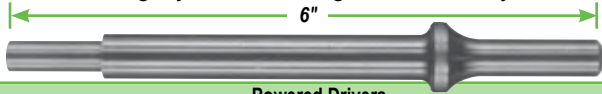

Powered Drivers			Order No.	Incl.
Standard Sizes				
4-piece Kit			PH-2226-G	▼
Guide ID /mm	Driver OD	Pilot		
.312" / 7.92	.487" / 12.4	.300" / 7.62	PH-2228A-G	
.312" / 7.92	.423" / 10.7	.304" / 7.72	PH-2228-G	x
.343" / 8.71	.422" / 10.7	.336" / 8.53	PH-2229A-G	
.343" / 8.71	.487" / 12.4	.337" / 8.56	PH-2229-G	x
.372" / 9.47	.487" / 12.4	.367" / 9.32	PH-2231-G	x
.437" / 11.10	.612" / 15.5	.429" / 10.90	PH-2230-G	x
Metric Sizes				
6-piece Kit			PH-2600-G	▼
Guide ID /in.	Driver OD	Pilot		
5.0mm / .196"	9.0 / .355"	4.75 / .187"	PH-2250-G	x
5.5mm / .217"	10.5 / .412"	5.21 / .205"	PH-2255-G	x
6.0mm / .236"	10.5 / .412"	5.72 / .225"	PH-2260-G	x
6.6mm / .260"	11.8 / .463"	6.30 / .248"	PH-2234-G	x
7.0mm / .275"	11.0 / .432"	6.60 / .260"	PH-2235-G	x
8.0mm / .315"	11.7 / .462"	7.80 / .307"	PH-2236-G	x
9.0mm / .353"	12.4 / .487"	8.81 / .347"	PH-2237-G	
10mm / .393"	15.5 / .612"	8.56 / .387"	PH-2238-G	
11mm / .433"	15.5 / .612"	10.85 / .427"	PH-2239-G	

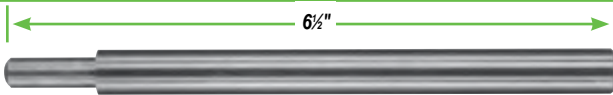

Manual Drivers			Order No.	Incl.
Standard Sizes				
4-piece Kit			GP-500A-G	▼
Guide ID /mm	Driver OD	Pilot		
.312" / 7.92	.422" / 10.7	.305" / 7.75	GP-431-G	x
.312" / 7.92	.487" / 12.4	.302" / 7.67	GP-531-G	x
.343" / 8.71	.422" / 10.7	.336" / 8.53	GP-533-G	
.343" / 8.71	.487" / 12.4	.336" / 8.53	GP-534-G	x
.372" / 9.47	.487" / 12.4	.367" / 9.32	GP-537-G	x
.437" / 11.10	.611" / 15.5	.428" / 10.87	GP-743-G	
Metric Sizes				
6-piece Kit			GP-600M-G	▼
Guide ID /in.	Driver OD	Pilot		
6.6mm / .260"	11.7 / .462"	6.22 / .245"	GP-6.6MM-G	x
7mm / .275"	10.7 / .422"	6.78 / .267"	GP-7MM-G	x
8mm / .315"	12.3 / .486"	7.77 / .306"	GP-8MM-G	x
9mm / .353"	12.3 / .485"	8.84 / .348"	GP-9MM-G	x
10mm / .393"	15.5 / .611"	9.80 / .386"	GP-10MM-G	x
11mm / .433"	15.5 / .611"	10.82 / .426"	GP-11MM-G	x



Air Hammer

- Delivers 3500 blows per minute
- Weighs 3 lbs.
- .401" tool opening

Description	Order No.
Air Hammer	AH-335
Replacement Retainer Spring	AH-5RS

Universal Driver Tool

- Sized to extend Diesel Guide Drivers at right
- 4.75" OAL
- .401" ID
- Order No. **CL-7333**

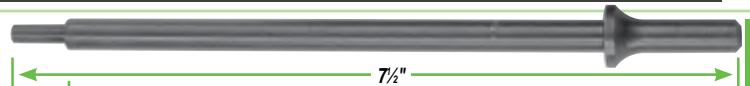

Extra-Long Powered Valve Guide Drivers

- For use with overhead cam heads
- 1° negative angle to prevent guide mushrooming
- Pilots are slightly smaller than guide ID
- 7.5" long

Guide ID / IN	Driver OD	Pilot	Order No.
4.0mm / .157"	9.0 / .355"	3.80 / .150"	PHL-2240-G
4.5mm / .177"	9.0 / .355"	4.30 / .170"	PHL-2245-G
5.0mm / .196"	9.0 / .355"	4.75 / .187"	PHL-2250-G
5.5mm / .217"	10.5 / .412"	5.21 / .205"	PHL-2255-G
6.0mm / .230"	9.1 / .358"	5.72 / .225"	PHL-2258-G
6.0mm / .236"	10.5 / .412"	5.72 / .225"	PHL-2260-G
6.6mm / .260"	11.8 / .463"	6.29 / .248"	PHL-2234-G
7.0mm / .275"	11.0 / .432"	6.60 / .260"	PHL-2235-G
7.9mm / .313"	10.7 / .423"	7.72 / .304"	PHL-2228-G
8.0mm / .315"	11.7 / .462"	7.80 / .307"	PHL-2236-G
8.7mm / .343"	12.4 / .487"	8.56 / .337"	PHL-2229-G
9.5mm / .375"	12.4 / .487"	9.32 / .367"	PHL-2231-G

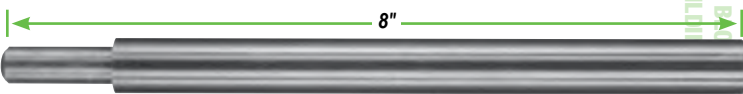

Extra Long Manual Valve Guide Drivers

- 8" OAL
- Pilot approximately 1" long
- NOTE:** Due to the nature of these valve guide drivers, they cannot be warranted against breakage, but are guaranteed for dimensional accuracy.

Guide ID / IN	Driver OD	Pilot	Order No.
4.0mm / .157"	9.0 / .355"	3.80 / .150"	GPL-2240-G
4.5mm / .177"	9.0 / .355"	4.30 / .170"	GPL-2245-G
5.0mm / .196"	9.0 / .355"	4.75 / .187"	GPL-2250-G
5.5mm / .217"	10.5 / .412"	5.21 / .205"	GPL-2255-G
6.0mm / .230"	9.1 / .358"	5.72 / .225"	GPL-2258-G
6.0mm / .236"	10.5 / .412"	5.72 / .225"	GPL-2260-G

Air-Powered Valve Guide Drivers for Diesel Engines

- Drive guides in from the shoulder instead of from the top
- Installing drivers have the proper recess to drive guides in for the correct installed height
- Remove / install guides faster – no measuring necessary
- For most standard pneumatic tools

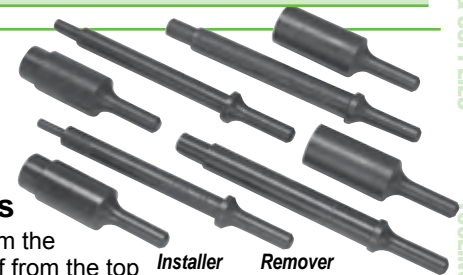

Application	Installer Major/ Counter Bore ID	Order No.	Remover Shank/Pilot OD	Order No.
Cummins	.752" / .503"	DVG-Ci	.595" / .450"	DVG-CR
Cummins 8.3 6CT	.552" / —	DVG-8.3	.491" / .304"	DVG-71R
Caterpillar 3116	.515" / .475"	DVG-3116	.491" / .304"	DVG-71R
Caterpillar 3126	.633" / .506"	DVG-3126	.595" / .354"	DVG-3468R
Caterpillar 3306	.660" / —	DVG-3306	.595" / .354"	DVG-3468R
Caterpillar 3406-3408	.709" / —	DVG-3468i	.595" / .354"	DVG-3468R
Caterpillar 3406-3408B	.632" / —	DVG-3468Bi	.595" / .354"	DVG-3468R
Detroit GMC 53	.502" / .421"	DVG-53i	.491" / .246"	DVG-53R
Detroit GMC 71/92	.502" / .435"	DVG-71i	.491" / .304"	DVG-71R
International DT 466	.640" / .440"	DVG-466i	.595" / .354"	DVG-3468R
Mack	.675" / —	DVG-Mi	.620" / .484"	DVG-MR
Mack 4	.689" / .678"	DVG-M4	.595" / .354"	DVG-3468R



"We take our job of getting your order to you quickly very seriously. We use several different carriers allowing us to get your products to you when you need them at a price you can afford."

- Becky, Goodson Shipping, 4 years of service

CYLINDER HEAD
REBUILDING

CLEANING,
ASSEMBLY & SAFETY

SHORT BLOCK
REBUILDING

CRANKSHAFT/
FLYWHEEL GRINDING

MISCELLANEOUS
TOOLS & SUPPLIES

BRAKE SERVICE
TOOLING

MEASURING
TOOLS

V-TWIN & METRIC
HARD PARTS

tech tips

Install guides to same height every time!
from the techxperts™

American Made



Pneumatic Driver Body (AVG-1)

Locking Nut (AVG-2) and installation sleeve have flats for positive lock and release adjustment.

Adjustable installation sleeve (AVG-3) adjusts from 0" to 1 1/4" guide height and fits guides to .700" OD.

Adjustable Powered Valve Guide Driver With Replaceable Pilots

- Standardize the correct installed height on one guide then repeat it on all others
- Screw-in pilots with 5/16" - 18 threads • 6 1/2" overall length

Description	Order No.	Includes
Standard Valve Guide Driver Kit	AVG-STD	▼
Metric Valve Guide Driver Kit	AVG-MM	▼
Pneumatic Body Only 5/8" - 18 thread	AVG-1	x x
Installation Sleeve	AVG-3	x x
Locking Nut	AVG-2	x x
Replaceable Pilots	Diameter	
	.312"	AVG-312 x
	.343"	AVG-343 x
	.372"	AVG-372 x
	.437"	AVG-437 x
	5.0mm	AVG-5MM x
	5.5mm	AVG-55MM
	6.0mm	AVG-6MM x
	6.6mm	AVG-66MM
	7.0mm	AVG-7MM x
	8.0mm	AVG-8MM x
	9.0mm	AVG-9MM

Use thread locker on pilot to resist loosening while in use.

Cast Iron and Manganese Bronze Valve Guides for Harley-Davidson on page 123



Universal Repair Guides

- Unfinished ID ready to be reamed with Goodson's exclusive carbide reamers (page 27)
- Manganese bronze

ID	OD	Length	Order No.
7.0mm	.740"	2.700"	UVBG-7MM
.308"	.740"	2.700"	UVBG-308
.372"	.740"	2.700"	UVBG-372

Valve Guide OD Machining Tool Does 3 Jobs at Once!

- Face the guide top to the correct size
- Sizes the guide OD for press-on seals
- Chamfers the top to prevent seal damage
- Cutters & pilots are interchangeable and chuck into any portable drill, drill press or seat & guide machine



Individual Cutters

Guide OD	Order No.
.415"	10.5 VSC-415
.428"	10.8 VSC-428
.475"	12.1 VSC-475
.495"	12.6 VSC-495
.500"	12.7 VSC-500
.530"	13.5 VSC-530
.562"	14.3 VSC-562
.625"	15.9 VSC-625

Pilots

Guide ID	Order No.
9/32"	7.0 VP-7MM
5/16"	7.9 VP-312
1 1/32"	8.7 VP-343
3/8"	9.5 VP-375

Cutter and Pilot Assemblies

Guide OD	Pilot Size	Order No.
.415"	10.5 5/16" 7.9	VSC-415312
.428"	10.9 5/16" 7.9	VSC-428312
.475"	12.1 5/16" 7.9	VSC-475312
.500"	12.7 5/16" 7.9	VSC-500312
.500"	12.7 1 1/32" 8.7	VSC-500343
.500"	12.7 3/8" 9.5	VSC-500375
.530"	13.5 5/16" 7.9	VSC-530312
.530"	13.5 1 1/32" 8.7	VSC-530343
.530"	13.5 3/8" 9.5	VSC-530375
.562"	14.3 1 1/32" 8.7	VSC-562343
.562"	14.3 3/8" 9.5	VSC-562375
.625"	15.9 3/8" 9.5	VSC-625375

Harley valve guides on page 124

Cast Iron False Valve Guides

Universal Applications

ID	OD	Length	Order No.
.312"	.439"	2.281"	CIG-312
.342"	.502"	3.062"	CIG-342
.372"	.502"	2.750"	CIG-372
.343"	.564"	2.750"	OG-343
.373"	.564"	2.750"	OG-373

24 Valve 7mm Cummins Diesel (.511" seal surface) see tooling, page 26

ID	OD	Length	Order No.	
Inlet	.275"	.502"	1.940"	CIG-3021
Exhaust	.275"	.502"	2.020"	CIG-3022

Ford 6.0L (.513" x 659" seal surface) see tooling, page 26

ID	OD	Length	Order No.
.275"	.4395"	2.332"	CIG-3055

7.3 Powerstroke Use with Core Drill Reamer CDR-563-CB, page 26

ID	OD	Length	Order No.
.3146"	.5652"	2.440"	CIG-8476

Manganese Bronze False Valve Guides

Universal Applications

ID	OD	Length	Order No.
.250"	.283"	1.250"	BVG-283-125
.311"	.439"	3.062"	BVG-311
.343"	.502"	2.375"	BVG-343
.372"	.502"	2.375"	BVG-372

Knurling Arbors

- Piloted for positive centering
- Use by hand or with electric drill & speed reducer
- **Not for use on chilled, hardened or bronze guides**

Inch	mm	Order No.
.236"	6.00	WKA-6MM-G
.275"	7.00	WKA-7MM-G
.312"	7.92	WKA-312-G
.343"	8.71	WKA-343-G
.375"	9.53	WKA-375-G
1 Quart Knurlube (946.6mL)		WLB-47-G

tech tips
from the techxperts™
Use with
Knurlube

NOTE: We don't stock knurling arbors smaller than 6mm because smaller guides are chilled and these arbors may fail.



Electric Drill Drive Adaptors For Knurling Arbors and/or Reamers

Use **WSR-41-3-G** (1/4" sq.) or **WSR-41-4-G** (3/16" sq.) with **WSR-41-7-G** (3/8" drill adaptor). Clamp 3/8" drive in drill to drive reamers directly.

Description	Order No.
A Drill Adaptor for 3/8" drill	WSR-41-7-G
B 1/4" Adaptor for arbors/reamers larger than .281"	WSR-41-3-G
C 3/16" Adaptor for arbors/reamers .281" or smaller	WSR-41-4-G
D Slip on Adaptor (converts WSR-41-3-G to .1875")	WSR-41-5-G



Knurlube

- High pressure lube prevents tool damage
- Extends knurler life by reducing friction and arbor wear

Size	Order No.
8 oz. / 236.6mL	WLB-46-G
32 oz. / 946.4mL	WLB-47-G



Bronze Reaming Oil

- Prevents build-up
- Extends reamer life
- Improves valve guide finish

Size	Order No.
16 oz. / 473.2mL	BW-303-G
32 oz. / 946.4mL	BW-303A-G
1 Gal. / 1.893L	BW-305-G



Valve Guide OD Knurling Tool

- Enlarge guides to fit bore
- Ideal for rare metric sizes and aluminum heads with damaged guide bores
- Works on most materials, **except** chilled or hardened guides

Description	Order No.
Complete Tool	VGK-25
Replacement Knurling Wheel	VGK-25W
Replacement Knurling Rollers (2)	VGK-25R



Hold guide firmly in Vise, Drill Press or Seat & Guide machine; tighten the knurler and turn it around the guide by hand. Increase OD up to .002".

tech tips
from the techxperts™

Bronze-Wall® Bushings

- Spiral inserts rebuild cast-iron guides worn .030"
- Highly durable Phosphor-Bronze
- Thread easily into tapped bore
- Helps guides and stems last longer
- .038" wire for reamed guides

Size	Qty.	Order No.
Standard Bushings		
1 1/32"	50	BW-020B-G
3/8"	50	BW-050B-G

Bronze bushings thread easily into tapped bores. Replace guides at any time by simply uncoiling the old ones.



Bronze-Wall 2 Bushings

- Spiral inserts rebuild cast-iron guides worn .030"
- Highly durable Phosphor-Bronze
- Thread easily into tapped bore
- Helps guides and stems last longer
- .035" wire for broached guides
- Easy to install and size using Sizing Ball and Driver instead of Broach and Reamer

Size	Qty.	Order No.
Standard Bushings		
3/16"	50	BW2B-312
1 1/32"	50	BW2B-343
3/8"	50	BW2B-375

tech tips

Right Hand Rotation Only.

For best results, keep your RPM about the same as your hone RPM, use the same rate of speed and number of strokes per minute.



Ultra-Finish Plateau Valve Guide Soft Hones

- Use AFTER guide honing to remove microscopic peaks and cuffs without enlarging the guide ID
- Abrasive impregnated nylon bristles
- Use liberal amounts of honing oil for best results

Hole Diameter	Hone	Head	Overall	Order No.	
in	mm	Dia.	Length	Length	
.2187"	5.5	.241"	1.00"	4.00"	UF-5.5MM
.2500"	6.4	.275"	1.25"	4.50"	UF-6.4MM
.2813"	7.0	.309"	1.25"	4.50"	UF-7MM
.3125"	8.0	.343"	1.25"	4.50"	UF-8MM
.3437"	9.0	.378"	1.25"	4.50"	UF-9MM
.3750"	10.0	.413"	1.25"	4.50"	UF-10MM
.4375"	11.0	.481"	1.25"	4.50"	UF-11MM
.4688"	12.0	.516"	1.25"	4.50"	UF-12MM
.5000"	13.0	.550"	1.50"	5.00"	UF-13MM
.5625"	14.0	.618"	1.50"	5.00"	UF-14MM
.6250"	16.0	.688"	1.50"	5.00"	UF-16MM
.6875"	17.5	.756"	1.50"	5.00"	UF-17.5MM
.7500"	19.0	.825"	1.50"	5.00"	UF-19MM
.8125"	20.5	.893"	1.50"	6.00"	UF-20.5MM

NOTE: Larger size Ultra-Finish hones on page 81

CYLINDER HEAD REBUILDING
CLEANING, ASSEMBLY & SAFETY
SHORT BLOCK REBUILDING
FLYWHEEL GRINDING
CRANKSHAFT/ TOOLS & SUPPLIES
MISCELLANEOUS
BRAKE SERVICE TOOLING
MEASURING TOOLS
V-TWIN & METRIC HARD PARTS



"Did you know that Goodson still ships orders COD? If you prefer not to use a credit card or set up an open account, you can still order from Goodson. Ask us about COD."

- Pam, Goodson Accounting, 16 years of service

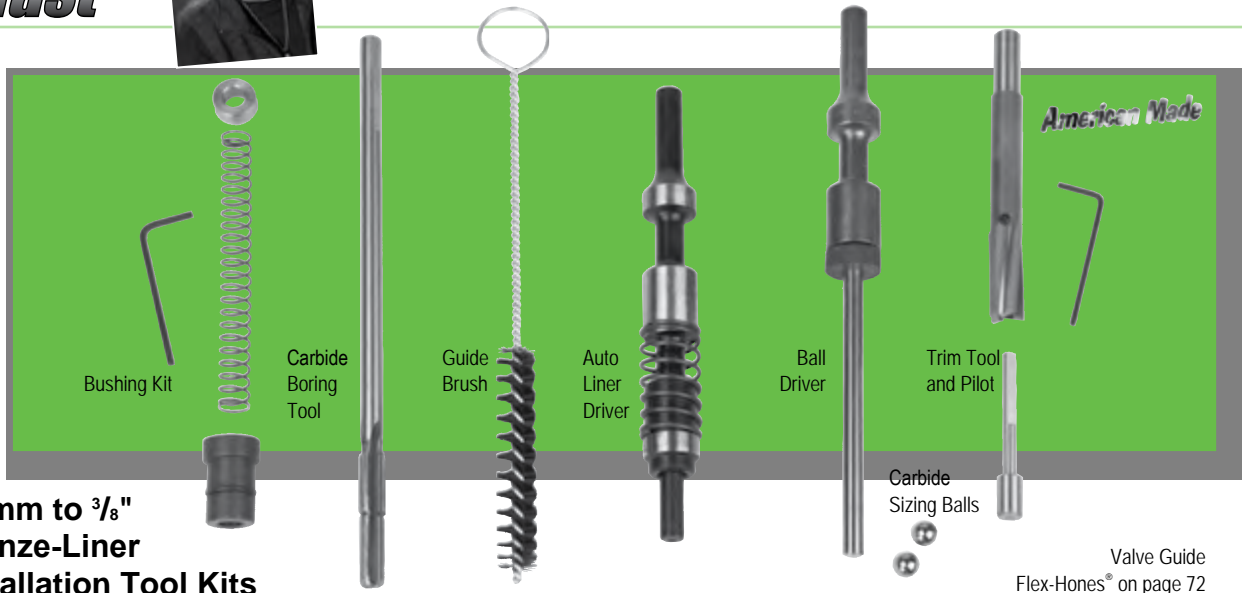

5.0mm to 3/8" Bronze-Liner Installation Tool Kits

Phosphor-Bronze is an ideal valve guide material – it's more durable than cast iron, conducts heat away faster and retains lubrication better to reduce wear. Install rugged, thin-wall (.030") Bronze-Liners in cast iron or aluminum heads to repair guides and deliver performance better than new! Plus, Bronze-Liners install quickly with simple tools. If a Bronze-Liner ever wears out, you can quickly and easily replace it with a new one to restore performance. **Removal Tools, page 35.**

Valve Guide
Flex-Hones® on page 72

Kits include ▼	5.0mm Guides*	5.5mm Guides*	6.0mm Guides	7.0mm Guides
Master Tool Kits	CL-5MM	CL-5.5MM	CL-6MM	CL-7MM
Carbide Boring Tool	CL-2028C	CL-2026C	CL-2024C	CL-2007C
Bushing Kit	CL-2004	CL-2002	CL-2003	CL-2001
Ball Driver	CL-4454P	CL-4452P	CL-4452P	CL-4446P
Carbide Sizing Balls	.1965" CL-51965 .1970" CL-5197	.2175" CL-52175 .2180" CL-5218	.2370" CL-5237 .2380" CL-5238	.2770" CL-5277 .2780" CL-5278
Auto-Driver	CL-3610	CL-3600	CL-3600	CL-3507
Trim Tool	.402" OD CL-5602	.402" OD CL-5602	.402" OD CL-5602	.500" OD CL-5600
Trim Tool Pilot	CL-5636	CL-5634	CL-5634	CL-5626
Guide Brush	GVP-9N	GVP-10N	GVP-10N	WCB-44

* 5.0mm and 5.5mm guides require our tooling, see page 35 for tech tip

When Working By Hand, Kits Require Seat Centering Cones - See Chart Below

Kits include ▼	5/16" Guides	8.0mm Guides	11/32" Guides	3/8" Guides
Master Tool Kits	CL-312	CL-8MM	CL-343	CL-375
Carbide Boring Tool	CL-2005C	CL-2008C	CL-2012C	CL-2014C
Bushing Kit	CL-2000	CL-2000	CL-2000	CL-2000
Ball Driver	CL-4444P	CL-4444P	CL-4444P	CL-4444P
Carbide Sizing Balls	.3125" CL-53125 .3130" CL-5313	.3160" CL-5316 .3170" CL-5317	.3440" CL-5344 .3445" CL-53445	.3750" CL-5375 .3760" CL-5376
Auto-Driver	CL-3500	CL-3500	CL-3504	CL-3506
Trim Tool	.500" OD CL-5600	.500" OD CL-5600	.500" OD CL-5600	.500" OD CL-5600
Trim Tool Pilot	CL-5620	CL-5620	CL-5622	CL-5624
Guide Brush	WCB-44	WCB-44	WCB-44	WCB-44

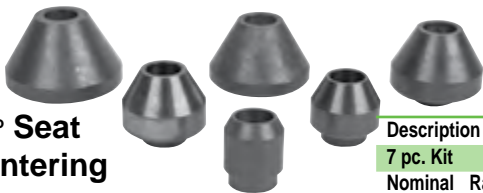

60° Seat Centering Cones

- Center firmly in the valve seat
- Cones feature a .625" ID
- Steel construction
- Use the Seat Centering Cones with the Master Tool Kits (above) for proper alignment of the reamer and guide bore

Description	Order No.
7 pc. Kit	CL-6500 ▼
Nominal Range	
1" 0.970"-0.730"	CL-6310 x
1¼" 1.230"-0.740"	CL-6308 x
1½" 1.475"-0.805"	CL-6306 x
1¾" 1.730"-0.860"	CL-6304 x
2" 1.950"-0.875"	CL-6302 x
2¼" 2.230"-1.000"	CL-6300 x
2½" 2.550"-1.875"	CL-6312 x

tech tips
from the techxperts™



The centering cone must fit the valve seat properly so using the correct size is essential. This is NOT a one-size-fits-all tool. If you have a cone that is too small for the seat it could slip through the opening. If you have one that's too large, the side of the combustion chamber could interfere or you won't have enough of the cone in the seat area for it to be stable and centered.

CYLINDER HEAD REBUILDING
CLEANING, ASSEMBLY & SAFETY
SHORT BLOCK REBUILDING
CRANKSHAFT/ FLYWHEEL GRINDING
MISCELLANEOUS TOOLS & SUPPLIES
BRAKE SERVICE TOOLING
MEASURING TOOLS
V-TWIN & METRIC HARD PARTS

Bronze-Liners & Tooling



Carbide Sizing Balls

- Finished to .00008" roundness
- Within the 90 Rockwell range
- The finished ID of the Bronze-Liner will be .001" smaller than the ball used

Size	Order No.	Size	Order No.
5.0mm .1960"	CL-5196	8.0mm .3150"	CL-5315
.1965"	CL-51965	.3160"	CL-5316
.1970"	CL-5197	.3170"	CL-5317
5.5mm .2165"	CL-52165	11/32" .3430"	CL-5343
.2175"	CL-52175	.3435"	CL-53435
.2180"	CL-5218	.3440"	CL-5344
6.0mm .2360"	CL-5236	.3445"	CL-53445
.2370"	CL-5237	.3450"	CL-5345
.2380"	CL-5238	.3460"	CL-5346
7.0mm .2760"	CL-5276	3/8" .3730"	CL-5373
.2770"	CL-5277	.3740"	CL-5374
.2780"	CL-5278	.3745"	CL-53745
5/16" .3120"	CL-5312	.3750"	CL-5375
.3125"	CL-53125	.3755"	CL-53755
.3130"	CL-5313	.3760"	CL-5376
.3140"	CL-5314		

Phosphor-Bronze liners outlast original guides and are easy to replace

Thin-Wall .030" Bronze-Liners

- Outlast original guides
- Cross-hatch promotes oil retention
- Rounded nose design makes installation quick and easy
- Stripe helps you identify rounded end • Phosphor-bronze

tech tips from the techxperts™

NOTE: 5.0 & 5.5mm Guides do NOT interchange with competitors' guides. You MUST use our tooling with these guides.

Guide Size	Liner Size		Box of 16	Box of 100
	OD	Length	Order No.	Order No.
5.0mm	+ .030"	2.00"	CL-500	CL-500A
5.5mm	+ .030"	2.50"	CL-550	CL-550A
6.0mm	+ .030"	2.50"	CL-600	CL-600A
7.0mm	+ .030"	2.50"	CL-700	CL-700A
.312"	+ .030"	2.50"	CL-1220	CL-1220A
8.0mm	+ .030"	2.50"	CL-1420	CL-1420A
.343"	+ .030"	3.00"	CL-1640	CL-1640A
.375"	+ .030"	3.00"	CL-1830	CL-1830A
Oversize Bronze Liners				
.343" +.002"	+ .032"	3.00"	CL-1640-2	CL-1640-2A
.375" +.002"	+ .032"	2.50"	CL-1820-2	CL-1820-2A



Removal Tool

Remove bronze liners without damaging the bore

Description	Order No.
5.0mm	CL-7356
5.5mm	CL-7354
6.0mm	CL-7352
7.0mm	CL-7344
5/16"	CL-7310
8.0mm	CL-7320
11/32"	CL-7330
3/8"	CL-7340

Universal Driver Tool

- Fits all removal tools at left and is designed to work with your air hammer
- .401" ID
- Order No. **CL-7333**



Chamfer Tool & T-Wrench

Use these optional accessories to remove any burrs that may be created when trimming the liner to length

Description	Order No.
Chamfer Tool	CL-5800
T-Wrench	CL-5870

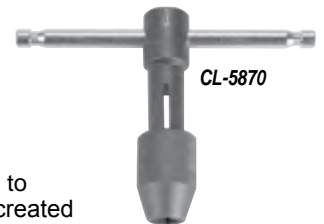

CL-5870



CL-5800

Mitutoyo

Small Hole Gauge Set

- See if rebuilding or replacing is needed by checking actual guide wear
- Check guide bosses for proper interference fit during replacement
- Check and maintain correct stem-to-guide ID clearance
- 4-piece set has combined range of .125" to .500"
- With storage pouch
- Order No. **SHG-5**



Mitutoyo

Split Ball Bore Gauge

- Dial gauge with large contact area
- Measures quickly & accurately to .0001" (.0025mm)
- Works in threaded or knurled guide IDs
- Range: .280"-.400"
- Easy to change contacts
- Includes molded plastic storage case
- Order No. **MVG-34**



CYLINDER HEAD REBUILDING
CLEANING, ASSEMBLY & SAFETY
SHORT BLOCK REBUILDING
FLYWHEEL GRINDING
CRANKSHAFT/ FLYWHEEL GRINDING
MISCELLANEOUS TOOLS & SUPPLIES
BRAKE SERVICE TOOLING
MEASURING TOOLS
V-TWIN & METRIC HARD PARTS



"We want every aspect of your transaction to be trouble-free. That's why we strive to keep everything as simple for you as possible. We're always looking for new ways to serve you better and we welcome your ideas for how to do that."

- Renee, Goodson Accounting, 26 years of service

CYLINDER HEAD
REBUILDING

Valve Seal Puller

- .810" tool dia.
- Fits Multi-Valve Engines
- Lifts from the bottom of the seal
- Works within the confines of lifter bucket bores
- Fingers grip seal for fast, easy removal
- Works on most domestic and import vehicles
- New and improved seal puller with stronger 3 jaw pulling action.

Description	Order No.
Valve Seal Puller	VSP-323
Replacement Shaft	VSP-323-4
Replacement O-Ring	VSP-323-5
Replacement Jaw Set	VSP-323-3
Replacement Jaw Sleeve	VSP-323-1
Black Split Sleeve	VSP-323-2

Parts are interchangeable with VSP-320



3 Fingers Grip
Seals Firmly!



Universal Seal Pliers

- Works on OHC and in-line engines with recessed springs
- Long, serrated jaws reach into confined areas and grip seals firmly
- Heat-treated steel with easy-grip handles
- Order No. VSP-823



CLEANING,
ASSEMBLY & SAFETY

SHORT BLOCK
REBUILDING

CRANKSHAFT/
FLYWHEEL GRINDING

Aluminum Seal Drivers

- Seal drivers are designed to fit over valve stem and drive seals squarely on top of valve guide
- A must-have tool for installing valve seals

Seal Size	Order No.
6.0mm	VSD-6MM
7.0mm	VSD-7MM
.312"	VSD-312
.343"	VSD-343
.375"	VSD-375



MISCELLANEOUS
TOOLS & SUPPLIES

BRAKE SERVICE
TOOLING

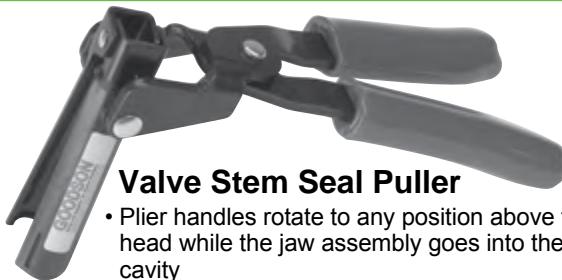

Valve Stem Seal Puller

- Plier handles rotate to any position above the head while the jaw assembly goes into the spring cavity
- Can be used straight or at any angle up to 90°
- Jaw tip includes thin wedge for "hooking" underneath stubborn valve stem seals
- 4 vertical raised ridges on inner jaw diameter help grip the outside diameter of the seal
- Order No. VSP-629

Calibrated Spring

- Check Spring Tester Accuracy
- Highest-quality spring steel
- Calibrated to show pressure at a specified compressed height (includes calibration certificate)
- Rating: Min. = 100 lbs.
Max. = 285 lbs.
- Order No. VST-95



MEASURING
TOOLS

Conversion Calculator

We've tried to convert as many SAE measurements to Metric (and vice versa) as possible. In some cases there hasn't been enough room.

If you need to convert a measurement, here are the formulas:

Starting Measurement	Conversion Formula	Converted Measurement
Inches (in)	Inches x 25.4	Millimeters (mm)
Feet (ft)	Feet x .3048	Meters (m)
Millimeters (mm)	Millimeters ÷ 25.4	Inches (in)
Fahrenheit (F)	(5÷9) x (F - 32)	Celsius (C)
Celsius (C)	(9÷5) x (C + 32)	Fahrenheit (F)

Height Indicator

- Measure compressed spring height when testing pressure
- Ideal for high performance and checking identical springs
- For Rimac® and other spring testers
- Height Scale displays inches and metric
- Includes Dial Indicator, and Mounting Kit (additional dial indicators on page 121)
- Order No. VST-25

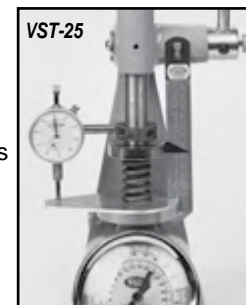

V-TWIN & METRIC
HARD PARTS

Valve Spring Testing

American Made

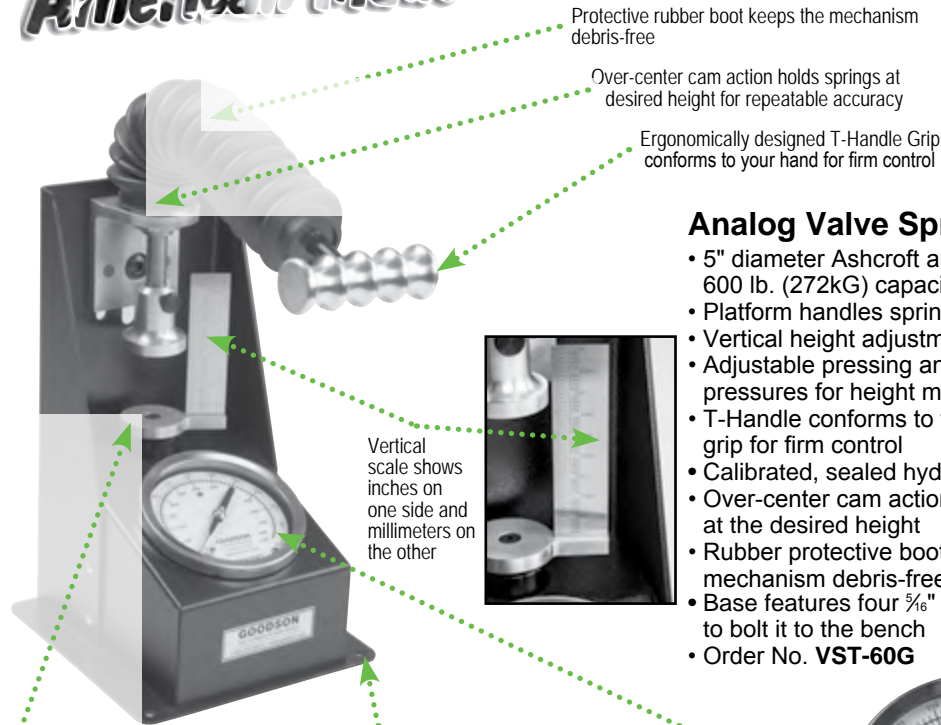

Protective rubber boot keeps the mechanism debris-free

Over-center cam action holds springs at desired height for repeatable accuracy

Ergonomically designed T-Handle Grip conforms to your hand for firm control

Vertical scale shows inches on one side and millimeters on the other



Platform handles springs up to 2" diameter and 4.5" OAL

Base includes four 5/16" holes for securely mounting the Valve Spring Tester to your bench

Easy to read 5" diameter Ashcroft-quality analog pressure gauge shows both pounds and kilograms with 600 pound capacity

Analog Valve Spring Tester

- 5" diameter Ashcroft analog pressure gauge with 600 lb. (272kG) capacity in 10 lb. (4.54kG) increments
- Platform handles springs up to 2" diameter x 4½" OAL
- Vertical height adjustments in ¼" increments
- Adjustable pressing anvil for fine-tuning open and closed pressures for height measurement
- T-Handle conforms to the operator's grip for firm control
- Calibrated, sealed hydraulic load cell
- Over-center cam action holds spring at the desired height
- Rubber protective boot keeps the mechanism debris-free
- Base features four 5/16" mounting holes to bolt it to the bench
- Order No. **VST-60G**

TECHNICAL SPECS:

UNIT WEIGHT: 19½ lbs.

FOOTPRINT: 8½" sq.

HEIGHT: 28" with handle fully extended



Goodson
EXCLUSIVE



Easy-to-use Travel Stop with adjustable set screws lets you set an exact position, allowing repeated testing at a desired height. Two set screws allow you to adjust for installed spring height and max lift (near coil bind).

Arbor style handle makes compressing springs fast and easy

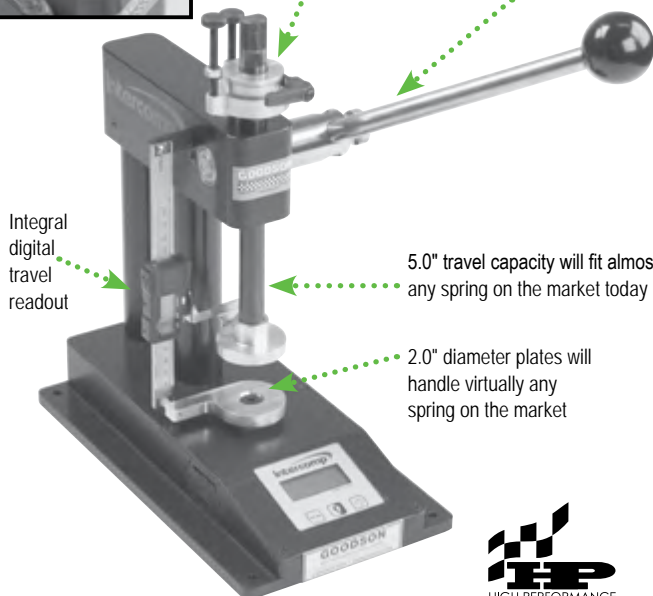

Integral digital travel readout

5.0" travel capacity will fit almost any spring on the market today

2.0" diameter plates will handle virtually any spring on the market



Protect Your Valuable Valve Spring Tester with this Cover!

- 10"x14"x18" • Same cover fits either Spring Tester
- Heavy-weight, breathable black Sundura® fabric won't hold in moisture
- Order No. **GMC-VST**

More Machine Covers on page 23.

Intercomp® Digital Arbor Valve Spring Tester

- 1,500 lb / 680.4 kg load cell in 1 lb. increments
- Force units switchable from pounds to kilograms
- Billet 6061 T-6 Aluminum construction
- Digital travel readout at .001"/inch or .01/mm
- 5" travel capacity • 2.0" diameter spring pads
- Easy to read backlit screen
- Operates on 9V battery (included)
- Adjustable stop to repeatedly check springs at the same heights
- Order No. **VST-2000**



CYLINDER HEAD
REBUILDING

CLEANING,
ASSEMBLY & SAFETY

SHORT BLOCK
REBUILDING

FLYWHEEL GRINDING
CRANKSHAFT/
GRINDING

MISCELLANEOUS
TOOLS & SUPPLIES

BRAKE SERVICE
TOOLING

MEASURING
TOOLS

V-TWIN & METRIC
HARD PARTS



Pneumatic Head:
Adjustable to 25° in either direction for canted valves



Head Support:
Table adjusts 45° to the front and 30° to the rear



Positive Stops: Adjusts front and rear angles



Speed Knobs:
Allows quick positioning of workpiece



Foot Pedal:
Easy, hands-free operation



Quick Release Knob:
Allows fast positioning to opposite cam bank

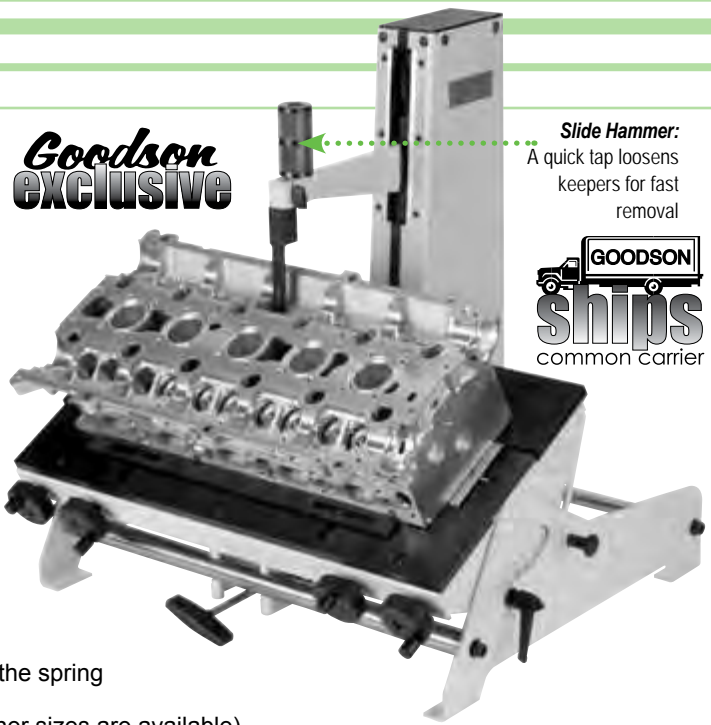

**Goodson
exclusive**

Slide Hammer:
A quick tap loosens keepers for fast removal



Pneumatic Valve Spring Press

- Pneumatic valve support holds valve closed as you compress the spring
- Adjustable stainless steel plate won't damage the head
- 28mm Valve Spring Adaptor (**CF-502**) is standard with unit (other sizes are available)
- Ideal for use on heads with recessed springs • For aluminum and cast iron heads
- Ships fully assembled • Replacement Parts Available • Measures 28"L x 24"W x 26"H
- Order No. **PSB-5000**

American Made

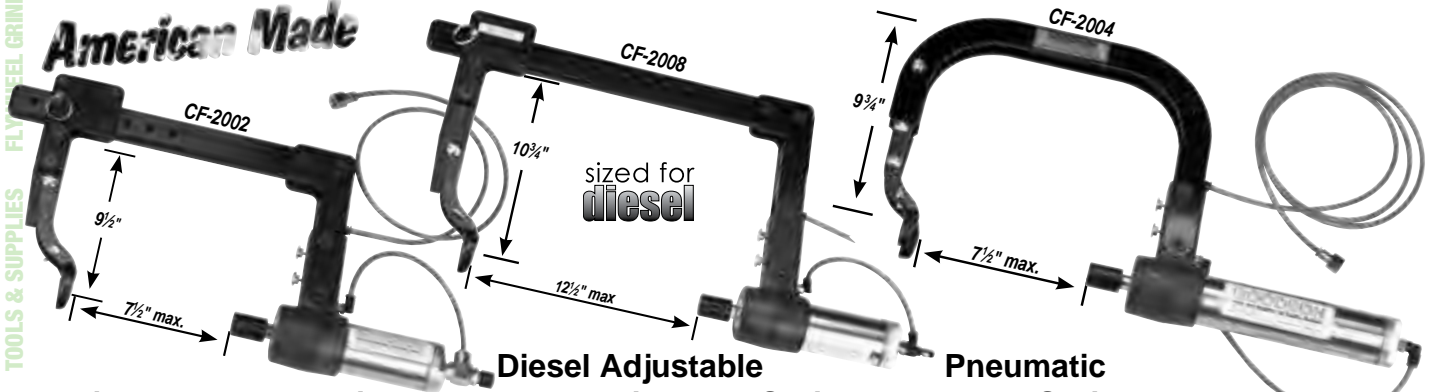

Adjustable Pneumatic Valve Spring Compressor

- Develops up to 325 lbs. of force with 130 PSI
- For springs from 3/4" to 1 3/4" dia.
- CNC-machined 6061 T6 aircraft-quality aluminum frame is adjustable in 1/4" increments
- Includes adjustable jaws (**CF-44**)
- Stainless steel cylinder with viton grade seals • 2" cylinder travel
- Fingertip controls
- Full 1 year warranty

Description	Order No.
Valve Spring Compressor	CF-2002
Replacement Parts and Accessories	
Valve Spring Adaptor Jaw	CF-44
1/4" Green Air Line (lin. ft.)	CF-2001-AL
Air Control Needle Valve	CF-2001-NV
Int. / Ex. Button	CF-2003-C
1/4" NPT L-Fitting	CF-2003-BCE
Air Cylinder 2" Travel	CF-2001-AC
1/8" NPT L-Fitting	CF-2003-L

Diesel Adjustable Pneumatic Valve Spring Compressor

- Develops up to 325 lbs. of force with 130 PSI
- For springs from 3/4" to 1 3/4" dia.
- CNC-machined 6061 T6 aircraft-quality aluminum frame is adjustable in 1/4" increments
- Includes adjustable jaws (**CF-44**)
- Stainless steel cylinder with viton grade seals • 2" cylinder travel
- Fingertip controls
- Full 1 year warranty

Description	Order No.
Valve Spring Compressor	CF-2008
Replacement Parts and Accessories	
Valve Spring Adaptor Jaw	CF-44
1/4" Green Air Line (lin. ft.)	CF-2001-AL
Air Control Needle Valve	CF-2001-NV
Int. / Ex. Button	CF-2003-C
1/4" NPT L-Fitting	CF-2003-BCE
Air Cylinder 2" Travel	CF-2001-AC
1/8" NPT L-Fitting	CF-2003-L

Pneumatic Valve Spring Compressor

- Develops up to 325 lbs. of force with 130 PSI
- Operates on as little as 90 PSI
- Handles springs from 3/4" to 1 3/4" diameter
- Includes adjustable jaws (**CF-44**)
- 4" cylinder travel • Steel frame
- Stainless steel cylinder with viton grade seals
- Fingertip controls
- Full 1 years warranty

Description	Order No.
Valve Spring Compressor	CF-2004
Replacement Parts and Accessories	
Valve Spring Adaptor Jaw	CF-44
1/4" Green Air Line (lin. ft.)	CF-2001-AL
Air Control Needle Valve	CF-2001-NV
Intake and Exhaust Button	CF-2003-C
1/4" NPT L-Fitting	CF-2003-BCE
Air Cylinder 4" Travel	CF-2003-AC
1/8" NPT L-Fitting	CF-2003-L

Valve Spring Compressors

**Goodson
exclusive**

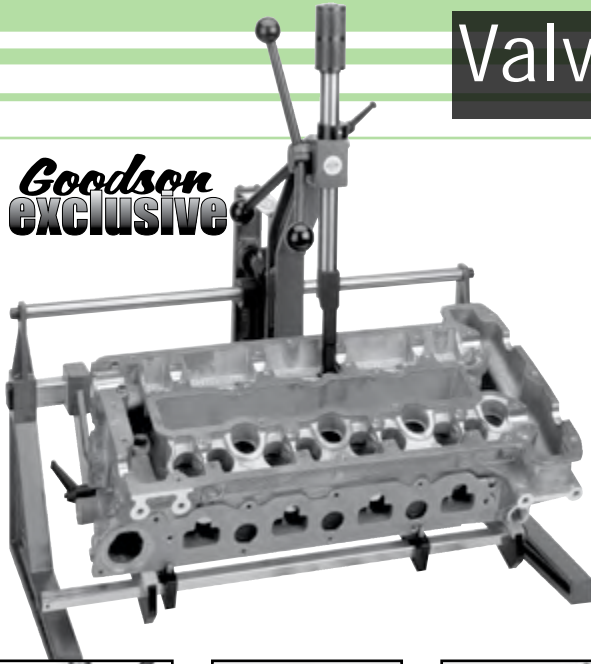

Speed Up Valve Spring Replacement With The Manual Valve Spring Bench

- Remove and install valve springs on heads with recessed springs
- 26"L x 22"W x 35"H footprint and weighs 31 lbs.
- Includes 28mm dia. spring adaptor (**CF-502**), other size spring adaptors also available (see chart below)
- Locking collar can be used to stop vertical travel or to keep the spring compressed while assembling keepers
- Frame tilts up to 25° in either direction for canted valves
- Full cylinder head support is adjustable from 0 to 45°
- Integral slide hammer easily releases stuck keepers
- Replacement parts available
- Order No. **CF-500**

Keeper Tools on p. 40-41



Lock Collar:
Can be used to stop vertical travel or to hold spring compressed while assembling keepers



Adjustable Frame:
Adjustable to 25° in either direction for canted valves



Locking Arm:
Holds the C-frame securely in position at the desired angle



Head Support:
Adjustable from 0-45° and locks in place

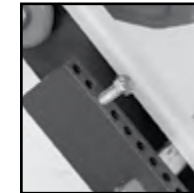

Dowel Pins:
Keeps the workpiece in place at any head support angle



Slide Hammer:
A quick tap releases keepers that are stuck in retainers

Spring Adaptors for Valve Spring Benches

- Fit both manual (**CF-500**) and pneumatic (**PSB-5000**) spring benches
- 1/2" pin diameter
- Solid steel construction with nylon wear insert
- Nylon insert is replaceable

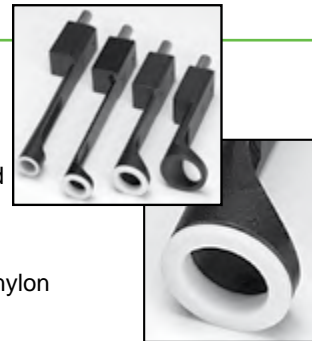

Description	Reac	Adaptor	Insert
18mm	4 1/2"	CF-518	CF-518-1
23mm	4 1/2"	CF-501	CF-501-1
28mm	3 1/2"	CF-502	CF-502-1
35mm	2 1/2"	CF-503	insert not required



Valve Spring Adaptor Jaws

- Fit frames with double locking screws to secure jaws such as Goodson **CF-2002**, **CF-2004**, **CF-2008** and **CF-140** • Heavy duty jaws are non-adjustable (Has a 1 5/8" max spring diameter)

Description	Order No.
Standard Duty 1.000"-1.875" (25.4-47.6mm) Range	CF-44
Heavy Duty (non-adjustable)	CF-44HD

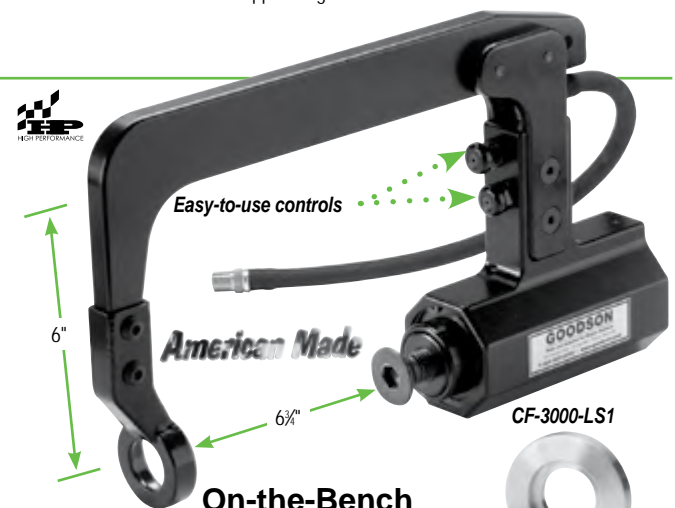

On-the-Bench Pneumatic Spring Compressor

- Handles springs up to 1500 lbs. at 90 PSI!
- Standard heavy-duty jaw fits springs up to 1.600" diameter
- Optional jaw fits springs to 1.740" diameter
- Features a dual stage cylinder that produces more force each time the control is pressed
- **Guaranteed to a maximum of 90 psi/620.5 kPa pressure**

Description	Order No
Hi-Perf. Spring Compressor with 1.600" ID Jaw	CF-3000B
Replacement Standard Jaw, 1.600" ID	CF-3002
Adaptor Jaw, 1.740"/44.2mm ID	CF-3003
LS1 Series Jaw Adaptor (1.750 OD) use with CF-3003	CF-3000-LS1
Rebuild Seal Kit (includes Intake Button Return Spring)	CF-3000SK
Replacement Intake Button Return Spring	CF-3004
Intake Trigger Assembly	CF-20004A
Exhaust Trigger Assembly	CF-20004B

CYLINDER HEAD REBUILDING
CLEANING, ASSEMBLY & SAFETY
SHORT BLOCK REBUILDING
FLYWHEEL GRINDING
CRANKSHAFT/
MISCELLANEOUS TOOLS & SUPPLIES
BRAKE SERVICE TOOLING
MEASURING TOOLS
V-TWIN & METRIC HARD PARTS



"You'll always get fast, reliable service from Goodson, even on international orders. We'll do whatever it takes to make sure you get your shop supplies as quickly and easily as possible - anywhere in the world."

- Kim, Goodson Customer Service Manager, 35 yrs. of service

CYLINDER HEAD
REBUILDING

CLEANING,
ASSEMBLY & SAFETY

SHORT BLOCK
REBUILDING

CRANKSHAFT/
FLYWHEEL GRINDING

MISCELLANEOUS
TOOLS & SUPPLIES

BRAKE SERVICE
TOOLING

MEASURING
TOOLS

V-TWIN & METRIC
HARD PARTS

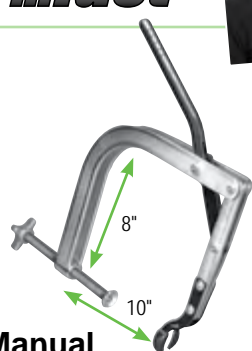

Manual Valve Spring Compressor

- Weighs only 6 lbs
- High leverage allows for easy, one-hand operation
- Covers a range from 10" high to 8" deep
- Works with most L-head and valve-in-head engines
- Fits truck & tractor engines
- Jaws adjust for small, medium and large springs

Description	Order No.
Spring Compressor	CF-140
Replacement Jaw Set	CF-44
HD Replacement Jaw Set	CF-44HD

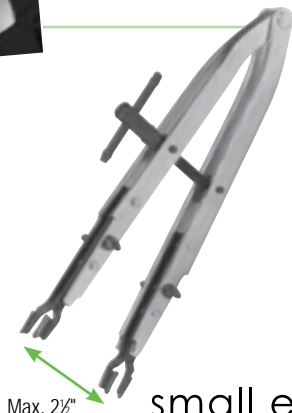

small engine powersports

Manual Valve Spring Compressor

- Compress **only** the spring for fast and easy keeper removal
- Fully adjustable steel jaws have maximum opening of 2 1/2" (63.5mm)
- For springs 1/2" (12.7mm) to 1 1/8" (28.6mm) in diameter
- Cadmium finished spring steel construction
- Order No. **CF-131**

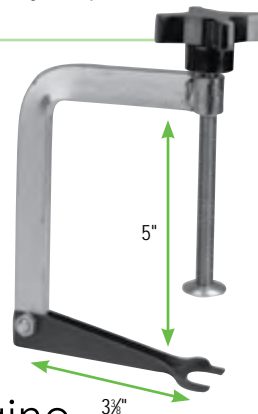

Manual Valve Spring Compressor For Small Engines

- Steel construction
- 20# max. spring pressure
- Once you lock the compressor in position, your hands are free to work
- Includes 2 jaw sets - small, for springs up to 7/8" (22.2mm) and large, for springs up to 1 1/8" 27.0mm)
- Order No. **CF-600**

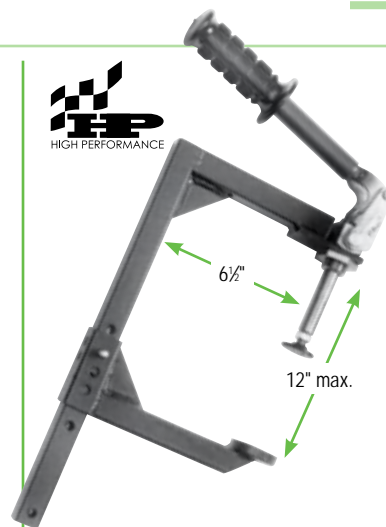

Manual Valve Spring Compressors

- Handle valve springs from a range of applications
- Welded, gusseted all-steel construction takes plenty of abuse
- Plenty of leverage to compress valve springs
- Order No. **CF-1500**



Keeper Installation Tools

- Spring-loaded plunger
- For single & multi-groove keepers
- Reaches keeper grooves located farther from the valve tip • Ideal for use with **CF-500** (p. 39) and **PSB-5000** (p. 38)

Best Keeper Tool on the Market!

Size	Order No.
4mm / .1563"	VKI-4
5mm / .2031"	VKI-5
6mm / .2344"	VKI-6
7mm / .2812"	VKI-7
8mm / .3125"	VKI-8
Replacement Rubber Sleeve	VKI-56

Valve Spring Compressor Adaptor

- Fit seat and guide machines or drill press
- Puts collet or drill press chuck behind adaptor
- Allows more room to remove or re-install valve keepers and associated components
- Fits 1/2" collet or Jacobs chuck (not included)

OD (mm)	Reach (mm)	Order No.
3/4" (19.1)	3 3/4" (95.3)	CF-6
1 3/8" (20.6)	3 3/4" (95.3)	CF-8
1" (25.4)	3 3/4" (95.3)	CF-10
1 1/4" (31.7)	3 3/4" (95.3)	CF-12
1 1/2" (38.1)	3 3/4" (95.3)	CF-15

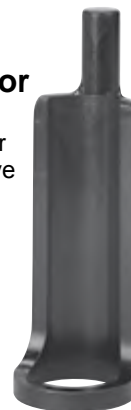

Small OHV Engine Keeper Removal & Installation Tool

- Easy to use - Uses your own body weight as leverage
- Works with 3.5mm to 5.5mm single groove valves only
- Complete set includes a remover with powerful magnet to hold the keepers in place after removal, universal installer and two non-slip valve chamber pads

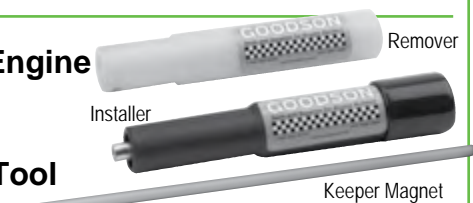

Description	Order No.
Keeper Removal Installation Tool	VKI-35
Keeper Magnet - 6 5/8" holder with .170" dia. Earth magnets	VKM-17

Adaptors for Deeply Recessed Springs

- Open top design gives easy access to keepers
- Durable, non-marring material
- Fit on Split-Jaw Spring Adaptors such as our **CF-44** (p. 39)

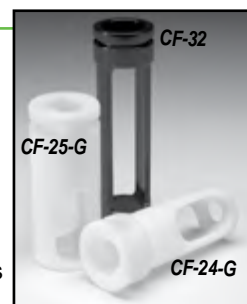

Description	OD	Height	Order No.
Small Metal Adaptor	26mm	4" (101.6mm)	CF-32
Medium Nylon Adaptor	27mm	3" (76.2mm)	CF-24-G
Large Nylon Adaptor	32mm	3" (76.2mm)	CF-25-G

Valve Spring Compressors

V-Twin On-the-Engine Valve Spring Compressor

Replace broken valve springs, install high performance valve springs, remove and replace valve guide seals all without disassembling the bike. Just remove the gas tank and get to work. Use on Sportster, Evolution, Twin-Cam and most aftermarket V-Twins. Kit includes valve spring compressor, adaptor for compressing beehive springs, valve seal driver/installer and head pressurizing hose. Order No. **CF-HDIF**

Visit the Goodson Blog for more information on using the On-The-Engine Spring Compressor

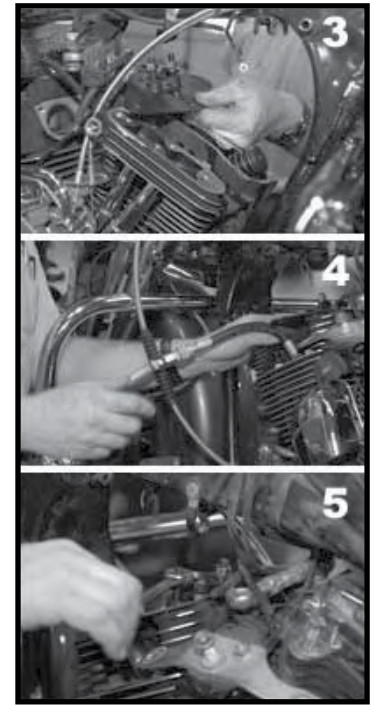
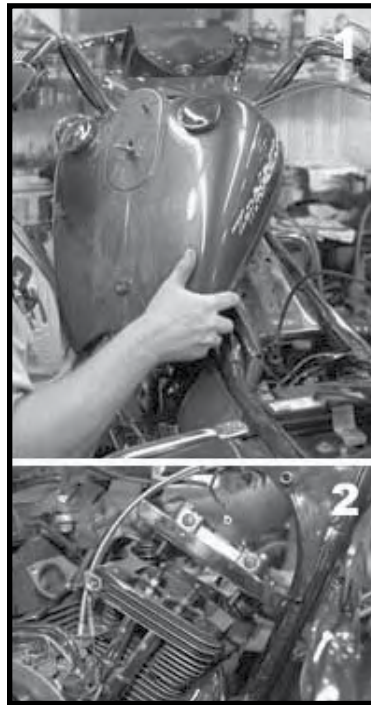
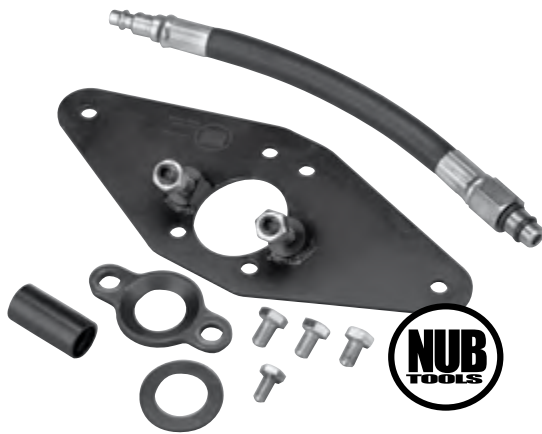

CYLINDER HEAD
REBUILDING

CLEANING,
ASSEMBLY & SAFETY

SHORT BLOCK
REBUILDING

CRANKSHAFT/
FLYWHEEL GRINDING

MISCELLANEOUS
TOOLS & SUPPLIES

BRAKE SERVICE
TOOLING

MEASURING
TOOLS

V-TWIN & METRIC
HARD PARTS



Standard Valve Spring Adaptors

- For threaded shaft spring compressors
- Thumb screw adjustment
- Single locking screw secures jaw to frame

Adjustment Range	Order No.
.875" - 1.875" (22.2-47.6mm)	CF-21A-G
1.00" - 2.000" (25.4-50.8mm)	CF-22C-G
1.50" - 2.500" (38.1-63.5mm)	CF-23-G
Replacement Thumb Screw	CF-700-2-G

Heavy Duty Valve Spring Adaptors

- Heavy duty jaws are not adjustable

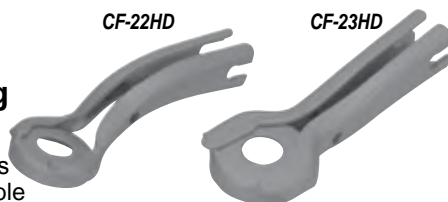

Spring Size Range	Order No.
1.00" - 2.000" (25.4-50.8mm)	CF-22HD
1.50" - 2.500" (38.1-63.5mm)	CF-23HD

Pneumatic Valve Spring Compressor Rebuild Kit

- For pneumatic spring compressors with threaded shaft such as Plews, Clark Feather, etc.
- Includes seals, valves, springs and o-rings
- Order No. **CF-700-RK**

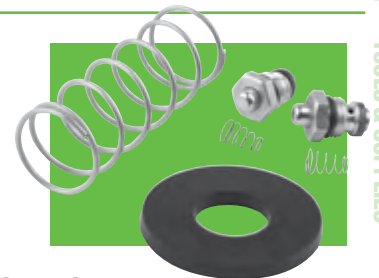

Keeper Tools

Description	Order No.
Keeper Tool	CF-842
Keeper Magnet - 6 $\frac{1}{16}$ " holder .170" dia. earth magnet	VKM-17
Keeper-Keeper - PVC $\frac{1}{4}$ " holes keep keepers in	VK-15



"Our staff of ASE-Certified Techxperts® can help you solve problems fast! Call with questions about product applications, machining precision, longer tool life, improving efficiency, cost savings or any other technical topic. We're here to help you!"

- Erik, Goodson Tech Support Manager, 18 years of service

CYLINDER HEAD
REBUILDING

CLEANING,
ASSEMBLY & SAFETY

SHORT BLOCK
REBUILDING

CRANKSHAFT/
FLYWHEEL GRINDING

MISCELLANEOUS
TOOLS & SUPPLIES

BRAKE SERVICE
TOOLING

MEASURING
TOOLS

V-TWIN & METRIC
HARD PARTS

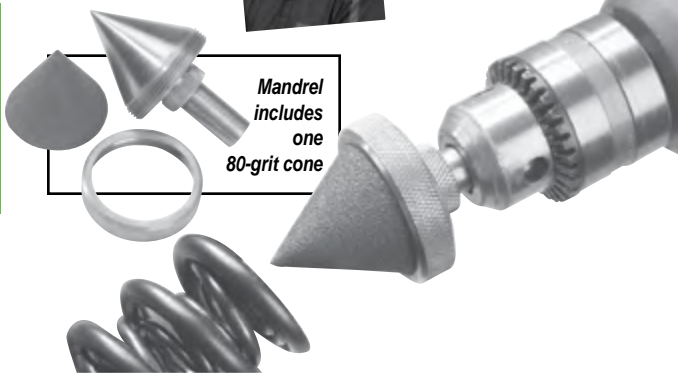

Mandrel includes one 80-grit cone

Small Chamfering Cones & Mandrels Make Deburring and Chamfering Easy In Tight Spaces

These mandrels are available in two diameters – 3/4" and 1 1/2" diameters with a 1/2" shank to fit most portable drills. The small diameter fits easily into tight spaces such as Beehive Valve Springs (see page 127) or bolt holes. The mandrel is designed to support a 60° abrasive cone which is held securely by the retaining ring. One 80-grit cone is included with initial purchase.

Description	Order No.
3/4" Dia. Mandrel	CC-34
3/4" Dia. Abrasive Cones 80 grit	CC-35
3/4" Dia. Abrasive Cones 120 grit	CC-36
1 1/2" Dia. Mandrel	CC-60
1 1/2" Dia. Abrasive Cones 80 grit	CC-61
1 1/2" Dia. Abrasive Cones 120 grit	CC-62



3-D Fast Cut™ Adjustable Spring Pad Cutters on page 10

Valve Spring Seat Cutters

- Resize valve spring seats to maintain spring-to-valve concentricity or use to enlarge seats for over-size dual springs
- Requires special pilot – see chart below

Carbide Tipped Cutter Bodies
(use VP pilots below)

OD	ID	Order No.
1.320"	.630"	VSS-1320
1.350"	.625"	VSS-1350
1.500"	.625"	VSS-1500
1.550"	.625"	VSS-1550
1.625"	.625"	VSS-1625
1.680"	.750"	VSS-1680HD
1.750"	.625"	VSS-1750

Hardened & Ground Pilots

Guide ID	Order No.
9/32"	VP-7MM
5/16"	VP-312
11/32"	VP-343
3/8"	VP-375

tech tips

from the techxperts™
You must use these pilots with the VSS and VSC cutters. The flat sides are necessary for a proper fit.

Universal Gel Lube

- Sprays on as a liquid and forms into a gel within seconds
- Penetrating formula blends freely with motor oil
- Multiple uses, including cams, lifters, rocker arms, bearings, pistons/wrist pins, cylinders, etc. Provides lubrication for engines subjected to prolonged storage before initial start-up
- Aerosol*
- Order No. **GL-8U**



*Hazardous Goods Fees Will Apply if Shipped By Air



8 Piece Valve Train Checking Spring Set

- 1.250" OD
- Spring Steel construction
- Essential for high-performance engine building and engine blueprinting
- Maintain a positive valve train position while checking valve to piston clearance
- Order No. **VTS-8**



Buy the Kit and SAVE!

Dial Indicated Valve Stem Height Gauges

- 5 sizes to choose from
- Small diameter extended measuring body allows extra height for dial indicator clearance
- Use with our large-faced Dial Indicator to check valve tip height



Description	Order No.	Incl.
Valve Stem Height Gauge Kit w/Stand	VSH-KIT	▼
Valve Stem Height Gauge Kit	VSH-200	▼
Dial Indicator (2" travel, .001" graduations)	MDI-2	x x
Dial Indicator (1" travel, .001" graduations)	EDI-1	
Measuring Bodies	OD ID OAL	
	.750" .625" 3.830"	VSH-205 x
	.900" .770" 2.840"	VSH-203 x
	.900" .770" 3.840"	VSH-204 x
	1.060" .812" 2.840"	VSH-201 x x
	1.250" 1.090" 3.300"	VSH-202 x x
Tool Stand	TS-5	x
1" Checking Standard	MCS-1	

More dial indicators on page 121

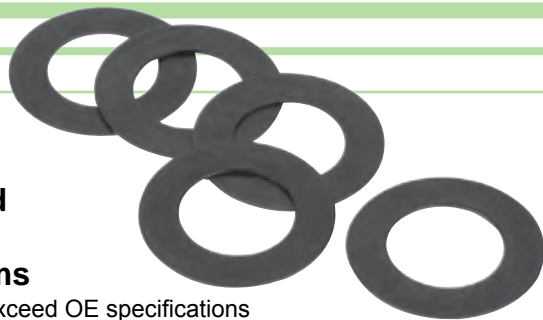

Non-Serrated Valve Spring Booster Shims

- Shims meet or exceed OE specifications
- Made of prime quality cold rolled steel
- Support valve springs better than serrated shims • Won't compress
- Maintains pressure and protects head from spring abrasion
- Non-serrated shims won't damage spring pad area on aluminum heads or cause lateral loads or harmonics

Special Orders are available.

Size		50 count High Performance			100 count		
OD	ID	.060"	.030"	.015"	.060"	.030"	.015"
1.000"	0.688"				A-101	B-101	C-101
	0.765"				A-104	B-104	
1.100"	0.719"					B-106	
1.218"	0.875"				A-105	B-105	
1.250"	0.625"	A-107-HP	B-107-HP	C-107-HP	A-107	B-107	C-107
	0.812"	A-203-HP	B-203-HP	C-203-HP	A-203	B-203	C-203
	0.875"				A-201	B-201	
1.360"	1.000"	A-102-HP	B-102-HP	C-102-HP	A-102	B-102	
1.375"	0.765"	A-301-HP	B-301-HP	C-301-HP		B-301	
1.437"	0.785"	A-305-HP	B-305-HP	C-305-HP			
1.438"	0.645"	A-306-HP	B-306-HP	C-306-HP			
1.480"	0.703"	A-303-HP	B-303-HP	C-303-HP	A-303	B-303	
1.500"	0.645"	A-306S-HP	B-306S-HP	C-306S-HP			
	1.031"	A-103-HP	B-103-HP	C-103-HP	A-103	B-103	
1.634"	0.643"	A-601-HP	B-601-HP	C-601-HP			



Magnetic Head Bolt Washer & Valve Spring Shim Removal Tools

- Hollow design allows easy access over studs or head castings
- Powerful earth magnets grab firmly, letting you lift the washer or shim easily

Description	Order No.	Incl.		
Magnetic Remover Set	MWR-SET	▼		
Washer Removers	ID	OD		
	0.250"	0.625"	MWR-14	x
	0.500"	0.865"	MWR-12	x
	0.450"	0.812"	MWR-716	x
Shim Remover	0.708"	1.355"	MVSR-2	x

No More Guesswork... Measure CCs Accurately!

Cylinder Head CC-ing Equipment

- Use glass buret with alcohol or solvent
- Positive on/off fluid control valve
- Clear acrylic plate lets you see when the combustion chamber is full
- Mix Measuring Concentrate with water to make 1 gallon

Description	Order No.	Incl.
CC-Measurement Kit	CCB-KIT	▼
100cc Glass Buret	CCB-100	x
5" x 5" x 3/8" Acrylic Plate	GCB-3	x
Buret Cleaning Brush - 35 1/2" OAL	GCB-BRUSH	x
Buret Stand	GCB-1	x
Buret Clamp	GCB-2	x
Funnel	CCB-FUNNEL	x
Measuring Liquid Concentrate (Yields 1 Gal.)	GCB-LIQUID	
4" Precision Cylinder Head Level	LEV-4	
Replacement Vial for 4" level	VGL-101	
100cc Glass Beaker	GC-100	
Universal Cylinder Head Holders (pair)	HH-200	

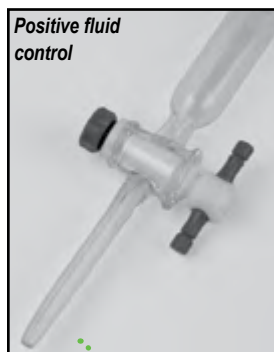
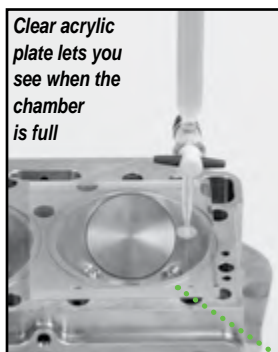

100cc Glass Buret allows use with alcohol or solvent

Clamp gives you ability to fully adjust the height of the buret in relation to your cylinder head

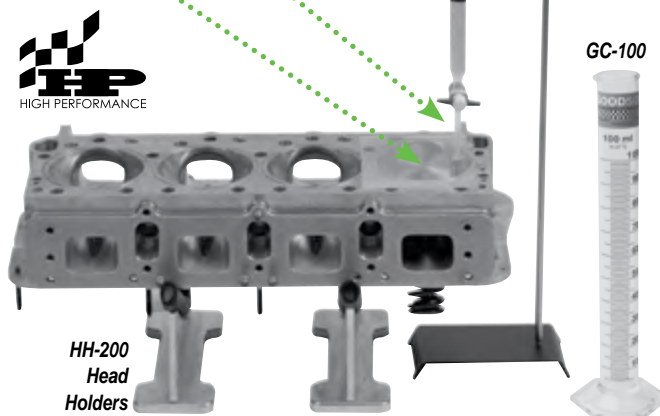

CYLINDER HEAD REBUILDING

CLEANING, ASSEMBLY & SAFETY

SHORT BLOCK REBUILDING

FLYWHEEL GRINDING

CRANKSHAFT/ TOOLS & SUPPLIES

BRAKE SERVICE TOOLING

MEASURING TOOLS

V-TWIN & METRIC HARD PARTS

full service ...fast



"We work hard to earn your business; every day, every order. You can count on Goodson to be your most reliable and friendly source for shop supplies."

- Richard, Goodson Customer Service - 19 years of service

CYLINDER HEAD
REBUILDING

CLEANING,
ASSEMBLY & SAFETY

SHORT BLOCK
REBUILDING

CRANKSHAFT/
FLYWHEEL GRINDING

MISCELLANEOUS
TOOLS & SUPPLIES

BRAKE SERVICE
TOOLING

MEASURING
TOOLS

V-TWIN & METRIC
HARD PARTS

resharpening
available

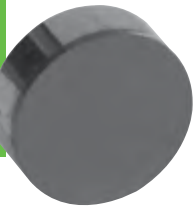

PCD Inserts for Aluminum

- A must for shops committed to meeting today's strict surface finish requirements
- Fits machines with 3/8" and 1/2" CBN holder
- 1/2" diameter inserts require shim (included)
- Use with Resurfacing Spray (HPS-16) for best results (see page 45)

Diameter	Thickness	Sided	Order No.
3/8" (9.53mm)	1/8"	Single	PCDS-375
1/2" (9.53mm)	1/8"	Single	2379264
1/2" (12.7mm)	3/16"	Single	PCDS-500
1/2" (12.7mm)	3/16"	Single	2379265
1/2" (12.7mm)	3/16"	Single w/screw hole	2X6145

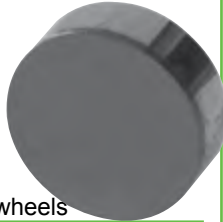

CBN Cutter Inserts For Cast Iron

- Faster and cleaner than segments and wheels

Titanium-Nitride Coated		Goodson	Uncoated Radiac
Dia.	Thick.	Order No.	Order No.
3/8"	1/8" Double	CBN-375D	-----
	1/8" Single	CBN-375S	2X5346
	3/16" Double	-----	2359232
1/2"	1/8" Single	-----	2X5357
	1/8" Double	CBN-500D*	2X5299
	3/16" Single	CBN-500S	2359233
3/8"	3/16" Solid	-----	2359234
	3/8" Single Sided with Screw Hole	-----	2X6144
	3/8" Special Edge Prep for Diesel	-----	2379268

Sharp Uncoated

3/8"	1/8"	Single	CBNS-38	-----	-----
1/2"	3/8"	Single	CBNS-12	-----	-----
1/16" Thick Carbide Shim*			CBN-500SHIM		

*Shim required on DCM machine

resharpening
available

CBN Resharping Service

Send your CBNs to Goodson to have them sharpened

Description	Order No.
Single Sided CBN Resharping	RESHARP-CBNS
Double Sided CBN Resharping	RESHARP-CBND

resharpening
available

Enlarged for clarity



Super Abrasive For Cast Iron Diesel Heads

- Designed for cast diesel heads with hardened pre-cups • Won't chip
- Fits all overhead surfacers with 1/2" diameter insert capacity
- Will NOT work on standard cast heads
- .500" (12.7mm) diameter • .125" (3.2mm) thick
- Order No. DRD-500

*NOTE: A 1/16" thick carbide shim must be used with DRD-500 on DCM machines
• Order No. CBN-500SHIM

tech tips

from the techxperts™

Confirm level calibration
before every use.



2-Way Resurfacing Set-up Level

- Top-quality CNC machined T-6 aluminum frame with hardened & ground tool-steel contact pads
- Level both directions at once • Includes 6" precision vials (LEV-8-1) • Weighs just 2 lbs.
- Order No. LEV-TR

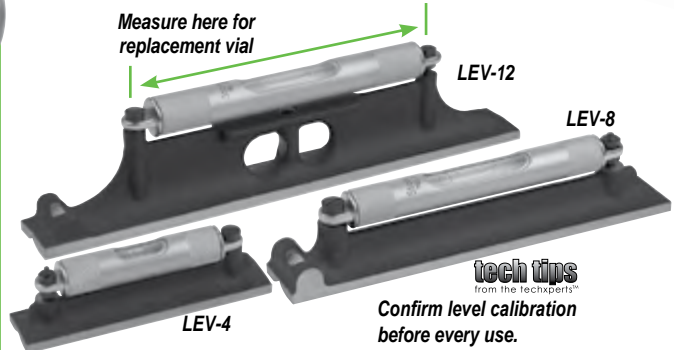

tech tips
from the techxperts™

Confirm level calibration
before every use.

Precision Levels and Vials

- Graduated vials with satin-chromed, brass protective covers that rotate to close tightly
- Base castings are seasoned, then precision machined and finished on a bearing surface • Replaceable vials
- Adjustable for precise calibration
- 1 division equals .0005" per inch
- Fits pilots from 6mm to .437"



VGL-100
(pilot sold
separately)

Description	Order No.	Replacement Vial
4" Valve Guide Level (3" vial)	VGL-100	VGL-101
4" Level (3" vial - nominal)	LEV-4	VGL-101
8" Level (6" vial - nominal)	LEV-8	LEV-8-1
12" Level (8" vial - nominal)	LEV-12	LEV-12-1

Import / Metric Cylinder Head Stud Stretchers

- Save time, don't remove the studs from a head for resurfacing • Put stud stretchers on two studs and leave the rest • Sold in pairs

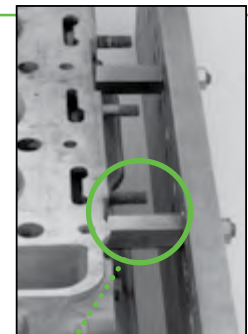

Length	Thread	Order No.
3"	8mm x 1.25	SS-20
3 3/4"	8mm x 1.25	SS-30
3 3/4"	10mm x 1.25	SS-40

Cylinder Head Resurfacing

CYLINDER HEAD
REBUILDING

CLEANING,
ASSEMBLY & SAFETY

SHORT BLOCK
REBUILDING

CRANKSHAFT/
FLYWHEEL GRINDING

MISCELLANEOUS
TOOLS & SUPPLIES

BRAKE SERVICE
TOOLING

MEASURING
TOOLS

V-TWIN & METRIC
HARD PARTS

Selection Guide: which abrasive works best on what materials...

ALUM	CAST IRON	STEEL	Ceramic (40g)
			Nor-Zon® (40g)
			Zirconia Alumina (40g)
			Silicon-Carbide (40g)
			Silicon-Carbide (80g)

Cylinder Head Resurfacing Belts

A belt has three important parts: abrasive, bond and backing. Goodson belts are made for top performance and long life. Our belts also feature a unique splice that permits use in both directions for even longer wear; when worn one way, turn belt around to resurface more heads.

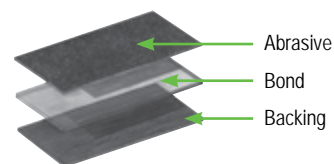
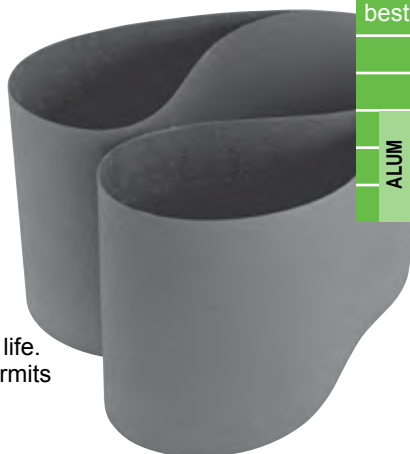

Abrasive: Match the abrasive to the workpiece (aluminum, cast iron or steel) and to your machine for the longest belt life.

Bond: Double-layer, heat-resistant resin holds abrasive firmly. Bond is so strong that grains wear out instead of loosening.

Backing: Waterproof, poly-back belt won't tear or fray. It's the toughest backing of any resurfacing belt.

To check which size belt is needed to fit your machine, see the groups of resurfacers listed below.



Silicon-Carbide 40-grit:

- Good-quality • Black
- Primarily for cast iron but can resurface aluminum if extra care is used
- Down-pressure optional
- * **SGS-14-86-60 is a 60 grit belt**

Silicon-Carbide 80-grit:

- Good-quality • Black
- Designed especially to resurface aluminum
- Down-pressure not recommended

Ceramic 40-grit:

- Best-quality • Maroon
- Perfectly uniform grain
- Outlasts other types of belts
- For cast iron or steel
- Down-pressure recommended

Nor-Zon® 40-grit:

- Better-quality
- Blue
- Grains fracture under pressure to stay sharp
- For cast iron or steel
- Down-pressure recommended

Zirconia Alumina 40-grit:

- Better-quality
- Excels on severe applications
- Grains fracture under pressure to stay sharp
- For stainless steel, alloy and aluminum
- Blue/Green

Belt Size	Machine	Order No.	Order No.	Order No.	Order No.	Order No.
10" x 103"						SGZ-10-103
11 1/2" x 76"	(A)	SGS-11-76	SGA-11-76		SGB-11-76	SGZ-11-76
11 1/2" x 79"	(B)	SGS-11-79	SGA-11-79		SGB-11-79	SGZ-11-79
11 1/2" x 89"	(C)	SGS-11-89	SGA-11-89		SGB-11-89	SGZ-11-89
11 1/2" x 91"	(D)	SGS-11-91	SGA-11-91			
14" x 86"	(E)	SGS-14-86-60*	SGA-14-86			SGZ-14-86
14" x 103"	(F)	SGS-14-103	SGA-14-103		SGB-14-103	SGZ-14-103
14" x 107 1/2"	(G)	SGS-14-107	SGA-14-107		SGB-14-107	SGZ-14-107
14" x 113 1/2"	(H)	SGS-14-113	SGA-14-113	SCB-14-113	SGB-14-113	SGZ-14-113
15" x 127 1/2"	(I)	SGS-15-127	SGA-15-127	SCB-15-127	SGB-15-127	SGZ-15-127

A) Winona Van Norman BG-600 B) RMC, Peterson RG-1203 C) RMC-800, Serv-Equip PG-1229 D) Peterson RG-1234 & Kansas Instruments Automotive Craftsman F) Master Tool G) Kwik-Way 870 Master Surfacer H) Storm Vulcan / Anderson AB-1000A, Peterson PG-1400 I) Storm Vulcan / Anderson AB-1540A, Anderson AB-1540, IDL HS-4350, Peterson PG-1500, Winona Van Norman BR-1500, BG-1515 & BG-1520

Colors may vary due to manufacturing process. Guaranteed for 1 year from original purchase date.

Belt Resurfacer Coolant

- Semi-synthetic
- Rust-inhibiting
- For ALL belt resurfacers with a coolant sump
- Dilute 30 parts water: 1 part coolant



Size	Order No.
1 Gallon (3.79L)	SGB-10
5 Gallons (18.39L)	SGB-50

High Performance Resurfacing Spray

- Prolongs cutter life
- Enhances surface finish
- Refreshing scent
- Aerosol*
- Order No. **HPS-16**



* Hazardous Goods Fees Apply When Shipped By Air

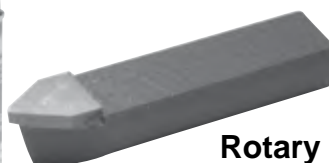

Rotary Broach Tool Bit For Van Norman 530, 570 & VM-2000

- Tool Bits sold individually
- Order No. **VN-65C**

Enlarged for clarity

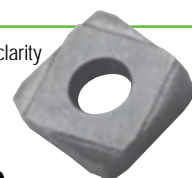

Carbide Cutter Replacement Tips For Storm Vulcan Broach Style Surfacers

- Fits Storm Mill 85, 85B, 85BE, 85C, 85N and 280
- Order No. **SV-85BE**

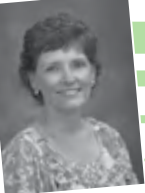

"We are committed to maintaining your privacy. Information about you and your business is never sold, rented or given to anyone outside of our company."
- Sue, Goodson Database Manager - 33 years of service

tech tips
from the techxperts™

4 Keys to Refurfacing Aluminum Heads

- 1 - Choose the correct abrasive**
Use a speckled wheel segment to grind aluminum heads.
- 2 - Lubricate, Lubricate, Lubricate**
Put a light coat of **Grind Aid (GRA-10)** on the abrasive to reduce aluminum build up. Speed up the travers and reduce the cut to .0005" to .0010" per pass.
- 3 - Dress for Success**
Keep grains open by dressing often. Don't dress before the last pass, but be sure to apply Grind Aid liberally so the stone yields a finer surface finish.
- 4 - Keep heat build-up to a minimum**
The greatest danger is heat build up that can cause scoring as aluminum transfers to the stone. Take shallow cuts and use plenty of lubrication to prevent this.

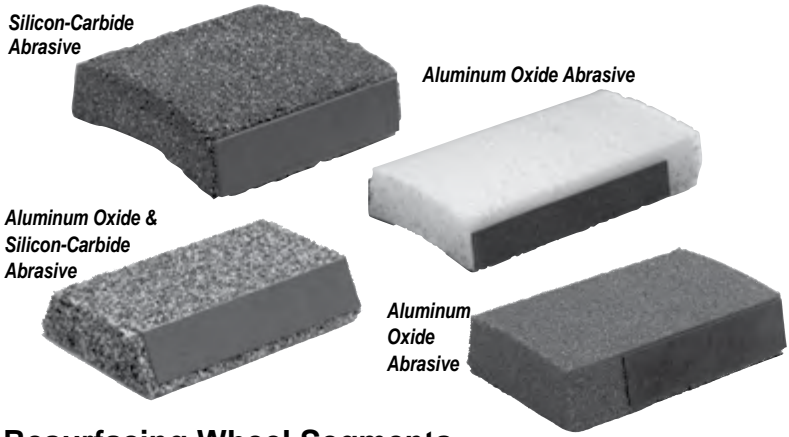

Resurfacing Wheel Segments

Segments are available in a variety of compositions. Match the abrasive to the material for best results and longest life. Order segments in 8,10 or 12 piece sets.

Width	Thickness	Length	Application	Abrasive	Color	Order No.
2.56"/65mm	0.98"/25mm	3.94"/100mm	Cast Iron & Aluminum	Silicon-Carbide	Black	GS-PBS
			Steel & Hardened Steels	Aluminum Oxide	White	GS-PBS-1
			Aluminum, Cast Iron, Hardened Iron & Steel	Aluminum Oxide and Silicon-Carbide	Speckled	GS-PBS-2
			Steel & Hardened Metals	Aluminum Oxide	Ruby	GS-PBS-3
For Peterson/Peterson Berco 1055 AWL, RSC950 (std.), SYP320, -360, -1000, -1300, RSC1200, -1550, RPYS1500 models. For Winona Van Norman SM-2000, SM-4000/5000, MG-4000, SM-6000C/6000A and MG-3000/3850 models. For Storm Vulcan RT7Y Late (Serial No. 103152 and up) and RT 17Y Late (Serial No. 128697 and up) models.						
3.13"/79mm	0.81"/21mm	3.13"/79mm	Cast Iron & Aluminum	Silicon-Carbide	Black	GS-SVS
			Aluminum, Cast Iron, Hardened Iron & Steel	Aluminum-Oxide and Silicon-Carbide	Speckled	GS-SVS-2
			Steel & Hardened Metals	Aluminum Oxide	Ruby	GS-SVS-3
For Peterson/Peterson Berco RG-32, RTY, RG-35, RG-300/900 models. For Storm Vulcan RT 7Y Early (Serial no. up to 103151) and RT 17Y Early (Serial no. up to 128696)						
1.97"/50mm	0.67"/17mm	3.62"/92mm	Cast Iron & Aluminum	Silicon-Carbide	Black	GS-RGS
For Peterson/Peterson Berco RG-32, RG-300/900 models.						
2.56"/65mm	0.79"/20mm	3.94"/100mm	Steel & Hardened Metals	Silicon-Carbide	Black	GS-KWS
			Aluminum, Cast Iron, Hardened Iron & Steel	Aluminum-Oxide and Silicon-Carbide	Speckled	GS-KWS-2
For Kwik-Way 858 and 862 models						

tech tips
from the techxperts™

To maintain proper cutting action Goodson strongly recommends that you replace your cylinder head resurfacing segments in full sets. See your user's manual for wheel diameter and number of segments required. Due to manufacturing process colors may vary.
Need help choosing the abrasive? Call the Goodson Techxperts™

Resurfacing Segments are guaranteed for 1 year from original purchase date

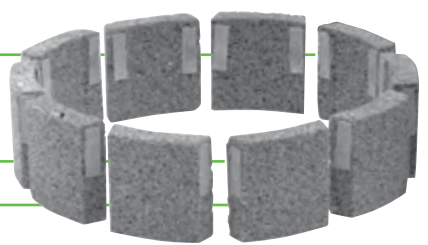

Grind Aid

- Cools and lubricates
- Stops premature grain fracturing
- Improves surface finish
- Handy twist tube with cover
- Reduces glazing and loading
- Essential when resurfacing aluminum heads
- Order No. **GRA-10**

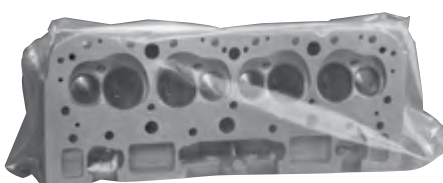

Cylinder Head Storage Bags

- 3 mil thickness
- 17"x44" / 43.2 cm x 111.8cm
- 100 per roll
- Order No. **BC-17**

More storage bags on page 69

Rust Shield Aerosol*

- Choose between short and long term protection
- Spray on right after resurfacing
- Remove short term with soap & water and long term with solvent

Formula	Order No.
Short Term	RS-16
Long Term	RS-16-OD



CYLINDER HEAD REBUILDING
CLEANING, ASSEMBLY & SAFETY
SHORT BLOCK REBUILDING
CRANKSHAFT/ FLYWHEEL GRINDING
MISCELLANEOUS TOOLS & SUPPLIES
BRAKE SERVICE TOOLING
MEASURING TOOLS
V-TWIN & METRIC HARD PARTS

Cylinder Head Resurfacing

The most complete resurfacing program in the industry ...

1. Consistent high quality abrasives

Each Goodson resurfacer wheel is made to the highest standards of roundness, balance and strength. Extensive quality control, start-to-finish, lets us back our abrasives with our Iron-Clad Guarantee of total satisfaction.

2. Full inventory

Since we specialize in the distribution of abrasives to machine shops world wide we always carry an extensive inventory. Call Goodson, we have what you need on our shelves.

3. Same day shipping

We usually ship your order the same day that we receive it. Along with our huge inventory, our shipping speed ensures consistently faster delivery when you order from Goodson.



Surface Grinding Coolant

- Synthetic
- Water soluble

- Non-foaming • Dilute 20:1

Size	Order No.
1 Gallon / 3.78 L	SGC-10
5 Gallons / 18.93 L	SGC-50

Blanchard Cylinders

- Includes gasket pad for mounting onto a Blanchard Grinder
- Also ideal for resurfacing clutch plates
- Wheel measures 11" x 5" x 9"
- Tape wound for added safety
- Excellent grade for most grinding conditions and metals
- Order No. **U69755**

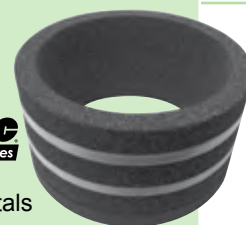

Single-piece Resurfacer Wheels

- Meet or exceed OE standards established for general purpose grinding applications
- Silicon-Carbide abrasive • Banding will wear off to expose more abrasive



GS-48



GS-954

Peterson			
Machine Model(s)	Size: dia. x height x face width	Grit	Order No.
All 14" Dry Grinders	14" x 1½" x 4" Plate	36	GS-48
1054	16" x 2" x 2" Inserted Nut	16	GS-954



GS-545



GS-545B



GS-545BL / U422304

Kwik-Way			
Machine Model(s)	Size: dia. x height x face width	Grit	Order No.
545,545H,855	12" x 3" x 1½" (Serrated) Plate	16	GS-545
545B,856,855-5,860	14" x 3" x 1½" (Serrated) Plate	24	GS-545B
545BL,860A, L & T	16" x 3" x 1½" (Serrated) Plate	24	GS-545BL
860A, L & T	16" x 3" x 1½" (Serrated) Plate	36	U422304

Grinding Wheels are guaranteed for 1 year from original purchase date



GS-10

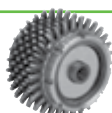

GS-17A



FG-1165-G



FG-1070A-G

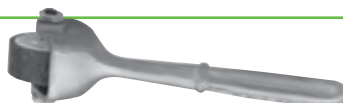

FG-1045-G



GS-14



GS-17

Grinding Wheel Dressers & Replacement Cutters

Diamond Dresser Tools are available on pages 106-107

Cutter Assemblies				Replacement Cutters					
Applications	OD	W	Order No.	Pieces	Washers	OD	ID	Thick	Order No.
VN, Lempco, Storm RT-7Y, 17Y	2.500"	1.625"	GS-10	14 stars	1 w/locking tangs	2.50"	1.50"	.062"	GS-14
Peterson (12mm shaft)	2.375"	1.625"	GS-17A	8 stars	5 1 w/locking tangs	2.375"	1.50"	.093"	GS-17
WVN SM2000, 4000, 5000, 6000C, 6000A, MG3000, 3850	1.250"	.978"	FG-1165-G	7 stars	none	1.25"	.313"	.095"	FG-1161-G
Peterson & DCM	2.375"	2.262"	FG-1070A-G	5 stars		2.375"	1.132"	.1375"	FG-1070-G
Hand held			FG-1045-G	1 stone	none	1.50"	.313"	.625"	FG-1044-G



"Goodson accepts major credit cards, debit cards, bank drafts and personal checks. Call us for more information."

- Bev, Goodson Accounting/Purchasing Manager - 35 years of service

**Goodson
exclusive**

CYLINDER HEAD
REBUILDING

CLEANING,
ASSEMBLY & SAFETY

SHORT BLOCK
REBUILDING

CRANKSHAFT/
FLYWHEEL GRINDING

MISCELLANEOUS
TOOLS & SUPPLIES

BRAKE SERVICE
TOOLING

MEASURING
TOOLS

V-TWIN & METRIC
HARD PARTS



Pistol Grip Vacuum Tester

- Lightweight - only 1.9 lbs. without the plate
- Pulls and holds up to 24 PSI vacuum on as little as 90 PSI
- Quick coupling Robinair fittings
- Easy to reach controls for single-handed operation
- Hard-anodized billet aluminum
- Tester includes one 4.75" vacuum plate

Description	Order No.
Pistol Grip Vacuum Tester Kit with 4.75" Vacuum Plate	DVC-2011
Optional Vacuum Plates	
Robinair Fitting Replacement Plate Set	DVC-7KIT
2.00" (50.8mm dia.)	DVC-2
3.00" (76.2mm dia.)	DVC-3
4.75" (120.7mm dia.)	DVC-475
6.00" (152.4mm dia.)	DVC-6
2"x3" (50.8x76.2mm)	DVC-23
3"x4" (76.2x101.6mm)	DVC-34
Plate Lube 8 oz. (236.6 mL)	DVC-PL
Parts & Accessories	
Pressure Gauge	DVC-GAUGE
Flexible Hose Kit w/3' Air Line (optional)	DVC-2011-HK
1/8" NPT "L" Fitting	CF-2003-L
1/8" NPT Female Coupling	LDP-AR-6
Inline Air Filter	DVC-FILTER
1/8" x 1/8" Straight Fitting	DVC-SF
Nipple Coupling	DVC-1N
Air Line	CF-2001-AL
Robinair Fitting	DVC-SN
1/8" NPT Male Coupling	DVC-1M

Exhaust port filter keeps the vacuum running smoothly and quietly

DVC-2011 comes complete with pistol grip and a 4.75" vacuum plate. Other plates shown below.

Optional Hose Kit includes 3 feet of 1/4" Air Line, L-Fitting, Filter, Straight Fitting and Straight Coupler. All parts are also sold separately.

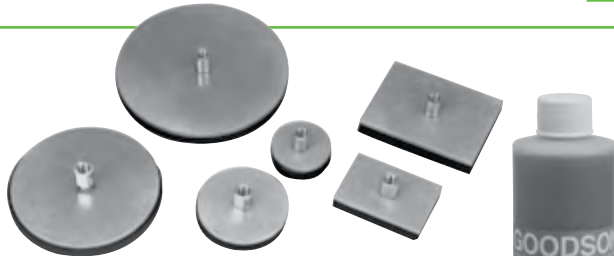

Replacement Vacuum Tester Plates for Sioux™ 1630K

- Closed cell foam for an exceptional seal
- Replacement foam also available separately
- Several sizes to choose from or ask for a custom size
- Plate lube improves the seal for even better vacuum holding power

Sioux-Style Replacement Plates for the 1630K Tester		
Size	OE No.	Order No.
2.00" (50.8mm dia.)	1630-2	SVT-2
3.00" (76.2mm dia.)	1630-3	SVT-3
4.75" (120.7mm dia.)	1630-4	SVT-475
6" (152.4mm dia.)	1630-6	SVT-6
2"x3" (50.8 x 76.2mm)		SVT-23
3"x4" (76.2 x 101.6mm)		SVT-34
Replacement Sioux-Style Fitting		DVC-SX
Accessories & Replacement Parts		
Description		Order No.
6 Pc. Replacement Foam Set - 1 of each size		FOAM-KIT
Plate Lube - 8 oz. (236.6 mL)		DVC-PL
Replacement Line Filter		DVC-FILTER
Replacement Mat - 11" x 31" x 3/8"		DVC-1131

Heavy Duty Manual Vacuum Tester

- A steady reading of 25" (63.5cm) indicates proper valve seating
- All metal construction
- 4 1/2" plate, fittings and plate lube included
- DVC Plates (above) will fit this tester

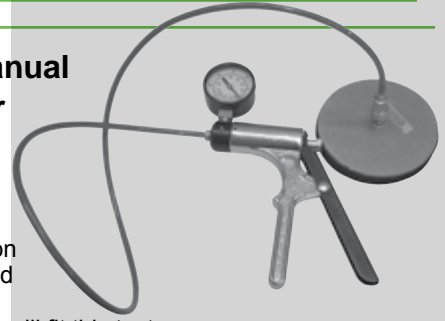

Description	Order No.
Manual Vacuum Tester	DVC-101-HD
Replacement 4.75" Plate	DVC-475
Plate Lube - 8 oz. (236.6 mL)	DVC-PL

Vacuum Testing

Vacuum testing is the fastest method for testing valve to seat integrity. Simply assemble your machined cylinder head and install the spark plugs. Use a reliable vacuum source producing approximately 24 lbs. HG on the vacuum gauge and a closed cell foam test plate with a through fitting to draw down or evacuate the combustion chamber.

Once you've reached 24 lbs. HG on the gauge and close the vacuum to the chamber. Watch the gauge for a drop in vacuum. It should hold steady confirming that you have achieved valve to seat mating.

Coat the face of your closed cell foam test plate with Plate Lube (DVC-PL) to condition the foam. This produces a soft, yielding material that will fill minor head surface blemishes or imperfections.

tech tips
from the techxperts™

Dye Penetrant Crack Detection

Identify surface cracks in minutes!

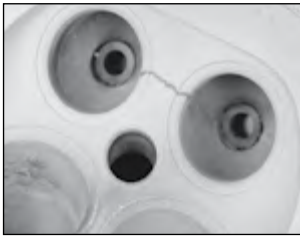

Alumni-Chek

- Find surface cracks on aluminum & cast iron without electricity or special lights
- Ideal for aluminum, but also works on brass, cast-iron, steel, carbide, and Stellite • Even the tiniest cracks show as bright red • Complete kit includes Cleaner, Penetrant, Developer and Shop Towels (also available separately)

Description	Order No.	Incl.
Complete Kit	AC-KIT*	▼
Cleaner Aerosol	AC-1*	x
Penetrant Aerosol	AC-2*	x
Developer Aerosol	AC-3*	x
5 Towels	WST-5	x

tech tips

Keep all Ultra-Violet and Black Lights a minimum of 18" from magnetic fields to from the techxperts™ prevent damage to the tungsten element and voiding the warranty.



Ultra-Violet Light Inspection

- Put into a running engine to find hidden leaks
- Check engines, transmissions and radiators **IN** the vehicle
- Use before disassembly to plan repairs
- Use after rebuilding to ensure satisfaction, or to find and fix warranty complaints
- Add dye to oil, coolant or fluid • No pre-cleaning required
- Run vehicle briefly to distribute the dye • Inspect with UV light • Finds even the tiniest of leaks

Description	Order No.
Replacement Bulbs	120W-110VAC bulb only (Model 1210) GLO-120WB
Lens	Ultra-violet lens GLO-LENS
Dye	Oil Dye for gasoline engines (1 fl. oz.) GLO-GED

tech tips

from the techxperts™
Step 1: Spray cleaner evenly on the surface and allow it to dry completely.

Step 2: Spray on Penetrant. Allow to saturate for 5 minutes. Wipe off excess to avoid false readings.

Step 3: Spray on thin layers of developer to build up a uniform powdery film.

Step 4: Flaws and cracks will glow brightly when viewed under the black light (Applies only to Goodson Glow).



GOODSON Glow Blacklight Crack Detection Kit

- Easily detect surface cracks that could easily be missed with just visual inspection
- Cracks & flaws glow brightly under black light after treatment with Cleaner, Penetrant and Developer

Description	Order No.	Incl.
Goodson Glow Kit	GLO-KIT*	▼
Cleaner Aerosol	GLO-1*	x
Penetrant Aerosol	GLO-2*	x
Developer Aerosol	GLO-3*	x
110V Blacklight	GLO-4	x
5 Cloth Towels	WST-5	x
Replacement Bulb for GLO-4	GLO-4-B	
Storage Case	TRADE-MCB	x

Crack Detection Powder & Oil Carrier

- For wet method crack detection
- Mix powder with oil carrier
- Use **GLO-300** Light (left) to view results

	Size	Order No.
Powder	4 oz. / 113.4g	GCR-14A-4
	1 lb. / 453.6g	GCR-14A
Oil Carrier	5 Gallons / 18.93L	GCR-50



Magnetic Crack Detection Oil & Spray

- Oil impregnated with magnetic powder (**GCR-14**) to glow under black-light • Low viscosity
- Flows easily into small cracks
- Oil clarity makes cracks easier to see

Description	Order No.
Aerosol* 16 oz.	MFA-16*
5 Gallons / 18.93L	MFA-50

CYLINDER HEAD REBUILDING
CLEANING, ASSEMBLY & SAFETY
SHORT BLOCK REBUILDING
FLYWHEEL, GRINDING
CRANKSHAFT/ TOOLS & SUPPLIES
MISCELLANEOUS
BRAKE SERVICE TOOLING
MEASURING TOOLS
V-TWIN & METRIC HARD PARTS

... another satisfied customer

"Goodson's Fluorescent Magnetic Powder works great! Cracks glow bright yellow under black light. We find the fluorescent powder much more effective at picking up cracks than any powder that we have used in thirty years of crack detection."
Steve & Ed Walsh - Steve's Machine Shop Service Liberty, NY, Goodson Customer since 1994

American Made

Specifications

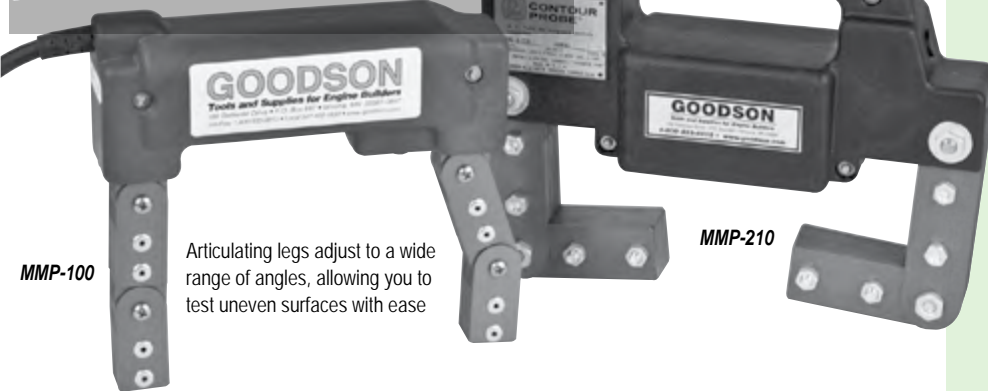

MMP-100

Articulating legs adjust to a wide range of angles, allowing you to test uneven surfaces with ease

MMP-210

MMP-100 / MMP-100S

- Physical: 7 3/8" x 9 1/4" x 2 1/8"
187 x 235 x 54mm
- Max. Span: 12" (304.8mm)
across poles
- Voltage: 115V (MMP-100)
230V (MMP-100S)
- Line Current: 4 amp (MMP-100)
3 amp (MMP-100S)
- Weight: 6.5 lb (2.95 kg)
- Cord: 10' L, 3-wire

MMP-210 / MMP-210S

- Physical: 10 1/2" x 11" x 2 3/4"
266 x 280 x 70mm
- Max. Span: 18" (457mm) across
poles
- Voltage: 115V (MMP-210)
230V (MMP-210S)
- Line Current: 8 amp (MMP-210)
3 amp (MMP-210S)
- Weight: 13 lb (5.9 kg)
- Cord: 10' L, 3-wire

Magnetic Crack Detection Units

- Articulating legs conform to virtually any surface configuration
- Designed for one-person operation • Lightweight
- No transformer box to drag around • 230V units feature a pigtail on the cord
- Easy to access switches • Full 1-Year Manufacturer's Warranty for Repair
- 50% duty cycle (example: 2 minutes on, 2 minutes off)
- Produce a strong AC magnetic field

Description	Order No.
115V Electronic Crack Detector with 10# Pull	MMP-100
115V Heavy Duty Electronic Crack Detector with 22# Pull	MMP-210
230V Electronic Crack Detector with 10# Pull	MMP-100S
230V Heavy Duty Electronic Crack Detector with 22# Pull	MMP-210S

American Made



Non-Fluorescent Magnetic Powder for Dry Method Particle Inspection

- Works with all dry magnets including Magnaflux® and Parker
- Store in a moisture free environment

Color/Size	1 lb.	5 lb.	25 lb.
White	WCD-100-G	WCD-500-G	WCD-2500-G
Yellow	WCD-101-G	WCD-501-G	WCD-2501-G
Red	WCD-103-G	WCD-503-G	WCD-2503-G

13W Fluorescent UV Leak Detection Light

- Uses a single 13W Ultraviolet fluorescent bulb • Effective up to 24" from surface • Nylon-tipped double hooks for hands-free use • Rocker style switch • 25' 18/2 power cord
- Measures 11.3"L x 2.3"W x 2.3"D • Weighs just 35.2 oz.
- 1 year limited warranty

Description	Order No.
Fluorescent Detection Light	GLO-4
Replacement Bulb	GLO-4-B



Magnetic Powder Applicators

- A quick & easy method for distributing magnetic powder

Description	Order No.
Atomizer Assembly for small areas (1 oz.)	MM-301
Applicator Bulb for large areas	WCD-266-G
Replacement Bulb for Atomizer Jar	MM-301-1

We find the fluorescent powder much more effective at picking up cracks than any powder we have used in 30 years of crack detection!
- Steve's Machine Shop, Liberty, NY

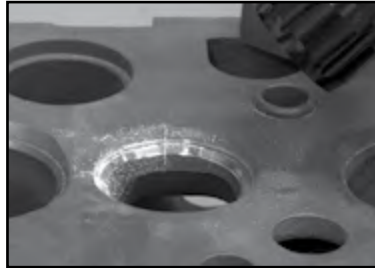

Green Fluorescent Magnetic Powder

- For dry magnetic inspection methods
- Makes crack detection easier
- Cracks glow bright yellow under ultraviolet light but can also be seen under normal lighting conditions

Quantity	Order No.
1 lb.	FCP-107-G
5 lb.	FCP-507-G



Goodson
EXCLUSIVE

Magnetic Crack Inspection Kits

Goodson carries a variety of magnetic crack detection methods including these two kits. We include heavy-duty 110V adjustable-leg magnets that are made right here in America. Kits also include lights, magnetic powder atomizers, and fluorescence enhancing safety glasses. All items are also available separately.

Description	Order No.	Incl.
Fluorescent Magnetic Crack Detection Kit	FCD-KIT	▼
High Performance Fluorescent Crack Detection Kit	FCD-HP-KIT	▼
115V Heavy Duty Electronic Crack Detector	MMP-210	x x
Magnetic Powder Atomizer Assembly (1 oz. capacity)	MM-301	x x
Magnetic Crack Detection Oil Spray*	MFA-16*	x
AC Blacklight	GLO-4	x
Fluorescence Enhancing Glasses	GLO-9940	x
Compact LED UV Inspection Light Kit (Glasses included)	GLO-400	x
Fluorescent Magnetic Powder 1 lb.	FCP-107-G	x x

*Hazardous Goods Fees Apply When Shipped By Air

ULTRA-BRIGHT LIGHT!



Compact 100W LED UV Crack Inspection Light

- Power comparable to high-intensity 100-watt lamps
- Inspection range of up to 10 feet (3M)
- Compact design fits easily into tight, cramped spaces
- 100 thousand hour LED service life
- Rugged, corrosion-resistant, anodized aluminum lamp body stands up to years of heavy shop use
- Rechargeable lithium-ion battery (included) provides 4 hours of continuous inspection between charges
- Includes AC charger, fluorescence enhancing glasses and lanyard
- Order No. **GLO-400**

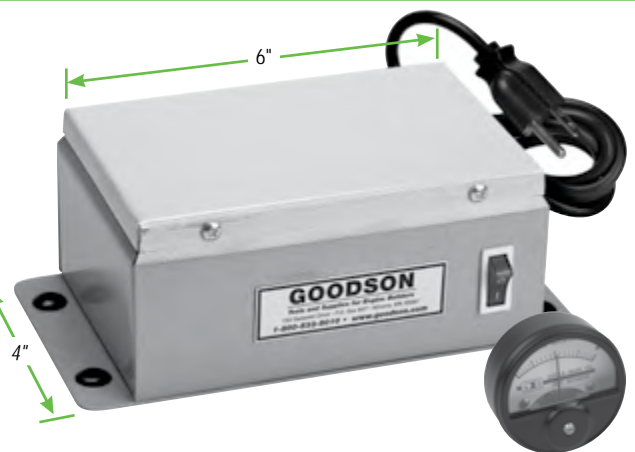

Small Parts Demagnetizer

Don't jeopardize your engine work! Heat, friction and magnetic particle inspection can cause magnetism to build up in your engine components. If not removed, it will attract ferrous materials in engine lubrication and may cause premature engine failure. This easy to use table demagnetizer is a fast and easy way to ensure that all residual magnetism is eliminated from engine components. Use with the optional Magnetic Field Indicator (MFI-10010) to be sure all remaining magnetism is eliminated.

Description	Order No.
Small Parts Demagnetizer	SPD-46
Magnetic Field Indicator	MFI-10010

CYLINDER HEAD REBUILDING
CLEANING, ASSEMBLY & SAFETY
SHORT BLOCK REBUILDING
FLYWHEEL, GRINDING
CRANKSHAFT/
TOOLS & SUPPLIES
MISCELLANEOUS
BRAKE SERVICE TOOLING
MEASURING TOOLS
V-TWIN & METRIC HARD PARTS



"At Goodson, we're always on the lookout for new or improved tools that make engine rebuilding easier. If you have a tool you think we'd be interested in, give us a call."
- Dave, Goodson National Sales Manager, 23 yrs. of service

CYLINDER HEAD
REBUILDING

CLEANING,
ASSEMBLY & SAFETY

SHORT BLOCK
REBUILDING

CRANKSHAFT/
FLYWHEEL GRINDING

MISCELLANEOUS
TOOLS & SUPPLIES

BRAKE SERVICE
TOOLING

MEASURING
TOOLS

V-TWIN & METRIC
HARD PARTS

shown actual size



melted center reveals
overheating



Heat Tabs

- Provides visual evidence of engine overheating
- Special heat sensitive metal centers melt and fall out when engine exceeds the melting point of the tab
- Marine Heat Tabs are sold in packs of 50, all others are 100 per pack
- Attach to heads with Heat Tab Adhesive (below)

Description	Melting Point	Order No.
Round Heat Tabs	255-260° F / 124-127° C	RHT-100
Round Ironite Heat Tabs	255-260° F / 124-127° C	HT-100RD
Round Diesel Heat Tabs	225-235° F / 107-110° C	DHT-100
Heat Tab Adhesive (3 oz./88.7mL tube)		HTA-3

tech tips

from the techxperts™

Protect yourself from unjustified warranty claims with a simple Heat Tab

When you attach a heat tab to the engine it provides visual evidence that an engine has been overheated. A special heat sensitive metal has been formed into the center of the tab. When an engine reaches the tab's melting point, this metal will melt and flow out. This is a positive method of determining that a rebuilt engine has been heated beyond normal operating temperature, voiding the warranty. Attach a Heat Tab to the upper portion of the block or to the cylinder head casting with **HTA-3** Heat Tab Adhesive (above). **DO NOT** attach to manifolds or shielding.

Leak Detection Mat

- Commercial-grade Neoprene
- Resists petroleum products, abrasion, swelling, sunlight and aging
- Repair worn mats or make custom leak detection plates
- Measures 3' x 4' x 3/16" thick
- Order No. **LDP-34MAT**



Seal-All™

- Seals pin holes, porosity and small cracks in heads & blocks
- Penetrates and seals
- Out-performs ceramics
- Bonds with existing rust & corrosion to prevent spread
- Heat at 175°-200°F (79.4°-93.3°C) for 4 hours to cure
- Not for use on assembled engines
- 32 oz. (46 mL)
- Order No. **CPS-32**



Fluid Weld®

- For cast iron or aluminum heads and blocks
- Use as a sealant for threaded or press-fit parts like valve guides and seats, threaded crack repair plugs, replacement studs, etc.
- Seals small cracks • Non-toxic
- Non-flammable
- **NOT** for use on assembled engines
- Withstands temperatures to 3000°F



Size	Order No.
2 oz. (59 mL)	FW-2
8.8 oz. (260 mL)	FW-88

All Weather Seal

- Seals intakes & head gasket leaks
- Seals cracks in cylinder heads & engine blocks
- Prevents anti-freeze seepage through gaskets and hoses
- Lubricates water pump seals
- Mixes with all anti-freeze and coolant
- Works in less than 5 minutes
- Fast-acting, non-corrosive, non-clogging
- Can be used with coolant or anti-freeze
- 16 oz./455 mL • Order No. **AWS-16**



For use in a
running engine!

Engine Seal Tabs Seal And Prevent Leaks In Any Cooling System

- Use in a running engine
- For water leaks in cylinder heads, blocks, radiators, water pumps, heater cores, manifolds, etc.
- 3½ gram tablets treat up to a 9 quart cooling system
- 20 tabs per pack
- Order No. **EST-10**

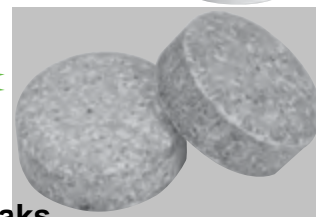

Threaded Crack Repair Plugs

- Iron • Tapered • Threaded plugs
- Cast to rigid specifications

Plug Size	Qty.	Order No.
.200" x 1/8"	100	CRP-200
.200" x 1/4"	100	CRP-201
.235" x 1/8"	100	CRP-235
.327" x 1/8"	50	CRP-327



irontite
The Professional's Choice



High Speed Steel Drills

- 118° points for fast chip removal

Plug Size	Order No.
.200"	CRD-200
.235"	CRD-235
.327"	CRD-327

irontite
The Professional's Choice

Tapered Reamers

- High Speed Steel

Plug Size	Order No.
.200"	Not Required
.235"	CRR-235
.327"	CRR-327

Tapered Taps

- High strength steel machined to match plug taper & thread

Plug Size	Order No.
.200"	CRT-200
.235"	CRT-235
.327"	CRT-327

.235" Crack Repair Kit

- Complete kit includes everything you need to repair cracked cast iron heads using the cold repair process
- Manual included
- Learn more about repairing cracks with this process

Description	Order No.	Incl.
Complete Repair Kit:	CRK-150	▼
100 - .235" x 1/8" Threaded Iron Plugs	CRP-235	x
High Strength Steel Drill	CRD-235	x
High Strength Steel Tapered Reamer	CRR-235	x
High Strength Steel Tapered Taps (2)	CRT-235	x
Cut-Off Saw with Blade	CR-SAW	x
Replacement Saw Blade	CR-BLADE	x
7.5 oz. Tap Oil	TAP-O	x
All Weather Seal	AWS-16	x
16 oz. Ceramic Seal	CRS-16	x

Ceramic Motor Seal

- Permanently seals leaking head gaskets, cracked heads and blocks (aluminum or cast iron)
- Coats the engine to inhibit rust formation and salt water corrosion during normal operation
- Seals porous castings in the cooling system
- Stops coolant leaks
- Promotes heat dissipation for added power
- 16 oz./455 mL
- Order No. **CRS-16**



Jet Valve Eliminator Kit

- Some Mitsubishi/Chrysler 2.6L heads had jet valves while some didn't
- This kit lets you use a jet valve equipped head in place of one without
- 11mm diameter, 1.0 pitch threaded plugs replace entire valve body assembly
- Easier than welding the holes closed
- Package of 4 converts one 2.6L head
- Order No. **JVE-26**



Rust Inhibitor for Pressure Testing

- Clear fluid inhibits rust and does not discolor or cloud the test tank solution
- Lets you see better to pressure test
- Biocide and anti-rust additives extend tank solution life while preventing corrosion
- Synthetic formula
- Mix 20:1 with water
- Yields 20 gallons
- Order No. **PRI-10**



Head-Bolt Hole Clean-out Taps

- Clean threaded holes to prevent false torque wrench readings
- Lifts rust, dirt, chips and other debris as you remove the tool
- Use with lube and a socket wrench or slow drill
- Repairs minor damage

Size	Pitch	Length	Order No.
1/2"	13	3 3/8" OAL	BCT-1/2
7/16"	14	3 3/8" OAL	BCT-7/16
10mm	2.0mm	8" Shank For LS1	BCT-10X2L
11mm	1.5mm	8" Shank	BCT-11L
11mm	2.0mm	8" Shank For LS1	BCT-11X2L

CYLINDER HEAD
REBUILDING

CLEANING,
ASSEMBLY & SAFETY

SHORT BLOCK
REBUILDING

FLYWHEEL, GRINDING
CRANKSHAFT/
REBUILDING

MISCELLANEOUS
TOOLS & SUPPLIES

BRAKE SERVICE
TOOLING

MEASURING
TOOLS

V-TWIN & METRIC
HARD PARTS

... another satisfied customer



"Our Top Alcohol Dragster cylinder heads have about a zillion studs of various sizes. With the Goodson Stud Removers and Installers (page 55), we now make short work out of this very tedious process."

- Dean Dubbin, DPM Awnings (NHRA Top Alcohol Dragster), Goodson customer since 2010

CYLINDER HEAD REBUILDING

CLEANING, ASSEMBLY & SAFETY

SHORT BLOCK REBUILDING

CRANKSHAFT/ FLYWHEEL GRINDING

MISCELLANEOUS TOOLS & SUPPLIES

BRAKE SERVICE TOOLING

MEASURING TOOLS

V-TWIN & METRIC HARD PARTS

Find all 10 Goodson Girls in the 2018 Catalog And You Could Be a Winner!

GG, the Goodson Girl, is hiding in 10 places in the catalog (this page doesn't count).



When you've found all 10 pictures of the Goodson Girl, call Goodson at 1-800-533-8010. You will need to identify each location (page number and placement) to win. Any of the three Goodson Girl styles (page NP-1) may be hidden in the catalog.



Mercedes .015" Head Saver Shims

- Shim cam towers if more than .015" is removed when resurfacing head
- Restores valve clearance & timing
- For 4, 5 & 6-cylinder Mercedes gas or diesel engines
- Each set shims all cam towers in one head
- Order No. **MHS-40**

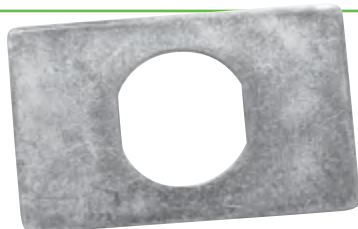

Rocker Arm Pedestal Shims

- Compensate rocker arm/push rod distance after head/block machining
- Use original rocker arm specs

Application	Qty.	Order No.
Ford 302/351	50	RASF-20-50
Ford 302/351	100	RASF-20-100

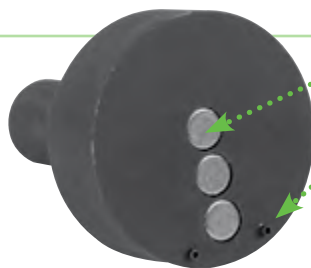

Powerful earth magnets hold discs secure for resizing

Tabs keep VADs from sliding

Magnetic VAD Holder

No more waiting for a special size – take an existing VAD and grind it to the size you need right on your valve refacer. Powerful magnets hold the VAD securely while you resize them. Tabs keep the VADs from sliding off the holder while grinding.

Description	Order No.
Magnetic VAD Holder	VDR-UNI
Replacement Magnet	VDR-MAG

Resize VADs at your shop quickly and easily **tech tips** from the techxperts™

Has this happened to you? You're adjusting the clearance between the valve stem and the cams and the stock Valve Adjustment Disc (VAD) isn't the right thickness. You need a 2.25 in a 28mm diameter and the thinnest ones available are 2.50. What are you going to do?

You could wait to have them resized by your supplier, but hey, you're a machinist! You have all of the tools and abilities right in your shop to modify the VADs you have into the VADs you need.

Place the VAD that you need to resize on your Magnetic VAD Holder (VDR-UNI, above). The powerful earth magnets will hold it securely. Using your Valve Grinder's stem end wheel, grind the VAD to the thickness you need. You're now ready to install it in the head. All in a few minutes instead of a few days.

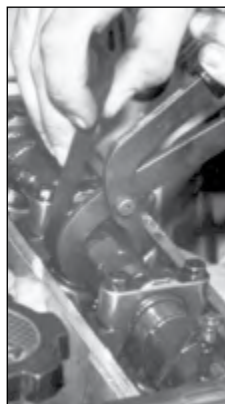

VAD Adjusting Tools For Toyota

- Reach around the cam to depress the lifter
- Wedge holds the lifter down to free the Valve Adjustment Disc
- Reach in to remove and replace the disc
- For most models prior to 2004

Description	Order No.
Pliers and Wedge	VBT-40
Wedge only	VDL-20



Hard to find replacements for OE

Smog Plugs for Ford 302, 351

- Replace smog plugs damaged during head cleaning
- 5/8" x 11 thread outside, 7/16" x 14 thread inside
- Order No. **EMP-34**

Convert your Bridgeport-type mill into a cylinder head machining center!



Lock the fixture to your mill bed using your standard T-Bolts (not included)

Two towers secure to the mill bed and support the cradle assembly



Vertical Mill Heavy-Duty 360° Roll-Over Fixture

- Uses the Universal Quick-Mount Bar Set (included) to hold the workpiece securely in place
- Position workpieces quickly & accurately
- Locks to your table using your standard T-nuts
- Handles workpieces up to 24" long
- Cradle accommodates in-line and canted valves with offset movement up to 15°
- Width adjusts in 3/4" increments • Instructions included
- Quick-Mount Bar Set can also be used as a replacement on most popular seat & guide machines

Description	Order No.
Roll-Over Fixture with Quick-Mount Bar Set	VM-42
Replacement Quick-Mount Bar Set	QMB-95

GM Vortec Adaptor Plate Set For Van Norman & Storm-Vulcan Rotary Broaches

- Required when using the Van Norman VN 530 / 570 or Storm-Vulcan 850 Storm-Mill Rotary Broaches
- Two plate set • Includes fasteners
- Order No. **VN-VOR**



Installation

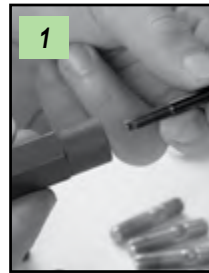

1 - Insert stud into correct size installer.



2 - Hand set the stud into the cylinder head.



3 - Use a standard 3/4" wrench or socket to tighten stud into place. Each installer is fitted with a steel ball inside to prevent over-tightening.



Removal



1 - Place the remover over the stud to be removed. Using 2 wrenches, back the stud out of the head.

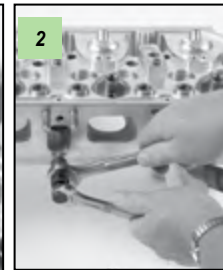

2 - Removers can be used in virtually any position.



Super-Stud™ Stud Installers & Removers

- Size stamped for easy identification • Installers include a steel ball inside to prevent over-tightening on the stud
- Removers have a 3/4" OD Hex body with a 5/8" hex jam nut on top

Description	Order No.
Stud Installers	
3/8" Fine	ASI-375
3/8" Coarse	ASI-375C
7/16" Fine	ASI-437
Stud Removers	
3/8" Fine	ASR-375
3/8" Coarse	ASR-375C
7/16" Fine	ASR-437

Brass or Steel Shim Stock Packs

- A handy assortment • 4" x 6" each (120 sq. in.)
- One each of .001", .002", .003", .005", .010" thick

Description	Order No.
Brass	SSB-50
Steel	SSS-51

CYLINDER HEAD
REBUILDING
CLEANING, ASSEMBLY & SAFETY
SHORT BLOCK REBUILDING
CRANKSHAFT/ FLYWHEEL GRINDING
MISCELLANEOUS TOOLS & SUPPLIES
BRAKE SERVICE TOOLING
MEASURING TOOLS
V-TWIN & METRIC HARD PARTS



"You always get more than great products from Goodson ... you also get great value!"
— Shane, Goodson Receiving, 1 year of service

CYLINDER HEAD
REBUILDING

Manual Rocker Arm Stud Puller

- Heavy-duty ball bearing action
- Creates less stress and friction
- Fits 5/16" (7.9mm) and 3/8" (9.53mm) threaded studs
- Not recommended for use on thermally cleaned heads

Description	Order No.
Complete Stud Puller	SP-600
Drive Nut	SP-601
Puller Body	SP-602
5/16" and 3/8" Mandrel	SP-603
Thrust Bearing	SP-604



CLEANING,
ASSEMBLY & SAFETY

SHORT BLOCK
REBUILDING

Universal Threaded Stud Extractor

- Use with your pneumatic impact tools & sockets (15/16" socket removes, 1 1/16" installs)
- Requires only 3/4" clearance to adjacent studs
- For threaded studs only
- Hardened 3-jaw clamping system
- Internal taper support
- Hollow body allows long studs to extend through the tool
- 1 1/2" dia. x 2 7/8" long • 1/4" - 1/2" range

Description	Order No.
Universal Stud Extractor	PSR-500
Replacement Parts	PSR-JAWS
Spring Set	PSR-3S
Snap Ring	PSR-SR



CRANKSHAFT/
FLYWHEEL GRINDING

MISCELLANEOUS
TOOLS & SUPPLIES



Chevy Conversion Plate Set

- Convert early model, 6-bolt heads for late model, 7-bolt applications
- Works with stock exhaust systems
- Use the standard exhaust manifold gasket or seal with High-Temp Silicone
- Order No. **CHC-10**

BRAKE SERVICE
TOOLING

MEASURING
TOOLS

Cut through even the hardest metals with Cutting & Tapping Fluid

- Spray clings to the surface of the tool to prolong tool life • Ideal for stainless steel, high nickel alloys, titanium and more
- Use for reaming, seat cutting and CBN cutting
- Aerosol* • Order No. **CTF-14**



*Hazardous Goods Fees Apply When Shipped by Air

V-TWIN & METRIC
HARD PARTS

S-373P
Pilot shown installed

Rocker Arm Stud Conversion Kit

- Convert pressed-in rocker arm studs to threaded studs
- Remove stud, face stud boss, then drill and tap the stud hole
- Use with a seat and guide machine

Description	Order No.	Incl.
Conversion Kit	S-450-KIT	▼
Stud Boss Facer	S-450-F	x
3/8" Drill Bit	S-373D	x
7/16" x 14 Thread Tap	S-437T	x
3/8" Pilot	S-373P	
2 Pc. Tap Guide	S-350G	

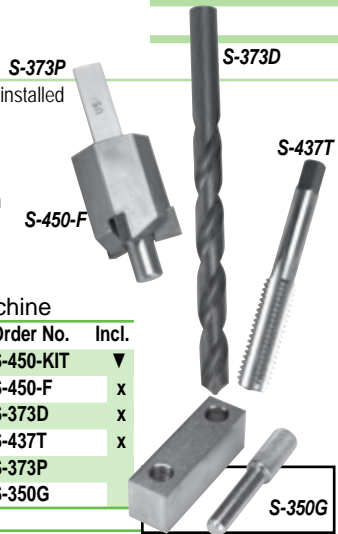

Torque-Angle Indicator

- When torque is given as degrees of turn past a certain ft./lb., use this gauge to show degrees
- Hold metal base with one hand
- Plastic dial turns as you tighten
- Fits between a socket-driven extension and the socket
- 1/2" square drive
- Order No. **TQR-4554**



Head Bolt Spot Facer

- Spot face head bolt seat parallel to new deck surface after angle milling
- Allows proper head bolt torquing
- Cutting tip radius matches OE design to avoid stress points and cracks
- .468" shank with flat
- High Speed Steel construction

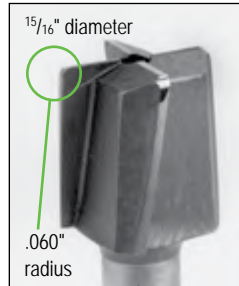

Description	Order No.
Spot Facer	HBF-15
1/16" Pilot (sold separately)	GFP-437

Two Blade Spot Facer

- 1 1/4" OD Spot Facer located on 3/8" stud
- Removes unneeded material for easier removal and installation of screw-in studs
- Replaceable carbide blades

Description	Order No.	Incl.
Stud Boss Facer	SBF-5587	▼
Stud Boss Facer Tip (each) for SBF-5587 only	SBF-5587T	x
Stud Boss Facer Screw (each)	SBF-5587S	x
Replacement Stud Boss Facer 3/8" Pilot (optional)	SBF-5587P	

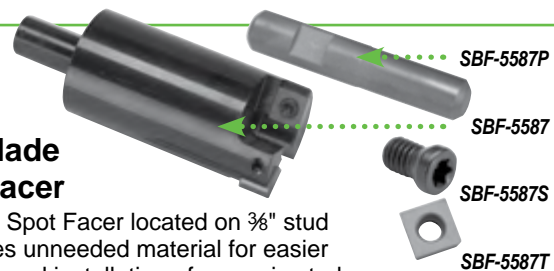

Head Holders and Stands

American Made

Economy Cylinder Head Holder

- Holds head with either side up
- Tapered pins fit any size head bolt hole and loosen with a twist
- Ideal for guide sizing with ample clearance to remove arbors and reamers
- All steel construction
- Two piece set
- Order No. **HH-100-G**

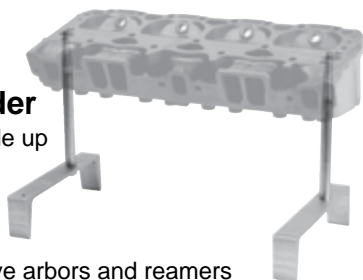

Ultra-Sturdy Cylinder Head Holder

- 360° stand holds head securely in position
- Tie-rod to prevent tipping
- Slip-resistant neoprene covered rails
- Fits domestic, foreign, truck & motorcycle heads
- 3-piece set
- 15 1/4" centerline
- Order No. **HH-450**

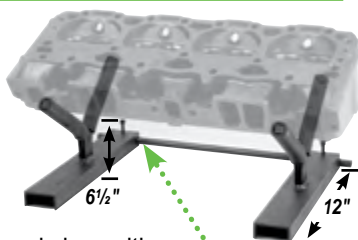

Set screws hold the two pieces firmly in place

Universal Cylinder Head Holder

- Accommodates all types of cylinder heads
- Sturdy, durable, lightweight aluminum construction
- Slip-resistant neoprene covered rails
- Place heads quickly into any position and rotate them easily through 360°
- Requires no bolts, clamps or adaptors
- 2 piece set • Order No. **HH-200**



Professional Measuring & Inspection Stand

- Length adjusts up to 23"
- Rotate work to view or measure
- Solid aluminum frame with self lubricating, corrosion and chemical-resistant wear surfaces
- Order No. **PMIS-30**



CYLINDER HEAD REBUILDING

CLEANING, ASSEMBLY & SAFETY

SHORT BLOCK REBUILDING

FLYWHEEL GRINDING

CRANKSHAFT/ MISCELLANEOUS TOOLS & SUPPLIES

BRAKE SERVICE TOOLING

MEASURING TOOLS

V-TWIN & METRIC HARD PARTS

Parts Tags & Marker

- Won't tear or wash off
- Heavy wire ties
- Tough enough to go through a jet wash or hot tank
- Includes 2 Super-Permanent markers with specially formulated ink to withstand most chemicals and extreme heat and steam up to 500°F
- Tag dimensions: 3 1/2" L x 5/8" W with 5/32" hole for wire tie



Description

1000 Parts tags, with 2 markers
Super-Permanent Marker only

Order No.

IDT-1000
IDT-MARKER

Shrink Wrap

- Easy-to-use
- High-clarity film
- Keep machined surfaces clean
- Protects from dirt, dust and moisture
- No need to stock several bag sizes

Size

5" x 1000' w/ Extended Core
18" x 1500' with 3" core

Order No.

SW-5
SW-18

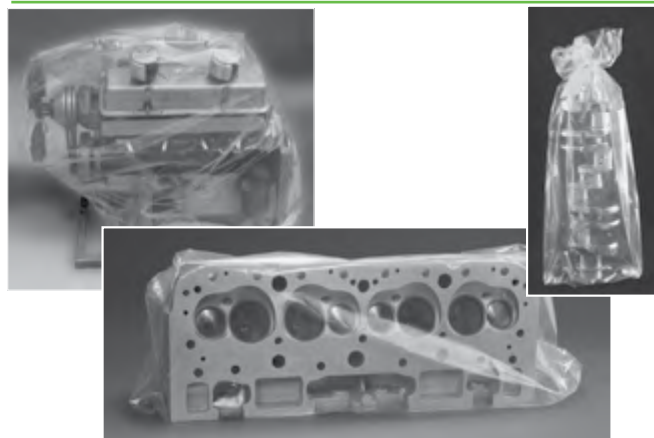

Engine & Parts Storage Bags

- Rugged, 3-mil thickness resists tearing
- Engine bags feature 4-mil thickness for extra strength
- Protects your professional work

- Waterproof • Protect finished work from damage • 4 sizes fit most common rebuilt assemblies • Jumbo engine bags are extra-strong and big enough to accommodate complete engines • Jumbo head bags fit the largest cylinder heads
- Ideal for storing heads, cranks, blocks, etc.

Size	Description	Quantity	Order No.
16" x 37"	Heads, cranks, misc.	box of 100	BC-15
17" x 44"	Jumbo head bag	roll of 100	BC-17
27" x 18" x 36"	Box-style for blocks	box of 50	BE-20
44" x 52"	Jumbo engine bag	roll of 50	BE-44



"When you call Goodson, you speak to a person, not a machine. We work hard to make sure you spend as little time waiting on hold as possible."

— Paige, Goodson Customer Service, 2 years of service

CYLINDER HEAD
REBUILDING

CLEANING,
ASSEMBLY & SAFETY

SHORT BLOCK
REBUILDING

CRANKSHAFT/
FLYWHEEL GRINDING

MISCELLANEOUS
TOOLS & SUPPLIES

BRAKE SERVICE
TOOLING

MEASURING
TOOLS

V-TWIN & METRIC
HARD PARTS

Aluminum Oxide Cloth Utility Shop Rolls

- 1" x 50 yards
- Easy to use ... just unroll and tear to length
- Use with butterfly mandrels at right



Grit	Order No.
60	UR-1-60
80	UR-1-80
100	UR-1-100
120	UR-1-120
180	UR-1-180
320	UR-1-320

Crocus Cloth

- Must be used with Lapping Oil
- Great for final touch-ups on cranks, rod pins, valve stems, cams, etc.
- Use with slotted mandrels at right



Description	Order No.
1" x 50 yd. Roll	UR-1-CROCUS
4 oz. Lapping Oil	LP-LO-4
8 oz. Lapping Oil	LP-LO-8

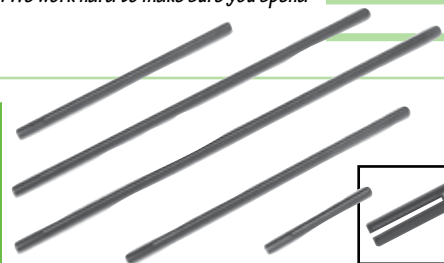

Slotted Butterfly Mandrels

- Use with roll abrasives such as those at left • Several lengths available

Length	Order No.
3"	BM-3
6"	BM-6
8"	BM-8
10"	BM-10
12"	BM-12

Replacement Abrasive Packs and Mandrels

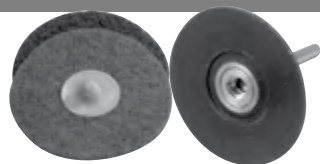

Replaceable Roll Lock Discs

10 per pack.

Dia.	Order No.
2" Medium	RSCD-2M
Coarse	RSCD-2C
3" Medium	RSCD-3M
Coarse	RSCD-3C
Disc Holder	Order No.
2" Dia.	RLH-2
3" Dia.	RLH-3

Straight Cartridge Rolls

- 1½" long, ⅛" hole
- Fully glued • Box of 50

Dia.	Grit	Order No.
¼"	40	SCR-250-40
	80	SCR-250-80
	120	SCR-250-120
⅜"	40	SCR-375-40
	80	SCR-375-80
	120	SCR-375-120
½"	40	SCR-500-40
	60	SCR-500-60
	80	SCR-500-80
¾"	40	SCR-750-40
	80	SCR-750-80
	120	SCR-750-120

Straight Cartridge Rolls

- 1" long, ⅛" hole
- Fully glued • Box of 50

Dia.	Grit	Order No.
¼"	60	SCR-1-250-60
	80	SCR-1-250-80

Roll Mandrels

Use with straight and tapered cartridge rolls • ⅝" pilot x ¼" dia.

Length	Order No.
2¾"	CR-275
4"	CR-40
6"	CR-60
8"	CRM-8H
10"	CRM-10H
12"	CRM-12H

Half-Tapered Cartridge Rolls

- 1½" long, ⅛" hole
- Fully glued • Box of 50

Dia.	Grit	Order No.
⅜"	40	HTR-375-40
	80	HTR-375-80
	120	HTR-375-120
½"	40	HTR-500-40
	80	HTR-500-80
	320	HTR-375-320

Full-Tapered Cartridge Rolls

- 1½" long, ⅛" hole
- Fully glued • Box of 50

Dia.	Grit	Order No.
¾"	40	FTR-375-40
	80	FTR-375-80
	120	FTR-375-120
	320	FTR-375-320
½"	40	FTR-500-40
	60	FTR-500-60
	80	FTR-500-80
	100	FTR-500-100
120		FTR-500-120
		FTR-500-120
⅝"	40	FTR-625-40
	80	FTR-625-80

Mirrored Safety Glasses

- Wrap-around design
- Tinted lenses provide sun glare protection • Universal bridge • Polycarbonate lenses • **Do not** use as welders helpers
- Order No. PGL-21



Premium Quality

Cross Buffs®

Box of 10

Dia.	Grit	Order No.
2-Ply		
¾"	V. Fine	CB-75VF
	Med.	CB-75M
1"	V. Fine	CB-1VF
	Med.	CB-1M
1½"	V. Fine	CB-15VF
	Med.	CB-15M
3-Ply		
1½"	V. Fine	CB-125VF-HD
	Med.	CB-125M-HD
1½"	V. Fine	CB-15VF-HD
	Med.	CB-15M-HD



Abrasive Flapwheels

1" wide, ¼" x 20 threaded. 1 each.

Dia.	Grit	Order No.
1½"	80	APK-7
2"	80	APK-8
2½"	80	APK-9
1"	120	AFW-1-120
2"	120	AFW-2-120
3"	120	AFW-3-120

Cross Buff® / Flap Wheel Mandrel

- Use with Cross Buffs & Flap Wheels above

Description	Order No.
4" Mandrel	CB-MANDREL
Set Screw (3)	CB-SCREW



NOTE: Extreme caution must be used when porting & polishing. Be sure to wear safety glasses.

Professional Porting & Polishing Tools



48 Piece Deluxe Porting Kit

- Professional grade porting supplies
- Packed in a clear plastic storage case

Description	Order No.	Incl.
48 Pc. Kit	DPK-100	▼
Replacement Abrasives	Grit	Kit Qty.
Flap Wheels - 1"x1"x1/4"	120	2
Cross Buffs 2 Ply, 1 1/2"	Med.	2
	Very Fine	2
Cross Buff/Flapwheel Mandrel		1
1/4" Dia. Straight	40	2
Cartridge Rolls	80	5
3/8" Dia. Straight	40	2
Cartridge Rolls	80	5
3/4" Dia. Straight	40	2
Cartridge Rolls	80	2
1/2" Dia. Half Tapered	40	2
Cartridge Rolls	80	5
3/8" Dia. Full Tapered	40	2
Cartridge Rolls	80	5
Cartridge Roll Mandrel	2 3/4" Long	1
	4" Long	1
Mounted Points - 3/8" x 3/4"	60	1
	1 1/16" x 1 1/4"	60

See previous page for replacement abrasive quantities

small engine
powersports

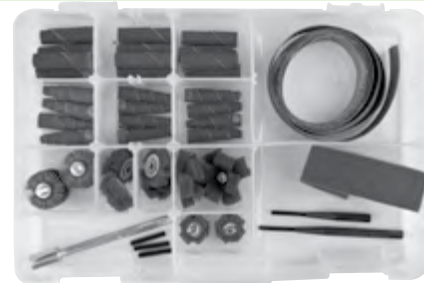

44 Piece Small Engine Porting Kit

- Professional grade porting supplies
- Packed in a clear plastic storage case

Description	Order No.	Incl.
44 Pc. Kit	SEPK-5	▼
Replacement Abrasives	Grit	Kit Qty.
Flap Wheels - 1"x1"x1/4"	120	2
Cross Buffs 2 Ply	3/4" Very Fine	2
	1" Medium	2
	Very Fine	2
	1 1/2" Very Fine	2
Cross Buff/Flapwheel Mandrel		1
3/8" Dia. Straight	80	4
Cartridge Rolls	120	4
	320	4
3/8" Half Tapered Cartridge Rolls	80	4
3/8" Full Tapered	80	4
Cartridge Rolls	120	4
1" x 2 Yds. Abrasive Roll	120	1
	320	1
Cartridge Roll Mandrel	2 3/4" Long	1
	4" Long	1

See previous page for replacement abrasive quantities

Intake Port Reshaping Kit

- Superior formula uses 2-part epoxy
- Won't shrink when dry
- Mix ratio is 1:1 by weight
- Mix and knead the parts together by hand until the yellow and black colors have combined to make a uniform olive green color
- Working time at 70°F: Golfball size mix: 40 minutes max.; Baseball to softball size: 30 minutes max.
- Cure time at 70°F: full hardness in 6 to 8 hours
- Once cured, forms a hard coating resistant to abrasion, impact, water, chemicals and solvents
- **Not** for use in contact with potable water or exhaust ports
- Can be milled or machined
- Withstands temperatures up to 500°F/ 260°C
- Kit includes epoxy, gloves and mixing sticks
- Yields 16 oz./453.6g of material
- 24 month shelf-life
- Order No. **PRK-99**



tech tips
from the techxperts™

Adhesion of PRK-99 will be only as good as the cleanliness and soundness of the substrate. Remove all dirt, oil and grease. Sandblasting is acceptable. Scraping, wire brushing and other manual cleaning methods may also work.

Quick Change Mandrels & Abrasive Sleeves

- 5 sleeves per pack • 1" x 1"
- Mandrel has 1/4" shaft



Description	Grit	Order No.
Mandrel		GMS-101
Sleeves	40	GMS-140
	60	GMS-160



110V Electric Die Grinder

- 3/4" collet • 8' cord • 110V • 2.5 amp • 25,000 RPM
- Includes 2 collet wrenches
- Optional Speed Control lets you vary from 200 to 25,000 RPM • 6' cord • 110V • 15 amp

Description	Order No.
25,000 RPM Die Grinder	GEO-600
Variable Speed Control	GEO-SC
1/4" Grinder Replacement Collet	GEO-600-5
Grinder Replacement Collet Nut	GEO-600-4

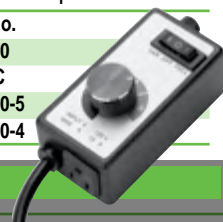

NOTE: Extreme caution must be used when porting & polishing. Be sure to wear safety glasses.

CYLINDER HEAD
REBUILDING

CLEANING,
ASSEMBLY & SAFETY

SHORT BLOCK
REBUILDING

CRANKSHAFT/
FLYWHEEL, GRINDING

MISCELLANEOUS
TOOLS & SUPPLIES

BRAKE SERVICE
TOOLING

MEASURING
TOOLS

V-TWIN & METRIC
HARD PARTS

... another
satisfied
customer

"When rebuilding several motors at a time, your organizer trays are very important. We love the thought given in the products and how parts remain in important order!"

- George Bernacchi, BB Tire Shop, via Facebook

CYLINDER HEAD
REBUILDING

FR-34-C

FR-45-C

1/4" Shank Carbide Rotary Double Cut Files

Dia.	Length	Shank	Order No.
1/2"	1 1/8"	1.1"	FR-34-C
1/4"	1"	1.0"	FR-45-C

CLEANING,
ASSEMBLY & SAFETY

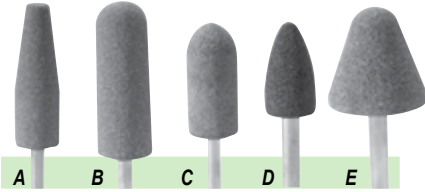

SHORT BLOCK
REBUILDING

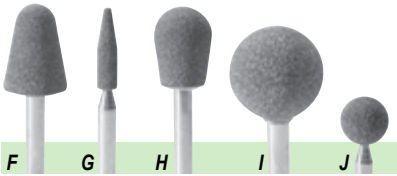

CRANKSHAFT/
FLYWHEEL GRINDING

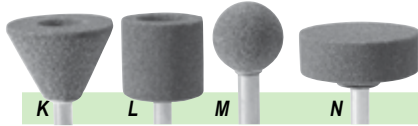

MISCELLANEOUS
TOOLS & SUPPLIES

1/4" Shank Mounted Points

• Aluminum-Oxide abrasive is ideal for roughing cast iron • 1 1/2" shank length

Dia.	Length	Grit	Order No.
A 3/4"	2 1/2"	60	GM-1
B 7/8"	2 3/4"	60	GM-3
C 7/8"	1"	60	GM-11
D 1 1/16"	1 1/4"	60	GM-12
E 1 1/4"	1 1/4"	60	GM-4
F 3/4"	1 1/8"	60	GM-5
G 1/4"	1 1/16"	60	GM-15
H 3/4"	1"	60	GM-23
I 1"	1"	60	GM-25
J 5/8"	5/8"	60	GM-26
K 1 3/8"	1"	60	GM-31
L 1"	1"	60	GM-38
M 3/4"	3/4"	40	GM-40
N 1 1/2"	1 1/16"	60	GM-236

BRAKE SERVICE
TOOLING

MEASURING
TOOLS

tech tips

from the techxperts™

Stay Safe:

Always ensure your burr shank is well inserted into your collet and clamped down tightly.

Keep pressure light and keep the burr moving focusing on the highest material first.

Ensure your work is secured tightly to your work bench.

Don't snag or jam your burr into your work

Wear eye protection as a minimum, but better still, use a full shield for your face.

V-TWIN & METRIC
HARD PARTS

Short Long

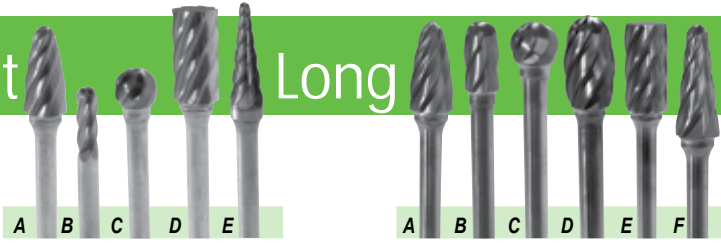

Open Fluted Rotary Files for Aluminum

Choose between 2 shank lengths – 1 1/2" and 6" in several sizes. All of the files feature a 1/4" diameter shank

	Dia.	Length	Order No.
A	1/2"	1"	AFR-34
B	1/4"	1 5/16"	AFR-45
C	1/2"	1/2"	AFR-55
D	1/2"	1"	AFR-93
E	3/8"	1 3/16"	AFR-121

	Dia.	Length	Order No.
A	1/2"	1"	LAFR-34
B	3/8"	3/4"	LAFR-45
C	1/2"	7/16"	LAFR-55
D	1/2"	7/8"	LAFR-70
E	1/2"	1"	LAFR-93
F	3/8"	1 1/16"	LAFR-121

Save when you
buy the kit!

6" Long Shank Double Cut Carbide Rotary Files

• 1/4" diameter shank

Dia.	Length	Order No.	Incl.
Complete 5 Pc. Kit			LFR-KIT ▼
A	1/2"	1 1/8"	LFR-34C x
B	1/4"	1/2"	LFR-45C x
C	1/2"	1/2"	LFR-55C x
D	1/2"	1 1/8"	LFR-46C x
E	1/2"	1 1/8"	LFR-141C x

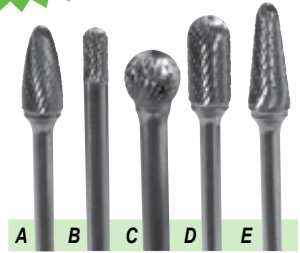

Carbide Single Cut Rotary Files for Aluminum

- 1/8" heat treated steel shanks
- For all non-ferrous metals
- 1 1/2" shank length (nominal)

Dia.	Cut Length	Order No.
1/4"	1/2"	FRA-51F
1/4"	1/2"	FRA-51C
1/4"	1/2"	FRA-51A
1/4"	1/4"	FRA-51E

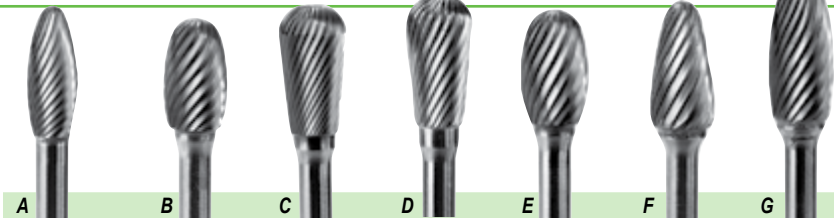
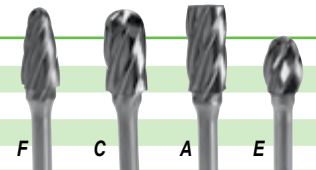

1/4" Carbide Rotary Files

- Nose design reduces back-gouging
- 1/4" shank • Shanks 4" long except MRT-56C at 6" long

Dia.	Lgth.	Order No.	Dia.	Lgth.	Order No.
A .375"	1.000"	MSH-34C	E .500"	.880"	MSE-54C
B .437"	.875"	MSE-44C	F .500"	1.000"	MSF-54C
C .500"	.975"	MRT-54C	G .500"	1.245"	MSH-54C
D .500"	1.000"	MRT-56C			

Parts Organization

Dual Overhead Cam Cylinder Head Organizer Tray

- Store valves, springs, retainers, keepers, valve lash adjusters & camshafts
- Keep valve lash adjusters from getting mixed up and changing the valve adjustment
- Heavy duty construction
- Oil and solvent resistant
- 23¼" x 26½" x 2"
- Order No. **DOHC-1**

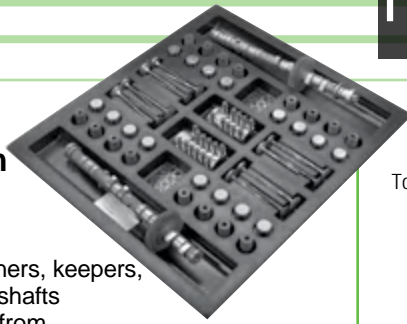

Stackable Cylinder Head Organizer Trays

- Store valves, springs, retainers and keepers in order of assembly • Impervious to oil and most solvents
- Measures 28" x 12½" x 3"H
- Order No. **SHO-8**

Valve Train Tray For 4, 6 or 8-Cylinder OHV Engines

- Heavy duty construction
- Keeps push rods, rockers, lifters, etc. in order
- 64 compartments
- Measures 11½"W x 13½"D x 1½" H
- Order No. **VTO-80**

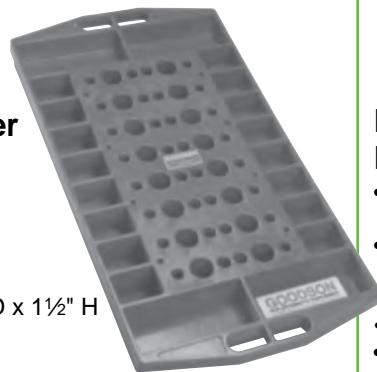

Bifocal Magnifying Safety Glasses

- Safety glasses and cheaters all in one

Diopter	Order No.
1.00	BSG-100
1.25	BSG-125
1.50	BSG-150

Engine Storage Cart

- An efficient space-saver
- Heavy-duty casters
- Holds all engine parts off the floor from tear-down to reassembly in less than 4 square feet
- Move the whole engine easily
- Some assembly required
- Order No. **EC-200**

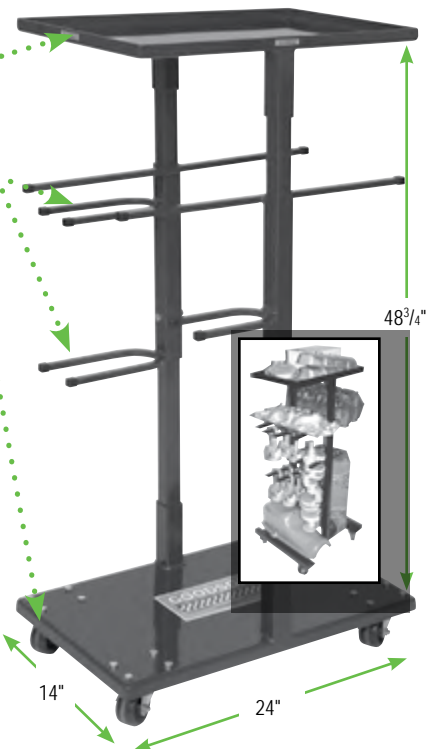

Top tray features 1" deep lip to keep parts from rolling off

Solid steel hangers hold piston rods and crankshafts

Heavy duty casters make moving the engine and cart easy

CYLINDER HEAD REBUILDING

CLEANING, ASSEMBLY & SAFETY

SHORT BLOCK REBUILDING

CRANKSHAFT/ FLYWHEEL GRINDING

Ford/Chevy Small Block Organizer Tray

- Store pistons, rods, lifters, push rods & camshafts
- Formed compartments keep engine components securely in place
- Measures: 24¼" x 25½" x 1½"D
- Order No. **iEO-80**

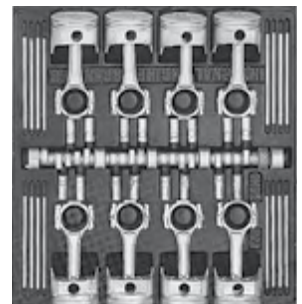

MISCELLANEOUS TOOLS & SUPPLIES

BRAKE SERVICE TOOLING



Mirrored Safety Glasses

- Wrap-around design
- Tinted lenses provide sun glare protection
- Universal bridge
- Polycarbonate lenses
- **Do not** use as welders helpers
- Order No. **PGL-21**

MEASURING TOOLS

V-TWIN & METRIC HARD PARTS

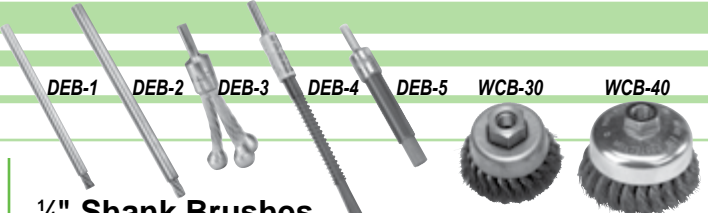

End Brushes

Dia. / Wire gauge / Type	Order No.
Standard Duty	
1/2" .020" crimped	GBC-4
3/4" .020" crimped	GBC-6
1" .020" crimped	GBC-10
1 1/2" .020" crimped	GBC-14
1 3/4" .012" crimped	NH-16
2 3/4" .012" crimped	NH-26
1 3/4" .014" galv. for alum.	ANH-16
2 3/4" .014" galv. for alum.	ANH-26
Ultra Duty (listed left to right)	
1/2" .014" crimped	GBC-4A
1 1/8" .020" knotted, 1 1/4" L	GBC-12
1 1/8" .020" knotted, 7/8" L	GBC-12HD
3/4" .020" knotted	NH-6

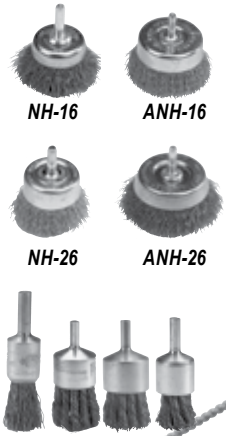

1/4" Shank Brushes

Deep Well End Brush as brush wears cut back to expose new wire			
Dia.	Wire Gauge	Grade	Order No.
1/4"	.012"	6" long Economy	DEB-1
3/8"	.017"	6" long Economy	DEB-2
Flare Brush use to remove carbon from engine ports			
1/2" ball, 3/8" cable		Ultra-duty	DEB-3
Port Brush as brush wears cut back spring for new wire			
1/4"	.014"	4" long Standard	DEB-4
1/2"	.020"	2 1/2" long Ultra-duty	DEB-5
Cup Brush 5/8"-11 NC - fits standard 4 1/2" angle grinder			
3"	.014" twisted	Ultra-duty	WCB-30
4"	.014" twisted	Ultra-duty	WCB-40

Engine Prep Brushes

Application	Order No.
For small feed hole in block 1/4" x 2" x 10", nylon	OB-1
For Block Oil Return Line 5/16" x 2 1/2" x 12", nylon	OB-2
Like OB-2 but more flexible 5/16" x 2 1/2" x 12", nylon	OB-2A
For Block Oil Return Lines 3/8" x 2 1/2" x 12", nylon	OB-3
For diesel injector 1 3/4" brush, stainless	DIB-1
For lifter bores 1" x 3" x 14", nylon	LBB-100

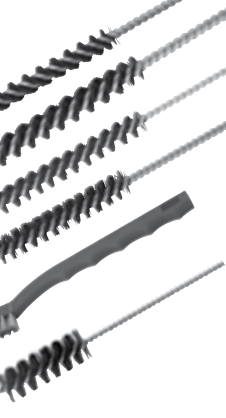

Manual Guide Cleaning Brush

- 1/2" Dia. Nylon bristles
- OAL: 8 3/4"
- Order No. **WCB-44**



Round Fiber Parts Brush

- 11" long • Nylon bristles
- Plastic Handle
- Order No. **PCB-348**

Lifter Bore Brushes

Dia.	Order No.
7/8"	LBB-875
1"	LBB-100
1 1/8"	LBB-1125

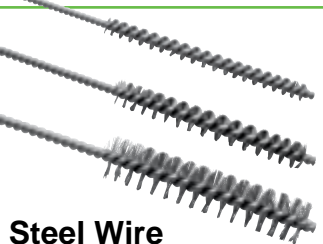

Steel Wire Oil Gallery Brushes

Desc.	Order No.
3-pc. Kit	OGB-SK ▼
1/4" x 3" x 24"	OGB-1 x
3/8" x 3" x 24"	OGB-2 x
5/8" x 3" x 24"	OGB-3 x



Nylon Bristle Oil Gallery Brushes

Desc.	Order No.
5-pc. Kit	OGB-KIT ▼
3/8" x 3" x 34"	OGB-38 x
1/2" x 2 1/2" x 34"	OGB-42 x
5/8" x 3" x 34"	OGB-5 x
3/4" x 3" x 34"	OGB-7 x
3/4" x 3" x 40"	OGB-8 x

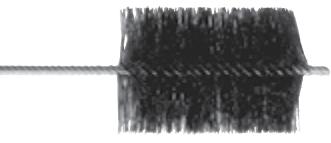

Bore Washing Brushes

Dia.	Length	Order No.
2"	36"	CBB-200
2 1/4"	36"	CBB-225
2 1/2"	36"	CBB-250
2 3/4"	18 1/2"	CWB-27W
3 1/2"	18 1/2"	CWB-35
4"	18 1/2"	CWB-40
4 1/2"	18 1/2"	CWB-45
5"	18 1/2"	CWB-50

Flow Through Parts Washing Brush

- 24" long hose slides over discharge nozzle on parts washer
- Order No. **PWB-FLO-1**



Pushrod Brush

- Clean the inside diameter of your pushrods with this brush
- Fits pushrods as small as .080" ID
- 12" overall length
- Order No. **PRB-80**

5 Pc. Nylon Valve Guide Brush Set

- Complete set includes 5 popular nylon brush sizes
- From 3/16" to 1/2" dia.
- Order No. **GVP-SET**

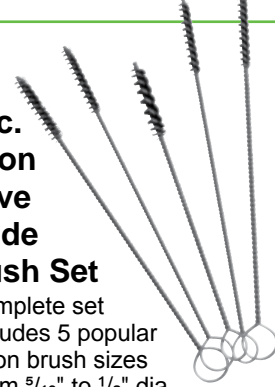

Valve Guide Brushes

Size	Steel Brushes		Nylon Brushes	
	OAL	Order No.	OAL	Order No.
5/16" x 2 1/2"	9 1/2"	GVP-1	12"	GVP-1N
1 1/2" x 2 1/2"	9 1/2"	GVP-2	12"	GVP-2N
3/8" x 2 1/2"	9 1/2"	GVP-3	12"	GVP-3N
7/16" x 2 1/2"	9 1/2"	GVP-4	12"	GVP-4N
1/2" x 2 1/2"	-----	-----	10 1/2"	GVP-5N
9/16" x 2 1/2"	-----	-----	10 1/2"	GVP-6N
3mm x 1 1/4"	-----	-----	8"	GVP-7N
4mm x 1 1/4"	8"	GVP-8S	8"	GVP-8N
5mm x 1 1/4"	8"	GVP-9S	8"	GVP-9N
6mm x 1 1/4"	8"	GVP-10S	8"	GVP-10N
7mm x 1 1/4"	8"	GVP-11S	8"	GVP-11N



Parts Cleaning



Radial Wire Brushes

Radial Wire Brushes

- American made oil tempered high carbon steel wire
- High density for faster cleaning and longer life
- Excellent balance • 1/2" - 5/8" arbor

Size	Wire	Duty	Order No.
6" x 1 3/16"	.014" Crimped	Std.	ADA-6
7" x 7/8"	.014" Crimped	Heavy	DA-7
6" x 3/16"	.016" Twisted	Super	TS-6
8" x 3/4"	.016" Twisted	Super	TS-8
6" x 7/16"	.023" Knotted	Ultra	QTC-6



Buy the Kit,
SAVE!

BG-KIT

Engine Rebuild Brush Kit

- Includes the brushes you'll need for an average engine job
- A great starting place, then add more brushes as you need them
- Replacement brushes available

Description	Order No.
Standard Brush Kit - 10 Pc. Kit	BG-KIT ▼
4" Nylon Cylinder Washing Brush	CWB-40 x
1 1/2" Nylon Valve Guide Brush	GVP-2N x
3/8" Nylon Valve Guide Brush	GVP-3N x
Lifter Bore Brush	LBB-100 x
Small Nylon Feed Hole Brush	OB-1 x
Block Oil Return Line Brush	OB-2 x
3/8" Oil Gallery Brush	OGB-38 x
1/2" Oil Gallery Brush	OGB-42 x
5/8" Oil Gallery Brush	OGB-5 x
Round Fiber Parts Brush	PCB-348 x

BG-150

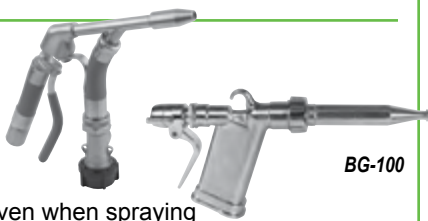

BG-100

Hydro-Air Guns

- Hold the BG-150 by the air supply hose
- The grip stays cool even when spraying hot water • BG-100 Trigger Action gun uses water and air pressure to deliver a powerful stream of "cold steam"
- BG-100 includes siphon tube, extension nozzle & flushing adaptor and connects to openings 3/4" to 1 1/2" in diameter

Description	Order No.
Hydro-Air Gun	BG-150
Trigger-Action Hydro-Air Gun	BG-100
Replacement Nozzle for BG-100	BG-NOZZLE

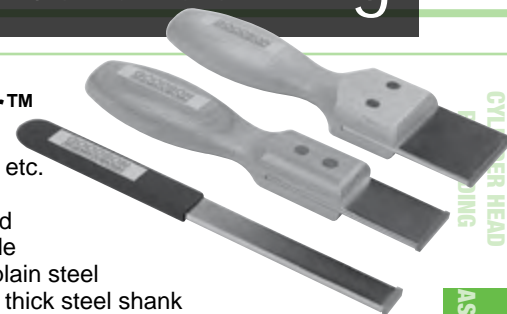

Super Scraper™

- Remove gaskets, carbon, rust, paint, etc.
- Precision-ground
- Solid carbide-tipped
- Double-edged blade
- Lasts longer than plain steel
- Nickel-chrome • 1/8" thick steel shank
- For all metals including aluminum

Width	Order No.	Incl.
3 Pc. Set	SS-SET	▼
5/8"	SS-4U625	x
1 1/4"	SS-4U	x
2"	SS-4U2	x



Pneumatic Scraper

- Faster and easier than scraping by hand
- Beveled, 1" steel blade • Removes gaskets with 2500, 3/64" strokes per minute • Resharpenable blade

Description	Order No.
Complete Tool	AGS-310
Replacement Blade	AGS-310B
Premium Replacement Blade	AGS-310BP

Roloc Bristle Discs

- Effective on cast iron, yet safe for aluminum
- Abrasive grains embedded in plastic bristles that break down exposing new grain

Roloc Bristle Discs

Size	Color	Grit	Max. RPM	Order No.
2"	Green	50	25,000	RBD-2G
	Yellow	80	25,000	RBD-2Y
	White	120	25,000	RBD-2W
3"	Green	50	18,000	RBD-3G
	Yellow	80	18,000	RBD-3Y

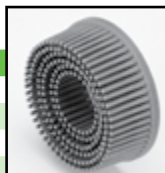

Holders

Size	Description	Order No.
2"	Roloc-Type Holder	RLH-2
3"	Roloc-Type Holder	RLH-3



ARMEX®

Maintenance XL Formula Soda Blast Cleaning Media

- 270 micron / 70 Grit Formula
- Use to strip clean almost any car surface including, steel, aluminum, Fiberglas® and plastics
- Ideal for blocks, heads and intake manifolds
- Dissolves in warm water, minimizing particle ingestion that can block fuel lines and passageways
- Won't damage the surface you're cleaning
- Non-toxic and non-hazardous with a pH of 8.2
- 50 lb. / 22.7 kG bags
- Order No. **SMB-170**



CYLINDER HEAD
CLEANING
ASSEMBLY & SAFETY
CLEANING,
ASSEMBLY & SAFETY
SHORT BLOCK
REBUILDING
FLYWHEEL, GRINDING
CRANKSHAFT/
MISCELLANEOUS
TOOLS & SUPPLIES
BRAKE SERVICE
TOOLING
MEASURING
TOOLS
V-TWIN & METRIC
HARD PARTS



"We believe that every customer is important. If you need one of our tools or supplies overnight or have a last minute change on your order you can count on Goodson. You'll always receive the kind of courteous, personal attention that shows how much we appreciate you doing business with us."
- Cammy, Goodson Operations Manager, 1 year of service

CYLINDER HEAD
REBUILDING

CLEANING,
ASSEMBLY & SAFETY

SHORT BLOCK
REBUILDING

CRANKSHAFT/
FLYWHEEL GRINDING

MISCELLANEOUS
TOOLS & SUPPLIES

BRAKE SERVICE
TOOLING

MEASURING
TOOLS

V-TWIN & METRIC
HARD PARTS

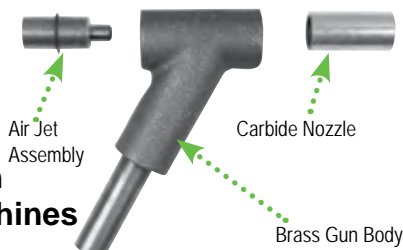

Glass Bead Gun for Smaller Machines

- Solid brass body
- Fits Trinco, Econoline, etc.
- Includes Gun Body, Nozzle and Air Jet Assembly
- Replacement parts available

Description	Order No.
Complete Gun For Smaller Machines	GB-113
Replacement Parts	
Gun body only	GB-111
Carbide nozzle 19.05mm OD, 7.94mm ID	GB-204
Air jet assembly 3.97mm ID, 25 CFM	GB-330

Replacement Trigger-Control Glass Bead Gun



- Uses 9 CFM of compressed air
- Gun includes replaceable ceramic nozzle
- Nozzle diameter: 3/16"
- For most economy bench-top glass bead cabinets
- Fits most cabinets with 1/2" ID media supply line, threaded for 1/4" air line fitting

Description	Order No.
Trigger-Control Glass Bead Gun	GB-9
Replacement Ceramic Nozzles (3 pack)	GB-9-NOZ

Glass Beads

- Clean parts thoroughly without removing material
- 50 lb. bag • Size #8
- Safe for ferrous & non-ferrous materials
- Order No. **GB-CM**

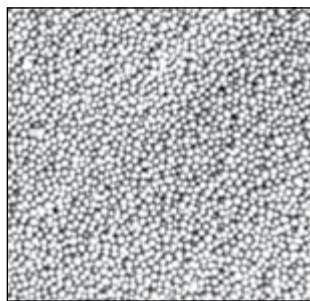

Glass Bead Cabinet Window Film

- Protects the inside of glass bead cabinet windows
- Save time and money – replace the film rather than the glass • 24" x 10' roll
- Order No. **GB-FILM**

tech tips
from the techxperts™

For best results, attach film to cabinet window with ordinary double-faced tape (not included).

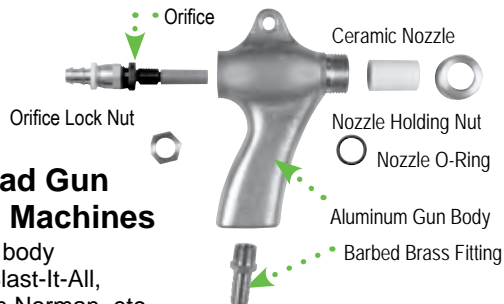

Glass Bead Gun for Large Machines

- Solid brass body
- Fits Zero, Blast-It-All, Winona Van Norman, etc.
- Includes .313" ID ceramic nozzle

Description	Order No.
Complete Gun For Larger Machines	GB-100
Replacement Parts	
Gun body only	GB-101
Barbed Brass fitting	GB-04
Nozzle holding nut (not included in kit)	GB-54

Rebuild Kits	Order No.	Includes
.250" ID	GB-4-OK	▼
.313" ID	GB-5-OK	▼
.375" ID	GB-6-OK	▼
.437" ID	GB-7-OK	▼
Ceramic Nozzles .250" ID	GB-74	x
7/8" OD x 1 3/8" .313" ID	GB-75	x
.375" ID	GB-76	x
.437" ID	GB-77	x
Replacement Orifices	GB-64	x
	GB-65	x
	GB-66	x
	GB-67	x
Lock Nut	GB-52	x x x x
O-Ring	GB-53	x x x x



Glass Bead Gloves

- 30" overall length
- For ports up to 10" diameter
- Durable cloth-lined Neoprene glove with nylon sleeve
- Sleeve design makes attaching glove to your machine, faster and easier • Clamp sold separately

Port Size	Description	Order No.
Up to 8" (20.32 cm)	Single: left-hand glove	GB-654-G
	Single: right-hand glove	GB-655-G
	Pair: one right-hand & one left-hand	GB-660-G
Up to 10" (25.4 cm)	Pair+: one right-hand, two left-hand	GB-663-G
	Single: left-hand glove	GB-754-G
	Single: right-hand glove	GB-755-G
8" and 10"	Pair: one right-hand & one left-hand	GB-770-G
	Replacement Clamp: fits both port sizes	GB-CLAMP

SAFETY TIP: NEVER point the Glass Bead Gun at the cabinet window or your co-workers!

Cleaning Media



Ceramic Diagonals (20 lb.)
For soft materials such as brass and aluminum. $\frac{5}{16}$ " dia., $\frac{5}{8}$ " long
Order No. **PTM-20CR**



Steel Ballcones (20 lb.)
Ideal for Springs.
.385" ball in .475" cone
Order No. **PTM-20BC**

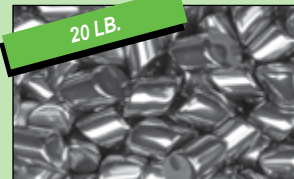

Steel Diagonals (20 lb.)
Ideal for valves.
 $\frac{5}{16}$ " dia., $\frac{5}{8}$ " long
Order No. **PTM-20D**

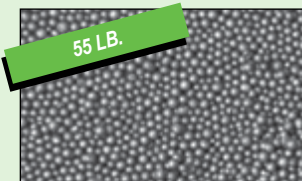

Steel Shot, 170 grade (55 lb.)
Ideal for cleaning cast iron heads.
Diameter varies from .017" to .024".
Order No. **SS-CM**

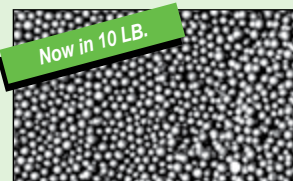

Stainless Steel Shot, Conditioned.
Clean aluminum heads to look like new.
Restores bright aluminum finish. Lasts longer than plain carbon steel shot.
Diameter varies from .006" to .016".
10 lb.
Order No. **SS-CS10**

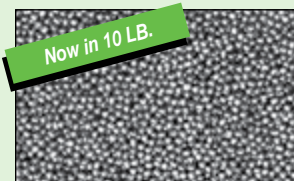

Stainless Steel Cut Wire Shot
Unconditioned. Clean cast iron or aluminum heads before and normalize after welding. Helps prevent surface corrosion after blasting.
.020" Diameter. 10 lb.
Order No. **SS-CW10**



Hot Tank Gloves

- Sold in pairs
- Not for solvent use
- Shoulder length features eyelets & strings at tops to prevent slipping

Description	Order No.
Gauntlet Length (14" long)	HTG-200
Elbow Length (18 $\frac{1}{2}$ " long)	HTG-200E
Shoulder Length (34 $\frac{1}{2}$ " long)	HTG-200L



See Pages 126-127 for Keepers

Keeper-Keeper

- Screws closed tightly
- $\frac{1}{4}$ " holes
- Ideal for tumbling keepers
- Solvent resistant PVC
- Order No. **VK-15**



See Page 125 for Valve Stems

Valve Stem Protectors

- Protects against parts tumbler damage
- Slips on and off easily
- 16 per package
- Order No. **VSP-16**



Parts Tumbler Solution

- Dilute 30:1 with water
- For best results, dry parts with compressed air • 1 gallon / 3.78L
- Order No. **PT-SOL**

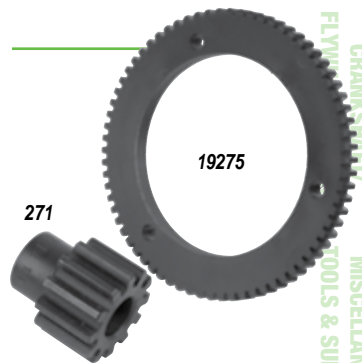

Replacement Gears For Sioux™ 710 Parts Tumbler

- Replaces discontinued Sioux™ parts

Description	Order No.
Steel Gear	271
Fiber Gear	19275



Full Length Neoprene Shop Apron

- Protects from caustics, steam, grease and oil
- Bib-style • 35" x 45"
- Order No. **HTA-300**

Shown with Shoulder Length Hot Tank Gloves (above)

Cloth Shop Apron

- Bib-style apron
- Heavy duty black fabric
- Several handy pockets
- Embroidered Goodson Racing logo
- Machine Washable
- Order No. **CA-100**



Parts Tumbler Basket

- Fits Goodson, K.I., Axe, RMC, and Peterson
- 8" x 12" x 12"
- Order No. **PT-BASKET**

CYLINDER HEAD REBUILDING
CLEANING, ASSEMBLY & SAFETY
SHORT BLOCK REBUILDING
FLYWHEEL CRANKSHAFT
MISCELLANEOUS TOOLS & SUPPLIES
BRAKE SERVICE TOOLING
MEASURING TOOLS
V-TWIN & METRIC HARD PARTS



Cosmoline

- Brush directly from can onto freshly-machined engine components
- Protects iron, steel and aluminum
- Soften with mineral oil to dip small parts

Quantity	Order No.
2 lbs.	RPC-2A
35 lbs.	RPC-35A

Rust Proofing Oil

- Apply full strength
- Creates a protective film
- Washes off with standard solvents
- Brush or spray on using the Sure Shot Sprayer (below)
- 1 Gallon / 3.78 L
- Order No. **RPO-10**



Rust Shield

Short-term

- Non-sticky
- Lasts several weeks
- Wipes off with just a towel

Long-term

- Formula is thicker and protects much longer but requires a solvent to remove

Formula	Order No.
Short Term	RS-16*
Long Term	RS-16-OD*

*Hazardous Fees Apply If Shipped By Air

Rust Shield for Shop Equipment

- Stops rust without causing rancidity
- Apply to machine parts such as ways
- Mixes with coolant – no need to remove before machining
- 1 Gallon / 3.78 L
- Order No. **RS-128**



Silver Anodized Aluminum 24 oz. Sure Shot® Sprayer

- Pressurize it with shop air – 80-150 psi
- No hoses or cords to limit movement
- Spray nozzle adjusts from stream to spray
- Can be used with most oil, solvent and water based materials
- **Not for paint or caustics**



Description	Order No.
Sure Shot Sprayer	PS-2014
Replacement Tank-Body O-Ring	PS-2014OR
Replacement Nozzle Washer	PS-2014NW

Snap Together Adjustable Coolant Hoses

- Hoses hold any shape • Chemical Resistant
- Ideal for most common shop machines

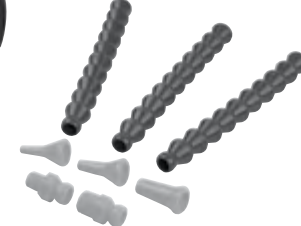

Size: 1/4" Hose Kit
Includes: 18" hose, 1/4" & 1/8" NPT fittings, 1/16", 1/8" & 1/4" round nozzles

Application: Most parts washers, wet-type seat grinders, valve refacers

Order No.: **ACH-400**

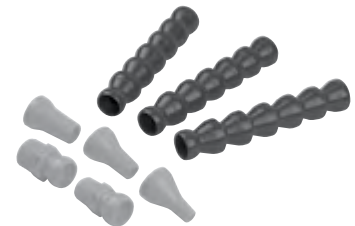

Size: 1/2" Hose Kit
Includes: 16 1/2" hose, 3/8" & 1/2" NPT fittings, 1/4", 3/8" & 1/2" round nozzles

Application: Most cylinder hones and flywheel grinders

Order No.: **ACH-600**

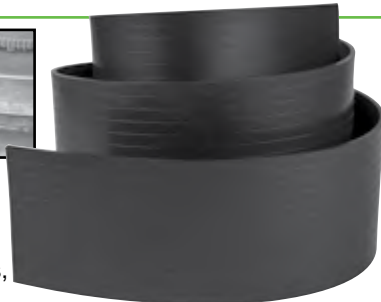

Universal Coolant Magnet

- Ideal for Honing Tanks, Flywheel Grinders, Crankshaft Grinders, Head Surfacers and more
- Prevents metal swarf from passing into the coolant tank
- Cut or shape to fit machine bases and return ways
- Measures 3"x48" • Can be trimmed to any size needed
- Order No. **UCM-348**



Size: 1" Flare Nozzle for 1/4" Hose
Order No.: **ACH-407**



Size: 1 1/4" Flare Nozzle for 1/2" Hose
Order No.: **ACH-807**

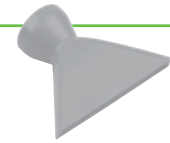

Size: 2 1/2" Flare Nozzle for 1/2" Hose
Order No.: **ACH-809**



NPT	Hose ID	Order No.
1/4"	1/4"	ACH-406
3/8"	1/2"	ACH-804
1/2"	1/2"	ACH-805

Hose ID	Length	Order No.
1/4"	11"	ACH-401
1/2"	11"	ACH-801

Coolant & Solvent Pumps

170 Gal. Per Hour Pump

- HP: 1/125
- Capacity: 170 gal/hr. at 1" depth • Hi-temp Seals
- Voltage: 115
- Size: 4" x 3 1/4" x 2 3/4"
- Order No. **COP-166**



1200 Gal. Per Hour Pump

- HP: 1/6
- Capacity: 1200 gal/hr. at 1" depth
- Voltage: 115
- Size: 7 3/4" x 6 1/8" x 4 5/16"
- Order No. **COP-1833**



Sludge Filter Bag

- Fits any machine with a coolant sump
- Replace costly OE filters with this economical, universal sock
- Adds filtration to machines that don't have enough • 8" x 24" polyester knit sock
- Order No. **SB-1**



Great All-Purpose Cleaner!

Ideal for Cleaning

- Carbon Build-Up
- Coolants
- Dirt
- Grease
- General Oil
- Cutting Oil
- Lubricants
- Silicone / Greases
- Sulfur / Chlorinated Oils
- Water-Soluble Oils
- Rubber
- Tire Marks
- Smoke Residue

Multi-Purpose Parts Degreasing Detergent

- Highly versatile detergent cleans a variety of things in and around your shop - floors, machines, parts, countertops, benchtops and more
- 1 gallon detergent concentrate typically yields up to 65 gallons of cleaner
- **Not for use in Jet Wash**

Size	Order No.
1 Gallon (3.78L)	PD-10
5 Gallons (18.39L)	PD-50



Liquid Dilution Rates

Normal Soils:
2 to 4 oz. to 1 gal. water

Heavy Soils:
4 to 8 oz. to 1 gal. water

Extreme Soils:
8 to 12 oz. to 1 gal. water

Cleaning Solutions



Defoaming Agent Stops Foaming In Coolants

- For jet washers, air-agitated hot tanks and coolant sumps
- Highly concentrated – start with 1 ounce in 50 gallons

Size	Order No.
8 oz. / 236.6mL	D-FOAM-10
1 gallon / 3.78L	D-FOAM-128

Pro Jet Spray Cleaning Powder

- Heavy-duty • Non-caustic
- Penetrates to emulsify encrusted dirt, grease and oil on cast iron & aluminum
- Won't foam excessively
- Additives prevent scale build-up in jet spray components
- Use to maximum 165° F/ 73.9° C
- Mix ratio: 4 oz. powder to 1 gallon of water
- 50 lb. / 22.68 kg pail
- Order No. **PJS-50**



Concentrated Hot Tank Detergent Powders For Ferrous Parts

- Strong alkaline
- Removes dirt, heavy oil, grease, carbon, light rust and paint
- Mix ratio 1/2 lb. powder to 1 gal. of water
- 25 lbs.
- Order No. **D-Ci25**



Concentrated Hot Tank Detergent Powders For Non-Ferrous Parts

- Safe on aluminum & sensitive metals, rubber & plastic parts
- Removes heavy grease and oil
- 50 lb. pail
- Mix ratio: 1/4 lb. powder to 1 gallon of water
- Order No. **D-AL50**



Micro Biostat

- Controls bacteria and fungus in coolant reservoirs
- Treat at 1 oz. per 5 gallons of capacity
- Operate machine for 30 minutes then empty the reservoir
- Refill with coolant and treat 1 oz. per 10 gallons
- Re-treat every 10 days to 2 weeks as needed so it can't happen again
- 20 oz. / 591.5mL bottle
- Order No. **GBP-20**



pH Test Strips

- Easy to use • 100 tests per package
- Use the handy guide on the box to determine pH between 0 and 14
- Order No. **HT-PH**



tech tips

from the techxperts™

Pay attention to the mix ratio on cleaning products!

It's important that you start mixing on the weak side and work your way up. An overly strong concentration is just as ineffective as an overly weak mixture. Use pH Test Strips to check the concentration.

CYLINDER HEAD
REBUILDING

CLEANING,
ASSEMBLY & SAFETY

SHORT BLOCK
REBUILDING

CRANKSHAFT/
FLYWHEEL, GRINDING

MISCELLANEOUS
TOOLS & SUPPLIES

BRAKE SERVICE
TOOLING

MEASURING
TOOLS

V-TWIN & METRIC
HARD PARTS



"I make sure that all Goodson products are packaged properly and include instructions or important information that is useful to our customers."

- Jill, Goodson Receiving Department - 15 years of service

CYLINDER HEAD
REBUILDING

Organize, Clean And Store Small Parts With GOODSON

Small Parts Baskets

- Galvanized, welded ¼" mesh
- Withstands most solvents
- Not for use in caustics



Small Basket with Lid

- 2½" dia. x 7" L
- Order No. **PWB-2**



Medium Basket with Lid

- 4½" dia. x 7" L
- Order No. **PWB-4**

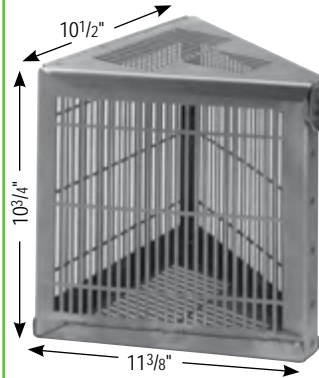

Jet Wash Parts Basket Makes a 24" Circle

- Triangle-shaped • Sit side by side on Jet Wash table
- Fit more baskets in the machine to clean faster
- Order No. **JWB-6**

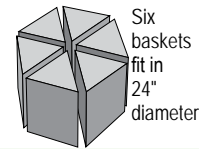

CLEANING,
ASSEMBLY & SAFETY



Single Basket with Handle

- 8" dia. x 9" L
- Lid & clip sold separately
- Order No. **PWB-10**

SHORT BLOCK
REBUILDING

CRANKSHAFT/
FLYWHEEL GRINDING

Single Basket with Lid, Clip & Handle

- 8" dia. x 9" L
- Order No. **PWB-15**



MISCELLANEOUS
TOOLS & SUPPLIES

Double Basket with Clip

- 9" dia.
- 16" L
- Hinged on one side
- Order No. **PWB-25**



BRAKE SERVICE
TOOLING



Lid & Clip

- For PWB-10
- Order No. **PWB-10L**

Clip Only

- Order No. **PWB-15C**

MEASURING
TOOLS

Machine Washable Cotton Shop Towels

- 15" square
- Highly absorbent
- Hundreds of uses
- Color may vary



V-TWIN & METRIC
HARD PARTS

Disposable Assembly Wipes

- Snow-white
- Pop-up box • 9" x 17"
- Ideal for a multitude of uses at the shop, at the track, even at home!



Quantity	Order No.
5 Pack	WST-5
50 Pack	WST-50

Quantity	Order No.
100	AW-100
220	AW-250

Flock Lined Nitrile Parts Gloves

- Nitrile exterior with diamond grip pattern
- Flock lined • Won't swell • 13" long
- Safe for solvents • Sold as pairs

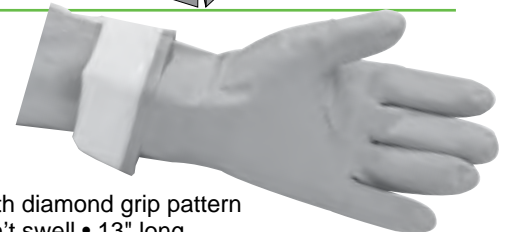

Size	Order No.
Large	PWG-SOL-L
X-Large	PWG-SOL-XL

Get the Right Size Gloves

Size	Inches
L	3.5" to 4.0"
XL	3.9" to 4.4"



Unlined Nitrile Gloves

- 8 mil thick textured Nitrile
- Dispenser style box holds 50 gloves
- 12" Long • Fit either hand
- Not for prolonged direct exposure to harsh chemicals



Size	Qty.	Order No.
Large	50	PNGL-L
X-Large	50	PNGL-XL

Shrink Wrap

- Easy-to-use
- High-clarity film
- Keep machined surfaces clean
- Protects from dirt, dust and moisture
- No need to stock several bag sizes



Size	Order No.
5" x 1000' w/ Extended Core	SW-5
18" x 1500' with 3" core	SW-18

Parts Organization & Cleaning



Parts Tags & Marker

- Won't tear or wash off
- Heavy wire ties
- Tough enough to go through a jet wash or hot tank

- Includes 2 Super-Permanent markers with specially formulated ink to withstand most chemicals and extreme heat and steam up to 500°F
- Tag dimensions: 3 1/2" L x 5/8" W with 5/32" hole for wire tie

Description	Order No.
1000 Parts tags, with 2 markers	IDT-1000
Super-Permanent Marker only	IDT-MARKER

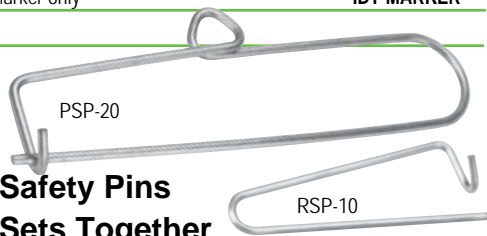

Organizer Safety Pins Keep Part Sets Together

- Parts Safety Pin** • Organize valve springs, rods, etc., from disassembly to cleaning to reassembly
- Rod & Cap Mini Pin** • Keep connecting rods & rod caps together to prevent mix-ups

Description	Order No.
Parts Safety Pin (3 3/4" x 12")	PSP-20
Rod & Cap Mini Pin (3/4" x 4")	RSP-10



Engine & Parts Storage Bags

- Rugged, 3-mil thickness resists tearing
- Engine bags feature 4-mil thickness for extra strength
- Protects your professional work

- Waterproof • Protect finished work from damage • 4 sizes fit most common rebuilt assemblies • Jumbo engine bags are extra-strong and big enough to accommodate complete engines • Jumbo head bags fit the largest cylinder heads
- Ideal for storing heads, cranks, blocks, etc.

Size	Description	Quantity	Order No.
16" x 37"	Heads, cranks, misc.	box of 100	BC-15
17" x 44"	Jumbo head bag	roll of 100	BC-17
27" x 18" x 36"	Box-style for blocks	box of 50	BE-20
44" x 52"	Jumbo engine bag	roll of 50	BE-44

String Micron Filters

- 2.5" x 10" L to fit all standard 10" filter housing units including UltraSonic, LLC models 2400FA, 3200FA, 3800FLT and 6000FLT
- String wound filters offer high structural strength to withstand severe operating conditions

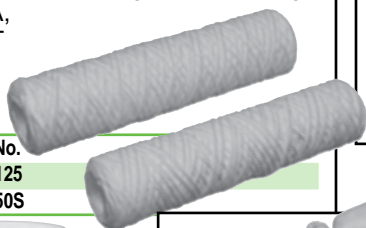

Description	Order No.
125 Micron Filter	USCF-125
50 Micron Filter	USCF-50S

ULTRA 1300
 Dimensions: 13"Lx10.5"Wx12"H
 Basket Frame: 10.75"Lx9"Wx3.9"D
 Working Depth: 5.5"
 Volume: 2.6 Gal.
 Ultrasonic Power: 200W
 Electrical: 120V
 Heater: 400kW



Ultrasonic Detergents

- Safe for ferrous metals & aluminum
- Medium Duty can be used on plastic
- For ultrasonic immersion tanks
- Medium Duty includes rust preventive
- 5 gallons / 18.39L containers



Description	Mix Ratio	Order No.
Medium Duty	1:20	USD-MD50
Heavy Duty	1:10	USD-HD50
Caustic	1:10	USD-CD50

Replacement Cartridge Filters (2 1/8" x 9"L)

Filtration	Order No.
30 microns	USF-30*
50 microns	USF-50*

*will not fit Tabletop Ultrasonic Cleaners at right

3" x 14" Oil Absorbent Tube

- Remove excess oil from your Ultrasonic Cleaner • Replace every 4 to 12 weeks as needed
- Order No. OA-1-SM



Table Top Ultrasonic Cleaners

- Digital Touch Controls
- Stainless Steel Construction
- Operator-Controlled Pause Function
- Movable Basket • Timed Cycles
- Auto Safety Shut-off

Description	Order No.
ULTRA 1300	USC-1300
ULTRA 2000	USC-2000
Oil Absorbent Tube	OA-1-SM

ULTRA 2000
 Dimensions: 21.5"Lx13"Wx12"H
 Basket Frame: 18.25"Lx10"Wx3.9"D
 Working Depth: 5.5"
 Volume: 5.2 Gal.
 Ultrasonic Power: 400W
 Electrical: 120V
 Heater: 500kW



CYLINDER HEAD
REBUILDING

CLEANING,
ASSEMBLY & SAFETY

SHORT BLOCK
REBUILDING

CRANKSHAFT/
FLYWHEEL, GRINDING

MISCELLANEOUS
TOOLS & SUPPLIES

BRAKE SERVICE
TOOLING

MEASURING
TOOLS

V-TWIN & METRIC
HARD PARTS

NEW



Last Blast Spray Paint

- Quick-dry formula lets you handle parts in minutes
- Pigment won't smudge
- Resists abrasion, corrosion and most solvents
- Paint heads, blocks and parts just like OE
- Withstands heat up to 250°F/121.1°C
- 12 oz. cans
- **Last Blast** restores a "fresh from the bead-blaster" look to all types of cast iron
- **Aluminum Last Blast** makes aluminum heads and parts look new
- **Color Last Blast** in popular, factory colors
- Aerosol*

Color	Order No.
Cast Iron Gray	LB-1*
Aluminum Gray	ALB-1*
GM Black (Gloss)	CLB-58*
Ford/Chrys. Red	CLB-59*
Ford Blue	CLB-60*
Chevy Orange	CLB-61*

*Hazardous Goods Fees Apply When Shipped By Air

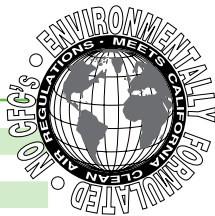

Hi-Temp Last Blast

- Hard, chemical-resistant finish
- Withstands continuous heat up to 1200°F/648.9°C
- Won't deteriorate like ordinary paints
- For blocks, manifolds or any external parts subjected to high heat
- Dries tack-free in 10 min., then heat at 450°F/232.2°C for 1 hour to create a professional, durable finish
- Aerosol*

Color	Order No.
Cast Iron Gray	LB-1-HT*
Aluminum Gray	ALB-1-HT*
Black (Matte)	CLB-58-HT*

*Hazardous Goods Fees Apply When Shipped By Air



Metal Markers

- No shaking needed
- Quick drying
- Withstands oil, grease and surface contact
- Won't lose its brilliance or legibility



Color	Order No.
Orange	MM-STD
Black	MM-010
Yellow	MM-030
White	MM-050
Green	MM-060
Red	MM-070
Blue	MM-080

High-Performance Hylomar® Gasket Maker & Thread Sealer

- Maintains seal integrity up to 600°F / 315.5°C
- Polyol-based compound turns from a gel into flexible putty within minutes of application
- Non-hardening formula is impervious to oil, gasoline, glycol and other engine fluids
- Oxygen-sensor safe
- Seals gaps .01" or less
- 100 gram tube
- Order No. **HBS-1**



2" Dispensing Pliers for Flexible Tubes

- Maximizes the use of all the material in the tube due to its effective means of application
- Dispenses the thickest sealant through a very small opening, permitting better application control
- Reduces both cleanup time and the possibility of skin contact or other problems caused by excess material squeeze-out
- Order No. **EB-416**



Disposable Assembly Wipes

- Snow-white
- Shows dirt easily
- Pop-up box
- 9" x 17"
- Ideal for a multitude of uses at the shop, at the track, even at home!



Quantity	Order No.
100	AW-100
220	YOUR BEST VALUE! AW-250

Assembly & Break-In

Press Fit Lube

- A light coat eases press fit
- Ideal for valve guides, piston pins, cylinder sleeves, etc.
- Eliminates the scoring, gouging and galling of parts during press fitting
- 6 oz. / 177.4mL • Aerosol*
- Order No. **PFL-200**

*Hazardous Goods Fees Apply When Shipped By Air

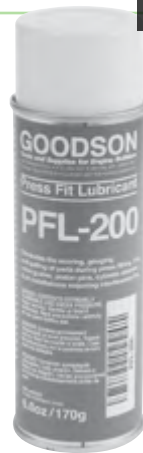

Press Fit Lubricant

- A light coat eases assembly
- Multiple applications
- Eliminates scoring, gouging and galling of parts during press fitting

Description	Order No.
Aerosol 7 oz. / 207 mL	B-200*
Brush Applicator 200 mL	B-200L

*Hazardous Goods Fees Apply When Shipped By Air



Extreme Pressure Lube

- Withstands pressures up to 50,000 PSI
- Highly refined petroleum product
- Contains no lead, graphite or minerals
- Won't corrode fine surfaces or emulsify with cooling liquids
- Surfaces stay lubed and protected
- In a grease form • 4 fl. oz. / 118.29mL
- Order No. **EPL-4**

Universal Gel Lube

- Sprays on as a liquid and forms into a gel within seconds
- Penetrating formula blends with motor oil
- Multiple uses, including cams, lifters, rocker arms, bearings, pistons/wrist pins, cylinders, etc.
- Provides lubrication for engines subjected to prolonged storage before initial start-up
- Aerosol*
- Order No. **GL-8U**

*Hazardous Goods Fees Will Apply if Shipped By Air



First Lube Engine Assembly Lube

- Prevent dry engine start-ups after long-term storage
- Contains Zinc and Moly
- Clings and forms a slick wall between moving parts
- Withstands start-up pressure
- Compatible with all motor oils

Size	Order No.
8 oz. / 236.6mL	FL-10
1 gallon / 3.78L	FL-128



Cam-Shield® Camshaft Assembly Paste

- Provides anti-wear protection for camshafts during break-in
- 2500 parts per million of Zinc
- Use with mechanical and hydraulic camshafts & lifters
- For racing, street, classic, agricultural, diesel and marine camshafts

Size	Order No.
5/8 oz. / 22.18mL Packet	CSAP-625
4 oz. / 118.29mL Brush Top Jar	CSAP-4



Blood Friction Master® Engine Assembly Lube

- Contains a low friction additive (PTFE) for dry start-ups
- Ideal for long-term storage
- Forms a slick wall between moving parts
- Clings until dissolved by oil
- Withstands start-up pressure
- Compatible with all motor oils
- Ideal for high performance

Size	Order No.
8 oz./236.6 mL w/brush	AL-22-8
1 gal./3.78 L w/pump	AL-22-10



Spray Assembly Lube

- Ideal for prelubricating parts to ease assembly
- Eliminates critical initial run-in of new and rebuilt high-performance engine components
- Spray on bearings, crankshafts, pistons, rings, etc.
- Aerosol* • Order No. **SAL-11**

* Hazardous Goods Fees Apply If Shipped By Air



CYLINDER HEAD REBUILDING
CLEANING, ASSEMBLY & SAFETY
SHORT BLOCK REBUILDING
CRANKSHAFT/PISTON GRINDING
MISCELLANEOUS TOOLS & SUPPLIES
BRAKE SERVICE TOOLING
MEASURING TOOLS
V-TWIN & METRIC HARD PARTS



"We offer every customer the opportunity to open a Goodson account for faster, easier ordering and to save you money on C.O.D. shipments. Call today for details!"

- Diane, Goodson Customer File Maintenance - 17 years of service

CYLINDER HEAD REBUILDING
CLEANING, ASSEMBLY & SAFETY
SHORT BLOCK REBUILDING
CRANKSHAFT/ FLYWHEEL GRINDING
MISCELLANEOUS TOOLS & SUPPLIES
BRAKE SERVICE TOOLING
MEASURING TOOLS
V-TWIN & METRIC HARD PARTS

Flex-Hones® For any type and size of cylinder

- Abrasive globules each have independent suspension
- Self-centering • Self-aligning • Self-compensating for wear
- Applications are interchangeable, select bore size
- Right Hand rotation only
- **Brake Rotor Flex-Hones®**, pg. 114
- **Plateau Soft Hones**, pg. 33 & 81
- **Honing Oil**, pg. 73

Silicon-Carbide

Ideal for all materials including cast iron, bronze, phosphor bronze and aluminum.

Aluminum-Oxide

Ideal for hard surfaces such as Nicasil and hardened steel

Diamond

Ideal for heat treated steel, high nickel stainless steel, chromes or plated bores, MMX aluminum alloys, ceramics and carbide

Ordering The Right Flex-Hone®

SIZE: Order by actual cylinder ID. All Flex-Hones® are produced oversize. If your cylinder ID is non-standard, order the next larger size. For example, for a cylinder that has been machined to 3 3/8" diameter, order a 3 1/2" cylinder hone. The "flex" that's built into the Flex-Hone® will adjust to the size difference. **NOTE:** If purchasing the 120 Grit Heavy Duty Flex-Hones®, order on cylinder size. **APPLICATION:** Typically, when using chrome or cast iron rings, you should use 120 grit Flex-Hones®; when using Moly rings, use 240 or 320 grit Flex-Hones®.

Heavy Duty 320 Grit Flex-Hones®

- Silicon-Carbide • Order on size

Size	OAL	Order No.
4"	13 1/2"	BGD-400320
4 1/4"	13 3/4"	BGD-425320
4 1/2"	13 7/8"	BGD-450320

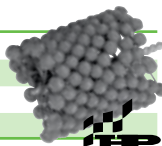

Valve Guide Flex-Hones®

- Kit includes the most popular sizes for valve guide work

	400 Grit Diamond	320 Grit Silicon-Carbide	240 Grit Silicon-Carbide
Size mm	OAL	Order No.	Order No. Incl.
6 Pc. Valve Guide Kit			VG-FKIT ▼
1 1/64"	4.5 6"	-----	VG-F-4.5MM
1 3/64"	5.0 8"	-----	VG-F-5MM
7/32"	5.5 8"	-----	VG-F-5.5MM
1/4"	6.4 8"	VGFD-6.4MM	VG-F-6.4MM x
9/32"	7.0 8"	VGFD-7MM	VG-F-7MM x
5/16"	8.0 8"	VGFD-8MM	VG-F-8MM x
11/32"	9.0 8"	VGFD-9MM	VG-F-9MM x
3/8"	10.0 8"	VGFD-10MM	VG-F-10MM x
7/16"	11.0 8"	-----	VG-F-11MM x
15/32"	12.0 8"	-----	VG-F-12MM
1/2"	12.7 8"	VG-F-12.7MM	-----
33/64"	13.0 8"	-----	VG-F-13MM
9/16"	14.0 8"	-----	VG-F-14MM
19/32"	15.0 8"	-----	VG-F-15MM

Right Hand Rotation Only!

For best results, always use with an ample flow of honing oil.

		Silicon-Carbide						Aluminum Oxide					
		120 Grit Standard		120 Grit Heavy-Duty		180 Grit Standard		180 Grit - Long		320 Grit Standard		240 Grit Standard	
Size	mm	OAL	Order No.	OAL	Order No.	OAL	Order No.	OAL	Order No.	OAL	Order No.	OAL	Order No.
5/8"	15.9					8"	BH-625						
3/4"	19.1					8"	BH-750						
13/16"	20.6					8"	BH-820						
7/8"	22.2					8"	BH-875						
1"	25.4					8"	BH-1000						
1 1/8"	28.6					8"	BH-1125						
1 1/4"	31.8					8"	BH-1250			8"	BG-125320		
1 1/2"	34.9					8"	BH-1375						
1 5/8"	38.1					8"	BH-1500						
1 3/4"	41.3					8"	BH-1625						
1 7/8"	44.5					8"	BH-1750	17 1/2"	CBF-175				
2"	50.8	8"	BG-210			8"	BH-2000	17 1/2"	CBF-200				
2 1/4"	57.2	8"	BG-225			8"	BH-2250	17 1/2"	CBF-225	8"	BG-225320	8"	BA-225240
2 1/2"	60.2											8"	BA-237240
2 3/4"	63.5	8"	BG-250			8"	BH-2500	17 1/2"	CBF-250			8"	BA-250240
2 7/8"	66.5											8"	BA-262240
3"	69.8	8"	BG-275			8"	BH-2750	17 1/2"	CBF-275			8"	BA-275240
3 1/4"	76.2	8"	BG-300	13 1/2"	BGD-300					8"	BG-300320	8"	BA-300240
3 1/2"	82.6	13 1/2"	BG-325	13 1/2"	BGD-325					13 1/2"	BG-325320	13 1/2"	BA-325240
3 3/4"	88.9	13 1/2"	BG-350	13 1/2"	BGD-350					13 1/2"	BG-350320	13 1/2"	BA-350240
4"	95.3	13 1/2"	BG-375	13 1/2"	BGD-375					13 1/2"	BG-375320	13 1/2"	BA-375240
4 1/8"	101.6			13 1/2"	BGD-400								
4 1/4"	104.8	13 1/2"	BG-418							13 1/2"	BG-418320	13 1/2"	BA-418240
4 1/2"	107.9			13 1/2"	BGD-425								
4 3/4"	114.3	13 1/2"	BG-438							13 1/2"	BG-438320		
4 7/8"	114.3			13 1/2"	BGD-450								
5"	117.5	13 1/2"	BG-462							13 1/2"	BG-462320	13 1/2"	BA-462240
5 1/8"	127.0			17 1/2"	BGD-500								
5 1/4"	139.7			17 1/2"	BGD-550								
6"	152.4			17 1/2"	BGD-600								
6 1/2"	165.1			17 1/2"	BGD-650								



Coolants and Lubricants

We don't stock one type of coolant and claim that it suits all types of grinding, nor do we carry one type of oil and try to sell it for every application. Each of our many types of coolants, lubricants and oils is formulated to deliver better results and longevity in its specific use. All of our coolants prolong the life of grinding wheels, retard corrosion and rancidity. Colors may vary. **Note: Dilution ratio is water to coolant.**

All-Purpose Grinding Coolant

A synthetic water soluble coolant that "Licks Rust". Dilute 30:1

Size	Yield	Order No.
1 gal.(3.78L)	30 gallons	CGC-1288
5 gal.(18.9L)	150 gallons	CGC-5288

Crank & Cam Grinding Coolant

Synthetic, non-nitrate, high lubricity coolant. Dilute 20:1

Size	Yield	Order No.
1 gal.(3.78L)	20 gallons	CGC-10
5 gal.(18.9L)	100 gallons	CGC-50

Multi-Duty Grinding Coolant

Medium-duty, low foaming, synthetic coolant with rust inhibitors. Safe for ferrous and non-ferrous metals alike. No nitrates, phenols, chlorine or sulfur. Dilute 30:1

Size	Yield	Order No.
1 gal.(3.78L)	30 gallons	GPC-10
5 gal.(18.9L)	150 gallons	GPC-50

Belt-Resurfacing Coolant

For all belt-type resurfacers with or without down-pressure. Dilute 30:1

Size	Yield	Order No.
1 gal.(3.78L)	30 gallons	SGB-10
5 gal.(18.9L)	150 gallons	SGB-50

Resurfacing Coolant

Non-foaming, non-nitrate coolant for single-piece or resurfacing wheels. Dilute 20:1

Size	Yield	Order No.
1 gal.(3.78L)	20 gallons	SGC-10
5 gal.(18.9L)	100 gallons	SGC-50

Flywheel Grinding Coolant

Includes a synthetic rust inhibitor that prevents rancidity. For all flywheel grinders. Dilute 30:1

Size	Yield	Order No.
1 gal.(3.78L)	30 gallons	FG-1101-G
5 gal.(18.9L)	150 gallons	FG-1102-G

Cutting Oils

Knurlube

Lubricate while knurling.

Size	Order No.
8 oz.(236.6mL)	WLB-46-G
32 oz.(946.4mL)	WLB-47-G

Cutting Aids (Aerosol*)

Helps tools cut through the hardest of metals. Clings to the surface of the tool, keeping it cool while prolonging its life.

Size	Order No.
Cutting & Tapping Fluid	CTF-14*
Resurfacing Spray	HPS-16*

*Hazardous Goods Fees Apply If Shipped By Air

Valve Seat Cutting Fluid

High-silicone lube reduces drag on cutters for a better finish, longer tool life. Dilute 9:1. Water soluble.

Size	Order No.
16 oz.(473.2mL)	SCF-2
1 gal.(3.78L)	SCF-10

Bronze Reaming Oil

Cuts bronze build-up while reaming. Longer tool life. Better valve guide finish.

Size	Order No.
16 oz.(473.2mL)	BW-303-G
32 oz.(946.6mL)	BW-303A-G
1 gal.(3.78L)	BW-305-G

Lap Oil

This very fine oil prolongs the life of diamond laps. A light coat cools, lubricates and prevents wear.

Size	Order No.
4 oz.(118.3mL)	LP-LO-4
8 oz.(236.6mL)	LP-LO-8

Tap Oil

Makes tapping easier & faster. Breaks down surface tension. Eliminates scuff marks & gouging. Reduces tap breakage & improves thread quality.

Size	Order No.
7.5 oz.(221.8mL)	TAP-O

Grinding & Honing Oils (Not Water Soluble)

Cylinder Honing Oil (Clear)

Ideal for portable hones and all makes of automotive honing machines. Mixes readily with other brands (including Sunnen®).

Size	Order No.
1 gal.(3.78L)	HO-10
5 gal.(18.9L)	HO-50
55 gallons	HO-550

Rod Honing Oil (Dark Brown)

Keeps stones clean & free-cutting during rod reconditioning, pin fitting and other honing jobs. Will mix with other brands (including Sunnen®).

Size	Order No.
1 gal.(3.78L)	RHO-10
5 gal.(18.9L)	RHO-50

Titanium Valve Grinding Aid

Mix ratio of 1:4. Add to valve grinding oil.

Size	Order No.
32 oz.(946.6mL)	VGA-T32

Diamond Honing Oil (Brown)

Specially formulated to withstand the cutting pressures created when using our Diamond Valve Guide Honing System.

Size	Order No.
8 oz.(236.6mL)	DHO-8
1 gal.(3.78L)	DHO-10
5 gal.(18.9L)	DHO-50

Valve Grinding Oil (Light Yellow)

Universal valve grinding oil extends wheel life. Mineral based.

Size	Order No.
1 gal.(3.78L)	VGO-10
5 gal.(18.9L)	VGO-50

Severe Duty Valve Grinding Oil (Brown)

For grinding titanium, Inconel®, stainless steel and stellite valves.

Size	Order No.
1 gal.(3.78L)	VGO-SD10
5 gal.(18.9L)	VGO-SD50

Machine Lubricants

Flywheel Grinder Table Lubricant

Helps extend flywheel grinder life. This high-pressure oil is designed to lubricate table bearings and ways. For all makes of flywheel grinders.

Size	Order No.
1 gal.(3.78L)	FG-1131-G

Way Oil

Adhesive oil formulated to provide extended lubrication and rust protection for machine-tool ways.

Size	Order No.
1 gal.(3.78L)	WO-50

Rust Shield for Shop Equipment

Prevents rust and won't cause rancidity. Protective film mixes with coolant so you don't have to clean it off before using the machine.

Size	Order No.
1 gal.(3.78L)	RS-128

... another satisfied customer

"Outstanding customer service; Always. Goodson has gone above and beyond to assure we have the tooling we need here at the school."

- Jimmy Stray, School of Automotive Machinists & Technology, Houston, TX, Goodson customer since 1992

CYLINDER HEAD REBUILDING

CLEANING, ASSEMBLY & SAFETY

SHORT BLOCK REBUILDING

CRANKSHAFT/ FLYWHEEL GRINDING

MISCELLANEOUS TOOLS & SUPPLIES

BRAKE SERVICE TOOLING

MEASURING TOOLS

V-TWIN & METRIC HARD PARTS

WINONA VAN NORMAN, VAN NORMAN, PETERSON, KI (PK447S)

1-EDGE CUTTER BIT

Fits Model Numbers	Type	Bit Dia.	Order No.
777, 900, 905, 944, 965	General	1/4"	VN-1
777S, 777S4, 944S, CB11, BC22XL	General	3/8"	VGS-1
	Hard Sleeves	3/8"	VGS-2
	Sleeve Cutter	3/8"	VGS-3
888, 999	General	7/16"	VN-360

Original Van Norman

Fits Model Numbers	Type	Bit Dia.	Order No.
777S, 944S	Hard Sleeves	3/8"	777-179

HOLDERS FOR 6-EDGE TIPS - Use RT-6B and RT-6BT

Fits Model Numbers	Length	Height	Order No.
777, 900, 905, 944, 965	1 7/8"	3/4"	VN-135
	2 1/2"	3/4"	VN-136
777S, 777S4, 944S	2"	1 3/8"	VN-122

Bore Range: 2.65" to 4.50"

Standard Carbide Replacement Cutter Tip	RT-6B
Titanium Coated Carbide Replacement Tip	RT-6BT

MISCELLANEOUS PARTS

Fits 6-Edge Holders Above	Description	Order No.
	Bit Screw	VN-130

enlarged for clarity

KWIK-WAY

1-EDGE CUTTER BIT FOR OE HOLDERS

Fits Model Numbers	Type	Bit Dia.	Order No.
F, FT, FL, FN, FR, FS,	Rough	5/16"	KWL-R
FW, FWS, FWSII, FX	Finish	5/16"	KWL-F
Models After 1770	Sleeve Cutter	5/16"	KWL-C

HOLDER FOR 6-EDGE TIPS - Uses RT-6B or RT-6BT Tips

Fits Model Numbers	Length	Height	Order No.
FL, FN, FR, FS, FT, FW	2 1/16"	5/8"	KWL-116

Standard Carbide Replacement Cutter Tip	RT-6B
Titanium Coated Carbide Replacement Cutter Tip	RT-6BT

PETERSON-BERCO

1-EDGE CUTTER BIT FOR OE HOLDERS

Fits Model Numbers	Length	Bit Dia.	Order No.
ACP-151-A, ACP-151-BL, SCP-151-P	1 3/4"	10mm	PB-151

ROTLER

1-EDGE CUTTER BIT FOR OE HOLDERS

Fits Model Numbers	Length	Bit Dia.	Order No.
All Bars	1 3/4"	1 1/32"	RL-1
Sleeve Cutter for All Bars	1 3/4"	1 1/32"	RL-1C

HOLDER WITH 3-EDGE TIP - Includes one RL-2T Tip

Fits Model Numbers	Length	Bit Dia.	Order No.
All Bars	1 1/4"	1 1/32"	RL-2H
Replacement Screw for RL-2H			RL-2S
Replacement Cutter Tip			RL-2T

STORM-VULCAN

1-EDGE CUTTER BIT FOR OE HOLDERS

Fits Model Numbers	Length	Bit Dia.	Order No.
NS, BCG, BCT, 220, 260	3/4"	5/16"	S-1

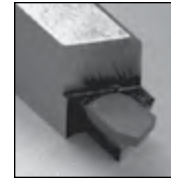

Single-Piece (Solid) Style

Holder with integral cutting bit. Excellent cutting performance. Resharpenable. When no longer usable, replace entire cutter.



1-Edge Replaceable Type

Tool holder with separate bit. Excellent cutting yet economical. Resharpener the cutter bit many times. When no longer usable, replace only the bit.

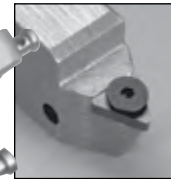

6-Edge Replaceable Type

Lowest-cost choice. Holders take 6-edge, replaceable tips. When one edge wears, turn to new surface. Never need to resharpen - just replace the tip.

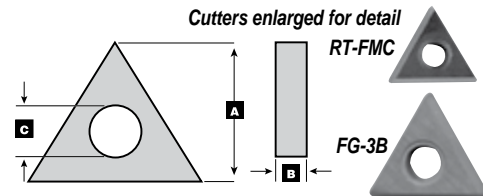

Replacement Tips & Parts

• Fit most boring bar holders

A	B	C	Edges	Order No.
Standard Carbide				
.358"	.097"	.108"	3	SEQ-1
.345"	.094"	.140"	6	RT-6B
.447"	.124"	.149"	3	RT-FMC
.360"	.094"	.124"	3	FG-3B
.327"	.094"	.140"	3	RL-2T
Titanium Coated				
.345"	.094"	.140"	6	RT-6BT

Van Norman, Peterson or Kansas Instruments OE Catspaw Screws For 777S or PK-447S & 944S

Description	Order No.
Catspaw Screws (1 each)	
For #1 Shoe (0.625"L)	800-114
For #2 Shoe (0.740"L)	800-115
For #3, 4 & 5 Shoe (0.940"L)	800-116



Use with diamond abrasives



Mineral Based Honing Oil

- Formulated for general purpose automotive machine shop honing
- Excellent for con rods, piston pins, king pins or general shop honing
- Compatible with most popular honing machines
- 5 Gal. (18.93L)
- Order No. **MAN-845**



Honing Oil Concentrate

- Formulated for general purpose automotive machine shop honing
- Compatible with most popular honing machines
- Add your own Mineral Oil
- Mix Ratio: 10:1 for MAN-845-5 and 2:1 to make MB-30-5
- 5 Gal. (18.93L)
- Order No. **MAN-C**



Mineral Based Multi-Purpose Honing Oil

- High performance lubricity agents with sulfur extreme pressure additives
- Won't weld or tear the work-piece
- Works on metals from aluminum to zirconium
- 5 Gal. (18.93L)
- Order No. **MB-30**



Water Based Honing Coolant Concentrate

- Suitable as a grinding coolant or general purpose metal working fluid for ferrous and non-ferrous parts
- 5 Gal. (18.93L) makes up to 55 gal.
- Mix Ratio: 10:1

	Order No.
Hardened Steel	SCC-205
Cast Iron	SCC-605



Vegetable Based Honing Oil

- Petroleum free, ideal for general use
- No additives such as sulfur, chlorine or fluorine
- Can be used with conventional vitrified honing abrasives and metal-bond superabrasives
- 5 Gal. (18.93L)
- Order No. **SHO-500**

CYLINDER HEAD REBUILDING
CLEANING, ASSEMBLY & SAFETY
SHORT BLOCK REBUILDING
CRANKSHAFT/ FLYWHEEL GRINDING
MISCELLANEOUS TOOLS & SUPPLIES
BRAKE SERVICE TOOLING
MEASURING TOOLS
V-TWIN & METRIC HARD PARTS

Tensioner Stop Block for Chrysler 2.7 DOHC

- Eliminate broken timing chains, bent valves and chain backlash
- For VIN code R, U & V
- Mechanically supports hydraulic adjusters
- Use with plunger screw or bottom plate tensioners



Application	Order No.
For New Chain & Tensioner	DT-27
For Used Chain (modifications may be required)	DT-27U

Diamond Laps & Accessories for Rottler

- A light lap oil coat cools and lubricates
- Remove build-up with lint-free cloth and Dressing Stick while lap rotates

Diamond Laps		
Machine	OD ID	Order No.
Rottler	1 3/4" 1/4"	LP-RFA
Accessories		
Very Fine Lap Oil (4 fl. oz.)		LP-LO-4
Very Fine Lap Oil (8 fl. oz.)		LP-LO-8
Dressing Stick		LP-DS

Other Diamond Laps available by Special Order



Boring Bar O-Ring Cutter Replaceable Tool Bits & Holders

- Cut grooves for O-rings to enhance gasket sealing for high-performance engines • Machines a groove .037" wide.

Description	Application	Order No.
Tool Bits	Standard	KWVN-57
	Premium	KWVN-57C6

To avoid breakage, use the standard cutter on cast iron blocks only and the Premium cutter on hard blocks. **CAUTION:** Avoid column drop as this will break the tips as well.



Fine Lapping Oil

- A fine, light oil
- Apply lightly to cool and lubricate

Description	Order No.
Very Fine Lap Oil (4 fl. oz.)	LP-LO-4
Very Fine Lap Oil (8 fl. oz.)	LP-LO-8



1 lb. Roll Copper or Stainless Steel O-Ring Wire

- Copper: .0403" dia.
- Stainless: .0410" dia.

Description	Order No.
Copper	OWC-0403
Stainless Steel	OWS-041



tech tips
from the techxperts™

- 1 - Extend the range of your hone with the Master Holder and Stone Supports on the bottom of page 77
- 2 - Use with 1/2" non-pistol grip drill
- 3 - Heavy Duty units can also be used in manual hone cabinets

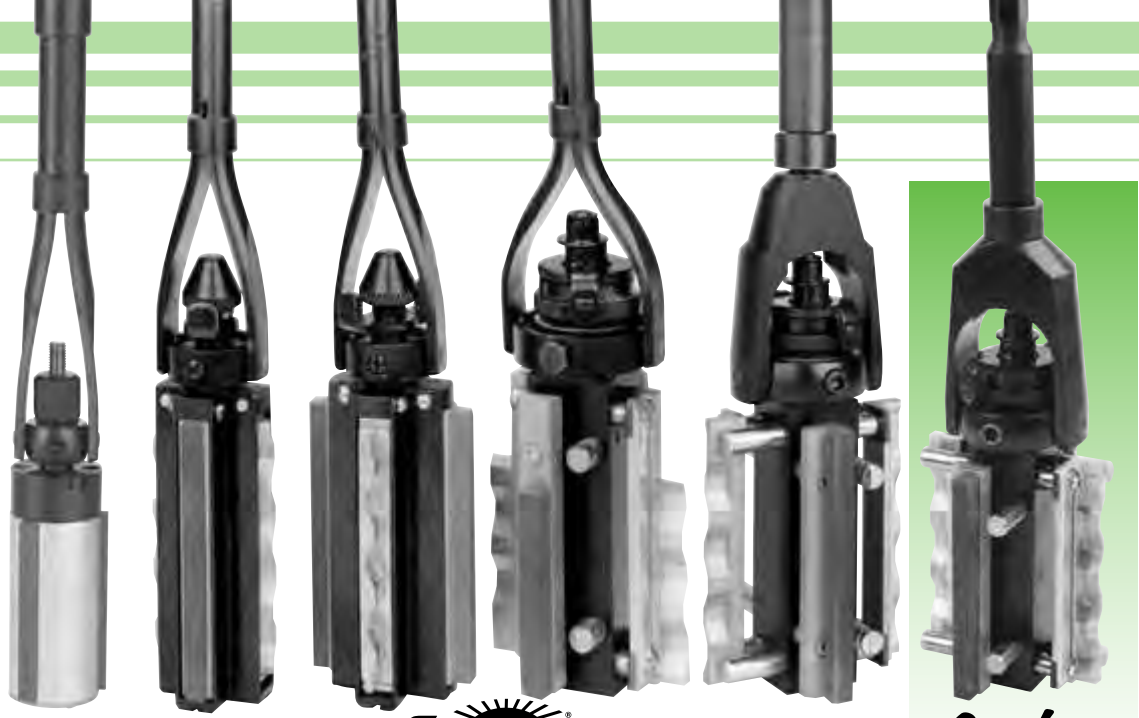
**SUNNEN****Goodson
exclusive****Portable Cylinder Hone Mandrels** (stones sold separately)

Shaft extensions available.

	Junior Midget	Midget	Junior	Standard	Heavy-Duty	Heavy-Duty
Brand	Sunnen®	Sunnen®	Sunnen®	Sunnen®	Sunnen®	Goodson
Honing Range	1.25" - 1.75"	1.75" - 2.00"	2.00" - 2.60"	2.50" - 5.50"	2.50" - 5.50"	2.50" - 5.50"
Drive Shank	2.00" (incl.)	2.00" (incl.)	2.00" (incl.)	2.00" (incl.)	6.00" (incl.)	6.00" (incl.)
Drive Extension	12.00" (incl.)	12.00" (incl.)	12.00" (incl.)	12.00" (incl.)	12.00" (incl.)	12.00" (incl.)
Thread	3/8" - 14	3/8" - 14	3/8" - 14	3/8" - 14	3/8" - 11	3/8" - 11
Order No.	SNJ-10	SN-75	JN-95	AN-112	AN-815	GH-2555

NOTE: Goodson is only authorized to ship Sunnen® products within the Western Hemisphere



Worldwide Shipping

**SUNNEN****Mineral Based
Honing Oil**

- Formulated for general purpose automotive machine shop honing
- 5 gallons / 18.93L
- **Not** water soluble
- Order No. **MAN-845**

**Clear Mineral Based
Honing Oil**

- Helps keep stones clean and free-cutting
- Ideal for portable hones and all makes of automotive honing machines
- Mixes easily with other brands, including Sunnen®
- **Not** water soluble

Size	Order No.
1 Gal./3.78L	HO-10
5 Gal./18.9L	HO-50

**Honing Stones**

- Sets have 2 holders with 4" integral stones
- and 2 holders with aluminum wipers
- Ideal for Cast Iron

SUNNEN

Grit	Range	mm	Finish	Sunnen	Order No.
For Sunnen® Junior Midget Hone (SNJ-10)					
150 Grit	1.25" - 1.44"	31.8-36.6	45 Ra	----	SNJ1-J45
	1.42" - 1.60"	36.1-40.6	45 Ra	----	SNJ2-J45
	1.58" - 1.77"	40.1-44.9	45 Ra	----	SNJ3-J45
400 Grit	1.25" - 1.44"	31.8-36.6	8 Ra	----	SNJ1-J87
	1.42" - 1.60"	36.1-40.6	8 Ra	----	SNJ2-J87
	1.58" - 1.77"	40.1-44.9	8 Ra	----	SNJ3-J87
For Sunnen® Midget Hone (SN-75)					
70 Grit	1.75" - 2.00"	44.5-50.8	120 Ra	S18-J17	SN-100
150 Grit	1.75" - 2.00"	44.5-50.8	45 Ra	S18-J45	SN-200
220 Grit	1.75" - 2.00"	44.5-50.8	32 Ra	S18-J55	SN-300
280 Grit	1.75" - 2.00"	44.5-50.8	20 Ra	S18-J65	SN-500
400Grit	1.75" - 2.00"	44.5-50.8	8 Ra	----	S18-J87
For Sunnen® Junior Hone (JN-95)					
70 Grit	2.00" - 2.20"	50.8-55.9	120 Ra	T20-J17	JN-100
	2.20" - 2.40"	55.9-60.9	120 Ra	U22-J17	JN-101
	2.40" - 2.60"	60.9-66.0	120 Ra	V24-J17	JN-102
150 Grit	2.00" - 2.20"	50.8-55.9	45 Ra	S20-J45	JN-200
	2.20" - 2.40"	55.9-60.9	45 Ra	U22-J45	JN-201
	2.40" - 2.60"	60.9-66.0	45 Ra	V24-J45	JN-202
220 Grit	2.00" - 2.20"	50.8-55.9	32 Ra	T20-J65	JN-300
	2.20" - 2.40"	55.9-60.9	32 Ra	U22-J55	JN-301
	2.40" - 2.60"	60.9-66.0	20 Ra	V24-J65	JN-502
280 Grit	2.00" - 2.20"	50.8-55.9	20 Ra	T20-J65	JN-500
	2.20" - 2.40"	55.9-60.9	20 Ra	U22-J65	JN-501
	2.40" - 2.60"	60.9-66.0	20 Ra	V24-J65	JN-502
400 Grit	2.00" - 2.20"	50.8-55.9	8 Ra	----	T20-J87
	2.20" - 2.40"	55.9-60.9	8 Ra	----	U22-J87
	2.40" - 2.60"	60.9-66.0	8 Ra	----	V24-J87



American Made

Goodson and Sunnen® Cylinder Honing Stones For all popular AN-style Hones and Hone Bodies

- Integral holder type Honing stone sets have 4 pieces: 2 holders with stones and 2 holders with aluminum wipers • Fit Sunnen® AN Standard, AN Heavy-Duty and Goodson **GH-2555** hones • Use with honing oil
- Stones for Short or Blind Holes are 2^{13/16}" long;
All other stones are 4" long

Grit	Bore Range		Usage	Finish	SUNNEN®		GOODSON
	in	mm			Order No.	Sunnen No.	Order No.
70 Grit Roughing	2.5"-2.7"	63.5-68.6	Cast Iron	120 Ra	AN-115	G25-J17	HN-115S
	2.7"-4.1"	68.6-104.1	Cast Iron	120 Ra	AN-100	M27-J17	HN-100S
			Cast Iron	120 Ra	---	---	HN-100R ¹
			Short/Blind	120 Ra	AN-100-71	M27-J17-71	HN-102S
			Harley / VW	120 Ra	AN-100F	M27-J17	HN-100F
	3.5"-5.5"	88.9-139.7	Cast Iron	120 Ra	AN-101	N37-J17	HN-101S
			Cast Iron	120 Ra	---	---	HN-101R ¹
			Short/Blind	120 Ra	AN-101-71	N37-J17-71	HN-104S
			Hard Sleeves	55 Ra	AN-131	N37-J11	HN-131S
	Use Master Holder & Sleeve Support	4.7"-15.0"	119.4-381	Cast Iron	120 Ra	AN-106	W47-J17
Hard Sleeves				55 Ra	AN-136	W47-J11	HN-136S
150 Grit Medium	2.5"-2.7"	63.5-68.6	Cast Iron	45 Ra	AN-215	G25-J45	HN-215S
	2.7"-4.1"	68.6-104.1	Cast Iron	45 Ra	AN-200	M27-J45	HN-200S
			Short/Blind	45 Ra	AN-200-71	M27-J45-71	HN-202S
			Hard Sleeves	30 Ra	---	---	HN-230S
			Cast Iron	45 Ra	AN-201	N37-J45	HN-201S
	3.5"-5.5"	88.9-139.7	Short/Blind	45 Ra	AN-201-71	N37-J45-71	HN-204S
			Hard Sleeves	30 Ra	AN-231	N37-J43	HN-231S
			Cast Iron	45 Ra	AN-206	W47-J45	HN-206S
			Hard Sleeves	30 Ra	AN-236	W47-J43	HN-236S
	Use Master Holder & Sleeve Support	4.7"-15.0"	119.4-381.0	Cast Iron	32 Ra	AN-300	M27-J55
Short/Blind				32 Ra	AN-300-71	M27-J55-71	HN-302S
220 Grit Finishing	2.7"-4.1"	68.6-104.1	Cast Iron	32 Ra	AN-301	N37-J55	HN-301S
			Short/Blind	32 Ra	AN-301-71	N37-J55-71	HN-304S
			Cast Iron	32 Ra	AN-306	W47-J55	HN-306S
Use Master Holder & Sleeve Support	4.7"-15.0"	119.4-381	Cast Iron	32 Ra	---	---	HN-306S
			Cast Iron	20 Ra	AN-515	G25-J65	HN-515S
280 Grit Fine Finish	2.5"-2.7"	63.5-68.6	Cast Iron	20 Ra	AN-500	M27-J65	HN-500S
	2.7"-4.1"	68.6-104.1	Short/Blind	20 Ra	AN-500-71	M27-J65-71	HN-502S
			Hard Sleeves	12 Ra	AN-530	M27-J63	HN-530S
			Cast Iron	20 Ra	AN-501	N37-J65	HN-501S
			Short/Blind	20 Ra	AN-501-71	N37-J65-71	HN-504S
	3.5"-5.5"	88.9-139.7	Hard Sleeves	12 Ra	---	---	HN-531S
			Hard Sleeves	12 Ra	AN-536	W47-J63	HN-536S
			Cast Iron	20 Ra	AN-506	W47-J65	HN-506S
			Cast Iron	8 Ra	G25-J87	G25-J87	HN-615S
	Use Master Holder & Sleeve Support	4.7"-15.0"	119.4-381.0	Cast Iron	8 Ra	M27-J87	M27-J87
Hard Sleeves				5 Ra	M27-J85	M27-J85	HN-630S
Cast Iron				8 Ra	N37-J87	N37-J87	HN-601S
Hard Sleeves				5 Ra	N37-J85	N37-J85	HN-631S
400 Grit Extra Fine Finish	2.5"-2.7"	63.5-68.6	Cast Iron*	2-3 Ra	G25-C05	G25-C05	---
	2.7"-4.1"	68.6-104.1	Cast Iron*	2-3 Ra	MM33-C05	MM33-C05	---
			Cast Iron*	2-3 Ra	NN40-C05	NN40-C05	---
Cork Polishing	2.5"-3.3"	63.5-83.8	Cast Iron*	2-3 Ra	---	---	---
	3.3"-4.2"	83.8-106.7	Cast Iron*	2-3 Ra	---	---	---
	4.0"-5.6"	101.6-142.2	Cast Iron*	2-3 Ra	---	---	---

(*Cast Iron – 3 Ra., Hard Sleeves – 2 Ra., Steel– 3 Ra.)

¹Ruby Aluminum-Oxide abrasive for longer life in rough cutting use



Master Holder & Stone Supports

- Holds one 4" stone set
- Stones sold separately
- AN-365 requires use of AN-260
- Larger sizes available upon special order

Master Holder

Dia. Range Order No.

4.7"-7.0" AN-355

6.0"-9.0" AN-365

Stone Supports for AN-365

6.0"-9.0" AN-260

Note: Larger sizes available by special order.

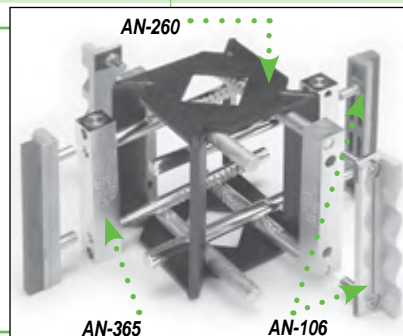

CYLINDER HEAD
REBUILDING

CLEANING,
ASSEMBLY & SAFETY

SHORT BLOCK
REBUILDING

CRANKSHAFT/
FLYWHEEL GRINDING

MISCELLANEOUS
TOOLS & SUPPLIES

BRAKE SERVICE
TOOLING

MEASURING
TOOLS

V-TWIN & METRIC
HARD PARTS



"Turn to the Goodson website to find information and place orders from anywhere at any time. And be sure to follow us on Facebook and Twitter."

- Crystal, Goodson Advertising, 4 years of service

CYLINDER HEAD REBUILDING
CLEANING, ASSEMBLY & SAFETY
SHORT BLOCK REBUILDING
CRANKSHAFT/ FLYWHEEL GRINDING
MISCELLANEOUS TOOLS & SUPPLIES
BRAKE SERVICE TOOLING
MEASURING TOOLS
V-TWIN & METRIC HARD PARTS

Keyway Honing Stone Sets

- Two-stroke engines have intake and exhaust ports that interrupt the operation of your honing stone
- These stones allow the hone to pass the intake and exhaust ports while maintaining consistent pressure to remove material accurately and easily
- Use with any AN- or GH-series hone (p. 76)
- For Cast Iron

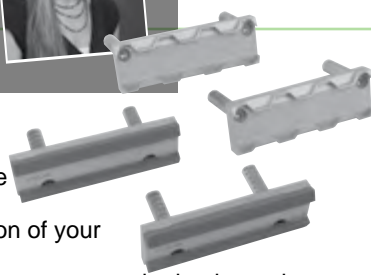

Grit	Range	mm	Finish	Type	Order No.
150 Grit	2.5" - 3.3"	63.5 - 83.8	45 Ra	Alum.	GY25-J45
Medium	3.3" - 4.2"	83.8 - 106.7	45 Ra	Alum.	MY33-J45
280 Grit	2.5" - 3.3"	63.5 - 83.8	20 Ra	Brass	GY25-J65
Fine Finish	3.3" - 4.2"	83.8 - 106.7	20 Ra	Soft	MY33-J65
400 Grit	2.5" - 3.3"	63.5 - 83.8	8 Ra	Brass	GY25-J85
Extra Fine	3.3" - 4.2"	83.8 - 106.7	8 Ra	Soft	MY33-J85

EHU
type stones

GEHN type stones



Stones & Shoes for Sunnen Hone Machines

- Premium-quality replacements for all CV-616, and CK-10 hones equipped with Sunnen® Master Holder Sets
- Diameter Range: 4.125" - 5.000" (104.8 - 127.0mm)
- Use with Master Holder Set CK-3045A (sold separately)
- 2 stones per set

Stones	Goodson - 1 set			Sunnen - 6 sets		
	Use	Grit	Finish	Order No.	Order No.	Order No.
Hard Blocks	70	60 Ra		GEHN-116	EHN-116	
Air Cooled Cyl.	70	60 Ra		GEHN-123	EHN-123	
Hard Blocks	220	22-32 Ra		GEHN-512	EHN-512	
Air Cooled Cyl.	220	22-32 Ra		GEHN-518	EHN-518	
Hard Blocks	70	60 Ra		GEHU-123	EHU-123	
Roughing	70	60 Ra		GEHU-133	EHU-133	
Hard Blocks	220	22-32 Ra		GEHU-518	EHU-518	
Gen. Purp.	220	22-32 Ra		GEHU-525	EHU-525	
Aluminum	220	30-36 Ra		GJHU-525	JHU-525	
High Nickel	280	20-25 Ra		GJHU-623	JHU-623	
Finishing	280	16-23 Ra		GJHU-625	JHU-625	
High Nickel	400	7-14 Ra		GJHU-818	JHU-818	
Aluminum	400	7-14 Ra		GJHU-820	JHU-820	
Accessories				Qty.	Order No.	
Sunnen® Master Holder Set				1	CK-3045A	
Sunnen® Centering Guide (includes CK-3070)				1	CK-3090A	
Sunnen® Guide Shoe & Screw Set				1	CK-3070	
Sunnen® Guide Shoe & Screw Set				1	CK-3120	
Goodson Wear Shoe				2	C-3070K	
Goodson Stabilizing Shoe				2	C-3120K	

For Rod Honing Stones and Shoes see page 83



Tooling for Honing Dart Blocks & Ductile Sleeves

- Recommended for Dart™ Machinery
- Use with Sulfurated Rod Honing Oil (RHO-10 or RHO-50, p. 73) for all stone applications below

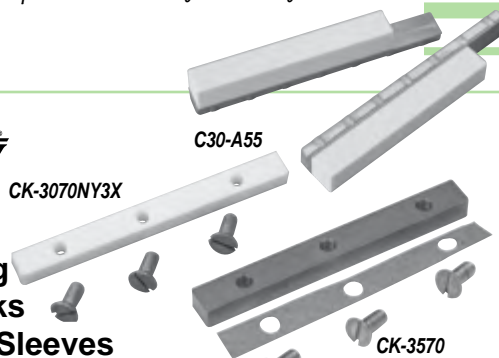

Description	Order No.
Honing Stone Sets For Portable Tooling	
80 Grit	N37-A25
220 Grit	N37-A55
280 Grit	AN-501
400 Grit	MM33-J85
For CK/CV Type Machines	
80 Grit Stone Set (6)	C30-A25
150 Grit Stone Set (6)	C30-A45
220 Grit Stone Set (6)	C30-A55
280 Grit Stone Set (6)	C30-J65
400 Grit Stone Set (6)	C30-J85
Hardened Steel Guide Shoe (1)	CK-3570
Delron® Guide Shoe (1)	CK-3070NY3X
Goodson Brand Shoes For CK/CV Type Machines	
Hardened Steel Guide Shoe (1)	GCK-3570
Delron® Guide Shoe (1)	GCK-3070NY3X

tech tips For CK & CV Machines, **DO NOT** use Bronze Guide Shoes, use from the Techxperts™ Hardened Steel and Delron shoes above (1 of each)

tech tips
from the techxperts™

Achieving a plateaued cylinder is a multi-step process. One that is far too detailed for the small space available here. Read more about this process on the Goodson Blog. Search for **Plateau Honing 101**.



Ultra-Finish Plateau Hones

- For Portable Hones, Hone Cabinets and CV/CK Tooling
- Abrasive impregnated nylon bristles
- Ideal for high-performance rebuilding and rebuilding newer style engines that use low-tension rings
- Superior plateau finish so rings will seal immediately
- Reduces break-in time
- Allows closer tolerances for improved compression, better oil control, lower emissions
- Fits AN- or GH-series hones

For Portable Hones and Hone Cabinets - Includes 1 pair			
AN/GH-Style	3.78" - 4.68"	96.0 - 118.9	MM-PHT-731
For Sunnen CV / CK Hone Heads - Includes 1 pair			
Standard	3.10" - 5.00"	78.7 - 127.0	C30-PHT-731

Note: Others available by special order.

Cylinder Boring & Honing

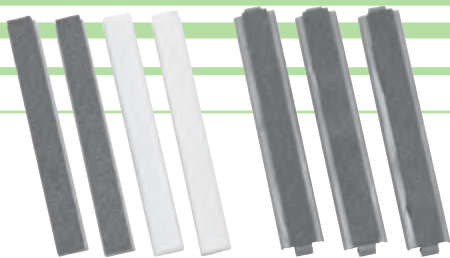

Original Ammco Honing Stone Sets

For Ammco 500 Hones

- Includes 2 stones and 2 felt wipers
- Use dry for best performance
- ½"W x 4"L

Grit	Qty	OE #	Order No.
60	4	#619	AHS-70
220	4	#620	AHS-220
400	4	#621	AHS-400

For Ammco 3800 Hones

- Includes 3 stones
- Use liberal amounts of honing oil
- Clip on • ¾"W x 4"L

Grit	Qty	OE #	Order No.
100	3	#4040	AHS-110
180	3	#3840	AHS-111
280	3	#3810	AHS-112
400	3	#3833	AHS-113

Lisle® Honing Stone Sets

- Clip-on style mounts in seconds
- 5"/127mm long stones and wipers
- Each set contains two stones and two felt wipers
- Use dry

Replaces Lisle® No.	Grit	Order No.
15500	80	HL-80
15510	180	HL-180
15520	280	HL-280
15590	500	HL-500

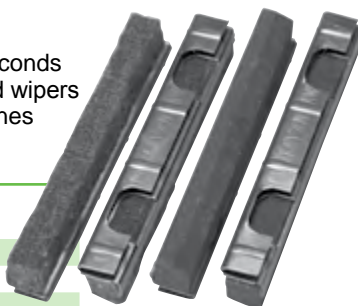

tech tips Why so many honing oils?

The HO series of honing oil was designed by the Goodson tech staff, to be clear and is formulated to offer the machinist a more aggressive result when honing various cast iron and steel alloys. Some say it has a drier effect that allows faster stock removal while keeping the honing stones, clean and more free cutting.

We went with a clear oil instead of a dark because you can easily monitor the swarf content of the oil. Since you can see what kind of gunk you're accumulating, you can change filters and filter paper as needed to lengthen the over-all life of the oil in the honing tank. We recommend Goodson HO oil for Vitriified Stones only.

Goodson HO oil is true oil and it can be mixed with other brands of honing oils, such as the Sunnen MAN-845 and others. This oil is not designed to be mixed or used with any water-based honing solutions.

The RHO series honing oil was developed for high pressure honing such as connecting rod honing. This oil also contains additional lubricants to enhance honing these smaller diameters that are on the big end of the connecting rod generally made from iron and steel, but may also have a brass or bronze bushing that also needs to be honed to size. Goodson RHO oil is just what you need as it contains additives to make this possible.

Like Goodson HO oil, RHO is compatible with most other connecting rod honing oils but, again, never mix this oil with any water-based honing solution.

The newest addition to our selection of honing oils is the DHO series. This honing oil was designed for higher pressure that occurs when honing small diameters in materials such as Bronze, Manganese Bronze and other combinations of bronze materials using diamond abrasives such as the Goodson Hyper-Finish System and the Sunnen Diamond Sizing Tool.

Goodson incorporated an additional lubrication into the formula to allow the oil to act slicker when honing the smaller diameters in these softer bronze valve guide materials. This oil can be mixed with our RHO series of honing oil or with Sunnen MAN-845 types of honing oil. As with the other Goodson honing oils, Do Not mix with water.

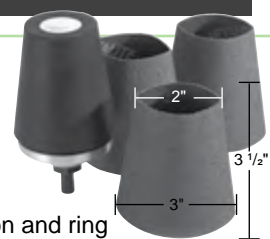

82° 3" Dia. Chamfering Cones & Mandrel

- Chamfer sharp edges for safe piston and ring installation • Handles all diameter cylinders or sleeves
- 82° abrasive cones measure 3½" (88.9mm) high with 2"/50.8mm base and 3" (76.2mm) top diameter
- Fits ⅝" (9.53mm) or larger drill • Kit (CC-100) includes mandrel and three 50 Grit Aluminum Oxide cones (CC-15)
- Due to manufacturing process, abrasive color may vary

Description	Order No.	Incl.
3" Top Dia. Chamfering Cone Kit	CC-100	▼
Replacement ⅝" Drill Adaptor	CC-100-1	x
Aluminum Oxide Chamfering Cones (red)		
40 Grit	CC-14	
50 Grit	CC-15	x
80 Grit	CC-20	
Premium Zirconia Chamfering Cones (blue)		
50 Grit	CCZ-15	
80 Grit	CCZ-20	

45° 5"/127mm dia. Chamfering Cones & Mandrel

- Large diameter cones chamfer the top of the cylinder to an exact 45° angle in one pass
- ½"/12.7mm steel shank permanently embedded in the base
- Cone height: 3½"/88.9mm
- Kit includes mandrel & one 36-grit cone (CC-30)
- Due to manufacturing process, abrasive color may vary

Description	Order No.	Incl.
5" Chamfering Cone Kit	CC-130	▼
Chamfering Cones		
Abrasive	Grit	
Aluminum Oxide (red)	36	CC-30
	50	CC-50
	80	CC-80
Premium Zirconia (blue)	36	CCZ-36
	50	CCZ-50
	80	CCZ-80

Clear Honing Oil

- Helps keep stones clean and free-cutting
- Ideal for portable hones and all makes of automotive honing machines
- Mixes easily with other brands, including Sunnen®
- Not water soluble

Size	Order No.
1 gal./3.78L	HO-10
5 gal./18.9L	HO-50



CYLINDER HEAD REBUILDING

CLEANING, ASSEMBLY & SAFETY

SHORT BLOCK REBUILDING

CRANK REBUILDING

SCCELLANEOUS TOOLS & SUPPLIES

BRAKE SERVICE TOOLING

MEASURING TOOLS

V-TWIN & METRIC HARD PARTS

... another satisfied customer

"Your company should hold a seminar on how to run a company. I received your products the day following my order. When ordering from other companies they tell me it'll be 2-4 weeks because they are busy. It's nice to have great service these days. Thank you and keep up the great work!"

- Ray Temple, Waupaca, Wisconsin, Goodson customer since 2009

CYLINDER HEAD REBUILDING

CLEANING, ASSEMBLY & SAFETY



Honing Stones for Nicasil

- Deglaze Nicasil cylinders with portable hones
- 150 Grit Aluminum-Oxide abrasive
- Resizing cylinders requires diamond abrasive
- For AN-style and GH-style hones

Inches	Metric	Order No.
2.500" - 3.300"	(64 - 84mm)	GG25-A43
3.300" - 4.200"	(84 - 107mm)	MM33-A43
4.000" - 5.600"	(102 - 142mm)	NN40-A43



SHORT BLOCK REBUILDING



Honing Stone Sets For Nicasil

- For deglazing Nicasil with a CV/CK Honing Machine
- Diameter Range:
 - 3.0" - 5.0" (76.2-127.0mm) in standard automotive head
 - 2.6" - 3.5" (66.0-88.9mm) in junior head
- 150 grit aluminum oxide abrasive
- 2 stones per set; 6 sets per package
- Order No. EHU-412

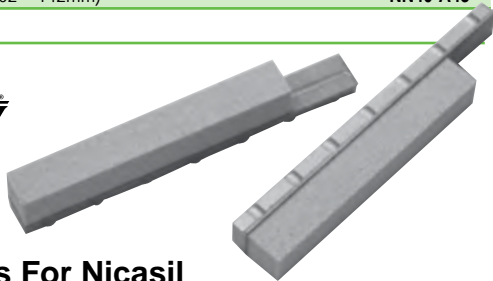

CRANKSHAFT/ FLYWHEEL GRINDING

MISCELLANEOUS TOOLS & SUPPLIES

1" Thick Rod Hone Filter Mat

- Synthetic material
- Traps abrasive particles & metal filings BEFORE they enter the storage tank
- Cushions parts to prevent damage
- Replace when clogged
- 1" (25.4mm) thick

Inches	Metric	Order No.
18" x 25"	45.7 x 63.5 cm	RH-MAT
26" x 40"	66.0 x 101.6 cm	RH-MAT-2
33" x 48"	83.8 x 121.9 cm	RH-MAT-3

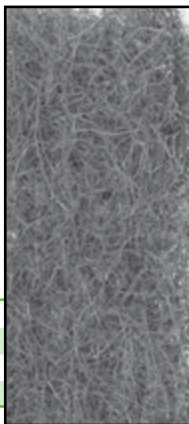

TOOLING

MEASURING TOOLS

Hone Cabinet Filter Paper

- Reduce sump and filter clean-up
- Extend oil life
- Filter paper in the bottom of hone machine removes debris before oil enters the sump
- When full, dispose of properly
- 2 - 60" x 60" sheets (trim to fit)
- Order No. HN-FP

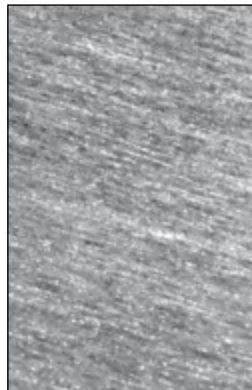

V-TWIN & METRIC HARD PARTS

tech tips

from the techxperts™ Tips for Honing Nicasil

Nicasil is an electro-deposited (electroplated) composite of nickel and silicon carbide. Components are uniformly dispersed throughout the resulting material. Care must be used when honing this material as the plating is normally applied in thicknesses no greater than .003". If you remove too much of the Nicasil, you will need to have the cylinder bores re-plated. The wear ratio on Nicasil is 10:1 so .010" wear in a normal cylinder would be only .001" on Nicasil.

An aluminum-oxide abrasive is necessary for honing Nicasil as silicon-carbide is a part of the material and abrasives will not cut materials of similar density and composition.

We recommend using our Rod Honing Oil when working on Nicasil. The additives that make it ideal for high pressure honing also help the aluminum oxide abrasive cut cleaner and faster on a Nicasil surface.

Rod Honing Oil

- Includes additives for high pressure cutting
- Keeps stones clean and free-cutting during rod reconditioning, pin fitting and other honing applications
- Will mix with other honing oils (including Sunnen®)



Size	Order No.
1 gal./3.78L	RHO-10
5 gal./18.9L	RHO-50

Standard Duty 240 Grit Aluminum Oxide Flex-Hones® For Nicasil

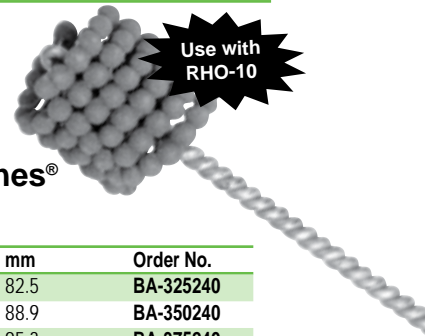

Inch	mm	Order No.	Inch	mm	Order No.
2¼"	57.2	BA-225240	3¼"	82.5	BA-325240
2⅝"	60.2	BA-237240	3½"	88.9	BA-350240
2½"	63.5	BA-250240	3¾"	95.3	BA-375240
2⅞"	66.5	BA-262240	4⅞"	104.8	BA-418240
2¾"	69.8	BA-275240	4⅝"	117.5	BA-462240
3"	76.2	BA-300240	More Flex-Hones® on page 72		

Cylinder Boring & Honing

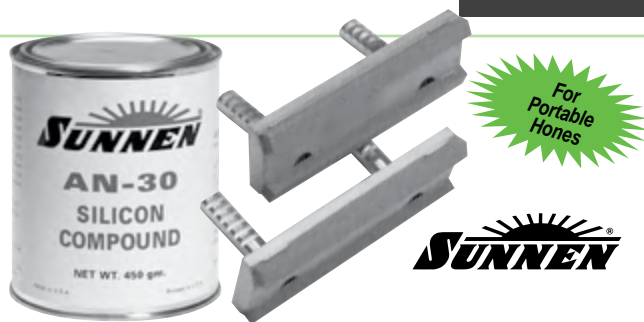

For Portable Honing



Hone High-Silicon Aluminum Alloy Blocks With Ease – Honing Stones & Silicon Compound

- Stones fit both the Sunnen® AN-112 and AN-815 and the Goodson GH-2555 Portable Honing Mandrels
- Use each stone set progressively until the final bore size is achieved • For Hone Diameter: 3.3" to 4.2"
- To create the final condition, coat the felt set and the honed cylinder surface with the Silicon Compound (AN-30) and lap the cylinders
- After completion, the cylinder will have a dull matte finish
- Piston and rings will ride on silicon instead of aluminum
- Silicon Compound 1 lb. / 450g

Description	Order No.
Roughing (280 grit)	MM33-J63
Finishing (400 grit)	MM33-J85
Polishing (600 grit)	MM33-CO5
Felt Set	MM33-FO5
Silicon Compound	AN-30



Mandrel Driver for Align Honing Machines

- For Sunnen® CH-100 & similar align honing machines
- Graduated adjustment knob advances and retracts honing stones
- Quick release lever allows hone removal and installation without resetting
- Stone pressure adjusts with dial
- Automatically advances stones during honing
- **NOT** for portable honing applications
- Order No. **CH-75A**



Main Bore Align Hone Mandrels

- For the Sunnen® CH-100 Aline Honing Machine
- Hone unit includes 1 set of 10 stones and 1 set of 20 shoes (replacement stones & shoes available)

Range		Mandrels		Shoes (10/box)
mm		Order No.		Order No.
2.4"-2.7"	61-69	10RY-2400G		RG-D
2.7"-3.0"	69-77	10RY-2700G		RG-D
3.0"-3.5"	77-89	10RY-3000H		RH-D
Stones 5/box		RY24-J49 (recommended for cast iron)		
fit all mandrels above		RY24-J45 (recommended for aluminum)		

Right Hand Rotation Only.

tech tips

For best results, keep your RPM about the same as your hone RPM, use the same rate of speed from the techxperts™ and number of strokes per minute.

Ultra-Finish Plateau Soft Hones

- Remove microscopic peaks and scuffs without enlarging bores • Use with a portable drill • Abrasive impregnated nylon bristles • Ideal for high-performance engine rebuilding and for engines that use low-tension rings
- Use **after** honing
- Gives a superior plateau finish so rings seal immediately, reducing break-in time
- Allows closer tolerances for improved compression, better oil control, lower emissions
- For best results, use liberal amounts of honing oil (**HO-50**, pg. 73) • **NOT** interchangeable with Flex-Hones®

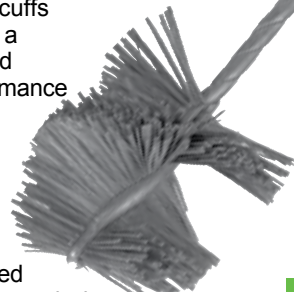

Hole Diameter Range	Hone Dia.	Hone Head Length	Overall Length	Order No.	
in mm					
.875"-1.00"	22-25	1.250"	2.00"	10.00"	UF-100
1.00"-1.25"	25-32	1.500"	2.00"	10.00"	UF-125
1.25"-1.75"	32-45	2.000"	2.00"	10.00"	UF-175
1.75"-2.25"	45-57	2.500"	2.00"	10.00"	UF-200
2.25"-2.75"	57-70	3.000"	3.00"	10.00"	UF-250
2.50"-3.00"	63-76	3.500"	4.00"	14.00"	UF-300
3.00"-3.50"	76-89	4.000"	4.00"	14.00"	UF-350
3.50"-4.00"	89-102	4.500"	4.00"	14.00"	UF-400
4.00"-4.50"	102-114	5.000"	5.00"	14.00"	UF-450
4.50"-5.00"	114-127	5.500"	5.00"	14.00"	UF-500

Valve Guide Plateau Hones on page 33



Replacement PF Filter Cartridges

- Cartridges remove grit, metal and dirt from honing oil
- Fit Sunnen® CK-10, CV-616, LBB-1810, PF-150 and CH-100 honing machines



Description	Application	Qty.	Order No.
Extra Fine	Oil Only	4 Pk.	PF-105-4
Fine	Oil Only	4 Pk.	PF-110-4
Extra Fine	Water Only	1 Pk.	PF-104
Fine (Fiberglass)	Water Only	1 Pk.	PF-160

Machine Capacities

Mfr.	Machine	Capacity
Sunnen	LBB-1699	15 Gal.
	LBB-1660	15 Gal.
	LBB-1810	25 Gal.
	LBB-1803	25 Gal.
	EC-3500	32 Gal.
	ML-3500	32 Gal.
	ML-5000	32 Gal.
	ML-2000	28 Gal.
	CK-10	55 Gal.
	CV-616	55 Gal.
	SV-10	55 Gal.
	CK-21	63.5 Gal.

Machine Capacities

Mfr.	Machine	Capacity
Rottler	H85AXY	70 Gal.
	H85A	70 Gal.
	H85AX	70 Gal.
	H86A	70 Gal.
	H86AX	70 Gal.
	H86AXY	70 Gal.

tech tips
from the techxperts™

CYLINDER HEAD REBUILDING
CLEANING, ASSEMBLY & SAFETY
SHORT BLOCK REBUILDING
FLYWHEEL GRINDING
CRANKSHAFT/TOOLS & SUPPLIES
MISCELLANEOUS
BRAKE SERVICE TOOLING
MEASURING TOOLS
V-TWIN & METRIC HARD PARTS

... another satisfied customer

"I bought your regular honing oil, and it does a fine job and it cuts well, however, when I found out the RHO honing oil might be a better deal, I began taking gallons of RHO honing oil and adding it to my tank to make it hone better, and sure enough I found that by adding the RHO honing oil, the stones cut faster without clogging."

- George Livergood, Action Machine Shop, Goodson customer since 2010

CYLINDER HEAD REBUILDING
CLEANING, ASSEMBLY & SAFETY
SHORT BLOCK REBUILDING
CRANKSHAFT/ FLYWHEEL GRINDING
MISCELLANEOUS TOOLS & SUPPLIES
BRAKE SERVICE TOOLING
MEASURING TOOLS
V-TWIN & METRIC HARD PARTS



Stones Guide Shoe

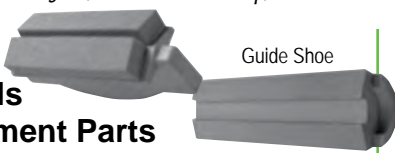

CR-Series Mandrels Stones & Replacement Parts

Honing Stones for Manual Honing*

Fit Mandrels	Finish	Sunnen Order No.	Goodson Order No.
CR-1450 to 1750	Medium	CR-2	-----
	Fine	CR-4	HC-4
CR-1900 & Larger	Aluminum/Titanium	CR-9	-----
	Roughing	CR-10	HC-10
	Medium	CR-12	HC-12
	Fine	CR-14	HC-14
For Power Hone	Roughing	CR-10N	-----

Guide Shoes (2 per box)

CR-1450 to 1750	Die Cast	CR-40D	C-40D
CR-1900 & larger	Die Cast	CR-50D	-----
	Bronze	CR-50B	-----

Wedge & Wedge Plates

CR-1450 to 1750	Wedge	CR-70	-----
	Small Plate	CR-75	-----
	Large Plate	CR-85	-----
CR-1900 to 2500	Wedge	CR-100	-----
CR-1900 & Larger	Small Plate	CR-110	-----
	Large Plate	CR-120	-----
CR-2900	Wedge	CR-200	-----

Sunnen® Tension Block For CR-2900 & Larger	LN-1337A
Sunnen® Shoe Clamps (4 + screws) for CR-1900 & larger	CR-45A

*Sunnen® honing stones include 2/box, Goodson include 1/box



Mandrel Driver for Portable Use of CR-, PL- and ML-Series Hones

- Ideal for spindle bushings mounted on axles and other jobs that can't be taken to the honing machine
- For holes 3/4"/19.05mm ID and larger, where length is at least 3 times the diameter
- ID Range: .744" - 3.875"/19mm - 98mm
- Graduated adjustment knob advances and retracts stones • 275 - 450 RPM range
- Use with any 1/2"/12.7mm drill or larger
- Order No. **GGN-150**



Rod Honing Oil

- Includes additives for high pressure cutting
- Keeps stones clean and free-cutting during rod reconditioning, pin fitting and other honing applications
- Will mix with other honing oils (including Sunnen®)

Size	Order No.
1 gal./3.78L	RHO-10
5 gal./18.9L	RHO-50

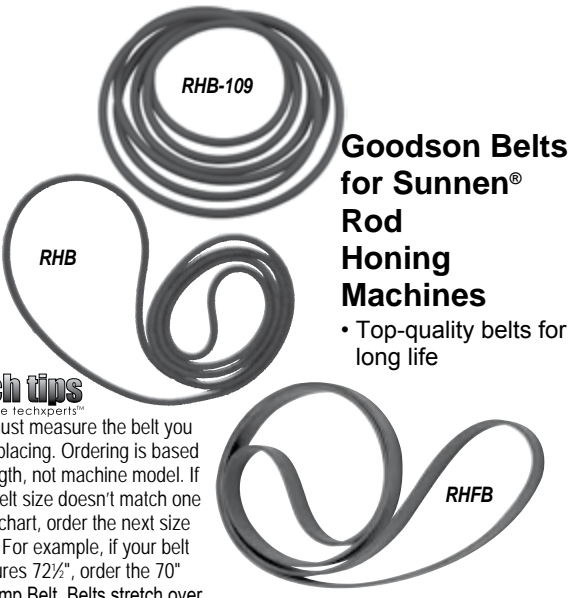

Goodson Belts for Sunnen® Rod Honing Machines

- Top-quality belts for long life

tech tips

from the techxperts™
You must measure the belt you are replacing. Ordering is based on length, not machine model. If your belt size doesn't match one in the chart, order the next size down. For example, if your belt measures 72 1/2", order the 70" Oil Pump Belt. Belts stretch over time so the shorter belt will fit.

Size	Order No.
Oil Pump Belts (.250" dia.)	
70"/1.78m	RHB-70
74"/1.88m	RHB-74
85"/2.16m	RHB-85
109"/2.77m	RHB-109
Flat Belts	
37 1/4" x 5/8"/945.9x15.9mm	RHFB-37
45 1/2" x 5/8"/1155.7x15.9mm	RHFB-45
46 1/2" x 5/8"/1181.1x15.9mm	RHFB-46

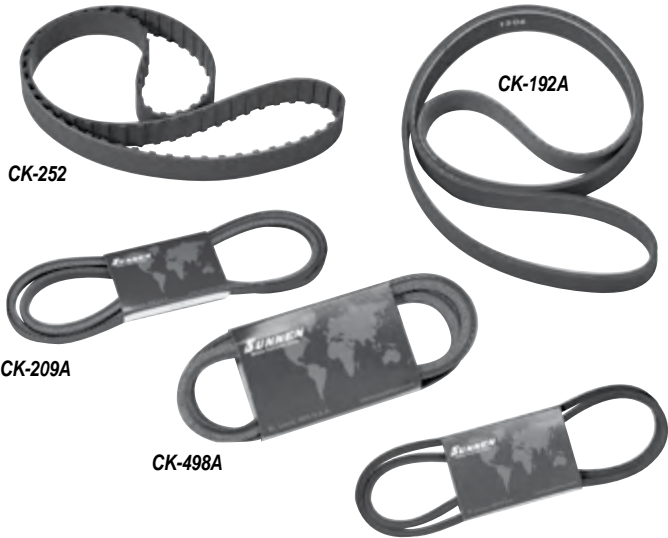

Replacement Parts for CV-616 Honing Machine

Replacement Belts	Order No.
Timing Belt	CK-252
Flat Belt	CK-192A
"V" Belt, Upper	CK-209A
"V" Belt, Lower	CK-498A
"V" Belt, Blower	CK-1267A
Replacement Fiber Planetary Gear Set	CK-234A



Rod Honing Stones & Mandrels



AK20-A

HS / SL
Stones

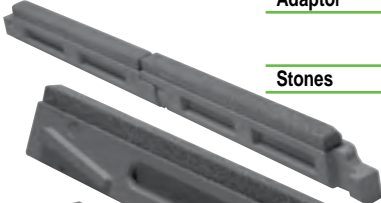

HP / PL
Stones

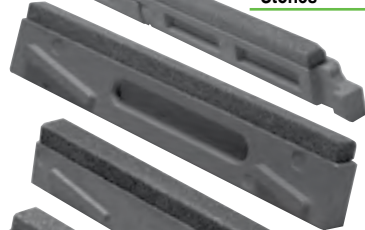

HM / ML
Stones

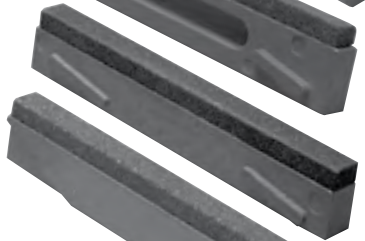

HK / KL
Stones

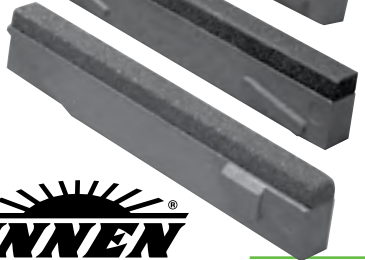

Bronze
Guide
Shoes

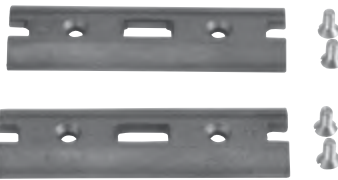

Rod Honing Stones, Guide Shoes & Replacement Parts

• Premium-quality • Choose Goodson or Sunnen®

		Goodson		Sunnen®		
Adaptor	Use			Order No.		
	For Sunnen® KL Series Mandrel					
	Includes Retainer			AK20-A		
Stones	Use	Order No.	Qty.	Order No.	Sunnen No.	Qty.
	For Sunnen® SL720 - SL2300 Mandrel					
	Roughing	-----		SL-5		6
	General Purpose	-----		SL-7		6
	Finishing	-----		SL-13		6
	For Sunnen® PL Series Mandrel					
	Roughing	HP-5	1	PL-5	P28-J27	12
	General Purpose	HP-7	1	PL-7	P28-J47	12
	Finishing	HP-13	1	PL-13	P28-J67	12
	For Sunnen® ML Series Mandrel					
	Roughing	HM-5	1	ML-5	P20-J25	12
	General Purpose	HM-7	1	ML-7	P20-J47	12
	Finishing	HM-13	1	ML-13	P20-J67	12
	For Sunnen® KL Series Mandrel					
	Roughing	HK-5	1	KL-5	K20-J25	12
	General Purpose	HK-7	1	KL-7	K20-J47	12
	Finishing	HK-13	1	KL-13	K20-J67	12
	Steel	-----		KL-14	K20-A69	12
Bronze Guide Shoes		Order No.	Qty.	Order No.	Qty.	
	For Sunnen® KL and ML Series Mandrel					
	.775"-.805" 19.7-20.4mm	-----		UA-B	2	
	.838"-.899" 21.3-22.8mm	-----		UB-B	2	
	.900"-.993" 22.9-25.2mm	-----		UC-B	2	
	.994"-1.125" 25.2-28.6mm	-----		UD-B	2	
	1.119"-1.250" 28.4-31.8mm	-----		UE-B	2	
Note: Bronze guide shoes outlast die cast 6 to 1.						
Zinc Alloy Guide Shoes		Order No.	Qty.			
	For Sunnen® PL and ML Series Mandrel					
	1.355" - 1.500" 34.4-38.1mm	-----		WC-D	2	
	1.480" - 1.625" 37.6- 41.3mm	-----		WD-D	2	

special order

Almost anything from the Sunnen® Automotive line can be ordered through Goodson. Contact us for details!

Diamond Stone Dresser

- Diamond stone on durable metal tool
- Order No. **MAN-700**

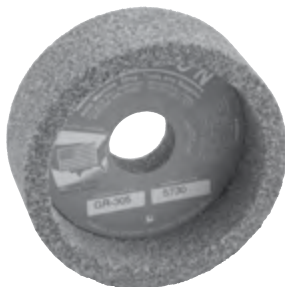

Rod and Cap Grinding Wheels

- Fits Sunnen® Rod and Cap Grinding Machines • Recessed design

Size	Order No.
4"x1½"x1"	GR-305
101.6x38.1x25.4 mm	
6"x2"x1¼"	GR-805
152.4x50.8x31.8 mm	

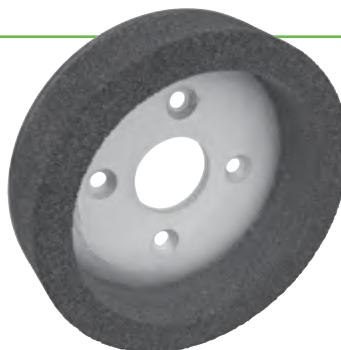

Delta Cap Cutter Premium Grinding Wheel

- Fits Delta Cap Cutter Model #6200XHD
- 7" OD x 1½" thick x 5½" ID
- Plate mounted & balanced for smooth grinding • Ideal for welded main caps
- Order No. **GR-6200XHD**



Rod & Cap Grinding Wheels

- For Sunnen® and other popular brand cap grinders • Fits CRG 700, 750, 770, 780, 805 & 920K • Softer than GR-805 • 6" x 2" x 1¼"
- Order No. **F343793**



CYLINDER HEAD REBUILDING
CLEANING, ASSEMBLY & SAFETY
SHORT BLOCK REBUILDING
CRANKSHAFT/ FLYWHEEL GRINDING
MISCELLANEOUS TOOLS & SUPPLIES
BRAKE SERVICE TOOLING
MEASURING TOOLS
V-TWIN & METRIC HARD PARTS

... another satisfied customer

"This tool works!"

- Dennis Terrill, Terrill Motor Machine, Fort Lauderdale, FL, Goodson customer since 1990

CYLINDER HEAD REPAIRING

CLEANING, ASSEMBLY & SAFETY

SHORT BLOCK REBUILDING

CRANKSHAFT/ FLYWHEEL GRINDING

MISCELLANEOUS TOOLS & SUPPLIES

BRAKE SERVICE TOOLING

MEASURING TOOLS

V-TWIN & METRIC HARD PARTS

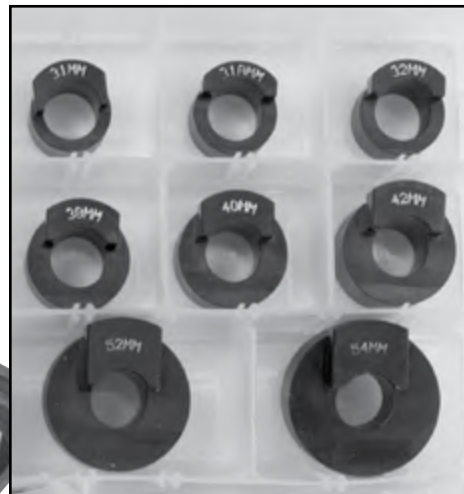

sized for diesel



American Made

Universal Tapered Pin Bushing Press Kit For Light & Medium Duty Diesel Engines

This press kit is specially designed to remove and replace tapered bushings in most common light to medium duty diesel applications. Don't spend time making a fixture that's dedicated to a single size. Our Tapered Pin Bushing Press Kit is ready to go when you receive it. All you need is the correct bushing driver to get started.

Choosing A Driver

1. Measure the wrist pin diameter.
2. Select a driver from the chart at right that is .030" to .040" smaller.
3. Measure the thickness of the bushing.
4. Select the driver with a Step size that is 50% to 60% of the bushing thickness.

tech tips from the techxperts™

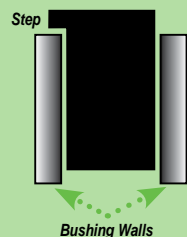

EXAMPLE:

Wrist Pin Dia. 1.185"

Nearest Driver Dia. 1.158"

Bushing Thickness .150"

40% of Thickness 0.090"

Select Bushing Driver TBD-31

Order No. TBD-RESIZE

tech tips

from the techxperts™

When pressing together always press the rod onto the bushing and **NOT** the bushing into the rod. This prevents the bushing from collapsing or folding up.

Description	Order No.	Includes
Complete Wrist Pin Bushing Press Kit	TB-KIT	▼
Wrist Pin Press Base (select drivers below)	TB-BASE	▼ x
Press Tube - Small (27x21x120mm)	TPT-SM	x
Press Tube - Large (30x31x110mm)	TPT-LG	x
Wrist Pin Ring (50x5x20/26mm)	WPR-001	x
Wrist Pin Parallels (2) 8x10x50mm	WPP-2	x
Extended Mandrel (8 1/2" long)	TB-MANDREL	x

Wrist Pin Bushing Drivers sold by dimension, not application				
MM	Nominal	Actual	Step	
25	1.000"	0.957"	0.063"	TBD-25
26	1.063"	0.990"	0.058"	TBD-26
27	1.060"	1.032"	0.067"	TBD-27
28	1.100"	1.006"	0.055"	TBD-28
30	1.180"	1.102"	0.075"	TBD-30
31	1.220"	1.158"	0.090"	TBD-31
31	1.220"	1.198"	0.067"	TBD-31A
32	1.260"	1.222"	0.078"	TBD-32
33	1.300"	1.268"	0.068"	TBD-33
34	1.340"	1.304"	0.073"	TBD-34
36	1.420"	1.377"	0.075"	TBD-36
38	1.500"	1.458"	0.076"	TBD-38
40	1.570"	1.554"	0.068"	TBD-40
42	1.650"	1.614"	0.097"	TBD-42
45	1.770"	1.742"	0.089"	TBD-45
46	1.810"	1.772"	0.108"	TBD-46
50	1.970"	1.940"	0.083"	TBD-50
52	2.050"	2.012"	0.114"	TBD-52
54	2.130"	2.099"	0.081"	TBD-54

Goodson Press Fit Lube (6 oz. Aerosol can)	PFL-200*	
--	----------	--

*Hazardous Goods Fees Apply When Shipped Air

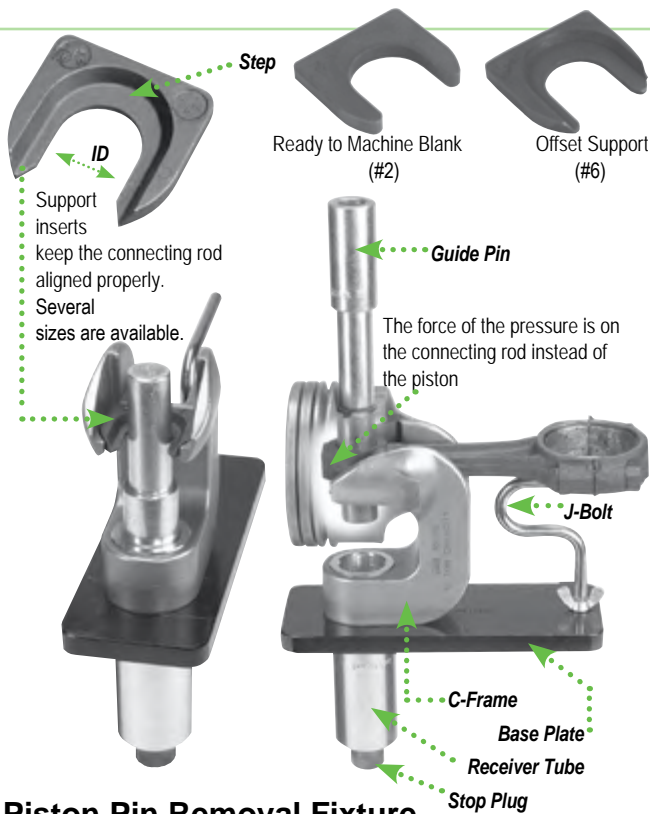

Piston Pin Removal Fixture

- Use to remove or install interference fit piston pins
- Force of removal is against the piston pin and connecting rod – no pressure is exerted on the piston itself
- Tooled to fit most popular engines with pin diameters of 0.859" through 1.087"
- Replacement Support Inserts & Guide Pins sold separately

tech tips
from the techxperts™

For Small Block Chevy use Support Insert #1 or Offset #6, for Big Block Chevy, use Support Insert #5, Support #2 is a blank, ready to be machined to your exact specifications.

Description	ID	Step	Order No.	Incl.
Complete Kit			PPE-7082	▼
Replacement C-Frame			PPE-302186	x
Replacement Support Inserts	#1	0.945" .100"	PPE-39889	x
	#2	1.110" .275"	PPE-39890	x
	#3	1.000" .182"	PPE-39888	x
	#4	1.110" .182"	PPE-39886	x
	#5	1.000" .100"	PPE-39887	x
	#6	0.945" .100"	PPE-39822	x
Replacement Guide Pins	0.859"		PPE-17940	x
	0.897"		PPE-17936	x
	0.926"		PPE-17937	x
	0.970"		PPE-17938	x
	0.992"		PPE-17939	x
	1.032"		PPE-17941	x
	1.055"		PPE-17942	x
	1.087"		PPE-18729	x

Replacement Parts

J" Bolt (Rear Support)	PPE-302224	x
Wing Nut	PPE-10588	x
1 1/2" / 30.2mm Stop Plug	PPE-17830D	x
Base Plate	PPE-17929	x
Receiving Tube	PPE-17931B	x
Body Guide	PPE-17932B	x
5/2" / 139.7mm Spring	PPE-17934	x
Guide Pin Driver	PPE-17935	x
1 1/2" / 41.3mm External Spiral Lock	PPE-17945	x



Universal Piston Pin Press-Out Tool

- Use with a shop press
- Top quality steel tooling
- Standard set handles most applications
- You can modify for individual needs

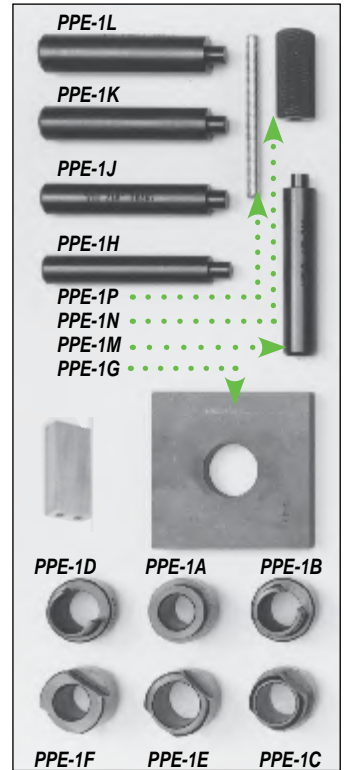

Description	Order No.	Incl.
Piston Pin Extractor Kit	PPE-1	▼
Piston Support Fixtures		
.800" hole	PPE-1A	x
.865" hole	PPE-1F	x
.950" hole	PPE-1B	x
1.010" hole	PPE-1C	x
1.010" hole	PPE-1D	x
1.110" hole	PPE-1E	x
Fixture Base Block	PPE-1G	x
Pin Pressing Drifts		
.760" dia.	PPE-1H	x
.812" dia.	PPE-1J	x
.875" dia.	PPE-1K	x
1.000" dia.	PPE-1L	x
Tapped Handle	PPE-1M	x
Threaded Rod	PPE-1N	x
Threaded Adaptor	PPE-1P	x
Rod Support	PPE-1GM	x

Kit now includes the rod support for tapered boss pistons

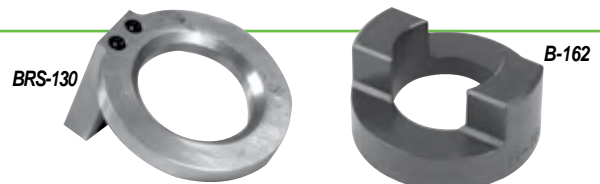

GOODSON Rod Support for Sunnen® Pin Press Tooling

- Remove late model connecting rods from tapered boss pistons
- Aluminum construction prevents connecting rod damage • Fits Sunnen® tooling

Description	Order No.
GOODSON Rod Support	BRS-130
Sunnen® Reducing Ring	B-162

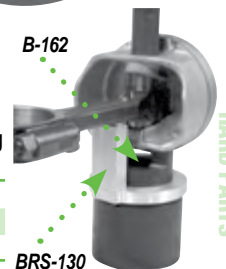

CYLINDER HEAD REBUILDING
CLEANING, ASSEMBLY & SAFETY
SHORT BLOCK REBUILDING
CRANKSHAFT/ FLYWHEEL GRINDING
MISCELLANEOUS TOOLS & SUPPLIES
BRAKE SERVICE TOOLING
MEASURING TOOLS
V-TWIN & METRIC HARD PARTS



"Our easy-to-use, comprehensive catalog features more than 8,000 tool and supplies. Feel free to call if you're not sure what to order or if you have questions. We'll do everything we can to help you get what you need."

- Diane, Goodson Purchasing - 4 years of service

CYLINDER HEAD REBUILDING
CLEANING, ASSEMBLY & SAFETY

Piston Installing Deadblow Hammer

- 1-piece design
- Specially formulated, urethane compound is cut and split resistant
- Convex-faced
- Non-mushrooming material
- Offset head
- Ideal for fast, mar-free piston installation
- Weighs 1.7 lbs./.77 kg
- Order No. **PK-200**



SHORT BLOCK REBUILDING



Piston Ring Expander

- Remove & install most rings
- Tapered jaws
- 3/4" to 1/4" 1.2mm to 6.35mm ring width
- Order No. **PRE-500**

CRANKSHAFT/ FLYWHEEL GRINDING

MISCELLANEOUS TOOLS & SUPPLIES



Band Ring Compressor Kits

- Install rings safely and easily
- Hardened steel for durability
- Trigger ratchet mechanism for tightened compressions

Description	Order No.	Incl.
6 Pc. Band Ring Compressor Kit	GPS-98	▼
9 Pc. Band Ring Compressor Kit	GPS-99	▼
Compressing Pliers	GPS-98A	x x
Bands Range in. mm		
1.875" - 2.125"	47.63-53.98	GPS-98Q
2.125" - 2.375"	53.98-60.33	GPS-98R
2.375" - 2.625"	60.33-66.68	GPS-98S
2.625" - 2.875"	66.68-73.03	GPS-98T
2.875" - 3.125"	73.03-79.38	GPS-98B
3.125" - 3.375"	79.38-85.73	GPS-98C
3.375" - 3.625"	85.76-92.08	GPS-98D
3.625" - 3.875"	92.08-98.43	GPS-98E
3.875" - 4.125"	98.43-104.78	GPS-98F
4.125" - 4.375"	104.78-111.13	GPS-98G
4.500" - 4.750"	114.30-120.65	GPS-98H
4.750" - 5.000"	120.65-127.00	GPS-98I
5.000" - 5.250"	127.00-133.35	GPS-98J
5.250" - 5.500"	133.35-139.70	GPS-98N
5.500" - 5.750"	139.70-146.05	GPS-98K
5.750" - 6.000"	146.05-152.40	GPS-98M
6.000" - 6.250"	152.40-158.75	GPS-98U
6.250" - 6.500"	158.75-165.10	GPS-98V

BRAKE SERVICE TOOLING

MEASURING TOOLS

V-TWIN & METRIC HARD PARTS

Gas Porting Tools for High Performance

- Virtually eliminate side ring clearance by drilling gas ports in your piston ring lands
- These tiny ports apply compression pressure directly to the back of the ring, pushing it against the cylinder wall with greater force while minimizing compression leakage
- Gas ports work best with piston-compression heights of 1.2" or less on engines running at high rpm (7,000 or higher)
- These simple Tool Kits take all of the guess-work out of gas porting and include everything you'll need to get started
- The complete kit includes: Drill Fixture, Depth Bushing and one Drill Bit

US Patent No. US D617,664 S



Description	Size	Order No.
Gas Porting Tool Kits	.043"	GPT-043
	.062" and 1.5mm	GPT-062
Replacement Drill Bits (5 pack)	.040" for GPT-043	GPT-040-DB
	.062" for GPT-062	GPT-062-DB

Minnesota Fast Freeze

- Instantly chills seats and guides to -50°F / -45.5°C
- Creates interference fit with heated aluminum heads
- Finish seat and guide work faster than ever • Aerosol*
- Use on tight bushings, pins, shafts, etc.
- Order No. **MFF-8***



*Hazardous Goods Fees Apply When Shipped By Air

Press Fit Lubricants

- A light coat eases press fit
- Ideal for valve guides, piston pins, cylinder sleeves, etc.
- Eliminates the scoring, gouging and galling of parts during press fitting



Description	Order No.
Goodson Aerosol 6 oz. (170 g)	PFL-200*
Sunnen® Aerosol 7 oz. (198 g)	B-200*
Sunnen® Brush Applicator 200 mL (not shown)	B-200L

*Hazardous Goods Fees Apply When Shipped By Air

The Original Goodson Powered Ring Filers

American Made

- No more tedious filing and checking and filing and checking to get desired end gap; set it once and cut multiple rings
- Easy to read integral dial indicator and positive ring stop make repeatable precision quick and easy
- Fits 2 1/2"-5"/63.5-127mm diameter rings
- Adjustable guide holds rings square to the cutting wheel
- Table pivots past cutting wheel
- No open ways to gather grinding dust that causes premature wear
- Handy knurled in-feed adjustment knob
- High torque motor

Diamond Dresser is securely held in place by the ring clamping pin



Lighted Rocker Switch



Built-in deburring wheel eliminates the need to hand hone or deburr rings after filing

Description	Order No.
Powered Ring Filer with Deburring Wheel 110V / 60 cycle	PRF-812DW
Powered Ring Filer with Deburring Wheel 220V / 50 cycle	PRF-822DW
Replacement Deburring Wheel	PRF-DW
2 1/2" Replacement Grinding Wheel (60 grit) for pre-2008 models	PRF-1001
3" Replacement Grinding Wheel (60 grit)	PRF-1002
Replacement Diamond Dresser	PRF-812D
Replacement Table Spring	PRF-SPRING
Sundura® Canvas Machine Cover	GMC-PRF

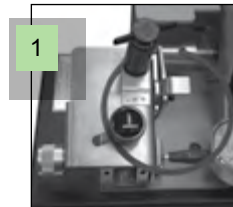

1 Stainless Steel Table

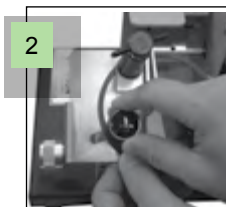

2 Eccentric adjusts quickly and easily

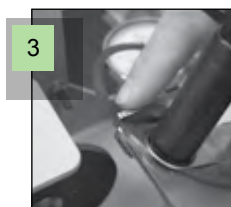

3 Positive ring stop

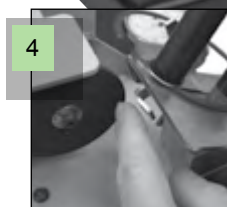

4 Table pivots past grinding wheel



GMC-PRF

Manual Ring Grinder

- Produce end gap rings squarely
- Heavy duty aluminum casting
- Precisely machined for long life
- Silicon-carbide wheel holds shape and produces clean precise cuts
- Includes 1 grinding wheel (replacements available)
- Wheel measures 2 1/2" OD x 7/16" ID x 1/8" thick

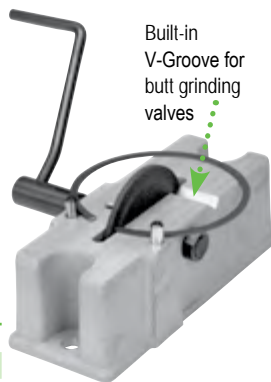

Built-in V-Groove for butt grinding valves

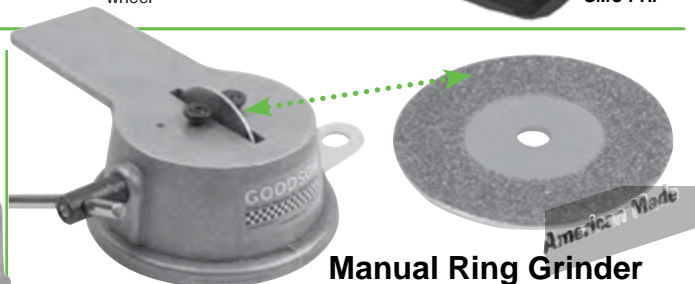

Manual Ring Grinder

- Universal design lets you grind almost any make, type or size of piston ring
- Includes 1 diamond abrasive wheel

Description	Order No.
Piston Ring Grinder	PRF-250
Replacement Wheel	PRF-250W

Description	Order No.
Universal Piston Ring Filer	PRF-500
Replacement Diamond Abrasive Wheel	PRF-870-DW

Fine Abrasive Stick

- Radiused for easier ring deburring after end gapping
- 4" L x 1/2" radius (101.6mm x 12.7mm)
- Works on all types of rings
- Works on ring ID radii
- Order No. **RS-103**

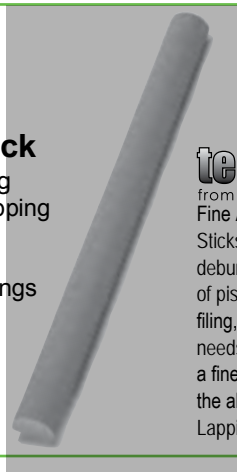

tech tips

from the techxperts™
Fine Abrasive
Sticks work great for deburring the ends of piston rings after filing, or any part that needs deburring. For a finer finish, soak the abrasive stick in Lapping Oil (LP-LO-4).

Ring Squaring Tools

- Minimizes ring overworking
- Helps keep the ring square while measuring ring gap
- Positive support
- Works well with narrow or light tension rings • 4 sizes available
- Each size fits multiple bore sizes
- Easy to use



Range in.	mm	Order No.
3.00" to 3.35"	76.20 to 85.09mm	RST-3000-3350
3.30" to 3.65"	83.82 to 92.71mm	RST-3300-3650
3.90" to 4.25"	99.06 to 107.95mm	RST-3900-4250
4.20" to 4.55"	106.68 to 115.37mm	RST-4200-4550

CYLINDER HEAD REBUILDING
CLEANING, ASSEMBLY & SAFETY
SHORT BLOCK REBUILDING
FLYWHEEL GRINDING
CRANKSHAFT/GRINDING
MISCELLANEOUS TOOLS & SUPPLIES
BRAKE SERVICE TOOLING
MEASURING TOOLS
V-TWIN & METRIC HARD PARTS

... another satisfied customer



"All of the business I have done with Goodson has been excellent. My sales rep is very helpful, polite and courteous. My rating of her and your tech staff on a scale of 1 to 10 is a 12! Keep up the good work."

- Richard Stokes, Carquest, Winchester, Virginia, Goodson customer since 1990

CYLINDER HEAD REBUILDING
CLEANING, ASSEMBLY & SAFETY

SHORT BLOCK REBUILDING

CRANKSHAFT/ FLYWHEEL GRINDING

MISCELLANEOUS TOOLS & SUPPLIES

TOOLING
BRAKE SERVICE

MEASURING TOOLS

V-TWIN & METRIC HARD PARTS

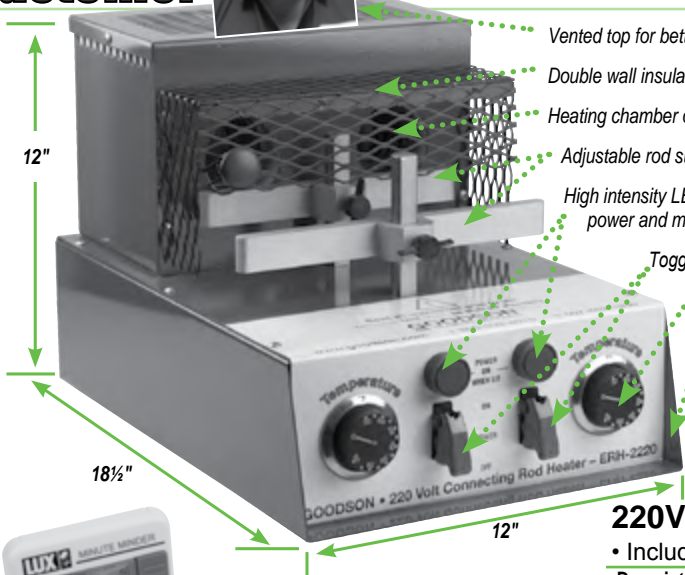

- Vented top for better performance
- Double wall insulated heat chambers with safety screen covering
- Heating chamber opening measures 2 1/8" to fit standard eyes
- Adjustable rod supports to accommodate most automotive connecting rods
- High intensity LED lamps tell that elements have power and may be hot
- Toggle switches with flip-up covers to prevent accidental activation
- Elements operate on separate thermostats
- Powder-coated, heavy-gauge steel housing for long life
- Non-slip rubber feet provide stability

Goodson
exclusive

220V, Single-Phase Electric Rod Heater

- Includes a digital timer and 450° temperature crayon



ERH-TIMER

American Made



WorldwideShipping

Use with our Piston Pin Installing Fixture (PIF-25) sold separately (see page 89 for a complete description).



Description	Order No.	Incl.
220V, 50/60 Hz Single Phase Electric Rod Heater	ERH-2220	▼
Digital Read-Out Timer (battery included)	ERH-TIMER	x
Replacement Toggle Switch (ea.)	ERH-SWITCH	
Replacement Toggle Switch Guard (ea.)	ERH-TSG	
Replacement Thermostat (ea.)	ERH-THERM	
Replacement Coil (ea.)	ERH-COIL	
Replacement LED Light Assembly (ea.)	ERH-LED	
Replacement Bezel Knob (ea.)	ERH-KNOB	
Replacement Thumbscrew (ea.)	ERH-TST	
450° Melting Point Temperature Indicator Crayon	TIC-450	x
Piston Pin Installation Fixture	PIF-25	

Assemble 8 rods & pistons in as little as 5 minutes

Gas-Fired Rod Heater

- Needs no warm-up time – start assembling rods and pistons almost immediately
- Heats piston pin ends so fast that the rest of the rod stays cool
- Minimal cool down time after assembly
- Ceramic lined enclosure contains flame, keeping hands safe
- One knob controls the pilot and gas flow, another sets air flow for ideal combustion
- Burner lights easily with a striker (not included)
- No heat coils to burn out or circuitry to fail
- Includes one 600°F Temperature Crayon (see right)
- Propane model includes gas regulator and hose assembly
- Natural Gas model hooks up to your natural gas service

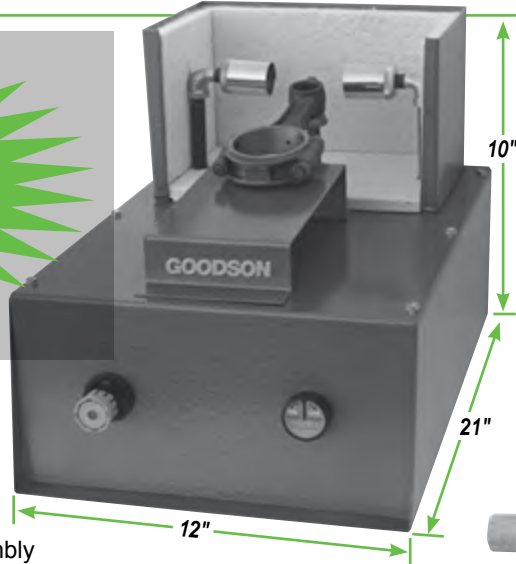

Gauntlet Style Heat & Flame Resistant Gloves

- Heavy, lined red terrycloth
- 13 1/2" Long
- Safe to 450°F / 232.2°C
- Order No. **HFR-300**



Temperature Indicating Crayons

- Mark the workpiece before heating
- Melts when temperature is reached
- 3 melting points to choose from

Melting Point	Order No.
450°F / 232.22°C	TIC-450
500°F / 260.00°C	TIC-500
600°F / 315.56°C	TIC-600

American Made



WorldwideShipping

Description	Order No.
Rod Heater for Propane	RH-50
Rod Heater for Natural Gas	RH-50N
600°F Temperature Crayon	TIC-600

Rod & Piston Work

Works great with Rod Heaters on previous page!

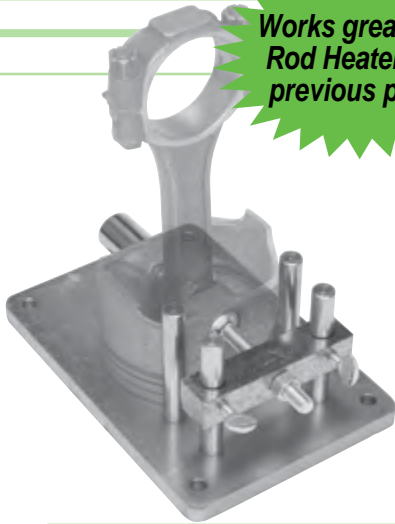

Piston Pin Installing Fixture

- Adjustable stops prevent over-centering rods
- Adjust the stop once and you're ready to assemble a full set of rods
- Base is pre-drilled to mount to a workbench
- Order No. **PIF-25**



Rod Bolt Boots

- Plastic boots protect crank journals & rod bolts during piston installation
- Save crank journals from rod bolt damage
- Don't risk your reputation for quality
- Reusable
- Set of 16
- Order No. **RBP-16**

Rod Clamping Vise

- Align rods and caps perfectly
- Smooth jaws won't damage connecting rods like an ordinary vise
- Clamp rods firmly to align parting faces while torquing rod bolts
- Clamp in a vise or bolt to a workbench
- Order No. **RCV-20**

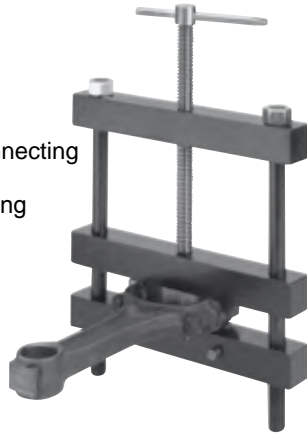

Heavy-Duty Rod Bolt Installing Block

- Mount universal block in a vise to support rod while installing bolts
- Hardened aluminum won't slip
- If the top wears, you can restore it with a file or belt grinder
- Ream holes larger to accommodate oversize bolts
- Order No. **RB-50**



Connecting Rod not included

The best engine pre-lube tank in the industry!

American Made



Improved ON/Off Ball Valve



Built-in pressure gauge shows tank pressure



Patent-pending Filler Cap. Designed to safely release any pressure left in tank after draining.

10 Quart Engine Pre-Lube Tank

- 10 quart capacity is big enough for all but monster engines
- Corrosion-resistant aluminum tank eliminates contamination from rust
- Large 1 $\frac{3}{4}$ " diameter filler hole lets you pour oil right from the bottle - no funnel required
- Includes 3 fittings (1/4" x 1/4", 1/4" x 1/8" and GM LS-1)
- Replacement Parts available

Description	Order No.
10 Quart Pre-Lube Tank	EPL-110
Replacement 8' Hose	EPL-HOSE
LS1 Fitting	EPL-LS1
1/4" Replacement Fitting	EPL-14
1/8" Replacement Fitting	EPL-18
Replacement Gauge	EPL-CG
Replacement Cap Gasket (only for discontinued EPL-120)	EPL-G
Mini Ball Valve	EPL-MBV



8' long, 1/4" diameter hose gives you lots of length to work with

CYLINDER HEAD REBUILDING
CLEANING, ASSEMBLY & SAFETY
SHORT BLOCK REBUILDING
CRANKSHAFT/FLYWHEEL GRINDING
MISCELLANEOUS TOOLS & SUPPLIES
BRAKE SERVICE TOOLING
MEASURING TOOLS
V-TWIN & METRIC HARD PARTS



"Technology has merely provided us with more efficient ways to give you, our customers, the quality of service you deserve! Our goal is to make ordering shop supplies faster & easier for you, whether you order by phone or through our website."

- Cheryl, Goodson Computer Systems Analyst - 23 years of service

CYLINDER HEAD REBUILDING
CLEANING, ASSEMBLY & SAFETY

Oil Gallery Plug Installer / Staker

- Set depth and lock plug in a single step
- Arbor nose aligns cup plug, then follows with two 180° staker lugs to set depth and lock oil gallery plug securely in place
- Use with Oil Gallery Plugs below
- Order No. **ST-SB**



SHORT BLOCK REBUILDING

Oil Gallery Plugs

- Replace lost or damaged originals
- 1/4" pipe plugs
- For use at the rear of Small Block Chevy oil galleries or other engines with similar size plugs
- 25 per box
- Order No. **OP-250**

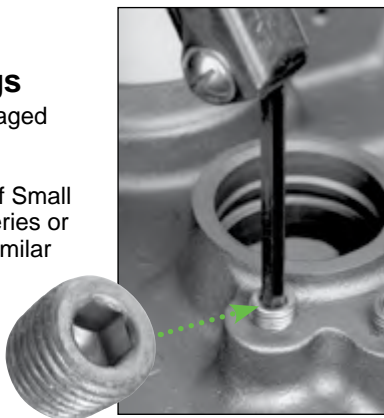

CRANKSHAFT/ FLYWHEEL GRINDING

Oil Gallery Brushes

Steel Wire	Order No.	Incl.
3-pc. Kit		
Size Length	OGB-SK	▼
1/4" x 3" 24"	OGB-1	x
3/8" x 3" 24"	OGB-2	x
5/8" x 3" 24"	OGB-3	x
Nylon Bristle		
5-pc. Kit		
Size Length	OGB-KIT	▼
3/8" x 3" 34"	OGB-38	x
1/2" x 2 1/2" 34"	OGB-42	x
5/8" x 3" 34"	OGB-5	x
3/4" x 3" 34"	OGB-7	x
3/4" x 3" 40"	OGB-8	x

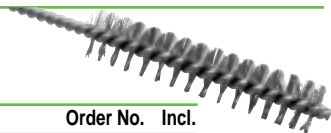

BRAKE SERVICE TOOLING

Oil Gallery Wax

- Preheat the part to be removed, apply wax to its base, allow to cool and remove the part
- Choose between wax sticks and blocks of beeswax



BWS-1

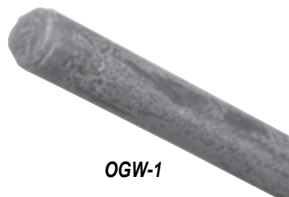

OGW-1

Description	Order No.
Oil Gallery Wax - 6" sticks (3 oz.)	OGW-1
Beeswax Stick - 1" x 3/4" x 3" (1 oz.)	BWS-1

MEASURING TOOLS
V-TWIN & METRIC HARD PARTS



Adjust size to fit filters from 2 1/2" to 6 1/2" diameters
Stud mounts in center hole of the oil filter

Includes 1 Replaceable Blade

Oil Filter Inspection Tool

- Check for contaminants with every oil change
- Cut open the filter canister for inspection
- Fits 2 1/2" to 6 1/2" diameter filters
- Includes a single blade

Description	Order No.
Oil Filter Inspection Tool	FIT-1-G
Replacement Cutter Blade	FIT-W

Oil Pump Pickup Tube Driver

- For all GM pumps
- Replace pickup tubes easily with a light mallet
- Driver grips the pickup tube flare
- Gives control for fast alignment and installation



Application	Tube OD	Order No.
Small Block	5/8"/15.9mm	TI-25
Big Block	3/4"/19.1mm	TI-30

Oil Gallery Plug Removers

- Power plugs out with an impact wrench
- Threaded plug inside prevents bit from backing into the holder
- 1/2" drive – fits impact wrenches
- Hardened tool-steel holder with lifetime breakage guarantee
- Tool-steel bit can be reground or replaced
- Set screw holds bit firmly in place

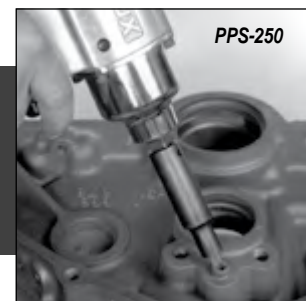
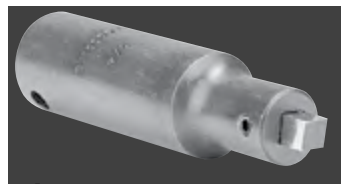

PPS-250

Description	Size	Order No.	Incl.
Plug Remover Kit	in mm	PPS-KIT	▼
Replacement Tool	3/16" 4.76	PPS-187	x
	1/4" 6.35	PPS-250	x
	5/32" 7.14	PPS-281*	x
	5/16" 7.94	PPS-312	x
	3/8" 9.53	PPS-375	x
Replacement Bits	3/16" 4.76	PPS-187B	
	1/4" 6.35	PPS-250B	
	5/16" 7.94	PPS-312B	
	3/8" 9.53	PPS-375B	

NOTE: *No bit is needed for PPS-281 (square socket).

new

High Performance Lifter Bore Burnishing Tool Kits

- Sized for high performance aluminum blocks such as Top Fuel or Top Alcohol Dragsters and Funny Cars

Description	Order No.	Incl.
Complete Set	LBB-625-KIT	▼
	LBB-1000-KIT	▼
15" Slide Shaft	LBB-1	x x
Slide Hammer	GAO-2	x x
Lifter Bore Burnishing Balls		
1.0000" dia.	LBB-1.000	x
1.0010" dia.	LBB-1.001	x
1.0625" dia.	LBB-1.0625	x
1.0635" dia.	LBB-1.0635	x
Accessories		
Jam Nut	LBB-NUT	x x
Storage Case	LBB-CASE	x x
Lifter Bore Brushes		
7/8" (.875" dia.)	LBB-875	
1" (1.00" dia.)	LBB-100	x
1 1/8" (1.125" dia.)	LBB-1125	x



Lifter Bore Burnishing Tool

- Eliminates burrs caused by shot blasting
- Drive the burnishing tool into the bore with a soft hammer, then slide-hammer it back out
- 60Rc burnishing balls deburr faster
- Won't oversize the bore

Description	Order No.	Incl.
Full Kit:	LBB-1500	▼
Slide Shaft	GAO-1	x
Slide Hammer	GAO-2	x
Jam Nut	LBB-NUT	x
Lifter Bore Burnishing Balls		
Complete Set	LBB-3SET	▼
GM .845" dia.	LBB-GM1	x x
Ford .876" dia.	LBB-FO1	x x
Chrysler .906" dia.	LBB-CR1	x x

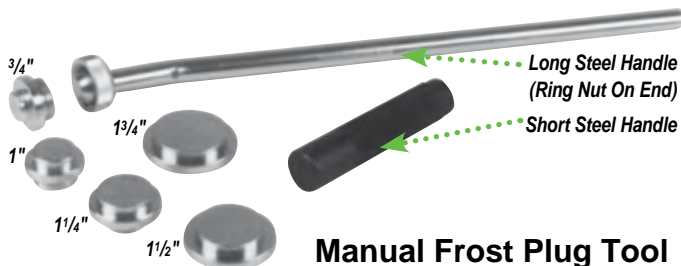

Manual Frost Plug Tool

- Minimizes the chance of frost plug distortion and leakage
- Two handle lengths – use the short handle for rebuild jobs, and the long handle for engines still in the vehicle
- Kit includes five sizes of installing plugs, ring nut and two steel handles • All items also available individually

Description	Order No.	Incl.
Complete Kit	FP-20	▼
Installing Plugs		
in. mm		
3/4"	19.1	FP-1 x
1"	25.4	FP-2 x
1 1/4"	31.8	FP-3 x
1 1/2"	38.1	FP-4 x
1 3/4"	44.5	FP-5 x
Ring Nut	FP-6	x
Steel Handle		
18"L	FP-7	x
6"L	FP-8	x

Retainer for 6" Mandrel

Honall Head

Wedge for 6" Mandrel

6" Mandrel

Retainer for 6.75" Mandrel

Adaptor

Wedge for 6.75" Mandrel

6.75" Extended Mandrel

Roughing or Finishing Stone

Truing Sleeve

Sunnen® Lifter Bore Honers

- Restore bore size and finish after shot blasting
- Install oversize lifters for high-performance
- Stones work in cast iron bores or ones sleeved with brass or steel
- Wide stones contact a large area giving better stability for hand honing
- Cross oil ports without catching
- Wedge-type adjustment is a simple, positive way to expand or contract the stone to the precise size needed
- Use a 3/8" (9.5mm) or 1/2" (12.7mm) hand-held electric or air drill at approx. 200 RPM
- Use with honing oil
- All parts MUST be ordered separately to make a complete unit**

tech tips
from the techxperts™

NOTE: Wedges may come with a tab that must be removed **BEFORE** using them with the P-180 Head

Description	Order No
Honall Head	P-180
Adaptor	PAK20-A
Roughing Stone (280 Grit) 12/box	Y20-J67
Finishing Stone (400 Grit) 12/box	Y20-J87
Standard Lifter Bore Tooling (6" Reach)	
Mandrel .838" - .869" Range	AAY20838BH6LH
.869" - .900" Range	AAY20869BH6LH
Wedge	Y20-W-6LH
Retainer	LN-3688A-6LH
Truing Sleeve .838" - .869" Range	S-838
.869" - .900" Range	S-869
Extended Reach Lifter Bore Tooling (6 1/2" Reach)	
Mandrel .838" - .869" Range	AAY20838675LH
.869" - .900" Range	AAY20869675LH
Wedge	Y20-W-675LH
Retainer	LN-3688A675LH
Truing Sleeve .838" - .869" Range	S-838
.869" - .900" Range	S-869



Rod Honing Oil

- Includes additives for high pressure cutting
- Keeps stones clean and free-cutting during rod reconditioning, pin fitting and other honing applications
- Will mix with other honing oils (including Sunnen®)

Size	Order No.
1 Gal. (3.78L)	RHO-10
5 Gal. (18.9L)	RHO-50

CYLINDER HEAD REBUILDING ASSEMBLY & SAFETY CLEANING, REBUILDING SHORT BLOCK REBUILDING FLYWHEEL GRINDING MISCELLANEOUS TOOLS & SUPPLIES BRAKE SERVICE TOOLING MEASURING TOOLS V-TWIN & METRIC HARD PARTS

... another satisfied customer

"It's a pleasant surprise to deal with a company that obviously cares about customer service. Your website was easy to use and order feedback assuring. Keep up the good work."

— Norm Cameron, St. Petersburg, FL, Goodson customer since 2017

CYLINDER HEAD REBUILDING
CLEANING, ASSEMBLY & SAFETY
SHORT BLOCK REBUILDING
CRANKSHAFT/ FLYWHEEL GRINDING
MISCELLANEOUS TOOLS & SUPPLIES
BRAKE SERVICE TOOLING
MEASURING TOOLS
V-TWIN & METRIC HARD PARTS



new

Powder Coated Steel Storage Rack Included with kit purchase

Universal Cam Bearing Tool

- Remove and install hundreds of sizes of cam bearings with just four mandrels!
- Expanding Mandrels cover a 1.370"-2.250" range
- Adjusts to undersize bearings so you can remove and install them from virtually any block
- *Interchangeable with Dura-Bond*

Description	Order No.	Incl.
Universal Cam Bearing Tool	CBT-300	▼
Replacement Segment with Sleeve		
Max Dia. 1.370"	CBT-5M	x
1.682"	CBT-6M	x
1.875"	CBT-7M	x
2.250"	CBT-8M	x
Replacement Backing Plate		
Max Dia. 1.370"	CBT-5W	x
1.682"	CBT-6W	x
1.875"	CBT-7W	x
2.250"	CBT-8W	x
Replacement Neoprene Sleeve		
Max Dia. 1.370"	CBT-5NS	x
1.682"	CBT-6NS	x
1.875"	CBT-7NS	x
2.250"	CBT-8NS	x
Drivers		
Length 5" (pictured above)	CBT-1B	x
24"	CBT-2B	x
36" (pictured above)	CBT-3B	x
48"	CBT-4B	x
Miscellaneous Replacement Parts		
1 1/16" Expander with stud	CBT-3E	x
1 5/8" Expander with stud	CBT-4E	x
1/2"x13 Stud	CBT-1S	x
Guide Cone	CBT-1C	x
Threaded Impact Cap (New Style)	CBT-300-CAP	x
Steel Storage Rack	CBT-300-WR	x

new

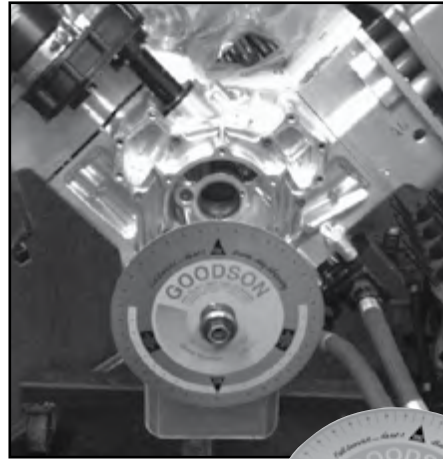

This is one of those MUST have tools for the shop and trailer. We have needed our Goodson Degree wheel at the track a few times and in a few minutes we are done and ready to go! Thanks again great equipment.

— Dean Dubbin, DMP Awnings (NHRA Top Alcohol Dragster), Goodson customer since 2010

Degree Wheel

- Check cam timing, duration and overlap
- Degree wheel measures 11" / 279.4mm dia. with 1 1/8" / 47.6mm hole • Small ID Adaptor Kit mounts it to cranks using 7/16" to 3/4" fasteners or use the turning tool for that engine to mount the wheel
- Use with 1/2" drive ratchet

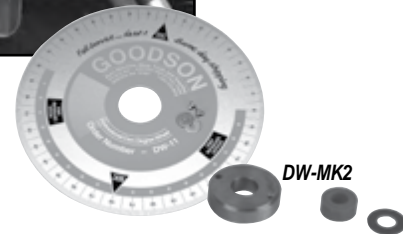

Wheel / Adaptors	Order No.	Incl.
Automotive Degreasing Kit	DW-KIT-2	▼
Degree Wheel	DW-11	x
Small ID Adaptor Kit	DW-MK2	x

Lifting Sling

- Lift up to 1800 lbs. (816.5 kg) safely and easily
- 1" x 36" (25.4x914.4mm) looped sling
- Secure the sling to the workpiece and move it with your overhead hoist
- Durable, nylon webbing
- Not for use with caustics or temperatures exceeding 190°F / 87.8°C
- Order No. **LS-3**



Bearing Scraper

- Eliminate bearing high spots after installation to assure correct oil clearance
- Solid, wire wound, wood handle for strength and resistance to splitting
- 4" / 101.6mm blade with 3 cutting edges
- Order No. **BS-30**

Whether you're regrinding cores for stock applications or custom grinding for diesel and high performance, you can count on Goodson Cam Grinding Wheels to deliver an excellent finish

Goodson abrasives are second to none. We work with our manufacturer to get you the most ideal grain that's bonded to be free-cutting, yet still shed before loading up. Our Premium wheels are ideal for steel high performance camshafts of 55 to 65 Rc and for Stellite overlays. Goodson makes all Camshaft Grinding Wheels to your specifications in-house for fast turn-around and delivery. Choose from the sizes below or custom order your cam wheel today!



Cam Grinding Wheels - WAA54-L5V1

Diameter	Width	Arbor	Order No.
18"	3/4"	19mm 6" 152mm	E341420
457mm	7/8"	22mm 6" 152mm	E335351
	1"	25mm 6" 152mm	E335352
	1 1/8"	29mm 6" 152mm	E335353
	1 1/4"	32mm 6" 152mm	E335354

Cam Grinding Wheels - 43A602-K8-V1

18"	3/4"	19mm 6" 152mm	E342030
457mm	7/8"	22mm 6" 152mm	E339945
	1"	25mm 6" 152mm	E342031
	1 1/4"	32mm 6" 152mm	E348558

Cam Grinding Wheels - 70BL801

18"	3/4"	19mm 6" 152mm	E416880
457mm	7/8"	22mm 6" 152mm	E427392

Due to the manufacturing process, actual colors may vary

Cam Grinding Wheels - WAA100

18"	3/4"	19mm 6" 152mm	E379225
457mm	7/8"	22mm 6" 152mm	E397667
	1 1/4"	32mm 6" 152mm	E348558

Standard Goodson Cam Grinding Wheels - 100 grit

Diameter	Width	Arbor	Order No.
18"	3/4"	19mm 6" 152mm	GCC 18 x 0.750 x 6
457mm	7/8"	22mm 6" 152mm	GCC 18 x 0.875 x 6
	1"	25mm 6" 152mm	GCC 18 x 1.000 x 6
	1 1/8"	29mm 6" 152mm	GCC 18 x 1.125 x 6
	1 1/4"	32mm 6" 152mm	GCC 18 x 1.250 x 6

All Radiac Camshaft Grinding Wheels are the same grit, grain and bond that you have ordered in the past.

Torque-Angle Indicator

- When torque is given as degrees of turn past a certain ft./lb., use this gauge to show degrees
- 1/2" square drive
- Hold metal base with one hand
- Plastic dial turns as you tighten
- Fits between a socket-driven extension and the socket
- Order No. **TQR-4554**



Bore Washing Brushes

- Clean tunnel housing bores and full-annular grooved area
- Heavy, hand-driven shank

Dia.	Length	Order No.
2"	36"	CBB-200
2 1/4"	36"	CBB-225
2 1/2"	36"	CBB-250
2 3/4"	18 1/2"	CWB-27W
3 1/2"	18 1/2"	CWB-35
4"	18 1/2"	CWB-40
4 1/2"	18 1/2"	CWB-45
5"	18 1/2"	CWB-50



Diamond Impregnated Cam Dresser

- 7/16" OD
- 1 9/16" OAL
- .094" Face Width
- .370 Face Length
- Fits most cam grinders
- Order No. **2V9507**

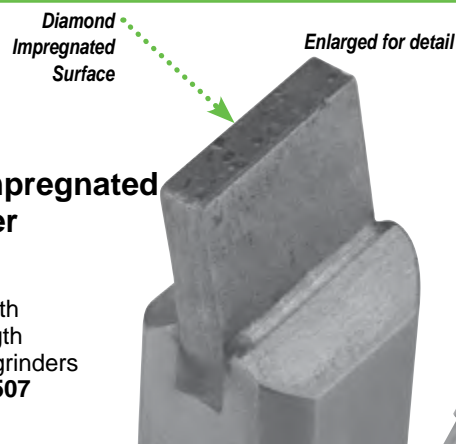

Cam Bearing Flex-Hones®

- Silicon-Carbide globules laminated to high density nylon
- Includes 18" drive rod
- 180 grit

Inch	mm	Order No.
1 1/4"	45	CBF-175
2"	51	CBF-200
2 1/4"	57	CBF-225
2 1/2"	64	CBF-250
2 3/4"	70	CBF-275

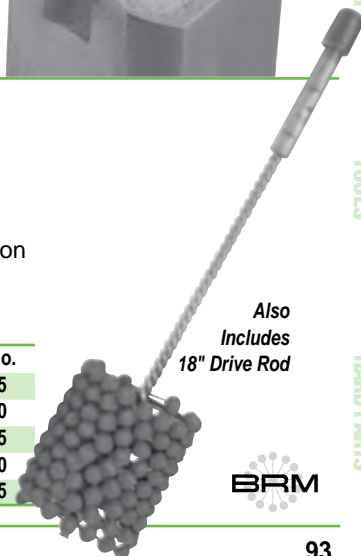

CYLINDER HEAD REBUILDING
CLEANING, ASSEMBLY & SAFETY
SHORT BLOCK REBUILDING
CRANKSHAFT/FLYWHEEL GRINDING
MISCELLANEOUS TOOLS & SUPPLIES
BRAKE SERVICE TOOLING
MEASURING TOOLS
V-TWIN & METRIC HARD PARTS

full service
...fast



"The Mach-B division of Goodson offers many services such as ANSI compliant speed testing, balance testing, grinding wheel shaping, resizing and more." – Jon, Goodson Production, 36 years of service



Goodson crankwheels are made-to-order in-house

Other sources stock finished wheels, which makes it virtually impossible to stock a full size range. If they don't have what you need, they may charge more and delay your order for weeks. That's why Goodson makes every wheel to order. We always have the right wheel because we take a Type 1 straight wheel, size it, shape it, speed test it and ship it.

For future reference write down your

Crank Wheel Number (s)

Select the shape



Hub

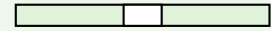

Straight

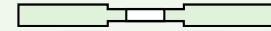

Recessed 2 Sides

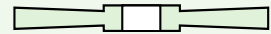

Tapered

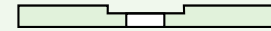

Recessed 1 Side

Select your wheel grade:

WAA Superior Grade - 54 grit
Excellent dimensional accuracy, corner radii and surface finish. For multiple applications including weld grinding. Ideal for grinding anything from cast to steel. Finishing and roughing wheel. Aluminum-oxide abrasive for light to medium stock removal.



GCH Superior Grade - 54 grit
Better form holding ability, cuts cooler and needs less dressing. Use on crank journals with Rockwell hardness of 35 Rc or less. Use on crankshafts of cast or forged steel, Nodular iron. Ideal for large radii, thrust and plunge grinding. Great for high-performance.



GCD Premium Grade - 60 grit
For harder materials. Good form holding ability; cuts cooler and needs less dressing. Grains yield faster, cooler grinding. Use on journals with Rockwell hardness of 35 Rc or more. Ideal for diesel, high-performance, industrial and billet steel.



Increase coolant flow with Crankwheel Slotting

Slotting facilitates the flow of coolant to the thrust and radius areas of the crankshaft. Don't waste time waiting on other suppliers who outsource their crankwheels for slotting – Goodson has a shop full of equipment, so we slot wheels in house!

Grade	Diameter	Face Width	Arbor Size	Machine	Shape
WAA - Superior	Diameters are available from	Most sizes from	Arbor size of your	Identify the make	We send the stan-
GCD - Premium	18" to 36" in most	3/4" to 2 5/8" (custom	grinder. Any arbor	and model of your	dard shape for your
GCH - Superior	grades.	widths are no extra	hole from 3" to 12".	grinder.	grinder unless you
		charge).			specify otherwise.

Grade x Diameter x Face Width x Arbor Size x Machine x Shape

Please note, all wheels are delivered .015" oversize to allow for side dressing when mounting

CRANKSHAFT/
FLYWHEEL GRIND

MISCELLANEOUS
TOOLS & SUPPLIES

BRAKE SERVICE
TOOLING

MEASURING
TOOLS

V-TWIN & METRIC
HARD PARTS

Crankshaft Grinding Wheels



	WAA	GCH	GCD
Dia. Face Width			
Fits Storm Vulcan 14, 15			
18"		3/4"-1"	
3" Arbor	1 1/64"-1 1/4"		
	1 17/64"-1 1/2"		
	1 33/64"-1 3/4"		
	1 49/64"-2"		
Fits Storm Vulcan 15, 15 Special, 1550, 1648			
20"		3/4"-1"	
3" Arbor	1 1/64"-1 1/4"		
	1 17/64"-1 1/2"		
	1 33/64"-1 3/4"		
	1 49/64"-2"		
Fits Kwik-Way / Lemppo			
20"		3/4"-1"	
3 3/4" Arbor	1 1/64"-1 1/4"		
	1 17/64"-1 1/2"		
	1 33/64"-1 3/4"		
	1 49/64"-2"		
Fits Kwik-Way / Lemppo 519 & Storm Vulcan 15A (early)			
22"		3/4"-1"	
5" Arbor	1 1/64"-1 1/4"		
	1 17/64"-1 1/2"		
	1 33/64"-1 3/4"		
	1 49/64"-2"		
Fits Peterson Berco 180			
22"		3/4"-1"	
8" Arbor	1 1/64"-1 1/4"		
	1 17/64"-1 1/2"		
	1 33/64"-1 3/4"		
	1 49/64"-2"		
Fits Storm Vulcan 15A (late), 15A Special; RMC/Robbi REX-1200			
24"		3/4"-1"	
5" Arbor	1 1/64"-1 1/4"		
	1 17/64"-1 1/2"		
	1 33/64"-1 3/4"		
	1 49/64"-2"		
Fits Kwik-Way / Lemppo KGA and NKG Series			
24"		3/4"-1"	
5" Arbor	1 1/64"-1 1/4"		
	1 17/64"-1 1/2"		
	1 33/64"-1 3/4"		
	1 49/64"-2"		
Van Norman 438, 448, 460, 465;			
Winona Van Norman/Zanrosso CG-210 (early); Storm Vulcan Scledum 200			
24"		3/4"-1"	
8" Arbor	1 1/64"-1 1/4"		
	1 17/64"-1 1/2"		
	1 33/64"-1 3/4"		
	1 49/64"-2"		
Storm Vulcan 15C			
25"		3/4"-1"	
5" Arbor	1 1/64"-1 1/4"		
	1 17/64"-1 1/2"		
	1 33/64"-1 3/4"		
	1 49/64"-2"		
AMC K1100; Peterson Berco 180, 225; Scledum 200, 230; Van Norman 438, 448, 460, 465, 475, 476; Winona Van Norman CG-210 (late), CG-840			
26"		3/4"-1"	
8" Arbor	1 1/64"-1 1/4"		
	1 17/64"-1 1/2"		
	1 33/64"-1 3/4"		
	1 49/64"-2"		
	2 1/64"-2 1/4"		

	WAA	GCH	GCD
Dia. Face Width			
Schou 1500/270, 1600, 260			
27 1/2"		3/4"-1"	
8 5/64" Arbor	1 1/64"-1 1/4"		
	1 17/64"-1 1/2"		
	1 33/64"-1 3/4"		
	1 49/64"-2"		
	2 1/64"-2 1/4"		
Peterson Berco 260; SV Scledum 230, 270/280; Zanrosso Mito 250; Van Norman 400, 438, 439, 475, 476, 666; RMC/Robbi REX-1500			
28"		3/4"-1"	
8" Arbor	1 1/64"-1 1/4"		
	1 17/64"-1 1/2"		
	1 33/64"-1 3/4"		
	1 49/64"-2"		
	2 1/64"-2 1/4"		
	2 17/64"-2 5/8"		
Seest MC62			
30"		3/4"-1"	
6" Arbor	1 1/64"-1 1/4"		
	1 33/64"-1 3/4"		
	1 49/64"-2"		
Zanrosso Mito 280; Storm Vulcan Scledum 270/280; RMC / Robbi REX-1800, REX 2200L			
30"		3/4"-1"	
8" Arbor	1 1/64"-1 1/4"		
	1 17/64"-1 1/2"		
	1 33/64"-1 3/4"		
	1 49/64"-2"		
	2 1/64"-2 1/4"		
	2 17/64"-2 5/8"		
AMC 1400, K1500, K1800; Van Norman 467, 477; Zanrosso			
32"		3/4"-1"	
8" Arbor	1 1/64"-1 1/4"		
	1 17/64"-1 1/2"		
	1 33/64"-1 3/4"		
	1 49/64"-2"		
	2 1/64"-2 1/4"		
	2 17/64"-2 5/8"		
Peterson Berco 280, 300; RMC Robbi REX-1800RM; REX-2200, REX-2200RM, REX-2700RM, REX-3100RM			
32"		3/4"-1"	
12" Arbor	1 1/64"-1 1/4"		
	1 17/64"-1 1/2"		
	1 33/64"-1 3/4"		
	1 49/64"-2"		
	2 1/64"-2 1/4"		
	2 17/64"-2 5/8"		
Peterson Berco 300, 350; Storm Vulcan Scledum 250; RMC / Robbi REX-2200M, 2700M, 3100M; Winona Van Norman 111			
36"		3/4"-1"	
12" Arbor	1 1/64"-1 1/4"		
	1 17/64"-1 1/2"		
	1 33/64"-1 3/4"		
	1 49/64"-2"		
	2 1/64"-2 1/4"		
	2 17/64"-2 5/8"		

tech tips NOTE: All wheels are delivered .015" oversized to allow for side dressing when mounting the wheel



Ask us about resizing or reshaping your existing wheel!

a division of Goodson Shop Supplies

CYLINDER HEAD REBUILDING
 CLEANING, ASSEMBLY & SAFETY
 SHORT BLOCK REBUILDING
 CRANKSHAFT/FLYWHEEL GRINDING
 MISCELLANEOUS TOOLS & SUPPLIES
 BRAKE SERVICE TOOLING
 MEASURING TOOLS
 V-TWIN & METRIC HARD PARTS

"Just received my order — two days earlier than expected. Thanks for expediting my order so I can complete the job for my customer."

- Marvin Davenport, Davenport Racing - Goodson Customer since 2014

CYLINDER HEAD REBUILDING

CLEANING, ASSEMBLY & SAFETY

SHORT BLOCK REBUILDING

CRANKSHAFT/FLYWHEEL GRINDING

MISCELLANEOUS TOOLS & SUPPLIES

BRAKE SERVICE TOOLING

MEASURING TOOLS

V-TWIN & METRIC HARD PARTS

Reluctor Ring Installation Tool

- All steel construction
- Adjustable depth for popular flange widths
- Fits Generation III engines: 4.8/LR4, 5.3/LM7 and 6.0/LQ4
- Aligns GM# 12559353 & 12586768 Sensor Rings on the crankshaft in the correct phased position
- Indexes in dowel hole of flange to dowel hole in sensor ring • Extended length fits manual transmission flange

Goodson
exclusive



• US Patent No. 7,716,827

Description	Order No.
Reluctor Ring Installation Tool	RRJ-350
Temperature Indicating Crayon (450° F/232°C)	TIC-450

tech tips

Heat reductor ring to 450°F (232°C) then slide it onto the casting. Be sure to deburr all components before beginning from the techxperts™ assembly. Any sharp edges will cause the reductor ring to catch on the casting, making assembly impossible.

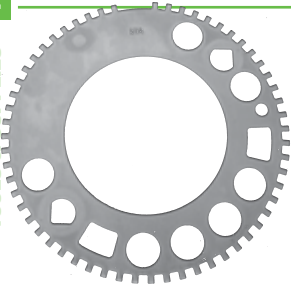

Callies 24 Tooth Billet Steel Reluctor Ring

- For LS1 & LS6 Engines
- Single Piece
- Order No. RR-24T

GM Steel 58 Tooth Reluctor Ring

- Single Piece Steel
- Fits LS2, LS3 & LS7
- Order No. RR-58T



Professional Measuring & Inspection Stand For Cranks & Cams

- Length adjusts up to 23" to fit journal spacing
- Rotate work to view or measure
- Solid aluminum frame with self-lubricating, corrosion and chemical-resistant wear surfaces
- Order No. PMIS-30

Dampener Installer

- Install harmonic dampeners without thrust bearing damage
- Screw tool into hole in the crankshaft end
- Use the nut and thrust bearing to draw the harmonic dampener onto the crankshaft snout
- Fits 7/16" x 20" and 1/2" x 20" holes • 3 piece set
- Order No. DIT-2



Eliptibur Tool

- Fastest, safest way to chamfer crank oil holes
- Simplify deburring and chamfering of angularly drilled holes on cylindrical surfaces
- Easily produces a chamfer of relative uniformity and depth
- Self-centering, spring loaded pilot
- Includes one replaceable blade
- For 30Rc or softer crankshafts

Description	Order No.
Eliptibur Tool (1 blade included)	EBT-15
Replacement Blade	EBT-15B
Replacement Pilot	EBT-15N

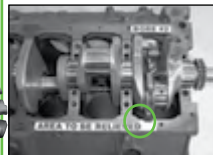

Create a relief in the block for rod #2 at the pan rail area using your normal process.



Place the arbor in main saddles 1 & 2, keeping the flange nearest to the pointer against #2.



Rotate the arbor and adjust the pointer until the tapered end passes freely through the relief with a minimum of clearance.



Lock the pointer in position with the set screw and check the clearance.



Once satisfied, scribe a line on the pointer opposite the set screw.

Must have when building a Stroker Engine!

Stroker Mimic™

- Lightweight and easy to use
- Eliminates the need to repeatedly install and remove the crankshaft, pistons, the rod assembly and the necessary bearings when clearancing a block for a stroker crank
- Once the Stroker Mimic™ has been set to a particular crank, rod and piston combination, the tool can be marked or measured for future reference



Description	Order No.
Stroker Mimic™ Fixture for 350 Blocks	SM-350
Replacement Pointer for SM-350	SM-351



Cam & Crank Grinding Coolant

- Semi synthetic
- Non-nitrite
- High-lubricity
- Dilute 20 parts water to 1 part coolant

Size	Order No.
1 gallon (3.78L)	CGC-10
5 gallons (18.93L)	CGC-50

Hand-Held Dressing Sticks

- Keep your crankshaft grinding wheels cutting clean



Hard Silicon-Carbide

- 1" x 1" x 6"
- Use to deglaze wheel side
- Removes material with light pressure
- Order No. **GG-112**

Dense Granular Norbide

- 3/16" x 1/2" x 3"
- For fine tuning radius and side relieving wheels
- Order No. **DS-NOR**

Hardness Tester

- Calculate Rockwell Hardness quickly and accurately
- Range: 15 to 65 Rockwell on C-Scale
- Features a steel ball of precise weight and shape which is dropped from an exact height to yield an accurate Rc reading
- Check overheated or repaired crankshaft journals to confirm correct hardness
- Also use on flywheels
- Weighs just 4 oz. • 9 1/4" long
- Includes case & instructions
- Order No. **HT-45RC**



Crankshaft Straightening Peening Tool

- Designed for narrow journals on some new-style V6 crankshafts
- Peen crankshafts in the radius area of damaged journals to straighten
- Long-shank
- Offset-radius face
- 10" long • 0.0625" radius
- 0.125" diameter

Description	Order No.
Peening Tool	CPT-062
Safety Glasses	PGL-21

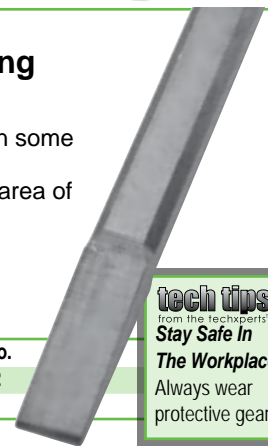

tech tips
from the TechExperts™
Stay Safe In
The Workplace!
Always wear protective gear.

Plastigage

- Accurately measure bearing clearance
- Color coded by size
- Put a piece on rod or main bearing and torque the cap
- Remove and inspect – width of crushed Plastigage shows clearance
- Use at the workbench or in the vehicle
- 10 per pack

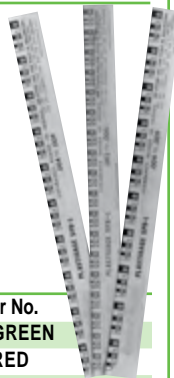

Clearance Range	Order No.
.001" to .003" / .025 to .076mm	PG-GREEN
.002" to .006" / .051 to .152mm	PG-RED
.004" to .009" / .102 to .229mm	PG-BLUE
10pk. Assortment (5 Green, 3 Red, 2 Blue)	PG-10PK

Stroke Checker

- Accurately measure strokes up to 6"
- Works with any precision caliper to accurately measure crankshaft strokes
- Measures strokes up to 6" with an accuracy of .001"
- Rigid, hard-anodized aluminum frame is fully adjustable
- Fits almost any crankshaft
- Order No. **CSG-1**

See page 121 for our selection of calipers



Crankshaft Journal Radius Gauge

- 16 radii ... 1/32" to 17/64"
- Measure radii or reground journals quickly
- Blades are clearly marked in 1/64" increments
- Use in holder or remove to use blades separately
- Order No. **RG-16**

Universal Quick-Set Crankgrinder Dial Indicator

- 3/8" diameter shaft • 12" long.
- .125" travel, .050" per revolution
- Rotating, lockable bezel graduated in .001" from -.025" to +.025"
- Order No. **MDI-12**

More Dial Indicators on page 121



Starrett

CYLINDER HEAD REBUILDING
CLEANING, ASSEMBLY & SAFETY
SHORT BLOCK REBUILDING
CRANKSHAFT/FLYWHEEL GRINDING
MISCELLANEOUS TOOLS & SUPPLIES
BRAKE SERVICE TOOLING
MEASURING TOOLS
V-TWIN & METRIC HARD PARTS



"If you're not sure what to order or if you have any questions, give us a call! We're here from 8am to 5pm Central Time, weekdays to serve you. We can help you get the most from our products and your equipment."

- Chris, Goodson ASE-Certified Master Machinist, 31 years of service

CYLINDER HEAD
REBUILDING

CLEANING,
ASSEMBLY & SAFETY

SHORT BLOCK
REBUILDING

CRANKSHAFT/
FLYWHEEL GRINDING

MISCELLANEOUS
TOOLS & SUPPLIES

BRAKE SERVICE
TOOLING

MEASURING
TOOLS

V-TWIN & METRIC
HARD PARTS

Premium Aluminum-Oxide Crank Polishing Belts

- J-weight cloth backing with a high strength mylar joint
- Phenolic resin-over-resin bond
- Aluminum oxide abrasive
- Polish better and outlast other standard polishing belts
- Color may vary due to manufacturing process



STRAIGHT-EDGE (10 per box)

Length	Width	600 grit	800 grit
60"	3/4"	R60x3/4x600	R60x3/4x800
	1"	R60x1x600	R60x1x800
64"	3/4"	R64x3/4x600	R64x3/4x800
	1"	R64x1x600	R64x1x800
72"	3/4"	R72x3/4x600	R72x3/4x800
	1"	R72x1x600	R72x1x800
77"	1"	R77x1x600	R77x1x800
91"	3/4"	R91x3/4x600	R91x3/4x800
	1"	R91x1x600	R91x1x800

All abrasives are guaranteed for 1 year from the original purchase date

Micro Finish Scotch-Brite Style Abrasive Rolls

- Ideal for hand polishing of high-performance crankshafts
- Non-directional polish
- Won't remove material
- Aluminum oxide abrasive with a high-strength resin bond
- Measures: 3/4"x10'
- 1 Per Box
- Order No. **GFR-750**



Premium Ceramic Micro Polishing Belts

- Recommended to use with our polishing rouge to enhance the finish
- Structured Abrasive
- 5 per box

Size (LxW)	Order No.
60" x 1"	GSW-60x1
64" x 1"	GSW-64x1
70" x 1"	GSW-70x1
72" x 1"	GSW-72x1
77" x 1"	GSW-77x1
Polishing Rouge	CPR-16

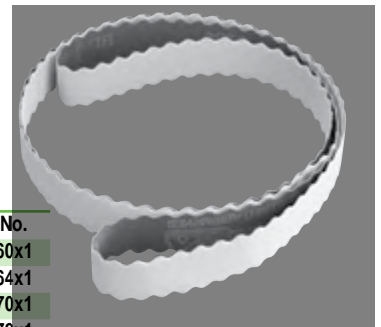

Crankshaft Polishing Belt Sample Pack

Want to try some different polishing belts but don't want to buy a large quantity? Here's your chance! These sample packs include 5 of our most popular belts. Contents may vary.

Belt Length x Width	Order No.
64" x 1"	PCP-64PAK
72" x 1"	PCP-72PAK

Heavy Duty Steel Stamps

- For hard materials
- Order in sets or individually
- For a single stamp, state character desired after Order No.
Example: **SCH-1/4(3)** Single Character stamp, 1/4" size, Number "3"



Char. Size	Shank Size	Number Sets	Order No.
1/8"	5/16"		SFH-1/8
3/16"	3/8"		SFH-3/16
Single Characters			
3/16"	3/8"		SCH-3/16
1/4"	7/16"		SCH-1/4

Crankshaft Grinder Steady Rest Shoes for Peterson-Berco

- 5/16" thick
- Use same shoe for upper and lower replacement
- Order No. **RBE-200**



Crank Welding Plug Rods

- 3 diameters available
- Each rod is 12 1/2" long and cuts off easily
- Sharpen ends with your existing pencil sharpener
- 5 Crank Welding Plug Rods per pack

Size	Order No.
.250"	CWPR-250
.312"	CWPR-312
.375"	CWPR-375



Crankshaft Polishing Belts

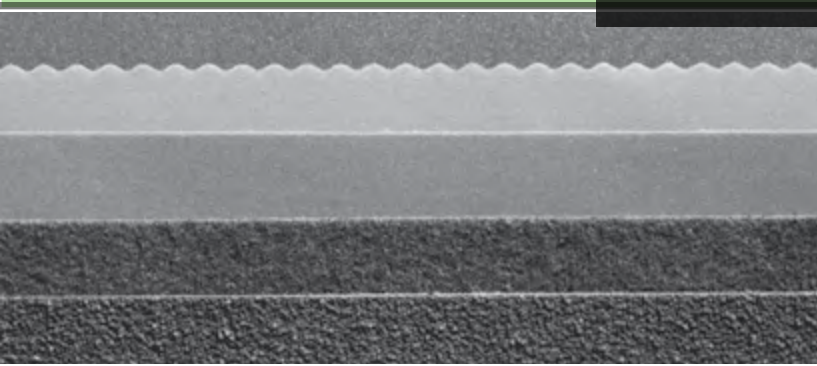

Standard Polishing Belts

Good quality, flexible, woven cloth-back belts polish better and outlast other general-use belts. New belts can be used to remove minor journal damage without grinding while broken-in belts give a fine finish. Aluminum oxide abrasive. 2-layer glue bond. Colors may vary due to manufacturing.

STANDARD STRAIGHT-EDGE (10 per box)				
Lgth	Width	240 grit	320 grit	400 grit
60"	3/4"	-----	60x3/4x320	60x3/4x400
	1"	60x1x240	60x1x320	60x1x400
64"	3/4"	64x3/4x240	64x3/4x320	64x3/4x400
	1"	64x1x240	64x1x320	64x1x400
	1 1/2"	64x1 1/2x240	-----	-----
	1 3/4"	-----	64x1 3/4x320	-----
70"	2"	-----	64x2x320	-----
	3/4"	-----	70x3/4x320	-----
	1"	70x1x240	70x1x320	70x1x400
72"	1 1/4"	-----	70x1 1/4x320	-----
	3/4"	72x3/4x240	72x3/4x320	72x3/4x400
	1"	72x1x240	72x1x320	72x1x400
	1 1/4"	72x1 1/4x240	72x1 1/4x320	-----
	1 3/4"	72x1 3/4x240	72x1 3/4x320	-----
77"	2"	72x2x240	72x2x320	-----
	3/4"	-----	77x3/4x320	-----
	1"	77x1x240	77x1x320	77x1x400
	1 3/4"	-----	77x1 3/4x320	-----
91"	2"	-----	77x2x320	-----
	3/4"	-----	91x3/4x320	-----
	1"	-----	91x1x320	91x1x400
91"	1 1/4"	-----	-----	-----
	1 3/4"	-----	91x1 3/4x320	-----
	2"	-----	91x2x320	-----
	-----	-----	-----	-----

All abrasives are guaranteed for 1 year from the original purchase date

Standard Scalloped Edge Crankshaft Polishing Belts

- 10 per box • 320 grit • 1" wide
- Ideal for radius polishing

Length	Order No.
64"	S64x1x320
72"	S72x1x320



Fine Finish

- Aluminum-oxide • Flexible, woven back
- 2-layer resin bond
- Very aggressive
- Sharper grains cut faster without sacrificing finish • The "Blue Backed Belt"

Fine Finish (10 per box)			
Lgth	Width	320 grit	400 grit
60"	1"	G-60x1x320	G-60x1x400
64"	1"	G-64x1x320	G-64x1x400
72"	1"	G-72x1x320	G-72x1x400
77"	1"	G-77x1x320	G-77x1x400

Scotch-Brite Style Micro Finish

- Rigid, 3-dimensional back • Resin bond • Aluminum-oxide abrasive • Non-directional finish

Micro-Finish (1 per box)		
Lgth	Width	Order No.
60"	3/4"	GFB-60 x 3/4
	1"	GFB-60 x 1
64"	3/4"	GFB-64 x 3/4
	1"	GFB-64 x 1
70"	3/4"	GFB-70 x 3/4
	1"	GFB-70 x 1
72"	3/4"	GFB-72 x 3/4
	1"	GFB-72 x 1
77"	1"	GFB-77 x 1
	1"	GFB-91 x 1

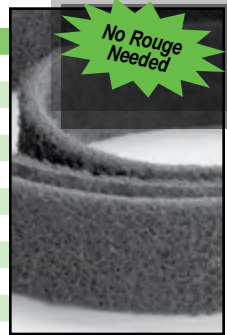

Scotch-Brite Style Super-Micro Finish

- Produces a mirror-like non-directional finish • Resin bond
- Silicon-Carbide abrasive • For final finish

Super-Micro Finish (1 per box)		
Lgth	Width	Order No.
60"	3/4"	SGFB-60 x 3/4
	1"	SGFB-60 x 1
64"	3/4"	SGFB-64 x 3/4
	1"	SGFB-64 x 1
70"	3/4"	SGFB-70 x 3/4
	1"	SGFB-70 x 1
72"	3/4"	SGFB-72 x 3/4
	1"	SGFB-72 x 1
77"	3/4"	SGFB-77 x 3/4
	1"	SGFB-77 x 1
91"	3/4"	SGFB-91 x 3/4
	1"	SGFB-91 x 1

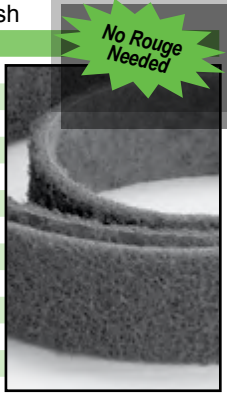

Abrasive Cork Super-Fine Finish

- Satin finish • Won't disturb polished radii • Silicon-carbide

Abrasive Cork (1 per box)		
Lgth	Width	Order No.
64"	3/4"	CPB-64-3/4
	1"	CPB-64-1
70"	3/4"	CPB-70-3/4
	1"	CPB-70-1
72"	3/4"	CPB-72-3/4
	1"	CPB-72-1
77"	3/4"	CPB-77-3/4
	1"	CPB-77-1
91"	3/4"	CPB-91-3/4
	1"	CPB-91-1



tech tips Store belts and abrasives in a dry, moisture free area.
from the techxperts™

CYLINDER HEAD REBUILDING
CLEANING, ASSEMBLY & SAFETY
SHORT BLOCK REBUILDING
CRANKSHAFT/FLYWHEEL GRINDING
MISCELLANEOUS TOOLS & SUPPLIES
BRAKE SERVICE TOOLING
MEASURING TOOLS
V-TWIN & METRIC HARD PARTS



"Hablamos español. Para su conveniencia tenemos representantes bilingües que le puedan ayudar con su orden."

- Maria, Goodson Ventas y Servicio, 1 años de servicio

CYLINDER HEAD
REBUILDING

CLEANING,
ASSEMBLY & SAFETY

SHORT BLOCK
REBUILDING

CRANKSHAFT/
FLYWHEEL GRINDING

MISCELLANEOUS
TOOLS & SUPPLIES

BRAKE SERVICE
TOOLING

MEASURING
TOOLS

V-TWIN & METRIC
HARD PARTS

Crankshaft Polishing Starter Kit

Includes 1 each of:

- Grind Aid,
- Polishing Rouge,
- Abrasive Dresser and
- 5-Pack of our most popular 72" belts
- Order No. **CP-KIT**

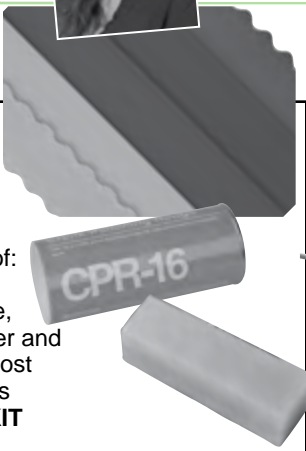

Grind Aid

- Cools and lubricates
- Reduces loading-up and grain fracturing
- Belts produce a better finish and last up to twice as long
- Use only on cloth-back belts such as those shown on pages 98 & 99
- Order No. **GRA-10**



Polishing Rouge

- Produces high luster finish
- Use with light pressure, for cork or fine grit polishing to finish crank journals perfectly
- Hard, dry compound becomes viscous with heat • White • 16 oz. / 454 g
- Order No. **CPR-16**

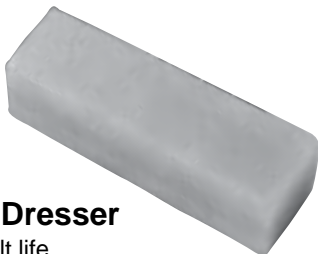

Abrasive Dresser

- Prolongs belt life
- Hold at 45° angle on moving belt to remove foreign material
- Restores cutting ability of grains
- 2" x 2" x 4" / 51 x 51 x 102mm
- Order No. **ACB-224**

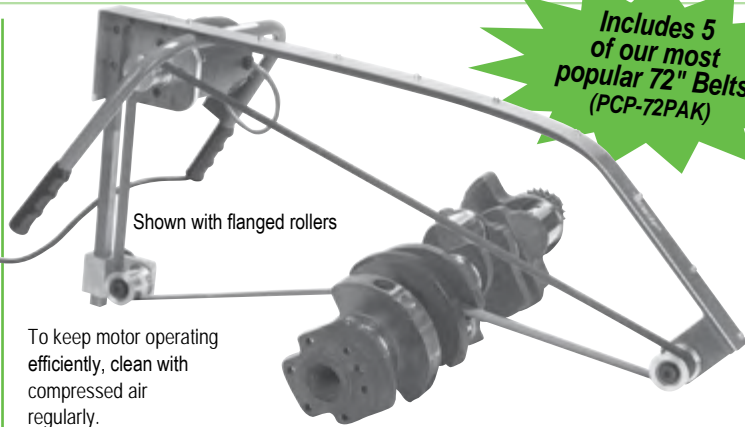

Shown with flanged rollers

To keep motor operating efficiently, clean with compressed air regularly.

Includes 5 of our most popular 72" Belts (PCP-72PAK)

American Made

tech tips
from the techsperts™ *Extend the life of your polishing belts by releasing the tension when not in use.*



72" Crankshaft Polisher

- Flex resistant steel frame
- Weighs 15 lbs. (6.8 kg)
- Crowned rollers keep snug belt running true
- 1" nominal = 1.625"
- 2" nominal = 2.625"
- 1/2 HP motor designed for high RPM not heavy loads
- Specify flanged or unflanged rollers when ordering

Roller Width		HP	Max. RPM	Order No.	
Nominal	Actual				
1" / 25mm	1.625" / 41mm	1/2	10,000	PCP-1072	
2" / 51mm	2.625" / 67mm	1/2	10,000	PCP-1072-2	
Replacement Parts and Rollers				Includes	
Flanged Roller Sets		1"		PCP-1	▼
(3 piece set)		2"		PCP-2	▼
Unflanged Roller Sets		1"		PCP-1S	▼
(3 piece set)		2"		PCP-2S	▼
Flanged Drive Roller		1"		PCP-1D	1
Fits 3/8" shaft - 1 ea.		2"		PCP-2D	1
Flanged Roller Assembly		1"		PCP-1F	2
3/8" x 16 thread - 1 ea.		2"		PCP-2F	2
Unflanged Roller Assembly		1"		PCP-1-1EA	2
3/8" x 16 thread - 1 ea.		2"		PCP-2-EA	2
Bearing - 1 ea.				PCP-BRG	
Replacement Switch				PCP-SWITCH-72	
Replacement Motor				PCP-MOTOR-72	
Replacement Motor Brush Set (also fits 220V)				PCP-BRUSH-72	

220 Volt, 50 cycle Motor Export Model

Roller Width		HP	Max. RPM	Order No.
Nominal	Actual			
1"	1.625"	1/2	10,000	PCP-1072E
2"	2.625"	1/2	10,000	PCP-1072-2E
Replacement Motor				PCP-1072E-M
Replacement Motor Brush Set (also fits 220V)				PCP-BRUSH-72

Crankshaft & Flywheel Tools

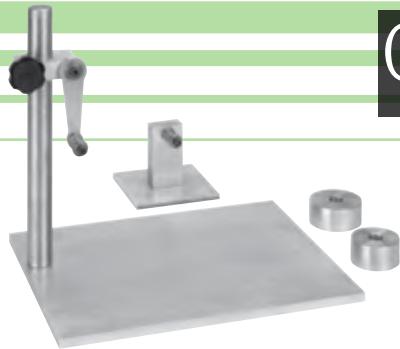

Rod Balancing Stand

- Ideal for static balancing parts
- Also use to weigh rotating and reciprocating masses and record the information for dynamic balancing
- Heavy-duty steel construction
- Includes 1-2" (50.8mm) and 1-2.3" (58.4mm) support discs
- Height adjustment accommodates different rod sizes
- Order No. **BS-201**



Heavy Metal

An essential component when balancing rods & pistons to crankshafts to ensure proper engine operation. Contains 90% Tungsten



HEAVY METAL - TUNGSTEN 90%

Hole in	Press Fit + in/mm	1.0" Long Grams	Order No.	1.2" Long Grams	Order No.
1/2"	.002"/.05	57	HM-57	65	HM-72
3/4"	.002"/.05	122	HM-122	147	HM-162
7/8"	.002"/.05	169	HM-169	198	HM-198
1"	.002"/.05	227	HM-227	265	HM-265

NOTE: Due to market fluctuations, heavy metal prices are subject to change without notice. Please confirm pricing when ordering.

Pin Pal Puller

- Remove dowels fast
- Adjusts to pull all sizes of dowels
- Locking pliers with special hardened jaws hold firm while 4 lb. slide hammer forces dowels out
- Also pulls pressed-in hollow tubes or frozen shafts
- Rugged steel construction



Description	Order No.
Complete Tool	GA-300
Replacement Jaws	GA-300E-R



Mirrored Safety Glasses

- Wrap-around design
- Tinted lenses provide sun glare protection
- Universal bridge
- Polycarbonate lenses
- Do not use as welders helpers
- Order No. **PGL-21**



6100 Gram Balancing Scales

- Scales feature automatic tare weight correction
- 1.0 Gram / 0.100 Ounce increments
- Operates on 9V battery (not included) or 110V converter (included) • Low battery indicator
- Order No. **BS-6100**

It is essential, when pulling a dowel, that the tightening sleeve is installed with the flared end toward the collet. **tech tips** This will allow the tightening sleeve to slide over the from the techxperts™ collet, locking it to the dowel you are removing. Also, be sure to select the correct collet size for the dowel you are removing.

Dowel Puller and Collets

- Slide hammer action removes stubborn dowels
- Use on blocks, heads, flywheels, etc.
- Split collets grip firmly without causing damage
- A high-quality tool that lets you reuse dowel pins
- Choose from SAE or Metric kits
- All items also sold separately

Description	Order No.	Incl.		
Standard Kit	GA-600	▼		
Metric Kit	GA-600M	▼		
Slide Shaft	GAO-1	x x		
Slide Hammer	GAO-2	x x		
Tightening Sleeve	GAO-3	x x		
Gripping Collets				
OD	ID	mm		
1"	.1575"	4.00	GAO-22	x
1"	.1875"	4.76	GAO-4	
1"	.1969"	5.00	GAO-13	x
1"	.2362"	6.00	GAO-14	x
1"	.2500"	6.35	GAO-5	x
1"	.2756"	7.00	GAO-26	
1"	.3125"	7.94	GAO-6	x
1"	.3150"	8.00	GAO-10	x
1"	.3750"	9.53	GAO-7	x
1"	.3937"	10.00	GAO-23	
1"	.4375"	11.11	GAO-8	x
1"	.4724"	12.00	GAO-24	
1"	.5000"	12.70	GAO-9	
1"	.5512"	14.00	GAO-25	
1"	.5625"	14.29	GAO-19	
1"	.6250"	15.88	GAO-20	
1"	.6400"	16.26	GAO-15	
1"	.6750"	17.15	GAO-11	
1"	.6875"	17.46	GAO-17	
1"	.7350"	18.67	GAO-12	
1"	.7500"	19.05	GAO-18	
1"	.8000"	20.32	GAO-16	
Removal Basin	GAO-21	x x		

Parts are stamped for easy identification & reordering

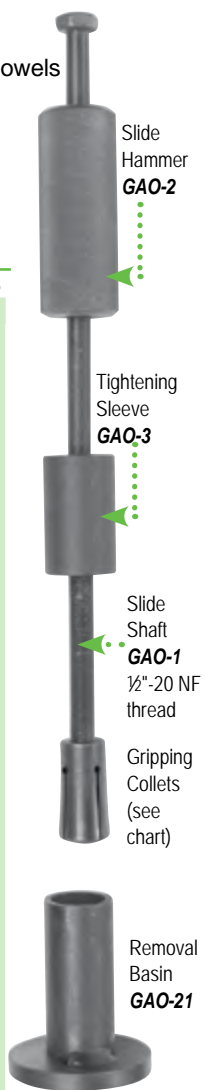

CYLINDER HEAD REBUILDING
CLEANING, ASSEMBLY & SAFETY
SHORT BLOCK REBUILDING
CRANKSHAFT/FLYWHEEL GRINDING
MISCELLANEOUS TOOLS & SUPPLIES
BRAKE SERVICE TOOLING
MEASURING TOOLS
V-TWIN & METRIC HARD PARTS

... another satisfied customer



"Goodson was able to help me select the right grinding stones for our racing clutch and flywheel program. Their support and technical advice is always available to keep our program on the right track."

- Johnny Ahten, Johnny Ahten Racing - Goodson customers since 2005

CYLINDER HEAD REBUILDING

CLEANING, ASSEMBLY & SAFETY

SHORT BLOCK REBUILDING

CRANKSHAFT/ FLYWHEEL GRINDING

MISCELLANEOUS TOOLS & SUPPLIES

BRAKE SERVICE TOOLING

MEASURING TOOLS

V-TWIN & METRIC HARD PARTS

Flywheel Radius Cutter Tip Holder

- For WVN/VN FG-5000
- Holder measures 1.5"L with a .312" dia. shank
- Includes 1 indexable FG-3B cutter tip

Description	Order No.
Tip Holder	FG-5011
Replacement Tip	FG-3B



Flywheel Grinding Coolant

- Formula eliminates rancid coolant
- Synthetic inhibitors • Dilute 30:1

Size	Order No.
1 Gal. / 3.78L	FG-1101-G
5 Gal. / 18.8L	FG-1102-G



Flywheel Cutter Tip For Winona Van Norman 570 Rotary Broach

- 3-edge carbide cutting tip for use with the special flywheel attachment
- Order VN-FW

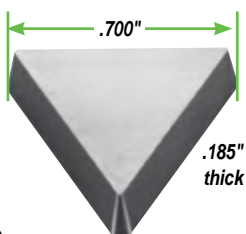

Flywheel Depth Gauge with Dial Indicator

- Measure flywheel before and after grinding to maintain proper depth specifications
- Gauge Assembly includes Dial Indicator, Bar & Magnets
- Spindle Extensions sold separately

Description	Order No.
Gauge Assembly	FGG-12
Spindle 1.5"	DIS-1.5
Extensions 2.5"	DIS-2.5
3.0"	DIS-3.0

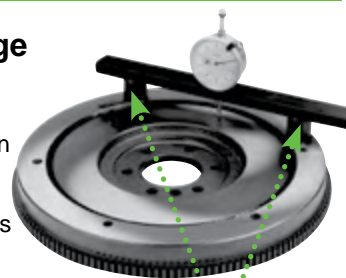

Magnetic feet adjust to flywheel diameter

Flywheel Grinder Bolt Adaptors



FG-LOCK

- Replace shoulder bolts with standard hardware
- Low-cost adaptor converts any 1/2" or 7/16" bolt to a 3/4" ID
- Includes countersunk adaptor with bolts for extra clearance

Fits	Size	Order No.
DCM, Peterson, KW	1/2" x 13	FG-DCP-KIT
WVN	7/16" x 14	FG-AB-KIT
WVN Table Insert	OD: 5/8" x 11, ID: 7/16" x 14	FG-LOCK



Goodson Techxperts™ on staff to help you



GS-10



GS-17A



FG-1165-G



FG-1070A-G



FG-1045-G



GS-14



GS-17

Grinding Wheel Dressers & Replacement Cutters

Diamond Dresser Tools are available on pages 106-107

Applications	Cutter Assemblies			Replacement Cutters					
	OD	W	Order No.	Pieces	Washers	OD	ID	Thick	Order No.
VN, Lempco, Storm RT-7Y, 17Y	2.500"	1.625"	GS-10	14 stars	1 w/locking tangs	2.50"	1.50"	.062"	GS-14
Peterson (12mm shaft)	2.375"	1.625"	GS-17A	8 stars	5 1 w/locking tangs	2.375"	1.50"	.093"	GS-17
WVN SM2000, 4000, 5000, 6000C, 6000A, MG3000, 3850	1.250"	.978"	FG-1165-G	7 stars	none	1.25"	.313"	.095"	FG-1161-G
Peterson & DCM	2.375"	2.262"	FG-1070A-G	5 stars		2.375"	1.132"	.1375"	FG-1070-G
Hand held			FG-1045-G	1 stone	none	1.50"	.313"	.625"	FG-1044-G

Flywheel Grinding Stones

tech tips from the techxperts™

How to Measure A Flywheel Stone

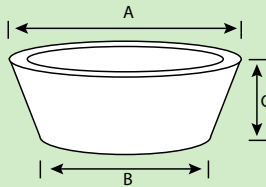

For Best Results... Choose The Right Flywheel Stone From Goodson

Goodson stones feature 50% more useable abrasive and much stronger construction, yet sell at prices comparable to ordinary stones. With Goodson stones you'll get longer wheel life and lower-cost flywheel grinding.

Cast Iron:

Cast Iron (soft) flywheels need to be ground with harder stones. Experiment to find the best stone. A starting point is the FGW-57, our best all-around stone for Cast Iron.

Cast Steel:

Cast Steel (medium) flywheels require medium-hard stones. The FGW-65 is our best all-around stone for Cast Steel.

Billet Steel:

Billet Steel (very hard) flywheels need to be ground with softer stones. Our best all-around stone for Billet Steel is the FGW-50-2. It's our most friable and free-cutting, requiring minimal dressing.

Mounting Adaptor For Small Diameter Stones

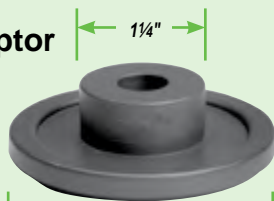

- Many flywheel grinders have lower mounting flanges that won't fit inside 3" and 4" diameter flared-cup stones
- Use this adaptor to avoid damage when mounting small stones
- Fits most small diameter stones
- Order No. **FG-FLANGE**

tech tips

from the techxperts™

Be sure to use ample coolant to flush away swarf and help the stones perform better.



More
Flywheel
Stones
on page 104

CAST IRON (Passenger cars, light trucks)

(A / B x C x Arbor)	Description	Order No.
6" / 4 1/2" x 2 5/8" x 1 1/4"	Harder than FGW-57, lasts longer, black	FGW-67
6" / 4 1/2" x 2 5/8" x 1 1/4"	Best all-around for cast iron, black	FGW-57
6" x 2 1/2" x 1 1/4"	Straight-sided FGW-57, black	FGW-57S
6" / 4 1/2" x 2 5/8" x 1 1/4"	Softer than FGW-57, grinds faster, black	FGW-47
6" / 4 3/4" x 2 7/8" x 1 1/4"	Silicon-carbide, ideal for top fuel, black	FGW-37
4" / 3" x 2" x 1 1/4"	Small diameter FGW-57, black	FGW-61
4" / 3" x 2" x 1 1/4"	Small diameter FGW-37, black	FGW-374
3" x 2" x 1 1/4"	Green Silicon-Carbide, Premium	FGW-93

CAST STEEL (Industrial, agricultural, OTR trucks)

(A / B x C x Arbor)	Description	Order No.
6" / 4 1/2" x 2" x 1 1/4"	Harder than FGW-65 lasts longer, lt. gray	FGW-53
6" / 4 1/2" x 2 5/8" x 1 1/4"	Best all-around for Cast Steel, speckled	FGW-65
6" / 4 1/2" x 2 5/8" x 1 1/4"	Slightly softer than FGW-65, black	FGW-495
4" / 3" x 2" x 1 1/4"	Small diameter FGW-65, speckled	FGW-69
6" / 4 1/2" x 2 5/8" x 1 1/4"	Softer than FGW-65, grinds faster, black	FGW-49

BILLET STEEL (Import vehicles, high-performance)

(A / B x C x Arbor)	Description	Order No.
6" / 4 1/2" x 2 5/8" x 1 1/4"	Harder, ruby stone, lasts longer	FGW-64
6" / 4 1/2" x 2 5/8" x 1 1/4"	Harder, pink stone, lasts longer	FGW-62-1
6" / 4 1/2" x 2 1/2" x 1 1/4"	Harder than FGW-50-2	FGW-50
6" / 4 1/2" x 2 1/2" x 1 1/4"	Best all-around for Billet Steel	FGW-50-2
4" / 3 1/2" x 1 1/2" x 1 1/4"	Harder, pink stone, lasts longer	FGW-63-1
4" / 3" x 2" x 1 1/4"	Taller than FGW-56, more abrasive, white	FGW-306
4" / 3 1/2" x 1 1/2" x 1 1/4"	Premium	FGW-56P
4" / 3 1/2" x 1 1/2" x 1 1/4"	Small diameter, off white	FGW-56
3" / 2 1/4" x 1 1/4" x 3/4"	Small diameter, light gray	FGW-59
3" x 2" x 1 1/4"	Sugar white stone	FGW-92

NOTE: Due to manufacturing process, colors may vary.

All abrasives are guaranteed for 1 year from original purchase date.

Flywheel Grinding Stones for Small Arbors and Special Machines

Use	Shape	A / B	Height	Order No.
Winona VanNorman 444 Rotary Grinder - 7/8" Arbor				
Cast Flywheels	Flared	5" / 4"	3"	GCV-544
Winona VanNorman 570 Rotary Broach - 15/16" Arbor				
Cast Flywheels	Flared	5" / 33/4"	1 3/4"	GCV-305

All abrasives are guaranteed for 1 year from original purchase date



CYLINDER HEAD REBUILDING
CLEANING, ASSEMBLY & SAFETY
SHORT BLOCK REBUILDING
CRANKSHAFT/FLYWHEEL GRINDING
MISCELLANEOUS TOOLS & SUPPLIES
BRAKE SERVICE TOOLING
MEASURING TOOLS
V-TWIN & METRIC HARD PARTS



tech tips
from the techxperts™
Never dress your Superabrasive with the dresser attachment on your machine

FlyMaster®
CBN Super Abrasive Flywheel Grinding Wheels

• For cast iron • Light to heavy applications

(A / B x C x Arbor)	Abrasive	Shape	Grit	Order No.
2" / 1 ³ / ₈ " x 7/8" x 3/8"	CBN	Cup	100	2H0998
3" / 2" x 1 ¹ / ₄ " x 1 ¹ / ₄ "	CBN	Cup	100	261453
3 ³ / ₄ " / 2 ⁵ / ₈ " x 1 ¹ / ₂ " x 1 ¹ / ₄ "	CBN	Cup	100	2371052
3 ³ / ₄ " / 2 ⁵ / ₈ " x 1 ¹ / ₂ " x 1 ¹ / ₄ "	CBN	Cup	60	34296362
5" / 3 ³ / ₄ " x 1 ³ / ₄ " x 1 ¹ / ₄ "	CBN	Cup	100	2379270
6" / 4 ⁵ / ₈ " x 1 ¹ / ₈ " x 1 ¹ / ₄ "	CBN	Cup	100	2367275*
6" / 4 ⁵ / ₈ " x 1 ¹ / ₈ " x 1 ¹ / ₄ "	CBN	Cup	60	2G7480
CBN Dressing Stick 1/2" x 1/2" x 6"				DS-CBN
6" / 4 ⁵ / ₈ " x 1 ¹ / ₈ " x 1 ¹ / ₄ "	Diamond	Cup		2E5742‡

*Most popular application ‡ For Coated Surfaces Only



Flywheel Spindle Adaptor for 2" Superabrasive Cup

This special adaptor is needed for Audi and some Volkswagen applications. Complete unit includes Adaptor Spindle, Flange and Bolt. Order No. 7401842



Flywheel Grinding Stones

• Four Abrasive formulas to choose from

SILICON-CARBIDE ABRASIVE

Ductile Iron, Cast Iron & Steel (Black)

(A / B x C x Arbor)	Hardness	Shape	Order No.
3" / 2 ¹ / ₂ " x 1 ¹ / ₂ " x 1 ¹ / ₄ "	Med. Hard	Flared	U364512
4" / 3" x 2" x 1 ¹ / ₄ "	Med. Soft	Flared	U335369
6" / 4 ¹ / ₂ " x 2 ¹ / ₂ " x 1 ¹ / ₄ "	Soft	Flared	U324494
	Med. Soft	Flared	U324495
	Med. Hard	Flared	U335376
	Hard	Flared	U335377
	Med. Soft	Flared	U357854
	Med. Hard	Flared	U343805
6" / 4 ³ / ₄ " x 3" x 1 ¹ / ₄ "	Med. Hard	Flared	U68578

EXTENDED LIFE CERAMIC

Ductile Iron, Cast Iron and Steel (Black)

(A / B x C x Arbor)	Hardness	Shape	Order No.
6" / 4 ¹ / ₂ " x 3" x 1 ¹ / ₄ "	Med. Hard	Flared	U370095

tech tips
from the techxperts™

How to Measure A Flywheel Stone

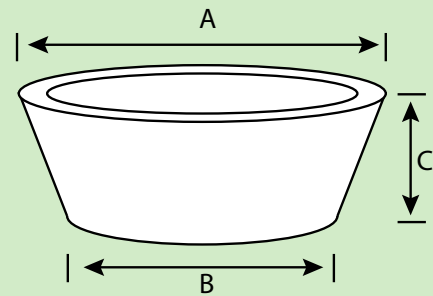

ALUMINUM-OXIDE ABRASIVE

Mild Steel & Hardened Steel (White)

(A / B x C x Arbor)	Hardness	Shape	Order No.
6" / 4 ¹ / ₂ " x 2 ¹ / ₂ " x 1 ¹ / ₄ "	Soft	Flared	F342636
	Medium	Flared	F335373

ALUMINUM-OXIDE ABRASIVE

Light to Medium Stock Removal on Steel, Cast Iron & Ductile Iron (Ruby)

(A / B x C x Arbor)	Hardness	Shape	Order No.
4" / 3" x 2" x 1 ¹ / ₄ "	Medium	Flared	F348769
6" / 4 ¹ / ₂ " x 2 ¹ / ₂ " x 1 ¹ / ₄ "	Soft	Flared	F372039
	Med. Soft	Flared	F348771
	Medium	Flared	F348772
	Hard	Flared	F348773

Colors may vary due to the manufacturing process



Deburring Tool

- Swivel tool chamfers sharp, machined edges, bolt holes, and much more
- DT-6 includes cutters for aluminum and cast iron

Description	Order No.
Deburring Tool	DT-6
Replacement Cutters	
Steel/Aluminum	DT-10
Cast Iron/Brass	DT-20



14mm Spark Plug Thread Chaser

- Ideal for spark plug hole cleaning
- Re-forms the original material by burnishing, not cutting, and won't create new chips to clean out
- Order No. **SPB-14**

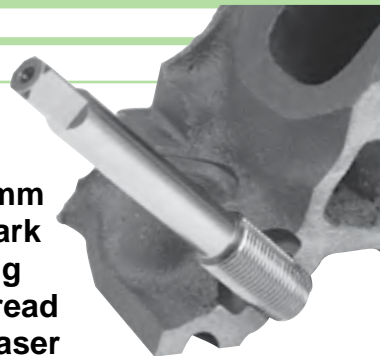

Burr Buster

- Use on air float tables, seat & guide machines, beds of crankshaft grinders and flywheel grinder tables
- Deburrs gasket surfaces on heads, blocks, manifolds, etc.
- 120 grit premium grade abrasive
- 1½" x 2¾" x 9"
- Order No. **BB-9**

Bench Grinder Wheels

- 40 and 60 grit for general grinding
- 100 grit for sharpening carbide tools
- Includes bushings to reduce arbor hole from ¾" to ½"
PLUS a ⅝" bushing adaptor



Size	Grit	Order No.
General Purpose Wheels: For steel and cast iron		
6" x ¾"	60	GG-666
6" x 1"	60	GG-686
7" x 1"	40	GG-784
8" x 1"	40	GG-884
8" x 1"	60	GG-886
Green Grit Wheels: For sharpening carbide tools		
6" x ½"	100	GGC-641
6" x ¾"	100	GGC-661
6" x 1"	100	GGC-681



GS-00



GS-0

Grinding Wheel Star Dressers

Description	Order No.
Hand dresser for wheels up to 10" dia.	GS-0
Replacement Cutter Sets	
4 blades, 2 spacers, ¼" ID for GS-0 dresser	GS-00
4 blades, 2 spacers, ½" ID for GS-1 dresser	GS-11

Deburring Wheels for Bench Grinders

- Medium-hard wheels are better suited for heat sensitive materials
- Use to clean and polish white metal
- Buff and Blend Wheels deliver the same results as a wire brush but are much safer to work with

Description	Size	Qty.	Order No.
Medium-Hard Deburring Wheel	6" x 1" x 1"	1	SCW-68M
Buff and Blend Wheels	6" x ½" x 1"	5	BBD-65

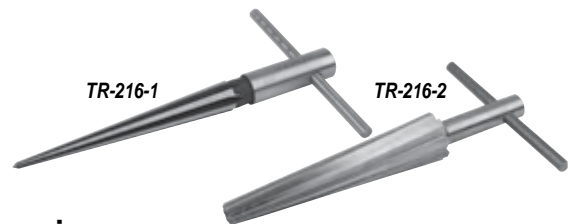

Premium Tapered Reamers

- Use by hand or with a powered driver to deburr or enlarge tapered holes for tie-rod ends or ball joints
- Use in ½" chuck at approximately 40 RPM

OAL	Flute	Small End	Big End	Taper	Order No.
5¾"	3¾" long	⅛" dia.	½" dia.	—	TR-216-1
6½"	4½" long	⅞" dia.	1" dia.	1½" per ft.	TR-216-2

Maxxeon WorkStar™ 220 LED Compact Inspection Light

- 6" inspection light weighs just 1 ounce
- Black anodized T6 aluminum body
- Threaded joints have rubber O-ring seals
- Push-button switch is rated at 100,000 cycles and is sealed to keep out dirt and grit
- Runs on 3-AAAA alkaline batteries (included) up to 4 hours
- Order No. **DFL-220**



Maxxeon WorkStar™ 420 Inspector Maxx Rechargeable Work Light

- 6 inline LEDs with a custom lens creates a huge floodlight beam - no rings, no shadows, no hot spots
- Worklight = 200 lumens, Flashlight = 135 lumens
- Rechargeable battery (not replaceable, USB charger cord included)
- Measures: 7"L x 7/8"W x 1/2" Thick • Weighs 2.2 ounces
- Order No. **DFL-420**



CYLINDER HEAD REBUILDING
CLEANING, ASSEMBLY & SAFETY
SHORT BLOCK REBUILDING
CRANKSHAFT/FLYWHEEL GRINDING
MISCELLANEOUS TOOLS & SUPPLIES
BRAKE SERVICE TOOLING
MEASURING TOOLS
V-TWIN & METRIC HARD PARTS

Diamond Dresser Tools

shown at approximately full size

CYLINDER HEAD
REBUILDING

CLEANING,
ASSEMBLY & SAFETY

SHORT BLOCK
REBUILDING

CRANKSHAFT/
FLYWHEEL GRINDING

MISCELLANEOUS
TOOLS & SUPPLIES

BRAKE SERVICE
TOOLING

MEASURING
TOOLS

V-TWIN & METRIC
HARD PARTS



Diamond: Selected for very high point definition. A sharper diamond cuts faster and gives a superior finish.

Matrix: Matrix material is bronze or copper-based for a tight hold on the diamond & high heat transfer.

Holder: Cold rolled steel. Threaded types have precision threads over a long distance to screw easily into tool holders and support cutting point firmly to prevent vibration.

Diamonds are stamped for easy identification and re-ordering

Premium Diamond Resetting Service:

Send your worn premium diamonds to Goodson for fast resetting. Prices quoted upon request. Reset when wear facets exceed $\frac{1}{16}$ " on a $\frac{1}{2}$ to $\frac{3}{4}$ carat diamond and $\frac{1}{8}$ " on a 1 carat or larger.

Diamond Dressers for most shop machines are in stock and ready-to-ship

A diamond tool is only as good as the diamond itself. GOODSON diamonds are furnished by the most respected supplier in the U.S. Each is subjected to a microscopic examination by experts and must meet strict standards to be accepted. This rigorous inspection and careful control during manufacturing assures consistent high quality. Our diamond tools deliver the highest levels of performance and longevity.

In addition to our standard diamond tools, GOODSON stocks a wide selection of Premium Quality diamonds. These diamonds last longer and improve wheel performance. They stay sharp longer and have more points so they can be reset more times. Because of this quality, they will dress harder wheels and wheels will need to be dressed less frequently.

	Machine	Description	Carat	Radiac #	Standard	Premium	
Valve Refacers	B&D, Skil, Sioux™, Thor, VanDorn, WVN	3/8"x1 1/8"	1/8	2335660	G-1	G-1P	
	Kwik-Way, Tobin Arp (S&D)	5/16"x2 1/2"	1/8	2335662	G-3	—	
	Kwik-Way, Valve Master (1714)	1/2"x3 3/4" 20NF	1/8	—	G-4	—	
	Sioux™ (1713, 1715), IDL, WVN (CG50, CG80)	3/8"x2 3/4" 24NF	1/8	2335664	G-5	G-5P	
	IDL, WVN (CG-50, CG-80)	3/8"x3 1/4" 24NF	1/8	—	G-80	G-80P	
	US	7/16"x2"	1/8	—	G-6	—	
	Skil (Talent)	5/16"x2 1/4" 18NC	1/8	—	G-9	—	
	Kwik-Way	7/16"x2 3/4" 20NF	1/8	2335670	G-17	G-17P	
	Valve Seat Grinders	B&D, S&D, Van Dorn	3/8"x2 1/4" 24NF	1/8	2335661	G-2	—
		Kwik-Way	1/2"x3 3/4" 20NF	1/8	—	G-4	—
Sioux™ (1715), K-W (NSG), Thor		3/8"x2 3/4" 24NF	1/8	2335664	G-5	G-5P	
Hall HD (13-1938P), Skil, Snap-On, B&D		5/16"x2 1/4" 24NF	1/8	2335666	G-8	G-8P	
KO Lee, Skil		5/16"x2 1/4" 18NC	1/8	—	G-9	—	
Sioux™ Heavy Duty (1715B, 1719)		3/8" hex RH	1/8	—	G-11	—	
Goodson Universal Wheel Dresser		8mm x 1.25mm	1/8	—	—	G-13P	
Sioux™ Heavy Duty (1715A)		3/8"x2 3/4" 24NF	1/8	—	G-15	—	
Kwik-Way Heavy Duty Wheel Dresser		1/2"x3" 20NF	1/8	2335671	G-18	G-18P	
Clutch Grinders		Lempco AC, NAC, VAC & Do-ALL	7/16"x2"	1/8	—	G-6	—
Piston Grinders	Van Norman 75, 76 & Relio	3/8"x1 1/8"	1/8	2335660	G-1	G-1P	
	Storm-Vulcan D-3	7/16"x2"	1/8	—	G-6	—	
Drum Lathes	Van Norman (all except 302, 302H)	3/8"x1 1/8"	1/8	2335660	G-1	G-1P	
	Barret, V.N. 302, 302H	3/8"x3"	1/8	—	G-1L	—	
	Lempco	7/16"x2"	1/8	—	G-6	—	
	Ammco 5000	1/2"x1 1/2"	1/8	—	G-19	—	
Rod Grinders	Sunnen® Rod & Cap Grinder (CRG-500)	3/8"x1 1/8"	1/8	2335660	G-1	G-1P	
	Storm-Vulcan No. 65 Rod Grinder	1/2"x3 3/4" 20NF	1/8	—	G-4	—	
Crank & Cam Grinders	Storm-Vulcan 14, 15, 15A, 15C, 75, 75A	1/2"x3"	3/4	2354244	G-25	—	
		1/2"x3"	1	—	G-25A	—	
	Scledum	10mmx1 5/8"	3/4	—	G-27	—	
	Winona Van Norman/Zanrosso,	7/16"x1 1/4", 5/8" head	3/4	—	G-30	—	
	Lempco, Landis	7/16"x1 1/4", 5/8" head	1	—	G-30A	—	
	Berco	tapered, step type	1	2354254	G-32A	G-32AP	
	Berco	tapered, step type	1 1/2	2354255	G-32B	—	
	Storm-Vulcan, WVN CG210, 250, 280	1/2"x2" 70° rad. dress	3/4	—	G-33	—	
	Universal Cluster Dresser (photo pg. 93)	7/16"x1 1/8", 15°	—	2V9507	2V9507	—	
	Flywheel Grinder	Kwik-Way 796	7/16"x2"	1/8	—	G-6	—

tech tips

from the techxperts™

- 1. Set tool at a proper angle.** Position at 10° to 15° from surface. Smaller angles blunt the diamond. Larger angles may cause the wheel to remove matrix material.
- 2. Prevent vibration in the holder.** Any looseness in the tool holder will allow vibration of the tool resulting in poor finish on the wheel.

- 3. Turn coolant on before dressing.** Wheels used wet should be dressed wet. To keep diamond cool, turn coolant on before starting to dress. (If wheel is dressed dry, air-cool diamond between cuts but don't quench with water.)
- 4. Start at highest point.** Wheels often wear unevenly & may have high & low spots. Set tool to dress high spots first, feed in about .001" per pass until done. This prevents overheating & damage.

- 5. Use steady travel.** Uneven travel causes an uneven finish. The best rate is found by experiment, but whatever the rate of travel, it must be even.
 - 6. Turn the tool in the holder.** Turn the tool often to expose new diamond surface to the wheel.
 - 7. Don't bump or drop diamond.** They are hard but brittle, and can be harmed if dropped or bumped.
- CAUTION: Grinding Wheel must never touch the matrix or holder**

CYLINDER HEAD REBUILDING
CLEANING, ASSEMBLY & SAFETY
SHORT BLOCK REBUILDING
FLYWHEEL GRINDING
CRANKSHAFT/GRINDING
MISCELLANEOUS TOOLS & SUPPLIES
BRAKE SERVICE TOOLING
MEASURING TOOLS
V-TWIN & METRIC HARD PARTS



"Be sure to check out the Goodson website for product specials, tech tips, Safety Data Sheets and much more."

- Janet, Goodson Advertising Manager, 17 years of service

CYLINDER HEAD
REBUILDING

CLEANING,
ASSEMBLY & SAFETY

SHORT BLOCK
REBUILDING

CRANKSHAFT/
FLYWHEEL GRINDING

MISCELLANEOUS
TOOLS & SUPPLIES

BRAKE SERVICE
TOOLING

MEASURING
TOOLS

V-TWIN & METRIC
HARD PARTS



Bearing Cap

SX-18004
Brush Set

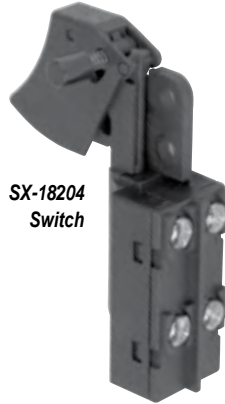

SX-18204
Switch

Replacement Parts For Sioux™ Drivers

Keep your Sioux™ Seat Grinders running at peak efficiency with these replacement parts

- Drive Spindle is spring loaded for dual action grinding
- Brush set is a pair of direct replacement carbon brushes for armature and measures 3/8"x1/2"
- Fit Sioux™ 1710 and 1792 drivers

Description	Order No.
Bearing Cap for Sioux™ 1710 Electric	SX-23694
Brush Set for Sioux™ 1710 Electric	SX-18004
Switch for Sioux™ 1710 Electric with plastic handle only	SX-18204*
Bearing Cap for Sioux™ 1792 Pneumatic	SX-33970

*Metal handle switch is no longer available

More vacuum testing products
on page 48

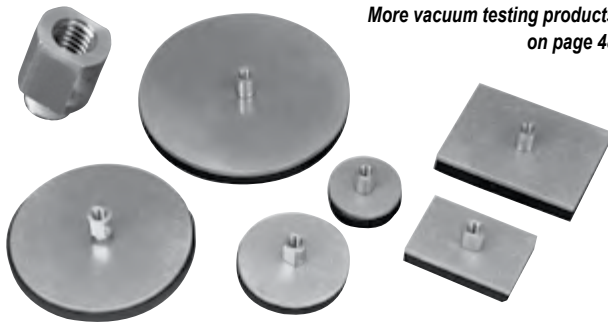

Sioux-Style Replacement Vacuum Tester Parts

- For Sioux™ 1630K Tester which is no longer manufactured
- Closed cell foam for an exceptional seal

Sioux-Style Replacement Plates for the 1630K Tester		
Size	OE No.	Order No.
2" / 50.8mm dia.	1630-2	SVT-2
3" / 76.2mm dia.	1630-3	SVT-3
4.75" / 120.7mm dia.	1630-4	SVT-475
6" / 152.4mm dia.	1630-6	SVT-6
2"x3" / 50.8 x76.2mm		SVT-23
3x4" / 76.2 x101.6mm		SVT-34
Replacement Parts for the 1630K Tester		
Replacement Fitting		DVC-SX
Replacement Gauge		1630-GAUGE

Sioux-Style Pilots & Bushings

Riser Bushings

Pilot

- Replacement parts for the popular 1716 Seat Wheel Dresser no longer available from Sioux™
- .375" top pilot features a groove to fit Black & Decker holders

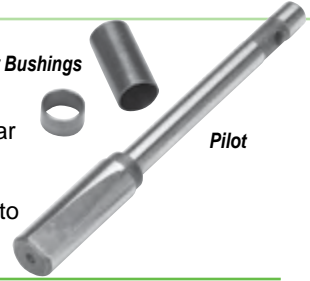

Description	Order No.
.385" Top Pilot	1718A
.375" Top Pilot	1718-BD
.572" Dressing Stand Pilot for Sioux™ 1716 Dresser	1718-B
Riser Bushings (2) for .385" Pilots	SK-9-10
Riser Bushings (2) for .572" Pilots	SK-11-12

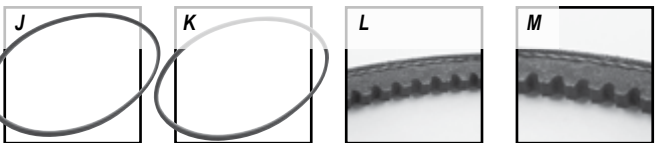
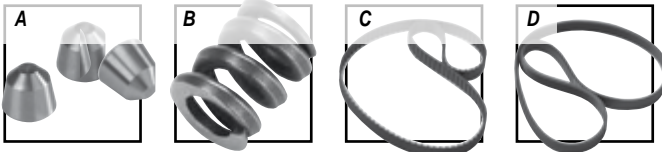

special order Many more replacement parts available

Replacement Parts for Sioux™ Valve Refacers

Description	Fits Model No.	Order No.
A- Chuck Balls (3 pc.)	680, 2075	24185
B- Chuck Springs (9 Pc.)	680, 2075	SX-53615
C- Cog Style 24"x1/2" 120 teeth	680	SX-14467
D- Serpentine 29 3/8"x1/2" 5 grooves	680	SX-14471
E- Spindle Belt 28 3/8"x1/2" 5 groove	2075	SX-65117
F- Chuck Belt 23 3/8"x3/8", 115 teeth	2075	SX-14473
G- Replacement Belt for Grinding Head Fits Serial #s up to 34999(2)	645	SX-14400
H- Chuck Belt Fits Serial #s 34999 & up (also coolant pump belt for #s 35217 & up).	645	SX-14401
J- Belt for Motor Shaft; Fits Serial #s up to 34999	645	SX-14402
K- Coolant Pump Belt; Fits Serial #s 34999-35216	645	SX-14403
L- Belt for Motor Shaft; Fits Serial #s 35000 & up	645	SX-14445
M- Replacement Belt for Grinding Head; Fits Serial #s 35000-58700	645	SX-14453
N- Replacement Belt for Grinding Head; Fits Serial #s 58701 & up	645	SX-14461
O- Replacement Switch (1100V, AC)	2001, 2075	SX-18221

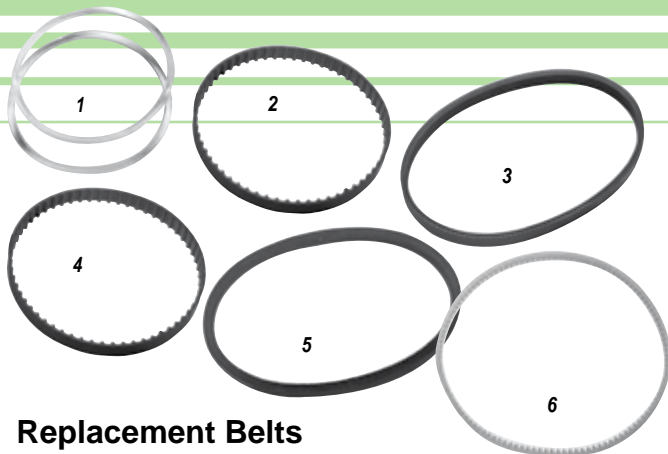

Replacement Belts For Kwik-Way Valve Refacers

Application	Machine	Order No.
1 Spindle Belt 14.5" L "O" Ring - 1 Pr.	SVS II	000-2303-62
2 Chuck Belt 10" Cog, 50 tooth	SVS II	001-1899-90
3 Spindle Belt 18" Serpentine	SVS	001-1905-20
4 Chuck Belt 12" Cog, 60 tooth	SVS or VS	001-1899-99
5 Spindle Belt 16" V-Belt	VS	001-1900-67
6 Chuck Belt 19" 120 tooth	VS	001-1900-75

Replacement Chuck Balls For Kwik-Way Valve Refacers

- Measure chuck ball diameter before ordering to ensure correct replacement
- 6 per set

Diameter	Order No.
1/2"	010-2101-27
17/32"	010-2101-35

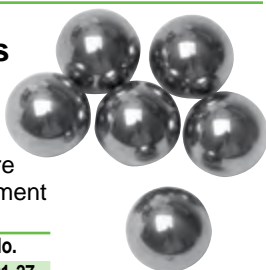

enlarged to show detail



◀ Collet is unavailable from OE



◀ Replace with two-piece set

Collet for Black & Decker™ Valve Refacers

- Two-piece set replaces the Black & Decker Twin Grip collet (no longer available)
- Remove the damaged, worn or broken collet and replace with this set
- Accommodates 1/4" (6.35mm) to 3/8" (9.53mm) valve stems
- Order No. **BVR-38**

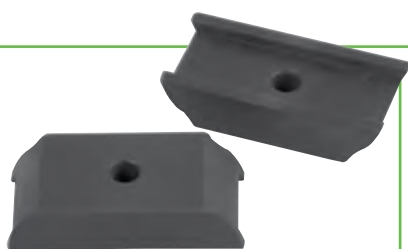

Valve Refacer Steady Rest Shoes for Sunnen® VR-7000 & VR-8000

- Sold by the pair
- Order No. **SUN-1202A**

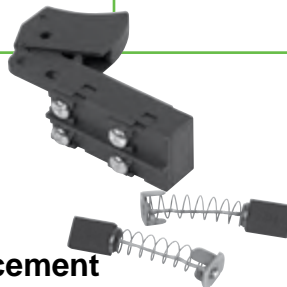

Replacement Parts for Kwik-Way Seat Grinding Drivers

Description	Order No.
Trigger Switch	000-1201-20
2 Pc. Brush Set	003-0072-43

See page 19 for Seat Grinding Drivers



Automotive Machinist DVDs

Taught by Butch Reilly from Spokane Community College. Easy to understand DVDs are a great addition to any machinist's library.

Title	Run Length	Order No.	Incl.
7 DVD Set (one of each below)		DVD-SET	▼
Engine Balancing	138 min.	DVD-EB	x
Cylinder Honing	46 min.	DVD-CH	x
Cylinder Boring	52 min.	DVD-CB	x
Crankshaft Grinding (2 DVD set)	113 min.	DVD-CG2	x
Using a Micrometer	34 min.	DMV-1	x
Reconditioning Rods	64 min.	DRV-1	x

Power Building Videos on DVD

The **Rotating Assemblies** 2-DVD set includes highly detailed, easy to understand information on parts selection and more. The **Engine Building** 3-DVD set includes a stock Small Block Chevy and a mild performance Small Block Ford.



Description	Run Length	Order No.
Rotating Assemblies	4 hours	DVD-RA2
Engine Building	5 hours	DVD-EB3

How to Build and Modify GM LS-Series Engines

This manual includes information on cylinder head preparation, camshafts, rotating assemblies, assembly and induction/nitrous.
Order No. **MA-148**

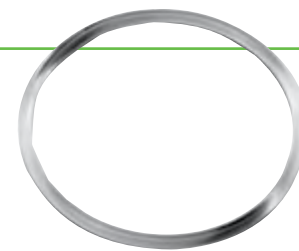

Replacement Chuck Belt For Black & Decker

- Chuck belt for the aluminum housing unit • Replaces OE V-type belt
- .200" thick x 12 3/4" long (5.08mm x 323.85mm)
- Order No. **BVR-B**

CYLINDER HEAD
REBUILDING

ASSEMBLY & SAFETY
CLEANING,

SHORT BLOCK
REBUILDING

CRANKSHAFT/
FLYWHEEL GRINDING

MISCELLANEOUS
TOOLS & SUPPLIES

BRAKE SERVICE
TOOLING

MEASURING
TOOLS

V-TWIN & METRIC
HARD PARTS



"If you need engine building tools and supplies, you need Goodson! We're dedicated to providing you with the best quality products, the best value and the best service in the industry."
- Mike, Goodson Receiving - 1 years of service

CYLINDER HEAD REBUILDING
CLEANING, ASSEMBLY & SAFETY
SHORT BLOCK REBUILDING
CRANKSHAFT/ FLYWHEEL GRINDING
MISCELLANEOUS TOOLS & SUPPLIES
BRAKE SERVICE TOOLING
MEASURING TOOLS
V-TWIN & METRIC HARD PARTS

Brake Lathe Tip Holders

Machine	Model	Use	OE No.	Order No.
Ammco	1000, 2002, 3000, 4000, 4100, 7500, 7700	For Drums 1/2" x 3/8" x 2 1/2"	9872	TAM-41R
All-Tool	747	Use: RT-A series,		
Hoffman	660	negative rake tips		
Performance	6600, 7200, 7100, 7600			
Ammco	3000, 3850, 4000, 4100,	For Rotors 3/8" x 3/8" x 1 1/2"	10701	TAM-701 (R)
Performance	7000 & 6900, 6950 Twin Cutters	Use: RT-A series,	10702	TAM-702 (L)
Hoffman	660	negative rake tips		
All-Tool	747			
Ammco	3000, 3850, 4000, 4100, 7000 & 6900, 6950 Twin Cutters	For Rotors 3/8" x 3/8" x 1 1/2"	25968	TAM-25968 (R)
		Use: RT-3A & RT-3AS series,	25969	TAM-25969 (L)
		positive rake tips		
Bear	1410, 1466, 1467, 1468, 1469, 14781	Drums and Rotors 3/8" x 3/8" x 3"	90495	TBR-44R (R)
		Use: RT-B series,	90494	TBR-44L (L)
		negative rake tips		
Ammco	Direction: Left	3/8" x 3/8" x 1 1/8"		TAM-312L
Hoffman	Direction: Right	3/8" x 3/8" x 1 1/8"		TAM-312R
Performance, All-Tool		Use: RT-312 series tips		
Ammco	Direction: Left	3/8" x 3/8" x 1 1/8"		DTAM-312L
Hoffman	Direction: Right	3/8" x 3/8" x 1 1/8"		DTAM-312R
Accu-turn	Direction: Left	3/8" x 3/8" x 2 3/4"		TFM-312L
FMC, Bear,	Direction: Right	3/8" x 3/8" x 2 3/4"		TFM-312R
Hoffman, Kwik-Way, Snap-On, etc.		Use: RT-312 series tips		
Accu-turn	Direction: Left	3/8" x 3/8" x 2 3/4"		DTFM-312L
FMC, Bear,	Direction: Right	3/8" x 3/8" x 2 3/4"		DTFM-312R

Measurements for Solid Carbide, Honed Edge Carbide & Titanium Coated Carbide Cutting Tips



Measure to Find the Right Tip

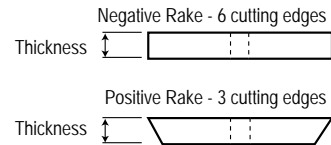
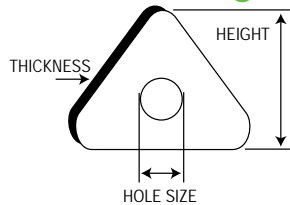
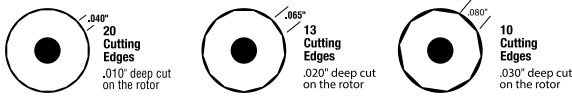

RT-A Height: .350" Thick: .095" Hole: .135" Rake: NEG	RT-3AS Height: .357" Thick: .104" Hole: .127" Rake: POS	RT-3A Height: .343" Thick: .093" Hole: .133" Rake: POS	RT-373 Height: .625" Thick: .125" Hole: .117" Rake: POS	RT-AC Height: .445" Thick: .131" Hole: .145" Rake: POS	RT-FMC Height: .452" Thick: .125" Hole: .090" Rake: POS	RT-B Height: .343" Thick: .105" Hole: .130" Rake: NEG
RT-HF Height: .714" Thick: .185" Hole: .200" Rake: NEG	RT-KW Height: .358" Thick: .101" Hole: .125" Rake: POS	RT-H Height: .344" Thick: .125" Hole: .090" Rake: NEG	RT-HNT Height: .312" Thick: .103" Hole: .127" Rake: POS	RT-MRH Diameter: .235" Thick: .125" Hole: .108" Rake: POS	RT-VBG Height: .344" Thick: .098" Hole: .124" Rake: POS	RT-VN Height: .545" Thick: .125" Hole: N/A Rake: POS
RT-VNS Height: .547" Thick: .121" Hole: N/A Rake: POS	RT-VNH Height: .545" Thick: .095" Hole: .135" Rake: NEG	RT-VNA Height: .535" Thick: .188" Hole: .148" Rake: NEG	RT-KWL-T Height: .338" Thick: .100" Hole: .123" Rake: POS	RT-VNP-L OR -R Height: .902" Thick: .100" Hole: N/A Rake: POS	RT-312 Diameter: .311" Thick: .100" Hole: .150" Rake: POS	RT-360 Height: .311" Thick: .100" Hole: N/A Rake: POS

Tips Are Shown Actual Size

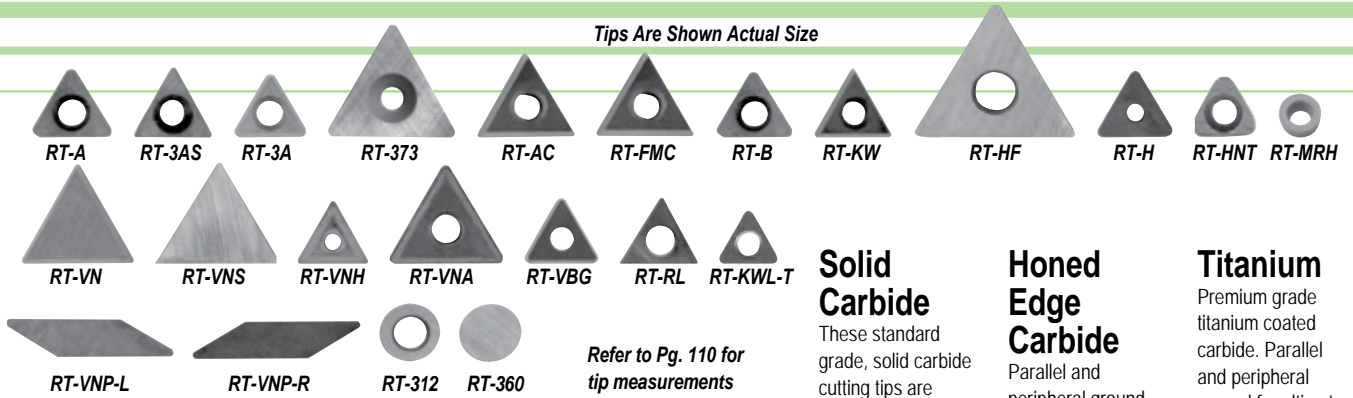

Solid Carbide

These standard grade, solid carbide cutting tips are parallel ground for resurfacing cast iron drums and rotors.

Honed Edge Carbide

Parallel and peripheral ground. Honed edges deliver a better finish on cast iron and composite rotors.

Titanium

Premium grade titanium coated carbide. Parallel and peripheral ground for ultimate performance on cast iron & composite rotors.

Machine	Model(s)	OE No.	Edges	Rake	Screws	Order No.	Order No.	Order No.
Ammco	700, 710, OTC Lathes, 1000, 2002, 3000, 4000, 4100, 7000, 7500, 7700	6914	6	Neg	Yes	RT-A	RT-A-H	RT-A-T
	3850 smaller (1/64") radius	6918	3	Pos	Yes	RT-3AS	RT-3AS-H	RT-3AS-T
	larger (1/32") radius	7681	3	Pos	Yes	RT-3A	RT-3A-H	RT-3A-T
	6900,6950 negative rake (std.)	6914	6	Neg	Yes	RT-A	RT-A-H	RT-A-T
Twin Cutters:	positive rake (standard) 1/64" (finer finish)	6918	3	Pos	Yes	RT-3AS	RT-3AS-H	RT-3AS-T
	positive rake (modified) 1/32" (more durable)	7681	3	Pos	Yes	RT-3A	RT-3A-H	RT-3A-T
	7900	6914	6	Neg	Yes	RT-A	RT-A-H	RT-A-T
	Ammco HD	5000, 6000, 6002	5677	3	Pos	No	RT-373	---
Accu-Turn	All combination disc/drum lathes	433796	3	Pos	Yes	RT-AC	RT-AC-H	RT-AC-T
	On-The-Car Lathes	878051	6	Neg	Yes	RT-A	RT-A-H	RT-A-T
All-Tool	747	3331	6	Neg	Yes	RT-A	RT-A-H	RT-A-T
Bean	B-401, B-410, B-501, B-601	90487	3	Pos	Yes	RT-FMC	RT-FMC-H	RT-FMC-T
Bear	1410,1466,1467,1468, 1469, 1478	2264,72265,772834	6	Neg	Yes	RT-B	RT-B-H	---
	10-1430, 10-1435	W136	6	Neg	No	RT-HF	---	RT-HF-T
FMC	600, 601, 700, 701, RotoTruer	90487	3	Pos	Yes	RT-FMC	RT-FMC-H	RT-FMC-T
	505, On-The-Car Lathe	91212	3	Pos	Yes	RT-KW	RT-KW-H	RT-KW-T
Hoffman	660	3331	6	Neg	Yes	RT-A	RT-A-H	RT-A-T
Horvath	All	1605	6	Neg	No	RT-H	---	---
Hunter	BL300 On-The-Car Lathe	221580-2	6	Neg	Yes	RT-A	RT-A-H	RT-A-T
	BL-500, BL-501, BL-505	6918	3	Pos	Yes	RT-3AS	RT-3AS-H	RT-3AS-T
	BL-500	221-678-3	3	Pos	Yes	RT-HNT	---	---
	Micro Tips of OCL-400 Lathe	221-626-3	3	Pos	Yes	RT-MRH	---	---
Kwik-Way	CBL, NCL, SDL Kwik-Lathe OTC Lathe	109-1092-23	3	Pos	Yes	RT-KW	RT-KW-H	RT-KW-T
	Lightening Lathe	109-1092-45	3	Pos	Yes	---	---	RT-KWL-T
Performance	6600,7200,7100, 7600	3331	6	Neg	Yes	RT-A	RT-A-H	RT-A-T
Pro-Cut	On-The-Car Lathe	50-701, 50-742	3	Pos	Yes	RT-VBG	RT-VBG-H	RT-VBG-T
RJ West	915D Disc Lathes	W136	6	Neg	No	RT-HF	---	RT-HF-T
	Perfect 400, 1115HD	W139	3	Pos	Yes	RT-AC	RT-AC-H	RT-AC-T
RTI	BRC35 On-The-Car Lathe	91212	3	Pos	Yes	RT-3A	RT-3A-H	RT-3A-T
Snap-On	YA282,YA277,YA278, YA180 OTC Lathe	109-1092-23	3	Pos	Yes	RT-KW	RT-KW-H	RT-KW-T
Van	204, 204D, 205, 205DC, 415, 243XV	29687	3	Pos	No	RT-VN	RT-VN-H	RT-VN-T
Norman and Rels	Smaller (1/64") radius	---	3	Pos	No	RT-VNS	RT-VNS-H	RT-VNS-T
	Older Model 204	21933	6	Neg	No	RT-VNH	---	---
	204, 304, 405	29005	6	Neg	No	RT-VNA	---	RT-VNA-T
	303,304,305,404,405,V22	304-7167	2	Pos	No	RT-VNP-L	---	RT-VNP-LT
	204,205,205DR,300,302,333,243,243XV	302-7167	2	Pos	No	RT-VNP-R	---	RT-VNP-RT
	Rels 2000 rotor	45016, 45021	3	Pos	Yes	RT-RL	---	---
VBG	On-The-Car Lathe	50-701	3	Pos	Yes	RT-VBG	RT-VBG-H	RT-VBG-T
Round Tips	Fits TAM-312 and TFM-312 Holders	RT-312,RT-312T	360°	Pos	Yes	RT-312	---	RT-312T
	solid	Fits TAM-360SET, TFM-360SET, RJH and CT Holders	CT10	360°	Pos	No	RT-360	---

NOTE: The table above shows the original-equipment cutting tips for Ammco machines. Most of them use negative-rake tool systems. However, some Ammco machines (especially the 4000 and 7000-series) have been modified in the field by using the TAM-25968 and TAM-25969 positive-rake tool holders (see previous page). If your machine is shown above to have 6-edge tips but has 3-edge tips, it has been modified – please order our RT-3A or RT-3AS series tips.

CYLINDER HEAD REBUILDING
CLEANING, ASSEMBLY & SAFETY
SHORT BLOCK REBUILDING
FLYWHEEL GRINDING
CRANKSHAFT/ MISCELLANEOUS TOOLS & SUPPLIES
BRAKE SERVICE TOOLING
MEASURING TOOLS
V-TWIN & METRIC HARD PARTS

Brake Lathe Tools & Silencers

GOODTOOL
Now exclusively from Goodson



Neoprene Brake Lathe Silencer

- Longer lasting than rubber
- Neoprene material resists deterioration associated with standard rubber belts
- 7 weights
- Measures: 34" L x 5/8" W x 3/16" Thick
- Order No. **GT-6030N**

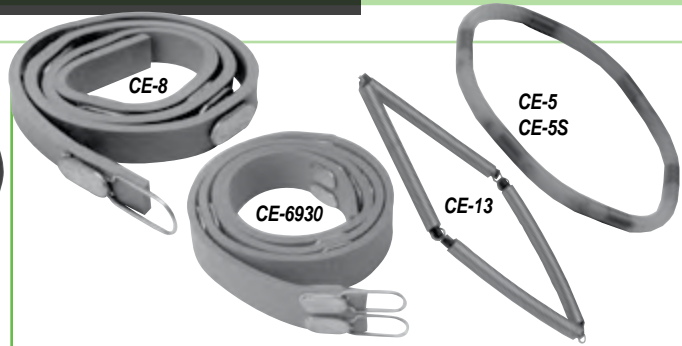

Silencers For Vented Rotors

Style	Size	OE No.	Order No.
Rubber Strap	34"L x 5/8"W x 3/16" thick	6920	CE-8
	36"L x 1 1/4"W x 3/16" thick	6930	CE-6930
Spring	Fits 6" to 9" rotors		CE-13
Rubber Tube	9" Diameter, 6 weights		CE-5
	8" Diameter, 4 weights		CE-5S

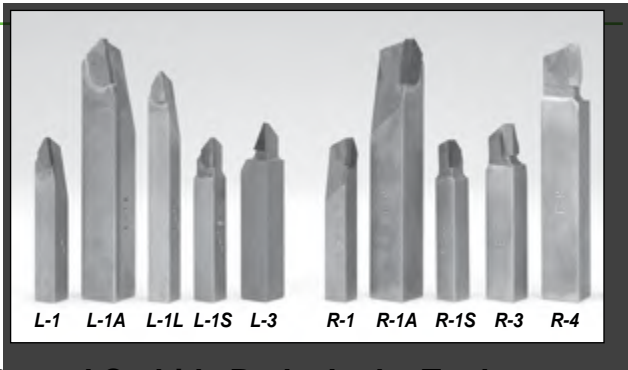

Brazed Carbide Brake Lathe Tools

- Fit most popular brake drum lathes

Left Hand Cutting Tools

Size	Application	Order No.
3/8" sq. x 2 1/2"	Replaces Bean 43-46L; Bear 23211; Star CB-8; VN 302-7272 for 303, 304, 304H	L-1
5/8" sq. x 4"	Replaces Ammco 5725, for 5000; Star CB-30; VN "Big Brute" for 310-404 Hardspots	L-1A
3/8" sq. x 3 1/2"	Extra long L-1 for small dia. drums	L-1L
3/8" sq. x 2 1/2"	Master carbide-tipped with 7° rake angle	L-1S
1/2" sq. x 2 3/4"	Replaces Ammco 4726 heavy-duty tool Ammco 4726 for 5000 & 6000 dual facing tool and 3000, 4000, 4100 & 7700 lathes	L-3

Right Hand Cutting Tools

Size	Application	Order No.
3/8" sq. x 2 1/2"	Replaces Bean 43-46R; Bear 20718; Star LB-16; VN 302-7171 for 204, 300, 302, 302H, 333, 243XV; and Barrett & Lempco	R-1
5/8" sq. x 4"	Replaces Ammco 5720 for 5000; Lempco SHD, DH, 530 Kwik-Way Heavy Duty	R-1A
3/8" sq. x 2 1/2"	Master carbide-tipped with 7° rake angle	R-1S
1/2" sq. x 2 3/4"	Replaces Ammco 4725 for 3000, 4000, 4100, 7100 drum lathes	R-3
5/8" sq. x 4"	Replaces Bear 24034; Star CB-35	R-4

Hardspot Cutters

Left Hand

Size	Use	Order No.
3/8"x1/2"x2 3/8"	Drums	L-5
	Discs	L-6

Right Hand

Size	Use	Order No.
3/8"x1/2"x2 3/8"	Drums	R-5
	Discs	R-6



L-6 L-5 R-5 R-6

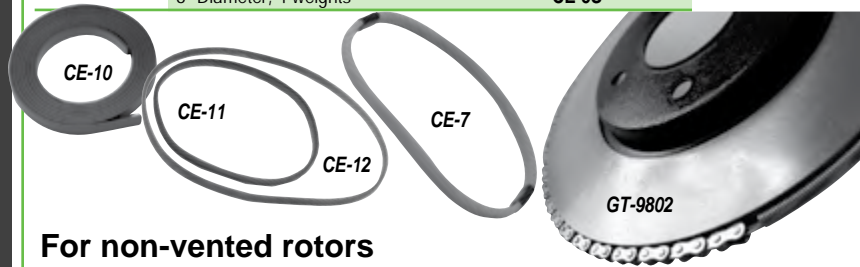

For non-vented rotors

Style	Size	Order No.
Magnetic Strap	48" long	CE-10
Rubber Band	6 1/2" dia. x 5/16" W x 3/16" thick	CE-11
	9 1/4" dia. x 5/16" W x 3/16" thick	CE-12
Rubber Tube	Fits 6" to 9" rotors	CE-7
Chain Band	Nickel plated with 4-springs	GT-9802



For vented and non-vented rotors

Style	Application	Order No.
Clamp-On	For Bench model lathes	CE-6
	For On-The-Car lathes	CE-26
Friction	Most Ammco lathes	7075 ▼
	Replacement Pucks for 7075	CE-9 x
	Replacement Mounting Bracket	GT-10283 x
	Replacement Wrench	GT-11497 x

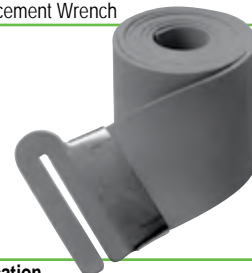

CE-1, CE-2

For Drums

Style	Application	Order No.
Rubber Strap	Automobiles 5'L x 2 7/8"W x 1/8" thick	CE-1
	Trucks 6'6"L x 2 7/8"W x 1/8" thick	CE-2

1" Arbor for Ammco

- Fits Ammco models 2002, 3000, 4000, 4100, 7000, 7500 and 7700
- 7/8" x 9 LH thread
- Precision ground between centers using only one set-up for the greatest accuracy
- Factory checked for runout of less than .001"
- Heat treated, stress relieved tool steel
- For drums & rotors up to 125 lbs.
- Order No. **GT-3101**



1HP Motor for Ammco Brake Lathes

- Fits 3000, 4000, 4100, 7000, 7500, & 7700 models
- 208 / 230 / 115V • 60Hz
- 1725 RPM
- Order No. **GT-2165**

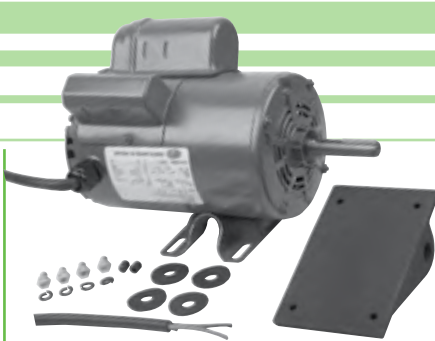

Right Angle Drive Assembly for Ammco Brake Lathes

- Fits 3000 & 4000 lathes
- Eliminates radial & axial play
- Order No. **GT-9815**



GT-3102



GT-20442N



GT-3110

1" Arbor Accessories

Description	Model(s)	Thread	Order No.
Arbor Nuts	Fits all Ammco but 1101	7/8" x 9 LH	GT-3102
	All arbors but Ammco	1" x 8 LH	GT-20442N
Centering Spring			GT-3110
1" Spacers for ALL Brake Lathes		Length	Order No.
		1/2"	GT-3125
		Flexible	GT-9492



Replacement Work Light

- 30" adjustable arm
- 5/8" round mounting end
- Uses up to 100W standard base bulb (not included)
- Easily accessible switch
- Fits most Ammco models
- Order No. **GT-7963**



Replacement Switch for Ammco Brake Lathes

- Easy to install
- Fits most models
- Order No. **GT-7893**

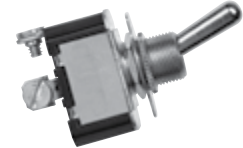

GT-10318

GT-10868

GT-32111

Ammco Rotor & Drum Feed Screws & Nuts

Description	Order No.
Rotor Feed Nut (early)	GT-10868
Rotor Feed Nut (late)	GT-10868X
Drum Feed Nut (all)	GT-4670
Rotor Feed Screw (4000)	GT-32111
Rotor Feed Screw (7000)	GT-10318



GT-10868X



GT-4670



GT-11227

GT-25913

GT-3031

GT-3165

Tooling Hold Down Pieces For Ammco

Description	Order No.	Incl.
Stud Assembly	GT-25900	▼
6 1/2" Stud	GT-25913	x
Nut Assembly (must be used with 6 1/2" Stud)	GT-11227	x
5 1/2" Stud	GT-3031	
Washers (2)	GT-3165	



enlarged to show detail

Brass Wear Inserts For Ammco

Dia. x Lgth.	Order No.
3/16" x 1/8"	GT-3141
1/64" x 1/4"	GT-3142
(most popular)	
1/4" x 1/64"	GT-9836



3163

3164

Replacement Seals For Ammco

Application	OD	Order No.
Feed Screw	1.25"	3163
Spindle	3.55"	3164

Replacement Screw for Twin Cutter Tool Bit Holders

- Square Head Screw
- Order No. **GT-9249**



Small Ammco Replacement Parts

Description	Order No.
Locking Knob	6854
Cross Feed Shear Gear with C-Clip	7996



CYLINDER HEAD REBUILDING
CLEANING, ASSEMBLY & SAFETY
SHORT BLOCK REBUILDING
FLYWHEEL GRINDING
MISCELLANEOUS TOOLS & SUPPLIES
BRAKE SERVICE TOOLING
MEASURING TOOLS
V-TWIN & METRIC HARD PARTS

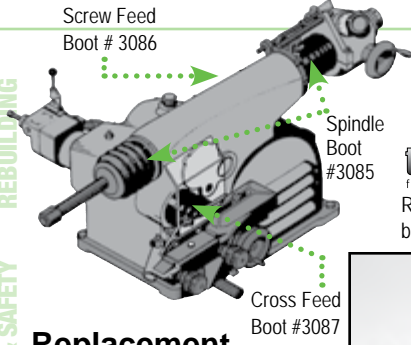

tech tips
from the techxperts™
Rubber is the standard boot material on most brake lathes



Replacement Boot Packs

- Keep extra boots on hand for routine maintenance or emergency replacement
- Fits Ammco 3000, 4000, 4100, 7000, 7700

Description	Order No.	Incl.
Neoprene Boot Pack	GT-BOOT-PK	▼
Rubber Boot Pack	RSB-BOOT-PK	▼
Neoprene Spindle Boot Kit	SBR-KIT	▼
Rubber Spindle Boot Kit	RSB-KIT	▼
Rubber Spindle Boot	RSB-3085	x x
Neoprene Spindle Boot	3085	x x
Screw Feed Dust Boot	3086	x x
Cross Feed Dust Boot	3087	x x
Boot Ring	23682	x x x x
C-Clip	SBR-4435	x x x x
Snap Ring	SBR-3159	x x x x



Replacement Parts Pack

- Save time – never be caught without one of these essential brake lathe replacement parts again
- Save money – pack price is lower than ordering all of the parts separately
- Save on shipping – purchasing these parts together costs less in shipping than ordering them individually at different times. You pay shipping and handling one time instead of several • All parts are also sold separately

Description	Order No.	Incl.
Replacement Parts Pack	GT-PARTS-PK	▼
Cross Feed Shear Gear	7996	2
Replacement Locking Knob	6854	2
Feed Seal	3163	1
Spindle Seal	3164	1
Neoprene Spindle Boot	3085	1
Screw Feed Dust Boot	3086	1
Cross Feed Dust Boot	3087	1

Drive Pulleys & Belts for Ammco

- Fit Ammco 3000, 4000, 4100, 7000 & 7100
- Serpentine design runs quieter and increases arbor speed by 175RPMs
- Virtually eliminates vibration

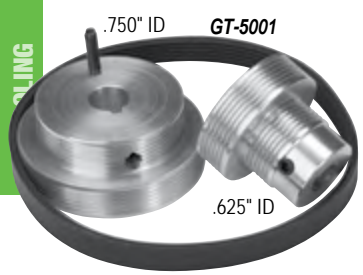

New-Style (Serpentine)

Description	Order No.
Pulley Set (Includes 20¼" belt & 2 pulleys)	GT-5001
20¼" Belt	GT-5002
19" Belt	GT-5003

Original-Style (V-belt)

Description	Order No.
Drive Pulley (Motor)	GT-3024
Driven Pulley (Arbor with drive pin)	GT-7784-1
25" Belt (replaces OE 3161)	GT-3161
24" Belt (replaces OE 10241)	GT-10241

tech tips Install the drive pulley from the techxperts™ with the pin toward the right angle drive. The roll-pins drive against each other. A nylon sleeve prevents metal to metal contact.

See page 72 for more Flex-Hones®

Brake Rotor Flex-Hones®

- Provide a non-directional finish
- Use with a 3/8" variable speed drill at 600-1000 RPM
- Zirconium abrasive
- Use dry

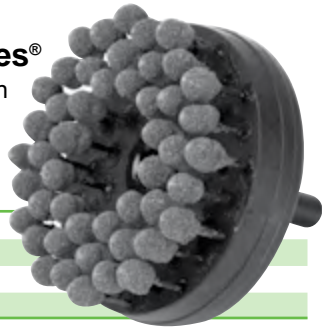

Type	Grit	Order No.
Fine	240	BRF-25F
Medium	120	BRF-25M
Coarse	60	BRF-25C

Brake Drum Swedge Cutting Tool

- Hard-to-find tool cuts wheel stud swedges to remove and replace pressed-in wheel studs
- Use with a drill press or mill
- Carbide tipped
- For 1/2" stud
- Order No. **ST-500**



Brake Lathe Replacement Parts



Brake Drum Grinding Wheel

- Aluminum-Oxide abrasive

For Van Norman / Rels 204, 300, 302, 303, 333 & 404 Drum Grinders

Size	OE No.	Shape	Order No.
3" x 1/2" x 1"	8522	Recessed	GDV-304
3 1/2" x 1/2" x 1"	8931	Recessed	GDV-354
4" x 1/2" x 1"	8523	Recessed	GDV-404

For Ammco 3050 and 5000 Drum Grinders

Size	OE No.	Shape	Order No.
3" x 3/4" x 7/8"	5410	Recessed	GDA-205
4" x 3/4" x 7/8"	5405	Recessed	GDA-206

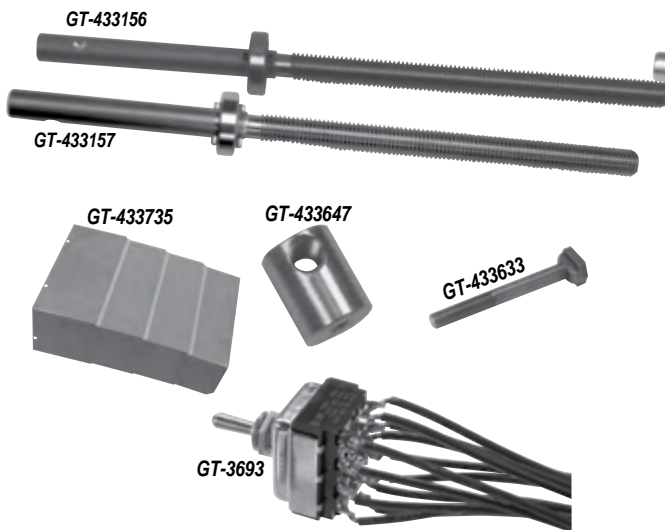

Assorted Accu-Turn Replacement Parts

Description	Order No.
Rotor Feed Screw Assembly (1/2" 20TPI)	GT-433156
Drum Feed Screw Assembly (1/2" 13TPI)	GT-433157
Telescoping Way Assembly (fits all except 8989)	GT-433735
Rotor Feed Nut (fine thread)	GT-433647
T-Bolt	GT-433633
Drum Feed Nut (not shown) (coarse thread)	GT-433646
Replacement Switch (12 Poles)	GT-3693

Don't buy a new brake lathe ... expand your existing one to handle rotors up to 15"

Lead Screw Bushing

- Easy installation
- Increases lathe capacity to 15"
- Ideal for machining large rotors common on SUVs and large pick-ups
- Fits Ammco 3000 and 4000 Brake Lathes
- Order No. **LSB-78529**



Brake Shoe Grinding Sleeves

ID	Lgth.	Grit	Application	Order No.
3"	5 1/4"	40	Fits most models	AS-2
3"	6"	40	Fits most models	AS-3
3"	6 5/8"	40	Fits most models	AS-4
3"	7 1/2"	40	Fits most models	AS-6
2 7/8"	4 1/2"	50	Fits Ammco 2007	AS-7

Rotor & Drum Feed Screws & Nuts For FMC & Bean

Description	Order No.
Rotor Feed Screw	GT-90071
Rotor Feed Nut	GT-90077
Drum Feed Screw	GT-90667
Drum Feed Nut	GT-1016845

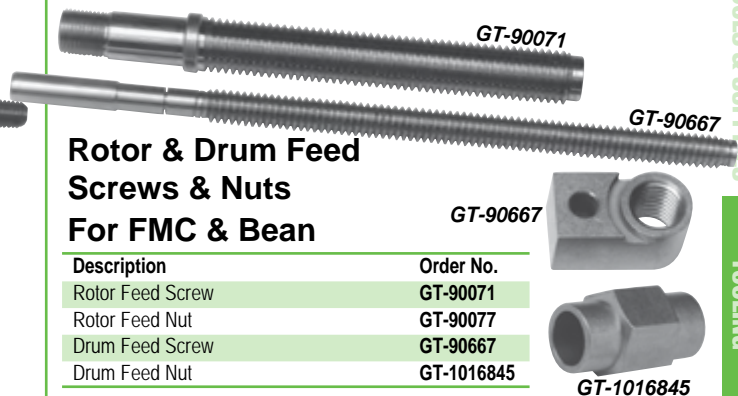

Replacement Motor for Ammco Lathes on page 113

Replacement Feed Motor For Accu-Turn Brake Lathes

- For 7700, 8920, 8910, 8911, 8989, 8922 • 1/60 HP • 6 RPM
- 120V, 60Hz
- 1.5 Amps • Includes fan
- 2 year limited mfr. warranty
- Ships without blade attached to prevent damage
- Order No. **GT-3641**

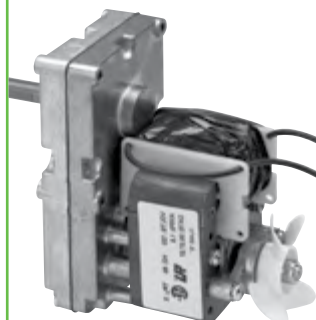

CYLINDER HEAD REBUILDING
CLEANING, ASSEMBLY & SAFETY
SHORT BLOCK REBUILDING
FLYWHEEL GRINDING
MISCELLANEOUS TOOLS & SUPPLIES
BRAKE SERVICE TOOLING
MEASURING TOOLS
V-TWIN & METRIC HARD PARTS

full service
...fast



"We pride ourselves on getting orders to our customers quickly. We stock a wide variety of products so that we can get your order to you in 3 days or less."
- Brian, Goodson Receiving, 27 years of service

CYLINDER HEAD REBUILDING
CLEANING, ASSEMBLY & SAFETY
SHORT BLOCK REBUILDING
CRANKSHAFT/ FLYWHEEL GRINDING
MISCELLANEOUS TOOLS & SUPPLIES
BRAKE SERVICE TOOLING
MEASURING TOOLS
V-TWIN & METRIC HARD PARTS

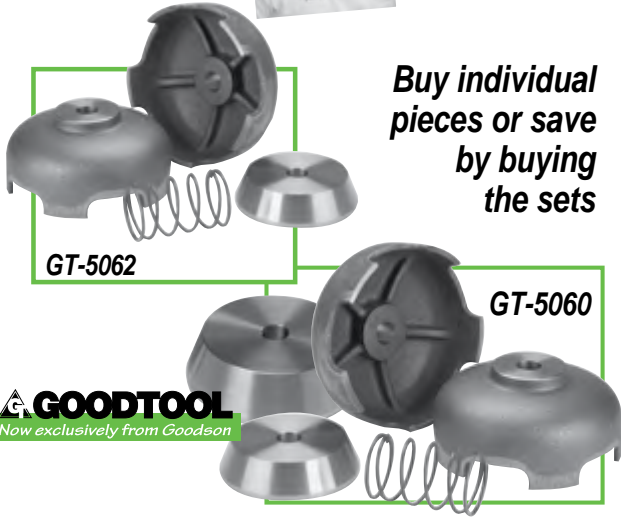

Buy individual pieces or save by buying the sets

GOODTOOL
Now exclusively from Goodson

Truck Mounting Adaptor Sets For Brake Lathes With 1" Arbors

Description	Order No. Incl.
Standard Truck Set	GT-5062 ▼
Master Truck Set	GT-5060 ▼
Centering Cones 3.750" x 5.125"	GT-5053 1 1
4.500" x 5.500"	GT-5052 1 1
5.000" x 6.125"	GT-5054 1 1
Bell Clamps 6.500" OD	GT-5055 1 2
7.750" OD	GT-5056 1 1
Heavy-duty Spring 2.515" OD x 2.217"ID x 4" L	GT-5059 1 1

tech tips

from the techxperts™
When using bell clamps and centering cones always be sure they are clean and free of any dirt or rust.
Keep a light coating of oil on them to prevent rusting.
Never use a cone or a bell clamp for anything other than mounting a brake rotor or drum onto the brake lathe.
Replace any worn or damaged cones or bell clamps.
Always use the largest bell clamp that will fit the rotor or drum for the best support.



GOODTOOL
Now exclusively from Goodson

Automotive Bell Clamps for Brake Lathes

OD Size: 4.500"	OD Size: 5.750"
Arbor Size: 1.000"	Arbor Size: 1.000"
Order No.: GT-9490	Order No.: GT-3123

Brake Conditioning Spray

- Spray on rotors and drums to stop noise at the source
- OE approved spray-on metalizing treatment
- Effective from -100°F to +2000°F
- Prevents rust and seizure of lug nuts and threads
- Overspray won't damage calipers, rubber components or seals
- Aerosol*
- Order No. **BS-12***



* Hazardous Fees Apply When Shipped By Air

Pastelub™ Synthetic High Temp Brake Lubricant

- OE recommended
- High pressure resistant
- Recommended for the backs of brake pads
- Not for use on friction surfaces
- 2400°F Ultra high-temperatures range
- Patented "real synthetic" Swiss formula won't melt, rub or wash off brake parts • Gray
- No silicone or petroleum to weaken the carrier base
- Order No. **BPL-2400**



Ceramlub-2800™ Extreme High Temperature Lubricant

- Use on brake caliper slides, etc.
- Contains ceramic pressure solids and high concentrations of anti-corrosive agents
- Specifically designed for use on caliper slides, rubber seals and O-Rings
- A great complement to Pastelub™ Hi-Temp Lubricant
- Purple
- Order No. **CBL-2800**

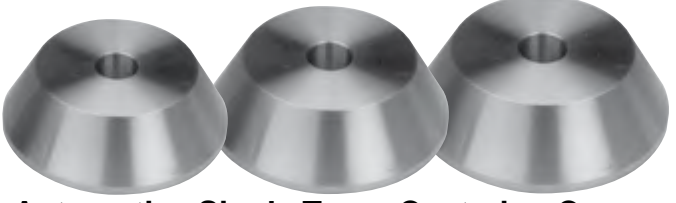

Automotive Single Taper Centering Cones for Brake Lathes

Range: 1.703" to 2.750"	Range: 2.328" to 2.986"	Range: 2.890" to 3.500"
Arbor Size: 1.000"	Arbor Size: 1.000"	Arbor Size: 1.000"
Order No.: GT-3904	Order No.: GT-3108	Order No.: GT-3107



Build Your Own Valve Guide Gauge Set! Order the Valve Guide Gauge (P-300), Setting Fixture (P-610A) and the Valve Guide Probe you need.

Valve Guide Gauge Set

- The only way to be sure clearance is correct is to gauge it
- Checks all types of guides for size and roundness FAST
- Set up and measure valve guide IDs quickly and easily
- Complete set includes gauge, 3 probes (.312", .344" and .375"), hex wrench, setting fixture and metal storage case with spaces for all components
- Dial calibrated in .0002" increments

Description	Order No.	Incl.
Complete Valve Guide Gauge Set	P-310	▼
Valve Guide Gauge	P-300	x
Setting Fixture	P-610A	x
Valve Guide Probes		
Size	Range in.	mm
.236"	.244" to .264"	5.69 to 6.71
.250"	.238" to .278"	6.05 to 7.05
.281"	.269" to .309"	6.83 to 7.85
.312"	.300" to .340"	7.62 to 8.64
.344"	.332" to .372"	8.43 to 9.45
.375"	.363" to .403"	9.22 to 10.24
.406"	.394" to .434"	10.01 to 11.02
.438"	.426" to .466"	10.82 to 11.84
.469"	.457" to .497"	11.61 to 12.62
.500"	.488" to .528"	12.40 to 13.41



Split Ball Bore Gauge

- Dial gauge with large contact area
- Measures quickly & accurately to .0001"
- Works in threaded or knurled guide IDs
- Range: .280"-.400" • Easy to change contacts
- Order No. **MVG-34**



Sunnen® AG-Series Precision Gauge

- Dial reads directly in "tenths" (.0001")
- Checks rod journal bore for distortion
- Measures size instantly
- Wear-compensated gauge points for permanent accuracy
- Rugged construction – all moving parts are enclosed in the housing
- Includes Point Sets listed below (optional point sets are available, call for information)

Description	Order No.
.375" - 3.375" (9.5 - 85.7mm) Range Gauge	AG-300
Standard Point Set (.720" - 1.530" Range)	AG-210
Medium Point Set (1.50" - 2.25" Range)	AG-620
Large Point Set (1.932" - 2.687" Range)	AG-630

Point sets will NOT fit AG-gauges lower than Serial No. 4000

Rod Bolt Stretch Gauge

- Accurate to .001"
- Features a 1½" dial gauge
- Heavy-duty tension spring for repeatable accuracy
- For bolts from 1" to 2½" long



Description	Order No.
Rod Bolt Stretch Gauge	RBSG-3
Optional Contact Point	ERBG-3T

tech tips

Most engine rod failures aren't from faulty parts, they're from improper installation.

When you're installing the rods, you need to check the rod bolt stretch by performing a series of torquing and loosening and recording the readings.

Here's how:

1. Torque the bolts to 15 foot pounds and measure the stretch. Record the reading, then loosen the bolts.
2. Repeat at 15 foot pounds and record the reading.
3. Repeat, increasing to 30 foot pounds, record the reading.
4. Repeat, increasing to 60 foot pounds, record the reading.
5. Repeat at 60 foot pounds and record the reading.

Each time you loosen the bolts, measure to be sure that the rod bolts have returned to within .001" of the starting size. If you have a greater variation, get rid of the rod bolts and start with new ones.

When you're conducting final assembly, be sure you use the stretch specified by your rod manufacturer. Attach a rod bolt stretch gauge to the connecting rod bolt and zero it. Use an extra-long box wrench to tighten until the proper stretch is achieved.

CYLINDER HEAD REBUILDING
CLEANING, ASSEMBLY & SAFETY
SHORT BLOCK REBUILDING
FLYWHEEL GRINDING
CRANKSHAFT/ TOOLS & SUPPLIES
MISCELLANEOUS
BRAKE SERVICE
MEASURING TOOLS
V-TWIN & METRIC HARD PARTS

American Made

Dial Bore Gauge Setting Fixture

- Fast, accurate setting from 2" to 6"
- Billet steel construction with a tool black finish
- Sets most popular bore gauges including Mitutoyo, Phase II, Fowler and Peacock • Will not fit Sunnen® Bore Gauges (see page 119 for Sunnen setting fixture)
- .001" increment micrometer • 3 setting standards (1", 2" & 3") included • Carrying case included
- Order No. **DBG-FIX**

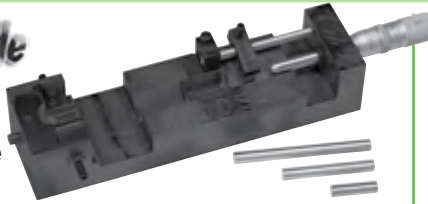

Cylinder Dial Bore Gauge Sets

- Easy to read • Insulated grip
- Measure cylinders up to 9" deep
- Graduations: .0005" • Self-centering
- Chrome plated handle
- Includes extension holder and fitted case

Range	Order No.
0.7" - 1.4" (18-35.6mm)	FBG-7
1.4" - 6.0" (35-150mm)	FBG-146



Dial Bore Gauge Set

- Rugged bore gauge with protected dial
- Carbide tipped contact points
- .0001" (.001mm) graduations • Indication stability: .00008"
- Accuracy: .0002" • Shoe can be rotated for a fresh wear surface • Sets up with a standard micrometer (see page 120) or **DBG-FIX** (pictured above)

Range	Description	Order No.
2.0"-6.0"	11 anvils and 4 spacers	MMCB-06
Replacement Spacers for anvils 2" & larger	.020"	MMCB-06-020
	.040"	MMCB-06-040
	.080"	MMCB-06-080
	.120"	MMCB-06-120
Replacement Lens		MMCB-06LENS
Replacement Dial Indicator		MMCB-06IND
Replacement Dial Cover		MMCB-06COVER

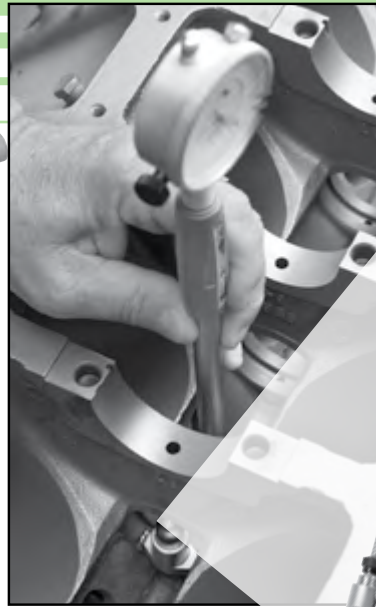

90° Dial Bore Gauges

- Measure cam bores, main bores and other hard-to-reach areas directly
- No passing through other bores to measure inboard journals • .100" travel in .0001" increments
- Metric has 3mm travel in .01mm resolution
- 3 spacers, 11 probes and case included

Range	Graduations	Order No.
2.0" - 6.0"	.0001" / .0025mm	MCB-90
50-160mm	.01mm	DMBG-50160



Economy Bore Gauges

- Includes: .050" travel indicator, 3 spacers (.100", .050" and .020"), probes and case

Description	Range	Probes	Resolution	Order No.
Standard US	2" - 6"	11	.0005"	EBG-265
Standard US	2" - 6"	11	.0001"	EBG-261
Metric	35 - 160mm	12	.01mm	MCBG-160
11 Pc. Replacement Spacer Set				EBG-ANVILS



Internal Electronic Caliper

- Ideal for measuring mating port runners and bowl diameters
- Hardened contact surfaces
- Robust housing with large LCD display
- Range: 0.5" to 6.0" • Reading: .01" (.3mm) / 1/64th
- Spring loaded locking nut
- Order No. **IEC-56**

Sunnen® Dial Bore Gauges

Sunnen Dial Bore Gauges



- Standard Sunnen Dial Bore Gauges read out in tenths
- Also available in five-tenths and metric (special order)
- Diameter ranges from .495" to 6.000" (see chart for gauge ranges)
- All models below feature all-carbide gauging points, wear-proof ball crank and adjustable centralizers
- Include molded storage case with all tools and wrenches required for setup and adjustment

Shock-Shield protects dial from hand heat and jarring to assure accurate reliable readings.

All standard Sunnen Dial Bore Gauges are TENTH READING. Metric and .0005" readouts are also available (special order). Dial can be indexed 90° for easy reading at any angle.

Adjustable centralizers for proper centering over the entire diameter range. One twist adjusts gauge tension so head goes into and out of any size hole smoothly.

Patented wear-proof ball crank assures repeatability over a long life.

Carbide indicating points are long wearing and replaceable.

Transfer Rod

Indexable Centralizer Points

GA-4141

- Measures to within .200" of the bottom of a blind bore
- Carbide balls replaceable in the indicating fingers only
- Set with SCF-502 Setting Fixture
- Non-retractable gauge

GR-6241

- Measures to within .270" of the bottom of a blind bore
- Carbide balls replaceable in the indicating fingers only
- Set with SCF-502 Setting Fixture
- Retractable gauge

GR-9241

- Measures to within .335" of the bottom of a blind bore
- Carbide balls replaceable in indicating fingers and extension points
- Set with SCF-502 Setting Fixture
- Retractable gauge

GA-2121 / GA-2125 GR-2241 / GR-2245

- Measures to within 500" of the bottom of a blind bore
- Carbide balls replaceable in indicating fingers and extension points
- Set with CF-1126 Setting Fixture
- Non-retractable gauge

Diameter Range		Max Gauging Depth		Overall Length		.0001" Reading	.0005" Reading
in	mm	in	mm	in	mm	Order No.	Order No.
.495" to .750"	12.6 to 19.0	7.00"	175	11.8125"	302	GA-4141	—
.740" to 1.19"	18.9 to 30.2	12.00"	300	17.6875"	451	GR-6241	—
1.18" to .2.00"	30.0 to 50.8	12.00"	300	17.75"	452	GR-9241	—
2.00" to 6.00"	50.0 to 150.0	12.00"	300	17.00	432	GA-2121	GA-2125
2.00" to 6.00"	50.0 to 150.0	24.00"	600	29.00	737	GR-2241	GR-2245

Small Diameter Dial Bore Gauge & Accessories

- Dial Bore Gauge assembly consists of .0001" (.002mm) reading indicator, probe retractor and probe retainer bushing in a reinforced nylon insulating shroud
- Dial Bore Gauge diameter range: 0.054" to 0.535" (1.37 to 13.6mm)

Description	Order No.
1-Small Diameter Dial Bore Gauge	GR-3000
2-Adjustable Probes	Range in mm
	.165" to .189" 5.69 to 6.71 G-1180
	.185" to .209" 6.05 to 7.05 G-1200
	.205" to .228" 6.83 to 7.85 G-1220
	.224" to .248" 7.62 to 8.64 G-1240
	.244" to .268" 8.43 to 9.45 G-1260
	.264" to .287" 9.22 to 10.24 G-1280
	.283" to .307" 10.01 to 11.02 G-1300
	.303" to .327" 10.82 to 11.84 G-1320
	.323" to .346" 11.61 to 12.62 G-1340
	.343" to .366" 12.40 to 13.41 G-1360
	.362" to .386" 12.40 to 13.41 G-1380
3-Transfer Pin (fits all probes above)	G-2264
4-Probe Extension	KZIX-3500

How to Order:

1 - Gauge

2 - Probe

3 - Transfer Pin

4 - Probe

Extension



SCF-502 shown with GR-6241

CF-1126 shown with GR-2121

SCF-502 with CF-540 Size Setting Adaptor shown with GR-3000 Gauge

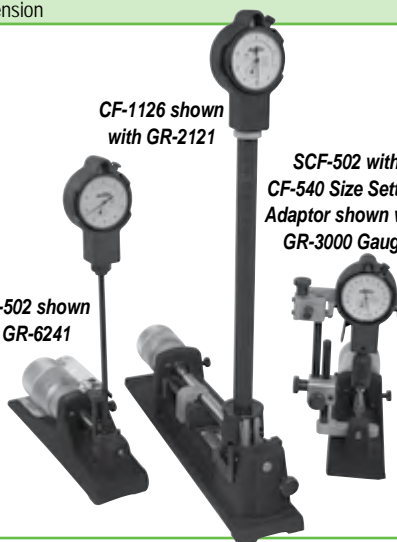

Dial Bore Gauge Setting Fixtures

- Models combine to cover a continuous range of .054" to 8" in .0001" increments
- Heavy stress-relieved cast iron bases
- Lapped carbide micrometer anvils
- Built-in magnifier
- Each setting fixture includes a master calibrating ring
- Size Setting Adaptor centers gauge probes between parallel reference surfaces on SCF-502 Setting Fixture

Range	Order No.
.054" to 2.00"	SCF-502
Size Setting Adaptor	CF-540
2.00" to 8.00"	CF-1126

Gauges & Setting Fixtures Sold Separately

CYLINDER HEAD
REBUILDING
ASSEMBLY & SAFETY
REBUILDING
SHORT BLOCK
FLYWHEEL GRINDING
CRANKSHAFT/
MISCELLANEOUS
BRAKE SERVICE
MEASURING TOOLS
V-TWIN & METRIC
HARD PARTS

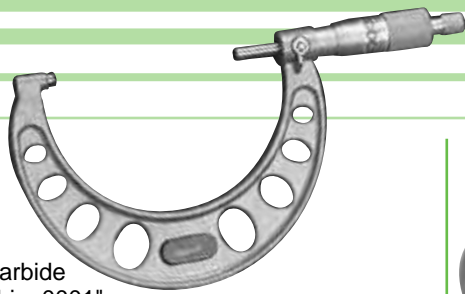

Premium Micrometers

- Precision ground carbide anvil parallel to within .0001"
- .0001" graduations • Set includes wood storage case

Description	Range	Order No.	Incl.
Micrometer Set	(wood storage case)	EMS-06	▼
Individual Micrometers	0"-1"	EMIC-01	x
	1"-2"	EMIC-12	x
Each Micrometer	2"-3"	EMIC-23	x
includes a Standard,	3"-4"	EMIC-34	x
Spanner Wrench & Case	4"-5"	EMIC-45	x
	5"-6"	EMIC-56	x

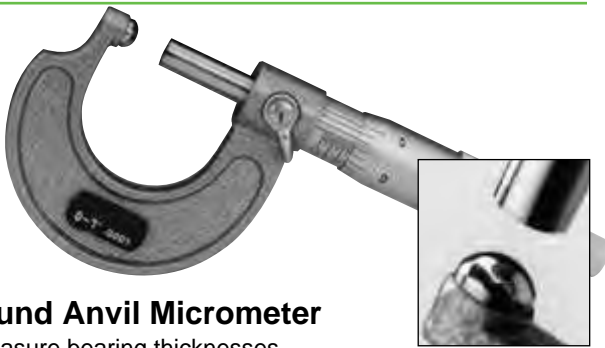

Round Anvil Micrometer

- Measure bearing thicknesses
- Ratchet spindle • 0-1" range • Precise to .0001"
- Order No **MIC-01-B**

Checking Standards

- Use to set up dial indicators in special application gauging and to check micrometer accuracy
- Made of hardened, ground and lapped tool-steel
- Meet or exceed federal accuracy specifications

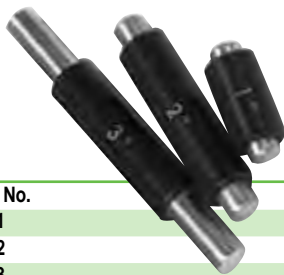

Length	Order No.
1"	MCS-1
2"	MCS-2
3"	MCS-3

Valve Seat Run-Out Gauge

- Measure run-out to .001"
- Hardened guide bushings and contact pilot
- Quick thumb screw set-up
- Jeweled bearing indicator reads to $\pm .050$ " with .001" precision
- Range: 1.00" - 2.50"



Pilot Size	Order No.
.375" / 9.53mm	VSG-375
.385" / 9.78mm	VSG-385



Open and close the padded jaws to accommodate most micrometers and dial bore gauges

Easy to reach knob adjusts the head angle



Micrometer Stand

- Heavy cast iron construction
- Use to hold micrometers, standards or just about anything you need an extra hand for
- Swivel head and padded jaws won't damage expensive measuring tools
- Order No. **MIC-FIX**



Use the Micrometer Stand When Setting Your Dial Bore Gauge



Mitutoyo

Small Hole Gauge Set

- See if rebuilding or replacement is needed by checking actual guide wear
- Check guide bosses for proper interference fit during replacement
- Check and maintain correct stem to guide ID clearance
- 4-piece set has combined range of .125"-.500" / 3.2-12.7mm
- Storage case included
- Order No. **SHG-5**



Precision Valve Seat Run-Out Gauge

- Use with .375" Top Pilot
- Measure run-out to .0001" directly from the seat
- Locked to the pilot
- Dial indicator remains stationary while rotating contact pointer
- .800" - 2.500" dia. range
- Order No. **SCG-375**



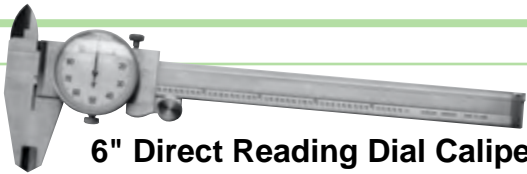

6" Direct Reading Dial Caliper

- Four way measurement - outside, inside, depth and step
- Hardened stainless steel with satin chrome finish
- Precision ground and lapped measuring surfaces
- Reads direct to .001" or with .100" graduations on beam
- Adjustable bezel with lock
- Thumb roll with lock
- 1 1/8" jaw length
- Large easy to read dial
- Covered rack • Deluxe fitted case
- Order No. **MDC-03**



12" Direct Reading Dial Caliper

- .001" single revolution • Hardened measuring face
- Precision Ground • Micro-lapped for accuracy
- Adjusting slide for fine adjustment
- Take Inside, Outside and Depth measurements
- Satin Chrome finish with engraved graduations
- Clamp for repetitive readings
- Accurate to .001" per 6"
- Covered Rack • Deluxe fitted case
- Order No. **EDC-12**

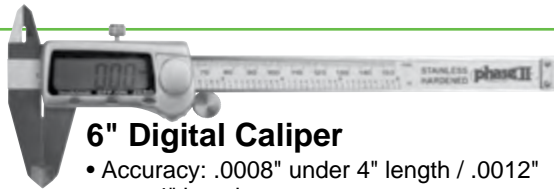

6" Digital Caliper

- Accuracy: .0008" under 4" length / .0012" over 4" length
- .0005" (.01mm) resolution
- Automatic floating zero
- Used to take Inside and Outside measurements
- Direct inch/metric Conversion
- Large, high-contrast LCD display
- On/Off Button • Deluxe fitted case

Description	Order No.
Digital Caliper	EEDC-06
Replacement Battery	EDC-06B

Conversion Calculator

We've tried to convert as many SAE measurements to Metric (and vise versa) as possible. In some cases there hasn't been enough room.

If you need to convert a measurement, here are the formulas:

Starting Measurement	Conversion Formula	Converted Measurement
Inches (in)	Inches x 25.4	Millimeters (mm)
Feet (ft)	Feet x .3048	Meters (m)
Millimeters (mm)	Millimeters ÷ 25.4	Inches (in)
Fahrenheit (F)	(5÷9) x (F - 32)	Celsius (C)
Celsius (C)	(9÷5) x (C + 32)	Fahrenheit (F)

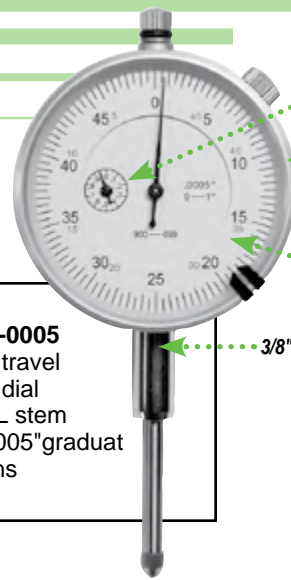

Revolution Counter (included on most models)

Adjustable bezel for zero settings

Shatter resistant crystal

3/8" stem

- EDI-0005**
- 1" travel
 - 2" dial
 - 1"L stem
 - .0005" graduations

All Indicators have lug back



EDI-1

- 1" travel • 2" dial
- 1"L stem
- .001" graduations



MDI-2

- 2" travel • 3" dial
- 2"L stem
- .001" graduations

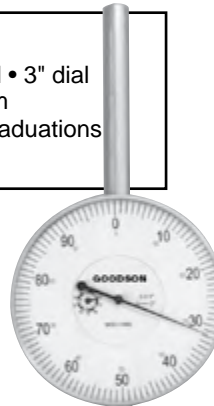

MDI-12

- .125" travel
- 2" dial
- 12"L stem
- .001" graduations

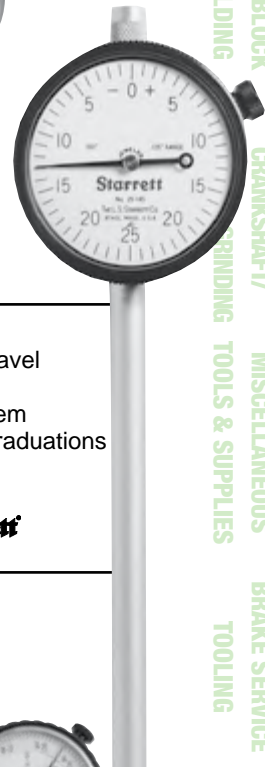

Metric Dial Indicator & Accessories

- Use your metric dial indicator with standard spindle extensions!
- The Metric Dial Indicator Point Adaptor mounts to your dial indicator to convert its threads from 2.25mm to 2x48 TPI.

Description	Order No.
Metric Dial Indicator	MDI-25MM
Metric Dial Indicator Point Adaptor	DIS-MTE
Spindle Extensions 1 1/2"	DIS-1.5
2 1/2"	DIS-2.5
3"	DIS-3.0

CYLINDER HEAD REBUILDING
CLEANING, ASSEMBLY & SAFETY
SHORT BLOCK REBUILDING
CRANKSHAFT/GRINDING TOOLS & SUPPLIES
MISCELLANEOUS TOOLING
BRAKE SERVICE
MEASURING TOOLS
V-TWIN & METRIC HARD PARTS



Dial indicators sold separately

Deck Bridge Tools

- Verify deck height without removing block from roll over fixture
- Flat anvil surface makes full contact
- Use Deck Bridge with either 1 or 2 dial indicators
- Designed for multiple set-ups

Description	Order No.
Deck Bridge (4½" span)	MDBS-2
Dial Indicator (12" OAL)	MDI-12
Dial Indicator Flat Anvil	MDI-12A
Economy Dial Indicator	EDI-1

• **MDI-12A**



America Made

Precision Straight Edges & Warp Gauge

- Accuracy .0005" per foot

Description	Order No.
24" straightedge, 1 precision edge	DIS-24
36" straightedge, 1 precision edge	DIS-36
24" straightedge, 2 precision edges	DIS-20
35" straightedge, 2 precision edges	DIS-30

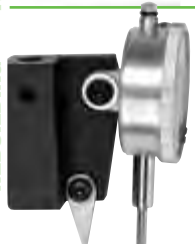

Valve Seat Height Gauge

- Confirm seat height to fire deck location
- Adjusts for all popular seat diameters
- Accurate to .001"
- Seat contact probe aligns on valve seat while gauge rides along the fire deck
- Pilot aligns in valve guide (pilot sold separately)
- Adjustable to fit popular seat diameters from .750" to 3.00"

Includes Dial Indicator

Description	Fits Pilot	Order No.
Valve Seat Height Gauge Kit	.375"	VSHG-375
Replacement Dial Indicator		EDI-1

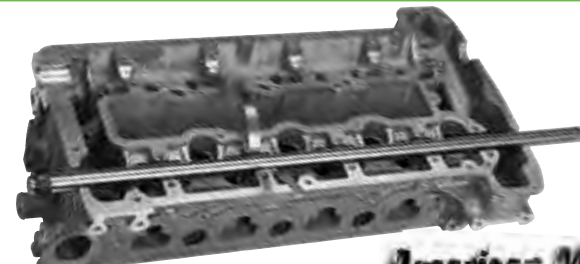

America Made

26" Round Warp Gauge

- Use with feeler gauges (below)
- ¾" diameter tool steel
- Includes anti-roll collar and eye bolt allowing you to hang it for safe storage
- Order No. **EWG-100**

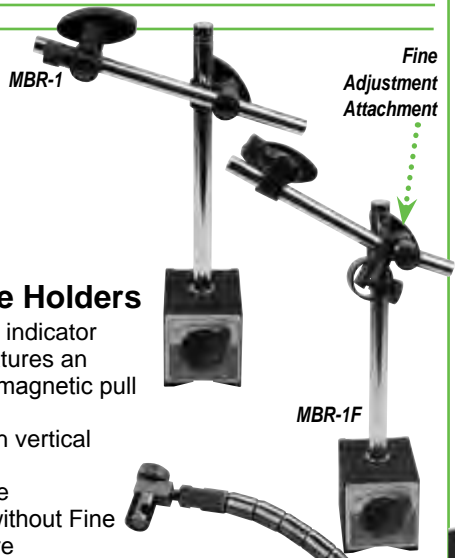

Universal Magnetic Base Holders

- Fit any type of dial indicator
- Magnetic base features an on-off switch with magnetic pull of 90 pounds
- ¾" diameter 7" high vertical column
- 2" x 2½" x 2¼" base
- Available with or without Fine Adjustment Feature

Description	Order No.
Universal Holder	MBR-1
With Fine Adjustment	MBR-1F

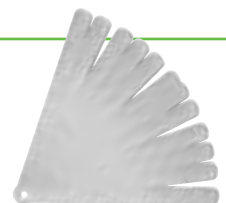

12" Feeler Gauges

- Measure piston-to-wall clearance when honing, to find ring end gap and to check cylinder heads with a straight-edge
- Also useful for shimming while straightening heads and for machine set-ups

Complete Kit	Order No.	
Thick .0015"	FE-KIT	▼
.0020"	FE-0015	x
.0020"	FE-002	x
.0030"	FE-003	x
.0040"	FE-004	x
.0050"	FE-005	x
.0060"	FE-006	x
.0070"	FE-007	x
.0080"	FE-008	x
.0090"	FE-009	x
.0100"	FE-010	x
.0150"	FE-015	x
.0200"	FE-020	x



6 Piece Telescoping Gauge Set

- Compress spring plunger and lock by twisting handle
- Insert into bore and release plunger – it will expand to fit
 - Lock again and remove
 - Measure with a micrometer
- Double plunger design for consistent measuring
- Long-lasting finish
- Size range: ⅝" - 6"
- Order No. **MTG-6**

Magnetic Mounting Base With 13" Flexible Arm

- Adjusts easily and locks tightly in any position
- 150 pounds of magnetic force
- Locks in place with a single lever
- Order No. **MFB-1**

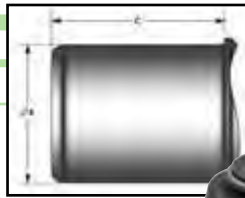

Solid Viton Seals With Metal Jacket & Choker Spring

16 Per Package

Stem Dia.	OAL	Seal OD	A	B	C	D	Order No.
7.0mm	0.510"	0.665"	0.560"	—	0.375"	—	71028
.312"	0.412"	0.566"	0.420"	—	0.275"	—	71010
.312"	0.514"	0.671"	0.530"	—	0.330"	—	71045
.375"	0.516"	0.661"	0.562"	—	0.210"	—	71011



Solid Viton Seals With Metal Jacket & Integral Spring Base

16 Per Package

• Spring Shoulder Diameter: 0.970"

Stem Dia.	OAL	Seal OD	A	B	C	D	Order No.
7.0mm	0.974"	1.457"	0.560"	—	0.700"	—	71030

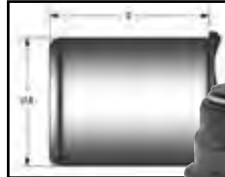

OE Style Seals Solid Teflon With Metal Jacket

16 Per Package

Stem Dia.	OAL	Seal OD	A	B	C	D	Order No.
.312"	0.385"	0.565"	0.420"	—	—	0.315"	71032
.312"	0.375"	0.630"	0.530"	—	—	0.295"	71033
.343"	0.375"	0.630"	0.530"	—	—	0.365"	71034
.375"	0.375"	0.660"	0.562"	—	—	0.315"	71035
.375"	0.400"	0.720"	0.625"	—	—	0.310"	71036

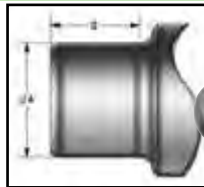

Aluminum Seal Drivers

• A must-have tool for installing valve seals

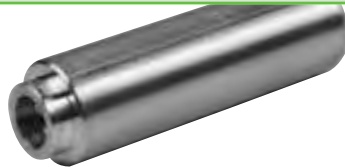

Seal Size	Order No.	Seal Size	Order No.
6.0mm	VSD-6MM	1 ¹ / ₃₂ "	VSD-343
7.0mm	VSD-7MM	3 ¹ / ₈ "	VSD-375
7/16"	VSD-312		



Aluminum Seal Drivers

These installation tools for OE style seals are manufactured from high strength 6061-T6 Aluminum for increased durability when compared to plastic installers.

Application	Color	Fits Seal Up To	Order No.
Evolution (5/16" Stem)	Red	0.575"	20-20830
Pan/Shovelhead 74"	Black	0.673"	20-20833
Ironhead Sportster	White	0.638"	20-20832
Shovelhead 80"	Blue	0.728"	20-20831



Valve Seat Inserts

- For Harley-Davidson®
- Easy to machine
- Effectively dissipate heat for consistent valve sealing
- Hardness increases during engine break-in
- Radiused for easy installation



Replacement Valve Seats For Shovel Head 1200 & 1340

Application	OD	ID	Thickness	Order No.
Exhaust	1.944"	1.575"	.400"	10-HC493
Intake	2.135"	1.750"	.400"	10-HC542

Overize Seats For Shovel, Evolution & Twin Cam – machining required

OD	ID	Thickness	Order No.
1.630"	1.180"	.385"	10-HC414
1.757"	1.410"	.430"	10-HC447
1.882"	1.530"	.410"	10-HC478
2.008"	1.610"	.440"	10-HC510
2.040"	1.700"	.425"	10-HC518
2.070"	1.610"	.460"	10-HC526
2.132"	1.800"	.460"	10-HC541
2.163"	1.750"	.455"	10-HC549

For Iron Head Sportster

Application	OD	ID	Thickness	Order No.
Exhaust	1.757"	1.371"	.315"	10-HC446
Intake	2.068"	1.750"	.315"	10-HC525

Universal Repair Seat

	OD	ID	Thickness	Order No.
Powdered	1.339"	1.024"	.375"	10-SC340
Metal	1.693"	1.299"	.434"	10-SC430
	1.820"	1.375"	.450"	10-HC462
	1.945"	1.375"	.440"	10-HC494
	2.257"	1.550"	.500"	10-HC573

Nickel Chrome Valve Seats on Page 14

tech tips When installing seats preheat head to 400° and freeze the seat for easier installation. Press fit .006" to .008".

.421" Valve Seal Cutter

- Evo/Twin Cam
- Will shorten and re-chamfer the guide top, increasing seal-to-retainer clearance for higher lift camshafts
- Can also be used to modify .530" guides to .421" guides
- Guide OD: .421" • Pilot Size: .312"
- Use with HVS-421 seal (above)
- Order No. **VSC-420312**



CYLINDER HEAD REBUILDING & SAFETY
 SHORT BLOCK REBUILDING
 CRANKSHAFT/ FLYWHEEL GRINDING
 MISCELLANEOUS TOOLS & SUPPLIES
 BRAKE SERVICE TOOLS
 MEASURING TOOLS
 V-TWIN & METRIC HARD PARTS

... another satisfied customer

"Absolutely amazing! You have to have the most courteous and friendly people working there. Always a pleasure to order from Goodson. A lot of companies could learn from your staff. To top it off, the supplies are top notch and ship very quickly."
- Dan Degenhardt, Degenhardt Garage, Coon Valley, WI, Goodson Customer since 1999



Guide Driver for Reduced Diameter Top Valve Guides

The guide top fits into the groove between the driver and the bushing to center and drive the guide into place. Puts pressure on the step top of the guide, not the seal area. Required for installing 20-2120 & 20-2130 series guides (below).
Order No. **VGD-315420**

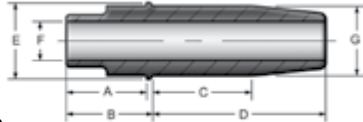

Evolution, Twin-Cam & Sportster With 5/16" (.312") Valves

• Use with 71010 Viton Seals or 71032 OE Style Seals

Intake							Manganese Bronze	Cast Iron
A	B	C	D	E	F	G		
.650"	.700"	.800"	1.400"	.615"	.3098"	.5620"	20-2120M	20-2120C
						.5630"	20-2121M	20-2121C
						.5640"	20-2122M	20-2122C
						.5720"	20-2129M	20-2129C
Exhaust							Manganese Bronze	Cast Iron
A	B	C	D	E	F	G		
.650"	.700"	1.150"	1.450"	.615"	.3098"	.5620"	20-2130M	20-2130C
						.5630"	20-2131M	20-2131C
						.5640"	20-2132M	20-2132C
						.5720"	20-2139M	20-2139C

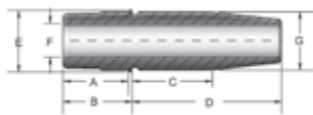

Evolution

• Use with 71045 Viton Seals

Intake							Manganese Bronze	Cast Iron
A	B	C	D	E	F	G		
.620"	.665"	.737"	1.435"	.615"	.3100"	.5620"	20-20860M	20-20860C
						.5630"	20-20861M	20-20861C
						.5640"	20-20862M	20-20862C
						.5720"	20-20869M	20-20869C
Exhaust							Manganese Bronze	Cast Iron
A	B	C	D	E	F	G		
.620"	.665"	1.135"	1.435"	.615"	.3096"	.5625"	20-20870M	20-20870C
						.5635"	20-20871M	20-20871C
						.5645"	20-20872M	20-20872C
						.5725"	20-20879M	20-20879C

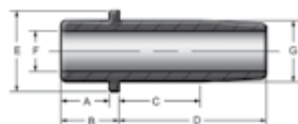

Shovel & Pan Heads

• Use with 71011 Viton Seals or 71035 OE Style Seals

Intake Or Exhaust							Manganese Bronze	Cast Iron
A	B	C	D	E	F	G		
.450"	.540"	.810"	1.340"	.745"	.3745"	.5650"	20-2020M	20-2020C
						.5660"	20-2021M	20-2021C
						.5670"	20-2022M	20-2022C
						.5680"	20-2023M	20-2023C
						.5750"	20-2029M	20-2029C

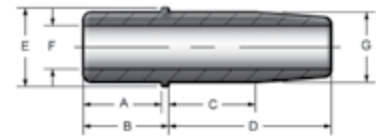

Twin Cam

• Use with 71028 Viton Seals

Intake							Manganese Bronze	Cast Iron
A	B	C	D	E	F	G		
.685"	.735"	.702"	1.305"	.615"	.2750"	.5620"	20-20690M	20-20690C
						.5630"	20-20691M	20-20691C
						.5640"	20-20692M	20-20692C
						.5720"	20-20699M	20-20699C
Exhaust							Manganese Bronze	Cast Iron
A	B	C	D	E	F	G		
.650"	.700"	1.150"	1.450"	.615"	.3098"	.5620"	20-20700M	20-20700C
						.5630"	20-20701M	20-20701C
						.5640"	20-20702M	20-20702C
						.5720"	20-20709M	20-20709C

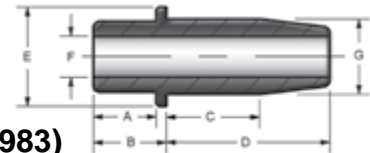

Sportster (1970-1983)

• Use with 71033 (intake) and 71034 (exhaust) Viton Seals

Intake							Manganese Bronze	Cast Iron
A	B	C	D	E	F	G		
.470"	.545"	.700"	1.225"	.745"	.3085"	.5650"	20-2320C	20-2320C
						.5660"	20-2321C	20-2321C
						.5670"	20-2322C	20-2322C
						.5750"	20-2329C	20-2329C
Exhaust							Manganese Bronze	Cast Iron
A	B	C	D	E	F	G		
.470"	.545"	0.600"	1.225"	.745"	.3375"	.5650"	20-2330C	20-2330C
						.5660"	20-2331C	20-2331C
						.5670"	20-2332C	20-2332C
						.5750"	20-2339C	20-2339C

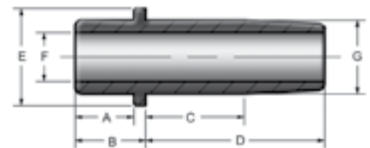

Shovel Head 80" (1978-1983)

• Use with 71011 Viton Valve seals or 71036 OE Style Seals

Intake							Manganese Bronze	Cast Iron
A	B	C	D	E	F	G		
.450"	.540"	.755"	1.370"	.745"	.3745"	.6250"	20-2050M	20-2050C
						.6260"	20-2051M	20-2051C
						.6270"	20-2052M	20-2052C
						.6500"	20-50HSM	20-50HSC
Exhaust							Manganese Bronze	Cast Iron
A	B	C	D	E	F	G		
.450"	.540"	.755"	1.370"	.745"	.3745"	.6250"	20-2060M	20-2060C
						.6260"	20-2061M	20-2061C
						.6270"	20-2062M	20-2062C
						.6500"	20-60HSM	20-60HSC

High Performance Valves



tech tips
from the techxperts™

Always check and confirm
running clearances when
installing new valves.



Black Diamond® Valves for Harley-Davidson® Engines

- **Light and strong with optimum airflow**

A combination of FEA stress analysis and flow bench testing of prototype valves allows our engineers to optimally balance valve mass, strength and airflow characteristics.

A unique tulip and dish are designed for each application.

- **Stellite tips for rocker applications**

Stellite is welded to the valve tips in rocker actuated applications for resistance the impact and abrasive wear common in rocker arm systems. This welded stellite can never come loose.

- **Black Diamond™ Valves**

One piece forged stainless steel valves impregnated by a special German process to improve wear properties and reduce friction. This process provides resistance to corrosion and wear that is superior to that of a hard chromium and electrolysis nickel plating.

Application	Type	Head Diameter	Stem Diameter	Tulip Radius	Angle	Overall Length	Black Diamond™
Milwaukee Eight™	Intake	1.571" (39.90mm)	0.2347"	0.235	10°	4.015"	20-21012
	Intake	1.591" (40.40mm)	0.2347"	0.235	10°	4.015"	20-21015
	Intake	1.630" (41.40mm)	0.2347"	0.235	10°	4.055"	20-21013
	Exhaust	1.264" (32.11mm)	0.2342"	0.460	24°	4.050"	20-21016
	Exhaust	1.184" (32.11mm)	0.2342"	0.460	24°	4.050"	20-21017
Pan Head 1948-1965	Intake	1.750" (44.45mm)	0.3765"	0.234	23°	3.800"	20-4257
	Exhaust	1.750" (44.45mm)	0.3760"	0.234	29°	3.820"	20-4195
Sportster 1957-1969	Intake	1.825" (46.36mm)	0.3090"	0.375	23°	3.562"	20-4258
	Exhaust	1.570" (39.88mm)	0.3384"	0.236	29°	3.512"	20-4197
	Exhaust	1.630" (41.40mm)	0.3384"	0.236	29°	3.512"	20-4197-1
Sportster 1970-1983	Intake	1.935" (49.15mm)	0.3090"	0.256	23°	3.620"	20-4196
	Intake	1.950" (49.53mm)	0.3090"	0.256	23°	3.690"	20-4167
	Intake	2.000" (50.80mm)	0.3090"	0.256	23°	3.620"	20-4196-1
	Exhaust	1.570" (39.88mm)	0.3384"	0.236	29°	3.512"	20-4197
	Exhaust	1.630" (41.40mm)	0.3384"	0.236	29°	3.512"	20-4197-1
	Exhaust	1.750" (44.45mm)	0.3384"	0.236	29°	3.620"	20-4168
Shovelhead 74" 1966-1977	Intake	1.950" (49.53mm)	0.3765"	0.234	23°	3.885"	20-4194
	Intake	2.000" (50.80mm)	0.3765"	0.234	23°	3.885"	20-4256
	Exhaust	1.750" (44.45mm)	0.3760"	0.234	29°	3.810"	20-4195
	Exhaust	1.780" (45.21mm)	0.3760"	0.234	29°	3.820"	20-4195S
	Exhaust	1.812" (46.02mm)	0.3760"	0.234	29°	3.820"	20-4195-1
Shovelhead 80" 1978-1983	Intake	1.950" (49.53mm)	0.3780"	0.234	23°	3.885"	20-4294
	Exhaust	1.750" (44.45mm)	0.3775"	0.234	29°	3.810"	20-4295
Evolution 1984-1999	Intake	1.840" (46.74mm)	0.3100"	0.236	23°	4.445"	20-4171
	Intake	1.990" (50.55mm)	0.3108"	0.675	25°	4.440"	20-20905
	Intake	1.940" (49.28mm)	0.3108"	0.675	25°	4.440"	20-20910
	Intake	1.900" (48.26mm)	0.3108"	0.675	25°	4.440"	20-20915
	Intake (Racing)	1.900" (48.26mm)	0.3100"	0.344	28°	4.420"	20-4171R
	Intake	2.150" (54.61mm)	0.3108"	0.550	24°	4.480"	20-20900
	Exhaust	1.615" (41.02mm)	0.3096"	0.236	29°	4.525"	20-4170
	Exhaust (Racing)	1.630" (41.40mm)	0.3096"	0.500	40°	4.525"	20-4170R
	Exhaust	1.650" (41.91mm)	0.3106"	0.750	25°	4.515"	20-20920
	Exhaust	1.610" (40.89mm)	0.3106"	0.750	25°	4.510"	20-20925
	Exhaust	1.585" (40.26mm)	0.3106"	0.750	25°	4.505"	20-20930
	Evo Sportster Conversion	Intake	1.715" (43.56mm)	0.3100"	0.236	23°	4.550"
Exhaust	1.480" (37.59mm)	0.3096"	0.500	40°	4.625"	20-2012	
Twin Cam 88"-103" 2005-2017	Intake	1.805" (45.85mm)	0.2760"	0.413	1.700°R	4.420"	20-20322
	Intake	1.900" (48.26mm)	0.2760"	0.344	28°	4.420"	20-20323R
	Exhaust	1.575" (40.00mm)	0.2755"	0.354	22°	4.520"	20-20325
Buell® XB9™ 2003-2007	Exhaust	1.630" (41.40mm)	0.2755"	0.500	34°	4.520"	20-20326R
	Intake	1.805" (45.85mm)	0.2760"	0.344	28°	4.525"	20-20260
	Intake	1.900" (48.26mm)	0.2760"	0.344	28°	4.500"	20-20262
	Exhaust	1.575" (40.00mm)	0.2755"	0.500	34°	4.610"	20-20265
Exhaust	1.615" (41.02mm)	0.2755"	0.500	34°	4.590"	20-20266	

CYLINDER HEAD
REBUILDING
CLEANING,
ASSEMBLY & SAFETY
SHORT BLOCK
REBUILDING
FLYWHEEL GRINDING
CRANKSHAFT/
MISCELLANEOUS
TOOLS & SUPPLIES
BRAKE SERVICE
TOOLING
MEASURING
TOOLS
V-TWIN & METRIC
HARD PARTS

Panhead 1948-1965 Valve Spring Kit

- OE Replacement
- Springs are heat-treated and shot peened for long life
- Kits include 4 Retainers, 4 Springs and 4 Keepers and 4 Basewashers

Max Lift	Installed Height	Seat Pressure	Open Pressure	@ Lift	Order No.
.415"	1.375"	129 lbs.	272 lbs.	.415"	20-20430



Shovelhead™ 74" 1966-1977 Valve Spring Kit

- Springs heat-treated and shot peened for long life
- Kits include 4 Retainers, 4 Springs and 4 Keepers and 4 Basewashers

Max Lift	Installed Height	Seat Pressure	Open Pressure	@ Lift	Order No.
.600"	1.510"	152 lbs.	387 lbs.	.600"	20-2110



Lightweight Racing Spring Kit 7075-T6 Retainers offset 0.070" for taller installed height. Basewashers are counter-bored to accept a 0.665" OD seal.

Max Lift	Installed Height	Seat Pressure	Open Pressure	@ Lift	Order No.
.600"	1.510"	152 lbs.	387 lbs.	.600"	20-20450



Lightweight Racing Spring Kit Steel Retainers

Max Lift	Installed Height	Seat Pressure	Open Pressure	@ Lift	Order No.
.415"	1.375"	129 lbs.	272 lbs.	.415"	20-20435

OE Replacement Steel Retainers, Keepers & Basewashers

Evolution™ 1984-1999 Valve Spring Kit

- Springs heat-treated and shot peened for long life
- Kits include 4 Retainers, 4 Springs and 4 Keepers and 4 Basewashers

Max Lift	Installed Height	Seat Pressure	Open Pressure	@ Lift	Order No.
.600"	1.810"	175 lbs.	380 lbs.	.600"	20-20132

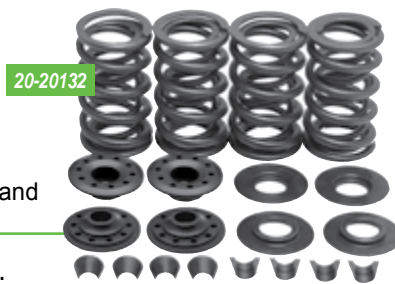

Lightweight Racing Spring Kit Steel Retainers, Keepers & Basewashers

Max Lift	Installed Height	Seat Pressure	Open Pressure	@ Lift	Order No.
.655"	1.860"	185 lbs.	450 lbs.	.655"	20-20081

Lightweight Racing Spring Kit Steel Retainers, Keepers & Basewashers



V-Twin On-the-Engine Valve Spring Compressor

Replace broken valve springs, install high performance valve springs, remove and replace valve guide seals all without disassembling the bike – just remove the gas tank and get to work. Use on Sportster, Evolution, Twin-Cam and most aftermarket V-Twins. Kit includes valve spring compressor, adaptor for compressing beehive springs, valve seal driver/installer and head pressurizing hose. Order No. **CF-HDIF**

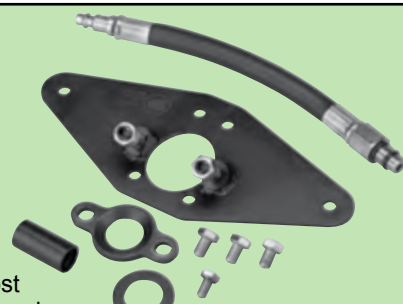

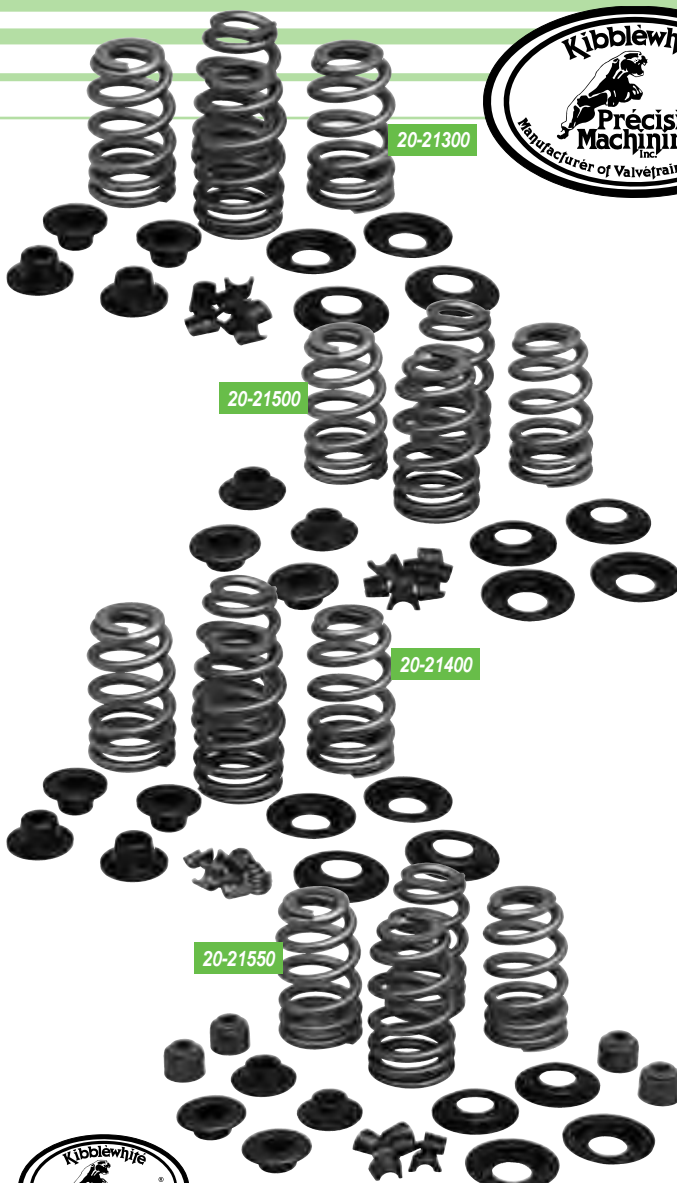

Beehive Valve Spring Sets for 5/16" (.312") Valves

- 9° taper on .660" lift kits
- Advanced spring design with special attention to cam and spring harmonics, stress, mass and operating RPM
- Premium grade, super clean ground chrome silicon wire
- Kits include 4 Retainers, 4 Springs and 4 Keepers and 4 Basewashers

Max Lift	Installed Height	Seat Pressure	Open Pressure	@ Lift	Order No.
.610"	1.860"	175 lbs.	400 lbs.	.610"	20-21300
.660"	1.860"	178 lbs.	371 lbs.	.660"	20-21500

Beehive Valve Spring Sets for 7mm Valves

- 9° taper on .660" lift kits
- Advanced spring design with special attention to cam and spring harmonics, stress, mass and operating RPM
- Premium grade, super clean ground chrome silicon wire
- Kits include 4 Retainers, 4 Springs and 4 Keepers and 4 Basewashers

Max Lift	Installed Height	Seat Pressure	Open Pressure	@ Lift	Order No.
.610"	1.860"	175 lbs.	400 lbs.	.610"	20-21400
.660"	1.860"	178 lbs.	371 lbs.	.660"	20-21550



Don't see what you're looking for? Goodson can special order virtually anything in the Kibblewhite Precision Machining catalog.

Compression Release Valves

- 2 per pack
- 10 x 1.0mm thread
- High temperature resistant knobs
- Shorter thread sections makes installation easier with less drilling required than with OE-style



Application	Length	Thread	Order No.
Evolution	1.050"	.350"L	20-21250
Twin Cam	1.380"	.350"L	20-21255
OE Replacement	1.250"	.350"L	20-21260

Pan/Shovel Spring Seat Cutting Tool

- Convert Pan & early Shovels to late style Shovel easily to attain higher lift
- Spacer stops the cutter at the correct height for uniform spring spacing
- Use with lower spring collars (HHC-4) or stock late-style lower spring collars (1980-1984) • OD: 1.680" • ID: 0.750"

Description	Order No.
Spring Seat Cutting Tool	VSS-1680HD
.375" Spring Pad Pilot	VP-375



Keeper Installation Tools

- Spring-loaded plunger
- For single & multi-groove keepers
- Reaches keeper grooves located farther from the valve tip • Ideal for use with **CF-500** (p. 39) and **PSB-5000** (p. 38)

Best Keeper Tool on the Market!



Size	Order No.
4mm / .1563"	VKI-4
5mm / .2031"	VKI-5
6mm / .2344"	VKI-6
7mm / .2812"	VKI-7
8mm / .3125"	VKI-8
Replacement Rubber Sleeve	VKI-56

CYLINDER HEAD REBUILDING ASSEMBLY & SAFETY CLEANING SHORT BLOCK REBUILDING FLYWHEEL GRINDING TOOLS & SUPPLIES MISCELLANEOUS BRAKE SERVICE TOOLS MEASURING TOOLS V-TWIN & METRIC HARD PARTS

RAPIDEX

A rapid-use index of product categories

Cylinder Head Rebuilding

Pilots.....	1-3
Valve Seat Work.....	4-22
Valve Refacing.....	23-25
Reamers.....	26-27
Valve Guide Resizing.....	28-30
Valve Guide Replacement.....	31-35
Valve Seal Work.....	36
Valve Spring Work.....	37-43
Cylinder Head Resurfacing.....	44-47
Crack Detection & Repair.....	48-53
Porting & Polishing.....	58-60

Cleaning, Assembly & Safety

Parts Storage & Organizers.....	61, 69
Wire Wheels & Brushes.....	62-63
Cleaning.....	62-69
Parts Baskets.....	68
Last Blast Paint & Metal Markers.....	70
Assembly Lubes.....	71
Flex-Hones®.....	72

Index Falls between pages 72 and 73

Coolants & Lubricants.....	73
----------------------------	----

Short Block Rebuilding

Cylinder Boring & Honing.....	74-81
Boring Bar Tooling & Supplies.....	74-75
Honing Stones.....	76-81
Rod Honing.....	82-83
Rod & Piston Work.....	84-89
Lifter Bore Tooling.....	91
Camshaft Work.....	92-93

Crankshaft/Flywheel Grinding

Crankshaft Grinding Wheels.....	94-95
Crankshaft Grinding & Polishing.....	96-100
Flywheel Grinding.....	102-104

Miscellaneous Tools

Diamond Dresser Tools.....	106-107
Machine Replacement Parts.....	108-109

Brake Service Tooling

Brake Tips & Holders.....	110-111
Brake Lathe Silencers.....	112
Brake Lathe Replacement Parts.....	113-115
Brake Lathe Mounting Adaptors.....	116

Measuring Tools

Dial Bore Gauges.....	118-119
Micrometers.....	120
Calipers & Dial Indicators.....	121

V-Twin & Metric Hard Parts

Seats & Seat Inserts.....	123
Valve Guides.....	124
Replacement Valves.....	125
Valve Springs.....	126-127

© Copyright 2018, Goodson Mfg. Co., Inc. All copy and illustrations are copyrighted. Absolutely no mechanical or electronic reproduction or use of any part is allowed without our prior written permission. Goodson reserves the right to correct printing errors. Prices are subject to change without notice.

GOODSON Gear

Sport Goodson gear around the shop, at the track or just out and about!

Description	Color	Sizes	Order No.
Ladies' Cotton T-Shirt	Black	M, L, XL	RWW-GTB-"size"
Pre-Shrunk Cotton T-Shirts	White	L, XL, XXL	RW-GTW-"size"
	Black	L, XL, XXL	RW-GTB-"size"
Caps	Black	adjustable	RW-GR-CAP
Polyester/Cotton Sweatshirts	Gray	L, XL, XXL	RW-SS-"size"
	Black	L, XL, XXL	RW-SB-"size"
Microfiber Jacket	Black	L, XL, XXL	RW-MFJ-"size"
Shop Apron	Black	n/a	CA-100
Can Cooler	Black	n/a	RW-CC
Stocking Hat	Black	n/a	RW-SH

MEASURING TOOLS
 BRAKE SERVICE TOOLING
 MISCELLANEOUS TOOLS & SUPPLIES
 CRANKSHAFT/GRINDING
 SHORT BLOCK REBUILDING
 CLEANING, ASSEMBLY & SAFETY
 CYLINDER HEAD REBUILDING
 V-TWIN & METRIC HARD PARTS

Source Code

Account Number

Stay Connected
With Goodson

3-D Fast Cut™ Seat Cutting System is the most complete tool system available

- Cut precise multi-angle seats with your existing pilots
- Remove material and contour bowls with the bowl profiler tool holder
- Cut spring pads with the universal spring pad cutter
- Convert your Sunnen® or Mira® brazed cutters to 3-D with cutter holders
- Drive brazed carbide or indexable counter-bore cutters with the seat cutter driver



**Get Instant
Horsepower**

See pages 4 to 10 for complete details

