

Dell EMC PowerEdge R540

Technical Guide

Notes, cautions, and warnings

 **NOTE:** A NOTE indicates important information that helps you make better use of your product.

 **CAUTION:** A CAUTION indicates either potential damage to hardware or loss of data and tells you how to avoid the problem.

 **WARNING:** A WARNING indicates a potential for property damage, personal injury, or death.

Contents

Figures	5
Tables	6
Chapter 1: System Overview	7
Introduction.....	7
New technologies.....	7
Chapter 2: System features	9
Product comparison.....	9
Technical specifications.....	10
Chapter 3: Chassis overview	12
Front view of the system.....	12
Left control panel view.....	13
Right control panel view.....	16
Back panel features.....	17
Inside the system.....	19
Security features.....	21
Chapter 4: Processors	23
Supported processors.....	23
Chipset.....	25
Chapter 5: System memory	26
General memory module installation guidelines.....	27
Chapter 6: Storage	29
IDSDM with vFlash card.....	30
Optical Drives.....	30
Tape Drives.....	30
Boot Optimized Storage Subsystem.....	30
Chapter 7: Networking and PCIe	32
LAN on Motherboard(LOM).....	32
PCIe Expansion cards.....	32
Chapter 8: Trusted platform module	34
Chapter 9: Video specifications	35
Chapter 10: Power, Thermal, and Acoustics	36
Power consumption and energy efficiency.....	36
Power supply units.....	37

Thermal and Acoustics.....	37
Thermal design.....	37
Acoustical design.....	38
Chapter 11: Rack rails.....	39
Chapter 12: Dell EMC OpenManage systems management.....	49
iDRAC with Lifecycle controller.....	50
Server and Chassis Managers.....	56
Dell EMC consoles.....	56
Automation Enablers.....	56
Integration with third-party consoles.....	57
Connections for third-party consoles.....	57
Dell EMC Update Utilities.....	57
Dell resources.....	57
Chapter 13: Appendix A. Additional specifications.....	58
PSU specifications.....	58
System dimensions.....	59
Chassis weight.....	59
Environmental specifications.....	59
Chapter 14: Appendix B. Standards compliance.....	60
Chapter 15: Appendix C Additional resources.....	61
Chapter 16: Appendix D. Support and deployment services.....	62
Dell EMC ProDeploy Enterprise Suite	62
Dell EMC ProDeploy Plus.....	62
Dell EMC ProDeploy.....	63
Dell EMC Basic Deployment.....	63
Dell EMC Residency Services.....	63
Deployment services.....	63
Dell EMC Remote Consulting Services.....	63
Dell EMC Data Migration Service.....	63
ProSupport Enterprise Suite.....	63
ProSupport Plus.....	64
ProSupport.....	64
ProSupport One for Data Center.....	64
Support Technologies.....	65
Additional professional services.....	66
Dell Education Services.....	66
Dell EMC Global Infrastructure Consulting Services.....	66
Dell EMC Managed Services.....	66

1	Dell EMC PowerEdge R540.....	7
2	Front view of 12 x 3.5 inch drive system.....	12
3	Front view of 8 x 3.5 inch drive system.....	12
4	Left control panel without optional iDRAC Quick Sync 2.0 indicator.....	13
5	Left control panel with optional iDRAC Quick Sync 2.0 indicator.....	14
6	iDRAC Quick Sync 2 indicators.....	15
7	Right control panel.....	16
8	Back panel features of 12 x 3.5 inch + 2 x 3.5 inch (rear) drive system.....	17
9	Back panel features of 12 x 3.5 inch + 2 x 3.5 inch (rear) drive system.....	17
10	Back panel features of 12 x 3.5 inch drive system with butterfly riser.....	18
11	Inside the system without rear drive cage.....	20
12	Inside the system with rear drive cage.....	21
13	Boot Optimized Storage Subsystem (BOSS).....	31
14	Configuration A: LOM riser + 3 x low profile slot + riser blank.....	32
15	Configuration B: LOM riser + Right riser + 2 x 3.5 inch rear hard drive.....	32
16	Configuration C: LOM riser + Left riser + Right riser + 2 x 3.5 inch rear hard drive.....	33
17	Configuration D: LOM riser + Butterfly riser + 3 x low profile slot.....	33
18	Sliding rails with optional CMA.....	39
19	Static rails.....	40
20	Static rails in 2-post center mount configuration.....	41
21	Sliding rails with CMA.....	42
22	Pull out inner rail.....	44
23	Rail standoff seated in J-slots.....	44
24	Slide system into the rack.....	45
25	Pull out the intermediate rail.....	46
26	Attach the inner rails to the system.....	47
27	Install system into the extended rails.....	48
28	Slide system into the rack.....	48
29	Dell EMC OpenManage Portfolio.....	49
30	Dimensions of the PowerEdge R540 system.....	59
31	ProDeploy Enterprise Suite capabilities.....	62
32	ProSupport Enterprise Suite.....	64
33	ProSupport One for Data Center model.....	65
34	SupportAssist model.....	65

1	New technologies.....	7
2	Feature comparison.....	9
3	Technical specifications.....	10
4	R540 chassis options.....	12
5	Features available on the front of the system.....	13
6	Left control panel.....	14
7	Status LED indicators and descriptions.....	14
8	iDRAC Quick Sync 2 indicators and descriptions.....	15
9	Right control panel.....	16
10	iDRAC Direct LED indicator codes.....	17
11	Back panel features of R540.....	18
12	Security features.....	21
13	Supported Processors for R540.....	23
14	Supported Memory.....	26
15	DIMM Performance Details.....	26
16	Supported RAS features.....	27
17	PERC series controller offerings.....	29
18	BOSS RAID controller features.....	31
19	Supported video resolution options.....	35
20	Power tools and technologies.....	36
21	Acoustical reference points and output comparisons.....	38
22	Static, Sliding, or Stab-in/Drop-in sliding rails.....	41
23	Rail Adjustability Range and Rail Depth.....	42
24	Rail component.....	46
25	iDRAC feature comparison.....	50
26	Dell resources.....	57
27	PSU specifications.....	58
28	Dimensions of the PowerEdge R540 system.....	59
29	Chassis weight.....	59
30	Industry standard documents.....	60
31	Additional resources.....	61

System Overview

R540 Overview

Power your applications with a versatile 2-socket, 2U general-purpose rack server. Support various applications such as virtualization, video streaming, web tech, data analytics, and mail and messaging with the flexible Dell EMC PowerEdge R540. Its balanced combination of resources, expandability, and affordability adapt to the changing demands of a modern data center. Optimize your application performance with one-button tuning. Scale for future requirements with up to 14 x 3.5" drives. Embedded diagnostics and SupportAssist help to maximize uptime without added effort, in a worry-free environment.



Figure 1. Dell EMC PowerEdge R540

Topics:

- [Introduction](#)
- [New technologies](#)

Introduction

The PowerEdge R540 is a general-purpose platform with highly expandable memory - up to 512 GB with single processor and up to 1 TB with dual processors, and impressive I/O capabilities to match.

NOTE: 768 GB max memory is recommended for performance optimized configurations.

The R540 features:

- The 2nd Generation Intel® Xeon® Scalable processors product family (with up to 20 cores and two threads per core)
- Up to six channels with two DIMMs per channel per CPU and 16 DIMMs (supports DDR4 RDIMM)
- PCI Express (PCIe) 3.0 enabled expansion slots (with up to 48 lanes per CPU)
- M.2 based Boot Optimized Storage Solution module
- Modular storage and PCIe riser options

New technologies

The following are the new technologies that are featured on the PowerEdge R540:

Table 1. New technologies

New technology	Detailed description
The 2 nd Generation Intel® Xeon® Scalable processor	The 2 nd Generation Intel® Xeon® Processor product family has advanced features such as, embedded PCIe lanes

Table 1. New technologies (continued)

New technology	Detailed description
	<p>for improved I/O performance that delivers exceptional performance and value.</p> <p>For details, see the Processor section.</p>
Intel C620 series chipset	<p>The R540 system uses the Intel C620 chipset. It is a 2 chip platform - CPU and PCH.</p>
2666 MT/s DDR4 memory	<p>The Intel® Xeon® Scalable processor product family supports 2666 MT/s memory and sixteen 288-pin DIMMs.</p> <p>The R540 system supports:</p> <ul style="list-style-type: none"> ● 6x DDR4 Channels per socket, 2 DIMMs per channel ● Up to 2666 MT/s (configuration-dependent) ● RDIMMs up to 32 GB, LRDIMMs 64 GB <p>For details, see the Memory section.</p>
iDRAC9 with Lifecycle Controller	<p>The new embedded systems management solution for the Dell EMC systems features hardware and firmware inventory and alerting, data center level power monitoring, and faster performance.</p> <p>For details, see the Dell EMC OpenManage systems management section</p>
PERC S140	<p>This new software RAID solution supports:</p> <ul style="list-style-type: none"> ● RAID 0, 1, 5, and Non-RAID ● SATA hard drive and SSD devices only ● Up to eight 3.5 inch and 2.5 inch hot-plug SATA HDDs or SSDs ● Software RAID is through the Intel Lewisburg chipset ● Software RAID solution is supported on Linux and Windows <p>For details, see the Storage section.</p>
LCD bezel	<p>The PowerEdge R540 LCD control panel is embedded in an optional front bezel for easy access and management.</p>
Wireless Management	<p>The Quick Sync 2 BLE/WiFi module offers secure, wireless access to the embedded iDRAC, SupportAssist Collections, remote RACADM, and VNC remote console connectivity.</p>

System features

Compared to previous generations, the PowerEdge R540 offers faster processing power and advanced system management. The PowerEdge R540 also provides extraordinary storage capacity options, making it well-suited for data-intensive applications that require greater storage, while not sacrificing the I/O performance.

Topics:

- [Product comparison](#)
- [Technical specifications](#)

Product comparison

Table 2. Feature comparison

Feature	PowerEdge R540	PowerEdge R530
Processors	The 2 nd Generation Intel® Xeon® Scalable processor family	Intel® Xeon® Processor E5-2600 v3 or E5-2600 v4 product family
Chipset	Intel C620 series chipset	Intel C610
Memory	16x DDR4 RDIMM/LRDIMM	12 x DDR4 RDIMM/LRDIMM
Drive bays	12 x 3.5 inch SAS/SATA Rear: 2 x 3.5 inch SAS/SATA	12 x 3.5 inch SAS/SATA
PCIe Slots	Up to 5 x PCIe Gen3	Up to 3 x PCIe Gen3, and 2 x PCIe Gen2
RAID Controller	PERC 9/10/11	Mini-PERC 9
Backplane	<ul style="list-style-type: none"> • 14 x 3.5 inches or 2.5 inch SATA/SAS • 8 x 3.5 inch SATA/SAS • 2 x 2.5 inches rear SATA/SAS 	<ul style="list-style-type: none"> • 8 x 2.5 inches or 3.5 inches SAS/SATA
Embedded NIC	2x 1 Gb LOM and optional LAN on riser card: <ul style="list-style-type: none"> • 2X 1 GbE • 2X 10 GbE • 2X 10 GbE SFP+ 	4 x 1 Gb
Power Supplies	<ul style="list-style-type: none"> • 450 W AC Cable PSU • 495 W AC • 750 W AC • 750 W Mixed Mode HVDC (For China Only) • 750 W Mixed Mode (DC input for China Use Only) • 1100 W AC • 1100 W Mixed Mode HVDC 	<ul style="list-style-type: none"> • 450 W AC Cable PSU • 495 W AC • 750 W AC • 1100 W AC • 750 W DC
Remote Management	iDRAC9	iDRAC8
TPM	TPM 2.0 China, TPM1.2, TPM2.0	TPM China, TPM1.2, TPM2.0
Rear USB 3.0 port	Two rear ports	One rear port
iDRAC Direct front port	Micro-AB USB	Micro-AB USB

Table 2. Feature comparison (continued)

Feature	PowerEdge R540	PowerEdge R530
Cooling Fan	Up to 6 fan support	Up to 6 fan support
IDSDM Module	Internal Dual SD Module (IDSDM) and vFlash	Internal Dual SD Module (IDSDM)
BOSS Module	M.2 SATA interface	None

Technical specifications

Table 3. Technical specifications

Feature	PowerEdge R540 technical specification
Form factor	2U rack
Processor	The 2 nd Generation Intel® Xeon® Processor Scalable Family
Processor sockets	2 sockets
Internal interconnect	Up to 3 Intel Ultra Path Interconnect (Intel® UPI); up to 11.2 GT/s
Chipset	Intel C620 series Chipset
Memory	<ul style="list-style-type: none"> • Supports DDR4 RDIMM • Up to 512 GB RDIMM and 1 TB LRDIMMs • 16 DIMM slots: 8 GB, 16 GB, 32 GB, DDR4 up to 2666 MT/s
I/O slots	Up to 5 x PCIe Gen3 slots plus a dedicated PERC and LOM slot
Storage controllers	<p>Software RAID:</p> <ul style="list-style-type: none"> • S140 <p>Internal controllers:</p> <ul style="list-style-type: none"> • H750 • H350 • H740P • H730P • H330 <p>External controllers:</p> <ul style="list-style-type: none"> • HBA355e • H840 • 12 Gb/s Ext SAS HBA <p>SAS Hot Bus Adapters:</p> <ul style="list-style-type: none"> • HBA350i • HBA 330
Hard drives	12 x 3.5 inch + 2 x 2.5-inch rear drive bays (supports 2.5-inch drive using 3.5-inch adapter)
Embedded network adapter	LOM1: 2x1G LOM Riser: 2x1GbE, 2X10GbE, 2x10GbE SFP+
Power supply	Two hot-plug PSUs or option for single cabled PSU <ul style="list-style-type: none"> • 495 W, 750 W, 1100 W hot-plug PSU • Bronze efficiency 450 W cabled AC PSU
Supported operating systems	<ul style="list-style-type: none"> • Canonical® Ubuntu® LTS • Citrix® XenServer® • Microsoft Windows Server® with Hyper-V

Table 3. Technical specifications (continued)

Feature	PowerEdge R540 technical specification
	<ul style="list-style-type: none"> ● Red Hat® Enterprise Linux ● SUSE® Linux Enterprise Server ● VMware® ESXi <p>For more information, go to www.dell.com/ossupport</p>
Systems management	<p>Dell EMC Systems management consoles and tools:</p> <ul style="list-style-type: none"> ● OpenManage Enterprise ● OpenManage Mobile ● OpenManage Power Manager <p>Embedded Management:</p> <ul style="list-style-type: none"> ● iDRAC9 ● iDRAC9 Direct ● iDRAC REST API with Redfish ● Quick Sync 2 BLE/wireless module <p>Dell EMC OpenManage Integrations :</p> <ul style="list-style-type: none"> ● Microsoft® System Center ● VMware® vCenter™ ● BMC Truesight ● Red Hat® Ansible® Modules <p>Dell EMC OpenManage Connections:</p> <ul style="list-style-type: none"> ● Micro Focus Operations Manager I ● Nagios Core and Nagios XI ● IBM Tivoli® Netcool/OMNIbus
Dimensions and weight	<ul style="list-style-type: none"> ● Height: 86.8 mm (3.41") ● Width*: 434 mm (17.08") ● Depth*: 703.76 mm (27.71") ● Weight: 29.68 kg (65.43 lb) <p> NOTE: *Dimensions do not include bezel.</p>
Recommended support	<p>Dell ProSupport Plus for critical systems or Dell ProSupport for premium hardware and software support for your PowerEdge solution. Consulting and deployment offerings are also available.</p> <p>Contact your Dell representative for more information. Availability and terms of Dell Services vary by region. For more information, go to Dell.com/ServiceDescriptions.</p>

Chassis overview

The PowerEdge R540 is a dual socket, 2U rack server with up to 16 DIMMs, storage capacity of up to 12 drive slots, and the 2nd Generation Intel® Xeon® Scalable Family processors.

Table 4. R540 chassis options

Chassis Options	Configurations
Eight drive chassis	Up to eight 3.5 or 2.5 inches in 3.5-inch adapter front accessible SAS/SATA drives.
Twelve drive chassis	Up to twelve 3.5 or 2.5 inches in front accessible SAS/SATA drives and two optional 3.5 inch rear accessible SAS/SATA drives.

Topics:

- [Front view of the system](#)
- [Back panel features](#)
- [Inside the system](#)
- [Security features](#)

Front view of the system

The front view displays the features available on the front of the system.



Figure 2. Front view of 12 x 3.5 inch drive system



Figure 3. Front view of 8 x 3.5 inch drive system

Table 5. Features available on the front of the system

Item	Ports, panels, and slots	Icon	Description
1	Left control panel	N/A	<p>Contains the system health and system ID, status LED, and the iDRAC Quick Sync 2 (wireless) indicator.</p> <p>i NOTE: The iDRAC Quick Sync 2 indicator is available only on certain configurations.</p> <ul style="list-style-type: none"> • Status LED: Enables you to identify any failed hardware components. There are up to five status LEDs and an overall system health LED (Chassis health and system ID) bar. For more information, see the Status LED indicators section. • Quick Sync 2 (wireless): Indicates a Quick Sync enabled system. The Quick Sync feature is optional. This feature allows management of the system by using mobile devices. This feature aggregates hardware or firmware inventory and various system level diagnostic and error information that can be used in troubleshooting the system. For more information, see the Integrated Dell Remote Access Controller User’s Guide at Dell.com/idracmanuals.
2	Drive slots	N/A	Enable you to install drives that are supported on your system. For more information about drives, see the Technical specifications section.
3	Right control panel	N/A	Contains the power button, USB ports, iDRAC Direct (Micro-AB USB), VGA port.
4	Information tag	N/A	The Information tag is a slide-out label panel that contains system information such as Service Tag, NIC, MAC address, and so on. If you have opted for the secure default access to iDRAC, the Information tag also contains the iDRAC secure default password.
5	Optical drive (optional)	N/A	<p>One optional slim SATA DVD-ROM drive or DVD+/-RW drive.</p> <p>i NOTE: DVD devices are data only.</p>

Left control panel view

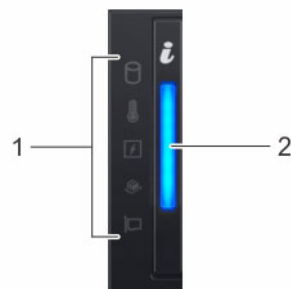

Figure 4. Left control panel without optional iDRAC Quick Sync 2.0 indicator

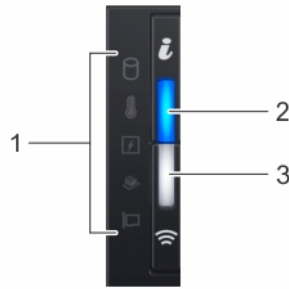

Figure 5. Left control panel with optional iDRAC Quick Sync 2.0 indicator

Table 6. Left control panel

Item	Indicator, button, or connector	Icon	Description
1	Status LED indicators	N/A	Indicate the status of the system. For more information, see the Status LED indicator section.
2	System health and system ID indicator		
3	iDRAC Quick Sync 2 wireless indicator (optional)		



Status LED indicators

NOTE: The indicators display solid amber if any error occurs.

Table 7. Status LED indicators and descriptions

Icon	Description	Condition	Corrective action
	Drive indicator	The indicator turns solid amber if there is a drive error.	<ul style="list-style-type: none"> Check the System event log to determine if the drive has an error. Run the appropriate Online Diagnostics test. Restart the system and run embedded diagnostics (ePSA). If the drives are configured in a RAID array, restart the system, and enter the host adapter configuration utility.
	Temperature indicator	The indicator turns solid amber if the system experiences a thermal error (for example, the ambient temperature is out of range or there is a fan failure).	Ensure that none of the following conditions exist: <ul style="list-style-type: none"> A cooling fan has been removed or has failed. System cover, air shroud, or back filler bracket is removed. Ambient temperature is too high. External airflow is obstructed.
	Electrical indicator	The indicator turns solid amber if the system experiences an electrical error (for example, voltage out of range, or a failed power supply unit (PSU) or voltage regulator).	Check the System event log or system messages for the specific issue. If it is due to a problem with the PSU, check the LED on the PSU. Reseat the PSU.

Table 7. Status LED indicators and descriptions (continued)

Icon	Description	Condition	Corrective action
	Memory indicator	The indicator turns solid amber if a memory error occurs.	Check the System event log or system messages for the location of the failed memory. Reseat the memory module.
	PCIe indicator	The indicator turns solid amber if a PCIe card experiences an error.	Restart the system. Update any required drivers for the PCIe card. Reinstall the card.

iDRAC Quick Sync 2 indicator codes

iDRAC Quick Sync 2 module (optional) is located on the left control panel of your system.



Figure 6. iDRAC Quick Sync 2 indicators

Table 8. iDRAC Quick Sync 2 indicators and descriptions

iDRAC Quick Sync 2 indicator code	Condition	Corrective action
Off (default state)	Indicates that the iDRAC Quick Sync 2 feature is turned off. Press the iDRAC Quick Sync 2 button to turn on the iDRAC Quick Sync 2 feature.	If the LED fails to turn on, reseat the left control panel flex cable and check.
Solid white	Indicates that iDRAC Quick Sync 2 is ready to communicate. Press the iDRAC Quick Sync 2 button to turn off.	If the LED fails to turn off, restart the system.
Blinks white rapidly	Indicates data transfer activity.	NA
Blinks white slowly	Indicates that firmware update is in progress.	NA
Blinks white five times rapidly and then turns off	Indicates that the iDRAC Quick Sync 2 feature is disabled.	Check if iDRAC Quick Sync 2 feature is configured to be disabled by iDRAC. For more information, see <i>Integrated Dell Remote Access Controller User's Guide</i> at www.dell.com/idracmanuals or <i>Dell OpenManage Server Administrator User's Guide</i> at www.dell.com/openmanagemanuals .
Solid amber	Indicates that the system is in fail-safe mode.	Restart the system.
Blinking amber	Indicates that the iDRAC Quick Sync 2 hardware is not responding properly.	Restart the system.

Right control panel view

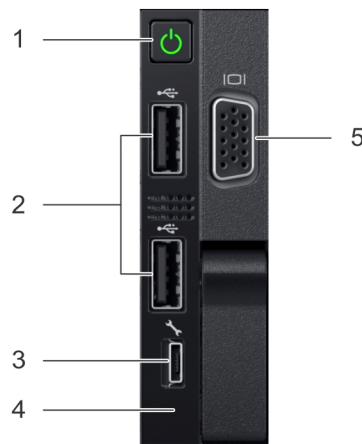





Figure 7. Right control panel

Table 9. Right control panel

Item	Indicator, button, or connector	Icon	Description
1	Power button		Indicates if the system is powered on or off. Press the power button to manually power on or off the system. NOTE: Press the power button to gracefully shut down an ACPI-compliant operating system.
2	USB port		The USB ports are 4-pin, 2.0-compliant. These ports enable you to connect USB devices to the system.
3	iDRAC Direct (Micro-AB USB)		The iDRAC Direct (Micro-AB USB) port enables you to access the iDRAC Direct (Micro-AB) features. For more information, see the iDRAC User's Guide at Dell.com/idracmanuals .
4	iDRAC Direct (Micro-AB USB) LED	N/A	The iDRAC Direct (Micro-AB USB) LED indicator lights up to indicate that the iDRAC Direct port is connected. For more information, see the iDRAC Direct LED indicator codes section.
5	VGA port		Enables you to connect a display device to the system. For more information, see the Technical specifications section.

iDRAC Direct LED indicator codes

The iDRAC Direct LED indicator lights up to indicate that the port is connected and is being used as a part of the iDRAC subsystem.

You can configure iDRAC Direct by using a USB to micro USB (type AB) cable, which you can connect to your laptop or tablet. The following table describes iDRAC Direct activity when the iDRAC Direct port is active:

Table 10. iDRAC Direct LED indicator codes

iDRAC Direct LED indicator code	Condition
Solid green for two seconds	Indicates that the laptop or tablet is connected.
Flashing green (on for two seconds and off for two seconds)	Indicates that the laptop or tablet connected is recognized.
Turns off	Indicates that the laptop or tablet is unplugged.

Back panel features

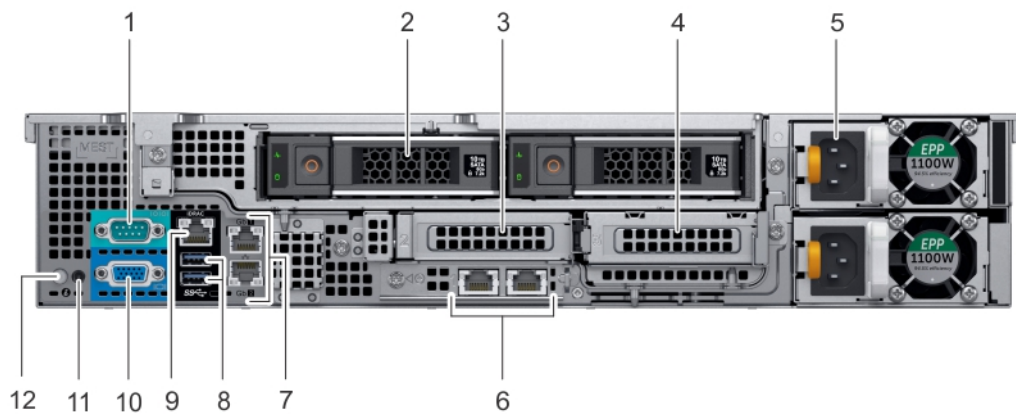

Figure 8. Back panel features of 12 x 3.5 inch + 2 x 3.5 inch (rear) drive system

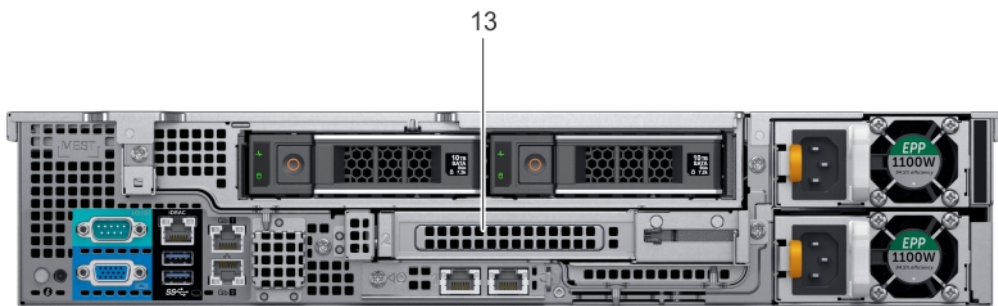

Figure 9. Back panel features of 12 x 3.5 inch + 2 x 3.5 inch (rear) drive system

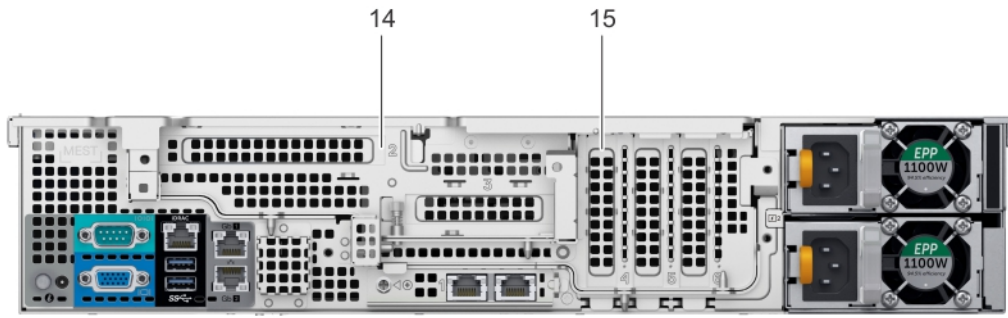

Figure 10. Back panel features of 12 x 3.5 inch drive system with butterfly riser

- | | |
|----------------------------------|----------------------------------|
| 1. Serial port | 2. Drive (rear) |
| 3. Low profile riser right slot | 4. Low profile riser left slot |
| 5. Power supply unit (PSU) | 6. LOM riser ports |
| 7. Ethernet ports | 8. USB 3.0 ports |
| 9. iDRAC9 dedicated network port | 10. VGA port |
| 11. CMA power port | 12. System identification button |
| 13. Full height riser slot | 14. Butterfly riser slot |
| 15. PCIe slot | |

Table 11. Back panel features of R540









Item	Features	Icon	Description
1	Serial port		Use the serial port to connect a serial device to the system. For more information about the supported serial port, see the Technical specifications section.
2	Drive	N/A	Two optional rear drives supported for 12 x 3.5 inch system.
3	Low profile riser right slot	N/A	Use the card slot to connect half-height PCIe expansion card on low profile riser.
4	Low profile riser left slot	N/A	Use the card slot to connect half-height PCIe expansion card on low profile riser.
5	Power supply unit (PSU)	N/A	For information about supported PSUs, see the Technical specifications section.
6	LOM riser ports		Use the Ethernet or SFP+ ports to connect Local Area Networks (LANs) to the system. For more information about the supported Ethernet or SFP+ ports, see the Technical specifications section.
7	Ethernet ports (2)		Use the Ethernet ports to connect Local Area Networks (LANs) to the system. For more information about the supported Ethernet ports, see the Technical specifications section.
8	USB 3.0 port		Use the USB 3.0 port to connect USB devices to the system. These ports are 4-pin, USB 3.0-compliant.
9	iDRAC9 dedicated network port		Use the iDRAC9 dedicated network port to securely access the embedded iDRAC on a separate management network, see the Integrated Dell Remote Access Controller User's Guide at Dell.com/idracmanuals .
10	VGA port		Use the VGA port to connect a display to the system. For more information about the supported VGA port, see the Technical specifications section.
11	CMA power port	N/A	The Cable Management Arm (CMA) power port enables you to connect to the CMA.

Table 11. Back panel features of R540 (continued)

Item	Features	Icon	Description
12	System identification button		<p>Press the system ID button:</p> <ul style="list-style-type: none"> • To locate a particular system within a rack. • To turn the system ID on or off. <p>To reset iDRAC, press and hold the button for more than 15 seconds.</p> <p> NOTE:</p> <ul style="list-style-type: none"> • To reset iDRAC using system ID, ensure that the system ID button is enabled in the iDRAC setup. • If the system stops responding during POST, press and hold the system ID button (for more than five seconds) to enter the BIOS progress mode.
13	Full height riser slot		Use the card slots to connect full-height PCIe expansion cards on full height riser.
14	Butterfly riser slot		Use the card slots to connect full-height PCIe expansion cards on butterfly riser.
15	PCIe slot		Use the card slots to connect up to three half-height PCIe expansion cards on the system board.

Inside the system

 **NOTE:** Components that are hot swappable are marked orange and touch points on the components are marked blue.

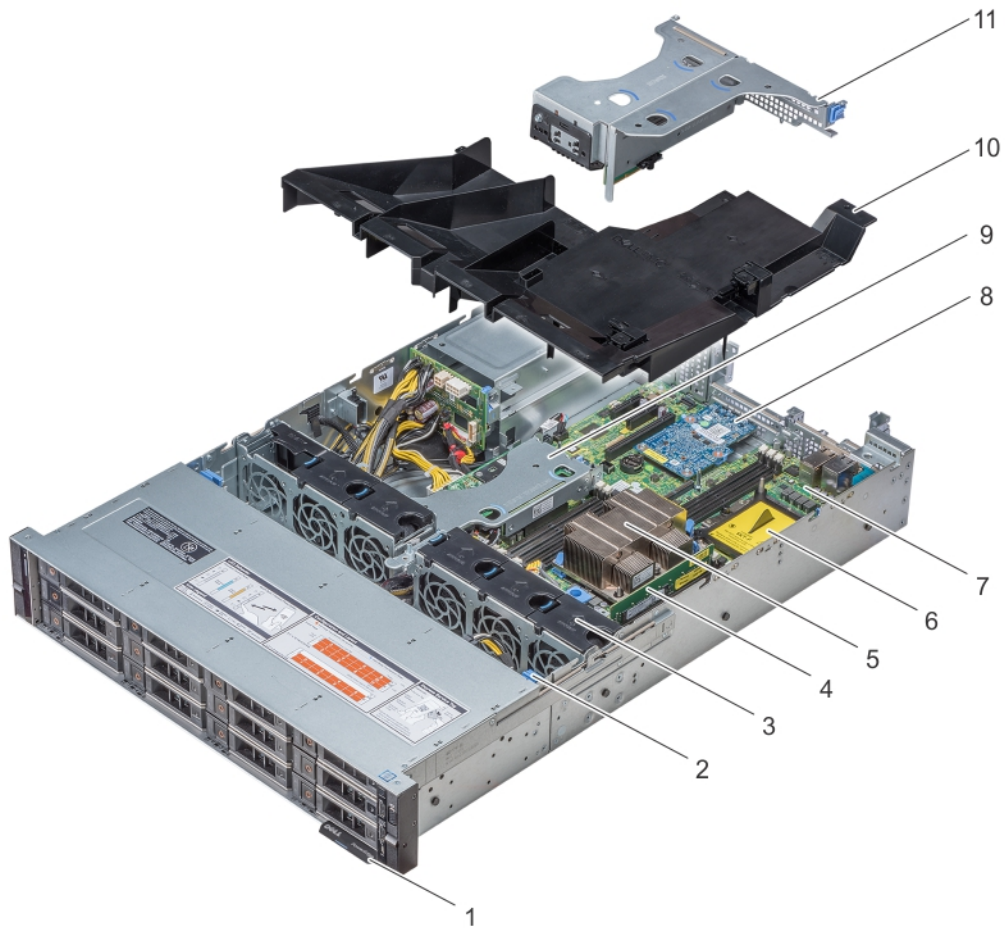

Figure 11. Inside the system without rear drive cage

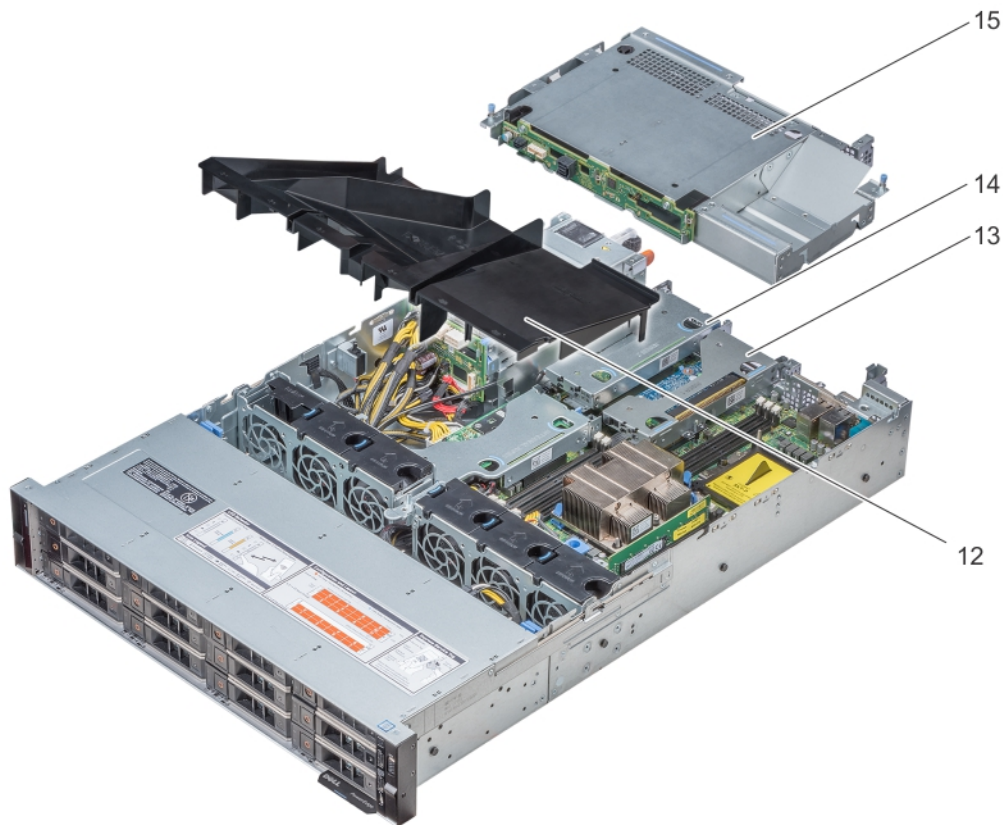

Figure 12. Inside the system with rear drive cage

- | | |
|-----------------------------|--|
| 1. Information tag | 2. Drive backplane |
| 3. Cooling fans | 4. Memory module |
| 5. CPU 1 | 6. CPU 2 |
| 7. System board | 8. LOM riser card |
| 9. Internal PERC riser | 10. Air shroud |
| 11. Butterfly riser | 12. Air shroud (12 x 3.5 inch + 2 x 3.5 inch rear hard drive system) |
| 13. Low profile riser right | 14. Low profile riser left |
| 15. Drive cage (rear) | |

Security features

The latest generation of PowerEdge servers has the features listed in the table to help ensure the security of your data center.

Table 12. Security features

Security feature	Description
Cover latch	The system cover contains a non-keyed locking mechanism integrated into the latch.
Bezel	A standard bezel is an optional metal bezel mounted to the chassis front and shows the Dell EMC ID. A lock on the bezel protects unauthorized access to hard drives. The system status remains viewable when the bezel is installed.
TPM	The Trusted Platform Module (TPM) is used to generate/store keys, protect/authenticate passwords, and create/store digital certificates. TPM 1.2, 2.0 and China 2.0 is supported.
Power-off security	The power button functionality can be disabled in the system BIOS for added security.
Intrusion detection switch	An internal intrusion detection switch allows users to be alerted with pop-up screen message when the system cover has been removed.

Table 12. Security features (continued)

Security feature	Description
Secure mode	The system BIOS features an option to enter the secure boot mode through system setup. This mode includes options to lock out the power button or set up a system password.

Processors

The Dell EMC PowerEdge R540 featuring the 2nd Generation Intel® Xeon® Scalable processor family offers versatility across diverse workloads. These processors are designed for next-generation data centers running on software defined infrastructure and are supercharged for efficiency, performance, and agile services delivery across cloud-native and traditional applications. The 2nd Generation Intel® Xeon® scalable processor family supports workloads for cloud computing, high-performance computing, networking, and storage for data centers.

Processor features

The 2nd Generation Intel® Xeon® Processor Scalable Family provides the foundation for a powerful data center platform. It is the most advanced compute core featuring a new core micro architecture optimized to accelerate a wide range of compute workloads. The key features are as follows:

- **Higher Per-Core Performance:** Up to 28 cores (20 cores with R540), delivery high performance, and scalability for compute-intensive workloads across compute, storage, and network usages. The 2nd Generation Intel® Xeon® Scalable Processors can offer even greater core or frequencies, or both.
- **Greater Memory Bandwidth/Capacity:** 50% increased memory bandwidth and capacity. 6 memory channels vs. 4 memory channels of previous generation for memory intensive workloads.
- **Expanded I/O:** 48 lanes of PCIe 3.0 bandwidth and throughput for demanding I/O-intensive workloads.
- **Intel Ultra Path Interconnect (UPI):** Up to three Intel UPI channels increase scalability of the platform to as many as eight sockets, and improves inter-CPU bandwidth for I/O intensive workloads.
- **Intel Advanced Vector Extensions 512 (Intel AVX-512)** with a single AVX512 fused multiply add (FMA) execution units. SKUs which support Advanced RAS enable a second FMA execution unit.
- **Security without Compromise:** Near-zero encryption overhead enables higher performance on all secure data transactions with enhanced hardware mitigation.
- **Intel Deep Learning Boost:** Accelerate data-intensive workloads within the CPU with inferencing capabilities.

Topics:

- [Supported processors](#)
- [Chipset](#)

Supported processors

 **NOTE:** For more information about Intel Xeon Scalable Processors, see www.intel.com.

Table 13. Supported Processors for R540

Processor number	TDP (W)	Core count	Segment
6126	125	12	Gold
6130	125	16	Gold
6138	125	20	Gold
6226	125	12	Gold
6222V	115	20	Gold
6209U	125	20	Gold
6230	125	20	Gold
5122	105	4	Gold

Table 13. Supported Processors for R540 (continued)

Processor number	TDP (W)	Core count	Segment
5118	105	12	Gold
5120	105	14	Gold
5117	105	10	Gold
5220	125	18	Gold
5218	125	16	Gold
5222	105	4	Gold
5215	85	10	Gold
5217	115	8	Gold
5218R	125	20	Gold
4112	85	4	Silver
4108	85	8	Silver
4110	85	8	Silver
4114	85	10	Silver
4116	85	12	Silver
4214	85	12	Silver
4214R	100	12	Silver
4215	85	8	Silver
4216	100	16	Silver
4208	85	8	Silver
4210	85	10	Silver
4210R	100	10	Silver
3104	85	6	Bronze
3106	85	8	Bronze
3206R	85	8	Bronze
3204	85	6	Bronze

Processor Configurations

The R540 supports two processors with up to 28 cores per processor.

Single CPU Configuration

The R540 functions normally if there is just a single processor that is placed in the processor 1 socket. The system will not boot if only processor 2 socket is populated. With single processor configuration, only the right riser will be functional.

Processor Installation

For processor installation instructions, see the Disassembly and reassembly section.

Chipset

The DELL EMC PowerEdge R540 use the Intel C620 series chipset (PCH) that provides extensive I/O support. Functions and capabilities include:

- ACPI Power Management Logic Support, Revision 4.0a
- PCI Express Base Specification Revision 3.0
- Integrated Serial ATA host controller supports data transfer rates of up to 6 Gb/s on all ports.
- xHCI USB controller with super speed USB 3.0 ports
- Direct Media Interface
- Enhanced Serial Peripheral Interface
- Flexible I/O - Allows some high-speed I/O signals to be configured as PCIe root ports, PCIe uplink for use with certain PCH SKUs, SATA (and sSATA), or USB 3.0.
- General Purpose Input Output (GPIO)
- Low Pin Count interface, interrupt controller, and timer functions
- System Management Bus Specification, Version 2.0
- Integrated Clock Controller or Real-Time Clock Controller
- Intel High Definition Audio and Intel Smart Sound Technology
- Integrated 10/100/1000 Mbps Ethernet MAC
- Supports Intel Rapid Storage Technology Enterprise
- Supports Intel Active Management Technology and Server Platform Services
- Supports Intel Virtualization Technology for Directed I/O
- Supports Intel Trusted Execution Technology
- JTAG Boundary Scan support
- Intel QuickAssist Technology
- Intel Trace Hub for debug

For more information, go to [Intel.com](https://www.intel.com)

System memory

NOTE: 768 GB max memory is recommended for performance optimized configurations.

Supported DIMM types are:

- RDIMMs (Registered DIMM) - Provides for higher capacity options and advanced RAS features. It is the most commonly used DIMM type, and offers the best mix of frequency, capacity, and rank structure choices. LRDIMMs (Load Reduced DIMM) - Provides maximum capacity beyond that of an RDIMM but at a higher power consumption. Uses a buffer to reduce memory loading to a single load on all DDR signals, allowing for greater density.
- LRDIMMs (Load Reduced DIMM) - Provides maximum capacity beyond that of an RDIMM but at a higher power consumption. Uses a buffer to reduce memory loading to a single load on all DDR signals, allowing for greater density.

Supported memory

Table 14. Supported Memory

Feature	R540 (DDR4)
DIMM type	RDIMM, LRDIMM
Transfer speed	2666 MT/s
	2400 MT/s
	2133 MT/s
	1866 MT/s
Voltage	1.2 V

Memory speed

The R540 supports memory speeds of 2666 MT/s, 2400 MT/s, 2133 MT/s, and 1866MT/s depending on the DIMM types installed and the configuration. The default speed is the highest common supported speed between the CPUs and DIMMs. The operating speed of the memory is also determined by the maximum speed that is supported by the processor, the speed settings in the BIOS, and the operating voltage of the system.

Table 15. DIMM Performance Details

DIMM type	DIMM ranking	Capacity	DIMM rated voltage, speed	The 2 nd Generation Intel® Xeon® Processor scalable processor family	
				1 DPC	2 DPC
RDIMM	1R/2R	8 GB, 16 GB, 32 GB	DDR4 (1.2 V), 2666	2666 MT/s	2666 MT/s
LRDIMM	2R	64 GB	DDR4 (1.2 V), 2666	2666 MT/s	2666 MT/s

Topics:

- [General memory module installation guidelines](#)

General memory module installation guidelines

Memory Configurations

NOTE: Memory configurations that fail to observe these guidelines can prevent system from booting, stop responding during memory configuration, or operating with reduced memory.

The PowerEdge R540 system support flexible memory configurations ranging from capacities of 8 GB to 1 TB. CPU1 supports up to 10 DIMMs. CPU2 supports up to 6 DIMMs. The R540 system supports memory configuration according to the following population rules:

- Mixing DIMMs with different rank is supported with condition of not more than two different ranks of DIMMs can be installed in a system.
- Speed: If memory modules with different speeds are installed, they operate at the speed of the slowest installed memory module(s) or slower depending on the system DIMM configuration.
- DIMMs with different data widths can be mixed. DIMMs with x4 and x8 data widths are supported and mixing is allowed.
- When mixing memory modules with different capacities, populate the sockets with memory modules with highest capacity first. For example, slot A1 populated first, then A2, and so on... The second CPU mirrors the first CPU population.

Memory RAS features

Reliability, availability, and serviceability (RAS) features help keep the system online and operational without significant impact to performance, and can decrease data loss and being unresponsive due to errors. RAS aids in rapid, accurate diagnosis of faults which require service.

Table 16. Supported RAS features

Feature	Description
Dense configuration optimized profile	Increased memory reliability can be a result from this selectable platform profile that adjusts parameters to reduce faults regarding refresh rates, speed, temperature, and voltage.
Memory demand and patrol scrubbing	Demand scrubbing is the ability to write corrected data back to the memory once a correctable error is detected on a read transaction. Patrol scrubbing proactively searches the system memory, repairing correctable errors.
Recovery from single DRAM device failure (SDDC)	Recovery from Single DRAM Device Failure (SDDC) provides error checking and correction that protects against any single memory chip failure and multi bit errors from any portion of a single memory chip.
Failed DIMM isolation	This feature provides the ability to identify a specific failing DIMM channel pair, thereby enabling the user to replace only the failed DIMM pair.
Memory mirroring	Memory mirroring is a method of keeping a duplicate (secondary or mirrored) copy of the contents of memory as a redundant backup for use if the primary intra-socket memory fails. The mirrored copy of the memory is stored in memory of the same processor socket.
Memory address parity protection	This feature provides the ability to detect transient errors on the address lines of the DDR channel.
Memory sparing (rank)	Memory sparing allocates one rank per channel as a spare. If excessive correctable errors occur in a rank or channel, they are moved to the spare area while the operating system is running to prevent the errors from causing an uncorrectable failure.

Table 16. Supported RAS features (continued)

Feature	Description
Memory thermal throttling	This feature helps to optimize power/performance and can also be used to prevent DIMMs from overheating.

Storage

The PowerEdge R540 provide scalable storage that allows you to adapt to your workload and operational demands. R540 supports up to 12 x 3.5 or 2.5 inches in 3.5-inch adapter front access hard drives, with optional 2 x 3.5-inch rear drive configuration. With comprehensive storage options, the R540 offer various internal and external storage controllers, supports different drive types, chassis, backplanes, and varied numbers of drives.

Storage controllers

Dell EMC's RAID controller options offer performance improvements, including the Mini PERC solution. Mini PERC provides a base RAID hardware controller that is installed on a dedicated PCIe slot. It is installed on the dedicated PCIe slot using a small form factor and high-density connector on the system board.

The new PERC controller offerings leverage heavily on previous generation PERC family. The premium performance PERC series controller drives better IOPs and enhanced the SSD performance.

Table 17. PERC series controller offerings

Performance Level	Controller and Description
Entry	S140—SATA
Value	HBA355e, HBA350i, H350, H730P, HBA330, H330, 12 Gb/s Ext SAS HBA
Value Performance	H750, H730P
Premium Performance	H750, H840, H740P

NOTE: The new generation PERC 11 H750, H350, and HBA350i adapters cannot be mixed with the PERC H740P, H730P, HBA330, H330 adapters of the previous generations in one system.

Supported drives - SAS and SATA

The PowerEdge R540 system supports internal drives:

- Up to 14 x 3.5 inch hot-swappable HDDs or 2.5 inch hot-swappable SSDs or HDDs using hybrid carrier to fit in the 3.5 inch drive bay [12 x 3.5 inch front accessible + 2 x 3.5 inch rear accessible] .
- Up to 12 x 3.5 inch hot-swappable HDDs or 2.5 inch hot-swappable SSDs or HDDs using hybrid carrier to fit in the 3.5 inch drive bay .
- Up to 8 x 3.5 inch hot-swappable HDDs or 2.5 inch hot-swappable SSDs or HDDs using hybrid carrier to fit in the 3.5 inch drive bay .

Topics:

- [IDSDM with vFlash card](#)
- [Optical Drives](#)
- [Tape Drives](#)
- [Boot Optimized Storage Subsystem](#)

IDSDM with vFlash card

The PowerEdge R540 system supports Internal Dual SD module (IDSDM) and vFlash card. In the current generation of PowerEdge servers, IDSDM and vFlash card are combined into a single card module, and are available in these configurations:

- vFlash or
- IDSDM or
- vFlash and IDSDM

The IDSDM/vFlash card sits in the back of the system, in a Dell-proprietary slot. IDSDM/vFlash card supports three micro SD cards (two cards for IDSDM and one card for vFlash). Micro SD cards capacity for IDSDM is 16/32/64 GB while for vFlash the micro SD card capacity is 16 GB.

Boot Optimized Storage Subsystem (BOSS)

BOSS is a simple RAID solution card that is designed specifically for booting the system's operating system, which supports up to two 6 Gbps M.2 SATA drives. This card has a x8 connector using PCIe gen 2.0 x2 lanes, available only in the low-profile and half-height form factor.

Optical Drives

The PowerEdge R540 supports one of the following internal optical drive options:

- DVD-ROM
- DVD+ROM

Tape Drives

The R540 do not support internal tape drives. However, external tape backup devices are supported on R540.

Supported external tape drives:

- External RD1000 USB
- External LTO-5, LTO-6, LTO-7 and 6 Gb SAS tape drives
- 114X rack mount chassis with LTO-5, LTO-6, and LTO-7 6Gb SAS tape drives
- TL1000 with LTO-5, LTO-6, and LTO-7 6 Gb SAS and 8GB FC tape drives
- TL2000 with LTO-5, LTO-6, and LTO-7 6 Gb SAS and 8GB FC tape drives
- TL4000 with LTO-5, LTO-6, and LTO-7 6 Gb SAS and 8GB FC tape drives
- ML6000 with LTO-5, LTO-6, and LTO-7 6 Gb SAS and 8GB FC tape drives

Boot Optimized Storage Subsystem

The Boot Optimized Storage Subsystem (BOSS) is an alternative, high speed location to install the operating system. This ensures that the drive based storage is not used by the operating system. BOSS is a simple RAID solution card designed specifically for booting the system's operating system, which supports up to two 6 Gbps M.2 SATA drives. This card has a x8 connector using PCIe gen 2.0 x2 lanes, available only in the low-profile and half-height form factor.

NOTE: The BOSS is recommended for non-virtualized operating systems. Virtualized operating systems are best supported by the IDSDM.

BOSS is an half height PCIe M.2 SATA carrier card that installed on a PCIe slot to draw power and provide system management bus sideband access into the BOSS's thermal field replacement unit (TFRU). The TFRU controls BOSS's localized active cooling fan solution and provide status to iDRAC. SATA data is exposed via the NPIO connector that is cabled to the system board or backplane.

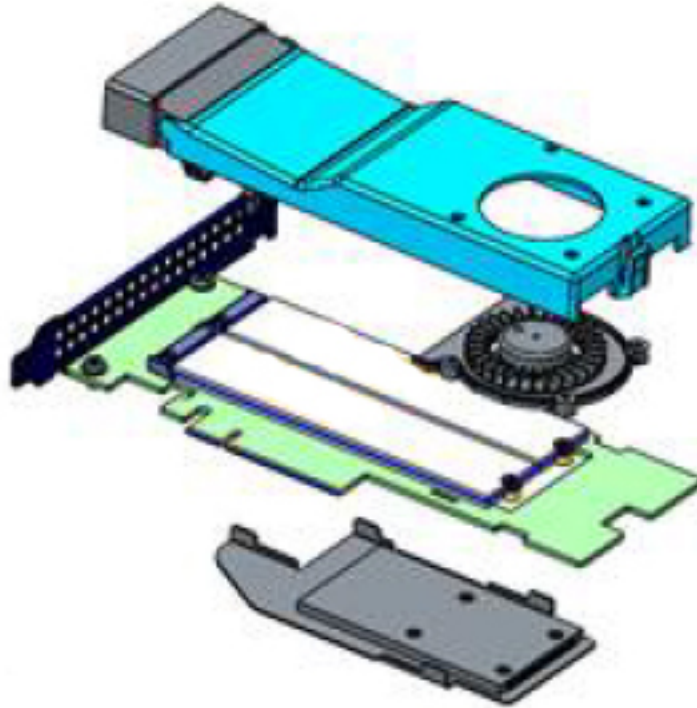

Figure 13. Boot Optimized Storage Subsystem (BOSS)

Table 18. BOSS RAID controller features

Function/Feature	Supported
Stripe size supported	64k
Configuration (HII)	Yes
Full initialization	No
Fast initialization	Yes ⓘ NOTE: Performed on virtual disk creation by default.
Background initialization	No

Networking and PCIe

The Dell EMC PowerEdge R540 offers balanced, scalable I/O capabilities, including integrated PCIe 3.0-capable expansion slots. The Lan On Motherboard(LOM) option enable you to choose the right network fabric without using up a valuable PCI slot.

Topics:

- LAN on Motherboard(LOM)
- PCIe Expansion cards

LAN on Motherboard(LOM)

The Dell EMC PowerEdge R540 system supports two 1 Gbps on board Network Interface Controller (NIC) ports on the back panel. The R540 also supports extra two optional NIC ports with following LOM options:

- Two 1GbE ports
- Two 10GbE ports
- Two 10GbE SFP+ ports

PCIe Expansion cards

The PowerEdge R540 system supports up to five PCI express (PCIe) generation 3 expansion cards slots plus 1x LOM riser slot.

Supported risers for R540.

1. LOM riser
2. Right riser
3. Left riser
4. Butterfly riser

Below are PCIe slots configuration supported by R540:

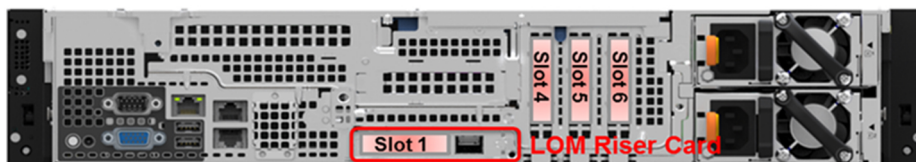

Figure 14.

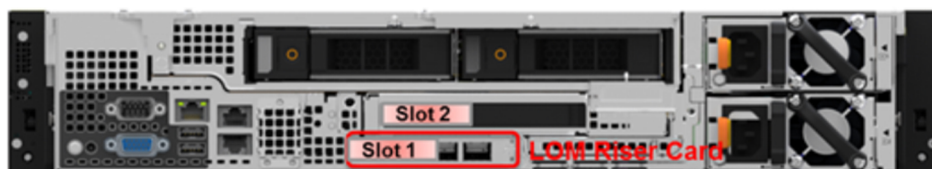

Figure 15. Configuration B: LOM riser + Right riser + 2 x 3.5 inch rear hard drive

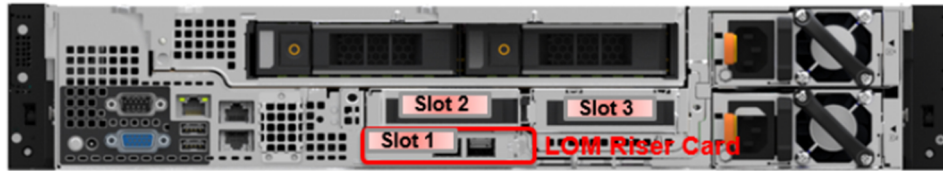

Figure 16. Configuration C: LOM riser + Left riser + Right riser + 2 x 3.5 inch rear hard drive

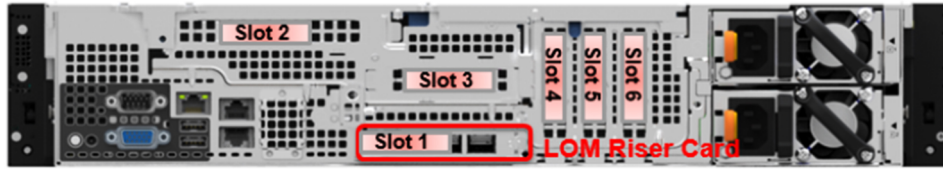

Figure 17. Configuration D: LOM riser + Butterfly riser + 3 x low profile slot

Trusted platform module

The Trusted Platform Module (TPM) is used to generate and store keys, protect or authenticate passwords, and create and store digital certificates. The Intel's TXT (Trusted Execution Technology) functionality along with Microsoft's Platform Assurance feature in Windows Server 2016 is supported. TPM can also be used to enable the BitLocker hard drive encryption feature in Windows Server 2012/2016.

The TPM chip is on the Plug-in Module (PIM) and bound only to one system board.

The system board has a connector for the plug-in module, and it is factory-installed.

There are four types of TPM module options:

- No TPM
- TPM 1.2
- TPM 2.0

Video specifications

The PowerEdge R540 system supports Matrox G200eW3 graphics card.

Table 19. Supported video resolution options

Resolution	Refresh Rate	Horizontal Freq.	Pixel Clock
1024 x 768	60 Hz	48.4 kHz	65.0 MHz
1280 x 800	60 Hz	49.7 kHz	83.5 MHz
1280 x 1024	60 Hz	64.0 kHz	108.0 MHz
1360 x 768	60 Hz	47.71 kHz	85.5 MHz
1440 x 900	60 Hz	55.9 kHz	106.5 MHz
1600 x 900	60 Hz (RB)	55.54 kHz	97.75 MHz
1600 x 1200	60 Hz	75.0 kHz	162.0 MHz
1680 x 1050	60 Hz (RB)	64.7 kHz	119.0 MHz
1920 x 1080	60 Hz	67.158 kHz	173.0 MHz
1920 x 1200	60 Hz	74.556 kHz	193.25 MHz

Power, Thermal, and Acoustics

The lower overall system-level power draw is a result of the breakthrough system design developed by Dell EMC. The system aims to maximize performance per watt through a combination of energy efficient technologies, optimized thermal designs and intelligent fan control algorithms. The system fan control algorithms use an extensive array of sensors that automatically monitor power and thermal activity to minimize fan speeds based on system cooling requirements, reducing the power required for cooling.

Topics:

- Power consumption and energy efficiency
- Power supply units
- Thermal and Acoustics

Power consumption and energy efficiency

With the rise in the cost of energy that is coupled with increasing data center density, Dell EMC provides tools and technologies to help you realize greater performance with lower energy cost and wastage. More efficient data center usage can reduce costs by slowing the need for additional data center space. The following table lists the tools and technologies that Dell EMC offers to help you achieve your data center goals by lowering power consumption and increasing energy efficiency.

Table 20. Power tools and technologies

Feature	Description
Power supply units (PSU) portfolio	PSU portfolio includes intelligent features such as dynamically optimizing efficiency while maintaining availability and redundancy.
Tools for right-sizing	Enterprise Infrastructure Planning Tool (EIPT) is a tool that helps you to plan and tune your computer and infrastructure equipment for maximum efficiency. EIPT helps you by calculating hardware power consumption, power infrastructure, and storage. You can learn more at Dell.com/calc
Industry compliance	Dell EMC's servers are compliant with all relevant industry certifications and guidelines, including 80 PLUS, Climate Savers, and ENERGY STAR.
Power monitoring accuracy	PSU power monitoring improvements include: <ul style="list-style-type: none"> • Power monitoring accuracy of 1%, whereas the industry standard is 5% • More accurate reporting of power • Better performance under a power cap
Power capping	Use Dell EMC's systems management to set the power cap limit for your systems to limit the output of a PSU and reduce system power consumption. Dell is the first hardware vendor to leverage Intel Node Manager for circuit-breaker fast capping.
Systems management	Dell EMC's servers are compliant with all relevant industry certifications and guidelines, including 80 PLUS, Climate Savers, and ENERGY STAR. Dell OpenManage Power Center delivers group power management at the rack, row, and data center level for

Table 20. Power tools and technologies (continued)

Feature	Description
	servers, power distribution units, and uninterruptible power supplies.
Active power management	<p>Intel® Node Manager is an embedded technology that provides individual server- level power reporting and power limiting functionality. Dell offers a complete power management solution that is comprised of Intel Node Manager that is accessed through Dell iDRAC9 Enterprise and OpenManage Power Center that allows policy- based management of power and thermals at the individual server, rack, and data center level. Hot spare reduces power consumption of redundant power supplies.</p> <p>Thermal control of fan speed optimizes the thermal settings for your environment to reduce fan consumption and lower system power consumption. Idle power enables Dell servers to run as efficiently when idle as when at full workload.</p>
Fresh Air cooling	FAC is supported with certain configuration limitations. With the thermal design and reliability of Dell products, you can have the capability to operate at excursion- based temperatures beyond the industry standard of 35°C (95°F) without impacting your availability model. This solution takes into account servers, networking, storage, and other infrastructure.
Rack infrastructure	<p>Dell EMC offers some of the industry's highest- efficiency power infrastructure solutions, including:</p> <ul style="list-style-type: none"> ● Power distribution units (PDUs) ● Uninterruptible power supplies (UPSs) ● Energy smart containment rack enclosures

Power supply units

Energy Smart power supplies have intelligent features, such as the ability to dynamically optimize efficiency while maintaining availability and redundancy. Also featured are enhanced power-consumption reduction technologies, such as high-efficiency power conversion and advanced thermal-management techniques, and embedded power-management features including high-accuracy power monitoring. The system supports two hot-swappable AC power supplies with 1 + 1 redundancy, auto-sensing and auto-switching capability. A single cabled AC power supply option is also available for the R540.

Thermal and Acoustics

The system's thermal management delivers high performance through optimized cooling of components at the lowest fan speeds across a wide range of ambient temperatures from 10°C to 35°C (50°F to 95°F) and to extended ambient temperature ranges. These optimizations result in lower fan power consumption which translate to lower system power and data center power consumption.

Thermal design

The thermal design of the system reflects the following:

- **Optimized thermal design:** The system layout is architected for optimum thermal design. System component placement and layout are designed to provide maximum airflow coverage to critical components with minimal expense of fan power.

- **Comprehensive thermal management:** The thermal control system regulates the system fan speeds based on feedback from system component temperature sensors, as well as for system inventory and subsystem power draw. Temperature monitoring includes components such as processors, DIMMs, chipset, system inlet air temperature and hard disk drives.
- **Open and closed loop fan speed control:** Open loop fan control uses system configuration to determine fan speed based on system inlet air temperature. Closed loop thermal control uses temperature feedback to dynamically adjust fan speeds based on system activity and cooling requirements.
- **User-configurable settings:** With the understanding and realization that every customer has a unique set of circumstances or expectations from the system, in this generation of servers, we have introduced limited user-configurable settings in the iDRAC9 BIOS setup screen. For more information, see the Dell EMC PowerEdge system Installation and Service Manual on Dell.com/Support/Manuals and “Advanced Thermal Control: Optimizing across Environments and Power Goals” on Dell.com.
- **Cooling redundancy:** The system allows N+1 fan redundancy, allowing continuous operation with one fan failure in the system.

Acoustical design

Dell EMC focuses on sound quality in addition to sound power level and sound pressure level. Sound quality describes how disturbing or pleasing a sound is interpreted, and Dell EMC references several psychacoustical metrics and thresholds in delivering it. Tone prominence is one such metric. Sound power and sound pressure levels increase with greater populations or higher utilization, while sound quality remains good even as the frequency content changes. A reference for comparison to sound pressure levels for familiar noise sources is given in the following table. An extensive description of Dell EMC Enterprise acoustical design and metrics is available in the [Dell Enterprise Acoustics](#) white paper.

Table 21. Acoustical reference points and output comparisons

Value measured at your ears		Equivalent familiar noise experience
LpA, dBA, re 20 µPa	Loudness, sones	
90	80	Loud concert
75	39	Data center, vacuum cleaner, voice must be elevated to be heard
60	10	Conversation levels
45	4	Whispering, open office layout, normal living room
35	2	Quiet office
30	1	Quiet library
20	0	Recording studio

Rack rails

The rail offerings for the R540 consist of two general types: sliding and static

Sliding rails features summary

The sliding rails (two varieties are offered) allow the system to be fully extended out of the rack for service. They are available with or without the optional cable management arm (CMA).

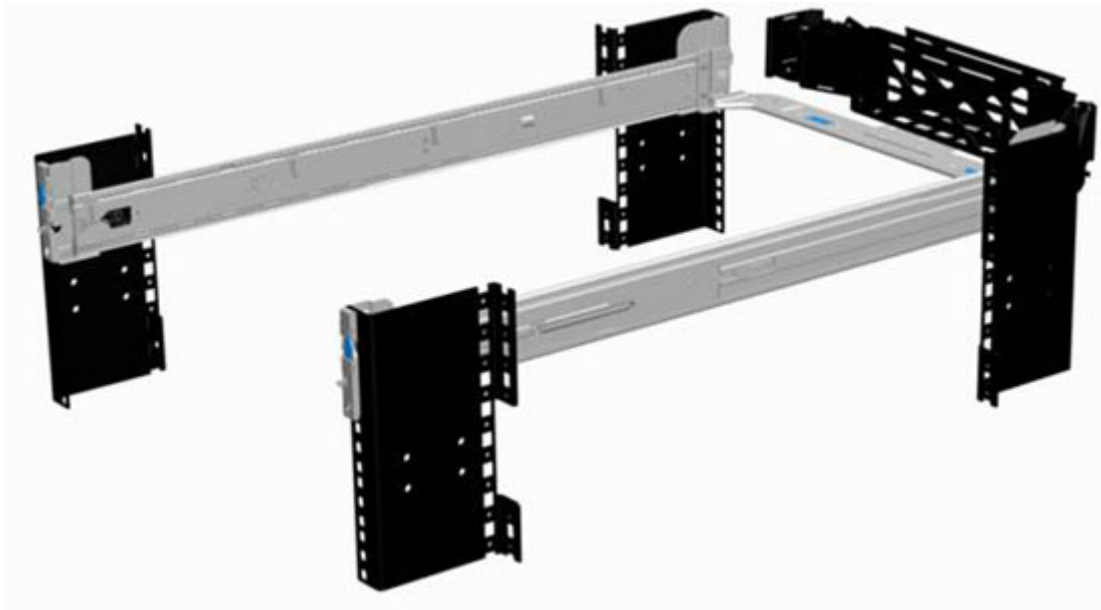

Figure 18. Sliding rails with optional CMA

ReadyRails-Sliding rails for 4-post racks

- Supports Drop-in Installation of the chassis to the rails.
- Support for tool-less installation in 19" EIA-310-E compliant square or unthreaded round hole 4-post racks including all generations of the Dell racks.
- Support for tooled installation in 19" EIA-310-E compliant threaded hole 4-post racks.
- Support full extension of the system out of the rack to allow serviceability of key internal components.
- Support for optional cable management arm (CMA).
- Minimum rail mounting depth without the CMA: 714 mm.
- Minimum rail mounting depth with the CMA: 845 mm.
- Square-hole rack adjustment range: 631-868 mm.
- Round-hole rack adjustment range: 617-861 mm.
- Threaded-hole rack adjustment range: 631-883 mm.

Stab-in/Drop-in sliding rails for 4-post racks (New for 14G systems)

- Supports drop-in or stab-in installation of the chassis to the rails.
- Support for tool-less installation in 19" EIA-310-E compliant square, unthreaded round hole racks including all generations of the Dell racks. Also supports tool-less installation in threaded round hole 4-post racks.
- Required for installing R540 in a Dell EMC Titan or Titan-D rack.
- Support full extension of the system out of the rack to allow serviceability of key internal components.
- Support for optional cable management arm (CMA).
- Minimum rail mounting depth without the CMA: 714 mm.

- Minimum rail mounting depth with the CMA: 845 mm.
- Square-hole rack adjustment range: 603-915 mm.
- Round-hole rack adjustment range: 603-915 mm.
- Threaded-hole rack adjustment range: 603-915 mm.

Static rails

The static rails support a wider variety of racks than the sliding rails. However, they do not support serviceability in the rack and are thus not compatible with the CMA.

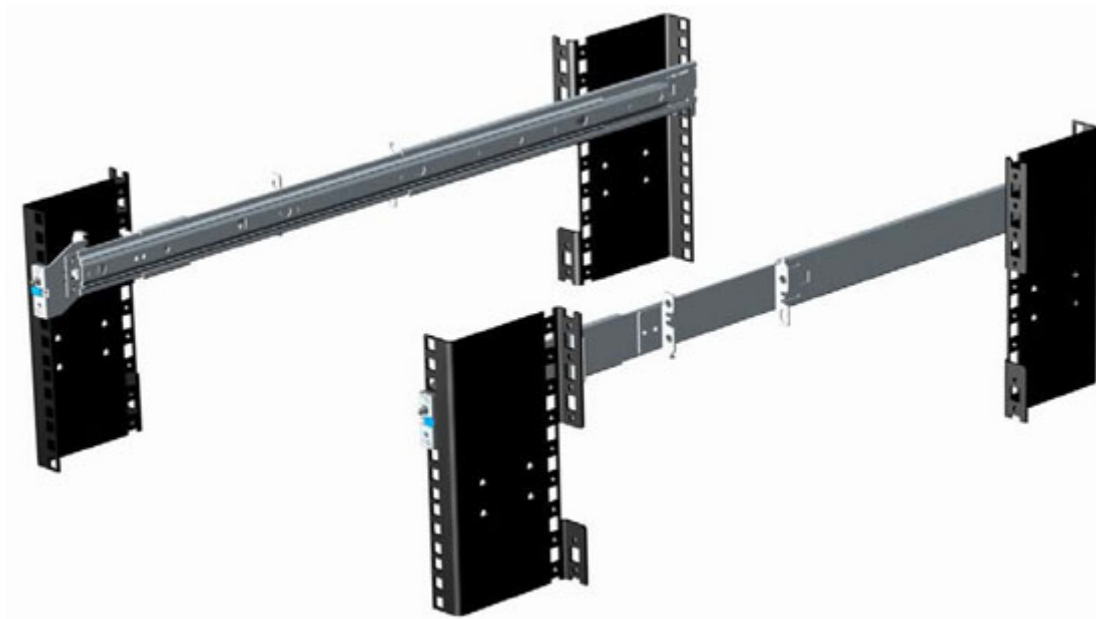

Figure 19. Static rails

Static rails features summary

Static Rails for 4-post & 2-post Racks:

- Supports Stab-in installation of the chassis to the rails.
- Support tool-less installation in 19" EIA-310-E compliant square or unthreaded round hole 4-post racks including all generations of Dell racks.
- Support tooled installation in 19" EIA-310-E compliant threaded hole 4-post and 2-post racks.
- Minimum rail mounting depth: 622 mm.
- Square-hole rack adjustment range: 608-879 mm.
- Round-hole rack adjustment range: 594-872 mm.
- Threaded-hole rack adjustment range: 608-890 mm.

NOTE: One key factor in selecting the proper rails is identifying the type of rack in which they are installed.

2-Post racks installation

If installing to 2-Post (Telco) racks, the ReadyRails Static rails (B4) must be used. Both sliding rails support mounting in 4-post racks only.



Figure 20. Static rails in 2-post center mount configuration

Installation in the Dell EMC Titan or Titan-D racks

If installing to Titan or Titan-D racks, the Stab-in/Drop-in Sliding rails (B13) must be used. This rail collapses down sufficiently to fit in racks with mounting flanges spaced about 24 inches apart from front to back. The Stab-in/Drop-in Sliding rail allows bezels of the servers and storage systems to be in alignment when installed in these racks.

System-to-Rail Installation Method

If the customer prefers to use the stab-in installation method for installing their systems to the rails, the Stab-in/Drop-in Sliding rails(B13) or the ReadyRails Static rail (B4) must be selected.

NOTE: ReadyRails Sliding rails (B6) are drop-in only.

Table 22. Static, Sliding, or Stab-in/Drop-in sliding rails

Rail identifier	Rail type	Installation method	Supported rack types					
			Dell EMC Titan or Titan-D Racks	4-Post			2-Post	
				Square	Round	Thread	Flush	Center
B6	Ready Rails Sliding	Drop-in	X	√	√	√ *	X	X
B13	Stab-in/Drop-in Sliding	Stab-in/Drop-in	√	√	√	√	X	X
B4	Ready Rails Static	Stab-in	X	√	√	√ *	√ *	√

* Minor conversion required

NOTE: No screws are required for the Stab-in/Drop-in Sliding (B13) rails when mounting the rails to the racks

NOTE: Screws are not included in either kit as threaded racks are offered with various thread designations. Users must therefore provide their own screws when mounting the rails in threaded racks.

NOTE: Screw head diameter for the sliding rails must be 10 mm or less.

Other key factors governing proper rail selection include the following:

- Spacing between the front and rear mounting flanges of the rack
- Type and location of any equipment mounted in the back of the rack such as power distribution units (PDUs)
- Overall depth of the rack

The static rails offer a greater adjustability range and a smaller overall mounting footprint than the sliding rails. This is because of their reduced complexity and lack of need for CMA support.

Table 23. Rail Adjustability Range and Rail Depth

Rail Identifier	Rail Type	Rail Adjustability Range (mm)*						Rail Depth (mm)+	
		Square		Round		Threaded		Without CMA	With CMA
		Min	Max	Min	Max	Min	Max		
B6	Ready Rails Sliding	676	868	662	861	676	883	714	845
B13	Stab-in/ Drop-in Sliding	603	915	603	915	603	915	714	845
B4	Ready Rails Static	608	879	594	872	604	890	622	N/A

* Values represent the distance between the front and rear mounting flanges on the rack

+ Measured from the front surface of the front rack mounting flange

NOTE: For situations where CMA support is not required, the outer CMA mounting brackets can be removed from the sliding rails to reduce the overall length of the rails and eliminate potential interferences with rear-mounted PDUs or the rack rear door.

NOTE: For the ReadyRails Sliding rails(B6) and ReadyRails Static rails (B4), the adjustment range of the rails is a function of the type of rack in which they are being mounted. The Min/Max values listed above represent the allowable distance between the front and rear mounting flanges in the rack. Rail depth without the CMA represents the minimum depth of the rail with the outer CMA brackets removed (if applicable) as measured from the front mounting flanges of the rack.

Cable management arm (CMA)

The optional cable management arm (CMA) organizes and secures the cords and cables exiting the back of the systems. It unfolds to allow the systems to extend out of the rack without having to detach the cables. Some key features of the CMA include:

- Large U-shaped baskets to support dense cable loads.
- Open vent pattern for optimal airflow.
- Ability to be mounted on either side by simply swinging the spring-loaded brackets from one side to the other.
- Utilizes hook-and-loop straps rather than plastic tie wraps to eliminate the risk of cable damage during cycling.
- Includes a low-profile fixed tray to both support and retain the CMA in its fully closed position.
- Both the CMA and the tray mount without the use of tools via simple and intuitive snap-in designs.

The CMA can be mounted to either side of the sliding rails without the use of tools or the need for conversion. However, it is recommended that it be mounted on the side opposite to the power supplies to allow easier access to the power supplies and rear hard drives (if applicable) for service or replacement.



Figure 21. Sliding rails with CMA

Rack Installation

The R540 offers two different varieties of sliding rails: ReadyRail Sliding rails (B6), and combination Stab-in/Drop-in Sliding rails (B13). Only one variety of static rail is offered: ReadyRails Static rails (B4).

A "drop-in" design means that the system is installed vertically into the rails by inserting the standoffs on the sides of the system into the "J-slots" in the inner rail members with the rails in the fully extended position. The recommended method of installation is to first insert the rear standoffs on the system into the rear J-slots on the rails to free up a hand and then rotate the system down into the remaining J-slots while using the free hand to hold the rail against the side of the system.

A "stab-in" design means that the inner (chassis) rail members must first be attached to the sides of the system and then inserted into the outer (cabinet) members installed in the rack. For 2U systems, it is recommended that two people perform this operation.

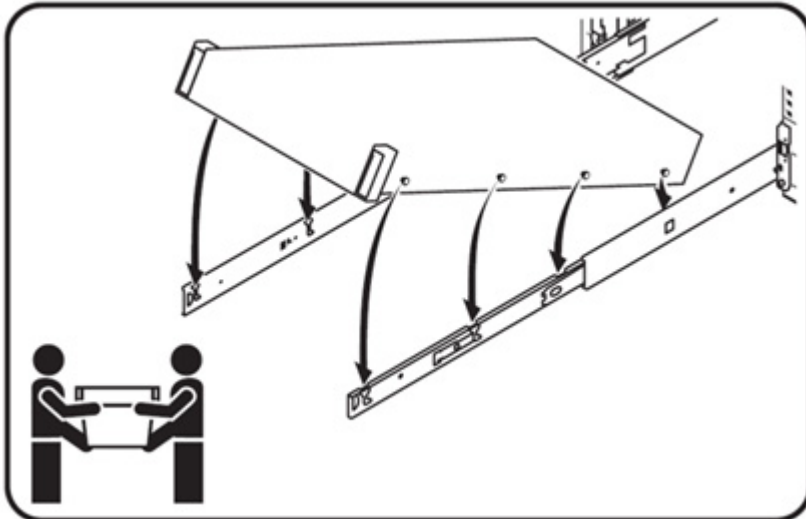

NOTE: The 2U system requires two people for installation due to its heavier weight.

Installing system into the rack (option A: Drop-In)

1. Pull the inner rails out of the rack until they lock into place.



Figure 22. Pull out inner rail

2. Locate the rear rail standoff on each side of the system and lower them into the rear J-slots on the slide assemblies.
3. Rotate the system downward until all the rail standoffs are seated in the J-slots.

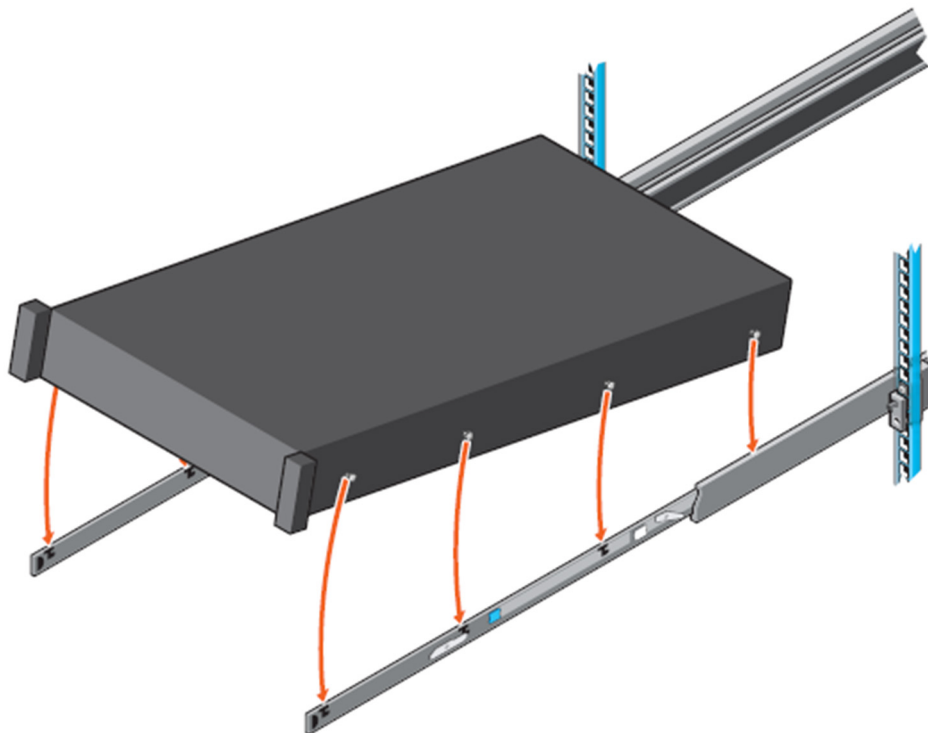

Figure 23. Rail standoffs seated in J-slots

4. Push the system inward until the lock levers click into place.
5. Pull the blue slide release lock tabs forward on both rails and slide the system into the rack until the system is in the rack.

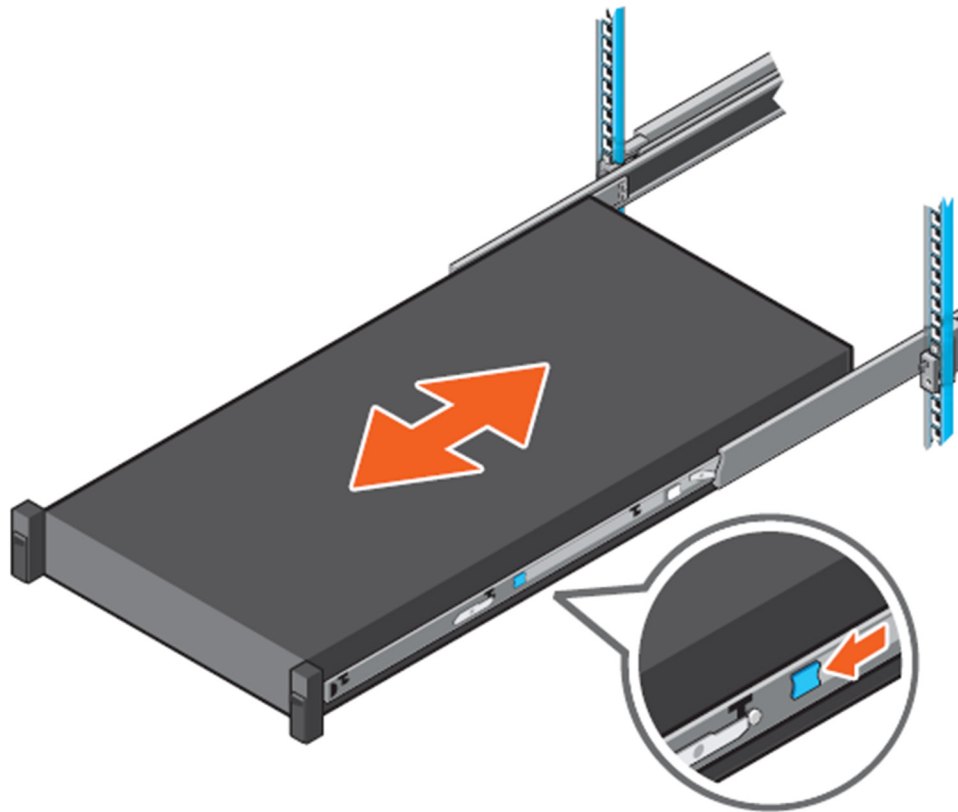

Figure 24. Slide system into the rack

Installing the system into the rack (option B: Stab-In)

1. Pull the intermediate rails out of the rack until they lock into place.
2. Release the inner rail lock by pulling forward on the white tabs and sliding the inner rail out of the intermediate rails.

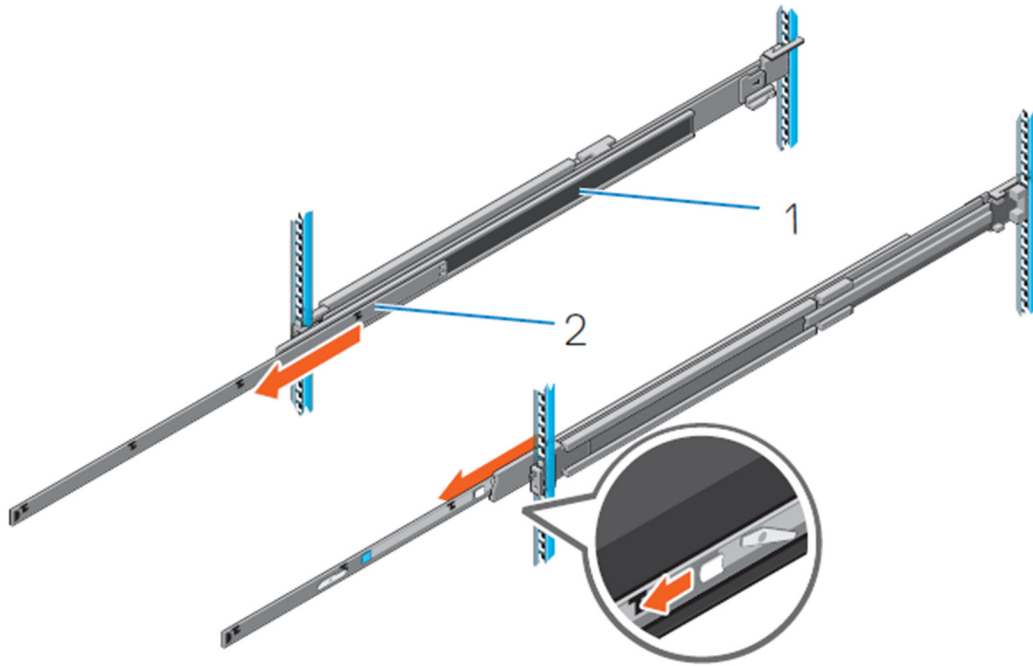

Figure 25. Pull out the intermediate rail

Table 24. Rail component

Number	Component
1	Intermediate rail
2	Inner rail

3. Attach the inner rails to the sides of the system by aligning the J-slots on the rail with the standoffs on the system and sliding forward on the system until they lock into place.

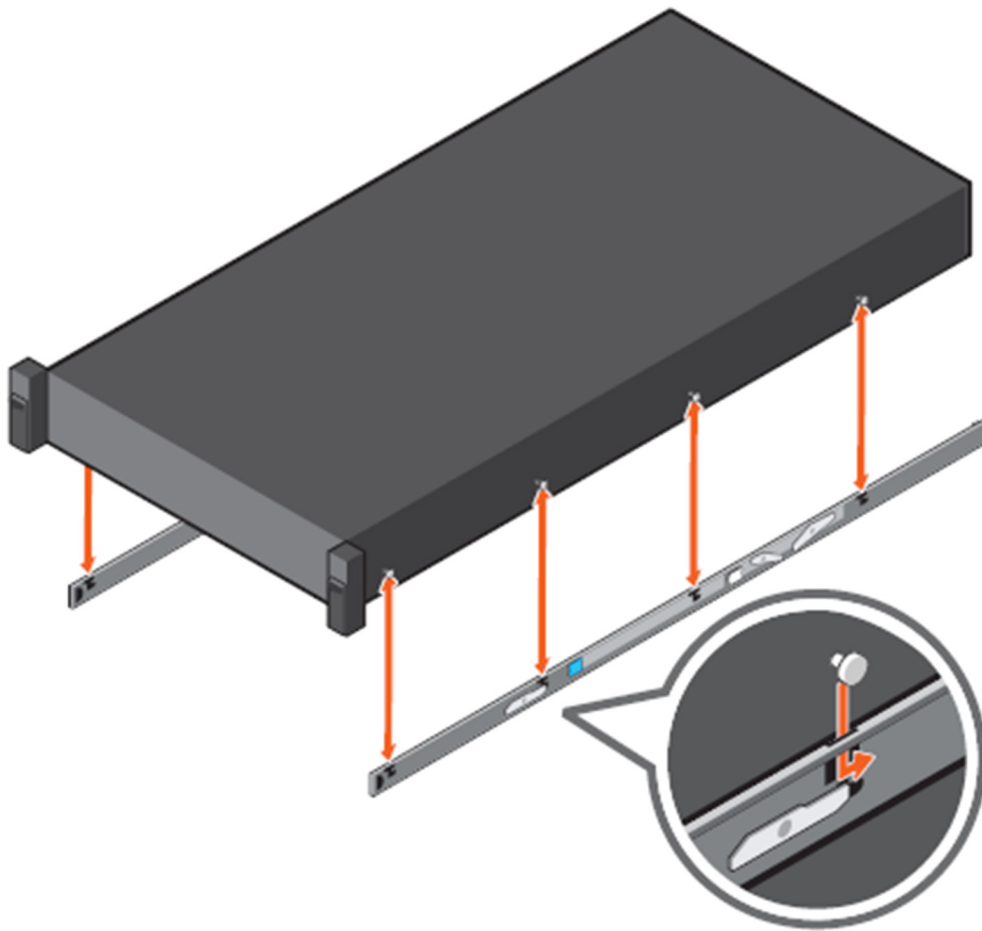

Figure 26. Attach the inner rails to the system

4. With the intermediate rails extended, install the system into the extended rails.

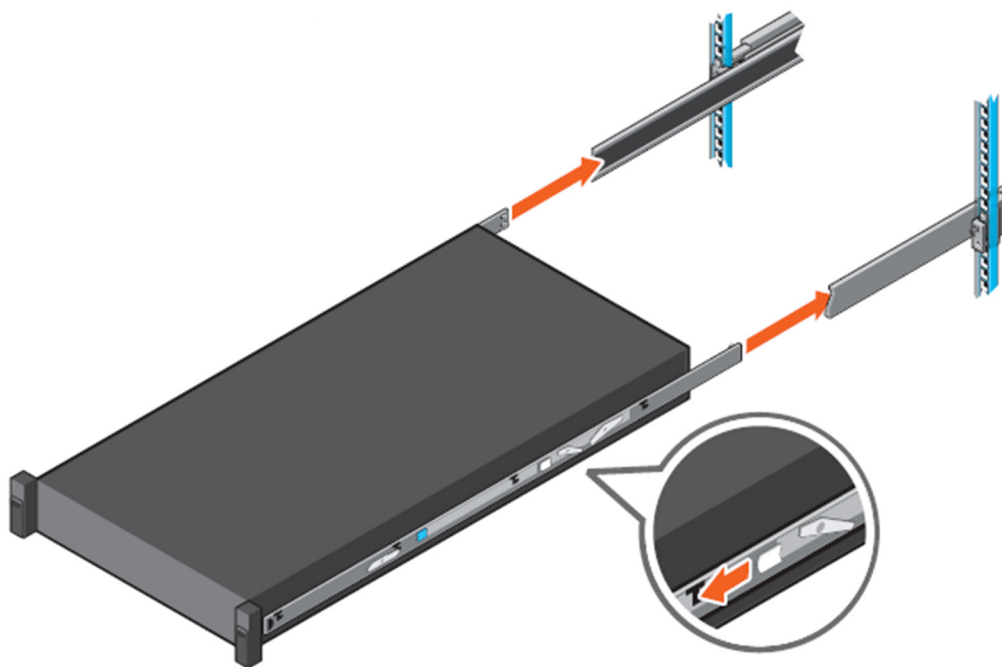

Figure 27. Install system into the extended rails

5. Pull the blue slide release lock tabs forward on both the rails, and slide the system into the rack.

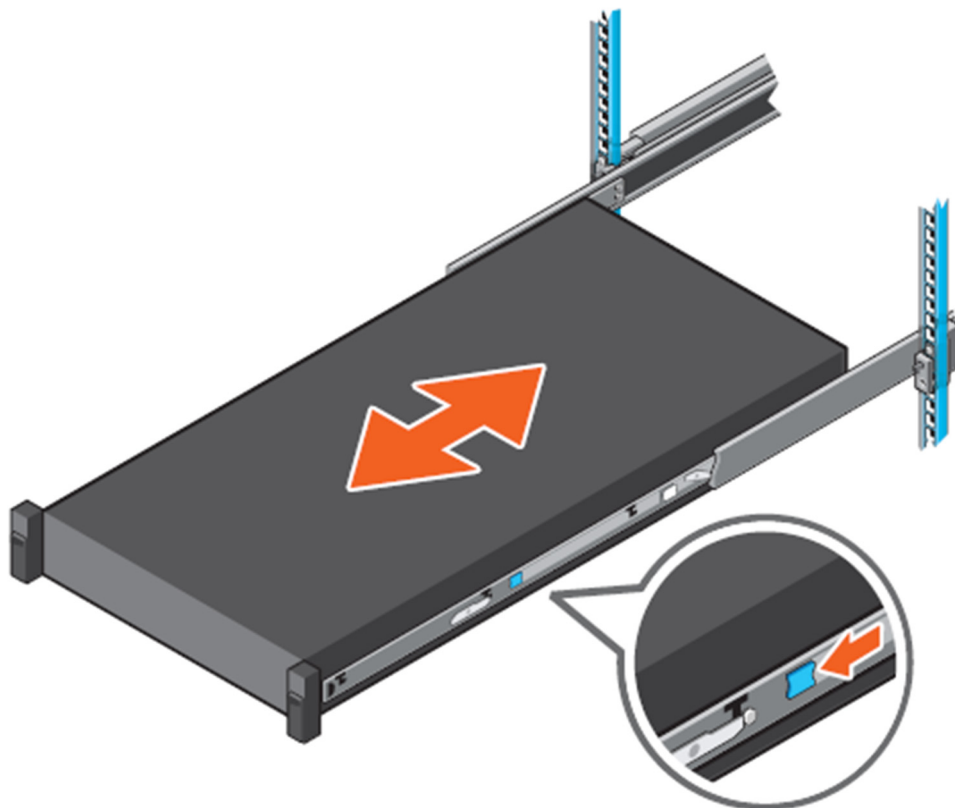

Figure 28. Slide system into the rack

Dell EMC OpenManage systems management

Dell EMC OpenManage Portfolio

Simplifying hardware management through ease of use and automation

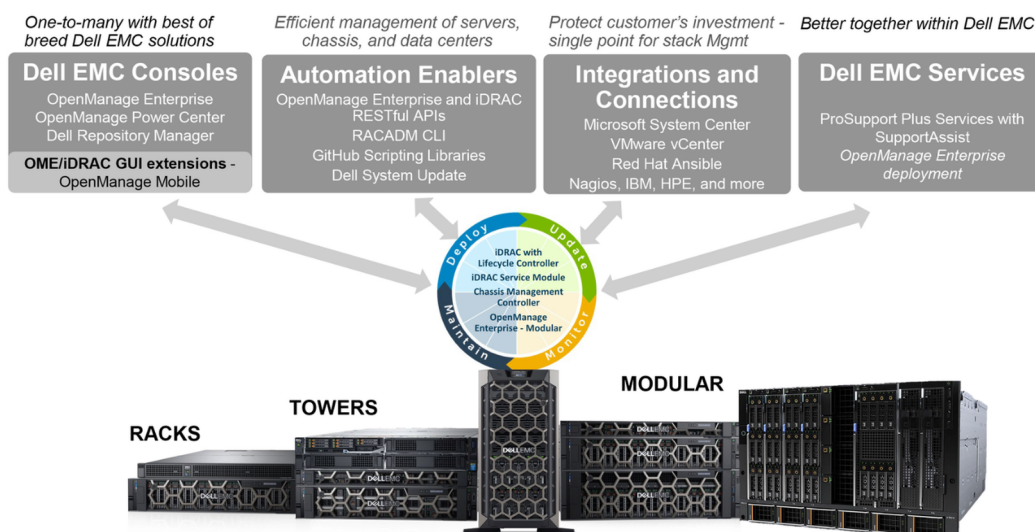

Figure 29. Dell EMC OpenManage Portfolio

Dell EMC delivers management solutions that help IT Administrators effectively deploy, update, monitor, and manage IT assets. OpenManage solutions and tools enable you to quickly respond to problems by helping them to manage Dell EMC servers effectively and efficiently; in physical, virtual, local, and remote environments, operating in-band, and out-of-band (agent-free). The OpenManage portfolio includes innovative embedded management tools such as the integrated Dell Remote Access Controller (iDRAC), Chassis Management Controller and Consoles like OpenManage Enterprise, OpenManage Power Manager plug in, and tools like Repository Manager.

Dell EMC has developed comprehensive systems management solutions based on open standards and has integrated with management consoles that can perform advanced management of Dell hardware. Dell EMC has connected or integrated the advanced management capabilities of Dell hardware into offerings from the industry's top systems management vendors and frameworks such as Ansible, thus making Dell EMC platforms easy to deploy, update, monitor, and manage.

The key tools for managing Dell EMC PowerEdge servers are iDRAC and the one-to-many OpenManage Enterprise console. OpenManage Enterprise helps the system administrators in complete lifecycle management of multiple generations of PowerEdge servers. Other tools such as Repository Manager, which enables simple yet comprehensive change management.

OpenManage tools integrate with systems management framework from other vendors such as VMware, Microsoft, Ansible, and ServiceNow. This enables you to use the skills of the IT staff to efficiently manage Dell EMC PowerEdge servers.

Topics:

- [iDRAC with Lifecycle controller](#)
- [Server and Chassis Managers](#)
- [Dell EMC consoles](#)
- [Automation Enablers](#)
- [Integration with third-party consoles](#)
- [Connections for third-party consoles](#)
- [Dell EMC Update Utilities](#)
- [Dell resources](#)

iDRAC with Lifecycle controller

The integrated Dell Remote Access Controller 9 (iDRAC9) with Lifecycle Controller is embedded within every Dell EMC PowerEdge server and provides functionality that helps IT administrators deploy, update, monitor, and maintain servers with no need for any additional software to be installed. iDRAC functions regardless of operating system or hypervisor presence because from a pre-OS or bare-metal state, iDRAC is ready to work because it is embedded within each server from the factory.

iDRAC features and comparison

The R540 supports the following iDRAC licenses – Basic (default), Express (upgrade) and Enterprise (upgrade).

Table 25. iDRAC feature comparison

Feature	iDRAC9 Basic	iDRAC9 Express	iDRAC9 Express for Blades	iDRAC9 Enterprise	iDRAC9 Datacenter
Interfaces / Standards					
iDRAC RESTful API and Redfish	Yes	Yes	Yes	Yes	Yes
IPMI 2.0	Yes	Yes	Yes	Yes	Yes
DCMI 1.5	Yes	Yes	Yes	Yes	Yes
Web-based GUI	Yes	Yes	Yes	Yes	Yes
RACADM command line (local/remote)	Yes	Yes	Yes	Yes	Yes
SMASH-CLP (SSH-only)	Yes	Yes	Yes	Yes	Yes
Telnet	Yes	Yes	Yes	Yes	Yes
SSH	Yes	Yes	Yes	Yes	Yes
Serial Redirection	Yes	Yes	Yes	Yes	Yes
WSMan	Yes	Yes	Yes	Yes	Yes
Network Time Protocol	No	Yes	Yes	Yes	Yes
Connectivity					
Shared NIC (LOM)	Yes	Yes	N/A	Yes	Yes
Dedicated NIC	Yes	Yes	Yes	Yes	Yes
VLAN tagging	Yes	Yes	Yes	Yes	Yes
IPv4	Yes	Yes	Yes	Yes	Yes
IPv6	Yes	Yes	Yes	Yes	Yes
DHCP	Yes	Yes	Yes	Yes	Yes
DHCP with zero touch	No	No	No	Yes	Yes
Dynamic DNS	Yes	Yes	Yes	Yes	Yes
OS pass-through	Yes	Yes	Yes	Yes	Yes
iDRAC Direct -Front panel USB	Yes	Yes	Yes	Yes	Yes
Connection View	Yes	Yes	No	Yes	Yes

Table 25. iDRAC feature comparison (continued)

Feature	iDRAC9 Basic	iDRAC9 Express	iDRAC9 Express for Blades	iDRAC9 Enterprise	iDRAC9 Datacenter
Connection View - LLDP transmit	No	No	No	No	Yes
Security					
Role-based authority	Yes	Yes	Yes	Yes	Yes
Local users	Yes	Yes	Yes	Yes	Yes
SSL encryption	Yes	Yes	Yes	Yes	Yes
Secure Enterprise Key Manager	No	No	No	Yes (with SEKM license)	Yes (with SEKM license)
IP blocking	No	Yes	Yes	Yes	Yes
Directory services (AD, LDAP)	No	No	No	Yes	Yes
Two-factor authentication (smart card)	No	No	No	Yes	Yes
Single sign-On	No	No	No	Yes	Yes
PK authentication (for SSH)	No	Yes	Yes	Yes	Yes
FIPS 140-2	Yes	Yes	Yes	Yes	Yes
Secure UEFI boot - certificate management	Yes	Yes	Yes	Yes	Yes
Lock down mode	No	No	No	Yes	Yes
Unique iDRAC default password	Yes	Yes	Yes	Yes	Yes
Customizable Security Policy Banner - login page	Yes	Yes	Yes	Yes	Yes
Easy Multi Factor Authentication	No	No	No	No	Yes
Auto Certificate Enrollment (SSL Certs)	No	No	No	No	Yes
iDRAC Quick Sync 2 - optional auth for read operations	Yes	Yes	Yes	Yes	Yes
iDRAC Quick Sync 2 - add mobile device number to LCL	Yes	Yes	Yes	Yes	Yes
System Erase of internal storage devices	Yes	Yes	Yes	Yes	Yes
Remote Presence					
Power control	Yes	Yes	Yes	Yes	Yes

Table 25. iDRAC feature comparison (continued)

Feature	iDRAC9 Basic	iDRAC9 Express	iDRAC9 Express for Blades	iDRAC9 Enterprise	iDRAC9 Datacenter
Boot control	Yes	Yes	Yes	Yes	Yes
Serial-over-LAN	Yes	Yes	Yes	Yes	Yes
Virtual Media	No	No	Yes	Yes	Yes
Virtual Folders	No	No	No	Yes	Yes
Remote File Share	No	No	No	Yes	Yes
HTML5 access to Virtual Console	No	No	Yes	Yes	Yes
Virtual Console	No	No	Yes	Yes	Yes
VNC connection to OS	No	No	No	Yes	Yes
Quality/bandwidth control	No	No	No	Yes	Yes
Virtual Console collaboration (up to six simultaneous users)	No	No	No (One user only)	Yes	Yes
Virtual Console chat	No	No	No	Yes	Yes
Virtual Flash partitions	No	No	No	Yes	Yes
NOTE: vFlash is not available in iDRAC9 for PowerEdge Rx5xx/Cx5xx.					
Group Manager	No	No	No	Yes	Yes
HTTP / HTTPS support along with NFS/CIFS	Yes	Yes	Yes	Yes	Yes
Power and Thermal					
Real-time power meter	Yes	Yes	Yes	Yes	Yes
Power thresholds and alerts	No	Yes	Yes	Yes	Yes
Real-time power graphing	No	Yes	Yes	Yes	Yes
Historical power counters	No	Yes	Yes	Yes	Yes
Power capping	No	No	No	Yes	Yes
Power Center integration	No	No	No	Yes	Yes
Temperature monitoring	Yes	Yes	Yes	Yes	Yes
Temperature graphing	No	Yes	Yes	Yes	Yes
PCIe airflow customization (LFM)	No	No	No	No	Yes

Table 25. iDRAC feature comparison (continued)

Feature	iDRAC9 Basic	iDRAC9 Express	iDRAC9 Express for Blades	iDRAC9 Enterprise	iDRAC9 Datacenter
Custom Exhaust Control	No	No	No	No	Yes
Custom Delta-T control	No	No	No	No	Yes
System Airflow Consumption	No	No	No	No	Yes
Custom PCIe inlet temperature	No	No	No	No	Yes
Health Monitoring					
Full agent-free monitoring	Yes	Yes	Yes	Yes	Yes
Predictive failure monitoring	Yes	Yes	Yes	Yes	Yes
SNMPv1, v2, and v3 (traps and gets)	Yes	Yes	Yes	Yes	Yes
Email Alerting	No	Yes	Yes	Yes	Yes
Configurable thresholds	Yes	Yes	Yes	Yes	Yes
Fan monitoring	Yes	Yes	Yes	Yes	Yes
Power Supply monitoring	Yes	Yes	Yes	Yes	Yes
Memory monitoring	Yes	Yes	Yes	Yes	Yes
CPU monitoring	Yes	Yes	Yes	Yes	Yes
RAID monitoring	Yes	Yes	Yes	Yes	Yes
NIC monitoring	Yes	Yes	Yes	Yes	Yes
HD monitoring (enclosure)	Yes	Yes	Yes	Yes	Yes
Out of Band Performance Monitoring	No	No	No	Yes	Yes
Alerts for excessive SSD wear	Yes	Yes	Yes	Yes	Yes
Customizable settings for Exhaust Temperature	Yes	Yes	Yes	Yes	Yes
Serial Console Logs	No	No	No	No	Yes
SMART logs for Storage Drives	No	No	No	No	Yes
Idle Server detection	No	No	No	No	Yes
Telemetry Streaming	No	No	No	No	Yes
Update					

Table 25. iDRAC feature comparison (continued)

Feature	iDRAC9 Basic	iDRAC9 Express	iDRAC9 Express for Blades	iDRAC9 Enterprise	iDRAC9 Datacenter
Remote agent-free update	Yes	Yes	Yes	Yes	Yes
Embedded update tools	Yes	Yes	Yes	Yes	Yes
Update from repository (Auto-Update)	No	No	No	Yes	Yes
Schedule update from repository	No	No	No	Yes	Yes
Improved PSU firmware updates	Yes	Yes	Yes	Yes	Yes
Deployment and Configuration					
Local configuration via F10	Yes	Yes	Yes	Yes	Yes
Embedded OS deployment tools	Yes	Yes	Yes	Yes	Yes
Embedded configuration tools	Yes	Yes	Yes	Yes	Yes
Auto-Discovery	No	Yes	Yes	Yes	Yes
Remote OS deployment	No	Yes	Yes	Yes	Yes
Embedded driver pack	Yes	Yes	Yes	Yes	Yes
Full configuration inventory	Yes	Yes	Yes	Yes	Yes
Inventory export	Yes	Yes	Yes	Yes	Yes
Remote configuration	Yes	Yes	Yes	Yes	Yes
Zero-touch configuration	No	No	No	Yes	Yes
System Retire/Repurpose	Yes	Yes	Yes	Yes	Yes
Server Configuration Profile in GUI	Yes	Yes	Yes	Yes	Yes
Add BIOS configuration to iDRAC GUI	Yes	Yes	Yes	Yes	Yes
Diagnostics, Service, and Logging					
Embedded diagnostic tools	Yes	Yes	Yes	Yes	Yes
Part Replacement	No	Yes	Yes	Yes	Yes
NOTE: After performing part replacement on RAID hardware, and the process is complete for replacing firmware and configuration, Lifecycle Logs reports double part replacement entries which is expected behavior.					

Table 25. iDRAC feature comparison (continued)

Feature	iDRAC9 Basic	iDRAC9 Express	iDRAC9 Express for Blades	iDRAC9 Enterprise	iDRAC9 Datacenter
Server Configuration Backup	No	No	No	Yes	Yes
Easy Restore (system configuration)	Yes	Yes	Yes	Yes	Yes
Server Configuration Restore	Yes	Yes	Yes	Yes	Yes
Easy Restore Auto Timeout	Yes	Yes	Yes	Yes	Yes
NOTE: Server Backup and Restore features are not available in iDRAC9 for PowerEdge Rx5xx/Cx5xx.					
LED Health status indicators	Yes	Yes	N/A	Yes	Yes
LCD screen (iDRAC9 requires optional)	Yes	Yes	N/A	Yes	Yes
Quick Sync (require NFC bezel, 13G only)	N/A	N/A	N/A	N/A	Yes
iDRAC Quick Sync 2 (BLE/Wi-Fi hardware)	Yes	Yes	Yes	Yes	Yes
iDRAC Direct (front USB management port)	Yes	Yes	Yes	Yes	Yes
iDRAC Service Module (iSM) embedded	Yes	Yes	Yes	Yes	Yes
iSM to in-band alert forwarding to consoles	Yes	Yes	Yes	Yes	Yes
SupportAssist Collection (embedded)	Yes	Yes	Yes	Yes	Yes
Crash screen capture	No	Yes	Yes	Yes	Yes
Crash video capture 1	No	No	No	Yes	Yes
Agent Free Crash Video Capture (Windows only)	No	No	No	No	Yes
Boot capture	No	No	No	Yes	Yes
Manual reset for iDRAC (LCD ID button)	Yes	Yes	Yes	Yes	Yes

Table 25. iDRAC feature comparison (continued)

Feature	iDRAC9 Basic	iDRAC9 Express	iDRAC9 Express for Blades	iDRAC9 Enterprise	iDRAC9 Datacenter
Remote reset for iDRAC (requires iSM)	Yes	Yes	Yes	Yes	Yes
Virtual NMI	Yes	Yes	Yes	Yes	Yes
OS watchdog	Yes	Yes	Yes	Yes	Yes
System Event Log	Yes	Yes	Yes	Yes	Yes
Lifecycle Log	Yes	Yes	Yes	Yes	Yes
Enhanced Logging in Lifecycle Controller Log	Yes	Yes	Yes	Yes	Yes
Work notes	Yes	Yes	Yes	Yes	Yes
Remote Syslog	No	No	No	Yes	Yes
License management	Yes	Yes	Yes	Yes	Yes
Improved Customer Experience					
iDRAC -Faster processor, more memory	N/A	Yes	N/A	Yes	Yes
GUI rendered in HTML5	N/A	Yes	N/A	Yes	Yes
Add BIOS configuration to iDRAC GUI	N/A	Yes	N/A	Yes	Yes
iDRAC support for SW RAID licensing	N/A	Yes	N/A	Yes	Yes

Server and Chassis Managers

- Integrated Dell Remote Access Controller (iDRAC)
- iDRAC Service Module (iSM)

Dell EMC consoles

- Dell EMC OpenManage Enterprise
- Dell EMC Repository Manager (DRM)
- Dell EMC OpenManage Enterprise Power Manager plugin to OpenManage Enterprise
- Dell EMC OpenManage Mobile (OMM)

Automation Enablers

- OpenManage Ansible Modules
- iDRAC RESTful APIs (Redfish)
- Standards-based APIs (Python, PowerShell)
- RACADM Command Line Interface (CLI)
- GitHub Scripting Libraries

Integration with third-party consoles

- Dell EMC OpenManage Integrations with Microsoft System Center
- Dell EMC OpenManage Integration for VMware vCenter (OMIVV)
- Dell EMC OpenManage Ansible Modules
- Dell EMC OpenManage Integration with ServiceNow

Connections for third-party consoles

- Micro Focus and other HPE tools
- OpenManage Connection for IBM Tivoli
- OpenManage Plug-in for Nagios Core and XI

Dell EMC Update Utilities

- Dell System Update (DSU)
- Dell EMC Repository Manager (DRM)
- Dell EMC Update Packages (DUP)
- Dell EMC Server Update Utility (SUU)
- Dell EMC Platform Specific Bootable ISO (PSBI)

Dell resources

For additional information about white papers, videos, blogs, forums, technical material, tools, usage examples, and other information, go to the OpenManage page at <https://www.dell.com/openmanagemanuals> or the following product pages:

Table 26. Dell resources

Resource	Location
Integrated Dell Remote Access Controller (iDRAC)	https://www.dell.com/idracmanuals
iDRAC Service Module (iSM)	https://www.dell.com/support/article/sln310557
OpenManage Ansible Modules	https://www.dell.com/support/article/sln310720
OpenManage Essentials (OME)	https://www.dell.com/support/article/sln310714
OpenManage Mobile (OMM)	https://www.dell.com/support/article/sln310980
OpenManage Integration for VMware vCenter (OMIVV)	https://www.dell.com/support/article/sln311238
OpenManage Integration for Microsoft System Center (OMIMSSC)	https://www.dell.com/support/article/sln312177
Dell EMC Repository Manager (DRM)	https://www.dell.com/support/article/sln312652
Dell EMC System Update (DSU)	https://www.dell.com/support/article/sln310654
Dell EMC Platform Specific Bootable ISO (PSBI)	Dell.com/support/article/sln296511
Dell EMC Chassis Management Controller (CMC)	www.dell.com/support/article/sln311283
OpenManage Connections for Partner Consoles	https://www.dell.com/support/article/sln312320
OpenManage Enterprise Power Manager	https://www.dellemc.com/solutions/openmanage/power-management.htm
OpenManage Integration with ServiceNow (OMISNOW)	Dell.com/support/article/sln317784

 **NOTE:** Features may vary by server. Please refer to the product page on <https://www.dell.com/manuals> for details.

Appendix A. Additional specifications

The following sections contain information about additional system specifications.

Topics:

- [PSU specifications](#)
- [System dimensions](#)
- [Chassis weight](#)
- [Environmental specifications](#)

PSU specifications

The PowerEdge R540 system supports the following AC or DC power supply units (PSU).

Table 27. PSU specifications

PSU	Class	Heat dissipation (maximum)	Frequency	Voltage
1100 W AC	Platinum	4100 BTU/hr	50/60 Hz	100–240 V AC, autoranging
1100 W DC	Platinum	4416 BTU/hr	50/60 Hz	200–380 V DC, autoranging
750 W AC	Platinum	2891 BTU/hr	50/60 Hz	100–240 V AC, autoranging
750 W AC (Mixed Mode)	Platinum	2891 BTU/hr	50/60 Hz	100–240 V AC, autoranging
750 W DC	Platinum	2902 BTU/hr	50/60 Hz	240 V DC
495 W AC	Platinum	1908 BTU/hr	50/60 Hz	100–240 V AC, autoranging

NOTE: Heat dissipation is calculated using the PSU wattage rating.

NOTE: This system is also designed to connect to the IT power systems with a phase-to-phase voltage not exceeding 230 V.

System dimensions

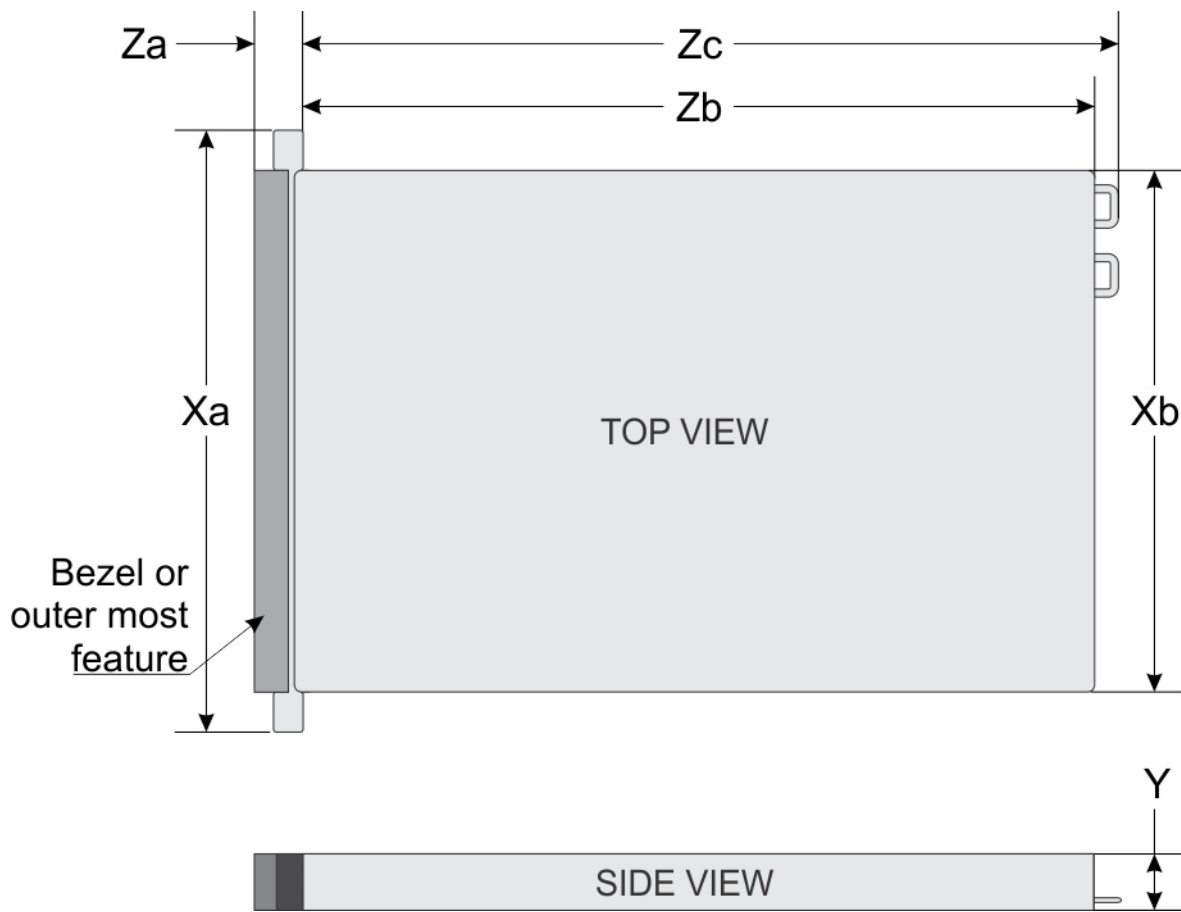

Figure 30. Dimensions of the PowerEdge R540 system

Table 28. Dimensions of the PowerEdge R540 system

Xa	Xb	Y	Za (with bezel)	Za (without bezel)	Zb	Zc
482.0 mm (18.97 inches)	434.0 mm (17.08 inches)	86.8 mm (3.41 inches)	35.84 mm (1.41 inches)	22 mm (0.87 inches)	647.07 mm (25.47 inches)	681.755 mm (26.84 inches)

Chassis weight

Table 29. Chassis weight

System	Maximum weight (with all drives/SSDs)
8 x 3.5 inch	25.4 kg (55.99 lb)
12 x 3.5 inch	29.68 kg (65.43 lb)

Environmental specifications

See Dell EMC PowerEdge R540 installation service manuals on Dell.com/Support for detailed environmental specifications.

Appendix B. Standards compliance

Table 30. Industry standard documents

Standard	URL for information and specifications
ACPI Advance Configuration and Power Interface Specification, v2.0c	acpi.info
Ethernet IEEE 802.3-2005	standards.ieee.org/getieee802/802.3.html
HDG Hardware Design Guide Version 3.0 for Microsoft Windows Server	microsoft.com/whdc/system/platform/pcdesign/desguide/serverdg.mspx
IPMI Intelligent Platform Management Interface, v2.0	intel.com/design/servers/ipmi
DDR4 Memory DDR4 SDRAM Specification	jedec.org/standards-documents/docs/jesd79-4.pdf
PCI Express PCI Express Base Specification Rev. 2.0 and 3.0	pcisig.com/specifications/pciexpress
PMBus Power System Management Protocol Specification, v1.2	pmbus.info/specs.html
SAS Serial Attached SCSI, v1.1	t10.org
SATA Serial ATA Rev. 2.6; SATA II, SATA 1.0a Extensions, Rev. 1.2	sata-io.org
SMBIOS System Management BIOS Reference Specification, v2.7	dmtf.org/standards/smbios
TPM Trusted Platform Module Specification, v1.2 and v2.0	trustedcomputinggroup.org
UEFI Unified Extensible Firmware Interface Specification, v2.1	uefi.org/specifications
USB Universal Serial Bus Specification, Rev. 2.0	usb.org/developers/docs

Appendix C Additional resources

Table 31. Additional resources

Resource	Description of contents	Location
PowerEdge R540 Installation Service Manuals	<p>This manual, available in PDF format, provides the following information:</p> <ul style="list-style-type: none"> • Chassis features • System Setup program • System messages • System codes and indicators • System BIOS • Remove and replace procedures • Troubleshooting • Diagnostics • Jumpers and connectors 	Dell.com/Support/Manuals
PowerEdge R540 Getting Started Guide	<p>This guide ships with the system, and is also available in PDF format. This guide provides the following information:</p> <ul style="list-style-type: none"> • Initial setup steps • Key system features • Technical specifications 	Dell.com/Support/Manuals
Rack Installation Instructions	This document ships with the rack kits, and provides instructions for installing a server in a rack.	Dell.com/Support/Manuals
Information Update	This document ships with the system, is also available in PDF format online, and provides information on system updates.	Dell.com/Support/Manuals
System Information Label	The system information label documents the system board layout and system jumper settings. Text is minimized due to space limitations and translation considerations. The label size is standardized across platforms.	Inside the system chassis cover
Quick Resource Locator (QRL)	This code on the chassis can be scanned by a phone application to access additional information and resources for the server, including videos, reference materials, service tag information, and Dell contact information.	Inside the system chassis cover
Energy Smart Solution Advisor (ESSA)	The Dell online ESSA enables easier and more meaningful estimates to help you determine the most efficient configuration possible. Use ESSA to calculate the power consumption of your hardware, power infrastructure, and storage.	Dell.com/calc

Appendix D. Support and deployment services

Topics:

- Dell EMC ProDeploy Enterprise Suite
- Deployment services
- Dell EMC Remote Consulting Services
- Dell EMC Data Migration Service
- ProSupport Enterprise Suite
- ProSupport Plus
- ProSupport
- ProSupport One for Data Center
- Support Technologies
- Additional professional services
- Dell Education Services
- Dell EMC Global Infrastructure Consulting Services
- Dell EMC Managed Services

Dell EMC ProDeploy Enterprise Suite

ProDeploy Enterprise Suite gets your server out of the box and into optimized production—fast. Our elite deployment engineers with broad and deep experience utilizing best-in-class processes along with our established global scale can help you around the clock and around the globe. From simple to the most complex server installations and software integration, we take the guess work and risk out of deploying your new server technology.

		Basic Deployment	ProDeploy	ProDeploy Plus
Pre-deployment	Single point of contact for project management		•	In-region
	Site readiness review		•	•
	Implementation planning		•	•
	Technology Service Manager (TSM) engagement for ProSupport Plus entitled devices			•
Deployment	Deployment service hours	Business hours	24x7	24x7
	Onsite hardware installation*	•	•	•
	Packaging materials disposal	•	•	•
	Install and configure system software		•	Onsite
Post-deployment	Project documentation with knowledge transfer		•	•
	Deployment verification		•	•
	Configuration data transfer to Dell EMC technical support		•	•
	30-days of post-deployment configuration assistance			•
	Training credits for Dell EMC Education Services			•

Figure 31. ProDeploy Enterprise Suite capabilities

NOTE: Hardware installation not applicable on selected software products.

Dell EMC ProDeploy Plus

From beginning to end, ProDeploy Plus provides the skill and scale needed to successfully execute demanding deployments in today's complex IT environments. Certified Dell EMC experts start with extensive environmental assessments and detailed migration planning and recommendations. Software installation includes set up of most versions of Dell EMC SupportAssist and

OpenManage system management utilities. Post-deployment configuration assistance, testing, and product orientation services are also available.

Dell EMC ProDeploy

ProDeploy provides full service installation and configuration of both server hardware and system software by certified deployment engineers including set up of leading operating systems and hypervisors as well as most versions of Dell EMC SupportAssist and OpenManage system management utilities. To prepare for the deployment, we conduct a site readiness review and implementation planning exercise. System testing, validation, and full project documentation with knowledge transfer complete the process.

Dell EMC Basic Deployment

Basic Deployment delivers worry-free professional installation by experienced technicians who know Dell EMC servers inside and out.

Dell EMC Residency Services

Residency Services helps customers transition to new capabilities quickly with the assistance of on-site or remote Dell EMC experts whose priorities and time you control. Residency experts can provide post implementation management and knowledge transfer related to a new technology acquisition or day-to-day operational management of the IT infrastructure.

Deployment services

Deployment services details and exceptions can be found in service description documents at the Enterprise Configuration and Deployment page on Dell.com.

Dell EMC Remote Consulting Services

When you are in the final stages of your PowerEdge server implementation, you can rely on Dell EMC Remote Consulting Services and our certified technical experts to help you optimize your configuration with best practices for your software, virtualization, server, storage, networking, and systems management.

Dell EMC Data Migration Service

Protect your business and data with our single point of contact to manage your data migration project. Your project manager will work with our experienced team of experts to create a plan using industry-leading tools and proven processes based on global best practices to migrate your existing files and data so your business system get up and running quickly and smoothly.

ProSupport Enterprise Suite

With Dell EMC ProSupport Services, we can help you keep your operation running smoothly, so you can focus on running your business. We will help you maintain peak performance and availability of your most essential workloads. Dell EMC ProSupport is a suite of support services that enable you to build the solution that is right for your organization. Choose support models based on how you use technology and where you want to allocate resources. From the desktop to the data center, address everyday IT challenges, such as unplanned downtime, mission-critical needs, data and asset protection, support planning, resource allocation, software application management and more. Optimize your IT resources by choosing the right support model.

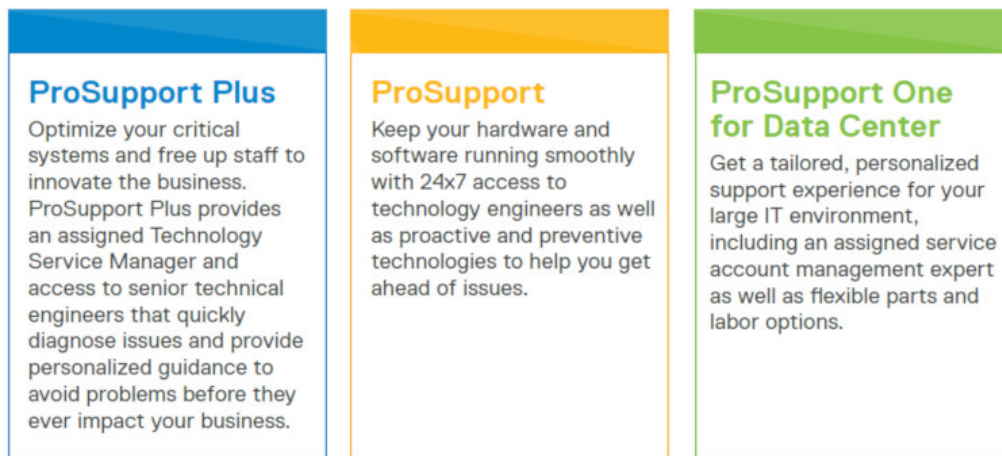

Figure 32. ProSupport Enterprise Suite

ProSupport Plus

When you purchase PowerEdge servers, we recommend ProSupport Plus, our proactive and preventative support, for business-critical systems. ProSupport Plus provides all the benefits of ProSupport, plus the following:

- An assigned Services Account Manager (SAM) who knows your business and your environment
- Access to senior ProSupport engineers for faster issue resolution
- Personalized, preventive recommendations based on analysis of support trends and best practices from across the Dell EMC customer base to reduce support issues and improve performance
- Predictive analysis for issue prevention and optimization enabled by SupportAssist
- Proactive monitoring, issue detection, notification and automated case creation for accelerated issue resolution enabled by SupportAssist
- On-demand reporting and analytics-based recommendations enabled by SupportAssist and TechDirect

ProSupport

Our ProSupport service offers highly trained experts around the clock and around the globe to address your IT needs. We will help you minimize disruptions and maximize availability of your PowerEdge server workloads with:

- 24x7x365 access to certified hardware and software experts
- Collaborative 3rd party support
- Hypervisor and OS support
- Consistent level of support available for Dell EMC hardware, software and solutions
- Onsite parts and labor response options including next business day or four-hour mission critical

ProSupport One for Data Center

ProSupport One for Data Center offers flexible site-wide support for large and distributed data centers with more than 1,000 assets. This offering is built on standard ProSupport components that leverage our global scale but are tailored to your company's needs. While not for everyone, it offers a truly unique solution for Dell EMC's largest customers with the most complex environments.

- Team of designated Technology Services Managers with remote, on-site options
- Designated ProSupport One technical and field engineers who are trained on your environment and configurations
- On-demand reporting and analytics-based recommendations enabled by SupportAssist and TechDirect
- Flexible on-site support and parts options that fit your operational model
- A tailored support plan and training for your operations staff

Enterprise Support Services Feature Comparison			
	ProSupport	ProSupport Plus	ProSupport One for Data Center
Remote technical support	24x7	24x7	24x7
Onsite support	Next business day or Mission Critical	Next business day or Mission Critical	Flexible
Automated issue detection and case creation	•	•	•
Self-service case initiation and management	•	•	•
Hypervisor, Operating Environment Software and OS support	•	•	•
Priority access to specialized support experts		•	•
Designated Technology Service Manager		•	•
Personalized assessments and recommendations		•	•
On-demand support and utilization reports		•	•
Systems Maintenance guidance		Semiannual	Optional
Designated technical and field support teams			•

Figure 33. ProSupport One for Data Center model

Support Technologies

Powering your support experience with predictive, data-driven technologies.

SupportAssist

The best time to solve a problem is before it happens. The automated proactive and predictive technology SupportAssist* helps reduce steps and time to resolution, often detecting issues before they become a crisis. Benefits include:

- Value - SupportAssist is available to all customers at no additional charge.
- Improve productivity - replace manual, high-effort routines with automated support.
- Accelerate time to resolution - receive issue alerts, automatic case creation and proactive contact from Dell EMC experts.
- Gain insight and control - optimize enterprise devices with on-demand ProSupport Plus reporting in TechDirect and get predictive issue detection before the problem starts.

SupportAssist is included with all support plans but features vary based on service level agreement.

	Basic Hardware Warranty	ProSupport	ProSupport Plus
Automated issue detection and system state information collection	•	•	•
Proactive, automated case creation and notification		•	•
Predictive issue detection for failure prevention			•
Recommendation reporting available on-demand in TechDirect			•

Figure 34. SupportAssist model

Get started at Dell.com/SupportAssist

TechDirect

Boost your IT teams productivity when supporting Dell EMC systems. With over 1.4 million self-dispatches processed each year, TechDirect has proven its effectiveness as a support tool. You can:

- Self-dispatch replacement parts
- Request technical support
- Integrate APIs into your help desk

Or, access all your Dell EMC certification and authorization needs. Train your staff on Dell EMC products as TechDirect allows you to:

- Download study guides
- Schedule certification and authorization exams

- View transcripts of completed courses and exams

Register at techdirect.dell.com

Additional professional services

Dell Education Services

Dell Education Services offers the PowerEdge server training courses designed to help you achieve more with your hardware investment. The curriculum is designed in conjunction with the server development team, as well as Dell EMC's technical support team, to ensure that the training delivers the information and practical, hands-on skills you and your team need to confidently manage and maintain your Dell EMC server solution. To learn more or register for a class today, visit LearnDell.com/Server.

Dell EMC Global Infrastructure Consulting Services

Dell EMC Global Infrastructure Consulting Services use skilled solution architects, innovative tools, automated analysis and Dell EMC's intellectual property to give rapid insight into the root causes of unnecessary complexity. We seek better answers than traditional service models, and our strategy is to help quickly identify high-impact, short-duration projects that deliver return on investment (ROI) and free up resources. The results are practical, action-oriented plans with specific, predictable, measurable outcomes. From data center optimization to server virtualization to systems management, our consulting services can help build a more efficient enterprise.

Dell EMC Managed Services

Dell EMC Managed Services are a modular set of lifecycle services designed to help you automate and centrally configure, deploy, and manage your day-to-day data center operations. These services extend your existing on-premise IT infrastructure with off-premise cloud services designed to better address challenges with mobility, highly distributed organizations, security, compliance, business continuity, and disaster preparedness.