

Dual-Stack Split for SAP Systems Based on SAP NetWeaver 7.0 to 7.03 on Windows





Content

1	Introduction	5
1.1	About This Document - Dual-Stack Split for SAP Systems Based on SAP NetWeaver 7.0 to 7.0 EHP3 on Windows	5
1.2	Use Cases of Dual-Stack Split	6
1.3	About Software Provisioning Manager	7
1.4	Naming Conventions	7
1.5	New Features	7
1.6	Constraints	8
1.7	SAP Notes for the Dual-Stack Split	9
1.8	Accessing the SAP Library	10
1.9	How to Use this Guide	10
2	Split Options Covered by this Guide	12
2.1	Split Options Covered by this Guide	12
2.2	Split Option: Move Java Database	12
2.3	Split Option: Keep Database	15
3	Planning	20
3.1	Planning Checklist	20
3.2	Domain or Local Installation	22
3.3	User Management	23
4	Preparation	24
4.1	Preparation Checklist	24
4.2	Necessary z/OS Group and User IDs	25
4.3	Performing Basic Windows Preparation Steps	27
4.4	Required User Authorization for Running the Installer	29
4.5	Using Virtual Host Names	31
4.6	Performing a Full System Backup	31
4.7	Preparing the Dual-Stack Split Media	32
	Downloading the Software Provisioning Manager Archive	33
	Using the Physical Media from the Installation Package	34
	Downloading Installation Media	35
5	Splitting the Dual-Stack System	37
5.1	Splitting Checklist	37
5.2	Prerequisites for Running the Installer	40
5.3	Running the Installer	40

5.4	Additional Information About the Installer.	42
	Useful Information About the Installer.	42
	Interrupted Processing of the Installer.	43
	Performing Remote Processing of the Installer.	44
	Starting the Installer GUI Separately.	46
	Running the Installer in Accessibility Mode.	48
	Troubleshooting with the Installer.	49
6	Follow-Up Activities.	51
6.1	Follow-Up Activities Checklist.	51
6.2	Maintaining the Connection to the System Landscape Directory.	53
6.3	Follow-Up Activities for the Enhanced Change and Transport System.	54
	Configuring Source Systems for Non-ABAP Transports.	55
	Configuring Target Systems for Non-ABAP Transports.	55
	Configuring the CTS Deploy Web Service.	56
	Configuring Transport Routes.	57
	Splitting Within a System Landscape.	57
6.4	Cleaning Up the System Landscape.	61
7	Additional Information.	63
7.1	Move Java Database: Restoring Instances.	63
7.2	Keep Database: Restoring Instances.	63
7.3	Removing the Java Stack.	64
7.4	Performing a Domain Installation Without Being a Domain Administrator.	65
7.5	Verifying and Adjusting the <code>instanceID</code> of an AS Java Instance.	69
A	Appendix.	72
A.1	Online Information from SAP.	72
A.2	Online Information from IBM.	73
A.3	Using PowerShell.	74

Document History

Note

Before you start the implementation, make sure you have the latest version of this document, which is available at <https://support.sap.com/sltoolset>  *System Provisioning* .

The following table provides an overview on the most important document changes:

Table 1:

Version	Date	Description
1.9	2016-10-07	Updated version for software provisioning manager 1.0 SP18 (SL Toolset 1.0 SP18)
1.8	2016-06-06	Updated version for software provisioning manager 1.0 SP17 (SL Toolset 1.0 SP17)
1.7	2016-02-15	Updated version for software provisioning manager 1.0 SP10 (SL Toolset 1.0 SP16)
1.6	2015-10-12	Updated version for software provisioning manager 1.0 SP09 (SL Toolset 1.0 SP15)
1.5	2015-09-14	Updated version for software provisioning manager 1.0 SP09 (SL Toolset 1.0 SP14)
1.4	2015-04-27	Updated version for software provisioning manager 1.0 SP08 (SL Toolset 1.0 SP13)
1.3	2014-11-24	Updated version for software provisioning manager 1.0 SP07 (SL Toolset 1.0 SP12)
1.2	2014-07-07	Updated version for software provisioning manager 1.0 SP06 (SL Toolset 1.0 SP11)
1.1	2014-03-17	Updated version for software provisioning manager 1.0 SP05 (SL Toolset 1.0 SP10)
1.0	2013-10-28	Initial version

1 Introduction

1.1 About This Document - Dual-Stack Split for SAP Systems Based on SAP NetWeaver 7.0 to 7.0 EHP3 on Windows

This document explains how to use Software Provisioning Manager 1.0 SP18, which is part of SL Toolset 1.0 SP18, to split a dual-stack (ABAP+Java) system into one ABAP and one Java stack each with its own system ID. You can also use Software Provisioning Manager 1.0 (“the installer” for short) to remove the Java stack of your SAP dual stack-system.

The split procedure is valid for:

- Optional dual-stack SAP NetWeaver systems (such as SAP NetWeaver BW systems with SAP BE_x Web)
- Dual-stack SAP Business Suite systems based on SAP NetWeaver 7.0 and 7.0 including enhancement package 1 to 3.

For a detailed list of supported SAP system products and releases, see SAP Note [1797362](#). For information about supported operating system and database platforms, see the Product Availability Matrix at <http://support.sap.com/pam>.

Related Information

[Use Cases of Dual-Stack Split \[page 6\]](#)

[About Software Provisioning Manager \[page 7\]](#)

[Naming Conventions \[page 7\]](#)

[New Features \[page 7\]](#)

[Constraints \[page 8\]](#)

[SAP Notes for the Dual-Stack Split \[page 9\]](#)

[Accessing the SAP Library \[page 10\]](#)

[How to Use this Guide \[page 10\]](#)

1.2 Use Cases of Dual-Stack Split

Dual-Stack System

A dual-stack system is an SAP system that contains installations of both SAP NetWeaver Application Server for ABAP and SAP NetWeaver Application Server for Java. It has the following characteristics:

- Common SAP system ID (<SAPS ID>) for its ABAP and Java stacks
- Common startup framework
- Common database (with different schemes for ABAP and Java)

Dual-Stack Split

While splitting off the Java part of a dual-stack system into a separate system, the dual-stack system is reduced to an ABAP system. To do this, the tool runs a system copy and uses the Java system copy export to reinstall the Java system separately and with a new SAP system ID. The ABAP stack of the former dual-stack system is not affected by this procedure.

The separated systems can either use their own databases (Split Option: *Move Java Database*) or both use the existing database in the ABAP system (Split Option: *Keep Database*).

For more information, see:

- [Split Option: Move Java Database \[page 12\]](#)
- [Split Option: Keep Database \[page 15\]](#)
- SAP Note [1797362](#)

Use Case

- For information about the use cases for splitting a dual-stack system, see SAP Note [1655335](#).
- If you no longer need the Java stack of your SAP dual-stack system, you can remove it as described in [Removing the Java Stack \[page 64\]](#).
- The procedure described in this guide mainly applies to splitting a single SAP dual-stack system. For more information about splitting systems within a system landscape, see [Splitting Within a System Landscape \[page 57\]](#).

More Information

For more information about dual-stack split, see <http://scn.sap.com/docs/DOC-25162>.

1.3 About Software Provisioning Manager

Software Provisioning Manager 1.0 is the successor of the product- and release-specific delivery of provisioning tools, such as SAPinst. Before you run it, we recommend that you always download the latest version of Software Provisioning Manager 1.0. Software Provisioning Manager 1.0 is part of the Software Logistics Toolset 1.0 ("SL Toolset" for short). This way, you automatically get the latest fixes and supported processes. For more information about Software Provisioning Manager as well as products and releases supported by it, see SAP Note [1680045](#) and <http://scn.sap.com/docs/DOC-30236>. "SAPinst" has therefore been renamed to "Software Provisioning Manager 1.0" in this documentation. However, the term "SAPinst" is still used in:

- Texts and screen elements in the Software Provisioning Manager GUI
- Naming of executables, for example `sapinst.exe`

In the following, we generally refer to Software Provisioning Manager 1.0 as the "installer". We only use the term "Software Provisioning Manager 1.0" if this is required for technical reasons.

Related Information

[Preparing the Dual-Stack Split Media \[page 32\]](#)

1.4 Naming Conventions

- *SAP system* refers to *SAP NetWeaver system* or *SAP system based on SAP NetWeaver*.
- *Dual-stack system* refers to *SAP NetWeaver ABAP+Java system* or *SAP ABAP+Java system based on SAP NetWeaver*.
"ABAP+Java" means "dual stack", that is an SAP system that contains installations of both Application Server ABAP (AS ABAP) and Application Server Java (AS Java). A dual-stack system has the following characteristics: Common <SID> for all application servers and the database Common startup framework Common database (with different schemas for ABAP and Java)
- **Only valid for Microsoft Failover Clustering:** As of Windows Server 2008 the cluster feature is called *Failover Clustering*. For practical reasons we are continuing to use the previous terminology *Microsoft Cluster Service* and abbreviation *MSCS* in some sections of this guide and the corresponding installation documentation of your release.

1.5 New Features

The table below provides an overview of the new features in Software Provisioning Manager.

Make sure that you also read the release notes for your SAP product at <http://help.sap.com> >> <Product Area> > <Product> > <Release> > *What's New – Release Notes* >

Table 2:

Feature	Description	Availability
Adjust instanceID of an SAP Java System	<p>An inconsistency of the <code>instanceID</code> parameter is caused by using an unsupported procedure to create or maintain the system. When <code>instanceID</code> is not consistent, future running of software logstscs scenarios, such as system rename, upgrade, and so on might fail. The option <i>Adjust instanceID for a Java System</i> helps you to overcome this. It is available in Software Provisioning Manager as option ► Software Life-Cycle Options ► Additional Preparation Options ► Adjust instanceID for a Java System ▾.</p> <p>For more information, see Verifying and Adjusting the instanceID of an AS Java Instance [page 69].</p>	Software Provisioning Manager 1.0 SP10 (SL Toolset 1.0 SP16)
Diagnostics Agent	<p>The Diagnostics Agent is no longer installed automatically with the SAP system. The <i>Install Diagnostics Agent</i> check box on the <i>Install Diagnostics Agent</i> screen is no longer available.</p> <p>You now have to install the Diagnostics Agent always separately. We recommend that you install it prior to the installation of your SAP system(s).</p> <p>For more information, see the Diagnostics Agent Installation Strategy attached to SAP Note 1365123, to SAP Note 1833501, and to SAP Note 1858920 and the attached <i>Diagnostics Agent Setup Guide</i>.</p>	Software Provisioning Manager 1.0 SP10 (SL Toolset 1.0 SP16)
Support of Oracle 12 database	<p>You can now perform all Software Provisioning Manager 1.0 tasks (installation, system copy, system rename) for SAP systems with the Oracle 12 database.</p> <p>For more information, see http://support.sap.com/pam.</p>	Software Provisioning Manager 1.0 SP08 (SL Toolset 1.0 SP13)
Feedback Evaluation Form available in the Software Provisioning Manager:	<p>SAP SE's aim is to provide fast and efficient procedures. To evaluate the procedure you just carried out, we need information generated by the tool during process execution and your experience with the tool itself. A new evaluation form contains a simple questionnaire and XML data generated during the procedure.</p> <p>Port 4239 is used for displaying the feedback evaluation form. For more information, see the <i>Prerequisites</i> section in Running the System Rename Tool [page 40].</p>	Software Provisioning Manager 1.0 SP07 (SL Toolset 1.0 SP12)

1.6 Constraints

You need to consider some constraints before you start splitting your SAP dual-stack system.

- **⚠ Caution**

SAP is going to restrict maintenance for operating system versions that have been initially released with SAP kernel 7.2<x> but are no longer supported for SAP kernel 7.40 and higher. The following Software Provisioning Manager operating system versions are affected:

- WINDOWS SERVER ON IA32 32BIT
- WINDOWS ON IA64
- WINDOWS ON X86_64 64BIT: < 6.0 aka Windows 2008

With the release of Software Provisioning Manager 1.0 SPS 18, the 70SWPM*.SAR archive will stop working on the above listed outdated operating system versions.

Instead of using the 70SWPM*.SAR archive, you must use the RMOS70SWPM*.SAR archive for these outdated operating system versions.

Keep in mind that the RMOS70SWPM*.SAR archive will not receive improvements in the future. SAP maintenance for RMOS70SWPM*.SAR will be finally stopped by the end of 2017.

SAP recommends upgrading the operating system to a more recent version and using RMOS70SWPM*.SAR to export from existing SAP systems.

- The dual-stack split procedure does **not** support the splitting of the following:
 - SAP NetWeaver Process Integration systems
 - SAP Solution Manager systems
 - Heterogeneous systems
- The dual-stack split procedure does **not** implicate the following:
 - Prerequisites Checker
 - SAP host agent
 - Diagnostics agent
 - Dialog instances

You can ignore sections in the installation documentation that focus on these options.

- **i Note**

If these options are installed on your SAP dual-stack system and you want to use them on the Java system after the split, you need to install them again on the Java system using the installation media that you used to install your dual-stack system.



- The migration of the operating system or the database platform during the split is not supported.
- If your source or target database is SAP MaxDB, keep in mind that dual-stack split is only supported for SAP systems running on SAP MaxDB 7.8 or higher.

1.7 SAP Notes for the Dual-Stack Split

You **must** read the following SAP Notes **before** you start the dual-stack split. These SAP Notes contain the most recent information on the dual-stack split, as well as corrections to the dual-stack split documentation. Make sure that you have the most up-to-date version of each SAP Note, which you can find at <http://support.sap.com/notes>



Table 3: SAP Notes for the Dual-Stack Split

SAP Note Number	Title	Description
1680045 	Release Note for Software Provisioning Manager 1.0	Software provisioning manager 1.0 with installation, system copy, system re-name and dual-stack split for SAP NetWeaver-based systems
1797362 	Dual-Stack Split for Systems Based on SAP NetWeaver	Problems discovered after the publication of the dual-stack split guide
1655335 	Use Cases for Splitting Dual-Stack Systems	—

1.8 Accessing the SAP Library

The references to the **SAP NetWeaver Library** documentation in this guide always refer to the following on the SAP Help Portal:

- **SAP NetWeaver 7.0:**
<http://help.sap.com/nw70>
- **SAP NetWeaver 7.0 including Enhancement Package 1:**
<http://help.sap.com/nw701>
- **SAP NetWeaver 7.0 including Enhancement Package 2:**
<http://help.sap.com/nw702>
- **SAP NetWeaver 7.0 including Enhancement Package 3:**
<http://help.sap.com/nw703>

1.9 How to Use this Guide

This documentation comprises the description of the dual-stack split procedure and dual-stack-split-specific steps.

For general or installation-specific information, see the **Java** installation guide relevant for your database and operating system platform, which you can find at:

<https://help.sap.com/slttoolset> > *Area System Provisioning* > *Guide for Installation of Systems Based on SAP NetWeaver 7.0 / 7.0 EHPs* > *Installation Guides by Database* > <Database> > <OS Platform> > *Java* >

In the following, we refer to this documentation as “installation guide”.

Procedure

1. You decide on the split option that you want to use. The following split options are available for central, distributed, and high-availability systems:
 - “Move Java Database” (non-MCOD)
 - “Keep Database” (MCOD)

For more information, see [Split Options Covered by this Guide \[page 12\]](#).

2. You follow the list of steps at the beginning of each phase:
 - [Planning \[page 20\]](#)
 - [Preparation \[page 24\]](#)
 - [Splitting \[page 37\]](#)
 - [Follow-up Activities \[page 51\]](#)

2 Split Options Covered by this Guide

2.1 Split Options Covered by this Guide

This section shows the split options covered by this guide. You have to decide which option you want to use because the steps you have to perform vary according to the split option that you choose.

- [Move Java Database \[page 12\]](#)
- [Keep Database \[page 15\]](#)

2.2 Split Option: Move Java Database

The split option “Move Java Database” offers the possibility to split a dual-stack system into one ABAP system and one Java system each with its own database (non-MCOD).

Only valid for Microsoft Failover Clustering: If your system is a high-availability system with Microsoft Failover Clustering (previously known as MSCS), the split option “Move Java Database” offers the possibility to split a clustered dual-stack system into one ABAP cluster system and one Java cluster system each with its own database (non-MCOD).

If you want to install two Oracle databases on one host, read SAP Note [98252](#) before installing the second database instance.

Move Java Database for Central Systems

When you choose the “Move Java Database” option for a central system, the tool exports the Java stack of the dual-stack system and uses this export to reinstall all main instances on a single host. This equates to an installation of a central system.

These are the following instances:

- Central instance (CI)
- Central services instance for Java (SCS)
- Database instance (DB)

i Note

If required, you can install the central instance and the central services instance on the ABAP system host again.

Once the installation has finished and after the System Landscape Directory has been reconfigured, the tool removes all Java parts from the dual-stack system.

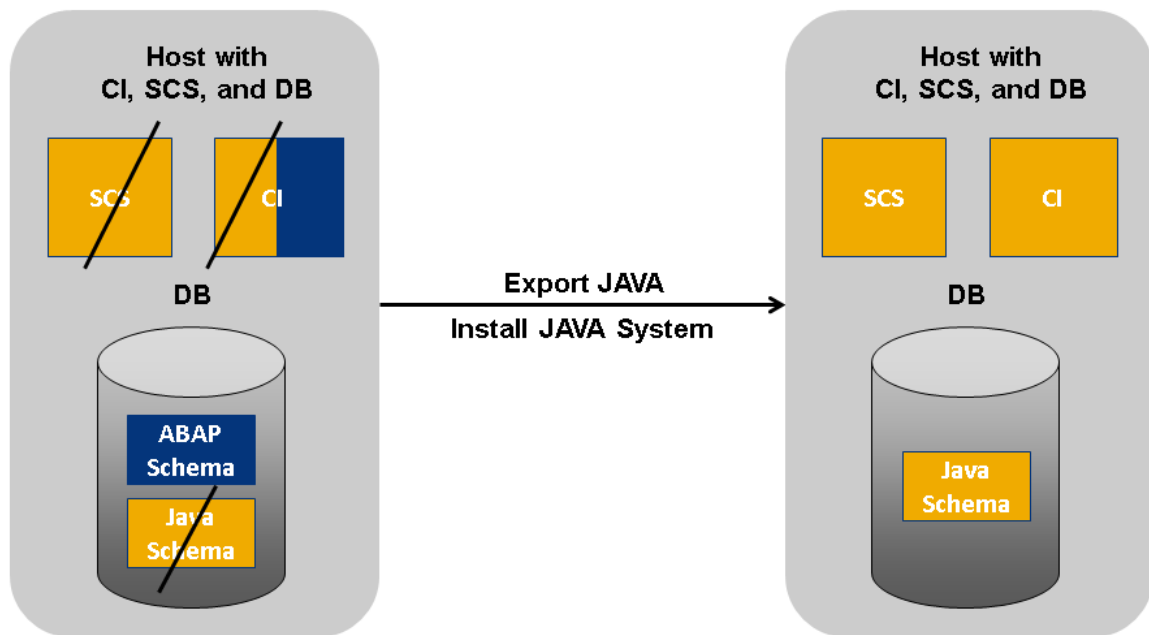

SCS = Java Central Services Instance
 CI = Central Instance
 DB = Database Instance

Figure 1: Split Option: Move Java Database for Central Systems

Move Java Database for Distributed System

When you choose the “Move Java Database” option for a distributed system, the tool exports the Java stack of the dual-stack system, and uses this export to reinstall the main instances on several hosts. Every instance can run on a separate host. This equates to an installation of a distributed system.

These are the following instances:

- Central instance (CI)
- Central services instance for Java (SCS)
- Database instance (DB)

i Note

If required, you can reinstall the central instance and the central services instance on the ABAP system hosts.

After the installation has finished and the System Landscape Directory has been reconfigured, the tool removes all Java parts from the dual-stack system.

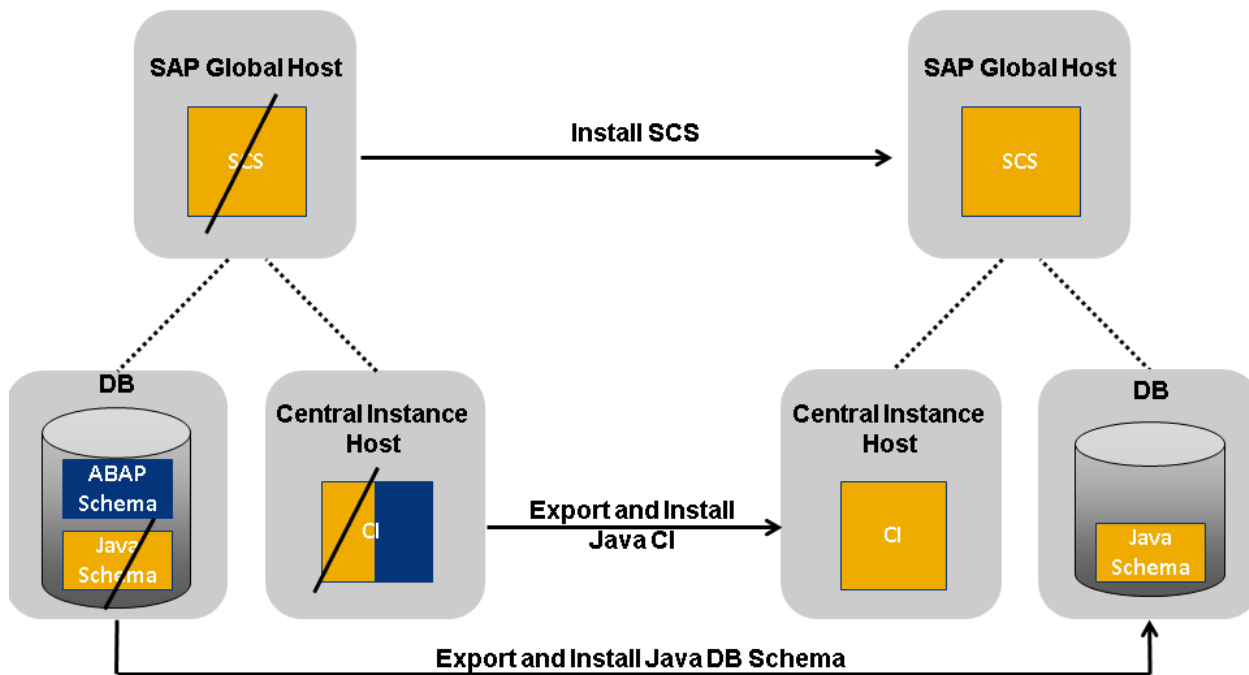

SCS = Java Central Services Instance
 CI = Central Instance
 DB = Database Instance

Figure 2: Split Option: Move Java Database for Distributed System

Move Java Database for High-Availability Systems

When you choose the “Move Java Database” option for a high-availability system, the tool exports the Java stack of the dual-stack cluster system, and uses this export to reinstall all mandatory instances on a separate cluster system for Java.

These are the mandatory instances:

- Central services instance for Java (SCS)
- Enqueue replication server instance (ERS instance) for the SCS instance
- Database instance (DB)
- Central instance
- Dialog instance

After the installation has finished and the System Landscape Directory has been reconfigured, the tool removes all Java parts from the dual-stack cluster system.

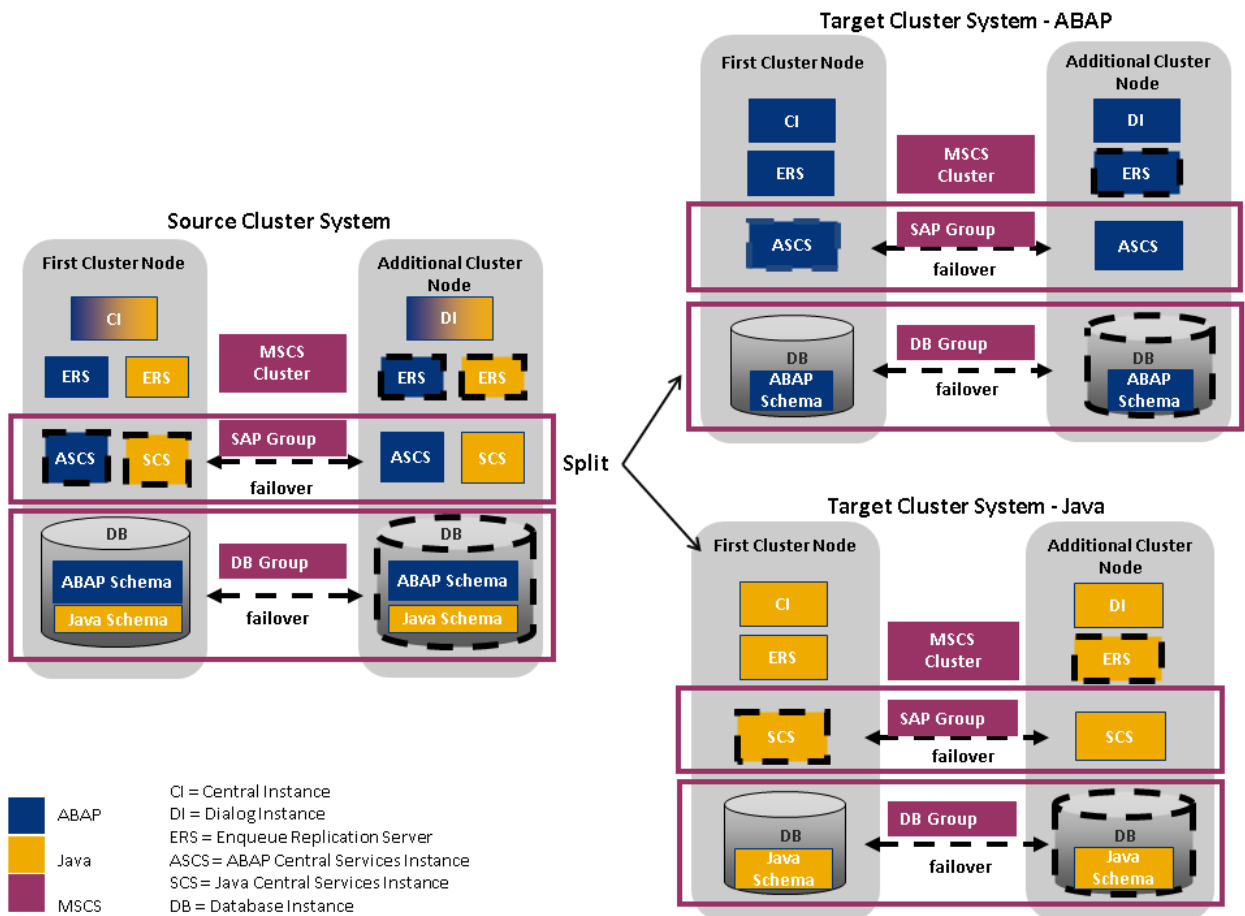

Figure 3: Split Option: Move Java Database for High-Availability System

2.3 Split Option: Keep Database

The split option “Keep Database” offers the possibility for the Java system to reuse the existing database of the dual-stack system using MCOD (multiple components – one database).

Only valid for Microsoft Failover Clustering: If your system is a high-availability system with Microsoft Failover Clustering (MSCS), the split option “Keep Database” offers the possibility to split a clustered dual-stack system into one ABAP cluster system and one Java cluster system both using the same database (MCOD).

Keep Database for Central and Distributed Systems

When you choose the “Keep Database” option, the tool exports the Java file system on the dual-stack system. It uses this export to reinstall a central services instance (SCS) and a central instance (CI) for Java. They can be installed on one host, on different hosts, or on the source system hosts again. Additionally, the tool adapts the Java schema of the database of the dual-stack system to the target Java system.

After the installation has finished and the System Landscape Directory has been reconfigured, the tool removes all Java parts from the dual-stack system except the Java database schema.

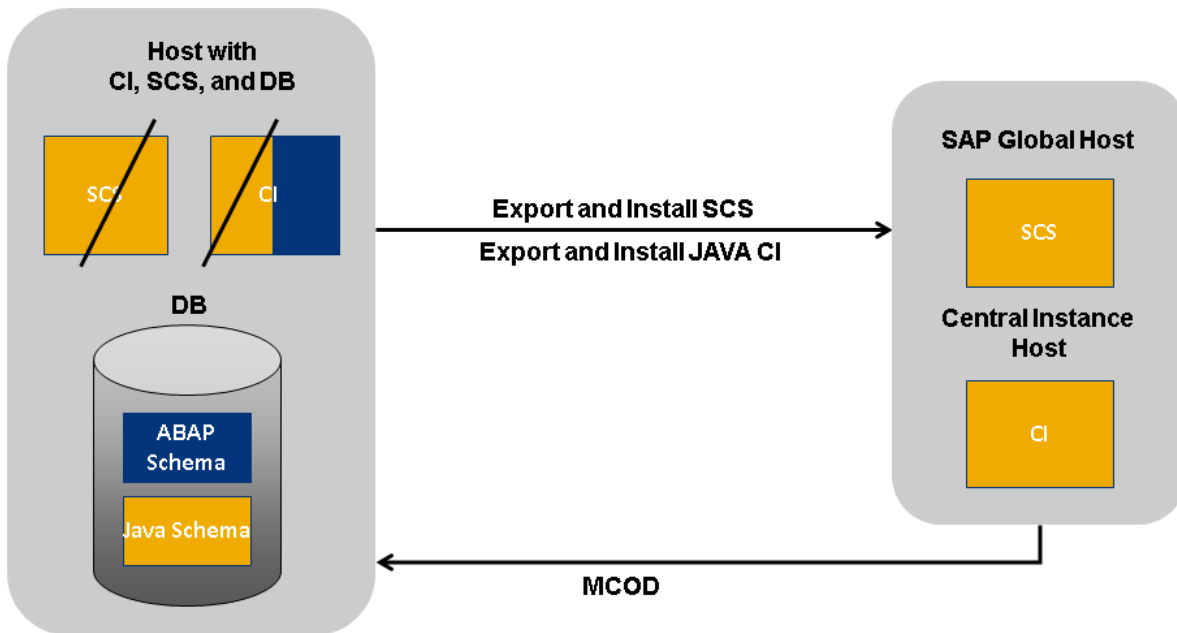

ABAP
 Java

SCS = Java Central Services Instance
 CI = Central Instance
 DB = Database Instance

Figure 4: Split Option: Keep Database for Central Systems

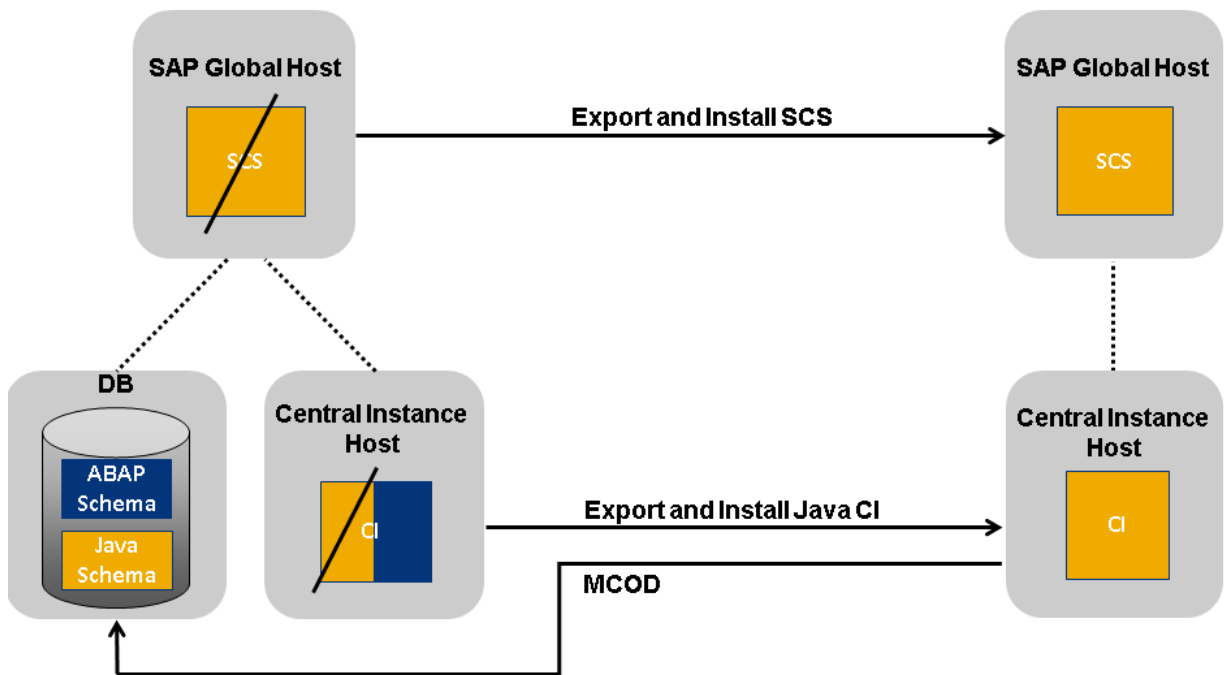

ABAP
 Java

SCS = Java Central Services Instance
 CI = Central Instance
 DB = Database Instance

Figure 5: Split Option: Keep Database for Distributed Systems

Keep Database for High-Availability Systems

When you choose the “Keep Database” option for a high-availability system, you can choose between the following scenarios:

- **Move SCS to New or Other Cluster**

The tool exports the Java stack of the dual-stack cluster system and uses this export to install a central services instance and a central instance on a separate cluster system for Java. Additionally, the tool adapts the Java schema of the database of the former dual-stack cluster system to the target Java cluster system.

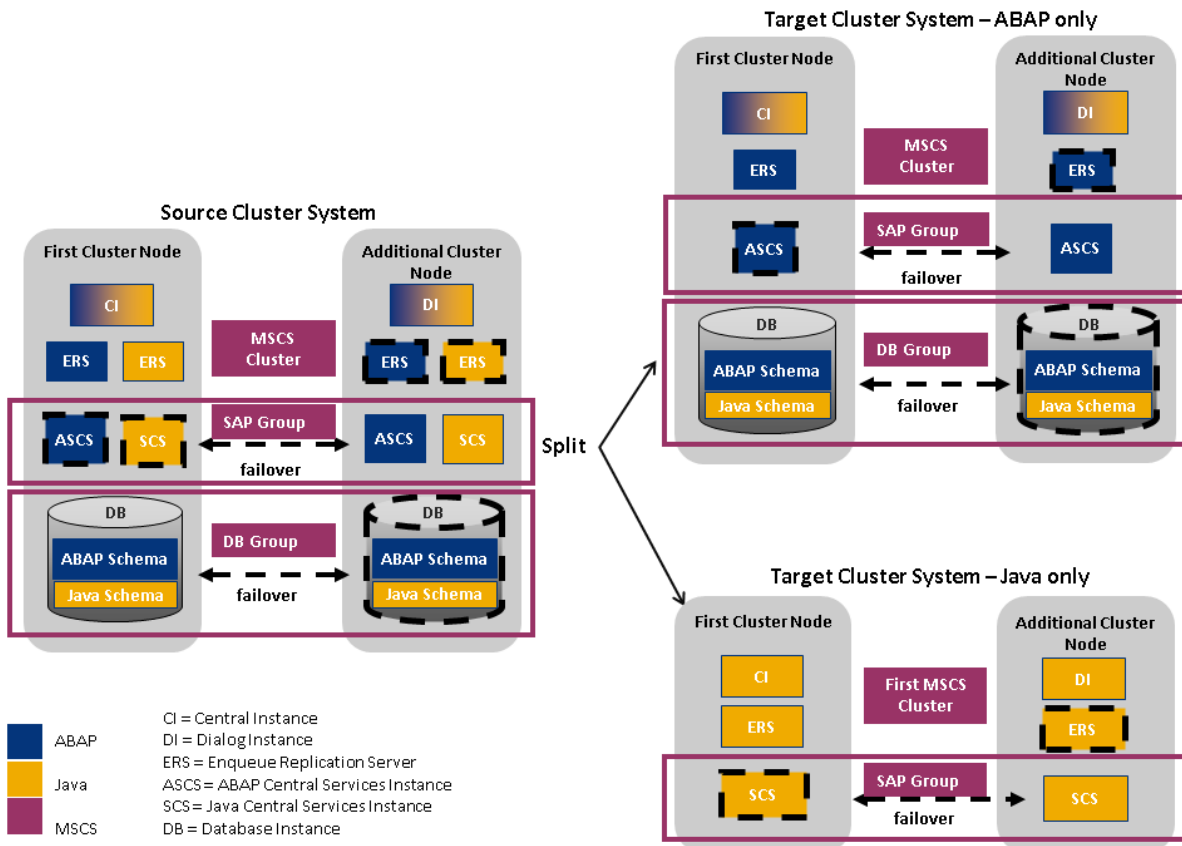

Figure 6: Split Option: Keep Database for High-Availability Systems – Move SCS to New or Other Cluster

- **Keep SCS on the Source Cluster System**

The tool exports the Java central services instance of the source cluster system and uses this export to install the SCS with a new system ID in a separate cluster on the target cluster system. Additionally, the tool adapts the Java schema of the database to the target Java SID.

i Note

This scenario is supported as of Windows Server 2008.

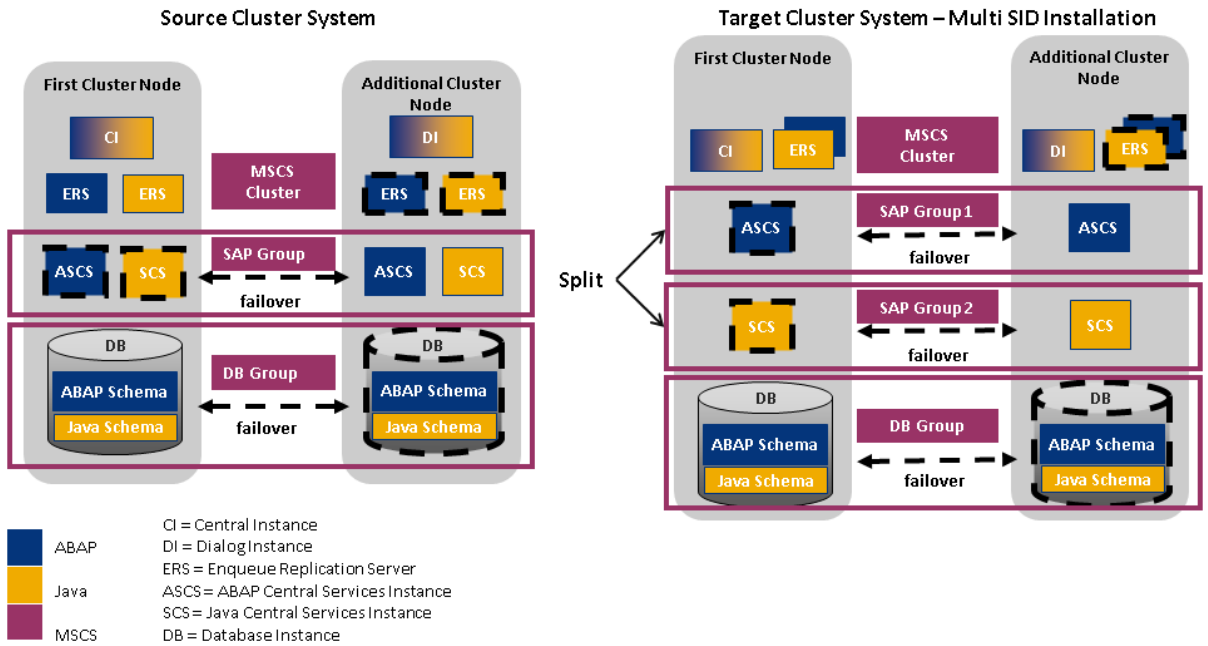

Figure 7: Split Option: Keep Database for High-Availability Systems – Keep SCS on the Source Cluster System

After the installation has finished and the System Landscape Directory has been reconfigured, the tool removes all Java parts from the dual-stack cluster system except the Java database schema.

3 Planning

3.1 Planning Checklist

This section includes the planning steps that you have to perform when you want to install the new Java system on one or more hosts.

➔ Recommendation

We recommend that you first perform the dual-stack split procedure in a test system to identify possible further application-specific post-split activities required for your scenario.

Perform the planning steps according to the split option and your system variant.

i Note

Most of the required planning steps listed in this section are not described in this documentation. You can find the detailed description in the **Java** installation guide relevant for your database and operating system platform, which you can find at:

<https://help.sap.com/slttoolset> > *Area System Provisioning* > *Guide for Installation of Systems Based on SAP NetWeaver 7.0 / 7.0 EHPs* > *Installation Guides by Database* > <Database> > <OS Platform> > *Java* >

In the following, we refer to this documentation as “installation guide”.

Prerequisites

You have decided on your [split option \[page 12\]](#).

Integration

1. You check the hardware and software requirements for the Java installation host.
For more information, see *Hardware and Software Requirements* in the installation guide.
2. You read about [user management \[page 23\]](#).
3. You identify basic SAP system installation parameters.
For more information, see *Basic SAP System Parameters* in the installation guide.
Be aware of the following dual-stack-split-specific deviations:
 - *SAP System Parameters*:
 - User management

- We do **not** recommend that you make modifications in the user management settings. For more information, see [User Management \[page 23\]](#).
- System Landscape Directory (SLD)
You can ignore SLD parameters.
 - **“Move Java Database”** and **Oracle** only: *SAP System Database Parameters*: Java database schema
We recommend that you choose a schema ID that is different from your SAP system ID.
It might cause problems when you copy a system if `<SCHEMA_ID>` is the same as `<SAPSID>`, and the database-specific method used for the copy does not allow you to rename the database schemes. In certain situations, you might create a system copy with a new `<SAPSID>`, but where the database schema has the old `<SAPSID>`. This is not a technical problem, but might be confusing to the system administrator.
4. You decide whether you want to perform a domain or local installation.
For more information, see [Domain or Local Installation \[page 22\]](#).
 5. Depending on your split option, proceed in one of the following ways:
 - **“Move Java Database”**
 - **SAP MaxDB:**
 - You plan your system configuration.
For more information, see *SAP MaxDB System Configuration* in the installation guide.
 - For the database installation, you decide how to distribute your system components to disk.
For more information, see *Distribution of SAP System Components to Disk* in the installation guide.
 - **Oracle** database: For the database installation, you decide how to distribute your database components to disk.
For more information, see *Distribution of SAP System Components to Disk* in the installation guide.
 - **IBM DB2 for Linux, UNIX, and Windows:** You plan the setup of your database carefully.
For more information, see *Setup of Database Layout* in the installation guide.
 - **MS SQL Server:** For the database installation, you decide how to distribute your database components to disk.
For more information, see *Distribution of SAP System Components to Disk* in the installation guide.
 - **IBM DB2 for z/OS:** You plan your system configuration.
For more information, see *System Configuration* in the installation guide.
 - **“Keep Database”**
 - **SAP MaxDB:** You plan your system configuration.
For more information, see *SAP MaxDB System Configuration* in the installation guide.
 - **IBM DB2 for z/OS:** You plan your system configuration.
For more information, see *System Configuration* in the installation guide.
 6. You decide on the transport host to use.
For more information, see *SAP System Transport Host* in the installation guide.
 7. You plan for adapting the transport routes within your system landscape. For more information, see [Splitting Within a System Landscape \[page 57\]](#).
 8. **Oracle** only: You decide if you want to use Multiple Oracle Homes.
For more information, see *Multiple Oracle Homes* in the installation guide.
 9. **IBM DB2 for z/OS** only: If you want to execute a *Software Life-Cycle Option* with the tool in an SAP system with **thick client** connectivity, see *Special Considerations Regarding Connectivity for Software Life-Cycle Options* in the installation guide.
 10. To install a high-availability system with **Microsoft Cluster Service (MSCS)**, you perform the MSCS-specific planning steps as described in the installation guide.

11. You can continue with [Preparation \[page 24\]](#).

3.2 Domain or Local Installation

Use

Before you install the SAP system, you have to decide whether you want to perform a **domain** or **local** installation, since this affects how the user account information is stored and accessed.

For more information about the differences between a local and domain installation, go to [▶ Start ▶ Help and Support ▶](#) and search for *What is the difference between a domain and a workgroup?*.

Domain Installation

In a domain installation, the user account information is stored centrally in one database on the domain controller and is accessible by all hosts in the system.

You have to perform a domain installation if one of the following applies:

- You install a system distributed over several hosts.
- You install a high-availability system with Microsoft Failover Clustering.
- You use a common transport host for several SAP systems running on different computers.

Local Installation

In a local installation, all Windows account information is stored locally on one host and is not visible to any other hosts in the system.

If the SAP system is to run on a **single** machine (central system), you can perform a local installation.

i Note

If your SAP system was installed as a local installation and you want to later change to a domain installation, you can use the system rename option. For more information, see the *System Rename Guide* for your SAP system at:

<http://support.sap.com/sitoolset> [▶](#) [Software Logistics Toolset 1.0](#) [▶](#) [Documentation](#) [▶](#) [System Provisioning](#) [▶](#)

More Information

[Required User Authorization for the Installation \[page 29\]](#)

3.3 User Management

The dual-stack split procedure does not change the user management and you cannot choose which kind of user management you want to use for the target AS Java system. That is, the separated Java system and the ABAP system both use the user management of the former dual-stack system. The following is possible:

- If the dual-stack system uses AS ABAP as data source for the User Management Engine (UME), after the split the separated Java stack will also use the ABAP UME.
- If the dual-stack system uses an LDAP directory as source for user data, this is also valid for the Java stack.

In both cases, manual configuration is not required.

We do **not** recommend that you make modifications to the user management settings.

For more information, see **SAP Note**[718383](#).

i Note

If the UME data source is configured to use an ABAP data source and the UME data source configuration file is not one of the supported files mentioned in **SAP Note**[718383](#), the tool does not work.

4 Preparation

4.1 Preparation Checklist

This section includes the preparation steps that you have to perform when you want to install the new Java system on one or more hosts.

i Note

Most of the required preparation steps listed in this section are not described in this documentation. You can find the detailed description in the **Java** installation guide relevant for your database and operating system platform, which you can find at:

<https://help.sap.com/slttoolset> ► *Area System Provisioning* ► *Guide for Installation of Systems Based on SAP NetWeaver 7.0 / 7.0 EHPs* ► *Installation Guides by Database* ► *<Database>* ► *<OS Platform>* ► *Java* ►

In the following, we refer to this documentation as "installation guide".

1. You disable the Windows Server firewall on each host.
For more information about disabling the Windows firewall, see the relevant section in the installation guide.
2. You perform basic preparations on Windows.
For more information, see [Performing Basic Windows Preparation Steps \[page 27\]](#).
3. Make sure that you use an account with the required user authorization to run the installer.
For more information, see [Required User Authorization for Running the Installer \[page 29\]](#).
4. If applicable, you set up virtual host names.
For more information, see [Using Virtual Host Names \[page 31\]](#).
5. **IBM DB2 for Linux, UNIX, and Windows** only: `JSizeCheck` requires monitoring functions that are no longer available with IBM DB2 for Linux, UNIX, and Windows version 10.5 by default. Before you start a Java export, you have to create these monitoring functions as follows:
 1. Log on as user `db2<dbsid>`.
 2. Execute the following command:

```
db2updvl05 -r -d <DBSID> -u db2<dbsid> -p <password>
```
6. If required, you prepare the SAP system transport host for your SAP system.
For more information, see *Preparing the SAP System Transport Host* in the installation guide.
7. If the Java stack is used as non-ABAP target system, we recommend that you clean up the import queue by importing all transport requests in the queue. If this is not possible, you must copy the import buffer after performing the dual-stack split. For more information, see [Configuring Target Systems for Non-ABAP Transports \[page 55\]](#).
8. Check whether SAP JVM 4 is installed in the source dual-stack system.
If SAP JVM 4 is not installed, download it from <https://support.sap.com/swdc> for the operating system of the central instance of the dual-stack system. The downloaded SAP JVM 4 is then prompted during the export. Follow the instructions of the installer.

9. If you want to use customized UME data source configuration file, see the [SAP Library \[page 10\]](#) for your release at:
 ▶ [Application Help](#) ▶ [Function-Oriented View <Language>](#) ▶ [Security](#) ▶ [Identity Management](#) ▶ [User Management of the Application Server Java](#) ▶ [Configuring User Management](#) ▶ [UME Data Sources](#) ▶ [LDAP Directory as Data Source](#) ▶ [Customizing a UME Data Source Configuration](#) ▶
10. You make sure that the required media are available on each host.
 You can download the Java stack and database installation media from SAP Service Marketplace as described in [Preparing the Dual Stack Split Media \[page 32\]](#).
11. **High-availability with Microsoft Cluster Service (MSCS):** To install a high-availability system with Microsoft Cluster Service (MSCS), you also perform the MSCS-specific preparation tasks as described in the installation guide.
12. **High-availability with Microsoft Cluster Service (MSCS):** If you choose the split option [Keep Database](#) with the scenario “Keep SCS on the Source Cluster System”, you perform the following steps:
 - You provide additional disk storage on the target cluster system.
 For more information, see *Distribution of SAP System Components to Disks for MSCS, Directories in an MSCS Configuration, and IP Addresses in an MSCS Configuration* in the installation guide.
 - You provide an additional IP address and an additional virtual host name for the Java system.
 For more information, see *Mapping Host Names to IP Addresses for MSCS* in the installation guide.
13. If you decided to use the split option [Keep Database](#), you [perform a full system backup \[page 31\]](#) of the dual-stack system.
14. You can continue with [Splitting the Dual-Stack System \[page 37\]](#).

4.2 Necessary z/OS Group and User IDs

The following are lists of the group and z/OS user IDs necessary for your SAP system on DB2 for z/OS. If these group or user IDs do not already exist in your system, you must create them. For more information, see <http://service.sap.com/instguidesnw> ▶ [SAP Security Guide for IBM DB2 for z/OS](#) ▶ [<Your SAP NetWeaver release>](#) ▶ [Operations](#) ▶ [Database-Specific Guides](#) ▶ [SAP Security Guide: DB2 for z/OS](#) ▶ [Security Settings for z/OS](#) ▶.

Users and Groups for z/OS

Table 4: Necessary z/OS Group and User IDs

Group/User ID	Description	Usage Type
DB Connect User ID for AS Java	Permanent user needed for the database connection. You are free to choose the name of this user. If you are installing both usage types, we advise you to choose different names for the user IDs for AS ABAP and AS Java.	AS Java

Group/User ID	Description	Usage Type
Group ID for Java Schema	Permanent group needed for the Java schema. This group ID must be the same as the name of the Java schema that you specify during installation. If you are installing both usage types, you must choose different names for the group IDs for ABAP schema and Java schema.	AS Java

Users and Groups for z/OS UNIX System Services

Before the installation, you must create each of the following groups and users in RACF for your SCS or ASCS instance on z/OS USS.

For each group and user listed in the following table, you must create an entry in the table `/etc/uaiastable`, to ensure that each group and user can be used in both upper and lowercase.

For more information, see <http://service.sap.com/instguidesnw> >> <Your SAP NetWeaver release> > [Operations](#) > [Database-Specific Guides](#) > [SAP Security Guide: DB2 for z/OS](#) > [Security Settings for z/OS](#) >

Table 5: Necessary z/OS UNIX System Services Group and User IDs

Group/User ID	Description	Usage Type
sapsys Group ID	Permanent group needed for the central services instance on z/OS.	AS ABAP AS Java
<sapsid>adm User ID	Permanent user needed for the central services instance on z/OS.	AS ABAP AS Java
User ID to install an SAP central services instance on z/OS	Temporary user needed for the SAP central services instance installation.	AS ABAP AS Java
sapinst Group ID	Permanent group needed for the central services instance on z/OS.	AS ABAP AS Java
sapadm User ID	Permanent user needed from the SAP Host Agent	SAP Host Agent
daaadm User ID	Permanent user needed from the SAP Diagnostic Agent	SAP Diagnostic Agent

Users and Groups for the Application Server on Windows

The following tables display the users and groups that are automatically created by installer on your application server for Windows during the installation:

Table 6: Groups and Members

Groups	Members
sapsys	<ul style="list-style-type: none">• <sapsid>adm• root
sapinst	<ul style="list-style-type: none">• <sapsid>adm• root

Table 7: Users and Their Groups

User	Primary Group	Secondary Groups
<sapsid>adm	sapsys	sapinst
root	sapsys	sapinst

Enhanced ASCII Setup on z/OS

To enable enhanced ASCII support, see the procedure in the *Security Guide for SAP on IBM DB2 for z/OS*, section [▶ Security Settings for z/OS](#), which you can find under

<http://service.sap.com/instguidesnw> > <Your SAP NetWeaver release> > Operations > Database-Specific Guides > SAP Security Guide: DB2 for z/OS > Security Settings for z/OS > z/OS Security > z/OS User IDs > User ID <sapsid>adm to Run the SAP Central Services Instance on z/OS

4.3 Performing Basic Windows Preparation Steps

Use

This section informs you about basic preparation steps that you have to perform before you install the SAP system, including the following:

- Checking the Windows file system
- Checking the Windows domain structure (domain installation only)
- Deciding whether you want to use organizational units (OUs) in the Windows domain (domain installation only)

Procedure

Checking the Windows File System

You need to check that you are using the Windows file system NTFS on hosts where you want to install the SAP system. NTFS supports full Windows security and long file names.

Note

Do **not** install the SAP system on a FAT partition or REFS partition.

Perform the check as follows:

- Windows Server 2012 (R2):
 1. Open PowerShell in elevated mode, and enter the following command:
`get-volume`
 2. Check that the value *FileSystem* is NTFS.
- Windows Server 2008 (R2):
 1. Open the Windows Explorer.
 2. Select the relevant disk.
 3. Choose **► Properties ► General ►**.
The system displays the type of file system in use.
 4. Check that the file system is NTFS.

Checking the Windows Domain Structure

Note

You do **not** need this step for a local installation.

For a domain installation, we recommend that you check that all SAP system hosts are members of a single Windows domain. We recommend this for all SAP system setups.

We assume that you are familiar with checking Windows domain structures. For more information, see the Windows documentation.

In Windows, you can implement either of the following domain models for the SAP system:

- Extra domain
In this model, the SAP system is embedded in its own domain, which is specially defined for SAP. A second domain exists for the user accounts.
In Windows, the SAP domain and user domain must be incorporated in a domain tree. In this tree, the user accounts must form the root domain and the SAP domain must be a child domain of this.
- Single domain
In this model, the SAP system, and the user accounts are included in a single domain.

Caution

You cannot create local users and groups on the host that is used as domain controller. Therefore, we do **not** support running an SAP instance (including the database instance) on the host where the domain controller is installed.

Deciding Whether to Use Organizational Units (OUs) in the Windows Domain

Note

You do **not** need this step for a local installation.

For a domain installation, the installer needs to create certain OS users for SAP and database operations in the Windows domain, also called the “Active Directory” (AD). These users are created by default in the AD container “Users”.

Depending on a customer's AD landscape and security policy, there are certain restrictions on where to store users and groups in AD. Contact the administrator of your AD infrastructure to understand where to store all SAP and database-related domain users and domain groups.

The SAP installer offers to define an existing OU in AD to create all needed SAP and database users in this OU.

There are many different scenarios and prerequisites concerning how to use OUs. For more information, see SAP Note [2247673](#), which explains these issues in detail and shows some examples of how to use them.

Caution

The installer does **not** create OUs. The installer does **not** move existing domain users or groups. The installer does **not** delete existing users, groups, OUs, nor any other object in a Windows domain.

The only exception to this rule is the Uninstall option in SWPM.

4.4 Required User Authorization for Running the Installer

Use

Although the installer automatically grants the required rights to the user account used for the installation, you have to check whether this account has the required authorization to perform the installation. The authorization required depends on whether you intend to perform a **domain** or **local** installation. If necessary, you have to ask the system administrator to grant the account the necessary authorization **before** you start the installation. If you attempt the installation with an account that has not the required authorization, the installation aborts.

This section informs you about the authorization required for a domain and a local installation.

Procedure

Caution

Do **not** use the user `<sapsid>adm` for the installation of the SAP system.

Domain Installation

For a domain installation the account used for the installation needs to be a member of the local `Administrators` and the domain `Admins` group of the domain involved. All machines in the system must belong to the same domain. In a domain installation, the user information is stored centrally on the domain controller and can be accessed by all hosts in the system.

If the SAP system is to be distributed across **more than one** machine, SAP strongly recommends you to perform a domain installation to avoid authorization problems.

Caution

- If you install a system distributed over several hosts as a local installation, this can lead to authorization problems for the operating system users `<sapsid>adm` and `SAPService<SAPSID>`. It can also lead to problems with the transport directory, which is usually shared by several SAP systems. SAP does **not** support distributed SAP systems running with a local user account..
- In a Microsoft failover cluster configuration, you always have to perform a **domain** installation.
- For performance and security reasons, SAP does not support an SAP system installation on a domain controller.
- If for any reason, the account used for the installation is not a member of the domain `Admins` group, you can perform the installation with a domain user who is a member of the local `Administrators` group. However, the domain administrator has to prepare the system appropriately for you. For more information, see [Performing a Domain Installation without being a Domain Administrator \[page 65\]](#).

For a domain installation, you need to:

1. Check that the account used for the installation is a member of the domain `Admins` group.
2. If required, obtain these rights by asking the system administrator to enter the account as a member of the domain `Admins` group.

Local Installation

For a local installation the account used for the installation needs to be a member of the local `Administrators` group of the machine involved. In a local installation, all Windows account information is stored locally on one host and is not visible to any other hosts in the system.

If the SAP system is to run on a **single** machine, you can perform a local installation.

Caution

Do not use the Windows built-in account `Administrator` or the renamed built-in account to install your SAP system with the installer. The built-in account only has restricted network access rights that are required by the installer. If you renamed the built-in account `Administrator`, do not create a new account named `Administrator`.

For a local installation, you need to:

1. Check that the account used for the installation is a member of the local `Administrators` group.
2. If required, obtain these rights by asking the system administrator to enter the account as a member of the local `Administrators` group.

4.5 Using Virtual Host Names

You can use one or more virtual TCP/IP host names for SAP servers within an SAP server landscape to hide their physical network identities from each other. This can be useful when quickly moving SAP servers or complete server landscapes to alternative hardware without having to reinstall or reconfigure.

Caution

- Only use virtual host names if this is explicitly stated in the parts of this installation guide specific to high availability. Otherwise, use the physical host name.
- Do not start the installer with the command line parameter `SAPINST_USE_HOSTNAME=<virtual hostname>` on failover cluster nodes.

Prerequisites

- Make sure that the virtual host name can be correctly resolved in your Domain Name System (DNS) setup.
- Make sure that you configured the Windows operating system properly to use virtual host names. For more information, see SAP Note [1564275](#).

Procedure

To install a **non-high-availability** system using virtual host names, proceed as described in SAP Note [1564275](#).

4.6 Performing a Full System Backup

If you decided to use the split option “Keep Database”, you **must** perform a full system backup of the dual-stack system, or at least a backup of the Java database schema before you start the split procedure.

Note

If your system is a high-availability system, make sure that you perform a backup of both cluster nodes of the dual-stack system.

If you decided to use the split option “Move Java Database”, you do not need to perform a backup before you start the split procedure.

For more information about backing up your database, see the database-specific backup and recovery documentation in the [SAP Library \[page 10\]](#) for your release and database at:

- **SAP NetWeaver 7.0:**
 - ▶ [System Administration and Maintenance Information](#) ▶ [Technical Operations for SAP NetWeaver](#) <Language> ▶ [General Administration Tasks](#) ▶ [Database Administration](#) ▶ <Your Database> ▶
- **SAP NetWeaver 7.0 including Enhancement Package 1:**
 - ▶ [System Administration and Maintenance Information](#) ▶ [Technical Operations for SAP NetWeaver](#) <Language> ▶ [General Administration Tasks](#) ▶ [Database Administration](#) ▶ <Your Database> ▶
- **SAP NetWeaver 7.0 including Enhancement Package 2:**
 - ▶ [Application Help](#) ▶ [Function-Oriented View](#) <Language> ▶ [Solution Life Cycle Management by Key Capability](#) ▶ [General Administration Tasks](#) ▶ [Database Administration](#) ▶ <Your Database> ▶
- **SAP NetWeaver 7.0 including Enhancement Package 3:**
 - ▶ [Application Help](#) ▶ [Function-Oriented View](#) <Language> ▶ [Database Administration](#) ▶ <Your Database> ▶

4.7 Preparing the Dual-Stack Split Media

This section describes how to prepare the media that is required for the dual-stack split, which are available as follows.

- The Software Provisioning Manager archive containing the installer.
You always have to download the latest version of the Software Provisioning Manager archive.
- The media containing the software to be installed, which are available as follows:
 - You normally obtain the physical installation media as part of the installation package. You can find them listed under *Using the Physical Installation Media from the Installation Package* below.
 - You can also download the complete installation media apart from the Software Provisioning Manager archive from SAP, as described in *Downloading Installation Media* below.

For more information about which kernel version to use, see [SAP Note 1680045](#). In addition, check the Product Availability Matrix at: <http://support.sap.com/pam>.

Related Information

[Downloading the Software Provisioning Manager Archive \[page 33\]](#)

[Using the Physical Media from the Installation Package \[page 34\]](#)

[Downloading Installation Media \[page 35\]](#)

4.7.1 Downloading the Software Provisioning Manager Archive

You always have to download and unpack the Software Provisioning Manager 1.0 archive (70SWPM10SP<Support_Package_Number>_<Version_Number>.SAR) from the software distribution center because you have to use the latest version.

Prerequisites

Make sure the latest version of the SAPCAR archiving tool is available on each installation host.

You require the SAPCAR archiving tool to be able to unpack software component archives (*.SAR files), which is the format of software lifecycle media and tools that you can download from the SAP software distribution center.

If required, you can download the latest version of SAPCAR from:

<http://support.sap.com/swdc> > Support Packages and Patches > Alphabetical list of products > S > SAPCAR

For more information about SAPCAR, see SAP Note [212876](#).

Procedure

1. Download the latest version of the Software Provisioning Manager 1.0 archive 70SWPM10SP<Support_Package_Number>_<Version_Number>.SAR from:

<http://support.sap.com/swdc> > Support Packages and Patches > Alphabetical list of products > S > SL Toolset > SL Toolset <Release> > Entry by Component > Software Provisioning Manager > Software Provisioning Manager 1.0 > Support Package Patches > <OS>

i Note

If you have an operating system version that has been initially released with SAP kernel 7.2<X> but is no longer supported for SAP kernel 7.40 and higher, instead of the 70SWPM*.SAR archive you must download the RMOS70SWPM*.SAR archive for these outdated operating system versions. For more information, see [Constraints \[page 8\]](#)

2. Unpack the Software Provisioning Manager archive to a local directory using the following command:

```
SAPCAR -xvf <Path>\<Download_Directory>\<Archive>.SAR -R <Path>\<Unpack_Directory>
```

3. Unpack the Software Provisioning Manager archive to a local directory using the following command:

```
SAPCAR -xvf <Path_To_Download_Directory>\<Archive>.SAR -R <Unpack_Directory>
```

i Note

Make sure that all users have read permissions for the directory where you want to unpack the installer.

Caution

Make sure that you unpack the Software Provisioning Manager archive to a dedicated folder. Do not unpack it to the same folder as other installation media.

4.7.2 Using the Physical Media from the Installation Package

This section describes how you use the physical installation media as part of the installation package.

Procedure

1. Identify the required media as listed below.

The following table lists the media required for the dual-stack split:

Table 9:

SAP Instance Installation	Required Media
Central services instance	<ul style="list-style-type: none">○ Software Provisioning Manager archive
Central instance	<ul style="list-style-type: none">○ Software Provisioning Manager archive○ Java media○ RDBMS Client DVD
Move Java Database only: Database instance	<ul style="list-style-type: none">○ Software Provisioning Manager archive○ Java media○ MS SQL Server, Oracle Database: RDBMS media○ MS SQL Server, Oracle Database: RDBMS patch media (if available)

2. Make the installation media available on each installation host as follows:
 - a. Download and unpack the latest version of Software Provisioning Manager as described in [Downloading the Software Provisioning Manager Archive \[page 33\]](#).
 - b. Make the installation media containing the software to be split available.

You can do this in one of the following ways:

- Copy the required media folders directly to the hosts.
- Mount media on a central media server that can be accessed from the hosts.

Caution

- If you copy the media to disk, make sure that the paths to the destination location of the copied media do not contain any blanks and commas.
- If you perform a domain installation and do not want to copy the media but use network drives for mapping the installation media, make sure that the `<sapsid>adm` user has access to the UNC paths of the network drives.

4.7.3 Downloading Installation Media













This section describes how you download installation media from the SAP Software Download Center.

Procedure

1. Download and unpack the latest version of Software Provisioning Manager as described in [Downloading the Software Provisioning Manager Archive \[page 33\]](#).
2. Create a download directory on the host on which you want to run the installer.
3. Identify **all** download objects that belong to one installation medium according to the following criteria:

Note

Installation media might be split into several files. In this case, you have to reassemble the required files after the download.

- Download path or location:
You can download installation media from the SAP Software Download Center using one of the following paths:
 - <http://support.sap.com/swdc>  [Software Downloads](#)  [Installations & Upgrades](#)  [By Alphabetical Index \(A-Z\)](#)  [<First_Letter_Of_Product>](#)  [<Product_Version>](#) 
 - <http://support.sap.com/swdc>  [Software Downloads](#)  [Installations & Upgrades](#)  [By Category](#)  [<Product>](#)  [<Product_Version>](#) 
 - For downloading the kernel media, proceed as described in the *Kernel Media* section of SAP Note [1680045](#) .
- Material number
All download objects that are part of an installation medium have the same material number and an individual sequence number:
`<Material_Number>_<Sequence_Number>`

Example

```
51031387_1  
51031387_2  
...
```

- Title
All objects that are part of a medium have the same title, such as `<Solution><Media_Name><OS>` or `<Database>RDBMS<OS>` for RDBMS media.
4. Download the objects to the download directory.
 5. To correctly recombine the media that are split into small parts, unpack all parts into the same directory.

In the unpacking directory, the system creates a subdirectory with a short text describing the medium and copies the data into it. The data is now all in the correct directory, the same as on the medium that was physically produced. For more information, see SAP Note [1258173](#) .

Caution

Make sure that you unpack each installation media to a separate folder. Do not unpack installation media to the same folder were you unpack the Software Provisioning Manager archive.

Related Information

[Downloading Installation Media \[page 35\]](#)

5 Splitting the Dual-Stack System

5.1 Splitting Checklist

This section includes the splitting steps that you have to perform for the following split options:

- “Move Java Database”
- “Keep Database”

Detailed information about the steps is available in the relevant section.

Note

Some of the required processing steps listed in this section are not described in this documentation. You can find the detailed description in the **Java** installation guide relevant for your database and operating system platform, which you can find at:

<https://help.sap.com/slttoolset> ► *Area System Provisioning* ► *Guide for Installation of Systems Based on SAP NetWeaver 7.0 / 7.0 EHPs* ► *Installation Guides by Database* ► *<Database>* ► *<OS Platform>* ► *Java* ►

In the following, we refer to this documentation as “installation guide”.

Move Java Database

Central System

1. **Oracle:** You install the Oracle database software.
For more information, see *Installing the Oracle Database Software* in the installation guide.
2. **Oracle:** If required, you set up multiple Oracle Homes.
For more information, see *Setting Up Multiple Homes* in the installation guide.
3. **MS SQL Server:** You install the MS SQL Server database software.
For more information, see *Installing the SQL Server Database Software* in the installation guide.
4. You [check the prerequisites \[page 40\]](#) and [export the Java stack using the installer \[page 40\]](#).

Caution

Make sure that you stop the Java stack of the source system before you start the export. This is not required if you perform the export for test purposes only, that is, you do not use the export in a productive system.

To stop the Java stack, use transaction `SMICM` on the ABAP stack.

You can decide whether you want the Java stacks of all instances to be activated or deactivated after the export. If you decide to deactivate them, you can restart them later as described in [Move Java Database: Restarting Instances \[page 63\]](#).

5. You restart the source system.
6. You [check the prerequisites \[page 40\]](#) and [run the installer \[page 40\]](#) to install a Java only system using the export from the dual-stack system.

Note

Make sure that you choose a system ID for the Java target system that is different from the dual-stack source system ID.

For a list of forbidden system IDs, see also the  help in the tool dialog.

7. You continue with [Follow-Up Activities \[page 51\]](#).

Distributed and High-Availability System

1. **Oracle:** On the database instance host of the Java system, you install the Oracle database software. For more information, see *Installing the Oracle Database Software* in the installation guide.
2. **Oracle:** If required, you set up multiple Oracle Homes on the database instance host. For more information, see *Setting Up Multiple Homes* in the installation guide.
3. On the database instance host of the dual-stack system, you [check the prerequisites \[page 40\]](#) and [run the installer \[page 40\]](#) to export the Java database schema.
4. On the central instance host of the dual-stack system, you [check the prerequisites \[page 40\]](#) and [run the installer \[page 40\]](#) to export the Java parts of the file system of the central instance.

Caution

Make sure that you stop the Java stack of the source system before you start the export. This is not required if you perform the export for test purposes only, that is, you do not use the export in a productive system.

To stop the Java stack, use transaction `SMICM` on the ABAP stack.

You can decide whether you want the Java stacks of all instances to be activated or deactivated after the export. If you decide to deactivate them, you can restart them later as described in [Move Java Database: Restarting Instances \[page 63\]](#).

5. You restart the source system.
6. You merge the export directories of the database instance and of the central instance.
7. You [check the prerequisites \[page 40\]](#) and [run the installer \[page 40\]](#) to install a central services instance for the Java target system.

Note

Make sure that you choose a system ID for the Java target system that is different from the dual-stack source system ID.

For a list of forbidden system IDs, see also the  help in the tool dialog.

8. You [check the prerequisites \[page 40\]](#) and [run the installer \[page 40\]](#) to install a database instance for the Java target system using the export from the dual-stack system.
9. You [check the prerequisites \[page 40\]](#) and [run the installer \[page 40\]](#) to install a central instance for the Java target system using the export from the dual-stack system.
10. You continue with [Follow-Up Activities \[page 51\]](#).

Keep Database

1. On the **central instance host** of the dual-stack system, you [check the prerequisites \[page 40\]](#) and [run the installer \[page 40\]](#) to export the file system of the central instance.

Caution

Make sure that you stop the Java stack of the source system before you start the export. This is not required if you perform the export for test purposes only, that is, you will not use the export in a productive system.

To stop the Java stack, use transaction `SMICM` on the ABAP stack.

You can decide whether you want the Java stacks of all instances to be activated or deactivated after the export. If you decide to deactivate them, you can restart them later as described in [Move Java Database: Restarting Instances \[page 63\]](#).

2. You restart the source system.
3. You [check the prerequisites \[page 40\]](#) and [run the installer \[page 40\]](#) to install a central services instance for the Java target system.

Note

Make sure that you choose a system ID for the Java target system that is different from the dual-stack source system ID.

For a list of forbidden system IDs, see also the [F1](#) help in the tool dialog.

4. **All databases except IBM DB2 for z/OS:** On the **database instance host** of the dual-stack system, you [check the prerequisites \[page 40\]](#) and [run the installer \[page 40\]](#) to adapt the database for the Java target system.

Note

Make sure that you enter the profile directory of the Java target system in the *SAP System > General Parameters* screen.

5. **IBM DB2 for z/OS only:** On the **central instance host** of the dual-stack system, you [check the prerequisites \[page 40\]](#) and [run the installer \[page 40\]](#) to adapt the database for the Java target system.

Note

Make sure that you enter the profile directory of the Java target system in the *SAP System > General Parameters* screen.

6. You [check the prerequisites \[page 40\]](#) and [run the installer \[page 40\]](#) to install a central instance for the Java target system using the export from the dual-stack system.
7. You continue with [Follow-Up Activities \[page 51\]](#).

5.2 Prerequisites for Running the Installer

Make sure you fulfil the following prerequisites before running the installer:

- Make sure that you use an account with the [required user authorization to run the installer \[page 29\]](#).
- Make sure that you have specified the most important SAP system parameters as described in the *Basic Installation Parameters* section of the installation guide for your operating system and database **before** you start the installer.
- Make sure that the following ports are not used by other processes:
 - Port 21212 is used by default for communication between the installer GUI server and the installer GUI client.
If this port cannot be used, you can assign a free port number by executing `sapinst.exe` with the following command line parameter:
`SAPINST_DIALOG_PORT=<Port_Number>`
 - Port 4239 is used by default for displaying the feedback evaluation form at the end of the installer processing.
The filled-out evaluation form is then sent to SAP using HTTPS.
If this port cannot be used, you can assign a free port number by executing `sapinst.exe` with the following command line parameter:
`SAPINST_HTTP_PORT=<Port_Number>`
- You need at least 300 MB of free space in the installer directory for each installer option. In addition, you need 60-200 MB free space for the installer executables.

5.3 Running the Installer

This section describes how to run the installer to perform the dual-stack split. The installer includes a GUI client and a GUI server, which both use Java.

The procedure describes a scenario where the installer, GUI client, and GUI server are run on the same host. In the following, GUI client and GUI server are addressed as “installer GUI”.

Prerequisites

For more information, see [Prerequisites for Running the Installer \[page 40\]](#).

Procedure

1. Make the installer available on the host. Make sure that it is available **locally**. We do **not** recommend that you use Network File System (NFS) because reading from media mounted with NFS might fail.
For more information, see [Preparing the Dual-Stack Split Media \[page 32\]](#).

2. Log on to the host using an account with the required user authorization to run the installer.
3. Start the installer by double-clicking `sapinst.exe` from the directory to which you unpacked the system rename media archive file.

The installer GUI starts automatically by displaying the *Welcome* screen.

The GUI starts automatically by displaying the *Welcome* screen.

i Note

If you need to run the installer in accessibility mode, open a command prompt, change to the `<Path_To_Unpack_Directory>` directory, and execute `sapinst.exe -accessible`.

For more information, see [Running the Installer in Accessibility Mode \[page 48\]](#).

4. In the *Welcome* screen, choose **Dual-Stack Split** `<Split_Option>`.
In addition, if you want to use the split option “Move Java Database”, choose `<Your_System_Variant>`.
Perform the export and processing steps exactly in the order in which they appear.
5. If the installer prompts you to log off from your system, log off and on again.
The installer restarts automatically.
6. Follow the instructions in the installer input screens and enter the required parameters.

i Note

- If the installer asks for the Java media, make sure that you provide a Java media with the same release level as your dual-stack system.
- For more information about the input parameters, position the cursor on the parameter and press **F1**.

i Note

- **IBM DB2 for Linux, UNIX, and Windows only:**
When you are asked for the security administrator, enter a user that has DB2 `SECADM` authorities. By default, `db2<DBSID_source>` has these authorities. If you perform the system rename in a domain, enter for the security administrator a user name specified with the related domain name: `<Domain>\<User>`, for example `Domain10\db2td1`.
- **SAP MaxDB on Windows only:**
In the *Storage Based Copy Configuration File for SAP MaxDB* screen, enter the path to the database-specific configuration file `sapdbConfig.txt`, which you stored locally on the host.
- **Oracle on Windows only:**
In the *ABAP Schema Name* screen, make sure that the name of the ABAP schema is correct.

i Note

For more information about the input parameters, position the cursor on the parameter and press **F1**.

After you have entered all requested input parameters, the installer displays the *Parameter Summary* screen. This screen shows both the parameters that you entered and those that the installer set by default. If required, you can revise the parameters before starting the dual-stack split procedure.

7. To start the dual-stack split, choose *Start*.
The installer starts and displays the progress of the dual-stack split procedure.
When the dual-stack split option has finished successfully, the installer displays the message *Execution of <Split_Option> has completed*.

8. We recommend that you delete the directory `%userprofile%\sdtgui\`.
9. If you copied installation media to your hard disk, you can delete these files when the installation has successfully completed.

5.4 Additional Information About the Installer

5.4.1 Useful Information About the Installer

This section contains some useful technical background information about the installer and the installer GUI.

- When you start the installer, it automatically starts the installer GUI.
- The installer creates the installation directory `sapinst_instdir`, which is located directly in the `%ProgramFiles%` directory. If the installer is not able to create `sapinst_instdir` there, it tries to create `sapinst_instdir` in the directory defined by the environment variable `TEMP`.

➔ Recommendation

We recommend that you keep all installation directories until the system is completely and correctly installed.

- For each installation option, the installer creates a subdirectory located in the `sapinst_instdir` directory.
- The installer extracts itself to a temporary directory called `sapinst_exe.xxxxxx.xxxx`, which is located in `%TEMP%`, `%TMP%`, `%TMPDIR%`, or `%SystemRoot%`. These files are deleted after the installer has stopped running. The temporary directory `sapinst_exe.xxxxxx.xxxx` sometimes remains undeleted. You can safely delete it. The temporary directory also contains the log file `dev_selfex.out` from the extraction process, which might be useful if an error occurs.

⚠ Caution

If the installer cannot find a temporary directory, the installation terminates with the error `FCO-00058`.

- To see a list of all available installer properties, open a command prompt and start the installer with command line parameter `-p`:
`sapinst.exe -p`
- If you need to run the installer in accessibility mode, make sure that you have activated and adjusted accessibility settings as described in [Running the Installer in Accessibility Mode \[page 48\]](#).
- If required, you can stop the installer by choosing **▶ SAPinst ▶ Exit Process ▶** in the installer GUI menu.

i Note

If you need to terminate the installer, choose **▶ File ▶ Close GUI only ▶** in the menu of the *Program Starter* window.

5.4.2 Interrupted Processing of the Installer

Use

The processing of the installer might be interrupted for one of the following reasons:

- An error occurred during the *Define Parameters* or *Execute* phase:
The installer does not abort the installation in error situations. If an error occurs, the installation pauses and a dialog box appears. The dialog box contains a short description of the choices listed in the table below as well as a path to a log file that contains detailed information about the error.
- You interrupted the installation by choosing *Exit Process* in the *SAPinst* menu.

Caution

If you stop an option in the *Execute* phase, any system or component **installed** by this option is incomplete and not ready to be used. Any system or component **uninstalled** by this option is not completely uninstalled.

The following table describes the options in the dialog box:

Table 10:

Option	Definition
<i>Retry</i>	<p>The installer retries the installation from the point of failure without repeating any of the previous steps.</p> <p>This is possible because the installer records the installation progress in the <code>keydb.xml</code> file.</p> <p>We recommend that you view the entries in the log files, try to solve the problem, and then choose <i>Retry</i>.</p> <p>If the same or a different error occurs, the installer displays the same dialog box again.</p>
<i>Stop</i>	<p>The installer stops the installation, closing the dialog box, the installer GUI, and the GUI server.</p> <p>The installer records the installation progress in the <code>keydb.xml</code> file. Therefore, you can continue the installation from the point of failure without repeating any of the previous steps (see the procedure below).</p>
<i>Continue</i>	<p>The installer continues the installation from the current point.</p>
<i>View Log</i>	<p>Access installation log files.</p>

Procedure

This procedure describes the steps to restart an installation, which you stopped by choosing *Stop*, or to continue an interrupted installation after an error.

1. Log on to the installation host as a user with the required permissions as described in [Running the Installer \[page 40\]](#).
2. Make sure that the installation media are still available on the installation host.

➔ Recommendation



Make the installation media **locally** available. For example, if you use remote file shares on other Windows hosts, CIFS shares on third-party SMB-servers, or Network File System (NFS), reading from media mounted with NFS might fail.

3. Restart the installer by double-clicking **sapinst.exe** from the directory to which you unpacked the Software Provisioning Manager archive.

i Note

4. From the tree structure on the *Welcome* screen, select the installation option that you want to continue and choose *Next*.
The *What do you want to do?* screen appears.
5. On the *What do you want to do?* screen, decide between the following alternatives and continue with *Next*:

Table 11:

Alternative	Behavior
<i>Run a new option</i>	<p>The installer does not continue the interrupted installation option. Instead, it moves the content of the old installation directory and all installation-specific files to a backup directory. Afterwards, you can no longer continue the old installation option.</p> <p>The following naming convention is used for the backup directory:</p> <pre>log_<Day>_<Month>_<Year>_<Hours>_<Minutes>_<Seconds></pre> <p> Example</p> <pre>log_01_Oct_2008_13_47_56</pre> <p> Caution</p> <p>The installer moves all the files and folders to a new log directory, even if these files and folders are owned by other users. If there are any processes currently running on these files and folders, they might no longer function properly.</p>
<i>Continue with the old option</i>	The installer continues the interrupted installation option from the point of failure.

5.4.3 Performing Remote Processing of the Installer

You use this procedure to process the installer on a **remote** host. In this case, the installer runs on the **remote host**, and the installer GUI runs on the **local** host. The local host is the host from which you control the installation with the installer GUI. The installer GUI connects using a secure SSL connection to the installer.

If your security policy requires that the person performing the installation by running the installer GUI on the local host is not allowed to know administrator credentials on the remote host, you can specify another operating system user for authentication purposes. You do this using the `SAPINST_REMOTE_ACCESS_USER` parameter when starting the `sapinst.exe` from the command line. You have to confirm that the user is a trusted one. For more information, see SAP Note [1745524](#).

Prerequisites

- The remote host meets the prerequisites for starting the installer as described in [Prerequisites for Running the Installer \[page 40\]](#).
- Both computers are in the same network and can ping each other.
To test this:
 1. Log on to your remote host and enter the command `ping <Local_Host>`.
 2. Log on to the local host and enter the command `ping <Remote_Host>`.
- Make sure that the `sapinst.exe` on the remote host and the `sapinstgui.exe` on the local host have exactly the same version. You can check this by using the option `-sfxver` as described in the procedure below and in the procedure in [Starting the Installer GUI Separately \[page 46\]](#).
- If you need to specify another operating system user with the `SAPINST_REMOTE_ACCESS_USER` command line parameter, make sure that this user exists on the remote host.

Procedure

1. Log on to your remote host as a user that has the [required authorization for running the installer \[page 29\]](#).
2. Make the installation media available on your remote host.
For more information, see [Preparing the Dual-Stack Split Media \[page 32\]](#).
3. Open a command prompt and change to the directory to which you unpacked the archive `SWPM10SP<Support_Package_Number>_<Version_Number>.SAR`.
4. Check the version of the `sapinst` executable by entering the following command:
`sapinst -sfxver`
The version of the `sapinst` executable must be exactly the same as the version of the `sapinstgui` executable on the local host (see also [Starting the Installer GUI Separately \[page 46\]](#)).
5. Execute **`sapinst.exe -nogui`**

i Note

If you need to specify another operating system user for authentication purposes, enter the following command:

```
sapinst.exe -nogui SAPINST_REMOTE_ACCESS_USER=<Specified_OS_User>
```

The installer now starts and waits for the connection to the installer GUI. You see the following in the *Program Starter* window:

```
guiengine: no GUI connected; waiting for a connection on host <Host_Name>, port  
<Port_Number> to continue with the installation
```

6. Start the installer GUI on your **local** host as described in [Starting the Installer GUI Separately \[page 46\]](#).

5.4.4 Starting the Installer GUI Separately

You use this procedure to start the installer GUI separately.

You need to start the installer GUI separately in the following cases:

- You closed the installer GUI using **File > Close GUI only** from the installer menu while the installer is still running.
- You want to perform a remote installation, where the installer GUI runs on a different host from the installer. For more information, see [Performing a Remote Installation \[page 44\]](#).

Prerequisites

- The host on which you want to start the installer GUI meets the prerequisites for starting the installer as described in [Prerequisites for Running the Installer \[page 40\]](#).

i Note

If you want to run the installer on a UNIX host, make sure that you meet the prerequisites for the installer listed in the relevant UNIX guide.

- Make sure that the `sapinst.exe` on the remote host and the `sapinstgui.exe` on the local host have exactly the same version. You can check this by using the option `-sfxver` as described in the procedure below and in the procedure in [Performing a Remote Installation \[page 44\]](#).

Procedure

In this procedure, the following variables are used: `<Remote_Host>` is the name of the remote host, and `<Port_Number_Gui_Server_To_Gui_Client>` is the port the GUI server uses to communicate with the GUI client (21212 by default).

i Note

If you want to run the installer GUI on a remote host, it is mandatory to start the installer using the `-nogui` property. If you have already started the installer without the `-nogui` property and want to run the GUI on a different host, you have to exit the installation process by choosing **SAPInst > Exit Process** and then follow the steps described in [Interrupted Installation \[page 43\]](#). Use the `-nogui` property to restart the installer and start the installer GUI on the intended host.

Starting the Installer GUI on Windows

1. Make the installer software available on the host on which you want to start the installer GUI.

- For more information, see [Preparing the Dual-Stack Split Media \[page 32\]](#).
2. Start the installer GUI by executing `<Drive>:\<Path_To_Unpack_Directory>\sapinstgui.exe` with the appropriate command line parameters:
 - If you want to perform a remote installation, proceed as follows:
 1. Check the version of `sapinstgui.exe` by entering the following command:

```
sapinstgui.exe -sfxver
```

 The version of the `sapinstgui` executable must be exactly the same as the version of the `sapinst` executable on the remote host (see also [Performing a Remote Installation \[page 44\]](#)).
 2. Start the installer GUI by entering the following command:

```
sapinstgui.exe -host <Remote_Host> -port  
<Port_Number_Gui_Server_To_Gui_Client>
```
 - If you closed the installer GUI using **File > Close GUI only** and want to reconnect to the installer, proceed as follows:
 - If you are performing a local installation with the installer and the installer GUI running on the same host, execute the following command:

```
sapinstgui.exe -port <Port_Number_Gui_Server_To_Gui_Client>
```
 - If you are performing a remote installation with the installer and the installer GUI running on different hosts, execute the following command:

```
sapinstgui.exe -host <Remote_Host> -port  
<Port_Number_Gui_Server_To_Gui_Client>
```
 3. The installer GUI starts and connects to the installer.

Starting the Installer GUI on UNIX

1. Make the installer software available on the host on which you want to start the installer GUI. For more information, see [Preparing the Dual-Stack Split Media \[page 32\]](#).
2. Start the `sapinstgui` executable with the appropriate command line parameters:
 - If you want to perform a remote installation, proceed as follows:
 1. Check the version of the `sapinstgui` executable by entering the following command:

```
<Path_To_Unpack_Directory>/sapinstgui -sfxver
```

 The version of the `sapinstgui` executable must be exactly the same as the version of the `sapinst` executable on the remote host (see also [Performing a Remote Installation \[page 44\]](#)).
 2. Start the installer GUI by entering the following command:

```
<Path_To_Unpack_Directory>/sapinstgui -host <Remote_Host> -port  
<Port_Number_Gui_Server_To_Gui_Client>
```
 - If you closed the installer GUI using **File > Close GUI only** and want to reconnect to the installer, proceed as follows:
 - If you are performing a local installation with the installer and the installer GUI running on the same host, execute the following command:

```
<Path_To_Unpack_Directory>/sapinstgui -port  
<Port_Number_Gui_Server_To_Gui_Client>
```
 - If you are performing a remote installation with the installer and the installer GUI running on different hosts, execute the following command:

```
<Path_To_Unpack_Directory>/sapinstgui -host <Remote_Host> -port  
<Port_Number_Gui_Server_To_Gui_Client>
```
3. The installer GUI starts and connects to the installer.

5.4.5 Running the Installer in Accessibility Mode

Use

You can also run the installer in accessibility mode. The following features are available:

- Keyboard access:
This feature is generally available for all operating systems.
- High-contrast color:
This feature is derived from the Windows display properties. You can use it either for a local installation or for a remote installation.
- Custom font setting:
This feature is derived from the Windows display properties. You can use it either for a local installation or for a remote installation.

Procedure

Activating and Adjusting Accessibility Settings on Windows

You first have to activate and adjust the relevant settings for the font size and color schemes **before** you start the installer or the installer GUI.

i Note

The following procedure applies for Windows Server 2012 and might be different when using another Windows operating system.

1. Right click on your Windows desktop and choose *Personalize*.
2. Select *Adjust font size (DPI)* and choose *Larger scale (120 DPI)*.
To define other font size schemes, choose *Custom DPI*.
3. In the right-hand pane, select *Window Color and Appearance*.
Select a color scheme from the *Color scheme* drop-down box.
To define your own color schemes, choose *Advanced*.

Running the Installer in Accessibility Mode

You can either perform a local installation, where the installer and the installer GUI are running on the same host, or a remote installation, where the installer and the installer GUI are running on different hosts.

- Local installation:
Start the software provisioning manager as described in [Running the System Rename Tool \[page 40\]](#) by executing the following command:
sapinst.exe -accessible
- Remote installation:
 1. Start the installer on the remote host by executing the following command from the command line as described in [Performing a Remote Installation \[page 44\]](#):
sapinst.exe -nogui

2. Start the installer GUI on the local host by executing the following command from the command line as described in [Starting the Installer GUI Separately \[page 46\]](#):

```
sapinstgui.exe -accessible -host <Remote_Host> -port  
<Port_Number_Gui_Server_To_Gui_Client>
```

5.4.6 Troubleshooting with the Installer

Use

This section tells you how to proceed when errors occur during the processing of the installer.

If an error occurs, the installer does one of the following:

- It stops the installer
- It displays a dialog informing you about the error

Procedure

1. Check SAP Note [1548438](#) for known installer issues.
2. To view the log file, choose [View Logs](#).
3. If an error occurs during the *Define Parameters* or *Execute* phase, do one of the following:
 - Try to solve the problem
 - Stop the installer by choosing *Stop* from the error message or **SAPinst** > *Exit Process* in the tool menu.

For more information, see [Interrupted Installation \[page 43\]](#).

After resolving the problem, you can continue the processing of the installer by choosing *Retry*.

4. Check the log and trace files of the GUI server and the installer GUI in the directory %userprofile%\sdtgui\ for errors.
 - If the installer GUI does not start, check the file sdtstart.err in the current %userprofile% directory.
 - If you experience network connection problems in a failover cluster, check IPv4 host name resolution as described in SAP Note [1365796](#).
5. Ignore error messages in the SDM logs that software components are not available. For more information, see SAP Note [828978](#).
6. If you cannot resolve the problem, create a customer message using component BC-INS. For more information about using subcomponents of BC-INS, see SAP Note [1669327](#).
7. When exporting a distributed system using local export directories, the created export directories need to be merged, that is copied together. Make sure that the SOURCE.PROPERTIES file is the one created when exporting the central instance (see also section **System Copy Procedure** > *Distributed System or High-Availability System* in the system copy guide). Otherwise the import aborts with the following error:

```
FJS-00003 TypeError: sourceProps.get ("src.ci.host") has no properties (in  
script NW_Java_OneHost ind ind ind ind, line 11804: ???) FCO-00011 the step  
InitPrivateContext with step Key |NW_Java_OneHost|ind|ind|ind|ind|0|  
NW_OneHost_System| ind|ind|ind|ind|1|0|NW_CI_Instance|ind|ind|ind|ind|11|0|
```

```
NW_CI_Instance_Configure_Java|ind|ind|ind|ind|3|0|NW_RUN_MIGRATION_CONTROLLER|
ind|ind|ind|ind|2|0|InitPrivateContext was executed with status ERROR
```

Solution: Copy the SOURCE.PROPERTIES file from the central instance export to the Java export medium or add the property src.id.host to the SOURCE.PROPERTIES file using the value created by the central instance export.





6 Follow-Up Activities

6.1 Follow-Up Activities Checklist

This section includes the follow-up activities that you have to perform for the split options “Move Java Database” and “Keep Database”.













Context

i Note

Some of the follow-up activities listed in this section are not described in this documentation. You can find the detailed description in the **Java** system copy guide relevant for your operating system platform at <http://service.sap.com/sltoolset>  <https://help.sap.com/sltoolset>  *Area System Provisioning*  *Guide for System Copy for Systems Based on SAP NetWeaver 7.0/7.0 EHPs*  *<OS Platform>* 

In the following, we refer to this documentation as “system copy guide”.

Procedure

1. On the Java target system, you change the Java VM parameters as described in SAP Note [1603093](#) , if necessary.
2. On the Java target system, you install the SAP license.
High-Availability System only: If your system is a high-availability system, you install a license on each cluster node of the Java target system.
For more information, see *Installing the License Key* in the system copy guide.
3. On the Java target system, you [maintain the connection to the system landscape directory \[page 53\]](#).
4. On the Java target system, you generate the public-key certificates.
For more information, see *Generating Public-Key Certificates* in the system copy guide.
5. **IBM DB2 for Linux and UNIX and Windows** only: On the Java target system, you enable the recoverability of the database.
For more information, see *Enabling Recoverability of the Database* in the system copy guide.
6. You must recreate the JCo destinations as described in the documentation *Creating JCo Destinations* in the [SAP Library \[page 10\]](#) at:  *Application Help*  *Function-Oriented View*  *Application Platform by Key Capability*  *Java Technology*  *Java Development Manual*  *Using Java*  *Core Development Tasks*  *Developing User Interfaces*  *Web Dynpro for Java*  *Ensuring Quality*  *Web Dynpro Content Administrator* .

See also SAP Note [899144](#).

7. You perform the required usage type and software unit-specific follow-up activities, such as configuring SAP Java Connector (SAP JCo) settings.

For more information, see the follow-up activities section in the system copy guide.

i Note

BI Java only:

As of SAP NetWeaver 7.0 Support Package 8, you can run the wizard-based configuration task *BI-Java / Technical configuration of BI-Java (repeatable, reproducible)* using the configuration wizard to automatically configure the BI Java usage type.

For more information, see the [SAP Library \[page 10\]](#) at: [► Configuration and Deployment Information](#) [► Technology Consultant's Guide <Language>](#) [► Enterprise Reporting, Query, and Analysis](#) [► Wizard-Based Configuration of BI Java](#) [►](#)

8. We recommend that you perform regression testing.
9. Depending on your system variant, proceed in one of the following ways:
 - Central system
On the source system, you [run the installer \[page 40\]](#) to remove the Java parts in the file system and in the database.
 - Distributed or High-Availability System
 1. On the **central instance host** of the source system, you [run the installer \[page 40\]](#) to remove the Java parts from the central instance.
 2. On the **dialog instance host** of the source system, you [run the installer \[page 40\]](#) to remove the Java parts from the dialog instance.
 3. On the **central services instance host** of the source system, you [run the installer \[page 40\]](#) to remove the central services instance.
 4. On the **enqueue replication server instance host** of the source system, you [run the installer \[page 40\]](#) to remove the enqueue replication server instance.
 5. “**Move Java Database**” only: On the **database host** of the source system, you [run the installer \[page 40\]](#) to remove the Java database schema.
10. On the **ABAP system**, you call transaction RZ10 to reimport the profiles from the file system.
11. If the ABAP system is part of a non-ABAP transport landscape, you perform [Follow-Up Activities for the Enhanced Change and Transport System \[page 54\]](#) .
12. If required and not already done so, you [configure the CTS Deploy Web Service \[page 56\]](#) on the ABAP system.
13. You [clean up the system landscape data \[page 61\]](#).
14. To remove obsolete SLD data, see the following document: <http://scn.sap.com/docs/DOC-8516> [►](#) [How-to Manage House-Cleaning in the System Landscape Directory - Duplicate System Entries](#) [►](#)

6.2 Maintaining the Connection to the System Landscape Directory

After installing the Java system, you need to reconfigure the connection between the System Landscape Directory (SLD), the source system, and the target system.

The steps required differ depending on whether you use a local or a central SLD. To maintain the connection to the SLD, you can either run the wizard-based configuration task `System Landscape Directory Setup After Dual-Stack Split` or perform the required steps manually as described below.

i Note

These steps are only required if the connection to the SLD was established on the source system before the split.

Prerequisites

- If you want to use the configuration wizard, you need an SAP NetWeaver AS for Java system 7.0 Support Package 14 or higher in your landscape.
- `SLDAPIUSER` credentials are available in the ABAP system.

Using the Configuration Wizard

1. To run the wizard-based configuration task `System Landscape Directory Setup After Dual-Stack Split` using the configuration wizard, proceed as described in the [SAP Library \[page 10\]](#) at:
 - SAP NetWeaver 7.0:
▶ [Technology Consultant's Guide](#) > [Configuration Wizard](#) ▶
 - SAP NetWeaver 7.0 including Enhancement Package <Number>:
▶ [Technology Consultant's Guide](#) > [Configuration Wizard](#) ▶
2. If the former dual-stack system was registered to SLD, the system data of the dual-stack system were not deleted by running the configuration wizard. So you have to manually delete these system data from the SLD. For more information, see the blog *Dual-Stack Split – How to Ensure Correct Technical System Data in SLD and LMDB after the Split* at: <http://scn.sap.com/community/it-management/blog/2013/11/29/dual-stack-split-how-to-ensure-correct-technical-system-data-in-sld-and-lmdb-after-the-split>

Performing Manual Steps

If you do not want to use the configuration wizard, you have to perform the following steps manually according to your requirements.

For more information about how to perform the individual tasks, see the relevant sections in the *System Landscape Directory – User Manual* and the *System Landscape Directory – Post-Installation Guide* relevant for your release level at: <http://scn.sap.com/docs/DOC-8042>.

- **Local SLD:**

1. Create users, groups, and roles.
For more information, see *Configuring SLD User Authorizations* in the post-installation guide.
2. Configure the SLD Server.
For more information, see *Configuring Server and Persistence Parameters* in the post-installation guide.
3. Configure the ABAP Gateway in the SLD.
For more information, see *Configuring the SLD Bridge*.
4. Maintain the connection between the ABAP system and the SLD.
 1. Configure the SLD Data Supplier Service.
For more information, see *Configuring the SLD Data Supplier: Default Settings* in the user manual.
 2. Maintain the RFC destination.
For more information, see *Creating an RFC Destination for the SLD ABAP API on the J2EE Side* in the user manual.
 3. Maintain the HTTP connection parameters on the ABAP system.
For more information, see *Creating an HTTP Destination for the SLD ABAP API on the ABAP Side* in the user manual.
5. Maintain the connection between the Java system and the SLD.
 1. Configure the SLD Data Supplier Service in the Visual Administrator.
For more information, see *Setting Up the SLD Data Supplier for J2EE-Based Systems* in the user manual.
 2. Generate a CIM client for accessing the SLD.
For more information, see *Configuring the Interface for CIM Client Generation* in the user manual.

- **Central SLD**

The following steps are described in the System Landscape Directory post-installation guide.

1. Create users, groups, and roles.
For more information, see *Configuring SLD User Authorizations* in the post-installation guide.
2. Maintain the connection between the Java system and the SLD.
 1. Configure the SLD Data Supplier Service in the Visual Administrator.
For more information, see *Setting Up the SLD Data Supplier for J2EE-Based Systems* in the user manual.
 2. Generate a CIM client for accessing the SLD.
For more information, see *Configuring the Interface for CIM Client Generation* in the user manual.

6.3 Follow-Up Activities for the Enhanced Change and Transport System

If you used the enhanced Change and Transport System as transport tool in your dual-stack system before the split, you need to reconfigure the transport routes within the landscape after installing the Java system.

The steps that you have to perform differ depending on the role of the split system within the transport landscape.

Also check the application-specific documentation for configuration details for CTS+ configuration. For SAP applications you can usually find this documentation at <http://scn.sap.com/docs/DOC-8576>.

6.3.1 Configuring Source Systems for Non-ABAP Transports

In the source system, you have to perform the following configuration steps for non-ABAP transports.

Procedure

1. On the domain controller, use transaction `STMS` to create a non-ABAP system with the `<SAPSID>` of the new Java system. We recommend that you continue using the ABAP system of the former dual stack as communication system. To classify it as a source system, select the *Activate Organizer* flag.

For more information, see the [SAP Library \[page 10\]](#) of your release at:

► [Application Help](#) ► [Function-Oriented View](#) ► [Solution Life Cycle Management by Key Capability](#) ► [Software Life Cycle Management](#) ► [Software Logistics](#) ► [Change and Transport System](#) ► [Change and Transport System - Overview \(BC-CTS\)](#) ► [Transporting Non-ABAP Objects in Change and Transport System](#) ► [Performing Configuration Steps for Non-ABAP Transports](#) ► [Defining and Configuring Non-ABAP Systems](#) ►

i Note

Keep in mind that ABAP and non-ABAP objects can no longer be part of the same transport request. There will be different transport requests for ABAP objects and for non-ABAP objects.

2. In the domain controller, delete the parameters for non-ABAP transports from the configuration of the ABAP stack of the original dual-stack system.

For more information about these parameters, see *Parameters for non-ABAP transports* in the [SAP Library \[page 10\]](#) of your release at:

► [Application Help](#) ► [Function-Oriented View](#) ► [Solution Life Cycle Management by Key Capability](#) ► [Software Life Cycle Management](#) ► [Software Logistics](#) ► [Change and Transport System](#) ► [Transport Management System \(BC-CTS-TMS\)](#) ► [Performing Configuration Steps for Non-ABAP Transports](#) ► [Defining and Configuring Non-ABAP Systems](#) ►

6.3.2 Configuring Target Systems for Non-ABAP Transports

In the target system, you have to perform the following configuration steps for non-ABAP transports.

Procedure

1. Use transaction `STMS` to create a non-ABAP system with the `<SAPSID>` of the new Java system. We recommend that you continue to use the ABAP system of the former dual-stack as communication system. To classify it as a target system, select the *Activate Deployment Service* flag and make the appropriate settings for the deployment method.

For information about individual applications, see the application-specific documentation for CTS+ configuration. For SAP applications which you can usually find at <https://scn.sap.com/docs/DOC-8576>.

For general information about how to create a non-ABAP target system, see the [SAP Library \[page 10\]](#) of your release at:

► [Application Help](#) ► [Function-Oriented View](#) ► [Solution Life Cycle Management by Key Capability](#) ► [Software Life Cycle Management](#) ► [Software Logistics](#) ► [Change and Transport System](#) ► [Change and Transport System - Overview \(BC-CTS\)](#) ► [Transporting Non-ABAP Objects in Change and Transport System](#) ► [Performing Configuration Steps for Non-ABAP Transports](#) ► [Defining and Configuring Non-ABAP Systems](#) ►

2. In the ABAP communication system, [configure the CTS Deploy Web Service \[page 56\]](#).
3. In the domain controller, delete the parameters for non-ABAP transports from the configuration of the ABAP stack of the original dual-stack system.

For more information on the parameters, see *Parameters for non-ABAP transports* in the [SAP Library \[page 10\]](#) of your release at:

► [Application Help](#) ► [Function-Oriented View](#) ► [Solution Life Cycle Management by Key Capability](#) ► [Software Life Cycle Management](#) ► [Software Logistics](#) ► [Change and Transport System](#) ► [Transport Management System \(BC-CTS-TMS\)](#) ► [Performing Configuration Steps for Non-ABAP Transports](#) ►

4. If you have not cleaned up the import queue as described in the [Preparation Checklist \[page 24\]](#), you must copy the import buffer of the ABAP system to the Java system. This ensures the processing of pending transport queues.

Proceed as follows:

Copy the buffer file to a file named `<SAPSID of new Java system>` and move it to the following directory:
`<Drive>:\usr\sap\trans\buffer`

6.3.3 Configuring the CTS Deploy Web Service

Context

After installing the Java system, you need to reconfigure the `CTS Deploy Web Service`.

This step is only required if you used the enhanced Change and Transport System as transport tool in your dual-stack system before the split and if the split system is used as a target system for “non-ABAP” transports.

For information about how to move the `CTS Deploy Web Service` host, see SAP Note [1823824](#).

Procedure

1. In your ABAP system in the client that you use for transports, call transaction `SM59`.
2. Check the `CTS Deploy Web Service` and adjust the host, port, and authentication details if required.

For more information, see the *Configuring the HTTP Connection* section in *Configuring the CTS Deploy Web Service* in the [SAP Library \[page 10\]](#) of your release at:

▶ [Application Help](#) ▶ [Function-Oriented View](#) ▶ [Solution Life Cycle Management](#) ▶ [Software Logistics](#) ▶ [Change and Transport System](#) ▶ [Transport Management System \(BC-CTS-TMS\)](#) ▶ [Performing Configuration Steps for Non-ABAP Transports](#) ▶.

Use the new Java system as host of the system where the `CTS Deploy Web Service` runs.

3. We recommend that you use the new [Connection Test](#) to make sure that the connection works properly.

6.3.4 Configuring Transport Routes

Context

In the TMS of the domain controller, create the transport routes.

Procedure

- For the source system, create the transport routes between the new Java source system and the next system in the transport track.
- For the target system, create the transport routes between the previous Java system in the transport track and the new Java system, and between the new Java system and the next system in the transport track.

Next Steps

For more information, see the [SAP Library \[page 10\]](#) of your release at:

▶ [Application Help](#) ▶ [Function-Oriented View <Language>](#) ▶ [Solution Life Cycle Management by Key Capability](#) ▶ [Software Life Cycle Management](#) ▶ [Software Logistics](#) ▶ [Change and Transport System](#) ▶ [Transport Management System \(BC-CTS-TMS\)](#) ▶ [Configuring TMS](#) ▶ [Configuring the Transport Routes](#) ▶.

6.3.5 Splitting Within a System Landscape

Since an SAP system is usually part of a system landscape, dependencies between systems and adapting transport routes within the system landscape are topics to consider when planning a dual-stack split.

This section provides information for planning the dual-stack split within an exemplary system landscape composed of a development system (DEV), a test system (QAS), and a productive system (PRD), and it lists the required steps for adapting the transport routes.

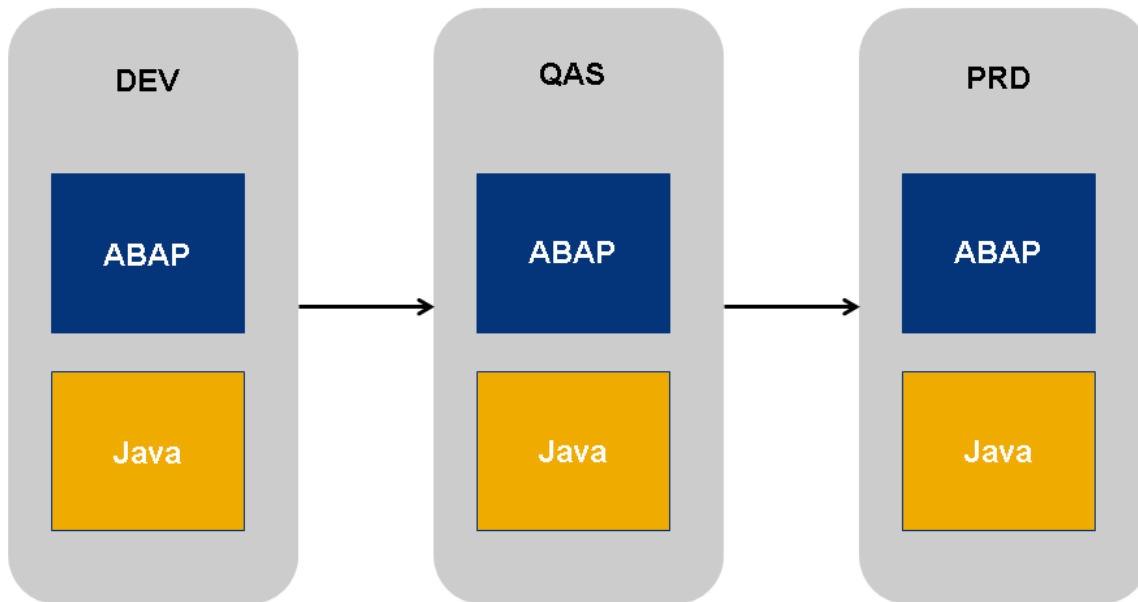

Figure 8: System Landscape Before Split

Process Flow

1. You split the first system in the transport track.
In this example this means that you split the dual-stack system DEV into an ABAP system DEV and a Java system JDS.
2. In the Transport Management System (TMS), you create a Java system (JDS) with the ABAP system (DEV) as communication system, and select the *Activate Transport Organizer* flag.
3. In the TMS, you delete the configuration settings of the Java system in the ABAP system (DEV).
4. In the TMS, you create the transport route between the new Java system (JDS) and the next system in the transport track (QAS).

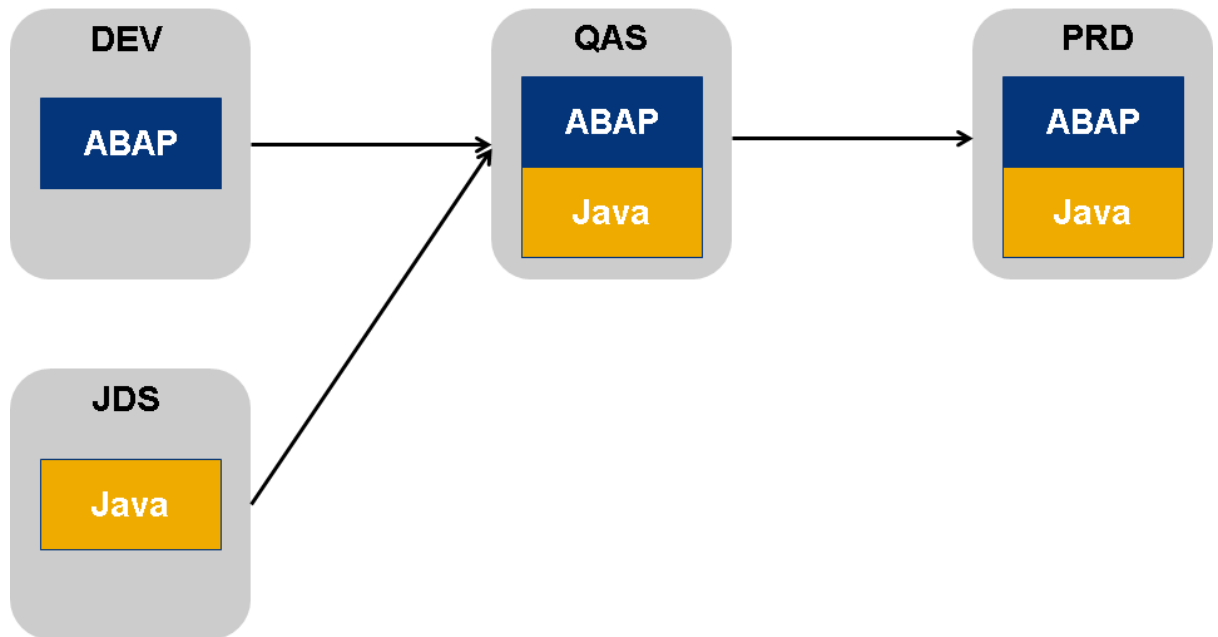

Figure 9: System Landscape After the First Split with Adapted Transport Routes

5. You split the next system in the transport track.
In this example this means that you split the dual-stack system QAS into an ABAP system QAS and a Java system JQS.
6. In the TMS, you create a Java system (JQS) with the ABAP system (QAS) as communication system, and select the *Activate Deployment Service* flag.
7. In the ABAP system (QAS), you adjust the CTS Deploy Web Service.
8. In the TMS, you delete the configuration settings of the Java system in the ABAP system (QAS).
9. If required, you copy the import buffer of the ABAP system (QAS) to the Java system (JQS). This ensures the processing of pending transport tracks.
10. In the TMS, you create the transport routes between the previous Java system in the transport track (JDS) and the new Java system (JQS) and between JQS and the next system in the transport track (PRD).

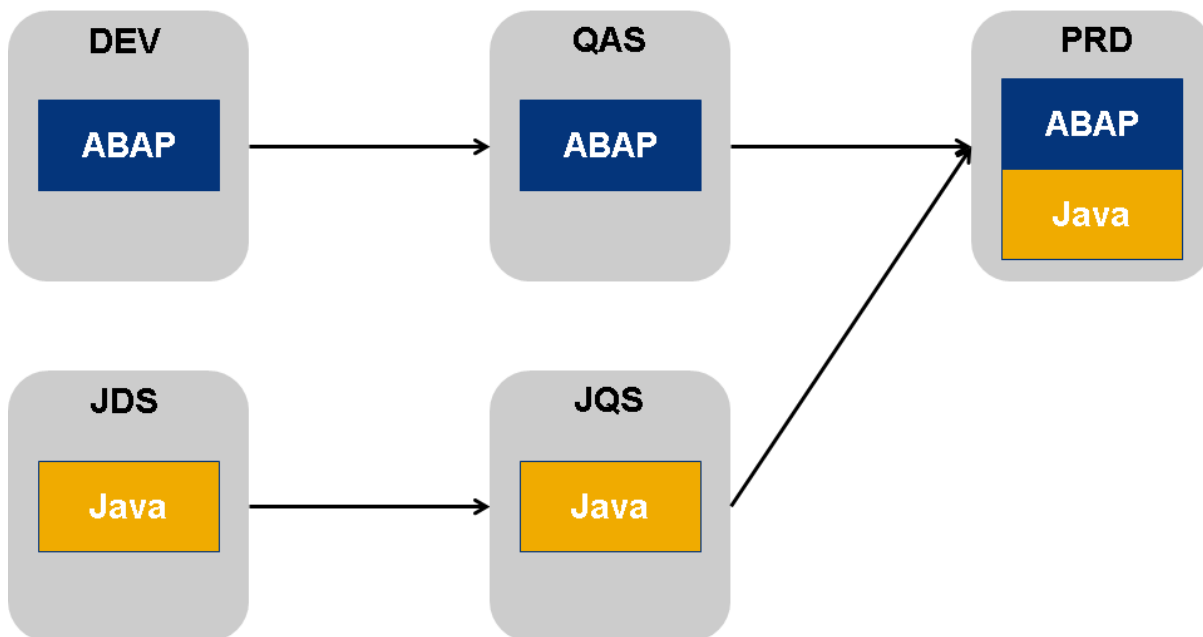

Figure 10: System Landscape After the Second Split with Adapted Transport Routes

11. You split the next system in the transport track.
In this example this means that you split the last dual-stack system in the transport track PRD into an ABAP system PRD and a Java system JPS.
12. In the TMS, you create a Java system (JPS) with the ABAP system (PRD) as communication system, and select the *Activate Deployment Service* flag.
13. In the ABAP system (PRD), you configure the CTS Deploy Web Service.
14. In the TMS, you delete the configuration settings of the Java system in the ABAP system (PRD).
15. You copy the import buffer of the ABAP system (PRD) to the Java system (JPS). This ensures the processing of pending transport tracks.
16. In the TMS, you create the transport route between the new Java system (JPS) and the Java system preceding in the transport track (JQS).

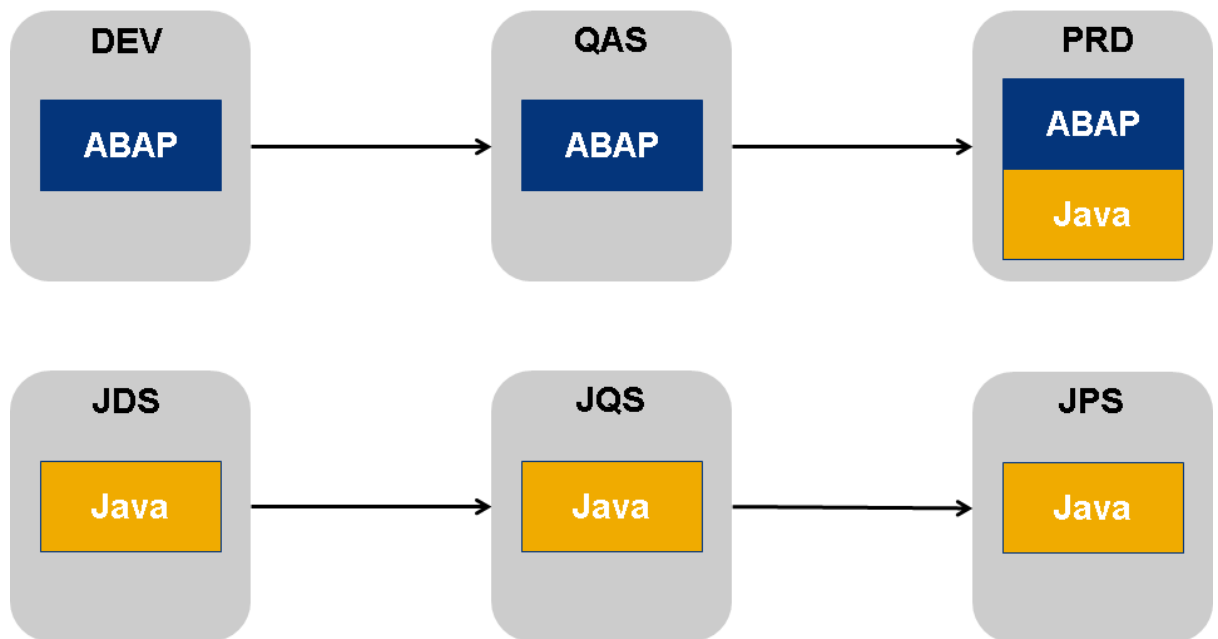

Figure 11: System Landscape After the Last Split with Adapted Transport Routes

Related Information

[Configuring Source Systems for Non-ABAP Transports \[page 55\]](#)

[Configuring Target Systems for Non-ABAP Transports \[page 55\]](#)

[Configuring the CTS Deploy Web Service \[page 56\]](#)

[Configuring Transport Routes \[page 57\]](#)

6.4 Cleaning Up the System Landscape

To ensure data consistency for future maintenance, you have to clean up the system landscape data first in the SLD, and then in transaction SMSY, respectively the Landscape Management Database (LMDB) in the SAP Solution Manager.

Make sure that the entries for the removed Java stack are no longer part of the former dual-stack system in SLD and transaction SMSY, respectively LMDB.

-
1. Log on to the SLD User Interface (http://<Host_Name>:port/sld).
 2. In the *Technical Systems* view, locate the Java System that you previously have split from the dual stack and remove it.
 3. Remove the obsolete Java System from the SAP Solution Manager:
 - In SAP Solution Manager 7.1, the deletion of the Java system in the SLD is propagated automatically to LMDB and SMSY.
 - If you still operate a SAP Solution Manager 7.01 system, call transaction SMSY and delete the technical system of type “Java”.
 - If the Java system is still in use – for example, in a Product System or Logical Component – you must first remove it from all uses.

More Information

For more information about how to proceed, see the following:

- SAP Note [1873543](#) and <http://support.sap.com/solutionmanager>.
- The blog *Dual-Stack Split – How to Ensure Correct Technical System Data in SLD and LMDB after the Split* at: <http://scn.sap.com/community/it-management/blog/2013/11/29/dual-stack-split-how-to-ensure-correct-technical-system-data-in-sld-and-lmdb-after-the-split>

7 Additional Information

7.1 Move Java Database: Restoring Instances

Use

If you encounter severe problems during the split and decide to stop it, you can use the source system as a dual-stack system again. You then have to restart all instances of the source system.

Note

This is only possible if you have not yet removed the Java stack of the dual-stack source system.

Procedure

1. Edit the central instance profile `<SAPSID>_DVEBMGS<Instance_Number>_<Host_Name>`: Replace the line `rdisp/j2ee_start=0` with `rdisp/j2ee_start=1`.
2. Restart the central instance service.
In SAP MMC, choose  *All tasks*  *Restart service* .
3. Restart the instance by calling transaction `SMICM`.

7.2 Keep Database: Restoring Instances

Use

If you encounter severe problems during the split and decide to stop, you can use the source system as a dual-stack system again if you made a backup of your source database before the split. You then have to restart all instances of the source system.

Note

This is possible only if you have not yet removed the Java stack of the dual-stack source system.

Prerequisites

A backup of your source database is available.

Procedure

1. Reimport your source database.
2. Edit the central instance profile `<SID>_DVEBMGS<XX>_<hostname>`: Replace the line `rdisp/j2ee_start=0` with `rdisp/j2ee_start=1`.
3. Restart the central instance service.
In SAP MMC, choose **All tasks > Restart service**.
4. Restart the instance by calling transaction SMICM.

7.3 Removing the Java Stack

Use

Using this procedure, you will permanently delete the Java stack from the system without the need to start the dual stack split procedure.

i Note

During the removal process, all Java database content, all Java file systems and subdirectories of the Java stack are deleted. Before you start, make sure that you have saved a copy of all files and directories that you want to keep to a secure location.

Prerequisites

Before you start the removal procedure, perform the following:

- Shut down the J2EE cluster using transaction SMICM
- Set `rdisp/j2ee_start = 0` in the central and all dialog instance profiles
- Restart the instance services as follows:
 - **Windows:**
In SAP MMC on the relevant instances, choose **All Tasks > Restart Service**.
 - **UNIX/IBM i:**
Log on as `<sapsid>adm` and execute the following for the relevant instances:
`sapcontrol -nr <Instance_Number> -function RestartService`

Procedure

1. Start the tool and choose split option *Move Database* as described in [Running the Installer \[page 40\]](#).
2. Depending on your system variant, perform the steps listed below:
 - **Central System**
 - *Remove Java Stack from Dual-Stack System*
 - **Distributed System**
 - *Remove Java Stack from Dual-Stack Central Instance*
 - *Remove Java Stack from Dual-Stack Dialog Instance*
 - *Remove SCS Instance from Dual-Stack System*
 - *Remove Java Schema of Dual-Stack Database Instance*
 - **High-Availability System**
 - *Remove Java Stack from Dual-Stack Central Instance*
 - *Remove Java Stack from Dual-Stack Dialog Instance*
 - *Remove SCS Instance from Dual-Stack System*
 - *Remove ERS Instance from Dual-Stack System*
 - *Remove Java Schema of Dual-Stack Database Instance*

Caution

You must skip the export and installation steps.

3. After you remove the Java stack, you have to remove the Java stack data from the SLD, transaction SMSY and LMDB in the SAP Solution Manager.
For more information, see [Cleaning Up the System Landscape \[page 61\]](#).
The removal of the technical Java system from the SLD is important for the system landscape data consistency.

7.4 Performing a Domain Installation Without Being a Domain Administrator

Use

You normally perform a domain installation of the SAP system with a user who is a member of the domain `Admins` group, as described in [Required User Authorization for Running the Installer \[page 29\]](#). If for any reason, the account used for the installation is not a member of the domain `Admins` group, you can perform the installation with a domain user who is a member of the local `Administrators` group. In this case, the domain administrator has to prepare the system appropriately for you. The domain administrator can perform the following steps either using the installer or manually:

1. Create the new global group `SAP_<SAPSID>_GlobalAdmin`.
2. Create the two new SAP system users `<sapsid>adm` and `SAPService<SAPSID>`.
3. Add the users `<sapsid>adm` and `SAPService<SAPSID>` to the newly created group `SAP_<SAPSID>_GlobalAdmin`.

4. The following steps are only required for IBM DB2 for Linux, UNIX and Windows:

1. Create the database administration group `db<dbSID>adm` and the database control group `db<dbSID>ctl`.
2. Create the new DB2 database administrator `db2<dbSID>`.
3. Add users `<sapsid>adm` and `SAPService<SAPSID>` to the group `db<dbSID>ctl`. Add the user `db2<dbSID>` to the group `db<dbSID>adm`.
4. If you want the database connect user (`sap<sapsid>db`) to be part of the `<sapsid>adm` domain, you have to create the user and its group `db<dbSID>mon` manually.

Caution

As of Enhancement Package 3 for SAP NetWeaver 7.0, you can specify the name of the Java connect user (`sap<sapsid>db`) independently from the SAP schema name during the dialog phase of the installer.

We recommend, however, that you keep the names of the connect user and the database schema identical in standard use cases. If you are performing a system copy using database means, DB2 is not able to change the schema name and you can then choose a connect user name that is different from the schema name.

Make sure that you choose the correct value during the dialog phase of the installer.

5. Create the database extended security groups `DB2ADMNS_<DBSID>` and `DB2USERS_<DBSID>`.
6. Add users `db2<dbSID>` and `SAPService<SAPSID>` to the database extended security group `DB2ADMNS_<DBSID>`.

Note

The installer creates the operating system user for the SAP Host Agent by default as a local user that is not a member of the local `Administrators` group. If you want to create this user manually as a domain user, you must perform the following steps:

1. Create the new global group `SAP_SAP_GlobalAdmin`.
2. Create the SAP system user `sapadm`.
3. Add the user `sapadm` to the newly created group `SAP_SAP_GlobalAdmin`.

However, for security reasons we strongly recommend you to create this users as a local user.

Prerequisites

- You must be domain administrator to perform the required steps.
- Windows Server 2008 (R2) and Windows Server 2012 (R2):
You must have installed the feature *Remote Server Administration Tools* as follows:
 - Windows Server 2012 (R2):
Open PowerShell in elevated mode, and enter the following command:
add-windowsfeature RSAT-ADDS
 - Windows Server 2008 (R2):
 1. Choose **Start** > *Administrative Tools* > *Server Manager* .

2. In the *Server Manager* window, select *Features*.
3. Select the feature ► *Remote Server Administration Tools* ► *Role Administration Tools* ► *Active Directory Domain Services Tools* ►.

Procedure

Creating the Required Users and Groups Using the Installer

On the host where the SAP system is to be installed, the domain administrator [runs the installer \[page 40\]](#), and chooses ► *<Product>* ► *Software Life-Cycle Options* ► *Additional Preparation Options* ► *Operating System Users and Groups* ► to have the group and users created automatically.

Creating the Required Users and Groups Manually

i Note

To create the users and groups specific to the SAP Host Agent, you must follow the procedure below, and replace the users and groups with those for the SAP Host Agent.

Creating the New Global Group SAP_<SAPSID>_GlobalAdmin

Perform the following steps:

- Windows Server 2012 (R2):
Open PowerShell in elevated mode, and enter the following command:
net group SAP_<SAPSID>_GlobalAdmin /add /domain
- Windows Server 2008 (R2):
 1. Log on as domain administrator.
 2. Start the *Active Directory Users and Computers Console* by choosing:
► *Start* ► *Control Panel* ► *Administrative Tools* ► *Active Directory Users and Computers* ►.
 3. Right-click *Users* in *Tree*, and choose ► *New* ► *Group* ►.
 4. Enter the following:
Group name: **SAP_<SAPSID>_GlobalAdmin**
 5. Select the following:
 1. *Group scope:* Global
 2. *Group type:* Security
 6. Choose *OK*.

Creating the New SAP System Users <sapsid>adm and SAPService<SAPSID>

Perform the following steps:

- Windows Server 2012 (R2):
 1. Open PowerShell in elevated mode.
 2. Create the <sapsid>adm user with the following command:
net user sapsid>adm <password> /add /domain
 3. Create the SAPService<SAPSID> user with the following command:
net user SAPService<SAPSID> <password> /add /domain

- Windows Server 2008 (R2):
 1. In *Active Directory Users and Computers Console*, right-click *Users* in *Tree* and choose:
 - ▶ *New* ▶ *User* ▶
 2. Enter the following:

Table 12:

Field	Input for <sapsid>adm	Input for SAPService<SAPSID>
First name:	None	None
Initials:	None	None
Last name:	None	None

3. Choose *Next* and enter the following:
 - Password*: <password>
 - Confirm password*: <password>
4. Select *Password never expires*.

i Note

Make sure that no other options are selected.

5. Choose ▶ *Next* ▶ *Finish* ▶.

Adding the Manually Created Users to Groups

i Note

To add the users specific to the SAP Host Agent to the relevant groups, you must follow the procedure below, and replace the users and groups with those for the SAP Host Agent.

Adding the <sapsid>adm User to the SAP_<SAPSID>_GlobalAdmin Group

- Windows Server 2012 (R2):
 - Open PowerShell in elevated mode, and enter the following command:

```
net group SAP_<SAPSID>_GlobalAdmin <sapsid>adm /add /domain
```
- Windows Server 2008 (R2):
 1. In the *Users* folder, double-click the newly created user account <sapsid>adm in the list on the right.
 2. Choose ▶ *Member* ▶ *Add* ▶.
 3. Select the new *SAP_<SAPSID>_GlobalAdmin* group and choose *Add* to add it to the list.

i Note

By default, the user is also a member of the *Domain Users* group.

4. Choose *OK* twice.

Adding the SAPService<SAPSID> User to the SAP_<SAPSID>_GlobalAdmin Group

- Windows Server 2012 (R2):
Open PowerShell in elevated mode, and enter the following command:
`net group SAP_<SAPSID>_GlobalAdmin SAPService<SAPSID> /add /domain`
- Windows Server 2008 (R2):
 1. In the *Users* folder, double-click the newly created user account *SAPService<SAPSID>* in the list on the right.
 2. Choose **Member** > **Add**.
 3. Select the new *SAP_<SAPSID>_GlobalAdmin* group.
 4. Choose *Add* to add it to the list, and then *OK*.
 5. Choose *OK* to close *SAPService<SAPSID>Properties*.
 6. Close the *Active Directory Users and Computers Management Console*.

7.5 Verifying and Adjusting the `instanceID` of an AS Java Instance

Using option *Adjust instanceID of an AS Java Instance*, you can verify the correctness of the `instanceID` and `box number` parameters of an existing AS Java instance, and adjust them if required.

Prerequisites

- The AS Java instance can be started.
- **Caution:** Software Provisioning Manager performs changes in the database which are related to J2EE Engine configuration. Therefore it is recommended that you back up the J2EE Engine configuration using the `ConfigTool`. You can do this by exporting configurations `cluster_data`, `HttpHosts`, `apps`, `jms_provider`, and `WebContainer` using `OfflineConfigEditor` and configuration of `<SAPSID>/Server <xxx>/Services/Key Storage` using the `Visual Administrator`.

Context

When to Use Option *Adjust instanceID of an AS Java Instance*

- Software Update Manager (SUM) fails due to incorrect parameter `instanceID`.

Example

An error like the following occurs during the upgrade of a Java system based on SAP NetWeaver 7.0x:

```
The detected instance ID IDXXXXX and the one calculated from the box number
IDXXXXX do not match. A possible reason for this could be that you have changed
the box number in the central instance instance.properties file.
```

- Software provisioning manager (70SWPM*.SAR) fails due to incorrect parameter `instanceID`.

Example

An error like the following occurs during system copy, dual-stack split, or system rename of a Java system based on SAP NetWeaver 7.0x with Software Provisioning Manager:

```
The source or target cluster ID is not present on the system! The current
(source) cluster ID is XXXXX and the new (target) cluster ID is XXXXX
```

- You are in doubt about consistency or correctness of the `instanceID` parameter of an AS Java instance.

Background Information About How *Adjust instanceID of an AS Java Instance Works*

Software logistics tools (Software Provisioning Manager, Software Update Manager) verify if the `instanceID` parameter corresponds to the box number of an SAP system based on SAP NetWeaver AS for Java. If the `instanceID` parameter is not consistent, Software Provisioning Manager fails.

The Box number has the format `<SAPSID><instance_name><host_name>` and is used as a parameter for the `instanceID` generation. `instanceID` is a unique identifier generated for each instance and is stored in the SAP system database schema when creating a new Java system.

An inconsistency between `instanceID` and `box number` is caused by applying an unsupported procedure to create or maintain the system. Using Software Provisioning Manager for system copy or system rename (changing the `<SAPSID>`, host name, or instance name) guarantees consistency.

Adjust instanceID of an AS Java Instance changes the `box number` and `instanceID` in the database and synchronizes the `instance.properties` file.

More Information

For more information, such as troubleshooting and FAQ, see SAP Note [2259748](#) .

Procedure

1. Stop the AS Java instance or dual-stack instance and make sure that the database is running running.
2. Start Software Provisioning Manager (the installer) and choose option *Adjust instanceID of an AS Java Instance*.

The procedure how to start Software Provisioning Manager (the installer) is described in section [Running the Installer \[page 40\]](#)

3. Follow the instructions given on the screens.

Next Steps

Perform the following activities after applying the correction:

1. Calculate the box number using the `SAPLOCALHOST` profile parameter in lower case.
2. Calculate the correct `instanceID` using the tool attached to SAP Note [1987497](#) .

3. Adapt the `/usr/sap/<SAPSID>/<instance_name>/j2ee/cluster/bootstrap/bootstrap.properties` file: Assign the `instance.prefix` property to the correct `instanceID`.
4. Examine the instance profile - if `j2ee/instance_id` exists, change it to the new `instanceID`.
5. Open the `OfflineConfigEditor` and expand `cluster_data`
If the `performerID` property exists, change it to the new `instanceID`.
6. If you have **EP: Knowledge Management and Collaboration** installed on your system, you have to do the following adjustments for the **Scheduler Service**:
Assign scheduler tasks to the new system IDs of the target system. This is required because after applying the correction, tasks are still assigned to the IDs of the source system.
For more information, see the *SAP Library* for your release at:

Table 13:

URL	Path
<ul style="list-style-type: none"> ○ SAP NetWeaver 7.0:http://help.sap.com/nw70 ○ SAP NetWeaver 7.0 including EHP1:http://help.sap.com/nw701 ○ SAP NetWeaver 7.0 including EHP2:http://help.sap.com/nw702 ○ SAP NetWeaver 7.0 including EHP3:http://help.sap.com/nw703 	<ul style="list-style-type: none"> ▶ <i>Application Help</i> ▶ <i>Function-Oriented View</i> <Language> ▶ <i>Information Integration: Key Areas</i> ▶ <i>Knowledge Management</i> ▶ <i>Administration Guide</i> ▶ <i>Minimal Configuration for Knowledge Management</i> ▶ <i>Cluster Only: Assigning Tasks to Nodes</i> ▶

A Appendix

A.1 Online Information from SAP









More information is available online as follows:

Table 14: Documentation

Description	Internet Address	Title
SAP Front End installation Guide	http://scn.sap.com/docs/DOC-25456	<i>SAP Front End Installation Guide – <Current Release></i>
Software Provisioning Manager 1.0 SP <No> Guides	http://help.sap.com/sltoolset ▶ <i>System Provisioning</i> ▶	<i>Software Provisioning Manager 1.0 SP <No> Install, copy, transform, split, rename, and uninstall products based on SAP NetWeaver AS ABAP and AS Java</i>
Maintenance Planning Guide	https://scn.sap.com/docs/DOC-35437	<i>Maintenance Planning Guide for SAP Solution Manager <Release, SP></i>

Table 15: General Quick Links

Description	Internet Address
SAP Help Portal	http://help.sap.com
SAP NetWeaver Library in SAP Help Portal	http://help.sap.com/netweaver
SAP ERP Library in SAP Help Portal	http://help.sap.com/erp
SAP CRM Library in SAP Help Portal	http://help.sap.com/crm
SAP SRM Library in SAP Help Portal	http://help.sap.com/srm
SAP SCM Library in SAP Help Portal	http://help.sap.com/scm
SL toolset	http://help.sap.com/sltoolset
Software logistics in application lifecycle management	http://scn.sap.com/community/it-management/alm/software-logistics
SAP Notes	https://support.sap.com/notes

Description	Internet Address
Supported platforms and operating systems	http://scn.sap.com/community/database  Related Resources 
Product availability matrix (PAM)	http://support.sap.com/pam 
System sizing (Quick sizer tool)	http://sap.com/sizing 
SAP NetWeaver capabilities	http://scn.sap.com/community/netweaver 
Application lifecycle management for SAP NetWeaver	http://scn.sap.com/community/it-management/alm 
Information about SAP support package stacks	http://support.sap.com/sp-stacks 
SAP Solution Manager	http://support.sap.com/solutionmanager 

A.2 Online Information from IBM

You can use the following IBM DB2 for Linux, UNIX, and Windows welcome page as a starting point to all kinds of documentation for your relevant database version: <http://www.ibm.com/support/knowledgecenter/en/SSEPGG> 

The following tables provide direct links to IBM DB2 online documentation and manuals, listed by database version:

Table 16: IBM DB2 Knowledge Center







Database Version	Internet Address
DB2 V9.1	http://publib.boulder.ibm.com/infocenter/db2luw/v9/index.jsp 
DB2 V9.5	http://publib.boulder.ibm.com/infocenter/db2luw/v9r5/index.jsp 
DB2 V9.7	http://publib.boulder.ibm.com/infocenter/db2luw/v9r7/index.jsp 
DB2 10.1	http://publib.boulder.ibm.com/infocenter/db2luw/v10r1 
DB2 10.5	http://publib.boulder.ibm.com/infocenter/db2luw/v10r5/index.jsp 
DB2 11.1	http://www.ibm.com/support/knowledgecenter/SSEPGG_11.1.0/com.ibm.db2.luw.kc.doc/welcome.html 

Table 17: IBM Manuals

Database Version	Internet Address
DB2 V9.1	http://www.ibm.com/support/docview.wss?rs=71&uid=swg27009552 ➤
DB2 V9.5	http://www.ibm.com/support/docview.wss?rs=71&uid=swg27009727 ➤
DB2 V9.7	http://www.ibm.com/support/docview.wss?rs=71&uid=swg27015148 ➤
DB2 10.1	http://www.ibm.com/support/docview.wss?uid=swg27024478 ➤
DB2 10.5	http://www.ibm.com/support/docview.wss?uid=swg27038855 ➤

A.3 Using PowerShell

For Windows Server 2012 (R2), SAP only uses Windows PowerShell to run and describe Windows commands.

Windows PowerShell is a powerful tool integrated in the Windows operating system. It uses object-oriented methodology, which allows fast and stable script development.

For more information about the Windows PowerShell, see:

<http://technet.microsoft.com/en-us/scriptcenter/dd742419.aspx> ➤

There you can find links to the online help, online documentation, scripting repository, downloads, and blogs.

If you want to use the PowerShell feature, note the following:

- Windows Server 2012 R2
Windows Server 2012 R2 contains PowerShell 4.0.
- Windows Server 2012
Windows Server 2012 contains PowerShell 3.0.
You can update to PowerShell 4.0 (search the internet for *Windows Management Framework 4.0*).
- Windows Server 2008 R2
Windows Server 2008 R2 contains PowerShell 2.0.
For more information about PowerShell 2.0, see <http://support.microsoft.com/kb/968929> ➤.
You can update to PowerShell 3.0 or 4.0 (search the internet for *Windows Management Framework 3.0* or *Windows Management Framework 4.0*).
- Windows Server 2008
You have to activate the PowerShell feature with **Start** > **Administrative Tools** > **Server Manager** > **Features** .
On Windows Server 2008, you can update to PowerShell 3.0 (search the internet for *Windows Management Framework 3.0*).



How to Start PowerShell

Caution

Make sure that you start the PowerShell in administrator mode.

- Windows Server 2012 (R2)
Open the command prompt and enter the command:
`powershell.exe`

To start PowerShell on Windows Server 2008 (R2), you have the following options:

- From the command prompt, by entering the command:
`powershell.exe`
- From the *Start* Menu:
 - PowerShell 1.0:
Choose **Start** > *All Programs* > *Windows PowerShell 1.0* > *Windows PowerShell* 
 - PowerShell 2.0:
Choose **Start** > *All Programs* > *Windows PowerShell* > *Windows PowerShell* 

How to Work with PowerShell

Most commands that are used in `cmd.exe` are also available in the PowerShell (defined as aliases).

You can use well-known commands, such as `cd`, `type`, `copy`, `move`, `mkdir`, `delete`, `rmdir`. There is also online help available, which you can access by typing the command: `help` (or `help <command>`).

This is a list of differences between PowerShell and `cmd.exe`:

- Before you can run PowerShell scripts (text files with the file extension `.ps1` that contain PowerShell statements), you might have to change the default security setting to allow the execution of non-signed scripts as follows:
`set-executionpolicy ("unrestricted")`
- By default, when double-clicking PowerShell scripts (`.ps1` files) in the Windows explorer, this does not execute the script as is the default for `.cmd` files, but opens the script in an editor. If you want to activate automatic script execution after a double-click, you have to change the value `HKEY_CLASSES_ROOT\Microsoft.PowerShellscript.1\Shell\Open\Command` from `notepad.exe` to the full path of the PowerShell executable.
- The output of PIPE commands is not just a stream of characters (strings) but a stream of objects. You can easily access the properties and methods for these objects (see the process list DLL example below).
- The current working directory is not part of the directory search path that the PowerShell looks at for scripts and programs. The PowerShell only searches directories listed in the environment variable `path`. Therefore, you might have to run a local program with `./sapcontrol.exe` or specify its full path.
- You can use the UNIX-like directory delimiters, such as `cd /usr/sap/C11`.
- You can have your current working directory in a UNC path (`cd \\sapglobalhost\sapmnt`).
- The shell distinguishes between environment variables and shell variables:
 - Use of shell variables:
Definition: `$x="hello"`

Reference: `write-host $x`

- Use of an environment variable:

Definition: `$env:x="hello"`

Reference: `write-host $env:x`

- The PowerShell has an interesting container concept called `ps-drives`. Within `ps-drives` you can navigate in other objects, such as the registry or shell internal lists in the same way as you typically navigate in a file system (`cd`, `dir`, `del`, and so on).
`dir env`: to get a list of environment variables
`dir variable`: to get the list of shell variables
`dir HKLM`: to get a list of registry keys in `HKEY_LOCAL_MACHINE`
`get-psdrive` to get a list of available `ps-drives`
- Windows PowerShell has full access to the .NET runtime. You can directly access missing functions in the PowerShell via .NET.
- With Windows PowerShell, you can create GUI-class user interfaces using Windows forms.

PowerShell Commands

The following table lists some PowerShell commands that are available on Windows Server 2012 (R2):

Table 18:

Command	Explanation
<code>stop-service sap*</code>	Stops all Windows services with service name starting with "SAP"
<code>get-process</code>	Lists currently started processes on your system
<code>get-process sort starttime select -last 1</code>	Lists the last started process on your computer
<code>get-process sort starttime select -last 1 format-list -proper *</code>	Lists all properties of the last started process
<code>get-process sort starttime select -last 1 get-member</code>	Lists all process class members (properties and methods) of the last started process
<code>get-process %{\$_name;"-----"; \$_modules}</code>	Lists all processes, and the executables and DLLs the processes loaded
<code>\$processes = (get-process sort starttime)</code>	Defines a shell variable <code>\$processes</code> , which contains an array of process objects
<code>\$processes.length</code>	The number of processes in the array (is equivalent to the number of processes on your computer)

Command	Explanation
<code>\$processes[\$processes.length-1].kill()</code>	Invokes the kill method (terminate process) of the last started process
<code>(dir a.txt).set_attributes("readonly")</code>	Sets the file a.txt to "read-only"

Important Disclaimers and Legal Information

Coding Samples

Any software coding and/or code lines / strings ("Code") included in this documentation are only examples and are not intended to be used in a productive system environment. The Code is only intended to better explain and visualize the syntax and phrasing rules of certain coding. SAP does not warrant the correctness and completeness of the Code given herein, and SAP shall not be liable for errors or damages caused by the usage of the Code, unless damages were caused by SAP intentionally or by SAP's gross negligence.

Accessibility

The information contained in the SAP documentation represents SAP's current view of accessibility criteria as of the date of publication; it is in no way intended to be a binding guideline on how to ensure accessibility of software products. SAP in particular disclaims any liability in relation to this document. This disclaimer, however, does not apply in cases of willful misconduct or gross negligence of SAP. Furthermore, this document does not result in any direct or indirect contractual obligations of SAP.

Gender-Neutral Language

As far as possible, SAP documentation is gender neutral. Depending on the context, the reader is addressed directly with "you", or a gender-neutral noun (such as "sales person" or "working days") is used. If when referring to members of both sexes, however, the third-person singular cannot be avoided or a gender-neutral noun does not exist, SAP reserves the right to use the masculine form of the noun and pronoun. This is to ensure that the documentation remains comprehensible.

Internet Hyperlinks

The SAP documentation may contain hyperlinks to the Internet. These hyperlinks are intended to serve as a hint about where to find related information. SAP does not warrant the availability and correctness of this related information or the ability of this information to serve a particular purpose. SAP shall not be liable for any damages caused by the use of related information unless damages have been caused by SAP's gross negligence or willful misconduct. All links are categorized for transparency (see: <http://help.sap.com/disclaimer>).

Open Source Software and Third Party Components

Please refer to <https://scn.sap.com/docs/DOC-42044> for information respecting open source software components made available by SAP as part of SAP NetWeaver and any specific conditions that apply to your use of such open source software components. Please refer to <https://scn.sap.com/docs/DOC-42045> for information relating to SAP's use of third party software with or within SAP NetWeaver.

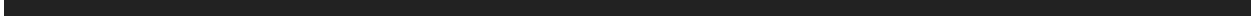



**go.sap.com/registration/
contact.html**

© 2016 SAP SE or an SAP affiliate company. All rights reserved.
No part of this publication may be reproduced or transmitted in any form or for any purpose without the express permission of SAP SE or an SAP affiliate company. The information contained herein may be changed without prior notice.
Some software products marketed by SAP SE and its distributors contain proprietary software components of other software vendors. National product specifications may vary.
These materials are provided by SAP SE or an SAP affiliate company for informational purposes only, without representation or warranty of any kind, and SAP or its affiliated companies shall not be liable for errors or omissions with respect to the materials. The only warranties for SAP or SAP affiliate company products and services are those that are set forth in the express warranty statements accompanying such products and services, if any. Nothing herein should be construed as constituting an additional warranty.
SAP and other SAP products and services mentioned herein as well as their respective logos are trademarks or registered trademarks of SAP SE (or an SAP affiliate company) in Germany and other countries. All other product and service names mentioned are the trademarks of their respective companies.
Please see <http://www.sap.com/corporate-en/legal/copyright/index.epx> for additional trademark information and notices.