

Nemschoff

PRICEBOOK February 2014

nemschoff.com 800.203.8916



OUR STORY At Nemschoff, we believe that people make a difference, things should be built to last, and design can improve the way we live, work, and heal. We've built our company, our furniture, and our reputation in Healthcare on this belief, and we continue this tradition by providing innovative solutions for any high-use environment, including education and public spaces. Our products combine high-quality materials and expertise, thoughtful features, and unparalleled comfort, into a unique style of craft and design that you will only find at Nemschoff. We've stayed true to this path for over 60 years, and we're proud to offer you a broad portfolio of solutions that make a difference in people's lives.

Welcoming & Waiting Contents



Lounge Seating

- | | | |
|-------------------------------------|---------------------------|---------------------------|
| 11 Boulevard | 52 Florabella | 78 Monarch |
| 12 Brava Classic | 53 Franklin | 80 Oliver |
| 15 Brava Platform ◀ | 55 Hadleigh | 81 Olivia + |
| 20 Brooklyn | 57 Harmon | 83 Ottoman |
| 22 Cities Small Crosstown ◀ | 59 Iris | 84 Pamona |
| 26 Cities Medium Crosstown | 60 Lauderdale | 86 Riva |
| 29 Cities Large Crosstown | 62 Leonard II | 88 Sophia |
| 31 Cities Small Downtown ◀ + | 64 Marco Grande | 90 Steps ◀ |
| 35 Cities Medium Downtown | 66 Marco Grande II | 97 Valor |
| 38 Cities Large Downtown | 68 Marsack | 99 Workhaven |
| 40 Cities Small Uptown ◀ + | 70 Marsack II | ◀ Spanner table available |
| 44 Cities Medium Uptown | 72 Maurice | + Plus model available |
| 47 Cities Large Uptown | 73 Meridian | |
| 49 Evita ◀ | 75 Mod Pod ◀ | |

Multiple & Tandem Seating

- | | | |
|----------------------------|-------------------------|---------------------------|
| 102 2600 Series ◀ | 130 Brava 862 + | 153 Monarch + |
| 104 2700 Series ◀ + | 133 Brava 863 + | 155 Pause ◀ |
| 108 2750 Series ◀ | 136 Capella | 159 Princeton ◀ + |
| 111 2770 Series ◀ | 138 Horizon ◀ + | 161 Reliant ◀ + |
| 114 Andante ◀ + | 144 Marco + | 168 Torii + |
| 119 Anderson ◀ + | 146 Mayfield ◀ + | 170 Valor + |
| 121 Auburn ◀ + | 148 Meridian ◀ + | ◀ Spanner table available |
| | | + Plus model available |



Welcoming & Waiting Contents



Side, Stacking & Folding Chairs

- | | | |
|--------------------------------|--------------------------------|-------------------------------------|
| 172 Alberto Side Chair | 179 Dex Folding Chair | 185 Romeo/Juliet Stack Chair |
| 173 Altair Side Chair + | 181 Dex Stack Chair | 186 Torii Side Chair |
| 174 Andante Stack Chair | 182 Diane Side Chair | 187 Valor Stack Chair |
| 176 Capella Side Chair | 183 Monarch Stack Chair | + Plus model available |
| 177 Cities Side Chair | 184 Revive Side Chair | |



Occasional Tables

- | | | |
|--------------------------------|-------------------------|--------------------------|
| 190 2000 Series | 205 Florabella | 215 Pamona |
| 192 Auburn | 206 Hadleigh | 218 Reliant |
| 193 Boulevard | 207 Horizon | 220 Riva |
| 195 Brava | 208 Hudson | 221 Rockwood |
| 196 Brooklyn | 209 Lauderdale | 222 Torii |
| 197 Capella | 210 Marco Grande | 223 Valor |
| 198 Carlson | 211 Marsack | 224 Custom Tables |
| 199 Cities | 212 Meridian | |
| 201 Cubes and Cylinders | 213 Monarch | |
| 204 Evita | 214 Olivia | |

Patient Areas Contents



Patient Chairs

- | | | |
|-----------------------------|----------------------------|------------------------|
| 231 2750 Series | 244 Cities Downtown | 255 Meridian |
| 233 Andante + | 246 Cities Uptown | 256 Monarch |
| 235 Ashton | 248 Easy Access | 257 Nala |
| 236 Brava + | 250 Hadleigh | 261 Olivia |
| 238 Brooklyn | 251 Harmon | 262 Revive |
| 239 Capella | 252 Horizon | 264 Torii |
| 240 Centé | 253 Marco | 266 Valor |
| 242 Cities Crosstown | 254 McKinley | + Plus model available |

Recliners

- | | | |
|--|---|-----------------------|
| 267 2755 Adjustable Back Chair | 277 Cities Uptown CompactComfort | 286 Lancaster |
| 268 2755 CompactComfort | 279 Consoul | 287 Leonard II |
| 269 Auburn | 280 Culla | 288 Oliver |
| 271 Brava Adjustable Back Chair | 281 Erica Adjustable Back Chair | 289 Pamona |
| 273 Brava CompactComfort | 282 Erica CompactComfort | 290 Pristo II |
| 275 Capella Adjustable Back Chair | 283 Hadleigh Adjustable Back Chair | 292 Wallsaver |
| 276 Capella CompactComfort | 285 Horizon | |

Treatment Chairs

- | | | |
|------------------------|-------------------------|-------------------------|
| 294 Pristo II + | 298 Serenity II | 302 Serenity III |
| 296 Pristo IIT | 300 Serenity IIS | + Plus model available |

Rockers & Gliders

- | | | |
|---|------------------------------------|---------------------------|
| 304 Auburn Glider | 310 Cities Crosstown Rocker | 320 Horizon Glider |
| 305 Avery Rocker | 312 Cities Downtown Rocker | 321 Marco Glider |
| 306 Brava Glider | 314 Cities Downtown Glider | 322 Olivia Glider |
| 308 Capella Glider | 316 Cities Uptown Rocker | 323 Torii Rocker |
| 309 Capella Adjustable Back Glider | 318 Cities Uptown Glider | 324 Torii Glider |



Patient Areas Contents



Overbed Tables

- 325** EZ-123
- 326** Oasis
- 328** Overbed Table



Sleepover Seating

- | | | |
|---------------------------------------|-------------------------------------|----------------------------------|
| 329 Atwater Settee | 337 Merge Flop Sofa | 347 SleepOver 1-2-3 Chair |
| 330 Beaumont Chair and Settee | 339 Monarch Chair and Settee | 348 SleepOver Bench |
| 331 Brava Flop Sofa | 341 Oliver Settee | 350 SleepOver Flop Sofa |
| 332 Brava Settee | 342 Pamona Flop Sofa | 352 SleepOver Settee |
| 333 Consoul Chair and Settee | 343 Revive Guest Center | 354 SleepOver Sofa |
| 335 Leonard II Sofa and Settee | 346 Serenity II Chair | |



Casegoods

- | | |
|----------------------|----------------------|
| 356 Bedford | 380 Pristo |
| 364 Finley | 381 Pristo II |
| 368 Hadleigh | 382 Revive |
| 372 Montello | 388 Sovereign |
| 375 Perinatal | 393 Ten |
| 376 Prague II | |

Casegoods Systems

- 397** Terra
- 403** Terra for Treatment Areas



Display & Accessories

- 416** Revive Display System

Specialty Contents



Children's Furniture

- 418** Erica Junior
- 419** Junior 200
- 420** Junior Recliner



Behavioral Health

Casegoods

- 421** Bedsides and Nightstands
- 422** Chests
- 423** Wardrobes
- 425** Desks
- 427** Beds

Seating

- 431** High Use
- 432** Marsack III
- 434** Meridian



Caregiver Stools

- 436** Physician Stools
- 437** Lab Stools

Reference Contents

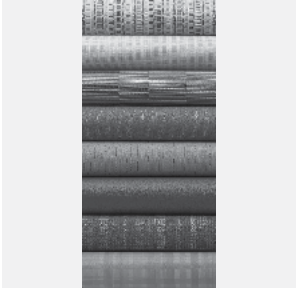

439 [Illustrated Glossary](#)

445 [Model Number Index](#)

451 [Fabrics](#)

Nemschoff Performance Fabrics

Graded-In Fabrics

Customer's Own Material (COM)

455 [Finishes](#)

About Nemschoff Finishes

Finish Colors

457 [Hardware](#)

459 [Warranties & Certifications](#)

Flammability

Five-Year Fabric Warranty

Limited Lifetime Warranty

GREENGUARD Certification

462 [Ordering](#)

Online Ordering

Pacesetter Program

General Terms and Conditions

Collections by Brand

Trademarks

Welcoming & Waiting



Boulevard Lounge Seating



More Information

- Illustrated Glossary ▶ 439
- Fabrics ▶ 451
- Flammability (CTB-133) ▶ 459
- Finishes ▶ 456
- Ordering and Warranties ▶ 462

Standard Features

- Solid hardwood frame
- Wood arm caps
- Non-marring 7/8" rubber-cushioned glides
- Nemschoff healthcare wood finish
- GREENGUARD Gold Certified
- Limited Lifetime Warranty

Available Options

- Moisture barrier + \$67 per seat or back
- CTB-133 + \$81/yd
- Two fabrics + \$62
- Three (or more) fabrics + \$88

Specification Decisions

- Select fabric
- Select standard wood finish
- Add moisture barrier
- Add CTB-133
- Apply multiple fabrics

Flammability Type

- Type 7

Coordinating Products

- Boulevard Tables

Key Dimensions

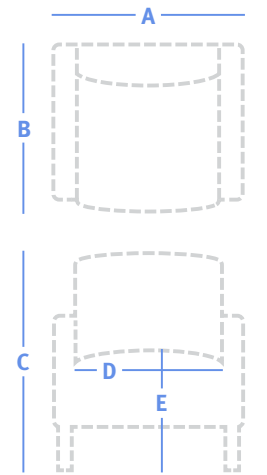

A	Overall Width	See price table
B	Overall Depth	33.5"
C	Overall Height	32"
D	Seat Width	
	Chair:	22"
	Settee:	42"
	Sofa:	62"
E	Seat Height	17.5"
F	Arm Height	25.5"

	32" W, Chair									76 lbs 4.75 yds
	Model	Series 2	Series 3	Series 4	Series 5	Series 6	Series 7	Series 8	COM	
	101/32	\$1,863	\$1,938	\$2,265	\$2,440	\$2,535	\$2,661	\$2,741	\$1,938	

	52" W, Settee									97 lbs 5.75 yds
	Model	Series 2	Series 3	Series 4	Series 5	Series 6	Series 7	Series 8	COM	
	101/52	\$3,007	\$3,098	\$3,493	\$3,706	\$3,821	\$3,973	\$4,070	\$3,098	

	72" W, Sofa									130 lbs 7.5 yds
	Model	Series 2	Series 3	Series 4	Series 5	Series 6	Series 7	Series 8	COM	
	101/72	\$3,617	\$3,735	\$4,250	\$4,527	\$4,678	\$4,876	\$5,003	\$3,735	

Brava Classic Lounge Seating



Standard Features

- Solid maple frame
- Mortise and tenon joinery
- Spring seat construction
- Clean-out design
- Replaceable components
- Upholstered arms
- Non-marring 7/8" rubber-cushioned glides
- Nemschoff healthcare wood finish
- GREENGUARD Gold Certified
- Limited Lifetime Warranty

Available Options

- Moisture barrier + \$67 per seat or back
- Black urethane arm caps + \$113
- Desert or Pewter urethane arm caps + \$205
- Wood arm caps + \$113
- CTB-133 + \$81/yd
- Two fabrics + \$62
- Three (or more) fabrics + \$88
- Arm with literature storage (LSF, RSF, both sides) + \$485 per arm

Specification Decisions

- Select fabric
 - Select standard wood finish
 - Add wood or urethane arm caps
 - Add moisture barrier
 - Add CTB-133
 - Apply multiple fabrics
 - Add arm with literature storage
- Model numbers with **S** indicate standard seat and back covers, and model numbers with **P** indicate removable covers.

Flammability Type

- Type 6

Coordinating Products

- [Brava Platform Lounge Seating](#)
- [Brava 862 Multiple Seating](#)
- [Brava 863 Multiple Seating](#)
- [Brava Side Chair](#)
- [Brava Tables](#)
- [Brava Adjustable Back Chair](#)
- [Brava CompactComfort Recliner](#)
- [Brava Patient Chair](#)
- [Brava Glider](#)
- [Brava Flop Sofa](#)
- [Brava Sleep Settee](#)

Key Dimensions

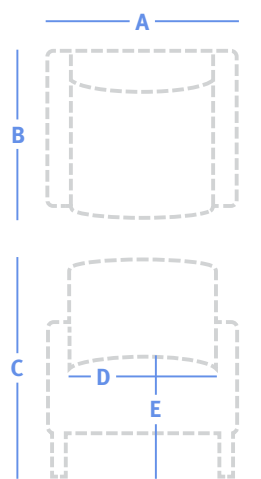





A	Overall Width	See price table
B	Overall Depth	28.5"
C	Overall Height	32"
D	Seat Width	
	Chair:	21.5", 23.5", 25.5"
	Settee / Two Seat:	40.5", 43.5", 47.5", 48.5", 51.5"
	Sofa / Three Seat:	65.25", 65.5", 67", 71.25", 71.5", 73.5"
E	Seat Height	18.75"
F	Arm Height	25"

More Information

- Illustrated Glossary ▶ 439
- Fabrics ▶ 451
- Flammability (CTB-133) ▶ 459
- Finishes ▶ 456
- Ordering and Warranties ▶ 462

Brava Classic Lounge Seating

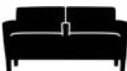
	28.5" W, Chair									48 lbs 4.5 yds
	Model	Series 2	Series 3	Series 4	Series 5	Series 6	Series 7	Series 8	COM	
	861-10-1 S	\$2,079	\$2,222	\$2,461	\$2,710	\$3,006	\$3,305	\$3,679	\$2,222	
	861-10-1 P	\$2,346	\$2,489	\$2,728	\$2,977	\$3,273	\$3,572	\$3,946	\$2,489	
	30.5" W, Chair									50 lbs 4.5 yds
	Model	Series 2	Series 3	Series 4	Series 5	Series 6	Series 7	Series 8	COM	
	861-10-2 S	\$2,079	\$2,222	\$2,461	\$2,710	\$3,006	\$3,305	\$3,679	\$2,222	
	861-10-2 P	\$2,346	\$2,489	\$2,728	\$2,977	\$3,273	\$3,572	\$3,946	\$2,489	
	32.5" W, Chair									52 lbs 6 yds
	Model	Series 2	Series 3	Series 4	Series 5	Series 6	Series 7	Series 8	COM	
	861-10-3 S	\$2,060	\$2,251	\$2,569	\$2,901	\$3,296	\$3,695	\$4,194	\$2,251	
	861-10-3 P	\$2,331	\$2,522	\$2,840	\$3,172	\$3,567	\$3,966	\$4,465	\$2,522	
	50.5" W, Two seat									74 lbs 6.5 yds
	Model	Series 2	Series 3	Series 4	Series 5	Series 6	Series 7	Series 8	COM	
	861-20-1 S	\$3,462	\$3,669	\$4,013	\$4,373	\$4,801	\$5,233	\$5,774	\$3,669	
	861-20-1 P	\$3,903	\$4,110	\$4,454	\$4,814	\$5,242	\$5,674	\$6,215	\$4,110	
	50.5" W, Two seat with divider arm									81 lbs 7 yds
	Model	Series 2	Series 3	Series 4	Series 5	Series 6	Series 7	Series 8	COM	
	861-25-1 S	\$3,834	\$4,057	\$4,428	\$4,815	\$5,276	\$5,741	\$6,323	\$4,057	
	861-25-1 P	\$4,321	\$4,544	\$4,915	\$5,302	\$5,763	\$6,228	\$6,810	\$4,544	
	54.5" W, Two seat									78 lbs 7 yds
	Model	Series 2	Series 3	Series 4	Series 5	Series 6	Series 7	Series 8	COM	
	861-20-2 S	\$3,446	\$3,669	\$4,040	\$4,427	\$4,888	\$5,353	\$5,935	\$3,669	
	861-20-2 P	\$3,887	\$4,110	\$4,481	\$4,868	\$5,329	\$5,794	\$6,376	\$4,110	
	54.5" W, Settee									72 lbs 6.25 yds
	Model	Series 2	Series 3	Series 4	Series 5	Series 6	Series 7	Series 8	COM	
	861-2 S	\$3,470	\$3,669	\$4,000	\$4,346	\$4,757	\$5,173	\$5,693	\$3,669	
	861-2 P	\$3,911	\$4,110	\$4,441	\$4,787	\$5,198	\$5,614	\$6,134	\$4,110	
	54.5" W, Two seat with divider arm									85 lbs 7.25 yds
	Model	Series 2	Series 3	Series 4	Series 5	Series 6	Series 7	Series 8	COM	
	861-25-2 S	\$3,826	\$4,057	\$4,441	\$4,842	\$5,319	\$5,801	\$6,404	\$4,057	
	861-25-2 P	\$4,313	\$4,544	\$4,928	\$5,329	\$5,806	\$6,288	\$6,891	\$4,544	
	58.5" W, Two seat									82 lbs 9.5 yds
	Model	Series 2	Series 3	Series 4	Series 5	Series 6	Series 7	Series 8	COM	
	861-20-3 S	\$3,905	\$4,208	\$4,711	\$5,237	\$5,862	\$6,494	\$7,284	\$4,208	
	861-20-3 P	\$4,410	\$4,713	\$5,216	\$5,742	\$6,367	\$6,999	\$7,789	\$4,713	
	58.5" W, Two seat with divider arm									89 lbs 9.5 yds
	Model	Series 2	Series 3	Series 4	Series 5	Series 6	Series 7	Series 8	COM	
	861-25-3 S	\$3,800	\$4,103	\$4,606	\$5,132	\$5,757	\$6,389	\$7,179	\$4,103	
	861-25-3 P	\$4,293	\$4,596	\$5,099	\$5,625	\$6,250	\$6,882	\$7,672	\$4,596	

Lounge Seating

Multiple & Tandem Seating

Side, Stacking & Folding Chairs

Occasional Tables

Brava Classic Lounge Seating

	72.75" W, Three seat									100 lbs 8.5 yds
	Model	Series 2	Series 3	Series 4	Series 5	Series 6	Series 7	Series 8	COM	
	861-30-1 S	\$4,517	\$4,788	\$5,238	\$5,709	\$6,268	\$6,833	\$7,540	\$4,788	
	861-30-1 P	\$5,092	\$5,363	\$5,813	\$6,284	\$6,843	\$7,408	\$8,115	\$5,363	
	78.75" W, Three seat									106 lbs 9 yds
	Model	Series 2	Series 3	Series 4	Series 5	Series 6	Series 7	Series 8	COM	
	861-30-2 S	\$4,522	\$4,809	\$5,286	\$5,784	\$6,376	\$6,974	\$7,723	\$4,809	
	861-30-2 P	\$5,100	\$5,387	\$5,864	\$6,362	\$6,954	\$7,552	\$8,301	\$5,387	
	78.75" W, Three seat with divider arms									120 lbs 10 yds
	Model	Series 2	Series 3	Series 4	Series 5	Series 6	Series 7	Series 8	COM	
	861-35-2 S	\$5,470	\$5,789	\$6,318	\$6,872	\$7,530	\$8,195	\$9,026	\$5,789	
	861-35-2 P	\$6,165	\$6,484	\$7,013	\$7,567	\$8,225	\$8,890	\$9,721	\$6,484	
	80.75" W, Three seat									109 lbs 10 yds
	Model	Series 2	Series 3	Series 4	Series 5	Series 6	Series 7	Series 8	COM	
	861-30-3 S	\$4,490	\$4,809	\$5,338	\$5,892	\$6,550	\$7,215	\$8,046	\$4,809	
	861-30-3 P	\$5,068	\$5,387	\$5,916	\$6,470	\$7,128	\$7,793	\$8,624	\$5,387	
	80.75" W, Sofa									96 lbs 8 yds
	Model	Series 2	Series 3	Series 4	Series 5	Series 6	Series 7	Series 8	COM	
	861-3 S	\$4,533	\$4,788	\$5,212	\$5,654	\$6,181	\$6,713	\$7,378	\$4,788	
	861-3 P	\$5,108	\$5,363	\$5,787	\$6,229	\$6,756	\$7,288	\$7,953	\$5,363	
	80.75" W, Three seat with divider arms									123 lbs 11 yds
	Model	Series 2	Series 3	Series 4	Series 5	Series 6	Series 7	Series 8	COM	
	861-35-3 S	\$5,438	\$5,789	\$6,371	\$6,980	\$7,704	\$8,435	\$9,350	\$5,789	
	861-35-3 P	\$6,133	\$6,484	\$7,066	\$7,675	\$8,399	\$9,130	\$10,045	\$6,484	
	84.75" W, Three seat									112 lbs 12.5 yds
	Model	Series 2	Series 3	Series 4	Series 5	Series 6	Series 7	Series 8	COM	
	861-30-4 S	\$4,468	\$4,867	\$5,529	\$6,221	\$7,043	\$7,874	\$8,914	\$4,867	
	861-30-4 P	\$5,053	\$5,452	\$6,114	\$6,806	\$7,628	\$8,459	\$9,499	\$5,452	
	84.75" W, Three seat with divider arms									126 lbs 12.75 yds
	Model	Series 2	Series 3	Series 4	Series 5	Series 6	Series 7	Series 8	COM	
	861-35-4 S	\$5,435	\$5,842	\$6,517	\$7,223	\$8,062	\$8,909	\$9,970	\$5,842	
	861-35-4 P	\$6,137	\$6,544	\$7,219	\$7,925	\$8,764	\$9,611	\$10,672	\$6,544	

Brava Platform Lounge Seating



More Information

Illustrated Glossary ▶ 439

Fabrics ▶ 451

Flammability (CTB-133) ▶ 459

Finishes ▶ 456

Ordering and Warranties ▶ 462

Standard Features

- Solid maple frame
- Mortise and tenon joinery
- Spring seat construction
- Clean-out design
- Replaceable components
- Upholstered arms
- Non-marring 7/8" rubber-cushioned glides
- Nemschoff healthcare wood finish
- GREENGUARD Gold Certified
- Limited Lifetime Warranty

Available Options

- Moisture barrier + \$67 per seat or back
- Black urethane arm caps + \$113
- Desert or Pewter urethane arm caps + \$205
- Wood arm caps + \$113
- CTB-133 + \$81/yd
- Two fabrics + \$62
- Three (or more) fabrics + \$88
- Arm with literature storage (LSF, RSF, both sides) + \$485 per arm

Specification Decisions

- Select fabric
 - Select standard wood finish
 - Add wood or urethane arm caps
 - Add moisture barrier
 - Add CTB-133
 - Apply multiple fabrics
 - Add arm with literature storage
- Model numbers with **S** indicate standard seat and back covers, and model numbers with **P** indicate removable covers.

Flammability Types

- Type 6 (with arms)
- Type 5 (without arms)
- Type 4 (Bench)

Coordinating Products

- [Brava Classic Lounge Seating](#)
- [Brava 862 Multiple Seating](#)
- [Brava 863 Multiple Seating](#)
- [Brava Side Chair](#)
- [Brava Tables](#)
- [Brava Adjustable Back Chair](#)
- [Brava CompactComfort Recliner](#)
- [Brava Patient Chair](#)
- [Brava Glider](#)
- [Brava Flop Sofa](#)
- [Brava Sleep Settee](#)

Key Dimensions

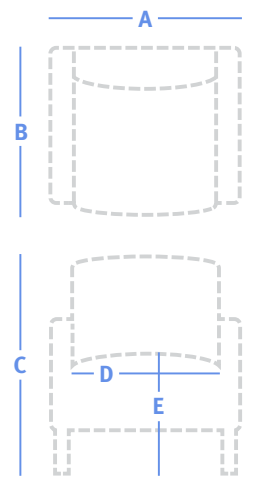

A	Overall Width	See price table
B	Overall Depth	28.5"
C	Overall Height	32"
D	Seat Width	
	Chair:	21.5", 26"
	Two Seat:	26", 47.5"
	Three Seat:	73.5", 78"
E	Seat Height	18.75"
F	Arm Height	25"

Welcoming & Waiting

Brava Platform Lounge Seating









	26.5" W, Chair without arms									36 lbs 3.25 yds
	Model	Series 2	Series 3	Series 4	Series 5	Series 6	Series 7	Series 8	COM	
	860-11 S	\$1,811	\$1,914	\$2,086	\$2,266	\$2,480	\$2,696	\$2,967	\$1,914	
	860-11 P	\$2,041	\$2,144	\$2,316	\$2,496	\$2,710	\$2,926	\$3,197	\$2,144	
	28.5" W, Chair									52 lbs 4.75 yds
	Model	Series 2	Series 3	Series 4	Series 5	Series 6	Series 7	Series 8	COM	
	860-10 S	\$2,382	\$2,533	\$2,785	\$3,048	\$3,360	\$3,676	\$4,071	\$2,533	
	860-10 P	\$2,686	\$2,837	\$3,089	\$3,352	\$3,664	\$3,980	\$4,375	\$2,837	
	52.5" W, Two seat without arms									68 lbs 6.5 yds
	Model	Series 2	Series 3	Series 4	Series 5	Series 6	Series 7	Series 8	COM	
	860-21 S	\$3,366	\$3,573	\$3,917	\$4,277	\$4,705	\$5,137	\$5,678	\$3,573	
	860-21 P	\$3,795	\$4,002	\$4,346	\$4,706	\$5,134	\$5,566	\$6,107	\$4,002	
	54.5" W, Two seat									84 lbs 6.75 yds
	Model	Series 2	Series 3	Series 4	Series 5	Series 6	Series 7	Series 8	COM	
	860-20 S	\$4,014	\$4,229	\$4,587	\$4,960	\$5,404	\$5,853	\$6,414	\$4,229	
	860-20 P	\$4,522	\$4,737	\$5,095	\$5,468	\$5,912	\$6,361	\$6,922	\$4,737	
	54.5" W, Settee									78 lbs 6.25 yds
	Model	Series 2	Series 3	Series 4	Series 5	Series 6	Series 7	Series 8	COM	
	860-2 S	\$3,982	\$4,181	\$4,512	\$4,858	\$5,269	\$5,685	\$6,205	\$4,181	
	860-2 P	\$4,484	\$4,683	\$5,014	\$5,360	\$5,771	\$6,187	\$6,707	\$4,683	
	54.5" W, Two seat with divider arm									91 lbs 7.25 yds
	Model	Series 2	Series 3	Series 4	Series 5	Series 6	Series 7	Series 8	COM	
	860-25 S	\$4,283	\$4,514	\$4,898	\$5,299	\$5,776	\$6,258	\$6,861	\$4,514	
	860-25 P	\$4,825	\$5,056	\$5,440	\$5,841	\$6,318	\$6,800	\$7,403	\$5,056	
	52.25" W, One seat without arms, with LSF table, literature caddy and literature recess									78 lbs 3.25 yds
	Model	Series 2	Series 3	Series 4	Series 5	Series 6	Series 7	Series 8	COM	
	860-21LD S	\$3,168	\$3,271	\$3,443	\$3,623	\$3,837	\$4,053	\$4,324	\$3,271	
	860-21LD P	\$3,561	\$3,664	\$3,836	\$4,016	\$4,230	\$4,446	\$4,717	\$3,664	
	52.25" W, One seat without arms, with RSF table, literature caddy and literature recess									78 lbs 3.25 yds
	Model	Series 2	Series 3	Series 4	Series 5	Series 6	Series 7	Series 8	COM	
	860-21RD S	\$3,168	\$3,271	\$3,443	\$3,623	\$3,837	\$4,053	\$4,324	\$3,271	
	860-21RD P	\$3,561	\$3,664	\$3,836	\$4,016	\$4,230	\$4,446	\$4,717	\$3,664	
	52.25" W, One seat without arms, with LSF table and literature recess									78 lbs 3.25 yds
	Model	Series 2	Series 3	Series 4	Series 5	Series 6	Series 7	Series 8	COM	
	860-21LT S	\$3,168	\$3,271	\$3,443	\$3,623	\$3,837	\$4,053	\$4,324	\$3,271	
	860-21LT P	\$3,561	\$3,664	\$3,836	\$4,016	\$4,230	\$4,446	\$4,717	\$3,664	
	52.25" W, One seat without arms, with RSF table and literature recess									78 lbs 3.25 yds
	Model	Series 2	Series 3	Series 4	Series 5	Series 6	Series 7	Series 8	COM	
	860-21RT S	\$3,168	\$3,271	\$3,443	\$3,623	\$3,837	\$4,053	\$4,324	\$3,271	
	860-21RT P	\$3,561	\$3,664	\$3,836	\$4,016	\$4,230	\$4,446	\$4,717	\$3,664	

Patient Areas

Specialty

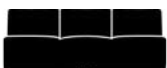
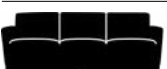
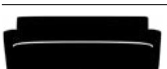
Reference

Brava Platform Lounge Seating

	53.25" W, One seat with RSF table, literature caddy and literature recess 87 lbs 3.5 yds								
	Model	Series 2	Series 3	Series 4	Series 5	Series 6	Series 7	Series 8	COM
	860-20RD S	\$3,813	\$3,924	\$4,110	\$4,303	\$4,534	\$4,766	\$5,057	\$3,924
	860-20RD P	\$4,284	\$4,395	\$4,581	\$4,774	\$5,005	\$5,237	\$5,528	\$4,395
	53.25" W, One seat with LSF table, literature caddy and literature recess 87 lbs 3.5 yds								
	Model	Series 2	Series 3	Series 4	Series 5	Series 6	Series 7	Series 8	COM
	860-20LD S	\$3,813	\$3,924	\$4,110	\$4,303	\$4,534	\$4,766	\$5,057	\$3,924
	860-20LD P	\$4,284	\$4,395	\$4,581	\$4,774	\$5,005	\$5,237	\$5,528	\$4,395
	53.25" W, One seat with RSF table and literature recess 87 lbs 3.5 yds								
	Model	Series 2	Series 3	Series 4	Series 5	Series 6	Series 7	Series 8	COM
	860-20RT S	\$3,813	\$3,924	\$4,110	\$4,303	\$4,534	\$4,766	\$5,057	\$3,924
	860-20RT P	\$4,284	\$4,395	\$4,581	\$4,774	\$5,005	\$5,237	\$5,528	\$4,395
	53.25" W, One seat with LSF table and literature recess 87 lbs 3.5 yds								
	Model	Series 2	Series 3	Series 4	Series 5	Series 6	Series 7	Series 8	COM
	860-20LT S	\$3,813	\$3,924	\$4,110	\$4,303	\$4,534	\$4,766	\$5,057	\$3,924
	860-20LT P	\$4,284	\$4,395	\$4,581	\$4,774	\$5,005	\$5,237	\$5,528	\$4,395
	79" W, Sofa without arms 100 lbs 9.5 yds								
	Model	Series 2	Series 3	Series 4	Series 5	Series 6	Series 7	Series 8	COM
	860-31 S	\$5,184	\$5,487	\$5,990	\$6,516	\$7,141	\$7,773	\$8,563	\$5,487
	860-31 P	\$5,843	\$6,146	\$6,649	\$7,175	\$7,800	\$8,432	\$9,222	\$6,146
	80.75" W, Three seat 117 lbs 9 yds								
	Model	Series 2	Series 3	Series 4	Series 5	Series 6	Series 7	Series 8	COM
	860-30 S	\$5,770	\$6,057	\$6,534	\$7,032	\$7,624	\$8,222	\$8,971	\$6,057
	860-30 P	\$6,497	\$6,784	\$7,261	\$7,759	\$8,351	\$8,949	\$9,698	\$6,784
	80.75" W, Sofa with continuous cushion 104 lbs 8 yds								
	Model	Series 2	Series 3	Series 4	Series 5	Series 6	Series 7	Series 8	COM
	860-3 S	\$5,807	\$6,062	\$6,486	\$6,928	\$7,455	\$7,987	\$8,652	\$6,062
	860-3 P	\$6,535	\$6,790	\$7,214	\$7,656	\$8,183	\$8,715	\$9,380	\$6,790
	80.75" W, Three seat with divider arms 131 lbs 10 yds								
	Model	Series 2	Series 3	Series 4	Series 5	Series 6	Series 7	Series 8	COM
	860-35 S	\$6,178	\$6,497	\$7,026	\$7,580	\$8,238	\$8,903	\$9,734	\$6,497
	860-35 P	\$6,958	\$7,277	\$7,806	\$8,360	\$9,018	\$9,683	\$10,514	\$7,277
	78.25" W, Two seat without arms, with LSF table, literature caddy and literature recess 110 lbs 6.5 yds								
	Model	Series 2	Series 3	Series 4	Series 5	Series 6	Series 7	Series 8	COM
	860-31LD S	\$4,989	\$5,196	\$5,540	\$5,900	\$6,328	\$6,760	\$7,301	\$5,196
	860-31LD P	\$5,613	\$5,820	\$6,164	\$6,524	\$6,952	\$7,384	\$7,925	\$5,820
	80.75" W, Two seat without arms, with center table, literature caddy and literature recess 110 lbs 6.5 yds								
	Model	Series 2	Series 3	Series 4	Series 5	Series 6	Series 7	Series 8	COM
	860-31CD S	\$4,989	\$5,196	\$5,540	\$5,900	\$6,328	\$6,760	\$7,301	\$5,196
	860-31CD P	\$5,613	\$5,820	\$6,164	\$6,524	\$6,952	\$7,384	\$7,925	\$5,820

Lounge Seating

Multiple & Tandem Seating

Side, Stacking & Folding Chairs

Occasional Tables

Welcoming & Waiting

Brava Platform Lounge Seating

	78.25" W, Two seat without arms, with LSF table and literature recess 110 lbs 6.5 yds								
	Model	Series 2	Series 3	Series 4	Series 5	Series 6	Series 7	Series 8	COM
	860-31LT S	\$4,989	\$5,196	\$5,540	\$5,900	\$6,328	\$6,760	\$7,301	\$5,196
	860-31LT P	\$5,613	\$5,820	\$6,164	\$6,524	\$6,952	\$7,384	\$7,925	\$5,820

	80.75" W, Two seat without arms, with center table and literature recess 110 lbs 6.5 yds								
	Model	Series 2	Series 3	Series 4	Series 5	Series 6	Series 7	Series 8	COM
	860-31CT S	\$4,989	\$5,196	\$5,540	\$5,900	\$6,328	\$6,760	\$7,301	\$5,196
	860-31CT P	\$5,613	\$5,820	\$6,164	\$6,524	\$6,952	\$7,384	\$7,925	\$5,820

Patient Areas

	80.75" W, Two seat without arms with center literature caddy 100 lbs 6.5 yds								
	Model	Series 2	Series 3	Series 4	Series 5	Series 6	Series 7	Series 8	COM
	860-31CV S	\$4,989	\$5,196	\$5,540	\$5,900	\$6,328	\$6,760	\$7,301	\$5,196
	860-31CV P	\$5,613	\$5,820	\$6,164	\$6,524	\$6,952	\$7,384	\$7,925	\$5,820

	78.25" W, Two seat without arms, with RSF table, literature caddy and literature recess 110 lbs 6.5 yds								
	Model	Series 2	Series 3	Series 4	Series 5	Series 6	Series 7	Series 8	COM
	860-31RD S	\$4,989	\$5,196	\$5,540	\$5,900	\$6,328	\$6,760	\$7,301	\$5,196
	860-31RD P	\$5,613	\$5,820	\$6,164	\$6,524	\$6,952	\$7,384	\$7,925	\$5,820

	78.25" W, Two seat without arms, with RSF table and literature recess 110 lbs 6.5 yds								
	Model	Series 2	Series 3	Series 4	Series 5	Series 6	Series 7	Series 8	COM
	860-31RT S	\$4,989	\$5,196	\$5,540	\$5,900	\$6,328	\$6,760	\$7,301	\$5,196
	860-31RT P	\$5,613	\$5,820	\$6,164	\$6,524	\$6,952	\$7,384	\$7,925	\$5,820

Specialty

	79.25" W, Two seat with LSF table and literature recess 119 lbs 5.75 yds								
	Model	Series 2	Series 3	Series 4	Series 5	Series 6	Series 7	Series 8	COM
	860-30LT S	\$5,587	\$5,770	\$6,075	\$6,393	\$6,771	\$7,154	\$7,632	\$5,770
	860-30LT P	\$6,280	\$6,463	\$6,768	\$7,086	\$7,464	\$7,847	\$8,325	\$6,463

	80.75" W, Two seat with center table, literature caddy and literature recess 128 lbs 6.75 yds								
	Model	Series 2	Series 3	Series 4	Series 5	Series 6	Series 7	Series 8	COM
	860-30CD S	\$5,726	\$5,941	\$6,299	\$6,672	\$7,116	\$7,565	\$8,126	\$5,941
	860-30CD P	\$6,439	\$6,654	\$7,012	\$7,385	\$7,829	\$8,278	\$8,839	\$6,654

	79.25" W, Two seat with LSF table, literature caddy and literature recess 119 lbs 5.75 yds								
	Model	Series 2	Series 3	Series 4	Series 5	Series 6	Series 7	Series 8	COM
	860-30LD S	\$5,587	\$5,770	\$6,075	\$6,393	\$6,771	\$7,154	\$7,632	\$5,770
	860-30LD P	\$6,280	\$6,463	\$6,768	\$7,086	\$7,464	\$7,847	\$8,325	\$6,463

Reference

	80.75" W, Two seat with center table and literature recess 128 lbs 6.75 yds								
	Model	Series 2	Series 3	Series 4	Series 5	Series 6	Series 7	Series 8	COM
	860-30CT S	\$5,726	\$5,941	\$6,299	\$6,672	\$7,116	\$7,565	\$8,126	\$5,941
	860-30CT P	\$6,439	\$6,654	\$7,012	\$7,385	\$7,829	\$8,278	\$8,839	\$6,654

	80.75" W, Two seat with center literature caddy 118 lbs 6.75 yds								
	Model	Series 2	Series 3	Series 4	Series 5	Series 6	Series 7	Series 8	COM
	860-30CV S	\$5,726	\$5,941	\$6,299	\$6,672	\$7,116	\$7,565	\$8,126	\$5,941
	860-30CV P	\$6,439	\$6,654	\$7,012	\$7,385	\$7,829	\$8,278	\$8,839	\$6,654

Brava Platform Lounge Seating

	79.25" W, Two seat with RSF table and literature recess 118 lbs 5.75 yds								
	Model	Series 2	Series 3	Series 4	Series 5	Series 6	Series 7	Series 8	COM
	860-30RT S	\$5,587	\$5,770	\$6,075	\$6,393	\$6,771	\$7,154	\$7,632	\$5,770
	860-30RT P	\$6,280	\$6,463	\$6,768	\$7,086	\$7,464	\$7,847	\$8,325	\$6,463

	79.25" W, Two seat with RSF table, literature caddy and literature recess 118 lbs 5.75 yds								
	Model	Series 2	Series 3	Series 4	Series 5	Series 6	Series 7	Series 8	COM
	860-30RD S	\$5,587	\$5,770	\$6,075	\$6,393	\$6,771	\$7,154	\$7,632	\$5,770
	860-30RD P	\$6,280	\$6,463	\$6,768	\$7,086	\$7,464	\$7,847	\$8,325	\$6,463

Brava Platform Lounge Benches

Standard Features

Same standard features as Brava Platform Lounge Seating

Available Options

Same options as Brava Platform Lounge Seating

Key Dimensions

- Overall Width: See price table
- Overall Depth: 27"
- Overall Height: 18.75"

	26.5" W, Bench 38 lbs 2 yds								
	Model	Series 2	Series 3	Series 4	Series 5	Series 6	Series 7	Series 8	COM
	860-B1 S	\$1,798	\$1,861	\$1,967	\$2,078	\$2,210	\$2,343	\$2,509	\$1,861
	860-B1 P	\$2,022	\$2,085	\$2,191	\$2,302	\$2,434	\$2,567	\$2,733	\$2,085

	52.5" W, Bench 60 lbs 3.75 yds								
	Model	Series 2	Series 3	Series 4	Series 5	Series 6	Series 7	Series 8	COM
	860-B2 S	\$2,249	\$2,368	\$2,567	\$2,774	\$3,021	\$3,271	\$3,582	\$2,368
	860-B2 P	\$2,534	\$2,653	\$2,852	\$3,059	\$3,306	\$3,556	\$3,867	\$2,653

	78.5" W, Bench 87 lbs 5.5 yds								
	Model	Series 2	Series 3	Series 4	Series 5	Series 6	Series 7	Series 8	COM
	860-B3 S	\$2,807	\$2,982	\$3,273	\$3,578	\$3,940	\$4,305	\$4,763	\$2,982
	860-B3 P	\$3,165	\$3,340	\$3,631	\$3,936	\$4,298	\$4,663	\$5,121	\$3,340

Brooklyn Lounge Seating



Standard Features

- Solid maple frame
- Mortise and tenon joinery
- Spring seat construction
- Clean-out design
- Replaceable components
- Wood arm caps
- Wallsaver legs
- Non-marring 7/8" rubber-cushioned glides
- Nemschoff healthcare wood finish
- GREENGUARD Gold Certified
- Limited Lifetime Warranty

Available Options

- Moisture barrier + \$67 per seat or back
- Black urethane arm caps + \$113
- CTB-133 + \$81/yd
- Two fabrics + \$62
- Three (or more) fabrics + \$88

Specification Decisions

- Select fabric
 - Select standard wood finish
 - Add urethane arm caps
 - Add moisture barrier
 - Add CTB-133
 - Apply multiple fabrics
- Model numbers with **S** indicate standard seat and back covers, and model numbers with **P** indicate removable covers.

Flammability Type

- Type 6

Coordinating Products

- [Brooklyn Tables](#)
- [Brooklyn Patient Chair](#)

Key Dimensions

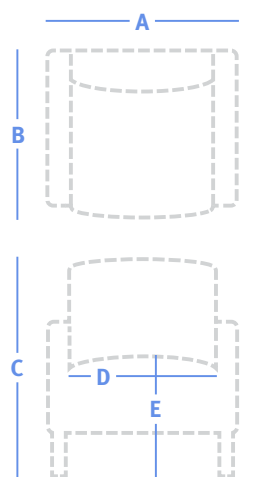









A	Overall Width	See price table
B	Overall Depth	28.25"
C	Overall Height	34"
D	Seat Width	
	Chair:	21.5", 23.25", 27.25"
	Settee / Two Seat:	21.5", 46.5", 56"
	Sofa / Three Seat:	21.5", 70.75", 83"
E	Seat Height	18.75"
F	Arm Height	24.5", 25.5"

More Information

- Illustrated Glossary ▶ 439
- Fabrics ▶ 451
- Flammability (CTB-133) ▶ 459
- Finishes ▶ 456
- Ordering and Warranties ▶ 462

Brooklyn Lounge Seating

	26.75" W, Chair									48 lbs 3.25 yds
	Model	Series 2	Series 3	Series 4	Series 5	Series 6	Series 7	Series 8	COM	
	770-1 S	\$1,630	\$1,733	\$1,905	\$2,085	\$2,299	\$2,515	\$2,786	\$1,733	
	770-1 P	\$1,838	\$1,941	\$2,113	\$2,293	\$2,507	\$2,723	\$2,994	\$1,941	
	29.5" W, Chair									87 lbs 6 yds
	Model	Series 2	Series 3	Series 4	Series 5	Series 6	Series 7	Series 8	COM	
	776-10 S	\$2,467	\$2,658	\$2,976	\$3,308	\$3,703	\$4,102	\$4,601	\$2,658	
	776-10 P	\$2,786	\$2,977	\$3,295	\$3,627	\$4,022	\$4,421	\$4,920	\$2,977	
	33.5" W, Chair									89 lbs 6 yds
	Model	Series 2	Series 3	Series 4	Series 5	Series 6	Series 7	Series 8	COM	
	776-1 S	\$2,654	\$2,845	\$3,163	\$3,495	\$3,890	\$4,289	\$4,788	\$2,845	
	776-1 P	\$2,996	\$3,187	\$3,505	\$3,837	\$4,232	\$4,631	\$5,130	\$3,187	
	51.5" W, Settee									82 lbs 4.5 yds
	Model	Series 2	Series 3	Series 4	Series 5	Series 6	Series 7	Series 8	COM	
	770-2 S	\$2,442	\$2,585	\$2,824	\$3,073	\$3,369	\$3,668	\$4,042	\$2,585	
	770-2 P	\$2,753	\$2,896	\$3,135	\$3,384	\$3,680	\$3,979	\$4,353	\$2,896	
	51.5" W, Settee with intervening arm and leg									87 lbs 5.25 yds
	Model	Series 2	Series 3	Series 4	Series 5	Series 6	Series 7	Series 8	COM	
	770-22 S	\$2,837	\$3,004	\$3,282	\$3,573	\$3,918	\$4,267	\$4,704	\$3,004	
	770-22 P	\$3,198	\$3,365	\$3,643	\$3,934	\$4,279	\$4,628	\$5,065	\$3,365	
	62.25" W, Settee									145 lbs 9.25 yds
	Model	Series 2	Series 3	Series 4	Series 5	Series 6	Series 7	Series 8	COM	
	776-2 S	\$4,322	\$4,617	\$5,107	\$5,619	\$6,228	\$6,843	\$7,612	\$4,617	
	776-2 P	\$4,877	\$5,172	\$5,662	\$6,174	\$6,783	\$7,398	\$8,167	\$5,172	
	76" W, Sofa									115 lbs 6 yds
	Model	Series 2	Series 3	Series 4	Series 5	Series 6	Series 7	Series 8	COM	
	770-3 S	\$3,366	\$3,557	\$3,875	\$4,207	\$4,602	\$5,001	\$5,500	\$3,557	
	770-3 P	\$3,793	\$3,984	\$4,302	\$4,634	\$5,029	\$5,428	\$5,927	\$3,984	
	76" W, Sofa with intervening arms and legs									125 lbs 7.75 yds
	Model	Series 2	Series 3	Series 4	Series 5	Series 6	Series 7	Series 8	COM	
	770-33 S	\$4,135	\$4,382	\$4,792	\$5,221	\$5,732	\$6,247	\$6,891	\$4,382	
	770-33 P	\$4,661	\$4,908	\$5,318	\$5,747	\$6,258	\$6,773	\$7,417	\$4,908	
	89.25" W, Sofa									195 lbs 12.25 yds
	Model	Series 2	Series 3	Series 4	Series 5	Series 6	Series 7	Series 8	COM	
	776-3 S	\$5,954	\$6,345	\$6,994	\$7,671	\$8,478	\$9,292	\$10,311	\$6,345	
	776-3 P	\$6,716	\$7,107	\$7,756	\$8,433	\$9,240	\$10,054	\$11,073	\$7,107	

Lounge Seating

Multiple & Tandem Seating

Side, Stacking & Folding Chairs

Occasional Tables

Cities Small Crosstown Lounge Seating



Standard Features

- Solid maple frame
- Mortise and tenon joinery
- Spring seat construction
- Wipe-out design
- Replaceable components
- Wood arm caps
- Non-marring 7/8" rubber-cushioned glides
- Nemschoff healthcare wood finish
- GREENGUARD Gold Certified
- Limited Lifetime Warranty

Available Options

- Moisture barrier + \$67 per seat or back
- Five arm cap styles + \$0
- Four foot styles + \$0
- Four back styles + \$0
- Two arm styles + \$0
- CTB-133 + \$81/yd
- Two fabrics + \$62
- Three (or more) fabrics + \$88
- Attached table (LSF, RSF – see price table)

Specification Decisions

- Select fabric
- Select standard wood finish
- Add moisture barrier
- Add CTB-133
- Apply multiple fabrics
- Add attached table
- Select arm cap style

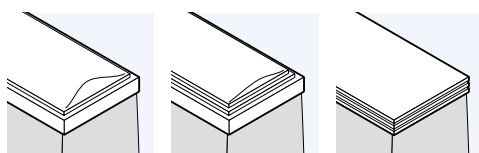

C Chicago **L** Los Angeles **N** New Orleans

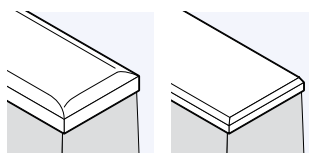

Y New York **W** Williamsburg

- Select foot style

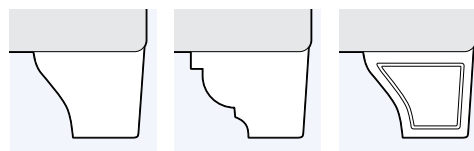

B Boston **C** Chicago **P** Philadelphia

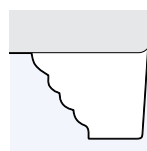

S San Francisco

- Select back style. All styles have a wipe-out feature.

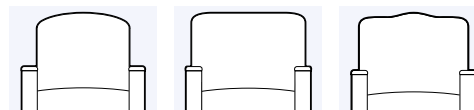

A Arcade back **D** T-back **K** Camel T-back

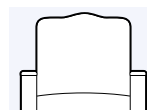

Q Camel square back

- Select arm style



E Elliptical arm **C** Closed arm

Model numbers with **S** indicate standard seat and back covers, and model numbers with **P** indicate removable covers.

Flammability Types

- Type 8
- Type 3 (Bench)

More Information

Illustrated Glossary ▶ 439

Fabrics ▶ 451

Flammability (CTB-133) ▶ 459

Finishes ▶ 456

Ordering and Warranties ▶ 462

Cities Small Crosstown Lounge Seating

Coordinating Products

- [Cities Medium Crosstown Lounge Seating](#)
- [Cities Large Crosstown Lounge Seating](#)
- [Cities Small Downtown Lounge Seating](#)
- [Cities Medium Downtown Lounge Seating](#)
- [Cities Large Downtown Lounge Seating](#)
- [Cities Small Uptown Lounge Seating](#)
- [Cities Medium Uptown Lounge Seating](#)
- [Cities Large Uptown Lounge Seating](#)
- [Cities Side Chair](#)
- [Cities Tables](#)
- [Cities Crosstown Patient Chair](#)
- [Cities Downtown Patient Chair](#)
- [Cities Uptown Patient Chair](#)
- [Cities Uptown CompactComfort Recliner](#)
- [Cities Crosstown Rocker](#)
- [Cities Downtown Rocker](#)
- [Cities Uptown Rocker](#)
- [Cities Downtown Glider](#)
- [Cities Uptown Glider](#)
- [SleepOver Sofa](#)
- [SleepOver Settee](#)

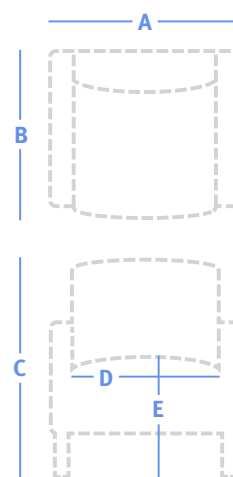

Key Dimensions



A	Overall Width	See price table
B	Overall Depth	26"
C	Overall Height	33"
D	Seat Width	
	Chair:	19.5", 23.5"
	Two Seat:	39"
	Three Seat:	58.5"
	Four Seat:	78"
E	Seat Height	18.5"
F	Arm Height	25.5"

	26.5" W, Chair									35 lbs 3.5 yds
	Model	Series 2	Series 3	Series 4	Series 5	Series 6	Series 7	Series 8	COM	
	Cities-SCXXXX-10SX	\$1,238	\$1,349	\$1,535	\$1,728	\$1,959	\$2,191	\$2,482	\$1,349	
	Cities-SCXXXX-10PX	\$1,400	\$1,511	\$1,697	\$1,890	\$2,121	\$2,353	\$2,644	\$1,511	
	30.5" W, Chair									35 lbs 3.75 yds
	Model	Series 2	Series 3	Series 4	Series 5	Series 6	Series 7	Series 8	COM	
	Cities-SCXXXX-1WSX	\$1,414	\$1,533	\$1,732	\$1,939	\$2,186	\$2,436	\$2,747	\$1,533	
	Cities-SCXXXX-1WPX	\$1,598	\$1,717	\$1,916	\$2,123	\$2,370	\$2,620	\$2,931	\$1,717	
	47" W, Two seat									64 lbs 5 yds
	Model	Series 2	Series 3	Series 4	Series 5	Series 6	Series 7	Series 8	COM	
	Cities-SCXXXX-20SX	\$2,005	\$2,164	\$2,429	\$2,706	\$3,035	\$3,367	\$3,783	\$2,164	
	Cities-SCXXXX-20PX	\$2,265	\$2,424	\$2,689	\$2,966	\$3,295	\$3,627	\$4,043	\$2,424	

Cities Small Crosstown Lounge Seating

	49" W, Two seat with intervening arm and leg 70 lbs 5.75 yds								
	Model	Series 2	Series 3	Series 4	Series 5	Series 6	Series 7	Series 8	COM
	Cities-SCXXXX-22SX	\$2,391	\$2,574	\$2,879	\$3,197	\$3,575	\$3,958	\$4,436	\$2,574
	Cities-SCXXXX-22PX	\$2,700	\$2,883	\$3,188	\$3,506	\$3,884	\$4,267	\$4,745	\$2,883
	67" W, Three seat 92 lbs 6.5 yds								
	Model	Series 2	Series 3	Series 4	Series 5	Series 6	Series 7	Series 8	COM
	Cities-SCXXXX-30SX	\$2,674	\$2,881	\$3,225	\$3,585	\$4,013	\$4,445	\$4,986	\$2,881
	Cities-SCXXXX-30PX	\$3,020	\$3,227	\$3,571	\$3,931	\$4,359	\$4,791	\$5,332	\$3,227
	67" W, Three seat with intervening arms and legs 104 lbs 8.25 yds								
	Model	Series 2	Series 3	Series 4	Series 5	Series 6	Series 7	Series 8	COM
	Cities-SCXXXX-33SX	\$3,370	\$3,633	\$4,070	\$4,526	\$5,070	\$5,618	\$6,304	\$3,633
	Cities-SCXXXX-33PX	\$3,806	\$4,069	\$4,506	\$4,962	\$5,506	\$6,054	\$6,740	\$4,069
	95" W, Four seat with intervening arms and legs 140 lbs 10.5 yds								
	Model	Series 2	Series 3	Series 4	Series 5	Series 6	Series 7	Series 8	COM
	Cities-SCXXXX-44SX	\$4,440	\$4,775	\$5,331	\$5,912	\$6,603	\$7,301	\$8,174	\$4,775
	Cities-SCXXXX-44PX	\$5,013	\$5,348	\$5,904	\$6,485	\$7,176	\$7,874	\$8,747	\$5,348

Cities Small Crosstown Benches

Standard Features

Same standard features as Cities Small Crosstown Lounge Seating

Available Options

Same options as Cities Small Crosstown Lounge Seating

Key Dimensions

- Overall Width: See price table
- Overall Depth: 23"
- Overall Height: 18.75"

	25.5" W, Bench 33 lbs 2.75 yds								
	Model	Series 2	Series 3	Series 4	Series 5	Series 6	Series 7	Series 8	COM
	Cities-SCXX0X-B1S0	\$985	\$1,072	\$1,218	\$1,370	\$1,551	\$1,734	\$1,963	\$1,072
	Cities-SCXX0X-B1P0	\$1,114	\$1,201	\$1,347	\$1,499	\$1,680	\$1,863	\$2,092	\$1,201
	45.5" W, Bench 39 lbs 3.75 yds								
	Model	Series 2	Series 3	Series 4	Series 5	Series 6	Series 7	Series 8	COM
	Cities-SCXX0X-B2S0	\$1,285	\$1,404	\$1,603	\$1,810	\$2,057	\$2,307	\$2,618	\$1,404
	Cities-SCXX0X-B2P0	\$1,454	\$1,573	\$1,772	\$1,979	\$2,226	\$2,476	\$2,787	\$1,573
	65.5" W, Bench 45 lbs 4.5 yds								
	Model	Series 2	Series 3	Series 4	Series 5	Series 6	Series 7	Series 8	COM
	Cities-SCXX0X-B3S0	\$1,595	\$1,738	\$1,977	\$2,226	\$2,522	\$2,821	\$3,195	\$1,738
	Cities-SCXX0X-B3P0	\$1,804	\$1,947	\$2,186	\$2,435	\$2,731	\$3,030	\$3,404	\$1,947

Cities Small Crosstown Lounge Seating

Cities Spanner Tables

Standard Features

- Same standard features as Cities Small Crosstown Lounge Seating, plus:
 - Laminate or veneer tops
 - Straight table apron on Crosstown
 - Dry-construction joinery

Available Options

- Five tabletop edge styles + \$0

Specification Decisions

- Select standard wood finish
- Select standard laminate
- Select edge style



C Chicago



L Los Angeles

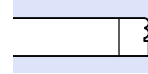

N New Orleans

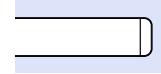

Y New York

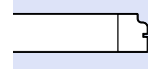

W Williamsburg

19.5" W, Spanner table with legs

24 lbs

Model	Price	Depth	Height
Cities-SUX000-S10X	\$823	19.5"	

19.5" W, Spanner table without legs

24 lbs

Model	Price	Depth	Height
Cities-SUX000-S00X	\$523	19.5"	

27.25" W, Corner spanner table with legs

29 lbs

Model	Price	Depth	Height
Cities-SUX000-C10X	\$1,415	27.25"	

Cities Medium Crosstown Lounge Seating



Standard Features

- Solid maple frame
- Mortise and tenon joinery
- Spring seat construction
- Wipe-out design
- Replaceable components
- Wood arm caps
- 5/8" x 2" bar glides
- Nemschoff healthcare wood finish
- GREENGUARD Gold Certified
- Limited Lifetime Warranty

Available Options

- Moisture barrier + \$67 per seat or back
- Five arm cap styles + \$0
- Four foot styles + \$0
- Four back styles + \$0
- Two arm styles + \$0
- CTB-133 + \$81/yd
- Two fabrics + \$62
- Three (or more) fabrics + \$88

Specification Decisions

- Select fabric
- Select standard wood finish
- Add moisture barrier
- Add CTB-133
- Apply multiple fabrics
- Select arm cap style

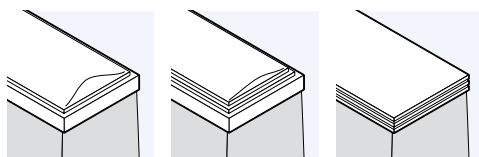

C Chicago **L** Los Angeles **N** New Orleans

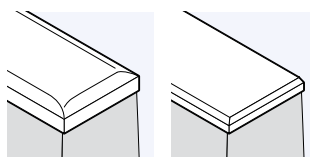

Y New York **W** Williamsburg

- Select foot style

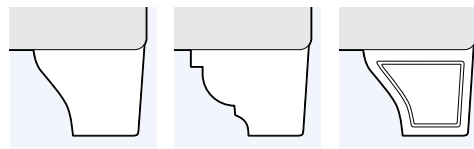

B Boston **C** Chicago **P** Philadelphia

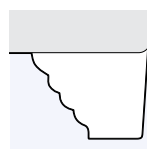

S San Francisco

- Select back style

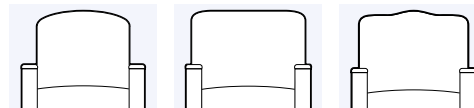

A Arcade back with wipe-out **D** T-back with wipe-out **K** Camel T-back with wipe-out
R Arcade back without wipe-out **T** T-back without wipe-out **L** Camel T-back without wipe-out

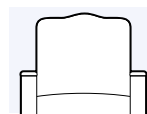

Q Camel square back with wipe-out

M Camel square back without wipe-out

- Select arm style



E Elliptical arm **C** Closed arm

Model numbers with **S** indicate standard seat and back covers, and model numbers with **P** indicate removable covers.

Flammability Type

- Type 6

More Information

Illustrated Glossary ▶ 439

Fabrics ▶ 451

Flammability (CTB-133) ▶ 459

Finishes ▶ 456

Ordering and Warranties ▶ 462

Cities Medium Crosstown Lounge Seating

Lounge Seating

Multiple & Tandem Seating

Side, Stacking & Folding Chairs

Occasional Tables

Coordinating Products

- [Cities Small Crosstown Lounge Seating](#)
- [Cities Large Crosstown Lounge Seating](#)
- [Cities Small Downtown Lounge Seating](#)
- [Cities Medium Downtown Lounge Seating](#)
- [Cities Large Downtown Lounge Seating](#)
- [Cities Small Uptown Lounge Seating](#)
- [Cities Medium Uptown Lounge Seating](#)
- [Cities Large Uptown Lounge Seating](#)
- [Cities Side Chair](#)
- [Cities Tables](#)
- [Cities Crosstown Patient Chair](#)
- [Cities Downtown Patient Chair](#)
- [Cities Uptown Patient Chair](#)
- [Cities Uptown CompactComfort Recliner](#)
- [Cities Crosstown Rocker](#)
- [Cities Downtown Rocker](#)
- [Cities Uptown Rocker](#)
- [Cities Downtown Glider](#)
- [Cities Uptown Glider](#)
- [SleepOver Sofa](#)
- [SleepOver Settee](#)

Key Dimensions

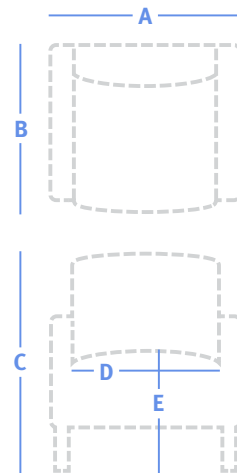

A	Overall Width	See price table
B	Overall Depth	27.25"
C	Overall Height	32.5"
D	Seat Width	
	Chair:	19.25"
	Two Seat:	21.25", 42.5"
	Three Seat:	63.75"
E	Seat Height	18.5"
F	Arm Height	25.75"



28" W, Chair

51 lbs | 4.5 yds

Model	Series 2	Series 3	Series 4	Series 5	Series 6	Series 7	Series 8	COM
Cities-MCXXXX-10S0	\$2,127	\$2,270	\$2,509	\$2,758	\$3,054	\$3,353	\$3,727	\$2,270
Cities-MCXXXX-10P0	\$2,400	\$2,543	\$2,782	\$3,031	\$3,327	\$3,626	\$4,000	\$2,543



50" W, Two seat

85 lbs | 6 yds

Model	Series 2	Series 3	Series 4	Series 5	Series 6	Series 7	Series 8	COM
Cities-MCXXXX-20S0	\$3,545	\$3,736	\$4,054	\$4,386	\$4,781	\$5,180	\$5,679	\$3,736
Cities-MCXXXX-20P0	\$3,994	\$4,185	\$4,503	\$4,835	\$5,230	\$5,629	\$6,128	\$4,185



53" W, Two seat with intervening arm and leg

109 lbs | 7.5 yds

Model	Series 2	Series 3	Series 4	Series 5	Series 6	Series 7	Series 8	COM
Cities-MCXXXX-22S0	\$3,922	\$4,161	\$4,558	\$4,973	\$5,467	\$5,966	\$6,589	\$4,161
Cities-MCXXXX-22P0	\$4,422	\$4,661	\$5,058	\$5,473	\$5,967	\$6,466	\$7,089	\$4,661

Cities Medium Crosstown Lounge Seating

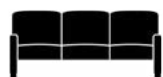

71.5" W, Three seat

131 lbs | 7.75 yds

Model	Series 2	Series 3	Series 4	Series 5	Series 6	Series 7	Series 8	COM
Cities-MCXXXX-30S0	\$4,644	\$4,891	\$5,301	\$5,730	\$6,241	\$6,756	\$7,400	\$4,891
Cities-MCXXXX-30P0	\$5,231	\$5,478	\$5,888	\$6,317	\$6,828	\$7,343	\$7,987	\$5,478



77" W, Three seat with intervening arms and legs

147 lbs | 10.75 yds

Model	Series 2	Series 3	Series 4	Series 5	Series 6	Series 7	Series 8	COM
Cities-MCXXXX-33S0	\$5,531	\$5,874	\$6,443	\$7,038	\$7,746	\$8,460	\$9,354	\$5,874
Cities-MCXXXX-33P0	\$6,236	\$6,579	\$7,148	\$7,743	\$8,451	\$9,165	\$10,059	\$6,579

Cities Large Crosstown Lounge Seating



More Information

Illustrated Glossary ▶ 439

Fabrics ▶ 451

Flammability (CTB-133) ▶ 459

Finishes ▶ 456

Ordering and Warranties ▶ 462

Standard Features

- Solid maple frame
- Mortise and tenon joinery
- Spring seat construction
- Replaceable components
- Wood arm caps
- 5/8" x 2" bar glides
- Nemschoff healthcare wood finish
- GREENGUARD Gold Certified
- Limited Lifetime Warranty

Available Options

- Moisture barrier + \$67 per seat or back
- Five arm cap styles + \$0
- Four foot styles + \$0
- Four back styles + \$0
- Two arm styles + \$0
- CTB-133 + \$81/yd
- Two fabrics + \$62
- Three (or more) fabrics + \$88

Specification Decisions

- Select fabric
- Select standard wood finish
- Add moisture barrier
- Add CTB-133
- Apply multiple fabrics
- Select arm cap style

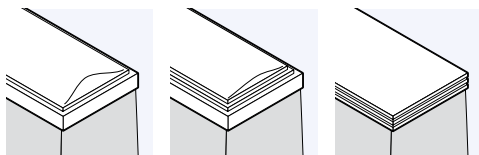

C Chicago **L** Los Angeles **N** New Orleans

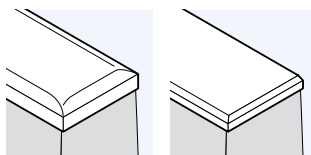

Y New York **W** Williamsburg

- Select foot style

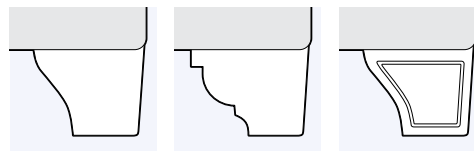

B Boston **C** Chicago **P** Philadelphia

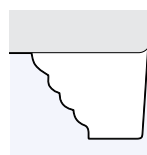

S San Francisco

- Select back style

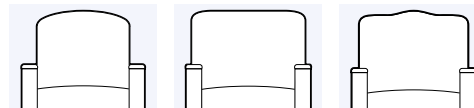

R Arcade back without wipe-out **T** T-back without wipe-out **L** Camel T-back without wipe-out

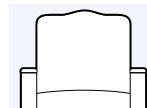

M Camel square back without wipe-out

- Select arm style

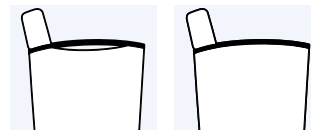

E Elliptical arm **C** Closed arm

Model numbers with **S** indicate standard seat and back covers, and model numbers with **P** indicate removable covers.

Flammability Type

- Type 8

Cities Large Crosstown Lounge Seating

Coordinating Products

- [Cities Small Crosstown Lounge Seating](#)
- [Cities Medium Crosstown Lounge Seating](#)
- [Cities Small Downtown Lounge Seating](#)
- [Cities Medium Downtown Lounge Seating](#)
- [Cities Large Downtown Lounge Seating](#)
- [Cities Small Uptown Lounge Seating](#)
- [Cities Medium Uptown Lounge Seating](#)
- [Cities Large Uptown Lounge Seating](#)
- [Cities Side Chair](#)
- [Cities Tables](#)
- [Cities Crosstown Patient Chair](#)
- [Cities Downtown Patient Chair](#)
- [Cities Uptown Patient Chair](#)
- [Cities Uptown CompactComfort Recliner](#)
- [Cities Crosstown Rocker](#)
- [Cities Downtown Rocker](#)
- [Cities Uptown Rocker](#)
- [Cities Downtown Glider](#)
- [Cities Uptown Glider](#)
- [SleepOver Sofa](#)
- [SleepOver Settee](#)

Key Dimensions

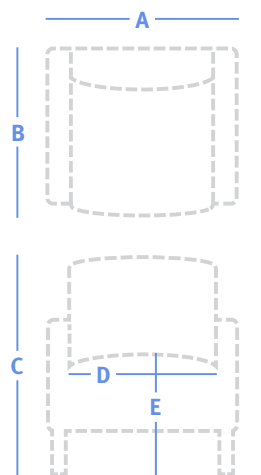

A	Overall Width	See price table
B	Overall Depth	30"
C	Overall Height	31.5"
D	Seat Width	
	Chair:	21.25"
	Two Seat:	42.5"
	Three Seat:	63.75"
E	Seat Height	18.5"
F	Arm Height	24"

	31.5" W, Chair									90 lbs 5.25 yds
	Model	Series 2	Series 3	Series 4	Series 5	Series 6	Series 7	Series 8	COM	
	Cities-LCXXXX-10S0	\$2,543	\$2,710	\$2,988	\$3,279	\$3,624	\$3,973	\$4,410	\$2,710	
	Cities-LCXXXX-10P0	\$2,869	\$3,036	\$3,314	\$3,605	\$3,950	\$4,299	\$4,736	\$3,036	
	52" W, Two seat									121 lbs 7.25 yds
	Model	Series 2	Series 3	Series 4	Series 5	Series 6	Series 7	Series 8	COM	
	Cities-LCXXXX-20S0	\$4,166	\$4,397	\$4,781	\$5,182	\$5,659	\$6,141	\$6,744	\$4,397	
	Cities-LCXXXX-20P0	\$4,694	\$4,925	\$5,309	\$5,710	\$6,187	\$6,669	\$7,272	\$4,925	
	74" W, Three seat									146 lbs 9.5 yds
	Model	Series 2	Series 3	Series 4	Series 5	Series 6	Series 7	Series 8	COM	
	Cities-LCXXXX-30S0	\$5,740	\$6,043	\$6,546	\$7,072	\$7,697	\$8,329	\$9,119	\$6,043	
	Cities-LCXXXX-30P0	\$6,466	\$6,769	\$7,272	\$7,798	\$8,423	\$9,055	\$9,845	\$6,769	

Cities Small Downtown Lounge Seating



More Information

Illustrated Glossary ▶ 439

Fabrics ▶ 451

Flammability (CTB-133) ▶ 459

Finishes ▶ 456

Ordering and Warranties ▶ 462

Standard Features

- Solid maple frame
- Mortise and tenon joinery
- Spring seat construction
- Wipe-out design
- Replaceable components
- Wood arm caps
- Non-marring 7/8" rubber-cushioned glides
- Nemschoff healthcare wood finish
- GREENGUARD Gold Certified
- Limited Lifetime Warranty
- See nemschoff.com for weight ratings (BDXXAX-OB30, BDXXAX-OB40)

Available Options

- Moisture barrier + \$67 per seat or back
- Five arm cap styles + \$0
- Four foot styles + \$0
- Three back styles + \$0
- Two rail styles
- CTB-133 + \$81/yd
- Two fabrics + \$62
- Three (or more) fabrics + \$88
- Attached tables (LSF, RSF – see price table)

Specification Decisions

- Select fabric
- Select standard wood finish
- Add moisture barrier
- Add CTB-133
- Apply multiple fabrics
- Add attached table
- Select arm cap style

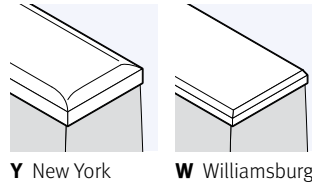

- Select foot style

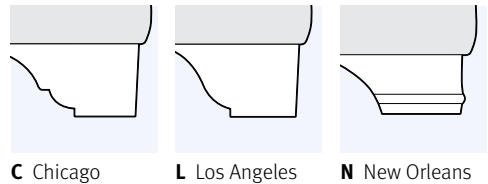

C Chicago **L** Los Angeles **N** New Orleans

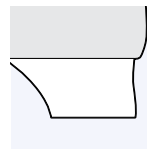

W Williamsburg

- Select back style. All styles have a wipe-out feature.

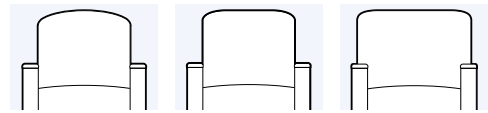

A Arcade back **B** Square back **D** T-back

- Select rail style

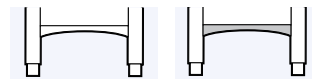

U Upholstered **W** Wood

Model numbers with **S** indicate standard seat and back covers, and model numbers with **P** indicate removable covers.

Flammability Types

- Type 8
- Type 3 (

Cities Small Downtown Lounge Seating

Coordinating Products

- [Cities Small Crosstown Lounge Seating](#)
- [Cities Medium Crosstown Lounge Seating](#)
- [Cities Large Crosstown Lounge Seating](#)
- [Cities Medium Downtown Lounge Seating](#)
- [Cities Large Downtown Lounge Seating](#)
- [Cities Small Uptown Lounge Seating](#)
- [Cities Medium Uptown Lounge Seating](#)
- [Cities Large Uptown Lounge Seating](#)
- [Cities Side Chair](#)
- [Cities Tables](#)
- [Cities Crosstown Patient Chair](#)
- [Cities Downtown Patient Chair](#)
- [Cities Uptown Patient Chair](#)
- [Cities Uptown CompactComfort Recliner](#)
- [Cities Crosstown Rocker](#)
- [Cities Downtown Rocker](#)
- [Cities Uptown Rocker](#)
- [Cities Downtown Glider](#)
- [Cities Uptown Glider](#)
- [SleepOver Sofa](#)
- [SleepOver Settee](#)

Key Dimensions

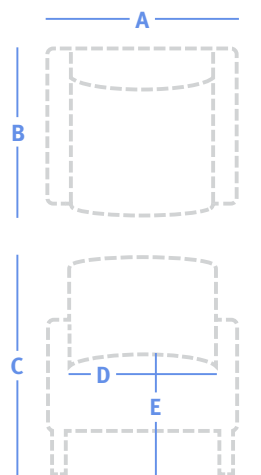

A	Overall Width	See price table
B	Overall Depth	23.75"
C	Overall Height	33.5"
D	Seat Width	
	Chair:	19.5", 23.5", 30", 40"
	Two Seat:	19.5", 39"
	Three Seat:	19.5", 58.5"
E	Seat Height	18.5"
F	Arm Height	25.25"

										35 lbs 3.5 yds
	24.5" W, Chair	Model	Series 2	Series 3	Series 4	Series 5	Series 6	Series 7	Series 8	COM
		Cities-SDXXXX-10SX	\$1,238	\$1,349	\$1,535	\$1,728	\$1,959	\$2,191	\$2,482	\$1,349
		Cities-SDXXXX-10PX	\$1,400	\$1,511	\$1,697	\$1,890	\$2,121	\$2,353	\$2,644	\$1,511
	28.5" W, Chair	Model	Series 2	Series 3	Series 4	Series 5	Series 6	Series 7	Series 8	COM
		Cities-SDXXXX-1WSX	\$1,414	\$1,533	\$1,732	\$1,939	\$2,186	\$2,436	\$2,747	\$1,533
		Cities-SDXXXX-1WPX	\$1,606	\$1,717	\$1,903	\$2,096	\$2,327	\$2,559	\$2,850	\$1,717
	34.5" W, Plus chair	Model	Series 2	Series 3	Series 4	Series 5	Series 6	Series 7	Series 8	COM
		Cities-BDXXAX-OB30	\$3,259	\$3,418	\$3,683	\$3,960	\$4,289	\$4,621	\$5,037	\$3,418
	59 lbs 5 yds									
	44.5" W, Plus chair	Model	Series 2	Series 3	Series 4	Series 5	Series 6	Series 7	Series 8	COM
		Cities-BDXXAX-OB40	\$3,747	\$3,914	\$4,192	\$4,483	\$4,828	\$5,177	\$5,614	\$3,914
	64 lbs 5.25 yds									

Cities Small Downtown Lounge Seating

	44" W, Two seat 64 lbs 5 yds
	Model Series 2 Series 3 Series 4 Series 5 Series 6 Series 7 Series 8 COM
	Cities-SDXXXX-20SX \$2,005 \$2,164 \$2,429 \$2,706 \$3,035 \$3,367 \$3,783 \$2,164
	Cities-SDXXXX-20PX \$2,265 \$2,424 \$2,689 \$2,966 \$3,295 \$3,627 \$4,043 \$2,424
	46.5" W, Two seat with intervening arm and leg 70 lbs 5.75 yds
	Model Series 2 Series 3 Series 4 Series 5 Series 6 Series 7 Series 8 COM
	Cities-SDXXXX-22SX \$2,391 \$2,574 \$2,879 \$3,197 \$3,575 \$3,958 \$4,436 \$2,574
	Cities-SDXXXX-22PX \$2,700 \$2,883 \$3,188 \$3,506 \$3,884 \$4,267 \$4,745 \$2,883
	64" W, Three seat 92 lbs 6.5 yds
	Model Series 2 Series 3 Series 4 Series 5 Series 6 Series 7 Series 8 COM
	Cities-SDXXXX-30SX \$2,674 \$2,881 \$3,225 \$3,585 \$4,013 \$4,445 \$4,986 \$2,881
	Cities-SDXXXX-30PX \$3,020 \$3,227 \$3,571 \$3,931 \$4,359 \$4,791 \$5,332 \$3,227
	69" W, Three seat with intervening arms and legs 104 lbs 8.5 yds
	Model Series 2 Series 3 Series 4 Series 5 Series 6 Series 7 Series 8 COM
	Cities-SDXXXX-33SX \$3,362 \$3,633 \$4,083 \$4,554 \$5,113 \$5,678 \$6,385 \$3,633
	Cities-SDXXXX-33PX \$3,798 \$4,069 \$4,519 \$4,990 \$5,549 \$6,114 \$6,821 \$4,069
	91" W, Four seat with intervening arms and legs 140 lbs 11 yds
	Model Series 2 Series 3 Series 4 Series 5 Series 6 Series 7 Series 8 COM
	Cities-SDXXXX-44SX \$4,424 \$4,775 \$5,357 \$5,966 \$6,690 \$7,421 \$8,336 \$4,775
	Cities-SDXXXX-44PX \$4,997 \$5,348 \$5,930 \$6,539 \$7,263 \$7,994 \$8,909 \$5,348

Lounge Seating

Multiple & Tandem Seating

Side, Stacking & Folding Chairs

Occasional Tables

Cities Small Downtown Benches

Standard Features

Same standard features as Cities Small Downtown Lounge Seating

Available Options

Same options as Cities Small Downtown Lounge Seating

Key Dimensions

- Overall Width: See price table
- Overall Depth: 23"
- Overall Height: 20"

	24.5" W, Bench 33 lbs 2.25 yds
	Model Series 2 Series 3 Series 4 Series 5 Series 6 Series 7 Series 8 COM
	Cities-SDXX0X-B1S0 \$1,001 \$1,072 \$1,192 \$1,316 \$1,464 \$1,614 \$1,801 \$1,072
	Cities-SDXX0X-B1P0 \$1,130 \$1,201 \$1,321 \$1,445 \$1,593 \$1,743 \$1,930 \$1,201
	44.75" W, Bench 39 lbs 3.25 yds
	Model Series 2 Series 3 Series 4 Series 5 Series 6 Series 7 Series 8 COM
	Cities-SDXX0X-B2S0 \$1,301 \$1,404 \$1,576 \$1,756 \$1,970 \$2,186 \$2,457 \$1,404
	Cities-SDXX0X-B2P0 \$1,470 \$1,573 \$1,745 \$1,925 \$2,139 \$2,355 \$2,626 \$1,573
	65" W, Bench 45 lbs 4 yds
	Model Series 2 Series 3 Series 4 Series 5 Series 6 Series 7 Series 8 COM
	Cities-SDXX0X-B3S0 \$1,611 \$1,738 \$1,950 \$2,171 \$2,435 \$2,701 \$3,033 \$1,738
	Cities-SDXX0X-B3P0 \$1,820 \$1,947 \$2,159 \$2,380 \$2,644 \$2,910 \$3,242 \$1,947

Cities Small Downtown Lounge Seating

Cities Spanner Tables

Standard Features

Same standard features as Cities Small Downtown Lounge Seating, plus:

- Laminate or veneer tops
- Crowned table apron on Downtown
- Dry-construction joinery

Available Options

- Five tabletop edge styles + \$0

Specification Decisions

- Select standard wood finish
- Select standard laminate
- Select edge style

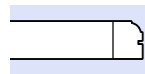

C Chicago



L Los Angeles



N New Orleans



Y New York



W Williamsburg

19.5" W, Spanner table with legs

24 lbs

Model	Price	Depth	Height
Cities-SUX000-S10X	\$823	19.5"	

19.5" W, Spanner table without legs

24 lbs

Model	Price	Depth	Height
Cities-SUX000-S00X	\$523	19.5"	

27.25" W, Corner spanner table with legs

29 lbs

Model	Price	Depth	Height
Cities-SUX000-C10X	\$1,415	27.25"	

Cities Medium Downtown Lounge Seating



More Information

Illustrated Glossary ▶ 439

Fabrics ▶ 451

Flammability (CTB-133) ▶ 459

Finishes ▶ 456

Ordering and Warranties ▶ 462

Standard Features

- Solid maple frame
- Mortise and tenon joinery
- Spring seat construction
- Wipe-out design
- Replaceable components
- Wood arm caps
- Non-marring 7/8" rubber-cushioned glides
- Nemschoff healthcare wood finish
- GREENGUARD Gold Certified
- Limited Lifetime Warranty

Available Options

- Moisture barrier + \$67 per seat or back
- Black urethane arm caps + \$113
- Six arm cap styles + \$0
- Six back styles + \$0
- Two rail styles + \$0
- CTB-133 + \$81 /yd
- Two fabrics + \$62
- Three (or more) fabrics + \$88

Specification Decisions

- Select fabric
- Select standard wood finish
- Add moisture barrier
- Add CTB-133
- Apply multiple fabrics
- Select arm cap style

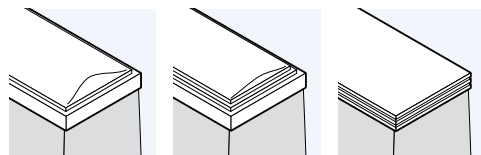

C Chicago **L** Los Angeles **N** New Orleans

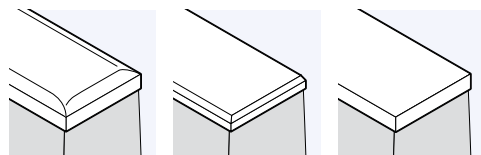

Y New York **W** Williamsburg **U** Optional Black Urethane

- Select foot style

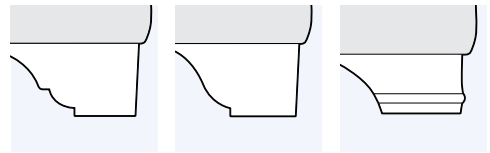

C Chicago **L** Los Angeles **N** New Orleans

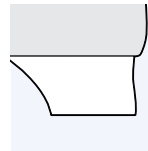

W Williamsburg

- Select back style

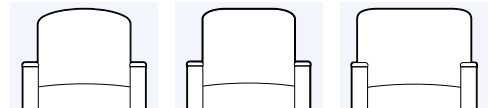

A Arcade back with wipe-out **B** Square back with wipe-out **D** T-back with wipe-out

R Arcade back without wipe-out **S** Square back without wipe-out **T** T-back without wipe-out

- Select rail style

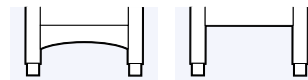

U Upholstered **O** Without rail

Model numbers with **S** indicate standard seat and back covers, and model numbers with **P** indicate removable covers.

Flammability Type

- Type 8

Cities Medium Downtown Lounge Seating

Coordinating Products

- [Cities Small Crosstown Lounge Seating](#)
- [Cities Medium Crosstown Lounge Seating](#)
- [Cities Large Crosstown Lounge Seating](#)
- [Cities Small Downtown Lounge Seating](#)
- [Cities Large Downtown Lounge Seating](#)
- [Cities Small Uptown Lounge Seating](#)
- [Cities Medium Uptown Lounge Seating](#)
- [Cities Large Uptown Lounge Seating](#)
- [Cities Side Chair](#)
- [Cities Tables](#)
- [Cities Crosstown Patient Chair](#)
- [Cities Downtown Patient Chair](#)
- [Cities Uptown Patient Chair](#)
- [Cities Uptown CompactComfort Recliner](#)
- [Cities Crosstown Rocker](#)
- [Cities Downtown Rocker](#)
- [Cities Uptown Rocker](#)
- [Cities Downtown Glider](#)
- [Cities Uptown Glider](#)
- [SleepOver Sofa](#)
- [SleepOver Settee](#)

Key Dimensions

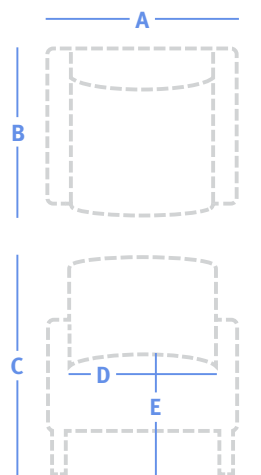

A	Overall Width	See price table
B	Overall Depth	28.25"
C	Overall Height	31.5"
D	Seat Width	
	Chair:	22.5"
	Two Seat:	22.5", 43"
	Three Seat:	64.5"
E	Seat Height	18.5"
F	Arm Height	24.5"

		29.5" W, Chair								71 lbs 4.5 yds
	Model	Series 2	Series 3	Series 4	Series 5	Series 6	Series 7	Series 8	COM	
	Cities-MDXXXX-10S0	\$2,127	\$2,270	\$2,509	\$2,758	\$3,054	\$3,353	\$3,727	\$2,270	
	Cities-MDXXXX-10P0	\$2,400	\$2,543	\$2,782	\$3,031	\$3,327	\$3,626	\$4,000	\$2,543	
		48.5" W, Two seat								101 lbs 6.75 yds
	Model	Series 2	Series 3	Series 4	Series 5	Series 6	Series 7	Series 8	COM	
	Cities-MDXXXX-20S0	\$3,481	\$3,696	\$4,054	\$4,427	\$4,871	\$5,320	\$5,881	\$3,696	
	Cities-MDXXXX-20P0	\$3,925	\$4,140	\$4,498	\$4,871	\$5,315	\$5,764	\$6,325	\$4,140	
		51.5" W, Two seat with intervening arm and leg								109 lbs 7.75 yds
	Model	Series 2	Series 3	Series 4	Series 5	Series 6	Series 7	Series 8	COM	
	Cities-MDXXXX-22S0	\$3,894	\$4,141	\$4,551	\$4,980	\$5,491	\$6,006	\$6,650	\$4,141	
	Cities-MDXXXX-22P0	\$4,391	\$4,638	\$5,048	\$5,477	\$5,988	\$6,503	\$7,147	\$4,638	

Cities Medium Downtown Lounge Seating



70" W, Three seat

131 lbs | 8.75 yds

Model	Series 2	Series 3	Series 4	Series 5	Series 6	Series 7	Series 8	COM
Cities-MDXXXX-30S0	\$4,553	\$4,832	\$5,295	\$5,780	\$6,356	\$6,937	\$7,665	\$4,832
Cities-MDXXXX-30P0	\$5,133	\$5,412	\$5,875	\$6,360	\$6,936	\$7,517	\$8,245	\$5,412



75.5" W, Three seat with intervening arms and legs

147 lbs | 11 yds

Model	Series 2	Series 3	Series 4	Series 5	Series 6	Series 7	Series 8	COM
Cities-MDXXXX-33S0	\$5,503	\$5,854	\$6,436	\$7,045	\$7,769	\$8,500	\$9,415	\$5,854
Cities-MDXXXX-33P0	\$6,206	\$6,557	\$7,139	\$7,748	\$8,472	\$9,203	\$10,118	\$6,557

Lounge Seating

Multiple & Tandem Seating

Side, Stacking & Folding Chairs

Occasional Tables

Cities Large Downtown Lounge Seating



Standard Features

- Solid maple frame
- Mortise and tenon joinery
- Spring seat construction
- Replaceable components
- Wood arm caps
- Non-marring 7/8" rubber-cushioned glides
- Nemschoff healthcare wood finish
- GREENGUARD Gold Certified
- Limited Lifetime Warranty

Available Options

- Moisture barrier + \$67 per seat or back
- Five arm cap styles + \$0
- Four foot styles + \$0
- Three back styles + \$0
- Two rail styles + \$0
- CTB-133 + \$81/yd
- Two fabrics + \$62
- Three (or more) fabrics + \$88

Specification Decisions

- Select fabric
- Select standard wood finish
- Add moisture barrier
- Add CTB-133
- Apply multiple fabrics
- Select arm cap style

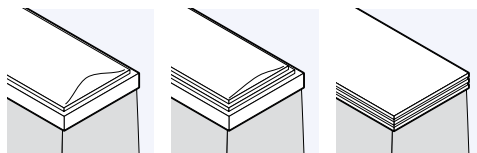

C Chicago **L** Los Angeles **N** New Orleans

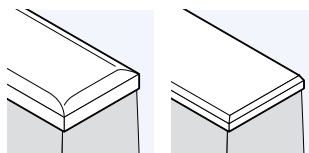

Y New York **W** Williamsburg

- Select foot style

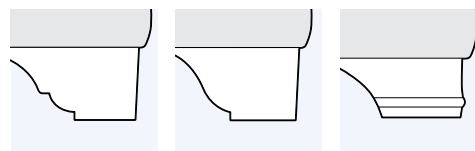

C Chicago **L** Los Angeles **N** New Orleans

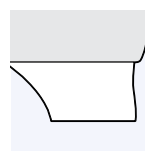

W Williamsburg

- Select back style

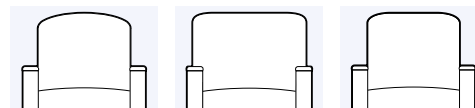

R Arcade back without wipe-out **D** T-back without wipe-out **S** Square back without wipe-out

- Select rail style

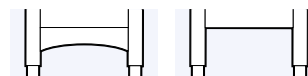

U Upholstered **O** Without rail

Model numbers with **S** indicate standard seat and back covers, and model numbers with **P** indicate removable covers.

Flammability Type

- Type 8

More Information

Illustrated Glossary ▶ 439

Fabrics ▶ 451

Flammability (CTB-133) ▶ 459

Finishes ▶ 456

Ordering and Warranties ▶ 462

Cities Large Downtown Lounge Seating

Coordinating Products

- [Cities Small Crosstown Lounge Seating](#)
- [Cities Medium Crosstown Lounge Seating](#)
- [Cities Large Crosstown Lounge Seating](#)
- [Cities Small Downtown Lounge Seating](#)
- [Cities Medium Downtown Lounge Seating](#)
- [Cities Small Uptown Lounge Seating](#)
- [Cities Medium Uptown Lounge Seating](#)
- [Cities Large Uptown Lounge Seating](#)
- [Cities Side Chair](#)
- [Cities Tables](#)
- [Cities Crosstown Patient Chair](#)
- [Cities Downtown Patient Chair](#)
- [Cities Uptown Patient Chair](#)
- [Cities Uptown CompactComfort Recliner](#)
- [Cities Crosstown Rocker](#)
- [Cities Downtown Rocker](#)
- [Cities Uptown Rocker](#)
- [Cities Downtown Glider](#)
- [Cities Uptown Glider](#)
- [SleepOver Sofa](#)
- [SleepOver Settee](#)

Key Dimensions

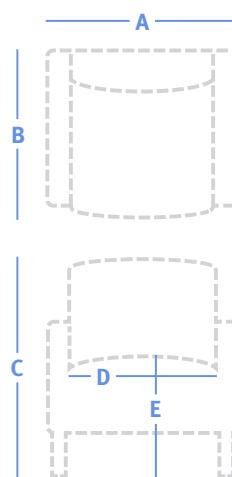

A	Overall Width	See price table
B	Overall Depth	29"
C	Overall Height	31"
D	Seat Width	
	Chair:	22.25"
	Two Seat:	42.5"
	Three Seat:	64.5"
E	Seat Height	18.5"
F	Arm Height	23.75"



31" W, Chair

90 lbs | 4.75 yds

Model	Series 2	Series 3	Series 4	Series 5	Series 6	Series 7	Series 8	COM
Cities-LDXXXX-10S0	\$2,559	\$2,710	\$2,962	\$3,225	\$3,537	\$3,853	\$4,248	\$2,710
Cities-LDXXXX-10P0	\$2,885	\$3,036	\$3,288	\$3,551	\$3,863	\$4,179	\$4,574	\$3,036



51.5" W, Two seat

121 lbs | 7 yds

Model	Series 2	Series 3	Series 4	Series 5	Series 6	Series 7	Series 8	COM
Cities-LDXXXX-20S0	\$4,174	\$4,397	\$4,768	\$5,155	\$5,616	\$6,081	\$6,663	\$4,397
Cities-LDXXXX-20P0	\$4,702	\$4,925	\$5,296	\$5,683	\$6,144	\$6,609	\$7,191	\$4,925

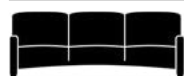

73.5" W, Three seat

146 lbs | 9.25 yds

Model	Series 2	Series 3	Series 4	Series 5	Series 6	Series 7	Series 8	COM
Cities-LDXXXX-30S0	\$5,748	\$6,043	\$6,533	\$7,045	\$7,654	\$8,269	\$9,038	\$6,043
Cities-LDXXXX-30P0	\$6,474	\$6,769	\$7,259	\$7,771	\$8,380	\$8,995	\$9,764	\$6,769

Cities Small Uptown Lounge Seating



Standard Features

- Solid maple frame
- Mortise and tenon joinery
- Spring seat construction
- Wipe-out design
- Replaceable components
- Wood arm caps
- Non-marring 7/8" rubber-cushioned glides
- Nemschoff healthcare wood finish
- GREENGUARD Gold Certified
- Limited Lifetime Warranty
- See nemschoff.com for weight ratings (BUXOAX-OB30, BUXOAX-OB40, SUXOXX-OB2)

Available Options

- Moisture barrier + \$67 per seat or back
- Five arm cap styles + \$0
- Three back styles + \$0
- Two rail styles + \$0
- CTB-133 + \$81/yard
- Two fabrics + \$62
- Three (or more) fabrics + \$88
- Attached table (LSF, RSF – see price table)

Specification Decisions

- Select fabric
- Select standard wood finish
- Add moisture barrier
- Add CTB-133
- Apply multiple fabrics
- Add attached table
- Select arm cap style

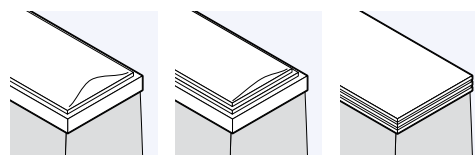

C Chicago **L** Los Angeles **N** New Orleans

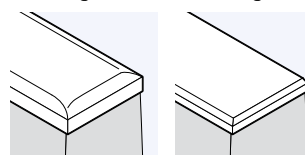

Y New York **W** Williamsburg

- Select back style

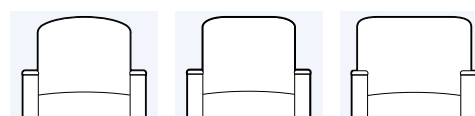

A Arcade back **B** Square back **D** T-back

- Select rail style



U Upholstered **W** Wood

Model numbers with **S** indicate standard seat and back covers, and model numbers with **P** indicate removable covers.

Flammability Type

- Type 3
- Type 4 (Plus models)

More Information

Illustrated Glossary ▶ 439

Fabrics ▶ 451

Flammability (CTB-133) ▶ 459

Finishes ▶ 456

Ordering and Warranties ▶ 462

Cities Small Uptown Lounge Seating

Lounge Seating

Multiple & Tandem Seating

Side, Stacking & Folding Chairs

Occasional Tables

Coordinating Products

- [Cities Small Crosstown Lounge Seating](#)
- [Cities Medium Crosstown Lounge Seating](#)
- [Cities Large Crosstown Lounge Seating](#)
- [Cities Small Downtown Lounge Seating](#)
- [Cities Medium Downtown Lounge Seating](#)
- [Cities Large Downtown Lounge Seating](#)
- [Cities Medium Uptown Lounge Seating](#)
- [Cities Large Uptown Lounge Seating](#)
- [Cities Side Chair](#)
- [Cities Tables](#)
- [Cities Crosstown Patient Chair](#)
- [Cities Downtown Patient Chair](#)
- [Cities Uptown Patient Chair](#)
- [Cities Uptown CompactComfort Recliner](#)
- [Cities Crosstown Rocker](#)
- [Cities Downtown Rocker](#)
- [Cities Uptown Rocker](#)
- [Cities Downtown Glider](#)
- [Cities Uptown Glider](#)
- [SleepOver Sofa](#)
- [SleepOver Settee](#)

Key Dimensions

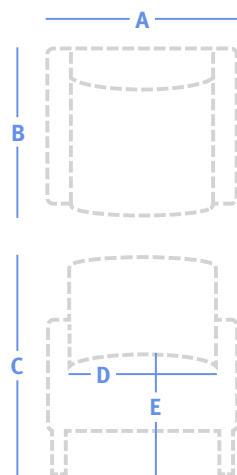

A	Overall Width	See price table
B	Overall Depth	24"
C	Overall Height	33.75"
D	Seat Width	
	Chair:	19.5", 23.5", 29.75", 39.75", 40"
	Two Seat:	39", 39.75"
	Three Seat:	58.5", 60"
	Four Seat:	78"
E	Seat Height	18.5"
F	Arm Height	25"

	24.5" W, Chair									35 lbs 2.5 yds
	Model	Series 2	Series 3	Series 4	Series 5	Series 6	Series 7	Series 8	COM	
	Cities-SUX0XX-10SX	\$1,270	\$1,349	\$1,482	\$1,620	\$1,785	\$1,951	\$2,159	\$1,349	
	Cities-SUX0XX-10PX	\$1,432	\$1,511	\$1,644	\$1,782	\$1,947	\$2,113	\$2,321	\$1,511	
	28.5" W, Chair									38 lbs 3 yds
	Model	Series 2	Series 3	Series 4	Series 5	Series 6	Series 7	Series 8	COM	
	Cities-SUX0XX-1WSX	\$1,438	\$1,533	\$1,692	\$1,858	\$2,056	\$2,255	\$2,505	\$1,533	
	Cities-SUX0XX-1WPX	\$1,622	\$1,717	\$1,876	\$2,042	\$2,240	\$2,439	\$2,689	\$1,717	
	34" W, Plus chair									59 lbs 4 yds
	Model	Series 2	Series 3	Series 4	Series 5	Series 6	Series 7	Series 8	COM	
	Cities-BUXOAX-OB30	\$3,291	\$3,418	\$3,630	\$3,851	\$4,115	\$4,381	\$4,713	\$3,418	
	44" W, Plus chair									64 lbs 4 yds
	Model	Series 2	Series 3	Series 4	Series 5	Series 6	Series 7	Series 8	COM	
	Cities-SUX0XX-OB2	\$2,635	\$2,762	\$2,974	\$3,195	\$3,459	\$3,725	\$4,057	\$2,762	

Welcoming & Waiting

Cities Small Uptown Lounge Seating

	44" W, Plus chair									64 lbs 4.25 yds
	Model	Series 2	Series 3	Series 4	Series 5	Series 6	Series 7	Series 8	COM	
	Cities-BUXOAX-OB40	\$3,779	\$3,914	\$4,139	\$4,375	\$4,654	\$4,937	\$5,290	\$3,914	
	44" W, Two seat									64 lbs 4.25 yds
	Model	Series 2	Series 3	Series 4	Series 5	Series 6	Series 7	Series 8	COM	
	Cities-SUX0XX-20SX	\$2,029	\$2,164	\$2,389	\$2,625	\$2,904	\$3,187	\$3,540	\$2,164	
	Cities-SUX0XX-20PX	\$2,289	\$2,424	\$2,649	\$2,885	\$3,164	\$3,447	\$3,800	\$2,424	
	46.5" W, Two seat with intervening arm and leg									70 lbs 4.5 yds
	Model	Series 2	Series 3	Series 4	Series 5	Series 6	Series 7	Series 8	COM	
	Cities-SUX0XX-22SX	\$2,431	\$2,574	\$2,813	\$3,062	\$3,358	\$3,657	\$4,031	\$2,574	
	Cities-SUX0XX-22PX	\$2,740	\$2,883	\$3,122	\$3,371	\$3,667	\$3,966	\$4,340	\$2,883	
	64" W, Three seat									92 lbs 5.75 yds
	Model	Series 2	Series 3	Series 4	Series 5	Series 6	Series 7	Series 8	COM	
	Cities-SUX0XX-30SX	\$2,698	\$2,881	\$3,186	\$3,504	\$3,882	\$4,265	\$4,743	\$2,881	
	Cities-SUX0XX-30PX	\$3,044	\$3,227	\$3,532	\$3,850	\$4,228	\$4,611	\$5,089	\$3,227	
	69" W, Three seat with intervening arms and legs									104 lbs 6.75 yds
	Model	Series 2	Series 3	Series 4	Series 5	Series 6	Series 7	Series 8	COM	
	Cities-SUX0XX-33SX	\$3,418	\$3,633	\$3,991	\$4,364	\$4,808	\$5,257	\$5,818	\$3,633	
	Cities-SUX0XX-33PX	\$3,854	\$4,069	\$4,427	\$4,800	\$5,244	\$5,693	\$6,254	\$4,069	
	91" W, Four seat with intervening arms and legs									140 lbs 8.75 yds
	Model	Series 2	Series 3	Series 4	Series 5	Series 6	Series 7	Series 8	COM	
	Cities-SUX0XX-44SX	\$4,496	\$4,775	\$5,238	\$5,723	\$6,299	\$6,880	\$7,608	\$4,775	
	Cities-SUX0XX-44PX	\$5,069	\$5,348	\$5,811	\$6,296	\$6,872	\$7,453	\$8,181	\$5,348	

Patient Areas

Specialty

Cities Small Uptown Benches

Standard Features

Same standard features as Cities Small Uptown Lounge Seating

Available Options

Same options as Cities Small Uptown Lounge Seating

Key Dimensions

- Overall Width: See price table
- Overall Depth: 22.75"
- Overall Height: 20"

Reference

	23.75" W, Bench									33 lbs 1.25 yds
	Model	Series 2	Series 3	Series 4	Series 5	Series 6	Series 7	Series 8	COM	
	Cities-SUX00X-B1S0	\$1,033	\$1,072	\$1,139	\$1,208	\$1,290	\$1,373	\$1,477	\$1,072	
	Cities-SUX00X-B1P0	\$1,162	\$1,201	\$1,268	\$1,337	\$1,419	\$1,502	\$1,606	\$1,201	
	44" W, Bench									39 lbs 2.25 yds
	Model	Series 2	Series 3	Series 4	Series 5	Series 6	Series 7	Series 8	COM	
	Cities-SUX00X-B2S0	\$1,333	\$1,404	\$1,524	\$1,648	\$1,796	\$1,946	\$2,133	\$1,404	
	Cities-SUX00X-B2P0	\$1,502	\$1,573	\$1,693	\$1,817	\$1,965	\$2,115	\$2,302	\$1,573	

Cities Small Uptown Lounge Seating



64.25" W, Bench

45 lbs | 3.25 yds

Model	Series 2	Series 3	Series 4	Series 5	Series 6	Series 7	Series 8	COM
Cities-SUX00X-B3S0	\$1,635	\$1,738	\$1,910	\$2,090	\$2,304	\$2,520	\$2,791	\$1,738
Cities-SUX00X-B3P0	\$1,844	\$1,947	\$2,119	\$2,299	\$2,513	\$2,729	\$3,000	\$1,947

Cities Spanner Tables

Standard Features

- Same standard features as Cities Small Uptown Lounge Seating, plus:
- Laminate or veneer tops
- Crowned table apron on Uptown
- Dry-construction joinery

Available Options

- Five tabletop edge styles + \$0

Specification Decisions

- Select standard wood finish
- Select standard laminate
- Select edge style



C Chicago



L Los Angeles



N New Orleans



Y New York

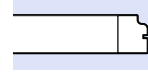

W Williamsburg

19.5" W, Spanner table with legs

24 lbs

Model	Price	Depth	Height
Cities-SUX000-S10X	\$823	19.5"	

19.5" W, Spanner table without legs

24 lbs

Model	Price	Depth	Height
Cities-SUX000-S00X	\$523	19.5"	

27.25" W, Corner spanner table with legs

29 lbs

Model	Price	Depth	Height
Cities-SUX000-C10X	\$1,415	27.25"	

Cities Medium Uptown Lounge Seating



Standard Features

- Solid maple frame
- Mortise and tenon joinery
- Spring seat construction
- Wipe-out design
- Replaceable components
- Wood arm caps
- Non-marring 7/8" rubber-cushioned glides
- Nemschoff healthcare wood finish
- GREENGUARD Gold Certified
- Limited Lifetime Warranty

Available Options

- Moisture barrier + \$67 per seat or back
- Five arm cap styles + \$0
- Six back styles + \$0
- Upholstered rail + \$0
- CTB-133 + \$81/yd
- Two fabrics + \$62
- Three (or more) fabrics + \$88

Specification Decisions

- Select fabric
- Select standard wood finish
- Add moisture barrier
- Add CTB-133
- Apply multiple fabrics

- Select arm cap style

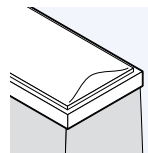

C Chicago

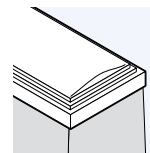

L Los Angeles

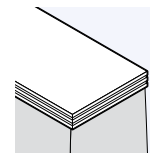

N New Orleans

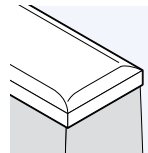

Y New York

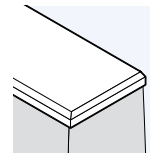

W Williamsburg

- Select back style

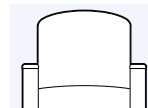

A Arcade back with wipe-out

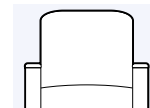

B Square back with wipe-out

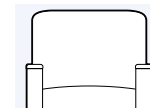

D T-back with wipe-out

R Arcade back without wipe-out

S Square back without wipe-out

T T-back without wipe-out

- Select rail style

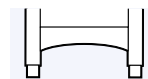

U Upholstered

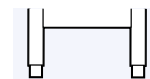

O Without rail

Model numbers with **S** indicate standard seat and back covers, and model numbers with **P** indicate removable covers.

Flammability Type

- Type 4

More Information

Illustrated Glossary ▶ 439

Fabrics ▶ 451

Flammability (CTB-133) ▶ 459

Finishes ▶ 456

Ordering and Warranties ▶ 462

Cities Medium Uptown Lounge Seating

Coordinating Products

- [Cities Small Crosstown Lounge Seating](#)
- [Cities Medium Crosstown Lounge Seating](#)
- [Cities Large Crosstown Lounge Seating](#)
- [Cities Small Downtown Lounge Seating](#)
- [Cities Medium Downtown Lounge Seating](#)
- [Cities Large Downtown Lounge Seating](#)
- [Cities Small Uptown Lounge Seating](#)
- [Cities Large Uptown Lounge Seating](#)
- [Cities Side Chair](#)
- [Cities Tables](#)
- [Cities Crosstown Patient Chair](#)
- [Cities Downtown Patient Chair](#)
- [Cities Uptown Patient Chair](#)
- [Cities Uptown CompactComfort Recliner](#)
- [Cities Crosstown Rocker](#)
- [Cities Downtown Rocker](#)
- [Cities Uptown Rocker](#)
- [Cities Downtown Glider](#)
- [Cities Uptown Glider](#)
- [SleepOver Sofa](#)
- [SleepOver Settee](#)

Key Dimensions

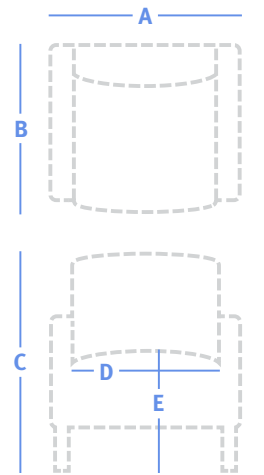

A	Overall Width	See price table
B	Overall Depth	28.5"
C	Overall Height	31.25"
D	Seat Width	
	Chair:	22"
	Two Seat:	42.5", 43"
	Three Seat:	64.5"
E	Seat Height	18.5"
F	Arm Height	23.75"

Lounge Seating

Multiple & Tandem Seating

Side, Stacking & Folding Chairs

Occasional Tables



28.5" W, Chair

71 lbs | 4 yds

Model	Series 2	Series 3	Series 4	Series 5	Series 6	Series 7	Series 8	COM
Cities-MUX0XX-10S0	\$2,143	\$2,270	\$2,482	\$2,703	\$2,967	\$3,233	\$3,565	\$2,270
Cities-MUX0XX-10P0	\$2,416	\$2,543	\$2,755	\$2,976	\$3,240	\$3,506	\$3,838	\$2,543



48.5" W, Two seat

101 lbs | 6 yds

Model	Series 2	Series 3	Series 4	Series 5	Series 6	Series 7	Series 8	COM
Cities-MUX0XX-20S0	\$3,505	\$3,696	\$4,014	\$4,346	\$4,741	\$5,140	\$5,639	\$3,696
Cities-MUX0XX-20P0	\$3,949	\$4,140	\$4,458	\$4,790	\$5,185	\$5,584	\$6,083	\$4,140

Cities Medium Uptown Lounge Seating



51.5" W, Two seat with intervening arm and leg

109 lbs | 7 yds

Model	Series 2	Series 3	Series 4	Series 5	Series 6	Series 7	Series 8	COM
Cities-MUX0XX-22S0	\$3,918	\$4,141	\$4,512	\$4,899	\$5,360	\$5,825	\$6,407	\$4,141
Cities-MUX0XX-22P0	\$4,415	\$4,638	\$5,009	\$5,396	\$5,857	\$6,322	\$6,904	\$4,638



70" W, Three seat

131 lbs | 8.25 yds

Model	Series 2	Series 3	Series 4	Series 5	Series 6	Series 7	Series 8	COM
Cities-MUX0XX-30S0	\$4,569	\$4,832	\$5,269	\$5,725	\$6,269	\$6,817	\$7,503	\$4,832
Cities-MUX0XX-30P0	\$5,149	\$5,412	\$5,849	\$6,305	\$6,849	\$7,397	\$8,083	\$5,412



75.5" W, Three seat with intervening arms and legs

147 lbs | 10.25 yds

Model	Series 2	Series 3	Series 4	Series 5	Series 6	Series 7	Series 8	COM
Cities-MUX0XX-33S0	\$5,527	\$5,854	\$6,397	\$6,964	\$7,639	\$8,320	\$9,172	\$5,854
Cities-MUX0XX-33P0	\$6,230	\$6,557	\$7,100	\$7,667	\$8,342	\$9,023	\$9,875	\$6,557

Cities Large Uptown Lounge Seating



More Information

Illustrated Glossary ▶ 439

Fabrics ▶ 451

Flammability (CTB-133) ▶ 459

Finishes ▶ 456

Ordering and Warranties ▶ 462

Standard Features

- Solid maple frame
- Mortise and tenon joinery
- Spring seat construction
- Replaceable components
- Wood arm caps
- Non-marring 7/8" rubber-cushioned glides
- Nemschoff healthcare wood finish
- GREENGUARD Gold Certified
- Limited Lifetime Warranty

Available Options

- Moisture barrier + \$67 per seat or back
- Five arm cap styles + \$0
- Three back styles + \$0
- Two rail styles + \$0
- CTB-133 + \$81/yd
- Two fabrics + \$62
- Three (or more) fabrics + \$88

Specification Decisions

- Select fabric
- Select standard wood finish
- Add moisture barrier
- Add CTB-133
- Apply multiple fabrics
- Select arm cap style

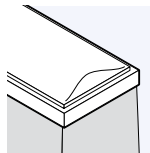

C Chicago

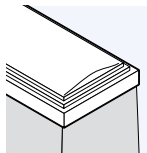

L Los Angeles

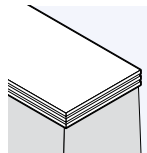

N New Orleans

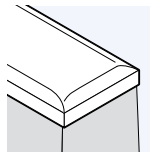

Y New York

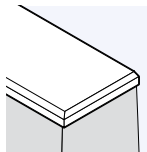

W Williamsburg

- Select back style. All styles are without the wipe-out feature.

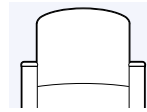

R Arcade back without wipe-out

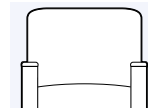

T T-back without wipe-out

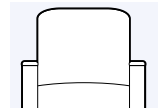

S Square back without wipe-out

- Select rail style

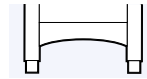

U Upholstered

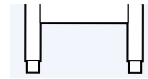

O Without rail

Model numbers with **S** indicate standard seat and back covers, and model numbers with **P** indicate removable covers.

Flammability Type

- Type 4

Cities Large Uptown Lounge Seating

Coordinating Products

- [Cities Small Crosstown Lounge Seating](#)
- [Cities Medium Crosstown Lounge Seating](#)
- [Cities Large Crosstown Lounge Seating](#)
- [Cities Small Downtown Lounge Seating](#)
- [Cities Medium Downtown Lounge Seating](#)
- [Cities Large Downtown Lounge Seating](#)
- [Cities Small Uptown Lounge Seating](#)
- [Cities Medium Uptown Lounge Seating](#)
- [Cities Side Chair](#)
- [Cities Tables](#)
- [Cities Crosstown Patient Chair](#)
- [Cities Downtown Patient Chair](#)
- [Cities Uptown Patient Chair](#)
- [Cities Uptown CompactComfort Recliner](#)
- [Cities Crosstown Rocker](#)
- [Cities Downtown Rocker](#)
- [Cities Uptown Rocker](#)
- [Cities Downtown Glider](#)
- [Cities Uptown Glider](#)
- [SleepOver Sofa](#)
- [SleepOver Settee](#)

Key Dimensions

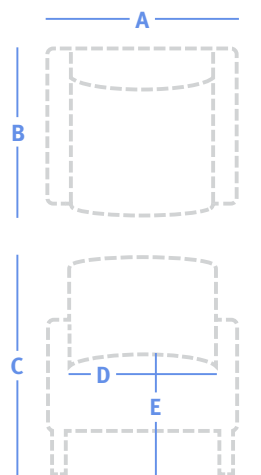

A	Overall Width	See price table
B	Overall Depth	29"
C	Overall Height	31"
D	Seat Width	
	Chair:	22.5"
	Two Seat:	42.75"
	Three Seat:	64.75"
E	Seat Height	18.5"
F	Arm Height	23.5"

	31" W, Chair									85 lbs 4.5 yds
	Model	Series 2	Series 3	Series 4	Series 5	Series 6	Series 7	Series 8	COM	
	Cities-LUX0XX-10S0	\$2,567	\$2,710	\$2,949	\$3,198	\$3,494	\$3,793	\$4,167	\$2,710	
	Cities-LUX0XX-10P0	\$2,893	\$3,036	\$3,275	\$3,524	\$3,820	\$4,119	\$4,493	\$3,036	
	51.5" W, Two seat									118 lbs 6.5 yds
	Model	Series 2	Series 3	Series 4	Series 5	Series 6	Series 7	Series 8	COM	
	Cities-LUX0XX-20S0	\$4,190	\$4,397	\$4,741	\$5,101	\$5,529	\$5,961	\$6,502	\$4,397	
	Cities-LUX0XX-20P0	\$4,718	\$4,925	\$5,269	\$5,629	\$6,057	\$6,489	\$7,030	\$4,925	
	73.5" W, Three seat									146 lbs 8.75 yds
	Model	Series 2	Series 3	Series 4	Series 5	Series 6	Series 7	Series 8	COM	
	Cities-LUX0XX-30S0	\$5,764	\$6,043	\$6,506	\$6,991	\$7,567	\$8,148	\$8,876	\$6,043	
	Cities-LUX0XX-30P0	\$6,490	\$6,769	\$7,232	\$7,717	\$8,293	\$8,874	\$9,602	\$6,769	

Evita Lounge Seating



More Information

Illustrated Glossary ▶ 439

Fabrics ▶ 451

Flammability (CTB-133) ▶ 459

Finishes ▶ 456

Ordering and Warranties ▶ 462

Standard Features

- Solid maple frame
- Mortise and tenon joinery
- Spring seat construction
- Clean-out design
- Replaceable components
- Non-marring ¾" rubber-cushioned glides
- Nemschoff healthcare wood finish
- GREENGUARD Gold Certified
- Limited Lifetime Warranty

Available Options

- Moisture barrier + \$67 per seat or back
- CTB-133 + \$81/yd
- Two fabrics + \$62
- Three (or more) fabrics + \$88
- Attached table (LSF, RSF – see price table)

Specification Decisions

- Select fabric
- Select standard wood finish
- Add moisture barrier
- Add CTB-133
- Apply multiple fabrics
- Add attached table

Model numbers with **S** indicate standard seat and back covers, and model numbers with **P** indicate removable covers.

Flammability Types

- Type 8
- Type 3 (Bench)

Coordinating Products

- Evita Tables

Key Dimensions

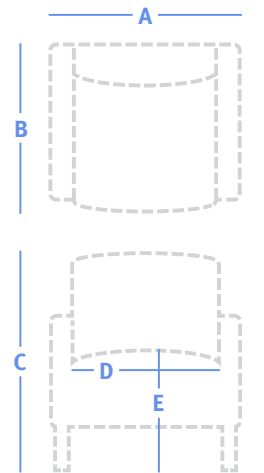



A	Overall Width	See price table
B	Overall Depth	25.75"
C	Overall Height	32.75"
D	Seat Width	
	Chair:	19.5"
	Two Seat:	39"
	Three Seat:	60"
	Four Seat:	78"
E	Seat Height	18.75"
F	Arm Height	25.25"

Evita Lounge Seating

	25" W, Chair									34 lbs 3 yds
	Model	Series 2	Series 3	Series 4	Series 5	Series 6	Series 7	Series 8	COM	
	2800-10 S	\$1,212	\$1,307	\$1,466	\$1,632	\$1,830	\$2,029	\$2,279	\$1,307	
	2800-10 P	\$1,369	\$1,464	\$1,623	\$1,789	\$1,987	\$2,186	\$2,436	\$1,464	

	45" W, Two seat									55 lbs 4.25 yds
	Model	Series 2	Series 3	Series 4	Series 5	Series 6	Series 7	Series 8	COM	
	2800-20 S	\$1,755	\$1,890	\$2,115	\$2,351	\$2,630	\$2,913	\$3,266	\$1,890	
	2800-20 P	\$1,982	\$2,117	\$2,342	\$2,578	\$2,857	\$3,140	\$3,493	\$2,117	

	47" W, Two seat with intervening arm and leg									61 lbs 5 yds
	Model	Series 2	Series 3	Series 4	Series 5	Series 6	Series 7	Series 8	COM	
	2800-22 S	\$2,110	\$2,269	\$2,534	\$2,811	\$3,140	\$3,472	\$3,888	\$2,269	
	2800-22 P	\$2,383	\$2,542	\$2,807	\$3,084	\$3,413	\$3,745	\$4,161	\$2,542	

	65" W, Three seat									75 lbs 5.75 yds
	Model	Series 2	Series 3	Series 4	Series 5	Series 6	Series 7	Series 8	COM	
	2800-30 S	\$2,256	\$2,439	\$2,744	\$3,062	\$3,440	\$3,823	\$4,301	\$2,439	
	2800-30 P	\$2,549	\$2,732	\$3,037	\$3,355	\$3,733	\$4,116	\$4,594	\$2,732	

	69" W, Three seat with intervening arms and legs									86 lbs 7 yds
	Model	Series 2	Series 3	Series 4	Series 5	Series 6	Series 7	Series 8	COM	
	2800-33 S	\$2,981	\$3,204	\$3,575	\$3,962	\$4,423	\$4,888	\$5,470	\$3,204	
	2800-33 P	\$3,366	\$3,589	\$3,960	\$4,347	\$4,808	\$5,273	\$5,855	\$3,589	

	87" W, Four seat with one intervening arm and leg									101 lbs 8 yds
	Model	Series 2	Series 3	Series 4	Series 5	Series 6	Series 7	Series 8	COM	
	2800-40 S	\$3,012	\$3,267	\$3,691	\$4,133	\$4,660	\$5,192	\$5,857	\$3,267	
	2800-40 P	\$3,405	\$3,660	\$4,084	\$4,526	\$5,053	\$5,585	\$6,250	\$3,660	

	91" W, Four seat with intervening arms and legs									112 lbs 9 yds
	Model	Series 2	Series 3	Series 4	Series 5	Series 6	Series 7	Series 8	COM	
	2800-44 S	\$3,823	\$4,110	\$4,587	\$5,085	\$5,677	\$6,275	\$7,024	\$4,110	
	2800-44 P	\$4,317	\$4,604	\$5,081	\$5,579	\$6,171	\$6,769	\$7,518	\$4,604	

Evita Lounge Seating

Lounge Seating

Multiple & Tandem Seating

Side, Stacking & Folding Chairs

Occasional Tables

Evita Benches

Standard Features

Same standard features as Evita Lounge Seating

Available Options

Same options as Evita Lounge Seating

Key Dimensions

- Overall Width: See price table
- Overall Depth: 22"
- Overall Height: 18.75"

	25" W, Bench								28 lbs 1.25 yds
	Model	Series 2	Series 3	Series 4	Series 5	Series 6	Series 7	Series 8	COM
	2800-B1 S	\$1,038	\$1,077	\$1,144	\$1,213	\$1,295	\$1,378	\$1,482	\$1,077
	2800-B1 P	\$1,168	\$1,207	\$1,274	\$1,343	\$1,425	\$1,508	\$1,612	\$1,207

	45" W, Bench								52 lbs 2.25 yds
	Model	Series 2	Series 3	Series 4	Series 5	Series 6	Series 7	Series 8	COM
	2800-B2 S	\$1,342	\$1,413	\$1,533	\$1,657	\$1,805	\$1,955	\$2,142	\$1,413
	2800-B2 P	\$1,512	\$1,583	\$1,703	\$1,827	\$1,975	\$2,125	\$2,312	\$1,583

Evita Spanner Table

Standard Features

- Solid maple frame
- Laminate or veneer top

Specification Decisions

- Select standard wood finish or laminate

	19.5" W, Spanner table; laminate				24 lbs
	Model	Price	Depth	Height	
	2800-ST	\$451	21.25"	14.75"	

	19.5" W, Spanner table; veneer				24 lbs
	Model	Price	Depth	Height	
	2800-STV	\$550	21.25"	14.75"	

	28" W, Corner coffee table with support legs; laminate top				29 lbs
	Model	Price	Depth	Height	
	2800-CT	\$1,279	28"	14.75"	

	28" W, Corner coffee table with support legs; veneer top				29 lbs
	Model	Price	Depth	Height	
	2800-CTV	\$1,561	28"	14.75"	

Florabella Lounge Seating



Standard Features

- Heavy-duty steel construction
- Grey urethane legs
- Wipe-out design
- Replaceable components
- Grey urethane arm caps
- Non-marring glides
- GREENGUARD Gold Certified
- Limited Lifetime Warranty

Available Options

- Moisture barrier + \$67 per seat or back
- Wood legs + \$269
- Wood arm caps + \$113
- Upholstered arm caps + \$113
- Two fabrics + \$62
- Three (or more) fabrics + \$88

Specification Decisions

- Select fabric
- Add moisture barrier
- Apply multiple fabrics
- Add wood legs and specify wood finish
- Add wood or upholstered arm caps

Coordinating Products

- [Florabella Tables](#)

Key Dimensions

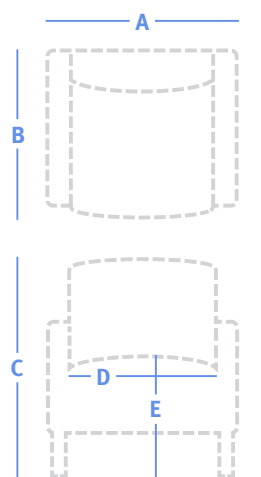

A	Overall Width	See price table
B	Overall Depth	31.5"
C	Overall Height	30.5"
D	Seat Width	
	Chair:	23"
	Settee:	45"
	Sofa:	67"
E	Seat Height	17.5"
F	Arm Height	24"

More Information

- Illustrated Glossary ▶ 439
- Fabrics ▶ 451
- Flammability (CTB-133) ▶ 459
- Finishes ▶ 456
- Ordering and Warranties ▶ 462

	31.5" W, Chair									55 lbs 4 yds
	Model	Series 2	Series 3	Series 4	Series 5	Series 6	Series 7	Series 8	COM	
	FLBL-00001	\$2,325	\$2,388	\$2,663	\$2,811	\$2,891	\$2,997	\$3,064	\$2,388	

	53.5" W, Settee									85 lbs 5.75 yds
	Model	Series 2	Series 3	Series 4	Series 5	Series 6	Series 7	Series 8	COM	
	FLBL-00002	\$3,034	\$3,125	\$3,520	\$3,733	\$3,848	\$4,000	\$4,097	\$3,125	

	75.5" W, Sofa									115 lbs 7.5 yds
	Model	Series 2	Series 3	Series 4	Series 5	Series 6	Series 7	Series 8	COM	
	FLBL-00003	\$3,307	\$3,425	\$3,940	\$4,217	\$4,368	\$4,566	\$4,693	\$3,425	

Franklin Lounge Seating



More Information

Illustrated Glossary ▶ 439

Fabrics ▶ 451

Flammability (CTB-133) ▶ 459

Finishes ▶ 456

Ordering and Warranties ▶ 462

Standard Features

- Solid maple frame
- Mortise and tenon joinery
- Spring seat construction
- Replaceable components
- Non-marring 5/8" x 2" plastic bar glides
- Nemschoff healthcare wood finish
- GREENGUARD Gold Certified
- Limited Lifetime Warranty

Available Options

- Moisture barrier + \$67 per seat or back
- Non-marring 7/8" rubber-cushioned glides + \$0
- CTB-133 + \$81/yd
- Two fabrics + \$62
- Three (or more) fabrics + \$88

Specification Decisions

- Select fabric
- Select standard wood finish
- Add moisture barrier
- Add CTB-133
- Apply multiple fabrics

Model numbers with **S** indicate standard seat and back covers, and model numbers with **P** indicate removable covers.

Flammability Types

- Type 4
- Type 3 (Bench)

Key Dimensions

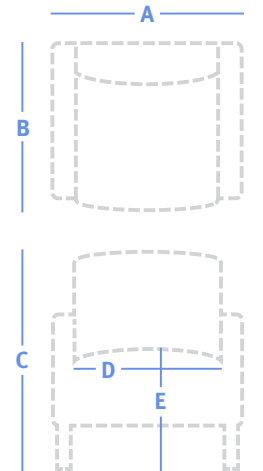

A	Overall Width	See price table
B	Overall Depth	27.75"
C	Overall Height	30.5"
D	Seat Width	
	Chair:	22.5"
	Two Seat:	44.75", 45"
	Three Seat:	66.25", 67.5"
E	Seat Height	18.5"
F	Arm Height	23.25"

Model	30.75" W, Chair								85 lbs 4.75 yds
	Series 2	Series 3	Series 4	Series 5	Series 6	Series 7	Series 8	COM	
774-10 S	\$2,476	\$2,627	\$2,879	\$3,142	\$3,454	\$3,770	\$4,165	\$2,627	
774-10 P	\$2,792	\$2,943	\$3,195	\$3,458	\$3,770	\$4,086	\$4,481	\$2,943	

Model	50.75" W, Two seat								130 lbs 7 yds
	Series 2	Series 3	Series 4	Series 5	Series 6	Series 7	Series 8	COM	
774-20 S	\$4,043	\$4,266	\$4,637	\$5,024	\$5,485	\$5,950	\$6,532	\$4,266	
774-20 P	\$4,555	\$4,778	\$5,149	\$5,536	\$5,997	\$6,462	\$7,044	\$4,778	

Model	57" W, Two seat with intervening arm and leg								153 lbs 8 yds
	Series 2	Series 3	Series 4	Series 5	Series 6	Series 7	Series 8	COM	
774-22 S	\$4,304	\$4,559	\$4,983	\$5,425	\$5,952	\$6,484	\$7,149	\$4,559	
774-22 P	\$4,852	\$5,107	\$5,531	\$5,973	\$6,500	\$7,032	\$7,697	\$5,107	

Franklin Lounge Seating

	71.5" W, Three seat									144 lbs 9.25 yds
	Model	Series 2	Series 3	Series 4	Series 5	Series 6	Series 7	Series 8	COM	
774-30 S	\$5,565	\$5,860	\$6,350	\$6,862	\$7,471	\$8,086	\$8,855	\$5,860		
774-30 P	\$6,269	\$6,564	\$7,054	\$7,566	\$8,175	\$8,790	\$9,559	\$6,564		

	83.5" W, Three seat with intervening arms and legs									202 lbs 11.25 yds
	Model	Series 2	Series 3	Series 4	Series 5	Series 6	Series 7	Series 8	COM	
774-33 S	\$5,953	\$6,312	\$6,908	\$7,530	\$8,271	\$9,019	\$9,954	\$6,312		
774-33 P	\$6,711	\$7,070	\$7,666	\$8,288	\$9,029	\$9,777	\$10,712	\$7,070		

Franklin Bench

Standard Features

Same standard features as Franklin Lounge Seating

Available Options

Same options as Franklin Lounge Seating, plus:

- Plastic rubber-cushioned glides + \$0

Key Dimensions

- Overall Width: See price table
- Overall Depth: 23"
- Overall Height: 20.5"

	45.5" W, Bench									39 lbs 3.25 yds
	Model	Series 2	Series 3	Series 4	Series 5	Series 6	Series 7	Series 8	COM	
774-B2 S	\$1,425	\$1,528	\$1,700	\$1,880	\$2,094	\$2,310	\$2,581	\$1,528		
774-B2 P	\$1,609	\$1,712	\$1,884	\$2,064	\$2,278	\$2,494	\$2,765	\$1,712		

Hadleigh Lounge Seating



More Information

- Illustrated Glossary ▶ 439
- Fabrics ▶ 451
- Flammability (CTB-133) ▶ 459
- Finishes ▶ 456
- Ordering and Warranties ▶ 462

Standard Features

- Solid maple frame
- Mortise and tenon joinery
- Spring seat construction
- Replaceable components
- Clean-out design
- Wood arm caps
- Non-marring 7/8" rubber-cushioned glides
- Nemschoff healthcare wood finish
- GREENGUARD Gold Certified
- Limited Lifetime Warranty

Available Options

- Moisture barrier + \$67 per seat or back
- CTB-133 + \$81/yd
- Two fabrics + \$62
- Three (or more) fabrics + \$88

Specification Decisions

- Select fabric
 - Select standard wood finish
 - Add moisture barrier
 - Add CTB-133
 - Apply multiple fabrics
- Model numbers with **S** indicate standard seat and back covers, and model numbers with **P** indicate removable covers.

Flammability Types

- Type 4
- Type 3 (Bench)

Coordinating Products

- [Hadleigh Tables](#)
- [Hadleigh Patient Chair](#)
- [Hadleigh Adjustable Back Chair](#)
- [Hadleigh Casegoods](#)

Key Dimensions

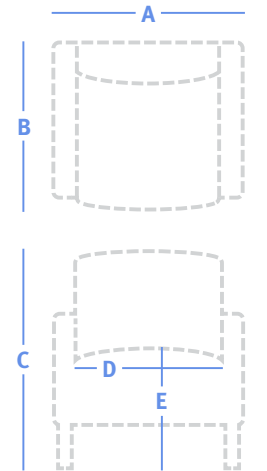

A	Overall Width	See price table
B	Overall Depth	25"
C	Overall Height	32.75"
D	Seat Width	
	Chair:	21.25"
	Two Seat:	42.5", 43.25"
	Three Seat:	63.75", 65"
E	Seat Height	18.75"
F	Arm Height	25.25"

	28" W, Chair									28 lbs 1.75 yds
	Model	Series 2	Series 3	Series 4	Series 5	Series 6	Series 7	Series 8	COM	
	280-10 S	\$1,534	\$1,589	\$1,682	\$1,779	\$1,894	\$2,010	\$2,156	\$1,589	
	280-10 P	\$1,725	\$1,780	\$1,873	\$1,970	\$2,085	\$2,201	\$2,347	\$1,780	
	49.75" W, Two seat									58 lbs 3.5 yds
	Model	Series 2	Series 3	Series 4	Series 5	Series 6	Series 7	Series 8	COM	
	280-20 S	\$2,443	\$2,554	\$2,740	\$2,933	\$3,164	\$3,396	\$3,687	\$2,554	
	280-20 P	\$2,750	\$2,861	\$3,047	\$3,240	\$3,471	\$3,703	\$3,994	\$2,861	

Hadleigh Lounge Seating



50.75" W, Two seat with divider arm

31 lbs | 3.5 yds

Model	Series 2	Series 3	Series 4	Series 5	Series 6	Series 7	Series 8	COM
280-25 S	\$2,920	\$3,031	\$3,217	\$3,410	\$3,641	\$3,873	\$4,164	\$3,031
280-25 P	\$3,284	\$3,395	\$3,581	\$3,774	\$4,005	\$4,237	\$4,528	\$3,395



71.75" W, Three seat

83 lbs | 5 yds

Model	Series 2	Series 3	Series 4	Series 5	Series 6	Series 7	Series 8	COM
280-30 S	\$3,220	\$3,379	\$3,644	\$3,921	\$4,250	\$4,582	\$4,998	\$3,379
280-30 P	\$3,626	\$3,785	\$4,050	\$4,327	\$4,656	\$4,988	\$5,404	\$3,785



73.5" W, Three seat with divider arms

86 lbs | 5 yds

Model	Series 2	Series 3	Series 4	Series 5	Series 6	Series 7	Series 8	COM
280-35 S	\$4,228	\$4,387	\$4,652	\$4,929	\$5,258	\$5,590	\$6,006	\$4,387
280-35 P	\$4,755	\$4,914	\$5,179	\$5,456	\$5,785	\$6,117	\$6,533	\$4,914

Hadleigh Bench

Standard Features

Same standard features as Hadleigh Lounge Seating

Available Options

Same options as Hadleigh Lounge Seating

Key Dimensions

- Overall Width: See price table
- Overall Depth: 18"
- Overall Height: 18.75"



44" W, Bench

30 lbs | 1.5 yds

Model	Series 2	Series 3	Series 4	Series 5	Series 6	Series 7	Series 8	COM
280-B2 S	\$989	\$1,036	\$1,116	\$1,199	\$1,298	\$1,397	\$1,522	\$1,036
280-B2 P	\$1,114	\$1,161	\$1,241	\$1,324	\$1,423	\$1,522	\$1,647	\$1,161

Harmon Lounge Seating



More Information

Illustrated Glossary ▶ 439

Fabrics ▶ 451

Flammability (CTB-133) ▶ 459

Finishes ▶ 456

Ordering and Warranties ▶ 462

Standard Features

- Solid maple frame
- Mortise and tenon joinery
- Spring seat construction
- Clean-out design
- Replaceable components
- Wood arms with wood insets
- Wallsaver legs
- Non-marring 7/8" rubber-cushioned glides
- Nemschoff healthcare wood finish
- GREENGUARD Gold Certified
- Limited Lifetime Warranty

Available Options

- Moisture barrier + \$67 per seat or back
- Wood back + \$228
- Upholstered back with wood slats + \$228
- Urethane arm insets + \$113
- Upholstered arm insets + \$113
- CTB-133 + \$81/yd
- Two fabrics + \$62
- Three (or more) fabrics + \$88

Specification Decisions

- Select fabric
- Select standard wood finish
- Add moisture barrier
- Add CTB-133
- Apply multiple fabrics
- Add arm inset style
- Add back style

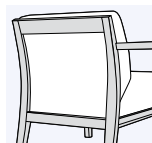

Upholstered back

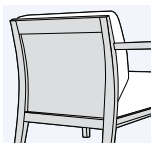

Wood back

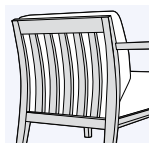

Upholstered back with wood slats

Model numbers with **S** indicate standard seat and back covers, and model numbers with **P** indicate removable covers.

Flammability Type

- Type 4

Coordinating Products

- [Harmon Patient Chair](#)

Key Dimensions

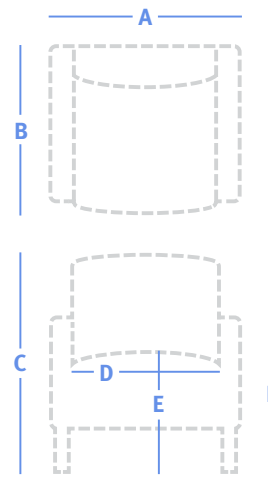

A	Overall Width	See price table
B	Overall Depth	29.75"
C	Overall Height	32"
D	Seat Width	
	Chair:	24"
	Settee:	43.5"
	Sofa:	65.5"
E	Seat Height	18.25"
F	Arm Height	25.75"

Harmon Lounge Seating

	27" W, Chair 36 lbs 2.25 yds								
	Model	Series 2	Series 3	Series 4	Series 5	Series 6	Series 7	Series 8	COM
	708-1 S	\$1,958	\$2,029	\$2,149	\$2,273	\$2,421	\$2,571	\$2,758	\$2,029
	708-1 P	\$2,202	\$2,273	\$2,393	\$2,517	\$2,665	\$2,815	\$3,002	\$2,273
	46.5" W, Settee 54 lbs 3 yds								
	Model	Series 2	Series 3	Series 4	Series 5	Series 6	Series 7	Series 8	COM
	708-2 S	\$3,081	\$3,176	\$3,335	\$3,501	\$3,699	\$3,898	\$4,148	\$3,176
	708-2 P	\$3,463	\$3,558	\$3,717	\$3,883	\$4,081	\$4,280	\$4,530	\$3,558
	68.5" W, Sofa 73 lbs 4 yds								
	Model	Series 2	Series 3	Series 4	Series 5	Series 6	Series 7	Series 8	COM
	708-3 S	\$4,118	\$4,245	\$4,457	\$4,678	\$4,942	\$5,208	\$5,540	\$4,245
	708-3 P	\$4,628	\$4,755	\$4,967	\$5,188	\$5,452	\$5,718	\$6,050	\$4,755

Iris Lounge Seating



More Information

Illustrated Glossary ▶ 439

Fabrics ▶ 451

Flammability (CTB-133) ▶ 459

Finishes ▶ 456

Ordering and Warranties ▶ 462

Standard Features

- Solid maple frame
- Mortise and tenon joinery
- Spring seat construction
- Replaceable components
- Non-marring 7/8" rubber-cushioned glides
- Detachable seat cushion
- Nemschoff healthcare wood finish
- GREENGUARD Gold Certified
- Limited Lifetime Warranty

Available Options

- Moisture barrier + \$67 per seat or back
- CTB-133 + \$81/yd
- Two fabrics + \$62
- Three (or more) fabrics + \$88

Specification Decisions

- Select fabric
- Select standard wood finish
- Add moisture barrier
- Add CTB-133
- Apply multiple fabrics

Flammability Type

- Type 7

Key Dimensions

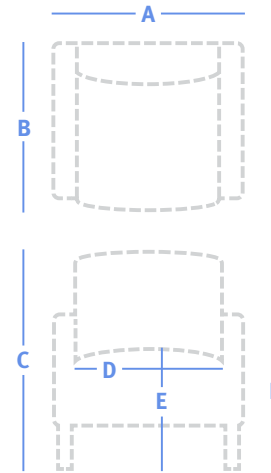

A	Overall Width	See price table
B	Overall Depth	32"
C	Overall Height	40"
D	Seat Width	
	Chair:	27"
	Settee:	50"
E	Seat Height	18.5"
F	Arm Height	23.5"



31" W, Chair with arms

56 lbs | 5.5 yds

Model	Series 2	Series 3	Series 4	Series 5	Series 6	Series 7	Series 8	COM
971-1	\$2,902	\$3,077	\$3,368	\$3,673	\$4,035	\$4,400	\$4,858	\$3,077



31" W, Chair without arms

50 lbs | 5.5 yds

Model	Series 2	Series 3	Series 4	Series 5	Series 6	Series 7	Series 8	COM
970-1	\$2,538	\$2,713	\$3,004	\$3,309	\$3,671	\$4,036	\$4,494	\$2,713



54" W, Settee with arms

78 lbs | 7.75 yds

Model	Series 2	Series 3	Series 4	Series 5	Series 6	Series 7	Series 8	COM
971-2	\$4,998	\$5,245	\$5,655	\$6,084	\$6,595	\$7,110	\$7,754	\$5,245



54" W, Settee without arms

84 lbs | 7.75 yds

Model	Series 2	Series 3	Series 4	Series 5	Series 6	Series 7	Series 8	COM
970-2	\$4,635	\$4,882	\$5,292	\$5,721	\$6,232	\$6,747	\$7,391	\$4,882

Lauderdale Lounge Seating



Standard Features

- Solid maple frame
- Spring seat construction
- Clean-out design
- Replaceable components
- Wood arm caps
- Detachable seat and back cushion
- Non-marring 7/8" rubber-cushioned glides
- Nemschoff healthcare wood finish
- GREENGUARD Gold Certified
- Limited Lifetime Warranty

Available Options

- Moisture barrier + \$67 per seat or back
- Black urethane arm caps + \$113
- Fully upholstered arms + \$113
- CTB-133 + \$81/yd
- Two fabrics + \$62
- Three (or more) fabrics + \$88

Specification Decisions

- Select fabric
- Select standard wood finish
- Add moisture barrier
- Add CTB-133
- Apply multiple fabrics
- Add urethane arm caps
- Add upholstered arms

Model numbers with **S** indicate standard seat and back covers, and model numbers with **P** indicate removable covers.

Flammability Type

- Type 6

Coordinating Products

- Lauderdale Tables

Key Dimensions

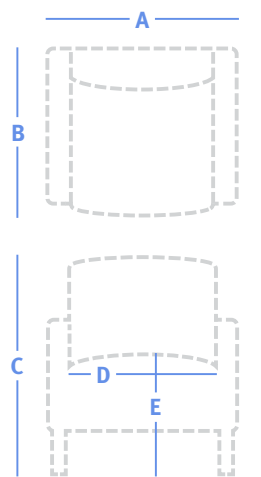

A	Overall Width	See price table
B	Overall Depth	26.5"
C	Overall Height	32"
D	Seat Width	
	Chair:	21.25", 25"
	Settee / Two Seat:	21.25", 45.25", 48"
	Sofa / Three Seat:	21.25", 69.25", 70"
E	Seat Height	18.5"
F	Arm Height	25.25"

More Information

Illustrated Glossary ▶ 439

Fabrics ▶ 451

Flammability (CTB-133) ▶ 459

Finishes ▶ 456

Ordering and Warranties ▶ 462

Lauderdale Lounge Seating

	26.75" W, Chair									59 lbs 2.75 yds
	Model	Series 2	Series 3	Series 4	Series 5	Series 6	Series 7	Series 8	COM	
	771-1 S	\$2,111	\$2,198	\$2,344	\$2,496	\$2,677	\$2,860	\$3,089	\$2,198	
	771-1 P	\$2,375	\$2,462	\$2,608	\$2,760	\$2,941	\$3,124	\$3,353	\$2,462	
	32" W, Chair									78 lbs 4.5 yds
	Model	Series 2	Series 3	Series 4	Series 5	Series 6	Series 7	Series 8	COM	
	775-1 S	\$2,292	\$2,435	\$2,674	\$2,923	\$3,219	\$3,518	\$3,892	\$2,435	
	775-1 P	\$2,585	\$2,728	\$2,967	\$3,216	\$3,512	\$3,811	\$4,185	\$2,728	
	50.75" W, Settee									91 lbs 4.25 yds
	Model	Series 2	Series 3	Series 4	Series 5	Series 6	Series 7	Series 8	COM	
	771-2 S	\$3,455	\$3,590	\$3,815	\$4,051	\$4,330	\$4,613	\$4,966	\$3,590	
	771-2 P	\$3,886	\$4,021	\$4,246	\$4,482	\$4,761	\$5,044	\$5,397	\$4,021	
	55" W, Settee									100 lbs 6 yds
	Model	Series 2	Series 3	Series 4	Series 5	Series 6	Series 7	Series 8	COM	
	775-2 S	\$3,798	\$3,989	\$4,307	\$4,639	\$5,034	\$5,433	\$5,932	\$3,989	
	775-2 P	\$4,277	\$4,468	\$4,786	\$5,118	\$5,513	\$5,912	\$6,411	\$4,468	
	50.75" W, Two seat with intervening arm and leg									97 lbs 5 yds
	Model	Series 2	Series 3	Series 4	Series 5	Series 6	Series 7	Series 8	COM	
	771-22 S	\$3,790	\$3,949	\$4,214	\$4,491	\$4,820	\$5,152	\$5,568	\$3,949	
	771-22 P	\$4,264	\$4,423	\$4,688	\$4,965	\$5,294	\$5,626	\$6,042	\$4,423	
	74.75" W, Sofa									103 lbs 5.75 yds
	Model	Series 2	Series 3	Series 4	Series 5	Series 6	Series 7	Series 8	COM	
	771-3 S	\$4,631	\$4,814	\$5,119	\$5,437	\$5,815	\$6,198	\$6,676	\$4,814	
	771-3 P	\$5,209	\$5,392	\$5,697	\$6,015	\$6,393	\$6,776	\$7,254	\$5,392	
	77" W, Sofa									116 lbs 8 yds
	Model	Series 2	Series 3	Series 4	Series 5	Series 6	Series 7	Series 8	COM	
	775-3 S	\$4,987	\$5,242	\$5,666	\$6,108	\$6,635	\$7,167	\$7,832	\$5,242	
	775-3 P	\$5,617	\$5,872	\$6,296	\$6,738	\$7,265	\$7,797	\$8,462	\$5,872	
	74.75" W, Three seat with intervening arms and legs									111 lbs 7.25 yds
	Model	Series 2	Series 3	Series 4	Series 5	Series 6	Series 7	Series 8	COM	
	771-33 S	\$5,306	\$5,537	\$5,921	\$6,322	\$6,799	\$7,281	\$7,884	\$5,537	
	771-33 P	\$5,971	\$6,202	\$6,586	\$6,987	\$7,464	\$7,946	\$8,549	\$6,202	

Lounge Seating

Multiple & Tandem Seating

Side, Stacking & Folding Chairs

Occasional Tables

Leonard II Lounge Seating



Standard Features

- Solid maple frame
- Spring seat construction
- Replaceable components
- Wood arm caps
- Non-marring 7/8" x 2" plastic bar glides
- Nemschoff healthcare wood finish
- GREENGUARD Gold Certified
- Limited Lifetime Warranty

Available Options

- Moisture barrier + \$67 per seat or back
- Classic upholstered bottom panel (Chair) + \$92 + \$170
- Classic upholstered bottom panel (Two seat) + \$248
- Classic upholstered bottom panel (Three seat) + \$248
- Fully upholstered arms + \$113
- Black urethane arm caps + \$113
- CTB-133 + \$81/yd
- Two fabrics + \$62
- Three (or more) fabrics + \$88

Specification Decisions

- Select fabric
- Select standard wood finish
- Add moisture barrier
- Add classic panel
- Add upholstered arms or urethane arm caps
- Add CTB-133
- Apply multiple fabrics

Model numbers with **S** indicate standard seat and back covers, and model numbers with **P** indicate removable covers.

Flammability Type

- Type 6

Coordinating Products

- [Leonard II Recliner](#)
- [Leonard II Sleep Double Sofa and Sleep Settee](#)

Key Dimensions

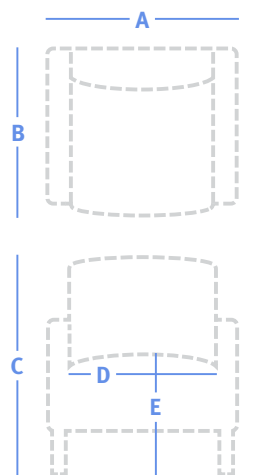

A	Overall Width	See price table
B	Overall Depth	31.75"
C	Overall Height	34.25"
D	Seat Width	
	Chair:	25"
	Two Seat:	50"
	Three Seat:	75"
E	Seat Height	18"
F	Arm Height	25"

More Information

- Illustrated Glossary ▶ 439
- Fabrics ▶ 451
- Flammability (CTB-133) ▶ 459
- Finishes ▶ 456
- Ordering and Warranties ▶ 462

Leonard II Lounge Seating



32.5" W, Chair

72 lbs | 6 yds

Model	Series 2	Series 3	Series 4	Series 5	Series 6	Series 7	Series 8	COM
814-10 S	\$2,083	\$2,274	\$2,592	\$2,924	\$3,319	\$3,718	\$4,217	\$2,274
814-10 P	\$2,356	\$2,547	\$2,865	\$3,197	\$3,592	\$3,991	\$4,490	\$2,547



57" W, Two seat

104 lbs | 9 yds

Model	Series 2	Series 3	Series 4	Series 5	Series 6	Series 7	Series 8	COM
814-20 S	\$3,326	\$3,613	\$4,090	\$4,588	\$5,180	\$5,778	\$6,527	\$3,613
814-20 P	\$3,760	\$4,047	\$4,524	\$5,022	\$5,614	\$6,212	\$6,961	\$4,047



82.25" W, Three seat

136 lbs | 11.25 yds

Model	Series 2	Series 3	Series 4	Series 5	Series 6	Series 7	Series 8	COM
814-30 S	\$4,458	\$4,817	\$5,413	\$6,035	\$6,776	\$7,524	\$8,459	\$4,817
814-30 P	\$5,037	\$5,396	\$5,992	\$6,614	\$7,355	\$8,103	\$9,038	\$5,396

Lounge Seating

Multiple & Tandem Seating

Side, Stacking & Folding Chairs

Occasional Tables

Marco Grande Lounge Seating



Standard Features

- Solid maple frame
- Spring seat construction
- Clean-out design
- Replaceable components
- Wood arms
- Non-marring 7/8" rubber-cushioned glides
- Nemschoff healthcare wood finish
- GREENGUARD Gold Certified
- Limited Lifetime Warranty

Available Options

- Moisture barrier + \$67 per seat or back
- CTB-133 + \$81/yd
- Two fabrics + \$62
- Three (or more) fabrics + \$88

Specification Decisions

- Select fabric
- Select standard wood finish
- Add moisture barrier
- Add CTB-133
- Apply multiple fabrics

Model numbers with **S** indicate standard seat and back covers, and model numbers with **P** indicate removable covers.

Flammability Types

- Type 4
- Type 2 (Ottoman)

Coordinating Products

- [Marco Grande II Lounge Seating](#)
- [Marco Multiple Seating](#)
- [Marco Grande Tables](#)
- [Marco Patient Chair](#)
- [Marco Glider](#)

Key Dimensions

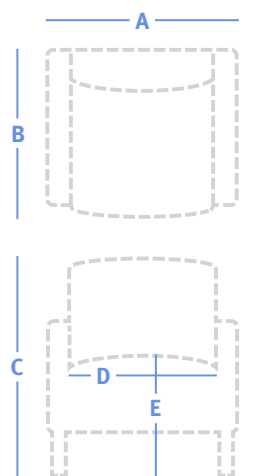

A	Overall Width	See price table
B	Overall Depth	32.5"
C	Overall Height	31.5"
D	Seat Width	
	Chair:	24.25"
	Settee:	45.5", 48"
	Sofa:	68.25", 72"
E	Seat Height	17.5"
F	Arm Height	22"

More Information

- Illustrated Glossary ▶ 439
- Fabrics ▶ 451
- Flammability (CTB-133) ▶ 459
- Finishes ▶ 456
- Ordering and Warranties ▶ 462

Marco Grande Lounge Seating

										38 lbs 3 yds
	28.75" W, Chair	Model	Series 2	Series 3	Series 4	Series 5	Series 6	Series 7	Series 8	COM
	732-1 S		\$1,787	\$1,882	\$2,041	\$2,207	\$2,405	\$2,604	\$2,854	\$1,882
	732-1 P		\$2,013	\$2,108	\$2,267	\$2,433	\$2,631	\$2,830	\$3,080	\$2,108
	53" W, Settee	Model	Series 2	Series 3	Series 4	Series 5	Series 6	Series 7	Series 8	COM
	732-2 S		\$2,906	\$3,065	\$3,330	\$3,607	\$3,936	\$4,268	\$4,684	\$3,065
	732-2 P		\$3,274	\$3,433	\$3,698	\$3,975	\$4,304	\$4,636	\$5,052	\$3,433
	53" W, Settee with divider arm	Model	Series 2	Series 3	Series 4	Series 5	Series 6	Series 7	Series 8	COM
	732-25 S		\$3,256	\$3,415	\$3,680	\$3,957	\$4,286	\$4,618	\$5,034	\$3,415
	732-25 P		\$3,666	\$3,825	\$4,090	\$4,367	\$4,696	\$5,028	\$5,444	\$3,825
	77" W, Sofa	Model	Series 2	Series 3	Series 4	Series 5	Series 6	Series 7	Series 8	COM
	732-3 S		\$4,026	\$4,249	\$4,620	\$5,007	\$5,468	\$5,933	\$6,515	\$4,249
	732-3 P		\$4,536	\$4,759	\$5,130	\$5,517	\$5,978	\$6,443	\$7,025	\$4,759
	77" W, Sofa with divider arms	Model	Series 2	Series 3	Series 4	Series 5	Series 6	Series 7	Series 8	COM
	732-35 S		\$4,726	\$4,949	\$5,320	\$5,707	\$6,168	\$6,633	\$7,215	\$4,949
	732-35 P		\$5,320	\$5,543	\$5,914	\$6,301	\$6,762	\$7,227	\$7,809	\$5,543

Marco Grande Ottoman

Standard Features

Same standard features as Marco Grande Lounge Seating

Available Options

Same options as Marco Grande Lounge Seating

Key Dimensions

- Overall Width: See price table
- Overall Depth: 17"
- Overall Height: 14.5"

										12 lbs 1.75 yds
	22.5" W, Ottoman	Model	Series 2	Series 3	Series 4	Series 5	Series 6	Series 7	Series 8	COM
	732-59		\$405	\$460	\$553	\$650	\$765	\$881	\$1,027	\$460

Lounge Seating
Multiple & Tandem Seating
Side, Stacking & Folding Chairs
Occasional Tables

Marco Grande II Lounge Seating



Standard Features

- Solid maple frame
- Spring seat construction
- Clean-out design
- Replaceable components
- Wood arms
- Non-marring 7/8" rubber-cushioned glides
- Nemschoff healthcare wood finish
- GREENGUARD Gold Certified
- Limited Lifetime Warranty

Available Options

- Moisture barrier + \$67 per seat or back
- CTB-133 + \$81/yd
- Two fabrics + \$62
- Three (or more) fabrics + \$88

Specification Decisions

- Select fabric
- Select standard wood finish
- Add moisture barrier
- Add CTB-133
- Apply multiple fabrics

Model numbers with **S** indicate standard seat and back covers, and model numbers with **P** indicate removable covers.

Flammability Types

- Type 4
- Type 2 (Ottoman)

Coordinating Products

- [Marco Grande Lounge Seating](#)
- [Marco Multiple Seating](#)
- [Marco Grande Tables](#)
- [Marco Patient Chair](#)
- [Marco Glider](#)

Key Dimensions

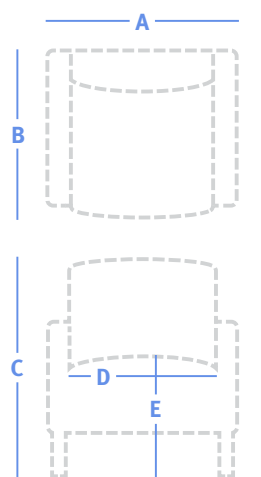

A	Overall Width	See price table
B	Overall Depth	32"
C	Overall Height	32.5"
D	Seat Width	
	Chair:	24.25"
	Settee:	45.25", 48.25"
	Sofa:	68.25", 72"
E	Seat Height	18.5"
F	Arm Height	24.25"

More Information

- Illustrated Glossary ▶ 439
- Fabrics ▶ 451
- Flammability (CTB-133) ▶ 459
- Finishes ▶ 456
- Ordering and Warranties ▶ 462

Marco Grande II Lounge Seating

	28.75" W, Chair									40 lbs 3 yds
	Model	Series 2	Series 3	Series 4	Series 5	Series 6	Series 7	Series 8	COM	
	736-1 S	\$1,838	\$1,933	\$2,092	\$2,258	\$2,456	\$2,655	\$2,905	\$1,933	
	736-1 P	\$2,070	\$2,165	\$2,324	\$2,490	\$2,688	\$2,887	\$3,137	\$2,165	
	53" W, Settee									72 lbs 5 yds
	Model	Series 2	Series 3	Series 4	Series 5	Series 6	Series 7	Series 8	COM	
	736-2 S	\$2,974	\$3,133	\$3,398	\$3,675	\$4,004	\$4,336	\$4,752	\$3,133	
	736-2 P	\$3,350	\$3,509	\$3,774	\$4,051	\$4,380	\$4,712	\$5,128	\$3,509	
	53" W, Settee with divider arm									74 lbs 5 yds
	Model	Series 2	Series 3	Series 4	Series 5	Series 6	Series 7	Series 8	COM	
	736-25 S	\$3,281	\$3,440	\$3,705	\$3,982	\$4,311	\$4,643	\$5,059	\$3,440	
	736-25 P	\$3,694	\$3,853	\$4,118	\$4,395	\$4,724	\$5,056	\$5,472	\$3,853	
	77" W, Sofa									102 lbs 7 yds
	Model	Series 2	Series 3	Series 4	Series 5	Series 6	Series 7	Series 8	COM	
	736-3 S	\$4,069	\$4,292	\$4,663	\$5,050	\$5,511	\$5,976	\$6,558	\$4,292	
	736-3 P	\$4,585	\$4,808	\$5,179	\$5,566	\$6,027	\$6,492	\$7,074	\$4,808	
	77" W, Sofa with divider arms									106 lbs 7 yds
	Model	Series 2	Series 3	Series 4	Series 5	Series 6	Series 7	Series 8	COM	
	736-35 S	\$4,775	\$4,998	\$5,369	\$5,756	\$6,217	\$6,682	\$7,264	\$4,998	
	736-35 P	\$5,375	\$5,598	\$5,969	\$6,356	\$6,817	\$7,282	\$7,864	\$5,598	

Marco Grande II Ottoman

Standard Features

Same standard features as Marco Grande II Lounge Seating

Available Options

Same options as Marco Grande II Lounge Seating

Key Dimensions

- Overall Width: See price table
- Overall Depth: 17"
- Overall Height: 14.5"

	22.5" W, Ottoman									12 lbs 1.75 yds
	Model	Series 2	Series 3	Series 4	Series 5	Series 6	Series 7	Series 8	COM	
	736-59	\$498	\$555	\$647	\$744	\$859	\$976	\$1,121	\$555	

Marsack Lounge Seating



Standard Features

- Spring seat construction
- Clean-out design
- Replaceable components
- Black urethane arm caps
- Laminate-wrapped side panels
- Ultra-heavy
- Non-marring 5/8" x 2" plastic bar glides
- GREENGUARD Gold Certified
- Limited Lifetime Warranty

Available Options

- Moisture barrier + \$67 per seat or back
- CTB-133 + \$81/yd
- Two fabrics + \$62
- Three (or more) fabrics + \$88

Specification Decisions

- Select fabric
- Select standard laminate finish
- Add moisture barrier
- Add CTB-133
- Apply multiple fabrics

Model numbers with **S** indicate standard seat and back covers, and model numbers with **P** indicate removable covers.

Flammability Type

- Type 4

Coordinating Products

- [Marsack II Lounge Seating](#)
- [Marsack Tables](#)
- [Marsack III Behavioral Health Seating](#)

Key Dimensions

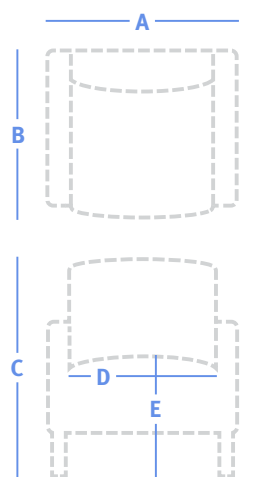

A	Overall Width	See price table
B	Overall Depth	29.5"
C	Overall Height	32.5"
D	Seat Width	
	Chair:	23"
	Settee:	46"
	Sofa:	69"
E	Seat Height	18.75"
F	Arm Height	24.5"

More Information

- Illustrated Glossary ▶ 439
- Fabrics ▶ 451
- Flammability (CTB-133) ▶ 459
- Finishes ▶ 456
- Ordering and Warranties ▶ 462

Marsack Lounge Seating

Lounge Seating

Multiple & Tandem Seating

Side, Stacking & Folding Chairs

Occasional Tables

	29" W, Chair									92 lbs 2.25 yds
	Model	Series 2	Series 3	Series 4	Series 5	Series 6	Series 7	Series 8	COM	
	700-10 S	\$2,199	\$2,270	\$2,390	\$2,514	\$2,662	\$2,812	\$2,999	\$2,270	
	700-10 P	\$2,472	\$2,543	\$2,663	\$2,787	\$2,935	\$3,085	\$3,272	\$2,543	
	49.5" W, Settee									128 lbs 3.5 yds
	Model	Series 2	Series 3	Series 4	Series 5	Series 6	Series 7	Series 8	COM	
	700-20 S	\$3,585	\$3,696	\$3,882	\$4,075	\$4,306	\$4,538	\$4,829	\$3,696	
	700-20 P	\$4,029	\$4,140	\$4,326	\$4,519	\$4,750	\$4,982	\$5,273	\$4,140	
	52.25" W, Settee with divider arm									141 lbs 4.25 yds
	Model	Series 2	Series 3	Series 4	Series 5	Series 6	Series 7	Series 8	COM	
	700-25 S	\$4,024	\$4,159	\$4,384	\$4,620	\$4,899	\$5,182	\$5,535	\$4,159	
	700-25 P	\$4,524	\$4,659	\$4,884	\$5,120	\$5,399	\$5,682	\$6,035	\$4,659	
	70.5" W, Sofa									156 lbs 6.5 yds
	Model	Series 2	Series 3	Series 4	Series 5	Series 6	Series 7	Series 8	COM	
	700-30 S	\$4,625	\$4,832	\$5,176	\$5,536	\$5,964	\$6,396	\$6,937	\$4,832	
	700-30 P	\$5,205	\$5,412	\$5,756	\$6,116	\$6,544	\$6,976	\$7,517	\$5,412	
	76.5" W, Sofa with divider arms									188 lbs 6.25 yds
	Model	Series 2	Series 3	Series 4	Series 5	Series 6	Series 7	Series 8	COM	
	700-35 S	\$5,714	\$5,913	\$6,244	\$6,590	\$7,001	\$7,417	\$7,937	\$5,913	
	700-35 P	\$6,424	\$6,623	\$6,954	\$7,300	\$7,711	\$8,127	\$8,647	\$6,623	

Marsack Benches

Standard Features



Same standard features as Marsack Lounge Seating

Available Options

Same options as Marsack Lounge Seating

Key Dimensions

- Overall Width: See price table
- Overall Depth: 26.5"
- Overall Height: 18.75"

	26" W, Bench									49 lbs 1.5 yds
	Model	Series 2	Series 3	Series 4	Series 5	Series 6	Series 7	Series 8	COM	
	700-B1 S	\$1,208	\$1,255	\$1,335	\$1,418	\$1,517	\$1,616	\$1,741	\$1,255	
	700-B1 P	\$1,359	\$1,406	\$1,486	\$1,569	\$1,668	\$1,767	\$1,892	\$1,406	
	46.5" W, Bench									65 lbs 2.5 yds
	Model	Series 2	Series 3	Series 4	Series 5	Series 6	Series 7	Series 8	COM	
	700-B2 S	\$1,565	\$1,644	\$1,777	\$1,915	\$2,080	\$2,246	\$2,454	\$1,644	
	700-B2 P	\$1,763	\$1,842	\$1,975	\$2,113	\$2,278	\$2,444	\$2,652	\$1,842	

Marsack II Lounge Seating



Standard Features

- Spring seat construction
- Clean-out design
- Replaceable components
- Black urethane arm caps
- Laminate-wrapped side panels
- Nemschoff healthcare wood finish
- Ultra-heavy
- Non-marring 5/8" x 2" rubber-cushioned glides
- GREENGUARD Gold Certified
- Limited Lifetime Warranty

Available Options

- Moisture barrier + \$67 per seat or back
- CTB-133 + \$81/yd
- Two fabrics + \$62
- Three (or more) fabrics + \$88

Specification Decisions

- Select fabric
- Select standard laminate finish
- Add moisture barrier
- Add CTB-133
- Apply multiple fabrics

Model numbers with **S** indicate standard seat and back covers, and model numbers with **P** indicate removable covers.

Coordinating Products

- [Marsack Lounge Seating](#)
- [Marsack Tables](#)
- [Marsack III Behavioral Health Seating](#)

Flammability Type

- Type 4

Key Dimensions

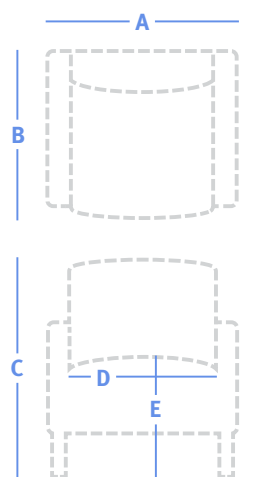

A	Overall Width	See price table
B	Overall Depth	29"
C	Overall Height	33.25"
D	Seat Width	
	Chair:	23"
	Settee:	46"
	Sofa:	69"
E	Seat Height	18.75"
F	Arm Height	24.5"

More Information

- Illustrated Glossary ▶ 439
- Fabrics ▶ 451
- Flammability (CTB-133) ▶ 459
- Finishes ▶ 456
- Ordering and Warranties ▶ 462

Marsack II Lounge Seating

Lounge Seating

Multiple & Tandem Seating

Side, Stacking & Folding Chairs

Occasional Tables

	29" W, Chair									92 lbs 2.75 yds
	Model	Series 2	Series 3	Series 4	Series 5	Series 6	Series 7	Series 8	COM	
	702-10 S	\$2,182	\$2,269	\$2,415	\$2,567	\$2,748	\$2,931	\$3,160	\$2,269	
	702-10 P	\$2,455	\$2,542	\$2,688	\$2,840	\$3,021	\$3,204	\$3,433	\$2,542	
	49.5" W, Two seat									128 lbs 4.25 yds
	Model	Series 2	Series 3	Series 4	Series 5	Series 6	Series 7	Series 8	COM	
	702-20 S	\$3,560	\$3,695	\$3,920	\$4,156	\$4,435	\$4,718	\$5,071	\$3,695	
	702-20 P	\$4,004	\$4,139	\$4,364	\$4,600	\$4,879	\$5,162	\$5,515	\$4,139	
	52.25" W, Two seat with divider arm									141 lbs 4.25 yds
	Model	Series 2	Series 3	Series 4	Series 5	Series 6	Series 7	Series 8	COM	
	702-25 S	\$4,024	\$4,159	\$4,384	\$4,620	\$4,899	\$5,182	\$5,535	\$4,159	
	702-25 P	\$4,524	\$4,659	\$4,884	\$5,120	\$5,399	\$5,682	\$6,035	\$4,659	
	70.5" W, Three seat									156 lbs 5.25 yds
	Model	Series 2	Series 3	Series 4	Series 5	Series 6	Series 7	Series 8	COM	
	702-30 S	\$4,665	\$4,832	\$5,110	\$5,401	\$5,746	\$6,095	\$6,532	\$4,832	
	702-30 P	\$5,245	\$5,412	\$5,690	\$5,981	\$6,326	\$6,675	\$7,112	\$5,412	
	76.5" W, Three seat with divider arms									188 lbs 5.25 yds
	Model	Series 2	Series 3	Series 4	Series 5	Series 6	Series 7	Series 8	COM	
	702-35 S	\$5,746	\$5,913	\$6,191	\$6,482	\$6,827	\$7,176	\$7,613	\$5,913	
	702-35 P	\$6,456	\$6,623	\$6,901	\$7,192	\$7,537	\$7,886	\$8,323	\$6,623	

Marsack II Benches

Standard Features

Same standard features as Marsack II Lounge Seating

Available Options

Same options as Marsack II Lounge Seating

Key Dimensions

- Overall Width: See price table
- Overall Depth: 26.5"
- Overall Height: 18.75"

	26" W, Bench									49 lbs 1.5 yds
	Model	Series 2	Series 3	Series 4	Series 5	Series 6	Series 7	Series 8	COM	
	702-B1 S	\$1,208	\$1,255	\$1,335	\$1,418	\$1,517	\$1,616	\$1,741	\$1,255	
	702-B1 P	\$1,359	\$1,406	\$1,486	\$1,569	\$1,668	\$1,767	\$1,892	\$1,406	
	46.5" W, Bench									65 lbs 2.5 yds
	Model	Series 2	Series 3	Series 4	Series 5	Series 6	Series 7	Series 8	COM	
	702-B2 S	\$1,565	\$1,644	\$1,777	\$1,915	\$2,080	\$2,246	\$2,454	\$1,644	
	702-B2 P	\$1,763	\$1,842	\$1,975	\$2,113	\$2,278	\$2,444	\$2,652	\$1,842	

Maurice Lounge Seating



Standard Features

- Solid maple frame
- Mortise and tenon joinery
- Spring seat construction
- Clean-out design
- Non-marring 7/8" plastic glides
- Nemschoff healthcare wood finish
- GREENGUARD Gold Certified
- Limited Lifetime Warranty

Available Options

- Moisture barrier + \$67 per seat or back
- CTB-133 + \$81/yd
- Two fabrics + \$62
- Three (or more) fabrics + \$88

Specification Decisions

- Select fabric
 - Select standard wood finish
 - Add moisture barrier
 - Add CTB-133
 - Apply multiple fabrics
- Model numbers with **S** indicate standard seat and back covers, and model numbers with **P** indicate removable covers.

Flammability Type

- Type 7

Key Dimensions

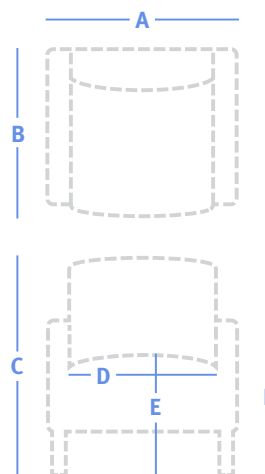

A	Overall Width	See price table
B	Overall Depth	34"
C	Overall Height	37.5"
D	Seat Width	
	Chair:	21.25"
	Settee:	41.75"
	Sofa:	64.5"
E	Seat Height	18.5"
F	Arm Height	26.5"

More Information

- Illustrated Glossary ▶ 439
- Fabrics ▶ 451
- Flammability (CTB-133) ▶ 459
- Finishes ▶ 456
- Ordering and Warranties ▶ 462

	34.25" W, Chair									45 lbs 7.25 yds
	Model	Series 2	Series 3	Series 4	Series 5	Series 6	Series 7	Series 8	COM	
	905-10 S	\$1,871	\$2,102	\$2,486	\$2,887	\$3,364	\$3,846	\$4,449	\$2,102	
	905-10 P	\$2,124	\$2,355	\$2,739	\$3,140	\$3,617	\$4,099	\$4,702	\$2,355	

	54.5" W, Settee									66 lbs 10 yds
	Model	Series 2	Series 3	Series 4	Series 5	Series 6	Series 7	Series 8	COM	
	905-20 S	\$2,638	\$2,957	\$3,486	\$4,040	\$4,698	\$5,363	\$6,194	\$2,957	
	905-20 P	\$2,993	\$3,312	\$3,841	\$4,395	\$5,053	\$5,718	\$6,549	\$3,312	

	77.25" W, Sofa									86 lbs 12 yds
	Model	Series 2	Series 3	Series 4	Series 5	Series 6	Series 7	Series 8	COM	
	905-30 S	\$3,352	\$3,735	\$4,370	\$5,034	\$5,824	\$6,622	\$7,620	\$3,735	
	905-30 P	\$3,801	\$4,184	\$4,819	\$5,483	\$6,273	\$7,071	\$8,069	\$4,184	

Meridian Lounge Seating



More Information

Illustrated Glossary ▶ 439

Fabrics ▶ 451

Flammability (CTB-133) ▶ 459

Finishes ▶ 456

Ordering and Warranties ▶ 462

Standard Features

- Solid hardwood frame
- Upholstered arms
- Non-marring glides
- Loose seat and tight back cushions
- Nemschoff healthcare wood finish
- GREENGUARD Gold Certified
- Limited Lifetime Warranty

Available Options

- Moisture barrier + \$67 per seat or back
- Black urethane arm caps + \$113
- Wood arm caps + \$113
- D-ring to attach seat cushion to unit + \$47
- CTB-133 + \$81/yd
- Two fabrics + \$62
- Three (or more) fabrics + \$88

Specification Decisions

- Select fabric
- Select standard wood finish
- Add moisture barrier
- Add CTB-133
- Apply multiple fabrics
- Add wood or urethane arm caps
- Add D-ring

Coordinating Products

- [Meridian Multiple Seating](#)
- [Meridian Patient Chair](#)
- [Meridian Tables](#)
- [Meridian Behavioral Health Seating](#)

Flammability Type

- Type 4

Key Dimensions

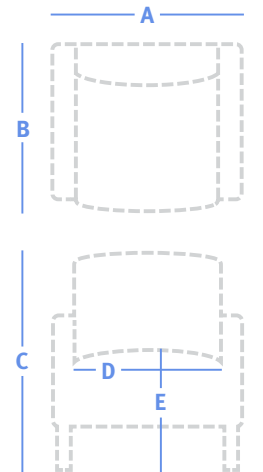

A	Overall Width	See price table
B	Overall Depth	30"
C	Overall Height	29"
D	Seat Width	
	Chair:	20.75", 24"
	Settee:	20.75", 24", 41.5", 42"
	Sofa:	24", 62.25, 63
E	Seat Height	18"
F	Arm Height	24"



27" W, Chair

64 lbs | 5 yds

Model	Series 2	Series 3	Series 4	Series 5	Series 6	Series 7	Series 8	COM
ML31/27	\$1,500	\$1,579	\$1,923	\$2,107	\$2,208	\$2,340	\$2,424	\$1,579



50" W, Two seat

104 lbs | 7 yds

Model	Series 2	Series 3	Series 4	Series 5	Series 6	Series 7	Series 8	COM
ML31/50	\$1,966	\$2,076	\$2,557	\$2,816	\$2,956	\$3,141	\$3,259	\$2,076

Meridian Lounge Seating

	51.5" W, Two seat with intervening arm and leg									116 lbs 9 yds
	Model	Series 2	Series 3	Series 4	Series 5	Series 6	Series 7	Series 8	COM	
	ML31-2	\$2,627	\$2,769	\$3,387	\$3,720	\$3,900	\$4,138	\$4,290	\$2,769	
	71" W, Sofa									144 lbs 9 yds
	Model	Series 2	Series 3	Series 4	Series 5	Series 6	Series 7	Series 8	COM	
	ML31/71	\$2,434	\$2,576	\$3,194	\$3,527	\$3,707	\$3,945	\$4,097	\$2,576	
	75.75" W, Three seat with intervening arms and legs									163 lbs 13 yds
	Model	Series 2	Series 3	Series 4	Series 5	Series 6	Series 7	Series 8	COM	
	ML31-3	\$3,685	\$3,890	\$4,783	\$5,263	\$5,524	\$5,867	\$6,087	\$3,890	
	100" W, Four seat with intervening arms and legs									210 lbs 17 yds
	Model	Series 2	Series 3	Series 4	Series 5	Series 6	Series 7	Series 8	COM	
	ML31-4	\$4,719	\$4,988	\$6,155	\$6,784	\$7,125	\$7,573	\$7,861	\$4,988	
	27" W, High back chair									69 lbs 5.75 yds
	Model	Series 2	Series 3	Series 4	Series 5	Series 6	Series 7	Series 8	COM	
	ML31H/27	\$1,708	\$1,799	\$2,194	\$2,407	\$2,522	\$2,674	\$2,771	\$1,799	
	50" W, High back settee									114 lbs 7.5 yds
	Model	Series 2	Series 3	Series 4	Series 5	Series 6	Series 7	Series 8	COM	
	ML31H/50	\$2,128	\$2,246	\$2,761	\$3,038	\$3,189	\$3,387	\$3,514	\$2,246	
	33" W, Chair									100 lbs 6.25 yds
	Model	Series 2	Series 3	Series 4	Series 5	Series 6	Series 7	Series 8	COM	
	ML35/33	\$1,974	\$2,072	\$2,501	\$2,732	\$2,858	\$3,023	\$3,128	\$2,072	
	57" W, Settee									120 lbs 7.75 yds
	Model	Series 2	Series 3	Series 4	Series 5	Series 6	Series 7	Series 8	COM	
	ML35/57	\$2,806	\$2,928	\$3,460	\$3,747	\$3,902	\$4,107	\$4,238	\$2,928	
	81" W, Sofa									160 lbs 9.25 yds
	Model	Series 2	Series 3	Series 4	Series 5	Series 6	Series 7	Series 8	COM	
	ML35/81	\$3,310	\$3,456	\$4,091	\$4,433	\$4,619	\$4,863	\$5,019	\$3,456	

Mod Pod Lounge System



More Information

- Illustrated Glossary ▶ 439
- Fabrics ▶ 451
- Flammability (CTB-133) ▶ 459
- Finishes ▶ 456
- Ordering and Warranties ▶ 462

Standard Features

- Hexagon-shaped seats
- Wipe-out design
- Powder-coated legs
- Veneer table tops
- GREENGUARD Gold Certification
- Limited Lifetime Warranty

Available Options

- Moisture barrier + \$67 per seat or back
- Attached veneer tables (See price table)
- Laminate or fusion maple or black Durawrap tops + \$0
- Anodized aluminum or black connection bracket set for seat-to-seat attachment (CBMOD) + \$307
- CTB-133 + \$81/yd
- Two fabrics + \$62
- Three (or more) fabrics + \$88
- Removable covers + \$104

Specification Decisions

- Select powder coat finish (MST Metallic Silver Textured, XTT Titanium Textured)
- Select fabric
- Add moisture barrier
- Add CTB-133
- Apply multiple fabrics
- Add removable covers
- Create a seating configuration plan. List unit model numbers from left to right.
- Add connecting brackets for seat-to-seat connections or select seats, tables and accessory units. Specify side to attach tables (LSF, RSF). Tables include brackets.
- Select laminate, Fusion maple, or Black Durawrap for table tops, if required.
- Follow the online quoting system to determine if male or female connections are needed with each item.

For more details about configuring and ordering this lounge system, visit our website nemschoff.com/products/mod-pod-lounge-system choose Design Resources > Literature > Pricing.

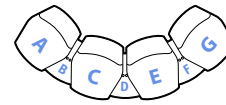

Example Mod Pod Lounge configuration plan

Unit	Model #	Description	Ganging
A	MOD	Chair	Ganged RSF
B	MODST	Spanner Table	Ganged RSF & LSF
C	MOD	Chair	Ganged RSF & LSF
D	MODST	Spanner Table	Ganged RSF & LSF
E	MOD	Chair	Ganged RSF & LSF
F	MODST	Spanner Table	Ganged RSF & LSF
G	MOD	Chair	Ganged LSF

Furniture ships inside a protective bag to which a shipping label is affixed. Any site-specific installation instructions (location designation or place in specific configuration — with ganged or modular components) will be on the label. Do not remove the protective bag prior to product being staged in the indicated location on-site.

Flammability Type

- Type 5

Key Dimensions

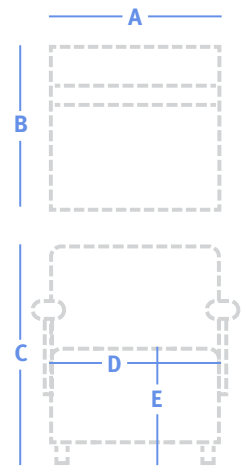

A	Overall Width	See price table
B	Overall Depth	30"
C	Overall Height	33.5"
D	Seat Width	
	Chair:	24"
	Settee:	48"
	Bench:	48"
E	Seat Height	19"
F	Arm Height	25"

Mod Pod Lounge

	24" W, Chair 43 lbs 2.5 yds								
	Model	Series 2	Series 3	Series 4	Series 5	Series 6	Series 7	Series 8	COM
	MOD	\$1,428	\$1,467	\$1,639	\$1,731	\$1,782	\$1,848	\$1,890	\$1,467

	24" W, Chair with casters 43 lbs 3 yds								
	Model	Series 2	Series 3	Series 4	Series 5	Series 6	Series 7	Series 8	COM
	MOD-C	\$1,385	\$1,432	\$1,638	\$1,749	\$1,809	\$1,889	\$1,939	\$1,432

	48" W, Settee 70 lbs 4.25 yds								
	Model	Series 2	Series 3	Series 4	Series 5	Series 6	Series 7	Series 8	COM
	MODLS	\$2,095	\$2,162	\$2,454	\$2,611	\$2,697	\$2,809	\$2,881	\$2,162

	48" W, Bench 49 lbs 3.5 yds								
	Model	Series 2	Series 3	Series 4	Series 5	Series 6	Series 7	Series 8	COM
	MODB/48	\$1,547	\$1,602	\$1,843	\$1,972	\$2,042	\$2,135	\$2,194	\$1,602

Gusset 15 lbs .25 yds								
Model	Series 2	Series 3	Series 4	Series 5	Series 6	Series 7	Series 8	COM
GMOD	\$72	\$75	\$93	\$102	\$107	\$114	\$118	\$75

Mod Pod Arm

Specification Decisions

- Select powder coat finish
- Select LSF or RSF (EAMOD)

Right or left end arm with female connecting bracket 4 lbs								
Model	Price							
EAMOD	\$372							

Inner arm with male and female connecting brackets 4 lbs								
Model	Price							
IAMOD	\$437							

Mod Pod Lounge System

Lounge Seating

Multiple & Tandem Seating

Side, Stacking & Folding Chairs

Occasional Tables

Mod Pod Tables

Available Options

- Standard laminate
- Fusion maple or Black Durawrap

Specification Decisions

- Select powder coat finish
- Select wood or add laminate or Durawrap tabletop material

	21.75" W, End table with one bracket		15 lbs
	Model	Price	
	MODET	\$999	
	21.75" W, Inner table with two brackets		12 lbs
	Model	Price	
	MODIT	\$882	
	13.75" W, Spanner table with two brackets		10 lbs
	Model	Price	
	MODST	\$696	
	29.5" W, Corner table with two brackets		17 lbs
	Model	Price	
	MODCT	\$1,058	

Monarch Lounge Seating



Standard Features

- Solid maple frame
- Mortise and tenon joinery
- Spring seat construction
- Clean-out design
- Replaceable components
- Black urethane arm caps
- Wallsaver legs
- Non-marring 7/8" nylon glides
- Nemschoff healthcare wood finish
- GREENGUARD Gold Certified
- Limited Lifetime Warranty

Available Options

- Moisture barrier + \$67 per seat or back
- Wood arm caps + \$113
- CTB-133 + \$81/yd
- Two fabrics + \$62
- Three (or more) fabrics + \$88

Specification Decisions

- Select fabric
- Select standard wood finish
- Add moisture barrier
- Add CTB-133
- Apply multiple fabrics
- Add wood arm caps

Model numbers with **S** indicate standard seat and back covers, and model numbers with **P** indicate removable covers.

Flammability Type

- Type 4

Coordinating Products

- [Monarch Multiple Seating](#)
- [Monarch Stack Chair](#)
- [Monarch Tables](#)
- [Monarch Patient Chair](#)
- [Monarch Sleep Chair and Settee](#)

Key Dimensions

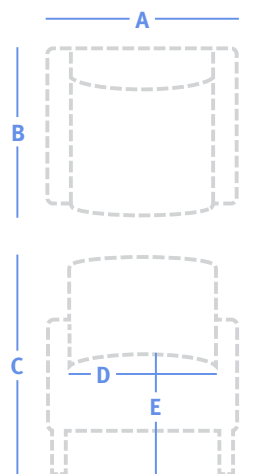

A	Overall Width	See price table
B	Overall Depth	28.25"
C	Overall Height	32.5"
D	Seat Width	
	Chair:	22"
	Two Seat:	44"
	Three Seat:	66"
E	Seat Height	18.75"
F	Arm Height	26"

More Information

Illustrated Glossary ▶ 439

Fabrics ▶ 451

Flammability (CTB-133) ▶ 459

Finishes ▶ 456

Ordering and Warranties ▶ 462

Monarch Lounge Seating



25.5" W, Chair

42 lbs | 3.25 yds

Model	Series 2	Series 3	Series 4	Series 5	Series 6	Series 7	Series 8	COM
894-10 S	\$1,073	\$1,176	\$1,348	\$1,528	\$1,742	\$1,958	\$2,229	\$1,176
894-10 P	\$1,215	\$1,318	\$1,490	\$1,670	\$1,884	\$2,100	\$2,371	\$1,318



47.5" W, Two seat

67 lbs | 5 yds

Model	Series 2	Series 3	Series 4	Series 5	Series 6	Series 7	Series 8	COM
894-20 S	\$1,486	\$1,645	\$1,910	\$2,187	\$2,516	\$2,848	\$3,264	\$1,645
894-20 P	\$1,684	\$1,843	\$2,108	\$2,385	\$2,714	\$3,046	\$3,462	\$1,843



69.5" W, Three seat

88 lbs | 7 yds

Model	Series 2	Series 3	Series 4	Series 5	Series 6	Series 7	Series 8	COM
894-30 S	\$2,136	\$2,359	\$2,730	\$3,117	\$3,578	\$4,043	\$4,625	\$2,359
894-30 P	\$2,420	\$2,643	\$3,014	\$3,401	\$3,862	\$4,327	\$4,909	\$2,643

Lounge Seating

Multiple & Tandem Seating

Side, Stacking & Folding Chairs

Occasional Tables

Oliver Lounge Seating



Standard Features

- Solid maple frame
- Mortise and tenon joinery
- Spring seat construction
- Clean-out design
- Replaceable components
- Non-marring 7/8" plastic glides
- Nemschoff healthcare wood finish
- GREENGUARD Gold Certified
- Limited Lifetime Warranty

Available Options

- Moisture barrier + \$67 per seat or back
- CTB-133 + \$81/yd
- Two fabrics + \$62
- Three (or more) fabrics + \$88

Specification Decisions

- Select fabric
- Select standard wood finish
- Add moisture barrier
- Add CTB-133
- Apply multiple fabrics

Model numbers with **S** indicate standard seat and back covers, and model numbers with **P** indicate removable covers.

Flammability Type

- Type 3

Coordinating Products

- [Oliver Recliner](#)
- [Oliver Sleep Settee](#)
- [Olivia Tables](#)
- [Olivia Patient Chair](#)
- [Olivia Glider](#)

Key Dimensions

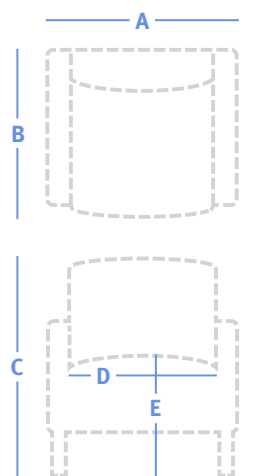

A	Overall Width	See price table
B	Overall Depth	29.75"
C	Overall Height	35"
D	Seat Width	
	Chair:	22"
	Settee:	41"
	Sofa:	62.5"
E	Seat Height	18.75"
F	Arm Height	24.75"

More Information

- Illustrated Glossary ▶ 439
- Fabrics ▶ 451
- Flammability (CTB-133) ▶ 459
- Finishes ▶ 456
- Ordering and Warranties ▶ 462



27.75" W, Chair

30 lbs | 2.25 yds

Model	Series 2	Series 3	Series 4	Series 5	Series 6	Series 7	Series 8	COM
902-10 S	\$2,061	\$2,132	\$2,252	\$2,376	\$2,524	\$2,674	\$2,861	\$2,132
902-10 P	\$2,317	\$2,388	\$2,508	\$2,632	\$2,780	\$2,930	\$3,117	\$2,388



47.75" W, Settee

50 lbs | 4.25 yds

Model	Series 2	Series 3	Series 4	Series 5	Series 6	Series 7	Series 8	COM
902-20 S	\$3,011	\$3,146	\$3,371	\$3,607	\$3,886	\$4,169	\$4,522	\$3,146
902-20 P	\$3,389	\$3,524	\$3,749	\$3,985	\$4,264	\$4,547	\$4,900	\$3,524



70" W, Sofa

70 lbs | 5.25 yds

Model	Series 2	Series 3	Series 4	Series 5	Series 6	Series 7	Series 8	COM
902-30 S	\$3,912	\$4,079	\$4,357	\$4,648	\$4,993	\$5,342	\$5,779	\$4,079
902-30 P	\$4,402	\$4,569	\$4,847	\$5,138	\$5,483	\$5,832	\$6,269	\$4,569

Olivia Lounge Seating



More Information

Illustrated Glossary ▶ 439

Fabrics ▶ 451

Flammability (CTB-133) ▶ 459

Finishes ▶ 456

Ordering and Warranties ▶ 462

Standard Features

- Solid maple frame
- Spring seat construction
- Clean-out design
- Replaceable components
- Upholstered arms
- Non-marring 7/8" rubber-cushioned glides
- Nemschoff healthcare wood finish
- GREENGUARD Gold Certified
- Limited Lifetime Warranty
- See nemschoff.com for weight ratings (903-510B)

Available Options

- Moisture barrier + \$67 per seat or back
- CTB-133 + \$81/yd
- Two fabrics + \$62
- Three (or more) fabrics + \$88

Specification Decisions

- Select fabric
- Select standard wood finish
- Add moisture barrier
- Add CTB-133
- Apply multiple fabrics

Model numbers with **S** indicate standard seat and back covers, and model numbers with **P** indicate removable covers.

Flammability Type

- Type 6

Coordinating Products

- [Olivia Tables](#)
- [Olivia Patient Chair](#)
- [Olivia Glider](#)
- [Oliver Lounge](#)

Key Dimensions

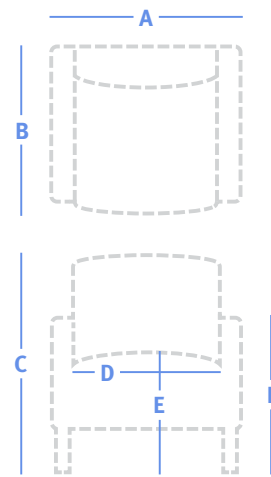

A	Overall Width	See price table
B	Overall Depth	30"
C	Overall Height	35"
D	Seat Width	
	Chair:	21.25", 29.5"
	Settee:	39", 41"
	Sofa:	58.5", 62.5"
E	Seat Height	18.75"
F	Arm Height	25.25"

Olivia Lounge Seating



28" W, Chair

34 lbs | 3.5 yds

Model	Series 2	Series 3	Series 4	Series 5	Series 6	Series 7	Series 8	COM
903-10 S	\$1,863	\$1,974	\$2,160	\$2,353	\$2,584	\$2,816	\$3,107	\$1,974
903-10 P	\$2,100	\$2,211	\$2,397	\$2,590	\$2,821	\$3,053	\$3,344	\$2,211



38" W, Plus chair

50 lbs | 5.25 yds

Model	Series 2	Series 3	Series 4	Series 5	Series 6	Series 7	Series 8	COM
903-510B	\$3,480	\$3,647	\$3,925	\$4,216	\$4,561	\$4,910	\$5,347	\$3,647



47.75" W, Settee

52 lbs | 6 yds

Model	Series 2	Series 3	Series 4	Series 5	Series 6	Series 7	Series 8	COM
903-20 S	\$2,661	\$2,852	\$3,170	\$3,502	\$3,897	\$4,296	\$4,795	\$2,852
903-20 P	\$3,004	\$3,195	\$3,513	\$3,845	\$4,240	\$4,639	\$5,138	\$3,195



47.75" W, Settee with divider arm

55 lbs | 6.75 yds

Model	Series 2	Series 3	Series 4	Series 5	Series 6	Series 7	Series 8	COM
903-25 S	\$3,002	\$3,217	\$3,575	\$3,948	\$4,392	\$4,841	\$5,402	\$3,217
903-25 P	\$3,389	\$3,604	\$3,962	\$4,335	\$4,779	\$5,228	\$5,789	\$3,604



70" W, Sofa

72 lbs | 8.25 yds

Model	Series 2	Series 3	Series 4	Series 5	Series 6	Series 7	Series 8	COM
903-30 S	\$3,401	\$3,664	\$4,101	\$4,557	\$5,101	\$5,649	\$6,335	\$3,664
903-30 P	\$3,841	\$4,104	\$4,541	\$4,997	\$5,541	\$6,089	\$6,775	\$4,104



70" W, Sofa with divider arms

78 lbs | 9 yds

Model	Series 2	Series 3	Series 4	Series 5	Series 6	Series 7	Series 8	COM
903-35 S	\$4,123	\$4,410	\$4,887	\$5,385	\$5,977	\$6,575	\$7,324	\$4,410
903-35 P	\$4,653	\$4,940	\$5,417	\$5,915	\$6,507	\$7,105	\$7,854	\$4,940

Ottoman Lounge Seating



More Information

Illustrated Glossary ▶ 439

Fabrics ▶ 451

Flammability (CTB-133) ▶ 459

Finishes ▶ 456

Ordering and Warranties ▶ 462

Standard Features

- Solid hardwood frame
- Nemschoff healthcare wood finish
- GREENGUARD Gold Certified
- Limited Lifetime Warranty

Available Options

- Moisture barrier + \$67 per seat
- CTB-133 + \$81/yd
- Two fabrics + \$62

Specification Decisions

- Select fabric
- Select standard wood finish
- Add CTB-133
- Apply multiple fabrics

Flammability Type

- Type 4

Key Dimensions

- Overall Width: See price table
- Overall Height: 17" (Round)
- Overall Height: 13" (Square)

	23"W x 23"D, Square ottoman									30 lbs 2 yds
	Model	Series 2	Series 3	Series 4	Series 5	Series 6	Series 7	Series 8	COM	
	1722/23	\$975	\$998	\$1,101	\$1,157	\$1,187	\$1,227	\$1,252	\$998	
	24" dia, Round ottoman									30 lbs 1.5 yds
	Model	Series 2	Series 3	Series 4	Series 5	Series 6	Series 7	Series 8	COM	
	1723/24	\$931	\$966	\$1,121	\$1,204	\$1,249	\$1,309	\$1,347	\$966	
	36" dia, Round ottoman									45 lbs 2.25 yds
	Model	Series 2	Series 3	Series 4	Series 5	Series 6	Series 7	Series 8	COM	
	1723/36	\$1,166	\$1,225	\$1,483	\$1,621	\$1,697	\$1,796	\$1,859	\$1,225	

Lounge Seating

Multiple & Tandem Seating

Side, Stacking & Folding Chairs

Occasional Tables

Pamona Lounge Seating



Standard Features

- Mortise and tenon joinery
- Spring seat construction
- Clean-out design
- Replaceable components
- Upholstered arms
- Powder-coated metal legs
- Wallsaver legs
- Non-marring 1" glides
- GREENGUARD Gold Certified
- Limited Lifetime Warranty

Available Options

- Moisture barrier + \$67 per seat or back
- Wood arm caps + \$113
- Black urethane arm caps + \$113
- CTB-133 + \$81/yd
- Two fabrics + \$62
- Three (or more) fabrics + \$88

Specification Decisions

- Select fabric
 - Select powder coat finish
 - Add moisture barrier
 - Add CTB-133
 - Apply multiple fabrics
 - Add wood or urethane arm caps
- Model numbers with **S** indicate standard seat and back covers, and model numbers with **P** indicate removable covers.

Flammability Type

- Type 6

Coordinating Products

- [Pamona Tables](#)
- [Pamona Recliner](#)
- [Pamona Flop Sofa](#)

Key Dimensions

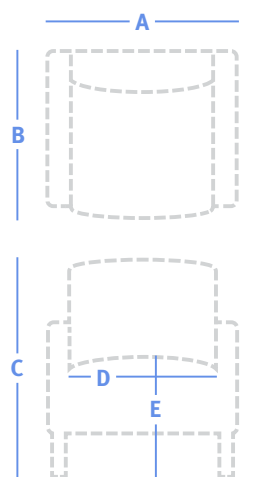

A	Overall Width	See price table
B	Overall Depth	30.75"
C	Overall Height	33.25"
D	Seat Width	
	Chair:	24"
	Settee:	46.75"
	Sofa:	64.75"
E	Seat Height	18.25"
F	Arm Height	25"

More Information

- Illustrated Glossary ▶ 439
- Fabrics ▶ 451
- Flammability (CTB-133) ▶ 459
- Finishes ▶ 456
- Ordering and Warranties ▶ 462

Pamona Lounge Seating

 31.25" W, Chair 51 lbs 5 yds		Series 2	Series 3	Series 4	Series 5	Series 6	Series 7	Series 8	COM
		Model							
797-1 S	\$1,812	\$1,971	\$2,236	\$2,513	\$2,842	\$3,174	\$3,590	\$1,971	
797-1 P	\$2,049	\$2,208	\$2,473	\$2,750	\$3,079	\$3,411	\$3,827	\$2,2082	
 54" W, Settee 62 lbs 6.5 yds		Series 2	Series 3	Series 4	Series 5	Series 6	Series 7	Series 8	COM
		Model							
797-2 S	\$2,640	\$2,847	\$3,191	\$3,551	\$3,979	\$4,411	\$4,952	\$2,847	
797-2 P	\$2,982	\$3,189	\$3,533	\$3,893	\$4,321	\$4,753	\$5,294	\$3,189	
 72" W, Sofa 73 lbs 8 yds		Series 2	Series 3	Series 4	Series 5	Series 6	Series 7	Series 8	COM
		Model							
797-3 S	\$3,419	\$3,674	\$4,098	\$4,540	\$5,067	\$5,599	\$6,264	\$3,674	
797-3 P	\$3,860	\$4,115	\$4,539	\$4,981	\$5,508	\$6,040	\$6,705	\$4,115	

Lounge Seating

Multiple & Tandem Seating

Side, Stacking & Folding Chairs

Occasional Tables

Riva Lounge Seating



Standard Features

- Spring seat construction
- Clean-out design
- Brushed metal legs
- Non-marring 1" glides
- Loose seat and back cushion
- GREENGUARD Gold Certified
- Limited Lifetime Warranty

Available Options

- Moisture barrier + \$67 per seat or back
- CTB-133 + \$81/yd
- Two fabrics + \$62
- Three (or more) fabrics + \$88
- Bolsters (see price table)

Specification Decisions

- Select fabric
- Add moisture barrier
- Add CTB-133
- Apply multiple fabrics
- Add bolsters

Flammability Type

- Type 7

Coordinating Products

- Riva Tables

Key Dimensions

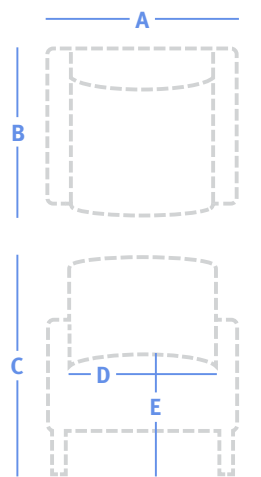

A	Overall Width	See price table
B	Overall Depth	31"
C	Overall Height	32"
D	Seat Width	
	Chair:	25"
	Two Seat:	50"
	Three Seat:	75.5"
E	Seat Height	18"
F	Arm Height	27"

More Information

- Illustrated Glossary ▶ 439
- Fabrics ▶ 451
- Flammability (CTB-133) ▶ 459
- Finishes ▶ 456
- Ordering and Warranties ▶ 462

	32.25" W, Chair										61 lbs 9 yds
	Model	Series 2	Series 3	Series 4	Series 5	Series 6	Series 7	Series 8	COM		
	812-10	\$2,215	\$2,430	\$2,788	\$3,161	\$3,605	\$4,054	\$4,615	\$2,430		

	59" W, Two seat										95 lbs 12 yds
	Model	Series 2	Series 3	Series 4	Series 5	Series 6	Series 7	Series 8	COM		
	812-20	\$3,568	\$3,879	\$4,395	\$4,935	\$5,577	\$6,225	\$7,036	\$3,879		

	83.25" W, Three seat										140 lbs 17.5 yds
	Model	Series 2	Series 3	Series 4	Series 5	Series 6	Series 7	Series 8	COM		
	812-30	\$4,766	\$5,181	\$5,869	\$6,589	\$7,444	\$8,309	\$9,390	\$5,181		

Riva Lounge Seating

Lounge Seating

Multiple & Tandem Seating

Side, Stacking & Folding Chairs

Occasional Tables

Riva Benches

Standard Features

Same standard features as Riva Lounge Seating

Available Options

Same options as Riva Lounge Seating

Key Dimensions

- Overall Width: See price table
- Overall Height: 18"

	24" W, Square bench 30 lbs 1.5 yds								
	Model	Series 2	Series 3	Series 4	Series 5	Series 6	Series 7	Series 8	COM
	812-B1	\$1,597	\$1,644	\$1,724	\$1,807	\$1,906	\$2,005	\$2,130	\$1,644

	36" W, Square bench 51 lbs 2.75 yds								
	Model	Series 2	Series 3	Series 4	Series 5	Series 6	Series 7	Series 8	COM
	812-B2	\$1,886	\$1,973	\$2,119	\$2,271	\$2,452	\$2,635	\$2,864	\$1,973

	44" W x 16" D, Bench 41 lbs 2.25 yds								
	Model	Series 2	Series 3	Series 4	Series 5	Series 6	Series 7	Series 8	COM
	812-B3	\$1,658	\$1,729	\$1,849	\$1,973	\$2,121	\$2,271	\$2,458	\$1,729

Riva Bolster

Key Dimensions

- Overall Width: 24"

	Bolster 2 lbs 1 yd								
	Model	Series 2	Series 3	Series 4	Series 5	Series 6	Series 7	Series 8	COM
	812-Riva Bolster	\$138	\$161	\$201	\$243	\$292	\$342	\$404	\$161

Sophia Lounge Seating



Standard Features

- Solid maple frame
- Mortise and tenon joinery
- Spring seat construction
- Clean-out design
- Replaceable components
- Wood arm caps
- Curved stainless-look metal legs
- Non-marring 2 1/4" plastic glides
- Nemschoff healthcare wood finish
- GREENGUARD Gold Certified
- Limited Lifetime Warranty

Available Options

- Moisture barrier + \$67 per seat or back
- CTB-133 + \$81/yard
- Two fabrics + \$62
- Three (or more) fabrics + \$88

Specification Decisions

- Select fabric
- Select standard wood finish
- Add moisture barrier
- Add CTB-133
- Apply multiple fabrics

Model numbers with **S** indicate standard seat and back covers, and model numbers with **P** indicate removable covers.

Flammability Type

- Type 6

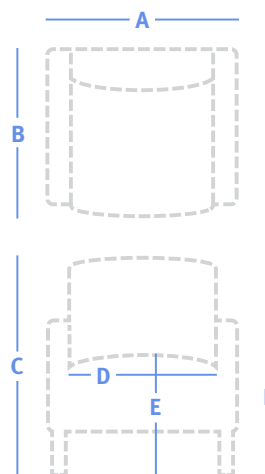

Key Dimensions



A	Overall Width	See price table
B	Overall Depth	28"
C	Overall Height	30.75"
D	Seat Width	
	Chair:	22"
	Settee:	44"
	Sofa:	66"
E	Seat Height	18"
F	Arm Height	23.5"

More Information

- Illustrated Glossary ▶ 439
- Fabrics ▶ 451
- Flammability (CTB-133) ▶ 459
- Finishes ▶ 456
- Ordering and Warranties ▶ 462

Model	Series								Weight Fabric
	Series 2	Series 3	Series 4	Series 5	Series 6	Series 7	Series 8	COM	
28.5" W, Chair 50 lbs 4 yds									
	Series 2	Series 3	Series 4	Series 5	Series 6	Series 7	Series 8	COM	
815-10 S	\$1,481	\$1,608	\$1,820	\$2,041	\$2,305	\$2,571	\$2,903	\$1,608	
815-10 P	\$1,674	\$1,801	\$2,013	\$2,234	\$2,498	\$2,764	\$3,096	\$1,801	
50.5" W, Two seat 80 lbs 6 yds									
	Series 2	Series 3	Series 4	Series 5	Series 6	Series 7	Series 8	COM	
815-20 S	\$2,386	\$2,577	\$2,895	\$3,227	\$3,622	\$4,021	\$4,520	\$2,577	
815-20 P	\$2,696	\$2,887	\$3,205	\$3,537	\$3,932	\$4,331	\$4,830	\$2,887	
53" W, Two seat with intervening arm and leg 90 lbs 7.25 yds									
	Series 2	Series 3	Series 4	Series 5	Series 6	Series 7	Series 8	COM	
815-22 S	\$2,834	\$3,065	\$3,449	\$3,850	\$4,327	\$4,809	\$5,412	\$3,065	
815-22 P	\$3,202	\$3,433	\$3,817	\$4,218	\$4,695	\$5,177	\$5,780	\$3,433	

Sophia Lounge Seating



72.5" W, Three seat

107 lbs | 7.75 yds

Model	Series 2	Series 3	Series 4	Series 5	Series 6	Series 7	Series 8	COM
815-30 S	\$3,185	\$3,432	\$3,842	\$4,271	\$4,782	\$5,297	\$5,941	\$3,432
815-30 P	\$3,597	\$3,844	\$4,254	\$4,683	\$5,194	\$5,709	\$6,353	\$3,844



77.5" W, Three seat with intervening arms and legs

127 lbs | 9.75 yds

Model	Series 2	Series 3	Series 4	Series 5	Series 6	Series 7	Series 8	COM
815-33 S	\$4,013	\$4,324	\$4,840	\$5,380	\$6,022	\$6,670	\$7,481	\$4,324
815-33 P	\$4,532	\$4,843	\$5,359	\$5,899	\$6,541	\$7,189	\$8,000	\$4,843

Lounge Seating

Multiple & Tandem Seating

Side, Stacking & Folding Chairs

Occasional Tables

Steps Lounge System



Standard Features

- Spring seat construction
- Clean-out design
- Replaceable components
- Removable covers
- Upholstered arms (select models)
- Powder-coated metal legs
- Adjustable 1¼" glides
- Nemschoff healthcare wood finish
- GREENGUARD Gold Certified
- Limited Lifetime Warranty

Available Options

- Moisture barrier + \$67 per seat or back
- Black urethane arm caps + \$113
- Wood arm caps + \$113
- CTB-133 + \$81/yd
- Two fabrics + \$62
- Three (or more) fabrics + \$88

Specification Decisions

- Select fabric
- Select powder coat finish
- Add moisture barrier
- Add CTB-133
- Apply multiple fabrics
- Add wood arm caps
- Add urethane arm caps
- Add intervening arms
- Select seats, tables and accessory units. Specify side to attach tables (LSF, RSF).

- Select seat style



Straight seat



Outside wedge



Inside wedge

- Select back height



Low back



Mid back



High back

- Select arm style



Armless



Arm left



Arm right

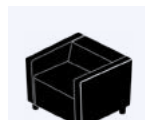

Two arms (straight configurations only)

- Create a seating configuration plan. List unit model numbers from left to right.
- Determine placement for tables or accessories. List seats, tables, accessory units and required ganging in the order they will appear. Ganging is determined when facing the unit. Designate either right-side facing (RSF) or left-side facing (LSF).
- Follow the online quoting system to determine if male or female connections are needed with each item.

Steps Lounge System

Lounge Seating

Multiple & Tandem Seating

Side, Stacking & Folding Chairs

Occasional Tables

Specification Decisions, continued

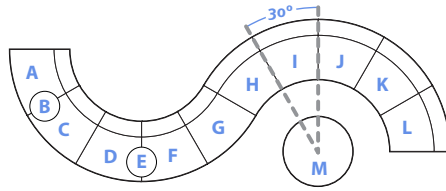

Example Steps Lounge configuration plan

Unit	Model #	Description	Ganging
A	866-OWA	Seat	Ganged RSF
B	866-TA	Table	n/a
C	866-OWA	Seat	Ganged RSF & LSF
D	866-OWB	Seat	Ganged RSF & LSF
E	866-TA	Table	n/a
F	866-OWB	Seat	Ganged RSF & LSF
G	866-OWB	Seat	Ganged RSF & LSF
H	866-IWC	Seat	Ganged RSF & LSF
I	866-IWC	Seat	Ganged RSF & LSF
J	866-IWC	Seat	Ganged RSF & LSF
K	866-IWB	Seat	Ganged RSF & LSF
L	866-IWB	Seat	Ganged LSF
M	866-32	Ottoman	n/a

For more details about configuring and ordering this lounge system, visit our website nemschoff.com/products/steps-lounge-system choose Design Resources > Literature > Pricing.

Furniture ships inside a protective bag to which a shipping label is affixed. Any site-specific installation instructions (location designation or place in specific configuration — with ganged or modular components) will be on the label. Do not remove the protective bag prior to product being staged in the indicated location on-site.

Flammability Type

- Type 6

Key Dimensions

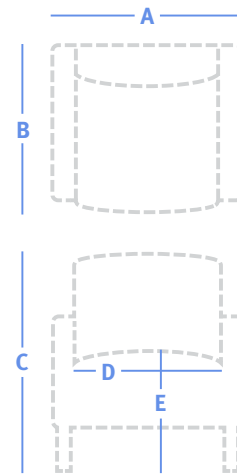



A	Overall Width	See price table
B	Overall Depth	30.5"
C	Overall Height	
	Low-Back (A):	25.25"
	Mid-Back (B):	33"
	High-Back (C):	44"
D	Seat Width	
	Straight Seat:	32"
	Inside Wedge:	20.25" (front) 40" (rear)
	Outside Wedge:	40" (front) 20.25" (rear)
E	Seat Height	18"
F	Arm Height	25.25"

Steps Lounge System

Steps Lounge Low Back

	25.25" H, Low back straight seat without arms 4.75 yds								
	Model	Series 2	Series 3	Series 4	Series 5	Series 6	Series 7	Series 8	COM
	866-STA	\$1,162	\$1,313	\$1,565	\$1,828	\$2,140	\$2,456	\$2,851	\$1,313

	25.25" H, Low back straight seat with left arm 6.25 yds								
	Model	Series 2	Series 3	Series 4	Series 5	Series 6	Series 7	Series 8	COM
	866-STAL	\$1,271	\$1,470	\$1,801	\$2,147	\$2,558	\$2,974	\$3,494	\$1,470

	25.25" H, Low back straight seat with right arm 6.25 yds								
	Model	Series 2	Series 3	Series 4	Series 5	Series 6	Series 7	Series 8	COM
	866-STAR	\$1,271	\$1,470	\$1,801	\$2,147	\$2,558	\$2,974	\$3,494	\$1,470

	25.25" H, Low back straight seat with left and right arms 8 yds								
	Model	Series 2	Series 3	Series 4	Series 5	Series 6	Series 7	Series 8	COM
	866-STALR	\$1,373	\$1,628	\$2,052	\$2,494	\$3,021	\$3,553	\$4,218	\$1,628

	25.25" H, Low back outside wedge without arms 3.25 yds								
	Model	Series 2	Series 3	Series 4	Series 5	Series 6	Series 7	Series 8	COM
	866-OWA	\$1,210	\$1,313	\$1,485	\$1,665	\$1,879	\$2,095	\$2,366	\$1,313

	25.25" H, Low back outside wedge with left arm 4.75 yds								
	Model	Series 2	Series 3	Series 4	Series 5	Series 6	Series 7	Series 8	COM
	866-OWAL	\$1,319	\$1,470	\$1,722	\$1,985	\$2,297	\$2,613	\$3,008	\$1,470

	25.25" H, Low back outside wedge with right arm 4.75 yds								
	Model	Series 2	Series 3	Series 4	Series 5	Series 6	Series 7	Series 8	COM
	866-OWAR	\$1,319	\$1,470	\$1,722	\$1,985	\$2,297	\$2,613	\$3,008	\$1,470

	25.25" H, Low back inside wedge without arms 4.25 yds								
	Model	Series 2	Series 3	Series 4	Series 5	Series 6	Series 7	Series 8	COM
	866-IWA	\$1,178	\$1,313	\$1,538	\$1,774	\$2,053	\$2,336	\$2,689	\$1,313

	25.25" H, Low back inside wedge with left arm 5.75 yds								
	Model	Series 2	Series 3	Series 4	Series 5	Series 6	Series 7	Series 8	COM
	866-IWAL	\$1,287	\$1,470	\$1,775	\$2,093	\$2,471	\$2,854	\$3,332	\$1,470

	25.25" H, Low back inside wedge with right arm 5.75 yds								
	Model	Series 2	Series 3	Series 4	Series 5	Series 6	Series 7	Series 8	COM
	866-IWAR	\$1,287	\$1,470	\$1,775	\$2,093	\$2,471	\$2,854	\$3,332	\$1,470

Steps Lounge System

Lounge Seating

Multiple & Tandem Seating

Side, Stacking & Folding Chairs

Occasional Tables

Steps Lounge Mid Back

	33" H, Mid back inside wedge with left arm 80 lbs. 7 yds								
	Model	Series 2	Series 3	Series 4	Series 5	Series 6	Series 7	Series 8	COM
	866-IWBL	\$1,405	\$1,628	\$1,999	\$2,386	\$2,847	\$3,312	\$3,894	\$1,628
	33" H, Mid back inside wedge with right arm 80 lbs. 7 yds								
	Model	Series 2	Series 3	Series 4	Series 5	Series 6	Series 7	Series 8	COM
	866-IWBR	\$1,405	\$1,628	\$1,999	\$2,386	\$2,847	\$3,312	\$3,894	\$1,628
	33" H, Mid back inside wedge without arms 72 lbs. 5.5 yds								
	Model	Series 2	Series 3	Series 4	Series 5	Series 6	Series 7	Series 8	COM
	866-IWB	\$1,295	\$1,470	\$1,761	\$2,066	\$2,428	\$2,793	\$3,251	\$1,470
	33" H, Mid back outside wedge with left arm 72 lbs. 5.5 yds								
	Model	Series 2	Series 3	Series 4	Series 5	Series 6	Series 7	Series 8	COM
	866-OWBL	\$1,453	\$1,628	\$1,919	\$2,224	\$2,586	\$2,951	\$3,409	\$1,628
	33" H, Mid back outside wedge with right arm 5.5 yds								
	Model	Series 2	Series 3	Series 4	Series 5	Series 6	Series 7	Series 8	COM
	866-OWBR	\$1,453	\$1,628	\$1,919	\$2,224	\$2,586	\$2,951	\$3,409	\$1,628
	33" H, Mid back outside wedge without arms 3.75 yds								
	Model	Series 2	Series 3	Series 4	Series 5	Series 6	Series 7	Series 8	COM
	866-OWB	\$1,351	\$1,470	\$1,669	\$1,876	\$2,123	\$2,373	\$2,684	\$1,470
	33" H, Mid back straight seat with left arm 7.5 yds								
	Model	Series 2	Series 3	Series 4	Series 5	Series 6	Series 7	Series 8	COM
	866-STBL	\$1,389	\$1,628	\$2,025	\$2,440	\$2,934	\$3,433	\$4,056	\$1,628
	33" H, Mid back straight seat with right arm 7.5 yds								
	Model	Series 2	Series 3	Series 4	Series 5	Series 6	Series 7	Series 8	COM
	866-STBR	\$1,389	\$1,628	\$2,025	\$2,440	\$2,934	\$3,433	\$4,056	\$1,628
	33" H, Mid back straight seat with left and right arms 7.5 yds								
	Model	Series 2	Series 3	Series 4	Series 5	Series 6	Series 7	Series 8	COM
	866-STBLR	\$1,546	\$1,785	\$2,182	\$2,597	\$3,091	\$3,590	\$4,213	\$1,785
	33" H, Mid back straight seat without arms 64 lbs. 5.75 yds								
	Model	Series 2	Series 3	Series 4	Series 5	Series 6	Series 7	Series 8	COM
	866-STB	\$1,287	\$1,470	\$1,775	\$2,093	\$2,471	\$2,854	\$3,332	\$1,470

Steps Lounge System

Steps Lounge High Back

	44" H, High back inside wedge with left arm 8.5 yds								
	Model	Series 2	Series 3	Series 4	Series 5	Series 6	Series 7	Series 8	COM
	866-IWCL	\$1,514	\$1,785	\$2,235	\$2,706	\$3,265	\$3,830	\$4,537	\$1,785

	44" H, High back inside wedge with right arm 8.5 yds								
	Model	Series 2	Series 3	Series 4	Series 5	Series 6	Series 7	Series 8	COM
	866-IWCR	\$1,514	\$1,785	\$2,235	\$2,706	\$3,265	\$3,830	\$4,537	\$1,785

	44" H, High back inside wedge without arms 6.75 yds								
	Model	Series 2	Series 3	Series 4	Series 5	Series 6	Series 7	Series 8	COM
	866-IWC	\$1,413	\$1,628	\$1,986	\$2,359	\$2,803	\$3,252	\$3,813	\$1,628

	44" H, High back outside wedge with left arm 7 yds								
	Model	Series 2	Series 3	Series 4	Series 5	Series 6	Series 7	Series 8	COM
	866-OWCL	\$1,562	\$1,785	\$2,156	\$2,543	\$3,004	\$3,469	\$4,051	\$1,785

	44" H, High back outside wedge with right arm 7 yds								
	Model	Series 2	Series 3	Series 4	Series 5	Series 6	Series 7	Series 8	COM
	866-OWCR	\$1,562	\$1,785	\$2,156	\$2,543	\$3,004	\$3,469	\$4,051	\$1,785

	44" H, High back outside wedge without arms 4.75 yds								
	Model	Series 2	Series 3	Series 4	Series 5	Series 6	Series 7	Series 8	COM
	866-OWC	\$1,477	\$1,628	\$1,880	\$2,143	\$2,455	\$2,771	\$3,166	\$1,628

	44" H, High back straight seat with left arm 8.75 yds								
	Model	Series 2	Series 3	Series 4	Series 5	Series 6	Series 7	Series 8	COM
	866-STCL	\$1,506	\$1,785	\$2,248	\$2,733	\$3,309	\$3,890	\$4,618	\$1,785

	44" H, High back straight seat with right arm 8.75 yds								
	Model	Series 2	Series 3	Series 4	Series 5	Series 6	Series 7	Series 8	COM
	866-STCR	\$1,506	\$1,785	\$2,248	\$2,733	\$3,309	\$3,890	\$4,618	\$1,785

	44" H, High back straight seat with left and right arms 8.75 yds								
	Model	Series 2	Series 3	Series 4	Series 5	Series 6	Series 7	Series 8	COM
	866-STCLR	\$1,664	\$1,943	\$2,406	\$2,891	\$3,467	\$4,048	\$4,776	\$1,943

	44" H, High back straight seat without arms 71 lbs. 7.25 yds								
	Model	Series 2	Series 3	Series 4	Series 5	Series 6	Series 7	Series 8	COM
	866-STC	\$1,397	\$1,628	\$2,012	\$2,413	\$2,890	\$3,372	\$3,975	\$1,628

Steps Lounge System

Lounge Seating

Multiple & Tandem Seating

Side, Stacking & Folding Chairs

Occasional Tables

Steps Lounge Intermediate Arm

Standard Features

Same standard features as Steps Lounge System

Available Options

Same options as Steps Lounge System

Key Dimensions

- Overall Width: see price table
- Overall Depth: 16.5"
- Overall Height: 8"
- Arm Height: 26.25" (when applied to seat)



4" W, Intermediate arm .75 yds

Model	Series 2	Series 3	Series 4	Series 5	Series 6	Series 7	Series 8	COM
866-A	\$607	\$630	\$670	\$712	\$761	\$811	\$873	\$630

Steps Benches

Standard Features

Same standard features as Steps Lounge System

Available Options

Same options as Steps Lounge System

Key Dimensions

- Overall Width: See price table
- Overall Height: 18.25"
- Overall Depth: 30.5"



32" W, Straight bench 3 yds

Model	Series 2	Series 3	Series 4	Series 5	Series 6	Series 7	Series 8	COM
866-B	\$1,016	\$1,103	\$1,249	\$1,401	\$1,582	\$1,765	\$1,994	\$1,103



36" W, Inner wedge bench 2.5 yds

Model	Series 2	Series 3	Series 4	Series 5	Series 6	Series 7	Series 8	COM
866-BW	\$1,016	\$1,103	\$1,249	\$1,401	\$1,582	\$1,765	\$1,994	\$1,103

Steps Ottoman

Standard Features

Same standard features as Steps Lounge System

Available Options

Same options as Steps Lounge System

Key Dimensions

- Overall Width: See price table
- Overall Height: 18"



32.5" dia, Ottoman 2.5 yds

Model	Series 2	Series 3	Series 4	Series 5	Series 6	Series 7	Series 8	COM
866-32	\$1,068	\$1,155	\$1,301	\$1,453	\$1,634	\$1,817	\$2,046	\$1,155



42.5" dia, Ottoman 3.75 yds

Model	Series 2	Series 3	Series 4	Series 5	Series 6	Series 7	Series 8	COM
866-42	\$1,335	\$1,470	\$1,695	\$1,931	\$2,210	\$2,493	\$2,846	\$1,470

Steps Lounge System

Steps Tables

Standard Features

- Powder-coated legs
- Laminate top
- Non-marring glides
- 866-T8 is an offset table support to provide an over-the-lap work surface.

Specification Decisions

- Select laminate or veneer tabletop
- Select powder coat finish



14" dia, Inline table power module

Model	Price	Height
866-T0	\$158	0"



20" dia, Round end table

Model	Price	Height
866-T7	\$1,208	24.25"



20" dia, Round end table with offset base

Model	Price	Height
866-T8	\$998	24.25"



32" W square inline table

Model	Price	Depth	Height
866-ST32	\$1,365	26.75"	17"



30-degree inline table

Model	Price	Depth	Height
866-WT30	\$735	26.75"	17"



55" W, 90-degree inline table

Model	Price	Depth	Height
866-RCT	\$1,050	26.75"	17"



Tablet table

Model	Price	Depth	Height
866-TA	\$459	14"	22.25"

Valor Lounge Seating



More Information

Illustrated Glossary ▶ 439

Fabrics ▶ 451

Flammability (CTB-133) ▶ 459

Finishes ▶ 456

Ordering and Warranties ▶ 462

Standard Features

- Heavy-duty steel construction
- Powder-coated metal frame
- Spring seat construction
- Clean-out design
- Replaceable components
- Black urethane arms
- Non-marring 1³/₁₆" glides
- GREENGUARD Gold Certified
- Limited Lifetime Warranty

Available Options

- Moisture barrier + \$67 per seat or back
- CTB-133 + \$81/yard
- Two fabrics + \$62
- Three (or more) fabrics + \$88
- Wood arm caps + \$113

Specification Decisions

- Select fabric
- Select powder coat finish
- Add moisture barrier
- Add CTB-133
- Apply multiple fabrics
- Add wood arm caps

Model numbers with **S** indicate standard seat and back covers, and model numbers with **P** indicate removable covers.

Flammability Type

- Type 8

Coordinating Products

- [Valor Multiple Seating](#)
- [Valor Stack Chair](#)
- [Valor Tables](#)
- [Valor Patient Chair](#)

Key Dimensions

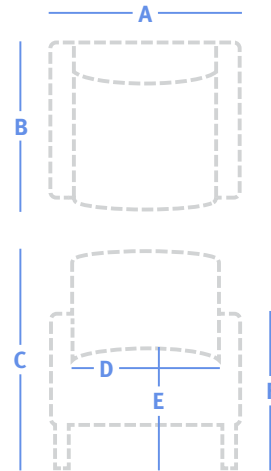

A	Overall Width	See price table
B	Overall Depth	28"
C	Overall Height	32.75"
D	Seat Width	
	Chair:	21.5"
	Two Seat:	44"
	Three Seat:	66"
E	Seat Height	18"
F	Arm Height	25.5"

Valor Lounge Seating



26" W, Chair

60 lbs | 2.75 yds

Model	Series 2	Series 3	Series 4	Series 5	Series 6	Series 7	Series 8	COM
892-10 S	\$1,036	\$1,123	\$1,269	\$1,421	\$1,602	\$1,785	\$2,014	\$1,123
892-10 P	\$1,171	\$1,258	\$1,404	\$1,556	\$1,737	\$1,920	\$2,149	\$1,258



48" W, Two seat

85 lbs | 4.5 yds

Model	Series 2	Series 3	Series 4	Series 5	Series 6	Series 7	Series 8	COM
892-20 S	\$1,595	\$1,738	\$1,977	\$2,226	\$2,522	\$2,821	\$3,195	\$1,738
892-20 P	\$1,804	\$1,947	\$2,186	\$2,435	\$2,731	\$3,030	\$3,404	\$1,947



70" W, Three seat

130 lbs | 6.25 yds

Model	Series 2	Series 3	Series 4	Series 5	Series 6	Series 7	Series 8	COM
892-30 S	\$2,051	\$2,250	\$2,581	\$2,927	\$3,338	\$3,754	\$4,274	\$2,250
892-30 P	\$2,321	\$2,520	\$2,851	\$3,197	\$3,608	\$4,024	\$4,544	\$2,520

Work Haven Lounge Seating



More Information

- Illustrated Glossary ▶ 439
- Fabrics ▶ 451
- Flammability (CTB-133) ▶ 459
- Finishes ▶ 456
- Ordering and Warranties ▶ 462

Standard Features

- Solid hardwood frame
- Upholstered arms
- Black wood legs or casters (see price table)
- Laminate tablet arm (select models)
- Nemschoff healthcare wood finish
- GREENGUARD Gold Certified
- Limited Lifetime Warranty

Available Options

- Moisture barrier + \$67 per seat or back
- Veneer tablet arm + \$119
- Grommet for tablet storage + \$91
- CTB-133 + \$81/yd
- Two fabrics + \$62
- Three (or more) fabrics + \$88

Specification Decisions

- Select fabric
- Select tablet arm receptacle location
- Select veneer, laminate or Black Durawrap on tablet arm (LSF, RSF)
- Add moisture barrier
- Add CTB-133
- Apply multiple fabrics
- Add grommet on tablet arm
- Add storage shelf

Flammability Type

- Type 6

Key Dimensions

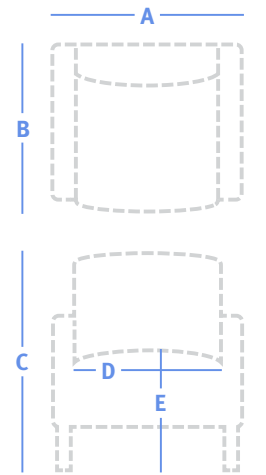

A	Overall Width	See price table
B	Overall Depth	29.5"
C	Overall Height	34"
D	Seat Width	
	Chair:	20"
	Settee:	40"
E	Seat Height	18.5"
F	Arm Height	25"



29" W, Chair with casters

79 lbs | 5 yds

Model	Series 2	Series 3	Series 4	Series 5	Series 6	Series 7	Series 8	COM
170/29	\$1,587	\$1,666	\$2,010	\$2,194	\$2,295	\$2,427	\$2,511	\$1,666

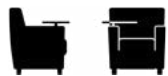

29" W, Chair with casters and laminate tablet arm

79 lbs | 5 yds

Model	Series 2	Series 3	Series 4	Series 5	Series 6	Series 7	Series 8	COM
170/29TA	\$2,057	\$2,136	\$2,480	\$2,664	\$2,765	\$2,897	\$2,981	\$2,136

Workhaven Lounge Seating

	29" W, Chair with casters and laminate shelf									79 lbs 5 yds
	Model	Series 2	Series 3	Series 4	Series 5	Series 6	Series 7	Series 8	COM	
	170/29SH	\$1,831	\$1,910	\$2,254	\$2,438	\$2,539	\$2,671	\$2,755	\$1,910	

	29" W, Chair with casters, laminate tablet arm and laminate shelf									79 lbs 5 yds
	Model	Series 2	Series 3	Series 4	Series 5	Series 6	Series 7	Series 8	COM	
	170/29SHTA	\$2,298	\$2,377	\$2,721	\$2,905	\$3,006	\$3,138	\$3,222	\$2,377	

	29" W, Chair									79 lbs 5 yds
	Model	Series 2	Series 3	Series 4	Series 5	Series 6	Series 7	Series 8	COM	
	171/29	\$1,587	\$1,666	\$2,010	\$2,194	\$2,295	\$2,427	\$2,511	\$1,666	

	29" W, Chair with laminate tablet arm									79 lbs 5 yds
	Model	Series 2	Series 3	Series 4	Series 5	Series 6	Series 7	Series 8	COM	
	171/29TA	\$2,057	\$2,136	\$2,480	\$2,664	\$2,765	\$2,897	\$2,981	\$2,136	

	29" W, Chair with laminate shelf									79 lbs 5 yds
	Model	Series 2	Series 3	Series 4	Series 5	Series 6	Series 7	Series 8	COM	
	171/29 SH	\$1,831	\$1,910	\$2,254	\$2,438	\$2,539	\$2,671	\$2,755	\$1,910	

	29" W, Chair with laminate tablet arm and laminate shelf									79 lbs 5 yds
	Model	Series 2	Series 3	Series 4	Series 5	Series 6	Series 7	Series 8	COM	
	171/29SHTA	\$2,298	\$2,377	\$2,721	\$2,905	\$3,006	\$3,138	\$3,222	\$2,377	

	49" W, Settee									124 lbs 6.75 yds
	Model	Series 2	Series 3	Series 4	Series 5	Series 6	Series 7	Series 8	COM	
	171/49	\$2,739	\$2,845	\$3,309	\$3,558	\$3,694	\$3,872	\$3,986	\$2,845	

2600 Series Multiple Seating



More Information

- Illustrated Glossary ▶ 439
- Fabrics ▶ 451
- Flammability (CTB-133) ▶ 459
- Finishes ▶ 456
- Ordering and Warranties ▶ 462

Standard Features

- Solid maple frame
- Mortise and tenon joinery
- Spring seat construction
- Clean-out design
- Replaceable components
- 5/8" x 2" plastic bar glides
- Wood arms
- Sled base
- Structural steel support beneath the seat
- Nemschoff healthcare wood finish
- GREENGUARD Gold Certified
- Limited Lifetime Warranty

Available Options

- Moisture barrier + \$67 per seat or back
- Four back styles + \$0
- CTB-133 + \$81/yd
- Two fabrics + \$62
- Three (or more) fabrics + \$88
- Attached tables – LSF or RSF (see price table)

Specification Decisions

- Select fabric
- Select standard wood finish
- Select a back style

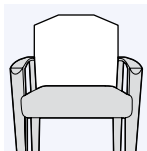

M Bevel

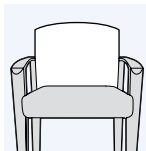

P Crown

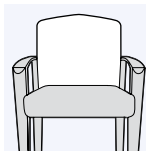

S Arcade

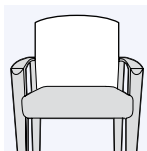

Q Square

- Add moisture barrier
- Add CTB-133
- Apply multiple fabrics
- Add attached table

Model numbers with **S** indicate standard seat and back covers, and model numbers with **P** indicate removable covers.

Flammability Type

- Type 3

Coordinating Products

- 2000 Series Tables

Key Dimensions

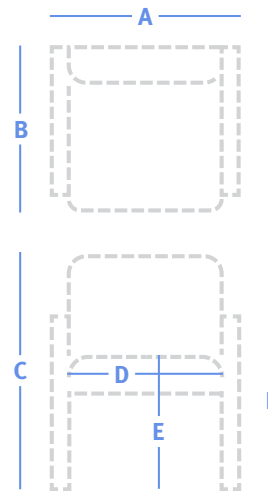

A	Overall Width	See price table
B	Overall Depth	25"
C	Overall Height	33.25"
D	Seat Width	
	Chair:	20"
	Two Seat:	34.25", 40.25"
	Three Seat:	59.25"
	Four Seat:	80"
E	Seat Height	18.5"
F	Arm Height	25.25"

2600 Series Multiple Seating

Welcoming & Waiting

	23.75" W, Chair									35 lbs 1.75 yds
	Model	Series 2	Series 3	Series 4	Series 5	Series 6	Series 7	Series 8	COM	
	2600X-10 S	\$1,045	\$1,100	\$1,193	\$1,290	\$1,405	\$1,521	\$1,667	\$1,100	
	2600X-10 P	\$1,177	\$1,232	\$1,325	\$1,422	\$1,537	\$1,653	\$1,799	\$1,232	

	44.5" W, Two seat									64 lbs 3 yds
	Model	Series 2	Series 3	Series 4	Series 5	Series 6	Series 7	Series 8	COM	
	2600X-20 S	\$1,585	\$1,680	\$1,839	\$2,005	\$2,203	\$2,402	\$2,652	\$1,680	
	2600X-20 P	\$1,787	\$1,882	\$2,041	\$2,207	\$2,405	\$2,604	\$2,854	\$1,882	

Patient Areas

	46" W, Two seat with intervening arm and leg									70 lbs 3 yds
	Model	Series 2	Series 3	Series 4	Series 5	Series 6	Series 7	Series 8	COM	
	2600X-22 S	\$1,849	\$1,944	\$2,103	\$2,269	\$2,467	\$2,666	\$2,916	\$1,944	
	2600X-22 P	\$2,083	\$2,178	\$2,337	\$2,503	\$2,701	\$2,900	\$3,150	\$2,178	

	46" W, Two seat with divider arm									67 lbs 3.25 yds
	Model	Series 2	Series 3	Series 4	Series 5	Series 6	Series 7	Series 8	COM	
	2600X-25 S	\$1,772	\$1,875	\$2,047	\$2,227	\$2,441	\$2,657	\$2,928	\$1,875	
	2600X-25 P	\$1,997	\$2,100	\$2,272	\$2,452	\$2,666	\$2,882	\$3,153	\$2,100	

	64.5" W, Three seat									92 lbs 4.75 yds
	Model	Series 2	Series 3	Series 4	Series 5	Series 6	Series 7	Series 8	COM	
	2600X-30 S	\$2,081	\$2,232	\$2,484	\$2,747	\$3,059	\$3,375	\$3,770	\$2,232	
	2600X-30 P	\$2,349	\$2,500	\$2,752	\$3,015	\$3,327	\$3,643	\$4,038	\$2,500	

Specialty

	68" W, Three seat with intervening arms and legs									104 lbs 4.75 yds
	Model	Series 2	Series 3	Series 4	Series 5	Series 6	Series 7	Series 8	COM	
	2600X-33 S	\$2,635	\$2,786	\$3,038	\$3,301	\$3,613	\$3,929	\$4,324	\$2,786	
	2600X-33 P	\$2,970	\$3,121	\$3,373	\$3,636	\$3,948	\$4,264	\$4,659	\$3,121	

	68" W, Three seat with divider arms									98 lbs 4.75 yds
	Model	Series 2	Series 3	Series 4	Series 5	Series 6	Series 7	Series 8	COM	
	2600X-35 S	\$2,468	\$2,619	\$2,871	\$3,134	\$3,446	\$3,762	\$4,157	\$2,619	
	2600X-35 P	\$2,783	\$2,934	\$3,186	\$3,449	\$3,761	\$4,077	\$4,472	\$2,934	

	86.5" W, Four seat with one intervening arm and leg									122 lbs 6 yds
	Model	Series 2	Series 3	Series 4	Series 5	Series 6	Series 7	Series 8	COM	
	2600X-40 S	\$2,943	\$3,134	\$3,452	\$3,784	\$4,179	\$4,578	\$5,077	\$3,134	
	2600X-40 P	\$3,320	\$3,511	\$3,829	\$4,161	\$4,556	\$4,955	\$5,454	\$3,511	

Reference

	90" W, Four seat with intervening arms and legs									140 lbs 6 yds
	Model	Series 2	Series 3	Series 4	Series 5	Series 6	Series 7	Series 8	COM	
	2600X-44 S	\$3,486	\$3,677	\$3,995	\$4,327	\$4,722	\$5,121	\$5,620	\$3,677	
	2600X-44 P	\$3,928	\$4,119	\$4,437	\$4,769	\$5,164	\$5,563	\$6,062	\$4,119	

	90" W, Four seat with divider arms and one intervening leg									131 lbs 6 yds
	Model	Series 2	Series 3	Series 4	Series 5	Series 6	Series 7	Series 8	COM	
	2600X-45 S	\$3,193	\$3,384	\$3,702	\$4,034	\$4,429	\$4,828	\$5,327	\$3,384	
	2600X-45 P	\$3,600	\$3,791	\$4,109	\$4,441	\$4,836	\$5,235	\$5,734	\$3,791	

2600 Series Multiple Seating

2600 Series Benches

Standard Features

Same standard features as the 2600 Series Multiple Seating

Available Options

Same options as 2600 Series Multiple Seating

Key Dimensions

- Overall Width: See price table
- Overall Depth: 24"
- Overall Height: 21.5"
- Seat Height: 18.5"

	24" W, Bench									28 lbs 1.5 yds
	Model	Series 2	Series 3	Series 4	Series 5	Series 6	Series 7	Series 8	COM	
	2600-B1 S	\$806	\$853	\$933	\$1,016	\$1,115	\$1,214	\$1,339	\$853	
	2600-B1 P	\$909	\$956	\$1,036	\$1,119	\$1,218	\$1,317	\$1,442	\$956	

	44.5" W, Bench									52 lbs 2.5 yds
	Model	Series 2	Series 3	Series 4	Series 5	Series 6	Series 7	Series 8	COM	
	2600-B2 S	\$1,090	\$1,169	\$1,302	\$1,440	\$1,605	\$1,771	\$1,979	\$1,169	
	2600-B2 P	\$1,231	\$1,310	\$1,443	\$1,581	\$1,746	\$1,912	\$2,120	\$1,310	

2600 Series Spanner Tables

Standard Features

- Solid maple legs
- Laminate top with wood edge
- Wood rail
- Nemschoff healthcare wood finish
- GREENGUARD Gold Certified
- Limited Lifetime Warranty

Specification Decisions

- Select standard wood finish
 - Select standard laminate
 - Select LSF or RSF (2600-CT)
- 26/TE is only applicable to a spanner table at the end of a run.

	26" W, Truncated spanner corner table				29 lbs
	Model	Price	Depth	Height	
	2600-CT	\$1,044	26"	–	

	19.5" W, Spanner table				24 lbs
	Model	Price	Depth	Height	
	2600-ST	\$468	19.5"	–	

Optional leg for use with spanner table (at end of run)				
Model	Price	Depth	Height	
26/TE	\$282	–	–	

2700 Series Multiple Seating



Standard Features

- Solid maple frame
- Mortise and tenon joinery
- Spring seat construction
- Clean-out design
- Replaceable components
- Wood arms
- Non-marring 7/8" rubber-cushioned glides
- Nemschoff healthcare wood finish
- GREENGUARD Gold Certified
- Limited Lifetime Warranty
- See nemschoff.com for weight ratings (2700S-OB30, 2700S-OB40, 2700-OB2)

- Add moisture barrier
- Add CTB-133
- Apply multiple fabrics
- Add attached table
- Add laminate arm caps
- Add wallsaver legs

Model numbers with **S** indicate standard seat and back covers, and model numbers with **P** indicate removable covers.

Flammability Type

- Type 3)
- Type 4 (Plus model)

Coordinating Products

- [2000 Series Tables](#)

Key Dimensions

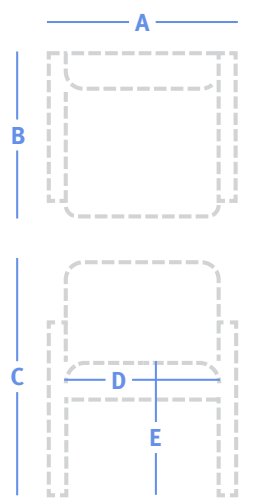

A	Overall Width	See price table
B	Overall Depth	24.5", 25.5" (OB30), 25" (OB40)
C	Overall Height	33.5", 32" (OB30), 33.25" (OB40)
D	Seat Width	Chair: 20", 30", 40" Two Seat: 20", 40" Three Seat: 20", 60" Four Seat: 20", 80"
E	Seat Height	18.5"
F	Arm Height	25.5"

Available Options

- Moisture barrier + \$67 per seat or back
- Laminate arm caps + \$113
- Wallsaver legs + \$117
- CTB-133 + \$81/yd
- Two fabrics + \$62
- Three (or more) fabrics + \$88
- Attached tables – LSF or RSF (see price table)

Specification Decisions

- Select fabric
- Select standard wood finish
- Select a back style

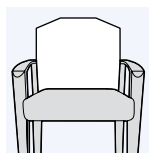

M Bevel

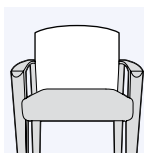

P Crown

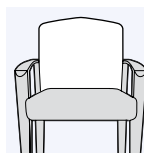

S Arcade

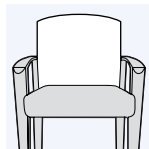

Q Square

More Information

Illustrated Glossary ▶ 439









Fabrics ▶ 451

Flammability (CTB-133) ▶ 459

Finishes ▶ 456

Ordering and Warranties ▶ 462

2700 Series Multiple Seating

	23.75" W, Chair 35 lbs 1.75 yds								
	Model	Series 2	Series 3	Series 4	Series 5	Series 6	Series 7	Series 8	COM
	2700X-10 S	\$1,045	\$1,100	\$1,193	\$1,290	\$1,405	\$1,521	\$1,667	\$1,100
	2700X-10 P	\$1,177	\$1,232	\$1,325	\$1,422	\$1,537	\$1,653	\$1,799	\$1,232
	34" W, Plus chair 37 lbs 3 yds								
	Model	Series 2	Series 3	Series 4	Series 5	Series 6	Series 7	Series 8	COM
	2700S-OB30	\$2,376	\$2,471	\$2,630	\$2,796	\$2,994	\$3,193	\$3,443	\$2,471
	44" W, Plus chair 42 lbs 3.25 yds								
	Model	Series 2	Series 3	Series 4	Series 5	Series 6	Series 7	Series 8	COM
	2700S-OB40	\$2,650	\$2,753	\$2,925	\$3,105	\$3,319	\$3,535	\$3,806	\$2,753
	44.5" W, Plus chair 66 lbs 3.25 yds								
	Model	Series 2	Series 3	Series 4	Series 5	Series 6	Series 7	Series 8	COM
	2700-OB2	\$2,049	\$2,153	\$2,325	\$2,504	\$2,718	\$2,935	\$3,204	\$2,153
	44.5" W, Two seat 64 lbs 3 yds								
	Model	Series 2	Series 3	Series 4	Series 5	Series 6	Series 7	Series 8	COM
	2700X-20 S	\$1,585	\$1,680	\$1,839	\$2,005	\$2,203	\$2,402	\$2,652	\$1,680
	2700X-20 P	\$1,787	\$1,882	\$2,041	\$2,207	\$2,405	\$2,604	\$2,854	\$1,882
	46" W, Two seat with intervening arm and leg 70 lbs 3 yds								
	Model	Series 2	Series 3	Series 4	Series 5	Series 6	Series 7	Series 8	COM
	2700X-22 S	\$1,849	\$1,944	\$2,103	\$2,269	\$2,467	\$2,666	\$2,916	\$1,944
	2700X-22 P	\$2,083	\$2,178	\$2,337	\$2,503	\$2,701	\$2,900	\$3,150	\$2,178
	46" W, Two seat with divider arm 67 lbs 3.25 yds								
	Model	Series 2	Series 3	Series 4	Series 5	Series 6	Series 7	Series 8	COM
	2700X-25 S	\$1,772	\$1,875	\$2,047	\$2,227	\$2,441	\$2,657	\$2,928	\$1,875
	2700X-25 P	\$1,997	\$2,100	\$2,272	\$2,452	\$2,666	\$2,882	\$3,153	\$2,100
	64.5" W, Three seat 92 lbs 4.75 yds								
	Model	Series 2	Series 3	Series 4	Series 5	Series 6	Series 7	Series 8	COM
	2700X-30 S	\$2,081	\$2,232	\$2,484	\$2,747	\$3,059	\$3,375	\$3,770	\$2,232
	2700X-30 P	\$2,349	\$2,500	\$2,752	\$3,015	\$3,327	\$3,643	\$4,038	\$2,500
	68" W, Three seat with intervening arms and legs 104 lbs 4.75 yds								
	Model	Series 2	Series 3	Series 4	Series 5	Series 6	Series 7	Series 8	COM
	2700X-33 S	\$2,635	\$2,786	\$3,038	\$3,301	\$3,613	\$3,929	\$4,324	\$2,786
	2700X-33 P	\$2,970	\$3,121	\$3,373	\$3,636	\$3,948	\$4,264	\$4,659	\$3,121
	68" W, Three seat with divider arms 98 lbs 4.75 yds								
	Model	Series 2	Series 3	Series 4	Series 5	Series 6	Series 7	Series 8	COM
	2700X-35 S	\$2,468	\$2,619	\$2,871	\$3,134	\$3,446	\$3,762	\$4,157	\$2,619
	2700X-35 P	\$2,783	\$2,934	\$3,186	\$3,449	\$3,761	\$4,077	\$4,472	\$2,934

2700 Series Multiple Seating

	86.5" W, Four seat with one intervening arm and leg 122 lbs 6 yds								
	Model	Series 2	Series 3	Series 4	Series 5	Series 6	Series 7	Series 8	COM
	2700X-40 S	\$2,943	\$3,134	\$3,452	\$3,784	\$4,179	\$4,578	\$5,077	\$3,134
	2700X-40 P	\$3,320	\$3,511	\$3,829	\$4,161	\$4,556	\$4,955	\$5,454	\$3,511

	90" W, Four seat with intervening arms and legs 140 lbs 6 yds								
	Model	Series 2	Series 3	Series 4	Series 5	Series 6	Series 7	Series 8	COM
	2700X-44 S	\$3,486	\$3,677	\$3,995	\$4,327	\$4,722	\$5,121	\$5,620	\$3,677
	2700X-44 P	\$3,928	\$4,119	\$4,437	\$4,769	\$5,164	\$5,563	\$6,062	\$4,119

	90" W, Four seat with divider arms and one intervening leg 131 lbs 6 yds								
	Model	Series 2	Series 3	Series 4	Series 5	Series 6	Series 7	Series 8	COM
	2700X-45 S	\$3,193	\$3,384	\$3,702	\$4,034	\$4,429	\$4,828	\$5,327	\$3,384
	2700X-45 P	\$3,600	\$3,791	\$4,109	\$4,441	\$4,836	\$5,235	\$5,734	\$3,791

2700 Series Benches

Standard Features

Same standard features as the 2700 Series Multiple Seating

Available Options

Same options as 2700 Series Multiple Seating

Key Dimensions

- Overall Width: See price table
- Overall Depth: 24"
- Overall Height: 21.5"

	24" W, Bench 28 lbs 1.5 yds								
	Model	Series 2	Series 3	Series 4	Series 5	Series 6	Series 7	Series 8	COM
	2700-B1 S	\$806	\$853	\$933	\$1,016	\$1,115	\$1,214	\$1,339	\$853
	2700-B1 P	\$909	\$956	\$1,036	\$1,119	\$1,218	\$1,317	\$1,442	\$956

	44.5" W, Bench 52 lbs 2.5 yds								
	Model	Series 2	Series 3	Series 4	Series 5	Series 6	Series 7	Series 8	COM
	2700-B2 S	\$1,090	\$1,169	\$1,302	\$1,440	\$1,605	\$1,771	\$1,979	\$1,169
	2700-B2 P	\$1,231	\$1,310	\$1,443	\$1,581	\$1,746	\$1,912	\$2,120	\$1,310

2700 Series Multiple Seating

2700 Series Spanner Tables

Standard Features

- Solid maple legs
- Laminate top with wood edge
- Wood rail
- Nemschoff healthcare wood finish
- GREENGUARD Gold Certified
- Limited Lifetime Warranty

Specification Decisions

- Select standard wood finish
 - Select standard laminate
 - Select table attachment option (LSF, RSF)
- 27/TE is only applicable to a spanner table at the end of a run.



26" W, Truncated spanner corner table 29 lbs

Model	Price	Depth	Height
2700-CT	\$1,044	26"	–



19.5" W, Spanner table 24 lbs

Model	Price	Depth	Height
2700-ST	\$468	19.5"	–

Optional leg for use with spanner table (at end of run)

Model	Price	Depth	Height
27/TE	\$282	–	–

2750 Series Multiple Seating



Standard Features

- Solid maple frame
- Mortise and tenon joinery
- Spring seat construction
- Clean-out design
- Replaceable components
- Black urethane arm caps
- Non-marring 7/8" rubber-cushioned glides
- Nemschoff healthcare wood finish
- GREENGUARD Gold Certified
- Limited Lifetime Warranty

Available Options

- Moisture barrier + \$67 per seat or back
- Wallsaver legs + \$117
- Pewter or Desert urethane arm caps + \$205
- Divider arm + \$199
- CTB-133 + \$81/yd
- Two fabrics + \$62
- Three (or more) fabrics + \$88
- Attached tables (LSF, RSF –see price table)

Specification Decisions

- Select fabric
- Select standard wood finish
- Select a back style

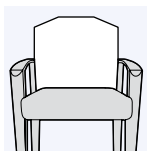

M Bevel

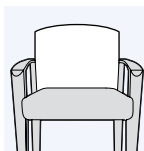

P Crown

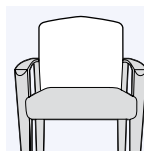

S Arcade

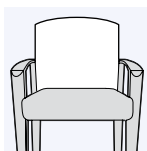

Q Square

- Add urethane arm cap
- Add divider arm
- Add moisture barrier
- Add CTB-133
- Apply multiple fabrics
- Add attached table

Model numbers with **S** indicate standard seat and back covers, and model numbers with **P** indicate removable covers.

Flammability Type

- Type 3

Coordinating Products

- [2750 Series Patient Chairs](#)
- [2000 Series Tables](#)

Key Dimensions

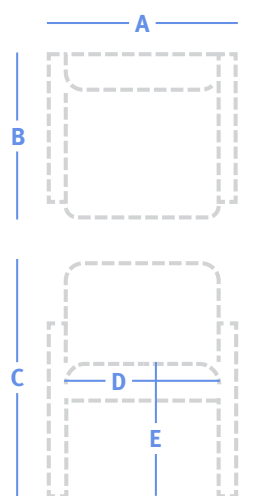

A	Overall Width	See price table
B	Overall Depth	24.5"
C	Overall Height	33.25"
D	Seat Width	
	Chair:	20"
	Two Seat:	20", 40"
	Three Seat:	20", 60"
	Four Seat:	20", 80"
E	Seat Height	18.5"
F	Arm Height	26"

More Information

Illustrated Glossary ▶ 439

Fabrics ▶ 451

Flammability (CTB-133) ▶ 459

Finishes ▶ 456

Ordering and Warranties ▶ 462

2750 Series Multiple Seating

	23.75" W, Chair									35 lbs 1.75 yds
	Model	Series 2	Series 3	Series 4	Series 5	Series 6	Series 7	Series 8	COM	
	2750X-10 S	\$1,045	\$1,100	\$1,193	\$1,290	\$1,405	\$1,521	\$1,667	\$1,100	
	2750X-10 P	\$1,177	\$1,232	\$1,325	\$1,422	\$1,537	\$1,653	\$1,799	\$1,232	
	44.5" W, Two seat									64 lbs 3 yds
	Model	Series 2	Series 3	Series 4	Series 5	Series 6	Series 7	Series 8	COM	
	2750X-20 S	\$1,585	\$1,680	\$1,839	\$2,005	\$2,203	\$2,402	\$2,652	\$1,680	
	2750X-20 P	\$1,787	\$1,882	\$2,041	\$2,207	\$2,405	\$2,604	\$2,854	\$1,882	
	46" W, Two seat with intervening arm and leg									70 lbs 3 yds
	Model	Series 2	Series 3	Series 4	Series 5	Series 6	Series 7	Series 8	COM	
	2750X-22 S	\$1,849	\$1,944	\$2,103	\$2,269	\$2,467	\$2,666	\$2,916	\$1,944	
	2750X-22 P	\$2,083	\$2,178	\$2,337	\$2,503	\$2,701	\$2,900	\$3,150	\$2,178	
	64.5" W, Three seat									92 lbs 4.75 yds
	Model	Series 2	Series 3	Series 4	Series 5	Series 6	Series 7	Series 8	COM	
	2750X-30 S	\$2,081	\$2,232	\$2,484	\$2,747	\$3,059	\$3,375	\$3,770	\$2,232	
	2750X-30 P	\$2,349	\$2,500	\$2,752	\$3,015	\$3,327	\$3,643	\$4,038	\$2,500	
	68" W, Three seat with intervening arms and legs									104 lbs 4.75 yds
	Model	Series 2	Series 3	Series 4	Series 5	Series 6	Series 7	Series 8	COM	
	2750X-33 S	\$2,634	\$2,785	\$3,037	\$3,300	\$3,612	\$3,928	\$4,323	\$2,785	
	2750X-33 P	\$2,969	\$3,120	\$3,372	\$3,635	\$3,947	\$4,263	\$4,658	\$3,120	
	86.5" W, Four seat with one intervening arm and leg									122 lbs 6 yds
	Model	Series 2	Series 3	Series 4	Series 5	Series 6	Series 7	Series 8	COM	
	2750X-40 S	\$2,943	\$3,134	\$3,452	\$3,784	\$4,179	\$4,578	\$5,077	\$3,134	
	2750X-40 P	\$3,320	\$3,511	\$3,829	\$4,161	\$4,556	\$4,955	\$5,454	\$3,511	
	90" W, Four seat with intervening arms and legs									140 lbs 6 yds
	Model	Series 2	Series 3	Series 4	Series 5	Series 6	Series 7	Series 8	COM	
	2750X-44 S	\$3,486	\$3,677	\$3,995	\$4,327	\$4,722	\$5,121	\$5,620	\$3,677	
	2750X-44 P	\$3,928	\$4,119	\$4,437	\$4,769	\$5,164	\$5,563	\$6,062	\$4,119	

2750 Series Multiple Seating

2750 Series Benches

Standard Features

Same standard features as the 2750 Series Multiple Seating

Available Options

Same options as 2750 Series Multiple Seating

Key Dimensions

- Overall Width: See price table
- Overall Depth: 24"
- Overall Height: 21.5"
- Seat Height: 18.5"
- Arm Height: 21.5"

		24" W, Bench 28 lbs 1.5 yds							
	Model	Series 2	Series 3	Series 4	Series 5	Series 6	Series 7	Series 8	COM
	2750-B1 S	\$805	\$852	\$932	\$1,015	\$1,114	\$1,213	\$1,338	\$852
	2750-B1 P	\$908	\$955	\$1,035	\$1,118	\$1,217	\$1,316	\$1,441	\$955

		44.5" W, Bench 52 lbs 2.5 yds							
	Model	Series 2	Series 3	Series 4	Series 5	Series 6	Series 7	Series 8	COM
	2750-B2 S	\$1,089	\$1,168	\$1,301	\$1,439	\$1,604	\$1,770	\$1,978	\$1,168
	2750-B2 P	\$1,230	\$1,309	\$1,442	\$1,580	\$1,745	\$1,911	\$2,119	\$1,309

2750 Series Spanner Tables

Standard Features

- Solid maple legs
- Laminate top with wood edge
- Wood rail
- Nemschoff healthcare wood finish
- GREENGUARD Gold Certified
- Limited Lifetime Warranty

Specification Decisions

- Select standard wood finish
 - Select standard laminate
 - Select table attachment option
- 27/TE is only applicable to a spanner table at the end of a run.

		26" W, Truncated spanner corner table 29 lbs			
	Model	Price	Depth	Height	
	2750-CT	\$1,044	26"		

		19.5" W, Spanner table 24 lbs			
	Model	Price	Depth	Height	
	2750-ST	\$468	19.5"		

		Optional leg for use with spanner table (at end of run)			
	Model	Price	Depth	Height	
	27-TE	\$282			

2770 Series Multiple Seating



More Information

- Illustrated Glossary ▶ 439
- Fabrics ▶ 451
- Flammability (CTB-133) ▶ 459
- Finishes ▶ 456
- Ordering and Warranties ▶ 462

Standard Features

- Solid maple frame
- Mortise and tenon joinery
- Spring seat construction
- Clean-out design
- Replaceable components
- Wood arms
- Brushed metal accent rail
- Non-marring 7/8" rubber-cushioned glides
- Nemschoff healthcare wood finish
- GREENGUARD Gold Certified
- Limited Lifetime Warranty

Available Options

- Moisture barrier + \$67 per seat or back
- Wallsaver legs + \$117
- Divider arm + \$199
- CTB-133 + \$81/yd
- Two fabrics + \$62
- Three (or more) fabrics + \$88
- Add attached tables (LSF, RSF –see price table)

Specification Decisions

- Select fabric
- Select standard wood finish
- Select a back style

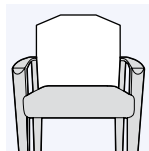

M Bevel

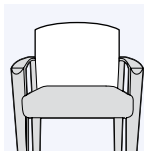

P Crown

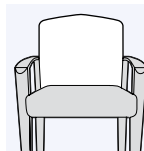

S Arcade

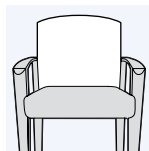

Q Square

- Add divider arm
- Add moisture barrier
- Add CTB-133
- Apply multiple fabrics
- Add attached table (LSF, RSF)
- Add wallsaver legs

Model numbers with **S** indicate standard seat and back covers, and model numbers with **P** indicate removable covers.

Flammability Type

- Type 3

Coordinating Products

- [2750 Series Patient Chairs](#)
- [2000 Series Tables](#)

Key Dimensions

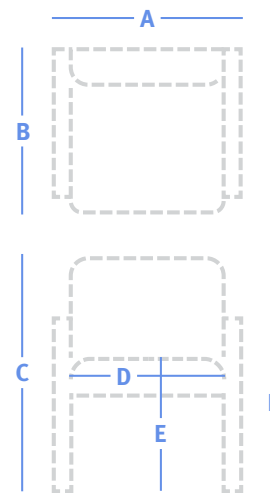

A	Overall Width	See price table
B	Overall Depth	24.5"
C	Overall Height	32.75"
D	Seat Width	
	Chair:	20"
	Two Seat:	20", 40"
	Three Seat:	20", 60.5"
	Four Seat:	20", 80"
E	Seat Height	18.5"
F	Arm Height	25.5"

2770 Series Multiple Seating

	23.75" W, Chair									31 lbs 1.75 yds
	Model	Series 2	Series 3	Series 4	Series 5	Series 6	Series 7	Series 8	COM	
	2770X-10 S	\$1,288	\$1,343	\$1,436	\$1,533	\$1,648	\$1,764	\$1,910	\$1,343	
	2770X-10 P	\$1,450	\$1,505	\$1,598	\$1,695	\$1,810	\$1,926	\$2,072	\$1,505	
	44.5" W, Two seat									48 lbs 3 yds
	Model	Series 2	Series 3	Series 4	Series 5	Series 6	Series 7	Series 8	COM	
	2770X-20 S	\$1,912	\$2,007	\$2,166	\$2,332	\$2,530	\$2,729	\$2,979	\$2,007	
	2770X-20 P	\$2,153	\$2,248	\$2,407	\$2,573	\$2,771	\$2,970	\$3,220	\$2,248	
	46" W, Two seat with intervening arm and leg									54 lbs 3 yds
	Model	Series 2	Series 3	Series 4	Series 5	Series 6	Series 7	Series 8	COM	
	2770X-22 S	\$2,214	\$2,309	\$2,468	\$2,634	\$2,832	\$3,031	\$3,281	\$2,309	
	2770X-22 P	\$2,492	\$2,587	\$2,746	\$2,912	\$3,110	\$3,309	\$3,559	\$2,587	
	68" W, Three seat									68 lbs 4.75 yds
	Model	Series 2	Series 3	Series 4	Series 5	Series 6	Series 7	Series 8	COM	
	2770X-30 S	\$2,487	\$2,638	\$2,890	\$3,153	\$3,465	\$3,781	\$4,176	\$2,638	
	2770X-30 P	\$2,804	\$2,955	\$3,207	\$3,470	\$3,782	\$4,098	\$4,493	\$2,955	
	68" W, Three seat with intervening arms and legs									80 lbs 4.75 yds
	Model	Series 2	Series 3	Series 4	Series 5	Series 6	Series 7	Series 8	COM	
	2770X-33 S	\$3,121	\$3,272	\$3,524	\$3,787	\$4,099	\$4,415	\$4,810	\$3,272	
	2770X-33 P	\$3,514	\$3,665	\$3,917	\$4,180	\$4,492	\$4,808	\$5,203	\$3,665	
	86.5" W, Four seat with one intervening arm and leg									122 lbs 6 yds
	Model	Series 2	Series 3	Series 4	Series 5	Series 6	Series 7	Series 8	COM	
	2770X-40 S	\$3,395	\$3,586	\$3,904	\$4,236	\$4,631	\$5,030	\$5,529	\$3,586	
	2770X-40 P	\$3,826	\$4,017	\$4,335	\$4,667	\$5,062	\$5,461	\$5,960	\$4,017	
	90" W, Four seat with intervening arms and legs									140 lbs 6 yds
	Model	Series 2	Series 3	Series 4	Series 5	Series 6	Series 7	Series 8	COM	
	2770-44 S	\$4,101	\$4,292	\$4,610	\$4,942	\$5,337	\$5,736	\$6,235	\$4,292	
	2770-44 P	\$4,616	\$4,807	\$5,125	\$5,457	\$5,852	\$6,251	\$6,750	\$4,807	

Welcoming & Waiting

Patient Areas

Specialty

Reference

2770 Series Multiple Seating

2770 Series Benches

Standard Features

Same standard features as 2770 Series Multiple Seating

Available Options

Same options as 2770 Series Multiple Seating, plus:

- Divider arm + \$199 (2770-B2)

Key Dimensions

- Overall Width: See price table
- Overall Depth: 24.5"
- Overall Height: 25.25"
- Seat Height: 18.5"
- Arm Height: 25.25"

	23.75" W, Bench 24 lbs 1.5 yds								
	Model	Series 2	Series 3	Series 4	Series 5	Series 6	Series 7	Series 8	COM
	2770-B1 S	\$988	\$1,035	\$1,115	\$1,198	\$1,297	\$1,396	\$1,521	\$1,035
	2770-B1 P	\$1,113	\$1,160	\$1,240	\$1,323	\$1,422	\$1,521	\$1,646	\$1,160

	44.5" W, Bench 36 lbs 2.5 yds								
	Model	Series 2	Series 3	Series 4	Series 5	Series 6	Series 7	Series 8	COM
	2770-B2 S	\$1,338	\$1,417	\$1,550	\$1,688	\$1,853	\$2,019	\$2,227	\$1,417
	2770-B2 P	\$1,509	\$1,588	\$1,721	\$1,859	\$2,024	\$2,190	\$2,398	\$1,588

2770 Series Spanner Tables

Standard Features

- Solid maple legs
- Laminate top with wood edge
- Wood rail
- Nemschoff healthcare wood finish
- GREENGUARD Gold Certified
- Limited Lifetime Warranty

Specification Decisions

- Select standard wood finish
 - Select standard laminate
 - Select table attachment option
- 27/TE is only applicable to a spanner table at the end of a run.

	26" W, Truncated spanner corner table 29 lbs			
	Model	Price	Depth	Height
	2770-CT	\$1,044	26"	–

	19.5" W, Spanner table 24 lbs			
	Model	Price	Depth	Height
	2770-ST	\$468	19.5"	–

Optional leg for use with spanner table (at end of run)				
	Model	Price	Depth	Height
	27/TE	\$282	–	–

Andante Multiple Seating



Standard Features

- Solid hardwood frame
- Powder-coated steel interior frame (Black or MSS Metallic silver)
- Bentwood arms
- Wipe-out design
- Nemschoff healthcare wood finish
- GREENGUARD Gold Certified
- Limited Lifetime Warranty
- See nemschoff.com for weight ratings (ANXX-00028, ANXX-00029)

Available Options

- Moisture barrier + \$67 per seat or back
- Removable seat cover + \$136 per seat
- CTB-133 + \$81/yd
- Two fabrics + \$62
- Three (or more) fabrics + \$88
- Attached tables (LSF, RSF –see price table)

Specification Decisions

- Select fabric
- Select standard wood finish
- Select powder coat finish
- Add moisture barrier
- Add CTB-133
- Apply multiple fabrics
- Add attached table
- Add removable covers

Flammability Type

- Type 4
- Type 4 (Plus models)

Coordinating Products

- [Andante Patient Chair](#)
- [Andante Stack Chair](#)

Key Dimensions

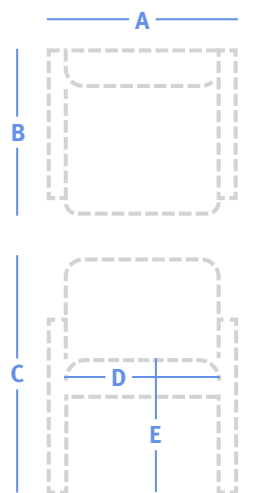

A	Overall Width	See price table
B	Overall Depth	26.5"
C	Overall Height	32"
D	Seat Width	
	Chair:	19", 23", 26.5", 30", 40"
	Two Seat:	19", 46"
	Three Seat:	19", 57", 69"
	Four Seat:	19", 76", 92"
E	Seat Height	18"
F	Arm Height	25"

More Information

- Illustrated Glossary ▶ 439
- Fabrics ▶ 451
- Flammability (CTB-133) ▶ 459
- Finishes ▶ 456
- Ordering and Warranties ▶ 462



23.5" W, Chair

29 lbs | 1.5 yds

Model	Series 2	Series 3	Series 4	Series 5	Series 6	Series 7	Series 8	COM
ANXX-00001	\$1,428	\$1,451	\$1,554	\$1,610	\$1,640	\$1,680	\$1,705	\$1,451



27.5" W, Chair

30 lbs | 1.75 yds

Model	Series 2	Series 3	Series 4	Series 5	Series 6	Series 7	Series 8	COM
ANXX-00004	\$1,566	\$1,593	\$1,714	\$1,778	\$1,813	\$1,860	\$1,889	\$1,593



34.5" W, Plus chair

38 lbs | 2.25 yds

Model	Series 2	Series 3	Series 4	Series 5	Series 6	Series 7	Series 8	COM
ANXX-00028	\$2,154	\$2,189	\$2,344	\$2,427	\$2,472	\$2,532	\$2,570	\$2,189

Andante Multiple Seating

Lounge Seating











Multiple & Tandem Seating

Side, Stacking & Folding Chairs

Occasional Tables

	44.5" W, Plus chair 46 lbs 2.75 yds								
	Model	Series 2	Series 3	Series 4	Series 5	Series 6	Series 7	Series 8	COM
	ANXX-00029	\$2,413	\$2,456	\$2,645	\$2,747	\$2,802	\$2,875	\$2,921	\$2,456
	44.5" W, Two seat 51 lbs 3 yds								
	Model	Series 2	Series 3	Series 4	Series 5	Series 6	Series 7	Series 8	COM
	ANXX-00002	\$2,655	\$2,702	\$2,908	\$3,019	\$3,079	\$3,159	\$3,209	\$2,702
	52.5" W, Two seat 54 lbs 3.5 yds								
	Model	Series 2	Series 3	Series 4	Series 5	Series 6	Series 7	Series 8	COM
	ANXX-00005	\$2,865	\$2,920	\$3,161	\$3,290	\$3,360	\$3,453	\$3,512	\$2,920
	44.5" W, Two seat with intervening arm and leg 52 lbs 3 yds								
	Model	Series 2	Series 3	Series 4	Series 5	Series 6	Series 7	Series 8	COM
	ANXX-00018	\$2,505	\$2,552	\$2,758	\$2,869	\$2,929	\$3,009	\$3,059	\$2,552
	52.5" W, Two seat with intervening arm and leg 55 lbs 3.5 yds								
	Model	Series 2	Series 3	Series 4	Series 5	Series 6	Series 7	Series 8	COM
	ANXX-00021	\$2,738	\$2,793	\$3,034	\$3,163	\$3,233	\$3,326	\$3,385	\$2,793
	44.5" W, Settee 46 lbs 2.75 yds								
	Model	Series 2	Series 3	Series 4	Series 5	Series 6	Series 7	Series 8	COM
	ANXX-00013	\$2,413	\$2,456	\$2,645	\$2,747	\$2,802	\$2,875	\$2,921	\$2,456
	44" W, Chair with RSF end table 45 lbs 1.5 yds								
	Model	Series 2	Series 3	Series 4	Series 5	Series 6	Series 7	Series 8	COM
	ANXX-00009	\$2,752	\$2,775	\$2,878	\$2,934	\$2,964	\$3,004	\$3,029	\$2,775
	52" W, Chair with RSF end table 47 lbs 1.75 yds								
	Model	Series 2	Series 3	Series 4	Series 5	Series 6	Series 7	Series 8	COM
	ANXX-00011	\$2,854	\$2,881	\$3,002	\$3,066	\$3,101	\$3,148	\$3,177	\$2,881
	65.5" W, Three seat 72 lbs 4.5 yds								
	Model	Series 2	Series 3	Series 4	Series 5	Series 6	Series 7	Series 8	COM
	ANXX-00003	\$3,603	\$3,674	\$3,983	\$4,150	\$4,240	\$4,359	\$4,435	\$3,674
	77.5" W, Three seat 77 lbs 5.25 yds								
	Model	Series 2	Series 3	Series 4	Series 5	Series 6	Series 7	Series 8	COM
	ANXX-00006	\$3,903	\$3,986	\$4,347	\$4,541	\$4,646	\$4,785	\$4,874	\$3,986

Andante Multiple Seating

	65.5" W, Three seat with intervening arms and legs									76 lbs 4.5 yds
	Model	Series 2	Series 3	Series 4	Series 5	Series 6	Series 7	Series 8	COM	
	ANXX-00019	\$3,536	\$3,607	\$3,916	\$4,083	\$4,173	\$4,292	\$4,368	\$3,607	
	77.5" W, Three seat with intervening arms and legs									80 lbs 5.25 yds
	Model	Series 2	Series 3	Series 4	Series 5	Series 6	Series 7	Series 8	COM	
	ANXX-00022	\$3,575	\$3,658	\$4,019	\$4,213	\$4,318	\$4,457	\$4,546	\$3,658	
	65.5" W, Chair and Settee									68 lbs 4.25 yds
	Model	Series 2	Series 3	Series 4	Series 5	Series 6	Series 7	Series 8	COM	
	ANXX-00014	\$3,554	\$3,621	\$3,913	\$4,070	\$4,156	\$4,268	\$4,340	\$3,621	
	69.5" W, Chair and Settee									70 lbs 4.5 yds
	Model	Series 2	Series 3	Series 4	Series 5	Series 6	Series 7	Series 8	COM	
	ANXX-00016	\$3,798	\$3,869	\$4,178	\$4,345	\$4,435	\$4,554	\$4,630	\$3,869	
	65.5" W, Chair and Settee with intervening arm and leg									70 lbs 4.25 yds
	Model	Series 2	Series 3	Series 4	Series 5	Series 6	Series 7	Series 8	COM	
	ANXX-00024	\$3,228	\$3,295	\$3,587	\$3,744	\$3,830	\$3,942	\$4,014	\$3,295	
	69.5" W, Chair and Settee with intervening arms and legs									71 lbs 4.5 yds
	Model	Series 2	Series 3	Series 4	Series 5	Series 6	Series 7	Series 8	COM	
	ANXX-00026	\$3,532	\$3,603	\$3,912	\$4,079	\$4,169	\$4,288	\$4,364	\$3,603	
	65" W, Settee with LSF end table									63 lbs 2.75 yds
	Model	Series 2	Series 3	Series 4	Series 5	Series 6	Series 7	Series 8	COM	
	ANXX-00015	\$3,245	\$3,288	\$3,477	\$3,579	\$3,634	\$3,707	\$3,753	\$3,288	
	69" W, Settee with LSF end table									65 lbs 2.75 yds
	Model	Series 2	Series 3	Series 4	Series 5	Series 6	Series 7	Series 8	COM	
	ANXX-00017	\$3,295	\$3,338	\$3,527	\$3,629	\$3,684	\$3,757	\$3,803	\$3,338	
	65" W, Two seat with RSF end table									67 lbs 3 yds
	Model	Series 2	Series 3	Series 4	Series 5	Series 6	Series 7	Series 8	COM	
	ANXX-00010	\$3,440	\$3,487	\$3,693	\$3,804	\$3,864	\$3,944	\$3,994	\$3,487	
	77" W, Two seat with RSF end table									70 lbs 3.5 yds
	Model	Series 2	Series 3	Series 4	Series 5	Series 6	Series 7	Series 8	COM	
	ANXX-00012	\$3,868	\$3,923	\$4,164	\$4,293	\$4,363	\$4,456	\$4,515	\$3,923	

Andante Multiple Seating

Lounge Seating

Multiple & Tandem Seating

Side, Stacking & Folding Chairs

Occasional Tables



65.5" W, Two seat with spanner table

71 lbs | 3 yds

Model	Series 2	Series 3	Series 4	Series 5	Series 6	Series 7	Series 8	COM
ANXX-00007	\$3,450	\$3,497	\$3,703	\$3,814	\$3,874	\$3,954	\$4,004	\$3,497



77.5" W, Two seat with spanner table

77 lbs | 3.5 yds

Model	Series 2	Series 3	Series 4	Series 5	Series 6	Series 7	Series 8	COM
ANXX-00008	\$3,741	\$3,796	\$4,037	\$4,166	\$4,236	\$4,329	\$4,388	\$3,796



87" W, Four seat with intervening arms and legs

99 lbs | 6 yds

Model	Series 2	Series 3	Series 4	Series 5	Series 6	Series 7	Series 8	COM
ANXX-00020	\$4,541	\$4,636	\$5,048	\$5,270	\$5,390	\$5,549	\$5,650	\$4,636



103" W, Four seat with intervening arms and legs

105 lbs | 7 yds

Model	Series 2	Series 3	Series 4	Series 5	Series 6	Series 7	Series 8	COM
ANXX-00023	\$4,570	\$4,680	\$5,161	\$5,420	\$5,560	\$5,745	\$5,863	\$4,680



86.5" W, Two seat and Settee with intervening arms and legs

93 lbs | 5.75 yds

Model	Series 2	Series 3	Series 4	Series 5	Series 6	Series 7	Series 8	COM
ANXX-00025	\$4,159	\$4,250	\$4,645	\$4,858	\$4,973	\$5,125	\$5,222	\$4,250



94.5" W, Two seat and Settee with intervening arms and legs

96 lbs | 6.25 yds

Model	Series 2	Series 3	Series 4	Series 5	Series 6	Series 7	Series 8	COM
ANXX-00027	\$4,256	\$4,354	\$4,783	\$5,014	\$5,140	\$5,305	\$5,410	\$4,354

Andante Multiple Seating

Andante Spanner Tables

Standard Features

Same standard features as Andante Multiple Seating

Specification Decisions

- Select standard wood finish
- Select powder coat finish (BK Black, MSS Metallic Silver)



21" W, Spanner end table

20 lbs

Model	Price	Depth	Height
ANXX-00030	\$837	23.5"	15.75"



25" W, Spanner end table

23 lbs

Model	Price	Depth	Height
ANXX-00031	\$868	23.5"	15.75"

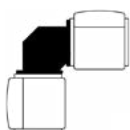

20.25" W, Spanner table

17 lbs

Model	Price	Depth	Height
ANXX-00032	\$673	18.75"	15.75"



24.25" W, Spanner table

20 lbs

Model	Price	Depth	Height
ANXX-00033	\$703	18.75"	15.75"



25" W, Spanner corner table

17 lbs

Model	Price	Depth	Height
ANXX-00034	\$751	18.75"	15.75"

Anderson Multiple Seating



More Information

Illustrated Glossary ▶ 439

Fabrics ▶ 451

Flammability (CTB-133) ▶ 459

Finishes ▶ 456

Ordering and Warranties ▶ 462

Standard Features

- Heavy-duty steel construction
- Powder-coated frame
- Wipe-out design
- Replaceable components
- Wood arm caps
- Non-marring 1" adjustable glides
- Arcade back
- GREENGUARD Gold Certified
- Limited Lifetime Warranty
- See nemschoff.com for weight ratings (FX600-OB30, FX600-OB40)

Available Options

- Moisture barrier + \$67 per seat or back
- Black urethane arm caps + \$113
- Square back + \$0
- CTB-133 + \$81/yd
- Two fabrics + \$62
- Three (or more) fabrics + \$88
- Attached tables (LSF, RSF –see price table)

Specification Decisions

- Select fabric
- Select standard wood finish
- Select powder coat finish
- Add moisture barrier
- Add CTB-133
- Apply multiple fabrics
- Add urethane arm caps
- Add Square back

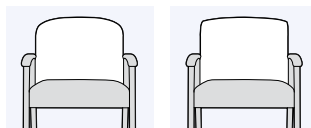

Arcade back Square back

- Add attached table

Flammability Type





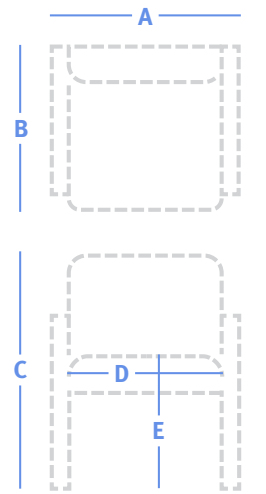

- Type 3
- Type 4 (Plus models)

Key Dimensions



A	Overall Width	See price table
B	Overall Depth	26", 25.75" (OB30, OB40)
C	Overall Height	33", 32" (OB30, OB40)
D	Seat Width	Chair: 20.5", 30", 40" Two seat: 40.5", 41.5" Three seat: 62.25", 63"
E	Seat Height	18.75", 19" (OB30, OB40)
F	Arm Height	24.5"

Anderson Multiple Seating

	24" W, Chair 32 lbs 1.5 yds								
	Model	Series 2	Series 3	Series 4	Series 5	Series 6	Series 7	Series 8	COM
	FX600-10	\$802	\$849	\$928	\$1,010	\$1,109	\$1,199	\$1,322	\$849
	34" W, Plus chair 40 lbs 3.5 yds								
	Model	Series 2	Series 3	Series 4	Series 5	Series 6	Series 7	Series 8	COM
	FX600-OB30	\$1,474	\$1,584	\$1,768	\$1,960	\$2,189	\$2,400	\$2,688	\$1,584
	44" W, Plus chair 44 lbs 3.75 yds								
	Model	Series 2	Series 3	Series 4	Series 5	Series 6	Series 7	Series 8	COM
	FX600-OB40	\$1,641	\$1,759	\$1,956	\$2,161	\$2,407	\$2,633	\$2,942	\$1,759
	45.5" W, Two seat 50 lbs 2.75 yds								
	Model	Series 2	Series 3	Series 4	Series 5	Series 6	Series 7	Series 8	COM
	FX600-20	\$1,272	\$1,359	\$1,504	\$1,654	\$1,834	\$2,000	\$2,226	\$1,359
	46.25" W, Two seat with intervening arm and leg 52 lbs 2.75 yds								
	Model	Series 2	Series 3	Series 4	Series 5	Series 6	Series 7	Series 8	COM
	FX600-22	\$1,441	\$1,528	\$1,673	\$1,823	\$2,003	\$2,169	\$2,395	\$1,528
	66.25" W, Three seat 93 lbs 4.25 yds								
	Model	Series 2	Series 3	Series 4	Series 5	Series 6	Series 7	Series 8	COM
	FX600-30	\$1,649	\$1,783	\$2,006	\$2,239	\$2,517	\$2,773	\$3,123	\$1,783
	68.25" W, Three seat with intervening arms and legs 97 lbs 4.25 yds								
	Model	Series 2	Series 3	Series 4	Series 5	Series 6	Series 7	Series 8	COM
	FX600-33	\$2,158	\$2,292	\$2,515	\$2,748	\$3,026	\$3,282	\$3,632	\$2,292

Spanner Table

Standard Features

- Heavy-duty steel construction
- Powder-coated metal frame
- Self-edged laminate top
- Adjustable 1" glides

Specification Decisions

- Select standard wood finish
- Select standard laminate
- Select powder coat finish
- Select table attachment option

26.25" W, Carlson corner spanner table 28 lbs

Model	Price	Depth	Height
FX620-CT	\$612	26.25"	16"

Auburn Multiple Seating



More Information

Illustrated Glossary ▶ 439

Fabrics ▶ 451

Flammability (CTB-133) ▶ 459

Finishes ▶ 456

Ordering and Warranties ▶ 462

Standard Features

- Solid hardwood frame
- Wipe-out design
- Replaceable components
- Wood arms with extended profile
- Non-marring 3/4" glides
- Laminate tabletops on select models
- Nemschoff healthcare wood finish
- GREENGUARD Gold Certified
- Limited Lifetime Warranty
- See nemschoff.com for weight ratings (A18, A38)

Available Options

- Moisture barrier + \$67 per seat or back
- Panel arms (open wood arm models) + \$134 per pair
- Removable covers + \$170 per seat and back, + \$339 per Settee seat and back
- CTB-133 + \$81/yd
- Two fabrics + \$62
- Three (or more) fabrics + \$88

Specification Decisions

- Select fabric
- Select standard wood finish
- Add moisture barrier
- Add CTB-133
- Apply multiple fabrics
- Add attached table (LSF, RSF)
- Add removable covers
- Add veneer or laminate top
- Add panel arms

Flammability Types

- Type 3
- Type 8 (with panel arms)
- Type 4 (Plus models)

Coordinating Products

- [Auburn Tables](#)
- [Auburn Recliner](#)
- [Auburn Glider](#)

Key Dimensions

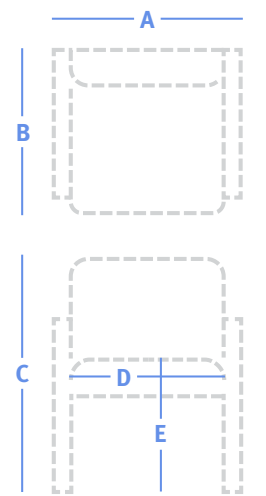

A	Overall Width	See price table
B	Overall Depth	24"
C	Overall Height	31.5"
D	Seat Width	
	Chair:	19.5", 22", 30", 31"
	Two Seat:	19.5", 39", 44"
	Three Seat:	19.5", 58.5", 66"
	Four Seat:	19.5", 78", 88"
	Five Seat:	19.5", 97.5", 110"
E	Seat Height	18", 17.5" (A18, A38)
F	Arm Height	25"

Auburn Multiple Seating

Open Wood Arms

	23" W, Chair, open wood arms 28 lbs 1.5 yds								
	Model	Series 2	Series 3	Series 4	Series 5	Series 6	Series 7	Series 8	COM
	A10	\$1,159	\$1,182	\$1,285	\$1,341	\$1,371	\$1,411	\$1,436	\$1,182

	25.5" W, Chair, open wood arms 33 lbs 1.75 yds								
	Model	Series 2	Series 3	Series 4	Series 5	Series 6	Series 7	Series 8	COM
	A15	\$1,320	\$1,347	\$1,468	\$1,532	\$1,567	\$1,614	\$1,643	\$1,347

	33.5" W, Plus chair 44 lbs 2.25 yds								
	Model	Series 2	Series 3	Series 4	Series 5	Series 6	Series 7	Series 8	COM
	A18	\$2,116	\$2,151	\$2,306	\$2,389	\$2,434	\$2,494	\$2,532	\$2,151

	34.5" W, Plus chair 48 lbs 4.25 yds								
	Model	Series 2	Series 3	Series 4	Series 5	Series 6	Series 7	Series 8	COM
	A38	\$2,139	\$2,206	\$2,498	\$2,655	\$2,741	\$2,853	\$2,925	\$2,206

	44" W, Two seat, open wood arms 57 lbs 3 yds								
	Model	Series 2	Series 3	Series 4	Series 5	Series 6	Series 7	Series 8	COM
	AS10-2	\$2,227	\$2,274	\$2,480	\$2,591	\$2,651	\$2,731	\$2,781	\$2,274

	49" W, Two seat, open wood arms 67 lbs 3.25 yds								
	Model	Series 2	Series 3	Series 4	Series 5	Series 6	Series 7	Series 8	COM
	AS15-2	\$2,541	\$2,592	\$2,816	\$2,936	\$3,001	\$3,087	\$3,142	\$2,592







	44" W, Two seat with intervening arm and leg, open wood arms 48 lbs 3 yds								
	Model	Series 2	Series 3	Series 4	Series 5	Series 6	Series 7	Series 8	COM
	A10-2	\$2,021	\$2,068	\$2,274	\$2,385	\$2,445	\$2,525	\$2,575	\$2,068

	49" W, Two seat with intervening arm and leg, open wood arms 53 lbs 3.25 yds								
	Model	Series 2	Series 3	Series 4	Series 5	Series 6	Series 7	Series 8	COM
	A15-2	\$2,304	\$2,355	\$2,579	\$2,699	\$2,764	\$2,850	\$2,905	\$2,355

	44" W, Settee, open wood arms 51 lbs 3.25 yds								
	Model	Series 2	Series 3	Series 4	Series 5	Series 6	Series 7	Series 8	COM
	AS10-2-LS	\$1,912	\$1,963	\$2,187	\$2,307	\$2,372	\$2,458	\$2,513	\$1,963

	49" W, Settee, open wood arms 61 lbs 3.5 yds								
	Model	Series 2	Series 3	Series 4	Series 5	Series 6	Series 7	Series 8	COM
	AS15-2-LS	\$2,300	\$2,355	\$2,596	\$2,725	\$2,795	\$2,888	\$2,947	\$2,355

Auburn Multiple Seating

	66" W, Three seat, open wood arms 81 lbs 4.5 yds								
	Model	Series 2	Series 3	Series 4	Series 5	Series 6	Series 7	Series 8	COM
	AS10-3	\$3,179	\$3,250	\$3,559	\$3,726	\$3,816	\$3,935	\$4,011	\$3,250
	73" W, Three seat, open wood arms 96 lbs 4.75 yds								
	Model	Series 2	Series 3	Series 4	Series 5	Series 6	Series 7	Series 8	COM
	AS15-3	\$3,627	\$3,702	\$4,029	\$4,204	\$4,299	\$4,425	\$4,505	\$3,702
	66" W, Three seat with intervening arms and legs, open wood arms 69 lbs 4.5 yds								
	Model	Series 2	Series 3	Series 4	Series 5	Series 6	Series 7	Series 8	COM
	A10-3	\$2,884	\$2,955	\$3,264	\$3,431	\$3,521	\$3,640	\$3,716	\$2,955
	73" W, Three seat with intervening arms and legs, open wood arms 74 lbs 4.75 yds								
	Model	Series 2	Series 3	Series 4	Series 5	Series 6	Series 7	Series 8	COM
	A15-3	\$3,291	\$3,366	\$3,693	\$3,868	\$3,963	\$4,089	\$4,169	\$3,366
	66" W, Chair with Settee, open wood arms 73 lbs 4.75 yds								
	Model	Series 2	Series 3	Series 4	Series 5	Series 6	Series 7	Series 8	COM
	AS10-3-CH-LS	\$3,440	\$3,515	\$3,842	\$4,017	\$4,112	\$4,238	\$4,318	\$3,515
	73" W, Chair with Settee, open wood arms 88 lbs 5.25 yds								
	Model	Series 2	Series 3	Series 4	Series 5	Series 6	Series 7	Series 8	COM
	AS15-3-CH-LS	\$3,922	\$4,005	\$4,366	\$4,560	\$4,665	\$4,804	\$4,893	\$4,005
	66" W, Two seat with spanner table, open wood arms 77 lbs 3 yds								
	Model	Series 2	Series 3	Series 4	Series 5	Series 6	Series 7	Series 8	COM
	AS10-3-IT	\$3,125	\$3,172	\$3,378	\$3,489	\$3,549	\$3,629	\$3,679	\$3,172
	73" W, Two seat with spanner table, open wood arms 87 lbs 3.25 yds								
	Model	Series 2	Series 3	Series 4	Series 5	Series 6	Series 7	Series 8	COM
	AS15-3-IT	\$3,561	\$3,612	\$3,836	\$3,956	\$4,021	\$4,107	\$4,162	\$3,612
	87" W, Four seat, open wood arms 104 lbs 6 yds								
	Model	Series 2	Series 3	Series 4	Series 5	Series 6	Series 7	Series 8	COM
	AS10-4	\$4,131	\$4,226	\$4,638	\$4,860	\$4,980	\$5,139	\$5,240	\$4,226
	97" W, Four seat, open wood arms 124 lbs 6.25 yds								
	Model	Series 2	Series 3	Series 4	Series 5	Series 6	Series 7	Series 8	COM
	AS15-4	\$4,714	\$4,812	\$5,241	\$5,472	\$5,598	\$5,763	\$5,868	\$4,812

Lounge Seating

Multiple & Tandem Seating

Side, Stacking & Folding Chairs

Occasional Tables

Auburn Multiple Seating

	87" W, Four seat with intervening arms and legs, open wood arms 90 lbs 6 yds
Model	Series 2 Series 3 Series 4 Series 5 Series 6 Series 7 Series 8 COM
A10-4	\$3,746 \$3,841 \$4,253 \$4,475 \$4,595 \$4,754 \$4,855 \$3,841

	97" W, Four seat with intervening arms and legs, open wood arms 95 lbs 6.25 yds
Model	Series 2 Series 3 Series 4 Series 5 Series 6 Series 7 Series 8 COM
A15-4	\$4,276 \$4,374 \$4,803 \$5,034 \$5,160 \$5,325 \$5,430 \$4,374

	87" W, Two seat with Settee, open wood arms 102 lbs 6.25 yds
Model	Series 2 Series 3 Series 4 Series 5 Series 6 Series 7 Series 8 COM
AS10-4-2CH-LS	\$4,383 \$4,481 \$4,910 \$5,141 \$5,267 \$5,432 \$5,537 \$4,481

	97" W, Two seat with Settee, open wood arms 122 lbs 7 yds
Model	Series 2 Series 3 Series 4 Series 5 Series 6 Series 7 Series 8 COM
AS15-4-2CH-LS	\$4,992 \$5,102 \$5,583 \$5,842 \$5,982 \$6,167 \$6,285 \$5,102

	87" W, Three seat with spanner table, open wood arms 100 lbs 4.5 yds
Model	Series 2 Series 3 Series 4 Series 5 Series 6 Series 7 Series 8 COM
AS10-4-IT	\$4,053 \$4,124 \$4,433 \$4,600 \$4,690 \$4,809 \$4,885 \$4,124

	97" W, Three seat with spanner table, open wood arms 115 lbs 4.75 yds
Model	Series 2 Series 3 Series 4 Series 5 Series 6 Series 7 Series 8 COM
AS15-4-IT	\$4,621 \$4,696 \$5,023 \$5,198 \$5,293 \$5,419 \$5,499 \$4,696

	87" W, Chair and Settee with spanner table, open wood arms 94 lbs 4.75 yds
Model	Series 2 Series 3 Series 4 Series 5 Series 6 Series 7 Series 8 COM
AS10-4-CH-IT-LS	\$3,027 \$3,102 \$3,429 \$3,604 \$3,699 \$3,825 \$3,905 \$3,102

	97" W, Chair and Settee with spanner table, open wood arms 94 lbs 5 yds
Model	Series 2 Series 3 Series 4 Series 5 Series 6 Series 7 Series 8 COM
AS15-4-CH-IT-LS	\$5,143 \$5,222 \$5,566 \$5,750 \$5,851 \$5,983 \$6,067 \$5,222

	108" W, Five seat with intervening arms and legs, open wood arms 112 lbs 7.5 yds
Model	Series 2 Series 3 Series 4 Series 5 Series 6 Series 7 Series 8 COM
A10-5	\$4,608 \$4,726 \$5,241 \$5,518 \$5,669 \$5,867 \$5,994 \$4,726

	120.5" W, Five seat with intervening arms and legs, open wood arms 117 lbs 7.75 yds
Model	Series 2 Series 3 Series 4 Series 5 Series 6 Series 7 Series 8 COM
A15-5	\$5,005 \$5,127 \$5,659 \$5,946 \$6,101 \$6,306 \$6,437 \$5,127

Auburn Multiple Seating

Lounge Seating

Multiple & Tandem Seating

Side, Stacking & Folding Chairs

Occasional Tables

Fully Upholstered Arm Panels

	23" W, Chair, fully upholstered arm panels 58 lbs 3.5 yds
	Model Series 2 Series 3 Series 4 Series 5 Series 6 Series 7 Series 8 COM
	A30 \$1,249 \$1,349 \$1,589 \$1,719 \$1,789 \$1,881 \$1,941 \$1,349
	25.5" W, Chair, fully upholstered arm panels 63 lbs 3.75 yds
	Model Series 2 Series 3 Series 4 Series 5 Series 6 Series 7 Series 8 COM
	A35 \$1,478 \$1,537 \$1,794 \$1,933 \$2,008 \$2,107 \$2,170 \$1,537
	44" W, Two seat, fully upholstered arm panels 100 lbs 5.5 yds
	Model Series 2 Series 3 Series 4 Series 5 Series 6 Series 7 Series 8 COM
	AS30-2 \$2,288 \$2,375 \$2,753 \$2,956 \$3,067 \$3,212 \$3,305 \$2,375
	49" W, Two seat, fully upholstered arm panels 110 lbs 5.75 yds
	Model Series 2 Series 3 Series 4 Series 5 Series 6 Series 7 Series 8 COM
	AS35-2 \$2,419 \$2,510 \$2,905 \$3,118 \$3,233 \$3,385 \$3,482 \$2,510
	44" W, Two seat with intervening arm and leg, fully upholstered arm panels 95 lbs 5.75 yds
	Model Series 2 Series 3 Series 4 Series 5 Series 6 Series 7 Series 8 COM
	A30-2 \$2,280 \$2,371 \$2,766 \$2,979 \$3,094 \$3,246 \$3,343 \$2,371
	49" W, Two seat with intervening arm and leg, fully upholstered arm panels 105 lbs 6 yds
	Model Series 2 Series 3 Series 4 Series 5 Series 6 Series 7 Series 8 COM
	A35-2 \$2,604 \$2,699 \$3,111 \$3,333 \$3,453 \$3,612 \$3,713 \$2,699
	40.5" W, Settee, fully upholstered arm panels 83 lbs 4.75 yds
	Model Series 2 Series 3 Series 4 Series 5 Series 6 Series 7 Series 8 COM
	AS30-2-LS \$2,300 \$2,375 \$2,702 \$2,877 \$2,972 \$3,098 \$3,178 \$2,375
	49" W, Settee, fully upholstered arm panels 93 lbs 5 yds
	Model Series 2 Series 3 Series 4 Series 5 Series 6 Series 7 Series 8 COM
	AS35-2-LS \$2,630 \$2,709 \$3,053 \$3,237 \$3,338 \$3,470 \$3,554 \$2,709
	66" W, Three seat, fully upholstered arm panels 128 lbs 7.5 yds
	Model Series 2 Series 3 Series 4 Series 5 Series 6 Series 7 Series 8 COM
	AS30-3 \$2,908 \$3,026 \$3,541 \$3,818 \$3,969 \$4,167 \$4,294 \$3,026

Auburn Multiple Seating



73" W, Three seat with intervening arms and legs, fully upholstered arm panels 143 lbs | 7.75 yds

Model	Series 2	Series 3	Series 4	Series 5	Series 6	Series 7	Series 8	COM
AS35-3	\$3,603	\$3,725	\$4,257	\$4,544	\$4,699	\$4,904	\$5,035	\$3,725



66" W, Three seat with intervening arms and legs, fully upholstered arm panels 132 lbs | 7.5 yds

Model	Series 2	Series 3	Series 4	Series 5	Series 6	Series 7	Series 8	COM
A30-3	\$3,275	\$3,393	\$3,908	\$4,185	\$4,336	\$4,534	\$4,661	\$3,393



73" W, Three seat with intervening arms and legs, fully upholstered arm panels 147 lbs | 7.75 yds

Model	Series 2	Series 3	Series 4	Series 5	Series 6	Series 7	Series 8	COM
A35-3	\$3,746	\$3,868	\$4,400	\$4,687	\$4,842	\$5,047	\$5,178	\$3,868



60" W, Chair with settee, fully upholstered arm panels 109 lbs | 7.5 yds

Model	Series 2	Series 3	Series 4	Series 5	Series 6	Series 7	Series 8	COM
AS30-3-CH-LS	\$3,366	\$3,484	\$3,999	\$4,276	\$4,427	\$4,625	\$4,752	\$3,484



73" W, Chair with settee, fully upholstered arm panels 124 lbs | 7.75 yds

Model	Series 2	Series 3	Series 4	Series 5	Series 6	Series 7	Series 8	COM
AS35-3-CH-LS	\$3,822	\$3,944	\$4,476	\$4,763	\$4,918	\$5,123	\$5,254	\$3,944



66" W, Two seat with spanner table, fully upholstered arm panels 125 lbs | 5 yds

Model	Series 2	Series 3	Series 4	Series 5	Series 6	Series 7	Series 8	COM
AS30-3-IT	\$3,276	\$3,355	\$3,699	\$3,883	\$3,984	\$4,116	\$4,200	\$3,355



73" W, Two seat with spanner table, fully upholstered arm panels 135 lbs | 5.25 yds

Model	Series 2	Series 3	Series 4	Series 5	Series 6	Series 7	Series 8	COM
AS35-3-IT	\$3,458	\$3,541	\$3,902	\$4,096	\$4,201	\$4,340	\$4,429	\$3,541



87" W, Four seat, fully upholstered arm panels 156 lbs | 9.25 yds

Model	Series 2	Series 3	Series 4	Series 5	Series 6	Series 7	Series 8	COM
AS30-4	\$3,930	\$4,076	\$4,711	\$5,053	\$5,239	\$5,483	\$5,639	\$4,076



97" W, Four seat, fully upholstered arm panels 176 lbs | 9.5 yds

Model	Series 2	Series 3	Series 4	Series 5	Series 6	Series 7	Series 8	COM
AS35-4	\$4,500	\$4,650	\$5,303	\$5,654	\$5,844	\$6,095	\$6,256	\$4,650



87" W, Four seat with intervening arms and legs, fully upholstered arm panels 170 lbs | 10.25 yds

Model	Series 2	Series 3	Series 4	Series 5	Series 6	Series 7	Series 8	COM
A30-4	\$4,254	\$4,416	\$5,120	\$5,499	\$5,705	\$5,975	\$6,148	\$4,416

Auburn Multiple Seating

Lounge Seating

Multiple & Tandem Seating

Side, Stacking & Folding Chairs

Occasional Tables



97" W, Four seat with intervening arms and legs, fully upholstered arm panels										190 lbs 10.5 yds
Model	Series 2	Series 3	Series 4	Series 5	Series 6	Series 7	Series 8	COM		
A35-4	\$4,863	\$5,029	\$5,750	\$6,138	\$6,349	\$6,626	\$6,804	\$5,029		



79.5" W, Two seat with Settee, fully upholstered arm panels										148 lbs 9 yds
Model	Series 2	Series 3	Series 4	Series 5	Series 6	Series 7	Series 8	COM		
AS30-4-2CH-LS	\$4,151	\$4,293	\$4,911	\$5,244	\$5,424	\$5,662	\$5,814	\$4,293		



97" W, Two seat with Settee, fully upholstered arm panels										168 lbs 9.25 yds
Model	Series 2	Series 3	Series 4	Series 5	Series 6	Series 7	Series 8	COM		
AS35-4-2CH-LS	\$4,720	\$4,866	\$5,501	\$5,843	\$6,029	\$6,273	\$6,429	\$4,866		



108" W, Five seat with intervening arms and legs, fully upholstered arm panels										208 lbs 12.25 yds
Model	Series 2	Series 3	Series 4	Series 5	Series 6	Series 7	Series 8	COM		
A30-5	\$5,244	\$5,438	\$6,279	\$6,732	\$6,978	\$7,301	\$7,508	\$5,438		



120.5" W, Five seat with intervening arms and legs, fully upholstered arm panels										233 lbs 12.5 yds
Model	Series 2	Series 3	Series 4	Series 5	Series 6	Series 7	Series 8	COM		
A35-5	\$6,003	\$6,200	\$7,058	\$7,520	\$7,771	\$8,101	\$8,312	\$6,200		



60" W, Chair and Settee with spanner table, fully upholstered arm panels										150 lbs 7 yds
Model	Series 2	Series 3	Series 4	Series 5	Series 6	Series 7	Series 8	COM		
AS30-4-CH-IT-LS	\$4,282	\$4,392	\$4,873	\$5,132	\$5,272	\$5,457	\$5,575	\$4,392		



97" W, Chair and Settee with spanner table, fully upholstered arm panels										165 lbs 7.25 yds
Model	Series 2	Series 3	Series 4	Series 5	Series 6	Series 7	Series 8	COM		
AS35-4-CH-IT-LS	\$4,866	\$4,980	\$5,478	\$5,746	\$5,892	\$6,083	\$6,205	\$4,980		



87" W, Three seat with spanner table, fully upholstered arm panels										167 lbs 7.75 yds
Model	Series 2	Series 3	Series 4	Series 5	Series 6	Series 7	Series 8	COM		
AS30-4-IT	\$4,041	\$4,163	\$4,695	\$4,982	\$5,137	\$5,342	\$5,473	\$4,163		



97" W, Three seat with spanner table, fully upholstered arm panels										182 lbs 8 yds
Model	Series 2	Series 3	Series 4	Series 5	Series 6	Series 7	Series 8	COM		
AS35-4-IT	\$4,617	\$4,743	\$5,293	\$5,588	\$5,749	\$5,960	\$6,095	\$4,743		

Auburn Multiple Seating

Auburn Spanner Tables

Specification Decisions

- Select standard wood finish
- Select standard laminate
- Specify table attachment (LSF, RSF)

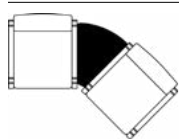

45-degree-radius corner table

18 lbs

Model	Price	Depth	Height
ARCT45-10	\$812	18.75"	14.75"

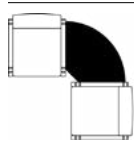

90-degree-radius corner table

21 lbs

Model	Price	Depth	Height
ARCT-10	\$812	18.75"	14.75"



21.75" W, Spanner end table

15 lbs

Model	Price	Depth	Height
AET-10	\$1,128	20.5"	14.75"



19.5" W, Spanner table

18 lbs

Model	Price	Depth	Height
AIT-10	\$521	18.75"	14.75"

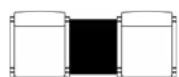

22" W, Spanner table

18 lbs

Model	Price	Depth	Height
AIT-15	\$521	18.75"	14.75"

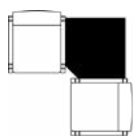

28" W, Spanner corner table

28 lbs

Model	Price	Depth	Height
ASCT-10	\$763	18.75"	14.75"
ASCT-30	\$812	18.75"	16"

Auburn Multiple Seating

Lounge Seating

Multiple & Tandem Seating

Side, Stacking & Folding Chairs

Occasional Tables

Auburn Benches

Features and Options

Same standard features as Auburn Multiple Seating

Key Dimensions

- Overall Width: See price table
- Overall Height: 18"
- Overall Depth: 20.5"

										53 lbs 1.75 yds
	44" W, Bench	Model	Series 2	Series 3	Series 4	Series 5	Series 6	Series 7	Series 8	COM
	A10B/44		\$1,709	\$1,736	\$1,857	\$1,921	\$1,956	\$2,003	\$2,032	\$1,736
										58 lbs 2 yds
	49" W, Bench	Model	Series 2	Series 3	Series 4	Series 5	Series 6	Series 7	Series 8	COM
	A15B/55		\$1,800	\$1,832	\$1,969	\$2,043	\$2,083	\$2,136	\$2,170	\$1,832
										73 lbs 2.5 yds
	66" W, Bench	Model	Series 2	Series 3	Series 4	Series 5	Series 6	Series 7	Series 8	COM
	A10B/66		\$2,448	\$2,487	\$2,659	\$2,751	\$2,802	\$2,868	\$2,910	\$2,487
										80 lbs 2.75 yds
	73" W, Bench	Model	Series 2	Series 3	Series 4	Series 5	Series 6	Series 7	Series 8	COM
	A15B/73		\$2,793	\$2,836	\$3,024	\$3,126	\$3,181	\$3,254	\$3,300	\$2,836
										57 lbs 3.25 yds
	44" W, Bench, fully upholstered side panels	Model	Series 2	Series 3	Series 4	Series 5	Series 6	Series 7	Series 8	COM
	AS30B/44		\$1,853	\$1,904	\$2,128	\$2,248	\$2,313	\$2,399	\$2,454	\$1,904
										79 lbs 4.25 yds
	66" W, Bench, fully upholstered side panels	Model	Series 2	Series 3	Series 4	Series 5	Series 6	Series 7	Series 8	COM
	AS30B/66		\$2,548	\$2,615	\$2,907	\$3,064	\$3,150	\$3,262	\$3,334	\$2,615
										59 lbs 3.75 yds
	49" W, Bench, fully upholstered side panels	Model	Series 2	Series 3	Series 4	Series 5	Series 6	Series 7	Series 8	COM
	AS35B/49		\$2,108	\$2,167	\$2,425	\$2,563	\$2,639	\$2,738	\$2,801	\$2,167
										81 lbs 4.75 yds
	73" W, Bench, fully upholstered side panels	Model	Series 2	Series 3	Series 4	Series 5	Series 6	Series 7	Series 8	COM
	AS35B/73		\$2,906	\$2,981	\$3,308	\$3,483	\$3,578	\$3,704	\$3,784	\$2,981

Brava 862 Multiple Seating



Standard Features

- Solid maple frame
- Mortise and tenon joinery
- Spring seat construction
- Clean-out design
- Replaceable components
- Removable covers (862C-OB30, 862C-OB40)
- Upholstered arms
- Wallsaver legs
- Non-marring 7/8" rubber-cushioned glides
- Nemschoff healthcare wood finish
- GREENGUARD Gold Certified
- Limited Lifetime Warranty
- See nemschoff.com for weight ratings (862C-OB30, 862C-OB40)

Available Options

- Moisture barrier + \$67 per seat or back
- Black urethane arm caps + \$113
- Desert or Pewter urethane arm caps + \$205
- Wood arm caps + \$113
- CTB-133 + \$81/yd
- Two fabrics + \$62
- Three (or more) fabrics + \$88

Specification Decisions

- Select fabric
 - Select standard wood finish
 - Add moisture barrier
 - Add CTB-133
 - Apply multiple fabrics
 - Add urethane or wood arm caps
- Model numbers with **S** indicate standard seat and back covers, and model numbers with **P** indicate removable covers.

Flammability Type

- Type 6

Coordinating Products

- [Brava Classic Lounge Seating](#)
- [Brava Platform Lounge Seating](#)
- [Brava 863 Multiple Seating](#)
- [Brava Side Chair](#)
- [Brava Tables](#)
- [Brava Adjustable Back Chair](#)
- [Brava CompactComfort Recliner](#)
- [Brava Patient Chair](#)
- [Brava Glider](#)
- [Brava Flop Sofa](#)
- [Brava Sleep Settee](#)

Key Dimensions

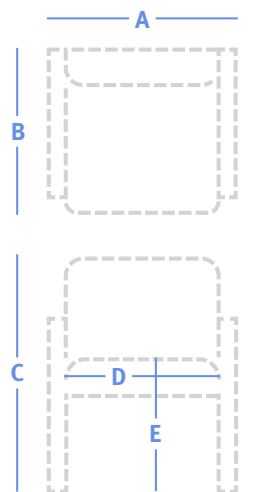

A	Overall Width	See price table
B	Overall Depth	26", 25.75" (OB30, OB40)
C	Overall Height	32" or 42.5"
D	Seat Width	Chair: 21.75", 29.25", 39.25" Two Seat: 43", 43.5" Three Seat: 64.25", 65.25"
E	Seat Height	18.75", 19.25" (OB30, OB40)
F	Arm Height	26.5"

More Information

- Illustrated Glossary ▶ 439
- Fabrics ▶ 451
- Flammability (CTB-133) ▶ 459
- Finishes ▶ 456
- Ordering and Warranties ▶ 462

Brava 862 Multiple Seating

	26.5" W, Chair 34 lbs 3 yds								
	Model	Series 2	Series 3	Series 4	Series 5	Series 6	Series 7	Series 8	COM
	862-10C S	\$1,937	\$2,032	\$2,191	\$2,357	\$2,555	\$2,754	\$3,004	\$2,032
	862-10C P	\$2,181	\$2,276	\$2,435	\$2,601	\$2,799	\$2,998	\$3,248	\$2,276
	34.75" W, Plus chair 46 lbs 3.75 yds								
	Model	Series 2	Series 3	Series 4	Series 5	Series 6	Series 7	Series 8	COM
	862C-OB30	\$4,270	\$4,389	\$4,588	\$4,795	\$5,042	\$5,292	\$5,603	\$4,389
	44.75" W, Plus chair 51 lbs 3.75 yds								
	Model	Series 2	Series 3	Series 4	Series 5	Series 6	Series 7	Series 8	COM
	862C-OB40	\$4,918	\$5,037	\$5,236	\$5,443	\$5,690	\$5,940	\$6,251	\$5,037
	47.75" W, Two seat 64 lbs 4.5 yds								
	Model	Series 2	Series 3	Series 4	Series 5	Series 6	Series 7	Series 8	COM
	862-20C S	\$3,207	\$3,350	\$3,589	\$3,838	\$4,134	\$4,433	\$4,807	\$3,350
	862-20C P	\$3,609	\$3,752	\$3,991	\$4,240	\$4,536	\$4,835	\$5,209	\$3,752
	50.25" W, Two seat with intervening arm and leg 71 lbs 5 yds								
	Model	Series 2	Series 3	Series 4	Series 5	Series 6	Series 7	Series 8	COM
	862-22C S	\$3,588	\$3,747	\$4,012	\$4,289	\$4,618	\$4,950	\$5,366	\$3,747
	862-22C P	\$4,038	\$4,197	\$4,462	\$4,739	\$5,068	\$5,400	\$5,816	\$4,197
	26.5" W, High back chair 35 lbs 3.25 yds								
	Model	Series 2	Series 3	Series 4	Series 5	Series 6	Series 7	Series 8	COM
	862-10H S	\$2,200	\$2,303	\$2,475	\$2,655	\$2,869	\$3,085	\$3,356	\$2,303
	862-10H P	\$2,477	\$2,580	\$2,752	\$2,932	\$3,146	\$3,362	\$3,633	\$2,580
	47.75" W, High back two seat 65 lbs 4.75 yds								
	Model	Series 2	Series 3	Series 4	Series 5	Series 6	Series 7	Series 8	COM
	862-20H S	\$3,470	\$3,621	\$3,873	\$4,136	\$4,448	\$4,764	\$5,159	\$3,621
	862-20H P	\$3,905	\$4,056	\$4,308	\$4,571	\$4,883	\$5,199	\$5,594	\$4,056
	50.25" W, High back two seat with intervening arm and leg 72 lbs 5.75 yds								
	Model	Series 2	Series 3	Series 4	Series 5	Series 6	Series 7	Series 8	COM
	862-22H S	\$3,833	\$4,016	\$4,321	\$4,639	\$5,017	\$5,400	\$5,878	\$4,016
	862-22H P	\$4,315	\$4,498	\$4,803	\$5,121	\$5,499	\$5,882	\$6,360	\$4,498
	69" W, Three seat 93 lbs 6 yds								
	Model	Series 2	Series 3	Series 4	Series 5	Series 6	Series 7	Series 8	COM
	862-30C S	\$4,413	\$4,604	\$4,922	\$5,254	\$5,649	\$6,048	\$6,547	\$4,604
	862-30C P	\$4,966	\$5,157	\$5,475	\$5,807	\$6,202	\$6,601	\$7,100	\$5,157
	74" W, Three seat with intervening arms and legs 106 lbs 7.25 yds								
	Model	Series 2	Series 3	Series 4	Series 5	Series 6	Series 7	Series 8	COM
	862-33C S	\$5,164	\$5,395	\$5,779	\$6,180	\$6,657	\$7,139	\$7,742	\$5,395
	862-33C P	\$5,812	\$6,043	\$6,427	\$6,828	\$7,305	\$7,787	\$8,390	\$6,043

Brava 862 Multiple Seating



69" W, High back three seat

94 lbs | 7 yds

Model	Series 2	Series 3	Series 4	Series 5	Series 6	Series 7	Series 8	COM
862-30H S	\$4,651	\$4,874	\$5,245	\$5,632	\$6,093	\$6,558	\$7,140	\$4,874
862-30H P	\$5,236	\$5,459	\$5,830	\$6,217	\$6,678	\$7,143	\$7,725	\$5,459



74" W, High back three seat with intervening arms and legs

107 lbs | 8.25 yds

Model	Series 2	Series 3	Series 4	Series 5	Series 6	Series 7	Series 8	COM
862-33H S	\$5,402	\$5,665	\$6,102	\$6,558	\$7,102	\$7,650	\$8,336	\$5,665
862-33H P	\$6,082	\$6,345	\$6,782	\$7,238	\$7,782	\$8,330	\$9,016	\$6,345

Brava 863 Multiple Seating



More Information

- Illustrated Glossary ▶ 439
- Fabrics ▶ 451
- Flammability (CTB-133) ▶ 459
- Finishes ▶ 456
- Ordering and Warranties ▶ 462

Standard Features

- Solid maple frame
- Mortise and tenon joinery
- Spring seat construction
- Replaceable components
- Removable covers (863C-OB30, 863C-OB40)
- Clean-out design
- Wood arms
- Wallsaver legs
- Non-marring 7/8" rubber-cushioned glides
- Nemschoff healthcare wood finish
- GREENGUARD Gold Certified
- Limited Lifetime Warranty
- See nemschoff.com for weight ratings (862C-OB30, 862C-OB40)

Available Options

- Moisture barrier + \$67 per seat or back
- Black urethane arm caps + \$113
- Desert or Pewter urethane arm caps + \$205
- CTB-133 + \$81/yd
- Two fabrics + \$62
- Three (or more) fabrics + \$88

Specification Decisions

- Select fabric
- Select standard wood finish
- Add moisture barrier
- Add CTB-133
- Apply multiple fabrics
- Add urethane arm caps

Model numbers with **S** indicate standard seat and back covers, and model numbers with **P** indicate removable covers.

Flammability Types

- Type 4
- Type 5 (High back)

Coordinating Products

- [Brava Classic Lounge Seating](#)
- [Brava Platform Lounge Seating](#)
- [Brava 862 Multiple Seating](#)
- [Brava Side Chair](#)
- [Brava Tables](#)
- [Brava Adjustable Back Chair](#)
- [Brava CompactComfort Recliner](#)
- [Brava Patient Chair](#)
- [Brava Glider](#)
- [Brava Flop Sofa](#)
- [Brava Sleep Settee](#)

Key Dimensions

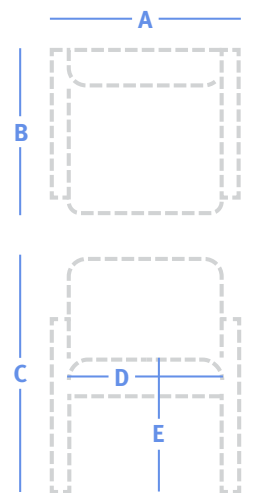



A	Overall Width	See price table
B	Overall Depth	26", 25.75" (OB30, OB40)
C	Overall Height	32" or 42.5"
D	Seat Width	
	Chair:	21.75", 30", 40"
	Two Seat:	43", 43.5"
	Three Seat:	64.5", 65.25"
E	Seat Height	18.75", 19.25" (OB30, OB40)
F	Arm Height	26.5"

Brava 863 Multiple Seating

	25.75" W, Chair 33 lbs 1.75 yds								
	Model	Series 2	Series 3	Series 4	Series 5	Series 6	Series 7	Series 8	COM
	863-10C S	\$1,778	\$1,833	\$1,926	\$2,023	\$2,138	\$2,254	\$2,400	\$1,833
	863-10C P	\$1,998	\$2,053	\$2,146	\$2,243	\$2,358	\$2,474	\$2,620	\$2,053

	34" W, Plus chair 46 lbs 2.75 yds								
	Model	Series 2	Series 3	Series 4	Series 5	Series 6	Series 7	Series 8	COM
	863C-OB30	\$3,875	\$3,962	\$4,108	\$4,260	\$4,441	\$4,624	\$4,853	\$3,962

	44" W, Plus chair 51 lbs 2.75 yds								
	Model	Series 2	Series 3	Series 4	Series 5	Series 6	Series 7	Series 8	COM
	863C-OB40	\$4,462	\$4,549	\$4,695	\$4,847	\$5,028	\$5,211	\$5,440	\$4,549

	47" W, Two seat 63 lbs 3.25 yds								
	Model	Series 2	Series 3	Series 4	Series 5	Series 6	Series 7	Series 8	COM
	863-20C S	\$3,050	\$3,153	\$3,325	\$3,505	\$3,719	\$3,935	\$4,206	\$3,153
	863-20C P	\$3,429	\$3,532	\$3,704	\$3,884	\$4,098	\$4,314	\$4,585	\$3,532

	49.5" W, Two seat with intervening arm and leg 69 lbs 3.25 yds								
	Model	Series 2	Series 3	Series 4	Series 5	Series 6	Series 7	Series 8	COM
	863-22C S	\$3,446	\$3,549	\$3,721	\$3,901	\$4,115	\$4,331	\$4,602	\$3,549
	863-22C P	\$3,872	\$3,975	\$4,147	\$4,327	\$4,541	\$4,757	\$5,028	\$3,975

	25.75" W, High back chair 34 lbs 2 yds								
	Model	Series 2	Series 3	Series 4	Series 5	Series 6	Series 7	Series 8	COM
	863-10H S	\$2,041	\$2,104	\$2,210	\$2,321	\$2,453	\$2,586	\$2,752	\$2,104
	863-10H P	\$2,294	\$2,357	\$2,463	\$2,574	\$2,706	\$2,839	\$3,005	\$2,357

	47" W, High back two seat 64 lbs 4 yds								
	Model	Series 2	Series 3	Series 4	Series 5	Series 6	Series 7	Series 8	COM
	863-20H S	\$3,296	\$3,423	\$3,635	\$3,856	\$4,120	\$4,386	\$4,718	\$3,423
	863-20H P	\$3,707	\$3,834	\$4,046	\$4,267	\$4,531	\$4,797	\$5,129	\$3,834

	49.5" W, High back two seat with intervening arm and leg 70 lbs 4 yds								
	Model	Series 2	Series 3	Series 4	Series 5	Series 6	Series 7	Series 8	COM
	863-22H S	\$3,693	\$3,820	\$4,032	\$4,253	\$4,517	\$4,783	\$5,115	\$3,820
	863-22H P	\$4,152	\$4,279	\$4,491	\$4,712	\$4,976	\$5,242	\$5,574	\$4,279

	68.25" W, Three seat 91 lbs 5 yds								
	Model	Series 2	Series 3	Series 4	Series 5	Series 6	Series 7	Series 8	COM
	863-30C S	\$4,247	\$4,406	\$4,671	\$4,948	\$5,277	\$5,609	\$6,025	\$4,406
	863-30C P	\$4,776	\$4,935	\$5,200	\$5,477	\$5,806	\$6,138	\$6,554	\$4,935

	73.25" W, Three seat with intervening arms and legs 103 lbs 5 yds								
	Model	Series 2	Series 3	Series 4	Series 5	Series 6	Series 7	Series 8	COM
	863-33C S	\$5,038	\$5,197	\$5,462	\$5,739	\$6,068	\$6,400	\$6,816	\$5,197
	863-33C P	\$5,662	\$5,821	\$6,086	\$6,363	\$6,692	\$7,024	\$7,440	\$5,821

Brava 863 Multiple Seating



68.25" W, High back three seat

92 lbs | 6 yds

Model	Series 2	Series 3	Series 4	Series 5	Series 6	Series 7	Series 8	COM
863-30H S	\$4,485	\$4,676	\$4,994	\$5,326	\$5,721	\$6,120	\$6,619	\$4,676
863-30H P	\$5,047	\$5,238	\$5,556	\$5,888	\$6,283	\$6,682	\$7,181	\$5,238

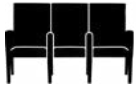

73.25" W, High back three seat with intervening arms and legs

104 lbs | 6 yds

Model	Series 2	Series 3	Series 4	Series 5	Series 6	Series 7	Series 8	COM
863-33H S	\$5,277	\$5,468	\$5,786	\$6,118	\$6,513	\$6,912	\$7,411	\$5,468
863-33H P	\$5,934	\$6,125	\$6,443	\$6,775	\$7,170	\$7,569	\$8,068	\$6,125

Lounge Seating

Multiple & Tandem Seating

Side, Stacking & Folding Chairs

Occasional Tables

Capella Multiple Seating



Standard Features

- Solid maple frame
- Mortise and tenon joinery
- Spring seat construction
- Replaceable components
- Upholstered arms
- Non-marring 7/8" rubber-cushioned glides
- Nemschoff healthcare wood finish
- GREENGUARD Gold Certified
- Limited Lifetime Warranty

Available Options

- Moisture barrier + \$67 per seat or back
- CTB-133 + \$81/yd
- Two fabrics + \$62
- Three (or more) fabrics + \$88

Specification Decisions

- Select fabric
- Select standard wood finish
- Add moisture barrier
- Add CTB-133
- Apply multiple fabrics

Model numbers with **S** indicate standard seat and back covers, and model numbers with **P** indicate removable covers.

Flammability Type

- Type 6

Coordinating Products

- [Auburn Benches](#)
- [Capella Tables](#)
- [Capella Patient Chair](#)
- [Capella Adjustable Back Chair](#)
- [Capella CompactComfort Recliner](#)
- [Capella Glider](#)
- [Capella Adjustable Back Glider](#)

Key Dimensions

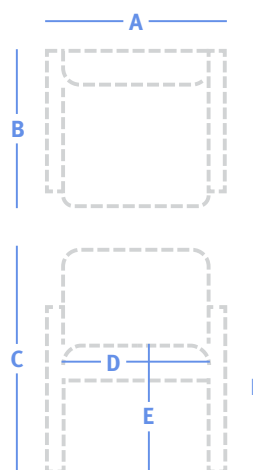

A	Overall Width	See price table
B	Overall Depth	24.25"
C	Overall Height	34.75"
D	Seat Width	
	Chair:	20"
	Settee:	20", 40.5"
	Sofa:	20", 61.5"
E	Seat Height	18.75"
F	Arm Height	25"

More Information

Illustrated Glossary ▶ 439

Fabrics ▶ 451

Flammability (CTB-133) ▶ 459

Finishes ▶ 456

Ordering and Warranties ▶ 462

Capella Multiple Seating

	25" W, Chair									24 lbs 2.5 yds
	Model	Series 2	Series 3	Series 4	Series 5	Series 6	Series 7	Series 8	COM	
	740-10 S	\$1,500	\$1,579	\$1,712	\$1,850	\$2,015	\$2,181	\$2,389	\$1,579	
	740-10 P	\$1,690	\$1,769	\$1,902	\$2,040	\$2,205	\$2,371	\$2,579	\$1,769	
	46" W, Two seat									38 lbs 3.75 yds
	Model	Series 2	Series 3	Series 4	Series 5	Series 6	Series 7	Series 8	COM	
	740-20 S	\$2,414	\$2,533	\$2,732	\$2,939	\$3,186	\$3,436	\$3,747	\$2,533	
	740-20 P	\$2,718	\$2,837	\$3,036	\$3,243	\$3,490	\$3,740	\$4,051	\$2,837	
	46.75" W, Two seat with intervening arm and leg									42 lbs 4.25 yds
	Model	Series 2	Series 3	Series 4	Series 5	Series 6	Series 7	Series 8	COM	
	740-22 S	\$2,878	\$3,013	\$3,238	\$3,474	\$3,753	\$4,036	\$4,389	\$3,013	
	740-22 P	\$3,240	\$3,375	\$3,600	\$3,836	\$4,115	\$4,398	\$4,751	\$3,375	
	66.75" W, Three seat									52 lbs 5.5 yds
	Model	Series 2	Series 3	Series 4	Series 5	Series 6	Series 7	Series 8	COM	
	740-30 S	\$3,197	\$3,372	\$3,663	\$3,968	\$4,330	\$4,695	\$5,153	\$3,372	
	740-30 P	\$3,602	\$3,777	\$4,068	\$4,373	\$4,735	\$5,100	\$5,558	\$3,777	
	68.25" W, Three seat with intervening arms and legs									62 lbs 6 yds
	Model	Series 2	Series 3	Series 4	Series 5	Series 6	Series 7	Series 8	COM	
	740-33 S	\$4,061	\$4,252	\$4,570	\$4,902	\$5,297	\$5,696	\$6,195	\$4,252	
	740-33 P	\$4,572	\$4,763	\$5,081	\$5,413	\$5,808	\$6,207	\$6,706	\$4,763	

Capella Bench

Standard Features

Same standard features as Capella Multiple Seating

Available Options

Same available options as Capella Multiple Seating

Key Dimensions

- Overall Width: See price table
- Overall Depth: 21.75"
- Overall Height: 24.25"
- Seat Height: 19.25"

	46.25" W, Bench									39 lbs 2 yds
	Model	Series 2	Series 3	Series 4	Series 5	Series 6	Series 7	Series 8	COM	
	740-B2 S	\$1,581	\$1,644	\$1,750	\$1,861	\$1,993	\$2,126	\$2,292	\$1,644	
	740-B2 P	\$1,779	\$1,842	\$1,948	\$2,059	\$2,191	\$2,324	\$2,490	\$1,842	

Horizon Multiple Seating



Standard Features

- Solid hardwood frame
- Wipe-out design
- Replaceable components
- Wood arms
- Non-marring 3/4" glides
- Nemschoff healthcare wood finish
- GREENGUARD Gold Certified
- Limited Lifetime Warranty
- See nemschoff.com for weight ratings (H18, H38)

• Available Options

- Moisture barrier + \$67 per seat or back
- Panel arms + \$134
- Black urethane arm caps + \$113
- Removable covers + \$170 per Chair seat and back, \$339 per Settee seat and back
- CTB-133 + \$81/yd
- Two fabrics + \$62
- Three (or more) fabrics + \$88

Specification Decisions

- Select fabric
- Select standard wood finish
- Add moisture barrier
- Add CTB-133
- Apply multiple fabrics
- Add attached table (LSF, RSF)
- Add removable covers
- Add urethane arm caps
- Add panel arms

Flammability Type

- Type 4
- Type 8 (with panel arms)

Coordinating Products

- [Horizon Tables](#)
- [Horizon Recliner](#)
- [Horizon Patient Chair](#)

Key Dimensions

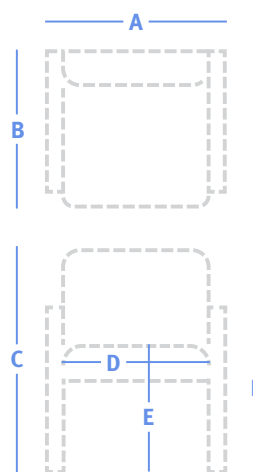

A	Overall Width	See price table
B	Overall Depth	25"
C	Overall Height	31.5"
D	Seat Width	
	Chair:	19.5", 22", 30"
	Two Seat	39", 44"
	Three Seat:	58.5", 66"
E	Seat Height	18", 17.5" (H18, H38)
F	Arm Height	25"

More Information

- Illustrated Glossary ▶ 439
- Fabrics ▶ 451
- Flammability (CTB-133) ▶ 459
- Finishes ▶ 456
- Ordering and Warranties ▶ 462

Horizon Multiple Seating

Lounge Seating

Multiple & Tandem Seating

Side, Stacking & Folding Chairs

Occasional Tables

	23" W, Chair									26 lbs 1.75 yds
	Model	Series 2	Series 3	Series 4	Series 5	Series 6	Series 7	Series 8	COM	
	723	\$1,032	\$1,059	\$1,180	\$1,244	\$1,279	\$1,326	\$1,355	\$1,059	
	25.5" W, Chair									27 lbs 2 yds
	Model	Series 2	Series 3	Series 4	Series 5	Series 6	Series 7	Series 8	COM	
	823	\$1,164	\$1,195	\$1,333	\$1,407	\$1,447	\$1,500	\$1,533	\$1,195	
	33.5" W, Plus chair with open arms									43 lbs 2.5 yds
	Model	Series 2	Series 3	Series 4	Series 5	Series 6	Series 7	Series 8	COM	
	H18	\$1,747	\$1,786	\$1,958	\$2,050	\$2,101	\$2,167	\$2,209	\$1,786	
	36.5" W, Plus chair with upholstered arms									86 lbs 4 yds
	Model	Series 2	Series 3	Series 4	Series 5	Series 6	Series 7	Series 8	COM	
	H38	\$1,861	\$1,924	\$2,199	\$2,347	\$2,427	\$2,533	\$2,600	\$1,924	
	39" W, Two seat									56 lbs 2.75 yds
	Model	Series 2	Series 3	Series 4	Series 5	Series 6	Series 7	Series 8	COM	
	722-2	\$2,058	\$2,101	\$2,290	\$2,392	\$2,447	\$2,520	\$2,566	\$2,101	
	49" W, Two seat									58 lbs 3.25 yds
	Model	Series 2	Series 3	Series 4	Series 5	Series 6	Series 7	Series 8	COM	
	822-2	\$2,224	\$2,275	\$2,499	\$2,619	\$2,684	\$2,770	\$2,825	\$2,275	
	44" W, Two seat with intervening arm and leg									46 lbs 2.75 yds
	Model	Series 2	Series 3	Series 4	Series 5	Series 6	Series 7	Series 8	COM	
	723-2	\$1,806	\$1,849	\$2,038	\$2,140	\$2,195	\$2,268	\$2,314	\$1,849	
	49" W, Two seat with intervening arm and leg									48 lbs 3.25 yds
	Model	Series 2	Series 3	Series 4	Series 5	Series 6	Series 7	Series 8	COM	
	823-2	\$2,037	\$2,088	\$2,312	\$2,432	\$2,497	\$2,583	\$2,638	\$2,088	
	44" W, Settee									50 lbs 3 yds
	Model	Series 2	Series 3	Series 4	Series 5	Series 6	Series 7	Series 8	COM	
	722-2-LS	\$1,847	\$1,894	\$2,100	\$2,211	\$2,271	\$2,351	\$2,401	\$1,894	
	49" W, Settee									52 lbs 3.5 yds
	Model	Series 2	Series 3	Series 4	Series 5	Series 6	Series 7	Series 8	COM	
	822-2-LS	\$2,623	\$2,678	\$2,919	\$3,048	\$3,118	\$3,211	\$3,270	\$2,678	

Horizon Multiple Seating



66" W, Three seat

76 lbs | 3.75 yds

Model	Series 2	Series 3	Series 4	Series 5	Series 6	Series 7	Series 8	COM
722-3	\$2,794	\$2,853	\$3,111	\$3,249	\$3,325	\$3,424	\$3,487	\$2,853



73" W, Three seat

79 lbs | 4.25 yds

Model	Series 2	Series 3	Series 4	Series 5	Series 6	Series 7	Series 8	COM
822-3	\$3,185	\$3,252	\$3,544	\$3,701	\$3,787	\$3,899	\$3,971	\$3,252



66" W, Three seat with intervening arms and legs

66 lbs | 3.75 yds

Model	Series 2	Series 3	Series 4	Series 5	Series 6	Series 7	Series 8	COM
723-3	\$2,583	\$2,642	\$2,900	\$3,038	\$3,114	\$3,213	\$3,276	\$2,642



73" W, Three seat with intervening arms and legs

69 lbs | 4.25 yds

Model	Series 2	Series 3	Series 4	Series 5	Series 6	Series 7	Series 8	COM
823-3	\$2,917	\$2,984	\$3,276	\$3,433	\$3,519	\$3,631	\$3,703	\$2,984



66" W, Chair with Settee

73 lbs | 4 yds

Model	Series 2	Series 3	Series 4	Series 5	Series 6	Series 7	Series 8	COM
722-3-CH-LS	\$2,955	\$3,018	\$3,293	\$3,441	\$3,521	\$3,627	\$3,694	\$3,018



73" W, Chair with Settee

76 lbs | 4.5 yds

Model	Series 2	Series 3	Series 4	Series 5	Series 6	Series 7	Series 8	COM
822-3-CH-LS	\$3,348	\$3,419	\$3,728	\$3,895	\$3,985	\$4,104	\$4,180	\$3,419



66" W, Two seat with spanner table

76 lbs | 2.75 yds

Model	Series 2	Series 3	Series 4	Series 5	Series 6	Series 7	Series 8	COM
722-3-IT	\$2,889	\$2,932	\$3,121	\$3,223	\$3,278	\$3,351	\$3,397	\$2,932



73" W, Two seat with spanner table

79 lbs | 3.25 yds

Model	Series 2	Series 3	Series 4	Series 5	Series 6	Series 7	Series 8	COM
822-3-IT	\$3,289	\$3,340	\$3,564	\$3,684	\$3,749	\$3,835	\$3,890	\$3,340



87" W, Four seat

96 lbs | 4.75 yds

Model	Series 2	Series 3	Series 4	Series 5	Series 6	Series 7	Series 8	COM
722-4	\$3,631	\$3,706	\$4,033	\$4,208	\$4,303	\$4,429	\$4,509	\$3,706



97" W, Four seat

100 lbs | 5.5 yds

Model	Series 2	Series 3	Series 4	Series 5	Series 6	Series 7	Series 8	COM
822-4	\$4,136	\$4,223	\$4,601	\$4,804	\$4,915	\$5,060	\$5,153	\$4,223

Horizon Multiple Seating

Lounge Seating

Multiple & Tandem Seating

Side, Stacking & Folding Chairs

Occasional Tables

	87" W, Four seat with intervening arms and legs									86 lbs 4.75 yds
Model	Series 2	Series 3	Series 4	Series 5	Series 6	Series 7	Series 8	COM		
723-4	\$3,356	\$3,431	\$3,758	\$3,933	\$4,028	\$4,154	\$4,234	\$3,431		

	97" W, Four seat with intervening arms and legs									90 lbs 5.5 yds
Model	Series 2	Series 3	Series 4	Series 5	Series 6	Series 7	Series 8	COM		
823-4	\$3,791	\$3,878	\$4,256	\$4,459	\$4,570	\$4,715	\$4,808	\$3,878		

	87" W, Chair and Settee with spanner table									93 lbs 4 yds
Model	Series 2	Series 3	Series 4	Series 5	Series 6	Series 7	Series 8	COM		
722-4-CH-IT-LS	\$3,791	\$3,854	\$4,129	\$4,277	\$4,357	\$4,463	\$4,530	\$3,854		

	97" W, Chair and Settee with spanner table									97 lbs 4.5 yds
Model	Series 2	Series 3	Series 4	Series 5	Series 6	Series 7	Series 8	COM		
822-4-CH-IT-LS	\$4,301	\$4,372	\$4,681	\$4,848	\$4,938	\$5,057	\$5,133	\$4,372		

	87" W, Three seat with spanner table									96 lbs 3.75 yds
Model	Series 2	Series 3	Series 4	Series 5	Series 6	Series 7	Series 8	COM		
722-4-IT	\$3,623	\$3,682	\$3,940	\$4,078	\$4,154	\$4,253	\$4,316	\$3,682		

	97" W, Three seat with spanner table									100 lbs 4.25 yds
Model	Series 2	Series 3	Series 4	Series 5	Series 6	Series 7	Series 8	COM		
822-4-IT	\$4,132	\$4,199	\$4,491	\$4,648	\$4,734	\$4,846	\$4,918	\$4,199		

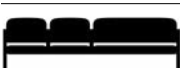
	87" W, Two seat with Settee									93 lbs 5 yds
Model	Series 2	Series 3	Series 4	Series 5	Series 6	Series 7	Series 8	COM		
722-4-2CH-LS	\$3,697	\$3,776	\$4,120	\$4,304	\$4,405	\$4,537	\$4,621	\$3,776		

	97" W, Two seat with Settee									97 lbs 5.75 yds
Model	Series 2	Series 3	Series 4	Series 5	Series 6	Series 7	Series 8	COM		
822-4-2CH-LS	\$4,185	\$4,276	\$4,671	\$4,884	\$4,999	\$5,151	\$5,248	\$4,276		

	108" W, Five seat with intervening arms and legs									106 lbs 5.75 yds
Model	Series 2	Series 3	Series 4	Series 5	Series 6	Series 7	Series 8	COM		
723-5	\$4,131	\$4,222	\$4,617	\$4,830	\$4,945	\$5,097	\$5,194	\$4,222		

	120.5" W, Five seat with intervening arms and legs									111 lbs 6.5 yds
Model	Series 2	Series 3	Series 4	Series 5	Series 6	Series 7	Series 8	COM		
823-5	\$4,671	\$4,773	\$5,220	\$5,460	\$5,590	\$5,762	\$5,872	\$4,773		

Horizon Multiple Seating

Horizon Benches

Standard Features

Same standard features as Horizon Multiple Seating

Available Options

Same available options as Horizon Multiple Seating

Key Dimensions

- Overall Width: See price table
- Overall Depth: 20.5"
- Overall Height: 18"



44" W, Bench

33 lbs | 1.75 yds

Model	Series 2	Series 3	Series 4	Series 5	Series 6	Series 7	Series 8	COM
723B/44	\$1,443	\$1,470	\$1,591	\$1,655	\$1,690	\$1,737	\$1,766	\$1,470



66" W, Bench

45 lbs | 2.5 yds

Model	Series 2	Series 3	Series 4	Series 5	Series 6	Series 7	Series 8	COM
723B/66	\$2,067	\$2,106	\$2,278	\$2,370	\$2,421	\$2,487	\$2,529	\$2,106



49" W, Bench

35 lbs | 2 yds

Model	Series 2	Series 3	Series 4	Series 5	Series 6	Series 7	Series 8	COM
823B/49	\$1,642	\$1,673	\$1,811	\$1,885	\$1,925	\$1,978	\$2,011	\$1,673



73" W, Bench

47 lbs | 2.75 yds

Model	Series 2	Series 3	Series 4	Series 5	Series 6	Series 7	Series 8	COM
823B/73	\$2,357	\$2,400	\$2,589	\$2,691	\$2,746	\$2,819	\$2,865	\$2,400

Horizon Multiple Seating

Lounge Seating

Multiple & Tandem Seating

Side, Stacking & Folding Chairs

Occasional Tables

Horizon Tables

Standard Features

- Wood tops
- Laminate tops (select models)
- Non-marring ¾" glides
- Nemschoff healthcare wood finish
- GREENGUARD Gold Certified
- Limited Lifetime Warranty

Specification Decisions

- Select standard wood finish
- Select table attachment option (LSF, RSF)
- Add standard laminate



21.25" W, Spanner end table

20 lbs

Model	Price	Depth	Height
HET-723	\$966	20.5"	14.75"



23.75" W, Spanner end table

21 lbs

Model	Price	Depth	Height
HET-823	\$1,106	20.5"	14.75"



19.5" W, Spanner table

18 lbs

Model	Price	Depth	Height
HIT-723	\$538	14.75"	18.75"

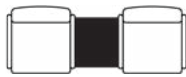

22" W, Spanner table

18 lbs

Model	Price	Depth	Height
HIT-823	\$538	14.75"	18.75"

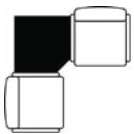

28" W, Spanner corner table

28 lbs

Model	Price	Depth	Height
HSCT-723	\$787	14.75"	18.75"
HRCT-723	\$834	14.75"	18.75"

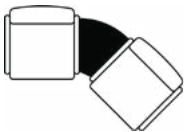

45-degree-radius corner table

18 lbs

Model	Price	Depth	Height
HRCT45-723	\$834	14.75"	18.75"

Marco Multiple Seating



Standard Features

- Solid maple frame
- Mortise and tenon joinery
- Spring seat construction
- Clean-out design
- Replaceable components
- Wood arms
- Wallsaver legs
- Non-marring 7/8" rubber-cushioned glides
- Nemschoff healthcare wood finish
- GREENGUARD Gold Certified
- Limited Lifetime Warranty
- See nemschoff.com for weight ratings (735-OB30, 735-OB40)

Available Options

- Moisture barrier + \$67 per seat or back
- CTB-133 + \$81/yd
- Two fabrics + \$62
- Three (or more) fabrics + \$88

Specification Decisions

- Select fabric
- Select standard wood finish
- Add moisture barrier
- Add CTB-133
- Apply multiple fabrics

Model numbers with **S** indicate standard seat and back covers, and model numbers with **P** indicate removable covers.

Flammability Type

- Type 3
- Type 4 (Plus models)

Coordinating Products

- [Marco Grande Lounge Seating](#)
- [Marco Grande II Lounge Seating](#)
- [Marco Grande Tables](#)
- [Marco Patient Chair](#)
- [Marco Glider](#)

Key Dimensions

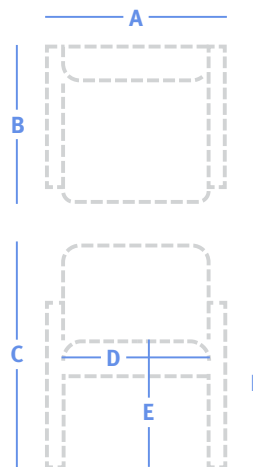

A	Overall Width	See price table
B	Overall Depth	26.5"
C	Overall Height	34.25", 36.5" (OB30, OB40)
D	Seat Width	
	Chair:	20", 30", 40"
	Two Seat:	20", 40"
	Three Seat:	20", 60"
E	Seat Height	18.75", 19.25" (OB30, OB40)
F	Arm Height	25"

More Information

- Illustrated Glossary ▶ 439
- Fabrics ▶ 451
- Flammability (CTB-133) ▶ 459
- Finishes ▶ 456
- Ordering and Warranties ▶ 462

Marco Multiple Seating

Lounge Seating

Multiple & Tandem Seating

Side, Stacking & Folding Chairs

Occasional Tables



23.75" W, Chair

26 lbs | 2.5 yds

Model	Series 2	Series 3	Series 4	Series 5	Series 6	Series 7	Series 8	COM
735-10 S	\$1,230	\$1,309	\$1,442	\$1,580	\$1,745	\$1,911	\$2,119	\$1,309
735-10 P	\$1,388	\$1,467	\$1,600	\$1,738	\$1,903	\$2,069	\$2,277	\$1,467



33.5" W, Plus chair

38 lbs | 3.25 yds

Model	Series 2	Series 3	Series 4	Series 5	Series 6	Series 7	Series 8	COM
735-OB30	\$2,730	\$2,833	\$3,005	\$3,185	\$3,399	\$3,615	\$3,886	\$2,833



43.5" W, Plus chair

43 lbs | 3.5 yds

Model	Series 2	Series 3	Series 4	Series 5	Series 6	Series 7	Series 8	COM
735-OB40	\$3,135	\$3,246	\$3,432	\$3,625	\$3,856	\$4,088	\$4,379	\$3,246



44" W, Two seat

48 lbs | 4.75 yds

Model	Series 2	Series 3	Series 4	Series 5	Series 6	Series 7	Series 8	COM
735-20 S	\$1,950	\$2,101	\$2,353	\$2,616	\$2,928	\$3,244	\$3,639	\$2,101
735-20 P	\$2,203	\$2,354	\$2,606	\$2,869	\$3,181	\$3,497	\$3,892	\$2,354



45.75" W, Two seat with intervening arm

54 lbs | 4.75 yds

Model	Series 2	Series 3	Series 4	Series 5	Series 6	Series 7	Series 8	COM
735-22 S	\$2,348	\$2,499	\$2,751	\$3,014	\$3,326	\$3,642	\$4,037	\$2,499
735-22 P	\$2,648	\$2,799	\$3,051	\$3,314	\$3,626	\$3,942	\$4,337	\$2,799



64" W, Three seat

72 lbs | 7 yds

Model	Series 2	Series 3	Series 4	Series 5	Series 6	Series 7	Series 8	COM
735-30 S	\$2,573	\$2,796	\$3,167	\$3,554	\$4,015	\$4,480	\$5,062	\$2,796
735-30 P	\$2,909	\$3,132	\$3,503	\$3,890	\$4,351	\$4,816	\$5,398	\$3,132



66.5" W, Three seat with intervening arms and legs

80 lbs | 7 yds

Model	Series 2	Series 3	Series 4	Series 5	Series 6	Series 7	Series 8	COM
735-33 S	\$3,385	\$3,608	\$3,979	\$4,366	\$4,827	\$5,292	\$5,874	\$3,608
735-33 P	\$3,818	\$4,041	\$4,412	\$4,799	\$5,260	\$5,725	\$6,307	\$4,041

Mayfield Multiple Seating



Standard Features

- Solid hardwood frame
- Mortise and tenon joinery
- Clean-out design
- Replaceable components
- Wood arm caps
- Arcade back
- Wallsaver legs
- Non-marring 7/8" rubber-cushioned glides
- Nemschoff healthcare wood finish
- GREENGUARD Gold Certified
- Limited Lifetime Warranty
- See nemschoff.com for weight ratings (FX200-OB30, FX200-OB40)

Available Options

- Moisture barrier + \$67 per seat or back
- Black urethane arm caps + \$113
- Square back + \$0
- CTB-133 + \$81/yd
- Two fabrics + \$62
- Three (or more) fabrics + \$88
- Attached tables (LSF or RSF – see price table)

Specification Decisions

- Select fabric
- Select standard wood finish
- Add moisture barrier
- Add CTB-133
- Apply multiple fabrics
- Add attached table
- Add Square back
- Add urethane arm caps

Flammability Type

- Type 3
- Type 4 (Plus models)

Coordinating Products

- [Rockwood Tables](#)

Key Dimensions

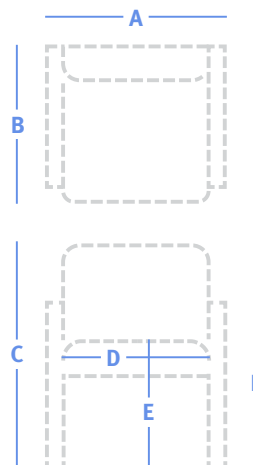

A	Overall Width	See price table
B	Overall Depth	23.75", 25.75" (OB30, OB40)
C	Overall Height	33", 32" (OB30, OB40)
D	Seat Width	Chair: 20.75", 30", 40" Settee: 20.75", 41" Three Seat: 20.75", 63"
E	Seat Height	18.75"
F	Arm Height	24.5"

More Information

- Illustrated Glossary ▶ 439
- Fabrics ▶ 451
- Flammability (CTB-133) ▶ 459
- Finishes ▶ 456
- Ordering and Warranties ▶ 462

Mayfield Multiple Seating

	23.75" W, Chair 23 lbs 1.5 yds
	Model Series 2 Series 3 Series 4 Series 5 Series 6 Series 7 Series 8 COM
	FX200-10 \$838 \$885 \$964 \$1,046 \$1,145 \$1,235 \$1,358 \$885
	34" W, Plus chair 37 lbs 3.5 yds
	Model Series 2 Series 3 Series 4 Series 5 Series 6 Series 7 Series 8 COM
	FX200-OB30 \$1,494 \$1,604 \$1,788 \$1,980 \$2,209 \$2,420 \$2,708 \$1,604
	44" W, Plus chair 42 lbs 3.75 yds
	Model Series 2 Series 3 Series 4 Series 5 Series 6 Series 7 Series 8 COM
	FX200-OB40 \$1,662 \$1,780 \$1,977 \$2,182 \$2,428 \$2,654 \$2,963 \$1,780
	45" W, Two seat 41 lbs 2.75 yds
	Model Series 2 Series 3 Series 4 Series 5 Series 6 Series 7 Series 8 COM
	FX200-20 \$1,329 \$1,416 \$1,561 \$1,711 \$1,891 \$2,057 \$2,283 \$1,416
	45.75" W, Two seat with intervening arm and leg 43 lbs 2.75 yds
	Model Series 2 Series 3 Series 4 Series 5 Series 6 Series 7 Series 8 COM
	FX200-22 \$1,506 \$1,593 \$1,738 \$1,888 \$2,068 \$2,234 \$2,460 \$1,593
	66" W, Three seat 84 lbs 4.25 yds
	Model Series 2 Series 3 Series 4 Series 5 Series 6 Series 7 Series 8 COM
	FX200-30 \$1,726 \$1,860 \$2,083 \$2,316 \$2,594 \$2,850 \$3,200 \$1,860
	67.75" W, Three seat with intervening arms and legs 88 lbs 4.25 yds
	Model Series 2 Series 3 Series 4 Series 5 Series 6 Series 7 Series 8 COM
	FX200-33 \$2,257 \$2,391 \$2,614 \$2,847 \$3,125 \$3,381 \$3,731 \$2,391



Spanner Table

Standard Features

- Solid maple frame
- Laminate top
- Non-marring 7/8" glides

Specification Decisions

- Select standard wood finish
- Select standard laminate
- Select table attachment option(LSF, RSF)

 	26.25" W, Rockwood corner spanner table 28 lbs
	Model Price Depth Height
	FX120-CT \$573 26.25" 16"

Meridian Multiple Seating



Standard Features

- Solid hardwood frame
- Wipe-out design
- Replaceable components
- Wood arms
- Non-marring 3/4" glides
- Nemschoff healthcare wood finish
- GREENGUARD Gold Certified
- Limited Lifetime Warranty
- See nemschoff.com for weight ratings (M18)

Available Options

- Moisture barrier + \$67 per seat or back
- Panel arms + \$134
- Black urethane arm caps + \$113
- Removable covers + \$170 per Chair seat and back, \$339 per Settee seat and back
- CTB-133 + \$81/yd
- Two fabrics + \$62
- Three (or more) fabrics + \$88
- Attached tables (LSF, RSF –see price table)

Specification Decisions

- Select fabric
- Select standard wood finish
- Add moisture barrier
- Add CTB-133
- Apply multiple fabrics
- Add attached table
- Add removable covers
- Add urethane arm caps
- Add panel arms

Flammability Types

- Type 4
- Type 8 (with panel arms)

Coordinating Products

- [Meridian Lounge Seating](#)
- [Meridian Patient Chair](#)
- [Meridian Tables](#)
- [Meridian Behavioral Health Seating](#)

Key Dimensions

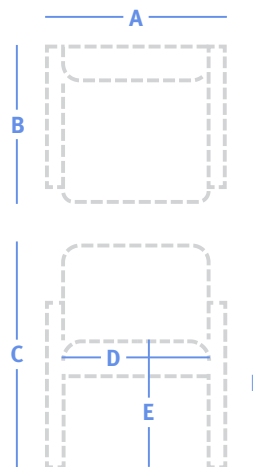

A	Overall Width	See price table
B	Overall Depth	25.5"
C	Overall Height	31.5"
D	Seat Width	
	Chair:	19.5", 22", 30"
	Two Seat:	39", 44"
E	Seat Height	18"
F	Arm Height	25"

More Information

- Illustrated Glossary ▶ 439
- Fabrics ▶ 451
- Flammability (CTB-133) ▶ 459
- Finishes ▶ 456
- Ordering and Warranties ▶ 462

Meridian Multiple Seating

	23" W, Chair									26 lbs 1.75 yds
	Model	Series 2	Series 3	Series 4	Series 5	Series 6	Series 7	Series 8	COM	
	M10	\$1,068	\$1,095	\$1,216	\$1,280	\$1,315	\$1,362	\$1,391	\$1,095	
	25.5" W, Chair									27 lbs 2 yds
	Model	Series 2	Series 3	Series 4	Series 5	Series 6	Series 7	Series 8	COM	
	M15	\$1,142	\$1,173	\$1,311	\$1,385	\$1,425	\$1,478	\$1,511	\$1,173	
	33.5" W, Plus chair									43 lbs 2.5 yds
	Model	Series 2	Series 3	Series 4	Series 5	Series 6	Series 7	Series 8	COM	
	M18	\$1,526	\$1,565	\$1,737	\$1,829	\$1,880	\$1,946	\$1,988	\$1,565	
	44" W, Two seat									56 lbs 2.75 yds
	Model	Series 2	Series 3	Series 4	Series 5	Series 6	Series 7	Series 8	COM	
	MS10-2	\$2,075	\$2,118	\$2,307	\$2,409	\$2,464	\$2,537	\$2,583	\$2,118	
	49" W, Two seat									58 lbs 3.25 yds
	Model	Series 2	Series 3	Series 4	Series 5	Series 6	Series 7	Series 8	COM	
	MS15-2	\$2,327	\$2,378	\$2,602	\$2,722	\$2,787	\$2,873	\$2,928	\$2,378	
	44" W, Two seat with intervening arm and leg									46 lbs 2.75 yds
	Model	Series 2	Series 3	Series 4	Series 5	Series 6	Series 7	Series 8	COM	
	M10-2	\$1,871	\$1,914	\$2,103	\$2,205	\$2,260	\$2,333	\$2,379	\$1,914	
	49" W, Two seat with intervening arm and leg									48 lbs 3.25 yds
	Model	Series 2	Series 3	Series 4	Series 5	Series 6	Series 7	Series 8	COM	
	M15-2	\$2,004	\$2,055	\$2,279	\$2,399	\$2,464	\$2,550	\$2,605	\$2,055	
	44" W, Settee									50 lbs 3 yds
	Model	Series 2	Series 3	Series 4	Series 5	Series 6	Series 7	Series 8	COM	
	MS10-2-LS	\$1,822	\$1,869	\$2,075	\$2,186	\$2,246	\$2,326	\$2,376	\$1,869	
	49" W, Settee									52 lbs 3.5 yds
	Model	Series 2	Series 3	Series 4	Series 5	Series 6	Series 7	Series 8	COM	
	MS15-2-LS	\$2,107	\$2,162	\$2,403	\$2,532	\$2,602	\$2,695	\$2,754	\$2,162	
	66" W, Three seat									76 lbs 3.75 yds
	Model	Series 2	Series 3	Series 4	Series 5	Series 6	Series 7	Series 8	COM	
	MS10-3	\$2,945	\$3,004	\$3,262	\$3,400	\$3,476	\$3,575	\$3,638	\$3,004	

Meridian Multiple Seating

	73" W, Three seat									79 lbs 4.25 yds
	Model	Series 2	Series 3	Series 4	Series 5	Series 6	Series 7	Series 8	COM	
	MS15-3	\$3,327	\$3,394	\$3,686	\$3,843	\$3,929	\$4,041	\$4,113	\$3,394	

	66" W, Three seat with intervening arms and legs									66 lbs 3.75 yds
	Model	Series 2	Series 3	Series 4	Series 5	Series 6	Series 7	Series 8	COM	
	M10-3	\$2,673	\$2,732	\$2,990	\$3,128	\$3,204	\$3,303	\$3,366	\$2,732	

	73" W, Three seat with intervening arms and legs									69 lbs 4.25 yds
	Model	Series 2	Series 3	Series 4	Series 5	Series 6	Series 7	Series 8	COM	
	M15-3	\$2,866	\$2,933	\$3,225	\$3,382	\$3,468	\$3,580	\$3,652	\$2,933	

	66" W, Chair with Settee									73 lbs 4 yds
	Model	Series 2	Series 3	Series 4	Series 5	Series 6	Series 7	Series 8	COM	
	MS10-3-CH-LS	\$3,118	\$3,181	\$3,456	\$3,604	\$3,684	\$3,790	\$3,857	\$3,181	

	73" W, Chair with Settee									76 lbs 4.5 yds
	Model	Series 2	Series 3	Series 4	Series 5	Series 6	Series 7	Series 8	COM	
	MS15-3-CH-LS	\$3,529	\$3,600	\$3,909	\$4,076	\$4,166	\$4,285	\$4,361	\$3,600	

	66" W, Two seat with spanner table									76 lbs 2.75 yds
	Model	Series 2	Series 3	Series 4	Series 5	Series 6	Series 7	Series 8	COM	
	MS10-3-IT	\$3,044	\$3,087	\$3,276	\$3,378	\$3,433	\$3,506	\$3,552	\$3,087	

	73" W, Two seat with spanner table									79 lbs 3.25 yds
	Model	Series 2	Series 3	Series 4	Series 5	Series 6	Series 7	Series 8	COM	
	MS15-3-IT	\$3,466	\$3,517	\$3,741	\$3,861	\$3,926	\$4,012	\$4,067	\$3,517	

	87" W, Four seat									96 lbs 4.75 yds
	Model	Series 2	Series 3	Series 4	Series 5	Series 6	Series 7	Series 8	COM	
	MS10-4	\$3,831	\$3,906	\$4,233	\$4,408	\$4,503	\$4,629	\$4,709	\$3,906	

	97" W, Four seat									100 lbs 5.5 yds
	Model	Series 2	Series 3	Series 4	Series 5	Series 6	Series 7	Series 8	COM	
	MS15-4	\$4,002	\$4,089	\$4,467	\$4,670	\$4,781	\$4,926	\$5,019	\$4,089	

	87" W, Four seat with intervening arms and legs									86 lbs 4.75 yds
	Model	Series 2	Series 3	Series 4	Series 5	Series 6	Series 7	Series 8	COM	
	M10-4	\$3,299	\$3,374	\$3,701	\$3,876	\$3,971	\$4,097	\$4,177	\$3,374	

Welcoming & Waiting

Patient Areas

Specialty

Reference









Meridian Multiple Seating

Lounge Seating

Multiple & Tandem Seating

Side, Stacking & Folding Chairs

Occasional Tables

	97" W, Four seat with intervening arms and legs 90 lbs 5.5 yds
Model	Series 2 Series 3 Series 4 Series 5 Series 6 Series 7 Series 8 COM
M15-4	\$3,725 \$3,812 \$4,190 \$4,393 \$4,504 \$4,649 \$4,742 \$3,812
	87" W, Three seat with spanner table 96 lbs 3.75 yds
Model	Series 2 Series 3 Series 4 Series 5 Series 6 Series 7 Series 8 COM
MS10-4-IT	\$3,823 \$3,882 \$4,140 \$4,278 \$4,354 \$4,453 \$4,516 \$3,882
	97" W, Three seat with spanner table 100 lbs 4.25 yds
Model	Series 2 Series 3 Series 4 Series 5 Series 6 Series 7 Series 8 COM
MS15-4-IT	\$4,355 \$4,422 \$4,714 \$4,871 \$4,957 \$5,069 \$5,141 \$4,422
	87" W, Chair and Settee with spanner table 93 lbs 4 yds
Model	Series 2 Series 3 Series 4 Series 5 Series 6 Series 7 Series 8 COM
MS10-4-CH-IT-LS	\$4,239 \$4,302 \$4,577 \$4,725 \$4,805 \$4,911 \$4,978 \$4,302
	97" W, Chair and Settee with spanner table 97 lbs 4.5 yds
Model	Series 2 Series 3 Series 4 Series 5 Series 6 Series 7 Series 8 COM
MS15-4-CH-IT-LS	\$4,535 \$4,606 \$4,915 \$5,082 \$5,172 \$5,291 \$5,367 \$4,606
	87" W, Two seat with Settee 93 lbs 5 yds
Model	Series 2 Series 3 Series 4 Series 5 Series 6 Series 7 Series 8 COM
MS10-4-2CH-LS	\$3,900 \$3,979 \$4,323 \$4,507 \$4,608 \$4,740 \$4,824 \$3,979
	97" W, Two seat with Settee 97 lbs 5.75 yds
Model	Series 2 Series 3 Series 4 Series 5 Series 6 Series 7 Series 8 COM
MS15-4-2CH-LS	\$4,327 \$4,418 \$4,813 \$5,026 \$5,141 \$5,293 \$5,390 \$4,418
	108" W, Five seat with intervening arms and legs 106 lbs 5.75 yds
Model	Series 2 Series 3 Series 4 Series 5 Series 6 Series 7 Series 8 COM
M10-5	\$4,061 \$4,152 \$4,547 \$4,760 \$4,875 \$5,027 \$5,124 \$4,152
	120.5" W, Five seat with intervening arms and legs 111 lbs 6.5 yds
Model	Series 2 Series 3 Series 4 Series 5 Series 6 Series 7 Series 8 COM
M15-5	\$4,591 \$4,693 \$5,140 \$5,380 \$5,510 \$5,682 \$5,792 \$4,693

Meridian Multiple Seating

Meridian Spanner Tables

Standard Features

- Wood tabletops
- Laminate tabletops (select models)
- Non-marring ¾" glides
- Nemschoff healthcare wood finish
- GREENGUARD Gold Certified
- Limited Lifetime Warranty

Specification Decisions

- Select standard wood finish
- Select table attachment option (LSF, RSF)
- Add standard laminate



21.25" W, Spanner end table

20 lbs

Model	Price	Depth	Height
MET-10	\$1,015	20.5"	14.75"



23.75" W, Spanner end table

21 lbs

Model	Price	Depth	Height
MET-15	\$1,141	20.5"	14.75"

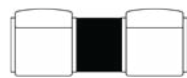

19.5" W, Spanner table

16 lbs

Model	Price	Depth	Height
MIT-10	\$561	20.5"	14.75"

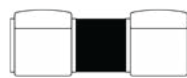

20.5" W, Spanner table

16 lbs

Model	Price	Depth	Height
MIT-15	\$634	20.5"	14.75"

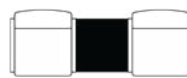

21" W, Spanner end table

18 lbs

Model	Price	Depth	Height
MLIT-30	\$668	25"	18.75"

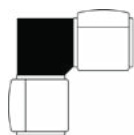

28" W, Spanner corner table

28 lbs

Model	Price	Depth	Height
MSCT-10	\$736	18.75"	14.75"
MRCT-10	\$820	18.75"	14.75"

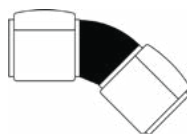

45-degree-radius corner table

18 lbs

Model	Price	Depth	Height
MRCT45-10	\$820	18.75"	14.75"

Monarch Multiple Seating



More Information

- Illustrated Glossary ▶ 439
- Fabrics ▶ 451
- Flammability (CTB-133) ▶ 459
- Finishes ▶ 456
- Ordering and Warranties ▶ 462

Standard Features

- Solid maple frame
- Mortise and tenon joinery
- Memory foam seat
- Wipe-out design
- Replaceable components
- Black urethane arm caps
- Wallsaver legs
- Non-marring 7/8" glides
- Nemschoff healthcare wood finish
- GREENGUARD Gold Certified
- Limited Lifetime Warranty
- See nemschoff.com for weight ratings (893-OB30, 893-OB40)

Available Options

- Moisture barrier + \$67 per seat or back
- Wood arm caps + \$113
- CTB-133 + \$81/yd
- Two fabrics + \$62
- Three (or more) fabrics + \$88

Specification Decisions

- Select fabric
 - Select standard wood finish
 - Add moisture barrier
 - Add CTB-133
 - Apply multiple fabrics
 - Add wood arm caps
- Model numbers with **S** indicate standard seat and back covers, and model numbers with **P** indicate removable covers.

Flammability Type

- Type 3
- Type 4 (Plus models)

Coordinating Products

- [Monarch Lounge Seating](#)
- [Monarch Stack Chair](#)
- [Monarch Tables](#)
- [Auburn Benches](#)
- [Monarch Sleep Chair and Settee](#)

Key Dimensions

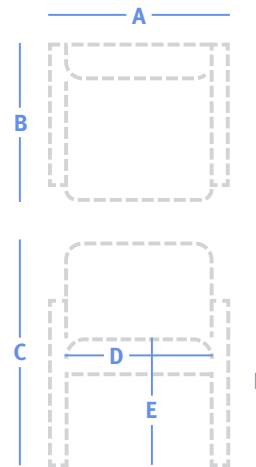

A	Overall Width	See price table
B	Overall Depth	24.5"
C	Overall Height	33.5", 34.5" (OB30, OB40)
D	Seat Width	Chair: 20.25" Two Seat: 20.25", 40.5" Three Seat: 20.25", 60.75"
E	Seat Height	18.75"
F	Arm Height	27"

		22.75" W, Chair 1.5 yds							
		Series 2	Series 3	Series 4	Series 5	Series 6	Series 7	Series 8	COM
	893-10 S	\$784	\$831	\$911	\$994	\$1,093	\$1,192	\$1,317	\$831
	893-10 P	\$884	\$931	\$1,011	\$1,094	\$1,193	\$1,292	\$1,417	\$931
		22.75" W, Chair without arms 1.5 yds							
		Series 2	Series 3	Series 4	Series 5	Series 6	Series 7	Series 8	COM
	893-11 S	\$707	\$754	\$834	\$917	\$1,016	\$1,115	\$1,240	\$754
	893-11 P	\$798	\$845	\$925	\$1,008	\$1,107	\$1,206	\$1,331	\$845

Monarch Multiple Seating

	32.5" W, Plus chair									40 lbs 2.25 yds
	Model	Series 2	Series 3	Series 4	Series 5	Series 6	Series 7	Series 8	COM	
	893-OB30	\$1,157	\$1,228	\$1,348	\$1,472	\$1,620	\$1,770	\$1,957	\$1,228	

	42.5" W, Plus chair									51 lbs 2.5 yds
	Model	Series 2	Series 3	Series 4	Series 5	Series 6	Series 7	Series 8	COM	
	893-OB40	\$1,254	\$1,333	\$1,466	\$1,604	\$1,769	\$1,935	\$2,143	\$1,333	

	22.75" W, Two seat									2.5 yds
	Model	Series 2	Series 3	Series 4	Series 5	Series 6	Series 7	Series 8	COM	
	893-20 S	\$1,295	\$1,374	\$1,507	\$1,645	\$1,810	\$1,976	\$2,184	\$1,374	
	893-20 P	\$1,460	\$1,539	\$1,672	\$1,810	\$1,975	\$2,141	\$2,349	\$1,539	

	44.25" W, Two seat with intervening arm and leg									2.5 yds
	Model	Series 2	Series 3	Series 4	Series 5	Series 6	Series 7	Series 8	COM	
	893-22 S	\$1,397	\$1,476	\$1,609	\$1,747	\$1,912	\$2,078	\$2,286	\$1,476	
	893-22 P	\$1,575	\$1,654	\$1,787	\$1,925	\$2,090	\$2,256	\$2,464	\$1,654	

	45.75" W, Three seat									3.5 yds
	Model	Series 2	Series 3	Series 4	Series 5	Series 6	Series 7	Series 8	COM	
	893-30 S	\$1,842	\$1,953	\$2,139	\$2,332	\$2,563	\$2,795	\$3,086	\$1,953	
	893-30 P	\$2,077	\$2,188	\$2,374	\$2,567	\$2,798	\$3,030	\$3,321	\$2,188	

	68.25" W, Three seat with intervening arms and legs									3.5 yds
	Model	Series 2	Series 3	Series 4	Series 5	Series 6	Series 7	Series 8	COM	
	893-33 S	\$2,068	\$2,179	\$2,365	\$2,558	\$2,789	\$3,021	\$3,312	\$2,179	
	893-33 P	\$2,330	\$2,441	\$2,627	\$2,820	\$3,051	\$3,283	\$3,574	\$2,441	

Monarch Bench

Standard Features

Same standard features as Monarch Multiple Seating

Available Options

Same available options as Monarch Multiple Seating

Key Dimensions

- Overall Width: See price table
- Overall Depth: 24.5"
- Overall Height: 33.5"
- Seat Width: 40.25"
- Arm Height: 27"

	42.75" W, Bench									1.25 yds
	Model	Series 2	Series 3	Series 4	Series 5	Series 6	Series 7	Series 8	COM	
	893-B2 S	\$976	\$1,015	\$1,082	\$1,151	\$1,233	\$1,316	\$1,420	\$1,015	
	893-B2 P	\$1,066	\$1,137	\$1,257	\$1,381	\$1,529	\$1,679	\$1,866	\$1,137	

Pause Multiple Seating



More Information

Illustrated Glossary ▶ 439

Fabrics ▶ 451

Flammability (CTB-133) ▶ 459

Finishes ▶ 456

Ordering and Warranties ▶ 462

Standard Features

- Solid hardwood frame
- Replaceable components
- Wipe-out design
- Suspended beam structure
- Moisture barrier on seat
- Wood arms
- Reconfigurable seating positions and widths
- Removable covers (applied railroaded)
- Quilted upholstery
- Non-marring ¾" glides on hardwood models
- Nemschoff healthcare wood finish
- GREENGUARD Gold Certified
- Limited Lifetime Warranty

Available Options

- Powder-coated metal frame + \$0
- Hard rubber glides on wood models + \$28
- Wallsaver glides on wood models + \$39
- CTB-133 + \$81/yd
- Two fabrics + \$62
- Three (or more) fabrics + \$88
- Upholstered arm caps (available on wood frame) + \$34 per cap
- Black urethane arm caps (available on metal frame) + \$70 per arm cap
- Attached tables (LSF, RSF –see price table)

Specification Decisions

- Select fabric
- Select wood or metal frame
- Select standard wood finish or powder coat finish
- Add CTB-133
- Apply multiple fabrics
- Add attached table
- Add wallsaver glides

Flammability Type

- Type 4

Key Dimensions

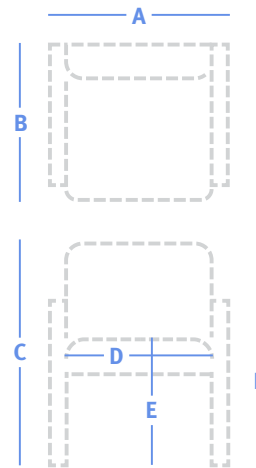

A	Overall Width	See price table
B	Overall Depth	26"
C	Overall Height	34"
D	Seat Width	
	Chair:	20", 30", 40"
	Settee:	42"
	Three Seat:	64", 86"
E	Seat Height	18"
F	Arm Height	25"

Pause Multiple Seating

	24" W, Chair									46 lbs 2 yds
	Model	Series 2	Series 3	Series 4	Series 5	Series 6	Series 7	Series 8	COM	
	PAUS-24010	\$2,232	\$2,263	\$2,401	\$2,475	\$2,515	\$2,568	\$2,601	\$2,263	

	34" W, Chair									55 lbs 2.5 yds
	Model	Series 2	Series 3	Series 4	Series 5	Series 6	Series 7	Series 8	COM	
	PAUS-34018	\$2,421	\$2,460	\$2,632	\$2,724	\$2,775	\$2,841	\$2,883	\$2,460	

	46" W, Settee									65 lbs 3.25 yds
	Model	Series 2	Series 3	Series 4	Series 5	Series 6	Series 7	Series 8	COM	
	PAUS-46001	\$2,710	\$2,761	\$2,985	\$3,105	\$3,170	\$3,256	\$3,311	\$2,761	

	46" W, Settee with divider arm									68 lbs 3.25 yds
	Model	Series 2	Series 3	Series 4	Series 5	Series 6	Series 7	Series 8	COM	
	PAUS-46002	\$2,988	\$3,039	\$3,263	\$3,383	\$3,448	\$3,534	\$3,589	\$3,039	

	68" W, Sofa									85 lbs 4.5 yds
	Model	Series 2	Series 3	Series 4	Series 5	Series 6	Series 7	Series 8	COM	
	PAUS-68001	\$3,237	\$3,308	\$3,617	\$3,784	\$3,874	\$3,993	\$4,069	\$3,308	

	68" W, Three seat with divider arm									88 lbs 4.5 yds
	Model	Series 2	Series 3	Series 4	Series 5	Series 6	Series 7	Series 8	COM	
	PAUS-68002	\$3,647	\$3,718	\$4,027	\$4,194	\$4,284	\$4,403	\$4,479	\$3,718	

	68" W, Three seat with divider arms									91 lbs 4.5 yds
	Model	Series 2	Series 3	Series 4	Series 5	Series 6	Series 7	Series 8	COM	
	PAUS-68003	\$4,059	\$4,130	\$4,439	\$4,606	\$4,696	\$4,815	\$4,891	\$4,130	

	90" W, Four seat									105 lbs 5.75 yds
	Model	Series 2	Series 3	Series 4	Series 5	Series 6	Series 7	Series 8	COM	
	PAUS-90001	\$3,814	\$3,905	\$4,300	\$4,513	\$4,628	\$4,780	\$4,877	\$3,905	

	90" W, Four seat with divider arm									108 lbs 5.75 yds
	Model	Series 2	Series 3	Series 4	Series 5	Series 6	Series 7	Series 8	COM	
	PAUS-90002	\$4,249	\$4,340	\$4,735	\$4,948	\$5,063	\$5,215	\$5,312	\$4,340	

	90" W, Four seat with two divider arms									111 lbs 5.75 yds
	Model	Series 2	Series 3	Series 4	Series 5	Series 6	Series 7	Series 8	COM	
	PAUS-90003	\$4,684	\$4,775	\$5,170	\$5,383	\$5,498	\$5,650	\$5,747	\$4,775	

Pause Multiple Seating



90" W, Four seat with three divider arms

114 lbs | 5.75 yds

Model	Series 2	Series 3	Series 4	Series 5	Series 6	Series 7	Series 8	COM
PAUS-90004	\$5,119	\$5,210	\$5,605	\$5,818	\$5,933	\$6,085	\$6,182	\$5,210

2" W Adjustable arm

Model	Cost	Depth	Height
PAUS-00001	\$505	20.5"	11.25"

Pause Benches

Standard Features

Same standard features as Pause Multiple Seating

Available Options

Same available options as Pause Multiple Seating

Key Dimensions

- Overall Width: See price table
- Overall Depth: 24" or 26"
- Overall Height: 25"
- Seat Height: 18"
- Arm Height: 25"



46" W, Bench

47 lbs | 1.75 yds

Model	Series 2	Series 3	Series 4	Series 5	Series 6	Series 7	Series 8	COM
PAUS-46000	\$2,292	\$2,319	\$2,440	\$2,504	\$2,539	\$2,586	\$2,615	\$2,319



68" W, Bench

60 lbs | 2.25 yds

Model	Series 2	Series 3	Series 4	Series 5	Series 6	Series 7	Series 8	COM
PAUS-68000	\$3,107	\$3,142	\$3,297	\$3,380	\$3,425	\$3,485	\$3,523	\$3,142



90" W, Bench

75 lbs | 3 yds

Model	Series 2	Series 3	Series 4	Series 5	Series 6	Series 7	Series 8	COM
PAUS-90000	\$3,308	\$3,355	\$3,561	\$3,672	\$3,732	\$3,812	\$3,862	\$3,355

Pause Multiple Seating

Pause Spanner Tables

Standard Features

- Same standard features as Pause Multiple Seating, plus:
- Durawrap tabletops
- Gang both sides only

Specification Decisions

- Select standard wood finish
- Specify table attachment LSF or RSF

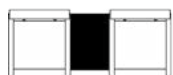

13" W, Rectangular end table

13 lbs

Model	Price	Depth	Height
PSTB-00010	\$1,334	17.5"	–



20.5" W, Square spanner table

16 lbs

Model	Price	Depth	Height
PSTB-00020	\$742	17.5"	–

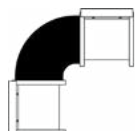

34.5" W, Corner radius spanner table

19 lbs

Model	Price	Depth	Height
PSTB-00090	\$1,112	34.5"	20"

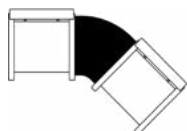

20.5" W, Corner radius spanner table

13 lbs

Model	Price	Depth	Height
PSTB-00045	\$1,112	20.5"	18.5"

Princeton Multiple Seating



More Information

Illustrated Glossary ▶ 439

Fabrics ▶ 451

Flammability (CTB-133) ▶ 459

Finishes ▶ 456

Ordering and Warranties ▶ 462

Standard Features

- Solid hardwood frame
- Mortise and tenon joinery
- Replaceable components
- Wipe-out design
- Wood arm caps
- Arcade back
- Non-marring 7/8" rubber-cushioned glides
- Nemschoff healthcare wood finish
- GREENGUARD Gold Certified
- Limited Lifetime Warranty
- See nemschoff.com for weight ratings (FX500-OB30, FX500-OB40)

Available Options

- Moisture barrier + \$67 per seat or back
- Black urethane arm caps + \$113
- Square back + \$0
- CTB-133 + \$81/yd
- Two fabrics + \$62
- Three (or more) fabrics + \$88
- Attached tables (LSF, RSF –see price table)

Specification Decisions

- Select fabric
- Select standard wood finish
- Add moisture barrier
- Add CTB-133
- Apply multiple fabrics
- Add attached table
- Add Square back

Flammability Type

- Type 3
- Type 4 (Plus models)

Coordinating Products

- [Rockwood Tables](#)

Key Dimensions

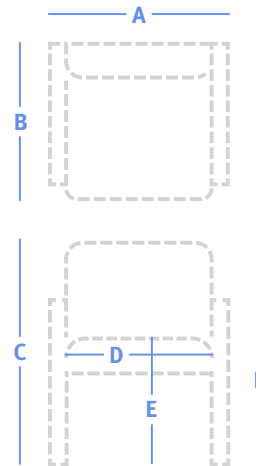

A	Overall Width	See price table
B	Overall Depth	25.5"
C	Overall Height	33.25", 32" (OB30, OB40)
D	Seat Width	
	Chair:	20.75", 30", 40"
	Two Seat:	41.5", 41.75"
	Three Seat:	62.25", 63"
E	Seat Height	18.75"
F	Arm Height	24.75"

Princeton Multiple Seating

	23.75" W, Chair									23 lbs 1.5 yds
	Model	Series 2	Series 3	Series 4	Series 5	Series 6	Series 7	Series 8	COM	
	FX500-10	\$807	\$854	\$933	\$1,015	\$1,114	\$1,204	\$1,327	\$854	

	34" W, Plus chair									37 lbs 3.5 yds
	Model	Series 2	Series 3	Series 4	Series 5	Series 6	Series 7	Series 8	COM	
	FX500-OB30	\$1,436	\$1,546	\$1,730	\$1,922	\$2,151	\$2,362	\$2,650	\$1,546	

	44" W, Plus chair									42 lbs 3.75 yds
	Model	Series 2	Series 3	Series 4	Series 5	Series 6	Series 7	Series 8	COM	
	FX500-OB40	\$1,599	\$1,717	\$1,914	\$2,119	\$2,365	\$2,591	\$2,900	\$1,717	

	45" W, Two seat									41 lbs 2.75 yds
	Model	Series 2	Series 3	Series 4	Series 5	Series 6	Series 7	Series 8	COM	
	FX500-20	\$1,279	\$1,366	\$1,511	\$1,661	\$1,841	\$2,007	\$2,233	\$1,366	

	45.75" W, Two seat with intervening arm and leg									43 lbs 2.75 yds
	Model	Series 2	Series 3	Series 4	Series 5	Series 6	Series 7	Series 8	COM	
	FX500-22	\$1,450	\$1,537	\$1,682	\$1,832	\$2,012	\$2,178	\$2,404	\$1,537	

	66" W, Three seat									84 lbs 4.25 yds
	Model	Series 2	Series 3	Series 4	Series 5	Series 6	Series 7	Series 8	COM	
	FX500-30	\$1,660	\$1,794	\$2,017	\$2,250	\$2,528	\$2,784	\$3,134	\$1,794	

	67.75" W, Three seat with intervening arms and legs									88 lbs 4.25 yds
	Model	Series 2	Series 3	Series 4	Series 5	Series 6	Series 7	Series 8	COM	
	FX500-33	\$2,172	\$2,306	\$2,529	\$2,762	\$3,040	\$3,296	\$3,646	\$2,306	

Spanner Table

Standard Features

- Solid maple frame
- Laminate top
- Non-marring 7/8" glides

Specification Decisions

- Select standard wood finish
- Select standard laminate
- Select table attachment option (LSF, RSF)

	26.25" W, Rockwood corner spanner table				28 lbs
	Model	Price	Depth	Height	
	FX120-CT	\$573	26.25"	16"	

Reliant Multiple Seating



More Information

- Illustrated Glossary ▶ 439
- Fabrics ▶ 451
- Flammability (CTB-133) ▶ 459
- Finishes ▶ 456
- Ordering and Warranties ▶ 462

Standard Features

- Heavy-duty metal construction
- Powder-coated frame
- Wipe-out design
- Replaceable components
- Wood arm caps
- Non-marring glides
- Plastic seat and back (select models)
- Veneer tabletops (select models)
- Nemschoff healthcare wood finish
- GREENGUARD Gold Certified
- Limited Lifetime Warranty
- See nemschoff.com for weight ratings (RE18)

Available Options

- Moisture barrier + \$67 per seat or back
- Black urethane arm caps + \$113
- Removable covers + \$170 per Chair seat and back, \$339 per Settee seat and back
- CTB-133 + \$81/yd
- Two fabrics + \$62
- Three (or more) fabrics + \$88
- Attached tables (LSF, RSF – see price table)

Specification Decisions

- Select model with plastic seat and back, plastic seat and back with upholstered pads, or upholstered seat and back
- Select plastic seat and back color (models RE40, RES40, RE50, and RES50)
 - OUS** Light Sand Speckle **OSS** Dark Sand Speckle
 - 7KS** Light Grey Speckle **6KS** Dark Grey Speckle
- Select fabric
- Select standard wood finish
- Select powder coat finish
- Add moisture barrier
- Add CTB-133
- Apply multiple fabrics
- Add attached table
- Add removable covers

Flammability Type

- Type 3
- Type 4 (Plus models)

Coordinating Products

- [Reliant Tables](#)

Key Dimensions

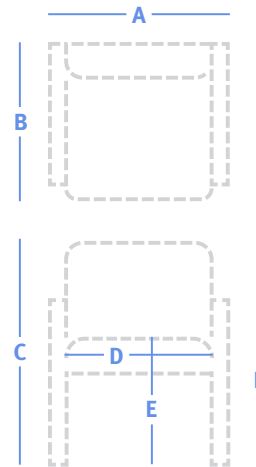



A	Overall Width	See price table
B	Overall Depth	25"
C	Overall Height	32"
D	Seat Width	
	Chair:	19.5", 22", 30"
	Two Seat:	19.5", 39", 44"
	Three Seat:	19.5", 58.5", 66"
E	Seat Height	17.5"
F	Arm Height	26"

Reliant Multiple Seating

Plastic Seat and Back (upholstered seat and back pads on select models)

		23" W, Chair, plastic seat and back 33 lbs							
		Model	Price						
		RE40	\$1,340						

		23" W, Chair, plastic seat and back with upholstered pads 34 lbs .75 yds								
		Model	Series 2	Series 3	Series 4	Series 5	Series 6	Series 7	Series 8	COM
		RE50	\$1,373	\$1,384	\$1,436	\$1,464	\$1,479	\$1,499	\$1,511	\$1,384

	44" W, Two seat, plastic seat and back 63 lbs							
	Model	Price						
	RES40-2	\$2,634						

	44" W, Two seat, plastic seat and back with upholstered pads 65 lbs 1.5 yds								
	Model	Series 2	Series 3	Series 4	Series 5	Series 6	Series 7	Series 8	COM
	RES50-2	\$2,701	\$2,724	\$2,827	\$2,883	\$2,913	\$2,953	\$2,978	\$2,724

	44" W, Two seat with intervening arm and leg, plastic seat and back 52 lbs							
	Model	Price						
	RE40-2	\$2,369						

	44" W, Two seat with intervening arm and leg, plastic with upholstered pads 54 lbs 1.5 yds								
	Model	Series 2	Series 3	Series 4	Series 5	Series 6	Series 7	Series 8	COM
	RE50-2	\$2,427	\$2,450	\$2,553	\$2,609	\$2,639	\$2,679	\$2,704	\$2,450

	65.5" W, Three seat, plastic seat and back 83 lbs							
	Model	Price						
	RES40-3	\$3,516						

	65.5" W, Three seat, plastic seat and back with upholstered pads 86 lbs 2.25 yds								
	Model	Series 2	Series 3	Series 4	Series 5	Series 6	Series 7	Series 8	COM
	RES50-3	\$3,599	\$3,634	\$3,789	\$3,872	\$3,917	\$3,977	\$4,015	\$3,634

	65.5" W, Three seat with intervening arms and legs, plastic seat and back 72 lbs							
	Model	Price						
	RE40-3	\$3,399						

	65.5" W, Three seat with intervening arms and legs, plastic with upholstered pads 72 lbs 2.25 yds								
	Model	Series 2	Series 3	Series 4	Series 5	Series 6	Series 7	Series 8	COM
	RE50-3	\$3,480	\$3,515	\$3,670	\$3,753	\$3,798	\$3,858	\$3,896	\$3,515

Reliant Multiple Seating

Lounge Seating

Multiple & Tandem Seating

Side, Stacking & Folding Chairs

Occasional Tables



65.5" W, Two seat with spanner table, plastic seat and back									82 lbs
Model	Series 2	Series 3	Series 4	Series 5	Series 6	Series 7	Series 8	COM	
RES40-3-IT	–	\$3,622	–	–	–	–	–	–	



65.5" W, Two seat with spanner table, plastic seat and back with upholstered pads									82 lbs 1.5 yds
Model	Series 2	Series 3	Series 4	Series 5	Series 6	Series 7	Series 8	COM	
RES50-3-IT	\$3,722	\$3,745	\$3,848	\$3,904	\$3,934	\$3,974	\$3,999	\$3,745	



87" W, Four seat, plastic seat and back									103 lbs
Model	Series 2	Series 3	Series 4	Series 5	Series 6	Series 7	Series 8	COM	
RES40-4	–	\$4,437	–	–	–	–	–	–	



87" W, Four seat with intervening arms and legs, plastic seat and back									93 lbs
Model	Series 2	Series 3	Series 4	Series 5	Series 6	Series 7	Series 8	COM	
RE40-4	–	\$4,427	–	–	–	–	–	–	



87" W, Three seat with spanner table, plastic seat and back									103 lbs
Model	Series 2	Series 3	Series 4	Series 5	Series 6	Series 7	Series 8	COM	
RES40-4-IT	–	\$4,569	–	–	–	–	–	–	



87" W, Three seat with spanner table, plastic seat and back with upholstered pads									103 lbs 2.25 yds
Model	Series 2	Series 3	Series 4	Series 5	Series 6	Series 7	Series 8	COM	
RES50-4-IT	\$4,690	\$4,725	\$4,880	\$4,963	\$5,008	\$5,068	\$5,106	\$4,725	



87" W, Four seat, plastic seat and back with upholstered pads									107 lbs 3 yds
Model	Series 2	Series 3	Series 4	Series 5	Series 6	Series 7	Series 8	COM	
RES50-4	\$4,541	\$4,588	\$4,794	\$4,905	\$4,965	\$5,045	\$5,095	\$4,588	



87" W, Four seat with intervening arms and legs, plastic with upholstered pads									97 lbs 3 yds
Model	Series 2	Series 3	Series 4	Series 5	Series 6	Series 7	Series 8	COM	
RE50-4	\$4,530	\$4,577	\$4,783	\$4,894	\$4,954	\$5,034	\$5,084	\$4,577	



108" W, Five seat with intervening arms and legs, plastic seat and back									113 lbs
Model	Series 2	Series 3	Series 4	Series 5	Series 6	Series 7	Series 8	COM	
RE40-5	–	\$5,458	–	–	–	–	–	–	



108" W, Five seat with intervening arms and legs, plastic with upholstered pads									117 lbs 3.75 yds
Model	Series 2	Series 3	Series 4	Series 5	Series 6	Series 7	Series 8	COM	
RE50-5	\$5,585	\$5,644	\$5,902	\$6,040	\$6,116	\$6,215	\$6,278	\$5,644	

Reliant Multiple Seating

Upholstered Seat and Back

		23" W, Chair, upholstered seat and back 33 lbs 1.5 yds								
		Model	Series 2	Series 3	Series 4	Series 5	Series 6	Series 7	Series 8	COM
		RE10	\$1,222	\$1,245	\$1,348	\$1,404	\$1,434	\$1,474	\$1,499	\$1,245

		25.5" W, Chair, upholstered seat and back 34 lbs 1.75 yds								
		Model	Series 2	Series 3	Series 4	Series 5	Series 6	Series 7	Series 8	COM
		RE15	\$1,385	\$1,412	\$1,533	\$1,597	\$1,632	\$1,679	\$1,708	\$1,412

		33.5" W, Plus chair 41 lbs 2 yds								
		Model	Series 2	Series 3	Series 4	Series 5	Series 6	Series 7	Series 8	COM
		RE18	\$2,112	\$2,143	\$2,281	\$2,355	\$2,395	\$2,448	\$2,481	\$2,143

	44" W, Two seat, upholstered seat and back 63 lbs 3 yds								
	Model	Series 2	Series 3	Series 4	Series 5	Series 6	Series 7	Series 8	COM
	RES10-2	\$2,469	\$2,516	\$2,722	\$2,833	\$2,893	\$2,973	\$3,023	\$2,516

	49" W, Two seat, upholstered seat and back 65 lbs 3.25 yds								
	Model	Series 2	Series 3	Series 4	Series 5	Series 6	Series 7	Series 8	COM
	RES15-2	\$2,853	\$2,904	\$3,128	\$3,248	\$3,313	\$3,399	\$3,454	\$2,904

	44" W, Two seat with intervening arm and leg, upholstered seat and back 63 lbs 3 yds								
	Model	Series 2	Series 3	Series 4	Series 5	Series 6	Series 7	Series 8	COM
	RE10-2	\$2,238	\$2,285	\$2,491	\$2,602	\$2,662	\$2,742	\$2,792	\$2,285

	49" W, Two seat with intervening arm and leg, upholstered seat and back 65 lbs 3.25 yds								
	Model	Series 2	Series 3	Series 4	Series 5	Series 6	Series 7	Series 8	COM
	RE15-2	\$2,444	\$2,495	\$2,719	\$2,839	\$2,904	\$2,990	\$3,045	\$2,495

	44" W, Settee, upholstered seat and back 57 lbs 3.25 yds								
	Model	Series 2	Series 3	Series 4	Series 5	Series 6	Series 7	Series 8	COM
	RES10-2-LS	\$2,234	\$2,285	\$2,509	\$2,629	\$2,694	\$2,780	\$2,835	\$2,285

	49" W, Settee, upholstered seat and back 59 lbs 3.5 yds								
	Model	Series 2	Series 3	Series 4	Series 5	Series 6	Series 7	Series 8	COM
	RES15-2-LS	\$2,440	\$2,495	\$2,736	\$2,865	\$2,935	\$3,028	\$3,087	\$2,495

	65.5" W, Three seat, upholstered seat and back 83 lbs 4.5 yds								
	Model	Series 2	Series 3	Series 4	Series 5	Series 6	Series 7	Series 8	COM
	RES10-3	\$3,348	\$3,419	\$3,728	\$3,895	\$3,985	\$4,104	\$4,180	\$3,419

Reliant Multiple Seating

Lounge Seating

Multiple & Tandem Seating

Side, Stacking & Folding Chairs

Occasional Tables



73" W, Three seat, upholstered seat and back									86 lbs 4.75 yds
Model	Series 2	Series 3	Series 4	Series 5	Series 6	Series 7	Series 8	COM	
RES15-3	\$3,801	\$3,876	\$4,203	\$4,378	\$4,473	\$4,599	\$4,679	\$3,876	



65.5" W, Three seat with intervening arms and legs, upholstered seat and back									83 lbs 4.5 yds
Model	Series 2	Series 3	Series 4	Series 5	Series 6	Series 7	Series 8	COM	
RE10-3	\$3,038	\$3,109	\$3,418	\$3,585	\$3,675	\$3,794	\$3,870	\$3,109	



73" W, Three seat with intervening arms and legs, upholstered seat and back									86 lbs 4.75 yds
Model	Series 2	Series 3	Series 4	Series 5	Series 6	Series 7	Series 8	COM	
RE15-3	\$3,506	\$3,581	\$3,908	\$4,083	\$4,178	\$4,304	\$4,384	\$3,581	



66" W, Chair with settee, upholstered seat and back									80 lbs 4.75 yds
Model	Series 2	Series 3	Series 4	Series 5	Series 6	Series 7	Series 8	COM	
RES10-3-CH-LS	\$3,550	\$3,625	\$3,952	\$4,127	\$4,222	\$4,348	\$4,428	\$3,625	



73" W, Chair with settee, upholstered seat and back									83 lbs 5.25 yds
Model	Series 2	Series 3	Series 4	Series 5	Series 6	Series 7	Series 8	COM	
RES15-3-CH-LS	\$4,025	\$4,108	\$4,469	\$4,663	\$4,768	\$4,907	\$4,996	\$4,108	



65.5" W, Two seat with spanner table, upholstered seat and back									42 lbs 3 yds
Model	Series 2	Series 3	Series 4	Series 5	Series 6	Series 7	Series 8	COM	
RES-10-3-IT	\$3,477	\$3,524	\$3,730	\$3,841	\$3,901	\$3,981	\$4,031	\$3,524	



73" W, Two seat with spanner table, upholstered seat and back									86 lbs 3.25 yds
Model	Series 2	Series 3	Series 4	Series 5	Series 6	Series 7	Series 8	COM	
RES15-3-IT	\$3,942	\$3,993	\$4,217	\$4,337	\$4,402	\$4,488	\$4,543	\$3,993	



87" W, Four seat, upholstered seat and back									103 lbs 6 yds
Model	Series 2	Series 3	Series 4	Series 5	Series 6	Series 7	Series 8	COM	
RES10-4	\$4,219	\$4,314	\$4,726	\$4,948	\$5,068	\$5,227	\$5,328	\$4,314	



97" W, Four seat, upholstered seat and back									107 lbs 6.25 yds
Model	Series 2	Series 3	Series 4	Series 5	Series 6	Series 7	Series 8	COM	
RES15-4	\$4,792	\$4,890	\$5,319	\$5,550	\$5,676	\$5,841	\$5,946	\$4,890	





87" W, Four seat with intervening arms and legs, upholstered seat and back									93 lbs 6 yds
Model	Series 2	Series 3	Series 4	Series 5	Series 6	Series 7	Series 8	COM	
RE10-4	\$4,020	\$4,115	\$4,527	\$4,749	\$4,869	\$5,028	\$5,129	\$4,115	

Reliant Multiple Seating

	97" W, Four seat with intervening arms and legs, upholstered seat and back 97 lbs 6.75 yds
Model	Series 2 Series 3 Series 4 Series 5 Series 6 Series 7 Series 8 COM
RE15-4	\$4,557 \$4,663 \$5,127 \$5,376 \$5,512 \$5,690 \$5,804 \$4,663

	87" W, Two seat with settee, upholstered seat and back 100 lbs 6.25 yds
Model	Series 2 Series 3 Series 4 Series 5 Series 6 Series 7 Series 8 COM
RES10-4-2CH-LS	\$4,426 \$4,524 \$4,953 \$5,184 \$5,310 \$5,475 \$5,580 \$4,524

	97" W, Two seat with settee, upholstered seat and back 104 lbs 7 yds
Model	Series 2 Series 3 Series 4 Series 5 Series 6 Series 7 Series 8 COM
RES15-4-2CH-LS	\$5,019 \$5,129 \$5,610 \$5,869 \$6,009 \$6,194 \$6,312 \$5,129

	87" W, Three seat with spanner table, upholstered seat and back 103 lbs 4.5 yds
Model	Series 2 Series 3 Series 4 Series 5 Series 6 Series 7 Series 8 COM
RES-10-4-IT	\$4,373 \$4,444 \$4,753 \$4,920 \$5,010 \$5,129 \$5,205 \$4,444

	97" W, Three seat with spanner table, upholstered seat and back 107 lbs 4.75 yds
Model	Series 2 Series 3 Series 4 Series 5 Series 6 Series 7 Series 8 COM
RES15-4-IT	\$4,963 \$5,038 \$5,365 \$5,540 \$5,635 \$5,761 \$5,841 \$5,038

	87" W, Chair and settee with spanner table, upholstered seat and back 100 lbs 4.75 yds
Model	Series 2 Series 3 Series 4 Series 5 Series 6 Series 7 Series 8 COM
RES10-4-CH-IT-LS	\$4,561 \$4,636 \$4,963 \$5,138 \$5,233 \$5,359 \$5,439 \$4,636

	97" W, Chair and settee with spanner table, upholstered seat and back 104 lbs 5 yds
Model	Series 2 Series 3 Series 4 Series 5 Series 6 Series 7 Series 8 COM
RES15-4-CH-IT-LS	\$5,168 \$5,247 \$5,591 \$5,775 \$5,876 \$6,008 \$6,092 \$5,247

Reliant Benches

Standard Features

Same standard features as Reliant Multiple Seating

Available Options

- Same available options as Reliant Multiple Seating

Key Dimensions





- Overall Width: See price table
- Overall Depth: 20.5"
- Overall Height: 17.5"

	44" W, Bench, upholstered seat 40 lbs 1.75 yds
Model	Series 2 Series 3 Series 4 Series 5 Series 6 Series 7 Series 8 COM
RE10B/44	\$1,892 \$1,919 \$2,040 \$2,104 \$2,139 \$2,186 \$2,215 \$1,919

Reliant Multiple Seating

	49" W, Bench, upholstered seat 52 lbs 2 yds								
	Model	Series 2	Series 3	Series 4	Series 5	Series 6	Series 7	Series 8	COM
	RE15B/49	\$2,195	\$2,226	\$2,364	\$2,438	\$2,478	\$2,531	\$2,564	\$2,226
	66" W, Bench, upholstered seat 42 lbs 2.5 yds								
	Model	Series 2	Series 3	Series 4	Series 5	Series 6	Series 7	Series 8	COM
	RE10B/66	\$2,562	\$2,601	\$2,773	\$2,865	\$2,916	\$2,982	\$3,024	\$2,601
	73" W, Bench, upholstered seat 54 lbs 2.75 yds								
	Model	Series 2	Series 3	Series 4	Series 5	Series 6	Series 7	Series 8	COM
	RE15B/73	\$2,986	\$3,029	\$3,218	\$3,320	\$3,375	\$3,448	\$3,494	\$3,029

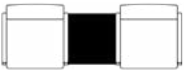
Reliant Spanner Tables

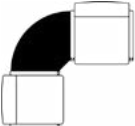
	Standard Features	Available Options	Specification Decisions	
	Same standard features as Reliant Tables	<ul style="list-style-type: none"> Laminate or veneer top + \$0 	<ul style="list-style-type: none"> Select standard wood finish Select laminate or veneer top Specify table attachment option (LSF, RSF) 	
	21.25" W, Spanner end table 11 lbs			
	Model	Price	Depth	Height
	RET-10	\$1,164	19"	15.5"
	23.25" W, Spanner end table 12 lbs			
	Model	Price	Depth	Height
	RET-15	\$1,310	19"	15.5"
	19.5" W, Spanner table 8 lbs			
	Model	Price	Depth	Height
	RIT-10	\$647	21"	15.5"
	22" W, Spanner table 8 lbs			
	Model	Price	Depth	Height
	RIT-15	\$694	21"	15.5"
	18.25" W, Corner spanner table 9 lbs			
	Model	Price	Depth	Height
	RRCT45-10	\$969	18.25"	15.5"

Torii Multiple Seating



Standard Features

- Solid maple frame
- Mortise and tenon joinery
- Spring seat construction
- Replaceable components
- Wipe-out design
- Swoop back
- Wood arm caps
- Non-marring 7/8" rubber-cushioned glides
- Nemschoff healthcare wood finish
- GREENGUARD Gold Certified
- Limited Lifetime Warranty
- See nemschoff.com for weight ratings (283-OB30, 283-OB40)

Available Options

- Moisture barrier + \$67 per seat or back
- Arcade back + \$0

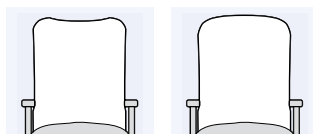

Swoop back (standard)

Arcade back

- Radius-edge arm + \$0
- CTB-133 + \$81/yd
- Two fabrics + \$62
- Three (or more) fabrics + \$88

Specification Decisions

- Select fabric
- Select standard wood finish
- Add moisture barrier
- Add CTB-133
- Apply multiple fabrics
- Add Arcade back
- Add radius-edge

Model numbers with **S** indicate standard seat and back covers, and model numbers with **P** indicate removable covers.

Flammability Type

- Type 3
- Type 4 (Plus models)

Coordinating Products

- [Torii Side Chair](#)
- [Torii Tables](#)
- [Torii Patient Chair](#)
- [Torii Glider](#)
- [Torii Rocker](#)

Key Dimensions

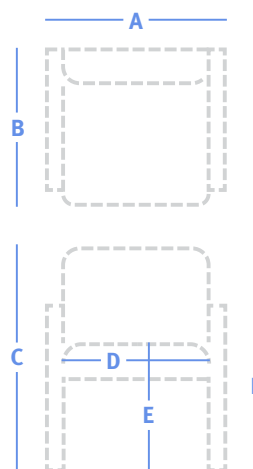

A	Overall Width	See price table
B	Overall Depth	25"
C	Overall Height	33"
D	Seat Width	
	Chair:	20", 30", 40"
	Settee:	20", 41"
	Three Seat:	20", 62.25"
E	Seat Height	18.25", 19" (OB30, OB40)
F	Arm Height	26"

More Information

- Illustrated Glossary ▶ 439
- Fabrics ▶ 451
- Flammability (CTB-133) ▶ 459
- Finishes ▶ 456
- Ordering and Warranties ▶ 462

Torii Multiple Seating

Lounge Seating

Multiple & Tandem Seating

Side, Stacking & Folding Chairs

Occasional Tables

	24" W, Chair									30 lbs 1.5 yds
	Model	Series 2	Series 3	Series 4	Series 5	Series 6	Series 7	Series 8	COM	
	283-10 S	\$1,302	\$1,349	\$1,429	\$1,512	\$1,611	\$1,710	\$1,835	\$1,349	
	283-10 P	\$1,464	\$1,511	\$1,591	\$1,674	\$1,773	\$1,872	\$1,997	\$1,511	
	34.25" W, Plus chair									38 lbs 3 yds
	Model	Series 2	Series 3	Series 4	Series 5	Series 6	Series 7	Series 8	COM	
	283-OB30	\$2,798	\$2,893	\$3,052	\$3,218	\$3,416	\$3,615	\$3,865	\$2,893	
	44.25" W, Plus chair									43 lbs 3.25 yds
	Model	Series 2	Series 3	Series 4	Series 5	Series 6	Series 7	Series 8	COM	
	283-OB40	\$3,105	\$3,208	\$3,380	\$3,560	\$3,774	\$3,990	\$4,261	\$3,208	
	45.25" W, Two seat									46 lbs 2.75 yds
	Model	Series 2	Series 3	Series 4	Series 5	Series 6	Series 7	Series 8	COM	
	283-20 S	\$2,149	\$2,236	\$2,382	\$2,534	\$2,715	\$2,898	\$3,127	\$2,236	
	283-20 P	\$2,418	\$2,505	\$2,651	\$2,803	\$2,984	\$3,167	\$3,396	\$2,505	
	45.25" W, Two seat with intervening arm and leg									49 lbs 2.75 yds
	Model	Series 2	Series 3	Series 4	Series 5	Series 6	Series 7	Series 8	COM	
	283-22 S	\$2,316	\$2,403	\$2,549	\$2,701	\$2,882	\$3,065	\$3,294	\$2,403	
	283-22 P	\$2,605	\$2,692	\$2,838	\$2,990	\$3,171	\$3,354	\$3,583	\$2,692	
	66.5" W, Three seat									65 lbs 4 yds
	Model	Series 2	Series 3	Series 4	Series 5	Series 6	Series 7	Series 8	COM	
	283-30 S	\$3,366	\$3,493	\$3,705	\$3,926	\$4,190	\$4,456	\$4,788	\$3,493	
	283-30 P	\$3,786	\$3,913	\$4,125	\$4,346	\$4,610	\$4,876	\$5,208	\$3,913	
	66.5" W, Three seat with intervening arms and legs									68 lbs 4 yds
	Model	Series 2	Series 3	Series 4	Series 5	Series 6	Series 7	Series 8	COM	
	283-33 S	\$3,544	\$3,671	\$3,883	\$4,104	\$4,368	\$4,634	\$4,966	\$3,671	
	283-33 P	\$3,985	\$4,112	\$4,324	\$4,545	\$4,809	\$5,075	\$5,407	\$4,112	

Valor Multiple Seating



Standard Features

- Heavy-duty steel construction
- Powder-coated frame
- Memory foam seat
- Dynamic flexing back
- Wipe-out design
- Replaceable components
- Black urethane arms
- Non-marring 1¼" glides
- GREENGUARD Gold Certified
- Limited Lifetime Warranty
- See nemschoff.com for weight ratings (891-OB30, 891-OB40)

Available Options

- Moisture barrier + \$67 per seat or back
- Wallsaver glides + \$0
- CTB-133 + \$81/yard
- Two fabrics + \$62
- Three (or more) fabrics + \$88

Specification Decisions

- Select fabric
- Select powder coat finish
- Add moisture barrier
- Add CTB-133
- Apply multiple fabrics
- Add wallsaver glides

Model numbers with **S** indicate standard seat and back covers, and model numbers with **P** indicate removable covers.

Flammability Type

- Type 3

Coordinating Products

- [Valor Lounge Seating](#)
- [Valor Stack Chair](#)
- [Valor Tables](#)
- [Valor Patient Chair](#)
- [Auburn Benches](#)

Key Dimensions

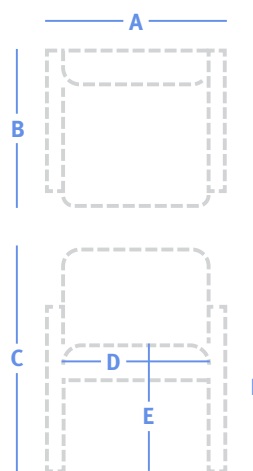

A	Overall Width	See price table
B	Overall Depth	24.5", 25.25 (OB30, OB40)
C	Overall Height	34"
D	Seat Width	Chair: 19.25", 30", 40" Two Seat: 39.5" Three Seat: 59.25"
E	Seat Height	18"
F	Arm Height	26.25"

More Information

- Illustrated Glossary ▶ 439
- Fabrics ▶ 451
- Flammability (CTB-133) ▶ 459
- Finishes ▶ 456
- Ordering and Warranties ▶ 462

Valor Multiple Seating

Lounge Seating

Multiple & Tandem Seating

Side, Stacking & Folding Chairs

Occasional Tables

		23.25" W, Chair 30 lbs 1.75 yds								
		Model	Series 2	Series 3	Series 4	Series 5	Series 6	Series 7	Series 8	COM
		891-10 S	\$612	\$667	\$760	\$857	\$972	\$1,088	\$1,234	\$667
		891-10 P	\$693	\$748	\$841	\$938	\$1,053	\$1,169	\$1,315	\$748
	33.25" W, Plus chair 55 lbs 2.75 yds									
	Model	Series 2	Series 3	Series 4	Series 5	Series 6	Series 7	Series 8	COM	
	891-OB30	\$767	\$854	\$1,000	\$1,152	\$1,333	\$1,516	\$1,745	\$854	
	43.25" W, Plus chair 66 lbs 2.75 yds									
	Model	Series 2	Series 3	Series 4	Series 5	Series 6	Series 7	Series 8	COM	
	891-OB40	\$901	\$988	\$1,134	\$1,286	\$1,467	\$1,650	\$1,879	\$988	
	43.25" W, Two seat 63 lbs 2.75 yds									
	Model	Series 2	Series 3	Series 4	Series 5	Series 6	Series 7	Series 8	COM	
	891-20 S	\$1,143	\$1,230	\$1,376	\$1,528	\$1,709	\$1,892	\$2,121	\$1,230	
	891-20 P	\$1,291	\$1,378	\$1,524	\$1,676	\$1,857	\$2,040	\$2,269	\$1,378	
	45" W, Two seat with intervening arm and leg 65 lbs 2.75 yds									
	Model	Series 2	Series 3	Series 4	Series 5	Series 6	Series 7	Series 8	COM	
	891-22 S	\$1,246	\$1,333	\$1,479	\$1,631	\$1,812	\$1,995	\$2,224	\$1,333	
	891-22 P	\$1,406	\$1,493	\$1,639	\$1,791	\$1,972	\$2,155	\$2,384	\$1,493	
	63.25" W, Three seat 88 lbs 4.5 yds									
	Model	Series 2	Series 3	Series 4	Series 5	Series 6	Series 7	Series 8	COM	
	891-30 S	\$1,544	\$1,687	\$1,926	\$2,175	\$2,471	\$2,770	\$3,144	\$1,687	
	891-30 P	\$1,747	\$1,890	\$2,129	\$2,378	\$2,674	\$2,973	\$3,347	\$1,890	
	66.5" W, Three seat with intervening arms and legs 90 lbs 4.5 yds									
	Model	Series 2	Series 3	Series 4	Series 5	Series 6	Series 7	Series 8	COM	
	891-33 S	\$1,738	\$1,881	\$2,120	\$2,369	\$2,665	\$2,964	\$3,338	\$1,881	
	891-33 P	\$1,964	\$2,107	\$2,346	\$2,595	\$2,891	\$3,190	\$3,564	\$2,107	

Valor Bench

Standard Features



Same standard features as Valor Multiple Seating

Available Options

Same available options as Valor Multiple Seating

Key Dimensions

- Overall Width: See price table
- Overall Depth: 24.5"
- Overall Height: 26.25"
- Seat Height: 19.5"
- Arm Height: 26.25"

		43.25" W, Bench 70 lbs 1.25 yds								
		Model	Series 2	Series 3	Series 4	Series 5	Series 6	Series 7	Series 8	COM
		891-B2 S	\$976	\$1,015	\$1,082	\$1,151	\$1,233	\$1,316	\$1,420	\$1,015
		891-B2 P	\$1,098	\$1,137	\$1,204	\$1,273	\$1,355	\$1,438	\$1,542	\$1,137

Alberto Side Chair



Standard Features

- Solid hardwood frame
- Mortise and tenon joinery
- Wood arms
- Non-marring 7/8" rubber-cushioned glides
- Nemschoff healthcare wood finish
- GREENGUARD Gold Certified
- Limited Lifetime Warranty

Flammability Type

- Type 1

Key Dimensions

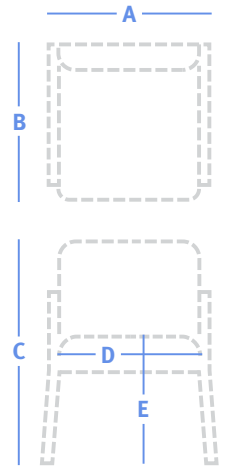

A	Overall Width	See price table
B	Overall Depth	25"
C	Overall Height	34.75"
D	Seat Width	19"
E	Seat Height	18" (wood) 18.75" (upholstered)
F	Arm Height	26.25"

Available Options

- Moisture barrier + \$67 per seat or back
- CTB-133 + \$81/yd
- Two fabrics + \$62
- Three (or more) fabrics + \$88

Specification Decisions

- Select standard wood finish
- Add moisture barrier
- Add CTB-133
- Apply multiple fabrics

More Information

- Illustrated Glossary ▶ 439
- Fabrics ▶ 451
- Flammability (CTB-133) ▶ 459
- Finishes ▶ 456
- Ordering and Warranties ▶ 462



22.75" W, Side chair with arms and molded plywood seat and back

20.25 lbs

Model	Price
60-92W	\$1,135



22.75" W, Side chair with arms and upholstered seat and back

20.25 lbs | 1.5 yds

Model	Series 2	Series 3	Series 4	Series 5	Series 6	Series 7	Series 8	COM
60-92U	\$996	\$1,043	\$1,123	\$1,206	\$1,305	\$1,404	\$1,529	\$1,043

Altair Side Chair



More Information

Illustrated Glossary ▶ 439

Fabrics ▶ 451

Flammability (CTB-133) ▶ 459

Finishes ▶ 456

Ordering and Warranties ▶ 462

Standard Features

- Solid maple frame
- Mortise and tenon joinery
- Spring seat construction
- Wipe-out design
- Non-marring 7/8" rubber-cushioned glides
- Nemschoff healthcare wood finish
- GREENGUARD Gold Certified
- Limited Lifetime Warranty

Available Options

- Moisture barrier + \$67 per seat or back
- CTB-133 + \$81/yd
- Two fabrics + \$62
- Three (or more) fabrics + \$88

Specification Decisions

- Select fabric
- Select standard wood finish
- Add moisture barrier
- Add CTB-133
- Apply multiple fabrics

Model numbers with **S** indicate standard seat and back covers, and model numbers with **P** indicate removable covers.

Flammability Type

- Type 1

Key Dimensions

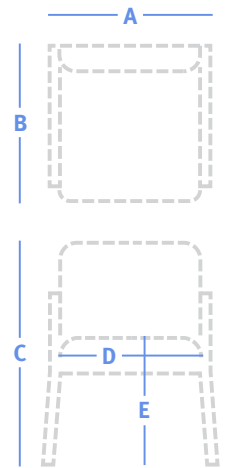

A	Overall Width	See price table
B	Overall Depth	22.75"
C	Overall Height	31.5"
D	Seat Width	18", 22"
E	Seat Height	18.5"
F	Arm Height	24.5"

		20.5" W, Side chair								18 lbs 1 yd
Model		Series 2	Series 3	Series 4	Series 5	Series 6	Series 7	Series 8	COM	
	309-91 S	\$811	\$842	\$895	\$951	\$1,017	\$1,083	\$1,166	\$842	
	309-91 P	\$913	\$944	\$997	\$1,053	\$1,119	\$1,185	\$1,268	\$944	
		20.5" W, Side chair with arms								18 lbs 1 yd
Model		Series 2	Series 3	Series 4	Series 5	Series 6	Series 7	Series 8	COM	
	309-92 S	\$897	\$928	\$981	\$1,037	\$1,103	\$1,169	\$1,252	\$928	
	309-92 P	\$1,009	\$1,040	\$1,093	\$1,149	\$1,215	\$1,281	\$1,364	\$1,040	
		24.5" W, Plus chair								22 lbs 1.5 yds
Model		Series 2	Series 3	Series 4	Series 5	Series 6	Series 7	Series 8	COM	
	309-OB91 S	\$1,084	\$1,131	\$1,211	\$1,294	\$1,393	\$1,492	\$1,617	\$1,131	
	309-OB91 P	\$1,220	\$1,267	\$1,347	\$1,430	\$1,529	\$1,628	\$1,753	\$1,267	

Andante Stack Chair



Standard Features

- Solid hardwood frame
- Powder-coated steel interior frame (BK Black or MSS Metallic Silver)
- Bentwood arms
- Wipe-out design
- Stacks up to three high
- Nemschoff healthcare wood finish
- GREENGUARD Gold Certified
- Limited Lifetime Warranty

Available Options

- Moisture barrier + \$67 per seat or back
- CTB-133 + \$81/yd
- Two fabrics + \$62
- Three (or more) fabrics + \$88

Specification Decisions

- Select fabric
- Select standard wood finish
- Select powder-coated finish (MSS Metallic Silver, BK Black)
- Add moisture barrier
- Add CTB-133
- Apply multiple fabrics

Flammability Type

- Type 3

Coordinating Products

- [Andante Multiple Seating](#)
- [Andante Patient Chair](#)

Key Dimensions

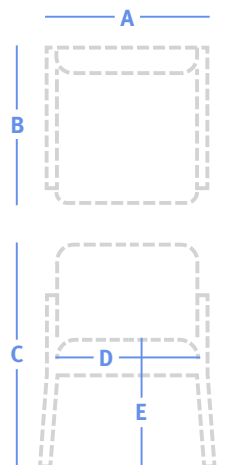

A	Overall Width	See price table
B	Overall Depth	23.5"
C	Overall Height	33"
D	Seat Width	18"
E	Seat Height	18"
F	Arm Height	25"

More Information

- Illustrated Glossary ▶ 439
- Fabrics ▶ 451
- Flammability (CTB-133) ▶ 459
- Finishes ▶ 456
- Ordering and Warranties ▶ 462



23" W, Stack chair

19 lbs | 1.25 yds

Model	Series 2	Series 3	Series 4	Series 5	Series 6	Series 7	Series 8	COM
ANXX-00036	\$1,063	\$1,082	\$1,168	\$1,214	\$1,240	\$1,273	\$1,294	\$1,082

Brava Side Chair



More Information

- Illustrated Glossary ▶ 439
- Fabrics ▶ 451
- Flammability (CTB-133) ▶ 459
- Finishes ▶ 456
- Ordering and Warranties ▶ 462

Standard Features

- Solid maple frame
- Mortise and tenon joinery
- Spring seat construction
- Non-marring 7/8" rubber-cushioned glides
- Nemschoff healthcare wood finish
- GREENGUARD Gold Certified
- Limited Lifetime Warranty

Available Options

- Moisture barrier + \$67 per seat or back
- CTB-133 + \$81/yd
- Two fabrics + \$62
- Three (or more) fabrics + \$88

Specification Decisions

- Select fabric
- Select standard wood finish
- Add moisture barrier
- Add CTB-133
- Apply multiple fabrics

Model numbers with **S** indicate standard seat and back covers, and model numbers with **P** indicate removable covers.

Flammability Type

- Type 4

Coordinating Products

- [Brava Classic Lounge Seating](#)
- [Brava Platform Lounge Seating](#)
- [Brava 862 Multiple Seating](#)
- [Brava 863 Multiple Seating](#)
- [Brava Tables](#)
- [Brava Adjustable Back Chair](#)
- [Brava CompactComfort Recliner](#)
- [Brava Patient Chair](#)
- [Brava Glider](#)
- [Brava Flop Sofa](#)
- [Brava Sleep Settee](#)

Key Dimensions

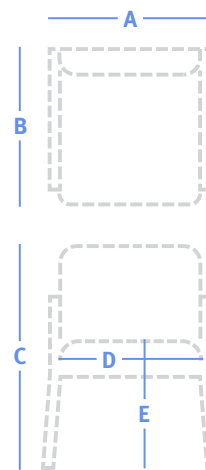

A	Overall Width	See price table
B	Overall Depth	23"
C	Overall Height	32.25"
D	Seat Width	19"
E	Seat Height	19"



19" W, Side chair

19 lbs | 1.75 yds

Model	Series 2	Series 3	Series 4	Series 5	Series 6	Series 7	Series 8	COM
862-91 S	\$1,256	\$1,311	\$1,404	\$1,501	\$1,616	\$1,732	\$1,878	\$1,311
862-91 P	\$1,414	\$1,469	\$1,562	\$1,659	\$1,774	\$1,890	\$2,036	\$1,469

Capella Side Chair



Standard Features

- Solid maple frame
- Mortise and tenon joinery
- Spring seat construction
- Non-marring 7/8" rubber-cushioned glides
- Nemschoff healthcare wood finish
- GREENGUARD Gold Certified
- Limited Lifetime Warranty

Available Options

- Moisture barrier + \$67 per seat or back
- CTB-133 + \$81/yd
- Two fabrics + \$62
- Three (or more) fabrics + \$88

Specification Decisions

- Select fabric
- Select standard wood finish
- Add moisture barrier
- Add CTB-133
- Apply multiple fabrics

Model numbers with **S** indicate standard seat and back covers, and model numbers with **P** indicate removable covers.

Flammability Type

- Type 4

Coordinating Products

- [Capella Multiple Seating](#)
- [Capella Tables](#)
- [Capella Patient Chair](#)
- [Capella Adjustable Back Chair](#)
- [Capella CompactComfort Recliner](#)
- [Capella Glider](#)
- [Capella Adjustable Back Glider](#)

Key Dimensions

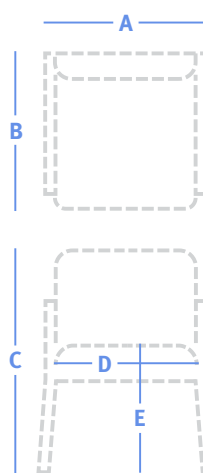

A	Overall Width	See price table
B	Overall Depth	23.5"
C	Overall Height	32"
D	Seat Width	18.25", 19"
E	Seat Height	18.5"

More Information

- Illustrated Glossary ▶ 439
- Fabrics ▶ 451
- Flammability (CTB-133) ▶ 459
- Finishes ▶ 456
- Ordering and Warranties ▶ 462

		19" W, Side chair								19 lbs 1.75 yds
Model		Series 2	Series 3	Series 4	Series 5	Series 6	Series 7	Series 8	COM	
	740-91 S	\$1,204	\$1,259	\$1,352	\$1,449	\$1,564	\$1,680	\$1,826	\$1,259	
	740-91 P	\$1,356	\$1,411	\$1,504	\$1,601	\$1,716	\$1,832	\$1,978	\$1,411	
		18.25" W, Bar stool								18.5 lbs 1.75 yds
Model		Series 2	Series 3	Series 4	Series 5	Series 6	Series 7	Series 8	COM	
	740-28 S	\$1,480	\$1,535	\$1,628	\$1,725	\$1,840	\$1,956	\$2,102	\$1,535	
	740-28 P	\$1,665	\$1,720	\$1,813	\$1,910	\$2,025	\$2,141	\$2,287	\$1,720	

Cities Side Chair



More Information

Illustrated Glossary ▶ 439

Fabrics ▶ 451

Flammability (CTB-133) ▶ 459

Finishes ▶ 456

Ordering and Warranties ▶ 462

Standard Features

- Solid maple frame
- Mortise and tenon joinery
- Spring seat construction
- Wipe-out design
- Replaceable components
- Wood arm caps
- Wallsaver legs
- Non-marring 7/8" rubber-cushioned glides
- Nemschoff healthcare wood finish
- GREENGUARD Gold Certified
- Limited Lifetime Warranty

Available Options

- Moisture barrier + \$67 per seat or back
- Three arm cap styles + \$0
- Two back styles + \$0
- CTB-133 + \$81/yd
- Two fabrics + \$62
- Three (or more) fabrics + \$88

Specification Decisions

- Select fabric
- Select standard wood finish
- Select wood arm cap style

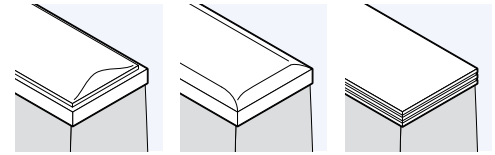

C Chicago

Y New York

N New Orleans

- Select back style

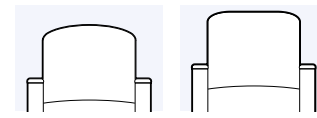

A Arcade back

S Square back

- Add moisture barrier
- Add CTB-133
- Apply multiple fabrics

Model numbers with **S** indicate standard seat and back covers, and model numbers with **P** indicate removable covers.

Flammability Type

- Type 3

Cities Side Chair

Coordinating Products

- [Cities Small Crosstown Lounge Seating](#)
- [Cities Medium Crosstown Lounge Seating](#)
- [Cities Large Crosstown Lounge Seating](#)
- [Cities Small Downtown Lounge Seating](#)
- [Cities Medium Downtown Lounge Seating](#)
- [Cities Large Downtown Lounge Seating](#)
- [Cities Small Uptown Lounge Seating](#)
- [Cities Medium Uptown Lounge Seating](#)
- [Cities Large Uptown Lounge Seating](#)
- [Cities Tables](#)
- [Cities Crosstown Patient Chair](#)
- [Cities Downtown Patient Chair](#)
- [Cities Uptown Patient Chair](#)
- [Cities Uptown CompactComfort Recliner](#)
- [Cities Crosstown Rocker](#)
- [Cities Downtown Rocker](#)
- [Cities Uptown Rocker](#)
- [Cities Downtown Glider](#)
- [Cities Uptown Glider](#)
- [SleepOver Sofa](#)
- [SleepOver Settee](#)

Key Dimensions

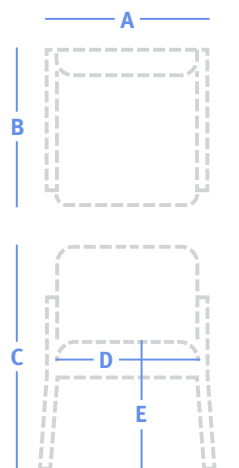

A	Overall Width	See price table
B	Overall Depth	27.5"
C	Overall Height	32.5"
D	Seat Width	19.5"
E	Seat Height	18.25"
F	Arm Height	25.5"



23.75" W, Side chair with arms

35 lbs | 1.5 yds

Model	Series 2	Series 3	Series 4	Series 5	Series 6	Series 7	Series 8	COM
Cities-SGXX-92 S	\$1,298	\$1,345	\$1,425	\$1,508	\$1,607	\$1,706	\$1,831	\$1,345
Cities-SGXX-92 P	\$1,460	\$1,507	\$1,587	\$1,670	\$1,769	\$1,868	\$1,993	\$1,507

Dex Folding Chair



More Information

- Illustrated Glossary ▶ 439
- Fabrics ▶ 451
- Flammability (CTB-133) ▶ 459
- Finishes ▶ 456
- Ordering and Warranties ▶ 462

Standard Features

- Engineered wood
- Mortise and tenon joinery
- Wallsaver leg
- Secure folding mechanism without pinch points
- Non-marring 1" rubber-cushioned glides
- 5" profile when folded
- Nemschoff healthcare wood finish
- GREENGUARD Gold Certified
- Limited Lifetime Warranty

Available Options

- Moisture barrier + \$67 per seat or back
- Wall mount bracket (holds two chairs) + \$23
- Hook for hanging chair + \$35
- CTB-133 + \$81/yd

Specification Decisions

- Select fabric, if required
- Select standard wood finish
- Add moisture barrier
- Add CTB-133
- Add hook
- Add wall mount bracket

Model numbers with **S** indicate standard seat and back covers, and model numbers with **P** indicate removable covers.

Can be hung on the Herman Miller Compass rail

Flammability Type

- Type 1

Coordinating Products

- [Dex Stack Chair](#)

Key Dimensions

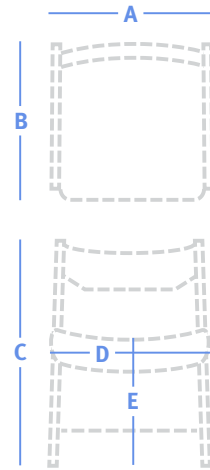







A	Overall Width	See price table
B	Overall Depth	24.75"
C	Overall Height	33.5"
D	Seat Width	18"
E	Seat Height	18"

	21.25" W, Folding chair with upholstered seat and back									18.5 lbs 1 yd
	Model	Series 2	Series 3	Series 4	Series 5	Series 6	Series 7	Series 8	COM	
	68-91U S	\$563	\$594	\$647	\$703	\$769	\$835	\$918	\$594	
	68-91U P	\$635	\$666	\$719	\$775	\$841	\$907	\$990	\$666	

	21.25" W, Folding chair with wood seat and upholstered back									18.5 lbs 0.5 yd
	Model	Series 2	Series 3	Series 4	Series 5	Series 6	Series 7	Series 8	COM	
	68-91UB S	\$590	\$605	\$632	\$660	\$693	\$726	\$767	\$605	
	68-91UB P	\$663	\$678	\$705	\$733	\$766	\$799	\$840	\$678	

Dex Folding Chair

21.25" W, Folding chair with upholstered seat and wood back										18.5 lbs 0.75 yd	
			Model	Series 2	Series 3	Series 4	Series 5	Series 6	Series 7	Series 8	COM
			68-91US S	\$594	\$617	\$657	\$699	\$748	\$798	\$860	\$617
			68-91US P	\$669	\$692	\$732	\$774	\$823	\$873	\$935	\$692

21.25" W, Folding chair with wood seat and back										18.5 lbs	
			Model	Price							
			68-91W	\$543							

Dex Stack Chair



More Information

Illustrated Glossary ▶ 439

Fabrics ▶ 451

Flammability (CTB-133) ▶ 459

Finishes ▶ 456

Ordering and Warranties ▶ 462

Standard Features

- Solid maple frame
- Mortise and tenon joinery
- Wallsaver legs
- Non-marring 1" rubber-cushioned glides
- Stacks up to three high
- Nemschoff healthcare wood finish
- GREENGUARD Gold Certified
- Limited Lifetime Warranty

Available Options

- Moisture barrier + \$67 per seat or back
- Black urethane arm caps + \$113
- CTB-133 + \$81/yd

Specification Decisions

- Select fabric, if required
- Select standard wood finish
- Add moisture barrier
- Add CTB-133
- Add urethane arm caps

Model numbers with **S** indicate standard seat and back covers, and model numbers with **P** indicate removable covers.

Flammability Type

- Type 1

Coordinating Products

- [Dex Folding Chair](#)

Key Dimensions

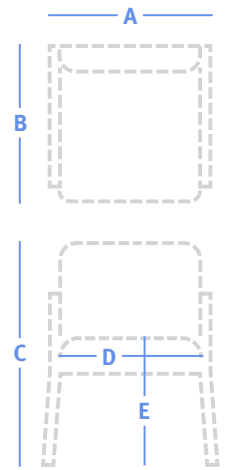

A	Overall Width	See price table
B	Overall Depth	22.5"
C	Overall Height	33.75"
D	Seat Width	18.25", 21.5"
E	Seat Height	18.25"
F	Arm Height	25.75"

Chair Icon	Chair Icon	25.5" W, Stack chair with upholstered seat and wood back									21.5 lbs 0.75 yd
		Model	Series 2	Series 3	Series 4	Series 5	Series 6	Series 7	Series 8	COM	
		68-92US S	\$772	\$795	\$835	\$877	\$926	\$976	\$1,038	\$795	
		68-92US P	\$868	\$891	\$931	\$973	\$1,022	\$1,072	\$1,134	\$891	
Chair Icon	Chair Icon	25.5" W, Stack chair with upholstered seat and back									21.5 lbs 1 yd
		Model	Series 2	Series 3	Series 4	Series 5	Series 6	Series 7	Series 8	COM	
		68-92U S	\$705	\$736	\$789	\$845	\$911	\$977	\$1,060	\$736	
		68-92U P	\$794	\$825	\$878	\$934	\$1,000	\$1,066	\$1,149	\$825	
Chair Icon	Chair Icon	25.5" W, Stack chair with wood seat and upholstered back									18.5 lbs 1 yd
		Model	Series 2	Series 3	Series 4	Series 5	Series 6	Series 7	Series 8	COM	
		68-92UB S	\$738	\$769	\$822	\$878	\$944	\$1,010	\$1,093	\$769	
		68-92UB P	\$831	\$862	\$915	\$971	\$1,037	\$1,103	\$1,186	\$862	
Chair Icon	Chair Icon	25.5" W, Stack chair with wood seat and back									18.5 lbs
		Model	Price	Depth	Height						
		68-92W	\$708	22.5"	33.5"						

Diane Side Chair



Standard Features

- Solid hardwood frame
- Non-marring 1" rubber-cushioned glides
- Nemschoff healthcare wood finish
- GREENGUARD Gold Certified
- Limited Lifetime Warranty

Available Options

- Moisture barrier + \$67 per seat or back
- CTB-133 + \$81/yd

Specification Decisions

- Select fabric
- Select standard wood finish
- Add moisture barrier
- Add CTB-133

Model numbers with **S** indicate standard seat and back covers, and model numbers with **P** indicate removable covers.

Flammability Type

- Type 1

Key Dimensions

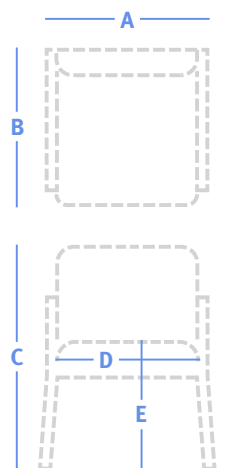

A	Overall Width	See price table
B	Overall Depth	22.75"
C	Overall Height	33.5"
D	Seat Width	19"
E	Seat Height	18"
F	Arm Height	23" (front) - 26" (rear)

More Information

- Illustrated Glossary ▶ 439
- Fabrics ▶ 451
- Flammability (CTB-133) ▶ 459
- Finishes ▶ 456
- Ordering and Warranties ▶ 462



22.5" W, Side chair with arms

19.25 lbs | 1 yd

Model	Series 2	Series 3	Series 4	Series 5	Series 6	Series 7	Series 8	COM
236-10 S	\$993	\$1,024	\$1,077	\$1,133	\$1,199	\$1,265	\$1,348	\$1,024
236-10 P	\$1,116	\$1,147	\$1,200	\$1,256	\$1,322	\$1,388	\$1,471	\$1,147

Monarch Stack Chair



More Information

- Illustrated Glossary ▶ 439
- Fabrics ▶ 451
- Flammability (CTB-133) ▶ 459
- Finishes ▶ 456
- Ordering and Warranties ▶ 462

Standard Features

- Solid maple frame
- Mortise and tenon joinery
- Memory foam seat
- Wipe-out design
- Replaceable components
- Black urethane arm caps
- Wallsaver legs
- Non-marring 7/8" glides
- Stacks up to three high
- Nemschoff healthcare wood finish
- GREENGUARD Gold Certified
- Limited Lifetime Warranty

Available Options

- Moisture barrier + \$67 per seat or back
- Wood arm caps + \$113
- CTB-133 + \$81/yd
- Two fabrics + \$62
- Three (or more) fabrics + \$88

Specification Decisions

- Select fabric
- Select standard wood finish
- Add moisture barrier
- Add CTB-133
- Add wood arm caps
- Apply multiple fabrics

Model numbers with **S** indicate standard seat and back covers, and model numbers with **P** indicate removable covers.

Flammability Type

- Type 3



Coordinating Products

- [Monarch Lounge Seating](#)
- [Monarch Multiple Seating](#)
- [Monarch Tables](#)
- [Monarch Patient Chair](#)
- [Monarch Sleep Chair and Settee](#)

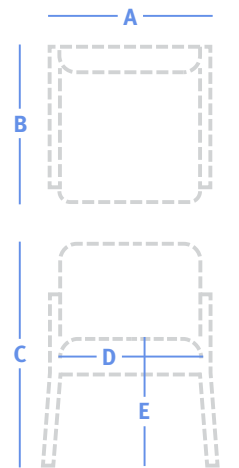
Key Dimensions



A	Overall Width	See price table
B	Overall Depth	24.5"
C	Overall Height	33.5"
D	Seat Width	22"
E	Seat Height	18.75"
F	Arm Height	27"

		24.5" W, Stack chair								22 lbs 1.5 yds	
		Series 2	Series 3	Series 4	Series 5	Series 6	Series 7	Series 8	COM		
		893-92 S	\$773	\$820	\$900	\$983	\$1,082	\$1,181	\$1,306	\$820	
		893-92 P	\$872	\$919	\$999	\$1,082	\$1,181	\$1,280	\$1,405	\$919	

Revive Side Chair



Standard Features

- Powder-coated metal frame
- Clean-out design
- Wood arm caps
- 2.5-degree back flex
- Non-marring glides
- GREENGUARD Gold Certified
- Limited Lifetime Warranty

Available Options

- Moisture barrier + \$67 per seat or back
- Black urethane arm caps + \$113
- CTB-133 + \$81/yd
- Two fabrics + \$62
- Three (or more) fabrics + \$88
- Wood or laminate infill panel + \$134

Specification Decisions

- Select fabric
- Select powder-coated finish
- Add moisture barrier
- Add CTB-133
- Apply multiple fabrics
- Add urethane arm caps
- Add infill panel

Flammability Types

- Type 5
- Type 6 (with arm panel)

Coordinating Products

- [Revive Patient Chair](#)
- [Revive Casegoods](#)
- [Revive Daystands](#)
- [Revive Display System](#)

Key Dimensions

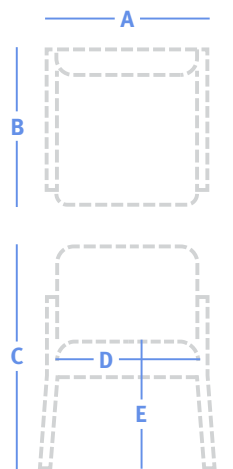

A	Overall Width	See price table
B	Overall Depth	22.5"
C	Overall Height	33"
D	Seat Width	20.5"
E	Seat Height	18.5"
F	Arm Height	24"

More Information

- Illustrated Glossary ▶ 439
- Fabrics ▶ 451
- Flammability (CTB-133) ▶ 459
- Finishes ▶ 456
- Ordering and Warranties ▶ 462



25" W, Side chair with arms and upholstered seat and back, open arm									20.5 lbs 2.5 yds
Model	Series 2	Series 3	Series 4	Series 5	Series 6	Series 7	Series 8	COM	
RV12	\$1,554	\$1,593	\$1,765	\$1,857	\$1,908	\$1,974	\$2,016	\$1,593	



25" W, Side chair with arms and upholstered seat, back, arm panel									20.5 lbs 3 yds
Model	Series 2	Series 3	Series 4	Series 5	Series 6	Series 7	Series 8	COM	
RV12SPA	\$1,589	\$1,636	\$1,842	\$1,953	\$2,013	\$2,093	\$2,143	\$1,636	



25" W, Side chair with arms and upholstered seat and back, short arm panel									20.5 lbs 3.5 yds
Model	Series 2	Series 3	Series 4	Series 5	Series 6	Series 7	Series 8	COM	
RV12HPA	\$1,621	\$1,676	\$1,917	\$2,046	\$2,116	\$2,209	\$2,268	\$1,676	

Romeo/Juliet Stack Chair



More Information

- Illustrated Glossary ▶ 439
- Fabrics ▶ 451
- Flammability (CTB-133) ▶ 459
- Finishes ▶ 456
- Ordering and Warranties ▶ 462

Standard Features

- Solid hardwood front legs
- Powder-coated metal back legs (MST Textured metallic silver, BK Black, XTT Textured titanium)
- Curved wood back
- Stacks up to eight high (Romeo models or Juliet models)
- Wallsaver legs (Juliet)
- Non-marring glides
- Nemschoff healthcare wood finish
- GREENGUARD Gold Certified
- Limited Lifetime Warranty

Available Options

- Moisture barrier + \$67 per seat or back
- CTB-133 + \$81

Specification Decisions

- Select fabric
- Select standard wood finish
- Select powder-coated finish

Romeo and Juliet chairs do not stack together.

Flammability Type

- Type 1

Key Dimensions

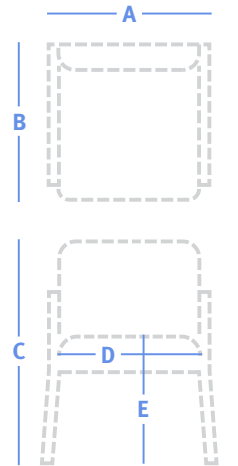

A	Overall Width	See price table
B	Overall Depth	23.5"
C	Overall Height	33"
D	Seat Width	18"
E	Seat Height	18.5"
F	Arm Height	26"

		22" W, Romeo stack chair with wood seat and back								19 lbs
		Model	Price							
		110	\$918							
		22" W, Romeo stack chair with upholstered seat and wood back								19 lbs 0.75 yd
		Model	Series 2	Series 3	Series 4	Series 5	Series 6	Series 7	Series 8	COM
		111	\$1,000	\$1,011	\$1,063	\$1,091	\$1,106	\$1,126	\$1,138	\$1,011
		22" W, Juliet stack chair with upholstered seat and wood back								19 lbs 0.75 yd
		Model	Series 2	Series 3	Series 4	Series 5	Series 6	Series 7	Series 8	COM
		114	\$1,000	\$1,011	\$1,063	\$1,091	\$1,106	\$1,126	\$1,138	\$1,011
		22" W, Juliet stack chair with wood seat and back								19 lbs
		Model	Price							
		115	\$918							

Torii Side Chair



Standard Features

- Solid maple frame
- Mortise and tenon joinery
- Spring seat construction
- Wipe-out design
- Replaceable components
- Non-marring 7/8" rubber-cushioned glides
- Nemschoff healthcare wood finish
- GREENGUARD Gold Certified
- Limited Lifetime Warranty

Available Options

- Moisture barrier + \$67 per seat or back
- CTB-133 + \$81/yd
- Two fabrics + \$62
- Three (or more) fabrics + \$88

Specification Decisions

- Select fabric
- Select standard wood finish
- Add moisture barrier
- Add CTB-133
- Apply multiple fabrics

Model numbers with **S** indicate standard seat and back covers, and model numbers with **P** indicate removable covers.

Flammability Type

- Type 1

Coordinating Products

- [Torii Multiple Seating](#)
- [Torii Tables](#)
- [Torii Patient Chair](#)
- [Torii Glider](#)
- [Torii Rocker](#)

Key Dimensions

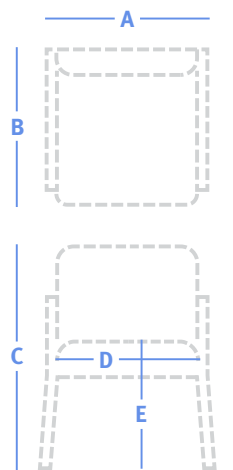

A	Overall Width	See price table
B	Overall Depth	23.25"
C	Overall Height	32"
D	Seat Width	22"
E	Seat Height	18.75"
F	Arm Height	24.75"

More Information

Illustrated Glossary ▶ 439

Fabrics ▶ 451

Flammability (CTB-133) ▶ 459

Finishes ▶ 456

Ordering and Warranties ▶ 462

22.5" W, Side chair										20 lbs 1.5 yds
Model	Series 2	Series 3	Series 4	Series 5	Series 6	Series 7	Series 8	COM		
283-91 S	\$956	\$1,003	\$1,083	\$1,166	\$1,265	\$1,364	\$1,489	\$1,003		
283-91 P	\$1,077	\$1,124	\$1,204	\$1,287	\$1,386	\$1,485	\$1,610	\$1,124		

23.5" W, Side chair with arms										22 lbs 1.5 yds
Model	Series 2	Series 3	Series 4	Series 5	Series 6	Series 7	Series 8	COM		
283-92 S	\$1,062	\$1,109	\$1,189	\$1,272	\$1,371	\$1,470	\$1,595	\$1,109		
283-92 P	\$1,196	\$1,243	\$1,323	\$1,406	\$1,505	\$1,604	\$1,729	\$1,243		

Valor Stack Chair



More Information

- Illustrated Glossary ▶ 439
- Fabrics ▶ 451
- Flammability (CTB-133) ▶ 459
- Finishes ▶ 456
- Ordering and Warranties ▶ 462

Standard Features

- Heavy-duty steel construction
- Powder-coated metal frame
- Memory foam seat
- Black urethane arms
- Wipe-out design
- Replaceable components
- Nylon glides
- Stacks up to three high
- GREENGUARD Gold Certified
- Limited Lifetime Warranty

Available Options

- Moisture barrier + \$67 per seat or back
- Wallsaver glides + \$0
- CTB-133 + \$81/yd
- Two fabrics + \$62
- Three (or more) fabrics + \$88

Specification Decisions

- Select fabric
- Select powder-coated finish
- Add moisture barrier
- Add CTB-133
- Apply multiple fabrics
- Add wallsaver glides

Model numbers with **S** indicate standard seat and back covers, and model numbers with **P** indicate removable covers.

Flammability Type

- Type 3

Coordinating Products

- [Valor Lounge Seating](#)
- [Valor Multiple Seating](#)
- [Valor Tables](#)
- [Valor Patient Chair](#)

Key Dimensions

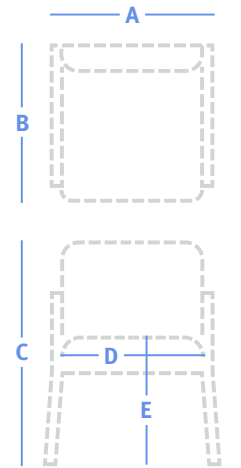

A	Overall Width	See price table
B	Overall Depth	24.5"
C	Overall Height	34"
D	Seat Width	22.75",
E	Seat Height	18.75"
F	Arm Height	26.25"

		24.75" W, Stack chair								29 lbs 1.75 yds
Model		Series 2	Series 3	Series 4	Series 5	Series 6	Series 7	Series 8	COM	
 	891-91 S	\$571	\$626	\$719	\$816	\$931	\$1,047	\$1,193	\$626	
	891-91 P	\$647	\$702	\$795	\$892	\$1,007	\$1,123	\$1,269	\$702	

		25.5" W, Stack chair with arms								36 lbs 1.75 yds
Model		Series 2	Series 3	Series 4	Series 5	Series 6	Series 7	Series 8	COM	
 	891-92 S	\$637	\$692	\$785	\$882	\$997	\$1,113	\$1,259	\$692	
	891-92 P	\$721	\$776	\$869	\$966	\$1,081	\$1,197	\$1,343	\$776	

Whisk Stack Chair



Standard Features

- Powder-coated metal frame
- Beech seat and back on select models
- Wipe-out design
- Spring seat construction
- Replaceable components
- Wood arm caps
- Wallsaver legs
- 15/16" dia black nylon glides
- Side chair (no arms) stacks up to four high
- Side chair (with arms) stacks up to three high
- Nemschoff healthcare wood finish
- GREENGUARD Gold Certified
- Limited Lifetime Warranty

Available Options

- Moisture barrier + \$67 per seat or back
- CTB-133 + \$81/yd
- Black urethane arm caps + 113

Specification Decisions

- Select fabric
- Select standard wood finish
- Select powder-coated finish
- Add moisture barrier
- Add CTB-133
- Add urethane arm caps

Model numbers with **S** indicate standard seat and back covers, and model numbers with **P** indicate removable covers.

Flammability Type

- Type 1

Key Dimensions

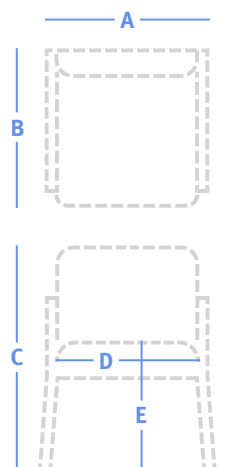

A	Overall Width	See price table
B	Overall Depth	24"
C	Overall Height	32.5"
D	Seat Width	22"
E	Seat Height	18.75"
F	Arm Height	26.25"

More Information

- Illustrated Glossary ▶ 439
- Fabrics ▶ 451
- Flammability (CTB-133) ▶ 459
- Finishes ▶ 456
- Ordering and Warranties ▶ 462



24" W, Side chair with upholstered seat and wood back

22 lbs | 1 yd

Model	Series 2	Series 3	Series 4	Series 5	Series 6	Series 7	Series 8	COM
67-91 S	\$654	\$685	\$738	\$794	\$860	\$926	\$1,009	\$685
67-91 P	\$737	\$768	\$821	\$877	\$943	\$1,009	\$1,092	\$768



24" W, Side chair with upholstered seat and back

22 lbs | 1.5 yds

Model	Series 2	Series 3	Series 4	Series 5	Series 6	Series 7	Series 8	COM
67-91U S	\$600	\$647	\$727	\$810	\$909	\$1,008	\$1,133	\$647
67-91U P	\$678	\$725	\$805	\$888	\$987	\$1,086	\$1,211	\$725

Whisk Stack Chair



24" W, Side chair with arms and upholstered seat and wood back

22 lbs | 1 yd

Model	Series 2	Series 3	Series 4	Series 5	Series 6	Series 7	Series 8	COM
67-92 S	\$754	\$785	\$838	\$894	\$960	\$1,026	\$1,109	\$785
67-92 P	\$849	\$880	\$933	\$989	\$1,055	\$1,121	\$1,204	\$880



24" W, Side chair with arms and upholstered seat and back

22 lbs | 1.5 yds

Model	Series 2	Series 3	Series 4	Series 5	Series 6	Series 7	Series 8	COM
67-92U S	\$694	\$741	\$821	\$904	\$1,003	\$1,102	\$1,227	\$741
67-92U P	\$783	\$830	\$910	\$993	\$1,092	\$1,191	\$1,316	\$830

Lounge Seating

Multiple & Tandem Seating

Side, Stacking & Folding Chairs

Occasional Tables

2000 Series Tables



Standard Features

- Solid maple frame
- Replaceable components
- Laminate or veneer top with wood edge
- 7/8" rubber-cushioned glides on the end tables
- Brushed metal accent side rail (2770)
- Nemschoff healthcare wood finish
- GREENGUARD Gold Certified
- Limited Lifetime Warranty

Coordinating Products

- [2600 Series Multiple Seating](#)
- [2700 Series Multiple Seating](#)
- [2750 Series Multiple Seating](#)
- [2770 Series Multiple Seating](#)

More Information









- Illustrated Glossary ▶ 439
- Finishes ▶ 456
- Ordering and Warranties ▶ 462

Specification Decisions

- Select standard wood finish or laminate
- See 2600 Series, 2700 Series, 2750 Series and 2700 Series Multiple Seating for spanner tables

	26.25" W, Corner coffee table; laminate top 29 lbs							
	<table border="1"> <thead> <tr> <th>Model</th> <th>Price</th> <th>Depth</th> <th>Height</th> </tr> </thead> <tbody> <tr> <td>2000-T4</td> <td>\$1,082</td> <td>26.25"</td> <td>17.75"</td> </tr> </tbody> </table>	Model	Price	Depth	Height	2000-T4	\$1,082	26.25"
Model	Price	Depth	Height					
2000-T4	\$1,082	26.25"	17.75"					
	26.25" W, Corner coffee table; veneer top 29 lbs							
	<table border="1"> <thead> <tr> <th>Model</th> <th>Price</th> <th>Depth</th> <th>Height</th> </tr> </thead> <tbody> <tr> <td>2000-T4V</td> <td>\$1,319</td> <td>26.25"</td> <td>17.75"</td> </tr> </tbody> </table>	Model	Price	Depth	Height	2000-T4V	\$1,319	26.25"
Model	Price	Depth	Height					
2000-T4V	\$1,319	26.25"	17.75"					
	24" W, Square end table; laminate top 30 lbs							
	<table border="1"> <thead> <tr> <th>Model</th> <th>Price</th> <th>Depth</th> <th>Height</th> </tr> </thead> <tbody> <tr> <td>2XXX-T1</td> <td>\$1,162</td> <td>20"</td> <td>20"</td> </tr> </tbody> </table>	Model	Price	Depth	Height	2XXX-T1	\$1,162	20"
Model	Price	Depth	Height					
2XXX-T1	\$1,162	20"	20"					
	24" W, Square end table; veneer top 30 lbs							
	<table border="1"> <thead> <tr> <th>Model</th> <th>Price</th> <th>Depth</th> <th>Height</th> </tr> </thead> <tbody> <tr> <td>2XXX-T1V</td> <td>\$1,418</td> <td>20"</td> <td>20"</td> </tr> </tbody> </table>	Model	Price	Depth	Height	2XXX-T1V	\$1,418	20"
Model	Price	Depth	Height					
2XXX-T1V	\$1,418	20"	20"					
	44.5" W, Square end table; laminate top 42 lbs							
	<table border="1"> <thead> <tr> <th>Model</th> <th>Price</th> <th>Depth</th> <th>Height</th> </tr> </thead> <tbody> <tr> <td>2XXX-T2</td> <td>\$1,713</td> <td>20"</td> <td>20"</td> </tr> </tbody> </table>	Model	Price	Depth	Height	2XXX-T2	\$1,713	20"
Model	Price	Depth	Height					
2XXX-T2	\$1,713	20"	20"					

2000 Series Tables

 	44.5" W, Square end table; veneer top 42 lbs								
	<table border="1"> <thead> <tr> <th>Model</th> <th>Price</th> <th>Depth</th> <th>Height</th> </tr> </thead> <tbody> <tr> <td>2XXX-T2V</td> <td>\$2,089</td> <td>20"</td> <td>20"</td> </tr> </tbody> </table>	Model	Price	Depth	Height	2XXX-T2V	\$2,089	20"	20"
Model	Price	Depth	Height						
2XXX-T2V	\$2,089	20"	20"						
 	30" W, Triangle end table; laminate top								
	<table border="1"> <thead> <tr> <th>Model</th> <th>Price</th> <th>Depth</th> <th>Height</th> </tr> </thead> <tbody> <tr> <td>2XXX-T3</td> <td>\$1,491</td> <td>24"</td> <td>20.5"</td> </tr> </tbody> </table>	Model	Price	Depth	Height	2XXX-T3	\$1,491	24"	20.5"
Model	Price	Depth	Height						
2XXX-T3	\$1,491	24"	20.5"						
 	30" W, Triangle end table; veneer top								
	<table border="1"> <thead> <tr> <th>Model</th> <th>Price</th> <th>Depth</th> <th>Height</th> </tr> </thead> <tbody> <tr> <td>2XXX-T3V</td> <td>\$1,818</td> <td>24"</td> <td>20.5"</td> </tr> </tbody> </table>	Model	Price	Depth	Height	2XXX-T3V	\$1,818	24"	20.5"
Model	Price	Depth	Height						
2XXX-T3V	\$1,818	24"	20.5"						
 	22" W, Square table with metal accent rail; laminate top 32 lbs								
	<table border="1"> <thead> <tr> <th>Model</th> <th>Price</th> <th>Depth</th> <th>Height</th> </tr> </thead> <tbody> <tr> <td>2770-T1</td> <td>\$1,251</td> <td>20"</td> <td>20"</td> </tr> </tbody> </table>	Model	Price	Depth	Height	2770-T1	\$1,251	20"	20"
Model	Price	Depth	Height						
2770-T1	\$1,251	20"	20"						
 	22" W, Square table with metal accent rail; veneer top 32 lbs								
	<table border="1"> <thead> <tr> <th>Model</th> <th>Price</th> <th>Depth</th> <th>Height</th> </tr> </thead> <tbody> <tr> <td>2770-T1V</td> <td>\$1,525</td> <td>20"</td> <td>20"</td> </tr> </tbody> </table>	Model	Price	Depth	Height	2770-T1V	\$1,525	20"	20"
Model	Price	Depth	Height						
2770-T1V	\$1,525	20"	20"						

Lounge Seating

Multiple & Tandem Seating

Side, Stacking & Folding Chairs

Occasional Tables

Auburn Tables

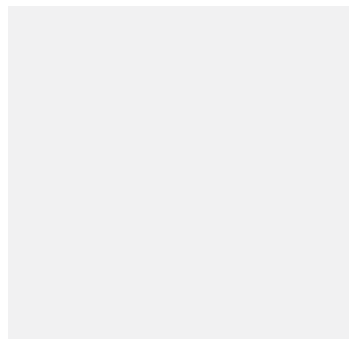

Standard Features

- Solid hardwood frame
- Laminate or veneer top with wood edge
- Nemschoff healthcare wood finish
- GREENGUARD Gold Certified
- Limited Lifetime Warranty

Coordinating Products

- [Auburn Multiple Seating](#)
- [Auburn Recliner](#)
- [Auburn Glider](#)

Specification Decisions

- Select standard wood finish
 - Select standard laminate, if required
 - Select table top material (laminate or veneer)
- See Auburn Multiple Seating for spanner tables

More Information

[Illustrated Glossary](#) ▶ 439

[Finishes](#) ▶ 456

[Ordering and Warranties](#) ▶ 462

		23.5" W, Rectangular coffee table				20 lbs
	Model	Price	Depth	Height		
	AT-10-1	\$1,396	20.5"	14.75"		
	AT-10-2	\$1,396	20.5"	16"		

		42.5" W, Rectangular coffee table				33 lbs
	Model	Price	Depth	Height		
	AT-10-3	\$1,977	20.5"	14.75"		
	AT-10-4	\$1,977	20.5"	16"		

Boulevard Tables



Standard Features

- Solid hardwood legs
- Laminate or veneer top with wood edge
- 3/4" plastic glides
- Nemschoff healthcare wood finish
- GREENGUARD Gold Certified
- Limited Lifetime Warranty

Coordinating Products

- [Boulevard Lounge Seating](#)

Specification Decisions













- Select standard wood finish or laminate

More Information

[Illustrated Glossary](#) ▶ 439



[Finishes](#) ▶ 456



[Ordering and Warranties](#) ▶ 462

		20" W, Square coffee table				18 lbs
		Model	Price	Depth	Height	
		112-1	\$1,561	20"	16"	
		20" W, Square end table				18 lbs
		Model	Price	Depth	Height	
		112-2	\$1,561	20"	23"	
		24" W, Square coffee table				22 lbs
		Model	Price	Depth	Height	
		112-3	\$1,812	24"	16"	
		24" W, Square end table				22 lbs
		Model	Price	Depth	Height	
		112-4	\$1,812	24"	23"	
		30" W, Square coffee table				36 lbs
		Model	Price	Depth	Height	
		112-5	\$1,956	30"	16"	
		30" W, Square end table				36 lbs
		Model	Price	Depth	Height	
		112-6	\$1,956	30"	23"	



Boulevard Tables



Welcoming & Waiting

		36" W, Square coffee table			50 lbs
		Model	Price	Depth	Height
		112-7	\$2,072	36"	16"



		36" W, Square end table			50 lbs
		Model	Price	Depth	Height
		112-8	\$2,131	36"	23"



Patient Areas



		20" W Rectangular coffee table			46 lbs
		Model	Price	Depth	Height
		112-9	\$2,131	54"	16"



		20" W, Rectangular end table			46 lbs
		Model	Price	Depth	Height
		112-10	\$2,131	54"	23"

Specialty



		24" dia, Round coffee table			18 lbs
		Model	Price	Depth	Height
		113-1	\$1,892	24"	16"

		24" dia, Round end table			18 lbs
		Model	Price	Depth	Height
		113-2	\$1,892	24"	23"

		30" dia, Round coffee table			30 lbs
		Model	Price	Depth	Height
		113-3	\$2,038	30"	16"

		30" dia, Round end table			30 lbs
		Model	Price	Depth	Height
		113-4	\$2,038	30"	23"

Reference

		36" dia, Round coffee table			46 lbs
		Model	Price	Depth	Height
		113-5	\$2,129	36"	16"

Brava Tables



More Information

Illustrated Glossary ▶ 439

Finishes ▶ 456

Ordering and Warranties ▶ 462

Standard Features

- Solid maple frame
- Laminate or veneer top with wood edge
- 7/8" rubber-cushioned glides
- Nemschoff healthcare wood finish
- GREENGUARD Gold Certified
- Limited Lifetime Warranty

- [Brava Side Chair](#)
- [Brava Adjustable Back Chair](#)
- [Brava CompactComfort Recliner](#)
- [Brava Patient Chair](#)
- [Brava Glider](#)
- [Brava Flop Sofa](#)
- [Brava Sleep Settee](#)

Specification Decisions

- Select standard wood finish or laminate

Coordinating Products

- [Brava Classic Lounge Seating](#)
- [Brava Platform Lounge Seating](#)
- [Brava 862 Multiple Seating](#)
- [Brava 863 Multiple Seating](#)



44" W, Rectangular coffee table; laminate top

27 lbs

Model	Price	Depth	Height
861-T9	\$1,472	18"	14.5"



44" W, Rectangular coffee table; veneer top

27 lbs

Model	Price	Depth	Height
861-T9V	\$1,796	18"	14.5"



27.25" W, Square end table; laminate top

25 lbs

Model	Price	Depth	Height
861-T6	\$1,260	27.25"	18"



27.25" W, Square end table; veneer top

25 lbs

Model	Price	Depth	Height
861-T6V	\$1,537	27.25"	18"

Brooklyn Tables



Standard Features

- Solid maple frame
- Replaceable components
- Laminate or veneer top with wood edge
- Nemschoff healthcare wood finish
- GREENGUARD Gold Certified
- Limited Lifetime Warranty

Specification Decisions

- Select standard wood finish or laminate

Coordinating Products

- [Brooklyn Lounge Seating](#)
- [Brooklyn Patient Chair](#)

More Information

[Illustrated Glossary](#) ▶ 439

[Finishes](#) ▶ 456

[Ordering and Warranties](#) ▶ 462

		42" W, Rectangular coffee table				38 lbs
		Model	Price	Depth	Height	
		776-T9	\$1,502	18"	14.5"	
		24" W, Square end table				30 lbs
		Model	Price	Depth	Height	
		776-T6	\$1,196	24"	18"	

Capella Tables



Standard Features

- Solid maple legs
- Replaceable components
- Laminate or veneer top with wood edge
- Nemschoff healthcare wood finish
- GREENGUARD Gold Certified
- Limited Lifetime Warranty

Specification Decisions

- Select standard wood finish or laminate

Coordinating Products

- [Capella Multiple Seating](#)
- [Capella Side Chair](#)
- [Capella Patient Chair](#)
- [Capella Adjustable Back Chair](#)
- [Capella CompactComfort Recliner](#)
- [Capella Glider](#)
- [Capella Adjustable Back Glider](#)

More Information

[Illustrated Glossary](#) ▶ 439

[Finishes](#) ▶ 456

[Ordering and Warranties](#) ▶ 462

	20" W, Square end table; laminate top				24 lbs
	Model	Price	Depth	Height	
	740-6	\$1,220	20"	18"	
	20" W, Square end table; veneer top				24 lbs
	Model	Price	Depth	Height	
	740-6V	\$1,488	20"	18"	
	42" W, Rectangular coffee table; laminate top				30 lbs
	Model	Price	Depth	Height	
	740-9	\$1,472	18"	14.5"	
	42" W, Rectangular coffee table; veneer top				30 lbs
	Model	Price	Depth	Height	
	740-9V	\$1,795	18"	14.5"	

Carlson Tables



Standard Features

- Heavy-duty steel construction
- Replaceable components
- Powder-coated metal legs
- Self-edged laminate top
- Adjustable 1" glides
- GREENGUARD Gold Certified
- Limited Lifetime Warranty

Coordinating Products

- [Anderson Multiple Seating](#)

More Information

[Illustrated Glossary](#) ▶ 439

[Finishes](#) ▶ 456

[Ordering and Warranties](#) ▶ 462

Specification Decisions

- Select standard laminate
 - Select powder-coat finish
- See Anderson Multiple Seating for spanner tables



19.5" W, Square coffee table

24 lbs



Model	Price	Depth	Height
FX620-T1	\$872	19.5"	16"



48" W, Rectangular coffee table

30 lbs

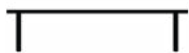

Model	Price	Depth	Height
FX620-T2	\$1,054	18"	16"



26.25" W, Corner coffee table

28 lbs



Model	Price	Depth	Height
FX620-T4	\$905	26.25"	16"

Cities Tables



More Information

Illustrated Glossary ▶ 439

Finishes ▶ 456

Ordering and Warranties ▶ 462

Standard Features

- Solid maple frame
- Replaceable components
- Laminate or veneer top with wood edge
- Crowned table apron (Downtown, Uptown)
- Straight apron (Crosstown)
- Nemschoff healthcare wood finish
- GREENGUARD Gold Certified
- Limited Lifetime Warranty

Available Options

- Five table top edge styles + \$0

Specification Decisions

- Select standard wood finish or laminate
- Select edge style:

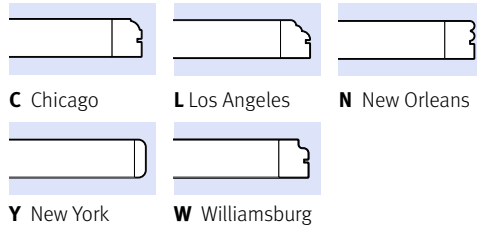

Coordinating Products

- [Cities Small Crosstown Lounge Seating](#)
- [Cities Medium Crosstown Lounge Seating](#)
- [Cities Large Crosstown Lounge Seating](#)
- [Cities Small Downtown Lounge Seating](#)
- [Cities Medium Downtown Lounge Seating](#)
- [Cities Large Downtown Lounge Seating](#)
- [Cities Small Uptown Lounge Seating](#)
- [Cities Medium Uptown Lounge Seating](#)
- [Cities Large Uptown Lounge Seating](#)
- [Cities Side Chair](#)
- [Cities Crosstown Patient Chair](#)
- [Cities Downtown Patient Chair](#)
- [Cities Uptown Patient Chair](#)
- [Cities Uptown CompactComfort Recliner](#)
- [Cities Crosstown Rocker](#)
- [Cities Downtown Rocker](#)
- [Cities Uptown Rocker](#)
- [Cities Downtown Glider](#)
- [Cities Uptown Glider](#)
- [SleepOver Sofa](#)
- [SleepOver Settee](#)

See Cities Lounge Seating for spanner tables

	19.5" W, Square coffee table; laminate top				24 lbs
	Model	Price	Depth	Height	
	Cities-SUX000-S200	\$1,074	19.5"	17"	
	27" W, Corner coffee table; laminate top				29 lbs
	Model	Price	Depth	Height	
	Cities-SUX000-C200	\$1,676	27"	17"	
	19.5" W, Square coffee table; laminate top				24 lbs
	Model	Price	Depth	Height	
	Cities-SXX000-T000	\$1,105	19.5"	16"	
	19.5" W, Square coffee table; veneer top				24 lbs
	Model	Price	Depth	Height	
	Cities-SXX000-T000V	\$1,348	19.5"	16"	

Welcoming & Waiting

Cities Tables



24" W, Square end table; laminate top

38 lbs

Model	Price	Depth	Height
Cities-SXX000-T100	\$1,220	24"	20"



24" W, Square end table; veneer top

38 lbs

Model	Price	Depth	Height
Cities-SXX000-T100V	\$1,488	24"	20"

Patient Areas



30" W, Square end table; laminate top

41 lbs

Model	Price	Depth	Height
Cities-SXX000-T200	\$1,288	30"	24"



30" W, Square end table; veneer top

41 lbs

Model	Price	Depth	Height
Cities-SXX000-T200V	\$1,572	30"	24"



36" W, Square coffee table; laminate top

53 lbs

Model	Price	Depth	Height
Cities-SXX000-T300	\$1,444	36"	16"

Specialty



36" W, Square coffee table; veneer top

53 lbs

Model	Price	Depth	Height
Cities-SXX000-T300V	\$1,761	36"	16"



42" W, Square coffee table; laminate top

57 lbs

Model	Price	Depth	Height
Cities-SXX000-T400	\$1,651	42"	16"



42" W, Square coffee table; veneer top

57 lbs

Model	Price	Depth	Height
Cities-SXX000-T400V	\$2,015	42"	16"

Reference

Cubes & Cylinders Tables



Standard Features

- High-density particleboard
- Non-marring 7/8" rubber-cushioned glides
- Nemschoff healthcare wood finish
- GREENGUARD Gold Certified
- Limited Lifetime Warranty

More Information

Illustrated Glossary ▶ 439

Finishes ▶ 456

Ordering and Warranties ▶ 462

Cubes Tables

Standard Features

Same standard features, plus:

- Laminate or veneer top and exterior surfaces

Available Options

- 3" black plinth base (1" offset) + \$113
- 3" matching plinth base (1" offset) + \$113
- Radiused wood edge (select models)

Specification Decisions

- Specify cube height (16", 18", 21", or 24")
- Select standard laminate
- Add plinth base (black or matching)

Key Dimensions

- Laminate Cubes

Product	Weight (lbs)
15" W, cube	Height x 1.9
24" W, cube	Height x 2.5
30" W, cube	Height x 3.8

15" W, Cube; laminate				
Model	Price	Depth	Height	
195-CB4 Cube	\$484	30"	16", 18", 21", 24"	

15" W, Cube with radius top edge; laminate				
Model	Price	Depth	Height	
195-CBR4 Cube	\$1,172	30"	16", 18", 21", 24"	

Cubes & Cylinders Tables

	24" W, Cube; laminate			
	Model	Price	Depth	Height
	195-CB5 Cube	\$506	24"	16", 18", 21", 24"

	24" W, Cube with radius top edge; laminate			
	Model	Price	Depth	Height
	195-CBR5 Cube	\$1,204	24"	16", 18", 21", 24"

	30" W, Cube; laminate			
	Model	Price	Depth	Height
	195-CB6 Cube	\$608	30"	16", 18", 21", 24"

	30" W, Cube with radius top edge; laminate			
	Model	Price	Depth	Height
	195-CBR6 Cube	\$1,471	30"	16", 18", 21", 24"

Cylinders Tables

Standard Features

Same standard features, plus:

- Laminate top and exterior surfaces

Available Options

- 3" black plinth base + \$113
- 3" matching plinth base + \$113

Specification Decisions

- Specify cylinder height (16", 18", 21", or 24")
- Select standard laminate
- Add plinth base (black or matching)

Key Dimensions

- Laminate Cylinders

Product	Weight (lbs)
18" dia, cylinder	Height x 1.3
24" dia, cylinder	Height x 2.1
30" dia, cylinder	Height x 3.3
35" dia, cylinder	Height x 4.3

- Maple veneer Cylinders

Product	Weight (lbs)
18" dia, cylinder	Height x 1.9
24" dia, cylinder	Height x 2.5
30" dia, cylinder	Height x 3.8

	18" dia, Cylinder; laminate		
	Model	Price	Height
	195-CY18 Cylinder	\$722	16", 18", 21", 24"

	18" dia, Cylinder; maple veneer		
	Model	Price	Height
	195-CW18M Cylinder	\$1,431	16", 18", 21", 24"

Cubes & Cylinders Tables

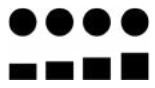

24" dia, Cylinder; laminate

Model	Price	Height
195-CY24 Cylinder	\$869	16", 18", 21", 24"

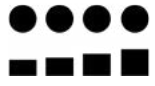

24" dia, Cylinder; maple veneer

Model	Price	Height
195-CW24M Cylinder	\$1,708	16", 18", 21", 24"

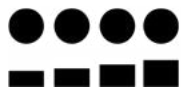

30" dia, Cylinder; laminate

Model	Price	Height
195-CY30 Cylinder	\$1,063	16", 18", 21", 24"

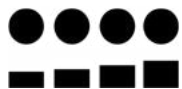

30" dia, Cylinder; maple veneer

Model	Price	Height
195-CW30M Cylinder	\$1,742	16", 18", 21", 24"

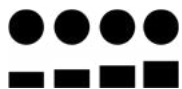

35" dia, Cylinder; laminate

Model	Price	Height
195-CY35 Cylinder	\$1,280	16", 18", 21", 24"

Lounge Seating

Multiple & Tandem Seating

Side, Stacking & Folding Chairs

Occasional Tables

Evita Tables



Standard Features

- Solid maple legs
- Replaceable components
- Laminate or veneer top with wood edge
- 3/4" rubber-cushioned glides
- Nemschoff healthcare wood finish
- GREENGUARD Gold Certified
- Limited Lifetime Warranty

Specification Decisions

- Select standard wood finish or laminate
- See Evita Lounge Seating for spanner tables

Coordinating Products

- [Evita Lounge Seating](#)

More Information

[Illustrated Glossary](#) ▶ 439

[Finishes](#) ▶ 456

[Ordering and Warranties](#) ▶ 462

 	24.5" W, Rectangular end table; laminate top				24 lbs
	Model	Price	Depth	Height	
	2800-T1	\$921	21.5"	16.75"	
 	24.5" W, Rectangular end table; veneer top				24 lbs
	Model	Price	Depth	Height	
	2800-T1V	\$1,124	21.5"	16.75"	
 	17.75" W Oval end table; laminate top				13 lbs
	Model	Price	Depth	Height	
	2800-7	\$1,020	12.75"	22.5"	
	2800-8	\$1,222	24"	22.5"	
 	17.75" W Oval end table; veneer top				14 lbs
	Model	Price	Depth	Height	
	2800-7V	\$1,245	12.75"	22.5"	
	2800-8V	\$1,380	24"	22.5"	

Florabella Tables



More Information

Illustrated Glossary ▶ 439

Finishes ▶ 456

Ordering and Warranties ▶ 462

Standard Features

- Solid maple legs with grey urethane sleeves
- Laminate table top with wood edge
- Nemschoff healthcare wood finish
- GREENGUARD Gold Certified
- Limited Lifetime Warranty

Specification Decisions

- Select standard wood finish
- Select standard laminate

Coordinating Products

- [Florabella Lounge Seating](#)

	24" dia, Round coffee table 22 lbs			
	Model	Price	Height	
	FLBL-00005	\$1,818	17.5"	
	24" dia, Round end table 24 lbs			
	Model	Price	Height	
	FLBL-00004	\$1,737	23.5"	
	60" W, Oval coffee table 48 lbs			
	Model	Price	Depth	Height
	FLBL-00006	\$1,922	29"	17.5"

Hadleigh Tables



Standard Features

- Solid maple frame
- Laminate or veneer top with wood edge
- 7/8" rubber-cushioned glides
- Nemschoff healthcare wood finish
- GREENGUARD Gold Certified
- Limited Lifetime Warranty

Coordinating Products

- [Hadleigh Lounge Seating](#)
- [Hadleigh Patient Chair](#)
- [Hadleigh Adjustable Back Chair](#)
- [Hadleigh Casegoods](#)

Specification Decisions

- Select standard wood finish or laminate

More Information

[Illustrated Glossary](#) ▶ 439

[Finishes](#) ▶ 456

[Ordering and Warranties](#) ▶ 462



21.75" W, Square end table; laminate top

27 lbs

Model	Price	Depth	Height
280-T5	\$890	21.75"	18"
280-T6	\$913	21.75"	21"



21.75" W, Square end table; veneer top

27 lbs

Model	Price	Depth	Height
280-T5V	\$1,086	21.75"	18"
280-T6V	\$1,115	21.75"	21"



44" W, Rectangular coffee table; laminate top

40 lbs

Model	Price	Depth	Height
280-T9	\$1,035	18"	16.5"



44" W, Rectangular coffee table; veneer top

40 lbs

Model	Price	Depth	Height
280-T9V	\$1,262	18"	16.5"

Horizon Tables

Lounge Seating

Multiple & Tandem Seating

Side, Stacking & Folding Chairs

Occasional Tables

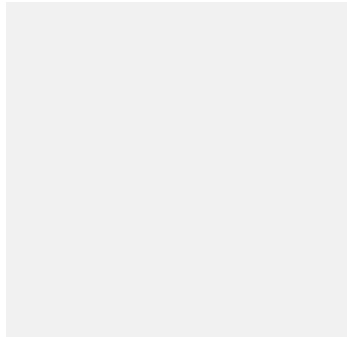

Standard Features

- Solid hardwood frame
- Laminate or veneer top with wood edge
- Nemschoff healthcare wood finish
- GREENGUARD Gold Certified
- Limited Lifetime Warranty

Coordinating Products

- [Horizon Multiple Seating](#)
- [Horizon Recliner](#)
- [Horizon Patient Chair](#)

Specification Decisions

- Select standard wood finish or laminate
- See Horizon Multiple Seating for spanner tables

More Information

[Illustrated Glossary](#) ▶ 439

[Finishes](#) ▶ 456

[Ordering and Warranties](#) ▶ 462

	23" W, Rectangular coffee table				15 lbs
	Model	Price	Depth	Height	
	721-1	\$1,296	20.5"	14.75"	
	42" W, Rectangular coffee table				28 lbs
	Model	Price	Depth	Height	
	721-3	\$1,878	20.5"	14.75"	

Hudson Tables



Standard Features

- Brushed stainless look base
- Laminate or veneer top
- Nemschoff healthcare wood finish
- GREENGUARD Gold Certified
- Limited Lifetime Warranty

Specification Decisions

- Select standard wood finish or laminate

More Information

Illustrated Glossary ▶ 439

Finishes ▶ 456

Ordering and Warranties ▶ 462

	20" W, Square coffee table; laminate top				35 lbs
	Model	Price	Depth	Height	
	802-5	\$1,591	20"	17"	

	20" W, Square coffee table; veneer top				35 lbs
	Model	Price	Depth	Height	
	802-5V	\$1,670	20"	17"	

	40" W, Rectangular coffee table; laminate top				49 lbs
	Model	Price	Depth	Height	
	802-9	\$1,787	18"	13"	

	40" W, Rectangular coffee table; veneer top				49 lbs
	Model	Price	Depth	Height	
	802-9V	\$1,918	18"	13"	

Lauderdale Tables



More Information

Illustrated Glossary ▶ 439

Finishes ▶ 456

Ordering and Warranties ▶ 462

Standard Features

- Solid maple frame
- Replaceable components
- Laminate top with solid maple edge
- Nemschoff healthcare wood finish
- GREENGUARD Gold Certified
- Limited Lifetime Warranty

Specification Decisions

- Select standard wood finish

- Select standard laminate

Coordinating Products

- [Lauderdale Lounge Seating](#)



24" W, Square end table

28 lbs

Model	Price	Depth	Height
775-T6	\$1,471	24"	18"



42" W, Rectangular coffee table

35 lbs

Model	Price	Depth	Height
775-T9	\$1,953	18"	14.5"

Lounge Seating

Multiple & Tandem Seating

Side, Stacking & Folding Chairs

Occasional Tables

Marco Grande Tables



Standard Features

- Solid maple legs
- Replaceable components
- Laminate or veneer top with wood edge
- Nemschoff healthcare wood finish
- GREENGUARD Gold Certified
- Limited Lifetime Warranty

Coordinating Products

- [Marco Grande Lounge Seating](#)
- [Marco Grande II Lounge Seating](#)
- [Marco Multiple Seating](#)
- [Marco Patient Chair](#)
- [Marco Glider](#)

Specification Decisions

- Select standard wood finish or laminate

More Information

[Illustrated Glossary](#) ▶ 439

[Finishes](#) ▶ 456

[Ordering and Warranties](#) ▶ 462

	19" W, Square end table; laminate top 15 lbs
Model	Price Depth Height
732-6	\$1,190 19" 19"

	19" W, Square end table; veneer top 15 lbs
Model	Price Depth Height
732-6V	\$1,451 19" 19"

	19" dia, Round end table; laminate top 14 lbs
Model	Price Height
732-7	\$964 19"

	19" dia, Round end table; veneer top 14 lbs
Model	Price Height
732-7V	\$1,176 19"

	48" W, Rectangular coffee table; laminate top 33 lbs
Model	Price Depth Height
732-9	\$1,839 18" 14.5"

	48" W, Rectangular coffee table; veneer top 33 lbs
Model	Price Depth Height
732-9V	\$2,244 18" 14.5"

Marsack Tables

Lounge Seating

Multiple & Tandem Seating

Side, Stacking & Folding Chairs

Occasional Tables

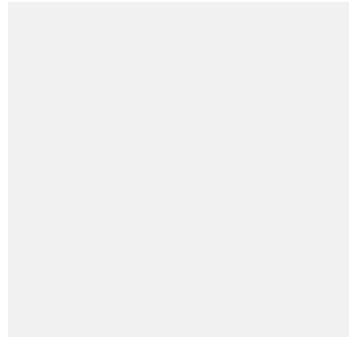

Standard Features

- Heavy-duty construction
- Replaceable components
- Laminate top
- Laminate-wrapped side panels
- GREENGUARD Gold Certified
- Limited Lifetime Warranty

Coordinating Products

- [Marsack Lounge Seating](#)
- [Marsack II Lounge Seating](#)
- [Marsack III Behavioral Health Seating](#)

Specification Decisions

- Select standard laminate

More Information

[Illustrated Glossary](#) ▶ 439

[Finishes](#) ▶ 456

[Ordering and Warranties](#) ▶ 462



26" W, Rectangular end table				52 lbs
Model	Price	Depth	Height	
700-T1	\$1,371	26.5"	18.5"	

Meridian Tables



Standard Features

- Solid hardwood frame
- Replaceable components
- Veneer top with wood edge
- Nemschoff healthcare wood finish
- GREENGUARD Gold Certified
- Limited Lifetime Warranty

See Meridian Multiple Seating for spanner tables

Coordinating Products

- [Meridian Lounge Seating](#)
- [Meridian Multiple Seating](#)
- [Meridian Patient Chair](#)
- [Meridian Behavioral Health Seating](#)

Available Options

- Laminate top with wood edge + \$0

Specification Decisions

- Select standard wood finish or laminate

More Information

[Illustrated Glossary](#) ▶ 439

[Finishes](#) ▶ 456

[Ordering and Warranties](#) ▶ 462

	23" W, Rectangular coffee table 18 lbs			
	Model	Price	Depth	Height
	MT-10-1	\$1,191	20.5"	14.75"
	MT-10-2	\$1,191	20.5"	16"

	23.5" W, Square coffee table 20 lbs			
	Model	Price	Depth	Height
	MT-10-3	\$1,191	23.5"	14.75"
	MT-10-4	\$1,191	23.5"	16"

	42" W, Rectangular coffee table 31 lbs			
	Model	Price	Depth	Height
	MT-10-5	\$1,776	20.5"	14.75"
	MT-10-6	\$1,773	20.5"	16"

	23.5" W, Square end table 22 lbs			
	Model	Price	Depth	Height
	MLT-30-1	\$1,275	23.5"	18.75"

	30" W, Square end table 24 lbs			
	Model	Price	Depth	Height
	MLT-30-2	\$1,389	30"	18.75"

Monarch Tables



More Information

Illustrated Glossary ▶ 439

Finishes ▶ 456

Ordering and Warranties ▶ 462

Standard Features

- Solid maple frame
- Laminate top with wood edge
- 7/8" rubber-cushioned glides
- Nemschoff healthcare wood finish
- GREENGUARD Gold Certified
- Limited Lifetime Warranty

Available Options

- Veneer top with wood edge + \$250

Specification Decisions

- Select standard wood finish
- Select standard laminate

- Add veneer top

Coordinating Products

- [Monarch Lounge Seating](#)
- [Monarch Multiple Seating](#)
- [Monarch Stack Chair](#)
- [Monarch Patient Chair](#)
- [Monarch Sleep Chair and Settee](#)



20" W, Square end table

Model	Price	Depth	Height
893-T5	\$480	20"	18"

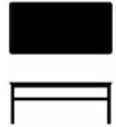

40" W, Rectangular coffee table

Model	Price	Depth	Height
893-T9	\$615	20"	16"

Olivia Tables



Standard Features

- Solid maple frame
- Replaceable components
- Laminate or veneer top with wood edge
- Nemschoff healthcare wood finish
- GREENGUARD Gold Certified
- Limited Lifetime Warranty

Coordinating Products

- [Olivia Lounge Seating](#)
- [Olivia Patient Chair](#)
- [Olivia Glider](#)

Specification Decisions

- Select standard wood finish or laminate

More Information

[Illustrated Glossary](#) ▶ 439

[Finishes](#) ▶ 456

[Ordering and Warranties](#) ▶ 462



20" W, Square end table; laminate top

24 lbs

Model	Price	Depth	Height
903-5	\$1,220	20"	18"



20" W, Square end table; veneer top

24 lbs

Model	Price	Depth	Height
903-5V	\$1,488	20"	18"



42" W, Rectangular coffee table; laminate top

30 lbs

Model	Price	Depth	Height
903-9	\$1,472	18"	14.5"



42" W, Rectangular coffee table; veneer top

30 lbs

Model	Price	Depth	Height
903-9V	\$1,796	18"	14.5"

Pamona Tables



Standard Features

- Powder-coated metal frame
- Replaceable components
- Laminate, veneer or solid surface tops (see price table)
- Nemschoff healthcare wood finish
- GREENGUARD Gold Certified
- Limited Lifetime Warranty

Coordinating Products

- [Pamona Lounge Seating](#)
- [Pamona Recliner](#)
- [Pamona Flop Sofa](#)

More Information











Illustrated Glossary ▶ 439

Finishes ▶ 456

Ordering and Warranties ▶ 462



Specification Decisions

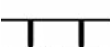

- Select powder-coat finish for frame
- Select standard wood finish, laminate or solid surface top

 	25" W, Rectangular coffee table; laminate top				48 lbs
	Model	Price	Depth	Height	
	797-T11	\$1,457	42"	16.5"	
 	25" W, Rectangular coffee table; veneer top				48 lbs
	Model	Price	Depth	Height	
	797-T11V	\$1,747	42"	16.5"	
 	25" W, Rectangular coffee table; solid surface top				60 lbs
	Model	Price	Depth	Height	
	797-T11SS	\$2,275	42"	16.5"	
 	46" W, Rectangular coffee table; laminate top				52 lbs
	Model	Price	Depth	Height	
	797-T9	\$1,295	24"	16.5"	
 	46" W, Rectangular coffee table; veneer top				52 lbs
	Model	Price	Depth	Height	
	797-T9V	\$1,586	24"	16.5"	
 	46" W, Rectangular coffee table; solid surface top				67 lbs
	Model	Price	Depth	Height	
	797-T9SS	\$2,114	24"	16.5"	

Pamona Tables



Welcoming & Waiting

	18" dia, Round end table; laminate top 20 lbs			
	Model	Price	Height	
	797-T7	\$1,073	22"	

	18" dia, Round end table; veneer top 20 lbs			
	Model	Price	Height	
	797-T7V	\$1,310	22"	

Patient Areas

	18" dia, Round end table; solid surface top 23 lbs			
	Model	Price	Height	
	797-T7SS	\$1,679	22"	

	22" dia, Round end table; laminate top 23 lbs			
	Model	Price	Height	
	797-T8	\$1,125	22"	

	22" dia, Round end table; veneer top 23 lbs			
	Model	Price	Height	
	797-T8V	\$1,379	22"	

Specialty



	22" dia, Round end table; solid surface top 28 lbs			
	Model	Price	Height	
	797-T8SS	\$1,733	22"	

	18" W, Square end table; laminate top 21 lbs			
	Model	Price	Depth	Height
	797-T5	\$1,129	18"	22"

	18" W, Square end table; veneer top 21 lbs			
	Model	Price	Depth	Height
	797-T5V	\$1,366	18"	22"

Reference

	18" W, Square end table; solid surface top 25 lbs			
	Model	Price	Depth	Height
	797-T5SS	\$1,736	18"	22"

	22" W, Square end table; laminate top 25 lbs			
	Model	Price	Depth	Height
	797-T6	\$1,242	22"	22"

Pamona Tables

 	22" W, Square end table; veneer top 25 lbs								
	<table border="1"> <thead> <tr> <th>Model</th> <th>Price</th> <th>Depth</th> <th>Height</th> </tr> </thead> <tbody> <tr> <td>797-T6V</td> <td>\$1,495</td> <td>22"</td> <td>22"</td> </tr> </tbody> </table>	Model	Price	Depth	Height	797-T6V	\$1,495	22"	22"
Model	Price	Depth	Height						
797-T6V	\$1,495	22"	22"						
 	22" W, Square end table; solid surface top 31 lbs								
	<table border="1"> <thead> <tr> <th>Model</th> <th>Price</th> <th>Depth</th> <th>Height</th> </tr> </thead> <tbody> <tr> <td>797-T6SS</td> <td>\$1,849</td> <td>22"</td> <td>22"</td> </tr> </tbody> </table>	Model	Price	Depth	Height	797-T6SS	\$1,849	22"	22"
Model	Price	Depth	Height						
797-T6SS	\$1,849	22"	22"						
 	18" W, Rectangular dining table; laminate top 60 lbs								
	<table border="1"> <thead> <tr> <th>Model</th> <th>Price</th> <th>Depth</th> <th>Height</th> </tr> </thead> <tbody> <tr> <td>797-T10</td> <td>\$1,424</td> <td>54"</td> <td>30"</td> </tr> </tbody> </table>	Model	Price	Depth	Height	797-T10	\$1,424	54"	30"
Model	Price	Depth	Height						
797-T10	\$1,424	54"	30"						
 	18" W, Rectangular dining table; veneer top 60 lbs								
	<table border="1"> <thead> <tr> <th>Model</th> <th>Price</th> <th>Depth</th> <th>Height</th> </tr> </thead> <tbody> <tr> <td>797-T10V</td> <td>\$1,741</td> <td>54"</td> <td>30"</td> </tr> </tbody> </table>	Model	Price	Depth	Height	797-T10V	\$1,741	54"	30"
Model	Price	Depth	Height						
797-T10V	\$1,741	54"	30"						
 	18" W, Rectangular dining table; solid surface top 72 lbs								
	<table border="1"> <thead> <tr> <th>Model</th> <th>Price</th> <th>Depth</th> <th>Height</th> </tr> </thead> <tbody> <tr> <td>797-T10SS</td> <td>\$2,269</td> <td>54"</td> <td>30"</td> </tr> </tbody> </table>	Model	Price	Depth	Height	797-T10SS	\$2,269	54"	30"
Model	Price	Depth	Height						
797-T10SS	\$2,269	54"	30"						

Lounge Seating

Multiple & Tandem Seating

Side, Stacking & Folding Chairs

Occasional Tables

Reliant Tables



Standard Features

- Powder-coated metal legs
- Replaceable components
- Veneer top with solid wood edge
- Solid maple apron
- Nemschoff healthcare wood finish
- GREENGUARD Gold Certified
- Limited Lifetime Warranty

Specification Decisions

- Select powder-coat finish
 - Select standard wood finish, laminate or Durawrap
- See Reliant Multiple Seating for spanner tables

Coordinating Products

- [Reliant Multiple Seating](#)

More Information

Illustrated Glossary ▶ 439
 Finishes ▶ 456
 Ordering and Warranties ▶ 462

Available Options

- Laminate top with wood edge + \$0
- Durawrap top + \$0

■	20" W, Square coffee table 16 lbs			
	Model	Price	Depth	Height
□	RLT-16-1	\$1,479	20"	15.5"
■	24" W, Square coffee table 18 lbs			
	Model	Price	Depth	Height
□	RLT-16-3	\$1,573	24"	15.5"
■	30" W, Square coffee table 32 lbs			
	Model	Price	Depth	Height
□	RLT-16-5	\$1,869	30"	15.5"
■	36" W, Square coffee table 46 lbs			
	Model	Price	Depth	Height
□	RLT-16-7	\$2,047	36"	15.5"
■	20" W, Rectangular coffee table 32 lbs			
	Model	Price	Depth	Height
	RLT-16-9	\$1,869	42"	15.5"
□	RLT-16-11	\$2,047	54"	15.5"
■	28" W, Rectangular coffee table 19 lbs			
	Model	Price	Depth	Height
	RSCT-10	\$915	18.25"	15.5"
□	RRCT-10	\$969	18.25"	15.5"
●	24" dia, Round coffee table 16 lbs			
	Model	Price	Height	
	RLT-17-1	\$1,802	15.5"	





















Reliant Tables

Lounge Seating

Multiple & Tandem Seating

Side, Stacking & Folding Chairs

Occasional Tables

 	30" dia, Round coffee table 28 lbs			
	Model	Price	Height	
	RLT-17-3	\$1,952	15.5"	
 	36" dia, Round coffee table 42 lbs			
	Model	Price	Height	
	RLT-17-5	\$2,047	15.5"	
 	20" W, Square end table 16 lbs			
	Model	Price	Depth	Height
	RLT-16-2	\$1,479	20"	21"
 	24" W, Square end table 18 lbs			
	Model	Price	Depth	Height
	RLT-16-4	\$1,573	24"	21"
 	30" W, Square end table 32 lbs			
	Model	Price	Depth	Height
	RLT-16-6	\$1,869	30"	21"
 	36" W, Square end table 46 lbs			
	Model	Price	Depth	Height
	RLT-16-8	\$2,047	36"	21"
 	20" W, Rectangular end table 32 lbs			
	Model	Price	Depth	Height
	RLT-16-10	\$1,869	42"	21"
	RLT-16-12	\$2,047	54"	21"
 	24" dia, Round end table 16 lbs			
	Model	Price	Height	
	RLT-17-2	\$1,802	21"	
 	30" dia, Round end table 28 lbs			
	Model	Price	Height	
	RLT-17-4	\$1,952	21"	
 	36" dia, Round end table 42 lbs			
	Model	Price	Height	
	RLT-17-6	\$2,047	21"	

Riva Tables



Standard Features

- Brushed metal base and legs
- Replaceable components
- Laminate or veneer top with wood edge
- Nemschoff healthcare wood finish
- GREENGUARD Gold Certified
- Limited Lifetime Warranty

Coordinating Products

- [Riva Lounge Seating](#)

Specification Decisions

- Select powder-coat finish
- Select standard wood or laminate finish

More Information

[Illustrated Glossary](#) ▶ 439

[Finishes](#) ▶ 456

[Ordering and Warranties](#) ▶ 462

	20" W, Square end table; laminate top 27 lbs								
	<table border="1"> <thead> <tr> <th>Model</th> <th>Price</th> <th>Depth</th> <th>Height</th> </tr> </thead> <tbody> <tr> <td>812-5</td> <td>\$1,302</td> <td>20"</td> <td>17"</td> </tr> </tbody> </table>	Model	Price	Depth	Height	812-5	\$1,302	20"	17"
Model	Price	Depth	Height						
812-5	\$1,302	20"	17"						

	20" W, Square end table; veneer top 27 lbs								
	<table border="1"> <thead> <tr> <th>Model</th> <th>Price</th> <th>Depth</th> <th>Height</th> </tr> </thead> <tbody> <tr> <td>812-5V</td> <td>\$1,588</td> <td>20"</td> <td>17"</td> </tr> </tbody> </table>	Model	Price	Depth	Height	812-5V	\$1,588	20"	17"
Model	Price	Depth	Height						
812-5V	\$1,588	20"	17"						

	48" W, Rectangular coffee table; laminate top 40 lbs								
	<table border="1"> <thead> <tr> <th>Model</th> <th>Price</th> <th>Depth</th> <th>Height</th> </tr> </thead> <tbody> <tr> <td>812-9</td> <td>\$1,498</td> <td>18"</td> <td>14.5"</td> </tr> </tbody> </table>	Model	Price	Depth	Height	812-9	\$1,498	18"	14.5"
Model	Price	Depth	Height						
812-9	\$1,498	18"	14.5"						

	48" W, Rectangular coffee table; veneer top 40 lbs								
	<table border="1"> <thead> <tr> <th>Model</th> <th>Price</th> <th>Depth</th> <th>Height</th> </tr> </thead> <tbody> <tr> <td>812-9V</td> <td>\$1,826</td> <td>18"</td> <td>14.5"</td> </tr> </tbody> </table>	Model	Price	Depth	Height	812-9V	\$1,826	18"	14.5"
Model	Price	Depth	Height						
812-9V	\$1,826	18"	14.5"						

Rockwood Tables



Standard Features

- Solid maple frame
- Replaceable components
- Laminate top
- Non-marring 7/8" glides
- Nemschoff healthcare wood finish
- GREENGUARD Gold Certified
- Limited Lifetime Warranty

See Mayfield and Princeton Multiple Seating for spanner tables

Coordinating Products

- [Mayfield Multiple Seating](#)
- [Princeton Multiple Seating](#)

More Information

[Illustrated Glossary](#) ▶ 439

[Finishes](#) ▶ 456

[Ordering and Warranties](#) ▶ 462

Specification Decisions

- Select standard wood finish
- Select standard laminate

 	19.5" W, Square end table				24 lbs
	Model	Price	Depth	Height	
	FX120-T1	\$816	19.5"	16"	
 	26.25" W, Corner end table				28 lbs
	Model	Price	Depth	Height	
	FX120-T4	\$847	26.25"	16"	
 	48" W, Rectangular coffee table				30 lbs
	Model	Price	Depth	Height	
	FX120-T2	\$988	18"	16"	

Torii Tables



Standard Features

- Solid maple frame
- Replaceable components
- Laminate or veneer top with wood edge
- Cove style edge
- 7/8" rubber-cushioned glides
- Nemschoff healthcare wood finish
- GREENGUARD Gold Certified
- Limited Lifetime Warranty

Specification Decisions

- Select standard wood finish or laminate
- Add radius edge

Coordinating Products

- [Torii Multiple Seating](#)
- [Torii Side Chair](#)
- [Torii Patient Chair](#)
- [Torii Glider](#)

Available Options





- Radius edge + \$0

More Information

[Illustrated Glossary](#) ▶ 439

[Finishes](#) ▶ 456

[Ordering and Warranties](#) ▶ 462

 	21.25" W, Square end table; laminate top				28 lbs
	Model	Price	Depth	Height	
	283-6	\$881	21.25"	16"	
 	21.25" W, Square end table; veneer top				28 lbs
	Model	Price	Depth	Height	
	283-6V	\$1,074	21.25"	16"	
 	28" W, Square end table; laminate top				36 lbs
	Model	Price	Depth	Height	
	283-7	\$969	28"	16"	
 	28" W, Square end table; veneer top				36 lbs
	Model	Price	Depth	Height	
	283-7V	\$1,182	28"	16"	

Valor Tables



More Information

Illustrated Glossary ▶ 439

Finishes ▶ 456

Ordering and Warranties ▶ 462

Standard Features

- Heavy-duty steel construction
- Powder-coated metal legs
- Replaceable components
- Laminate with wood edge
- Non-marring 7/8" glides
- Nemschoff healthcare wood finish
- GREENGUARD Gold Certified
- Limited Lifetime Warranty

Available Options

- Veneer with wood edge + \$250

Specification Decisions

- Select powder-coat finish
- Select standard wood finish or laminate

Coordinating Products

- [Valor Lounge Seating](#)
- [Valor Multiple Seating](#)
- [Valor Stack Chair](#)
- [Valor Patient Chair](#)



20" W, Square end table

35 lbs

Model	Price	Depth	Height
891-T5	\$480	20"	18"



22" W, Square end table

35 lbs

Model	Price	Depth	Height
891-T6	\$503	22"	18"



40" W, Rectangular coffee table

Model	Price	Depth	Height
891-T9	\$615	20"	16"

Lounge Seating

Multiple & Tandem Seating

Side, Stacking & Folding Chairs

Occasional Tables

Custom Tables

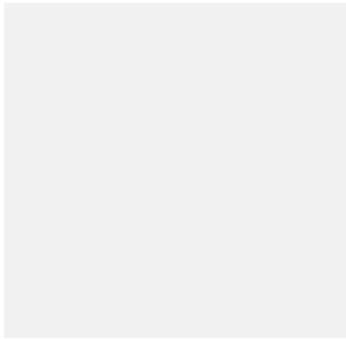

Standard Features

- 1.25" thick, high-pressure laminate tops on high-density core
- Five table base choices
- Self-leveling glides or rubber-cushioned glides (select bases)
- Choice of leg and edge detail
- 3" radiused corners
- Choice of straight or curved rail (select tables)
- Select bases are wheelchair accessible
- Nemschoff healthcare wood finish
- GREENGUARD Gold Certified
- Limited Lifetime Warranty

More Information

- Illustrated Glossary ▶ 439
- Finishes ▶ 456
- Hardware ▶ 457
- Ordering and Warranties ▶ 462

Specification Decisions

Table Tops

- Select standard wood finish or laminate
- Corner type: Square or Radiused
3" radiused corner available only with Edge Detail A, D, E, or EE. Square corner not available with Edge Detail D.
- Edge style:

A Square corner, laminate	C Chicago 1" W Wood	D Vinyl
E 1.25" W Wood	EE 1.75" W Wood	L Los Angeles 1" W Wood
N New Orleans 1" W Wood	W Williamsburg 1" W Wood	Y New York 0.375" W Wood

- Edge wood: **M** (Maple) or **O** (Oak)
- Edge finish or color (for D-edge, select vinyl color)
- Top overhang: 1.5" or 0.3125"(square tables only)

Table Bases

Occasional Table Base

Available for round, square and rectangular Table Tops where the longest side is less than 60".

TL 16"
TM 20"
TH 24"
TS 27"
TC 29.5"

Conference and Dining Table Base

Available for most Table Tops. See pricing table for details.

4 29½"H Maple base	5 29.5"H Maple base	8/8L 29.5"H, rail, square leg
9 29.5"H, no rail, square leg	9T 29.5"H, no rail, tapered leg	4H Accessible 31.5"H, Maple base
9H Accessible 31.5"H, no rail, square leg	9TH Accessible 31.5"H, no rail, tapered leg	

Table Base rail detail

Straight rail	Curved rail

Rails are available for table bases TL, TM, TH, TS, TC, 8, and 8L.

Table Base leg style:

P Leg	S Leg	T Leg

- Table Base leg finish
Select standard wood finish

Custom Tables

Lounge Seating

Multiple & Tandem Seating

Side, Stacking & Folding Chairs

Occasional Tables

Custom Tables | Table Tops



Round Table Top											
Diameter	A-Edge	D-Edge	E-Edge	EE-Edge	Y-Edge	L-Edge	C-Edge	W-Edge	N-Edge	Weight	Base Options
24"	\$180	\$181	\$1,083	\$1,234	\$1,085	\$1,085	\$1,085	\$1,085	\$1,085	18 lbs	Occasional
30"	\$219	\$245	\$1,168	\$1,396	\$1,138	\$1,138	\$1,138	\$1,138	\$1,138	24 lbs	Occasional, 4, 4H, 8, 9, 9H, 9T, 9TH
36"	\$273	\$331	\$1,308	\$1,574	\$1,295	\$1,295	\$1,295	\$1,295	\$1,295	36 lbs	Occasional, 4, 4H, 8, 9, 9H, 9T, 9TH
42"	\$461	\$518	\$1,583	\$1,826	\$1,585	\$1,585	\$1,585	\$1,585	\$1,585	47 lbs	Occasional, 4, 4H, 8, 9, 9H, 9T, 9TH
48"	\$473	\$556	\$1,718	\$1,995	\$1,744	\$1,744	\$1,744	\$1,744	\$1,744	62 lbs	Occasional, 8, 9, 9H, 9T, 9TH
54"	\$776	\$854	\$2,319	\$2,696	\$2,015	\$2,015	\$2,015	\$2,015	\$2,015	78 lbs	Occasional, 8, 9, 9H, 9T, 9TH
60"	\$776	\$854	\$2,319	\$2,682	\$2,499	\$2,499	\$2,499	\$2,499	\$2,499	90 lbs	Occasional, 8, 9, 9H, 9T, 9TH



Square Table Top, Radiused Corner											
Size	A-Edge	D-Edge	E-Edge	EE-Edge	Y-Edge	L-Edge	C-Edge	W-Edge	N-Edge	Weight	Base Options
18"	\$179	\$129	\$1,031	\$1,142	\$478	\$478	\$478	\$478	\$478	13 lbs	Occasional
21"	\$173	\$146	\$1,043	\$1,152	\$497	\$497	\$497	\$497	\$497	18 lbs	Occasional
24"	\$201	\$157	\$1,083	\$1,152	\$547	\$547	\$547	\$547	\$547	23 lbs	Occasional
30"	\$254	\$221	\$1,218	\$1,351	\$675	\$675	\$675	\$675	\$675	31 lbs	Occasional, 4, 4H, 8, 9, 9H, 9T, 9TH
36"	\$314	\$269	\$1,355	\$1,531	\$906	\$906	\$906	\$906	\$906	40 lbs	Occasional, 4, 4H, 8, 9, 9H, 9T, 9TH
42"	\$502	\$440	\$1,510	\$1,731	\$1,052	\$1,052	\$1,052	\$1,052	\$1,052	60 lbs	Occasional, 8, 9, 9H, 9T, 9TH
48"	\$518	\$485	\$1,710	\$1,931	\$1,178	\$1,178	\$1,178	\$1,178	\$1,178	79 lbs	Occasional, 5, 8L, 9, 9H, 9T, 9TH

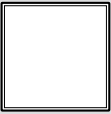

Square Table Top, Square Corner											
Size	A-Edge	D-Edge	E-Edge	EE-Edge	Y-Edge	L-Edge	C-Edge	W-Edge	N-Edge	Weight	Base Options
18"	\$121	–	\$546	\$578	–	–	–	–	–	31 lbs	Occasional
21"	\$126	–	\$563	\$626	–	–	–	–	–	40 lbs	Occasional
24"	\$141	–	\$583	\$647	–	–	–	–	–	23 lbs	Occasional
30"	\$192	–	\$711	\$819	–	–	–	–	–	31 lbs	Occasional, 4, 4H, 8, 9, 9H, 9T, 9TH
36"	\$252	–	\$850	\$1,355	–	–	–	–	–	40 lbs	Occasional, 4, 4H, 8, 9, 9H, 9T, 9TH
42"	\$439	–	\$1,007	\$1,199	–	–	–	–	–	60 lbs	Occasional, 8, 9, 9H, 9T, 9TH
48"	\$454	–	\$1,203	\$1,396	–	–	–	–	–	79 lbs	Occasional, 5, 8L, 9, 9H, 9T, 9TH

Custom Tables

Custom Tables | Table Tops

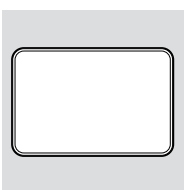

Rectangular Table Top, Radiused Corner

Size	A-Edge	D-Edge	E-Edge	EE-Edge	Y-Edge	L-Edge	C-Edge	W-Edge	N-Edge	Weight	Base Options
18"x21"	\$183	\$142	\$1,035	\$1,148	\$476	\$476	\$476	\$476	\$476	15 lbs	Occasional
18"x24"	\$195	\$149	\$1,045	\$1,144	\$482	\$482	\$482	\$482	\$482	18 lbs	Occasional
18"x30"	\$219	\$181	\$1,110	\$1,220	\$581	\$581	\$581	\$581	\$581	21 lbs	Occasional
18"x36"	\$244	\$205	\$1,146	\$1,298	\$674	\$674	\$674	\$674	\$674	24 lbs	Occasional
18"x48"	\$297	\$284	\$1,282	\$1,431	\$848	\$848	\$848	\$848	\$848	30 lbs	Occasional
21"x24"	\$198	\$151	\$1,066	\$1,177	\$535	\$535	\$535	\$535	\$535	21 lbs	Occasional
21"x30"	\$221	\$183	\$1,131	\$1,242	\$540	\$540	\$540	\$540	\$540	24 lbs	Occasional
21"x36"	\$248	\$214	\$1,169	\$1,321	\$643	\$643	\$643	\$643	\$643	27 lbs	Occasional
21"x48"	\$306	\$289	\$1,308	\$1,457	\$799	\$799	\$799	\$799	\$799	38 lbs	Occasional
24"x30"	\$225	\$192	\$1,157	\$1,270	\$608	\$608	\$608	\$608	\$608	25 lbs	Occasional, 8, 9, 9H, 9T, 9TH
24"x36"	\$254	\$220	\$1,195	\$1,351	\$691	\$691	\$691	\$691	\$691	30 lbs	Occasional, 8, 9, 9H, 9T, 9TH
30"x36"	\$279	\$255	\$1,275	\$1,451	\$743	\$743	\$743	\$743	\$743	43 lbs	Occasional, 8, 9, 9H, 9T, 9TH
30"x42"	\$343	\$324	\$1,332	\$1,516	\$861	\$861	\$861	\$861	\$861	47 lbs	Occasional, 8, 9, 9H, 9T, 9TH
30"x48"	\$356	\$340	\$1,399	\$1,592	\$917	\$917	\$917	\$917	\$917	49 lbs	Occasional, 8, 9, 9H, 9T, 9TH
30"x60"	\$418	\$440	\$1,643	\$1,880	\$1,093	\$1,093	\$1,093	\$1,093	\$1,093	61 lbs	5, 8, 9, 9H, 9T, 9TH
30"x72"	\$480	\$525	\$1,829	\$2,053	\$1,444	\$1,444	\$1,444	\$1,444	\$1,444	74 lbs	5, 8, 9, 9H, 9T, 9TH
36"x42"	\$397	\$385	\$1,447	\$1,640	\$970	\$970	\$970	\$970	\$970	52 lbs	Occasional, 8, 9, 9H, 9T, 9TH
36"x48"	\$405	\$397	\$1,503	\$1,704	\$968	\$968	\$968	\$968	\$968	59 lbs	Occasional, 5, 8, 9, 9H, 9T, 9TH
36"x60"	\$476	\$504	\$1,744	\$1,976	\$1,186	\$1,186	\$1,186	\$1,186	\$1,186	89 lbs	5, 8, 9, 9H, 9T, 9TH
36"x72"	\$542	\$580	\$1,973	\$2,196	\$1,451	\$1,451	\$1,451	\$1,451	\$1,451	89 lbs	5, 8, 9, 9H, 9T, 9TH
36"x84"	\$702	\$740	\$2,647	\$2,923	\$1,980	\$1,980	\$1,980	\$1,980	\$1,980	117 lbs	5, 8L, 9, 9H, 9T, 9TH
36"x96"	\$702	\$740	\$2,647	\$2,923	\$2,287	\$2,287	\$2,287	\$2,287	\$2,287	139 lbs	5, 8L, 9, 9H, 9T, 9TH
36"x120"	\$1,122	\$1,074	\$2,909	\$3,298	\$2,675	\$2,675	\$2,675	\$2,675	\$2,675	148 lbs	5, 8, 9, 9H, 9T, 9TH

Custom Tables

Lounge Seating

Multiple & Tandem Seating

Side, Stacking & Folding Chairs

Occasional Tables

Custom Tables | Table Tops

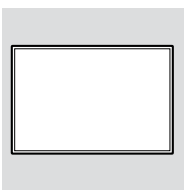

Rectangular Table Top, Square Corner

Size	A-Edge	D-Edge	E-Edge	EE-Edge	Y-Edge	L-Edge	C-Edge	W-Edge	N-Edge	Weight	Base Options
18"x21"	\$125	-	\$551	\$636	-	-	-	-	-	15 lbs	Occasional
18"x24"	\$129	-	\$560	\$645	-	-	-	-	-	18 lbs	Occasional
18"x30"	\$156	-	\$626	\$703	-	-	-	-	-	21 lbs	Occasional
18"x36"	\$182	-	\$660	\$783	-	-	-	-	-	24 lbs	Occasional
18"x48"	\$234	-	\$800	\$917	-	-	-	-	-	30 lbs	Occasional
21"x24"	\$132	-	\$574	\$653	-	-	-	-	-	21 lbs	Occasional
21"x30"	\$158	-	\$642	\$718	-	-	-	-	-	24 lbs	Occasional
21"x36"	\$193	-	\$674	\$800	-	-	-	-	-	27 lbs	Occasional
21"x48"	\$243	-	\$816	\$935	-	-	-	-	-	38 lbs	Occasional
24"x30"	\$161	-	\$653	\$733	-	-	-	-	-	25 lbs	Occasional, 8, 9, 9H, 9T, 9TH
24"x36"	\$193	-	\$692	\$819	-	-	-	-	-	30 lbs	Occasional, 8, 9, 9H, 9T, 9TH
30"x36"	\$221	-	\$773	\$913	-	-	-	-	-	43 lbs	Occasional, 8, 9, 9H, 9T, 9TH
30"x42"	\$275	-	\$825	\$974	-	-	-	-	-	47 lbs	Occasional, 8, 9, 9H, 9T, 9TH
30"x48"	\$293	-	\$895	\$1,429	-	-	-	-	-	49 lbs	Occasional, 8, 9, 9H, 9T, 9TH
30"x60"	\$353	-	\$1,135	\$1,347	-	-	-	-	-	61 lbs	5, 8, 9, 9H, 9T, 9TH
30"x72"	\$418	-	\$1,321	\$1,520	-	-	-	-	-	74 lbs	5, 8, 9, 9H, 9T, 9TH
36"x42"	\$332	-	\$941	\$1,103	-	-	-	-	-	52 lbs	Occasional, 8, 9, 9H, 9T, 9TH
36"x48"	\$345	-	\$998	\$1,170	-	-	-	-	-	59 lbs	Occasional, 5, 8, 9, 9H, 9T, 9TH
36"x60"	\$414	-	\$1,145	\$1,439	-	-	-	-	-	89 lbs	5, 8, 9, 9H, 9T, 9TH
36"x72"	\$478	-	\$1,469	\$1,660	-	-	-	-	-	89 lbs	5, 8, 9, 9H, 9T, 9TH
36"x84"	\$643	-	\$2,139	\$2,388	-	-	-	-	-	117 lbs	5, 8L, 9, 9H, 9T, 9TH
36"x96"	\$643	-	\$2,139	\$2,388	-	-	-	-	-	139 lbs	5, 8L, 9, 9H, 9T, 9TH
36"x120"	\$1,060	-	\$2,403	\$2,764	-	-	-	-	-	148 lbs	5, 8, 9, 9H, 9T, 9TH

Custom Tables

Custom Tables | Occasional Bases



Models	Price
TL 16"H	All sizes are \$449
TM 20"H	
TH 24"H	
TS 27"H	
TC 29.5"H	

Custom Tables | Conference and Dining Bases

- Select a straight or curved rail with 8 and 8L.
- 4H, 9H, and 9TH are wheelchair accessible.
- Bases 8 and 8L come with bar glides. All other bases have self-leveling glides.

Base	Height	Spread	Weight	Price	Top Options
4	29.5"	18"	18 lbs	\$574	Round (30", 36", 42") Square (30", 36")
4H	31.5"	18"	18 lbs	\$574	Round (30", 36", 42") Square (30", 36")
5	29.5"	18"	32 lbs	\$1,050	Square (48") Rectangular (30" wide x 60" or 72"; 36" wide x 48", 60", 72", 84", or 96")
5	29.5"	18"	32 lbs	\$2,004	Rectangular (36" x 120")
8	29.5"		15 lbs	\$472	Rectangular (24" wide x 30" or 36"; 30" wide x 36", 42", or 48")
8	29.5"		15 lbs	\$494	Round (30", 36", 42", 54", 60") Rectangular (30" wide x 60" or 72"; 36" wide x 42")
8	29.5"		15 lbs	\$494	Square (30", 36", 42")
8	29.5"		15 lbs	\$541	Rectangular (36" wide x 48")
8	29.5"		15 lbs	\$943	Rectangular (36" wide x 120")
8L	29.5"		15 lbs	\$542	Rectangular (36" wide x 84" or 96")
9	29.5"		15 lbs	\$316	Rectangular (24" wide x 30" or 36"; 30" wide x 36", 42", or 48")
9	29.5"		15 lbs	\$331	Round (30", 36", 42", 48", 54", 60") Square (30", 36", 42", 48") Rectangular (30" wide x 60" or 72"; 36" wide x 42", 48", 60", or 72")
9	29.5"		15 lbs	\$495	Rectangular (36" wide x 84" or 96")
9	29.5"		15 lbs	\$473	Rectangular (36" x 120")
9H	31.5"		15 lbs	\$316	Rectangular (24" wide x 30" or 36"; 30" wide x 36", 42", or 48")
9H	31.5"		15 lbs	\$331	Round (30", 36", 42", 48", 54", 60") Square (30", 36", 42", 48") Rectangular (30" wide x 60" or 72"; 36" wide x 42", 48", 60", or 72")
9H	31.5"		15 lbs	\$495	Rectangular (36" wide x 84" or 96")
9H	31.5"		15 lbs	\$473	Rectangular (36" wide x 120")

Custom Tables

Custom Tables | Conference and Dining Bases

Base	Height	Spread	Weight	Price	Top Options
9T	29.5"		15 lbs	\$326	Rectangular (24"wide x 30" or 36"; 30"wide x 36", 42", or 48")
9T	29.5"		15 lbs	\$343	Round (30", 36", 42", 48", 54", 60") Square (30", 36", 42", 48") Rectangular (30" wide x 60" or 72"; 36" wide x 42", 48", 60", or 72")
9T	29.5"		15 lbs	\$512	Rectangular (36" wide x 84" or 96")
9T	29.5"		15 lbs	\$490	Rectangular (36" wide x 120")
9TH	31.5"		15 lbs	\$326	Rectangular (24"wide x 30" or 36"; 30"wide x 36", 42", or 48")
9TH	31.5"		15 lbs	\$343	Round (30", 36", 42", 48", 54", 60") Square (30", 36", 42", 48") Rectangular (30" wide x 60" or 72"; 36" wide x 42", 48", 60", or 72")
9TH	31.5"		15 lbs	\$512	Rectangular (36" wide x 84" or 96")
9TH	31.5"		15 lbs	\$490	Rectangular (36" wide x 120")

Lounge Seating

Multiple & Tandem Seating

Side, Stacking & Folding Chairs

Occasional Tables

Patient Areas

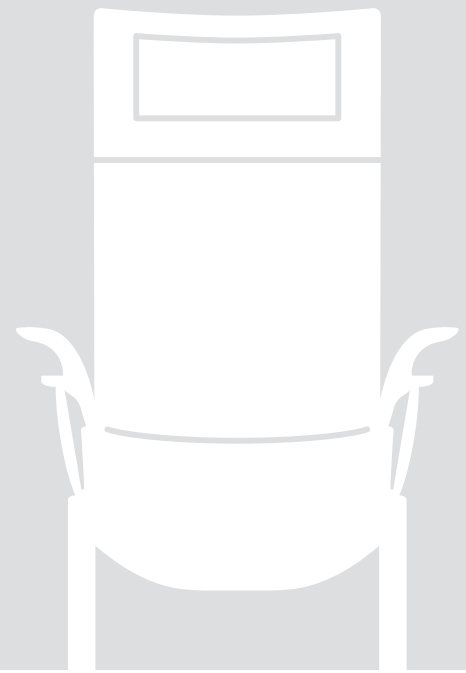

2750 Series Patient Chairs



More Information

Illustrated Glossary ▶ 439

Fabrics ▶ 451

Flammability (CTB-133) ▶ 459

Finishes ▶ 456

Ordering and Warranties ▶ 462

Standard Features

- Solid maple frame
- Mortise and tenon joinery
- Spring seat construction
- Replaceable components
- Firm, flat seat (2755-0)
- Extended hand grip (2755-0)
- Clean-out design
- Black urethane arm caps
- Retractable laminate footrest (2755-0)
- Wallsaver edge (2755-0)
- 2" Tilt and roll casters (2755-0)
- Non-marring $\frac{7}{8}$ " plastic rubber-cushioned glides (2750-51)
- Nemschoff healthcare wood finish
- GREENGUARD Gold Certified
- Limited Lifetime Warranty

Available Options

- Moisture barrier + \$67 per seat or back
- Desert or Pewter urethane arm caps (2750-51 only) + \$205
- CTB-133 + \$81/yard
- Two fabrics + \$62
- Three (or more) fabrics + \$88

Specification Decisions

- Select fabric
- Select standard wood finish
- Select standard laminate (2755-0)
- Add urethane arm caps
- Add moisture barrier
- Add CTB-133
- Apply multiple fabrics

Model numbers with **S** indicate standard seat and back covers, and model numbers with **P** indicate removable covers.

Flammability Types

- Type 5 (2750-51)
- Type 3 (2755-0)
- Type 2 (Footstool)

Coordinating Products

- [2750 Series Multiple Seating](#)
- [2770 Series Multiple Seating](#)
- [2000 Series Tables](#)

Key Dimensions

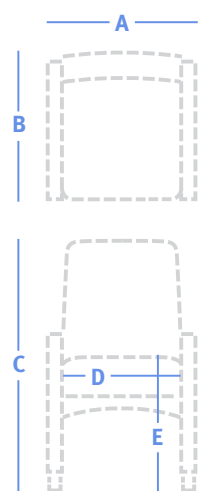

A	Overall Width	See price table
B	Overall Depth	31.5" (2750-51) 23.5" (2755-0)
C	Overall Height	39.5" (2750-51) 41.75" (2755-0)
D	Seat Width	20" (2750-51) 22" (2755-0)
E	Seat Height	18.5" (2750-51) 22" (2755-0)
F	Arm Height	25.5" (2750-51) 27" (2755-0)

Footstool dimensions

Depth	12"
Height	12"

Welcoming & Waiting

2750 Series Patient Chairs



23.75" W, High back patient chair

38 lbs | 2 yds

Model	Series 2	Series 3	Series 4	Series 5	Series 6	Series 7	Series 8	COM
2750-51 S	\$1,230	\$1,293	\$1,399	\$1,510	\$1,642	\$1,775	\$1,941	\$1,293
2750-51 P	\$1,386	\$1,449	\$1,555	\$1,666	\$1,798	\$1,931	\$2,097	\$1,449



17" W, Footstool

8 lbs | 1.25 yds

Model	Series 2	Series 3	Series 4	Series 5	Series 6	Series 7	Series 8	COM
2750-59 S	\$309	\$348	\$415	\$484	\$566	\$649	\$753	\$348
2750-59 P	\$351	\$390	\$457	\$526	\$608	\$691	\$795	\$390

Patient Areas



29.25" W, Patient chair

41 lbs | 2 yds

Model	Series 2	Series 3	Series 4	Series 5	Series 6	Series 7	Series 8	COM
2755-O S	\$1,848	\$1,911	\$2,017	\$2,128	\$2,260	\$2,393	\$2,559	\$1,911
2755-O P	\$2,078	\$2,141	\$2,247	\$2,358	\$2,490	\$2,623	\$2,789	\$2,141

Specialty

Reference

Andante Patient Chair



More Information

Illustrated Glossary ▶ 439

Fabrics ▶ 451

Flammability (CTB-133) ▶ 459

Finishes ▶ 456

Ordering and Warranties ▶ 462

Standard Features

- Solid hardwood frame
- Powder-coated interior frame (BK Black, MSS Metallic Silver)
- Bentwood arms
- Wipe-out design
- Replaceable components
- Integrated headrest
- Dynamic flex back (select models)
- Non-marring ¾" glides
- Nemschoff healthcare wood finish
- GREENGUARD Gold Certified
- Limited Lifetime Warranty

Available Options

- Moisture barrier + \$67 per seat or back
- Field recoverable seat + \$148
- CTB-133 + \$81/yd
- Two fabrics + \$62
- Three (or more) fabrics + \$88
- Removable seat cover + \$148

Specification Decisions

- Select fabric
 - Select standard wood finish
 - Add moisture barrier
 - Add CTB-133
 - Apply multiple fabrics
 - Add removable seat cover
- Footstool does not fit under chair

Flammability Type

- Type 5

Coordinating Products

- [Andante Multiple Seating](#)
- [Andante Stack Chair](#)

Key Dimensions

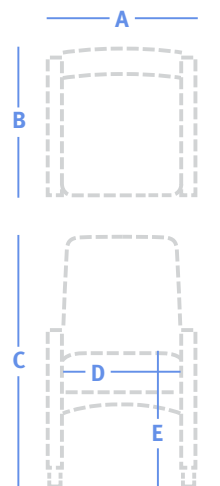

A	Overall Width	See price table
B	Overall Depth	29"
C	Overall Height	45"
D	Seat Width	21.5"
E	Seat Height	18"
F	Arm Height	25"

Footstool dimensions

	Depth	18"
	Height	16.5"

Welcoming & Waiting

Andante Patient Chairs



26" W, Flex patient chair

24 lbs | 3 yds

Model	Series 2	Series 3	Series 4	Series 5	Series 6	Series 7	Series 8	COM
ANXX-00041	\$2,456	\$2,503	\$2,709	\$2,820	\$2,880	\$2,960	\$3,010	\$2,503



26" W, High back patient chair

52 lbs | 2.75 yds

Model	Series 2	Series 3	Series 4	Series 5	Series 6	Series 7	Series 8	COM
ANXX-00035	\$2,048	\$2,091	\$2,280	\$2,382	\$2,437	\$2,510	\$2,556	\$2,091



31" W, Plus chair

26 lbs | 4.5 yds

Model	Series 2	Series 3	Series 4	Series 5	Series 6	Series 7	Series 8	COM
ANXX-00037	\$2,298	\$2,369	\$2,678	\$2,845	\$2,935	\$3,054	\$3,130	\$2,369



20" W, Footstool

11 lbs | 0.75 yds

Model	Series 2	Series 3	Series 4	Series 5	Series 6	Series 7	Series 8	COM
ANXX-00043	\$954	\$965	\$1,017	\$1,045	\$1,060	\$1,080	\$1,092	\$965

Patient Areas

Specialty

Reference

Ashton Patient Chair



More Information

Illustrated Glossary ▶ 439

Fabrics ▶ 451

Flammability (CTB-133) ▶ 459

Finishes ▶ 456

Ordering and Warranties ▶ 462

Standard Features

- Powder-coated metal frame
- Wipe-out design
- Wood arm caps
- Wallsaver legs
- Non-marring 1" adjustable glides
- Nemschoff healthcare wood finish
- GREENGUARD Gold Certified
- Limited Lifetime Warranty

Available Options

- Moisture barrier + \$67 per seat or back
- Black urethane arm caps + \$113
- CTB-133 + \$81/yd
- Two fabrics + \$62
- Three (or more) fabrics + \$88

Specification Decisions

- Select fabric
- Select standard wood finish
- Select powder coat finish
- Add moisture barrier
- Add CTB-133
- Apply multiple fabrics
- Add urethane arm caps

Flammability Type

- Type 5

Key Dimensions

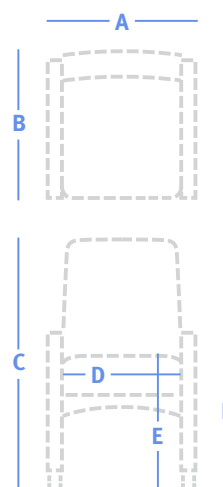

A	Overall Width	See price table
B	Overall Depth	27"
C	Overall Height	39.75"
D	Seat Width	20.25"
E	Seat Height	18.75"
F	Arm Height	25.25"



24" W, High back patient chair

40 lbs | 2.5 yds

Model	Series 2	Series 3	Series 4	Series 5	Series 6	Series 7	Series 8	COM
FX604-1	\$1,021	\$1,100	\$1,231	\$1,368	\$1,532	\$1,683	\$1,889	\$1,100

Brava Patient Chair



More Information

Illustrated Glossary ▶ 439

Fabrics ▶ 451

Flammability (CTB-133) ▶ 459

Finishes ▶ 456

Ordering and Warranties ▶ 462

Standard Features

- Solid maple frame
- Mortise and tenon joinery
- Spring seat construction
- Clean-out design
- Replaceable components
- Removable covers (862H-OB30, 862H-OB40, 863H-OB30, 863H-OB40,)
- Upholstered arms
- Fold-down arm (LSF, RSF, both)
- Non-marring $\frac{7}{8}$ " plastic rubber-cushioned glides
- Nemschoff healthcare wood finish
- GREENGUARD Gold Certified
- Limited Lifetime Warranty
- See nemschoff.com for weight ratings (862H-OB30, 862H-OB40, 863H-OB30, 863H-OB40,)

Available Options

- Moisture barrier + \$67 per seat or back
- Wood arm caps + \$113
- Black urethane arm caps + \$113
- Desert or Pewter urethane arm caps + \$205
- CTB-133 + \$81/yd
- Two fabrics + \$62
- Three (or more) fabrics + \$88
- Folding table in chair back + \$308 (16"W x 12"D x 32.5"H)

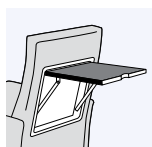

Folding table

Specification Decisions

- Select fabric
- Select standard wood finish
- Add moisture barrier
- Add CTB-133
- Apply multiple fabrics
- Add wood or urethane arm caps
- Add folding table with Durawrap finish

Model numbers with **S** indicate standard seat and back covers, and model numbers with **P** indicate removable covers.

Flammability Type

- Type 6
- Type 5 (863H-OB30, 863H-OB40)

Coordinating Products

- [Brava Classic Lounge Seating](#)
- [Brava Platform Lounge Seating](#)
- [Brava 862 Multiple Seating](#)
- [Brava 863 Multiple Seating](#)
- [Brava Side Chair](#)
- [Brava Tables](#)
- [Brava Adjustable Back Chair](#)
- [Brava CompactComfort Recliner](#)
- [Brava Glider](#)
- [Brava Flop Sofa](#)
- [Brava Sleep Settee](#)

Key Dimensions

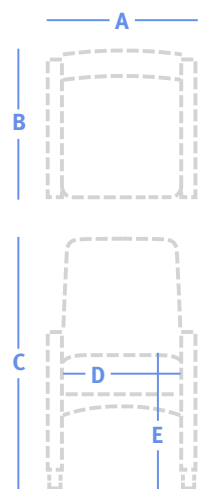

A	Overall Width	See price table
B	Overall Depth	26.5"
C	Overall Height	42.5"
D	Seat Width	21.5"
E	Seat Height	18.75"
F	Arm Height	27"

Brava Patient Chair

	26.5" W, Patient chair with LSF fold-down arm 53 lbs 3.75 yds								
	Model	Series 2	Series 3	Series 4	Series 5	Series 6	Series 7	Series 8	COM
	862-10HDL S	\$2,755	\$2,874	\$3,073	\$3,280	\$3,527	\$3,777	\$4,088	\$2,874
	862-10HDL P	\$3,100	\$3,219	\$3,418	\$3,625	\$3,872	\$4,122	\$4,433	\$3,219
	26.5" W, Patient chair with RSF fold-down arm 53 lbs 3.75 yds								
	Model	Series 2	Series 3	Series 4	Series 5	Series 6	Series 7	Series 8	COM
	862-10HDR S	\$2,755	\$2,874	\$3,073	\$3,280	\$3,527	\$3,777	\$4,088	\$2,874
	862-10HDR P	\$3,100	\$3,219	\$3,418	\$3,625	\$3,872	\$4,122	\$4,433	\$3,219
	26.5" W, Patient chair with RSF and LSF fold-down arms 53 lbs 4 yds								
	Model	Series 2	Series 3	Series 4	Series 5	Series 6	Series 7	Series 8	COM
	862-10HDB S	\$3,363	\$3,490	\$3,702	\$3,923	\$4,187	\$4,453	\$4,785	\$3,490
	862-10HDB P	\$3,782	\$3,909	\$4,121	\$4,342	\$4,606	\$4,872	\$5,204	\$3,909
	26.5" W, High back chair 35 lbs 3.25 yds								
	Model	Series 2	Series 3	Series 4	Series 5	Series 6	Series 7	Series 8	COM
	862-10H S	\$2,200	\$2,303	\$2,475	\$2,655	\$2,869	\$3,085	\$3,356	\$2,303
	862-10H P	\$2,477	\$2,580	\$2,752	\$2,932	\$3,146	\$3,362	\$3,633	\$2,580
	34.75" W, High back Plus chair 46 lbs 4.25 yds								
	Model	Series 2	Series 3	Series 4	Series 5	Series 6	Series 7	Series 8	COM
	862H-OB30	\$4,836	\$4,971	\$5,196	\$5,432	\$5,711	\$5,994	\$6,347	\$4,971
	44.75" W, High back Plus chair 51 lbs 4.25 yds								
	Model	Series 2	Series 3	Series 4	Series 5	Series 6	Series 7	Series 8	COM
	862H-OB40	\$5,572	\$5,707	\$5,932	\$6,168	\$6,447	\$6,730	\$7,083	\$5,707
	25.75" W, High back chair 34 lbs 2 yds								
	Model	Series 2	Series 3	Series 4	Series 5	Series 6	Series 7	Series 8	COM
	863-10H S	\$2,041	\$2,104	\$2,210	\$2,321	\$2,453	\$2,586	\$2,752	\$2,104
	863-10H P	\$2,294	\$2,357	\$2,463	\$2,574	\$2,706	\$2,839	\$3,005	\$2,357
	34" W, High back Plus chair 46 lbs 3.25 yds								
	Model	Series 2	Series 3	Series 4	Series 5	Series 6	Series 7	Series 8	COM
	863H-OB30	\$4,442	\$4,545	\$4,717	\$4,897	\$5,111	\$5,327	\$5,598	\$4,545
	44" W, High back Plus chair 51 lbs 3.25 yds								
	Model	Series 2	Series 3	Series 4	Series 5	Series 6	Series 7	Series 8	COM
	863H-OB40	\$5,116	\$5,219	\$5,391	\$5,571	\$5,785	\$6,001	\$6,272	\$5,219

Patient Chairs

Recliners

Treatment Chairs

Rockers & Gliders

Overbed Tables

Sleepover Seating

Casegoods

Display & Accessories

Brooklyn Patient Chair



Standard Features

- Solid maple frame
- Mortise and tenon joinery
- Replaceable components
- Spring seat construction
- Wood arm caps
- Wallsaver legs
- Clean-out design
- Non-marring 7/8" plastic rubber-cushioned glides
- Nemschoff healthcare wood finish
- GREENGUARD Gold Certified
- Limited Lifetime Warranty

Available Options

- Moisture barrier + \$67 per seat or back
- Black urethane arm caps + \$113
- CTB-133 + \$81/yd
- Two fabrics + \$62
- Three (or more) fabrics + \$88

Specification Decisions

- Select fabric
- Select standard wood finish
- Add moisture barrier
- Add CTB-133
- Apply multiple fabrics
- Add urethane arm caps

Model numbers with **S** indicate standard seat and back covers, and model numbers with **P** indicate removable covers.

Flammability Type

- Type 6

Coordinating Products

- [Brooklyn Lounge Seating](#)
- [Brooklyn Tables](#)

Key Dimensions

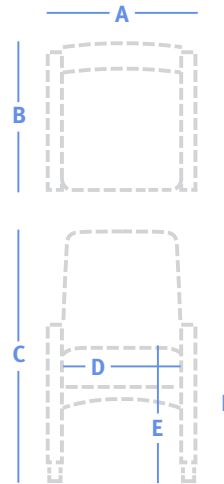

A	Overall Width	See price table
B	Overall Depth	28"
C	Overall Height	40"
D	Seat Width	20.25"
E	Seat Height	18.5"
F	Arm Height	25"

More Information

- Illustrated Glossary ▶ 439
- Fabrics ▶ 451
- Flammability (CTB-133) ▶ 459
- Finishes ▶ 456
- Ordering and Warranties ▶ 462



27" W, High back patient chair

52 lbs | 3.5 yds

Model	Series 2	Series 3	Series 4	Series 5	Series 6	Series 7	Series 8	COM
776-51 S	\$2,113	\$2,224	\$2,410	\$2,603	\$2,834	\$3,066	\$3,357	\$2,224
776-51 P	\$2,380	\$2,491	\$2,677	\$2,870	\$3,101	\$3,333	\$3,624	\$2,491

Capella Patient Chair



More Information

Illustrated Glossary ▶ 439

Fabrics ▶ 451

Flammability (CTB-133) ▶ 459

Finishes ▶ 456

Ordering and Warranties ▶ 462

Standard Features

- Solid maple frame
- Mortise and tenon joinery
- Spring seat construction
- Clean-out design
- Replaceable components
- Upholstered arms
- Non-marring $\frac{7}{8}$ " rubber-cushioned glides
- Nemschoff healthcare wood finish
- GREENGUARD Gold Certified
- Limited Lifetime Warranty

Available Options

- Moisture barrier + \$67 per seat or back
- CTB-133 + \$81/yd
- Two fabrics + \$62
- Three (or more) fabrics + \$88

Specification Decisions

- Select fabric
- Select standard wood finish
- Add moisture barrier
- Add CTB-133
- Apply multiple fabrics

Model numbers with **S** indicate standard seat and back covers, and model numbers with **P** indicate removable covers.

Flammability Types

- Type 4
- Type 2 (Footstool)

Coordinating Products

- [Capella Multiple Seating](#)
- [Capella Side Chair](#)
- [Capella Tables](#)
- [Capella Adjustable Back Chair](#)
- [Capella CompactComfort Recliner](#)
- [Capella Glider](#)
- [Capella Adjustable Back Glider](#)

Key Dimensions

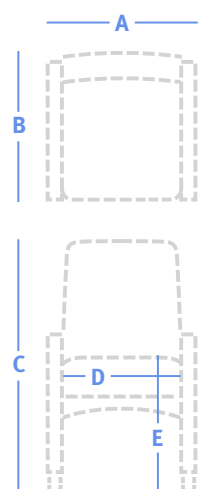

A	Overall Width	See price table
B	Overall Depth	24.75"
C	Overall Height	40.5"
D	Seat Width	20.5"
E	Seat Height	18.75"
F	Arm Height	25"

Footstool dimensions

Depth	12"
Height	12"



25.5" W, High back patient chair

27 lbs | 2.5 yds

Model	Series 2	Series 3	Series 4	Series 5	Series 6	Series 7	Series 8	COM
740-51 S	\$2,058	\$2,137	\$2,270	\$2,408	\$2,573	\$2,739	\$2,947	\$2,137
740-51 P	\$2,315	\$2,394	\$2,527	\$2,665	\$2,830	\$2,996	\$3,204	\$2,394



17" W, Footstool

8 lbs | 1.25 yds

Model	Series 2	Series 3	Series 4	Series 5	Series 6	Series 7	Series 8	COM
740-59 S	\$309	\$348	\$415	\$484	\$566	\$649	\$753	\$348
740-59 P	\$351	\$390	\$457	\$526	\$608	\$691	\$795	\$390

Centé Patient Chair



Standard Features

- Powder-coated metal frame (XTT Titanium Textured)
- Wipe-out design
- Replaceable components
- Grey urethane arm caps
- Upholstered seat and back
- Seat and back suspension with soft permeable mesh fabric
- Elevated forward incline and shift control mechanism
- GREENGUARD Gold Certified
- Twelve-year Warranty

Available Options

- Moisture barrier + \$67 per seat or back
- Tilt and roll casters + \$68
- CTB-133 (for fabric) + \$81/yd (for fabric)

Specification Decisions

- Select fabric or Centé Mesh Fabric. Centé Mesh available in:

PK01 Cave	PK02 Slate	PK03 Khaki
PK04 Grain	PK05 Sage	PK06 Pacific

- Add moisture barrier (with fabric only)
- Add CTB-133 (for fabric)
- Add rear casters

Flammability Types

- Type 5 (except CNXX-00003)
- CNXX00003 meets CTB-133

Key Dimensions

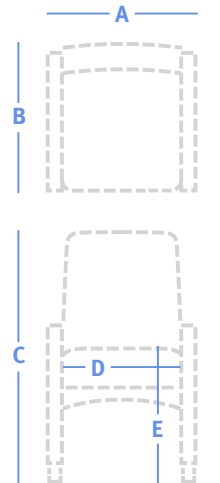

A	Overall Width	See price table
B	Overall Depth	25" - 31"
C	Overall Height	49"
D	Seat Width	20.75"
E	Seat Height	17.5"
F	Arm Height	27.5"
Footstool dimensions		
	Depth	17.5"
	Height	12.5"

More Information

- Illustrated Glossary ▶ 439
- Fabrics ▶ 451
- Flammability (CTB-133) ▶ 459
- Finishes ▶ 456
- Ordering and Warranties ▶ 462



28" W, Flex patient chair, mesh									51 lbs
Model	Series 2	Series 3	Series 4	Series 5	Series 6	Series 7	Series 8	COM	
CNXX-00003		\$2,086							\$2,086









28" W, Flex patient chair with upholstered back									51 lbs 1.5 yds
Model	Series 2	Series 3	Series 4	Series 5	Series 6	Series 7	Series 8	COM	
CNXX-00003UPB	\$2,383	\$2,406	\$2,509	\$2,565	\$2,595	\$2,635	\$2,660	\$2,406	



28" W, Flex patient chair with upholstered back and seat									51 lbs 3.75 yds
Model	Series 2	Series 3	Series 4	Series 5	Series 6	Series 7	Series 8	COM	
CNXX-00003UPB/UPS	\$2,515	\$2,574	\$2,832	\$2,970	\$3,046	\$3,145	\$3,208	\$2,574	

Centé Patient Chair

	28" W, Flex patient chair with upholstered seat									51 lbs 0.75 yd
	Model	Series 2	Series 3	Series 4	Series 5	Series 6	Series 7	Series 8	COM	
	CNXX-00003UPS	\$2,243	\$2,254	\$2,306	\$2,334	\$2,349	\$2,369	\$2,381	\$2,254	
	28" W, Tilt patient chair, mesh									50 lbs
	Model	Series 2	Series 3	Series 4	Series 5	Series 6	Series 7	Series 8	COM	
	CNXX-00002		\$3,191						\$3,191	
	28" W, Tilt patient chair with upholstered back									50 lbs 1.5 yds
	Model	Series 2	Series 3	Series 4	Series 5	Series 6	Series 7	Series 8	COM	
	CNXX-00002UPB	\$3,486	\$3,509	\$3,612	\$3,668	\$3,698	\$3,738	\$3,763	\$3,509	
	28" W, Tilt patient chair with upholstered back and seat									50 lbs 3.75 yds
	Model	Series 2	Series 3	Series 4	Series 5	Series 6	Series 7	Series 8	COM	
	CNXX-00002UPB/UPS	\$3,620	\$3,679	\$3,937	\$4,075	\$4,151	\$4,250	\$4,313	\$3,679	
	28" W, Tilt patient chair with upholstered seat									50 lbs 0.75 yd
	Model	Series 2	Series 3	Series 4	Series 5	Series 6	Series 7	Series 8	COM	
	CNXX-00002UPS	\$3,346	\$3,357	\$3,409	\$3,437	\$3,452	\$3,472	\$3,484	\$3,357	
	20" W, Footstool									9 lbs
	Model	Series 2	Series 3	Series 4	Series 5	Series 6	Series 7	Series 8	COM	
	CNXX-00001		\$817							

Patient Chairs

Recliners

Treatment Chairs

Rockers & Gliders

Overbed Tables

Sleepover Seating

Casegoods

Display & Accessories

Cities Crosstown Patient Chair



Standard Features

- Solid maple frame
- Mortise and tenon joinery
- Spring seat construction
- Wipe-out design
- Replaceable components
- Wood arm caps
- Closed arm style
- Non-marring 7/8" rubber-cushioned glides
- Nemschoff healthcare wood finish
- GREENGUARD Gold Certified
- Limited Lifetime Warranty

Available Options

- Moisture barrier + \$67 per seat or back
- Five arm cap styles + \$0
- Four foot styles + \$0
- Two back styles + \$0
- Two arms styles + \$0
- CTB-133 + \$81/yd
- Two fabrics + \$62
- Three (or more) fabrics + \$88

Specification Decisions

- Select fabric
- Select standard wood finish
- Select arm cap style

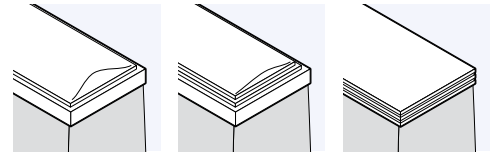

C Chicago **L** Los Angeles **N** New Orleans

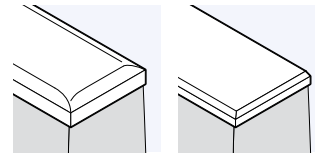

Y New York **W** Williamsburg

- Select foot style

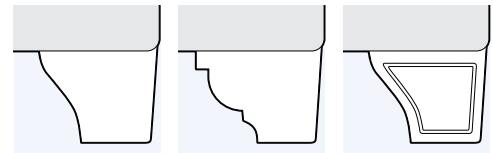

B Boston **C** Chicago **P** Philadelphia

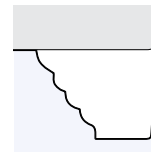

S San Francisco

- Select back style. All styles have a wipe-out feature.

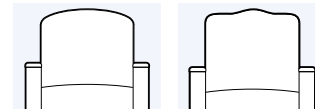

A Arcade back **Q** Camel square back

- Select arm style

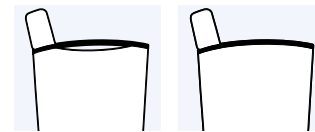

E Elliptical arm **C** Closed arm

- Add CTB-133
- Apply multiple fabrics
- Add moisture barrier

Model numbers with **S** indicate standard seat and back covers, and model numbers with **P** indicate removable covers.

More Information

Illustrated Glossary ▶ 439

Fabrics ▶ 451

Flammability (CTB-133) ▶ 459

Finishes ▶ 456

Ordering and Warranties ▶ 462

Cities Crosstown Patient Chair

Flammability Types

- Type 8
- Type 2 (Footstool)

Coordinating Products

- [Cities Small Crosstown Lounge Seating](#)
- [Cities Medium Crosstown Lounge Seating](#)
- [Cities Large Crosstown Lounge Seating](#)
- [Cities Small Downtown Lounge Seating](#)
- [Cities Medium Downtown Lounge Seating](#)
- [Cities Large Downtown Lounge Seating](#)
- [Cities Small Uptown Lounge Seating](#)
- [Cities Medium Uptown Lounge Seating](#)
- [Cities Large Uptown Lounge Seating](#)
- [Cities Side Chair](#)
- [Cities Tables](#)
- [Cities Downtown Patient Chair](#)
- [Cities Uptown Patient Chair](#)
- [Cities Uptown CompactComfort Recliner](#)
- [Cities Crosstown Rocker](#)
- [Cities Downtown Rocker](#)
- [Cities Uptown Rocker](#)
- [Cities Downtown Glider](#)
- [Cities Uptown Glider](#)
- [SleepOver Sofa](#)
- [SleepOver Settee](#)

Key Dimensions

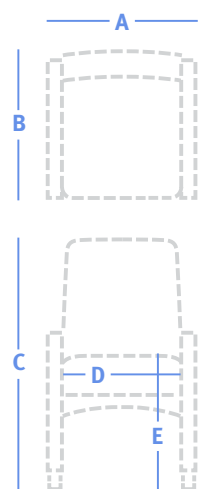

A	Overall Width	See price table
B	Overall Depth	26.5"
C	Overall Height	39.5"
D	Seat Width	19.5"
E	Seat Height	18.5"
F	Arm Height	25"

Footstool dimensions

Depth	12"
Height	12"



26.5" W, High back patient chair

44 lbs | 4.5 yds

Model	Series 2	Series 3	Series 4	Series 5	Series 6	Series 7	Series 8	COM
Cities-SCXXXX-51SX	\$1,976	\$2,119	\$2,358	\$2,607	\$2,903	\$3,202	\$3,576	\$2,119
Cities-SCXXXX-51PX	\$2,231	\$2,374	\$2,613	\$2,862	\$3,158	\$3,457	\$3,831	\$2,374



17" W, Footstool

7 lbs | 1.25 yds

Model	Series 2	Series 3	Series 4	Series 5	Series 6	Series 7	Series 8	COM
Cities-SXXXXX-59SX	\$309	\$348	\$415	\$484	\$566	\$649	\$753	\$348
Cities-SXXXXX-59PX	\$351	\$390	\$457	\$526	\$608	\$691	\$795	\$390

Cities Downtown Patient Chair



Standard Features

- Solid maple frame
- Mortise and tenon joinery
- Spring seat construction
- Wipe-out design
- Replaceable components
- Wood arm caps
- Non-marring 7/8" rubber-cushioned glides
- Nemschoff healthcare wood finish
- GREENGUARD Gold Certified
- Limited Lifetime Warranty

Available Options

- Moisture barrier + \$67 per seat or back
- Five arm cap styles + \$0
- Four foot styles + \$0
- Two back styles + \$0
- Two rail styles + \$0
- CTB-133 + \$81/yd
- Two fabrics + \$62
- Three (or more) fabrics + \$88

Specification Decisions

- Select fabric
- Select standard wood finish
- Select arm cap style

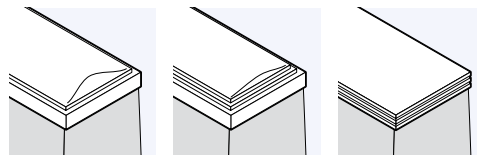

C Chicago **L** Los Angeles **N** New Orleans

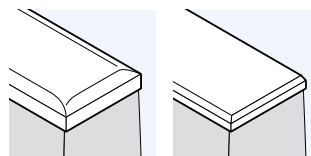

Y New York **W** Williamsburg

- Select foot style

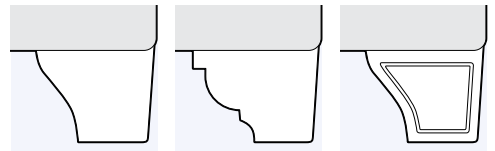

B Boston **C** Chicago **P** Philadelphia

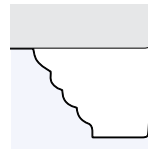

S San Francisco

- Select back style. All styles have a wipe-out feature.

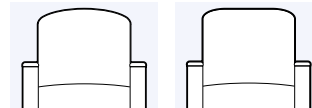

A Arcade back **B** Square back

- Select rail style

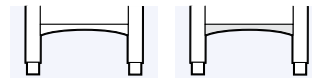

U Upholstered **W** Wood

- Add CTB-133
- Apply multiple fabrics
- Add moisture barrier

Model numbers with **S** indicate standard seat and back covers, and model numbers with **P** indicate removable covers.

Flammability Types

- Type 8
- Type 2 (Footstool)

More Information

Illustrated Glossary ▶ 439

Fabrics ▶ 451

Flammability (CTB-133) ▶ 459

Finishes ▶ 456

Ordering and Warranties ▶ 462

Cities Downtown Patient Chair

Coordinating Products

- [Cities Small Crosstown Lounge Seating](#)
- [Cities Medium Crosstown Lounge Seating](#)
- [Cities Large Crosstown Lounge Seating](#)
- [Cities Small Downtown Lounge Seating](#)
- [Cities Medium Downtown Lounge Seating](#)
- [Cities Large Downtown Lounge Seating](#)
- [Cities Small Uptown Lounge Seating](#)
- [Cities Medium Uptown Lounge Seating](#)
- [Cities Large Uptown Lounge Seating](#)
- [Cities Side Chair](#)
- [Cities Tables](#)
- [Cities Crosstown Patient Chair](#)
- [Cities Uptown Patient Chair](#)
- [Cities Uptown CompactComfort Recliner](#)
- [Cities Crosstown Rocker](#)
- [Cities Downtown Rocker](#)
- [Cities Uptown Rocker](#)
- [Cities Downtown Glider](#)
- [Cities Uptown Glider](#)
- [SleepOver Sofa](#)
- [SleepOver Settee](#)

Key Dimensions

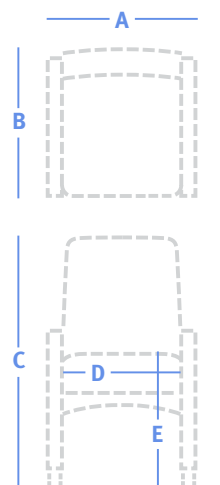

A	Overall Width	See price table
B	Overall Depth	26.5", 27.5"
C	Overall Height	39.5", 42"
D	Seat Width	19.5", 21.5"
E	Seat Height	18.5"
F	Arm Height	25", 25.5"

Footstool dimensions

Depth	12"
Height	12"



24.5" W, High back patient chair

38 lbs | 4.25 yds

Model	Series 2	Series 3	Series 4	Series 5	Series 6	Series 7	Series 8	COM
Cities-SDXXXX-51SX	\$1,984	\$2,119	\$2,344	\$2,580	\$2,859	\$3,142	\$3,495	\$2,119
Cities-SDXXXX-51PX	\$2,239	\$2,374	\$2,599	\$2,835	\$3,114	\$3,397	\$3,750	\$2,374



28" W, High back patient chair

48 lbs | 5 yds

Model	Series 2	Series 3	Series 4	Series 5	Series 6	Series 7	Series 8	COM
Cities-MDXXXX-51SX	\$2,369	\$2,528	\$2,793	\$3,070	\$3,399	\$3,731	\$4,147	\$2,528
Cities-MDXXXX-51PX	\$2,673	\$2,832	\$3,097	\$3,374	\$3,703	\$4,035	\$4,451	\$2,832



17" W, Footstool

7 lbs | 1.25 yds

Model	Series 2	Series 3	Series 4	Series 5	Series 6	Series 7	Series 8	COM
Cities-SDXXXX-59SX	\$309	\$348	\$415	\$484	\$566	\$649	\$753	\$348
Cities-SDXXXX-59PX	\$351	\$390	\$457	\$526	\$608	\$691	\$795	\$390

Cities Uptown Patient Chair



Standard Features

- Solid maple frame
- Mortise and tenon joinery
- Spring seat construction
- Wipe-out design
- Replaceable components
- Wood arm caps
- Non-marring 7/8" rubber-cushioned glides
- Nemschoff healthcare wood finish
- GREENGUARD Gold Certified
- Limited Lifetime Warranty

More Information

Illustrated Glossary ▶ 439

Fabrics ▶ 451

Flammability (CTB-133) ▶ 459

Finishes ▶ 456

Ordering and Warranties ▶ 462

Available Options

- Moisture barrier + \$67 per seat or back
- Five arm cap styles + \$0
- Two back styles + \$0
- Two rail styles + \$0
- CTB-133 + \$81/yd
- Two fabrics + \$62
- Three (or more) fabrics + \$88

Specification Decisions

- Select fabric
- Select standard wood finish
- Select arm cap style

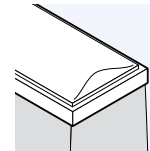

C Chicago

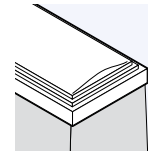

L Los Angeles

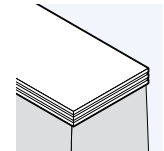

N New Orleans

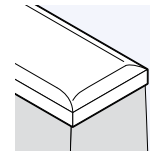

Y New York

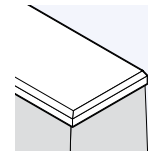

W Williamsburg

- Select back style. All styles have a wipe-out feature.

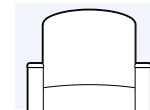

A Arcade back

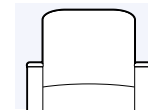

B Square back

- Select rail style

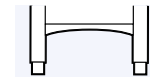

U Upholstered

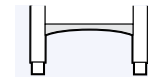

W Wood

- Add CTB-133
- Apply multiple fabrics
- Add moisture barrier

Model numbers with **S** indicate standard seat and back covers, and model numbers with **P** indicate removable covers.

Flammability Types

- Type 4
- Type 2 (Footstool)

Cities Uptown Patient Chair

Coordinating Products

- [Cities Small Crosstown Lounge Seating](#)
- [Cities Medium Crosstown Lounge Seating](#)
- [Cities Large Crosstown Lounge Seating](#)
- [Cities Small Downtown Lounge Seating](#)
- [Cities Medium Downtown Lounge Seating](#)
- [Cities Large Downtown Lounge Seating](#)
- [Cities Small Uptown Lounge Seating](#)
- [Cities Medium Uptown Lounge Seating](#)
- [Cities Large Uptown Lounge Seating](#)
- [Cities Side Chair](#)
- [Cities Tables](#)
- [Cities Crosstown Patient Chair](#)
- [Cities Downtown Patient Chair](#)
- [Cities Uptown CompactComfort Recliner](#)
- [Cities Crosstown Rocker](#)
- [Cities Downtown Rocker](#)
- [Cities Uptown Rocker](#)
- [Cities Downtown Glider](#)
- [Cities Uptown Glider](#)
- [SleepOver Sofa](#)
- [SleepOver Settee](#)

Key Dimensions

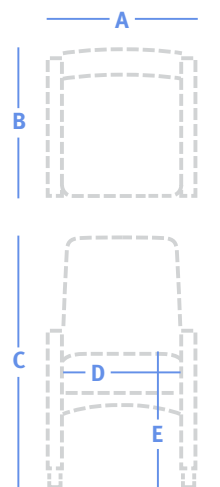

A	Overall Width	See price table
B	Overall Depth	26.5", 27.5"
C	Overall Height	39.5", 42"
D	Seat Width	19.5", 21.5"
E	Seat Height	18.5"
F	Arm Height	25"

Footstool dimensions

Depth	12"
Height	12"



24.5" W, High back patient chair

38 lbs | 3.75 yds

Model	Series 2	Series 3	Series 4	Series 5	Series 6	Series 7	Series 8	COM
Cities-SUX0XX-51SX	\$2,000	\$2,119	\$2,318	\$2,525	\$2,772	\$3,022	\$3,333	\$2,119
Cities-SUX0XX-51PX	\$2,255	\$2,374	\$2,573	\$2,780	\$3,027	\$3,277	\$3,588	\$2,374



28" W, High back patient chair

48 lbs | 4 yds

Model	Series 2	Series 3	Series 4	Series 5	Series 6	Series 7	Series 8	COM
Cities-MUX0XX-51SX	\$2,401	\$2,528	\$2,740	\$2,961	\$3,225	\$3,491	\$3,823	\$2,528
Cities-MUX0XX-51PX	\$2,705	\$2,832	\$3,044	\$3,265	\$3,529	\$3,795	\$4,127	\$2,832



17" W, Footstool

7 lbs | 1.25 yds

Model	Series 2	Series 3	Series 4	Series 5	Series 6	Series 7	Series 8	COM
Cities-SUX0XX-59SX	\$309	\$348	\$415	\$484	\$566	\$649	\$753	\$348
Cities-SUX0XX-59PX	\$351	\$390	\$457	\$526	\$608	\$691	\$795	\$390

Easy Access Patient Chair



Standard Features

- Solid maple frame
- Mortise and tenon joinery
- Spring seat construction
- Replaceable components
- Adjustable footrest
- Nemschoff healthcare wood finish
- GREENGUARD Gold Certified
- Limited Lifetime Warranty

- Two fabrics + \$62
- Three (or more) fabrics + \$88

Specification Decisions

- Select fabric
- Select standard wood finish
- Add moisture barrier
- Add CTB-133
- Apply multiple fabrics

Flammability Type

- Type 3

More Information

- Illustrated Glossary ▶ 439
- Fabrics ▶ 451
- Flammability (CTB-133) ▶ 459
- Finishes ▶ 456
- Ordering and Warranties ▶ 462

Available Options

- Moisture barrier + \$67 per seat or back
- CTB-133 + \$81/yd

Key Dimensions

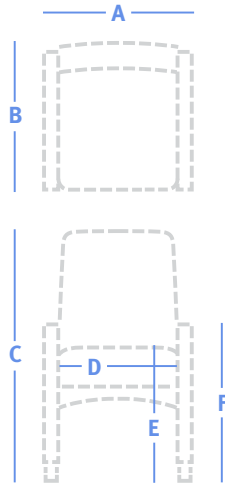

		314H	314B	2750H	314	316
A	Overall Width	22.25"	22.25"	22.5"	22.75"	22.75"
B	Overall Depth	23.75"	24.75"	23.75"	24.75"	24.75"
C	Overall Height	44.5"	38.75"	44.5"	38.75"	38.75"
D	Seat Width	18.25"	18.25"	18.25"	18.25"	18.25"
E	Seat Height	24.75"	24.75"	24.75"	24.75"	24.75"
F	Arm Height	31"	31"	31.5"	31"	31"



13" D Seat, pitched .5 degree toward the front

29 lbs | 1.75 yds

Model	Series 2	Series 3	Series 4	Series 5	Series 6	Series 7	Series 8	COM
314B	\$1,165	\$1,220	\$1,313	\$1,410	\$1,525	\$1,641	\$1,787	\$1,220



13" D Seat, pitched 4 degrees toward the back

29 lbs | 1.75 yds

Model	Series 2	Series 3	Series 4	Series 5	Series 6	Series 7	Series 8	COM
314H	\$1,165	\$1,220	\$1,313	\$1,410	\$1,525	\$1,641	\$1,787	\$1,220

Easy Access Patient Chair



13" D Seat, pitched 4 degrees toward the back with urethane arm caps 32 lbs | 1.75 yds

Model	Series 2	Series 3	Series 4	Series 5	Series 6	Series 7	Series 8	COM
2750H	\$1,429	\$1,484	\$1,577	\$1,674	\$1,789	\$1,905	\$2,051	\$1,484



18" D Seat, chair with flat arm rests 29 lbs | 1.5 yds

Model	Series 2	Series 3	Series 4	Series 5	Series 6	Series 7	Series 8	COM
314	\$1,174	\$1,221	\$1,301	\$1,384	\$1,483	\$1,582	\$1,707	\$1,221



18" D Seat, chair with upholstered flat arm rests 29 lbs | 1.75 yds

Model	Series 2	Series 3	Series 4	Series 5	Series 6	Series 7	Series 8	COM
316	\$1,214	\$1,269	\$1,362	\$1,459	\$1,574	\$1,690	\$1,836	\$1,269

Patient Chairs

Recliners

Treatment Chairs

Rockers & Gliders

Overbed Tables

Sleepover Seating

Casegoods

Display & Accessories

Hadleigh Patient Chair



Standard Features

- Solid maple frame
- Mortise and tenon joinery
- Spring seat construction
- Clean-out design
- Wood arm caps
- Replaceable components
- Non-marring 7/8" rubber-cushioned glides
- Nemschoff healthcare wood finish
- GREENGUARD Gold Certified
- Limited Lifetime Warranty

Available Options

- Moisture barrier + \$67 per seat or back
- CTB-133 + \$81/yd
- Two fabrics + \$62
- Three (or more) fabrics + \$88

Specification Decisions

- Select fabric
- Select standard wood finish
- Add CTB-133
- Apply multiple fabrics
- Add moisture barrier

Model numbers with **S** indicate standard seat and back covers, and model numbers with **P** indicate removable covers.

Flammability Type

- Type 4
- Type 2 (Footstool)

Coordinating Products

- [Hadleigh Lounge Seating](#)
- [Hadleigh Tables](#)
- [Hadleigh Adjustable Back Chair](#)
- [Hadleigh Casegoods](#)

Key Dimensions

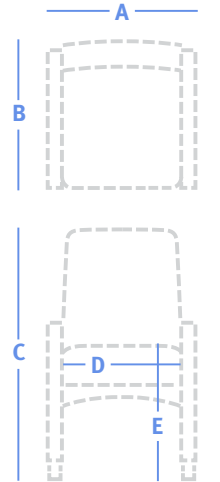

A	Overall Width	See price table
B	Overall Depth	25.25"
C	Overall Height	39"
D	Seat Width	21.5"
E	Seat Height	18.75"
F	Arm Height	25.25"

Footstool dimensions

Depth	12"
Height	11.75"

More Information

- Illustrated Glossary ▶ 439
- Fabrics ▶ 451
- Flammability (CTB-133) ▶ 459
- Finishes ▶ 456
- Ordering and Warranties ▶ 462



28" W, High back patient chair

40 lbs | 2.25 yds

Model	Series 2	Series 3	Series 4	Series 5	Series 6	Series 7	Series 8	COM
280-51 S	\$2,068	\$2,139	\$2,259	\$2,383	\$2,531	\$2,681	\$2,868	\$2,139
280-51 P	\$2,325	\$2,396	\$2,516	\$2,640	\$2,788	\$2,938	\$3,125	\$2,396



17" W, Footstool

8 lbs | 1.25 yds

Model	Series 2	Series 3	Series 4	Series 5	Series 6	Series 7	Series 8	COM
280-59 S	\$309	\$348	\$415	\$484	\$566	\$649	\$753	\$348
280-59 P	\$351	\$390	\$457	\$526	\$608	\$691	\$795	\$390

Harmon Patient Chair



More Information

Illustrated Glossary ▶ 439

Fabrics ▶ 451

Flammability (CTB-133) ▶ 459

Finishes ▶ 456

Ordering and Warranties ▶ 462

Standard Features

- Solid maple frame
- Mortise and tenon joinery
- Spring seat construction
- Clean-out design
- Wood arms with wood insets
- Wallsaver legs
- Non-marring 7/8" glides
- Upholstered back
- Nemschoff healthcare wood finish
- GREENGUARD Gold Certified
- Limited Lifetime Warranty

Available Options

- Moisture barrier + \$67 per seat or back
- Black urethane arm inset + \$113
- Upholstered arm inset + \$113
- Wood back + \$228
- Upholstered back with slats + \$228
- CTB-133 + \$81/yd
- Two fabrics + \$62
- Three (or more) fabrics + \$88

Specification Decisions

- Select fabric
- Select standard wood finish
- Add arm inset style
- Add back style

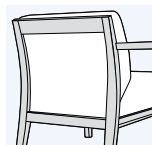

Upholstered back

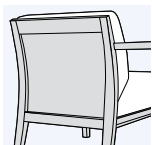

Wood back

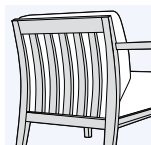

Upholstered back with wood slats

- Add CTB-133
- Apply multiple fabrics
- Add moisture barrier

Model numbers with **S** indicate standard seat and back covers, and model numbers with **P** indicate removable covers.

Flammability Type

- Type 5

Coordinating Products

- [Harmon Lounge Seating](#)

Key Dimensions

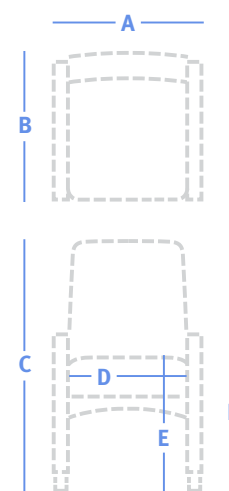

A	Overall Width	See price table
B	Overall Depth	26.5"
C	Overall Height	42"
D	Seat Width	21.5"
E	Seat Height	18.75"
F	Arm Height	26.75"



24.75" W, High back patient chair

41 lbs | 2.25 yds

Model	Series 2	Series 3	Series 4	Series 5	Series 6	Series 7	Series 8	COM
708-51 S	\$1,417	\$1,488	\$1,608	\$1,732	\$1,880	\$2,030	\$2,217	\$1,488
708-51 P	\$1,596	\$1,667	\$1,787	\$1,911	\$2,059	\$2,209	\$2,396	\$1,667

Horizon Patient Chair



Standard Features

- Solid hardwood frame
- Clean-out design
- Replaceable components
- Wood arm caps
- Laminate footrest
- Nemschoff healthcare wood finish
- GREENGUARD Gold Certified
- Limited Lifetime Warranty

Available Options

- Moisture barrier + \$67 per seat or back
- CTB-133 + \$81/yd
- Removable covers + \$170
- Two fabrics + \$62
- Three (or more) fabrics + \$88

Specification Decisions

- Select fabric
- Select standard wood finish
- Select standard laminate
- Add moisture barrier
- Add CTB-133
- Apply multiple fabrics
- Add removable covers

Flammability Type

- Type 3

Coordinating Products

- [Horizon Multiple Seating](#)
- [Horizon Tables](#)
- [Horizon Recliner](#)
- [Horizon Glider](#)

Key Dimensions

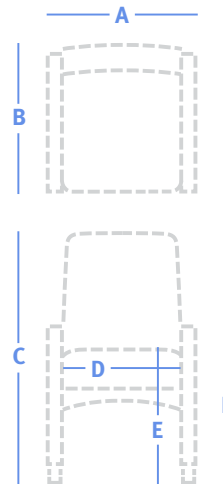

A	Overall Width	See price table
B	Overall Depth	25"
C	Overall Height	38.5"
D	Seat Width	19.5"
E	Seat Height	24.5"
F	Arm Height	32"

More Information

Illustrated Glossary ▶ 439

Fabrics ▶ 451

Flammability (CTB-133) ▶ 459

Finishes ▶ 456

Ordering and Warranties ▶ 462



23" W, Patient chair

32 lbs | 1 3/4 yds

Model	Series 2	Series 3	Series 4	Series 5	Series 6	Series 7	Series 8	COM
727	\$1,638	\$1,665	\$1,786	\$1,850	\$1,885	\$1,932	\$1,961	\$1,665

Marco Patient Chair



More Information

Illustrated Glossary ▶ 439

Fabrics ▶ 451

Flammability (CTB-133) ▶ 459

Finishes ▶ 456

Ordering and Warranties ▶ 462

Standard Features

- Solid maple frame
- Mortise and tenon joinery
- Spring seat construction
- Clean-out design
- Replaceable components
- Wood arms
- Wallsaver legs
- Non-marring 7/8" plastic rubber-cushioned glides
- Nemschoff healthcare wood finish
- GREENGUARD Gold Certified
- Limited Lifetime Warranty

Available Options

- Moisture barrier + \$67 per seat or back
- CTB-133 + \$81/yd
- Two fabrics + \$62
- Three (or more) fabrics + \$88

Specification Decisions

- Select fabric
- Select standard wood finish
- Add CTB-133
- Apply multiple fabrics
- Add moisture barrier

Model numbers with **S** indicate standard seat and back covers, and model numbers with **P** indicate removable covers.

Flammability Type

- Type 4
- Type 2 (Footstool)

Coordinating Products

- [Marco Grande Lounge Seating](#)
- [Marco Grande II Lounge Seating](#)
- [Marco Multiple Seating](#)
- [Marco Grande Tables](#)
- [Marco Glider](#)

Key Dimensions

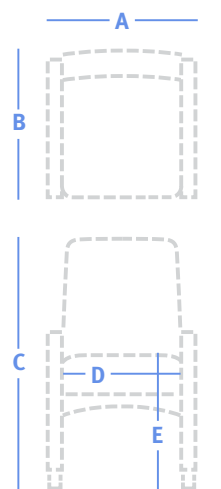

A	Overall Width	See price table
B	Overall Depth	27"
C	Overall Height	40.5"
D	Seat Width	19.75"
E	Seat Height	18.75"
F	Arm Height	25"

Footstool dimensions

Depth	12"
Height	12"

	23.5" W, High back patient chair									28 lbs 2.75 yds
	Model	Series 2	Series 3	Series 4	Series 5	Series 6	Series 7	Series 8	COM	
	735-51 S	\$1,670	\$1,757	\$1,903	\$2,055	\$2,236	\$2,419	\$2,648	\$1,757	
	735-51 P	\$1,881	\$1,968	\$2,114	\$2,266	\$2,447	\$2,630	\$2,859	\$1,968	
	17" W, Footstool									7 lbs 1.25 yds
	Model	Series 2	Series 3	Series 4	Series 5	Series 6	Series 7	Series 8	COM	
	735-59 S	\$250	\$289	\$356	\$425	\$507	\$590	\$694	\$289	
	735-59 P	\$285	\$324	\$391	\$460	\$542	\$625	\$729	\$324	

McKinley Patient Chair



Standard Features

- Solid hardwood frame
- Mortise and tenon joinery
- Clean-out design
- Replaceable components
- Wood arm caps
- Wallsaver legs
- Non-marring 7/8" plastic rubber-cushioned glides
- Nemschoff healthcare wood finish
- GREENGUARD Gold Certified
- Limited Lifetime Warranty

Available Options

- Moisture barrier + \$67 per seat or back
- Black urethane arm caps + \$113
- CTB-133 + \$81/yard
- Two fabrics + \$62
- Three (or more) fabrics + \$88

Specification Decisions

- Select fabric
- Select standard wood finish
- Add CTB-133
- Apply multiple fabrics
- Add moisture barrier
- Add urethane arm caps

Flammability Type

- Type 5

Key Dimensions

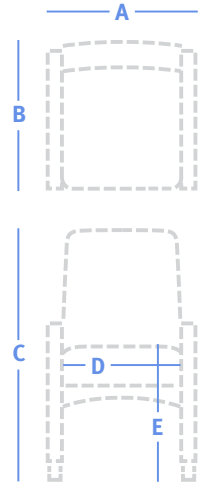

A	Overall Width	See price table
B	Overall Depth	28.5"
C	Overall Height	43"
D	Seat Width	21"
E	Seat Height	18.75"
F	Arm Height	25.75"

More Information

Illustrated Glossary ▶ 439

Fabrics ▶ 451

Flammability (CTB-133) ▶ 459

Finishes ▶ 456

Ordering and Warranties ▶ 462



24" W, High back patient chair

28 lbs | 2.5 yds

Model	Series 2	Series 3	Series 4	Series 5	Series 6	Series 7	Series 8	COM
FX551-1	\$886	\$965	\$1,096	\$1,233	\$1,397	\$1,548	\$1,754	\$965

Meridian Patient Chair



More Information

Illustrated Glossary ▶ 439

Fabrics ▶ 451

Flammability (CTB-133) ▶ 459

Finishes ▶ 456

Ordering and Warranties ▶ 462

Standard Features

- Solid hardwood frame
- Wipe-out design
- Replaceable components
- Wood arms
- Non-marring ¾" glides
- Nemschoff healthcare wood finish
- GREENGUARD Gold Certified
- Limited Lifetime Warranty

Available Options

- Moisture barrier + \$67 per seat or back
- Black urethane arm caps + \$113
- CTB-133 + \$81/yd
- Two fabrics + \$62
- Three (or more) fabrics + \$88

Specification Decisions

- Select fabric
- Select standard wood finish
- Add urethane arm caps
- Add CTB-133
- Apply multiple fabrics
- Add moisture barrier

Flammability Type

- Type 5

Coordinating Products

- [Meridian Lounge Seating](#)
- [Meridian Multiple Seating](#)
- [Meridian Tables](#)
- [Meridian Behavioral Health Seating](#)

Key Dimensions

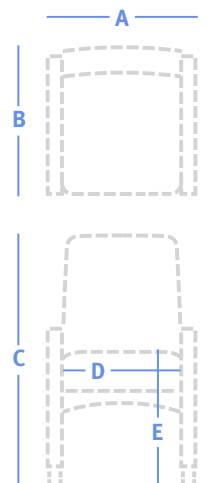

A	Overall Width	See price table
B	Overall Depth	25.5"
C	Overall Height	43"
D	Seat Width	19.5"
E	Seat Height	18"
F	Arm Height	25"

	23" W, High back patient chair								26 lbs 2.25 yds
	Model	Series 2	Series 3	Series 4	Series 5	Series 6	Series 7	Series 8	COM
	MP10	\$1,075	\$1,110	\$1,265	\$1,348	\$1,393	\$1,453	\$1,491	\$1,110

	25.5" W, High back patient chair								32 lbs 2.5 yds
	Model	Series 2	Series 3	Series 4	Series 5	Series 6	Series 7	Series 8	COM
	MP15	\$1,232	\$1,271	\$1,443	\$1,535	\$1,586	\$1,652	\$1,694	\$1,271

Monarch Patient Chair



Standard Features

- Solid maple frame
- Mortise and tenon joinery
- Memory foam seat
- Wipe-out design
- Replaceable components
- Black urethane arm caps
- Wallsaver legs
- Non-marring 7/8" glides
- Nemschoff healthcare wood finish
- GREENGUARD Gold Certified
- Limited Lifetime Warranty

Available Options

- Moisture barrier + \$67 per seat or back
- Wood arm caps + \$113
- CTB-133 + \$81/yd
- Two fabrics + \$62
- Three (or more) fabrics + \$88

Specification Decisions

- Select fabric
- Select standard wood finish
- Add CTB-133
- Apply multiple fabrics
- Add moisture barrier
- Add wood arm caps

Model numbers with **S** indicate standard seat and back covers, and model numbers with **P** indicate removable covers.

Flammability Type

- Type 3

Coordinating Products

- [Monarch Lounge Seating](#)
- [Monarch Multiple Seating](#)
- [Monarch Stack Chair](#)
- [Monarch Tables](#)
- [Monarch Sleep Chair and Settee](#)

Key Dimensions

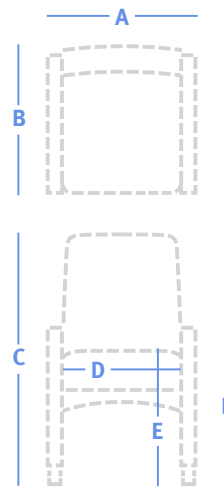

A	Overall Width	See price table
B	Overall Depth	25.5"
C	Overall Height	43"
D	Seat Width	20.25"
E	Seat Height	18.5"
F	Arm Height	27"

More Information

- Illustrated Glossary ▶ 439
- Fabrics ▶ 451
- Flammability (CTB-133) ▶ 459
- Finishes ▶ 456
- Ordering and Warranties ▶ 462



22.75" W, High back patient chair

29 lbs | 1.75 yds

Model	Series 2	Series 3	Series 4	Series 5	Series 6	Series 7	Series 8	COM
893-51 S	\$936	\$991	\$1,084	\$1,181	\$1,296	\$1,412	\$1,558	\$991
893-51 P	\$1,055	\$1,110	\$1,203	\$1,300	\$1,415	\$1,531	\$1,677	\$1,110

Nala Patient Chair



More Information

Illustrated Glossary ▶ 439

Fabrics ▶ www.nemschoff.com

Flammability (CTB-133) ▶ 459

Finishes ▶ 456

Ordering and Warranties ▶ 462

Standard Features

- Harmonic tilt (CR43)
- Fixed back, 15-degree angle (CR41)
- Seat and back suspension
- Titanium powder-coated aluminum frame (XTS)
- Dark grey urethane arm pads (G1)
- Integrated handle
- 24-degree recline range
- Seat and back suspension integrated on back of the seat
- Ships cartoned and drop-shipped
- GREENGUARD Gold Certified
- Cradle to Cradle Silver certification
- Twelve-year Warranty

Available Options

- Moisture barrier + \$101
- Pivoting arms + \$113
- Tilt and roll casters + \$79
- Handle + \$74
- Handle and headrest pillow + \$175

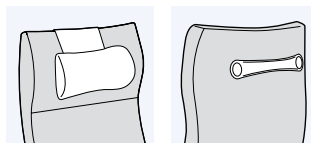

Headrest pillow Handle

- CTB-133 (Chair) + \$317
- CTB-133 (Footstool) + \$138

Specification Decisions

- Select Fixed back (CR41) or Harmonic tilt (CR43)

- Select fixed arms (2) or add pivoting arms (3)
- Select no tilt and roll (N) or add tilt and roll (W)
- Select no handle or pillow (N) or add handle (H) or add handle and pillow (P)
- Specify upholstery configuration



Configuration 1

Fabric 1: seat, inside back, outside back, headrest



Configuration 2

Fabric 1: seat
Fabric 2: inside back, outside back, headrest



Configuration 3

Fabric 1: seat, inside back, headrest
Fabric 2: outside back



Configuration 4

Fabric 1: seat, headrest
Fabric 2: inside back, outside back



Configuration 5

Fabric 1: seat, inside back, outside back
Fabric 2: headrest

Note:

Pillow always matches seat upholstery in all configurations

- Select "No CTB-133" (skip this step) or "meets CTB-133" (FR)
- Select no moisture barrier (NN) or add moisture barrier (6S)
- Note base finish (XTS)
- Note arm pad finish (G1)
- Select fabric 1 (see nemschoff.com for fabric options)
 - Configuration 1:* seat, inside back, outside back, headrest
 - Configuration 2:* seat
 - Configuration 3:* seat, inside back, headrest
 - Configuration 4:* seat, headrest
 - Configuration 5:* seat, inside back, outside back
- Select fabric 2 (see nemschoff.com for fabric options)
 - Configuration 1:* none
 - Configuration 2:* inside back, outside back, headrest
 - Configuration 3:* outside back
 - Configuration 4:* inside back, outside back
 - Configuration 5:* headrest

Flammability Type

- Type 6

Nala Patient Chair

Complete Product Number Example

CR433.WP4FR6SXTG13P02V601

Model
 Arm style
 Tilt and roll option
 Handle / pillow options
 Upholstery configuration
 CTB-133 option
 Moisture barrier option
 Base finish
 Arm pad finish
 Fabric 1
 Fabric 2

Key Dimensions

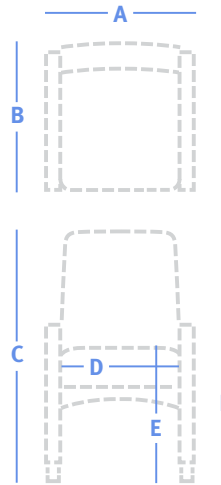

A	Overall Width	See price table
B	Overall Depth	28.5"
C	Overall Height	50.5"
D	Seat Width	22.25"
E	Seat Height	18" – 18.75" (lowest to highest point)
F	Arm Height	27.5"

Footstool dimensions

Depth	16.5"
Height	16.5"

Description:

Harmonic tilt, pivoting arms, tilt and roll, handle and pillow, upholstery configuration 4, meets CTB-133, moisture barrier, titanium base finish, graphite arm pad finish, 3P02 fabric 1, V601 fabric 2.



33" W, Fixed back patient chair

72 lbs

Model	Upholstery Configuration				
CR41	1	2	3	4	5

<i>Fabric 1 Yardage</i>	3 yds	1.5 yds	2.5 yds	2 yds	3 yds
-------------------------	-------	---------	---------	-------	-------

Base Price

\$2,197

Fabric 1 Upcharge

Grade	1	2	3	4	5
1	-	-	-	-	-
3	\$96	\$38	\$76	\$58	\$96
4	\$145	\$58	\$116	\$88	\$145
C	\$142	\$57	\$114	\$86	\$142
D	\$163	\$66	\$131	\$99	\$163
E	\$207	\$82	\$166	\$125	\$207
F	\$257	\$103	\$205	\$154	\$257
G	\$273	\$110	\$219	\$164	\$273

<i>Fabric 2 Yardage</i>	-	2.5 yds	1.5 yds	2.5 yds	1.5 yds
-------------------------	---	---------	---------	---------	---------

Fabric 2 Upcharge

Grade	1	2	3	4	5
1	-	-	-	-	-
3	-	\$76	\$38	\$76	\$38
4	-	\$116	\$58	\$116	\$58
C	-	\$114	\$57	\$114	\$57
D	-	\$131	\$66	\$131	\$66
E	-	\$166	\$82	\$166	\$82
F	-	\$205	\$103	\$205	\$103
G	-	\$219	\$110	\$219	\$110

Nala Patient Chair



33" W, Harmonic tilt patient chair 80 lbs

Model	Upholstery Configuration				
-------	--------------------------	--	--	--	--

CR43	1	2	3	4	5
------	---	---	---	---	---

<i>Fabric 1 Yardage</i>	3 yds	1.5 yds	2.5 yds	2 yds	3 yds
-------------------------	-------	---------	---------	-------	-------

Fabric 1 Upcharge

Base Price

\$2,546

Grade	1	-	-	-	-
-------	---	---	---	---	---

3	\$96	\$38	\$76	\$58	\$96
----------	------	------	------	------	------

4	\$145	\$58	\$116	\$88	\$145
----------	-------	------	-------	------	-------

C	\$142	\$57	\$114	\$86	\$142
----------	-------	------	-------	------	-------

D	\$163	\$66	\$131	\$99	\$163
----------	-------	------	-------	------	-------

E	\$207	\$82	\$166	\$125	\$207
----------	-------	------	-------	-------	-------

F	\$257	\$103	\$205	\$154	\$257
----------	-------	-------	-------	-------	-------

G	\$273	\$110	\$219	\$164	\$273
----------	-------	-------	-------	-------	-------

<i>Fabric 2 Yardage</i>	-	2.5 yds	1.5 yds	2.5 yds	1.5 yds
-------------------------	---	---------	---------	---------	---------

Fabric 2 Upcharge

Grade	1	-	-	-	-
-------	---	---	---	---	---

3	-	\$76	\$38	\$76	\$38
----------	---	------	------	------	------

4	-	\$116	\$58	\$116	\$58
----------	---	-------	------	-------	------

C	-	\$114	\$57	\$114	\$57
----------	---	-------	------	-------	------

D	-	\$131	\$66	\$131	\$66
----------	---	-------	------	-------	------

E	-	\$166	\$82	\$166	\$82
----------	---	-------	------	-------	------

F	-	\$205	\$103	\$205	\$103
----------	---	-------	-------	-------	-------

G	-	\$219	\$110	\$219	\$110
----------	---	-------	-------	-------	-------

Patient Chairs

Recliners

Treatment Chairs

Rockers & Gliders

Overbed Tables

Sleeper Seating

Casegoods

Display & Accessories

Nala Patient Chair

Nala Footstool

Specification Decisions

- Select Nala Footstool (CR900)
- Select "No CTB-133" (skip this step) or "meets CTB-133" (FR)
- Note base finish (XTS)
- Select fabric (see nemschoff.com for fabric options)

Footstool does not fit under chair



25.25" W, Footstool

16.5 lbs

Model

CR900

Fabric Yardage 1 yd

Base Price

\$776

Fabric Upcharge

Grade	Price
1	-
3	\$38
4	\$58
C	\$57
D	\$66
E	\$82
F	\$103
G	\$110

Olivia Patient Chair



More Information

Illustrated Glossary ▶ 439

Fabrics ▶ 451

Flammability (CTB-133) ▶ 459

Finishes ▶ 456

Ordering and Warranties ▶ 462

Standard Features

- Solid maple frame
- Mortise and tenon joinery
- Spring seat construction
- Clean-out design
- Non-marring 7/8" plastic rubber-cushioned glides
- Upholstered arms
- Nemschoff healthcare wood finish
- GREENGUARD Gold Certified
- Limited Lifetime Warranty

Available Options

- Moisture barrier + \$67 per seat or back
- CTB-133 + \$81/yd
- Two fabrics + \$62
- Three (or more) fabrics + \$88

Specification Decisions

- Select fabric
- Select standard wood finish
- Add CTB-133
- Apply multiple fabrics
- Add moisture barrier

Model numbers with **S** indicate standard seat and back covers, and model numbers with **P** indicate removable covers.

Flammability Type

- Type 6

Coordinating Products

- [Olivia Lounge Seating](#)
- [Olivia Tables](#)
- [Olivia Glider](#)

Key Dimensions

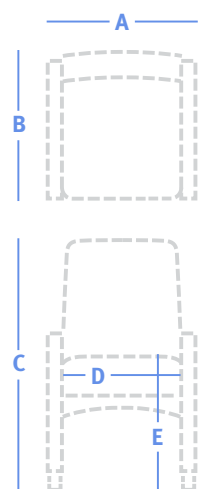

A	Overall Width	See price table
B	Overall Depth	31"
C	Overall Height	39.5"
D	Seat Width	21.25"
E	Seat Height	18"
F	Arm Height	25.5"



28.25" W, High back patient chair

37 lbs | 4.25 yds

Model	Series 2	Series 3	Series 4	Series 5	Series 6	Series 7	Series 8	COM
903-51 S	\$2,318	\$2,453	\$2,678	\$2,914	\$3,193	\$3,476	\$3,829	\$2,453
903-51 P	\$2,613	\$2,748	\$2,973	\$3,209	\$3,488	\$3,771	\$4,124	\$2,748

Revive Patient Chair



More Information

Illustrated Glossary ▶ 439

Fabrics ▶ 451

Flammability (CTB-133) ▶ 459

Finishes ▶ 456

Ordering and Warranties ▶ 462

Standard Features

- Powder-coated metal frame
- Wipe-out design
- Wood arm caps
- Dynamic flexing back (2.5-degrees)
- Non-marring plastic glides
- GREENGUARD Gold Certified
- Limited Lifetime Warranty

Available Options

- Laminate infill arm panel + \$134
- Wood infill arm panel + \$134
- Black urethane arm caps + \$113
- CTB-133 + \$81/yd
- Two fabrics + \$62
- Three (or more) fabrics + \$88
- Adjustable neck pillow + see price table
- Magazine holder (LSF) + \$186
- Pullout drink holder (black) + \$180
- Sliding storage tray (RSF) + \$121
- Removable covers + \$170

Specification Decisions

- Select fabric
- Select powder coat finish
- Add CTB-133
- Apply multiple fabrics
- Add moisture barrier
- Add urethane arm caps
- Add adjustable neck pillow
- Add panel arms (V wood, L laminate)
- Add magazine holder (LSF)
- Add Pullout drink holder
- Add sliding storage tray
- Add removable covers

Flammability Types

- Type 5 (Open arms)
- Type 6 (Arm panels)
- Type 2 (Footstool)

Coordinating Products

- [Revive Side Chair](#)
- [Revive Casegoods](#)
- [Revive Daystands](#)
- [Revive Display System](#)
- [Revive Guest Center](#)

Key Dimensions

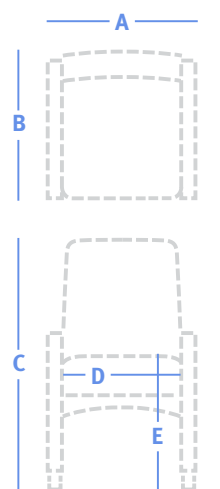







A	Overall Width	See price table
B	Overall Depth	25", 26"
C	Overall Height	43", 47"
D	Seat Width	20", 20.5"
E	Seat Height	18.5"
F	Arm Height	24"

Footstool dimensions

	Depth	13"
	Height	12"

Revive Patient Chair

	25" W, High back patient chair									32 lbs 2.5 yds
	Model	Series 2	Series 3	Series 4	Series 5	Series 6	Series 7	Series 8	COM	
	RV10	\$1,554	\$1,593	\$1,765	\$1,857	\$1,908	\$1,974	\$2,016	\$1,593	
	25" W, High back patient chair with short panel arms									37 lbs 3 yds
	Model	Series 2	Series 3	Series 4	Series 5	Series 6	Series 7	Series 8	COM	
	RV10SPA	\$1,589	\$1,636	\$1,842	\$1,953	\$2,013	\$2,093	\$2,143	\$1,636	
	25" W, High back patient chair with panel arms									37 lbs 3.5 yds
	Model	Series 2	Series 3	Series 4	Series 5	Series 6	Series 7	Series 8	COM	
	RV10HPA	\$1,621	\$1,676	\$1,917	\$2,046	\$2,116	\$2,209	\$2,268	\$1,676	
	25" W, Mid back patient chair									32 lbs 2.5 yds
	Model	Series 2	Series 3	Series 4	Series 5	Series 6	Series 7	Series 8	COM	
	RV11	\$1,554	\$1,593	\$1,765	\$1,857	\$1,908	\$1,974	\$2,016	\$1,593	
	25" W, Mid back patient chair with short panel arms									37 lbs 3 yds
	Model	Series 2	Series 3	Series 4	Series 5	Series 6	Series 7	Series 8	COM	
	RV11SPA	\$1,589	\$1,636	\$1,842	\$1,953	\$2,013	\$2,093	\$2,143	\$1,636	
	25" W, Mid back patient chair with panel arms									37 lbs 3.5 yds
	Model	Series 2	Series 3	Series 4	Series 5	Series 6	Series 7	Series 8	COM	
	RV11HPA	\$1,621	\$1,676	\$1,917	\$2,046	\$2,116	\$2,209	\$2,268	\$1,676	
	Adjustable neck pillow									2 lbs .5 yds
	Model	Series 2	Series 3	Series 4	Series 5	Series 6	Series 7	Series 8	COM	
	-	\$171	\$178	\$213	\$231	\$241	\$255	\$263	\$178	
	20" W, Footstool									14 lbs .75 yds
	Model	Series 2	Series 3	Series 4	Series 5	Series 6	Series 7	Series 8	COM	
	RV70	\$220	\$231	\$283	\$311	\$326	\$346	\$358	\$231	

Patient Chairs

Recliners

Treatment Chairs

Rockers & Gliders

Overbed Tables

Sleepover Seating

Casegoods

Display & Accessories

Torii Patient Chair



Standard Features

- Solid maple frame
- Mortise and tenon joinery
- Spring seat construction
- Clean-out design
- Replaceable components
- Swoop back style
- Wood arm caps
- Non-marring $\frac{7}{8}$ " plastic rubber-cushioned glides
- Nemschoff healthcare wood finish
- GREENGUARD Gold Certified
- Limited Lifetime Warranty

Available Options

- Moisture barrier + \$67 per seat or back
- Arcade back + \$0

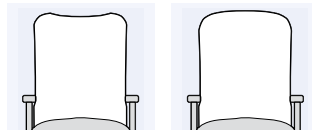
Swoop back
(standard)

Arcade back

- Radius edge + \$0
- CTB-133 + \$81/yd
- Two fabrics + \$62
- Three (or more) fabrics + \$88

Specification Decisions

- Select fabric
- Select standard wood finish
- Add CTB-133
- Apply multiple fabrics
- Add moisture barrier
- Add Arcade back

Model numbers with **S** indicate standard seat and back covers, and model numbers with **P** indicate removable covers.

Flammability Types

- Type 5
- Type 2 (Footstool)

Coordinating Products

- [Torii Multiple Seating](#)
- [Torii Side Chair](#)
- [Torii Tables](#)
- [Torii Glider](#)

Key Dimensions

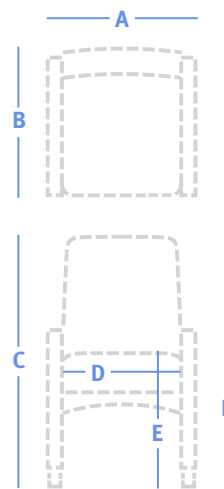

A	Overall Width	See price table
B	Overall Depth	27"
C	Overall Height	42"
D	Seat Width	19.75"
E	Seat Height	18.75"
F	Arm Height	26"

Footstool dimensions

	Depth	12"
	Height	12.75"

More Information

Illustrated Glossary ▶ 439

Fabrics ▶ 451

Flammability (CTB-133) ▶ 459

Finishes ▶ 456

Ordering and Warranties ▶ 462



24" W, High back patient chair

38 lbs | 2.25 yds

Model	Series 2	Series 3	Series 4	Series 5	Series 6	Series 7	Series 8	COM
283-51 S	\$1,586	\$1,657	\$1,777	\$1,901	\$2,049	\$2,199	\$2,386	\$1,657
283-51 P	\$1,785	\$1,856	\$1,976	\$2,100	\$2,248	\$2,398	\$2,585	\$1,856



17" W, Footstool

8 lbs | 1.25 yds

Model	Series 2	Series 3	Series 4	Series 5	Series 6	Series 7	Series 8	COM
283-59 S	\$309	\$348	\$415	\$484	\$566	\$649	\$753	\$348
283-59 P	\$351	\$390	\$457	\$526	\$608	\$691	\$795	\$390

- Patient Chairs
- Recliners
- Treatment Chairs
- Rockers & Gliders
- Overbed Tables
- Sleeper Seating
- Casegoods
- Display & Accessories

Valor Patient Chair



Standard Features

- Heavy-duty steel construction
- Powder-coated metal frame
- Memory foam seat
- Wipe-out design
- Replaceable components
- Black urethane arms
- Non-marring 7/8" glides
- GREENGUARD Gold Certified
- Limited Lifetime Warranty

Available Options

- Moisture barrier + \$67 per seat or back
- CTB-133 + \$81

Specification Decisions

- Select fabric
- Select powder coat finish
- Add CTB-133
- Add moisture barrier

Model numbers with **S** indicate standard seat and back covers, and model numbers with **P** indicate removable covers.

Flammability Type

- Type 3

Coordinating Products

- [Valor Lounge Seating](#)
- [Valor Multiple Seating](#)
- [Valor Stack Chair](#)
- [Valor Tables](#)

Key Dimensions

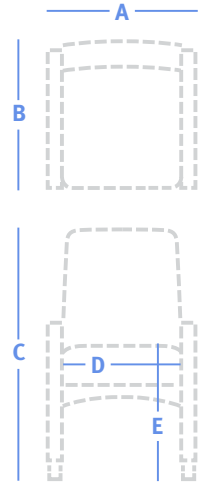

A	Overall Width	See price table
B	Overall Depth	25.25"
C	Overall Height	43.25"
D	Seat Width	20"
E	Seat Height	18"
F	Arm Height	26.25"

More Information

- Illustrated Glossary ▶ 439
- Fabrics ▶ 451
- Flammability (CTB-133) ▶ 459
- Finishes ▶ 456
- Ordering and Warranties ▶ 462



23.25" W, High back patient chair

37 lbs | 2 yds

Model	Series 2	Series 3	Series 4	Series 5	Series 6	Series 7	Series 8	COM
891-51 S	\$733	\$796	\$902	\$1,013	\$1,145	\$1,278	\$1,444	\$796
891-51 P	\$829	\$892	\$998	\$1,109	\$1,241	\$1,374	\$1,540	\$892

2755 Series Adjustable Back Chair



More Information

Illustrated Glossary ▶ 439

Fabrics ▶ 451

Flammability (CTB-133) ▶ 459

Finishes ▶ 456

Ordering and Warranties ▶ 462

Standard Features

- Solid maple frame
- Mortise and tenon joinery
- Spring seat construction
- Replaceable components
- Black urethane arm caps
- Non-marring $\frac{7}{8}$ " plastic rubber-cushioned glides
- Locking gas spring recline mechanism
- Infinite back adjustment within 111 degrees
- Wallsaver legs
- Wallsaver edge
- Nemschoff healthcare wood finish
- GREENGUARD Gold Certified
- Limited Lifetime Warranty; five years on mechanism

Available Options

- Moisture barrier + \$67 per seat or back
- Desert or Pewter urethane arm caps +\$205
- CTB-133 + \$81/yd
- Two fabrics + \$62
- Three (or more) fabrics + \$88

Specification Decisions

- Select fabric
- Select standard wood finish
- Add CTB-133
- Apply multiple fabrics
- Add moisture barrier
- Add urethane arm caps

Model numbers with **S** indicate standard seat and back covers, and model numbers with **P** indicate removable covers.

Flammability Type

- Type 5

Coordinating Products

- [2755 Series CompactComfort Recliner](#)

Key Dimensions

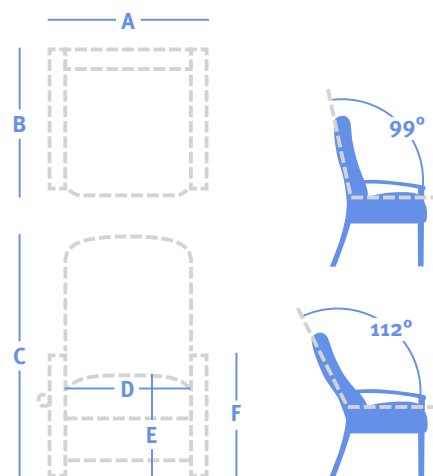

A	Overall Width	See price table
B	Overall Depth	29" 34" (reclined)
C	Overall Height	44.5"
D	Seat Width	21.5"
E	Seat Height	18.75"
F	Arm Height	26"



25.75" W, Adjustable back chair

44 lbs | 2.5 yds

Model	Series 2	Series 3	Series 4	Series 5	Series 6	Series 7	Series 8	COM
2755-52 S	\$1,828	\$1,907	\$2,040	\$2,178	\$2,343	\$2,509	\$2,717	\$1,907
2755-52 P	\$2,057	\$2,136	\$2,269	\$2,407	\$2,572	\$2,738	\$2,946	\$2,136



17" W, Footstool

8 lbs | 1.25 yds

Model	Series 2	Series 3	Series 4	Series 5	Series 6	Series 7	Series 8	COM
2750-59 S	\$309	\$348	\$415	\$484	\$566	\$649	\$753	\$348
2750-59 P	\$351	\$390	\$457	\$526	\$608	\$691	\$795	\$390

2755 Series CompactComfort Recliner



Standard Features

- Solid maple frame
- Mortise and tenon joinery
- Spring seat construction
- Replaceable components
- Black urethane arm caps
- Non-marring 7/8" plastic rubber-cushioned glides
- Wallsaver legs
- Wallsaver edge
- Locking gas spring recline mechanism
- Fold-out footrest
- Infinite back adjustment within 108 degrees
- Nemschoff healthcare wood finish
- GREENGUARD Gold Certified
- Limited Lifetime Warranty; five years on mechanism

Available Options

- Moisture barrier + \$67 per seat or back
- Tilt and roll, 2" single-wheel casters + \$280
- Desert or Pewter urethane arm caps + \$205
- CTB-133 + \$81/yd
- Two fabrics + \$62
- Three (or more) fabrics + \$88

Specification Decisions

- Select fabric
- Select standard wood finish
- Add CTB-133
- Apply multiple fabrics
- Add moisture barrier
- Add urethane arm caps
- Add tilt and roll casters

Model numbers with **S** indicate standard seat and back covers, and model numbers with **P** indicate removable covers.

Flammability Type

- Type 5

Coordinating Products

- [2755 Series Adjustable Back Chair](#)

Key Dimensions

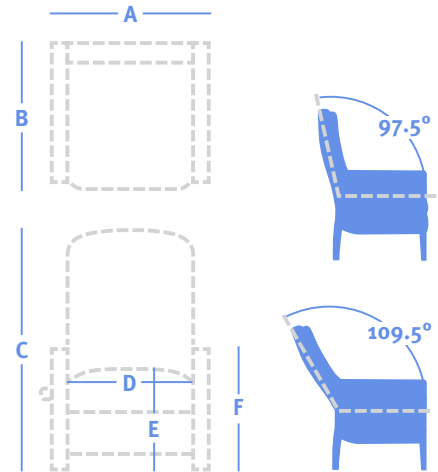

A	Overall Width	See price table
B	Overall Depth	29.5" 53.5" (reclined)
C	Overall Height	43.75"
D	Seat Width	21.5"
E	Seat Height	18.75"
F	Arm Height	26"

More Information

- Illustrated Glossary ▶ 439
- Fabrics ▶ 451
- Flammability (CTB-133) ▶ 459
- Finishes ▶ 456
- Ordering and Warranties ▶ 462

		27.5" W, CompactComfort recliner								71 lbs 3.5 yds
Model		Series 2	Series 3	Series 4	Series 5	Series 6	Series 7	Series 8	COM	
	2755-62 S	\$3,000	\$3,111	\$3,297	\$3,490	\$3,721	\$3,953	\$4,244	\$3,111	
	2755-62 P	\$3,374	\$3,485	\$3,671	\$3,864	\$4,095	\$4,327	\$4,618	\$3,485	

		27.5" W, CompactComfort recliner with firm flat seat								71 lbs 3.5 yds
Model		Series 2	Series 3	Series 4	Series 5	Series 6	Series 7	Series 8	COM	
	2755-620 S	\$3,151	\$3,262	\$3,448	\$3,641	\$3,872	\$4,104	\$4,395	\$3,262	
	2755-620 P	\$3,543	\$3,654	\$3,840	\$4,033	\$4,264	\$4,496	\$4,787	\$3,654	

Auburn Recliner



More Information

Illustrated Glossary ▶ 439

Fabrics ▶ 451

Flammability (CTB-133) ▶ 459

Finishes ▶ 456

Ordering and Warranties ▶ 462

Standard Features

- Wood arm caps with extended profile
- Nemschoff healthcare wood finish
- GREENGUARD Gold Certified
- Limited Lifetime Warranty; five years on mechanism

Available Options

- Moisture barrier + \$67 per seat or back
- Black urethane arm caps (mounted on top of wood arm caps and include a wood reveal) + \$113
- 100-mm single-wheel swivel casters + \$253
- 11" x 16" Folding side table (Durawrap) + \$483
- CTB-133 + \$81
- Stainless steel push bar + \$227
- Magazine pouch (MG - see price table)
- Headrest pillow (HP - see price table)
- Removable covers + \$170
- Two fabrics + \$62
- Three (or more) fabrics + \$88

Specification Decisions

- Select fabric
- Select standard wood finish
- Add CTB-133
- Apply multiple fabrics
- Add moisture barrier
- Add urethane arm caps
- Add casters
- Add folding side table (select Durawrap)
- Add push bar
- Add magazine pouch
- Add headrest pillow
- Add removable covers

Flammability Type

- Type 6

Coordinating Products

- [Auburn Multiple Seating](#)

- [Auburn Tables](#)

- [Auburn Glider](#)

Key Dimensions

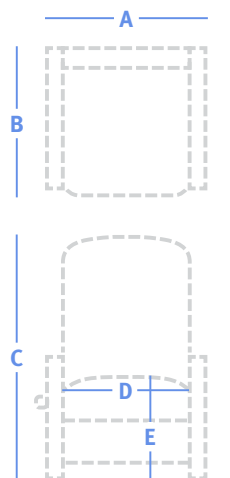

A	Overall Width	See price table
B	Overall Depth	35", 37" 67.5" (reclined)
C	Overall Height	43"
D	Seat Width	23.5"
E	Seat Height	18.5"
F	Arm Height	24.5"

Auburn Recliner



29.5" W, Three-position recliner with push back

105 lbs | 6 yds

Model	Series 2	Series 3	Series 4	Series 5	Series 6	Series 7	Series 8	COM
ABRN_00030	\$2,207	\$2,302	\$2,714	\$2,936	\$3,056	\$3,215	\$3,316	\$2,302



29.5" W, Wallsaver recliner with LSF pull strap

109 lbs | 6 yds

Model	Series 2	Series 3	Series 4	Series 5	Series 6	Series 7	Series 8	COM
ABRN_00050	\$2,460	\$2,555	\$2,967	\$3,189	\$3,309	\$3,468	\$3,569	\$2,555



31.5" W, Flat-fold recliner with LSF outside handle

133 lbs | 8 yds

Model	Series 2	Series 3	Series 4	Series 5	Series 6	Series 7	Series 8	COM
ABRN_00060	\$3,495	\$3,621	\$4,171	\$4,466	\$4,627	\$4,838	\$4,973	\$3,621

Headrest pillow

| 1.75 yds

Model	Series 2	Series 3	Series 4	Series 5	Series 6	Series 7	Series 8	COM
HP	\$75	\$86	\$138	\$166	\$181	\$201	\$213	\$86

Magazine pouch

| 1.75 yds

Model	Series 2	Series 3	Series 4	Series 5	Series 6	Series 7	Series 8	COM
MG	\$63	\$74	\$126	\$154	\$169	\$189	\$201	\$74

Brava Adjustable Back Chair



More Information

Illustrated Glossary ▶ 439

Fabrics ▶ 451

Flammability (CTB-133) ▶ 459

Finishes ▶ 456

Ordering and Warranties ▶ 462

Standard Features

- Solid maple frame
- Mortise and tenon joinery
- Spring seat construction
- Replaceable components
- Non-marring $\frac{7}{8}$ " plastic rubber-cushioned glides
- Wallsaver legs and edge
- Locking gas spring recline mechanism
- Infinite back adjustment within 111 degrees
- Nemschoff healthcare wood finish
- GREENGUARD Gold Certified
- Limited Lifetime Warranty; five years on mechanism

Available Options

- Moisture barrier + \$67 per seat or back
- Black urethane arm caps + \$113
- Desert or Pewter urethane arm caps + \$205
- Wood arm caps (862-52) + \$113
- CTB-133 + \$81/yd
- Two fabrics + \$62
- Three (or more) fabrics + \$88

Specification Decisions

- Select fabric
- Select standard wood finish
- Add CTB-133
- Apply multiple fabrics
- Add moisture barrier
- Add wood or urethane arm caps

Model numbers with **S** indicate standard seat and back covers, and model numbers with **P** indicate removable covers.

Flammability Types

- Type 6
- Type 5 (open arms)

Coordinating Products

- [Brava Classic Lounge Seating](#)
- [Brava Platform Lounge Seating](#)
- [Brava 862 Multiple Seating](#)
- [Brava 863 Multiple Seating](#)
- [Brava Side Chair](#)
- [Brava Tables](#)
- [Brava CompactComfort Recliner](#)
- [Brava Patient Chair](#)
- [Brava Glider](#)
- [Brava Flop Sofa](#)
- [Brava Sleep Settee](#)

Key Dimensions

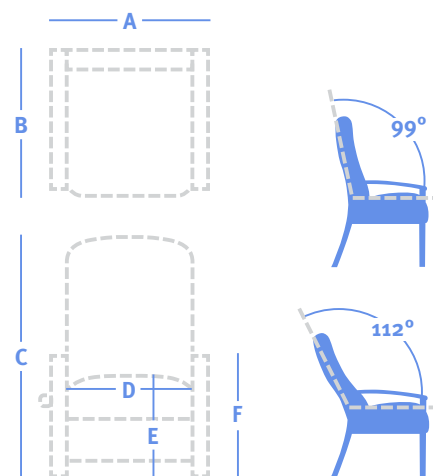

A	Overall Width	See price table
B	Overall Depth	27" 35" (reclined)
C	Overall Height	44"
D	Seat Width	20.75", 21.5"
E	Seat Height	18.75"
F	Arm Height	26.5"

Welcoming & Waiting

Brava Adjustable Back Chair



25.75" W, Adjustable back chair with open wood arms

44 lbs | 2.5 yds

Model	Series 2	Series 3	Series 4	Series 5	Series 6	Series 7	Series 8	COM
863-52 S	\$2,694	\$2,773	\$2,906	\$3,044	\$3,209	\$3,375	\$3,583	\$2,773
863-52 P	\$3,027	\$3,106	\$3,239	\$3,377	\$3,542	\$3,708	\$3,916	\$3,106



26.5" W, Adjustable back chair with fully upholstered arms

44 lbs | 3.5 yds

Model	Series 2	Series 3	Series 4	Series 5	Series 6	Series 7	Series 8	COM
862-52 S	\$2,859	\$2,970	\$3,156	\$3,349	\$3,580	\$3,812	\$4,103	\$2,970
862-52 P	\$3,216	\$3,327	\$3,513	\$3,706	\$3,937	\$4,169	\$4,460	\$3,327

Patient Areas

Specialty

Reference

Brava CompactComfort Recliner



More Information

Illustrated Glossary ▶ 439

Fabrics ▶ 451

Flammability (CTB-133) ▶ 459

Finishes ▶ 456

Ordering and Warranties ▶ 462

Standard Features

- Solid maple frame
- Mortise and tenon joinery
- Spring seat construction
- Replaceable components
- Non-marring 7/8" plastic rubber-cushioned glides
- Wallsaver legs and edge
- Locking gas spring recline mechanism
- Infinite back adjustment within 108 degrees
- Fold-out footrest
- Nemschoff healthcare wood finish
- GREENGUARD Gold Certified
- Limited Lifetime Warranty; five years on mechanism

Available Options

- Moisture barrier + \$67 per seat or back
- Black urethane arm caps + \$113
- Desert or Pewter urethane arm caps + \$205
- Wood arm caps (862-62) + \$113
- CTB-133 + \$81/yard
- Tilt and roll, 2" single-wheel casters + \$280
- Two fabrics + \$62
- Three (or more) fabrics + \$88

Specification Decisions

- Select fabric
- Select standard wood finish
- Add CTB-133
- Apply multiple fabrics
- Add moisture barrier
- Add wood or urethane arm caps
- Add tilt and roll casters

Model numbers with **S** indicate standard seat and back covers, and model numbers with **P** indicate removable covers.

Flammability Type

- Type 6

Coordinating Products

- [Brava Classic Lounge Seating](#)
- [Brava Platform Lounge Seating](#)
- [Brava 862 Multiple Seating](#)
- [Brava 863 Multiple Seating](#)
- [Brava Side Chair](#)
- [Brava Tables](#)
- [Brava Adjustable Back Chair](#)
- [Brava Patient Chair](#)
- [Brava Glider](#)
- [Brava Flop Sofa](#)
- [Brava Sleep Settee](#)

Key Dimensions

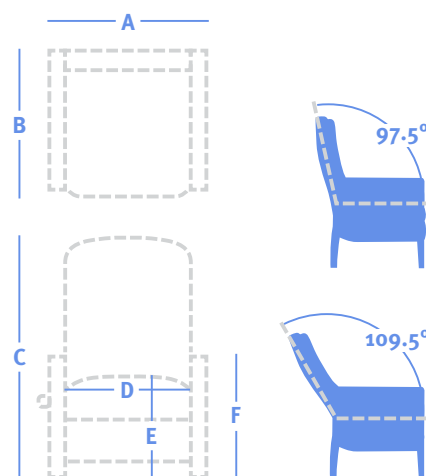

A	Overall Width	See price table
B	Overall Depth	30" 53.75" (reclined)
C	Overall Height	43.75"
D	Seat Width	21.5"
E	Seat Height	19"
F	Arm Height	26.5"

Welcoming & Waiting

Brava CompactComfort Recliner



26.75" W, CompactComfort recliner with open wood arms 73 lbs | 3.25 yds

Model	Series 2	Series 3	Series 4	Series 5	Series 6	Series 7	Series 8	COM
863-62 S	\$3,335	\$3,438	\$3,610	\$3,790	\$4,004	\$4,220	\$4,491	\$3,438
863-62 P	\$3,748	\$3,851	\$4,023	\$4,203	\$4,417	\$4,633	\$4,904	\$3,851



27.5" W, CompactComfort recliner with fully upholstered arms 73 lbs | 4.5 yds

Model	Series 2	Series 3	Series 4	Series 5	Series 6	Series 7	Series 8	COM
862-62 S	\$3,492	\$3,635	\$3,874	\$4,123	\$4,419	\$4,718	\$5,092	\$3,635
862-62 P	\$3,929	\$4,072	\$4,311	\$4,560	\$4,856	\$5,155	\$5,529	\$4,072

Patient Areas

Specialty

Reference

Capella Adjustable Back Chair



More Information

Illustrated Glossary ▶ 439

Fabrics ▶ 451

Flammability (CTB-133) ▶ 459

Finishes ▶ 456

Ordering and Warranties ▶ 462

Standard Features

- Solid maple frame
- Mortise and tenon joinery
- Spring seat construction
- Replaceable components
- Upholstered arms
- Non-marring $\frac{7}{8}$ " plastic rubber-cushioned glides
- Wallsaver edge
- Locking gas spring recline mechanism
- Infinite back adjustment within 111 degrees
- Nemschoff healthcare wood finish
- GREENGUARD Gold Certified
- Limited Lifetime Warranty; five years on mechanism

Available Options

- Moisture barrier + \$67 per seat or back
- CTB-133 + \$81/yd
- Two fabrics + \$62
- Three (or more) fabrics + \$88

Specification Decisions

- Select fabric
- Select standard wood finish
- Add CTB-133
- Apply multiple fabrics
- Add moisture barrier

Model numbers with **S** indicate standard seat and back covers, and model numbers with **P** indicate removable covers.

Flammability Types

- Type 6
- Type 2 (Footstool)

Coordinating Products

- [Capella Multiple Seating](#)
- [Capella Side Chair](#)
- [Capella Tables](#)
- [Capella Patient Chair](#)
- [Capella CompactComfort Recliner](#)
- [Capella Glider](#)
- [Capella Adjustable Back Glider](#)

Key Dimensions

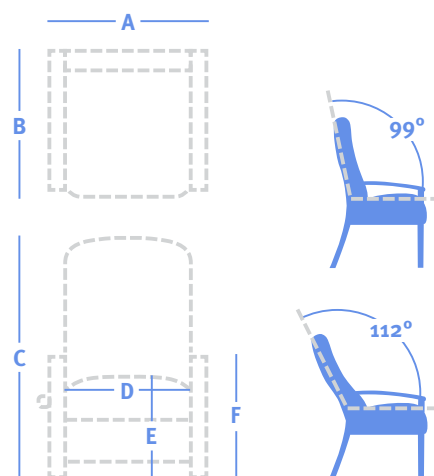

A	Overall Width	See price table
B	Overall Depth	26.75" 33.75" (reclined)
C	Overall Height	44.5"
D	Seat Width	20.5"
E	Seat Height	18.75"
F	Arm Height	24.75"

Footstool dimensions

Depth	12"
Height	12"

	27.25" W, Adjustable back chair									32 lbs 2.75 yds
	Model	Series 2	Series 3	Series 4	Series 5	Series 6	Series 7	Series 8	COM	
	740-52 S	\$2,672	\$2,759	\$2,905	\$3,057	\$3,238	\$3,421	\$3,650	\$2,759	
	740-52 P	\$3,004	\$3,091	\$3,237	\$3,389	\$3,570	\$3,753	\$3,982	\$3,091	
	17" W, Footstool									8 lbs 1.25 yds
	Model	Series 2	Series 3	Series 4	Series 5	Series 6	Series 7	Series 8	COM	
	740-59 S	\$309	\$348	\$415	\$484	\$566	\$649	\$753	\$348	
	740-59 P	\$351	\$390	\$457	\$526	\$608	\$691	\$795	\$390	

Capella CompactComfort Recliner



Standard Features

- Solid maple frame
- Mortise and tenon joinery
- Spring seat construction
- Replaceable components
- Upholstered arms
- Non-marring 7/8" plastic rubber-cushioned glides
- Wallsaver edge
- Locking gas spring recline mechanism
- Infinite back adjustment within 108 degrees
- Fold-out footrest
- Nemschoff healthcare wood finish
- GREENGUARD Gold Certified
- Limited lifetime warranty; five years on mechanism

More Information

- Illustrated Glossary ▶ 439
- Fabrics ▶ 451
- Flammability (CTB-133) ▶ 459
- Finishes ▶ 456
- Ordering and Warranties ▶ 462

Available Options

- Moisture barrier + \$67 per seat or back
- Tilt and roll, 2" single-wheel casters + \$280
- CTB-133 + \$81/yd
- Two fabrics + \$62
- Three (or more) fabrics + \$88

Specification Decisions

- Select fabric
- Select standard wood finish
- Add CTB-133
- Apply multiple fabrics
- Add moisture barrier
- Add tilt and roll casters

Model numbers with **S** indicate standard seat and back covers, and model numbers with **P** indicate removable covers.

Flammability Type

- Type 6

Coordinating Products

- [Capella Multiple Seating](#)
- [Capella Side Chair](#)
- [Capella Tables](#)
- [Capella Patient Chair](#)
- [Capella Adjustable Back Chair](#)
- [Capella Glider](#)
- [Capella Adjustable Back Glider](#)

Key Dimensions

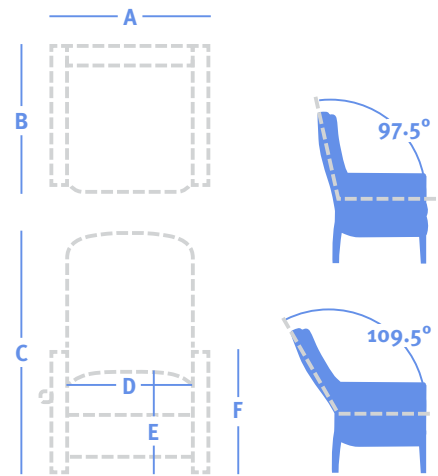

A	Overall Width	See price table
B	Overall Depth	29.25" 54.25"(reclined)
C	Overall Height	44"
D	Seat Width	20.75"
E	Seat Height	18.75"
F	Arm Height	24.75"



27.5" W, CompactComfort recliner

70 lbs | 5.5 yds

Model	Series 2	Series 3	Series 4	Series 5	Series 6	Series 7	Series 8	COM
740-62 S	\$3,394	\$3,569	\$3,860	\$4,165	\$4,527	\$4,892	\$5,350	\$3,569
740-62 P	\$3,823	\$3,998	\$4,289	\$4,594	\$4,956	\$5,321	\$5,779	\$3,998

Cities Uptown CompactComfort Recliner



More Information

Illustrated Glossary ▶ 439

Fabrics ▶ 451

Flammability (CTB-133) ▶ 459

Finishes ▶ 456

Ordering and Warranties ▶ 462

Standard Features

- Solid maple frame
- Mortise and tenon joinery
- Spring seat construction
- Replaceable components
- Wood arm caps
- Non-marring $\frac{7}{8}$ " plastic rubber-cushioned glides
- Wallsaver edge
- Locking gas spring recline mechanism
- Infinite back adjustment within 108 degrees
- Fold-out footrest
- Nemschoff healthcare wood finish
- GREENGUARD Gold Certified
- Limited Lifetime Warranty; five years on mechanism

Available Options

- Moisture barrier + \$67 per seat or back
- Five arm cap styles + \$0
- CTB-133 + \$81
- Tilt and roll, 2" single-wheel casters + \$280
- Two fabrics + \$62
- Three (or more) fabrics + \$88

Specification Decisions

- Select fabric
- Select standard wood finish
- Select arm cap style

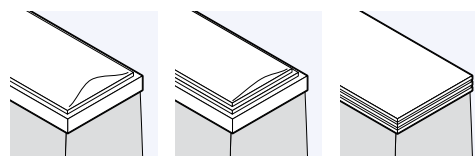

C Chicago

L Los Angeles

N New Orleans

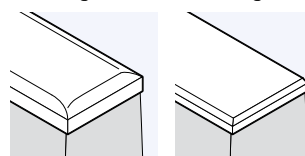

Y New York

W Williamsburg

- Add CTB-133
- Apply multiple fabrics
- Add moisture barrier
- Add tilt and roll casters

Model numbers with **S** indicate standard seat and back covers, and model numbers with **P** indicate removable covers.

Flammability Type

- Type 6

Cities Uptown CompactComfort Recliner

Coordinating Products

- [Cities Small Crosstown Lounge Seating](#)
- [Cities Medium Crosstown Lounge Seating](#)
- [Cities Large Crosstown Lounge Seating](#)
- [Cities Small Downtown Lounge Seating](#)
- [Cities Medium Downtown Lounge Seating](#)
- [Cities Large Downtown Lounge Seating](#)
- [Cities Small Uptown Lounge Seating](#)
- [Cities Medium Uptown Lounge Seating](#)
- [Cities Large Uptown Lounge Seating](#)
- [Cities Side Chair](#)
- [Cities Tables](#)
- [Cities Crosstown Patient Chair](#)
- [Cities Downtown Patient Chair](#)
- [Cities Uptown Patient Chair](#)
- [Cities Crosstown Rocker](#)
- [Cities Downtown Rocker](#)
- [Cities Uptown Rocker](#)
- [Cities Downtown Glider](#)
- [Cities Uptown Glider](#)
- [SleepOver Sofa](#)
- [SleepOver Settee](#)

Key Dimensions

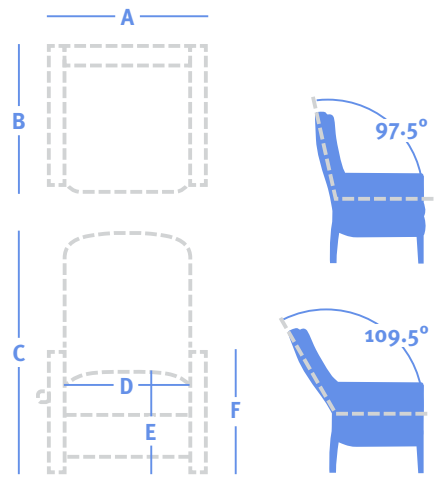

A	Overall Width	See price table
B	Overall Depth	29" 52" (reclined)
C	Overall Height	44"
D	Seat Width	20.5"
E	Seat Height	18.75"
F	Arm Height	25.25"



27" W, CompactComfort recliner

74 lbs | 5 yds

Model	Series 2	Series 3	Series 4	Series 5	Series 6	Series 7	Series 8	COM
Cities-SUX000-62 S	\$3,389	\$3,548	\$3,813	\$4,090	\$4,419	\$4,751	\$5,167	\$3,548
Cities-SUX000-62 P	\$3,815	\$3,974	\$4,239	\$4,516	\$4,845	\$5,177	\$5,593	\$3,974

Consoul Recliner



More Information

Illustrated Glossary ▶ 439

Fabrics ▶ 451

Flammability (CTB-133) ▶ 459

Finishes ▶ 456

Ordering and Warranties ▶ 462

Standard Features

- Solid maple frame
- Mortise and tenon joinery
- Spring seat construction
- Clean-out design
- Replaceable components
- Upholstered arms
- Dual arm controls for back recline
- Infinite back recline from upright to fully flat
- Sleep surface dimensions 24.75" x 77.5"
- Independently operating footrest
- 3" swivel casters, front-locking
- Wallsaver bumper
- Nemschoff healthcare wood finish
- GREENGUARD Gold Certified
- Limited Lifetime Warranty; ten years on mechanism

Available Options

- Moisture barrier + \$67 per seat or back
- Option package 1: Arm caps (wood or urethane) with thermoplastic (ABS) protective base + \$615
- Option package 2: Arm caps (wood or urethane) with thermoplastic (ABS) protective base and in-arm storage + \$897
- Monitor arm (LSF, RSF) + \$410
- Tablet table (LSF, RSF) laminate with wood edge + \$513
- Adjustable headrest + \$159
- CTB-133 + \$81/yard
- Two fabrics + \$62
- Three (or more) fabrics + \$88

Specification Decisions

- Select fabric
- Select wallsaver bumper color (Black, Desert, Pewter)
- Add option package 1 or package 2
- Select standard wood finish, if required

- Select thermoplastic (ABS) color, if required (Black, Desert, Pewter)
- Add moisture barrier
- Add CTB-133
- Apply multiple fabrics
- Add monitor arm
- Add tablet table, specify laminate and wood edge color
- Add headrest

Model numbers with **S** indicate standard seat and back covers, and model numbers with **P** indicate removable covers.

Flammability Type

- Type 6

Coordinating Products

- [Consoul Sleep Chair and Settee](#)

Key Dimensions

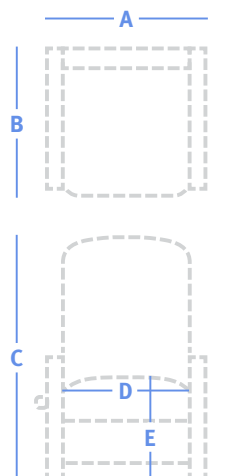

A	Overall Width	See price table
B	Overall Depth	37.75" 81" (reclined)
C	Overall Height	43.5"
D	Seat Width	24"
E	Seat Height	18.75"
F	Arm Height	26.25"



34" W, Recliner

147 lbs | 7.25 yds

Model	Series 2	Series 3	Series 4	Series 5	Series 6	Series 7	Series 8	COM
798-66 S	\$3,172	\$3,403	\$3,787	\$4,188	\$4,665	\$5,147	\$5,750	\$3,403
798-66 P	\$3,581	\$3,812	\$4,196	\$4,597	\$5,074	\$5,556	\$6,159	\$3,812

Culla Recliner



Standard Features

- Solid maple frame
- Mortise and tenon joinery
- Spring seat construction
- Replaceable components
- Wood arm caps
- Non-marring 2¼" glides
- Wallsaver edge
- Combination Glider/Recliner
- Must be 17" from wall to fully recline
- Independent footrest
- Nemschoff healthcare wood finish
- GREENGUARD Gold Certified
- Limited Lifetime Warranty; five years on mechanism

Available Options

- Moisture barrier + \$67 per seat or back
- Black urethane arm caps + \$113
- Tilt and roll, 2" single wheel casters + \$280
- 2" twin rubber-wheel casters, front fixed with brakes, rear swivel + \$349
- CTB-133 + \$81/yd
- Two fabrics + \$62
- Three (or more) fabrics + \$88

Specification Decisions

- Select fabric
- Select standard wood finish
- Add CTB-133

- Apply multiple fabrics
- Add moisture barrier
- Add urethane arm caps
- Add tilt and roll casters

Model numbers with **S** indicate standard seat and back covers, and model numbers with **P** indicate removable covers.

Flammability Type

- Type 6

Key Dimensions

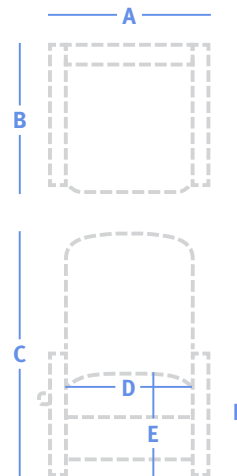

A	Overall Width	See price table
B	Overall Depth	34.5" 65" (reclined)
C	Overall Height	43.25"
D	Seat Width	23.5"
E	Seat Height	18.25"
F	Arm Height	24.5"

More Information

- Illustrated Glossary ▶ 439
- Fabrics ▶ 451
- Flammability (CTB-133) ▶ 459
- Finishes ▶ 456
- Ordering and Warranties ▶ 462



33" W, Combination glider/recliner

135 lbs | 6.5 yds

Model	Series 2	Series 3	Series 4	Series 5	Series 6	Series 7	Series 8	COM
287-68 S	\$3,336	\$3,543	\$3,887	\$4,247	\$4,675	\$5,107	\$5,648	\$3,543
287-68 P	\$3,762	\$3,969	\$4,313	\$4,673	\$5,101	\$5,533	\$6,074	\$3,969

Erica Adjustable Back Chair



More Information

Illustrated Glossary ▶ 439

Fabrics ▶ 451

Flammability (CTB-133) ▶ 459

Finishes ▶ 456

Ordering and Warranties ▶ 462

Standard Features

- Solid maple frame
- Mortise and tenon joinery
- Spring seat construction
- Replaceable components
- Wallsaver edge
- Non-marring $\frac{7}{8}$ " plastic rubber-cushioned glides
- Locking gas spring recline mechanism
- Infinite back adjustment within 111 degrees
- Nemschoff healthcare wood finish
- GREENGUARD Gold Certified
- Limited Lifetime Warranty; five years on mechanism

Available Options

- Moisture barrier + \$67 per seat or back
- CTB-133 + \$81/yd
- Two fabrics + \$62
- Three (or more) fabrics + \$88

Specification Decisions

- Select fabric
- Select standard wood finish
- Add CTB-133
- Apply multiple fabrics
- Add moisture barrier

Model numbers with **S** indicate standard seat and back covers, and model numbers with **P** indicate removable covers.

Flammability Types

- Type 5
- Type 2 (Footstool)

Coordinating Products

- Erica CompactComfort Recliner
- Erica Junior Children's Furniture

Key Dimensions

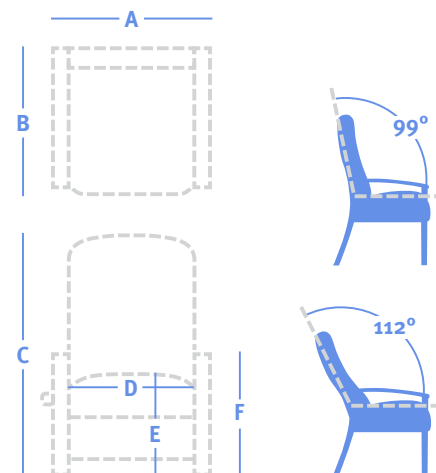

A	Overall Width	See price table
B	Overall Depth	27" 35" (reclined)
C	Overall Height	44"
D	Seat Width	21.25"
E	Seat Height	18.75"
F	Arm Height	25.25"

Footstool dimensions

Depth	12"
Height	12"

			27.5" W, Adjustable back chair							44 lbs 2.75 yds	
Model	Series 2	Series 3	Series 4	Series 5	Series 6	Series 7	Series 8	COM			
 286-52 S	\$2,224	\$2,311	\$2,457	\$2,609	\$2,790	\$2,973	\$3,202	\$2,311			
 286-52 P	\$2,502	\$2,589	\$2,735	\$2,887	\$3,068	\$3,251	\$3,480	\$2,589			
			17" W, Footstool							8 lbs 1.25 yds	
Model	Series 2	Series 3	Series 4	Series 5	Series 6	Series 7	Series 8	COM			
 286-59 S	\$309	\$348	\$415	\$484	\$566	\$649	\$753	\$348			
 286-59 P	\$351	\$390	\$457	\$526	\$608	\$691	\$795	\$390			

Erica CompactComfort Recliner



Standard Features

- Solid maple frame
- Mortise and tenon joinery
- Spring seat construction
- Replaceable components
- Wallsaver edge
- Non-marring 7/8" plastic rubber-cushioned glides
- Fold-out footrest
- Locking gas spring recline mechanism
- Infinite back positions adjustment within 108 degrees
- Nemschoff healthcare wood finish
- GREENGUARD Gold Certified
- Limited Lifetime Warranty; five years on mechanism

Available Options

- Moisture barrier + \$67 per seat or back
- Tilt and roll, 2" single wheel casters + \$280
- CTB-133 + \$81/yd
- Two fabrics + \$62
- Three (or more) fabrics + \$88

Specification Decisions

- Select fabric
- Select standard wood finish
- Add CTB-133
- Apply multiple fabrics
- Add moisture barrier
- Add tilt and roll casters

Model numbers with **S** indicate standard seat and back covers, and model numbers with **P** indicate removable covers.

Flammability Types

- Type 5

Coordinating Products

- [Erica Adjustable Back Chair](#)
- [Erica Junior Children's Furniture](#)

Key Dimensions

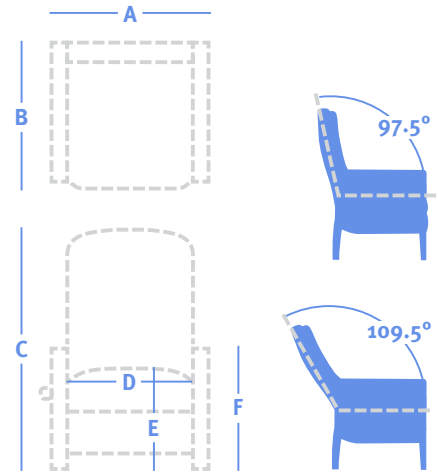

A	Overall Width	See price table
B	Overall Depth	28" 53.25" (reclined)
C	Overall Height	44.25"
D	Seat Width	21.25"
E	Seat Height	18.75"
F	Arm Height	25.25"

More Information

- Illustrated Glossary ▶ 439
- Fabrics ▶ 451
- Flammability (CTB-133) ▶ 459
- Finishes ▶ 456
- Ordering and Warranties ▶ 462



28.5" W, CompactComfort recliner

71 lbs | 3.5 yds

Model	Series 2	Series 3	Series 4	Series 5	Series 6	Series 7	Series 8	COM
286-62 S	\$3,504	\$3,615	\$3,801	\$3,994	\$4,225	\$4,457	\$4,748	\$3,615
286-62 P	\$3,938	\$4,049	\$4,235	\$4,428	\$4,659	\$4,891	\$5,182	\$4,049

Hadleigh Adjustable Back Chair



More Information

Illustrated Glossary ▶ 439

Fabrics ▶ 451

Flammability (CTB-133) ▶ 459

Finishes ▶ 456

Ordering and Warranties ▶ 462

Standard Features

- Solid maple frame
- Mortise and tenon joinery
- Spring seat construction
- Replaceable components
- Non-marring 7/8" plastic rubber-cushioned glides
- Locking gas spring recline mechanism
- Infinite back adjustment within 111 degrees
- Wallsaver edge
- Nemschoff healthcare wood finish
- GREENGUARD Gold Certified
- Limited Lifetime Warranty; five years on mechanism

Available Options

- Moisture barrier + \$67 per seat or back
- CTB-133 + \$81/yd
- Two fabrics + \$62
- Three (or more) fabrics + \$88

Specification Decisions

- Select fabric
- Select standard wood finish
- Add CTB-133
- Apply multiple fabrics
- Add moisture barrier

Model numbers with **S** indicate standard seat and back covers, and model numbers with **P** indicate removable covers.

Flammability Types

- Type 5
- Type 2 (Footstool)

Coordinating Products

- [Hadleigh Tables](#)
- [Hadleigh Lounge Seating](#)
- [Hadleigh Patient Chair](#)
- [Hadleigh Adjustable Back Chair](#)
- [Hadleigh Casegoods](#)

Key Dimensions

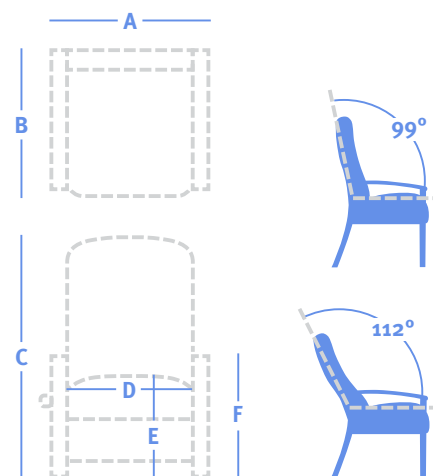

A	Overall Width	See price table
B	Overall Depth	26.5" 32.5" (reclined)
C	Overall Height	44"
D	Seat Width	21.25"
E	Seat Height	18.75"
F	Arm Height	25.25"

Footstool dimensions

Depth	12"
Height	11.75"

	27.75" W, Adjustable back chair									44 lbs 2.75 yds
	Model	Series 2	Series 3	Series 4	Series 5	Series 6	Series 7	Series 8	COM	
	280-52 S	\$2,124	\$2,211	\$2,357	\$2,509	\$2,690	\$2,873	\$3,102	\$2,211	
	280-52 P	\$2,390	\$2,477	\$2,623	\$2,775	\$2,956	\$3,139	\$3,368	\$2,477	
	17" W, Footstool									8 lbs 1.25 yds
	Model	Series 2	Series 3	Series 4	Series 5	Series 6	Series 7	Series 8	COM	
	280-59 S	\$309	\$348	\$415	\$484	\$566	\$649	\$753	\$348	
	280-59 P	\$351	\$390	\$457	\$526	\$608	\$691	\$795	\$390	

Horizon Recliner



Standard Features

- Wood arm caps
- Nemschoff healthcare wood finish
- GREENGUARD Gold Certified
- Limited Lifetime Warranty; five years on mechanism

Available Options

- Moisture barrier + \$67 per seat or back
- Black urethane arm caps + \$113
- 100-mm single-wheel swivel casters + \$253
- 11" x 16", folding table (Durawrap) + \$483
- CTB-133 + \$81
- Stainless steel push bar + \$227
- Magazine pouch (MG - see price table)
- Headrest pillow (HP - see price table)
- Removable covers + \$170
- Two fabrics + \$62
- Three (or more) fabrics + \$88

Specification Decisions

- Select fabric
- Select standard wood finish
- Add CTB-133
- Apply multiple fabrics
- Add moisture barrier
- Add urethane arm caps
- Add casters
- Add folding side table (select Durawrap)
- Add push bar
- Add magazine pouch
- Add headrest pillow
- Add removable covers

Model numbers with **S** indicate standard seat and back covers, and model numbers with **P** indicate removable covers.

Flammability Type

- Type 6

Coordinating Products

- [Horizon Multiple Seating](#)
- [Horizon Tables](#)
- [Horizon Patient Chair](#)

Key Dimensions

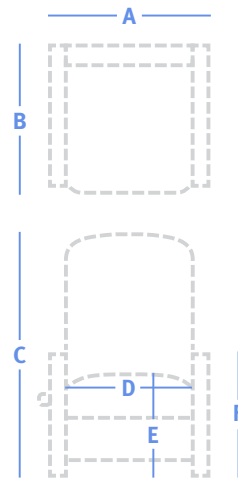

A	Overall Width	See price table
B	Overall Depth	36.5", 37.5", 38.5" 65" (reclined)
C	Overall Height	44.5"
D	Seat Width	21"
E	Seat Height	18.5", 18.75"
F	Arm Height	24"

More Information

Illustrated Glossary ▶ 439

Fabrics ▶ 451

Flammability (CTB-133) ▶ 459

Finishes ▶ 456

Ordering and Warranties ▶ 462

Horizon Recliner

**29" W, Three-position recliner with push back**

120 lbs | 6 yds

Model	Series 2	Series 3	Series 4	Series 5	Series 6	Series 7	Series 8	COM
HRZN_00030	\$2,106	\$2,201	\$2,613	\$2,835	\$2,955	\$3,114	\$3,215	\$2,201

**29" W, Wallsaver recliner with LSF pull strap**

124 lbs | 6 yds

Model	Series 2	Series 3	Series 4	Series 5	Series 6	Series 7	Series 8	COM
HRZN_00050	\$2,461	\$2,556	\$2,968	\$3,190	\$3,310	\$3,469	\$3,570	\$2,556

**31" W, Flat-fold recliner with LSF outside handle**

148 lbs | 8 yds

Model	Series 2	Series 3	Series 4	Series 5	Series 6	Series 7	Series 8	COM
HRZN_00060	\$3,480	\$3,606	\$4,156	\$4,451	\$4,612	\$4,823	\$4,958	\$3,606

Headrest pillow

1.75 yds

Model	Series 2	Series 3	Series 4	Series 5	Series 6	Series 7	Series 8	COM
HP	\$75	\$86	\$138	\$166	\$181	\$201	\$213	\$86

Magazine pouch

1.75 yds

Model	Series 2	Series 3	Series 4	Series 5	Series 6	Series 7	Series 8	COM
MG	\$63	\$74	\$126	\$154	\$169	\$189	\$201	\$74

Patient Chairs

Recliners

Treatment Chairs

Rockers & Gliders

Overbed Tables

Sleepover Seating

Casegoods

Display & Accessories

Lancaster Recliner



Standard Features

- Solid hardwood frame
- Replaceable components
- Clean-out design
- Upholstered arms
- Non-marring 2¼" glides
- Wallsaver edge
- Push-back mechanism
- Three seated positions
- Nemschoff healthcare wood finish
- GREENGUARD Gold Certified
- Limited Lifetime Warranty; five years on mechanism

Available Options

- Moisture barrier + \$67 per seat or back
- Black urethane arm caps + \$113
- Wood arm caps + \$113
- Four 3" twin-wheel casters with brakes + \$316
- CTB-133 + \$81/yd
- Two fabrics + \$62
- Three (or more) fabrics + \$88

Specification Decisions

- Select fabric
- Select standard wood finish
- Add CTB-133
- Apply multiple fabrics
- Add moisture barrier
- Add wood or urethane arm caps
- Add casters

Flammability Type

- Type 6

Key Dimensions

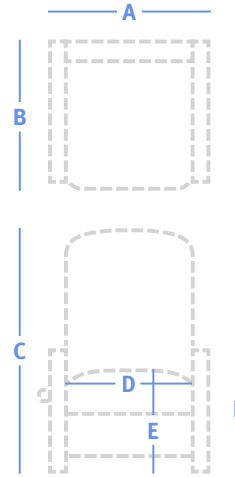

A	Overall Width	See price table
B	Overall Depth	34" 66" reclined))
C	Overall Height	43.75"
D	Seat Width	23"
E	Seat Height	19.5"
F	Arm Height	26"

More Information

- Illustrated Glossary ▶ 439
- Fabrics ▶ 451
- Flammability (CTB-133) ▶ 459
- Finishes ▶ 456
- Ordering and Warranties ▶ 462



30.75" W, Recliner

87 lbs | 6.5 yds

Model	Series 2	Series 3	Series 4	Series 5	Series 6	Series 7	Series 8	COM
FX906-66	\$2,160	\$2,365	\$2,706	\$3,062	\$3,488	\$3,879	\$4,414	\$2,365

Leonard II Recliner



More Information

Illustrated Glossary ▶ 439

Fabrics ▶ 451

Flammability (CTB-133) ▶ 459

Finishes ▶ 456

Ordering and Warranties ▶ 462

Standard Features

- Solid maple frame
- Mortise and tenon joinery
- Spring seat construction
- Replaceable components
- 5/8" x 2" plastic bar glides
- Wood arm caps
- Independently operating footrest
- Infinite back recline from upright to fully flat
- Wallsaver edge
- Must be 22" from wall to fully recline
- Footrest breaks away at 55 lbs
- Nemschoff healthcare wood finish
- GREENGUARD Gold Certified
- Limited Lifetime Warranty; ten years on mechanism

Available Options

- Moisture barrier + \$67 per seat or back
- Black urethane arm caps + \$113
- Fully upholstered arms + \$113
- Remove center seam + \$0
- 2" twin rubber-wheel casters; front wheels fixed with brakes, rear wheels swivel + \$337
- 2" twin rubber-wheel casters; front wheels fixed with brakes, rear wheels swivel with brakes + \$345
- CTB-133 + \$81/yd
- Two fabrics + \$62
- Three (or more) fabrics + \$88

Specification Decisions

- Select fabric
- Select standard wood finish
- Add CTB-133
- Apply multiple fabrics
- Add moisture barrier

- Add urethane arm caps
- Add fully upholstered arms
- Remove center seam
- Add casters

Model numbers with **S** indicate standard seat and back covers, and model numbers with **P** indicate removable covers.

Flammability Type

- Type 6

Coordinating Products

- [Leonard II Lounge Seating](#)
- [Leonard II Sleep Double Sofa and Sleep Settee](#)

Key Dimensions

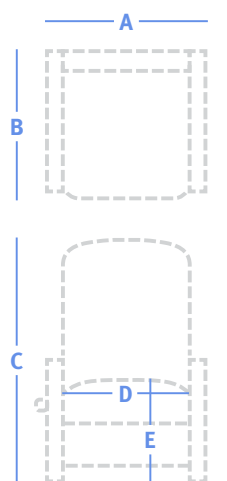

A	Overall Width	See price table
B	Overall Depth	34" 75" (reclined)
C	Overall Height	43.25"
D	Seat Width	24.75"
E	Seat Height	19"
F	Arm Height	25"



35" W, Recliner

105 lbs | 6.75 yds

Model	Series 2	Series 3	Series 4	Series 5	Series 6	Series 7	Series 8	COM
814-62 S	\$2,933	\$3,148	\$3,506	\$3,879	\$4,323	\$4,772	\$5,333	\$3,148
814-62 P	\$3,311	\$3,526	\$3,884	\$4,257	\$4,701	\$5,150	\$5,711	\$3,526

Oliver Recliner



Standard Features

- Solid maple frame
- Spring seat construction
- Replaceable components
- Three seated positions (902)
- Handle lever recline (904)
- Non-marring 7/8" plastic rubber-cushioned glides
- 5/8" x 2" plastic bar glides (904)
- Wallsaver edge
- Must be 18.5" from wall to fully recline (902)
- Must be 3.5" from wall to fully recline (904)
- Nemschoff healthcare wood finish
- GREENGUARD Gold Certified
- Limited Lifetime Warranty; five years on mechanism

Available Options

- Moisture barrier + \$67 per seat or back
- Two front swivel casters (904-66) + \$106
- Two front swivel and two rear fixed casters with brakes (904-66) + \$337
- Headcloth + \$0
- CTB-133 + \$81/yd
- Two fabrics + \$62
- Three (or more) fabrics + \$88

Specification Decisions

- Select fabric
- Select standard wood finish
- Add CTB-133
- Apply multiple fabrics
- Add moisture barrier

- Add casters
- Add headcloth

Model numbers with **S** indicate standard seat and back covers, and model numbers with **P** indicate removable covers.

Flammability Type

- Type 6

Coordinating Products

- [Oliver Lounge Seating](#)
- [Oliver Sleep Settee](#)

Key Dimensions

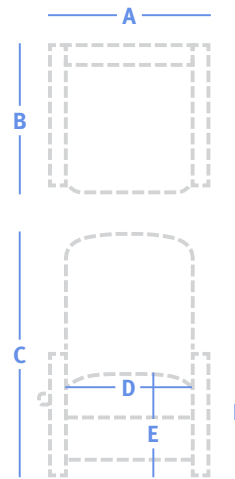

A	Overall Width	See price table
B	Overall Depth	34", 35" 63.5", 67.25 (reclined)
C	Overall Height	40.5"
D	Seat Width	21"
E	Seat Height	18.75"
F	Arm Height	25"

More Information

- Illustrated Glossary ▶ 439
- Fabrics ▶ 451
- Flammability (CTB-133) ▶ 459
- Finishes ▶ 456
- Ordering and Warranties ▶ 462

34" W, Recliner		80 lbs 6.5 yds							
Model	Series 2	Series 3	Series 4	Series 5	Series 6	Series 7	Series 8	COM	
902-62 S	\$3,439	\$3,646	\$3,990	\$4,350	\$4,778	\$5,210	\$5,751	\$3,646	
902-62 P	\$3,877	\$4,084	\$4,428	\$4,788	\$5,216	\$5,648	\$6,189	\$4,084	

34.25" W, Wallsaver recliner		97 lbs 7.25 yds							
Model	Series 2	Series 3	Series 4	Series 5	Series 6	Series 7	Series 8	COM	
904-66 S	\$3,478	\$3,709	\$4,093	\$4,494	\$4,971	\$5,453	\$6,056	\$3,709	
904-66 P	\$3,924	\$4,155	\$4,539	\$4,940	\$5,417	\$5,899	\$6,502	\$4,155	

Pamona Recliner



More Information

Illustrated Glossary ▶ 439

Fabrics ▶ 451

Flammability (CTB-133) ▶ 459

Finishes ▶ 456

Ordering and Warranties ▶ 462

Standard Features

- Solid maple frame
- Mortise and tenon joinery
- Spring seat construction
- Replaceable components
- Upholstered arms
- Wallsaver edge
- Powder-coated metal legs
- 1" dia adjustable glides
- Push-back mechanism for footrest; finger-pull to recline
- Infinite recline adjustment within a comfortable range
- Nemschoff healthcare wood finish
- GREENGUARD Gold Certified
- Limited Lifetime Warranty; five years on mechanism

Available Options

- Moisture barrier + \$67 per seat or back
- Black urethane arm caps + \$113
- Wood arm caps + \$113
- 3" twin-wheel casters; front swivel with brakes, rear swivel + \$128
- CTB-133 + \$81/yd
- Two fabrics + \$62
- Three (or more) fabrics + \$88

Specification Decisions

- Select fabric
- Select standard wood finish
- Select powder coat finish
- Add CTB-133
- Apply multiple fabrics
- Add moisture barrier
- Add wood or urethane arm caps
- Add casters

Model numbers with **S** indicate standard seat and back covers, and model numbers with **P** indicate removable covers.

Flammability Type

- Type 6

Coordinating Products

- [Pamona Lounge Seating](#)
- [Pamona Tables](#)
- [Pamona Flop Sofa](#)

Key Dimensions

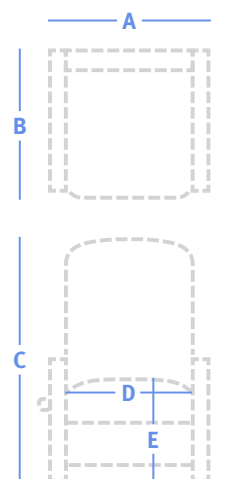

A	Overall Width	See price table
B	Overall Depth	33" 63.5" (reclined)
C	Overall Height	44.5"
D	Seat Width	22.5"
E	Seat Height	18.5"
F	Arm Height	24.75"



31.5" W, Recliner

92 lbs | 6.25 yds

Model	Series 2	Series 3	Series 4	Series 5	Series 6	Series 7	Series 8	COM
797-66 S	\$2,798	\$2,997	\$3,328	\$3,674	\$4,085	\$4,501	\$5,021	\$2,997
797-66 P	\$3,158	\$3,357	\$3,688	\$4,034	\$4,445	\$4,861	\$5,381	\$3,357

Prísto II Recliner



More Information

Illustrated Glossary ▶ 439

Fabrics ▶ 451

Flammability (CTB-133) ▶ 459

Finishes ▶ 456

Ordering and Warranties ▶ 462

Standard Features

- Solid maple frame
- Mortise and tenon joinery
- Spring seat construction
- Replaceable components
- Removable seat and back covers
- Push-back mechanism
- 3" twin-wheel casters, front fixed with brakes, rear swivel
- Wood legs (PRCL-14)
- Wallsaver edge
- Must be 19" from wall to fully recline
- Nemschoff healthcare wood finish
- GREENGUARD Gold Certified
- Limited Lifetime Warranty; ten years on mechanism

Available Options

- Square back (PRCL-14) + \$0
- Moisture barrier + \$67 per seat or back
- CTB-133 + \$81/yd
- Two fabrics + \$62
- Three (or more) fabrics + \$88
- Black urethane arm caps (PRCL-12, PRCL-13) + \$113
- Soft radius edge (PRCL-14) + \$0
- Folding side table with or without cup holder (laminated, RSF) + \$308
- Adjustable tray table (laminated, RSF) + \$701

Specification Decisions

- Select fabric
- Select back style
- Add moisture barrier
- Add CTB-133
- Apply multiple fabrics
- Add urethane or wood arm caps
- Add soft radius edge
- Add folding side table
- Add adjustable tray table

Flammability Type

- Type 6

Coordinating Products

- [Prísto Casegoods](#)
- [Prísto II Casegoods](#)
- [Prísto II Treatment Chair](#)
- [Prísto IIT Treatment Chair](#)

Key Dimensions

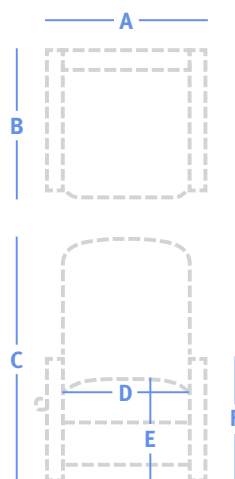

A	Overall Width	See price table
B	Overall Depth	33.5" 61.5" (reclined)
C	Overall Height	46"
D	Seat Width	23", 27.5"
E	Seat Height	19"
F	Arm Height	25.5"

Prísto II Recliner

		29" W, Recliner with maple arms, legs and trim								139 lbs 6 yds
Model		Series 2	Series 3	Series 4	Series 5	Series 6	Series 7	Series 8	COM	
 	PRCL-14	\$3,755	\$3,946	\$4,264	\$4,596	\$4,991	\$5,390	\$5,889	\$3,946	

		31" W, Recliner with maple arm caps and trim								139 lbs 6.25 yds
Model		Series 2	Series 3	Series 4	Series 5	Series 6	Series 7	Series 8	COM	
 	PRCL-13	\$3,747	\$3,946	\$4,277	\$4,623	\$5,034	\$5,450	\$5,970	\$3,946	

		31" W, Recliner with fully upholstered arms and trim								148 lbs 7.5 yds
Model		Series 2	Series 3	Series 4	Series 5	Series 6	Series 7	Series 8	COM	
 	PRCL-12	\$3,707	\$3,946	\$4,343	\$4,758	\$5,252	\$5,751	\$6,374	\$3,946	

Patient Chairs

Recliners

Treatment Chairs

Rockers & Gliders

Overbed Tables

Sleepover Seating

Casegoods

Display & Accessories

Wallsaver Recliner



Standard Features

- Mortise and tenon joinery
- Spring seat construction
- Replaceable components
- 41" or 47" back heights
- Three recline positions
- Non-marring 5/8" x 2" glides
- Wallsaver edge
- Must be 4" from wall to fully recline (733-66M, 772-66M, 778-66M)
- Must be 6.5" from wall to fully recline (733-66H, 772-66H, 778-66H)
- Multiple arm styles
- Nemschoff healthcare wood finish
- GREENGUARD Gold certified
- Limited Lifetime Warranty; five years on mechanism

Available Options

- Moisture barrier + \$67 per seat or back
- Two front swivel casters + \$106
- 2" twin rubber-wheel swivel casters; front swivel, rear with brakes + \$337
- CTB-133 + \$81/yd
- Two fabrics + \$62
- Three (or more) fabrics + \$88

Specification Decisions

- Select fabric
- Select standard wood finish
- Add CTB-133
- Apply multiple fabrics
- Add moisture barrier
- Add casters

Model numbers with **S** indicate standard seat and back covers, and model numbers with **P** indicate removable covers.

Flammability Type

- Type 6

Key Dimensions

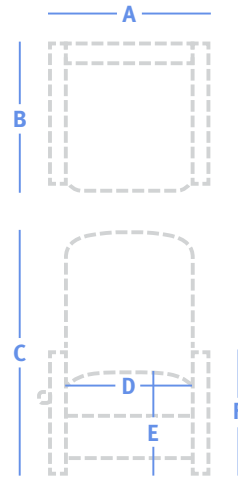

A	Overall Width	See price table
B	Overall Depth	33, 33.5", 34" 65" 68" (reclined)
C	Overall Height	41", 46.75", 47"
D	Seat Width	23.5"
E	Seat Height	18.75"
F	Arm Height	24.5", 25", 25.25"

More Information

Illustrated Glossary ▶ 439





Fabrics ▶ 451

Flammability (CTB-133) ▶ 459

Finishes ▶ 456

Ordering and Warranties ▶ 462

Wallsaver Recliner

	31.5" W, Wallsaver recliner with Allegro arms								90 lbs 6.25 yds
	Model	Series 2	Series 3	Series 4	Series 5	Series 6	Series 7	Series 8	COM
	733-66M S	\$3,219	\$3,418	\$3,749	\$4,095	\$4,506	\$4,922	\$5,442	\$3,418
	733-66M P	\$3,630	\$3,829	\$4,160	\$4,506	\$4,917	\$5,333	\$5,853	\$3,829
	31.5" W, Wallsaver recliner with Karisma arms								90 lbs 6 yds
	Model	Series 2	Series 3	Series 4	Series 5	Series 6	Series 7	Series 8	COM
	772-66M S	\$3,014	\$3,205	\$3,523	\$3,855	\$4,250	\$4,649	\$5,148	\$3,205
	772-66M P	\$3,399	\$3,590	\$3,908	\$4,240	\$4,635	\$5,034	\$5,533	\$3,590
	31.5" W, Wallsaver recliner with Pristo arms								90 lbs 6.5 yds
	Model	Series 2	Series 3	Series 4	Series 5	Series 6	Series 7	Series 8	COM
	778-66M S	\$2,998	\$3,205	\$3,549	\$3,909	\$4,337	\$4,769	\$5,310	\$3,205
	778-66M P	\$3,383	\$3,590	\$3,934	\$4,294	\$4,722	\$5,154	\$5,695	\$3,590
	31.5" W, Wallsaver high back recliner with Allegro arms								90 lbs 6.5 yds
	Model	Series 2	Series 3	Series 4	Series 5	Series 6	Series 7	Series 8	COM
	733-66H S	\$3,281	\$3,488	\$3,832	\$4,192	\$4,620	\$5,052	\$5,593	\$3,488
	733-66H P	\$3,700	\$3,907	\$4,251	\$4,611	\$5,039	\$5,471	\$6,012	\$3,907
	31.5" W, Wallsaver high back recliner with Karisma arms								90 lbs 6.5 yds
	Model	Series 2	Series 3	Series 4	Series 5	Series 6	Series 7	Series 8	COM
	772-66H S	\$3,037	\$3,244	\$3,588	\$3,948	\$4,376	\$4,808	\$5,349	\$3,244
	772-66H P	\$3,427	\$3,634	\$3,978	\$4,338	\$4,766	\$5,198	\$5,739	\$3,634
	31.5" W, Wallsaver high back recliner with Pristo arms								90 lbs 6.75 yds
	Model	Series 2	Series 3	Series 4	Series 5	Series 6	Series 7	Series 8	COM
	778-66H S	\$3,027	\$3,242	\$3,600	\$3,973	\$4,417	\$4,866	\$5,427	\$3,242
	778-66H P	\$3,417	\$3,632	\$3,990	\$4,363	\$4,807	\$5,256	\$5,817	\$3,632

Patient Chairs

Recliners

Treatment Chairs

Rockers & Gliders

Overbed Tables

Sleepover Seating

Casegoods

Display & Accessories

Prísto II Treatment Chair



More Information

Illustrated Glossary ▶ 439

Fabrics ▶ 451

Flammability (CTB-133) ▶ 459

Finishes ▶ 456

Ordering and Warranties ▶ 462

Standard Features

- Mortise and tenon joinery
- Spring seat construction
- Replaceable components
- Clean-out design
- Removable covers
- Black urethane arm caps (PRCL-130B)
- Wood arm caps and trim (PRRT-13)
- Upholstered arm caps (PRRT-12)
- Three-position footrest (PRCL-130B)
- Must be 5" from wall to fully recline (PRCL-130B)
- Wallsaver edge
- 5" casters, front swivel with brakes, rear fixed
- Padded push bar
- Arcade back
- Nemschoff healthcare wood finish
- GREENGUARD Gold Certified
- Limited Lifetime Warranty; ten years on mechanism
- See nemschoff.com for weight ratings (PRCL-130B)

Available Options

- Moisture barrier + \$67 per seat or back
- Black urethane arm caps + \$113 (PRRT-13, PRRT-12)
- Wood arm caps + \$113 (PRCL-130B)
- Fully-upholstered arms + \$113 (PRCL-130B)
- Square back + \$0
- Grey foam headrest with straps + \$316
- Folding side table with or without cup holder (RSF) (11.75" W x 22" D x 22.25" H) + \$308
- Swivel table (LSF) + \$308 (PRRT-13, PRRT-12)
- Adjustable tray table (RSF; laminate) + \$701
- Optional activation button location (front inside arm) + \$62 (PRRT-13, PRRT-12)
- Dual activation button (mid and front inside arm) + \$289
- Adjustable .5" IV rod + \$149
- IV rod holder + \$101
- Oxygen tank holder (accommodates cylinder sizes D and E) + \$207
- Fold-down arm (RSF only) + \$608 (PRRT-13, PRRT-12)

- Arm support (laminated) + \$788
 - Foam arm support (for use with arm support) + \$342
 - Utility hook (RSF) + \$178
 - Central brake and steer caster system (factory installed) + \$677 (PRRT-13, PRRT-12)
 - CTB-133 + \$81/yd
 - Two fabrics + \$62
 - Three (or more) fabrics + \$88
- An IV rod holder is required to support adjustable IV rod, arm support and foam arm supports.
- IV rods and arm supports must be used separately when using the same IV holder.
- Swivel table (LSF) prevents interference with the recline lever handle.

Specification Decisions

- Select fabric
- Select standard wood finish
- Add CTB-133
- Apply multiple fabrics
- Add moisture barrier
- Add urethane arm caps
- Add square back
- Add headrest
- Add folding side table with or without cup holder (select laminate)
- Add adjustable tray table (select laminate)
- Add optional activation button
- Add dual activation buttons
- Add IV rod
- Add IV rod holder
- Add oxygen tank holder
- Add fold-down arm
- Add arm support (select laminate)
- Add foam arm support
- Add utility hook
- Add central brake and steer casters

Flammability Type

- Type 6

Prísto II Treatment Chair

Coordinating Products

- [Prísto Casegoods](#)
- [Prísto II Casegoods](#)
- [Prísto II Recliner](#)
- [Prísto IIT Treatment Chair](#)

Key Dimensions

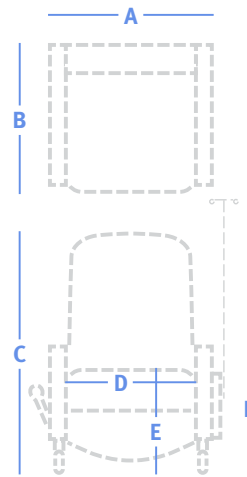

A	Overall Width	See price table 38.25" with arm folded down
B	Overall Depth	36" 76" (fully reclined)
C	Overall Height	47"
D	Seat Width	24"
E	Seat Height	19"
F	Arm Height	25.5"



34.5" W, Treatment chair with wood arm caps and trim

139 lbs | 6.25 yds

Model	Series 2	Series 3	Series 4	Series 5	Series 6	Series 7	Series 8	COM
PRRT-13	\$4,868	\$5,067	\$5,398	\$5,744	\$6,155	\$6,571	\$7,091	\$5,067



34.5" W, Treatment chair with upholstered arm caps and trim

139 lbs | 7.5 yds

Model	Series 2	Series 3	Series 4	Series 5	Series 6	Series 7	Series 8	COM
PRRT-12	\$4,828	\$5,067	\$5,464	\$5,879	\$6,373	\$6,872	\$7,495	\$5,067



37.25" W, Plus Treatment chair

170 lbs | 8.5 yds

Model	Series 2	Series 3	Series 4	Series 5	Series 6	Series 7	Series 8	COM
PRCL-130B	\$5,213	\$5,484	\$5,934	\$6,405	\$6,964	\$7,529	\$8,236	\$5,484

Prísto IIT Treatment Chair



Standard Features

- Spring seat construction
- Replaceable components
- Removable covers
- Wood arm caps and trim (PRTT-13 only)
- Upholstered arm caps and trim (PRTT-12 only)
- Trendelenburg
- 5" caster, front swivel with brakes, rear fixed
- Arcade back
- Nemschoff healthcare wood finish
- GREENGUARD Gold Certified
- Limited Lifetime Warranty; ten years on mechanism

Available Options

- Moisture barrier + \$67 per seat or back
- Black urethane arm caps + \$113
- Square back + \$0
- Grey foam headrest with straps + \$316
- Folding side table with or without cup holder (RSF) (11.75" W x 22" D x 22.25" H) + \$308
- Swivel table (LSF) + \$308
- Adjustable tray table (RSF; laminate) + \$701
- Optional activation button location (front inside arm) + \$62
- Dual activation button (mid and front inside arm) + \$289
- Adjustable .5" IV rod + \$149
- IV rod holder + \$101
- Oxygen tank holder (accommodates cylinder sizes D and E) + \$207
- Fold-down arm (RSF only) + \$608
- Arm support (laminated) + \$788
- Foam arm support (use with arm support) + \$342
- Utility hook (RSF) + \$178
- Central brake and steer caster system (factory-installed) + \$677
- CTB-133 + \$81/yd
- Two fabrics + \$62
- Three (or more) fabrics + \$88

An IV rod holder is required to support adjustable IV rod, arm support and foam arm supports.

IV rods and arm supports must be used separately when using the same IV holder.

Swivel table (LSF) prevents interference with the recline lever handle.

Specification Decisions

- Select fabric
- Add moisture barrier
- Add CTB-133
- Apply multiple fabrics
- Add urethane arm caps
- Add square back
- Add headrest
- Add folding side table with or without cup holder (select laminate)
- Add adjustable tray table (select laminate)
- Add optional activation button
- Add dual activation buttons
- Add IV rod
- Add IV rod holder
- Add fold-down arm
- Add oxygen tank holder
- Add arm support (select laminate)
- Add foam arm support
- Add utility hook
- Add central brake and steer casters

Flammability Type

- Type 6

More Information

Illustrated Glossary ▶ 439

Fabrics ▶ 451

Flammability (CTB-133) ▶ 459

Finishes ▶ 456

Ordering and Warranties ▶ 462

Prísto IIT Treatment Chair

Coordinating Products

- [Prísto Casegoods](#)
- [Prísto II Casegoods](#)
- [Prísto II Recliner](#)
- [Prísto II Treatment Chair](#)

Key Dimensions

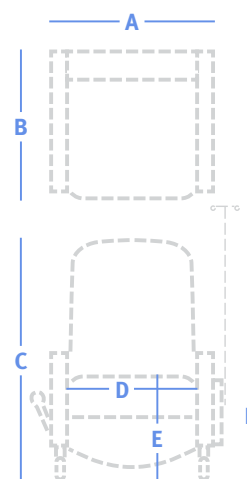

A	Overall Width	See price table 38.25" with arm folded down
B	Overall Depth	41" 79.25" (fully reclined)
C	Overall Height	47.5"
D	Seat Width	24.5"
E	Seat Height	19"
F	Arm Height	25"

	34.5" W, Treatment chair with wood arm caps and trim									144 lbs 6.25 yds
	Model	Series 2	Series 3	Series 4	Series 5	Series 6	Series 7	Series 8	COM	
PRTT-13	\$5,182	\$5,381	\$5,712	\$6,058	\$6,469	\$6,885	\$7,405	\$5,381		

	34.5" W, Treatment chair with upholstered arm caps and trim									144 lbs 7.5 yds
	Model	Series 2	Series 3	Series 4	Series 5	Series 6	Series 7	Series 8	COM	
PRTT-12	\$4,943	\$5,182	\$5,579	\$5,994	\$6,488	\$6,987	\$7,610	\$5,182		

Patient Chairs
Recliners
Treatment Chairs
Rockers & Gliders
Overbed Tables
Sleepover Seating
Casegoods
Display & Accessories

Serenity II Treatment Chair



Standard Features

- Mortise and tenon joinery
- Spring seat construction
- Replaceable components
- Removable covers
- Black urethane arm caps
- Adjustable upholstered headrest
- Wallsaver edge
- Trendelenburg (bar is 1.25" from floor when fully reclined)
- 5" caster, front swivel with brakes, rear fixed
- GREENGUARD Gold Certified
- Limited Lifetime Warranty; ten years on mechanism

Available Options

- Moisture barrier + \$67 per seat or back
- Grey foam headrest with straps + \$316
- Upholstered back pad (reduces seat depth by 2") + \$262
- Heat (8' cord length) + \$1,008
- Heat and massage (8' cord length) + \$1,270
- Folding side table with or without cup holder (RSF) + \$308 (11.75" W x 22" D x 22.25" H)
- Adjustable tray table (RSF; laminate) + \$701
- Slide-out footrest + \$714
- Optional activation button location (front inside arm) + \$62
- Dual activation button (mid and front inside arm) + \$289
- Adjustable .5" IV rod + \$149
- IV rod holder + \$101
- Oxygen tank holder (accommodates cylinder sizes D and E) + \$207
- Arm support (laminated) + \$788
- Foam arm support (use with arm support) + \$342
- Utility hook (RSF) + \$178
- Central brake and steer caster system (factory-installed) + \$677
- CTB-133 + \$81/yd
- Two fabrics + \$62
- Three (or more) fabrics + \$88

An IV rod holder is required to support adjustable IV rod, arm support and foam arm supports.

IV rods and arm supports must be used separately when using the same IV holder.

Specification Decisions

- Select fabric
- Add CTB-133
- Apply multiple fabrics
- Add moisture barrier
- Add headrest
- Add upholstered back pad (not available with heat or heat and massage)
- Add heat
- Add heat and massage
- Add folding side table with or without cup holder (select laminate)
- Add adjustable tray table (select laminate)
- Add slide-out footrest
- Add optional activation button
- Add dual activation buttons
- Add IV rod
- Add IV rod holder
- Add oxygen tank holder
- Add arm support (select laminate)
- Add foam arm support
- Add utility hook
- Add central brake and steer casters

Flammability Type

- Type 6

More Information

Illustrated Glossary ▶ 439

Fabrics ▶ 451

Flammability (CTB-133) ▶ 459

Finishes ▶ 456

Ordering and Warranties ▶ 462

Serenity II Treatment Chair

Coordinating Products

- [Serenity IIS Treatment Chair](#)
- [Serenity III Treatment Chair](#)
- [Serenity II Sleep Chair](#)

Key Dimensions

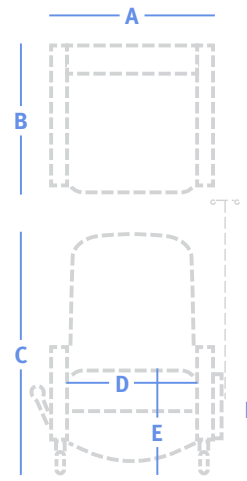

A	Overall Width	See price table
B	Overall Depth	42" 78" (fully reclined)
C	Overall Height	45.25"
D	Seat Width	24.5"
E	Seat Height	19.5"
F	Arm Height	26.5"



35" W, Treatment chair

134 lbs | 6.75 yds

Model	Series 2	Series 3	Series 4	Series 5	Series 6	Series 7	Series 8	COM
790-12	\$4,996	\$5,211	\$5,569	\$5,942	\$6,386	\$6,835	\$7,396	\$5,211

Serenity IIS Treatment Chair



More Information

Illustrated Glossary ▶ 439

Fabrics ▶ 451

Flammability (CTB-133) ▶ 459

Finishes ▶ 456

Ordering and Warranties ▶ 462

Standard Features

- Mortise and tenon joinery
- Spring seat construction
- Replaceable components
- Removable covers
- Black urethane arm caps
- Wallsaver edge
- 5" caster, front swivel with brakes, rear fixed
- Nemschoff healthcare wood finish
- GREENGUARD Gold Certified
- Limited Lifetime Warranty; ten years on mechanism

Available Options

- Moisture barrier + \$67 per seat or back
- Upholstered back pad (reduces seat depth by 2") + \$262
- Adjustable upholstered headrest + \$XXX
- Grey foam headrest with straps + \$132
- Heat (8' cord length) + \$1,008
- Heat and massage (8' cord length) + \$1,270
- Folding side table with or without cup holder (RSF) + \$308 (11.75" W x 22" D x 22.25" H)
- Adjustable tray table (RSF; laminate) + \$701
- Slide-out footrest + \$714
- Optional activation button location (front inside arm) + \$62
- Dual activation button (mid and front inside arm) + \$289
- Adjustable .5" IV rod + \$149
- IV rod holder + \$101
- Oxygen tank holder (accommodates cylinder sizes D and E) + \$207
- Foam arm support (for use with arm support) + \$342
- Arm support (laminated) + \$788
- Utility hook (RSF) + \$178
- Trendelenburg bar + \$289
- Push bar + \$142
- Central brake and steer caster system (factory-installed) + \$677
- CTB-133 + \$81/yd
- Two fabrics + \$62
- Three (or more) fabrics + \$88

An IV rod holder is required to support adjustable IV rod, arm support and foam arm supports.

IV rods and arm supports must be used separately when using the same IV holder.

Specification Decisions

- Select fabric
- Add CTB-133
- Apply multiple fabrics
- Add moisture barrier
- Add headrest
- Add upholstered back pad (not available with heat or heat and massage)
- Add heat
- Add heat and massage
- Add folding side table with or without cup holder (select laminate)
- Add adjustable tray table (select laminate)
- Add slide-out footrest
- Add optional activation button
- Add dual activation buttons
- Add IV rod
- Add IV rod holder
- Add oxygen tank holder
- Add foam arm support
- Add arm support (select laminate)
- Add utility hook
- Add Trendelenburg bar
- Add push bar
- Add central brake and steer casters

Flammability Type

- Type 6

Serenity IIS Treatment Chair

Coordinating Products

- [Serenity II Treatment Chair](#)
- [Serenity IIS Treatment Chair](#)
- [Serenity III Treatment Chair](#)
- [Serenity II Sleep Chair](#)

Key Dimensions

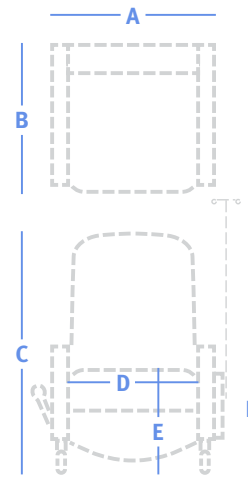

A	Overall Width	See price table
B	Overall Depth	36.5" 66.75" (fully reclined)
C	Overall Height	44.5"
D	Seat Width	22.25"
E	Seat Height	20.5"
F	Arm Height	26.5"



31.5" W, Treatment chair

130 lbs | 6.25 yds

Model	Series 2	Series 3	Series 4	Series 5	Series 6	Series 7	Series 8	COM
792-12	\$4,499	\$4,698	\$5,029	\$5,375	\$5,786	\$6,202	\$6,722	\$4,698

Patient Chairs

Recliners

Treatment Chairs

Rockers & Gliders

Overbed Tables

Sleeper Seating

Casegoods

Display & Accessories

Serenity III Treatment Chair



Standard Features

- Mortise and tenon joinery
- Spring seat construction
- Replaceable components
- Removable covers
- Black urethane arm caps
- Wallsaver edge
- Adjustable upholstered headrest and back pad
- Slide-out footrest
- 5" caster, front swivel with brakes, rear fixed
- Nemschoff healthcare wood finish
- GREENGUARD Gold Certified
- Limited Lifetime Warranty; ten years on mechanism

Available Options

- Moisture barrier + \$67 per seat or back
- Grey foam headrest with straps + \$316
- Wood arm caps + \$113
- Fully upholstered arms + \$113
- Heat (8' cord length) + \$1,008
- Heat and massage (8' cord length) + \$1,270
- Folding side table with or without cup holder (RSF) + \$308 (11.75" W x 22" D x 22.25" H)
- Adjustable tray table (RSF; laminate) + \$701
- Optional activation button location (front inside arm) + \$62
- Dual activation button (mid and front inside arm) + \$289
- Adjustable 1/2" IV rod + \$149
- IV rod holder + \$101
- Oxygen tank holder (accommodates cylinder sizes D and E) + \$207
- Arm support (laminated) + \$788
- Foam arm support (for use with arm support) + \$342
- Utility hook (RSF) + \$178
- Push bar + \$142
- Trendelenburg bar (bar is 1.25" from floor when fully reclined) + \$289
- Central brake and steer caster system (factory-installed) + \$677

- CTB-133 + \$81/yd
- Two fabrics + \$62
- Three (or more) fabrics + \$88

An IV rod holder is required to support adjustable IV rod, arm support and foam arm supports.

IV rods and arm supports must be used separately when using the same IV holder.

If heat is ordered, there will be no back pad.

Specification Decisions

- Select fabric
- Add CTB-133
- Apply multiple fabrics
- Add moisture barrier
- Add wood arm caps
- Add fully upholstered arms
- Add heat (will not include back pad)
- Add heat and massage (will not include back pad)
- Add folding side table with or without cup holder (select laminate)
- Add adjustable tray table (select laminate)
- Add optional activation button
- Add dual activation buttons
- Add IV rod
- Add IV rod holder
- Add oxygen tank holder
- Add arm support (select laminate)
- Add foam arm support
- Add utility hook
- Add push bar
- Add Trendelenburg bar
- Add central brake and steer casters

Flammability Type

- Type 6

More Information

Illustrated Glossary ▶ 439

Fabrics ▶ 451

Flammability (CTB-133) ▶ 459

Finishes ▶ 456

Ordering and Warranties ▶ 462

Serenity III Treatment Chair

Coordinating Products

- [Serenity II Treatment Chair](#)
- [Serenity IIS Treatment Chair](#)
- [Serenity III Treatment Chair](#)
- [Serenity II Sleep Chair](#)

Key Dimensions

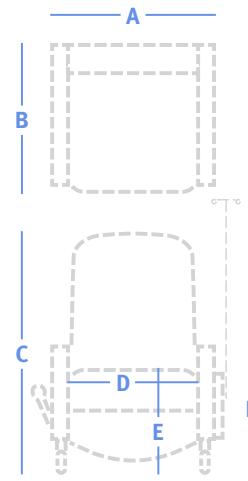

A	Overall Width	See price table
B	Overall Depth	36" 78" (fully reclined)
C	Overall Height	45.25"
D	Seat Width	24.5"
E	Seat Height	19.5"
F	Arm Height	26.5"



35" W, Treatment chair

130 lbs | 8.25 yds

Model	Series 2	Series 3	Series 4	Series 5	Series 6	Series 7	Series 8	COM
791-12	\$5,283	\$5,546	\$5,983	\$6,439	\$6,983	\$7,531	\$8,217	\$5,546

Auburn Glider



Standard Features

- Replaceable components
- Wood arm caps with pommel grip
- Nemschoff healthcare wood finish
- GREENGUARD Gold Certified
- Limited Lifetime Warranty; five years on mechanism

Available Options

- Moisture barrier + \$67 per seat or back
- Black urethane arm caps + \$113
- Magazine pouch + \$74
- CTB-133 + \$81/yd
- Two fabrics + \$62
- Three (or more) fabrics + \$88

Specification Decisions

- Select fabric
- Select standard wood finish
- Add CTB-133
- Apply multiple fabrics
- Add moisture barrier
- Add urethane arm caps
- Add magazine pouch

Flammability Type

- Type 6

Coordinating Products

- [Auburn Multiple Seating](#)
- [Auburn Tables](#)
- [Auburn Recliner](#)

Key Dimensions

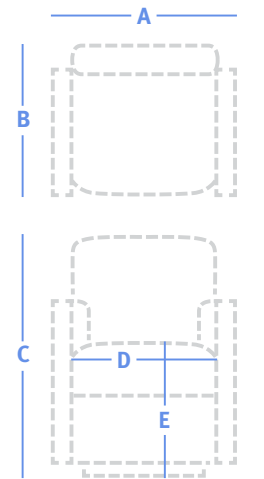

A	Overall Width	See price table
B	Overall Depth	28"
C	Overall Height	39.5"
D	Seat Width	19.5", 22"
E	Seat Height	18"
F	Arm Height	26"

More Information

- Illustrated Glossary ▶ 439
- Fabrics ▶ 451
- Flammability (CTB-133) ▶ 459
- Finishes ▶ 456
- Ordering and Warranties ▶ 462

		23.5" W, Glider								90 lbs 4.5 yds
	Model	Series 2	Series 3	Series 4	Series 5	Series 6	Series 7	Series 8	COM	
	AG30	\$2,484	\$2,555	\$2,864	\$3,031	\$3,121	\$3,240	\$3,316	\$2,555	

		26" W, Glider								96 lbs 4.75 yds
	Model	Series 2	Series 3	Series 4	Series 5	Series 6	Series 7	Series 8	COM	
	AG35	\$2,810	\$2,885	\$3,212	\$3,387	\$3,482	\$3,608	\$3,688	\$2,885	

Avery Rocker



More Information

Illustrated Glossary ▶ 439

Fabrics ▶ 451

Flammability (CTB-133) ▶ 459

Finishes ▶ 456

Ordering and Warranties ▶ 462

Standard Features

- Solid maple frame
- Mortise and tenon joinery
- Spring seat construction
- Clean-out design
- Replaceable components
- Brushed metal accent rail
- Wood arm caps
- Wallsaver edge
- Nemschoff healthcare wood finish
- GREENGUARD Gold Certified
- Limited Lifetime Warranty

Available Options

- Moisture barrier + \$67 per seat or back
- Wood accent rail (front and back) + \$109
- CTB-133 + \$81/yd
- Two fabrics + \$62
- Three (or more) fabrics + \$88

Specification Decisions

- Select fabric
- Add CTB-133
- Apply multiple fabrics
- Add moisture barrier
- Add wood rail

Model numbers with **S** indicate standard seat and back covers, and model numbers with **P** indicate removable covers.

Flammability Type

- Type 4

Key Dimensions

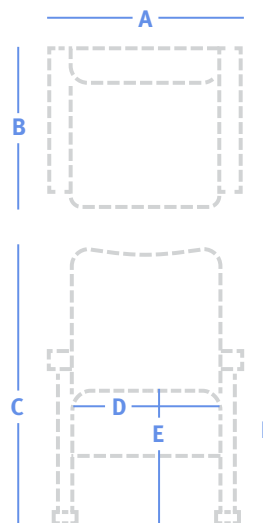

A	Overall Width	See price table
B	Overall Depth	35"
C	Overall Height	40.5"
D	Seat Width	21.5"
E	Seat Height	18.75"
F	Arm Height	25.25"



25.25" W, Rocker

32 lbs | 2.25 yds

Model	Series 2	Series 3	Series 4	Series 5	Series 6	Series 7	Series 8	COM
288-60 S	\$2,122	\$2,193	\$2,313	\$2,437	\$2,585	\$2,735	\$2,922	\$2,193
288-60 P	\$2,386	\$2,457	\$2,577	\$2,701	\$2,849	\$2,999	\$3,186	\$2,457

Brava Glider



More Information

Illustrated Glossary ▶ 439

Fabrics ▶ 451

Flammability (CTB-133) ▶ 459

Finishes ▶ 456

Ordering and Warranties ▶ 462

Standard Features

- Mortise and tenon joinery
- Spring seat construction
- Clean-out design
- Replaceable components
- Wallsaver edge
- Concealed glider mechanism
- Nemschoff healthcare wood finish
- GREENGUARD Gold Certified
- Limited Lifetime Warranty; five years on mechanism

Available Options

- Moisture barrier + \$67 per seat or back
- Black urethane arm caps + \$113
- Desert or Pewter urethane arm caps + \$205
- Wood arm caps (862) + \$113
- CTB-133 + \$81/yd
- Two fabrics + \$62
- Three (or more) fabrics + \$88
- Passive lock + \$260
- Active lock + \$227

Specification Decisions

- Select fabric
- Add CTB-133
- Apply multiple fabrics
- Add moisture barrier
- Add wood or urethane arm caps
- Add passive or active lock

Model numbers with **S** indicate standard seat and back covers, and model numbers with **P** indicate removable covers.

Flammability Type

- Type 6

Coordinating Products

- [Brava Classic Lounge Seating](#)
- [Brava Platform Lounge Seating](#)
- [Brava 862 Multiple Seating](#)
- [Brava 863 Multiple Seating](#)
- [Brava Side Chair](#)
- [Brava Tables](#)
- [Brava Adjustable Back Chair](#)
- [Brava CompactComfort Recliner](#)
- [Brava Patient Chair](#)
- [Brava Flop Sofa](#)
- [Brava Sleep Settee](#)

Key Dimensions

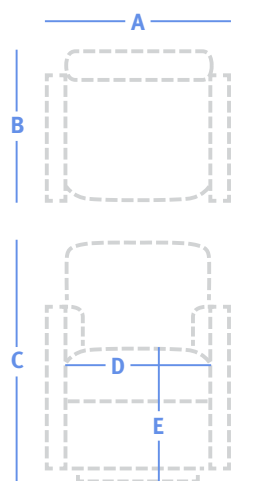

A	Overall Width	See price table
B	Overall Depth	26.25"
C	Overall Height	42.5"
D	Seat Width	20.75", 21.5"
E	Seat Height	18.25"
F	Arm Height	26.75"

Brava Glider

 		25.5" W, Glider with open wood arms								69 lbs 3.25 yds
		Model	Series 2	Series 3	Series 4	Series 5	Series 6	Series 7	Series 8	COM
		863-50 S	\$3,232	\$3,335	\$3,507	\$3,687	\$3,901	\$4,117	\$4,388	\$3,335
		863-50 P	\$3,633	\$3,736	\$3,908	\$4,088	\$4,302	\$4,518	\$4,789	\$3,736

 		26.5" W, Glider with fully upholstered arms								73 lbs 4.5 yds
		Model	Series 2	Series 3	Series 4	Series 5	Series 6	Series 7	Series 8	COM
		862-50 S	\$3,553	\$3,696	\$3,935	\$4,184	\$4,480	\$4,779	\$5,153	\$3,696
		862-50 P	\$3,997	\$4,140	\$4,379	\$4,628	\$4,924	\$5,223	\$5,597	\$4,140

Patient Chairs

Recliners

Treatment Chairs

Rockers & Gliders

Overbed Tables

Sleepover Seating

Casegoods

Display & Accessories

Capella Glider



Standard Features

- Mortise and tenon joinery
- Spring seat construction
- Replaceable components
- Upholstered arms
- Wallsaver edge
- Concealed glider mechanism
- GREENGUARD Gold Certified
- Limited Lifetime Warranty; five years on mechanism

Coordinating Products

- [Capella Multiple Seating](#)
- [Capella Side Chair](#)
- [Capella Tables](#)
- [Capella Patient Chair](#)
- [Capella Adjustable Back Chair](#)
- [Capella CompactComfort Recliner](#)
- [Capella Adjustable Back Glider](#)

Key Dimensions

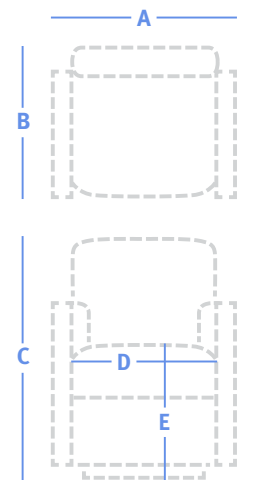

A	Overall Width	See price table
B	Overall Depth	24.5"
C	Overall Height	39.75"
D	Seat Width	20"
E	Seat Height	18.75"
F	Arm Height	25"

More Information

Illustrated Glossary ▶ 439

Fabrics ▶ 451

Flammability (CTB-133) ▶ 459

Finishes ▶ 456

Ordering and Warranties ▶ 462

Available Options

- Moisture barrier + \$67 per seat or back
- Passive lock + \$260
- Active lock + \$227
- CTB-133 + \$81/yd
- Two fabrics + \$62
- Three (or more) fabrics + \$88

Specification Decisions

- Select fabric
- Add CTB-133
- Apply multiple fabrics
- Add moisture barrier
- Add passive or active lock

Model numbers with **S** indicate standard seat and back covers, and model numbers with **P** indicate removable covers.

Front to back motion is approximately 4.5".

Flammability Type

- Type 6



24.5" W, Glider

50 lbs | 4.75 yds

Model	Series 2	Series 3	Series 4	Series 5	Series 6	Series 7	Series 8	COM
740-50CL S	\$2,447	\$2,598	\$2,850	\$3,113	\$3,425	\$3,741	\$4,136	\$2,598
740-50CL P	\$2,759	\$2,910	\$3,162	\$3,425	\$3,737	\$4,053	\$4,448	\$2,910

Capella Adjustable Back Glider



More Information

Illustrated Glossary ▶ 439

Fabrics ▶ 451

Flammability (CTB-133) ▶ 459

Finishes ▶ 456

Ordering and Warranties ▶ 462

Standard Features

- Mortise and tenon joinery
- Spring seat construction
- Replaceable components
- Upholstered arms
- Wallsaver edge
- Infinite back adjustment within 111 degrees
- Concealed glider mechanism
- GREENGUARD Gold Certified
- Limited Lifetime Warranty; five years on mechanism

Available Options

- Moisture barrier + \$67 per seat or back
- Passive lock + \$260
- Active lock + \$227
- CTB-133 + \$81/yard
- Two fabrics + \$62
- Three (or more) fabrics + \$88

Specification Decisions

- Select fabric
- Add CTB-133
- Apply multiple fabrics
- Add moisture barrier
- Add passive or active lock

Model numbers with **S** indicate standard seat and back covers, and model numbers with **P** indicate removable covers.

Front to back motion is approximately 4.5".

The back must be 16" from the wall to allow for gliding motion when fully reclined.

Flammability Type

- Type 6

Coordinating Products

- [Capella Multiple Seating](#)
- [Capella Side Chair](#)
- [Capella Tables](#)
- [Capella Patient Chair](#)
- [Capella Adjustable Back Chair](#)
- [Capella CompactComfort Recliner](#)
- [Capella Glider](#)

Key Dimensions

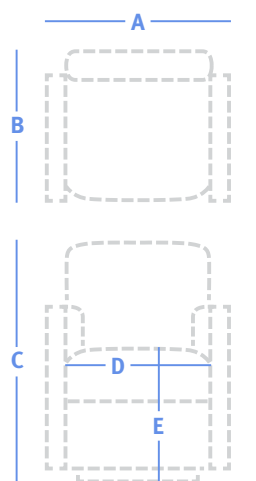

A	Overall Width	See price table
B	Overall Depth	26.75"
C	Overall Height	43.5"
D	Seat Width	20.5"
E	Seat Height	18.75"
F	Arm Height	24.75"



26.5" W, Adjustable back glider

55 lbs | 5.5 yds

Model	Series 2	Series 3	Series 4	Series 5	Series 6	Series 7	Series 8	COM
740-54 S	\$3,187	\$3,362	\$3,653	\$3,958	\$4,320	\$4,685	\$5,143	\$3,362
740-54 P	\$3,591	\$3,766	\$4,057	\$4,362	\$4,724	\$5,089	\$5,547	\$3,766

Cities Crosstown Rocker



Standard Features

- Mortise and tenon joinery
- Spring seat construction
- Replaceable components
- Wipe-out design
- Wood arm caps
- Concealed rocking mechanism
- Non-marring 5/8" x 2" plastic bar glides
- Wallsaver edge
- Nemschoff healthcare wood finish
- GREENGUARD Gold Certified
- Limited Lifetime Warranty

Available Options

- Moisture barrier + \$67 per seat or back
- Five arm cap styles + \$0
- Four foot styles + \$0
- Two back style + \$0
- Two arm styles + \$0
- CTB-133 + \$81/yd
- Two fabrics + \$62
- Three (or more) fabrics + \$88

Specification Decisions

- Select fabric
- Select standard wood finish
- Select arm cap style

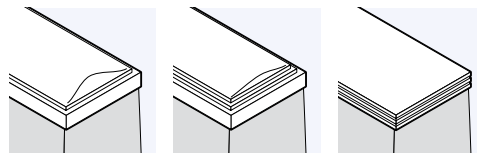

C Chicago **L** Los Angeles **N** New Orleans

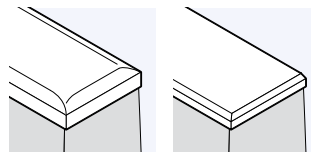

Y New York **W** Williamsburg

- Select foot style

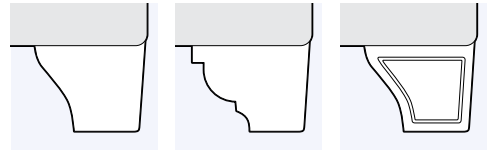

B Boston **C** Chicago **P** Philadelphia

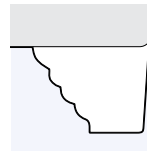

S San Francisco

- Select back style. All styles have a wipe-out feature.

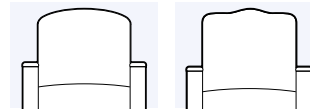

A Arcade back **Q** Camel square back

- Select arm style

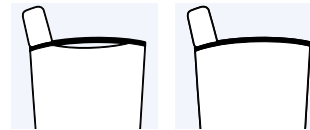

E Elliptical arm **C** Closed arm

- Add moisture barrier
- Add CTB-133
- Apply multiple fabrics

Model numbers with **S** indicate standard seat and back covers, and model numbers with **P** indicate removable covers.

Flammability Type

- Type 6

More Information

Illustrated Glossary ▶ 439

Fabrics ▶ 451

Flammability (CTB-133) ▶ 459

Finishes ▶ 456

Ordering and Warranties ▶ 462

Cities Crosstown Rocker

Coordinating Products

- [Cities Small Crosstown Lounge Seating](#)
- [Cities Medium Crosstown Lounge Seating](#)
- [Cities Large Crosstown Lounge Seating](#)
- [Cities Small Downtown Lounge Seating](#)
- [Cities Medium Downtown Lounge Seating](#)
- [Cities Large Downtown Lounge Seating](#)
- [Cities Small Uptown Lounge Seating](#)
- [Cities Medium Uptown Lounge Seating](#)
- [Cities Large Uptown Lounge Seating](#)
- [Cities Side Chair](#)
- [Cities Tables](#)
- [Cities Crosstown Patient Chair](#)
- [Cities Downtown Patient Chair](#)
- [Cities Uptown Patient Chair](#)
- [Cities Uptown CompactComfort Recliner](#)
- [Cities Downtown Rocker](#)
- [Cities Uptown Rocker](#)
- [Cities Downtown Glider](#)
- [Cities Uptown Glider](#)

Key Dimensions

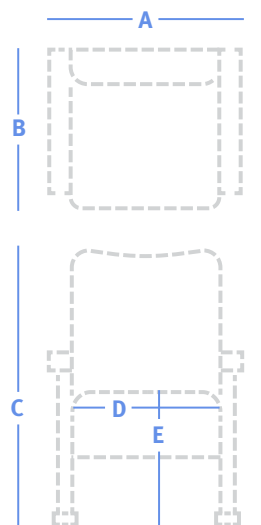

A	Overall Width	See price table
B	Overall Depth	27.5"
C	Overall Height	38.5"
D	Seat Width	19.5"
E	Seat Height	18.75"
F	Arm Height	25.5"



27.25" W, Rocker

49 lbs | 4 yds

Model	Series 2	Series 3	Series 4	Series 5	Series 6	Series 7	Series 8	COM
Cities-SCXXX-61SX	\$2,105	\$2,232	\$2,444	\$2,665	\$2,929	\$3,195	\$3,527	\$2,232
Cities-SCXXX-61PX	\$2,373	\$2,500	\$2,712	\$2,933	\$3,197	\$3,463	\$3,795	\$2,500

Patient Chairs

Recliners

Treatment Chairs

Rockers & Gliders

Overbed Tables

Sleeper Seating

Casegoods

Display & Accessories

Cities Downtown Rocker



More Information

- Illustrated Glossary ▶ 439
- Fabrics ▶ 451
- Flammability (CTB-133) ▶ 459
- Finishes ▶ 456
- Ordering and Warranties ▶ 462

Standard Features

- Mortise and tenon joinery
- Spring seat construction
- Replaceable components
- Wipe-out design
- Wood arm caps
- Non-marring 7/8" rubber-cushioned glides
- Wallsaver edge
- Nemschoff healthcare wood finish
- GREENGUARD Gold Certified
- Limited Lifetime Warranty

Available Options

- Moisture barrier + \$67 per seat or back
- Five arm cap styles + \$0
- Four foot styles + \$0
- Two back styles + \$0
- Two rail styles + \$0
- CTB-133 + \$81/yd
- Two fabrics + \$62
- Three (or more) fabrics + \$88

Specification Decisions

- Select fabric
- Select standard wood finish
- Select arm cap style

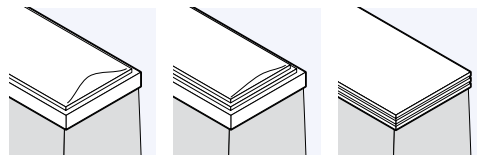

C Chicago **L** Los Angeles **N** New Orleans

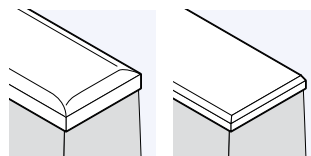

Y New York **W** Williamsburg

- Select foot style

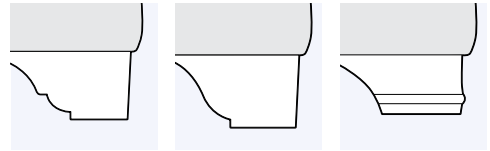

C Chicago **L** Los Angeles **N** New Orleans

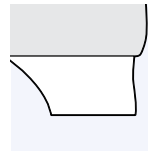

W Williamsburg

- Select back style. All styles have a wipe-out feature.

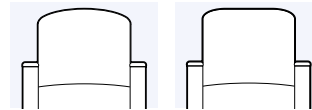

A Arcade back **B** Square back

- Select rail style

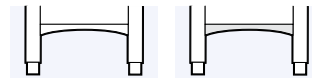

U Upholstered **W** Wood

- Add moisture barrier
- Add CTB-133
- Apply multiple fabrics

Model numbers with **S** indicate standard seat and back covers, and model numbers with **P** indicate removable covers.

Flammability Type

- Type 6

Cities Downtown Rocker

Coordinating Products

- [Cities Small Crosstown Lounge Seating](#)
- [Cities Medium Crosstown Lounge Seating](#)
- [Cities Large Crosstown Lounge Seating](#)
- [Cities Small Downtown Lounge Seating](#)
- [Cities Medium Downtown Lounge Seating](#)
- [Cities Large Downtown Lounge Seating](#)
- [Cities Small Uptown Lounge Seating](#)
- [Cities Medium Uptown Lounge Seating](#)
- [Cities Large Uptown Lounge Seating](#)
- [Cities Side Chair](#)
- [Cities Tables](#)
- [Cities Crosstown Patient Chair](#)
- [Cities Downtown Patient Chair](#)
- [Cities Uptown Patient Chair](#)
- [Cities Uptown CompactComfort Recliner](#)
- [Cities Crosstown Rocker](#)
- [Cities Uptown Rocker](#)
- [Cities Downtown Glider](#)
- [Cities Uptown Glider](#)

Key Dimensions

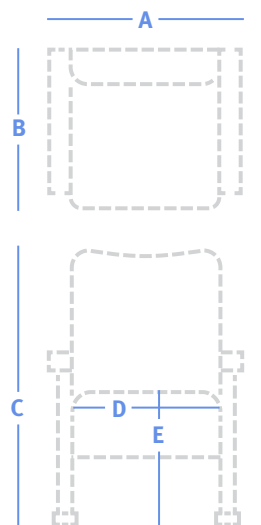

A	Overall Width	See price table
B	Overall Depth	26"
C	Overall Height	39.5"
D	Seat Width	20"
E	Seat Height	18.75"
F	Arm Height	25.5"



25.5" W, Rocker

Model	Series 2	Series 3	Series 4	Series 5	Series 6	Series 7	Series 8	COM
Cities-SDXXXX-61SX	\$2,113	\$2,232	\$2,431	\$2,638	\$2,885	\$3,135	\$3,446	\$2,232
Cities-SDXXXX-61PX	\$2,381	\$2,500	\$2,699	\$2,906	\$3,153	\$3,403	\$3,714	\$2,500

40 lbs | 3.75 yds

Cities Downtown Glider



Standard Features

- Mortise and tenon joinery
- Spring seat construction
- Replaceable components
- Wipe-out design
- Wood arm caps
- Concealed glider mechanism
- Wallsaver edge
- Nemschoff healthcare wood finish
- GREENGUARD Gold Certified
- Limited Lifetime Warranty; five years on mechanism

Available Options

- Moisture barrier + \$67 per seat or back
- Five arm cap styles + \$0
- Four foot styles + \$0
- Two back styles + \$0
- Two rail styles + \$0
- Passive lock + \$260
- Active lock + \$227
- CTB-133 + \$81/yd
- Two fabrics + \$62
- Three (or more) fabrics + \$88

Specification Decisions

- Select fabric
- Select standard wood finish
- Select arm cap style

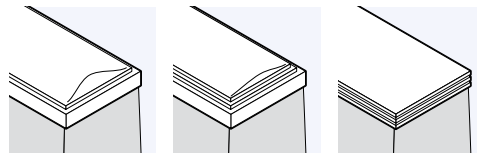

C Chicago **L** Los Angeles **N** New Orleans

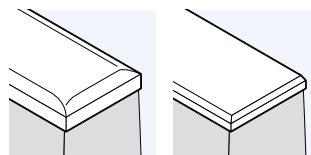

Y New York **W** Williamsburg

- Select back style. All styles have a wipe-out feature.

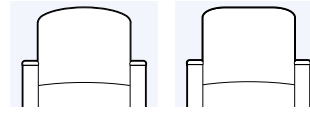

A Arcade back **B** Square back

- Select rail style

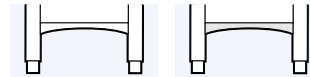

U Upholstered **W** Wood

- Add moisture barrier
- Add CTB-133
- Apply multiple fabrics
- Add passive or active lock

Model numbers with **S** indicate standard seat and back covers, and model numbers with **P** indicate removable covers.

Flammability Type

- Type 6

Coordinating Products

- [Cities Small Crosstown Lounge Seating](#)
- [Cities Medium Crosstown Lounge Seating](#)
- [Cities Large Crosstown Lounge Seating](#)
- [Cities Small Downtown Lounge Seating](#)
- [Cities Medium Downtown Lounge Seating](#)
- [Cities Large Downtown Lounge Seating](#)
- [Cities Small Uptown Lounge Seating](#)
- [Cities Medium Uptown Lounge Seating](#)
- [Cities Large Uptown Lounge Seating](#)

Cities Downtown Glider

- [Cities Side Chair](#)
- [Cities Tables](#)
- [Cities Crosstown Patient Chair](#)
- [Cities Downtown Patient Chair](#)
- [Cities Uptown Patient Chair](#)
- [Cities Uptown CompactComfort Recliner](#)
- [Cities Crosstown Rocker](#)
- [Cities Downtown Rocker](#)
- [Cities Uptown Rocker](#)
- [Cities Uptown Glider](#)

Key Dimensions

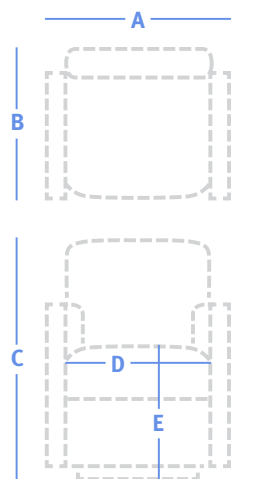

A	Overall Width	See price table
B	Overall Depth	26.5"
C	Overall Height	39.5"
D	Seat Width	20"
E	Seat Height	18.75"
F	Arm Height	25.5"



24" W, Glider

38 lbs | 3.75 yds

Model	Series 2	Series 3	Series 4	Series 5	Series 6	Series 7	Series 8	COM
Cities-SDX0XX-50CL SX	\$2,146	\$2,265	\$2,464	\$2,671	\$2,918	\$3,168	\$3,479	\$2,265
Cities-SDX0XX-50CL PX	\$2,418	\$2,537	\$2,736	\$2,943	\$3,190	\$3,440	\$3,751	\$2,537

Patient Chairs

Recliners

Treatment Chairs

Rockers & Gliders

Overbed Tables

Sleeper Seating

Casegoods

Display & Accessories

Cities Uptown Rocker



More Information

Illustrated Glossary ▶ 439

Fabrics ▶ 451

Flammability (CTB-133) ▶ 459

Finishes ▶ 456

Ordering and Warranties ▶ 462

Standard Features

- Morise and tenon joinery
- Spring seat construction
- Wipe-out design
- Replaceable components
- Wood arm caps
- Non-marring 7/8" rubber-cushioned glides
- Wallsaver edge
- Nemschoff healthcare wood finish
- GREENGUARD Gold Certified
- Limited Lifetime Warranty

Available Options

- Moisture barrier + \$67 per seat or back
- Five arm cap styles + \$0
- Two back styles + \$0
- Two rail styles + \$0
- CTB-133 + \$81/yd
- Two fabrics + \$62
- Three (or more) fabrics + \$88

Specification Decisions

- Select fabric
- Select standard wood finish
- Select arm cap style

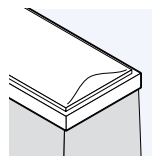

C Chicago

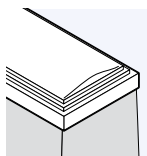

L Los Angeles

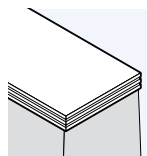

N New Orleans

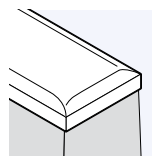

Y New York

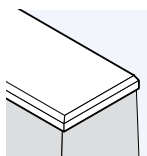

W Williamsburg

- Select back style. All styles have a wipe-out feature.

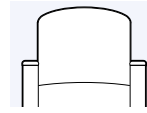

A Arcade back

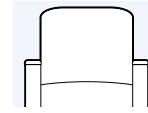

B Square back

- Select rail style

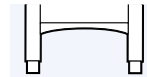

U Upholstered

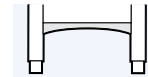

W Wood

- Add moisture barrier
- Add CTB-133
- Apply multiple fabrics

Model numbers with **S** indicate standard seat and back covers, and model numbers with **P** indicate removable covers.

Flammability Type

- Type 6

Cities Uptown Rocker

Coordinating Products

- [Cities Small Crosstown Lounge Seating](#)
- [Cities Medium Crosstown Lounge Seating](#)
- [Cities Large Crosstown Lounge Seating](#)
- [Cities Small Downtown Lounge Seating](#)
- [Cities Medium Downtown Lounge Seating](#)
- [Cities Large Downtown Lounge Seating](#)
- [Cities Small Uptown Lounge Seating](#)
- [Cities Medium Uptown Lounge Seating](#)
- [Cities Large Uptown Lounge Seating](#)
- [Cities Side Chair](#)
- [Cities Tables](#)
- [Cities Crosstown Patient Chair](#)
- [Cities Downtown Patient Chair](#)
- [Cities Uptown Patient Chair](#)
- [Cities Uptown CompactComfort Recliner](#)
- [Cities Crosstown Rocker](#)
- [Cities Downtown Rocker](#)
- [Cities Downtown Glider](#)
- [Cities Uptown Glider](#)

Key Dimensions

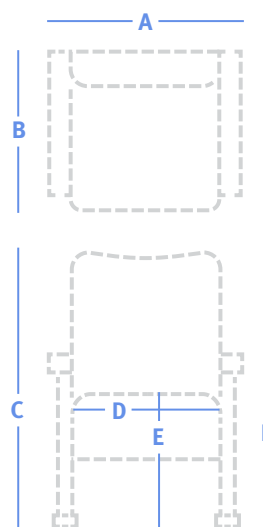

A	Overall Width	See price table
B	Overall Depth	26"
C	Overall Height	39.5"
D	Seat Width	20"
E	Seat Height	18.5"
F	Arm Height	25"

 	25.5" W, Rocker	40 lbs 3 yds							
	Model	Series 2	Series 3	Series 4	Series 5	Series 6	Series 7	Series 8	COM
	Cities-SUX0XX-61SX	\$2,182	\$2,277	\$2,436	\$2,602	\$2,800	\$2,999	\$3,249	\$2,277
	Cities-SUX0XX-61PX	\$2,456	\$2,551	\$2,710	\$2,876	\$3,074	\$3,273	\$3,523	\$2,551

Cities Uptown Glider



Standard Features

- Mortise and tenon joinery
- Spring seat construction
- Wipe-out design
- Replaceable components
- Wood arm caps
- Concealed glider mechanism
- 2¼" dia plastic glides
- Wallsaver edge
- Nemschoff healthcare wood finish
- GREENGUARD Gold Certified
- Limited Lifetime Warranty; five years on mechanism

Available Options

- Moisture barrier + \$67 per seat or back
- Five arm cap styles + \$0
- Two back styles + \$0
- Two rail styles + \$0
- Passive lock + \$260
- Active lock + \$227
- CTB-133 + \$81/yd
- Two fabrics + \$62
- Three (or more) fabrics + \$88

Specification Decisions

- Select fabric
- Select standard wood finish
- Select arm cap style

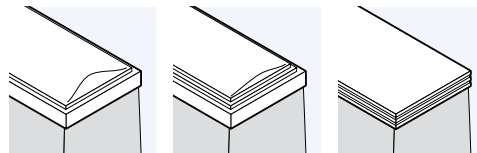

C Chicago **L** Los Angeles **N** New Orleans

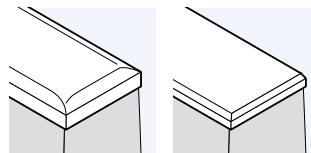

Y New York **W** Williamsburg

- Select back style. All styles have a wipe-out feature.

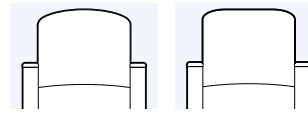

A Arcade back **B** Square back

- Select rail style

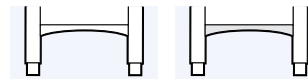

U Upholstered **W** Wood

- Add moisture barrier
- Add CTB-133
- Apply multiple fabrics
- Add passive or active lock

Model numbers with **S** indicate standard seat and back covers, and model numbers with **P** indicate removable covers.

Flammability Types

- Type 6
- Type 5 (MUXX0XX-50CL)

More Information

- Illustrated Glossary ▶ 439
- Fabrics ▶ 451
- Flammability (CTB-133) ▶ 459
- Finishes ▶ 456
- Ordering and Warranties ▶ 462

Cities Uptown Glider

Coordinating Products

- [Cities Small Crosstown Lounge Seating](#)
- [Cities Medium Crosstown Lounge Seating](#)
- [Cities Large Crosstown Lounge Seating](#)
- [Cities Small Downtown Lounge Seating](#)
- [Cities Medium Downtown Lounge Seating](#)
- [Cities Large Downtown Lounge Seating](#)
- [Cities Small Uptown Lounge Seating](#)
- [Cities Medium Uptown Lounge Seating](#)
- [Cities Large Uptown Lounge Seating](#)
- [Cities Side Chair](#)
- [Cities Tables](#)
- [Cities Crosstown Patient Chair](#)
- [Cities Downtown Patient Chair](#)
- [Cities Uptown Patient Chair](#)
- [Cities Uptown CompactComfort Recliner](#)
- [Cities Crosstown Rocker](#)
- [Cities Downtown Rocker](#)
- [Cities Uptown Rocker](#)
- [Cities Downtown Glider](#)
- [SleepOver Sofa](#)
- [SleepOver Settee](#)

Key Dimensions

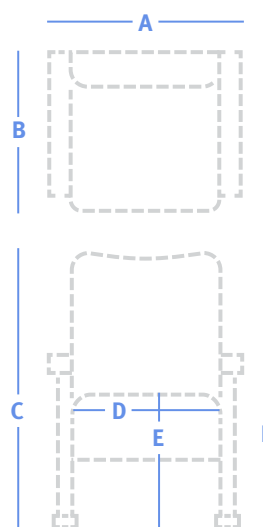

A	Overall Width	See price table
B	Overall Depth	26.5"
C	Overall Height	39"
D	Seat Width	19.5", 21"
E	Seat Height	18.5"
F	Arm Height	24.5"

		24" W, Glider								38 lbs 3.75 yds
		Model	Series 2	Series 3	Series 4	Series 5	Series 6	Series 7	Series 8	COM
		Cities-SUX0XX-50CL SX	\$2,444	\$2,563	\$2,762	\$2,969	\$3,216	\$3,466	\$3,777	\$2,563
		Cities-SUX0XX-50CL PX	\$2,752	\$2,871	\$3,070	\$3,277	\$3,524	\$3,774	\$4,085	\$2,871
		28" W, Glider								51 lbs 4 yds
		Model	Series 2	Series 3	Series 4	Series 5	Series 6	Series 7	Series 8	COM
		Cities-MUX0XX-50CL SX	\$2,905	\$3,032	\$3,244	\$3,465	\$3,729	\$3,995	\$4,327	\$3,032
		Cities-MUX0XX-50CL PX	\$3,269	\$3,396	\$3,608	\$3,829	\$4,093	\$4,359	\$4,691	\$3,396

Horizon Glider



Standard Features

- Replaceable components
- Wood arm caps
- Nemschoff healthcare wood finish
- GREENGUARD Gold Certified
- Limited Lifetime Warranty

Available Options

- Moisture barrier + \$67 per seat or back
- Black urethane arm caps + \$113
- Magazine pouch + \$74
- CTB-133 + \$81/yd
- Two fabrics + \$62
- Three (or more) fabrics + \$88

Specification Decisions

- Select fabric
- Select standard wood finish
- Add CTB-133
- Apply multiple fabrics
- Add moisture barrier
- Add urethane arm caps
- Add magazine pouch

Flammability Type

- Type 6

Coordinating Products

- [Horizon Multiple Seating](#)
- [Horizon Tables](#)
- [Horizon Recliner](#)
- [Horizon Patient Chair](#)

Key Dimensions

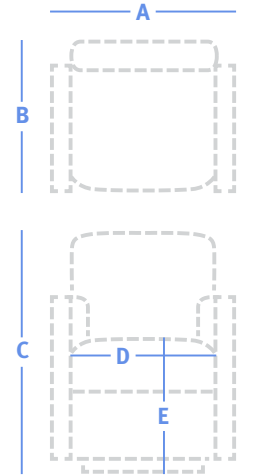

A	Overall Width	See price table
B	Overall Depth	28"
C	Overall Height	39.5"
D	Seat Width	19.5", 22"
E	Seat Height	18"
F	Arm Height	26"

More Information

- Illustrated Glossary ▶ 439
- Fabrics ▶ 451
- Flammability (CTB-133) ▶ 459
- Finishes ▶ 455
- Ordering and Warranties ▶ 462



23.5" W, Glider

90 lbs | 4.5 yds

Model	Series 2	Series 3	Series 4	Series 5	Series 6	Series 7	Series 8	COM
HG30	\$2,287	\$2,358	\$2,667	\$2,834	\$2,924	\$3,043	\$3,119	\$2,358



26" W, Glider

96 lbs | 4.75 yds

Model	Series 2	Series 3	Series 4	Series 5	Series 6	Series 7	Series 8	COM
HG35	\$2,615	\$2,690	\$3,017	\$3,192	\$3,287	\$3,413	\$3,493	\$2,690

Marco Glider



More Information

Illustrated Glossary ▶ 439

Fabrics ▶ 451

Flammability (CTB-133) ▶ 459

Finishes ▶ 456

Ordering and Warranties ▶ 462

Standard Features

- Mortise and tenon joinery
- Spring seat construction
- Replaceable components
- Wood arms
- Concealed glider mechanism
- Wallsaver edge
- Nemschoff healthcare wood finish
- GREENGUARD Gold Certified
- Limited Lifetime Warranty; five years on mechanism

Available Options

- Moisture barrier + \$67 per seat or back
- Passive lock + \$260
- Active lock + \$227
- CTB-133 + \$81/yd
- Two fabrics + \$62
- Three (or more) fabrics + \$88

Specification Decisions

- Select fabric
- Select standard wood finish
- Add CTB-133
- Apply multiple fabrics
- Add moisture barrier
- Add passive or active lock

Model numbers with **S** indicate standard seat and back covers, and model numbers with **P** indicate removable covers.

Front to back motion is approximately 4.5" at floor level.

Flammability Type

- Type 6

Coordinating Products

- [Marco Grande Lounge Seating](#)
- [Marco Grande II Lounge Seating](#)
- [Marco Multiple Seating](#)
- [Marco Grande Tables](#)
- [Marco Patient Chair](#)

Key Dimensions

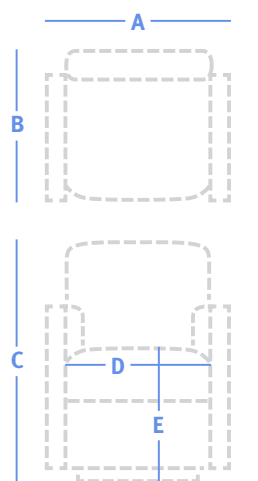

A	Overall Width	See price table
B	Overall Depth	27.5"
C	Overall Height	40.25"
D	Seat Width	19.5"
E	Seat Height	18.75"
F	Arm Height	25"



24" W, Glider

63 lbs | 4.5 yds

Model	Series 2	Series 3	Series 4	Series 5	Series 6	Series 7	Series 8	COM
735-50CL S	\$1,807	\$1,950	\$2,189	\$2,438	\$2,734	\$3,033	\$3,407	\$1,950
735-50CL P	\$2,041	\$2,184	\$2,423	\$2,672	\$2,968	\$3,267	\$3,641	\$2,184

Olivia Glider



Standard Features

- Mortise and tenon joinery
- Spring seat construction
- Clean-out design
- Replaceable components
- Upholstered arms
- Wallsaver edge
- Concealed glider mechanism
- GREENGUARD Gold Certified
- Limited Lifetime Warranty; five years on mechanism

Available Options

- Moisture barrier + \$67 per seat or back
- Passive lock + \$260
- Active lock + \$227
- CTB-133 + \$81/yd
- Two fabrics + \$62
- Three (or more) fabrics + \$88

Specification Decisions

- Select fabric
- Add CTB-133
- Apply multiple fabrics
- Add moisture barrier
- Add passive or active lock

Model numbers with **S** indicate standard seat and back covers, and model numbers with **P** indicate removable covers.

Front to back motion is approximately 4.5".

The back must be 7" from the wall to allow for

gliding motion.

Flammability Type

- Type 6

Coordinating Products

- [Olivia Lounge Seating](#)
- [Olivia Tables](#)
- [Olivia Patient Chair](#)

Key Dimensions

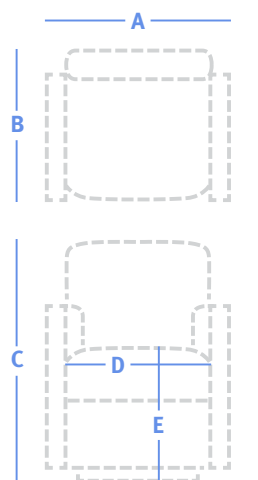

A	Overall Width	See price table
B	Overall Depth	30"
C	Overall Height	35"
D	Seat Width	21.25"
E	Seat Height	18.75"
F	Arm Height	25.25"

More Information

Illustrated Glossary ▶ 439

Fabrics ▶ 451

Flammability (CTB-133) ▶ 459

Finishes ▶ 456

Ordering and Warranties ▶ 462



28" W, Glider

60 lbs | 5.5 yds

Model	Series 2	Series 3	Series 4	Series 5	Series 6	Series 7	Series 8	COM
903-50 S	\$2,405	\$2,580	\$2,871	\$3,176	\$3,538	\$3,903	\$4,361	\$2,580
903-50 P	\$2,715	\$2,890	\$3,181	\$3,486	\$3,848	\$4,213	\$4,671	\$2,890

Torii Rocker



More Information

Illustrated Glossary ▶ 439

Fabrics ▶ 451

Flammability (CTB-133) ▶ 459

Finishes ▶ 456

Ordering and Warranties ▶ 462

Standard Features

- Mortise and tenon joinery
- Spring seat construction
- Clean-out design
- Replaceable components
- Wood arm caps
- Non-marring $\frac{7}{8}$ " rubber-cushioned glides
- Swoop-back style
- Wallsaver edge
- Must be 6" from the wall
- Nemschoff healthcare wood finish
- GREENGUARD Gold Certified
- Limited Lifetime Warranty

Available Options

- Moisture barrier + \$67 per seat or back
- Arcade back + \$0
- Soft-radius edge + \$0
- CTB-133 + \$81/yd
- Two fabrics + \$62
- Three (or more) fabrics + \$88

Specification Decisions

- Select fabric
- Select standard wood finish
- Add CTB-133
- Apply multiple fabrics
- Add moisture barrier
- Add Arcade back
- Add soft-radius edge

Model numbers with **S** indicate standard seat and back covers, and model numbers with **P** indicate removable covers.

Flammability Type

- Type 5

Coordinating Products

- [Torii Multiple Seating](#)
- [Torii Side Chair](#)
- [Torii Tables](#)
- [Torii Patient Chair](#)
- [Torii Glider](#)

Key Dimensions

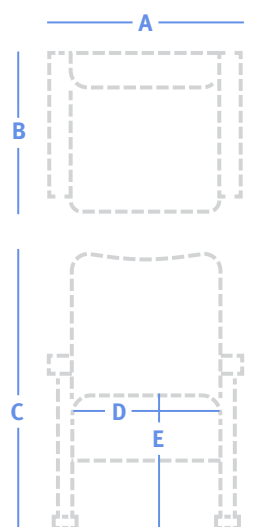

A	Overall Width	See price table
B	Overall Depth	27"
C	Overall Height	41.25"
D	Seat Width	21"
E	Seat Height	18.75"
F	Arm Height	25.75"



25.25" W, Rocker

40 lbs | 2.25 yds

Model	Series 2	Series 3	Series 4	Series 5	Series 6	Series 7	Series 8	COM
283-61 S	\$1,865	\$1,936	\$2,056	\$2,180	\$2,328	\$2,478	\$2,665	\$1,936
283-61 P	\$2,098	\$2,169	\$2,289	\$2,413	\$2,561	\$2,711	\$2,898	\$2,169

Torii Glider



Standard Features

- Spring seat construction
- Clean-out design
- Replaceable components
- Wood arm caps
- Wallsaver edge
- Nemschoff healthcare wood finish
- GREENGUARD Gold Certified
- Limited Lifetime Warranty; five years on mechanism

Flammability Type

- Type 5

Coordinating Products

- [Torii Multiple Seating](#)
- [Torii Side Chair](#)
- [Torii Tables](#)
- [Torii Patient Chair](#)
- [Torii Rocker](#)

Available Options

- Moisture barrier + \$67 per seat or back
- Passive lock + \$260
- Active lock + \$227
- Arcade back + \$0
- Soft radius-edge + \$0
- CTB-133 + \$81/yd
- Two fabrics + \$62
- Three (or more) fabrics + \$88

Key Dimensions

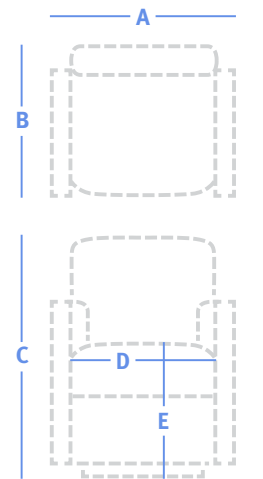

A	Overall Width	See price table
B	Overall Depth	28.5"
C	Overall Height	41"
D	Seat Width	20.75"
E	Seat Height	18.75"
F	Arm Height	25.5"

More Information

Illustrated Glossary ▶ 439

Fabrics ▶ 451

Flammability (CTB-133) ▶ 459

Finishes ▶ 456

Ordering and Warranties ▶ 462

Specification Decisions

- Select fabric
- Select standard wood finish
- Add CTB-133
- Apply multiple fabrics
- Add moisture barrier
- Add passive or active lock
- Add Arcade back
- Add soft radius-edge

Model numbers with **S** indicate standard seat and back covers, and model numbers with **P** indicate removable covers.

Front to back motion is approximately 4.5" at floor level.



25.25" W, Glider

68 lbs | 2.5 yds

Model	Series 2	Series 3	Series 4	Series 5	Series 6	Series 7	Series 8	COM
283-50CL S	\$1,822	\$1,901	\$2,034	\$2,172	\$2,337	\$2,503	\$2,711	\$1,901
283-50CL P	\$2,051	\$2,130	\$2,263	\$2,401	\$2,566	\$2,732	\$2,940	\$2,130

EZ-123 Overbed Table



More Information

Illustrated Glossary ▶ 439

Finishes ▶ 456

Hardware ▶ 457

Ordering and Warranties ▶ 462

Standard Features

- Heavy-duty steel construction
- K-shaped base (Black, Pewter)
- Laminated top with molded urethane edge (EZ-123)
- Durawrap kidney-shaped top with spill-containing edge (EZ-123K)
- Large 18.5" x 34.5" top
- Adjustable gas spring mechanism with automatic lock
- 2" twin-wheel casters
- Ships assembled and blanket-wrapped
- GREENGUARD Gold Certified
- Five-year Warranty

Available Options

- Framed vanity mirror with storage + 186

Specification Decisions

- Select standard laminate (EZ-123)
- Select Durawrap finish (EZ-123K)
- Select urethane edge color (EZ-123)
 - UEP** Pewter **UEC** Cloud **UES** Sable
- Select table base color
- Add vanity

Key Dimensions

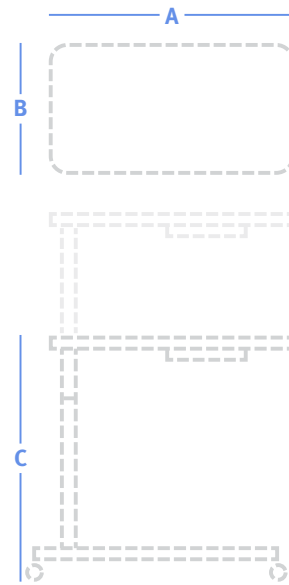

A	Width	34.5"
B	Depth	18.5"
C	Height Range	29.75" – 45.75"



34.5" W, Overbed table

55 lbs

Model	Price
EZ-123	\$1,033



34.5" W, Overbed table with kidney-shaped top

55 lbs

Model	Price
EZ-123K	\$1,033

Oasis Overbed Table



Standard Features

- Heavy-duty steel construction
- Ash grey (8D) powder-coated steel base
- Laminated top with urethane spill-containing edge
- Rounded inside tray edges
- Column mechanism with roller bearings
- 2" minimum clearance base
- Casters
- X- or U-shaped base
- Ships cartoned
- GREENGUARD Gold Certified
- Five-year Warranty

Available Options

- Framed vanity mirror with storage + \$186
- See price table for specific model numbers

Specification Decisions

- Select standard laminate
 - Select urethane edge color
- UEP** Pewter **UEC** Cloud **UES** Sable
- Add vanity

Key Dimensions

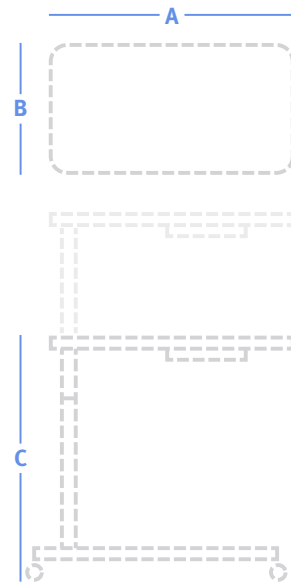

A	Width	44"
B	Depth	20"
C	Height Range	28.25" – 46"

More Information









Illustrated Glossary ▶ 439

Finishes ▶ 456

Hardware ▶ 457

Ordering and Warranties ▶ 462

Oasis Overbed Table

	44" W, Overbed table with X base	65 lbs	
Model	Price	Depth	Height Range
OAS123-X	\$1,215	20"	29.75" - 45.75"
	44" W, Overbed table with X base and patient tray	73 lbs	
Model	Price	Depth	Height Range
OAS123-X-P	\$1,321	20"	29.75" - 45.75"
	44" W, Overbed table with X base and caregiver tray	73 lbs	
Model	Price	Depth	Height Range
OAS123-X-N	\$1,321	20"	29.75" - 45.75"
	44" W, Overbed table with X base, caregiver tray, and patient tray	81 lbs	
Model	Price	Depth	Height Range
OAS123-X-NP	\$1,424	20"	29.75" - 45.75"
	44" W, Overbed table with U base	65 lbs	
Model	Price	Depth	Height Range
OAS123-U	\$1,215	20"	29.75" - 45.75"
	44" W, Overbed table with U base and patient tray	73 lbs	
Model	Price	Depth	Height Range
OAS123-U-P	\$1,321	20"	29.75" - 45.75"
	44" W, Overbed table with U base and caregiver tray	73 lbs	
Model	Price	Depth	Height Range
OAS123-U-N	\$1,321	20"	29.75" - 45.75"
	44" W, Overbed table with U base, caregiver tray, and patient tray	81 lbs	
Model	Price	Depth	Height Range
OAS123-U-NP	\$1,424	20"	29.75" - 45.75"

Patient Chairs

Recliners

Treatment Chairs

Rockers & Gliders

Overbed Tables

Sleepover Seating

Casegoods

Display & Accessories

Overbed Table



Standard Features

- Laminated top (Honey Maple, White) with urethane edge
- Chrome-plated steel base
- Casters
- Vanity mirror (FXZ26V)
- Ships with base in carton, top blanket-wrapped
- GREENGUARD Gold Certified
- Five-year Warranty

Key Dimensions



A	Width	30"
B	Depth	15"
C	Height Range	29.5" – 44.5"

More Information

- Illustrated Glossary ▶ 439
- Finishes ▶ 456
- Hardware ▶ 457
- Ordering and Warranties ▶ 462

Specification Decisions

- Select laminate top color
91 White **OG** Honey Maple
- Select urethane edge color
UEP Pewter **UEC** Cloud **UES** Sable

Additional laminate colors available on quantities of 25 or more.



30" W, Overbed table

24 lbs

Model	Price	Depth	Height Range
FXZ26	\$615	15"	29.5" - 44.5"



30" W, Overbed table with vanity

30 lbs

Model	Price	Depth	Height Range
FXZ26V	\$782	15"	29.5" - 44.5"

Atwater Sleep Settee



More Information

Illustrated Glossary ▶ 439

Fabrics ▶ 451

Flammability (CTB-133) ▶ 459

Finishes ▶ 456

Ordering and Warranties ▶ 462

Standard Features

- Replaceable components
- Removable covers
- Upholstered arms
- Non-marring 2¼" plastic glides
- Heavy-duty pull-out mechanism
- Pull-out sleep surface
- Two separate 28" x 80" sleep surfaces
- Antimicrobial surface at head and foot area
- Nemschoff healthcare wood finish
- GREENGUARD Gold Certified
- Limited Lifetime Warranty; five years on mechanism

Available Options

- Moisture barrier + \$67 per seat or back
- Wood arm caps + \$113
- Black urethane arm caps + \$113
- 2" twin-wheel casters, front fixed with brakes, back swivel + \$158
- CTB-133 + \$81/yard
- Two fabrics + \$62
- Three (or more) fabrics + \$88

Specification Decisions

- Select fabric
- Select standard wood finish
- Add moisture barrier
- Add CTB-133
- Apply multiple fabrics
- Add casters
- Add urethane or wood arm caps

Flammability Type

- Type 7

Key Dimensions

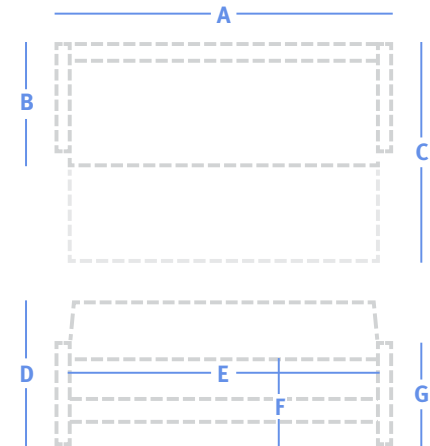

A	Width	See price table
B	Depth	36.5"
C	Extended Depth	85"
D	Overall Height	35"
E	Seat Width	56.75"
F	Seat Height	17.75"
G	Arm Height	24.5"

Model	64.25" W, Sleep settee								251 lbs 12.5 yds
	Series 2	Series 3	Series 4	Series 5	Series 6	Series 7	Series 8	COM	
FX156-27	\$4,414	\$4,809	\$5,464	\$6,149	\$6,968	\$7,721	\$8,750	\$4,809	

Beaumont Sleep Chair and Settee



Standard Features

- Replaceable components
- Removable covers
- Fully upholstered arms
- Non-marring 2 ¼" glides
- Heavy-duty mechanism
- Pull-out sleep surface
- Sleep surface dimensions (Chair) 27" x 80"
- Sleep surface dimensions (Settee) 54" x 80"
- Antimicrobial surface at head and foot
- Nemschoff healthcare wood finish
- GREENGUARD Gold Certified
- Limited Lifetime Warranty; five years on mechanism

Available Options

- Moisture barrier + \$67 per seat or back
- Wood arm caps + \$113
- Black urethane arm caps + \$113
- 2" twin-wheel casters, front fixed with brakes, back swivel + \$158
- CTB-133 + \$81/yd
- Two fabrics + \$62
- Three (or more) fabrics + \$88

Specification Decisions

- Select fabric
- Select standard wood finish
- Add moisture barrier
- Add CTB-133
- Apply multiple fabrics
- Add casters

- Add urethane or wood arm caps

Flammability Type

- Type 7

Key Dimensions

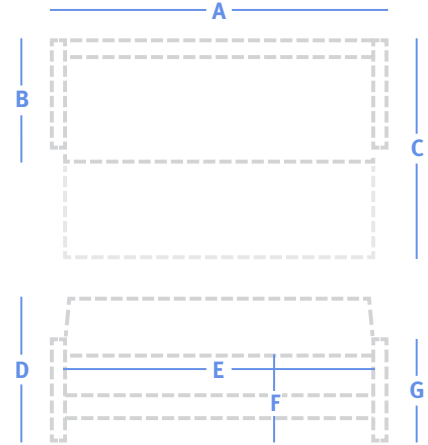

A	Width	See price table
B	Depth	36.5"
C	Extended Depth	85"
D	Overall Height	35"
E	Seat Width	
	Chair	27.25"
	Settee	54"
F	Seat Height	17.75"
G	Arm Height	24.5"

More Information

Illustrated Glossary ▶ 439

Fabrics ▶ 451

Flammability (CTB-133) ▶ 459

Finishes ▶ 456

Ordering and Warranties ▶ 462



34.5" W, Sleep chair

131 lbs | 7.5 yds

Model	Series 2	Series 3	Series 4	Series 5	Series 6	Series 7	Series 8	COM
FX153-17	\$2,543	\$2,780	\$3,173	\$3,584	\$4,076	\$4,527	\$5,145	\$2,780



61.5" W, Sleep settee

237 lbs | 12.5 yds

Model	Series 2	Series 3	Series 4	Series 5	Series 6	Series 7	Series 8	COM
FX153-27	\$3,621	\$4,016	\$4,671	\$5,356	\$6,175	\$6,928	\$7,957	\$4,016

Brava Flop Sofa



More Information

Illustrated Glossary ▶ 439

Fabrics ▶ 451

Flammability (CTB-133) ▶ 459

Finishes ▶ 456

Ordering and Warranties ▶ 462

Standard Features

- Mortise and tenon joinery
- Spring seat construction
- Replaceable components
- Upholstered arms
- Non-marring 7/8" rubber-cushioned glides
- Removable seat and back covers
- Back cushion flops down to convert to sleep surface (no mechanism)
- Sleep surface dimensions 78.5" x 30"
- Antimicrobial, moisture-proof and cleanable sleep surface
- Nemschoff healthcare wood finish
- GREENGUARD Gold Certified
- Limited Lifetime Warranty

Available Options

- Moisture barrier + \$67 per seat or back
- Wood arm caps + \$113
- Black urethane arm caps + \$113
- Desert or Pewter urethane arm caps + \$205
- CTB-133 + \$81/yd
- Two fabrics + \$62
- Three (or more) fabrics + \$88

Specification Decisions

- Select fabric
- Select standard wood finish
- Add moisture barrier
- Add CTB-133
- Apply multiple fabrics
- Add wood or urethane arm caps

Flammability Type

- Type 7

Coordinating Products

- [Brava Classic Lounge Seating](#)
- [Brava Platform Lounge Seating](#)
- [Brava 862 Multiple Seating](#)
- [Brava 863 Multiple Seating](#)
- [Brava Side Chair](#)
- [Brava Tables](#)
- [Brava Adjustable Back Chair](#)
- [Brava CompactComfort Recliner](#)
- [Brava Patient Chair](#)
- [Brava Glider](#)
- [Brava Sleep Settee](#)

Key Dimensions

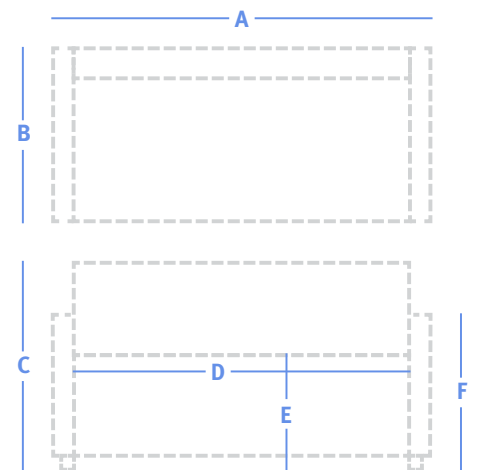

A	Overall Width	See price table
B	Overall Depth	35.25"
C	Overall Height	32.25"
D	Seat Width	71"
E	Seat Height	18"
F	Arm Height	22.5"



78.5" W, Flop sofa

141 lbs | 14 yds

Model	Series 2	Series 3	Series 4	Series 5	Series 6	Series 7	Series 8	COM
861-37	\$3,964	\$4,411	\$5,152	\$5,927	\$6,848	\$7,779	\$8,943	\$4,411

Brava Sleep Settee



Standard Features

- Mortise and tenon joinery
- Spring seat construction
- Replaceable components
- Upholstered arms
- Non-marring 7/8" rubber-cushioned glides
- Dual extending sides (15" on left and right)
- Sleep surface dimensions 78" x 25"
- Integral vented storage compartment
- Nemschoff healthcare wood finish
- GREENGUARD Gold Certified
- Limited Lifetime Warranty; five years on mechanism

Available Options

- Moisture barrier + \$67 per seat or back
- Wood arm caps + \$113
- Black urethane arm caps + \$113
- Desert or Pewter urethane arm caps + \$205
- Four 2" twin-wheel swivel casters with brakes + \$421
- CTB-133 + \$81/yd
- Two fabrics + \$62
- Three (or more) fabrics + \$88

Specification Decisions

- Select fabric
- Select standard wood finish
- Add moisture barrier
- Add CTB-133
- Apply multiple fabrics
- Add wood or urethane arm caps
- Add casters

Model numbers with **S** indicate standard seat and back covers, and model numbers with **P** indicate removable covers.

Flammability Type

- Type 6

Coordinating Products

- [Brava Classic Lounge Seating](#)
- [Brava Platform Lounge Seating](#)
- [Brava 862 Multiple Seating](#)
- [Brava 863 Multiple Seating](#)
- [Brava Side Chair](#)
- [Brava Tables](#)
- [Brava Adjustable Back Chair](#)
- [Brava CompactComfort Recliner](#)
- [Brava Patient Chair](#)
- [Brava Glider](#)
- [Brava Flop Sofa](#)

Key Dimensions

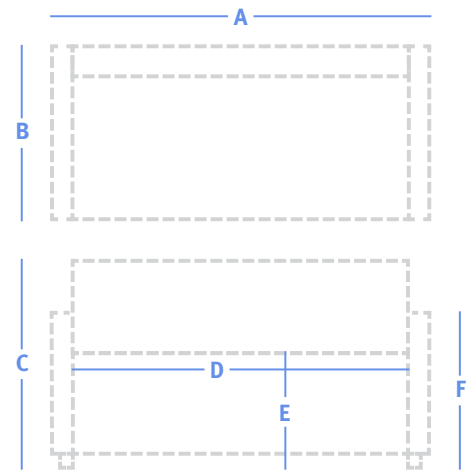

A	Overall Width	See price table 84.75" (extended)
B	Overall Depth	31.75"
C	Overall Height	33.5"
D	Seat Width	47.75"
E	Seat Height	19"
F	Arm Height	24.75"

More Information

- Illustrated Glossary ▶ 439
- Fabrics ▶ 451
- Flammability (CTB-133) ▶ 459
- Finishes ▶ 456
- Ordering and Warranties ▶ 462



55.25" W, Sleep settee

183 lbs | 9.75 yds

Model	Series 2	Series 3	Series 4	Series 5	Series 6	Series 7	Series 8	COM
861-27 S	\$4,269	\$4,580	\$5,096	\$5,636	\$6,278	\$6,926	\$7,737	\$4,580
861-27 P	\$4,819	\$5,130	\$5,646	\$6,186	\$6,828	\$7,476	\$8,287	\$5,130

Consoul Sleep Chair and Settee



More Information

Illustrated Glossary ▶ 439

Fabrics ▶ 451

Flammability (CTB-133) ▶ 459

Finishes ▶ 456

Ordering and Warranties ▶ 462

Standard Features

- Solid maple frame
- Spring seat construction
- Replaceable components
- Clean-out design
- Upholstered arms
- Removable covers
- Wallsaver bumper
- 3" swivel casters, front-locking
- One-hand pull to convert to a completely flat sleep surface
- Sleep surface dimensions (Chair) 24.25" x 77.5"
- Sleep surface dimensions (Settee) 54.25" x 77.5"
- Antimicrobial surface for the foot area
- Nemschoff healthcare wood finish
- GREENGUARD Gold Certified
- Limited Lifetime Warranty; ten years on mechanism

Available Options

- Moisture barrier + \$67 per seat or back
- Option package 1: Arm caps (wood or urethane) with thermoplastic (ABS) protective base + \$615
- Option package 2: Arm caps (wood or urethane) with thermoplastic (ABS) protective base and in-arm storage + \$897
- Monitor arm (LSF, RSF) + \$410
- Tablet table (LSF, RSF; laminate with wood edge) + \$513
- CTB-133 + \$81/yd
- Two fabrics + \$62
- Three (or more) fabrics + \$88

Specification Decisions

- Select fabric
- Select wallsaver bumper color (Black, Desert, Pewter)
- Add option package 1 or package 2
- Select standard wood finish, if required
- Select thermoplastic (ABS) color, if required (Black, Desert, Pewter)
- Add moisture barrier
- Add CTB-133
- Apply multiple fabrics
- Add monitor arm
- Add tablet table (specify laminate and wood edge color)

Flammability Type

- Type 7

Coordinating Products

- [Consoul Recliner](#)

Key Dimensions

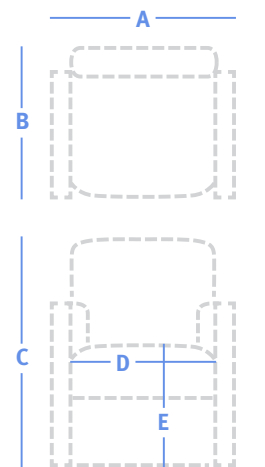

A	Overall Width	See price table
B	Overall Depth	40" 88" (extended)
C	Overall Height	34.5"
D	Seat Width	24.5", 54.25"
E	Seat Height	17.75"
F	Arm Height	26.5"

Consoul Sleep Chair and Settee



35.5" W, Sleep chair

184 lbs | 7.25 yds

Model	Series 2	Series 3	Series 4	Series 5	Series 6	Series 7	Series 8	COM
798-17	\$3,479	\$3,711	\$4,095	\$4,496	\$4,974	\$5,456	\$6,059	\$3,711



62.5" W, Sleep settee

293 lbs | 16 yds

Model	Series 2	Series 3	Series 4	Series 5	Series 6	Series 7	Series 8	COM
798-27	\$4,500	\$5,011	\$5,858	\$6,743	\$7,797	\$8,860	\$10,191	\$5,011

Leonard II Sleep Double Sofa and Sleep Settee



More Information

Illustrated Glossary ▶ 439

Fabrics ▶ 451

Flammability (CTB-133) ▶ 459

Finishes ▶ 456

Ordering and Warranties ▶ 462

Standard Features

- Spring seat construction
- Replaceable components
- Removable covers (Double sofa)
- Wood arm caps
- Non-marring 2¼" glides
- LSF or RSF extension (Settee)
- Sleep surface dimensions (Settee) 78" x 25"
- Sleep surface dimensions (Sofa) 80" x 54"
- Antimicrobial, moisture-proof and cleanable sleep surface (Double sofa)
- Integral storage compartments
- Nemschoff healthcare wood finish
- GREENGUARD Gold Certified
- Limited Lifetime Warranty; five years on mechanism

Available Options

- Moisture barrier + \$67 per seat or back
- Classic upholstered bottom panel + 271
- Fully upholstered arms + \$113
- Black urethane arm caps + \$113
- CTB-133 + \$81/yd
- Two fabrics + \$62
- Three (or more) fabrics + \$88

Specification Decisions

- Select fabric
- Select standard wood finish
- Select LSF or RSF extension (Settee)
- Add moisture barrier
- Add CTB-133
- Apply multiple fabrics
- Add urethane or fully upholstered arm caps
- Add fully upholstered arms
- Add classic panel (Double sofa)

Model numbers with **S** indicate standard seat and back covers, and model numbers with **P** indicate removable covers.

Sofa uses a standard XL full sheet.

Flammability Type

- Type 7

Coordinating Products

- [Leonard II Lounge Seating](#)
- [Leonard II Recliner](#)

Key Dimensions

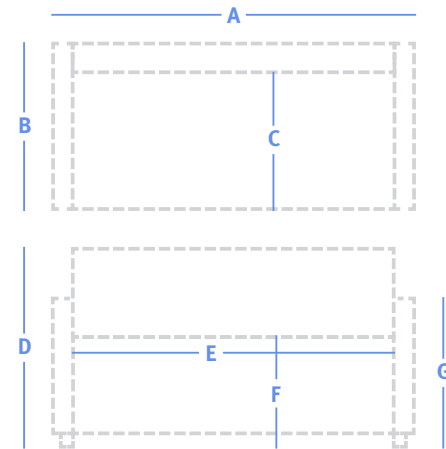

A	Overall Width	See price table 85" (extended Settee)
B	Overall Depth	37.75"
C	Seat Depth	31.75" 57" (extended Sofa)
D	Overall Height	33", 35.5"
E	Seat Width	47.25", 80"
F	Seat Height	18.75"
G	Arm Height	25.75"

Leonard II Sleep Double Sofa and Sleep Settee

		88" W, Sleep double sofa								278 lbs 11.25 yds
Model		Series 2	Series 3	Series 4	Series 5	Series 6	Series 7	Series 8	COM	
814-37		\$5,727	\$6,086	\$6,682	\$7,304	\$8,045	\$8,793	\$9,728	\$6,086	

		55.25" W, Sleep settee with LSF or RSF extension								155 lbs 9.75 yds
Model		Series 2	Series 3	Series 4	Series 5	Series 6	Series 7	Series 8	COM	
814-27X S		\$4,129	\$4,440	\$4,956	\$5,496	\$6,138	\$6,786	\$7,597	\$4,440	
814-27X P		\$4,662	\$4,973	\$5,489	\$6,029	\$6,671	\$7,319	\$8,130	\$4,973	

Merge Flop Sofa



More Information

Illustrated Glossary ▶ 439

Fabrics ▶ 451

Flammability (CTB-133) ▶ 459

Finishes ▶ 456

Ordering and Warranties ▶ 462

Standard Features

- Mortise and tenon joinery
- Spring seat construction
- Replaceable components
- Clean-out design
- Upholstered arms
- Continuous seat cushion
- Back cushion flops down to convert to sleep surface (no mechanism); dimensions 82" x 30"
- Laminated panel beneath back cushion and laminated back panel
- Plinth base with 2¼" plastic glides
- Antimicrobial, moisture-proof and cleanable sleep surface
- Removable covers
- GREENGUARD Gold Certified
- Limited Lifetime Warranty; five years on mechanism

Available Options

- Moisture barrier + \$67 per seat or back
- Solid surface arm caps + \$308
- Black urethane or wood arm caps + \$113
- Upholstered back panel + \$513
- CTB-133 + \$81/yard
- Two fabrics + \$62
- Three (or more) fabrics + \$88
- Laminate front panels + \$0
- Stationary center table, laminated top + \$513
- Adjustable center table, laminated top + \$1,538
- Solid surface tabletop + \$820
- Veneer tabletop + \$154
- Storage drawer (upholstered or laminated front) + \$185
- Storage drawer (Durawrap front) + \$216
- Drawer liner + \$62 each
- Footrest (lever mounted on laminated recessed panel) + \$410
- Upholstered arm panel for footrest mount + \$0
- Concealed, front-locking casters + \$513

Specification Decisions

- Select fabric
- Select standard wood finish or laminate, if required
- Add moisture barrier
- Add CTB-133
- Apply multiple fabrics
- Add footrest (LSF, RSF or both)
- Add laminated front panels
- Add storage drawers (one, two or three)
- Add stationary or adjustable center table
- Add upholstered back panel
- Add solid-surface, urethane, or wood arm caps
- Add casters
- Add drawer liners

Each footrest adds 1" to overall width

Footrest and storage drawer cannot be ordered on the same seating position

Stationary and adjustable center table is 26.75" W x 21.25" D

Table adjusts from 19" H to 29.5" H

Flammability Type



- Type 7

Merge Flop Sofa

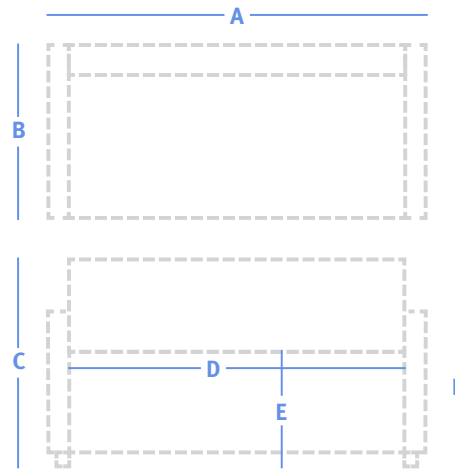
Key Dimensions



A	Overall Width	See price table
B	Overall Depth	35" 57" (extended footrest)
C	Overall Height	33.5"
D	Seat Width	74.75"
E	Seat Height	19"
F	Arm Height	23.75"

 	82" W, Flop sofa									376 lbs 10 yds
	Model	Series 2	Series 3	Series 4	Series 5	Series 6	Series 7	Series 8	COM	
865-37	\$4,133	\$4,452	\$4,981	\$5,535	\$6,193	\$6,858	\$7,689	\$4,452		

Monarch Sleep Chair and Settee



More Information

Illustrated Glossary ▶ 439

Fabrics ▶ 451

Flammability (CTB-133) ▶ 459

Finishes ▶ 456

Ordering and Warranties ▶ 462

Standard Features

- Solid maple frame
- Mortise and tenon joinery
- Spring seat construction
- Replaceable components
- Removable covers
- Clean-out design
- Black urethane arm caps
- 2" front-locking, total-lock casters
- Sleep surface dimensions (Chair) 24.25" x 77.5"
- Sleep surface dimensions (Settee) 54.25" x 77.5"
- One-hand pull to convert to a completely flat sleep surface
- Antimicrobial surface at foot area
- Nemschoff healthcare wood finish
- GREENGUARD Gold Certified
- Limited Lifetime Warranty; five years on mechanism

Available Options

- Moisture barrier + \$67 per seat or back
- Wood arm caps + \$113
- CTB-133 + \$81
- Two fabrics + \$62
- Three (or more) fabrics + \$88
- Tablet table (LSF, RSF; laminated with wood edge) + \$513
- Monitor arm (LSF, RSF) + \$410

Specification Decisions

- Select fabric
- Select standard wood finish
- Add moisture barrier
- Add CTB-133
- Apply multiple fabrics
- Add wood arm caps
- Add tablet table (LSF, RSF), specify laminate and wood edge color
- Add monitor arm (Indicate LSF or RSF)

Flammability Type

- Type 7

Coordinating Products

- [Monarch Lounge Seating](#)
- [Monarch Multiple Seating](#)
- [Monarch Stack Chair](#)
- [Monarch Tables](#)
- [Monarch Patient Chair](#)

Key Dimensions

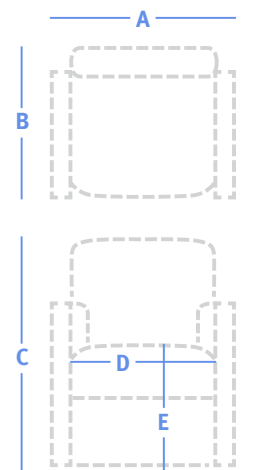

A	Overall Width	See price table
B	Overall Depth	36.75", 37.75" 86" (extended)
C	Overall Height	34"
D	Seat Width	24.25", 54.5"
E	Seat Height	17.5"
F	Arm Height	24.25"

Welcoming & Waiting

Monarch Sleep Chair and Settee



29.5" W, Sleep chair

164 lbs | 6.5 yds

Model	Series 2	Series 3	Series 4	Series 5	Series 6	Series 7	Series 8	COM
894-17	\$3,504	\$3,711	\$4,055	\$4,415	\$4,843	\$5,275	\$5,816	\$3,711



59.5" W, Sleep settee

248 lbs | 13.75 yds

Model	Series 2	Series 3	Series 4	Series 5	Series 6	Series 7	Series 8	COM
894-27	\$4,572	\$5,011	\$5,739	\$6,500	\$7,405	\$8,319	\$9,462	\$5,011

Patient Areas

Specialty

Reference

Oliver Sleep Settee



More Information

Illustrated Glossary ▶ 439

Fabrics ▶ 451

Flammability (CTB-133) ▶ 459

Finishes ▶ 456

Ordering and Warranties ▶ 462

Standard Features

- Mortise and tenon joinery
- Spring seat construction
- Replaceable components
- Upholstered arms
- LSF or RSF extension
- Non-marring $\frac{7}{8}$ " rubber-cushioned glides
- Sleep surface dimensions 78" x 25"
- Integral storage compartment
- Nemschoff healthcare wood finish
- GREENGUARD Gold Certified
- Limited Lifetime Warranty; five years on mechanism

Available Options

- Moisture barrier + \$67 per seat or back
- Four 2" twin-wheel swivel casters with brakes + \$421
- CTB-133 + \$81/yard
- Two fabrics + \$62
- Three (or more) fabrics + \$88

Specification Decisions

- Select fabric
- Select standard wood finish
- Select LSF or RSF extension
- Add moisture barrier
- Add CTB-133
- Apply multiple fabrics
- Add casters

Model numbers with **S** indicate standard seat and back covers, and model numbers with **P** indicate removable covers.

Flammability Type

- Type 6

Coordinating Products

- [Oliver Lounge Seating](#)
- [Oliver Recliner](#)

Key Dimensions

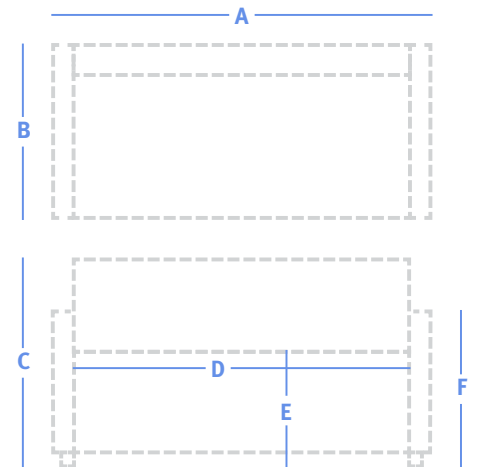

A	Overall Width	60.25" 89.75" Extended
B	Overall Depth	31.75"
C	Overall Height	33"
D	Seat Width	47.25"
E	Seat Height	18.5"
F	Arm Height	25.5"

		60" W, Sleep settee with LSF or RSF extension							155 lbs 10.25 yds	
Model		Series 2	Series 3	Series 4	Series 5	Series 6	Series 7	Series 8	COM	
902-27X S		\$4,033	\$4,360	\$4,903	\$5,470	\$6,145	\$6,826	\$7,678	\$4,360	
902-27X P		\$4,557	\$4,884	\$5,427	\$5,994	\$6,669	\$7,350	\$8,202	\$4,884	

Pamona Flop Sofa



Standard Features

- Mortise and tenon joinery
- Spring seat construction
- Replaceable components
- Removable seat and back covers
- Upholstered arms
- Powder-coated metal legs
- Wallsaver legs
- 1" plastic glides
- Back cushion flops down to convert to sleep surface (no mechanism)
- Sleep surface dimensions 80.25" x 30"
- Antimicrobial, moisture-proof and cleanable sleep surface
- GREENGUARD Gold Certified
- Limited Lifetime Warranty

Available Options

- Moisture barrier + \$67 per seat or back
- Black urethane arm caps + \$113
- Wood arm caps + \$113
- 3" twin-wheel swivel casters with brake and directional lock on rear only; standard legs in front + \$341
- CTB-133 + \$81/yard
- Two fabrics + \$62
- Three (or more) fabrics + \$88

Specification Decisions

- Select fabric
- Select powder-coated finish
- Add moisture barrier
- Add CTB-133
- Apply multiple fabrics
- Add urethane arm caps
- Add casters

Flammability Type

- Type 7

Coordinating Products

- [Pamona Lounge Seating](#)
- [Pamona Tables](#)
- [Pamona Recliner](#)

Key Dimensions

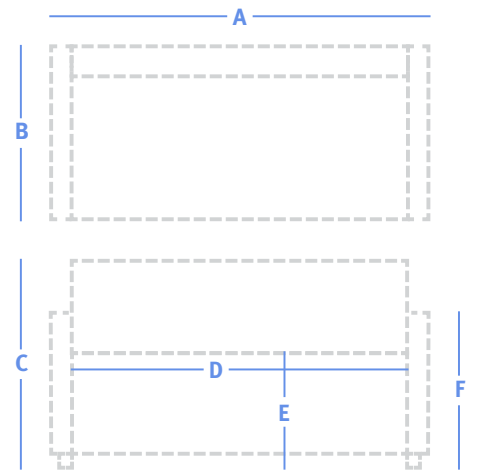

A	Overall Width	80.25"
B	Overall Depth	36"
C	Overall Height	32.75"
D	Seat Width	71"
E	Seat Height	18.5"
F	Arm Height	22.75"

More Information

- Illustrated Glossary ▶ 439
- Fabrics ▶ 451
- Flammability (CTB-133) ▶ 459
- Finishes ▶ 456
- Ordering and Warranties ▶ 462



80.25" W, Flop sofa

141 lbs | 12 yds

Model	Series 2	Series 3	Series 4	Series 5	Series 6	Series 7	Series 8	COM
797-37	\$3,452	\$3,835	\$4,470	\$5,134	\$5,924	\$6,722	\$7,720	\$3,835

Revive Guest Center



More Information

Illustrated Glossary ▶ 439

Fabrics ▶ 451

Flammability (CTB-133) ▶ 459

Finishes ▶ 456

Ordering and Warranties ▶ 462

Standard Features

- Wipe-out design
- Powder-coated legs
- Sliding sleep deck with no mechanism (except RVS36/80X2, RVS36/80X2-FP)
- Removable upholstery on sleep deck
- Upholstery applied railroaded
- Sleep surface dimensions (single) 72" x 28"
- Sleep surface dimensions (double) 72" x 49.75"
- Two storage drawers with laminate or veneer fronts
- Rear storage trough on twin size (RVS15/72, RVS15/72-FP)
- GREENGUARD Gold Certified
- Limited Lifetime Warranty

Available Options

- Moisture barrier + \$67 per seat or back
- Tablet arm + \$119
- Tablet arm with light receptacle + \$170
- Side table + \$385
- Infill panel (cannot be combined with caster lift) + \$189
- CTB-133 + \$81/yard
- Two fabrics + \$62
- Three (or more) fabrics + \$88
- Deck tray + \$106
- Caster lift + \$391

Specification Decisions

- Select fabric
- Select powder-coated finish
- Select laminated or veneer finish for drawer fronts
- Add moisture barrier
- Add CTB-133
- Apply multiple fabrics
- Add lower infill panel
- Add deck tray
- Add tablet arm
- Add tablet arm with light receptacle
- Add side table
- Add caster lift

Upholstery applied railroaded as standard.

Caster lift cannot be combined with infill panel.

Flammability Type

- Type 7

Coordinating Products

- [Revive Side Chair](#)
- [Revive Patient Chair](#)
- [Revive Casegoods](#)
- [Revive Daystands](#)
- [Revive Display System](#)

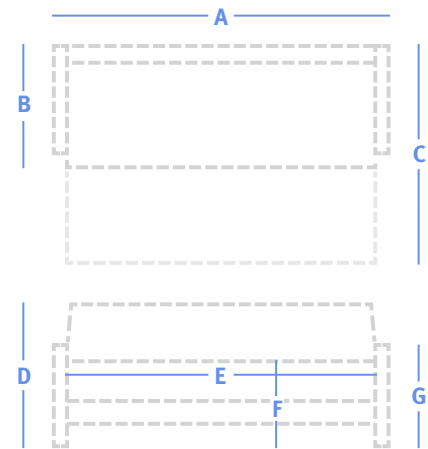

Key Dimensions



A	Width	See price table
B	Depth	28", 34"
C	Extended Depth	34", 46", 49.75"
D	Overall Height	33"
E	Seat Width	72"
F	Seat Height	17.5"
G	Arm Height	24"



Revive Guest Center



Welcoming & Waiting

		72" W, Single guest center without arms									200 lbs 6 yds
Model	Series 2	Series 3	Series 4	Series 5	Series 6	Series 7	Series 8	COM			
RVS10/72	\$3,775	\$3,842	\$4,134	\$4,291	\$4,377	\$4,489	\$4,561	\$3,842			

		72" W, Single guest center without arms, with fascia panel									200 lbs 6 yds
Model	Series 2	Series 3	Series 4	Series 5	Series 6	Series 7	Series 8	COM			
RVS10/72-FP	\$3,152	\$3,219	\$3,511	\$3,668	\$3,754	\$3,866	\$3,938	\$3,219			

Patient Areas



		72" W, Twin guest center without arms, with rear storage trough									250 lbs 6 yds
Model	Series 2	Series 3	Series 4	Series 5	Series 6	Series 7	Series 8	COM			
RVS15/72	\$4,410	\$4,477	\$4,769	\$4,926	\$5,012	\$5,124	\$5,196	\$4,477			



		72" W, Twin guest center without arms, with fascia panel and rear storage trough									250 lbs 6 yds
Model	Series 2	Series 3	Series 4	Series 5	Series 6	Series 7	Series 8	COM			
RVS15/72-FP	\$3,785	\$3,852	\$4,144	\$4,301	\$4,387	\$4,499	\$4,571	\$3,852			

		80" W, Guest center with single arm									225 lbs 7 yds
Model	Series 2	Series 3	Series 4	Series 5	Series 6	Series 7	Series 8	COM			
RVS30/80	\$4,413	\$4,523	\$5,004	\$5,263	\$5,403	\$5,588	\$5,706	\$4,523			

Specialty



		80" W, Guest center with single arm and fascia panel									225 lbs 8 yds
Model	Series 2	Series 3	Series 4	Series 5	Series 6	Series 7	Series 8	COM			
RVS30/80-FP	\$3,792	\$3,902	\$4,383	\$4,642	\$4,782	\$4,967	\$5,085	\$3,902			

		80" W, Guest center with twin arms and rear storage trough									250 lbs 7 yds
Model	Series 2	Series 3	Series 4	Series 5	Series 6	Series 7	Series 8	COM			
RVS35/80	\$4,865	\$4,975	\$5,456	\$5,715	\$5,855	\$6,040	\$6,158	\$4,975			

		80" W, Guest center with twin arms, fascia panel and rear storage trough									250 lbs 8 yds
Model	Series 2	Series 3	Series 4	Series 5	Series 6	Series 7	Series 8	COM			
RVS35/80-FP	\$4,241	\$4,351	\$4,832	\$5,091	\$5,231	\$5,416	\$5,534	\$4,351			

Reference

		80" W, Guest center with single arced arm									225 lbs 7 yds
Model	Series 2	Series 3	Series 4	Series 5	Series 6	Series 7	Series 8	COM			
RVS31/80	\$4,413	\$4,523	\$5,004	\$5,263	\$5,403	\$5,588	\$5,706	\$4,523			

		80" W, Guest center with single arced arm and fascia panel									225 lbs 8 yds
Model	Series 2	Series 3	Series 4	Series 5	Series 6	Series 7	Series 8	COM			
RVS31/80-FP	\$3,792	\$3,902	\$4,383	\$4,642	\$4,782	\$4,967	\$5,085	\$3,902			

Revive Guest Center

 	80" W, Guest center with twin arced arms and rear storage trough								250 lbs 8 yds
	Model	Series 2	Series 3	Series 4	Series 5	Series 6	Series 7	Series 8	COM
	RVS36/80	\$4,865	\$4,975	\$5,456	\$5,715	\$5,855	\$6,040	\$6,158	\$4,975
 	80" W, Guest center with twin arced arms, fascia panel and rear storage trough								250 lbs 9.5 yds
	Model	Series 2	Series 3	Series 4	Series 5	Series 6	Series 7	Series 8	COM
	RVS36/80-FP	\$3,792	\$3,902	\$4,383	\$4,642	\$4,782	\$4,967	\$5,085	\$3,902
 	80" W, Guest center with double sleep surface and fold-down back								235 lbs 9.5 yds
	Model	Series 2	Series 3	Series 4	Series 5	Series 6	Series 7	Series 8	COM
	RVS36/80X2	\$4,896	\$5,046	\$5,699	\$6,050	\$6,240	\$6,491	\$6,652	\$5,046
	RVS36/80X2-FP	\$4,321	\$4,431	\$4,912	\$5,171	\$5,311	\$5,496	\$5,614	\$4,431
 	72" W, Guest center bench								180 lbs 3.25 yds
	Model	Series 2	Series 3	Series 4	Series 5	Series 6	Series 7	Series 8	COM
	RVSB10/72	\$3,194	\$3,245	\$3,469	\$3,589	\$3,653	\$3,739	\$3,795	\$3,245
 	72" W, Guest center bench with fascia panel								181 lbs 3.25 yds
	Model	Series 2	Series 3	Series 4	Series 5	Series 6	Series 7	Series 8	COM
	RVSB10/72-FP	\$2,572	\$2,623	\$2,846	\$2,966	\$3,031	\$3,117	\$3,172	\$2,623
 	72" W, Guest center bench								205 lbs 4.5 yds
	Model	Series 2	Series 3	Series 4	Series 5	Series 6	Series 7	Series 8	COM
	RVSB15/72	\$3,266	\$3,337	\$3,646	\$3,813	\$3,903	\$4,022	\$4,098	\$3,337
 	72" W, Guest center bench with fascia panel								205 lbs 4.5 yds
	Model	Series 2	Series 3	Series 4	Series 5	Series 6	Series 7	Series 8	COM
	RVSB15/72-FP	\$2,647	\$2,715	\$3,007	\$3,164	\$3,249	\$3,360	\$3,433	\$2,715

Patient Chairs

Recliners

Treatment Chairs

Rockers & Gliders

Overbed Tables

Sleepover Seating

Casegoods

Display & Accessories

Serenity II Sleep Chair



Standard Features

- Mortise and tenon joinery
- Spring seat construction
- Replaceable components
- Removable back and seat covers
- Urethane arm caps
- Infinite recline positions, from upright to fully flat (chair needs to be 18" from the wall to fully recline)
- Sleep surface dimensions 24.25" x 79"
- Independent footrest and back operation
- 5" casters, front swivel with brakes, rear fixed
- Nemschoff healthcare wood finish
- GREENGUARD Gold Certified
- Limited Lifetime Warranty; five years on mechanism

Available Options

- Moisture barrier + \$67 per seat or back
- Optional activation button location + \$63
- Dual activation button location + \$289
- CTB-133 + \$81/yd
- Two fabrics + \$62
- Three (or more) fabrics + \$88

Specification Decisions

- Select fabric
- Add moisture barrier
- Add CTB-133
- Apply multiple fabrics
- Add recline activation

Flammability Type

- Type 6

Coordinating Products

- [Serenity II Treatment Chair](#)
- [Serenity IIS Treatment Chair](#)
- [Serenity III Treatment Chair](#)

Key Dimensions

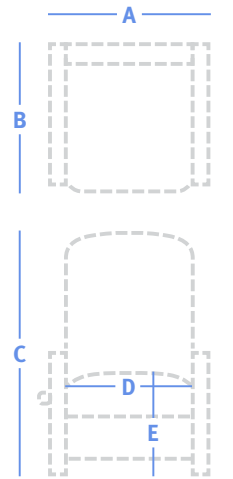

A	Overall Width	See price table
B	Overall Depth	43.5" 79" (extended)
C	Overall Height	49"
D	Seat Width	24.25"
E	Seat Height	19.5"
F	Arm Height	26.5"

More Information

- Illustrated Glossary ▶ 439
- Fabrics ▶ 451
- Flammability (CTB-133) ▶ 459
- Finishes ▶ 456
- Ordering and Warranties ▶ 462



35" W, Sleep chair

132 lbs | 6.75 yds

Model	Series 2	Series 3	Series 4	Series 5	Series 6	Series 7	Series 8	COM
790-17	\$3,831	\$4,046	\$4,404	\$4,777	\$5,221	\$5,670	\$6,231	\$4,046

SleepOver 1-2-3 Chair



More Information

Illustrated Glossary ▶ 439

Fabrics ▶ 451

Flammability (CTB-133) ▶ 459

Finishes ▶ 456

Ordering and Warranties ▶ 462

Standard Features

- Mortise and tenon joinery
- Spring seat construction
- Replaceable components
- Wood arm caps
- Non-marring $\frac{5}{8}$ " x 2" glides
- Sleep surface dimensions (standard) 22.75" x 72"
- Sleep surface dimensions (wide) 28.75" x 72"
- Integral storage compartment
- Removable cover on sleep surface
- Nemschoff healthcare wood finish
- GREENGUARD Gold Certified
- Limited Lifetime Warranty; five years on mechanism

Available Options

- Moisture barrier + \$67 per seat or back
- Black urethane arm caps + \$113
- Two front 2" swivel casters + \$104
- 2" twin-wheel swivel casters, rear with brakes + \$326
- CTB-133 + \$81/yd
- Two fabrics + \$62
- Three (or more) fabrics + \$88

Specification Decisions

- Select standard wood finish
- Select fabric
- Add moisture barrier
- Add CTB-133
- Apply multiple fabrics
- Add casters
- Add urethane arm caps

Model numbers with **S** indicate standard seat and back covers, and model numbers with **P** indicate removable covers.

Flammability Type

- Type 6

Coordinating Products

- [SleepOver Bench](#)
- [SleepOver Flop Sofa](#)
- [SleepOver Settee](#)
- [SleepOver Sofa](#)

Key Dimensions

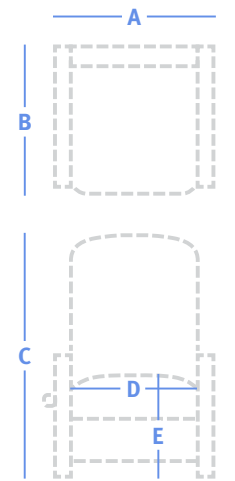

A	Overall Width	See price table
B	Overall Depth	35.25" 70.25" (extended)
C	Overall Height	36.75"
D	Seat Width	22.75", 28.75"
E	Seat Height	18.75"
F	Arm Height	24.5"

	31.25" W, Sleep chair									106 lbs 7 yds
	Model	Series 2	Series 3	Series 4	Series 5	Series 6	Series 7	Series 8	COM	
	780-17 S	\$2,948	\$3,171	\$3,542	\$3,929	\$4,390	\$4,855	\$5,437	\$3,171	
	780-17 P	\$3,329	\$3,552	\$3,923	\$4,310	\$4,771	\$5,236	\$5,818	\$3,552	
	37.25" W, Wide sleep chair									118 lbs 10.5 yds
	Model	Series 2	Series 3	Series 4	Series 5	Series 6	Series 7	Series 8	COM	
	780-17W S	\$3,161	\$3,496	\$4,052	\$4,633	\$5,324	\$6,022	\$6,895	\$3,496	
	780-17W P	\$3,581	\$3,916	\$4,472	\$5,053	\$5,744	\$6,442	\$7,315	\$3,916	

SleepOver Bench



Standard Features

- Mortise and tenon joinery
- Spring seat construction
- Replaceable components
- Upholstered arms on select models
- Non-marring 7/8" rubber-cushioned glides
- Sleep surface dimensions 76.25" x 36"
- Antimicrobial, moisture-proof and cleanable sleep surface
- Integral storage compartment
- Nemschoff healthcare wood finish
- GREENGUARD Gold Certified
- Limited Lifetime Warranty

Available Options

- Moisture barrier + \$67 per seat or back
- Black urethane arm caps on select models + \$113
- Wood arm caps on select models + \$113
- Four 2" twin-wheel swivel casters with brakes + \$345
- CTB-133 + \$81/yd
- Two fabrics + \$62
- Three (or more) fabrics + \$88

Specification Decisions

- Select fabric
- Add moisture barrier
- Add CTB-133
- Apply multiple fabrics
- Add casters
- Add wood or urethane arm caps

Model numbers with **S** indicate standard seat and back covers, and model numbers with **P** indicate removable covers.

Flammability Types

- Type 4
- Type 7 (with back)

Coordinating Products

- [SleepOver 1-2-3 Chair](#)
- [SleepOver Flop Sofa](#)
- [SleepOver Settee](#)
- [SleepOver Sofa](#)

Key Dimensions

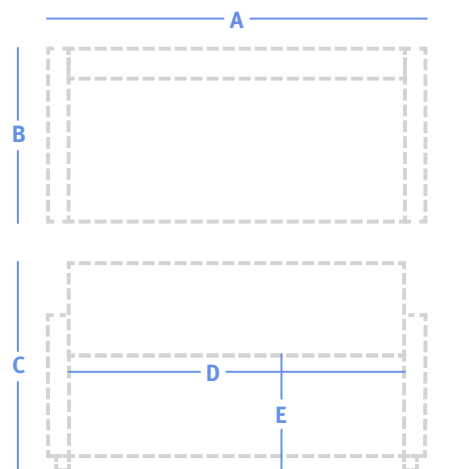

A	Overall Width	See price table
B	Overall Depth	20.25" - 24" (back)
C	Overall Height	24.75", 18.5", 33.5"
D	Seat Width	78.25"
E	Seat Height	18.5"
F	Arm Height	24.75"

More Information

Illustrated Glossary ▶ 439

Fabrics ▶ 451

Flammability (CTB-133) ▶ 459

Finishes ▶ 456

Ordering and Warranties ▶ 462

SleepOver Bench

										161 lbs 8.25 yds
	78.25" W, Bench									
	Model	Series 2	Series 3	Series 4	Series 5	Series 6	Series 7	Series 8	COM	
	781-B17 S	\$3,508	\$3,771	\$4,208	\$4,664	\$5,208	\$5,756	\$6,442	\$3,771	
	781-B17 P	\$3,961	\$4,224	\$4,661	\$5,117	\$5,661	\$6,209	\$6,895	\$4,224	
	90.75" W, Bench with arms									191 lbs 9 yds
	Model	Series 2	Series 3	Series 4	Series 5	Series 6	Series 7	Series 8	COM	
	781-B17A S	\$3,740	\$4,027	\$4,504	\$5,002	\$5,594	\$6,192	\$6,941	\$4,027	
	781-B17A P	\$4,224	\$4,511	\$4,988	\$5,486	\$6,078	\$6,676	\$7,425	\$4,511	
	78.25" W, Bench with back									217 lbs 10.25 yds
	Model	Series 2	Series 3	Series 4	Series 5	Series 6	Series 7	Series 8	COM	
	781-B17B S	\$3,791	\$4,118	\$4,661	\$5,228	\$5,903	\$6,584	\$7,436	\$4,118	
	781-B17B P	\$4,285	\$4,612	\$5,155	\$5,722	\$6,397	\$7,078	\$7,931	\$4,612	
	90.75" W, Bench with arms and back									247 lbs 11.5 yds
	Model	Series 2	Series 3	Series 4	Series 5	Series 6	Series 7	Series 8	COM	
	781-B17AB S	\$3,888	\$4,255	\$4,864	\$5,500	\$6,257	\$7,022	\$7,978	\$4,255	
	781-B17AB P	\$4,399	\$4,766	\$5,375	\$6,011	\$6,768	\$7,533	\$8,489	\$4,766	

Patient Chairs

Recliners

Treatment Chairs

Rockers & Gliders

Overbed Tables

Sleepover Seating

Casegoods

Display & Accessories

SleepOver Flop Sofa



Standard Features

- Mortise and tenon joinery
- Spring seat construction
- Replaceable components
- Plinth base
- Wood legs (785-37)
- Brushed-aluminum legs (796-37)
- Removable seat and back covers
- Back cushion flops down to convert to sleep surface (no mechanism)
- Upholstered arms
- Sleep surface dimensions 78.75" x 27.5"
- Antimicrobial, moisture proof, and cleanable sleep surface
- Integral storage compartments (location based on model)
- Non-marring 2¼" glides
- GREENGUARD Gold Certified
- Limited Lifetime Warranty

Available Options

- Moisture barrier + \$67 per seat or back
- Brushed stainless steel-look legs (785-37) + \$338
- CTB-133 + \$81/yard
- Two fabrics + \$62
- Three (or more) fabrics + \$88

Specification Decisions

- Select fabric
- Select standard wood finish
- Add moisture barrier
- Add CTB-133
- Apply multiple fabrics

Flammability Type

- Type 7

Coordinating Products

- [SleepOver 1-2-3 Chair](#)
- [SleepOver Bench](#)
- [SleepOver Settee](#)
- [SleepOver Sofa](#)

Key Dimensions

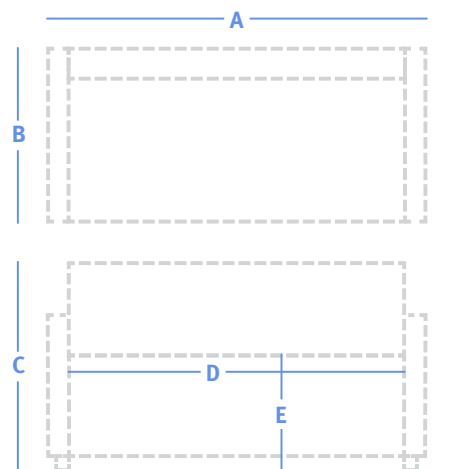

A	Overall Width	See price table
B	Overall Depth	35.5", 34", 36.25"
C	Overall Height	33", 34.25"
D	Seat Width	55"
E	Seat Height	18"
F	Arm Height	22.5"

More Information

Illustrated Glossary ▶ 439











Fabrics ▶ 451

Flammability (CTB-133) ▶ 459

Finishes ▶ 456

Ordering and Warranties ▶ 462

SleepOver Flop Sofa

		79.75" W, Flop sofa with arm storage								152 lbs 15 yds
Model		Series 2	Series 3	Series 4	Series 5	Series 6	Series 7	Series 8	COM	
785-37		\$4,231	\$4,710	\$5,504	\$6,334	\$7,321	\$8,319	\$9,566	\$4,710	
		79.25" W, Flop sofa with arm storage, plinth base, and under-seat drawers								202 lbs 15 yds
Model		Series 2	Series 3	Series 4	Series 5	Series 6	Series 7	Series 8	COM	
793-37		\$4,231	\$4,710	\$5,504	\$6,334	\$7,321	\$8,319	\$9,566	\$4,710	
		79.25" W, Flop sofa with flush arm storage, plinth base, and under-seat drawers								202 lbs 15 yds
Model		Series 2	Series 3	Series 4	Series 5	Series 6	Series 7	Series 8	COM	
794-37		\$4,231	\$4,710	\$5,504	\$6,334	\$7,321	\$8,319	\$9,566	\$4,710	
		79.25" W, Flop sofa with narrow arm storage and under-seat storage								202 lbs 15 yds
Model		Series 2	Series 3	Series 4	Series 5	Series 6	Series 7	Series 8	COM	
795-37		\$4,231	\$4,710	\$5,504	\$6,334	\$7,321	\$8,319	\$9,566	\$4,710	
		81.25" W, Flop sofa with arm storage and aluminum legs								152 lbs 12 yds
Model		Series 2	Series 3	Series 4	Series 5	Series 6	Series 7	Series 8	COM	
796-37		\$4,327	\$4,710	\$5,345	\$6,009	\$6,799	\$7,597	\$8,595	\$4,710	

Patient Chairs

Recliners

Treatment Chairs

Rockers & Gliders

Overbed Tables

Sleeper Seating

Casegoods

Display & Accessories

SleepOver Settee



More Information

Illustrated Glossary ▶ 439

Fabrics ▶ 451

Flammability (CTB-133) ▶ 459

Finishes ▶ 456

Ordering and Warranties ▶ 462

Standard Features

- Mortise and tenon joinery
- Spring seat construction
- Replaceable components
- Wood arm caps (782, 783)

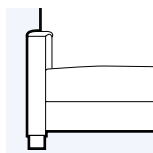

782 Cities

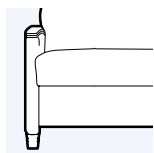

783 Concerto

- Upholstered arms (784)

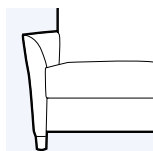

784 Prelude

- Non-marring $\frac{5}{8}$ " x 2" glides (except 783, 784)
- Sleep surface dimensions 78" x 25"
- Integral storage compartment
- Nemschoff healthcare wood finish
- GREENGUARD Gold Certified
- Limited Lifetime Warranty; five years on mechanism

Available Options

- Moisture barrier + \$67 per seat or back
- 2" twin-wheel swivel casters with brakes + \$421
- Three arm cap choices (782XX-27) + \$0
- Three leg choices (782XX-27) + \$0
- Side extension for sleep surface (LSF, RSF)
- CTB-133 + \$81/yd
- Two fabrics + \$62
- Three (or more) fabrics + \$88

Specification Decisions

- Select fabric
- Select standard wood finish
- Select arm cap style (782XX-27)

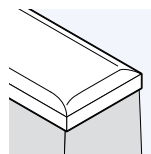

Y New York

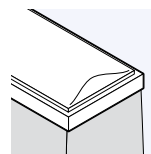

C Chicago

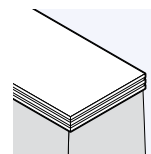

N New Orleans

- Select foot style (782XX-27)

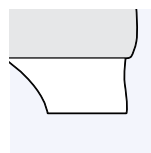

W Williamsburg

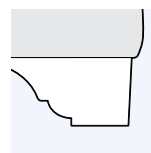

C Chicago

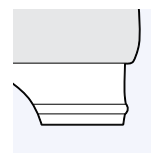

N New Orleans

- Select side extension for sleep surface
- Add moisture barrier
- Add CTB-133
- Apply multiple fabrics
- Add casters

Model numbers with **S** indicate standard seat and back covers, and model numbers with **P** indicate removable covers.

Flammability Type

- Type 6

Coordinating Products

- [SleepOver 1-2-3 Chair](#)
- [SleepOver Bench](#)
- [SleepOver Flop Sofa](#)
- [SleepOver Sofa](#)

SleepOver Settee

Key Dimensions

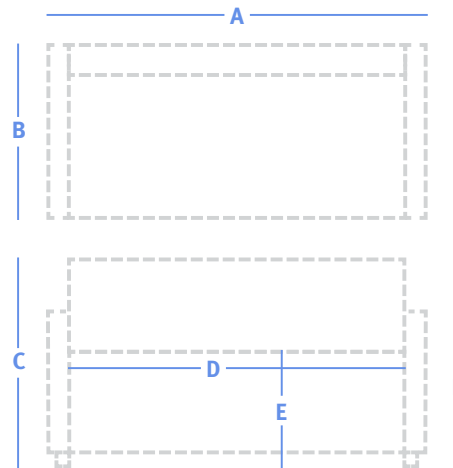

A	Overall Width	See price table 85" 87" Extended
B	Overall Depth	31.5"
C	Overall Height	31.5"
D	Seat Width	48"
E	Seat Height	18.5"
F	Arm Height	25"



55" W, Settee with Cities arm caps and foot style

151 lbs | 10 yds

Model	Series 2	Series 3	Series 4	Series 5	Series 6	Series 7	Series 8	COM
782XX-27XS	\$4,041	\$4,360	\$4,889	\$5,443	\$6,101	\$6,766	\$7,597	\$4,360
782XX-27XP	\$4,565	\$4,884	\$5,413	\$5,967	\$6,625	\$7,290	\$8,121	\$4,884



55" W, Settee with wood Concerto arms

151 lbs | 9.5 yds

Model	Series 2	Series 3	Series 4	Series 5	Series 6	Series 7	Series 8	COM
783-27XS	\$4,057	\$4,360	\$4,863	\$5,389	\$6,014	\$6,646	\$7,436	\$4,360
783-27XP	\$4,581	\$4,884	\$5,387	\$5,913	\$6,538	\$7,170	\$7,960	\$4,884



57" W, Settee with upholstered Prelude arm

151 lbs | 10 yds

Model	Series 2	Series 3	Series 4	Series 5	Series 6	Series 7	Series 8	COM
784-27XS	\$4,041	\$4,360	\$4,889	\$5,443	\$6,101	\$6,766	\$7,597	\$4,360
784-27XP	\$4,565	\$4,884	\$5,413	\$5,967	\$6,625	\$7,290	\$8,121	\$4,884

SleepOver Sofa



More Information

Illustrated Glossary ▶ 439

Fabrics ▶ 451

Flammability (CTB-133) ▶ 459

Finishes ▶ 456

Hardware ▶ 457

Ordering and Warranties ▶ 462

Standard Features

- Mortise and tenon joinery
- Replaceable components
- Removable covers
- Wood arm caps (786, 787)

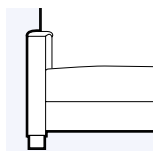

786 Cities

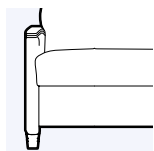

787 Concerto

- Upholstered arms (788)

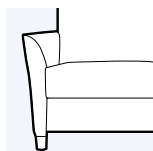

788 Prelude

- Sleep surface 80" x 39"
- Wood storage drawers with full extension drawer glides
- Laminate drawer fronts
- 5/8" x 2" glides
- Nemschoff healthcare wood finish
- GREENGUARD Gold Certified
- Limited Lifetime Warranty; five years on mechanism

Available Options

- Moisture barrier + \$67 per seat or back
- Three arm cap choices (786X-37) + \$0
- CTB-133 + \$81/yd
- Two fabrics + \$62
- Three (or more) fabrics + \$88

Specification Decisions

- Select fabric
- Select standard wood finish
- Select standard laminate
- Select arm cap style (786X-37)

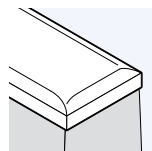

Y New York

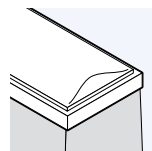

C Chicago

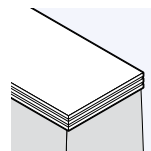

N New Orleans

- Add moisture barrier
- Add CTB-133
- Apply multiple fabrics

Flammability Type

- Type 7

Coordinating Products



- [SleepOver 1-2-3 Chair](#)
- [SleepOver Bench](#)
- [SleepOver Flop Sofa](#)
- [SleepOver Settee](#)

SleepOver Sofa

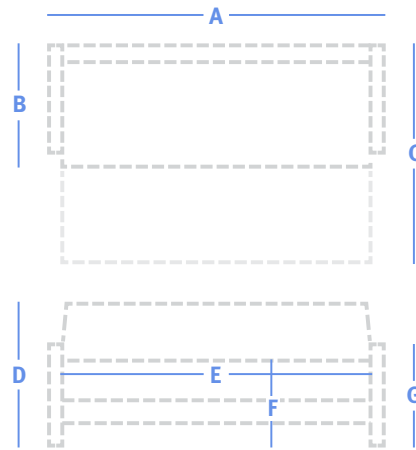
Key Dimensions



A	Width	See price table
B	Depth	30"
C	Extended Depth	44.5", 45.5" (786X)
D	Overall Height	35.25"
E	Seat Width	80"
F	Seat Height	18.5"
G	Arm Height	24.75"

	86.5" W, Sofa with Cities arm caps 249 lbs 14.5 yds								
	Model	Series 2	Series 3	Series 4	Series 5	Series 6	Series 7	Series 8	COM
	786X-37	\$4,808	\$5,271	\$6,039	\$6,841	\$7,795	\$8,759	\$9,965	\$5,271
	86.5" W, Sofa with wood Concerto arms 249 lbs 13.5 yds								
	Model	Series 2	Series 3	Series 4	Series 5	Series 6	Series 7	Series 8	COM
	787-37	\$4,840	\$5,271	\$5,986	\$6,733	\$7,621	\$8,519	\$9,641	\$5,271
	88.5" W, Sofa with upholstered Prelude arm 249 lbs 14.75 yds								
	Model	Series 2	Series 3	Series 4	Series 5	Series 6	Series 7	Series 8	COM
	788-37	\$4,800	\$5,271	\$6,052	\$6,868	\$7,839	\$8,819	\$10,046	\$5,271

Patient Chairs

Recliners

Treatment Chairs

Rockers & Gliders

Overbed Tables

Sleepover Seating

Casegoods

Display & Accessories

Bedford Casegoods



Standard Features

- Maple veneer case or maple veneer case with cherry inlay
- Dry construction joinery
- Replaceable components
- Nemschoff healthcare wood finish
- GREENGUARD Gold Certified
- Limited Lifetime Warranty

More Information

- Illustrated Glossary ▶ 439
- Finishes ▶ 456
- Hardware ▶ 457
- Ordering and Warranties ▶ 462

Bedford Bedside Cabinets and Nightstands

Standard Features

- Same standard features as Bedford Casegoods, plus:
- Laminate top with maple edges
 - Wood drawer pans
 - Vented back panel (bedside cabinets)
 - Concealed hinges

Available Options

- Two foot styles + \$0
- Casters + \$273
- Door and drawer pulls + \$0
- Gallery design + \$232
- OP/10 Cam locks + \$34
- OP/17 Plastic drawer liner + \$52 ea

Specification Decisions

- Select standard wood finish for maple veneer
 - 40** Wheat **43** Plum
 - 44** Wild Cherry **45** Pecan
- Add gallery design, see nemschoff.com
- Add casters
- Add locks
- Add plastic drawer liners
- Select standard laminate
- Select foot style
 - B** Bun foot **T** Tube foot
- Select pull style
 - 1** Bedford **2** Bedford
 - 2C** Bedford **3** Bedford
 - 3C** Bedford **3N** Bedford

	19.5" W, Bedside cabinet - one drawer, one door; maple with cherry inlay				80 lbs
	Model	Price	Depth	Height	
	BFFA01	\$1,162	20"	34"	
	19.5" W, Bedside cabinet - one drawer, one door; maple				80 lbs
	Model	Price	Depth	Height	
	BFFA01A	\$1,107	20"	34"	

Bedford Casegoods

	19.5" W, Bedside cabinet - three drawer; maple with cherry inlay 80 lbs		
Model	Price	Depth	Height
BFFA03	\$1,381	20"	30"
	19.5" W, Bedside cabinet - three drawer; maple 80 lbs		
Model	Price	Depth	Height
BFFA03A	\$1,314	20"	30"
	19.5" W, Nightstand - one drawer; maple with cherry inlay 64 lbs		
Model	Price	Depth	Height
BFFG01	\$941	20"	22"
	19.5" W, Nightstand - one drawer; maple 64 lbs		
Model	Price	Depth	Height
BFFG01A	\$894	20"	22"

Bedford Chests

Standard Features

Same standard features as Bedford Casegoods, plus:

- Laminate top with maple edges
- Wood drawer pans

Available Options

- Two foot styles + \$0
- Door and drawer pulls + \$0
- Gallery design + \$118
- See [page 410](#) for additional options

Specification Decisions

- Select standard wood finish for maple veneer

- Select maple with cherry inlay finish

40 Wheat **43** Plum
44 Wild Cherry **45** Pecan

Maple with Cherry Inlay (Veneer)

- Select standard laminate

- Select foot style

B Bun foot **T** Tube foot

- Select pull style

1 Bedford **2** Bedford
2C Bedford **3** Bedford
3C Bedford **3N** Bedford

- See [page 410](#) for additional options

	25.5" W, Narrow chest - three drawer; maple with cherry inlay 95 lbs		
Model	Price	Depth	Height
BFFC03	\$1,495	20"	30"
	25.5" W, Narrow chest - three drawer; maple 95 lbs		
Model	Price	Depth	Height
BFFC03A	\$1,419 \$	20"	30"
	31.5" W, Chest - three drawer; maple with cherry 110 lbs		
Model	Price	Depth	Height
BFFB03	\$1,828	20"	30"

Bedford Casegoods



31.5" W, Chest - three drawer; maple

110 lbs

Model	Price	Depth	Height
BFFB03A	\$1,736	20"	30"



31.5" W, Chest - four drawer; maple with cherry inlay

115 lbs

Model	Price	Depth	Height
BFFB04	\$2,126	20"	38"



31.5" W, Chest - four drawer; maple

115 lbs

Model	Price	Depth	Height
BFFB04A	\$2,021	20"	38"

Bedford Headboards, Footboard, Headwall and Bed Locator

Standard Features

- Same standard features as Bedford Casegoods., plus
- Maple veneer case
- Veneer top (headwall)
- 270-degree hinges (headwall)

Available Options

- Gallery design (CA/H33-BFF, BFFP/3F, BFFP/3H) + \$146
- Gallery design (CA/H46-BFF) + \$186
- Gallery design (CA/H50-BFF) + \$218
- Wall-mount security fasteners (headboards) + \$55
- Drawer and door pulls (Headwalls) + \$0
- Electric duplex - specify line or emergency power (Bed locator) + \$114
- Night light (Bed locator) + \$184
- Bed receptacle simplex (Bed locator) + \$208
- 37-pin Adapter (Bed locator) + \$304

Specification Decisions

- Select standard wood finish for maple veneer
 - Select maple with cherry inlay finish

40 Wheat	43 Plum
44 Wild Cherry	45 Pecan

Maple with Cherry Inlay (Veneer)
 - Select pull style
 - Add gallery design, see nemschoff.com
 - Add fasteners
 - Add electrical options
- Headboards that mount to adjustable bed frames include wood legs and mounting hardware.
- Headboards and footboards for hospital beds can be modified in size and can include mounting holes.
- Custom headwalls are available. Contact your customer service representative for pricing.



42.75" W, Twin headboard for adjustable bed frames; maple with cherry inlay

24 lbs

Model	Price	Depth	Height
CA/H33-BFF	\$717		35.5"



42.75" W, Twin headboard for adjustable bed frames; maple

24 lbs

Model	Price	Depth	Height
CA/H33-BFFA	\$685		35.5"

Bedford Casegoods

	57.75" W, Full headboard for adjustable bed frames; maple with cherry inlay				33 lbs
	Model	Price	Depth	Height	
	CA/H46-BFF	\$891		35.5"	
	57.75" W, Full headboard for adjustable bed frames; maple				33 lbs
	Model	Price	Depth	Height	
	CA/H46-BFFA	\$850		35.5"	
	63.75" W, Queen headboard for adjustable bed frames; maple with cherry inlay				39 lbs
	Model	Price	Depth	Height	
	CA/H50-BFF	\$1,043		35.5"	
	63.75" W, Queen headboard for adjustable bed frames; maple				39 lbs
	Model	Price	Depth	Height	
	CA/H50-BFFA	\$998		35.5"	
	39" W - 60" W, Adjustable bed frame				15 lbs
	Model	Price	Depth	Height	
	CA/1	\$182			
	35" W, Footboard for hospital beds; maple with cherry inlay				20 lbs
	Model	Price	Depth	Height	
	BFFP/3F	\$393		16"	
	35" W, Footboard for hospital beds; maple				20 lbs
	Model	Price	Depth	Height	
	BFFP/3FA	\$376		16"	
	35" W, Headboard with cherry inlay for hospital beds				23 lbs
	Model	Price	Depth	Height	
	BFFP/3H	\$401		16"	
	35" W, Headboard for hospital beds; maple				23 lbs
	Model	Price	Depth	Height	
	BFFP/3HA	\$384		16"	
	96" W, Headwall; maple with cherry inlay				183 lbs
	Model	Price	Depth	Height	
	BFFU/21	\$13,980	14.25"	27.25"	

Patient Chairs

Recliners

Treatment Chairs

Rockers & Gliders

Overbed Tables

Sleepover Seating

Casegoods

Display & Accessories

Bedford Casegoods

	96" W, Headwall; maple				183 lbs
Model		Price	Depth	Height	
BFFU/21A		\$13,439	14.25"	27.25"	
Bed locator base unit					
Model		Price	Depth	Height	
BLBU		\$2,000			

Bedford Mirror

Standard Features

- Solid maple frame

Specification Decisions

- Select standard wood finish

	25" W, Mirror; maple				30 lbs
Model		Price	Depth	Height	
BFFM39A		\$310		45"	

Bedford Wardrobes and Armoires

Standard Features

- Same standard features as Bedford Casegoods, plus:
- Maple veneer case
 - Veneer top with maple edges (wardrobes 72" or higher)
 - Laminate top with maple edges
 - Wood drawer pans
 - Concealed hinges

Available Options

- Two foot styles + \$0
- Add door and drawer pulls + \$0
- Wood two-drawer interior cabinet + \$518
- See [page 412](#) for additional options

Specification Decisions

- Select standard wood finish for maple veneer
- Select maple with cherry inlay finish











40 Wheat	43 Plum
44 Wild Cherry	45 Pecan
- Select standard laminate, if required
- Select foot style

B Bun foot	T Tube foot
-------------------	--------------------
- Select pull style

1 Bedford	2 Bedford
2C Bedford	3 Bedford
3C Bedford	3N Bedford
- See [page 412](#) for additional options

	25.5" W, Wardrobe (hinged right) - fixed shelf and clothes bar; maple with cherry inlay				173 lbs
Model		Price	Depth	Height	
BFFW25		\$2,293	24"	76"	

Bedford Casegoods

	25.5" W, Wardrobe (hinged right) - fixed shelf and clothes bar; maple 173 lbs		
Model	Price	Depth	Height
BFFW25A	\$2,178	24"	76"
	25.5" W, Wardrobe (hinged left) - fixed shelf and clothes bar; maple with cherry inlay 173 lbs		
Model	Price	Depth	Height
BFFW26	\$2,293	24"	76"
	25.5" W, Wardrobe (hinged left) - fixed shelf and clothes bar; maple 173 lbs		
Model	Price	Depth	Height
BFFW26A	\$2,178	24"	76"
	31.5" W, TV armoire - three drawers, no doors; maple with cherry inlay - TV opening: 22" W x 20.75" D x 16.75" H 207 lbs		
Model	Price	Depth	Height
BFFT30	\$3,365	24.5"	58"
	31.5" W, TV armoire - three drawers, no doors; maple - TV opening: 22" W x 20.75" D x 16.75" H 207 lbs		
Model	Price	Depth	Height
BFFT30A	\$3,196	24.5"	58"
	31.5" W, TV armoire - pocket doors, three drawers; maple with cherry inlay - TV opening: 22" W x 20.75" D x 16.75" H 217 lbs		
Model	Price	Depth	Height
BFFT31	\$3,703	24.5"	58"
	31.5" W, TV armoire - pocket doors, three drawers; maple - TV opening: 22" W x 20.75" D x 16.75" H 217 lbs		
Model	Price	Depth	Height
BFFT31A	\$3,517	24.5"	58"
	37.5" W, Wardrobe - two doors, fixed shelf, clothes bar; maple with cherry inlay 213 lbs		
Model	Price	Depth	Height
BFFW38	\$2,716	24"	72"
	37.5" W, Wardrobe - two doors, fixed shelf, clothes bar; maple 213 lbs		
Model	Price	Depth	Height
BFFW38A	\$2,581	24"	72"
	37.5" W, TV armoire - pocket doors, three drawers; maple with cherry inlay - TV opening: 28" W x 20.75" D x 21.25" H 217 lbs		
Model	Price	Depth	Height
BFFT39	\$4,148	24.5"	58"

Patient Chairs

Recliners

Treatment Chairs

Rockers & Gliders







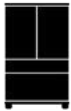

Overbed Tables

Sleepover Seating

Casegoods

Display & Accessories

Bedford Casegoods

	37.5" W, TV armoire - pocket doors, three drawers; maple - TV opening: 28" W x 20.75" D x 21.25" H	217 lbs							
	<table border="1"> <thead> <tr> <th>Model</th> <th>Price</th> <th>Depth</th> <th>Height</th> </tr> </thead> <tbody> <tr> <td>BFFT39A</td> <td>\$3,943</td> <td>24.5"</td> <td>58"</td> </tr> </tbody> </table>	Model	Price	Depth	Height	BFFT39A	\$3,943	24.5"	58"
Model	Price	Depth	Height						
BFFT39A	\$3,943	24.5"	58"						
	49" W, Wardrobe - two doors and center divider; maple with cherry inlay	213 lbs							
	<table border="1"> <thead> <tr> <th>Model</th> <th>Price</th> <th>Depth</th> <th>Height</th> </tr> </thead> <tbody> <tr> <td>BFFW50</td> <td>\$3,314</td> <td>24"</td> <td>72"</td> </tr> </tbody> </table>	Model	Price	Depth	Height	BFFW50	\$3,314	24"	72"
Model	Price	Depth	Height						
BFFW50	\$3,314	24"	72"						
	49" W, Wardrobe - two doors and center divider; maple	213 lbs							
	<table border="1"> <thead> <tr> <th>Model</th> <th>Price</th> <th>Depth</th> <th>Height</th> </tr> </thead> <tbody> <tr> <td>BFFW50A</td> <td>\$3,149</td> <td>24"</td> <td>72"</td> </tr> </tbody> </table>	Model	Price	Depth	Height	BFFW50A	\$3,149	24"	72"
Model	Price	Depth	Height						
BFFW50A	\$3,149	24"	72"						
	55" W, TV wardrobe (hinged right) - pocket doors, three drawers; maple with cherry inlay - TV opening: 28" W x 20.75" D x 21.25" H	380 lbs							
	<table border="1"> <thead> <tr> <th>Model</th> <th>Price</th> <th>Depth</th> <th>Height</th> </tr> </thead> <tbody> <tr> <td>BFFT55</td> <td>\$6,105</td> <td>24.5"</td> <td>60"</td> </tr> </tbody> </table>	Model	Price	Depth	Height	BFFT55	\$6,105	24.5"	60"
Model	Price	Depth	Height						
BFFT55	\$6,105	24.5"	60"						
	55" W, TV wardrobe (hinged right) - pocket doors, three drawers; maple - TV opening: 28" W x 20.75" D x 21.25" H	380 lbs							
	<table border="1"> <thead> <tr> <th>Model</th> <th>Price</th> <th>Depth</th> <th>Height</th> </tr> </thead> <tbody> <tr> <td>BFFT55A</td> <td>\$5,801</td> <td>24.5"</td> <td>60"</td> </tr> </tbody> </table>	Model	Price	Depth	Height	BFFT55A	\$5,801	24.5"	60"
Model	Price	Depth	Height						
BFFT55A	\$5,801	24.5"	60"						
	55" W, TV wardrobe (hinged left) - pocket doors, three drawers; maple with cherry inlay	380 lbs							
	<table border="1"> <thead> <tr> <th>Model</th> <th>Price</th> <th>Depth</th> <th>Height</th> </tr> </thead> <tbody> <tr> <td>BFFT56</td> <td>\$6,105</td> <td>24.5"</td> <td>64"</td> </tr> </tbody> </table>	Model	Price	Depth	Height	BFFT56	\$6,105	24.5"	64"
Model	Price	Depth	Height						
BFFT56	\$6,105	24.5"	64"						
	55" W, TV wardrobe (hinged left) - pocket doors, three drawers; maple	380 lbs							
	<table border="1"> <thead> <tr> <th>Model</th> <th>Price</th> <th>Depth</th> <th>Height</th> </tr> </thead> <tbody> <tr> <td>BFFT56A</td> <td>\$5,801</td> <td>24.5"</td> <td>64"</td> </tr> </tbody> </table>	Model	Price	Depth	Height	BFFT56A	\$5,801	24.5"	64"
Model	Price	Depth	Height						
BFFT56A	\$5,801	24.5"	64"						
	60" W, TV wardrobe - two side wardrobes, pocket doors, three drawers; maple with cherry inlay	380 lbs							
	<table border="1"> <thead> <tr> <th>Model</th> <th>Price</th> <th>Depth</th> <th>Height</th> </tr> </thead> <tbody> <tr> <td>BFFT60</td> <td>\$6,447</td> <td>24.5"</td> <td>64"</td> </tr> </tbody> </table>	Model	Price	Depth	Height	BFFT60	\$6,447	24.5"	64"
Model	Price	Depth	Height						
BFFT60	\$6,447	24.5"	64"						
	60" W, TV wardrobe - two side wardrobes, pocket doors, three drawers; maple	380 lbs							
	<table border="1"> <thead> <tr> <th>Model</th> <th>Price</th> <th>Depth</th> <th>Height</th> </tr> </thead> <tbody> <tr> <td>BFFT60A</td> <td>\$6,123</td> <td>24.5"</td> <td>64"</td> </tr> </tbody> </table>	Model	Price	Depth	Height	BFFT60A	\$6,123	24.5"	64"
Model	Price	Depth	Height						
BFFT60A	\$6,123	24.5"	64"						

Bedford Casegoods

Bedford Writing Table

Standard Features

Same standard features as Bedford Casegoods, plus:

- Maple veneer case
- Laminate top
- Wood drawer pans

Available Options

- Drawer and door pulls + \$0
- OP/10 cam lock + \$34

Specification Decisions

- Select standard wood finish for maple veneer
- Select maple with cherry inlay finish

40 Wheat	43 Plum
44 Wild Cherry	45 Pecan
- Select laminate
- Select pull style

1 Bedford	2 Bedford
2C Bedford	3 Bedford
3C Bedford	3N Bedford
- Add lock

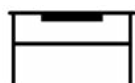
**48" W, Writing table with lower shelf; maple with cherry inlay**

120 lbs

Model	Price	Depth	Height
BFFF48	\$1,068	24.5"	30"

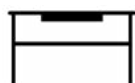
**48" W, Writing table with lower shelf; maple**

120 lbs

Model	Price	Depth	Height
BFFF48A	\$1,014	24.5"	30"

Patient Chairs

Recliners

Treatment Chairs

Rockers & Gliders

Overbed Tables

Sleepover Seating

Casegoods

Display & Accessories

Finley Casegoods



Standard Features

- Laminate case
- Dry construction joinery
- Replaceable components
- Nemschoff healthcare wood finish
- GREENGUARD Gold Certified
- Limited Lifetime Warranty

More Information

- Illustrated Glossary ▶ 439
- Finishes ▶ 456
- Hardware ▶ 457
- Ordering and Warranties ▶ 462

Finley Bedside Cabinets

Standard Features

- Same standard features as Finley Casegoods, plus:
- Durawrap tops, drawer fronts, doors, and base rails
- Plastic drawer pans
- Vented back panel
- Concealed hinges

Available Options

- Drawer and door pulls + \$0
- Casters + \$103
- Locking casters + \$182
- OP/10 cam locks + \$34 ea
- OP/16W wood drawer pans + \$84 ea
- OP/17 plastic drawer liners (for wood drawer pans) + \$52

Specification Decisions

- Select standard laminate
- Select Durawrap
- Select pull style
- Add casters
- Add locks
- Add wood drawer pans
- Add plastic drawer liners



20" W, Bedside cabinet - one drawer, one door and adjustable shelf

64 lbs

Model	Price	Depth	Height
FX702-01	\$736	19.25"	29.75"



20" W, Bedside cabinet - three drawers

52 lbs

Model	Price	Depth	Height
FX702-03	\$891	19.25"	29.75"

Finley Casegoods

Finley Chests

Standard Features

- Same standard features as Finley Casegoods, plus:
- Durawrap tops, drawer fronts, doors, and base rails
 - Plastic drawer pans

Available Options

- Drawer and door pulls
- See [page 410](#) for additional options

Specification Decisions

- Select standard laminate
- Select Durawrap
- Select pull style
- See [page 410](#) for additional options

**32" W, Chest - three drawers**

110 lbs

Model	Price	Depth	Height
FX702-3	\$1,087	19.25"	29.75"

**32" W, Chest - four drawers**

116 lbs

Model	Price	Depth	Height
FX702-4	\$1,238	19.25"	38"

**32" W, Chest - five drawers**

122 lbs

Model	Price	Depth	Height
FX702-5	\$1,389	19.25"	46"

Finley Headboards, Footboard and Bed Locator

Standard Features

Same standard features as Finley Casegoods

Available Options

- Wall mount security fasteners (headboards) + \$55
- Electric duplex - specify line or emergency power (Bed locator) + \$117
- Night light (Bed locator) + \$189
- Bed receptacle simplex (Bed locator) + \$214
- 37-pin Adapter (Bed locator) + \$312

Specification Decisions

- Select standard laminate
 - Add security fasteners
 - Add electrical options
- Headboards that mount to adjustable bed frames include wood legs and mounting hardware.
- Headboards and footboards for hospital beds can be modified in size and can include mounting holes.
- Contact your customer service representative for pricing.

**42.75" W, Twin headboard for adjustable bed frames**

24 lbs

Model	Price	Depth	Height
CA/H33-FX702	\$403		35.5"

**57.75" W, Full headboard for adjustable bed frames**

33 lbs

Model	Price	Depth	Height
CA/H46-FX702	\$501		35.5"

Finley Casegoods

	63.75" W, Queen headboard for adjustable bed frames				39 lbs
	Model CA/H50-FX702	Price \$586	Depth	Height 35.5"	
	39" W - 60" W, Adjustable bed frame				15 lbs
	Model CA/1	Price \$182	Depth	Height	
	35" W, Headboard for hospital beds				18 lbs
	Model FX702-3H	Price \$231	Depth	Height 18"	
	35" W, Footboard for hospital beds				15 lbs
	Model FX702-3F	Price \$217	Depth	Height 15"	
	Bed locator base unit				-
	Model BLBU	Price \$2,000	Depth	Height	

Finley Wardrobes and Armoires

Standard Features

- Same standard features as Finley Casegoods, plus:
- Durawrap tops, drawer fronts, doors, and base rails
 - Plastic drawer pans
 - Concealed hinges

Available Options

- Drawer and door pulls + \$0
- Laminate interior cabinet (2 plastic drawer pans, field installable) on FX702-25, -26, -39 + \$458
- See [page 412](#) for additional options

Specification Decisions

- Select standard laminate
- Select Durawrap
- Select pull styles
- See [page 412](#) for additional options

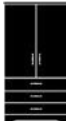
	24.5" W, Wardrobe (hinged right)				173 lbs
	Model FX702-25	Price \$1,257	Depth 22.75"	Height 72"	
	24.5" W, Wardrobe (hinged left)				173 lbs
	Model FX702-26	Price \$1,257	Depth 22.75"	Height 72"	
	38" W, TV Armoire - TV opening: 29W x 22.5D x 26.5H				217 lbs
	Model FX702-38	Price \$2,221	Depth 24"	Height 72"	

Finley Casegoods

**38" W, Double wardrobe**

213 lbs

Model	Price	Depth	Height
FX702-39	\$1,921	22.75"	72"

**51.5" W, TV wardrobe (hinged right) - TV opening: 29W x 22.5D x 26.5H**

380 lbs

Model	Price	Depth	Height
FX702-43	\$3,521	24"	72"

**51.5" W, TV wardrobe (hinged left) - TV opening: 29W x 22.5D x 26.5H**

380 lbs

Model	Price	Depth	Height
FX702-44	\$3,521	24"	72"

Patient Chairs

Recliners

Treatment Chairs

Rockers & Gliders

Overbed Tables

Sleepover Seating

Casegoods

Display & Accessories

Hadleigh Casegoods



Standard Features

- Maple veneer case
- Radiused edges
- Dry construction joinery
- Replaceable components
- Nemschoff healthcare wood finish
- GREENGUARD Gold Certified
- Limited Lifetime Warranty

Coordinating Products

- [Hadleigh Lounge Seating](#)
- [Hadleigh Tables](#)
- [Hadleigh Patient Chair](#)
- [Hadleigh Adjustable Back Chair](#)

More Information

[Illustrated Glossary](#) ▶ 439

[Finishes](#) ▶ 456

[Hardware](#) ▶ 457

[Ordering and Warranties](#) ▶ 462

Hadleigh Bedside Cabinets and Nightstand

Standard Features

- Same standard features as Hadleigh Casegoods, plus:
- Laminate top
 - Concealed hinges
 - Vented back panel
 - Wood drawer pans

Available Options

- Door and drawer pulls + \$0
- OP/13 casters + \$112
- OP/13LK locking casters + \$200
- OP/10 Cam locks + \$34 ea
- OP/17 Plastic drawer liner + \$52 ea

Specification Decisions

- Select standard wood finish
- Select standard laminate
- Select pull style
- Add casters
- Add locks
- Add plastic drawer liners



24.75" W, Nightstand - one drawer

55 lbs

Model	Price	Depth	Height
HDLG/01	\$1,048	20"	22"



24.75" W, Bedside Cabinet - one drawer and door

102 lbs

Model	Price	Depth	Height
HDLA/01	\$1,087	20.25"	30.25"



24.75" W, Bedside Cabinet - three drawers

119 lbs

Model	Price	Depth	Height
HDLA/03	\$1,247	20.25"	30.25"

Hadleigh Casegoods

Hadleigh Chests

Standard Features

Same standard features as Hadleigh Casegoods, plus:

- Maple veneer top
- Wood drawer pans

Available Options

- Door and drawer pulls + \$0
- See [page 410](#) for additional options

Specification Decisions

- Select standard wood finish
- Select pull style
- See [page 410](#) for additional options

**36.75" W, Chest - three drawers**

119 lbs

Model	Price	Depth	Height
HDLB/3	\$1,660	20.25"	30.25"

**36.75" W, Chest - four drawers**

173 lbs

Model	Price	Depth	Height
HDLB/4	\$1,919	20.25"	38.25"

**36.75" W, Chest - five drawers**

226 lbs

Model	Price	Depth	Height
HDLB/5	\$2,128	20.25"	46"

Hadleigh Headboards, Footboard, Headwall and Bed locator

Standard Features

Same standard features as Hadleigh Casegoods, plus:

- 270-degree hinges (headwalls)

Available Options

- Door and drawer pulls + \$0
- Wall mount security fasteners (Headboards) + \$55
- Electric duplex - specify line or emergency power (Bed locator) + \$117
- Night light (Bed locator) + \$189
- Bed receptacle simplex (Bed locator) + \$214
- 37-pin Adapter (Bed locator) + \$312

Specification Decisions

- Select standard wood finish
- Select pull style
- Add fasteners
- Add electrical options

42.75" W, Twin headboard for adjustable bed frames

15 lbs

Model	Price	Depth	Height
CA/H33-HDL	\$607		35.5"

57.75" W, Full headboard for adjustable bed frames

24 lbs

Model	Price	Depth	Height
CA/H46-HDL	\$754		35.5"

Hadleigh Casegoods

63.75" W, Queen headboard for adjustable bed frames

33 lbs

Model	Price	Depth	Height
CA/H50-HDL	\$882		35.5"

39" W - 60" W, Adjustable bed frame

15 lbs

Model	Price	Depth	Height
CA/1	\$182		

38" W, Headboard for hospital beds

16 lbs

Model	Price	Depth	Height
HDLP/3H	\$387		18"

38" W, Footboard for hospital beds

14 lbs

Model	Price	Depth	Height
HDLP/3F	\$371		15"

95.25" W, Headwall

171 lbs

Model	Price	Depth	Height
HDLU/21	\$13,655	14"	27.5"

Bed locator base unit

-

Model	Price	Depth	Height
BLBU	\$1,951		

Hadleigh Wardrobes and Armoires

Standard Features

- Same standard features as Hadleigh Casegoods, plus:
- Maple tops
 - Concealed hinges
 - Wood drawer pans

Available Options

- Drawer and door pulls + \$0
- OP/15C Wood two drawer interior cabinets + \$518
- See [page 412](#) for additional options

Specification Decisions

- Select standard wood finish
- Select pull style
- See [page 412](#) for additional options

32" W, Wardrobe (hinged right)

227 lbs

Model	Price	Depth	Height
HDLW/25	\$2,270	26"	77"

32" W, Wardrobe with (hinged left)

227 lbs

Model	Price	Depth	Height
HDLW/26	\$2,270	26"	77"

Hadleigh Casegoods

**44" W, Wardrobe - two doors**

298 lbs

Model	Price	Depth	Height
HDLW/38	\$2,762	26"	77"

**38.25" W, TV armoire - TV opening: 24.5W x 21.5D x 27H**

338 lbs

Model	Price	Depth	Height
HDLT/30	\$3,545	26"	72"

**51" W, TV wardrobe (hinged right) - TV opening: 29W x 22.5D x 26.5H**

440 lbs

Model	Price	Depth	Height
HDLT/50	\$5,189	26"	72"

**51" W, TV wardrobe (hinged left) - TV opening: 29W x 22.5D x 26.5H**

440 lbs

Model	Price	Depth	Height
HDLT/51	\$5,189	26"	72"

Patient Chairs

Recliners

Treatment Chairs

Rockers & Gliders

Overbed Tables

Sleepover Seating

Casegoods

Display & Accessories

Montello Casegoods



Standard Features

- Laminate case
- Dry construction joinery
- Replaceable components
- Nemschoff healthcare wood finish
- GREENGUARD Gold Certified
- Limited Lifetime Warranty

More Information

- Illustrated Glossary ▶ 439
- Finishes ▶ 456
- Hardware ▶ 457
- Ordering and Warranties ▶ 462

Montello Bedside Cabinets

Standard Features

- Same standard features as Montello Casegoods, plus:
- Laminate top with urethane edge (cloud, pewter, sable)
- Plastic drawer pans
- Vented back panel
- Concealed hinges
- Twin wheel 2" casters

Available Options

- Drawer and door pulls + \$0
- Casters with brakes + \$80
- OP/10 cam locks + \$34 ea
- Wood drawer pans + \$84 ea
- OP/17 plastic drawer liners (for wood drawer pans) + \$52

Specification Decisions

- Select standard laminate
- Select pull style
- Select urethane edge color
- Add casters with brakes
- Add locks
- Add wood drawer pans
- Add plastic drawer liners



20.5" W, Bedside cabinet - one drawer, one door and adjustable shelf

52 lbs

Model	Price	Depth	Height
FX700-01	\$651	21.5"	32.5"



20.5" W, Bedside cabinet - three drawer

52 lbs

Model	Price	Depth	Height
FX700-03	\$704	21.5"	32.5"

Montello Casegoods

Montello Headboard, Footboard, Headwall and Bed Locator

Standard Features

- Same standard features as Montello Casegoods, plus:
- Laminate top (headwalls)
 - 270-degree hinges (headwalls)

Available Options

- Drawer and door pulls + \$0
- Wall mount security fasteners (headboards) + \$55
- Electric duplex - specify line or emergency power (Bed locator) + \$117
- Night light (Bed locator) + \$189
- Bed receptacle simplex (Bed locator) + \$214
- 37-pin Adapter (Bed locator) + \$312

Specification Decisions

- Select standard laminate
- Select pull style
- Add security fasteners
- Add electrical options

	36" W, Headboard for hospitable beds				16 lbs
	Model	Price	Depth	Height	
	FX700-H	\$142		18"	
	36" W, Footboard for hospitable beds				14 lbs
	Model	Price	Depth	Height	
	FX700-F	\$137		15"	
	96" W, Headwall				163 lbs
	Model	Price	Depth	Height	
	FX700-21	\$9,740	14.5"	24.25"	
	Bed locator base unit				-
	Model	Price	Depth	Height	
	BLBU	\$1,951			

Patient Chairs

Recliners

Treatment Chairs

Rockers & Gliders

Overbed Tables

Sleepover Seating

Casegoods

Display & Accessories

Montello Casegoods

Montello Wardrobe and Armoire

Standard Features

- Same standard features as Montello Casegoods, plus:
- Laminate top
 - Plastic drawer pans
 - Concealed hinges
 - Brushed metal legs

Available Options

- Drawer and door pulls + \$0
- Laminate interior cabinet (2 plastic drawer pans, field installable) on FX700-38 + \$458
- OP/15B Wood two drawer interior cabinets (FX700-38) + \$518
- Wood drawer pans + \$89 ea
- See [page 412](#) for additional options

Specification Decisions

- Select standard laminate
- Select pull style
- Add drawer pans
- See [page 412](#) for additional options



33.5" W, TV armoire - TV opening: 22.75" W x 21.5" D x 26.5" H

226 lbs

Model	Price	Depth	Height
FX700-30	\$2,016	25"	72"



37.5" W, Wardrobe - two doors

213 lbs

Model	Price	Depth	Height
FX700-38	\$1,769	25"	72"

Perinatal Casegoods



Standard Features

- Maple veneer case and laminated top
- Dry construction joinery
- Replaceable components
- Black urethane edge on bottom panel
- Wood drawer pans
- 5" swivel casters, two locking
- Nemschoff healthcare wood finish
- GREENGUARD Gold Certified
- Limited lifetime warranty

Coordinating Products

- [Finley Casegoods](#)
- [Prague II Casegoods](#)

More Information

Illustrated Glossary ▶ 439

Finishes ▶ 456

Hardware ▶ 457

Ordering and Warranties ▶ 462

Perinatal Case Cart

Standard Features

- Same standard as Perinatal Casegoods features, plus:
- Large work surface with drop-leaf extension
 - Pass-through drawers
 - Casters

Available Options

- Drawer and door pulls + \$0
- OP/10 Cam locks + \$34
- OP10/A Cam lock with elbow catch + \$61

Specification Decisions

- Select standard wood finish
- Select laminate
- Select pull style
- Add locks



36" W, Perinatal case cart

158 lbs

Model	Price	Depth	Height
CSNT/20	\$4,807	23"	37"

Perinatal Monitor Unit

Standard Features

- Same standard as Perinatal Casegoods features, plus:
- Two pullout keyboard shelves, 45.75" H
 - Electrical chase

Available Options

- Drawer and door pulls + 0\$
- OP/10 Cam locks + \$34
- OP10/A Cam lock with elbow catch + \$61

Specification Decisions

- Select standard wood finish
- Select laminate
- Select pull style
- Add locks



34.5" W, Perinatal monitor unit

229 lbs

Model	Price	Depth	Height
MMNT/20	\$3,961	27"	54"

Prague II Casegoods



Standard Features

- Laminate case
- Dry construction joinery
- Replaceable components
- Plastic drawer pans
- Nemschoff healthcare wood finish
- GREENGUARD Gold Certified
- Limited Lifetime Warranty

More Information

- Illustrated Glossary ▶ 439
- Finishes ▶ 456
- Hardware ▶ 457
- Ordering and Warranties ▶ 462

Prague II Bedside Cabinets

Standard Features

- Same standard features as Prague II Casegoods, plus:
- Durawrap tops, drawer fronts, doors and base rails
- Vented back panel
- Concealed hinges

Available Options

- Drawer and door pulls + \$0
- Casters + \$103
- Locking casters + \$182
- OP/10 Cam locks + \$34
- Wood drawer pans + \$84
- OP/17 Plastic drawer liner (for wood drawer pans) + \$52

Specification Decisions

- Select standard laminate
- Select Durawrap
- Select pull style
- Add casters
- Add locks
- Add wood drawer pans
- Add plastic drawer liners



20" W, Bedside - one drawer, one door and adjustable shelf

64 lbs

Model	Price	Depth	Height
FX704-01	\$736	19.25"	29.75"



20" W, Bedside - three drawers

52 lbs

Model	Price	Depth	Height
FX704-03	\$891	19.25"	29.75"

Prague II Casegoods

Prague II Chests

Standard Features

Same standard features as Prague II Casegoods, plus:

- Durawrap tops, drawer fronts, doors and base rails

Available Options

- Drawer and door pulls + \$0
- See [page 410](#) for additional options

Specification Decisions

- Select standard laminate
- Select Durawrap
- Select pull style
- See [page 410](#) for additional options

**32" W, Chest - three drawers**

110 lbs

Model	Price	Depth	Height
FX704-3	\$1,087	19.25"	29.75"

**32" W, Chest - four drawers**

116 lbs

Model	Price	Depth	Height
FX704-4	\$1,238	19.25"	38"

**32" W, Chest - five drawers**

122 lbs

Model	Price	Depth	Height
FX704-5	\$1,389	19.25"	46.25"

Prague II Headboards, Footboard, and Bedside Locator

Standard Features

Same standard features as Prague II Casegoods

Available Options

- Wall mount security fasteners (headboards) + \$55
- Electric duplex - specify line or emergency power (Bed locator) + \$114
- Night light (Bed locator) + \$184
- Bed receptacle simplex (Bed locator) + \$208
- 37-pin Adapter (Bed locator) + \$304

Specification Decisions

- Select standard laminate
 - Add security fasteners
 - Add electrical options
- Headboards that mount to adjustable bed frames include wood legs and mounting hardware.
- Headboards and footboards for hospital beds can be modified in size and can include mounting holes.
- Contact your customer service representative for pricing

42.75" W, Twin headboard for adjustable bed frames

24 lbs

Model	Price	Depth	Height
CA/H33-FX704	\$403		35.5"

57.75" W, Full headboard for adjustable bed frames

33 lbs

Model	Price	Depth	Height
CA/H46-FX704	\$501		35.5"

Prague II Casegoods

63.75" W, Queen headboard for adjustable bed frames 39 lbs

Model	Price	Depth	Height
CA/H50-FX704	\$586		35.5"

39" W - 60" W, Adjustable bed frame 15 lbs

Model	Price	Depth	Height
CA/1	\$182		

35" W, Headboard for hospital beds 18 lbs

Model	Price	Depth	Height
FX704-3H	\$231		18"

35" W, Footboard for hospital beds 15 lbs

Model	Price	Depth	Height
FX704-3F	\$217		15"

Bed locator for base unit

Model	Price	Depth	Height
BLBU	\$2,000		

Prague II Wardrobes and Armoires

Standard Features

- Same standard features as Prague II Casegoods, plus:
- Durawrap tops, drawer fronts, doors and base rails
- Concealed hinges

Available Options

- Drawer and door pulls + \$0
- Laminate interior cabinet (2 plastic drawer pans, field installable) on FX704-25, 26, 39 + \$458
- See [page 412](#) for additional options

Specification Decisions

- Select standard laminate
- Select Durawrap
- Select pull style
- See [page 412](#) for additional options

24.5" W, Wardrobe (hinged right) 173 lbs

Model	Price	Depth	Height
FX704-25	\$1,257	22.75"	72"

24.5" W, Wardrobe (hinged left) 173 lbs

Model	Price	Depth	Height
FX704-26	\$1,257	22.75"	72"

38" W, Double wardrobe 213 lbs

Model	Price	Depth	Height
FX704-39	\$1,921	22.75"	72"

Prague II Casegoods

**38" W, TV armoire - TV opening: 29W x 22.5D x 26.5H**

217 lbs

Model	Price	Depth	Height
FX704-38	\$2,221	24"	72"

**51.5" W, TV wardrobe (hinged right) - TV opening: 29W x 22.5D x 26.5H**

380 lbs

Model	Price	Depth	Height
FX704-43	\$3,521	24"	72"

**51.5" W, TV wardrobe (hinged left) - TV opening: 29W x 22.5D x 26.5H**

380 lbs

Model	Price	Depth	Height
FX704-44	\$3,521	24"	72"

Patient Chairs

Recliners

Treatment Chairs

Rockers & Gliders

Overbed Tables

Sleepover Seating

Casegoods

Display & Accessories

Prísto Casegoods



Standard Features

- Laminate case
- Laminate top with urethane edge (Cloud, Pewter, Sable) on PRBT models
- Laminate top with HPVC edge (Alabaster, Black, Mocha, Putty) on PRLT models
- Dry construction joinery
- Replaceable components
- Vented back panel
- Concealed hinges
- Urethane pulls (Cloud, Pewter, Sable)
- Wood drawer pans on PRBT models
- Plastic drawer pans on PRLT models
- 2" twin-wheel front-locking casters
- GREENGUARD Gold Certified
- Limited Lifetime Warranty

Available Options

- Fluted oak or maple trim + \$80
- Solid surface top + \$91
- OP/10 Cam locks + \$34
- Wood drawer pans (PRLT models) + \$84
- OP/17 Plastic drawer liners (for wood drawer pans) +\$52

Specification Decisions

- Select standard laminate
- Select edge color
- Select pull color
- Add fluted oak or maple trim
- Add solid surface top
- Add locks
- Add wood drawer pans
- Add plastic drawer liners

Coordinating Products

- [Prísto Casegoods](#)
- [Prísto II Casegoods](#)
- [Prísto II Recliner](#)
- [Prísto II Treatment Chair](#)
- [Prísto IIT Treatment Chair](#)

More Information

Illustrated Glossary ▶ 439

Finishes ▶ 456

Hardware ▶ 457

Ordering and Warranties ▶ 462

	20" W, Bedside - one wood drawer, one door and adjustable shelf				95 lbs
	Model	Price	Depth	Height	
	PRBT1	\$1,897	21.25"	32.5"	
	20" W, Bedside - three wood drawers				97 lbs
	Model	Price	Depth	Height	
	PRBT3	\$2,020	21.25"	32.5"	
	20" W, Bedside - one plastic drawer, one door and adjustable shelf				62 lbs
	Model	Price	Depth	Height	
	PRLT1	\$1,537	21.25"	32.5"	
	20" W, Bedside - three plastic drawers				67 lbs
	Model	Price	Depth	Height	
	PRLT3	\$1,624	21.25"	32.5"	

Prísto II Casegoods



More Information

Illustrated Glossary ▶ 439

Finishes ▶ 456

Hardware ▶ 457

Ordering and Warranties ▶ 462

Standard Features

- Laminate case
- Durawrap tops, drawer fronts, doors, and bottoms
- Dry construction joinery
- Replaceable components
- Wood drawer pans
- Secondary top surface with nickel-coated posts
- 2" twin-wheel front-locking casters
- Integrated pulls
- Vented back panel
- Concealed hinges
- GREENGUARD Gold Certified
- Limited Lifetime Warranty

Available Options

- OP/10 Cam locks + \$34
- OP/17 Plastic drawer liners +\$52

Specification Decisions

- Select standard laminate
- Select Durawrap for secondary top surface
- Add locks
- Add plastic drawer liners

Coordinating Products

- [Prísto Casegoods](#)
- [Prísto II Casegoods](#)
- [Prísto II Recliner](#)
- [Prísto II Treatment Chair](#)
- [Prísto IIT Treatment Chair](#)



21" W, Bedside - one wood drawer and door

102 lbs

Model	Price	Depth	Height
PRST-1	\$1,391	21.75"	35.5"



21" W, Bedside - three drawers

106 lbs

Model	Price	Depth	Height
PRST-3	\$1,479	21.75"	35.5"

Patient Chairs

Recliners

Treatment Chairs

Rockers & Gliders

Overbed Tables

Sleepover Seating

Casegoods

Display & Accessories

Revive Casegoods



Standard Features

- Laminate case and tops
- Dry construction joinery
- Replaceable components
- Powder-coated metal legs
- Self-closing drawers
- Full extension drawers
- Integrated drawer and door pulls
- Non-marring adjustable glides
- Nemschoff healthcare wood finish
- GREENGUARD Gold Certified
- Limited Lifetime Warranty

Coordinating Products

- [Revive Side Chair](#)
- [Revive Patient Chair](#)
- [Revive Display System](#)
- [Revive Display System Guest Center](#)

More Information

- Illustrated Glossary ▶ 439
- Finishes ▶ 456
- Hardware ▶ 457
- Ordering and Warranties ▶ 462

Revive Bedside Cabinets

Standard Features



- Same standard features as Revive Casegoods; plus:
- Rounded corners on surfaces

Available Options

- Drawer and door pulls + \$0
- Casters + \$0
- Plinth base + \$0
- DL Door locks + \$62
- LI Drawer locks + \$62
- Grab bar + \$381
- Lighting mount (with grab bar only) + \$120

Specification Decisions

- Select standard laminate
- Add pull style
- Add casters or plinth base
- Add locks
- Add grab bars
- Add lighting mount

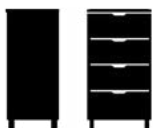
	19.75" W, Bedside cabinet - three drawers				100 lbs
	Model	Price	Depth	Height	
	REVV-00101	\$1,788	16.5"	30"	
	19.75" W, Bedside cabinet (hinged right)				65 lbs
	Model	Price	Depth	Height	
	REVV-00102	\$945	16.5"	30"	
	19.75" W, Bedside cabinet (hinged left)				65 lbs
	Model	Price	Depth	Height	
	REVV-00103	\$945	16.5"	30"	
	19.75" W, Bedside - four drawers				120 lbs
	Model	Price	Depth	Height	
	REVV-00104	\$2,570	16.5"	38.25"	







Revive Casegoods

		19.75" W, Bedside cabinet (hinged right), one shelf			80 lbs
		Model	Price	Depth	Height
		REVV-00105	\$1,421	16.5"	38.25"
		19.75" W, Bedside cabinet (hinged left), one shelf			80 lbs
		Model	Price	Depth	Height
		REVV-00106	\$1,421	16.5"	38.25"
		19.75" W, Bedside cabinet - shelf			70 lbs
		Model	Price	Depth	Height
		REVV-00107	\$1,118	16.5"	30"
		19.75" W, Bedside cabinet - one drawer			75 lbs
		Model	Price	Depth	Height
		REVV-00108	\$1,177	16.5"	38.25"

Revive Chests

		Standard Features	Available Options	Specification Decisions	
		Same standard features as Revive Casegoods; plus:	<ul style="list-style-type: none"> • Drawer and door pulls + \$0 • Plinth base + \$0 • See page 410 for additional options 	<ul style="list-style-type: none"> • Select standard laminate • Add pull style • Add plinth base • See page 410 for additional options 	
		<ul style="list-style-type: none"> • Rounded corners on surfaces 			
		32" W, Chest - three drawers			140 lbs
		Model	Price	Depth	Height
		REVV-00201	\$2,236	16.5"	30"
		32" W, Chest - two doors and shelf			100 lbs
		Model	Price	Depth	Height
		REVV-00202	\$1,191	16.5"	30"
		32" W, Chest - drawer and shelf			90 lbs
		Model	Price	Depth	Height
		REVV-00203	\$1,254	16.5"	30"
		32" W, Chest - one drawer			80 lbs
		Model	Price	Depth	Height
		REVV-00204	\$1,181	16.5"	30"

Revive Casegoods

	38.25" W, Chest - three drawers and work surface				155 lbs
	Model	Price	Depth	Height	
	REVV-00205	\$2,902	16.5"	37"	
	38.25" W, Chest - two doors, work surface and inside shelf				115 lbs
	Model	Price	Depth	Height	
	REVV-00206	\$1,994	16.5"	37"	
	38.25" W, Chest - one drawer and work surface				105 lbs
	Model	Price	Depth	Height	
	REVV-00207	\$2,025	16.5"	37"	
	63.25" W, Double chest - six drawers				215 lbs
	Model	Price	Depth	Height	
	REVV-00208	\$3,939	16.5"	30"	
	63.25" W, Chest - three LSF drawers, two doors and shelf				175 lbs
	Model	Price	Depth	Height	
	REVV-00209	\$3,031	16.5"	30"	
	63.25" W, Chest - three RSF drawers, two doors and shelf				175 lbs
	Model	Price	Depth	Height	
	REVV-00210	\$3,031	16.5"	30"	
	63.25" W, Chest - four doors and inside shelves				135 lbs
	Model	Price	Depth	Height	
	REVV-00211	\$2,124	16.5"	30"	

Revive Casegoods

Revive Daystands

Standard Features









- Same standard features as Revive Casegoods; plus:
- Rounded corners on surfaces

Available Options

- Drawer and door pulls + \$0
- Casters + \$0
- Plinth base + \$0
- Locks + \$62
- Grab bar + \$381
- Lighting mount (with grab bar only) + \$120

Specification Decisions

- Select standard laminate
- Add pull style
- Add casters or plinth base
- Add locks
- Add grab bars
- Add lighting mount

	24" W, Daystand (hinged left)					55 lbs
	Model	Price	Depth	Height		
	REVV-00501	\$1,131	19.25"	24"		
	24" W, Daystand (hinged right)					55 lbs
	Model	Price	Depth	Height		
	REVV-00502	\$1,131	19.25"	24"		
	24" W, Daystand with drawer					55 lbs
	Model	Price	Depth	Height		
	REVV-00503	\$1,324	19.25"	24"		
	24" W, Daystand with shelf					55 lbs
	Model	Price	Depth	Height		
	REVV-00504	\$997	19.25"	24"		
	24" W, Daystand (hinged left)					65 lbs
	Model	Price	Depth	Height		
	REVV-00505	\$1,803	19.25"	28"		
	24" W, Daystand (hinged right)					65 lbs
	Model	Price	Depth	Height		
	REVV-00506	\$1,803	19.25"	28"		
	24" W, Daystand with drawer					65 lbs
	Model	Price	Depth	Height		
	REVV-00507	\$1,995	19.25"	28"		
	26" W, Daystand (hinged left)					83 lbs
	Model	Price	Depth	Height		
	REVV-00508	\$2,236	19.25"	34"		

Revive Casegoods

	26" W, Daystand (hinged right)				83 lbs
	Model	Price	Depth	Height	
	REVV-00509	\$2,236	19.25"	34"	
	26" W, Daystand with drawer				83 lbs
	Model	Price	Depth	Height	
	REVV-00510	\$2,049	19.25"	34"	
	26" W, Daystand (hinged left)				85 lbs
	Model	Price	Depth	Height	
	REVV-00511	\$2,377	19.25"	40"	
	26" W, Daystand (hinged right)				85 lbs
	Model	Price	Depth	Height	
	REVV-00512	\$2,377	19.25"	40"	
	26" W, Daystand with drawer				85 lbs
	Model	Price	Depth	Height	
	REVV-00513	\$2,192	19.25"	40"	

Revive Casegoods

Revive Wardrobes and Armoires

Standard Features









Same standard features as Revive Casegoods

Available Options

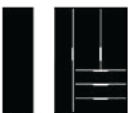
- Drawer and door pulls + \$0
- Plinth base + \$0
- See page 412 for additional options

Specification Decisions

- Select standard laminate
- Add plinth base
- Add pulls

	32" W, Armoire - two doors with top shelf and three drawers - TV opening: 30" W x 17.5" H	210 lbs
Model	Price	Depth
REVV-00301	\$3,299	18"
		Height
		66"
	38" W, Armoire - two doors with top shelf and three drawers - TV opening: 30" W x 17.5" H	235 lbs
Model	Price	Depth
REVV-00302	\$3,585	18"
		Height
		66"
	43" W, Armoire - two doors, top shelf, three drawers and RSF wardrobe - TV opening: 30" W x 17.5" H	285 lbs
Model	Price	Depth
REVV-00303	\$4,082	22"
		Height
		66"
	43" W, Armoire - two doors, top shelf, three drawers and LSF wardrobe - TV opening: 30" W x 17.5" H	285 lbs
Model	Price	Depth
REVV-00304	\$4,082	22"
		Height
		66"
	24.5" W, Wardrobe (hinged right) - two drawers and clothes bar	200 lbs
Model	Price	Depth
REVV-00401	\$2,626	22"
		Height
		72"
	24.5" W, Wardrobe (hinged left) - two drawers and clothes bar	200 lbs
Model	Price	Depth
REVV-00402	\$2,626	22"
		Height
		72"
	32" W, Wardrobe - two doors - two drawers and clothes bar	240 lbs
Model	Price	Depth
REVV-00403	\$3,053	22"
		Height
		72"
	38" W, Wardrobe - two doors - two drawers and clothes bar	280 lbs
Model	Price	Depth
REVV-00404	\$3,339	22"
		Height
		72"

Patient Chairs

Recliners

Treatment Chairs

Rockers & Gliders

Overbed Tables

Sleepover Seating

Casegoods

Display & Accessories

Sovereign Casegoods



Standard Features

- Dry construction joinery
- Replaceable components
- Nemschoff healthcare wood finish
- GREENGUARD Gold Certified
- Limited Lifetime Warranty

More Information

Illustrated Glossary ▶ 439

Finishes ▶ 456

Hardware ▶ 457

Ordering and Warranties ▶ 462

Sovereign Bedside Cabinets and Nightstands

Standard Features

- Same standard features as Sovereign Casegoods, plus:
- Oak veneer case with solid oak edges, doors and drawer fronts
 - Laminate top with oak edges
 - Wood drawers

Available Options

- Solid maple trim or maple veneer (M) + \$0
- Soft radius wood edges + \$0
- Drawer and door pulls + \$0
- OP/17 Plastic drawer liner + \$52
- OP/13 Casters + \$112
- OP/13LK Locking casters + \$200
- OP/10 Cam locks + \$34

Specification Decisions

- Select standard wood finish
- Add (M) Solid maple trim or maple veneer
- Select standard laminate
- Add (R) soft radius wood edge
- Select pull style
- Plastic drawer liners
- Add casters
- Add locks



21.25" W, Bedside cabinet - one drawer and door

70 lbs

Model	Price	Depth	Height
SVNA/1	\$1,027	20"	29.5"



21.25" W, Bedside cabinet - three drawers

74 lbs

Model	Price	Depth	Height
SVNA/3	\$1,116	20"	29.5"



21.25" W, Nightstand

60 lbs

Model	Price	Depth	Height
SVNG/1	\$830	20"	23"

Sovereign Casegoods

Sovereign Chests

Standard Features

- Same standard features as Sovereign Casegoods, plus:
- Oak veneer case with solid oak edges, doors and drawer fronts
- Laminate top with oak edges
- Wood drawers

Available Options

- Solid maple trim or maple veneer (M) + \$0
- Soft radius wood edges + \$0
- Drawer and door pulls + \$0
- See [page 410](#) for additional options

Specification Decisions

- Select standard wood finish
- Add (R) soft radius wood edge
- Select standard laminate
- Select pull style
- See [page 410](#) for additional options

**33.25" W, Chest - three drawers**

110 lbs

Model	Price	Depth	Height
SVNB/3	\$1,444	20"	29.5"

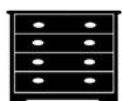
**33.25" W, Chest - four drawers**

116 lbs

Model	Price	Depth	Height
SVNB/4	\$1,727	20"	38"

**33.25" W, Chest - five drawers**

122 lbs

Model	Price	Depth	Height
SVNB/5	\$1,870	20"	46.5"

Sovereign Mirror

Standard Features

- Solid oak frame
- Dry construction joinery
- Nemschoff healthcare wood finish
- GREENGUARD Gold Certified
- Limited Lifetime Warranty

Available Options

- (M) Solid maple trim or maple veneer + \$0
- Soft radius wood edges + \$0

Specification Decisions

- Select standard wood finish
- Add solid maple trim or maple veneer
- Add soft radius wood edge

**25" W, Plate glass mirror**

27 lbs

Model	Price	Depth	Height
SVNM/39	\$292		45"

Sovereign Casegoods

Sovereign Headboards, Footboard, Headwalls and Bed Locator

Standard Features

- Same standard features as Sovereign Casegoods, plus:
- Oak veneer case
 - Veneer top with oak edges (headwall)

Available Options

- Solid maple trim or maple veneer (M) + \$0
- Soft radius wood edges + \$0
- Door pull (Headwalls) + \$0
- Wall mount security fasteners (Headboards) + \$55
- Electric duplex - specify line or emergency power (Bed locator) + \$117
- Night light (Bed locator) + \$189
- Bed receptacle simplex (Bed locator) + \$214
- 37-pin Adapter (Bed locator) + \$312

Specification Decisions

- Select standard wood finish
- Select standard laminate
- Add solid maple trim
- Add soft radius wood edge
- Add door pulls
- Add security fasteners
- Add electrical options

Headboards that mount to adjustable bed frames include wood legs and mounting hardware.

Headboards and footboards for hospital beds can be modified in size and can include mounting holes.

Contact your customer service representative for pricing

42.75" W, Twin headboard for adjustable bed frames

27 lbs

Model	Price	Depth	Height
CA/H33-SVN	\$1,491		41"

57.75" W, Full headboard for adjustable bed frames

36 lbs

Model	Price	Depth	Height
CA/H46-SVN	\$1,849		41"

63.75" W, Queen headboard for adjustable bed frames

41 lbs

Model	Price	Depth	Height
CA/H50-SVN	\$2,161		41"

39" W - 60" W, Adjustable bed frame

15 lbs

Model	Price	Depth	Height
CA/1	\$182		

39.75" W, Headboard for hospital beds

14 lbs



Model	Price	Depth	Height
SVNP/36HC	\$839		18"

39.75" W, Footboard for hospital beds

15 lbs



Model	Price	Depth	Height
SVNP/36FC	\$817		15"

Sovereign Casegoods

96" W, Headwall				171 lbs
Model	Price	Depth	Height	
SVNU/21	\$13,739	14.25"	27.25"	

Bed locator base unit		-
Model	Price	
BLBU	\$2,000	

Sovereign Desks and Hutch

Standard Features

- Same standard features as Sovereign Casegoods, plus:
- Oak veneer case
- Laminate worksurface with oak edges (Desks)
- Laminate shelves with oak edges (Hutch)
- Wood drawers (Desks)

Available Options

- Solid maple trim or maple veneer (M) + \$0
- Soft radius wood edges + \$0
- Door and drawer pulls + \$0
- OP/42 Unframed replaceable tackboard (Hutch) + \$90
- OP/16W File drawer + \$85
- OP/10 Cam locks + \$34
- OP/41 Cam fasteners (required to attach hutch to desk) + \$51
- Plastic drawer liners + \$51

Specification Decisions

- Select standard wood finish
 - Add solid maple trim or maple veneer
 - Add soft radius wood edge
 - Select pull style
 - Add OP/42 Tackboard
 - Add OP/16W File drawers
 - Add OP/10 Cam locks
 - Add OP/41 Cam fasteners
- OP/16W file drawer replaces two desk pedestal wood drawers

47" W, Desk - three-drawer pedestal (right hand)				150 lbs
Model	Price	Depth	Height	
SVND/44	\$1,775	23.5"	29.5"	

47" W, Desk - three-drawer pedestal (left hand)				150 lbs
Model	Price	Depth	Height	
SVND/45	\$1,775	23.5"	29.5"	

42" W, Hutch				55 lbs
Model	Price	Depth	Height	
SVNH/45	\$635	9"	23"	

Sovereign Casegoods

Sovereign Storage, Wardrobes and Armoires

Standard Features

- Same standard features as Sovereign Casegoods, plus:
- Veneer top with oak edges
- Wood drawers

Available Options

- Solid maple trim or maple veneer (M) + \$0
- Soft radius wood edges + \$0
- Drawer and door pulls + \$0
- OP/15C Wood two drawer interior cabinets + \$518
- See [page 412](#) for additional options

Specification Decisions

- Select standard wood finish
- Add (R) soft radius wood edge
- Select standard laminate
- Select pull style
- See [page 412](#) for additional options



25.5" W, Storage unit (hinged left)

177 lbs

Model	Price	Depth	Height
SVNS/24	\$1,924	23.75"	71.5"



27.25" W, Wardrobe with drawer (hinged right)

177 lbs

Model	Price	Depth	Height
SVNW/23	\$1,781	23.75"	71.5"



27.25" W, Wardrobe with drawer (hinged left)

177 lbs

Model	Price	Depth	Height
SVNW/24	\$1,781	23.75"	71.5"



39.25" W, TV armoire - two drawers and upper doors (TV opening: 30.5"W x 20.75"D x 24.75"H)

243 lbs

Model	Price	Depth	Height
SVNT/30	\$3,508	23.75"	60"



39.5" W, Wardrobe - two doors

220 lbs

Model	Price	Depth	Height
SVNW/36	\$2,237	23.75"	71.5"

Ten Casegoods



Standard Features

- Maple veneer case
- Dry construction joinery
- Replaceable components
- Nemschoff healthcare wood finish
- GREENGUARD Gold Certified
- Limited Lifetime Warranty

More Information

Illustrated Glossary ▶ 439

Finishes ▶ 456

Hardware ▶ 457

Ordering and Warranties ▶ 462

Ten Bedside Cabinets

Standard Features

- Same standard as Ten Casegoods features, plus:
- Laminate top with urethane edge (Cloud, Pewter, Sable)
 - Wood drawers
 - Concealed hinges
 - Black laminate base rail

Available Options

- Drawer and door pulls + \$0
- OP 10 cam locks + \$34
- OP/13 caster base + \$112
- OP/13LK caster base with locks + \$200
- OP/17 Plastic drawer liner + \$52

Specification Decisions

- Select standard wood finish
- Select standard laminate
- Select urethane color edge
- Select pull style
- Add OP 10 cam locks
- Add casters
- Add plastic drawer liners



19.5" W, Bedside cabinet - one drawer and one door

80 lbs

Model	Price	Depth	Height
TENA/1	\$1,075	20.75"	29.75"



19.5" W, Bedside cabinet - three drawers

80 lbs

Model	Price	Depth	Height
TENA/3	\$1,275	20.75"	29.75"

Patient Chairs

Recliners

Treatment Chairs

Rockers & Gliders

Overbed Tables

Sleepover Seating

Casegoods

Display & Accessories

Ten Casegoods

Ten Chests

Standard Features

- Same standard as Ten Casegoods features, plus:
- Wood drawers
 - Black laminate base rail

Available Options

- Door and drawer pulls + \$0
- See [page 410](#) for additional options

Specification Decisions

- Select standard wood finish
- Select standard laminate
- Select pull style
- See [page 410](#) for additional options



31" W, Chest - three drawers

110 lbs

Model	Price	Depth	Height
TENB/03	\$1,590	19"	29.75"



31" W, Chest - four drawers

115 lbs

Model	Price	Depth	Height
TENB/04	\$1,850	19"	38"



31" W, Chest - five drawers

122 lbs

Model	Price	Depth	Height
TENB/05	\$2,077	19"	46.25"

Ten Headboards, Footboard and Bed Locator

Standard Features

Same standard as Ten Casegoods features.

Available Options

- Door pull (Hheadwalls) + \$0
- Wall mount security fasteners (Headboards) + \$55
- Electric duplex - specify line or emergency power (Bed locator) + \$117
- Night light (Bed locator) + \$189
- Bed receptacle simplex (Bed locator) + \$214
- 37-pin Adapter (Bed locator) + \$312

Specification Decisions

- Select standard wood finish
 - Add door pulls
 - Add security fasteners
 - Add electrical options
- Headboards that mount to adjustable bed frames include wood legs and mounting hardware.
- Headboards and footboards for hospital beds can be modified in size and can include mounting holes.
- Contact your customer service representative for pricing

42.75" W, Twin headboard for adjustable bed frames

24 lbs

Model	Price	Depth	Height
CA/H33-TEN	\$551		37"

57.75" W, Full headboard for adjustable bed frames

33 lbs

Model	Price	Depth	Height
CA/H46-TEN	\$685		37"

Ten Casegoods

63.75" W, Queen headboard for adjustable bed frames					39 lbs
Model	Price	Depth	Height		
CA/H50-TEN	\$802		37"		

39" - 60" W, Adjustable bed frame					15 lbs
Model	Price	Depth	Height		
CA/1	\$182		39"-60"		

35" W, Headboard for hospital beds					23 lbs
Model	Price	Depth	Height		
TENP/3H	\$351	1"	18"		

35" W, Footboard for hospital beds					20 lbs
Model	Price	Depth	Height		
TENP/3F	\$343	1"	15"		

Bed locator base unit					-
Model	Price	Depth	Height		
BLBU	\$1,951				

Ten Wardrobes

Standard Features

Same standard as Ten Casegoods features, plus:

- Wood drawers
- Concealed hinges
- Black laminate base rail

Available Options

- Drawer and door pulls + \$0
- OP/15C Wood two drawer interior cabinets (TENW/25, 26, 39) + \$518
- See [page 412](#) for additional options

Specification Decisions

- Select standard wood finish
- Select pull style
- See [page 412](#) for additional options

25" W, Wardrobe (hinged right)					173 lbs
Model	Price	Depth	Height		
TENW/25	\$1,995	23.5"	72"		

25" W, Wardrobe (hinged left)					173 lbs
Model	Price	Depth	Height		
TENW/26	\$1,995	23.5"	72"		

37" W, Double wardrobe					213 lbs
Model	Price	Depth	Height		
TENW/39	\$2,361	23.5"	72"		

Ten Casegoods



37" W, Double wardrobe - three lower drawers - TV opening: 30.5" W x 21.75" D x 26.25" H

217 lbs

Model	Price	Depth	Height
TENT/38	\$3,502	23.5"	72"



50" W, TV wardrobe (hinged right) - TV opening: 29" W x 22.5" D x 26.5" H

380 lbs

Model	Price	Depth	Height
TENT/43	\$5,307	23.5"	72"



50" W, TV wardrobe (hinged left) - TV opening: 29" W x 22.5" D x 26.5" H

380 lbs

Model	Price	Depth	Height
TENT/44	\$5,307	23.5"	72"

Terra Casegoods



Standard Features

- Laminate case and top with PVC edge
- Plinth base with adjustable glides
- Dry construction joinery
- Replaceable components
- Nemschoff healthcare wood finish
- GREENGUARD Gold Certified
- Limited Lifetime Warranty

Coordinating Products

- [Terra Casegoods for Treatment Areas](#)

More Information

Illustrated Glossary ▶ 439

Fabrics ▶ 451

Flammability (CTB-133) ▶ 459

Finishes ▶ 456

Hardware ▶ 457

Ordering and Warranties ▶ 462

Terra Bedside Cabinets

Standard Features

- Same standard as Terra Casegoods features, plus:
- Quiet, soft-closing drawers and doors
 - Wood drawers
 - Concealed hinges
 - Adjustable shelf

Available Options

- Veneer case + \$205
- Drawer and door pulls + \$0
- Solid surface top + \$410
- Powder-coated legs + \$359
- Twin wheel front locking casters + \$231
- OP/10 cam locks + \$34
- Plastic drawer liner + \$62

Powder-coated legs must be field-installed and ship in a separate package

Specification Decisions

- Select laminate or add wood finish
- Select pull style
- Add solid surface top
- Add powder-coated legs or casters
- Add locks
- Add plastic drawer liners



18.75" W, Bedside cabinet - one drawer, one door (hinged right)

84 lbs

Model	Price	Depth	Height
TRA01	\$1,083	19"	32.25"



18.75" W, Bedside cabinet- one drawer, one door (hinged left)

84 lbs

Model	Price	Depth	Height
TRA02	\$1,083	19"	32.25"



18.75" W, Bedside cabinet - three drawers

104 lbs

Model	Price	Depth	Height
TRA03	\$1,253	19"	32.25"

Terra Casegoods

Terra Benches

Standard Features

Same standard as Terra Casegoods features.

Available Options

- Powder-coated legs + \$359
- Moisture barrier + \$67

Specification Decisions

- Select fabric
- Select laminate
- Add powder-coated legs
- Add moisture barrier

Key Dimensions

- Overall Width: See price table
- Overall Depth: 16"
- Overall Height: 18.5"
- Seat Height: 18.5"



16" W, Bench

32 lbs | 1.25 yds

Model	Series 2	Series 3	Series 4	Series 5	Series 6	Series 7	Series 8	COM
TRA39	\$371	\$410	\$477	\$546	\$628	\$711	\$815	\$410



32" W, Bench

52 lbs | 1.75 yds

Model	Series 2	Series 3	Series 4	Series 5	Series 6	Series 7	Series 8	COM
TRA40	\$714	\$769	\$862	\$959	\$1,074	\$1,190	\$1,336	\$769



48" W, Bench

72 lbs | 2.25 yds

Model	Series 2	Series 3	Series 4	Series 5	Series 6	Series 7	Series 8	COM
TRA41	\$1,006	\$1,077	\$1,197	\$1,321	\$1,469	\$1,619	\$1,806	\$1,077

Terra Chests

Standard Features

Same standard as Terra Casegoods features, plus:

- Quiet, soft-closing drawers and doors (see specific models)
- Concealed hinges (models with doors)
- Adjustable shelves (see specific models)

Available Options

- Drawer and door pulls + \$0
- Powder-coated legs + \$359
- See [page 410](#) for additional options
- Powder-coated legs must be field-installed and ship inside units

Specification Decisions

- Select laminate or add wood finish
- Select pull style
- Add powder-coated legs
- See [page 410](#) for additional options



30.75" W, Chest - two drawers

99 lbs

Model	Price	Depth	Height
TRA04	\$1,453	20.25"	30"



30.75" W, Chest - one drawer

113 lbs

Model	Price	Depth	Height
TRA05	\$1,308	20.25"	30"





30.75" W, Chest - three drawers

146 lbs

Model	Price	Depth	Height
TRA06	\$1,670	20.25"	30"

Terra Casegoods

	30.75" W, Narrow chest - two doors				81 lbs
	Model	Price	Depth	Height	
	TRA07	\$1,017	14.25"	30"	
	42.25" W, Narrow chest - two doors				114 lbs
	Model	Price	Depth	Height	
	TRA08	\$1,373	14.25"	30"	
	42.25" W, Chest - two doors				145 lbs
	Model	Price	Depth	Height	
	TRA09	\$1,960	20.25"	30"	
	42.25" W, Chest - one drawer				153 lbs
	Model	Price	Depth	Height	
	TRA10	\$1,765	20.25"	30"	
	42.25" W, Chest - three drawers				186 lbs
	Model	Price	Depth	Height	
	TRA11	\$2,254	20.25"	30"	

Terra Desks

Standard Features

- Same standard as Terra Casegoods features, plus:
- Quiet, soft-closing drawers and doors
 - Wood drawers

Available Options

- Veneer case + \$400
- Solid surface top + \$820
- Powder-coated legs (TRA28, 29) + \$359
- OP/10 Cam locks (TRA28, 29) + \$34
- Plastic drawer liner (TRA36) + \$62

Specification Decisions

- Select laminate or add wood finish
- Select pull style
- Add solid surface top
- Add powder-coated legs
- Add OP/10 Cam locks
- Add plastic drawer liners

	54" W, Desk - three RSF drawers				167 lbs
	Model	Price	Depth	Height	
	TRA28	\$1,845	20.25"	30"	
	54" W, Desk - three LSF drawers				167 lbs
	Model	Price	Depth	Height	
	TRA29	\$1,845	20.25"	30"	
	54" W, Desk top with side panel				53 lbs
	Model	Price	Depth	Height	
	TRA30	\$665	20.25"	30"	

Terra Casegoods

Terra Wardrobes, Armoires and Credenzas

Standard Features

- Same standard as Terra Casegoods features, plus:
- Quiet, soft-closing drawers and doors (see specific models)
- Concealed hinges (models with doors)
- Adjustable shelves (see specific models)
- Clothes bar

Available Options

- Drawer and door pulls + \$0
 - Powder-coated legs + \$359
 - See [page 412](#) for additional options
- Powder-coated legs must be field-installed and ship inside units

Specification Decisions

- Select laminate or add wood finish
- Select pull style
- Add powder-coated legs
- See [page 412](#) for additional options

	18.75" W, Wardrobe (hinged right)				100 lbs
	Model	Price	Depth	Height	
	TRA22	\$1,083	20.25"	47.75"	

	18.75" W, Wardrobe with one drawer and one door (hinged left)				117 lbs
	Model	Price	Depth	Height	
	TRA25	\$1,191	20.25"	47.75"	

	18.75" W, Narrow wardrobe (hinged right)				79 lbs
	Model	Price	Depth	Height	
	TRA26	\$758	14.25"	47.75"	







	18.75" W, Narrow wardrobe (hinged left)				79 lbs
	Model	Price	Depth	Height	
	TRA27	\$758	14.25"	47.75"	

	24.5" W, Wardrobe (hinged right)				163 lbs
	Model	Price	Depth	Height	
	TRA18	\$2,164	20"	75.25"	

	24.5" W, Wardrobe (hinged left)				163 lbs
	Model	Price	Depth	Height	
	TRA19	\$2,164	20"	75.25"	

	24.5" W, Wardrobe - one drawer and one door (hinged right)				183 lbs
	Model	Price	Depth	Height	
	TRA20	\$2,381	20"	75.25"	

Terra Casegoods

	24.5" W, Wardrobe - one drawer and one door (hinged left)	183 lbs	
Model	Price	Depth	Height
TRA21	\$2,381	20"	75.25"
	37.25" W, Wardrobe - two doors	191 lbs	
Model	Price	Depth	Height
TRA12	\$2,516	20.25"	47.75"
	37.25" W, Wardrobe - two doors, two drawers	224 lbs	
Model	Price	Depth	Height
TRA13	\$2,768	20.25"	47.75"
	37.25" W, Wardrobe - left offset door and regular door	192 lbs	
Model	Price	Depth	Height
TRA14	\$2,516	20.25"	47.75"
	37.25" W, Wardrobe - right offset door and regular door	192 lbs	
Model	Price	Depth	Height
TRA15	\$2,516	20.25"	47.75"
	37.25" W, Narrow wardrobe - two doors	151 lbs	
Model	Price	Depth	Height
TRA16	\$1,761	14.25"	47.75"
	37.25" W, Narrow wardrobe - two doors, two drawers	178 lbs	
Model	Price	Depth	Height
TRA17	\$1,938	14.25"	47.75"

Patient Chairs

Recliners

Treatment Chairs

Rockers & Gliders

Overbed Tables

Sleepover Seating

Casegoods

Display & Accessories

Terra Casegoods

Terra Pre-Configured Units

Standard Features

- Same standard as Terra Casegoods features, plus:
- Concealed hinges
 - Adjustable shelves
 - Clothes bar

Available Options

- Drawer and door pulls + \$0
 - Powder-coated legs + \$359
 - See [page 410](#) and [page 412](#) for additional options
- Powder-coated legs must be field-installed and ship inside units

Specification Decisions

- Select laminate or add wood finish
- Select pull style
- Add powder-coated legs
- See [page 410](#) and [page 412](#) for additional options

66" W, Chest - two doors and RSF desk				166 lbs
Model	Price	Depth	Height	
 TRA37	\$2,962	20.25"	30"	

66" W, Chest - two doors and LSF desk				166 lbs
Model	Price	Depth	Height	
 TRA38	\$2,962	20.25"	30"	

61.25" W, Credenza - four doors				198 lbs
Model	Price	Depth	Height	
 TRA33	\$2,941	20.25"	30"	

61.25" W, Narrow credenza - four doors				162 lbs
Model	Price	Depth	Height	
 TRA34	\$2,059	14.25"	30"	

74" W, Wardrobe - four doors				382 lbs
Model	Price	Depth	Height	
 TRA31	\$2,265	20.25"	47.75"	

74" W, Narrow wardrobe - four doors				302 lbs
Model	Price	Depth	Height	
 TRA32	\$1,586	14.25"	47.75"	

87.25" W, Wardrobe (hinged right) with desk with two doors				329 lbs
Model	Price	Depth	Height	
 TRA35	\$4,442	20.25"	75.25"	

87.25" W, Wardrobe with door (hinged right) and three drawers				329 lbs
Model	Price	Depth	Height	
 TRA36	\$4,442	20.25"	75.25"	

Terra Casegoods for Treatment Areas



Standard Features

- Laminate case and top with PVC edge
- Plinth base with adjustable glides
- Dry construction joinery
- Replaceable components
- Nemschoff healthcare wood finish
- GREENGUARD Gold Certified
- Limited Lifetime Warranty

Coordinating Products

- [Terra Casegoods](#)

More Information

Illustrated Glossary ▶ 439

Fabrics ▶ 451

Flammability (CTB-133) ▶ 459

Finishes ▶ 456

Hardware ▶ 457

Ordering and Warranties ▶ 462

Terra for Treatment Areas Pre-configured Units

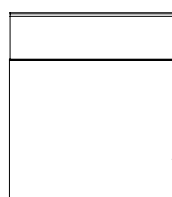

Privacy Screen
(40" wide x 48" high)

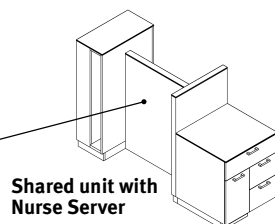

Shared unit with Nurse Server

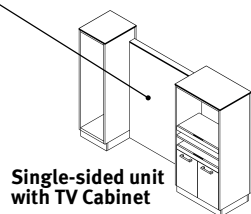

Single-sided unit with TV Cabinet

Standard Features

Same standard features as Terra Casegoods for Treatment Areas features, plus:

- Laminate privacy panel between the end cabinets

Available Options

- See [page 407](#) for additional options

Specification Decisions

- Determine if a single-sided or shared configuration is required
- Select standard laminate or add wood finish
- Select pull style
- See [page 407](#) for additional options

Benches are not included

All pre-configured weights are based on a total of all units included plus an adjustable resin screen.



80.75" W, Single-sided unit - TV cabinet and LSF wardrobe

345 lbs

Model	Price	Depth	Height
TRA100	\$3,212	18"	54"

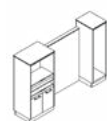

80.75" W, Single-sided unit - TV cabinet and RSF wardrobe

345 lbs

Model	Price	Depth	Height
TRA101	\$3,212	18"	54"

Terra Casegoods for Treatment Areas

**84" W, Single-sided unit - TV cabinet, desk, and LSF wardrobe**

380 lbs

Model	Price	Depth	Height
TRA103	\$3,414	18"	54"

**84" W, Single-sided unit - TV cabinet, desk, and RSF wardrobe**

380 lbs

Model	Price	Depth	Height
TRA104	\$3,414	18"	54"

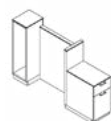
**82.5" W, Single-sided unit - nurse server and LSF wardrobe**

319 lbs

Model	Price	Depth	Height
TRA106	\$3,354	18"	54"

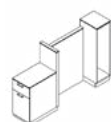
**82.5" W, Single-sided unit - nurse server and RSF wardrobe**

319 lbs

Model	Price	Depth	Height
TRA107	\$3,354	18"	54"

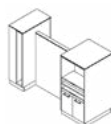
**80.75" W, Shared unit - TV cabinet and wardrobe**

600 lbs

Model	Price	Depth	Height
TRA102	\$4,474	30"	54"

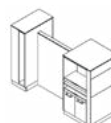
**84" W, Shared unit - TV cabinet, desk and wardrobe**

671 lbs

Model	Price	Depth	Height
TRA105	\$4,764	30"	54"

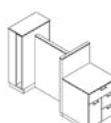
**82.5" W, Shared unit - shared nurse server and wardrobe**

628 lbs

Model	Price	Depth	Height
TRA108	\$4,109	30"	54"

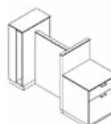
**82.5" W, Shared unit - shared nurse server, one drawer with recycle center**

548 lbs

Model	Price	Depth	Height
TRA109	\$3,064	30"	54"

Terra Casegoods for Treatment Areas

Terra Treatment Nurse Servers

Standard Features

- Same standard as Terra Casegoods for Treatment Areas features, plus:
- Quiet, soft-closing drawers
 - Hands-free waste disposal

Available Options

- Drawer and door pulls + \$0
- See [page 407](#) for additional options

Specification Decisions

- Select laminate or add wood finish
- Select pull style
- See [page 407](#) for additional options



18" W, Nurse server ganged RSF with 35 quart waste disposal

160 lbs

Model	Price	Depth	Height
TRA50	\$1,635	25.75"	36"



18" W, Nurse server ganged LSF with 35 quart waste disposal

160 lbs

Model	Price	Depth	Height
TRA51	\$1,635	25.75"	36"



29" W, Shared nurse server with 35 quart waste disposal

320 lbs

Model	Price	Depth	Height
TRA52	\$2,045	25.75"	36"



29" W, Shared nurse server with recycling containers

400 lbs

Model	Price	Depth	Height
TRA53	\$1,900	25.75"	36"

Terra Treatment TV Cabinets

Standard Features

- Same standard as Terra Casegoods for Treatment Areas features, plus:
- See [page 407](#) for model-specific features

Available Options

- Drawer and door pulls + \$0
- See [page 407](#) for additional options

Specification Decisions

- Select laminate or add wood finish
- Select pull style
- See [page 407](#) for additional options

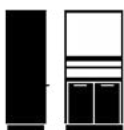

27.75" W, TV cabinet ganged RSF

186 lbs

Model	Price	Depth	Height
TRA59	\$1,493	18"	54"



27.75" W, TV cabinet ganged LSF

186 lbs

Model	Price	Depth	Height
TRA60	\$1,493	18"	54"

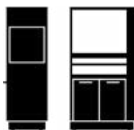

25.75" W, Shared TV cabinet

372 lbs

Model	Price	Depth	Height
TRA63	\$2,410	29.75"	54"

Terra Casegoods for Treatment Areas

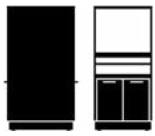

29" W, TV cabinet with desk ganged RSF

221 lbs

Model	Price	Depth	Height
TRA61	\$1,695	18"	54"



29" W, TV cabinet with desk ganged LSF

221 lbs

Model	Price	Depth	Height
TRA62	\$1,695	18"	54"

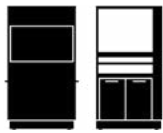

29" W, Shared TV cabinet with desk

443 lbs

Model	Price	Depth	Height
TRA64	\$2,700	29.75"	54"

Terra Treatment Wardrobes

Standard Features

- Same standard as Terra Casegoods for Treatment Areas features, plus:
- See [page 407](#) for model-specific features

Available Options

- Drawer and door pulls + \$0
- See [page 407](#) for additional options

Specification Decisions

- Select laminate or add wood finish
- Select pull style
- See [page 407](#) for additional options



15" W, Wardrobe ganged RSF with three clothes hooks

74.5 lbs

Model	Price	Depth	Height
TRA56	\$955	18"	54"

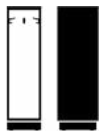

15" W, Wardrobe ganged LSF with three clothes hook

74.5 lbs

Model	Price	Depth	Height
TRA57	\$955	18"	54"

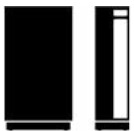

15" W, Shared wardrobe with clothes bar

144 lbs

Model	Price	Depth	Height
TRA58	\$1,300	29.75"	54"

Terra Treatment Partition

Standard Features

- Same standard as Terra Casegoods for Treatment Areas features, plus:
- Fixed laminate panel
- 2" glides

Available Options

- 2" swivel locking casters + \$200
- Solid surface top cap + \$89
- See [page 407](#) for additional options

Specification Decisions

- Select standard laminate or add wood finish
- See [page 407](#) for additional options



45.5" W, Movable partition

Model	Price	Depth	Height
TRA54	\$1,036	40"	54"

Terra Casegoods for Treatment Areas

Terra Treatment Benches

Standard Features

Same standard as Terra Casegoods for Treatment Areas features

Available Options

- Powder-coated legs + \$359
- Moisture barrier + \$67

Specification Decisions

- Select fabric
- Select laminate
- Add powder-coated legs
- Add moisture barrier

		39" W, Bench								46 lbs 1.75 yds
	Model	Series 2	Series 3	Series 4	Series 5	Series 6	Series 7	Series 8	COM	
	TRA67	\$903	\$950	\$1,027	\$1,108	\$1,205	\$1,302	\$1,424	\$950	

		39" W, Bench with storage								53 lbs 1.75 yds
	Model	Series 2	Series 3	Series 4	Series 5	Series 6	Series 7	Series 8	COM	
	TRA68	\$1,084	\$1,131	\$1,208	\$1,289	\$1,386	\$1,483	\$1,605	\$1,131	

Terra Casegoods for Treatment Areas Options

Preconfigured Units		Cam lock (OP/10) ¹	Cam lock with elbow catch (OP/10A) ¹	Power and data in the desk ²	Power in the TV cabinet ³	Veneer case	Solid surface top ⁴	Resin panel (fixed) ⁵	Resin panel (adjustable) ⁵
TRA100	80.75" W, Single sided pre-configured unit with TV cabinet and LSF wardrobe		\$61		\$248	\$625	\$700	\$550	\$1,000
TRA101	80.75" W, Single sided pre-configured unit with TV cabinet and RSF wardrobe		\$61		\$248	\$625	\$700	\$550	\$1,000
TRA102	80.75" W, Shared pre-configured unit with TV cabinet and wardrobe		\$61		\$492	\$625	\$900	\$550	\$1,000
TRA103	84" W, Single sided pre-configured unit with TV cabinet, desk, and LSF wardrobe		\$61	\$405	\$248	\$625	\$800	\$550	\$1,000
TRA104	84" W, Single sided pre-configured unit with TV cabinet, desk, and RSF wardrobe		\$61	\$405	\$248	\$625	\$800	\$550	\$1,000
TRA105	84" W, Shared pre-configured unit with TV cabinet, desk and wardrobe		\$61	\$405	\$492	\$625	\$900	\$550	\$1,000
TRA106	82.5" W, Single sided pre-configured unit with nurse server and LSF wardrobe	\$34				\$625	\$800	\$550	\$1,000
TRA107	82.5" W, Single sided pre-configured unit with nurse server and RSF wardrobe	\$34				\$625	\$800	\$550	\$1,000
TRA108	82.5" W, Shared pre-configured unit with shared nurse server and wardrobe	\$34				\$625	\$900	\$550	\$1,000
TRA109	82.5" W, Shared pre-configured unit with shared nurse server and wardrobe	\$34				\$625	\$900	\$550	\$1,000

Terra Casegoods for Treatment Areas Pre-Configured Units

		Cam lock (OP/10) ¹	Cam lock with elbow catch (OP/10A) ¹	Power and data in the desk ²	Power in the TV cabinet ³	Veneer case	Solid surface top ⁴	Resin panel (fixed) ⁵	Resin panel (adjustable) ⁵
Freestanding Models									
TRA50	18" W, Nurse server ganged RSF with 35 quart waste disposal	\$34				\$200	\$500		
TRA51	18" W, Nurse server ganged LSF with 35 quart waste disposal	\$34				\$200	\$500		
TRA52	29" W, Shared nurse server with 35 quart waste disposal	\$34				\$200	\$550		
TRA53	29" W, Shared nurse server with recycling containers	\$34				\$200	\$550		
TRA54	45.5" W, Movable partition					\$200		\$550	\$1,000
TRA56	15" W, Wardrobe ganged RSF with three clothes hooks					\$200	\$300		
TRA57	15" W, Wardrobe ganged LSF with three clothes hook					\$200	\$300		
TRA58	15" W, Shared wardrobe with clothes bar					\$200	\$350		
TRA59	27.75" W, TV cabinet ganged RSF		\$61	\$405	\$248	\$300	\$400		
TRA60	27.75" W, TV cabinet ganged LSF		\$61	\$405	\$248	\$300	\$550		
TRA63	25.75" W, Shared TV cabinet		\$61	\$405	\$465	\$300	\$500		
TRA61	29" W, TV cabinet with desk ganged RSF		\$61	\$405	\$248	\$300	\$550		
TRA62	29" W, TV cabinet with desk ganged LSF		\$61	\$405	\$248	\$300	\$550		
TRA64	29" W, Shared TV cabinet with desk		\$61	\$405	\$465	\$300	\$550		

Footnotes

¹ Includes two keys per lock and master keys are available for \$6 list.

² Located on the back ledge of the desk, includes one outlet, two USB ports and CAT6 data.

³ Located on the back panel of the TV cabinet and/or behind the lowest pullout self. Once power module is included on single-side models and two are included on shared models.

⁴ Available in Bisque (QB), Glacier white (CQ) and Cameo (58) as standard options. Contact your Customer Service Representative for additional colors.

⁵ Available in Varia pure white, Hush Gesso or Ion Wheat as standard options. Contact your Customer Service Representative for additional patterns.

For more information see the [Terra Casegoods for Treatment Areas Product Guide](https://www.nemschoff.com) at [nemschoff.com](https://www.nemschoff.com)

Casegood Options

Chests, Dressers and Credenzas

		<i>Carm lock (OP/10)¹</i>	<i>Carm lock with elbow catch (OP/10A)¹</i>	<i>Casters (OP/13)²</i>	<i>Locking casters (OP/13LK)²</i>	<i>Wood drawer pans³</i>	<i>Plastic drawer liners (removable)</i>	<i>Veneer case</i>	<i>Solid surface top⁴</i>
Bedford									
BFFB03	31.5" W, Chest – three drawer; maple with cherry	\$34				\$89	\$79		
BFFB03A	31.5" W, Chest – three drawer; maple	\$34				\$89	\$79		
BFFB04	31.5" W, Chest – four drawer; maple with cherry inlay	\$34					\$79		
BFFB04A	31.5" W, Chest – four drawer; maple	\$34					\$79		
BFFC03	25.5" W, Narrow chest – three drawer; maple with cherry inlay	\$34		\$112	\$200		\$65		
BFFC03A	25.5" W, Narrow chest – three drawer; maple	\$34		\$112	\$200		\$65		
Finley									
FX702-3	32" W, Chest – three drawers	\$34		\$112	\$200	\$84	\$52		
FX702-4	32" W, Chest – four drawers	\$34		\$112	\$200	\$89	\$79		
FX702-5	32" W, Chest – five drawers	\$34				\$89	\$79		
Hadleigh									
HDLB/3	36.75" W, Chest – three drawers	\$34		\$112	\$200		\$79		
HDLB/4	36.75" W, Chest – four drawers	\$34		\$112	\$200		\$79		
HDLB/5	36.75" W, Chest – five drawers	\$34					\$79		
Prague II									
FX704-3	32" W, Chest – three drawers	\$34				\$89	\$65		
FX704-4	32" W, Chest – four drawers	\$34				\$89	\$65		
FX704-5	32" W, Chest – five drawers	\$34				\$89	\$65		
Revive									
REVV-00201	32" W, Chest – three drawers	\$62							
REVV-00202	32" W, Chest – two doors and shelf	\$62							
REVV-00203	32" W, Chest – drawer and shelf	\$62							
REVV-00204	32" W, Chest – one drawer	\$62							
REVV-00205	38.25" W, Chest – three drawers and work surface	\$62							
REVV-00206	38.25" W, Chest – two doors, work surface and inside shelf	\$62							
REVV-00207	38.25" W, Chest – one drawer and work surface	\$62							
REVV-00208	38.25" W, Double chest – six drawers	\$62							
REVV-00209	63.25" W, Chest – three LSF drawers, two doors and shelf	\$62							

Casegood Options

Chests, Dressers and Credenzas

		Cam lock (OP/10) ¹	Cam lock with elbow catch (OP/10A) ¹	Casters (OP/13) ²	Locking casters (OP/13LK) ²	Wood drawer pans ³	Plastic drawer liners (removable)	Veneer case	Solid surface top ⁴
REVV-00210	63.25" W, Chest – three RSF drawers, two doors and shelf	\$62							
REVV-00211	63.25" W, Chest – four doors and inside shelves	\$62							
Sovereign									
SVNB/3	33.25" W, Chest – three drawers	\$34		\$112	\$200				
SVNB/4	33.25" W, Chest – four drawers	\$34		\$112	\$200		\$79		
SVNB/5	33.25" W, Chest – five drawers	\$34					\$79		
SVNM/39	25" W, Plate glass mirror								
Ten									
TENB/03	31" W, Chest – three drawers	\$34		\$112	\$200		\$79		
TENB/04	31" W, Chest – four drawers	\$34		\$112	\$200		\$79		
TENB/05	31" W, Chest – five drawers	\$34					\$79		
Terra									
TRA04	30.75" W, Chest – two drawers	\$34						\$410	\$513
TRA05	30.75" W, Chest – one drawer	\$34					\$82	\$410	\$513
TRA06	30.75" W, Chest – three drawers	\$34					\$82	\$410	\$513
TRA07	30.75" W, Narrow chest – two doors		\$61					\$308	\$513
TRA08	42.25" W, Narrow chest – two doors		\$61					\$308	\$667
TRA09	42.25" W, Chest – two doors	\$34						\$513	\$667
TRA10	42.25" W, Chest – one drawer	\$34						\$513	\$667
TRA11	42.25" W, Chest – three drawers	\$34						\$513	\$667
TRA33	61.25" W, Credenza – four doors		\$61					\$410	\$923
TRA34	61.25" W, Narrow credenza – four doors		\$61					\$410	\$923
TRA37	66" W, Chest – two doors and RSF desk	\$34	\$61					\$410	\$923
TRA38	66" W, Chest – two doors and LSF desk	\$34	\$61					\$410	\$923

Footnotes

¹ Includes two keys per lock and master keys are available for \$6 list.

² Add 2.5" to overall height. Casters can be field installed.

³ Wood drawers are available on models that include plastic drawer pans as a standard features.

⁴ Available in Bisque (QB), Glacier white (CQ) and Cameo (58) as standard. Contact your Customer Service Representative for additional colors.

Casegood Options

Armoires, Wardrobes, Wall and Storage Units

		Cam lock (OP/10) ¹	Cam lock and chain latch (OP/10A) ¹	Plastic drawer liners (removable)	Robe hook (OP/6)	Hangers (non-removable) (OP/9)	Pull-out swivel (OP/TVS)	Polycarbonate Mirror (11.5" w x 15.5" h) (OP/1)	Polycarbonate Mirror (13.5" w x 47.5" h) (OP/2)	Continuous hinge (special order) (OP/24)	Veneer case	Solid surface top ²	Gallery Design
Bedford													
BFFT30	31.5" W, TV armoire – three drawers, no doors; maple with cherry inlay	\$34	\$61	\$79			\$207						\$120
BFFT30A	31.5" W, TV armoire – three drawers, no doors; maple	\$34	\$61	\$79			\$207						\$120
BFFT31	31.5" W, TV armoire – pocket doors, three drawers; maple with cherry inlay	\$34	\$61	\$79			\$207						\$120
BFFT31A	31.5" W, TV armoire – pocket doors, three drawers; maple	\$34	\$61	\$79			\$207						\$120
BFFT39	37.5" W, TV armoire – pocket doors, three drawers; maple with cherry inlay	\$34	\$61				\$207						\$120
BFFT39A	37.5" W, TV armoire – pocket doors, three drawers; maple	\$34	\$61				\$207						\$120
BFFT55	55" W, TV wardrobe (hinged right) – pocket doors, three drawers; maple with cherry inlay	\$34	\$61		\$4	\$13	\$207						\$174
BFFT55A	55" W, TV wardrobe (hinged right) – pocket doors, three drawers; maple	\$34	\$61		\$4	\$13	\$207						\$174
BFFT56	55" W, TV wardrobe (hinged left) – pocket doors, three drawers; maple with cherry inlay	\$34	\$61		\$4	\$13	\$207						\$174
BFFT56A	55" W, TV wardrobe (hinged left) – pocket doors, three drawers; maple	\$34	\$61		\$4	\$13	\$207						\$174
BFFT60	60" W, TV wardrobe – two side wardrobes, pocket doors, three drawers; maple with cherry inlay	\$34	\$61		\$4	\$13	\$207						\$174
BFFT60A	60" W, TV wardrobe – two side wardrobes, pocket doors, three drawers; maple	\$34	\$61		\$4	\$13	\$207						\$174
BFFW25	25.5" W, Wardrobe (hinged right) – fixed shelf and clothes bar; maple with cherry inlay	\$34			\$4	\$13		\$155	\$261				\$120
BFFW25A	25.5" W, Wardrobe (hinged right) – fixed shelf and clothes bar; maple	\$34			\$4	\$13		\$155	\$261				\$120
BFFW26	25.5" W, Wardrobe (hinged left) – fixed shelf and clothes bar; maple with cherry inlay	\$34			\$4	\$13		\$155	\$261				\$120
BFFW26A	25.5" W, Wardrobe (hinged left) – fixed shelf and clothes bar; maple	\$34			\$4	\$13		\$155	\$261				\$120

Patient Chairs

Recliners

Treatment Chairs

Rockers & Gliders

Overbed Tables

Sleepover Seating

Casegoods

Display & Accessories

Casegood Options

Armoires, Wardrobes, Wall and Storage Units

		Cam lock (OP/10) ¹	Cam lock and chain latch (OP/10A) ¹	Plastic drawer liners (removable)	Robe hook (OP/6)	Hangers (non-removable) (OP/9)	Pull-out swivel (OP/TVS)	Polycarbonate Mirror (11.5" w x 15.5" h) (OP/1)	Polycarbonate Mirror (13.5" w x 47.5" h) (OP/2)	Continuous hinge (special order) (OP/24)	Veneer case	Solid surface top ²	Gallery Design
BFFW38	37.5" W, Wardrobe – two doors, fixed shelf, clothes bar; maple with cherry inlay		\$61		\$4	\$13		\$155	\$261				\$161
BFFW38A	37.5" W, Wardrobe – two doors, fixed shelf, clothes bar; maple		\$61		\$4	\$13		\$155	\$261				\$161
BFFW50	49" W, Wardrobe – two doors and center divider; maple with cherry inlay	\$34			\$4	\$13		\$155	\$261				\$161
BFFW50A	49" W, Wardrobe – two doors and center divider; maple	\$34			\$4	\$13		\$155	\$261				\$161
Finley													
FX702-25	24.5" W, Wardrobe (hinged right)	\$34											
FX702-26	24.5" W, Wardrobe (hinged left)	\$34						\$155	\$261				
FX702-39	38" W, Double wardrobe		\$61					\$155	\$261				
FX702-38	38" W, TV Armoire – TV opening: 29W x 22.5D x 26.5H	\$34	\$61				\$207						
FX702-43	51.5" W, TV wardrobe (hinged right) – TV opening: 29W x 22.5D x 26.5H	\$34	\$61				\$207						
FX702-44	51.5" W, TV wardrobe (hinged left) – TV opening: 29W x 22.5D x 26.5H	\$34	\$61				\$207						
Hadleigh													
HDLW/25	32" W, Wardrobe (hinged right)	\$34			\$4	\$13							
HDLW/26	32" W, Wardrobe with (hinged left)	\$34			\$4	\$13							
HDLW/38	44" W, Wardrobe – two doors		\$61		\$4	\$13							
HDLT/30	38.25" W, TV armoire – TV opening: 24.5W x 21.5D x 27H	\$34	\$61	\$79			\$207						
HDLT/50	51" W, TV wardrobe (hinged right) – TV opening: 29W x 22.5D x 26.5H	\$34	\$61	\$79	\$4	\$13	\$207						
HDLT/51	51" W, TV wardrobe (hinged left) – TV opening: 29W x 22.5D x 26.5H	\$34	\$61	\$79	\$4	\$13	\$207						
Montello													
FX700-30	33.5" W, TV armoire – TV opening: 22.75W x 21.5D x 26.5H	\$34	\$61	\$65			\$207						
FX700-38	37.5" W, Wardrobe – two doors	\$34			\$4			\$155	\$261				
Prague II													
FX704-25	24.5" W, Wardrobe (hinged right)	\$34			\$4	\$13		\$155	\$261				
FX704-26	24.5" W, Wardrobe with (hinged left)	\$34			\$4	\$13		\$155	\$261				

Casegood Options

Wardrobes and Armoires

		Cam lock (OP/10) ¹	Cam lock and chain latch (OP/10A) ²	Plastic drawer liners (removable)	Robe hook (OP/6)	Hangers (non-removable) (OP/9)	Pull-out swivel (OP/TVS)	Polycarbonate Mirror (11.5" w x 15.5" h) (OP/1)	Polycarbonate Mirror (13.5" w x 47.5" h) (OP/2)	Continuous hinge (special order) (OP/24)	Veneer case	Solid surface top ²	Gallery Design
FX704-39	38" W, Double wardrobe		\$61		\$4	\$13		\$155	\$261				
FX704-38	38" W, TV armoire – TV opening: 29W x 22.5D x 26.5H	\$34	\$61				\$207						
FX704-43	51.5" W, TV wardrobe (hinged right) – TV opening: 29W x 22.5D x 26.5H	\$34	\$61		\$4	\$13	\$207						
FX704-44	51.5" W, TV wardrobe (hinged left) – TV opening: 29W x 22.5D x 26.5H	\$34	\$61		\$4	\$13	\$207						
Revive													
REVV-00301	32" W, Armoire – two doors, top shelf and three drawers	\$34	\$61										
REVV-00302	38" W, Armoire – two doors, top shelf and three drawers	\$34	\$61										
REVV-00303	43" W, Armoire – two doors, top shelf, three drawers and RSF wardrobe	\$34	\$61										
REVV-00304	43" W, Armoire – two doors, top shelf, three drawers and LSF wardrobe	\$34	\$61										
REVV-00401	24.5" W, Wardrobe (hinged right) – two drawers and clothes bar	\$34											
REVV-00402	24.5" W, Wardrobe (hinged left) – two drawers and clothes bar	\$34											
REVV-00403	32" W, Wardrobe – two doors – two drawers and clothes bar	\$34	\$61										
REVV-00404	38" W, Wardrobe – two doors – two drawers and clothes bar	\$34	\$61										
Sovereign													
SVNJ/4	31.5" W, Wall unit with two fixed and two adjustable shelves												
SVNS/23	25.5" W, Storage unit (hinged right)	\$34		\$65	\$4	\$13		\$155	\$261				
SVNS/24	25.5" W, Storage unit (hinged left)	\$34		\$65	\$4	\$13		\$155	\$261				
SVNT/30	39.25" W, TV armoire – two drawers and upper doors	\$34	\$61				\$207						
SVNW/23	27.25" W, Wardrobe with drawer (hinged right)	\$34			\$4	\$13		\$155	\$261				
SVNW/24	27.25" W, Wardrobe with drawer (hinged left)	\$34			\$4	\$13		\$155	\$261				
SVNW/36	39.5" W, Wardrobe – two doors		\$61		\$4	\$13		\$155	\$261				

Patient Chairs

Recliners

Treatment Chairs

Rockers & Gliders

Overbed Tables

Sleepover Seating

Casegoods

Display & Accessories

Casegood Options

Wardrobes and Armoires

		Cam lock (OP/10) ¹	Cam lock and chain latch (OP/10A) ²	Plastic drawer liners (removable)	Robe hook (OP/6)	Hangers (non-removable) (OP/9)	Pull-out swivel (OP/TVS)	Polycarbonate Mirror (11.5" w x 15.5" h) (OP/1)	Polycarbonate Mirror (13.5" w x 47.5" h) (OP/2)	Continuous hinge (special order) (OP/24)	Veneer case	Solid surface top ²	Gallery Design
Ten													
TENW/25	25" W, Wardrobe (hinged right)	\$34			\$4	\$13							
TENW/26	25" W, Wardrobe (hinged left)	\$34			\$4	\$13							
TENT/43	50" W, TV wardrobe (hinged right) – TV opening: 29W x 22.5D x 26.5H	\$34	\$61		\$4	\$13	\$207						
TENT/44	50" W, TV wardrobe (hinged left) – TV opening: 29W x 22.5D x 26.5H	\$34	\$61		\$4	\$13	\$207						
TENT/38	37" W, Double wardrobe – three lower drawers	\$34	\$61				\$207						
TENW/39	37" W, Double wardrobe	\$34	\$61		\$4	\$13		\$155	\$261				
Terra													
TRA12, 2 door	37.25" W, Wardrobe – two doors	\$34		\$62							\$308	\$564	
TRA13, 2 dr/2 door	37.25" W, Wardrobe – two doors, two drawers	\$34		\$62							\$308	\$564	
TRA14, 2 door (door offset to left)	37.25" W, Wardrobe – left offset door and regular door	\$34		\$62	\$4	\$13					\$308	\$564	
TRA15, 2 door (door offset to right)	37.25" W, Wardrobe – right offset door and regular door	\$34		\$62	\$4	\$13					\$308	\$564	
TRA16, 2 door narrow Wardrobe	37.25" W, Narrow wardrobe – two doors	\$34		\$62							\$308	\$564	
TRA17, 2 dr/2door narrow Wardrobe	37.25" W, Narrow wardrobe – two doors, two drawers	\$34									\$308	\$564	
TRA18, 1 door (hinged right)	24.5" W, Wardrobe (hinged right)	\$34			\$4	\$13		\$155	\$261		\$205		
TRA19, 1 door (hinged left)	24.5" W, Wardrobe (hinged left)	\$34			\$4	\$13		\$155	\$261		\$205		
TRA20, 1 dr/1 door (hinged right)	24.5" W, Wardrobe – one drawer and one door (hinged right)	\$34			\$4	\$13		\$155	\$261		\$205		
TRA21, 1 dr/1 door (hinged left)	24.5" W, Wardrobe – one drawer and one door (hinged left)	\$34			\$4	\$13		\$155	\$261		\$205		
TRA22, 1 door (hinged right)	18.75" W, Wardrobe (hinged right)	\$34									\$205	\$410	
TRA23, 1 door (hinged left)	18.75" W, Wardrobe (hinged left)	\$34									\$205	\$410	

Casegood Options

Wardrobes and Armoires

		Cam lock (OP/10) ¹	Cam lock and chain latch (OP/10A) ²	Plastic drawer liners (removable)	Robe hook (OP/6)	Hangers (non-removable) (OP/9)	Pull-out swivel (OP/TVS)	Polycarbonate Mirror (11.5" w x 15.5" h) (OP/1)	Polycarbonate Mirror (13.5" w x 47.5" h) (OP/2)	Continuous hinge (special order) (OP/24)	Veneer case	Solid surface top ²	Gallery Design
TRA24, 1 dr/1 door Wardrobe (hinged right)	18.75" W, Wardrobe with one drawer and one door (hinged right)	\$34		\$62							\$205	\$410	
TRA25, 1 dr/1 door Wardrobe (hinged left)	18.75" W, Wardrobe with one drawer and one door (hinged left)	\$34		\$62							\$205	\$410	
TRA26, 1 door narrow (hinged right)	18.75" W, Narrow wardrobe (hinged right)	\$34									\$205	\$410	
TRA27, 1 door narrow (hinged left)	18.75" W, Narrow wardrobe (hinged left)	\$34									\$205	\$410	
TRA31, 4 door Wardrobe	74" W, Wardrobe – four doors	\$34									\$410	\$1,025	
TRA32, 4 door narrow Wardrobe	74" W, Narrow wardrobe – four doors	\$34									\$410	\$1,025	
TRA35, 1 door/ Wardrobe (hinged right) w/2 door Desk	87.25" W, Wardrobe (hinged right) with desk with two doors	\$34			\$4	\$13		\$155	\$261		\$410	\$1,025	
TRA36, 1 door/ Wardrobe (hinged left) w/2 door Desk	87.25" W, Wardrobe with door (hinged right) and three drawers	\$34		\$82	\$4	\$13		\$155	\$261		\$410	\$1,025	

Footnotes

¹ Includes two keys per lock and master keys are available for \$6 list.

² Available in Bisque (QB), Glacier white (CQ) and Cameo (58) as standard. Contact your Customer Service Representative for additional colors.

Revive Display System



Standard Features

- Powder-coated finish on the rail with wood or laminated center strip
- Integrated card and photo display groove
- Protective bumpers
- End caps to secure accessories
- Wall cleats for rail-to-wall attachment
- Display systems include three hooks, 11" display shelf, magazine holder and two adjustable brackets
- Nemschoff healthcare wood finish
- GREENGUARD Gold Certified
- Limited Lifetime Warranty

Specification Decisions

- Select powder coat finish
- Select wood or laminate for the center strip finish
- Add tack surface for center strip
- Select tack surface finish
- Add 11" or 17" display rail shelf
- Add magazine holder
- Add small or large marker board
- Add adjustable universal brackets
- Add hooks

Coordinating Products

- [Revive Side Chair](#)
- [Revive Patient Chair](#)
- [Revive Casegoods](#)
- [Revive Daystands](#)

Available Options

- Tack surface for center strip
- **OU** Light Sand **OS** Dark Sand
- **6K** Dark Grey **7K** Light Grey
- 48" Tack surface + \$33
- 72" Tack surface + \$46
- 11" Display rail shelf (SH/11) + \$218
- 17" Display rail shelf (SH/17) + \$257
- Magazine holder (MH) + \$252
- Small marker board (MBS) + \$331
- Large marker board (MBL) + \$378
- Adjustable universal bracket (UB) + \$47
- Hook (H) + \$47

	48" Display system - includes hooks, display shelf, magazine holder & brackets	18 lbs
	Model	Price
	RVR/48-PKG-1	\$1,446

	72" Display system - includes hooks, display shelf, magazine holder & brackets	20 lbs
	Model	Price
	RVR/72-PKG-1	\$1,488

	Display system rails	5 lbs	
	Model	Price	Width
	RVR/48	\$135	48"
	RVR/72	\$176	72"

More Information

- Illustrated Glossary ▶ 439
- Finishes ▶ 456
- Ordering and Warranties ▶ 462

Specialty

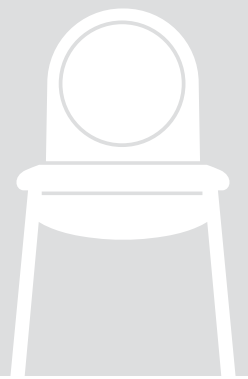

Erica Junior Children's Furniture



Standard Features

- Solid maple frame
- Mortise and tenon joinery
- Laminated top and standard black edge on the table
- Non-marring 7/8" rubber-cushioned glides
- Nemschoff healthcare wood finish
- GREENGUARD Gold Certified
- Limited Lifetime Warranty

Available Options

- CTB-133 + \$81/yd
- E-wood edge (table) +\$914

Specification Decisions

- Select fabric
- Selecte laminate (tabletop)
- Select standard wood finish or children's furniture finish

- A** Tangerine **B** Black **E** Lime
G Grape **H** Blueberry **R** Cherry
Y Lemon

- Add CTB-133
- Add E-wood edge

Flammability Type

- Type 1

Coordinating Products

- [Erica Adjustable Back Chair](#)
- [Erica CompactComfort Recliner](#)

Key Dimensions

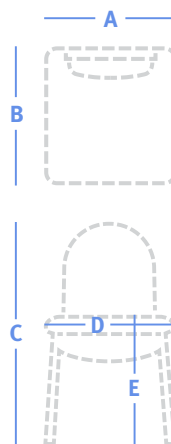

A	Overall Width	See price table
B	Overall Depth	15"
C	Overall Height	24"
D	Seat Width	13.25"
E	Seat Height	13.5"

More Information

- Illustrated Glossary ▶ 439
- Fabrics ▶ 451
- Flammability (CTB-133) ▶ 459
- Standard wood and laminate finishes ▶ 456
- Ordering and Warranties ▶ 462



14.5" W, Junior side chair

14 lbs | 0.75 yds

Model	Series 2	Series 3	Series 4	Series 5	Series 6	Series 7	Series 8	COM
JR/286	\$603	\$626	\$666	\$708	\$757	\$807	\$869	\$626



36" dia., Junior table

31 lbs

Model	Price	Height
JR/286-5	\$694	21.75"

Junior 200 Children's Furniture



More Information

Illustrated Glossary ▶ 439

Fabrics ▶ 451

Flammability (CTB-133) ▶ 459

Standard Wood and Laminate Finishes
▶ 456

Ordering and Warranties ▶ 462

Standard Features

- Solid maple frame
- Non-marring $\frac{7}{8}$ " rubber-cushioned glides
- Casters on toy box
- Laminated top with vinyl edge on table
- Nemschoff healthcare wood finish
- GREENGUARD Gold Certified
- Limited Lifetime Warranty

Available Options

- E-wood edge (table) + \$914

Specification Decisions

- Select fabric
 - Select standard wood finish or standard children's furniture finish
- | | | |
|--------------------|--------------------|-----------------|
| A Tangerine | B Black | E Lime |
| G Grape | H Blueberry | R Cherry |
| Y Lemon | | |
- Select standard laminate, if required
 - Add moisture barrier
 - Add CTB-133
 - Add E-wood edge

Flammability Type

- Type 1

Coordinating Products

- [Junior Recliner](#)[Recliner](#)

Key Dimensions

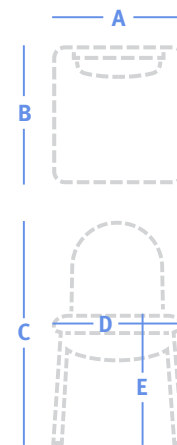

A	Overall Width	See price table
B	Overall Depth	15"
C	Overall Height	24"
D	Seat Width	14"
E	Seat Height	13.5"



14.5" W, Junior side chair

14 lbs | 0.75 yds

Model	Series 2	Series 3	Series 4	Series 5	Series 6	Series 7	Series 8	COM
JR/200	\$603	\$626	\$666	\$708	\$757	\$807	\$869	\$626



18" W, Toy box with casters

24 lbs

Model	Price	Depth	Height
JR/200 TB	\$540	18"	14.5"



36" dia., Junior table

31 lbs

Model	Price	Height
JR/200-5	\$694	21.75"

Junior Recliner



Standard Features

- Solid maple frame
- Spring seat construction
- Replaceable components
- Upholstered arm caps
- Three seated positions
- Push bar with black textured powder-coated finish
- Adjustable footrest
- Field-adjustable recliner mechanism tension
- Wallsaver edge
- Must be 6" from wall to fully recline
- Four 75-mm black casters, rear with brakes
- GREENGUARD Gold Certified
- Limited Lifetime Warranty

Available Options

- Moisture barrier + \$67 per seat or back
- Grey foam headrest + \$316
- Folding side table (LSF, RSF) + \$308
- Adjustable tray table (LSF only) + \$701
- Caster upgrade kit; factory install - 3" twin-wheel, swivel casters with brakes + \$184
- Caster upgrade kit; field install - 3" twin-wheel, swivel casters with brakes + \$413
- CTB-133 + \$81/yard

Specification Decisions

- Select fabric
- Select standard laminate, if required
- Add moisture barrier
- Add CTB-133
- Add headrest
- Add folding side table
- Add adjustable tray table
- Add caster upgrade (factory-installed)
- Add caster upgrade (field-installed)

Flammability Type

- Type 6

Coordinating Products

- [Junior 200 Children's Furniture](#)

Key Dimensions

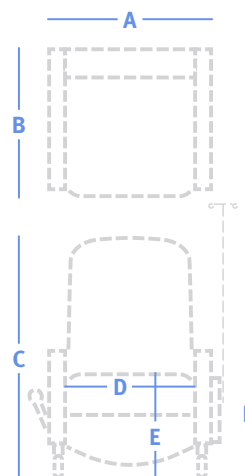

A	Overall Width	See price table
B	Overall Depth	36-63 1/2"
C	Overall Height	42"
D	Seat Width	15.75"
E	Seat Height	19.5"
F	Arm Height	24.5"

More Information

- Illustrated Glossary ▶ 439
- Fabrics ▶ 451
- Flammability (CTB-133) ▶ 459
- Finishes ▶ 456
- Ordering and Warranties ▶ 462



22.5" W, Junior recliner

138 lbs | 6 yds

Model	Series 2	Series 3	Series 4	Series 5	Series 6	Series 7	Series 8	COM
PRJR12	\$4,948	\$5,139	\$5,457	\$5,789	\$6,184	\$6,583	\$7,082	\$5,139

Behavioral Health Casegoods



More Information

Illustrated Glossary ▶ 439

Finishes ▶ 456

Hardware ▶ 457

Ordering and Warranties ▶ 462

Standard Features

- Laminate case with matching HPVC edge
- Maple veneer case with solid maple shelves, doors and bottoms
- Dry construction joinery
- Replaceable components
- Tamper-resistant fasteners
- Non-removable wood drawers with metal guides
- Reinforced shelves, fixed in place
- Integral drawer pulls
- Nemschoff healthcare wood finish
- GREENGUARD Gold Certified
- Limited Lifetime Warranty

Available Options

- Three edge styles

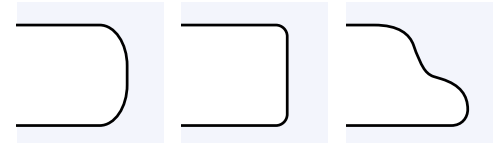

Rounded
(standard)

1/8" radius

Double round

For specific options, see the appropriate product section on the following pages.

Coordinating Products

- [High Use Behavioral Health Seating](#)
- [Marsack III Behavioral Health Seating](#)
- [Meridian Behavioral Health Seating](#)

Behavioral Health Bedside Cabinets and Nightstands

Standard Features

- Same standard features as Behavioral Health Casegoods, plus:
- Vented back panel

Available Options

- See [page 429](#) for additional options

Specification Decisions

- Select standard laminate or wood finish
- Select edge detail
- See [page 429](#) for additional options



19.25" W, Bedside cabinet - three shelves; laminate

55 lbs

Model	Price	Depth	Height
BHBA/00M	\$902	19.5"	29.75"



19.25" W, Bedside cabinet - three shelves; wood

55 lbs

Model	Price	Depth	Height
BHBA/00W	\$971	19.5"	29.75"



19.25" W, Bedside cabinet - three drawers; laminate

61 lbs

Model	Price	Depth	Height
BHBA/03M	\$1,060	19.5"	29.75"



19.25" W, Bedside cabinet - three drawers; wood

61 lbs

Model	Price	Depth	Height
BHBA/03W	\$1,136	19.5"	29.75"



19.25" W, Nightstand - one drawer; laminate

45 lbs

Model	Price	Depth	Height
BHBG/01M	\$863	19.5"	21.25"

Behavioral Health Casegoods

	19.25" W, Nightstand - one drawer; wood				45 lbs
	Model	Price	Depth	Height	
	BHBG/01W	\$931	19.5"	21.25"	
	19.25" W, Nightstand - two shelves; laminate				42 lbs
	Model	Price	Depth	Height	
	BHBG/00M	\$530	19.5"	21.25"	
	19.25" W, Nightstand - two shelves; wood				42 lbs
	Model	Price	Depth	Height	
	BHBG/00W	\$598	19.5"	21.25"	

Behavioral Health Chests

Standard Features	Available Options	Specification Decisions
Same standard features as Behavioral Health Casegoods	Same edges options as Behavioral Health Casegoods • See page 429 for additional options	• Select standard laminate or wood finish • Select edge detail • See page 429 for additional options

	31.25" W, Chest - three shelves; laminate				84 lbs
	Model	Price	Depth	Height	
	BHBC/01M	\$753	19.5"	29.75"	
	31.25" W, Chest - three shelves; wood				84 lbs
	Model	Price	Depth	Height	
	BHBC/01W	\$886	19.5"	29.75"	
	31.25" W, Chest - four shelves; laminate				104 lbs
	Model	Price	Depth	Height	
	BHBC/02M	\$1,019	19.5"	38.25"	
	31.25" W, Chest - four shelves; wood				104 lbs
	Model	Price	Depth	Height	
	BHBC/02W	\$1,172	19.5"	38.25"	
	31.25" W, Chest - three drawers; laminate				95 lbs
	Model	Price	Depth	Height	
	BHBC/03M	\$1,347	19.5"	29.75"	

Behavioral Health Casegoods

	31.25" W, Chest - three drawers; wood 95 lbs			
	Model	Price	Depth	Height
	BHBC/03W	\$1,375	19.5"	29.75"
	31.25" W, Chest - four drawers; laminate 120 lbs			
	Model	Price	Depth	Height
	BHBC/04M	\$1,550	19.5"	38.25"
	31.25" W, Chest - four drawers; wood 120 lbs			
	Model	Price	Depth	Height
	BHBC/04W	\$1,581	19.5"	38.25"

Behavioral Health Wardrobes

Standard Features

Same standard features as Behavioral Health Casegoods, plus:

- Continuous hinges on doors
- Sloped tops





Available Options

Same edges options as Behavioral Health Casegoods, plus:











- Flat top + \$0
- See [page 429](#) for additional options

Specification Decisions

- Select standard laminate or wood finish
- Select edge detail
- Add flat top
- See [page 429](#) for additional options

	24.5" W, Wardrobe - one shelf, J-bar and two drawers; laminate 173 lbs			
	Model	Price	Depth	Height
	BHBW/20M	\$879	22.5"	84.5"
	24.5" W, Wardrobe - one shelf, J-bar and two drawers; wood 173 lbs			
	Model	Price	Depth	Height
	BHBW/20W	\$1,110	22.5"	84.5"
	24.5" W, Wardrobe - five shelves; laminate 191 lbs			
	Model	Price	Depth	Height
	BHBW/21M	\$967	22.5"	84.5"
	24.5" W, Wardrobe - five shelves; wood 191 lbs			
	Model	Price	Depth	Height
	BHBW/21W	\$1,220	22.5"	84.5"
	24.5" W, Wardrobe - right hinged door, one shelf, J-bar and two drawers; laminate 271 lbs			
	Model	Price	Depth	Height
	BHBW/23M	\$1,578	23.75"	84.5"

Behavioral Health Casegoods

	24.5" W, Wardrobe - right hinged door, one shelf, J-bar and two drawers; wood 271 lbs							
	<table border="1"> <thead> <tr> <th>Model</th> <th>Price</th> <th>Depth</th> <th>Height</th> </tr> </thead> <tbody> <tr> <td>BHBW/23W</td> <td>\$1,996</td> <td>23.75"</td> <td>84.5"</td> </tr> </tbody> </table>	Model	Price	Depth	Height	BHBW/23W	\$1,996	23.75"
Model	Price	Depth	Height					
BHBW/23W	\$1,996	23.75"	84.5"					
	24.5" W, Wardrobe - left hinged door, one shelf, J-bar and two drawers; laminate 271 lbs							
	<table border="1"> <thead> <tr> <th>Model</th> <th>Price</th> <th>Depth</th> <th>Height</th> </tr> </thead> <tbody> <tr> <td>BHBW/24M</td> <td>\$1,578</td> <td>23.75"</td> <td>84.5"</td> </tr> </tbody> </table>	Model	Price	Depth	Height	BHBW/24M	\$1,578	23.75"
Model	Price	Depth	Height					
BHBW/24M	\$1,578	23.75"	84.5"					
	24.5" W, Wardrobe - left hinged door, one shelf, J-bar and two drawers; wood 271 lbs							
	<table border="1"> <thead> <tr> <th>Model</th> <th>Price</th> <th>Depth</th> <th>Height</th> </tr> </thead> <tbody> <tr> <td>BHBW/24W</td> <td>\$1,996</td> <td>23.75"</td> <td>84.5"</td> </tr> </tbody> </table>	Model	Price	Depth	Height	BHBW/24W	\$1,996	23.75"
Model	Price	Depth	Height					
BHBW/24W	\$1,996	23.75"	84.5"					
	24.5" W, Wardrobe - right hinged door and five shelves; laminate 239 lbs							
	<table border="1"> <thead> <tr> <th>Model</th> <th>Price</th> <th>Depth</th> <th>Height</th> </tr> </thead> <tbody> <tr> <td>BHBW/25M</td> <td>\$1,749</td> <td>23.75"</td> <td>84.5"</td> </tr> </tbody> </table>	Model	Price	Depth	Height	BHBW/25M	\$1,749	23.75"
Model	Price	Depth	Height					
BHBW/25M	\$1,749	23.75"	84.5"					
	24.5" W, Wardrobe - right hinged door and five shelves; wood 239 lbs							
	<table border="1"> <thead> <tr> <th>Model</th> <th>Price</th> <th>Depth</th> <th>Height</th> </tr> </thead> <tbody> <tr> <td>BHBW/25W</td> <td>\$2,166</td> <td>23.75"</td> <td>84.5"</td> </tr> </tbody> </table>	Model	Price	Depth	Height	BHBW/25W	\$2,166	23.75"
Model	Price	Depth	Height					
BHBW/25W	\$2,166	23.75"	84.5"					
	24.5" W, Wardrobe - left hinged door and five shelves; laminate 239 lbs							
	<table border="1"> <thead> <tr> <th>Model</th> <th>Price</th> <th>Depth</th> <th>Height</th> </tr> </thead> <tbody> <tr> <td>BHBW/26M</td> <td>\$1,749</td> <td>23.75"</td> <td>84.5"</td> </tr> </tbody> </table>	Model	Price	Depth	Height	BHBW/26M	\$1,749	23.75"
Model	Price	Depth	Height					
BHBW/26M	\$1,749	23.75"	84.5"					
	24.5" W, Wardrobe - left hinged door and five shelves; wood 239 lbs							
	<table border="1"> <thead> <tr> <th>Model</th> <th>Price</th> <th>Depth</th> <th>Height</th> </tr> </thead> <tbody> <tr> <td>BHBW/26W</td> <td>\$2,166</td> <td>23.75"</td> <td>84.5"</td> </tr> </tbody> </table>	Model	Price	Depth	Height	BHBW/26W	\$2,166	23.75"
Model	Price	Depth	Height					
BHBW/26W	\$2,166	23.75"	84.5"					
	39.25" W, Double wardrobe - center divide, one shelf, J-bar and two drawers; laminate 204 lbs							
	<table border="1"> <thead> <tr> <th>Model</th> <th>Price</th> <th>Depth</th> <th>Height</th> </tr> </thead> <tbody> <tr> <td>BHBW/30M</td> <td>\$1,099</td> <td>22.5"</td> <td>84.5"</td> </tr> </tbody> </table>	Model	Price	Depth	Height	BHBW/30M	\$1,099	22.5"
Model	Price	Depth	Height					
BHBW/30M	\$1,099	22.5"	84.5"					
	39.25" W, Double wardrobe - center divide, one shelf, J-bar and two drawers; wood 204 lbs							
	<table border="1"> <thead> <tr> <th>Model</th> <th>Price</th> <th>Depth</th> <th>Height</th> </tr> </thead> <tbody> <tr> <td>BHBW/30W</td> <td>\$1,387</td> <td>22.5"</td> <td>84.5"</td> </tr> </tbody> </table>	Model	Price	Depth	Height	BHBW/30W	\$1,387	22.5"
Model	Price	Depth	Height					
BHBW/30W	\$1,387	22.5"	84.5"					
	39.25" W, Double wardrobe - five shelves and center divide; laminate 251 lbs							
	<table border="1"> <thead> <tr> <th>Model</th> <th>Price</th> <th>Depth</th> <th>Height</th> </tr> </thead> <tbody> <tr> <td>BHBW/31M</td> <td>\$1,210</td> <td>22.5"</td> <td>84.5"</td> </tr> </tbody> </table>	Model	Price	Depth	Height	BHBW/31M	\$1,210	22.5"
Model	Price	Depth	Height					
BHBW/31M	\$1,210	22.5"	84.5"					

Behavioral Health Casegoods

	39.25" W, Double wardrobe - five shelves and center divide; wood 251 lbs			
	Model	Price	Depth	Height
	BHBW/31W	\$1,526	22.5"	84.5"
	39.25" W, Double wardrobe - two doors, center divide, one shelf, J-bar and two drawers; laminate 414 lbs			
	Model	Price	Depth	Height
	BHBW/39M	\$1,973	23.75"	84.5"
	39.25" W, Double wardrobe - two doors, center divide, one shelf, J-bar and two drawers; wood 414 lbs			
	Model	Price	Depth	Height
	BHBW/39W	\$2,493	23.75"	84.5"
	39.25" W, Double wardrobe - two doors, five shelves, and center divide; laminate 331 lbs			
	Model	Price	Depth	Height
	BHBW/40M	\$2,186	23.75"	84.5"
	39.25" W, Double wardrobe - two doors, five shelves, and center divide; wood 331 lbs			
	Model	Price	Depth	Height
	BHBW/40W	\$2,708	23.75"	84.5"

Behavioral Health Desks

Standard Features

Same standard features as Behavioral Health Casegoods, plus:

- Wood-encased steel foot stretcher

Available Options

Same edges options as Behavioral Health Casegoods, plus:

- Pencil drawer + \$55
- OP/41 Cam fasteners (required to attach hutch to desk) + \$51
- Hutch (requires cam fastener to attach to desk)
- See [page 429](#) for additional options

Specification Decisions

- Select standard laminate or wood finish
- Select edge detail
- Add pencil drawer
- Add hutch and cam fastener
- See [page 429](#) for additional options

	36" W, Writing table; laminate 62 lbs			
	Model	Price	Depth	Height
	BHBD/40M	\$688	24.5"	29.75"
	36" W, Writing table; wood 62 lbs			
	Model	Price	Depth	Height
	BHBD/40W	\$809	24.5"	29.75"

Behavioral Health Casegoods



44.5" W, Desk - three RSF shelves; laminate

105 lbs

Model	Price	Depth	Height
BHBD/42M	\$934	24.5"	29.75"



44.5" W, Desk - three RSF shelves; wood

105 lbs

Model	Price	Depth	Height
BHBD/42W	\$1,075	24.5"	29.75"



44.5" W, Desk - three LSF shelves; laminate

105 lbs

Model	Price	Depth	Height
BHBD/43M	\$934	24.5"	29.75"



44.5" W, Desk - three LSF shelves; wood

105 lbs

Model	Price	Depth	Height
BHBD/43W	\$1,075	24.5"	29.75"



44.5" W, Desk - three RSF drawers; laminate

115 lbs

Model	Price	Depth	Height
BHBD/44M	\$1,390	24.5"	29.75"



44.5" W, Desk - three RSF drawers; wood

115 lbs

Model	Price	Depth	Height
BHBD/44W	\$1,735	24.5"	29.75"



44.5" W, Desk - three LSF drawers; laminate

115 lbs

Model	Price	Depth	Height
BHBD/45M	\$1,390	24.5"	29.75"



44.5" W, Desk - three LSF drawers; wood

115 lbs

Model	Price	Depth	Height
BHBD/45W	\$1,735	24.5"	29.75"

36" W, Hutch; laminate

Model	Price	Depth	Height
BHBH/40M	\$363	9.5"	29"

36" W, Hutch; wood

Model	Price	Depth	Height
BHBH/40W	\$481	9.5"	29"

Behavioral Health Casegoods

44.5" W, Hutch; laminate

Model	Price	Depth	Height
BHBH/45M	\$427	9.5"	29.5"

44.5" W, Hutch; wood

Model	Price	Depth	Height
BHBH/45W	\$562	9.5"	29.5"

Behavioral Health Beds

Standard Features

Same standard features as Behavioral Health Casegoods, plus:

- Steel core for added weight and structure includes floor mount attachment (BHHD/68W only)

Available Options

Same edges options as Behavioral Health Casegoods, plus:

- One drawer on left, right, or end with metal guides + \$139
- Two wood drawers on left or right side + \$220
- Security hold points (includes four) + \$68
- Laminate headboard + \$220
- Wood headboard + \$269
- Two upholstered seat cushions (see price table)
- Two upholstered bolster cushions (see price table)
- See page 429 for additional options

Specification Decisions

- Select standard laminate or wood finish
- Select edge detail
- Add drawers
- Add security hold points
- Add headboard
- Add upholstered seat cushion and/or bolster
- See page 429 for additional options

Flammability Type

- Type 7 (cushion)



37.5" W, Platform bed; laminate

163 lbs

Model	Price	Depth	Height
BHBP/68M	\$1,458	84.5"	24.5"



37.5" W, Platform bed; wood

163 lbs

Model	Price	Depth	Height
BHBP/68W	\$1,730	84.5"	24.5"



37.5" W, Heavy duty platform bed; wood

201 lbs

Model	Price	Depth	Height
BHHD/68W	\$1,993	84.5"	24.5"

Behavioral Health Casegoods

36" W, Upholstered seat cushions for behavioral health beds 6.5 yds

Model	Series 2	Series 3	Series 4	Series 5	Series 6	Series 7	Series 8	COM
BH Upholstered seat cushion	\$1,210	\$1,418	\$1,761	\$2,121	\$2,550	\$2,981	\$3,522	\$1,418

33" W, Upholstered bolster cushions for behavioral health beds 3.5 yds

Model	Series 2	Series 3	Series 4	Series 5	Series 6	Series 7	Series 8	COM
BH Upholstered bolster cushion	\$874	\$986	\$1,172	\$1,365	\$1,595	\$1,828	\$2,119	\$986

Behavioral Health Casegoods

Casegood Options

		Cam lock (OP/10) ¹	Wood drawer guides ²	Plastic drawer liners (non-removable) ³	Wall-mount attachment ⁴	Floor-mount attachment ⁴	Floor-free attachment ⁴	Wall and floor-mount attachment ⁴
BHBG/01M	19.25" W, Nightstand - one drawer; laminate	\$34	\$204	\$50	\$70		\$205	
BHBG/01W	19.25" W, Nightstand - one drawer; wood	\$34	\$204	\$50	\$70		\$205	
BHBG/00M	19.25" W, Nightstand - two shelves; laminate		\$204	\$50	\$70		\$205	
BHBG/00W	19.25" W, Nightstand - two shelves; wood		\$204	\$50	\$70		\$205	
BHBA/00M	19.25" W, Bedside cabinet - three shelves; laminate		\$204	\$50	\$70		\$205	
BHBA/00W	19.25" W, Bedside cabinet - three shelves; wood		\$204	\$50	\$70		\$205	
BHBA/03M	19.25" W, Bedside cabinet - three drawers; laminate	\$34	\$204	\$50	\$70		\$205	
BHBA/03W	19.25" W, Bedside cabinet - three drawers; laminate	\$34	\$204	\$50	\$70		\$205	
BHBC/01M	31.25" W, Chest - three shelves; laminate		\$204	\$75	\$70		\$205	
BHBC/01W	31.25" W, Chest - three shelves; wood		\$204	\$75	\$70		\$205	
BHBC/02M	31.25" W, Chest - four shelves; laminate		\$204	\$75	\$70		\$205	
BHBC/02W	31.25" W, Chest - four shelves; wood		\$204	\$75	\$70		\$205	
BHBC/03M	31.25" W, Chest - three drawers; laminate	\$34	\$204	\$75	\$70		\$205	
BHBC/03W	31.25" W, Chest - three drawers; wood	\$34	\$204	\$75	\$70		\$205	
BHBC/04M	31.25" W, Laminate chest with four drawers	\$34	\$204	\$75	\$70		\$205	
BHBC/04W	31.25" W, Wood chest with four drawers	\$34	\$204	\$75	\$70		\$205	
BHBW/20M	24.5" W, Wardrobe - one shelf, J-bar and two drawers; laminate	\$34	\$204		\$70		\$205	
BHBW/20W	24.5" W, Wardrobe - one shelf, J-bar and two drawers; wood	\$34	\$204		\$70		\$205	
BHBW/21M	24.5" W, Wardrobe - five shelves; laminate				\$70		\$205	
BHBW/21W	24.5" W, Wardrobe - five shelves; wood				\$70		\$205	
BHBW/23M	24.5" W, Wardrobe - right hinged door, one shelf, J-bar and two drawers; laminate	\$34	\$204	\$50	\$70		\$205	
BHBW/23W	24.5" W, Wardrobe - right hinged door, one shelf, J-bar and two drawers; wood	\$34	\$204	\$50	\$70		\$205	
BHBW/24M	24.5" W, Wardrobe - left hinged door, one shelf, J-bar and two drawers; laminate	\$34	\$204	\$50	\$70		\$205	
BHBW/24W	24.5" W, Wardrobe - left hinged door, one shelf, J-bar and two drawers; wood	\$34	\$204	\$50	\$70		\$205	
BHBW/25M	24.5" W, Wardrobe - right hinged door and five shelves; laminate	\$34			\$70		\$205	
BHBW/25W	24.5" W, Wardrobe - right hinged door and five shelves; wood	\$34			\$70		\$205	
BHBW/26M	24.5" W, Wardrobe - left hinged door and five shelves; laminate	\$34			\$70		\$205	

Behavioral Health Casegoods

		Cam lock (OP/10) ¹	Wood drawer guides ²	Plastic drawer liners (non-removable) ³	Wall-mount attachment ⁴	Floor-mount attachment ⁴	Floor-free attachment ⁴	Wall and floor-mount attachment ⁴
BHBW/26W	24.5" W, Wardrobe - left hinged door and five shelves; wood	\$34			\$70		\$205	
BHBW/30M	39.25" W, Double wardrobe - center divide, one shelf, J-bar and two drawers; laminate		\$204	\$50	\$70		\$205	
BHBW/30W	39.25" W, Double wardrobe - center divide, one shelf, J-bar and two drawers; wood		\$204	\$50	\$70		\$205	
BHBW/31M	39.25" W, Double wardrobe - five shelves and center divide; laminate				\$70		\$205	
BHBW/31W	39.25" W, Double wardrobe - five shelves and center divide; wood				\$70		\$205	
BHBW/39M	39.25" W, Double wardrobe - two doors, center divide, one shelf, J-bar and two drawers; laminate	\$34	\$204	\$50	\$70		\$205	
BHBW/39W	39.25" W, Double wardrobe - two doors, center divide, one shelf, J-bar and two drawers; wood	\$34	\$204	\$50	\$70		\$205	
BHBW/40M	39.25" W, Double wardrobe - two doors, five shelves, and center divide; laminate	\$34			\$70		\$205	
BHBW/40W	39.25" W, Double wardrobe - two doors, five shelves, and center divide; wood	\$34			\$70		\$205	
BHBD/40M	36" W, Writing table; laminate							\$205
BHBD/40W	36" W, Writing table; wood							\$205
BHBD/42M	44.5" W, Desk - three RSF shelves; laminate							\$205
BHBD/42W	44.5" W, Desk - three RSF shelves; wood							\$205
BHBD/43M	44.5" W, Desk - three LSF shelves; laminate							\$205
BHBD/43W	44.5" W, Desk - three LSF shelves; wood							\$205
BHBD/44M	44.5" W, Desk - three RSF drawers; laminate	\$34	\$204	\$50				\$205
BHBD/44W	44.5" W, Desk - three RSF drawers; wood	\$34	\$204	\$50				\$205
BHBD/45M	44.5" W, Desk - three LSF drawers; laminate	\$34	\$204	\$50				\$205
BHBD/45W	44.5" W, Desk - three LSF drawers; wood	\$34	\$204	\$50				\$205
BHBP/68M	37.5" W, Platform bed; laminate	\$34	\$204	\$50		\$205		
BHBP/68W	37.5" W, Platform bed; wood	\$34	\$204	\$50		\$205		
BHHD/68W	37.5" W, Heavy duty platform bed; wood	\$34	\$204	\$50		STANDARD		

Footnotes

- ¹ Includes two keys per lock and master keys are available for \$6 list
- ² Wood drawer guides replace the standard metal drawer guides
- ³ Plastic drawer liners are not available with wood drawer guides
- ⁴ See **Mounting** in the Illustrated Glossary (page 442)

High Use Behavioral Health Seating



More Information

- Illustrated Glossary ▶ 439
- Fabrics ▶ 451
- Flammability (CTB-133) ▶ 459
- Finishes ▶ 456
- Ordering and Warranties ▶ 462

Standard Features

- Solid maple frame
- Mortise and tenon joinery
- Enclosed underside
- Wipe-out design
- Tamper resistant glides
- Nemschoff healthcare wood finish
- GREENGUARD Gold Certified
- Limited Lifetime Warranty

Available Options

- Moisture barrier + \$67 per seat or back
- Two fabrics + \$62

Specification Decisions

- Select fabric
- Select standard wood finish
- Add moisture barrier
- Add CTB-133
- Apply multiple fabrics

Flammability Type

- Type 1

Coordinating Products

- Behavioral Health Casegoods
- Marsack III Behavioral Health Seating
- Meridian Behavioral Health Seating

Key Dimensions

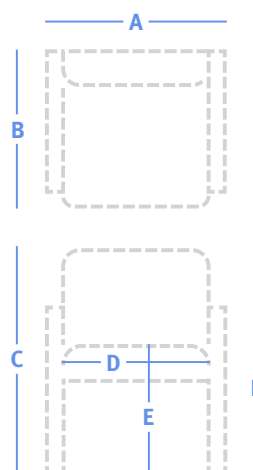

A	Overall Width	See price table
B	Overall Depth	23"
C	Overall Height	31"
D	Seat Width	18.5"
E	Seat Height	18"
F	Arm Height	25"



22.5" W, Side chair with heavy duty sled base

20 lbs | 1.25 yds

Model	Series 2	Series 3	Series 4	Series 5	Series 6	Series 7	Series 8	COM
360-91	\$669	\$708	\$775	\$844	\$926	\$1,009	\$1,113	\$708



22.5" W, Side chair with arms and heavy duty sled base

24 lbs | 1.25 yds

Model	Series 2	Series 3	Series 4	Series 5	Series 6	Series 7	Series 8	COM
360-90	\$720	\$759	\$826	\$895	\$977	\$1,060	\$1,164	\$759

Marsack III Behavioral Health Seating



Standard Features

- Mortise and tenon joinery
- Replaceable components
- Wipe-out design
- Ultra-heavy
- Laminate-wrapped side panels
- Secured black urethane arm caps
- Enclosed underside
- Tamper-resistant glides
- Nemschoff healthcare wood finish
- GREENGUARD Gold Certified
- Limited Lifetime Warranty

Available Options

- Moisture barrier + \$67 per seat or back
- Wood arm caps + \$113
- CTB-133 + \$81
- Two fabrics + \$62
- Three (or more) fabrics + \$88

Specification Decisions

- Select fabric
- Select standard laminate
- Add wood arm caps
- Select standard wood finish, if required
- Add moisture barrier
- Add CTB-133
- Apply multiple fabrics

Flammability Type

- Type 4

Coordinating Products

- [Marsack Lounge Seating](#)
- [Marsack II Lounge Seating](#)
- [Marsack Tables](#)
- [Behavioral Health Casegoods](#)
- [High Use Behavioral Health Seating](#)
- [Meridian Behavioral Health Seating](#)

Key Dimensions

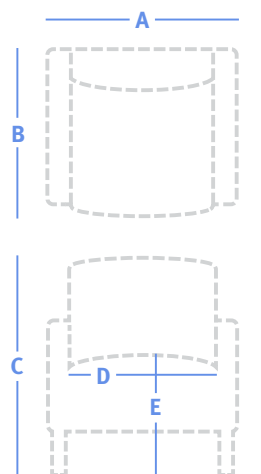

A	Overall Width	See price table
B	Overall Depth	29.5"
C	Overall Height	32.5"
D	Seat Width	
	Chair:	23"
	Two Seat:	46"
	Three Seat:	69"
E	Seat Height	18.75"
F	Arm Height	24.5"

More Information

Illustrated Glossary ▶ 439





Fabrics ▶ 451

Flammability (CTB-133) ▶ 459

Finishes ▶ 456

Ordering and Warranties ▶ 462

Marsack III Behavioral Health Seating

	29" W, Chair									106 lbs 3 yds
	Model	Series 2	Series 3	Series 4	Series 5	Series 6	Series 7	Series 8	COM	
	703-10BH	\$2,336	\$2,415	\$2,548	\$2,686	\$2,851	\$3,017	\$3,225	\$2,415	
	49.5" W, Two seat									137 lbs 5 yds
	Model	Series 2	Series 3	Series 4	Series 5	Series 6	Series 7	Series 8	COM	
	703-20BH	\$2,662	\$2,805	\$3,044	\$3,293	\$3,589	\$3,888	\$4,262	\$2,805	
	52.25" W, Two seat with divider arm									155 lbs 5 yds
	Model	Series 2	Series 3	Series 4	Series 5	Series 6	Series 7	Series 8	COM	
	703-25BH	\$4,172	\$4,315	\$4,554	\$4,803	\$5,099	\$5,398	\$5,772	\$4,315	
	70.5" W, Three seat									181 lbs 7 yds
	Model	Series 2	Series 3	Series 4	Series 5	Series 6	Series 7	Series 8	COM	
	703-30BH	\$4,787	\$5,002	\$5,360	\$5,733	\$6,177	\$6,626	\$7,187	\$5,002	
	76.5" W, Three seat with divider arms									217 lbs 7 yds
	Model	Series 2	Series 3	Series 4	Series 5	Series 6	Series 7	Series 8	COM	
	703-35BH	\$5,846	\$6,061	\$6,419	\$6,792	\$7,236	\$7,685	\$8,246	\$6,061	

Meridian Behavioral Health Seating



Standard Features

- Solid hardwood frame
- Wipe-out design
- Ultra-heavy
- Secured wood arm caps
- Enclosed underside
- Tamper-resistant glides
- Nemschoff healthcare wood finish
- GREENGUARD Gold Certified
- Limited Lifetime Warranty

Available Options

- Moisture barrier + \$67 per seat or back
- Fully upholstered arm + \$113
- Black urethane arm cap + \$113
- CTB-133 + \$81/yd
- Two fabrics + \$62
- Three (or more) fabrics + \$88

Specification Decisions

- Select fabric
- Select standard wood finish
- Add upholstered arm or urethane arm caps
- Add moisture barrier
- Add CTB-133
- Apply multiple fabrics

Flammability Type

- Type 6

Coordinating Products

- [Behavioral Health Casegoods](#)
- [High Use Behavioral Health Seating](#)
- [Marsack III Behavioral Health Seating](#)
- [Meridian Lounge Seating](#)
- [Meridian Multiple Seating](#)
- [Meridian Patient Chair](#)
- [Meridian Tables](#)

Key Dimensions

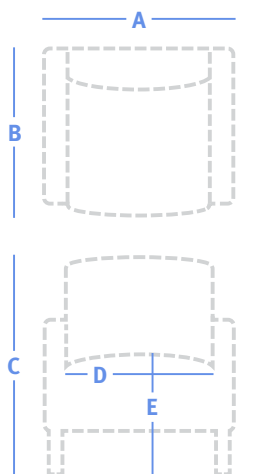

A	Overall Width	See price table
B	Overall Depth	30"
C	Overall Height	29"
D	Seat Width	
	Chair:	20.75"
	Two Seat:	20.75"
	Three Seat:	20.75"
E	Seat Height	18"
F	Arm Height	24"

More Information

Illustrated Glossary ▶ 439

Fabrics ▶ 451

Flammability (CTB-133) ▶ 459

Finishes ▶ 456

Ordering and Warranties ▶ 462

Meridian Behavioral Health Seating

**27" W, Chair**

5 yds

Model	Series 2	Series 3	Series 4	Series 5	Series 6	Series 7	Series 8	COM
ML30/27BH	\$1,528	\$1,687	\$1,952	\$2,229	\$2,558	\$2,890	\$3,306	\$1,687

**51.5" W, Two seat with intervening arm**

9 yds

Model	Series 2	Series 3	Series 4	Series 5	Series 6	Series 7	Series 8	COM
ML30/2BH	\$2,578	\$2,865	\$3,342	\$3,840	\$4,432	\$5,030	\$5,779	\$2,865

**75.75" W, Three seat with intervening arms**

13 yds

Model	Series 2	Series 3	Series 4	Series 5	Series 6	Series 7	Series 8	COM
ML30/3BH	\$3,544	\$3,959	\$4,647	\$5,367	\$6,222	\$7,087	\$8,168	\$3,959

Physician Stools



Standard Features

- Black composite base with nylon casters (FX9602)
- Aluminum base with polyurethane casters (FX9604)
- Polished aluminum base with polyurethane casters (FX9606)
- High-density fire-resistant foam
- Seamless upholstery
- Vinyl colors
 - 1** Black **2** Charcoal **3** Navy
 - 4** Tan **5** Khaki
- Ships cartoned and drop-shipped
- GREENGUARD Gold certified
- Five-year Warranty

Available Options

- Glides + \$0
- Pressure-locking casters + \$118

Specification Decisions

- Select vinyl
- Add glides
- Add pressure-locking casters

Flammability Type

Flammability requirements can be accommodated as a special. Please contact your customer service representative.

More Information

- Illustrated Glossary ▶ 439
- Finishes ▶ 456
- Ordering and Warranties ▶ 462



Stool with single-lever seat adjustment

18 lbs | 1 yds

Model	Vinyl/COM	Seat Diameter	Base Diameter	Height Range
FX9602	\$394	16.25"	23.5"	17.25"-22.5"



Stool with D-ring seat adjustment

19 lbs | 1 yds

Model	Vinyl/COM	Seat Diameter	Base Diameter	Height Range
FX9604	\$502	16.25"	23.5"	16.75"-21"



Stool with 360-degree hand ring seat adjustment

20 lbs | 1 yds

Model	Vinyl/COM	Seat Diameter	Base Diameter	Height Range
FX9606	\$559	16.25"	24"	16.25"-21"

Lab Stools



More Information

Illustrated Glossary ▶ 439

Finishes ▶ 456

Hardware ▶ 457

Ordering and Warranties ▶ 462

Standard Features

- Aluminum base with polyurethane casters (FX8602, FX8604, FX8610)
- Polished aluminum base with polyurethane casters (FX8606, FX8612)
- Adjustable aluminum foot ring (FX8608, FX8610, FX8612)
- Black composite base with polyurethane casters (FX8608)
- High-density fire-resistant foam
- Seamless upholstery
- Vinyl colors
 - 1** Black **2** Charcoal **3** Navy
 - 4** Tan **5** Khaki
- Supportive backrest on mid-height and tall stools
- Backrest adjustable tilt (select models)
- Ships cartoned and drop-shipped
- GREENGUARD Gold certified
- Five-year warranty

Available Options

- Glides + \$0
- Pressure-locking casters + \$118

Specification Decisions

- Select vinyl
- Add glides
- Add pressure-locking casters

Flammability Type

Flammability requirements can be accommodated as a special. Please contact your customer service representative.



Lab stool with D-ring seat adjustment and backrest

30 lbs | 1 yds

Model	Vinyl/COM	Seat Diameter	Base Diameter	Height Range
FX8602	\$713	16.25"	23.5"	16.75"-21"
FX8608	\$820	16.25"	25"	22.5"-29.5"



Lab stool with dual lever for seat adjustment and backrest tilt

36 lbs | 1.5 yds

Model	Vinyl/COM	Seat Diameter	Base Diameter	Height Range
FX8606	\$1,282	18.5"	24"	16.25"-21.25"
FX8612	\$1,407	18.5"	24"	20.25"-28"



Lab stool with lever-operated tilt backrest

36 lbs | 1 yd

Model	Vinyl/COM	Seat Diameter	Base Diameter	Height Range
FX8604	\$918	18.5"	23.5"	17"-21.25"
FX8610	\$1,043	18.5"	23.5"	20.25"-27.25"

Reference



Illustrated Glossary

Nemschoff furniture is rich with healthcare-appropriate features designed for comfort, durability, safety, and ease of use. This glossary explains many of them. If you would like additional information, see individual product specification pages.

A

Antimicrobial properties in upholsteries prevent the spread of germs and diseases in healthcare environments. These textiles have been treated with antimicrobial agents to provide lasting protection.

Assembly is required on some Nemschoff products upon delivery.

- Tables 36" or larger ship with legs unattached to bases.
- Overbed Table (FX26) ships with the base, column, and top unattached.
- Treatment chair options, such as arm supports and IV Rods, ship unattached to the chair.
- Orders for Steps Lounge with a configuration of three or more units ship unattached and must be ganged in the field.
- Spanner tables, end tables, and corner tables that are attached to multiple and tandem seating ship unattached.
- Preconfigured units for Terra Casegoods for Treatment Areas ship as separate units that are connected in the field.
- All Terra Casegoods ship optional powder-coated legs inside the units, requiring field installation. Exceptions are benches and desks. The three-drawer bedside cabinet legs will ship in a separate package.
- The privacy screen in Terra Casegoods for Treatment Areas requires a finished panel to be assembled in the field.
- Most drawer and door hardware ships inside the casegood units for protection during shipment.
- Some casegoods in the Finley, Prague II, Prísto, Sovereign, and Ten collections have casters with stem mounts. Casters are shipped unattached and bagged in the top drawer of casegoods. They ship with temporary glides that need to be removed during installation.

B

Back flex is a comfort feature of Centé and Andante patient chairs. This feature is made possible by a soft flex motion in the back of the patient chair.

C

Casters are wheels attached to the legs or bases of select seating, tables, and casegoods to provide a greater range of use and mobility, including ease of movement to facilitate cleaning or transporting patients (Pristo and Serenity Treatment Chairs). Nemschoff offers four general types of standard casters including models with brakes to keep furniture in place. Variations of these types include swivel (allows

furniture to move freely in any direction) and tilt-and-roll casters (enables stationary chairs to be tilted and rolled for straight-line travel). Note: Standard caster type will be indicated for each product (see product page for details).

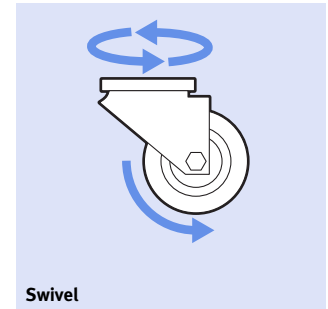
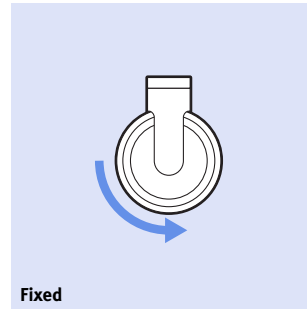

Central Brake and Steer (CBS) is an optional caster/wheel system used to control a Treatment Chair's mobility with a simple three-position foot pedal with red and green pedal position indicators. When the red pedal indicator is depressed, the wheels are locked to keep the chair fixed in place. When the green pedal indicator is depressed, the swivel function is locked so the chair can be pushed forward in a straight line. When the pedal is parallel to the floor, all four wheels are free to roll and swivel, letting the chair move forward, backward, and side to side.

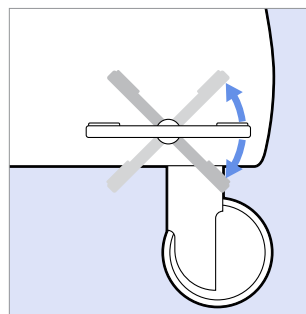

Illustrated Glossary

Clean-Out and Wipe-Out designs allow for thorough, efficient cleaning of many Nemschoff seating products. A clean-out is a non-visible gap between the seat and back of a chair where crumbs and debris can be pushed through by a tool or a hand. A wipe-out is a larger, visible horizontal gap where materials can pass through easily.

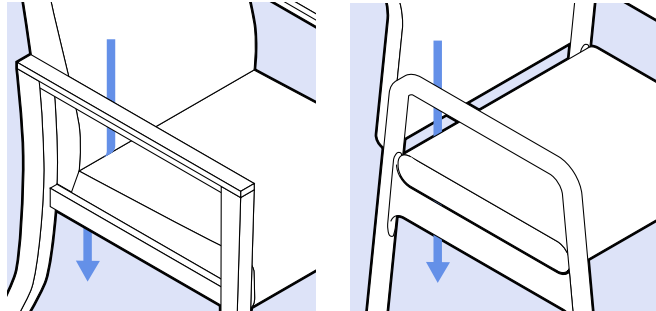

Clean-Out

Wipe-Out

Configuration must be specified for modular lounge seating systems like Mod Pod and Steps. To make a configuration plan:

- Select seats, tables, and accessory units.
- Determine placement for tables or accessories. List seats, tables, accessory units, and required ganging in the order they will appear, from left to right. Ganging is determined when facing the unit. Designate either right-side facing (RSF) or left-side facing (LSF).
- Follow the online quoting system to determine if male or female connections are needed with each item.

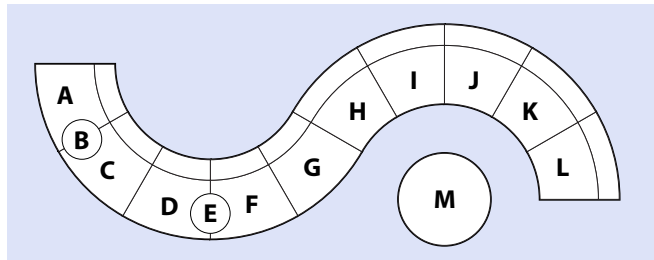

Example **configuration** plan drawing for Steps Lounge seating.

Unit	Model #	Description	Ganging
A	866-OWA	Seat	Ganged RSF
B	866-TA	Table	n/a
C	866-OWA	Seat	Ganged RSF & LSF
D	866-OWB	Seat	Ganged RSF & LSF
E	866-TA	Table	n/a
F	866-OWB	Seat	Ganged RSF & LSF
G	866-OWB	Seat	Ganged RSF & LSF
H	866-IWC	Seat	Ganged RSF & LSF
I	866-IWC	Seat	Ganged RSF & LSF
J	866-IWC	Seat	Ganged RSF & LSF
K	866-IWB	Seat	Ganged RSF & LSF
L	866-IWB	Seat	Ganged LSF
M	866-32	Ottoman	n/a

Corner blocks are a quality construction feature of Nemschoff seating. Most Nemschoff chair seats are constructed with full-surface, wood corner blocks that are glued, stapled, and screwed to major joints of the seat frame. This method reinforces the overall assembly, creating a stable seat that will not wiggle or squeak.

D

Drawer liners are available for many casegoods with wooden drawer pans. These plastic liners provide a protective barrier to extend the longevity of the product. Standard liners can be lifted out of the drawer for easy cleaning, and are designed with radiused corners so all debris can be completely removed. The liners can also be used to move patients' belongings. Drawer liners in Behavioral Health casegoods are non-removable and tamper-resistant.

Dry construction (see **Replaceable components**)

Durawrap is a thermally fused laminate. It covers the primary face and edges of furniture in one continuous sheet, creating a unique wrap-around grain design. It is used primarily on doors, tops, drawer fronts, and base rails to seal the face and edge without a visible seam, a process which prevents moisture from getting into the core material.

G

Glides are small plastic or rubber pads that are fastened to the bottoms of legs of chairs, tables, and casegoods. With proper maintenance, they act as a barrier between the furniture and the floor. Glides must be cleaned regularly to prevent the accumulation of debris, which may have an adverse effect on floor surfaces. Some glides are adjustable to facilitate leveling.

Glider locking mechanisms are controlled through optional active and passive locks. Active locks are manually activated by an outside lever, letting users choose when to engage or disengage them. Passive locks automatically disengage when someone sits in the chair, enabling the gliding motion. Passive locks automatically engage when the user exits the chair.

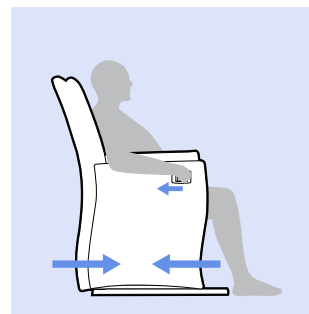

Active Locks

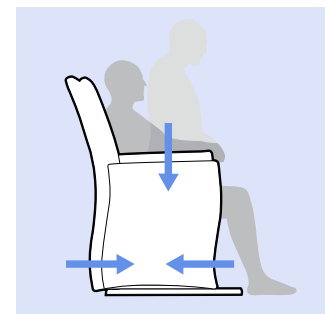

Passive Locks

Illustrated Glossary

GREENGUARD is a stringent, third-party moderated certification that identifies products manufactured with low emissions of volatile organic compounds (VOCs). It is designed to protect human health by improving indoor air quality and helping consumers identify products that are made in a green and sustainable way. The GREENGUARD Gold standard is established by other criteria that deems products to be low-emission and safe, specifically in school and healthcare facilities. The majority of Nemschoff products are GREENGUARD and GREENGUARD Gold certified. Visit greenguard.org for more information about GREENGUARD Certification.

H

Handedness designation is an important consideration when purchasing seating and casegoods products with table, desk, or side attachments. We recommend accommodating both left-handed and right-handed users when creating your order. Handedness is determined when facing the product. When purchasing products with attachments, please specify left-side facing (LSF) attachments or right-side facing (RSF) attachments.

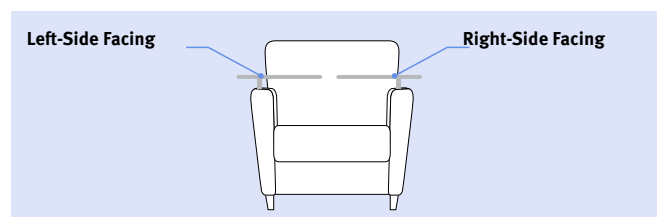

L

Lay flat position allows the back and footrest of a recliner to align in a completely horizontal position. This position creates a surface suitable for sleeping, perhaps as an alternative to a cot or traditional sleep chair. (See also Recline mechanisms)

Left-side facing (LSF) is a term used to describe the location of a feature on a Nemschoff product. If a feature is LSF, the feature will be on the left side when facing the product. (See also **Right-side facing (RSF)** and Handedness)

Leveling is an important step to take during product installation to ensure that mechanical parts (like drawer guides and hinges) run true and that gaps between doors and drawer fronts are consistent. Any product larger than a chest (like wardrobes and armoires) will need to be leveled with the product's adjustable leveling glides. If a product has feet, the leveling glides will be in the foot. If a product has a plinth-style base or side panels that go to the floor, the leveling glides will be in the corner brackets that touch the floor.

Locks of several types are featured in Nemschoff casegoods. Some drawers have cam-style locks that are operated by inserting a key and turning. This type of lock provides security for belongings in bedside

cabinets and drawers. Double-door armoires and similar cabinets have hooked elbow locks that secure doors to the armoire from the inside. This type of latch prevents doors from unintentionally opening and closing.

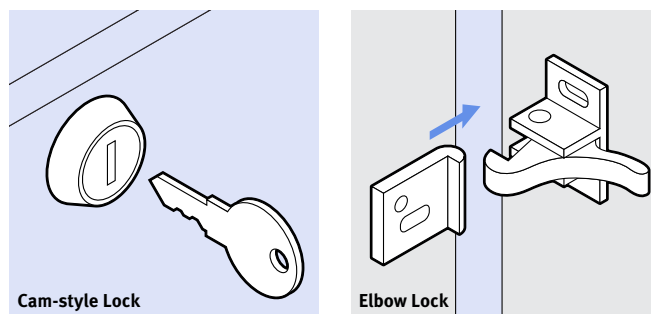

M

Moisture barrier is an optional impermeable layer of material beneath seating upholstery that is designed to prevent moisture from seeping into filling materials. It provides an invisible layer of protection that helps furniture last longer without detracting from appearances.

Mortise and tenon joinery is a high-quality, reinforcing wood construction used in many Nemschoff products. A mortise and tenon joint is made by inserting a tenon (a projection at the end of a wooden component) into a mortise (a recess cut into another wooden component). Mortise and tenon joints fit tightly together like puzzle pieces and are glued for added strength. This type of joinery is stronger than glue, nails, or screws alone. It can withstand continual usage in a healthcare environment, providing exceptional durability.

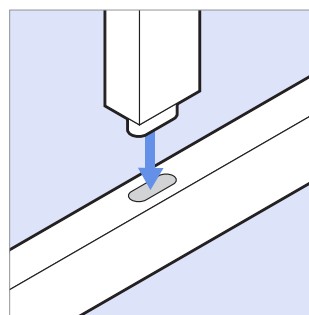

Illustrated Glossary

Mounting options used for Behavioral Health furniture are available for applications where patients' access to loose furniture may present a danger to the staff or themselves. The wall-mount option anchors casegoods directly to a wall through the back panel of the casegoods unit. This option usually includes a concealed rail that can also be mounted to the floor to minimize side-to-side movement of the wall-mounted unit. The floor-mount option anchors platform beds and some seating to the floor. The wall-and floor-mount option anchors desks to both the floor and a wall. The floor-free-mount option supports elevated casegoods at the bottom and anchors the back of the cabinet to a wall.

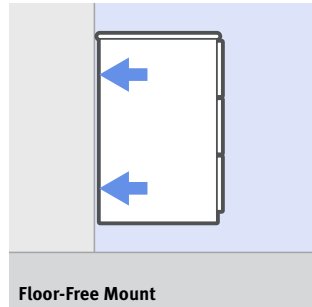
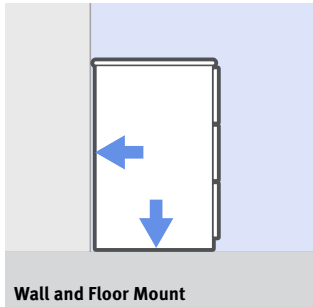
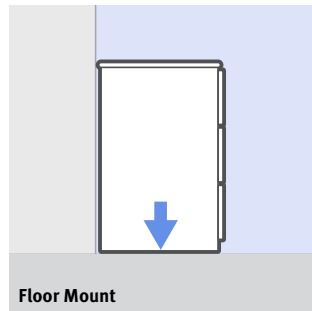
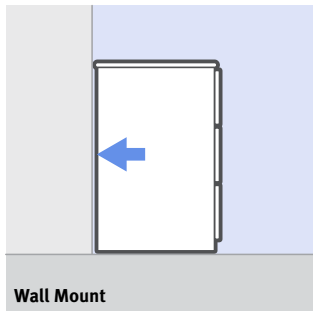

Multiple fabrics can be selected (up to three different fabrics per product – some offering even more) for many Nemschoff seating products. Choosing multiple fabrics allows for high-performance fabrics to be used in the specific areas where they're most needed. For example, easy-to-clean, abrasion-resistant polyurethane can be used on the seat and headrest, combined with a softer woven fabric for the back where wear is less of an issue.

Choosing multiple fabrics offers aesthetic flexibility. For example, you can create design continuity among multiple pieces by combining colors and patterns to help coordinate them. Visit [nemschoff.com](https://www.nemschoff.com) to download Multiple Fabric Drawings that will guide you through the specification process, or work with your customer service representative. Multiple Fabric Drawings must be supplied when an order is placed. For more information on associated costs, see [page 454](#).

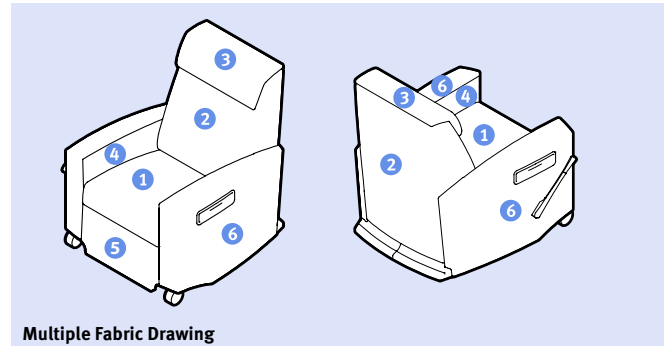

N

Nemschoff Healthcare Wood Finish is a proprietary polyurethane-based formula created to address the heavy use and frequent cleaning required in the healthcare market. It is designed to be smooth, durable, scratch-resistant, and non-yellowing. It has been successfully tested against 85 hospital-grade cleaning substances including 100-percent bleach or ammonia for 16 hours. This finish protects our products from cracks caused by temperature and moisture changes, and scratches caused by heavy use, providing substantial infection control by properly sealing the wood. This special formulation is also GREENGUARD Gold certified.

P

Plus Seating is designed for people of larger statures. Nemschoff's plus seating is spacious and rated to support static load maximums of either 700 or 1,000 pounds, while retaining the comfort and style of standard Nemschoff models. Most plus models are available in 30" or 40" seat widths.

Illustrated Glossary

R

Recline mechanisms help users achieve comfortable seating positions. Nemschoff offers a variety of recline mechanisms that operate in unique ways to address a range of patient and caregiver needs.

- The **three-position mechanism** offers upright, TV, and reclined positions. It operates by a user positioning his or her weight back into the chair while pushing on the arms, causing the back to recline while the footrest extends in one continuous motion. Because movement is controlled solely by the user of the chair, he or she must have the strength to activate it.
- The **independent foot and back mechanism** is the most common type of recline mechanism offered in Nemschoff products. It features a back and footrest that operate separately. The back is controlled by a release button, allowing it to move freely. A lever located on the outside arm controls the footrest. This mechanism allows for multiple postures, is the easiest to operate, and helps caregivers and guests assist a patient with chair operation.
- The **Prísto II Plus mechanism** operates with independent back and footrest positions optimized for bariatric users. The chair has a more limited back recline, easing the transition between the reclined and upright positions. The footrest includes three positions designed to prevent the knees of bariatric patients from being overextended.
- The **Wallsaver recline mechanism** allows a transition from an upright to fully reclined position with a minimal footprint—permitting placement as close as 4 to 6 inches from a wall (depending on model). The activation of the footrest and initial recline occur when the user pulls on a lever on the side of the chair or a loop on the inside of the arm (depending on model). Full recline occurs when the user positions his or her body weight back into the chair while pushing on the arms. To transition from a recline position to an upright position, the user moves forward in the chair, pulls forward with the arms, and then closes the footrest with the back of his or her lower legs. Because the movement is controlled primarily by the user, he or she must have the strength to operate it.
- The **Adjustable Back Chair (ABC) mechanism** offers a slight back recline, providing an extra level of comfort when compared to a stationary Patient Chair. Movement is controlled by a locking gas spring. When activated, the back reclines smoothly into infinite positions within a limited angle, making it practical for areas where a traditional recliner's footprint might be too big.
- The **CompactComfort mechanism** (like the Adjustable Back Chair mechanism) offers a slight back recline with infinite positions within a limited range. It also features an independently operated footrest to provide even more comfortable positions. The limited angle of adjustments gives it a smaller footprint that makes it practical for many applications.

	Mechanism						Positions	
	<i>Three position</i>	<i>Independent foot and back</i>	<i>Prísto II Plus</i>	<i>Wallsaver</i>	<i>Adjustable Back Chair</i>	<i>CompactComfort</i>	<i>Lay flat</i>	<i>Trendelenburg</i>
Recliners								
2755 Series						•		
Auburn	•			•			•	
Brava					•	•		
Capella					•	•		
Cities Uptown						•		
Consoul		•					•	
Culla		•						
Erica					•	•		
Hadleigh					•			
Horizon	•			•			•	
Lancaster	•							
Leonard II		•					•	
Oliver	•							
Oliver Wallsaver				•				
Pamona	•							
Prísto II Plus			•				•	
Wallsaver				•				
Gliders								
Capella Glider					•			
Sleeper								
Serenity II		•					•	
Treatment Chairs								
Prísto II Treatment		•						•
Prísto IIT		•						•
Serenity IIS		•						•
Serenity II		•						•
Serenity III		•						•
Junior Treatment	•							

Illustrated Glossary

Removable covers (noted as (P) models) have seat and/or back covers that can be replaced easily on-site. The upholstery is attached with industrial-strength hook and loop fasteners that prevent the covers from slipping. (See also **Standard (S)** models.)

Replaceable components are a feature of many Nemschoff products. Replaceable components are able to be removed and replaced in the field, extending the useful lifetime of Nemschoff furniture and increasing ROI. Many Nemschoff casegoods are built with dry construction, a technique that uses a series of mechanical fasteners that lock together instead of glue or screws. This allows damaged components be easily replaced in the field, extending the lifetime of products.

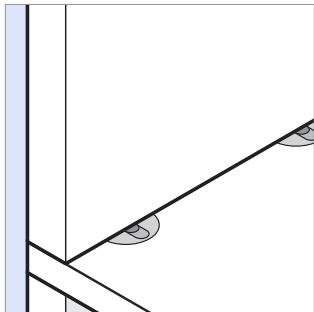

Replaceable components use dry construction techniques.

Right-side facing (RSF) is a term used to describe the location of a feature on a Nemschoff product. If a feature is RSF, the feature will be on the right side when facing the product. (See also **Left-side facing (LSF)** and **Handedness**.)

S

Soft-closing drawers have special track systems that prevent drawers from creating unwanted noise when closing. The track system contains a mechanism that activates as the drawer is closing, automatically guiding the drawer to the closed position while cushioning the closing force. This is a helpful feature in any setting where slamming sounds could be disruptive.

Solid wood panels Cross-oriented layers of solid wood panels provide strength and stiffness in both directions, creating a very stable panel that is stronger and more stable than solid wood alone and ideal for high use or behavioral health applications.

Spring seat construction was designed with an intense, 24/7 healthcare environment in mind. It has a unique, quiet suspension system that consists of a variety of materials designed to equalize overall support, enhancing the product comfort and durability. The springs create a very smooth ride to the seat while creating an arched design that keeps the seat taut and prevents upholstery from sagging.

Stacking chairs are designed to be stored nested in a stable stack. They can be stacked to maximize storage space.

Standard (S) models have non-removable seat and back covers. If a chair is a standard model, it requires a professional upholsterer to reupholster it. (See also **Removable covers**.)

T

Tamper-resistant hardware is used in most Nemschoff furniture. Screws and dry construction fittings use fasteners that cannot be loosened or removed with standard flat or Phillips screwdrivers. These specialty fasteners provide added security by minimizing tampering with furniture in the field.

Thermoplastic (ABS), otherwise known as acrylonitrile butadiene styrene, is a common thermoplastic known for its resilient, impervious nature and high impact resistance. It is lightweight and resistant to extreme temperatures.

W

Wallsaver is a feature designed to protect both furniture and walls from wear and tear. This feature may include a bead welt material that is sewn into the seam along the back perimeter of a chair or a sloped design of the rear legs that prevents a chair body from coming in contact with a wall. Nemschoff offers wallsaver features as standard on many seating products. (See also Wallsaver recline mechanism under **Recline mechanisms**.)

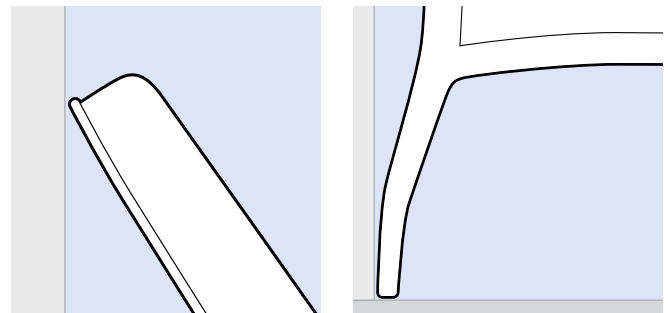

Model Number Index

Model number includes	Page	Collection	Product
60	172	Alberto	Side Chair
67	188	Whisk	Stack Chair
68-91...	179	Dex	Folding Chair
68-92...	181	Dex	Stack Chair
101/...	11	Boulevard	Lounge Seating
110 111	185	Romeo/Juliet	Stack Chair
112-... 113-...	193	Boulevard	Tables
114 115	185	Romeo/Juliet	Stack Chair
170/... 171/...	99	Workhaven	Lounge Seating
195-C...	201	Cubes & Cylinders	Tables
236...	182	Diane	Side Chair
280-... 280-1... 280-2... 280-3...	55	Hadleigh	Lounge Seating
280-51...	250	Hadleigh	Patient Chair
280-52...	283	Hadleigh	Adjustable Back Chair
280-59...	250	Hadleigh	Patient Chair
280-B2...	55	Hadleigh	Lounge Seating Bench
280-T...	206	Hadleigh	Tables
283-...	168	Torii	Multiple Seating
283-50CL...	324	Torii	Glider
283-51... 283-59...	264	Torii	Patient Chair
283-6...	222	Torii	Tables

Model number includes	Page	Collection	Product
283-61...	324	Torii	Rocker
283-7...	222	Torii	Tables
283	186	Torii	Side Chair
283-OB...	168	Torii	Multiple Seating
286-52...	281	Erica	Adjustable Back Chair
286-59...	281	Erica	Adjustable Back Chair
286-62...	282	Erica	CompactComfort Recliner
287-68...	280	Culla	Recliner
288-60...	305	Avery	Rocker
309-9... 309-OB...	173	Altair	Side Chair
314... 316...	248	Easy Access	Patient Chairs
360-9...	431	High Use	Behavioral Health Seating
700-...	68	Marsack	Lounge Seating
700-T...	211	Marsack	Tables
702-...	70	Marsack II	Lounge Seating
703-...	432	Marsack III	Behavioral Health
708-1... 708-2... 708-3...	57	Harmon	Lounge Seating
708-51...	251	Harmon	Patient Chair
721-1... 721-3...	207	Horizon	Tables
722-... 723-...	138	Horizon	Multiple Seating
727...	252	Horizon	Patient Chair

Model Number Index

Model number includes	Page	Collection	Product	Model number includes	Page	Collection	Product
732-1... 732-2... 732-3... 732-5...	64	Marco Grande	Lounge Seating	775-...	60	Lauderdale	Lounge Seating
732-6...	210	Marco Grande	Tables	775-T...	209	Lauderdale	Tables
732-7... 732-9...	210	Marco Grande	Tables	776-1... 776-2... 776-3...	20	Brooklyn	Lounge Seating
733-66...	292	Wallsaver	Recliner	776-51...	238	Brooklyn	Patient Chair
735-30... 735-33... 735-OB...	144	Marco	Multiple Seating	776-T...	196	Brooklyn	Tables
735-50...	321	Marco	Glider	778-66...	292	Wallsaver	Recliner
735-51... 735-59...	253	Marco	Patient Chair	780-17...	347	SleepOver 1-2-3	Chair
736-...	66	Marco Grande II	Lounge Seating	781-B17...	348	SleepOver	Bench
740-1... 740-2...	136	Capella	Multiple Seating	782... 783... 784...	352	SleepOver	Settee
740-28...	176	Capella	Side Chair	785...	350	SleepOver	Flop Sofa
740-30... 740-33...	136	Capella	Multiple Seating	786...	354	SleepOver	Sofa
740-50...	308	Capella	Glider	790-12...	298	Serenity II	Treatment Chair
740-51...	239	Capella	Patient Chair	790-17...	346	Serenity II	Chair
740-52...	275	Capella	Adjustable Back Chair	791-12...	302	Serenity III	Treatment Chair
740-54...	309	Capella	Adjustable Back Glider	792-12...	300	Serenity IIS	Treatment Chair
740-59...	239	Capella	Patient Chair	793-37... 794-37... 795-37... 796-37...	350	SleepOver	Flop Sofa
740-6... 740-6V...	197	Capella	Tables	797-1... 797-2... 797-3...	84	Pamona	Lounge Seating
740-62...	309	Capella	CompactComfort Recliner	797-37...	342	Pamona	Flop Sofa
740-9... 740-9V...	197	Capella	Tables	797-66...	289	Pamona	Recliner
740-91...	176	Capella	Side Chair	797-T...	215	Pamona	Tables
740-B2...	136	Capella	Multiple Seating Bench	798-17... 798-27...	333	Consoul	Sleepover Seating
770-...	20	Brooklyn	Lounge Seating	798-66...	279	Consoul	Recliner
771-...	60	Lauderdale	Lounge Seating	802-...	208	Hudson	Tables
772-...	292	Wallsaver	Recliner	812-1... 812-2... 812-3...	86	Riva	Lounge Seating
774-...	53	Franklin	Lounge Seating	812-5... 812-9...	220	Riva	Tables

Model Number Index

Model number includes	Page	Collection	Product
814-1...814-2... 814-3...	62	Leonard II	Lounge Seating
814-27... 814-37...	335	Leonard II	Sleepover Seating
814-62...	287	Leonard II	Recliner
815-1... 815-2... 815-3...	88	Sophia	Lounge Seating
822-... 823...	138	Horizon	Multiple Seating
860-...	15	Brava Platform	Lounge System
861-1... 861-2...	12	Brava Classic	Lounge Seating
861-27...	331	Brava	Sleepover Seating
861-3...	12	Brava Classic	Lounge Seating
861-37...	331	Brava	Sleepover Seating
861-T...	195	Brava	Tables
862-10...862-20... 862-30... 862C-O... 862H-O...	130	Brava 862	Multiple Seating
862-10HD...	236	Brava	Patient Chair
862-50...	306	Brava	Glider
862-52...	271	Brava	Adjustable Back Chair
862-62...	273	Brava	CompactComfort Recliner
862-91...	175	Brava	Side Chair
863-10... 863-20... 863-30... 863C-OB... 863H-OB...	133	Brava 863	Multiple Seating
863-50...	306	Brava	Glider
863-52...	271	Brava	Adjustable Back Chair
865-37...	337	Merge	Sleepover Seating
866-32... 866-42...	90	Steps	Lounge System Ottoman
866-...	90	Steps	Lounge System

Model number includes	Page	Collection	Product
891-1... 891-2... 891-3... 891-OB...	170	Valor	Multiple Seating
891-51...	266	Valor	Patient Chair
891-91... 891-92...	187	Valor	Stack Chair
891-T...	223	Valor	Tables
892	97	Valor	Lounge Seating
893-1... 893-2... 893-3... 893-OB...	153	Monarch	Multiple Seating
893-51...	256	Monarch	Patient Chair
893-92...	183	Monarch	Stack Chair
893-T...	213	Monarch	Tables
894-10... 894-20... 894-30...	78	Monarch	Lounge Seating
894-17... 894-27...	339	Monarch	Sleepover Seating
902-10... 902-20... 902-30...	80	Oliver	Lounge Seating
902-62...	288	Oliver	Recliner
903-1... 903-2... 903-3... 903-51OB...	81	Olivia	Lounge Seating
903-5... 903-5V...	214	Olivia	Tables
903-50...	322	Olivia	Glider
903-51...	261	Olivia	Patient Chair
903-9... 903-9V...	214	Olivia	Tables
904-66...	288	Oliver	Recliner
905-10... 905-20... 905-30...	72	Maurice	Lounge Seating
909-27...	341	Oliver	Sleepover Seating
970-1... 970-2...	59	Iris	Lounge Seating
971-1... 971-2...	59	Iris	Lounge Seating
1722/...	83	Ottoman	Lounge Seating
2XXX-T...	190	2000 Series	Tables

Model Number Index

Model number includes	Page	Collection	Product	Model number includes	Page	Collection	Product
2600...	101	2600 Series	Multiple Seating	ARCT...	129	Auburn	Multiple Seating Spanner Table
2700...	104	2700 Series	Multiple Seating	AS-10-...	121	Auburn	Multiple Seating
2700-OB...				AS-15-...			
2750-5...	231	2750 Series	Patient Chair	AS10-... AS15-...	121	Auburn	Multiple Seating
2750-B...	108	2750 Series	Multiple Seating	AS30-...AS35-...			
2750-H...	248	Easy Access	Patient Chair	ASCT...	129	Auburn	Multiple Seating Spanner Table
2750X-...	108	2750 Series	Multiple Seating	AT-...	192	Auburn	Tables
2755-O...	231	2750 Series	Patient Chair	BFF...	356	Bedford	Casegoods
2755-52...	267	2755 Series	Adjustable Back Chair	BH...	421	Behavioral Health	Casegoods
2755-62...	268	2755 Series	CompactComfort Recliner	Cities-LC...	29	Cities Large Crosstown	Lounge Seating
2770...	111	2770 Series	Multiple Seating	Cities-LD...	38	Cities Large Downtown	Lounge Seating
2800-1... 2800-2...	49	Evita	Lounge Seating	Cities-LU...	47	Cities Large Uptown	Lounge Seating
2800-3...2800-4...				Cities-MC...	26	Cities Medium Crosstown	Lounge Seating
2800-7...	204	Evita	Tables	Cities-MD...	35	Cities Medium Downtown	Lounge Seating
2800-8...				Cities-BD...			
2800-B...	49	Evita	Lounge Seating Bench	Cities-MU... Cities-BU...	44	Cities Medium Uptown	Lounge Seating
2800-CT...	51	Evita	Lounge Seating Spanner Tables	Cities-SU...OB...			
2800-ST...				Cities-MU...50CL...	318	Cities Uptown	Glider
2800-T...	204	Evita	Tables	Cities-MU...51...	246	Cities Uptown	Patient Chair
A10-... A15-...A18-...	121	Auburn	Multiple Seating	Cities-SC...	22	Cities Small Crosstown	Lounge Seating
A30-... A35-... A38-...				Cities-SD...	31	Cities Small Downtown	Lounge Seating
ABRN-...	269	Auburn	Recliner	Cities-SD...51...	244	Cities Downtown	Patient Chair
AET-...	121	Auburn	Multiple Seating Spanner Table	Cities-SG...	177	Cities	Side Chair
AG-...	304	Auburn	Glider	Cities-SU...	40	Cities Small Uptown	Lounge Seating
AIT-...	129	Auburn	Multiple Seating Spanner Table	Cities-SU...50CL...	318	Cities Uptown	Glider
ANXX...	114	Andante	Multiple Seating	Cities-SU...51...	246	Cities Uptown	Patient Chair
ANXX...30	118	Andante	Multiple Seating Spanner Table	Cities-SU...61...	316	Cities Uptown	Rocker
ANXX...34				CN...	240	Centé	Patient Chair
ANXX...35	233	Andante	Patient Chair	CR...	240	Centé	Patient Chair
ANXX...36	174	Andante	Stack Chair				
ANXX...41	233	Andante	Patient Chair				
ANXX...43							

Model Number Index

Model number includes	Page	Collection	Product
CSNT...	463	Perinatal	Casegoods
EAMOD	75	Mod Pod	Lounge System
EZ-123...	325	EZ-123	Overbed Tables
FLBL-...01, 02, 03	52	Florabella	Lounge Seating
FLBL-...04, 05, 06	205	Florabella	Tables
FX120-CT	146 159	Mayfield Princeton	Multiple Seating Spanner Table
FX120-T...	146 159	Rockwood	Tables
FX153-...	330	Beaumont	Sleep Chair and Settee
FX156-...	329	Atwater	Sleep Settee
FX200-...	146	Mayfield	Multiple Seating
FX500-... FX500-OB...	159	Princeton	Multiple Seating
FX551-...	254	McKinley	Patient Chair
FX600-... FX600-OB...	119	Anderson	Multiple Seating
FX604-...	235	Ashton	Patient Chair
FX620-T... FX620-CT...	198	Carlson	Tables
FX700-...	372	Montello	Casegoods
FX702-...	364	Finley	Casegoods
FX704-...	376	Prague II	Casegoods
FX860... FX861...	437	Caregiver Stools	Lab Stools
FX906...	286	Lancaster	Recliner
FX960...	437	Caregiver Stools	Physician Stools
FXZ2...	328	Overbed Tables	Overbed Table
GMOD	75	Mod Pod	Lounge System
H	416	Revive	Display System
H18, H38	138	Horizon	Multiple Seating

Model number includes	Page	Collection	Product
HDL...	368	Hadleigh	Casegoods
HET-...	138	Horizon	Multiple Seating Spanner Table
HIT-...	138	Horizon	Multiple Seating Spanner Inner Table
HRCT...	138	Horizon	Multiple Seating Corner Table
HRZN_...	284	Horizon	Recliner
HSCT...	138	Horizon	Multiple Seating Corner Table
IMOD	75	Mod Pod	Lounge System
JR/200...	419	Junior 200	Children's Furniture
JR/286...	418	Erica Junior	Children's Furniture
M10... M15... M18	148	Meridian	Multiple Seating
MB...	416	Revive	Display System
MET-...	212	Meridian	Tables
MH	416	Revive	Display System
MIT-...	148	Meridian	Multiple Seating Spanner Table
ML30/...	434	Meridian	Behavioral Health Seating
ML31... ML35...	73	Meridian	Lounge Seating
MLH...	73	Meridian	Lounge Seating
MLIT-...	148	Meridian	Multiple Seating
MLT-...	212	Meridian	Tables
MMNT...	463	Perinatal	Casegoods
MOD...	75	Mod Pod	Lounge Systems
MP10... MP15...	255	Meridian	Patient Chair
MRCT...	148	Meridian	Multiple Seating Spanner Tables
MS10-... MS15-...	148	Meridian	Multiple Seating
MSCT...	148	Meridian	Multiple Seating Spanner Table

Model Number Index

Model number includes	Page	Collection	Product
MT-10...	212	Meridian	Tables
OAS123-...	326	Oasis	Overbed Tables
PAUS-...	155	Pause	Multiple Seating
PRBT...	380	Pristo	Casegoods
PRCL-... PRCL-...OB	294	Pristo II	Treatment Chair
PRJR...	420	Junior	Recliner
PRLT...	380	Pristo	Casegoods
PRRT-...	294	Pristo II	Treatment Chair
PRST...	381	Pristo II	Casegoods
PRTT-...	296	Pristo IIT	Treatment Chair
PTSB-...	155	Pause	Multiple Seating Spanner Table
RE10... RE15... RE18	161	Reliant	Multiple Seating
RE40... RE50...	161	Reliant	Multiple Seating
RES10-... RES15-...	161	Reliant	Multiple Seating
RES40... RES50...	161	Reliant	Multiple Seating
RET-...	218	Reliant	Tables
REV...	382	Revive	Casegoods
RIT-...	218	Reliant	Multiple Seating Spanner Tables
RLT-...	218	Reliant	Tables
RRCT...	218	Reliant	Tables
RSCT-...	218	Reliant	Tables
RV10... RV11...	262	Revive	Patient Chair
RV12...	184	Revive	Side Chair
RV70	262	Revive	Patient Chair
RVR/...	416	Revive	Display System

Model number includes	Page	Collection	Product
RVS...	343	Revive	Sleepover Seating
SCXXXX-59...	242	Cities Crosstown	Patient Chair
SCXXXX-61...	310	Cities Crosstown	Rocker
SDX0XX-50CL...	314	Cities Downtown	Glider
SDX0XX-61...	312	Cities Downtown	Rocker
SDXXXX-59...	244	Cities Downtown	Patient Chair
SH/...	416	Revive	Display System
SUX000-62...	277	Cities Uptown	CompactComfort Recliner
SUX000-C200 SUX000-S200	199	Cities	Tables
SUXXXX-59	246	Cities Uptown	Patient Chair
SVN...	388	Sovereign	Casegoods
SXX000-T...	199	Cities	Tables
TEN...	393	Ten	Casegoods
TRA01 through TRA68	397	Terra	Casegoods
TRA100 through TRA109	403	Terra	Casegoods for Treatment Areas
UB	416	Revive	Display System

Fabrics

Nemschoff's Performance Fabric Program is designed for furniture used in a healthcare environment, with an emphasis on durability and cleanability. Nemschoff Performance Fabrics include more than 700 choices. More offerings are available through our Graded-In Fabrics. Both of these options offer the benefit of a streamlined, seamless ordering process. Of course, you may also specify your own fabrics through the COM option.

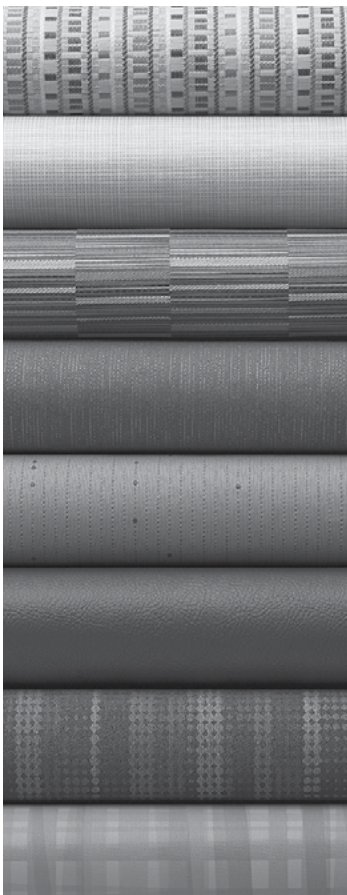

Nemschoff Performance Fabrics

In today's 24/7 healthcare environments, furniture needs to stand up to around-the-clock use. But it also needs to provide comfortable, inviting environments for patients, families, and caregivers. The Nemschoff Performance Fabric program was designed to meet both of these needs, combining proven performance for healthcare applications with welcoming residential and hospitality aesthetics.

Durability

All Nemschoff Performance Fabrics are vetted for durability: They must meet the minimum standard of 50,000 double rubs to stand up to the demands of a healthcare environment. Most performance fabrics rate even higher, maintaining their integrity through 500,000 double rubs or more. (All Nemschoff Performance Fabrics include a five-year warranty. For more details, see "Warranties and Certifications," [page 459](#).)

Cleanability

Performance Fabrics often have inherent characteristics to help minimize the spread of infection. Many are made with antimicrobial materials, and most are cleanable with a diluted bleach solution and many other common healthcare cleaners.

Sustainability

Nemschoff is also committed to sustainability, and that extends to our Performance Fabrics. We source them from materials with as little impact on the environment as possible, favoring PVC-free and solvent-free materials, as well as those that include recycled content.

Fabric Availability

Nemschoff has partnered with Maharam, CF Stinson, Momentum, and DesignTex to offer more than 700 fabric choices, including their latest technologies for healthcare and most up-to-date designs. All Performance Fabrics have proven compatibility with Nemschoff products to ensure our high standards for fit and finish are met. You can see the full selection and order samples at: nemschoff.com/design-resources/materials/fabrics

The program is divided into three material types: Non-Woven Upholstery, Impermeable Woven, and Woven Upholstery.

Choosing Material Types

Non-Woven Upholstery

Appropriate for high-use zones such as patient rooms, treatment areas, or seats and headrests, these fabrics are coated with vinyl, polyurethane, or silicone. Vinyls, available in rich colors and unique textures and patterns, are a top choice where fluid spills are common or frequent cleaning and disinfecting are needed, and they are attractively priced. Our PVC-free polyurethanes also provide excellent moisture resistance or fluid barriers, but, unlike vinyl, they have a softer, more sophisticated look and feel. Silicone, the latest non-woven option, is also PVC-free, solvent-free, ink-erasable, and inherently antimicrobial.

Fabrics in this category are cleanable with a diluted bleach solution. Several options are also ink-resistant.

Impermeable Woven Upholstery

This category includes impermeable Crypton® and Woven Agion®, which are surface-treated with antimicrobial agents to inhibit the spread of infection in healthcare environments. All fabrics in this category are also GREENGUARD Gold certified.

Many of these fabrics are cleanable with a diluted bleach solution.

Woven Upholstery

Often used in Welcoming & Waiting spaces, many woven options are solution-dyed nylon and highly resistant to discoloration and fading. Most of them include a pattern, letting you create a greater visual impact in the healthcare environment. The collection has a strong focus on recycled content.

All woven Performance Fabrics can be used with harsh cleaning agents, including a bleach solution.

Fabrics



For more about Nemschoff Performance Fabrics

View the latest options, see pricing, and order samples at nemschoff.com/design-resources/materials/fabrics



Multiple Fabric option

You can specify up to three different fabrics for many Nemschoff seating products. Visit nemschoff.com, and choose your product. On the product page, click the Literature link under **Design Resources**.

The Literature link will open a window where you can choose a Multiple Fabric Drawing to guide you in specifying multiple fabrics, or work with your Customer Service Representative.

For costs associated with applying Multiple Fabrics, see [page 454](#).



For more about Graded-In Fabrics

View a full list of vendors and patterns, find a detailed guide on pricing, and learn how to determine CTB compliance and calculate the cost for treatments and barriers at: dfabrics.nemschoff.com/dfabrics/search.asp

Selecting Your Fabric

Nemschoff's Performance Fabric program facilitates scheduling your order upon receipt so you don't have to worry about computing and procuring the proper yardage. We also take full responsibility for ensuring the fabric meets our high quality standards. There's no need for you to follow up—Nemschoff does all the work.

Ordering a Fabric Sample

Fabric samples can be ordered through the website, nemschoff.com/design-resources/materials/fabrics.

Graded-In Fabrics

While Nemschoff's Performance Fabric program is designed to tailor perfectly with our furniture lines and meet the stringent requirements of healthcare, we also work closely with many textile vendors whose fabrics can be specified for our products.

Selecting Your Fabric

This program lets you choose from thousands of patterns and colors from a wide variety of brands, while relying on us to order and inspect the fabric and assume responsibility for adequate yardage. All Graded-In fabrics are vetted for weight, appropriateness for healthcare, and compatibility with Nemschoff equipment and the upholstery process to ensure our high standards for tailoring are met.

When specifying Graded-In fabrics, due to lead times of the fabric sources, the projected completion date of your order may exceed our normal lead times. Nemschoff assumes no responsibility for defects, appearances, color inaccuracies, shortages, wear, or performance of the textiles from these suppliers.

Ordering a Fabric Sample

Fabric samples can be ordered by visiting the specific vendor's website or contacting its customer service department.

Customer's Own Material (COM)

While we recommend selecting from our Nemschoff Performance Fabrics (NPF) or one of our graded-in vendors for the most seamless process, we also provide the option to use COM. Nemschoff does, however, reserve the right to reject covering which is unsuitable for upholstery on our products. This may be due to inadequate weight, fit for healthcare or upholsterability on our products.

Selecting Your Fabric

To select fabric outside of the NPF and Graded-In Fabric programs, a few steps are required in the specifications of the order.

Nemschoff provides guidelines for calculating the total yardage for COM material (see [page 453](#)). When specifying, it's important to note the required yardage is based on the application instructions of the pattern as well as managing quality issues. Nemschoff will provide yardage requirements upon receipt of order. If flaws are found in the fabric, Nemschoff will promptly notify you of the issue, and you will need to supply additional yardage.

Nemschoff assumes no responsibility for defects, appearance, color inaccuracies, shortages, wear, or performance of COM upholstery.

For information on how to determine CTB 133/ASTM E-1537 flammability standards compatibility and pricing, please refer to [page 459](#).

Note that Nemschoff will dispose of excess upholstery material at the time of shipment unless expressly requested to return it with the product shipment.

Orders that include Customer's Own Leather (COL)

Please contact your customer service representative.

Orders That Include COM Upholstery

Customers are responsible for ensuring delivery of COM fabric to Nemschoff. Orders for COM-upholstered products will be scheduled into production upon receipt of all COM and identification swatches. Please work with your CSR if you can supply written confirmation of fabric vendor ship dates, to ensure the best possible lead time. Since shipment of COM orders depends upon fabric availability, lead times may vary from Nemschoff's normal schedules.

When supplying COM fabrics to Nemschoff, please include:

- Fabric supplier
- Fabric name and number
- Color name and number
- A representative fabric swatch for identification purposes (be sure to mark the face side)
- Any nonstandard treatments applied to the fabric, such as Nano-Tex™ or DuraBlock®

Fabrics

- Written instructions on any fabric application deviations (i.e., “stripes to be applied vertically,” or “fabric cut into or across the roll”). Without these required instructions, fabric will be applied to the product based on the vendor’s standard application.

Getting the Fabric to Nemschoff

COM must be shipped prepaid F.O.B. to:

Nemschoff
2218 Julson Court
Sheboygan, WI 53081

Shipment must include:

- Customer’s purchase order number
- Nemschoff order number
- Product and model number for which the material is intended

Important: COM must be supplied as **continuous yardage** to ensure appropriate yields.

Split Orders

If a portion of your order does not require COM and you prefer that portion be scheduled right away, Nemschoff will enter the order immediately at your request. Split shipments are subject to additional shipping and handling charges.

Canceled or Changed Orders

Nemschoff assumes no responsibility for additional COM material due to a change of upholstery. It is your responsibility to arrange for return of material if an order is changed or canceled.

Determining Total Yardage Needed

To determine how many yards of COM fabric you need to provide, **follow these guidelines for 54” wide, nondirectional material:**

- If you do not have a repeat pattern, simply use the COM yardage requirement listed on the price page.
- If you have a repeat pattern, multiply the COM yardage requirement by the appropriate calculation factor, and round up to the nearest ¼ yard.

Use a calculation factor of 1.07 if the fabric’s pattern repeat is 4" x 4" or less. Use a calculation factor of 1.12 if the repeat is up to 6" x 6". For more information, contact your customer service representative.

Example:

Chair model 740-10 has a yardage requirement of 2.25 yards. The COM fabric has a repeat pattern of 5" horizontal and 5" vertical.

2.25 yardage requirement
x **1.12** calculation factor
= **2.52** yards
Round up to **2.75** yards.

Determining if Additional Yardage is Needed

Additional yardage may be required if:

- The fabric is less than 54" wide.
- The fabric's pattern is directional or requires matching.
- The fabric requires processing such as treated upholstery or acrylic backing, which often causes shrinking. Customers are responsible for extra yardage required due to shrinkage.
- You are specifying multiple fabrics.

If any of the above conditions apply, please contact your Customer Service Representative to determine the appropriate yardage.

Fabrics

Determining if Your Fabric Needs a Flammability Treatment or Barrier

Determining if Your Fabric is Compatible with CTB 133/ASTM E-1537

CTB 133 is the foundation for open-flame testing in many states and is the basis for National Standard ASTM E1537. (For more information, see “Flammability” on page 459.)

To determine if your fabric can meet the guidelines or if it will need additional barriers and/or treatment:

- 1 In the Pricebook, find your selected product.
- 2 Locate the “Flammability Type” on the product’s page in this book.
- 3 For NPF and Graded-In fabrics, find the “Flammability Class” for your fabric in the respective fabric sections of the Nemschoff website. For COM fabrics, consult the fabric’s manufacturer.
- 4 Using the chart below, find the intersection point of the Product Flammability Type and the Fabric Flammability Class to determine compliance.

Product Flammability Type	Fabric Flammability Class						
	1	2	3	4	5	6	7
1	OK	OK	OK	T/B	OK	OK	T/B
2	OK	OK	OK	T/B	OK	OK	T/B
3	OK	OK	OK	T/B	OK	T/B	×
4	OK	OK	OK	T/B	T/B	T/B	×
5	OK	OK	OK	T/B	T/B	T/B	×
6	OK	OK	OK	T/B	T/B	T/B	×
7	OK	OK	OK	T/B	T/B	×	×
8	OK	OK	OK	T/B	T/B	T/B	×

Key	
OK	Meets CTB 133 / ASTM E-1537
T/B	Requires treatment or barrier
×	Cannot meet CTB 133 / ASTM E-1537

About Treatments and Barriers

For some product and fabric combinations, an additional treatment or barrier is needed for the product to comply with CTB 133. A treatment is a coating applied to the fabric. A barrier is an added layer of fabric beneath the upholstery layer. Nemschoff will determine which method is best-suited to the product you are specifying.

Calculating the Cost of a Treatment or Barrier

In all cases, the cost of a treatment or barrier is \$81 per yard. To calculate the cost of a treatment or barrier, simply multiply the total yardage needed by \$81.

Multiple Fabric Charges

An additional \$62 per unit applies to all multiple fabric orders using two fabrics and \$88 per unit using three or more fabrics.

Changed or Canceled Orders

Any orders in production that require changes or cancellations will be charged a labor and restocking fee.

Finishes

Our quality is more than surface deep. We offer dozens of beautiful finishes designed to withstand the rigors of healthcare environments and coordinate with other products from the Nemschoff and Herman Miller portfolios.

About Nemschoff Finishes

Wood & Veneer

We use veneer with a matching wood edge band to seal the core. The veneer is stained with a color of your choice and Nemschoff's Healthcare Wood Finish is applied for long-lasting performance.

Bedford Classics

The distinctive two-toned look of Bedford Classics Maple veneer is created with an Italian Cherry perimeter. A wood edge band, your choice of stain colors, and our Nemschoff Healthcare Wood Finish provide aesthetic flexibility without compromising durability.

Laminate

We use high-pressure laminates and melamine panels in solid colors, woodgrain, or a variety of patterns. Both materials are durable and available in identical finishes. Laminates provide extra resistance to dents, and melamine is thermally fused to resist peeling.

Durawrap

Durawrap is a thermally-fused laminate. It covers the primary face and edges of the furniture in one continuous sheet, creating a unique wrap-around grain design. It is used primarily on doors, tops, drawer fronts, and base rails to seal the face and edge without a visible seam, a process which prevents moisture from getting into the core material.

Solid Surface

Corian is a seamless, non-porous material that is durable, stain-resistant, certified for food contact, nontoxic and nonallergenic. It is low in pollutants and aids in infection prevention, microbial resistance, and preventing mold and mildew.

Resin

Varia Ecoresin by 3form is a polyester-based, dynamic interlayer system that delivers design versatility and light transmission. The material is lightweight and half the density of glass, which makes for easier installation and reconfiguration. It also has excellent chemical resistance, contains 40 percent recycled content, and is GREENGUARD certified.

Powder Coat

Powder coat is typically applied to steel, giving you the economies of steel pricing with a wide variety of aesthetic options. This finish is extremely durable, consistent, and once cured, it emits no pollutants.

Urethane

Urethane is a soft, durable, molded component that adds comfort and durability to arm caps, bumpers, protective edges, and some cabinet tops.

HPVC Edge Banding

Thicker than standard vinyl banding, 3 mm HPVC edge banding provides enhanced durability, while its softer, slightly rounded edges create a more user-friendly environment.

Thermoplastic (ABS)

Otherwise known as acrylonitrile butadiene styrene, it is a common thermoplastic known for its resilient, impervious nature and high impact resistance. It is lightweight and resistant to extreme temperatures.

Finishes

See nemschoff.com
to view all Finishes

Wood & Veneer

UL Natural Maple

5K Honey Maple

8K Light Brown Cherry

ED Aged Cherry

0Z Medium Cherry

UX Walnut Cherry

2U Light Brown Walnut

40 Dark Brown Walnut

IZ Aged Teak

Bedford Classics

40 Wheat

43 Plum

44 Wild Cherry

45 Pecan

Woodgrain Laminate

HM Natural Maple

0G Honey Maple

PX Light Brown Cherry

HX Aged Cherry

WY Medium Cherry

HY Walnut Cherry

76 Light Brown Walnut

0W Dark Brown Walnut

2K Aged Teak

Solid Laminate

98 Studio White

91 White

8D Ash Grey

LU Soft White

8Q Folkstone Grey

Laminate, continued

WL Sandstone

0X Dark Folkstone Grey

0V Dark Sandstone

0R Light Khaki

1K Dark Khaki

0U Light Sand

0S Dark Sand

Durawrap

98 Studio White

91 White

8Q Folkstone Grey

0R Light Khaki

HM Natural Maple

0G Honey Maple

PX Light Brown Cherry

HX Aged Cherry

76 Light Brown Walnut

HY Walnut Cherry

WY Medium Cherry

0W Dark Brown Walnut

2K Aged Teak

Solid Surface

CQ Glacier White

58 Cameo

QB Bisque

Resin

Varia Pure

Hush Gesso

Ion Wheat

Powder Coat

8D Ash Grey

LU Soft White

MSS Metallic Silver

XTS Titanium

MST Metallic Silver (Textured)

XTT Titanium (Textured)

G2 Graphite Satin

3K Nickel

G1 Graphite (Textured)

4K Umber

BK Black

Urethane

For Arm Caps

Black

Desert

Pewter

For Top Edges

Cloud

Sand

Sable

HPVC Edge

Cloud

Pewter

Sable

Thermoplastic (ABS)

Black

Desert

Pewter

Hardware

Our extensive collection of durable, high-quality drawer and door pulls satisfies a variety of aesthetic needs. Every option shown here is compatible with our entire casegoods line. To learn more about the casegoods pull selection, contact your local Account Manager, a Nemschoff Authorized Dealer or Nemschoff Customer Service.

Bedford



1 Brass



2 Cloud
2C Chrome



3 Brass
3C Chrome
3N Brushed Nickel

Montello



8 Brushed Nickel

Sovereign



Drawer Pull
9 Brass



Door Pull
9K Brass

Hardware

Pristo

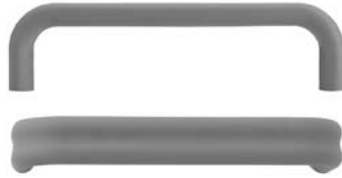

- 10** Cloud **12** Sable
- 11** Pewter

Contemporary



- 16** Black

Cirrus



- 13** Espresso
- 14** Ice

Prague II



- 17** Nickel **17R** Rubbed Bronze
- 17B** Burnished Brass

Hadleigh



- Drawer Pull*
- 15** Dark Antique

Terra



- 18** Nickel Satin

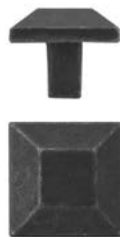

- Door Pull*
- 15K** Dark Antique



- 19** Nickel Satin

Warranties & Certifications

Nemschoff is dedicated to providing safe, quality products that are specifically designed for the demands of the healthcare industry. We warrant our fabrics and products, ensure our products meet the rigorous CTB 133 flammability standard, and offer many products meeting the GREENGUARD environmental certification.

Flammability

Nemschoff products are designed and tested for compliance with the rigorous CTB 133 flammability certification.

About the CTB 133 Flammability Standard

CTB 133, known formally as California Technical Bulletin 133: Flammability Test Procedure for Seating Furniture for Use in Public Occupancies, is an open-flame test procedure designed for testing furniture for use in public occupancies.

Established by the California Bureau of Home Furnishings and Thermal Insulation in 1991, the testing procedures dictate that furniture be ignited via an open flame in a specifically designed room. Numerous measurements are then taken.

How CTB 133 tests work

To pass CTB 133, all the following must occur:

- The upholstered product must self-extinguish within an hour.
- The temperature at the ceiling cannot increase more than 200° F.
- The temperature at 4 feet above the floor cannot increase more than 50° F.
- The opacity at 4 feet above the floor cannot exceed 75 percent.
- The carbon monoxide concentration in the room cannot exceed 1,000 ppm for more than five minutes.
- The product weight loss due to combustion cannot exceed 3 pounds in the first 10 minutes of the test.
- The rate of heat release cannot exceed 80 kW.
- The total heat release cannot exceed 25 MJ in the first 10 minutes.

Nemschoff and CTB 133

At Nemschoff, we've always taken a lead role in ensuring our furniture meets public safety requirements including reducing the risk of flammability. We were the first in the industry to

build a test facility compliant with CTB 133, the foundation for open-flame furniture testing in many states and the basis for National Standard ASTM E1537.

Through its extensive testing, Nemschoff continues to build its knowledge of which design elements to include, and how, when manufacturing CTB 133-compliant products.

Elements that factor into these decisions include the configuration of the product, internal construction of the product, fabric construction, type of filling material (including foam), type of thread, and type of thermobarriers (when needed).

Because of this process, the majority of Nemschoff-upholstered products are compliant with CTB 133. Please note that there are a few exceptions. If CTB 133 compliance is required, it must be noted on the purchase order to ensure the standard is met.

Five-Year Fabric Warranty

Nemschoff offers a five-year warranty on Nemschoff Performance Fabrics. The terms of the warranty are as follows:

Seller warrants woven and non-woven upholstery on the Nemschoff Performance Fabric Program when applied to Seller's products. Warranty covers defects of material and workmanship under normal use and service for five (5) years from the date of shipment.

This warranty applies only to the original owner and the original use of the product. All Graded-In and COM upholstery default to the supplier's warranty.

This warranty is void in cases of damage in transit, negligence, abuse, abnormal usage, misuse, accidents, and improper cleaning and maintenance. Normal aging and wear of woven and non-woven upholstery are exempt from this warranty.

Warranties & Certifications

THERE IS NO OTHER EXPRESS WARRANTY. SELLER HEREBY DISCLAIMS ALL IMPLIED WARRANTIES INCLUDING THE IMPLIED WARRANTY OF MERCHANTABILITY AND FITNESS FOR ANY PARTICULAR PURPOSE INDICATED BY BUYER TO SELLER.

There are no representations as to the capacity of performance of the products sold hereunder except as set forth in the quotation specifications, if any, and such representations are expressly conditioned upon the correctness of the data furnished by Buyer and upon the products being properly installed and maintained.

As Buyer's sole remedy under the warranty, Nemschoff, at its option, will repair or replace the material at no charge to the original owner of record. If the material is no longer in manufacture, one of comparable value will be substituted. Nemschoff will pay freight charges provided that the replacement or return has previously been authorized by the company under the terms of this warranty.

IT IS EXPRESSLY AGREED THAT THIS REMEDY OF REPAIR, REPLACEMENT OR CREDIT, AT SELLER'S OPTION, IS BUYER'S EXCLUSIVE REMEDY UNDER THIS WARRANTY. IN NO EVENT SHALL SELLER BE LIABLE FOR CONSEQUENTIAL DAMAGES.

Expenses incurred by Buyer for repair or replacement of Seller's product will not be allowed except by written permission of Seller.

Limited Lifetime Warranty

Nemschoff offers a Limited Lifetime Warranty for all of its products. The terms of the warranty are as follows:

Seller warrants the products it manufactures against defects of material and workmanship under normal use and service for the useful life of the product from the date of shipment provided that the product is in use by the original owner and has been used for only the original purpose. This warranty is void in cases of damage in transit, negligence, user modification, abuse, abnormal usage, improper use of cleaning chemicals, misuse, accidents, and improper maintenance.

As Buyer's sole remedy under the warranty, Nemschoff, at its option, will repair or replace defective parts at no charge to the original owner of record. Nemschoff will pay freight charges provided that the replacement or return has previously been authorized by the company under the terms

of this warranty. Normal aging and wear of fabrics, filling materials, mechanisms, mechanical components, and finishes are exempt from this warranty. With proper use and maintenance, the limitations of our warranty are as follows:

- 10 years for all mechanisms and mechanical components of Serenity® and Pristo® Treatment Chairs, Consoul Sleepover Seating, and Consoul and Leonard Recliners.
- 12 years for all mechanisms and mechanical components of Nala® and Centé® Patient Chairs.
- 5 years for all other mechanisms and mechanical components.
- 5 years for Overbed Tables and Caregiver Stools.

THERE IS NO OTHER EXPRESS WARRANTY. SELLER HEREBY DISCLAIMS ALL IMPLIED WARRANTIES INCLUDING THE IMPLIED WARRANTY OF MERCHANTABILITY AND FITNESS FOR ANY PARTICULAR PURPOSE INDICATED BY BUYER TO SELLER.

There are no representations as to the capacity or performance of the products sold hereunder except as set forth in the quotation specifications, if any, and such representations are expressly conditioned upon the correctness of the data furnished by Buyer and upon the products being properly installed and maintained.

IT IS EXPRESSLY AGREED THAT THIS REMEDY OF REPAIR, REPLACEMENT OR CREDIT, AT SELLER'S OPTION, IS BUYER'S EXCLUSIVE REMEDY UNDER THIS WARRANTY. IN NO EVENT SHALL SELLER BE LIABLE FOR CONSEQUENTIAL DAMAGES.

On equipment furnished by Seller but manufactured by others, the written warranty, if any, of the manufacturer will be assigned to Buyer. However, Seller does not adopt and does not guarantee or represent that manufacturer will comply with any of the terms of the warranty of such manufacturer.

Expenses incurred by Buyer in repairing or replacing Seller's product will not be allowed except by written permission of Seller.

Seller, in its manufacture and sale of these products, will assume no liability as to possible infringement of patents or copyrights by virtue of the use of said products in combination with other elements or structures or when manufactured to Buyer's specifications.



For more about care and cleaning

Learn about recommended care and cleaning procedures that can help keep your Nemschoff products eligible for warranty coverage. Visit nemschoff.com/customer-service and navigate to the Maintenance Topic.

Warranties & Certifications



For more about **GREENGUARD Certification**

Learn more at
www.greenguard.org

GREENGUARD Certification

GREENGUARD is a stringent, third-party moderated certification that identifies products manufactured with low emissions of volatile organic compounds (VOCs). It is designed to protect human health by improving indoor air quality and help consumers identify products that are made in a green and sustainable way. The GREENGUARD Gold standard is established by other criteria that deems products to be low-emission and safe for human use, specifically in school and healthcare facilities. Most of Nemschoff's products are GREENGUARD Gold Certified.

Ordering

We do everything we can to make sure the ordering process for Nemschoff products is straightforward and convenient, from beginning through delivery. And when you choose products from our Pacesetter program, the delivery can be quick as well.

Online Ordering

Nemschoff strives to make the ordering process for our products simple and easy to access for our Dealers. Purchase orders can be submitted online at dealers.nemschoff.com through your Dealer account; for a step-by-step guide, please see the information below. If you don't have a Dealer account or if you have questions about the process, please contact Customer Service at 800-203-8916.

Step-by-Step Guide

1. Log on to Nemschoff Dealer Daily

Go to dealers.nemschoff.com and enter your Dealer ID and password. If you do not have an ID and password, or you have forgotten it, click the link for help, and we will automatically email the information to you. If you are still unable to access Dealer Daily, please contact your customer service representative.

2. Access Nemschoff Online Ordering

Click on "Toolbox" at the top of the Dealer Daily page to see a list of Nemschoff's online tools. Click the "Online Order" button.

3. Identify the End User

Click "Create Quote — End Users" to search for customers or end users. Once you identify the correct customer, click the link in the Customer ID column.

4. Select the Product Collection

You will be prompted to choose between Nemschoff and Brandrud collections. If you are not sure which collection you need, refer to [page 467](#) in the price list for a list of products.

5. Identify Dealer Contact and Ship-to Address

Enter your name, email, and phone number at the prompts. Then choose a ship-to address from the list provided.

6. Add New Line

Prepare to start specifying your products by clicking the "Add New Line" link.

7. Identify the Product

On the Model Builder screen, select the product line. Then select the model series and specific model. Once you make these selections, the Model Builder will provide a "Build" button.

8. Specify the Product

Click the "Build" button on the Model Builder screen. Look through the list of options offered for each product, and click the button next to each of your selections. The system will automatically proceed to the next option, adding your selections to the Model Builder page and updating the pricing.

9. Options Complete

When you've finished choosing options, an "Options Complete" pop-up will appear. Click the "OK" button.

10. Enter the Quantity

Enter the quantity and any comment information for each particular specification. Once you click "Save," the specification will be added to your quote or invoice.

11. Make Changes if Needed

To change a line item, click on the link in the "Edit" column of that line number. You will be directed back to the Model Builder screen, where you can edit the quantity, comments, and date.

Some options can be changed using the "Edit" button. To clear your selections and start the specification process again, click "Re-Build." After all changes are complete, click the "Save" button.

12. Print the Quote

Use the options at the bottom of your screen to choose how much information you want to print out. Selecting "Print Quote" will provide you with the list price and dealer price. "Print All" will show the list price, net price, and GPO member price. "Print Member Only" will give you the list price and GPO member price.

Ordering



13. Submit Your Order

Your order is now complete. Click the “Submit Quote” link at the bottom of the page.

14. Confirm Your Order

A PDF of your order will be automatically sent to the email address you provided in the Dealer/Sold to email field. Please review the order detail information.

Please contact Customer Service at 800-203-8916 for additional information.

All Purchase Orders should be made out to Nemschoff.

PaceSetter Program

Nemschoff’s PaceSetter program is an option if you don’t want to wait to enjoy the design, quality, and performance of Nemschoff furniture. We’ve chosen 36 of our most popular options and streamlined production so that they can ship to you in 15 business days or less.

How It Works

The PaceSetter program allows ordering of up to 40 units per order (each seating position equals one unit, i.e., a three-seat unit would equal three units) in any design configuration of the available products. Contact your Customer Service Representative to ensure the upholstery is available in an expedited lead time. (For warranties, see [page 467](#). For Flammability, see [page 459](#).)

The minimum order size is \$1,500 list. Items included in the program are listed on the website at nemschoff.com/customer-service/pacesetter-program and are indicated in the price list with the PaceSetter logo.

PaceSetter products will ship in 15 business days or less from the receipt of a clean order and fabric. If you require an expedited lead time for any product that is not included in the PaceSetter Program, contact your Customer Service Representative.

Submitting the Order

All PaceSetter orders must be clearly marked “PaceSetter” and should be submitted online via the Nemschoff Dealer Daily. Orders must be sent separately from regular lead time orders. Orders sent by fax, mail, or email will not be accepted for PaceSetter.

Changing the Order

Once a PaceSetter order is entered, changes will not be accepted.

Returns

No return of furniture will be accepted without our written consent and shipping instructions.

Freight and Delivery

All PaceSetter shipments are F.O.B. factory. Pricing does not include shipping and handling.

Payment

Payment is due 30 days after the date of the invoice, subject to credit approval, with a finance charge of 1 to 1.5 percent monthly for late payments after maturity. Deposits are applied to the final invoice.

Please remit payment to:

Nemschoff
3045 Eagle Way
Chicago, IL 60678-1030

General Terms and Conditions

Acceptance of Terms

These terms and conditions of sale (Terms) govern all sales of products (Products) by Nemschoff Chairs, Inc. to Buyer specified in any document (Document) of which they are a part. If the Terms and conditions of any Buyer Document differ from these Terms, these Terms shall be construed as a counteroffer and not an acceptance of Buyer’s terms and conditions, which are hereby rejected. These Terms constitute the agreement between Nemschoff and Buyer. Buyer’s failure to dissent from these terms in writing within five (5) days of receipt thereof or Buyer’s acceptance of the Products shall constitute acceptance of these Terms. No change to these Terms will be effective unless made in writing and signed by Nemschoff.

Quotation and Prices

A price quotation is valid for sixty (60) business days except as otherwise stated in writing. Unless otherwise stated in writing by Nemschoff, all prices quoted shall be exclusive of shipping, insurance, taxes, license fees, customs duties and other related charges, and Buyer shall pay all such charges. If Nemschoff, in its sole discretion, chooses to pay any such charges, Buyer shall

Ordering

reimburse Nemschoff in full upon demand. Any volume-based discounts set forth in a Document will be rescinded if Buyer fails to meet the conditions for such discounts specified in the Document.

Payment

Except as otherwise specified, all payments are due and payable in U.S. dollars within thirty (30) days from the invoice date. Nemschoff may require alternative payment terms including, without limitation, a letter of credit or payment in advance. Payments not made by the due date may incur, at the sole discretion of Nemschoff, a late payment service charge of the lesser of one and one-half percent (1½ percent) per month or the maximum rate permitted by law, computed from the date payment was due. All payments and deposits are non-refundable. Nemschoff retains a purchase money security interest or other security interest in the Products and their proceeds, including insurance proceeds, until Buyer has made payments required. Buyer agrees to take any acts (including executing and delivering all Documents) reasonably requested by Nemschoff to protect, maintain and perfect Nemschoff's security interest.

Terms

Net 30 days after date of invoice, subject to credit approval, with a finance charge of 1½ percent monthly for late payments after maturity. First orders may require a 25 percent deposit with order. Deposits are applied to final invoice of order.

Please remit payment to:

Nemschoff
3045 Eagle Way
Chicago, IL 60678-1030

Shipping / Delivery

Nemschoff list prices include standard surface freight to any point within the 48 contiguous United States for orders greater than \$100,000 List. For orders less than \$100,000, a shipping and handling charge will apply. The shipping and handling charge will be provided as part of each quotation. For orders shipped to Alaska or Hawaii, freight included is only to the point of embarkment. Shipments beyond that point are freight-collect.

Shipping and delivery dates are estimates. Specific delivery dates are available and may incur additional costs. Dates are coordinated and quoted through Nemschoff Customer Service. Nemschoff shall not be liable for any delay in delivery on or assume any liability in connection with shipment. Shipments will arrive within 10 business days after ship date.

International shipments must be secured with credit arrangements satisfactory to Nemschoff, in its sole discretion, prior to shipment from Nemschoff's facilities. Extra international packaging, cartoning, skidding, or other packing arrangements will be quoted and added to pricing.

Shipments will arrive blanket-wrapped unless otherwise specified.

All products shall be delivered F.O.B. to Nemschoff's place of shipment. Risk of loss and damage shall pass to Buyer upon Nemschoff's tender of delivery to a carrier at the F.O.B. point, and any loss or damage thereafter shall not relieve Buyer from any payment obligation. The carrier shall not be deemed an agent of Nemschoff.

If Nemschoff insures shipment, Buyer shall pay insurance costs as invoiced by Nemschoff. Notation on the carrier's bill of lading is required for all freight claims.

Furniture ships inside a protective bag to which a shipping label is affixed. Any site-specific installation instructions (location designation or place in specific configuration — with ganged or modular components) will be on the label. Do not remove the protective bag prior to product being staged in the indicated location on site.

The customer is responsible for all unloading. Drivers do not unload the truck. Your product will arrive on an 80-foot combined tractor/trailer unit which requires a loading dock. The carrier will call the customer 24 hours prior to delivery.

Customer pickups can be arranged at the customer's request and are subject to dock fees. The customer will provide loading and proper equipment to facilitate blanket-wrapped shipments.

Shipping Delays

If the customer requests a delay of shipment of an order 30 business days or less before scheduled shipping date, the customer is responsible for storage charges. Nemschoff may transfer the merchandise to storage at the customer's risk and expense. Such transfer to storage shall be deemed delivery to customer for all purposes, including invoicing and payment.

Changes, Delays of Production or Cancellation

Buyer's order for Product may be changed, delayed or canceled only with the prior written consent of Nemschoff. Buyer shall compensate Nemschoff for any resulting loss or damage including, without limitation, the cost of labor, materials, and overhead expenses by paying a fee of 65 percent of the value of the purchase order as of the date of cancellation. In addition, customer-initiated delays of shipments exceeding 180 days from the original delivery date will be deemed a cancellation and are subject to this cancellation policy.

Export Control

Buyer shall comply with all applicable laws, regulations and treaties relating to the sale and destination of the Products, including without limitation, U.S. export control regulations. Buyer agrees not to sell any of the Products in any territory or country prohibited by applicable U.S. laws and to obtain representations from its customers that they will not resell or transfer any of the Products to such countries or territories. Buyer will defend, indemnify and hold Nemschoff harmless for any damages or costs to Nemschoff arising from Buyer's failure to comply with this term.

Inspection

All Products delivered hereunder shall be deemed accepted by Buyer, unless written notice of defect of nonconformity is received by Nemschoff within 10 days of receipt of Products at Buyer's designated receiving address, provided that Buyer may only reject Products for failure to meet the Products' specifications.

Remedies

Nemschoff retains the right to terminate or delay the shipment of any order by reason of Buyer's bankruptcy or insolvency, breach of any terms, unauthorized assignment or the pendency of any proceedings against Buyer under any statute for the relief of debtors.

Limitation of Liability

To the extent not prohibited by applicable law: (a) Nemschoff's aggregate liability to Buyer for any claim relating to the Products is limited to the amounts Buyer has paid to Nemschoff for the Products; and (b) Nemschoff will not be liable for any indirect, punitive, special, incidental or consequential damages in connection with or arising out of these terms, the Document, the Products, or the sale, installation, maintenance, use, performance or nonperformance of the Products including — but not limited to — replacement costs, loss of business, revenue, profits, use data or other economic advantage, however they arise and even if Nemschoff has been previously advised of the possibility of such damages. The parties acknowledge that if Nemschoff provides the Products to Buyer, it does so in reliance upon the limitations of liability and the disclaimers of warranties and damages, and that these limitations and disclaimers form an essential part of the contract between the parties. Liability for damages will be thus limited and excluded even if any exclusive remedy provided for in these Terms fails of its essential purpose.

Intellectual Property Rights

Any Intellectual Property Right on a worldwide basis including, without limitation, patentable inventions (whether or not applied for), patents, patent rights, copyrights, work of authorship, moral rights, trademarks, service marks, trade names, trade dress, trade secrets and all applications and registrations of all of the foregoing resulting from the performance of these Terms that is conceived, developed, discovered or reduced to practice by Nemschoff, shall be the exclusive

Ordering

property of Nemschoff. Specifically, Nemschoff shall exclusively own all rights, title and interest (including, without limitation, all Intellectual Property Rights throughout the world) in and to the Products and any and all inventions, works of authorship, layouts, know-how, ideas or information discovered, developed, made, conceived or reduced to practice, by Nemschoff, in the course of the performance of these Terms.

Miscellaneous

Nothing in these Terms shall imply license or other rights with respect to any Intellectual Property Rights of Nemschoff or its suppliers, and Nemschoff reserves all such rights. All waivers of any right hereunder must be in writing and signed by Nemschoff.

Waiver or breach by the other party of any provision of these Terms shall not be deemed a waiver of future compliance with these Terms, which shall remain in full force and effect.

If any provision of these Terms is held invalid by any U.S. law or regulation or by any U.S. court having jurisdiction, such invalidity will not affect the enforceability of other provisions.

These Terms and Buyer's rights may not be assigned by Buyer without the prior written consent of Nemschoff. Any unauthorized assignment by Buyer shall be void.

These Terms shall be governed by the laws of the state of Wisconsin without reference to any conflict-of-law rule that would cause the application of the laws of any other jurisdiction and without regard to the U.N. Convention on Contracts for the International Sale of Goods. Buyer and Nemschoff expressly agree that any unresolved disputes shall be resolved exclusively in the District Court for the Eastern District of Wisconsin or in the Circuit Court of Wisconsin, County of Milwaukee.

These terms constitute the entire agreement between Nemschoff and Buyer with respect to the Buyer's purchases of the Products and supersedes all prior agreements and understandings with respect to such purchase and may not be changed or amended, or superseded by conflicting terms and conditions submitted by Buyer except by a written instrument signed by an authorized Nemschoff representative.

Cartoning Charges

Category A – \$93 list

Tables	Footboards
Table Bases	Bedside Cabinets
Table Tops	Mirrors
Guest Chairs	Cushions & Bolsters
Footstools	Junior Chairs
Coat Racks	Toy Boxes
Overbed Tables	Three Drawer Chests
Bookshelves	Benches
Headboards	

Category B – \$172 list

Chairs	Settees & Two Seat Units
Rockers & Gliders	Four & Five Drawer Chests
Recliners	

Category C – \$244 list

Sofas & Three Seat Units	Platform Beds
Desks	Treatment Chairs
Wardrobes	Double Dressers
TV Armoires	

Collections by Brand

If you know which collection a Nemschoff product belongs to, this index will tell you what brand to enter when placing an order online.

Nemschoff Collections

- 2000 Series
- 2600, 2700
- 2750
- 2755
- 2770
- Alberto
- Altair
- Anderson
- Ashton
- Atwater
- Avery
- Beaumont
- Bedford
- Behavioral Health
- Brava
- Brooklyn
- Capella
- Caregiver Stools
- Carlson
- Cities
- Consoul
- Cubes and Cylinders
- Custom Tables
- Culla
- Dex
- Diane
- Easy Access
- Evita
- Erica
- EZ-123
- Finley
- Franklin
- Geneva
- Hadleigh
- Harmon
- Hudson
- Iris
- Junior Treatment
- Lancaster
- Lara
- Lauderdale
- Leonard II
- Marco
- Marco Grande
- Marsack
- Maurice
- Mayfield
- McKinley
- Merge
- Monarch
- Montello
- Oasis Overbed Tables
- Oliver
- Olivia
- Overbed Tables
- Pamona
- Perinatal
- Prague II
- Princeton
- Prito
- Riva
- Rockwood
- Serenity
- Sovereign
- SleepOver
- Sophia
- Steps
- Ten
- Terra
- Torii
- Valor
- Wallsaver
- Whisk

Brandrud Collections

- Andante
- Auburn
- Boulevard
- Centé
- Florabella
- Horizon
- Meridian
- Mod Pod
- Ottoman
- Nala
- Pause
- Reliant
- Revive
- Romeo/Juliet
- Work Haven

Trademarks

The following are trademarks of their respective owners and may not be used or reproduced without their express written permission.

Trademarks of Nemschoff Chairs, Inc.

ABC®
 Centé®
 Cities®
 CompactComfort®
 Consoul™
 Dex™
 Flop®
 Florabella™ Collection
 Fold-Flat Comforter®
 Harmon™
 Improving The Health Of Healthcare
 Environments®
 Monarch™
 Nemschoff®
 Palisade™
 Pamona™
 Pause®
 Pristo®
 Public Areas, Personal Spaces®
 Real World R & D®
 Revive™
 Serenity®
 SleepOver®
 Terra™
 Valor™
 We define personal space within public areas®
 Whisk™

Trademarks of Herman Miller, Inc.

Durawrap™
 Maharam®
 Nala®

Other Trademarks

Agion® is a registered trademark of Agion Technologies, Inc.

Corian® is a registered trademark of E.I. duPont de Nemours and Company Corporation.

Crypton® is a registered trademark of Crypton, Inc.

DesignTex™ is a trademark of Steelcase Inc.
 GREENGUARD is a registered trademark of the GREENGUARD Environmental Institute.

MOMENTUM® is a registered trademark of Momentum Textiles, Inc.

Varia Ecoresin® is a registered trademark of 3Form Inc.





Our Customer Service
Representatives are ready
to answer questions
and work with you to
find the best solution for
any challenge.

Nemschoff
909 North 8th Street
Sheboygan, WI 53081

P.O. Box 129
Sheboygan, WI 53082-0129

Toll-Free: 800.203.8916
Fax: 920.459.1234
sales@nemschoff.com