



Garage Essentials

SEPTEMBER 2023 - MARCH 2024

ISSUE 49



All the equipment you need

Heaters

Battery Support

Lighting

Diagnostics

Lifts

Tools and more...



Local Service **National Strength**



Are you interested in joining the UK's fastest growing network of independent garages?

Our Servicesure AutoCentres programme has been created with input from garage owners who run workshops and garages just like yours.

It's been specifically designed to identify service and repair opportunities to help your business grow.

We also offer a range of exclusive business support services that will save you time and money.

As a member of Servicesure AutoCentres you have access to a wide range of benefits. Every Single one of them has been added to the programme to help your business prosper. Some of the benefits will help you generate more revenue or provide a better service whilst others could save you money.

You can choose to use as many or as few of the benefits as you want and they can be started at any point of your membership.

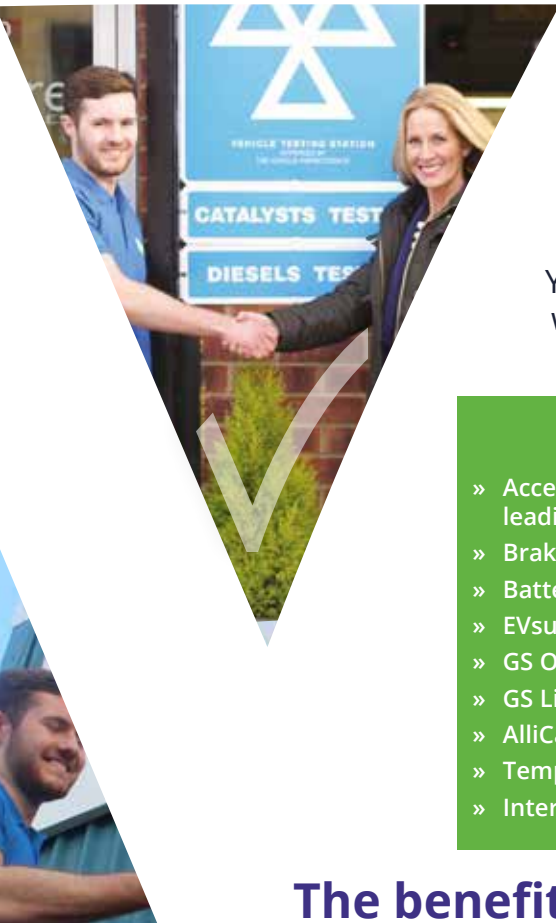

Benefits include:

- » Access to our market leading National Warranty
- » Brakesure
- » Batterysure
- » EVsure
- » GS Onestop
- » GS Lite
- » AlliCat
- » Temporary technical staff
- » Interest Free credit
- » Training
- » Personalised videos
- » Business Insurance opportunities
- » Courtesy car and car sales
- » Full marketing support service
- » Branded clothing
- » Sponsorship
- » Brand Awareness through Social media
- » Waste Management
- » Plus many more

The benefits massively outweigh the subscription!

For more information call:
0330 041 2118

The UK's fastest growing network of garages











































Welcome

GSF Car Parts is one of the UK's leading automotive parts distributors, supplying thousands of independent garages throughout the UK with parts, tools, garage equipment and specialist training.

We supply the highest quality OE and OE matching brands to provide choice and value. We have long-term strategic relationships with key OE component manufacturers and maintain the highest level of quality product, availability and technical leadership.



The new Garage Essentials catalogue contains a wide range of leading brand workshop tools, garage equipment, vehicle diagnostics and specialist training, including a host of new products.

Our team of experts are on hand to answer any questions - contact them on **0121 749 8801** or garage.equipment@gsgroup.com

 servicesure AUTOCENTRES	2	FIND YOUR LOCAL BRANCH	4
MEET THE TEAM	4	LEASING	6
 HEATERS	7-12	 BODYSHOP	45-48
			
ZM PARAFFIN DIESEL SPACE HEATERS		PULLING TOWERS	
THERMOBILE FLUE KIT / OIL FIRED HEATERS / FIRED CABINETS / SUSPENDED UNIT		PLASTIC WELDING	
ELECTRIC FAN HEATERS		 WELDING & HEAT INDUCTION	49-52
FIREBALL ELECTRIC FAN HEATERS			
 BATTERY SUPPORT	13-18	WELDERS	
 		INDUCTION HEAT TROLLEY	
JUMP STARTER, AIR COMPRESSOR & PRESSURE WASHER		HEATER KIT	
BATTERY CHARGERS / TESTER & SCANNERS		 COMPRESSORS	53-54
AGM BOOSTER PACKS			
CAPACITOR BOOSTERS		BELT DRIVEN PISTON	
 WORKSHOP LIGHTS	19-20	DIRECT-DRIVE	
		 WHEEL ALIGNMENT	55-56
RECHARGABLE COMPACTS			
HEAD TORCH		4 WHEEL LASER ALIGNMENT	
 DIAGNOSTICS	21-44	 WHEEL & TYRE	57-59
    			
    		WHEEL ALIGNMENT	
DIAGNOSTIC TERMS		TYRE / WHEEL BALANCER & CHANGER	
AUTEL PACKAGES / TPMS		 LIFTING	60-68
TEXA PACKAGES		  	
BOSCH KTS PACKAGES		SCISSOR LIFTS	
DELPHI ADVANCED DIAGNOSTIC SOLUTIONS		TWO POST LIFTS	
LAUNCH UK PACKAGES / DPF CLEANING GUN		COMMERCIAL VEHICLE COLUMN LIFT	
HELLA PACKAGES		FOUR POST LIFTS	
MAVERICK PACKAGES		MECHANICAL VEHICLE SKATES	
ADAS BUNDLES		TROLLEY JACKS	
POWERHAND DIGITAL MULTIMETER		 MOT	69-71
POWERPROBE		 	
SENSOR TEST LEAD KITS & ACCESSORIES		MOT / ATL PACKAGES	
DIESEL & ENGINE TOOLS			
PRESSURE & VACCUM TESTING			
ELECTRICAL TESTING			
		 TOOLS	72-78
			
		TRANSMISSIONS	
		DIESEL & ENGINE	
		EV & HYBRID	
		SAFETY PRODUCTS	
		WORKSTATIONS & BENCHES	
		BRAKE FLUID TESTER / BRAKE BLEEDER	
		 POWER TOOLS	79-85
			
		GRINDERS POWER PACKS IMPACT WRENCHES POLISHERS & MANY MORE...	
		 GENERAL WORKSHOP	86-91
			
		STORAGE	
		HAND TOOLS	
		TOOL SETS	
		 AIR CONDITIONING	92-94
		 	
		AIR CON UNITS R744 R134A R1234YF	
		 TRAINING ONLINE DIGITAL & ONSITE	95-98
			99

Meet the Garage Essentials team

Our team of experts is available to help you invest in the right equipment for your business growth

- 
Nigel Dixon
 nigel.dixon@gsfgroup.com
 07407 874 339
- 
David Tout
 david.tout@gsfgroup.com
 07769 145 727
- 
Eddie Murkin
 eddie.murkin@gsfgroup.com
 07826 511 590
- 
Martin Gallagher
 martin.gallagher@gsfgroup.com
 07823 469 772

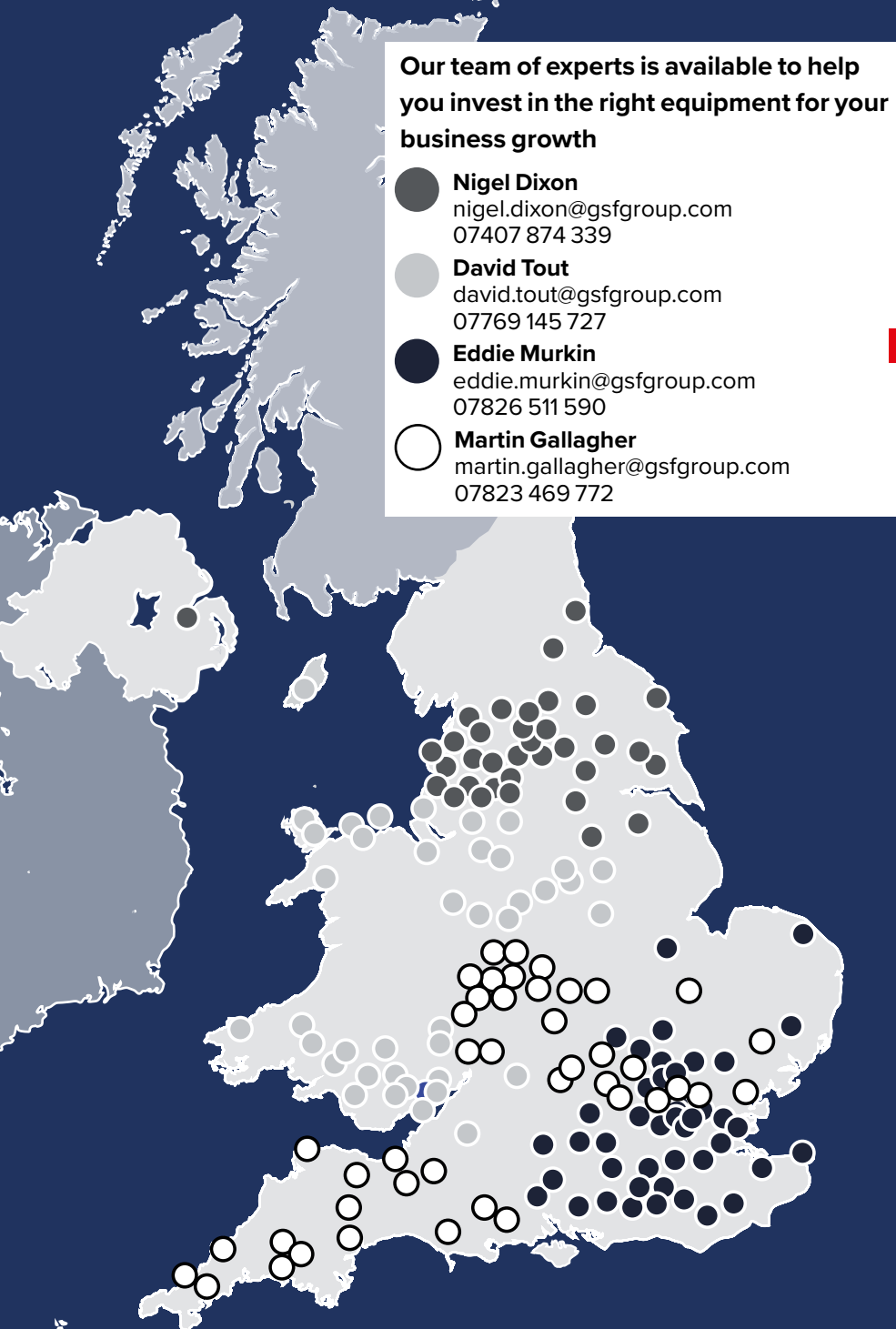

Branches Nationwide

GSF Car Parts has 180 branches nationwide, supported by strategically located regional and national distribution centres.

Our branches have excellent availability of parts for all makes and models.

Accrington	BB5 1QX	01254 239911
Andover	SP10 4EY	01264 839999
Anglesey	LL60 6HR	01248 422000
Ashford	TN24 0TL	01233 502379
Aylesbury	HP19 8RY	01296 737873
Banbury	OX16 2RL	01295 221133
Barnstaple	EX32 8QA	01271 375801
Basingstoke	RG22 4AD	01256 710200
Belfast	BT12 6HT	028 9066 3866
Beverley	HU17 0GJ	01482 871771
Birmingham	Castle Vale B35 7AR	0121 749 8815
Birmingham	Halesowen B62 8HN	0121 561 3001
Birmingham	Smethwick B66 1NU	0121 565 6340
Birmingham	Solihull B90 4NZ	0121 221 3000
Blackburn	BB1 3AR	01254 53463
Blackpool	FY4 2RP	01253 843373
Bournemouth	BH8 8BH	01202 509459
Bradford	Central BD4 7EA	01274 733888
Bridgend	CF31 3TP	01656 649493
Bridlington	YO16 4SJ	01262 400900
Brighton	Hove BN3 7BA	01273 701777
Bristol	Avonmouth BS11 9YE	0117 322 6799
Bristol	Central Easton BS5 0SP	0117 955 7654
Bristol	North Aztec West BS32 4RR	0117 322 4078
Bristol	South Ashton Gate BS3 2LD	0117 338 0380
Bromsgrove	B60 3DX	01527 575444
Burgess Hill	RH15 9RD	01444 258831
Burnley	BB11 4AA	01282 450005
Burton	DE14 2WD	01283 500006
Bury	BL9 6AQ	01617 614012
Caernarfon	LL55 2BD	01286 673504
Camborne	TR14 0PY	01209 220000
Cambridge	CB4 2PF	01223 640999
Cannock	WS11 7FJ	01543 431400
Cardiff	Birchgrove CF14 4QA	02920 628686
Cardiff	East CF24 1RF	02920 489150
Cardiff	South CF11 8BA	029 2034 7900
Carmarthen	SA31 2BG	01267 237977
Castleford	WF10 4SB	01977 558833
Chard	TA20 2DA	01460 65051
Chelmsford	CM2 6TG	01245 460460
Cheltenham	North GL51 9NZ	01242 252100
Cheltenham	South GL51 8PL	01242 225620
Chester	CH1 4LT	01244 377118
Chichester	PO19 7BJ	01243 771331

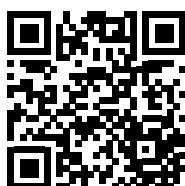

For the most up to the minute branch listing with full contact details, log onto our website and search by your postcode.

[gsfgroup.com/our-locations](https://www.gsfgroup.com/our-locations)

Our team are on hand to offer expert advice and first-class service to get you the parts you need as soon as you need them.



Chorley	PR7 1NY	01257 233833
Clitheroe	BB7 1QD	01200 425525
Colchester	CO4 9XP	01206 203006
Coleford	GL16 8PN	01594 832092
Coventry	CV6 5RY	024 7666 9988
Crewe	CW1 6AE	01270 214216
Croydon	CR0 4TQ	0208 970 7734
Daventry	NN11 8RB	01327 871009
Derby North	DE1 3QB	01332 202802
Derby South	DE1 2SX	01332 346680
Doncaster	DN2 4NH	01302 762762
Dover	CT16 3PT	01304 210712
Durham	DH1 1TH	0191 336 1990
East Grinstead	RH19 1XZ	01342 321456
Eastbourne	BN22 8PW	01323 410817
Enfield	EN3 7TY	0208 443 8090
Exeter	EX2 8RG	01392 258279
Farnham	GU9 9LQ	01252 333891
Frome	BA11 4BG	01373 465961
Gateshead	NE21 5TR	0191 204 9555
Gloucester North	GL4 3SJ	01452 528800
Gloucester South	GL2 5DH	01452 212212
Goole	DN14 6XF	01405 658031
Harlow	CM20 2GF	01279 342200
Harrogate	HG1 4QE	01423 889021
Haslemere	GU27 1DW	01428 654444
Hastings	TN38 9BA	01424 435588
Haverfordwest	SA62 4BR	01437 760428
Hayes	UB3 1AP	0208 573 0033
Heathrow	TW14 0LW	020 8917 3800
Hemel Hempstead	HP3 9AJ	01442 868040
Henfield	BN5 9DE	01273 495880
High Wycombe	HP13 7EJ	01494 441234
Horsham	RH12 2NW	01403 257325
Huddersfield	HD2 1AG	01484 434333
Hull	HU2 0JX	01482 328308
Ipswich	IP1 5BN	01473 748166
Isle of Man	IM1 5AT	01624 620000
Kidderminster	DY11 7AR	01562 864333
Leamington Spa	CV31 3LH	01926 451980
Leeds East	LS8 5EL	0113 201 9030
Leeds South	LS10 2AZ	0113 292 4999
Leeds West	LS4 2AR	0113 244 3637
Leicester	LE4 0JD	0116 234 0200
Letchworth	SG6 1JF	01462 708800

Lewes	BN7 2FB	01273 487828
Lincoln	LN6 7QY	01522 575333
Littlehampton	BN17 5DF	01903 719990
Liverpool Aintree	L9 5AY	0151 525 1764
Liverpool Bootle	L5 9UB	0151 207 6667
Llandudno	LL31 9PN	01492 592144
Llanelli	SA14 8LQ	01554 775772
Luton	LU1 3XJ	01582 506940
Macclesfield	SK10 1LT	01625 427733
Maidstone	ME15 6HA	01622 766410
Malvern	WR14 1GF	01684 882699
Manchester Dukinfield	SK16 4UP	01613 396500
Manchester Trafford Park	M17 1QR	0161 876 0466
Manchester Wythenshawe	M22 4QE	0161 946 7929
Mansfield	NG19 9BG	01623 594900
Merthyr	CF48 4XA	01443 699002
Middlesbrough	TS6 6RU	01642 386477
Milton Keynes	MK1 1EQ	01908 872278
Neath	SA10 7NH	01639 641118
Newcastle	NE12 9SZ	0191 205 8313
Newport	NP19 4SL	01633 280001
Newquay	TR9 6TL	01637 849377
Northallerton	DL6 2XE	01609 779551
Northampton	NN1 2PN	01604 609080
Northwich	CW9 7LU	01606 353200
Norwich	NR6 6RA	01603 780900
Nottingham	NG2 3GG	01159 503723
Oldham	OL1 3PA	01616 268384
Otley	LS21 3DT	01943 467514
Oxford Abingdon	OX14 5JX	01235 550555
Oxford Cowley	OX4 2RD	01865 972972
Penryn	TR10 9EP	01326 372651
Peterborough	PE1 5WS	01733 293444
Plymouth North	PL7 1RF	01752 330011
Plymouth South	PL4 0SF	01752 668931
Poole	BH12 3PF	01202 741060
Porthmadog	LL49 9NZ	01766 515414
Portsmouth	PO3 6FH	02392 728970
Preston	PR1 5DP	01772 281711
Reading	RG2 0AU	01189 873030
Redditch	B98 7SE	01527 520445
Rhyl	LL18 2AB	01745 355505
Rochdale	OL16 5RD	01706 678000
Romford	RM11 2SJ	020 8598 8800
Ross-on-Wye	HR9 7BW	01989 769921

Saltash	PL12 6LD	01752 623203
Sheffield	S9 5EX	01142 617888
Shrewsbury	SY1 4YA	01743 440088
Sidcup	DA14 5BL	020 8302 7624
Sittingbourne	ME10 2PD	01795 402402
Skipton	BD23 2QR	01756 799500
Slough	SL1 4QU	01753 215080
Southampton North	SO50 4NT	023 8124 2636
Southampton West	SO40 9LA	023 8086 3900
Southend	SS2 5TE	01702 277 969
Southport	PR8 5RG	01704 536446
St Helens	WA9 5GZ	01744 649 510
Staples Corner	NW2 7JA	0208 208 6444
Stoke	ST4 1PU	01782 844395
Strood	ME2 4LY	01634 712212
Sunderland	NE35 9LZ	0191 644 4789
Swansea	SA6 8JG	01792 790080
Swindon	SN3 4NS	01793 836940
Sydenham	SE26 5AQ	020 8314 4750
Taunton	TA2 8RX	01823 259691
Telford	TF7 4NZ	01952 581666
Thanet	CT9 5TH	01843 298676
Thurrock	RM20 3FH	01708 890740
Tiverton	EX16 6SW	01884 256767
Torquay	TQ2 7QL	01803 242400
Tottenham	N17 7RQ	020 8104 8020
Tunbridge Wells	TN2 3EH	01892 518028
Wakefield	WF2 9LP	01924 851 899
Warrington	WA5 0LS	01925 669759
Watford North	WD24 5RR	01923 239039
Watford South	WD18 7EN	01923 229255
Welling	DA16 3DP	020 8317 7774
Welwyn Garden City	AL7 1EW	01707 429 870
Weston-Super-Mare	BS24 9ES	01934 886544
Weymouth	DT3 4FL	01305 360875
Widnes	WA8 8FZ	0151 424 5056
Wigan	WN1 3DG	01942 502 844
Wirral	CH43 3DS	0151 676 0959
Wolverhampton	WV2 2HU	01902 350940
Woodford	IG8 8HF	020 3280 2611
Worcester	WR4 9GN	01905 299900
Worthing	BN14 8PQ	01903 823123
Wrexham	LL11 4YL	01978 365392
Yeovil	BA22 8XG	01935 609 955
York	YO30 4US	01904 829239

FINELY TUNED FINANCE

Kennet Equipment Leasing is one of the UK's leading equipment finance suppliers. We are dedicated to providing leasing solutions that fit your requirements perfectly.

WHY YOU SHOULD LEASE

- Fast finance approval
- No large deposit to find
- Payments remain the same throughout
- Tax advantages to leasing
- No need to use cash, overdrafts or loans
- New starts and sole trader businesses can lease
- No security on your property
- New or used equipment from £1,000 in value

Terms and conditions may vary dependent on credit rating

For Illustrations purposes

ADAS MACHINE



**PURCHASE
FOR
£9,595 +VAT**

OR

**FINANCE FROM AS
LITTLE AS
£51.50 +VAT PER WEEK***

WHEEL ALIGNMENT SYSTEM



**PURCHASE
FOR
£4,500 +VAT**

OR

**FINANCE FROM AS
LITTLE AS
£23.63 +VAT PER WEEK***

Finance examples quoted are based on a 5 year term and based on a company trading 3 years (finance can be offered to companies trading less than 3 years). All quotes are subject to status, terms and conditions and affordability checks apply. Payments will be collected Monthly and not weekly. Other finance options are available. GSF Car Parts Limited is an Introducer Appointed Representative of Kennet Equipment Leasing Limited. Kennet Equipment Leasing Limited is authorised and regulated by the FCA, FRN:676024, authorised for credit broking and lending. Kennet work with a panel of lenders. GSF/MAG/04.1.23 V1

**CALL OUR TEAM ON 0121 749 8801
FOR MORE INFORMATION**

**All prices are subject to change without prior notice due to market fluctuation.
 **All Prices Excl VAT

ZM HEATERS
SUPER QUIET PORTABLE
PARAFFIN DIESEL SPACE HEATERS

ZM Heaters offer high specification heaters, sourced direct from world-renowned factories, to the UK market at exceptionally low prices



£299

125,000 BTU

£199

70,000 BTU

PART NO: ZMQ-K125 / 987AA7280

PART NO: ZMQ-K70 / 987AA7270

23% more heat than other units

	987AA7270	987AA7280
OUTPUT RANGE KW (BTU)	20KW (70,000)	36KW (125,000)
WEIGHT	12KG	24KG
MAX FUEL USAGE	1.9 LITRES PER HOUR	3.6 LITRES PER HOUR
AIR FLOW	400 M3 PER HOUR	900 M3 PER HOUR
TANK CAPACITY	19 LITRE	38 LITRE
MOVE WITH	CARRY HANDLE	TROLLEY & WHEELS

ZM HEATERS
PORTABLE HEAVY DUTY PARAFFIN
KEROSENE SPACE HEATERS

Powerful, durable heaters offering significantly better heat. Sourced from a world-leading factory, this range offers better quality and reliability than many other heaters that will cost far more.



60,000 BTU

Powerful & Durable

£299

PART NO: ZMIR-K60 / 987AA7250

	987AA7250
OUTPUT RANGE KW (BTU)	17.6KW (60,000)
WEIGHT	13.5KG
MAX FUEL USAGE	1.7 LITRES PER HOUR
AIR FLOW	100 M3 PER HOUR
TANK CAPACITY	13 LITRE
MOVE WITH	CARRY HANDLE

- Quick, cost-effective heat, no installation, near-100% efficiency
- Run on diesel, red diesel, paraffin or heating oils
 - Supplied with UK 220-240V mains plug
 - Built-in variable thermostat control for auto on/off cycling
 - Full safety controls include flame-out and overheat shut-down
 - UK manual including service procedures, trouble-shooting, parts diagrams etc
 - Fast delivery – typically delivered next working day
 - 12 months warranty-spares & service parts in UK stock



THE LEADERS IN EFFICIENT WORKSHOP HEATING

NEW

Manual ignition bio oil heaters with flue kit

- Fast return on investment
- Efficient, virtually soot-free combustion
- Built in fuel tank, filters and pump
- Flame failure protection
- Overflow protection for burner dish
- Overhear protection (except Bio B)
- Includes complete flue kit (roof seal, fitting kit & two wall bands); legislation compliant PG1/1 (04)
- Bio Energy 2 & Bio Energy 3 feature a burner draw system or easier lighting and cleaning plus a heat exchanger for higher efficiency



Flue kit available



CALL FOR LATEST PRICE

THERMOBILE STAINLESS STEEL FLUE KIT INCLUDED

- Gives approx 5.2m (17ft ground clearance)
- 4 x 1m flue pipes
- 1 x Terminal
- 2 x Adjustable wall fixing brackets
- 1 x High temperature silicone rubber roof seal and fixing kit for profiled or corrugated roof and cladding
- 1 x Tee-Pee (flue to heater)
- Additional 1m flue pipe available

FINANCE OPTIONS AVAILABLE

These heaters operate on the following fuels:

- Bio Diesel Oil
- HVO
- Processed Fuel Oil
- Rapeseed, Linseed and some Vegetable Oils

MODEL	PART NUMBERS	HEAT CAPACITY MIN (BTU/HR)	HEAT CAPACITY MAX (BTU/HR)	CONSUMPTION (MIN)	CONSUMPTION (MAX)	FUEL TANK CAPACITY	FAN CAPACITY
BIO ENERGY B THERMO (RADIANT HEATER)	BIOBTHERMO-PACKAGE	68,000	102,000	2 LITRE/HR	3 LITRE/HR	50 LITRES	1000m ³ /hr
BIO ENERGY 1	GEQBIO1PACKAGE	68,000	102,000	2 LITRE/HR	3 LITRE/HR	50 LITRES	1000m ³ /hr
BIO ENERGY 2	GEQBIO2PACKAGE	85,000	146,000	2.5 LITRE/HR	4.3 LITRE/HR	55 LITRES	3000m ³ /hr
BIO ENERGY 3	GEQBIO3PACKAGE	130,000	210,000	3.8 LITRE/HR	6.2 LITRE/HR	55 LITRES	3000m ³ /hr

Manual ignition Bio Oil heaters must be connected to a suitable flue system (min height of 1m above roof apex and 6m above ground level). A full range of flue accessories are available.

*Waste Oil is subject to licensing control: Heaters burning Waste Oil fall under Chapter IV of the Industrial Emissions Directive (IED) A relevant permit is required under Schedule 13A of the Environmental Permitting Guidance (EPR). Full details at www.thermobile.co.uk, under 'News'.

THERMOBILE
PROHEAT OIL FIRED CABINET HEATER
with integral fuel tank and room thermostat

No space for a bulk fuel tank? Proheat is your solution!

- Use with 28 seconds fuel (paraffin/kerosene) or 35 second fuel (heating oil/diesel)
- Low-noise radial fan
- Proheat 30 & 60: 240V. Proheat 100: 400v
- Equipped with thermostat
- Capacities of 30, 64 and 97kW net 4-sided adjusted outlet opening guarantees equal air distribution Summer/Winter circuit for heating/ventilation



ERP Compliant

Flue Kit and Swivel Head Kit available

Gas version available

 **FINANCE OPTIONS AVAILABLE**

CALL FOR LATEST PRICE

MODEL	PART NUMBERS	NET HEAT OUTPUT (BTU/HR)	MAX KW	CONSUMPTION (L/HR)	AIR FLOW (M3/HR)	FUEL TANK CAPACITY
PROHEAT 30	GEQPROHEAT30	104,000	30.4	3.4	1900	55
PROHEAT 60	GEQPROHEAT60	221,600	64.4	7.2	4500	75
PROHEAT 100	GEQPROHEAT100	333,352	97.7	10.5	8800	-
FUEL TANK	GEQPRO100FUEL TANK	-	-	-	-	100



THERMOBILE
PSO OIL FIRED
CABINETS
Connects to a Bulk Fuel Tank



- ERP Compliant
- 91% heat efficiency
- Flue Kit available

ERP Compliant

CALL FOR
LATEST PRICE

- Use with 28 seconds fuel (paraffin/kerosene) or 35 second fuel (heating oil/diesel)
- 13 models - heat outputs up to 381kW (1.3m Btu/hr)
- Combustion air inlet as standard
- Thermostat, time control, oil filter and fire valve
- Main fan filters available dusty/ hazardous spaces
- Also available: Stainless Steel Flue Kits - ask for details

MODEL	PART NUMBERS	NET HEAT OUTPUT (BTU/HR)
GEQPSO 30	GEQPSO30	102,000
GEQPSO 45	GEQPSO45	153,600
GEQPSO 60	GEQPSO60	205,352
GEQPSO 90	GEQPSO90	307,000

FINANCE OPTIONS AVAILABLE

THERMOBILE
SUSPENDED UNIT HEATERS
Heating Oil, Natural Gas or Propane



- Choose oil or gas fired
- ERP Compliant

CALL FOR
LATEST PRICE

MODEL	KW	VOLTAGE	HEATED AIRFLOW M ³ /HR	FLUE SIZE DIAMETER
OUH30	102,360	230V	102,000	5"
OUH45	153,540	230V	153,600	5"
OUH60	204,720	230V	205,352	5"

FINANCE OPTIONS AVAILABLE

**All prices are subject to change without prior notice due to market fluctuation.
**All Prices Excl VAT

ELECTRIC FAN HEATERS

SIP

FIREBALL TURBOFAN 2000 ELECTRIC FAN HEATER

PART NO: 09128

- 6,820BTU/hr (2kW) powerful heating output
- Automatic shut-off for higher energy savings
- Heavy-duty powder-coated finish for durability
- PTC Element for safer temperature control
- Ideal for conventional fan applications

£35



NEW

SIP

FIREBALL TURBOFAN 3001 ELECTRIC FAN HEATER

PART NO: 09215

- Variable heat power settings
- Positive Thermal Coefficient (PTC) technology
- Compact and lightweight design for great portability
- Powder-coated steel body with painted finish
- No Heat output given which is 9,556 BTU/hr (2.8kW)

£59



NEW

SIP

FIREBALL TURBOFAN 5000 ELECTRIC FAN HEATER

PART NO: 09220

- 17,064BTU/hr (5kW) powerful heating output
- Automatic shut-off for higher energy savings
- Heavy-duty powder-coated finish for durability
- PTC Element for safer temperature control
- Ideal for conventional fan applications

£109



NEW



DIESEL/PARAFFIN SPACE HEATERS



SIP

**FIREBALL XD75 DIESEL/
PARAFFIN SPACE HEATER**

PART NO: 09592

- 75,000BTU/hr (20kW) heat output
- 530mtr³ (18,717ft³) approx. heating area
- 26ltr heavy-duty steel fuel tank
- High-quality low maintenance air pump
- Heavy-duty powder-coated finish

£290

SIP

**FIREBALL XD100 DIESEL/
PARAFFIN SPACE HEATER**

PART NO: 09593

- 100,000BTU/hr (30kW) heat output
- 700mtr³ (24,720ft³) approx. heating area
- 26ltr heavy-duty steel fuel tank
- High-quality low maintenance air pump
- Combustion chamber cool-down safety feature
- Heavy-duty powder-coated finish

£369

SIP

**FIREBALL 350 CORDLESS
PROPANE SPACE HEATER**

PART NO: 09267

- 34,128BTU/hr (10kW) powerful heating output
- Large 230mtr³ (8,122ft³) approximate heating area
- Quality rechargeable 18v DC 5.2Ah Lithium battery
- Up to 8hrs continuous runtime on single charge

£149



**All prices are subject to change without prior notice due to market fluctuation.
**All Prices Excl VAT

LOKITHOR 5-IN-1 JUMP STARTER, AIR COMPRESSOR & PRESSURE WASHER

PART NO: SNCAW401

POWERFUL PERFORMANCE - 2500A starting current, capable of making up to 60 jump starts*, suitable for petrol and diesel engines, including: cars, motorcycles, boats, RVs, ATVs, SUVs, vans, tractors, mowers and more.

SAFE & INTELLIGENT - Real time battery voltage detection alarms the user of any battery abnormalities. built-in battery management system safety measures include; short-circuit protection, overcurrent protection, reverse polarity protection, overheating protection, over-cranking protection, spark-proof technology and supply interruption protection.

BUILT FOR TOUGH CONDITIONS - IP65 rated and capable of operating in temperatures between -20°C to 60°C.

£295

NEW



- Lithium Polymer Batteries
- 2 Year Warranty
- Detachable Clamps
- 12v Charging
- Voltmeter

500 LUMEN LIGHT



DIGITAL INTERFACE DISPLAY

Gives you battery status, fast charge status, voltage indicator, tyre pressure info and more!

60W INPUT & OUTPUT

Fast charging via USB-C devices

INCLUDES:

Jump starter | Inflatable hose | Jump starter clamps | Nozzle adaptors | USB-C cable & charger | Storage bag | Packing bag | User manual



SCAN CODE
TO SEE MORE!

5-IN-1



AIR COMPRESSOR
150 PSI



LED FLASHLIGHT
500 LUMEN



PRESSURE WASHER
200 PSI



POWER BANK
20,000MAH



JUMP STARTER
2,500 PEAK AMPS

*Under test conditions, actual number of starts may vary based on charge status, temperature and engine size



LOKITHOR

4-IN-1 JUMP STARTER & AIR COMPRESSOR

PART NO: SNCJA302

NEW



AIR COMPRESSOR
150 PSI



LED FLASHLIGHT
500 LUMEN



POWER BANK
20,000MAH



JUMP STARTER
2,500 PEAK AMPS



4-IN-1

- Lithium Polymer
- 2 Year Warranty
- Detachable Clamps
- 12v Charging
- Voltmeter



SCAN CODE TO SEE MORE!

60W INPUT & OUTPUT
Fast charging for USB-C device



INCLUDES

Jump starter | Inflatable hose | Jump starter clamps | Nozzle adaptors | USB-C cable & charger | Storage bag | Packing bag | User manual

DIGITAL INTERFACE DISPLAY

Gives you battery status, fast charge status, voltage indicator, tyre pressure info and more!

£188



BATTERY CHARGERS

SIP

CHARGESTAR D15

PART NO: 03506

NEW

- 12v charging output
- 8 step fully automatic charging cycle
- Intelligent microprocessor for fast, easy & safe charging
- Lightweight & compact design
- Reverse polarity protection
- Crocodile clamps & leads
- Easy-to-read digital display



£69

SIP

CHARGESTAR D40

PART NO: 03556

NEW

- 12v/24v charging output
- 12v & 24v battery charging with battery type auto detection
- 8 step fully automatic charging cycle
- Intelligent microprocessor for fast, easy & safe charging
- Lightweight & compact design
- Reverse polarity protection
- Heavy-duty crocodile clamps and leads
- Easy-to-read digital LCD screen



£139

SIP
STARTMASTER DSC250B
DIGITAL STARTER
CHARGER

PART NO: 03585

- 12v/24v charging voltage / 250A (1v) peak start current
- 300Ah max. battery capacity and max. 30A charging current
- Auto detects 12v or 24v battery with low activation voltage (1v)
- 4 charge rate settings for added versatility



NEW

£320

NEW

£500

SIP
STARTMASTER DSC350B
DIGITAL STARTER
CHARGER

PART NO: 03586

- 12v/24v charging voltage / 350A (1v) peak start current
- 550Ah max. battery capacity and max. 50A charging current
- Auto detects 12v or 24v battery with low activation voltage (1v)
 - 4 charge rate settings for added versatility

GYS
GYSFLASH 100-12 HF
5.0M CABLES

PART NO: 29002



£696

The GYSFLASH 100-12 HF is a 100 A, high-power, stabilised power supply featuring inverter technology with five separate functions: • Battery support: sustains 12 V (liquid or gel), automotive batteries during diagnostic work

- Advanced battery charger: ensures ideal charging cycles to maintain the batteries of even the most modern vehicles
- Showroom mode: maintains batteries in showroom vehicles
- «BATTERY CHANGE» mode will maintain an electrical power supply to preserve the vehicle's memory settings
- High-power, stabilised power supply: both the voltage and current can be adjusted
- Advanced features Intuitive interface Compact Cables
- Automatic restart / Cable testing and calibrating
- Showroom mode lock feature / "Easy charge" mode
- Activate and adjust an "expert" charging curve
- Automatic SOS recovery for sulphated batteries

GYS
GYSPACK PRO 800

PART NO: 072107



£425

Professional, self-contained starter for all vehicles fitted with 12 V batteries. It comes equipped with a powerful and robust spiral-cell battery

- Featuring a lead-acid battery (in start-up mode: 700 A at 1V/c and 2,500 A at peak battery)
- With its compact design and light weight of 18.4 kg, the GYSPACK PRO 800 can be easily moved around a worksite
- Buzzer and an indicator light offer reverse-polarity protection
- Built-in circuit breaker protects your vehicle from power surges or short circuits and avoid sparks when connecting the clamps
- Can be fully recharged from the mains completely unattended thanks to its automatic external 230 V charger
- GYSPACK PRO 800 has a display screen showing the internal battery's state of charge



BATTERY CHARGERS



£60

SIP
ADVANCED GX5

PART NO: 03572

- Multi-step microprocessor-controlled charging
- Automatic maintenance mode on all compatible batteries
- High-quality advanced digital interface for easy use
- Supply, test, lead, Lithium, and reconditioning modes
- Energy-efficient for high cost savings



£119

SIP
ADVANCED GX10

PART NO: 03573

- Multi-step microprocessor-controlled charging
- Automatic maintenance mode on all compatible batteries
- High-quality advanced digital interface for easy use
- Supply, test, lead, Lithium, and reconditioning modes
- Energy-efficient for high cost savings



£145

SIP
ADVANCED GX15

PART NO: 03574

- Multi-step microprocessor-controlled charging
- Automatic maintenance mode on all compatible batteries
- High-quality advanced digital interface for easy use
- Supply, test, lead, Lithium, and reconditioning modes
- Energy-efficient for high cost savings

GYS
SOLAR POWERED CHARGER WITH ACCESSORIES

PART NO: 72411

- Multi-step microprocessor-controlled charging
- Automatic maintenance mode on all compatible batteries
- High-quality advanced digital interface for easy use
- Supply, test, lead, Lithium, and reconditioning modes
- Energy-efficient for high cost savings

NEW



£35

SIP
T11 12V/24V BATTERY TESTER & ELECTRICAL SYSTEM ANALYZER

PART NO: 03568

- Offers starter, alternator, and mass ground testing
- Suitable for ATV, motorcycle, and car batteries
- Integrated LCD screen and easy-to-use touchpad
- Supplied in a premium carry and storage case

NEW



£319

GYS

GYSFLASH 30.12 PL UK

PART NO: 26070

NEW



£278

Lead-acid/lithium battery charger and battery support unit 12 v

- 3 charging currents: 7 A, 15 A and 30 A. The user can select the charging current according to the technology and capacity of the battery
- Showroom/Diag mode, ensures current compensation up to 30 A when using electrical accessories of a demonstration vehicle and during the diagnostic phase
- Supply mode, provides a stabilised power supply so the GYSFlash 30:12 PL can be used as a Battery Support unit
- Will charge deeply discharged batteries from as low as 2V
- Protection of the vehicle's on-board electronics: protection against short circuits, polarity reversal and overcharging. Spark prevention system
- Automatic stand-by mode if the battery is disconnected.
- Integrated temperature sensor to prevent internal electronics' overheating
- Simplified interface to prevent user error

GYS

BATIUM 7.12 UK

PART NO: 24557

NEW



£129

Workshop smart charger suitable for cars & vans

- Protection for vehicle electronics allows safe charging batteries whilst still connected to vehicle
- Charges all common battery types including gel, silver/calcium, EFB & AGM stop/start (up to 130Ah)
- Charges 50% faster than traditional chargers
- Charges deeply discharged batteries from 2volts/cell – most chargers cannot do this

BATTERY TESTERS & SCANNERS

SEALEY

BATTERY MONITOR REMOTE SENSOR

PART NO: BT2020

- Displays real time battery power, voltage and temperature
- Wireless connection with dedicated app which supports up to four devices (IOS & Android compatible)
- Guide user back to the vehicle by automatically recording the last parking location
- Record the route, cost and driving habits of each trip, which can be exported to Excel
- Automatically monitor the starting and charging system of the vehicle and notify if abnormal
- Compatible with most batteries including lead sealed, AGM and Gel
- Supports up to four devices
- Store historical data in the device for up to 30 days



£30

GYS

SURGE PROTECTION 12V

PART NO: 41318

- The surge protection preserves the electronics of a vehicle by absorbing the over voltage peak during welding, battery disconnect & reconnection



£21



AGM BOOSTER PACKS

SIP
RESCUE PAC 1600 12V

PART NO: 03936

- 12v internal battery voltage
- 1600A boost peak rate and 700A cranking rate
- Rechargeable AGM portable pack for boost starting
- 12v DC takeoff powers devices direct from booster
- Integrated LED charge rate indication

NEW

Best Seller



£135



SIP
RESCUE PAC 3000

12/24V
PART NO: 03937

- 12v/24v internal battery voltage
- 3000A boost peak rate and 1200A cranking rate
- Rechargeable AGM portable pack for boost-starting
- 2x 12v DC sockets power devices direct from booster
- Reverse hook-up alarm and circuit overload protection

NEW



£285



SIP
PRO BOOSTER 5024 12V/24V

PART NO: 07192

- 5000A boost peak rate and 1680A cranking rate
- Rechargeable AGM portable pack for boost-starting
- 12v DC output socket for charging electronic devices
- Robust and shockproof ABS casing for high durability
- Reverse polarity protection for peace-of-mind



£645

SIP
PRO BOOSTER 6200 12V/24V

PART NO: 07174

- 6200A boost peak rate and 1880A cranking rate
- Rechargeable AGM portable pack for boost-starting
- 12v DC output socket for charging electronic devices
- Robust and shockproof ABS casing for high durability
- Reverse polarity protection with audible alert

NEW



£800

CAPACITOR BOOSTERS

CAPACITOR BOOSTER			
PART NO	DESCRIPTION	DETAIL	PRICE
07001	600A 12V	<ul style="list-style-type: none"> • Lightweight capacitor energy cell • 60 Second preparation 'ready' time for fast boosting capability • Powerful, portable and compact design 	£99
07003	1000A 12V	<ul style="list-style-type: none"> • Lightweight capacitor energy cell • 90 Second preparation 'ready' time for fast boosting capability • Powerful, portable and compact design 	£139
07005	1600A 12V	<ul style="list-style-type: none"> • Lightweight capacitor energy cell • 90 Second preparation 'ready' time for fast boosting capability • Powerful, portable and compact design 	£175



**All prices are subject to change without prior notice due to market fluctuation.
**All Prices Excl VAT

RECHARGEABLE COMPACT WORK LIGHT

NEW

UNILITE FOLDING INSPECTION LIGHT

PART NO: IL-925R

NEW

£55



- 925 lumen white COB LED at the front
- 475 lumen white COB LED at the rear
- 150 lumen SMD LED on top
- Compact hand-held size
- Super tough aluminium and nylon construction
- 180° vertical folding head for flexible positioning

925 Lumen

UNILITE RECHARGEABLE FOLDING WORK LIGHT

PART NO: IL-175R

NEW

£32



- 175 lumen white COB LED at the front
- 150 lumen white COB LED at the rear
- 70 lumen SMD LED on top
- Compact pocket size with a folding head
- Durable construction with IK07 copolymer and aluminium
- Pocket clip for easy carrying
- Strong magnets for hands-free work
- Quick 2-hour USB-C charging
- 3-hour runtime, extendable to 6 hours with dimming

175 Lumen

HEADTORCH

NEW

UNILITE RECHARGEABLE DUAL BEAM HEADTORCH

PART NO: HT-650R

£66



650 Lumen

- 650 lumen white COB LED with a 6500k colour temperature
- Circular COB LED for wide flood lighting
- Additional 450 lumen CREE LED spot beam for focused illumination
- Dual power options - rechargeable 1100mAh Li-polymer battery or 3 AAA batteries



£63.75

UNILITE SLR-1450

PART NO: SLR-1450

- 1450 lumen white COB LED, 6500k
- 150 lumen 6500k white LED flashlight
- 45 lumen Red and Red flash modes
- 'LG' 3.7v 5000mAh 21700 Li-ion battery
- Super tough copolymer and aluminium construction
- 180° rotating handle/stand with carabiner snap hook
- Strong magnets within the stand
- Glow-in-the-dark strip for extra visibility
- Battery level and charging indicators
- Faster 2A USB-C charging - 3-hour charge time
- 1m high-quality USB-C cable included
- Removable battery for convenient spare option

NEW



£6.70

UNILITE UK-USB-PLUG

PART NO: UK-USB-PLUG

The UK-USB-PLUG has a single USB port to quickly charge a Unilite torch

UNILITE
ALUMINIUM LED
INSPECTION LIGHT

PART NO: PL-3

- High power 275 lumen white SMD LEDs
- Durable die-cast aluminium construction
- Rubberised micro-switch for easy control
- Strong magnetic base for hands-free placement
- Useful rear aluminium pocket clip for portability
- IPX4 water resistant for added durability in wet conditions
- Powered by 3 x AAA batteries



CALL FOR
LATEST PRICE

UNILITE
LED DETAILING LIGHT

PART NO: CRI-3350

- Maximum Output: 3350 lumens, high CRI 96+ COB LED
- Five colour temperature settings: 2700k, 3500k, 4500k, 5500k, 6500k
- Dual power options: rechargeable Li-ion battery and mains
- Memory function for last colour used
- Toughened aluminium, nylon, and TPR construction
- Built-in aluminium heat sink
- 180° adjustable stand/handle with tripod attachment hole and magnet
- IP65 dust and water resistance, IK07 shock resistance



UNILITE
COMPACT CRI WORKLIGHT

PART NO: CRI-1250R

- 1250 lumen 10W high CRI 96+ COB (Chip-on-Board) light source
- Three coloured COB LED options with CCT (Correlated Colour Temperature) of 2700k, 4500k, and 6500k
- Press and hold function for smooth dimming
- 250 lumen 3W SMD LED flood beam top torch
- 5W UV LEDs on the front (385nm) for specialized applications
- Super tough aluminium / polycarbonate structure for durability
- Strong integral magnets on the back and base for hands-free attachment
- Retractable 360° rotating hanging hook for positioning
- Glow-in-the-dark strip around the LED for easy locating in low-light conditions
- Battery level and charging with indicator LEDs for convenient monitoring

£70



UNILITE
MULTI BATTERY SITE LIGHT

PART NO: MTB-5300

- 5300 lumen 50W 6500K COB LED
- Dual Power - rechargeable & mains powered
- Takes up to 20V 6.0Ah batteries from Milwaukee, De Walt, Makita & Metabo - 4 adapters included
- Secure battery compartment cover (note: larger 6.0Ah batteries may need to be used without cover)
- Super tough heavy duty nylon construction
- Rotating stand with holes for attaching tripod/magnet
- IP65 Dust & water resistant / IK07 Shock proof
- Memory Switch - remember last mode used
- 2A USB Powerbank - works with any battery Installed
- 4 x Battery level & charging indicators

CALL FOR
LATEST PRICE

NEW

DIAGNOSTIC MEANINGS

- SGW** **Secure Gateway**
 Many vehicle manufacturers have started protecting their vehicles with a diagnostic Secure Gateway and firewalls to prevent unauthorized access essentially locking out the diagnostic tool. The number of vehicle manufacturers that are locked will increase in the next few years. These include Volkswagen, Audi, Seat, Skoda, Mercedes, Fiat, Chrysler, Kia, Hyundai to name a few.
 When choosing a diagnostic tool, make sure it is the right tool for your workshop with the correct vehicle access you require. Call the GE team for advice
- DoIP** **Diagnostics over Internet Protocol**
 Used on some later Volvo and Jaguar Land Rover Vehicles
- CAN** **Controller Area Network**
 Used by almost all vehicle manufacturers to communicate between ECU's on a vehicle and sometimes through the 16 pin OBD Port
- CAN FD** **Controller Area Network Flexi Data Rate**
 30-times faster data rate than CAN bus, used by many newer vehicles
- LIN** **Local Interconnect Network**
 Single wire, serial network
- J2534** **SAE J2534 Pass-Thru**
 Some diagnostic tools can support J2534 to connect the diagnostic tool to the vehicle via the manufacturer's diagnostic software, enabling ECU re-flashing, and in some cases, diagnose vehicles with dealer level functionality.
- D-PDU** **Diagnostic Protocol Data Unit**
- RP1210** **RP1210 is used for reprogramming and diagnosing of emission related (mainly) Electronic Control Units (ECUs) in Trucks & Plant Machinery**
- Battery Support** **Battery Support charger recommended see pages 15, 16 and 17**



OBD EXTENTION LEAD

PART NO: SNC115.001

- Great Value OBD Extension Lead
- Saves your expensive diagnostic tool plug from damage
- Fits all 12V OBD Diagnostic Machines
- Extends your existing tool's OBD lead by 1 meter



£15

BREAKOUT BOX

PART NO: HU-PPECB

- The CAN-Bus circuit tester is suitable for 12 & 24V systems. Once plugged into the vehicles OBD port it will start to check the 16 pins for any voltage present. If voltage is present the respective LEDs will illuminate
- Test the vehicles link connector (OBD port) for any abnormalities
- Live display of communicating signals if present
- Provides quick access to all 16 pin connections during vehicle repair and diagnosis
- Monitor the input voltage during ECU programming with audible low voltage alarm.



£140

SEALEY

OBD READER

PART NO: VS8812

- **OBDII/EOBD COMPLIANT VEHICLES**
 Petrol 2001 and Diesel 2004 onwards
- **CAN ENABLED**
 Retrieves generic P0, P2 and P3 and U10 codes and picks up manufacturer specific P1, P3 and U1 codes
- **THIS EASY TO USE TOOL**
 Read and Clear Emission Fault Codes
- **COMPREHENSIVE INSTRUCTIONS**
 Supplied.



£39.90

AUTEL
MAXISYS ULTRA

PART NO: MSULTRA

£5,250

12.9" Screen



- MaxiSYS Ultra is the first diagnostic tool to be designed to match the growth of more complex automotive electrical systems and Electric Vehicles
- The Ultra has a super large screen, our fastest processors, our largest ever SSD memory and even a docking station as standard
- MaxiSYS Ultra and MS919 are supplied with the all new MaxiFLASH VCMII as standard
- Extended 2 years warranty
- 3-year Software free updates included
- Guided Maintenance
- 80+ Manufacturers
- Full diagnostics
- 26 Service Functions
- Channel coding and programming
- MaxiFlash VCMII included
- Built-In Oscilloscope
- Built-In Waveform Generator
- Built-In Multimeter
- Built-In CAN bus Check
- System Topology
- Repair Assistant
- Accurate recommendation
- Relevant Cases
- Tech Services Bulletins

FINANCE OPTIONS AVAILABLE

AUTEL
MAXISYS MS919

PART NO: APMS919

£3,995

9.7" Screen



- The all-new MaxiSYS MS919 shares exactly the same software and multi-purpose VCMII as the Ultra, but the diagnostic tablet is without the docking station, has a smaller screen and smaller memory.
- MS919 represents excellent value for money, retaining all the software and VCMII features of the Ultra
- MaxiSYS Ultra and MS919 are supplied with the all new MaxiFLASH VCMII as standard
- Extended 2 years warranty
- 1-year Software free updates included
- Guided Maintenance
- 80+ Manufacturers
- Full diagnostics
- 26 Service Functions
- Channel coding and programming
- MaxiFlash VCMII included
- Built-In Oscilloscope
- Built-In Waveform Generator
- Built-In Multimeter
- Built-In CAN bus Check
- System Topology
- Repair Assistant
- Accurate recommendation
- Relevant Cases
- Tech Services Bulletins

FINANCE OPTIONS AVAILABLE

**All prices are subject to change without prior notice due to market fluctuation.
 **All Prices Excl VAT

AUTEL MAXISYS MS909

PART NO: AT LAPMS909

ADAS
 UPGRADEABLE TO ADAS
 CALIBRATION



9.7" Screen



ADAS software upgrade: £650

Now with 2 years updates

£2,995

- The all new MaxiSYS MS909, is the replacement to the MS Elite and shares the same tablet hardware as the MS919
- MS909 is supplied with 2 years updates as standard
- MS909 combines diagnostics, service, extensive live data, channel coding and ECU re-flashing
- the MS909 has all new software specialist capabilities that is have named Repair Assist, DTC Analysis, Topology Mapping and Relevant Cases

KEY FEATURES

- Extended 2 years warranty
- Repair Assistant
- 1-year Software free updates included Accurate recommendation
- MaxiFlash VCI J2534 included Relevant Cases
- 80+ Manufacturers
- Tech Services Bulletins
- Full diagnostics
- 26 Service Functions
- Channel coding and programming
- System Topology

Software Updates + Bolt-ons

<p>Future 12 months Update £995 excl. VAT</p>	<p>ADAS Software Upgrade £650.00 excl. VAT</p>
--	---



FINANCE OPTIONS AVAILABLE

OPTIONAL COMPATIBLE ACCESSORIES

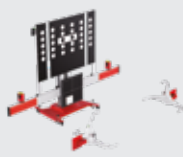

ADAS MAIN FRAME

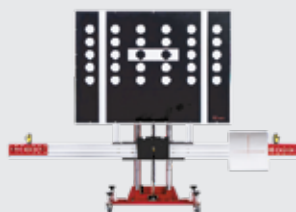

ACCESSORY KIT



CONNECTOR KIT

**BATTERY SUPPORT UNIT
 RECOMMENDED SEE PAGE 15-17**

AUTEL
MAXISYS
MS906 S PRO
PART NO: APMSMS906SPRO



8" Screen

£1,795

- MaxiSYS MS906SPRO EU, is the replacement the MS908s. MS906SProEU is excellent for busy workshop tool, or technician, that requires superior coverage and capability, but at a very affordable price.
- MS906SPro EU includes a number of great features such as outstanding coverage with 80+ manufacturers, full diagnostics, service functions, channel coding and programming.

KEY FEATURES

- 80+ Manufacturers ADAS Upgradeable
- Bluetooth Connectivity
- Live Data/Record/Playback
- 24 Months UK Support AutoVIN Technology
- 24 Months UK Warranty

- Enhanced European Software
- All Modules - Chassis, Powertrain, Body etc
- Read and Clear Codes

FINANCE OPTIONS AVAILABLE

AUTEL
MAXISYS MS906S
PART NO: APMS906SEU



8" Screen

£1,399



- MaxiSYS MS906S EU is the 'little brother' to the MS906SPRO EU. Faster, lighter, better value and much more powerful than its competitors

KEY FEATURES

- 80+ Manufacturers
- Bluetooth Connectivity Live Data/Record/Playback
- 24 Months UK Support AutoVIN Technology
- 24 Months UK Warranty
- Enhanced European Software

- All Modules - Chassis, Powertrain, Body etc
- Read and Clear Codes

FINANCE OPTIONS AVAILABLE

**All prices are subject to change without prior notice due to market fluctuation.
**All Prices Excl VAT

TPMS

AUTEL TPMS DIAGNOSTIC AND TPMS PROGRAMMER

PART NO: ITS600

- MaxiTPMS® ITS600 EU is an all new TPMS tool that can work in conjunction with the new TBE tyre wear tool

KEY FEATURES

- Optical Scanner Identifies VIN/MMY
- Exclusive TPMS Status Screen
- Fast OBD II Relearn
- Opy By OBD Sensor Programming for Faster Service
- Batch Program Up to 20 Autel 1-Sensors
- Activate, Read, Relearn All Known TPMS Sensors
- Wireless OBDII Connection via Bluetooth VCI
- Tyre Pressure Placard Value Reset
- Includes 4 Commonly Used Maintenance Service Functions
- 24 Months UK Telephone Support
- 24 Months UK Warranty

£449



NEW

5.5" Screen

Supplied with
FREE UK Software
updates



AUTEL MX SENSOR

- Autel's universal MX-Sensors at 433MHz can be programmed to replace 90% of the sensors on the road today and are built to match or exceed OEM sensors in frequency, strength and durability
- he 4-SKU sensor solution can greatly reduce sensor inventory investment and improve customer service
- Autel's MX-Sensor values are independently tested and certified to meet the SAE industry standard J1205 / J1206 ratings
- Autel MX Sensors are available with Metal or Rubber Value Stems

CALL FOR
LATEST PRICE



NEW

AUTEL
TPMS VALVE METAL PART NO: APMX433 **£25**

AUTEL
TPMS VALVE RUBBER PART NO: APMXSENSOR1RUBBER **£25**

TEXA

VOICE/MULTIHUB CAR

- Axone voice
- IDC5 Premium Car Software
- TXT Multihub
- 12 months Car Texpack
- 12 months Car Technical Support
- 3 Year warranty

FEATURES

- Network cable (Ethernet) reserved for DoIP operations (ISO 13400)
- USB socket for all types of diagnosis, including the Pass-Thru (SAE J2534-1 and SAE J2534-2)
- Bluetooth module for conventional diagnoses
- Wi-Fi module for the diagnostic operations that use standard CAN and DoIP

The top-of-the-range solution versatile, quick, intuitive, in any situation



CALL FOR LATEST PRICE

TEXA

MINI/NANO CAR

The AXONE NEMO MINI is TEXA's latest solution for multi-brand diagnosis. It comprises a Windows 10 operating system powered by an Intel Celeron N4120 processor., 8GB RAM, 256GB SSD storage,

WiFi & Bluetooth connectivity and a user friendly 11.6" multi-touch capacitive display that provides a clear view when conducting diagnostic operations. This AXONE NEMO MINI Car/LCV package

FEATURES

- Axone Nemo Mini
- IDC5 Premium Car Software
- Navigator Nano S
- 12 months Car Texpack
- 12 months Car Technical Support
- 2 Year warranty

Designed to meet the needs of the technician

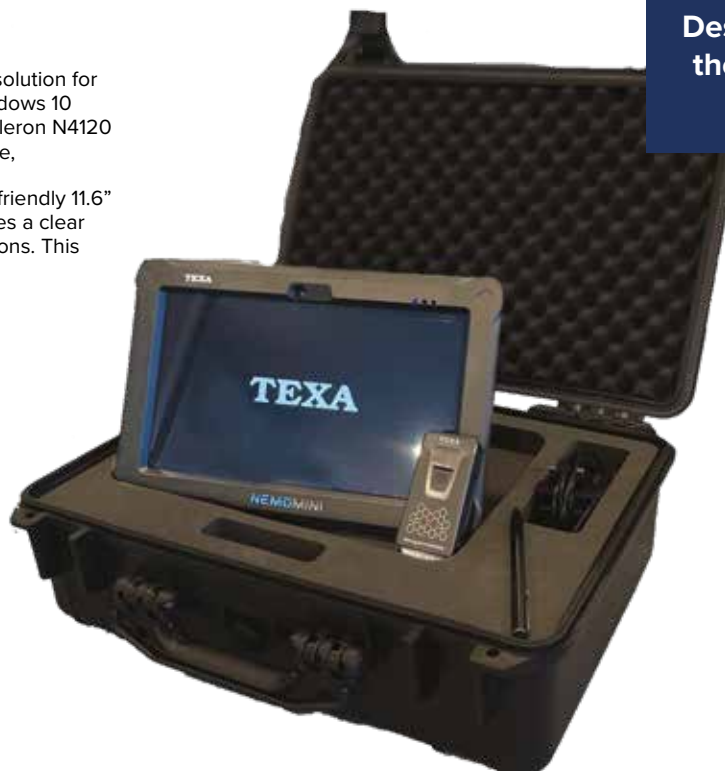

CALL FOR LATEST PRICE

**All prices are subject to change without prior notice due to market fluctuation.
**All Prices Excl VAT

BOSCH KTS PACKAGES

KTS 560 & 590: Modern control unit diagnosis for the highest level of efficiency and accuracy. The robust communication modules KTS 560 and KTS 590 are optimally suited for the use of the Bosch diagnostic software ESI[tronic] 2.0

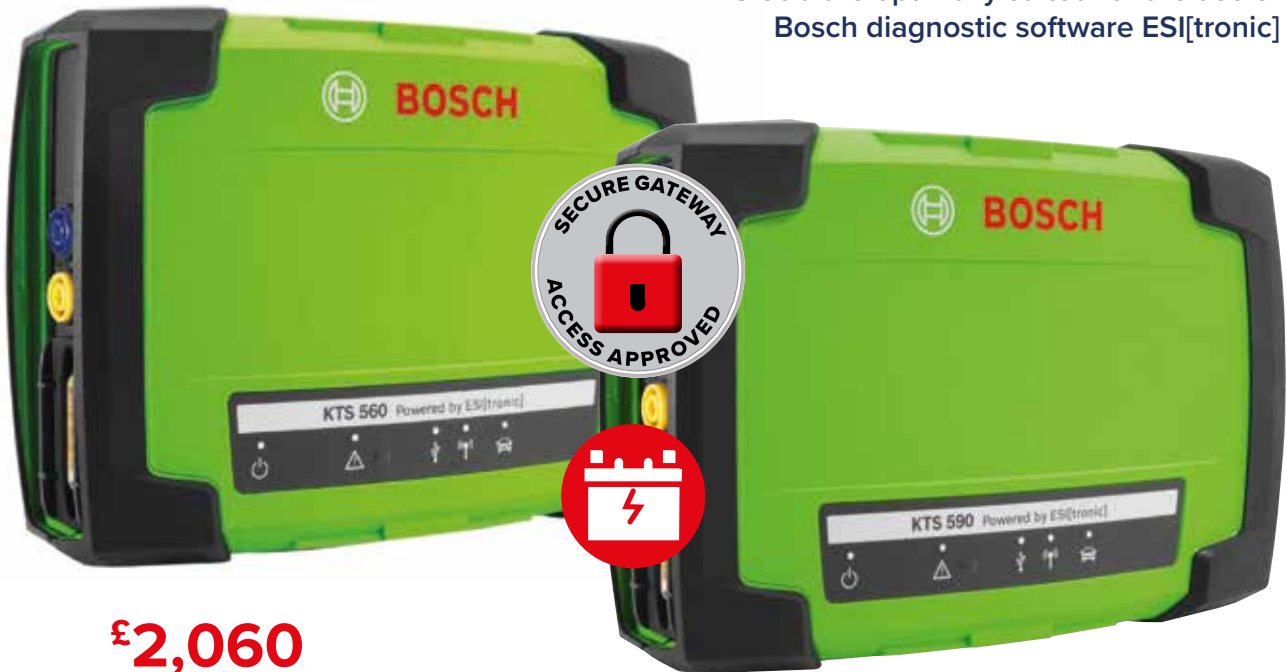

£2,060

£2,650

THE BENEFITS OF THE KTS 560 AND 590 AT A GLANCE

- Support of all current vehicle interfaces based on Ethernet and parallel operation of several BUS systems, including JLR vehicles
- Advanced PassThru interface for programming
- Works on any Windows 10 OR 11 PC on which the Bosch diagnosis application ESI[tronic]2.0 is installed and licensed
- (Rugged Windows laptops available from GSF, please contact the GE Team for details)
- Mobile and stable operation thanks to powerful Bluetooth interface
- Up to three CAN and K-Line interfaces can be used at the same time
- Wireless Bluetooth connection to the workshop PC allows increased coverage enabling mobile use throughout the workshop
- Rugged construction for long-term everyday workshop use
- KTS 590 also includes a 2-channel oscilloscope.

FINANCE OPTIONS AVAILABLE

**BATTERY SUPPORT UNIT
RECOMMENDED SEE PAGE 15-17**

ESI-TRONIC 1 YEAR SOFTWARE OPTIONS

DESCRIPTION	PART NO	DETAILS	PRICE
ESI DIAGNOSTIC	1987P12821	Diagnostic Package with diagnose and experience based repair • (A) Vehicle information / Equipment catalogue • (SD) ECU Diagnosis • (TSB/EBR) Service bulletins, Known faults	£646
ESI ADVANCED	1987P12841 1687P15131	Advanced Package with diagnose and guided troubleshooting • (A) Vehicle information / Equipment catalogue • (SD) Diagnosis of control units • (TSB/EBR) Service bulletins, Known faults • (CoRe) Connected Repair	£1,133
ESI MASTER	1987P12911 1687P15131	Master Package with diagnose, guided troubleshooting, circuit diagrams & maintenance schedules • (A) Vehicle information / Equipment catalogue • (SD) Diagnosis of control units • (TSB/EBR) Service bulletins, Known faults • (SIS) Repair instructions and manuals • (P) Circuit diagrams for comfort systems • (M) Maintenance schedules and information • (CoRe) Connected Repair	£1,442

**DELPHI
DS180**

NEW



**CALL FOR
LATEST PRICE**

Delphi Advanced Diagnostics Solutions

Welcome to the BlueTech Experience!

Delphi Technologies believe every workshop should have access to the best technology and functionality required to carry out the highest quality repairs

**Laptop/Tablet
Also Available**



**Free Online Training
Once Purchase Has
Been Made**

Choose the hardware and software solutions that meet your needs!

HARDWARE

DS180
PART NO: SV60250

£1,775

**FINANCE OPTIONS
AVAILABLE**

SOFTWARE

CAR SOFTWARE 1 YR
PART NO: SV60270

£631.25

CAR SOFTWARE 3 YR
PART NO: SV60272

£1,595

BLUETECH FEATURES



Flight recorder:
Perfect for a one-man road test. Select your parameters, hit "Record" and review when back in the workshop. With its 4GB internal storage capability, enjoy even more space to record all the data you need.

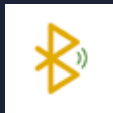

WIFI and Bluetooth connectivity to the PC:
Wireless communication providing freedom to work anywhere in the workshop, whilst maintaining a seamless connection to the vehicle.



360° Multi colour indicator:
Lets you check the status of the VCI at any time from every angle and position.



Integrated DoIP:
No need of any, DoIP adaptor cable. With its built-in functionality, the VCI can be plugged directly on DoIP communicating vehicles.



Universal:
VCI can be used for cars, light commercial vehicles, trucks, buses and coaches, trailers.



Pass-thru support:
Quick and easy access to OEM flash-programming services.



Battery voltage monitor:
Don't let a dead vehicle battery stop you working.



CAN FD channels:
Future-proof design to make the diagnostic possible on vehicles requiring this data-communication protocol.

Truck and Bus diagnostic software options available.
Please call 0121 749 8801 or enquire with your local branch

**BATTERY SUPPORT UNIT
RECOMMENDED SEE PAGE 15-17**

**All prices are subject to change without prior notice due to market fluctuation.
**All Prices Excl VAT

DELPHI
DS480 Tablet
Power of a laptop, convenience of a tablet!

NEW



- Microsoft Surface Pro 7+
- 12.3" screen
- Quad-Core 11Gen, I5 Processor
- 8GB / 128 Memory
- 6+ hours battery live when in use
- 1x USB-C
- 1x USB-A
- Front and Rear Camera
- Wireless WiFi6, BT 5.0
- 77g weight (tablet only)
- Active Pen included with holder
- Detachable hub for future development
- Safety strap
- Rugged case with built in stand
- 2-point safety strap

HARDWARE

DS480
PART NO: SV60251

£3,095

 **FINANCE OPTIONS AVAILABLE**

SOFTWARE

CAR SOFTWARE 1 YR
PART NO: SV60270

£631.25

CAR SOFTWARE 3 YR
PART NO: SV60272

£1,595

LAUNCH UK
X-431 EURO PRO 5 LINK
WITH HAYNES PRO
PART NO: 1010025



£2,695

The PRO 5 Link is supplied with the latest Launch development, the advanced Smartlink®C VCI. This advanced interface supports multiple communication and diagnostic protocols, these include, DOIP, CAN FD, J2534/1/2, D-PDU, RP-1210/C, 5GMHz wifi, Ethernet, USB 2.0

The PRO 5 Link uses the latest in Launch diagnostic technology. Intelligent diagnostics automatically identifies the vehicle through the VIN

KEY FEATURES

- ADAS dynamic calibrations are included, static calibrations are covered with purchase of the ADAS PRO & ADAS Mobile calibration frames
- Local intelligent diagnostics
- Remote diagnostics, using the Launch SRO platform
- Compatible with multiple protocols
- Two years diagnostics software included
- One year Launch CarSet electronics powered by Haynes Pro database included
- Two-year Launch UK warranty
- One click software updates



FINANCE OPTIONS AVAILABLE

LAUNCH UK
X-431 EURO TURBO COMPACT
PROFESSIONAL DIAGNOSTIC DEVICE
PART NO: 1010023



£1,250

X-431 EURO TURBO, based on the Android 9 operating system, is a new 8 Inch vehicle diagnostic device developed by LAUNCHUK

TABLET FUNCTIONS

- OS: Android 9.0
- CPU: 2.0 GHz 4 Cores
- Internal memory: 3GB
- Storage: Internal 32GB
- Screen: 8" 1280x800 IPS
- Battery: 5000mAh
- Wifi: 2.4GHz and 5GHz
- Camera: Front 2MP, Rear 5MP

INCLUDES ELEVEN SPECIAL SERVICE FUNCTIONS

- Electronic park brake reset
- Oil light / service reset
- Steering angle reset
- Battery matching
- Brake bleeding
- Electric throttle relearn
- Tyre pressure monitoring reset
- DPF regeneration
- Crankshaft position sensor learn (Gear learn)
- Immobiliser
- Injector coding
- Comprehensive data stream information can be displayed in different formats:
 - Up to four data streams can be overlaid for comparison
 - Up to 12 individual data streams displayed as a graph
 - Data stream in a list with actual and expected values including measurement

FINANCE OPTIONS AVAILABLE

2 years software with the option for Haynes Pro Electronics

**All prices are subject to change without prior notice due to market fluctuation.
**All Prices Excl VAT

LAUNCH UK CRP129 EVO C-READER PROFESSIONAL

PART NO: 1011023

A professional diagnostics tool, is a cost-effective and powerful machine. It supports all 10 modes of OBD-II. 5" touch screen, Auto-VIN technology

SPECIAL SERVICE FUNCTIONS

- Oil lamp/service reset
- Steering angle sensor reset
- Electric parking brake reset
- Throttle matching
- Battery management system reset
- Diesel particulate filter reset
- Injector programming

£265



LAUNCH UK DIAGUN

PART NO: 1110002

Hand held and very portable, complete with printer and Built in Battery Tester. Ideal for mobile technicians. Wide vehicle model coverage, powerful diagnostic function and accurate test data

- Read and Erase Fault Codes
- Live Data
- Actuators
- Oil Reset Service
- Steering Angle Calibration
- Electronic Parking Brake Reset (EPB):
- Battery Register/ Battery Maintenance (BRM): Allows the scan tool to evaluate the battery charge state, monitor the close-circuit current, register the new battery replacement, and activate the rest state of the vehicle battery system
- ABS Bleeding
- Electronic Throttle Position Reset/Learn (ETP)
- Diesel Particulate Filter (DPF) Regeneration
- Tyre Pressure Monitor System Reset (TPMS)
- Gear Learning
- Immobilizer Matching
- Fuel Injector Coding: Diesel & Petrol injector coding



£850



LAUNCH UK
DPF CLEANING GUN

PART NO: 3027001

The Launch DPF cleaning gun is designed to help with the cleaning of Diesel Particulate Filters

- With the DPF cleaning gun, you can spray a cleaning fluid straight onto the DPF via the pressure sensor or vacuum connection.
- The gun is simply filled with Launch DPF cleaning fluid and connected to a compressed air line, enabling you to spray at pressure into the DPF.



NEW

£155

LAUNCH **NEW**
DPF GUN
PARTICULATE FILTER
CLEANING FLUID
1000ML
PART NO: 2951002

- With the DPF cleaning gun, you can spray a cleaning fluid straight onto the DPF via the pressure sensor. The gun is simply filled with Launch DPF cleaning fluid and connected to a compressed air line, enabling you to spray at pressure into the DPF
- Once applied, the fluid will start dissolving soot inside the filter. You can apply the fluid without removal or other unnecessary work. Heavily contaminated cases may require a forced DPF regeneration

£16.95

LIMITED OFFER
WITH FREE TABLET

HELLA MEGA MACS ONE WITH ANDROID TABLET

PART NO: 15265101
10609341

Transform your phone or android tablet into a multifunctional diagnostics tool with the mega macs ONE.

£1,895

KEY FEATURES

- Read and delete fault codes of all ECUs
- ADAS software as standard
- Cyber security management
- Global scan and result storage
- Clear vehicle identification through VIN
- Live data readings
- Actuator tests
- Coding
- Service resets

FINANCE OPTIONS AVAILABLE



HELLA
REMOTE DIAGNOSTICS

PART NO: 12705091

macsRemote makes any repair possible, regardless of vehicle make or model and enables coding and programming tasks to be carried out that would otherwise require a visit to the dealer

By connecting macsRemote to the vehicle and creating a job ticket via our online portal, our technical team can remotely access all of the vehicle's electronic systems and perform the required tasks

KEY FEATURES

- Remote calibration
- Remote software updates
- Remote programming



FREE android tablet & rugged case with every macs remote

Remote: calibrations | software updates | programming

FREE Demos & Aftersales Support

£845

**All prices are subject to change without prior notice due to market fluctuation.

**All Prices Excl VAT

HELLA

MEGA MACS PC AND MICROSOFT® SURFACE GO TABLET WITH RUGGED CASE

PART NO: 15265101
10609341

FREE Demos & Aftersales Support

The mega macs PC diagnostics tool is user-friendly, with intuitive, easy to use software, enabling even complex diagnostic tasks to be performed with minimal training.

It also provides full access to HGS Technical Data, with wiring diagrams, symptom-based troubleshooting and step-by-step repair guides for 40,000+ models.



MMPC WITH TABLET & 1-YEAR SOFTWARE:

£2,350

KEY FEATURES

- Read and delete fault codes of all ECUs
- ADAS software as standard
- Cyber security management
- Full access to HGS Technical Data
- Global scan and result storage
- Clear vehicle identification through VIN
- Fault code explanation with detailed possible causes
- Live data readings
- Actuator tests
- Coding
- Service resets including BMW CBS, Longlife and DPF

**BATTERY SUPPORT UNIT
RECOMMENDED SEE PAGE 15-17**

**FINANCE OPTIONS
AVAILABLE**

HELLA
MEGA MACS X

PART NO: 15265851

The new and highly innovative mega macs X from Hella Gutmann Solutions is a revolution in vehicle diagnostics. A flexible, modular system with state-of-the-art diagnostic technology at its core, a range of software options and accessories ensures the mega macs X provides the optimal diagnostic solution whatever your workshop requirements may be, now and as your needs grow.



Tablet available at additional cost

FREE Demos & Aftersales Support

FROM
£2,840
INCLUDING 1 YEAR BASIC SOFTWARE

ADDITIONALS	
PART NO	DESCRIPTION
12705091	MAC REMOTE
15265851	MEGA MACS X
15265961	HELLA GUTMANN TABLET
15267601	X2 1-YEAR SOFTWARE LICENSE
15267611	X3 1-YEAR SOFTWARE LICENSE
15267631	X5 1-YEAR SOFTWARE LICENSE
15266241	MT-HV PRO INCLUDES HV CABLES + LOW VOLTAGE MEASUREMENT MODULE AND CABLES



FINANCE OPTIONS AVAILABLE

BATTERY SUPPORT UNIT RECOMMENDED SEE PAGE 15-17

KEY FEATURES (BASED ON X5 SOFTWARE LEVEL)

- Reading/deleting trouble codes
- DoIP technology
- ADAS Software
- Guided diagnostics
- Cyber Security management
- Full HGS Technical data
- Software levels tailored to workshop needs
- Multimeter & 2-channel oscilloscope available at extra cost
- Guided high-voltage measurements (with MT-HV Pro)

**All prices are subject to change without prior notice due to market fluctuation.

**All Prices Excl VAT

MAVERICK GENUINE FORD TOOL BUNDLE

PART NO: FORD DIFOSP0001, LAPASP0037

- Includes Panasonic Toughbook CF-D1 'A' Grade
- 100% Genuine Ford VCI
- 12 months Genuine Ford IDS/FDRS licence included
- Supports all current Ford European production vehicles up to 2023 and beyond
- CFR and DLC cables & USB wireless cards included



£4,779.34

FINANCE OPTIONS AVAILABLE

Initial training course included

MAVERICK VOLVO TOOL BUNDLE

PART NO: DIVOSP0020, LAPASP0037

- Includes Panasonic Toughbook CF-D1 'A' Grade
- 100% Genuine Volvo DiCE VCI
- Fully DOIP compatible for use with the latest XC range
- Includes DOIP adapter



£2,927.52

FINANCE OPTIONS AVAILABLE

Initial training course included

MAVERICK GENUINE PSA TOOL BUNDLE

PART NO: DIPSSP0015, LAPASP0037

- Panasonic Toughbook CF-D1 'A' Grade
- 100% Genuine PSA VCI
- Compatible with Diagbox, GDS2 and SPS
- Supports newer Vauxhall vehicles from 2020
- In-depth 2-day training course available.



£3,847.73

FINANCE OPTIONS AVAILABLE

Initial training course included

MAVERICK VAG TOOL BUNDLE

PART NO: LIFOSP0004 DIVASP0013, LAPASP0037

- Includes Panasonic Toughbook CF-D1 'A' Grade
- 100% Genuine VAG Tool
- For all VASS vehicles from 2000 onwards
- Assistance with VASS registration
- Opus Mongoose-Plus available as an alternative when VAS tool not available
- In-depth 2-day training course available.



£3,572.10

FINANCE OPTIONS AVAILABLE

Initial training course included

MAVERICK JAGUAR LAND ROVER TOOL BUNDLE

PART NO: LAPASP0038 - GRADE A PANASONIC CF-D1 TABLET
DIJLSP0011 - JLR SDD VCI INTERFACE
DIJLSP0015 - JLR DOIP DA- DONGLE D-PDU

- Includes Panasonic Toughbook CF-D1 'A' Grade
- 100% Genuine Jaguar Land Rover DA-DOIP D-PDU VCI
- Cost-effective alternative to JLR Pathfinder tool.
- Covers DOIP, CAN & Multi-CAN systems
- Initial training course included. In-depth 2-day training course available



£3,239.94

FINANCE OPTIONS AVAILABLE

Initial training course included

MAVERICK BMW TOOL BUNDLE

PART NO: DIBMSP0007, LAPASP0037

- Includes Panasonic Toughbook CF-D1 'A' Grade
- 100% Genuine BMW ICOM Next A VCI BMW software preloaded
- Supports diagnostic & programming functions for BMW, BMW-I, MINI, Rolls-Royce & BMW Motorrad
- BMW key reader optional
- In-depth 2-day training course available.



£3,242.74

FINANCE OPTIONS AVAILABLE

Initial training course included



ADAS

HELLA ADAS

As pioneers of ADAS calibration equipment, Hella Gutmann offers a range of solutions to suit all workshop needs; from the original CSC SE kit through the CSC mobile solution right through to the very latest solution – the CSC Digital.

REQUEST A DEMO TO FIND THE RIGHT SOLUTION FOR YOUR WORKSHOP

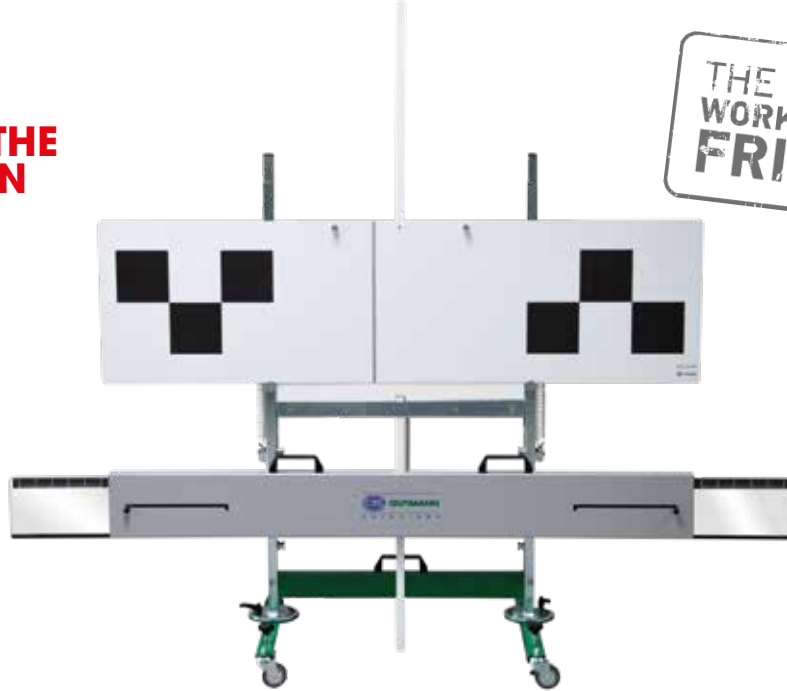

CALL FOR LATEST PRICE

FINANCE OPTIONS AVAILABLE

HELLA CSC MOBILE
PART NO:10624001



HELLA CSC SE BASE FRAME & WHEEL MODULE
PART NO: 015269101 & 015269101



HELLA CSC DIGITAL & WHEEL MODULE
PART NO: 015269501 & 015269101

**All prices are subject to change without prior notice due to market fluctuation.
**All Prices Excl VAT



RCCS 3 is the brand new unit designed and engineered by TEXA for the ADAS calibration

TEXA ADAS

RCCS 3 BT DIGITAL ADAS MASTER VOICE DIAGNOSTIC HARDWARE KIT

PART NO: UKGC3301

DIAGNOSTIC TOOL

- AXONE Voice
- IDC5 Premium Car Software
- IDC5 Supercar Software
- TXT MULTIHUB
- AXONE Voice Handle
- 3 Years Warranty

RCCS3 EQUIPMENT

- RCCS 3 Calibration Rig
- 2 x Self Centering Wheel Clamps
- 2 x Flags
- 2 x Laser Heads
- 2 x Laser Support
- Digital Measures

- Centering Laser
- Digital Level
- Support Bracket for RCCS
- LCV Extension Kit
- Honda Type 2 Calibration Panel
- 2 Years Warranty

PRICES ARE FOR BOTH ADAS AND DIAGNOSTIC TOOL

£17,495

12 Months Car Texpack Software Updates
12 Months Car Tex@info Technical Support

EXTEND YOUR SOFTWARE & SAVE!

PACKAGE INCLUDES AN ADDITIONAL 2 YEARS SOFTWARE UPDATES & TECH SUPPORT
PART NO: UKGC3308

£18,700

FINANCE OPTIONS AVAILABLE



ADAS

AUTEL ADAS BUNDLES

NEW

FINANCE OPTIONS AVAILABLE

FREE DEMOS & AFTERSALES SUPPORT

- | | |
|-------------|--|
| 10000851 | Main Frame + Wheel Clamps + VAG-LDW Board (CSC0601/01) |
| 10000851/04 | ACC Mirror |
| CSC0602/01 | Reflector |
| CSC0602/06 | Hex Wrench |
| CSC0602/07 | Mini Reflector |



CALL FOR LATEST PRICE

FULL PACKAGE BUNDLE

- | | |
|-----------------|--|
| 10000851 | Main Frame + Wheel Clamps + VAG-LDW Board (CSC0601/01) |
| 10000851/04 | ACC Mirror |
| CSC0602/01 | Reflector |
| CSC0602/06 | Hex Wrench |
| CSC0602/07 | Mini Reflector |
| CSC0600/02 | Supporting Lane Brackets |
| CSC0601/08 | Honda Lane Maintenance Pattern Type 2 (Left and Right) |
| CSC0601/05 | Honda Lane Maintenance Pattern Type 1 |
| CSC0601/11 & 15 | Toyota / Lexus Lane Maintenance Patterns 1 & 2 |
| CSC0601/09 | Hyundai / Kia Lane Maintenance |
| CSC0601/02 | Mercedes Benz Lane Maintenance |
| CSC0601/06L&R | Nissan / Infinity Lane & Driveway Maintenance |
| CSC0601/07 | Hyundai / Kia Lane Maintenance |

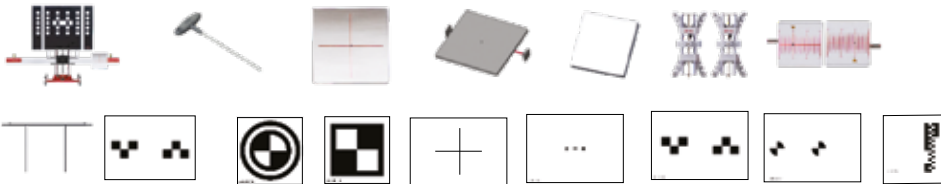

CALL FOR LATEST PRICE

ADAS SOFTWARE

ADAS

If you already have an MS908 or MS Elite, simply buy the ADAS software when you buy your ADAS frame to upgrade your tool

CALL FOR LATEST PRICE

MS909

If you buy either the Basic Package or the Common Package, but don't have an existing MS908Pro or Elite, then it is possible to buy a ADAS MS909 at the same time.



CALL FOR LATEST PRICE

**All prices are subject to change without prior notice due to market fluctuation.

**All Prices Excl VAT

BOSCH ADAS SYSTEM PART NO: DAS3000

New bumper plate for precise distance measurement to the bumper. Printout which documents the correct alignment of the calibration device. Controlling vehicle specific calibration easily with diagnostic software ES[tronic] 2.0 Online, in conjunction with KTS (not included – see page 27), conforms with OEM requirements. Trolley with universal fixture designed for installation of multiple Target boards: rapid and accurate 1-point, 2-point and sequential calibrations. XL Multi-function board covers all OEM Radar mounting heights.



Easy to use

Installation and training included

£9,595

- State-of-the-art calibration equipment for front and rear facing camera & radar systems
- Camera-based – for greater accuracy and increased speed
- Combined VAG target and radar reflector (included)
- Accurate positioning in relation to the "vehicle driving axis"
- Universal wheel clamp with targets
- Automatic distance measurement (distance target via reference panel)

- Positioning software included (Requires DCU 220 or own laptop)
- Multibrand target support and all-makes capable with vehicle-specific calibration via Bosch ES[tronic] 2.0 software."

 **FINANCE OPTIONS AVAILABLE**

ELECTRICAL TESTING

POWERHAND
DIGITAL AUTOMOTIVE MULTIMETER
PART NO: SIN-400.3150

- Overload protection
- Low battery indicator
- K-Type temperature probe included

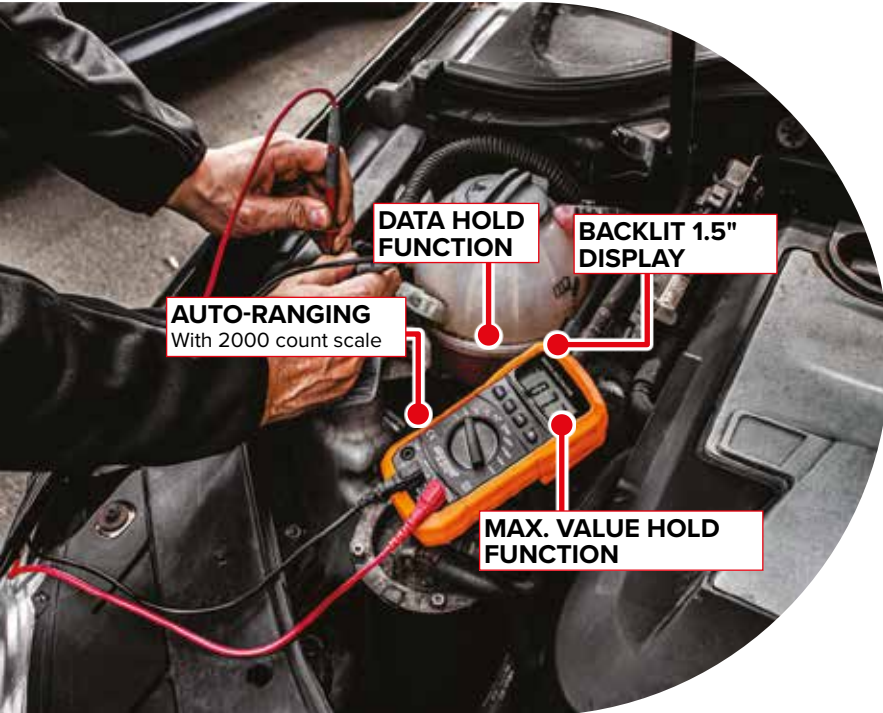

£25

POWER PROBE 3
PART NO: PP-3CSRED

FEATURES INCLUDE

Relay & component testing, continuity testing, bad ground indicator, short circuit indicator and more

DC VOLTMETER INDICATORS

Provide active feedback

APPLY POWER & GROUND

For functional component testing

8 AMP CIRCUIT BREAKER

Protects the tool from overload

LED LIGHTS

For a quick visual indicator

AUDIBLE MONITORING OF ELECTRICAL SIGNALS



£107

POWER PROBE 3
CARBON-FIBRE VERSION KIT
PART NO: PP-319CARB



£147

**All prices are subject to change without prior notice due to market fluctuation.

**All Prices Excl VAT

POWERPROBE SENSOR TEST LEAD KIT

PART NO: HU-PPESTLK

- Contains a wide range of connection leads for quick & easy diagnosis of faults on most sensors, valves, solenoids, actuators, injectors, starter circuit, ignition coils and more on Asian & European cars, trucks, agricultural vehicles, boats and motorcycles
- Comes with a guide for adaptor lead sizes to use with different car makes
- Differs from other kits in that it includes Y-style leads for quick connection to meters or scopes, avoiding using time consuming straight through leads to make up test leads.

£190



CAT IV DIGITAL MULTIMETER CAT III 1000V & CAT IV 600V

PART NO: IDM-0003

- Overload protection
- Low battery indicator
- K-Type temperature probe included
- IP67 rated



£135

POWERHAND IN-LINE SPARK PLUG TESTER

PART NO: SIN-400.3121

- Quick easy check for presence of Spark
- Lights up when current is present
- Perfect for intermittent HT faults
- Suitable for most Petrol engines











£3.90

PRESSURE & VACCUM TESTING

HUBITOOLS
REPLACE DOZENS OF YOUR STANDARD
DIAGNOSIS KITS... WITH JUST ONE

THE COMPRESSION TESTER MASTER SET CAN BE USED TO TEST;

 Vacuum Pressure	 Petrol & Diesel	 Cooling System Pressure	 Fuel Pressure Engine Compression
 Ad Blue Pressure	 Oil Pressure	 Particle Filter Pressure	 Turbo Pressure

NEW

9 SPECIFIC PROFESSIONAL QUICK COUPLING ADAPTORS

HEAVY DUTY STORAGE & CARRY CASE

0 - 300BAR HIGH PRESSURE SENSOR

-1 - 3BAR PRESSURE SENSOR

VACUUM ADAPTORS

UNIVERSAL DIESEL COMPRESSION ADAPTOR

UNIVERSAL PETROL COMPRESSION ADAPTOR

UNIVERSAL FIT
Simply combine the correct heads and spacers

UNIVERSAL FALSE GLOW PLUG
Simply mount in place of the original glow plug to perform a diesel compression test

SEALING CONES
60° 8.2mm | 90° 8.2mm | 90° 6.8mm | 120° 6.8mm

UNIVERSAL FIT
Simply combine the correct thread adaptor and sealing cone

HU-HU35025

HU-HU35039

HU-HU35037

**All prices are subject to change without prior notice due to market fluctuation.
**All Prices Excl VAT

THE SELECTION OF ADDITIONAL TOOLS AVAILABLE CAN TAKE YOUR MASTER SET EVEN FURTHER

Perform precise and accurate tests on the most common diesel rail engines

2000bar sensor | Sensor plug for direct pump pressure | 2x M12x150 hoses for most common applications | Retrieving reservoir

When used with the HU-HU35025, this set provides all the hardware needed to perform precise and accurate tests for measuring and diagnosing the most common rail engines

Each adaptor features a M12x150 thread, the other ends are M12x125 | M14x150 | M14x100 | M16x100



HU-HU35028

EASILY & SAFELY TEST THE DIESEL COMMON RAIL PRESSURE

Suitable for both in-line (engine running) and for direct pump pressure (whilst cranking)

SCREW-IN ADAPTORS
M8x1 | M9x1 | M10x1 | M10x1.25

UNIVERSAL FALSE INJECTOR

Simply mount in place of the original injector to perform a diesel compression test

CAN BE USED WITH THE INCLUDED OR ORIGINAL BRIDGE

Also suitable for engines featuring one bridge for 2 injectors

For use with the most popular diesel pump brands on the market

HU35025	HU35028	HU35026	HU35039	HU35031	HU35030	HU35037
Universal digital pressure tester	90° Common rail adaptors (6pcs)	Diesel high pressure kit	Diesel glow plug compression adapter	Common rail dummy regulator set	Common rail high pressure cap set	Diesel injector compression adapter
£1,224	£315	£410	POA	£110	£52	POA

ELECTRICAL TESTING

Why do you need a PicoScope?

Could you use a scan tool instead of a labscope? No, you need both.

A scan tool only points you in the right direction, perhaps indicating a misfire on a specific cylinder, but rarely does it pinpoint a fault. For example, is the misfire caused by an ignition, injector, or a compression-related issue?

Reliance on a scan tool alone can lead you to "parts darts" where you might find yourself replacing more and more parts until the fault goes away.

PICO

PICOSCOPE (SOMETIMES KNOWN AS A LABSCOPE) TURNS YOUR LAPTOP OR DESKTOP PC INTO A POWERFUL DIAGNOSTIC TOOL



- See the changing signals inside wires
- FAST SETUP with PicoBNC+ probe recognition
- Scope-powered PicoBNC+ probes (no more batteries)
- Fast sampling and deep memory for intermittent faults
- PicoScope Automotive software - Free software updates
- Future-proof with PicoBNC+ interface
- Compatible with PicoScope 6 and PicoScope 7 software
- Guided tests, Waveform Library and PicoDiagnostics



CALL FOR LATEST PRICE

FULL RANGE OF KITS AVAILABLE			
2-Channel Starter Kit	4-Channel Starter Kit	2-Channel Standard Kit	4-Channel Standard Kit
4-Channel Diesel Kit	4-Channel Advanced Kit	4-Channel Master Kit	4-Channel Accessors Kit
4-Channel EV Kit	Off-Highway Elite Kit	Off-Highway Entry Kit	Off-Highway ExpertKit

FINANCE OPTIONS AVAILABLE

GYS **DENT PULLING WORKSTATIONS**

PART NO: 53618

EASYLINER 39.02

- Remove dents without disassembling
- Repair without replacing
- Reduce the down-time
- Increase your margin
- Improve your profitability



**Complete kit
available U53018**

£1,336

 **FINANCE OPTIONS
AVAILABLE**



GYS **AUTOPULSE 220-M1 WITH ACCESSORIES**

PART NO: 65024

- AUTOPULSE 220-M1 is the MIG / MAG pulsed generator with integrated wire feeder for car body repairs
- Equipped with a digital PFC (Power Factor Correction) it supplies pulsed welding quality comparable to three-phase products. Designed for the highest performance it features several synergic curves and exceptional arc quality
- Versatile, it can carry out all types of welding: Steel, Aluminium and Brazing
- Welding processes : standard, pulse, pulse in pulse, cold pulse and manual
- Trigger modes : 2T, 4T, SPOT, DELAY and TACK function
- Its full synergic mode determinates automatically the optimal welding parameters which can be adjusted (wire speed, voltage, current, self)
- 4 microprocessors to give four times the processing power. Wheel drive system with 2 active drive rolls. Suitable for wire reels of Ø 200 mm. Automatic torch detection while pulling the trigger
- Large colour screen for easy control of the welding cycle set up. 2 control knobs and 4 keys for easy and intuitive navigation of the menus. Updatable machine and synergies via USB key. Save up to 500 welding programs for repetitive tasks

£4,375

 **FINANCE OPTIONS
AVAILABLE**

LASER
PULLING TOWER

PART NO: 92657



- Portable pulling tower suitable for use on steel & aluminium panel repair
- Pulling force up to 550kg
- Counterbalanced by a pneumatic suction anchoring plate, therefore no fixings required
- Dimensions: 350 x 350 x 1650mm
- Weight: 20kg
- Adjustable mechanical hoist with 15 height positions
- Supplied with hook gripping head, eyebolts & hooks

£999

LASER
VERTICAL PULL KIT FOR PULLING TOWER

PART NO: 92660



- An additional anchoring plate / suction pad specifically for use with the Power-TEC Pulling Tower (Part No. 92657)
- Provides an additional anchor point to counterbalance the tower to be used vertically
- Dimensions: 280 x 330mm
- Attaches via pneumatic suction, therefore no fixings required

£300

LASER
POLE EXTENSION FOR PULLING TOWER

PART NO: 92659

- A steel extension pole specifically for use with the Power-TEC Pulling Tower (Part No. 92657), which adds an additional 700mm with 7 adjustable height positions and allows the tower to be used on truck and van roof panel repairs.

£200



LASER COLD GLUE DENT PULLING KIT PDR

PART NO: 92645

- An innovative PDR dent pulling kit that uses cold glue rather than hot glue. With only the heat from the user's hands required to prep the glue for use, no external heat source is required. The kit includes a guide handle together with slide hammer for dent pulling, and is supplied in a rugged blow mould storage case
- Paintless dent removal using hand warmed 'cold glue'
- Kit includes: 4 alloy glue adaptor pads, slide hammer, hand-pull handle and 50g of cold glue
- No need for external heat source, gas or electrical power
- Glue is easily removed by hand and can be reused if kept clean and free from grease. Replacement glue available, see Power-Tec Part No. 92646
- Safe for use on all vehicle types including EV/Hybrid vehicles. No risk of voltage spikes (associated with traditional 'welding' repair methods).



£121.50

LASER COLD GLUE 50G FOR PDR

PART NO: 92646

- 50g of cold glue, suitable for use as part of a paintless dent repair (PDR) or automotive body repair. Used as an alternative to a hot glue system, this sticky adhesive is warmed up in the user's hands before use or use with most PDR dent removal kits, such as Power-Tec Part No. 92645
- No need for external heat source, gas or electrical power
- The glue is easily removed by hand
- The glue can be re-used if kept clean and free from grease
- Supplied in metal storage tin.



£30

PLASTIC WELDING

GYS GYSPOT 3902

PART NO: 52215

- 230V steel dent puller with 3800A output current, ideal for all steel straightening and dent pulling jobs
- Simple to use thanks to its automatic gun and its user friendly control pane
- The welding is triggered automatically by a simple contact between the tool and the part to be straightened

READY TO USE

- Earth cable 70 mm² (2m long cable)
- Multi function gun (2m, 70 mm² cables with connector)
- Inertia hammer • Dent pulling with stars • Welding of studs, rivets and rings • Contact shrinking, graphite pen. 4m long mains supply cable and accessories box with consumables

OPTIONS

- Manuspot / Trolley / Levelling bar / Quick spot air gun



£850



PLASTIC WELDING

GYS

CORDLESS STAPLER FOR BUMPER REPAIRS

PART NO: 58118

APPLICATIONS

- Bumpers
- Dashboards
- Trim
- All type of plastics without disassembling

- Rechargeable lithium battery + Work LED light at the tip of the tool (to get better precision in darker environments) + Adjustable stapler head (90° to 135°)

SUPPLIED WITH

- Transport case
- Charger 230V
- 100 staples (type U: 0,6 mm - 0,8 mm)
- 100 staples (type V : 0,6 mm)



£530

GYS

PLASTICS WELDING KIT WITH CONSUMABLES AND SCRAPER

PART NO: 70974

- Repairs
- Bumpers - Radiator grill - Headlight surroundings - Body panel
- Easy to use, the hot air plastic welding station is designed to weld vehicle plastic parts
- wide adjustable temperature range (160-480°C) raises the temperature of the plastics to their melting point making them soft and easily repairable
- air flow rate can be adjusted to maintain a homogeneous fusion of the plastic
- LCD Screen
- Optional Trolley available



£328

GYS

GLUE PULLER PRO KIT WITH DILUENT SPRAY

PART NO: 58699

- Paintless dent repair set. Ideal complement to all dent pulling systems. Glue Puller Pro adapted for steel and aluminium

BENEFITS

- No grinding of the car body
- Reduced operation time
- Limited immobilization time of the vehicle
- No paint touch ups

COMPLETE SET READY TO USE

- 1 Case 2 Glue Lifter 3 6 tips (2 x Ø 32 mm, 2 x Ø 20 mm et 2 x Ø 15 mm) 4 Diluent spray 5 250 W glue gun (140°C > 220°C) 6 10 glue sticks: - x 5 white: for ambient temperature >20°C - x 5 transparent : for ambient temperature



£239

**All prices are subject to change without prior notice due to market fluctuation.

**All Prices Excl VAT

Welding & Heat Induction

GYS

INVERTER MIG WELDER 200AMP

PART NO: 66595

Inverter MIG welder 160Amp with digital display for fast set up of welding parameters, no more blowing holes in panels!! Adjustable arc dynamic. Suitable for automotive workshop use welding steel, stainless & Aluminium (up to 10mm)

240VOLT

- Use gas or gasless
- Takes 0.6mm – 1mm wire
- Fast set up guide on control panel
- Bright digital display
- Complete with MIG torch, arc electrode holder & earth lead



£890

GYS

25AMP PLASMA CUTTER PACK EASYCUT 25

PART NO: 72046

- Powerful 25Amp plasma cutter ideal for cutting most types of metal up to 8mm. Compact & lightweight with an easy to use control panel.
- Features no contact arc ignition
- Powerful but compact plasma cutter
- Max cut 8mm steel (6mm Aluminium)
- Clean cut 6mm steel (4mm Aluminium)
- Quality Trafimet torch with quick change consumables
- Ideal for both vehicle workshops & body shops



Cuts like a knife through butter!

£690

GYS
INDUCTION HEATER AND TROLLEY KIT
PART NO: U20226



Straight Inductor head included
PART NUMBER: 067899

Heavy duty induction heater which produces instant flameless heat. Ideal for automotive workshop use eg. Track rod ends, manifold bolts, bleed nipples, lambda sensors etc

Removing Oxy-Acetylene from your garage could save up to 30% on your insurance

Up to 92% cheaper to run than gas

- 3700 Watt output (240V)
- Liquid cooled for intensive use
- Heats a M10 nut in 1 second
- Safe to use – no risk of burning components
- Additional straight inductor head
- Ideal for alloy wheel nut removal

£2,799

FINANCE OPTIONS AVAILABLE

**All prices are subject to change without prior notice due to market fluctuation.
 **All Prices Excl VAT

Welding & Heat Induction

SIP 1500W INDUCTION HEATER KIT

PART NO: 1156

- SIP 1500w Induction Heater Kit is ideal for heating and releasing rusted-on or hard-to-remove parts such as nuts, bolts and fastenings. Designed for use in garages, workshops or automotive environments
- Powerful and compact (1500w)
- Reaches temperatures of 800°C in 20 seconds
- 4-piece induction kit supplied
- Easy-to-use, simple to power design
- Lightweight and portable with strap



£650

GYS ARC WELDER 160AMP

PART NO: 36635



- Gysmi E163
- Suitable for all types of electrodes such as steel, stainless steel or cast iron
- Very good penetration and perfect arc stability
- Delivered in a case with earth clamp and electrode holder
- IP21 protection rate, it is suitable for outdoor work on site
- Low consumption of 16A-230V
- Protected and compatible with a Generator 6Kw
- Inverter technology
- Adjustable hot start
- Anti-sticking
- Arc force

£290

GYS LCD GYSMATIC 5/13 TRUE COLOUR

PART NO: 37908



- Essential for safety, the GYSMATIC TRUE COLOR XL optoelectronic hood protects the welder's face and eyes from UV, infrared and splashes
- Fully automatic, the mask switches from clear to tinted state in a fraction of a second as soon as it is primed
- Optimum visibility: XL screen • High sensitivity thanks to 4 sensors • TIG welding > 2A • Active filter : shades 5-9 / 9-13
- Range 5-9 : special low intensity • Choice of 7 dark shades (5>13) to suit all your operations welding and cutting. • TRUE COLOUR technology

£150



GYS

INVERTER MIG WELDER MIG-MAG SINGLE PHASE SYNERGIC

PART NO: 32903

- **M1 GYS AUTO** with accessories
- The **M1 GYS AUTO** is a single phase MIG-MAG, with torch connector, recommended for welding steel, stainless steel, aluminium and for MIG brazing of high-tensile strength steels with CuSi and CuAl wires (ideal for car body repairs)
- **SYNERGIC MODE**
The machine determines the optimum wire speed by selecting: - the type of wire - the wire diameter - the welding current
- **SPOOL GUN CONNECTOR**
The Spool Gun torch is ideal for car body repairs of aluminium, AlSi5 and AlSi12
- **4 DRIVE ROLLS MOTOR**
Suitable for ø200mm and ø300mm wire reels (15kg max)
- Saving welding parameters
- Memory save feature for each torch and activation of the 'last used' welding parameters (wire diameter, wire type & mode)
- 3 Welding modes available
- Standard (2T) - Spot - Delay
- Accessories
- Delivered with: - 1 torch 150A - 3m - 1 earth clamp 200A - 3m (regulator not included)



£1,500

FINANCE OPTIONS AVAILABLE



GYS

INVERTER MIG WELDER AUTOPULSE 220-M1

PART NO: 65024

- The AUTOPULSE 220-M1 is the MIG / MAG pulsed generator with integrated wire feeder for car body. Equipped with a digital PFC (Power Factor Correction) it supplies pulsed welding quality comparable to three-phase products. Designed for the highest performance it features several synergic curves and exceptional arc quality. Versatile, it can carry out all types of welding: Steel, Aluminium and Brazing (CuSi3/CuAl8). Its intuitive interface and its high precision wire feed are ideal for car-body with best welding quality even on thin sheet
- 3 interface options for ease of use : - EASY (simplified module) - EXPERT (complete module) - ADVANCED (specific modules)

£3,990

FINANCE OPTIONS AVAILABLE

GYS

DUAL GAS KIT GAS ART 580 & OXYGEN

PART NO: 40366



£150

GYS

EASYMIG 85 RTWK

PART NO: U65536

- No gas required
- Complete with Gauntlet and Hand Shield



£299

**All prices are subject to change without prior notice due to market fluctuation.

**All Prices Excl VAT

NUAIR MICRO

- Compact design and very quiet operation
- Simple Electro-mechanical control
- Advanced cooling system
- POLY-V belt drive system
- IE3 High efficiency Motors
- High quality air
- Long life and reliability
- Flexible Range - 2.2kW - 5.5kW



FINANCE OPTIONS AVAILABLE

CALL FOR
LATEST PRICE

FIXED SPEED RECEIVER MOUNTED

PART NUMBER	MODEL		START	KW	HP	VOLT	L/MIN	CFM	BAR	PSI	DB(A)	KG	LXWXH (MM)	OFFER PRICE
F-V77JT60FNM501	MICRO SE 2.2-10 M - 200	200	DOL	2.2	3	230	240	8.5	10	145	58	144	1440 x 510 x 1280	£2,869
F-V77JP92FNM701	MICRO 4.0-10 - 200	200	SDS	4	5.5	400	485	17.1	10	145	60	151	1440 x 510 x 1280	£3,154

FIXED SPEED RECEIVER MOUNTED WITH DRYER

PART NUMBER	MODEL		START	KW	HP	VOLT	L/MIN	CFM	BAR	PSI	DB(A)	KG	LXWXH (MM)	OFFER PRICE
F-V77JT60FNM601	MICRO SE 2.2-10 M-200 ES	200	DOL	2.2	3	230	240	8.5	10	145	58	144	1440 x 510 x 1280	£3,848
F-V77JP72FNM801	MICRO SE 4.0-10 - 200 ES	200	DOL	4	5.5	400	485	17.1	10	145	60	180	1440 x 510 x 1280	£3,996

NUAIR CUBE

- Four maintenance timers
- Auto-restart after power failure.
- Programmable cooling fan temperature
- Programmable remote control starting
- Flexible range - 4kw - 7.5kw with freestanding cabinet or with 270lt & 500lt air receiver and with on board refrigerated dryer.



FINANCE OPTIONS AVAILABLE

CALL FOR
LATEST PRICE

FIXED SPEED RECEIVER MOUNTED

PART NUMBER	MODEL		START	KW	HP	VOLT	L/MIN	CFM	BAR	PSI	DB(A)	KG	LXWXH (MM)	OFFER PRICE
V91PO92FNM201	CUBE 7.5-10-270	270	DOL	7.5	10	400	1050	37.1	10	145	67	194	1200 x 600 x 1450	£3,809

FIXED SPEED RECEIVER MOUNTED WITH DRYER

PART NUMBER	MODEL		START	KW	HP	VOLT	L/MIN	CFM	BAR	PSI	DB(A)	KG	LXWXH (MM)	OFFER PRICE
V91PO92FNM301	CUBE 7.5-10-270 ES	270	DOL	7.5	10	400	1050	37.1	10	145	67	215	1200 x 600 x 1450	£4,784

NUAIR G-TEC

- Unique full feature air compressor station
- Simple installation
- Quiet operation
- Sophisticated controls
- Advanced cooling system
- Simple maintenance
- POLY-V belt drive system
- High quality compressed air
- High pressure version
- Long life and reliability



FINANCE OPTIONS AVAILABLE

CALL FOR
LATEST PRICE

FIXED SPEED RECEIVER MOUNTED WITH DRYER + DUAL FILTRATION

PART NUMBER	MODEL		START	KW	HP	VOLT	L/MIN	CFM	BAR	PSI	DB(A)	KG	LXWXH (MM)	OFFER PRICE
PS-V91SP-92PWG380	G-TEC 110-270 DF	270	SDS	11	15	400	1500	53.0	10	145	65	350	1560 x 700 x 1580	£5,739



NUAIR

BELT DRIVEN, SINGLE STAGE COMPRESSORS

- Low Noise
- Portable belt drive TECH series compressor with convenient control panel, larger wheels and long handle for maximum portability
- Fitted with the new and highly regarded B28B PRO Low Noise compressor pump unit
- Lubricated design for longer life and lower noise
- Advanced cooling system which concentrates cooling air flow to the compressor head
- Simple maintenance



CALL FOR LATEST PRICE



1 year warranty on compressor,
2 year warranty on pump (subject to T&C's)

BELT DRIVEN, SINGLE STAGE COMPRESSORS												
PART NO:	MODEL	MOTOR		CAPACITY		PRESSURE		RECEIVER	NOISE	VOLT	AMP	OFFER PRICE
		KW	HP	L/MIN	CFM	BAR	PSI	LT	DB(A)			
S-28HA504FPS135	NB2800B/150/3M/TECH PRO	2.2	3	355	12.5	10	145	150	76	230	13	£644
S-28LA504FPS136	NB2800B/200/3M/TECH PRO	2.2	3	355	12.5	10	145	200	76	230	13	£662
S-36HN504FPS142	B3800B-PRO/150 FM3 UK	2.2	3	355	13.95	10	145	150	77	230	16	£658
S-36LN504FPS141	B3800B-PRO/200 FM3 UK	2.2	3	355	13.95	10	145	200	77	230	16	£683
S-36LN541FPS143	B3800B-PRO/200 FT3 UK	2.2	3	395	14	10	145	200	77	400	16	£725

NUAIR

BELT DRIVEN PROFESSIONAL AIR COMPRESSORS - VERTICAL

- Fitted with proven Low Noise B38B single stage lubricated compressor pump unit
- Advanced cooling system that directs cooling air to the head, valves and after-cooler for lower temperatures
- Belt driven arrangement allows lower speed operation and reduced noise levels
- Economical stop/start control

CALL FOR LATEST PRICE



1 year warranty on compressor,
2 year warranty on pump (subject to T&C's)

BELT DRIVEN, SINGLE STAGE, VERTICAL COMPRESSORS											
PART NO:	MODEL	MOTOR		CAPACITY		PRESSURE		RECEIVER	NOISE	VOLT	OFFER PRICE
		KW	HP	L/MIN	CFM	BAR	PSI	LT	DB(A)		
S-36HY504FPS149	B3800B-PRO/150 FM3 UK	2.2	3	355	13.95	10	145	150	77	230	£798
S-36HY684FPS168	NB3800B-PRO/150V 4FM	3	4	495	18	10	145	150	77	230	£1,053



NUAIR

BELT DRIVEN, TWO STAGE, VERTICAL COMPRESSOR

- Fitted with proven NB5 lubricated compressor pump unit
- Advanced cooling system that directs cooling air to the head, valves and after-cooler for lower temperatures
- Belt driven arrangement allows lower speed operation and reduced noise levels
- High quality electric motor, 4kW (5.5Hp) 400v/3/50hz with full overload protection

CALL FOR LATEST PRICE



1 year warranty on compressor,
2 year warranty on pump (subject to T&C's)

BELT DRIVEN, TWO STAGE, VERTICAL COMPRESSORS											
PART NO:	MODEL	MOTOR		CAPACITY		PRESSURE		RECEIVER	NOISE	VOLT	OFFER PRICE
		KW	HP	L/MIN	CFM	BAR	PSI	LT	DB(A)		
S-N5NY701FPS070	NB5/5.5FT/270V	4	5.5	640	22.9	11	160	270	77	400	£1,400



**All prices are subject to change without prior notice due to market fluctuation.
**All Prices Excl VAT

TIROPLUS TYRE CHANGER & WHEEL BALANCER PACKAGE DEAL

TECALEMIT TTC/TIROPLUS TYRE CHANGER

- Clamping range 10" – 26"
- Max Wheel diameter 1070mm
- Max Wheel width 380mm
- Bead breaker force 2800kg
- Assistant system with 3 operating arms
- TIROROLLER - Assists with the removal of the tyre from the rim
- TIROFOLLOWER - Follows the wheel rotation through the fitting cycle
- TIROLIFTER DISC - Assists with the lifting of the lower bead during tyre removal



TECALEMIT TBM/TIROPLUS WHEEL BALANCER

- Internal data entry & weight positioning arm
- Adhesive weight position guide
- Automatic rotation & positioning via One-touch operation
- Hidden Weight* and weight optimisation programs
- Data memory stores common wheel size combinations

£3,995

FINANCE OPTIONS AVAILABLE



TECALEMIT TYRE CHANGERS

- Tecalemit G-frame concept* eliminates chassis flex
- Leverless operation* ideal for RFT technology
- Variable speed turntable* - precise control
- Ergo Control bead breaker* - helps prevent damage

MODEL NO.	DESCRIPTION
TTC/9620/T	22" Tyre Changer with Technoroller
TTC/9624S/T	24" Tyre Changer with Technoroller & Ergo Control
TTC/9628S/T	28" Tyre Changer with Technoroller & Ergo Control
TTC/9628S/LL/T	28" Tyre Changer with Technoroller & Ergo Control
TTC/9630S/T	Tilt Back Tyre Changer with Centre Post Locking

*Model Dependent Specifications

FINANCE OPTIONS AVAILABLE

TECALEMIT WHEEL BALANCERS

- 65, 70 or 80kg chassis's - adequate capacity
- Internal rim illumination* - visible weight positioning
- Laser weight positioning* - precise weight placement
- Pneumatic clamping* - reduces effort

MODEL NO.	DESCRIPTION
TBM/960A	65kg Chassis, LED Display
TBM/V/985A	65kg Chassis, Video Display
TBM/9165L	70kg Chassis, LED Display
TBM/V/9660L	70kg Chassis, Video Display
TBM/WAVE5	80kg Chassis, Sonar

Buy as a Combo Deal and Save even more



TECALEMIT F10 HIGH PERFORMANCE, HIGH EFFICIENCY

PART NO: TTC/F10/RAL7040

- S-TALON Tyre Leverless System
- Mechanical central clamping
- Variable speed turning pedestal
- Double synchronize bead breakers
- Tyre side lift
- Tubeless inflation device

CALL FOR
LATEST PRICE

FINANCE OPTIONS AVAILABLE



4 WHEEL LASER ALIGNMENT



GTR/430

TECALEMIT GTR/400 SERIES

- 4-wheel laser alignment system
- Precision engineered components
- High resolution laser
- In built laser levelling system
- Easy quick set up time
- Suitable for wheel from 12" - 23"
- Low clearance measuring heads to clear front spoilers
- Optional digital camber/caster gauge upgrade available
- Version available with Zigbee wireless interface and Autodata database for live readings



GTR/400/LITE

CALL FOR LATEST PRICE

FINANCE OPTIONS AVAILABLE

MODEL NO.	DESCRIPTION
GTR/400/LITE	Laser Aligner with Wall Hanger
GTR/400/PRO	GTR/400/LITE + Turnplates & Clamp
GTR/420/W	Laser Aligner with On-dock Charging
GTR/420/W/KIT	GTR/420/W + Camber/Caster Gauge
GTR/430	Trolley Based Aligner with Autodata

TECALEMIT GTR/3020 PC BASED WHEEL ALIGNER PART NO: GTR/3020

- Full 4 wheel 8 CCD alignment system
- Quick and easy measurements
- Wireless CCD measuring heads
- Precision measurement of angles
- Haweka Pro-clamp wheel mounting system
- PC controlled with Windows operating system
- Extensive vehicle database
- Colour before / after printout

CALL FOR LATEST PRICE



FINANCE OPTIONS AVAILABLE



TECALEMIT GTR/8400 3D 4 CAMERA WHEEL ALIGNER PART NO: GTR/8400

- Four wide-angle cameras provide alignment measurements
- 3D model allows you to see alignment angles on the screen in real-time
- Self-centring clamping arms fit 12" to 24" wheels

CALL FOR LATEST PRICE



FINANCE OPTIONS AVAILABLE

**All prices are subject to change without prior notice due to market fluctuation.
**All Prices Excl VAT

TECALEMIT

TIRO PLUS PACK

TTC TIRO PLUS & TBM TIRO PLUS

PART NO: TTC/TIROPLUS/1 & TBM/TIROPLUS

TECALEMIT

TYRE CHANGER TTC TIRO PLUS

PART NO: TTC/TIROPLUS/1

- Clamping range 10" – 26"
- Max Wheel diameter 1070mm
- Max Wheel width 380mm
- Bead breaker force 2800kg
- Versatile three arm assistant system, ideal for RFT Tyres
- **TIOROLLER** Assists with the removal of the tyre from the rim
- **TIROFOLLOWER** Follows the wheel rotation through the fitting cycle
- **TIROLIFTERDISC** Assists with the lifting of the lower bead during tyre removal

FINANCE OPTIONS AVAILABLE

CALL FOR LATEST PRICE



FINANCE OPTIONS AVAILABLE

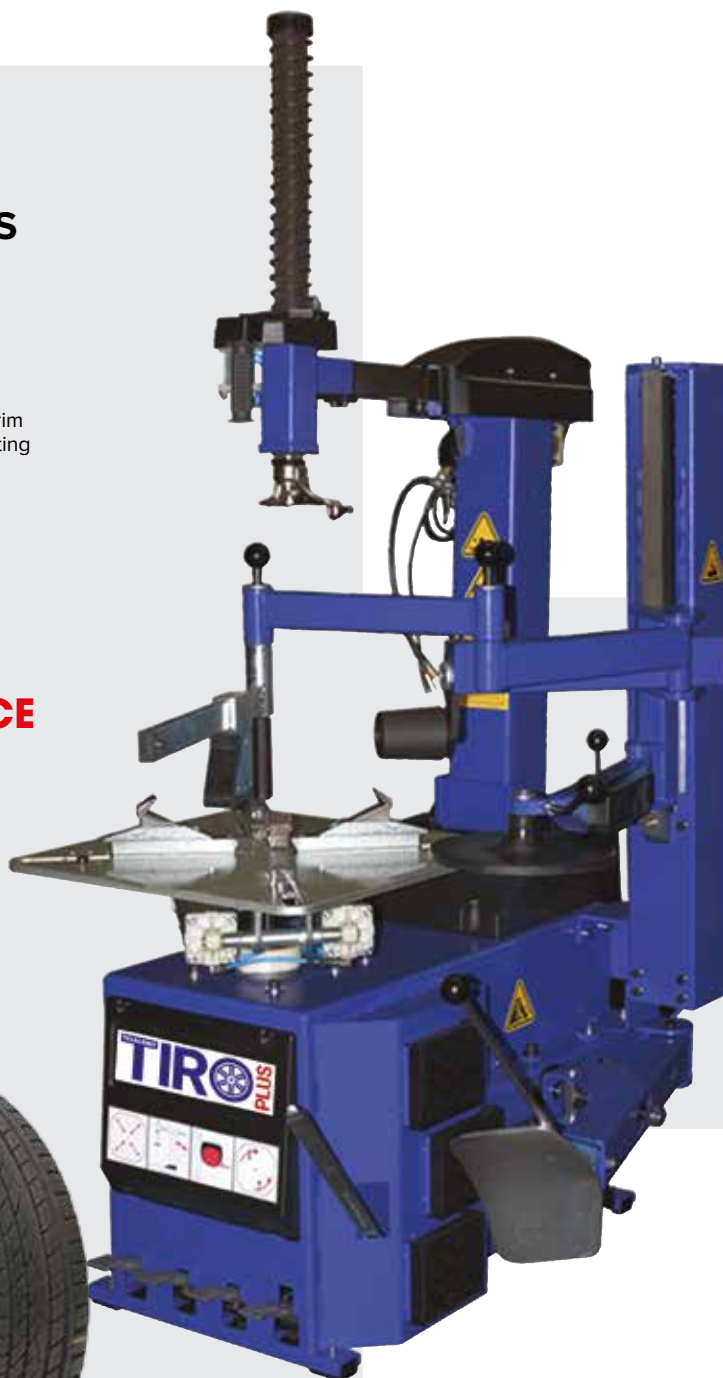

TECALEMIT WHEEL BALANCER TBM TIRO PLUS

PART NO: TBM/TIROPLUS

- Internal data entry & weight positioning arm
- Adhesive weight position guide
- Automatic rotation & positioning via One-touch operation
- Data memory to store common wheel size combinations
- Hidden weight and optimisation facility

CALL FOR LATEST PRICE

HOFMANN
GEODYNA 7200
WHEEL BALANCER

PART NO: EEWB768AE1

Make the most of a video display along with advanced data input and patented measurement systems thanks to the Hofmann Geodyna 7200 video wheel balancer, which is designed for cars, light trucks and motorcycles

- 2D SAPE (Semi-Automatic Parameter Entry): Measure the wheel offset and wheel rim diameter in one process
- Hidden weight mode: Place adhesive weights behind spokes, giving you an appealing cosmetic finish
- VPM measuring system: Achieve accuracy and reliability by limiting discrepancies caused by changes in ambient temperature
- Tyre matching mode: Optimise tyre to rim and use fewer weights
- Small footprint: The compact unit makes the most of your garage space
- QuickBal: Reduce measurement time by 30%
- EasyAlu: Automatic configuration of the inside position for weight
- Constant measuring speed
- User friendly interface with video display

£3,199



FINANCE OPTIONS AVAILABLE

HOFMANN
GEODYNA 7100
WHEEL BALANCER

PART NO: EEWB767AE1

Includes 2D SAPE (Semi-Automatic Parameter Entry) to measure wheel offset and wheel diameter in one process, the VPI measuring system for high accuracy, and split weight mode to hide weights behind spokes for a better finish.

Pair up the Geodyna 7100 with the Hofmann Monty® 3300 20 Smart tyre changer to create a tyre and wheel service package for your workshop

- 2D SAPE (Semi-Automatic Parameter Entry): Measure the wheel offset and wheel rim diameter in one process
- Hidden weight mode: Place adhesive weights behind spokes, giving you an appealing cosmetic finish
- VPM measuring system: Achieve accuracy and reliability by limiting discrepancies caused by changes in ambient temperature
- Tyre matching mode: Optimise tyre to rim and use fewer weights
- QuickBal: Reduce measurement time by 30%
- User friendly LED interface: The display guides you through the balancing process step by step

£2,199

FINANCE OPTIONS AVAILABLE

**All prices are subject to change without prior notice due to market fluctuation.
**All Prices Excl VAT

HOFMANN

3300-24 TYRE CHANGER

PART NO: EEWH762AED

Use automatic turntable speed control while also dealing with larger and ultra-high performance tyres with the Hofmann Monty 3300-24 smartSpeed tyre changer.

It offers a high productivity speed via the built-in smartSpeed inverter technology which automatically controls the speed of the turntable dependant on the torque required when mounting/demounting the tyre, along with a large 24-inch outer clamping range.

Pair up the Monty 3300-24 smartSpeed with the Hofmann Geodyna® 7200 wheel balancer to create a tyre and wheel service package for your workshop.

- Pneumatic tilting column: Move the tilting column backwards easily so you are free to access the tyre
- Assist arm: Mount and demount tyres with ease using the drop centre & rim centre pressing tools
- Two pneumatic cylinders: Get a 30-40% increase in clamp force compared to single cylinder designs
- Mount/demount function: The steel head and plastic inserts protect the wheel rim when mounting and demounting tyres
- smartSpeed: Automatically select the best speed for the operation being performed giving you a more controlled operation
- Built in tool box, tyre inflator and standard gauge: Provides ease of use and ergonomic benefits
- Wheel clamps: The 3300 24 has a total clamping up to 28in (with additional adaptors; 24in as standard)



£ FINANCE OPTIONS AVAILABLE

CALL FOR LATEST PRICE

SPECIAL OFFER: PACKAGE DEAL

PART NO: EEWH762AED/EEWB767AE1

Package 1



£5,600

£ FINANCE OPTIONS AVAILABLE

PART NO: EEWH762AED/EEWB768AE1

Package 2



£6,300

£ FINANCE OPTIONS AVAILABLE



SCISSOR LIFTS

NEW



SELF-INSTALL
£4,995

CONTINENTAL
3.0T MIDRISE SCISSOR LIFT

PART NO: S.30H SL MH

FINANCE OPTIONS AVAILABLE

- Premium Quality German manufactured with an attractive checker plate design
- Dual hydraulic system - double cylinder in every scissor, no air supply necessary
- Base frame hot-dip galvanized
- Platforms made from slip-resistant bulb plate
- 3-Year Parts only Warranty, Self-installation
- Installation available at extra cost

TECALEMIT
SCISSOR LIFTS

- Short platform and full length options
- Mid-rise and full height options
- Surface and recessed options
- Single and 3 phase options
- Wheel alignment and ATL MOT options



Ideal for servicing, brake work & tyre bays



CALL FOR LATEST PRICE

SCISSOR LIFT		
MODEL NO.	CAPACITY	PLATFORM LENGTH / CONFIGURATION
SF/9130/1/SI	3.0T	1.4m Surface Mounted, Mid-rise
SF/8993	3.5T	1.4m Surface Mounted, Full height
SF/8994	4.0T	1.5-1.9m Recessed, Full height
SF/9095/EV	4.5T	4.8m Recessed, Full height
SF/9065/EV	5.0T	5.2m Recessed, Full height
SF/9440	4.0T	4.8m Low profile, Full height

SF/9130/1/SI only available as single phase and is a self-installed lift, installation is available at an additional cost.

FINANCE OPTIONS AVAILABLE

**All prices are subject to change without prior notice due to market fluctuation.
**All Prices Excl VAT

2 POST LIFTS

NEW

EV READY LIFTS

Interchangeable Forks for lifting EVs by their wheels



CALL FOR LATEST PRICE

TECALEMIT SF/9235/EVR/KIT EV READY 3.5T 2-POST LIFT

- Simple & easy to swap between lifting pads & forks
- Baseless design with clear floor between columns
- Suitable for lifting vehicles up to 3500kg GVW
- Asymmetrical, 3-stage lifting arm design
- Low pad lifting height of just 95mm
- Fast lifting time of 45 seconds

 **FINANCE OPTIONS AVAILABLE**

CALL FOR LATEST PRICE

NEW



MADE IN ITALY

TECALEMIT SF/9492 4.0T HYDRAULIC 2-POST LIFT

- Low lift pad height of just 98mm
- 'Soft-Start' Bosch Rexroth compact power module
- 3 stage symmetrical arms for lifting a wide range of vehicles
- Optional high lift pad extensions for lifting vehicles with higher ground clearance available

 **FINANCE OPTIONS AVAILABLE**



CALL FOR LATEST PRICE

TECALEMIT 2-POST LIFTS

- A range of mechanical and hydraulic lifts
- Single and 3 phase options
- Base frame and baseless options
- Ideal for servicing and transmission work

Options for a small car right up to a long wheelbase van

 **FINANCE OPTIONS AVAILABLE**

2-POST LIFTS

MODEL NO.	CAPACITY	PAD HEIGHT / CONFIGURATION
SF/9010/H	3.0T	90mm, Mechanical with Base
SF/9230	3.0T	95mm, Mechanical Baseless
SF/9010/H/32	3.2T	90mm, Mechanical with Base
SF/9035	3.6T	90mm, Mechanical with Base
SF/9224	4.0T	103mm, Mechanical Baseless
SF/9023	3.2T	95mm, Hydraulic Baseless
SF/8893	4.0T	125mm, Hydraulic Baseless
SF/9025	5.0T	125mm, Hydraulic Baseless
SF/9196	5.5T	125mm, Hydraulic Baseless
SF/2700	7.0T	127mm, Hydraulic Baseless

Single phase upgrades only available on hydraulic lifts at an additional cost.



NEW



TECALEMIT
COMMERCIAL VEHICLE COLUMN LIFTS

- SF/9490 Wireless 4 unit mobile column lift
- 30.0t total capacity (7.5t per column)
- 120-second lifting time
- Adjustable wheel forks
- Expandable to 6, 8 or 12-column configurations
- Powered by rechargeable 24v batteries
- Advanced synchronization system for smooth lifting
- Height limit switch for safety
- Mechanical lock on each column
- 24v Control panel with up/down button and emergency stop on all columns
- LCD for current height, battery level, and mode type
- Completely mobile with no cables or trip hazards

CALL FOR
LATEST PRICE

FINANCE OPTIONS
AVAILABLE

**All prices are subject to change without prior notice due to market fluctuation.
**All Prices Excl VAT

LIFTMASTER
'WIDE' ELECTRO/MECHANICAL
BASELESS EV 2 POST LIFT
C/W SYMMETRICAL ROTATING ARMS
SPECIFICALLY SUITABLE ELECTRIC VEHICLES &
DROP IN HEIGHT EXTENSIONS

PART NO: LMS3500EV

- The innovative low-profile arms with rotating terminal offer incredibly flexible use, making the lift suitable for lifting all types of vehicles - from the standard city cars to sports cars - including the most modern electric vehicles - up to the VW T6 with long wheelbase
- Automatic lubrication system to ensure constant lubrication during lifting & descent
- Electro-Mechanical Synchronisation ensures the carriages are kept within a 20mm level tolerance
- Low pad height of 96mm
- Front arm reach: 792mm to 1,200mm
- Rear arm reach: 792mm to 1,200mm

CALL FOR
LATEST PRICE



3500KG
WEIGHT LIFTING
CAPACITY

MADE IN
ITALY

EV ⚡ READY

 **FINANCE OPTIONS**
AVAILABLE

CONTINENTAL
3.0T 2-POST
MECHANICAL LIFT

PART NO: 2.30M SL

- Premium Quality German manufactured lift
- Carriage fitted with 4 maintenance free roller bearings
- Electronically synchronised columns made from hot rolled steel
- 3 year warranty as standard
- 2-Post lift Includes delivery & installation to a prepared site

£4,500



 **FINANCE OPTIONS**
AVAILABLE



2 POST LIFTS

LIFTMASTER

BASELESS, ELECTRO/HYDRAULIC, ASYMMETRIC 2 POST LIFT C/W 2 STAGE ARMS, C/W 65MM EXTENSIONS

SINGLE PHASE PART NO: LME4001 | 3 PHASE PART NO: LME4003

- Baseless two post lift, clear floor with no obstructions, easy to use.
- Mechanical safety latch with automatic engagement ensuring maximum safety when lift is in standing position
- Top shut-off bar to prevent damage when lifting high vehicles
- Twin hydraulic rams are designed for intensive use and minimise down time, by requiring little maintenance
- Robust arm locking device
- 4 x 65mm height extensions included

CALL FOR LATEST PRICE

FINANCE OPTIONS AVAILABLE



4000KG
WEIGHT LIFTING CAPACITY



NEW

BENDPAK

2 POST LIFT – CLEARFLOOR BI-METRIC TRIPLE REACH ARMS C/W SCREW PAD, 63MM & 125MM HEIGHT ADAPTERS

PART NO: 10AP

- Exclusive Bi-Metric triple reach arm design for more versatile arm positioning
- Expandable top beam to accommodate wide or narrow drive-thru configurations
- Double-telescoping screw pads offer increased versatility
- Automatic arm restraints withstand over 900 Kg of side force
- Single-point safety release
- 14-piece standard adapter set

CALL FOR LATEST PRICE

FINANCE OPTIONS AVAILABLE

4536KG
WEIGHT LIFTING CAPACITY



LIFTMASTER

'WIDE' ELECTRO/MECHANICAL BASELESS 2 POST LIFT C/W SYMMETRICAL 3 STAGE FRONT ARMS SUITABLE FOR DROP IN HEIGHT EXTENSIONS

PART NO: LMS3500W

- Automatic lubrication system to ensure constant lubrication during lifting & descent
- Electro-Mechanical Synchronisation ensures the carriages are kept within a 20mm level tolerance
- Low pad height of 95mm
- Symmetrical arm configuration with two long 4-stage front arms & two long 2-stage rear arms ideal to lift cars & car derived vans

CALL FOR LATEST PRICE

FINANCE OPTIONS AVAILABLE

3500KG
WEIGHT LIFTING CAPACITY

MADE IN ITALY

**All prices are subject to change without prior notice due to market fluctuation.
**All Prices Excl VAT

4 POST LIFTS



- Available in a range of lifting capacities & platform lengths
- Surface mount and recessed options
- Single and 3 phase options
- Radius plates and jacking beam can be fitted for MOT purposes on many models

 **FINANCE OPTIONS AVAILABLE**

TECALEMIT 4-POST LIFTS

Ideal for MOT testing and wheel alignment



CALL FOR LATEST PRICE

SERVICE & MOT LIFTS

MODEL NO.	CAPACITY	PLATFORM LENGTH / CONFIGURATION
SF/9436/SR	3.5T	4.3m, 120mm min. height
SF/9006	4.0T	4.5m, 130mm min. height
SF/9084	4.0T	5.0m, 165mm min. height
SF/9250	5.0T	5.2m, 170mm min. height
SF/8976	6.0T	6.0m, 190mm min. height



CALL FOR LATEST PRICE

WHEEL ALIGNMENT LIFTS

MODEL NO.	CAPACITY	PLATFORM LENGTH / CONFIGURATION
SF/9944/4	4.0T	4.0m, 190mm min. height
SF/9008/4	4.0T	5.0m, 200mm min. height
SF/9008/6	5.0T	5.2m, 190mm min. height
SF/9008/7	5.0T	5.7m, 155mm min. height
SF/8976/4	6.0T	6.0m, 190mm min. height

 **FINANCE OPTIONS AVAILABLE**



CALL FOR LATEST PRICE

ATL & OPTL LIFTS

MODEL NO.	CAPACITY	PLATFORM LENGTH / CONFIGURATION
SF/9254	4.0T	4.3m, 145mm min. height
SF/9057	4.0T	5.2m, 130mm min. height
SF/9257	5.0T	5.7m, 155mm min. height
SF/9265	5.0T	6.5m, 155mm min. height
SF/8976/ATL	6.0T	6.0m, 240mm min. height

 **FINANCE OPTIONS AVAILABLE**



4 POST LIFTS

LIFTMASTER

**CLASS IV 4 POST MOT BAY
| ATL 4 POST LIFT
C/W 4460MM PLATFORMS, PLAY
DETECTORS, CAPTIVE TURN
PLATES & 2000KG JACKING BEAM,
ITALIAN ROLLER BRAKER TESTER
& HEADLAMP BEAM ALIGNER**

PART NO: 4ATLEF446B

- A full site survey will be completed by our area sales manager, this will include a CAD layout plan of the MOT equipment and your existing workshop
- Full support will be given with all DVSA applications and sign off processes. These will be undertaken by our area sales manager.
- Flexible service, calibration & warranty plans are available
- Groundworks can be undertaken by our inhouse team
- 4 Post Lifts can be upgraded to Scissor Lifts
- 4 Post Lifts or Scissor Lifts can include 'dual revenue' wheel alignment platforms.



**Class VII
also available**

**CALL FOR
LATEST PRICE**



**FINANCE OPTIONS
AVAILABLE**

BENDPACK

4 POST LIFT

C/W 4166MM PLATFORMS

PART NO: HD9



- Platforms accommodate wide or narrow vehicles
- Platforms include rail kit for jacking beam or optional accessories
- Optional caster kit available
- Internal "anti-sway" slider blocks in each column



£5,038

**FINANCE OPTIONS
AVAILABLE**

BENDPACK

4 POST LIFT

C/W 4775MM PLATFORMS & EXTRA HEIGHT 2197MM

PART NO: HD9XW



- Platforms accommodate wide or narrow vehicles
- Platforms include rail kit for jacking beam or optional accessories
- Optional caster kit available
- Internal "anti-sway" slider blocks in each column



£5,290

**FINANCE OPTIONS
AVAILABLE**

HURRICANE MECHANICAL VEHICLE SKATES

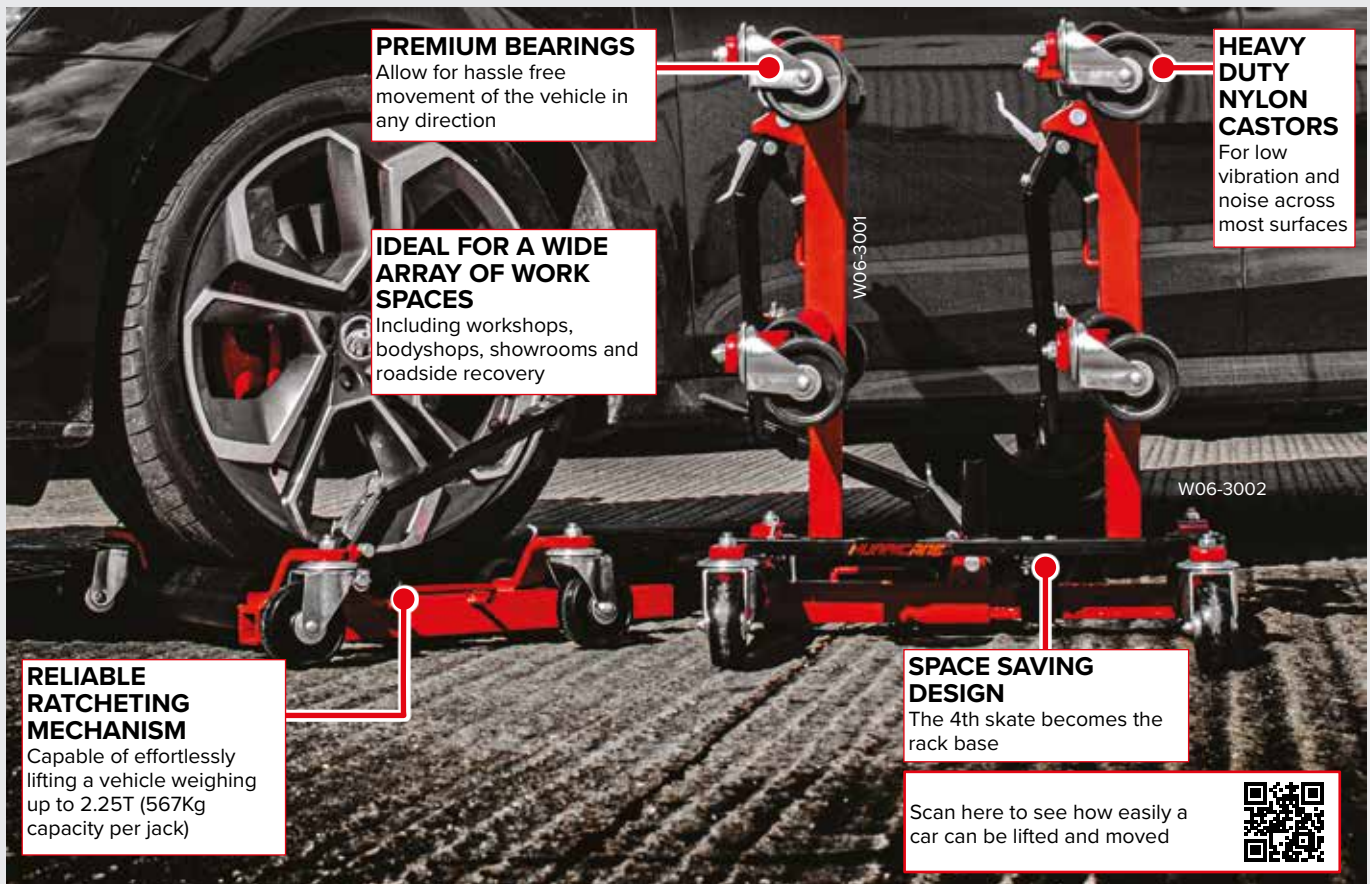

PREMIUM BEARINGS
Allow for hassle free movement of the vehicle in any direction

IDEAL FOR A WIDE ARRAY OF WORK SPACES
Including workshops, bodyshops, showrooms and roadside recovery

HEAVY DUTY NYLON CASTORS
For low vibration and noise across most surfaces

RELIABLE RATCHETING MECHANISM
Capable of effortlessly lifting a vehicle weighing up to 2.25T (567Kg capacity per jack)

SPACE SAVING DESIGN
The 4th skate becomes the rack base

Scan here to see how easily a car can be lifted and moved



- Reliable ratcheting mechanism: Capable of effortlessly lifting a vehicle weighing up to 2.25T [567Kg capacity per jack]
- Heavy duty nylon castors: For low vibration and noise across most surfaces
- Premium Bearings: Allow for hassle free movement of the vehicle in any direction
- Ideal for a wide array of workspaces: Including workshops, body shops, showrooms and roadside recovery
- Fits tyre widths up to 11"

4 SKATES AND STORAGE RACK
£399.99



	W06-3001	W06-3002
DESCRIPTION	VEHICLE SKATE - SINGLE	Rack for 3+1 Skates
WEIGHT CAPACITY	567kg per skate	-
FITS TYRE WIDTHS	Up to 11"	-



TROLLEY JACKS

WINNTEC

LOW-PROFILE TROLLEY JACK CONT. DESCENT 2 TONNE

PART NO: SIP09701

- 2 Tonne maximum weight capacity
- 75 - 510mm lifting height range
- Ultra-low profile design for low vehicles
- 'Turbo-Lift' system raises contact saddle to the vehicle surface in one swift motion
- Rubber grip and PU contact saddle pad



£200

WINNTEC TURBO-LIFT TROLLEY JACK 3 TONNE

PART NO: SIP09702

- 3 Tonne maximum weight capacity
- 120 - 450mm lifting height range
- 'Turbo-Lift' system raises contact saddle to the vehicle surface in one swift motion
- PU wheels reduces noise/floor damage
- Safety release valve for safe lowering
- Chrome-plated pistons and main ram
- Heat-treated chromed moving parts
- Durable rubber grip and jack saddle



PU Wheels

Low profile

£200

WINNTEC LONG CHASSIS TROLLEY JACK 5 TONNE

PART NO: SIP09885

- 5 Tonne maximum weight capacity
- 150mm - 680mm max. lifting height
- Designed for extreme heavy-duty operation
- Auto overload safety, universal joint valves
- Long ergonomic handle for better usage
- Steel wheels reduce noise and damage
- Integrated jack load control knob



£690

Heavy duty

SEALEY STANDARD CHASSIS TROLLEY JACK WITH AXLE STANDS PAIR | 3 TONNE

PART NO: SEA3010CX

- **VERSATILE LIFTING RANGE**
Minimum saddle height 133mm, maximum saddle height 515mm
- **HEAVY-DUTY CASTORS AND LARGE SADDLE DESIGN**
- **SUPPLIED WITH 2x Pin Type Axle Stands, 3 Tonne**
- **SUITABLE FOR** Loaded vans up to 3.5 Tonne GVW
- **FITTED WITH SAFETY OVERLOAD AND PUMP** through valve



£220

SEALEY LOW PROFILE CHASSIS TROLLEY JACK ORANGE | 2 TONNE

PART NO: SEA1020LEO

- **LOW ENTRY LIFTING RANGE**
Minimum saddle height 85mm, maximum saddle height 385mm
- **PROFILED LIFTING ARM** Allows low clearance height making this unit suitable for sports
- **ONE PIECE HYDRAULIC UNIT**
- **WHITE SADDLE** Aids positioning under vehicle
- **HEAVY DUTY CHASSIS**



£80

SEALEY SHORT CHASSIS TROLLEY JACK HI-VIS GREEN | 2 TONNE

PART NO: SEA1050CXHV

- **VERSATILE LIFTING RANGE**
Minimum saddle height 130mm, maximum saddle height 330mm
- **OVERLOAD PROTECTION**
- **STRONG CHASSIS**
- **EASY TO MANOEUVRE**



£60

SEALEY SHORT CHASSIS TROLLEY JACK WITH STORAGE CASE 2 TONNE

PART NO: SEA1050CXD

- **VERSATILE LIFTING RANGE**
Minimum saddle height 130mm, maximum saddle height 330mm
- **OVERLOAD PROTECTION**
- **EASY-TO-STORE** Supplied in tough storage
- **SUITABLE FOR** The hobby user or as an emergency mobile jack



£65



NEW



CONTINENTAL FULL ATL PACKAGE CLASS IV & VII

- Scissor or 4-Post Lift option (Hydraulic Operation with attractive galvanised checker-plated platforms)
- Hydraulic Wheel Play Detectors (Wireless on Scissor lifts)
- Low-Profile Jacking Beam (Manual or Air Operated on Scissor lifts)
- MTS Connected Emissions Tester - 27" Flat Screen, Printer, Keyboard & Mouse (Bluetooth or Cabled option) (Bluetooth includes OBD (VCI) Emissions Interface)
- Turnplates
- MTS Connected Brake Tester (Controlled Via Emissions unit)
- Hinged Galvanised Brake Tester cover plates as standard
- 4 X 4 Facility as standard
- Twin Laser Headlamp Aligner
- 2 x Convex Mirrors
- Brake Pedal Depressor

**CALL FOR
LATEST PRICE**

**Premium DVSA Approved
Automated Test Lanes for MOT
testing with 3 year warranty**

OPTIONAL

- Brake Tester adapter plate and software for motorcycle testing
- 40" wall-mounted screen (Displays brake tester and emissions readings)

BENEFITS

- 3 years manufacturer's warranty
- Manufactured and supported in the UK
- Site survey
- Project management from conception to completion
- CAD drawing service
- Delivery and installation
- Includes first 5/6 months calibrations

**FINANCE OPTIONS
AVAILABLE**

TECALEMIT COMPLETE MOT PACKAGES FROM THE MOT EXPERTS

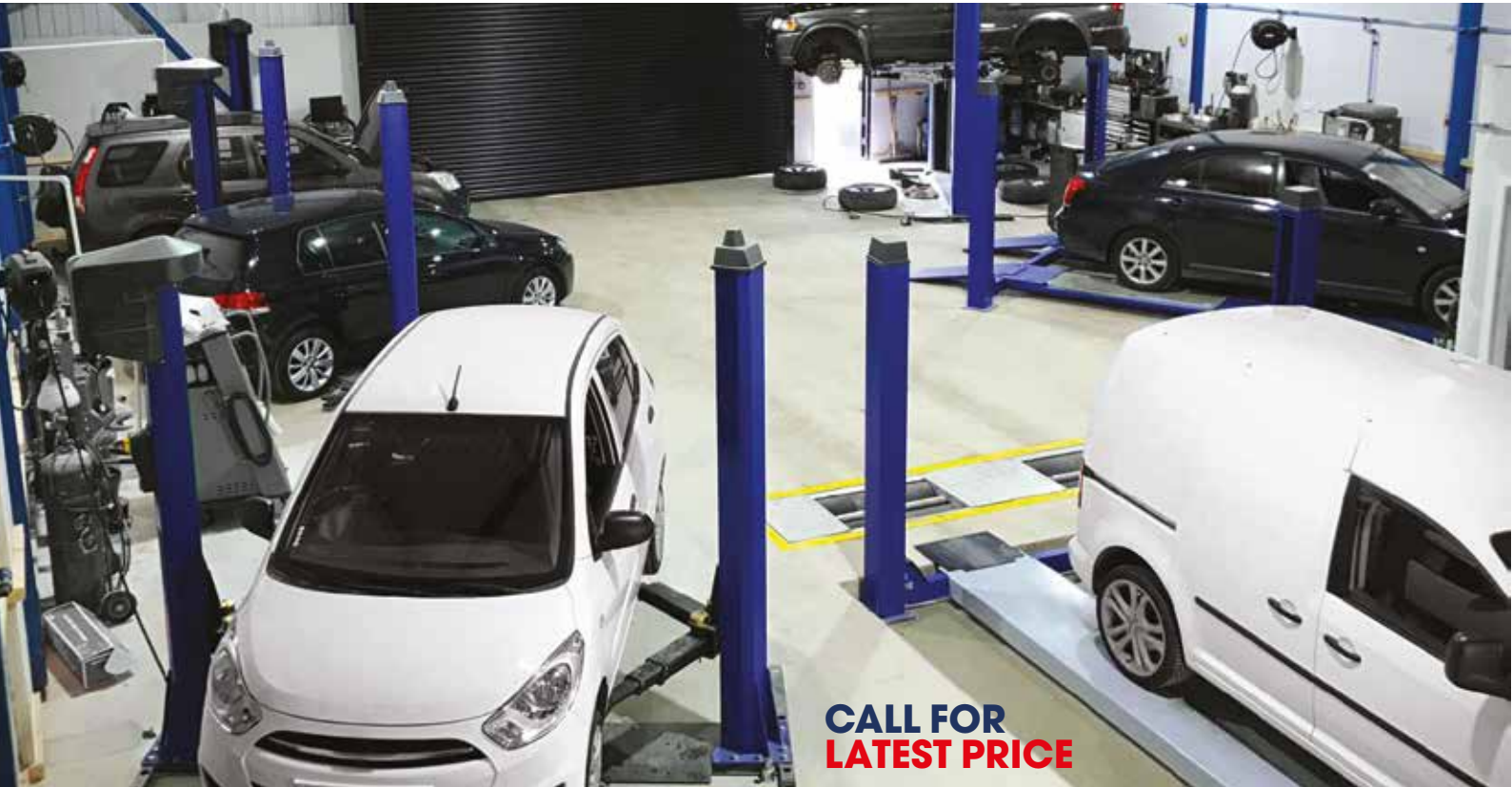

**CALL FOR
LATEST PRICE**

CALL TODAY TO ARRANGE YOUR FREE CONSULTATION



Flush fit Play Detectors for easy compliance with +/- 6mm DVSA level requirements. Standard on all Tecalemit ATL lift packages.



Cable Protectors prevents chaffing, tangling and snagging, for longevity and reliability. Standard on all Tecalemit ATL 4-Post Lift packages.



Space-saving Tecalemit Scissor Lift options available for both Class 4 & Class 7 testing. Ideal for workshops with width restrictions.



Large 680mm square High Visibility LED brake tester display available as an optional extra on Tecalemit MOT packages.



- Choice of platform lengths from 4.3m - 6.5m
- Choice of lifting capacities from 3.5T - 6.0T
- Available in ATL, OPTL or MOT specifications
- Options with or without emission tester
- Options to include Classes 1 & 2, 3, and 5

5 Years
PEACE OF MIND

- 5 Years Servicing
- 5 Years Calibrations
- 5 Years Warranty

MOT BAY PACKAGES



Class 1 & 2 Upgrades Available



NEW



TEXA ELIGHT

- eLight is the most advanced headlight alignment system on the market today, and the first with integrated electronic diagnostics.
- eLight's digital electronics use a built-in camera, a system of algorithms and integrated autodiagnosics to identify the type of headlight and to guarantee maximum precision of alignment.
- eLight can even produce a detailed report, based on digital analysis, for attachment to the garage worksheet, and is already fully compatible with the legislation governing PTI centres due to be introduced in 2021.

TILT ANGLE

- Measuring range $\pm 6\%$ vertical; $\pm 10\%$ horizontal
- Accuracy $\pm 0.1\%$ vertical; $\pm 0.2\%$ horizontal

LUMINOUS INTENSITY

- Measuring range 150,000 cd – 240 Lux/25 m
- Accuracy $\pm 5\%$

CONNECTIVITY LAN, Wi-Fi, RS232, Bluetooth

- *Only ONED version

eLight: the first smart headlight alignment system



**CALL FOR
LATEST PRICE**

TRANSMISSION

LASER TRANSMISSION SUPPORT ARM

PART NO: 8579

- Combined with a traditional gearbox jack the patented Laser 8579 simplifies gearbox removal and fitting by supporting the gearbox from above. It does this by attaching to a traditional vertical gearbox jack and providing a specially shaped arm that goes up the side of the gearbox

£200



LASER ENGINE/GEARBOX SUPPORT

PART NO: 5750

- Designed for transverse-engined vehicles, the frame will support the engine and/or gearbox when carrying out repair operations like clutch or gearbox removal, DMF change, removing and replacing engine and gearbox mounts, for cam belt replacement, etc
- With car on ramp, engine/gearbox position and height can be adjusted from underneath

£215



LASER ATF OIL DISPENSER WITH ADAPTORS

PART NO: 5641

- A handy dispenser for replacing ATF transmission fluid
- 8 assorted adaptors for increased applications (see instruction booklet for adaptor applications)
- Manually operated pump with integrated pressure gauge

£109



LASER ATF ADAPTOR SET 20 PIECE

PART NO: 7606

- A comprehensive range of transmission fluid (ATF) refilling adaptors for many makes of vehicles
- For use on automatic transmissions without a dipstick and with most ATF Oil Dispensers
- Application list available - with cross reference to numbered products - please see useful downloads below
- Manufactured from composite material

£72



LASER MASTER CLUTCH KIT TROLLEY

PART NO: 62012

- Brings together all the must-have clutch tools from our catalogue in one kit including model specific tooling.
- Stored in its own dedicated 4 drawer trolley with engineered foam to keeping everything in place, the 62012 kit can be quickly

£2,895



**Most comprehensive
clutch kit yet!**

LASER WET PLATE DOUBLE CLUTCH REMOVAL & FITTING KIT FOR VW GROUP

PART NO: 8136

- Includes all the special tools required to remove and refit the wet style double clutch assembly found across the VW Group vehicle range.
- Use with DTI gauge and stand like Laser 6084 or similar

£250



LASER DSG GEN1 & GEN2 CLUTCH SETTING GAUGE KIT

PART NO: 7914

- Speeds up and simplify the fitting of DSG clutch kits to GEN1 and GEN2 DSG transmission systems. This has been specifically designed to work with Laser Clutch Puller and Press Kit

£220



LASER DSG CLUTCH REMOVAL KIT FOR VAG

PART NO: 6718

- DSG clutch removal tool set for VAG 7 speed gearboxes found in Audi A3, Volkswagen Golf and Touareg. NB, Gen 2 clutches (fitted from 06/2011 onwards) will also require Laser Part No. 7914.
- Designed to allow the safe removal and refitting of the twin clutches used in VAG 6 & 7 speed gearboxes.

£238



LASER OIL ATF DISPENSER 7L

PART NO: 4792

- Manually operated oil dispenser comes complete with a range of Automatic Transmission Fluid adaptors with quick fix coupling. Simply open the ball valve and the pump handle will dispense 70cc per cycle.

£240



DIESEL TOOLS

LASER ENGINE TIMING KIT FOR FORD 2.0 ECOBLUE DIESEL

PART NO: 7323

- This timing kit has been designed for the latest Ford 2.0D EcoBlue TDCi engine which features an innovative "belt in oil" design where the synchronous drive belt is sited inside the oiled area of the engine



£170

LASER INJECTOR EXTRACTOR SET FOR FORD ECOBLUE 2.0 DIESEL

PART NO: 8288

- The Laser 8288 injector puller set has been designed to pull the Ford EcoBlue diesel injector in one piece. Previously the EcoBlue injectors could only be removed if the fuel return connection and Piezo head were removed by breaking them off, rendering the injector unusable. This kit allows these injectors to be pulled out without needing to break the injector first



£250

LASER INJECTOR EXTRACTION KIT FOR FORD ECOBLUE 2.0 DIESEL

PART NO: 7912

- Has been designed to extract seized injectors from the Ford 2.0L Diesel EcoBlue engines in the method described by Ford. Injector removal is required for any service or repair work that requires the removal of the cam cover, cylinder head or cam shafts. NOTE: This method is for seized injector only and will render the injector unserviceable



£145

LASER INJECTION PUMP REMOVER/ INSTALLER FOR FORD TRANSIT 2.0 ECOBUE DIESEL

PART NO: 7324

- Injection pump remover and installer for Ford 2.0 EcoBlue diesel
- Applications: Ford Transit, Transit Custom and Tourneo Custom with 2.0L EcoBlue TDCi engines. AWD, FWD and RWD variants (from 2016)
- Engine codes: YLFS, YMFS, YNFS, YLF6, YMF6, YNF6, YLR6, YMR6 and YNRS



£95

LASER VIBRATION DAMPER PULLEY PULLER FOR FORD 2.0 ECOBLUE TDCI

PART NO: 7334

- Vibration damper pulley puller for Ford 2.0 EcoBlue TDCi engines, designed to remove the front pulley when accessing the timing belt
- Removes the front pulley to gain access to the timing belt
- Applications: Ford Edge (2018 - 21), Focus (2018 - on), Focus Active (2019 - on), Galaxy (2018 - 21), Kuga (2019 - on), Mondeo (2019 - 21), S-MAX (2018 - 21), Transit (2016 - on), Transit Custom (2016 - on) and Tourneo Custom (2016 - on)



£55

ENGINE TOOLS

LASER TURBO SYSTEM TESTER SET

PART NO: 7981

- 13 piece turbo system tester set to identify any pressure leakage within the turbo system using standard workshop air. To fit most turbo systems on cars and light commercial vehicles
- Twelve stepped adaptors for pipe sizes: 31 - 38mm, 46 - 51mm, 55 - 60mm, 65 - 70mm, 75 - 80mm and 85 - 90mm
- Pressure gauge with shut off valve and regulator to help prevent over-pressurisation



£140

LASER COOLING SYSTEM PRESSURE TEST KIT

PART NO: 5614

- A comprehensive coolant system pressure testing kit for universal use
- 25 pieces, including 17 individually sized threaded adaptors, pressure testing pump with gauge, 2 connectors for pressure testing bayonet style caps and an adaptor cap wrench
- Adaptors have quick-release couplings and pump is fitted with large, easy to read dial clearly marked in both psi and bar



£300

LASER COOLANT SYSTEM FLUSHER

PART NO: 7686

- Flushes cooling systems using workshop air and water
- Hand held with five pipe size connections: 19, 29, 32, 36.5 and 40mm
- Trigger action with locking clip
- Standard air line and water hose fitting
- Helps remove contaminated coolant after head gasket replacement.



£30



£27

LASER
OIL FILTER CUP WRENCH
TESLA TRANSMISSION FILTER

PART NO: 8617

- Tesla range of vehicles use a spin on oil filter on their transmissions; 2 wheel drive vehicles have one filter on the rear transmission with all-wheel drive vehicles having two filters, one on the front and one on the rear. The Laser 8617 filter cup is engineered to fit the filters and allow for safe removal, as well as allowing the new filter to be fitted with a 1/2" D torque wrench
- Applications include: Tesla Model 3, Model Y & Model X
- Fits 14 flute 63.8mm (A/F) transmission filter
- Use with 1/2" D socketry or a 21mm spanner
- 1/2" D allows for use of a torque wrench for correct tightening.



£320

LASER EV INSULATED TOOL KIT

3 DRAWER TOOLBOX | 27 PIECE

PART NO: 8328

- Robust 3 drawer tool box (510 x 230 x 265mm) contains a selection of fully insulated tools to suit the needs of any mechanic working on hybrid and electric vehicles, or by electricians. The hand tools are suitable for live working up to 1000V AC / 1500V DC and include a ratchet and hex sockets, screwdrivers, spanners, pliers, an insulated cable stripping knife and magnetic pick up tool
- Insulated combination pliers (35mm jaw opening) & insulated side cutters (19mm jaw opening) both with two colour VDE insulated handles with slip guards; insulated screwdrivers: Ph2 x 100mm long, flat 5.5mm x 125mm long; 5x insulated open ended spanners: 8, 10, 12, 14, 17mm
- Insulated 3/8" D ratchet (72 teeth); 9x 3/8" D insulated sockets: 7, 8, 10, 12, 14, 15, 17, 19, 22mm; length 71mm. 100mm extension bar providing greater access; insulated cable knife ideal for stripping standard cables; 420mm long flexible magnetic pick up tool, with 250g pick up capacity

LASER
WORKSHOP EV PACKAGE WITH MOBILE
SHADOW BOARD KIT

PART NO: 8294

- A complete package of tools, PPE and safety products for workshop use, when servicing or repairing high voltage vehicles. Supplied on a mobile shadow board for ease of access and security
- An 88 piece package of all necessary safety requirements for working on vehicle systems up to 1000v, stored conveniently on a shadow board and mounted on a mobile trolley for ease of movement around workshops and/or bodyshops
- High visibility ensures nothing can accidentally go missing and forms part of a safety management process, essential when working on high voltage systems, where there is greater risk accidental injury to employees
- Contents: insulated tools and test instruments, high voltage PPE (insulated gloves and face shield), high voltage signage and safety barriers, lock-out procedure safety products, insulated floor matting and shrouding for added safety, rescue pole and electric shock first-aid poster



£2,999

LASER
VEHICLE FIRE BLANKET
6X8M

PART NO: 8396

- Electric vehicle battery fires can produce very high temperatures if left unchecked. The Laser 8396 fire blanket has been introduced to help reduce and control the risk of a vehicle fire spreading to other nearby structures and vehicles by starving the fire of oxygen and thereby keeping the temperatures under control
- Size: 6 x 8 meters, thickness 0.45mm
- Material: E glass cloth coated with silicone. Can withstand direct temperatures up to 550°C
- Suitable for electric, hybrid, petrol and diesel vehicles
- Reuse - the 8396 fire blanket should be considered a consumable product, however, if the blanket shows no signs of mechanical damage or heat degradation it may be reused



£675

EV & HYBRID

LASER

EV CABINET WITH FOAM INLAYS, TOOLS & SAFETY PRODUCTS

PART NO: 8490

- A comprehensive set of insulated tools, test instruments, PPE and signage for high voltage service and repair work, in a dedicated 7 drawer cabinet with tool control foam inlays
- A 125 piece comprehensive kit, for service and maintenance work on EV & PHEV vehicles, containing everything required for safe working on systems up to 1000v
- Contents: Drawer 1; 35 piece insulated socketry & torque. Drawer 2; 10 piece insulated pliers and cutters. Drawer 3; 20 piece insulated screwdrivers. Drawer 4; insulated wrenches and hex keys. Drawer 5; 20 piece miscellaneous insulated tools for EV and PHEV maintenance
- Drawer 6; voltage tester 1000v CATIV, insulation tester 1000v CATIII, amps clamp 80A CATIII, slim fit test probe set CATIII
- High voltage PPE (insulated gloves and face shield), high voltage signs, lock-out and warning tags, safety posts & chain, rescue pole
- All tools are contained in bespoke routed foam trays (drawers 1 – 6), and all safety products have their own place within or attached to the cabinet, ensuring nothing can accidentally go missing.



LASER

EV ELECTRO-HYDRAULIC TABLE LIFT



 **FINANCE OPTIONS AVAILABLE**



- A mobile 230V electro-hydraulic table lift with an adjustable, tilting, lifting platform which allows easy access under the vehicle for disassembly and removal of EV battery packs, engines and transmissions. Fitted with a wooden composite table surface with specially milled openings for easy battery fastener/EV connection or transmission access

1 TONNE PART NO: 8524

- Lift capacity: SWL 1 tonne
- Table dimensions: 1760 x 1130mm; adjustable working height: 1100 – 2000mm
- Weight: 200kg
- Features: 4 steering wheels (2 braked), adjustable tilting table top, double hydraulic cylinders, low friction Polyethylene (PE) sliders, anti-crush stops to prevent trapped hands, dead-man control and a 5m retracting mains cable

£3,999

1.4 TONNE PART NO: 8525

- Lift capacity: SWL 1.4 tonnes
- Table dimensions: 1760 x 1130mm; adjustable working height: 800 – 2000mm
- Weight: 200kg
- Features: 4 steerable wheels (2 braked), adjustable tilting table top, double hydraulic cylinders, low friction Polyethylene (PE) sliders, anti-crush stops to prevent trapped hands, dead-man control and a 5m retracting mains cable.

£4,599

LASER
EV BATTERY
ADJUSTABLE
MOBILE BENCH

SWL 800KG

PART NO: 8339

- Adjustable mobile bench, specifically designed to aid the removal of underslung EV batteries (max Safe Working Load: 800kg) from the vehicle and move them around the workshop for safe storage and/or repair
- Mobile bench with individual height adjustable heavy-duty castors, allows for height/tilt adjustment (70mm max) to ensure batteries remain level and in alignment with the vehicle when either removing or installing
- 6" x 2" (150 x 50mm) rubber wheels with safety locks (400kg capacity per wheel), fitted to height adjustable legs, with threaded adjustment and thrust bearing. Use with 13mm Hex ratchet, spanner or socket
- Dimensions: 1500 x 1020 x 780mm (with wheels raised). Tested to 25% overload capacity
- Steel top plate (2mm thick), supplied with 6x wooden support beams to avoid damage to the underside of battery casing. UK Registered Design
- Specifically designed for the removal and installation of EV batteries when used in conjunction with a standard 2-post vehicle lift. Ideal for use in conjunction with Laser EV Battery Lifting Frame, Part No. 8338. Made in Sheffield.



£1,799

FINANCE OPTIONS AVAILABLE

LASER
EV BATTERY
LIFTING FRAME
FOR 4/6 POINT LIFTING
SWL 700KG

PART NO: 8338

- A fully adjustable and universal EV battery lifting system, suitable for all types of underslung/skateboard style of EV batteries (max SWL: 700kg), suitable for both four and six point lifting requirements
- Main lifting beam with moveable lifting eye, for use with workshop lifting hoist/engine crane (1 tonne model required, Part No. 8337)
- Three transverse beams, with adjustable lifting brackets (2x beams for 4-point lifting, 3x beams for 6-point lifting)
- Six adjustable chain slings, plus 6 each of M12, M16 and M20 eyebolts for attachment to EV battery lifting points
- SWL: 700kg, tested to 50% overload capacity. Specifically designed for lifting and moving EV batteries when they have been removed from the vehicle. Ideal for use in conjunction with Laser EV Battery Mobile Adjustable Bench, Part No. 8339. Made in Sheffield



£1,799

FINANCE OPTIONS AVAILABLE

BRAKE FLUID TESTING

BENDIX **FLUTEST** **BRAKE FLUID TESTER WITH OPTIONAL** **PRINTER CAPABILITY**

PART NO: BEN1150

- Accurate, reliable and repeatable results
- Operates off 12V power supply (vehicle own battery)
- User friendly – LCD screen instructions guide operator through complete testing cycle
- Measures up to 320°C/608° suitable for use on all grades of new & used brake fluids, including racing fluids
- Multi language display – 19 languages, selectable by user
- Compatible with printer for test results (987AB2430).



Approved by
brake system
manufacturers

£250

LASER **MEASURING TOOL SET DTI** **3 PIECE**

PART NO: 7687

- A comprehensive DTI (Dial Test indicator) gauge set, designed to be used for the accurate measurement of engine, brake and machine components
- 2 Dial Test Indicators with magnetic stand
- 1 x Dial Test Indicator: Size 60mm, diameter 0 - 10 x 0.01mm
- 1 x Dial Test Indicator: Size 30mm, diameter 0 - 0.8 x 0.01mm
- High strength, switchable magnet combined with shallow Vee base to allow attachment to both flat and curved surfaces



£100

LASER **BRAKE TOOL 3/16" SAE (4.75MM)**

PART NO: 8641

- Hand-held brake pipe flaring tool that is capable of forming both SAE single and double flares in 3/16" (4.75mm) copper and cupro-nickel brake pipes
- A 3/16" (4.75mm) SAE hand-held brake pipe flaring tool for forming single & double flares
- Suitable for use on & off the vehicle



£65

LASER **BRAKE PIPE BENDER & CLAMP SET**

PART NO: 8568

- This set combines a specialist automotive pipe bender designed for brake pipework with a set of brake pipe clamps to enable the new pipe to be held next to the existing pipe while still attached to the car
- A compact brake pipe bender/straightener tool ideal for on-vehicle use.



£32

LASER **BRAKE FIXING IMPACT BIT SET 3/8"D**

PART NO: 8286

- A set of 5 brake fixing impact bit sockets designed to suit the most commonly used brake disc and drum holding screws. The 3/8"D 40mm long socket bits cover Hex 5 and 6mm; Torx® T30, T40 and T50
- 5mm Hex applications: Saab, Vauxhall. Use with Connect replacement screws, Part Nos. 34130, 34135, 34136 and 34138
- 6mm Hex applications: BMW. Use with Connect replacement screws, Part No. 34132
- T30 applications: Fiat, Honda, Mercedes-Benz, PSA. Use with Connect replacement screws, Part Nos. 34131, 34137 and 34141

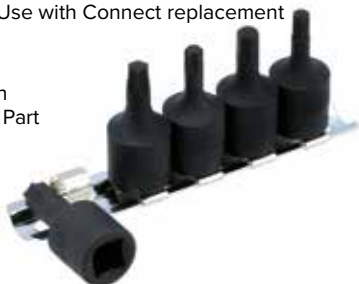

£9

LASER **BRAKE PIPE REAMER**

PART NO: 8520

- Compact reamer features a countersink S2 steel blade to deburr internal diameters from 3mm to 10mm
- Compact internal deburring tool
- Size range: 3-10mm
- Effective on copper & cupro-nickel brake pipes
- PP+TPR soft grip handle for comfort
- Also suitable for use on stainless steel & plastics.



£10



BRAKE FLUID TESTING

LAUNCH PRO-1 PLUS BRAKE BLEEDER & FLUID EXCHANGER

PART NO: 1433002

- Launch UK PRO 1 Plus is a compact, fully-featured brake and clutch fluid exchange device, suitable for all systems
- Pressure adjustable between 0.6-3.0 Bar
- 3.5M fluid delivery hose
- Compatible with all braking systems
- 5 Litre fluid tank
- One-man operation
- Fluid suction function



£570

SEALEY BRAKE PISTON WIND-BACK TOOL KIT 30 PIECE

PART NO:VS0285

- Comprehensive master set of adaptors suit a wide range of vehicle applications
- Suitable for push-back and wind-back brake pistons
- Includes left and right-handed thrust bolt assemblies
- Left-handed thrust bolt required for Citroen, Ford and Renault applications
- Precision made adaptor plates with thrust bolt assembly and reaction plate



£100

LASER BRAKE CALIPER CLEANING FILE DOUBLE SIDED

PART NO: 8474

- Double sided cleaning file suitable for removing brake dust, corrosion and the build up of road dirt from brake calipers and carriers when replacing brake pads and discs
- Designed for the removal of brake dust & corrosion
- Extra slim style - only 10mm
- Flat 155mm parallel blade with diagonal coarse grooves to prevent clogging
- Double sided for ease of use



£15

LASER HIGH PRESSURE BRAKE BLEEDER

PART NO:8395

- 12v powered brake bleeder has an adjustable fluid pressure output from zero to 3.5 bar (50psi)
- Designed to be used with a 5L brake fluid container (included)
- Finished in a durable, brake fluid safe, paint with clearly marked switches and dial.
- Designed and manufactured in Germany
- Supplied with euro cap adaptor - additional adaptors available



£799

SEALEY WORKSHOP VACUUM BRAKE & CLUTCH BLEEDER 2L

PART NO:VS0203

- Easy, fast, one-person operation using workshop air supply (90psi)
- Does not require vehicle-specific reservoir caps
- Draws fluid from the bleed screw enabling either bleeding or full replacement of fluid in system
- Operation automatically stops when 2L tank is full, preventing spillage
- Includes reservoir replenishing bottle, instructions and air line quick connector.



£130

LASER BRAKE CALIPER SPREADER, HYDRAULIC

PART NO: 8092

- Hydraulic brake caliper spreader for 2, 4 and 6 piston calipers, supplied with three sizes of spreader pad
- Hydraulic high force brake caliper spreader. Supplied with T-handle
- Spread range: 37 - 71mm
- Supplied with 3 sets of pads: 90 x 60mm, 150 x 60mm, 180 x 60mm
- For large 2, 4, and 6 piston calipers
- Centrally located hydraulic ram evenly spreads the force to prevent misalignment



£75

**All prices are subject to change without prior notice due to market fluctuation.

**All Prices Excl VAT



MILWAUKEE® tools and batteries come with a standard 1 year warranty. Warranty extensions are available by visiting www.milwaukeetools.co.uk



MILWAUKEE® tools warranty can be extended from 1 year to a maximum of 3 years (1+2). With the exception of MX FUEL™ tools for which warranty can be extended from 1 year to a maximum of 2 years (1+1).



All MILWAUKEE® REDLITHIUM™ batteries include MX FUEL™ batteries come with a standard 1 year warranty which can be extended to a maximum of 2 years (1+1).

All warranty extensions are subject to registering online within 30 days of the purchase date.

MILWAUKEE GUIDE

M12 = 12 volt Battery | M18 = 18 volt Battery

REDLITHIUM™ batteries provide up to 40% more run-time, 20% more power and 50% more recharges than conventional lithium-Ion batteries.



CONNECTED TOOLS

ONE-KEY™ tool control enables wireless tool customisation for increased productivity and consistent results.



ONE-KEY™ tool tracking & security offers a Cloud-based inventory management platform that supports both location tracking and theft prevention.

DIGITAL INVENTORY TOOL TRACKING CONNECTED TOOLS

MILWAUKEE

M18 FHIWF12-503X

M18 FUEL™ IMPACT WRENCH WITH FRICTION RING ½” RECEPTION KIT

PART NO: GEQ4933471259

- Includes 3 x M18 batteries, 1 x charger
- Compact size of 213mm
- 4-Mode drive control
- Delivers 1356Nm fastening torque



£450

RECOMMEND RUBBER BOOT PROTECTOR

MILWAUKEE

M12 FPP2BA-202B

M12™ COMBI DRILL & MULTI TOOL KIT

PART NO: GEQ4933478987

- M12 FMT
- M12 FPD
- 2 x M12 B2 Battery packs
- C12 C Charger



£350

CARRY BAG

MILWAUKEE

M18 FPP2AI-502B

M18 FUEL™ HIGH TORQUE IMPACT WRENCH & GREASE GUN KIT

PART NO: GEQ4933472104

- M18FHIWF12
- M18GG
- 2 x 5.0Ah Batteries



£450

CARRY BAG

MILWAUKEE

M18™ BRUSHLESS PERCUSSION DRILL

PART NO: GEQ4933464518

- Supplied with 2 x batteries
- Measuring only 180mm in length
- Advanced 13mm heavy duty metal chuck
- LED light



£320

KIT BOX

MILWAUKEE
M18™ FUEL™ COMPACT
IMPACT WRENCH WITH
1/2" FRICTION RING

PART NUMBER GEQ4933478443

NO BATTERIES OR CHARGER

- All new Tri-LED Lighting
- Compact design at only 124mm in length
- Power efficiency under load - outstanding torque of 339Nm

£135



DYNACASE

MILWAUKEE
M18 BPD-402C
M18™ COMPACT
PERCUSSION
DRILL KIT

PART NO: GEQ4933443518

- Supplied with 2 x batteries
- Compact percussion drill measuring only 198mm in length
- High performance 4-pole motor
- 13mm metal chuck

£135



KIT BOX

MILWAUKEE
CUT OFF TOOL

PART NO: GEQ4933464618

NO BATTERIES OR CHARGER

- Fast accurate cutting with up to 20,000 RPM
- Multi-material cutting capability
- Optimised for one-handed use

£115



MILWAUKEE
M12 IR-201B
M12™ COMPACT 3/8" IMPACT
RATCHET KIT

PART NO: GEQ4933448110

- Supplied with battery
- Variable speed metal paddle switch trigger
- Reinforced housing
- Compact design for tight spaces
- On board fuel gauge and LED light

£125



MILWAUKEE
M12 FUEL™
SUB COMPACT 1/2"
IMPACT WRENCH

PART NO: GEQ4933464615

NO BATTERIES OR CHARGER

- Up to 339Nm of maximum torque
- Brushless POWER STATE™ motor
- Digital overload protection

£115



HD BOX

MILWAUKEE
M12 FIWF12-622X
M12 FUEL™ 1/2"
IMPACT WRENCH
WITH FRICTION
RING KIT

PART NO: GEQ4933464617

- 1 x 6.0Ah battery
- Charger

£220



HD BOX

MILWAUKEE
M12 SUB COMPACT
PERCUSSION DRILL
KIT

PART NO: GEQ4933443889

INCLUDES

- 1 x charger
- Supplied with 2 x batteries
- Metal chuck
- 2-speed setting
- LED light

£220



HD BOX

MILWAUKEE
M18 FMTIW2F12-502X
M18 GEN 2 FUEL™ MID-TORQUE
IMPACT WRENCH WITH 1/2"
FRICTION RING KIT

PART NO: GEQ4933478451

- Includes charger, 2 x M18 batteries
- All new Tri-LED Lighting
- Compact design at only 152mm in length

£325



HD BOX

**All prices are subject to change without prior notice due to market fluctuation.

**All Prices Excl VAT

MILWAUKEE
M18 FUEL 1" HIGH TORQUE
D-HANDLE IMPACT WRENCH

PART NO: GEQ4933471757

- Supplied with 1 x battery
- Mode 4 bolt removal, provides a maximum nut-busting torque of 2711Nm
- ONE-KEY tool control enables wireless tool customisation
- ONE-KEY tool tracking & security (Cloud-based inventory management)



£790

MILWAUKEE
M18 ONEFHIWF12-503X
M18™ ONEKEY™ HIGH TORQUE
IMPACT WRENCH WITH FRICTION
RING ½" RECEPTION KIT

PART NO: GEQ4933464770

- 3 x 5.0Ah batteries
- Rapid charger



HD BOX

£480

MILWAUKEE
C12 RT-0
M12™ COMPACT ROTARY TOOL

PART NO: GEQ4933427183

NO BATTERIES OR CHARGER

- Versatile cordless solution for cutting
- Variable speed (5000 - 32,000 rpm)
- 3.2mm collet fits most current accessories in the market



£64

MILWAUKEE
M12 FUEL TYRE BUFFER

PART NO: GEQ4933472215

NO BATTERIES OR CHARGER

- Two-speed mode selector for reaming & buffing applications
- 7/16" quick change chuck
- Variable speed trigger
- On board fuel gauge and LED light



£110

HD BOX

MILWAUKEE
M12 FID-0
M12 FUEL™
IMPACT DRIVER

PART NO: GEQ4933459822

NO BATTERIES
OR CHARGER



£130

MILWAUKEE
M12 FUEL ANGLED
DIE GRINDER

PART NO: GEQ4933471438

NO BATTERIES OR CHARGER

- Compact size
- 4-Mode speed control
- To be used with discs up to ø50mm



£132

MILWAUKEE

**M18 FAP180-502X
M18 FUEL™ POLISHER KIT**

PART NO: GEQ4933451551

- 2 x 5.0Ah batteries
- Charger



£535

HD BOX

MILWAUKEE

**M18 FSAGV115XPDB-0
M18 FUEL™ 115MM BRAKING
VARIABLE SPEED SMALL ANGLE
GRINDER**

PART NO: GEQ4933478774

NO BATTERIES OR CHARGER



£140

MILWAUKEE

**M18 BPD-402C
M18™ COMPACT
PERCUSSION
DRILL KIT**

PART NO: GEQ4933443518

- Supplied with 2 x batteries
- Compact percussion drill measuring only 198mm in length
- High performance 4-pole motor
- 13mm metal chuck



£136

HD BOX

MILWAUKEE

**M18 FHZ-0X
M18 FUEL™ HACKZALL**

PART NO: GEQ4933459887

NO BATTERIES OR CHARGER

- Compact, one-handed design
- LED light
- Quik-lok blade clamp



£175

MILWAUKEE

**M18 FAP180-0
M18 FUEL™ POLISHER**

PART NO: GEQ4933451549

NO BATTERIES OR CHARGER

- Variable speed selection ranging from 360-2200RPM
- Removable dust protection guard
- World's first cordless polisher with 8 position variable speed selection, 3 position bale handle



£185

MILWAUKEE

**M18 BMT-0X
M18™ COMPACT MULTI TOOL**

PART NO: GEQ4933446203

NO BATTERIES OR CHARGER

- Up to 50% faster and versatile cordless solution for cutting
- 12 variable speed settings from 12,000 - 18,000 orbits per minute
- Brightest LED workspace illumination



£100

MILWAUKEE

**HD18 AG-115-0
M18™ 115MM ANGLE GRINDER**

PART NO: GEQ4933411210

NO BATTERIES OR CHARGER

- High performance 4-pole motor
- Full metal gear case
- Reduced height of gear box and slim girth design



£110

MILWAUKEE

**M18 FSAGV115XPDB-0X
M18 115MM VARIABLE SPEED &
BRAKING ANGLE GRINDER WITH
PADDLE SWITCH**

PART NO: GEQ4933478773

NO BATTERIES OR CHARGER

- Speed dial for maximum control
- RAPIDSTOP™ for fastest disc brake
- Anti-vibration side handle
- 115mm keyless guard



£150

**All prices are subject to change without prior notice due to market fluctuation.

**All Prices Excl VAT

MILWAUKEE M12 FPP2H-622P M12 FUEL™ AUTOMOTIVE POWERPACK

PART NO: GEQ4933471743

- M12FIR38 3/8 Ratchet
- M12FIWF38 3/8 Impact Wrench
- 1 x M12B6 12V 6.0AH Battery
- 1 x M12B2 12V 2.0 AH Battery



HD BOX

£350

MILWAUKEE M12 BPRT-201X M12™ POP RIVET TOOL KIT

PART NO: GEQ4933464406

- 1 x 4 piece Retaining Tips,
- 1 x 2.0Ah battery
- Charger



PACKOUT CASE

£245

MILWAUKEE M18 BHG-502C M18™ HEATGUN KIT

PART NO: GEQ4933459773

- Supplied with 2 x 5.0Ah batteries
- Charger
- BMC



HD BOX

£430

MILWAUKEE M18 ONEFHIWF12-502X M18 ONEKEY™ HIGH TORQUE IMPACT WRENCH WITH FRICTION RING 1/2” RECEPTION KIT

PART NO: GEQ4933459728

- 2 x 5.0Ah battey
- Rapid charger



£410

MILWAUKEE M12 FDGS-422B M12 FUEL™ STRAIGHT DIE GRINDER KIT

PART NO: GEQ4933471437

- 1/4" & 1/8" Collets
- 1 x 4.0Ah Battery
- 1 x Charger



BAG

£240

MILWAUKEE M12 FDGA-422B M12 FUEL™ ANGLED DIE GRINDER KIT

PART NO: GEQ4933471440

- 1/4" & 1/8" Collets
- 1 x 4.0Ah Battery
- 1 x Charger



BAG

£260

MILWAUKEE M18 BMT-0X M18™ COMPACT MULTI TOOL

PART NO: GEQ4933446203

NO BATTERIES OR CHARGER



£100

MILWAUKEE M18 FIW2F38-0X M18 FUEL™ COMPACT IMPACT WRENCH WITH 3/8” FRICTION RING

PART NO: GEQ4933478650

NO BATTERIES OR CHARGER



DYNACASE

£128

MILWAUKEE
40" STEEL WORK CART

PART NO: GEQ4932478857

- 45kg rated soft-close drawers
- 90kg rated sliding bottom shelf
- V-grooves to hold material when cutting or measuring
- Foldable rear shelf with 22 kg weight capacity
- 2 moveable shelves for storing bottles, sprays and other equipment
- Magnetic power strip allows to charge batteries directly on the cart
- 125mm industrial casters (2x fixed, 2x swivelling with brakes)



£490

315KG
TOTAL WEIGHT
CAPACITY

MILWAUKEE
M12 FIW38-202B
M12 FUEL™ 3/8" IMPACT WRENCH KIT

PART NO: GEQ4933478785

- 2 x 2.0a batteries
- Charger



CARRY BAG

£170

MILWAUKEE
M18 CBLPP2F-302X
SHOCKWAVE™ BIT SET
31 PIECE

PART NO GEQ4932472060

- Laser hardened Wear Guard™ Tip
- Shock Zone™ geometry
- Designed to flex and reduces stress at the tipx



£9

MILWAUKEE
M12 FHIR38-201B
M12 FUEL™ HIGH SPEED RATCHET 3/8" KIT

PART NO: GEQ4933478809

- 1 x 2.0Ah battery
- 3/8" to 1/4" Adaptor
- Charger



CARRY BAG

£190

MILWAUKEE
M12 FIR38-201B
M12 FUEL™ 3/8" RATCHET KIT

PART NO: GEQ4933459799

- 1 x 2.0Ah battery
- 3/8" to 1/4" Adaptor
- Charger



CARRY BAG

£185

MILWAUKEE
M12 FRAIWF12-622X
M12 FUEL RIGHT ANGLE IMPACT WRENCH 1/2" KIT

PART NO: GEQ4933478807

- 1 x 6.0Ah battery
- 1 x 2.0Ah battery
- Charger



£240

MILWAUKEE
M12 FIR14-201B
M12 FUEL™ 1/4" RATCHET KIT

PART NO: GEQ4933459901

- 1 x 2.0Ah battery
- 1/4" to 3/8" Adaptor
- Charger



CARRY BAG

£195

**MILWAUKEE
METRIC COMBINATION
SPANNER SET 15 PIECE**

PART NO: GEQ4932464258

- Chrome alloy steel, chrome plated
- MAX BITE™ open-end grip reduces rounding and stripping
- Rounded I-Beam handle for comfortable handling grip
- Ink-filled labels for clear visibility
- Lifetime warranty

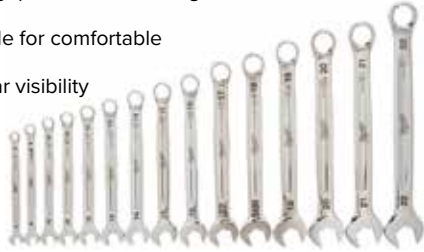

£89

**MILWAUKEE
M12 TLED-0
M12™ LED TORCH**

PART NO: GEQ4932430360

NO BATTERIES OR CHARGER

- 120 lumen LED light – 2x brighter/whiter than conventional incandescent bulbs
- M12™ LED electronics deliver 2x longer run time on a single charge with less heat
- Sealed aluminium head – designed for impact



£25

**MILWAUKEE
1/2 AUTOMOTIVE WHEEL SET 3 PIECE**

PART NO: GEQ4932451568

- Colour coded for easy identification
- Made from high quality alloy steel for strength and durability
- Set includes 1/2" impact sockets of 17mm, 19mm and 21mm length



£25

**MILWAUKEE
M18 TLED-0
M18™ LED TORCH**

PART NO: GEQ4932430361

NO BATTERIES OR CHARGER

- Sealed aluminium head
- The 120 lumen LED light is 2x brighter and whiter than conventional incandescent bulbs
- Integrated hook for hands-free use
- 135° rotating head



£25

**MILWAUKEE
M12 B2
M12™ 2.0AH
REDLITHIUM-ION™
BATTERY**

PART NO:
GEQ4932430064



£25

**MILWAUKEE
M18 B5
M18 5.0AH
REDLITHIUM-ION™
BATTERY**

PART NO: GEQ4932430483



£70

**MILWAUKEE
M12 6.0
REDLITHIUM-ION™
BATTERY**

PART NO:
GEQ4932451395



£55

**MILWAUKEE
M12-18FC
M12™-M18™ MULTI
FAST CHARGER**

PART NO:
GEQ4932451080



£49

**MILWAUKEE
M18 VC2-0
M18™ VACUUM
NO BATTERIES OR CHARGER**

PART NO: GEQ4933464029



£169

**MILWAUKEE
M12 RADIO
CHARGER
WITH
BLUETOOTH
NO BATTERIES
OR CHARGER**

PART NO: GEQ4933472115



£178

**MILWAUKEE
M12 TYRE
INFLATOR
NO BATTERIES OR CHARGER**

PART NO: GEQ4933464124



£147



MILWAUKEE
PACKOUT 2 DRAWER TOOL BOX

1 PIECE
PART NO:
GEQ4932472129



£224

MILWAUKEE
PACKOUT 3 DRAWER TOOL BOX

1 PIECE
PART NO:
GEQ4932472130



£240

MILWAUKEE
FOAM INSERT

2 PIECE |
FOR PACK
DRAWERTOOL BOX
PART NO: GEQ4932479157



£22

MILWAUKEE
PACKOUT FLAT TROLLEY

1 PIECE
PART NO: GEQ4932471068
• 113kg weight capacity
• Part of the
PACKOUT™
modular storage
system



£143

MILWAUKEE
PACKOUT
STARTER SET

PART NO: GEQ4932479957
• 1 x PACKOUT™ trolley box
• 1 x PACKOUT™ 2-drawers tool box
• 1 x PACKOUT™ slim organiser



£349

MILWAUKEE
PACKOUT™ FOAM INSERT

2 PIECE
PART NO: GEQ4932471428



£18

MILWAUKEE
PACKOUT CUSTOMISABLE
WORK SURFACE

1 PIECE
PART NO: GEQ4932472128



£85

**All prices are subject to change without prior notice due to market fluctuation.
**All Prices Excl VAT

SEALEY EXHAUST FUME EXTRACTION SYSTEM SINGLE DUCT

370W

PART NO: EFS101

- Wall mounting electric fan fitted with heat resistant ducting and exhaust pipe cone with exhaust gas analyser port.
- Ideal for bikes, cars and car-derived vans.
- Requires installation onto workshop wall and ducting to expel exhaust gases.
- Does not include electrical switch gear.
- Ideal for smaller garages and workshops where space is limited.
- Single hose configuration.



£1,550

SEALEY BEARING & SEAL INSTALLATION KIT

37 PIECE

PART NO: VS7024

- Lightweight design for the installation of bearings without damaging the bearing or housing.
- Contains three metal bearing drift sleeves and 34 nylon drifts.
- Can also be used to install oil



£190

SEALEY BENCH/PORTABLE PARTS CLEANING TANK 15L

PART NO: SM21

- One-piece tank with triple baked finish and fully sealed magnetic drive pump unit with replaceable impeller.
- Smaller capacity tank is suitable for benchtop mounting.
- Recirculated fluid is filtered before entering the pump and is directed over the workpiece with a flexible metal



£99

LASER MINIATURE COMBINATION SPANNER SET 3.2 - 5.5MM |

6 PIECE

PART NO: 7265

- Miniature Combination Spanner Set 3.2 - 5.5mm 6pc
- Single Hex sizes (6pt): 3.2, 3.5, 4, 4.5, 5mm. Length: 100mm.
- Bi-Hex size (12pt): 5.5mm. Length: 100mm.



£12

LASER ULTRA THIN OPEN ENDED SPANNER SET 10 PIECE

PART NO: 6996

- A complete set of double ended, ultra-thin open-ended spanners, from 6mm to 24mm, ideal when space is restricted.
- Contents: 6 x 7mm (2.1mm thick); 8 x 9mm, 10 x 11mm (2.5mm thick); 12 x 13mm, 14 x 15mm (3.5mm thick); 16 x 17mm (4.5mm thick); 18 x 19mm (4.5mm thick); 20 x 22mm (5.2mm thick), 21 x 23mm, 22 x 24mm (5.5mm thick).



£85

LASER COMBINATION SPANNER SET 8 - 19MM | 12 PIECE

8 - 19MM | 12 PIECE

PART NO: 1798

- Value set of metric combination spanners manufactured from chrome vanadium with a satin finish and polished jaws. A useful medium sized set that includes every size from 8mm to 19mm



£12

LASER COMBINATION SPANNER SET 6 - 32MM | 25 PIECE

6 - 32MM | 25 PIECE

PART NO: 6396

- Comprehensive set of 25 Bi-Hex (12pt) combination spanners in a fully polished finish.
- Sizes: 6, 7, 8, 9, 10, 11, 12, 13, 14, 15, 16, 17, 18, 19, 20, 21, 22, 23, 24, 25, 26, 27, 28, 30 and 32mm.
- Bi-Hex (12pt) profile with 15° offset head for faster and easier use in tight spaces.



£50



LASER
PRECISION TOOL KIT

33 PIECE

PART NO: 56049

- With extending driver, flexible shaft, 30 assorted bits & magnifying glass.



£9

LASER / KASMA
SOCKET SET 3/4" D 26 PIECE

PART NO: S4985

- 26 piece, heavy duty 3/4" drive socket set with Metric and AF sockets plus essential accessory set in metal storage case, manufactured from Chrome Vanadium with a fully polished finish.



£175

SEALEY
FOLDING MECHANIC'S MAT WITH HEADREST 35MM

PART NO: VS860

- 35mm Folding Mechanic's Mat with Headrest
- Highly portable foldable work mat with headrest.
- Can be used folded for kneeling or unfolded for under vehicle work
- Ideal for working on cold garage floors or for roadside repairs
- Folds away neatly with hook-and-loop straps when not in use



£45

SEALEY
3 DRAWER PORTABLE TOOLBOX

585MM

PART NO: AP1003



£129

SEALEY
HOSE CLIP REMOVAL TOOL SET

9 PIECE

PART NO: VS1662

- All the hose clip tools you are likely to need in one case
- Comprehensive set features heavy-duty construction with ratchet locking mechanism on most pliers
- Vinyl dipped handles give additional comfort



£103

SEALEY
MAGNETIC CABLE TIE HOLDER

RED

PART NO: APCTH



Fantastic Value

£22

SEALEY
PNEUMATIC MECHANIC'S SEAT

PART NO: SCR15



£75

SEALEY
TYRE STORAGE/TRANSPORT DOLLY

PART NO: STR006



£55

**All prices are subject to change without prior notice due to market fluctuation.
**All Prices Excl VAT

**SEALEY
HEAVY-DUTY WORKBENCH WITH
CUPBOARD**

PART NO: AP2010



£320

**SEALEY
23 DRAWER TOOL CHEST
COMBINATION WITH
BALL-BEARING SLIDES**

BLACK WITH 446 PIECE TOOL KIT

PART NO: TBTPBCOMBO4

FEATURES

- 10 Drawer Topchest with Ball Bearing Slides - Black
- Overall Size (W x D x H): 1265 x 435 x 490mm.



£3,300

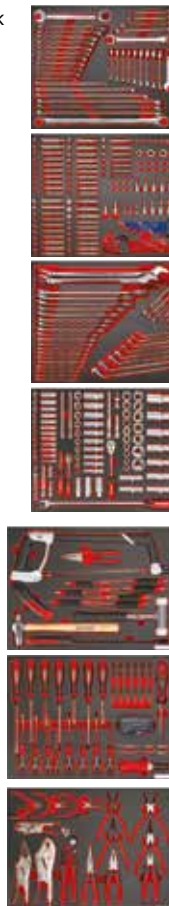

**SEALEY
14 DRAWER TOPCHEST,
MID-BOX & ROLL CAB STACK**

BLACK

PART NO: AP22BSTACK

FEATURES

- Smooth ball-bearing slides and cylinder locks with locking bar to secure the drawers in place for additional security.
- Side handle and four castors (two fixed and two locking) to aid mobility around the workshop.
- This item is heavy. Extra assistance must be provided at the delivery point to help its safe delivery.



£650

**SEALEY
TOOL CHEST COMBINATION
23 DRAWER WITH BALL BEARING
SLIDES BLACK**

PART NO: AP52COMBO2

- All heavy gauged steel construction
- 45mm ball bearing drawer slides
- Rust and solvent resistant



£1,800



SEALEY
STEEL INDUSTRIAL WORKBENCH

2.1M
PART NO: API2100



£500

SEALEY
MOBILE WORKSTATION
16 DRAWER WITH BALL-BEARING SLIDES

PART NO: AP24216

- Heavy gauge steel with double wall construction for extra strength and durability.
- Fitted with oversized, heavy-duty Ø160mm wheels, two fixed and two locking castors.
- Ball-bearing drawer slides provide superior performance and carry heavier loads.
- Each drawer fitted with catch to prevent unexpected opening when being transported around the workshop.



£1,090



SEALEY
ADJUSTABLE-HEIGHT MOBILE WORKSTATION

PART NO: AP200

£130

SEALEY
5 SHELF RACKING UNIT
150KG CAPACITY PER LEVEL

PART NO: AP6150GS



£60



SEALEY
SUPERLINE PRO® 4.9M STORAGE SYSTEM PART NO: APMSSTACK17SS

£4,300

PACKAGE INCLUDES

- APMS56 - Modular Floor Cabinet 2 Door Full Height 915mm
- APMS54 - Modular Wall Cabinet Tambour Front 680mm (x2)
- APMS53 - Modular Wall Cabinet 680mm (x3)
- APMS59 - Modular 5 Drawer Cabinet 680mm
- APMS52 - Modular 2 Door Floor Cabinet 680mm

- APMS58 - Modular 5 Drawer Mobile Cabinet 650mm
- APMS51 - Modular 4 Drawer Cabinet 680mm
- APMS55 - Modular Floor Cabinet Full Height 600mm
- APMS67 - Modular Sink Unit 680mm
- APMS50BP - Modular Back Panel 615mm (x5)
- APMS50UCD - Modular System Upright Connector Double (x4)

- APMS50UCS - Modular System Upright Connector Single (x2)
- APMS50SSC - Stainless Steel Worktop 2040mm
- APMS50SSB - Stainless Steel Worktop 680mm

**All prices are subject to change without prior notice due to market fluctuation.
 **All Prices Excl VAT

SEALEY WORKSTATION WITH 2 DRAWERS, 2 CUPBOARDS & OPEN STORAGE

PART NO: AP1905A

- Fully lockable and features adjustable feet to help stability when placed on an uneven surface
- Supplied flat-packed with two keys
- Overall Size (W x D x H): 1690 x 600 x 865mm



£700

SEALEY EXCLUSION ZONE KIT

PART NO: HP55K1COMBO



£160

SEALEY COMBINED PULLER SET

18 PIECE
 PART NO: PS977



£58

SEALEY MECHANICAL BEARING SEPARATOR/ PULLER SET

12 PIECE
 PART NO: PS984



£115

SEALEY OIL DRAIN PLUG MASTER THREAD REPAIR SET

PART NO: VS661



£65

SEALEY SUMP PLUG & WASHER ASSORTMENT

534 PIECE
 PART NO: VS663



£65

SEALEY MECHANIC'S KNEELING MAT

28MM EVA
 PART NO: VS8573



£10

LASER / KAMASA SOCKET SET 1/4" D

58 PIECE
 PART NO: 56017



£45

Very Useful &
 Great Value

SEALEY AUTOMOTIVE COOLANT FILLER SET

PART NO: SEAVS0043

- Multipurpose coolant filling system, supplied with six reservoir adaptors, to fit popular sizes of reservoir
- Built-in shut-off valve and cleverly designed flow pipe system helps prevent air locks



£55



COOLING EDGE
ARENA R1234YF
R1234YF FULLY
AUTOMATIC AIR CON
SERVICE STATION

PART NO: CE92009AL

MACHINE COMPONENTS

- 10L cylinder capacity
- Refrigerant tank scale
- Automatic oil/UV dye injection
- Comprehensive vehicle database
- Self service replacement filters
- 1.8 charge line with coupling
- Refrigerate tank lock
- Heater blanket
- Easy read pressure gauges
- Fully programmable
- 3Mtr Charge Lines With Couplings

DASHBOARD FACILITIES

- High contrast back lit digital display
- Membrane keyboard
- Quick stop safety button
- Thermal Printer

INCLUDES

- Free F Gas Training for One Person
- Free Delivery & Commissioning
- Free Technical Helpline



COOLING EDGE
ARENA R134A
R134A FULLY
AUTOMATIC AIR CON
SERVICE STATION

PART NO: CE92006AL

MACHINE COMPONENTS

- Fully programmable
- Comprehensive vehicle database
- 10kg refrigerant cylinder
- Easy read pressure gauges
- Automatic oil discharge
- 100L min vacuum pump
- 400g per min recovery pump
- Counters for machine servicing
- Heater blanket
- 3Mtr Charge Lines With Couplings

DASHBOARD FACILITIES

- High contrast back lit digital display
- Membrane keyboard
- Quick stop safety button
- Thermal Printer
- Language selection

INCLUDES

- Free F Gas Training for One Person
- Free Delivery & Commissioning
- Free Technical Helpline

£1,999

FINANCE OPTIONS AVAILABLE

£1,899

FINANCE OPTIONS AVAILABLE

AIR CON
STARTER PACK

PART NO: CEACC3K



£599

AIR CON
DIAGNOSTIC
PACK

PART NO: CEACC4K



£170

AIR CON
DIAGNOSTIC
PACK

PART NO: CEACC6K



£170

AIR CON
STARTER PACK

PART NO: CEACC5K



£130

**All prices are subject to change without prior notice due to market fluctuation.
 **All Prices Excl VAT

CTR KHEOS PLUS R134 FULLY AUTOMATIC AIR CON SERVICE STATION

PART NO: CE92006KP



£2,195

Terms and Conditions apply.
 The machine must be serviced after Year 1 and Year 2.

MACHINE COMPONENTS

- Fully programmable
- Comprehensive vehicle database
- 10kg refrigerant cylinder
- Easy read pressure gauges
- Automatic recovery/vacuum/charge
- Automatic oil discharge

- 100L/Min Vacuum Pump
- 400g per min recovery pump
- Counters for machine servicing
- Heater blanket

INCLUDES

- Free f gas training for one person
- Free delivery & commissioning
- Free technical helpline

FINANCE OPTIONS AVAILABLE

CTR KRISTAL BASE R1234YF R1234YF FULLY AUTOMATIC AIR CON SERVICE STATION

PART NO: CE92009KB



£2,695

Terms and Conditions apply.
 The machine must be serviced after Year 1 and Year 2.

MACHINE COMPONENTS

- 10 Litre cylinder capacity
- 1 Electronic scales for gas
- Automatic oil/uv dye injection
- Comprehensive vehicle database
- Self service replacement filters
- 2.5m charging line with couplings
- Refrigerant tank lock

INCLUDES

- Free F Gas training for one person
- Free delivery & commissioning
- Free technical helpline

FINANCE OPTIONS AVAILABLE

AIR CON DIAGNOSTIC PACK

PART NO: CEACC6K



ONLY
 £170

AIR CON STARTER PACK

PART NO: CEACC5K



£130

AIR CON STARTER PACK

PART NO: CEACC3K



£599

AIR CON DIAGNOSTIC PACK

PART NO: CEACC4K



£170



TEXA

705R SERVICE STATION FOR R134A

PART NO: UKA6001

The latest TEXA “entry level” recharge station for vehicle air conditioning systems, designed with the precise objective of offering mechanics a simple but complete unit for all recovery and recharge jobs involving only R134a refrigerant, at an extremely competitive price.



FINANCE OPTIONS AVAILABLE

TEXA

707 TOUCH SERVICE STATION FOR R1234YF

PART NO: UKA6012

Latest recharge and maintenance station for vehicle air conditioning systems. It is designed and made for maximum simplicity and effectiveness in servicing systems filled with the new R1234yf refrigerant, mandatory within the European Community since January 2011 and now increasingly common.



FINANCE OPTIONS AVAILABLE

TEXA

712 TOUCH SERVICE STATION FOR EITHER R134A OR R1234YF DATABASE ON SD CARD

PART NO: 712

It is a mid-range model which boasts the typical technical features of the top-range models such as:

- The automatic maintenance service management
- The measuring of the amount of oil recovered with an electronic scale.

It can be purchased in the R134a or R1234yf version.



FINANCE OPTIONS AVAILABLE

TEXA

780 TOUCH BI-GAS SERVICE STATION

PART NO: UKA6012

Top of the range. Allows users to alternate services on vehicles equipped with refrigerants R134a and R123yf, as it has two tanks and two separate circuits for recovery, recycling and recharging.

Other distinctive features: airtight oil bottles, scale locking/unlocking device, refrigerant weight accuracy check system, automatic cleaning device for all the hydraulic ducts.

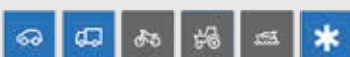

FINANCE OPTIONS AVAILABLE

CALL FOR LATEST PRICE

5

users included!



- Online Parts Catalogue
- VRM Parts Lookup
- Live Stock Availability
- 24/7 Online Parts Ordering
- Repair Times
- Fault Diagnostics
- Procedures
- Maintenance
- Adjustments
- Technical Drawings
- Fault Codes



WITH **HaynesPro**[®]

Helping your garage run smoothly

Technical Data, Fitment Times & Parts Ordering

0121 411 0770
Call us to start your FREE 14 day trial

14 day FREE trial

Monthly rolling contract

All inclusive PLATINUM +

Haynes e3 Technical	BRONZE	SILVER	PLATINUM	PLATINUM +
Product Support: Free email or telephone support during office hours	✓	✓	✓	✓
VRM Lookup: Access to technical data via a vehicle registration	✓	✓	✓	✓
Adjustment Data: Measurements, Dimensions, Settings	✓	✓	✓	✓
Lubricants & Fluids: Capacity, Viscosity, Type	✓	✓	✓	✓
Maintenance: Service procedures, service schedules, service times		✓	✓	✓
Repair Times: Produces estimates & quotes		✓	✓	✓
Procedures: Key programming, timing chains, service light resets		✓	✓	✓
Technical Drawings: Exploded drawings of components		✓	✓	✓
Fuse Locations: Locations of fuse boxes and fuse locations		✓	✓	✓
EOBD Locations: Locations of the EOBD interface			✓	✓
Engine Management: Schematic diagrams, component locations & fault code descriptions			✓	✓
Wiring Diagrams: Wiring schematics & component descriptions			✓	✓
Guided Fault Diagnostics: Component fault diagnostics			✓	✓

Packages start from **£12** per month

Monthly rolling contract

Bundle Options

AlliCat Online + e3technical		£12	£25	£50	£75
Vehicle Data	Provides accurate vehicle identification, with over 150 data fields				✓
Tyre Data	Tyre specifications for vehicles up to 3.5 tonnes				✓
OE Service Bulletins	Accurate vehicle specific manufacturer service bulletins				✓
Find A Fix	Identify and resolve issues help and tips from industry experts				✓
MOT	Identifying the vehicles MOT due date and warning you if it is due within 6 weeks, giving you the opportunity to book that customer's MOT at your workshop				✓

All prices listed above are a monthly subscription and are subject to VAT@ 20%.

Meeting the need for qualified staff in the ever growing MOT sector



Premier MOT Training is the UK's longest established independent Automotive & MOT Training Provider, catering to 600 plus students every year.

Specialising in Automotive Training for the Automotive Industry they cover a varied range of courses including Level 3 accreditation for those without formal industry qualifications, but with lots of experience; MOT Tester Training Classes 1, 2, 4 & 7; Class 3 and 5 bolt on and The Level 3 Managers qualification.

All our Trainers are qualified MOT Testers, qualified to Master Tech Level, all qualified in teaching training who have worked within the industry & colleges for many years to gain their expert knowledge.

Being one of the very few training providers who deliver the Award in MOT testing Classes 1 & 2 (motorbikes) at both of our in Essex and Derbyshire training centres.

We have a great working relationship with the DVSA and Awarding Bodies.

Donna Chapman, Managing Director, says "we have looked at the sheer numbers of tests being carried out and with over 9,000,000 tests being carried out in the first quarter of 2022, it's no wonder we've been inundated with students wanting training of this type." Readers may be interested to know that there are over

20,000 stations in the UK and almost 60,000 testers, so it's no wonder the market demand is at its highest.

Donna continues "One of the biggest areas we have noticed growth in is on Managers training.

With the recent DVSA changes a senior manager can now become the AEDM but if it isn't one of the Principles (AEP) and AEP must also attend the course.

We have also noticed several existing AEDM's returning for an up skill to help with their stations compliance.

Many stations aren't aware that site managers, even though it is not a requirement, can sit the managers course". Premier MOT have increased their availability of the Level 3 in MOT Centre Management courses to ensure we can meet the demand.

**CONTACT THE TEAM ON
0121 749 8801 FOR MORE DETAILS**



FOR ALL OF YOUR MOT STATIONS TRAINING NEEDS.

Award in MOT Testing | Hybrid & Electric Vehicles
MOT Pre Entry Qualification | Annual CPD Training & Assessment
Award in MOT Centre Management | F-Gas



Delphi **TRAINING ACADEMY**

**12 MONTHS ACCESS
CALL FOR MORE
INFORMATION**

£220

An e-learning platform that provides technicians with the ability to enhance their skills and knowledge across a wide range of topics.

8 MAIN TRAINING COURSES:

- Hybrid & Electric Vehicles
- ADAS
- Exhaust & After treatment
- Petrol Systems
- Diesel Systems
- Chassis Systems
- Vehicle Electrics
- Other Systems

FEATURES:

- **300+ individual training modules**
- Extensive video content filmed in real world workshop environment
- Interactive text and questions
- Engine simulator
- Training Needs Analysis questionnaires
- Own training profile containing all certificates earned
- Mock tests for IMI accreditation
- Designed for all devices including tablets and mobiles

Delphi Academy is a training platform developed by Delphi Technologies out of their state-of-the-art training facility in Warwick. The platform provides automotive technicians with an enhanced learning experience, offering not only face-to-face training but a wide range of training resources including (but not limited to) online videos, webinars, interactive simulations and access to industry expert lead information.

Titan 10 - Warwick

Delphi's Award-winning technical training centre directly incorporates Delphi's wealth of OEM technical expertise into Delphi's training material, ensuring you get only the best quality technical training, every time.

Developed by technicians for technicians

Delphi's training is all based on real world experience and scenarios. Case studies have shown that continued learning can also help automotive technicians stay motivated and engaged in their work. Learning new skills and techniques can provide a sense of personal fulfilment and satisfaction, and it can help technicians feel more confident and competent in their work.

COURSE CODE	DESCRIPTION	NO. OF DAYS	PRICE
DELSTT	Service technician - I.M.I. (Assessments only)	1	£250
DELDTT	Diagnostic technician - I.M.I. (Assessments only)	1	£250
DELFRG	F Gas Refridgerant Handling Qualification	1	£250
DELHV4	Hybrid and Electric Vehicles L4 NEW	2	£500
DELADS	Advanced Driver Assistance systems	2	£500
DELHV3	Hybrid and Electric Vehicles L3 NEW	2	£540
DELHVH	Hybrid and Electric Vehicle Hazards L2	2	£440
DELFFT	Fast fit Service Technician - I.M.I. (Assessments only)	1	£275
DELMST	Master Technician - I.M.I. (Assessments only)	1	£275
DELBR1	Braking Fundamentals	1	£225
DELSAS	Steering and Suspension	1	£225
DELWAT	Wheels and Tyres	1	£225
GEQDELEXH	Exhaust Systems	1	£225
DELVIO	Vehicle Inspection overview	1	£225
DELCST	Customer Service Training (Technical Staff)	1	£225
DELVE1	Vehicle Electrics 1	1	£225
DELOS1	Oscilloscope Introduction	1	£225
DELUE1	Understanding Emissions	1	£225
DELGE1	Gasoline Engine Management 1	1	£225
DELGE2	Gasoline Engine Management 2	1	£225
DELCR1	CR Hydraulic Diagnosis	1	£225
DELVE2	Vehicle Electrics 2	1	£225
DELVE3	Vehicle Electrics 3	1	£225
DELCR3	CR Advanced Diagnosis	1	£225
DELGD1	Gasoline Direct Injection	1	£225
DELOS2	Oscilloscope Advanced	1	£225
DELTOB	Turbo Operation & Diagnosis	1	£225
DELEAT	Exhaust After Treatment Operation & Diagnosis	1	£225
DELDSU	DS Diagnostic User	1	£225
DELCRI	Advanced Driver Assistance systems	2	£450
DELHV2	Hybrid and Electric Vehicles L2 NEW	2	£540
DELHV1	Hybrid and Electric Vehicles L1 NEW	1	£440

CPD M.O.T.



2023/2024



**MOT TESTER
ANNUAL TRAINING & ASSESSMENT**



**INSTITUTE OF THE
MOTOR INDUSTRY**

EMAIL: GARAGE.EQUIPMENT@GSFGROUP.COM PART NO: GEQCPDMOT

TRAINING SYLLABUS 2024

- Updates to testing standards since 20th May 2020
- Using the MOT testing service to check you're carrying out tests correctly
- Updating your user profile details on the MOT testing service
- Vehicle identification
- Tyres, lighting, brakes and suspension.
- The driver's view of the road
- The introduction section of the MOT inspection manual
- CPD courses run from 31st March 2023 to 31st March 2024.

DVSA MOT CHANGES

The DVSA have changed how existing MOT testers maintain their authorised status.

- All MOT testers are now required to:
- Complete 3 hours annual training
- Pass an Annual assessment
- Provide proof of training and assessment completion to DVSA

IMI CAN HELP EXISTING MOT TESTERS

IMI have created cost effective, flexible and time-saving packages, to meet all DVSA MOT Testers requirements:

- All MOT testers are now required to complete MOT annual training and annual assessment

MOTORCYCLE & CAR MODULE

Delivered by the IMI

- E-Learning module
- Assessment module

**CALL FOR
LATEST PRICE**

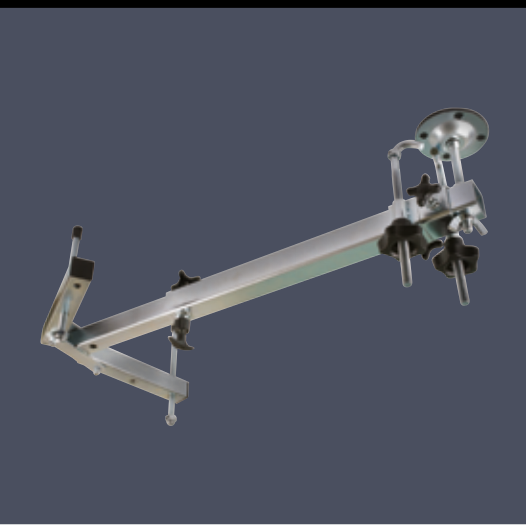

Lots of new products inside

Terms & Conditions

• Prices shown are for Trade Customers only. • Prices exclude VAT at current rate. • Prices correct at time of going to press September 2023. • Offer ends 31st March 2024. • Prices subject to change without notice. • Promotional items subject to availability. • Errors & Omissions excluded. • In all cases please contact local branch for full application/ fitment details. • Images shown are for illustration purposes only, and may or may not reflect the actual products. • Lease terms & conditions available FOC upon request. • All offers UK mainland only. • Specifications subject to change without notice. • Lease figures may vary according to status. • Non home owners & non established businesses may attract a higher rate. • All lease transactions are subject to a documentation fee.