



GREENBRIDGE

YOUR BRIDGE TO **BUNDLED**



PRODUCT CATALOG
2023 -2024

History of GREENBRIDGE

Greenbridge was originally founded in 1974 as Polychem and soon gained the reputation for having the broadest line of polyester, polypropylene and cord strapping in the industry. Complementary tools, equipment, and accessories were added to our product line. As we grew, so did our commitment to sustainable products and practices.

In 1998, Polychem established Evergreen as its recycling division and also to produce rPET. This assured a steady supply of 100% recycled PET resin for our growing portfolio of strapping and cord and created new markets for recycled rPET and other recycled material. Strategic acquisitions in the United States and Mexico sparked rapid growth and expanded our product portfolio to include corner board, strap accessories, power tools, equipment, and complete systems and services required for end-of-line packaging and supply chain solutions. Additional strategic acquisitions expanded our portfolio.

In 2003, we acquired a majority interest in OMS Americas, the second largest manufacturer of strapping systems in the world. In 2019, Dynaric was acquired, giving us new capabilities for printing on strap as well as additional production volume.

In 2020, Maillis, known for their jumbo coil capabilities, was acquired. This addition sparked growth and expanded our product portfolio to include more corner board options, additional power tools, equipment, and strap accessories.

In 2021, the organization rebranded as Greenbridge to reflect our commitment to providing proactive sustainability solutions to customers across North America. Given our experience in recycling and re-use, expertise in advanced manufacturing, focus on customer support and training, and ongoing investment in our people, plants, and processes, Greenbridge is a natural evolution of who we are and where we can make the greatest impact.

Our CO-BRANDS



TABLE OF CONTENTS

PLASTIC STRAPPING (Full Pallets Only)

Polypropylene (Polypro, PP).....	6 - 13
Polyester (PET).....	

CORD, CORD TOOLS + ACCESSORIES

Hot Melt.....	14 - 21
Woven.....	
Composite.....	
Lashing.....	
Bonded.....	

PLASTIC TOOLS, ACCESSORIES + KITS..... 22 - 46

CORNER BOARD..... 47 - 51

EQUIPMENT..... 52 - 65

SYSTEMS + HEADS..... 66 - 71

SERVICES

Tools + Equipment Repairs.....	72
--------------------------------	----

GUIDELINES..... 73 - 78

WARRANTY

The products provided by Greenbridge are made to rigid manufacturing standards and will be replaced if it is found that the product does not meet those standards. Greenbridge is not liable for any injury, loss or damage arising out of the use of its product. Greenbridge's only obligation shall be the replacement of product proven to be defective. Please make special note that machines and tools have a separate warranties.

WITH OUR INTEGRATED PRODUCT PORTFOLIO, GREENBRIDGE SATISFIES INDUSTRY-SPECIFIC, END-OF-LINE SECUREMENT SOLUTIONS

Need strap? We got that.

Hand tools and accessories? We got that, too.

Equipment? We have equipment to bundle, unitize and wrap.

And if you need parts and service, just ask. We service all brands.

Greenbridge's integrated approach to end-of-line packaging includes everything from high quality polyester and polypropylene strap and cord; printed strap for branding and identification purposes; corner board, tools for unitizing bundles to fully automatic strapping machines for securing pallets and loads. Our team can help you select strap and cord with the right strength and tension distribution as well as recommend the right tools and equipment and provide training. We support you across the life of your equipment with maintenance programs, repairs and helpful advice.



YOUR PRODUCTS ARE OUR PRIORITY

Greenbridge proudly serves a variety of industries. Our manual and power hand tools are effective and rugged enough for any environment. Our strapping and cord can perform nearly any task. And when you need something more specific, we have equipment and custom system options that will close the gap and get your products moving, securely. Greenbridge's team of experts can provide insights and recommendations for your securement needs. With over 50 years of experience, you can be certain we hold our products and our people to the highest standards. Put your trust in our skilled team of Sales, Service, and Engineering to bundle and customize the most efficient tools and strapping for your specific needs.

INDUSTRIES WE SERVE

*Appliances
Agriculture
Building Products*

*Can + Bottle
Corrugated
Distribution*

*Logistics
Printing
Protein*

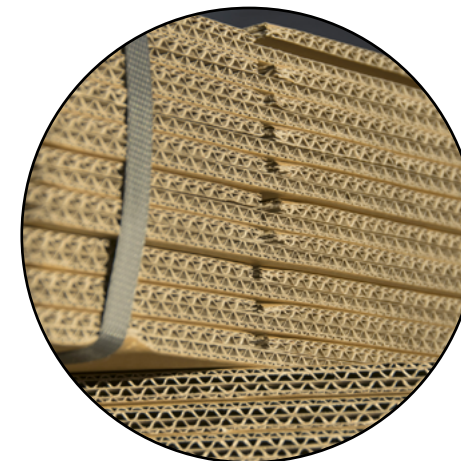

GREENBRIDGE STRAPPING PRODUCT CATEGORIES



Polypropylene

The most economical, and best suited for light to medium bundling and light unitizing/ palletizing.

Polyester

Rapidly replacing steel for medium to heavy duty unitizing/palletizing. Except for steel, polyester has the highest retained tension of all strapping.

Polyester Cord Strapping

Used like a flat rope; cord is portable and requires no tools. Cord comes in five types; bonded, woven, composite, hotmelt, and lashing. Woven has bi-directional fibers which provides split resistance.

Grades of Strapping

Machine/Systems Grade

Made to the highest specifications and contains no splices. It is made for use in high-speed automatic strapping machines.

Hand/Tool Grade

Made to less demanding specifications for hand applications including manual and power hand tools. Hand grade strapping may have up to one splice per coil.

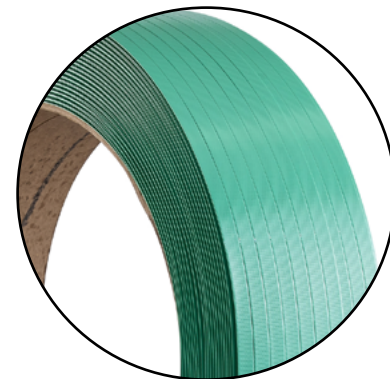

Strapping Texture

PET and PP strapping may be smooth or embossed and come in sheet and strand style products:

Smooth + Waxed

- Smooth strapping is generally run through friction seal equipment.
- Many smooth straps are waxed to work properly in a friction seal machine.

Embossed

- Embossed strapping is generally associated with heat seal equipment, however today there are exceptions as newer heat seal equipment will handle both smooth and embossed.
- Embossing allows for a more rapid melt for welding, split resistance, and in some strapping equipment, better feeding.
- Embossing gives the strap more rigidity (for the weight) for better feeding

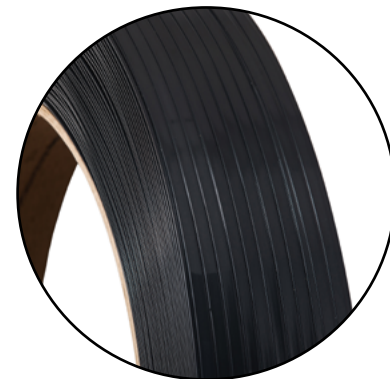

Polyester (PET)

PET can be smooth or embossed. It is only made in green or black. PET is glossy in appearance and very difficult to split.

Greenbridge's high tensile strength polyester strapping offers a superior product at a lower cost per foot than steel strapping. In most applications, heat or friction sealing the strap eliminates the extra cost and inventory of metal seals. More efficient, the typical PET coil weighs about half as much as a coil of steel and has more than twice the footage, reducing time consuming coil changeovers. For improved impact resistance, stain resistance, weather resistance, elongation, recovery, disposability and safety, polyester has no equal. When you combine all the above advantages with the fact that your customers are demanding it, the choice is clearly PET strapping.

Polyester (PET) Advantages

- High strength/tension
- PET is made in 3/8" minimum
- Low elongation
- Large packages
- Economics/high volume
- Recyclability/sustainability
- Safer than Steel

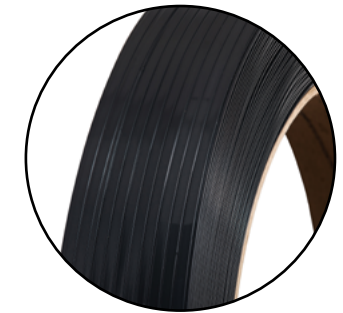

Polypropylene (PP)

Polypropylene is usually, but not always, textured or embossed. Polypropylene is most commonly made in black, white, yellow, and clear. Polypropylene is an economical solution.

Polypropylene (PP) Advantages

- Light duty bundling and arch machines (ex: newspapers)
- PP made in 3/16" minimum
- Easy to open seals
- Better colors, printing & branding
- Lighter weight (30 lb/coil vs. 50 lbs/coil)



Industry Key

MARKET	STRAP	REASON
NEWSPAPER	PP	Light duty
CORRUGATED (Bundling)	PP	Light duty
MAILING	PP	Light duty, clear
HAY BALES	PP	Printing & Colors, Low elongation
CAN & BOTTLE	PET	Large package, Low elongation, Retained tension
CORRUGATED (Pallets)	PET	Large package. Low elongation
LUMBER & BRICK	PET	High strength, High Tension
STEEL COILS	PET	High strength, High Tension

PLASTIC STRAPPING

HAND GRADE POLYESTER

POLYESTER STRAPPING FOR HEAVY DUTY USE

Minimal Elongation | Weather Resistant | Non-Corrosive | Safer than Steel

ITEM NUMBER	COLOR	CORE SIZE	NOMINAL WIDTH	NOMINAL THICKNESS	NOMINAL BREAK	FOOTAGE	WEIGHT PER PALLET	COILS PER PALLET	SMOOTH/EMBOSSSED	BOX/ BULK
HAND GRADE - POLYESTER (PET)										
HPD1260B3600	B	16 X 3	1/2"/12MM	0.02	600	3600	1280	56	SMOOTH - NO WAX	2/BOX
HPD1280B3250	B	16 X 3	1/2"/12MM	0.028	820	3250	1450	56	SMOOTH - NO WAX	2/BOX
HPC5890B4400	B	16 X 6	16MM	0.025	900	4400	1175	28	SMOOTH - NO WAX	BOXED
HPC5811G3600	G	16 X 6	16MM	0.03	1100	3600	1130	28	SMOOTH - NO WAX	BOXED
HPC5811B3600	B	16 X 6	16MM	0.03	1100	3600	1130	28	SMOOTH - NO WAX	BOXED
POWER TOOL GRADE - POLYESTER (PET)										
HPC581EG4600	G	16 X 6	16MM	0.03	1100	4,600	1405	28	EMBOSSSED - NO WAX	BULK
HPC58PTG4000	G	16 X 6	16MM	0.035	1400	4,000	1420	28	SMOOTH - WAXED	BULK
HPC583EG4000	G	16 X 6	16MM	0.035	1400	4,000	1375	28	EMBOSSSED - NO WAX	BULK
HPC5815G4200	G	16 X 6	16MM	0.035	1400	4,200	1440	28	SMOOTH - WAXED	BULK
HPC5816G4000	G	16 X 6	16MM	0.04	1600	4,000	1560	28	SMOOTH - WAXED	BULK
HPC584EG4000	G	16 X 6	16MM	0.04	1600	4,000	1565	28	EMBOSSSED - NO WAX	BULK
POWER TOOL GRADE - POLYESTER										
HPC1816G10500	G	16 X 6	1/2"/12MM	0.019	500	10500	675	12	Smooth - Waxed	BULK
HPC1818G9000	G	16 X 6	1/2"/12MM	0.021	600	9000	675	12	Smooth - Waxed	BULK
HPC1822G6500	G	16 X 6	1/2"/12MM	0.028	800	6500	675	12	Smooth - Waxed	BULK

HAND GRADE POLYESTER

POLYESTER STRAPPING FOR HEAVY DUTY USE

Minimal Elongation | Weather Resistant | Non-Corrosive | Safer than Steel

ITEM NUMBER	COLOR	CORE SIZE	NOMINAL WIDTH	NOMINAL THICKNESS	NOMINAL BREAK	FOOTAGE	WEIGHT PER PALLET	COILS PER PALLET	SMOOTH/EMBOSSSED	BOX/ BULK
SHEET - POLYESTER (PET)										
MPC1612G16000	G	16 X 6	3/8"/9MM	0.015	300	14500	16000	28	SMOOTH - NO WAX	BULK
MPC1614G14500	G	16 X 6	3/8"/9MM	0.02	400	14500	1755	28	SMOOTH - WAXED	BULK
MPC1715G11550	G	16 X 6	7/16"/10.5MM	0.021	500	11550	1675	28	SMOOTH - WAXED	BULK
MPC1725G11550	G	16 X 6	7/16"/10.5MM	0.022	500	11550	1755	28	SMOOTH - WAXED	BULK
MPC1717G9900	G	16 X 6	7/16"/10.5MM	0.024	550	9900	1655	28	SMOOTH - WAXED	BULK
MPC1720G9000	G	16 X 6	7/16"/10.5MM	0.026	600	9000	1595	28	SMOOTH - NO WAX	BULK
MPC1818G9000	G	16 X 6	1/2"/12MM	0.021	600	9000	635	12	SMOOTH - NO WAX	BULK
MPC1820G7200	G	16 X 6	1/2"/12MM	0.026	800	7200	1365	28	SMOOTH - WAXED	BULK
MPC1822G6500	G	16 X 6	1/2"/12MM	0.028	800	6500	610	12	SMOOTH - NO WAX	BULK

Greenbridge Recycled **Chopped Green PET** Strapping Policy

WHAT WE CAN TAKE:

- We purchase transparent green OR opaque green PET strapping only.
- Separation of colors is highly recommended.
- Transparent green PET holds a higher value.



RECYCLED PET PROTOCOL

- All strapping must be **GREEN PET ONLY** – no contamination
- Separation of colors is highly recommended
- Any contamination can result in a rejection of the delivery
- We cannot process PET strapping with PP strapping, paper, metal seals or other contamination
- All strapping must be very clean – zero tolerance
- We cannot accept strapping with any contamination – we do not have a way to clean material
- We do not accept chopped strapping in super sack bags, drums or cage/bladder totes
- Used boxes are accepted, but they must be clean
- We only pay for net weight of strapping in box

Contact Laurie Hall
lhall@greenbridge.com
 Direct phone:
 440-534-2033



CORD STRAPPING



- Economical vs. steel strapping
- Safe to use, handle, and dispose
- Light weight and portable
- Clean, will not stain or rust
- Elastic memory keeps loads tight
- Meets or exceeds ASTM designation D-3950
- Non-abrasive, non-marring
- Requires one tool to tension and cut
- AAR-53 approved sizes available
- Offers maximum impact resistance
- High joint efficiency + systems strength
- Custom color + print available

5 TYPES OF CORD STRAPPING

Bonded Cord Strapping (non-woven)

Bonded cord strapping is used as a safe, inexpensive product for bundling and securing a wide variety of items across a multitude of industries. From agriculture, nursery, landscaping, automotive, printing, light building products, to baling corrugated and plastic for recycling, bonded cord strapping is your best solution. Flame retardent regular duty bonded cord available.



BONDED

Woven Cord Strapping

Woven cord strapping provides additional bi-directional strength and split resistance often required in harsher environments. General purpose woven cord strapping is cost effective and ideal for securing and bundling light to medium/heavy loads for most industries. Heavy duty and extra heavy duty cord strapping are super tough-high tensile products designed for application to replace more expensive steel strapping. These products are used primarily for securing heavy and extra heavy loads in the bundling, metal and plastics industries as well as for rail car load securement.



WOVEN

Composite Cord Strapping

Composite cord strapping is made from polyester fibers coated with clear polypropylene. The clear polypropylene coating provides added water resistance protection and improved handling properties when threading the strapping under pallets and through metal buckles.



COMPOSITE

Hotmelt Cord Strapping

Hotmelt is the second generation of non-woven types. As the name implies, the bonding agent is a hot glue. It is more resistant to splitting and its surface is smooth. It has similar properties to Composite strapping. Coils will never get excessively sticky, even when left in storage for long periods of time, in any weather.



HOTMELT

Lashing

Lashing is our strongest product, with a break strength of up to 13,000 kg, (28,659 b). It is a woven type strap made from a higher strength yarn than our other products, and also has a higher material density (tight knit).



LASHING

Buckles for Cord Strapping



Phosphate finished buckles are for bonded and all woven cord to achieve proper joint strength.



Galvanized finished buckles are for composite cord to achieve proper joint strength.



How to Thread Cord Strapping onto Metal Buckles

BC2040 + BC3040

BATTERY-POWERED AND PNEUMATIC AIR TENSIONERS FOR CORD STRAP

Greenbridge's BC2040 battery-powered tensioner for cord strap tool produces tighter, safer and more secure package loads. The BC3040 is a Pneumatic version. Softer and safer cord strapping is easier on your hands, packages and contents. Your customers will appreciate their shipments arriving with less product damage strapped securely with cord strapping verses other methods of packaging.

Press down on top lever to load and cut cord strapping

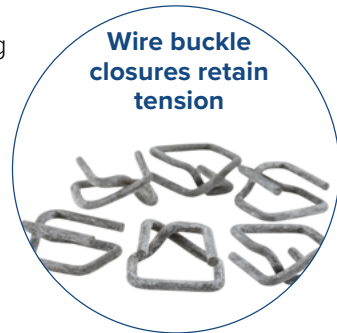

FEATURES

- Tool tensions and cuts cord strapping
- Secures strapping via a wire buckle
- Easy to use, two-step basic operation
- Strong, reliable, heavy-duty metal construction
- Very low maintenance

ACCESSORIES

The BC2040 comes with two batteries and a charger.



TOOL SPECS

Maximum Tension	2200 lbs.
Tensioning Speed	3.6"/sec.
Tool Length	13"
Tool Width	4.5"
Tool Height	6.3"
Tool Weight	11 lbs.
Strap Thickness	For cord up to 1.5" wide and .024" to .055" thick

TENSIONERS FOR CORD STRAPPING

CP3040

PNEUMATIC POWER TOOL FOR CORD STRAPPING

EQUIPMENT SPECS

Length	13"
Strap Size	Up to 1.5", .024 to .055 thick
Tension	Up to 3000 lbs
Weight	9.9lbs



Battery version available, BC2040

TH22

REGULAR DUTY WINDLASS CORD TENSIONER

EQUIPMENT SPECS

Length	10.5"
Strap Size	Up to 3/4"
Style	Windlass - non repairable
Weight	3 lbs



TH26

HEAVY DUTY WINDLASS CORD TENSIONER

EQUIPMENT SPECS

Length	12"
Strap Size	Up to 1.5"
Style	Heavy Duty Windlass
Weight	4 lbs



TH325

HEAVY DUTY WINDLASS CORD TENSIONER

EQUIPMENT SPECS

Length	11"
Strap Size	0.5" - 0.75"
Style	Heavy Duty Windlass
Weight	5 lbs



TENSIONERS FOR CORD STRAPPING

TH375

EXTRA HEAVY DUTY WINDLASS CORD TENSIONER

EQUIPMENT SPECS

Length	11"
Strap Size	.75" - 1.5"
Style	Extra Heavy Duty Windlass
Weight	9.9lbs



TRPB

EXTRA HEAVY DUTY WINDLASS CORD TENSIONER

EQUIPMENT SPECS

Length	12.5"
Strap Size	1/2", 5/8", 3/4"
Style	Extra Heavy Duty Windlass
Weight	4 lbs



BATTERY VS PNEUMATIC

HEAVY DUTY BATTERY

For portability and medium to heavy tensioning, battery powered tools are the answer. Whether out in the yard or way back in the plant, you won't need an air or electricity power source to operate these friction sealing tools.



HEAVY DUTY PNEUMATIC

For in-line production and medium to extra heavy tensioning applications an air powered friction sealing tool is your best choice. We recommend a counter balancer for tool suspension: use 400 0105 for tools up to 13 lbs. and 400 0237 for tools up to 24 lbs.



BONDED CORD STRAPPING - REGULAR DUTY 3"X5" CORE



ITEM NUMBER	WOVEN	STD. COLOR	NOMINAL WIDTH	FOOTAGE	BREAK	RECOMMENDED BUCKLE	COILS PER PALLET	COILS PER BOX	WEIGHT PER PALLET
PC2030	N/A	W	1/4"	7800	350	HAND TIE	48	4	850
PC3045	N/A	W/ L	3/8"	5250	500	HAND TIE	48	4	790
PC30RS	N/A	W/ L	3/8"	1125	500	HAND TIE	300	1	1200
PC301650Y	N/A	Y	3/8"	1650	500	HAND TIE	96	4	550
PC4060	N/A	W/ L	1/2"	3900	650	SB12HDP	48	4	830
PC5075	N/A	W	5/8"	3000	800	SB58XDP	48	4	790
PC5012	N/A	W	5/8"	2000	1175	SB58X15P	48	4	880

BONDED CORD STRAPPING - FLAME RETARDANT REGULAR DUTY 3"X5" CORE

ITEM NUMBER	WOVEN	STD. COLOR	NOMINAL WIDTH	FOOTAGE	BREAK	RECOMMENDED BUCKLE	COILS PER PALLET	COILS PER BOX	WEIGHT PER PALLET
PCA20S	N/A	Y	1/4"	3000	750	HAND TIE	120	4	690
PCA30S	N/A	Y	3/8"	3000	1150	HAND TIE	120	4	860
PCA40S	N/A	Y	1/2"	1500	1250	SB12HDP	120	4	590

COMPOSITE CORD STRAPPING - HEAVY DUTY 8X8 CORE



ITEM NUMBER	WOVEN	STD. COLOR	NOMINAL WIDTH	FOOTAGE	BREAK	RECOMMENDED BUCKLE	COILS PER PALLET	COILS PER BOX	WEIGHT PER PALLET
CC40	NO	W	1/2" X .040	3610	660	SB12HDG	72	2	1670
CC50	NO	W	5/8" X .040	2790	950	SB58XDG	72	2	1670
CC55	NO	W	5/8" X .040	2000	1200	SB58X15G	72	2	1670
CC60	NO	W	3/4" X .040	1968	1050	SB34XDG	72	2	1382
CC65	NO	W	3/4" X .045	1640	1400	SB34XDG	72	2	1310
CC69	NO	W	3/4" X .050	1640	1740	SB34X17G	72	2	1598
CC85	NO	W	1" X .045	1640	1800	SB1HDG	72	2	1742
CC89	NO	W	1" X .045	1300	2700	SB1XDG	72	2	1994
CC105	NO	W	1.25" X .055	770	3320	SB114XDG	72	2	1454
CC105A	NO	W	1.25" X .055	820	3285	SB114XDG	72	2	1598

ITEM NUMBER DESCRIPTION

PC	40	60	W	R
Polyester Cord=PC	Item Code	Break Strength	T/W=Woven N/A=Bonded	Color

STANDARD COLORS

W - WHITE O - ORANGE Y - YELLOW
L - BLUE R - RED G - GREEN
WB - WHITE WITH BLUE TRACER
*OTHER COLORS AVAILABLE UPON REQUEST

WOVEN CORD - GENERAL PURPOSE
3"X5" CORE



ITEM NUMBER	WOVEN	STD. COLOR	NOMINAL WIDTH	FOOTAGE	BREAK	RECOMMENDED BUCKLE	COILS PER PALLET	COILS PER BOX	WEIGHT PER PALLET
PC3045W	W	W/R	3/8"	5250	500	HAND TIE	48	4	980
PC4060W	W	W/Y/LT	1/2"	3900	700	SB12HDP	48	4	830
PC40WPT	W	W	1/2"	1500	700	SB12HDP	120	4	960
PC40T	W	W	1/2"	3900	700	SB12HDP	48	4	930
PC5075W	W	W	5/8"	3000	800	SB58XDP	48	4	880
PC50T	W	W	5/8"	3000	800	SB58XDP	48	4	800
PC6090W	W	W	3/4"	2100	950	SB34SDP	48	2	710
PC60WPT	W	W	3/4"	1000	950	SB34SDP	120	1	715
PC60T	W	W/G	3/4"	2100	950	SB34SDP	48	2	580

WOVEN CORD - HEAVY/EXTRA HEAVY DUTY
3"X5" CORE

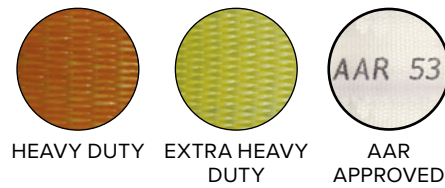

ITEM NUMBER	WOVEN	STD. COLOR	NOMINAL WIDTH	FOOTAGE	BREAK	RECOMMENDED BUCKLE	COILS PER PALLET	COILS PER BOX	WEIGHT PER PALLET
PC50WH	W	W	5/8"	2000	1500	SB58X15P	48	2	940
PC50TX	W	W/O	5/8"	2000	1500	SB58X15P	48	2	900
PC60TX	W	W/Y	3/4"	1675	1800	SB34X17P	48	2	870
PC65WQ	W	W/O	3/4"	1650	2400	SB34X17P	48	2	1070
PC75T	W	W/O/G	3/4"	1650	2400	SB34X17P	48	2	1020
PC75TA*	W	W	3/4"	1650	2400	SB34X17P	48	2	1020
PC100T**	W	W/O/Y	1"	660	2700	SB1HDP	48	4	470
PC100T1	W	W	1"	1080	2700	SB1HDP	48	2	800
PC105T**	W	W/O/Y	1 1/4"	660	3300	SB114XDP	48	4	600
PC105T1	W	W	1 1/4"	1080	3300	SB114XDP	48	2	940
PC105TA*	W	W/O/L	1 1/4"	660	3900	SB114XDP & SB105LAD	48	4	690
PC150TY	W	Y	1 1/2"	600	4400	SB114XDP	48	4	830
PC150TX	W	W/O	1 1/2"	600	5400	SB114XDP	48	4	810
PC150TXA*	W	W/O	1 1/2"	600	5400	SB150LAD	48	4	810

ITEM NUMBER DESCRIPTION

PC	105	W	X	O
Polyester Cord	Item Code	T/W=Tight Weave/Woven N/A=Bonded	Extra Heavy Duty	Color

* AAR Approved; Certificate available upon request.
** 1" up to 1 1/2" ribbon wound cord on 3" core.

HOTMELT BONDED CORD - HEAVY DUTY
8X8 CORE



ITEM NUMBER	TYPE	WIDTH	NOMINAL BREAK STRENGTH	LENGTH PER COIL	WEIGHT PER COIL	SUGGESTED BUCKLE
30143	HM B40	1/2"	882	820	3.7	N/A
PACKAGED 8 COILS PER BOX 288 COILS (36 BOXES) PER PALLET						
30192	HM45	1/2"	1,279	3,623	23.4	CB4LD
30048	HM48	1/2"	1,528	3,085	26.2	CB4LD
30193	HM55	5/8"	1,627	2,843	24.6	CB5HD
30594	HM65	3/4"	2,130	2,423	26.8	N6, N6HD
PACKAGED 2 COILS PER BOX 96 COILS (48 BOXES) PER PALLET						
30775	HM60	3/4"	1,625	2,641	20.9	N6, N6HD
PACKAGED 2 COILS PER BOX 72 COILS (36 BOXES) PER PALLET				COIL SIZE (INCHES): 3 X 5 1/2 X 11 COLOUR: NATURAL		

LASHING CORD - HEAVY DUTY
8X8 CORE

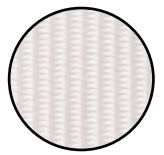

ITEM NUMBER	TYPE	WIDTH	NOMINAL BREAK STRENGTH	LENGTH PER COIL	WEIGHT PER COIL	SUGGESTED BUCKLE
*20150	AG40	1.625"	7700 LBS	820'	35 LBS	*BN1431
*20150-1	AG40	1.625"	7700 LBS	10,000'	429 LBS	*BN1431
*20201	AG50	1.625"	11000 LBS	656'	40 LBS	*BN1431
*20800	AG75	2"	16500 LBS	656'	57 LBS	*LG75

*AAR APPROVED

PRE-CUTS



Item Number	TYPE	WIDTH INCHES	NOMINAL BREAK STRENGTH LBS	LENGTH PER COIL FEET	WEIGHT PER COIL LBS	SUGGESTED BUCKLE
30011	HM11	7/16	300	18	28.16	C4
PACKAGED 500 PRE-CUTS PER BOX 16 BOXES PER PALLET				C4 BUCKLE ATTACHED		

THE EVOLUTION SERIES

FULLY AUTOMATIC, BATTERY POWERED SMART STRAPPING TOOLS NOW WITH APP!

The world's first lever-free tool on the market, the patent-protected EVOLUTION Series is a fully automatic, battery-operated smart-technology enabled strapping tool that redefines tensioning and sealing performance.



EVOLUTION LT

EVOLUTION LT SPECIFICATIONS

Maximum Tension	Up to 600 lbs.
Battery	18V, 4Ah Li-Ion
Seal	Friction Weld 7.2"/sec.
Polypropylene + Polyester Strap	
Tool Length	13"
Tool Width	5.5"
Tool Height	5.3"
Tool Weight	9.7 lbs. with battery
Strap Width	1/2"–5/8"
Recommended Strap Thickness	.019"–.036"
Includes Charger + 2 Batteries Option	Makita™ compatible (BL1840) spare battery

THE EVOLUTION HT IS A POWERHOUSE!

Pulls Up to 1,000 lbs. of tension and gets to full tension pronto.



EVOLUTION HT SPECIFICATIONS

Maximum Tension	Up to 1000 lbs.
Battery	18V, 4Ah Li-Ion
Seal	Friction Weld 4"/sec.
Polypropylene + Polyester Strap	
Tool Length	13"
Tool Width	5.3"
Tool Height	5.3"
Tool Weight	10.2 lbs. with battery
Strap Width	5/8" - 3/4"
Recommended Strap Thickness	.0028"–.05"
Includes Charger + 2 Batteries Option	Makita™ compatible (BL1840) spare battery

At the core of the EVOLUTION Series is integrated Bluetooth smart technology that enables all setups to be done on a smart phone or tablet. This rugged, ergonomically designed tool is lighter, faster, and gets to the desired tension faster than previous generations. Because there's no lever, it's also safer and easier to operate.

You need these tools.

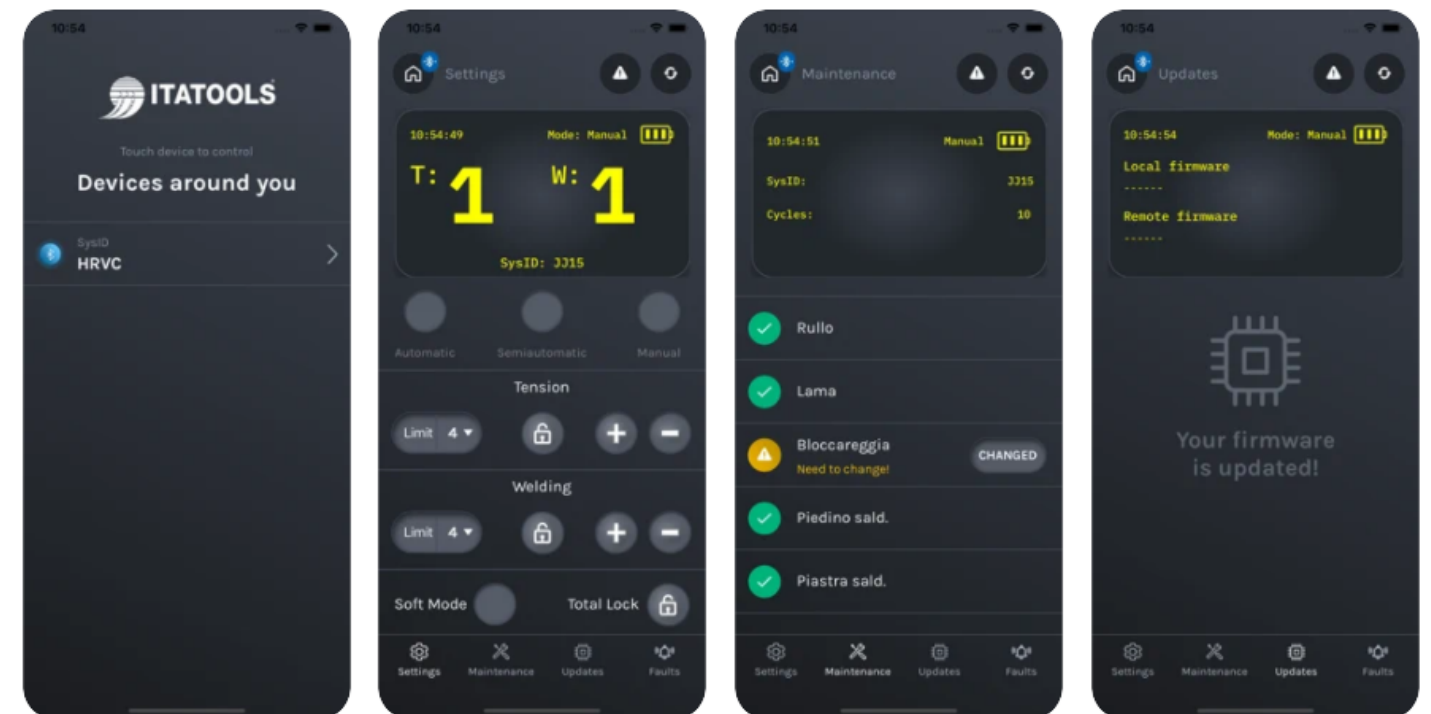

FEATURES

- Bluetooth-enabled smart technology
- Control all settings with app or touch screen
- Set + lock tensioning force, weld time + operating mode
- Allows supervisor to set + lock tool functions
- Soft mode setting for easily damaged products
- Maintenance screen includes battery status
- Install software updates with the app
- Intuitive interface, easy-to-master operation

B600 + B1200

FULLY AUTOMATIC, BATTERY POWERED FRICTION WELD STRAPPING TOOLS

HOW MUCH POWER DO YOU NEED?

The B600 tool pulls up to 600 lbs. of tension. and the B1200 tool pulls up to 1200 lbs. of tension.



Need a versatile strapping tool that can secure any assignment you throw at it? Greenbridge's B600 and B1200 fully automatic friction weld tools give you the strength and tension you need—pulling up to 1,200 pounds— with convenience of battery power. These powerful tools accommodate polypropylene and polyester plastic strapping. Simple strap guide changes and instructions are included to ensure proper strap tracking with this higher tensioning technology. The 14.8V lithium polymer battery weighs less and is more efficient in power output compared to nickel-cadmium and lithium-ion batteries of higher voltage. Both tools can be fully re-charged at any time without memory loss.

RUNS LONGER!

1 battery charge gets up to 300 cycles per charge.

FEATURES

- One button operation
- Lithium polymer battery
- DC brushless motors
- Tools come with 2 batteries, 1 charger

TOOL SPECS

	B600	B1200
Maximum Tension	600 lbs.	1200 lbs.
Battery	14.8V, 2.0Ah, Li-Po	14.8V, 3.0Ah, Li-Po
Seal	Friction weld	Friction weld
Tensioning Speed	10.4 inches/second	10.4 inches/second
Tool Length	11.8"	11.8"
Tool Width	5.9"	5.9"
Tool Height	6.3"	6.3"
Tool Weight	8.8 lbs.	8.8 lbs.
Strap Width	1/2"–5/8"	5/8"–3/4"
Recommended Strap Thickness	.019"–.030"	.031"–.050"
Battery Charge Time	20–40 minutes	20–40 minutes
Seal Strength	80% plus of the break strength of the parent strap based on quality	
Option	Suspension bracket, HD wear plate	

B300

ECONOMY BATTERY-POWERED, FRICTION WELD TOOL

TOOL SPECS

Maximum Tension	300 lbs.
Battery	14.4V, 3.0Ah, Li-Ion
Seal	Friction weld
Tensioning Speed	5"/second
Tool Length	12.5"
Tool Width	5.5"
Tool Height	6.5"
Tool Weight	8.8 lbs.
Strap Width	1/2" – 5/8"
Recommended Strap Thickness	.020 – .030
Seal Strength	75% plus of the break strength of the parent strap based on quality

ACCESSORIES

The B300 comes with two batteries and a charger.



B301 Charger	
Code	301CHG
Power Supply	60Hz 35W
Output	116.4V 3A 35W



B301 Battery	
Item Number	B301BAT
Type	Lithium Ion
Output	14.84V, 3.0Ah

MIGHTY MITE!
The B300 pulls up to 300 lbs. of tension



B2000

TOP-OF-THE-LINE, BATTERY-POWERED, FRICTION WELD TOOL

Optional 4.0Ah Battery



TOOL SPECS

Maximum Tension	2000 lbs.
Battery	36V, 2.0Ah, Li-Ion
Seal	Friction weld
Strap Type	Polyester
Tensioning Speed	7"/second
Tool Length	11.8"
Tool Width	5.9"
Tool Height	7.9"
Tool Weight	14.2 lbs.
Strap Width	1" – 1-1/4"
Recommended Strap Thickness	.040– .050
Seal Strength	80% plus of the break strength of the parent strap based on quality

ACCESSORIES

The B2000 comes with two batteries and a charger. Optional 3/4" strap guide is available.



B2000 Battery	
Item Number	B2000BAT
Type	Lithium Ion
Output	36V, 2.0Ah



B2000 Charger	
Code	2000CHG
Power Supply	60Hz 375W
Output	14.4V 3.6V 2A

B400

DESCRIPTION

EQUIPMENT SPECS

Maximum Tension	450 lbs.
Battery	4.8V, 3.0Ah, Li-Po
Seal	Friction Weld
Strap Type	Polypropylene + Polyester
Tensioning Speed	5.9"/sec.
Tool Length	11.4"
Tool Width	5.5"
Tool Height	6.6"
Tool Weight	7.9"
Strap Width	3/8", 7/16", 1/2", 5/8"
Recommended Strap Thickness	.019 – .030
Seal Strength	80% of Strap Break Strength



ACCESSORIES

The B400 comes with two batteries and a charger.

B1000

ROBUST, BATTERY-POWERED, FRICTION WELD TOOL

EQUIPMENT SPECS

Maximum Tension	1125 lbs.
Battery	14.8V, 3.0Ah, Li-Po
Seal	Friction weld
Tensioning Speed	5.9"/second
Tool Length	12.4"
Tool Width	5.5"
Tool Height	7.2"
Tool Weight	8.84 lbs.
Strap Width	5/8" – 3/4"
Recommended Strap Thickness	.031 – .050
Seal Strength	80% plus of the break strength



ACCESSORIES

The B1000 comes with two batteries and a charger.



B1000 Battery	
Item Number	B800BAT
Type	Lithium Polymer
Output	14.8V, 3Ah



B1000 Charger	
Code	400CHG
Power Supply	60Hz 80W
Output	16V 5A

B800

DESCRIPTION



EQUIPMENT SPECS

Maximum Tension	850 lbs
Battery	14.8V, 3.0Ah, Li-Po
Seal	Friction Weld
Strap Type	Polypropylene + Polyester
Tensioning Speed	5.9"/sec.
Tool Length	11.4"
Tool Width	5.5"
Tool Height	6.5"
Tool Weight	7.9"
Strap Width	3/8", 7/16", 1/2", 5/8"
Recommended Strap Thickness	.019 – .030
Seal Strength	80% of Strap Break Strength

ACCESSORIES

The B800 comes with two batteries and a charger.



B800 Battery	
Item Number	B800BAT
Type	Lithium Polymer
Output	14.8V, 3Ah



B800 Charger	
Code	400CHG
Power Supply	60Hz 80W
Output	16V 5A

MT320

BATTERY STRAPPING TOOL FOR PP AND PET STRAP

The MT320 battery strapping tool has adjustable functioning modes to fit your application: automatic, semi-automatic, manual and "soft". The MT 320 strapping tool is equipped with the latest generation Li-Ion batteries with no 'memory effect' and a brushless motor to ensure superior strapping tool performance at the highest cycle speed and tension in the market. Perfectly balanced, it is safe and easy to operate thanks to its unique opening system. The MT 320 is an effective and efficient strapping tool designed to exceed the requirements for a wide range of applications.

EQUIPMENT SPECS

Strap	PP/PET
Strap Width	From 10 mm up to 16 mm
Strap Thickness	From 0.5 mm up to 1.10 mm
Max. Tension	3.200 N
"SOFT" Mode	500 N
Max. Tension Speed	10.5 in/sec.
Join Type	Friction weld seal
Weight	8 Lbs. (Inc. battery)
Battery	Akku™ Power 14.4 V 3.3 Ah Li-ion



EXTREME

BATTERY STRAPPING TOOL FOR PLASTIC STRAP

TOOL SPECS

Strap	PP/PET
Strap Width	16mm/19mm
Strap Thickness	0.7 - 1.27
Max. Tension on single strap	4.200 N
Max. Tension on package	8.400 N
Max. Tension speed	9.0 mt/min
Join Type:	Friction weld
Weight	4 kg. (includes battery)
Battery	Akku Power SP5 18 Vdc 5 Ah Li-Ion



OPTIONS

- Additional Akku™ Power SP5 Battery 18 Vdc - 5 Ah Li-Ion
- Battery charger for Li-Ion Battery Akku™ Power

MT650

HEAVY-DUTY BATTERY STRAPPING TOOL FOR PP AND PET STRAP

The MT450 compact, versatile and easy to use battery strapping tool has adjustable functioning modes to fit your application: automatic, semi-automatic, manual and “soft”. Tension, Seal and Cut by pushing a single button (in automatic or semi-automatic mode). Perfectly balanced, it can perform both vertical and horizontal strapping. The brushless motor is powered with last generation Li-Ion battery for long lasting operation and performance.



TOOL SPECS

Strap	PP/PET
Strap Width	From 19 mm up to 25 mm
Strap Thickness	From 0.8 mm up to 1.30 mm with 19 mm From 0.8 mm up to 1.05 with 25mm
Max. Tension	4.500 N
Max. Tension Speed	6.1 in/sec.
Join Type	Friction weld seal
Weight	8.8 Lbs. (Inc. battery)
Battery	Akku™ Power 18.0 V 5.0 Ah Li-ion

PHT401

PNEUMATIC STRAPPING TOOL

TOOL SPECS

Maximum Tension	450 lbs.
Seal	Friction Weld
Strap Type	Polypropylene + Polyester
Tensioning Speed	11m/min
Tool Length	11"
Tool Width	6"
Tool Height	6.9"
Tool Weight	10.8 lbs
Strap Width	3/8", 7/16", 1/2", 5/8"
Recommended Strap Thickness	.020 – .029
Seal Strength	80% of Strap Break Strength

450lbs of Tension



PHT801

PNEUMATIC STRAPPING TOOL

850lbs of Tension

TOOL SPECS

L x W x H	11" x 6" x 6.9"
Weight	11.2 lbs.
Pressure Range	5.0 - 7 bar/70 - 99 psi
Pressure Consumption	14L/s - 29 cu ft/mi
Max Tension	850 lbs.
Tension Speed	9 m/min
Recommended Strap Size/Thickness	5/8", 3/4" polypropylene .030" - .040"



PHT1201

PNEUMATIC STRAPPING TOOL

TOOL SPECS

L x W x H	11.8" x 6" x 6.9"
Weight	11.2 lbs.
Pressure Range	5.0 - 7 bar/70 - 99 psi
Pressure Consumption	14L/s - 29 cu ft/mi
Max Tension	1250 lbs.
Tension Speed	9 m /min
Sealing/Joint Strength	Friction / 80% of Break
Recommended Strap Size/Thickness	5/8", 3/4" polyester .040" - .055"



1250lbs Tension

PHT1401

PNEUMATIC STRAPPING TOOL

TOOL SPECS

L x W x H	9.8" x 5.5" x 6.5"
Weight	11.2 lbs.
Air Pressure	6 - 7 bar/87 - 99 psi
Max Tension	1280 lbs.
Tension Speed	4 m /min
Sealing/Joint Strength	Friction / 80% of Break
Recommended Strap Size/Thickness	1" - 1 1/4" polyester only .040" - .050"



1280lbs Tension

PWT

PNEUMATIC FRICTION WELD TOOL

- When tensioning is not required.
- Ideal for baling applications
- Comes with integral suspension eyelet

TOOL SPECS

L x W x H	9.8" x 5.1" x 4.7"
Weight	5.7 lbs.
Pressure Range	4.5 - 7 bar/64 - 99 psi
Sealing/Joint Strength	Friction / 80% of Break
Recommended Strap Size/Thickness	7/16", 1/2", 5/8", 3/4" polypropylene or polyester/.016" - .055"



TENSIONERS FOR PLASTIC STRAPPING

TPSD

ECONOMY WINDLASS PLASTIC STRAPPING TENSIONER

TOOL SPECS

Length	10.5"
Weight	4 lbs.
Style	Economy windlass tensioner
Strap Size	3/8", 1/2", 5/8", 3/4"
Strap Type	Polypropylene & Polyester



TPHD

HEAVY DUTY WINDLASS PLASTIC STRAPPING TENSIONER

TOOL SPECS

Length	11"
Weight	5 lbs.
Style	Windlass tensioner, HD
Strap Size	3/8", 1/2", 5/8", 3/4" x .025 - .040
Strap Type	Polypropylene & Polyester



BEST SELLER!

TPXHD

EXTRA HEAVY DUTY WINDLASS PLASTIC STRAPPING TENSIONER

TOOL SPECS

Length	11"
Weight	5 lbs.
Style	Extra heavy duty windlass tensioner- parts available
Strap Size	Up to 3/4" wide and .040
Strap Type	Polypropylene & Polyester



THHP + STCUT

ECONOMY HAND PULL PLASTIC STRAPPING TENSIONER & CUTTER AND POLYPROPYLENE STRAP CUTTER

TOOL SPECS

Length	4"
Weight	1 lbs.
Style	Economy hand pull tensioner
Strap Size	3/8", 1/2"
Strap Type	Polypropylene



LENGTH 6"
Cuts all sizes of
Polypropylene Strapping

POLYPROPYLENE STRAPPING SEALERS

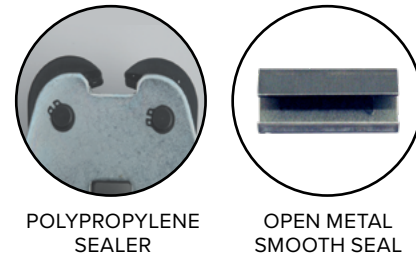

POLYPROPYLENE SEALER

OPEN METAL SMOOTH SEAL

LENGTH 19 1/2"



ITEM NUMBER	STRAP SIZE	SEALS USED	STYLE	WT.
S12HDPP	1/2"	OMS12, CMS12	Polypropylene sealer	4
S58HDPP	5/8", 025-.040	OMS58, CMS58	Polypropylene sealer	5
S34HDPP	3/4"	OMS34	Polypropylene sealer	5

LENGTH 19 1/2"



ITEM NUMBER	STRAP SIZE	SEALS USED	STYLE	WT.
S12SDPP	1/2"	OMS12, CMS12	Economy polypropylene sealer – non repairable	4
S58SDPP	5/8"	OMS58, CMS58	Economy polypropylene sealer – non repairable	4
S34SDPP	3/4"	OMS34	Economy polypropylene sealer – non repairable	4

POLYESTER STRAPPING SEALERS

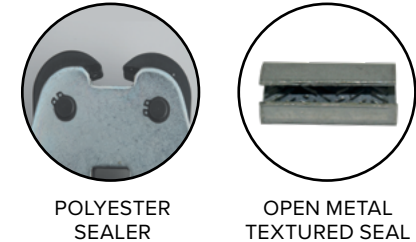

POLYESTER SEALER

OPEN METAL TEXTURED SEAL

LENGTH 19 1/2"



ITEM NUMBER	STRAP SIZE	SEALS USED	STYLE	WT.
S12HDPE	1/2", .015 – .035	SMS12	HD Polyester sealer	5
S58HDPE	5/8" up to .028	SMS58	HD Polyester sealer	5
S58HDPH	5/8", .029 – .040	SMS58	EHD Polyester sealer	5
S34HDPE	3/4" up to .050	SMS34HD	HD Polyester sealer	5

LENGTH 18 1/4"



ITEM NUMBER	STRAP SIZE	SEALS USED	STYLE	WT.
S12SDPE	1/2"	SMS12	Economy PET –non-repairable	5
S58SDPE	5/8" up to .028	SMS58	Economy PET –non-repairable	5
S58SDPH	5/8" over .028	SMS58	Economy PET heavy duty – non-repairable	5

LENGTH 19 1/2"



ITEM NUMBER	STRAP SIZE	SEALS USED	STYLE	WT.
SS34HDPE	3/4" up to .050	SMS34HD	Side Seal Heavy Duty Polyester sealer	7

SP4000

PUSH TYPE PNEUMATIC COMBINATION TENSIONER & SEALER

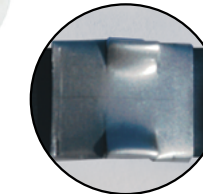

SP4000 Series Steel strapping tool for 1/2", 5/8" or 3/4"(13, 16 or 19mm) steel. Tensions and seals on steel strap up to .031" thick. Pulls tension up to 1,700 lbs. Tool weighs approximately 8.5 lbs. Utilizes push type seals and produces a single notch joint.

TOOL SPECS

L x W x H	13.8" X 5.5" X 6.7"
Weight	10.8 lbs.
Pressure Range	5.5 - 7 bar/78 - 99 psi
Pressure Consumption	12L/s - 25 cu ft/mi
Max. Tension	670-1700 lbs.
Tension Speed	12 m/min (2000N) 5 m/min (5500N) 6 m/min (7500N)
Sealing Thickness	Seal Single Reverse Notch RD: .016" - .031" HT: .016" - .025"

Use seals: SS12P, SS58P, SS34P. See page XX for seal/tool grid

SP4100

PUSH TYPE PNEUMATIC COMBINATION TENSIONER & SEALER

SP4100 Series Steel strapping tool for 3/4", 1" and 1-1/4" steel. Tensions and seals on steel strap up to .039 RD, .031HT thick. Pulls tension up to 3,300 lbs. Tool weighs approximately 23 lbs. Utilizes push type seals and produces a double notch joint.

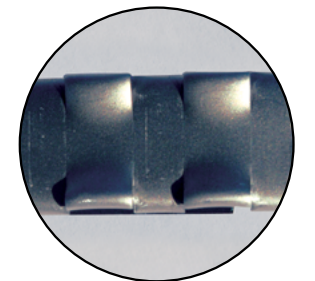
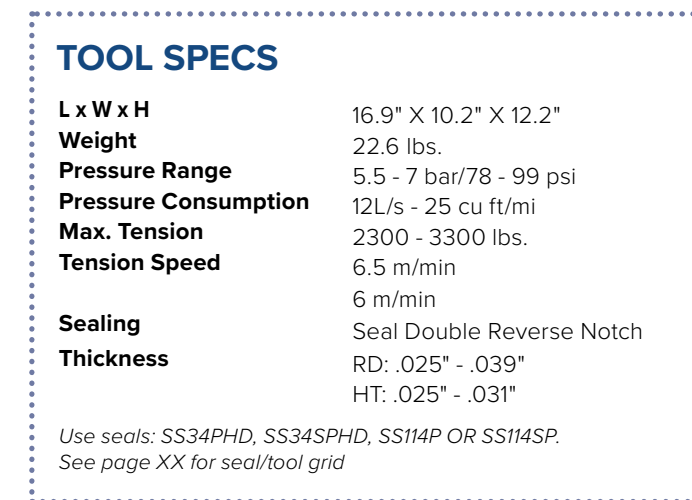

SP6119, SP6125 + SP6132
PNEUMATIC SEALERS



TOOL SPECS

	SP6119	SP6125	SP6132
L x W x H	12.6" x 5.5" x 7"	12.6" x 5.5" x 7"	12.6" x 5.5" x 7"
Weight	6.5 lbs.	6.5 lbs.	6.5 lbs.
Type	Push	Push	Push
Pressure	14 L/s -	14 L/s -	14 L/s -
Consumption	29 cu ft/minute	29 cu ft/minute	29 cu ft/minute
Seal	Various	Various	Various
Strap Size	3/4"	1"	1 1/4"
Thickness	RD .024 - .039 HT .025 - .031	RD .024 - .039 HT .025 - .031	RD .024 - .039 HT .025 - .031
Notch	Single Reverse	Single Reverse	Single Reverse

Single Notch Seal. See page XX for seal/tool grid

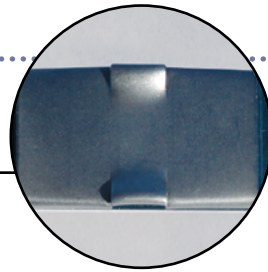

Use with SP3100 Tensioner below

SP3100
PUSH-TYPE PNEUMATIC TENSIONER

TOOL SPECS

L x W x H	13.5" x 4.5" x 3.5"
Weight	9.5 lbs.
Pressure Range	5.5 - 7 bar/70 - 99 psi
Pressure Consumption	14L/s - 29 cu ft/mi
Max. Tension	3300 lbs.
Tension Speed	6 m/min
Strap Size	3/4" - 1" - 1 1/4"
Thickness	.024" - .043"

For irregular or round surfaces. See page XX for seal/tool grid.



SPECIAL Inclined
SP3100 Available
9" x 6.5" x 10.5"

Use with SP6119, SP6125 &
SP6132 sealers above

PNEUMATIC TOOL ACCESSORIES
COUNTERBALANCERS

SPECIFICATIONS

Item Number	189195	189300
Weight	7 lbs.	7 lbs.
Supports Tool Weight Up To	13 lbs.	24 lbs.
Cable Length	6.5'	6.5'

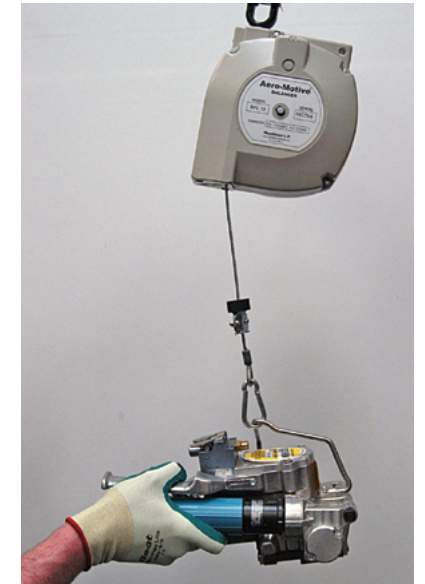

FILTER REGULATOR LUBRICATOR



SPECIFICATIONS

Item Number	186895
Weight	8 lbs.

BRASS CLEANING BRUSH

ITEM NUMBER: 198837

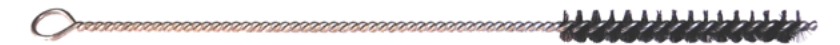

AIR SUPPLY



There are TWO important functions, pressure and volume. Without the proper volume as well as pressure, the tool will not perform or function properly. The air line should be constructed according to this diagram and drained daily.

PLASTIC STRAPPING DISPENSERS

DSHD2

HEAVY-DUTY OSCILLATED STEEL DISPENSER



XL Tool Bin Stores Tools and Seals

FEATURES

- Big 10" wheels
- XL Top Bin stores seals and tools
- Reel brake
- Requires Assembly

SPECIFICATIONS

Color	Black
Core Sizes	Core ID (16" only) / Core width up to 6"
Weight	55

SD62

HEAVY-DUTY RIBBON WOUND STEEL DISPENSER

FEATURES

- Big 10" wheels
- XL Top Bin stores seals and tools
- Reel brake
- Comes fully assembled

SPECIFICATIONS

Color	Black
Core Sizes	Core ID (16" only) / Core width up to 6"
Weight	55



DSSD

PLASTIC STRAPPING DISPENSER



Extra heavy duty reel brake prevents strap tangles resulting from the coil over spinning



XL top bin stores large tools



SPECIFICATIONS

Color	Black
Core Sizes	8" x 8" with included adapter 16" x 6", 16" x 3"
Style	Cart Dispenser
Wheels	10"
Weight	55

DS3050

PLASTIC STRAPPING DISPENSER

SPECIFICATIONS

Color	Black
Core Sizes	16" x 6", 16" x 3"
Style	Heavy Duty Floor, Wall & Forklift Dispenser
Weight	55



DSTB

HD TOOL BALANCER DISPENSER FOR PLASTIC STRAPPING



- Heavy Duty Steel Frame
- Fits 16x6 & 16x3 core
- 10" Semi-Pneumatic Wheels
- Locking Swivel Casters
- XL storage tray
- Tool Balancer arm to suspend bracket and power tool

Counterbalance, suspension bracket & power tools sold separately

ALL PLASTIC STRAPPING DISPENSERS ARE MADE IN THE USA

DSEL

EASY LOAD DISPENSER FOR PLASTIC STRAPPING

- Slide coil of strap in from the side
- Adjustable side plates
- No brake assembly
- Easy dispensing
- Two storage bins
- Handle is height adjustable



DSCD



With Adapter for Ribbon Wound Cord
For all 3"x5" Core Woven/Bonded and 8" x 8" Core adapter included. Composite Cord

Made in the USA

DSCDRW



For all Ribbon Wound Cord

OTHER KITS CAN BE MADE AVAILABLE, ASK YOUR SALES REP FOR INFO

MARINE CORD STRAPPING KITS



- Safely secure stretch wrap for winterizing boats, jet skis, etc.
- Convenient easy to handle coil size
- Portable - no tools or expensive dispensers required

SPECIFICATIONS

ITEM NUMBER	WOVEN	STD. COLOR	NOMINAL WIDTH	FOOTAGE	BREAK	COILS PER PALLET	COILS PER BOX	WEIGHT PER PALLET
PC40WPT	W	W	1/2"	1500	700	120	1	960
PC60WPT	W	W	3/4"	1000	950	120	1	715

Each coil comes individually boxed. Available in both 1/2" and 3/4" width

TREE STAKING WOVEN CORD

3" x 5.5" CORE

USED PRIMARILY IN THE LANDSCAPING AND NURSERY INDUSTRY

- Replaces traditional wire and hose
- Protects and preserves plants during transportation
- Secures tree limbs from splitting during growth season
- Secures large trees during transportation
- Used in hand tying applications such as baling



SPECIFICATIONS

ITEM NUMBER	WOVEN	STD. COLOR	NOMINAL WIDTH	FOOTAGE	BREAK	RECOMMENDED BUCKLE	COILS PER PALLET	COILS PER BOX	WEIGHT PER PALLET
PC60TG	W	G	3/4", 19mm	2100	950	SB34SDP	48	2	1104
PC75TG	W	G	3/4", 19mm	1650	2400	SB34X17P	48	2	1968

POLYPROPYLENE STRAP KITS

POLYPROPYLENE STRAPPING

HMK1500



1,500 feet of 1/2" x 300# break strength black polypropylene strapping, one hundred 1/2" steel buckles, one tensioner in a self-dispensing carton. 4 kits sold as 1 unit.

SPECIFICATIONS

Product Style	Embossed
Color	Black
Weight	20

HGK3000

3,000 feet of 1/2" x 300# break strength black polypropylene strapping, three hundred steel buckles, one tensioner in a self-dispensing carton.

SPECIFICATIONS

Product Style	Embossed
Color	Black
Weight	12



All items are available on a made-to-order basis. Please contact your Greenbridge sales rep for minimum order quantities, pricing and lead times.

BUCKLES FOR POLYPROPYLENE STRAPPING

STEEL BUCKLES FOR POLYPROPYLENE STRAPPING



ITEM NUMBER	STRAP SIZE	STYLE	PACKED PER BOX	WEIGHT PER BOX	RECOMMENDED NOMINAL STRAP BREAK
SB12SD	3/8, 1/2"	Standard	1M/Box	13	250 - 300 lbs
SB12HDP	1/2"	Heavy Duty	1M/Box	18	300 - 1000 lbs
SB58XDP	5/8"	Extra Heavy Duty	1M/Box	32	300 - 1000 lbs
SB34SDP	3/4"	Heavy Duty	1M/Box	22	300 - 1000 lbs
SB34XDP	3/4"	Extra Heavy Duty	1M/Box	42	1000 - 1700 lbs

PLASTIC BUCKLES FOR POLYPROPYLENE STRAPPING



ITEM NUMBER	STRAP SIZE	STYLE	PACK	WEIGHT
PB12	1/2"	—	2M/Box	8
PB58	5/8"	—	2M/Box	12

OPEN METAL SEALS - GALVANIZED FOR POLYPROPYLENE STRAPPING

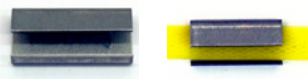

ITEM NUMBER	STRAP SIZE	STYLE	PACK	WEIGHT	LENGTH	GAUGE	SEALER USED
OMS38	3/8"	Open	1M/Box	8	1-1/4"	.021	S12HDPP
OMS12	1/2"	Open	1M/Box	12	1-1/4"	.025	S12HDPP
OMS58	5/8"	Open	1M/Box	12	1-1/4"	.025	S58HDPP
OMS34	3/4"	Open	1M/Box	16	1-1/4"	.025	S34HDPP

CLOSED METAL SEALS - GALVANIZED FOR POLYPROPYLENE STRAPPING

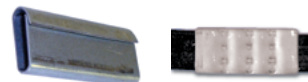

ITEM NUMBER	STRAP SIZE	STYLE	PACK	WEIGHT	LENGTH	GAUGE	SEALER USED
CMS12	1/2"	Closed	1M/Box	10	1-1/4"	.025	S12HDPP
CMS58	5/8"	Closed	1M/Box	16	1-1/4"	.025	S58SDPP

CLOSURES FOR POLYESTER STRAPPING TEXTURED SEALS, GALVANIZED



ITEM NUMBER	STRAP SIZE	STYLE	PACK	WEIGHT	LENGTH	GAUGE	SEALER USED
SMS12	1/2"	Open, Textured	1M/Box	13	1.187"	.030	S12SDPE, S12HDPE
SMS58	5/8"	Open, Textured	1M/Box	20	1.187"	.038	S58SDPE, S58SDPH, S58HDPE, S58HDPH
SMS34HD	3/4"	Open, Textured	1M/Box	39	1.375"	.077	S34HDPE, SS34HDPE

CLOSURES FOR SIGNODE®* SEALER SERRATED SEALS - NOT SANDPAPER



ITEM NUMBER	STRAP SIZE	STYLE	PACK	WEIGHT	LENGTH	GAUGE	SEALER USED
OSS12	1/2"	Open	1M/Box	20	1-1/4"	.051	D504, D506

*Signode® is a registered Trademark of signode industrial group

BUCKLES FOR CORD STRAPPING

PHOSPHATE FINISHED BUCKLES FOR BONDED AND WOVEN CORD STRAP



ITEM NUMBER	STRAP SIZE	WIRE GAUGE	STYLE	RECOMMENDED W/NOMINAL STRAP BREAK	PACKED PER BOX	WEIGHT PER BOX
SB12HDP	1/2"	0.120	Standard	300# - 1000#	1,000	18.5
SB12HDP200B	1/2"	0.120	Standard	300# - 1000#	200	3.7
SB34SDP	3/4"	0.120	Standard	300# - 1000#	1,000	22
SB34SDP150B	3/4"	0.120	Standard	300# - 1000#	150	3.3
SB34XDP	3/4"	0.159	Heavy Duty	1000# - 1700#	1,000	41
SB34X17P	3/4"	0.170	Extra Heavy Duty	1700# - 3000#	1,000	48
SB1HDP	1"	0.196	Heavy Duty	1800# - 2700#	500	36
SB1XDP	1"	0.234	Extra Heavy Duty	2700# - 3200#	250	30
SB114XDP	1 1/4" & 1 1/2"	0.272	Extra Heavy Duty	3300# - 5400#	250	47

GALVANIZED FINISHED BUCKLES FOR COMPOSITE CORD STRAP



ITEM NUMBER	STRAP SIZE	WIRE GAUGE	STYLE	RECOMMENDED W/NOMINAL STRAP BREAK	PACKED PER BOX	WEIGHT PER BOX
SB12HDG	1/2"	0.120	Standard	300# - 1000#	1,000	18.5
SB58XDG	5/8"	0.120	Standard	300# - 1000#	1,000	18.5
SB58X15G	5/8"	0.147	Heavy Duty	1000# - 1500#	1,000	29
SB34XDG	3/4"	0.159	Heavy Duty	1000# - 1700#	1,000	41
SB34X17G	3/4"	0.170	Extra Heavy Duty	1700# - 3000#	1,000	48
SB1HDG	1"	0.196	Heavy Duty	1800# - 3200#	500	36
SB1XDG	1"	0.234	Extra Heavy Duty	2700# - 3200#	250	30
SB114XDG	1 1/4" & 1 1/2"	0.272	Extra Heavy Duty	3300# - 5400#	250	47

LADDER BUCKLES FOR HEAVY DUTY CORD & LASHING STRAP



ITEM NUMBER	STRAP SIZE	WIRE GAUGE	STYLE	RECOMMENDED W/NOMINAL STRAP BREAK	PACKED PER BOX	WEIGHT PER BOX
SB105LAD	1 1/4"	4mm	Extra Heavy Duty	Up to 7700#	125	24
SB150LAD	1 1/2" & 1 5/8"	10mm	Extra Heavy Duty	Up to 18700#	50	31

SB8400

BATTERY-OPERATED STEEL TENSIONER

TOOL SPECS

Battery	14.8V, 3.0Ah, Li-Ion
Tension Mode	Manual/Automatic
Min. - Max	880lbs. - 2200lbs.
Tool Length	15.75"
Tool Width	4.72"
Tool Height	4.72"
Tool Weight	14.2 lbs.
Strap Width	3/4" / 1" / 1.25"
Recommended Strap Thickness	.023 - .043
Seal Strength	75% plus of the break strength of the parent strap based on quality

ACCESSORIES

The B8400 comes with two batteries and a charger.

SB8400 Battery		SB8400 Charger	
Item Number	301CHG	Code	B301BAT
Type	60Hz 35W	Power Supply	Lithium Ion
Output	110V 3A 35W	Output	14.8V, 3.0Ah



SB8500

BATTERY-OPERATED DOUBLE NOTCH STEEL SEALER

TOOL SPECS

Battery	14.8V, 3.0Ah, Li-Ion
Seal	Double Notch
Tool Length	13.7"
Tool Width	3.9"
Tool Height	3.2"
Tool Weight	9.9 lbs.
Strap Width	3/4" / 1" / 1.25"
Recommended Strap Thickness	.023 - .043
Seal Strength	75% plus of the break strength of the parent strap based on quality

ACCESSORIES

The B1000 comes with two batteries and a charger.

SB8500 Battery		SB8500 Charger	
Item Number	300CHG	Code	B300BAT
Type	60Hz 35W	Power Supply	Lithium Ion
Output	110V 3A 35W	Output	14.8V, 3.0Ah



STEEL MANUAL TOOLS

SM3000

SEALLESS STEEL MANUAL COMBINATION TOOL



EQUIPMENT SPECS

Length	13.8"
Weight	9.7 lbs.
Style	Sealless die cut joint
Strap Size	1/2", 5/8", and 3/4"

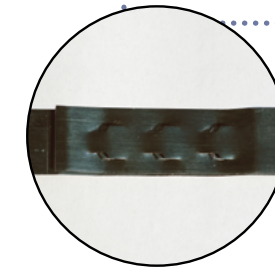

SEALLESS DIE CUT JOINT

MANUAL STEEL TENSIONERS

TSRD

TENSIONER

EQUIPMENT SPECS

Length	12"
Weight	4 lbs.
Style	Feedwheel - Flat Package
Strap Size	3/8" X .018 - 3/4" X .023 Regular Duty



TSMD

TENSIONER

EQUIPMENT SPECS

Length	15"
Weight	6 lbs.
Style	Feedwheel - Flat Package
Strap Size	3/8" X .018 - 3/4" X .025 Regular Duty



MANUAL STEEL TENSIONERS

TSHD TENSIONER

EQUIPMENT SPECS

Length 17"
Weight 4 lbs.
Style Heavy Duty Feedwheel – Flat Package
Strap Size 3/4" X .025 - 1-1/4" X .035 Regular Duty – High Tensile



TPSRD TENSIONER

EQUIPMENT SPECS

Length 9", 12"
Weight 5 lbs.
Style Push Type – Feedwheel – Round or Irregular Package
Strap Size 3/8" X .015 - 3/4" X .025 RD & HT

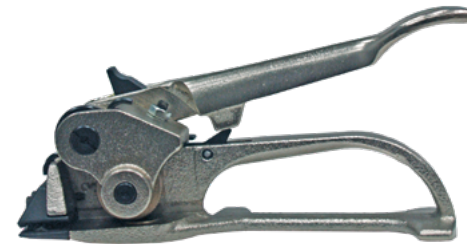

TPSHD TENSIONER

EQUIPMENT SPECS

Length 12"
Weight 5 lbs.
Style Push Type – Feedwheel – Round or Irregular Package
Strap Size 5/8" X .023HT - 1-1/4" X .035 RD & HT



TSWHD TENSIONER

EQUIPMENT SPECS

Length 24"
Weight 11 lbs.
Style Windlass Type- Flat Package
Strap Size 3/4" x .025HT – 1-1/4" x .035HT



ITEM NUMBER	LENGTH	STRAP SIZE	STYLE	SEAL	RECOMMND. SEAL	WT
SDD38	13"	3/8" X .015 - 3/8" X .025	Regular Duty	Double Down	SS38S	3
SDD12	13"	1/2" X .015 - 1/2" X .025	Regular Duty – High Tensile	Double Down	SS12S	3
SDD58	13"	5/8" X .015 - 5/8" X .025	Regular Duty – High Tensile	Double Down	SS58S	3
SDD34	13"	3/4" X .015 - 3/4" X .025	Regular Duty – High Tensile	Double Down	SS34S	3

ITEM NUMBER	LENGTH	STRAP SIZE	STYLE	SEAL	RECOMMND. SEAL	WT
SSU38	16½"	3/8" X .015 - 3/8" X .023	Regular Duty	Single Up	SS38P	3
SSU12	16½"	1/2" X .015 - 1/2" X .025	Regular Duty – High Tensile	Single Up	SS12P	3
SSU58	16½"	5/8" X .015 - 5/8" X .025	Regular Duty – High Tensile	Single Up	SS58P	3
SSU34	16½"	3/4" X .015 - 3/4" X .025	Regular Duty – High Tensile	Single Up	SS34P	3

ITEM NUMBER	LENGTH	STRAP SIZE	STYLE	SEAL	RECOMMND. SEAL	WT
SSD34	29"	Side Action 3/4" X .025 – .035	Regular Duty – High Tensile	Single Down	SS34VSPD / SS34SPHD	9
SSD114	29"	Side Action 1-1/4" X .025 – .035	Regular Duty – High Tensile	Single Down	SS114SP / SS114P	9
SDU34	29"	Side Action 3/4" X .025 – .035	Regular Duty – High Tensile	Double Up	SS34SPHD / SS34PHD	9
SDU114	29"	Side Action 1-1/4" X .025 – .035	Regular Duty – High Tensile	Double Up	SS114SP / SS114P / SS114T	9

(Handle and tool colors may vary from picture depending on model purchased.)

STEEL STRAPPING CUTTERS

SC100



EQUIPMENT SPECS

Weight 2 lbs.
Strap Size 3/8" – 3/4" - Regular Duty – High Tensile

SC200



EQUIPMENT SPECS

Weight 23 lbs.
Strap Size 3/8" – 1 1/4" x .031 - Regular Duty – High Tensile

SC300



EQUIPMENT SPECS

Weight 26 lbs.
Strap Size up to 2" x .035 - Regular Duty – High Tensile

STEEL SEALS

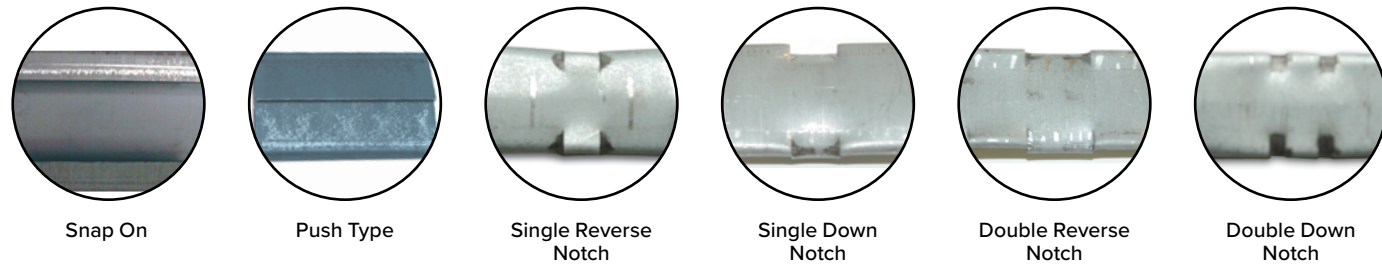

ITEM NUMBER	STRAP SIZE	SEAL TYPE	JOINT TYPE	SEAL LENGTH	GAUGE	TENSIONER	SEALER	STD PACK	WEIGHT
SS38S	3/8"	Snap-on	DN	1.00	.020	TSRD	SDD38	5M/case	25
SS12S	1/2"	Snap-on	DN	1.00	.020	TSRD or TSMD	SDD12	5M/case	30
SS58S	5/8"	Snap-on	DN	1.25	.020	TSRD or TSMD	SDD58	5M/case	44
SS34S	3/4"	Snap-on	DN	1.25	.020	TSRD or TSMD	SDD34	5M/case	53
SS34HDS	3/4"	Snap-on HD	DN	2.187	.031	TSHD	SSD34	2M/case	45
SS114HDS	1-1/4"	Snap-on HD	DC/DN	2.187	.031	TSHD	SDU114	1M/case	45
SS38P	3/8"	PUSH	SN	1.00	.025	TPSRD	SSU38	5M/case	40
SS12P	1/2"	PUSH	SN	.860	.025	TPSRD	SSU12	5M/case	50
SS58P	5/8"	PUSH	SN	.860	.025	TPSRD	SSU58	5M/case	50
SS34P	3/4"	PUSH	SN	.860	.025	TPSRD	SSU34	5M/case	60
SS34VSPH	3/4"	PUSH HD	SN	1.375	.035	TPSHD	SSD34	2.5M/case	67
SS34SPHD	3/4"	PUSH HD	DN	1.781	.035	TPSHD	SDU34	2M/case	70
SS34PHD	3/4"	PUSH HD	DN	2.187	.035	TPSHD	SDU34	1M/case	45
SS114SP	1-1/4"	PUSH HD	SN	1.50	.035	TPSHD	SSD114	1M/case	45
SS114P	1-1/4"	PUSH HD	DN	2.187	.035	TPSHD	SDU114	1M/case	70
SS114T	1-1/4"	THREAD-ON	DN	2.187	.031	TSWHD	SDU114	1M/case	32

SEAL/TOOL GRID



ITEM NUMBER	SIZE	SEAL	TYPE	LENGTH	GAUGE	NOTCH
SP4012	1/2"	SS12P	Push	.860	.025	Single
SP4016	5/8"	SS58P	Push	1.00	.025	Single
SP4019	3/4"	SS34P	Push	.860	.025	Single
ITEM NUMBER	SIZE	SEAL	TYPE	LENGTH	GAUGE	NOTCH
SP4119	3/4"	SS34SPHD, SS34PHD	Push	1.375	.035	Double
SP4125	1"	CALL FOR AVAILABILITY				
SP4132	1-1/4"	SS114P, SS114SP	Push	2.187	.035	Double
ITEM NUMBER	SIZE	SEAL	TYPE	LENGTH	GAUGE	NOTCH
SP6119	3/4"	Various	Push	1.375+	.025 - .035	Single
SP6125	1"	CALL FOR AVAILABILITY				
SP6132	1-1/4"	Various	Push	1.50+	.025 - .035	Single
ITEM NUMBER	SIZE	SEAL	TYPE	LENGTH	GAUGE	
SP3100	3/4" - 1-1/4"	3/4" - 1-1/4" Closed Push Type	Push	Various	Various	

MULTI PLY PAPER BOARD

GLUED, TREATED AND FORMED TO A 90° ANGLE

- Available in 2 grades and a multitude leg lengths and thicknesses
- Made from 100% recycled paper board and is 100% recyclable
- Protects edges and corners and adds stacking strength
- For unitizing and stabilizing pallet loads
- Provides internal and external strength and is reusable
- Maximizes packing cube on trucks and in warehouses
- Custom sizes cut to length, printing available

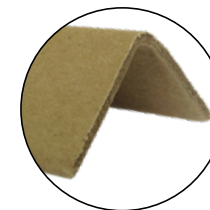

ECONOBOARD®
Unwrapped

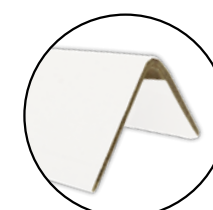

EDGEARMOR®
Wrapped

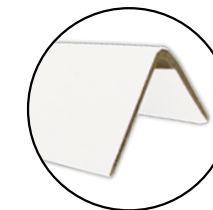

CORNER PROTECTORS®
Shorter pieces of EconoBoard®
and EdgeArmor

Made from 100%
Recycled Paperboard
100% Recyclable



APPLICATIONS

- Palletizing/Unitizing
- Agriculture/Food
- Graphic Arts/Paper
- Appliance
- Pharmaceutical
- Lumber/Forest Products
- Office Furniture
- Display Packaging
- Consumer Goods
- Window & Door Mfg.
- Brick, Block, & Tile
- Lighting Industry
- Window Treatments
- Compressors/Furnaces/AC
- Converted Steel/Metals



Stacking
Strength



Side
Protection



Vertical
Protection

ECONOBOARD - UNWRAPPED

FEATURES:

- Economical-provides additional packaging strength
- Secures and stabilizes loads
- Prevents strap from cutting into product and packaging
- Prevents corner and edge damage - saves money
- Made from 100% recycled paper board and is 100% recyclable
- Custom lengths and printing
- White color outer layer, also available in kraft

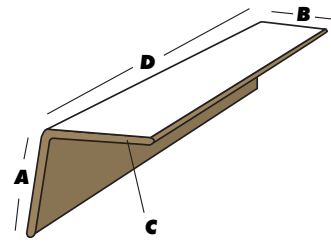
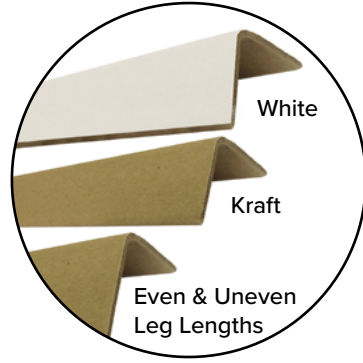

SPECIFICATIONS	
LEG LENGTH (A&B)	Even and uneven leg lengths totaling 3,4,5 and 6 inches
CALIPER (C)	.120 - .250 (3.05mm – 6.4mm)
LENGTH (D)	2.0 inches – 192 inches (50.8mm – 4,877mm)

* together the Econoboard leg lengths cannot exceed 6 inches (152.4mm)

PRODUCT CODE	THICKNESS	PIECES PER SKID				APPROX. WEIGHT PER LINEAR FOOT
		LENGTH (13"-24")	LENGTH (>24"-72")	* LENGTH (>72"-132")	* LENGTH (>132")	
4" TOTAL LEG - (2" X 2" CODE BELOW)						
EBB200200K/W	0.120	6000	3000	1800	1200	0.168
EBB200200K/W	0.140	5100	2550	1530	1020	0.195
EBB200200K/W	0.150	4800	2400	1440	960	0.211
EBB200200K/W	0.160	4500	2250	1350	900	0.222
EBB200200K/W	0.180	3900	1950	1170	780	0.249
EBB200200K/W	0.200	3600	1800	1080	720	0.276
EBB200200K/W	0.225	3300	1650	990	660	0.309
EBB200200K/W	0.250	3000	1500	900	600	0.341
5" TOTAL LEG - (2½" X 2½" CODE BELOW)						
EBB250250K/W	0.120	4800	2400	1200	1000	0.206
EBB250250K/W	0.140	4080	2040	1020	850	0.249
EBB250250K/W	0.150	3840	1920	960	800	0.260
EBB250250K/W	0.160	3600	1800	900	750	0.271
EBB250250K/W	0.180	3120	1560	780	650	0.309
EBB250250K/W	0.200	2880	1440	720	600	0.347
EBB250250K/W	0.225	2640	1320	660	550	0.379
EBB250250K/W	0.250	2400	1200	600	500	0.423
6" TOTAL LEG - (3" X 3" CODE BELOW)						
EBB300300K/W	0.120	4000	2000	1200	800	0.249
EBB300300K/W	0.140	3400	1700	1020	680	0.288
EBB300300K/W	0.150	3200	1600	960	640	0.309
EBB300300K/W	0.160	3000	1500	900	600	0.325
EBB300300K/W	0.180	2600	1300	780	520	0.367
EBB300300K/W	0.200	2400	1200	720	480	0.412
EBB300300K/W	0.225	2200	1100	660	440	0.455
EBB300300K/W	0.250	2000	1000	600	400	0.509

*Boards that are longer than 72" are palletized with fewer rows due to weight considerations.

EDGEARMOR - WRAPPED

FEATURES:

- Wrapped with a sharp white liner to enhance packaging
- Safer to handle, rounded edges help prevent paper cuts
- Liner wrap covers edges and protects against delamination
- Increases strength and prevents shipping and handling damage
- Dress up your product - "stand out" from the rest
- Made from 100% recycled paper board and is 100% recyclable
- Custom lengths and printing - also available in kraft color wrap

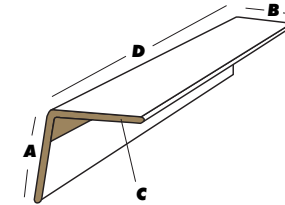
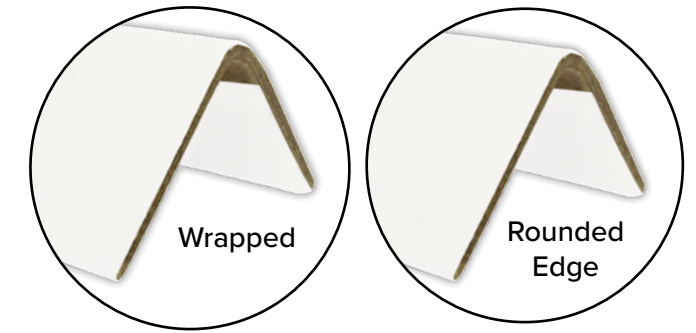

SPECIFICATIONS	
LEG LENGTH (A&B)	Even leg lengths 2x2, 2.5 x 2.5, and 3x3
CALIPER (C)	.120 - .250 inches (3.05mm – 6.4mm)
LENGTH (D)	2.0 inches – 192 inches (50.8mm – 4,877mm)

*together the EdgeArmor leg lengths cannot exceed 6 inches (152.4mm)

PRODUCT CODE	THICKNESS	PIECES PER SKID				APPROX. WEIGHT PER LINEAR FOOT
		LENGTH (13"-24")	LENGTH (>24"-72")	* LENGTH (>72"-132")	* LENGTH (>132")	
4" TOTAL LEG - (2" X 2" CODE BELOW)						
EAB200200K/W	0.120	6000	3000	1800	1200	0.168
EAB200200K/W	0.140	5100	2550	1530	1020	0.195
EAB200200K/W	0.150	4800	2400	1440	960	0.211
EAB200200K/W	0.160	4500	2250	1350	900	0.222
EAB200200K/W	0.180	3900	1950	1170	780	0.249
EAB200200K/W	0.200	3600	1800	1080	720	0.276
EAB200200K/W	0.225	3300	1650	990	660	0.309
EAB200200K/W	0.250	3000	1500	900	600	0.341
5" TOTAL LEG - (2½" X 2½" CODE BELOW)						
EAB250250K/W	0.120	4800	2400	1200	1000	0.206
EAB250250K/W	0.140	4080	2040	1020	850	0.249
EAB250250K/W	0.150	3840	1920	960	800	0.260
EAB250250K/W	0.160	3600	1800	900	750	0.271
EAB250250K/W	0.180	3120	1560	780	650	0.309
EAB250250K/W	0.200	2880	1440	720	600	0.347
EAB250250K/W	0.225	2640	1320	660	550	0.379
EAB250250K/W	0.250	2400	1200	600	500	0.423
6" TOTAL LEG - (3" X 3" CODE BELOW)						
EAB300300K/W	0.120	4000	2000	1200	800	0.249
EAB300300K/W	0.140	3400	1700	1020	680	0.288
EAB300300K/W	0.150	3200	1600	960	640	0.309
EAB300300K/W	0.160	3000	1500	900	600	0.325
EAB300300K/W	0.180	2600	1300	780	520	0.367
EAB300300K/W	0.200	2400	1200	720	480	0.412
EAB300300K/W	0.225	2200	1100	660	440	0.455
EAB300300K/W	0.250	2000	1000	600	400	0.509

PAPERBOARD CORNER PROTECTORS

SHORTER CUT LENGTHS OF ECONOBOARD® AND EDGEARMOR®

FEATURES:

- Protects package edges from securement strapping
- Corner protectors evenly distribute strap tension over a wider surface area.
- Allows for "tighter" packaging
- Made from 100% recycled paper board and is 100% recyclable
- Sizes from 2" to 12" (50.8mm to 304.8mm)
- Specify EconoBoard® or EdgeArmor® Corner Protectors

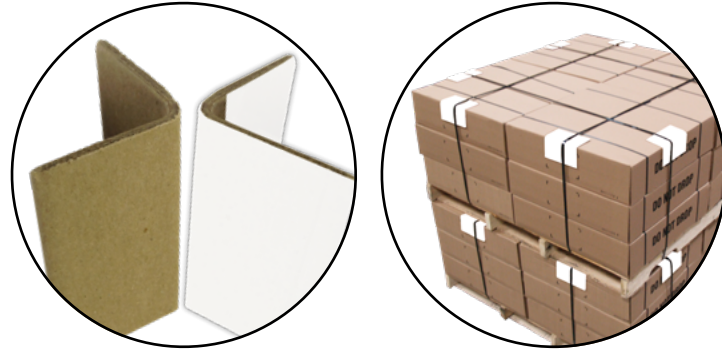

Corner Protectors: 36 boxes per skid
 (# of pieces per box as listed below)

PRODUCT CODE	THICKNESS	PIECES PER BOX							
		2" LENGTH	2.5" LENGTH	3" LENGTH	3.5" LENGTH	4" LENGTH	5" LENGTH	6" LENGTH	7"-12" LENGTH
2" X 2" CODE BELOW									
CEB200200K/W	0.120	1,560	1,040	1,040	780	780	520	520	260
CEB200200K/W	0.150	1,200	800	800	600	600	400	400	200
CEB200200K/W	0.160	1,200	800	800	600	600	400	400	200
CEB200200K/W	0.180	960	640	640	480	480	320	320	160
CEB200200K/W	0.200	960	640	640	480	480	320	320	160
CEB200200K/W	0.225	840	560	560	420	420	280	280	140
CEB200200K/W	0.250	720	480	480	360	360	240	240	120
2½" X 2½" & 3" X 3" CODE BELOW									
CEB250250K/W	0.120	1,080	720	720	540	540	360	360	180
CEB300300K/W	0.120	1,080	720	720	540	540	360	360	180
CEB250250K/W	0.150	900	600	600	450	450	300	300	150
CEB300300K/W	0.150	900	600	600	450	450	300	300	150
CEB250250K/W	0.160	900	600	600	450	450	300	300	150
CEB300300K/W	0.160	900	600	600	450	450	300	300	150
CEB250250K/W	0.180	720	480	480	360	360	240	240	120
CEB300300K/W	0.180	720	480	480	360	360	240	240	120
CEB250250K/W	0.200	720	480	480	360	360	240	240	120
CEB300300K/W	0.200	720	480	480	360	360	240	240	120
CEB250250K/W	0.225	630	420	420	315	315	210	210	105
CEB300300K/W	0.225	630	420	420	315	315	210	210	105
CEB250250K/W	0.250	540	360	360	270	270	180	180	90

Skid weight approximately (1300 lbs.) - ALL SIZES

PRINTED CORNER BOARD



FEATURES:

- Identify/Advertise
- Inventory Control
- Safety/Hazard Warning
- Prevent Damage
- Both EconoBoard® and EdgeArmor®

OPTIONS:

- One or two color printing is available for
- 2 x 2, 2.5 x 2.5 and 3 x 3 corner board orders.
- We can custom print your design or logo.

PLASTIC CORNER PROTECTORS

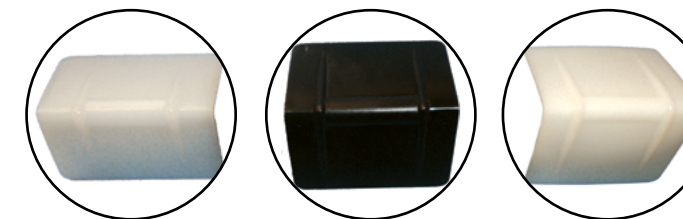

CP

122B

CP252

SPECIFICATIONS

ITEM NUMBER	COLOR	W SIZE	WIDTH	LEG	PACK	MAX. STRAP WIDTH	WT.
CP	Clear	All	1-7/8"	1"	1M/Box	3/4"	8
122B	Black	All	2-1/2"	1-3/4"	1M/Box	1-1/4"	27
CP252	Clear	All	2-1/2"	2"	1M/Box	1"	29

Greenbridge corner protectors prevent damage to tightly strapped shipments. Ribbed channels keep strapping in line.

PWEASEL AND PUNIT PALLET THREADER

The Pallet Threader will work with any standard 3/4" broom handle or buy the complete unit. Just take your metal or plastic strapping and thread it upward through one slot and down through the other. The tool will accommodate strap up to 1¼ inch in width.

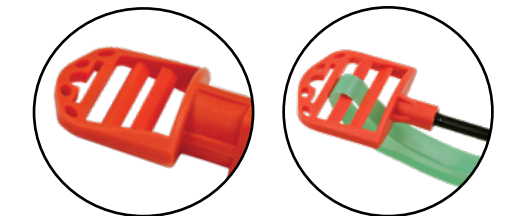

PWEASEL

PUNIT



Complete Unit
 2 Piece Rod, 5½ ft. Long

PC101 AUTOMATIC ARCH MACHINE

Looking for a better way to secure small boxes or orders for your shop or ecommerce application? You won't find better semi-automatic tabletop strappers than Greenbridge's PC101 and PC102. Shipped fully assembled and ready to use, these mighty mites are designed to quickly and efficiently secure each package with a minimum of effort. Virtually anyone can learn to operate these machines and we're ready to show you how.



SUPER FAST!
Up to 65 Straps Per Minute

FEATURES

- Cycle speed up to 65 straps per minute (based on arch size)
- German DC brushless motor technology
- 30% fewer parts – no belts, clutches or pulleys
- Waist-high quick change coil + strap feed
- Easy access operating control panel
- One-piece strap chute
- Easy access strap chute, no tools required
- Front foot bar pedal plus movable foot switch
- Sensor-controlled heater
- End of strap coil ejector/loop ejector
- Electronic brake/Auto loader
- Adjustable table height from 32" to 36"
- Easy to move + secure in place with lockable casters
- Choice of arch sizes

EQUIPMENT SPECS

- Cycle Rate:** Up to 65 straps per minute
- Package Weight:** Up to 100 lbs. per square foot
- Strap Tension:** Fully adjustable, up to 100 lbs.
- Polypropylene Strap:** 1/4", 3/8", 1/2" 5mm, 6mm, 9mm, 12mm
- Electrical Requirements:** 110V 60Hz 1 Phase
- Shipping Weight:** From 450-800 lbs.
- Core Size:** Must use 8 x 8
- Optional:** Photo-eye activation

PC102 VERSATILE SEMI-AUTOMATIC TABLETOP STRAPPER

EQUIPMENT SPECS

- Cycle Rate** 2.5 seconds/strap (60Hz)
- Tension** 30-90 lbs.
- Sealing Method** Heating element
- Polypropylene Strap Sizes** 1/4", 3/8", 1/2", 5/8", 6mm, 9mm, 12mm, 15.5mm
- Core Sizes** 8" x 8", 9" x 8", 11" x 8" *
- Reel Outside Diameter** 19"
- Electrical Requirements** AC 110, 60Hz, 1Ph
- Power Consumption** 0.57kw
- Machine Weight** 220 lbs. (closed cabinet), 185 lbs. (open cabinet)
- Layout Dimension** 29-1/2" H x 36-1/4" W x 23" D

*Core insert required. Part #300-1132



SAM-100 SEMI-AUTOMATIC TABLETOP BANDING MACHINE

EQUIPMENT SPECS

- Overall Width** 22.4" (570 mm)
- Overall Length** 29.9" (760 mm)
- Overall Height** 29.1"-30.7" (740 mm-780 mm)
- Machine Weight** 149.9 lbs. (68 kg.)
- Sealing Method** Heat Seal
- Sealing Head Location** 11.0" (280 mm) from the right of the machine
- Power Supply** 120V Single Phase
- Cycle Time** 2.0 Seconds*
- Cycle Initiation** Strap Insertion with "ACASS" System
- Tension** External Electronically Adjustable
- Min. Package Size** 4" (102 mm)H x 2.4" (61 mm)W
- Max. Package Weight** 180 lbs. (81.6 kg)
- Mobility** 4 Casters, two are locking
- Strapping Size** 1/4" (5 mm) - 5/8" (15.5 mm)
- Dispenser** 8" (203 mm) I.D./8" (203 mm) face/18" (457 mm) O.D.
9" (229 mm) I.D./8" (203 mm) face/18" (457 mm) O.D.



PC1000 AUTOMATIC ARCH MACHINE

Equipped with industry-leading features, the PC1000 is an innovative, high-speed automatic arch machine for high-volume applications. It comes standard with three different types of activation: push button, foot bar and remote foot switch.

The PC1000 offers optimal performance, high-cycle speed and is super easy to maintain.

SUPER FAST!
Up to 65 Straps Per Minute



FEATURES

- Cycle speed up to 65 straps per minute (based on arch size)
- German DC brushless motor technology
- 30% fewer parts – no belts, clutches or pulleys
- Waist-high quick change coil + strap feed
- Easy access operating control panel
- One-piece strap chute
- Easy access strap chute, no tools required
- Front foot bar pedal plus movable foot switch
- Sensor-controlled heater
- End of strap coil ejector/loop ejector
- Electronic brake/Auto loader
- Adjustable table height from 32" to 36"
- Easy to move + secure in place with lockable casters
- Choice of arch sizes

PC1000 Standard (12mm, 1/2")	
WIDTH	
	25 33 41 49 65 72 80 88
15	NA NA NA NA NA NA NA NA
19	NA NA NA NA NA NA NA NA
23	NA NA NA NA NA NA NA NA
31	NA NA NA NA NA NA NA NA
39	NA NA NA NA NA NA NA NA
47	NA NA NA NA NA NA NA NA

PC1000 Compact (5mm – 3/8")	
WIDTH	
	22 25 33 41 49 65 72
15	NA NA NA NA NA NA NA NA
19	NA NA NA NA NA NA NA NA
23	NA NA NA NA NA NA NA NA
31	NA NA NA NA NA NA NA NA
39	NA NA NA NA NA NA NA NA

EQUIPMENT SPECS

- Cycle Rate:** Up to 65 straps per minute
- Package Weight:** Up to 100 lbs. per square foot
- Strap Tension:** Fully adjustable, up to 100 lbs.
- Polypropylene Strap:** 1/4", 3/8", 1/2"
5mm, 6mm, 9mm, 12mm
- Electrical Requirements:** 110V 60Hz 1 Phase
- Shipping Weight:** From 450-800 lbs.
- Core Size:** Must use 8 x 8
- Optional:** Photo-eye activation

■ Stock item
 ■ Non-stock item special order
 ■ Arch size not available

PC1000SP SMALL PACKAGE

EQUIPMENT SPECS

- Cycle Rate:** up to 65 straps per minute
- Package Weight:** up to 100 lbs.
- Strap Tension:** up to 100 lbs.
- Polypropylene Strap:** 5mm, 6mm, 9mm, 3/8"
- Electrical Requirements:** 110V 60Hz 1 Phase
- Shipping Weight:** 450 LBS
- Optional:** Photo-Eye Activation

Up to 65 Straps Per Minute!



Capable of strapping packages as small as 1.7" wide x 3/8" high



PVC Pipe



Wood Trim

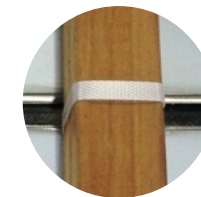

Wood Handles

PC1000P AUTOMATIC STRAPPING MACHINE WITH DUAL PNEUMATIC PRESS

Up to 47 Straps Per Minute!



EQUIPMENT SPECS

- Cycle Rate:** Compact: up to 47 straps per minute
Standard: up to 44 straps per minute up to 100 lbs.
- Package Weight:** Compact: up to 70 lbs.
Standard: up to 100 lbs.
- Strap Tension:** Compact: up to 70 lbs.
Standard: up to 100 lbs.
- Polypropylene Strap:** 5mm, 6mm, 9mm, 12mm, 1/4", 3/8", 1/2"
- Electrical Requirements:** 110V, 220V, 230V, 50/60Hz 1 Phase
- Shipping Weight:** 500 LBS

Ideal for strap compressible material such as corrugated papers, paper sheets, plastic sheets, bags and more

OPTIONAL FEATURES

- Photo-Eye Switch
- Rear Foot Bar Switch
- Lower Adjustable Table
- Height (30"-32")
- Max. Tension up to 100 lbs (for 9 mm, 1/2")

PC1500 + PC1500SS AUTOMATIC ARCH MACHINE

The PC1500 is an innovative high-speed automatic strapping machine loaded with all the industry standard features you need. The PC1500 delivers optimal performance for securing packages up to 100 pounds, including high-cycle speed and easy maintenance. The machine's strapping head is mounted in a side seal configuration that prevents debris from contaminating the seal head. This smart design keeps you running and helps avoid downtime. The PC15000 is a Greenbridge favorite and the most cost-effective strapping solution in its class today.



CONTACT YOUR REP FOR
STANDARD STAINLESS
STEEL ARCH SIZES

STANDARD FEATURES

- German DC brushless motor technology
- Waist-high, quick-change cord + strap feed
- Easy access operating control panel
- Easy access strap chute – no tools required
- Multiple strap function
- One-piece strap chute
- Sensor-controlled heater
- Smart LCD display
- End of coil strap ejector/loop ejector
- Electronic brake/auto loader
- Adjustable height roller top
- Lockable casters

PC1500	WIDTH					
	23	31	39	51	59	66
25	NA	NA		NA	NA	
33			NA		NA	NA
41						NA
49						
65	NA	NA		NA	NA	NA
72	NA	NA		NA	NA	NA

■ Stock item
■ Non-stock item special order
■ NA Arch size not available
■ Arch sizes do not come with table tops

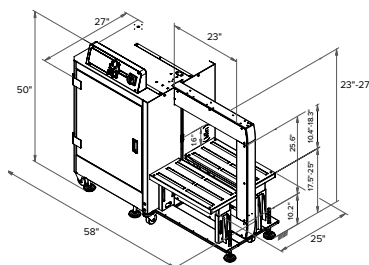

PC2000/PC2000P AUTOMATIC ARCH MACHINE

Greenbridge's PC2000 and PC2000P are world class, high-speed, fully automatic strapping machines. Both provide high reliability and performance, earning these machines the best price and value reputation in the market today. PC2000P is great for graphic arts.

SUPER FAST!
Up to 65 Straps
Per Minute



ALSO AVAILABLE IN
STAINLESS STEEL!

FEATURES

- Cycle speed up to 65 straps per minute (based on arch size)
- German DC brushless motor technology
- 30% fewer parts – no belts, clutches or pulleys
- Waist-high quick change coil + strap feed
- Easy access operating control panel
- One-piece strap chute
- Easy access strap chute, no tools required
- Front foot bar pedal plus movable foot switch
- Sensor-controlled heater
- End of strap coil ejector/loop ejector
- Electronic brake/Auto loader
- Adjustable table height from 32" to 36"
- Easy to move + secure in place with lockable casters
- Choice of arch sizes

Arch sizes available for strap from 1/4" - 1/2"

- 22"x15"
- 25"x19"
- 33"x23"
- 33"x31"
- 33"x39"
- 41"x31"

SPECIFICATIONS

- Cycle Rate:** Up to 65 straps per minute
- Package Weight:** Up to 100 lbs. per square foot
- Strap Tension:** Fully adjustable, up to 100 lbs.
- Polypropylene Strap:** 1/4", 3/8", 1/2"
5mm, 6mm, 9mm, 12mm
- Electrical Requirements:** 110V 60Hz 1 Phase
- Shipping Weight:** From 450-800 lbs.
- Core Size:** Must use 8 x 8
- Optional:** Photo-eye activation





PC2000CX

AUTOMATIC SIDE-SEAL ARCH MACHINE FOR PROTEIN + SEAFOOD INDUSTRIES



Greenbridge's PC2000CX is a world-class, high-speed fully automatic arch machine designed specifically for the protein markets. Manufactured with a stainless steel frame and rust-resistant and corrosion-retardant parts inside, the PC2000CX provides high reliability, ease of maintenance and performance in harsh environments, earning it the best price and value reputation in the market today.

For Poultry, Meat + Fish

-  Designed for harsh environments
-  Easy to operate
-  Dual cylinder pneumatic press
-  Variable speed belt conveyor

SPECIFICATIONS

Cycle Rate	Up to 65 straps per minute
Standard Arch Size	25" W x 19" H (Other arch sizes available)
Package Weight	Up to 100 lbs.
Strap Tension	Up to 115 lbs.
Polypropylene Strap	3/8", 1/2", 5mm, 6mm, 9mm, 12mm
Electrical Requirements	110V, 60Hz, 1 Phase
Shipping Weight	450 lbs.
Air Requirements	90 PSI, 8 CFM

STANDARD FEATURES

- Robust, compact strapping head
- Free access to strap guides
- Electronic tension control/auto strap ejector
- Siemens PLC control with dual photo eyes
- Hinged top plates (7 gauge)/splash guard over seal head
- Dual cylinder pneumatic press for agility + finely tuned package compression
- Pneumatic air gun for easy maintenance + cleaning
- Extra wide HD locking casters to handle quick movements in + out of station
- Fixed strap cutter near strap coil for convenience
- Multiple strap function for single, double, continuous strapping or transit mode
- Belt-driven table with variable conveyor speed of 10 to 60 meters per minute
- Up + down stream interlock with complete plug connection
- Easy reversible package flow
- Loop ejector

N3400

AUTOMATIC STRAPPING MACHINE

EQUIPMENT SPECS

Overall Width:	32.5" (828mm)
Overall Length:	37.6" (956mm) with external dispenser
Overall Height:	47.6" (1210mm)
Table Height:	61.6 - 66.3" (1565 - 1685mm)
Weight:	386 lbs. (175kg)
Cycle Time:	Up to 55 cycles per minute
Cycle Initiation	Photo eye sensor or footbar
Standard Arch Size:	600mm(W) x 600mm(H)
Strap Size:	1/4" - 1/2" (5mm - 12mm)
Package Size:	Min. 1.5" H x 6" W
Tension	Adjustable electronic control
Seal Head Location:	Bottom
Sealing Method:	Heat Seal
Mobility:	3" Casters
Power:	110 Volt Single Phase



N3400A

HIGH PERFORMANCE FULLY AUTOMATIC STRAPPING MACHINE

EQUIPMENT SPECS

Overall Width:	23.9" (608mm)
Overall Length:	47.2" (1200mm)
Overall Height:	60.6 - 69.6" (1540 - 1770mm)
Table Height:	30.3 - 39.3" (770- 1000mm)
Weight:	639 lbs. (290 kg)
Cycle Time:	Up to 35 cycles per minute
Cycle Initiation	Photo eye sensor
Standard Arch Size:	600mm(W) x 600mm(H)
Strap Size:	5mm - 12mm
Package Size:	Max. Governed By Arch Min. 1.5"H x 3" W
Tension	Adjustable electronic control
Seal Head Location:	Bottom
Sealing Method:	Heat Seal
Mobility:	3" Casters
Dispenser:	Externally located- 8" or 9" I. D./8" Face/18" O.D.
Power:	120 Volt Single Phase

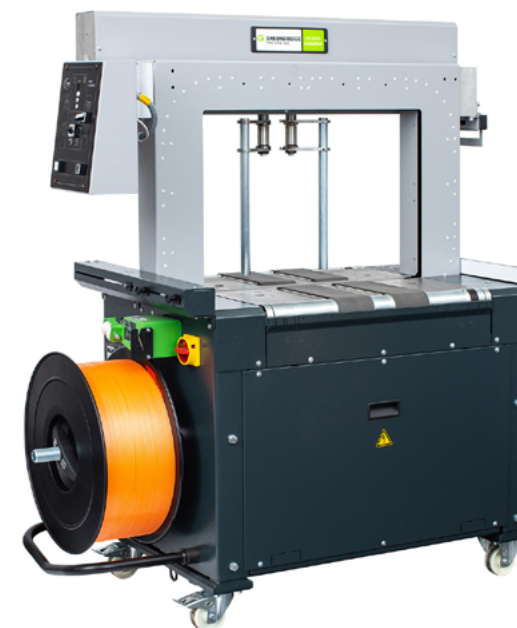

N3400V

HIGH SPEED VERTICAL AUTOMATIC STRAPPING MACHINE

EQUIPMENT SPECS

Overall Width:	17.1" (435mm)
Overall Length:	59.0" (1497mm)
Overall Height:	65.8 - 69.7" (1673 - 1773mm)
Table Height:	13.6" - 17.5" (344 - 444mm)
Weight:	441 lbs. (200kg)
Cycle Time:	Up to 45 cycles per minute
Cycle Initiation	Push button
Standard Arch Size:	576mm(W) x 567mm(H)
Strap Size:	1/4" - 1/2" (5mm - 12mm)
Package Size:	Max. Governed By Arch Min. 2.17" H x .2" W
Tension	Max. 240 lbs. (325 N)
Seal Head Location:	Side
Sealing Method:	Heat Seal
Mobility:	3" Casters
Dispenser:	Externally located- 8" or 9"l. D./8" Face/18"O.D.
Power:	110 Volt Single Phase



N3400C

HIGH-SPEED AUTOMATIC STRAPPING MACHINE

EQUIPMENT SPECS

Overall Width:	32.5" (828mm)
Overall Length:	37.6" (956mm)
Overall Height:	47.6" (1210mm) with external dispenser
Table Height:	61.6 - 66.3" (1565 - 1685mm)
Weight:	31.3 - 35.8" (795 - 910mm)
Cycle Time:	386 lbs. (175kg)
Cycle Initiation	Up to 55 cycles per minute
Standard Arch Size:	Photo eye sensor or footbar
Strap Size:	1/4" - 1/2" (5mm - 12mm)
Package Size:	Max. Governed By Arch Min. 1.37" H x 2.5" W
Tension	Adjustable electronic control
Seal Head Location:	Bottom
Sealing Method:	Heat Seal
Mobility:	3" Casters
Dispenser:	Internally located- 8" or 9"l. D./8" Face/18"O.D.
Power:	110 Volt Single Phase



N3400RA

RETRACTABLE ARCH STRAPPING MACHINE

EQUIPMENT SPECS

Capacity	Single strap, bundles/minute up to, depending on tension	20
Bundles	Width	40mm – 250m
	Height	5mm -170mm, depending on arch size
	Weight	Max 30 kg.
Strap Tension	Adjustable with 10 steps Automatic strap tensioning Tension at bundle in Foot Pounds:	Max. 325
Strapping Material		Polypropylene DIN EN 13 394
Strap Width		5 - 12mm
Strap Thickness		0.4 – 0.65mm
Strap Coil Core ID		200 - 228
Strap Coil Core OD		420
Width in mm:		160 - 190
Power Supply		1Wide Range Input 100-240V, 1AC; 47-63 Hz



NP7000

HIGH-SPEED AUTOMATIC STRAPPING MACHINE

EQUIPMENT SPECS

Overall Width:	32.5" (828mm)
Overall Length:	37.6" (956mm)
Overall Height:	47.6" (1210mm) with external dispenser
Table Height:	61.6 - 66.3" (1565 - 1685mm)
Weight:	31.3 - 35.8" (795 - 910mm)
Cycle Time:	386 lbs. (175kg)
Cycle Initiation	Up to 55 cycles per minute
Standard Arch Size:	Photo eye sensor or footbar
Strap Size:	1/4" - 1/2" (5mm - 12mm)
Package Size:	Max. Governed By Arch Min. 1.37" H x 2.5" W
Tension	Adjustable electronic control
Seal Head Location:	Bottom
Sealing Method:	Heat Seal
Mobility:	3" Casters
Dispenser:	Internally located- 8" or 9"l. D./8" Face/18"O.D.
Power:	110 Volt Single Phase



CB7000

CORRUGATED BUNDLER AUTOMATIC STRAPPING MACHINE

How do you avoid damage to corrugated across your supply chain? It starts with having the right bundling equipment to unitize product quickly, efficiently and securely. Equipment that works as hard as you do.

That's where Greenbridge comes in.

SUPER FAST!
Up To 33 Bundles Per Minute



CB7000 Is All Business

FEATURES

Full-color touch screen

is an intuitive, easy to use interface.

Robust, compact direct drive strapping head

The latest DC, German-made DC brushless motor technology provides the industry's highest level of accuracy + reliability.

Siemens PLC control

Provides easy adjustments, TEACH-IN programming + troubleshooting guides.

Patented jammed-strap ejection device

Makes it easy to remove jammed strap and get back to work.

Full-width pneumatic press

Provides the highest reliability and stability.

Free access to strap guides

No tools needed to access strap guides.

Multiple strap function

For single, double, continuous strapping or transit mode.

Variable Conveyor Speed

Fully automatic operation with a variable conveyor.

Strap end ejector

Eject end of strap from the inlet of strap feeding. Easy to clean + get the machine ready for next coil of strap.

Adjustable table height

Adjusts from 27.5" to 39"

OPTIONS

- Adjustable back stops
- Uplift support for heights greater than 39"

EQUIPMENT SPECS

Arch Sizes	65" (W) x 17" (H) 49" (W) x 17" (H)
Cycle Rate	Up to 24 bundles per minute (single strap) Up to 20 bundles per minute (double strap)
Strap Width	5mm, 6mm, 9mm polypropylene strap
Strap Tension	2 to 70 lbs.
Minimum Bundle Size	11" (L) x 8" (W) x 3/3" (H)
Bundle Weight	Max 88 lbs.
Transport Speed	49 to 196 feet per minute
Electrical Requirements	220V, 380V, 400V, 50/60Hz 3 Phase

CB7000SQ

SQUARING CORRUGATED BUNDLER AUTOMATIC STRAPPING MACHINE

How do you avoid damage to corrugated across your supply chain? It starts with having the right bundling equipment to unitize product quickly, efficiently and securely. Equipment that works as hard as you do.

That's where Greenbridge comes in.

SUPER FAST!
Up To 24 Bundles Per Minute



CB7000SQ Is All Business

FEATURES

Full-color touch screen

is an intuitive, easy to use interface.

Robust, compact direct drive strapping head

The latest DC, German-made DC brushless motor technology provides the industry's highest level of accuracy + reliability.

Siemens PLC control

Provides easy adjustments, TEACH-IN programming + troubleshooting guides.

No-tool strap guide access

How easy is this?

Automatic bundle size set-up system

The automatic setting mode lets you change bundle size change in 15 seconds, minimizing downtime.

Three-side squaring bundle control

Electric-driven side squaring + backstop devices optimize bundle integrity for strapping. Front + rear squaring mechanism with independent control system improves squaring performance over a wider range of bundle sizes.

Motorized full-width press bar

Delivers high reliability and stability of the movement. Increase strapping speed with easy adjustments to press bar positions.

Hinged roller table

Ergonomic design makes it easy and effortless to open the table top for cleaning + maintenance.

Ideal for small bundles –

even those as small as 8" (W) x10" (L).

EQUIPMENT SPECS

Arch Sizes	65" (W) x 17" (H)
Cycle Rate	Up to 24 bundles per minute (single strap)
Strap Width	5mm, 6mm, 9mm polypropylene strap
Strap Tension	2 to 70 lbs.
Transport Speed	49 to 196 feet per minute
Electrical Requirements	220V, 380V, 400V, 415V, 50/60Hz 3 Phase

OPTIONS

- Dual dispensers with auto coil change
- Uplift support for heights greater than 39"
- Greenbridge quality polypropylene strap
- Greenbridge equipment maintenance program
- Full-color touch screen

GEO
SEMI-AUTOMATIC ORBITAL WRAPPER

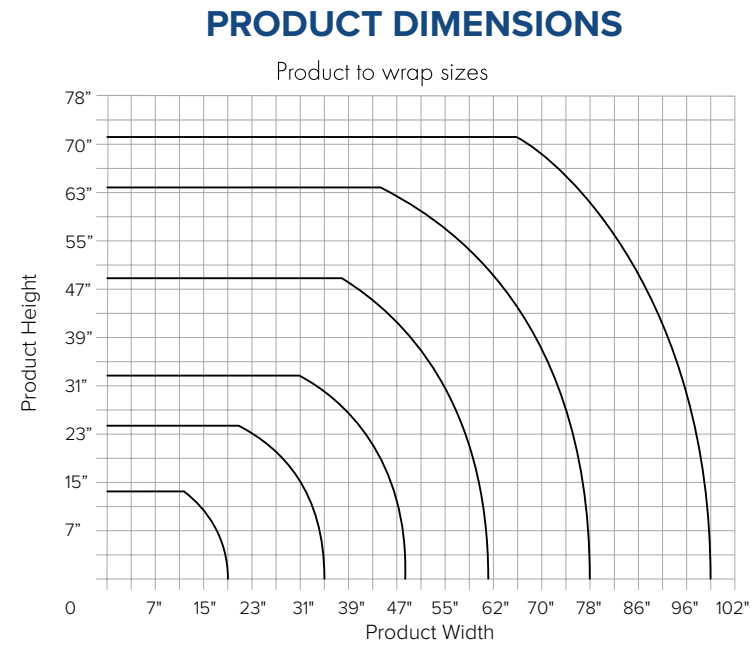
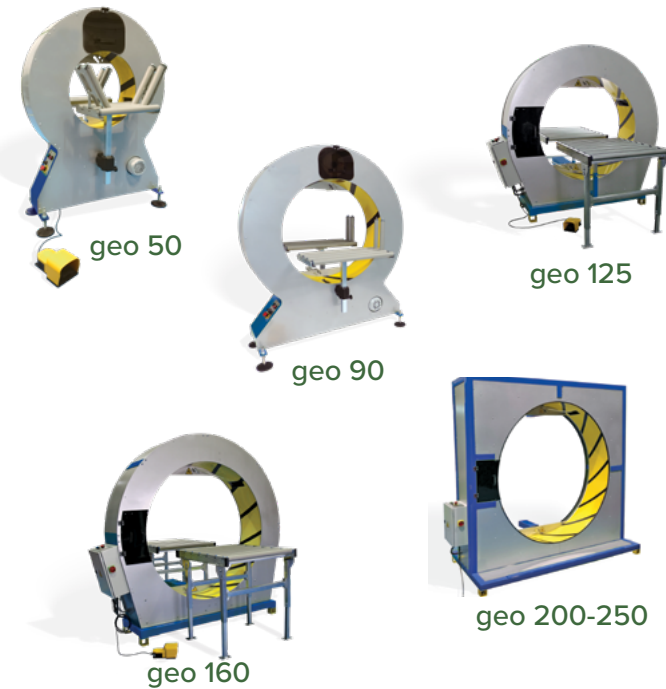

AXIS
SEMI & FULLY - AUTOMATIC ORBITAL WRAPPER FOR ROUND PACKAGES



AXIS PRODUCT DIMENSIONS
Product to wrap sizes

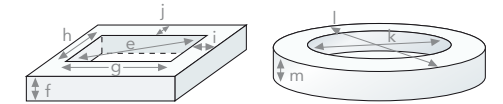

	Axis 50	Axis 90
e	13 - ∞ in	
f	0.4 - 10 in	
g	9.6 - ∞ in	
h	9.6 - ∞ in	
i	0.4 - 17.7 in	
j	0.4 - 17.7 in	
k	11 - 35 in	13 - 70 in
l	14 - 37 in	17.25 - 71 in
m	0.4 - 8 in	2 - 16.5 in

LUNA
FULLY-AUTOMATIC ORBITAL WRAPPER

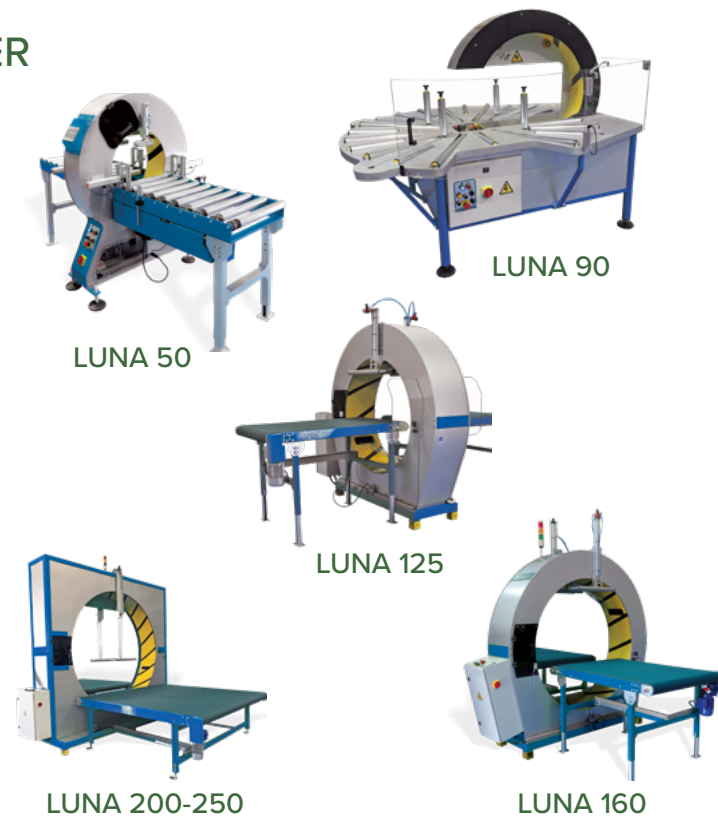
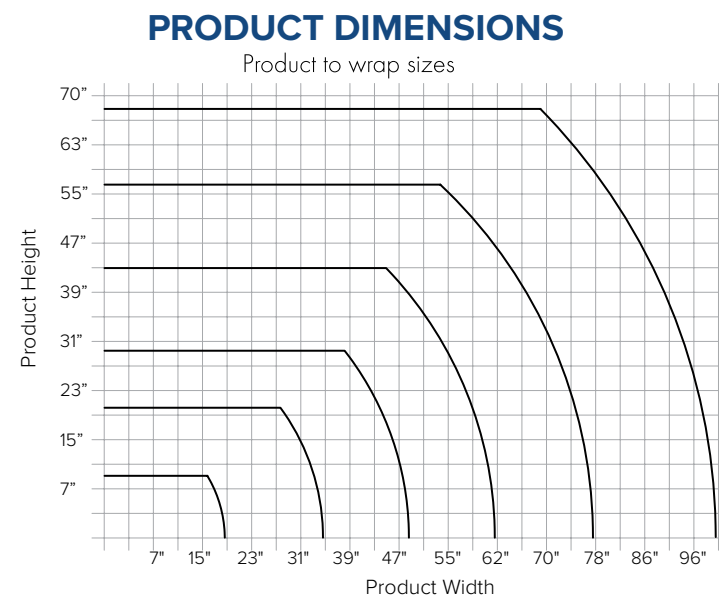

SATURN
ORBITAL WRAPPER

EQUIPMENT SPECS

Overall Width:	59"
Overall Length:	103"
Overall Height:	93"
Turntable Diameter:	60"/70"
Wrapping Height:	94"
Max Pallet Weight:	440 lbs.
Film Carriage Speed:	80" - 200"/min.
Film Roll ID:	3" x 19.7"
Power Consumption:	1.4 kW
Machine Net:	1455 Lbs



SX600 ULTRASONIC STRAPPING HEAD SOLUTIONS

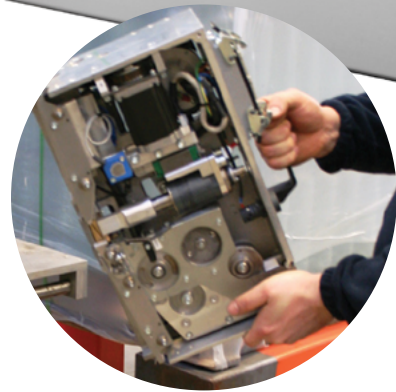
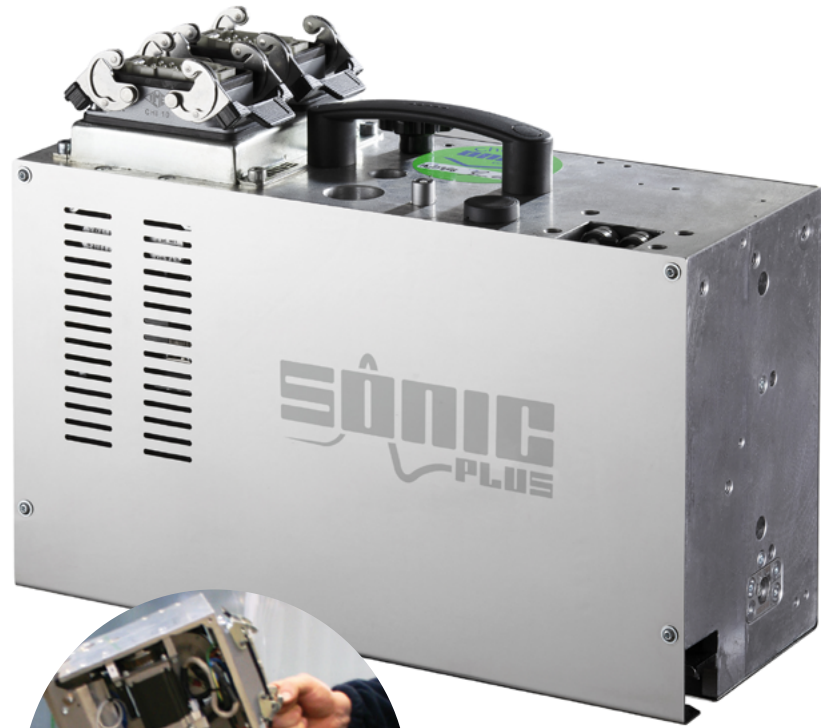

With its innovative ultrasonic weld system, the Greenbridge SX600 Ultrasonic strapping head is the newest, state-of-the-art design in strapping technology. With a compact size, the SX600 weighs in at just 44 pounds. It's so light, one person can easily move it alone, making head replacement much easier and safe. The SX600 features simple strap feeding and ultrasonic sealing technology for reliable seals on polypropylene or polyester strapping. If you're looking for a strapping head built for safer handling and maintenance friendly operation, **you need this strapping head.**



MAXIMIZE UP TIME!

Easy Component Exchange

AT JUST 44 POUNDS SX600 is Easy to Handle!

STANDARD FEATURES

- Ultrasonic sealing technology
- Reduced overall dimensions
- Easy strap feeding
- Reliable seals on PP or PET strap
- Option of automatic strap feeding device

BENEFITS

FAST CYCLE

- Variable speed
- Ultrasonic sealing

RELIABLE

- Fewer parts
- Linear Cam
- Downtime is virtually eliminated

SUPPORT WORKER SAFETY

- Lighter weight
- One person can lift + carry

ECONOMICAL

- Operates with cost efficient strap
- No lubrication required

SPECIFICATIONS

Dimensions	15.75" x 9.5" x 6.3"
Weight	44 lbs.
Strap Type	Polyester or Polypropylene
Strap Width	3/8" – 1/2"
Feeding + Recovery Speed	18' per second
Strap Tensioning	Up to 340 lbs.
Tensioning Regulation	Manual Adjustment
Utilization Temperature	50° – 122° F

TR MODULAR SERIES STRAPPING HEAD SOLUTIONS

The versatile TR Modular Series of strapping heads is engineered to allow rapid exchange of units in the head to enable maximum throughput and minimal delays during changeovers. Quick change modular parts include welding and clamping units. These heads include long-lasting, self-cleaning heater blades perfect for polyester strapping. Strap is easy to load, with auto re-feed and strap-in-place signals. Count on the TR Modular Series strapping heads to apply consistent strap tension to a pack, securing the load like a pro. **You need these heads.**



TR1400 for Metal Cans + Plastic Bottles – Versatility Plus!



TR1800 for Glass Bottles + Jars – Strong + Secure!



TR2000 for Brick + Lumber – Heavy Duty Power!

FEATURES + BENEFITS

- Modular clamping + welding units
- Heat-seal technology
- Proven, reliable tensioning technology
- Fast, consistent strap feed + alignment
- Rapid head replacement minimizes downtime
- Models to suit all industries
- One 0.75 Kw electric motor

EQUIPMENT SPECS

	TR1400	TR1800	TR2000
Strap Type	PP + PET	PET	PET
Strap Width	0.35" – 0.63"	0.47" – 0.75"	0.63" – 0.75"
Strap Thickness	.023" - .039"	.023" - .039"	.030" - .050"
Maximum Feeding + Recovery Speed	18' per second	8.8' per second	8.8' per second
Maximum Strap Tensioning	500 lbs.	900 lbs.	1500 lbs.
Dimensions	28.94" W x 11.42" D x 11.81 H		
Utilization Temperature	32° – 120° F		
Noise Level	<70 decibels		
Options	Strap refeeding device		

PBSU
BOTTOM SEAL AUTOMATIC STRAPPING MACHINE



FEATURES/OPTIONS

- Full Conveyor Integration
- Allen-Bradley™ PLC
- Corner Protection Pkg. Conditioning 2
- Custom Arch Sizes
- Electrical Head Index

SPECIFICATIONS

Industry	All
Strap	PET + PP
Head	SX600, TR1400, TR1800, TR19HT, TR2000
Power	480 VAC, 60 Hz, 3 phase, 20A
Arch	Modular, Aluminum Track
Compression	

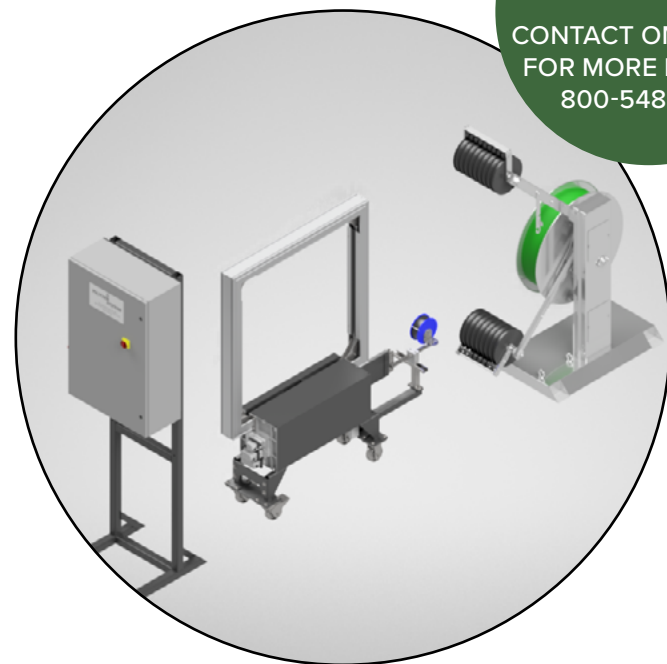

**CUSTOM
OPTIONS
AVAILABLE!**

CONTACT OMS SALES
FOR MORE DETAILS,
800-548-9557

PSSU
SIDE SEAL MACHINES FIXED HEAD



FEATURES

- Low Maintenance
- Easy Access to Strap Path
- High Tension Capable
- Quick Installation
- Fixed Head
- Fixed Track
- Unitizing Machine
- Optional: Mobility Frame with lockable castors

SPECIFICATIONS

Industry	General Application
Battery	PET + PP
Head	SX600, TR1400, TR1800, TR19HT, TR2000
Power	480 VAC, 60 Hz, 3 phase, 20A
Track	Extruded Aluminum-Modular Build

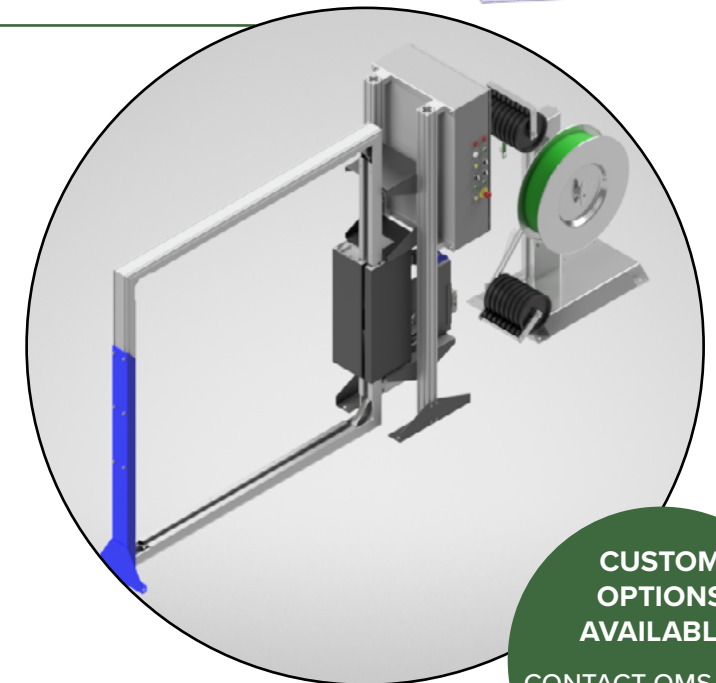

**CUSTOM
OPTIONS
AVAILABLE!**

CONTACT OMS SALES
FOR MORE DETAILS,
800-548-9557

PSBU/PSIU

SIDE SEAL MACHINES INDEXING HEAD WITH OR WITHOUT RETRACTABLE BAYONET



Front of PSBU



**All Electric
No Air Required**

Back of PSBU

**CUSTOM
OPTIONS
AVAILABLE!**

CONTACT OMS SALES
FOR MORE DETAILS,
800-548-9557

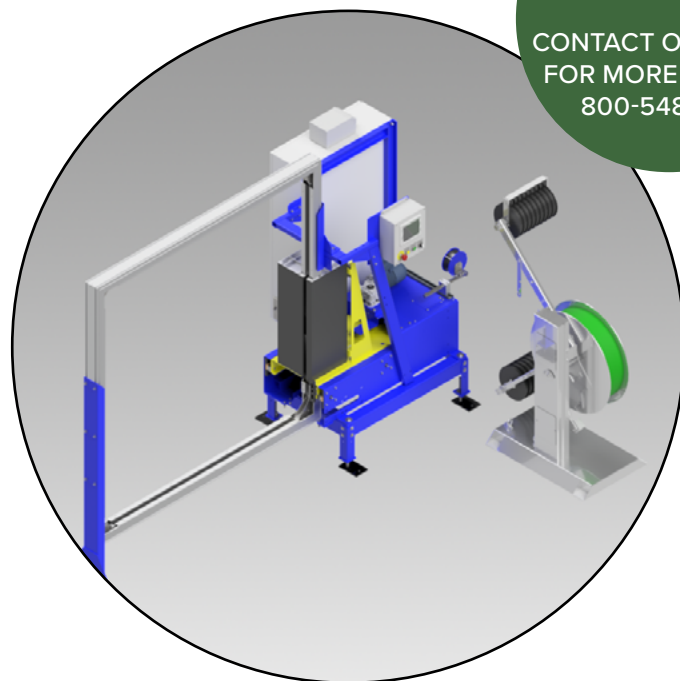

SPECIFICATIONS

CAN + BOTTLE

Industry	Can + Bottle, All other
Strap	3/8" (PET bottle and metal can) 7/16" or 1/2" (glass)
Head	SX600 TR1400 (PET bottle and metal can) TR19HT (glass)
Power	480 VAC, 60 Hz, 3 phase, 20A
Compression	Modular

GENERAL APPLICATION

Industry	Can + Bottle, All other
Strap	PET + PP
Head	SX600, TR1400, TR1800, TR19HT, TR2000
Power	480 VAC, 60 Hz, 3 phase, 20A
Track	Extruded Aluminum-Modular Build

MHBU

EXCLUSIVE, QUICK-CHANGE STRAPPING HEAD

When your application requires special configuration, you need to look at the flexibility of the MHB series and Greenbridge's ability to adapt and customize to your specification therefore lowering your overall cost of manufacturing.

The MHB series strapping machines are built strong. By using high quality materials and heavy-duty hardware the strapping unit will perform in even the toughest environments.

EQUIPMENT

- Tension adjustable with 10 steps
- Operation Terminal with Soft-Button
- DAT "Direct-Access-Technology"
- ASLF "Anti-Strap-Loss-Function" Constant strap control
- Wear-free Strap frame by stainless steel guide
- Wear-free, energy saving direct-drive motors
- Adjustable torque controlled strap tension
- Automatic Strap feed

BENEFITS

- User-friendly and intuitive
- Economical due to high availability
- Robust and extremely low maintenance
- Powerful
- Variable strap width

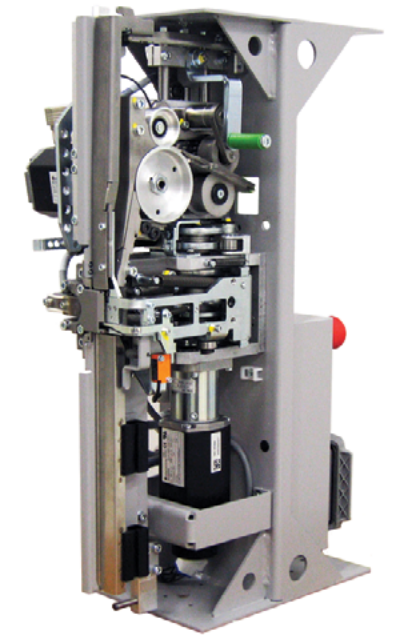

MHB SPARE HEAD

MHB

MULTIPLE HEAD SIDE SEAL STRAPPING MACHINE



The MHB is a custom built side seal strapping machine designed to strap product vertically. The unique head location is designed to minimize foreign matter from interrupting machine performance. Designing a multiple head system can dramatically increase your production. Constructed with heavy-duty material and hardware allows this machine to operate flawlessly in virtually any environment.

SERVICES, AGREEMENTS AND TRAINING

Greenbridge's customer commitment does not end with the purchase of the packaging systems equipment. The Equipment Group, at Greenbridge, performs tool repairs and maintains a large inventory of spare and replacement parts. The Equipment Group can also supervise the installation of all systems and provide on-site operator and maintenance training. Greenbridge offers machine maintenance agreements through regularly scheduled visits. We have Field Service technicians across the continental USA for quick response in case of an emergency.

STANDARD SERVICE PROGRAM

- Greenbridge has industry competitive service rates to help our customers when they need preventive maintenance or repairs on their equipment.
- On top of providing service for Greenbridge equipment, we also have the capability to provide service on multiple competitor equipment.
- Our Field Service technicians carry common wear items for the equipment. We also have a wide availability of parts in our Green, OH facility.
- We can provide on-site training for your operators and maintenance personnel to keep your machines in proper working conditions.
- We also provide phone support and video calls.



COMPLETE OMS HEAD REBUILD PROGRAM

- As part of the service calls or agreements, Greenbridge can also rebuild your strapping heads on-site.
- 1-2 days per strapping head
- Training for in-plant maintenance personnel for rebuilds.
- Emergency Service offered.



COMPLETE SERVICE AGREEMENTS

- Greenbridge offers tailored Service Agreements per each customer needs. We offer from 2 visits per year (bi-annual) all the way to a visit per month.
- Signing an agreement with Greenbridge will provide discounts on Labor & Parts.
- Customers with Agreements will be prioritized in case of an emergency (Less than 2 weeks' notice)
- Greenbridge head swap program available*



HOW TO SELECT THE PROPER TOOLS

PALLETS PER 8-HOUR SHIFT:

1-30 Pallets



MANUAL



BATTERY

31-80 Pallets



BATTERY



PNEUMATIC

81+ Pallets



GREENBRIDGE SYSTEMS

Installation of air powered tools

There are TWO important functions, pressure and volume. Without the proper volume as well as pressure, the tool will not perform or function properly.

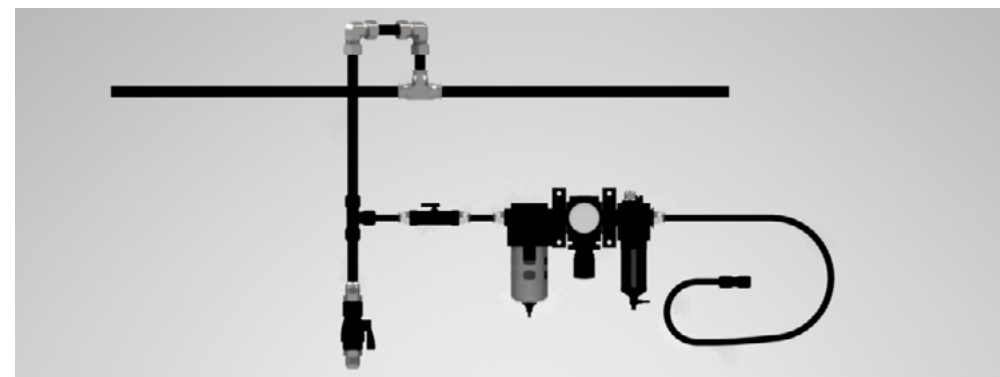

1. It is helpful if main air line is pitched so far end terminates in a water leg.
2. Branch lines, 1/2" pipe size, or larger should be taken from the top of the main line; never off the bottom.
3. Each branch line should have a water leg at its lowest point with a drain cock which should be periodically tested, drawing all the water off. The above precautions reduce the amount of moisture that reaches the filter-regulator-lubricator unit.
4. Locate the f-r-l unit above the elevation of the tool when practical, and as close to the strapping operation as possible. It should easily be accessible for draining, filling and adjusting.
5. Tool fittings (quick disconnect) should be a minimum of 3/8" ID.

GENERAL SAFETY RULE FOR PRODUCTS ON SKIDS OR PALLETS

Always place a minimum of 2 straps in the load direction. The load direction is always how the skid or pallet is placed on a truck oriented front to back.

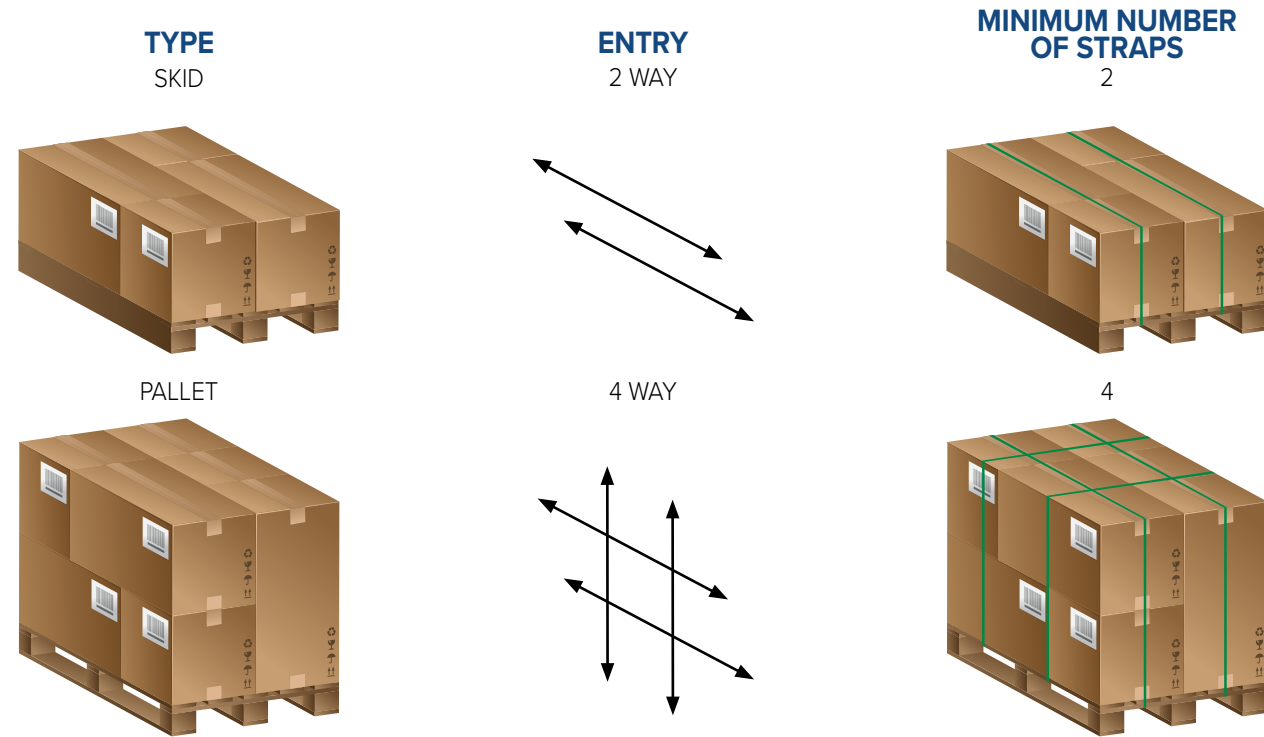

GENERAL BREAK STRENGTH GUIDELINES*

General starting point: Take the weight of the load x 1.5, divided by the number of straps.

EXAMPLE:



1,200 lbs.
2 straps

$$\frac{1,200 \times 1.5}{2} = 900$$

The break strength of the strap should be at least **900 lbs.**

*see caution & warranty below

Caution: Always proceed with caution. It is up to the user to determine if the load is safe.
Warranty: Seller warrants that the products sold herein will conform to Seller's specifications and will be free of defects in workmanship and materials for a period of one (1) year from the date of production. EXCEPT AS EXPRESSLY STATED HEREIN, SELLER MAKES NO REPRESENTATIONS OR WARRANTIES, EITHER EXPRESS OR IMPLIED AND EXPRESSLY DISCLAIMS ALL WARRANTIES REGARDING THE MERCHANTABILITY OR FITNESS FOR A PARTICULAR PURPOSE OF THE PRODUCTS DESCRIBED HEREIN. The equipment and procedures utilized to apply the product and environmental conditions are among the factors which may adversely affect the performance of the product. It is essential that the user evaluate whether the product is fit for a particular purpose and user's method of application.

FRICION BATTERY TOOL SELECTION GUIDE



B- Series	B300	B600	B1200	SB8400	SB8500
Features	<ul style="list-style-type: none"> Lowest Cost Light Tension 	<ul style="list-style-type: none"> One Button Tension, Seal and Cut Full Auto, Semi Auto and Manual DC Brushless Motors 	<ul style="list-style-type: none"> Battery Powered Powerful and Quick Strong and Reliable 	<ul style="list-style-type: none"> Battery Powered Powerful and Quick Double Notch Seal 	
TOOL PERFORMANCE					
Max tension (lbs)	300	600	1200	2200	N/A
Sealing	Friction	Friction	Friction	Friction	Double Notch
Joint Strength	75% of Strap Break	80% of Strap Break	80% of Strap Break	75% of Strap Break	75% of Strap Break
Tension Speed	5 in / sec	10.4 in / sec	7.9 in / sec	2 in / sec	N/A
STRAPPING RANGE					
Strap Type	PP or PET	PP or PET	PP or PET	Steel	Steel
Width (inches)	1/2" to 5/8"	1/2" to 5/8"	5/8" to 3/4"	3/4" to 1 1/4"	3/4" to 1 1/4"
Thickness (inches)	0.020" to 0.030"	0.019" to 0.030"	0.031" to 0.050"	.023" - .043"	.023" - .043"
TOOL FEATURES					
Manual Mode	Yes	Yes	Yes	Yes	Yes
Semi Automatic	No	Yes	Yes	N/A	N/A
Fully Automatic	No	Yes	Yes	N/A	N/A
Welding by button	No	Yes	Yes	N/A	N/A
Motors	2	3	3	1	1
PHYSICAL DIMENSIONS					
Weight (lbs)	8.8	8.8	8.8	14.2	9.9
Length (inches)	12.5	11.8	11.8	15.75	13.7
Width (inches)	5.5	5.9	5.9	4.72	3.9
Height (inches)	6.5	6.3	6.3	4.72	3.2
BATTERY - QUICK CHANGE					
Part Number	B300BAT	B600BAT	B1200BAT	B302BAT	B302BAT
Output	14.4V 3.0 A/H	14.8 V 2.0 A/H	14.8 V 3.2 A/H	14.8 V 3.0 A/H	14.8 V 3.0 A/H
Type	Lithium Ion	Lithium Polymer	Lithium Polymer	Lithium Ion	Lithium Ion
Charge Time	30 to 45 min	20 to 40 min	20 to 40 min	30 to 45 min	30 to 45 min
BATTERY CHARGER					
Included with Tool	1 Charger	1 Charger	1 Charger	1 Charger	1 Charger
Part Number	300CHG	600CHG	600CHG	301CHG	301CHG
Output	60 Hz 35W	60 Hz 80W	60 Hz 80W	60 Hz 120W	60 Hz 120W
Power Supply	16.4V 3A	16.8 V 5A	16.8 V 5A	21V 4A	21V 4A
OPTIONAL ACCESSORIES					
Suspension Bracket	190144	190259	190259	N/A	N/A
HD Wear Plate	189803	190258	190258	N/A	N/A
Counter Balancer	189195	189195	189195	N/A	N/A

FRICITION BATTERY TOOL SELECTION GUIDE



B- Series	B400	B800	B1000	B2000	EVO HT	EVO LT
Features	• Light Tension • Lowest Cost	• Mid Tension • Efficient tension/ seal technology	• High Tension • Value Priced High Tension Tool	• Highest Tension • Fully Automatic	• BlueTooth • Lever Free • Intuitive Interface	• BlueTooth • Lever Free • Intuitive Interface
TOOL PERFORMANCE						
Max tension (lbs)	450	850	1125	2000	600	600
Sealing	Friction	Friction	Friction	Friction	Friction	Friction
Joint Strength	80% of Strap Break	80% of Strap Break	80% of Strap Break	80% of Strap Break	80% of Strap Break	80% of Strap Break
Tension Speed	5.9 in / sec	5.9 in / sec	5.9 in / sec	7 in / sec	4 in / sec	7.2" / sec
STRAPPING RANGE						
Strap Type	PP or PET	PP or PET	PP or PET	PET	PP or PET	PP or PET
Width (inches)	3/8" to 5/8"	5/8" to 3/4"	5/8" to 3/4"	1" to 1 1/4"	5/8" to 3/4"	1/2" to 5/8"
Thickness (inches)	0.019" to 0.030"	0.025" to 0.040"	0.035" to 0.050"	0.031" to 0.055"	0.028" - 0.05"	.019"-0.036"
TOOL FEATURES						
Manual Mode	Yes	Yes	Yes	Yes	Yes	Yes
Semi Automatic	No	No	No	Yes	Yes	Yes
Fully Automatic	No	No	No	Yes	Yes	Yes
Welding by button	No	No	No	Yes	Yes	Yes
Motors	2	2	2	3	2	2
PHYSICAL DIMENSIONS						
Weight (lbs)	7.9	8.4	8.4	14.2	10.2	9.7
Length (inches)	11.4	12.4	12.4	11.8	12.8	13
Width (inches)	5.5	5.5	5.5	5.9	5.3	5.3
Height (inches)	6.5	7.2	7.2	7.9	5.3	5.3
BATTERY - QUICK CHANGE						
Part Number	B400BAT	B800BAT	B800BAT	B2000BAT	B302BAT	B302BAT
Output	14.8 V 2.0 A/H	14.8 V 3.0 A/H	14.8 V 3.0 A/H	36V 2.0 A/H	18V, 5ah Li-Ion	18V, 4ah Li-Ion
Type	Lithium Polymer	Lithium Polymer	Lithium Polymer	Lithium Ion	Lithium Ion	Lithium Ion
Charge Time	20 to 40 min	20 to 40 min	20 to 40 min	20 to 40 min	30 to 45 min	30 to 45 min
BATTERY CHARGER						
Included with Tool	1 Charger	1 Charger	1 Charger	1 Charger	1 Charger	1 Charger
Part Number	400CHG	400CHG	400CHG	2000CHG	301CHG	301CHG
Output	60 Hz 80W	60 Hz 80W	60 Hz 80W	60 Hz 375W	60 Hz 120W	60 Hz 120W
Power Supply	16.0 V 5A	16.0 V 5A	16.0 V 5A	14.4V 2A	21V 4A	21V 4A
OPTIONAL ACCESSORIES						
Suspension Bracket	190144	190144	190144	190259	408260	408260
HD Wear Plate	189803	189803	189803	N/A	N/A	N/A
Counter Balancer	189195	189195	189195	189300	189195	189195

PNEUMATIC TOOL SELECTION GUIDE



PHT- Series	PHT 401	PHT 801	PHT 1201	PHT 1401	PWT
Features	• Light Tension Range • PET & Polypropylene • Light to Medium Applications	• PET & Polypropylene • Med-Heavy Applications	• High Tension Tool • PET Only • Med-Heavy Applications	• 1-1.25" PET Tool (ideal for lumber & steel) • PET Only • Heavy Duty Applications	• Sealing Only • Ideal for Bailing • Integral Suspension bracket
TOOL PERFORMANCE					
Max tension (lbs)	450	850	1250	1280	N/A Seal Only
Sealing	Friction	Friction	Friction	Friction	Friction
Joint Strength	80% of Strap Break	80% of Strap Break	80% of Strap Break	80% of Strap Break	80% of Strap Break
Tension Speed	11m / min	9m / min	9m / min	4m / min	N/A
STRAPPING RANGE					
Strap Type	PP or PET	PP or PET	PET	PET	PP or PET
Width (inches)	3/8" to 5/8"	5/8" to 3/4"	5/8" to 3/4"	1" to 1 1/4"	7/16" to 3/4"
Thickness (inches)	0.020" to 0.029"	0.030" to 0.040"	0.040" to 0.055"	0.040" to 0.050	0.016" to 0.055"
TOOL FEATURES					
Release button	No	Yes	Yes	Yes	No
Manual Mode	Yes	Yes	Yes	Yes	Yes
Welding by lever	Yes	Yes	Yes	Yes	Yes
Motors	2	2	2	2	1
PHYSICAL DIMENSIONS					
Weight (lbs)	10.8	11.2	11.2	11.2	5.7
Length (inches)	11	11	11.8	9.8	9.8
Width (inches)	6	6	6	5.5	5.1
Height (inches)	6.9	6.9	6.9	6.5	4.7
AIR PRESSURE					
Pressure Range	5-7 bar/70-90 psi	5-7 bar/70-90 psi	5-7 bar/70-90 psi	6-7 bar/87-99 psi	4-7 bar/64-99 psi
Filter-Regulator- Lubricator	required	required	required	required	required
Pressure Consumption	14L/s - 29cu ft/mi	14L/s - 29cu ft/mi	14L/s - 29cu ft/mi	14L/s - 29cu ft/mi	14L/s - 29cu ft/mi
OPTIONAL ACCESSORIES					
HD Wear Plate	189605	189605	189605	189605	189605
Counter Balancer	189195	189195	189195	189195	189195

STEEL TO POLYESTER CONVERSION

STEEL TO POLYESTER CONVERSION TESTING GUIDELINES*

If a customer uses a pallet of steel each month, they are a good candidate for conversion to polyester strapping or woven or composite cord strapping.

		POLYESTER STRAPPING												
		3/4" x .050	3/4" x .040	5/8" x .040	5/8" x .035	5/8" x .300	1/2" x .028	1/2" x .021	1/2" x .018	7/16" x .021	3/8" x .019			
STEEL	3/4" x .031 HT													
	3/4" x .025 HT													
	3/4" x .023 HT													
	3/4" x .020 HT													
	3/4" x .023 RD													
	3/4" x .020 RD													
	3/4" x .017 RD													
	5/8" x .023 HT													
	5/8" x .020 HT													
	5/8" x .020 RD													
	5/8" x .017 RD													
	1/2" x .023 HT													
	1/2" x .020 HT													
	1/2" x .020 RD													
	1/2" x .017 RD													
	3/8" x .020 RD													

STEEL SPECIFICATIONS			
SIZE	BREAK	FEET/COIL	
3/8" x .017 RD	980	4710	
3/8" x .020 RD	880	3930	
1/2" x .017 RD	1305	3490	
1/2" x .020 RD	1180	2940	
1/2" x .023 RD	1340	2560	
5/8" x .020 RD	1470	2360	
5/8" x .023 RD	1670	2050	
3/4" x .020 RD	1760	1960	
3/4" x .023 RD	2010	1710	
3/4" x .025 HT	2800	1570	

POLYESTER SPECIFICATIONS			
PRODUCT NO.	SIZE	BREAK	FEET/COIL
1277	1/2" x .025	775	5800
1280	1/2" x .028	800	6500
1822	1/2" x .028	800	6500
5890	5/8" x .025	900	4400
5811	5/8" x .030	1100	3600
5814	5/8" x .035	1400	4200
58PT	5/8" x .035	1400	4000
583E	5/8" x .035	1400	4000
5816	5/8" x .040	1600	4000
584E	5/8" x .040	1600	4000
344E	3/4" x .040	1900	3000

STEEL TO CORD CONVERSION TESTING GUIDELINES*

		POLYESTER CORD STRAPPING					
		COMPOSITE	CC65	CC69	CC85	CC89	CC105
		WOVEN	PC50WH	PC55WX	PC75TA	PC105TA	PC150WXA
STEEL	5/8" x .020 RD						
	5/8" x .023 RD						
	5/8" x .020 HT						
	5/8" x .023 HT						
	3/4" x .020 RD						
	3/4" x .023 RD						
	3/4" x .020 HT						
	3/4" x .023 HT						
	3/4" x .025 HT						
	3/4" x .029 HT						
	3/4" x .031 HT						
	1-1/4" x .020 HT						
	1-1/4" x .025 HT						
	1-1/4" x .029 HT						
	1-1/4" x .031 HT						

COMPOSITE CORD SPECIFICATIONS			
PRODUCT NO.	SIZE	BREAK	FEET/COIL
CC65	3/4" x .045	1400	1640
CC69	3/4" x .050	1740	1640
CC85	1" x .045	1800	1640
CC89	1" x .045	2700	1300
CC105	1-1/4" x .055	3320	770

WOVEN CORD SPECIFICATIONS			
PRODUCT NO.	SIZE	BREAK	FEET/COIL
PC50WH	5/8"	1400	2000
PC55WX	5/8"	2000	2000
PC75TA	3/4" AAR	2400	1650
PC105TA	1-1/4" AAR	3900	660
PC150WXA	1-1/2" AAR	5400	500

*It is up to the user to determine whether a product is safe and fit for a particular purpose and user's method of application.
 *Every application varies, testing must be done thoroughly prior to converting.
 *American Association of Railroad Rules may apply.

Caution: Always proceed with caution. It is up to the user to determine if the load is safe.

Warranty: Seller warrants that the products sold herein will conform to Seller's specifications and will be free of defects in workmanship and materials for a period of one (1) year from the date of production. EXCEPT AS EXPRESSLY STATED HEREIN, SELLER MAKES NO REPRESENTATIONS OR WARRANTIES, EITHER EXPRESS OR IMPLIED AND EXPRESSLY DISCLAIMS ALL WARRANTIES REGARDING THE MERCHANTABILITY OR FITNESS FOR A PARTICULAR PURPOSE OF THE PRODUCTS DESCRIBED HEREIN. The equipment and procedures utilized to apply the product and environmental conditions are among the factors which may adversely affect the performance of the product. It is essential that the user evaluate whether the product is fit for a particular purpose and user's method of application.

Our Story

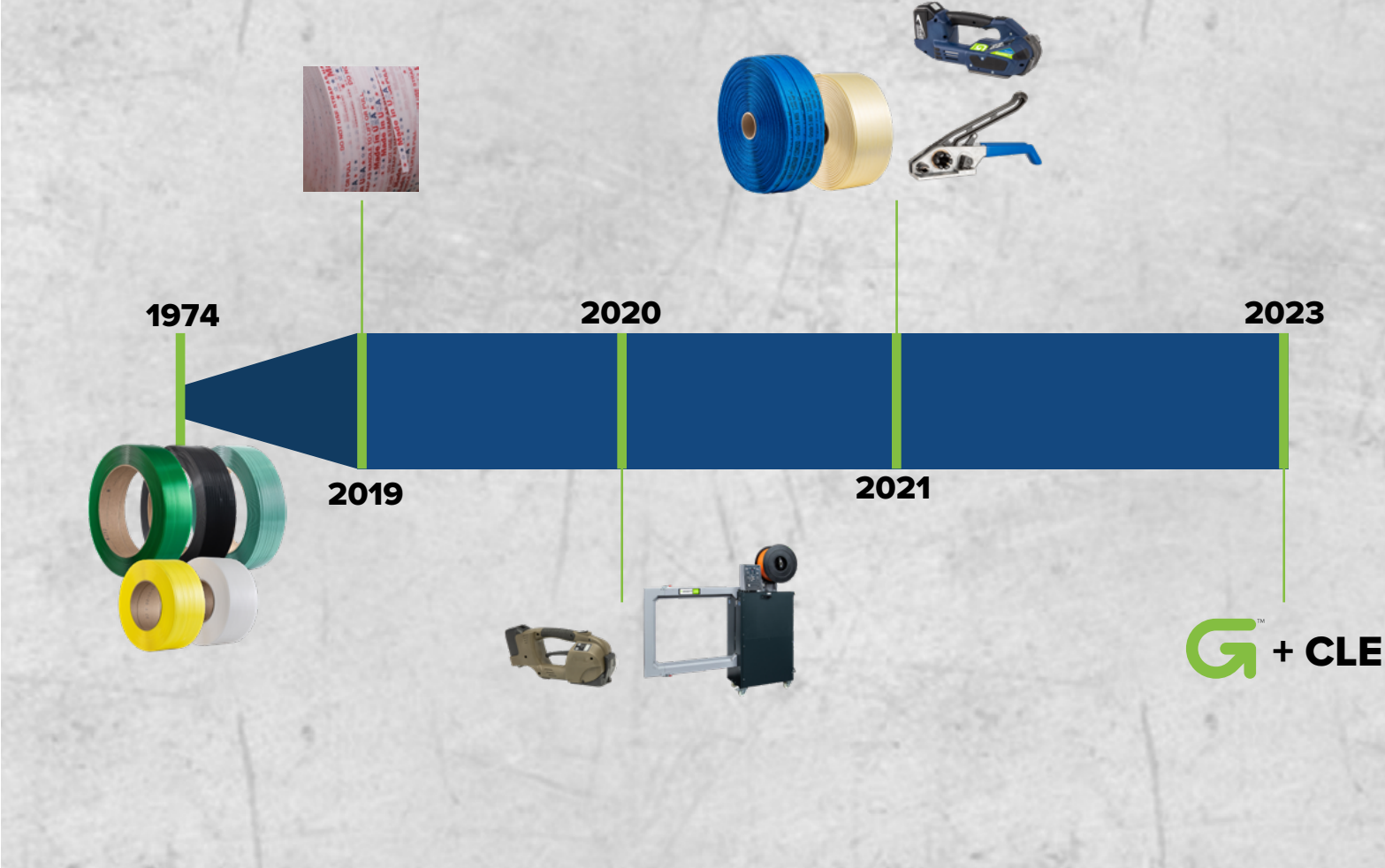

Greenbridge – Mentor, Ohio

6277 Heisley Road
Mentor, Ohio 44060
T 800-548-9557
F 440-352-9553

Greenbridge – Virginia Beach

5925 Thurston Avenue
Virginia Beach, VA 23455
T 800-526-0827
F 757-363-8016

Greenbridge – Green, Ohio

5555 Massillon Road
Green, OH 44720
T 440-357-1500
F 440-352-9552

Greenbridge – Cleveland

7000 Denison Avenue
Cleveland, Ohio 44102

Greenbridge – Croatia

Mihovljan 50/E, 49252,
Mihovljan, Croatia
T +385 49 354 281
T +385 49 354 287

Greenbridge – Itatools SRL

Via per Caronno, 23, 21040
Origgio VA, Italy
T +39 02 9645 0619

Greenbridge – Mexico

Justo Sierra #461, San Luis, 78430
Soledad de Graciano Sánchez,
S.L.P., Mexico
T +52 444 361 8008

