

# Grinding wheel adapter

and  
Accessories



grinding deserves SOLUTIONS

**GDS**<sup>®</sup>  
Made in Germany



# CONTENT

Status Oct. 2021

ANCA .....	4-18
Deckel/ISOG .....	19-20
EWAG .....	21-24
Haas .....	25-29
Hawema .....	30-31
Reinecker .....	32-34
Rollomatic .....	35-42
Saacke .....	43-46
Schneeberger .....	47-53
Schütte .....	54-57
SMP .....	58-59
Strausak .....	60-65
TTB .....	66
Vollmer .....	67-68
Walter .....	69-76
Zaro .....	77-78
Adapters for dressing, presetting etc. ....	79-80
Adapter SK40 and SK50 .....	81
Reduction adapters for gr. wheel adapters	82
Test and adjusting mandrels .....	83
Balancing technology .....	84-85
ZETA .....	86-88
Accessories .....	89
GDS sale and service partners .....	90-93
Space for your notes .....	94-95

## Grinding wheel adapter and accessories

Precision grinding requires an optimal spindle and a flawless grinding wheel, both of which depend on a perfect grinding wheel adapter.

## "Our quality for your success"

We adapt to your requirements and guarantee our quality.

GDS - the precision makers



Competence and innovation

## Our grinding wheel adapters are characterised by the following:



Maximum taper accuracy by using constantly controlled and calibrated measuring equipment.



Absolute accuracy of fit and optimum radial and axial run-out.



Extreme load-bearing capacity due to the use of tempered material and the best heat treating processes.



Optimum surface quality and associated long-term dimensional stability and precision, as well as spindle protection as a result of finished surfaces.



Balanced models for improved grinding results and spindle life.

# ANCA Internal taper 30 // Shaft $\varnothing 32$ mm // RS $\varnothing 50$ mm

For ANCA tool grinding machines with ring set  $\varnothing 50$  mm  
with integrated clamping and press-off system (M8 bolt)

## GWA Internal taper 30 // $\varnothing 32$ mm // RS $\varnothing 50$ mm

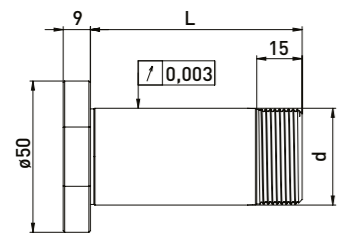
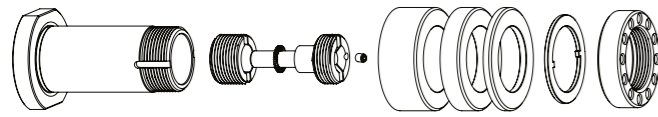

## GWA Internal taper 30 // $\varnothing 32$ mm // without RS

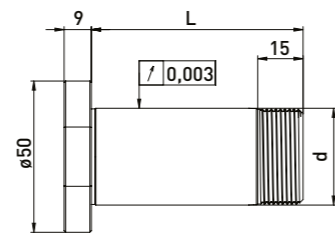
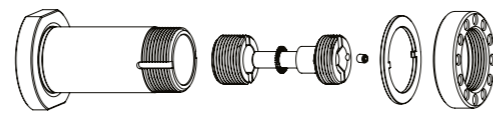

Delivered equipped:  
Installation system, ring set  $\varnothing 50$  mm, lock washer and clamping nut ANCA with balancing hole

Delivered equipped:  
Installation system, lock washer and clamping nut ANCA with balancing hole

Ring set  $\varnothing 50$  mm

Order No.	Internal taper	d	L	B20	B10	B4
300020612	30	32	53	1	1	2
300020622	30	32	70	1	2	4
300020632	30	32	85	2	2	3
300020642	30	32	100	2	3	4

Order No.	Internal taper	d	L
300020611	30	32	53
300020621	30	32	70
300020631	30	32	85
300020641	30	32	100

# ANCA Internal taper 30 // Shaft $\varnothing 32$ mm // RS $\varnothing 50$ mm

For ANCA tool grinding machines with ring set  $\varnothing 50$  mm  
with integrated clamping and press-off system (M14 x 1.5 nut)

## GWA Internal taper 30 // $\varnothing 32$ mm // RS $\varnothing 50$ mm

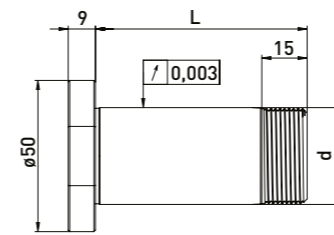
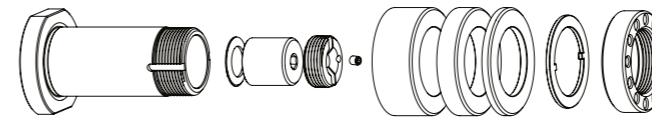

Delivered equipped:  
Installation system, ring set  $\varnothing 50$  mm, lock washer and clamping nut ANCA with balancing hole

Ring set  $\varnothing 50$  mm

Order No.	Internal taper	d	L	B20	B10	B4
300020212	30	32	53	1	1	4
300020222	30	32	70	1	2	4
300020232	30	32	85	2	2	3
300020242	30	32	100	2	3	4

## GWA Internal taper 30 // $\varnothing 32$ mm // without RS

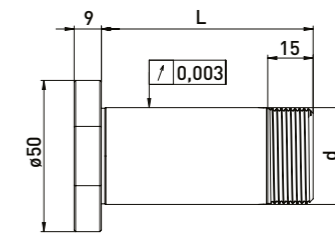
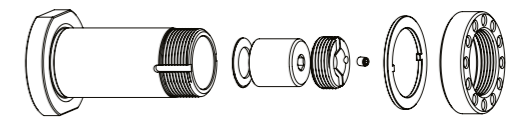

Delivered equipped:  
Installation system, lock washer and clamping nut ANCA with balancing hole

Order No.	Internal taper	d	L
300020211	30	32	53
300020221	30	32	70
300020231	30	32	85
300020241	30	32	100

## ANCA grinding wheel adapter Internal taper 30 // Shaft $\varnothing 32$ mm // Ring set $\varnothing 50$ mm

Order No.	Name
350050010	Universal assembly device $\varnothing 50$
350040030	Clamping nut wrench PC39 for ANCA nut
350020102	ANCA installation system with M8 screw
350060011	Assembly wrench set installation system ANCA (SW 6 + SW 2)
750000001	Clamping wrench SW 6,0 x 150
350020027	*Balancing weight pair for clamping nut $\varnothing 47$ // 70gmm

Order No.	Name
350011220	Spacer ring $\varnothing 50$ x $\varnothing 32$ x 20
350011210	Spacer ring $\varnothing 50$ x $\varnothing 32$ x 10
350011204	Spacer ring $\varnothing 50$ x $\varnothing 32$ x 4
350030040	Lock washer $\varnothing 43$ x $\varnothing 32$ x 2
350020050	Clamping nut ANCA balancing hole $\varnothing 47$ x 12 M31,5 x 1,5
350020026	*Clamping nut with balancing option $\varnothing 47$ x 12 M31,5 x 1,5

## Accessories ANCA grinding wheel adapter Internal taper 30 // Shaft $\varnothing 32$ mm // Ring set $\varnothing 50$ mm

Order No.	Name
350050010	Universal assembly device $\varnothing 50$
350040030	Clamping nut wrench PC39 for ANCA nut
350020101	Installation system with M14 x 1.5 nut
350060011	Assembly wrench set installation system ANCA (SW 6 + SW 2)
750000001	Clamping wrench SW 6,0 x 150
350020027	*Balancing weight pair for clamping nut $\varnothing 47$ // 70gmm

Order No.	Name
350011220	Spacer ring $\varnothing 50$ x $\varnothing 32$ x 20
350011210	Spacer ring $\varnothing 50$ x $\varnothing 32$ x 10
350011204	Spacer ring $\varnothing 50$ x $\varnothing 32$ x 4
350030040	Lock washer $\varnothing 43$ x $\varnothing 32$ x 2
350020050	Clamping nut ANCA balancing hole $\varnothing 47$ x 12 M31,5 x 1,5
350020026	*Clamping nut with balancing option $\varnothing 47$ x 12 M31,5 x 1,5

# ANCA Internal taper 30 // Shaft $\phi 31,75$ mm (1¼) // RS $\phi 50$ mm

For ANCA tool grinding machines with ring set  $\phi 50$  mm  
with integrated clamping and press-off system (M8 bolt)

## GWA Internal taper 30 // $\phi 31,75$ mm (1¼) // RS $\phi 50$ mm

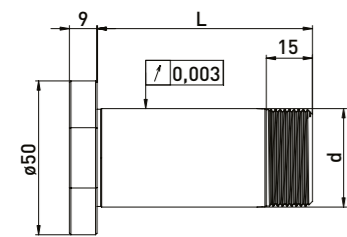
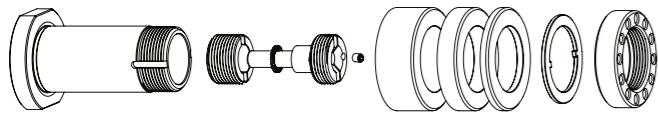

Delivered equipped:  
Installation system, ring set  $\phi 50$  mm, lock washer and clamping nut ANCA balancing hole

Order No.	Internal taper	d	L	Ring set $\phi 50$ mm		
				B20	B10	B4
300020512	30	31,75	53	1	1	2
300020522	30	31,75	70	1	2	4
300020532	30	31,75	85	2	2	3
300020542	30	31,75	100	2	3	4

## GWA Internal taper 30 // $\phi 31,75$ mm // without RS

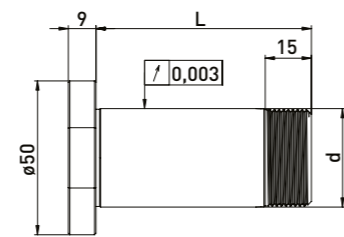
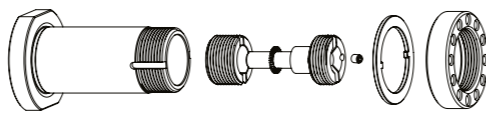

Delivered equipped:  
Installation system, lock washer and clamping nut ANCA balancing hole

Order No.	Internal taper	d	L
300020511	30	31,75	53
300020521	30	31,75	70
300020531	30	31,75	85
300020541	30	31,75	100

## Accessories ANCA grinding wheel adapter Internal taper 30 // Shaft $\phi 31,75$ mm (1¼) // Ring set $\phi 50$ mm

Order No.	Name	
350050010	Universal assembly device $\phi 50$	
350040030	Clamping nut wrench PC39 for ANCA nut	
350020102	ANCA installation system with M8 screw	
350060011	Assembly wrench set installation system ANCA (SW 6 + SW 2)	
750000001	Clamping wrench SW 6,0 x 150	
350020027	*Balancing weight pair for clamping nut $\phi 47$ // 70gmm	

Order No.	Name	
350011120	Spacer ring $\phi 50$ x $\phi 31,75$ x 20	
350011110	Spacer ring $\phi 50$ x $\phi 31,75$ x 10	
350011104	Spacer ring $\phi 50$ x $\phi 31,75$ x 4	
350030040	Lock washer $\phi 43$ x $\phi 32$ x 2	
350020050	Clamping nut ANCA balancing hole $\phi 47$ x 12 M31,5 x 1,5	
350020026	*Clamping nut with balancing option $\phi 47$ x 12 M31,5 x 1,5	

# ANCA Internal taper 30 // Shaft $\phi 31,75$ mm (1¼) // RS $\phi 50$ mm

For ANCA tool grinding machines with ring set  $\phi 50$  mm  
with integrated clamping and press-off system (M14 x 1.5 nut)

## GWA Internal taper 30 // $\phi 31,75$ mm (1¼) // RS $\phi 50$ mm

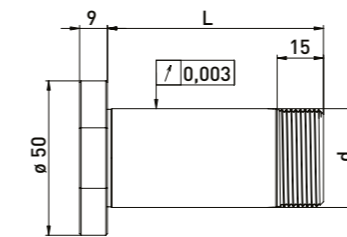
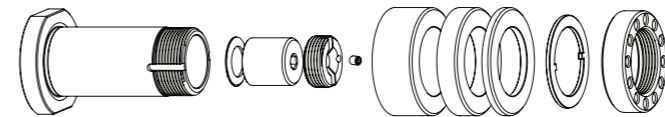

Delivered equipped:  
Installation system, ring set  $\phi 50$  mm, lock washer and clamping nut ANCA balancing hole

Order No.	Internal taper	d	L	Ring set $\phi 50$ mm		
				B20	B10	B4
300020112	30	31,75	53	1	1	2
300020122	30	31,75	70	1	2	4
300020132	30	31,75	85	2	2	3
300020142	30	31,75	100	2	3	4

## GWA Internal taper 30 // $\phi 31,75$ mm // without RS

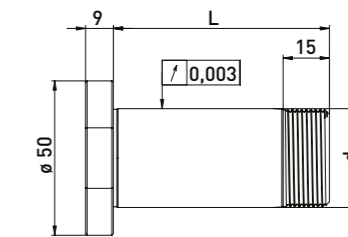
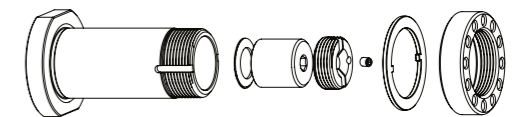

Delivered equipped:  
Installation system, lock washer and clamping nut ANCA balancing hole

Order No.	Internal taper	d	L
300020111	30	31,75	53
300020121	30	31,75	70
300020131	30	31,75	85
300020141	30	31,75	100

## Accessories ANCA grinding wheel adapter Internal taper 30 // Shaft $\phi 31,75$ mm (1¼) // Ring set $\phi 50$ mm

Order No.	Name	
350050010	Universal assembly device $\phi 50$	
350040030	Clamping nut wrench PC39 for ANCA nut	
350020101	Installation system with M14 x 1.5 nut	
350060011	Assembly wrench set installation system ANCA (SW 6 + SW 2)	
750000001	Clamping wrench SW 6,0 x 150	
350020027	*Balancing weight pair for clamping nut $\phi 47$ // 70gmm	

Order No.	Name	
350011120	Spacer ring $\phi 50$ x $\phi 31,75$ x 20	
350011110	Spacer ring $\phi 50$ x $\phi 31,75$ x 10	
350011104	Spacer ring $\phi 50$ x $\phi 31,75$ x 4	
350030040	Lock washer $\phi 43$ x $\phi 32$ x 2	
350020050	Clamping nut ANCA balancing hole $\phi 47$ x 12 M31,5 x 1,5	
350020026	*Clamping nut with balancing option $\phi 47$ x 12 M31,5 x 1,5	

# ANCA HSK-F40 // Shaft $\varnothing 20$ mm // RS $\varnothing 35$ mm

For ANCA tool grinding machines with ring set  $\varnothing 35$  mm

## GWA HSK-F40 // $\varnothing 20$ mm // RS $\varnothing 35$ mm

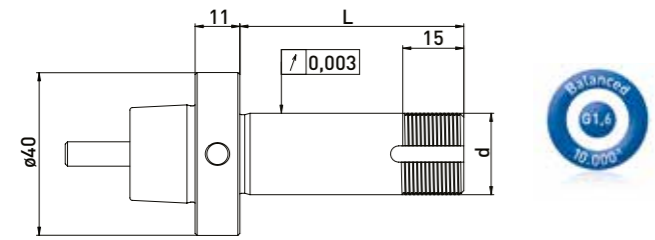
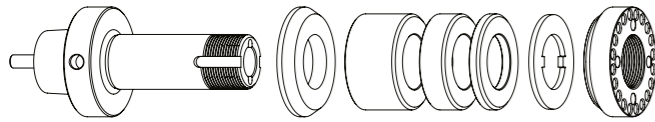

Delivered equipped:  
Installation system, reducing washer, ring set  $\varnothing 35$  mm, lock washer and clamping nut

Order No.	HSK	d	L	Ring set $\varnothing 35$ mm		
				B20	B10	B4
300022012	HSK-F40	20	55	1	1	2
300022022	HSK-F40	20	72	1	2	3
300022032	HSK-F40	20	85	2	2	2
300022042	HSK-F40	20	95	2	3	2

## Accessories ANCA grinding wheel adapter HSK-F40 // Shaft $\varnothing 20$ mm // Ring set $\varnothing 35$ mm

Order No.	Name	
350050050	Assembly device HSK40 $\varnothing 40$	
350040010	Clamping nut wrench PC27 for $\varnothing 20$	
350040011	Clamping nut wrench PC27 for $\varnothing 20$	

Order No.	Name	
350012020	Spacer ring $\varnothing 35 \times \varnothing 20 \times 20$	
350012010	Spacer ring $\varnothing 35 \times \varnothing 20 \times 10$	
350012004	Spacer ring $\varnothing 35 \times \varnothing 20 \times 4$	
350015006	Reducing washer $\varnothing 40 \times \varnothing 35 \times \varnothing 20 \times 6$	
350030020	Lock washer $\varnothing 50 \times \varnothing 20 \times 2$	
350020030	Clamping nut $\varnothing 35 \times 6$ M20 x 1 PC27	
350020070	Clamping nut $\varnothing 35 \times \varnothing 40 \times 12$ M20 x 1 with balancing bores M4	

# ANCA manual HSK-F40 // Shaft $\varnothing 20$ mm // RS $\varnothing 50$ mm

For ANCA tool grinding machines with ring set  $\varnothing 50$  mm  
with integrated clamping and press-off system M6 clamping screw

## GWA manual HSK-F40 // $\varnothing 20$ mm // RS $\varnothing 50$ mm

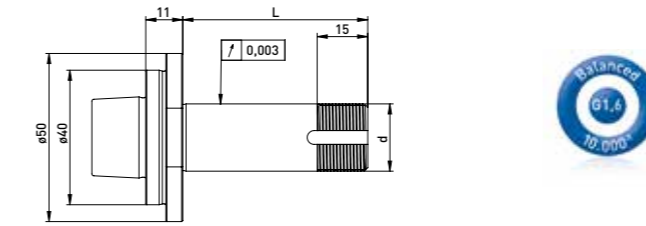
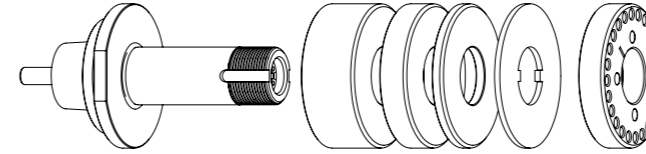

Delivered equipped:  
Installation system, ring set  $\varnothing 50$  mm, lock washer and clamping nut ANCA balancing hole

Order No.	HSK	d	L	Ring set $\varnothing 50$ mm		
				B20	B10	B4
300023012	HSK-F40	20	55	1	1	3
300023022	HSK-F40	20	72	2	1	2
300023032	HSK-F40	20	85	2	2	3
300023042	HSK-F40	20	95	3	1	3

## Accessories ANCA grinding wheel adapter manual HSK-F40 // Shaft $\varnothing 20$ mm // Ring set $\varnothing 50$ mm

Order No.	Name	
350050050	Assembly device HSK40 $\varnothing 40$	
350040010	Clamping nut wrench PC27 for $\varnothing 20$	
350040011	Clamping nut wrench PC27 for $\varnothing 20$	

## GWA manual HSK-F40 // $\varnothing 20$ mm // without RS

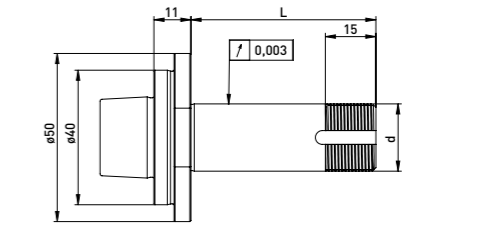
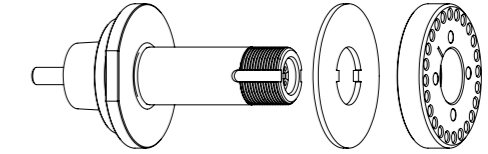

Delivered equipped:  
Installation system, lock washer and clamping nut ANCA balancing hole

Order No.	HSK	d	L
300023011	HSK-F40	20	55
300023021	HSK-F40	20	72
300023031	HSK-F40	20	85
300023041	HSK-F40	20	95

Order No.	Name	
350011020	Spacer ring $\varnothing 50 \times \varnothing 20 \times 20$	
350011010	Spacer ring $\varnothing 50 \times \varnothing 20 \times 10$	
350011004	Spacer ring $\varnothing 50 \times \varnothing 20 \times 4$	
350030010	Lock washer $\varnothing 50 \times \varnothing 20 \times 2$	
350020051	Clamping nut ANCA $\varnothing 50 \times 9,5$ M20 x 1	

For ANCA tool grinding machines with ring set  $\varnothing 50$  mm  
with integrated clamping and press-off system M6 clamping screw

For ANCA tool grinding machines with ring set  $\varnothing 50$  mm  
with integrated clamping and press-off system M6 clamping screw

GWA manual HSK-F40 //  $\varnothing 31,75$  mm (1¼) // RS  $\varnothing 50$  mm

GWA manual HSK-F40 //  $\varnothing 31,75$  mm // without RS

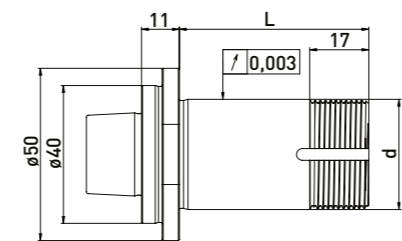
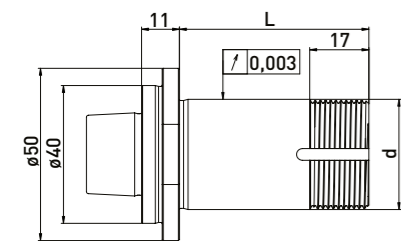
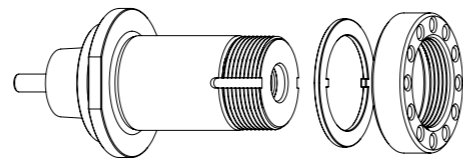
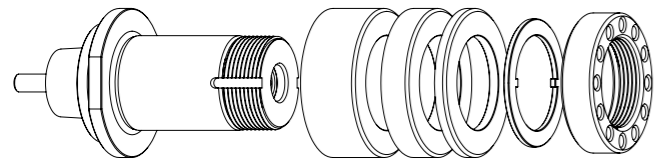

Delivered equipped:  
Installation system, ring set  $\varnothing 50$  mm, lock washer and clamping nut ANCA balancing hole

Delivered equipped:  
Installation system, lock washer and clamping nut ANCA balancing hole

Order No.	HSK	d	L	Ring set $\varnothing 50$ mm		
				B20	B10	B4
300023112	HSK-F40	31,75	55	1	1	3
300023122	HSK-F40	31,75	72	2	1	2
300023132	HSK-F40	31,75	85	2	2	3
300023142	HSK-F40	31,75	95	3	1	3

Order No.	HSK	d	L
300023111	HSK-F40	31,75	55
300023121	HSK-F40	31,75	72
300023131	HSK-F40	31,75	85
300023141	HSK-F40	31,75	95

GWA manual HSK-F40 //  $\varnothing 32$  mm // RS  $\varnothing 50$  mm

GWA manual HSK-F40 //  $\varnothing 32$  mm // without RS

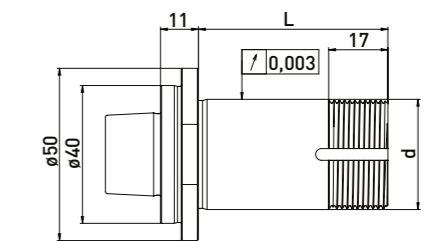
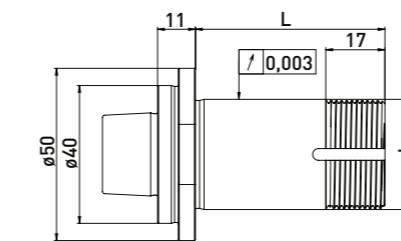
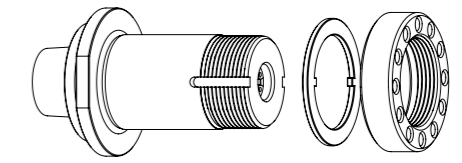
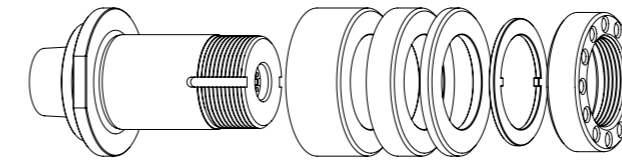

Delivered equipped:  
Installation system, ring set  $\varnothing 50$  mm, lock washer and clamping nut ANCA balancing hole

Delivered equipped:  
Installation system, lock washer and clamping nut ANCA balancing hole

Order No.	HSK	d	L	Ring set $\varnothing 50$ mm		
				B20	B10	B4
300023212	HSK-F40	32	55	1	1	3
300023222	HSK-F40	32	72	2	1	2
300023232	HSK-F40	32	85	2	2	3
300023242	HSK-F40	32	95	3	1	3

Order No.	HSK	d	L
300023211	HSK-F40	32	55
300023221	HSK-F40	32	72
300023231	HSK-F40	32	85
300023241	HSK-F40	32	95

Accessories ANCA grinding wheel adapter manual HSK-F40 // Shaft  $\varnothing 31,75$  mm (1¼) // Ring set  $\varnothing 50$  mm

Order No.	Name	
350050050	Assembly device HSK40 $\varnothing 40$	
350040030	Clamping nut wrench PC39 for ANCA nut	
350020027	*Balancing weight pair for clamping nut $\varnothing 47$ // 70gmm	

Order No.	Name	
350011120	Spacer ring $\varnothing 50$ x $\varnothing 31,75$ x 20	
350011110	Spacer ring $\varnothing 50$ x $\varnothing 31,75$ x 10	
350011104	Spacer ring $\varnothing 50$ x $\varnothing 31,75$ x 4	
350030040	Lock washer $\varnothing 43$ x $\varnothing 32$ x 2	
350020050	Clamping nut ANCA balancing hole $\varnothing 47$ x 12 M31,5 x 1,5	
350020026	*Clamping nut with balancing option $\varnothing 47$ x 12 M31,5 x 1,5	

Accessories ANCA grinding wheel adapter manual HSK-F40 // Shaft  $\varnothing 20$  mm // Ring set  $\varnothing 50$  mm

Order No.	Name	
350050050	Assembly device HSK40 $\varnothing 40$	
350040030	Clamping nut wrench PC39 for ANCA nut	
350020027	*Balancing weight pair for clamping nut $\varnothing 47$ // 70gmm	

Order No.	Name	
350011220	Spacer ring $\varnothing 50$ x $\varnothing 32$ x 20	
350011210	Spacer ring $\varnothing 50$ x $\varnothing 32$ x 10	
350011204	Spacer ring $\varnothing 50$ x $\varnothing 32$ x 4	
350030040	Lock washer $\varnothing 43$ x $\varnothing 32$ x 2	
350020050	Clamping nut ANCA balancing hole $\varnothing 47$ x 12 M31,5 x 1,5	
350020026	*Clamping nut with balancing option $\varnothing 47$ x 12 M31,5 x 1,5	

## ANCA automatic HSK-F40 // Shaft $\varnothing 20$ mm // RS $\varnothing 50$ mm

For ANCA tool grinding machines with ring set  $\varnothing 50$  mm

### GWA automatic HSK-F40 // $\varnothing 20$ mm // RS $\varnothing 50$ mm

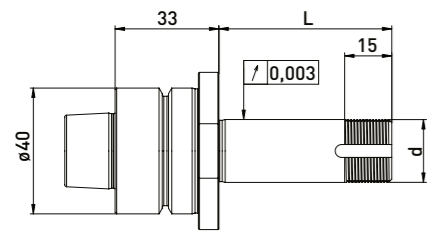
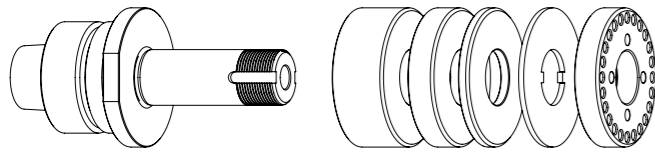

Delivered equipped:  
Ring set  $\varnothing 50$  mm, lock washer and clamping nut ANCA with balancing hole

Ring set  $\varnothing 50$ mm

Order No.	HSK	d	L	B20	B10	B4
300025012	HSK-F40	20	55	1	1	3
300025022	HSK-F40	20	72	2	1	2
300025032	HSK-F40	20	85	2	2	3
300025042	HSK-F40	20	95	3	1	3

### GWA automatic HSK-F40 // $\varnothing 20$ mm // without RS

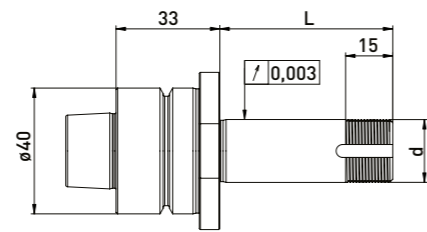
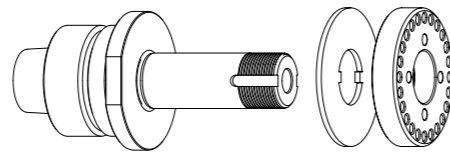

Delivered equipped:  
Lock washer and clamping nut ANCA with balancing hole

Order No.	HSK	d	L
300025011	HSK-F40	20	55
300025021	HSK-F40	20	72
300025031	HSK-F40	20	85
300025041	HSK-F40	20	95

### Accessories ANCA grinding wheel adapter automatic HSK-F40 // Shaft $\varnothing 20$ mm // Ring set $\varnothing 50$ mm

Order No.	Name	
350050050	Assembly device HSK40 $\varnothing 40$	
350040010	*Clamping nut wrench PC27 for $\varnothing 20$	
350040011	*Clamping nut wrench PC27 for $\varnothing 20$	
350020021	*Balancing weight pair for clamping nut $\varnothing 50$ // 100gmm	

Order No.	Name	
350011020	Spacer ring $\varnothing 50$ x $\varnothing 20$ x 20	
350011010	Spacer ring $\varnothing 50$ x $\varnothing 20$ x 10	
350011004	Spacer ring $\varnothing 50$ x $\varnothing 20$ x 4	
350030010	Lock washer $\varnothing 50$ x $\varnothing 20$ x 2	
350020051	Clamping nut ANCA $\varnothing 50$ x 9,5 M20 x 1	
350020020	*Clamping nut with balancing option $\varnothing 50$ x 8,5 M20 x 1,0	

## ANCA automatic HSK-F40 // Shaft $\varnothing 31,75$ mm (1 1/4) // RS $\varnothing 50$ mm

For ANCA tool grinding machines with ring set  $\varnothing 50$  mm

### GWA automatic HSK-F40 // $\varnothing 31,75$ mm (1 1/4) // RS $\varnothing 50$ mm

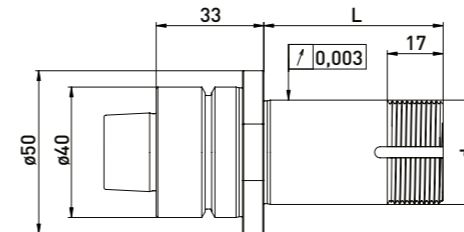
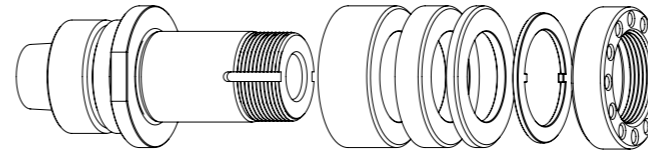

Delivered equipped:  
Ring set  $\varnothing 50$  mm, lock washer and clamping nut ANCA balancing hole

Ring set  $\varnothing 50$ mm

Order No.	HSK	d	L	B20	B10	B4
300025112	HSK-F40	31,75	55	1	1	3
300025122	HSK-F40	31,75	72	2	1	2
300025132	HSK-F40	31,75	85	2	2	3
300025142	HSK-F40	31,75	95	3	1	3

### GWA automatic HSK-F40 // $\varnothing 31,75$ mm // without RS

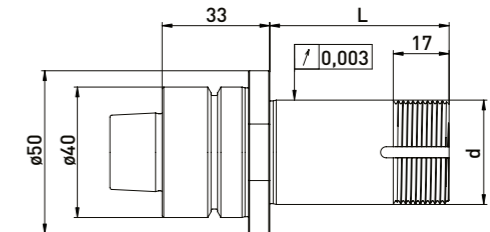
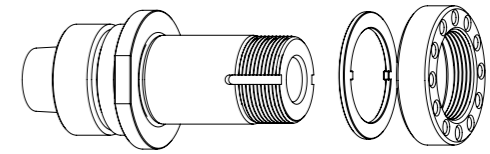

Delivered equipped:  
Lock washer and clamping nut ANCA balancing hole

Order No.	HSK	d	L
300025111	HSK-F40	31,75	55
300025121	HSK-F40	31,75	72
300025131	HSK-F40	31,75	85
300025141	HSK-F40	31,75	95

### Accessories ANCA grinding wheel adapter automatic HSK-F40 // Shaft $\varnothing 31,75$ mm (1 1/4) // Ring set $\varnothing 50$ mm

Order No.	Name	
350050010	Universal assembly device $\varnothing 50$	
350040030	Clamping nut wrench PC39 for ANCA nut	
350020027	*Balancing weight pair for clamping nut $\varnothing 47$ // 70gmm	

Order No.	Name	
350011120	Spacer ring $\varnothing 50$ x $\varnothing 31,75$ x 20	
350011110	Spacer ring $\varnothing 50$ x $\varnothing 31,75$ x 10	
350011104	Spacer ring $\varnothing 50$ x $\varnothing 31,75$ x 4	
350030040	Lock washer $\varnothing 43$ x $\varnothing 32$ x 2	
350020050	Clamping nut ANCA balancing hole $\varnothing 47$ x 12 M31,5 x 1,5	
350020026	*Clamping nut with balancing option $\varnothing 47$ x 12 M31,5 x 1,5	

## ANCA automatic HSK-F40 // Shaft $\varnothing 32$ mm // RS $\varnothing 50$ mm

For ANCA tool grinding machines with ring set  $\varnothing 50$  mm

### GWA automatic HSK-F40 // $\varnothing 32$ mm // RS $\varnothing 50$ mm

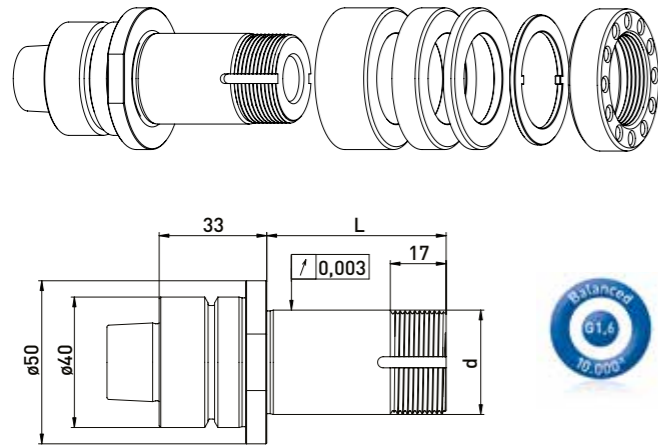

Delivered equipped:  
Ring set  $\varnothing 50$  mm, lock washer and clamping nut ANCA balancing hole

Order No.	HSK	d	L	Ring set $\varnothing 50$ mm		
				B20	B10	B4
300025212	HSK-F40	32	55	1	1	3
300025222	HSK-F40	32	72	2	1	2
300025232	HSK-F40	32	85	2	2	3
300025242	HSK-F40	32	95	3	1	3

### GWA automatic HSK-F40 // $\varnothing 32$ mm // without RS

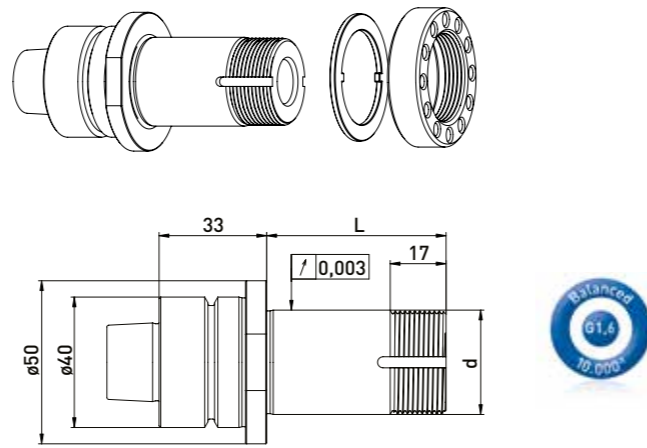

Delivered equipped:  
Lock washer and clamping nut ANCA balancing hole

Order No.	HSK	d	L
300025211	HSK-F40	32	55
300025221	HSK-F40	32	72
300025231	HSK-F40	32	85
300025241	HSK-F40	32	95

### Accessories ANCA grinding wheel adapter automatic HSK-F40 // Shaft $\varnothing 32$ mm // Ring set $\varnothing 50$ mm

Order No.	Name	Order No.	Name
350050010	Universal assembly device $\varnothing 50$	350011220	Spacer ring $\varnothing 50 \times \varnothing 32 \times 20$
350040030	Clamping nut wrench PC39 for ANCA nut	350011210	Spacer ring $\varnothing 50 \times \varnothing 32 \times 10$
350020027	*Balancing weight pair for clamping nut $\varnothing 47 // 70$ gmm	350011204	Spacer ring $\varnothing 50 \times \varnothing 32 \times 4$
		350030040	Lock washer $\varnothing 43 \times \varnothing 32 \times 2$
		350020050	Clamping nut ANCA balancing hole $\varnothing 47 \times 12$ M31,5 x 1,5
		350020026	*Clamping nut with balancing option $\varnothing 47 \times 12$ M31,5 x 1,5

## ANCA automatic HSK-F50 // Shaft $\varnothing 20$ mm // RS $\varnothing 50$ mm

For ANCA tool grinding machines with ring set  $\varnothing 50$  mm

### GWA automatic HSK-F50 // $\varnothing 20$ mm // RS $\varnothing 50$ mm

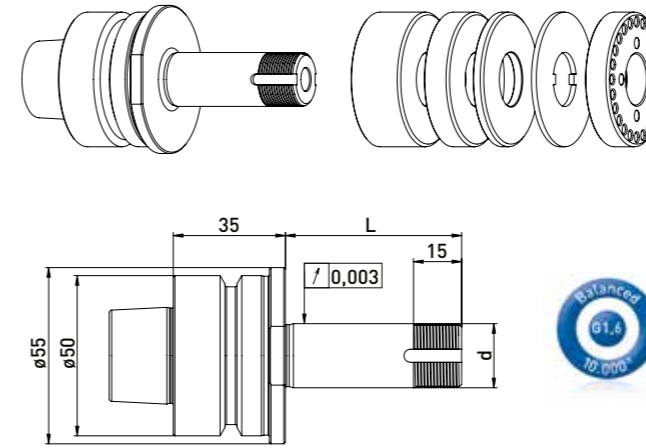

Delivered equipped:  
Ring set  $\varnothing 50$  mm, lock washer and clamping nut ANCA balancing hole

Order No.	HSK	d	L	Ring set $\varnothing 50$ mm		
				B20	B10	B4
300024012	HSK-F50	20	55	1	1	3
300024022	HSK-F50	20	72	2	1	2
300024032	HSK-F50	20	85	2	2	3
300024042	HSK-F50	20	95	3	1	3

### GWA automatic HSK-F50 // $\varnothing 20$ mm // without RS

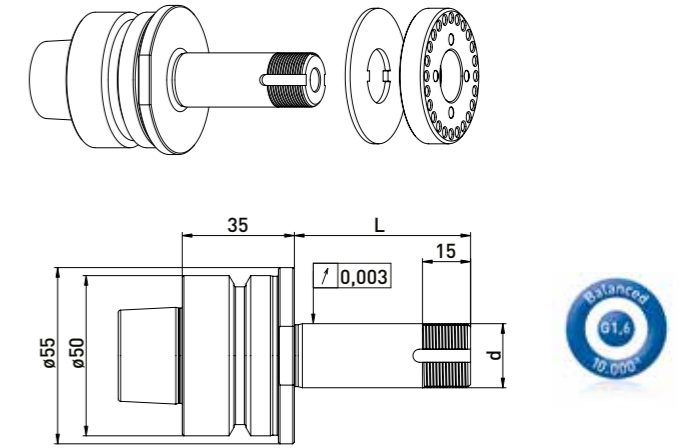

Delivered equipped:  
Lock washer and clamping nut ANCA balancing hole

Order No.	HSK	d	L
300024011	HSK-F50	20	55
300024021	HSK-F50	20	72
300024031	HSK-F50	20	85
300024041	HSK-F50	20	95

### Accessories ANCA grinding wheel adapter automatic HSK-F50 // Shaft $\varnothing 20$ mm // Ring set $\varnothing 50$ mm

Order No.	Name	Order No.	Name
350050010	Universal assembly device $\varnothing 50$	350011020	Spacer ring $\varnothing 50 \times \varnothing 20 \times 20$
350040010	*Clamping nut wrench PC27 for $\varnothing 20$	350011010	Spacer ring $\varnothing 50 \times \varnothing 20 \times 10$
350040011	*Clamping nut wrench PC27 for $\varnothing 20$	350011004	Spacer ring $\varnothing 50 \times \varnothing 20 \times 4$
350020021	*Balancing weight pair for clamping nut $\varnothing 50 // 100$ gmm	350030010	lock washer $\varnothing 50 \times \varnothing 20 \times 2$
		350020051	Clamping nut ANCA $\varnothing 50 \times 9,5$ M20 x 1
		350020020	*Clamping nut with balancing option $\varnothing 50 \times 8,5$ M20 x 1,0 PC27



# ANCA automatic HSK-F50 // Shaft $\varnothing 31,75$ mm (1¼) // RS $\varnothing 50$ mm

For ANCA tool grinding machines with ring set  $\varnothing 50$  mm

## GWA automatic HSK-F50 // $\varnothing 31,75$ mm (1¼) // RS $\varnothing 50$ mm

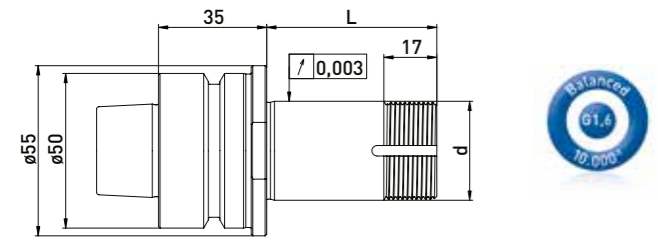
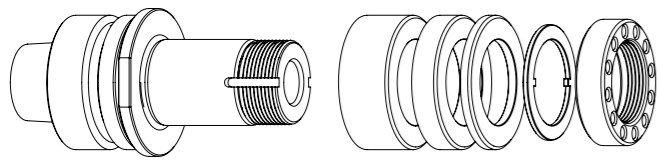

Delivered equipped:  
Ring set  $\varnothing 50$  mm, lock washer and clamping nut ANCA balancing hole

Order No.	HSK	d	L	Ring set $\varnothing 50$ mm		
				B20	B10	B4
300024112	HSK-F50	31,75	55	1	1	3
300024122	HSK-F50	31,75	72	2	1	2
300024132	HSK-F50	31,75	85	2	2	3
300024142	HSK-F50	31,75	95	3	1	3

## GWA automatic HSK-F50 // $\varnothing 31,75$ mm // without RS

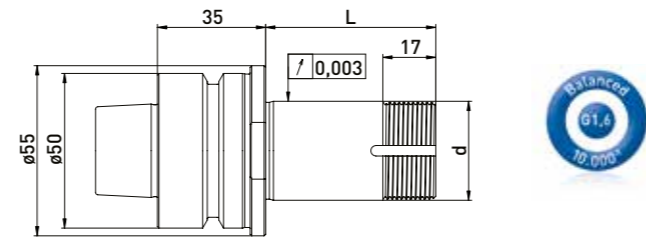
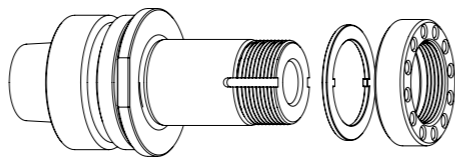

Delivered equipped:  
Lock washer and clamping nut ANCA balancing hole

Order No.	HSK	d	L
300024111	HSK-F50	31,75	55
300024121	HSK-F50	31,75	72
300024131	HSK-F50	31,75	85
300024141	HSK-F50	31,75	95

## Accessories ANCA grinding wheel adapter automatic HSK-F50 // Shaft $\varnothing 31,75$ mm (1¼) // Ring set $\varnothing 50$ mm

Order No.	Name	
350050010	Universal assembly device $\varnothing 50$	
350040030	Clamping nut wrench PC39 for ANCA nut	
350020027	*Balancing weight pair for clamping nut $\varnothing 47$ // 70gmm	

Order No.	Name	
350011120	Spacer ring $\varnothing 50$ x $\varnothing 31,75$ x 20	
350011110	Spacer ring $\varnothing 50$ x $\varnothing 31,75$ x 10	
350011104	Spacer ring $\varnothing 50$ x $\varnothing 31,75$ x 4	
350030040	Lock washer $\varnothing 43$ x $\varnothing 32$ x 2	
350020050	Clamping nut ANCA $\varnothing 47$ x 12 M31,5x1,5	
350020026	*Clamping nut with balancing option $\varnothing 47$ x 12 M31,5 x 1,5	

# ANCA automatic HSK-F50 // Shaft $\varnothing 32$ mm // RS $\varnothing 50$ mm

For ANCA tool grinding machines with ring set  $\varnothing 50$  mm

## GWA automatic HSK-F50 // $\varnothing 32$ mm // RS $\varnothing 50$ mm

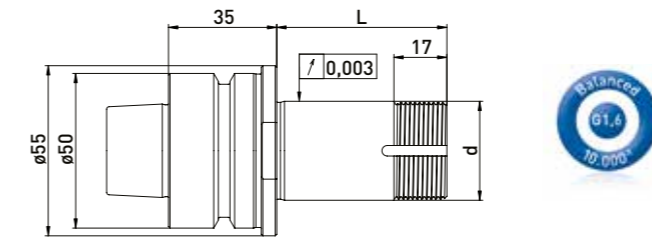
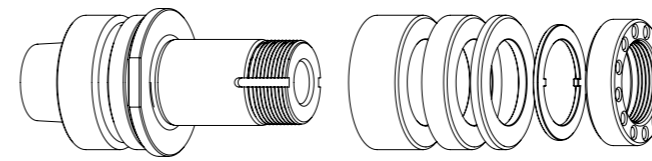

Delivered equipped:  
Ring set  $\varnothing 50$  mm, lock washer and clamping nut ANCA balancing hole

Order No.	HSK	d	L	Ring set $\varnothing 50$ mm		
				B20	B10	B4
300024212	HSK-F50	32	55	1	1	3
300024222	HSK-F50	32	72	2	1	2
300024232	HSK-F50	32	85	2	2	3
300024242	HSK-F50	32	95	3	1	3

## GWA automatic HSK-F50 // $\varnothing 32$ mm // without RS

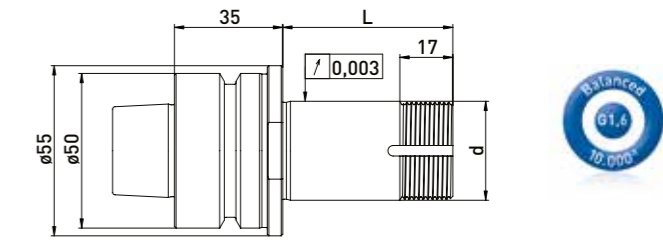
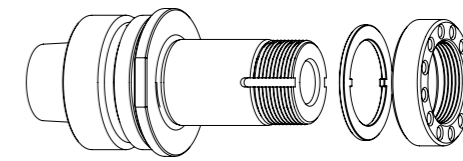

Delivered equipped:  
Lock washer and clamping nut ANCA balancing hole

Order No.	HSK	d	L
300024211	HSK-F50	32	55
300024221	HSK-F50	32	72
300024231	HSK-F50	32	85
300024241	HSK-F50	32	95

## Accessories ANCA grinding wheel adapter automatic HSK-F50 // Shaft $\varnothing 32$ mm // Ring set $\varnothing 50$ mm

Order No.	Name	
350050010	Universal assembly device $\varnothing 50$	
350040030	Clamping nut wrench PC39 for ANCA nut	
350020027	*Balancing weight pair for clamping nut $\varnothing 47$ // 70gmm	

Order No.	Name	
350011220	Spacer ring $\varnothing 50$ x $\varnothing 32$ x 20	
350011210	Spacer ring $\varnothing 50$ x $\varnothing 32$ x 10	
350011204	Spacer ring $\varnothing 50$ x $\varnothing 32$ x 4	
350030040	Lock washer $\varnothing 43$ x $\varnothing 32$ x 2	
350020050	Clamping nut ANCA balancing hole $\varnothing 47$ x 12 M31,5 x 1,5	
350020026	*Clamping nut with balancing option $\varnothing 47$ x 12 M31,5 x 1,5	

For ANCA tool grinding machines

## GWA similar SK40 with flat contact face

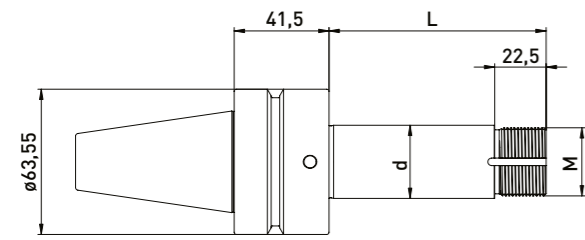
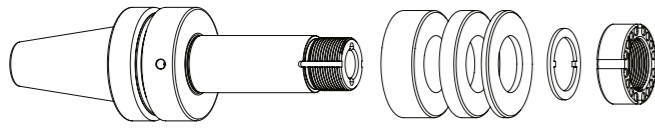

Delivered equipped:  
Ring set, lock washer and clamping nut with balancing option

Order No.	Fine thread	d	L	Ring set		
				B 20	B 10	B 4
300026052	M20 x 1,5	20	95	2	2	4
300026152	M30 x 1,5	31,75	95	2	2	4
300026252	M30 x 1,5	32	95	2	2	4
300026952	M50 x 1,5	50,8	95	2	2	4

## Accessories GWA similar SK40 with flat contact face

Order No.	Name	
350011020	Spacer ring $\phi 50 \times \phi 20 \times 20$	
350011010	Spacer ring $\phi 50 \times \phi 20 \times 10$	
350011004	Spacer ring $\phi 50 \times \phi 20 \times 4$	
350011420	Spacer ring $\phi 60 \times \phi 31,75 \times 20$	
350011410	Spacer ring $\phi 60 \times \phi 31,75 \times 10$	
350011404	Spacer ring $\phi 60 \times \phi 31,75 \times 4$	
350011320	Spacer ring $\phi 60 \times \phi 32 \times 20$	
350011310	Spacer ring $\phi 60 \times \phi 32 \times 10$	
350011304	Spacer ring $\phi 60 \times \phi 32 \times 4$	
250000549	Spacer ring $\phi 75 \times \phi 50,8 \times 20$	
250000548	Spacer ring $\phi 75 \times \phi 50,8 \times 10$	
250000547	Spacer ring $\phi 75 \times \phi 50,8 \times 4$	

## Accessories ANCA grinding wheel adapter similar SK40 with flat contact face

Order No.	Name	
250000552	Lock washer $\phi 37 \times \phi 20 \times 2$	
250000940	Lock washer $\phi 40 \times \phi 30 \times 2$	
250000550	Lock washer $\phi 64 \times \phi 50,2 \times 2$	

Order No.	Name	
250000553	Clamping nut with balancing option $\phi 40 \times 17 \text{ M}20 \times 1,5$	
250000485	Clamping nut with balancing option $\phi 45 \times 17 \text{ M}30 \times 1,5$	
250000551	Clamping nut with balancing option $\phi 70 \times 19 \text{ M}50 \times 1,5$	
350300131	Hook wrench 40-42 mm	
350300132	Hook wrench 45-50 mm	
350300133	Hook wrench 68-75 mm	

For Deckel/ISOG tool grinding machines with ring set  $\phi 35 \text{ mm}$

## GWA HSK-F50 // $\phi 20 \text{ mm}$ // RS $\phi 35 \text{ mm}$

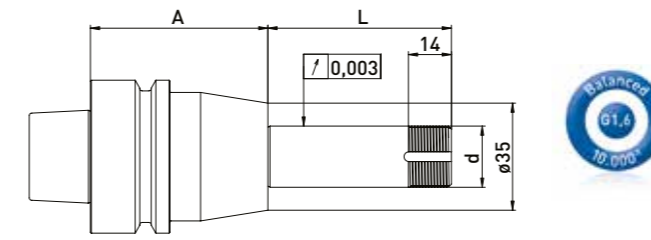
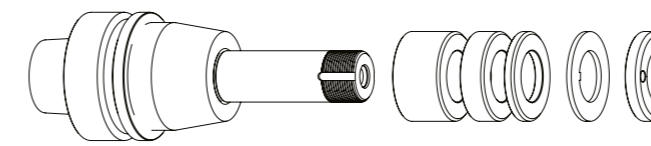

Delivered equipped:  
Ring set  $\phi 35 \text{ mm}$ , lock washer and clamping nut

Order No.	HSK	d	L	A	Ring set $\phi 35 \text{ mm}$		
					B 20	B 10	B 4
300032512	HSK-F50	20	48	38	-	2	4
300032522	HSK-F50	20	60	58	1	1	4
300032532	HSK-F50	20	90	58	2	2	4

## GWA HSK-F50 // $\phi 20 \text{ mm}$ // without RS

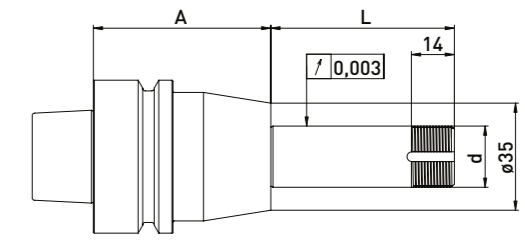
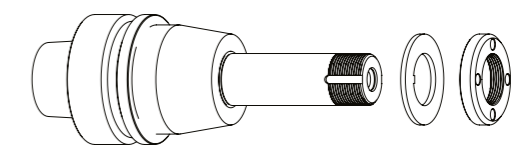

Delivered equipped:  
Lock washer and clamping nut

Order No.	HSK	d	L	A
300032511	HSK-F50	20	48	38
300032521	HSK-F50	20	60	58
300032531	HSK-F50	20	90	58

## Accessories Deckel/ISOG grinding wheel adapter HSK-F50 // Shaft $\phi 20 \text{ mm}$ // Ring set 35 mm

Order No.	Name	
350050010	Universal assembly device $\phi 50$	
350050020	Assembly device Deckel/ISOG	
350040010	Clamping nut wrench PC27 for $\phi 20$	
350040011	Clamping nut wrench PC27 for $\phi 20$	
350040040	*Clamping nut wrench PC29 for $\phi 20$ for clamping nut with balancing option	
350040041	*Clamping nut wrench PC29 for $\phi 20$	
350020081	*Balancing weight pair for clamping nut $\phi 35 // 40 \text{ gmm}$	

Order No.	Name	
350012020	Spacer ring $\phi 35 \times \phi 20 \times 20$	
350012010	Spacer ring $\phi 35 \times \phi 20 \times 10$	
350012004	Spacer ring $\phi 35 \times \phi 20 \times 4$	
250001397	Lock washer $\phi 35 \times 1,5$	
350020030	Clamping nut $\phi 35 \times 6 \text{ M}20 \times 1 \text{ PC}27$	
114050034	Clamping nut Deckel/ISOG $\phi 35 \times 7 \text{ PC}29$	
350020080	*Clamping nut with balancing option $\phi 35 \times \phi 40 \times 8 \times \text{M}20 \times 1 \text{ PC}29$	

## Deckel/ISOG HSK-F50 // Shaft $\varnothing 20$ mm // RS $\varnothing 50$ mm

For Deckel/ISOG tool grinding machines with ring set  $\varnothing 50$  mm

### GWA HSK-F50 // $\varnothing 20$ mm // RS $\varnothing 50$ mm

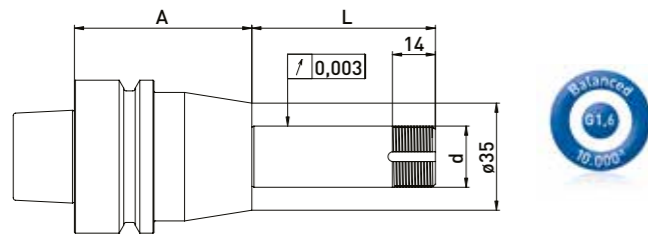
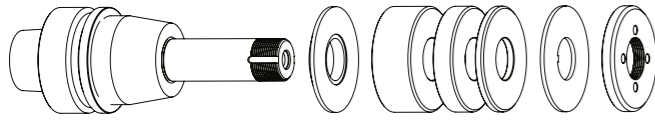

Delivered equipped:  
Reducing washer, ring set  $\varnothing 50$  mm, lock washer and clamping nut

Ring set  $\varnothing 50$  mm

Order No.	HSK	d	L	A	B 20	B 10	B 4
300032012	HSK-F50	20	48	38	-	2	3
300032022	HSK-F50	20	60	58	1	1	3
300032032	HSK-F50	20	90	58	2	2	3

### GWA HSK-F50 // $\varnothing 20$ mm // without RS

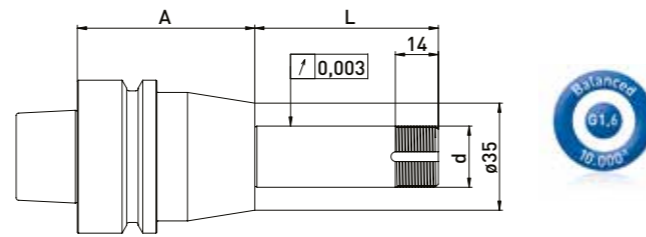
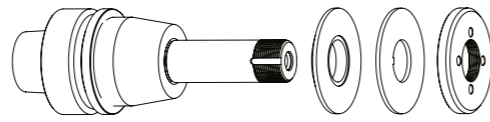

Delivered equipped:  
Reducing washer, lock washer and clamping nut

Order No.	HSK	d	L	A
300032011	HSK-F50	20	48	38
300032021	HSK-F50	20	60	58
300032031	HSK-F50	20	90	58

## EWAG $\varnothing 80$ mm // Shaft $\varnothing 20$ mm // RS $\varnothing 35$ mm

For EWAG tool grinding machines with ring set  $\varnothing 35$  mm

### GWA $\varnothing 80$ mm // $\varnothing 20$ mm // RS $\varnothing 35$ mm

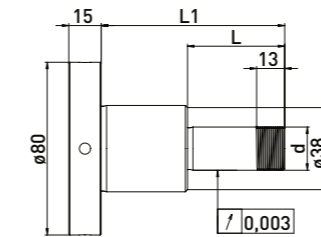
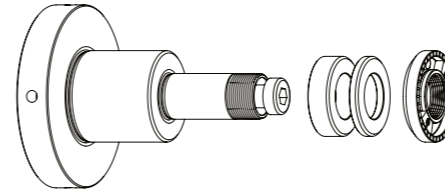

Delivered equipped:  
Ring set  $\varnothing 35$  mm, clamping nut with balancing weights and M10 clamping screw

Ring set  $\varnothing 35$  mm

Order No.	d	L	L1	B 10	B 4
300140012	20	45	85	2	3

### Accessories Deckel/ISOG grinding wheel adapter HSK-F50 // Shaft $\varnothing 20$ mm // Ring set 50 mm

Order No.	Name	
350050010	Universal assembly device $\varnothing 50$	
350050020	Assembly device Deckel/ISOG	
350040010	*Clamping nut wrench PC27 for $\varnothing 20$	
350040011	*Clamping nut wrench PC27 for $\varnothing 20$	
350020021	*Balancing weight pair for clamping nut $\varnothing 50$ // 100gmm	

Order No.	Name	
350011020	Spacer ring $\varnothing 50 \times \varnothing 20 \times 20$	
350011010	Spacer ring $\varnothing 50 \times \varnothing 20 \times 10$	
350011004	Spacer ring $\varnothing 50 \times \varnothing 20 \times 4$	
250001482	Lock washer $\varnothing 50 \times 2$	
350020060	Clamping nut $\varnothing 50 \times 6 \times M20 \times 1$ PC27	
350015003	Support washer $\varnothing 50 \times \varnothing 75 \times \varnothing 20 \times 6$	
350020020	*Clamping nut with balancing option $\varnothing 50 \times 8,5 M20 \times 1,0$ PC27	

### Accessories EWAG grinding wheel adapter 80 mm // Shaft $\varnothing 20$ mm // Ring set $\varnothing 35$ mm

Order No.	Name	
350020081	*Balancing weight pair for clamping nut $\varnothing 35$ // 40gmm	
350040040	*Clamping nut wrench PC29 for $\varnothing 20$ for clamping nut with balancing option	
350040041	*Clamping nut wrench PC29 for $\varnothing 20$	

Order No.	Name	
350012004	Spacer ring $\varnothing 35 \times \varnothing 20 \times 4$	
350012010	Spacer ring $\varnothing 35 \times \varnothing 20 \times 10$	
350020080	*Clamping nut with balancing option $\varnothing 35 \times \varnothing 40 \times 8 \times M20 \times 1$ PC29	

## EWAG ø80 mm // Shaft ø20 mm // RS ø35 mm

For EWAG tool grinding machines with ring set ø35 mm

### GWA ø80 mm // ø20 mm // RS ø35 mm

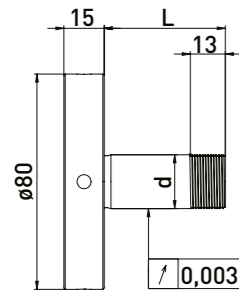
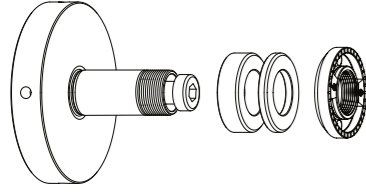

Delivered equipped:  
Ring set ø35 mm, clamping nut with balancing weights and M10 clamping screw

Order No.	d	L	Ring set ø35 mm	
			B 10	B 4
300141012	20	20	-	2
300141022	20	45	2	3

### Accessories EWAG grinding wheel adapter 80 mm // Shaft ø20 mm // Ring set ø35 mm

Order No.	Name	Order No.	Name
350020081	*Balancing weight pair for clamping nut ø35 // 40gmm	350012004	Spacer ring ø35 x ø20 x 4
350040040	*Clamping nut wrench PC29 for ø20 for clamping nut with balancing option	350012010	Spacer ring ø35 x ø20 x 10
350040041	*Clamping nut wrench PC29 for ø20	350020080	*Clamping nut with balancing option ø35 x ø40 x 8 x M20 x 1 PC29

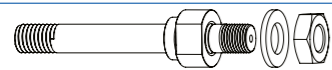

Order No.	Name
300149001	M10 adapter screw to ø10 EWAG M10 for article 300140012
300149002	M10 adapter screw to ø10 EWAG M10 for article 300141022

## EWAG ø80 mm // Shaft ø40 mm // RS 70 mm

For EWAG tool grinding machines with ring set ø70mm

### GWA ø80 mm // ø40 mm // RS 70 mm

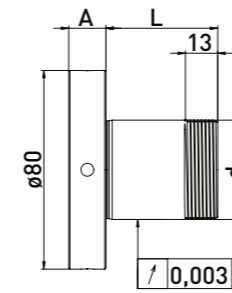
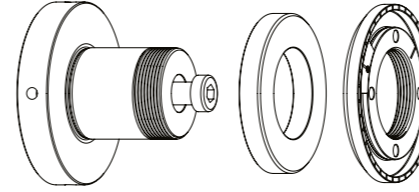

Delivered equipped:  
Spacer ring ø70 mm, clamping nut with balancing weights and M10 clamping screw

Order No.	d	L	A	Ring set ø70 mm
				B 12
300140242	40	45	15	1

### GWA ø80 mm // ø40 mm // without RS

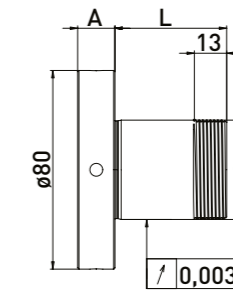
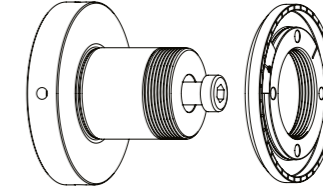

Delivered equipped:  
Clamping nut with balancing weights and M10 clamping screw

Order No.	d	L	A
300140212	40	20	15
300140222	40	20	30
300140232	40	20	49

### Accessories EWAG grinding wheel adapter ø80 mm // Shaft ø40 mm // RS 70 mm

Order No.	Name	Order No.	Name
350020082	*Balancing weight pair for clamping nut ø78 EWAG	350014012	Spacer ring ø70 x ø40 x 12
		350020025	*Clamping nut with balancing option ø78 x 8,5 x M40x1,5

For EWAG tool grinding machines

GWA  $\varnothing 125$  //  $\varnothing 50$  mm

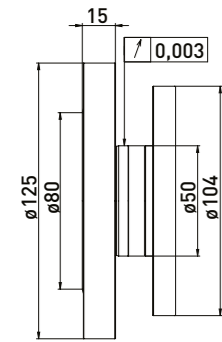
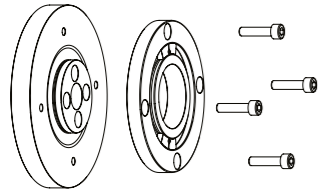

Delivered equipped:  
Flange and counter-flange with balancing weights and 4pc. M6x25 clamping screws

Order No.	Name
300140311	Grinding wheel adapter EWAG $\varnothing 125$ x $\varnothing 50$ x A15

Accessories EWAG grinding wheel adapter  $\varnothing 125$  // Shaft  $\varnothing 50$  mm

Order No.	Name
350020082	Balancing weight pair for clamping nut $\varnothing 78$ EWAG

For Haas tool grinding machines with ring set  $\varnothing 35$  mm

GWA Internal taper  $\varnothing 31,75$  mm (1¼) //  $\varnothing 20$  mm // RS  $\varnothing 35$  mm

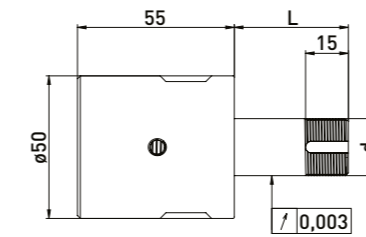
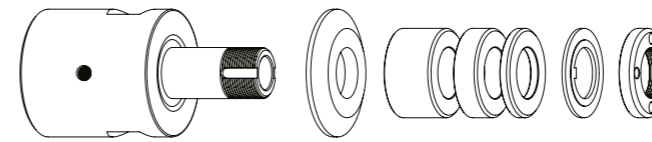

Delivered equipped:  
Installation skit, reducing washer, ring set  $\varnothing 35$  mm, lock washer and clamping nut

Order No.	Internal taper	d	L	Ring set $\varnothing 35$ mm		
				B20	B10	B4
300091512	31,75	20	40	-	1	3
300091522	31,75	20	60	1	1	3
300091532	31,75	20	100	2	3	3

GWA Internal taper  $\varnothing 31,75$  mm (1¼) //  $\varnothing 20$  mm //  $\varnothing 20$  mm

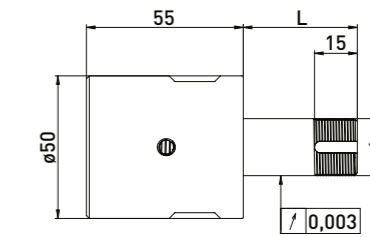
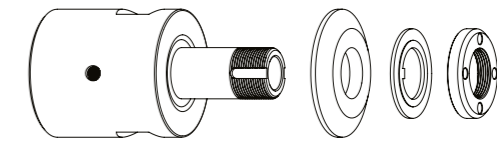

Delivered equipped:  
Installation kit, reducing washer, lock washer and clamping nut

Order No.	Internal taper	d	L
300091511	31,75	20	40
300091521	31,75	20	60
300091531	31,75	20	100

Accessories Haas grinding wheel adapter Internal taper  $\varnothing 31,75$  mm (1¼) // Shaft  $\varnothing 20$  mm // Ring set 35 mm

Order No.	Name	
350050010	Universal assembly device $\varnothing 50$	
350040010	Clamping nut wrench PC27 for $\varnothing 20$	
350040011	Clamping nut wrench PC27 for $\varnothing 20$	
350040040	*Clamping nut wrench PC29 for $\varnothing 20$ for clamping nut with blancing option	
350040041	*Clamping nut wrench PC29 for $\varnothing 20$	
350020081	*Balancing weight pair for clamping nut $\varnothing 35$ // 40gmm	
300101002	Installation kit NCT63 Haas	
300101003	Assembly wrench for Installation kit NCT63 M20 x 1,5	

Order No.	Name	
350012020	Spacer ring $\varnothing 35$ x $\varnothing 20$ x 20	
350012010	Spacer ring $\varnothing 35$ x $\varnothing 20$ x 10	
350012004	Spacer ring $\varnothing 35$ x $\varnothing 20$ x 4	
350015001	Reducing washer $\varnothing 50$ x $\varnothing 35$ x $\varnothing 20$ x 6	
350030020	Lock washer $\varnothing 35$ x $\varnothing 20$ x 2	
350020030	Clamping nut $\varnothing 35$ x 6 M20 x 1 PC27	
350020080	*Clamping nut with balancing option $\varnothing 35$ x $\varnothing 40$ x 8 x M20 x1 PC29	
350015005	Support washer $\varnothing 35$ x $\varnothing 60$ x $\varnothing 20$ x 6	

\*related items

## Haas Internal taper $\varnothing 31,75$ mm (1¼) // Shaft $\varnothing 20$ mm // RS $\varnothing 50$ mm

For Haas tool grinding machines with ring set  $\varnothing 50$  mm

### GWA Internal taper $\varnothing 31,75$ mm (1¼) // $\varnothing 20$ mm // RS $\varnothing 50$ mm

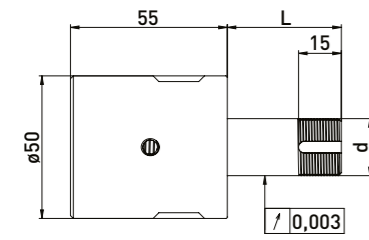
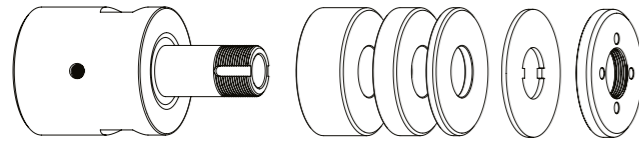

Delivered equipped:  
Installation kit, ring set  $\varnothing 50$  mm, lock washer and clamping nut

Ring set  $\varnothing 50$  mm

Order No.	Internal taper	d	L	B20	B10	B4
300091012	31,75	20	40	-	1	4
300091022	31,75	20	60	1	1	4
300091032	31,75	20	100	2	3	4

### GWA Internal taper $\varnothing 31,75$ mm (1¼) // $\varnothing 20$ mm // $\varnothing 20$ mm

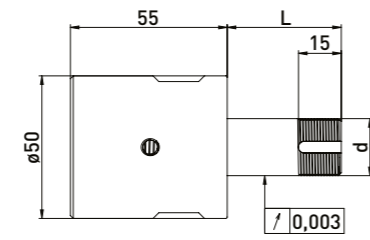
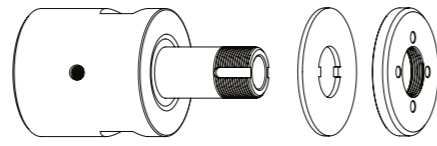

Delivered equipped:  
Installation kit, lock washer and clamping nut

Order No.	Internal taper	d	L
300091011	31,75	20	40
300091021	31,75	20	60
300091031	31,75	20	100

## Haas HSK-E50 // Shaft $\varnothing 20$ mm // RS $\varnothing 35$ mm

For Haas tool grinding machines with ring set  $\varnothing 35$  mm

### GWA HSK-E50 // $\varnothing 20$ mm // RS $\varnothing 35$ mm

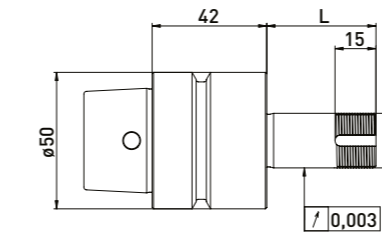
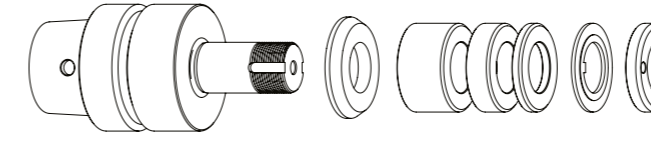

Delivered equipped:  
Reducing washer, ring set  $\varnothing 35$  mm, lock washer and clamping nut

Ring set  $\varnothing 35$  mm

Order No.	HSK	d	L	B20	B10	B4
300092512	HSK-E50	20	40	-	1	3
300092522	HSK-E50	20	60	1	1	3
300092532	HSK-E50	20	100	2	3	3

### GWA HSK-E50 // $\varnothing 20$ mm // without RS

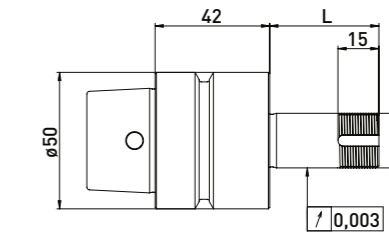
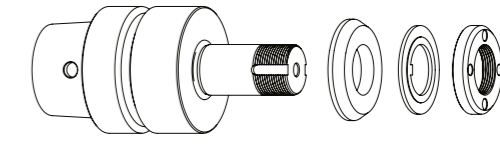

Delivered equipped:  
Reducing washer, lock washer and clamping nut

Order No.	HSK	d	L
300092511	HSK-E50	20	40
300092521	HSK-E50	20	60
300092531	HSK-E50	20	100

### Accessories Haas grinding wheel adapter Internal taper $\varnothing 31,75$ mm (1¼) // Shaft $\varnothing 20$ mm // Ring set 35 mm

Order No.	Name	
350050010	Universal assembly device $\varnothing 50$	
350040010	*Clamping nut wrench PC27 for $\varnothing 20$	
350040011	*Clamping nut wrench PC27 for $\varnothing 20$	
350020021	*Balancing weight pair for clamping nut $\varnothing 50$ // 100gmm	
300101002	Installation kit NCT63 Haas	
300101003	Assembly wrench for Installation kit NCT63 M20 x 1,5	

Order No.	Name	
350011020	Spacer ring $\varnothing 50$ x $\varnothing 20$ x 20	
350011010	Spacer ring $\varnothing 50$ x $\varnothing 20$ x 10	
350011004	Spacer ring $\varnothing 50$ x $\varnothing 20$ x 4	
350030010	Lock washer $\varnothing 50$ x $\varnothing 20$ x 2	
350020020	*Clamping nut with balancing option $\varnothing 50$ x 8,5 M20 x 1,0 PC27	
350015003	Support washer $\varnothing 50$ x $\varnothing 75$ x $\varnothing 20$ x 6	
350020060	Clamping nut $\varnothing 50$ x 6 x M20 x 1 PC27	

### Accessories Haas grinding wheel adapter HSK-E50 // Shaft $\varnothing 20$ mm // Ring set $\varnothing 35$ mm

Order No.	Name	
350050010	Universal assembly device $\varnothing 50$	
350040010	Clamping nut wrench PC27 for $\varnothing 20$	
350040011	Clamping nut wrench PC27 for $\varnothing 20$	
350040040	*Clamping nut wrench PC29 for $\varnothing 20$ for clamping nut with balancing option	
350040041	*Clamping nut wrench PC29 for $\varnothing 20$	
350020081	*Balancing weight pair for clamping nut $\varnothing 35$ // 40gmm	

Order No.	Name	
350012020	Spacer ring $\varnothing 35$ x $\varnothing 20$ x 20	
350012010	Spacer ring $\varnothing 35$ x $\varnothing 20$ x 10	
350012004	Spacer ring $\varnothing 35$ x $\varnothing 20$ x 4	
350015001	Reducing washer $\varnothing 50$ x $\varnothing 35$ x $\varnothing 20$ x 6	
350030020	Lock washer $\varnothing 35$ x $\varnothing 20$ x 2	
350020030	Clamping nut $\varnothing 35$ x 6 M20 x 1 PC27	
350020080	*Clamping nut with balancing option $\varnothing 35$ x $\varnothing 40$ x 8 x M20 x 1 PC29	
350015005	Support washer $\varnothing 35$ x $\varnothing 60$ x $\varnothing 20$ x 6	

## Haas HSK-E50 // Shaft $\varnothing 20$ mm // RS $\varnothing 50$ mm

For Haas tool grinding machines with ring set  $\varnothing 50$  mm

### GWA HSK-E50 // $\varnothing 20$ mm // RS $\varnothing 50$ mm

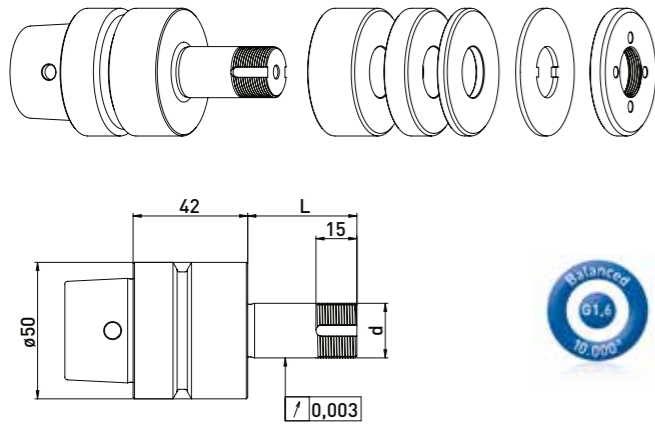

Delivered equipped:  
Ring set  $\varnothing 50$  mm, lock washer and clamping nut

### GWA HSK-E50 // $\varnothing 20$ mm // without RS

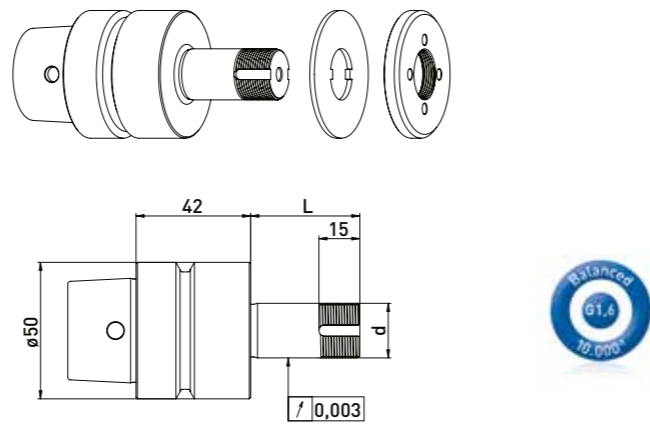

Delivered equipped:  
Lock washer and clamping nut

Ring set  $\varnothing 50$ mm

Order No.	HSK	d	L	B 20	B 10	B 4
300092012	HSK-E50	20	40	-	1	4
300092022	HSK-E50	20	60	1	1	4
300092032	HSK-E50	20	100	2	3	4

Order No.	HSK	d	L
300092011	HSK-E50	20	40
300092021	HSK-E50	20	60
300092031	HSK-E50	20	100

### Accessories Haas grinding wheel adapter HSK-E50 // Shaft $\varnothing 20$ mm // Ring set $\varnothing 50$ mm

Order No.	Name
350050010	Universal assembly device $\varnothing 50$
350040010	*Clamping nut wrench PC27 for $\varnothing 20$
350040011	*Clamping nut wrench PC27 for $\varnothing 20$
350020021	*Balancing weight pair for clamping nut $\varnothing 50$ // 100gmm

Order No.	Name
350011020	Spacer ring $\varnothing 50 \times \varnothing 20 \times 20$
350011010	Spacer ring $\varnothing 50 \times \varnothing 20 \times 10$
350011004	Spacer ring $\varnothing 50 \times \varnothing 20 \times 4$
350030010	Lock washer $\varnothing 50 \times \varnothing 20 \times 2$
350020060	Clamping nut $\varnothing 50 \times 6 \times M20 \times 1$ PC27
350020020	*Clamping nut with balancing option $\varnothing 50 \times 8,5 M20 \times 1,0$ PC27
350015003	Support washer $\varnothing 50 \times \varnothing 75 \times \varnothing 20 \times 6$

## Haas HSK-E50 and HSK-E80

For Haas tool grinding machines

### GWA HSK-E50 and HSK-E80

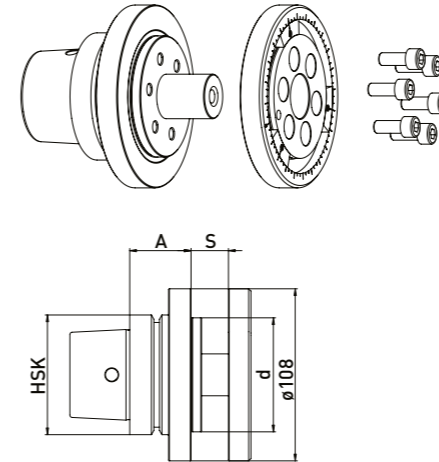

Delivered equipped:  
Clamping flange with balancing weights 3pc.  
and clamping screws 6pc.

Order No.	HSK	d	A	S
300093011	HSK-E50	51	42	8-25
300093111	HSK-E50	76,2	42	8-25
300094011	HSK-E80	51	42	8-25
300094111	HSK-E80	76,2	42	8-25
300094211	HSK-E80	51	55	25-40

### Accessories Haas grinding wheel adapter HSK-E50 and HSK-E80

Order No.	Name
250001059	Balancing weight $\varnothing 100 \times \varnothing 80 \times 7$

## Hawema HSK50 // Shaft $\varnothing 20$ mm // RS $\varnothing 35$ mm

For Hawema tool grinding machines with ring set  $\varnothing 35$  mm

### GWA HSK50 // $\varnothing 20$ mm // RS $\varnothing 35$ mm

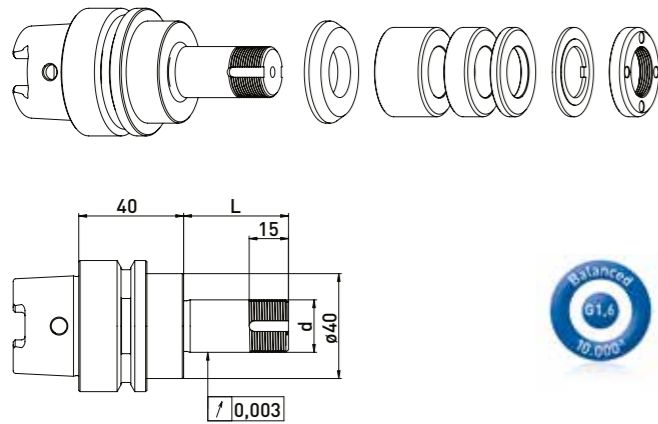

Delivered equipped:  
Reducing washer, ring set  $\varnothing 35$  mm, lock washer and clamping nut

#### Ring set $\varnothing 35$ mm

Order No.	HSK	d	L	B20	B10	B4
300012512	HSK50	20	40	-	1	3
300012522	HSK50	20	60	1	1	3
300012532	HSK50	20	75	1	2	4
300012542	HSK50	20	85	2	1	4
300012552	HSK50	20	100	2	3	3

### GWA HSK50 // $\varnothing 20$ mm // without RS

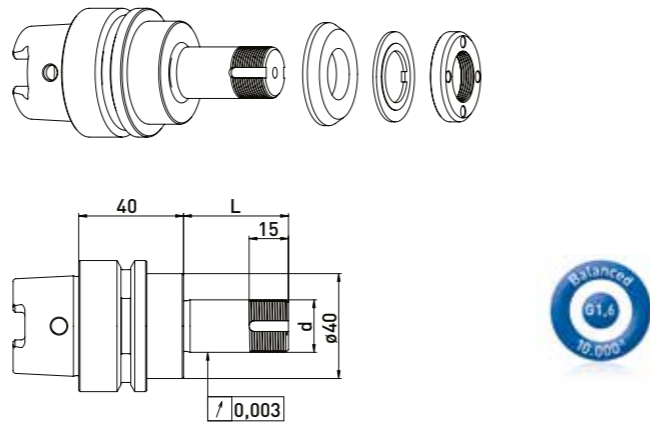

Delivered equipped:  
Reducing washer, lock washer and clamping nut

Order No.	HSK	d	L
300012511	HSK50	20	40
300012521	HSK50	20	60
300012531	HSK50	20	75
300012541	HSK50	20	85
300012551	HSK50	20	100

### Accessories Hawema grinding wheel adapter HSK50 // $\varnothing 20$ mm // Ring set $\varnothing 35$ mm

Order No.	Name	Order No.	Name
350050010	Universal assembly device $\varnothing 50$	350012020	Spacer ring $\varnothing 35 \times \varnothing 20 \times 20$
350040010	Clamping nut wrench PC27 for $\varnothing 20$	350012010	Spacer ring $\varnothing 35 \times \varnothing 20 \times 10$
350040011	Clamping nut wrench PC27 for $\varnothing 20$	350012004	Spacer ring $\varnothing 35 \times \varnothing 20 \times 4$
350040040	*Clamping nut wrench PC29 for $\varnothing 20$ for clamping nut with blancing option	350015006	Reducing washer $\varnothing 40 \times \varnothing 35 \times \varnothing 20 \times 6$
350040041	*Clamping nut wrench PC29 for $\varnothing 20$	350030020	Lock washer $\varnothing 35 \times \varnothing 20 \times 2$
350020081	*Balancing weight pair for clamping nut $\varnothing 35 // 40$ gmm	350020030	Clamping nut $\varnothing 35 \times 6$ M20 x 1 PC27
		350020080	*Clamping nut with balancing option $\varnothing 35 \times \varnothing 40 \times 8 \times$ M20 x 1 PC29
		350015005	Support washer $\varnothing 35 \times \varnothing 60 \times \varnothing 20 \times 6$

## Hawema HSK50 // Shaft $\varnothing 20$ mm // RS $\varnothing 50$ mm

For Hawema tool grinding machines with ring set  $\varnothing 50$  mm

### GWA HSK50 // $\varnothing 20$ mm // RS $\varnothing 50$ mm

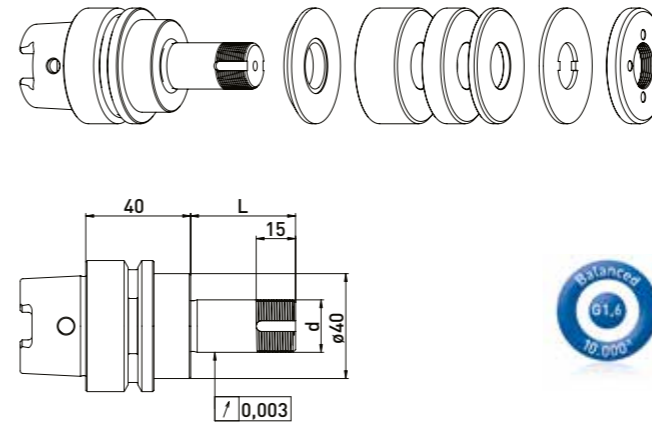

Delivered equipped:  
Reducing washer, ring set  $\varnothing 50$  mm, lock washer and clamping nut

#### Ring set $\varnothing 50$ mm

Order No.	HSK	d	L	B20	B10	B4
300012012	HSK50	20	40	-	1	3
300012022	HSK50	20	60	1	1	3
300012032	HSK50	20	75	1	2	4
300012042	HSK50	20	85	2	1	4
300012052	HSK50	20	100	2	3	3

### GWA HSK50 // $\varnothing 20$ mm // without RS

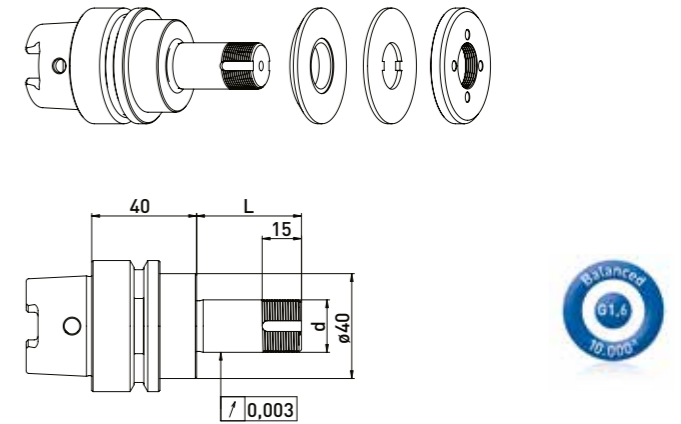

Delivered equipped:  
Reducing washer, lock washer and clamping nut

Order No.	HSK	d	L
300012011	HSK50	20	40
300012021	HSK50	20	60
300012031	HSK50	20	75
300012041	HSK50	20	85
300012051	HSK50	20	100

### Accessories Hawema grinding wheel adapter HSK50 // $\varnothing 20$ mm // Ring set $\varnothing 50$ mm

Order No.	Name	Order No.	Name
350050010	Universal assembly device $\varnothing 50$	350011020	Spacer ring $\varnothing 50 \times \varnothing 20 \times 20$
350040010	*Clamping nut wrench PC27 for $\varnothing 20$	350011010	Spacer ring $\varnothing 50 \times \varnothing 20 \times 10$
350040011	*Clamping nut wrench PC27 for $\varnothing 20$	350011004	Spacer ring $\varnothing 50 \times \varnothing 20 \times 4$
350020021	*Balancing weight pair for clamping nut $\varnothing 50 // 100$ gmm	350015002	Reducing washer $\varnothing 40 \times \varnothing 50 \times \varnothing 20 \times 6$
		350030010	Lock washer $\varnothing 50 \times \varnothing 20 \times 2$
		350020060	Clamping nut $\varnothing 50 \times 6 \times$ M20 x 1 PC27
		350020020	*Clamping nut with balancing option $\varnothing 50 \times 8,5$ M20 x 1,0 PC27
		350015003	Support washer $\varnothing 50 \times \varnothing 75 \times \varnothing 20 \times 6$



## Reinecker HSK50 // Shaft $\varnothing 20$ mm // RS $\varnothing 35$ mm

For Reinecker tool grinding machines with ring set  $\varnothing 35$  mm

### GWA HSK50 // $\varnothing 20$ mm // RS $\varnothing 35$ mm

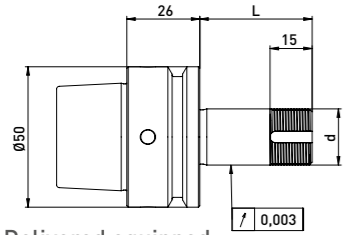
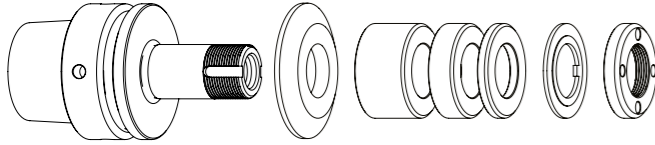

Delivered equipped:  
Reducing washer, ring set  $\varnothing 35$  mm, lock washer and clamping nut

Ring set  $\varnothing 35$  mm

Order No.	HSK	d	L	B20	B10	B4
300072512	HSK50	20	40	-	1	3
300072522	HSK50	20	60	1	1	3
300072532	HSK50	20	85	2	1	4
300072542	HSK50	20	110	3	2	3
300072552	HSK50	20	25	-	-	2
300072562	HSK50	20	50	-	2	3
300072572	HSK50	20	75	2	1	2

### GWA HSK50 // $\varnothing 20$ mm // without RS

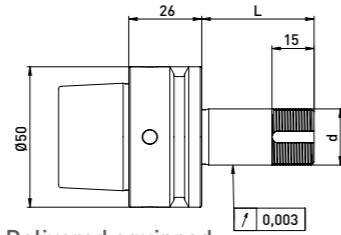
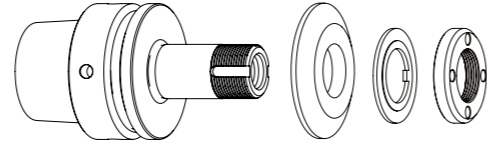

Delivered equipped:  
Reducing washer, lock washer and clamping nut

Order No.	HSK	d	L
300072511	HSK50	20	40
300072521	HSK50	20	60
300072531	HSK50	20	85
300072541	HSK50	20	110
300072551	HSK50	20	25
300072561	HSK50	20	50
300072571	HSK50	20	75

### Accessories Reinecker grinding wheel adapter HSK50 // $\varnothing 20$ mm // Ring set $\varnothing 35$ mm

Order No.	Name	
350050010	Universal assembly device $\varnothing 50$	
350040010	Clamping nut wrench PC27 for $\varnothing 20$	
350040011	Clamping nut wrench PC27 for $\varnothing 20$	
350040040	*Clamping nut wrench PC29 for $\varnothing 20$ for clamping nut with blancing option	
350040041	*Clamping nut wrench PC29 for $\varnothing 20$	
350020081	*Balancing weight pair for clamping nut $\varnothing 35$ // 40gmm	

Order No.	Name	
250000253	Clamping screw Reinecker L40 - $\varnothing 12$ x 116	
250000254	Clamping screw Reinecker L60 - $\varnothing 12$ x 136	
250000255	Clamping screw Reinecker L85 - $\varnothing 12$ x 161	
250000256	Clamping screw Reinecker L110 - $\varnothing 12$ x 186	

Order No.	Name	
350012020	Spacer ring $\varnothing 35$ x $\varnothing 20$ x 20	
350012010	Spacer ring $\varnothing 35$ x $\varnothing 20$ x 10	
350012004	Spacer ring $\varnothing 35$ x $\varnothing 20$ x 4	
350015001	Reducing washer $\varnothing 50$ x $\varnothing 35$ x $\varnothing 20$ x 6	
350030020	Lock washer $\varnothing 35$ x $\varnothing 20$ x 2	
350020030	Clamping nut $\varnothing 35$ x 6 M20 x 1 PC27	
350020080	*Clamping nut with balancing option $\varnothing 35$ x $\varnothing 40$ x 8 x M20 x 1 PC29	
350015005	Support washer $\varnothing 35$ x $\varnothing 60$ x $\varnothing 20$ x 6	

## Reinecker HSK50 // Shaft $\varnothing 20$ mm // RS $\varnothing 50$ mm

For Reinecker tool grinding machines with ring set  $\varnothing 50$  mm

### GWA HSK50 // $\varnothing 20$ mm // RS $\varnothing 50$ mm

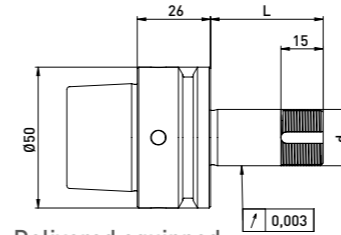
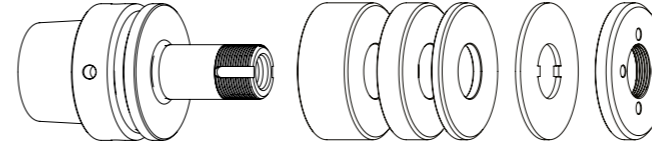

Delivered equipped:  
Ring set  $\varnothing 50$  mm, lock washer and clamping nut

Ring set  $\varnothing 50$  mm

Order No.	HSK	d	L	B20	B10	B4
300072012	HSK50	20	40	-	1	4
300072022	HSK50	20	60	1	1	4
300072032	HSK50	20	85	2	2	3
300072042	HSK50	20	110	3	2	4
300072052	HSK50	20	25	-	-	3
300072062	HSK50	20	50	1	1	2
300072072	HSK50	20	75	2	1	3

### GWA HSK50 // $\varnothing 20$ mm // without RS

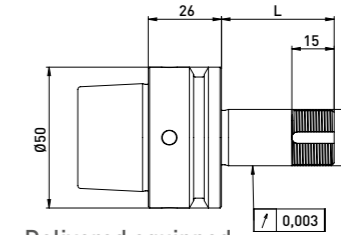
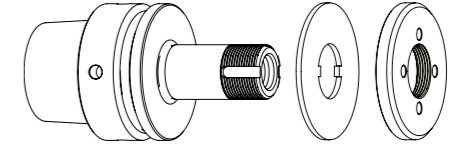

Delivered equipped:  
Lock washer and clamping nut

Order No.	HSK	d	L
300072011	HSK50	20	40
300072021	HSK50	20	60
300072031	HSK50	20	85
300072041	HSK50	20	110
300072051	HSK50	20	25
300072061	HSK50	20	50
300072071	HSK50	20	75

### Accessories Reinecker grinding wheel adapter HSK50 // $\varnothing 20$ mm // Ring set $\varnothing 50$ mm

Order No.	Name	
350050010	Universal assembly device $\varnothing 50$	
350040010	*Clamping nut wrench PC27 for $\varnothing 20$	
350040011	*Clamping nut wrench PC27 for $\varnothing 20$	
350020021	*Balancing weight pair for clamping nut $\varnothing 50$ // 100gmm	

Order No.	Name	
250000253	Clamping screw Reinecker L40 - $\varnothing 12$ x 116	
250000254	Clamping screw Reinecker L60 - $\varnothing 12$ x 136	
250000255	Clamping screw Reinecker L85 - $\varnothing 12$ x 161	
250000256	Clamping screw Reinecker L110 - $\varnothing 12$ x 186	

Order No.	Name	
350011020	Spacer ring $\varnothing 50$ x $\varnothing 20$ x 20	
350011010	Spacer ring $\varnothing 50$ x $\varnothing 20$ x 10	
350011004	Spacer ring $\varnothing 50$ x $\varnothing 20$ x 4	
350015003	Support washer $\varnothing 50$ x $\varnothing 75$ x $\varnothing 20$ x 6	
350030010	Lock washer $\varnothing 50$ x $\varnothing 20$ x 2	
350020060	Clamping nut $\varnothing 50$ x 6 x M20 x 1 PC27	
350020020	*Clamping nut with balancing option $\varnothing 50$ x 8,5 M20 x 1,0 PC27	

## Reinecker HSK50 // Shaft $\varnothing 31,75$ mm (1¼) // RS $\varnothing 60$ mm

For Reinecker tool grinding machines with ring set  $\varnothing 60$  mm

### GWA HSK50 // $\varnothing 31,75$ mm (1¼) // RS $\varnothing 60$ mm

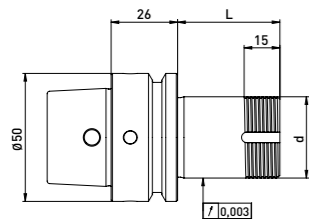
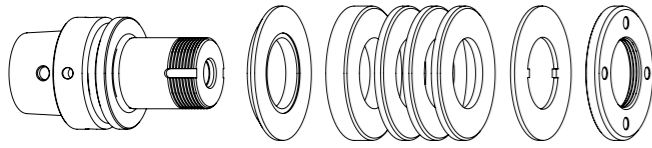

Delivered equipped:  
Ring set  $\varnothing 60$  mm, lock washer and clamping nut

### GWA HSK50 // $\varnothing 31,75$ mm (1¼) // ohne Ringsatz

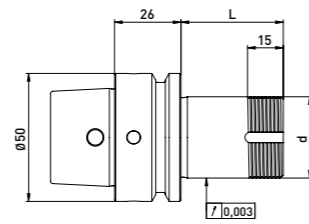
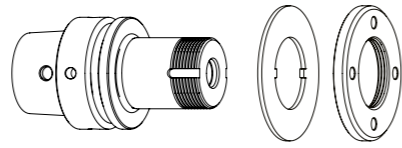

Delivered equipped:  
Lock washer and clamping nut

#### Ringsatz $\varnothing 60$ mm

Best.-Nr.	HSK	d	L	B20	B10	B4
300072112	HSK50	31,75	40	-	2	3
300072122	HSK50	31,75	60	1	1	3
300072132	HSK50	31,75	85	2	2	4
300072142	HSK50	31,75	100	3	2	3

Best.-Nr.	HSK	d	L
300072111	HSK50	31,75	40
300072121	HSK50	31,75	60
300072131	HSK50	31,75	85
300072141	HSK50	31,75	100

### Accessories Reinecker grinding wheel adapter HSK50 // $\varnothing 31,75$ mm (1¼) // Ringset $\varnothing 60$ mm

Best.-Nr.	Bezeichnung	
350050010	Universal assembly device $\varnothing 50$	
350040030	*Clamping nut wrench TK39 for clamping nut with blancing option	
350040020	Clamping nut wrench PC45 for $\varnothing 32$	
350020023	*Balancing weight pair for clamping nut $\varnothing 60$ // 200gmm	
Order No.	Name	
250000253	Clamping screw Reinecker L40 - $\varnothing 12$ x 116	
250000254	Clamping screw Reinecker L60 - $\varnothing 12$ x 136	
250000255	Clamping screw Reinecker L85 - $\varnothing 12$ x 161	
250000256	Clamping screw Reinecker L110 - $\varnothing 12$ x 186	

Best.-Nr.	Bezeichnung	
350011420	Spacer ring $\varnothing 60$ x $\varnothing 31,75$ x 20	
350011410	Spacer ring $\varnothing 60$ x $\varnothing 31,75$ x 10	
350011404	Spacer ring $\varnothing 60$ x $\varnothing 31,75$ x 4	
350015009	Support washer	
350030060	Lock washer $\varnothing 60$ x $\varnothing 32$ x 1,8	
350020066	Clamping nut $\varnothing 60$ x 6 x M32 x 1,5 PC45	
350020022	*Clamping nut with balancing option $\varnothing 60$ x 9 M32 x 1,5 PC39	

## Rollomatic $\varnothing 25$ mm // Shaft $\varnothing 20$ mm // RS $\varnothing 50$ mm

For Rollomatic tool grinding machines with ring set  $\varnothing 50$  mm

### GWA $\varnothing 25$ mm // $\varnothing 20$ mm // RS $\varnothing 50$ mm

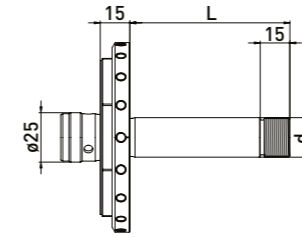
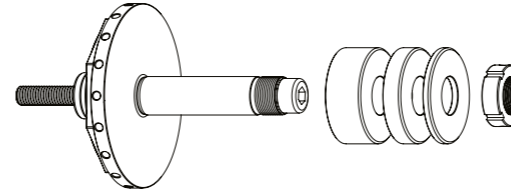

Delivered equipped:  
Ring set  $\varnothing 50$  mm, M10 clamping screw and clamping nut

#### Ring set $\varnothing 50$ mm

Order No.	d	L	B20	B10	B4
300150412	20	50	-	2	4
300150422	20	81	1	3	4

### Accessories Rollomatic grinding wheel adapter $\varnothing 25$ mm // Shaft $\varnothing 20$ mm // RS $\varnothing 50$ mm

Order No.	Name	
350040051	Hook wrench 30 - 32 mm	

Order No.	Name	
350011520	Spacer ring Rollomatic $\varnothing 50$ x $\varnothing 20$ x 20	
350011510	Spacer ring Rollomatic $\varnothing 50$ x $\varnothing 20$ x 10	
350011504	Spacer ring Rollomatic $\varnothing 50$ x $\varnothing 20$ x 4	
350020120	Clamping nut MRR20x1 M20 x 1 - $\varnothing 32$ x 10	
350015003	Support washer $\varnothing 50$ x $\varnothing 75$ x $\varnothing 20$ x 6	

## Rollomatic $\varnothing 25$ mm // Shaft $\varnothing 31,75$ mm (1¼)

For Rollomatic tool grinding machines

GWA  $\varnothing 25$  mm //  $\varnothing 31,75$  mm (1¼)

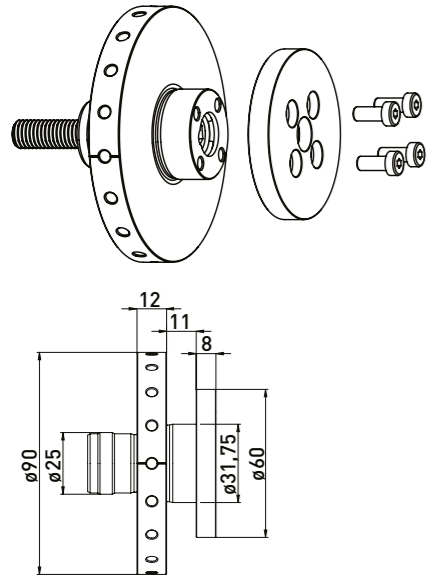

Delivered equipped:  
Clamping flange, 4pc. M5x12 cylinder screws and  
M10 clamping screw

Order No.	Name
300150510	Grinding wheel adapter Rollomatic $\varnothing 31,75$ x 11

## Rollomatic $\varnothing 25$ mm // Shaft $\varnothing 31,75$ mm (1¼) // RS $\varnothing 60$ mm

For Rollomatic tool grinding machines with ring set  $\varnothing 60$  mm

GWA  $\varnothing 25$  mm //  $\varnothing 31,75$  mm (1¼) // RS  $\varnothing 60$  mm

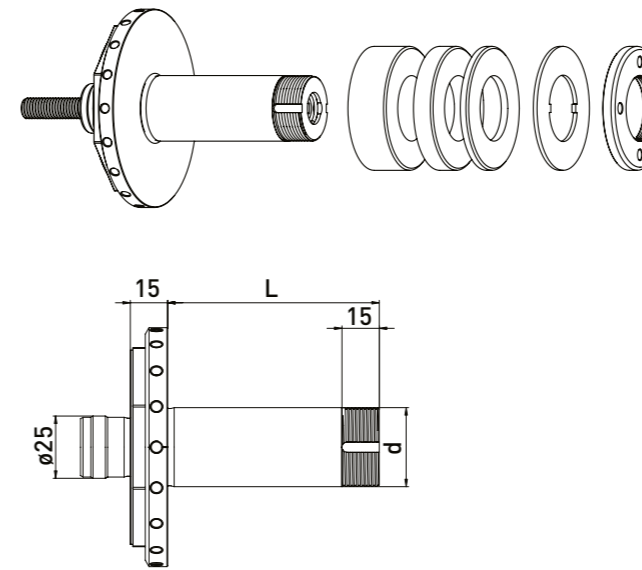





Delivered equipped:  
Ring set  $\varnothing 60$  mm, M10 clamping screw, lock washer  
and clamping nut

Order No.	d	L	Ring set $\varnothing 60$ mm		
			B 20	B 10	B 4
300150212	31,75	50	-	2	4
300150222	31,75	85	2	2	3
300150232	31,75	115	3	3	3

Accessories Rollomatic grinding wheel adapter  $\varnothing 25$  mm //  $\varnothing 31,75$  mm (1¼) // RS  $\varnothing 60$  mm

Order No.	Name
350040020	Clamping nut wrench PC45 for $\varnothing 32$ 

Order No.	Name
350011620	Spacer ring Rollomatic $\varnothing 60$ x $\varnothing 31,75$ x 20 
350011610	Spacer ring Rollomatic $\varnothing 60$ x $\varnothing 31,75$ x 10 
350011604	Spacer ring Rollomatic $\varnothing 60$ x $\varnothing 31,75$ x 4 
350030060	Lock washer $\varnothing 60$ x $\varnothing 32$ x 1,8 
350020066	Clamping nut $\varnothing 60$ x 6 x M32x1,5 PC45 

## Rollomatic $\varnothing 25$ mm // Shaft $\varnothing 32$ // RS $\varnothing 60$ mm

For Rollomatic tool grinding machines with ring set  $\varnothing 60$  mm

### GWA $\varnothing 25$ mm // $\varnothing 32$ mm // RS $\varnothing 60$ mm

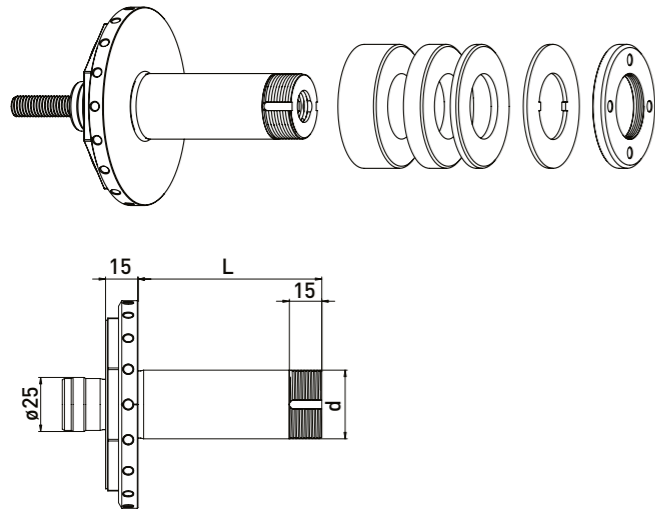

Delivered equipped:  
Ring set  $\varnothing 60$  mm, M10 clamping screw lock washer and clamping nut

Order No.	d	L	Ring set $\varnothing 60$ mm		
			B 20	B 10	B 4
300150312	32	50	-	2	4
300150322	32	85	2	2	3
300150332	32	115	3	3	3

### Accessories Rollomatic grinding wheel adapter $\varnothing 25$ mm // Shaft $\varnothing 32$ mm // RS $\varnothing 60$ mm

Order No.	Name	Order No.	Name
350040020	Clamping nut wrench PC45 for $\varnothing 32$	350011320	Spacer ring $\varnothing 60$ x $\varnothing 32$ x 20
		350011310	Spacer ring $\varnothing 60$ x $\varnothing 32$ x 10
		350011304	Spacer ring $\varnothing 60$ x $\varnothing 32$ x 4
		350030060	Lock washer $\varnothing 60$ x $\varnothing 32$ x 1,8
		350020066	Clamping nut $\varnothing 60$ x 6 x M32 x 1,5 PC45

## Rollomatic $\varnothing 25$ mm // stepped Shaft $\varnothing 25$ , $\varnothing 35$ , $\varnothing 50$ mm

For Rollomatic tool grinding machines

### GWA $\varnothing 25$ mm // stepped Shaft

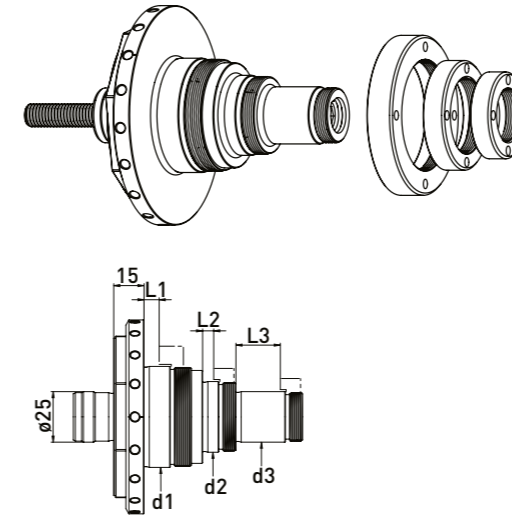

Delivered equipped:  
per 1 piece clamping nut  $\varnothing 38$  (350020110),  $\varnothing 48$  (350020111),  $\varnothing 70$  (350020113) and M10 clamping screw

Order No.	L1	L2	L3	d1	d2	d3
300150111	11,5	5,5	5,5	50	35	25
300150121	7,5	5,5	22	50	35	25

### Accessories Rollomatic grinding wheel adapter $\varnothing 25$ mm // stepped Shaft $\varnothing 25$ , $\varnothing 35$ , $\varnothing 50$ mm

Order No.	Name	for d	Order No.	Name
350020110	Clamping nut Rollomatic $\varnothing 38$ x 10 M24 x 1	25	350016001	Spacer ring $\varnothing 38$ x $\varnothing 25$ x 5
350020111	Clamping nut Rollomatic $\varnothing 48$ x 10 M34 x 1	35	350016002	Spacer ring $\varnothing 58$ x $\varnothing 40$ x 5
350020112	Clamping nut Rollomatic $\varnothing 58$ x 11 M39 x 1	40	350016003	Spacer ring $\varnothing 70$ x $\varnothing 50$ x 5
350020113	Clamping nut Rollomatic $\varnothing 70$ x 12 M49 x 1	50	350016005	Spacer ring $\varnothing 48$ x $\varnothing 35$ x 5

Delivered equipped:  
per 1 piece clamping nut  $\varnothing 38$  (350020110),  $\varnothing 58$  (350020112) and M10 clamping screw

Order No.	L1	L2	L3	d1	d2	d3
300150131	11,5	5,5		40	25	

Delivered equipped:  
per 1 piece clamping nut  $\varnothing 38$  (350020110),  $\varnothing 70$  (350020113) and M10 clamping screw

Order No.	L1	L2	L3	d1	d2	d3
300150141	11,5	5,5		50	25	

## Rollomatic HSK50 // stepped Shaft $\phi 25$ , $\phi 35$ , $\phi 50$ mm

For Rollomatic tool grinding machines

### GWA HSK50 // stepped Shaft

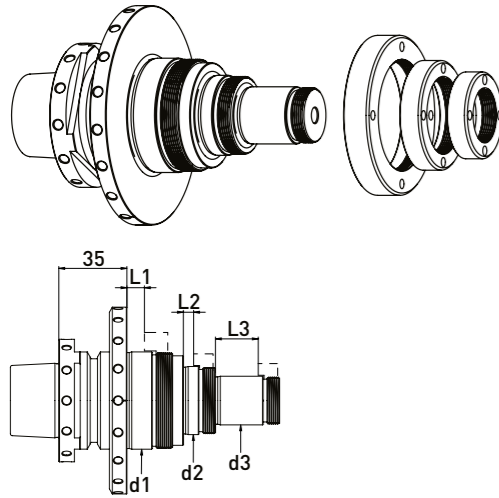

Delivered equipped:  
per 1 piece clamping nut  $\phi 38$  (350020110),  $\phi 48$  (350020111),  
 $\phi 70$  (350020113) and M10 clamping screw

Order No.	L1	L2	L3	d1	d2	d3
300150921	7,5	5,5	22	50	35	25

### Accessories Rollomatic grinding wheel adapter $\phi 25$ mm // stepped Shaft $\phi 25$ , $\phi 35$ , $\phi 50$ mm

Order No.	Name	for d	
350020110	Clamping nut Rollomatic $\phi 38 \times 10$ M24 x 1	25	
350020111	Clamping nut Rollomatic $\phi 48 \times 10$ M34 x 1	35	
350020112	Clamping nut Rollomatic $\phi 58 \times 11$ M39 x 1	40	
350020113	Clamping nut Rollomatic $\phi 70 \times 12$ M49 x 1	50	
Order No.	Name		
350016001	Spacer ring $\phi 38 \times \phi 25 \times 5$		
350016002	Spacer ring $\phi 58 \times \phi 40 \times 5$		
350016003	Spacer ring $\phi 70 \times \phi 50 \times 5$		
350016005	Spacer ring $\phi 48 \times \phi 35 \times 5$		

## Rollomatic HSK-E50 // Shaft $\phi 20$ mm // RS $\phi 50$ mm

For Rollomatic tool grinding machines with ring set  $\phi 50$  mm

### GWA HSK-E50 // $\phi 20$ mm // RS $\phi 50$ mm

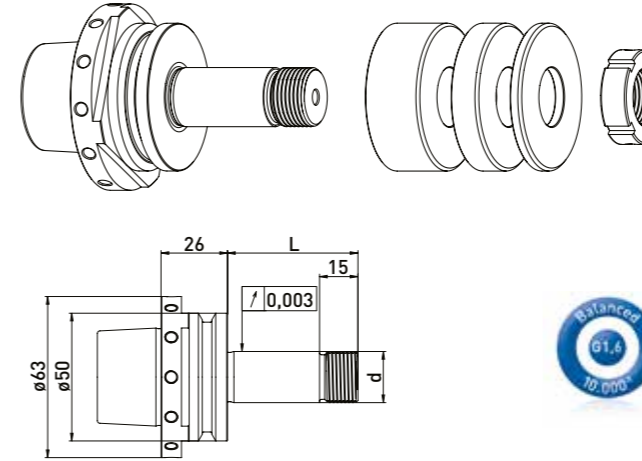

Delivered equipped:  
Ring set  $\phi 50$  mm and clamping nut

Order No.	HSK	d	L	Ring set $\phi 50$ mm		
				B20	B10	B4
300150612	HSK-E50	20	51	1	1	2
300150632	HSK-E50	20	81	2	2	2

### GWA HSK-E50 // $\phi 20$ mm // without RS

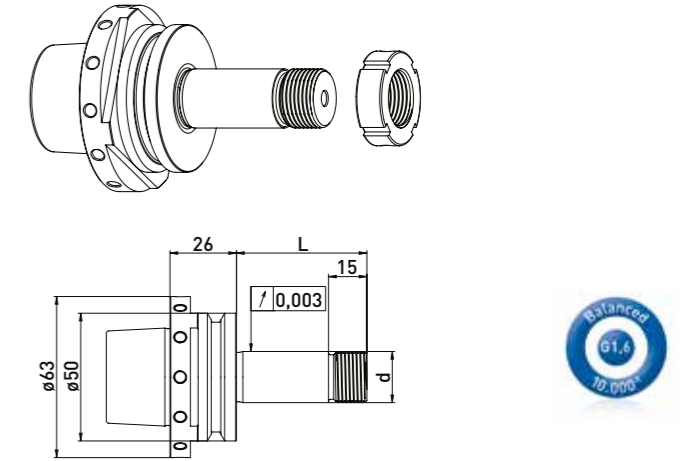

Delivered equipped:  
Clamping nut

Order No.	HSK	d	L
300150611	HSK-E50	20	51
300150631	HSK-E50	20	81

### Accessories Rollomatic grinding wheel adapter GWA HSK-E50 // Shaft $\phi 20$ mm // RS $\phi 50$ mm

Order No.	Name	
350040051	Hook wrench 30 - 32 mm	
Order No.	Name	
350011520	Spacer ring Rollomatic $\phi 50 \times \phi 20 \times 20$	
350011510	Spacer ring Rollomatic $\phi 50 \times \phi 20 \times 10$	
350011504	Spacer ring Rollomatic $\phi 50 \times \phi 20 \times 4$	
350020121	Clamping nut MRR20 x 1,5 M20 x 1,5 $\phi 32 \times 10$	
350015003	Support washer $\phi 50 \times \phi 75 \times \phi 20 \times 6$	

## Rollomatic HSK-E50 // Shaft $\varnothing 31,75$ mm (1¼) // RS $\varnothing 60$ mm

For Rollomatic tool grinding machines with ring set  $\varnothing 60$  mm

### GWA HSK-E50 // $\varnothing 31,75$ mm (1¼) // RS $\varnothing 60$ mm

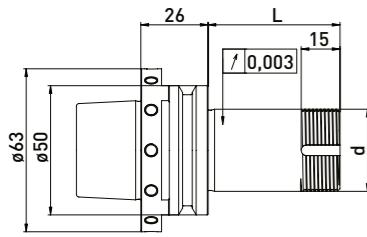
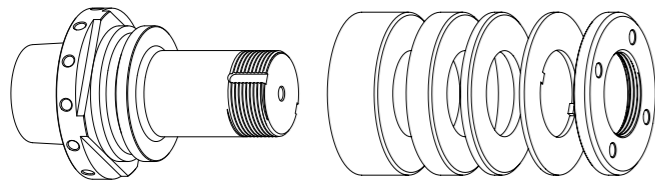

Delivered equipped:  
Ring set  $\varnothing 60$  mm and clamping nut

### GWA HSK-E50 // $\varnothing 31,75$ mm (1¼) // without RS

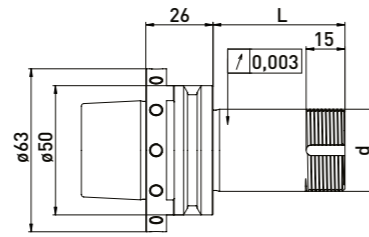
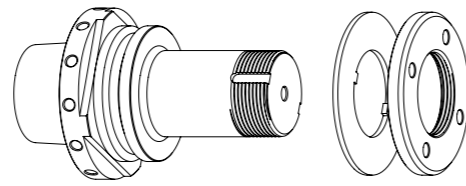

Delivered equipped:  
Clamping nut

#### Ring set $\varnothing 60$ mm

Order No.	HSK	d	L	B20	B10	B4
300150712	HSK-50E	31,75	51	-	1	3
300150732	HSK-50E	31,75	81	1	1	3

Order No.	HSK	d	L
300150711	HSK-50E	31,75	51
300150731	HSK-50E	31,75	81

### Accessories Rollomatic grinding wheel adapter HSK-E50 // Shaft $\varnothing 31,75$ mm (1¼) // Ring set $\varnothing 60$ mm

Order No.	Name
350040030	*Clamping nut wrench PC39 for clamping nut with blancing option
350040020	Clamping nut wrench PC45 for $\varnothing 32$
350020023	*Balancing weight pair for clamping nut $\varnothing 60$ // 200gmm

Order No.	Name
350011420	Spacer ring $\varnothing 60$ x $\varnothing 31,75$ x 20
350011410	Spacer ring $\varnothing 60$ x $\varnothing 31,75$ x 10
350011404	Spacer ring $\varnothing 60$ x $\varnothing 31,75$ x 4
350030060	Lock washer $\varnothing 60$ x $\varnothing 32$ x 1,8
350020066	Clamping nut $\varnothing 60$ x 6 x M32 x 1,5 PC45
350020022	*Clamping nut with balancing option $\varnothing 60$ x 9 M32 x 1,5 PC39

## Saacke HSK50 // Shaft $\varnothing 20$ mm // RS $\varnothing 35$ mm

For Saacke tool grinding machines with ring set  $\varnothing 35$  mm

### GWA HSK50 // $\varnothing 20$ mm // RS $\varnothing 35$ mm

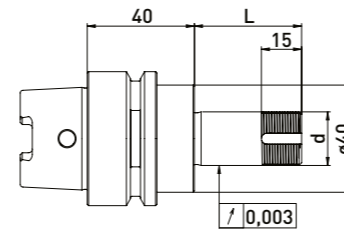
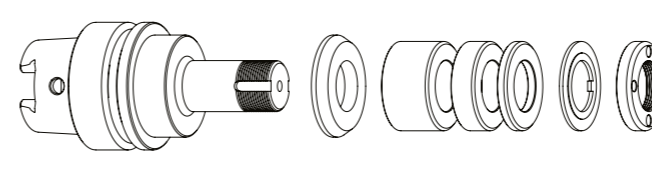

Delivered equipped:  
Reducing washer, ring set  $\varnothing 35$  mm, lock washer and clamping nut

### GWA HSK50 // $\varnothing 20$ mm // without RS

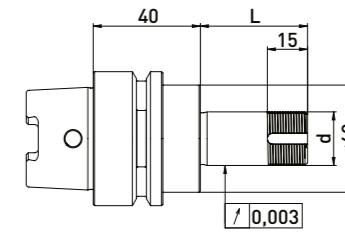
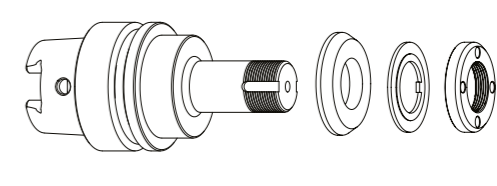

Delivered equipped:  
Reducing washer, lock washer and clamping nut

#### Ring set $\varnothing 35$ mm

Order No.	HSK	d	L	B20	B10	B4
300012512	HSK50	20	40	-	1	3
300012522	HSK50	20	60	1	1	3
300012532	HSK50	20	75	1	2	4
300012542	HSK50	20	85	2	1	4
300012552	HSK50	20	100	2	3	3

Order No.	HSK	d	L
300012511	HSK50	20	40
300012521	HSK50	20	60
300012531	HSK50	20	75
300012541	HSK50	20	85
300012551	HSK50	20	100

### Accessories Saacke grinding wheel adapter HSK50 // Shaft $\varnothing 20$ mm // Ring set $\varnothing 35$ mm

Order No.	Name
350050010	Universal assembly device $\varnothing 50$
350040010	Clamping nut wrench PC27 for $\varnothing 20$
350040011	Clamping nut wrench PC27 for $\varnothing 20$
350040040	*Clamping nut wrench PC29 for $\varnothing 20$ for clamping nut with Balancing option
350040041	*Clamping nut wrench PC29 for $\varnothing 20$
350020081	*Balancing weight pair for clamping nut $\varnothing 35$ // 40gmm

Order No.	Name
350012020	Spacer ring $\varnothing 35$ x $\varnothing 20$ x 20
350012010	Spacer ring $\varnothing 35$ x $\varnothing 20$ x 10
350012004	Spacer ring $\varnothing 35$ x $\varnothing 20$ x 4
350015006	Reducing washer $\varnothing 40$ x $\varnothing 35$ x $\varnothing 20$ x 6
350030020	Lock washer $\varnothing 35$ x $\varnothing 20$ x 2
350020030	Clamping nut $\varnothing 35$ x 6 M20 x 1 PC27
350020080	*Clamping nut with balancing option $\varnothing 35$ x $\varnothing 40$ x 8 x M20 x 1 PC29
350015005	Support washer $\varnothing 35$ x $\varnothing 60$ x $\varnothing 20$ x 6

## Saacke HSK50 // Shaft $\varnothing 20$ mm // RS $\varnothing 50$ mm

For Saacke tool grinding machines with ring set  $\varnothing 50$  mm

### GWA HSK50 // $\varnothing 20$ mm // RS $\varnothing 50$ mm

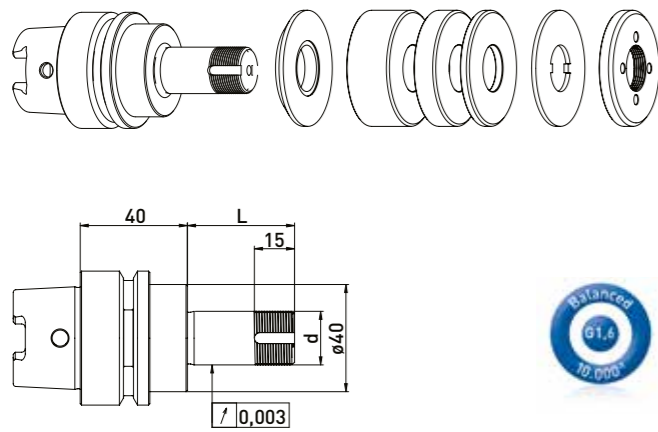

Delivered equipped:  
Reducing washer, ring set  $\varnothing 50$  mm, lock washer and clamping nut

### GWA HSK50 // $\varnothing 20$ mm // without RS

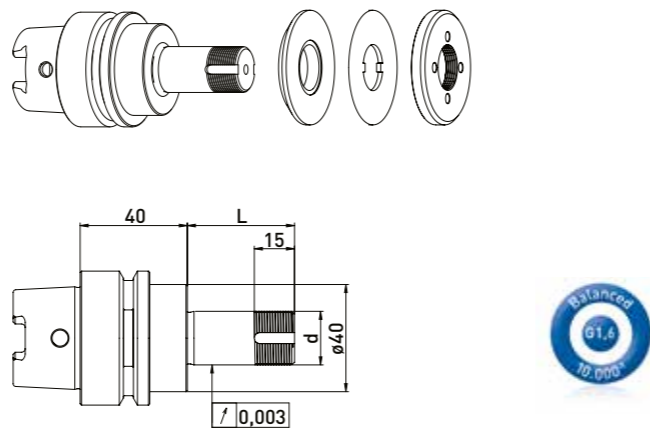

Delivered equipped:  
Reducing washer, lock washer and clamping nut

Ring set  $\varnothing 50$  mm

Order No.	HSK	d	L	B20	B10	B4
300012012	HSK50	20	40	-	1	3
300012022	HSK50	20	60	1	1	3
300012032	HSK50	20	75	1	2	4
300012042	HSK50	20	85	2	1	4
300012052	HSK50	20	100	2	3	3

Order No.	HSK	d	L
300012011	HSK50	20	40
300012021	HSK50	20	60
300012031	HSK50	20	75
300012041	HSK50	20	85
300012051	HSK50	20	100

### Accessories Saacke grinding wheel adapter HSK50 // Shaft $\varnothing 20$ mm // Ring set $\varnothing 50$ mm

Order No.	Name
350050010	Universal assembly device $\varnothing 50$
350040010	*Clamping nut wrench PC27 for $\varnothing 20$
350040011	*Clamping nut wrench PC27 for $\varnothing 20$
350020021	*Balancing weight pair for clamping nut $\varnothing 50$ // 100gmm

Order No.	Name
350011020	Spacer ring $\varnothing 50 \times \varnothing 20 \times 20$
350011010	Spacer ring $\varnothing 50 \times \varnothing 20 \times 10$
350011004	Spacer ring $\varnothing 50 \times \varnothing 20 \times 4$
350030010	Lock washer $\varnothing 50 \times \varnothing 20 \times 2$
350020060	Clamping nut $\varnothing 50 \times 6 \times M20 \times 1$ PC27
350020020	*Clamping nut with balancing option $\varnothing 50 \times 8,5$ M20 x 1,0 PC27
350015002	Reducing washer $\varnothing 40 \times \varnothing 50 \times \varnothing 20 \times 6$

## Saacke HSK50 // Shaft $\varnothing 31,75$ mm // RS $\varnothing 60$ mm

For Saacke tool grinding machines with ring set  $\varnothing 60$  mm

### GWA HSK50 // $\varnothing 31,75$ mm // RS $\varnothing 60$ mm

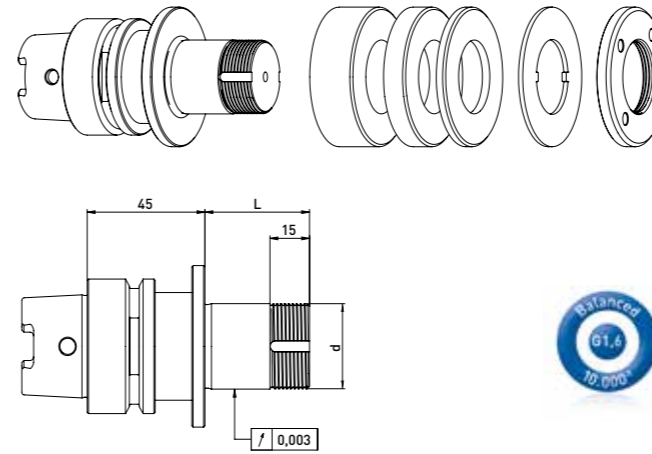

Delivered equipped:  
Reducing washer, ring set  $\varnothing 60$  mm, lock washer and clamping nut

### GWA HSK50 // $\varnothing 31,75$ mm // without RS

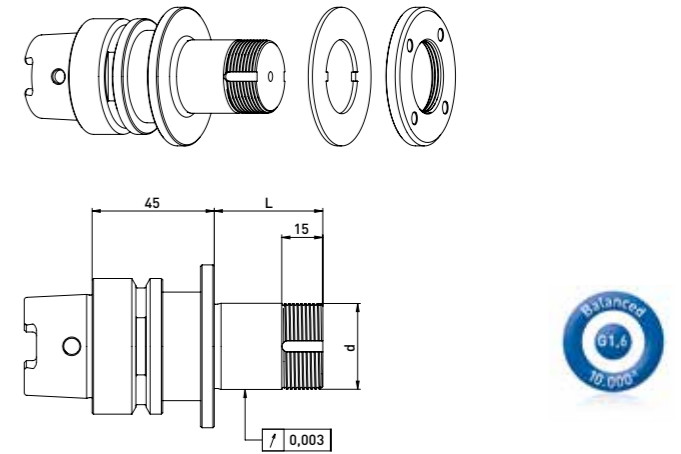

Delivered equipped:  
Reducing washer, lock washer and clamping nut

Ring set  $\varnothing 60$  mm

Order No.	HSK	d	L	B20	B10	B4
300012112	HSK50	20	40	-	1	3
300012122	HSK50	20	60	1	1	3
300012132	HSK50	20	75	1	2	4
300012142	HSK50	20	85	2	1	4
300012152	HSK50	20	100	2	3	3

Order No.	HSK	d	L
300012111	HSK50	20	40
300012121	HSK50	20	60
300012131	HSK50	20	75
300012141	HSK50	20	85
300012151	HSK50	20	100

### Accessories Saacke grinding wheel adapter HSK50 // Shaft $\varnothing 31,75$ mm // Ring set $\varnothing 60$ mm

Best.-Nr.	Bezeichnung
350050010	Universal assembly device $\varnothing 50$
350040030	*Clamping nut wrench TK39 for clamping nut with blancing option
350040020	Clamping nut wrench PC45 for $\varnothing 32$
350020023	*Balancing weight pair for clamping nut $\varnothing 60$ // 200gmm

Best.-Nr.	Bezeichnung
350011420	Spacer ring $\varnothing 60 \times \varnothing 31,75 \times 20$
350011410	Spacer ring $\varnothing 60 \times \varnothing 31,75 \times 10$
350011404	Spacer ring $\varnothing 60 \times \varnothing 31,75 \times 4$
350015009	Support washer
350030060	Lock washer $\varnothing 60 \times \varnothing 32 \times 1,8$
350020066	Clamping nut $\varnothing 60 \times 6 \times M32 \times 1,5$ PC45
350020022	*Clamping nut with balancing option $\varnothing 60 \times 9$ M32 x 1,5 PC39

## Saacke short taper // Shaft $\varnothing 20$ mm // RS $\varnothing 50$ mm

For Saacke tool grinding machines with ring set  $\varnothing 50$  mm

### GWA short taper // $\varnothing 20$ mm // RS $\varnothing 50$ mm

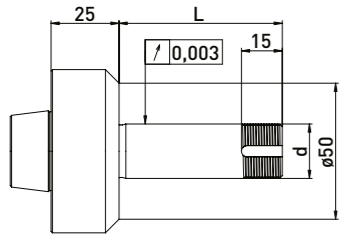
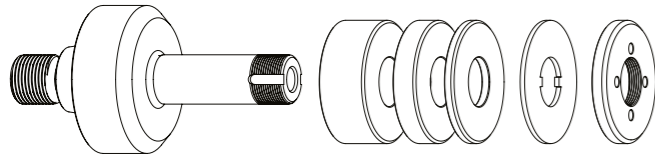

Delivered equipped:  
Ring set  $\varnothing 50$  mm, lock washer, tightening screw and clamping nut

Order No.	taper	d	L	Ring set $\varnothing 50$ mm		
				B20	B10	B4
300014012	Saacke	20	40	-	1	4
300014022	Saacke	20	60	1	1	4
300014042	Saacke	20	100	2	3	4

### Accessories Saacke grinding wheel adapter short taper // Shaft $\varnothing 20$ mm // Ring set $\varnothing 50$ mm

Order No.	Name	
350040010	*Clamping nut wrench PC27 for $\varnothing 20$	
350040011	*Clamping nut wrench PC27 for $\varnothing 20$	
350020021	*Balancing weight pair for clamping nut $\varnothing 50$ // 100gmm	

Order No.	Name
250000107	Tightening screw Saacke $\varnothing 20$ x 49

Order No.	Name	
350011020	Spacer ring $\varnothing 50$ x $\varnothing 20$ x 20	
350011010	Spacer ring $\varnothing 50$ x $\varnothing 20$ x 10	
350011004	Spacer ring $\varnothing 50$ x $\varnothing 20$ x 4	
350030010	Lock washer $\varnothing 50$ x $\varnothing 20$ x 2	
350020060	Clamping nut $\varnothing 50$ x 6 x M20 x 1 PC27	
350020020	*Clamping nut with balancing option $\varnothing 50$ x 8,5 M20 x 1,0 PC27	
350015003	Support washer $\varnothing 50$ x $\varnothing 75$ x $\varnothing 20$ x 6	

## Schneeberger HSK32 // Shaft $\varnothing 20$ mm // RS $\varnothing 35$ mm

For Schneeberger tool grinding machines with ring set  $\varnothing 35$  mm

### GWA HSK32 // $\varnothing 20$ mm // RS $\varnothing 35$ mm

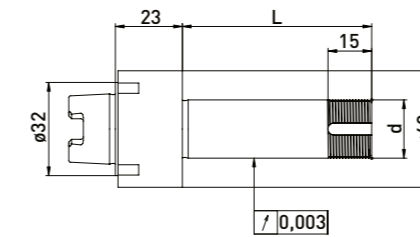
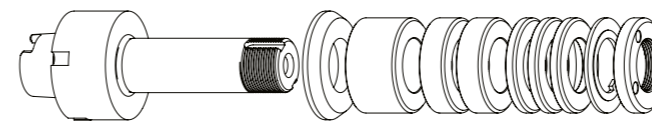

Delivered equipped:  
Reducing washer, ring set  $\varnothing 35$  mm, lock washer and clamping nut

Order No.	HSK	d	L	Ring set $\varnothing 35$ mm		
				B20	B10	B4
300045512	HSK32	20	65	1	2	3
300045522	HSK32	20	85	1	3	5
300045532	HSK32	20	110	2	3	7

### Accessories Schneeberger grinding wheel adapter short taper HSK32 // Shaft $\varnothing 20$ mm // Ring set $\varnothing 35$ mm

Best.-Nr.	Bezeichnung	
350050010	Universal assembly device $\varnothing 50$	
350050030	Assembly device Schneeberger For assembly on the workbench, in a vice or in the puniversal assembly device	
350040010	Clamping nut wrench PC27 for $\varnothing 20$	
350040011	Clamping nut wrench PC27 for $\varnothing 20$	
350040040	*Clamping nut wrench PC29 for $\varnothing 20$ for clamping nut with balancing option	
350040041	*Clamping nut wrench PC29 for $\varnothing 20$	
350020081	*Balancing weight pair for clamping nut $\varnothing 35$ // 40gmm	
213011050	Clamping screw Schneeberger M8/M8 x 62	

### GWA HSK32 // $\varnothing 20$ mm // without RS

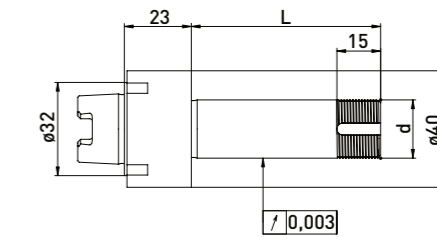
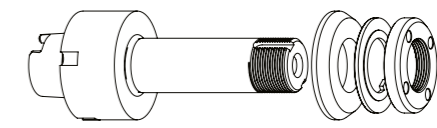

Delivered equipped:  
Reducing washer, lock washer and clamping nut

Order No.	HSK	d	L
300045511	HSK32	20	65
300045521	HSK32	20	85
300045531	HSK32	20	110

Best.-Nr.	Bezeichnung	
350012020	Spacer ring $\varnothing 35$ x $\varnothing 20$ x 20	
350012010	Spacer ring $\varnothing 35$ x $\varnothing 20$ x 10	
350012004	Spacer ring $\varnothing 35$ x $\varnothing 20$ x 4	
350015001	Reducing washer $\varnothing 50$ x $\varnothing 35$ x $\varnothing 20$ x 6	
350030020	Lock washer $\varnothing 35$ x $\varnothing 20$ x 2	
350020030	Clamping nut $\varnothing 35$ x 6 M20 x 1 PC27	
350020080	*Clamping nut with balancing option $\varnothing 35$ x $\varnothing 40$ x 8 x M20 x 1 PC29	



## Schneeberger HSK50 // Shaft $\varnothing 10$ mm // RS 20 mm

For Schneeberger tool grinding machines with ring set  $\varnothing 20$  mm

### GWA HSK50 // Shaft $\varnothing 10$ mm // RS $\varnothing 20$ mm

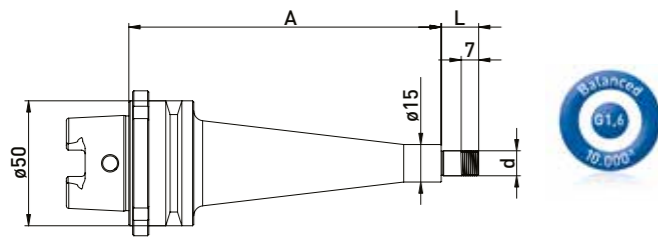
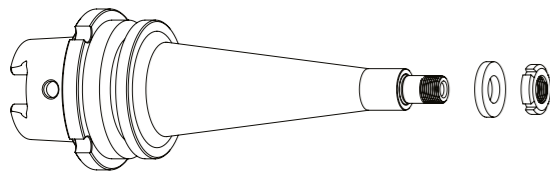

Delivered equipped:  
Ring set  $\varnothing 20$  mm and clamping nut

Ring set $\varnothing 20$ mm					
Order No.	HSK	d	L	A	B3
300044012	HSK50	10	15	60	3
300044022	HSK50	10	15	125	3

### Accessories Schneeberger grinding wheel adapter HSK50 // Shaft $\varnothing 10$ mm // Ring set $\varnothing 20$ mm

Order No.	Name
350040050	Hook wrench 16 - 20 mm



Order No.	Name
350016004	Spacer ring $\varnothing 20 \times \varnothing 10 \times 3$
350020114	Clamping nut $\varnothing 18 \times 4$ M10 x 0,75

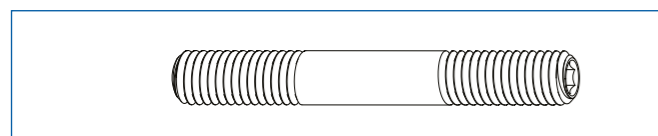

Order No.	Name
213011050	Clamping screw Schneeberger M8/M8 x 62

## Schneeberger HSK50 // Shaft $\varnothing 20$ mm // RS $\varnothing 35$ mm

For Schneeberger tool grinding machines with ring set  $\varnothing 35$  mm

### GWA HSK50 // $\varnothing 20$ mm // RS $\varnothing 35$ mm

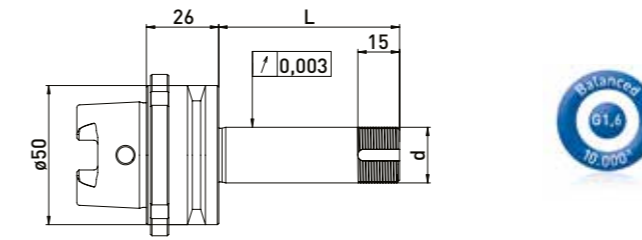
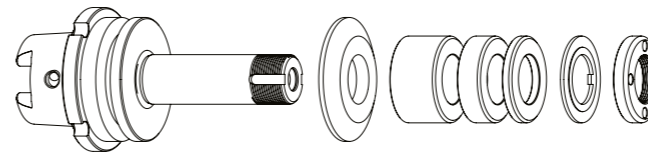

Delivered equipped:  
Reducing washer, ring set  $\varnothing 35$  mm, lock washer and clamping nut

Ring set $\varnothing 35$ mm						
Order No.	HSK	d	L	B20	B10	B4
300042512	HSK50	20	45	-	1	4
300042522	HSK50	20	65	1	1	4
300042532	HSK50	20	85	2	1	4
300042542	HSK50	20	110	3	2	2

### Accessories Schneeberger grinding wheel adapter HSK50 // Shaft $\varnothing 20$ mm // Ring set $\varnothing 35$ mm

Order No.	Name
350050010	Universal assembly device $\varnothing 50$
350050030	Assembly device Schneeberger For assembly on the workbench, in a vice or in the puniversal assembly device
350040010	Clamping nut wrench PC27 for $\varnothing 20$
350040011	Clamping nut wrench PC27 for $\varnothing 20$
350040040	*Clamping nut wrench PC29 for $\varnothing 20$ for clamping nut with blancing option
350040041	*Clamping nut wrench PC29 for $\varnothing 20$
350020081	*Balancing weight pair for clamping nut $\varnothing 35$ // 40gmm
213011050	Clamping screw Schneeberger M8/M8 x 62

### GWA HSK50 // $\varnothing 20$ mm // without RS

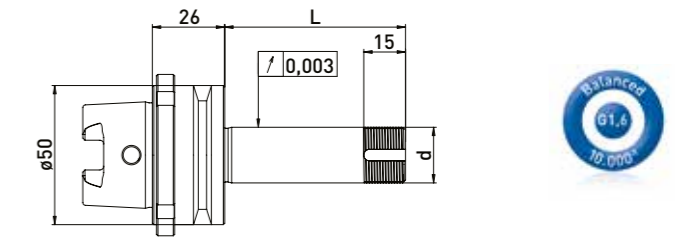
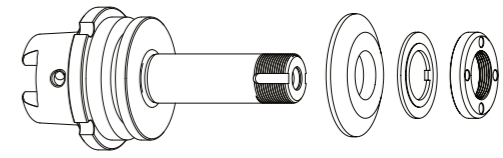

Delivered equipped:  
Reducing washer, lock washer and clamping nut

Order No.	HSK	d	L
300042511	HSK50	20	45
300042521	HSK50	20	65
300042531	HSK50	20	85
300042541	HSK50	20	110

Order No.	Name
350012020	Spacer ring $\varnothing 35 \times \varnothing 20 \times 20$
350012010	Spacer ring $\varnothing 35 \times \varnothing 20 \times 10$
350012004	Spacer ring $\varnothing 35 \times \varnothing 20 \times 4$
350015001	Reducing washer $\varnothing 50 \times \varnothing 35 \times \varnothing 20 \times 6$
350030020	Lock washer $\varnothing 35 \times \varnothing 20 \times 2$
350020030	Clamping nut $\varnothing 35 \times 6$ M20 x 1 PC27
350020080	*Clamping nut with balancing option $\varnothing 35 \times \varnothing 40 \times 8 \times$ M20 x 1 PC29

## Schneeberger HSK50 // Shaft $\varnothing 20$ mm // RS $\varnothing 50$ mm

For Schneeberger tool grinding machines with ring set  $\varnothing 50$  mm

### GWA HSK50 // $\varnothing 20$ mm // RS $\varnothing 50$ mm

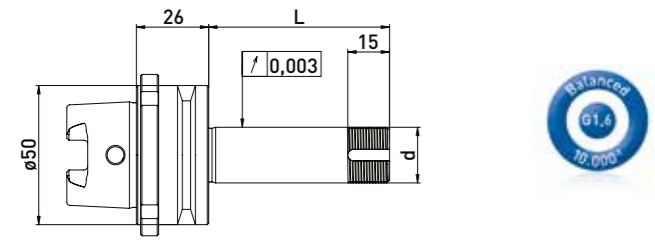
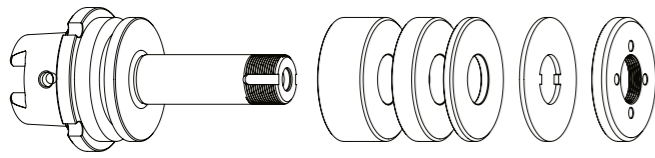

Delivered equipped:  
Ring set  $\varnothing 50$  mm, lock washer and clamping nut

### GWA HSK50 // $\varnothing 20$ mm // without RS

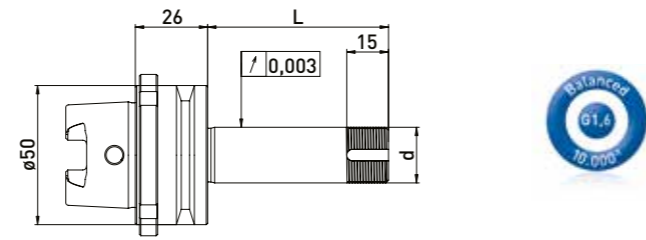
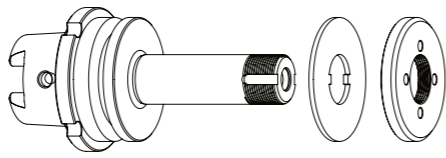

Delivered equipped:  
Lock washer and clamping nut

#### Ring set $\varnothing 50$ mm

Order No.	HSK	d	L	B20	B10	B4
300042012	HSK50	20	45	-	2	3
300042022	HSK50	20	65	1	2	3
300042032	HSK50	20	85	2	2	3
300042042	HSK50	20	110	3	2	4

Order No.	HSK	d	L
300042011	HSK50	20	45
300042021	HSK50	20	65
300042031	HSK50	20	85
300042041	HSK50	20	110

### Accessories Schneeberger grinding wheel adapter HSK50 // Shaft $\varnothing 20$ mm // Ring set $\varnothing 50$ mm

Order No.	Name	
350050010	Universal assembly device $\varnothing 50$	
350050030	Assembly device Schneeberger For assembly on the workbench, in a vice or in the puniversal assembly device	
350040010	*Clamping nut wrench PC27 for $\varnothing 20$	
350040011	*Clamping nut wrench PC27 for $\varnothing 20$	
350020021	*Balancing weight pair for clamping nut $\varnothing 50$ // 100gmm	
213011050	Clamping screw Schneeberger M8/M8 x 62	

Order No.	Name	
350011020	Spacer ring $\varnothing 50$ x $\varnothing 20$ x 20	
350011010	Spacer ring $\varnothing 50$ x $\varnothing 20$ x 10	
350011004	Spacer ring $\varnothing 50$ x $\varnothing 20$ x 4	
350030010	Lock washer $\varnothing 50$ x $\varnothing 20$ x 2	
350020060	Clamping nut $\varnothing 50$ x 6 x M20 x 1 PC27	
350020020	*Clamping nut with balancing option $\varnothing 50$ x 8,5 M20 x 1,0 PC27	

## Schneeberger HSK50 NGC // Shaft $\varnothing 20$ mm // RS $\varnothing 35$ mm

For Schneeberger tool grinding machines with ring set  $\varnothing 35$  mm

### GWA HSK50 NGC // $\varnothing 20$ mm // RS $\varnothing 35$ mm

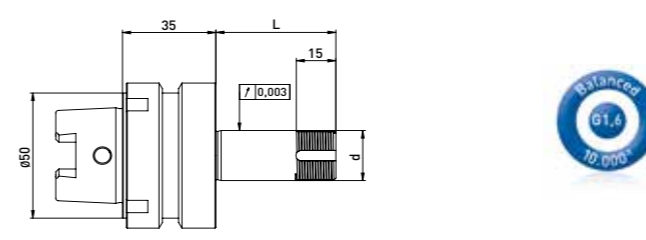
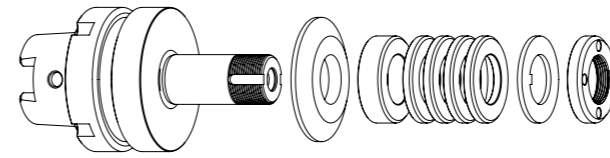

Delivered equipped:  
Reducing washer, ring set  $\varnothing 35$  mm, lock washer and clamping nut

### GWA HSK50 NGC // $\varnothing 20$ mm // without RS

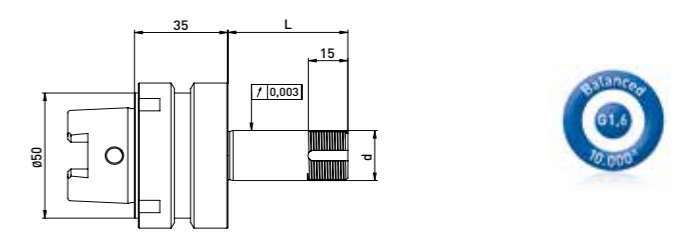
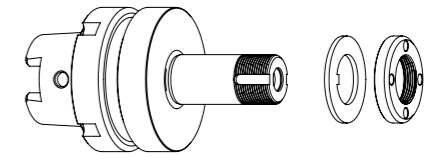

Delivered equipped:  
Lock washer and clamping nut

#### Ringset $\varnothing 35$ mm

Best.-Nr.	HSK	d	L	B20	B10	B4
300046512	HSK50	20	45	-	1	4
300046522	HSK50	20	65	1	1	4
300046532	HSK50	20	85	2	1	4
300046542	HSK50	20	110	3	2	2

Best.-Nr.	HSK	d	L
300046511	HSK50	20	45
300046521	HSK50	20	65
300046531	HSK50	20	85
300046541	HSK50	20	110

### Accessories Schneeberger grinding wheel adapter HSK50 NGC // Shaft $\varnothing 20$ mm // Ring set $\varnothing 35$ mm

Order No.	Name	
350050010	Universal assembly device $\varnothing 50$	
350050030	Assembly device Schneeberger For assembly on the workbench, in a vice or in the puniversal assembly device	
350040010	Clamping nut wrench PC27 for $\varnothing 20$	
350040011	Clamping nut wrench PC27 for $\varnothing 20$	
350040040	*Clamping nut wrench PC29 for $\varnothing 20$ for clamping nut with blancing option	
350040041	*Clamping nut wrench PC29 for $\varnothing 20$	
350020081	*Balancing weight pair for clamping nut $\varnothing 35$ // 40gmm	
213011050	Clamping screw Schneeberger M8/M8 x 62	

Order No.	Name	
350012020	Spacer ring $\varnothing 35$ x $\varnothing 20$ x 20	
350012010	Spacer ring $\varnothing 35$ x $\varnothing 20$ x 10	
350012004	Spacer ring $\varnothing 35$ x $\varnothing 20$ x 4	
350015001	Reducing washer $\varnothing 50$ x $\varnothing 35$ x $\varnothing 20$ x 6	
350030020	Lock washer $\varnothing 35$ x $\varnothing 20$ x 2	
350020030	Clamping nut $\varnothing 35$ x 6 M20 x 1 PC27	
350020080	*Clamping nut with balancing option $\varnothing 35$ x $\varnothing 40$ x 8 x M20 x 1 PC29	

## Schneeberger HSK50 NGC // Shaft $\varnothing 20$ mm // RS $\varnothing 50$ mm

For Schneeberger tool grinding machines with ring set  $\varnothing 50$  mm

### GWA HSK50 NGC // $\varnothing 20$ mm // RS $\varnothing 50$ mm

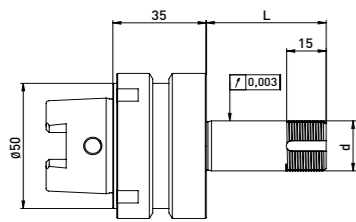
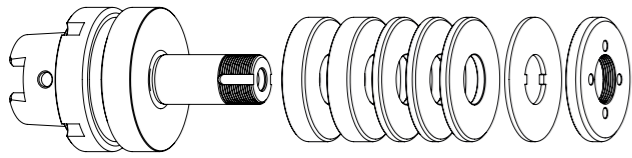

Delivered equipped:  
Ring set  $\varnothing 50$  mm, lock washer and clamping nut

### GWA HSK50 NGC // $\varnothing 20$ mm // without RS

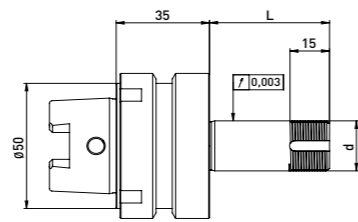
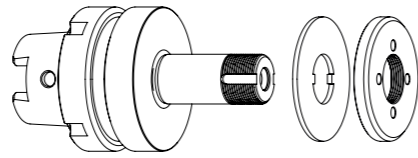

Delivered equipped:  
Lock washer and clamping nut

#### Ringsatz $\varnothing 50$ mm

Best.-Nr.	HSK	d	L	B20	B10	B4
300046012	HSK50	20	45	-	2	3
300046022	HSK50	20	65	1	2	3
300046032	HSK50	20	85	2	2	3
300046042	HSK50	20	110	3	2	4

Best.-Nr.	HSK	d	L
300046011	HSK50	20	45
300046021	HSK50	20	65
300046031	HSK50	20	85
300046041	HSK50	20	110

### Accessories Schneeberger grinding wheel adapter HSK50 NGC // Shaft $\varnothing 20$ mm // Ring set $\varnothing 50$ mm

Order No.	Name	
350050010	Universal assembly device $\varnothing 50$	
350050030	Assembly device Schneeberger For assembly on the workbench, in a vice or in the puniversal assembly device	
350040010	*Clamping nut wrench PC27 for $\varnothing 20$	
350040011	*Clamping nut wrench PC27 for $\varnothing 20$	
350020021	*Balancing weight pair for clamping nut $\varnothing 50$ // 100gmm	
213011050	Clamping screw Schneeberger M8/M8 x 62	

Order No.	Name	
350011020	Spacer ring $\varnothing 50$ x $\varnothing 20$ x 20	
350011010	Spacer ring $\varnothing 50$ x $\varnothing 20$ x 10	
350011004	Spacer ring $\varnothing 50$ x $\varnothing 20$ x 4	
350030010	Lock washer $\varnothing 50$ x $\varnothing 20$ x 2	
350020060	Clamping nut $\varnothing 50$ x 6 x M20 x 1 PC27	
350020020	*Clamping nut with balancing option $\varnothing 50$ x 8,5 M20 x 1,0 PC27	

## Schneeberger HSK50 // Shaft $\varnothing 20$ mm // RS $\varnothing 50$ mm

For Schneeberger tool grinding machines with ring set  $\varnothing 50$  mm

### GWA HSK50 // $\varnothing 20$ mm // RS $\varnothing 50$ mm

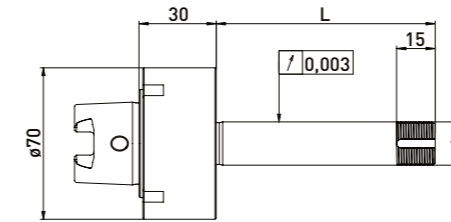
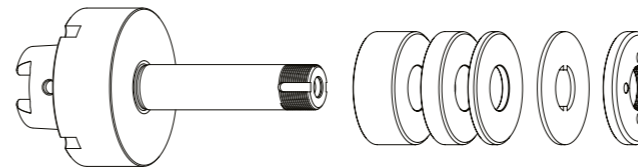

Delivered equipped:  
Ring set  $\varnothing 50$  mm, lock washer and clamping nut

### GWA HSK50 // $\varnothing 20$ mm // without RS

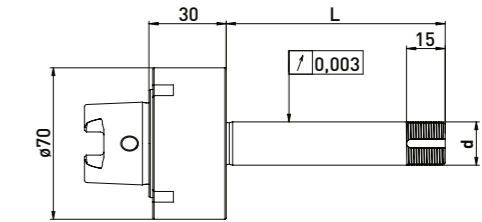
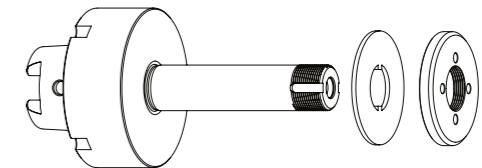

Delivered equipped:  
Lock washer and clamping nut

#### Ring set $\varnothing 50$ mm

Order No.	HSK	d	L	B20	B10	B4
300043012	HSK50	20	45	-	2	3
300043022	HSK50	20	85	2	2	3
300043032	HSK50	20	150	4	4	4

Order No.	HSK	d	L
300043011	HSK50	20	45
300043021	HSK50	20	85
300043031	HSK50	20	150

### Accessories Schneeberger grinding wheel adapter HSK50 // Shaft $\varnothing 20$ mm // Ring set $\varnothing 50$ mm

Order No.	Name	
350050010	Universal assembly device $\varnothing 50$	
350040010	*Clamping nut wrench PC27 for $\varnothing 20$	
350040011	*Clamping nut wrench PC27 for $\varnothing 20$	
350020021	*Balancing weight pair for clamping nut $\varnothing 50$ // 100gmm	
213011050	Clamping screw Schneeberger M8/M8 x 62	

Order No.	Name	
350011020	Spacer ring $\varnothing 50$ x $\varnothing 20$ x 20	
350011010	Spacer ring $\varnothing 50$ x $\varnothing 20$ x 10	
350011004	Spacer ring $\varnothing 50$ x $\varnothing 20$ x 4	
350030010	Lock washer $\varnothing 50$ x $\varnothing 20$ x 2	
350020060	Clamping nut $\varnothing 50$ x 6 x M20 x 1 PC27	
350020020	*Clamping nut with balancing option $\varnothing 50$ x 8,5 M20 x 1,0 PC27	

## Schütte HSK50 // Shaft $\varnothing 20$ mm // RS $\varnothing 35$ mm

For Schütte tool grinding machines with ring set  $\varnothing 35$  mm **Series 205**

### GWA HSK50 // $\varnothing 20$ mm // RS $\varnothing 35$ mm

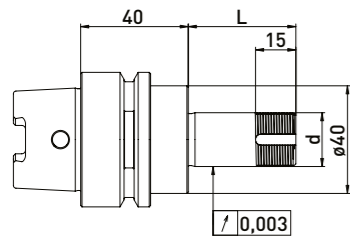
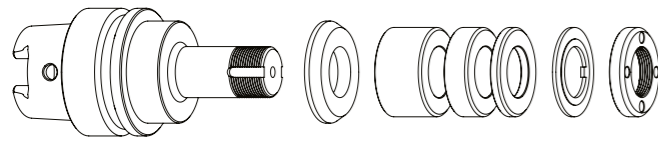

Delivered equipped:  
Reducing washer, ring set  $\varnothing 35$  mm, lock washer and clamping nut

#### Ring set $\varnothing 35$ mm

Order No.	HSK	d	L	B 20	B 10	B 4
300012512	HSK50	20	40	-	1	3
300012522	HSK50	20	60	1	1	3
300012532	HSK50	20	75	1	2	4
300012542	HSK50	20	85	2	1	4
300012552	HSK50	20	100	2	3	3

### GWA HSK50 // $\varnothing 20$ mm // without RS

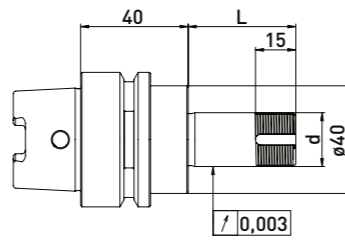
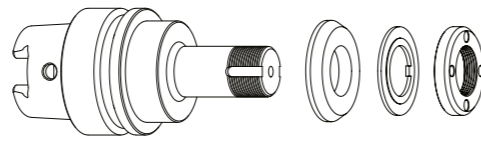

Delivered equipped:  
Reducing washer, lock washer and clamping nut

Order No.	HSK	d	L
300012511	HSK50	20	40
300012521	HSK50	20	60
300012531	HSK50	20	75
300012541	HSK50	20	85
300012551	HSK50	20	100

### Accessories Schütte grinding wheel adapter HSK50 // Shaft $\varnothing 20$ mm // Ring set $\varnothing 35$ mm

Order No.	Name	
350050010	Universal assembly device $\varnothing 50$	
350040010	Clamping nut wrench PC27 for $\varnothing 20$	
350040011	Clamping nut wrench PC27 for $\varnothing 20$	
350040040	*Clamping nut wrench PC29 for $\varnothing 20$ for clamping nut with blancing option	
350040041	*Clamping nut wrench PC29 for $\varnothing 20$	
350020081	*Balancing weight pair for clamping nut $\varnothing 35$ // 40gmm	

Order No.	Name	
350012020	Spacer ring $\varnothing 35$ x $\varnothing 20$ x 20	
350012010	Spacer ring $\varnothing 35$ x $\varnothing 20$ x 10	
350012004	Spacer ring $\varnothing 35$ x $\varnothing 20$ x 4	
350015006	Reducing washer $\varnothing 40$ x $\varnothing 35$ x $\varnothing 20$ x 6	
350030020	Lock washer $\varnothing 35$ x $\varnothing 20$ x 2	
350020030	Clamping nut $\varnothing 35$ x 6 M20 x 1 PC27	
350020080	*Clamping nut with balancing option $\varnothing 35$ x $\varnothing 40$ x 8 x M20 x 1 PC29	
350015005	Support washer $\varnothing 35$ x $\varnothing 60$ x $\varnothing 20$ x 6	

## Schütte HSK50 // Shaft $\varnothing 20$ mm // RS $\varnothing 50$ mm

For Schütte tool grinding machines with ring set  $\varnothing 50$  mm **Series 205**

### GWA HSK50 // $\varnothing 20$ mm // RS $\varnothing 50$ mm

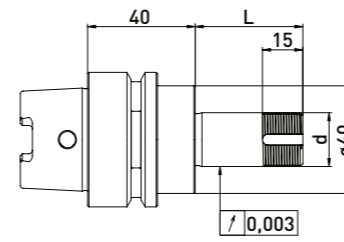
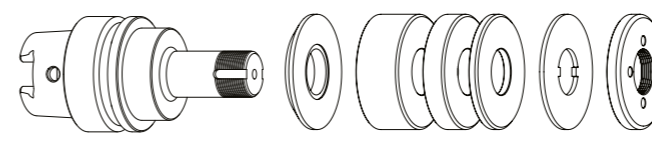

Delivered equipped:  
Ring set  $\varnothing 50$  mm, lock washer and clamping nut

#### Ring set $\varnothing 50$ mm

Order No.	HSK	d	L	B 20	B 10	B 4
300012012	HSK50	20	40	-	1	3
300012022	HSK50	20	60	1	1	3
300012032	HSK50	20	75	1	2	4
300012042	HSK50	20	85	2	1	4
300012052	HSK50	20	100	2	3	3

### GWA HSK50 // $\varnothing 20$ mm // without RS

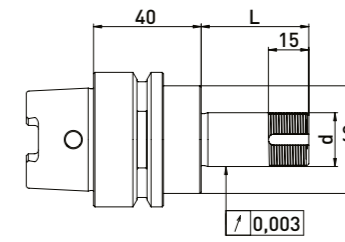
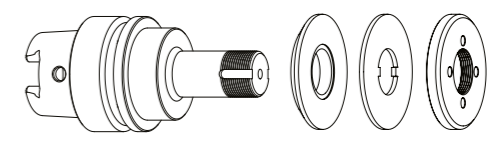

Delivered equipped:  
Lock washer and clamping nut

Order No.	HSK	d	L
300012011	HSK50	20	40
300012021	HSK50	20	60
300012031	HSK50	20	75
300012041	HSK50	20	85
300012051	HSK50	20	100

### Accessories Schütte grinding wheel adapter HSK50 // Shaft $\varnothing 20$ mm // Ring set $\varnothing 50$ mm

Order No.	Name	
350050010	Universal assembly device $\varnothing 50$	
350040010	*Clamping nut wrench PC27 for $\varnothing 20$	
350040011	*Clamping nut wrench PC27 for $\varnothing 20$	
350020021	*Balancing weight pair for clamping nut $\varnothing 50$ // 100gmm	

Order No.	Name	
350011020	Spacer ring $\varnothing 50$ x $\varnothing 20$ x 20	
350011010	Spacer ring $\varnothing 50$ x $\varnothing 20$ x 10	
350011004	Spacer ring $\varnothing 50$ x $\varnothing 20$ x 4	
350030010	Lock washer $\varnothing 50$ x $\varnothing 20$ x 2	
350020060	Clamping nut $\varnothing 50$ x 6 x M20 x 1 PC27	
350020020	*Clamping nut with balancing option $\varnothing 50$ x 8,5 M20 x 1,0 PC27	
350015002	Reducing washer $\varnothing 40$ x $\varnothing 50$ x $\varnothing 20$ x 6	

## Schütte HSK-E50 // Shaft $\varnothing 20$ mm // RS $\varnothing 35$ mm

For Schütte tool grinding machines with ring set  $\varnothing 35$  mm **Series 305**

### GWA HSK-E50 // $\varnothing 20$ mm // RS $\varnothing 35$ mm

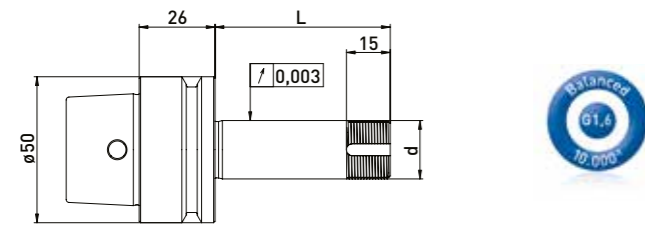
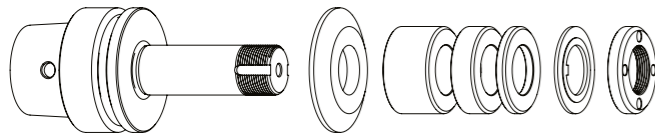

Delivered equipped:  
Reducing washer, ring set  $\varnothing 35$  mm, lock washer and clamping nut

Order No.	HSK	d	L	Ring set $\varnothing 35$ mm		
				B20	B10	B4
300052512	HSK-E50	20	40	-	1	3
300052522	HSK-E50	20	60	1	1	3
300052532	HSK-E50	20	85	2	1	4

### GWA HSK-E50 // $\varnothing 20$ mm // without RS

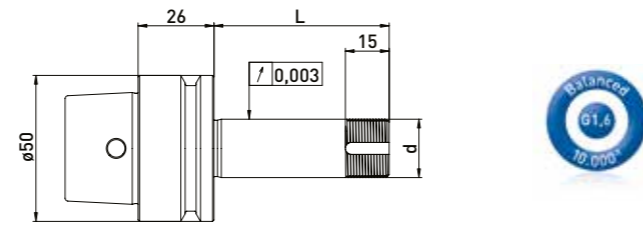
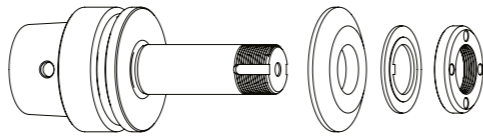

Delivered equipped:  
Reducing washer, lock washer and clamping nut

Order No.	HSK	d	L
300052511	HSK-E50	20	40
300052521	HSK-E50	20	60
300052531	HSK-E50	20	85

## Schütte HSK-E50 // Shaft $\varnothing 20$ mm // RS $\varnothing 50$ mm

For Schütte tool grinding machines with ring set  $\varnothing 50$  mm **Series 305**

### GWA HSK-E50 // $\varnothing 20$ mm // RS $\varnothing 50$ mm

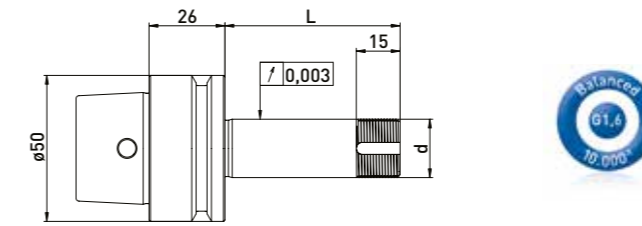
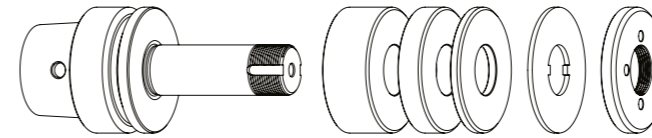

Delivered equipped:  
Ring set  $\varnothing 50$  mm, lock washer and clamping nut

Order No.	HSK	d	L	Ring set $\varnothing 50$ mm		
				B20	B10	B4
300052012	HSK-E50	20	40	-	1	4
300052022	HSK-E50	20	60	1	1	4
300052032	HSK-E50	20	85	2	2	3

### GWA HSK-E50 // $\varnothing 20$ mm // without RS

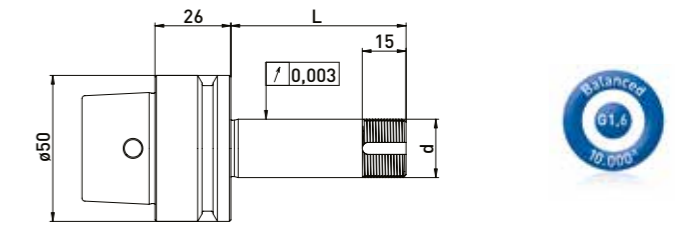
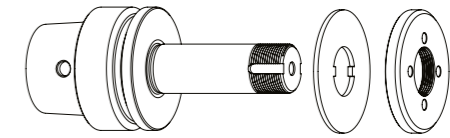

Delivered equipped:  
Lock washer and clamping nut

Order No.	HSK	d	L
300052011	HSK-E50	20	40
300052021	HSK-E50	20	60
300052031	HSK-E50	20	85

### Accessories Schütte grinding wheel adapter HSK-E50 // Shaft $\varnothing 20$ mm // Ring set $\varnothing 35$ mm

Order No.	Name	
350050010	Universal assembly device $\varnothing 50$	
350040010	Clamping nut wrench PC27 for $\varnothing 20$	
350040011	Clamping nut wrench PC27 for $\varnothing 20$	
350040040	*Clamping nut wrench PC29 for $\varnothing 20$ for clamping nut with blancing option	
350040041	*Clamping nut wrench PC29 for $\varnothing 20$	
350020081	*Balancing weight pair for clamping nut $\varnothing 35$ // 40gmm	

Order No.	Name	
350012020	Spacer ring $\varnothing 35$ x $\varnothing 20$ x 20	
350012010	Spacer ring $\varnothing 35$ x $\varnothing 20$ x 10	
350012004	Spacer ring $\varnothing 35$ x $\varnothing 20$ x 4	
350015001	Reducing washer $\varnothing 50$ x $\varnothing 35$ x $\varnothing 20$ x 6	
350030020	Lock washer $\varnothing 35$ x $\varnothing 20$ x 2	
350020030	Clamping nut $\varnothing 35$ x 6 M20 x 1 PC27	
350020080	*Clamping nut with balancing option $\varnothing 35$ x $\varnothing 40$ x 8 x M20 x 1 PC29	
350015005	Support washer $\varnothing 35$ x $\varnothing 60$ x $\varnothing 20$ x 6	

### Accessories Schütte grinding wheel adapter HSK-E50 // Shaft $\varnothing 20$ mm // Ring set $\varnothing 50$ mm

Order No.	Name	
350050010	Universal assembly device $\varnothing 50$	
350040010	*Clamping nut wrench PC27 for $\varnothing 20$	
350040011	*Clamping nut wrench PC27 for $\varnothing 20$	
350020021	*Balancing weight pair for clamping nut $\varnothing 50$ // 100gmm	

Order No.	Name	
350011020	Spacer ring $\varnothing 50$ x $\varnothing 20$ x 20	
350011010	Spacer ring $\varnothing 50$ x $\varnothing 20$ x 10	
350011004	Spacer ring $\varnothing 50$ x $\varnothing 20$ x 4	
350030010	Lock washer $\varnothing 50$ x $\varnothing 20$ x 2	
350020060	Clamping nut $\varnothing 50$ x 6 x M20 x 1 PC27	
350020020	*Clamping nut with balancing option $\varnothing 50$ x 8,5 M20 x 1,0 PC27	

## SMP HSK-E40 // Shaft $\varnothing 20$ mm // RS $\varnothing 35$ mm

For SMP tool grinding machines with ring set  $\varnothing 35$  mm

### GWA HSK-E40 // $\varnothing 20$ mm // RS $\varnothing 35$ mm

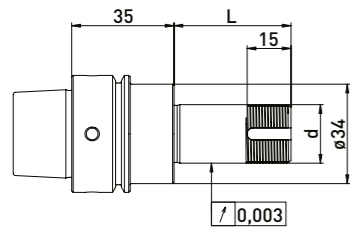
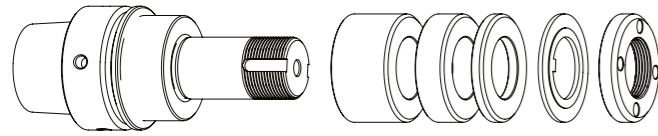

Delivered equipped:  
Ring set  $\varnothing 35$  mm, lock washer and clamping nut

### GWA HSK-E40 // $\varnothing 20$ mm // without RS

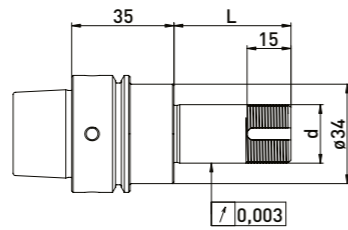
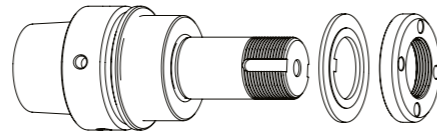

Delivered equipped:  
Lock washer and clamping nut

#### Ring set $\varnothing 35$ mm

Order No.	HSK	d	L	B20	B10	B4
300122512	HSK-E40	20	40	-	1	4
300122522	HSK-E40	20	60	1	1	4
300122532	HSK-E40	20	100	2	3	4

Order No.	HSK	d	L
300122511	HSK-E40	20	40
300122521	HSK-E40	20	60
300122531	HSK-E40	20	100

## SMP HSK-E40 // Shaft $\varnothing 20$ mm // RS $\varnothing 50$ mm

For SMP tool grinding machines with ring set  $\varnothing 50$  mm

### GWA HSK-E40 // $\varnothing 20$ mm // RS $\varnothing 50$ mm

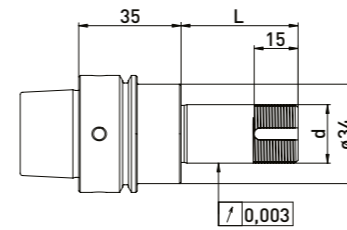
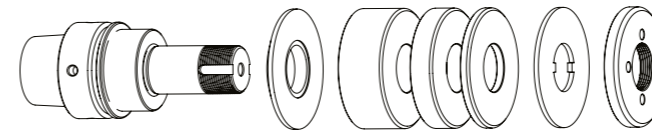

Delivered equipped:  
Reducing washer, ring set  $\varnothing 50$  mm, lock washer and clamping nut

### GWA HSK-E40 // $\varnothing 20$ mm // without RS

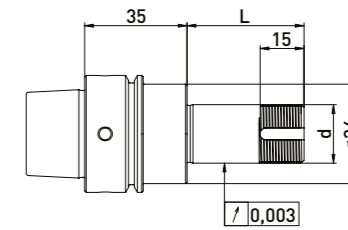
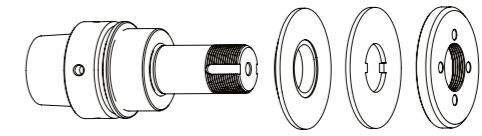

Delivered equipped:  
Reducing washer, lock washer and clamping nut

#### Ring set $\varnothing 50$ mm

Order No.	HSK	d	L	B20	B10	B4
300122012	HSK-E40	20	40	-	1	3
300122022	HSK-E40	20	60	1	1	3
300122032	HSK-E40	20	100	2	3	3

Order No.	HSK	d	L
300122011	HSK-E40	20	40
300122021	HSK-E40	20	60
300122031	HSK-E40	20	100

### Accessories SMP grinding wheel adapter HSK-E40 // Shaft $\varnothing 20$ mm // Ring set $\varnothing 35$ mm

Order No.	Name	
350050050	Assembly device $\varnothing 40$	
350040010	Clamping nut wrench PC27 for $\varnothing 20$	
350040011	Clamping nut wrench PC27 for $\varnothing 20$	
350040040	*Clamping nut wrench PC29 for $\varnothing 20$ for clamping nut with blancing option	
350040041	*Spannmutterschlüssel TK29 für $\varnothing 20$	
350020081	*Balancing weight pair for clamping nut $\varnothing 35$ // 40gmm	

Order No.	Name	
350012020	Spacer ring $\varnothing 35$ x $\varnothing 20$ x 20	
350012010	Spacer ring $\varnothing 35$ x $\varnothing 20$ x 10	
350012004	Spacer ring $\varnothing 35$ x $\varnothing 20$ x 4	
350030020	Lock washer $\varnothing 35$ x $\varnothing 20$ x 2	
350020030	Clamping nut $\varnothing 35$ x 6 M20 x 1 PC27	
350020080	*Clamping nut with balancing option $\varnothing 35$ x $\varnothing 40$ x 8 x M20 x 1 PC29	
350015005	Support washer $\varnothing 35$ x $\varnothing 60$ x $\varnothing 20$ x 6	

### Accessories SMP grinding wheel adapter HSK-E40 // Shaft $\varnothing 20$ mm // Ring set $\varnothing 50$ mm

Order No.	Name	
350050050	Assembly device $\varnothing 40$	
350040010	*Clamping nut wrench PC27 for $\varnothing 20$	
350040011	*Clamping nut wrench PC27 for $\varnothing 20$	
350020021	*Balancing weight pair for clamping nut $\varnothing 50$ // 100gmm	

Order No.	Name	
350011020	Spacer ring $\varnothing 50$ x $\varnothing 20$ x 20	
350011010	Spacer ring $\varnothing 50$ x $\varnothing 20$ x 10	
350011004	Spacer ring $\varnothing 50$ x $\varnothing 20$ x 4	
350015001	Reducing washer $\varnothing 50$ x $\varnothing 35$ x $\varnothing 20$ x 6	
350030010	Lock washer $\varnothing 50$ x $\varnothing 20$ x 2	
350020060	Clamping nut $\varnothing 50$ x 6 x M20 x 1 PC27	
350020020	*Clamping nut with balancing option $\varnothing 50$ x 8,5 M20 x 1,0 PC27	

## Strausak similar HSK50 // Shaft $\varnothing 20$ mm // RS $\varnothing 50$ mm

For Strausak Promat tool grinding machines for Ring set  $\varnothing 50$  mm

### GWA similar HSK50 // $\varnothing 20$ mm // RS $\varnothing 50$ mm

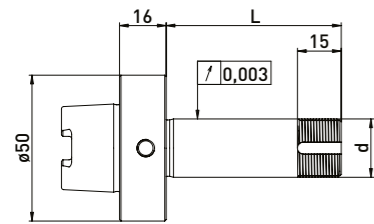
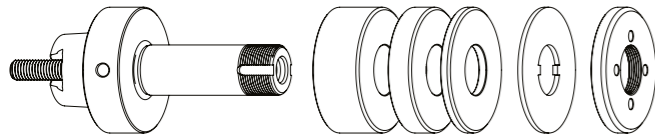

Delivered equipped:  
Ring set  $\varnothing 50$  mm, lock washer, clamping nut and tightening screw

Order No.	Taper	d	L	Ring set $\varnothing 50$ mm		
				B 20	B 10	B 4
300062032	similar HSK50	20	60	1	1	4

### GWA similar HSK50 // $\varnothing 20$ mm // without RS

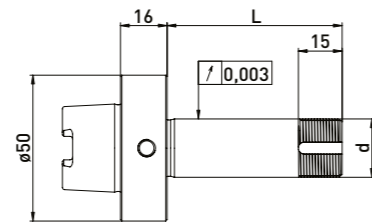
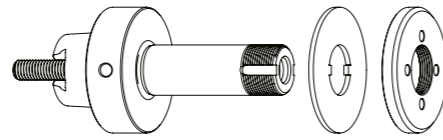

Delivered equipped:  
Lock washer, clamping nut and tightening screw

Order No.	Taper	d	L
300062031	similar HSK50	20	60

## Strausak similar HSK50 // Shaft $\varnothing 38$ mm // RS $\varnothing 62$ mm

For Strausak Promat tool grinding machines with ring set  $\varnothing 62$  mm

### GWA similar HSK50 // $\varnothing 38$ mm // RS 62 mm

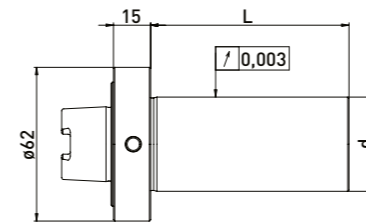
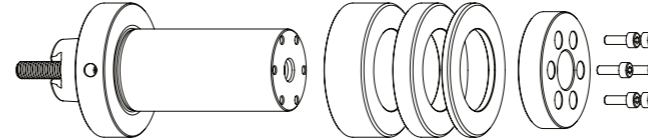

Delivered equipped:  
Ring set  $\varnothing 62$  mm, clamping flange, 4pc. allen screw and tightening screw

Order No.	Taper	d	L	Ring set $\varnothing 62$ mm		
				B 20	B 10	B 4
300062332	similar HSK50	38	80	2	2	4

### GWA similar HSK50 // $\varnothing 38$ mm // without RS

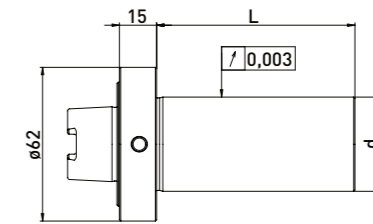
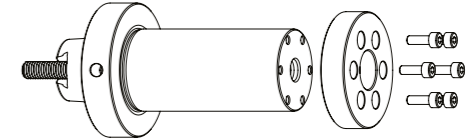

Delivered equipped:  
Clamping flange, 4pc. allen screw and tightening screw

Order No.	Taper	d	L
300062331	similar HSK50	38	80

### Accessories Strausak Promat grinding wheel adapter similar HSK50 // Shaft $\varnothing 20$ mm // Ring set $\varnothing 50$ mm

Order No.	Name	
350050010	Universal assembly device $\varnothing 50$	
350040010	*Clamping nut wrench PC27 for $\varnothing 20$	
350040011	*Clamping nut wrench PC27 for $\varnothing 20$	
350020021	*Balancing weight pair for clamping nut $\varnothing 50$ // 100gmm	

Order No.	Name	
350011020	Spacer ring $\varnothing 50 \times \varnothing 20 \times 20$	
350011010	Spacer ring $\varnothing 50 \times \varnothing 20 \times 10$	
350011004	Spacer ring $\varnothing 50 \times \varnothing 20 \times 4$	
350015003	Support washer $\varnothing 50 \times \varnothing 75 \times \varnothing 20 \times 6$	
350030010	Lock washer $\varnothing 50 \times \varnothing 20 \times 2$	
350020060	Clamping nut $\varnothing 50 \times 6 \times M20 \times 1$ PC27	
350020020	*Clamping nut with balancing option $\varnothing 50 \times 8,5 M20 \times 1,0$ PC27	

### Accessories Strausak Promat grinding wheel adapter similar HSK50 // Shaft $\varnothing 20$ mm // Ring set $\varnothing 50$ mm

Order No.	Name	
350050040	Assembly device Strausak $\varnothing 62$	

Order No.	Name	
350013320	Spacer ring $\varnothing 62 \times \varnothing 38 \times 20$	
350013310	Spacer ring $\varnothing 62 \times \varnothing 38 \times 10$	
350013304	Spacer ring $\varnothing 62 \times \varnothing 38 \times 4$	
350020040	Clamping flange $\varnothing 54 \times 12$	

## Strausak Internal taper // Shaft $\varnothing 20\text{mm}$ // RS $\varnothing 50\text{ mm}$

For Strausak Fleximat tool grinding machines with ring set  $\varnothing 50\text{ mm}$

### GWA Strausak Internal taper // $\varnothing 20\text{mm}$ // RS $\varnothing 50\text{ mm}$

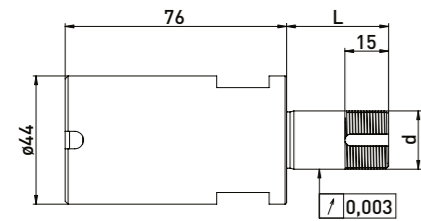
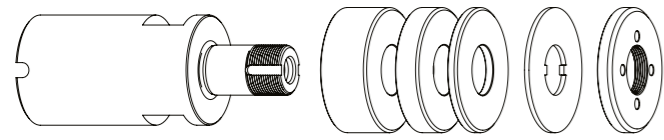

Delivered equipped:  
Ring set  $\varnothing 50\text{ mm}$ , lock washer, clamping nut and clamping screw

Order No.	Internal taper	d	L	Ring set $\varnothing 50\text{ mm}$		
				B20	B10	B4
300063012	Strausak	20	35	-	1	3
300063022	Strausak	20	60	1	1	4

### GWA Strausak Internal taper // $\varnothing 20\text{mm}$ // without RS

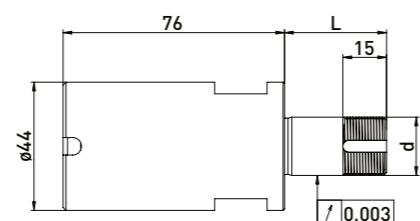
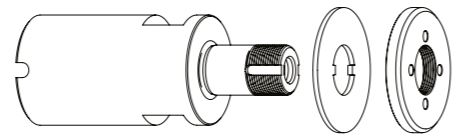

Delivered equipped:  
Lock washer, clamping nut and clamping screw

Order No.	Internal taper	d	L
300063011	Strausak	20	35
300063021	Strausak	20	60

## Strausak Internal taper // Shaft $\varnothing 38\text{mm}$ // RS $\varnothing 62\text{ mm}$

For Strausak Fleximat tool grinding machines with ring set  $\varnothing 62\text{ mm}$

### GWA Strausak Internal taper // $\varnothing 38\text{mm}$ // RS $\varnothing 62\text{ mm}$

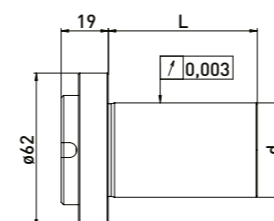
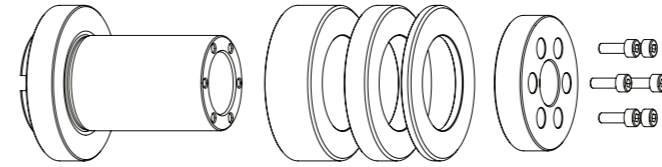

Delivered equipped:  
Ring set  $\varnothing 62\text{ mm}$ , clamping flange, allen screw 4pc. and tightening screw

Order No.	Internal taper	d	L	Ring set $\varnothing 62\text{ mm}$		
				B20	B10	B4
300063332	Strausak	38	60	1	2	4

### GWA Strausak Internal taper // $\varnothing 38\text{ mm}$ // without RS

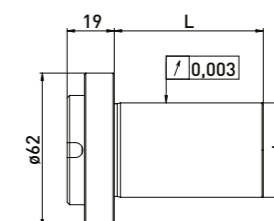
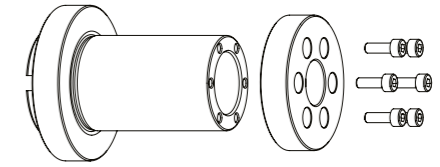

Delivered equipped:  
clamping flange, allen screw 4pc. and tightening screw

Order No.	Internal taper	d	L
300063331	Strausak	38	60

### Accessories Strausak Fleximat grinding wheel adapter Strausak Internal taper // Shaft $\varnothing 20\text{ mm}$ // Ring set $\varnothing 50\text{ mm}$

Order No.	Name	
350050010	Universal assembly device $\varnothing 50$	
350015007	Adapter sleeve Strausak clamping diameter $\varnothing 44$ <small>[Reduction for Strausak <math>\varnothing 44 \times \varnothing 50</math> for universal assembly device]</small>	
350040010	*Clamping nut wrench PC27 for $\varnothing 20$	
350040011	*Clamping nut wrench PC27 for $\varnothing 20$	
350020021	*Balancing weight pair for clamping nut $\varnothing 50 // 100\text{gmm}$	

Order No.	Name	
350011020	Spacer ring $\varnothing 50 \times \varnothing 20 \times 20$	
350011010	Spacer ring $\varnothing 50 \times \varnothing 20 \times 10$	
350011004	Spacer ring $\varnothing 50 \times \varnothing 20 \times 4$	
350030010	Lock washer $\varnothing 50 \times \varnothing 20 \times 2$	
350020060	Clamping nut $\varnothing 50 \times 6 \times \text{M}20 \times 1 \text{ PC}27$	
350020020	*Clamping nut with balancing option $\varnothing 50 \times 8,5 \text{ M}20 \times 1,0 \text{ PC}27$	

### Accessories Strausak Fleximat grinding wheel adapter Strausak Internal taper // Shaft $\varnothing 38\text{ mm}$ // Ring set $\varnothing 62\text{mm}$

Order No.	Name	
350050040	Assembly device Strausak $\varnothing 62$	

Order No.	Name	
350013320	Spacer ring $\varnothing 62 \times \varnothing 38 \times 20$	
350013310	Spacer ring $\varnothing 62 \times \varnothing 38 \times 10$	
350013304	Spacer ring $\varnothing 62 \times \varnothing 38 \times 4$	
350020040	Clamping flange $\varnothing 54 \times 12$	



## Strausak HSK-E50 // Shaft $\varnothing 20$ mm // RS $\varnothing 50$ mm

For Strausak tool grinding machines with ring set  $\varnothing 50$  mm

### GWA HSK-E50 // $\varnothing 20$ mm // RS $\varnothing 50$ mm

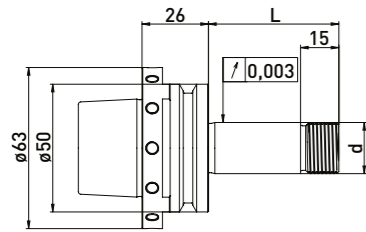
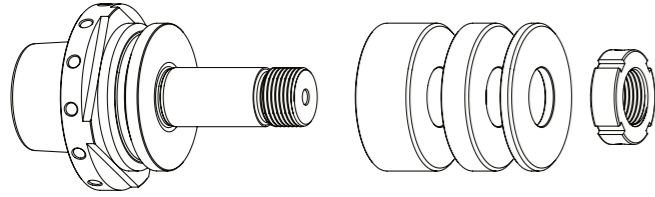

Delivered equipped:  
Ring set  $\varnothing 50$  mm and clamping nut

### GWA HSK-E50 // $\varnothing 20$ mm // without RS

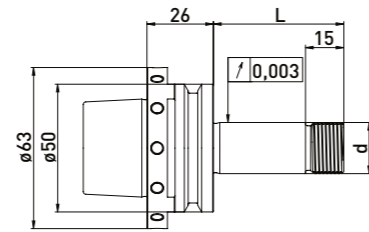
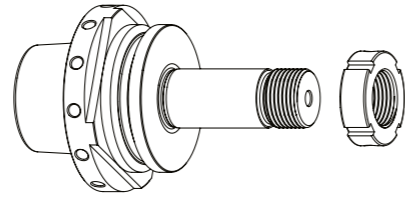

Delivered equipped:  
Clamping nut

#### Ring set $\varnothing 50$ mm

Order No.	HSK	d	L	B20	B10	B4
300150612	HSK-50	20	51	1	1	2
300150632	HSK-50	20	81	2	2	2

Order No.	HSK	d	L
300150611	HSK-50	20	51
300150631	HSK-50	20	81

## Strausak HSK-E50 // Shaft $\varnothing 31,75$ mm (1¼) // RS $\varnothing 60$ mm

For Strausak tool grinding machines with ring set  $\varnothing 60$  mm

### GWA HSK-E50 // $\varnothing 31,75$ mm // RS $\varnothing 60$ mm

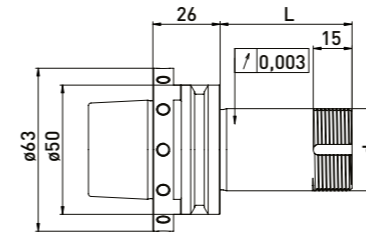
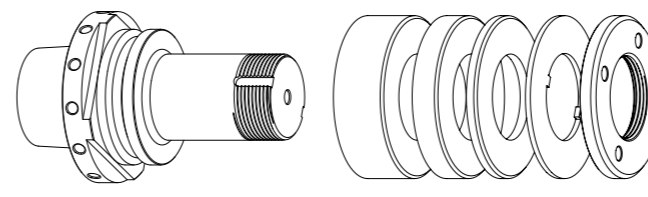

Delivered equipped:  
Ring set  $\varnothing 60$  mm, lock washer and clamping nut

### GWA HSK-E50 // $\varnothing 31,75$ mm // without RS

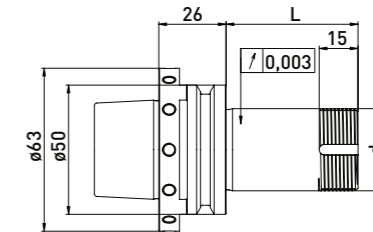
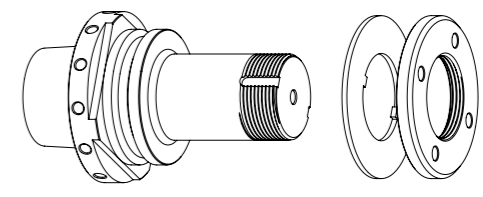







Delivered equipped:  
Lock washer and clamping nut

#### Ring set $\varnothing 60$ mm









Order No.	HSK	d	L	B20	B10	B4
300150712	HSK-50E	31,75	51	-	1	3
300150732	HSK-50E	31,75	81	1	1	3

Order No.	HSK	d	L
300150711	HSK-50E	31,75	51
300150731	HSK-50E	31,75	81

### Accessories Strausak grinding wheel adapter HSK-E50 // Shaft $\varnothing 20$ mm // Ring set $\varnothing 50$ mm

Order No.	Name	Order No.	Name
350040051	Hook wrench 30 - 32 mm 	350011520	Spacer ring Rollomatic $\varnothing 50 \times \varnothing 20 \times 20$ 
		350011510	Spacer ring Rollomatic $\varnothing 50 \times \varnothing 20 \times 10$ 
		350011504	Spacer ring Rollomatic $\varnothing 50 \times \varnothing 20 \times 4$ 
		350020121	Clamping nut MRR20 x 1,5 M20 x 1,5 $\varnothing 32 \times 10$ 
		350015003	Support washer $\varnothing 50 \times \varnothing 75 \times \varnothing 20 \times 6$ 

### Accessories Strausak grinding wheel adapter HSK-E50 // $\varnothing 31,75$ mm (1¼) // Ring set $\varnothing 60$ mm

Order No.	Name	Order No.	Name
350040030	*Clamping nut wrench PC39 for clamping nut with blancing option 	350011420	Spacer ring $\varnothing 60 \times \varnothing 31,75 \times 20$ 
350040020	Clamping nut wrench PC45 for $\varnothing 32$ 	350011410	Spacer ring $\varnothing 60 \times \varnothing 31,75 \times 10$ 
350020023	*Balancing weight pair for clamping nut $\varnothing 60$ // 200gmm 	350011404	Spacer ring $\varnothing 60 \times \varnothing 31,75 \times 4$ 
		350030060	Lock washer $\varnothing 60 \times \varnothing 32 \times 1,8$ 
		350020066	Clamping nut $\varnothing 60 \times 6 \times M32 \times 1,5$ PC45 
		350020022	*Clamping nut with balancing option $\varnothing 60 \times 9$ M32 x 1,5 PC39 

## TTB HSK-F40 // Shaft $\varnothing 20$ mm // RS $\varnothing 35$ mm

For TTB tool grinding machines with ring set  $\varnothing 35$  mm

### GWA HSK-F40 // $\varnothing 20$ mm // RS $\varnothing 35$ mm

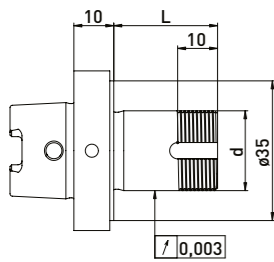
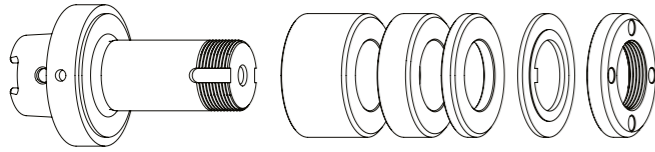

Delivered equipped:  
Ring set  $\varnothing 35$  mm, lock washer and clamping nut

Order No.	HSK	d	L	Ring set $\varnothing 35$ mm		
				B20	B10	B4
300132012	HSK-F40	20	26	-	-	4
300132022	HSK-F40	20	42	-	2	3
300132032	HSK-F40	20	60	1	2	3

### Accessories TTB grinding wheel adapter HSK-F40 // Shaft $\varnothing 20$ mm // Ring set $\varnothing 35$ mm

Order No.	Name	Order No.	Name
350050050	Assembly device $\varnothing 40$	350012020	Spacer ring $\varnothing 35 \times \varnothing 20 \times 20$
350040010	Clamping nut wrench PC27 for $\varnothing 20$	350012010	Spacer ring $\varnothing 35 \times \varnothing 20 \times 10$
350040011	Clamping nut wrench PC27 for $\varnothing 20$	350012004	Spacer ring $\varnothing 35 \times \varnothing 20 \times 4$
350040040	*Clamping nut wrench PC29 for $\varnothing 20$ for clamping nut with blancing option	350030020	Lock washer $\varnothing 35 \times \varnothing 20 \times 2$
350040041	*Clamping nut wrench PC29 for $\varnothing 20$	350020030	Clamping nut $\varnothing 35 \times 6$ M20 x 1 PC27
350020081	*Balancing weight pair for clamping nut $\varnothing 35 // 40$ gmm	350020080	*Clamping nut with balancing option $\varnothing 35 \times \varnothing 40 \times 8$ x M20 x 1 PC29
		350015005	Support washer $\varnothing 35 \times \varnothing 60 \times \varnothing 20 \times 6$

## Vollmer HSK50 // Schaft $\varnothing 20$ mm // RS $\varnothing 35$ mm

For Vollmer VGRIND tool grinding machines with ring set  $\varnothing 35$  mm

### GWA HSK50 // $\varnothing 20$ mm // RS $\varnothing 35$ mm

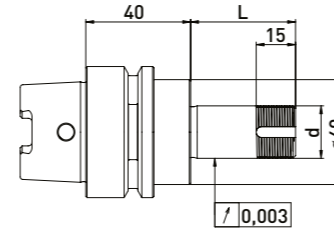
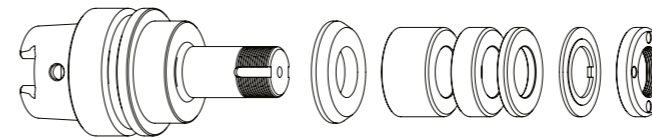

Delivered equipped:  
Reducing washer, ring set  $\varnothing 35$  mm, lock washer and clamping nut

Order No.	HSK	d	L	Ring set $\varnothing 35$ mm		
				B20	B10	B4
300012512	HSK50	20	40	-	1	3
300012522	HSK50	20	60	1	1	3
300012532	HSK50	20	75	1	2	4
300012542	HSK50	20	85	2	1	4
300012552	HSK50	20	100	2	3	3

### Accessories Vollmer grinding wheel adapter HSK50 // $\varnothing 20$ mm // Ring set $\varnothing 35$ mm

Order No.	Name	Order No.	Name
350050010	Universal assembly device $\varnothing 50$	350012020	Spacer ring $\varnothing 35 \times \varnothing 20 \times 20$
350040010	Clamping nut wrench PC27 for $\varnothing 20$	350012010	Spacer ring $\varnothing 35 \times \varnothing 20 \times 10$
350040011	Clamping nut wrench PC27 for $\varnothing 20$	350012004	Spacer ring $\varnothing 35 \times \varnothing 20 \times 4$
350040040	*Clamping nut wrench PC29 for $\varnothing 20$ for clamping nut with blancing option	350015006	Reducing washer $\varnothing 40 \times \varnothing 35 \times \varnothing 20 \times 6$
350040041	*Clamping nut wrench PC29 for $\varnothing 20$	350030020	Lock washer $\varnothing 35 \times \varnothing 20 \times 2$
350020081	*Balancing weight pair for clamping nut $\varnothing 35 // 40$ gmm	350020030	Clamping nut $\varnothing 35 \times 6$ M20 x 1 PC27
		350020080	*Clamping nut with balancing option $\varnothing 35 \times \varnothing 40 \times 8$ x M20 x 1 PC29
		350015005	Support washer $\varnothing 35 \times \varnothing 60 \times \varnothing 20 \times 6$

## Vollmer HSK50 // Shaft $\varnothing 20$ mm // RS $\varnothing 50$ mm

For Vollmer VGRIND tool grinding machines with ring set  $\varnothing 50$  mm

### GWA HSK50 // $\varnothing 20$ mm // RS $\varnothing 50$ mm

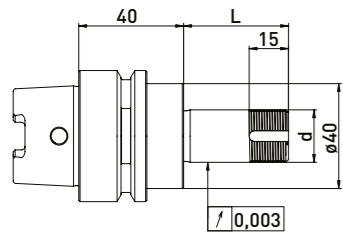
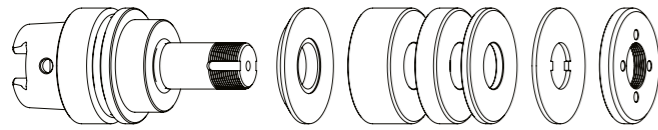

Delivered equipped:  
Reducing washer, ring set  $\varnothing 50$  mm, lock washer and clamping nut

Order No.	HSK	d	L	Ring set $\varnothing 50$ mm		
				B20	B10	B4
300012012	HSK50	20	40	-	1	3
300012022	HSK50	20	60	1	1	3
300012032	HSK50	20	75	1	2	4
300012042	HSK50	20	85	2	1	4
300012052	HSK50	20	100	2	3	3

### GWA HSK50 // $\varnothing 20$ mm // without RS

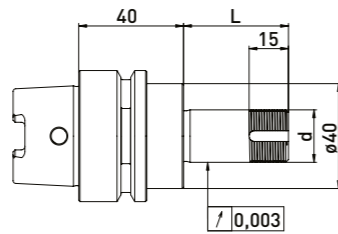
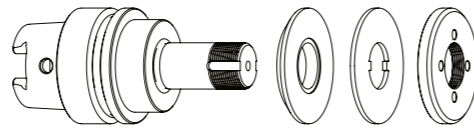

Delivered equipped:  
Reducing washer, lock washer and clamping nut

Order No.	HSK	d	L
300012011	HSK50	20	40
300012021	HSK50	20	60
300012031	HSK50	20	75
300012041	HSK50	20	85
300012051	HSK50	20	100

### Accessories Vollmer grinding wheel adapter HSK50 // $\varnothing 20$ mm // Ring set $\varnothing 50$ mm

Order No.	Name
350050010	Universal assembly device $\varnothing 50$
350040010	*Clamping nut wrench PC27 for $\varnothing 20$
350040011	*Clamping nut wrench PC27 for $\varnothing 20$
350020021	*Balancing weight pair for clamping nut $\varnothing 50$ // 100gmm

Order No.	Name
350011020	Spacer ring $\varnothing 50$ x $\varnothing 20$ x 20
350011010	Spacer ring $\varnothing 50$ x $\varnothing 20$ x 10
350011004	Spacer ring $\varnothing 50$ x $\varnothing 20$ x 4
350015002	Reducing washer $\varnothing 40$ x $\varnothing 50$ x $\varnothing 20$ x 6
350030010	Lock washer $\varnothing 50$ x $\varnothing 20$ x 2
350020060	Clamping nut $\varnothing 50$ x 6 x M20 x 1 PC27
350020020	*Clamping nut with balancing option $\varnothing 50$ x 8,5 M20 x 1,0 PC27
350015003	Support washer $\varnothing 50$ x $\varnothing 75$ x $\varnothing 20$ x 6

## Walter HSK40 // stepped Shaft $\varnothing 20$ , $\varnothing 32$ // RS $\varnothing 50$ and $\varnothing 60$ mm

For Walter tool grinding machines with ring set  $\varnothing 50$  and  $\varnothing 60$  mm

### GWA HSK40 // stepped $\varnothing 20$ $\varnothing 32$ mm // RS $\varnothing 50$ $\varnothing 60$ mm

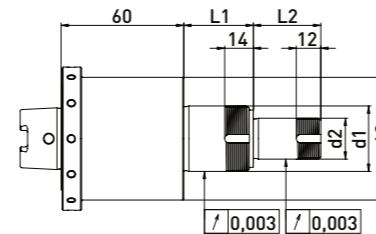
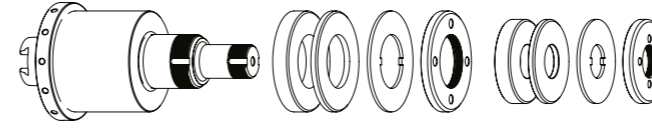

Delivered equipped:  
Ring set  $\varnothing 50$  and  $\varnothing 60$  mm, lock washer and clamping nut

Order No.	HSK	d1	d2	L1	L2	Ring set $\varnothing 50$ mm		Ring set $\varnothing 60$ mm	
						B20	B4	B10	B4
300103012	HSK40	32	20	34	33	1	2	1	2

### Accessories Walter grinding wheel adapter HSK40 // stepped Shaft $\varnothing 20$ , $\varnothing 30$ // RS $\varnothing 50$ and $\varnothing 60$ mm

#### Accessories $\varnothing 50$ mm

Order No.	Name
350011020	Spacer ring $\varnothing 50$ x $\varnothing 20$ x 20
350011010	Spacer ring $\varnothing 50$ x $\varnothing 20$ x 10
350011004	Spacer ring $\varnothing 50$ x $\varnothing 20$ x 4
350030010	Lock washer $\varnothing 50$ x $\varnothing 20$ x 2
350020060	Clamping nut $\varnothing 50$ x 6 x M20 x 1 PC27
350020020	*Clamping nut with balancing option $\varnothing 50$ x 8,5 M20 x 1,0 PC27
350020021	*Balancing weight pair for clamping nut $\varnothing 50$ // 100gmm
350040010	*Clamping nut wrench PC27 for $\varnothing 20$
350040011	*Clamping nut wrench PC27 for $\varnothing 20$

#### Accessories $\varnothing 60$ mm

Order No.	Name
350011320	Spacer ring $\varnothing 60$ x $\varnothing 32$ x 20
350011310	Spacer ring $\varnothing 60$ x $\varnothing 32$ x 10
350011304	Spacer ring $\varnothing 60$ x $\varnothing 32$ x 4
350030060	Lock washer $\varnothing 60$ x $\varnothing 32$ x 1,8
350020065	Clamping nut $\varnothing 60$ x 6 x M32x1 PC45
350040020	Clamping nut wrench PC45 for $\varnothing 32$

## Walter HSK40 // Shaft $\varnothing 20$ / Shaft $\varnothing 32$ mm // RS $\varnothing 50$ and $\varnothing 60$ mm

For Walter tool grinding machines with ring set  $\varnothing 50$  and  $\varnothing 60$  mm

### GWA HSK40 // $\varnothing 20$ / $\varnothing 32$ mm // RS $\varnothing 50$ / $\varnothing 60$ mm

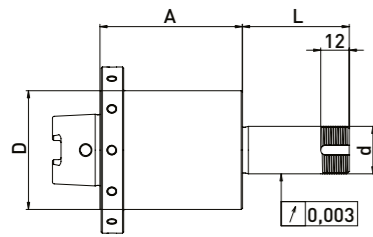
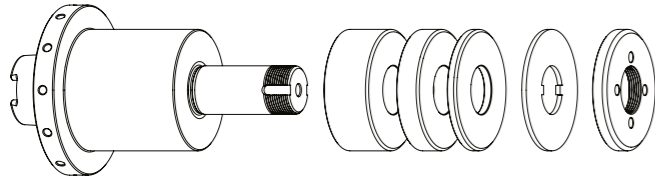

Delivered equipped:  
Ring set  $\varnothing 50$  mm or ring set  $\varnothing 60$ , lock washer and clamping nut

### Walter HSK40 // Shaft $\varnothing 20$ // Ring set $\varnothing 50$ mm

Order No.	HSK	d	D	A	L	B20	B10	B4
300103112	HSK40	20	50	60	45	-	2	3
300103122	HSK40	20	50	80	52	1	1	3

### Accessories $\varnothing 50$ mm

Order No.	Name
350011020	Spacer ring $\varnothing 50 \times \varnothing 20 \times 20$
350011010	Spacer ring $\varnothing 50 \times \varnothing 20 \times 10$
350011004	Spacer ring $\varnothing 50 \times \varnothing 20 \times 4$
350030010	Lock washer $\varnothing 50 \times \varnothing 20 \times 2$
350020060	Clamping nut $\varnothing 50 \times 6 \times M20 \times 1$ PC27
350020020	*Clamping nut with balancing option $\varnothing 50 \times 8,5 M20 \times 1,0$ PC27
350020021	*Balancing weight pair for clamping nut $\varnothing 50$ // 100gmm
350040010	*Clamping nut wrench PC27 for $\varnothing 20$
350040011	*Clamping nut wrench PC27 for $\varnothing 20$

### Walter HSK40 // Shaft $\varnothing 32$ and $31,75$ // Ring set $\varnothing 60$ mm

Order No.	HSK	d	D	A	L	B10	B4
300103132	HSK40	32	60	60	42	2	3
300103142	HSK40	31,75	60	60	45	1	1

### Accessories $\varnothing 60$ mm

Order No.	Name
350011320	Spacer ring $\varnothing 60 \times \varnothing 32 \times 20$
350011310	Spacer ring $\varnothing 60 \times \varnothing 32 \times 10$
350011304	Spacer ring $\varnothing 60 \times \varnothing 32 \times 4$
350011420	Spacer ring $\varnothing 60 \times \varnothing 31,75 \times 20$
350011410	Spacer ring $\varnothing 60 \times \varnothing 31,75 \times 10$
350011404	Spacer ring $\varnothing 60 \times \varnothing 31,75 \times 4$
350030060	Lock washer $\varnothing 60 \times \varnothing 32 \times 1,8$
350020066	Clamping nut $\varnothing 60 \times 6 \times M32 \times 1,5$ PC45
350020022	*Clamping nut with balancing option $\varnothing 60 \times 9 M32 \times 1,5$ PC39
350040030	*Clamping nut wrench TK39 for clamping nut with balancing option
350040020	Clamping nut wrench PC45 for $\varnothing 32$
350020023	*Balancing weight pair for clamping nut $\varnothing 60$ // 200gmm

## Walter HSK50 // Shaft $\varnothing 20$ mm // RS $\varnothing 35$ mm

For Walter tool grinding machines with ring set  $\varnothing 35$  mm

### GWA HSK50 // $\varnothing 20$ mm // RS $\varnothing 35$ mm

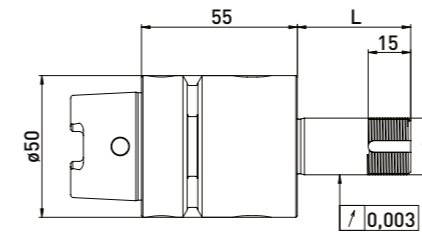
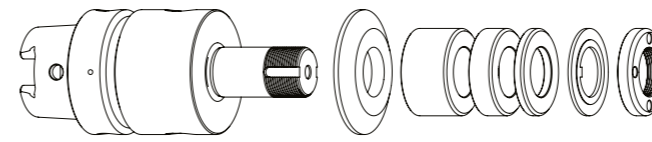

Delivered equipped:  
Reducing washer, ring set  $\varnothing 35$  mm, lock washer and clamping nut

Order No.	HSK	d	L	Ring set $\varnothing 35$ mm		
				B20	B10	B4
300102512	HSK50	20	40	-	1	3
300102522	HSK50	20	60	1	1	3
300102532	HSK50	20	85	2	2	4
300102542	HSK50	20	100	2	3	3

### Accessories Walter grinding wheel adapter HSK50 // Shaft $\varnothing 20$ mm // Ring set $\varnothing 35$ mm

Order No.	Name
350050010	Universal assembly device $\varnothing 50$
350040010	Clamping nut wrench PC27 for $\varnothing 20$
350040011	Clamping nut wrench PC27 for $\varnothing 20$
350040040	*Clamping nut wrench PC29 for $\varnothing 20$ for clamping nut with balancing option
350040041	*Clamping nut wrench PC29 for $\varnothing 20$
350020081	*Balancing weight pair for clamping nut $\varnothing 35$ // 40gmm

### GWA HSK50 // $\varnothing 20$ mm // without RS

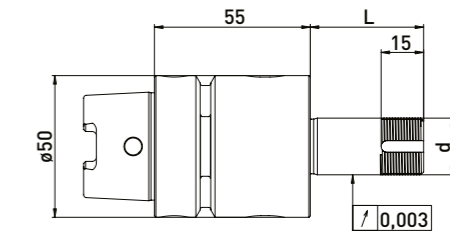
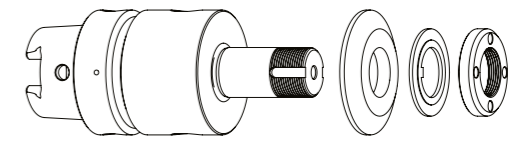

Delivered equipped:  
Reducing washer, lock washer and clamping nut

Order No.	HSK	d	L
300102511	HSK50	20	40
300102521	HSK50	20	60
300102531	HSK50	20	85
300102541	HSK50	20	100

Order No.	Name
350012020	Spacer ring $\varnothing 35 \times \varnothing 20 \times 20$
350012010	Spacer ring $\varnothing 35 \times \varnothing 20 \times 10$
350012004	Spacer ring $\varnothing 35 \times \varnothing 20 \times 4$
350015001	Reducing washer $\varnothing 50 \times \varnothing 35 \times \varnothing 20 \times 6$
350030020	Lock washer $\varnothing 35 \times \varnothing 20 \times 2$
350020030	Clamping nut $\varnothing 35 \times 6 M20 \times 1$ PC27
350020080	*Clamping nut with balancing option $\varnothing 35 \times \varnothing 40 \times 8 \times M20 \times 1$ PC29
350015005	Support washer $\varnothing 35 \times \varnothing 60 \times \varnothing 20 \times 6$

## Walter HSK50 // Shaft $\varnothing 20$ mm // RS $\varnothing 50$ mm

For Walter tool grinding machines with ring set  $\varnothing 50$  mm

### GWA HSK50 // $\varnothing 20$ mm // RS $\varnothing 50$ mm

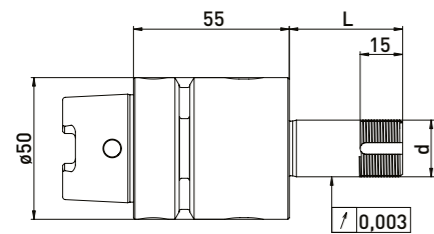
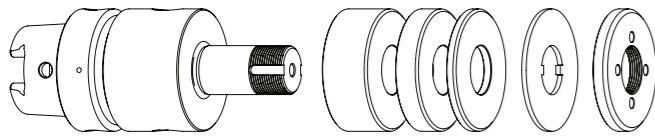

Delivered equipped:  
Ring set  $\varnothing 50$  mm, lock washer and clamping nut

### GWA HSK50 // $\varnothing 20$ mm // without RS

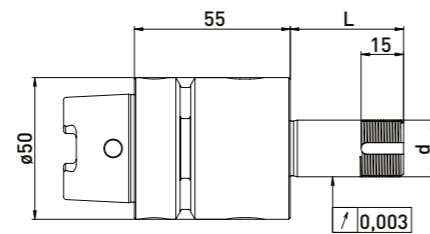
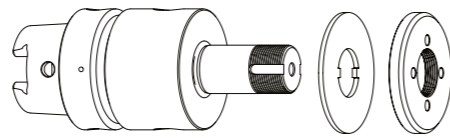

Delivered equipped:  
Lock washer and clamping nut

#### Ring set $\varnothing 50$ mm

Order No.	HSK	d	L	B20	B10	B4
300102012	HSK50	20	40	-	2	3
300102022	HSK50	20	60	1	2	3
300102032	HSK50	20	85	2	2	4
300102042	HSK50	20	100	2	3	5

Order No.	HSK	d	L
300102011	HSK50	20	40
300102021	HSK50	20	60
300102031	HSK50	20	85
300102041	HSK50	20	100

### Accessories Walter grinding wheel adapter HSK50 // Shaft $\varnothing 20$ mm // Ring set $\varnothing 50$ mm

Order No.	Name
350050010	Universal assembly device $\varnothing 50$
350040010	*Clamping nut wrench PC27 for $\varnothing 20$
350040011	*Clamping nut wrench PC27 for $\varnothing 20$
350020021	*Balancing weight pair for clamping nut $\varnothing 50$ // 100gmm

Order No.	Name
350011020	Spacer ring $\varnothing 50 \times \varnothing 20 \times 20$
350011010	Spacer ring $\varnothing 50 \times \varnothing 20 \times 10$
350011004	Spacer ring $\varnothing 50 \times \varnothing 20 \times 4$
350015002	Reducing washer $\varnothing 40 \times \varnothing 50 \times \varnothing 20 \times 6$
350020060	Clamping nut $\varnothing 50 \times 6 \times M20 \times 1$ PC27
350020020	*Clamping nut with balancing option $\varnothing 50 \times 8,5 M20 \times 1,0$ PC27

## Walter HSK50 // Shaft $\varnothing 31,75$ mm (1 1/4) // RS $\varnothing 60$ mm

For Walter tool grinding machines with ring set  $\varnothing 60$  mm

### GWA HSK50 // $\varnothing 31,75$ mm (1 1/4) // RS $\varnothing 60$ mm

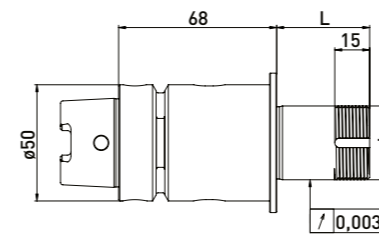
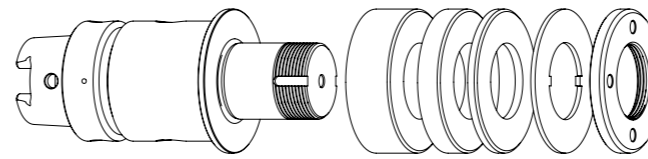

Delivered equipped:  
Ring set  $\varnothing 60$  mm, lock washer and clamping nut

### GWA HSK50 // $\varnothing 31,75$ mm (1 1/4) // without RS

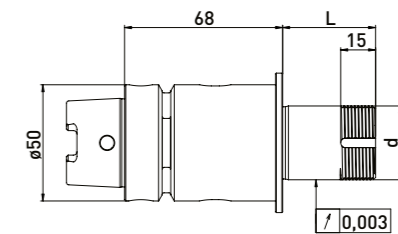
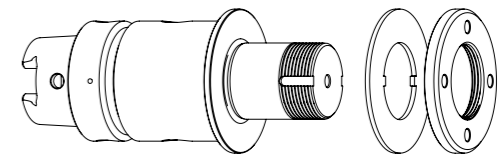

Delivered equipped:  
Lock washer and clamping nut

#### Ring set $\varnothing 60$ mm

Order No.	HSK	d	L	B20	B10	B4
300102112	HSK50	31,75	40	-	2	3
300102122	HSK50	31,75	60	1	2	3
300102132	HSK50	31,75	85	2	2	4
300102142	HSK50	31,75	100	3	2	3

Order No.	HSK	d	L
300102111	HSK50	31,75	40
300102121	HSK50	31,75	60
300102131	HSK50	31,75	85
300102141	HSK50	31,75	100

### Accessories Walter grinding wheel adapter HSK50 // Shaft $\varnothing 31,75$ mm (1 1/4) // Ring set $\varnothing 60$ mm

Order No.	Name
350050010	Universal assembly device $\varnothing 50$
350040030	*Clamping nut wrench PC39 for clamping nut with balancing option
350040020	Clamping nut wrench PC45 for $\varnothing 32$
350020023	*Balancing weight pair for clamping nut $\varnothing 60$ // 200gmm

Order No.	Name
350011420	Spacer ring $\varnothing 60 \times \varnothing 31,75 \times 20$
350011410	Spacer ring $\varnothing 60 \times \varnothing 31,75 \times 10$
350011404	Spacer ring $\varnothing 60 \times \varnothing 31,75 \times 4$
350030060	Lock washer $\varnothing 60 \times \varnothing 32 \times 1,8$
350020066	Clamping nut $\varnothing 60 \times 6 \times M32 \times 1,5$ PC45
350020022	*Clamping nut with balancing option $\varnothing 60 \times 9 M32 \times 1,5$ PC39

## Walter NCT // Shaft $\varnothing 20$ mm // RS $\varnothing 35$ mm

For Walter tool grinding machines with ring set  $\varnothing 35$  mm

### GWA NCT $\varnothing 31,75$ mm (1¼) // $\varnothing 20$ mm // RS $\varnothing 35$ mm

Tight with torque wrench 80Nm.

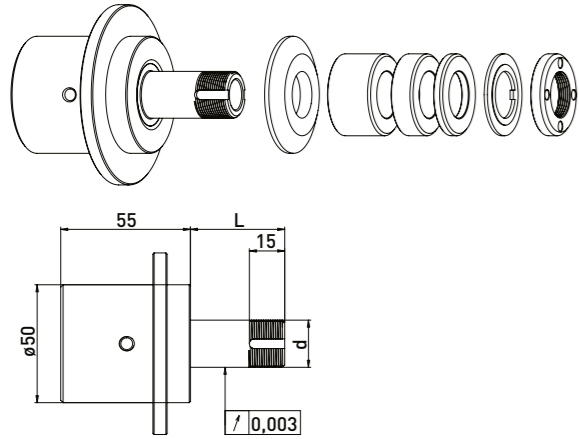

Delivered equipped:  
Reducing washer, ring set  $\varnothing 35$  mm, lock washer and clamping nut

### GWA NCT $\varnothing 31,75$ mm (1¼) // $\varnothing 20$ mm // without RS

Tight with torque wrench 80Nm.

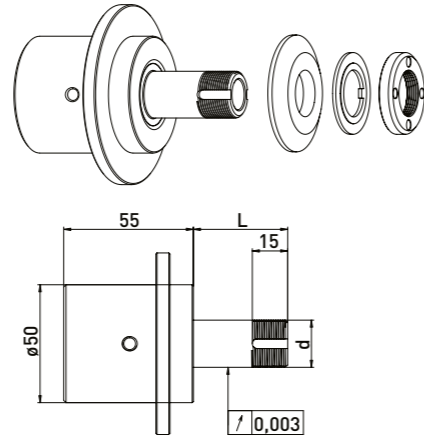

Delivered equipped:  
Reducing washer, lock washer and clamping nut

Ring set  $\varnothing 35$  mm

Order No.	Internal taper	d	L	B20	B10	B4
300101512	31,75	20	40	-	1	3
300101522	31,75	20	60	1	1	3
300101542	31,75	20	85	2	1	4
300101532	31,75	20	100	2	3	3

Order No.	Internal taper	d	L
300101511	31,75	20	40
300101521	31,75	20	60
300101541	31,75	20	85
300101531	31,75	20	100

## Walter NCT // Shaft $\varnothing 20$ mm // RS $\varnothing 50$ mm

For Walter tool grinding machines with ring set  $\varnothing 50$  mm

### GWA NCT $\varnothing 31,75$ mm (1¼) // $\varnothing 20$ mm // RS $\varnothing 50$ mm

Tight with torque wrench 80Nm.

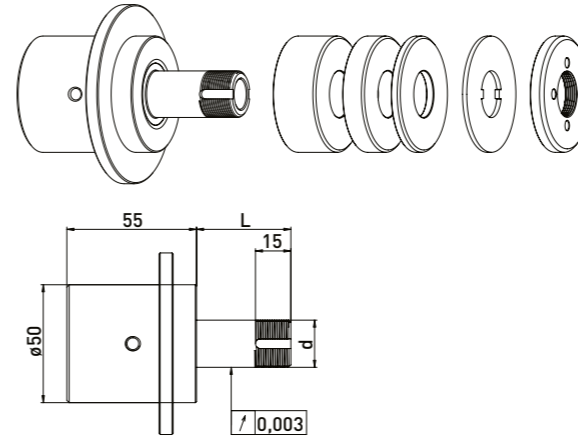

Delivered equipped:  
Ring set  $\varnothing 50$  mm, lock washer and clamping nut

### GWA NCT $\varnothing 31,75$ mm (1¼) // $\varnothing 20$ mm // without RS

Tight with torque wrench 80Nm.

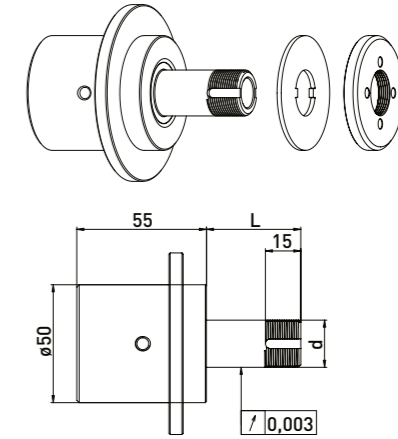

Delivered equipped:  
Lock washer and clamping nut

Ring set  $\varnothing 50$  mm

Order No.	Internal taper	d	L	B20	B10	B4
300101012	31,75	20	40	-	1	3
300101022	31,75	20	60	1	1	3
300101042	31,75	20	85	2	1	4
300101032	31,75	20	100	2	3	3

Order No.	Internal taper	d	L
300101011	31,75	20	40
300101021	31,75	20	60
300101041	31,75	20	85
300101031	31,75	20	100

### Accessories Walter grinding wheel adapter NCT // Shaft $\varnothing 20$ mm // Ring set $\varnothing 35$ mm

Order No.	Name	
350050010	Universal Assembly device $\varnothing 50$	
350040010	Clamping nut wrench PC27 for $\varnothing 20$	
350040011	Clamping nut wrench PC27 for $\varnothing 20$	
350040040	*Clamping nut wrench PC29 for $\varnothing 20$ for clamping nut with blancing option	
350040041	*Clamping nut wrench PC29 for $\varnothing 20$	
350020081	*Balancing weight pair for clamping nut $\varnothing 35$ // 40gmm	
300101001	Installation kit for NCT63 Walter	
300101003	Assembly wrench for installation kit NCT63 M20 x 1,5	

Order No.	Name	
350012020	Spacer ring $\varnothing 35$ x $\varnothing 20$ x 20	
350012010	Spacer ring $\varnothing 35$ x $\varnothing 20$ x 10	
350012004	Spacer ring $\varnothing 35$ x $\varnothing 20$ x 4	
350015001	Reducing washer $\varnothing 50$ x $\varnothing 35$ x $\varnothing 20$ x 6	
350030020	Lock washer $\varnothing 35$ x $\varnothing 20$ x 2	
350020030	Clamping nut $\varnothing 35$ x 6 M20 x 1 PC27	
350020080	*Clamping nut with balancing option $\varnothing 35$ x $\varnothing 40$ x 8 x M20 x 1 PC29	
350015005	Support washer $\varnothing 35$ x $\varnothing 60$ x $\varnothing 20$ x 6	

### Accessories Walter grinding wheel adapter NCT // Shaft $\varnothing 20$ mm // Ring set $\varnothing 50$ mm

Order No.	Name	
350050010	Universal Assembly device $\varnothing 50$	
350040010	*Clamping nut wrench PC27 for $\varnothing 20$	
350040011	*Clamping nut wrench PC27 for $\varnothing 20$	
350040040	*Clamping nut wrench PC29 for $\varnothing 20$ for clamping nut with blancing option	
350040041	*Clamping nut wrench PC29 for $\varnothing 20$	
350020021	*Balancing weight pair for clamping nut $\varnothing 50$ // 100gmm	
300101001	Installation kit for NCT63 Walter	
300101003	Assembly wrench for installation kit NCT63 M20 x 1,5	

Order No.	Name	
350011020	Spacer ring $\varnothing 50$ x $\varnothing 20$ x 20	
350011010	Spacer ring $\varnothing 50$ x $\varnothing 20$ x 10	
350011004	Spacer ring $\varnothing 50$ x $\varnothing 20$ x 4	
350030010	Lock washer $\varnothing 50$ x $\varnothing 20$ x 2	
350020060	Clamping nut $\varnothing 50$ x 6 x M20 x 1 PC27	
350020020	*Clamping nut with balancing option $\varnothing 50$ x 8,5 M20 x 1,0 PC27	

## Walter NCT // Shaft $\varnothing 31,75$ mm (1¼) // RS $\varnothing 60$ mm

For Walter tool grinding machines with ring set  $\varnothing 60$  mm

### GWA NCT $\varnothing 31,75$ mm // $\varnothing 31,75$ mm (1¼) // RS $\varnothing 60$ mm

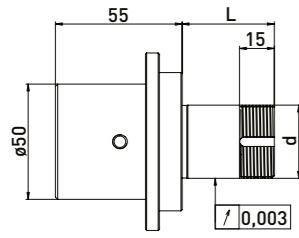
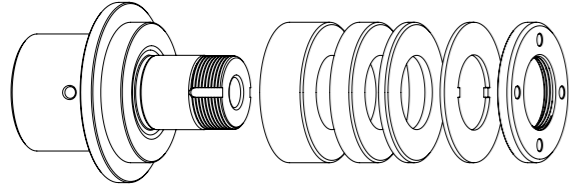

Delivered equipped:  
Ring set  $\varnothing 60$  mm, lock washer and clamping nut

### GWA NCT $\varnothing 31,75$ mm (1¼) // $\varnothing 31,75$ mm (1¼) // without RS

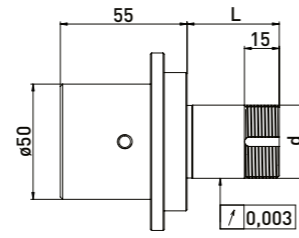
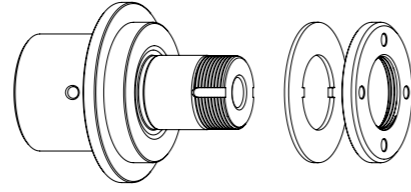

Delivered equipped:  
Lock washer and clamping nut

Ring set  $\varnothing 60$  mm

Order No.	Internal taper	d	L	B 20	B 10	B 4
300101112	31,75	31,75	40	-	1	5
300101122	31,75	31,75	60	1	1	5
300101132	31,75	31,75	85	1	4	4
300101142	31,75	31,75	100	2	3	5

Order No.	Internal taper	d	L
300101111	31,75	31,75	40
300101121	31,75	31,75	60
300101131	31,75	31,75	85
300101141	31,75	31,75	100

### Accessories Walter grinding wheel adapter NCT // Shaft $\varnothing 31,75$ mm (1¼) // Ring set $\varnothing 50$ mm

Order No.	Name	
350050010	Universal Assembly device $\varnothing 50$	
350040030	*Clamping nut wrench PC39 for clamping nut with blancing option	
350040020	Clamping nut wrench PC45 for $\varnothing 32$	
350020023	*Balancing weight pair for clamping nut $\varnothing 60$ // 200gmm	
300101001	Installation kit for NCT63 Walter	
300101003	Assembly wrench for installation kit NCT63 M20 x 1,5	

Order No.	Name	
350011420	Spacer ring $\varnothing 60$ x $\varnothing 31,75$ x 20	
350011410	Spacer ring $\varnothing 60$ x $\varnothing 31,75$ x 10	
350011404	Spacer ring $\varnothing 60$ x $\varnothing 31,75$ x 4	
350030060	Lock washer $\varnothing 60$ x $\varnothing 32$ x 1,8	
350020066	Clamping nut $\varnothing 60$ x 6 x M32 x 1,5 PC45	
350020022	*Clamping nut with balancing option $\varnothing 60$ x 9 M32 x 1,5 PC39	

## Zaro HSK50 // Shaft $\varnothing 20$ mm // RS $\varnothing 35$ mm

Fitted to Zaro tool grinding machines with ring set  $\varnothing 35$  mm

### GWA HSK50 // $\varnothing 20$ mm // RS $\varnothing 35$ mm

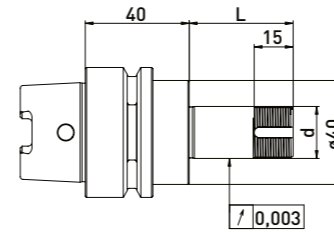
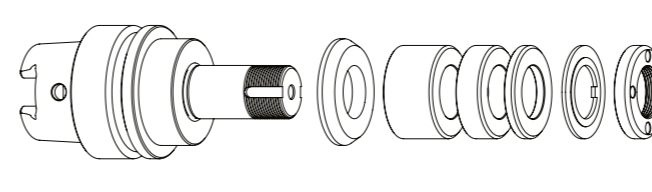

Delivered equipped:  
Reducing washer, ring set  $\varnothing 35$  mm, lock washer and clamping nut



### GWA HSK50 // $\varnothing 20$ mm // without RS

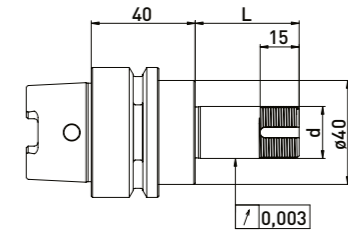
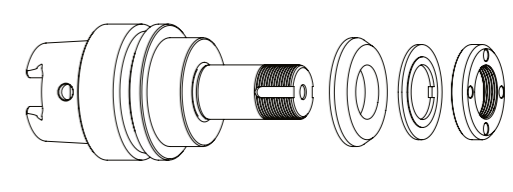

Delivered equipped:  
Reducing washer, lock washer and clamping nut



Ring set  $\varnothing 35$  mm

Order No.	HSK	d	L	B 20	B 10	B 4
300112512	HSK50	20	40	-	1	3
300112522	HSK50	20	60	1	1	3
300112532	HSK50	20	75	1	2	4
300112542	HSK50	20	85	2	1	4
300112552	HSK50	20	100	2	3	3

Order No.	HSK	d	L
300112511	HSK50	20	40
300112521	HSK50	20	60
300112531	HSK50	20	75
300112541	HSK50	20	85
300112551	HSK50	20	100

### Accessories Zaro grinding wheel adapter HSK50 // Shaft $\varnothing 20$ mm // Ring set $\varnothing 35$ mm

Order No.	Name	
350050010	Universal assembly device $\varnothing 50$	
350040010	Clamping nut wrench PC27 for $\varnothing 20$	
350040011	Clamping nut wrench PC27 for $\varnothing 20$	
350040040	*Clamping nut wrench PC29 for $\varnothing 20$ for clamping nut with blancing option	
350040041	*Clamping nut wrench PC29 for $\varnothing 20$	
350020081	*Balancing weight pair for clamping nut $\varnothing 35$ // 40gmm	

Order No.	Name	
350012020	Spacer ring $\varnothing 35$ x $\varnothing 20$ x 20	
350012010	Spacer ring $\varnothing 35$ x $\varnothing 20$ x 10	
350012004	Spacer ring $\varnothing 35$ x $\varnothing 20$ x 4	
350015001	Reducing washer $\varnothing 50$ x $\varnothing 35$ x $\varnothing 20$ x 6	
350030020	Lock washer $\varnothing 35$ x $\varnothing 20$ x 2	
350020030	Clamping nut $\varnothing 35$ x 6 M20 x 1 PC27	
350020080	*Clamping nut with balancing option $\varnothing 35$ x $\varnothing 40$ x 8 x M20 x 1 PC29	
350015005	Support washer $\varnothing 35$ x $\varnothing 60$ x $\varnothing 20$ x 6	

# Zaro HSK50 // Shaft $\varnothing 20$ mm // RS $\varnothing 50$ mm

Fitted to Zaro tool grinding machines with ring set  $\varnothing 50$  mm

## GWA HSK50 // $\varnothing 20$ mm // RS $\varnothing 50$ mm

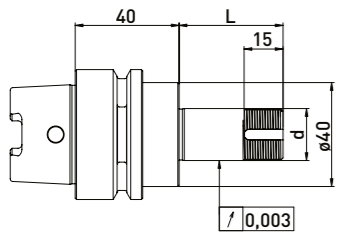
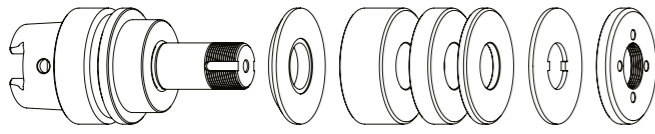

Delivered equipped:  
Reducing washer, ring set  $\varnothing 50$  mm, lock washer and clamping nut

Order No.	HSK	d	L	Ring set $\varnothing 50$ mm		
				B20	B10	B4
300112012	HSK50	20	40	-	1	3
300112022	HSK50	20	60	1	1	3
300112032	HSK50	20	75	1	2	4
300112042	HSK50	20	85	2	1	4
300112052	HSK50	20	100	2	3	3

## GWA HSK50 // $\varnothing 20$ mm // without RS

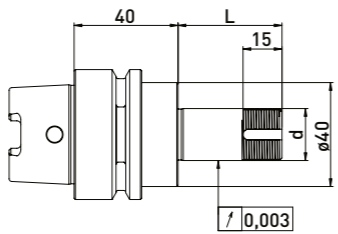
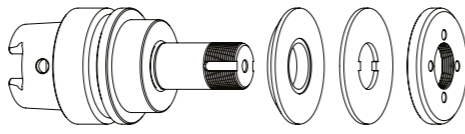

Delivered equipped:  
Reducing washer, lock washer and clamping nut

Order No.	HSK	d	L
300112011	HSK50	20	40
300112021	HSK50	20	60
300112031	HSK50	20	75
300112041	HSK50	20	85
300112051	HSK50	20	100

## Accessories Zaro grinding wheel adapter HSK50 // Shaft $\varnothing 20$ mm // Ring set $\varnothing 50$ mm

Order No.	Name
350050010	Universal assembly device $\varnothing 50$
350040010	*Clamping nut wrench PC27 for $\varnothing 20$
350040011	*Clamping nut wrench PC27 for $\varnothing 20$
350020021	*Balancing weight pair for clamping nut $\varnothing 50$ // 100gmm

Order No.	Name
350011020	Spacer ring $\varnothing 50 \times \varnothing 20 \times 20$
350011010	Spacer ring $\varnothing 50 \times \varnothing 20 \times 10$
350011004	Spacer ring $\varnothing 50 \times \varnothing 20 \times 4$
350015002	Reducing washer $\varnothing 40 \times \varnothing 50 \times \varnothing 20 \times 6$
350030010	Lock washer $\varnothing 50 \times \varnothing 20 \times 2$
350020060	Clamping nut $\varnothing 50 \times 6 \times M20 \times 1$ PC27
350020020	*Clamping nut with balancing option $\varnothing 50 \times 8,5 M20 \times 1,0$ PC27

# Adapters for dressing, presetting etc.

Adapter piece for tool grinding machines, dressing machines, presetting devices, balancing machines

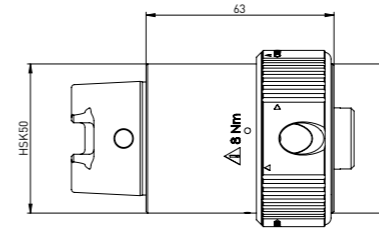

Order No.	Name
350130020	Adapter piece HSK50 on HSK40 A/C/E HSK50 B/D/F

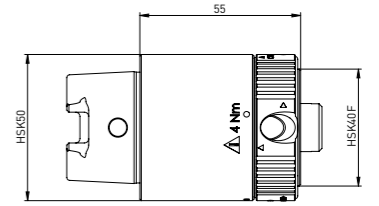

Order No.	Name
350130021	Adapter piece HSK50 on HSK32 A/C/E HSK40 B/D/F

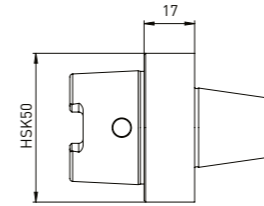

Order No.	Name
350130034	Adapter piece HSK50 on ANCA taper $\varnothing 30$

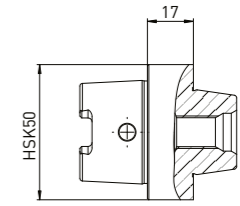

Order No.	Name
350130032	Adapter piece HSK50 on Haas/Walter taper

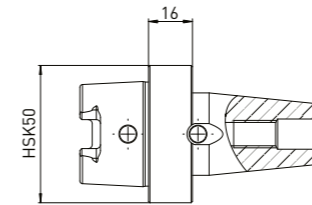

Order No.	Name
350130030	Adapter piece HSK50 on Strausak Fleximat

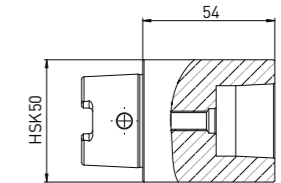

Order No.	Name
350130031	Adapter piece HSK50 on Strausak Promat

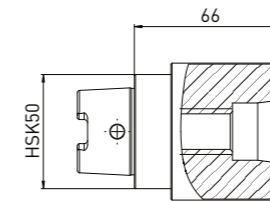

Order No.	Name
350130033	Adapter piece HSK50 on Saacke short taper

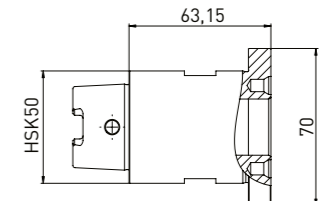

Order No.	Name
350130048	Adapter HSK50 x $\varnothing 25$ on Rollomatic



Adapters fine balanced SK40 and SK50 for tool grinding machines, dressing machines, presetting devices, balancing machines

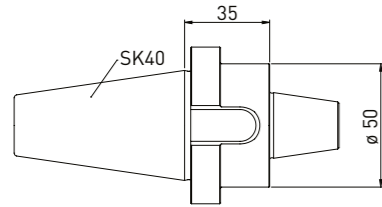

**Order No. Name**  
350130035 Adapter SK40 on ANCA taper  $\varnothing 30$

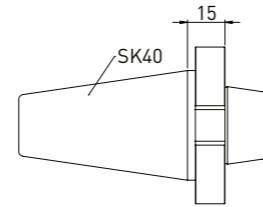

**Order No. Name**  
350130014 Adapter SK40 on Haas/Walter taper

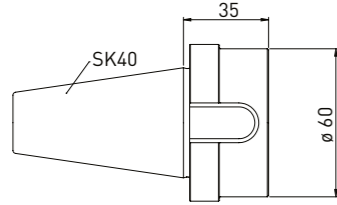

**Order No. Name**  
350130040 Adapter SK40 on Saacke short taper

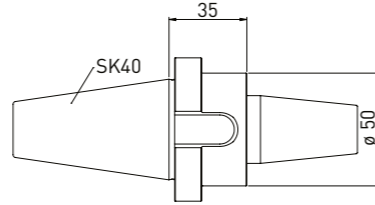

**Order No. Name**  
350130043 Adapter SK40 on Strausak Fleximat

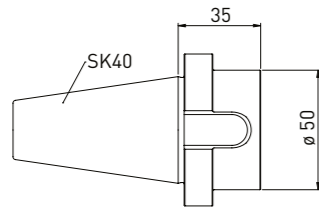

**Order No. Name**  
350130042 Adapter SK40 on Strausak Promat

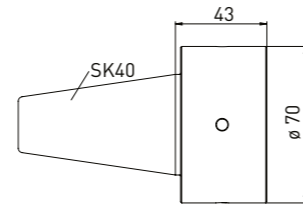

**Order No. Name**  
350130039 Adapter SK40 on Rollomatic  $\varnothing 25$

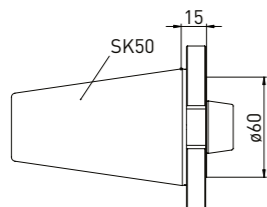

**Order No. Name**  
350130044 Adapter SK50 on Haas/Walter taper L15

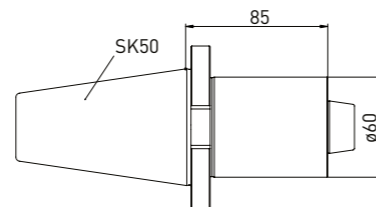

**Order No. Name**  
350130045 Adapter SK50 on Haas/Walter taper L85

## Adapter SK40 on HSK

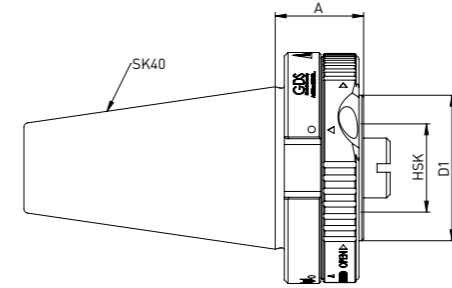

Order No.	A/C/E HSK shape	B/D/F HSK shape	A	D1
350130011	HSK32	HSK40	25	40
350130012	HSK40	HSK50	35	50
350130013	HSK50	HSK63	45	63

## Adapter SK50 on HSK

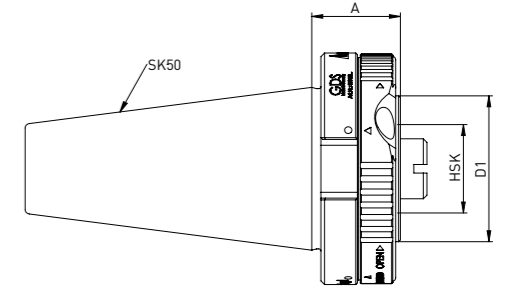

Order No.	A/C/E HSK shape	B/D/F HSK shape	A	D1
350130001	HSK32	HSK40	30	40
350130002	HSK40	HSK50	33	50
350130003	HSK50	HSK63	45	63

## Adapters for grinding wheel adapters from $\varnothing 20$ to $\varnothing 10$ // and $\varnothing 20$ to ER16 collet chuck

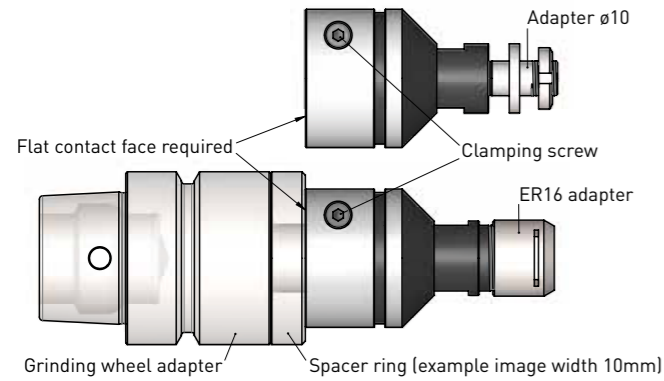

### Assembly example

Twist adapter onto M20 x 1 screw and bring to rear to flat contact face.

If needed, lay spacers down first so that the adapter meets the flat contact face.

Subsequently, tighten using spanner flat and secure with clamping screw.

### Adapter $\varnothing 20$ on $\varnothing 10$

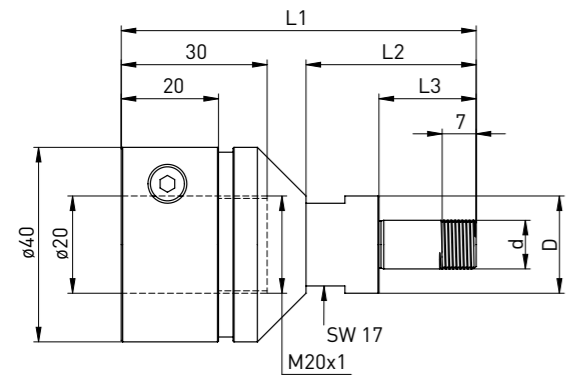

Delivered equipped:  
Clamping nut (350020114), Spacer rings 4pc. (350016004)

Order No.	D	d	L1	L2	L3
350130046	20	10	73	35	20

### Adapter $\varnothing 20$ on ER16

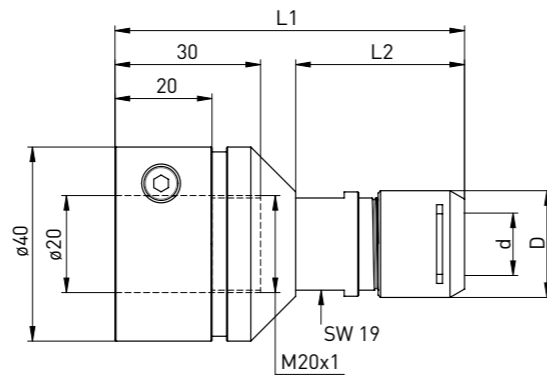

Delivered equipped:  
Mini clamping nut Silent ER16 (350020116)

Order No.	D	d	L1	L2
350130047	22	ER16	76	39

### Accessories Adapter $\varnothing 20$ on $\varnothing 10$

Order No.	Name - $\varnothing$
350016004	Spacer ring $\varnothing 20$ x $\varnothing 10$ x 3
350020114	clamping nut $\varnothing 18$ x 4 - M10 x 0,75
350040050	Hook wrench 16-20 mm

### Accessories Adapter $\varnothing 20$ on ER16

Order No.	Name
350125116	Mini clamping nut SILENT ER16
350126116	Clamping wrench for Mini clamping nut SILENT ER16

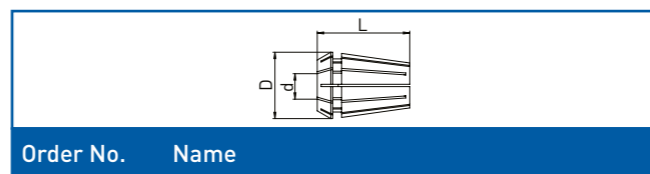

Order No.	Name
3501217**	Collet DIN 6499 ER16 ** $\varnothing$ 1-10mm

\*\*[Please complete the order number with the two-digit number that defines the diameter!] e.g. for  $\varnothing 1$  -> last digit 01 (350121701) for  $\varnothing 10$  last digit ->10 (350121710)

### HSK50 Test and angle dial

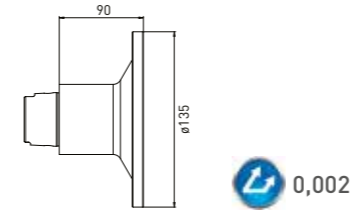

Order No.	Name
350090010	Test and angle dial HSK50

### HSK40 Test and angle dial

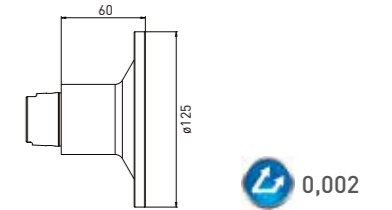

Order No.	Name
350090020	Test and angle dial HSK40

### Test and angle dial

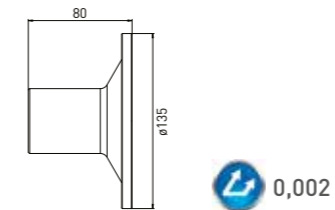

Order No.	Name
350090030	Angle dial Haas/Walter taper 31.75

### SK Test mandrel

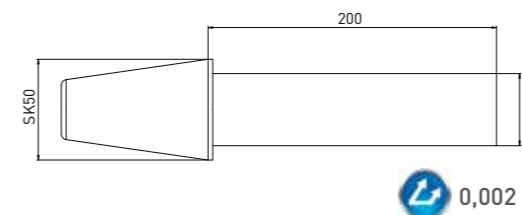

Order No.	Name
350090040	Test mandrel SK50 x $\varnothing 50$ x 200

### HSK Test mandrel

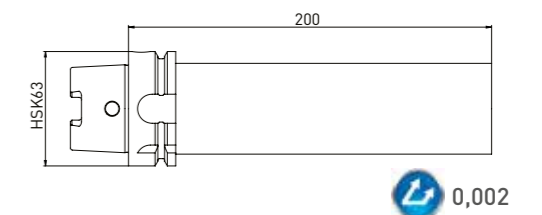

Order No.	Name
350090050	Test mandrel HSK63 x $\varnothing 50$ x 200

Equi'Z balancing accessories for tool grinding machines

Order No.	Name
400006001	Equi'Z Competition to HSK63 or SK40 for Tablet // Notebook // PC
400006004	Equi'Z Competition Stand Alone 1 plane, to HSK63 / SK40 / PSC 5, BMT200-1.OP40
400006005	Equi'Z Competition Stand Alone 1+2 plane, to HSK63 / SK40 / PSC 5, BMT200-2.OP40

Order No.	Name
400006003	Equi'Z Ultimate to HSK100 or SK50 for Tablet // Notebook // PC
400006006	Equi'Z Ultimate Stand Alone 1 plane, to HSK125 / SK50 / PSC 8, BMT200-1.OP100
400006007	Equi'Z Ultimate Stand Alone 1+2 plane, to HSK125 / SK50 / PSC 8, BMT200-2.OP100

For balancing machine:

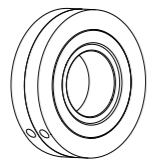

Order No.	Name
350080120	Balancing ring without scale 3-part 80gmm $\phi 60 \times \phi 20 \times 12$
350080130	Balancing ring without scale 3-part 80gmm $\phi 45 \times \phi 20 \times 12$

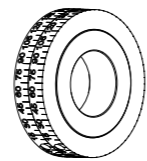

Order No.	Name
350080100	Balancing ring with scale 3-part 80gmm $\phi 60 \times \phi 20 \times 12$
350080110	Balancing ring with scale 3-part 80gmm $\phi 45 \times \phi 20 \times 12$

For grinding wheel adapters:

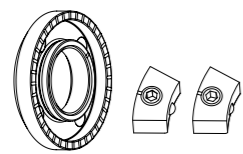

Order No.	Name
350020080	Clamping nut with balancing option $\phi 35 \times \phi 40 \times 8 \times M20 \times 1$ (without weights)
350020081	Balancing weight pair for clamping nut $\phi 35$ 40gmm
350040040	Clamping nut wrench PC29 for $\phi 20$

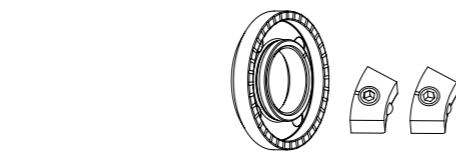

Order No.	Name
350020020	Clamping nut with balancing option $\phi 50 \times 8,5 M20 \times 1,0$ (without weights)
350020021	Balancing weight pair for clamping nut $\phi 50$ 100gmm
350040010	Clamping nut wrench PC 27 for $\phi 20$

Order No.	Name
350020026	Clamping nut with balancing option $\phi 47 \times 12 M31,5 \times 1,5$ (without weights)
350020027	Balancing weight pair for clamping nut $\phi 47$ 70gmm
350040030	Clamping nut wrench PC39 for $\phi 47$

Order No.	Name
350020022	Clamping nut with balancing option $\phi 60 \times 9 M32 \times 1,5$ (without weights)
350020023	Balancing weight pair for clamping nut $\phi 60$ 200gmm
350040030	Clamping nut wrench PC39 for $\phi 47$

Accessories Standard and Competition: Accessories Power and Ultimate:

Item No.	Name
350080221	Equi'Z Adapter Perfect Arbor Standard // Competition
350080250	Equi'Z Adapter HSK63-A Standard // Competition
350080252	Equi'Z Adapter HSK63-F Standard // Competition
350080260	Equi'Z Adapter HSK50-A Standard // Competition
350080262	Equi'Z Adapter HSK50-F Standard // Competition
350080270	Equi'Z Adapter HSK40-A Standard // Competition
350080272	Equi'Z Adapter HSK40-F Standard // Competition
350080280	Equi'Z Adapter HSK32-F Standard // Competition
350080285	Equi'Z Adapter HSK25-A Standard // Competition
350080286	Equi'Z Adapter HSK32-A Standard // Competition
350080290	Equi'Z Adapter SK30-A Standard // Competition
350080300	Equi'Z Adapter SK40-A Standard // Competition
350080399	Equi'Z Adapter BT30/ANSI Standard // Competition
350080400	Equi'Z Adapter BT30/PT45 Standard // Competition
350080401	Equi'Z Adapter BT30/PT60 Standard // Competition
350080402	Equi'Z Adapter BT40/PT15 Standard // Competition
350080403	Equi'Z Adapter BT40/PT30 Standard // Competition
350080404	Equi'Z Adapter BT40/PT45 Standard // Competition
350080405	Equi'Z Adapter BT40/PT60 Standard // Competition
350080406	Equi'Z Adapter BT40/PT75 Standard // Competition
350080407	Equi'Z Adapter BT40/PT90 Standard // Competition

Item No.	Name
350080222	Equi'Z Adapter Perfect Arbor Power // Ultimate
350080251	Equi'Z Adapter HSK63-A Power // Ultimate
350080255	Equi'Z Adapter HSK80-A Power // Ultimate
350080256	Equi'Z Adapter HSK100-A Power // Ultimate
350080263	Equi'Z Adapter HSK50-A Power // Ultimate
350080271	Equi'Z Adapter HSK40-A Power // Ultimate
350080287	Equi'Z Adapter HSK32-A Power // Ultimate
350080310	Equi'Z Adapter SK50-A Power // Ultimate
350080311	Equi'Z Adapter SK40-A Power // Ultimate
350080312	Equi'Z Adapter SK30-A Power // Ultimate
350080410	Equi'Z Adapter BT30/PT30 Power // Ultimate
350080411	Equi'Z Adapter BT30/PT45 Power // Ultimate
350080413	Equi'Z Adapter BT40/PT30 Power // Ultimate
350080414	Equi'Z Adapter BT40/PT45 Power // Ultimate
350080415	Equi'Z Adapter BT40/PT90 Power // Ultimate
350080416	Equi'Z Adapter BT50/PT30 Power // Ultimate
350080417	Equi'Z Adapter BT50/PT45 Power // Ultimate
350080418	Equi'Z Adapter BT50/PT90 Power // Ultimate

Accessories Standard, Competition, Power and Ultimate:

Item No.	Name
400006075	Equi'Z tablet stand
400006076	Equi'Z tablet tray

ZETA-clamping nuts for grinding wheel holders

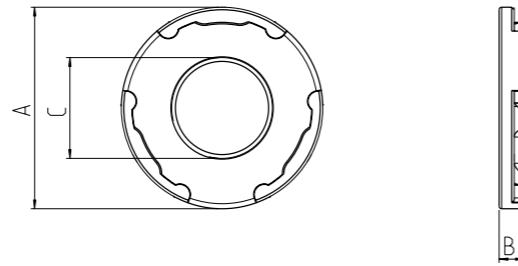

Item No.	Name
350020200	ZETA-clamping nut for grinding wheel holders Ø 40 x 5 - M20 x 1,0 Profile K
350020201	ZETA-clamping nut for grinding wheel holders Ø 50 x 6 - M20 x 1,0 Profile M

ZETA-safety clamping nut for grinding wheel holders

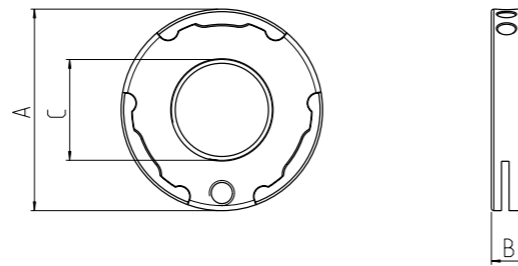

Item No.	Name
350020202	ZETA-safety clamping nut for grinding wheel holders Ø 40 x 8 - M20 x 1,0 Profile K
350020203	ZETA-safety clamping nut for grinding wheel holders Ø 50 x 9 - M20 x 1,0 Profile M

ZETA-balance clamping nut with 12 holes

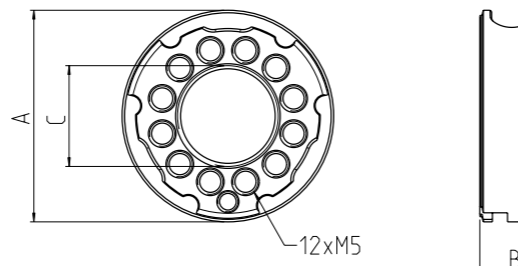

Item No.	Name
350020204	ZETA-balance clamping nut with 12 holes Ø 42 x 15 - M20 x 1,0 Profile I

ZETA-torque nut

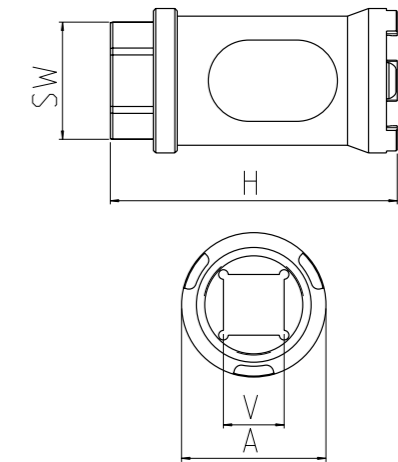

Item No.	Name
350040060	ZETA-Torque nut Ø 34 x 102 x 27 1/2" Profile K
350040061	ZETA-Torque nut Ø 50 x 122 x 27 1/2" Profile M
350040062	ZETA-Torque nut Ø 41 x 110 x 27 1/2" Profile I

ZETA-Screw-on-adapter

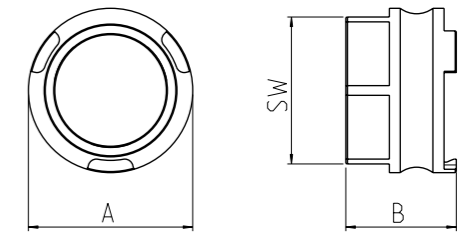

Item No.	Name
350040063	ZETA-Screw-on-adapter Ø 27 x 19 x 22 Profile K
350040064	ZETA-Screw-on-adapter Ø 32 x 21 x 30 Profile M
350040065	ZETA-Screw-on-adapter Ø 41 x 24 x 36 Profile I

With the ZETA operating tools you should always clamp **away** from the cutting tools.

ZETA-Standard spanner wrench

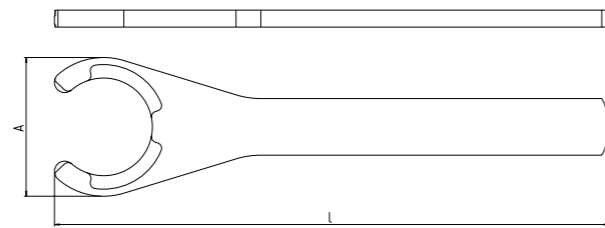

Item No.	Name
----------	------

350040066	ZETA-Standard spanner wrench Ø 44 x 175 Profile K
-----------	--

350040067	ZETA-Standard spanner wrench Ø 37 x 215 Profile M
-----------	--

350040068	ZETA-Standard spanner wrench Ø 40 x 215 Profile I
-----------	--

ZETA-torque wrench adapter

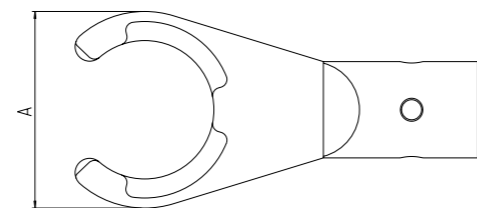

Item No.	Name
----------	------

350040069	ZETA-torque wrench adapter Ø 44 Profile K
-----------	--

350040070	ZETA-torque wrench adapter Ø 66 Profile M
-----------	--

350040071	ZETA-torque wrench adapter Ø 41 Profile I
-----------	--

ZETA-Torque wrench



Item No.	Name
----------	------

350040072	ZETA-torque spanner Ø 16 mm size 40-200Nm
-----------	--

Accessories for our grinding wheel adapters are to be found on each product page.

Universal assembly device ø50 fits a multitude of grinding wheel adapters.

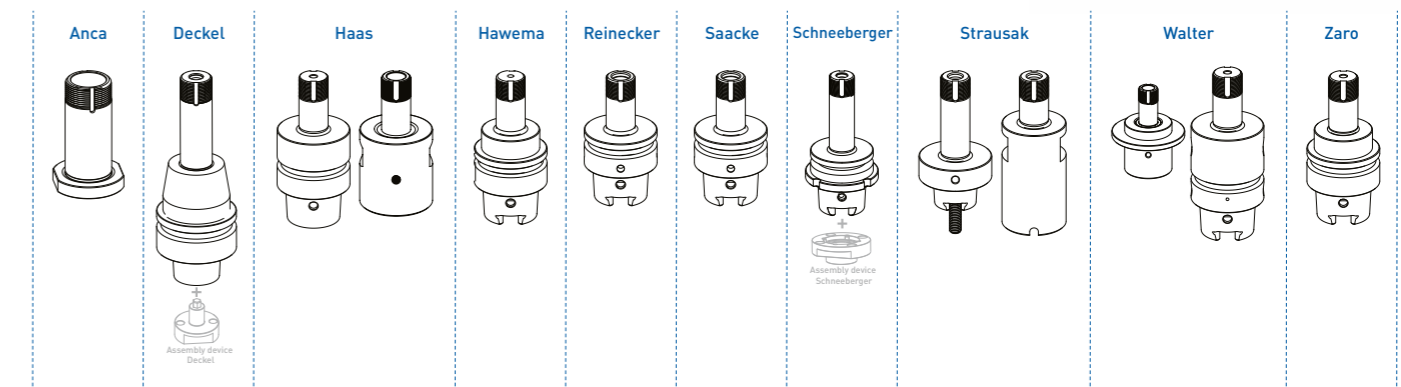

Clamping nut wrenches in various pitch circles.



Clamping nuts with balancing option and suitable balancing weights.



Our certified partners **take care of you**, where we can't be in person, providing optimal support and answers to your questions.



Local GDS partners offer the complete line of original GDS grinding wheel adaptors as well as clamping and balancing solutions for tool grinding.

From consulting to order processing, please contact your local GDS partners.

**GDS - the precision makers**



D- PLZ 0 - 6  
**Dr. MÜLLER DIAMANTMETALL AG**  
 Leprosenweg 34  
 82362 Weilheim i. Ob.  
 Tel: +49 (0) 881 - 90 11 55-0  
 Fax: +49 (0) 881 - 90 11 55-100  
 Email: [vertrieb@muedia.de](mailto:vertrieb@muedia.de)  
 Web: [www.muedia.de](http://www.muedia.de)

D- PLZ 0 - 6 (Clamping and balancing technology)  
**Balletshofer Schleiftechnik**  
 Am Geiselbach 28  
 86637 Zusamaltheim  
 Mobil: +49 (0)1 70 - 3 44 54 74  
 Fax: +49 (0) 82 96 - 90 98 96  
 Email: [info@balletshofer.com](mailto:info@balletshofer.com)  
 Web: [www.balletshofer.com](http://www.balletshofer.com)

D- PLZ 6 + 7  
**Fischer Präzisionswerkzeug-Maschinen GmbH & Co. KG**  
 Burghaldenstraße 2  
 71065 Sindelfingen  
 Tel: +49 (0) 70 31 - 81 10 - 25  
 Fax: +49 (0) 70 31 - 81 10 - 27  
 Email: [info@hf-fischer.de](mailto:info@hf-fischer.de)  
 Web: [www.hf-fischer.de](http://www.hf-fischer.de)

D- PLZ 8 + 9  
**Balletshofer Schleiftechnik**  
 Am Geiselbach 28  
 86637 Zusamaltheim  
 Mobil: +49 (0)1 70 - 3 44 54 74  
 Fax: +49 (0) 82 96 - 90 98 96  
 Email: [info@balletshofer.com](mailto:info@balletshofer.com)  
 Web: [www.balletshofer.com](http://www.balletshofer.com)



**AUSTRIA**  
**plan:b4u GmbH**  
 Colmarplatz 1 / Top XXIII  
 7000 Eisenstadt Austria  
 Tel: +43 664 127 3039  
 Email: [info@planb4u.com](mailto:info@planb4u.com)  
 Web: [www.planb4u.com](http://www.planb4u.com)

**BELARUSSIA**  
**AWM Precision GmbH**  
 Genshagener Straße 27  
 14974 Ludwigsfelde Germany  
 Tel: +49 (0) 33 78 - 5 18 63 67  
 Email: [arnold@awm-precision.com](mailto:arnold@awm-precision.com)  
 Web: [www.awm-precision.com](http://www.awm-precision.com)

**BELGIUM**  
**oelheld technologies SAS**  
 innovative fluid technology  
 Technopôle de Forbach-Sud  
 140, Avenue Jean-Eric Bousch  
 57600 Oeting France  
 Tel: +33 (0) 387-90 42 14  
 Fax: +33 (0) 387-84 66 91  
 Email: [martin.gundelach@oelheld.de](mailto:martin.gundelach@oelheld.de)  
 Web: [www.oelheld.com](http://www.oelheld.com)

**CZECH/SLOVAKIA**  
**Dr. MÜLLER DIAMANTMETALL AG**  
 Leprosenweg 34  
 82362 Weilheim i. Ob. Germany  
 Tel: +49 (0) 881 - 90 11 55-0  
 Fax: +49 (0) 881 - 90 11 55-100  
 Email: [vertrieb@muedia.de](mailto:vertrieb@muedia.de)  
 Web: [www.muedia.de](http://www.muedia.de)

**DENMARK**  
**M-Tech ApS**  
 Holkebjergvej 75  
 5250 Odense SV Denmark  
 Tel: +45 3034 1415  
 Email: [m-tech@jakobsen.mail.dk](mailto:m-tech@jakobsen.mail.dk)

**ESTONIA**  
**AWM Precision GmbH**  
 Genshagener Straße 27  
 14974 Ludwigsfelde Germany  
 Tel: +49 (0) 33 78 - 5 18 63 67  
 Email: [arnold@awm-precision.com](mailto:arnold@awm-precision.com)  
 Web: [www.awm-precision.com](http://www.awm-precision.com)

**FINLAND**  
**Diamack Oy**  
 Asentajankatu 9 C  
 48770 Kotka Finland  
 Tel: +358 5 - 21 41 20  
 Fax: +358 5 - 21 41 70  
 Email: [diamack@diamack.fi](mailto:diamack@diamack.fi)  
 Web: [www.diamack.fi](http://www.diamack.fi)

**FRANCE**  
**oelheld technologies SAS**  
 innovative fluid technology  
 Technopôle de Forbach-Sud  
 140, Avenue Jean-Eric Bousch  
 57600 Oeting France  
 Tel: +33 (0) 387-90 42 14  
 Fax: +33 (0) 387-84 66 91  
 Email: [martin.gundelach@oelheld.de](mailto:martin.gundelach@oelheld.de)  
 Web: [www.oelheld.com](http://www.oelheld.com)

**HUNGARY**  
**Szerszám Technika Kft.**  
 Dűlő u. 4.  
 1225 Budapest Hungary  
 Tel: +36 1 287 82 76  
 Fax: +36 1 287 82 77  
 Email: [info@szerszamtechnika.hu](mailto:info@szerszamtechnika.hu)  
 Web: [www.szerszamtechnika.hu](http://www.szerszamtechnika.hu)

**IRELAND**  
**oelheld technologies SAS**  
 innovative fluid technology  
 Technopôle de Forbach-Sud  
 140, Avenue Jean-Eric Bousch  
 57600 Oeting France  
 Tel: +33 (0) 387-90 42 14  
 Fax: +33 (0) 387-84 66 91  
 Email: [martin.gundelach@oelheld.de](mailto:martin.gundelach@oelheld.de)  
 Web: [www.oelheld.com](http://www.oelheld.com)

**ITALY**  
**Utensileria FAVRIN SrL**  
 Via Per Cabiate 79  
 22066 Mariano Comense Italy  
 Tel: +39 (0) 31 - 74 72 00  
 Fax: +39 (0) 31 - 75 12 22  
 Email: [utensileria-mariano@favrin.it](mailto:utensileria-mariano@favrin.it)  
 Web: [www.utensileria-favrin.it](http://www.utensileria-favrin.it)

**LATVIA**  
**AWM Precision GmbH**  
 Genshagener Straße 27  
 14974 Ludwigsfelde Germany  
 Tel: +49 (0) 33 78 - 5 18 63 67  
 Email: [arnold@awm-precision.com](mailto:arnold@awm-precision.com)  
 Web: [www.awm-precision.com](http://www.awm-precision.com)

**LITHUANIA**  
**AWM Precision GmbH**  
 Genshagener Straße 27  
 14974 Ludwigsfelde Germany  
 Tel: +49 (0) 33 78 - 5 18 63 67  
 Email: [arnold@awm-precision.com](mailto:arnold@awm-precision.com)  
 Web: [www.awm-precision.com](http://www.awm-precision.com)

**LUXEMBOURG**  
**oelheld technologies SAS**  
 innovative fluid technology  
 Technopôle de Forbach-Sud  
 140, Avenue Jean-Eric Bousch  
 57600 Oeting France  
 Tel: +33 (0) 387-90 42 14  
 Fax: +33 (0) 387-84 66 91  
 Email: [martin.gundelach@oelheld.de](mailto:martin.gundelach@oelheld.de)  
 Web: [www.oelheld.com](http://www.oelheld.com)

**NETHERLANDS**  
**oelheld technologies SAS**  
 innovative fluid technology  
 Technopôle de Forbach-Sud  
 140, Avenue Jean-Eric Bousch  
 57600 Oeting France  
 Tel: +33 (0) 387-90 42 14  
 Fax: +33 (0) 387-84 66 91  
 Email: [martin.gundelach@oelheld.de](mailto:martin.gundelach@oelheld.de)  
 Web: [www.oelheld.com](http://www.oelheld.com)

**POLAND**  
**Vollmer Polska sp z o.o.**  
 ul.Handlowa 11  
 41-807 Zabrze Poland  
 Tel: +48 32 733 08 69  
 Email: [info-pl@vollmer-group.com](mailto:info-pl@vollmer-group.com)  
 Web: [www.vollmer-group.com](http://www.vollmer-group.com)

**PORTUGAL // SPAIN**  
**Procut**  
 Parque Industrial Cruzeiro  
 Rua Nossa Senhora da Ajuda 150  
 4815-364 Moreira de Conegos Portugal  
 Tel: +351 253 56 12 11  
 Fax: +351 253 56 39 49  
 Email: [info@procut.pt](mailto:info@procut.pt)  
 Web: [www.procut.pt](http://www.procut.pt)

**SWEDEN**  
**Ehn & Land AB**  
 Bultvägen 4  
 553 02 Jönköping Sweden  
 Tel: +46 86 35 34-50  
 Fax: +46 86 35 34-70  
 Email: [info@ehnland.se](mailto:info@ehnland.se)  
 Web: [www.ehnland.se](http://www.ehnland.se)

**SWITZERLAND**  
**Ziegler + Cie AG**  
 Industriestraße 12  
 8404 Winterthur Switzerland  
 Tel: +41 (0) 52 234 20 20  
 Fax: +41 (0) 52 234 20 10  
 Email: [info@zieglerag.ch](mailto:info@zieglerag.ch)  
 Web: [www.zieglerag.ch](http://www.zieglerag.ch)

**UNITED KINGDOM**  
**oelheld UK Ltd**  
 Unit 16, Colomendy Business Park,  
 Erw Las, Denbigh LL16 5TA, UK  
 Tel: +44 (0)1745 814 777  
 Fax: +44 (0)1745 813 222  
 Email: [sales@oelheld.co.uk](mailto:sales@oelheld.co.uk)  
 Web: [www.oelheld.co.uk](http://www.oelheld.co.uk)

**UKRAINE**  
**AWM Precision GmbH**  
 Genshagener Straße 27  
 14974 Ludwigsfelde Germany  
 Tel: +49 (0) 33 78 - 5 18 63 67  
 Email: [arnold@awm-precision.com](mailto:arnold@awm-precision.com)  
 Web: [www.awm-precision.com](http://www.awm-precision.com)

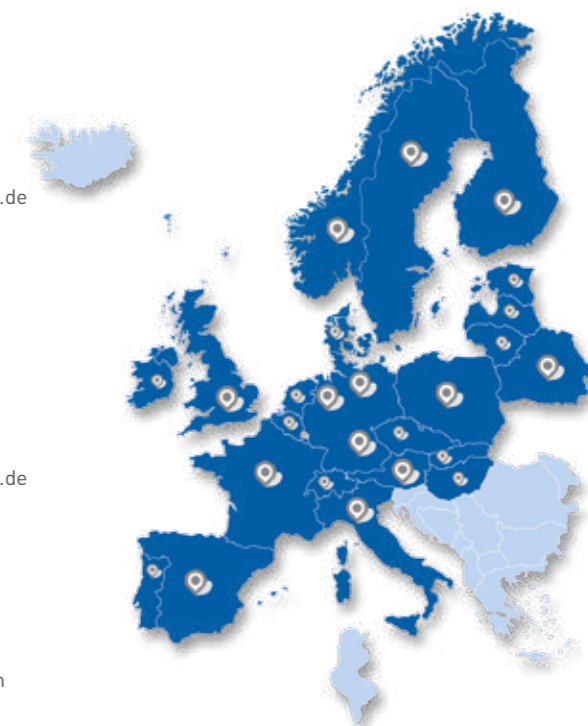

## CHINA

**HERZOG CHINA CO.,LTD.**  
4/F, No.3232 Beimen Road,  
Kunshan, Jiangsu 215316, China  
Tel: +86-512-55 19 05 78  
Fax: +86-512-55 19 05 76  
Email: dezhu@herzog-china.com  
Web: www.herzog-china.com

## Changzhou Technology Service Center

West Street 255#, Xixiashu Town,  
Xinbei District, Changzhou City,  
Jiangsu Province, China  
Tel: +86-519-83 85 09 55  
Email: dezhu@herzog-china.com

## South China Technology Service Center

FuYuan Business Center 206#, 1# 13th Alley,  
MaiYuan Road, XinAn Community, ChangAn Town,  
DongGuan City, GuangDong Province, China  
Tel: +86-769-81 88 99 62  
Email: dezhu@herzog-china.com

## INDIA

**TMS PRECISION TECH PVT. LTD**  
B2-302, Regency Cosmos  
Baner Road, Pune: 411045 India  
Tel: +91 904 999 0855  
Email: mayur.shinde@tmsprecisiontech.com  
Web: www.tmsprecisiontech.com

## IRAN

**plan:b4u GmbH**  
Colmarplatz 1 / Top XXIII  
7000 Eisenstadt Austria  
Tel: +43 664 127 3039  
Email: info@planb4u.com  
Web: www.planb4u.com

## IRAQ

**plan:b4u GmbH**  
Colmarplatz 1 / Top XXIII  
7000 Eisenstadt Austria  
Tel: +43 664 127 3039  
Email: info@planb4u.com  
Web: www.planb4u.com

## ISRAEL

**De-Paz Machinery  
- CNC machines & Accessories**  
Menachem Begin 80 Blvd  
Afula. 1871356 Israel  
Tel: +972-54-421 48 72  
Email: zion@de-paz.com  
Web: www.de-paz.com

## JAPAN

**NK Works Co., Ltd.**  
Nagoya Branch  
1-336 Namiki Nakamura-ku  
Nagoya Aichi 453-0856 Japan  
Tel: +81 52 - 4 19 - 25 01  
Email: y\_kawamura@nk-works.co.jp

## KAZAKHSTAN

**AWM Precision GmbH**  
Genshagener Straße 27  
14974 Ludwigsfelde Germany  
Tel: +49 (0) 33 78 - 5 18 63 67  
Email: arnold@awm-precision.com  
Web: www.awm-precision.com

## KOREA

**Central Technology Co. Ltd**  
D-1311, Gwangmyeong Techno Park, Haanro 60,  
Gwangmyeong-Si, Gyeonggi-Do, 423-050 Korea  
Tel: +82-2-897-0945  
Fax: +82-2-897-0943  
Email: ycr@centraltech.co.kr  
Web: www.centraltech.co.kr

## KUWAIT

**plan:b4u GmbH**  
Colmarplatz 1 / Top XXIII  
7000 Eisenstadt Austria  
Tel: +43 664 127 3039  
Email: info@planb4u.com  
Web: www.planb4u.com

## OMAN

**plan:b4u GmbH**  
Colmarplatz 1 / Top XXIII  
7000 Eisenstadt Austria  
Tel: +43 664 127 3039  
Email: info@planb4u.com  
Web: www.planb4u.com

## PACIFIC

**(Indonesia, Malaysia, Singapore)**  
**ALLIED CHANCE (S) PTE LTD**  
BLK. 1 Wholesale Ctr. #02-08  
Pasir Panjang Wholesale CTR. Singapore 110001  
Tel: +65-67 78 02 63  
Fax: +65-67 78 79 62  
Email: paul.lai@allied-chance.com

## QATAR

**plan:b4u GmbH**  
Colmarplatz 1 / Top XXIII  
7000 Eisenstadt Austria  
Tel: +43 664 127 3039  
Email: info@planb4u.com  
Web: www.planb4u.com

## RUSSIA

**AWM Precision GmbH**  
Genshagener Straße 27  
14974 Ludwigsfelde Germany  
Tel: +49 (0) 33 78 - 5 18 63 67  
Email: arnold@awm-precision.com  
Web: www.awm-precision.com

## SAUDI ARABIA

**plan:b4u GmbH**  
Colmarplatz 1 / Top XXIII  
7000 Eisenstadt Austria  
Tel: +43 664 127 3039  
Email: info@planb4u.com  
Web: www.planb4u.com

## TAIWAN

**HERZOG Taiwan Co., Ltd.**  
10F, No.70 Gongyequ 1st Rd., Situn Dist.  
Taichung City 40766, Taiwan (R.O.C.)  
Tel: +886-4-23 55-33 88  
Fax: +886-4-23 55-22 99  
Email: afly@costa.com.tw  
Web: www.costa.com.tw

## THAILAND

**SARABURI TOOLS&SUPPLY LTD.,PART /  
Clients Co.,Ltd. / WhizCut Asia Limited.**  
299/9 Moo.8,  
Huaysai, Nongkae Saraburi  
18230 Thailand  
Tel: + 66-36-390487  
Fax: +66-36-390486  
Mob: + 66-80-661 7722  
Email: sutee@saraburitools.com

## TURKEY

**Mikron Otomasyon ve CNC Teknolojileri**  
Yeni mahalle Yalı sokak  
Panorama Life Sitesi Nu:1  
34882 Yakacık Kartal Istanbul  
Tel: +90 216 671 03 24  
Email: info@mikronotomasyon.com  
Web: www.mikronotomasyon.com

## UNITED ARAB EMIRATES

**plan:b4u GmbH**  
Colmarplatz 1 / Top XXIII  
7000 Eisenstadt Austria  
Tel: +43 664 127 3039  
Email: info@planb4u.com  
Web: www.planb4u.com

## VIETNAM

**Central Technology Co. Ltd**  
D-1311, Gwangmyeong Techno Park, Haanro 60,  
Gwangmyeong-Si, Gyeonggi-Do, 423-050  
Korea  
Tel: +82-2-897-0945  
Fax: +82-2-897-0943  
Email: ycr@centraltech.co.kr  
Web: www.centraltech.co.kr



## ALGERIA

**oelheld technologies SAS**  
innovative fluid technology  
Technopôle de Forbach-Sud  
140, Avenue Jean-Eric Bousch  
57600 Oeting France  
Tel: +33 (0) 387-90 42 14  
Fax: +33 (0) 387-84 66 91  
Email: martin.gundelach@oelheld.de  
Web: www.oelheld.com

## AUSTRALIA

**Camco Cutting Tools Int'l Pty. Ltd.**  
1/25 Mareno Rd., P.O. Box 1575,  
Tullamarine, Victoria, 3043 Australia  
Tel: +61 (0)3 8336 1500  
Fax: +61 (0)3 8336 1499  
Mob: +61 (0)413 126 868  
Email: sales@camcointl.com

## BRAZIL

**Metalsystem**  
Rua João Pereira Chaves, 440  
RS 93032-320 Jardim America, São Leopoldo Brazil  
Tel: +55 51 8159-8455  
Email: vendas@metalsystem.ind.br  
Email: renato@metalsystem.ind.br  
Web: www.metalsystem.ind.br

## CANADA

**Toolroom Solutions Inc.**  
Ed Sinkora  
8824 Old Block House Ln  
22551 Spotsylvania USA  
Tel: +1 540 9 40 - 59 77  
Email: ed@toolroom.solutions

## MOROCCO

**oelheld technologies SAS**  
innovative fluid technology  
Technopôle de Forbach-Sud  
140, Avenue Jean-Eric Bousch  
57600 Oeting France  
Tel: +33 (0) 387-90 42 14  
Fax: +33 (0) 387-84 66 91  
Email: martin.gundelach@oelheld.de  
Web: www.oelheld.com

## TUNISIA

**oelheld technologies SAS**  
innovative fluid technology  
Technopôle de Forbach-Sud  
140, Avenue Jean-Eric Bousch  
57600 Oeting France  
Tel: +33 (0) 387-90 42 14  
Fax: +33 (0) 387-84 66 91  
Email: martin.gundelach@oelheld.de  
Web: www.oelheld.com

## USA

**Toolroom Solutions Inc.**  
Ed Sinkora  
8824 Old Block House Ln  
22551 Spotsylvania USA  
Tel: +1 540 9 40 - 59 77  
Email: ed@toolroom.solutions

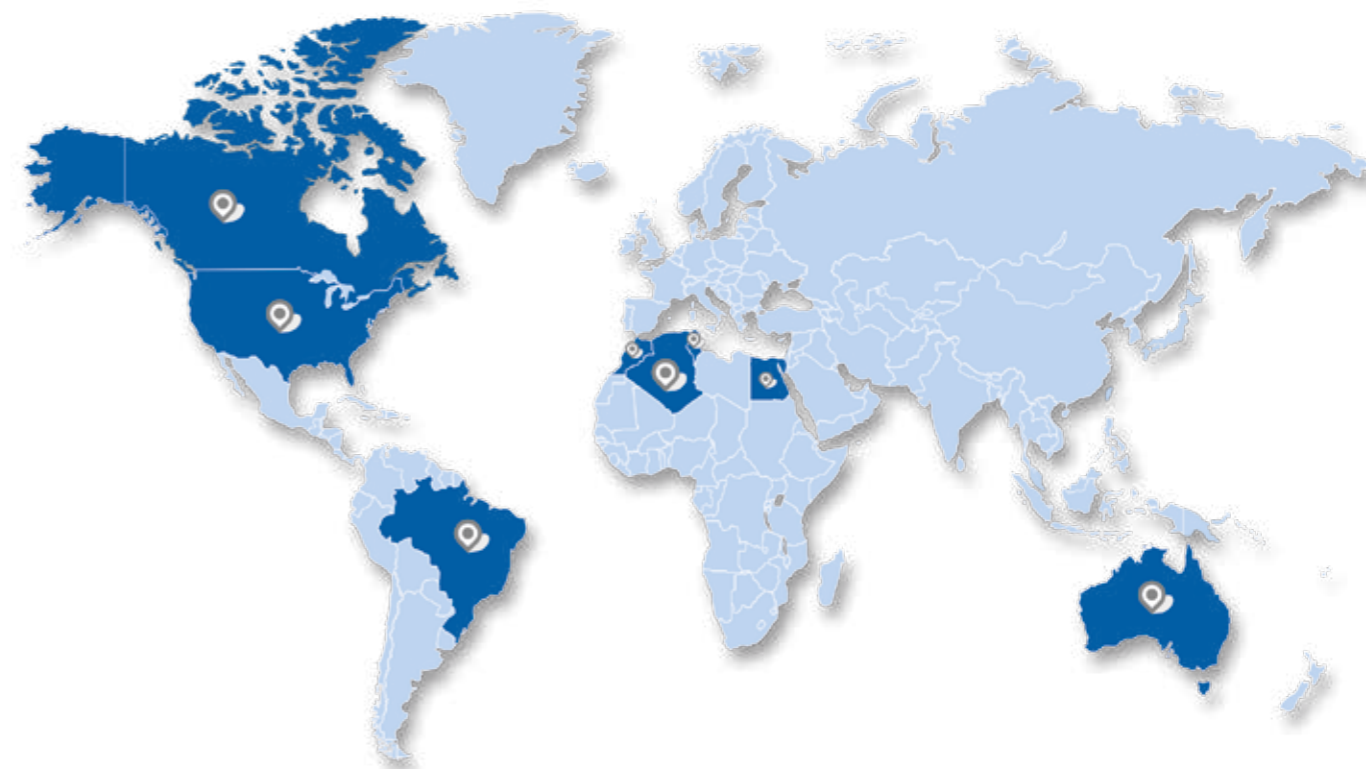

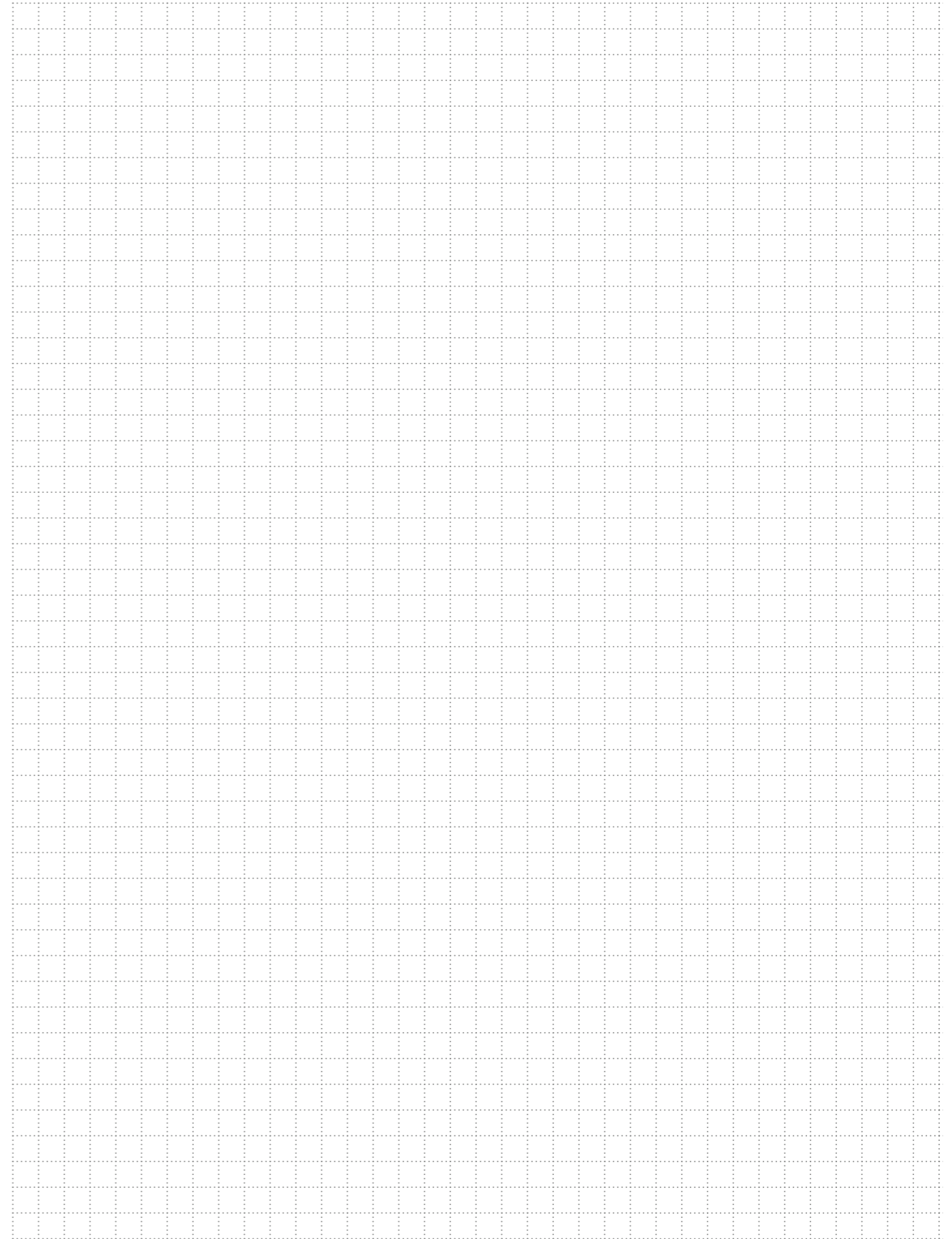
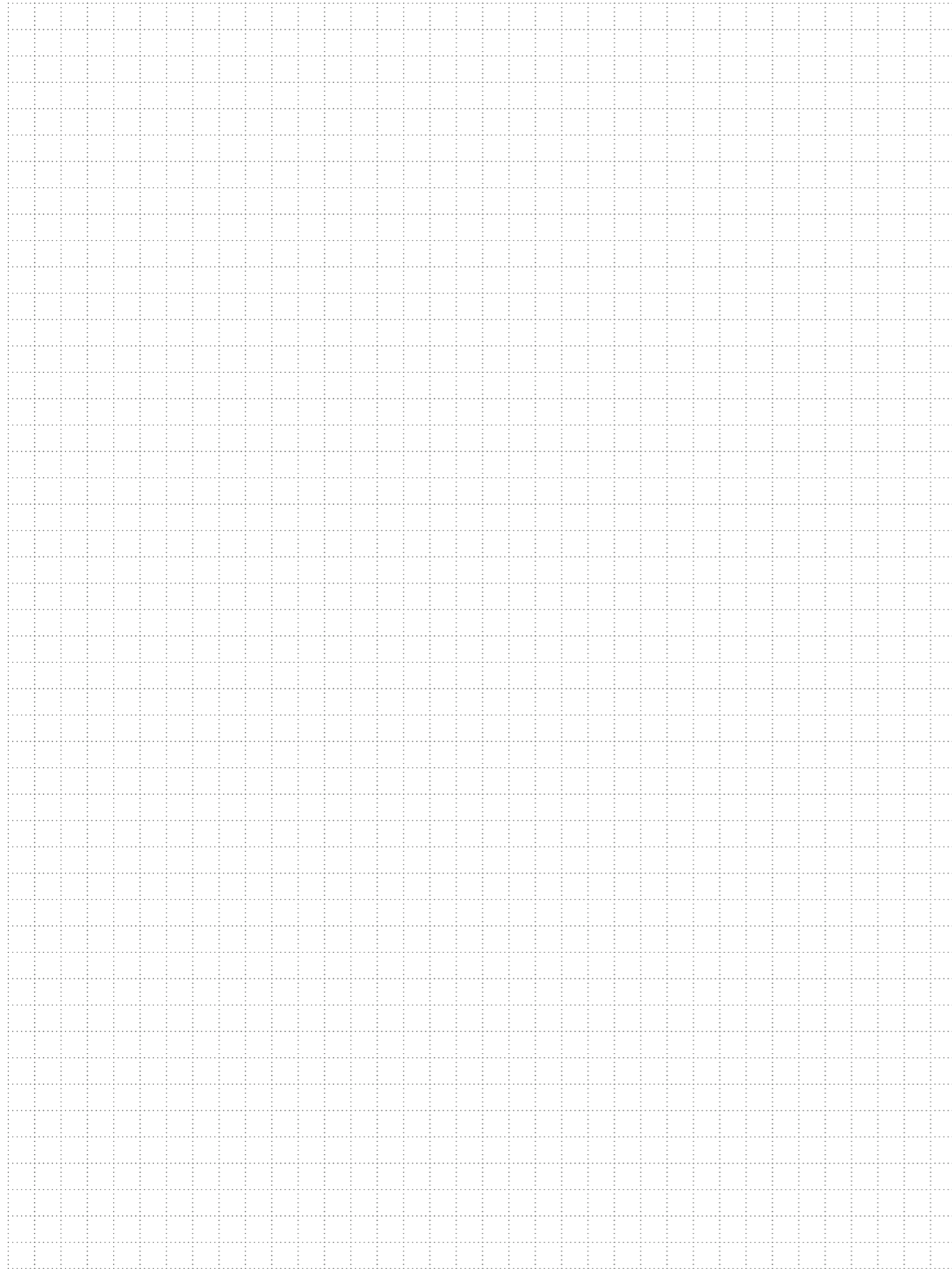



# REVOLUTION IN TOOLGRINDING

