



User Manual

Full HD Wireless Day/Night Network Camera

DCS-2230L

Preface

D-Link reserves the right to revise this publication and to make changes in the content hereof without obligation to notify any person or organization of such revisions or changes. Information in this document may become obsolete as our services and websites develop and change. Please refer to the www.mydlink.com website for the most current information.

Manual Revisions

Revision	Date	Description
1.0	November 10, 2014	Version A1 with firmware version 1.00

Trademarks

D-Link and the D-Link logo are trademarks or registered trademarks of D-Link Corporation or its subsidiaries in the United States or other countries. All other company or product names mentioned herein are trademarks or registered trademarks of their respective companies.

Apple®, Apple logo®, Safari®, iPhone®, iPad®, iPod touch® and Macintosh® are trademarks of Apple Inc., registered in the U.S. and other countries. App StoreSM is a service mark of Apple Inc.

Chrome™ browser, Google Play™ and Android™ are trademarks of Google Inc.

Internet Explorer®, Windows® and the Windows logo are trademarks of the Microsoft group of companies.

Copyright © 2014 by D-Link Corporation, Inc.

All rights reserved. This publication may not be reproduced, in whole or in part, without prior expressed written permission from D-Link Corporation, Inc.

Table of Contents

Product Overview	5	Network Setup.....	33
Package Contents.....	5	Wireless Setup.....	36
System Requirements	6	Dynamic DNS	37
Introduction.....	7	Image Setup	38
Features.....	8	Audio and Video.....	40
Hardware Overview	9	Preset.....	42
Front View.....	9	Motion Detection	44
Rear View	10	Time and Date.....	45
Side View.....	11	Event Setup.....	46
		SD Card.....	55
Installation	12	Advanced	56
Wireless Installation Considerations.....	12	Digital Input/Output.....	56
Zero Configuration Setup	13	ICR and IR.....	57
Camera Setup Wizard	17	HTTPS.....	58
Windows Users	17	Access List.....	59
Mac Users.....	18	SNMP	60
Manual Hardware Installation.....	20	Maintenance	61
WPS - Push Button Setup.....	21	Admin.....	61
Mount the Camera	22	System	62
mydlink.....	23	Firmware Upgrade.....	63
Configuration	24	Status	64
Using the Configuration Interface.....	24	Device Info	64
Live Video	25	Logs	65
Setup	27	Help.....	66
Setup Wizard	27		

DI/DO Specifications67

Technical Specifications68

Safety Statements71

Product Overview

Package Contents



DCS-2230L Full HD Wireless Day/Night Network Camera



CAT5 Ethernet cable



Power adapter



CD-ROM with User Manual and software



Quick Installation Guide

If any of the above items are missing, please contact your reseller.

Note: Using a power supply with a different voltage than the one included with your product will cause damage and void the warranty for this product.

System Requirements

Hardware Requirements	<ul style="list-style-type: none">• A microSD memory card (optional) is required for recording to onboard storage. SDHC Class 6 or above is recommended.
Network Requirements	<ul style="list-style-type: none">• An Ethernet-based cable or DSL modem• IEEE 802.11n/g wireless clients• 10/100 Ethernet• Broadband Internet connection
Web-based Configuration Utility Requirements	<p>Computer with the following:</p> <ul style="list-style-type: none">• Windows® XP/Vista/7/8, Linux-based, or Mac with OS X 10.6 or higher• An installed Ethernet adapter <p>Browser Requirements:</p> <ul style="list-style-type: none">• Internet Explorer 7.0 or higher• Firefox 12 or higher• Safari 6.0 or higher (with Java installed and enabled)• Chrome 20 or higher <p>Windows® Users: Make sure you have the latest version of Java installed. Visit www.java.com to download the latest version.</p>

Introduction

Congratulations on your purchase of the DCS-2230L Full HD Wireless Day/Night Network Camera. The DCS-2230L is a versatile surveillance solution for your small office or home. The full HD 1920 x 1080 resolution 2 megapixel progressive scan CMOS sensor lets you capture details like never before – especially important for face recognition. A built-in IR-cut filter and IR LED makes sure you don't miss an event no matter how bright or dark your surroundings are. To make things convenient, support for Wireless N means you can easily connect it to your network when setting up your camera on location.

Unlike a standard webcam, the DCS-2230L is a complete system with a built-in CPU and web server that transmits high quality video images for security and surveillance. The DCS-2230L can be accessed remotely, and controlled from any PC over your local network or through the Internet via a web browser. It also comes with the D-Link D-ViewCam™ software bundle that allows you to manage multiple network cameras using remote monitoring, scheduling, recording, motion detection, and notifications for a complete and cost-effective home security solution.

Features

Full HD Resolution

The DCS-2230L Full HD Wireless Day/Night Network Camera is equipped with a 2 megapixel progressive scan CMOS sensor that provides full HD 1920x1080 resolution, the video stream captures a larger scene and provides more details than an analog CCTV camera – so you can identify criminals more easily in critical surveillance applications.

Wireless N for Convenience

The DCS-2230L supports Wireless N, which lets you connect your camera to your network without using an Ethernet cable. This feature lets you set up your camera anywhere without worrying about running network cables to your location.

IR LED for Day and Night Functionality

The built-in IR-cut filter and IR LED enable night time viewing or recording in dark environments at ranges up to 16 feet (5 meters).

DI/DO for Connecting External Devices

Rounding out the flexibility of the DCS-2230L, you can connect an alarm or trigger to its DI/DO port for integration into a surveillance solution.

Remote Monitoring Utility

The D-ViewCam™ application adds enhanced features and functionality for the DCS-2230L and allows administrators to configure and access the DCS-2230L from a remote site via Intranet or Internet. Other features include image monitoring, recording images to a hard drive, viewing up to 32 cameras on one screen, and taking snapshots.

Built-in Mic and Speaker

Covering all the visual components, the DCS-2230L also has a built-in microphone and speaker, so you can transmit two-way audio easily.

mydlink Support

Embrace the power of the cloud by adding your DCS-2230L to the list of devices manageable via the free mydlink web portal.

Web Configuration

Using a standard web browser, administrators can configure and manage the DCS-2230L directly from its own web page via Intranet or Internet. This means you can access your DCS-2230L anytime, anywhere in the world.

Broad Range of Applications

With today's high-speed Internet services, the DCS-2230L can provide the ideal solution for delivering live video images over the Intranet and Internet for remote monitoring. The DCS-2230L allows remote access using a web browser for live image viewing, and allows the administrator to manage and control the DCS-2230L anytime, anywhere in the world.

Hardware Overview

Front View



1	Status LED	Indicates the camera's current status
2	WPS Status LED	Indicates the WPS connection status of the camera
3	Infrared LED	Used to illuminate the camera's field of view at night
4	PIR Sensor	Passive Infrared sensor for motion detection
5	Camera Lens	Records video of the surrounding area
6	Light Sensor	The IR-Cut Removable sensor monitors lighting conditions and switches between color and infrared accordingly
7	Microphone	Records audio from the surrounding area

Rear View

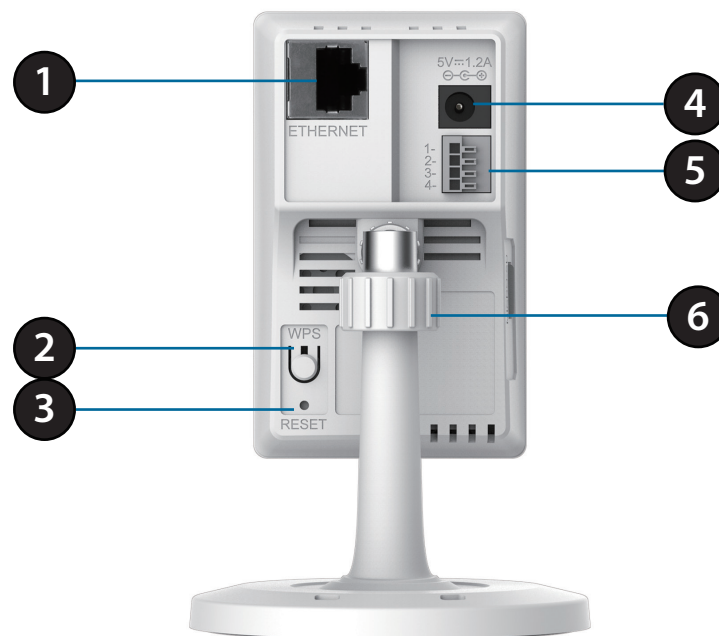

1	Ethernet Port	RJ45 connector for Ethernet
2	WPS Button	Press this button, then press the WPS button for 5 seconds on your router to set up a wireless connection automatically
3	Reset Button	Press and hold this button for 10 seconds to reset the camera
4	Power Connector	Connects to the included DC 5 V power adapter
5	DI/DO Connector	I/O connectors for external devices
6	Adjustment Ring	Tighten or loosen the adjustment ring to adjust the camera's position

Side View

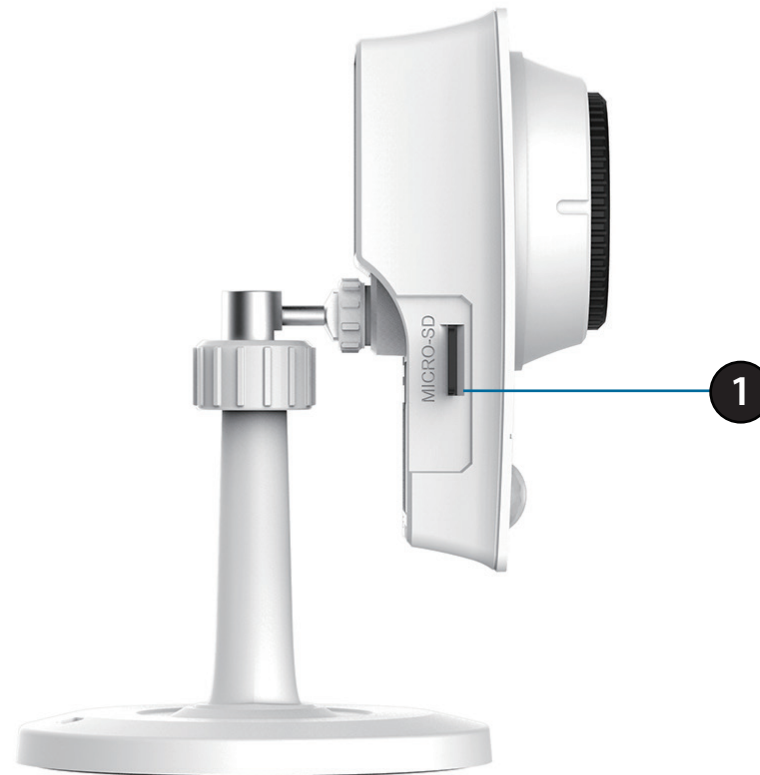

1	microSD Card Slot	Insert a microSD card for Local storage for storing recorded image and video
---	--------------------------	--

Installation

Wireless Installation Considerations

This D-Link device can connect to your wireless network from anywhere within the operating range of your wireless network. However, the number, thickness and location of walls, ceilings, or other objects that the wireless signals must pass through, may limit the range. Typical ranges vary depending on the types of materials and background RF (radio frequency) noise in your home or business. The key to maximizing wireless range is to follow these basic guidelines:

1. Minimize the number of walls and ceilings between your adapter and other network devices (such as your DCS-2230L) - each wall or ceiling can reduce your adapter's range from 3-90 feet (1-30 meters).
2. Be aware of the direct line between network devices. A wall that is 1.5 feet thick (.5 meters), at a 45-degree angle appears to be almost 3 feet (1 meter) thick. At a 2-degree angle, it looks over 42 feet (14 meters) thick. Position your devices so that the signal will travel straight through a wall or ceiling (instead of at an angle) for better reception.
3. Building materials make a difference. A solid metal door or aluminum studs may weaken the wireless signal. Try to position your access points, wireless routers, and other networking devices where the signal passes through drywall or open doorways. Materials and objects such as glass, steel, metal, walls with insulation, water (fish tanks), mirrors, file cabinets, brick, and concrete will degrade your wireless signal.
4. Keep your product at least 3-6 feet or 1-2 meters away from electrical devices or appliances that generate RF noise.
5. If you are using 2.4 GHz cordless phones or other radio frequency sources (such as microwave ovens), your wireless connection may degrade dramatically or drop completely. Make sure your 2.4 GHz phone base is as far away from your wireless devices as possible. The base transmits a signal even if the phone is not in use.

Zero Configuration Setup

If you have a D-Link Cloud Router, you can take advantage of Zero Configuration Setup. Zero Configuration automatically configures your camera's settings for you, and adds it to your mydlink account automatically. This type of setup allows you to set up your camera by simply plugging it in and connecting it to your router.

Connect your camera to your mydlink-enabled Cloud Router and Zero Configuration will automatically configure your DCS-2230L and automatically add the camera to your mydlink account. You can now remotely access your camera from the mydlink.com website to manage and monitor your DCS-2230L.

Connect the Ethernet Cable

If using an Ethernet connection: Connect the included Ethernet cable to the Ethernet port located on the back of the DCS-2230L and connect it to your router.

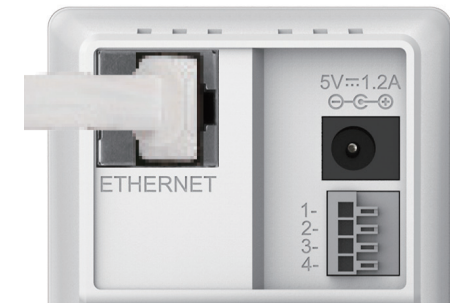

Attach the External Power Supply

Attach the external power supply to the DC Power receptor located on the rear panel of the DCS-2230L and connect it to your wall outlet or power strip.

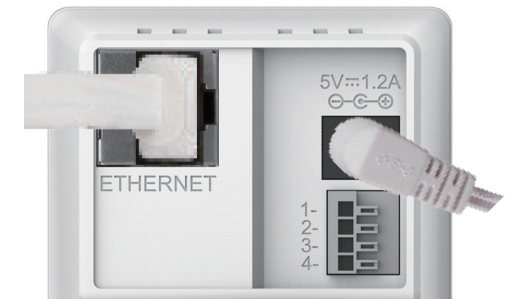

Optional: WPS Wireless Connection

Alternatively, if your router supports WPS, you can use the WPS button on the camera to easily create a secure wireless connection to your network.

To create a WPS connection:

Step 1

Press and hold the WPS button for approximately 5-6 seconds. The blue WPS status LED above the button will blink.

Step 2

Within 60 seconds press the WPS button on your router. On some routers, you may need to log in to the web interface and click on an on-screen button to activate the WPS feature. If you are not sure where the WPS button is on your router, please refer to your router's User Manual.

The DCS-2230L will automatically create a wireless connection to your router. While connecting, the status LED will flash. When the connection process is complete, the status LED will turn solid.

Note: If your router does not support WPS, you can still use the wired connection method on the previous page. After Zero Configuration setup is complete, your router's wireless settings will be automatically transferred to the camera.

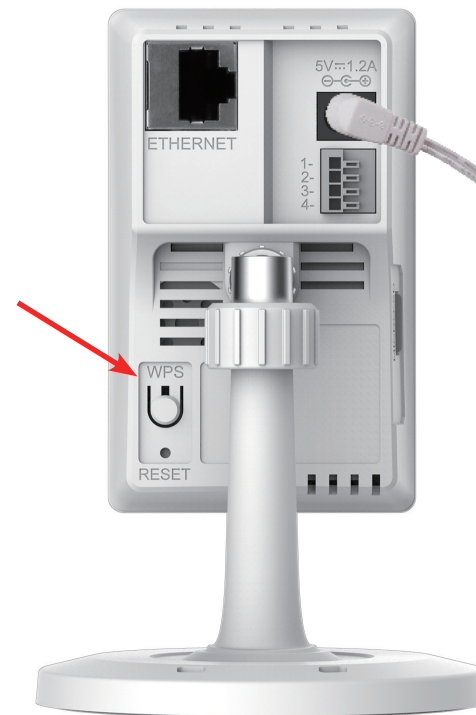

Check Your mydlink Account

From any computer, open a web browser, go to <http://www.mydlink.com> and log into your account. Once mydlink detects your camera, a **New Device Found!** notice will appear in the bottom-left corner. Click on the device name to continue.

mydlink

Welcome, Mehta P

My Devices Shared Devices My Services My Profile

DIR-605L
20019862

Router Status Settings

Model Name DIR-605L

Network Name (SSID) Taonet

Internet IP 192.168.1.103

LAN IP 192.168.0.1

Connected Devices 5 device(s)

0000.3kB
0008.4kB

Connection List

Device	Device Name	IP Address	MAC Address	Block
	CardboardBox	192.168.0.110	00:26:20:02:FE:FA	<input type="checkbox"/>
	--	192.168.0.120	04:54:53:50:53:18	<input type="checkbox"/>
	HeiGuy	192.168.0.100	00:1A:92:E2:4D:C9	<input type="checkbox"/>
	--	192.168.0.121	28:E0:2C:DC:0A:BE	<input type="checkbox"/>
	--	192.168.0.101	F0:A2:25:AA:8C:C3	<input type="checkbox"/>

Suspect List

Device	Device Name	Time	MAC Address	Block
--------	-------------	------	-------------	-------

New Devices!
DCS-2230L

A summary and confirmation notification will appear with the automatically configured details. Make a note of the details and click **OK** to add the camera to your account.

Confirming New Device

Do you want to add this new device to your mydlink account?

装置名稱: DCS-2230L
mydlink Number: 30034971
Network name (SSID): dlink-07725
Admin Password: 7D5XLBUX

You can change these default settings by going to 進階設定 after add it to your device list.

Section 2: Installation

Zero Configuration is now complete and your camera has been added to your mydlink account. You can now view your camera on the mydlink Live View tab.

Your camera is now set up, and you can skip to **mydlink on page 23** to learn more about the mydlink features of this camera, or to **Configuration on page 24** for advanced configuration of your camera.

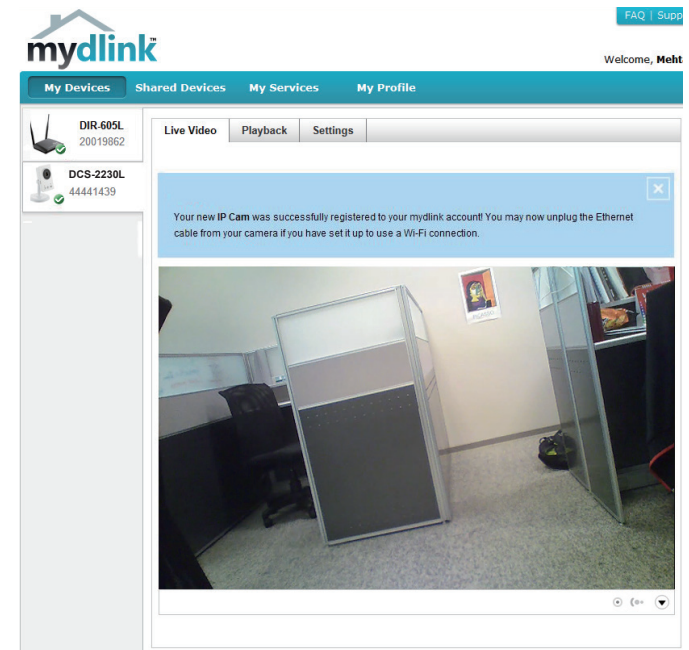

Camera Setup Wizard Windows Users

Insert the Installation CD-ROM into your computer's optical drive to start the autorun program.

Simply click **Set up your Cloud Camera** to go through the Setup Wizard, which will guide you step-by-step through the installation process from connecting your hardware to configuring your camera and registering it with your mydlink account.



Note: If the autorun program does not open, go to My Computer, browse to your CD drive, and double-click on the **autorun.exe** file.

Mac Users

Insert the Installation CD-ROM into your computer's CD drive. On the desktop, open your CD drive and double-click on the **SetupWizard** file.



Within 20-30 seconds, the Setup Wizard will open, which will guide you step-by-step through the installation process from connecting your hardware to configuring your camera and registering it with your mydlink account.

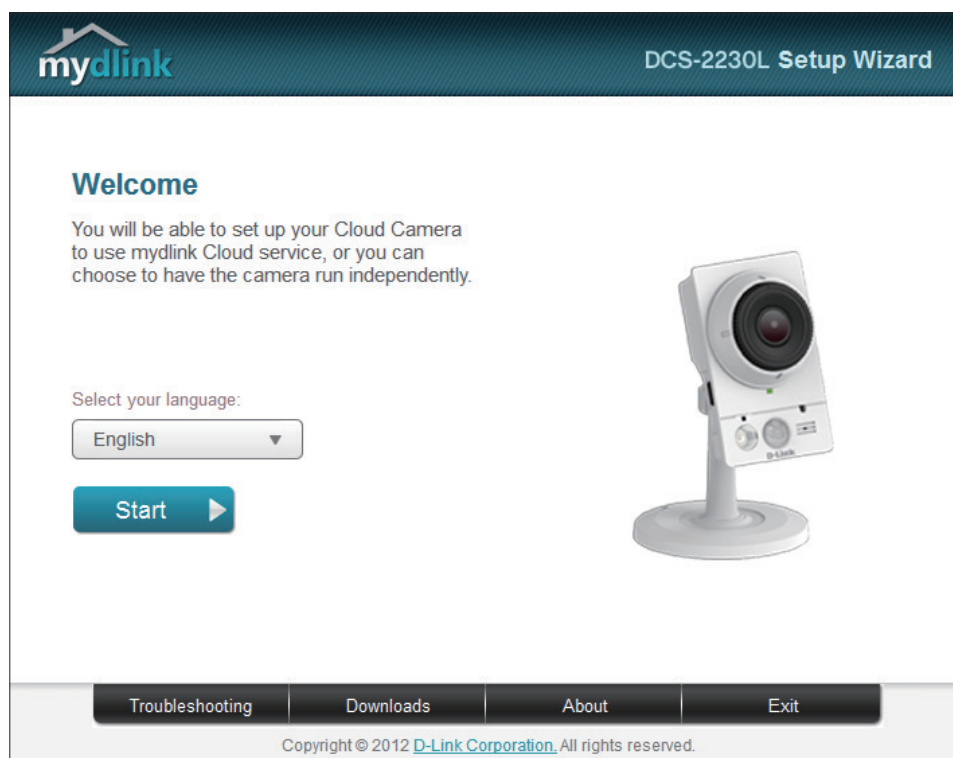

Section 2: Installation

Confirm your camera login details and IP address details and click **Done**.

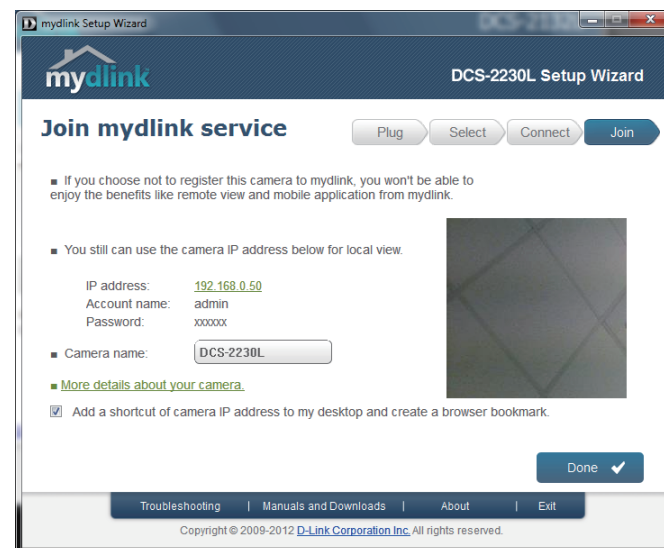

Your DCS-2230L camera is now set up. Log on to your mydlink account and explore the exciting benefits available to you.

Your camera is now set up, and you can skip to **mydlink on page 23** to learn more about the mydlink features of this camera, or go to **Configuration on page 24** for advanced configuration of your camera.

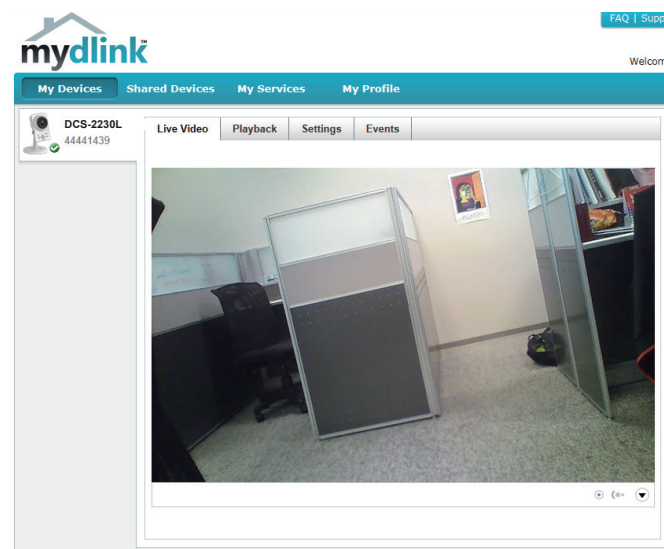

Manual Hardware Installation

If you wish to set up your camera without using the Camera Setup Wizard, please follow these steps.

Note: In order to use the mydlink features of this product, you will need to go through the Camera Setup Wizard.

Connect the Ethernet Cable

If using an Ethernet connection: Connect the included Ethernet cable to the Ethernet port located on the back of the DCS-2230L and connect it to your router.

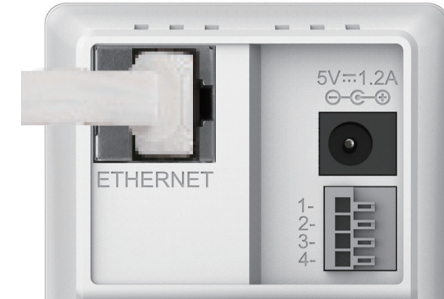

Attach the External Power Supply

Attach the external power supply to the DC Power receptor located on the rear panel of the DCS-2230L and connect it to your wall outlet or power strip.

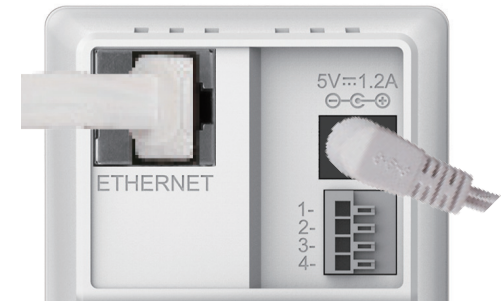

WPS - Push Button Setup

If your router supports WPS, you can use the WPS button on the camera to easily create a secure wireless connection to your network.

To create a WPS connection:

Step 1

Press and hold the WPS button for approximately 5-6 seconds. The blue WPS status LED above the button will blink.

Step 2

Within 60 seconds press the WPS button on your router. On some routers, you may need to log in to the web interface and click on an on-screen button to activate the WPS feature. If you are not sure where the WPS button is on your router, please refer to your router's User Manual.

The DCS-2230L will automatically create a wireless connection to your router. While connecting, the status LED will flash. When the connection process is complete, the status LED will turn solid.

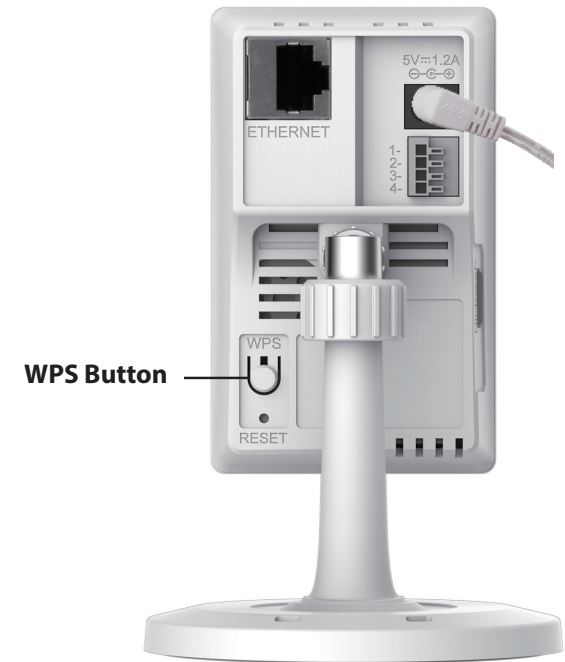

Mount the Camera

Please refer to the steps below to assist you with mounting the camera.

i We suggest that you configure the camera before mounting.

1. Place the mounting base where you want to position the camera and use a pencil to mark the holes.

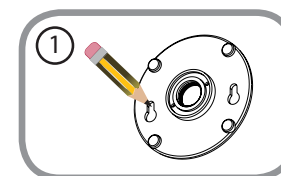

2. Depending on the material of the wall or ceiling, use proper tools to drill two holes or screws where you marked. If the wall is made out of concrete, drill the holes first, insert the plastic anchors and then the screws.

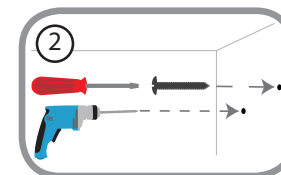

! The space between the camera and the screwheads should be 3mm.

3. Place the mounting base over the screw that is mounted on the wall. Make sure to fit the screw-heads over the big holes and slide it downward to lock firmly. Lightly pull the base forward to make sure that it is locked.

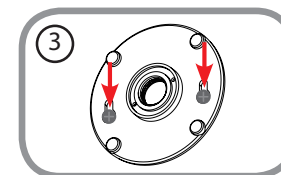

4. Place the base cover on the base and screw the camera stem clockwise into the mounting base.

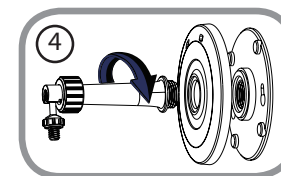

5. Adjust the angle of the camera as desired, then tighten the collar on the camera stem to lock it in place.

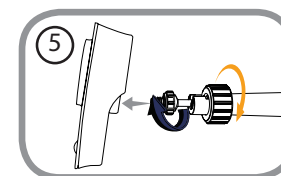

mydlink

After registering your DCS-2230L camera with a mydlink account in the Camera Installation Wizard. You will be able to remotely access your camera from the www.mydlink.com website. After signing in to your mydlink account, you will see a screen similar to the following:

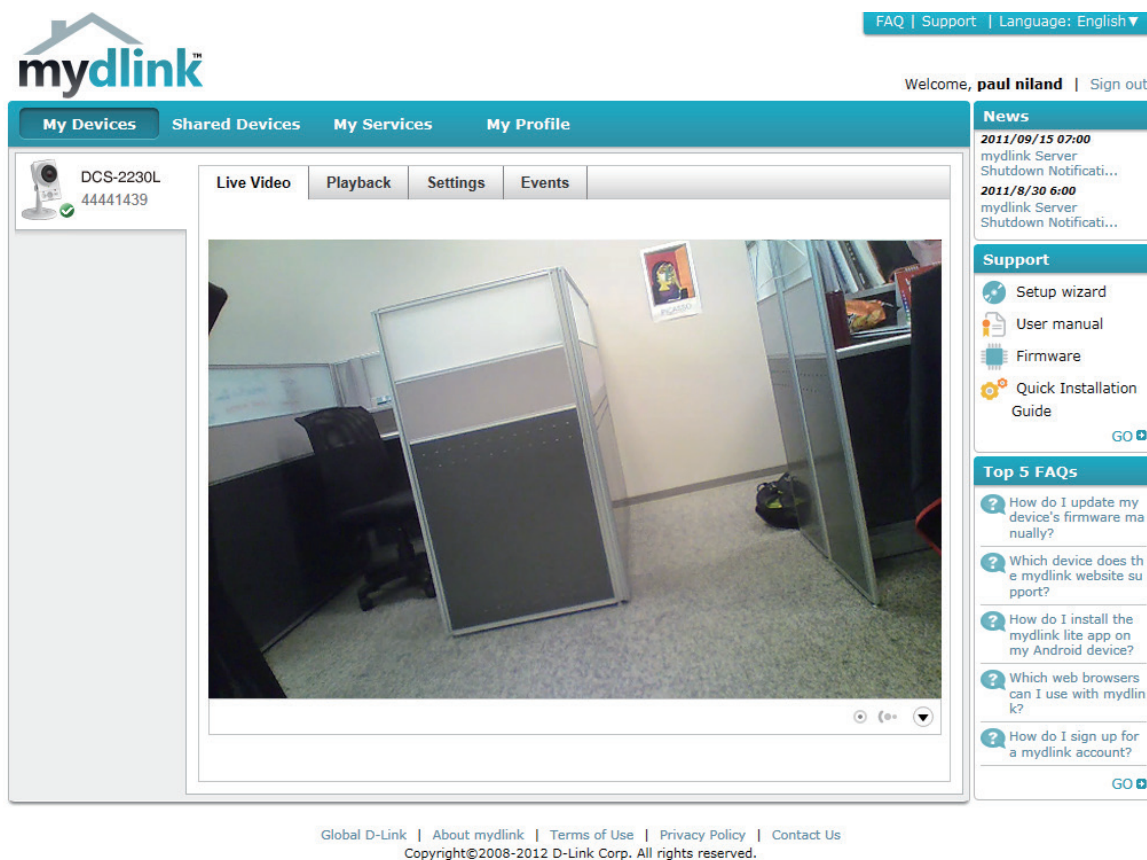

The screenshot displays the mydlink website interface. At the top left is the mydlink logo. To the right, there are links for 'FAQ | Support | Language: English'. Below this, a user greeting reads 'Welcome, paul niland | Sign out'. The main navigation bar includes 'My Devices', 'Shared Devices', 'My Services', and 'My Profile'. The 'My Devices' section is active, showing a camera icon and the device ID 'DCS-2230L 44441439'. Below this, there are tabs for 'Live Video', 'Playback', 'Settings', and 'Events'. The 'Live Video' tab is selected, displaying a real-time video feed of an office cubicle. To the right of the video feed, there are sections for 'News', 'Support', and 'Top 5 FAQs'. The 'Support' section includes links for 'Setup wizard', 'User manual', 'Firmware', and 'Quick Installation Guide'. The 'Top 5 FAQs' section lists common questions such as 'How do I update my device's firmware manually?' and 'Which device does the mydlink website support?'. At the bottom of the page, there are links for 'Global D-Link | About mydlink | Terms of Use | Privacy Policy | Contact Us' and a copyright notice: 'Copyright©2008-2012 D-Link Corp. All rights reserved.'

For more details on using your camera with mydlink, go to the **Support** section of the mydlink website and check the **User Manual** section for your product to find the latest instruction guide for your camera's mydlink features.

Configuration

Using the Configuration Interface

After completing the Camera Installation Wizard, you are ready to use your camera. The camera's built-in web configuration utility is designed to allow you to easily access and configure your DCS-2230L. At the end of the wizard, enter the IP address of your camera into a web browser, such as Mozilla Firefox. To log in, use the username **admin** and the password you created in the Installation Wizard. If you did not create a password, the default password is blank. After entering your password, click **OK**.









Live Video

This section shows your camera's live video. You may select any of the available icons listed below to operate the camera. You may also select your language using the drop-down menu on the left side of the screen.

You can zoom in and out on the live video image using your mouse. Right-click to zoom out or left-click to zoom in on the image.

SD Status: This option displays the status of the SD card. If no SD card has been inserted, this screen will display the message "Card Invalid."

IO Status: This option displays the status of your I/O device if a device has been connected.





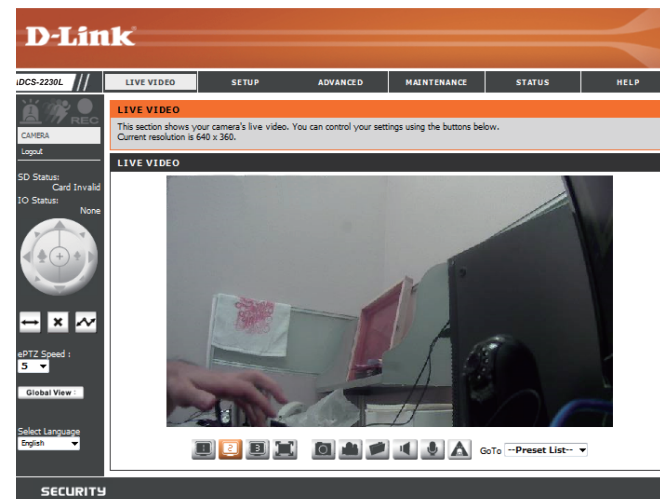





	Digital Input Indicator	This indicator will change color when a digital input signal is detected.
	Motion Trigger Indicator	This indicator will change color when a trigger event occurs. Note: The video motion feature for your camera must be enabled.
	Recording Indicator	When a recording is in progress, this indicator will change color.
	Control Pad	This control pad can be used to electronically pan, tilt, and zoom (ePTZ) within the camera's predefined view area, if one has been defined.
	Auto Pan	Starts the automatic panning function. The ROI will pan from back and forth within the FOV.
	Stop	Stops automatic panning.
	Preset Path	Starts the camera's motion along the predefined path.

ePTZ Speed: You may select a value between 0 and 64. 0 is the slowest and 64 is the fastest.



Global View: This window indicates the total field of view (FOV) of the camera. The red box indicates the visible region of interest (ROI).

Language: You may select the interface language using this menu.

- | | |
|---|--|
|  Video Profile 1 |  Record a Video Clip |
|  Video Profile 2 |  Set a Storage Folder |
|  Video Profile 3 |  Listen/Stop Audio In (from microphone) |
|  Full screen mode |  Start/Stop Audio Out (to speaker) |
|  Taking a Snapshot |  Start/Stop Digital Output |

Go To: If any presets have been defined, selecting a preset from this list will **(Preset List)** display it.

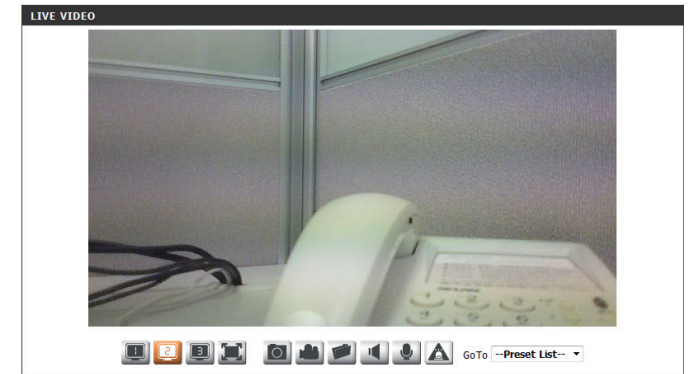

Setup Setup Wizard

To configure your DCS-2230L, click **Internet Connection Setup Wizard**. Alternatively, you may click **Manual Internet Connection Setup** to manually configure your DCS-2230L and skip to **Network Setup** on page 33.

To quickly configure your DCS-2230L's motion detection settings, click **Motion Detection Setup Wizard**. If you want to enter your settings without running the wizard, click **Manual Motion Detection Setup** and skip to **Motion Detection** on page 44.

INTERNET CONNECTION SETTINGS

In this section, you can setup the IP camera's wired network interface settings. If you are configuring this device for the first time, D-Link recommends that you click the Setup Wizard button, and follow the instructions on screen. If you wish to modify or configure the IP camera settings manually, click manual setup to enable the IP camera connection setup.

IP CAMERA MOTION DETECTION SETTINGS

In this section, you can setup the IP camera's Motion Detection settings. If you are configuring this device for the first time, D-Link recommends that you click the Setup Wizard button, and follow the instructions on screen. If you wish to modify or configure the Motion Detection manually, click manual setup to enable the Motion Detection setup.

Internet Connection Setup Wizard

This wizard will guide you through a step-by-step process to configure your new D-Link Camera and connect the camera to the Internet. Click **Next** to continue.

Note: Select DHCP if you are unsure of which settings to choose.

Click **Next** to continue.

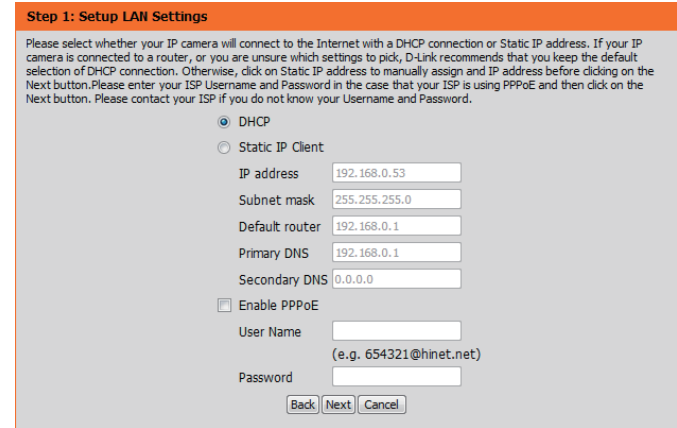
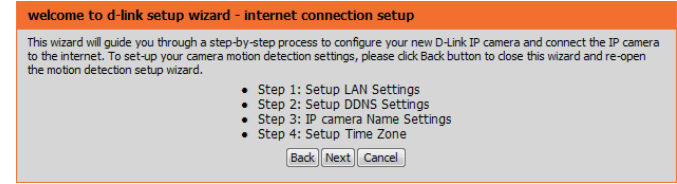

Section 4: Configuration

Select **Static IP** if your Internet Service Provider has provided you with connection settings, or if you wish to set a static address within your home network. Enter the correct configuration information and click **Next** to continue.

If you are using PPPoE, select **Enable PPPoE** and enter your User Name and Password, otherwise click **Next** to continue.

Step 1: Setup LAN Settings

Please select whether your IP camera will connect to the Internet with a DHCP connection or Static IP address. If your IP camera is connected to a router, or you are unsure which settings to pick, D-Link recommends that you keep the default selection of DHCP connection. Otherwise, click on Static IP address to manually assign and IP address before clicking on the Next button. Please enter your ISP Username and Password in the case that your ISP is using PPPoE and then click on the Next button. Please contact your ISP if you do not know your Username and Password.

DHCP

Static IP Client

IP address

Subnet mask

Default router

Primary DNS

Secondary DNS

Enable PPPoE

User Name

(e.g. 654321@hinet.net)

Password

If you have a Dynamic DNS account and would like the camera to update your IP address automatically, Select **Enable DDNS** and enter your host information. Click **Next** to continue.

Step 2: Setup DDNS Settings

If you have a Dynamic DNS account and would like the IP camera to update your IP address automatically, enable DDNS and enter in your host information below. Please click on the Next button to continue.

Enable DDNS

Server Address <<

Host Name

User Name

Password

Verify Password

Timeout (hours)

Enter a name for your camera and click **Next** to continue.

Step 3: IP camera Name Settings

D-Link recommends that you rename your IP camera for easy accessibility. You can then identify and connect to your IP camera via this name. Please assign a name of your choice before clicking on the Next button.

IP camera Name

Section 4: Configuration

Configure the correct time to ensure that all events will be triggered as scheduled. Click **Next** to continue.

If you have selected DHCP, you will see a summary of your settings, including the camera's IP address. Please write down all of this information as you will need it in order to access your camera.

Click **Apply** to save your settings.

Step 4: Setup Time Zone

Please configure the correct time to ensure that all events are triggered, captured and scheduled at the correct time and day and then click on the Next button.

Time Zone (GMT+08:00) Taipei

Enable Daylight Saving

Back Next Cancel

Step 5: Setup complete

Below is a summary of your IP camera settings. Click on the Back button to review or modify settings or click on the Apply button if all settings are correct. It is recommended to note down these settings in order to access your IP camera on the network or via your web browser.

IP Address	DHCP
IP camera Name	DCS-2230L
Time Zone	(UTC+08:00) Taipei
DDNS	Enable
PPPoE	Disable

Back Apply Cancel

Motion Detection Setup Wizard

This wizard will guide you through a step-by-step process to configure your camera's motion detection functions.

Click **Next** to continue.

Step 1

This step will allow you to enable or disable motion detection, specify the detection sensitivity, and adjust the camera's ability to detect movement.

You may specify whether the camera should capture a snapshot or a video clip when motion is detected.

Please see the **Motion Detection** section on **Motion Detection** on page 44 for information about how to configure motion detection.

Step 2

This step allows you to enable motion detection based on a customized schedule. Specify the day and hours. You may also choose to always record whenever motion is detected.

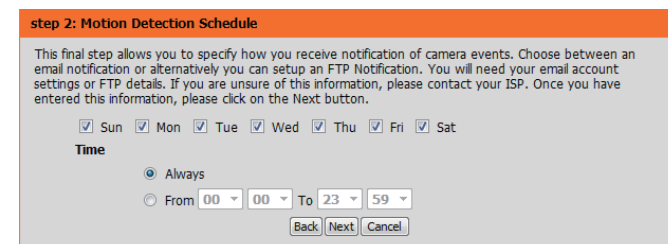
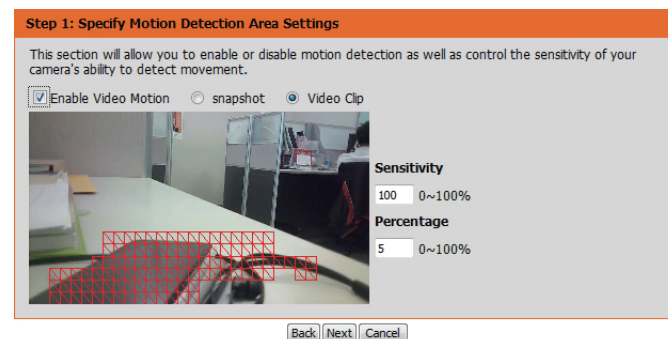
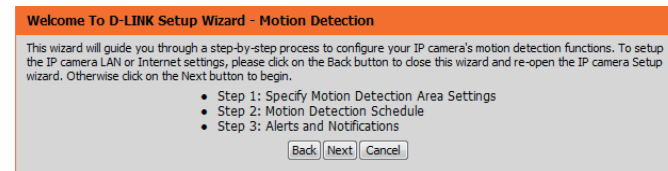

Section 4: Configuration

Step 3

This step allows you to specify how you will receive event notifications from your camera. You may choose not to receive notifications, or to receive notifications via e-mail or FTP.

Please enter the relevant information for your e-mail or FTP account.

Click **Next** to continue.

Step 3: Alerts and Notification

This final step allows you to specify how you receive notification of camera events. Choose between an email notification or alternatively you can setup an FTP Notification. You will need your email account settings or FTP details. If you are unsure of this information, please contact your ISP. Once you have entered this information, please click on the Next button.

Do not notify me

Email

Sender email address

Recipient email address

Server address

User name

Password

Port

FTP

Server address

Port

User name

Password

Remote folder name

Step 4

You have completed the Motion Detection Wizard.

Please verify your settings and click **Apply** to save them.

Step 4: Setup Complete

You have completed your IP camera setup. Please click the Back button if you want to review or modify your settings or click on the Apply button to save and apply your settings.

Motion Detection : Enable

EVENT : Video Clip

Schedule Day : Sun ,Mon ,Tue ,Wed ,Thu ,Fri ,Sat ,

Schedule Time : Always

Alerts and Notification : Email

Please wait a few moments while the camera saves your settings and restarts.

Step 4: Setup Complete

You have completed your IP camera setup. Please click the Back button if you want to review or modify your settings or click on the Apply button to save and apply your settings.

Changes saved.IP camera's network is restarting, please wait for 5 seconds ...

Network Setup

Use this section to configure the network connections for your camera. All relevant information must be entered accurately. After making any changes, click the **Save Settings** button to save your changes.

LAN Settings: This section lets you configure settings for your local area network.

DHCP: Select this connection if you have a DHCP server running on your network and would like your camera to obtain an IP address automatically.

If you choose DHCP, you do not need to fill out the IP address settings.

Static IP Address: You may obtain a static or fixed IP address and other network information from your network administrator for your camera. A static IP address may simplify access to your camera in the future.

IP Address: Enter the fixed IP address in this field.

Subnet Mask: This number is used to determine if the destination is in the same subnet. The default value is 255.255.255.0.

Default Gateway: The gateway used to forward frames to destinations in a different subnet. Invalid gateway settings may cause the failure of transmissions to a different subnet.

Primary DNS: The primary domain name server translates names to IP addresses.

Secondary DNS: The secondary DNS acts as a backup to the primary DNS.

NETWORK SETUP

You can configure your LAN and Internet settings here.

LAN SETTINGS

DHCP
 Static IP Client

IP address
 Subnet mask
 Default router
 Primary DNS
 Secondary DNS

 Enable UPnP presentation
 Enable UPnP port forwarding

Forwarding Port
 Forwarding Status UPnP forwarding is inactive

PPPOE SETTINGS

Enable Disable
 User Name
 Password
 Confirm password
 PPPoE Status PPPoE is inactive.

HTTP

HTTP port
 Access name for stream1
 Access name for stream2
 Access name for stream3

HTTPS

HTTPS port

Enable UPnP Presentation: Enabling this setting allows your camera to be configured as a UPnP device on your network.

Enable UPnP Port Forwarding: Enabling this setting allows the camera to add port forwarding entries into the router automatically on a UPnP capable network.

Enable PPPoE: Enable this setting if your network uses PPPoE.

User Name / Password: Enter the username and password for your PPPoE account. Re-enter your password in the Confirm Password field. You may obtain this information from your ISP.

HTTP Port: The default port number is 80.

Access Name for Stream 1~3: The default name is video#.mjpg, where # is the number of the stream.

HTTPS Port: You may use a PC with a secure browser to connect to the HTTPS port of the camera. The default port number is 443.

RTSP Port: The port number that you use for RTSP streaming to mobile devices, such as mobile phones or PDAs. The default port number is 554. You may specify the address of a particular stream. For instance, live1.sdp can be accessed at rtsp://x.x.x.x/video1.sdp where the x.x.x.x represents the IP address of your camera.

LAN SETTINGS	
<input checked="" type="radio"/> DHCP	
<input type="radio"/> Static IP Client	
IP address	<input type="text" value="192.168.0.53"/>
Subnet mask	<input type="text" value="255.255.255.0"/>
Default router	<input type="text" value="192.168.0.1"/>
Primary DNS	<input type="text" value="192.168.0.1"/>
Secondary DNS	<input type="text" value="0.0.0.0"/>
<input checked="" type="checkbox"/> Enable UPnP presentation	
<input type="checkbox"/> Enable UPnP port forwarding	
Forwarding Port	<input type="text" value="1024"/> <input type="button" value="Test"/>
Forwarding Status	UPnP forwarding is inactive

PPPOE SETTINGS	
<input type="radio"/> Enable <input checked="" type="radio"/> Disable	
User Name	<input type="text"/>
Password	<input type="text"/>
Confirm password	<input type="text"/>
PPPoE Status	PPPoE is inactive.

HTTP	
HTTP port	<input type="text" value="80"/>
Access name for stream1	<input type="text" value="video1.mjpg"/>
Access name for stream2	<input type="text" value="video2.mjpg"/>
Access name for stream3	<input type="text" value="video3.mjpg"/>

HTTPS	
HTTPS port	<input type="text" value="443"/>

RTSP	
Authentication	<input type="text" value="Disable"/>
RTSP port	<input type="text" value="554"/>
Access name for stream1	<input type="text" value="live1.sdp"/>
Access name for stream2	<input type="text" value="live2.sdp"/>
Access name for stream3	<input type="text" value="live3.sdp"/>

Enable CoS: Enabling the Class of Service setting implements a best-effort policy without making any bandwidth reservations.

Enable QoS: Enabling QoS allows you to specify a traffic priority policy to ensure a consistent Quality of Service during busy periods. If the DCS-2230L is connected to a router that itself implements QoS, the router's settings will override the QoS settings of the camera.

Enable IPV6: Enable the IPv6 setting to use the IPv6 protocol. Enabling the option allows you to manually set up the address, specify an optional IP address, specify an optional router and an optional primary DNS.

Enable Multicast for stream: The DCS-2230L allows you to multicast each of the available streams via group address and specify the TTL value for each stream. Enter the port and TTL settings you wish to use if you do not want to use the defaults.

Enable Bonjour: Enable Bonjour to broadcast to network devices (such as iPhones) using this protocol. You can enter a custom Bonjour Name for the router in the text box for identification.

COS SETTINGS

Enable CoS
 VLAN ID [0~4095]
 Live video
 Live audio
 Event/Alarm
 Management

QOS SETTINGS

Enable QoS
 Live video
 Live audio
 Event/Alarm
 Management

IPV6

Enable IPv6

 Manually setup the IP address
 Optional IP address / Prefix length /
 Optional default router
 Optional primary DNS

MULTICAST

Enable multicast for stream 1
 Multicast group address
 Multicast video port
 Multicast RTCP video port
 Multicast audio port
 Multicast RTCP audio port
 Multicast TTL [1~255]
 Enable multicast for stream 2
 Multicast group address
 Multicast video port
 Multicast RTCP video port
 Multicast audio port
 Multicast RTCP audio port
 Multicast TTL [1~255]
 Enable multicast for stream 3
 Multicast group address
 Multicast video port
 Multicast RTCP video port
 Multicast audio port
 Multicast RTCP audio port
 Multicast TTL [1~255]

Wireless Setup

This section allows you to set up and configure the wireless settings on your camera. After making any changes, click the **Save Settings** button to save your changes.

Site Survey: Click the **Rescan** button to scan for available wireless networks. After scanning, you can use the drop-down box to select an available wireless network. The related information (SSID, Wireless Mode, Channel, Authentication, Encryption) will be automatically filled in for you.

SSID: Enter the SSID of the wireless access point you wish to use.

Wireless Mode: Use the drop-down box to select the mode of the wireless network you wish to connect to. Infrastructure is normally used to connect to an access point or router. Ad-Hoc is usually used to connect directly to another computer.

Channel: If you are using Ad Hoc mode, select the channel of the wireless network you wish to connect to, or select Auto.

Authentication: Select the authentication you use on your wireless network - Open, Shared, WPA-PSK, or WPA2-PSK.

Encryption: If you use WPA-PSK or WPA2-PSK authentication, you will need to specify whether your wireless network uses TKIP or AES encryption. If you use Open or Shared authentication, WEP encryption should be the setting.

Key: If you use WEP, WPA-PSK, or WPA2-PSK authentication, enter the Key (also known as password) used for your wireless network.

WIRELESS SETUP

In this section, you can setup and configure the wireless settings on your camera.

WIRELESS CONFIGURATION

Enable Wireless	<input type="checkbox"/>
Site Survey	=== SSID List === <input type="button" value="Rescan"/>
SSID	<input type="text" value="default"/>
Wireless Mode	<input type="text" value="Infrastructure"/>
Channel	<input type="text" value="Auto"/>
Authentication	<input type="text" value="Open"/>
Encryption	<input type="text" value="Disable"/>
Default Key	<input type="text" value="1"/>
Key 1	<input type="text" value="*****"/>
Key 2	<input type="text" value="*****"/>
Key 3	<input type="text" value="*****"/>
Key 4	<input type="text" value="*****"/>

(5 or 13 ASCII, 10 or 26 HEX characters)

Dynamic DNS

DDNS (Dynamic Domain Name Server) will hold a DNS host name and synchronize the public IP address of the modem when it has been modified. A user name and password are required when using the DDNS service. After making any changes, click the **Save Settings** button to save your changes.

Enable DDNS: Select this checkbox to enable the DDNS function.

Server Address: Select your Dynamic DNS provider from the pull down menu or enter the server address manually.

Host Name: Enter the host name of the DDNS server.

User Name: Enter the user name or e-mail used to connect to your DDNS account.

Password: Enter the password used to connect to your DDNS server account.

Timeout: Enter the DNS timeout values you wish to use.

Status: Indicates the connection status, which is automatically determined by the system.

DYNAMIC DNS

The Dynamic DNS feature allows you to use a domain name that you have purchased (www.yourdomain.com) to access your IP camera with a dynamically assigned IP address. Most broadband Internet service providers assign dynamic (changing) IP addresses. By using a DDNS service, you can enter your domain name to connect to your IP camera no matter what your IP address is.

[Sign up for D-Link's Free DDNS service at www.DLinkDDNS.com.](http://www.DLinkDDNS.com)

Save Settings Don't Save Settings

DYNAMIC DNS SETTING

Enable DDNS

Server Address <<

Host Name

User Name

Password

Verify Password

Timeout (hours)

Status Active

Save Settings Don't Save Settings

Image Setup

In this section, you may configure the video image settings for your camera. A preview of the image will be shown in Live Video.

Enable Privacy Mask: The Privacy Mask setting allows you to specify up to 3 rectangular areas on the camera's image to be blocked/excluded from recordings and snapshots.

You may click and drag the mouse cursor over the camera image to draw a mask area. Right clicking on the camera image brings up the following menu options:

Disable All: Disables all mask areas

Enable All: Enables all mask areas

Reset All: Clears all mask areas.

Click **Save** for the mask to take effect.

Anti Flicker: If the video flickers, try enabling this setting.

Mirror: This will mirror the image horizontally.

Flip: This will flip the image vertically. When turning Flip on, you may want to consider turning Mirror on as well.

Power Line: Select the frequency used by your power lines to avoid interference or distortion.

White Balance: Use the drop-down box to change white balance settings to help balance colors for different environments. You can choose from **Auto**, **Outdoor**, **Indoor**, **Fluorescent**, and **Push Hold**.

IMAGE SETUP

Changes to your IP camera settings are made immediately.

PRIVACY MASK AREA OF VIDEO SETTING

Enable Privacy Mask Setting

- Privacy mask: mask 3 privacy area(s) on video.
- Click the right mouse button on the video control to show the popmenu.
- Press the left mouse button, drag and drop to set the privacy area.
- Privacy area can be enabled or disabled.
- After you finish all privacy mask settings, click the Save button.



IMAGE SETTINGS

Anti Flicker	<input type="radio"/> On	<input checked="" type="radio"/> Off
Mirror	<input type="radio"/> On	<input checked="" type="radio"/> Off
Flip	<input type="radio"/> On	<input checked="" type="radio"/> Off
Power Line	<input type="radio"/> 60 Hz	<input checked="" type="radio"/> 50 Hz
White Balance	Auto ▾	
Exposure Mode	Auto ▾	Max Gain 24 ▾ dB
Denoise	0 ▾	
Brightness	4 ▾	
Contrast	4 ▾	
Saturation	128 ▾	
Sharpness	4 ▾	

Exposure Mode: Changes the exposure mode. Use the drop-down box to set the camera for **Indoor**, **Outdoor**, or **Night** environments, or to **Moving** to capture moving objects. The **Low Noise** option will focus on creating a high-quality picture without noise. You can also create 3 different custom exposure modes. The Max Gain setting will allow you to control the maximum amount of gain to apply to brighten the picture.

Denoise: This setting controls the amount of noise reduction that will be applied to the picture.

Brightness: Adjust this setting to compensate for backlit subjects.

Contrast: Adjust this setting to alter the color intensity/strength.

Saturation: This setting controls the amount of coloration, from grayscale to fully saturated.

Sharpness: Specify a value from 0 to 8 to specify how much sharpening to apply to the image.

Reset Default: Click this button to reset the image to factory default settings.

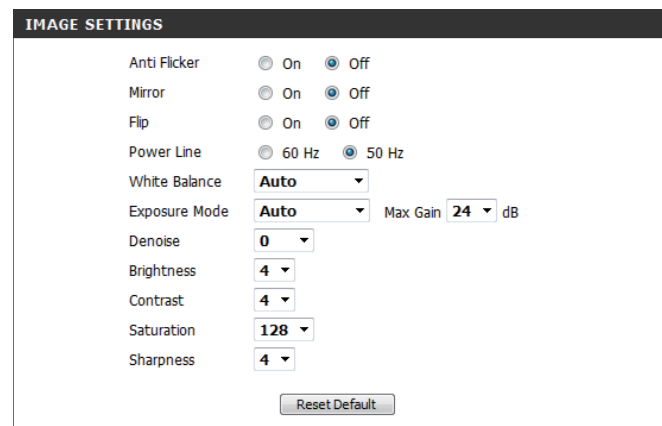

The screenshot shows the 'IMAGE SETTINGS' menu with the following options and values:

Setting	Value
Anti Flicker	Off
Mirror	Off
Flip	Off
Power Line	50 Hz
White Balance	Auto
Exposure Mode	Auto
Max Gain	24 dB
Denoise	0
Brightness	4
Contrast	4
Saturation	128
Sharpness	4

A 'Reset Default' button is located at the bottom right of the settings panel.

Audio and Video

You may configure up to 2 video profiles with different settings for your camera. Hence, you may set up different profiles for your computer and mobile display. In addition, you may also configure the two-way audio settings for your camera. After making any changes, click the **Save Settings** button to save your changes.

Aspect ratio: Set the aspect ratio of the video to 4:3 standard or 16:9 widescreen.

Mode: Set the video codec to be used to MJPEG or H.264. JPEG can be selected for image mode.

Frame size / View window area: Frame size determines the total capture resolution, and View window area determines the Live Video viewing window size. If the Frame size is larger than the Live Video size, you can use the ePTZ controls to look around.

16:9 1920x1080, 1280x720, 800x450, 640x360,
480x270, 320x176

4:3 1920x1080, 1280x720, 800x450, 640x360,
480x270, 320x176

Note: If your View window area is the same as your Frame size, you will not be able to use the ePTZ function.

Maximum frame rate: A higher frame rate provides smoother motion for videos, and requires more bandwidth. Lower frame rates will result in stuttering motion, and requires less bandwidth.

AUDIO AND VIDEO

This section allows you to configure the sound and video of your camera. You can configure different settings depending on whether you are viewing content from a PC or a Mobile Phone / PDA.

VIDEO SETTINGS

Aspect ratio 16:9 Warning: Change the aspect ratio will clear the settings of privacy mask and preset and motion detection.

VIDEO PROFILE 1

Mode H.264

Frame size 1280x720

View window area 1280x720

Maximum frame rate 25

Video quality

Constant bit rate 1M
 Fixed quality Excellent

VIDEO PROFILE 2

Mode JPEG

Frame size 800x450

View window area 640x360

Maximum frame rate 25

Video quality Excellent

VIDEO PROFILE 3

Mode MPEG4

Frame size 640x360

View window area 640x360

Maximum frame rate 25

Video quality

Constant bit rate 1M
 Fixed quality Excellent

AUDIO SETTINGS

Audio in off

Audio in gain level 20dB

Audio out off

Audio out volume level 10

Video Quality: This limits the maximum frame rate, which can be combined with the "Fixed quality" option to optimize the bandwidth utilization and video quality. If fixed bandwidth utilization is desired regardless of the video quality, choose "Constant bit rate" and select the desired bandwidth.

Constant bit rate: The bps will affect the bit rate of the video recorded by the camera. Higher bit rates result in higher video quality.

Fixed quality: Select the image quality level for the camera to try to maintain. High quality levels will result in increased bit rates.

Audio in off: Selecting this checkbox will mute incoming audio.

Audio in gain level: This setting controls the amount of gain applied to incoming audio to increase its volume.

Audio out off: Selecting this checkbox will mute outgoing audio.

Audio out volume level: This setting controls the amount of gain applied to outgoing audio to increase its volume.

VIDEO PROFILE 1	
Mode	H.264
Frame size	1280x720
View window area	1280x720
Maximum frame rate	25
Video quality	<input type="radio"/> Constant bit rate 1M <input checked="" type="radio"/> Fixed quality Excellent

VIDEO PROFILE 2	
Mode	JPEG
Frame size	800x450
View window area	640x360
Maximum frame rate	25
Video quality	Excellent

VIDEO PROFILE 3	
Mode	MPEG4
Frame size	640x360
View window area	640x360
Maximum frame rate	25
Video quality	<input type="radio"/> Constant bit rate 1M <input checked="" type="radio"/> Fixed quality Excellent

AUDIO SETTINGS	
<input type="checkbox"/> Audio in off	
Audio in gain level	20dB
<input type="checkbox"/> Audio out off	
Audio out volume level	10

Preset

This screen allows you to set preset points for the ePTZ function of the camera, which allows you to look around the camera's viewable area by using a zoomed view. Presets allow you to quickly go to and view a specific part of the area your camera is covering, and you can create preset sequences, which will automatically change the camera's view between the different presets according to a defined order and timing you can set.

Note: If your View window area is the same as your Frame size, you will not be able to use the ePTZ function.

Video Profile: This selects which video profile to use.

ePTZ Speed: You may select a value between 1 and 10.0 is the slowest and 10 is the fastest.

Arrow Buttons and Home Button: Use these buttons to move to a specific part of the viewing area, which you can then set as a preset. Click the Home button to return to the center of the viewing area.

Input Preset Name: Enter the name of the preset you want to create, then click the **Add** button to make a new preset. If an existing preset has been selected from the Preset List, you can change its name by typing in a new name, then clicking the **Rename** button.

Preset List: Click this drop-down box to see a list of all the presets that have been created. You can select one, then click the **GoTo** button to change the displayed camera view to the preset. Clicking the **Remove** button will delete the currently selected preset.

Preset Sequence: This section allows you to create a preset sequence, which automatically moves the camera's view between a set of preset views.

PRESET CONTROL
Using the Pan and Tilt controls, move the camera view to the required position. There are provides the tools for creating and saving Preset positions & Preset Sequence.

PRESET CONTROL
VIDEO PROFILE : 1
ePTZ Speed : 5

PRESET
Input Preset Name : **Add** **Rename**
Support(0~9,A~Z,a~z,*,/,_)
Preset List : --Preset List-- **GoTo** **Remove**

PRESET SEQUENCE
Preset Name : Dwell time

Preset List : --Preset List-- **Add**
Dwell time : 10 **Update** Second(s)[3~30]

Preset List: To add a preset to the sequence, select it from the drop-down box at the bottom of this window, set the **Dwell time** to determine how long the camera view will stay at that preset, then click the **Add** button. The preset name will appear in the list, followed by the dwell time to view that preset for.

You can rearrange your presets in the sequence by selecting a preset in the sequence, then clicking the arrow buttons to move it higher or lower in the current sequence.

Clicking the trash can button will remove the currently selected preset from the sequence.

If you want to change the dwell time for a preset, select it from the list, enter a new dwell time, then click the **Update** button.

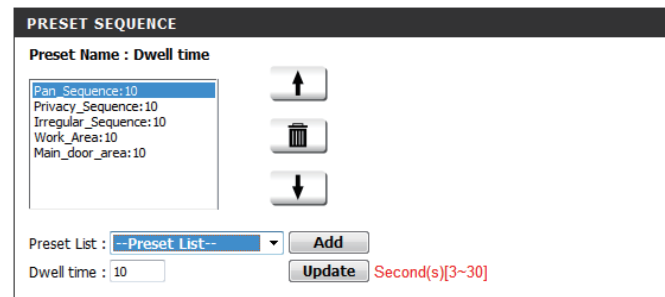

The screenshot shows a window titled "PRESET SEQUENCE". At the top, it says "Preset Name : Dwell time". Below this is a list of presets: "Pan_Sequence:10", "Privacy_Sequence:10", "Irregular_Sequence:10", "Work_Area:10", and "Main_door_area:10". To the right of the list are three buttons: an up arrow, a trash can, and a down arrow. Below the list is a dropdown menu labeled "Preset List" with "--Preset List--" selected, and an "Add" button. Below that is a "Dwell time" input field with "10" entered, and an "Update" button. To the right of the "Update" button, the text "Second(s)[3~30]" is displayed in red.

Motion Detection

Enabling Video Motion will allow your camera to use the motion detection feature. You may draw a finite motion area that will be used for monitoring. After making any changes, click the **Save Settings** button to save your changes.

Enable Video Motion: Select this box to enable the motion detection feature of your camera.

Enable PIR: Select this box to enable Passive Infrared detection.

Sensitivity: Specifies the measurable difference between two sequential images that would indicate motion. Please enter a value between 0 and 100.

Percentage: Specifies the amount of motion in the window being monitored that is required to initiate an alert. If this is set to 100%, motion is detected within the whole window will trigger a snapshot.

Draw Motion Area: Draw the motion detection area by dragging your mouse in the window (indicated by the red square).

Erase Motion Area: To erase a motion detection area, simply click on the red square that you wish to remove.

Right clicking on the camera image brings up the following menu options:

Select All: Draws a motion detection area over the entire screen.

Clear All: Clears any motion detection areas that have been drawn.

Restore: Restores the previously specified motion detection areas.

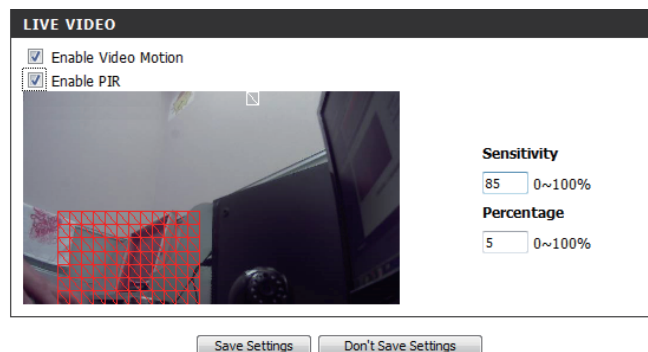
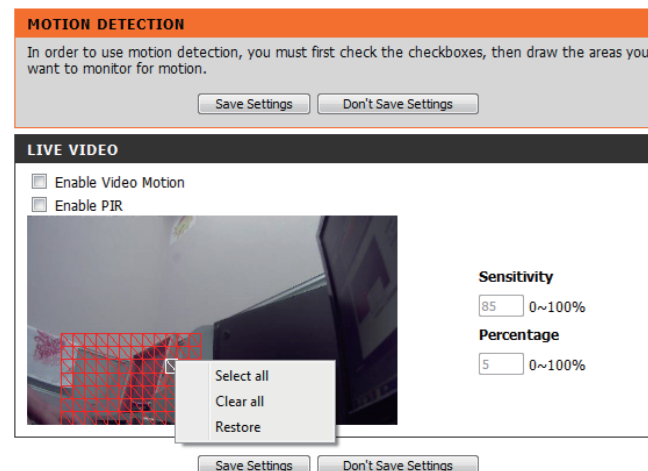

Time and Date

This section allows you to automatically or manually configure, update, and maintain the internal system clock for your camera. After making any changes, click the **Save Settings** button to save your changes.

Time Zone: Select your time zone from the drop-down menu.

Enable Daylight Saving: Select this to enable Daylight Saving Time.

Auto Daylight Saving: Select this option to allow your camera to configure the Daylight Saving settings automatically.

Set Date and Time Manually: Selecting this option allows you to configure the Daylight Saving date and time manually.

Offset: Sets the amount of time to be added or removed when Daylight Saving is enabled.

Synchronize with NTP Server: Enable this feature to obtain time automatically from an NTP server.

NTP Server: Network Time Protocol (NTP) synchronizes the DCS-2230L with an Internet time server. Choose the one that is closest to your location.

Set the Date and Time Manually: This option allows you to set the time and date manually.

Copy Your Computer's Time Settings: This will synchronize the time information from your PC.

TIME AND DATE

You can set the current time for the IP camera.

TIME CONFIGURATION

Time Zone (GMT+08:00) Taipei

Enable Daylight Saving

Auto Daylight Saving
 Set date and time manually

Offset +2:00

Start time	Month	Week	Day of week	Hour	Minutes
5	1	Sunday	00	00	00
End time	10	1	Sunday	00	00

AUTOMATIC TIME CONFIGURATION

Synchronize with NTP Server

NTP Server ntp.dlink.com.tw << Select NTP Server

SET DATE AND TIME MANUALLY

Set date and time manually

Year 2011	Month 1	Day 1
Hour 18	Minute 30	Second 55

Event Setup

In a typical application, when motion is detected, the DCS-2230L sends images to a FTP server or via e-mail as notifications. As shown in the illustration below, an event can be triggered by many sources, such as motion detection or external digital input devices. When an event is triggered, a specified action will be performed. You can configure the DCS-2230L to send snapshots or videos to your e-mail address or FTP site.

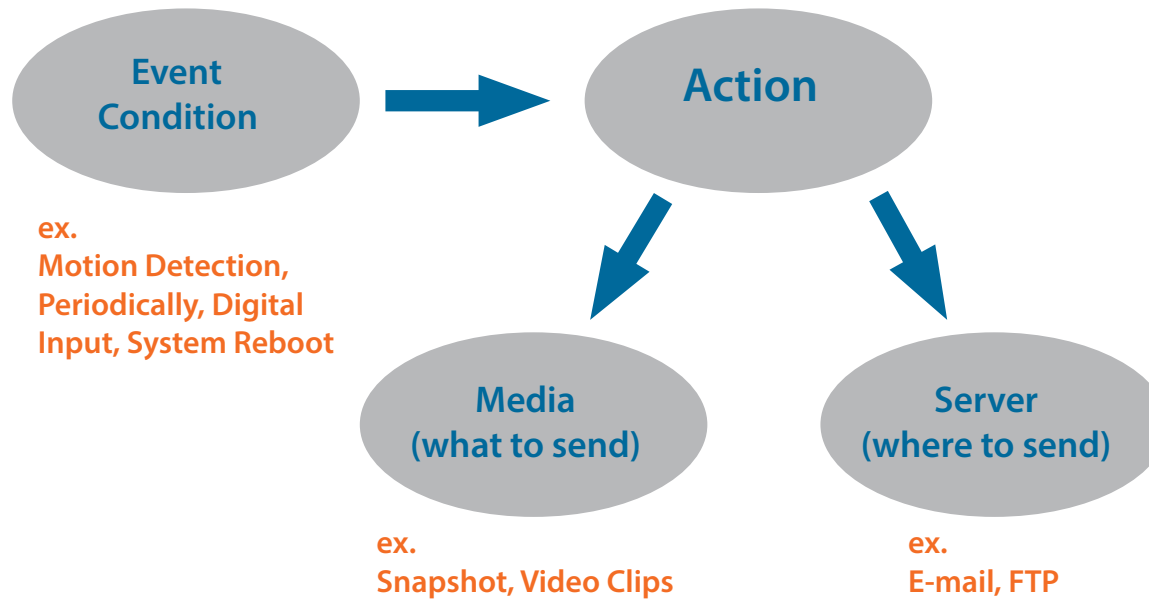

To start plotting an event, it is suggested to configure server and media columns first so that the DCS-2230L will know what action shall be performed when a trigger is activated.

Section 4: Configuration

The Event Setup page includes 4 different sections:

- Server
- Media
- Event
- Recording

1. To add a new item - "event, server or media," click **Add**. A screen will appear and allow you to update the fields accordingly.
2. To delete the selected item from the pull-down menu of event, server or media, click **Delete**.
3. Click on the item name to pop up a window for modifying.

EVENT SETUP

There are four sections in Event Setup page. They are event, server, media and recording. Click Add to pop a window to add a new item of event, server, media or recording. Click Delete to delete the selected item from event, server, media or recording. Click on the item name to pop a window to edit it. There can be at most 2 events and 1 recording. There can be at most 5 server and 5 media configurations.

SERVER

Name	Type	Address/Location
Server1	Email	mail.gandi.net

MEDIA

Media freespace: 6700KB

Name	Type	Source
Media1	Video clip	Profile 1

EVENT

Name	Status	Sun	Mon	Tue	Wed	Thu	Fri	Sat	Time	Trigger
Event1	OFF	V	V	V	V	V	V	V	00:00~23:59	Motion

RECORDING

Name	Status	Sun	Mon	Tue	Wed	Thu	Fri	Sat	Time	Source	Destination
------	--------	-----	-----	-----	-----	-----	-----	-----	------	--------	-------------

Add Server

You can configure up to 5 servers to save snapshots and/or video to. After making any changes, click the **Save Settings** button to save your changes. You can click Test to test your configurations.

Server Name: Enter the unique name of your server.

E-mail: Enter the configuration for the target e-mail server account.

FTP: Enter the configuration for the target FTP server account.

Network Storage: Specify a network storage device. Only one network storage device is supported.

SD Card: Use the camera's onboard SD card storage.

SERVER

You can set at most 5 different servers here for different event.

SERVER TYPE

Server Name:

Email

Sender email address

Recipient email address

Server address

User name

Password

Port

This server requires a secure connection (StartTLS)

FTP

Server address

Port

User name

Password

Remote folder name

Passive mode

Network storage

Network storage location
(for example: \\my_nas\disk\folder)

Workgroup

User name

Password

Primary WINS server

SD Card

Add Media

There are three types of media, **Snapshot**, **Video Clip**, and **System Log**. After making any changes, click the **Save Settings** button to save your changes.

Media Name: Enter a unique name for media type you want to create.

Snapshot: Select this option to set the media type to snapshots.

Source: Set the video profile to use as the media source. Refer to **Audio and Video on Audio and Video on page 40** for more information on video profiles.

Send pre-event image(s) [0~4]: Set the number of pre-event images to take. Pre-event images are images taken before the main event snapshot is taken.

Send post-event image(s) [0~7]: Set the number of post-event images to take. Post-event images are images taken after the main event snapshot is taken. You can set up to 7 post-event images to be taken.

File name prefix: The prefix name will be added on the file name.

Add date and time suffix to file name: Check it to add timing information as file name suffix.

MEDIA

You can set at most 5 different media here for different event.

Save Settings Don't Save Settings

MEDIA TYPE

Media name:

Snapshot

Source: Profile 1 ▾

Send pre-event image(s) [0~4]

Send post-event image(s) [0~7]

File Name Prefix:

Add date and time suffix to file name

Video Clip

Source: Profile 1 ▾

Pre-event recording: Second(s) [0~4]

Maximum duration: Second(s) [1~100]

Maximum file size: Kbytes [100~5000]

File Name Prefix:

System log

Save Settings Don't Save Settings

Video clip: Select this option to set the media type to video clips.

Source: Set the video profile to use as the media source. Refer to **Audio and Video on page 40** for more information on video profiles.

Pre-event recording: This sets how many seconds to record before the main event video clip starts. You can record up to 4 seconds of pre-event video.

Maximum duration: Set the maximum length of video to record for your video clips.

Maximum file size: Set the maximum file size to record for your video clips.

File name prefix: This is the prefix that will be added to the filename of saved video clips.

System log: Select this option to set the media type to system logs. This will save the event to the camera system log, but will not record any snapshots or video.

The screenshot shows a configuration window titled "MEDIA" with a subtitle "You can set at most 5 different media here for different event." Below the subtitle are two buttons: "Save Settings" and "Don't Save Settings". The main content area is titled "MEDIA TYPE" and contains three radio button options:

- Snapshot:** Selected. Includes a "Media name:" text box, a "Source:" dropdown menu (set to "Profile 1"), "Send" fields for "pre-event image(s) [0~4]" and "post-event image(s) [0~7]", a "File Name Prefix:" text box, and a checkbox for "Add date and time suffix to file name".
- Video Clip:** Includes a "Source:" dropdown menu (set to "Profile 1"), "Pre-event recording:" field (0~4 seconds), "Maximum duration:" field (1~100 seconds), "Maximum file size:" field (100~5000 kbytes), and a "File Name Prefix:" text box.
- System log:** Unselected.

At the bottom of the window are two buttons: "Save Settings" and "Don't Save Settings".

Add Event

Create and schedule up to 3 events with their own settings here. After making any changes, click the **Save Settings** button to save your changes.

Event name: Enter a name for the event.

Enable this event: Select this box to activate this event.

Priority: Set the priority for this event. The event with higher priority will be executed first.

Delay: Select the delay time before checking the next event. It is being used for events of motion detection, digital input, and PIR triggers.

Video Motion Detection: Motion is detected during live video monitoring. Select the window that needs to be monitored.

Periodic: The event is triggered in specified intervals. The trigger interval unit is in minutes.

Digital input: The external trigger input to the camera.

System Boot: Triggers an event when the system boots up.

Network Lost: Triggers an event when the network connection is lost.

Passive Infrared Sensor: Triggers an event when the PIR sensor is activated by moving infrared objects even in dark environment. Select **Always** or enter the time interval.

Time: Select the days and times when events will be detected.

EVENT

You can set at most 2 events like motion detection or digital input trigger here and arrange the detection schedule at the same time.

EVENT

Event name:

Enable this event

Priority: normal

Delay for seconds before detecting next event [For motion detection and digital input and Passive Infrared sensor]

TRIGGER

Video motion detection

Periodic
Trigger every minutes

Digital input

System boot

Network lost

Passive Infrared sensor

EVENT SCHEDULE

Sun Mon Tue Wed Thu Fri Sat

Time

Always

From 00 00 To 23 59

ACTION

Trigger D/O for seconds

Server1
Attached media: Media1

Trigger D/O: Select to trigger the digital output for a specific number of seconds when an event occurs.

Server: Specify the location where the event information should be saved to.

EVENT

Event name:

Enable this event

Priority: normal ▾

Delay for seconds before detecting next event [For motion detection and digital input and Passive Infrared sensor]

TRIGGER

Video motion detection

Periodic
Trigger every minutes

Digital input

System boot

Network lost

Passive Infrared sensor

EVENT SCHEDULE

Sun Mon Tue Wed Thu Fri Sat

Time

Always

From To

ACTION

Trigger D/O for seconds

Server1
Attached media: Media1 ▾

Add Recording

Here you can configure and schedule the recording settings. After making any changes, click the **Save Settings** button to save your changes.

Recording entry name: The unique name of the entry.

Enable this recording: Select this to enable the recording function.

Priority: Set the priority for this entry. The entry with a higher priority value will be executed first.

Source: The source of the stream.

Recording schedule: Schedule the recording entry via days and times.

Recording settings: Configuring the setting for the recording.

Destination: Select the folder where the recording file will be stored.

Total cycling recording size: Please input a HDD volume between 200 MB and 2 TB for recording space. The recording data will replace the oldest record when the total recording size exceeds this value. For example, if each recording file is 6 MB, and the total cyclical recording size is 600 MB, then the camera will record 100 files in the specified location (folder) and then will delete the oldest file and create a new file for cyclical recording.

Please note that if the free HDD space is not enough, the recording will stop. Before you set up this option please make sure your HDD has enough space, and it is better to not save other files in the same folder as recording files.

RECORDING

You can setup schedule recording to network storage with your specify week day and time period.

RECORDING

Recording entry name:

Enable this recording

Priority: normal

Source: Profile 1

RECORDING SCHEDULE

Sun
 Mon
 Tue
 Wed
 Thu
 Fri
 Sat

Time

Always
 From 00 00 To 23 59

RECORDING SETTINGS

Destination: None

Total cycling recording size: 1000 Mbytes [200~2000000]

Size of each file for recording: 10 Mbytes
 Time of each file for recording: 10 seconds

File Name Prefix:

Size of each file for recording: If this is selected, files will be separated based on the file size you specify.

Time of each file for recording: If this is selected, files will be separated based on the maximum length you specify.

File Name Prefix: The prefix name will be added on the file name of the recording file(s).

RECORDING

Recording entry name:

Enable this recording

Priority: normal

Source: Profile 1

RECORDING SCHEDULE

Sun Mon Tue Wed Thu Fri Sat

Time

Always

From To

RECORDING SETTINGS

Destination: None

Total cycling recording size: Mbytes [200~2000000]

Size of each file for recording: Mbytes

Time of each file for recording: seconds

File Name Prefix:

SD Card

Here you may browse and manage the recorded files which are stored on the SD card.

Format SD Card: Click this icon to automatically format the SD card and create "picture" & "video" folders.

View Recorded Picture: If the picture files are stored on the SD card, click on the picture folder and choose the picture file you would like to view.

Playback Recorded Video: If video files are stored on the SD card, click on the video folder and choose the video file you would like to view.

Refresh: Reloads the file and folder information from the SD card.

SD CARD

Here you could browse and manage the record files which stored in SD card.

SD CARD

SD Card: / SD Status : Ready

Files per Page: 10 Refresh 1 of 1

<input type="checkbox"/> Delete	File	Num of files	Size
<input type="checkbox"/>	Picture	8	
<input type="checkbox"/>	Video	1	

Total:119247KB, Used:31848KB, Free:87399KB

Advanced Digital Input/Output

This screen allows you to control the behavior of digital input and digital output devices. The I/O connector provides the physical interface for digital output (DO) and digital input (DI) that is used for connecting a variety of external alarm devices such as IR sensors and alarm relays. The digital input is used for connecting external alarm devices and once triggered images will be taken and e-mailed. After making any changes, click the **Save Settings** button to save your changes.

Select D/I or D/O Mode: The camera will send a signal when an event is triggered, depending upon the type of device connected to the DI circuit.

N.C. stands for **Normally Closed**. This means that the normal state of the circuit is closed. Therefore events are triggered when the device status changes to "Open."

N.O. stands for **Normally Open**. This means that the normal state of the circuit is open. Therefore events are triggered when the device status changes to "Closed."

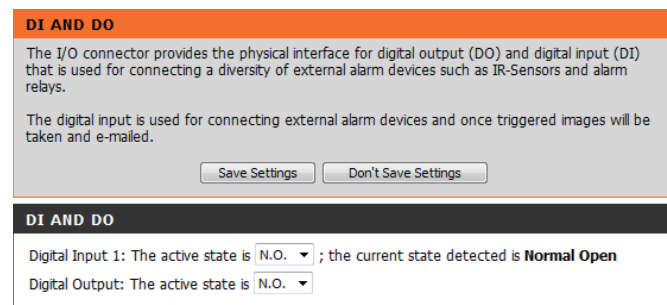

ICR and IR

Here you can configure the ICR and IR settings. An IR(Infrared) Cut-Removable(ICR) filter can be disengaged for increased sensitivity in low light environments.

Automatic: The Day/Night mode is set automatically. Generally, the camera uses Day mode and switches to Night mode when needed.

Day Mode: Day mode enables the IR Cut Filter.

Night Mode: Night mode disables the IR Cut Filter.

Schedule Mode: Set up the Day/Night mode using a schedule. The camera will enter Day mode at the starting time and return to Night mode at the ending time.

IR Light Control: The camera can enable or disable the IR (infrared) light according to your preferences. This setting lets you adjust IR strength depending on your specific application.

Off: The IR light will always be off.

On: The IR light will always be on.

Sync: The IR light will turn on when the ICR sensor is on.

Schedule: The IR light will turn on or off according to the schedule that you specify below.

ICR AND IR

An IR(Infrared) Cut-Removable(ICR) filter can be disengaged from the image path for increased sensitivity in low light environments. The ICR filter will automatically engage depending on the ambient light, allowing the camera to be effective in day/night environments.
 1. Select the Day/Night from the radio button. The available options are Automatic, Schedule mode, Day mode and Night mode.
 2. The default value is Automatic.

IR Light
 The built-in IR light illuminators will be activated automatically or manually so as to supplement the low light situation without additional equipment.

ICR

Removable IR-Cut filter trigger condition:

Automatic
 Day mode
 Night mode
 Schedule mode

Day mode(24hr)
 From To

IR LIGHT

IR Light Control

Off
 On
 Sync. With ICR
 Schedule

IR Light Control On(24hr)
 From To

HTTPS

This page allows you to install and activate an SSL certificate for secure HTTPS access to your camera. After making any changes, click the **Save Settings** button to save your changes.

Enable HTTPS Secure Connection: Enable the HTTPS service.

Create Certificate Method: Choose the way the certificate should be created. Three options are available:

- Create a self-signed certificate automatically
- Create a self-signed certificate manually
- Create a certificate request and install

Certificate Information: Displays the status and details of the certificate. Click on **CSR Property** and **Certificate Property** to view details of the certificates.

Note: The certificate cannot be removed while the HTTPS is still enabled. To remove the certificate, you must first uncheck **Enable HTTPS secure connection**.

HTTPS

To enable HTTPS, you have to create and install certificate first.

HTTPS

Enable HTTPS secure connection

Create certificate method

Create self-signed certificate automatically
 Create self-signed certificate manually
 Create certificate request and install

Create certificate: Private key existed

CERTIFICATE INFORMATION

Status	Active
Country	TW
State or province	Taiwan
Locality	Taipei
Organization	D-Link Taiwan
Organization Unit	R&D Dept.
Common Name	www.dlink.com.tw

Access List

Here you can set access permissions for users to view your DCS-2230L.

Allow list: The list of IP addresses that have the right to access the camera.

Start IP address: The starting IP Address of the devices (such as a computer) that have permission to access the video of the camera.

Note: A total of seven lists can be configured for both columns.

End IP address: The ending IP Address of the devices (such as a computer) that have permission to access the video of the camera. Click **Add** to save the changes made.

Delete allow list: Remove the customized setting from the Allow List.

Deny list: The list of IP addresses that have no access rights to the camera.

Delete deny list: Remove the customized setting from the Delete List.

For example:

When the range of the Allowed List is set from 1.1.1.0 to 192.255.255.255 and the range of the Denied List is set from 1.1.1.0 to 170.255.255.255. Only users with IPs located between 171.0.0.0 and 192.255.255.255 can access the DCS-2230L.

ACCESS LIST

Here you can set access permissions for users to view your IP camera.

ALLOW LIST

Start IP address

End IP address

Delete allow list

DENY LIST

Start IP address

End IP address

Delete deny list

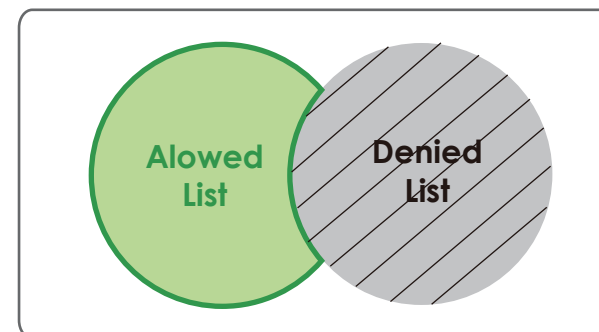

SNMP

The Simple Network Management Protocol is an application layer protocol that facilitates the exchange of management information between network devices. It helps network administrators to remotely manage network devices and find, solve network problems with ease.

Enable SNMPv1, SNMPv2c: Select this to enable SNMPv1 and 2.

Read/Write Community: Enter a name for the read community of your SNMP server.

Read Only Community: Enter a name for the write community of your SNMP server.

Enable SNMPv3: Select this to enable SNMPv3. You will need to ask your network administrator for the SNMP authentication information and input them into the fields below.

Read/Write and Read Only Security Names: Enter custom names for your read/write and read only SNMP accounts in the text boxes.

Authentication Type: Select the authentication protocol used for SNMP exchanges between this user and the local SNMP engine. SHA and MD5 protocols are supported.

Authentication/Encryption Password: Enter the authentication and encryption passwords for your read/write and read only SNMP accounts in these boxes.

SNMP

The Simple Network Management Protocol is an application layer protocol that facilitates the exchange of management information between network devices. It helps network administrators to remotely manage network devices and find, solve network problems with ease.

SNMP CONFIGURATION

Enable SNMPv1, SNMPv2c

Read/Write community

Read only community

Enable SNMPv3

Read/Write Security name

Authentication type

Authentication password

Encryption password

Read only security name

Authentication type

Authentication password

Encryption password

Maintenance

Admin

You may modify the name and administrator's password of your camera, as well as add and manage the user accounts for accessing the camera. You may also use this section to create a unique name and configure the OSD settings for your camera.

Admin Password Setting: Set a new password for the administrator's account. Retype it and click **Save** for it to take effect.

Add User Account: Add new user account. Click **Add** to save the account.

User Name: The user name for the new account.

Password: The password for the new account.

User List: All the existing user accounts will be displayed here. You may delete accounts included in the list, but you may want to reserve at least one as a guest account.

IP Camera Name: Create a unique name for your camera that will be added to the file name prefix when creating a snapshot or a video clip.

Enable OSD: Select this option to enable the On-Screen Display feature for your camera.

Label: Enter a label for the camera, which will be shown on the OSD when it is enabled.

Show Time: Select this option to enable the time-stamp display on the video screen. Click **Save** when you are done.

LED: You may specify whether or not to illuminate the status LED on the camera. Click **Save** when you are done.

ADMIN

Here you can change the administrator's password for your IP camera as well as add and/or delete user account(s). You can configure the information, such as IP camera's name and time via this page. You can also enable the OSD (On-Screen Display) feature in order to display the IP camera name and time stamp for your video recordings.

ADMIN PASSWORD SETTING

New Password 32 characters maximum
 Retype Password

ADD USER ACCOUNT

User Name 20 users maximum
 New Password 32 characters maximum
 Retype Password

USER LIST

User Name

DEVICE SETTING

IP camera Name 63 characters maximum
 Enable OSD
 Label 30 characters maximum
 Show Time

LED

LED On Off

System

In this section, you may backup, restore and reset the camera configuration, or reboot the camera.

Save To Local Hard Drive: You may save your current camera configuration as a file on your computer.

Load From Local Hard Drive: Locate a pre-saved configuration by clicking **Browse** and then restore the pre-defined settings to your camera by clicking **Load Configuration**.

Restore to Factory Default: You may reset your camera and restore the factory settings by clicking **Restore Factory Defaults**.

Reboot Device: This will restart your camera.

Enable Schedule Reboot: Check to enable this feature and select the days and times your DCS-2230L will automatically reboot. Click **Save** for it to take effect.

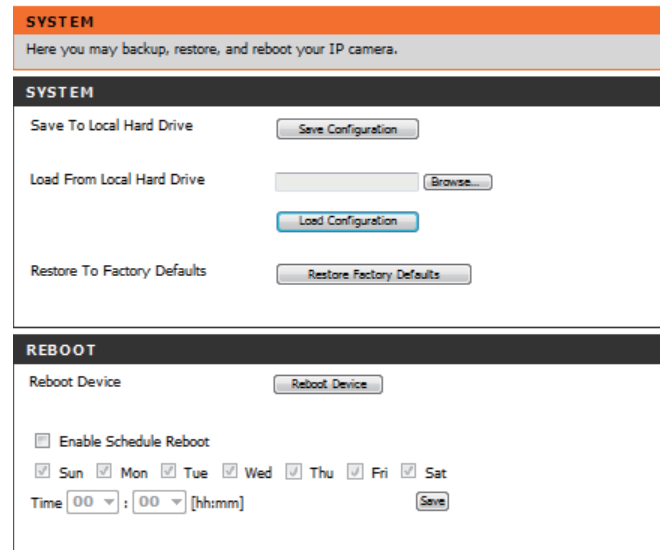

Firmware Upgrade

The camera's current firmware version will be displayed on this screen. You may visit the D-Link Support Website to check for the latest available firmware version.

To upgrade the firmware on your DCS-2230L, please download and save the latest firmware version from the D-Link Support Page to your local hard drive. Locate the file on your local hard drive by clicking the **Browse** button. Select the file and click the **Upload** button to start upgrading the firmware.

Current Firmware Version: Displays the detected firmware version.

Current Product Name: Displays the camera model name.

File Path: Locate the file (upgraded firmware) on your hard drive by clicking **Browse**.

Upload: Uploads the new firmware to your camera.

The screenshot shows a web interface for firmware upgrade. It features an orange header with the text 'FIRMWARE UPGRADE'. Below the header, there is a paragraph of text explaining that a new firmware upgrade may be available and recommending users to check the D-Link Support Page. A second paragraph provides instructions on how to upgrade the firmware: download the latest version from the D-Link Support Page, save it to a local hard drive, locate the file, click the 'Browse' button, and then click the 'Upload' button. Below this text is a section titled 'FIRMWARE INFORMATION' which displays the current firmware version as '0.03.00' and the current product name as 'DCS-2230L'. At the bottom of the interface is another section titled 'FIRMWARE UPGRADE' which contains a 'File Path:' label, a text input field, a 'Browse...' button, and an 'Upload' button.

Status

Device Info

This page displays detailed information about your device and network connection.

DEVICE INFO

All of your network connection details are displayed on this page. The firmware version is also displayed here.

INFORMATION

IP camera Name	DCS-2230L
Time & Date	Wed Jan 1 20:32:56 2014
Firmware Version	0.03.00
MAC Address	0A:CA:CA:22:10:14
IP Address	192.168.0.101
IP Subnet Mask	255.255.255.0
Default Gateway	192.168.0.2
Primary DNS	192.168.0.2
Secondary DNS	0.0.0.0
PPPoE	Disable
DDNS	Enable
Agent Version	2.0.17-b76

Logs

This page displays the log information of your camera. You may download the information by clicking **Download**. You may also click **Clear** to delete the saved log information.

SYSTEM LOG
The system log records IP camera events that have occurred.

CURRENT LOG

- 2011-01-01 19:01:11 Someone Create Certificate
- 2011-01-01 18:47:55 admin LOGIN OK FROM 192.168.0.51
- 2011-01-01 17:56:08 admin FROM 192.168.0.51 SET EVENT MEDIA 1 ; Name : Media1, Type : Video Clip
- 2011-01-01 17:56:08 admin FROM 192.168.0.51 SET EVENT TYPE 1 ; Trigger : Motion Detection
- 2011-01-01 17:55:47 admin FROM 192.168.0.51 SET EVENT SERVER 1 ; Name : Server1, Type : Email
- 2011-01-01 17:55:47 admin FROM 192.168.0.51 SET EVENT TYPE 1 ; Trigger : Motion Detection
- 2011-01-01 17:55:47 admin FROM 192.168.0.51 SET EVENT MEDIA 1 ; Name : Media1, Type : Video Clip
- 2011-01-01 17:33:37 admin LOGIN OK FROM 192.168.0.51
- 2011-01-01 17:32:45 SYSTEM SET IR LIGHT OFF
- 2011-01-01 17:32:21 IP CAMERA ACQUIRE DHCP IP 192.168.0.53
- 2011-01-01 17:32:17 NETWORK RECONNECT
- 2011-01-01 17:30:18 SYSTEM SET IR LIGHT ON
- 2011-01-01 17:28:51 NETWORK LOSS
- 2011-01-01 17:28:50 SYSTEM SET IR LIGHT OFF
- 2011-01-01 17:28:50 SYSTEM BOOTING
- 2011-01-01 14:51:44 SYSTEM SET IR LIGHT OFF
- 2011-01-01 08:35:12 SYSTEM SET IR LIGHT ON
- 2011-01-01 07:36:18 admin LOGIN OK FROM 172.17.5.125
- 2011-01-01 07:25:36 SYSTEM SET IR LIGHT OFF
- 2011-01-01 07:25:33 IP CAMERA ACQUIRE DHCP IP 172.17.5.143

Help

This page provides helpful information regarding camera operation.

HELP <ul style="list-style-type: none">• LIVE VIDEO• SETUP• MAINTENANCE• ADVANCED• STATUS
LIVE VIDEO <ul style="list-style-type: none">• Camera
SETUP <ul style="list-style-type: none">• Setup Wizard• Network Setup• Dynamic DNS• Image Setup• Audio and Video• Preset• Motion Detection• Time and Date• Event Setup• SD Card
ADVANCED <ul style="list-style-type: none">• DI and DO• ICR and IR• HTTPS• Access List• SNMP
MAINTENANCE <ul style="list-style-type: none">• Admin• System• Firmware Upgrade
STATUS <ul style="list-style-type: none">• Device Info• Log

DI/DO Specifications

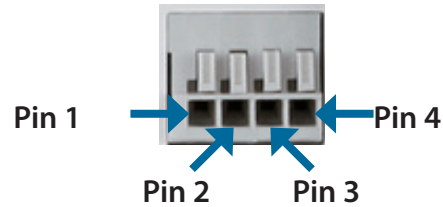

PIN	FUNCTION	NOTE
1	Digital Out (DO)	Uses an open-drain NFET transistor with the source connected to GND in camera. If used with an external relay, a diode must be connected in parallel with the load for protection against voltage transients. Max loading is 100 mA.
2	Digital In (DI)	A switch from DI to DND, activated by setting NO. or NC.
3	DC 5V OUTPUT	DC 5 V Output / Max. 100 mA
4	GND	GND

Internal 5V Power

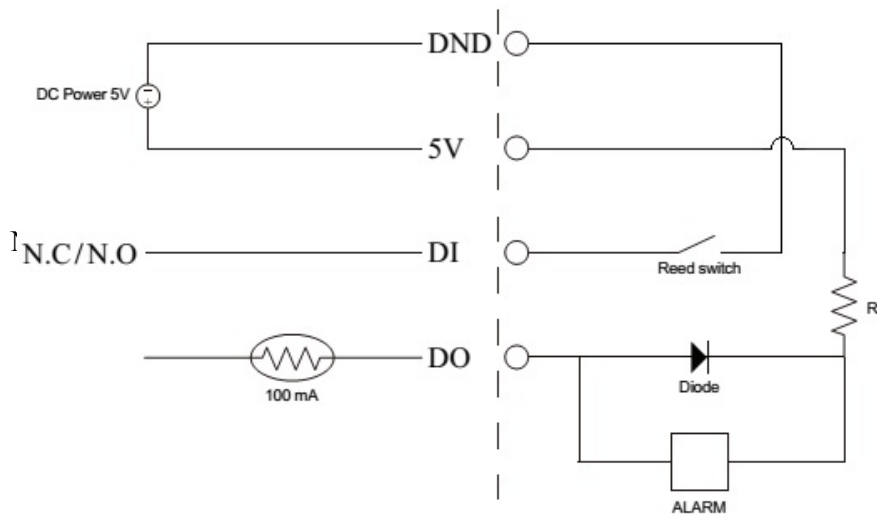

External 3~12V Power

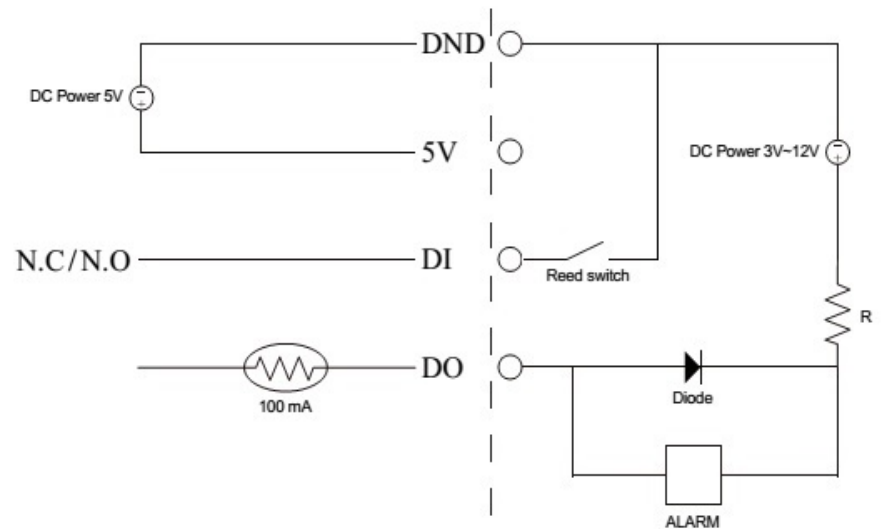

Technical Specifications

Camera	Camera Hardware Profile	<ul style="list-style-type: none"> ▪ 1/2.7" 2 Megapixel CMOS sensor ▪ 5 meter IR illumination distance ▪ Minimum illumination: 0 lux with IR LED on ▪ Built-in Infrared-Cut Removable (ICR) Filter module ▪ Built-in PIR sensor (5 meter) ▪ Built-in microphone and speaker ▪ 10x digital zoom 	<ul style="list-style-type: none"> ▪ Focal length: 2.8 mm ▪ Aperture: F1.8 ▪ Angle of view: <ul style="list-style-type: none"> ▪ (H) 103° ▪ (V) 55° ▪ (D) 118°
	Image Features	<ul style="list-style-type: none"> ▪ Configurable image size, quality, frame rate, and bit rate ▪ Time stamp and text overlays ▪ Configurable motion detection windows 	<ul style="list-style-type: none"> ▪ Configurable privacy mask zones ▪ Configurable shutter speed, brightness, saturation, contrast, and sharpness
	Video Compression	<ul style="list-style-type: none"> ▪ Simultaneous H.264/MJPEG format compression ▪ H.264 multicast streaming 	<ul style="list-style-type: none"> ▪ JPEG for still images
	Video Resolution	16:9 - Up to 30 fps at 1920 x 1080, 1280 x 720, 800 x 450, 640 x 360, 480 x 270	4:3 - Up to 30 fps at 1440 x 1080, 1280 x 960, 1024 x 768, 800 x 600, 600 x 480, 320 x 240
	Audio Support	G.711, AAC	
	External Device Interface	<ul style="list-style-type: none"> ▪ 10/100 BASE-T Fast Ethernet port ▪ 802.3af PoE (DCS-2210L only) ▪ IEEE 802.11n/b/g wireless with WPS (DCS-2230L only) 	<ul style="list-style-type: none"> ▪ DI/DO port ▪ microSD/SDHC card slot
Network	Network Protocols	IPv6 / IPv4 TCP/IP UDP ICMP DHCP client NTP client (D-Link) DNS client DDNS client (D-Link) SMTP client FTP client Bonjour	HTTP / HTTPS Samba client PPPoE UPnP port forwarding RTP / RTSP/ RTCP IP filtering QoS CoS Multicast IGMP ONVIF compliant
	Security	<ul style="list-style-type: none"> ▪ Administrator and user group protection ▪ Password authentication 	<ul style="list-style-type: none"> ▪ HTTP and RTSP digest encryption

Appendix B: Technical Specifications

System Management	System Requirements for Web Interface	<ul style="list-style-type: none"> Operating System: Microsoft Windows 8/7 (32/64-bit)/Vista (32/64-bit)/XP, Mac OS X 10.5 or above 	<ul style="list-style-type: none"> Browser: Internet Explorer 7, Firefox 12, Safari 7 or above
	Event Management	<ul style="list-style-type: none"> Motion detection, Periodic, Digital Input, System Boot, Network Lost, PIR Event notification and saving/uploading of snapshots/video clips via e-mail, FTP, network storage, or SD card 	<ul style="list-style-type: none"> Supports multiple SMTP and FTP servers Multiple event notifications Multiple recording methods for easy backup
	Remote Management	<ul style="list-style-type: none"> Take snapshots/video clips and save to local hard drive or NAS via web browser 	<ul style="list-style-type: none"> Configuration interface accessible via web browser
	Mobile Support	mydlink mobile app for iOS and Android mobile devices	
	D-ViewCam™ System Requirements	<ul style="list-style-type: none"> Operating System: Microsoft Windows 8/7 (32/64-bit)/Vista (32/64-bit)/XP 	<ul style="list-style-type: none"> Protocol: Standard TCP/IP
	D-ViewCam™ Software Functions	<ul style="list-style-type: none"> Remote management/control of up to 32 cameras Viewing of up to 32 cameras on one screen 	<ul style="list-style-type: none"> Supports all management functions provided in web interface Scheduled motion triggered, or manual recording options
General	Weight	DCS-2210L: 80 g DCS-2230L: 75 g	
	External Power Adaptor	Input: 100 to 240 V AC, 50/60 Hz	Output: 5 V DC, 1.2 A, 50/60 Hz
	Power Consumption	DCS-2210L: Max. 3.5 W DCS-2230L: Max. 4 W	
	Temperature	Operating: 0 to 40 °C (32 to 104 °F)	Storage: -20 to 70 °C (-4 to 158 °F)
	Humidity	Operating: 20% to 80% non-condensing	Storage: 5% to 95% non-condensing
	Certifications	CE CE LVD	FCC C-Tick

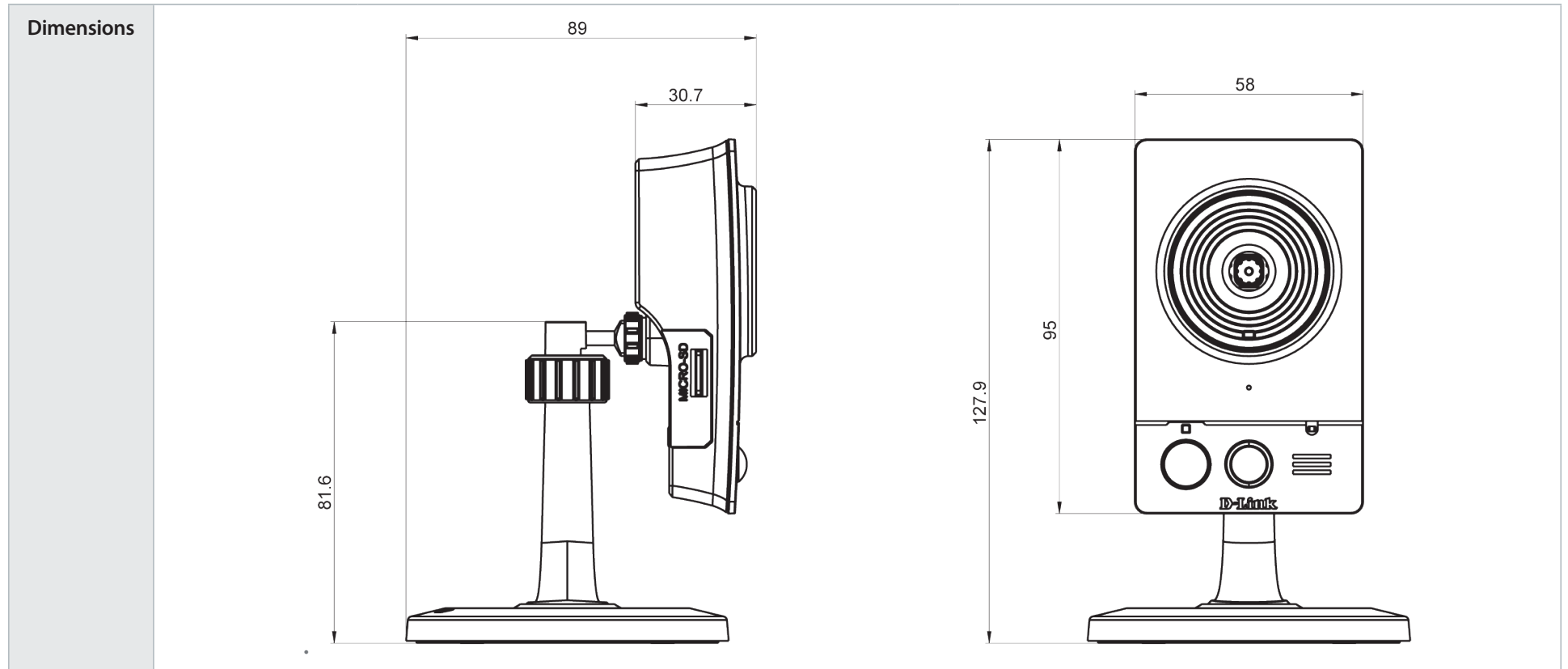

Safety Statements

CE Mark Warning:

This is a Class B product. In a domestic environment, this product may cause radio interference, in which case the user may be required to take adequate measures.

FCC Statement:

This equipment has been tested and found to comply with the limits for a Class B digital device, pursuant to part 15 of the FCC Rules. These limits are designed to provide reasonable protection against harmful interference in a residential installation. This equipment generates, uses, and can radiate radio frequency energy and, if not installed and used in accordance with the instructions, may cause harmful interference to radio communication. However, there is no guarantee that interference will not occur in a particular installation. If this equipment does cause harmful interference to radio or television reception, which can be determined by turning the equipment off and on, the user is encouraged to try to correct the interference by one or more of the following measures:

- Reorient or relocate the receiving antenna.
- Increase the separation between the equipment and receiver.
- Connect the equipment into an outlet on a circuit different from that to which the receiver is connected.
- Consult the dealer or an experienced radio/TV technician for help.

FCC Caution:

Any changes or modifications not expressly approved by the party responsible for compliance could void the user's authority to operate this equipment.

This device complies with Part 15 of the FCC Rules. Operation is subject to the following two conditions:

(1) This device may not cause harmful interference, and (2) this device must accept any interference received, including interference that may cause undesired operation.

IMPORTANT NOTICE:

FCC Radiation Exposure Statement:

This equipment complies with FCC radiation exposure limits set forth for an uncontrolled environment. This equipment should be installed and operated with minimum distance 20cm between the radiator & your body. This transmitter must not be co-located or operating in conjunction with any other antenna or transmitter.

The availability of some specific channels and/or operational frequency bands are country dependent and are firmware programmed at the factory to match the intended destination. The firmware setting is not accessible by the end user.

For detailed warranty information applicable to products purchased outside the United States, please contact the corresponding local D-Link office.

Industry Canada Notice:

This device complies with RSS-210 of the Industry Canada Rules. Operation is subject to the following two conditions:

(1) This device may not cause harmful interference, and (2) this device must accept any interference received, including interference that may cause undesired operation.

IMPORTANT NOTE:

Radiation Exposure Statement:

This equipment complies with IC radiation exposure limits set forth for an uncontrolled environment. This equipment should be installed and operated with minimum distance 20cm between the radiator & your body.

This device has been designed to operate with an antenna having a maximum gain of 2 dB. Antenna having a higher gain is strictly prohibited per regulations of Industry Canada. The required antenna impedance is 50 ohms.