



Sixnet[®] Series

BT/SN/RAM 6000

Hardware Guide | July 2015

Preface	4
Statement of Limited Warranty	8
Product Overview	9
Specifications	9
General Specifications	9
Mechanical Specifications	12
Power Specifications and Consumption	14
4-pin Molex Connector (BT/SN/RAM-6x00)	14
4-pin Screw Terminal (BT/SN/RAM-6xx1)	14
DC 2.5 mm Barrel Adapter	15
Power Specification	15
Electrical Specifications and Pinout (RAM 6000 units only)	16
Modem Views	17
Indicator Lights (LED)	18
Data Interface Specifications: Serial, Ethernet & USB	18
Ethernet Port	18
USB Device Port	18
Serial Port (DB9)	18
Serial Port Pin-Out	19
Connecting the modem to a DCE	20
RESET Button Functions	21
Ordering Guides	22
SN 6000 Series	22
RAM 6000 Series	23
Hardware Installation	24
Mounting the BT/SN/RAM 6000 Series Modem	24
DIN Rail Mounting & Removal	24
Cellular Antenna	25
Installation and Verification	26
Antenna and Diversity	27
Diversity/MIMO	27
GPS Antenna Requirements	27
Ethernet Cable	28
USB Cable	28
Serial Cable	29



Power Source 29

 Powering up the modem 29

 Testing the power connection 29

Thermal Performance and Considerations 30

 Hot Operating Conditions: 30

 Cold Operating Conditions: 31

Cleaning 31

Service and Support Information 32

This manual applies to the following products:

BT/SN/RAM-64xx

BT/SN/RAM-66xx

BT/SN/RAM-67xx

BT/SN/RAM-68xx

SN/RAM-69xx



Preface

Disclaimer

Portions of this document are intended solely as an outline of methodologies to be followed during the maintenance and operation of BT/SN/RAM 6000 equipment/software. It is not intended as a step-by-step guide or a complete set of all procedures necessary and sufficient to complete all operations.

While every effort has been made to ensure that this document is complete and accurate at the time of release, the information that it contains is subject to change. Red Lion Controls is not responsible for any additions to or alterations of the original document. Industrial networks vary widely in their configurations, topologies, and traffic conditions. This document is intended as a general guide only. It has not been tested for all possible applications, and it may not be complete or accurate for some situations.

Users of this document are urged to heed warnings and cautions summarized at the front of the document, such as electrical hazard warnings.

Compliance Information

Part 15 of the Federal Communications Commission (FCC) - A Rules: Interference

Every effort has been made to ensure that this equipment is designed to comply with the limits for a Class A digital device, as described in the FCC Rules. This equipment has been tested and found to comply with the limits for a Class A digital device, pursuant to Part 15 of the FCC Rules. These limits are designed to provide reasonable protection against harmful interference in a residential installation. This equipment generates, uses, and can radiate radio frequency energy and, if not installed and used in accordance with the instructions, may cause harmful interference to radio communications. Operation of this device in a residential area is likely to cause harmful interference in which case the user will be required to correct the interference at his/her own expense.

Industry Canada

This Class A digital apparatus meets all requirements of the Canadian Interference Causing Equipment Regulations. Operation is subject to the following two conditions; (1) this device may not cause harmful interference, and (2) this device must accept any interference received, including interference that may cause undesired operation.

Environmental Impact Statement

Red Lion equipment contains no hazardous materials as defined by the United States Environmental Protection Agency (USEPA). Red Lion recommends that all failed products be returned to Red Lion for failure analysis and proper disposal.

Toxic Emissions

Red Lion equipment releases no toxic emissions.



Trademark Acknowledgments

- Windows® /98/2000/7/8, Windows XP® are registered trademarks of the Microsoft Corporation.
- Microsoft is either a registered trademark or trademark of Microsoft Corporation in the United States and/or other countries.

Release Notes and Document Updates

The hard copy and flash drive versions of this document are revised only at major releases and, therefore, may not always contain the latest product information. As needed, Application Notes and or Product Bulletins will be provided between major releases to describe any new information or document changes.

The latest online version of this document and all product updates can be accessed through the Red Lion web site.

Publication History

The following information lists the release history of this document.

ISSUE/REVISION	RELEASE DATE	CONTENT DESCRIPTION
August 2014	August 2014	BT/SN/RAM 6000 Series Hardware Manual

Related Documents

The following information lists available documents related to this product.

ISSUE/REVISION	RELEASE DATE	CONTENT DESCRIPTION
July 2015, version 6	July 2015	SN/RAM 6000 & RAM 9000 Software Manual
August 2014, version 1.15	August 2014	IndustrialPro™ and MobilityPro™ Gateway Wireless Modems

Document Ordering Information

To order additional documentation, the user can contact the local sales representative or Red Lion through the contact numbers and/or e-mail addresses listed at the end of the document.

Document Comments

Red Lion appreciates all comments that will help us to improve our documentation quality. The user can submit comments through the Red Lion Customer Service. Simply email us.



Additional Product Information

Additional product information can be obtained by contacting the local sales representative or Red Lion through the contact numbers and/or e-mail addresses listed at the end of the document.

Safety Information

Environmental:

Warning: The unit may become very hot to the touch in high temperature environments, so extreme caution should be exercised in handling when energized. The unit should be disconnected from power and allowed to cool for approximately 5 minutes before touching in high temperature applications.

Pollution degree: 2 (Per IEC 61010-1)

Electrical:

Must be powered by a “Class 2 source” only.

Properly ground the unit before connecting anything else to it. If the equipment is used in a manner “not” specified by Red Lion, the protection provided by the equipment may be impaired.

Overvoltage category: II (Per IEC 61010-1)

Warnings/Cautions/Notes

Warnings apply to situations where personal injury or death may result.

Cautions apply where damage to equipment may result

Notes apply where additional noteworthy information, not in the general text flow but applicable, is made available to the user.

Hazardous Location and Installation Requirements

These products should not be used to replace proper safety interlocking. No software-based device (or any other solid-state device) should ever be designed to be responsible for the maintenance of consequential equipment or personnel safety. In particular, Red Lion disclaims any responsibility for damages, either direct or consequential, that result from the use of this equipment in any application.

All power, input and output (I/O) wiring must be in accordance with Class I, Division 2 wiring methods and in accordance with the authority having jurisdiction.



Suitable for use in Class I, Division 2, Groups A, B, C and D hazardous locations, or non-hazardous locations only.

WARNING – EXPLOSION HAZARD – Substitution of components may impair suitability for Class 1, Division 2.

WARNING – EXPLOSION HAZARD – When in hazardous locations, disconnect power before replacing or wiring modules.

WARNING – EXPLOSION HAZARD – Do not disconnect equipment unless power has been switched off or the area is known to be nonhazardous.

AVERTISSEMENTS POUR INSTALLATION ET ENDROITS DANGEREUX

Ces produits ne doivent pas être utilisés pour remplacer le verrouillage de sécurité approprié. Aucun dispositif basé sur un logiciel (ou tout autre dispositif à l'état solide) devraient jamais être conçus pour être responsable de l'entretien de l'équipement consécutifs ou la sécurité du personnel. En particulier, Red Lion décline toute responsabilité pour les dommages, directs ou indirects, résultant de l'utilisation de cet équipement dans n'importe quelle application.

Tout courant, câblage entrée et sortie (I / O) doit être conforme aux méthodes de câblage à la Classe I, Division 2 et conformément à l'autorité compétente.

Cet appareil est adapté pour utilisation en Classe I, Division 2, Groupes A, B, C, D endroits dangereux ou endroits non-dangereux.

AVERTISSEMENT – RISQUE D'EXPLOSION: La substitution de tout composant peut nuire à la conformité de Classe 1, Division 2.

AVERTISSEMENT – RISQUE D'EXPLOSION: Lorsque dans des endroits dangereux, débranchez le cordon d'alimentation avant de remplacer ou de brancher les modules.

AVERTISSEMENT – RISQUE D'EXPLOSION: Ne débranchez pas l'équipement à moins que l'alimentation ait été coupée ou que l'environnement est connu pour être non dangereux.



Statement of Limited Warranty

Red Lion, manufacturer of Red Lion products, warrants to Buyer that products, except software, manufactured by Red Lion will be free from defects in material and workmanship. Red Lion's obligation under this warranty will be limited to repairing or replacing, at Red Lion's option, the defective parts within three (3) years of the date of installation, or within three (3) years of the date of shipment from the point of manufacture, whichever is sooner. Products may be returned by Buyer only after permission has been obtained from Red Lion. Buyer will prepay all freight charges to return any products to the repair facility designated by Red Lion.

This limited warranty does not cover losses or damages which occur in shipment to or from Buyer or due to improper installation, maintenance, misuse, neglect of any cause other than ordinary commercial or industrial applications. In particular, Red Lion makes no warranties whatsoever with respect to implied warranties or merchantability or fitness for any particular purpose. All such warranties are hereby expressly disclaimed. No oral or written information or advice given by Red Lion or Red Lion's representative shall create a warranty or in any way increase the scope of this warranty.

This limited warranty is in lieu of all other warranties whether oral or written, expressed or implied. Red Lion's liability shall not exceed the price of the individual units, which are the basis of the claim. In no event shall Red Lion be liable for any loss of profits, loss of use of facilities or equipment, or other indirect, incidental or consequential damages.



Chapter 1 Product Overview

Specifications

General Specifications

Note: All specifications are subject to change. Consult the Red Lion® website for more information.

Wireless Interfaces	CDMA EVDO.A models
	<ul style="list-style-type: none"> Dual-band CDMA2000 EVDO Rev. A (with diversity) Backward compatible with 1xRTT and IS95
	GSM EDGE Models
	<ul style="list-style-type: none"> Quad-band 850/900/1800/1900 GSM
Wireless Interfaces	GSM HSPA+ Models
	<ul style="list-style-type: none"> Quad-band 800/850/1900/2100 MHz WCDMA (with diversity) HSDPA/HSUPA/HSPA+ Backward compatible with GPRS/EDGE/UMTS
	LTE Models
	<ul style="list-style-type: none"> See Frequency Specifications tables in Chapter 2
Programmable Platform	Configurable Events: up to 99 events can be triggered by over 200 system variables which in turn can trigger other outputs, write to IODB registers (for MODBUS/DNP3 access, as well as send SMS messages
	Software Development Kit (SDK)
	C/ C++/ Perl
System Performance	32-bit AM9 400 MHz CPU
	512 MB NAND
	128 MB RAM
Tunneling	IPsec, GRE, OpenVPN
Routing Protocols	OSPF, BGP, RIP
Clustering	VRRP
IP	NAT, Port Forwarding, Dynamic DNS, DHCP
	Stateful Inspection Firewall, IP Transparency, IP Fallback



Connectors	<p>Ethernet: 1 or 5 10/100Base-T RJ-45 ports Serial: 1 RS-232 (DB9) 115,200 bps USB: 1 USB 2.0 mm Antennas: 2 SMA connectors (antenna, diversity)</p>
GPS Port	<p>Narrow-band GPS: 1575.42 MHz ±2MHz minimum Wide-band GPS and GLONASS: 1565-1606 MHz recommended (RAM-69xx only)</p>
LED Indicators	<p>Power, WAN, Signal, RS232, GPS, Ethernet Link & Activity</p>
Power Input	<p>Input Voltage: 8-30 VDC (12 or 24 VDC nominal) Standby Power: 1.4W - 4.0W (typical) Transmitting: 660x: 2.0W - 2.9W 6621: 3.6W - 4.5W 67xx: 2.6W - 6.9W 6721: 4.3W - 8.7W 680x: 2.6W - 5.0W 6821: 4.2W - 6.6W 690x: 2.6W - 6.9W 6921: 4.3W - 8.7W PoE Operation (EB models only) IEEE 802.3af compliant Powered Device (PD) PoE Input: 37 - 57 VDC (48 VDC nominal) Heat Dissipation: 30 BTU/hour max MTBF BT6601EB 1530K Hours GB @ 40°C per MIL-HNDBK-217F2 MTBF BT6601 1,832K Hours GB @ 40°C per MIL-HNDBK-217F2</p>
Mechanical	<p>BT/SN/RAM-6x0x Dimensions: 120 x 96 x 32 mm (4.7" x 3.77" x 1.25") Weight: 453g (1lb) BT/SN/RAM-6x21 Dimensions: 120 x 96 x 51 mm (4.7" x 3.77" 2.0") Weight: 500g (1.1lbs)</p>
Environmental	<p>Operating Temp: -40 to +75°C* Shock: IEC60068-2-27 Vibration: IEC60068-2-6 Humidity: 5 to 95% non-condensing Ingress: IP30 protection</p>



Compliances:



The BT/SN/RAM 6000 Series products meet the following standards plus others:

Electrical Safety

These devices have been designed to meet the basic safety requirements of the following standards:

- CE per Low Voltage Directive and IEC 61010-1 (CE applies only to the -EU models. Please contact Red Lion for availability)
- UL508 (Industrial control equipment), ANSI/ISA 12.12.01 (Hazardous Locations)
- CSA C22.2 No. 142 and No. 213 (per cUL)

EMC (emissions and immunity)

- CE per the EMC directive (CE applies only to the -EU models. Please contact Red Lion for availability)
- EN 301 489-1,-7,-24; EN 301 908-1,-2; EN 301 511: Immunity and Emissions.
- FCC part 15 and ICES 003. See FCC statement on page 6.
- EN 55022 (CISPR22)

This equipment has been tested and found to comply with the limits for a Class A digital device, pursuant to part 15 of the FCC rules. These limits are designed to provide reasonable protection against harmful interference when the equipment is operated in a commercial environment. This equipment generates, uses, and can radiate radio frequency energy; and if not installed and used in accordance with the instructions, may cause harmful interference to radio communications. Operation of this equipment in a residential area is likely to cause harmful interference to radio communications, in which case the user will be required to correct the interference at their own expense. Warning: Changes or modifications to this unit not expressly approved by the party responsible for compliance could void the user's authority to operate the equipment.

Information to the user: If this equipment causes interference to radio or television reception, which can be determined by turning the equipment off and on, the user is encouraged to try to correct the interference by one or more of the following measures: In order to meet FCC emissions limits, this equipment must be used only with cables that comply with IEEE 802.3. If necessary, the user should consult the dealer or an experienced radio/television technician for additional suggestions. The user may find the following booklet prepared by the Federal Communications Commission helpful: "How to Identify and Resolve Radio-TV Interference Problems". This booklet is available from: U.S. Government Printing Office, Washington, DC 20402, Stock No. 004-000-00345-4



WEEE compliance



These devices comply with the WEEE directive. Do not throw away these devices in the standard trash. Contact Red Lion regarding proper disposal.

RoHS compliance



These devices comply with the RoHS directive and are considered lead and other hazardous substance free.

* +75°C See [Thermal Performance and Considerations](#) in Chapter 2.



Mechanical Specifications

Front View

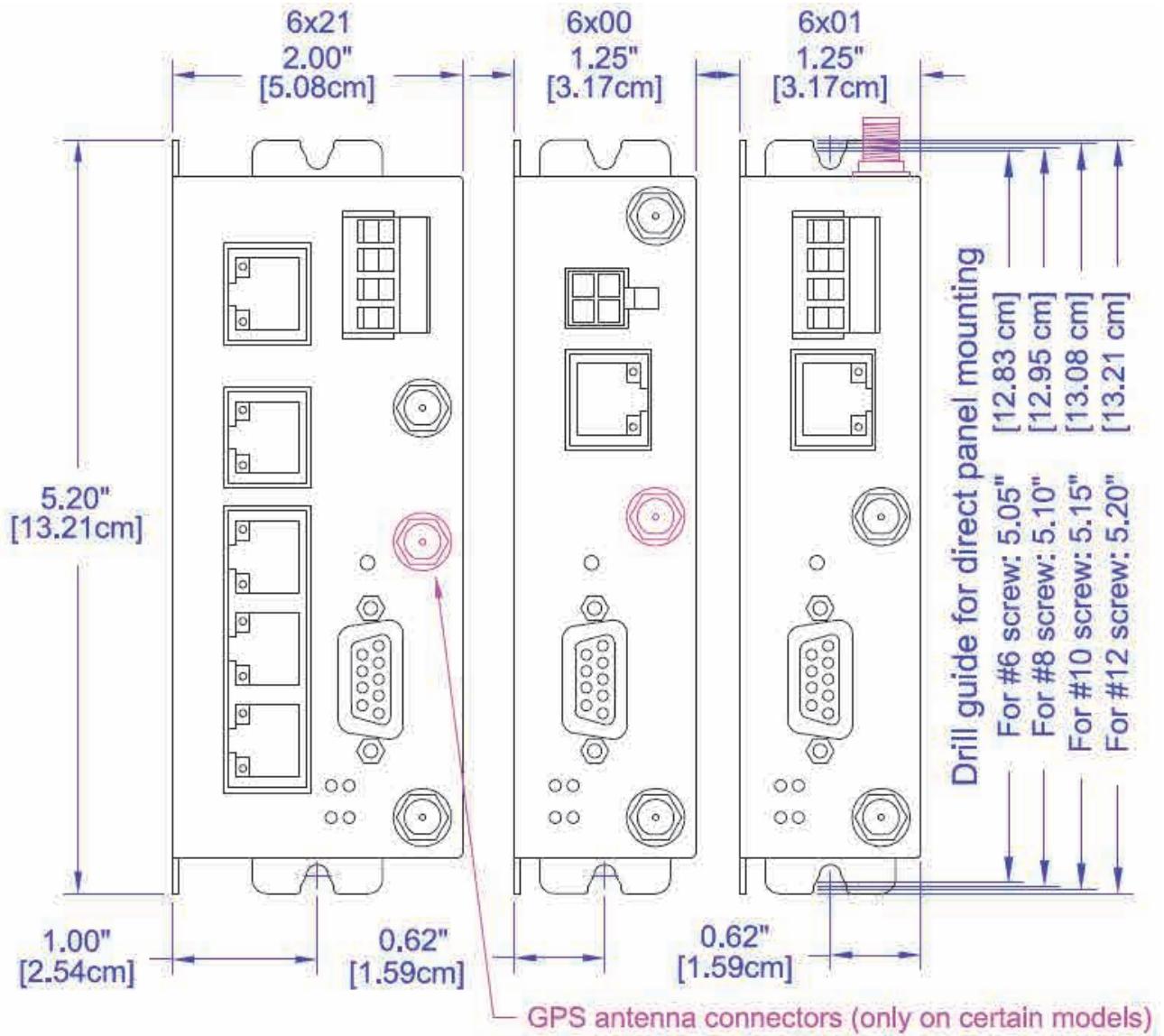

Note: GPS antenna is only available on RAM-69xx products



Side View

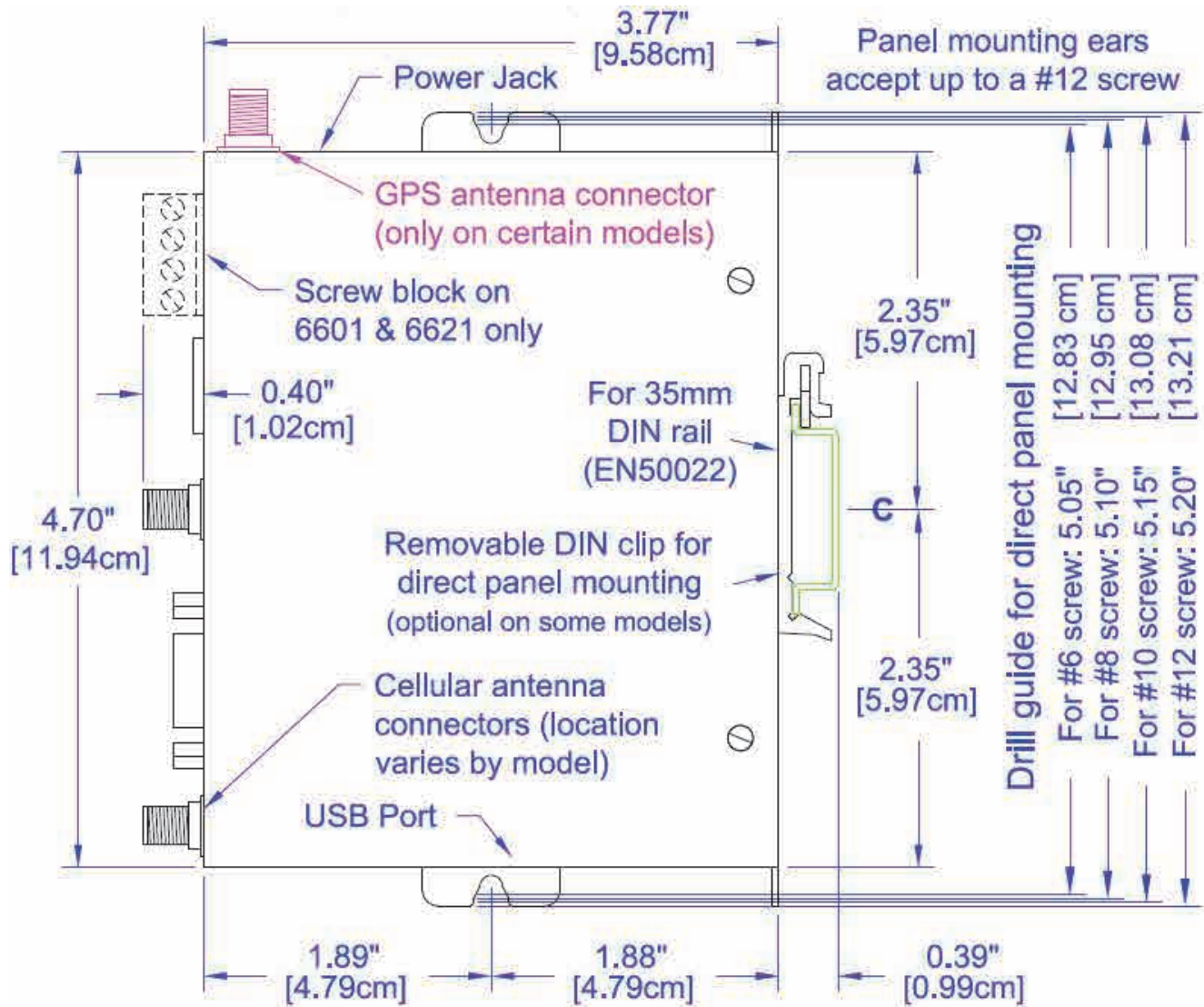

Note: GPS antenna is only available on RAM-69xx products



Power Specifications and Consumption

Power is supplied to the modem via:

- 4-pin Molex connector for the BT/SN/RAM-6x00 model
- 4-pin screw terminal for the BT/SN/RAM-6x01, BT/SN/RAM-6x01EB and BT/SN/RAM-6x21 models
- DC 2.5 mm barrel plug for all BT/SN/RAM-6000 models
- Power over Ethernet for all BT/SN/RAM-6x01EB models

4-pin Molex Connector (BT/SN/RAM-6x00)

Power is supplied to the modem via the 4-pin Molex connector on the front panel for the BT/SN/RAM-6x00 models. The pins are described as follows:

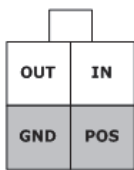

Pin	Name	Description
1	GND	Ground
2	POS	Power supply input (8 to 30 VDC)
3	IN	Digital and analog input
4	OUT	Digital output

Power Connector
(Facing Modem)

4-pin Screw Terminal (BT/SN/RAM-6xx1)

Power is supplied to the modem via the 4-pin Screw Terminal on the front panel for the BT/SN/RAM-6xx1 models. The pins are described as follows:

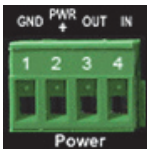

Pin	Name	Description
1	GND	Ground
2	PWR+	Power supply input (8 to 30 VDC)
3	OUT	Digital output
4	IN	Digital and analog input

Power Connector
(Facing Front)



DC 2.5 mm Barrel Adapter

Power is supplied to the modem via the barrel adapter on the left side of all BT/SN/RAM-6000 series modems. The contacts are described as follows:



Pin	Name	Description
Sleeve	GND	Ground
Tip	PWR+	Power supply input (8 to 30 VDC)

Power Connector
(left side)

Warning: DC 2.5 mm barrel adapter shall not be used in hazardous locations.

Power Specification

Power input to the modem is protected against reverse polarity and over-voltage. The modem's power consumption is as follows:

Typical Power Consumption (Watts)			
Model	Standby	Transmitting Minimum	Transmitting maximum
BT/SN/RAM-6401	1.4	2.0	5.0
BT/SN/RAM-6421	2.7	3.4	6.4
BT/SN/RAM-660x	1.4	2.0	2.9
BT/SN/RAM-6621	3.0	3.6	4.5
BT/SN/RAM-680x	1.4	2.6	5.0
BT/SN/RAM-6821	3.0	4.2	6.6
BT/SN/RAM-670x	1.6	2.6	6.9
BT/SN/RAM-6721	3.3	4.3	8.7
SN/RAM-690x	1.6	2.6	6.9
SN/RAM-6921	3.3	4.3	8.7

Wiring instructions are provided in the Hardware Installation section.

All modems are equipped with protection for reversed polarity and power surges over 33 volts. The modems are equipped with an internal 3 Amp fuse.



Electrical Specifications and Pinout (RAM 6000 units only)

1x Digital Input (DIN)

Configuration: unisolated level detection, reference to ground

Active level: 1.6VDC to 30VDC

Inactive level: 0VDC to 1.3VDC

Absolute Minimum VDC: -0.3VDC

Absolute Maximum VDC: 33VDC

Leakage IDC at 5VDC: 150uADC

1x Analog Input (Shared with Digital Input) (DIN/AI1)

Configuration: unisolated input, reference to ground

Resolution: 1024 (ADC 10-bit)

VDC per step: 4.8875855mVDC

Full scale level: 5VDC

Zero level: 0VDC

Absolute Minimum VDC: -0.3VDC

Absolute Maximum VDC: 8.3VDC

Leakage IDC at 5VDC: 265.96uADC TYPE

1x Digital Output (DOU)

Configuration: Open Collector, reference to ground





Absolute Maximum IDC: 500mADC (Vce = 750mVDC)

Absolute Maximum VDC: 30VDC (open circuit)

Absolute Minimum VDC: -0.4VDC (open circuit)



Modem Views

<p>4-pin power connector</p>		<ul style="list-style-type: none"> • BT/SN/RAM-6600 • SN/RAM-6700 • BT/SN/RAM-6800 • SN/RAM-6900**
<p>Screw-block power connector</p>		<ul style="list-style-type: none"> • BT/SN/RAM-6401* • BT/SN/RAM-6601 • SN/RAM-6701 • BT/SN/RAM-6801 • SN/RAM-6901**
<p>Screw-block power connector & PoE power input</p>		<ul style="list-style-type: none"> • BT/SN/RAM-6401EB* • BT/SN/RAM-6601EB • SN/RAM-6701EB • BT/SN/RAM-6801EB • SN/RAM-6901EB**
<p>Ethernet Switch</p>		<ul style="list-style-type: none"> • BT/SN/RAM-6421* • BT/SN/RAM-6621 • SN/RAM-6721 • BT/SN/RAM-6821 • SN/RAM-6921**

*The BT/SN/RAM-64xx series modems are not equipped with a diversity antenna connector

**The RAM models include GPS but the associated SMA connector is not shown in the images



Indicator Lights (LED)

LED	STATUS	CORRESPONDING STATE
Power	OFF	Modem is powered off
	ON	Modem is powered ON
	FLASH**	Firmware error
Signal	OFF	No signal available or signal strength is below -100 dBm
	ON	Excellent signal strength = greater than -69 dBm
	FLASH**	Fast: Every 300ms = -79 to -70 dBm
		Medium: Every 600ms = -89 to -80 dBm
Slow: Every 1200ms = -99 to -90 dBm		
WAN	OFF	Cellular connection is not established
	ON	Cellular connection is established - no network data activity
	FLASH**	Cellular connection is established - with network data activity
RS232	OFF	Serial connection is not established
	ON	Serial connection is established - no data activity with host
	*FLASH**	Serial connection is established - with data activity with host

* Depending on Serial Application

** There are 2 scenarios where all of the panel LEDs will flash rapidly: during a device firmware reflash and during a module firmware reflash.

Data Interface Specifications: Serial, Ethernet & USB

Ethernet Port

The modem's 10/100Mbps Ethernet port is compliant with the EIA-568 standard. The modem's ports are auto-sensing so they can be used with either a straight or crossover RJ45 cable to connect to host ports.

The BT/SN/RAM-6x21 features a 5-port Ethernet switch allowing connectivity to multiple local devices.

USB Device Port

This is a USB 2.0 Device interface on a Mini B (BT/SN/RAM-6xxx) connector. It offers Ethernet-over-USB functionality using the RNDIS driver for Windows 7, Windows XP and Windows Vista Operating systems only. The RNDIS driver must be installed before the USB interface can be used. The driver and instructions can be obtained by contacting a Technical Support representative.

Serial Port (DB9)

Our BT/SN/RAM modems have a standard RS232 DCE, serial interface with a DB9 connector style. The modems are DCE (Date Communication Equipment) devices and are compliant with EIA-232 standard.

Connect a DTE device to a DCE device using a straight pin-for-pin connection cable. To connect two DCE devices, use a null modem cable which crosses the 'transmit' and 'receive' lines in the cable. An example of a DTE device is a computer. Most other devices are DCE types.

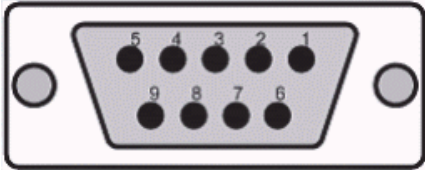

Serial Port Pin-Out:

9 pin connector on the modem (DCE)	
Female RS232 DB9	
Pin Number	Direction of signal:
1	Carrier detect (CD) Outgoing signal
2	Received data (RX) Outgoing data
3	Transmitted data (TX) Incoming data
4	Data terminal ready (DTR) Incoming handshaking signal
5	Signal ground
6	Data set ready (DSR) Outgoing handshaking signal
7	Request to send (RST) Incoming flow control signal
8	Clear to send (CTS) Outgoing flow control signal
9	Ring Indicator (RI) Outgoing signal

The TX (pin 3) wire is the one through which data from an attached device is transmitted to the DCE modem. The RX (pin 2) wire is the one on which data is transmitted by the DCE modem.

RTS and CTS are handshaking signals that complement one another by handling flow control. RTS and CTS wires are used when hardware flow control is enabled in both the modem and an attached device. On the other hand, software flow control uses special control characters transmitted from an application to a device attached to the modem. When software flow control is implemented, the RTS and CTS lines are not used.

DTS and DSR are also handshaking signals that are used to simply confirm that a device is attached and is turned on. DTR/DSR is rarely used as flow control signals when RTS/CTS is used.



Connecting the modem to a DCE:

In order to connect a modem to another DCE device, a null modem cable configuration is required. If flow control is not necessary i.e. no handshaking is required, the only pins to be used are TX, RX and GND. TX and RX have to be crossed between the modem (DCE) and the other DCE device. GND is connected to GND. Disable flow control on the modem and be sure that the attached device does not check for any of the handshaking signals. Below is an example diagram.

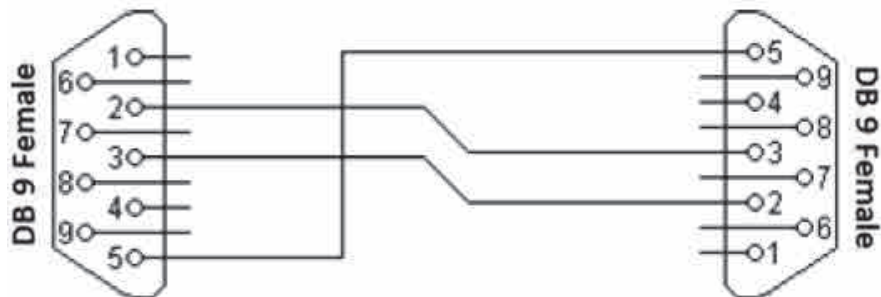

In the event that full handshaking is required, all handshaking signals should be cross-connected, i.e. RTS/CTS have to be crossed and DTR/DSR have to be crossed. In addition, TX and RX signals have to be crossed. Below is an example diagram.

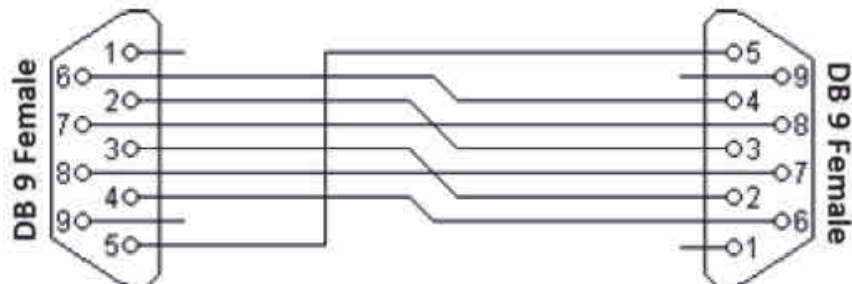

For further serial wiring information, refer to [Chapter 2](#) in this manual.

RESET Button Functions

Mode	Pattern	Description
Hard Reset	Press and hold for less than 3 seconds	Standard Reboot
Factory Restore	Press and hold between 3 and 10 seconds RS232 LED flashes quickly	This option is implemented in SN version 3.09 and higher. To restore default settings for older versions, rerun the SN Reflashing procedure found at Red Lion website.
FW Upgrade	Press and hold between 10 and 15 seconds WAN LED flashes quickly	Puts the modem in advanced firmware upgrade mode by restarting the modem and running the bootloader only. Do not use this mode unless instructed to by Red Lion Technical Support.
USB Pass-Through	Press and hold for longer than 15 seconds Signal LED flashes quickly	Puts the modem in main pass-through mode to the RF module, allowing CCT provisioning and PST support. Do not use this mode unless instructed to by Red Lion Technical Support.



Ordering Guides

SN 6000 Series

Part Number	Product Line	Serial RS-232	Ethernet 10/100	Cellular	Power Connector	Default Carriers **
SN-6600-XX	SN	1	1	3G/CDMA	Molex end connector cable	(SP) Sprint; (VZ) Verizon
SN-6600-XX-AC	SN	1	1	3G/CDMA	AC adapter	
SN-6600-XX-MX	SN	1	1	3G/CDMA	AC adapter/Molex end connector	
SN-6601-XX	SN	1	1	3G/CDMA	DC powered	
SN-6601-XX-AC	SN	1	1	3G/CDMA	AC adapter	
SN-6601EB-XX	SN	1	1	3G/CDMA	PoE (Power over Ethernet)	
SN-6621-XX	SN	1	5	3G/CDMA	DC powered	
SN-6621-XX-AC	SN	1	5	3G/CDMA	AC adapter	
SN-6800-XX	SN	1	1	3G/GSM	Molex end connector cable	(AT)AT&T; (BM) Bell Mobility; (AM) Generic*; (MTS) Manitoba; (RO) Rogers; (TE) TELUS
SN-6800-XX-AC	SN	1	1	3G/GSM	AC adapter	
SN-6800-XX-MX	SN	1	1	3G/GSM	AC adapter/Molex end connector	
SN-6801-XX	SN	1	1	3G/GSM	DC powered	
SN-68001-XX-AC	SN	1	1	3G/GSM	AC adapter	
SN-6801EB-XX	SN	1	1	3G/GSM	PoE (Power over Ethernet)	
SN-6821-XX	SN	1	5	3G/GSM	DC powered	
SN-6821-XX-AC	SN	1	5	3G/GSM	AC adapter	
SN-6900-XX	SN	1	1	4G LTE	Molex end connector cable	(AT) AT&T; (VZ) Verizon; (AM) Generic* Includes: BELL, TELUS and Rogers
SN-6901-XX	SN	1	1	4G LTE	DC powered	
SN-6901EB-XX	SN	1	1	4G LTE	PoE (Power Over Ethernet)	
SN-6921-XX	SN	1	5	4G LTE	DC powered	

* See Band/Frequency table for compatibility

** Carrier that is pre-configured on device. Carrier can be selected via software ONLY on SN/RAM-69xx models.

Where XX = Carrier code



RAM 6000 Series

Part Number	Product Line	Serial RS-232	Ethernet 10/100	Cellular	Power Connector	Supported Carriers**
RAM-6600-XX	RAM	1	1	3G/CDMA	Molex end connector cable	(SP) Sprint; (VZ) Verizon
RAM-6600-XX-AC	RAM	1	1	3G/CDMA	AC Adapter	
RAM-6600-XX-MX	RAM	1	1	3G/CDMA	AC adapter/Molex end connector	
RAM-6601-XX	RAM	1	1	3G/CDMA	DC powered	
RAM-6601-XX-AC	RAM	1	1	3G/CDMA	AC adapter	
RAM-6601EB-XX	RAM	1	1	3G/CDMA	PoE (Power over Ethernet)	
RAM-6621-XX	RAM	1	5	3G/CDMA	DC powered	
RAM-6621-XX-AC	RAM	1	5	3G/CDMA	AC adapter	
RAM-6800-XX	RAM	1	1	3G/GSM	Molex end connector cable	
RAM-6800-XX-AC	RAM	1	1	3G/GSM	AC adapter	
RAM-6800-XX-MX	RAM	1	1	3G/GSM	AC adapter/Molex end connector	
RAM-6801-XX	RAM	1	1	3G/GSM	DC powered	
RAM-6801-XX-AC	RAM	1	1	3G/GSM	AC adapter	
RAM-6801EB-XX	RAM	1	1	3G/GSM	PoE (Power over Ethernet)	
RAM-6821-XX	RAM	1	5	3G/GSM	DC powered	
RAM-6821-XX-AC	RAM	1	5	3G/GSM	AC adapter	
RAM-6900-XX	RAM	1	1	4G LTE	Molex end connector cable	(AT) AT&T; (VZ) Verizon; (AM) Generic* Includes: BELL, TELUS and Rogers
RAM-6901-XX	RAM	1	1	4G LTE	DC powered	
RAM-6901EB-XX	RAM	1	1	4G LTE	PoE (Power Over Ethernet)	
RAM-6921-XX	RAM	1	5	4G LTE	DC powered	

* See Band/Frequency table for compatibility

** Carrier that is pre-configured on device. Carrier can be selected via software ONLY on SN/RAM-69xx models.

Where XX = Carrier Code



Chapter 2 Hardware Installation

Mounting the BT/SN/RAM 6000 Series Modem

There are three different ways to mount a BT/SN/RAM 6000 series modem:

- Horizontally using two #6 screws pan or fillister head onto its horizontal mounting feet
- Vertically using two #6 screws pan or fillister head onto its vertical mounting feet
- Vertically using a DIN rail clip

Note: Allow enough room to route the Ethernet, serial, I/O and other cables.

DIN Rail Mounting & Removal

The BT/SN/RAM 6000 series has a DIN rail clip pre-mounted to the back of the unit. To panel mount the unit, the clip can be removed easily by removing the three (3) screws holding it in place. See the image at right for reference.



The DIN clip has an integral spring mechanism that keeps it securely attached to the rail. Refer to the diagrams below for how to mount and remove the unit to a standard EN50022 DIN rail.

Note: For best performance it is recommended that a DIN rail spacer (such as an end clamp) be used between the RTU and adjacent devices. This will leave an air gap for best heat dissipation off of the case.

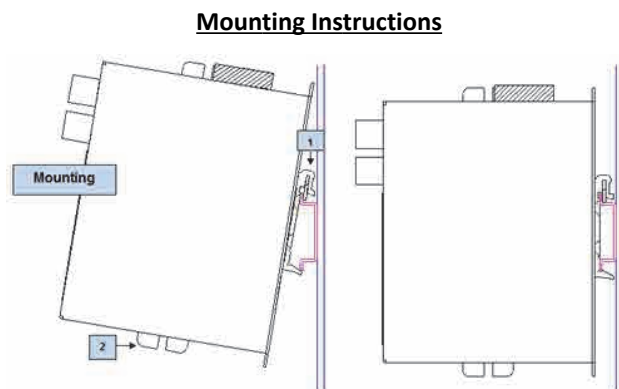

Recommended DIN rail mounting steps:

1. Hook the top back on the DIN rail clips on the unit over the DIN rail.
2. Push the bottom of the unit towards the DIN rail unit it snaps into place.

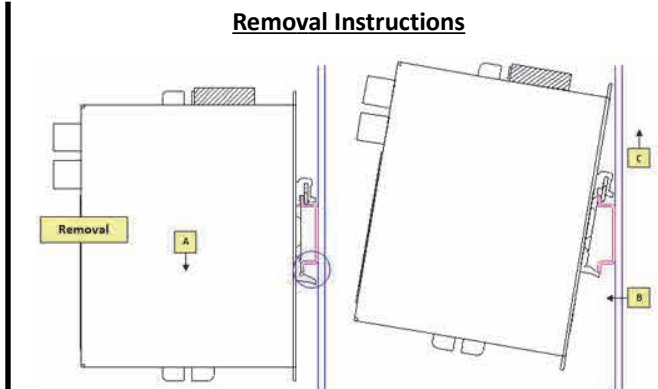

Recommended DIN rail removal steps:

- A. Push the whole unit down to free the bottom of the DIN rail clip. See blue circle areas.
- B. Pull the bottom of the unit away from the DIN rail.
- C. Unhook the top of the unit and remove it from the DIN rail.



Cellular Antenna

The selected cellular antenna(s) must meet the following specifications:

- Nominal 50 ohm impedance
- Voltage Standing Wave Ratio (VSWR) less than 2.5:1
- Male SMA connector

Frequency Specifications

BT/SN/RAM-66xx

Technology	Bands	Frequencies	Antenna Configuration
CDMA/EVDO	BC0, BC1	800/1900 MHz	Diversity Support

BT/SN/RAM-68xx

Technology	Bands	Frequencies	Antenna Configuration
HSPA+	1, 2, 5, 6, 8	800/850/900/1900/2100 MHz	Diversity Support
Fallback GSM/GPRS/EDGE	-	850/900/1800/1900 MHz	-

SN/RAM-67xx-VZ (Verizon Only)

Technology	Bands	Frequencies	Antenna Configuration
LTE	13	700 MHz	MIMO Required
Fallback CDMA/EVDO	BC0, BC1	800/1900 MHz	Diversity Support

SN/RAM-67xx

Technology	Bands	Frequencies	Antenna Configuration
LTE	1, 4, 17	700/1900 & 1700 (AWS)/ 2100(AWS) MHz	MIMO Required
Fallback HSPA+	1, 2, 5, 6	800/850/1900/2100	Diversity Support
Fallback GSM/GPRS/EDGE	-	850/900/1800/1900 MHz	-



SN/RAM-69xx

Technology	Bands	Frequencies	Antenna Configuration
LTE	2, 4, 5, 13, 17, 25	700/850/1900 & 1700 (AWS)/ 2100(AWS) MHz	MIMO Required
Fallback CDMA/EVDO	BC0, BC1, BC10	800/1900 MHz	Diversity Support
Fallback HSPA+	1, 2, 4, 5, 8	850/900/1900/2100 & 1700(AWS)/ 2100(AWS) MHz	Diversity Support
Fallback GSM/GPRS/EDGE	-	850/900/1800/1900 MHz	-

The length of the antenna cable may affect the signal strength. Choose the appropriate cable type and length. The table below provides can help pre-determine the loss to expect.

Cable Type	Loss per 100 feet
8216 (RG58)	31 dB
8267 (RG213)	7.6 dB
LMR-400	3.9 dB
LMR-500	3.15 dB
LMR-600	2.5 dB
LMR-1200	1.26 dB

Per FCC requirements the antenna gain including cable loss must not exceed 7.5 dBi in the Cellular band, 3 dBi in the PCS band, 5.5 dBi for LTE Band 4, and 9 dBi in the LTE Band 17 for RF exposure purposes of 2.1091. The antenna(s) used for this transmitter must be installed to provide a separation distance of at least 20 cm from all persons. The antenna(s) used for this transmitter must not be co-located or operating in conjunction with any other antenna or transmitter except in accordance with FCC multi-transmitter evaluation procedures.

Installation and Verification

When installing the antenna, follow the FCC and Industry Canada guidelines and keep the following in mind:

- Mount the antenna(s) at least 30 cm (12 inches) from other antennas
- Do not install the antenna in a closed metallic enclosure (such as a cabinet or the trunk of a car).

Once a modem has a signal, the Signal LED indicator will start flashing according to the signal strength. Additionally, the Web Interface can display the received signal strength (RSSI) on the status page. The modem should have at the very least one bar of signal strength.



Antenna and Diversity

The Red Lion 6000 series modems except for the BT/SN/RAM-64xx series have two antenna connectors available, labeled Antenna and Diversity.

- **Antenna:** This is the main antenna that is used for data transmission. It is mandatory to have the Antenna port connected to an antenna.
- **Diversity:** This is the diversity antenna, used to improve on the signal strength obtained from the main antenna. For SN/RAM-66xx/68xx units, this antenna is not mandatory for 3G connections, however it will improve throughput in low signal and fringe areas.

Diversity/MIMO

This port is used for RX diversity on 3G connections and MIMO for LTE connections. Receive Diversity or MIMO is a transmission technique that consists of using two separate antennas to achieve the most robust cellular signal possible. Diversity will help achieve fast, reliable data throughput in applications that require a high amount of bandwidth.

Note: This antenna is not mandatory for 3G, however it is recommended and will improve throughput in low signal and fringe areas. For SN/RAM-67xx/69xx units, this antenna is required for compliance with LTE MIMO operation.

To get the best performance, this second antenna should be placed at a minimum of $\frac{5}{8}$ of a wave length away from the other antenna. Therefore, the minimum spacing for antennas in the 800 MHz frequency is $\frac{5}{8} * 13.5'' = 8.5''$. The diversity antenna can be spaced further away than this, ideally in increments of 13.5'', 22'', 35'', etc. For a 1900 MHz only network, the optimal distance would be $\frac{5}{8} * 6.2'' = 4''$. Orienting the antennas differently from one another may also improve performance, particularly when the antennas are close together.



Warning: This device is not intended for use within close proximity of the human body. Antenna installation should allow for a separation of at least 20cm from all personnel.

GPS Antenna Requirements

The GPS chipset used in this device is capable of GPS and Glonass signal reception.

This unit uses a 50 ohm active antenna only. It is used for receiving signals only. Ascertain that the GPS antenna cabling uses an SMA-M type connector. For optimal results, the GPS antenna should be located so that it has clear and unobstructed access to the sky.



Parameter	Requirements	Comments
Frequency range	<ul style="list-style-type: none"> Narrow-band GPS: 1575.42 MHz \pm2 MHz minimum Wide-band GPS and GLONASS: 1565 - 1606 MHz recommended 	
Field of view (FoV)	<ul style="list-style-type: none"> Omni-directional in azimuth -45° to +90° in elevation 	
Polarization (Average Gv/Gh)	>0 dB	Vertical linear polarization is sufficient.
Free space average gain (Gv+Gh) over FOV	> -6 dBi (preferably > -3 dBi)	Gv and Gh are measured and averaged over -45° to +90° in elevation, and \pm 180° in azimuth
Gain	<ul style="list-style-type: none"> Maximum gain and uniform coverage in the high elevation angle and zenith Gain in azimuth plane is not desired 	
Average 3D gain	> -5 dBi	
Isolation between GNSS and Ant1	> 10 dB in all uplink bands	
Typical VSWR	< 2.5:1	
Polarization	Any other than LHCP (left-hand circular polarized) is acceptable	

Ethernet Cable

If you are connecting to the modem via the Ethernet port, you will need a straight or crossover category 5 cable with two 8-pin RJ45 connectors on each end.

To visually confirm that Ethernet cabling was done properly, check the LED indication on the Ethernet port located at the rear panel of the modem. The Link LED should be on when the right cable is used.

USB Cable

This is an Ethernet-over-USB connection which behaves like an Ethernet connection. It can only be connected to a PC with Windows 7, Windows XP or Windows Vista installed. If you are connecting to the modem via the USB port, you will need a Type A plug to Type B mini plug USB cable for the BT/SN/RAM-6000 series modems. In order for the USB connection to work, you need to install the Sixnet RNDIS USB driver which is available at [Red Lion website](#).



Serial Cable

The modem has all its serial port pins enabled. If all the pins are enabled on the attached serial device, it is important to know whether the device is using DTE or DCE as a communication mode.

The modem is a DCE device, so use a straight-through serial cable between the modem and a DTE device such as a terminal. Use a NULL modem cable adapter between the modem and a DCE device such as another modem.

If using custom wiring or if some pins are disabled, follow the guidelines below. The wiring will vary depending on whether the attached serial device is a DTE or DCE.

Modem		DTE		Modem		DCE
CTS	↔	CTS		CTS	↔	RTS
RTS	↔	RTS		RTS	↔	CTS
DTR	↔	DTR		DTR	↔	DSR
DSR	↔	DSR		DSR	↔	DTR
TX	↔	TX		TX	↔	RX
RX	↔	RX		RX	↔	TX
DCD	↔	DCD		DCD	↔	DCD
GND	↔	GND		GND	↔	GND
RI	↔	RI		RI	↔	RI

For specifications on Serial ports, refer to the [Serial Port section](#) in Chapter 1 of this manual.

Power Source

IMPORTANT

Any installations involving electrical wiring and connections should be done by someone who is experienced in this field.

As described in the Power specifications and consumption section, the modem can be powered using:

- 4-pin Molex connector for the BT/SN/RAM-6x00 models
- 4-pin screw terminal for the BT/SN/RAM-6x01, BT/SN/RAM-6x01EB and BT/SN/RAM-6x21 models
- DC 2.5mm round plug for all models
- PoE (Power over Ethernet) for BT/SN/RAM-6x01EB models

WARNING: DC 2.5 mm barrel adapter shall not be used in hazardous locations.

Powering up the modem

The modem will power up as soon as an 8 to 30 VDC voltage is applied to one of its power inputs and shuts off when this input voltage is below 4 VDC.

Testing the power connection

Check the PWR light on the modem: if it is turned on then the modem is powered. If it's off, then review the installation procedures, or contact Red Lion Technical Support for further assistance.



Thermal Performance and Considerations

These units are rated for operation from -40 to +75°C when the proper thermal considerations are taken into account. Please refer to the following information to maximize the performance of these units when they are operated under extreme temperatures.

Hot Operating Conditions:

These units have many modes of operation which can cause the power consumption and corresponding heat dissipation to vary greatly. This factor, along with others, can affect the performance and longevity of the unit. These units are rated for operation up to +75°C in typical applications where the wireless communication (cellular and/or Wi-Fi) is moderate*.

The maximum ambient temperature rating is further defined as follows:

- 60°C maximum for continuous operation:
 - The ambient temperature is defined as the temperature of the air immediately surrounding the unit.
 - For best performance and longevity, try to keep the ambient air temperature at or below 60°C as much as possible.
- 75°C for short term operation:
 - Short term is defined as 4 hours or less, per day.
 - Running at temperatures above 60°C for extended periods of time may reduce the performance and longevity of the unit.
 - Reduced wireless performance may occur when operating above +60°C.

* The above ratings are based on moderate wireless communications. If your wireless communications is atypically high or frequent then the maximum ambient operating temperature may be reduced. The wireless circuit(s) in these units may shutdown to protect from permanent damage when the internal circuitry temperature becomes extreme (typically around 95°C but may vary depending on model). If this condition is occurring in your application then you need to do one of the following:

- Reduce the ambient operating temperature which is the temperature of the air surrounding the outside of the unit. Here are some suggestions on how to reduce the temperature:
 - Make sure other hot devices are not mounted immediately adjacent or below the unit. It is recommended to use a DIN rail spacer between adjacent units so heat cannot transfer due to direct contact.
 - The use of one or more fans is a great way to reduce the ambient temperature around the unit.
- Reduce the rate or frequency of your communications. You may simply be polling or reporting too frequently. Constant communications can cause the temperature of the wireless circuitry to rise quickly and possibly reach the shutdown limit. Therefore, spacing out your communication sessions will provide for optimal performance and operation.

Note: Some models allow you to monitor the internal temperature of the cellular modem inside. For best performance, this internal temperature should be kept below 85°C. Refer to the Software Manual for details.



Cold Operating Conditions:

These units will operate down to -40°C when properly installed in an enclosure that protects them from direct exposure to the elements. These units are not rated for outdoor installation without protection. Please note that when operating below -30°C some reduction in the wireless performance may occur.

Cleaning

Clean only with a damp cloth. Excess moisture or harsh chemicals can cause damage to the unit.



Service and Support Information

Service Information

We sincerely hope that you never experience a problem with any Red Lion product. If you do need service, call Red Lion at 1-877-432-9908 for Technical Support. A trained specialist will help you quickly determine the source of the problem. Many problems are easily resolved with a single phone call. If it is necessary to return a unit to us, an RO (Repair Order) can be obtained on the [Red Lion website](#).

Red Lion tracks the flow of returned material with our RO system to ensure speedy service. You must include this RO number on the outside of the box so that your return can be processed immediately.

Be sure to have your original purchase order number and date purchased available.

We suggest that you give us a repair purchase order number in case the repair is not covered under our warranty. You will not be billed if the repair is covered under warranty.

Please supply us with as many details about the problem as you can. The information you supply will be written on the RO form and supplied to the repair department before your unit arrives. This helps us to provide you with the best service, in the fastest manner. Repairs are completed as soon as possible. If you need a quicker turn-around, ship the unit to us by air freight. We give priority service to equipment that arrives by overnight delivery.

We apologize for any inconvenience that the need for repair may cause you. We hope that our rapid service meets your needs. If you have any suggestions to help us improve our service, please give us a call. We appreciate your ideas and will respond to them.

For Your Convenience:

Please fill in the following and keep this manual with your **RED LION** system for future reference:

P.O. #: _____ Date Purchased: _____

Purchased From: _____

